

ARM® Architecture Reference Manual

ARMv8, for ARMv8-A architecture profile



ARM Architecture Reference Manual

ARMv8, for ARMv8-A architecture profile

Copyright © 2013-2017 ARM Limited or its affiliates. All rights reserved.

Release Information

The following releases of this document have been made.

Release history			
Date	Issue	Confidentiality	Change
30 April 2013	A.a-1	Confidential-Beta Draft	Beta draft of first issue, limited circulation
12 June 2013	A.a-2	Confidential-Beta Draft	Second beta draft of first issue, limited circulation
04 September 2013	A.a	Non-Confidential Beta	Beta release.
24 December 2013	A.b	Non-Confidential Beta	Second beta release.
18 July 2014	A.c	Non-Confidential Beta	Third beta release.
09 October 2014	A.d	Non-Confidential Beta	Fourth beta release.
17 December 2014	A.e	Non-Confidential Beta	Fifth beta release.
25 March 2015	A.f	Non-Confidential Beta	Sixth beta release.
10 July 2015	A.g	Non-Confidential Beta	Seventh beta release.
30 September 2015	A.h	Non-Confidential Beta	Eighth beta release.
28 January 2016	A.i	Non-Confidential Beta	Ninth beta release.
03 June 2016	A.j	Non-Confidential EAC	EAC release.
30 September 2016	A.k	Non-Confidential v8.0 EAC	Updated EAC release.
31 March 2017	B.a	Non-Confidential v8.1 EAC, v8.2 Beta	Initial release incorporating ARMv8.1 and ARMv8.2.

Proprietary Notice

This document is protected by copyright and other related rights and the practice or implementation of the information contained in this document may be protected by one or more patents or pending patent applications. No part of this document may be reproduced in any form by any means without the express prior written permission of ARM Limited (“ARM”). **No license, express or implied, by estoppel or otherwise to any intellectual property rights is granted by this document unless specifically stated.**

Your access to the information in this document is conditional upon your acceptance that you will not use or permit others to use the information for the purposes of determining whether implementations infringe any third party patents.

THIS DOCUMENT IS PROVIDED “AS IS”. ARM PROVIDES NO REPRESENTATIONS AND NO WARRANTIES, EXPRESS, IMPLIED OR STATUTORY, INCLUDING, WITHOUT LIMITATION, THE IMPLIED WARRANTIES OF MERCHANTABILITY, SATISFACTORY QUALITY, NON-INFRINGEMENT OR FITNESS FOR A PARTICULAR PURPOSE WITH RESPECT TO THE DOCUMENT. For the avoidance of doubt, ARM makes no representation with respect to, and has undertaken no analysis to identify or understand the scope and content of, third party patents, copyrights, trade secrets, or other rights.

This document may include technical inaccuracies or typographical errors.

This document may be translated into other languages for convenience, and you agree that if there is any conflict between the English version of this document and any translation, the terms of the English version shall prevail.

TO THE EXTENT NOT PROHIBITED BY LAW, IN NO EVENT WILL ARM BE LIABLE FOR ANY DAMAGES, INCLUDING WITHOUT LIMITATION ANY DIRECT, INDIRECT, SPECIAL, INCIDENTAL, PUNITIVE, OR CONSEQUENTIAL DAMAGES, HOWEVER CAUSED AND REGARDLESS OF THE THEORY OF LIABILITY, ARISING OUT OF ANY USE OF THIS DOCUMENT, EVEN IF ARM HAS BEEN ADVISED OF THE POSSIBILITY OF SUCH DAMAGES.

This document consists solely of commercial items. You shall be responsible for ensuring that any use, duplication or disclosure of this document complies fully with any relevant export laws and regulations to assure that this document or any portion thereof is not exported, directly or indirectly, in violation of such export laws. Use of the word “partner” in reference to ARM’s customers is not intended to create or refer to any partnership relationship with any other company. ARM may make changes to this document at any time and without notice.

If any of the provisions contained in these terms conflict with any of the provisions of any signed written agreement specifically covering this document with ARM, then the signed written agreement prevails over and supersedes the conflicting provisions of these terms.

Words and logos marked with ® or ™ are registered trademarks or trademarks of ARM Limited or its affiliates in the EU and/or elsewhere. All rights reserved. Other brands and names mentioned in this document may be the trademarks of their respective owners. You must follow the ARM trademark usage guidelines <http://www.arm.com/about/trademarks/guidelines/index.php>.

Copyright © 2013-2017 ARM Limited or its affiliates. All rights reserved.
ARM Limited. Company 02557590 registered in England.
110 Fulbourn Road, Cambridge, England CB1 9NJ.

LES-PRE-20327

In this document, where the term ARM is used to refer to the company it means “ARM or any of its subsidiaries as appropriate”.

————— **Note** —————

- The term ARM can refer to versions of the ARM architecture, for example ARMv8 refers to version 8 of the ARM architecture. The context makes it clear when the term is used in this way.
- This document describes only the ARMv8-A architecture profile. For the behaviors required by the previous version of this architecture profile, ARMv7-A, see the *ARM® Architecture Reference Manual, ARMv7-A and ARMv7-R edition*.

Confidentiality Status

This document is Non-Confidential. The right to use, copy and disclose this document may be subject to license restrictions in accordance with the terms of the agreement entered into by ARM and the party that ARM delivered this document to.

Product Status

Apart from the exceptions listed in *Limitations of issue B.a*, the information in this document is final, that is for a developed product. The exceptions have a *Beta* quality status, which means that they are work-in-progress.

Web Address

<http://www.arm.com>

Limitations of issue B.a

This issue B.a of the ARMv8 Architecture Reference Manual contains many improvements and corrections. Validation of this document has identified the following issues that ARM will address in future issues:

- The descriptions of the following architectural extensions are of beta quality and remain work in progress:
 - The ARMv8.2 architectural extension.
 - The *Reliability, Availability, and Serviceability* (RAS) Extension.
 - The *Scalable Vector Extension* (SVE).

In descriptive text, beta-quality information is colored red to show that it is work-in-progress. This quality status applies both to the colored text and to related content in pseudocode, in register descriptions, and in instruction descriptions that relate to these features.
- The ARMv8.2 architectural extension also supports the following optional features that will be documented in a future issue of this Manual:
 - The Dot Product feature that provides support for UDOT and SDOT instructions.
 - The Cryptographic feature that supports additional SHA and SM* cryptographic algorithms.
- In consultation with Architectural partners, ARM has changed the formal definition of the ARM memory model, and the new definition forms part of this Manual. While this redefinition has a significant impact on the structure of the memory model chapters, and on the conceptual framework and terminology used to describe the memory architecture, it has no practical implications for implementations of the ARMv8-A architecture.

- [Appendix K10 ARM Pseudocode Definition](#) requires further review and update. Since this appendix is informative, rather than being part of the architecture specification, this does not affect the quality status of this release.

Contents

ARM Architecture Reference Manual ARMv8, for ARMv8-A architecture profile

Preface

About this manual	xvi
Using this manual	xviii
Conventions	xxiii
Additional reading	xxv
Feedback	xxvi

Part A

ARMv8 Architecture Introduction and Overview

Chapter A1

Introduction to the ARMv8 Architecture

A1.1	About the ARM architecture	A1-30
A1.2	Architecture profiles	A1-32
A1.3	ARMv8 architectural concepts	A1-34
A1.4	Supported data types	A1-38
A1.5	Floating-point and Advanced SIMD support	A1-48
A1.6	The ARM memory model	A1-54
A1.7	ARMv8 architecture extensions	A1-55

Part B

The AArch64 Application Level Architecture

Chapter B1

The AArch64 Application Level Programmers' Model

B1.1	About the Application level programmers' model	B1-70
B1.2	Registers in AArch64 Execution state	B1-71
B1.3	Software control features and ELO	B1-76

Chapter B2	The AArch64 Application Level Memory Model	
B2.1	About the ARM memory model	B2-80
B2.2	Atomicity in the ARM architecture	B2-82
B2.3	Definition of the ARMv8 memory model	B2-86
B2.4	Caches and memory hierarchy	B2-97
B2.5	Alignment support	B2-102
B2.6	Endian support	B2-104
B2.7	Memory types and attributes	B2-107
B2.8	Mismatched memory attributes	B2-118
B2.9	Synchronization and semaphores	B2-121
Part C	The AArch64 Instruction Set	
Chapter C1	The A64 Instruction Set	
C1.1	About the A64 instruction set	C1-136
C1.2	Structure of the A64 assembler language	C1-137
C1.3	Address generation	C1-143
C1.4	Instruction aliases	C1-146
Chapter C2	About the A64 Instruction Descriptions	
C2.1	Understanding the A64 instruction descriptions	C2-148
C2.2	General information about the A64 instruction descriptions	C2-151
Chapter C3	A64 Instruction Set Overview	
C3.1	Branches, Exception generating, and System instructions	C3-156
C3.2	Loads and stores	C3-160
C3.3	Data processing - immediate	C3-176
C3.4	Data processing - register	C3-181
C3.5	Data processing - SIMD and floating-point	C3-189
Chapter C4	A64 Instruction Set Encoding	
C4.1	A64 instruction set encoding	C4-210
Chapter C5	The A64 System Instruction Class	
C5.1	The System instruction class encoding space	C5-312
C5.2	Special-purpose registers	C5-336
C5.3	A64 system instructions for cache maintenance	C5-405
C5.4	A64 system instructions for address translation	C5-427
C5.5	A64 system instructions for TLB maintenance	C5-454
Chapter C6	A64 Base Instruction Descriptions	
C6.1	About the A64 base instructions	C6-518
C6.2	Alphabetical list of A64 base instructions	C6-520
Chapter C7	A64 Advanced SIMD and Floating-point Instruction Descriptions	
C7.1	About the A64 SIMD and floating-point instructions	C7-976
C7.2	Alphabetical list of A64 floating-point and Advanced SIMD instructions	C7-978
Part D	The AArch64 System Level Architecture	
Chapter D1	The AArch64 System Level Programmers' Model	
D1.1	Exception levels	D1-1776
D1.2	Exception terminology	D1-1777
D1.3	Execution state	D1-1779
D1.4	Security state	D1-1780

D1.5	Virtualization	D1-1782
D1.6	Registers for instruction processing and exception handling	D1-1785
D1.7	Process state, PSTATE	D1-1791
D1.8	Program counter and stack pointer alignment	D1-1793
D1.9	Reset	D1-1795
D1.10	Exception entry	D1-1799
D1.11	Exception return	D1-1815
D1.12	The Exception level hierarchy	D1-1819
D1.13	Synchronous exception types, routing and priorities	D1-1826
D1.14	Asynchronous exception types, routing, masking and priorities	D1-1834
D1.15	Configurable instruction enables and disables, and trap controls	D1-1842
D1.16	System calls	D1-1878
D1.17	Mechanisms for entering a low-power state	D1-1879
D1.18	Self-hosted debug	D1-1884
D1.19	The Performance Monitors Extension	D1-1886
D1.20	Interprocessing	D1-1887
D1.21	The effect of implementation choices on the programmers' model	D1-1899
Chapter D2	AArch64 Self-hosted Debug	
D2.1	About self-hosted debug	D2-1906
D2.2	The debug exception enable controls	D2-1910
D2.3	Routing debug exceptions	D2-1911
D2.4	Enabling debug exceptions from the current Exception level and Security state	D2-1913
D2.5	The effect of powerdown on debug exceptions	D2-1915
D2.6	Summary of the routing and enabling of debug exceptions	D2-1916
D2.7	Pseudocode description of debug exceptions	D2-1918
D2.8	Breakpoint Instruction exceptions	D2-1919
D2.9	Breakpoint exceptions	D2-1921
D2.10	Watchpoint exceptions	D2-1940
D2.11	Vector Catch exceptions	D2-1955
D2.12	Software Step exceptions	D2-1956
D2.13	Synchronization and debug exceptions	D2-1970
Chapter D3	The AArch64 System Level Memory Model	
D3.1	About the memory system architecture	D3-1972
D3.2	Address space	D3-1973
D3.3	Mixed-endian support	D3-1974
D3.4	Cache support	D3-1975
D3.5	External aborts	D3-1997
D3.6	Memory barrier instructions	D3-1999
D3.7	Pseudocode description of general memory system instructions	D3-2000
Chapter D4	The AArch64 Virtual Memory System Architecture	
D4.1	About the Virtual Memory System Architecture (VMSA)	D4-2004
D4.2	The VMSAv8-64 address translation system	D4-2008
D4.3	VMSAv8-64 translation table format descriptors	D4-2060
D4.4	Memory access control	D4-2071
D4.5	Memory region attributes	D4-2090
D4.6	Virtualization Host Extensions	D4-2098
D4.7	MMU faults	D4-2103
D4.8	Translation Lookaside Buffers (TLBs)	D4-2113
D4.9	TLB maintenance requirements and the TLB maintenance instructions	D4-2119
D4.10	Caches in a VMSAv8-64 implementation	D4-2133
Chapter D5	The Performance Monitors Extension	
D5.1	About the Performance Monitors	D5-2138
D5.2	Accuracy of the Performance Monitors	D5-2140

D5.3	Behavior on overflow	D5-2142
D5.4	Attributability	D5-2144
D5.5	Effect of EL3 and EL2	D5-2145
D5.6	Event filtering	D5-2147
D5.7	Performance Monitors and Debug state	D5-2149
D5.8	Counter enables	D5-2150
D5.9	Counter access	D5-2151
D5.10	Events, event numbers, and mnemonics	D5-2152
D5.11	Performance Monitors Extension registers	D5-2176

Chapter D6 The Generic Timer in AArch64 state

D6.1	About the Generic Timer	D6-2180
D6.2	The AArch64 view of the Generic Timer	D6-2184

Chapter D7 AArch64 System Register Descriptions

D7.1	About the AArch64 System registers	D7-2190
D7.2	General system control registers	D7-2198
D7.3	Debug registers	D7-2554
D7.4	Performance Monitors registers	D7-2629
D7.5	Generic Timer registers	D7-2672

Part E The AArch32 Application Level Architecture

Chapter E1 The AArch32 Application Level Programmers' Model

E1.1	About the Application level programmers' model	E1-2728
E1.2	The Application level programmers' model in AArch32 state	E1-2729
E1.3	Advanced SIMD and floating-point instructions	E1-2740
E1.4	About the AArch32 System register interface	E1-2752
E1.5	Exceptions	E1-2753

Chapter E2 The AArch32 Application Level Memory Model

E2.1	About the ARM memory model	E2-2756
E2.2	Atomicity in the ARM architecture	E2-2758
E2.3	Definition of the ARMv8 memory model	E2-2762
E2.4	Caches and memory hierarchy	E2-2772
E2.5	Alignment support	E2-2777
E2.6	Endian support	E2-2779
E2.7	Memory types and attributes	E2-2782
E2.8	Mismatched memory attributes	E2-2792
E2.9	Synchronization and semaphores	E2-2795

Part F The AArch32 Instruction Sets

Chapter F1 The AArch32 Instruction Sets Overview

F1.1	Support for instructions in different versions of the ARM architecture	F1-2808
F1.2	Unified Assembler Language	F1-2809
F1.3	Branch instructions	F1-2811
F1.4	Data-processing instructions	F1-2812
F1.5	PSTATE and banked register access instructions	F1-2820
F1.6	Load/store instructions	F1-2821
F1.7	Load/store multiple instructions	F1-2824
F1.8	Miscellaneous instructions	F1-2825
F1.9	Exception-generating and exception-handling instructions	F1-2827
F1.10	System register access instructions	F1-2828
F1.11	Advanced SIMD and floating-point load/store instructions	F1-2829
F1.12	Advanced SIMD and floating-point register transfer instructions	F1-2831

F1.13	Advanced SIMD data-processing instructions	F1-2832
F1.14	Floating-point data-processing instructions	F1-2840

Chapter F2**About the T32 and A32 Instruction Descriptions**

F2.1	Format of instruction descriptions	F2-2844
F2.2	Standard assembler syntax fields	F2-2848
F2.3	Conditional execution	F2-2849
F2.4	Shifts applied to a register	F2-2852
F2.5	Memory accesses	F2-2854
F2.6	Encoding of lists of general-purpose registers and the PC	F2-2855
F2.7	General information about the T32 and A32 instruction descriptions	F2-2856
F2.8	Additional pseudocode support for instruction descriptions	F2-2868
F2.9	Additional information about Advanced SIMD and floating-point instructions ..	F2-2869

Chapter F3**T32 Instruction Set Encoding**

F3.1	T32 instruction set encoding	F3-2876
F3.2	About the T32 Advanced SIMD and floating-point instructions and their encoding	F3-2941

Chapter F4**A32 Instruction Set Encoding**

F4.1	A32 instruction set encoding	F4-2944
F4.2	About the A32 Advanced SIMD and floating-point instructions and their encoding	F4-3001

Chapter F5**T32 and A32 Base Instruction Set Instruction Descriptions**

F5.1	Alphabetical list of T32 and A32 base instruction set instructions	F5-3004
F5.2	Encoding and use of Banked register transfer instructions	F5-3674

Chapter F6**T32 and A32 Advanced SIMD and floating-point Instruction Descriptions**

F6.1	Alphabetical list of floating-point and Advanced SIMD instructions	F6-3680
------	--	---------

Part G**The AArch32 System Level Architecture****Chapter G1****The AArch32 System Level Programmers' Model**

G1.1	About the AArch32 System level programmers' model	G1-4308
G1.2	Exception levels	G1-4309
G1.3	Exception terminology	G1-4310
G1.4	Execution state	G1-4312
G1.5	Instruction Set state	G1-4314
G1.6	Security state	G1-4315
G1.7	Security state, Exception levels, and AArch32 execution privilege	G1-4318
G1.8	Virtualization	G1-4320
G1.9	AArch32 PE modes, and general-purpose and Special-purpose registers	G1-4322
G1.10	Process state, PSTATE	G1-4332
G1.11	Instruction set states	G1-4338
G1.12	Handling exceptions that are taken to an Exception level using AArch32	G1-4340
G1.13	Exception return to an Exception level using AArch32	G1-4360
G1.14	Asynchronous exception behavior for exceptions taken from AArch32 state ..	G1-4365
G1.15	AArch32 state exception descriptions	G1-4376
G1.16	Reset into AArch32 state	G1-4399
G1.17	Mechanisms for entering a low-power state	G1-4403
G1.18	The AArch32 System register interface	G1-4408
G1.19	Advanced SIMD and floating-point support	G1-4412
G1.20	Configurable instruction enables and disables, and trap controls	G1-4418

Chapter G2**AArch32 Self-hosted Debug**

G2.1	About self-hosted debug	G2-4454
------	-------------------------------	---------

G2.2	The debug exception enable controls	G2-4458
G2.3	Routing debug exceptions	G2-4459
G2.4	Enabling debug exceptions from the current Privilege level and Security state	G2-4461
G2.5	The effect of powerdown on debug exceptions	G2-4463
G2.6	Summary of permitted routing and enabling of debug exceptions	G2-4464
G2.7	Pseudocode description of debug exceptions	G2-4466
G2.8	Breakpoint Instruction exceptions	G2-4467
G2.9	Breakpoint exceptions	G2-4470
G2.10	Watchpoint exceptions	G2-4496
G2.11	Vector Catch exceptions	G2-4510
G2.12	Synchronization and debug exceptions	G2-4518

Chapter G3

The AArch32 System Level Memory Model

G3.1	About the memory system architecture	G3-4522
G3.2	Address space	G3-4523
G3.3	Mixed-endian support	G3-4524
G3.4	AArch32 cache and branch predictor support	G3-4525
G3.5	System register support for IMPLEMENTATION DEFINED memory features	G3-4549
G3.6	External aborts	G3-4550
G3.7	Memory barrier instructions	G3-4552
G3.8	Pseudocode description of general memory system instructions	G3-4553

Chapter G4

The AArch32 Virtual Memory System Architecture

G4.1	About VMSAv8-32	G4-4558
G4.2	The effects of disabling address translation stages on VMSAv8-32 behavior	G4-4567
G4.3	Translation tables	G4-4571
G4.4	The VMSAv8-32 Short-descriptor translation table format	G4-4576
G4.5	The VMSAv8-32 Long-descriptor translation table format	G4-4585
G4.6	Memory access control	G4-4605
G4.7	Memory region attributes	G4-4616
G4.8	Translation Lookaside Buffers (TLBs)	G4-4628
G4.9	TLB maintenance requirements	G4-4632
G4.10	Caches in VMSAv8-32	G4-4646
G4.11	VMSAv8-32 memory aborts	G4-4649
G4.12	Exception reporting in a VMSAv8-32 implementation	G4-4663
G4.13	Address translation instructions	G4-4682
G4.14	About the System registers for VMSAv8-32	G4-4689
G4.15	VMSAv8-32 organization of registers in the (coproc==0b1110) encoding space	G4-4704
G4.16	VMSAv8-32 organization of registers in the (coproc==0b1111) encoding space	G4-4707
G4.17	Functional grouping of VMSAv8-32 System registers	G4-4726
G4.18	Pseudocode description of VMSAv8-32 memory system operations	G4-4748

Chapter G5

The Generic Timer in AArch32 state

G5.1	About the Generic Timer in AArch32 state	G5-4752
G5.2	The AArch32 view of the Generic Timer	G5-4756

Chapter G6

AArch32 System Register Descriptions

G6.1	About the AArch32 System registers	G6-4764
G6.2	General system control registers	G6-4774
G6.3	Debug registers	G6-5239
G6.4	Performance Monitors registers	G6-5331
G6.5	Generic Timer registers	G6-5383

Part H	External Debug	
Chapter H1	About External Debug	
	H1.1 Introduction to external debug	H1-5430
	H1.2 External debug	H1-5431
	H1.3 Required debug authentication	H1-5432
Chapter H2	Debug State	
	H2.1 About Debug state	H2-5434
	H2.2 Halting the PE on debug events	H2-5435
	H2.3 Entering Debug state	H2-5442
	H2.4 Behavior in Debug state	H2-5445
	H2.5 Exiting Debug state	H2-5471
Chapter H3	Halting Debug Events	
	H3.1 Introduction to Halting debug events	H3-5474
	H3.2 Halting Step debug events	H3-5476
	H3.3 Halt Instruction debug event	H3-5486
	H3.4 Exception Catch debug event	H3-5487
	H3.5 External Debug Request debug event	H3-5490
	H3.6 OS Unlock Catch debug event	H3-5491
	H3.7 Reset Catch debug events	H3-5492
	H3.8 Software Access debug event	H3-5493
	H3.9 Synchronization and Halting debug events	H3-5494
Chapter H4	The Debug Communication Channel and Instruction Transfer Register	
	H4.1 Introduction	H4-5498
	H4.2 DCC and ITR registers	H4-5499
	H4.3 DCC and ITR access modes	H4-5502
	H4.4 Flow control of the DCC and ITR registers	H4-5506
	H4.5 Synchronization of DCC and ITR accesses	H4-5509
	H4.6 Interrupt-driven use of the DCC	H4-5514
	H4.7 Pseudocode description of the operation of the DCC and ITR registers	H4-5515
Chapter H5	The Embedded Cross-Trigger Interface	
	H5.1 About the Embedded Cross-Trigger (ECT)	H5-5518
	H5.2 Basic operation on the ECT	H5-5520
	H5.3 Cross-triggers on a PE in an ARMv8 implementation	H5-5524
	H5.4 Description and allocation of CTI triggers	H5-5525
	H5.5 CTI registers programmers' model	H5-5529
	H5.6 Examples	H5-5530
Chapter H6	Debug Reset and Powerdown Support	
	H6.1 About Debug over powerdown	H6-5534
	H6.2 Power domains and debug	H6-5535
	H6.3 Core power domain power states	H6-5536
	H6.4 Emulating low-power states	H6-5539
	H6.5 Debug OS Save and Restore sequences	H6-5541
	H6.6 Reset and debug	H6-5545
Chapter H7	The PC Sample-based Profiling Extension	
	H7.1 About the PC Sample-based Profiling Extension	H7-5548
Chapter H8	About the External Debug Registers	
	H8.1 Relationship between external debug and System registers	H8-5552
	H8.2 Endianness and supported access sizes	H8-5553
	H8.3 Synchronization of changes to the external debug registers	H8-5554

H8.4	Memory-mapped accesses to the external debug interface	H8-5558
H8.5	External debug interface register access permissions	H8-5561
H8.6	External debug interface registers	H8-5565
H8.7	Cross-trigger interface registers	H8-5570
H8.8	External debug register resets	H8-5572

Chapter H9 External Debug Register Descriptions

H9.1	About the debug registers	H9-5576
H9.2	External debug registers	H9-5577
H9.3	Cross-Trigger Interface registers	H9-5677

Part I Memory-mapped Components of the ARMv8 Architecture

Chapter I1 System Level Implementation of the Generic Timer

I1.1	About the Generic Timer specification	I1-5724
I1.2	Memory-mapped counter module	I1-5726
I1.3	Memory-mapped timer components	I1-5730
I1.4	Providing a complete set of counter and timer features	I1-5734
I1.5	Gray-count scheme for timer distribution scheme	I1-5736

Chapter I2 Recommended External Interface to the Performance Monitors

I2.1	About the external interface to the Performance Monitors registers	I2-5738
------	--	---------

Chapter I3 External System Control Register Descriptions

I3.1	About the external system control register descriptions	I3-5744
I3.2	Supported access sizes	I3-5745
I3.3	External Performance Monitors registers summary	I3-5746
I3.4	Performance Monitors external register descriptions	I3-5749
I3.5	Generic Timer memory-mapped registers overview	I3-5815
I3.6	Generic Timer memory-mapped register descriptions	I3-5816

Part J Architectural Pseudocode

Chapter J1 ARMv8 Pseudocode

J1.1	Pseudocode for AArch64 operations	J1-5860
J1.2	Pseudocode for AArch32 operation	J1-5930
J1.3	Shared pseudocode	J1-6006

Part K Appendixes

Appendix K1 Architectural Constraints on UNPREDICTABLE behaviors

K1.1	AArch32 CONSTRAINED UNPREDICTABLE behaviors	K1-6096
K1.2	AArch64 CONSTRAINED UNPREDICTABLE behaviors	K1-6119

Appendix K2 Recommended External Debug Interface

K2.1	About the recommended external debug interface	K2-6136
K2.2	PMUEVENT bus	K2-6139
K2.3	Recommended authentication interface	K2-6140
K2.4	Management registers and CoreSight compliance	K2-6141

Appendix K3 Recommendations for Performance Monitors Event Numbers for IMPLEMENTATION DEFINED Events

K3.1	ARM recommendations for IMPLEMENTATION DEFINED event numbers ...	K3-6152
------	--	---------

	K3.2	Summary of events for exceptions taken to an Exception level using AArch64	K3-6166
Appendix K4		Recommendations for reporting memory attributes on an interconnect	
	K4.1	ARM recommendations for reporting memory attributes on an interconnect ..	K4-6170
Appendix K5		Legacy Instruction Syntax for AArch32 Instruction Sets	
	K5.1	Legacy Instruction Syntax	K5-6172
Appendix K6		Address translation examples	
	K6.1	AArch64 Address translation examples	K6-6180
	K6.2	AArch32 Address translation examples	K6-6193
Appendix K7		Example OS Save and Restore Sequences	
	K7.1	Save Debug registers	K7-6204
	K7.2	Restore Debug registers	K7-6206
Appendix K8		Recommended Upload and Download Processes for External Debug	
	K8.1	Using memory access mode in AArch64 state	K8-6210
Appendix K9		Barrier Litmus Tests	
	K9.1	Introduction	K9-6214
	K9.2	Load-Acquire, Store-Release and barriers	K9-6217
	K9.3	Load-Acquire Exclusive, Store-Release Exclusive and barriers	K9-6221
	K9.4	Using a mailbox to send an interrupt	K9-6226
	K9.5	Cache and TLB maintenance instructions and barriers	K9-6227
	K9.6	ARMv7 compatible approaches for ordering, using DMB and DSB barriers ...	K9-6239
Appendix K10		ARM Pseudocode Definition	
	K10.1	About the ARM pseudocode	K10-6254
	K10.2	Pseudocode for instruction descriptions	K10-6255
	K10.3	Data types	K10-6257
	K10.4	Operators	K10-6262
	K10.5	Statements and control structures	K10-6268
	K10.6	Built-in functions	K10-6273
	K10.7	Miscellaneous helper procedures and functions	K10-6276
	K10.8	ARM pseudocode definition index	K10-6278
Appendix K11		Registers Index	
	K11.1	Introduction and register disambiguation	K11-6282
	K11.2	Alphabetical index of AArch64 registers and system instructions	K11-6287
	K11.3	Functional index of AArch64 registers and system instructions	K11-6296
	K11.4	Alphabetical index of AArch32 registers and system instructions	K11-6306
	K11.5	Functional index of AArch32 registers and system instructions	K11-6314
	K11.6	Alphabetical index of memory-mapped registers	K11-6324
	K11.7	Functional index of memory-mapped registers	K11-6329

Glossary

Preface

This preface introduces the *ARM Architecture Reference Manual, ARMv8, for ARMv8-A architecture profile*. It contains the following sections:

- [About this manual on page xvi.](#)
- [Using this manual on page xviii.](#)
- [Conventions on page xxiii.](#)
- [Additional reading on page xxv.](#)
- [Feedback on page xxvi.](#)

———— **Note** —————

This document describes only the ARMv8-A architecture profile. For the behaviors required by the ARMv7-A and ARMv7-R architecture profiles, see the *ARM[®] Architecture Reference Manual, ARMv7-A and ARMv7-R edition*.

About this manual

This manual describes the ARM® architecture v8, ARMv8. The architecture describes the operation of an ARMv8-A *Processing element (PE)*, and this manual includes descriptions of:

- The two Execution states, AArch64 and AArch32.
- The instruction sets:
 - In AArch32 state, the A32 and T32 instruction sets, that are compatible with earlier versions of the ARM architecture.
 - In AArch64 state, the A64 instruction set.
- The states that determine how a PE operates, including the current Exception level and Security state, and in AArch32 state the PE mode.
- The Exception model.
- The interprocessing model, that supports transitioning between AArch64 state and AArch32 state.
- The memory model, that defines memory ordering and memory management. This manual covers a single architecture profile, ARMv8-A, that defines a *Virtual Memory System Architecture (VMSA)*.
- The programmers' model, and its interfaces to System registers that control most PE and memory system features, and provide status information.
- The Advanced SIMD and floating-point instructions, that provide high-performance:
 - Single-precision, **half-precision**, and double-precision floating-point operations.
 - Conversions between double-precision, single-precision, and half-precision floating-point values.
 - Integer, single-precision floating-point, **half-precision floating-point**, and in A64, double-precision vector operations in all instruction sets.
 - Single-precision, **half-precision**, and double-precision floating-point vector operations in the A64 instruction set.
- The security model, that provides two security states to support secure applications.
- The virtualization model, that support the virtualization of Non-secure operation.
- The Debug architecture, that provides software access to debug features.

This manual gives the assembler syntax for the instructions it describes, meaning that it describes instructions in textual form. However, this manual is not a tutorial for ARM assembler language, nor does it describe ARM assembler language, except at a very basic level. To make effective use of ARM assembler language, read the documentation supplied with the assembler being used.

This manual is organized into parts:

- Part A** Provides an introduction to the ARMv8-A architecture, and an overview of the AArch64 and AArch32 Execution states.
- Part B** Describes the application level view of the AArch64 Execution state, meaning the view from EL0. It describes the application level view of the programmers' model and the memory model.
- Part C** Describes the A64 instruction set, that is available in the AArch64 Execution state. The descriptions for each instruction also include the precise effects of each instruction when executed at EL0, described as *unprivileged* execution, including any restrictions on its use, and how the effects of the instruction differ at higher Exception levels. This information is of primary importance to authors and users of compilers, assemblers, and other programs that generate ARM machine code.
- Part D** Describes the system level view of the AArch64 Execution state. It includes details of the System registers, most of which are not accessible from EL0, and the system level view of the programmers' model and the memory model. This part includes the description of self-hosted debug.

- Part E** Describes the application level view of the AArch32 Execution state, meaning the view from the EL0. It describes the application level view of the programmers' model and the memory model.
- **Note** —————
In AArch32 state, execution at EL0 is execution in User mode.
- Part F** Describes the T32 and A32 instruction sets, that are available in the AArch32 Execution state. These instruction sets are backwards-compatible with earlier versions of the ARM architecture. This part describes the precise effects of each instruction when executed in User mode, described as *unprivileged* execution or execution at EL0, including any restrictions on its use, and how the effects of the instruction differ at higher Exception levels. This information is of primary importance to authors and users of compilers, assemblers, and other programs that generate ARM machine code.
- **Note** —————
User mode is the only mode where software execution is unprivileged.
- Part G** Describes the system level view of the AArch32 Execution state, that is generally compatible with earlier versions of the ARM architecture. This part includes details of the System registers, most of which are not accessible from EL0, and the instruction interface to those registers. It also describes the system level view of the programmers' model and the memory model.
- Part H** Describes the Debug architecture for external debug. This provides configuration, breakpoint and watchpoint support, and a *Debug Communications Channel* (DCC) to a debug host.
- Part I** Describes additional features of the architecture that are not closely coupled to a *processing element* (PE), and therefore are accessed through memory-mapped interfaces. Some of these features are OPTIONAL.
- Part J** Provides pseudocode that describes various features of the ARMv8 architecture.
- Part K, Appendixes**
Provide additional information. Some appendixes give information that is not part of the ARMv8 architectural requirements. The cover page of each appendix indicates its status.

Using this manual

The information in this manual is organized into parts, as described in this section.

Part A, Introduction and Architecture Overview

Part A gives an overview of the ARMv8-A architecture profile, including its relationship to the other ARM PE architectures. It introduces the terminology used to describe the architecture, and gives an overview of the Executions states, AArch64 and AArch32. It contains the following chapter:

Chapter A1 Introduction to the ARMv8 Architecture

Read this for an introduction to the ARMv8 architecture.

Part B, The AArch64 Application Level Architecture

Part B describes the AArch64 state application level view of the architecture. It contains the following chapters:

Chapter B1 The AArch64 Application Level Programmers' Model

Read this for an application level description of the programmers' model for software executing in AArch64 state. It describes execution at EL0 when EL0 is using AArch64 state.

Chapter B2 The AArch64 Application Level Memory Model

Read this for an application level description of the memory model for software executing in AArch64 state. It describes the memory model for execution in EL0 when EL0 is using AArch64 state. It includes information about ARM memory types, attributes, and memory access controls.

Part C, The A64 Instruction Set

Part C describes the A64 instruction set, that is used in AArch64 state. It contains the following chapters:

Chapter C1 The A64 Instruction Set

Read this for a description of the A64 instruction set and common instruction operation details.

Chapter C2 About the A64 Instruction Descriptions

Read this to understand the format of the A64 instruction descriptions.

Chapter C3 A64 Instruction Set Overview

Read this for an overview of the individual A64 instructions, that are divided into five functional groups.

Chapter C4 A64 Instruction Set Encoding

Read this for a description of the A64 instruction set encoding.

Chapter C5 The A64 System Instruction Class

Read this for a description of the AArch64 system instructions and register descriptions, and the system instruction class encoding space.

Chapter C6 A64 Base Instruction Descriptions

Read this for information on key aspects of the A64 base instructions and for descriptions of the individual instructions, which are listed in alphabetical order.

Chapter C7 A64 Advanced SIMD and Floating-point Instruction Descriptions

Read this for information on key aspects of the A64 Advanced SIMD and floating-point instructions and for descriptions of the individual instructions, which are listed in alphabetical order.

Part D, The AArch64 System Level Architecture

Part D describes the AArch64 state system level view of the architecture. It contains the following chapters:

Chapter D1 *The AArch64 System Level Programmers' Model*

Read this for a description of the AArch64 state system level view of the programmers' model.

Chapter D2 *AArch64 Self-hosted Debug*

Read this for an introduction to, and a description of, self-hosted debug in AArch64 state.

Chapter D3 *The AArch64 System Level Memory Model*

Read this for a description of the AArch64 state system level view of the general features of the memory system.

Chapter D4 *The AArch64 Virtual Memory System Architecture*

Read this for a system level view of the AArch64 Virtual Memory System Architecture (VMSA), the memory system architecture of an ARMv8 implementation that is executing in AArch64 state.

Chapter D5 *The Performance Monitors Extension*

Read this for a description of an implementation of the ARM Performance Monitors, that are an optional non-invasive debug component.

Chapter D6 *The Generic Timer in AArch64 state*

Read this for a description of the AArch64 view of an implementation of the ARM Generic Timer.

Chapter D7 *AArch64 System Register Descriptions*

Read this for an introduction to, and description of, each of the AArch64 System registers.

Part E, The AArch32 Application Level Architecture

Part E describes the AArch32 state application level view of the architecture. It contains the following chapters:

Chapter E1 *The AArch32 Application Level Programmers' Model*

Read this for an application level description of the programmers' model for software executing in AArch32 state. It describes execution at EL0 when EL0 is using AArch32 state.

Chapter E2 *The AArch32 Application Level Memory Model*

Read this for an application level description of the memory model for software executing in AArch32 state. It describes the memory model for execution in EL0 when EL0 is using AArch32 state. It includes information about ARM memory types, attributes, and memory access controls.

Part F, The AArch32 Instruction Sets

Part F describes the T32 and A32 instruction sets, that are used in AArch32 state. It contains the following chapters:

Chapter F1 *The AArch32 Instruction Sets Overview*

Read this for an overview of the T32 and A32 instruction sets.

Chapter F2 *About the T32 and A32 Instruction Descriptions*

Read this to understand the format of the T32 and A32 instruction descriptions.

Chapter F3 *T32 Instruction Set Encoding*

Read this for a description of the T32 instruction set encoding. This includes the T32 encoding of the Advanced SIMD and floating-point instructions.

Chapter F4 *A32 Instruction Set Encoding*

Read this for a description of the A32 instruction set encoding. This includes the A32 encoding of the Advanced SIMD and floating-point instructions.

Chapter F5 T32 and A32 Base Instruction Set Instruction Descriptions

Read this for a description of each of the T32 and A32 base instructions.

Chapter F6 T32 and A32 Advanced SIMD and floating-point Instruction Descriptions

Read this for a description of each of the T32 and A32 Advanced SIMD and floating-point instructions.

Part G, The AArch32 System Level Architecture

Part G describes the AArch32 state system level view of the architecture. It contains the following chapters:

Chapter G1 The AArch32 System Level Programmers' Model

Read this for a description of the AArch32 state system level view of the programmers' model for execution in an Exception level that is using AArch32.

Chapter G2 AArch32 Self-hosted Debug

Read this for an introduction to, and a description of, self-hosted debug in AArch64 state.

Chapter G3 The AArch32 System Level Memory Model

Read this for a system level view of the general features of the memory system.

Chapter G4 The AArch32 Virtual Memory System Architecture

Read this for a description of the AArch32 Virtual Memory System Architecture (VMSA).

Chapter G5 The Generic Timer in AArch32 state

Read this for a description of the AArch32 view of an implementation of the ARM Generic Timer.

Chapter G6 AArch32 System Register Descriptions

Read this for a description of each of the AArch32 System registers.

Part H, External Debug

Part H describes the architecture for external debug. It contains the following chapters:

Chapter H1 About External Debug

Read this for an introduction to external debug, and a definition of the scope of this part of the manual.

Chapter H2 Debug State

Read this for a description of debug state, which the PE might enter as the result of a Halting debug event.

Chapter H3 Halting Debug Events

Read this for a description of the external debug events referred to as Halting debug events.

Chapter H4 The Debug Communication Channel and Instruction Transfer Register

Read this for a description of the communication between a debugger and the PE debug logic using the Debug Communications Channel and the Instruction Transfer register.

Chapter H5 The Embedded Cross-Trigger Interface

Read this for a description of the embedded cross-trigger interface.

Chapter H6 Debug Reset and Powerdown Support

Read this for a description of reset and powerdown support in the Debug architecture.

Chapter H7 *The PC Sample-based Profiling Extension*

Read this for a description of the PC Sample-based Profiling Extension that is an OPTIONAL extension to an ARMv8 implementation.

Chapter H8 *About the External Debug Registers*

Read this for some additional information about the external debug registers.

Chapter H9 *External Debug Register Descriptions*

Read this for a description of each external debug register.

Part I, Memory-mapped Components of the ARMv8 Architecture

Part I describes the memory-mapped components in the architecture. It contains the following chapters:

Chapter I1 *System Level Implementation of the Generic Timer*

Read this for a definition of a system level implementation of the Generic Timer.

Chapter I2 *Recommended External Interface to the Performance Monitors*

Read this for a description of the recommended memory-mapped and external debug interfaces to the Performance Monitors.

Chapter I3 *External System Control Register Descriptions*

Read this for a description of each memory-mapped system control register.

Part J, Architectural Pseudocode

Part J contains pseudocode that describes various features of the ARM architecture. It contains the following chapter:

Chapter J1 *ARMv8 Pseudocode*

Read this for the pseudocode definitions that describe various features of the ARMv8 architecture, for operation in AArch64 state and in AArch32 state.

Part K, Appendixes

This manual contains the following appendixes:

Appendix K1 *Architectural Constraints on UNPREDICTABLE behaviors*

Read this for a description of the architecturally-required constraints on UNPREDICTABLE behaviors in the ARMv8 architecture, including AArch32 behaviors that were UNPREDICTABLE in previous versions of the architecture.

Appendix K2 *Recommended External Debug Interface*

Read this for a description of the recommended external debug interface.

Note

This description is not part of the ARM architecture specification. It is included here as supplementary information, for the convenience of developers and users who might require this information.

Appendix K3 *Recommendations for Performance Monitors Event Numbers for IMPLEMENTATION DEFINED Events*

Read this for a description of ARM recommendations for the use of the IMPLEMENTATION DEFINED event numbers.

Note

This description is not part of the ARM architecture specification. It is included here as supplementary information, for the convenience of developers and users who might require this information.

Appendix K4 *Recommendations for reporting memory attributes on an interconnect*

Read this for the ARM recommendations about how the architectural memory attributes are reported on an interconnect.

Appendix K5 *Legacy Instruction Syntax for AArch32 Instruction Sets*

Read this for information about the pre-UAL syntax of the AArch32 instruction sets, which can still be valid for the A32 instruction set.

Appendix K6 *Address translation examples*

Read this for examples of translation table lookups using the translation regimes described in Chapter D4 *The AArch64 Virtual Memory System Architecture* and Chapter G4 *The AArch32 Virtual Memory System Architecture*.

Appendix K7 *Example OS Save and Restore Sequences*

Read this for software examples that perform the OS Save and Restore sequences for an ARMv8 debug implementation.

Note

[Chapter H6 *Debug Reset and Powerdown Support*](#) describes the OS Save and Restore mechanism.

Appendix K8 *Recommended Upload and Download Processes for External Debug*

Read this for information about implementing and using the ARM architecture.

Note

This description is not part of the ARM architecture specification. It is included here as supplementary information, for the convenience of developers and users who might require this information.

Appendix K9 *Barrier Litmus Tests*

Read this for examples of the use of barrier instructions provided by the ARMv8 architecture.

Note

This description is not part of the ARM architecture specification. It is included here as supplementary information, for the convenience of developers and users who might require this information.

Appendix K10 *ARM Pseudocode Definition*

Read this for definitions of the AArch32 pseudocode.

Appendix K11 *Registers Index*

Read this for an alphabetic and functional index of AArch32 and AArch64 registers, and memory-mapped registers.

Conventions

The following sections describe conventions that this book can use:

- *Typographic conventions*.
- *Signals*.
- *Numbers on page xxiv*.
- *Pseudocode descriptions on page xxiv*.
- *Assembler syntax descriptions on page xxiv*.

Typographic conventions

The typographical conventions are:

italic Introduces special terminology, and denotes citations.

bold Denotes signal names, and is used for terms in descriptive lists, where appropriate.

monospace Used for assembler syntax descriptions, pseudocode, and source code examples.
Also used in the main text for instruction mnemonics and for references to other items appearing in assembler syntax descriptions, pseudocode, and source code examples.

SMALL CAPITALS

Used in body text for a few terms that have specific technical meanings, and are defined in the *Glossary*.

Colored text Indicates a link. This can be:

- A URL, for example <http://infocenter.arm.com>.
- A cross-reference, that includes the page number of the referenced information if it is not on the current page, for example, *Assembler syntax descriptions on page xxiv*.
- A link, to a chapter or appendix, or to a glossary entry, or to the section of the document that defines the colored term, for example *Simple sequential execution* or *SCTLR*.

{ and } Braces, { and }, have two distinct uses:

Optional items

In syntax descriptions braces enclose optional items. In the following example they indicate that the <shift> parameter is optional:

```
ADD <Wd|WSP>, <Wn|WSP>, #<imm>{, <shift>}
```

Similarly they can be used in generalized field descriptions, for example [TCR_ELx](#).{I}PS refers to a field in the [TCR_ELx](#) registers that is called either IPS or PS.

Sets of items

Braces can be used to enclose sets. For example, [HCR_EL2](#).{E2H, TGE} refers to a set of two register fields, [HCR_EL2.E2H](#) and [HCR_EL2.TGE](#).

Signals

In general this specification does not define hardware signals, but it does include some signal examples and recommendations. The signal conventions are:

Signal level The level of an asserted signal depends on whether the signal is active-HIGH or active-LOW. Asserted means:

- HIGH for active-HIGH signals.
- LOW for active-LOW signals.

Lower-case n At the start or end of a signal name denotes an active-LOW signal.

Numbers

Numbers are normally written in decimal. Binary numbers are preceded by `0b`, and hexadecimal numbers by `0x`. In both cases, the prefix and the associated value are written in a monospace font, for example `0xFFFF0000`. To improve readability, long numbers can be written with an underscore separator between every four characters, for example `0xFFFF_0000_0000_0000`. Ignore any underscores when interpreting the value of a number.

Pseudocode descriptions

This manual uses a form of pseudocode to provide precise descriptions of the specified functionality. This pseudocode is written in monospace font, and is described in [Appendix K10 ARM Pseudocode Definition](#).

Assembler syntax descriptions

This manual contains numerous syntax descriptions for assembler instructions and for components of assembler instructions. These are shown in a monospace font, and use the conventions described in [Structure of the A64 assembler language on page C1-137](#), [Appendix K10 ARM Pseudocode Definition](#), and [Pseudocode operators and keywords on page K12-5648](#).

Additional reading

This section lists relevant publications from ARM and third parties.

See the Infocenter, <http://infocenter.arm.com>, for access to ARM documentation.

ARM publications

- *ARM® AMBA® 4 ATB Protocol Specification, ATBv1.0 and ATBv1.1*, (ARM IHI 0032B).
- *ARM® Architecture Reference Manual, ARMv7-A and ARMv7-R edition* (ARM DDI 0406).
- *ARM® Architecture Reference Manual Supplement, ARMv8, for the ARMv8-R AArch32 architecture profile* (ARM DDI 0568).
- *ARM® Debug Interface Architecture Specification, ADIv6.0* (ARM IHI 0074).
- *ARM® Debug Interface Architecture Specification, ADIv5.0 to ADIv5.2* (ARM IHI 0031).
- *ARM® Embedded Trace Macrocell Architecture Specification, ETMv4* (ARM IHI 0064).
- *ARM® Generic Interrupt Controller Architecture Specification, GIC architecture version 3.0 and version 4.0* (ARM IHI 0069).
- *ARM® CoreSight™ SoC Technical Reference Manual* (ARM DDI 0480).
- *ARM® CoreSight™ Architecture Specification* (ARM IHI 0029).
- *ARM® Procedure Call Standard for the ARM 64-bit Architecture* (ARM IHI 0055).
- *ARM® Reliability, Availability, and Serviceability (RAS) Specification, ARMv8, for the ARMv8-A architecture profile* (ARM DDI 0587).
- *ARM® Architecture Reference Manual Supplement, The Scalable Vector Extension (SVE), for ARMv8-A* (ARM DDI 0584).
- *ARM® Architecture Reference Manual Supplement, The Statistical Profiling Extension, for ARMv8-A* (ARM DDI 0586).

Other publications

The following publications are referred to in this manual, or provide more information:

- *Announcing the Advanced Encryption Standard (AES)*, Federal Information Processing Standards Publication 197, November 2001.
- IEEE Std 754-2008, *IEEE Standard for Floating-point Arithmetic*, August 2008.
- IEEE Std 754-1985, *IEEE Standard for Floating-point Arithmetic*, March 1985.
- *Secure Hash Standard (SHA)*, Federal Information Processing Standards Publication 180-2, August 2002.
- *The Galois/Counter Mode of Operation*, McGraw, D. and Viega, J., Submission to NIST Modes of Operation Process, January 2004.
- *Memory Consistency Models for Shared Memory-Multiprocessors*, Gharachorloo, Kourosh, 1995, Stanford University Technical Report CSL-TR-95-685.
- JEDEC Solid State Technology Association, *Standard Manufacturer's Identification Code, JEP106*.

Feedback

ARM welcomes feedback on its documentation.

Feedback on this manual

If you have comments on the content of this manual, send e-mail to errata@arm.com. Give:

- The title.
- The number, ARM DDI 0487B.a.
- The page numbers to which your comments apply.
- A concise explanation of your comments.

ARM also welcomes general suggestions for additions and improvements.

Part A

ARMv8 Architecture Introduction and Overview

Chapter A1

Introduction to the ARMv8 Architecture

This chapter introduces the ARM architecture. It contains the following sections:

- *About the ARM architecture* on page A1-30.
- *Architecture profiles* on page A1-32.
- *ARMv8 architectural concepts* on page A1-34.
- *Supported data types* on page A1-38.
- *Floating-point and Advanced SIMD support* on page A1-48.
- *The ARM memory model* on page A1-54.
- *ARMv8 architecture extensions* on page A1-55.

A1.1 About the ARM architecture

The ARM architecture described in this Architecture Reference Manual defines the behavior of an abstract machine, referred to as a *processing element*, often abbreviated to *PE*. Implementations compliant with the ARM architecture must conform to the described behavior of the processing element. It is not intended to describe how to build an implementation of the PE, nor to limit the scope of such implementations beyond the defined behaviors.

Except where the architecture specifies differently, the programmer-visible behavior of an implementation that is compliant with the ARM architecture must be the same as a simple sequential execution of the program on the processing element. This programmer-visible behavior does not include the execution time of the program.

The ARM Architecture Reference Manual also describes rules for software to use the processing element.

The ARM architecture includes definitions of:

- An associated debug architecture, see:
 - [Chapter D2 AArch64 Self-hosted Debug](#).
 - [Chapter G2 AArch32 Self-hosted Debug](#).
 - [Part H](#) of this manual, [External Debug](#) on page 5427.
- Associated trace architectures that define trace macrocells that implementers can implement with the associated processor hardware. For more information, see the [Embedded Trace Macrocell Architecture Specification](#).

The ARM architecture is a *Reduced Instruction Set Computer* (RISC) architecture with the following RISC architecture features:

- A large uniform register file.
- A *load/store* architecture, where data-processing operations only operate on register contents, not directly on memory contents.
- Simple addressing modes, with all load/store addresses determined from register contents and instruction fields only.

The architecture defines the interaction of the PE with memory, including caches, and includes a memory translation system. It also describes how multiple PEs interact with each other and with other observers in a system.

This document defines the ARMv8-A architecture *profile*. See [Architecture profiles](#) on page A1-32 for more information.

The ARM architecture supports implementations across a wide range of performance points. Implementation size, performance, and very low power consumption are key attributes of the ARM architecture.

An important feature of the ARMv8 architecture is backwards compatibility, combined with the freedom for optimal implementation in a wide range of standard and more specialized use cases. The ARMv8 architecture supports:

- A 64-bit Execution state, AArch64.
- A 32-bit Execution state, AArch32, that is compatible with previous versions of the ARM architecture.

———— **Note** —————

- The AArch32 Execution state is compatible with the ARMv7-A architecture profile, and enhances that profile to support some features included in the AArch64 Execution state.
- This document describes only the ARMv8-A architecture profile. For the behaviors required by the ARMv7-A and ARMv7-R architecture profiles, see the *ARM® Architecture Reference Manual, ARMv7-A and ARMv7-R edition*.

Features that are optional are explicitly defined as such in this Manual.

———— **Note** —————

The presence of an ID register field for a feature does not imply that the feature is optional.

Both Execution states support SIMD and floating-point instructions:

- AArch32 state provides:
 - SIMD instructions in the base instruction sets that operate on the 32-bit general-purpose registers.
 - Advanced SIMD instructions that operate on registers in the *SIMD and floating-point register* (SIMD&FP register) file.
 - Floating-point instructions that operate on registers in the SIMD&FP register file.
- AArch64 state provides:
 - Advanced SIMD instructions that operate on registers in the SIMD&FP register file.
 - Floating-point instructions that operate on registers in the SIMD&FP register file.

Note

See [Conventions on page xxiii](#) for information about conventions used in this manual, including the use of SMALL CAPITALS for particular terms that have ARM-specific meanings that are defined in the [Glossary](#).

A1.2 Architecture profiles

The ARM architecture has evolved significantly since its introduction, and ARM continues to develop it. Eight major versions of the architecture have been defined to date, denoted by the version numbers 1 to 8. Of these versions, the first three are now obsolete.

The generic names AArch64 and AArch32 describe the 64-bit and 32-bit Execution states:

AArch64 Is the 64-bit Execution state, meaning addresses are held in 64-bit registers, and instructions in the base instruction set can use 64-bit registers for their processing. AArch64 state supports the A64 instruction set.

AArch32 Is the 32-bit Execution state, meaning addresses are held in 32-bit registers, and instructions in the base instruction sets use 32-bit registers for their processing. AArch32 state supports the T32 and A32 instruction sets.

———— **Note** —————

The *Base instruction set* comprises the supported instructions other than the Advanced SIMD and floating-point instructions.

See sections [Execution state on page A1-34](#) and [The ARM instruction sets on page A1-35](#) for more information.

ARM defines three architecture profiles:

A Application profile, described in this manual:

- Supports a *Virtual Memory System Architecture* (VMSA) based on a *Memory Management Unit* (MMU).

———— **Note** —————

An ARMv8-A implementation can be called an AArchv8-A implementation.

- Supports the A64, A32, and T32 instruction sets.

R Real-time profile:

- Supports a *Protected Memory System Architecture* (PMSA) based on a *Memory Protection Unit* (MPU).
- Supports the A32 and T32 instruction sets.

M Microcontroller profile:

- Implements a programmers' model that is designed for low-latency interrupt processing, with hardware stacking of registers and support for writing interrupt handlers in high-level languages.
- Implements a variant of the R-profile PMSA.
- Supports a variant of the T32 instruction set.

———— **Note** —————

This Architecture Reference Manual describes only the ARMv8-A profile.

For information about the R and M architecture profiles, and earlier ARM architecture versions see:

- The *ARM® Architecture Reference Manual Supplement, ARMv8, for the ARMv8-R AArch32 architecture profile*.
- The *ARM® Architecture Reference Manual, ARMv7-A and ARMv7-R edition*.
- The *ARM®v8-M Architecture Reference Manual*.
- The *ARM®v7-M Architecture Reference Manual*.
- The *ARM®v6-M Architecture Reference Manual*.

A1.2.1 Debug architecture version

The ARM Debug architecture is fully integrated with the architecture, and does not have a separate version number.

A1.3 ARMv8 architectural concepts

ARMv8 introduces major changes to the ARM architecture, while maintaining a high level of consistency with previous versions of the architecture. The ARMv8 Architecture Reference Manual includes significant changes in the terminology used to describe the architecture. This section introduces both the ARMv8 architectural concepts and the associated terminology.

The following subsections describe key ARMv8 architectural concepts. Each section introduces the corresponding terms that are used to describe the architecture:

- [Execution state](#).
- [The ARM instruction sets on page A1-35](#).
- [System registers on page A1-35](#).
- [ARMv8 Debug on page A1-36](#).

A1.3.1 Execution state

The Execution state defines the PE execution environment, including:

- The supported register widths.
- The supported instruction sets.
- Significant aspects of:
 - The exception model.
 - The *Virtual Memory System Architecture* (VMSA).
 - The programmers' model.

The Execution states are:

- AArch64** The 64-bit Execution state. This Execution state:
- Provides 31 64-bit general-purpose registers, of which X30 is used as the procedure link register.
 - Provides a 64-bit *program counter* (PC), *stack pointers* (SPs), and *exception link registers* (ELRs).
 - Provides 32 128-bit registers for SIMD vector and scalar floating-point support.
 - Provides a single instruction set, A64. For more information, see [The ARM instruction sets on page A1-35](#).
 - Defines the ARMv8 Exception model, with up to four Exception levels, EL0 - EL3, that provide an *execution privilege* hierarchy, see [Exception levels on page D1-1776](#).
 - Provides support for 64-bit *virtual addressing*. For more information, including the limits on address ranges, see [Chapter D4 The AArch64 Virtual Memory System Architecture](#).
 - Defines a number of *Process state* (PSTATE) elements that hold PE state. The A64 instruction set includes instructions that operate directly on various PSTATE elements.
 - Names each System register using a suffix that indicates the lowest Exception level at which the register can be accessed.
- AArch32** The 32-bit Execution state. This Execution state:
- Provides 13 32-bit general-purpose registers, and a 32-bit PC, SP, and *link register* (LR). The LR is used as both an ELR and a procedure link register. Some of these registers have multiple *banked* instances for use in different PE *modes*.
 - Provides a single ELR, for exception returns from Hyp mode.
 - Provides 32 64-bit registers for Advanced SIMD vector and scalar floating-point support.
 - Provides two instruction sets, A32 and T32. For more information, see [The ARM instruction sets on page A1-35](#).
 - Supports the ARMv7-A exception model, based on *PE modes*, and maps this onto the ARMv8 Exception model, that is based on the Exception levels.
 - Provides support for 32-bit virtual addressing.

- Defines a number of *Process state (PSTATE)* elements that hold PE state. The A32 and T32 instruction sets include instructions that operate directly on various *PSTATE* elements, and instructions that access *PSTATE* by using the *Application Program Status Register (APSR)* or the *Current Program Status Register (CPSR)*.

Later subsections give more information about the different properties of the Execution states.

Transitioning between the AArch64 and AArch32 Execution states is known as *interprocessing*. The PE can move between Execution states only on a change of Exception level, and subject to the rules given in [Interprocessing on page D1-1887](#). This means different software layers, such as an application, an operating system kernel, and a hypervisor, executing at different Exception levels, can execute in different Execution states.

A1.3.2 The ARM instruction sets

In ARMv8 the possible instruction sets depend on the Execution state:

AArch64 AArch64 state supports only a single instruction set, called A64. This is a fixed-length instruction set that uses 32-bit instruction encodings.

For information on the A64 instruction set, see [Chapter C3 A64 Instruction Set Overview](#).

AArch32 AArch32 state supports the following instruction sets:

A32 This is a fixed-length instruction set that uses 32-bit instruction encodings.

T32 This is a variable-length instruction set that uses both 16-bit and 32-bit instruction encodings.

In previous documentation, these instruction sets were called the ARM and Thumb instruction sets. ARMv8 extends each of these instruction sets. In AArch32 state, the Instruction set state determines the instruction set that the PE executes.

For information on the A32 and T32 instruction sets, see [Chapter F1 The AArch32 Instruction Sets Overview](#).

The ARMv8 instruction sets support SIMD and scalar floating-point instructions. See [Floating-point and Advanced SIMD support on page A1-48](#).

A1.3.3 System registers

System registers provide control and status information of architected features.

The System registers use a standard naming format: <register_name>.<bit_field_name> to identify specific registers as well as control and status bits within a register.

Bits can also be described by their numerical position in the form <register_name>[x:y] or the generic form bits[x:y].

In addition, in AArch64 state, most register names include the lowest Exception level that can access the register as a suffix to the register name:

- <register_name>_ELx, where x is 0, 1, 2, or 3.

For information about Exception levels, see [Exception levels on page D1-1776](#).

The System registers comprise:

- The following registers that are described in this manual:
 - General system control registers.
 - Debug registers.
 - Generic Timer registers.
 - Optionally, Performance Monitor registers.

- Optionally, one or more of the following groups of registers that are defined in other ARM architecture specifications:
 - Trace System registers, as defined in the *Embedded Trace Macrocell Architecture Specification, ETMv4*.
 - Scalable Vector Extension System registers, as defined in the *ARM® Architecture Reference Manual Supplement, The Scalable Vector Extension (SVE), for ARMv8-A*.
 - Statistical Profiling Extension System registers, as defined in the *ARM® Architecture Reference Manual Supplement, The Statistical Profiling Extension, for ARMv8-A*.
 - Generic Interrupt Controller (GIC) System registers, see *The ARM Generic Interrupt Controller System registers*.
- Reliability, Availability, and Serviceability System registers, as defined in the *ARM® Reliability, Availability, and Serviceability (RAS) Specification, ARMv8, for the ARMv8-A architecture profile*. The RAS Extension is a mandatory extension to the ARMv8.2 architecture, and an OPTIONAL extension to the ARMv8.0 and the ARMv8.1 architectures.

For information about the AArch64 System registers, see [Chapter D7 AArch64 System Register Descriptions](#).

For information about the AArch32 System registers, see [Chapter G6 AArch32 System Register Descriptions](#).

The ARM Generic Interrupt Controller System registers

From version 3 of the ARM Generic Interrupt Controller architecture, GICv3, the GIC architecture specification defines a System register interface to some of its functionality. The System register summaries in this manual include these registers, see:

- [About the GIC System registers on page C5-333](#), for more information about the AArch64 GIC System registers.
- [Generic Interrupt Controller System registers, functional groups on page G4-4740](#), for more information about the AArch32 GIC System registers.

These sections give only short overviews of the GIC System registers. For more information, including descriptions of the registers, see the *ARM® Generic Interrupt Controller Architecture Specification, GIC architecture version 3.0 and version 4.0* (ARM IHI 0069).

———— Note —————

The programmers' model for earlier versions of the GIC architecture is wholly memory-mapped.

A1.3.4 ARMv8 Debug

ARMv8 supports the following:

Self-hosted debug

In this model, the PE generates *debug exceptions*. Debug exceptions are part of the ARMv8 Exception model.

External debug

In this model, *debug events* cause the PE to enter *Debug state*. In Debug state, the PE is controlled by an external debugger.

All ARMv8 implementations support both models. The model chosen by a particular user depends on the debug requirements during different stages of the design and development life cycle of the product. For example, external debug might be used during debugging of the hardware implementation and OS bring-up, and self-hosted debug might be used during application development.

For more information about self-hosted debug:

- In AArch64 state, see [Chapter D2 AArch64 Self-hosted Debug](#).

- In AArch32 state, see [Chapter G2 AArch32 Self-hosted Debug](#).

For more information about external debug, see [Part H External Debug](#).

A1.4 Supported data types

The ARMv8 architecture supports the following integer data types:

Byte	8 bits.
Halfword	16 bits.
Word	32 bits.
Doubleword	64 bits.
Quadword	128 bits.

The architecture also supports the following floating-point data types:

- Half-precision, see [Half-precision floating-point formats on page A1-42](#) for details.
- Single-precision, see [Single-precision floating-point format on page A1-44](#) for details.
- Double-precision, see [Double-precision floating-point format on page A1-45](#) for details.

It also supports:

- Fixed-point interpretation of words and doublewords. See [Fixed-point format on page A1-46](#).
- Vectors, where a register holds multiple elements, each of the same data type. See [Vector formats on page A1-39](#) for details.

The ARMv8 architecture provides two register files:

- A general-purpose register file.
- A SIMD&FP register file.

In each of these register files, the possible register widths depend on the Execution state.

In AArch64 state:

- A general-purpose register file contains 64-bit registers:
 - Many instructions can access these registers as 64-bit registers or as 32-bit registers, using only the bottom 32 bits.
- A SIMD&FP register file contains 128-bit registers:
 - The quadword integer data types only apply to the SIMD&FP register file.
 - The floating-point data types only apply to the SIMD&FP register file.
 - While the AArch64 vector registers support 128-bit vectors, the effective vector length can be 64-bits or 128-bits depending on the A64 instruction encoding used, see [Instruction Mnemonics on page C1-138](#).

For more information on the register files in AArch64 state, see [Registers in AArch64 Execution state on page B1-71](#).

In AArch32 state:

- A general-purpose register file contains 32-bit registers:
 - Two 32-bit registers can support a doubleword.
 - Vector formatting is supported, see [Figure A1-4 on page A1-42](#).
- A SIMD&FP register file contains 64-bit registers:
 - AArch32 state does not support quadword integer or floating-point data types.

———— **Note** —————

Two consecutive 64-bit registers can be used as a 128-bit register.

For more information on the register files in AArch32 state, see [The general-purpose registers, and the PC, in AArch32 state on page E1-2731](#).

A1.4.1 Vector formats

In an implementation that includes the SIMD instructions that operate on the SIMD&FP register file, a register can hold one or more packed elements, all of the same size and type. The combination of a register and a data type describes a vector of elements. The vector is considered to be an array of elements of the data type specified in the instruction. The number of elements in the vector is implied by the size of the data elements and the size of the register.

Vector indices are in the range 0 to (number of elements – 1). An index of 0 refers to the least significant end of the vector.

Vector formats in AArch64 state

In AArch64 state, the SIMD&FP registers can be referred to as V_n , where n is a value from 0 to 31.

The SIMD&FP registers support three data formats for loads, stores, and data-processing operations:

- A single, scalar, element in the least significant bits of the register.
- A 64-bit vector of byte, halfword, or word elements.
- A 128-bit vector of byte, halfword, word, or doubleword elements.

The element sizes are defined in [Table A1-1](#) with the vector format described as:

- For a 128-bit vector: $V_n\{.2D, .4S, .8H, .16B\}$.
- For a 64-bit vector: $V_n\{.1D, .2S, .4H, .8B\}$.

Table A1-1 SIMD elements in AArch64 state

Mnemonic	Size
B	8 bits
H	16 bits
S	32 bits
D	64 bits

[Figure A1-1 on page A1-40](#) shows the SIMD vectors in AArch64 state.

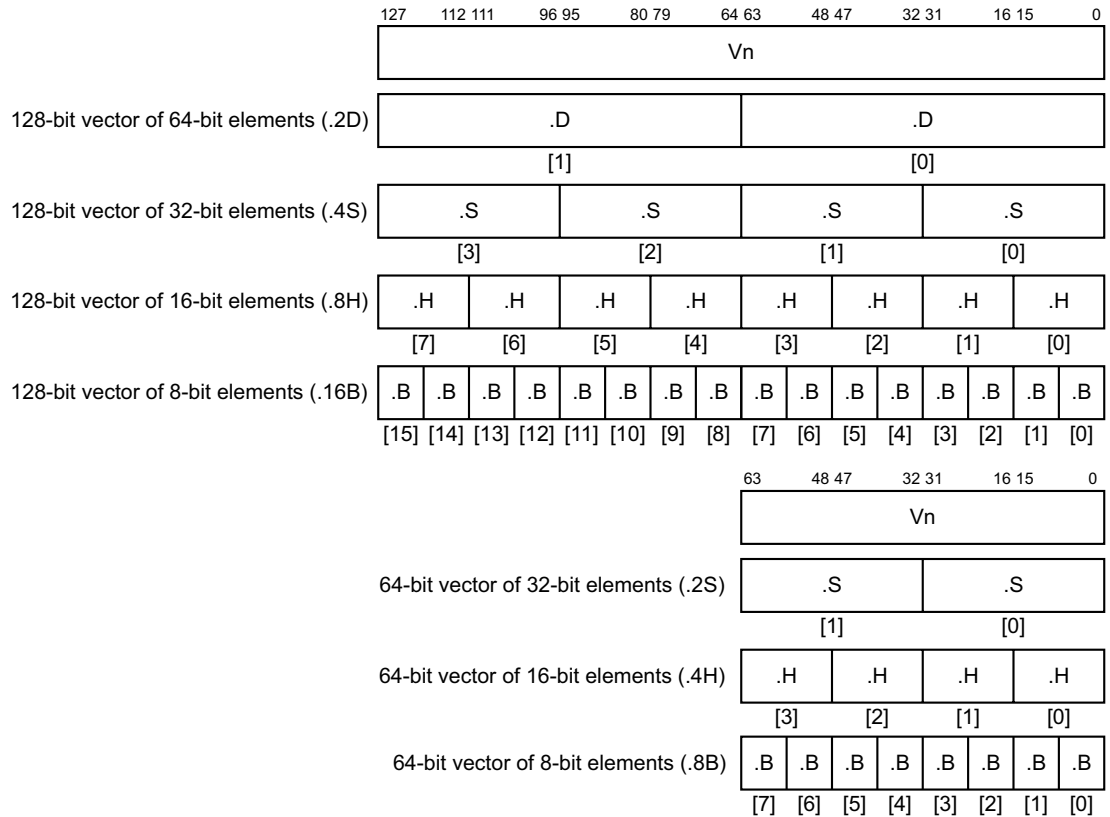

Figure A1-1 SIMD vectors in AArch64 state

Vector formats in AArch32 state

Table A1-2 shows the available formats. Each instruction description specifies the data types that the instruction supports.

Table A1-2 Advanced SIMD data types in AArch32 state

Data type specifier	Meaning
.<size>	Any element of <size> bits
.F<size>	Floating-point number of <size> bits
.I<size>	Signed or unsigned integer of <size> bits
.P<size>	Polynomial over {0, 1} of degree less than <size>
.S<size>	Signed integer of <size> bits
.U<size>	Unsigned integer of <size> bits

Polynomial arithmetic over {0, 1} on page A1-47 describes the polynomial data type.

The .F16 data type is the half-precision data type selected by the FPSCR.AHP bit, see *Half-precision floating-point formats* on page A1-42.

The .F32 data type is the ARM standard single-precision floating-point data type, see *Single-precision floating-point format* on page A1-44.

The instruction definitions use a data type specifier to define the data types appropriate to the operation. Figure A1-2 shows the hierarchy of the Advanced SIMD data types.

.8	.i8	.S8
		.U8
	.P8	
	-	
.16	.i16	.S16
		.U16
	.P16 †	
	.F16	
.32	.i32	.S32
		.U32
	-	
	.F32	
.64	.i64	.S64
		.U64
	.P64 ‡	
	-	

† Output format only. See VMULL instruction description.

‡ Available only if the Cyptographic Extension is implemented. See VMULL instruction description.

Figure A1-2 Advanced SIMD data type hierarchy in AArch32 state

For example, a multiply instruction must distinguish between integer and floating-point data types.

An integer multiply instruction that generates a double-width (long) result must specify the input data types as signed or unsigned. However, some integer multiply instructions use modulo arithmetic, and therefore do not have to distinguish between signed and unsigned inputs.

Figure A1-3 on page A1-42 shows the Advanced SIMD vectors in AArch32 state.

———— **Note** ————

In AArch32 state, a pair of even and following odd numbered doubleword registers can be concatenated and treated as a single quadword register.

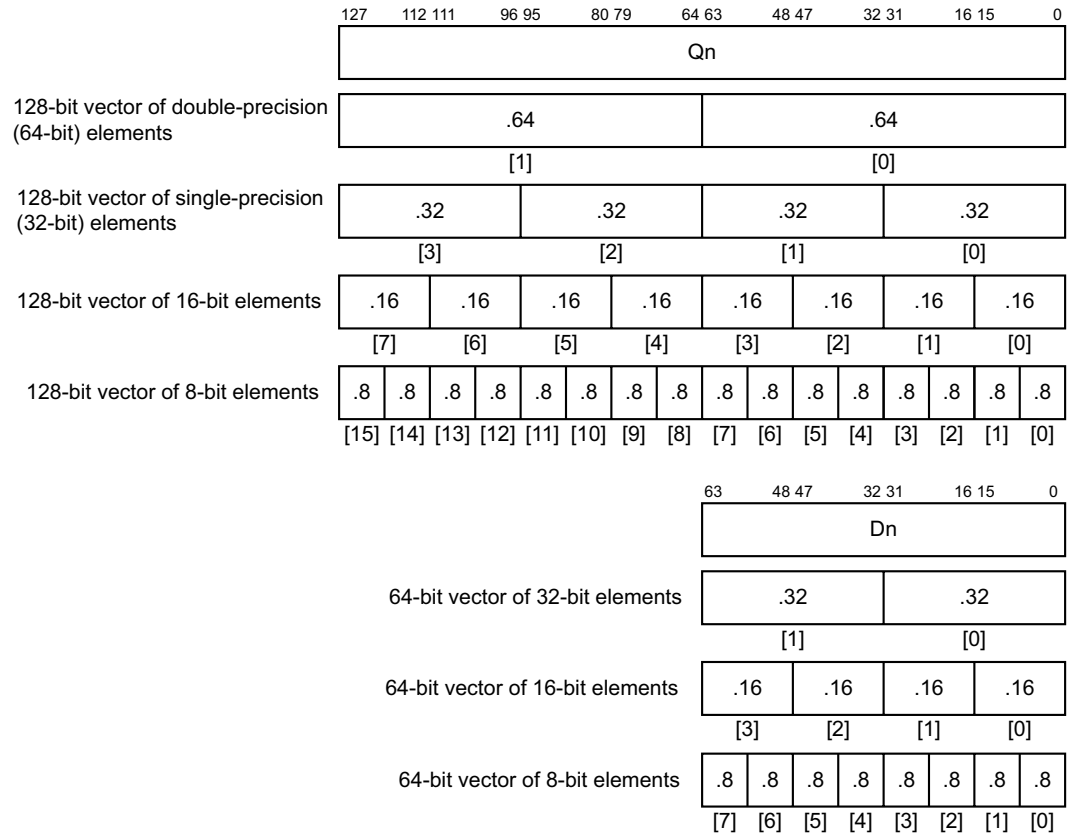

Figure A1-3 Advanced SIMD vectors in AArch32 state

The AArch32 general-purpose registers support vectors formats for use by the SIMD instructions in the Base instruction set. Figure A1-4 shows these formats, that means that a general-purpose register can be treated as either 2 halfwords or 4 bytes.

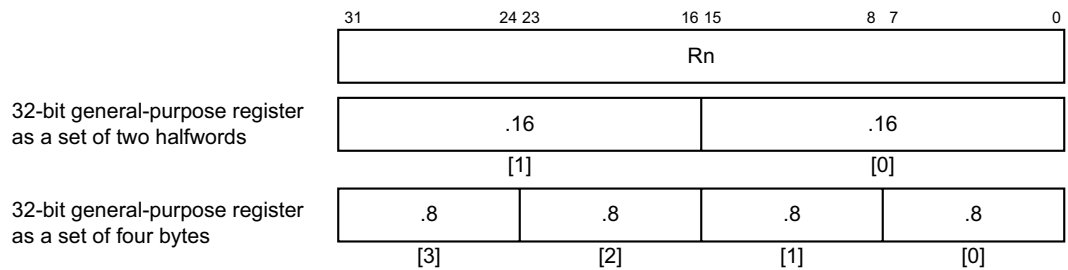

Figure A1-4 Vector formatting in AArch32 state

A1.4.2 Half-precision floating-point formats

ARMv8 supports two half-precision floating-point formats:

- IEEE half-precision, as described in the IEEE 754-2008 standard.
- ARM *alternative half-precision* format.

Both formats can be used for conversions to and from other floating-point formats. `FPCR.AHP` controls the format in AArch64 state and `FPSCR.AHP` controls the format in AArch32 state. **ARMv8.2-FP16 adds half-precision data-processing instructions, which always use the IEEE format. These instructions ignore the value of the relevant AHP field, and behave as if it has an *Effective value* of 0.**

The description of IEEE half-precision includes ARM-specific details that are left open by the standard, and is only an introduction to the formats and to the values they can contain. For more information, especially on the handling of infinities, NaNs, and signed zeros, see the IEEE 754 standard.

For both half-precision floating-point formats, the layout of the 16-bit format is the same. The format is:

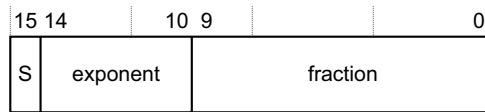

The interpretation of the format depends on the value of the exponent field, bits[14:10] and on which half-precision format is being used.

0 < exponent < 0x1F

The value is a normalized number and is equal to:

$$(-1)^S \times 2^{(\text{exponent}-15)} \times (1.\text{fraction})$$

The minimum positive normalized number is 2^{-14} , or approximately 6.104×10^{-5} .

The maximum positive normalized number is $(2 - 2^{-10}) \times 2^{15}$, or 65504.

Larger normalized numbers can be expressed using the alternative format when the exponent == 0x1F.

exponent == 0

The value is either a zero or a denormalized number, depending on the fraction bits:

fraction == 0

The value is a zero. There are two distinct zeros:

- +0** when S==0
- 0** when S==1.

fraction != 0

The value is a denormalized number and is equal to:

$$(-1)^S \times 2^{-14} \times (0.\text{fraction})$$

The minimum positive denormalized number is 2^{-24} , or approximately 5.960×10^{-8} .

Half-precision denormalized numbers are not flushed to zero by default. **When ARMv8.2-FP16 is implemented, the FPCR.FZ16 bit controls whether Flush-to-zero mode is enabled for half-precision data-processing instructions.** For details, see [Flush-to-zero on page A1-51](#).

exponent == 0x1F

The value depends on which half-precision format is being used:

IEEE half-precision

The value is either an infinity or a Not a Number (NaN), depending on the fraction bits:

fraction == 0

The value is an infinity. There are two distinct infinities:

- +infinity** When S==0. This represents all positive numbers that are too large to be represented accurately as a normalized number.
- infinity** When S==1. This represents all negative numbers with an absolute value that is too large to be represented accurately as a normalized number.

fraction != 0

The value is a NaN, and is either a *quiet NaN* or a *signaling NaN*.

The two types of NaN are distinguished by their most significant fraction bit, bit[9]:

- bit[9] == 0** The NaN is a signaling NaN. The sign bit can take any value, and the remaining fraction bits can take any value except all zeros.

bit[9] == 1 The NaN is a quiet NaN. The sign bit and remaining fraction bits can take any value.

Alternative half-precision

The value is a normalized number and is equal to:

$$-1^S \times 2^{16} \times (1.\text{fraction})$$

The maximum positive normalized number is $(2-2^{-10}) \times 2^{16}$ or 131008.

A1.4.3 Single-precision floating-point format

The single-precision floating-point format is as defined by the IEEE 754 standard.

This description includes ARM-specific details that are left open by the standard. It is only intended as an introduction to the formats and to the values they can contain. For full details, especially of the handling of infinities, NaNs, and signed zeros, see the IEEE 754 standard.

A single-precision value is a 32-bit word with the format:

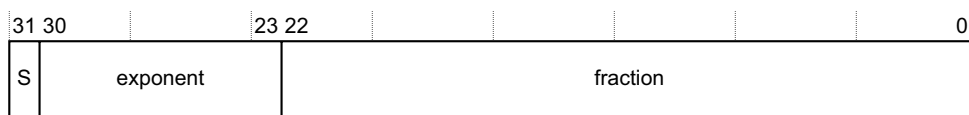

The interpretation of the format depends on the value of the exponent field, bits[30:23]:

0 < exponent < 0xFF

The value is a *normalized number* and is equal to:

$$(-1)^S \times 2^{(\text{exponent} - 127)} \times (1.\text{fraction})$$

The minimum positive normalized number is 2^{-126} , or approximately 1.175×10^{-38} .

The maximum positive normalized number is $(2 - 2^{-23}) \times 2^{127}$, or approximately 3.403×10^{38} .

exponent == 0

The value is either a zero or a *denormalized number*, depending on the fraction bits:

fraction == 0

The value is a zero. There are two distinct zeros:

+0 When S==0.

-0 When S==1.

These usually behave identically. In particular, the result is *equal* if +0 and -0 are compared as floating-point numbers. However, they yield different results in some circumstances. For example, the sign of the infinity that is the result of dividing by zero depends on the sign of the zero. The two zeros can be distinguished from each other by performing an integer comparison of the two words.

fraction != 0

The value is a *denormalized number* and is equal to:

$$(-1)^S \times 2^{-126} \times (0.\text{fraction})$$

The minimum positive denormalized number is 2^{-149} , or approximately 1.401×10^{-45} .

Denormalized numbers are always flushed to zero in Advanced SIMD processing in AArch32 state. They are optionally flushed to zero in floating-point processing and in Advanced SIMD processing in AArch64 state. For details, see [Flush-to-zero](#) on page A1-51.

exponent == 0xFF

The value is either an *infinity* or a *Not a Number* (NaN), depending on the fraction bits:

fraction == 0

The value is an infinity. There are two distinct infinities:

+infinity When S==0. This represents all positive numbers that are too large to be represented accurately as a normalized number.

-infinity When S==1. This represents all negative numbers with an absolute value that is too large to be represented accurately as a normalized number.

fraction != 0

The value is a NaN, and is either a *quiet NaN* or a *signaling NaN*.

The two types of NaN are distinguished by their most significant fraction bit, bit[22]:

bit[22] == 0

The NaN is a signaling NaN. The sign bit can take any value, and the remaining fraction bits can take any value except all zeros.

bit[22] == 1

The NaN is a quiet NaN. The sign bit and remaining fraction bits can take any value.

For details of the *default NaN*, see [NaN handling and the Default NaN on page A1-52](#).

———— **Note** —————

NaNs with different sign or fraction bits are distinct NaNs, but this does not mean that software can use floating-point comparison instructions to distinguish them. This is because the IEEE 754 standard specifies that a NaN compares as *unordered* with everything, including itself.

A1.4.4 Double-precision floating-point format

The double-precision floating-point format is as defined by the IEEE 754 standard. Double-precision floating-point is supported by both SIMD and floating-point instructions in AArch64 state, and only by floating-point instructions in AArch32 state.

This description includes implementation-specific details that are left open by the standard. It is only intended as an introduction to the formats and to the values they can contain. For full details, especially of the handling of infinities, NaNs, and signed zeros, see the IEEE 754 standard.

A double-precision value is a 64-bit doubleword, with the format:

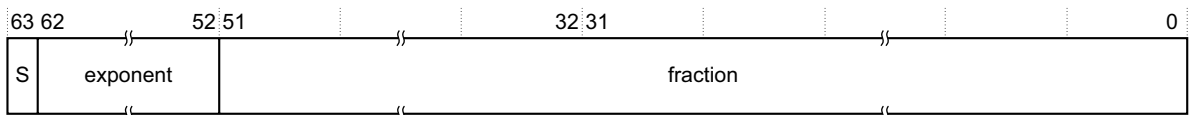

Double-precision values represent numbers, infinities, and NaNs in a similar way to single-precision values, with the interpretation of the format depending on the value of the exponent:

0 < exponent < 0x7FF

The value is a normalized number and is equal to:

$$(-1)^S \times 2^{(\text{exponent}-1023)} \times (1.\text{fraction})$$

The minimum positive normalized number is 2^{-1022} , or approximately 2.225×10^{-308} .

The maximum positive normalized number is $(2 - 2^{-52}) \times 2^{1023}$, or approximately 1.798×10^{308} .

exponent == 0

The value is either a zero or a denormalized number, depending on the fraction bits:

fraction == 0

The value is a zero. There are two distinct zeros that behave in the same way as the two single-precision zeros:

+0 when S==0

-0 when S==1.

fraction != 0

The value is a denormalized number and is equal to:

$$(-1)^S \times 2^{-1022} \times (0.\text{fraction})$$

The minimum positive denormalized number is 2^{-1074} , or approximately 4.941×10^{-324} .

Optionally, denormalized numbers are flushed to zero in floating-point calculations. For details, see [Flush-to-zero on page A1-51](#).

exponent == 0x7FF

The value is either an infinity or a NaN, depending on the fraction bits:

fraction == 0

The value is an infinity. As for single-precision, there are two infinities:

+infinity When S==0.

-infinity When S==1.

fraction != 0

The value is a NaN, and is either a *quiet NaN* or a *signaling NaN*.

The two types of NaN are distinguished by their most significant fraction bit, bit[51] of the doubleword:

bit[51] == 0

The NaN is a signaling NaN. The sign bit can take any value, and the remaining fraction bits can take any value except all zeros.

bit[51] == 1

The NaN is a quiet NaN. The sign bit and the remaining fraction bits can take any value.

For details of the *default NaN*, see [NaN handling and the Default NaN on page A1-52](#).

———— **Note** —————

NaNs with different sign or fraction bits are distinct NaNs, but this does not mean that software can use floating-point comparison instructions to distinguish them. This is because the IEEE 754 standard specifies that a NaN compares as *unordered* with everything, including itself.

A1.4.5 Fixed-point format

Fixed-point formats are used only for conversions between floating-point and fixed-point values. They apply to general-purpose registers.

Fixed-point values can be signed or unsigned, and can be 16-bit or 32-bit. Conversion instructions take an argument that specifies the number of fraction bits in the fixed-point number. That is, it specifies the position of the binary point.

A1.4.6 Conversion between floating-point and fixed-point values

ARMv8 supports the conversion of a scalar floating-point to or from a signed or unsigned fixed-point value in a general-purpose register.

The instruction argument #fbits indicates that the general-purpose register holds a fixed-point number with fbits bits after the binary point, where fbits is in the range 1 to 64 for a 64-bit general-purpose register, or 1 to 32 for a 32-bit general-purpose register.

More specifically:

- For a 64-bit register X_d :
 - The integer part is $X_d[63:\#fbits]$.
 - The fractional part is $X_d[(\#fbits-1):0]$.
- For a 32-bit register W_d or R_d :
 - The integer part is $W_d[31:\#fbits]$ or $R_d[31:\#fbits]$.
 - The fractional part is $W_d[(\#fbits-1):0]$ or $R_d[(\#fbits-1):0]$.

These instructions can cause the following floating-point exceptions:

- Invalid Operation** When the floating-point input is NaN or Infinity or when a numerical value cannot be represented within the destination register.
- Inexact** When the numeric result differs from the input value.
- Input Denormal** When Flush-to-zero mode is enabled and the denormal input is replaced by a zero.

———— **Note** —————

An out of range fixed-point result is saturated to the destination size.

For more information, see *Floating-point exceptions and exception traps* on page D1-1831.

A1.4.7 Polynomial arithmetic over {0, 1}

Some SIMD instructions that operate on SIMD&FP registers can operate on polynomials over {0, 1}, see *Supported data types* on page A1-38. The polynomial data type represents a polynomial in x of the form $b_{n-1}x^{n-1} + \dots + b_1x + b_0$ where b_k is bit[k] of the value.

The coefficients 0 and 1 are manipulated using the rules of Boolean arithmetic:

- $0 + 0 = 1 + 1 = 0$
- $0 + 1 = 1 + 0 = 1$
- $0 \times 0 = 0 \times 1 = 1 \times 0 = 0$
- $1 \times 1 = 1$.

That is:

- Adding two polynomials over {0, 1} is the same as a bitwise exclusive OR.
- Multiplying two polynomials over {0, 1} is the same as integer multiplication except that partial products are exclusive-ORed instead of being added.

A64, A32, and T32 provide instructions for performing polynomial multiplication of 8-bit values.

- For AArch32, see *VMUL (integer and polynomial)* on page F6-4026 and *VMULL (integer and polynomial)* on page F6-4031.
- For AArch64, see *PMUL* on page C7-1402 and *PMULL, PMULL2* on page C7-1404.

The Cryptographic Extension adds the ability to perform long polynomial multiplies of 64-bit values. See *PMULL, PMULL2* on page C7-1404.

Pseudocode description of polynomial multiplication

In pseudocode, polynomial addition is described by the EOR operation on bitstrings.

Polynomial multiplication is described by the `PolynomialMult()` function defined in *Chapter J1 ARMv8 Pseudocode*.

A1.5 Floating-point and Advanced SIMD support

———— **Note** ————

In AArch32 state, the SIMD instructions that operate on SIMD&FP registers are always described as the Advanced SIMD instructions, to distinguish them from the SIMD instructions in the base instruction sets, that operate on the 32-bit general-purpose registers. The A64 instruction set does not provide any SIMD instructions that operate on the general-purpose registers, and therefore some AArch64 state descriptions use SIMD as a synonym for Advanced SIMD. Unless the context clearly indicates otherwise, this section describes the support for SIMD instructions that operate on SIMD&FP registers.

- Full SIMD and floating-point support without exception trapping.
- Full SIMD and floating-point support with exception trapping.
- No floating-point or SIMD support. This option is licensed only for implementations targeting specialized markets.

———— **Note** ————

All systems that support standard operating systems with rich application environments provide hardware support for Advanced SIMD and floating-point. It is a requirement of the ARM Procedure Call Standard for AArch64, see *Procedure Call Standard for the ARM 64-bit Architecture*.

ARMv8 supports single-precision (32-bit) and double-precision (64-bit) floating-point data types and arithmetic as defined by the IEEE 754 floating-point standard. It also supports the half-precision (16-bit) floating-point data type for data storage, by supporting conversions between single-precision and half-precision data types and double-precision and half-precision data types. **When ARMv8.2-FP16 is implemented, it also supports the half-precision floating-point data type for data-processing operations.**

The SIMD instructions provide packed *Single Instruction Multiple Data (SIMD)* and single-element scalar operations, and support:

- Single-precision and double-precision arithmetic in AArch64 state.
- Single-precision arithmetic only in AArch32 state.
- **When ARMv8.2-FP16 is implemented, half-precision arithmetic is supported in AArch64 and AArch32 states.**

Floating-point support in AArch64 state SIMD is IEEE 754-2008 compliant with:

- Configurable rounding modes.
- Configurable Default NaN behavior.
- Configurable Flush-to-zero behavior.

Floating-point computation using AArch32 Advanced SIMD instructions remains unchanged from ARMv7. A32 and T32 Advanced SIMD floating-point always uses ARM standard floating-point arithmetic and performs IEEE 754 floating-point arithmetic with the following restrictions:

- Denormalized numbers are flushed to zero, see *Flush-to-zero on page A1-51*.
- Only default NaNs are supported, see *NaN handling and the Default NaN on page A1-52*.
- The Round to Nearest rounding mode is used.
- Untrapped floating-point exception handling is used for all floating-point exceptions.

If floating-point exception trapping is supported, floating-point exceptions, such as Overflow or Divide by Zero, can be handled without trapping. This applies to both SIMD and floating-point operations. When handled in this way, a floating-point exception causes a cumulative status register bit to be set to 1 and a default result to be produced by the operation. For more information about floating-point exceptions, see *Floating-point exceptions and exception traps on page D1-1831*.

In AArch64 state, the following registers control floating-point operation and return floating-point status information:

- The Floating-Point Control Register, **FPCR**, controls:
 - The half-precision format where applicable, **FPCR.AHP** bit.
 - Default NaN behavior, **FPCR.DN** bit.
 - Flush-to-zero behavior, **FPCR.{FZ, FZ16}** bits. If **ARMv8.2-FP16** is not implemented, **FPCR.FZ16** is RES0.
 - Rounding mode support, **FPCR.Rmode** field.
 - Len and Stride fields associated with execution in AArch32 state, and only supported for a context save and restore from AArch64 state. These fields are obsolete in ARMv8 and can be implemented as RAZ/WI. If they are implemented as RW and are programmed to a nonzero value, they make some AArch32 floating-point instructions UNDEFINED.
 - Floating-point exception trap controls, the **FPCR.{IDE, IXE, UFE, OFE, DZE, IOE}** bits, see *Floating-point exceptions and exception traps on page D1-1831*. In an implementation that does not support trapping of floating-point exceptions these bits are RES0.
- The Floating-Point Status Register, **FPSR**, provides:
 - Cumulative floating-point exceptions flags, **FPSR.{IDC, IXC, UFC, OFC, DZC, IOC and QC}**.
 - The AArch32 floating-point comparison flags **{N,Z,C,V}**. These bits are RES0 if AArch32 floating-point is not implemented.

———— **Note** —————

In AArch64 state, the process state flags, **PSTATE.{N,Z,C,V}** are used for all data-processing compares and any associated conditional execution.

AArch32 state provides a single Floating-Point Status and Control Register, **FPSCR**, combining the **FPCR** and **FPSR** fields.

For system level information about the SIMD and floating-point support, see *Advanced SIMD and floating-point support on page G1-4412*.

A1.5.1 Instruction support

- Load and store for single elements and vectors of multiple elements.

———— **Note** —————

Single elements are also referred to as scalar elements.

- Data processing on single and multiple elements for both integer and floating-point data types.
- Floating-point conversion between different levels of precision.
- Conversion between floating-point, fixed-point integer, and integer data types.
- Floating-point rounding.

For more information on the SIMD and floating-point instructions in AArch64 state, see *Chapter C3 A64 Instruction Set Overview*.

For more information on the Advanced SIMD and floating-point instructions in AArch32 state, see *Chapter F1 The AArch32 Instruction Sets Overview*.

A1.5.2 Floating-point standards, and terminology

The ARM includes support for all the required features of ANSI/IEEE Std 754-2008, *IEEE Standard for Binary Floating-Point Arithmetic*, referred to as IEEE 754-2008. However, some terms in this manual are based on the 1985 version of this standard, referred to as IEEE 754-1985:

- ARM floating-point terminology generally uses the IEEE 754-1985 terms. This section summarizes how IEEE 754-2008 changes these terms.

- References to IEEE 754 that do not include the issue year apply to either issue of the standard.

Table A1-3 shows how the terminology in this manual differs from that used in IEEE 754-2008.

Table A1-3 Floating-point terminology

This manual	IEEE 754-2008
Normalized ^a	Normal
Denormal, or denormalized	Subnormal
Round towards Minus Infinity (RM)	roundTowardsNegative
Round towards Plus Infinity (RP)	roundTowardsPositive
Round towards Zero (RZ)	roundTowardZero
Round to Nearest (RN)	roundTiesToEven
Round to Nearest with Ties to Away	roundTiesToAway
Rounding mode	Rounding-direction attribute

a. *Normalized number* is used in preference to *normal number*, because of the other specific uses of *normal* in this manual.

A1.5.3 ARM standard floating-point input and output values

ARMv8 provides full IEEE 754 floating-point arithmetic support. In AArch32 state, floating-point operations performed using Advanced SIMD instructions are limited to *ARM standard floating-point operation*, regardless of the selected rounding mode in the FPSCR. Unlike AArch32, AArch64 SIMD floating point arithmetic is performed using the rounding mode selected by the FPCR.

ARM standard floating-point arithmetic supports the following input formats defined by the IEEE 754 floating-point standard:

- Zeros.
- Normalized numbers.
- Denormalized numbers are flushed to 0 before floating-point operations, see [Flush-to-zero on page A1-51](#).
- NaNs.
- Infinities.

ARM standard floating-point arithmetic supports the Round to Nearest (roundTiesToEven) rounding mode defined by the IEEE 754 standard.

ARM standard floating-point arithmetic supports the following output result formats defined by the IEEE 754 standard:

- Zeros.
- Normalized numbers.
- Results that are less than the minimum normalized number are flushed to zero, see [Flush-to-zero on page A1-51](#).
- NaNs produced in floating-point operations are always the default NaN, see [NaN handling and the Default NaN on page A1-52](#).
- Infinities.

A1.5.4 Flush-to-zero

The performance of floating-point processing can be reduced when doing calculations involving denormalized numbers and Underflow exceptions. In many algorithms, this performance can be recovered, without significantly affecting the accuracy of the final result, by replacing the denormalized operands and intermediate results with zeros. To permit this optimization, ARM floating-point implementations have a processing mode called *Flush-to-zero* mode. Single-precision and double-precision AArch32 Advanced SIMD floating-point instructions always use Flush-to-zero mode. **When ARMv8.2-FP16 is implemented, Flush-to-zero mode can be enabled for all half-precision data-processing instructions using the FPCR.FZ16 bit in AArch64 state and the FPSCR.FZ16 bit in AArch32 state.**

Behavior in Flush-to-zero mode differs from standard IEEE 754 arithmetic in the following ways:

- All inputs to floating-point operations that are double-precision denormalized numbers or single-precision denormalized numbers are treated as though they were zero. This causes an Input Denormal floating-point exception, but does not cause an Inexact floating-point exception.

The Input Denormal floating-point exception occurs only in Flush-to-zero mode.

———— **Note** —————

When ARMv8.2-FP16 is implemented, when in Flush-to-zero mode, a half-precision floating-point number that is flushed to zero does not generate an Input Denormal floating-point exception. This is because this situation is much less exceptional than for double-precision or single-precision denormalized numbers.

In AArch32 state, the **FPSCR** contains a cumulative exception bit **FPSCR.IDC** and optional trap enable bit **FPSCR.IDE** corresponding to the Input Denormal floating-point exception.

In AArch64 state, the **FPSR** contains a cumulative exception bit **FPSR.IDC** and optional trap enable bit **FPCR.IDE** corresponding to the Input Denormal floating-point exception.

The occurrence of all floating-point exceptions except Input Denormal is determined using the input values after flush-to-zero processing has occurred.

- The result of a floating-point operation is flushed to zero if the result of the operation before rounding satisfies the condition:

$0 < \text{Abs}(\text{result}) < \text{MinNorm}$, where:

- **MinNorm is 2^{-14} for half-precision.**
- MinNorm is 2^{-126} for single-precision.
- MinNorm is 2^{-1022} for double-precision.

This causes the **FPSR.UFC** bit to be set to 1, and prevents any Inexact floating-point exception from occurring for the operation.

Underflow floating-point exceptions occur only when a result is flushed to zero.

In all implementations Underflow floating-point exceptions that occur in Flush-to-zero mode are always treated as untrapped, even when the Underflow trap enable bit, **FPCR.UFE**, is set to 1.

- An Inexact floating-point exception does not occur if the result is flushed to zero, even though the final result of zero is not equivalent to the value that would be produced if the operation were performed with unbounded precision and exponent range.

When an input or a result is flushed to zero, the value of the sign bit of the zero is preserved. That is, the sign bit of the zero matches the sign bit of the input or result that is being flushed to zero.

Flush-to-zero mode has no effect on half-precision numbers that are inputs to floating-point operations, or results from floating-point operations. **When ARMv8.2-FP16 is implemented and when Flush-to-zero mode is enabled, Flush-to-zero mode affects half-precision data-processing instructions, but has no effect on conversions between half-precision and single-precision or double-precision.**

———— **Note** ————

Flush-to-zero mode is incompatible with the IEEE 754 standard, and must not be used when IEEE 754 compatibility is a requirement. Flush-to-zero mode must be used with care. Although it can improve performance on some algorithms, there are significant limitations on its use. These are application-dependent:

- With many algorithms, it has no noticeable effect, because the algorithm does not normally use denormalized numbers.
 - With other algorithms, it can cause exceptions to occur or seriously reduce the accuracy of the results of the algorithm.
-

A1.5.5 NaN handling and the Default NaN

The IEEE 754 standard specifies that:

- An operation that causes an Invalid Operation floating-point exception generates a quiet NaN as its result if that exception is untrapped.
- An operation involving a quiet NaN operand, but not a signaling NaN operand, returns an input NaN as its result.

The floating-point processing behavior when Default NaN mode is disabled adheres to this, with the following additions:

- If an untrapped Invalid Operation floating-point exception occurs, the quiet NaN result is derived from:
 - The first signaling NaN operand, if the exception occurs because at least one of the operands is a signaling NaN.
 - Otherwise, the default NaN.
- If an untrapped Invalid Operation floating-point exception does not occur, but at least one of the operands is a quiet NaN, the result is derived from the first quiet NaN operand.

Depending on the operation, the exact value of a derived quiet NaN result may differ in both sign and number of fraction bits from its source. For a quiet NaN result derived from signaling NaN operand, the most significant fraction bit is set to 1.

———— **Note** ————

- In these descriptions, *first operand* relates to the left-to-right ordering of the arguments to the pseudocode function that describes the operation.
 - The IEEE 754 standard specifies that the sign bit of a NaN has no significance.
-

The SIMD and floating-point processing behavior when Default NaN mode is enabled is that the Default NaN is the result of all floating-point operations that either:

- Cause untrapped Invalid Operation floating-point exceptions.
- Have one or more quiet NaN inputs, but no signaling NaN inputs.

[Table A1-4 on page A1-53](#) shows the format of the default NaN for ARM floating-point operations.

Default NaN mode is selected for the floating-point processing by setting the [FPCR.DN](#) bit to 1.

Other aspects of the functionality of the Invalid Operation floating-point exception are not affected by Default NaN mode. These are that:

- If untrapped, it causes the [FPSR.IOC](#) bit to be set to 1.
- If trapped, it causes a user trap handler to be invoked.

Table A1-4 Default NaN encoding

	Half-precision, IEEE Format	Single-precision	Double-precision
Sign bit	0	0	0
Exponent	0x1F	0xFF	0x7FF
Fraction	Bit[9] == 1, bits[8:0] == 0	Bit[22] == 1, bits[21:0] == 0	Bit[51] == 1, bits[50:0] == 0

A1.6 The ARM memory model

The ARM memory model supports:

- Generating an exception on an unaligned memory access.
- Restricting access by applications to specified areas of memory.
- Translating virtual addresses provided by executing instructions into physical addresses.
- Altering the interpretation of multi-byte data between big-endian and little-endian.
- Controlling the order of accesses to memory.
- Controlling caches and address translation structures.
- Synchronizing access to shared memory by multiple PEs.

Virtual address (VA) support depends on the Execution state, as follows:

AArch64 state

Supports 64-bit virtual addressing, with the Translation Control Register determining the supported VA range. Execution at EL1 and EL0 supports two independent VA ranges, each with its own translation controls.

AArch32 state

Supports 32-bit virtual addressing, with the Translation Control Register determining the supported VA range. For execution at EL1 and EL0, system software can split the VA range into two subranges, each with its own translation controls.

The supported physical address space is IMPLEMENTATION DEFINED, and can be discovered by system software.

Regardless of the Execution state, the *Virtual Memory System Architecture* (VMSA) can translate VAs to blocks or pages of memory anywhere within the supported physical address space.

For more information, see:

For execution in AArch64 state

- [Chapter B2 The AArch64 Application Level Memory Model.](#)
- [Chapter D3 The AArch64 System Level Memory Model.](#)
- [Chapter D4 The AArch64 Virtual Memory System Architecture.](#)

For execution in AArch32 state

- [Chapter E2 The AArch32 Application Level Memory Model.](#)
- [Chapter G3 The AArch32 System Level Memory Model.](#)
- [Chapter G4 The AArch32 Virtual Memory System Architecture.](#)

A1.7 ARMv8 architecture extensions

The original ARMv8-A architecture is called ARMv8.0. The following sections of this manual describe or summarize the permitted extensions to ARMv8.0:

- [The ARMv8.0 Cryptographic Extension on page A1-56.](#)
- [The Performance Monitors Extension on page D1-1886.](#)
- [The IVIPT Extension on page D4-2135.](#)
- [Chapter H7 The PC Sample-based Profiling Extension.](#)
- [The Reliability, Availability, and Serviceability \(RAS\) Extension on page A1-63.](#)

In addition to describing ARMv8.0, this manual describes the following architectural extensions:

The ARMv8.1 architectural extension

The ARMv8.1 architecture extension adds both:

- Additional architectural features. Some of these are mandatory, others are optional. Some features must be implemented together.
- Additional architectural requirements. These are mandatory.

An implementation is ARMv8.1 compliant when all of the following apply:

- It includes all of the ARMv8.1 additional architectural features that are mandatory. [Architectural features added by ARMv8.1 on page A1-56](#) lists all of the ARMv8.1 additional architectural features.
- It includes all of the ARMv8.1 additional architectural requirements. [Additional requirements of ARMv8.1 on page A1-58](#) lists these requirements.

For more information, see [The ARMv8.1 architecture extension on page A1-56](#).

The ARMv8.2 architectural extension

The ARMv8.2 architecture extension is an extension to ARMv8.1. It adds both:

- Additional architectural features. Some of these are mandatory, others are optional. Some features must be implemented together.
- Additional architectural requirements. These are mandatory.

An implementation is ARMv8.2 compliant if all of the following apply:

- It is ARMv8.1 compliant.
- It includes all of the ARMv8.2 additional architectural features that are mandatory. [Architectural features added by ARMv8.2 on page A1-59](#) lists all of the ARMv8.2 additional architectural features.
- It includes all of the ARMv8.2 additional architectural requirements. [Additional requirements of ARMv8.2 on page A1-63](#) lists these requirements.

For more information, see [The ARMv8.2 architecture extension on page A1-59](#).

The Statistical Profiling Extension

SPE is an optional extension to ARMv8.2. That is, SPE requires the implementation of ARMv8.2.

For more information, see [The Statistical Profiling Extension on page A1-65](#).

The Scalable Vector Extension (SVE)

SVE is an optional extension to ARMv8.2. That is, SVE requires the implementation of ARMv8.2.

For more information, see [The Scalable Vector Extension \(SVE\) on page A1-66](#).

See also [Permitted implementation of subsets of ARMv8.1 and ARMv8.2 architectural features on page A1-56](#).

A1.7.1 Permitted implementation of subsets of ARMv8.1 and ARMv8.2 architectural features

An ARMv8.x compliant implementation can include any arbitrary subset of the architectural features of ARMv8.(x+1), subject only to those constraints that require that certain features be implemented together.

An ARMv8.x compliant implementation cannot include any features of ARMv8.(x+2).

A1.7.2 The ARMv8.0 Cryptographic Extension

The presence of this Extension in an implementation is subject to export license controls. The Cryptographic Extension is an extension of the SIMD support and operates on the vector register file. It provides instructions for the acceleration of encryption and decryption to support the following:

- AES
- SHA1
- SHA2-256

The Cryptographic Extension also provides multiply instructions that operate on long polynomials, see [PMULL](#), [PMULL2](#) on page C7-1404.

A1.7.3 The ARMv8.1 architecture extension

The ARMv8.1 architecture extension adds both architectural features and architectural requirements.

Architectural features added by ARMv8.1

The ARMv8.1 architecture extension adds the following architectural features, which are identified by the architectural feature name and a short description of the feature:

ARMv8.1-Atomics, ARMv8.1 Atomic instructions

ARMv8.1-Atomics introduces a set of atomic instructions:

- Compare and Swap instructions, CAS and CASP.
- Atomic memory operation instructions, LD<OP> and ST<OP>, where <OP> is one of ADD, CLR, EOR, SET, SMAX, SMIN, UMAX, and UMIN.
- Swap instruction, SWP.

These instructions are only added to the A64 instruction set.

This feature is mandatory in ARMv8.1 implementations.

Implementations of [ARMv8.1-VHE](#) require the implementation of ARMv8.1-Atomics.

The [ID_AA64ISAR0_EL1](#).Atomic field identifies the presence of ARMv8.1-Atomics.

For more information, see:

- [Compare and Swap](#) on page C3-172.
- [Atomic memory operations](#) on page C3-173.
- [Swap](#) on page C3-175.

ARMv8.1-SIMD, ARMv8.1 Advanced SIMD instructions

ARMv8.1-SIMD introduces Rounding Double Multiply Add/Subtract Advanced SIMD instructions. For more information, see:

For the A64 instruction set

- [SQRDMLAH \(by element\)](#) on page C7-1529.
- [SQRDMLAH \(vector\)](#) on page C7-1532.
- [SQRDMLSH \(by element\)](#) on page C7-1534.
- [SQRDMLSH \(vector\)](#) on page C7-1537.

For the T32 and A32 instruction sets

- [VQRDMLAH](#) on page F6-4104.
- [VQRDMLSH](#) on page F6-4108.

This feature is mandatory in ARMv8.1 implementations.

The [ID_AA64ISAR0_EL1.RDM](#) and [ID_ISAR5.RDM](#) fields identify the presence of ARMv8.1-SIMD.

ARMv8.1-LOR, Limited ordering regions

Limited ordering regions allow large systems to perform special load-acquire and store-release instructions that provide order between the memory accesses to a region of the physical address map as observed by a limited set of observers.

This feature is mandatory in ARMv8.1 implementations.

This feature is supported in AArch64 state only.

The [ID_AA64MMFR1_EL1.LO](#) field identifies the support for ARMv8.1-LOR.

For more information, see:

- [Limited ordering regions on page B2-96](#).

ARMv8.1-HPD, Hierarchical permission disables

ARMv8.1-HPD introduces the facility to disable the hierarchical attributes, APTable, PXNTable, and UXNTable, in the translation tables. This disable has no effect on the NSTable bit.

This feature is mandatory in ARMv8.1 implementations.

This feature is added only to the VMSAv8-64 translation regimes. ARMv8.2 extends this to the AArch32 translation regimes, see [ARMv8.2-AA32HPD](#).

The [ID_AA64MMFR1_EL1.HPDS](#) field identifies the support for ARMv8.1-HPD.

ARMv8.1-TTHM, Hardware management of the Access flag and dirty state

In ARMv8.0, all updates to the translation tables are performed by software. From ARMv8.1, in AArch64 state only, hardware can perform updates to the translation tables in two contexts:

- Hardware management of the Access flag.
- Hardware management of dirty state, with updates to a dirty state bit in the translation tables.

The dirty state bit is introduced in ARMv8.1.

Hardware management of dirty state can only be enabled when hardware management of the Access flag is also enabled.

This feature is OPTIONAL in ARMv8.1 implementations. It is IMPLEMENTATION DEFINED whether this is implemented.

The [ID_AA64MMFR1_EL1.HAFDBS](#) field identifies the support for ARMv8.1-TTHM.

For more information, see:

- [The dirty state bit on page D4-2081](#).
- [Hardware management of the Access flag and dirty state on page D4-2081](#).

ARMv8.1-PAN, Privileged access never

ARMv8.1-PAN adds a new bit to [PSTATE](#). When the value of this PAN state bit is 1, any privileged data access from EL1 or EL2 to a virtual memory address that is accessible at EL0 generates a Permission fault.

This feature is mandatory in ARMv8.1 implementations.

This feature is supported in AArch64 and AArch32 states.

The [ID_AA64MMFR1_EL1.PAN](#) and [ID_MMFR3.PAN](#) fields identify the support for ARMv8.1-PAN.

- [About the PAN bit on page D4-2072](#).
- [About the PAN bit on page G4-4608](#).

ARMv8.1-VMID16, 16-bit VMID

In an ARMv8.1 implementation, when EL2 is using AArch64, the VMID size is an IMPLEMENTATION DEFINED choice of 8 bits or 16 bits.

This feature is OPTIONAL in ARMv8.1 implementations. It is IMPLEMENTATION DEFINED whether this is implemented.

When implemented, this feature is supported only when EL2 is using AArch64.

The [ID_AA64MMFR1_EL1.VMIDBits](#) field identifies the supported VMID size.

For more information, see:

- [VMID size on page D4-2115](#).

ARMv8.1-VHE, Virtualization Host Extensions

ARMv8.1 introduces the *Virtualization Host Extensions* (VHE) that provide enhanced support for Type 2 hypervisors in Non-secure state.

This feature is mandatory in ARMv8.1 implementations.

An implementation that includes [ARMv8.1-VHE](#) requires [ARMv8.1-Atomics](#) to be implemented.

The [ID_AA64MMFR1_EL1.VH](#) field identifies the support for ARMv8.1-VHE.

The following fields indicate the presence of the Virtualization Host Extensions for debug, including the changes for the PC Sample-based Profiling Extension and the Performance Monitors Extension:

- [ID_AA64DFR0_EL1.DebugVer](#).
- [ID_DFR0_EL1](#).{CopSDBG, CopDBG}.

For more information, see:

- [Virtualization Host Extensions on page D4-2098](#).

ARMv8.1-PMU, ARMv8.1 PMU Extension

ARMv8.1 makes the following enhancements to the Performance Monitors Extension:

- The event number space is extended to 16 bits to allow additional IMPLEMENTATION DEFINED event types, and the reserved space for future additions to the architecturally-defined event types is extended.
- The HPMD bit is added to [MDCR_EL2](#). This bit disables event counting at EL2.
- The [STALL_FRONTEND](#) and [STALL_BACKEND](#) events are required to be implemented. For more information, see [Required events on page D5-2174](#).

The Performance Monitors Extension is an OPTIONAL feature of an implementation, but ARM strongly recommends that ARMv8.1 implementations include either:

- Version 3 of the Performance Monitors Extension, PMUV3, with a 16-bit evtCount field.
- An IMPLEMENTATION DEFINED form of performance monitors.

The [ID_AA64DFR0_EL1.PMUVer](#) and [ID_DFR0.PerfMon](#) fields identify the ARMv8.1 enhancements to Performance Monitors Extension.

An implementation of the ARMv8.1 extension must include all of the features that this section describes as mandatory. Such an implementation, when combined with the additional requirements of ARMv8.1, is also called an implementation of the ARMv8.1 architecture.

Additional requirements of ARMv8.1

The ARMv8.1 architecture includes some mandatory changes that are not associated with a feature. These are:

Changes to CRC32 instructions

All implementations of the ARMv8.1 architecture are required to implement the CRC32 instructions. These are OPTIONAL in ARMv8.0.

An implementation of the ARMv8.1 extension must comply with all of the additional requirements. Such an implementation, when combined with the mandatory architectural features of ARMv8.1, is also called an implementation of the ARMv8.1 architecture.

A1.7.4 The ARMv8.2 architecture extension

The ARMv8.2 architecture extension adds both architectural features and architectural requirements.

Architectural features added by ARMv8.2

The ARMv8.2 architecture extension adds the following architectural features, which are identified by the architectural feature name and a short description of the feature:

ARMv8.2-A64ISA, ARMv8.2 changes to the A64 ISA

ARMv8.2-A64ISA adds the BFC instruction to the A64 instruction set as an alias of BFM. It also requires that the new BFC instruction and the A64 pseudo-instruction REV64 are implemented by assemblers.

Note

In ARMv8.0 and ARMv8.1, the A64 pseudo-instruction REV64 is OPTIONAL.

This change to the instruction set and assembler requirements is mandatory in an ARMv8.2 implementation.

For more information, see:

- *BFC* on page C6-551.
- *REV64* on page C6-811.

ARMv8.2-ATS1E1, AT S1E1R and AT S1E1W instruction variants, taking account of PSTATE.PAN

ARMv8.2-ATS1E1 adds new variants of the AArch64 AT S1E1R and AT S1E1W instructions and the AArch32 ATS1CPR and ATS1CPW instructions. These new instructions factor in the PSTATE.PAN bit when determining whether or not the location will generate a permission fault for a privileged access, as is reported in the PAR.

In AArch64 state, the new instructions are:

- *AT S1E1RP*, Address Translate Stage 1 EL1 Read PAN on page C5-442.
- *AT S1E1WP*, Address Translate Stage 1 EL1 Write PAN on page C5-446.

In AArch32 state, the new instructions are:

- *ATS1CPRP*, Address Translate Stage 1 Current state PL1 Read PAN on page G6-4801.
- *ATS1CPWP*, Address Translate Stage 1 Current state PL1 Write PAN on page G6-4805.

This feature is mandatory in ARMv8.2 implementations.

This feature is supported in AArch64 and AArch32 states.

The ID_AA64MMFR1_EL1.PAN, ID_MMFR3_EL1.PAN, and ID_MMFR3.PAN fields identify the presence of ARMv8.2-ATS1E1.

For more information, see:

- *Address translation instructions* on page D4-2056.
- *ATSIC***, Address translation stage 1, current Security state on page G4-4683.
- *Encoding and availability of the address translation instructions* on page G4-4684.

ARMv8.2-FP16, Half-precision floating-point data processing

ARMv8.2-FP16 supports:

- Half-precision data-processing instructions for Advanced SIMD and floating-point in both AArch64 and AArch32 states.
- The FPCR.FZ16 and FPSCR.FZ16 bits, which enable a Flush-to-zero mode for half-precision data-processing instructions.

This is an OPTIONAL feature in ARMv8.2 implementations, unless SVE is implemented, in which case ARMv8.2-FP16 becomes a mandatory feature. It is IMPLEMENTATION DEFINED whether it is implemented. If this feature is implemented, then it is implemented in both Advanced SIMD and floating-point, and across both AArch64 and AArch32 states.

The ID_AA64PFR0_EL1.{FP, AdvSIMD} and MVFR1.{FPHP, SIMDHP} fields identify the presence of ARMv8.2-FP16.

For more information, see:

- *Half-precision floating-point formats* on page A1-42.
- *Flush-to-zero* on page A1-51.
- *Modified immediate constants in A64 instructions* on page C2-152.

ARMv8.2-LSMAOC, Load/Store Multiple atomicity and ordering controls

ARMv8.2-LSMAOC permits the deprecation of some LDM and STM ordering behaviors in AArch32 state. This means that:

- Accesses to ordered Device space using LDM or STM instructions do not have to do so in ascending address order.
- An interrupt is permitted to be taken within the sequence of memory accesses generated by an LDM or STM instruction.

ARMv8.2-LSMAOC also adds optional controls to manage this deprecation. These are:

- The LSMAOE bit in SCTLR_EL1, SCTLR_EL2, HSCTLR, and SCTLR indicates that LDM and STM are permitted to be reordered or interrupted in any memory type.
- The nTLSMD bit in SCTLR_EL1, SCTLR_EL2, HSCTLR, and SCTLR causes LDM and STM accesses to Device memory to cause an Alignment fault.

ID_AA64MMFR2_EL1.LSM, ID_MMFR4_EL1.LSM, and ID_MMFR4.LSM fields identify the support for ARMv8.2-LSMAOC.

For more information, see:

- *Multi-register loads and stores that access Device memory* on page E2-2790.
- *Taking an interrupt or other exception during a multiple-register load or store* on page G1-4374.

ARMv8.2-UAO, PSTATE override of Unprivileged Load/Store

ARMv8.2 adds a new bit to PSTATE. When the value of PSTATE.UAO is 1, and when executed at EL1 or at EL2 with HCR_EL2.{E2H, TGE} == {1, 1}, the memory accesses made by the Load/Store unprivileged instructions behave as if they were made by the Load/Store register instructions. See *Load/Store unprivileged* on page C3-164 and *Load/Store register* on page C3-160.

This feature is mandatory in ARMv8.2 implementations.

This feature is supported in AArch64 state only.

The ID_AA64MMFR2_EL1.UAO field identifies the support for ARMv8.2-UAO.

For more information, see:

- *About the UAO bit* on page D4-2072.

ARMv8.2-DCPoP, Data cache clean to Point of Persistence

ARMv8.2-DCPoP introduces a mechanism to identify and manage persistent memory locations in a shared memory hierarchy.

This feature is mandatory in ARMv8.2 implementations.

This feature is supported in AArch64 state only.

The ID_AA64ISAR1_EL1.DPB field identifies the support for ARMv8.2-DCPoP.

For more information about ARMv8.2-DCPoP, see:

- *Memory hierarchy* on page B2-98

ARMv8.2-VPIPT, VMID-aware PIPT instruction cache

ARMv8.2-VPIPT supports a new instruction cache type, described as the *VMID-aware PIPT* (VPIPT) instruction cache.

This feature is supported in AArch64 and AArch32 states.

The CTR_EL0.L1Ip and CTR.L1Ip fields identify the support for ARMv8.2-VPIPT.

For more information, see:

- *VPIPT (VMID-aware PIPT) instruction caches* on page D4-2134.
- *VPIPT (VMID-aware PIPT) instruction caches* on page G4-4647.

ARMv8.2-AA32HPD, AArch32 Hierarchical permission disables

ARMv8.1-HPD introduced the ability to disable the hierarchical attributes, APTable, PXNTable, and UXNTable, in the VMSAv8-64 translation regimes. ARMv8.2-AA32HPD extends this functionality to the VMSAv8-32 translation regimes when those regimes are using the Long descriptor translation table format.

This feature is OPTIONAL in ARMv8.2 implementations. It is IMPLEMENTATION DEFINED whether this is implemented.

The ID_MMFR4.HPDS field identifies the support for ARMv8.2-AA32HPD.

For more information, see:

- *Memory attribute fields in the VMSAv8-32 Long-descriptor translation table format descriptors* on page G4-4589.

ARMv8.2-TTPBHA, Translation table Page based hardware attributes

ARMv8.2 provides a mechanism to allow operating systems or hypervisors to make up to four bits of translation table level 3 descriptors available for IMPLEMENTATION DEFINED hardware use.

This facility is available for all translation regimes in AArch64 state and for translation regimes in AArch32 state that use the Long descriptor translation table format.

ARMv8.2-TTPBHA is OPTIONAL in ARMv8.2 implementations, but Page based hardware attributes can only be used when the corresponding Hierarchical permission disables bit has a value of 1. This means that the ARMv8.2-TTPBHA feature has a dependency on the ARMv8.2-HPD and ARMv8.1-HPD features.

The ID_AA64MMFR1_EL1.HPDS and ID_MMFR4.HPDS fields identify the support for ARMv8.2-TTPBHA.

For more information, see:

- *Memory attribute fields in the VMSAv8-64 translation table format descriptors* on page D4-2064.
- *Memory attribute fields in the VMSAv8-32 Long-descriptor translation table format descriptors* on page G4-4589.

ARMv8.2-LPA, Large PA and IPA support

ARMv8.2-LPA:

- Allows a larger intermediate physical address and physical address space of up to 52 bits when using the 64KB translation granule.
- Allows a level 1 block size where the block covers a 4TB address range for the 64KB translation granule if the implementation support 52 bits of physical address.

This is an OPTIONAL feature in ARMv8.2 implementations. It is IMPLEMENTATION DEFINED whether it is implemented.

This feature is supported in AArch64 state only.

The ID_AA64MMFR0_EL1.PARange field identifies the support for ARMv8.2-LPA.

For more information about ARMv8.2-LPA, see:

- *VMSA address types and address spaces* on page D4-2005.

- *Address size configuration* on page D4-2014.
- *Extending addressing above 48 bits* on page D4-2018.
- *VMSAv8-64 translation table level 0, level 1, and level 2 descriptor formats* on page D4-2060.
- *ARMv8 translation table level 3 descriptor formats* on page D4-2063.

ARMv8.2-LVA, Large VA support

ARMv8.2-LVA supports a larger virtual address space for each translation table base register of up to 52 bits when using the 64KB translation granule.

This is an OPTIONAL feature in ARMv8.2 implementations. It is IMPLEMENTATION DEFINED whether it is implemented.

If ARMv8.2-LVA is implemented, then any implemented trace macrocell must be at least ETMv4.2.

This feature is supported in AArch64 state only.

The ID_AA64MMFR2_EL1.VARange field identifies the support for ARMv8.2-LVA.

For more information about ARMv8.2-LVA, see:

- *VMSA address types and address spaces* on page D4-2005.
- *Address size configuration* on page D4-2014.
- *Extending addressing above 48 bits* on page D4-2018.
- *VMSAv8-64 translation table level 0, level 1, and level 2 descriptor formats* on page D4-2060.
- *ARMv8 translation table level 3 descriptor formats* on page D4-2063.

ARMv8.2-TTCNP, Translation table Common not private translations

ARMv8.2-TTCNP introduces the facility for multiple PEs in the same Inner Shareable domain to use the same translation tables for a given stage of address translation.

This feature is mandatory in ARMv8.2 implementations.

This facility is available for all translation regimes in AArch64 state and for translation regimes in AArch32 state that use the Long descriptor translation table format.

The ID_AA64MMFR2_EL1.CnP and ID_MMFR4.CnP fields identify the support for ARMv8.2-TTCNP.

For more information, see:

- *Common not private translations* on page D4-2114.
- *Common not private translations in VMSAv8-32* on page G4-4636.

ARMv8.2-TTS2UXN, Translation table stage 2 Unprivileged Execute-never

ARMv8.2-TTS2UXN introduces the facility in the stage 2 translation tables to allow the stage 2 control of whether memory is executable at EL1 independent of whether memory is executable at EL0.

This feature is mandatory in ARMv8.2 implementations.

This facility is available for stage 2 translation regimes in AArch64 state and AArch32 state.

The ID_AA64MMFR1_EL1.XNX and ID_MMFR4.XNX fields identify the support for ARMv8.2-TTS2UXN.

For more information, see:

- *Access permissions for instruction execution* on page D4-2075.
- *Access permissions for instruction execution* on page G4-4609.

ARMv8.2-Debug, ARMv8.2 Debug

ARMv8.2-Debug covers a selection of mandatory changes, including:

- If the core power domain is powered up and `DoubleLockStatus() == TRUE`, `EDPRSR.{DLK,SPD,PU}` is only permitted to read as `{UNKNOWN, 0, 0}`.

- The definition of External Catch debug events is extended to include reset entry.
- All CONSTRAINED UNPREDICTABLE cases that generate External Catch debug events are removed.
- Controls are added to EDECCR to control Exception Catch debug event generation on exception return.
- All IMPLEMENTATION DEFINED control of external debug accesses to OSLAR_EL1 is removed.
- ExternalSecureNoninvasiveDebugEnabled() cannot override software controls of counting attributable events in Secure state.

The fields that identify the support for ARMv8.2-Debug are:

- ID_AA64DFR0_EL1.DebugVer.
- ID_DFR0_EL1.{CopSDBG, CopDBG}.
- DBGDIDR.Version.
- ID_DFR0.{CopSDBG, CopDBG}.
- EDDEVARCH.ARCHID.

For more information, see:

- *Exception Catch debug events from ARMv8.2* on page H3-5489.
- *EDPISR.{DLK, SPD, PU} and the Core power domain* on page H6-5537.
- *Interaction with EL3* on page D5-2145.
- *External access disabled* on page H8-5561.

ARMv8.2-PCSample, PC Sample-based Profiling

In ARMv8.2, the control and implementation of the OPTIONAL PC Sample-based Profiling Extension is moved from ED*SR Debug registers to PM*SR registers in the Performance Monitors address space. See Chapter H7 *The PC Sample-based Profiling Extension*.

The EDDEVID.PCSample, DBGDEVID.PCSample, EDDEVID1.PCSROffset, DBGDEVID1.PCSROffset, and PMDEVID.PCSample fields identify the support for PC Sample-based Profiling from ARMv8.2 onwards.

An implementation of the ARMv8.2 extension must include all of the features that this section describes as mandatory. Such an implementation, when combined with the additional requirements of ARMv8.2, is also called an implementation of the ARMv8.2 architecture.

Additional requirements of ARMv8.2

The ARMv8.2 architecture includes some mandatory changes that are not associated with a feature. These are:

Changes to ACTLR2 and HCTLR2 registers

In AArch32 state, the ACTLR2 and HACTLR2 registers become mandatory.

Implementation of RAS Extension

The RAS Extension must be implemented, see *The Reliability, Availability, and Serviceability (RAS) Extension*.

An implementation of the ARMv8.2 extension must comply with all of the additional requirements. Such an implementation, when combined with the mandatory architectural features of ARMv8.2, is also called an implementation of the ARMv8.2 architecture.

A1.7.5 The Reliability, Availability, and Serviceability (RAS) Extension

The RAS Extension is a mandatory extension to the ARMv8.2 architecture, and an OPTIONAL extension to the ARMv8.0 and the ARMv8.1 architectures.

The RAS Extension in ARMv8.2 adds the implicit Error Synchronization Barrier field, IESB, to the SCTRL_ELx registers. The implementation of the IESB field is mandatory in an ARMv8.2 implementation, OPTIONAL in an ARMv8.1 implementation, and not permitted in an ARMv8.0 implementation.

The RAS Extension improves the dependability of a system by providing:

- Reliability, that is the continuity of correct service.
- Availability, that is the readiness for correct service.
- Serviceability, that is the ability to undergo modifications and repairs.

ID_AA64PFR0_EL1.RAS in AArch64 state, and ID_PFR0.RAS in AArch32 state, indicate whether the RAS Extension is implemented.

The RAS Extension introduces a new barrier instruction, the Error Synchronization Barrier (ESB) to the A32, T32, and A64 instruction sets.

The RAS Extension introduces the following System registers:

- In AArch64 state:
 - DISR_EL1 - Deferred Interrupt Status Register.
 - ERRIDR_EL1 - Error Record ID Register.
 - ERRSELR_EL1 - Error Record Select Register.
 - ERXADDR_EL1 - Selected Error Record Address Register.
 - ERXCTLR_EL1 - Selected Error Record Control Register.
 - ERXFR_EL1 - Selected Error Record Feature Register.
 - ERXMISC0_EL1 - Selected Error Record Miscellaneous Register 0.
 - ERXMISC1_EL1 - Selected Error Record Miscellaneous Register 1.
 - ERXSTATUS_EL1 - Selected Error Record Primary Status Register.
 - VDISR_EL2 - Virtual Deferred Interrupt Status Register.
 - VSESR_EL2 - Virtual SError Exception Syndrome Register.
- In AArch32 state:
 - DISR - Deferred Interrupt Status Register.
 - ERRIDR - Error Record ID Register.
 - ERRSELR - Error Record Select Register.
 - ERXADDR - Selected Error Record Address Register.
 - ERXADDR2 - Selected Error Record Address Register 2.
 - ERXCTLR - Selected Error Record Control Register.
 - ERXCTLR2 - Selected Error Record Control Register 2.
 - ERXFR - Selected Error Record Feature Register.
 - ERXFR2 - Selected Error Record Feature Register 2.
 - ERXMISC0 - Selected Error Record Miscellaneous Register 0.
 - ERXMISC1 - Selected Error Record Miscellaneous Register 1.
 - ERXMISC2 - Selected Error Record Miscellaneous Register 2.
 - ERXMISC3 - Selected Error Record Miscellaneous Register 3.
 - ERXSTATUS - Selected Error Record Primary Status Register.
 - VDFSR - Virtual SError Exception Syndrome Register.
 - VDISR - Virtual Deferred Interrupt Status Register.

In addition, the RAS Extension introduces a number of memory-mapped registers.

The RAS Extension modifies the following existing System registers:

- In AArch64 state:
 - HCR_EL2.
 - ID_AA64MMFR1_EL1.
 - ID_AA64PFR0_EL1.
 - ID_MMFR4_EL1.
 - ID_PFR0_EL1.
 - SCR_EL3.
 - ESR_ELx.
 - IFSR32_EL2.
 - For implementation of the ARMv8.2 IESB field, SCTLR_EL1x.
- In AArch32 state:
 - HCR2.
 - ID_MMFR4.
 - ID_PFR0.
 - SCR.
 - DFSR.
 - IFSR.
 - HSR.

All registers and fields that are exclusively associated with the RAS architecture are described in the *ARM® Reliability, Availability, and Serviceability (RAS) Specification, ARMv8, for the ARMv8-A architecture profile*.

A1.7.6 The Statistical Profiling Extension

The Statistical Profiling Extension is an OPTIONAL extension introduced by the ARMv8.2 architecture. Implementation of the Statistical Profiling Extension requires implementation of at least ARMv8.1 of the ARMv8-A architecture profile. The Statistical Profiling Extension is only supported in AArch64 state.

The Statistical Profiling Extension provides a non-invasive method of sampling software and hardware using randomized sampling of either architectural instructions, as defined by the instruction set architecture, or by microarchitectural operations.

[ID_AA64DFR0_EL1](#).PMSVer indicates whether the Statistical Profiling Extension is implemented.

The Statistical Profiling Extension introduces a new barrier instruction, the Profiling Synchronization Barrier, PSB CSYNC.

The Statistical Profiling Extension introduces the following System registers:

- PMIDR_EL1 - Profiling Buffer ID register.
- PMLIMITTR_EL1 - Profiling Buffer Limit Address register.
- PMBPTR_EL1 - Profiling Buffer Write Pointer register.
- PMBSR_EL1 - Profiling Buffer Status/Syndrome register.
- PMSCR_EL1 - Statistical Profiling Control register (EL1).
- PMSCR_EL2 - Statistical Profiling Control register (EL2).
- PMSEVFR_EL1 - Sampling Event Profile register.
- PMSFCR_EL1 - Sampling Event Filter register.
- PMSICR_EL1 - Sampling Interval Counter register.
- PMSIDR_EL1 - Sampling Profiling ID register.
- PMSIRR_EL1 - Sampling Interval Reload register.
- PMSLATFR_EL1 - Sampling Latency Filter register.

The Statistical Profiling Extension modifies the following existing System registers:

- ID_AA64DFR0_EL1.
- MDCR_EL2.
- MDCR_EL3.

All registers and fields that are exclusively associated with the Statistical Profiling Extension are described in the *ARM® Architecture Reference Manual Supplement, Statistical Profiling Extension*.

A1.7.7 The Scalable Vector Extension (SVE)

The Scalable Vector Extension is an OPTIONAL extension introduced by the ARMv8.2 architecture. SVE is supported in AArch64 state only.

The Scalable Vector Extension provides vector instructions that, primarily, support wider vectors than the ARM Advanced SIMD instruction set. The *ARM® Architecture Reference Manual Supplement, The Scalable Vector Extension (SVE), for ARMv8-A* describes the SVE.

ID_AA64PFR0_EL1.SVE indicates whether the Scalable Vector Extension is implemented.

The Scalable Vector Extension affects some AArch64 System registers, and those register changes are included in this issue of this Manual, where they are identified as SVE features. SVE also introduces new AArch64 System registers, however these do not appear in this manual. For more information about the new System registers introduced by SVE, please see the *ARM® Architecture Reference Manual Supplement, The Scalable Vector Extension (SVE), for ARMv8-A*.

The Scalable Vector Extension introduces the following System registers:

- ID_AA64ZFR0_EL1.
- ZCR_EL1.
- ZCR_EL2.
- ZCR_EL3.

The Scalable Vector Extension modifies the following existing System registers:

- CPACR_EL1.
- CPTR_EL2.
- CPTR_EL3.
- ESR_ELx.
- ID_AA64PFR0_EL1.
- TCR_EL1.
- TCR_EL2.

Part B

The AArch64 Application Level Architecture

Chapter B1

The AArch64 Application Level Programmers' Model

This chapter gives an application level view of the ARM programmers' model. It contains the following sections:

- *About the Application level programmers' model* on page B1-70.
- *Registers in AArch64 Execution state* on page B1-71.
- *Software control features and EL0* on page B1-76.

B1.1 About the Application level programmers' model

This chapter contains the programmers' model information required for application development.

The information in this chapter is distinct from the system information required to service and support application execution under an operating system, or higher level of system software. However, some knowledge of the system information is needed to put the Application level programmers' model into context.

Depending on the implementation choices, the architecture supports multiple levels of execution privilege, indicated by different *Exception levels* that number upwards from EL0 to EL3. EL0 corresponds to the lowest privilege level and is often described as unprivileged. The Application level programmers' model is the programmers' model for software executing at EL0. For more information see [Exception levels on page D1-1776](#).

System software determines the Exception level, and therefore the level of privilege, at which software runs. When an operating system supports execution at both EL1 and EL0, an application usually runs unprivileged at EL0. This:

- Permits the operating system to allocate system resources to an application in a unique or shared manner.
- Provides a degree of protection from other processes, and so helps protect the operating system from malfunctioning software.

This chapter indicates where some system level understanding is necessary, and where relevant it gives a reference to the system level description.

Execution at any Exception level above EL0 is often referred to as privileged execution.

For more information on the system level view of the architecture refer to [Chapter D1 The AArch64 System Level Programmers' Model](#).

B1.2 Registers in AArch64 Execution state

This section describes the registers and process state visible at EL0 when executing in the AArch64 state. It includes the following:

- [Registers in AArch64 state](#)
- [Process state, PSTATE on page B1-73](#)
- [System registers on page B1-74](#)

B1.2.1 Registers in AArch64 state

In the AArch64 application level view, an ARM processing element has:

R0-R30 31 general-purpose registers, R0 to R30. Each register can be accessed as:

- A 64-bit general-purpose register named X0 to X30.
- A 32-bit general-purpose register named W0 to W30.

See the register name mapping in [Figure B1-1](#).

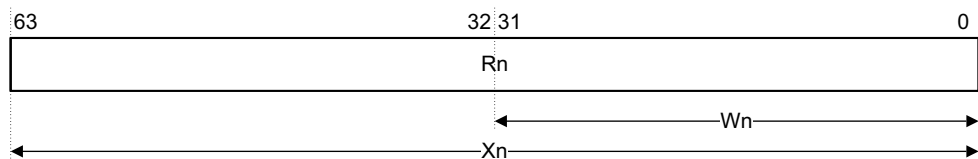

Figure B1-1 General-purpose register naming

The X30 general-purpose register is used as the procedure call link register.

———— **Note** —————

In instruction encodings, the value 0b11111 (31) is used to indicate the ZR (zero register). This indicates that the argument takes the value zero, but does not indicate that the ZR is implemented as a physical register.

SP A 64-bit dedicated Stack Pointer register. The least significant 32 bits of the stack-pointer can be accessed via the register name WSP.

The use of SP as an operand in an instruction, indicates the use of the current stack pointer.

———— **Note** —————

Stack pointer alignment to a 16-byte boundary is configurable at EL1. For more information see the *Procedure Call Standard for the ARM 64-bit Architecture*.

PC A 64-bit Program Counter holding the address of the current instruction.

Software cannot write directly to the PC. It can only be updated on a branch, exception entry or exception return.

———— **Note** —————

Attempting to execute an A64 instruction that is not word-aligned generates a PC alignment fault, see [PC alignment checking on page D1-1793](#).

V0-V31 32 SIMD&FP registers, V0 to V31. Each register can be accessed as:

- A 128-bit register named Q0 to Q31.
- A 64-bit register named D0 to D31.
- A 32-bit register named S0 to S31.
- A 16-bit register named H0 to H31.
- An 8-bit register named B0 to B31.

- A 128-bit vector of elements.
- A 64-bit vector of elements.

Where the number of bits described by a register name does not occupy an entire SIMD&FP register, it refers to the least significant bits. See [Figure B1-2](#).

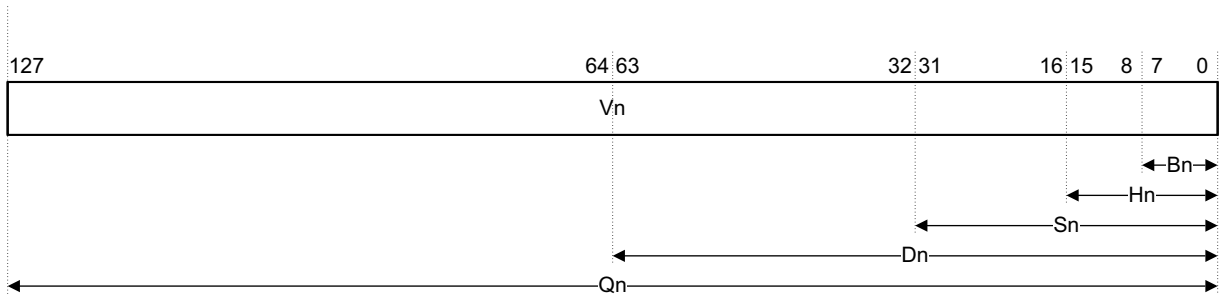

Figure B1-2 SIMD and floating-point register naming

For more information about data types and vector formats, see [Supported data types](#) on page A1-38.

FPCR, FPSR Two SIMD and floating-point control and status registers, [FPCR](#) and [FPSR](#).

See [Registers for instruction processing and exception handling](#) on page D1-1785 for more information on the registers.

Pseudocode description of registers in AArch64 state

In the pseudocode functions that access registers:

- The assignment form is used for register writes.
- The non-assignment for register reads.

The uses of the `X[]` function are:

- Reading or writing X0-X30, using `n` to index the required register.
- Reading the zero register ZR, accessed as `X[31]`.

———— **Note** —————

The pseudocode use of `X[31]` to represent the zero register does not indicate that hardware must implement this register.

The AArch64 `SP[]` function is used to read or write the current SP.

The AArch64 `PC[]` function is used to read the PC.

The AArch64 `V[]` function is used to read or write the Advanced SIMD and floating-point registers V0-V31, using a parameter `n` to index the required register.

The AArch64 `Vpart[]` function is used to read or write a part of one of V0-V31, using a parameter `n` to index the required register, and a parameter `part` to indicate the required part of the register, see the function description for more information.

The `SP[]`, `PC[]`, `V[]`, and `Vpart[]` functions are defined in [Chapter J1 ARMv8 Pseudocode](#).

B1.2.2 Process state, PSTATE

Process state or PSTATE is an abstraction of process state information. All of the instruction sets provide instructions that operate on elements of PSTATE.

The following PSTATE information is accessible at EL0:

The Condition flags

Flag-setting instructions set these. They are:

- N** Negative Condition flag. If the result of the instruction is regarded as a two's complement signed integer, the PE sets this to:
- 1 if the result is negative.
 - 0 if the result is positive or zero.
- Z** Zero Condition flag. Set to:
- 1 if the result of the instruction is zero.
 - 0 otherwise.
- A result of zero often indicates an equal result from a comparison.
- C** Carry Condition flag. Set to:
- 1 if the instruction results in a carry condition, for example an unsigned overflow that is the result of an addition.
 - 0 otherwise.
- V** Overflow Condition flag. Set to:
- 1 if the instruction results in an overflow condition, for example a signed overflow that is the result of an addition.
 - 0 otherwise.

Conditional instructions test the N, Z, C and V Condition flags, combining them with the Condition code for the instruction to determine whether the instruction must be executed. In this way, execution of the instruction is conditional on the result of a previous operation. For more information about conditional execution, see [Condition flags and related instructions on page C6-519](#).

The exception masking bits

- D** Debug exception mask bit. When EL0 is enabled to modify the mask bits, this bit is visible and can be modified. However, this bit is architecturally ignored at EL0.
- A** SError interrupt mask bit.
- I** IRQ interrupt mask bit.
- F** FIQ interrupt mask bit.

For each bit, the values are:

- 0** Exception not masked.
- 1** Exception masked.

Access at EL0 using AArch64 state depends on `SCTLR_EL1.UMA`. See [Traps to EL1 of EL0 accesses to the PSTATE.{D, A, I, F} interrupt masks on page D1-1846](#).

See [Process state, PSTATE on page D1-1791](#) for the system level view of PSTATE.

Accessing PSTATE fields at EL0

At EL0 using AArch64 state, **PSTATE** fields can be accessed using Special-purpose registers that can be directly read using the **MRS** instruction and directly written using the **MSR (register)** instructions. [Table B1-1](#) shows the Special-purpose registers that access the **PSTATE** fields that hold AArch64 state when the PE is at EL0 using AArch64. All other **PSTATE** fields do not have direct read and write access at EL0.

Table B1-1 Accessing PSTATE fields at EL0 using MRS and MSR (register)

Special-purpose register	PSTATE fields
NZCV	N, Z, C, V
DAIF	D, A, I, F

Software can also use the **MSR (immediate)** instruction to directly write to **PSTATE**.{D, A, I, F}. [Table B1-2](#) shows the **MSR (immediate)** operands that can directly write to **PSTATE**.{D, A, I, F} when the PE is at EL0 using AArch64 state.

Table B1-2 Accessing PSTATE.{D, A, I, F} at EL0 using MSR (immediate)

Operand	PSTATE fields	Notes
DAIFSet	D, A, I, F	Directly sets any of the PSTATE .{D,A, I, F} bits to 1
DAIFClr	D, A, I, F	Directly clears any of the PSTATE .{D, A, I, F} bits to 0

However, access to the **PSTATE**.{D, A, I, F} fields at EL0 using AArch64 state depends on [SCTLR_EL1.UMA](#). [Traps to EL1 of EL0 accesses to the PSTATE.{D, A, I, F} interrupt masks on page D1-1846](#).

Writes to the **PSTATE** fields have side-effects on various aspects of the PE operation. All of these side-effects, are guaranteed:

- Not to be visible to earlier instructions in the execution stream.
- To be visible to later instructions in the execution stream.

B1.2.3 System registers

System registers provide support for execution control, status and general system configuration. The majority of the System registers are not accessible at EL0.

However, some System registers can be configured to allow access from software executing at EL0. Any access from EL0 to a System register with the access right disabled causes the instruction to behave as UNDEFINED. The registers that can be accessed from EL0 are:

Cache ID registers The [CTR_EL0](#) and [DCZID_EL0](#) registers provide implementation parameters for EL0 cache management support.

Debug registers A debug communications channel is supported by the [MDCCSR_EL0](#), [DBGDTR_EL0](#), [DBGDTRRX_EL0](#) and [DBGDTRTX_EL0](#) registers.

Performance Monitors registers

See [Performance Monitors support on page B1-75](#).

Thread ID registers The [TPIDR_EL0](#) and [TPIDRRO_EL0](#) registers are two thread ID registers with different access rights.

Timer registers In ARMv8 the following operations are performed:

- Read access to the system counter clock frequency using [CNTFRQ_EL0](#).
- Physical and virtual timer count registers, [CNTPCT_EL0](#) and [CNTVCT_EL0](#).

- Physical up-count comparison, down-count value and timer control registers, [CNTP_CVAL_EL0](#), [CNTP_TVAL_EL0](#), and [CNTP_CTL_EL0](#).
- Virtual up-count comparison, down-count value and timer control registers, [CNTV_CVAL_EL0](#), [CNTV_TVAL_EL0](#), and [CNTV_CTL_EL0](#).

Performance Monitors support

The ARMv8 architecture defines optional Performance Monitors.

The basic form of the Performance Monitors is:

- A 64-bit cycle counter.
- Up to a maximum of 32 IMPLEMENTATION DEFINED event counters, where the number is identified by the [PMCR_EL0.N](#) field.
- System register access to the cycle counter and event registers, and related controls for:
 - Enabling and resetting counters.
 - Flagging overflows.
 - Generating interrupts on overflow.

Software can enable the cycle counter independently of the event counters.

Software executing at EL1 or a higher Exception level, for example an operating system, can enable access to the counters from EL0. This allows an application to monitor its own performance with fine grain control without requiring operating system support. For example, an application might implement per-function performance monitoring.

For details on the features, configuration and control of the Performance Monitors, see [Chapter D5 The Performance Monitors Extension](#).

EL0 access to Performance Monitors

To allow application code to make use of the Performance Monitors, software executing at a higher Exception level must set the following bits in the [PMUSERENR_EL0](#) System register:

EN	When set to 1, access to all Performance Monitors registers is allowed at EL0, except for writes to PMUSERENR_EL0 , and reads/writes of PMINTENSET_EL1 and PMINTENCLR_EL1 .
ER	When set to 1, read access to event counters is allowed at EL0. This includes read/write access to PMSELR_EL0 , so that the event counter to read through PMXEVCNTR_EL0 can be set.
CR	When set to 1, read access to PMCCNTR_EL0 is allowed at EL0.
SW	When set to 1, write access to PMSWINC_EL0 is allowed at EL0.

———— **Note** —————

Register [PMUSERENR_EL0](#) is always read-only at EL0.

B1.3 Software control features and EL0

The following sections describe the EL0 view of the ARMv8 software control features:

- [Exception handling](#)
- [Wait for Interrupt and Wait for Event](#)
- [The YIELD instruction](#)
- [Application level cache management on page B1-77](#)
- [Instructions relating to Debug on page B1-77](#)

B1.3.1 Exception handling

In the ARM architecture, an *exception* causes a change of program flow. Execution of an exception handler starts, at an Exception level higher than EL0, from a defined vector that relates to the exception taken.

Exceptions include:

- Interrupts.
- Memory system aborts.
- Exceptions generated by attempting to execute an instruction that is UNDEFINED.
- System calls.
- Secure monitor or Hypervisor traps.
- Debug exceptions.

Most details of exception handling are not visible to application level software, and are described in [Chapter D1 The AArch64 System Level Programmers' Model](#).

The SVC instruction causes a Supervisor Call exception. This provides a mechanism for unprivileged software to make a system call to an operating system.

The BRK instruction generates a Breakpoint Instruction exception. This provides a mechanism for debugging software using debugger executing on the same PE, see [Breakpoint Instruction exceptions on page D2-1919](#).

———— **Note** —————

The BRK instruction is supported only in the A64 instruction set. The equivalent instruction in the T32 and A32 instruction sets is BKPT.

B1.3.2 Wait for Interrupt and Wait for Event

Issuing a WFI instruction indicates that no further execution is required until a WFI wake-up event occurs, see [Wait For Interrupt on page D1-1882](#). This permits entry to a low-power state.

Issuing a WFE instruction indicates that no further execution is required until a WFE wake-up event occurs, see [Wait for Event mechanism and Send event on page D1-1879](#). This permits entry to a low-power state.

B1.3.3 The YIELD instruction

The YIELD instruction provides a hint that the task performed by a thread is of low importance so that it could yield, see [YIELD on page C6-973](#). This mechanism can be used to improve overall performance in a *Symmetric Multithreading* (SMT) or *Symmetric Multiprocessing* (SMP) system.

Examples of when the YIELD instruction might be used include a thread that is sitting in a spin-lock, or where the arbitration priority of the snoop bit in an SMP system is modified. The YIELD instruction permits binary compatibility between SMT and SMP systems.

The YIELD instruction is a NOP (No Operation) hint instruction.

The YIELD instruction has no effect in a single-threaded system, but developers of such systems can use the instruction to flag its intended use for future migration to a multiprocessor or multithreading system. Operating systems can use YIELD in places where a yield hint is wanted, knowing that it will be treated as a NOP if there is no implementation benefit.

B1.3.4 Application level cache management

A small number of cache management instructions can be enabled at EL0 from higher levels of privilege using the [SCTLR_EL1](#) System register. Any access from EL0 to an operation with the access right disabled causes the instruction to behave as UNDEFINED.

About the available operations, see [Application level access to functionality related to caches](#) on page B2-99.

B1.3.5 Instructions relating to Debug

[Exception handling on page B1-76](#) refers to the BRK instruction, which generates a Breakpoint Instruction exception. In addition, in both AArch64 state and AArch32 state, the HLT instruction causes the PE to halt execution and enter Debug state. This provides a mechanism for debugging software using a debugger that is external to the PE, see [Chapter H1 About External Debug](#).

———— **Note** —————

In AArch32 state, previous versions of the architecture defined the DBG instruction, that could provide a hint to the debug system. In ARMv8, this instruction executes as a NOP. ARM deprecates the use of the DBG instruction.

Chapter B2

The AArch64 Application Level Memory Model

This chapter gives an application level view of the memory model. It contains the following sections:

- *About the ARM memory model* on page B2-80.
- *Atomicity in the ARM architecture* on page B2-82.
- *Definition of the ARMv8 memory model* on page B2-86.
- *Caches and memory hierarchy* on page B2-97.
- *Alignment support* on page B2-102.
- *Endian support* on page B2-104.
- *Memory types and attributes* on page B2-107.
- *Mismatched memory attributes* on page B2-118.
- *Synchronization and semaphores* on page B2-121.

———— **Note** ————

In this chapter, System register names usually link to the description of the register in [Chapter D7 AArch64 System Register Descriptions](#), for example [SCTLR_EL1](#).

B2.1 About the ARM memory model

The ARM architecture is a weakly ordered memory architecture that permits the observation and completion of memory accesses in a different order from the program order. The following sections of this chapter provide the complete definition of the ARMv8 memory model, this introduction is not intended to contradict the definition found in those sections. In general, the basic principles of the ARMv8 memory model are:

- To provide a memory model that has similar weaknesses to those found in the memory models used by high-level programming languages such as C or Java. For example, by permitting independent memory accesses to be re-ordered as seen by other observers.
- To avoid the requirement for multi-copy atomicity in the majority of memory types.
- The provision of instructions and memory barriers to compensate for the lack of multi-copy atomicity in the cases where it would be needed.
- The use of address, data, and control dependencies in the creation of order so as to avoid having excessive numbers of barriers or other explicit instructions in common situations where some order is required by the programmer or the compiler.

This section contains:

- [Address space](#).
- [Memory type overview](#).

B2.1.1 Address space

Address calculations are performed using 64-bit registers. However, supervisory software can configure the top eight address bits for use as a tag, as described in [Address tagging in AArch64 state on page D4-2006](#). If this is done, address bits[63:56]:

- Are not considered when determining whether the address is valid.
- Are never propagated to the program counter.

Supervisory software determines the valid address range. Attempting to access an address that is not valid generates an MMU fault.

[Simple sequential execution](#) of instructions might overflow the valid address range. For more information, see [Instruction address space overflow on page D3-1973](#).

Memory accesses use the `Mem[]` function. This function makes an access of the required type. If supervisory software configures the top eight address bits for use as a tag, the top eight address bits are ignored.

The `AccType{}` enumeration defines the different access types.

————— Note —————

- [Chapter D3 The AArch64 System Level Memory Model](#) and [Chapter D4 The AArch64 Virtual Memory System Architecture](#) include descriptions of memory system features that are transparent to the application, including memory access, address translation, memory maintenance instructions, and alignment checking and the associated fault handling. These chapters also include pseudocode descriptions of these operations.
- For information on the pseudocode that relates to memory accesses, see [Basic memory access on page D3-2000](#), [Unaligned memory access on page D3-2001](#), and [Aligned memory access on page D3-2000](#).

B2.1.2 Memory type overview

ARMv8 provides the following mutually-exclusive memory types:

- | | |
|---------------|--|
| Normal | This is generally used for bulk memory operations, both read/write and read-only operations. |
| Device | The ARM architecture forbids Speculative reads of any type of Device memory. This means Device memory types are suitable attributes for read-sensitive Locations . |

[Locations](#) of the memory map that are assigned to peripherals are usually assigned the Device memory attribute.

Device memory has additional attributes that have the following effects:

- They prevent aggregation of reads and writes, maintaining the number and size of the specified memory accesses. See [Gathering on page B2-114](#).
- They preserve the access order and synchronization requirements, both for accesses to a single peripheral and where there is a synchronization requirement on the observability of one or more memory write and read accesses. See [Reordering on page B2-115](#)
- They indicate whether a write can be acknowledged other than at the end point. See [Early Write Acknowledgement on page B2-116](#).

For more information on Normal memory and Device memory, see [Memory types and attributes on page B2-107](#).

———— **Note** —————

Earlier versions of the ARM architecture defined a single Device memory type and a Strongly-ordered memory type. A *Note* in [Device memory on page B2-111](#) describes how these memory types map onto the ARMv8 memory types.

B2.2 Atomicity in the ARM architecture

Atomicity is a feature of memory accesses, described as *atomic* accesses. The ARM architecture description refers to two types of atomicity, *single-copy atomicity* and *multi-copy atomicity*. In the ARMv8 architecture, the atomicity requirements for memory accesses depend on the memory type, and whether the access is explicit or implicit. For more information, see:

- [Requirements for single-copy atomicity.](#)
- [Properties of single-copy atomic accesses on page B2-83.](#)
- [Multi-copy atomicity on page B2-83.](#)
- [Requirements for multi-copy atomicity on page B2-83.](#)
- [Concurrent modification and execution of instructions on page B2-84.](#)

For more information about the memory types, see [Memory type overview on page B2-80.](#)

B2.2.1 Requirements for single-copy atomicity

For explicit memory accesses generated from an Exception level the following rules apply:

- A read that is generated by a load instruction that loads a single general-purpose register and is aligned to the size of the read in the instruction is single-copy atomic.
- A write that is generated by a store instruction that stores a single general-purpose register and is aligned to the size of the write in the instruction is single-copy atomic.
- Reads that are generated by a Load Pair instruction that loads two general-purpose registers and are aligned to the size of the load to each register are treated as two single-copy atomic reads, one for each register being loaded.
- Writes that are generated by a Store pair instruction that stores two general-purpose registers and are aligned to the size of the store of each register are treated as two single-copy atomic writes, one for each register being stored.
- Load-Exclusive Pair instructions of two 32-bit quantities and Store-Exclusive Pair instructions of 32-bit quantities are single-copy atomic.
- When the Store-Exclusive of a Load-Exclusive/Store-Exclusive pair instruction using two 64-bit quantities succeeds, it causes a single-copy atomic update of the entire memory location being updated.

———— **Note** —————

To atomically load two 64-bit quantities, perform a Load-Exclusive pair/Store-Exclusive pair sequence of reading and writing the same value for which the Store-Exclusive pair succeeds, and use the read values from the Load-Exclusive pair.

- Where translation table walks generate a read of a translation table entry, this read is single-copy atomic.
- For the atomicity of instruction fetches, see [Concurrent modification and execution of instructions on page B2-84.](#)
- Reads to SIMD and floating-point registers of a single 64-bit or smaller quantity that is aligned to the size of the quantity being loaded are treated as single-copy atomic reads.
- Writes from SIMD and floating-point registers of a single 64-bit or smaller quantity that is aligned to the size of the quantity being stored are treated as single-copy atomic writes.
- Element or Structure Reads to SIMD and floating-point registers of 64-bit or smaller elements, where each element is aligned to the size of the element being loaded, have each element treated as a single-copy atomic read.
- Element or Structure Writes from SIMD and floating-point registers of 64-bit or smaller elements, where each element is aligned to the size of the element being stored, have each element treated as a single-copy atomic store.

- Reads to SIMD and floating-point registers of a 128-bit value that is 64-bit aligned in memory are treated as a pair of single-copy atomic 64-bit reads.
- Writes from SIMD and floating-point registers of a 128-bit value that is 64-bit aligned in memory are treated as a pair of single-copy atomic 64-bit writes.

All other memory accesses are regarded as streams of accesses to bytes, and no atomicity between accesses to different bytes is ensured by the architecture.

All accesses to any byte are single-copy atomic.

———— **Note** —————

In AArch64 state, no memory accesses from a DC ZVA have single-copy atomicity of any quantity greater than individual bytes.

If, according to these rules, an instruction is executed as a sequence of accesses, exceptions, including interrupts, can be taken during that sequence, regardless of the memory type being accessed. If any of these exceptions are returned from using their preferred return address, the instruction that generated the sequence of accesses is re-executed, and so any access performed before the exception was taken is repeated. See also [Taking an interrupt or other exception during a multiple-register load or store on page D1-1841](#).

———— **Note** —————

The exception behavior for these multiple access instructions means that they are not suitable for use for writes to memory for the purpose of software synchronization.

B2.2.2 Properties of single-copy atomic accesses

A memory access instruction that is single-copy atomic has the following properties:

1. For a pair of overlapping single-copy atomic store instructions, all of the overlapping writes generated by one of the stores are [Coherence-after](#) the corresponding overlapping writes generated by the other store.
2. For a single-copy atomic load instruction L_1 that overlaps a single-copy atomic store instruction S_2 , if one of the overlapping reads generated by L_1 [Reads-from](#) one of the overlapping writes generated by S_2 , then none of the overlapping writes generated by S_2 are [Coherence-after](#) the corresponding overlapping reads generated by L_1 .

For more information, see [Definition of the ARMv8 memory model on page B2-86](#).

B2.2.3 Multi-copy atomicity

In a multiprocessing system, writes to a memory location are *multi-copy atomic* if the following conditions are both true:

- All writes to the same location are *serialized*, meaning they are observed in the same order by all observers, although some observers might not observe all of the writes.
- A read of a location does not return the value of a write until all observers observe that write.

———— **Note** —————

Writes that are not coherent are not multi-copy atomic.

B2.2.4 Requirements for multi-copy atomicity

For Normal memory, writes are not required to be multi-copy atomic.

For Device memory, writes are not required to be multi-copy atomic.

The ARMv8 memory model is [Other-multi-copy atomic](#). For more information, see [Ordering constraints on page B2-90](#).

B2.2.5 Concurrent modification and execution of instructions

The ARMv8 architecture limits the set of instructions that can be executed by one thread of execution as they are being modified by another thread of execution without requiring explicit synchronization.

Concurrent modification and execution of instructions can lead to the resulting instruction performing any behavior that can be achieved by executing any sequence of instructions that can be executed from the same Exception level, except where the instruction before modification and the instruction after modification is a B, BL, NOP, BRK, SVC, HVC, or SMC instruction.

For the B, BL, NOP, BRK, SVC, HVC, and SMC instructions the architecture guarantees that, after modification of the instruction, behavior is consistent with execution of either:

- The instruction originally fetched.
- A fetch of the modified instruction.

If one thread of execution changes a conditional branch instruction, such as B or BL, to another conditional instruction and the change affects both the condition field and the branch target, execution of the changed instruction by another thread of execution before the change is synchronized can lead to either:

- The old condition being associated with the new target address.
- The new condition being associated with the old target address.

These possibilities apply regardless of whether the condition, either before or after the change to the branch instruction, is the *always* condition.

For all other instructions, to avoid UNPREDICTABLE or CONSTRAINED UNPREDICTABLE behavior, instruction modifications must be explicitly synchronized before they are executed. The required synchronization is as follows:

1. No PE must be executing an instruction when another PE is modifying that instruction.
2. To ensure that the modified instructions are observable, the PE that modified the instructions must issue the following sequence of instructions and operations:

```
; Coherency example for data and instruction accesses within the same Inner Shareable domain.  
; Enter this code with <Wt> containing a new 32-bit instruction,  
; to be held in Cacheable space at a location pointed to by Xn.  
STR Wt, [Xn]  
DC CVAU, Xn          ; Clean data cache by VA to point of unification (PoU)  
DSB ISH              ; Ensure visibility of the data cleaned from cache  
IC IVAU, Xn          ; Invalidate instruction cache by VA to PoU  
DSB ISH              ; Ensure completion of the invalidations
```

———— **Note** —————

The DC CVAU operation is not required if the area of memory is either Non-cacheable or Write-Through Cacheable.

3. In a multiprocessor system, the IC IVAU is broadcast to all PEs within the Inner Shareable domain of the PE running this sequence. However, when the modified instructions are observable, each PE that is executing the modified instructions must issue the following instruction to ensure execution of the modified instructions:

```
ISB                      ; Synchronize fetched instruction stream
```

For more information about the required synchronization operation, see [Synchronization and coherency issues between data and instruction accesses on page B2-100](#).

———— **Note** —————

For information about memory accesses caused by instruction fetches, see [Ordering relations on page B2-89](#).

B2.2.6 Possible implementation restrictions on using atomic instructions

In some implementations, and for some memory types, the properties of atomicity can be met only by functionality outside the PE. Some system implementations might not support atomic instructions for all regions of the memory. In particular, this can apply to:

- Any type of memory in the system that does not support hardware cache coherency.
- Device, Non-cacheable memory, or memory that is treated as Non-cacheable, in an implementation that does support hardware cache coherency.

In such implementations, it is defined by the system:

- Whether the atomic instructions are atomic in regard to other agents that access memory.
- If the atomic instructions are atomic in regard to other agents that access memory, which address ranges or memory types this applies to.

An implementation can choose which memory type is treated as Non-cacheable.

The memory types for which it is architecturally guaranteed that the atomic instructions will be atomic are:

- Inner Shareable, Inner Write-Back, Outer Write-Back Normal memory with Read allocation hints and Write allocation hints and not transient.
- Outer Shareable, Inner Write-Back, Outer Write-Back Normal memory with Read allocation hints and Write allocation hints and not transient.

If the atomic instructions are not atomic in regard to other agents that access memory, then performing an atomic instruction to such a location can have one or more of the following effects:

- The instruction generates a Synchronous external abort.
- The instruction generates a System Error interrupt.
- The instruction generates an IMPLEMENTATION DEFINED MMU fault reported using the Data Abort Fault status code of `ESR_ELx.DFSC = 110101`.

For the Non-secure EL1&0 translation regime, if the atomic instruction is not supported because of the memory type that is defined in the first stage of translation, or the second stage of translation is not enabled, then this exception is a first stage abort and is taken to EL1. Otherwise, the exception is a second stage abort and is taken to EL2.

- The instruction is treated as a NOP.
- The instructions are performed, but there is no guarantee that the memory accesses were performed atomically in regard to other agents that access memory. In this case, the instruction might also generate a System Error interrupt.

B2.3 Definition of the ARMv8 memory model

This section describes observation and ordering in the ARMv8 memory model. It contains the following subsections:

- [Locations](#).
- [Ordering and observability](#) on page B2-87.
- [Completion and endpoint ordering](#) on page B2-91.
- [Memory barriers](#) on page B2-92.
- [Limited ordering regions](#) on page B2-96.

For more information about endpoint ordering of memory accesses, see [Reordering](#) on page B2-115.

In the ARMv8 memory model, the Shareability memory attribute indicates the degree to which hardware must ensure memory coherency between a set of observers, see [Memory types and attributes](#) on page B2-107.

The ARMv8 memory system architecture defines additional memory attributes and associated behaviors, which are defined in the system level section of this manual. See:

- [Chapter D3 The AArch64 System Level Memory Model](#).
- [Chapter D4 The AArch64 Virtual Memory System Architecture](#).

See also [Mismatched memory attributes](#) on page B2-118.

B2.3.1 Locations

The ARMv8 memory model provides a set of definitions that are used to constrain the permitted sequences of accesses to memory. The ARMv8 memory model defines:

- The ordering of observation of memory accesses between different observers.
- The ordering of arrival of memory accesses arriving at an endpoint.
- The mechanisms to control the ordering of observation of memory accesses and the arrival of memory accesses at an endpoint.

Locations, Memory effects, and Observers

The ARMv8 memory model provides the following definition of a *Location* in memory:

Location

A *Location* refers to a single byte in memory.

As part of its execution an instruction might generate a [Memory effect](#). [Observers](#) in the system might observe the [Memory effects](#) of that instruction on a [Location](#). The ARMv8 memory model provides the following definitions of a [Memory effect](#) and an [Observer](#):

Memory effect

The *Memory effects* of an instruction are the read, write, or barrier effects of that instruction. For an instruction that accesses memory:

- A read effect is generated for each [Location](#) that is read by the instruction.
- A write effect is generated for each [Location](#) that is written by the instruction.

An instruction can generate both read and write effects.

The Memory effects of an instruction I_1 are said to appear in program order before the Memory effects of instruction I_2 if and only if I_1 occurs before I_2 in program order.

For the purposes of describing the ARMv8 memory model, all read and write effects access only Normal memory locations in a [Common Shareability Domain](#). Where this section refers to a read, write, or memory barrier without any qualification, then it is referring to the corresponding Memory effect.

Observer

An *Observer* refers to either a processing element, or some other memory accessing agent that can generate reads from or writes to memory.

Common Shareability Domain

A *Common Shareability Domain* for a program is the smallest Shareability domain that contains all of the active [Observers](#) of the [Memory effects](#) generated by a program.

B2.3.2 Ordering and observability

The ARMv8 memory model permits reordering of memory accesses. This section defines the constraints placed on the reordering of memory accesses using the following:

- Register value dependencies to establish order between instructions on a PE.
- Ordering constraints to establish order between accesses to a [Location](#).

Register value dependencies

The ARMv8 memory model defines the following dependencies between instructions:

Register dependency

A *Register dependency* from a first data value V_1 to a second data value V_2 exists within a PE if and only if either:

- The register, excluding the AArch64 zero register (XZR or WZR), that is used to hold V_1 is used in the calculation of V_2 .
- There is a Register dependency from V_1 to a third data value V_3 and there is a register dependency from V_3 to V_2 .

Register data dependency

A *Register data dependency* from a first data value V_1 to a second data value V_2 exists within a PE if and only if either:

- The register, excluding the AArch64 zero register (XZR or WZX) and the AArch32 PC, that is used to hold V_1 and is used in the calculation of V_2 , and the calculation between V_1 and the V_2 does not consist of either:
 - A conditional branch whose condition is determined by V_1 .
 - A conditional selection, move, or computation whose condition is determined by V_1 , where the input data values for the selection, move, or computation do not have a data dependency on V_1 .
- There is a Register data dependency from V_1 to a third data value V_3 , and there is a Register data dependency from V_3 to V_2 .

Address dependency

An *Address dependency* from a read R_1 to a subsequent read R_2 exists if and only if there is a [Register data dependency](#) from the data value that is returned by R_1 to the address used by R_2 .

An *Address dependency* from a read R_1 to a subsequent read W_2 exists if and only if there is a [Register data dependency](#) from the data value that is returned by R_1 to the address used by W_2 .

Data dependency

A *Data dependency* from a read R_1 to a subsequent write W_2 exists if and only if there is a [Register dependency](#) from the data value returned by R_1 to the data value written by W_2 .

Control dependency

A *Control dependency* from a read R_1 to a subsequent instruction I_2 exists if and only if there is a [Register dependency](#) from the data value returned by R_1 to the data value used in the evaluation of a conditional branch or the determination of a synchronous exception on an instruction and I_2 is only executed as a result of one of the possible outcomes of that conditional branch or synchronous exception.

Ordering and observability at a Location

[Memory effects](#) on a [Location](#) are related by the following relations:

Reads-from

A *Reads-from* relation that couples reads and writes to the same [Location](#) such that each read is paired with a single write in the program. A read R_2 of a [Location](#) Reads-from a write W_1 to the same [Location](#) if and only if R_2 takes its data from W_1 .

———— **Note** —————

The Reads-from relation represents a read being satisfied by a write and then returning the written data.

Coherence order

A *Coherence order* relation for each [Location](#) in the program that provides a total order on all writes from all coherent [Observers](#) to that [Location](#), starting with a notional write of the initial value.

———— **Note** —————

The Coherence order of a [Location](#) represents the order in which writes to the [Location](#) arrive at memory.

Coherence-after

A write W_2 to a [Location](#) is *Coherence-after* another write W_1 to the same [Location](#) if and only if W_2 is sequenced after W_1 in the [Coherence order](#) of the [Location](#).

A write W_2 to a [Location](#) is Coherence-after a read R_1 of the same location if and only if R_1 [Reads-from](#) a write W_3 to the same [Location](#) and W_2 is Coherence-after W_3 .

Overlapping accesses

Two [Memory effect](#) overlap if and only if they access the same [Location](#). Two instructions overlap if and only if one or more of their generated [Memory effects](#) overlap.

Observed-by

A read or a write RW_1 from an [Observer](#) is *Observed-by* a write W_2 from a different [Observer](#) if and only if W_2 is coherence-after RW_1 .

A write W_1 from an [Observer](#) is Observed-by a read R_2 from a different [Observer](#) if and only if R_2 [Reads-from](#) W_1 .

———— **Note** —————

The Observed-by relation only relates accesses generated by different [Observers](#).

DMB FULL

A DMB FULL is a DMB with neither the LD or the ST qualifier.

Where this section refers to DMB without any qualification, then it is referring to all types of DMB. Unless a specific shareability domain is defined, a DMB applies to the [Common Shareability Domain](#).

All properties that apply to DMB also apply to the corresponding DSB.

Ordering relations

In addition to the ordering relations for a single [Location](#), the ARMv8 memory model also provides ordering relations to describe the ordering of [Memory effects](#) to multiple [Locations](#). These are as follows:

Dependency-ordered-before

A dependency creates externally-visible order between a read and another [Memory effect](#) generated by the same [Observer](#). A read R_1 is *Dependency-ordered-before* a read or write RW_2 from the same [Observer](#) if and only if R_1 appears in program order before RW_2 and any of the following cases apply:

- There is an [Address dependency](#) or a [Data dependency](#) from R_1 to RW_2 .
- RW_2 is a write W_2 and there is a [Control dependency](#) from R_1 to W_2 .
- RW_2 is a read R_2 generated by an instruction appearing in program order after an instruction I_3 that generates a [Context synchronization event](#), and there is a [Control dependency](#) from R_1 to I_3 .
- RW_2 is a write W_2 appearing in program order after a read or a write RW_3 and there is an [Address dependency](#) from R_1 to RW_3 .
- RW_2 is a write W_2 that is [Coherence-after](#) a write W_3 and there is a [Control dependency](#) or a [Data dependency](#) from R_1 to W_3 .
- RW_2 is a read R_2 that [Reads-from](#) a write W_3 and there is an [Address dependency](#) or a [Data dependency](#) from R_1 to W_3 .

Atomic-ordered-before

Load-Exclusive and Store-Exclusive instructions provide some ordering guarantees, even in the absence of dependencies. A read R_1 is *Atomic-ordered-before* a read or a write RW_2 from the same [Observer](#) if and only if R_1 appears in program order before RW_2 and either of the following cases apply:

- RW_2 is a write W_2 such that R_1 and W_2 are generated by an atomic instruction or a successful Load-Exclusive/Store-Exclusive instruction pair to the same [Location](#).
- RW_2 is a read R_2 such that R_1 is Atomic-ordered-before a write W_3 and R_2 [Reads-from](#) W_3 .

For more information, see [Synchronization and semaphores on page B2-121](#).

Barrier-ordered-before

Barrier instructions order prior [Memory effects](#) before subsequent [Memory effects](#) generated by the same [Observer](#). A read or a write RW_1 is *Barrier-ordered-before* a read or a write RW_2 from the same [Observer](#) if and only if RW_1 appears in program order before RW_2 and any of the following cases apply:

- RW_1 appears in program order before a DMB FULL that appears in program order before RW_2 .
- RW_1 is a write W_1 generated by a Store-Release instruction and RW_2 is a read R_2 generated by a Load-Acquire instruction.
- RW_1 is a read R_1 and either:
 - R_1 appears in program order before a DMB LD that appears in program order before RW_2 .
 - R_1 is generated by a Load-Acquire instruction.
- RW_2 is a write W_2 and either:
 - RW_1 is a write W_1 appearing in program order before a DMB ST that appears in program order before W_2 .
 - W_2 is generated by a Store-Release instruction.
 - RW_1 appears in program order before a write W_3 generated by a Store-Release instruction and W_2 is [Coherence-after](#) W_3 .

Ordered-before

An arbitrary pair of **Memory effects** is ordered if it can be linked by a chain of ordered accesses consistent with external observation. A read or a write RW_1 is *Ordered-before* a read or a write RW_2 if and only if any of the following cases apply:

- RW_1 is **Observed-by** RW_2 .
- RW_1 is **Dependency-ordered-before** RW_2 .
- RW_1 is **Atomic-ordered-before** RW_2 .
- RW_1 is **Barrier-ordered-before** RW_2 .
- RW_1 is Ordered-before a read or a write that is Ordered-before RW_2 .

B2.3.3 Ordering constraints

The ARMv8 memory model is described as being **Other-multi-copy atomic**. The definition of Other-multi-copy atomic is as follows:

Other-multi-copy atomic

In an *Other-multi-copy atomic* system, it is required that a write from an **Observer**, if observed by a different **Observer**, is then observed by all other **Observers** that access the **Location** coherently. It is, however, permitted for an **Observer** to observe its own writes prior to making them visible to other observers in the system.

The **Other-multi-copy atomic** property of the ARMv8 memory model is enforced by placing constraints on the possible executions of a program. Those executions that meet the constraints given by the ordering model are said to be *architecturally well-formed*. An implementation that is executing a program is only permitted to exhibit behavior consistent with an architecturally well-formed execution.

An architecturally well-formed execution must satisfy both of the following requirements:

Internal visibility requirement

For a read or a write RW_1 that appears in program order before a read or a write RW_2 to the same **Location**, the internal visibility requirement requires that exactly one of the following statements is true:

- RW_2 is a write W_2 that is **Coherence-after** RW_1 .
- RW_1 is a write W_1 and RW_2 is a read R_2 such that either:
 - R_2 **Reads-from** W_1 .
 - R_2 **Reads-from** another write that is **Coherence-after** W_1 .
- RW_1 and RW_2 are both reads R_1 and R_2 such that R_1 **Reads-from** a write W_3 and either:
 - R_2 **Reads-from** W_3 .
 - R_2 **Reads-from** another write that is **Coherence-after** W_3 .

Note

If a **Memory effect** M_1 from an **Observer** appears in program order before a **Memory effect** M_2 from the same **Observer**, then M_1 will be seen to occur before M_2 by that **Observer**.

External visibility requirement

For a read or a write RW_1 that is **Ordered-before** a read or a write RW_2 , to the same **Location** and from a different **Observer**, the external visibility requirement requires that exactly one of the following statements is true:

- RW_2 is a write W_2 and RW_1 is **Observed-by** W_2 .
- RW_1 is a write W_1 and RW_2 is a read R_2 such that either:
 - W_1 is **Observed-by** R_2 .

- There is a write W_3 such that W_3 is **Observed-by** R_2 and W_1 is **Observed-by** W_3 .
- RW_1 and RW_2 are both reads R_1 and R_2 and there is a write W_3 such that either:
 - W_3 is **Observed-by** both R_1 and R_2 .
 - R_1 is **Observed-by** W_3 and W_3 is **Observed-by** R_2 .

———— **Note** —————

If a **Memory effect** M_1 is **Ordered-before** another **Memory effect** M_2 , to the same **Location** and from a different **Observer**, then M_1 will be seen to occur before M_2 by all **Observers** in the system.

B2.3.4 Completion and endpoint ordering

Interaction between **Observers** in a system is not restricted to communication via shared variables in coherent memory. For example, an **Observer** could configure an interrupt controller to raise an interrupt on another **Observer** as a form of message passing. These interactions typically involve an additional agent, which defines the instruction sequence that is required to establish communication links between different **Observers**. When these forms of interaction are used in conjunction with shared variables, a DSB instruction can be used to enforce ordering between them.

Peripherals

This section defines a Memory-mapped peripheral and the total order of reads and writes to a peripheral which is defined as the **Peripheral coherence order**:

Memory-mapped peripheral

A *Memory-mapped peripheral* occupies a memory region of IMPLEMENTATION DEFINED size and can be accessed using load and store instructions. **Memory effects** to a Memory-mapped peripheral can have side-effects, such as causing the peripheral to perform an action. Values that are read from addresses within a Memory-mapped peripheral might not correspond to the last data value written to those addresses. As such, **Memory effects** to a Memory-mapped peripheral might not appear in the **Reads-from** or **Coherence order** relations.

Peripheral coherence order

The *Peripheral coherence order* of a **Memory-mapped peripheral** is a total order on all reads and writes to that peripheral.

———— **Note** —————

The Peripheral coherence order for a **Memory-mapped peripheral** signifies the order in which accesses arrive at the endpoint.

For a read or a write RW_1 and a read or a write RW_2 to the same peripheral, then RW_1 will appear in the Peripheral coherence order for the peripheral before RW_2 if either of the following cases apply:

- RW_1 and RW_2 are accesses using Non-cacheable or Device attributes and RW_1 is **Ordered-before** RW_2 .
- RW_1 and RW_2 are accesses using Device-nGnRE or Device-nGnRnE attributes and RW_1 appears in program order before RW_2 .

Out-of-band-ordered-before

A read or a write RW_1 is *Out-of-band-ordered-before* a read or a write RW_2 if and only if either of the following cases apply:

- RW_1 appears in program order before a DSB instruction that begins an IMPLEMENTATION DEFINED instruction sequence indirectly leading to the generation of RW_2 .
- RW_1 is **Ordered-before** a read or a write RW_3 and RW_3 is **Out-of-band-ordered-before** RW_2 .

If a **Memory effect** M_1 is Out-of-band-ordered-before a read or a write M_2 , then M_1 is seen to occur before M_2 by all **Observers**.

B2.3.5 Memory barriers

Memory barrier is the general term applied to an instruction, or sequence of instructions, that forces synchronization events by a PE with respect to retiring Load/Store instructions. The memory barriers defined by the ARMv8 architecture provide a range of functionality, including:

- Ordering of Load/Store instructions.
- Completion of Load/Store instructions.
- Context synchronization.

The following subsections describe the ARMv8 memory barrier instructions:

- [Instruction Synchronization Barrier \(ISB\)](#)
- [Data Memory Barrier \(DMB\)](#).
- [Data Synchronization Barrier \(DSB\)](#) on page B2-93.
- [Shareability and access limitations on the data barrier operations](#) on page B2-93.
- [Load-Acquire, Store-Release](#) on page B2-94.
- [LoadLOAcquire, StoreLORelease](#) on page B2-95.

———— **Note** ————

Depending on the required synchronization, a program might use memory barriers on their own, or it might use them in conjunction with cache maintenance and memory management instructions that in general are only available when software execution is at EL1 or higher.

DMB and DSB instructions affect reads and writes to the memory system generated by Load/Store instructions and data or unified cache maintenance instructions being executed by the PE. Instruction fetches or accesses caused by a hardware translation table access are not explicit accesses.

Instruction Synchronization Barrier (ISB)

An ISB instruction flushes the pipeline in the PE, so that all instructions that come after the ISB instruction in program order are fetched from the cache or memory after the ISB instruction has completed. Using an ISB ensures that the effects of context-changing operations executed before the ISB are visible to the instructions fetched after the ISB instruction. Examples of context-changing operations that require the insertion of an ISB instruction to ensure the effects of the operation are visible to instructions fetched after the ISB instruction are:

- Completed cache and TLB maintenance instructions.
- Changes to System registers.

Any context-changing operations appearing in program order after the ISB instruction only take effect after the ISB has been executed.

The pseudocode function for the operation of an ISB is `InstructionSynchronizationBarrier()`.

See also [Memory barriers](#) on page D3-2002.

Data Memory Barrier (DMB)

The DMB instruction is a memory barrier instruction that ensures the relative order of memory accesses before the barrier with memory accesses after the barrier. The DMB instruction does not ensure the completion of any of the memory accesses for which it ensures relative order.

The full definition of the DMB is covered formally in the [Definition of the ARMv8 memory model](#) on page B2-86 and this introduction to the DMB instruction is not intended to contradict that section.

The basic principle of a DMB instruction is to introduce order between memory accesses that are specified to be affected by the DMB options supplied as arguments to the DMB instruction. The DMB instruction ensures that all affected memory accesses by the PE executing the DMB that appear in program order before the DMB and those which originate

from a different PE, to the extent required by the DMB options, which have been **Observed-by** the PE before the DMB is executed, are **Observed-by** each PE, to the extent required by the DMB options, before any affected memory accesses that appear in program order after the DMB are **Observed-by** that PE.

The use of a DMB creates order between the **Memory effects** of instructions as described in the definition of **Barrier-ordered-before**.

DMB only affects memory accesses and the operation of data cache and unified cache maintenance instructions, see [A64 Cache maintenance instructions on page D3-1985](#). It has no effect on the ordering of any other instructions executing on the PE. A DMB instruction intended to ensure the completion of cache maintenance instructions must have an access type of both loads and stores.

The pseudocode function for the operation of a DMB is `DataMemoryBarrier()`.

Data Synchronization Barrier (DSB)

A DSB is a memory barrier that ensures that memory accesses that occur before the DSB have completed before the completion of the DSB instruction. In doing this, it acts as a stronger barrier than a DMB and all ordering that is created by a DMB with specific options is also generated by a DSB with the same options.

Execution of a DSB:

- At EL2 ensures that any memory accesses caused by **Speculative** translation table walks from the Non-secure EL1&0 translation regime have been observed.
- At EL3 ensures that any memory accesses caused by speculative translation table walks from any of the following translation regimes have been observed:
 - The EL2 or EL2&0 translation regime.
 - The Secure EL1&0 translation regime.
 - The Non-secure EL1&0 translation regime.

For more information, see [Use of out-of-context translation regimes on page D4-2020](#).

A DSB completes when all of the following apply:

- All explicit memory accesses that are observed by PEe before the DSB is executed and are of the required access types, and are from observers in the same required shareability domain as PEe, are complete for the set of observers in the required shareability domain.
- If the required access types of the DSB is reads and writes, then all cache maintenance instructions and all TLB maintenance instructions issued by PEe before the DSB are complete for the required shareability domain.

In addition, no instruction that appears in program order after the DSB instruction can alter any state of the system or perform any part of its functionality other than:

- Being fetched from memory and decoded.
- Reading the general-purpose, SIMD and floating-point, Special-purpose, or System registers that are directly or indirectly read without causing side-effects until the DSB completes.

The pseudocode function for the operation of a DSB is `DataSynchronizationBarrier()`.

See also [Memory barriers on page D3-2002](#).

Shareability and access limitations on the data barrier operations

The DMB and DSB instructions take an argument that specifies:

- The shareability domain over which the instruction must operate. This is one of:
 - Full system.
 - Outer Shareable.
 - Inner Shareable.
 - Non-shareable.

- The accesses for which the instruction operates. This is one of:
 - Read and write accesses, both before and after the barrier instruction.
 - Write accesses only, before and after the barrier instruction.
 - Read accesses before the barrier instruction, and read and write accesses after the barrier instruction.

———— **Note** ————

This form of a DMB or DSB instruction can be described as a Load-Load/Store barrier.

For more information on whether an access is before or after a barrier instruction, see [Data Memory Barrier \(DMB\) on page B2-92](#) or [Data Synchronization Barrier \(DSB\) on page B2-93](#).

Table B2-1 shows how these options are encoded in the <option> field of the instruction:

Table B2-1 Encoding of the DMB and DSB <option> parameter

Accesses		Shareability domain			
Before the barrier	After the barrier	Full system	Outer Shareable	Inner Shareable	Non-shareable
Reads and writes	Reads and writes	SY	OSH	ISH	NSH
Writes	Writes	ST	OSHST	ISHST	NSHST
Reads	Reads and writes	LD	OSHL	ISHL	NSHL

See the instruction descriptions for more information:

- [DMB on page C6-612](#).
- [DSB on page C6-615](#).

———— **Note** ————

ISB also supports an optional limitation argument that can only contain one value that corresponds to full system operation, see [ISB on page C6-631](#).

Load-Acquire, Store-Release

ARMv8 provides a set of instructions with Acquire semantics for loads, and Release semantics for stores. See [Load-Acquire/Store-Release on page C3-165](#).

The full definition of the Load-Acquire instruction is covered formally in the [Definition of the ARMv8 memory model on page B2-86](#) and this introduction to the Load-Acquire instruction is not intended to contradict that section.

The basic principle of a Load-Acquire instruction is to introduce order between the memory access generated by the Load-Acquire instruction and the memory accesses appearing in program order after the Load-Acquire instruction, such that the memory access generated by the Load-Acquire instruction is **Observed-by** each PE, to the extent that that PE is required to observe the access coherently, before any of the memory accesses appearing in program order after the Load-Acquire instruction are **Observed-by** that PE, to the extent that the PE is required to observe the accesses coherently.

The use of a Load-Acquire instruction creates order between the **Memory effects** of instructions as described in the definition of [Barrier-ordered-before](#).

The full definition of the Store-Release instruction is covered formally in the [Definition of the ARMv8 memory model on page B2-86](#) and this introduction to the Store-Release instruction is not intended to contradict that section.

The basic principle of a Store-Release instruction is to introduce order between the memory accesses generated by the PEe executing the Store-Release instruction, together with those which originate from a different PE, to the extent that the PEe is required to observe them coherently, **Observed-by** the PEe before executing the Store-release.

The use of a Store-Release instruction creates order between the [Memory effects](#) of instructions as described in the definition of [Barrier-ordered-before](#).

In addition, the use of a Load-Acquire or a Store-Release instruction on accesses to a [Memory-mapped peripheral](#) introduces order between the [Memory effects](#) of the instructions that access that peripheral, as described in the definition of [Peripheral coherence order](#).

Load-Acquire and Store-Release, other than Load-Acquire Exclusive Pair and Store-Release-Exclusive Pair, access only a single data element. This access is single-copy atomic. The address of the data object must be aligned to the size of the data element being accessed, otherwise the access generates an Alignment fault.

Load-Acquire Exclusive Pair and Store-Release Exclusive Pair access two data elements. The address supplied to the instructions must be aligned to twice the size of the element being loaded, otherwise the access generates an Alignment fault.

A Store-Release Exclusive instruction only has the release semantics if the store is successful.

———— **Note** —————

- Each Load-Acquire Exclusive and Store-Release Exclusive instruction is essentially a variant of the equivalent Load-Exclusive or Store-Exclusive instruction. All usage restrictions and single-copy atomicity properties:
 - That apply to the Load-Exclusive instructions also apply to the Load-Acquire Exclusive instructions.
 - That apply to the Store-Exclusive instructions also apply to the Store-Release Exclusive instructions.
- The Load-Acquire/Store-Release instructions can remove the requirement to use the explicit DMB instruction.

LoadLOAcquire, StoreLORelease

For each PE, the Non-secure physical memory map is divided into a set of LORegions using a table that is held within the PE. Any physical address in the Non-secure memory map can be a member of one LORegion. If a physical address is assigned to more than one LORegion, then an implementation might treat it as if it has been assigned to fewer LORegions than that have been specified. A physical address in the Secure physical memory map cannot be a member of any LORegion. For more information, see [Limited ordering regions on page B2-96](#).

ARMv8.1 provides a set of instructions with Acquire semantics for loads, and Release semantics for stores that apply in relation to the defined LORegions. The new variants of the Load-Acquire and Store-Release instructions are LoadLOAcquire and StoreLORelease. See [Load-Acquire/Store-Release on page C3-165](#).

For all memory types, these instructions have the following ordering requirements:

- LoadLOAcquire has the same semantics as Load-Acquire except that the memory accesses affected lie within the same LORegion as the address of the memory access generated by the LoadLOAcquire instruction. See [Load-Acquire, Store-Release on page B2-94](#).
- StoreLORelease has the same semantics as Store-Release except that the memory accesses affected lie within the same LORegion as the address of the memory access generated by the StoreLORelease instruction. See [Load-Acquire, Store-Release on page B2-94](#).

In addition, for accesses to [Memory-mapped peripherals](#):

- LoadLOAcquire has the same semantics as Load-Acquire except that the affected [Memory effects](#) of instructions that access the peripheral lie within the same LORegion as the address of the memory access generated by the LoadLOAcquire instruction. See [Load-Acquire, Store-Release on page B2-94](#).
- StoreLORelease has the same semantics as Store-Release except that the affected [Memory effects](#) of instructions that access the peripheral lie within the same LORegion as the address of the memory access generated by the StoreLORelease instruction. See [Load-Acquire, Store-Release on page B2-94](#).

———— **Note** —————

The LoadLOAcquire/StoreLORelease instructions can remove the requirement to use the explicit DMB instruction.

B2.3.6 Limited ordering regions

ARMv8.1 introduces *limited ordering regions* (LORegions), which allow large systems to perform special load-acquire and store-release instructions that provide order between the memory accesses to a region of the physical address map as observed by a set of observers.

This feature is supported in AArch64 state only.

Specification of the LORegions

The LORegions are defined in the Non-secure physical memory map using a set of LORegion descriptors. The number of LORegion descriptors is IMPLEMENTATION DEFINED, and can be discovered by reading the [LORID_EL1](#) register.

Each LORegion descriptor consists of:

- A tuple of the following values:
 - A Start Address.
 - An End Address.
 - An LORegion Number.
- Valid bit which indicates whether that LORegion descriptor is valid

A memory location lies within the LORegion identified by the LORegion Number if the physical address lies between the Start Address and the End Address, inclusive. The Start Address must be defined to be aligned to 64KB and the End Address must be defined as the top byte of a 64KB block of memory.

The LORegion descriptors are programmed using the [LORSA_EL1](#), [LOREA_EL1](#), [LORN_EL1](#), and [LORC_EL1](#) registers in the System register space. These registers are only supported in the Non-secure memory map.

If a LoadLOAcquire or a StoreLORelease does not match with any LORegion, then:

- The LoadLOAcquire will behave as a Load-Acquire, and will be ordered in the same way with respect to all accesses, independent of their LORegions.
- The StoreLORelease will behave as a Store-Release, and will be ordered in the same way with respect to all accesses, independent of their LORegions.

———— **Note** —————

If no LORegions are implemented, then the LoadLOAcquire and StoreLORelease will therefore behave as a Load-Acquire and Store-Release.

A new access type [AccType_LIMITEDORDERED](#) has been added for these limited ordering instructions to be identified.

B2.4 Caches and memory hierarchy

The implementation of a memory system depends heavily on the microarchitecture and therefore many details of the memory system are IMPLEMENTATION DEFINED. ARMv8 defines the application level interface to the memory system, including a hierarchical memory system with multiple levels of cache. This section describes an application level view of this system. It contains the subsections:

- [Introduction to caches](#).
- [Memory hierarchy on page B2-98](#).
- [Application level access to functionality related to caches on page B2-99](#)
- [Implication of caches for the application programmer on page B2-100](#).
- [Preloading caches on page B2-101](#).

B2.4.1 Introduction to caches

A cache is a block of high-speed memory that contains a number of entries, each consisting of:

- Main memory address information, commonly known as a *tag*.
- The associated data.

Caches increase the average speed of a memory access. Caching takes account of two principles of locality:

Spatial locality

An access to one [Location](#) is likely to be followed by accesses to adjacent [Locations](#). Examples of this principle are:

- Sequential instruction execution.
- Accessing a data structure.

Temporal locality

An access to an area of memory is likely to be repeated in a short time period. An example of this principle is the execution of a software loop.

To minimize the quantity of control information stored, the spatial locality property groups several locations together under the same tag. This logical block is commonly known as a *cache line*. When data is loaded into a cache, access times for subsequent loads and stores are reduced, resulting in overall performance benefits. An access to information already in a cache is known as a *cache hit*, and other accesses are called *cache misses*.

Normally, caches are self-managing, with the updates occurring automatically. Whenever the PE accesses a cacheable memory location, the cache is checked. If the access is a cache hit, the access occurs in the cache. Otherwise, the access is made to memory. Typically, when making this access, a cache location is allocated and the cache line loaded from memory. ARMv8 permits different cache topologies and access policies, provided they comply with the memory coherency model described in this manual.

Caches introduce a number of potential problems, mainly because:

- Memory accesses can occur at times other than when the programmer would expect them.
- A data item can be held in multiple physical locations.

B2.4.2 Memory hierarchy

Typically memory close to a PE has very low latency, but is limited in size and expensive to implement. Further from the PE it is common to implement larger blocks of memory but these have increased latency. To optimize overall performance, an ARMv8 memory system can include multiple levels of cache in a hierarchical memory system that exploits this trade-off between size and latency. Figure B2-1 shows an example of such a system in an ARMv8-A system that supports virtual addressing.

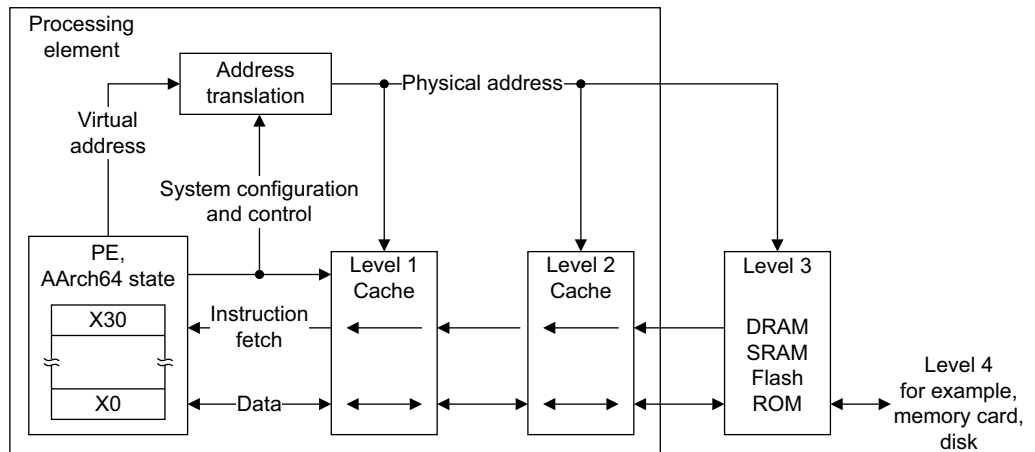

Figure B2-1 Multiple levels of cache in a memory hierarchy

———— **Note** ————

In this manual, in a hierarchical memory system, Level 1 refers to the level closest to the processing element, as shown in Figure B2-1.

Instructions and data can be held in separate caches or in a unified cache. A cache hierarchy can have one or more levels of separate instruction and data caches, with one or more unified caches that are located at the levels closest to the main memory. Memory coherency for cache topologies can be defined by two conceptual points:

Point of Unification (PoU)

The point at which the instruction cache, data cache, and translation table walks of a particular PE are guaranteed to see the same copy of a memory location. In many cases, the point of unification is the point in a uniprocessor memory system by which the instruction and data caches and the translation table walks have merged. The point of unification might coincide with the point of coherency.

Point of Coherency (PoC)

The point at which all agents that can access memory are guaranteed to see the same copy of a memory location for accesses of any memory type or cacheability attribute. In many cases this is effectively the main system memory, although the architecture does not prohibit the implementation of caches beyond the PoC that have no effect on the coherency between memory system agents.

———— **Note** ————

The presence of system caches can affect the determination of the point of coherency as described in *System level caches* on page D3-1996.

From ARMv8.2, a mechanism is introduced to explicitly identify and manage persistent memory in a shared memory hierarchy. In implementations that support this feature, data can be reliably written, then recovered after a power cycle from the persistent memory locations. ARMv8.2 supports the data cache management functionality that is necessary to maintain caches and persistent memory in a coherent memory system. Persistent memory is

sometimes referred to as non-volatile memory. By example, the Flash memory illustrated in Figure B2-1 on page B2-98 could be used to support this persistent memory feature. To support this feature, a further conceptual point is defined:

Point of Persistence (PoP)

The point in a memory system, should it exist, at or beyond the Point of Coherency, where a write to memory is maintained when system power is removed, and reliably recovered when power is restored to the affected locations in memory.

See also *About cache maintenance in AArch64 state* on page D3-1981.

The cacheability and shareability memory attributes

Cacheability and shareability are two attributes that describe the memory hierarchy in a multiprocessing system:

Cacheability This attribute defines whether memory locations are allowed to be allocated into a cache or not. Cacheability is defined independently for Inner and Outer Cacheability locations.

Shareability This attribute defines whether memory locations are shareable between different agents in a system. Marking a memory location as shareable for a particular domain requires hardware to ensure that the location is coherent for all agents in that domain. Shareability is defined independently for Inner and Outer Shareability domains.

For more information about Cacheability and Shareability, see *Memory types and attributes* on page B2-107.

B2.4.3 Application level access to functionality related to caches

As indicated in *About the Application level programmers' model* on page B1-70, the application level corresponds to execution at EL0. The architecture defines a set of cache maintenance instructions that software can use to manage cache coherency. Software executing at a higher Exception level can enable use of some of this functionality from EL0, as follows:

When the value of SCTLR_EL1.UCI is 1

Software executing at EL0 can access:

- The data cache maintenance instructions, DC CVAU, DC CVAC, DC CVAP, and DC CIVAC. See *The data cache maintenance instruction (DC)* on page D3-1987.
- The instruction cache maintenance instruction IC IVAU. See *The instruction cache maintenance instruction (IC)* on page D3-1986.

When the value of SCTLR_EL1.UCT is 1

Software executing at EL0 can access the cache type register. See *CTR_EL0*.

When the value of SCTLR_EL1.DZE is 1

Software executing at EL0 can access the data cache zero instruction DC ZVA. See *Data cache zero instruction* on page D3-1994.

The SCTLR_EL1.{UCI, UCT, DZE} control fields are only accessible by software executing at EL1 or higher.

This functionality is UNDEFINED at EL0 when the value of the corresponding SCTLR_EL1 control field is 0, see:

- *Traps to EL1 of EL0 execution of cache maintenance instructions* on page D1-1844.
- *Traps to EL1 of EL0 accesses to the CTR_EL0* on page D1-1845.
- *Traps to EL1 of EL0 execution of DC ZVA instructions* on page D1-1846.

When the value of SCTLR_EL1.UCI is 1:

- If a DC CVAU, DC CVAC, DC CVAP, or DC CIVAC cache maintenance instruction is executed at EL0, and the target address does not have read access permission at EL0, a Permission fault is generated.
- If the IC IVAU cache maintenance instruction, and the target address does not have read access permission at EL0, it is IMPLEMENTATION DEFINED whether a Permission fault is generated.

B2.4.4 Implication of caches for the application programmer

In normal operation, the caches are largely invisible to the application programmer. However they can become visible when there is a breakdown in the coherency of the caches. Such a breakdown can occur:

- When memory locations are updated by other agents in the system that do not use hardware management of coherency.
- When memory updates made from the application software must be made visible to other agents in the system, without the use of hardware management of coherency.

For example:

- In the absence of hardware management of coherency of DMA accesses, in a system with a DMA controller that reads memory locations that are held in the data cache of a PE, a breakdown of coherency occurs when the PE has written new data in the data cache, but the DMA controller reads the old data held in memory.
- In a Harvard cache implementation, where there are separate instruction and data caches, a breakdown of coherency occurs when new instruction data has been written into the data cache, but the instruction cache still contains the old instruction data.

Data coherency issues

Software can ensure the data coherency of caches in the following ways:

- By not using the caches in situations where coherency issues can arise. This can be achieved by:
 - Using Non-cacheable or, in some cases, Write-Through Cacheable memory.
 - Not enabling caches in the system.
- By using cache maintenance instructions to manage the coherency issues in software. See [Application level access to functionality related to caches on page B2-99](#).
- By using hardware coherency mechanisms to ensure the coherency of data accesses to memory for cacheable locations by observers within the different shareability domains, see [Non-shareable Normal memory on page B2-109](#) and [Shareable, Inner Shareable, and Outer Shareable Normal memory on page B2-108](#).

———— Note —————

The performance of these hardware coherency mechanisms is highly implementation-specific. In some implementations, the mechanism suppresses the ability to cache shareable locations. In other implementations, cache coherency hardware can hold data in caches while managing coherency between observers within the shareability domains.

———— Note —————

Not all these mechanisms are directly available to software operating at EL0 and might involve interaction with software operating at a higher Exception level.

Synchronization and coherency issues between data and instruction accesses

How far ahead of the current point of execution instructions are fetched from is IMPLEMENTATION DEFINED. Such prefetching can be either a fixed or a dynamically varying number of instructions, and can follow any or all possible future execution paths. For all types of memory:

- The PE might have fetched the instructions from memory at any time since the last [Context synchronization event](#) on that PE.
- Any instructions fetched in this way might be executed multiple times, if this is required by the execution of the program, without being refetched from memory. In the absence of a [Context synchronization event](#), there is no limit on the number of times such an instruction might be executed without being refetched from memory.

The ARM architecture does not require the hardware to ensure coherency between instruction caches and memory, even for locations of shared memory.

If software requires coherency between instruction execution and memory, it must manage this coherency using [Context synchronization events](#) and cache maintenance instructions. The following code sequence can be used to allow a PE to execute code that the same PE has written.

```
; Coherency example for data and instruction accesses within the same Inner Shareable domain.
; Enter this code with <Wt> containing a new 32-bit instruction,
; to be held in Cacheable space at a location pointed to by Xn.
    STR Wt, [Xn]
    DC CVAU, Xn      ; Clean data cache by VA to point of unification (PoU)
    DSB ISH         ; Ensure visibility of the data cleaned from cache
    IC IVAU, Xn     ; Invalidate instruction cache by VA to PoU
    DSB ISH         ; Ensure completion of the invalidations
    ISB             ; Synchronize the fetched instruction stream
```

———— **Note** ————

- For Non-cacheable or Write-Through accesses, the clean data cache by VA instruction is not required. However, the invalidate instruction cache instruction is required because the ARMv8-A AArch64 architecture allows Non-cacheable accesses to be held in an instruction cache. See [Non-cacheable accesses and instruction caches on page D3-1981](#).
- This code can be used when the thread of execution modifying the code is the same thread of execution that is executing the code. The ARMv8 architecture limits the set of instructions that can be executed by one thread of execution as they are being modified by another thread of execution without requiring explicit synchronization. See [Concurrent modification and execution of instructions on page B2-84](#).
- The system software controls whether these cache maintenance instructions are available to the application level by setting [SCTLR_ELI.UCI](#).

———— **Note** ————

If this sequence is not executed between writing data to a location and executing the instruction at that location, the lack of coherency between instruction caches and memory means that the instructions that are executed might be the old instruction or the updated instruction, and which is used can arbitrarily vary during execution. It must not be assumed by software, before the synchronization sequence is executed, that once the updated instruction has been seen, the old instruction will not be seen again.

B2.4.5 Preloading caches

The ARM architecture provides memory system hints PRFM, LDNP, and STNP that software can use to communicate the expected use of memory locations to the hardware. The memory system can respond by taking actions that are expected to speed up the memory accesses if they occur. The effect of these memory system hints is IMPLEMENTATION DEFINED. Typically, implementations use this information to bring the data or instruction locations into caches.

The Preload instructions are hints, and so implementations can treat them as NOPs without affecting the functional behavior of the device. The instructions cannot generate synchronous Data Abort exceptions, but the resulting memory system operations might, under exceptional circumstances, generate an asynchronous external abort, which is taken using an SError interrupt exception. For more information, see [Exception from a Data abort on page D1-1811](#).

[PrefetchHint](#){ } defines the prefetch hint types.

The [Hint_Prefetch\(\)](#) function signals to the memory system that memory accesses of the type hint to or from the specified address are likely to occur in the near future. The memory system might take some action to speed up the memory accesses when they do occur, such as preloading the specified address into one or more caches as indicated by the innermost cache level target and non-temporal hint stream.

For more information on PRFM and Load/Store instructions that provide hints to the memory system, see [Prefetch memory on page C3-171](#) and [Load/Store SIMD and Floating-point Non-temporal pair on page C3-168](#).

B2.5 Alignment support

This section describes alignment support. It contains the following subsections:

- [Instruction alignment](#).
- [Alignment of data accesses](#).
- [Unaligned data access restrictions on page B2-103](#).

B2.5.1 Instruction alignment

A64 instructions must be word-aligned.

Attempting to fetch an instruction from a misaligned location results in a PC alignment fault. See [PC alignment checking on page D1-1793](#).

B2.5.2 Alignment of data accesses

An unaligned access to any type of Device memory causes an Alignment fault.

The alignment requirements for accesses to Normal memory are as follows:

- For all instructions that load or store a single or multiple registers, other than Load-Exclusive/Store-Exclusive and Load-Acquire/Store-Release, if the address that is accessed is not aligned to the size of the data element being accessed, then one of the following occurs:
 - An Alignment fault is generated.
 - An unaligned access is performed.

When the value of `SCTLR_ELx.A` at the current Exception level is 1, alignment checking is enabled, and unaligned accesses generate Alignment faults.

———— **Note** —————

- The `SCTLR_EL1.A` bit applies to software running at EL0 and at EL1, although it can only be accessed from EL1 and higher.
 - Alignment checks are based on the size of the accessed elements, not the overall access size. This affects SIMD element and structure loads and stores, and also Load/Store pair instructions.
 - These alignment checking rules mean the ARMv8 architecture introduces requirements for 64-bit and 128-bit alignment checking.
- For all Load-Exclusive/Store-Exclusive and Load-Acquire/Store-Release memory accesses that access a single element or a pair of elements, an Alignment fault is generated if the address being accessed is not aligned to the size of the data structure being accessed.

A failed alignment check results in an Alignment fault, which is taken as a Data Abort exception, that is taken as follows:

- For an access from Non-secure EL0 or EL1, if the Alignment fault is generated only because the translation tables identify the address being accessed as Device memory then:
 - If the first stage of address translation marks the address as Device memory then the exception is taken to EL1.
 - If only the second stage of address translation marks the address as Device memory then the exception is taken to EL2.
- Otherwise, the exception is taken to the lowest Exception level that can handle the exception, consistent with the basic requirement that the Exception level never decreases on taking an exception. Therefore:
 - Alignment faults taken from EL0 or EL1 are taken to EL1 unless redirected by `HCR_EL2.TGE`
 - Alignment faults taken from EL2 are taken to EL2.
 - Alignment faults taken from EL3 are taken to EL3.

B2.5.3 Unaligned data access restrictions

The following points apply to unaligned data accesses in ARMv8:

- Accesses are not guaranteed to be single-copy atomic except at the byte access level, see [Atomicity in the ARM architecture on page B2-82](#).
- Unaligned accesses typically take a number of additional cycles to complete compared to a naturally-aligned access.
- An operation that performs an unaligned access can abort on any memory access that it makes, and can abort on more than one access. This means that an unaligned access that occurs across a page boundary can generate an abort on either side of the boundary.

B2.6 Endian support

General description of endianness in the ARM architecture describes the relationship between endianness and memory addressing in the ARM architecture.

The following subsections then describe the endianness schemes supported by the architecture:

- *Instruction endianness on page B2-105.*
- *Data endianness on page B2-105.*
- *Endianness of memory-mapped peripherals on page B2-106.*

B2.6.1 General description of endianness in the ARM architecture

This section only describes memory addressing and the effects of endianness for data elements up to quadwords of 128 bits. However, this description can be extended to apply to larger data elements.

For an address A, [Figure B2-2](#) shows, for big-endian and little-endian memory systems, the relationship between:

- The quadword at address A.
- The doubleword at address A and A+8.
- The words at addresses A, A+4, A+8, and A+12.
- The halfwords at addresses A, A+2, A+4, A+6, A+8, A+10, A+12, and A+14.
- The bytes at addresses A, A+1, A+2, A+3, A+4, A+5, A+6, A+7, A+8, A+9, A+10, A+11, A+12, A+13, A+14, and A+15.

The terms in [Figure B2-2](#) have the following definitions:

- B_A** Byte at address A.
- HW_A** Halfword at address A.
- MSByte** Most significant byte.
- LSByte** Least significant byte.

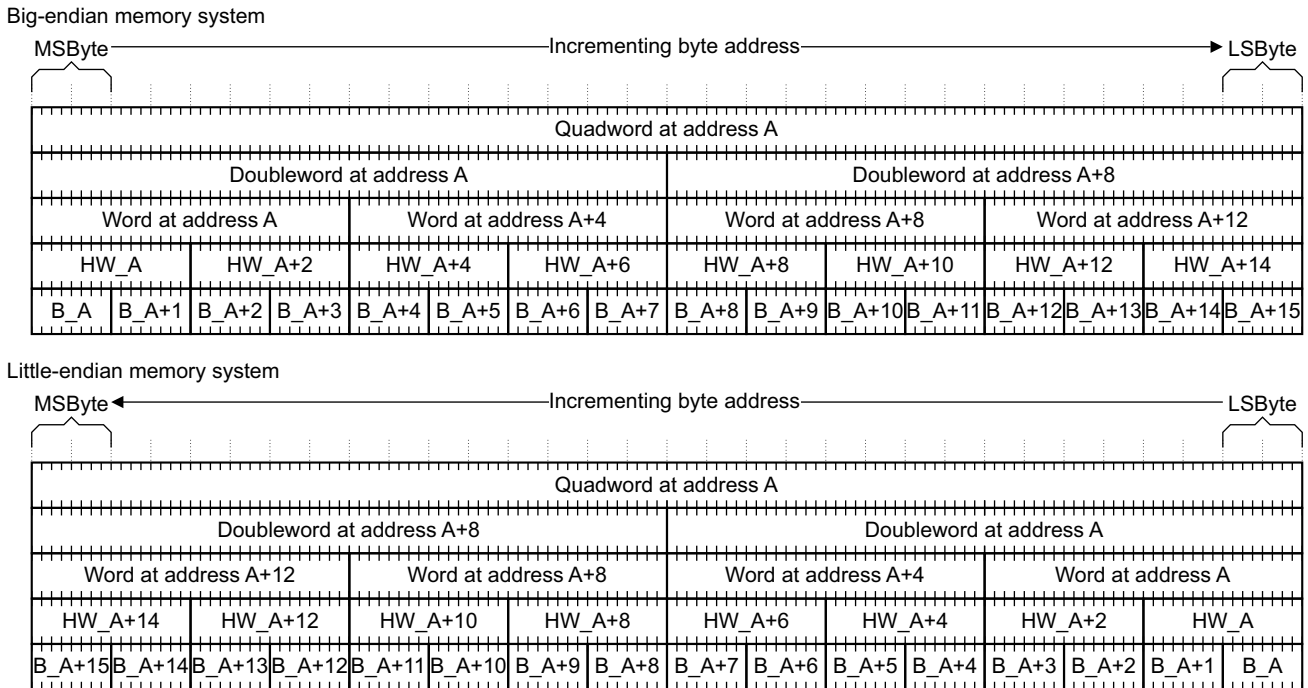

Figure B2-2 Endianness relationships

The big-endian and little-endian mapping schemes determine the order in which the bytes of a quadword, doubleword, word, or halfword are interpreted. For example, a load of a word from address 0x1000 always results in an access to the bytes at memory locations 0x1000, 0x1001, 0x1002, and 0x1003. The endianness mapping scheme determines the significance of these 4 bytes.

B2.6.2 Instruction endianness

In ARMv8-A, A64 instructions have a fixed length of 32 bits and are always little-endian.

B2.6.3 Data endianness

[SCTLR_ELI.E0E](#), configurable at EL1 or higher, determines the data endianness for execution at EL0.

The data size used for endianness conversions:

- Is the size of the data value that is loaded or stored for SIMD and floating-point register and general-purpose register loads and stores.
- Is the size of the data element that is loaded or stored for SIMD element and data structure loads and stores. For more information, see [Endianness in SIMD operations on page B2-106](#).

———— **Note** —————

This means the ARMv8 architecture introduces a requirement for 128-bit endian conversions.

Instructions to reverse bytes in a general-purpose register or a SIMD and floating-point register

An application or device driver might have to interface to memory-mapped peripheral registers or shared memory structures that are not the same endianness as the internal data structures. Similarly, the endianness of the operating system might not match that of the peripheral registers or shared memory. In these cases, the PE requires an efficient method to transform explicitly the endianness of the data.

[Table B2-2](#) shows the instructions that provide this functionality:

Table B2-2 Byte reversal instructions

Function	Instructions	Notes
Reverse bytes in 32-bit word or words ^a	REV32	For use with general-purpose registers
Reverse bytes in whole register	REV	For use with general-purpose registers
Reverse bytes in 16-bit halfwords	REV16	For use with general-purpose registers
Reverse elements in doublewords, vector	REV64	For use with SIMD and floating-point registers
Reverse elements in words, vector	REV32	For use with SIMD and floating-point registers
Reverse elements in halfwords, vector	REV16	For use with SIMD and floating-point registers

a. Can operate on multiple words.

Endianness in SIMD operations

SIMD element Load/Store instructions transfer vectors of elements between memory and the SIMD and floating-point register file. An instruction specifies both the length of the transfer and the size of the data elements being transferred. This information is used to load and store data correctly in both big-endian and little-endian systems.

For example:

```
LD1 {V0.4H}, [X1]
```

This loads a 64-bit register with four 16-bit values. The four elements appear in the register in array order, with the lowest indexed element fetched from the lowest address. The order of bytes in the elements depends on the endianness configuration, as shown in Figure B2-3. Therefore, the order of the elements in the registers is the same regardless of the endianness configuration.

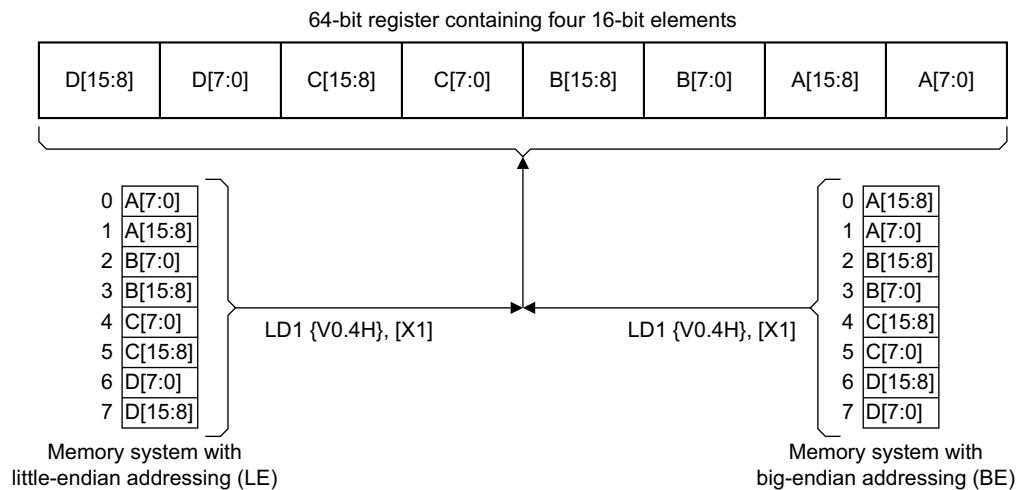

Figure B2-3 SIMD byte order example

The `BigEndian()` pseudocode function determines the current endianness of the data.

The `BigEndianReverse()` pseudocode function reverses the endianness of a bitstring.

The `BigEndian()` and `BigEndianReverse()` functions are defined in [Chapter J1 ARMv8 Pseudocode](#).

B2.6.4 Endianness of memory-mapped peripherals

All memory-mapped peripherals defined in the ARM architecture must be little-endian.

Peripherals to which this requirement applies include:

- Memory-mapped register interfaces to a debugger, or to a cross-trigger interface, see [Chapter H8 About the External Debug Registers](#).
- The memory-mapped register interface to the system level implementation of the Generic Timer, see [Chapter I1 System Level Implementation of the Generic Timer](#).
- A memory-mapped register interface to the Performance Monitors, see [Chapter I2 Recommended External Interface to the Performance Monitors](#).
- Memory-mapped register interfaces to an ARM Generic Interface Controller, see the *ARM® Generic Interrupt Controller Architecture Specification, GIC architecture version 3.0 and version 4.0*.
- The memory-mapped register interface to an ARM trace component. See, for example, the *ARM® Embedded Trace Macrocell Architecture Specification, ETMv4*.

B2.7 Memory types and attributes

In ARMv8 the ordering of accesses for addresses in memory, referred to as the memory order model, is defined by the memory attributes. The following sections describe this model:

- [Normal memory](#).
- [Device memory on page B2-111](#).
- [Memory access restrictions on page B2-117](#).

B2.7.1 Normal memory

The Normal memory type attribute applies to most memory in a system. It indicates that the hardware is permitted by the architecture to perform *Speculative* data read accesses to these locations, regardless of the access permissions for these locations.

The Normal memory type has the following properties:

- A write to a memory location with the Normal attribute completes in finite time. This means that it is globally observed for the shareability domain of the memory location in finite time. For a Non-cacheable location, the location is observed by all observers in finite time.
- A completed write to a memory location with the Normal attribute is globally observed for the shareability domain of the memory location in finite time without the need for explicit cache maintenance instructions or barriers. For a Non-cacheable location, the completed write is globally observed for all observers in finite time without the need for explicit cache maintenance instructions or barriers.
- Writes to a memory location with the Normal memory attribute that are Non-cacheable must reach the endpoint for that location in the memory system in finite time.
- Unaligned memory accesses can access Normal memory if the system is configured to generate such accesses.
- There is no requirement for the memory system beyond the PE to be able to identify the elements accessed by multi-register Load/Store instructions. See [Multi-register loads and stores that access Normal memory on page B2-111](#).

Note

- The Normal memory attribute is appropriate for locations of memory that are idempotent, meaning that they exhibit all of the following properties:
 - Read accesses can be repeated with no side-effects.
 - Repeated read accesses return the last value written to the resource being read.
 - Read accesses can fetch additional memory locations with no side-effects.
 - Write accesses can be repeated with no side-effects if the contents of the location accessed are unchanged between the repeated writes or as the result of an exception, as described in this section.
 - Unaligned accesses can be supported.
 - Accesses can be merged before accessing the target memory system.
- An instruction that generates a sequence of accesses as described in [Atomicity in the ARM architecture on page B2-82](#) might be abandoned as a result of an exception being taken during the sequence of accesses. On return from the exception the instruction is restarted, and therefore, one or more of the memory locations might be accessed multiple times. This can result in repeated write accesses to a location that has been changed between the write accesses.

The following sections describe the other attributes for Normal memory:

- [Shareable Normal memory on page B2-108](#).
- [Non-shareable Normal memory on page B2-109](#).
- [Cacheability attributes for Normal memory on page B2-109](#).

See also:

- [Multi-register loads and stores that access Normal memory on page B2-111.](#)
- [Atomicity in the ARM architecture on page B2-82.](#)
- [Memory barriers on page B2-92.](#) For accesses to Normal memory, a DMB instruction is required to ensure the required ordering.
- [Concurrent modification and execution of instructions on page B2-84.](#)

Shareable Normal memory

A Normal memory location has a Shareability attribute that is one of:

- Inner Shareable, meaning it applies across the Inner Shareable shareability domain.
- Outer Shareable, meaning it applies across both the Inner Shareable and the Outer Shareable shareability domains.
- Non-shareable.

The shareability attributes define the data coherency requirements of the location, that hardware must enforce. They do not affect the coherency requirements of instruction fetches, see [Synchronization and coherency issues between data and instruction accesses on page B2-100.](#)

———— Note —————

- System designers can use the shareability attribute to specify the locations in Normal memory for which coherency must be maintained. However, software developers must not assume that specifying a memory location as Non-shareable permits software to make assumptions about the incoherency of the location between different PEs in a shared memory system. Such assumptions are not portable between different multiprocessing implementations that might use the shareability attribute. Any multiprocessing implementation might implement caches that are shared, inherently, between different processing elements.
- This architecture assumes that all PEs that use the same operating system or hypervisor are in the same Inner Shareable shareability domain.

Shareable, Inner Shareable, and Outer Shareable Normal memory

The ARM architecture abstracts the system as a series of Inner and Outer Shareability domains.

Each Inner Shareability domain contains a set of observers that are data coherent for each member of that set for data accesses with the Inner Shareable attribute made by any member of that set.

Each Outer Shareability domain contains a set of observers that are data coherent for each member of that set for data accesses with the Outer Shareable attribute made by any member of that set.

The following properties also hold:

- Each observer is only a member of a single Inner Shareability domain.
- Each observer is only a member of a single Outer Shareability domain.
- All observers in an Inner Shareability domain are always members of the same Outer Shareability domain. This means that an Inner Shareability domain is a subset of an Outer Shareability domain, although it is not required to be a proper subset.

Note

- Because all data accesses to Non-cacheable locations are data coherent to all observers, Non-cacheable locations are always treated as Outer Shareable.
 - The Inner Shareable domain is expected to be the set of PEs controlled by a single hypervisor or operating system.
-

The details of the use of the shareability attributes are system-specific. [Example B2-1](#) shows how they might be used.

Example B2-1 Use of shareability attributes

In an implementation, a particular subsystem with two clusters of PEs has the requirement that:

- In each cluster, the data caches or unified caches of the PEs in the cluster are transparent for all data accesses to memory locations with the Inner Shareable attribute.
- However, between the two clusters, the caches:
 - Are not required to be coherent for data accesses that have only the Inner Shareable attribute.
 - Are coherent for data accesses that have the Outer Shareable attribute.

In this system, each cluster is in a different shareability domain for the Inner Shareable attribute, but all components of the subsystem are in the same shareability domain for the Outer Shareable attribute.

A system might implement two such subsystems. If the data caches or unified caches of one subsystem are not transparent to the accesses from the other subsystem, this system has two Outer Shareable shareability domains.

Having two levels of shareability means system designers can reduce the performance and power overhead for shared memory locations that do not need to be part of the Outer Shareable shareability domain.

For shareable Normal memory, the Load-Exclusive and Store-Exclusive synchronization primitives take account of the possibility of accesses by more than one observer in the same Shareability domain.

Non-shareable Normal memory

For Normal memory locations, the Non-shareable attribute identifies Normal memory that is likely to be accessed only by a single PE.

A location in Normal memory with the Non-shareable attribute does not require the hardware to make data accesses by different observers coherent, unless the memory is Non-cacheable. For a Non-shareable location, if other observers share the memory system, software must use cache maintenance instructions, if the presence of caches might lead to coherency issues when communicating between the observers. This cache maintenance requirement is in addition to the barrier operations that are required to ensure memory ordering.

For Non-shareable Normal memory, it is IMPLEMENTATION DEFINED whether the Load-Exclusive and Store-Exclusive synchronization primitives take account of the possibility of accesses by more than one observer.

Cacheability attributes for Normal memory

In addition to being Outer Shareable, Inner Shareable or Non-shareable, each region of Normal memory is assigned a Cacheability attribute that is one of:

- Write-Through Cacheable.
- Write-Back Cacheable.
- Non-cacheable.

Also, for Write-Through Cacheable and Write-Back Cacheable Normal memory regions:

- A region might be assigned cache allocation hints for read and write accesses.
- It is IMPLEMENTATION DEFINED whether the cache allocation hints can have an additional attribute of Transient or Non-transient.

For more information see [Cacheability, cache allocation hints, and cache transient hints on page D3-1977](#).

A memory location can be marked as having different cacheability attributes, for example when using aliases in a virtual to physical address mapping:

- If the attributes differ only in the cache allocation hint, this does not affect the behavior of accesses to that location.
- For other cases, see [Mismatched memory attributes on page B2-118](#).

The cacheability attributes provide a mechanism of coherency control with observers that lie outside the shareability domain of a region of memory. In some cases, the use of Write-Through Cacheable or Non-cacheable regions of memory might provide a better mechanism for controlling coherency than the use of hardware coherency mechanisms or the use of cache maintenance routines. To this end, the architecture requires the following properties for Non-cacheable or Write-Through Cacheable memory:

- A completed write to a memory location that is Non-cacheable or Write-Through Cacheable for a level of cache made by an observer accessing the memory system inside the level of cache is visible to all observers accessing the memory system outside the level of cache without the need of explicit cache maintenance.
- A completed write to a memory location that is Non-cacheable for a level of cache made by an observer accessing the memory system outside the level of cache is visible to all observers accessing the memory system inside the level of cache without the need of explicit cache maintenance.
- For accesses to Normal memory that is Non-cacheable, a DMB instruction ensures that all members of Group A reach a single peripheral or block of memory, of IMPLEMENTATION DEFINED size, before any member of Group B, where:
 - The definition of the operation of a DMB instruction defines Group A and Group B, see [Data Memory Barrier \(DMB\) on page B2-92](#).
 - The IMPLEMENTATION DEFINED size of the single peripheral or block of memory is defined by the peripheral or block of memory.

This applies for all types of DMB instruction.

———— **Note** —————

Implementations can use the cache allocation hints to indicate a probable performance benefit of caching. For example, a programmer might know that a piece of memory is not going to be accessed again and would be better treated as Non-cacheable. The distinction between memory regions with attributes that differ only in the cache allocation hints exists only as a hint for performance.

For Normal memory, the ARM architecture provides cacheability attributes that are defined independently for each of two conceptual levels of cache, the *inner* and the *outer* cache. The relationship between these conceptual levels of cache and the implemented physical levels of cache is IMPLEMENTATION DEFINED, and can differ from the boundaries between the Inner and Outer Shareability domains. However:

- Inner refers to the innermost caches, meaning the caches that are closest to the PE, and always includes the lowest level of cache.
- No cache that is controlled by the Inner cacheability attributes can lie outside a cache that is controlled by the Outer cacheability attributes.
- An implementation might not have any outer cache.

[Example B2-2 on page B2-111](#), [Example B2-3 on page B2-111](#), and [Example B2-4 on page B2-111](#) describe the possible ways of implementing a system with three levels of cache, *level 1* (L1) to *level 3* (L3).

Note

- L1 cache is the level closest to the PE, see [Memory hierarchy](#) on page B2-98.
 - When managing coherency, system designs must consider both the inner and outer cacheability attributes, as well as the shareability attributes. This is because hardware might have to manage the coherency of caches at one conceptual level, even when another conceptual level has the Non-cacheable attribute.
-

Example B2-2 Implementation with two inner and one outer cache levels

Implement the three levels of cache in the system, L1 to L3, with:

- The Inner cacheability attribute applied to L1 and L2 cache.
 - The Outer cacheability attribute applied to L3 cache.
-

Example B2-3 Implementation with three inner and no outer cache levels

Implement the three levels of cache in the system, L1 to L3, with the Inner cacheability attribute applied to L1, L2, and L3 cache. Do not use the Outer cacheability attribute.

Example B2-4 Implementation with one inner and two outer cache levels

Implement the three levels of cache in the system, L1 to L3, with:

- The Inner cacheability attribute applied to L1 cache.
 - The Outer cacheability attribute applied to L2 and L3 cache.
-

Multi-register loads and stores that access Normal memory

For all instructions that load or store more than one general-purpose register from an Exception level there is no requirement for the memory system beyond the PE to be able to identify the size of the elements accessed by these load or store instructions.

For all instructions that load or store more than one general-purpose register from an Exception level the order in which the registers are accessed is not defined by the architecture.

For all instructions that load or store one or more SIMD&FP registers from an Exception level, there is no requirement for the memory system beyond the PE to be able to identify the size of the element accessed by these load or store instructions.

B2.7.2 Device memory

The Device memory type attributes define memory locations where an access to the location can cause side-effects, or where the value returned for a load can vary depending on the number of loads performed. Typically, the Device memory attributes are used for memory-mapped peripherals and similar locations.

The attributes for ARMv8 Device memory are:

Gathering Identified as G or nG, see [Gathering](#) on page B2-114.

Reordering Identified as R or nR, see [Reordering](#) on page B2-115.

Early Write Acknowledgement hint

Identified as E or nE, see [Early Write Acknowledgement](#) on page B2-116.

The ARMv8 Device memory types are:

Device-nGnRnE	Device non-Gathering, non-Reordering, No Early write acknowledgement. Equivalent to the Strongly-ordered memory type in earlier versions of the architecture.
Device-nGnRE	Device non-Gathering, non-Reordering, Early Write Acknowledgement. Equivalent to the Device memory type in earlier versions of the architecture.
Device-nGRE	Device non-Gathering, Reordering, Early Write Acknowledgement. ARMv8 adds this memory type to the translation table formats found in earlier versions of the architecture. The use of barriers is required to order accesses to Device-nGRE memory.
Device-GRE	Device Gathering, Reordering, Early Write Acknowledgement. ARMv8 adds this memory type to the translation table formats found in earlier versions of the architecture. Device-GRE memory has the fewest constraints. It behaves similar to Normal memory, with the restriction that <i>Speculative</i> accesses to Device-GRE memory is forbidden.

Collectively these are referred to as *any Device memory type*. Going down the list, the memory types are described as getting *weaker*; conversely the going up the list the memory types are described as getting *stronger*.

———— **Note** —————

- As the list of types shows, these additional attributes are hierarchical. For example, a memory location that permits Gathering must also permit Reordering and Early Write Acknowledgement.
- The architecture does not require an implementation to distinguish between each of these memory types and ARM recognizes that not all implementations will do so. The subsection that describes each of the attributes, describes the implementation rules for the attribute.
- Earlier versions of the ARM architecture defined the following memory types:
 - Strongly-ordered memory. This is the equivalent of the Device-nGnRnE memory type.
 - Device memory. This is the equivalent of the Device-nGnRE memory type.

All of these memory types have the following properties:

- Speculative data accesses are not permitted to any memory location with any Device memory attribute. This means that each memory access to any Device memory type must be one that would be generated by a simple sequential execution of the program.

The following exceptions to this apply:

- Reads generated by the SIMD and floating-point instructions can access bytes that are not explicitly accessed by the instruction if the bytes accessed are in a 16-byte window, aligned to 16-bytes, that contains at least one byte that is explicitly accessed by the instruction.
- For Device memory with the Gathering attribute, reads generated by the LDNP instructions are permitted to access bytes that are not explicitly accessed by the instruction, provided that the bytes accessed are in a 128-byte window, aligned to 128-bytes, that contains at least one byte that is explicitly accessed by the instruction.
- Where a load or store instruction performs a sequence of memory accesses, as opposed to one single-copy atomic access as defined in the rules for single-copy atomicity, these accesses might occur multiple times as a result of executing the load or store instruction. See *Properties of single-copy atomic accesses on page B2-83*.

———— **Note** —————

- An instruction that generates a sequence of accesses as described in *Atomicity in the ARM architecture on page B2-82* might be abandoned as a result of an exception being taken during the sequence of accesses. On return from the exception, the instruction is restarted, and therefore, one or more of the memory locations might be accessed multiple times. This can result in repeated accesses to a location

where the program only defines a single access. For this reason, ARM strongly recommends that no accesses to Device memory are performed from a single instruction that spans the boundary of a translation granule or which in some other way could lead to some of the accesses being aborted.

- Write speculation that is visible to other observers is prohibited for all memory types.

-
- A write to a memory location with any Device memory attribute completes in finite time. This means that it is globally observed for all observers in the system in finite time.
 - If a location with any Device memory attribute changes without an explicit write by an observer, this change must also be globally observed for all observers in the system in finite time. Such a change might occur in a peripheral location that holds status information.
 - A completed write to a memory location with any Device memory attribute is globally observed for all observers in finite time without the need for explicit maintenance.
 - Data accesses to memory locations are coherent for all observers in the system, and correspondingly are treated as being Outer Shareable.
 - A memory location with any Device memory attribute cannot be allocated into a cache.
 - Writes to a memory location with any Device memory attribute must reach the endpoint for that address in the memory system in finite time. Typically, the endpoint is a peripheral or some physical memory.
 - For accesses to any Device memory type, a DMB instruction ensures that all members of Group A reach a single peripheral or block of memory, of IMPLEMENTATION DEFINED size, before any member of Group B, where:
 - The definition of the operation of a DMB instruction defines Group A and Group B, see [Data Memory Barrier \(DMB\) on page B2-92](#).
 - The IMPLEMENTATION DEFINED size of the single peripheral or block of memory is defined by the peripheral or block of memory.

This applies for all types of DMB instruction.

- All accesses to memory with any Device memory attribute must be aligned. Any unaligned access generates an Alignment fault at the first stage of translation that defined the location as being Device.

———— **Note** —————

In the Non-secure EL1&0 translation regime in systems where `HCR_EL2.TGE==1` and `HCR_EL2.DC==0`, any Alignment fault that results from the fact that all locations are treated as Device is a fault at the first stage of translation. This causes `ESR_EL2.ISS[24]` to be 0.

-
- Hardware does not prevent speculative instruction fetches from a memory location with any of the Device memory attributes unless the memory location is also marked as Execute-never for all Exception levels.

———— **Note** —————

This means that to prevent speculative instruction fetches from memory locations with Device memory attributes, any location that is assigned any Device memory type must also be marked as Execute-never for all Exception levels. Failure to mark a memory location with any Device memory attribute as Execute-never for all Exception levels is a programming error.

See also [Memory access restrictions on page B2-117](#).

The memory types for translation table walks cannot be defined as any Device memory type within the `TCR_ELx`. For the Non-secure EL1&0 translation regime, the memory accesses made during a stage 1 translation table walk are subject to a stage 2 translation, and as a result of this second stage of translation, the accesses from the first stage translation table walk might be made to memory locations with any Device memory type. These accesses might be made speculatively. When the value of the `HCR_EL2.PTW` bit is 1, a stage 2 permission fault is generated if a first stage translation table walk is made to any Device memory type.

———— **Note** —————

In general, making a translation table walk to any Device memory type is the result of a programming error.

For instruction fetches, if branches cause the program counter to point to an area of memory with the Device attribute which is not marked as Execute-never for the current Exception level, an implementation can either:

- Treat the instruction fetch as if it were to a memory location with the Normal Non-cacheable attribute.
- Take a Permission fault.

Gathering

In the Device memory attribute:

- G** Indicates that the location has the Gathering attribute.
nG Indicates that the location does not have the Gathering attribute, meaning it is non-Gathering.

The Gathering attribute determines whether it is permissible for either:

- Multiple memory accesses of the same type, read or write, to the same memory location to be merged into a single transaction.
- Multiple memory accesses of the same type, read or write, to different memory locations to be merged into a single memory transaction on an interconnect.

———— **Note** —————

This also applies to writebacks from the cache, whether caused by a *Natural eviction* or as a result of a cache maintenance instruction.

For memory types with the Gathering attribute, either of these behaviors is permitted, provided that the ordering and coherency rules of the memory location are followed.

For memory types with the non-Gathering attribute, neither of these behaviors is permitted. As a result:

- The number of memory accesses that are made corresponds to the number that would be generated by a simple sequential execution of the program.
- All accesses occur at their programmed size, except that there is no requirement for the memory system beyond the PE to be able to identify the elements accessed by multi-register Load/Store instructions. See [Multi-register loads and stores that access Device memory on page B2-116](#).

Gathering between memory accesses separated by a memory barrier that affects those memory accesses is not permitted. This applies if one memory access is in Group A and one memory access is in Group B. That is, gathering is not permitted between a memory access in Group A and a memory access in Group B if the two accesses are separated by a barrier that affects at least one of the accesses.

Gathering between two memory accesses generated by a Load-Acquire/Store-Release is not permitted.

A read from a memory location with the non-Gathering attribute cannot come from a cache or a buffer, but must come from the endpoint for that address in the memory system. Typically this is a peripheral or physical memory.

———— **Note** —————

- A read from a memory location with the Gathering attribute can come from intermediate buffering of a previous write, provided that:
 - The accesses are not separated by a DMB or DSB barrier that affects both of the accesses, for example if one access is in Group A and the other is in Group B.
 - The accesses are not separated by other ordering constructions that require that the accesses are in order. Such a construction might be a combination of Load-Acquire and Store-Release.
 - The accesses are not generated by a Store-Release instruction.

- The ARM architecture only defines programmer visible behavior. Therefore, gathering can be performed if a programmer cannot tell whether gathering has occurred.

An implementation is permitted to perform an access with the Gathering attribute in a manner consistent with the requirements specified by the Non-gathering attribute.

An implementation is not permitted to perform an access with the Non-gathering attribute in a manner consistent with the relaxations allowed by the Gathering attribute.

Reordering

In the Device memory attribute:

R Indicates that the location has the Reordering attribute. Accesses to the location can be reordered within the same rules that apply to accesses to Normal Non-cacheable memory. All memory types with the Reordering attribute have the same ordering rules as accesses to Normal Non-cacheable memory, see [Ordering relations on page B2-89](#).

nR Indicates that the location does not have the Reordering attribute, meaning it is non-Reordering.

Note

Some interconnect fabrics, such as PCIe, perform very limited re-ordering, which is not important for the software usage. It is outside the scope of the ARM architecture to prohibit the use of a Non-reordering memory type with these interconnects.

For all memory types with the non-Reordering attribute, the order of memory accesses arriving at a single peripheral of IMPLEMENTATION DEFINED size, as defined by the peripheral, must be the same order that occurs in a simple sequential execution of the program. That is, the accesses appear in program order. This ordering applies to all accesses using any of the memory types with the non-Reordering attribute. As a result, if there is a mixture of Device-nGnRE and Device-nGnRnE accesses to the same peripheral, these occur in program order. If the memory accesses are not to a peripheral, then this attribute imposes no restrictions.

Note

- The IMPLEMENTATION DEFINED size of the single peripheral is the same as applies for the ordering guarantee provided by the DMB instruction.
- The ARM architecture only defines programmer visible behavior. Therefore, reordering can be performed if a programmer cannot tell whether reordering has occurred.

An implementation:

- Is permitted to perform an access with the Reordering attribute in a manner consistent with the requirements specified by the non-Reordering attribute.
- Is not permitted to perform an access with the non-Reordering attribute in a manner consistent with the relaxations allowed by the Reordering attribute.

The non-Reordering attribute does not require any additional ordering, other than that which applies to Normal memory, between:

- Accesses with the non-Reordering attribute and accesses with the Reordering attribute.
- Accesses with the non-Reordering attribute and accesses to Normal memory.
- Accesses with the non-Reordering attribute and accesses to different peripherals of IMPLEMENTATION DEFINED size.

The non-Reordering attribute has no effect on the ordering of cache maintenance instructions, even if the memory location specified in the instruction has the non-Reordering attribute.

Early Write Acknowledgement

In the Device memory attribute:

- E** Indicates that the location has the Early Write Acknowledgement attribute.
nE Indicates that the location has the No Early Write Acknowledgement attribute.

Early Write Acknowledgement is a hint to the platform memory system. Assigning the No Early Write Acknowledgement attribute to a Device memory location recommends that only the endpoint of the write access returns a write acknowledgement of the access, and that no earlier point in the memory system returns a write acknowledge. This means that a DSB barrier, executed by the PE that performed the write to the No Early Write Acknowledgement location, completes only after the write has reached its endpoint in the memory system. Typically, this endpoint is a peripheral or physical memory.

When the Early Write Acknowledgement attribute is assigned to a Device memory location, there is no such recommendation for the handling of accesses to that location.

———— Note ————

- The Early Write Acknowledgement hint has no effect on the ordering rules. The purpose of signaling no Early Write Acknowledgement is to signal to the interconnect that the peripheral requires the ability to signal the acknowledgement. The No Write Acknowledgement signal also provides an additional semantic that can be interpreted by the driver that is accessing the peripheral.
- This attribute is treated as a hint, as the exact nature of the interconnects accessed by a PE is outside the scope of the ARM architecture definition, and not all interconnects provide a mechanism to ensure that a write has reached the physical endpoint of the memory system.
- ARM recommends that writes with the No Early Write Acknowledgement hint are used for PCIe configuration writes. However, the mechanisms by which PCIe configuration writes are identified are IMPLEMENTATION DEFINED.
- ARM strongly recommends that the Early Write Acknowledgement hint is not ignored by a PE, but is made available for use by the system.

Because the No Early Write Acknowledgement attribute is a hint:

- An implementation is permitted to perform an access with the Early Write Acknowledgement attribute in a manner consistent with the requirements specified by the No Early Write Acknowledgement attribute.
- An implementation is permitted to perform an access with the No Early Write Acknowledgement attribute in a manner consistent with the relaxations allowed by the Early Write Acknowledgement attribute.

Multi-register loads and stores that access Device memory

For all instructions that load or store more than one general-purpose register from an Exception level there is no requirement for the memory system beyond the PE to be able to identify the size of the elements accessed by these load or store instructions.

For all instructions that load or store more than one general-purpose register from an Exception level the order in which the registers are accessed is not defined by the architecture. This applies even to accesses to any type of Device memory.

For all instructions that load or store one or more floating-point and SIMD registers from an Exception level, there is no requirement for the memory system beyond the PE to be able to identify the size of the element accessed by these load or store instructions, even for access to any type of Device memory.

B2.7.3 Memory access restrictions

The following restrictions apply to memory accesses:

- For accesses to any two bytes, p and q , that are generated by the same instruction:
 - The bytes p and q must have the same memory type and shareability attributes, otherwise the results are CONSTRAINED UNPREDICTABLE. For example, an LD1, ST1, or an unaligned load or store that spans the boundary between Normal memory and Device memory is CONSTRAINED UNPREDICTABLE.
 - Except for possible differences in the cache allocation hints, ARM deprecates having different cacheability attributes for bytes p and q .

For the permitted CONSTRAINED UNPREDICTABLE behavior, see [Crossing a page boundary with different memory types or Shareability attributes on page K1-6123](#).

- If the accesses of an instruction that causes multiple accesses to any type of Device memory cross an address boundary that corresponds to the smallest implemented translation granule, then behavior is CONSTRAINED UNPREDICTABLE, and [Crossing a peripheral boundary with a Device access on page K1-6123](#) describes the permitted behaviors. For this reason, it is important that an access to a volatile memory device is not made using a single instruction that crosses an address boundary of the size of the smallest implemented translation granule.

———— **Note** —————

- The boundary referred to is between two Device memory regions that are both of the size of the smallest implemented translation granule and aligned to the size of the smallest implemented translation granule.
- This restriction means it is important that an access to a volatile memory device is not made using a single instruction that crosses an address boundary of the size of the smallest implemented translation granule.
- ARM expects this restriction to constrain the placing of volatile memory devices in the system memory map, rather than expecting a compiler to be aware of the alignment of memory accesses.

B2.8 Mismatched memory attributes

Memory attributes are controlled by privileged software. For more information, see [Chapter D4 The AArch64 Virtual Memory System Architecture](#).

Physical memory locations are accessed with *mismatched attributes* if all accesses to the location do not use a common definition of all of the following attributes of that location:

- Memory type, Device or Normal.
- Shareability.
- Cacheability, for the same level of the inner or outer cache, but excluding any cache allocation hints.

Collectively these are referred to as memory attributes.

———— **Note** —————

The terms *location* and *memory location* refer to any byte within the current coherency granule and are used interchangeably.

When a memory location is accessed with mismatched attributes, the only software visible effects are one or more of the following:

- Uniprocessor semantics for reads and writes to that memory location might be lost. This means:
 - A read of the memory location by one agent might not return the value most recently written to that memory location by the same agent.
 - Multiple writes to the memory location by one agent with different memory attributes might not be ordered in program order.
- There might be a loss of coherency when multiple agents attempt to access a memory location.
- There might be a loss of properties derived from the memory type, as described in later bullets in this section.
- If all Load-Exclusive/Store-Exclusive instructions executed across all threads to access a given memory location do not use consistent memory attributes, the Exclusives monitor state becomes UNKNOWN.
- Bytes written without the Write-Back cacheable attribute within the same Write-Back granule as bytes written with the Write-Back cacheable attribute might have their values reverted to the old values as a result of cache Write-Back.

The loss of properties associated with mismatched memory type attributes refers only to the following properties of Device memory that are additional to the properties of Normal memory:

- Prohibition of *Speculative* read accesses.
- Prohibition on Gathering.
- Prohibition on Re-ordering.

For the following situations, when a physical memory location is accessed with mismatched attributes, a more restrictive set of behaviors applies. The description of each situation also describes the behaviors that apply:

1. If the only memory type mismatch associated with a memory location across all users of the memory location is between different types of Device memory, then all accesses might take the properties of the weakest Device memory type.
2. Any agent that reads that memory location using the same common definition of the Shareability and Cacheability attributes is guaranteed to access it coherently, to the extent required by that common definition of the memory attributes, only if all the following conditions are met:
 - All writes are performed to an alias of the memory location that uses the same definition of the Shareability and Cacheability attributes.
 - Either:
 - In the Non-secure EL1&0 translation regime, `HCR_EL2.MI0CNCE` has a value of 0.
 - All aliases with write permission have the Inner Cacheability attribute the same as the Outer Cacheability attribute.

- Either:
 - All writes are performed to an alias of the memory location that has Inner Cacheability and Outer Cacheability attributes both as Non-cacheable.
 - All aliases to a memory location use a definition of the Shareability attributes that encompasses all the agents with permission to access the location.
- 3. The possible software-visible effects caused by mismatched attributes for a memory location are defined more precisely if all of the mismatched attributes define the memory location as one of:
 - Any Device memory type.
 - Normal Inner Non-cacheable, Outer Non-cacheable memory.

In these cases, the only permitted software-visible effects of the mismatched attributes are one or more of the following:

- Possible loss of properties derived from the memory type when multiple agents attempt to access the memory location.
- Possible reordering of memory transactions to the same memory location with different memory attributes, potentially leading to a loss of coherency or uniprocessor semantics. Any possible loss of coherency or uniprocessor semantics can be avoided by inserting DMB barrier instructions between accesses to the same memory location that might use different attributes.

Where there is a loss of the uniprocessor semantics, ordering, or coherency, the following approaches can be used:

1. If the mismatched attributes for a memory location all assign the same shareability attribute to the location, any loss of uniprocessor semantics, ordering, or coherency within a shareability domain can be avoided by use of software cache management. To do so, software must use the techniques that are required for the software management of the ordering or coherency of cacheable locations between agents in different shareability domains. This means:
 - Before writing to a location not using the Write-Back attribute, software must invalidate, or clean, a location from the caches if any agent might have written to the location with the Write-Back attribute. This avoids the possibility of overwriting the location with stale data.
 - After writing to a location with the Write-Back attribute, software must clean the location from the caches, to make the write visible to external memory.
 - Before reading the location with a cacheable attribute, software must invalidate, or clean and invalidate, the location from the caches, to ensure that any value held in the caches reflects the last value made visible in external memory.
 - Executing a DMB barrier instruction, with scope that applies to the common shareability of the accesses, between any accesses to the same memory location that use different attributes.

In all cases:

- [Location](#) refers to any byte within the current coherency granule.
- A clean and invalidate instruction can be used instead of a clean instruction, or instead of an invalidate instruction.
- In the sequences outlined in this section, all cache maintenance instructions and memory transactions must be completed, or ordered by the use of barrier operations, if they are not naturally ordered by the use of a common address, see [Ordering and completion of data and instruction cache instructions on page D3-1992](#).

Note

With software management of coherency, race conditions can cause loss of data. A race condition occurs when different agents write simultaneously to bytes that are in the same location, and the invalidate, write, clean sequence of one agent overlaps with the equivalent sequence of another agent. A race condition also occurs if the first operation of either sequence is a clean, rather than an invalidate.

2. If the mismatched attributes for a location mean that multiple cacheable accesses to the location might be made with different shareability attributes, then uniprocessor semantics, ordering, and coherency are guaranteed only if:
 - Each PE that accesses the location with a cacheable attribute performs a clean and invalidate of the location before and after accessing that location.
 - A DMB barrier with scope that covers the full shareability of the accesses is placed between any accesses to the same memory location that use different attributes.

———— **Note** —————

The Note in rule 1 of this list, about possible race conditions, also applies to this rule.

In addition, if multiple agents attempt to use Load-Exclusive or Store-Exclusive instructions to access a location, and the accesses from the different agents have different memory attributes associated with the location, the Exclusives monitor state becomes UNKNOWN.

ARM strongly recommends that software does not use mismatched attributes for aliases of the same location. An implementation might not optimize the performance of a system that uses mismatched aliases.

B2.9 Synchronization and semaphores

ARMv8 provides non-blocking synchronization of shared memory, using *synchronization primitives*. The information in this section about memory accesses by synchronization primitives applies to accesses to both Normal memory and to any type of Device memory.

———— **Note** ————

Use of the ARMv8 synchronization primitives scales for multiprocessing system designs.

Table B2-3 shows the synchronization primitives and the associated CLREX instruction.

Table B2-3 Synchronization primitives and associated instruction, A64 instruction set

Transaction size	Additional semantics	Load-Exclusive ^a	Store-Exclusive ^a	Other ^a
Byte	-	LDXRB	STXRB	-
	Load-Acquire/Store-Release	LDAXRB	STLXRB	-
Halfword	-	LDXRH	STXRH	-
	Load-Acquire/Store-Release	LDAXRH	STLXRH	-
Register ^b	-	LDXR	STXR	-
	Load-Acquire/Store-Release	LDAXR	STLXR	-
Pair ^b	-	LDXP	STXP	-
	Load-Acquire/Store-Release	LDAXP	STLXP	-
None	Clear-Exclusive	-	-	CLREX

a. Instruction in the A64 instruction set.

b. A register instruction operates on a doubleword if accessing an X register, or on a word if accessing a W register. A pair instruction operates on two doublewords if access X registers, or on two words if accessing W registers.

Except for the row showing the CLREX instruction, the two instructions in a single row are a Load-Exclusive/Store-Exclusive instruction pair. The model for the use of a Load-Exclusive/Store-Exclusive instruction pair accessing a non-aborting memory address *x* is:

- The Load-Exclusive instruction reads a value from memory address *x*.
- The corresponding Store-Exclusive instruction succeeds in writing back to memory address *x* only if no other observer, process, or thread has performed a more recent store to address *x*. The Store-Exclusive instruction returns a status bit that indicates whether the memory write succeeded.

A Load-Exclusive instruction marks a small block of memory for exclusive access. The size of the marked block is IMPLEMENTATION DEFINED, see [Marking and the size of the marked memory block on page B2-128](#). A Store-Exclusive instruction to any address in the marked block clears the marking.

———— **Note** ————

In this section, the term PE includes any observer that can generate a Load-Exclusive or a Store-Exclusive instruction.

The following sections give more information:

- [Exclusive access instructions and Non-shareable memory locations on page B2-122](#).
- [Exclusive access instructions and Shareable memory locations on page B2-124](#).
- [Marking and the size of the marked memory block on page B2-128](#).
- [Context switch support on page B2-128](#).

- [Load-Exclusive and Store-Exclusive instruction usage restrictions](#) on page B2-128.
- [Use of WFE and SEV instructions by spin-locks](#) on page B2-131.

B2.9.1 Exclusive access instructions and Non-shareable memory locations

For memory locations for which the shareability attribute is Non-shareable, the exclusive access instructions rely on a *local Exclusives monitor*, or *local monitor*, that marks any address from which the PE executes a Load-Exclusive instruction. Any non-aborted attempt by the same PE to use a Store-Exclusive instruction to modify any address is guaranteed to clear the marking.

A Load-Exclusive instruction performs a load from memory, and:

- The executing PE marks the physical memory address for exclusive access.
- The local monitor of the executing PE transitions to the Exclusive Access state.

A Store-Exclusive instruction performs a conditional store to memory that depends on the state of the local monitor:

If the local monitor is in the Exclusive Access state

- If the address of the Store-Exclusive instruction is the same as the address that has been marked in the monitor by an earlier Load-Exclusive instruction, then the store occurs. Otherwise, it is IMPLEMENTATION DEFINED whether the store occurs.
- A status value is returned to a register:
 - If the store took place, the status value is 0.
 - Otherwise, the status value is 1.
- The local monitor of the executing PE transitions to the Open Access state.

When an Exclusives monitor is in the Exclusive Access state, the monitor is *set*.

If the local monitor is in the Open Access state

- No store takes place.
- A status value of 1 is returned to a register.
- The local monitor remains in the Open Access state.

When an Exclusives monitor is in the Open Access state, the monitor is *clear*.

The Store-Exclusive instruction defines the register to which the status value is returned.

When a PE writes using any instruction other than a Store-Exclusive instruction:

- If the write is to a physical address that is not marked as Exclusive Access by its local monitor and that local monitor is in the Exclusive Access state, it is IMPLEMENTATION DEFINED whether the write affects the state of the local monitor.
- If the write is to a physical address that is marked as Exclusive Access by its local monitor, it is IMPLEMENTATION DEFINED whether the write affects the state of the local monitor.

It is IMPLEMENTATION DEFINED whether a store to a marked physical address causes a mark in the local monitor to be cleared if that store is by an observer other than the one that caused the physical address to be marked.

[Figure B2-4 on page B2-123](#) shows the state machine for the local monitor and the effect of each of the operations shown in the figure.

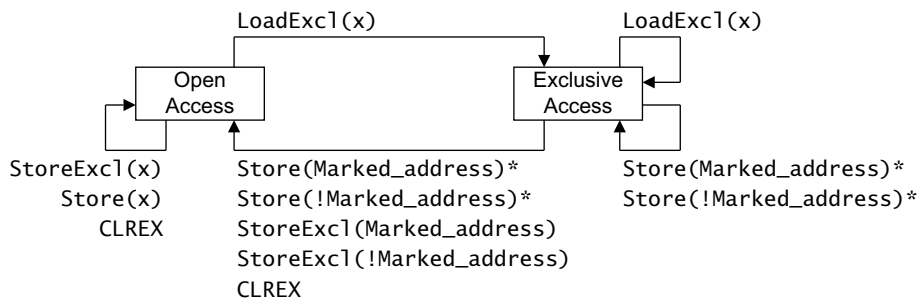

Operations marked * are possible alternative IMPLEMENTATION DEFINED options.
 In the diagram: `LoadExcl` represents any Load-Exclusive instruction
`StoreExcl` represents any Store-Exclusive instruction
`Store` represents any other store instruction.

Any `LoadExcl` operation updates the marked address to the most significant bits of the address `x` used for the operation.

Figure B2-4 Local monitor state machine diagram

For more information about marking, see [Marking and the size of the marked memory block](#) on page B2-128.

———— **Note** ————

For the local monitor state machine, as shown in [Figure B2-4](#):

- The IMPLEMENTATION DEFINED options for the local monitor are consistent with the local monitor being constructed so that it does not hold any physical address, but instead treats any access as matching the address of the previous Load-Exclusive instruction.
- A local monitor implementation can be unaware of Load-Exclusive and Store-Exclusive instructions from other PEs.
- The architecture does not require a load instruction by another PE, that is not a Load-Exclusive instruction, to have any effect on the local monitor.
- It is IMPLEMENTATION DEFINED whether the transition from Exclusive Access to Open Access state occurs when the Store or StoreExcl is from another observer.

Changes to the local monitor state resulting from speculative execution

The architecture permits a local monitor to transition to the Open Access state as a result of speculation, or from some other cause. This is in addition to the transitions to Open Access state caused by the architectural execution of an operation shown in [Figure B2-4](#).

An implementation must ensure that:

- The local monitor cannot be seen to transition to the Exclusive Access state except as a result of the architectural execution of one of the operations shown in [Figure B2-4](#).
- Any transition of the local monitor to the Open Access state not caused by the architectural execution of an operation shown in [Figure B2-4](#) must not indefinitely delay forward progress of execution.

B2.9.2 Exclusive access instructions and Shareable memory locations

In the context of this section, a shareable memory location is a memory location that has, or is treated as if it has, a Shareability attribute of Inner Shareable or Outer Shareable.

For shareable memory locations, exclusive access instructions rely on:

- A *local monitor* for each PE in the system, that marks any address from which the PE executes a Load-Exclusive. The local monitor operates as described in [Exclusive access instructions and Non-shareable memory locations on page B2-122](#), except that for shareable memory any Store-Exclusive is then subject to checking by the global monitor if it is described in that section as doing at least one of the following:

- Updating memory.
- Returning a status value of 0.

The local monitor can ignore accesses from other PEs in the system.

- A *global monitor* that marks a physical address as exclusive access for a particular PE. This marking is used later to determine whether a Store-Exclusive to that address that has not been failed by the local monitor can occur. Any successful write to the marked block by any other observer in the shareability domain of the memory location is guaranteed to clear the marking. For each PE in the system, the global monitor:

- Can hold at least one marked block.
- Maintains a state machine for each marked block it can hold.

———— **Note** —————

For each PE, the architecture only requires global monitor support for a single marked address. Any situation that might benefit from the use of multiple marked addresses on a single PE is UNPREDICTABLE or CONSTRAINED UNPREDICTABLE, see [Load-Exclusive and Store-Exclusive instruction usage restrictions on page B2-128](#).

———— **Note** —————

The global monitor can either reside within the PE, or exist as a secondary monitor at the memory interfaces. The IMPLEMENTATION DEFINED aspects of the monitors mean that the global monitor and local monitor can be combined into a single unit, provided that the unit performs the global monitor and local monitor functions defined in this manual.

For shareable memory locations, in some implementations and for some memory types, the properties of the global monitor require functionality outside the PE. Some system implementations might not implement this functionality for all locations of memory. In particular, this can apply to:

- Any type of memory in the system implementation that does not support hardware cache coherency.
- Non-cacheable memory, or memory treated as Non-cacheable, in an implementation that does support hardware cache coherency.

In such a system, it is defined by the system:

- Whether the global monitor is implemented.
- If the global monitor is implemented, which address ranges or memory types it monitors.

———— **Note** —————

To support the use of the Load-Exclusive/Store-Exclusive mechanism when address translation is disabled, a system might define at least one location of memory, of at least the size of the translation granule, in the system memory map to support the global monitor for all ARM PEs within a common Inner Shareable domain. However, this is not an architectural requirement. Therefore, architecturally-compliant software that requires mutual exclusion must not rely on using the Load-Exclusive/Store-Exclusive mechanism, and must instead use a software algorithm such as Lamport's Bakery algorithm to achieve mutual exclusion.

Because implementations can choose which memory types are treated as Non-cacheable, the only memory types for which it is architecturally guaranteed that a global Exclusives monitor is implemented are:

- Inner Shareable, Inner Write-Back, Outer Write-Back Normal memory with Read allocation hints and Write allocation hints and not transient.
- Outer Shareable, Inner Write-Back, Outer Write-Back Normal memory with Read allocation hints and Write allocation hints and not transient.

The set of memory types that support atomic instructions must include all of the memory types for which a global monitor is implemented.

If the global monitor is not implemented for an address range or memory type, then performing a Load-Exclusive or a Store-Exclusive instruction to such a location has one or more of the following effects:

- The instruction generates an external abort.
- The instruction generates an IMPLEMENTATION DEFINED MMU fault. This is reported using the Data Abort Fault status code of `ESR_ELx.DFSC = 110101`.

If the IMPLEMENTATION DEFINED MMU fault is generated for the Non-secure EL1&0 translation regime then:

- If the fault is generated because of the memory type defined in the first stage of translation, or if the second stage of translation is disabled, then this is a first stage fault and the exception is taken to EL1.
- Otherwise, the fault is a second stage fault and the exception is taken to EL2.

The priority of this fault is IMPLEMENTATION DEFINED.

- The instruction is treated as a NOP.
- The Load-Exclusive instruction is treated as if it were accessing a Non-shareable location, but the state of the local monitor becomes UNKNOWN.
- The Store-Exclusive instruction is treated as if it were accessing a Non-shareable location, but the state of the local monitor becomes UNKNOWN. In this case, if the store exclusive instruction is a store exclusive pair of 64-bit quantities, then the two quantities being stored might not be stored atomically.
- The value held in the result register of the Store-Exclusive instruction becomes UNKNOWN.

In addition, for write transactions generated by non-PE observers that do not implement exclusive accesses or other atomic access mechanisms, the effect that writes have on the global and local monitors used by ARM PEs is IMPLEMENTATION DEFINED. The writes might not clear the global monitors of other PEs for:

- Some address ranges.
- Some memory types.

Operation of the global Exclusives monitor

A Load-Exclusive instruction from shareable memory performs a load from memory, and causes the physical address of the access to be marked as exclusive access for the requesting PE. This access can also cause the exclusive access mark to be removed from any other physical address that has been marked by the requesting PE.

———— Note —————

The global monitor only supports a single outstanding exclusive access to shareable memory per PE.

A Load-Exclusive instruction by one PE has no effect on the global monitor state for any other PE.

A Store-Exclusive instruction performs a conditional store to memory:

- The store is guaranteed to succeed only if the physical address accessed is marked as exclusive access for the requesting PE and both the local monitor and the global monitor state machines for the requesting PE are in the Exclusive Access state. In this case:
 - A status value of 0 is returned to a register to acknowledge the successful store.
 - The final state of the global monitor state machine for the requesting PE is IMPLEMENTATION DEFINED.
 - If the address accessed is marked for exclusive access in the global monitor state machine for any other PE, then that state machine transitions to Open Access state.
- If no address is marked as exclusive access for the requesting PE, the store does not succeed:
 - A status value of 1 is returned to a register to indicate that the store failed.
 - The global monitor is not affected and remains in Open Access state for the requesting PE.
- If a different physical address is marked as exclusive access for the requesting PE, it is IMPLEMENTATION DEFINED whether the store succeeds or not:
 - If the store succeeds a status value of 0 is returned to a register, otherwise a value of 1 is returned.
 - If the global monitor state machine for the PE was in the Exclusive Access state before the Store-Exclusive instruction it is IMPLEMENTATION DEFINED whether that state machine transitions to the Open Access state.

The Store-Exclusive instruction defines the register to which the status value is returned.

In a shared memory system, the global monitor implements a separate state machine for each PE in the system. The state machine for accesses to shareable memory by PE(n) can respond to all the shareable memory accesses visible to it. This means that it responds to:

- Accesses generated by PE(n).
- Accesses generated by the other observers in the shareability domain of the memory location. These accesses are identified as (!n).

In a shared memory system, the global monitor implements a separate state machine for each observer that can generate a Load-Exclusive or a Store-Exclusive instruction in the system.

A global monitor:

- In the Exclusive Access state is *set*.
- In the Open Access state is *clear*.

Clear global monitor event

Whenever the global monitor state for a PE changes from Exclusive access to Open access, an event is generated and held in the Event register for that PE. This register is used by the Wait for Event mechanism, see [Mechanisms for entering a low-power state on page D1-1879](#).

Figure B2-5 shows the state machine for PE(n) in a global monitor.

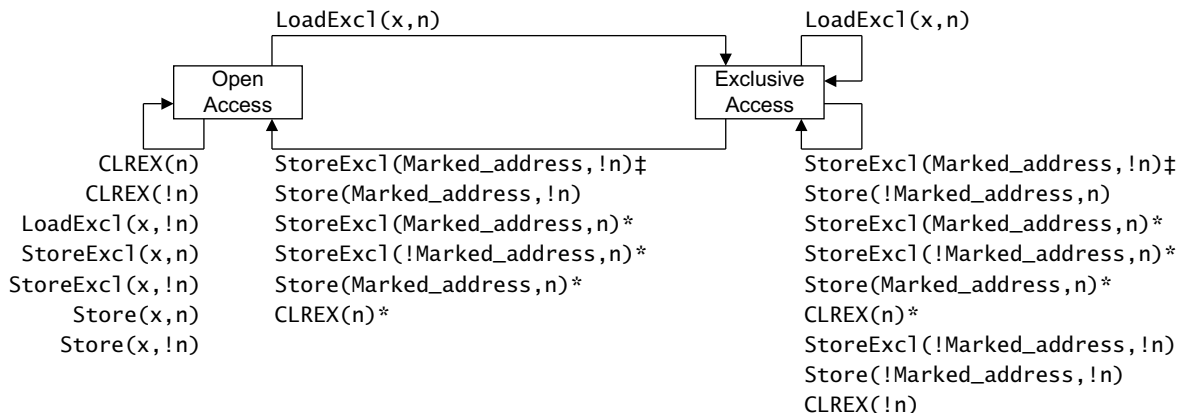

‡StoreExc1(Marked_address,!n) clears the monitor only if the StoreExc1 updates memory

Operations marked * are possible alternative IMPLEMENTATION DEFINED options.

In the diagram: LoadExc1 represents any Load-Exclusive instruction

StoreExc1 represents any Store-Exclusive instruction

Store represents any other store instruction.

Any LoadExc1 operation updates the marked address to the most significant bits of the address x used for the operation.

Figure B2-5 Global monitor state machine diagram for PE(n) in a multiprocessor system

For more information about marking, see [Marking and the size of the marked memory block on page B2-128](#).

———— Note ————

For the global monitor state machine, as shown in [Figure B2-5](#):

- The architecture does not require a load instruction by another PE, that is not a Load-Exclusive instruction, to have any effect on the global monitor.
- Whether a Store-Exclusive instruction successfully updates memory or not depends on whether the address accessed matches the marked shareable memory address for the PE issuing the Store-Exclusive instruction, and whether the local and global monitors are in the exclusive state. For this reason, [Figure B2-5](#) only shows how the operations by (!n) cause state transitions of the state machine for PE(n).
- A Load-Exclusive instruction can only update the marked shareable memory address for the PE issuing the Load-Exclusive instruction.
- When the global monitor is in the Exclusive Access state, it is IMPLEMENTATION DEFINED whether a CLREX instruction causes the global monitor to transition from Exclusive Access to Open Access state.
- It is IMPLEMENTATION DEFINED:
 - Whether a modification to a Non-shareable memory location can cause a global monitor to transition from Exclusive Access to Open Access state.
 - Whether a Load-Exclusive instruction to a Non-shareable memory location can cause a global monitor to transition from Open Access to Exclusive Access state.

B2.9.3 Marking and the size of the marked memory block

When a Load-Exclusive instruction is executed, the resulting marked block ignores the least significant bits of the 64-bit memory address.

When a Load-Exclusive instruction is executed, a marked block of size 2^a bytes is created by ignoring the least significant bits of the memory address. A marked address is any address within this marked block. The size of the marked memory block is called the *Exclusives reservation granule*. The Exclusives reservation granule is IMPLEMENTATION DEFINED in the range 4-512 words.

———— **Note** —————

This definition means that the Exclusives reservation granule is:

- 4 words in an implementation where a is 4.
- 512 words in an implementation where a is 11.

For example, in an implementation where a is 4, a successful LDXRB of address $0x341B4$ defines a marked block using bits[47:4] of the address. This means that the four words of memory from $0x341B0$ to $0x341BF$ are marked for exclusive access.

In some implementations the CTR identifies the Exclusives reservation granule, see [CTR_ELO](#). Otherwise, software must assume that the maximum Exclusives reservation granule, 512 words, is implemented.

B2.9.4 Context switch support

An exception return clears the local monitor. As a result, performing a CLREX instruction as part of a context switch is not required in most situations.

———— **Note** —————

Context switching is not an application level operation. However, this information is included here to complete the description of the exclusive operations.

B2.9.5 Load-Exclusive and Store-Exclusive instruction usage restrictions

The Load-Exclusive and Store-Exclusive instructions are intended to work together as a pair, for example a LDXP/STXP pair or a LDXR/STXR pair. To support different implementations of these functions, software must follow the notes and restrictions given here.

The following notes describe the use of a LoadExc1/StoreExc1 instruction pair, to indicate the use of any of the Load-Exclusive/Store-Exclusive instruction pairs shown in [Table B2-3 on page B2-121](#). In this context, a LoadExc1/StoreExc1 pair comprises two instructions in the same thread of execution:

- The exclusives support a single outstanding exclusive access for each PE thread that is executed. The architecture makes use of this by not requiring an address or size check as part of the `IsExclusiveLocal()` function. If the target virtual address of a StoreExc1 is different from the virtual address of the preceding LoadExc1 instruction in the same thread of execution, behavior can be CONSTRAINED UNPREDICTABLE with the following behavior:
 - The StoreExc1 either passes or fails, and the status value returned by the StoreExc1 is UNKNOWN.

———— **Note** —————

This means the StoreExc1 might pass for some instances of a LoadExc1/StoreExc1 pair with mismatched addresses, and fail for other instances of a LoadExc1/StoreExc1 pair with mismatched addresses.

- The data at the address accessed by the LoadExc1, and at the address accessed by the StoreExc1, is UNKNOWN.

This means software can rely on a LoadExc1/StoreExc1 pair to eventually succeed only if the LoadExc1 and the StoreExc1 are executed with the same virtual address.

- If two StoreExc1 instructions are executed without an intervening LoadExc1 instruction, the second StoreExc1 instruction returns a status value of 1. This means that:
 - ARM recommends that, in a given thread of execution, every StoreExc1 instruction has a preceding LoadExc1 instruction associated with it.

It is not necessary for every LoadExc1 instruction to have a subsequent StoreExc1 instruction.

- An implementation of the Load-Exclusive and Store-Exclusive instructions can require that, in any thread of execution, the transaction size of a StoreExc1 instruction is the same as the transaction size of the preceding LoadExc1 instruction executed in that thread. If the transaction size of a StoreExc1 instruction is different from the preceding LoadExc1 instruction in the same thread of execution, behavior can be **CONSTRAINED UNPREDICTABLE** with the following behavior:
 - The StoreExc1 either passes or fails, and the status value returned by the StoreExc1 is UNKNOWN.

———— **Note** —————

This means the StoreExc1 might pass for some instances of a LoadExc1/StoreExc1 pair with mismatched transaction sizes, and fail for other instances of a LoadExc1/StoreExc1 pair with mismatched transaction sizes.

- The block of data of the size of the larger of the transaction sizes used by the LoadExc1/StoreExc1 pair at the address accessed by the LoadExc1/StoreExc1 pair, is UNKNOWN.

This means software can rely on a LoadExc1/StoreExc1 pair to eventually succeed only if the LoadExc1 and the StoreExc1 have the same transaction size.

- An implementation of the LoadExc1 and StoreExc1 instructions can require that, in any thread of execution, the StoreExc1 instruction accesses the same number of registers as the preceding LoadExc1 instruction executed in that thread. If the StoreExc1 instruction accesses a different number of registers than the preceding LoadExc1 instruction in the same thread of execution, behavior is **CONSTRAINED UNPREDICTABLE**. As a result, software can rely on an LoadExc1/StoreExc1 pair to eventually succeed only if they access the same number of registers. For more information, see [CONSTRAINED UNPREDICTABLE behavior when Load-Exclusive/Store-Exclusive access a different number of registers on page B2-131](#).

- LoadExc1/StoreExc1 loops are guaranteed to make forward progress only if, for any LoadExc1/StoreExc1 loop within a single thread of execution, the software meets all of the following conditions:

- 1 Between the Load-Exclusive and the Store-Exclusive, there are no explicit memory accesses, preloads, direct or indirect System register writes, address translation instructions, cache or TLB maintenance instructions, exception generating instructions, exception returns, or indirect branches.
- 2 Between the Store-Exclusive returning a failing result and the retry of the corresponding Load-Exclusive:
 - There are no stores or PRFM instructions to any address within the Exclusives reservation granule accessed by the Store-Exclusive.
 - There are no loads or preloads to any address within the Exclusives reservation granule accessed by the Store-Exclusive that use a different VA alias to that address.
 - There are no direct or indirect System register writes, address translation instructions, cache or TLB maintenance instructions, exception generating instructions, exception returns, or indirect branches.
 - All loads and stores are to a block of contiguous virtual memory of not more than 512 bytes in size.

The Exclusives monitor can be cleared at any time without an application-related cause, provided that such clearing is not systematically repeated so as to prevent the forward progress in finite time of at least one of the threads that is accessing the Exclusives monitor.

- Implementations can benefit from keeping the LoadExc1 and StoreExc1 operations close together in a single thread of execution. This minimizes the likelihood of the Exclusives monitor state being cleared between the LoadExc1 instruction and the StoreExc1 instruction. Therefore, for best performance, ARM strongly recommends a limit of 128 bytes between LoadExc1 and StoreExc1 instructions in a single thread of execution.

- The architecture sets an upper limit of 2048 bytes on the Exclusives reservation granule that can be marked as exclusive. For performance reasons, ARM recommends that objects that are accessed by exclusive accesses are separated by the size of the Exclusives reservation granule. This is a performance guideline rather than a functional requirement.
- After taking a Data Abort exception, the state of the Exclusives monitors is UNKNOWN.
- For the memory location accessed by a LoadExc1/StoreExc1 pair, if the memory attributes for a StoreExc1 instruction are different from the memory attributes for the preceding LoadExc1 instruction in the same thread of execution, behavior is CONstrained UNPREDICTABLE. Where this occurs because the translation of the accessed address changes between the LoadExc1 instruction and the StoreExc1 instruction, the CONstrained UNPREDICTABLE behavior is as follows:

- The StoreExc1 either passes or fails, and the status value returned by the StoreExc1 is UNKNOWN.

———— **Note** —————

This means the StoreExc1 might pass for some instances of a LoadExc1/StoreExc1 pair with changed memory attributes, and fail for other instances of a LoadExc1/StoreExc1 pair with changed memory attributes.

- The data at the address accessed by the StoreExc1 is UNKNOWN.

———— **Note** —————

Another bullet point in this list covers the case where the memory attributes of a LoadExc1/StoreExc1 pair differ as a result of using different virtual addresses with different attributes that point to the same physical address.

- The effect of a data or unified cache invalidate, clean, or clean and invalidate instruction on a local or global Exclusives monitor that is in the Exclusive Access state is CONstrained UNPREDICTABLE, and the instruction might clear the monitor, or it might leave it in the Exclusive Access state. For address-based maintenance instructions, this also applies to the monitors of other PEs in the same shareability domain as the PE executing the cache maintenance instruction, as determined by the shareability domain of the address being maintained.

———— **Note** —————

ARM strongly recommends that implementations ensure that the use of such maintenance instructions by a PE in the Non-secure state cannot cause a denial of service on a PE in the Secure state.

- If the mapping of the virtual to physical address is changed between the LoadExc1 instruction and the STREX instruction, and the change is performed using a break-before-make sequence as described in [Using break-before-make when updating translation table entries on page D4-2120](#), if the StoreExc1 is performed after another write to the same physical address as the StoreExc1, and that other write was performed after the old translation was properly invalidated and that invalidation was properly synchronized, then the StoreExc1 will not pass its monitor check.

———— **Note** —————

ARM expects that, in many implementations, either:

- The TLB invalidation will clear either the local or global monitor.
- The physical address will be checked between the LoadExc1 and StoreExc1.

———— **Note** —————

In the event of repeatedly-contending LoadExc1/StoreExc1 instruction sequences from multiple PEs, an implementation must ensure that forward progress is made by at least one PE.

CONSTRAINED UNPREDICTABLE behavior when Load-Exclusive/Store-Exclusive access a different number of registers

As stated in this section, an implementation can require that the instructions of a Load-Exclusive/Store-Exclusive pair access the same number of registers. In such an implementation, this means behavior is CONSTRAINED UNPREDICTABLE if, in a single thread of execution, either:

- An LDXP instruction of two 32-bit quantities is followed by an STXR instruction of one 64-bit quantity at the same address.
- An LDXR instruction of one 64-bit quantity is followed by an STXP instruction of two 32-bit quantities at the same address.

In these cases, the CONSTRAINED UNPREDICTABLE behavior must be one of:

- The STXP or STXR instruction generates an external Data Abort.
- The STXP or STXR instruction generates an IMPLEMENTATION DEFINED MMU fault reported using the Data Abort Fault status code of `ESR_ELx.DFSC = 0b110101`.
- The STXP or STXR instruction always fails, returning a status of 1.
- The STXP or STXR instruction always passes, returning a status of 0.
- This STXP or STXR instruction has the same pass or fail behavior that it would have had if the instruction had used the same size and number of registers as the preceding LDXR or LDXP instruction.

B2.9.6 Use of WFE and SEV instructions by spin-locks

ARMv8 provides Wait For Event, Send Event, and Send Event Local instructions, WFE, SEV, and SEVL, that can assist with reducing power consumption and bus contention caused by PEs repeatedly attempting to obtain a spin-lock. These instructions can be used at the application level, but a complete understanding of what they do depends on a system level understanding of exceptions. They are described in [Wait for Event mechanism and Send event on page D1-1879](#). However, in ARMv8, when the global monitor for a PE changes from Exclusive Access state to Open Access state, an event is generated.

———— **Note** —————

This is equivalent to issuing an SEVL instruction on the PE for which the monitor state has changed. It removes the need for spinlock code to include an SEV instruction after clearing a spinlock.

Part C

The AArch64 Instruction Set

Chapter C1

The A64 Instruction Set

This chapter describes the A64 instruction set. It contains the following sections:

- *About the A64 instruction set* on page C1-136.
- *Structure of the A64 assembler language* on page C1-137.
- *Address generation* on page C1-143.
- *Instruction aliases* on page C1-146.

C1.1 About the A64 instruction set

The A64 instruction set is the instruction set supported in the AArch64 Execution state.

All A64 instructions have a width of 32 bits. The A64 encoding structure breaks down into the following functional groups:

- A miscellaneous group of branch instructions, exception generating instructions, and system instructions.
- Data-processing instructions associated with general-purpose registers. These instructions are supported by two *functional groups*, depending on whether the operands:
 - Are all held in registers.
 - Include an operand with a constant immediate value.
- Load and store instructions associated with the general-purpose register file and the SIMD and floating-point register file.
- SIMD and scalar floating-point data-processing instructions that operate on the SIMD and floating-point registers.

The encoding hierarchy within a functional group breaks down as follows:

- A functional group consists of a set of related instruction classes. [A64 instruction set encoding on page C4-210](#) provides an overview of the instruction encodings in the form of a list of instruction classes within their functional groups.
- An instruction class consists of a set of related instruction forms. Instruction forms are documented in one of two alphabetic lists:
 - The load, store, and data-processing instructions associated with the general-purpose registers, together with those in the other instruction classes. See [Chapter C6 A64 Base Instruction Descriptions](#).
 - The load, store, and data-processing instructions associated with the SIMD and floating-point support. See [Chapter C7 A64 Advanced SIMD and Floating-point Instruction Descriptions](#).
- An instruction form might support a single instruction syntax. Where an instruction supports more than one syntax, each syntax is an *instruction variant*. Instruction variants can occur because of differences in:
 - The size or format of the operands.
 - The register file used for the operands.
 - The addressing mode used for load/load/store memory operands.

Instruction variants might also arise as the result of other factors.

Instruction variants are described in the instruction description for the individual instructions.

A64 instructions have a regular bit encoding structure:

- 5-bit register operand fields at fixed positions within the instruction. For general-purpose register operands, the values 0-30 select one of 31 registers. The value 31 is used as a special case that can:
 - Indicate use of the current stack pointer, when identifying a load/store base register or in a limited set of data-processing instructions. See [The stack pointer registers on page D1-1785](#).
 - Indicate the value zero when used as a source register operand.
 - Indicate discarding the result when used as a destination register operand.

For SIMD and floating-point register access, the value used selects one of 32 registers.

- Immediate bits that provide constant data-processing values or address offsets are placed in contiguous bitfields. Some computed values in instruction variants use one or more immediate bitfields together with the secondary encoding bitfields.

All encodings that are not fully defined are described as unallocated. An attempt to execute an unallocated instruction is UNDEFINED, unless the behavior is otherwise defined in this Manual.

C1.2 Structure of the A64 assembler language

The following sections describe the A64 assembler syntax:

- [General requirements](#).
- [Common syntax terms](#).
- [Instruction Mnemonics on page C1-138](#).
- [Condition code on page C1-138](#).
- [Register names on page C1-139](#).

C1.2.1 General requirements

The letter W denotes a general-purpose register holding a 32-bit word, and X denotes a general-purpose register holding a 64-bit doubleword.

An A64 assembler recognizes both uppercase and lowercase variants of the instruction mnemonics and register names, but not mixed case variants. An A64 disassembler can output either uppercase or lowercase mnemonics and register names. Program and data labels are case-sensitive.

The A64 assembly language does not require the # character to introduce constant immediate operands, but an assembler must allow immediate values introduced with or without the # character. ARM recommends that an A64 disassembler outputs a # before an immediate operand.

In [Example C1-1 on page C1-138](#), the sequence // is used as a comment leader and A64 assemblers are encouraged to accept this syntax.

C1.2.2 Common syntax terms

The following syntax terms are used frequently throughout the A64 instruction set description.

UPPER	Text in upper-case letters is fixed. Text in lower-case letters is variable. This means that register name Xn indicates that the X is required, followed by a variable register number, for example X29.
< >	Any text enclosed by angle braces, < >, is a value that the user supplies. Subsequent text might supply additional information.
{ }	Any item enclosed by curly brackets, { }, is optional. A description of the item and how its presence or absence affects the instruction is normally supplied by subsequent text. In some cases curly braces are actual symbols in the syntax, for example when they surround a register list. These cases are called out in the surrounding text.
[]	Any items enclosed by square brackets, [], constitute a list of alternative characters. A single one of the characters can be used in that position and the subsequent text describes the meaning of the alternatives. In some case the square brackets are part of the syntax itself, such as addressing modes or vector elements. These cases are called out in the surrounding text.
a b	Alternative words are separated by a vertical bar, , and can be surrounded by parentheses to delimit them. For example, U(ADD SUB)W represents UADDW or USUBW.
±	This indicates an optional + or - sign. If neither is used then + is assumed.
uimmn	An n-bit unsigned, positive, immediate value.
simmn	An n-bit two's complement, signed immediate value, where n includes the sign bit.

SP	See Register names on page C1-139 .
Wn	See Register names on page C1-139 .
WSP	See Register names on page C1-139 .
WZR	See Register names on page C1-139 .
Xn	See Register names on page C1-139 .
XZR	See Register names on page C1-139 .

C1.2.3 Instruction Mnemonics

The A64 assembly language overloads instruction mnemonics and distinguishes between the different forms of an instruction based on the operand types. For example, the following ADD instructions all have different opcodes. However, the programmer must only remember one mnemonic, as the assembler automatically chooses the correct opcode based on the operands. The disassembler follows the same procedure in reverse.

Example C1-1 ADD instructions with different opcodes

```

ADD W0, W1, W2           // add 32-bit register
ADD X0, X1, X2           // add 64-bit register
ADD X0, X1, W2, SXTW     // add 64-bit extended register
ADD X0, X1, #42          // add 64-bit immediate
  
```

C1.2.4 Condition code

The A64 ISA has some instructions that set Condition flags or test Condition codes or both. For information about instructions that set the Condition flags or use the condition mnemonics, see [Condition flags and related instructions on page C6-519](#).

Table C1-1 shows the available Condition codes.

Table C1-1 Condition codes

cond	Mnemonic	Meaning (integer)	Meaning (floating-point) ^a	Condition flags
0000	EQ	Equal	Equal	Z == 1
0001	NE	Not equal	Not equal or unordered	Z == 0
0010	CS or HS	Carry set	Greater than, equal, or unordered	C == 1
0011	CC or LO	Carry clear	Less than	C == 0
0100	MI	Minus, negative	Less than	N == 1
0101	PL	Plus, positive or zero	Greater than, equal, or unordered	N == 0
0110	VS	Overflow	Unordered	V == 1
0111	VC	No overflow	Ordered	V == 0
1000	HI	Unsigned higher	Greater than, or unordered	C == 1 && Z == 0
1001	LS	Unsigned lower or same	Less than or equal	!(C == 1 && Z == 0)
1010	GE	Signed greater than or equal	Greater than or equal	N == V
1011	LT	Signed less than	Less than, or unordered	N != V

Table C1-1 Condition codes (continued)

cond	Mnemonic	Meaning (integer)	Meaning (floating-point) ^a	Condition flags
1100	GT	Signed greater than	Greater than	Z == 0 && N == V
1101	LE	Signed less than or equal	Less than, equal, or unordered	!(Z == 0 && N == V)
1110	AL	Always	Always	Any
1111	NV ^b	Always	Always	Any

- a. Unordered means at least one NaN operand.
b. The Condition code NV exists only to provide a valid disassembly of the 0b1111 encoding, otherwise its behavior is identical to AL.

C1.2.5 Register names

This section describes the AArch64 registers. It contains the following subsections:

- [General-purpose register file and zero register and stack pointer](#).
- [SIMD and floating-point register file](#) on page C1-140.
- [SIMD and floating-point scalar register names](#) on page C1-140.
- [SIMD vector register names](#) on page C1-141.
- [SIMD vector element names](#) on page C1-141.

General-purpose register file and zero register and stack pointer

The 31 general-purpose registers in the general-purpose register file are named R0-R30 and encoded in the instruction register fields with values 0-30. In a general-purpose register field the value 31 represents either the current stack pointer or the zero register, depending on the instruction and the operand position.

When the registers are used in a specific instruction variant, they must be qualified to indicate the operand data size, 32 bits or 64 bits, and the data size of the instruction.

When the data size is 32 bits, the lower 32 bits of the register are used and the upper 32 bits are ignored on a read and cleared to zero on a write.

Table C1-2 shows the qualified names for registers, where *n* is a register number 0-30.

Table C1-2 Naming of general-purpose registers, the zero register, and the stack pointer

Name	Size	Encoding	Description
Wn	32 bits	0-30	General-purpose register 0-30
Xn	64 bits	0-30	General-purpose register 0-30
WZR	32 bits	31	Zero register
XZR	64 bits	31	Zero register
WSP	32 bits	31	Current stack pointer
SP	64 bits	31	Current stack pointer

This list gives more information about the instruction arguments shown in Table C1-2:

- The names Xn and Wn both refer to the same general-purpose register, Rn.
- There is no register named W31 or X31.

- The name SP represents the stack pointer for 64-bit operands where an encoding of the value 31 in the corresponding register field is interpreted as a read or write of the current stack pointer. When instructions do not interpret this operand encoding as the stack pointer, use of the name SP is an error.
- The name WSP represents the current stack pointer in a 32-bit context.
- The name XZR represents the zero register for 64-bit operands where an encoding of the value 31 in the corresponding register field is interpreted as returning zero when read or discarding the result when written. When instructions do not interpret this operand encoding as the zero register, use of the name XZR is an error.
- The name WZR represents the zero register in a 32-bit context.
- The architecture does not define a specific name for general-purpose register R30 to reflect its role as the link register on procedure calls. However, an A64 assembler must always use W30 and X30 for this purpose, and additional software names might be defined as part of the Procedure Call Standard, see *Procedure Call Standard for the ARM 64-bit Architecture*.

SIMD and floating-point register file

The 32 registers in the SIMD and floating-point register file, V0-V31, hold floating-point operands for the scalar floating-point instructions, and both scalar and vector operands for the SIMD instructions. When they are used in a specific instruction form, the names must be further qualified to indicate the data shape, that is the data element size and the number of elements or lanes within the register. A similar requirement is placed on the general-purpose registers. See *General-purpose register file and zero register and stack pointer on page C1-139*.

———— **Note** —————

The data type is described by the instruction mnemonics that operate on the data. The data type is not described by the register name. The data type is the interpretation of bits within each register or vector element, whether these are integers, floating-point values, polynomials, or cryptographic hashes.

SIMD and floating-point scalar register names

SIMD and floating-point instructions that operate on scalar data only access the lower bits of a SIMD and floating-point register. The unused high bits are ignored on a read and cleared to 0 on a write.

[Table C1-3](#) shows the qualified names for accessing scalar SIMD and floating-point registers. The letter *n* denotes a register number between 0 and 31.

Table C1-3 SIMD and floating-point scalar register names

Size	Name
8 bits	Bn
16 bits	Hn
32 bits	Sn
64 bits	Dn
128 bits	Qn

SIMD vector register names

If a register holds multiple data elements on which arithmetic is performed in a parallel, SIMD, manner, then a qualifier describes the vector shape. The vector shape is the element size and the number of elements or lanes. If the element size in bits multiplied by the number of lanes does not equal 128, then the upper 64 bits of the register are ignored on a read and cleared to zero on a write.

Table C1-4 shows the SIMD vector register names. The letter *n* denotes a register number between 0 and 31.

Table C1-4 SIMD vector register names

Shape	Name
8 bits × 8 lanes	Vn.8B
8 bits × 16 lanes	Vn.16B
16 bits × 4 lanes	Vn.4H
16 bits × 8 lanes	Vn.8H
32 bits × 2 lanes	Vn.2S
32 bits × 4 lanes	Vn.4S
64 bits × 1 lane	Vn.1D
64 bits × 2 lanes	Vn.2D

SIMD vector element names

Appending a constant, zero-based element index to the register name inside square brackets indicates that a single element from a SIMD and floating-point register is used as a scalar operand. The number of lanes is not represented, as it is not encoded in the instruction and can only be inferred from the index value.

Table C1-5 shows the vector register names and the element index. The letter *i* denotes the element index.

Table C1-5 Vector register names with element index

Size	Name
8 bits	Vn.B[i]
16 bits	Vn.H[i]
32 bits	Vn.S[i]
64 bits	Vn.D[i]

An assembler must accept a fully qualified SIMD register name if the number of lanes is greater than the index value. See *SIMD vector register names*. For example, an assembler must accept all of the following forms as the name for the 32-bit element in bits [63:32] of the SIMD and floating-point register V9:

```
V9.S[1]    //standard disassembly
V9.2S[1]   //optional number of lanes
V9.4S[1]   //optional number of lanes
```

Note

The SIMD and floating-point register element name Vn.S[0] is not equivalent to the scalar SIMD and floating-point register name Sn. Although they represent the same bits in the register, they select different instruction encoding forms, either the vector element or the scalar form.

SIMD vector register list

Where an instruction operates on multiple SIMD and floating-point registers, for example vector Load/Store structure and table lookup operations, the registers are specified as a list enclosed by curly braces. This list consists of either a sequence of registers separated by commas, or a register range separated by a hyphen. The registers must be numbered in increasing order, modulo 32, in increments of one. The hyphenated form is preferred for disassembly if there are more than two registers in the list and the register number are increasing. The following examples are equivalent representations of a set of four registers V4 to V7, each holding four lanes of 32-bit elements:

```
{ V4.4S - V7.4S }           //standard disassembly  
{ V4.4S, V5.4S, V6.4S, V7.4S } //alternative representation
```

SIMD vector element list

Registers in a list can also have a vector element form. For example, the LD4 instruction can load one element into each of four registers, and in this case the index is appended to the list as follows:

```
{ V4.S - V7.S }[3]           //standard disassembly  
{ V4.4S, V5.4S, V6.4S, V7.4S }[3] //alternative with optional number of lanes
```

C1.3 Address generation

The A64 instruction set supports 64-bit addresses. The valid address range is determined by the following factors:

- The size of the implemented virtual address space.
- *Memory Management Unit* (MMU) configuration settings.

The top 8 bits of the 64-bit address can be used as a tag, see [Address tagging in AArch64 state on page D4-2006](#). For more information on memory management and address translation, see [Chapter D4 The AArch64 Virtual Memory System Architecture](#).

C1.3.1 Register indexed addressing

The A64 instruction set allows a 64-bit index register to be added to the 64-bit base register, with optional scaling of the index by the access size. Additionally it allows for sign-extension or zero-extension of a 32-bit value within an index register, followed by optional scaling.

C1.3.2 PC-relative addressing

The A64 instruction set has support for position-independent code and data addressing:

- PC-relative literal loads have an offset range of $\pm 1\text{MB}$.
- Process state flag and compare based conditional branches have a range of $\pm 1\text{MB}$. Test bit conditional branches have a restricted range of $\pm 32\text{KB}$.
- Unconditional branches, including branch and link, have a range of $\pm 128\text{MB}$.

PC-relative Load/Store operations, and address generation with a range of $\pm 4\text{GB}$ can be performed using two instructions.

C1.3.3 Load/Store addressing modes

Load/Store addressing modes in the A64 instruction set require a 64-bit base address from a general-purpose register X0-X30 or the current stack pointer, SP, with an optional immediate or register offset. [Table C1-6](#) shows the assembler syntax for the complete set of Load/Store addressing modes.

Table C1-6 A64 Load/Store addressing modes

Addressing Mode	Offset		
	Immediate	Register	Extended Register
Base register only (no offset)	[base{, #0}]	-	-
Base plus offset	[base{, #imm}]	[base, Xm{, LSL #imm}]	[base, Wm, (S U)XTW {#imm}]
Pre-indexed	[base, #imm]!	-	-
Post-indexed	[base], #imm	[base], Xm ^a	-
Literal (PC-relative)	label	-	-

- a. The post-indexed by register offset mode can be used with the SIMD Load/Store structure instructions described in [Load/Store Vector on page C3-169](#). Otherwise the post-indexed by register offset mode is not available.

Some types of Load/Store instruction support only a subset of the Load/Store addressing modes listed in [Table C1-6](#). Details of the supported modes are as follows:

- Base plus offset addressing means that the address is the value in the 64-bit base register plus an offset.
- Pre-indexed addressing means that the address is the sum of the value in the 64-bit base register and an offset, and the address is then written back to the base register.

- Post-indexed addressing means that the address is the value in the 64-bit base register, and the sum of the address and the offset is then written back to the base register.
- Literal addressing means that the address is the value of the 64-bit program counter for this instruction plus a 19-bit signed word offset. This means that it is a 4 byte aligned address within $\pm 1\text{MB}$ of the address of this instruction with no offset. Literal addressing can only be used for loads of at least 32 bits and for prefetch instructions. The PC cannot be referenced using any other addressing modes. The syntax for labels is specific to individual toolchains.
- An immediate offset can be unsigned or signed, and scaled or unscaled, depending on the type of Load/Store instruction. When the immediate offset is scaled it is encoded as a multiple of the transfer size, although the assembly language always uses a byte offset, and the assembler or disassembler performs the necessary conversion. The usable byte offsets therefore depend on the type of Load/Store instruction and the transfer size.

Table C1-7 shows the offset and the type of Load/Store instruction.

Table C1-7 Immediate offsets and the type of Load/Store instruction

Offset bits	Sign	Scaling	Write-Back	Load/Store type
0	-	-	-	Exclusive/acquire/release
7	Signed	Scaled	Optional	Register pair
9	Signed	Unscaled	Optional	Single register
12	Unsigned	Scaled	No	Single register

- A register offset means that the offset is the 64 bits from a general-purpose register, X_m , optionally scaled by the transfer size, in bytes, if LSL $\#imm$ is present and where imm must be equal to $\log_2(\text{transfer_size})$.
- An extended register offset means that offset is the bottom 32 bits from a general-purpose register W_m , sign-extended or zero-extended to 64 bits, and then scaled by the transfer size if so indicated by $\#imm$, where imm must be equal to $\log_2(\text{transfer_size})$. An assembler must accept W_m or X_m as an extended register offset, but W_m is preferred for disassembly.
- Generating an address lower than the value in the base register requires a negative signed immediate offset or a register offset holding a negative value.
- When stack alignment checking is enabled by system software and the base register is the SP, the current stack pointer must be initially quadword aligned, that is aligned to 16 bytes. Misalignment generates a Stack Alignment fault. The offset does not have to be a multiple of 16 bytes unless the specific Load/Store instruction requires this. SP cannot be used as a register offset.

Address calculation

General-purpose arithmetic instructions can calculate the result of most addressing modes and write the address to a general-purpose register or, in most cases, to the current stack pointer.

Table C1-8 shows the arithmetic instructions that can compute addressing modes.

Table C1-8 Arithmetic instructions to compute addressing modes

Addressing Form	Offset		
	Immediate	Register	Extended Register
Base register (no offset)	MOV Xd SP, base	-	-
Base plus offset	ADD Xd SP, base, #imm or SUB Xd SP, base, #imm	ADD <Xd SP>, base, Xm{,LSL#imm}	ADD <Xd SP>, base, Wm, (S U)XT(W H B) {#imm}
Pre-indexed	-	-	-
Post-indexed	-	-	-
Literal (PC-relative)	ADR Xd, label	-	-

Note

- To calculate a base plus immediate offset the ADD instructions defined in [Arithmetic \(immediate\) on page C3-176](#) accept an unsigned 12-bit immediate offset, with an optional left shift by 12. This means that a single ADD instruction cannot support the full range of byte offsets available to a single register Load/Store with a scaled 12-bit immediate offset. For example, a quadword LDR effectively has a 16-bit byte offset. To calculate an address with a byte offset that requires more than 12 bits it is necessary to use two ADD instructions. The following example shows this:

```
ADD Xd, base, #(imm & 0xFFF)
ADD Xd, Xd, #(imm>>12), LSL #12
```

- To calculate a base plus extended register offset, the ADD instructions defined in [Arithmetic \(extended register\) on page C3-182](#) provide a superset of the addressing mode that also supports sign-extension or zero-extension of a byte or halfword value with any shift amount between 0 and 4, for example:

```
ADD Xd, base, Wm, SXTW #3 // Xd = base + (SignExtend(Wm) LSL 3)
ADD Xd, base, Wm, UXTH #4 // Xd = base + (ZeroExtend(Wm<15:0>) LSL 4)
```

- If the same extended register offset is used by more than one Load/Store instruction, then, depending on the implementation, it might be more efficient to calculate the extended and scaled intermediate result just once, and then re-use it as a simple register offset. The extend and scale calculation can be performed using the SBFIZ and UBFIZ bitfield instructions defined in [Bitfield move on page C3-179](#), for example:

```
SBFIZ Xd, Xm, #3, #32 //Xd = "Wm, SXTW #3"
UBFIZ Xd, Xm, #4, #16 //Xd = "Wm, UXTH #4"
```

C1.4 Instruction aliases

Some instructions have an associated *architecture alias* that is used for disassembly of the encoding when the associated conditions are met. Architecture alias instructions are included in the alphabetic lists of instruction types and clearly presented as an alias form in descriptions for the individual instructions.

Chapter C2

About the A64 Instruction Descriptions

This chapter describes the *instruction descriptions* contained in [Chapter C6 A64 Base Instruction Descriptions](#) and [Chapter C7 A64 Advanced SIMD and Floating-point Instruction Descriptions](#).

It contains the following sections:

- [Understanding the A64 instruction descriptions on page C2-148](#).
- [General information about the A64 instruction descriptions on page C2-151](#).

C2.1 Understanding the A64 instruction descriptions

Each instruction description in [Chapter C6](#) and [Chapter C7](#) has the following content:

1. A title.
2. An introduction to the instruction.
3. The instruction encoding or encodings.
4. Any alias conditions.
5. A list of the assembler symbols for the instruction.
6. Pseudocode describing how the instruction operates.
7. Notes, if applicable.

The following sections describe each of these.

C2.1.1 The title

The title of an instruction description includes the base mnemonic for the instruction.

If different forms of an instruction use the same base mnemonic, each form has its own description. In this case, the title is the mnemonic followed by a short description of the instruction form in parentheses. This is most often used when an operand is an immediate value in one instruction form, but is a register in another form.

For example, in [Chapter C6](#) there are the following titles for different forms of the ADD instruction:

- *ADD (extended register)* on page C6-523.
- *ADD (immediate)* on page C6-525.
- *ADD (shifted register)* on page C6-527.

C2.1.2 An introduction to the instruction

This briefly describes the function of the instruction. The introduction is not a complete description of the instruction, and it is not definitive. If there is any conflict between it and the more detailed information that follows it, the more detailed information takes priority.

C2.1.3 The instruction encoding or encodings

This shows the instruction encoding diagram, or if the instruction has more than one encoding, shows all of the encoding diagrams. Each diagram has a subheading.

For example, for load and store instructions, the subheadings might be:

- Post-index.
- Pre-index.
- Unsigned offset.

Each diagram numbers the bits from 31 to 0. The diagram for an instruction at address A shows, from left to right, the bytes at addresses $A+3$, $A+2$, $A+1$, and A .

There might be variants of an encoding, if the *assembler syntax prototype* differs depending on the value in one or more of the encoding fields. In this case, each variant has a subheading that describes the variant and shows the distinguishing field value or values in parentheses. For example, in [Chapter C6](#) there are the following subheadings for variants of the ADC instruction encoding:

- 32-bit variant (sf = 0).
- 64-bit variant (sf = 1).

The assembler syntax prototype for an encoding or variant of an encoding shows how to form a complete assembler source code instruction that assembles to the encoding. Unless otherwise stated, the prototype is also the preferred syntax for a disassembler to disassemble the encoding to. Disassemblers are permitted to omit optional symbols that represent the default value of a field or set of fields, to produce more readable disassembled code, provided that the output re-assembles to the same encoding.

Each encoding diagram, and its associated assembler syntax prototypes, is followed by encoding-specific pseudocode that translates the fields of that encoding into inputs for the encoding-independent pseudocode that describes the operation of the instruction. See [Pseudocode describing how the instruction operates on page C2-150](#).

C2.1.4 Any alias conditions, if applicable

This is an optional part of an instruction description. If included, it describes the set of conditions for which an alternative mnemonic and its associated assembler syntax prototypes are preferred for disassembly by a disassembler. It includes a link to the alias instruction description that defines the alternative syntax. The alias syntax and the original syntax can be used interchangeably in the assembler source code.

ARM recommends that if a disassembler outputs the alias syntax, it consistently outputs the alias syntax.

C2.1.5 A list of the assembler symbols for the instruction

The *Assembler symbols* subsection of the instruction description contains a list of the symbols that the assembler syntax prototype or prototypes use, if any.

In assembler syntax prototypes, the following conventions are used:

- < > Angle brackets. Any symbol enclosed by these is a name or a value that the user supplies. For each symbol, there is a description of what the symbol represents. The description usually also specifies which encoding field or fields encodes the symbol.
- { } Brace brackets. Any symbols enclosed by these are optional. For each optional symbol, there is a description of what the symbol represents and how its presence or absence is encoded.
 In some assembler syntax prototypes, some brace brackets are mandatory, for example if they surround a register list. When the use of brace brackets is mandatory, they are separated from other syntax items by one or more spaces.
- # This usually precedes a numeric constant. All uses of # are optional in A64 assembler source code. ARM recommends that disassemblers output the # where the assembler syntax prototype includes it.
- +/- This indicates an optional + or - sign. If neither is coded, + is assumed.

Single spaces are used for clarity, to separate syntax items. Where a space is mandatory, the assembler syntax prototype shows two or more consecutive spaces.

Any characters not shown in this conventions list must be coded exactly as shown in the assembler syntax prototype. Apart from brace brackets, the characters shown are used as part of a meta-language to define the architectural assembler syntax for an instruction encoding or alias, but have no architecturally defined significance in the input to an assembler or in the output from a disassembler.

The following symbol conventions are used:

- <Xn> The 64-bit name of a general-purpose register (X0-X30) or the zero register (XZR).
- <Wn> The 32-bit name of a general-purpose register (W0-W30) or the zero register (WZR).
- <Xn|SP> The 64-bit name of a general-purpose register (X0-X30) or the current stack pointer (SP).
- <Wn|WSP> The 32-bit name of a general-purpose register (W0-W30) or the current stack pointer (WSP).
- <Bn>, <Hn>, <Sn>, <Dn>, <Qn>
 The 8, 16, 32, 64 or 128-bit name of a SIMD and floating-point register in a scalar context as described in section [Register names on page C1-139](#).
- <Vn> The name of a SIMD and floating-point register name in a vector context as described in [Register names on page C1-139](#).

If the description of a symbol specifies that the symbol is a register, the description might also specify that the range of permitted registers is extended or restricted. It also specifies any differences from the default rules for such fields.

———— **Note** —————

[Register names on page C1-139](#) provides the A64 register names.

C2.1.6 Pseudocode describing how the instruction operates

The *Operation* subsection of the instruction description contains this pseudocode.

It is encoding-independent pseudocode that provides a precise description of what the instruction does.

———— **Note** —————

For a description of ARM pseudocode, see [Appendix K10 ARM Pseudocode Definition](#). This appendix also describes the execution model for an instruction.

C2.1.7 Notes, if applicable

If applicable, other notes about the instruction appear under additional subheadings.

C2.2 General information about the A64 instruction descriptions

This section provides general information about the A64 instruction descriptions. Some of this information also applies to System register descriptions, for example the terms defined in *Fixed values in AArch64 instruction and System register descriptions* apply to the AArch64 descriptions throughout this manual. The following subsections provide this information:

- *Fixed values in AArch64 instruction and System register descriptions.*
- *Modified immediate constants in A64 instructions on page C2-152.*

C2.2.1 Fixed values in AArch64 instruction and System register descriptions

This section summarizes the terms used to describe fixed values in AArch64 register and instruction descriptions. The [Glossary](#) gives full descriptions of these terms, and each entry in this section includes a link to the corresponding [Glossary](#) entry.

———— **Note** ————

In register descriptions, the meaning of some bits depends on the PE state. This affects the definitions of RES0 and RES1, as shown in the [Glossary](#).

The following terms are used to describe bits or fields with fixed values:

RAZ Read-As-Zero. See [Read-As-Zero \(RAZ\)](#).

In diagrams, a RAZ bit can be shown as 0.

(0), RES0 Reserved, [Should-Be-Zero \(SBZ\)](#) or [RES0](#).

In instruction encoding diagrams, and sometimes in other descriptions, (0) indicates an SBZ bit. If the bit is set to 1, behavior is CONSTRAINED UNPREDICTABLE, and must be one of the following:

- The instruction is UNDEFINED.
- The instruction is treated as a NOP.
- The instruction executes as if the value of the bit was 0.
- Any destination registers of the instruction become UNKNOWN.

This notation can be expanded for fields, so a three-bit field can be shown as either (0)(0)(0) or as (000).

In register diagrams, but not in the A64 encoding and instruction descriptions, bits or fields can be shown as RES0. See the [Glossary](#) definition of [RES0](#) for more information.

———— **Note** ————

Some of the System instruction descriptions in this chapter are based on the *field description* of the input value for the instruction. These are register descriptions and therefore can include RES0 fields,

The (0) and RES0 descriptions can be applied to bits or bitfields that are read-only, or are write-only. The [Glossary](#) definitions cover these cases.

RAO Read-As-One. See [Read-As-One \(RAO\)](#).

In diagrams, a RAO bit can be shown as 1.

(1), RES1 Reserved, [Should-Be-One \(SBO\)](#) or [RES1](#).

In instruction encoding diagrams, and sometimes in other descriptions, (1) indicates a SBO bit. If the bit is set to 0, behavior is CONSTRAINED UNPREDICTABLE, and must be one of the following:

- The instruction is UNDEFINED.
- The instruction is treated as a NOP.
- The instruction executes as if the value of the bit was 1.
- Any destination registers of the instruction become UNKNOWN.

This notation can be expanded for fields, so a three-bit field can be shown as either (1)(1)(1) or as (111).

In register diagrams, but not in the A64 encoding and instruction descriptions, bits or fields can be shown as RES1. See the [Glossary](#) definition of [RES1](#) for more information.

————— **Note** —————

Some of the System instruction descriptions in this chapter are based on the *field description* of the input value for the instruction. These are register descriptions and therefore can include RES1 fields,

The (1) and RES1 descriptions can be applied to bits or bitfields that are read-only, or are write-only. The [Glossary](#) definitions cover these cases.

C2.2.2 Modified immediate constants in A64 instructions

It contains the following subsections:

- [Modified immediate constants in A64 floating-point instructions.](#)

Modified immediate constants in A64 floating-point instructions

[Table C2-1](#) shows the immediate constants available in FMOV (scalar, immediate) and FMOV (vector, immediate) floating-point instructions.

Table C2-1 A64 Floating-point modified immediate constants

Data type	immediate	Constant ^a
F16	abcdefgh	aBbbcdef gh000000
F32	abcdefgh	aBbbbbc defgh000 00000000 00000000
F64	abcdefgh	aBbbbbbb bbcdefgh 00000000 00000000 00000000 00000000 00000000 00000000

a. In this column, B = NOT(b). The bit pattern represents the floating-point number $(-1)^S \times 2^{\text{exp}} \times \text{mantissa}$, where $S = \text{UInt}(a)$, $\text{exp} = \text{UInt}(\text{NOT}(b):c:d)-3$ and $\text{mantissa} = (16+\text{UInt}(e:f:g:h))/16$.

The immediate value shown in the table is either:

- The value of the imm8 field for an FMOV (scalar, immediate) instruction, see [FMOV \(scalar, immediate\) on page C7-1229](#).
- The value obtained by concatenating the a:b:c:d:e:f:g:h fields field for an FMOV (vector, immediate) instruction, see [FMOV \(vector, immediate\) on page C7-1222](#).

[Table C2-2](#) shows the floating-point constant values encoded in the b:c:d:e:f:g:h fields of the FMOV (vector, immediate) instruction.

Table C2-2 Floating-point constant values

efgh	bcd							
	000	001	010	011	100	101	110	111
0000	2.0	4.0	8.0	16.0	0.125	0.25	0.5	1.0
0001	2.125	4.25	8.5	17.0	0.1328125	0.265625	0.53125	1.0625
0010	2.25	4.5	9.0	18.0	0.140625	0.28125	0.5625	1.125
0011	2.375	4.75	9.5	19.0	0.1484375	0.296875	0.59375	1.1875
0100	2.5	5.0	10.0	20.0	0.15625	0.3125	0.625	1.25
0101	2.625	5.25	10.5	21.0	0.1640625	0.328125	0.65625	1.3125
0110	2.75	5.5	11.0	22.0	0.171875	0.34375	0.6875	1.375
0111	2.875	5.75	11.5	23.0	0.1796875	0.359375	0.71875	1.4375
1000	3.0	6.0	12.0	24.0	0.1875	0.375	0.75	1.5
1001	3.125	6.25	12.5	25.0	0.1953125	0.390625	0.78125	1.5625

Table C2-2 Floating-point constant values (continued)

efgh	bcd							
	000	001	010	011	100	101	110	111
1010	3.25	6.5	13.0	26.0	0.203125	0.40625	0.8125	1.625
1011	3.375	6.75	13.5	27.0	0.2109375	0.421875	0.84375	1.6875
1100	3.5	7.0	14.0	28.0	0.21875	0.4375	0.875	1.75
1101	3.625	7.25	14.5	29.0	0.2265625	0.453125	0.90625	1.8125
1110	3.75	7.5	15.0	30.0	0.234375	0.46875	0.9375	1.875
1111	3.875	7.75	15.5	31.0	0.2421875	0.484375	0.96875	1.9375

Operation of modified immediate constants, floating-point instructions

For an A64 floating-point instruction that uses a modified immediate constant, the operation described by the [VFPEExpandImm\(\)](#) pseudocode function returns the value of the immediate constant.

Chapter C3

A64 Instruction Set Overview

This chapter provides an overview of the A64 instruction set. It contains the following sections:

- *Branches, Exception generating, and System instructions* on page C3-156.
- *Loads and stores* on page C3-160.
- *Data processing - immediate* on page C3-176.
- *Data processing - register* on page C3-181.
- *Data processing - SIMD and floating-point* on page C3-189.

For a structured breakdown of instruction groups by encoding, see [Chapter C4 A64 Instruction Set Encoding](#).

C3.1 Branches, Exception generating, and System instructions

This section describes the branch, exception generating, and system instructions. It contains the following subsections:

- [Conditional branch](#).
- [Unconditional branch \(immediate\)](#) on page C3-157.
- [Unconditional branch \(register\)](#) on page C3-157.
- [Exception generation and return](#) on page C3-157.
- [System register instructions](#) on page C3-158.
- [System instructions](#) on page C3-158.
- [Hint instructions](#) on page C3-159.
- [Barriers and CLREX instructions](#) on page C3-159.

For information about the encoding structure of the instructions in this instruction group, see [Branches, Exception Generating and System instructions](#) on page C4-214.

———— Note —————

Software must:

- Use only BLR or BL to perform a nested subroutine call when that subroutine is expected to return to the immediately following instruction, that is, the instruction with the address of the BLR or BL instruction incremented by four.
- Use only RET to perform a subroutine return, when that subroutine is expected to have been entered by a BL or BLR instruction.
- Use only B, BR, or the instructions listed in [Table C3-1](#) to perform a control transfer that is not a subroutine call or subroutine return described in this *Note*.

C3.1.1 Conditional branch

Conditional branches change the flow of execution depending on the current state of the Condition flags or the value in a general-purpose register. See [Table C1-1 on page C1-138](#) for a list of the Condition codes that can be used for cond.

[Table C3-1](#) shows the Conditional branch instructions.

Table C3-1 Conditional branch instructions

Mnemonic	Instruction	Branch offset range from the PC	See
B.cond	Branch conditionally	±1MB	B.cond on page C6-549
CBNZ	Compare and branch if nonzero	±1MB	CBNZ on page C6-573
CBZ	Compare and branch if zero	±1MB	CBZ on page C6-574
TBNZ	Test bit and branch if nonzero	±32KB	TBNZ on page C6-952
TBZ	Test bit and branch if zero	±32KB	TBZ on page C6-953

C3.1.2 Unconditional branch (immediate)

Unconditional branch (immediate) instructions change the flow of execution unconditionally by adding an immediate offset with a range of $\pm 128\text{MB}$ to the value of the program counter that fetched the instruction. The BL instruction also writes the address of the sequentially following instruction to general-purpose register, X30.

Table C3-2 shows the Unconditional branch instructions with an immediate branch offset.

Table C3-2 Unconditional branch instructions (immediate)

Mnemonic	Instruction	Immediate branch offset range from the PC	See
B	Branch unconditionally	$\pm 128\text{MB}$	B on page C6-550
BL	Branch with link	$\pm 128\text{MB}$	BL on page C6-560

C3.1.3 Unconditional branch (register)

Unconditional branch (register) instructions change the flow of execution unconditionally by setting the program counter to the value in a general-purpose register. The BLR instruction also writes the address of the sequentially following instruction to general-purpose register X30. The RET instruction behaves identically to BR, but provides an additional hint to the PE that this is a return from a subroutine. Table C3-3 shows Unconditional branch instructions that jump directly to an address held in a general-purpose register.

Table C3-3 Unconditional branch instructions (register)

Mnemonic	Instruction	See
BLR	Branch with link to register	BLR on page C6-561
BR	Branch to register	BR on page C6-562
RET	Return from subroutine	RET on page C6-805

C3.1.4 Exception generation and return

This section describes the following exceptions:

- [Exception generating.](#)
- [Exception return on page C3-158.](#)
- [Debug state on page C3-158.](#)

Exception generating

Table C3-4 shows the Exception generating instructions.

Table C3-4 Exception generating instructions

Mnemonic	Instruction	See
BRK	Breakpoint Instruction	BRK on page C6-563
HLT	Halt Instruction	HLT on page C6-628
HVC	Generate exception targeting Exception level 2	HVC on page C6-629
SMC	Generate exception targeting Exception level 3	SMC on page C6-827
SVC	Generate exception targeting Exception level 1	SVC on page C6-940

Exception return

Table C3-5 shows the Exception return instructions.

Table C3-5 Exception return instructions

Mnemonic	Instruction	See
ERET	Exception return using current ELR and SPSR	ERET on page C6-622

Debug state

Table C3-6 shows the Debug state instructions.

Table C3-6 Debug state instructions

Mnemonic	Instruction	See
DCPS1	Debug switch to Exception level 1	DCPS1 on page C6-609
DCPS2	Debug switch to Exception level 2	DCPS2 on page C6-610
DCPS3	Debug switch to Exception level 3	DCPS3 on page C6-611
DRPS	Debug restore PE state	DRPS on page C6-614

C3.1.5 System register instructions

For detailed information about the System register instructions, see [Chapter C5 The A64 System Instruction Class](#).
 Table C3-7 shows the System register instructions.

Table C3-7 System register instructions

Mnemonic	Instruction	See
MRS	Move System register to general-purpose register	MRS on page C6-772
MSR	Move general-purpose register to System register	MSR (register) on page C6-775
	Move immediate to PE state field	MSR (immediate) on page C6-773

C3.1.6 System instructions

For detailed information about the System instructions, see [Chapter C5 The A64 System Instruction Class](#).

Table C3-8 shows the System instructions.

Table C3-8 System instructions

Mnemonic	Instruction	See
SYS	System instruction	SYS on page C6-950
SYSL	System instruction with result	SYSL on page C6-951
IC	Instruction cache maintenance	IC on page C6-630 and Table C5-2 on page C5-318

Table C3-8 System instructions (continued)

Mnemonic	Instruction	See
DC	Data cache maintenance	DC on page C6-608 and Table C5-2 on page C5-318
AT	Address translation	AT on page C6-547 and Table C5-3 on page C5-319
TLBI	TLB Invalidate	TLBI on page C6-954 and Table C5-4 on page C5-320

C3.1.7 Hint instructions

[Table C3-9](#) shows the Hint instructions.

Table C3-9 Hint instructions

Mnemonic	Instruction	See
NOP	No operation	NOP on page C6-787
YIELD	Yield hint	YIELD on page C6-973
WFE	Wait for event	WFE on page C6-971
WFI	Wait for interrupt	WFI on page C6-972
SEV	Send event	SEV on page C6-824
SEVL	Send event local	SEVL on page C6-825
HINT	Unallocated hint	HINT on page C6-627

C3.1.8 Barriers and CLREX instructions

[Table C3-10](#) shows the barrier and CLREX instructions.

Table C3-10 Barriers and CLREX instructions

Mnemonic	Instruction	See
CLREX	Clear Exclusives monitor	CLREX on page C6-581
DSB	Data synchronization barrier	DSB on page C6-615
DMB	Data memory barrier	DMB on page C6-612
ISB	Instruction synchronization barrier	ISB on page C6-631

For more information about the barriers, see [Memory barriers on page B2-92](#).

For information about the allocated values for the data barriers, see:

- [DMB on page C6-612](#).
- [DSB on page C6-615](#).

C3.2 Loads and stores

This section describes the Load/Store instructions. It contains the following subsections:

- [Load/Store register](#).
- [Load/Store register \(unscaled offset\)](#) on page C3-161.
- [Load/Store Pair](#) on page C3-162.
- [Load/Store Non-temporal Pair](#) on page C3-163.
- [Load/Store unprivileged](#) on page C3-164.
- [Load-Exclusive/Store-Exclusive](#) on page C3-164.
- [Load-Acquire/Store-Release](#) on page C3-165.
- [LoadLOAcquire/StoreLORelease](#) on page C3-166.
- [Load/Store scalar SIMD and floating-point](#) on page C3-166.
- [Load/Store Vector](#) on page C3-169.
- [Prefetch memory](#) on page C3-171.
- [Compare and Swap](#) on page C3-172.
- [Atomic memory operations](#) on page C3-173.
- [Swap](#) on page C3-175.

Apart from Load-Exclusive, Store-Exclusive, Load-Acquire, and Store-Release, addresses can have any alignment unless strict alignment checking is enabled, that is if `SCTLR_ELx.A = 1`.

The additional control bits `SCTLR_ELx.SA` and `SCTLR_EL1.SA0` control whether the stack pointer must be quadword aligned when used as a base register. See [SP alignment checking on page D1-1793](#). Using a misaligned stack pointer generates an SP alignment fault exception.

For information about the encoding structure of the instructions in this instruction group, see [Loads and Stores on page C4-219](#).

———— Note —————

In some cases, Load/Store instructions can lead to CONSTRAINED UNPREDICTABLE behavior. See [AArch64 CONSTRAINED UNPREDICTABLE behaviors on page K1-6119](#).

C3.2.1 Load/Store register

The Load/Store register instructions support the following addressing modes:

- Base plus a scaled 12-bit unsigned immediate offset or base plus an unscaled 9-bit signed immediate offset.
- Base plus a 64-bit register offset, optionally scaled.
- Base plus a 32-bit extended register offset, optionally scaled.
- Pre-indexed by an unscaled 9-bit signed immediate offset.
- Post-indexed by an unscaled 9-bit signed immediate offset.
- PC-relative literal for loads of 32 bits or more.

See also [Load/Store addressing modes on page C1-143](#).

If a Load instruction specifies writeback and the register being loaded is also the base register, then behavior is CONSTRAINED UNPREDICTABLE and one of the following behaviors must occur:

- The instruction is treated as UNDEFINED.
- The instruction is treated as a NOP.
- The instruction performs the load using the specified addressing mode and the base register becomes UNKNOWN. In addition, if an exception occurs during the execution of such an instruction, the base address might be corrupted so that the instruction cannot be repeated.

If a Store instruction performs a writeback and the register that is stored is also the base register, then behavior is CONSTRAINED UNPREDICTABLE and one of the following behaviors must occur:

- The instruction is treated as UNDEFINED.
- The instruction is treated as a NOP.
- The instruction performs the store to the designated register using the specified addressing mode, but the value stored is UNKNOWN.

Table C3-11 shows the Load/Store Register instructions.

Table C3-11 Load/Store register instructions

Mnemonic	Instruction	See
LDR	Load register (register offset)	<i>LDR (register)</i> on page C6-675
	Load register (immediate offset)	<i>LDR (immediate)</i> on page C6-670
	Load register (PC-relative literal)	<i>LDR (literal)</i> on page C6-673
LDRB	Load byte (register offset)	<i>LDRB (register)</i> on page C6-679
	Load byte (immediate offset)	<i>LDRB (immediate)</i> on page C6-677
LDRSB	Load signed byte (register offset)	<i>LDRSB (register)</i> on page C6-688
	Load signed byte (immediate offset)	<i>LDRSB (immediate)</i> on page C6-685
LDRH	Load halfword (register offset)	<i>LDRH (register)</i> on page C6-683
	Load halfword (immediate offset)	<i>LDRH (immediate)</i> on page C6-681
LDRSH	Load signed halfword (register offset)	<i>LDRSH (register)</i> on page C6-693
	Load signed halfword (immediate offset)	<i>LDRSH (immediate)</i> on page C6-690
LDRSW	Load signed word (register offset)	<i>LDRSW (register)</i> on page C6-698
	Load signed word (immediate offset)	<i>LDRSW (immediate)</i> on page C6-695
	Load signed word (PC-relative literal)	<i>LDRSW (literal)</i> on page C6-697
STR	Store register (register offset)	<i>STR (register)</i> on page C6-873
	Store register (immediate offset)	<i>STR (immediate)</i> on page C6-870
STRB	Store byte (register offset)	<i>STRB (register)</i> on page C6-877
	Store byte (immediate offset)	<i>STRB (immediate)</i> on page C6-875
STRH	Store halfword (register offset)	<i>STRH (register)</i> on page C6-881
	Store halfword (immediate offset)	<i>STRH (immediate)</i> on page C6-879

C3.2.2 Load/Store register (unscaled offset)

The Load/Store register instructions with an unscaled offset support only one addressing mode:

- Base plus an unscaled 9-bit signed immediate offset.

See *Load/Store addressing modes* on page C1-143.

The Load/Store register (unscaled offset) instructions are required to disambiguate this instruction class from the Load/Store register instruction forms that support an addressing mode of base plus a scaled, unsigned 12-bit immediate offset, because that can represent some offset values in the same range.

The ambiguous immediate offsets are byte offsets that are both:

- In the range 0-255, inclusive.
- Naturally aligned to the access size.

Other byte offsets in the range -256 to 255 inclusive are unambiguous. An assembler program translating a Load/Store instruction, for example LDR, is required to encode an unambiguous offset using the unscaled 9-bit offset form, and to encode an ambiguous offset using the scaled 12-bit offset form. A programmer might force the generation of the unscaled 9-bit form by using one of the mnemonics in [Table C3-12](#). ARM recommends that a disassembler outputs all unscaled 9-bit offset forms using one of these mnemonics, but unambiguous offsets can be output using a Load/Store single register mnemonic, for example, LDR.

[Table C3-12](#) shows the Load/Store register instructions with an unscaled offset.

Table C3-12 Load/Store register (unscaled offset) instructions

Mnemonic	Instruction	See
LDUR	Load register (unscaled offset)	LDUR on page C6-739
LDURB	Load byte (unscaled offset)	LDURB on page C6-741
LDURSB	Load signed byte (unscaled offset)	LDURSB on page C6-743
LDURH	Load halfword (unscaled offset)	LDURH on page C6-742
LDURSH	Load signed halfword (unscaled offset)	LDURSH on page C6-745
LDURSW	Load signed word (unscaled offset)	LDURSW on page C6-747
STUR	Store register (unscaled offset)	STUR on page C6-917
STURB	Store byte (unscaled offset)	STURB on page C6-918
STURH	Store halfword (unscaled offset)	STURH on page C6-919

C3.2.3 Load/Store Pair

The Load/Store Pair instructions support the following addressing modes:

- Base plus a scaled 7-bit signed immediate offset.
- Pre-indexed by a scaled 7-bit signed immediate offset.
- Post-indexed by a scaled 7-bit signed immediate offset.

See also [Load/Store addressing modes on page C1-143](#).

If a Load Pair instruction specifies the same register for the two registers that are being loaded, then behavior is CONSTRAINED UNPREDICTABLE and one of the following behaviors must occur:

- The instruction is treated as UNDEFINED.
- The instruction is treated as a NOP.
- The instruction performs all the loads using the specified addressing mode and the register that is loaded takes an UNKNOWN value.

If a Load Pair instruction specifies writeback and one of the registers being loaded is also the base register, then behavior is **CONSTRAINED UNPREDICTABLE** and one of the following behaviors must occur:

- The instruction is treated as **UNDEFINED**.
- The instruction is treated as a **NOP**.
- The instruction performs all of the loads using the specified addressing mode, and the base register becomes **UNKNOWN**. In addition, if an exception occurs during the instruction, the base address might be corrupted so that the instruction cannot be repeated.

If a Store Pair instruction performs a writeback and one of the registers being stored is also the base register, then behavior is **CONSTRAINED UNPREDICTABLE** and one of the following behaviors must occur:

- The instruction is treated as **UNDEFINED**.
- The instruction is treated as a **NOP**.
- The instruction performs all the stores of the registers indicated by the specified addressing mode, but the value stored for the base register is **UNKNOWN**.

Table C3-13 shows the Load/Store Pair instructions.

Table C3-13 Load/Store Pair instructions

Mnemonic	Instruction	See
LDP	Load Pair	<i>LDP</i> on page C6-664
LDPSW	Load Pair signed words	<i>LDPSW</i> on page C6-667
STP	Store Pair	<i>STP</i> on page C6-867

C3.2.4 Load/Store Non-temporal Pair

The Load/Store Non-temporal Pair instructions support only one addressing mode:

- Base plus a scaled 7-bit signed immediate offset.

See *Load/Store addressing modes* on page C1-143.

The Load/Store Non-temporal Pair instructions provide a hint to the memory system that an access is non-temporal or streaming, and unlikely to be repeated in the near future. This means that data caching is not required. However, depending on the memory type, the instructions might permit memory reads to be preloaded and memory writes to be gathered to accelerate bulk memory transfers.

In addition, there is an exception to the usual memory ordering rules. If an address dependency exists between two memory reads, and a Load Non-temporal Pair instruction generated the second read, then in the absence of any other barrier mechanism to achieve order, the memory accesses can be observed in any order by the other observers within the shareability domain of the memory addresses being accessed.

If a Load Non-Temporal Pair instruction specifies the same register for the two registers that are being loaded, then behavior is **CONSTRAINED UNPREDICTABLE** and one of the following must occur:

- The instruction is treated as **UNDEFINED**.
- The instruction is treated as a **NOP**.
- The instruction performs all the loads using the specified addressing mode and the register that is loaded takes an **UNKNOWN** value.

Table C3-14 shows the Load/Store Non-temporal Pair instructions.

Table C3-14 Load/Store Non-temporal Pair instructions

Mnemonic	Instruction	See
LDNP	Load Non-temporal Pair	LDNP on page C6-662
STNP	Store Non-temporal Pair	STNP on page C6-865

C3.2.5 Load/Store unprivileged

The Load/Store unprivileged instructions support only one addressing mode:

- Base plus an unscaled 9-bit signed immediate offset.

See [Load/Store addressing modes on page C1-143](#).

The Load/Store unprivileged instructions can be used when the PE is at EL1 to perform unprivileged memory accesses. If the PE is executing in any other Exception level, then the access permissions for that level apply.

When the value of the PSTATE.UAO bit is 1, and when executed at EL1 or at EL2 with HCR_EL2.{E2H, TGE} == {1, 1}, the memory accesses made by the Load/Store unprivileged instructions behave as if they were made by the Load/Store register instructions. See [Load/Store unprivileged](#) and [Load/Store register](#) on page C3-160.

Table C3-15 shows the Load/Store unprivileged instructions.

Table C3-15 Load-Store unprivileged instructions

Mnemonic	Instruction	See
LDTR	Load unprivileged register	LDTR on page C6-718
LDTRB	Load unprivileged byte	LDTRB on page C6-720
LDTRSB	Load unprivileged signed byte	LDTRSB on page C6-722
LDTRH	Load unprivileged halfword	LDTRH on page C6-721
LDTRSH	Load unprivileged signed halfword	LDTRSH on page C6-724
LDTRSW	Load unprivileged signed word	LDTRSW on page C6-726
STTR	Store unprivileged register	STTR on page C6-901
STTRB	Store unprivileged byte	STTRB on page C6-903
STTRH	Store unprivileged halfword	STTRH on page C6-904

C3.2.6 Load-Exclusive/Store-Exclusive

The Load-Exclusive/Store-Exclusive instructions support only one addressing mode:

- Base register with no offset.

See [Load/Store addressing modes on page C1-143](#).

The Load-Exclusive instructions mark the physical address being accessed as an exclusive access. This exclusive access mark is checked by the Store-Exclusive instruction, permitting the construction of atomic read-modify-write operations on shared memory variables, semaphores, mutexes, and spinlocks. See [Synchronization and semaphores on page B2-121](#).

The Load-Exclusive/Store-Exclusive instructions other than Load-Exclusive pair and Store-Exclusive pair require natural alignment, and an unaligned address generates an Alignment fault. Memory accesses generated by Load-Exclusive pair or Store-Exclusive pair instructions must be aligned to the size of the pair, otherwise the access generates an Alignment fault. When a Store-Exclusive pair succeeds, it causes a single-copy atomic update of the entire memory location.

Table C3-16 shows the Load-Exclusive/Store-Exclusive instructions.

Table C3-16 Load-Exclusive/Store-Exclusive instructions

Mnemonic	Instruction	See
LDXR	Load Exclusive register	LDXR on page C6-750
LDXRB	Load Exclusive byte	LDXRB on page C6-751
LDXRH	Load Exclusive halfword	LDXRH on page C6-752
LDXP	Load Exclusive pair	LDXP on page C6-748
STXR	Store Exclusive register	STXR on page C6-922
STXRB	Store Exclusive byte	STXRB on page C6-924
STXRH	Store Exclusive halfword	STXRH on page C6-926
STXP	Store Exclusive pair	STXP on page C6-920

C3.2.7 Load-Acquire/Store-Release

The Load-Acquire/Store-Release instructions support only one addressing mode:

- Base register with no offset.

See [Load/Store addressing modes on page C1-143](#).

The Load-Acquire/Store-Release instructions can remove the requirement to use the explicit **DMB** memory barrier instruction. For more information about the ordering of Load-Acquire/Store-Release, see [Load-Acquire, Store-Release on page B2-94](#).

The Load-Acquire/Store-Release instructions other than Load-Acquire pair and Store-Release pair require natural alignment, and an unaligned address generates an Alignment fault. Memory accesses generated by Load-Acquire pair or Store-Release pair instructions must be aligned to the size of the pair, otherwise the access generates an Alignment fault.

A Store-Release Exclusive instruction only has the Release semantics if the store is successful.

Table C3-17 shows the Non-exclusive Load-Acquire/Store-Release instructions.

Table C3-17 Non-exclusive Load-Acquire and Store-Release instructions

Mnemonic	Instruction	See
LDAR	Load-Acquire register	LDAR on page C6-638
LDARB	Load-Acquire byte	LDARB on page C6-639
LDARH	Load-Acquire halfword	LDARH on page C6-640
STLR	Store-Release register	STLR on page C6-853
STLRB	Store-Release byte	STLRB on page C6-854
STLRH	Store-Release halfword	STLRH on page C6-855

Table C3-18 shows the Exclusive Load-Acquire/Store-Release instructions.

Table C3-18 Exclusive Load-Acquire and Store-Release instructions

Mnemonic	Instruction	See
LDAXR	Load-Acquire Exclusive register	LDAXR on page C6-643
LDAXRB	Load-Acquire Exclusive byte	LDAXRB on page C6-645
LDAXRH	Load-Acquire Exclusive halfword	LDAXRH on page C6-646
LDAXP	Load-Acquire Exclusive pair	LDAXP on page C6-641
STLXR	Store-Release Exclusive register	STLXR on page C6-859
STLXRB	Store-Release Exclusive byte	STLXRB on page C6-861
STLXRH	Store-Release Exclusive halfword	STLXRH on page C6-863
STLXP	Store-Release Exclusive pair	STLXP on page C6-856

C3.2.8 LoadLOAcquire/StoreLORelease

The Load-Acquire/Store-Release instructions support only one addressing mode:

- Base register with no offset.

See [Load/Store addressing modes on page C1-143](#).

The LoadLOAcquire/StoreLORelease instructions can remove the requirement to use the explicit **DMB** memory barrier instruction. For more information about the ordering of LoadLOAcquire/StoreLORelease, see [LoadLOAcquire, StoreLORelease on page B2-95](#).

The LoadLOAcquire/StoreLORelease instructions require natural alignment, and an unaligned address generates an Alignment fault.

Table C3-19 shows the LoadLOAcquire/StoreLORelease instructions.

Table C3-19 LoadLOAcquire and StoreLORelease instructions

Mnemonic	Instruction	See
LDLARB	LoadLOAcquire byte	LDLARB on page C6-659
LDLARH	LoadLOAcquire halfword	LDLARH on page C6-660
LDLAR	LoadLOAcquire register	LDLAR on page C6-661
STLLRB	StoreLORelease byte	STLLRB on page C6-850
STLLRH	StoreLORelease halfword	STLLRH on page C6-851
STLLR	StoreLORelease register	STLLR on page C6-852

C3.2.9 Load/Store scalar SIMD and floating-point

The Load/Store scalar SIMD and floating-point instructions operate on scalar values in the SIMD and floating-point register file as described in [SIMD and floating-point scalar register names on page C1-140](#). The memory addressing modes available, described in [Load/Store addressing modes on page C1-143](#), are identical to the general-purpose register Load/Store instructions, and like those instructions permit arbitrary address alignment unless strict alignment checking is enabled. However, unlike the Load/Store instructions that transfer general-purpose registers, Load/Store scalar SIMD and floating-point instructions make no guarantee of atomicity, even when the address is naturally aligned to the size of the data.

Load/Store scalar SIMD and floating-point register

The Load/Store scalar SIMD and floating-point register instructions support the following addressing modes:

- Base plus a scaled 12-bit unsigned immediate offset or base plus unscaled 9-bit signed immediate offset.
- Base plus 64-bit register offset, optionally scaled.
- Base plus 32-bit extended register offset, optionally scaled.
- Pre-indexed by an unscaled 9-bit signed immediate offset.
- Post-indexed by an unscaled 9-bit signed immediate offset.
- PC-relative literal for loads of 32 bits or more.

For more information on the addressing modes, see [Load/Store addressing modes](#) on page C1-143.

Note

The unscaled 9-bit signed immediate offset address mode requires its own instruction form, see [Load/Store scalar SIMD and floating-point register \(unscaled offset\)](#).

Table C3-20 shows the Load/Store instructions for a single SIMD and floating-point register.

Table C3-20 Load/Store single SIMD and floating-point register instructions

Mnemonic	Instruction	See
LDR	Load scalar SIMD&FP register (register offset)	LDR (register, SIMD&FP) on page C7-1364
	Load scalar SIMD&FP register (immediate offset)	LDR (immediate, SIMD&FP) on page C7-1358
	Load scalar SIMD&FP register (PC-relative literal)	LDR (literal, SIMD&FP) on page C7-1362
STR	Store scalar SIMD&FP register (register offset)	STR (register, SIMD&FP) on page C7-1635
	Store scalar SIMD&FP register (immediate offset)	STR (immediate, SIMD&FP) on page C7-1631

Load/Store scalar SIMD and floating-point register (unscaled offset)

The Load /Store scalar SIMD and floating-point register instructions support only one addressing mode:

- Base plus an unscaled 9-bit signed immediate offset.

See also [Load/Store addressing modes](#) on page C1-143.

The Load/Store scalar SIMD and floating-point register (unscaled offset) instructions are required to disambiguate this instruction class from the Load/Store single SIMD and floating-point instruction forms that support an addressing mode of base plus a scaled, unsigned 12-bit immediate offset. This is similar to the Load/Store register (unscaled offset) instructions, that disambiguate this instruction class from the Load/Store register instruction, see [Load/Store register \(unscaled offset\)](#) on page C3-161.

Table C3-21 shows the Load/Store SIMD and floating-point register instructions with an unscaled offset.

Table C3-21 Load/Store SIMD and floating-point register instructions

Mnemonic	Instruction	See
LDUR	Load scalar SIMD&FP register (unscaled offset)	LDUR (SIMD&FP) on page C7-1367
STUR	Store scalar SIMD&FP register (unscaled offset)	STUR (SIMD&FP) on page C7-1638

Load/Store SIMD and Floating-point register pair

The Load/Store SIMD and floating-point register pair instructions support the following addressing modes:

- Base plus a scaled 7-bit signed immediate offset.
- Pre-indexed by a scaled 7-bit signed immediate offset.
- Post-indexed by a scaled 7-bit signed immediate offset.

See also [Load/Store addressing modes on page C1-143](#).

If a Load pair instruction specifies the same register for the two registers that are being loaded, then behavior is CONSTRAINED UNPREDICTABLE and one of the following behaviors must occur:

- The instruction is treated as UNDEFINED.
- The instruction is treated as a NOP.
- The instruction performs all of the loads using the specified addressing mode and the register being loaded takes an UNKNOWN value.

Table C3-22 shows the Load/Store SIMD and floating-point register pair instructions.

Table C3-22 Load/Store SIMD and floating-point register pair instructions

Mnemonic	Instruction	See
LDP	Load pair of scalar SIMD&FP registers	LDP (SIMD&FP) on page C7-1355
STP	Store pair of scalar SIMD&FP registers	STP (SIMD&FP) on page C7-1628

Load/Store SIMD and Floating-point Non-temporal pair

The Load/Store SIMD and Floating-point Non-temporal pair instructions support only one addressing mode:

- Base plus a scaled 7-bit signed immediate offset.

See also [Load/Store addressing modes on page C1-143](#).

The Load/Store Non-temporal pair instructions provide a hint to the memory system that an access is non-temporal or streaming, and unlikely to be repeated in the near future. This means that data caching is not required. However, depending on the memory type, the instructions might permit memory reads to be preloaded and memory writes to be gathered to accelerate bulk memory transfers.

In addition, there is an exception to the usual memory ordering rules. If an address dependency exists between two memory reads, and a Load non-temporal pair instruction generated the second read, then in the absence of any other barrier mechanism to achieve order, those memory accesses can be observed in any order by the other observers within the shareability domain of the memory addresses being accessed.

If a Load Non-temporal pair instruction specifies the same register for the two registers that are being loaded, then behavior is CONSTRAINED UNPREDICTABLE and one of the following behaviors must occur:

- The instruction is treated as UNDEFINED.
- The instruction is treated as a NOP.
- The instruction performs all the loads using the specified addressing mode and the register that is loaded takes an UNKNOWN value.

Table C3-23 shows the Load/Store SIMD and floating-point Non-temporal pair instructions.

Table C3-23 Load/Store SIMD and floating-point Non-temporal pair instructions

Mnemonic	Instruction	See
LDNP	Load pair of scalar SIMD&FP registers	LDNP (SIMD&FP) on page C7-1353
STNP	Store pair of scalar SIMD&FP registers	STNP (SIMD&FP) on page C7-1626

C3.2.10 Load/Store Vector

The Vector Load/Store structure instructions support the following addressing modes:

- Base register only.
- Post-indexed by a 64-bit register.
- Post-indexed by an immediate, equal to the number of bytes transferred.

Load/Store vector instructions, like other Load/Store instructions, allow any address alignment, unless strict alignment checking is enabled. If strict alignment checking is enabled, then alignment checking to the size of the element is performed. However, unlike the Load/Store instructions that transfer general-purpose registers, the Load/Store vector instructions do not guarantee atomicity, even when the address is naturally aligned to the size of the element.

Load/Store structures

Table C3-24 shows the Load/Store structure instructions. A post-increment immediate offset, if present, must be 8, 16, 24, 32, 48, or 64, depending on the number of elements transferred.

Table C3-24 Load/Store multiple structures instructions

Mnemonic	Instruction	See
LD1	Load single 1-element structure to one lane of one register	LD1 (single structure) on page C7-1316
	Load multiple 1-element structures to one register or to two, three, or four consecutive registers	LD1 (multiple structures) on page C7-1312
LD2	Load single 2-element structure to one lane of two consecutive registers	LD2 (single structure) on page C7-1326
	Load multiple 2-element structures to two consecutive registers	LD2 (multiple structures) on page C7-1323
LD3	Load single 3-element structure to one lane of three consecutive registers	LD3 (single structure) on page C7-1336
	Load multiple 3-element structures to three consecutive registers	LD3 (multiple structures) on page C7-1333
LD4	Load single 4-element structure to one lane of four consecutive registers	LD4 (single structure) on page C7-1346
	Load multiple 4-element structures to four consecutive registers	LD4 (multiple structures) on page C7-1343
ST1	Store single 1-element structure from one lane of one register	ST1 (single structure) on page C7-1601
	Store multiple 1-element structures from one register, or from two, three, or four consecutive registers	ST1 (multiple structures) on page C7-1597
ST2	Store single 2-element structure from one lane of two consecutive registers	ST2 (single structure) on page C7-1608
	Store multiple 2-element structures from two consecutive registers	ST2 (multiple structures) on page C7-1605

Table C3-24 Load/Store multiple structures instructions (continued)

Mnemonic	Instruction	See
ST3	Store single 3-element structure from one lane of three consecutive registers	<i>ST3 (single structure)</i> on page C7-1615
	Store multiple 3-element structures from three consecutive registers	<i>ST3 (multiple structures)</i> on page C7-1612
ST4	Store single 4-element structure from one lane of four consecutive registers	<i>ST4 (single structure)</i> on page C7-1622
ST4	Store multiple 4-element structures from four consecutive registers	<i>ST4 (multiple structures)</i> on page C7-1619

Load single structure and replicate

Table C3-25 shows the Load single structure and replicate instructions. A post-increment immediate offset, if present, must be 1, 2, 3, 4, 6, 8, 12, 16, 24, or 32, depending on the number of elements transferred.

Table C3-25 Load single structure and replicate instructions

Mnemonic	Instruction	See
LD1R	Load single 1-element structure and replicate to all lanes of one register	LD1R on page C7-1320
LD2R	Load single 2-element structure and replicate to all lanes of two registers	LD2R on page C7-1330
LD3R	Load single 3-element structure and replicate to all lanes of three registers	LD3R on page C7-1340
LD4R	Load single 4-element structure and replicate to all lanes of four registers	LD4R on page C7-1350

C3.2.11 Prefetch memory

The Prefetch memory instructions support the following addressing modes:

- Base plus a scaled 12-bit unsigned immediate offset or base plus an unscaled 9-bit signed immediate offset.
- Base plus a 64-bit register offset. This can be optionally scaled by 8-bits, for example LSL#3.
- Base plus a 32-bit extended register offset. This can be optionally scaled by 8-bits.
- PC-relative literal.

The prefetch memory instructions signal to the memory system that memory accesses from a specified address are likely to occur in the near future. The memory system can respond by taking actions that are expected to speed up the memory access when they do occur, such as preloading the specified address into one or more caches. Because these signals are only hints, it is valid for the PE to treat any or all prefetch instructions as a NOP.

Because they are hints to the memory system, the operation of a PRFM instruction cannot cause a synchronous exception. However, a memory operation performed as a result of one of these memory system hints might in exceptional cases trigger an asynchronous event, and thereby influence the execution of the PE. An example of an asynchronous event that might be triggered is an SError interrupt.

A PRFM instruction can only have an effect on software visible structures, such as caches and translation lookaside buffers associated with memory locations that can be accessed by reads, writes, or execution as defined in the translation regime of the current Exception level.

A PRFM instruction is guaranteed not to access Device memory.

A PRFM instruction using a PLI hint must not result in any access that could not be performed by the PE speculatively fetching an instruction. Therefore, if all associated MMUs are disabled, a PLI hint cannot access any memory location that cannot be accessed by instruction fetches.

The PRFM instructions require an additional <prfop> operand to be specified, which must be one of the following:

PLDL1KEEP, PLDL1STRM, PLDL2KEEP, PLDL2STRM, PLDL3KEEP, PLDL3STRM

PSTL1KEEP, PSTL1STRM, PSTL2KEEP, PSTL2STRM, PSTL3KEEP, PSTL3STRM

PLIL1KEEP, PLIL1STRM, PLIL2KEEP, PLIL2STRM, PLIL3KEEP, PLIL3STRM

<prfop> is defined as <type><target><policy>.

Here:

<type>	Is one of:
	PLD Prefetch for load.
	PST Prefetch for store.
	PLI Preload instructions.

<target>	Is one of:	
	L1	Level 1 cache.
	L2	Level 2 cache.
	L3	Level 3 cache.
<policy>	Is one of:	
	KEEP	Retained or temporal prefetch, allocated in the cache normally.
	STRM	Streaming or non-temporal prefetch, for data that is used only once.

PRFUM explicitly uses the unscaled 9-bit signed immediate offset addressing mode, as described in *Load/Store register (unscaled offset)* on page C3-161.

Table C3-26 shows the Prefetch memory instructions.

Table C3-26 Prefetch memory instructions

Mnemonic	Instruction	See
PRFM	Prefetch memory (register offset)	<i>PRFM (register)</i> on page C6-798
	Prefetch memory (immediate offset)	<i>PRFM (immediate)</i> on page C6-794
	Prefetch memory (PC-relative offset)	<i>PRFM (literal)</i> on page C6-796
PRFUM	Prefetch memory (unscaled offset)	<i>PRFM (unscaled offset)</i> on page C6-800

C3.2.12 Compare and Swap

The Compare and Swap instructions support only one addressing mode:

- Base register only.

See also *Load/Store addressing modes* on page C1-143.

For the purpose of permission checking, and for watchpoints, all the new atomic instructions are treated as performing both a load and a store.

The CAS and CASP instructions require natural alignment, and an unaligned address generates an Alignment fault.

The instructions are provided with ordering options, which map to the acquire and release definitions used in the ARMv8-A architecture. The atomic instructions with release semantics have the same rules as Store-Release instructions regarding multi-copy atomicity.

For the CAS and CASP instructions, the architecture permits that a data read clears any Exclusives monitors associated with that location, even if the compare subsequently fails. If these instructions generate a synchronous Data Abort, the registers which are compared and loaded are restored to the values held in the registers before the instruction was executed.

Table C3-27 Compare and swap instructions

Mnemonic	Instruction	See
CAS	Compare and swap	<i>CAS, CASA, CASAL, CASL</i> on page C6-571
CASB	Compare and swap byte	<i>CASB, CASAB, CASALB, CASLB</i> on page C6-564
CASH	Compare and swap halfword	<i>CASH, CASAH, CASALH, CASLH</i> on page C6-566
CASP	Compare and swap pair	<i>CASP, CASPA, CASPAL, CASPL</i> on page C6-568

C3.2.13 Atomic memory operations

The atomic memory operation instructions support only one addressing mode:

- Base register only.

See also [Load/Store addressing modes](#) on page C1-143.

For the purpose of permission checking, and for watchpoints, all the new atomic instructions are treated as performing both a load and a store.

The LD<OP> and ST<OP> instructions require natural alignment, and an unaligned address generates an Alignment fault.

The instructions are provided with ordering options, which map to the acquire and release definitions used in the ARMv8-A architecture. The atomic instructions with release semantics have the same rules as Store-Release instructions regarding multi-copy atomicity.

For the LD<OP> instructions, where the source and destination registers are the same, if the instruction generates a synchronous Data Abort, then the source register is restored to the value it held before the instruction was executed.

The ST<OP> instructions are not regarded as doing a read for the purpose of a DMB LD barrier.

Table C3-28 Atomic memory operation instructions

Mnemonic	Instruction	See
LDADD	Atomic add	LDADD, LDADDA, LDADDAL, LDADDL on page C6-636
LDADDB	Atomic add on byte	LDADDB, LDADDAB, LDADDALB, LDADDLB on page C6-632
LDADDH	Atomic add on halfword	LDADDH, LDADDAH, LDADDALH, LDADDLH on page C6-634
LDCLR	Atomic bit clear	LDCLR, LDCLRA, LDCLRAL, LDCLRL on page C6-651
LDCLRB	Atomic bit clear on byte	LDCLRB, LDCLRAB, LDCLRALB, LDCLRLB on page C6-647
LDCLRH	Atomic bit clear on halfword	LDCLRH, LDCLRAH, LDCLRALH, LDCLRLH on page C6-649
LDEOR	Atomic exclusive OR	LDEOR, LDEORA, LDEORAL, LDEORL on page C6-657
LDEORB	Atomic exclusive OR on byte	LDEORB, LDEORAB, LDEORALB, LDEORLB on page C6-653
LDEORH	Atomic exclusive OR on halfword	LDEORH, LDEORAH, LDEORALH, LDEORLH on page C6-655
LDSET	Atomic bit set	LDSET, LDSETA, LDSETAL, LDSETL on page C6-704
LDSETB	Atomic bit set on byte	LDSETB, LDSETAB, LDSETALB, LDSETLB on page C6-700
LDSETH	Atomic bit set on halfword	LDSETH, LDSETAH, LDSETALH, LDSETLH on page C6-702
LDMAX	Atomic signed maximum	LDSMAX, LDSMAXA, LDSMAXAL, LDSMAXL on page C6-710
LDMAXB	Atomic signed maximum on byte	LDSMAXB, LDSMAXAB, LDSMAXALB, LDSMAXLB on page C6-706
LDMAXH	Atomic signed maximum on halfword	LDSMAXH, LDSMAXAH, LDSMAXALH, LDSMAXLH on page C6-708
LDMIN	Atomic signed minimum	LDSMIN, LDSMINA, LDSMINAL, LDSMINL on page C6-716
LDMINB	Atomic signed minimum on byte	LDSMINB, LDSMINAB, LDSMINALB, LDSMINLB on page C6-712
LDMINH	Atomic signed minimum on halfword	LDSMINH, LDSMINAH, LDSMINALH, LDSMINLH on page C6-714
LDUMAX	Atomic unsigned maximum	LDUMAX, LDUMAXA, LDUMAXAL, LDUMAXL on page C6-731
LDUMAXB	Atomic unsigned maximum on byte	LDUMAXB, LDUMAXAB, LDUMAXALB, LDUMAXLB on page C6-727

Table C3-28 Atomic memory operation instructions (continued)

Mnemonic	Instruction	See
LDUMAXH	Atomic unsigned maximum on halfword	LDUMAXH, LDUMAXAH, LDUMAXALH, LDUMAXLH on page C6-729
LDUMIN	Atomic unsigned minimum	LDUMIN, LDUMINA, LDUMINAL, LDUMINL on page C6-737
LDUMINB	Atomic unsigned minimum on byte	LDUMINB, LDUMINAB, LDUMINALB, LDUMINLB on page C6-733
LDUMINH	Atomic unsigned minimum on halfword	LDUMINH, LDUMINAH, LDUMINALH, LDUMINLH on page C6-735
STADD	Atomic add, without return	STADD, STADDL on page C6-836
STADDB	Atomic add on byte, without return	STADDB, STADDLB on page C6-832
STADDH	Atomic add on halfword, without return	STADDH, STADDLH on page C6-834
STCLR	Atomic bit clear, without return	STCLR, STCLRL on page C6-842
STCLRB	Atomic bit clear on byte, without return	STCLRB, STCLRLB on page C6-838
STCLRH	Atomic bit clear on halfword, without return	STCLRH, STCLRLH on page C6-840
STEOR	Atomic exclusive OR, without return	STEOR, STEORL on page C6-848
STEORB	Atomic exclusive OR on byte, without return	STEORB, STEORLB on page C6-844
STEORH	Atomic exclusive OR on halfword, without return	STEORH, STEORLH on page C6-846
STSET	Atomic bit set, without return	STSET, STSETL on page C6-887
STSETB	Atomic bit set on byte, without return	STSETB, STSETLB on page C6-883
STSETH	Atomic bit set on halfword, without return	STSETH, STSETLH on page C6-885
STMAX	Atomic signed maximum, without return	STSMAX, STSMAXL on page C6-893
STMAXB	Atomic signed maximum on byte, without return	STSMAXB, STSMAXLB on page C6-889
STMAXH	Atomic signed maximum on halfword, without return	STSMAXH, STSMAXLH on page C6-891
STMIN	Atomic signed minimum, without return	STSMIN, STSMINL on page C6-899
STMINB	Atomic signed minimum on byte, without return	STSMINB, STSMINLB on page C6-895
STMINH	Atomic signed minimum on halfword, without return	STSMINH, STSMINLH on page C6-897
STUMAX	Atomic unsigned maximum, without return	STUMAX, STUMAXL on page C6-909
STUMAXB	Atomic unsigned maximum on byte, without return	STUMAXB, STUMAXLB on page C6-905
STUMAXH	Atomic unsigned maximum on halfword, without return	STUMAXH, STUMAXLH on page C6-907

Table C3-28 Atomic memory operation instructions (continued)

Mnemonic	Instruction	See
STUMIN	Atomic unsigned minimum, without return	STUMIN , STUMINL on page C6-915
STUMINB	Atomic unsigned minimum on byte, without return	STUMINB , STUMINLB on page C6-911
STUMINH	Atomic unsigned minimum on halfword, without return	STUMINH , STUMINLH on page C6-913

C3.2.14 Swap

The swap instructions support only one addressing mode:

- Base register only.

See also [Load/Store addressing modes](#) on page C1-143.

For the purpose of permission checking, and for watchpoints, all the new atomic instructions are treated as performing both a load and a store.

The SWP instructions require natural alignment, and an unaligned address generates an Alignment fault.

The instructions are provided with ordering options, which map to the acquire and release definitions used in the ARMv8-A architecture. The atomic instructions with release semantics have the same rules as Store-Release instructions regarding multi-copy atomicity.

For the SWP instructions, where the source and destination registers are the same, if the instruction generates a synchronous Data Abort, then the source register is restored to the value it held before the instruction was executed.

Table C3-29 Swap instructions

Mnemonic	Instruction	See
SWP	Swap	SWP , SWPA , SWPAL , SWPL on page C6-945
SWPB	Swap byte	SWPB , SWPAB , SWPALB , SWPLB on page C6-941
SWPH	Swap halfword	SWPH , SWPAH , SWPALH , SWPLH on page C6-943

C3.3 Data processing - immediate

This section describes the instruction groups for data processing with immediate operands. It contains the following subsections:

- [Arithmetic \(immediate\)](#).
- [Logical \(immediate\)](#) on page C3-177.
- [Move \(wide immediate\)](#) on page C3-177.
- [Move \(immediate\)](#) on page C3-178.
- [PC-relative address calculation](#) on page C3-178.
- [Bitfield move](#) on page C3-179.
- [Bitfield insert and extract](#) on page C3-179.
- [Extract register](#) on page C3-179.
- [Shift \(immediate\)](#) on page C3-180.
- [Sign-extend and Zero-extend](#) on page C3-180.

For information about the encoding structure of the instructions in this instruction group, see [Data Processing -- Immediate](#) on page C4-210.

C3.3.1 Arithmetic (immediate)

The Arithmetic (immediate) instructions accept a 12-bit unsigned immediate value, optionally shifted left by 12 bits.

The Arithmetic (immediate) instructions that do not set Condition flags can read from and write to the current stack pointer. The flag setting instructions can read from the stack pointer, but they cannot write to it.

[Table C3-30](#) shows the Arithmetic instructions with an immediate offset.

Table C3-30 Arithmetic instructions with an immediate

Mnemonic	Instruction	See
ADD	Add	ADD (immediate) on page C6-525
ADDS	Add and set flags	ADDS (immediate) on page C6-531
SUB	Subtract	SUB (immediate) on page C6-930
SUBS	Subtract and set flags	SUBS (immediate) on page C6-936
CMP	Compare	CMP (immediate) on page C6-591
CMN	Compare negative	CMN (immediate) on page C6-586

C3.3.2 Logical (immediate)

The Logical (immediate) instructions accept a bitmask immediate value that is a 32-bit pattern or a 64-bit pattern viewed as a vector of identical elements of size $e = 2, 4, 8, 16, 32$ or 64 bits. Each element contains the same sub-pattern, that is a single run of 1 to $(e - 1)$ nonzero bits from bit 0 followed by zero bits, then rotated by 0 to $(e - 1)$ bits. This mechanism can generate 5334 unique 64 -bit patterns as 2667 pairs of pattern and their bitwise inverse.

———— **Note** —————

Values that consist of only zeros or only ones cannot be described in this way.

The Logical (immediate) instructions that do not set the Condition flags can write to the current stack pointer, for example to align the stack pointer in a function prologue.

———— **Note** —————

Apart from *ANDS*, and its *TST* alias, Logical (immediate) instructions do not set the Condition flags. However, the final results of a bitwise operation can be tested by a *CBZ*, *CBNZ*, *TBZ*, or *TBNZ* conditional branch.

Table C3-31 shows the Logical immediate instructions.

Table C3-31 Logical immediate instructions

Mnemonic	Instruction	See
AND	Bitwise AND	<i>AND (immediate)</i> on page C6-537
ANDS	Bitwise AND and set flags	<i>ANDS (immediate)</i> on page C6-540
EOR	Bitwise exclusive OR	<i>EOR (immediate)</i> on page C6-619
ORR	Bitwise inclusive OR	<i>ORR (immediate)</i> on page C6-790
TST	Test bits	<i>TST (immediate)</i> on page C6-956

C3.3.3 Move (wide immediate)

The Move (wide immediate) instructions insert a 16-bit immediate, or inverted immediate, into a 16-bit aligned position in the destination register. The value of the other bits in the destination register depends on the variant used. The optional shift amount can be any multiple of 16 that is smaller than the register size.

Table C3-32 shows the Move (wide immediate) instructions.

Table C3-32 Move (wide immediate) instructions

Mnemonic	Instruction	See
MOVZ	Move wide with zero	<i>MOVZ</i> on page C6-770
MOVN	Move wide with NOT	<i>MOVN</i> on page C6-768
MOVK	Move wide with keep	<i>MOVK</i> on page C6-767

C3.3.4 Move (immediate)

The Move (immediate) instructions are aliases for a single MOVZ, MOVN, or ORR (immediate with zero register), instruction to load an immediate value into the destination register. An assembler must permit a signed or unsigned immediate, as long as its binary representation can be generated using one of these instructions, and an assembler error results if the immediate cannot be generated in this way. On disassembly, it is unspecified whether the immediate is output as a signed or an unsigned value.

If there is a choice between the MOVZ, MOVN, and ORR instruction to encode the immediate, then an assembler must prefer MOVZ to MOVN, and MOVZ or MOVN to ORR, to ensure reversability. A disassembler must output ORR (immediate with zero register) MOVZ, and MOVN, as a MOV mnemonic except that the underlying instruction must be used when:

- ORR has an immediate that can be generated by a MOVZ or MOVN instruction.
- A MOVN instruction has an immediate that can be encoded by MOVZ.
- MOVZ #0 or MOVN #0 have a shift amount other than LSL #0.

Table C3-33 shows the Move (immediate) instructions.

Table C3-33 Move (immediate) instructions

Mnemonic	Instruction	See
MOV	Move (inverted wide immediate)	MOV (inverted wide immediate) on page C6-763
	Move (wide immediate)	MOV (wide immediate) on page C6-764
	Move (bitmask immediate)	MOV (bitmask immediate) on page C6-765

C3.3.5 PC-relative address calculation

The ADR instruction adds a signed, 21-bit immediate to the value of the program counter that fetched this instruction, and then writes the result to a general-purpose register. This permits the calculation of any byte address within $\pm 1\text{MB}$ of the current PC.

The ADRP instruction shifts a signed, 21-bit immediate left by 12 bits, adds it to the value of the program counter with the bottom 12 bits cleared to zero, and then writes the result to a general-purpose register. This permits the calculation of the address at a 4KB aligned memory region. In conjunction with an ADD (immediate) instruction, or a Load/Store instruction with a 12-bit immediate offset, this allows for the calculation of, or access to, any address within $\pm 4\text{GB}$ of the current PC.

———— **Note** —————

The term *page* used in the ADRP description is short-hand for the 4KB memory region, and is not related to the virtual memory translation granule size.

Table C3-34 shows the instructions used for PC-relative address calculations are as follows:

Table C3-34 PC-relative address calculation instructions

Mnemonic	Instruction	See
ADRP	Compute address of 4KB page at a PC-relative offset	ADRP on page C6-536
ADR	Compute address of label at a PC-relative offset.	ADR on page C6-535

C3.3.6 Bitfield move

The Bitfield move instructions copy a field of constant width from bit 0 in the source register to a constant bit position in the destination register, or from a constant bit position in the source register to bit 0 in the destination register. The remaining bits in the destination register are set as follows:

- For BFM, the remaining bits are unchanged.
- For UBFM the lower bits, if any, and upper bits, if any, are set to zero.
- For SBFM, the lower bits, if any, are set to zero, and the upper bits, if any, are set to a copy of the most-significant bit in the copied field.

Table C3-35 shows the Bitfield move instructions.

Table C3-35 Bitfield move instructions

Mnemonic	Instruction	See
BFM	Bitfield move	BFM on page C6-553
SBFM	Signed bitfield move	SBFM on page C6-820
UBFM	Unsigned bitfield move (32-bit)	UBFM on page C6-960

C3.3.7 Bitfield insert and extract

The Bitfield insert and extract instructions are implemented as aliases of the Bitfield move instructions. Table C3-36 shows the Bitfield insert and extract aliases.

Table C3-36 Bitfield insert and extract instructions

Mnemonic	Instruction	See
BFC	Bitfield insert clear	BFC on page C6-551
BFI	Bitfield insert	BFI on page C6-552
BFXIL	Bitfield extract and insert low	BFXIL on page C6-555
SBFIZ	Signed bitfield insert in zero	SBFIZ on page C6-819
SBFX	Signed bitfield extract	SBFX on page C6-822
UBFIZ	Unsigned bitfield insert in zero	UBFIZ on page C6-959
UBFX	Unsigned bitfield extract	UBFX on page C6-962

C3.3.8 Extract register

Depending on the register width of the operands, the Extract register instruction copies a 32-bit or 64-bit field from a constant bit position within a double-width value formed by the concatenation of a pair of source registers to a destination register.

Table C3-37 shows the Extract (immediate) instructions.

Table C3-37 Extract register instructions

Mnemonic	Instruction	See
EXTR	Extract register from pair	EXTR on page C6-625

C3.3.9 Shift (immediate)

Shifts and rotates by a constant amount are implemented as aliases of the Bitfield move or Extract register instructions. The shift or rotate amount must be in the range 0 to one less than the register width of the instruction, inclusive.

Table C3-38 shows the aliases that can be used as immediate shift and rotate instructions.

Table C3-38 Aliases for immediate shift and rotate instructions

Mnemonic	Instruction	See
ASR	Arithmetic shift right	<i>ASR (immediate)</i> on page C6-545
LSL	Logical shift left	<i>LSL (immediate)</i> on page C6-754
LSR	Logical shift right	<i>LSR (immediate)</i> on page C6-757
ROR	Rotate right	<i>ROR (immediate)</i> on page C6-812

C3.3.10 Sign-extend and Zero-extend

The Sign-extend and Zero-extend instructions are implemented as aliases of the Bitfield move instructions.

Table C3-39 shows the aliases that can be used as zero-extend and sign-extend instructions.

Table C3-39 Zero-extend and sign-extend instructions

Mnemonic	Instruction	See
SXTB	Sign-extend byte	<i>SXTB</i> on page C6-947
SXTH	Sign-extend halfword	<i>SXTH</i> on page C6-948
SXTW	Sign-extend word	<i>SXTW</i> on page C6-949
UXTB	Unsigned extend byte	<i>UXTB</i> on page C6-969
UXTH	Unsigned extend halfword	<i>UXTH</i> on page C6-970

C3.4 Data processing - register

This section describes the instruction groups for data processing with all register operands. It contains the following subsections:

- [Arithmetic \(shifted register\)](#).
- [Arithmetic \(extended register\)](#) on page C3-182.
- [Arithmetic with carry](#) on page C3-183.
- [Logical \(shifted register\)](#) on page C3-183.
- [Move \(register\)](#) on page C3-184.
- [Shift \(register\)](#) on page C3-184.
- [Multiply and divide](#) on page C3-185.
- [CRC32](#) on page C3-186.
- [Bit operation](#) on page C3-187.
- [Conditional select](#) on page C3-187.
- [Conditional comparison](#) on page C3-188.

For information about the encoding structure of the instructions in this instruction group, see [Data Processing -- Register](#) on page C4-253.

C3.4.1 Arithmetic (shifted register)

The Arithmetic (shifted register) instructions apply an optional shift operator to the second source register value before performing the arithmetic operation. The register width of the instruction controls whether the new bits are fed into the intermediate result on a right shift or rotate at bit[63] or bit[31].

The shift operators LSL, ASR, and LSR accept an immediate shift amount in the range 0 to one less than the register width of the instruction, inclusive.

Omitting the shift operator implies LSL #0, which means that there is no shift. A disassembler must not output LSL #0. However, a disassembler must output all other shifts by zero.

The current stack pointer, SP or WSP, cannot be used with this class of instructions. See [Arithmetic \(extended register\)](#) on page C3-182 for arithmetic instructions that can operate on the current stack pointer.

Table C3-40 shows the Arithmetic (shifted register) instructions.

Table C3-40 Arithmetic (shifted register) instructions

Mnemonic	Instruction	See
ADD	Add	ADD (shifted register) on page C6-527
ADDS	Add and set flags	ADDS (shifted register) on page C6-533
SUB	Subtract	SUB (shifted register) on page C6-932
SUBS	Subtract and set flags	SUBS (shifted register) on page C6-938
CMN	Compare negative	CMN (shifted register) on page C6-587
CMP	Compare	CMP (shifted register) on page C6-592
NEG	Negate	NEG (shifted register) on page C6-781
NEGS	Negate and set flags	NEGS on page C6-783

C3.4.2 Arithmetic (extended register)

The extended register instructions provide an optional sign-extension or zero-extension of a portion of the second source register value, followed by an optional left shift by a constant amount of 1-4, inclusive.

The extended shift is described by the mandatory extend operator SXTB, SXTL, SXTW, UXTB, UXTH, or UXTW. This is followed by an optional left shift amount. If the shift amount is not specified, the default shift amount is zero. A disassembler must not output a shift amount of zero.

For 32-bit instruction forms, the operators

For 64-bit instruction forms the additional operators UXTX and SXTX use all 64 bits of the second source register with an optional shift. In that case ARM recommends UXTX as the operator. If and only if at least one register is SP, ARM recommends use of the LSL operator name, rather than UXTX, and when the shift amount is also zero then both the operator and the shift amount can be omitted. UXTW and SXTW both use all 32 bits of the second source register with an optional shift. In that case ARM recommends UXTW as the operator. If and only if at least one register is WSP, ARM recommends use of the LSL operator name, rather than UXTW, and when the shift amount is also zero then both the operator and the shift amount can be omitted.

The non-flag setting variants of the extended register instruction permit the use of the current stack pointer as either the destination register and the first source register. The flag setting variants only permit the stack pointer to be used as the first source register.

In the 64-bit form of these instructions, the final register operand is written as *Wm* for all except the UXTX/LSL and SXTX extend operators. For example:

```
CMP X4, W5, SXTW
ADD X1, X2, W3, UXTB #2
SUB SP, SP, X1          // SUB SP, SP, X1, UXTX #0
```

Table C3-41 shows the Arithmetic (extended register) instructions.

Table C3-41 Arithmetic (extended register) instructions

Mnemonic	Instruction	See
ADD	Add	<i>ADD (extended register)</i> on page C6-523
ADDS	Add and set flags	<i>ADDS (extended register)</i> on page C6-529
SUB	Subtract	<i>SUB (extended register)</i> on page C6-928
SUBS	Subtract and set flags	<i>SUBS (extended register)</i> on page C6-934
CMN	Compare negative	<i>CMN (extended register)</i> on page C6-584
CMP	Compare	<i>CMP (extended register)</i> on page C6-589

C3.4.3 Arithmetic with carry

The Arithmetic with carry instructions accept two source registers, with the carry flag as an additional input to the calculation. They do not support shifting of the second source register.

Table C3-42 shows the Arithmetic with carry instructions

Table C3-42 Arithmetic with carry instructions

Mnemonic	Instruction	See
ADC	Add with carry	ADC on page C6-521
ADCS	Add with carry and set flags	ADCS on page C6-522
SBC	Subtract with carry	SBC on page C6-815
SBCS	Subtract with carry and set flags	SBCS on page C6-817
NGC	Negate with carry	NGC on page C6-785
NGCS	Negate with carry and set flags	NGCS on page C6-786

C3.4.4 Logical (shifted register)

The Logical (shifted register) instructions apply an optional shift operator to the second source register value before performing the main operation. The register width of the instruction controls whether the new bits are fed into the intermediate result on a right shift or rotate at bit[63] or bit[31].

The shift operators LSL, ASR, LSR, and ROR accept a constant immediate shift amount in the range 0 to one less than the register width of the instruction, inclusive.

Omitting the shift operator and amount implies LSL #0, which means that there is no shift. A disassembler must not output LSL #0. However, a disassembler must output all other shifts by zero.

———— **Note** ————

Apart from ANDS, TST, and BICS the logical instructions do not set the Condition flags, but the final result of a bit operation can usually directly control a CBZ, CBNZ, TBZ, or TBNZ conditional branch.

Table C3-43 shows the Logical (shifted register) instructions.

Table C3-43 Logical (shifted register) instructions

Mnemonic	Instruction	See
AND	Bitwise AND	AND (shifted register) on page C6-538
ANDS	Bitwise AND and set flags	ANDS (shifted register) on page C6-542
BIC	Bitwise bit clear	BIC (shifted register) on page C6-556
BICS	Bitwise bit clear and set flags	BICS (shifted register) on page C6-558
EON	Bitwise exclusive OR NOT	EON (shifted register) on page C6-617
EOR	Bitwise exclusive OR	EOR (shifted register) on page C6-620
ORR	Bitwise inclusive OR	ORR (shifted register) on page C6-792

Table C3-43 Logical (shifted register) instructions (continued)

Mnemonic	Instruction	See
MVN	Bitwise NOT	MVN on page C6-779
ORN	Bitwise inclusive OR NOT	ORN (shifted register) on page C6-788
TST	Test bits	TST (shifted register) on page C6-957

C3.4.5 Move (register)

The Move (register) instructions are aliases for other data processing instructions. They copy a value from a general-purpose register to another general-purpose register or the current stack pointer, or from the current stack pointer to a general-purpose register.

Table C3-44 MOV register instructions

Mnemonic	Instruction	See
MOV	Move register	MOV (register) on page C6-766
	Move register to SP or move SP to register	MOV (to/from SP) on page C6-762

C3.4.6 Shift (register)

In the Shift (register) instructions, the shift amount is the positive value in the second source register modulo the register size. The register width of the instruction controls whether the new bits are fed into the result on a right shift or rotate at bit[63] or bit[31].

[Table C3-45](#) shows the Shift (register) instructions.

Table C3-45 Shift (register) instructions

Mnemonic	Instruction	See
ASRV	Arithmetic shift right variable	ASRV on page C6-546
LSLV	Logical shift left variable	LSLV on page C6-755
LSRV	Logical shift right variable	LSRV on page C6-758
RORV	Rotate right variable	RORV on page C6-814

However, the Shift (register) instructions have a preferred set of aliases that match the shift immediate aliases described in [Shift \(immediate\) on page C3-180](#).

[Table C3-46](#) shows the aliases for Shift (register) instructions.

Table C3-46 Aliases for Variable shift instructions

Mnemonic	Instruction	See
ASR	Arithmetic shift right	ASR (register) on page C6-544
LSL	Logical shift left	LSL (register) on page C6-753
LSR	Logical shift right	LSR (register) on page C6-756
ROR	Rotate right	ROR (register) on page C6-813

C3.4.7 Multiply and divide

This section describes the instructions used for integer multiplication and division. It contains the following subsections:

- [Multiply](#).
- [Divide on page C3-186](#).

Multiply

The Multiply instructions write to a single 32-bit or 64-bit destination register, and are built around the fundamental four operand multiply-add and multiply-subtract operation, together with 32-bit to 64-bit widening variants. A 64-bit to 128-bit widening multiple can be constructed with two instructions, using *SMULH* or *UMULH* to generate the upper 64 bits. [Table C3-47](#) shows the Multiply instructions.

Table C3-47 Multiply integer instructions

Mnemonic	Instruction	See
MADD	Multiply-add	MADD on page C6-759
MSUB	Multiply-subtract	MSUB on page C6-776
MNEG	Multiply-negate	MNEG on page C6-761
MUL	Multiply	MUL on page C6-778
SMADDL	Signed multiply-add long	SMADDL on page C6-826
SMSUBL	Signed multiply-subtract long	SMSUBL on page C6-829
SMNEGL	Signed multiply-negate long	SMNEGL on page C6-828
SMULL	Signed multiply long	SMULL on page C6-831
SMULH	Signed multiply high	SMULH on page C6-830
UMADDL	Unsigned multiply-add long	UMADDL on page C6-964
UMSUBL	Unsigned multiply-subtract long	UMSUBL on page C6-966
UMNEGL	Unsigned multiply-negate long	UMNEGL on page C6-965
UMULL	Unsigned multiply long	UMULL on page C6-968
UMULH	Unsigned multiply high	UMULH on page C6-967

Divide

The Divide instructions compute the quotient of a division, rounded towards zero. The remainder can then be computed as (numerator - (quotient × denominator)), using the MSUB instruction.

If a signed integer division ($INT_MIN / -1$) is performed where INT_MIN is the most negative integer value representable in the selected register size, then the result overflows the signed integer range. No indication of this overflow is produced and the result that is written to the destination register is INT_MIN .

A division by zero results in a zero being written to the destination register, without any indication that the division by zero occurred.

Table C3-48 shows the Divide instructions.

Table C3-48 Divide instructions

Mnemonic	Instruction	See
SDIV	Signed divide	SDIV on page C6-823
UDIV	Unsigned divide	UDIV on page C6-963

C3.4.8 CRC32

The CRC32 instructions operate on the general-purpose register file to update a 32-bit CRC value from an input value comprising 1, 2, 4, or 8 bytes. There are two different classes of CRC instructions, CRC32, and CRC32C, that support two commonly used 32-bit polynomials, known as CRC-32 and CRC-32C.

To fit with common usage, the bit order of the values is reversed as part of the operation.

When bits[19:16] of [ID_AA64ISAR0_EL1](#) are set to 0b0001, the CRC instructions are implemented.

These instructions are optional in an ARMv8.0 implementation.

All implementations of ARMv8.1 architecture and later are required to implement the CRC32 instructions.

Table C3-49 shows the CRC instructions.

Table C3-49 CRC32 instructions

Mnemonic	Instruction	See
CRC32B	CRC-32 sum from byte	CRC32B , CRC32H , CRC32W , CRC32X on page C6-595
CRC32H	CRC-32 sum from halfword	CRC32B , CRC32H , CRC32W , CRC32X on page C6-595
CRC32W	CRC-32 sum from word	CRC32B , CRC32H , CRC32W , CRC32X on page C6-595
CRC32X	CRC-32 sum from doubleword	CRC32B , CRC32H , CRC32W , CRC32X on page C6-595
CRC32CB	CRC-32C sum from byte	CRC32CB , CRC32CH , CRC32CW , CRC32CX on page C6-597
CRC32CH	CRC-32C sum from halfword	CRC32CB , CRC32CH , CRC32CW , CRC32CX on page C6-597
CRC32CW	CRC-32C sum from word	CRC32CB , CRC32CH , CRC32CW , CRC32CX on page C6-597
CRC32CX	CRC-32C sum from doubleword	CRC32CB , CRC32CH , CRC32CW , CRC32CX on page C6-597

C3.4.9 Bit operation

Table C3-50 shows the Bit operation instructions.

Table C3-50 Bit operation instructions

Mnemonic	Instruction	See
CLS	Count leading sign bits	CLS on page C6-582
CLZ	Count leading zero bits	CLZ on page C6-583
RBIT	Reverse bit order	RBIT on page C6-804
REV	Reverse bytes in register	REV on page C6-806
REV16	Reverse bytes in halfwords	REV16 on page C6-808
REV32	Reverses bytes in words	REV32 on page C6-810
REV64	Reverse bytes in register	REV64 on page C6-811

C3.4.10 Conditional select

The Conditional select instructions select between the first or second source register, depending on the current state of the Condition flags. When the named condition is true, the first source register is selected and its value is copied without modification to the destination register. When the condition is false the second source register is selected and its value might be optionally inverted, negated, or incremented by one, before writing to the destination register.

Other useful conditional set and conditional unary operations are implemented as aliases of the four Conditional select instructions.

Table C3-51 shows the Conditional select instructions.

Table C3-51 Conditional select instructions

Mnemonic	Instruction	See
CSEL	Conditional select	CSEL on page C6-599
CSINC	Conditional select increment	CSINC on page C6-602
CSINV	Conditional select inversion	CSINV on page C6-604
CSNEG	Conditional select negation	CSNEG on page C6-606
CSET	Conditional set	CSET on page C6-600
CSETM	Conditional set mask	CSETM on page C6-601
CINC	Conditional increment	CINC on page C6-579
CINV	Conditional invert	CINV on page C6-580
CNEG	Conditional negate	CNEG on page C6-594

C3.4.11 Conditional comparison

The Conditional comparison instructions provide a conditional select for the NZCV Condition flags, setting the flags to the result of an arithmetic comparison of its two source register values if the named input condition is true, or to an immediate value if the input condition is false. There are register and immediate forms. The immediate form compares the source register to a small 5-bit unsigned value.

Table C3-52 shows the Conditional comparison instructions.

Table C3-52 Conditional comparison instructions

Mnemonic	Instruction	See
CCMN	Conditional compare negative (register)	CCMN (register) on page C6-576
CCMN	Conditional compare negative (immediate)	CCMN (immediate) on page C6-575
CCMP	Conditional compare (register)	CCMP (register) on page C6-578
CCMP	Conditional compare (immediate)	CCMP (immediate) on page C6-577

C3.5 Data processing - SIMD and floating-point

This section describes the instruction groups for data processing with SIMD and floating-point register operands.

[Common features of SIMD instructions](#) gives general information about SIMD instructions.

The following subsections describe the scalar floating-point data processing instructions:

- [Floating-point move \(register\)](#) on page C3-190.
- [Floating-point move \(immediate\)](#) on page C3-190.
- [Floating-point conversion](#) on page C3-191.
- [Floating-point round to integer](#) on page C3-192.
- [Floating-point multiply-add](#) on page C3-193.
- [Floating-point arithmetic \(one source\)](#) on page C3-193.
- [Floating-point arithmetic \(two sources\)](#) on page C3-194.
- [Floating-point minimum and maximum](#) on page C3-194.
- [Floating-point comparison](#) on page C3-194.
- [Floating-point conditional select](#) on page C3-195.

The following subsections describe the SIMD data processing instructions:

- [SIMD move](#) on page C3-195
- [SIMD arithmetic](#) on page C3-196.
- [SIMD compare](#) on page C3-198.
- [SIMD widening and narrowing arithmetic](#) on page C3-199.
- [SIMD unary arithmetic](#) on page C3-200.
- [SIMD by element arithmetic](#) on page C3-202.
- [SIMD permute](#) on page C3-203.
- [SIMD immediate](#) on page C3-203.
- [SIMD shift \(immediate\)](#) on page C3-203.
- [SIMD floating-point and integer conversion](#) on page C3-205.
- [SIMD reduce \(across vector lanes\)](#) on page C3-206.
- [SIMD pairwise arithmetic](#) on page C3-206.
- [SIMD table lookup](#) on page C3-207.
- [The Cryptographic Extension](#) on page C3-207.

For information about the encoding structure of the instructions in this instruction group, see [Data Processing -- Scalar Floating-Point and Advanced SIMD](#) on page C4-261.

For information about the floating-point exceptions, see [Floating-point exceptions and exception traps](#) on page D1-1831.

C3.5.1 Common features of SIMD instructions

A number of SIMD instructions come in three forms:

Wide	Indicated by the suffix <i>W</i> . The element width of the destination register and the first source operand is double that of the second source operand.
Long	Indicated by the suffix <i>L</i> . The element width of the destination register is double that of both source operands.
Narrow	Indicated by the suffix <i>N</i> . The element width of the destination register is half that of both source operands.

In addition, each vector form of the instruction is part of a pair, with a second and upper half suffix of 2, to identify the variant of the instruction:

- Where a SIMD operation widens or lengthens a 64-bit vector to a 128-bit vector, the instruction provides a second part operation that can extract the source from the upper 64 bits of the source registers.

- Where a SIMD operation narrows a 128-bit vector to a 64-bit vector, the instruction provides a second-part operation that can pack the result of a second operation into the upper part of the same destination register.

———— **Note** —————

This is referred to as a *lane set specifier*.

C3.5.2 Floating-point move (register)

The Floating-point move (register) instructions copy a scalar floating-point value from one register to another register without performing any conversion.

Some of the Floating-point move (register) instructions overlap with the functionality provided by the Advanced SIMD instructions DUP, INS, and UMOV. However, ARM recommends using the FMOV instructions when operating on scalar floating-point data to avoid the creation of scalar floating-point code that depends on the availability of the Advanced SIMD instruction set.

Table C3-53 shows the Floating-point move (register) instructions.

Table C3-53 Floating-point move (register) instructions

Mnemonic	Instruction	See
FMOV	Floating-point move register without conversion	<i>FMOV (register)</i> on page C7-1224
	Floating-point move to or from general-purpose register without conversion	<i>FMOV (general)</i> on page C7-1226

C3.5.3 Floating-point move (immediate)

The Floating-point move (immediate) instructions convert a small constant immediate floating-point value into a half-precision, single-precision, or double-precision scalar floating-point value in a SIMD and floating-point register.

The floating-point constant can be specified either in decimal notation, such as 12.0 or -1.2e1, or as a string beginning with 0x followed by a hexadecimal representation of the IEEE 754 half-precision, single-precision, or double-precision encoding. ARM recommends that a disassembler uses the decimal notation, provided that this displays the value precisely.

———— **Note** —————

When ARMv8.2-FP16 is not implemented, the only half-precision instructions that are supported are floating-point conversions between half-precision, single-precision, and double-precision.

The floating-point value must be expressible as $(\pm n/16 \times 2^r)$, where n is an integer in the range $16 \leq n \leq 31$ and r is an integer in the range of $-3 \leq r \leq 4$, that is a normalized binary floating-point encoding with one sign bit, four bits of fraction, and a 3-bit exponent.

Table C3-54 shows the Floating-point move (immediate) instruction:

Table C3-54 Floating-point move (immediate) instruction

Mnemonic	Instruction	See
FMOV	Floating-point move immediate	<i>FMOV (scalar, immediate)</i> on page C7-1229

C3.5.4 Floating-point conversion

The following subsections describe the conversion of floating-point values:

- [Convert floating-point precision.](#)
- [Convert between floating-point and integer or fixed-point.](#)

Convert floating-point precision

These instructions convert a floating-point scalar with one precision to a floating-point scalar with a different precision, using the current rounding mode as specified by [FPCR.RMode](#).

[Table C3-55](#) shows the Floating-point precision conversion instruction.

Table C3-55 Floating-point precision conversion instruction

Mnemonic	Instruction	See
FCVT	Floating-point convert precision (scalar)	FCVT on page C7-1096

Convert between floating-point and integer or fixed-point

These instructions convert a floating-point scalar in a SIMD and floating-point register to or from a signed or unsigned integer or fixed-point value in a general-purpose register. For a fixed-point value, a final immediate operand indicates that the general-purpose register holds a fixed-point number and `fbits` indicates the number of bits after the binary point. `fbits` is in the range 1- 32 inclusive for a 32-bit general-purpose register name, and 1-64 inclusive for a 64-bit general-purpose register name.

These instructions can cause the following floating-point exceptions:

Invalid Operation

Occurs if the floating-point input is a NaN, infinity, or a numerical value that cannot be represented in the destination register. An out-of-range integer or fixed-point result is saturated to the size of the destination register.

Inexact

Occurs if the numeric result that differs from the input value.

Input Denormal

As [Flush-to-zero on page A1-51](#) describes, when Flush-to-zero mode is enabled, occurs when zero replaces a double-precision or single-precision denormal input.

———— Note —————

When ARMv8.2-FP16 is implemented, a half-precision denormal input that is flushed to zero does not generate an Input Denormal exception.

[Table C3-56](#) shows the Floating-point and fixed-point conversion instructions.

Table C3-56 Floating-point and integer or fixed-point conversion instructions

Mnemonic	Instruction	See
FCVTAS	Floating-point scalar convert to signed integer, rounding to nearest with ties to away (scalar form)	FCVTAS (scalar) on page C7-1101
FCVTAU	Floating-point scalar convert to unsigned integer, rounding to nearest with ties to away (scalar form)	FCVTAU (scalar) on page C7-1106
FCVTMS	Floating-point scalar convert to signed integer, rounding toward minus infinity (scalar form)	FCVTMS (scalar) on page C7-1113

Table C3-56 Floating-point and integer or fixed-point conversion instructions (continued)

Mnemonic	Instruction	See
FCVTMU	Floating-point scalar convert to unsigned integer, rounding toward minus infinity (scalar form)	<i>FCVTMU (scalar) on page C7-1118</i>
FCVTNS	Floating-point scalar convert to signed integer, rounding to nearest with ties to even (scalar form)	<i>FCVTNS (scalar) on page C7-1125</i>
FCVTNU	Floating-point scalar convert to unsigned integer, rounding to nearest with ties to even (scalar form)	<i>FCVTNU (scalar) on page C7-1130</i>
FCVTPS	Floating-point scalar convert to signed integer, rounding toward positive infinity (scalar form)	<i>FCVTPS (scalar) on page C7-1135</i>
FCVTPU	Floating-point scalar convert to unsigned integer, rounding toward positive infinity (scalar form)	<i>FCVTPU (scalar) on page C7-1140</i>
FCVTZS	Floating-point scalar convert to signed integer, rounding toward zero (scalar form)	<i>FCVTZS (scalar, integer) on page C7-1152</i>
	Floating-point convert to signed fixed-point, rounding toward zero (scalar form)	<i>FCVTZS (scalar, fixed-point) on page C7-1150</i>
FCVTZU	Floating-point scalar convert to unsigned integer, rounding toward zero (scalar form)	<i>FCVTZU (scalar, integer) on page C7-1162</i>
	Floating-point scalar convert to unsigned fixed-point, rounding toward zero (scalar form)	<i>FCVTZU (scalar, fixed-point) on page C7-1160</i>
SCVTF	Signed integer scalar convert to floating-point, using the current rounding mode (scalar form)	<i>SCVTF (vector, integer) on page C7-1440</i>
	Signed fixed-point convert to floating-point, using the current rounding mode (scalar form)	<i>SCVTF (scalar, fixed-point) on page C7-1443</i>
UCVTF	Unsigned integer scalar convert to floating-point, using the current rounding mode (scalar form)	<i>UCVTF (vector, integer) on page C7-1677</i>
	Unsigned fixed-point convert to floating-point, using the current rounding mode (scalar form)	<i>UCVTF (scalar, fixed-point) on page C7-1680</i>

C3.5.5 Floating-point round to integer

The Floating-point round to integer instructions round a floating-point value to an integer floating-point value of the same size.

For these instructions:

- A zero input gives a zero result with the same sign.
- An infinite input gives an infinite result with the same sign.
- A NaN is propagated as in normal floating-point arithmetic.

These instructions can cause the following floating-point exceptions:

Invalid Operation

Occurs in response to a floating-point input of a signaling NaN.

Inexact, FRINTX instruction only

Occurs if the result is numeric and does not have the same numerical value as the input.

Input Denormal

As *Flush-to-zero* on page A1-51 describes, when Flush-to-zero mode is enabled, occurs when zero replaces a double-precision or single-precision denormal input.

———— **Note** —————

When ARMv8.2-FP16 is implemented, a half-precision denormal input that is flushed to zero does not generate an Input Denormal exception.

Table C3-57 shows the Floating-point round to integer instructions.

Table C3-57 Floating-point round to integer instructions

Mnemonic	Instruction	See
FRINTA	Floating-point round to integer, to nearest with ties to away	<i>FRINTA (scalar)</i> on page C7-1268
FRINTI	Floating-point round to integer, using current rounding mode	<i>FRINTI (scalar)</i> on page C7-1272
FRINTM	Floating-point round to integer, toward minus infinity	<i>FRINTM (scalar)</i> on page C7-1276
FRINTN	Floating-point round to integer, to nearest with ties to even	<i>FRINTN (scalar)</i> on page C7-1280
FRINTP	Floating-point round to integer, toward positive infinity	<i>FRINTP (scalar)</i> on page C7-1284
FRINTX	Floating-point round to integer exact, using current rounding mode	<i>FRINTX (scalar)</i> on page C7-1288
FRINTZ	Floating-point round to integer, toward zero	<i>FRINTZ (scalar)</i> on page C7-1292

C3.5.6 Floating-point multiply-add

Table C3-58 shows the Floating-point multiply-add instructions that require three source register operands.

Table C3-58 Floating-point multiply-add instructions

Mnemonic	Instruction	See
FMADD	Floating-point scalar fused multiply-add	<i>FMADD</i> on page C7-1168
FMSUB	Floating-point scalar fused multiply-subtract	<i>FMSUB</i> on page C7-1231
FNMADD	Floating-point scalar negated fused multiply-add	<i>FNMADD</i> on page C7-1252
FNMSUB	Floating-point scalar negated fused multiply-subtract	<i>FNMSUB</i> on page C7-1254

C3.5.7 Floating-point arithmetic (one source)

Table C3-59 shows the Floating-point arithmetic instructions that require a single source register operand.

Table C3-59 Floating-point arithmetic instructions with one source register

Mnemonic	Instructions	See
FABS	Floating-point scalar absolute value	<i>FABS (scalar)</i> on page C7-1041
FNEG	Floating-point scalar negate	<i>FNEG (scalar)</i> on page C7-1250
FSQRT	Floating-point scalar square root	<i>FSQRT (scalar)</i> on page C7-1302

C3.5.8 Floating-point arithmetic (two sources)

Table C3-60 shows the Floating-point arithmetic instructions that require two source register operands.

Table C3-60 Floating-point arithmetic instructions with two source registers

Mnemonic	Instruction	See
FADD	Floating-point scalar add	<i>FADD (scalar)</i> on page C7-1053
FDIV	Floating-point scalar divide	<i>FDIV (scalar)</i> on page C7-1166
FMUL	Floating-point scalar multiply	<i>FMUL (scalar)</i> on page C7-1239
FNMUL	Floating-point scalar multiply-negate	<i>FNMUL (scalar)</i> on page C7-1256
FSUB	Floating-point scalar subtract	<i>FSUB (scalar)</i> on page C7-1306

C3.5.9 Floating-point minimum and maximum

The $\min(x, y)$ and $\max(x, y)$ operations return a quiet NaN when either x or y is NaN.

As described in *Flush-to-zero* on page A1-51, in flush-to-zero mode, denormal operands are flushed to zero before comparison, and if the result of the comparison is the flushed value, then a zero value is returned. Where both x and y are zero, or denormal values flushed to zero, with different signs, then $+0.0$ is returned by $\max()$ and -0.0 by $\min()$.

The $\minNum(x, y)$ and $\maxNum(x, y)$ operations follow the IEEE 754-2008 standard and return the numerical operand when one operand is numerical and the other a quiet NaN. Apart from this additional handling of a single quiet NaN the result is then identical to $\min(x, y)$ and $\max(x, y)$.

Table C3-61 shows the Floating-point instructions that can perform floating-point minimum and maximum operations.

Table C3-61 Floating-point minimum and maximum instructions

Mnemonic	Instruction	See
FMAX	Floating-point scalar maximum	<i>FMAX (scalar)</i> on page C7-1172
FMAXNM	Floating-point scalar maximum number	<i>FMAXNM (scalar)</i> on page C7-1176
FMIN	Floating-point scalar minimum	<i>FMIN (scalar)</i> on page C7-1192
FMINNM	Floating-point scalar minimum number	<i>FMINNM (scalar)</i> on page C7-1196

C3.5.10 Floating-point comparison

These instructions set the NZCV Condition flags in PSTATE, based on the result of a comparison of two operands. If the floating-point comparisons are *unordered*, where one or both operands are a form of NaN, the C and V bits are set to 1 and the N and Z bits are cleared to 0.

———— **Note** ————

The NZCV flags in the FPSR are associated with AArch32 state. The A64 floating-point comparison instructions do not change the Condition flags in the FPSR.

For the conditional Floating-point comparison instructions, if the condition is TRUE, the flags are updated to the result of the comparison, otherwise the flags are updated to the immediate value that is defined in the instruction encoding.

The quiet compare instructions generate an Invalid Operation floating-point exception if either of the source operands is a signaling NaN. The signaling compare instructions generate an Invalid Operation floating-point exception if either of the source operands is any type of NaN.

Table C3-62 shows the Floating-point comparison instructions.

Table C3-62 Floating-point comparison instructions

Mnemonic	Instruction	See
FCMP	Floating-point quiet compare	FCMP on page C7-1090
FCMPE	Floating-point signaling compare	FCMPE on page C7-1092
FCCMP	Floating-point conditional quiet compare	FCCMP on page C7-1059
FCCMPE	Floating-point conditional signaling compare	FCCMPE on page C7-1061

C3.5.11 Floating-point conditional select

Table C3-63 shows the Floating-point conditional select instructions.

Table C3-63 Floating-point conditional select instructions

Mnemonic	Instruction	See
FCSEL	Floating-point scalar conditional select	FCSEL on page C7-1094

C3.5.12 SIMD move

The functionality of some data movement instructions overlaps with that provided by the scalar floating-point FMOV instructions described in [Floating-point move \(register\) on page C3-190](#).

Table C3-64 shows the SIMD move instructions.

Table C3-64 SIMD move instructions

Mnemonic	Instruction	See
DUP	Duplicate vector element to vector or scalar	DUP (element) on page C7-1028
DUP	Duplicate general-purpose register to vector	DUP (general) on page C7-1031
INS ^a	Insert vector element from another vector element	INS (element) on page C7-1308
	Insert vector element from general-purpose register	INS (general) on page C7-1310
MOV	Move vector element to vector element	MOV (element) on page C7-1379
	Move general-purpose register to vector element	MOV (from general) on page C7-1381
	Move vector element to scalar	MOV (scalar) on page C7-1377
	Move vector element to general-purpose register	MOV (to general) on page C7-1384
UMOV	Unsigned move vector element to general-purpose register	UMOV on page C7-1710
SMOV	Signed move vector element to general-purpose register	SMOV on page C7-1492

a. Disassembles as MOV.

C3.5.13 SIMD arithmetic

Table C3-65 shows the SIMD arithmetic instructions.

Table C3-65 SIMD arithmetic instructions

Mnemonic	Instruction	See
ADD	Add (vector and scalar form)	<i>ADD (vector)</i> on page C7-981
AND	Bitwise AND (vector form)	<i>AND (vector)</i> on page C7-994
BIC	Bitwise bit clear (register) (vector form)	<i>BIC (vector, register)</i> on page C7-997
BIF	Bitwise insert if false (vector form)	<i>BIF</i> on page C7-998
BIT	Bitwise insert if true (vector form)	<i>BIT</i> on page C7-999
BSL	Bitwise select (vector form)	<i>BSL</i> on page C7-1000
EOR	Bitwise exclusive OR (vector form)	<i>EOR (vector)</i> on page C7-1033
FABD	Floating-point absolute difference (vector and scalar form)	<i>FABD</i> on page C7-1036
FADD	Floating-point add (vector form)	<i>FADD (scalar)</i> on page C7-1053
FDIV	Floating-point divide (vector form)	<i>FDIV (vector)</i> on page C7-1164
FMAX	Floating-point maximum (vector form)	<i>FMAXP (vector)</i> on page C7-1186
FMAXNM	Floating-point maximum number (vector form)	<i>FMAXNM (vector)</i> on page C7-1174
FMIN	Floating-point minimum (vector form)	<i>FMIN (vector)</i> on page C7-1190
FMINNM	Floating-point minimum number (vector form)	<i>FMINNM (vector)</i> on page C7-1194
FMLA	Floating-point fused multiply-add (vector form)	<i>FMLA (vector)</i> on page C7-1214
FMLS	Floating-point fused multiply-subtract (vector form)	<i>FMLS (vector)</i> on page C7-1220
FMUL	Floating-point multiply (vector form)	<i>FMUL (vector)</i> on page C7-1237
FMULX	Floating-point multiply extended (vector and scalar form)	<i>FMULX</i> on page C7-1245
FRECPS	Floating-point reciprocal step (vector and scalar form)	<i>FRECPS</i> on page C7-1261
FRSQRTS	Floating-point reciprocal square root step (vector and scalar form)	<i>FRSQRTS</i> on page C7-1297
FSUB	Floating-point subtract (vector form)	<i>FSUB (vector)</i> on page C7-1304
MLA	Multiply-add (vector form)	<i>MLA (vector)</i> on page C7-1371
MLS	Multiply-subtract (vector form)	<i>MLS (vector)</i> on page C7-1375
MUL	Multiply (vector form)	<i>MUL (vector)</i> on page C7-1390
MOV	Move vector register (vector form)	<i>MOV (vector)</i> on page C7-1383
ORN	Bitwise inclusive OR NOT (vector form)	<i>ORN (vector)</i> on page C7-1398
ORR	Bitwise inclusive OR (register) (vector form)	<i>ORR (vector, register)</i> on page C7-1401
PMUL	Polynomial multiply (vector form)	<i>PMUL</i> on page C7-1402
SABA	Signed absolute difference and accumulate (vector form)	<i>SABA</i> on page C7-1419
SABD	Signed absolute difference (vector form)	<i>SABD</i> on page C7-1423

Table C3-65 SIMD arithmetic instructions (continued)

Mnemonic	Instruction	See
SHADD	Signed halving add (vector form)	SHADD on page C7-1457
SHSUB	Signed halving subtract (vector form)	SHSUB on page C7-1465
SMAX	Signed maximum (vector form)	SMAX on page C7-1470
SMIN	Signed minimum (vector form)	SMIN on page C7-1476
SQADD	Signed saturating add (vector and scalar form)	SQADD on page C7-1500
SQDMULH	Signed saturating doubling multiply returning high half (vector and scalar form)	SQDMULH (vector) on page C7-1519
SQRSHL	Signed saturating rounding shift left (register) (vector and scalar form)	SQRSHL on page C7-1544
SQRDMLAH	Signed saturating rounding doubling multiply accumulate returning high half	SQRDMLAH (vector) on page C7-1532
SQRDMLSH	Signed saturating rounding doubling multiply subtract returning high half	SQRDMLSH (vector) on page C7-1537
SQRDMULH	Signed saturating rounding doubling multiply returning high half (vector and scalar form)	SQRDMULH (vector) on page C7-1542
SQSHL	Signed saturating shift left (register) (vector and scalar form)	SQSHL (register) on page C7-1555
SQSUB	Signed saturating subtract (vector and scalar form)	SQSUB on page C7-1566
SRHADD	Signed rounding halving add (vector form)	SRHADD on page C7-1574
SRSHL	Signed rounding shift left (register) (vector and scalar form)	SRSHL on page C7-1579
SSHL	Signed shift left (register) (vector and scalar form)	SSHL on page C7-1585
SUB	Subtract (vector and scalar form)	SUB (vector) on page C7-1640
UABA	Unsigned absolute difference and accumulate (vector form)	UABA on page C7-1656
UABD	Unsigned absolute difference (vector form)	UABD on page C7-1660
UHADD	Unsigned halving add (vector form)	UHADD on page C7-1684
UHSUB	Unsigned halving subtract (vector form)	UHSUB on page C7-1686
UMAX	Unsigned maximum (vector form)	UMAX on page C7-1688
UMIN	Unsigned minimum (vector form)	UMIN on page C7-1694
UQADD	Unsigned saturating add (vector and scalar form)	UQADD on page C7-1716
UQRSHL	Unsigned saturating rounding shift left (register) (vector and scalar form)	UQRSHL on page C7-1718
UQSHL	Unsigned saturating shift left (register) (vector and scalar form)	UQSHL (register) on page C7-1726
UQSUB	Unsigned saturating subtract (vector and scalar form)	UQSUB on page C7-1731
URHADD	Unsigned rounding halving add (vector form)	URHADD on page C7-1737
URSHL	Unsigned rounding shift left (register) (vector and scalar form)	URSHL on page C7-1739
USHL	Unsigned shift left (register) (vector and scalar form)	USHL on page C7-1746

C3.5.14 SIMD compare

The SIMD compare instructions compare vector or scalar elements according to the specified condition and set the destination vector element to all ones if the condition holds, or to zero if the condition does not hold.

———— **Note** —————

Some of the comparisons, such as LS, LE, LO, and LT, can be made by reversing the operands and using the opposite comparison, HS, GE, HI, or GT.

Table C3-66 shows that SIMD compare instructions.

Table C3-66 SIMD compare instructions

Mnemonic	Instruction	See
CMEQ	Compare bitwise equal (vector and scalar form)	CMEQ (register) on page C7-1005
	Compare bitwise equal to zero (vector and scalar form)	CMEQ (zero) on page C7-1007
CMHS	Compare unsigned higher or same (vector and scalar form)	CMHS (register) on page C7-1019
CMGE	Compare signed greater than or equal (vector and scalar form)	CMGE (register) on page C7-1009
	Compare signed greater than or equal to zero (vector and scalar form)	CMGE (zero) on page C7-1011
CMHI	Compare unsigned higher (vector and scalar form)	CMHI (register) on page C7-1017
CMGT	Compare signed greater than (vector and scalar form)	CMGT (register) on page C7-1013
	Compare signed greater than zero (vector and scalar form)	CMGT (zero) on page C7-1015
CMLE	Compare signed less than or equal to zero (vector and scalar form)	CMLE (zero) on page C7-1021
CMLT	Compare signed less than zero (vector and scalar form)	CMLT (zero) on page C7-1023
CMTST	Compare bitwise test bits nonzero (vector and scalar form)	CMTST on page C7-1025
FCMEQ	Floating-point compare equal (vector and scalar form)	FCMEQ (register) on page C7-1063
	Floating-point compare equal to zero (vector and scalar form)	FCMEQ (zero) on page C7-1067
FCMGE	Floating-point compare greater than or equal (vector and scalar form)	FCMGE (register) on page C7-1070
	Floating-point compare greater than or equal to zero (vector and scalar form)	FCMGE (zero) on page C7-1074
FCMGT	Floating-point compare greater than (vector and scalar form)	FCMGT (register) on page C7-1077
	Floating-point compare greater than zero (vector and scalar form)	FCMGT (zero) on page C7-1081
FCMLE	Floating-point compare less than or equal to zero (vector and scalar form)	FCMLE (zero) on page C7-1084
FCMLT	Floating-point compare less than zero (vector and scalar form)	FCMLT (zero) on page C7-1087
FACGE	Floating-point absolute compare greater than or equal (vector and scalar form)	FACGE on page C7-1043
FACGT	Floating-point absolute compare greater than (vector and scalar form)	FACGT on page C7-1047

C3.5.15 SIMD widening and narrowing arithmetic

For information about the variants of these instructions, see *Common features of SIMD instructions* on page C3-189.

Table C3-67 shows the SIMD widening and narrowing arithmetic instructions.

Table C3-67 SIMD widening and narrowing arithmetic instructions

Mnemonic	Instruction	See
ADDHN, ADDHN2	Add returning high, narrow (vector form)	<i>ADDHN, ADDHN2</i> on page C7-983
PMULL, PMULL2	Polynomial multiply long (vector form)	<i>PMULL, PMULL2</i> on page C7-1404 See also <i>The Cryptographic Extension</i> on page C3-207
RADDHN, RADDHN2	Rounding add returning high, narrow (vector form)	<i>RADDHN, RADDHN2</i> on page C7-1406
RSUBHN, RSUBHN2	Rounding subtract returning high, narrow (vector form)	<i>RSUBHN, RSUBHN2</i> on page C7-1417
SABAL, SABAL2	Signed absolute difference and accumulate long (vector form)	<i>SABAL, SABAL2</i> on page C7-1421
SABDL, SABDL2	Signed absolute difference long (vector form)	<i>SABDL, SABDL2</i> on page C7-1425
SADDL, SADDL2	Signed add long (vector form)	<i>SADDL, SADDL2</i> on page C7-1429
SADDW, SADDW2	Signed add wide (vector form)	<i>SADDW, SADDW2</i> on page C7-1435
SMLAL, SMLAL2	Signed multiply-add long (vector form)	<i>SMLAL, SMLAL2 (vector)</i> on page C7-1485
SMLS, SMLS2	Signed multiply-subtract long (vector form)	<i>SMLS, SMLS2 (vector)</i> on page C7-1490
SMULL, SMULL2	Signed multiply long (vector form)	<i>SMULL, SMULL2 (vector)</i> on page C7-1496
SQDMLAL, SQDMLAL2	Signed saturating doubling multiply-add long (vector and scalar form)	<i>SQDMLAL, SQDMLAL2 (vector)</i> on page C7-1506
SQDMLS, SQDMLS2	Signed saturating doubling multiply-subtract long (vector and scalar form)	<i>SQDMLS, SQDMLS2 (vector)</i> on page C7-1513
SQDMULL, SQDMULL2	Signed saturating doubling multiply long (vector and scalar form)	<i>SQDMULL, SQDMULL2 (vector)</i> on page C7-1524
SSUBL, SSUBL2	Signed subtract long (vector form)	<i>SSUBL, SSUBL2</i> on page C7-1593
SSUBW, SSUBW2	Signed subtract wide (vector form)	<i>SSUBW, SSUBW2</i> on page C7-1595
SUBHN, SUBHN2	Subtract returning high, narrow (vector form)	<i>SUBHN, SUBHN2</i> on page C7-1642
UABAL, UABAL2	Unsigned absolute difference and accumulate long (vector form)	<i>UABAL, UABAL2</i> on page C7-1658
UABDL, UABDL2	Unsigned absolute difference long (vector form)	<i>UABDL, UABDL2</i> on page C7-1662
UADDL, UADDL2	Unsigned add long (vector form)	<i>UADDL, UADDL2</i> on page C7-1666
UADDW, UADDW2	Unsigned add wide (vector form)	<i>UADDW, UADDW2</i> on page C7-1672
UMLAL, UMLAL2	Unsigned multiply-add long (vector form)	<i>UMLAL, UMLAL2 (vector)</i> on page C7-1703
UMLS, UMLS2	Unsigned multiply-subtract long (vector form)	<i>UMLS, UMLS2 (vector)</i> on page C7-1708

Table C3-67 SIMD widening and narrowing arithmetic instructions (continued)

Mnemonic	Instruction	See
UMULL, UMULL2	Unsigned multiply long (vector form)	UMULL, UMULL2 (vector) on page C7-1714
USUBL, USUBL2	Unsigned subtract long (vector form)	USUBL, USUBL2 on page C7-1756
USUBW, USUBW2	Unsigned subtract wide (vector form)	USUBW, USUBW2 on page C7-1758

C3.5.16 SIMD unary arithmetic

For information about the variants of these instructions, see [Common features of SIMD instructions on page C3-189](#).

[Table C3-68](#) shows the SIMD unary arithmetic instructions.

Table C3-68 SIMD unary arithmetic instructions

Mnemonic	Instruction	See
ABS	Absolute value (vector and scalar form)	ABS on page C7-979
CLS	Count leading sign bits (vector form)	CLS (vector) on page C7-1001
CLZ	Count leading zero bits (vector form)	CLZ (vector) on page C7-1003
CNT	Population count per byte (vector form)	CNT on page C7-1027
FABS	Floating-point absolute (vector form)	FABS (vector) on page C7-1039
FCVTL, FCVTL2	Floating-point convert to higher precision long (vector form)	FCVTL, FCVTL2 on page C7-1108
FCVTN, FCVTN2	Floating-point convert to lower precision narrow (vector form)	FCVTN, FCVTN2 on page C7-1120
FCVTXN, FCVTXN2	Floating-point convert to lower precision narrow, rounding to odd (vector and scalar form)	FCVTXN, FCVTXN2 on page C7-1142
FNEG	Floating-point negate (vector form)	FNEG (vector) on page C7-1248
FRECPE	Floating-point reciprocal estimate (vector and scalar form)	FRECPE on page C7-1258
FRECPX	Floating-point reciprocal square root (scalar form)	FRECPX on page C7-1264
FRINTA	Floating-point round to integer, to nearest with ties to away (vector form)	FRINTA (scalar) on page C7-1268
FRINTI	Floating-point round to integer, using current rounding mode (vector form)	FRINTI (vector) on page C7-1270
FRINTM	Floating-point round to integer, toward minus infinity (vector form)	FRINTM (vector) on page C7-1274
FRINTN	Floating-point round to integer, to nearest with ties to even (vector form)	FRINTN (vector) on page C7-1278
FRINTP	Floating-point round to integer, toward positive infinity (vector form)	FRINTP (vector) on page C7-1282
FRINTX	Floating-point round to integer exact, using current rounding mode (vector form)	FRINTX (vector) on page C7-1286
FRINTZ	Floating-point round to integer, toward zero (vector form)	FRINTZ (vector) on page C7-1290
FRSQRT	Floating-point reciprocal square root estimate (vector and scalar form)	FRSQRT on page C7-1294
FSQRT	Floating-point square root (vector form)	FSQRT (vector) on page C7-1300

Table C3-68 SIMD unary arithmetic instructions (continued)

Mnemonic	Instruction	See
MVN	Bitwise NOT (vector form)	MVN on page C7-1392
NEG	Negate (vector and scalar form)	NEG (vector) on page C7-1395
NOT	Bitwise NOT (vector form)	NOT on page C7-1397
RBIT	Bitwise reverse (vector form)	RBIT (vector) on page C7-1408
REV16	Reverse elements in 16-bit halfwords (vector form)	REV16 (vector) on page C7-1409
REV32	Reverse elements in 32-bit words (vector form)	REV32 (vector) on page C7-1411
REV64	Reverse elements in 64-bit doublewords (vector form)	REV64 on page C7-1413
SADALP	Signed add and accumulate long pairwise (vector form)	SADALP on page C7-1427
SADDLP	Signed add long pairwise (vector form)	SADDLP on page C7-1431
SQABS	Signed saturating absolute value (vector and scalar form)	SQABS on page C7-1498
SQNEG	Signed saturating negate (vector and scalar form)	SQNEG on page C7-1527
SQXTN, SQXTN2	Signed saturating extract narrow (vector form)	SQXTN, SQXTN2 on page C7-1568
SQXTUN, SQXTUN2	Signed saturating extract unsigned narrow (vector and scalar form)	SQXTUN, SQXTUN2 on page C7-1571
SUQADD	Signed saturating accumulate of unsigned value (vector and scalar form)	SUQADD on page C7-1644
SXTL, SXTL2	Signed extend long	SXTL, SXTL2 on page C7-1646
UADALP	Unsigned add and accumulate long pairwise (vector form)	UADALP on page C7-1664
UADDLP	Unsigned add long pairwise (vector form)	UADDLP on page C7-1668
UQXTN, UQXTN2	Unsigned saturating extract narrow (vector form)	UQXTN, UQXTN2 on page C7-1733
URECPE	Unsigned reciprocal estimate (vector form)	URECPE on page C7-1736
URSQRTE	Unsigned reciprocal square root estimate (vector form)	URSQRTE on page C7-1743
USQADD	Unsigned saturating accumulate of signed value (vector and scalar form)	USQADD on page C7-1752
UXTL, UXTL2	Unsigned extend long	UXTL, UXTL2 on page C7-1760
XTN, XTN2	Extract narrow (vector form)	XTN, XTN2 on page C7-1766

C3.5.17 SIMD by element arithmetic

For information about the variants of these instructions, see *Common features of SIMD instructions* on page C3-189.

Table C3-69 shows the SIMD by element arithmetic instructions.

Table C3-69 SIMD by element arithmetic instructions

Mnemonic	Instruction	See
FMLA	Floating-point fused multiply-add (vector and scalar form)	<i>FMLA</i> (by element) on page C7-1210
FMLS	Floating-point fused multiply-subtract (vector and scalar form)	<i>FMLS</i> (by element) on page C7-1216.
FMUL	Floating-point multiply (vector and scalar form)	<i>FMUL</i> (by element) on page C7-1233
FMULX	Floating-point multiply extended (vector and scalar form)	<i>FMULX</i> (by element) on page C7-1241
MLA	Multiply-add (vector form)	<i>MLA</i> (by element) on page C7-1369
MLS	Multiply-subtract (vector form)	<i>MLS</i> (by element) on page C7-1373
MUL	Multiply (vector form)	<i>MUL</i> (by element) on page C7-1388
SMLAL, SMLAL2	Signed multiply-add long (vector form)	<i>SMLAL, SMLAL2</i> (by element) on page C7-1482
SMLSL, SMLSL2	Signed multiply-subtract long (vector form)	<i>SMLSL, SMLSL2</i> (by element) on page C7-1487
SMULL, SMULL2	Signed multiply long (vector form)	<i>SMULL, SMULL2</i> (by element) on page C7-1494
SQDMLAL, SQDMLAL2	Signed saturating doubling multiply-add long (vector and scalar form)	<i>SQDMLAL, SQDMLAL2</i> (by element) on page C7-1502
SQDMLSL, SQDMLSL2	Signed saturating doubling multiply-subtract long (vector form)	<i>SQDMLSL, SQDMLSL2</i> (by element) on page C7-1509
SQDMULH	Signed saturating doubling multiply returning high half (vector and scalar form)	<i>SQDMULH</i> (by element) on page C7-1516
SQDMULL, SQDMULL2	Signed saturating doubling multiply long (vector and scalar form)	<i>SQDMULL, SQDMULL2</i> (by element) on page C7-1521
SQRDMLAH	Signed saturating rounding doubling multiply accumulate returning high half	<i>SQRDMLSH</i> (by element) on page C7-1534
SQRDMLSH	Signed saturating rounding doubling multiply subtract returning high half	<i>SQRDMLSH</i> (vector) on page C7-1537
SQRDMULH	Signed saturating rounding doubling multiply returning high half (vector and scalar form)	<i>SQRDMULH</i> (by element) on page C7-1539
UMLAL, UMLAL2	Unsigned multiply-add long (vector form)	<i>UMLAL, UMLAL2</i> (by element) on page C7-1700
UMLSL, UMLSL2	Unsigned multiply-subtract long (vector form)	<i>UMLSL, UMLSL2</i> (by element) on page C7-1705
UMULL, UMULL2	Unsigned multiply long (vector form)	<i>UMULL, UMULL2</i> (by element) on page C7-1712

C3.5.18 SIMD permute

Table C3-70 shows the SIMD permute instructions.

Table C3-70 SIMD permute instructions

Mnemonic	Instruction	See
EXT	Extract vector from a pair of vectors	<i>EXT</i> on page C7-1034
TRN1	Transpose vectors (primary)	<i>TRN1</i> on page C7-1652
TRN2	Transpose vectors (secondary)	<i>TRN2</i> on page C7-1654
UZP1	Unzip vectors (primary)	<i>UZP1</i> on page C7-1762
UZP2	Unzip vectors (secondary)	<i>UZP2</i> on page C7-1764
ZIP1	Zip vectors (primary)	<i>ZIP1</i> on page C7-1768
ZIP2	Zip vectors (secondary)	<i>ZIP2</i> on page C7-1770

C3.5.19 SIMD immediate

Table C3-71 shows the SIMD immediate instructions.

Table C3-71 SIMD immediate instructions

Mnemonic	Instruction	See
BIC	Bitwise bit clear immediate	<i>BIC (vector, immediate)</i> on page C7-995
FMOV	Floating-point move immediate	<i>FMOV (vector, immediate)</i> on page C7-1222
MOVI	Move immediate	<i>MOVI</i> on page C7-1385
MVNI	Move inverted immediate	<i>MVNI</i> on page C7-1393
ORR	Bitwise inclusive OR immediate	<i>ORR (vector, immediate)</i> on page C7-1399

C3.5.20 SIMD shift (immediate)

For information about the variants of these instructions, see *Common features of SIMD instructions* on page C3-189.

Table C3-72 shows the SIMD shift immediate instructions.

Table C3-72 SIMD shift (immediate) instructions

Mnemonic	Instruction	See
RSHRN, RSHRN2	Rounding shift right narrow immediate (vector form)	<i>RSHRN, RSHRN2</i> on page C7-1415
SHL	Shift left immediate (vector and scalar form)	<i>SHL</i> on page C7-1459
SHLL, SHLL2	Shift left long (by element size) (vector form)	<i>SHLL, SHLL2</i> on page C7-1461
SHRN, SHR2	Shift right narrow immediate (vector form)	<i>SHRN, SHR2</i> on page C7-1463
SLI	Shift left and insert immediate (vector and scalar form)	<i>SLI</i> on page C7-1467
SQRSHRN, SQRSHRN2	Signed saturating rounded shift right narrow immediate (vector and scalar form)	<i>SQRSHRN, SQRSHRN2</i> on page C7-1546

Table C3-72 SIMD shift (immediate) instructions (continued)

Mnemonic	Instruction	See
SQRSHRUN, SQRSHRUN2	Signed saturating shift right unsigned narrow immediate (vector and scalar form)	SQRSHRUN, SQRSHRUN2 on page C7-1549
SQSHL	Signed saturating shift left immediate (vector and scalar form)	SQSHL (immediate) on page C7-1552
SQSHLU	Signed saturating shift left unsigned immediate (vector and scalar form)	SQSHLU on page C7-1557
SQSHRN, SQSHRN2	Signed saturating shift right narrow immediate (vector and scalar form)	SQSHRN, SQSHRN2 on page C7-1560
SQSHRUN, SQSHRUN2	Signed saturating shift right unsigned narrow immediate (vector and scalar form)	SQSHRUN, SQSHRUN2 on page C7-1563
SRI	Shift right and insert immediate (vector and scalar form)	SRI on page C7-1576
SRSHR	Signed rounding shift right immediate (vector and scalar form)	SRSHR on page C7-1581
SRSRA	Signed rounding shift right and accumulate immediate (vector and scalar form)	SRSRA on page C7-1583.
SSHLL, SSHLL2	Signed shift left long immediate (vector form)	SSHLL, SSHLL2 on page C7-1587
SSHR	Signed shift right immediate (vector and scalar form)	SSHR on page C7-1589
SSRA	Signed integer shift right and accumulate immediate (vector and scalar form)	SSRA on page C7-1591
SXTL, SXTL2	Signed integer extend (vector only)	SXTL, SXTL2 on page C7-1646
UQRSHRN, UQRSHRN2	Unsigned saturating rounded shift right narrow immediate (vector and scalar form)	UQRSHRN, UQRSHRN2 on page C7-1720
UQSHL	Unsigned saturating shift left immediate (vector and scalar form)	UQSHL (immediate) on page C7-1723
UQSHRN, UQSHRN2	Unsigned saturating shift right narrow immediate (vector and scalar form)	UQSHRN, UQSHRN2 on page C7-1728
URSHR	Unsigned rounding shift right immediate (vector and scalar form)	URSHR on page C7-1741
URSRA	Unsigned integer rounding shift right and accumulate immediate (vector and scalar form)	URSRA on page C7-1744
USHLL, USHLL2	Unsigned shift left long immediate (vector form)	USHLL, USHLL2 on page C7-1748
USHR	Unsigned shift right immediate (vector and scalar form)	USHR on page C7-1750
USRA	Unsigned shift right and accumulate immediate (vector and scalar form)	USRA on page C7-1754
UXTL, UXTL2	Unsigned integer extend (vector only)	UXTL, UXTL2 on page C7-1760

C3.5.21 SIMD floating-point and integer conversion

The SIMD floating-point and integer conversion instructions generate the Invalid Operation floating-point exception in response to a floating-point input of NaN, infinity, or a numerical value that cannot be represented within the destination register. An out-of-range integer or a fixed-point result is saturated to the size of the destination register. A numeric result that differs from the input raises the Inexact floating-point exception.

Table C3-73 shows the SIMD floating-point and integer conversion instructions.

Table C3-73 SIMD floating-point and integer conversion instructions

Mnemonic	Instruction	See
FCVTAS	Floating-point convert to signed integer, rounding to nearest with ties to away (vector and scalar form)	FCVTAS (vector) on page C7-1098
FCVTAU	Floating-point convert to unsigned integer, rounding to nearest with ties to away (vector and scalar form)	FCVTAU (vector) on page C7-1103
FCVTMS	Floating-point convert to signed integer, rounding toward minus infinity (vector and scalar form)	FCVTMS (vector) on page C7-1110
FCVTMU	Floating-point convert to unsigned integer, rounding toward minus infinity (vector and scalar form)	FCVTMU (vector) on page C7-1115
FCVTNS	Floating-point convert to signed integer, rounding to nearest with ties to even (vector and scalar form)	FCVTNS (vector) on page C7-1122
FCVTNU	Floating-point convert to unsigned integer, rounding to nearest with ties to even (vector and scalar form)	FCVTNU (vector) on page C7-1127
FCVTPS	Floating-point convert to signed integer, rounding toward positive infinity (vector and scalar form)	FCVTPS (vector) on page C7-1132
FCVTPU	Floating-point convert to unsigned integer, rounding toward positive infinity (vector and scalar form)	FCVTPU (vector) on page C7-1137
FCVTZS	Floating-point convert to signed integer, rounding toward zero (vector and scalar form)	FCVTZS (vector, integer) on page C7-1147
	Floating-point convert to signed fixed-point, rounding toward zero (vector and scalar form)	FCVTZS (vector, fixed-point) on page C7-1144
FCVTZU	Floating-point convert to unsigned integer, rounding toward zero (vector and scalar form)	FCVTZU (vector, integer) on page C7-1157
	Floating-point convert to unsigned fixed-point, rounding toward zero, (vector and scalar form)	FCVTZU (vector, fixed-point) on page C7-1154
SCVTF	Signed integer convert to floating-point (vector and scalar form)	SCVTF (vector, integer) on page C7-1440
	Signed fixed-point convert to floating-point (vector and scalar form)	SCVTF (vector, fixed-point) on page C7-1437
UCVTF	Unsigned integer convert to floating-point (vector and scalar form)	UCVTF (vector, integer) on page C7-1677
	Unsigned fixed-point convert to floating-point (vector and scalar form)	UCVTF (vector, fixed-point) on page C7-1674

C3.5.22 SIMD reduce (across vector lanes)

The SIMD reduce (across vector lanes) instructions perform arithmetic operations horizontally, that is across all lanes of the input vector. They deliver a single scalar result.

Table C3-74 shows the SIMD reduce (across vector lanes) instructions.

Table C3-74 SIMD reduce (across vector lanes) instructions

Mnemonic	Instruction	See
ADDV	Add (across vector)	ADDV on page C7-988
FMAXNMV	Floating-point maximum number (across vector)	FMAXNMV on page C7-1182
FMAXV	Floating-point maximum (across vector)	FMAXV on page C7-1188
FMINNMV	Floating-point minimum number (across vector)	FMINNMV on page C7-1202
FMINV	Floating-point minimum (across vector)	FMINV on page C7-1208
SADDLV	Signed add long (across vector)	SADDLV on page C7-1433
SMAXV	Signed maximum (across vector)	SMAXV on page C7-1474
SMINV	Signed minimum (across vector)	SMINV on page C7-1480
UADDLV	Unsigned add long (across vector)	UADDLV on page C7-1670
UMAXV	Unsigned maximum (across vector)	UMAXV on page C7-1692
UMINV	Unsigned minimum (across vector)	UMINV on page C7-1698

C3.5.23 SIMD pairwise arithmetic

The SIMD pairwise arithmetic instructions perform operations on pairs of adjacent elements and deliver a vector result.

Table C3-75 shows the SIMD pairwise arithmetic instructions.

Table C3-75 SIMD pairwise arithmetic instructions

Mnemonic	Instruction	See
ADDP	Add pairwise (vector and scalar form)	ADDP (vector) on page C7-986 ADDP (scalar) on page C7-985
FADDP	Floating-point add pairwise (vector and scalar form)	FADDP (vector) on page C7-1057 FADDP (scalar) on page C7-1055
FMAXNMP	Floating-point maximum number pairwise (vector and scalar form)	FMAXNMP (vector) on page C7-1180 FMAXNMP (scalar) on page C7-1178
FMAXP	Floating-point maximum pairwise (vector and scalar form)	FMAXP (vector) on page C7-1186 FMAXP (scalar) on page C7-1184
FMINNMP	Floating-point minimum number pairwise (vector and scalar form)	FMINNMP (vector) on page C7-1200 FMINNMP (scalar) on page C7-1198

Table C3-75 SIMD pairwise arithmetic instructions (continued)

Mnemonic	Instruction	See
FMINP	Floating-point minimum pairwise (vector and scalar form)	FMINP (vector) on page C7-1206 FMINP (scalar) on page C7-1204
SMAXP	Signed maximum pairwise	SMAXP on page C7-1472
SMINP	Signed minimum pairwise	SMINP on page C7-1478
UMAXP	Unsigned maximum pairwise	UMAXP on page C7-1690
UMINP	Unsigned minimum pairwise	UMINP on page C7-1696

C3.5.24 SIMD table lookup

Table C3-76 shows the SIMD table lookup instructions.

Table C3-76 SIMD table lookup instructions

Mnemonic	Instruction	See
TBL	Table vector lookup	TBL on page C7-1648
TBX	Table vector lookup extension	TBX on page C7-1650

C3.5.25 The Cryptographic Extension

The instructions provided by the optional Cryptographic Extension share the SIMD and floating-point register file. For more information, see:

- [Announcing the Advanced Encryption Standard.](#)
- [The Galois/Counter Mode of Operation.](#)
- [Announcing the Secure Hash Standard.](#)

Table C3-77 shows the Cryptographic Extension instructions.

Table C3-77 Cryptographic Extension instructions

Mnemonic	Instruction	See
AESD	AES single round decryption	AESD on page C7-990
AESE	AES single round encryption	AESE on page C7-991
AESIMC	AES inverse mix columns	AESIMC on page C7-992
AESMC	AES mix columns	AESMC on page C7-993
PMULL	Polynomial multiply long	PMULL, PMULL2 on page C7-1404
SHA1C	SHA1 hash update (choose)	SHA1C on page C7-1447
SHA1H	SHA1 fixed rotate	SHA1H on page C7-1448
SHA1M	SHA1 hash update (majority)	SHA1M on page C7-1449
SHA1P	SHA1 hash update (parity)	SHA1P on page C7-1450
SHA1SU0	SHA1 schedule update 0	SHA1SU0 on page C7-1451
SHA1SU1	SHA1 schedule update 1	SHA1SU1 on page C7-1452

Table C3-77 Cryptographic Extension instructions (continued)

Mnemonic	Instruction	See
SHA256H	SHA256 hash update (part 1)	SHA256H on page C7-1454
SHA256H2	SHA256 hash update (part 2)	SHA256H2 on page C7-1453
SHA256SU0	SHA256 schedule update 0	SHA256SU0 on page C7-1455
SHA256SU1	SHA256 schedule update 1	SHA256SU1 on page C7-1456

Chapter C4

A64 Instruction Set Encoding

This chapter describes the encoding of the A64 instruction set. It contains the following section:

- [A64 instruction set encoding on page C4-210.](#)

In this chapter:

- In the decode tables, an entry of - for a field value means the value of the field does not affect the decoding.
- In the decode diagrams, a shaded field indicates that the bits in that field are not used in that level of decode.

C4.1 A64 instruction set encoding

The A64 instruction encoding is:



Table C4-1 Main encoding table for the A64 instruction set

Decode fields	Decode group or instruction page
op0	
00xx	Unallocated.
100x	<i>Data Processing -- Immediate</i>
101x	<i>Branches, Exception Generating and System instructions on page C4-214</i>
x1x0	<i>Loads and Stores on page C4-219</i>
x101	<i>Data Processing -- Register on page C4-253</i>
x111	<i>Data Processing -- Scalar Floating-Point and Advanced SIMD on page C4-261</i>

C4.1.1 Data Processing -- Immediate

This section describes the encoding of the Data Processing -- Immediate group. This section is decoded from *A64 instruction set encoding*.



Table C4-2 Encoding table for the Data Processing -- Immediate group

Decode fields	Decode group or instruction page
op0	
00x	<i>PC-rel. addressing</i>
01x	<i>Add/subtract (immediate) on page C4-211</i>
100	<i>Logical (immediate) on page C4-211</i>
101	<i>Move wide (immediate) on page C4-212</i>
110	<i>Bitfield on page C4-213</i>
111	<i>Extract on page C4-213</i>

PC-rel. addressing

This section describes the encoding of the PC-rel. addressing instruction class. This section is decoded from *Data Processing -- Immediate*.

31	30	29	28	27	26	25	24	23						5	4		0	
op				immlo 1 0 0 0 0				immhi									Rd	

Decode fields**Instruction page****op**

0	ADR
1	ADRP

Add/subtract (immediate)

This section describes the encoding of the Add/subtract (immediate) instruction class. This section is decoded from *Data Processing -- Immediate* on page C4-210.

31	30	29	28	27	26	25	24	23	22	21						10	9		5	4		0
sf		op		S		1 0 0 0 1		shift		imm12									Rn		Rd	

Decode fields**Instruction page****sf op S shift**

-	-	-	1x	Unallocated.
0	0	0	-	ADD (immediate) - 32-bit variant on page C6-525
0	0	1	-	ADDS (immediate) - 32-bit variant on page C6-531
0	1	0	-	SUB (immediate) - 32-bit variant on page C6-930
0	1	1	-	SUBS (immediate) - 32-bit variant on page C6-936
1	0	0	-	ADD (immediate) - 64-bit variant on page C6-525
1	0	1	-	ADDS (immediate) - 64-bit variant on page C6-531
1	1	0	-	SUB (immediate) - 64-bit variant on page C6-930
1	1	1	-	SUBS (immediate) - 64-bit variant on page C6-936

Logical (immediate)

This section describes the encoding of the Logical (immediate) instruction class. This section is decoded from *Data Processing -- Immediate* on page C4-210.

31	30	29	28	27	26	25	24	23	22	21	16	15	10	9	5	4	0
sf	opc	1	0	0	1	0	0	N	immr	imms	Rn	Rd					

Decode fields			Instruction page
sf	opc	N	
0	-	1	Unallocated.
0	00	0	AND (immediate) - 32-bit variant on page C6-537
0	01	0	ORR (immediate) - 32-bit variant on page C6-790
0	10	0	EOR (immediate) - 32-bit variant on page C6-619
0	11	0	ANDS (immediate) - 32-bit variant on page C6-540
1	00	-	AND (immediate) - 64-bit variant on page C6-537
1	01	-	ORR (immediate) - 64-bit variant on page C6-790
1	10	-	EOR (immediate) - 64-bit variant on page C6-619
1	11	-	ANDS (immediate) - 64-bit variant on page C6-540

Move wide (immediate)

This section describes the encoding of the Move wide (immediate) instruction class. This section is decoded from [Data Processing -- Immediate on page C4-210](#).

31	30	29	28	27	26	25	24	23	22	21	20	5	4	0
sf	opc	1	0	0	1	0	1	hw	imm16	Rd				

Decode fields			Instruction page
sf	opc	hw	
-	01	-	Unallocated.
0	-	1x	Unallocated.
0	00	-	MOVN - 32-bit variant on page C6-768
0	10	-	MOVZ - 32-bit variant on page C6-770
0	11	-	MOVK - 32-bit variant on page C6-767
1	00	-	MOVN - 64-bit variant on page C6-768
1	10	-	MOVZ - 64-bit variant on page C6-770
1	11	-	MOVK - 64-bit variant on page C6-767

Bitfield

This section describes the encoding of the Bitfield instruction class. This section is decoded from *Data Processing -- Immediate* on page C4-210.

31	30	29	28	27	26	25	24	23	22	21	16	15	10	9	5	4	0
sf	opc	1	0	0	1	1	0	N	immr	imms	Rn	Rd					

Decode fields

Decode fields			Instruction page
sf	opc	N	
-	11	-	Unallocated.
0	-	1	Unallocated.
0	00	0	SBFM - 32-bit variant on page C6-820
0	01	0	BFM - 32-bit variant on page C6-553
0	10	0	UBFM - 32-bit variant on page C6-960
1	-	0	Unallocated.
1	00	1	SBFM - 64-bit variant on page C6-820
1	01	1	BFM - 64-bit variant on page C6-553
1	10	1	UBFM - 64-bit variant on page C6-960

Extract

This section describes the encoding of the Extract instruction class. This section is decoded from *Data Processing -- Immediate* on page C4-210.

31	30	29	28	27	26	25	24	23	22	21	20	16	15	10	9	5	4	0
sf	op21	1	0	0	1	1	1	N	o0	Rm	imms	Rn	Rd					

Decode fields

Decode fields					Instruction page
sf	op21	N	o0	imms	
-	x1	-	-	-	Unallocated.
-	00	-	1	-	Unallocated.
-	1x	-	-	-	Unallocated.
0	-	-	-	1xxxxx	Unallocated.
0	-	1	-	-	Unallocated.
0	00	0	0	0xxxxx	EXTR - 32-bit variant on page C6-625
1	-	0	-	-	Unallocated.
1	00	1	0	-	EXTR - 64-bit variant on page C6-625

C4.1.2 Branches, Exception Generating and System instructions

This section describes the encoding of the Branches, Exception Generating and System instructions group. This section is decoded from *A64 instruction set encoding* on page C4-210.

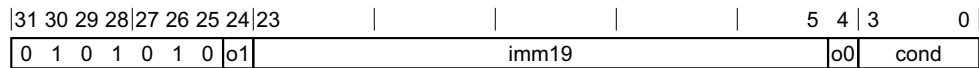

Table C4-3 Encoding table for the Branches, Exception Generating and System instructions group

Decode fields		Decode group or instruction page
op0	op1	
010	0xxx	<i>Conditional branch (immediate)</i>
010	1xxx	Unallocated.
110	00xx	<i>Exception generation on page C4-215</i>
110	0100	<i>System on page C4-215</i>
110	0101	Unallocated.
110	011x	Unallocated.
110	1xxx	<i>Unconditional branch (register) on page C4-217</i>
x00	-	<i>Unconditional branch (immediate) on page C4-217</i>
x01	0xxx	<i>Compare and branch (immediate) on page C4-218</i>
x01	1xxx	<i>Test and branch (immediate) on page C4-218</i>
x11	-	Unallocated.

Conditional branch (immediate)

This section describes the encoding of the Conditional branch (immediate) instruction class. This section is decoded from *Branches, Exception Generating and System instructions*.



Decode fields		Instruction page
o1	o0	
0	0	<i>B.cond</i>
0	1	Unallocated.
1	-	Unallocated.

Exception generation

This section describes the encoding of the Exception generation instruction class. This section is decoded from *Branches, Exception Generating and System instructions* on page C4-214.

31	30	29	28	27	26	25	24	23	21	20					5	4	2	1	0
1	1	0	1	0	1	0	0	opc				imm16				op2		LL	

Decode fields			Instruction page
opc	op2	LL	
-	xx1	-	Unallocated.
-	x1x	-	Unallocated.
-	1xx	-	Unallocated.
000	000	00	Unallocated.
000	000	01	SVC
000	000	10	HVC
000	000	11	SMC
001	000	x1	Unallocated.
001	000	00	BRK
001	000	1x	Unallocated.
010	000	x1	Unallocated.
010	000	00	HLT
010	000	1x	Unallocated.
011	000	-	Unallocated.
100	000	-	Unallocated.
101	000	00	Unallocated.
101	000	01	DCPS1
101	000	10	DCPS2
101	000	11	DCPS3
11x	000	-	Unallocated.

System

This section describes the encoding of the System instruction class. This section is decoded from *Branches, Exception Generating and System instructions* on page C4-214.

31	30	29	28	27	26	25	24	23	22	21	20	19	18	16	15	12	11	8	7	5	4	0	
1	1	0	1	0	1	0	1	0	0	L	op0	op1	CRn	CRm	op2	Rt							

Decode fields							Instruction page	Architecture version
L	op0	op1	CRn	CRm	op2	Rt		
0	00	-	000x	-	-	-	Unallocated.	-
0	00	-	0100	-	-	!= 11111	Unallocated.	-
0	00	-	0100	-	-	11111	MSR (immediate)	-
0	00	-	0101	-	-	-	Unallocated.	-
0	00	-	011x	-	-	-	Unallocated.	-
0	00	-	1xxx	-	-	-	Unallocated.	-
0	00	xx0	001x	-	-	-	Unallocated.	-
0	00	x0x	001x	-	-	-	Unallocated.	-
0	00	011	001x	-	-	!= 11111	Unallocated.	-
0	00	011	0010	!= 00x0	-	11111	HINT - Hints 8 to 15, and 24 to 127 variant on page C6-627	-
0	00	011	0010	0000	000	11111	NOP	-
0	00	011	0010	0000	001	11111	YIELD	-
0	00	011	0010	0000	010	11111	WFE	-
0	00	011	0010	0000	011	11111	WFI	-
0	00	011	0010	0000	100	11111	SEV	-
0	00	011	0010	0000	101	11111	SEVL	-
0	00	011	0010	0000	11x	11111	HINT - Hints 6 and 7 variant on page C6-627	-
0	00	011	0010	0010	!= 00x	11111	HINT - Hints 17 to 23 variant on page C6-627	-
0	00	011	0010	0010	000	11111	ESB	ARMv8.2
0	00	011	0010	0010	001	11111	PSB CSYNC	ARMv8.2
0	00	011	0011	-	000	-	Unallocated.	-
0	00	011	0011	-	001	-	Unallocated.	-
0	00	011	0011	-	010	11111	CLREX	-
0	00	011	0011	-	011	-	Unallocated.	-
0	00	011	0011	-	100	11111	DSB	-
0	00	011	0011	-	101	11111	DMB	-
0	00	011	0011	-	110	11111	ISB	-

Decode fields							Instruction page	Architecture version
L	op0	op1	CRn	CRm	op2	Rt		
0	00	011	0011	-	111	-	Unallocated.	-
0	00	1xx	001x	-	-	-	Unallocated.	-
0	01	-	-	-	-	-	SYS	-
0	1x	-	-	-	-	-	MSR (register)	-
1	00	-	-	-	-	-	Unallocated.	-
1	01	-	-	-	-	-	SYSL	-
1	1x	-	-	-	-	-	MRS	-

Unconditional branch (register)

This section describes the encoding of the Unconditional branch (register) instruction class. This section is decoded from [Branches, Exception Generating and System instructions on page C4-214](#).

31 30 29 28	27 26 25 24	21 20	16 15	10 9	5 4	0
1 1 0 1 0 1 1	opc	op2	op3	Rn	op4	

Decode fields					Instruction page
opc	op2	op3	Rn	op4	
-	-	-	-	!= 00000	Unallocated.
-	-	!= 000000	-	-	Unallocated.
-	!= 11111	-	-	-	Unallocated.
0000	11111	000000	-	00000	BR
0001	11111	000000	-	00000	BLR
0010	11111	000000	-	00000	RET
0011	-	-	-	-	Unallocated.
010x	-	-	!= 11111	-	Unallocated.
0100	11111	000000	11111	00000	ERET
0101	11111	000000	11111	00000	DRPS
011x	-	-	-	-	Unallocated.
1xxx	-	-	-	-	Unallocated.

Unconditional branch (immediate)

This section describes the encoding of the Unconditional branch (immediate) instruction class. This section is decoded from [Branches, Exception Generating and System instructions on page C4-214](#).

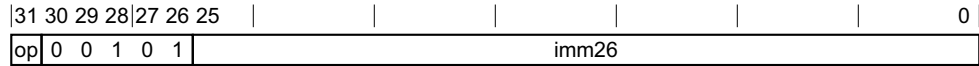

Decode fields		Instruction page
op		
0		B
1		BL

Compare and branch (immediate)

This section describes the encoding of the Compare and branch (immediate) instruction class. This section is decoded from *Branches, Exception Generating and System instructions on page C4-214*.

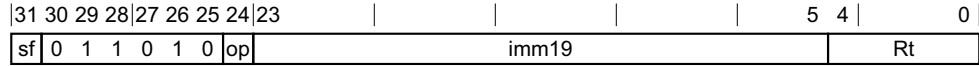

Decode fields		Instruction page
sf	op	
0	0	CBZ - 32-bit variant on page C6-574
0	1	CBNZ - 32-bit variant on page C6-573
1	0	CBZ - 64-bit variant on page C6-574
1	1	CBNZ - 64-bit variant on page C6-573

Test and branch (immediate)

This section describes the encoding of the Test and branch (immediate) instruction class. This section is decoded from *Branches, Exception Generating and System instructions on page C4-214*.

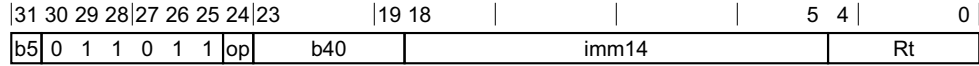

Decode fields		Instruction page
op		
0		TBZ
1		TBNZ

C4.1.3 Loads and Stores

This section describes the encoding of the Loads and Stores group. This section is decoded from *A64 instruction set encoding* on page C4-210.



Table C4-4 Encoding table for the Loads and Stores group

Decode fields						Decode group or instruction page
op0	op1	op2	op3	op4	op5	
0	00	1	00	000000	-	<i>Advanced SIMD load/store multiple structures</i> on page C4-220
0	00	1	01	0xxxxx	-	<i>Advanced SIMD load/store multiple structures (post-indexed)</i> on page C4-221
0	00	1	0x	1xxxxx	-	Unallocated.
0	00	1	10	x00000	-	<i>Advanced SIMD load/store single structure</i> on page C4-222
0	00	1	11	-	-	<i>Advanced SIMD load/store single structure (post-indexed)</i> on page C4-225
0	00	1	x0	x1xxxx	-	Unallocated.
0	00	1	x0	xx1xxx	-	Unallocated.
0	00	1	x0	xxx1xx	-	Unallocated.
0	00	1	x0	xxx1x	-	Unallocated.
0	00	1	x0	xxxxx1	-	Unallocated.
1	00	1	-	-	-	Unallocated.
-	00	0	0x	-	-	<i>Load/store exclusive</i> on page C4-229
-	00	0	1x	-	-	Unallocated.
-	01	-	0x	-	-	<i>Load register (literal)</i> on page C4-231
-	01	-	1x	-	-	Unallocated.
-	10	-	00	-	-	<i>Load/store no-allocate pair (offset)</i> on page C4-232
-	10	-	01	-	-	<i>Load/store register pair (post-indexed)</i> on page C4-233
-	10	-	10	-	-	<i>Load/store register pair (offset)</i> on page C4-233
-	10	-	11	-	-	<i>Load/store register pair (pre-indexed)</i> on page C4-234
-	11	-	0x	0xxxxx	00	<i>Load/store register (unscaled immediate)</i> on page C4-235
-	11	-	0x	0xxxxx	01	<i>Load/store register (immediate post-indexed)</i> on page C4-236
-	11	-	0x	0xxxxx	10	<i>Load/store register (unprivileged)</i> on page C4-237
-	11	-	0x	0xxxxx	11	<i>Load/store register (immediate pre-indexed)</i> on page C4-238

Table C4-4 Encoding table for the Loads and Stores group (continued)

Decode fields						Decode group or instruction page
op0	op1	op2	op3	op4	op5	
-	11	-	0x	1xxxxx	00	<i>Atomic memory operations on page C4-239</i>
-	11	-	0x	1xxxxx	10	<i>Load/store register (register offset) on page C4-250</i>
-	11	-	1x	-	-	<i>Load/store register (unsigned immediate) on page C4-251</i>

Advanced SIMD load/store multiple structures

This section describes the encoding of the Advanced SIMD load/store multiple structures instruction class. This section is decoded from *Loads and Stores on page C4-219*.

31	30	29	28	27	26	25	24	23	22	21	20	19	18	17	16	15	12	11	10	9	5	4	0
0	Q	0	0	1	1	0	0	0	L	0	0	0	0	0	0	opcode	size	Rn		Rt			

Decode fields		Instruction page
L	opcode	
0	0000	<i>ST4 (multiple structures)</i>
0	0001	Unallocated.
0	0010	<i>ST1 (multiple structures) - Four registers variant on page C7-1597</i>
0	0011	Unallocated.
0	0100	<i>ST3 (multiple structures)</i>
0	0101	Unallocated.
0	0110	<i>ST1 (multiple structures) - Three registers variant on page C7-1597</i>
0	0111	<i>ST1 (multiple structures) - One register variant on page C7-1597</i>
0	1000	<i>ST2 (multiple structures)</i>
0	1001	Unallocated.
0	1010	<i>ST1 (multiple structures) - Two registers variant on page C7-1597</i>
0	1011	Unallocated.
0	11xx	Unallocated.
1	0000	<i>LD4 (multiple structures)</i>
1	0001	Unallocated.
1	0010	<i>LD1 (multiple structures) - Four registers variant on page C7-1312</i>
1	0011	Unallocated.
1	0100	<i>LD3 (multiple structures)</i>
1	0101	Unallocated.

Decode fields			Instruction page
L	opcode		
1	0110		LD1 (multiple structures) - Three registers variant on page C7-1312
1	0111		LD1 (multiple structures) - One register variant on page C7-1312
1	1000		LD2 (multiple structures)
1	1001		Unallocated.
1	1010		LD1 (multiple structures) - Two registers variant on page C7-1312
1	1011		Unallocated.
1	11xx		Unallocated.

Advanced SIMD load/store multiple structures (post-indexed)

This section describes the encoding of the Advanced SIMD load/store multiple structures (post-indexed) instruction class. This section is decoded from [Loads and Stores on page C4-219](#).

31	30	29	28	27	26	25	24	23	22	21	20	16	15	12	11	10	9	5	4	0
0	Q	0	0	1	1	0	0	1	L	0	Rm	opcode	size	Rn	Rt					

Decode fields			Instruction page
L	Rm	opcode	
0	-	0001	Unallocated.
0	-	0011	Unallocated.
0	-	0101	Unallocated.
0	-	1001	Unallocated.
0	-	1011	Unallocated.
0	-	11xx	Unallocated.
0	!= 11111	0000	ST4 (multiple structures) - Register offset variant on page C7-1619
0	!= 11111	0010	ST1 (multiple structures) - Four registers, register offset variant on page C7-1598
0	!= 11111	0100	ST3 (multiple structures) - Register offset variant on page C7-1612
0	!= 11111	0110	ST1 (multiple structures) - Three registers, register offset variant on page C7-1598
0	!= 11111	0111	ST1 (multiple structures) - One register, register offset variant on page C7-1597
0	!= 11111	1000	ST2 (multiple structures) - Register offset variant on page C7-1605
0	!= 11111	1010	ST1 (multiple structures) - Two registers, register offset variant on page C7-1598
0	11111	0000	ST4 (multiple structures) - Immediate offset variant on page C7-1619
0	11111	0010	ST1 (multiple structures) - Four registers, immediate offset variant on page C7-1598
0	11111	0100	ST3 (multiple structures) - Immediate offset variant on page C7-1612

Decode fields			Instruction page
L	Rm	opcode	
0	11111	0110	ST1 (multiple structures) - <i>Three registers, immediate offset variant on page C7-1598</i>
0	11111	0111	ST1 (multiple structures) - <i>One register, immediate offset variant on page C7-1597</i>
0	11111	1000	ST2 (multiple structures) - <i>Immediate offset variant on page C7-1605</i>
0	11111	1010	ST1 (multiple structures) - <i>Two registers, immediate offset variant on page C7-1598</i>
1	-	0001	Unallocated.
1	-	0011	Unallocated.
1	-	0101	Unallocated.
1	-	1001	Unallocated.
1	-	1011	Unallocated.
1	-	11xx	Unallocated.
1	!= 11111	0000	LD4 (multiple structures) - <i>Register offset variant on page C7-1343</i>
1	!= 11111	0010	LD1 (multiple structures) - <i>Four registers, register offset variant on page C7-1313</i>
1	!= 11111	0100	LD3 (multiple structures) - <i>Register offset variant on page C7-1333</i>
1	!= 11111	0110	LD1 (multiple structures) - <i>Three registers, register offset variant on page C7-1313</i>
1	!= 11111	0111	LD1 (multiple structures) - <i>One register, register offset variant on page C7-1312</i>
1	!= 11111	1000	LD2 (multiple structures) - <i>Register offset variant on page C7-1323</i>
1	!= 11111	1010	LD1 (multiple structures) - <i>Two registers, register offset variant on page C7-1313</i>
1	11111	0000	LD4 (multiple structures) - <i>Immediate offset variant on page C7-1343</i>
1	11111	0010	LD1 (multiple structures) - <i>Four registers, immediate offset variant on page C7-1313</i>
1	11111	0100	LD3 (multiple structures) - <i>Immediate offset variant on page C7-1333</i>
1	11111	0110	LD1 (multiple structures) - <i>Three registers, immediate offset variant on page C7-1313</i>
1	11111	0111	LD1 (multiple structures) - <i>One register, immediate offset variant on page C7-1312</i>
1	11111	1000	LD2 (multiple structures) - <i>Immediate offset variant on page C7-1323</i>
1	11111	1010	LD1 (multiple structures) - <i>Two registers, immediate offset variant on page C7-1313</i>

Advanced SIMD load/store single structure

This section describes the encoding of the Advanced SIMD load/store single structure instruction class. This section is decoded from *Loads and Stores* on page C4-219.

31	30	29	28	27	26	25	24	23	22	21	20	19	18	17	16	15	13	12	11	10	9	5		4	0	
0	Q	0	0	1	1	0	1	0	L	R	0	0	0	0	0	opcode	S	size	Rn				Rt			

Decode fields										Instruction page
L	R	opcode	S	size						
0	-	11x	-	-	Unallocated.					
0	0	000	-	-	ST1 (single structure) - 8-bit variant on page C7-1601					
0	0	001	-	-	ST3 (single structure) - 8-bit variant on page C7-1615					
0	0	010	-	x0	ST1 (single structure) - 16-bit variant on page C7-1601					
0	0	010	-	x1	Unallocated.					
0	0	011	-	x0	ST3 (single structure) - 16-bit variant on page C7-1615					
0	0	011	-	x1	Unallocated.					
0	0	100	-	00	ST1 (single structure) - 32-bit variant on page C7-1601					
0	0	100	-	1x	Unallocated.					
0	0	100	0	01	ST1 (single structure) - 64-bit variant on page C7-1601					
0	0	100	1	01	Unallocated.					
0	0	101	-	00	ST3 (single structure) - 32-bit variant on page C7-1615					
0	0	101	-	10	Unallocated.					
0	0	101	0	01	ST3 (single structure) - 64-bit variant on page C7-1615					
0	0	101	0	11	Unallocated.					
0	0	101	1	x1	Unallocated.					
0	1	000	-	-	ST2 (single structure) - 8-bit variant on page C7-1608					
0	1	001	-	-	ST4 (single structure) - 8-bit variant on page C7-1622					
0	1	010	-	x0	ST2 (single structure) - 16-bit variant on page C7-1608					
0	1	010	-	x1	Unallocated.					
0	1	011	-	x0	ST4 (single structure) - 16-bit variant on page C7-1622					
0	1	011	-	x1	Unallocated.					
0	1	100	-	00	ST2 (single structure) - 32-bit variant on page C7-1608					
0	1	100	-	10	Unallocated.					
0	1	100	0	01	ST2 (single structure) - 64-bit variant on page C7-1608					
0	1	100	0	11	Unallocated.					
0	1	100	1	x1	Unallocated.					
0	1	101	-	00	ST4 (single structure) - 32-bit variant on page C7-1622					

Decode fields					Instruction page
L	R	opcode	S	size	
0	1	101	-	10	Unallocated.
0	1	101	0	01	ST4 (single structure) - 64-bit variant on page C7-1622
0	1	101	0	11	Unallocated.
0	1	101	1	x1	Unallocated.
1	0	000	-	-	LD1 (single structure) - 8-bit variant on page C7-1316
1	0	001	-	-	LD3 (single structure) - 8-bit variant on page C7-1336
1	0	010	-	x0	LD1 (single structure) - 16-bit variant on page C7-1316
1	0	010	-	x1	Unallocated.
1	0	011	-	x0	LD3 (single structure) - 16-bit variant on page C7-1336
1	0	011	-	x1	Unallocated.
1	0	100	-	00	LD1 (single structure) - 32-bit variant on page C7-1316
1	0	100	-	1x	Unallocated.
1	0	100	0	01	LD1 (single structure) - 64-bit variant on page C7-1316
1	0	100	1	01	Unallocated.
1	0	101	-	00	LD3 (single structure) - 32-bit variant on page C7-1336
1	0	101	-	10	Unallocated.
1	0	101	0	01	LD3 (single structure) - 64-bit variant on page C7-1336
1	0	101	0	11	Unallocated.
1	0	101	1	x1	Unallocated.
1	0	110	0	-	LD1R
1	0	110	1	-	Unallocated.
1	0	111	0	-	LD3R
1	0	111	1	-	Unallocated.
1	1	000	-	-	LD2 (single structure) - 8-bit variant on page C7-1326
1	1	001	-	-	LD4 (single structure) - 8-bit variant on page C7-1346
1	1	010	-	x0	LD2 (single structure) - 16-bit variant on page C7-1326
1	1	010	-	x1	Unallocated.
1	1	011	-	x0	LD4 (single structure) - 16-bit variant on page C7-1346
1	1	011	-	x1	Unallocated.
1	1	100	-	00	LD2 (single structure) - 32-bit variant on page C7-1326
1	1	100	-	10	Unallocated.
1	1	100	0	01	LD2 (single structure) - 64-bit variant on page C7-1326

Decode fields						Instruction page
L	R	opcode	S	size		
1	1	100	0	11		Unallocated.
1	1	100	1	x1		Unallocated.
1	1	101	-	00		LD4 (single structure) - 32-bit variant on page C7-1346
1	1	101	-	10		Unallocated.
1	1	101	0	01		LD4 (single structure) - 64-bit variant on page C7-1346
1	1	101	0	11		Unallocated.
1	1	101	1	x1		Unallocated.
1	1	110	0	-		LD2R
1	1	110	1	-		Unallocated.
1	1	111	0	-		LD4R
1	1	111	1	-		Unallocated.

Advanced SIMD load/store single structure (post-indexed)

This section describes the encoding of the Advanced SIMD load/store single structure (post-indexed) instruction class. This section is decoded from *Loads and Stores on page C4-219*.

31 30 29 28 27 26 25 24 23 22 21 20										16 15			13 12 11 10 9			5 4			0
0	Q	0	0	1	1	0	1	1	L	R	Rm	opcode	S	size	Rn	Rt			

Decode fields						Instruction page
L	R	Rm	opcode	S	size	
0	-	-	11x	-	-	Unallocated.
0	0	-	010	-	x1	Unallocated.
0	0	-	011	-	x1	Unallocated.
0	0	-	100	-	1x	Unallocated.
0	0	-	100	1	01	Unallocated.
0	0	-	101	-	10	Unallocated.
0	0	-	101	0	11	Unallocated.
0	0	-	101	1	x1	Unallocated.
0	0	!= 11111	000	-	-	ST1 (single structure) - 8-bit, register offset variant on page C7-1601
0	0	!= 11111	001	-	-	ST3 (single structure) - 8-bit, register offset variant on page C7-1615
0	0	!= 11111	010	-	x0	ST1 (single structure) - 16-bit, register offset variant on page C7-1602
0	0	!= 11111	011	-	x0	ST3 (single structure) - 16-bit, register offset variant on page C7-1616

Decode fields						Instruction page
L	R	Rm	opcode	S	size	
0	0	!= 11111	100	-	00	ST1 (single structure) - 32-bit, register offset variant on page C7-1602
0	0	!= 11111	100	0	01	ST1 (single structure) - 64-bit, register offset variant on page C7-1602
0	0	!= 11111	101	-	00	ST3 (single structure) - 32-bit, register offset variant on page C7-1616
0	0	!= 11111	101	0	01	ST3 (single structure) - 64-bit, register offset variant on page C7-1616
0	0	11111	000	-	-	ST1 (single structure) - 8-bit, immediate offset variant on page C7-1601
0	0	11111	001	-	-	ST3 (single structure) - 8-bit, immediate offset variant on page C7-1615
0	0	11111	010	-	x0	ST1 (single structure) - 16-bit, immediate offset variant on page C7-1602
0	0	11111	011	-	x0	ST3 (single structure) - 16-bit, immediate offset variant on page C7-1616
0	0	11111	100	-	00	ST1 (single structure) - 32-bit, immediate offset variant on page C7-1602
0	0	11111	100	0	01	ST1 (single structure) - 64-bit, immediate offset variant on page C7-1602
0	0	11111	101	-	00	ST3 (single structure) - 32-bit, immediate offset variant on page C7-1616
0	0	11111	101	0	01	ST3 (single structure) - 64-bit, immediate offset variant on page C7-1616
0	1	-	010	-	x1	Unallocated.
0	1	-	011	-	x1	Unallocated.
0	1	-	100	-	10	Unallocated.
0	1	-	100	0	11	Unallocated.
0	1	-	100	1	x1	Unallocated.
0	1	-	101	-	10	Unallocated.
0	1	-	101	0	11	Unallocated.
0	1	-	101	1	x1	Unallocated.
0	1	!= 11111	000	-	-	ST2 (single structure) - 8-bit, register offset variant on page C7-1608
0	1	!= 11111	001	-	-	ST4 (single structure) - 8-bit, register offset variant on page C7-1622
0	1	!= 11111	010	-	x0	ST2 (single structure) - 16-bit, register offset variant on page C7-1609
0	1	!= 11111	011	-	x0	ST4 (single structure) - 16-bit, register offset variant on page C7-1623
0	1	!= 11111	100	-	00	ST2 (single structure) - 32-bit, register offset variant on page C7-1609
0	1	!= 11111	100	0	01	ST2 (single structure) - 64-bit, register offset variant on page C7-1609
0	1	!= 11111	101	-	00	ST4 (single structure) - 32-bit, register offset variant on page C7-1623
0	1	!= 11111	101	0	01	ST4 (single structure) - 64-bit, register offset variant on page C7-1623
0	1	11111	000	-	-	ST2 (single structure) - 8-bit, immediate offset variant on page C7-1608
0	1	11111	001	-	-	ST4 (single structure) - 8-bit, immediate offset variant on page C7-1622
0	1	11111	010	-	x0	ST2 (single structure) - 16-bit, immediate offset variant on page C7-1609
0	1	11111	011	-	x0	ST4 (single structure) - 16-bit, immediate offset variant on page C7-1623

Decode fields						Instruction page
L	R	Rm	opcode	S	size	
0	1	11111	100	-	00	ST2 (single structure) - 32-bit, immediate offset variant on page C7-1609
0	1	11111	100	0	01	ST2 (single structure) - 64-bit, immediate offset variant on page C7-1609
0	1	11111	101	-	00	ST4 (single structure) - 32-bit, immediate offset variant on page C7-1623
0	1	11111	101	0	01	ST4 (single structure) - 64-bit, immediate offset variant on page C7-1623
1	0	-	010	-	x1	Unallocated.
1	0	-	011	-	x1	Unallocated.
1	0	-	100	-	1x	Unallocated.
1	0	-	100	1	01	Unallocated.
1	0	-	101	-	10	Unallocated.
1	0	-	101	0	11	Unallocated.
1	0	-	101	1	x1	Unallocated.
1	0	-	110	1	-	Unallocated.
1	0	-	111	1	-	Unallocated.
1	0	!= 11111	000	-	-	LD1 (single structure) - 8-bit, register offset variant on page C7-1316
1	0	!= 11111	001	-	-	LD3 (single structure) - 8-bit, register offset variant on page C7-1336
1	0	!= 11111	010	-	x0	LD1 (single structure) - 16-bit, register offset variant on page C7-1317
1	0	!= 11111	011	-	x0	LD3 (single structure) - 16-bit, register offset variant on page C7-1337
1	0	!= 11111	100	-	00	LD1 (single structure) - 32-bit, register offset variant on page C7-1317
1	0	!= 11111	100	0	01	LD1 (single structure) - 64-bit, register offset variant on page C7-1317
1	0	!= 11111	101	-	00	LD3 (single structure) - 32-bit, register offset variant on page C7-1337
1	0	!= 11111	101	0	01	LD3 (single structure) - 64-bit, register offset variant on page C7-1337
1	0	!= 11111	110	0	-	LD1R - Register offset variant on page C7-1320
1	0	!= 11111	111	0	-	LD3R - Register offset variant on page C7-1340
1	0	11111	000	-	-	LD1 (single structure) - 8-bit, immediate offset variant on page C7-1316
1	0	11111	001	-	-	LD3 (single structure) - 8-bit, immediate offset variant on page C7-1336
1	0	11111	010	-	x0	LD1 (single structure) - 16-bit, immediate offset variant on page C7-1317
1	0	11111	011	-	x0	LD3 (single structure) - 16-bit, immediate offset variant on page C7-1337
1	0	11111	100	-	00	LD1 (single structure) - 32-bit, immediate offset variant on page C7-1317
1	0	11111	100	0	01	LD1 (single structure) - 64-bit, immediate offset variant on page C7-1317
1	0	11111	101	-	00	LD3 (single structure) - 32-bit, immediate offset variant on page C7-1337
1	0	11111	101	0	01	LD3 (single structure) - 64-bit, immediate offset variant on page C7-1337
1	0	11111	110	0	-	LD1R - Immediate offset variant on page C7-1320

Decode fields							Instruction page
L	R	Rm	opcode	S	size		
1	0	11111	111	0	-		LD3R - Immediate offset variant on page C7-1340
1	1	-	010	-	x1		Unallocated.
1	1	-	011	-	x1		Unallocated.
1	1	-	100	-	10		Unallocated.
1	1	-	100	0	11		Unallocated.
1	1	-	100	1	x1		Unallocated.
1	1	-	101	-	10		Unallocated.
1	1	-	101	0	11		Unallocated.
1	1	-	101	1	x1		Unallocated.
1	1	-	110	1	-		Unallocated.
1	1	-	111	1	-		Unallocated.
1	1	!= 11111	000	-	-		LD2 (single structure) - 8-bit, register offset variant on page C7-1326
1	1	!= 11111	001	-	-		LD4 (single structure) - 8-bit, register offset variant on page C7-1346
1	1	!= 11111	010	-	x0		LD2 (single structure) - 16-bit, register offset variant on page C7-1327
1	1	!= 11111	011	-	x0		LD4 (single structure) - 16-bit, register offset variant on page C7-1347
1	1	!= 11111	100	-	00		LD2 (single structure) - 32-bit, register offset variant on page C7-1327
1	1	!= 11111	100	0	01		LD2 (single structure) - 64-bit, register offset variant on page C7-1327
1	1	!= 11111	101	-	00		LD4 (single structure) - 32-bit, register offset variant on page C7-1347
1	1	!= 11111	101	0	01		LD4 (single structure) - 64-bit, register offset variant on page C7-1347
1	1	!= 11111	110	0	-		LD2R - Register offset variant on page C7-1330
1	1	!= 11111	111	0	-		LD4R - Register offset variant on page C7-1350
1	1	11111	000	-	-		LD2 (single structure) - 8-bit, immediate offset variant on page C7-1326
1	1	11111	001	-	-		LD4 (single structure) - 8-bit, immediate offset variant on page C7-1346
1	1	11111	010	-	x0		LD2 (single structure) - 16-bit, immediate offset variant on page C7-1327
1	1	11111	011	-	x0		LD4 (single structure) - 16-bit, immediate offset variant on page C7-1347
1	1	11111	100	-	00		LD2 (single structure) - 32-bit, immediate offset variant on page C7-1327
1	1	11111	100	0	01		LD2 (single structure) - 64-bit, immediate offset variant on page C7-1327
1	1	11111	101	-	00		LD4 (single structure) - 32-bit, immediate offset variant on page C7-1347
1	1	11111	101	0	01		LD4 (single structure) - 64-bit, immediate offset variant on page C7-1347
1	1	11111	110	0	-		LD2R - Immediate offset variant on page C7-1330
1	1	11111	111	0	-		LD4R - Immediate offset variant on page C7-1350

Load/store exclusive

This section describes the encoding of the Load/store exclusive instruction class. This section is decoded from *Loads and Stores* on page C4-219.

31 30 29 28 27 26 25 24 23 22 21 20						16 15 14			10 9		5 4		0	
size	0	0	1	0	0	0	o2	L	o1	Rs	o0	Rt2	Rn	Rt

Decode fields							Instruction page	Architecture version
size	o2	L	o1	o0	Rt2			
-	1	-	1	-	!= 11111	Unallocated.	-	
0x	0	-	1	-	!= 11111	Unallocated.	-	
00	0	0	0	0	-	STXRB	-	
00	0	0	0	1	-	STLXRB	-	
00	0	0	1	0	11111	CASP, CASPA, CASPAL, CASPL - 32-bit, no memory ordering variant on page C6-568	ARMv8.1	
00	0	0	1	1	11111	CASP, CASPA, CASPAL, CASPL - 32-bit, release variant on page C6-568	ARMv8.1	
00	0	1	0	0	-	LDXRB	-	
00	0	1	0	1	-	LDAXRB	-	
00	0	1	1	0	11111	CASP, CASPA, CASPAL, CASPL - 32-bit, acquire variant on page C6-568	ARMv8.1	
00	0	1	1	1	11111	CASP, CASPA, CASPAL, CASPL - 32-bit, acquire and release variant on page C6-568	ARMv8.1	
00	1	0	0	0	-	STLLRB	ARMv8.1	
00	1	0	0	1	-	STLRB	-	
00	1	0	1	0	11111	CASB, CASAB, CASALB, CASLB - No memory ordering variant on page C6-564	ARMv8.1	
00	1	0	1	1	11111	CASB, CASAB, CASALB, CASLB - Release variant on page C6-564	ARMv8.1	
00	1	1	0	0	-	LDLARB	ARMv8.1	
00	1	1	0	1	-	LDARB	-	
00	1	1	1	0	11111	CASB, CASAB, CASALB, CASLB - Acquire variant on page C6-564	ARMv8.1	
00	1	1	1	1	11111	CASB, CASAB, CASALB, CASLB - Acquire and release variant on page C6-564	ARMv8.1	
01	0	0	0	0	-	STXRH	-	
01	0	0	0	1	-	STLXRH	-	
01	0	0	1	0	11111	CASP, CASPA, CASPAL, CASPL - 64-bit, no memory ordering variant on page C6-569	ARMv8.1	

Decode fields						Instruction page	Architecture version
size	o2	L	o1	o0	Rt2		
01	0	0	1	1	11111	CASP, CASPA, CASPAL, CASPL - <i>64-bit, release variant on page C6-569</i>	ARMv8.1
01	0	1	0	0	-	LDXRH	-
01	0	1	0	1	-	LDAXRH	-
01	0	1	1	0	11111	CASP, CASPA, CASPAL, CASPL - <i>64-bit, acquire variant on page C6-568</i>	ARMv8.1
01	0	1	1	1	11111	CASP, CASPA, CASPAL, CASPL - <i>64-bit, acquire and release variant on page C6-568</i>	ARMv8.1
01	1	0	0	0	-	STLLRH	ARMv8.1
01	1	0	0	1	-	STLRH	-
01	1	0	1	0	11111	CASH, CASAH, CASALH, CASLH - <i>No memory ordering variant on page C6-566</i>	ARMv8.1
01	1	0	1	1	11111	CASH, CASAH, CASALH, CASLH - <i>Release variant on page C6-566</i>	ARMv8.1
01	1	1	0	0	-	LDLARH	ARMv8.1
01	1	1	0	1	-	LDARH	-
01	1	1	1	0	11111	CASH, CASAH, CASALH, CASLH - <i>Acquire variant on page C6-566</i>	ARMv8.1
01	1	1	1	1	11111	CASH, CASAH, CASALH, CASLH - <i>Acquire and release variant on page C6-566</i>	ARMv8.1
10	0	0	0	0	-	STXR - <i>32-bit variant on page C6-922</i>	-
10	0	0	0	1	-	STLXR - <i>32-bit variant on page C6-859</i>	-
10	0	0	1	0	-	STXP - <i>32-bit variant on page C6-920</i>	-
10	0	0	1	1	-	STLXP - <i>32-bit variant on page C6-856</i>	-
10	0	1	0	0	-	LDXR - <i>32-bit variant on page C6-750</i>	-
10	0	1	0	1	-	LDAXR - <i>32-bit variant on page C6-643</i>	-
10	0	1	1	0	-	LDXP - <i>32-bit variant on page C6-748</i>	-
10	0	1	1	1	-	LDAXP - <i>32-bit variant on page C6-641</i>	-
10	1	0	0	0	-	STLLR - <i>32-bit variant on page C6-852</i>	ARMv8.1
10	1	0	0	1	-	STLR - <i>32-bit variant on page C6-853</i>	-
10	1	0	1	0	11111	CAS, CASA, CASAL, CASL - <i>32-bit, no memory ordering variant on page C6-571</i>	ARMv8.1
10	1	0	1	1	11111	CAS, CASA, CASAL, CASL - <i>32-bit, release variant on page C6-571</i>	ARMv8.1
10	1	1	0	0	-	LDLAR - <i>32-bit variant on page C6-661</i>	ARMv8.1

Decode fields						Instruction page	Architecture version
size	o2	L	o1	o0	Rt2		
10	1	1	0	1	-	LDAR - 32-bit variant on page C6-638	-
10	1	1	1	0	11111	CAS, CASA, CASAL, CASL - 32-bit, acquire variant on page C6-571	ARMv8.1
10	1	1	1	1	11111	CAS, CASA, CASAL, CASL - 32-bit, acquire and release variant on page C6-571	ARMv8.1
11	0	0	0	0	-	STXR - 64-bit variant on page C6-922	-
11	0	0	0	1	-	STLXR - 64-bit variant on page C6-859	-
11	0	0	1	0	-	STXP - 64-bit variant on page C6-920	-
11	0	0	1	1	-	STLXP - 64-bit variant on page C6-856	-
11	0	1	0	0	-	LDXR - 64-bit variant on page C6-750	-
11	0	1	0	1	-	LDAXR - 64-bit variant on page C6-643	-
11	0	1	1	0	-	LDXP - 64-bit variant on page C6-748	-
11	0	1	1	1	-	LDAXP - 64-bit variant on page C6-641	-
11	1	0	0	0	-	STLLR - 64-bit variant on page C6-852	ARMv8.1
11	1	0	0	1	-	STLR - 64-bit variant on page C6-853	-
11	1	0	1	0	11111	CAS, CASA, CASAL, CASL - 64-bit, no memory ordering variant on page C6-572	ARMv8.1
11	1	0	1	1	11111	CAS, CASA, CASAL, CASL - 64-bit, release variant on page C6-572	ARMv8.1
11	1	1	0	0	-	LDLAR - 64-bit variant on page C6-661	ARMv8.1
11	1	1	0	1	-	LDAR - 64-bit variant on page C6-638	-
11	1	1	1	0	11111	CAS, CASA, CASAL, CASL - 64-bit, acquire variant on page C6-571	ARMv8.1
11	1	1	1	1	11111	CAS, CASA, CASAL, CASL - 64-bit, acquire and release variant on page C6-571	ARMv8.1

Load register (literal)

This section describes the encoding of the Load register (literal) instruction class. This section is decoded from *Loads and Stores* on page C4-219.

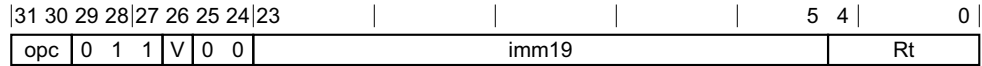

Decode fields

Instruction page

opc	V	Instruction page
00	0	LDR (literal) - 32-bit variant on page C6-673
00	1	LDR (literal, SIMD&FP) - 32-bit variant on page C7-1362
01	0	LDR (literal) - 64-bit variant on page C6-673
01	1	LDR (literal, SIMD&FP) - 64-bit variant on page C7-1362
10	0	LDRSW (literal)
10	1	LDR (literal, SIMD&FP) - 128-bit variant on page C7-1362
11	0	PRFM (literal)
11	1	Unallocated.

Load/store no-allocate pair (offset)

This section describes the encoding of the Load/store no-allocate pair (offset) instruction class. This section is decoded from *Loads and Stores* on page C4-219.

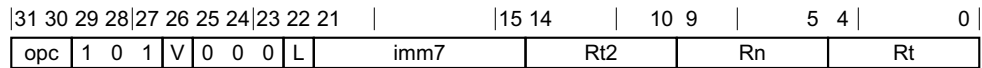

Decode fields

Instruction page

opc	V	L	Instruction page
00	0	0	STNP - 32-bit variant on page C6-865
00	0	1	LDNP - 32-bit variant on page C6-662
00	1	0	STNP (SIMD&FP) - 32-bit variant on page C7-1626
00	1	1	LDNP (SIMD&FP) - 32-bit variant on page C7-1353
01	0	-	Unallocated.
01	1	0	STNP (SIMD&FP) - 64-bit variant on page C7-1626
01	1	1	LDNP (SIMD&FP) - 64-bit variant on page C7-1353
10	0	0	STNP - 64-bit variant on page C6-865
10	0	1	LDNP - 64-bit variant on page C6-662

Decode fields			Instruction page
opc	V	L	
10	1	0	STNP (SIMD&FP) - 128-bit variant on page C7-1626
10	1	1	LDPN (SIMD&FP) - 128-bit variant on page C7-1353
11	-	-	Unallocated.

Load/store register pair (post-indexed)

This section describes the encoding of the Load/store register pair (post-indexed) instruction class. This section is decoded from *Loads and Stores* on page C4-219.

31	30	29	28	27	26	25	24	23	22	21	15	14	10	9	5	4	0
opc	1	0	1	V	0	0	1	L	imm7		Rt2		Rn		Rt		

Decode fields			Instruction page
opc	V	L	
00	0	0	STP - 32-bit variant on page C6-867
00	0	1	LDP - 32-bit variant on page C6-664
00	1	0	STP (SIMD&FP) - 32-bit variant on page C7-1628
00	1	1	LDP (SIMD&FP) - 32-bit variant on page C7-1355
01	0	0	Unallocated.
01	0	1	LDPSW
01	1	0	STP (SIMD&FP) - 64-bit variant on page C7-1628
01	1	1	LDP (SIMD&FP) - 64-bit variant on page C7-1355
10	0	0	STP - 64-bit variant on page C6-867
10	0	1	LDP - 64-bit variant on page C6-664
10	1	0	STP (SIMD&FP) - 128-bit variant on page C7-1628
10	1	1	LDP (SIMD&FP) - 128-bit variant on page C7-1355
11	-	-	Unallocated.

Load/store register pair (offset)

This section describes the encoding of the Load/store register pair (offset) instruction class. This section is decoded from *Loads and Stores* on page C4-219.

31	30	29	28	27	26	25	24	23	22	21	15	14	10	9	5	4	0
opc	1	0	1	V	0	1	0	L	imm7	Rt2	Rn	Rt					

Decode fields

Instruction page

opc	V	L	Instruction page
00	0	0	STP - 32-bit variant on page C6-868
00	0	1	LDP - 32-bit variant on page C6-665
00	1	0	STP (SIMD&FP) - 32-bit variant on page C7-1629
00	1	1	LDP (SIMD&FP) - 32-bit variant on page C7-1356
01	0	0	Unallocated.
01	0	1	LDPSW
01	1	0	STP (SIMD&FP) - 64-bit variant on page C7-1629
01	1	1	LDP (SIMD&FP) - 64-bit variant on page C7-1356
10	0	0	STP - 64-bit variant on page C6-868
10	0	1	LDP - 64-bit variant on page C6-665
10	1	0	STP (SIMD&FP) - 128-bit variant on page C7-1629
10	1	1	LDP (SIMD&FP) - 128-bit variant on page C7-1356
11	-	-	Unallocated.

Load/store register pair (pre-indexed)

This section describes the encoding of the Load/store register pair (pre-indexed) instruction class. This section is decoded from *Loads and Stores* on page C4-219.

31	30	29	28	27	26	25	24	23	22	21	15	14	10	9	5	4	0
opc	1	0	1	V	0	1	1	L	imm7	Rt2	Rn	Rt					

Decode fields

Instruction page

opc	V	L	Instruction page
00	0	0	STP - 32-bit variant on page C6-867
00	0	1	LDP - 32-bit variant on page C6-664
00	1	0	STP (SIMD&FP) - 32-bit variant on page C7-1628
00	1	1	LDP (SIMD&FP) - 32-bit variant on page C7-1355
01	0	0	Unallocated.
01	0	1	LDPSW

Decode fields			Instruction page
opc	V	L	
01	1	0	STP (SIMD&FP) - 64-bit variant on page C7-1628
01	1	1	LDP (SIMD&FP) - 64-bit variant on page C7-1355
10	0	0	STP - 64-bit variant on page C6-867
10	0	1	LDP - 64-bit variant on page C6-664
10	1	0	STP (SIMD&FP) - 128-bit variant on page C7-1628
10	1	1	LDP (SIMD&FP) - 128-bit variant on page C7-1355
11	-	-	Unallocated.

Load/store register (unscaled immediate)

This section describes the encoding of the Load/store register (unscaled immediate) instruction class. This section is decoded from *Loads and Stores* on page C4-219.

31	30	29	28	27	26	25	24	23	22	21	20	12	11	10	9	5	4	0
size	1	1	1	V	0	0	opc	0	imm9	0	0	Rn	Rt					

Decode fields			Instruction page
size	V	opc	
x1	1	1x	Unallocated.
00	0	00	STURB
00	0	01	LDURB
00	0	10	LDURSB - 64-bit variant on page C6-743
00	0	11	LDURSB - 32-bit variant on page C6-743
00	1	00	STUR (SIMD&FP) - 8-bit variant on page C7-1638
00	1	01	LDUR (SIMD&FP) - 8-bit variant on page C7-1367
00	1	10	STUR (SIMD&FP) - 128-bit variant on page C7-1638
00	1	11	LDUR (SIMD&FP) - 128-bit variant on page C7-1367
01	0	00	STURH
01	0	01	LDURH
01	0	10	LDURSH - 64-bit variant on page C6-745
01	0	11	LDURSH - 32-bit variant on page C6-745
01	1	00	STUR (SIMD&FP) - 16-bit variant on page C7-1638
01	1	01	LDUR (SIMD&FP) - 16-bit variant on page C7-1367
1x	0	11	Unallocated.

Decode fields			Instruction page
size	V	opc	
1x	1	1x	Unallocated.
10	0	00	STUR - 32-bit variant on page C6-917
10	0	01	LDUR - 32-bit variant on page C6-739
10	0	10	LDURSW
10	1	00	STUR (SIMD&FP) - 32-bit variant on page C7-1638
10	1	01	LDUR (SIMD&FP) - 32-bit variant on page C7-1367
11	0	00	STUR - 64-bit variant on page C6-917
11	0	01	LDUR - 64-bit variant on page C6-739
11	0	10	PRFM (unscaled offset)
11	1	00	STUR (SIMD&FP) - 64-bit variant on page C7-1638
11	1	01	LDUR (SIMD&FP) - 64-bit variant on page C7-1367

Load/store register (immediate post-indexed)

This section describes the encoding of the Load/store register (immediate post-indexed) instruction class. This section is decoded from [Loads and Stores on page C4-219](#).

31	30	29	28	27	26	25	24	23	22	21	20	12	11	10	9	5	4	0
size	1	1	1	V	0	0	opc	0	imm9			0	1	Rn	Rt			

Decode fields			Instruction page
size	V	opc	
x1	1	1x	Unallocated.
00	0	00	STRB (immediate)
00	0	01	LDRB (immediate)
00	0	10	LDRSB (immediate) - 64-bit variant on page C6-685
00	0	11	LDRSB (immediate) - 32-bit variant on page C6-685
00	1	00	STR (immediate, SIMD&FP) - 8-bit variant on page C7-1631
00	1	01	LDR (immediate, SIMD&FP) - 8-bit variant on page C7-1358
00	1	10	STR (immediate, SIMD&FP) - 128-bit variant on page C7-1631
00	1	11	LDR (immediate, SIMD&FP) - 128-bit variant on page C7-1358
01	0	00	STRH (immediate)
01	0	01	LDRH (immediate)
01	0	10	LDRSH (immediate) - 64-bit variant on page C6-690

Decode fields			Instruction page
size	V	opc	
01	0	11	LDRSH (immediate) - 32-bit variant on page C6-690
01	1	00	STR (immediate, SIMD&FP) - 16-bit variant on page C7-1631
01	1	01	LDR (immediate, SIMD&FP) - 16-bit variant on page C7-1358
1x	0	11	Unallocated.
1x	1	1x	Unallocated.
10	0	00	STR (immediate) - 32-bit variant on page C6-870
10	0	01	LDR (immediate) - 32-bit variant on page C6-670
10	0	10	LDRSW (immediate)
10	1	00	STR (immediate, SIMD&FP) - 32-bit variant on page C7-1631
10	1	01	LDR (immediate, SIMD&FP) - 32-bit variant on page C7-1358
11	0	00	STR (immediate) - 64-bit variant on page C6-870
11	0	01	LDR (immediate) - 64-bit variant on page C6-670
11	0	10	Unallocated.
11	1	00	STR (immediate, SIMD&FP) - 64-bit variant on page C7-1631
11	1	01	LDR (immediate, SIMD&FP) - 64-bit variant on page C7-1358

Load/store register (unprivileged)

This section describes the encoding of the Load/store register (unprivileged) instruction class. This section is decoded from *Loads and Stores* on page C4-219.

31	30	29	28	27	26	25	24	23	22	21	20				12	11	10	9			5	4		0
size	1	1	1	V	0	0	opc	0	imm9						1	0	Rn		Rt					

Decode fields			Instruction page
size	V	opc	
-	1	-	Unallocated.
00	0	00	STTRB
00	0	01	LDTRB
00	0	10	LDTRSB - 64-bit variant on page C6-722
00	0	11	LDTRSB - 32-bit variant on page C6-722
01	0	00	STTRH
01	0	01	LDTRH
01	0	10	LDTRSH - 64-bit variant on page C6-724

Decode fields			Instruction page
size	V	opc	
01	0	11	LDTRSH - 32-bit variant on page C6-724
1x	0	11	Unallocated.
10	0	00	STTR - 32-bit variant on page C6-901
10	0	01	LDTR - 32-bit variant on page C6-718
10	0	10	LDTRSW
11	0	00	STTR - 64-bit variant on page C6-901
11	0	01	LDTR - 64-bit variant on page C6-718
11	0	10	Unallocated.

Load/store register (immediate pre-indexed)

This section describes the encoding of the Load/store register (immediate pre-indexed) instruction class. This section is decoded from [Loads and Stores on page C4-219](#).

31 30 29 28				27 26 25 24				23 22 21 20				12 11 10 9				5 4		0
size	1	1	1	V	0	0	opc	0	imm9				1	1	Rn		Rt	

Decode fields			Instruction page
size	V	opc	
x1	1	1x	Unallocated.
00	0	00	STRB (immediate)
00	0	01	LDRB (immediate)
00	0	10	LDRSB (immediate) - 64-bit variant on page C6-685
00	0	11	LDRSB (immediate) - 32-bit variant on page C6-685
00	1	00	STR (immediate, SIMD&FP) - 8-bit variant on page C7-1631
00	1	01	LDR (immediate, SIMD&FP) - 8-bit variant on page C7-1358
00	1	10	STR (immediate, SIMD&FP) - 128-bit variant on page C7-1632
00	1	11	LDR (immediate, SIMD&FP) - 128-bit variant on page C7-1359
01	0	00	STRH (immediate)
01	0	01	LDRH (immediate)
01	0	10	LDRSH (immediate) - 64-bit variant on page C6-690
01	0	11	LDRSH (immediate) - 32-bit variant on page C6-690
01	1	00	STR (immediate, SIMD&FP) - 16-bit variant on page C7-1632
01	1	01	LDR (immediate, SIMD&FP) - 16-bit variant on page C7-1359

Decode fields			Instruction page
size	V	opc	
1x	0	11	Unallocated.
1x	1	1x	Unallocated.
10	0	00	STR (immediate) - 32-bit variant on page C6-870
10	0	01	LDR (immediate) - 32-bit variant on page C6-670
10	0	10	LDRSW (immediate)
10	1	00	STR (immediate, SIMD&FP) - 32-bit variant on page C7-1632
10	1	01	LDR (immediate, SIMD&FP) - 32-bit variant on page C7-1359
11	0	00	STR (immediate) - 64-bit variant on page C6-870
11	0	01	LDR (immediate) - 64-bit variant on page C6-670
11	0	10	Unallocated.
11	1	00	STR (immediate, SIMD&FP) - 64-bit variant on page C7-1632
11	1	01	LDR (immediate, SIMD&FP) - 64-bit variant on page C7-1359

Atomic memory operations

This section describes the encoding of the Atomic memory operations instruction class. This section is decoded from *Loads and Stores* on page C4-219.

31 30 29 28 27 26 25 24 23 22 21 20										16 15 14			12 11 10 9			5 4		0
size	1	1	1	V	0	0	A	R	1	Rs	o3	opc	0	0	Rn	Rt		

Decode fields								Instruction page	Architecture version
size	V	A	R	o3	opc	Rt			
-	0	-	-	1	001	-	Unallocated.	-	
-	0	-	-	1	01x	-	Unallocated.	-	
-	0	-	-	1	101	-	Unallocated.	-	
-	0	-	-	1	11x	-	Unallocated.	-	
-	0	0	-	1	100	-	Unallocated.	-	
-	0	1	1	1	100	-	Unallocated.	-	
-	1	-	-	-	-	-	Unallocated.	-	
00	0	0	0	0	000	!= 11111	LDADDB, LDADDAB, LDADDALB, LDADDLB - <i>No memory ordering variant on page C6-632</i>	ARMv8.1	
00	0	0	0	0	000	11111	STADDB, STADDLB - <i>No memory ordering variant on page C6-832</i>	ARMv8.1	

Decode fields							Instruction page	Architecture version
size	V	A	R	o3	opc	Rt		
00	0	0	0	0	001	!= 11111	LDCLRB, LDCLRAB, LDCLRALB, LDCLRLB - <i>No memory ordering variant on page C6-647</i>	ARMv8.1
00	0	0	0	0	001	11111	STCLRB, STCLRLB - <i>No memory ordering variant on page C6-838</i>	ARMv8.1
00	0	0	0	0	010	!= 11111	LDEORB, LDEORAB, LDEORALB, LDEORLB - <i>No memory ordering variant on page C6-653</i>	ARMv8.1
00	0	0	0	0	010	11111	STEORB, STEORLB - <i>No memory ordering variant on page C6-844</i>	ARMv8.1
00	0	0	0	0	011	!= 11111	LDSETB, LDSETAB, LDSETALB, LDSETLB - <i>No memory ordering variant on page C6-700</i>	ARMv8.1
00	0	0	0	0	011	11111	STSETB, STSETLB - <i>No memory ordering variant on page C6-883</i>	ARMv8.1
00	0	0	0	0	100	!= 11111	LDSMAXB, LDSMAXAB, LDSMAXALB, LDSMAXLB - <i>No memory ordering variant on page C6-706</i>	ARMv8.1
00	0	0	0	0	100	11111	STSMAXB, STSMAXLB - <i>No memory ordering variant on page C6-889</i>	ARMv8.1
00	0	0	0	0	101	!= 11111	LDSMINB, LDSMINAB, LDSMINALB, LDSMINLB - <i>No memory ordering variant on page C6-712</i>	ARMv8.1
00	0	0	0	0	101	11111	STSMINB, STSMINLB - <i>No memory ordering variant on page C6-895</i>	ARMv8.1
00	0	0	0	0	110	!= 11111	LDUMAXB, LDUMAXAB, LDUMAXALB, LDUMAXLB - <i>No memory ordering variant on page C6-727</i>	ARMv8.1
00	0	0	0	0	110	11111	STUMAXB, STUMAXLB - <i>No memory ordering variant on page C6-905</i>	ARMv8.1
00	0	0	0	0	111	!= 11111	LDUMINB, LDUMINAB, LDUMINALB, LDUMINLB - <i>No memory ordering variant on page C6-733</i>	ARMv8.1
00	0	0	0	0	111	11111	STUMINB, STUMINLB - <i>No memory ordering variant on page C6-911</i>	ARMv8.1
00	0	0	0	1	000	-	SWPB, SWPAB, SWPALB, SWPLB - <i>No memory ordering variant on page C6-941</i>	ARMv8.1
00	0	0	1	0	000	!= 11111	LDADDB, LDADDAB, LDADDALB, LDADDLB - <i>Release variant on page C6-632</i>	ARMv8.1
00	0	0	1	0	000	11111	STADDB, STADDLB - <i>Release variant on page C6-832</i>	ARMv8.1
00	0	0	1	0	001	!= 11111	LDCLRB, LDCLRAB, LDCLRALB, LDCLRLB - <i>Release variant on page C6-647</i>	ARMv8.1
00	0	0	1	0	001	11111	STCLRB, STCLRLB - <i>Release variant on page C6-838</i>	ARMv8.1

Decode fields							Instruction page	Architecture version
size	V	A	R	o3	opc	Rt		
00	0	0	1	0	010	!= 11111	LDEORB, LDEORAB, LDEORALB, LDEORLB - <i>Release variant on page C6-653</i>	ARMv8.1
00	0	0	1	0	010	11111	STEORB, STEORLB - <i>Release variant on page C6-844</i>	ARMv8.1
00	0	0	1	0	011	!= 11111	LDSETB, LDSETAB, LDSETALB, LDSETLB - <i>Release variant on page C6-700</i>	ARMv8.1
00	0	0	1	0	011	11111	STSETB, STSETLB - <i>Release variant on page C6-883</i>	ARMv8.1
00	0	0	1	0	100	!= 11111	LDSMAXB, LDSMAXAB, LDSMAXALB, LDSMAXLB - <i>Release variant on page C6-706</i>	ARMv8.1
00	0	0	1	0	100	11111	STSMAXB, STSMAXLB - <i>Release variant on page C6-889</i>	ARMv8.1
00	0	0	1	0	101	!= 11111	LDSMINB, LDSMINAB, LDSMINALB, LDSMINLB - <i>Release variant on page C6-712</i>	ARMv8.1
00	0	0	1	0	101	11111	STSMINB, STSMINLB - <i>Release variant on page C6-895</i>	ARMv8.1
00	0	0	1	0	110	!= 11111	LDUMAXB, LDUMAXAB, LDUMAXALB, LDUMAXLB - <i>Release variant on page C6-727</i>	ARMv8.1
00	0	0	1	0	110	11111	STUMAXB, STUMAXLB - <i>Release variant on page C6-905</i>	ARMv8.1
00	0	0	1	0	111	!= 11111	LDUMINB, LDUMINAB, LDUMINALB, LDUMINLB - <i>Release variant on page C6-733</i>	ARMv8.1
00	0	0	1	0	111	11111	STUMINB, STUMINLB - <i>Release variant on page C6-911</i>	ARMv8.1
00	0	0	1	1	000	-	SWPB, SWPAB, SWPALB, SWPLB - <i>Release variant on page C6-941</i>	ARMv8.1
00	0	1	0	0	000	-	LDADDB, LDADDAB, LDADDALB, LDADDLB - <i>Acquire variant on page C6-632</i>	ARMv8.1
00	0	1	0	0	001	-	LDCLRB, LDCLRAB, LDCLRALB, LDCLRLB - <i>Acquire variant on page C6-647</i>	ARMv8.1
00	0	1	0	0	010	-	LDEORB, LDEORAB, LDEORALB, LDEORLB - <i>Acquire variant on page C6-653</i>	ARMv8.1
00	0	1	0	0	011	-	LDSETB, LDSETAB, LDSETALB, LDSETLB - <i>Acquire variant on page C6-700</i>	ARMv8.1
00	0	1	0	0	100	-	LDSMAXB, LDSMAXAB, LDSMAXALB, LDSMAXLB - <i>Acquire variant on page C6-706</i>	ARMv8.1
00	0	1	0	0	101	-	LDSMINB, LDSMINAB, LDSMINALB, LDSMINLB - <i>Acquire variant on page C6-712</i>	ARMv8.1
00	0	1	0	0	110	-	LDUMAXB, LDUMAXAB, LDUMAXALB, LDUMAXLB - <i>Acquire variant on page C6-727</i>	ARMv8.1
00	0	1	0	0	111	-	LDUMINB, LDUMINAB, LDUMINALB, LDUMINLB - <i>Acquire variant on page C6-733</i>	ARMv8.1

Decode fields							Instruction page	Architecture version
size	V	A	R	o3	opc	Rt		
00	0	1	0	1	000	-	SWPB, SWPAB, SWPALB, SWPLB - <i>Acquire variant on page C6-941</i>	ARMv8.1
00	0	1	1	0	000	-	LDADDB, LDADDAB, LDADDALB, LDADDLB - <i>Acquire and release variant on page C6-632</i>	ARMv8.1
00	0	1	1	0	001	-	LDCLRB, LDCLRAB, LDCLRALB, LDCLRLB - <i>Acquire and release variant on page C6-647</i>	ARMv8.1
00	0	1	1	0	010	-	LDEORB, LDEORAB, LDEORALB, LDEORLB - <i>Acquire and release variant on page C6-653</i>	ARMv8.1
00	0	1	1	0	011	-	LDSETB, LDSETAB, LDSETALB, LDSETLB - <i>Acquire and release variant on page C6-700</i>	ARMv8.1
00	0	1	1	0	100	-	LDSMAXB, LDSMAXAB, LDSMAXALB, LDSMAXLB - <i>Acquire and release variant on page C6-706</i>	ARMv8.1
00	0	1	1	0	101	-	LDSMINB, LDSMINAB, LDSMINALB, LDSMINLB - <i>Acquire and release variant on page C6-712</i>	ARMv8.1
00	0	1	1	0	110	-	LDUMAXB, LDUMAXAB, LDUMAXALB, LDUMAXLB - <i>Acquire and release variant on page C6-727</i>	ARMv8.1
00	0	1	1	0	111	-	LDUMINB, LDUMINAB, LDUMINALB, LDUMINLB - <i>Acquire and release variant on page C6-733</i>	ARMv8.1
00	0	1	1	1	000	-	SWPB, SWPAB, SWPALB, SWPLB - <i>Acquire and release variant on page C6-941</i>	ARMv8.1
01	0	0	0	0	000	!= 11111	LDADDH, LDADDAH, LDADDALH, LDADDLH - <i>No memory ordering variant on page C6-634</i>	ARMv8.1
01	0	0	0	0	000	11111	STADDH, STADDLH - <i>No memory ordering variant on page C6-834</i>	ARMv8.1
01	0	0	0	0	001	!= 11111	LDCLRH, LDCLRAH, LDCLRALH, LDCLRLH - <i>No memory ordering variant on page C6-649</i>	ARMv8.1
01	0	0	0	0	001	11111	STCLRH, STCLRLH - <i>No memory ordering variant on page C6-840</i>	ARMv8.1
01	0	0	0	0	010	!= 11111	LDEORH, LDEORAH, LDEORALH, LDEORLH - <i>No memory ordering variant on page C6-655</i>	ARMv8.1
01	0	0	0	0	010	11111	STEORH, STEORLH - <i>No memory ordering variant on page C6-846</i>	ARMv8.1
01	0	0	0	0	011	!= 11111	LDSETH, LDSETAH, LDSETALH, LDSETLH - <i>No memory ordering variant on page C6-702</i>	ARMv8.1
01	0	0	0	0	011	11111	STSETH, STSETLH - <i>No memory ordering variant on page C6-885</i>	ARMv8.1

Decode fields							Instruction page	Architecture version
size	V	A	R	o3	opc	Rt		
01	0	0	0	0	100	!= 11111	LDSMAXH, LDSMAXAH, LDSMAXALH, LDSMAXLH - <i>No memory ordering variant on page C6-708</i>	ARMv8.1
01	0	0	0	0	100	11111	STSMAXH, STSMAXLH - <i>No memory ordering variant on page C6-891</i>	ARMv8.1
01	0	0	0	0	101	!= 11111	LDSMINH, LDSMINAH, LDSMINALH, LDSMINLH - <i>No memory ordering variant on page C6-714</i>	ARMv8.1
01	0	0	0	0	101	11111	STSMINH, STSMINLH - <i>No memory ordering variant on page C6-897</i>	ARMv8.1
01	0	0	0	0	110	!= 11111	LDUMAXH, LDUMAXAH, LDUMAXALH, LDUMAXLH - <i>No memory ordering variant on page C6-729</i>	ARMv8.1
01	0	0	0	0	110	11111	STUMAXH, STUMAXLH - <i>No memory ordering variant on page C6-907</i>	ARMv8.1
01	0	0	0	0	111	!= 11111	LDUMINH, LDUMINAH, LDUMINALH, LDUMINLH - <i>No memory ordering variant on page C6-735</i>	ARMv8.1
01	0	0	0	0	111	11111	STUMINH, STUMINLH - <i>No memory ordering variant on page C6-913</i>	ARMv8.1
01	0	0	0	1	000	-	SWPH, SWPAH, SWPALH, SWPLH - <i>No memory ordering variant on page C6-943</i>	ARMv8.1
01	0	0	1	0	000	!= 11111	LDADDH, LDADDAH, LDADDALH, LDADDLH - <i>Release variant on page C6-634</i>	ARMv8.1
01	0	0	1	0	000	11111	STADDH, STADDLH - <i>Release variant on page C6-834</i>	ARMv8.1
01	0	0	1	0	001	!= 11111	LDCLRH, LDCLRAH, LDCLRALH, LDCLRLH - <i>Release variant on page C6-649</i>	ARMv8.1
01	0	0	1	0	001	11111	STCLRH, STCLRLH - <i>Release variant on page C6-840</i>	ARMv8.1
01	0	0	1	0	010	!= 11111	LDEORH, LDEORAH, LDEORALH, LDEORLH - <i>Release variant on page C6-655</i>	ARMv8.1
01	0	0	1	0	010	11111	STEORH, STEORLH - <i>Release variant on page C6-846</i>	ARMv8.1
01	0	0	1	0	011	!= 11111	LDSETH, LDSETAH, LDSETALH, LDSETLH - <i>Release variant on page C6-702</i>	ARMv8.1
01	0	0	1	0	011	11111	STSETH, STSETLH - <i>Release variant on page C6-885</i>	ARMv8.1
01	0	0	1	0	100	!= 11111	LDSMAXH, LDSMAXAH, LDSMAXALH, LDSMAXLH - <i>Release variant on page C6-708</i>	ARMv8.1
01	0	0	1	0	100	11111	STSMAXH, STSMAXLH - <i>Release variant on page C6-891</i>	ARMv8.1
01	0	0	1	0	101	!= 11111	LDSMINH, LDSMINAH, LDSMINALH, LDSMINLH - <i>Release variant on page C6-714</i>	ARMv8.1

Decode fields							Instruction page	Architecture version
size	V	A	R	o3	opc	Rt		
01	0	0	1	0	101	11111	STSMINH, STSMINLH - <i>Release variant on page C6-897</i>	ARMv8.1
01	0	0	1	0	110	!= 11111	LDUMAXH, LDUMAXAH, LDUMAXALH, LDUMAXLH - <i>Release variant on page C6-729</i>	ARMv8.1
01	0	0	1	0	110	11111	STUMAXH, STUMAXLH - <i>Release variant on page C6-907</i>	ARMv8.1
01	0	0	1	0	111	!= 11111	LDUMINH, LDUMINAH, LDUMINALH, LDUMINLH - <i>Release variant on page C6-735</i>	ARMv8.1
01	0	0	1	0	111	11111	STUMINH, STUMINLH - <i>Release variant on page C6-913</i>	ARMv8.1
01	0	0	1	1	000	-	SWPH, SWPAH, SWPALH, SWPLH - <i>Release variant on page C6-943</i>	ARMv8.1
01	0	1	0	0	000	-	LDADDH, LDADDAH, LDADDALH, LDADDLH - <i>Acquire variant on page C6-634</i>	ARMv8.1
01	0	1	0	0	001	-	LDCLRH, LDCLRAH, LDCLRALH, LDCLRLH - <i>Acquire variant on page C6-649</i>	ARMv8.1
01	0	1	0	0	010	-	LDEORH, LDEORAH, LDEORALH, LDEORLH - <i>Acquire variant on page C6-655</i>	ARMv8.1
01	0	1	0	0	011	-	LDSETH, LDSETAH, LDSETALH, LDSETLH - <i>Acquire variant on page C6-702</i>	ARMv8.1
01	0	1	0	0	100	-	LDSMAXH, LDSMAXAH, LDSMAXALH, LDSMAXLH - <i>Acquire variant on page C6-708</i>	ARMv8.1
01	0	1	0	0	101	-	LDSMINH, LDSMINAH, LDSMINALH, LDSMINLH - <i>Acquire variant on page C6-714</i>	ARMv8.1
01	0	1	0	0	110	-	LDUMAXH, LDUMAXAH, LDUMAXALH, LDUMAXLH - <i>Acquire variant on page C6-729</i>	ARMv8.1
01	0	1	0	0	111	-	LDUMINH, LDUMINAH, LDUMINALH, LDUMINLH - <i>Acquire variant on page C6-735</i>	ARMv8.1
01	0	1	0	1	000	-	SWPH, SWPAH, SWPALH, SWPLH - <i>Acquire variant on page C6-943</i>	ARMv8.1
01	0	1	1	0	000	-	LDADDH, LDADDAH, LDADDALH, LDADDLH - <i>Acquire and release variant on page C6-634</i>	ARMv8.1
01	0	1	1	0	001	-	LDCLRH, LDCLRAH, LDCLRALH, LDCLRLH - <i>Acquire and release variant on page C6-649</i>	ARMv8.1
01	0	1	1	0	010	-	LDEORH, LDEORAH, LDEORALH, LDEORLH - <i>Acquire and release variant on page C6-655</i>	ARMv8.1
01	0	1	1	0	011	-	LDSETH, LDSETAH, LDSETALH, LDSETLH - <i>Acquire and release variant on page C6-702</i>	ARMv8.1
01	0	1	1	0	100	-	LDSMAXH, LDSMAXAH, LDSMAXALH, LDSMAXLH - <i>Acquire and release variant on page C6-708</i>	ARMv8.1

Decode fields							Instruction page	Architecture version
size	V	A	R	o3	opc	Rt		
01	0	1	1	0	101	-	LDSMINH, LDSMINAH, LDSMINALH, LDSMINLH <i>- Acquire and release variant on page C6-714</i>	ARMv8.1
01	0	1	1	0	110	-	LDUMAXH, LDUMAXAH, LDUMAXALH, LDUMAXLH <i>- Acquire and release variant on page C6-729</i>	ARMv8.1
01	0	1	1	0	111	-	LDUMINH, LDUMINAH, LDUMINALH, LDUMINLH <i>- Acquire and release variant on page C6-735</i>	ARMv8.1
01	0	1	1	1	000	-	SWPH, SWPAH, SWPALH, SWPLH <i>- Acquire and release variant on page C6-943</i>	ARMv8.1
10	0	0	0	0	000	!= 11111	LDADD, LDADDA, LDADDAL, LDADDL - <i>32-bit, no memory ordering variant on page C6-636</i>	ARMv8.1
10	0	0	0	0	000	11111	STADD, STADDL - <i>32-bit, no memory ordering variant on page C6-836</i>	ARMv8.1
10	0	0	0	0	001	!= 11111	LDCLR, LDCLRA, LDCLRAL, LDCLRRL - <i>32-bit, no memory ordering variant on page C6-651</i>	ARMv8.1
10	0	0	0	0	001	11111	STCLR, STCLRRL - <i>32-bit, no memory ordering variant on page C6-842</i>	ARMv8.1
10	0	0	0	0	010	!= 11111	LDEOR, LDEORA, LDEORAL, LDEORL - <i>32-bit, no memory ordering variant on page C6-657</i>	ARMv8.1
10	0	0	0	0	010	11111	STEOR, STEORL - <i>32-bit, no memory ordering variant on page C6-848</i>	ARMv8.1
10	0	0	0	0	011	!= 11111	LDSET, LDSETA, LDSETAL, LDSETL - <i>32-bit, no memory ordering variant on page C6-704</i>	ARMv8.1
10	0	0	0	0	011	11111	STSET, STSETL - <i>32-bit, no memory ordering variant on page C6-887</i>	ARMv8.1
10	0	0	0	0	100	!= 11111	LDSMAX, LDSMAXA, LDSMAXAL, LDSMAXL - <i>32-bit, no memory ordering variant on page C6-710</i>	ARMv8.1
10	0	0	0	0	100	11111	STSMAX, STSMAXL - <i>32-bit, no memory ordering variant on page C6-893</i>	ARMv8.1
10	0	0	0	0	101	!= 11111	LDSMIN, LDSMINA, LDSMINAL, LDSMINL - <i>32-bit, no memory ordering variant on page C6-716</i>	ARMv8.1
10	0	0	0	0	101	11111	STSMIN, STSMINL - <i>32-bit, no memory ordering variant on page C6-899</i>	ARMv8.1
10	0	0	0	0	110	!= 11111	LDUMAX, LDUMAXA, LDUMAXAL, LDUMAXL - <i>32-bit, no memory ordering variant on page C6-731</i>	ARMv8.1
10	0	0	0	0	110	11111	STUMAX, STUMAXL - <i>32-bit, no memory ordering variant on page C6-909</i>	ARMv8.1
10	0	0	0	0	111	!= 11111	LDUMIN, LDUMINA, LDUMINAL, LDUMINL - <i>32-bit, no memory ordering variant on page C6-737</i>	ARMv8.1

Decode fields							Instruction page	Architecture version
size	V	A	R	o3	opc	Rt		
10	0	0	0	0	111	11111	STUMIN, STUMINL - 32-bit, no memory ordering variant on page C6-915	ARMv8.1
10	0	0	0	1	000	-	SWP, SWPA, SWPAL, SWPL - 32-bit, no memory ordering variant on page C6-945	ARMv8.1
10	0	0	1	0	000	!= 11111	LDADD, LDADDA, LDADDAL, LDADDL - 32-bit, release variant on page C6-636	ARMv8.1
10	0	0	1	0	000	11111	STADD, STADDL - 32-bit, release variant on page C6-836	ARMv8.1
10	0	0	1	0	001	!= 11111	LDCLR, LDCLRA, LDCLRAL, LDCLRL - 32-bit, release variant on page C6-651	ARMv8.1
10	0	0	1	0	001	11111	STCLR, STCLRL - 32-bit, release variant on page C6-842	ARMv8.1
10	0	0	1	0	010	!= 11111	LDEOR, LDEORA, LDEORAL, LDEORL - 32-bit, release variant on page C6-657	ARMv8.1
10	0	0	1	0	010	11111	STEOR, STEORL - 32-bit, release variant on page C6-848	ARMv8.1
10	0	0	1	0	011	!= 11111	LDSET, LDSETA, LDSETAL, LDSETL - 32-bit, release variant on page C6-704	ARMv8.1
10	0	0	1	0	011	11111	STSET, STSETL - 32-bit, release variant on page C6-887	ARMv8.1
10	0	0	1	0	100	!= 11111	LDSMAX, LDSMAXA, LDSMAXAL, LDSMAXL - 32-bit, release variant on page C6-710	ARMv8.1
10	0	0	1	0	100	11111	STSMAX, STSMAXL - 32-bit, release variant on page C6-893	ARMv8.1
10	0	0	1	0	101	!= 11111	LDSMIN, LDSMINA, LDSMINAL, LDSMINL - 32-bit, release variant on page C6-716	ARMv8.1
10	0	0	1	0	101	11111	STSMIN, STSMINL - 32-bit, release variant on page C6-899	ARMv8.1
10	0	0	1	0	110	!= 11111	LDUMAX, LDUMAXA, LDUMAXAL, LDUMAXL - 32-bit, release variant on page C6-731	ARMv8.1
10	0	0	1	0	110	11111	STUMAX, STUMAXL - 32-bit, release variant on page C6-909	ARMv8.1
10	0	0	1	0	111	!= 11111	LDUMIN, LDUMINA, LDUMINAL, LDUMINL - 32-bit, release variant on page C6-737	ARMv8.1
10	0	0	1	0	111	11111	STUMIN, STUMINL - 32-bit, release variant on page C6-915	ARMv8.1
10	0	0	1	1	000	-	SWP, SWPA, SWPAL, SWPL - 32-bit, release variant on page C6-945	ARMv8.1
10	0	1	0	0	000	-	LDADD, LDADDA, LDADDAL, LDADDL - 32-bit, acquire variant on page C6-636	ARMv8.1

Decode fields							Instruction page	Architecture version
size	V	A	R	o3	opc	Rt		
10	0	1	0	0	001	-	LDCLR, LDCLRA, LDCLRAL, LDCLRL - 32-bit, acquire variant on page C6-651	ARMv8.1
10	0	1	0	0	010	-	LDEOR, LDEORA, LDEORAL, LDEORL - 32-bit, acquire variant on page C6-657	ARMv8.1
10	0	1	0	0	011	-	LDSET, LDSETA, LDSETAL, LDSETL - 32-bit, acquire variant on page C6-704	ARMv8.1
10	0	1	0	0	100	-	LDSMAX, LDSMAXA, LDSMAXAL, LDSMAXL - 32-bit, acquire variant on page C6-710	ARMv8.1
10	0	1	0	0	101	-	LDSMIN, LDSMINA, LDSMINAL, LDSMINL - 32-bit, acquire variant on page C6-716	ARMv8.1
10	0	1	0	0	110	-	LDUMAX, LDUMAXA, LDUMAXAL, LDUMAXL - 32-bit, acquire variant on page C6-731	ARMv8.1
10	0	1	0	0	111	-	LDUMIN, LDUMINA, LDUMINAL, LDUMINL - 32-bit, acquire variant on page C6-737	ARMv8.1
10	0	1	0	1	000	-	SWP, SWPA, SWPAL, SWPL - 32-bit, acquire variant on page C6-945	ARMv8.1
10	0	1	1	0	000	-	LDADD, LDADDA, LDADDAL, LDADDL - 32-bit, acquire and release variant on page C6-636	ARMv8.1
10	0	1	1	0	001	-	LDCLR, LDCLRA, LDCLRAL, LDCLRL - 32-bit, acquire and release variant on page C6-651	ARMv8.1
10	0	1	1	0	010	-	LDEOR, LDEORA, LDEORAL, LDEORL - 32-bit, acquire and release variant on page C6-657	ARMv8.1
10	0	1	1	0	011	-	LDSET, LDSETA, LDSETAL, LDSETL - 32-bit, acquire and release variant on page C6-704	ARMv8.1
10	0	1	1	0	100	-	LDSMAX, LDSMAXA, LDSMAXAL, LDSMAXL - 32-bit, acquire and release variant on page C6-710	ARMv8.1
10	0	1	1	0	101	-	LDSMIN, LDSMINA, LDSMINAL, LDSMINL - 32-bit, acquire and release variant on page C6-716	ARMv8.1
10	0	1	1	0	110	-	LDUMAX, LDUMAXA, LDUMAXAL, LDUMAXL - 32-bit, acquire and release variant on page C6-731	ARMv8.1
10	0	1	1	0	111	-	LDUMIN, LDUMINA, LDUMINAL, LDUMINL - 32-bit, acquire and release variant on page C6-737	ARMv8.1
10	0	1	1	1	000	-	SWP, SWPA, SWPAL, SWPL - 32-bit, acquire and release variant on page C6-945	ARMv8.1
11	0	0	0	0	000	!= 11111	LDADD, LDADDA, LDADDAL, LDADDL - 64-bit, no memory ordering variant on page C6-636	ARMv8.1
11	0	0	0	0	000	11111	STADD, STADDL - 64-bit, no memory ordering variant on page C6-836	ARMv8.1
11	0	0	0	0	001	!= 11111	LDCLR, LDCLRA, LDCLRAL, LDCLRL - 64-bit, no memory ordering variant on page C6-651	ARMv8.1

Decode fields							Instruction page	Architecture version
size	V	A	R	o3	opc	Rt		
11	0	0	0	0	001	11111	STCLR, STCLRL - 64-bit, no memory ordering variant on page C6-842	ARMv8.1
11	0	0	0	0	010	!= 11111	LDEOR, LDEORA, LDEORAL, LDEORL - 64-bit, no memory ordering variant on page C6-657	ARMv8.1
11	0	0	0	0	010	11111	STEOR, STEORL - 64-bit, no memory ordering variant on page C6-848	ARMv8.1
11	0	0	0	0	011	!= 11111	LDSET, LDSETA, LDSETAL, LDSETL - 64-bit, no memory ordering variant on page C6-704	ARMv8.1
11	0	0	0	0	011	11111	STSET, STSETL - 64-bit, no memory ordering variant on page C6-887	ARMv8.1
11	0	0	0	0	100	!= 11111	LDSMAX, LDSMAXA, LDSMAXAL, LDSMAXL - 64-bit, no memory ordering variant on page C6-710	ARMv8.1
11	0	0	0	0	100	11111	STSMAX, STSMAXL - 64-bit, no memory ordering variant on page C6-893	ARMv8.1
11	0	0	0	0	101	!= 11111	LDSMIN, LDSMINA, LDSMINAL, LDSMINL - 64-bit, no memory ordering variant on page C6-716	ARMv8.1
11	0	0	0	0	101	11111	STSMIN, STSMINL - 64-bit, no memory ordering variant on page C6-899	ARMv8.1
11	0	0	0	0	110	!= 11111	LDUMAX, LDUMAXA, LDUMAXAL, LDUMAXL - 64-bit, no memory ordering variant on page C6-731	ARMv8.1
11	0	0	0	0	110	11111	STUMAX, STUMAXL - 64-bit, no memory ordering variant on page C6-909	ARMv8.1
11	0	0	0	0	111	!= 11111	LDUMIN, LDUMINA, LDUMINAL, LDUMINL - 64-bit, no memory ordering variant on page C6-737	ARMv8.1
11	0	0	0	0	111	11111	STUMIN, STUMINL - 64-bit, no memory ordering variant on page C6-915	ARMv8.1
11	0	0	0	1	000	-	SWP, SWPA, SWPAL, SWPL - 64-bit, no memory ordering variant on page C6-945	ARMv8.1
11	0	0	1	0	000	!= 11111	LDADD, LDADDA, LDADDAL, LDADDL - 64-bit, release variant on page C6-637	ARMv8.1
11	0	0	1	0	000	11111	STADD, STADDL - 64-bit, release variant on page C6-836	ARMv8.1
11	0	0	1	0	001	!= 11111	LDCLR, LDCLRA, LDCLRAL, LDCLRL - 64-bit, release variant on page C6-652	ARMv8.1
11	0	0	1	0	001	11111	STCLR, STCLRL - 64-bit, release variant on page C6-842	ARMv8.1
11	0	0	1	0	010	!= 11111	LDEOR, LDEORA, LDEORAL, LDEORL - 64-bit, release variant on page C6-658	ARMv8.1
11	0	0	1	0	010	11111	STEOR, STEORL - 64-bit, release variant on page C6-848	ARMv8.1

Decode fields							Instruction page	Architecture version
size	V	A	R	o3	opc	Rt		
11	0	0	1	0	011	!= 11111	LDSET, LDSETA, LDSETAL, LDSETL - 64-bit, release variant on page C6-705	ARMv8.1
11	0	0	1	0	011	11111	STSET, STSETL - 64-bit, release variant on page C6-887	ARMv8.1
11	0	0	1	0	100	!= 11111	LDSMAX, LDSMAXA, LDSMAXAL, LDSMAXL - 64-bit, release variant on page C6-711	ARMv8.1
11	0	0	1	0	100	11111	STSMAX, STSMAXL - 64-bit, release variant on page C6-893	ARMv8.1
11	0	0	1	0	101	!= 11111	LDSMIN, LDSMINA, LDSMINAL, LDSMINL - 64-bit, release variant on page C6-717	ARMv8.1
11	0	0	1	0	101	11111	STSMIN, STSMINL - 64-bit, release variant on page C6-899	ARMv8.1
11	0	0	1	0	110	!= 11111	LDUMAX, LDUMAXA, LDUMAXAL, LDUMAXL - 64-bit, release variant on page C6-732	ARMv8.1
11	0	0	1	0	110	11111	STUMAX, STUMAXL - 64-bit, release variant on page C6-909	ARMv8.1
11	0	0	1	0	111	!= 11111	LDUMIN, LDUMINA, LDUMINAL, LDUMINL - 64-bit, release variant on page C6-738	ARMv8.1
11	0	0	1	0	111	11111	STUMIN, STUMINL - 64-bit, release variant on page C6-915	ARMv8.1
11	0	0	1	1	000	-	SWP, SWPA, SWPAL, SWPL - 64-bit, release variant on page C6-946	ARMv8.1
11	0	1	0	0	000	-	LDADD, LDADDA, LDADDAL, LDADDL - 64-bit, acquire variant on page C6-636	ARMv8.1
11	0	1	0	0	001	-	LDCLR, LDCLRA, LDCLRAL, LDCLRL - 64-bit, acquire variant on page C6-651	ARMv8.1
11	0	1	0	0	010	-	LDEOR, LDEORA, LDEORAL, LDEORL - 64-bit, acquire variant on page C6-657	ARMv8.1
11	0	1	0	0	011	-	LDSET, LDSETA, LDSETAL, LDSETL - 64-bit, acquire variant on page C6-704	ARMv8.1
11	0	1	0	0	100	-	LDSMAX, LDSMAXA, LDSMAXAL, LDSMAXL - 64-bit, acquire variant on page C6-710	ARMv8.1
11	0	1	0	0	101	-	LDSMIN, LDSMINA, LDSMINAL, LDSMINL - 64-bit, acquire variant on page C6-716	ARMv8.1
11	0	1	0	0	110	-	LDUMAX, LDUMAXA, LDUMAXAL, LDUMAXL - 64-bit, acquire variant on page C6-731	ARMv8.1
11	0	1	0	0	111	-	LDUMIN, LDUMINA, LDUMINAL, LDUMINL - 64-bit, acquire variant on page C6-737	ARMv8.1
11	0	1	0	1	000	-	SWP, SWPA, SWPAL, SWPL - 64-bit, acquire variant on page C6-945	ARMv8.1

Decode fields							Instruction page	Architecture version
size	V	A	R	o3	opc	Rt		
11	0	1	1	0	000	-	LDADD, LDADDA, LDADDAL, LDADDL - 64-bit, acquire and release variant on page C6-636	ARMv8.1
11	0	1	1	0	001	-	LDCLR, LDCLRA, LDCLRAL, LDCLRL - 64-bit, acquire and release variant on page C6-651	ARMv8.1
11	0	1	1	0	010	-	LDEOR, LDEORA, LDEORAL, LDEORL - 64-bit, acquire and release variant on page C6-657	ARMv8.1
11	0	1	1	0	011	-	LDSET, LDSETA, LDSETAL, LDSETL - 64-bit, acquire and release variant on page C6-704	ARMv8.1
11	0	1	1	0	100	-	LDSMAX, LDSMAXA, LDSMAXAL, LDSMAXL - 64-bit, acquire and release variant on page C6-710	ARMv8.1
11	0	1	1	0	101	-	LDSMIN, LDSMINA, LDSMINAL, LDSMINL - 64-bit, acquire and release variant on page C6-716	ARMv8.1
11	0	1	1	0	110	-	LDUMAX, LDUMAXA, LDUMAXAL, LDUMAXL - 64-bit, acquire and release variant on page C6-731	ARMv8.1
11	0	1	1	0	111	-	LDUMIN, LDUMINA, LDUMINAL, LDUMINL - 64-bit, acquire and release variant on page C6-737	ARMv8.1
11	0	1	1	1	000	-	SWP, SWPA, SWPAL, SWPL - 64-bit, acquire and release variant on page C6-945	ARMv8.1

Load/store register (register offset)

This section describes the encoding of the Load/store register (register offset) instruction class. This section is decoded from *Loads and Stores* on page C4-219.

31 30 29 28				27 26 25 24				23 22 21 20				16 15		13 12 11 10 9			5 4		0
size	1	1	1	V	0	0	opc	1	Rm	option	S	1	0	Rn	Rt				

Decode fields				Instruction page
size	V	opc	option	
-	-	-	x0x	Unallocated.
x1	1	1x	-	Unallocated.
00	0	00	!= 011	STRB (register) - Extended register variant on page C6-877
00	0	00	011	STRB (register) - Shifted register variant on page C6-877
00	0	01	!= 011	LDRB (register) - Extended register variant on page C6-679
00	0	01	011	LDRB (register) - Shifted register variant on page C6-679
00	0	10	!= 011	LDRSB (register) - 64-bit with extended register offset variant on page C6-688
00	0	10	011	LDRSB (register) - 64-bit with shifted register offset variant on page C6-688

Decode fields				Instruction page
size	V	opc	option	
00	0	11	!= 011	LDRSB (register) - 32-bit with extended register offset variant on page C6-688
00	0	11	011	LDRSB (register) - 32-bit with shifted register offset variant on page C6-688
00	1	00	!= 011	STR (register, SIMD&FP)
00	1	00	011	STR (register, SIMD&FP)
00	1	01	!= 011	LDR (register, SIMD&FP)
00	1	01	011	LDR (register, SIMD&FP)
00	1	10	-	STR (register, SIMD&FP)
00	1	11	-	LDR (register, SIMD&FP)
01	0	00	-	STRH (register)
01	0	01	-	LDRH (register)
01	0	10	-	LDRSH (register) - 64-bit variant on page C6-693
01	0	11	-	LDRSH (register) - 32-bit variant on page C6-693
01	1	00	-	STR (register, SIMD&FP)
01	1	01	-	LDR (register, SIMD&FP)
1x	0	11	-	Unallocated.
1x	1	1x	-	Unallocated.
10	0	00	-	STR (register) - 32-bit variant on page C6-873
10	0	01	-	LDR (register) - 32-bit variant on page C6-675
10	0	10	-	LDRSW (register)
10	1	00	-	STR (register, SIMD&FP)
10	1	01	-	LDR (register, SIMD&FP)
11	0	00	-	STR (register) - 64-bit variant on page C6-873
11	0	01	-	LDR (register) - 64-bit variant on page C6-675
11	0	10	-	PRFM (register)
11	1	00	-	STR (register, SIMD&FP)
11	1	01	-	LDR (register, SIMD&FP)

Load/store register (unsigned immediate)

This section describes the encoding of the Load/store register (unsigned immediate) instruction class. This section is decoded from *Loads and Stores* on page C4-219.

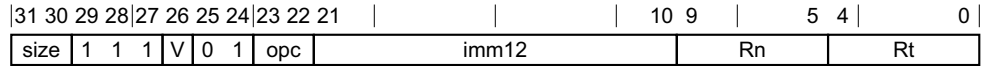

Decode fields

Instruction page

size	V	opc	Instruction page
x1	1	1x	Unallocated.
00	0	00	STRB (immediate)
00	0	01	LDRB (immediate)
00	0	10	LDRSB (immediate) - 64-bit variant on page C6-686
00	0	11	LDRSB (immediate) - 32-bit variant on page C6-686
00	1	00	STR (immediate, SIMD&FP) - 8-bit variant on page C7-1632
00	1	01	LDR (immediate, SIMD&FP) - 8-bit variant on page C7-1359
00	1	10	STR (immediate, SIMD&FP) - 128-bit variant on page C7-1633
00	1	11	LDR (immediate, SIMD&FP) - 128-bit variant on page C7-1360
01	0	00	STRH (immediate)
01	0	01	LDRH (immediate)
01	0	10	LDRSH (immediate) - 64-bit variant on page C6-691
01	0	11	LDRSH (immediate) - 32-bit variant on page C6-691
01	1	00	STR (immediate, SIMD&FP) - 16-bit variant on page C7-1632
01	1	01	LDR (immediate, SIMD&FP) - 16-bit variant on page C7-1359
1x	0	11	Unallocated.
1x	1	1x	Unallocated.
10	0	00	STR (immediate) - 32-bit variant on page C6-871
10	0	01	LDR (immediate) - 32-bit variant on page C6-671
10	0	10	LDRSW (immediate)
10	1	00	STR (immediate, SIMD&FP) - 32-bit variant on page C7-1632
10	1	01	LDR (immediate, SIMD&FP) - 32-bit variant on page C7-1359
11	0	00	STR (immediate) - 64-bit variant on page C6-871
11	0	01	LDR (immediate) - 64-bit variant on page C6-671
11	0	10	PRFM (immediate)
11	1	00	STR (immediate, SIMD&FP) - 64-bit variant on page C7-1632
11	1	01	LDR (immediate, SIMD&FP) - 64-bit variant on page C7-1359

C4.1.4 Data Processing -- Register

This section describes the encoding of the Data Processing -- Register group. This section is decoded from *A64 instruction set encoding* on page C4-210.

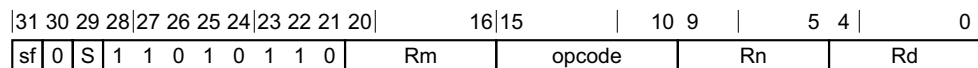

Table C4-5 Encoding table for the Data Processing -- Register group

Decode fields				Decode group or instruction page
op0	op1	op2	op3	
0	1	0110	-	<i>Data-processing (2 source)</i>
1	1	0110	-	<i>Data-processing (1 source) on page C4-254</i>
-	0	0xxx	-	<i>Logical (shifted register) on page C4-255</i>
-	0	1xx0	-	<i>Add/subtract (shifted register) on page C4-256</i>
-	0	1xx1	-	<i>Add/subtract (extended register) on page C4-257</i>
-	1	0000	-	<i>Add/subtract (with carry) on page C4-258</i>
-	1	0010	0	<i>Conditional compare (register) on page C4-258</i>
-	1	0010	1	<i>Conditional compare (immediate) on page C4-259</i>
-	1	0100	-	<i>Conditional select on page C4-259</i>
-	1	0xx1	-	Unallocated.
-	1	1xxx	-	<i>Data-processing (3 source) on page C4-260</i>

Data-processing (2 source)

This section describes the encoding of the Data-processing (2 source) instruction class. This section is decoded from *Data Processing -- Register*.



Decode fields			Instruction page
sf	S	opcode	
-	-	00000x	Unallocated.
-	-	011xxx	Unallocated.
-	-	1xxxxx	Unallocated.
-	0	0001xx	Unallocated.

Decode fields			Instruction page
sf	S	opcode	
-	0	0011xx	Unallocated.
-	1	-	Unallocated.
0	0	000010	UDIV - 32-bit variant on page C6-963
0	0	000011	SDIV - 32-bit variant on page C6-823
0	0	001000	LSLV - 32-bit variant on page C6-755
0	0	001001	LSRV - 32-bit variant on page C6-758
0	0	001010	ASRV - 32-bit variant on page C6-546
0	0	001011	RORV - 32-bit variant on page C6-814
0	0	010x11	Unallocated.
0	0	010000	CRC32B, CRC32H, CRC32W, CRC32X - CRC32B variant on page C6-595
0	0	010001	CRC32B, CRC32H, CRC32W, CRC32X - CRC32H variant on page C6-595
0	0	010010	CRC32B, CRC32H, CRC32W, CRC32X - CRC32W variant on page C6-595
0	0	010100	CRC32CB, CRC32CH, CRC32CW, CRC32CX - CRC32CB variant on page C6-597
0	0	010101	CRC32CB, CRC32CH, CRC32CW, CRC32CX - CRC32CH variant on page C6-597
0	0	010110	CRC32CB, CRC32CH, CRC32CW, CRC32CX - CRC32CW variant on page C6-597
1	0	000010	UDIV - 64-bit variant on page C6-963
1	0	000011	SDIV - 64-bit variant on page C6-823
1	0	001000	LSLV - 64-bit variant on page C6-755
1	0	001001	LSRV - 64-bit variant on page C6-758
1	0	001010	ASRV - 64-bit variant on page C6-546
1	0	001011	RORV - 64-bit variant on page C6-814
1	0	010xx0	Unallocated.
1	0	010x0x	Unallocated.
1	0	010011	CRC32B, CRC32H, CRC32W, CRC32X - CRC32X variant on page C6-595
1	0	010111	CRC32CB, CRC32CH, CRC32CW, CRC32CX - CRC32CX variant on page C6-597

Data-processing (1 source)

This section describes the encoding of the Data-processing (1 source) instruction class. This section is decoded from [Data Processing -- Register on page C4-253](#).

31	30	29	28	27	26	25	24	23	22	21	20	16	15	10	9	5	4	0
sf	1	S	1	1	0	1	0	1	1	0	opcode2	opcode			Rn	Rd		

Decode fields				Instruction page
sf	S	opcode2	opcode	
-	-	-	xx1xxx	Unallocated.
-	-	-	x1xxxx	Unallocated.
-	-	-	1xxxxx	Unallocated.
-	-	xxx1	-	Unallocated.
-	-	xxx1x	-	Unallocated.
-	-	xx1xx	-	Unallocated.
-	-	x1xxx	-	Unallocated.
-	-	1xxxx	-	Unallocated.
-	0	00000	00011x	Unallocated.
-	1	-	-	Unallocated.
0	0	00000	000000	RBIT - 32-bit variant on page C6-804
0	0	00000	000001	REV16 - 32-bit variant on page C6-808
0	0	00000	000010	REV - 32-bit variant on page C6-806
0	0	00000	000011	Unallocated.
0	0	00000	000100	CLZ - 32-bit variant on page C6-583
0	0	00000	000101	CLS - 32-bit variant on page C6-582
1	0	00000	000000	RBIT - 64-bit variant on page C6-804
1	0	00000	000001	REV16 - 64-bit variant on page C6-808
1	0	00000	000010	REV32
1	0	00000	000011	REV - 64-bit variant on page C6-806
1	0	00000	000100	CLZ - 64-bit variant on page C6-583
1	0	00000	000101	CLS - 64-bit variant on page C6-582

Logical (shifted register)

This section describes the encoding of the Logical (shifted register) instruction class. This section is decoded from [Data Processing -- Register on page C4-253](#).

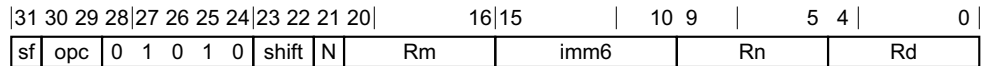

Decode fields				Instruction page
sf	opc	N	imm6	
0	-	-	1xxxxx	Unallocated.
0	00	0	-	AND (shifted register) - 32-bit variant on page C6-538
0	00	1	-	BIC (shifted register) - 32-bit variant on page C6-556
0	01	0	-	ORR (shifted register) - 32-bit variant on page C6-792
0	01	1	-	ORN (shifted register) - 32-bit variant on page C6-788
0	10	0	-	EOR (shifted register) - 32-bit variant on page C6-620
0	10	1	-	EON (shifted register) - 32-bit variant on page C6-617
0	11	0	-	ANDS (shifted register) - 32-bit variant on page C6-542
0	11	1	-	BICS (shifted register) - 32-bit variant on page C6-558
1	00	0	-	AND (shifted register) - 64-bit variant on page C6-538
1	00	1	-	BIC (shifted register) - 64-bit variant on page C6-556
1	01	0	-	ORR (shifted register) - 64-bit variant on page C6-792
1	01	1	-	ORN (shifted register) - 64-bit variant on page C6-788
1	10	0	-	EOR (shifted register) - 64-bit variant on page C6-620
1	10	1	-	EON (shifted register) - 64-bit variant on page C6-617
1	11	0	-	ANDS (shifted register) - 64-bit variant on page C6-542
1	11	1	-	BICS (shifted register) - 64-bit variant on page C6-558

Add/subtract (shifted register)

This section describes the encoding of the Add/subtract (shifted register) instruction class. This section is decoded from [Data Processing -- Register on page C4-253](#).

31 30 29 28				27 26 25 24				23 22 21 20				16 15		10 9		5 4		0	
sf	op	S	0	1	0	1	1	shift	0	Rm	imm6		Rn	Rd					

Decode fields					Instruction page
sf	op	S	shift	imm6	
-	-	-	11	-	Unallocated.
0	-	-	-	1xxxxx	Unallocated.
0	0	0	-	-	ADD (shifted register) - 32-bit variant on page C6-527
0	0	1	-	-	ADDS (shifted register) - 32-bit variant on page C6-533
0	1	0	-	-	SUB (shifted register) - 32-bit variant on page C6-932
0	1	1	-	-	SUBS (shifted register) - 32-bit variant on page C6-938
1	0	0	-	-	ADD (shifted register) - 64-bit variant on page C6-527
1	0	1	-	-	ADDS (shifted register) - 64-bit variant on page C6-533
1	1	0	-	-	SUB (shifted register) - 64-bit variant on page C6-932
1	1	1	-	-	SUBS (shifted register) - 64-bit variant on page C6-938

Add/subtract (extended register)

This section describes the encoding of the Add/subtract (extended register) instruction class. This section is decoded from [Data Processing -- Register on page C4-253](#).

31 30 29 28				27 26 25 24				23 22 21 20				16 15		13 12		10 9		5 4		0	
sf	op	S	0	1	0	1	1	opt	1	Rm	option	imm3	Rn	Rd							

Decode fields					Instruction page
sf	op	S	opt	imm3	
-	-	-	-	1x1	Unallocated.
-	-	-	-	11x	Unallocated.
-	-	-	x1	-	Unallocated.
-	-	-	1x	-	Unallocated.
0	0	0	00	-	ADD (extended register) - 32-bit variant on page C6-523
0	0	1	00	-	ADDS (extended register) - 32-bit variant on page C6-529
0	1	0	00	-	SUB (extended register) - 32-bit variant on page C6-928
0	1	1	00	-	SUBS (extended register) - 32-bit variant on page C6-934
1	0	0	00	-	ADD (extended register) - 64-bit variant on page C6-523

Decode fields					Instruction page
sf	op	S	opt	imm3	
1	0	1	00	-	ADDS (extended register) - 64-bit variant on page C6-529
1	1	0	00	-	SUB (extended register) - 64-bit variant on page C6-928
1	1	1	00	-	SUBS (extended register) - 64-bit variant on page C6-934

Add/subtract (with carry)

This section describes the encoding of the Add/subtract (with carry) instruction class. This section is decoded from [Data Processing -- Register on page C4-253](#).

31	30	29	28	27	26	25	24	23	22	21	20	16	15	10	9	5	4	0	
sf	op	S	1	1	0	1	0	0	0	0	0	Rm	opcode2	Rn	Rd				

Decode fields				Instruction page
sf	op	S	opcode2	
-	-	-	xxxxx1	Unallocated.
-	-	-	xxxx1x	Unallocated.
-	-	-	xxx1xx	Unallocated.
-	-	-	xx1xxx	Unallocated.
-	-	-	x1xxxx	Unallocated.
-	-	-	1xxxxx	Unallocated.
0	0	0	000000	ADC - 32-bit variant on page C6-521
0	0	1	000000	ADCS - 32-bit variant on page C6-522
0	1	0	000000	SBC - 32-bit variant on page C6-815
0	1	1	000000	SBCS - 32-bit variant on page C6-817
1	0	0	000000	ADC - 64-bit variant on page C6-521
1	0	1	000000	ADCS - 64-bit variant on page C6-522
1	1	0	000000	SBC - 64-bit variant on page C6-815
1	1	1	000000	SBCS - 64-bit variant on page C6-817

Conditional compare (register)

This section describes the encoding of the Conditional compare (register) instruction class. This section is decoded from [Data Processing -- Register on page C4-253](#).

31	30	29	28	27	26	25	24	23	22	21	20	16	15	12	11	10	9	5	4	3	0
sf	op	S	1	1	0	1	0	0	1	0	Rm	cond	0	o2	Rn	o3	nzcv				

Decode fields					Instruction page
sf	op	S	o2	o3	
-	-	-	-	1	Unallocated.
-	-	-	1	-	Unallocated.
-	-	0	-	-	Unallocated.
0	0	1	0	0	CCMN (register) - 32-bit variant on page C6-576
0	1	1	0	0	CCMP (register) - 32-bit variant on page C6-578
1	0	1	0	0	CCMN (register) - 64-bit variant on page C6-576
1	1	1	0	0	CCMP (register) - 64-bit variant on page C6-578

Conditional compare (immediate)

This section describes the encoding of the Conditional compare (immediate) instruction class. This section is decoded from [Data Processing -- Register on page C4-253](#).

31	30	29	28	27	26	25	24	23	22	21	20	16	15	12	11	10	9	5	4	3	0
sf	op	S	1	1	0	1	0	0	1	0	imm5	cond	1	o2	Rn	o3	nzcv				

Decode fields					Instruction page
sf	op	S	o2	o3	
-	-	-	-	1	Unallocated.
-	-	-	1	-	Unallocated.
-	-	0	-	-	Unallocated.
0	0	1	0	0	CCMN (immediate) - 32-bit variant on page C6-575
0	1	1	0	0	CCMP (immediate) - 32-bit variant on page C6-577
1	0	1	0	0	CCMN (immediate) - 64-bit variant on page C6-575
1	1	1	0	0	CCMP (immediate) - 64-bit variant on page C6-577

Conditional select

This section describes the encoding of the Conditional select instruction class. This section is decoded from [Data Processing -- Register on page C4-253](#).

31 30 29 28 27 26 25 24 23 22 21 20								16 15		12 11 10 9			5 4		0
sf	op	S	1	1	0	1	0	1	0	0	Rm	cond	op2	Rn	Rd

Decode fields				Instruction page
sf	op	S	op2	
-	-	-	1x	Unallocated.
-	-	1	-	Unallocated.
0	0	0	00	CSEL - 32-bit variant on page C6-599
0	0	0	01	CSINC - 32-bit variant on page C6-602
0	1	0	00	CSINV - 32-bit variant on page C6-604
0	1	0	01	CSNEG - 32-bit variant on page C6-606
1	0	0	00	CSEL - 64-bit variant on page C6-599
1	0	0	01	CSINC - 64-bit variant on page C6-602
1	1	0	00	CSINV - 64-bit variant on page C6-604
1	1	0	01	CSNEG - 64-bit variant on page C6-606

Data-processing (3 source)

This section describes the encoding of the Data-processing (3 source) instruction class. This section is decoded from [Data Processing -- Register on page C4-253](#).

31 30 29 28 27 26 25 24 23 21 20								16 15 14			10 9		5 4		0
sf	op54	1	1	0	1	1	op31	Rm	o0	Ra	Rn	Rd			

Decode fields				Instruction page
sf	op54	op31	o0	
-	00	010	1	Unallocated.
-	00	011	-	Unallocated.
-	00	100	-	Unallocated.
-	00	110	1	Unallocated.
-	00	111	-	Unallocated.
-	01	-	-	Unallocated.
-	1x	-	-	Unallocated.
0	00	000	0	MADD - 32-bit variant on page C6-759
0	00	000	1	MSUB - 32-bit variant on page C6-776

Decode fields				Instruction page
sf	op54	op31	o0	
0	00	001	0	Unallocated.
0	00	001	1	Unallocated.
0	00	010	0	Unallocated.
0	00	101	0	Unallocated.
0	00	101	1	Unallocated.
0	00	110	0	Unallocated.
1	00	000	0	MADD - 64-bit variant on page C6-759
1	00	000	1	MSUB - 64-bit variant on page C6-776
1	00	001	0	SMADDL
1	00	001	1	SMSUBL
1	00	010	0	SMULH
1	00	101	0	UMADDL
1	00	101	1	UMSUBL
1	00	110	0	UMULH

C4.1.5 Data Processing -- Scalar Floating-Point and Advanced SIMD

This section describes the encoding of the Data Processing -- Scalar Floating-Point and Advanced SIMD group. This section is decoded from *A64 instruction set encoding on page C4-210*.

31	28 27	24 23 22	19 18 17 16 15	10 9			0
op0	111	op1	op2	op3	op4		

Table C4-6 Encoding table for the Data Processing -- Scalar Floating-Point and Advanced SIMD group

Decode fields					Decode group or instruction page
op0	op1	op2	op3	op4	
0000	0x	x101	00	xxxx10	Unallocated.
0010	0x	x101	00	xxxx10	Unallocated.
0100	0x	x101	00	xxxx10	Cryptographic AES on page C4-263
0101	0x	x0xx	-	0xxx00	Cryptographic three-register SHA on page C4-264
0101	0x	x0xx	-	0xxx10	Unallocated.
0101	0x	x101	00	xxxx10	Cryptographic two-register SHA on page C4-265
0110	0x	x101	00	xxxx10	Unallocated.
0111	0x	x0xx	-	0xxx00	Unallocated.

Table C4-6 Encoding table for the Data Processing -- Scalar Floating-Point and Advanced SIMD group (continued)

Decode fields					Decode group or instruction page
op0	op1	op2	op3	op4	
0111	0x	x101	00	xxxx10	Unallocated.
01x1	00	00xx	-	0xxx1	<i>Advanced SIMD scalar copy on page C4-265</i>
01x1	01	00xx	-	0xxx1	Unallocated.
01x1	0x	0111	00	xxxx10	Unallocated.
01x1	0x	10xx	-	00xxx1	<i>Advanced SIMD scalar three same FP16 on page C4-266</i>
01x1	0x	10xx	-	01xxx1	Unallocated.
01x1	0x	1111	00	xxxx10	<i>Advanced SIMD scalar two-register miscellaneous FP16 on page C4-266</i>
01x1	0x	x0xx	-	1xxx0	Unallocated.
01x1	0x	x0xx	-	1xxx1	<i>Advanced SIMD scalar three same extra on page C4-268</i>
01x1	0x	x100	00	xxxx10	<i>Advanced SIMD scalar two-register miscellaneous on page C4-268</i>
01x1	0x	x110	00	xxxx10	<i>Advanced SIMD scalar pairwise on page C4-270</i>
01x1	0x	x1xx	1x	xxxx10	Unallocated.
01x1	0x	x1xx	x1	xxxx10	Unallocated.
01x1	0x	x1xx	-	xxxx00	<i>Advanced SIMD scalar three different on page C4-271</i>
01x1	0x	x1xx	-	xxxx1	<i>Advanced SIMD scalar three same on page C4-272</i>
01x1	10	-	-	xxxx1	<i>Advanced SIMD scalar shift by immediate on page C4-274</i>
01x1	11	-	-	xxxx1	Unallocated.
01x1	1x	-	-	xxxx0	<i>Advanced SIMD scalar x indexed element on page C4-276</i>
0x00	0x	x0xx	-	0xxx00	<i>Advanced SIMD table lookup on page C4-277</i>
0x00	0x	x0xx	-	0xxx10	<i>Advanced SIMD permute on page C4-278</i>
0x10	0x	x0xx	-	0xxx0	<i>Advanced SIMD extract on page C4-279</i>
0xx0	00	00xx	-	0xxx1	<i>Advanced SIMD copy on page C4-279</i>
0xx0	01	00xx	-	0xxx1	Unallocated.
0xx0	0x	0111	00	xxxx10	Unallocated.
0xx0	0x	10xx	-	00xxx1	<i>Advanced SIMD three same (FP16) on page C4-280</i>
0xx0	0x	10xx	-	01xxx1	Unallocated.
0xx0	0x	1111	00	xxxx10	<i>Advanced SIMD two-register miscellaneous (FP16) on page C4-281</i>
0xx0	0x	x0xx	-	1xxx0	Unallocated.
0xx0	0x	x0xx	-	1xxx1	<i>Advanced SIMD three same extra on page C4-282</i>
0xx0	0x	x100	00	xxxx10	<i>Advanced SIMD two-register miscellaneous on page C4-283</i>
0xx0	0x	x110	00	xxxx10	<i>Advanced SIMD across lanes on page C4-286</i>

Table C4-6 Encoding table for the Data Processing -- Scalar Floating-Point and Advanced SIMD group (continued)

Decode fields					Decode group or instruction page
op0	op1	op2	op3	op4	
0xx0	0x	x1xx	1x	xxxx10	Unallocated.
0xx0	0x	x1xx	x1	xxxx10	Unallocated.
0xx0	0x	x1xx	-	xxxx00	<i>Advanced SIMD three different on page C4-287</i>
0xx0	0x	x1xx	-	xxxxx1	<i>Advanced SIMD three same on page C4-288</i>
0xx0	10	0000	-	xxxxx1	<i>Advanced SIMD modified immediate on page C4-291</i>
0xx0	10	!= 0000	-	xxxxx1	<i>Advanced SIMD shift by immediate on page C4-292</i>
0xx0	11	-	-	xxxxx1	Unallocated.
0xx0	1x	-	-	xxxxx0	<i>Advanced SIMD vector x indexed element on page C4-294</i>
11x1	-	-	-	-	Unallocated.
1xx0	-	-	-	-	Unallocated.
x0x1	0x	x0xx	-	-	<i>Conversion between floating-point and fixed-point on page C4-295</i>
x0x1	0x	x1xx	-	000000	<i>Conversion between floating-point and integer on page C4-297</i>
x0x1	0x	x1xx	-	100000	Unallocated.
x0x1	0x	x1xx	-	x10000	<i>Floating-point data-processing (1 source) on page C4-302</i>
x0x1	0x	x1xx	-	xx1000	<i>Floating-point compare on page C4-304</i>
x0x1	0x	x1xx	-	xxx100	<i>Floating-point immediate on page C4-305</i>
x0x1	0x	x1xx	-	xxxx01	<i>Floating-point conditional compare on page C4-306</i>
x0x1	0x	x1xx	-	xxxx10	<i>Floating-point data-processing (2 source) on page C4-306</i>
x0x1	0x	x1xx	-	xxxx11	<i>Floating-point conditional select on page C4-307</i>
x0x1	1x	-	-	-	<i>Floating-point data-processing (3 source) on page C4-308</i>

Cryptographic AES

This section describes the encoding of the Cryptographic AES instruction class. This section is decoded from *Data Processing -- Scalar Floating-Point and Advanced SIMD* on page C4-261.

31	30	29	28	27	26	25	24	23	22	21	20	19	18	17	16	12	11	10	9	5	4	0
0	1	0	0	1	1	1	0	size	1	0	1	0	0	opcode	1	0	Rn					Rd

Decode fields		Instruction page
size	opcode	
-	x1xxx	Unallocated.
-	000xx	Unallocated.
-	1xxxx	Unallocated.
x1	-	Unallocated.
00	00100	AESE
00	00101	AESD
00	00110	AESMC
00	00111	AESIMC
1x	-	Unallocated.

Cryptographic three-register SHA

This section describes the encoding of the Cryptographic three-register SHA instruction class. This section is decoded from *Data Processing -- Scalar Floating-Point and Advanced SIMD on page C4-261*.

31	30	29	28	27	26	25	24	23	22	21	20	16	15	14	12	11	10	9	5	4	0
0	1	0	1	1	1	1	0	size	0	Rm	0	opcode	0	0	Rn						Rd

Decode fields		Instruction page
size	opcode	
-	111	Unallocated.
x1	-	Unallocated.
00	000	SHA1C
00	001	SHA1P
00	010	SHA1M
00	011	SHA1SU0
00	100	SHA256H
00	101	SHA256H2
00	110	SHA256SU1
1x	-	Unallocated.

Cryptographic two-register SHA

This section describes the encoding of the Cryptographic two-register SHA instruction class. This section is decoded from *Data Processing -- Scalar Floating-Point and Advanced SIMD* on page C4-261.

31	30	29	28	27	26	25	24	23	22	21	20	19	18	17	16	12	11	10	9	5	4	0	
0	1	0	1	1	1	1	0	size	1	0	1	0	0	opcode				1	0	Rn		Rd	

Decode fields		Instruction page
size	opcode	
-	xx1xx	Unallocated.
-	x1xxx	Unallocated.
-	1xxxx	Unallocated.
x1	-	Unallocated.
00	00000	SHA1H
00	00001	SHA1SU1
00	00010	SHA256SU0
00	00011	Unallocated.
1x	-	Unallocated.

Advanced SIMD scalar copy

This section describes the encoding of the Advanced SIMD scalar copy instruction class. This section is decoded from *Data Processing -- Scalar Floating-Point and Advanced SIMD* on page C4-261.

31	30	29	28	27	26	25	24	23	22	21	20	16	15	14	11	10	9	5	4	0
0	1	op	1	1	1	1	0	0	0	0	0	imm5	0	imm4	1	Rn		Rd		

Decode fields			Instruction page
op	imm5	imm4	
0	-	xxx1	Unallocated.
0	-	xx1x	Unallocated.
0	-	x1xx	Unallocated.
0	-	0000	DUP (element)
0	-	1xxx	Unallocated.
0	x0000	0000	Unallocated.
1	-	-	Unallocated.

Advanced SIMD scalar three same FP16

This section describes the encoding of the Advanced SIMD scalar three same FP16 instruction class. This section is decoded from *Data Processing -- Scalar Floating-Point and Advanced SIMD* on page C4-261.

31 30 29 28		27 26 25 24		23 22 21 20		16		15 14 13		11 10 9		5 4		0			
0	1	U	1	1	1	1	0	a	1	0	Rm	0	0	opcode	1	Rn	Rd

Decode fields			Instruction page	Architecture version
U	a	opcode		
-	-	110	Unallocated.	-
-	1	011	Unallocated.	-
0	0	011	FMULX	ARMv8.2
0	0	100	FCMEQ (register)	ARMv8.2
0	0	101	Unallocated.	-
0	0	111	FRECPS	ARMv8.2
0	1	100	Unallocated.	-
0	1	101	Unallocated.	-
0	1	111	FRSQRTS	ARMv8.2
1	0	011	Unallocated.	-
1	0	100	FCMGE (register)	ARMv8.2
1	0	101	FACGE	ARMv8.2
1	0	111	Unallocated.	-
1	1	010	FABD	ARMv8.2
1	1	100	FCMGT (register)	ARMv8.2
1	1	101	FACGT	ARMv8.2
1	1	111	Unallocated.	-

Advanced SIMD scalar two-register miscellaneous FP16

This section describes the encoding of the Advanced SIMD scalar two-register miscellaneous FP16 instruction class. This section is decoded from *Data Processing -- Scalar Floating-Point and Advanced SIMD* on page C4-261.

31	30	29	28	27	26	25	24	23	22	21	20	19	18	17	16	12	11	10	9	5	4	0
0	1	U	1	1	1	1	0	a	1	1	1	1	0	0	opcode	1	0	Rn				Rd

Decode fields			Instruction page	Architecture version
U	a	opcode		
-	-	00xxx	Unallocated.	-
-	-	010xx	Unallocated.	-
-	-	10xxx	Unallocated.	-
-	-	1100x	Unallocated.	-
-	-	11110	Unallocated.	-
-	0	011xx	Unallocated.	-
-	0	11111	Unallocated.	-
-	1	01111	Unallocated.	-
-	1	11100	Unallocated.	-
0	0	11010	FCVTNS (vector)	ARMv8.2
0	0	11011	FCVTMS (vector)	ARMv8.2
0	0	11100	FCVTAS (vector)	ARMv8.2
0	0	11101	SCVTF (vector, integer)	ARMv8.2
0	1	01100	FCMGT (zero)	ARMv8.2
0	1	01101	FCMEQ (zero)	ARMv8.2
0	1	01110	FCMLT (zero)	ARMv8.2
0	1	11010	FCVTPS (vector)	ARMv8.2
0	1	11011	FCVTZS (vector, integer)	ARMv8.2
0	1	11101	FRECPE	ARMv8.2
0	1	11111	FRECPX	ARMv8.2
1	0	11010	FCVTNU (vector)	ARMv8.2
1	0	11011	FCVTMU (vector)	ARMv8.2
1	0	11100	FCVTAU (vector)	ARMv8.2
1	0	11101	UCVTF (vector, integer)	ARMv8.2
1	1	01100	FCMGE (zero)	ARMv8.2
1	1	01101	FCMLE (zero)	ARMv8.2
1	1	01110	Unallocated.	-
1	1	11010	FCVTPU (vector)	ARMv8.2

Decode fields			Instruction page	Architecture version
U	a	opcode		
1	1	11011	FCVTZU (vector, integer)	ARMv8.2
1	1	11101	FRSQRT	ARMv8.2
1	1	11111	Unallocated.	-

Advanced SIMD scalar three same extra

This section describes the encoding of the Advanced SIMD scalar three same extra instruction class. This section is decoded from *Data Processing -- Scalar Floating-Point and Advanced SIMD* on page C4-261.

31 30 29 28		27 26 25 24		23 22 21 20		16 15 14		11 10 9		5 4		0			
0	1	U	1	1	1	1	0	size	0	Rm	1	opcode	1	Rn	Rd

Decode fields			Instruction page	Architecture version
U	size	opcode		
-	-	001x	Unallocated.	-
-	-	01xx	Unallocated.	-
-	-	1xxx	Unallocated.	-
0	-	0000	Unallocated.	-
0	-	0001	Unallocated.	-
1	-	0000	SQRDMLAH (vector)	ARMv8.1
1	-	0001	SQRDMLSH (vector)	ARMv8.1

Advanced SIMD scalar two-register miscellaneous

This section describes the encoding of the Advanced SIMD scalar two-register miscellaneous instruction class. This section is decoded from *Data Processing -- Scalar Floating-Point and Advanced SIMD* on page C4-261.

31 30 29 28		27 26 25 24		23 22 21 20		19 18 17 16		12 11 10 9		5 4		0						
0	1	U	1	1	1	1	0	size	1	0	0	0	0	opcode	1	0	Rn	Rd

Decode fields			Instruction page
U	size	opcode	
-	-	0000x	Unallocated.
-	-	00010	Unallocated.
-	-	0010x	Unallocated.
-	-	00110	Unallocated.

Decode fields			Instruction page
U	size	opcode	
-	-	01111	Unallocated.
-	-	1000x	Unallocated.
-	-	10011	Unallocated.
-	-	10101	Unallocated.
-	-	10111	Unallocated.
-	-	1100x	Unallocated.
-	-	11110	Unallocated.
-	0x	011xx	Unallocated.
-	0x	11111	Unallocated.
-	1x	10110	Unallocated.
-	1x	11100	Unallocated.
0	-	00011	SUQADD
0	-	00111	SQABS
0	-	01000	CMGT (zero)
0	-	01001	CMEQ (zero)
0	-	01010	CMLT (zero)
0	-	01011	ABS
0	-	10010	Unallocated.
0	-	10100	SQXTN, SQXTN2
0	0x	10110	Unallocated.
0	0x	11010	FCVTNS (vector)
0	0x	11011	FCVTMS (vector)
0	0x	11100	FCVTAS (vector)
0	0x	11101	SCVTF (vector, integer)
0	1x	01100	FCMGT (zero)
0	1x	01101	FCMEQ (zero)
0	1x	01110	FCMLT (zero)
0	1x	11010	FCVTPS (vector)
0	1x	11011	FCVTZS (vector, integer)
0	1x	11101	FRECPE
0	1x	11111	FRECPX
1	-	00011	USQADD

Decode fields			Instruction page
U	size	opcode	
1	-	00111	SQNEG
1	-	01000	CMGE (zero)
1	-	01001	CMLE (zero)
1	-	01010	Unallocated.
1	-	01011	NEG (vector)
1	-	10010	SQXTUN, SQXTUN2
1	-	10100	UQXTN, UQXTN2
1	0x	10110	FCVTXN, FCVTXN2
1	0x	11010	FCVTNU (vector)
1	0x	11011	FCVTMU (vector)
1	0x	11100	FCVTAU (vector)
1	0x	11101	UCVTF (vector, integer)
1	1x	01100	FCMGE (zero)
1	1x	01101	FCMLE (zero)
1	1x	01110	Unallocated.
1	1x	11010	FCVTPU (vector)
1	1x	11011	FCVTZU (vector, integer)
1	1x	11101	FRSQRTE
1	1x	11111	Unallocated.

Advanced SIMD scalar pairwise

This section describes the encoding of the Advanced SIMD scalar pairwise instruction class. This section is decoded from [Data Processing -- Scalar Floating-Point and Advanced SIMD on page C4-261](#).

31	30	29	28	27	26	25	24	23	22	21	20	19	18	17	16	12	11	10	9	5	4	0
0	1	U	1	1	1	1	0	size	1	1	0	0	0	opcode	1	0	Rn	Rd				

Decode fields			Instruction page	Architecture version
U	size	opcode		
-	-	00xxx	Unallocated.	-
-	-	010xx	Unallocated.	-
-	-	01110	Unallocated.	-
-	-	10xxx	Unallocated.	-

Decode fields			Instruction page	Architecture version
U	size	opcode		
-	-	1100x	Unallocated.	-
-	-	11010	Unallocated.	-
-	-	111xx	Unallocated.	-
-	1x	01101	Unallocated.	-
0	-	11011	ADDP (scalar)	-
0	00	01100	FMAXNMP (scalar) - Half-precision variant on page C7-1178	ARMv8.2
0	00	01101	FADDP (scalar) - Half-precision variant on page C7-1055	ARMv8.2
0	00	01111	FMAXP (scalar) - Half-precision variant on page C7-1184	ARMv8.2
0	01	01100	Unallocated.	-
0	01	01101	Unallocated.	-
0	01	01111	Unallocated.	-
0	10	01100	FMINNMP (scalar) - Half-precision variant on page C7-1198	ARMv8.2
0	10	01111	FMINP (scalar) - Half-precision variant on page C7-1204	ARMv8.2
0	11	01100	Unallocated.	-
0	11	01111	Unallocated.	-
1	-	11011	Unallocated.	-
1	0x	01100	FMAXNMP (scalar) - Single-precision and double-precision variant on page C7-1178	-
1	0x	01101	FADDP (scalar) - Single-precision and double-precision variant on page C7-1055	-
1	0x	01111	FMAXP (scalar) - Single-precision and double-precision variant on page C7-1184	-
1	1x	01100	FMINNMP (scalar) - Single-precision and double-precision variant on page C7-1198	-
1	1x	01111	FMINP (scalar) - Single-precision and double-precision variant on page C7-1204	-

Advanced SIMD scalar three different

This section describes the encoding of the Advanced SIMD scalar three different instruction class. This section is decoded from *Data Processing -- Scalar Floating-Point and Advanced SIMD* on page C4-261.

31 30 29 28 27 26 25 24 23 22 21 20								16 15		12 11 10 9			5 4		0
0	1	U	1	1	1	1	0	size	1	Rm	opcode	0	0	Rn	Rd

Decode fields			Instruction page
U	opcode		
-	00xx		Unallocated.
-	01xx		Unallocated.
-	1000		Unallocated.
-	1010		Unallocated.
-	1100		Unallocated.
-	111x		Unallocated.
0	1001	SQDMLAL, SQDMLAL2 (vector)	
0	1011	SQDMLSL, SQDMLSL2 (vector)	
0	1101	SQDMULL, SQDMULL2 (vector)	
1	1001	Unallocated.	
1	1011	Unallocated.	
1	1101	Unallocated.	

Advanced SIMD scalar three same

This section describes the encoding of the Advanced SIMD scalar three same instruction class. This section is decoded from [Data Processing -- Scalar Floating-Point and Advanced SIMD](#) on page C4-261.

31 30 29 28 27 26 25 24 23 22 21 20								16 15		11 10 9			5 4		0
0	1	U	1	1	1	1	0	size	1	Rm	opcode	1	Rn	Rd	

Decode fields			Instruction page
U	size	opcode	
-	-	00000	Unallocated.
-	-	0001x	Unallocated.
-	-	00100	Unallocated.
-	-	011xx	Unallocated.
-	-	1001x	Unallocated.
-	1x	11011	Unallocated.
0	-	00001	SQADD

Decode fields			Instruction page
U	size	opcode	
0	-	00101	SQSUB
0	-	00110	CMGT (register)
0	-	00111	CMGE (register)
0	-	01000	SSHL
0	-	01001	SQSHL (register)
0	-	01010	SRSHL
0	-	01011	SQRSHL
0	-	10000	ADD (vector)
0	-	10001	CMTST
0	-	10100	Unallocated.
0	-	10101	Unallocated.
0	-	10110	SQDMULH (vector)
0	-	10111	Unallocated.
0	0x	11000	Unallocated.
0	0x	11001	Unallocated.
0	0x	11010	Unallocated.
0	0x	11011	FMULX
0	0x	11100	FCMEQ (register)
0	0x	11101	Unallocated.
0	0x	11110	Unallocated.
0	0x	11111	FRECPS
0	1x	11000	Unallocated.
0	1x	11001	Unallocated.
0	1x	11010	Unallocated.
0	1x	11100	Unallocated.
0	1x	11101	Unallocated.
0	1x	11110	Unallocated.
0	1x	11111	FRSQRTS
1	-	00001	UQADD
1	-	00101	UQSUB
1	-	00110	CMHI (register)
1	-	00111	CMHS (register)

Decode fields			Instruction page
U	size	opcode	
1	-	01000	USHL
1	-	01001	UQSHL (register)
1	-	01010	URSHL
1	-	01011	UQRSHL
1	-	10000	SUB (vector)
1	-	10001	CMEQ (register)
1	-	10100	Unallocated.
1	-	10101	Unallocated.
1	-	10110	SQRDMULH (vector)
1	-	10111	Unallocated.
1	0x	11000	Unallocated.
1	0x	11001	Unallocated.
1	0x	11010	Unallocated.
1	0x	11011	Unallocated.
1	0x	11100	FCMGE (register)
1	0x	11101	FACGE
1	0x	11110	Unallocated.
1	0x	11111	Unallocated.
1	1x	11000	Unallocated.
1	1x	11001	Unallocated.
1	1x	11010	FABD
1	1x	11100	FCMGT (register)
1	1x	11101	FACGT
1	1x	11110	Unallocated.
1	1x	11111	Unallocated.

Advanced SIMD scalar shift by immediate

This section describes the encoding of the Advanced SIMD scalar shift by immediate instruction class. This section is decoded from *Data Processing -- Scalar Floating-Point and Advanced SIMD* on page C4-261.

31	30	29	28	27	26	25	24	23	22	19	18	16	15	11	10	9	5	4	0
0	1	U	1	1	1	1	1	0	immh	immb	opcode	1	Rn	Rd					

Decode fields

Decode fields			Instruction page
U	immh	opcode	
-	!= 0000	00001	Unallocated.
-	!= 0000	00011	Unallocated.
-	!= 0000	00101	Unallocated.
-	!= 0000	00111	Unallocated.
-	!= 0000	01001	Unallocated.
-	!= 0000	01011	Unallocated.
-	!= 0000	01101	Unallocated.
-	!= 0000	01111	Unallocated.
-	!= 0000	101xx	Unallocated.
-	!= 0000	110xx	Unallocated.
-	!= 0000	11101	Unallocated.
-	!= 0000	11110	Unallocated.
-	0000	-	Unallocated.
0	!= 0000	00000	SSHR
0	!= 0000	00010	SSRA
0	!= 0000	00100	SRSHR
0	!= 0000	00110	SRSRA
0	!= 0000	01000	Unallocated.
0	!= 0000	01010	SHL
0	!= 0000	01100	Unallocated.
0	!= 0000	01110	SQSHL (immediate)
0	!= 0000	10000	Unallocated.
0	!= 0000	10001	Unallocated.
0	!= 0000	10010	SQSHRN, SQSHRN2
0	!= 0000	10011	SQRSHRN, SQRSHRN2
0	!= 0000	11100	SCVTF (vector, fixed-point)
0	!= 0000	11111	FCVTZS (vector, fixed-point)
1	!= 0000	00000	USHR

Decode fields			Instruction page
U	immh	opcode	
1	!= 0000	00010	USRA
1	!= 0000	00100	URSHR
1	!= 0000	00110	URSRA
1	!= 0000	01000	SRI
1	!= 0000	01010	SLI
1	!= 0000	01100	SQSHLU
1	!= 0000	01110	UQSHL (immediate)
1	!= 0000	10000	SQSHRUN, SQSHRUN2
1	!= 0000	10001	SQRSHRUN, SQRSHRUN2
1	!= 0000	10010	UQSHRN, UQSHRN2
1	!= 0000	10011	UQRSHRN, UQRSHRN2
1	!= 0000	11100	UCVTF (vector, fixed-point)
1	!= 0000	11111	FCVTZU (vector, fixed-point)

Advanced SIMD scalar x indexed element

This section describes the encoding of the Advanced SIMD scalar x indexed element instruction class. This section is decoded from *Data Processing -- Scalar Floating-Point and Advanced SIMD* on page C4-261.

31	30	29	28	27	26	25	24	23	22	21	20	19	16	15	12	11	10	9	5	4	0
0	1	U	1	1	1	1	1	size	L	M	Rm	opcode	H	0	Rn	Rd					

Decode fields			Instruction page	Architecture version
U	size	opcode		
-	-	0000	Unallocated.	-
-	-	0010	Unallocated.	-
-	-	0100	Unallocated.	-
-	-	0110	Unallocated.	-
-	-	1000	Unallocated.	-
-	-	1010	Unallocated.	-
-	-	1110	Unallocated.	-
-	01	0001	Unallocated.	-
-	01	0101	Unallocated.	-
-	01	1001	Unallocated.	-

Decode fields			Instruction page	Architecture version
U	size	opcode		
0	-	0011	SQDMLAL, SQDMLAL2 (by element)	-
0	-	0111	SQDMLSL, SQDMLSL2 (by element)	-
0	-	1011	SQDMULL, SQDMULL2 (by element)	-
0	-	1100	SQDMULH (by element)	-
0	-	1101	SQRDMULH (by element)	-
0	-	1111	Unallocated.	-
0	00	0001	FMLA (by element) - <i>Scalar, half-precision variant on page C7-1210</i>	ARMv8.2
0	00	0101	FMLS (by element) - <i>Scalar, half-precision variant on page C7-1216</i>	ARMv8.2
0	00	1001	FMUL (by element) - <i>Scalar, half-precision variant on page C7-1233</i>	ARMv8.2
0	1x	0001	FMLA (by element) - <i>Scalar, single-precision and double-precision variant on page C7-1210</i>	-
0	1x	0101	FMLS (by element) - <i>Scalar, single-precision and double-precision variant on page C7-1216</i>	-
0	1x	1001	FMUL (by element) - <i>Scalar, single-precision and double-precision variant on page C7-1233</i>	-
1	-	0011	Unallocated.	-
1	-	0111	Unallocated.	-
1	-	1011	Unallocated.	-
1	-	1100	Unallocated.	-
1	-	1101	SQRDMAH (by element)	ARMv8.1
1	-	1111	SQRDMLSH (by element)	ARMv8.1
1	00	0001	Unallocated.	-
1	00	0101	Unallocated.	-
1	00	1001	FMULX (by element) - <i>Scalar, half-precision variant on page C7-1241</i>	ARMv8.2
1	1x	0001	Unallocated.	-
1	1x	0101	Unallocated.	-
1	1x	1001	FMULX (by element) - <i>Scalar, single-precision and double-precision variant on page C7-1241</i>	-

Advanced SIMD table lookup

This section describes the encoding of the Advanced SIMD table lookup instruction class. This section is decoded from *Data Processing -- Scalar Floating-Point and Advanced SIMD* on page C4-261.

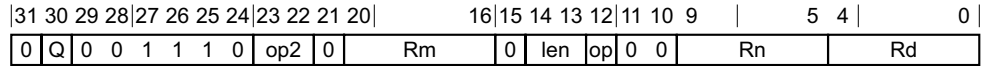

Decode fields			Instruction page
op2	len	op	
x1	-	-	Unallocated.
00	00	0	TBL - Single register table variant on page C7-1648
00	00	1	TBX - Single register table variant on page C7-1650
00	01	0	TBL - Two register table variant on page C7-1648
00	01	1	TBX - Two register table variant on page C7-1650
00	10	0	TBL - Three register table variant on page C7-1648
00	10	1	TBX - Three register table variant on page C7-1650
00	11	0	TBL - Four register table variant on page C7-1648
00	11	1	TBX - Four register table variant on page C7-1650
1x	-	-	Unallocated.

Advanced SIMD permute

This section describes the encoding of the Advanced SIMD permute instruction class. This section is decoded from [Data Processing -- Scalar Floating-Point and Advanced SIMD on page C4-261](#).

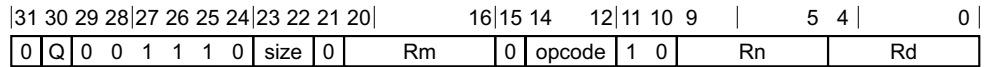

Decode fields		Instruction page
opcode		
000		Unallocated.
001		UZP1
010		TRN1
011		ZIP1
100		Unallocated.
101		UZP2
110		TRN2
111		ZIP2

Advanced SIMD extract

This section describes the encoding of the Advanced SIMD extract instruction class. This section is decoded from *Data Processing -- Scalar Floating-Point and Advanced SIMD* on page C4-261.

31 30 29 28 27 26 25 24 23 22 21 20								16 15 14				11 10 9			5 4		0
0	Q	1	0	1	1	1	0	op2	0	Rm	0	imm4	0	Rn	Rd		

Decode fields

Instruction page	
op2	
x1	Unallocated.
00	EXT
1x	Unallocated.

Advanced SIMD copy

This section describes the encoding of the Advanced SIMD copy instruction class. This section is decoded from *Data Processing -- Scalar Floating-Point and Advanced SIMD* on page C4-261.

31 30 29 28 27 26 25 24 23 22 21 20								16 15 14				11 10 9			5 4		0
0	Q	op	0	1	1	1	0	0	0	imm5	0	imm4	1	Rn	Rd		

Decode fields

Instruction page				
Q	op	imm5	imm4	
-	-	x0000	-	Unallocated.
-	0	-	0000	DUP (element)
-	0	-	0001	DUP (general)
-	0	-	0010	Unallocated.
-	0	-	0100	Unallocated.
-	0	-	0110	Unallocated.
-	0	-	1xxx	Unallocated.
0	0	-	0011	Unallocated.
0	0	-	0101	SMOV
0	0	-	0111	UMOV
0	1	-	-	Unallocated.
1	0	-	0011	INS (general)

Decode fields				Instruction page
Q	op	imm5	imm4	
1	0	-	0101	SMOV
1	0	x1000	0111	UMOV
1	1	-	-	INS (element)

Advanced SIMD three same (FP16)

This section describes the encoding of the Advanced SIMD three same (FP16) instruction class. This section is decoded from *Data Processing -- Scalar Floating-Point and Advanced SIMD* on page C4-261.

31 30 29 28 27 26 25 24 23 22 21 20										16 15 14 13				11 10 9			5 4		0
0	Q	U	0	1	1	1	0	a	1	0	Rm	0	0	opcode	1	Rn	Rd		

Decode fields			Instruction page	Architecture version
U	a	opcode		
0	0	000	FMAXNM (vector)	ARMv8.2
0	0	001	FMLA (vector)	ARMv8.2
0	0	010	FADD (vector)	ARMv8.2
0	0	011	FMULX	ARMv8.2
0	0	100	FCMEQ (register)	ARMv8.2
0	0	101	Unallocated.	-
0	0	110	FMAX (vector)	ARMv8.2
0	0	111	FRECPS	ARMv8.2
0	1	000	FMINNM (vector)	ARMv8.2
0	1	001	FMLS (vector)	ARMv8.2
0	1	010	FSUB (vector)	ARMv8.2
0	1	011	Unallocated.	-
0	1	100	Unallocated.	-
0	1	101	Unallocated.	-
0	1	110	FMIN (vector)	ARMv8.2
0	1	111	FRSQRTS	ARMv8.2
1	0	000	FMAXNMP (vector)	ARMv8.2
1	0	001	Unallocated.	-
1	0	010	FADDP (vector)	ARMv8.2
1	0	011	FMUL (vector)	ARMv8.2

Decode fields			Instruction page	Architecture version
U	a	opcode		
1	0	100	FCMGE (register)	ARMv8.2
1	0	101	FACGE	ARMv8.2
1	0	110	FMAXP (vector)	ARMv8.2
1	0	111	FDIV (vector)	ARMv8.2
1	1	000	FMINNMP (vector)	ARMv8.2
1	1	001	Unallocated.	-
1	1	010	FABD	ARMv8.2
1	1	011	Unallocated.	-
1	1	100	FCMGT (register)	ARMv8.2
1	1	101	FACGT	ARMv8.2
1	1	110	FMINP (vector)	ARMv8.2
1	1	111	Unallocated.	-

Advanced SIMD two-register miscellaneous (FP16)

This section describes the encoding of the Advanced SIMD two-register miscellaneous (FP16) instruction class. This section is decoded from [Data Processing -- Scalar Floating-Point and Advanced SIMD on page C4-261](#).

31 30 29 28 27 26 25 24 23 22 21 20 19 18 17 16										12 11 10 9			5 4		0				
0	Q	U	0	1	1	1	0	a	1	1	1	1	0	0	opcode	1	0	Rn	Rd

Decode fields			Instruction page	Architecture version
U	a	opcode		
-	-	00xxx	Unallocated.	-
-	-	010xx	Unallocated.	-
-	-	10xxx	Unallocated.	-
-	-	11110	Unallocated.	-
-	0	011xx	Unallocated.	-
-	0	11111	Unallocated.	-
-	1	11100	Unallocated.	-
0	0	11000	FRINTN (vector)	ARMv8.2
0	0	11001	FRINTM (vector)	ARMv8.2
0	0	11010	FCVTNS (vector)	ARMv8.2
0	0	11011	FCVTMS (vector)	ARMv8.2

Decode fields			Instruction page	Architecture version
U	a	opcode		
0	0	11100	FCVTAS (vector)	ARMv8.2
0	0	11101	SCVTF (vector, integer)	ARMv8.2
0	1	01100	FCMGT (zero)	ARMv8.2
0	1	01101	FCMEQ (zero)	ARMv8.2
0	1	01110	FCMLT (zero)	ARMv8.2
0	1	01111	FABS (vector)	ARMv8.2
0	1	11000	FRINTP (vector)	ARMv8.2
0	1	11001	FRINTZ (vector)	ARMv8.2
0	1	11010	FCVTPS (vector)	ARMv8.2
0	1	11011	FCVTZS (vector, integer)	ARMv8.2
0	1	11101	FRECPE	ARMv8.2
0	1	11111	Unallocated.	-
1	0	11000	FRINTA (vector)	ARMv8.2
1	0	11001	FRINTX (vector)	ARMv8.2
1	0	11010	FCVTNU (vector)	ARMv8.2
1	0	11011	FCVTMU (vector)	ARMv8.2
1	0	11100	FCVTAU (vector)	ARMv8.2
1	0	11101	UCVTF (vector, integer)	ARMv8.2
1	1	01100	FCMGE (zero)	ARMv8.2
1	1	01101	FCMLE (zero)	ARMv8.2
1	1	01110	Unallocated.	-
1	1	01111	FNEG (vector)	ARMv8.2
1	1	11000	Unallocated.	-
1	1	11001	FRINTI (vector)	ARMv8.2
1	1	11010	FCVTPU (vector)	ARMv8.2
1	1	11011	FCVTZU (vector, integer)	ARMv8.2
1	1	11101	FRSQRTE	ARMv8.2
1	1	11111	FSQRT (vector)	ARMv8.2

Advanced SIMD three same extra

This section describes the encoding of the Advanced SIMD three same extra instruction class. This section is decoded from *Data Processing -- Scalar Floating-Point and Advanced SIMD* on page C4-261.

31 30 29 28 27 26 25 24 23 22 21 20								16 15 14			11 10 9			5 4		0
0	Q	U	0	1	1	1	0	size	0	Rm	1	opcode	1	Rn	Rd	

Decode fields		Instruction page	Architecture version
U	opcode		
-	001x	Unallocated.	-
-	01xx	Unallocated.	-
0	0000	Unallocated.	-
0	0001	Unallocated.	-
0	1xxx	Unallocated.	-
1	0000	SQRDMLAH (vector)	ARMv8.1
1	0001	SQRDMLSH (vector)	ARMv8.1
1	11x1	Unallocated.	-

Advanced SIMD two-register miscellaneous

This section describes the encoding of the Advanced SIMD two-register miscellaneous instruction class. This section is decoded from *Data Processing -- Scalar Floating-Point and Advanced SIMD* on page C4-261.

31 30 29 28 27 26 25 24 23 22 21 20 19 18 17 16											12 11 10 9			5 4		0		
0	Q	U	0	1	1	1	0	size	1	0	0	0	0	opcode	1	0	Rn	Rd

Decode fields			Instruction page
U	size	opcode	
-	-	1000x	Unallocated.
-	-	10101	Unallocated.
-	-	11110	Unallocated.
-	0x	011xx	Unallocated.
-	0x	11111	Unallocated.
-	1x	10110	Unallocated.
-	1x	10111	Unallocated.
0	-	00000	REV64
0	-	00001	REV16 (vector)
0	-	00010	SADDLP
0	-	00011	SUQADD

Decode fields			Instruction page
U	size	opcode	
0	-	00100	CLS (vector)
0	-	00101	CNT
0	-	00110	SADALP
0	-	00111	SQABS
0	-	01000	CMGT (zero)
0	-	01001	CMEQ (zero)
0	-	01010	CMLT (zero)
0	-	01011	ABS
0	-	10010	XTN, XTN2
0	-	10011	Unallocated.
0	-	10100	SQXTN, SQXTN2
0	0x	10110	FCVTN, FCVTN2
0	0x	10111	FCVTL, FCVTL2
0	0x	11000	FRINTN (vector)
0	0x	11001	FRINTM (vector)
0	0x	11010	FCVTNS (vector)
0	0x	11011	FCVTMS (vector)
0	0x	11100	FCVTAS (vector)
0	0x	11101	SCVTF (vector, integer)
0	1x	01100	FCMGT (zero)
0	1x	01101	FCMEQ (zero)
0	1x	01110	FCMLT (zero)
0	1x	01111	FABS (vector)
0	1x	11000	FRINTP (vector)
0	1x	11001	FRINTZ (vector)
0	1x	11010	FCVTPS (vector)
0	1x	11011	FCVTZS (vector, integer)
0	1x	11100	URECPE
0	1x	11101	FRECPE
0	1x	11111	Unallocated.
1	-	00000	REV32 (vector)
1	-	00001	Unallocated.

Decode fields			Instruction page
U	size	opcode	
1	-	00010	UADDLP
1	-	00011	USQADD
1	-	00100	CLZ (vector)
1	-	00110	UADALP
1	-	00111	SQNEG
1	-	01000	CMGE (zero)
1	-	01001	CMLE (zero)
1	-	01010	Unallocated.
1	-	01011	NEG (vector)
1	-	10010	SQXTUN, SQXTUN2
1	-	10011	SLL, SLL2
1	-	10100	UQXTN, UQXTN2
1	0x	10110	FCVTXN, FCVTXN2
1	0x	10111	Unallocated.
1	0x	11000	FRINTA (vector)
1	0x	11001	FRINTX (vector)
1	0x	11010	FCVTNU (vector)
1	0x	11011	FCVTMU (vector)
1	0x	11100	FCVTAU (vector)
1	0x	11101	UCVTF (vector, integer)
1	00	00101	NOT
1	01	00101	RBIT (vector)
1	1x	00101	Unallocated.
1	1x	01100	FCMGE (zero)
1	1x	01101	FCMLE (zero)
1	1x	01110	Unallocated.
1	1x	01111	FNEG (vector)
1	1x	11000	Unallocated.
1	1x	11001	FRINTI (vector)
1	1x	11010	FCVTPU (vector)
1	1x	11011	FCVTZU (vector, integer)

Decode fields			Instruction page
U	size	opcode	
1	1x	11100	URSQRTE
1	1x	11101	FRSQRTE
1	1x	11111	FSQRT (vector)

Advanced SIMD across lanes

This section describes the encoding of the Advanced SIMD across lanes instruction class. This section is decoded from *Data Processing -- Scalar Floating-Point and Advanced SIMD* on page C4-261.

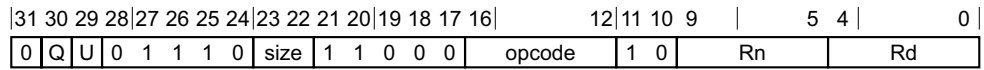

Decode fields			Instruction page	Architecture version
U	size	opcode		
-	-	0000x	Unallocated.	-
-	-	00010	Unallocated.	-
-	-	001xx	Unallocated.	-
-	-	0100x	Unallocated.	-
-	-	01011	Unallocated.	-
-	-	01101	Unallocated.	-
-	-	01110	Unallocated.	-
-	-	10xxx	Unallocated.	-
-	-	1100x	Unallocated.	-
-	-	111xx	Unallocated.	-
0	-	00011	SADDLV	-
0	-	01010	SMAXV	-
0	-	11010	SMINV	-
0	-	11011	ADDV	-
0	00	01100	FMAXNMV - <i>Half-precision variant on page C7-1182</i>	ARMv8.2
0	00	01111	FMAXV - <i>Half-precision variant on page C7-1188</i>	ARMv8.2
0	01	01100	Unallocated.	-
0	01	01111	Unallocated.	-
0	10	01100	FMINNMV - <i>Half-precision variant on page C7-1202</i>	ARMv8.2
0	10	01111	FMINV - <i>Half-precision variant on page C7-1208</i>	ARMv8.2

Decode fields			Instruction page	Architecture version
U	size	opcode		
0	11	01100	Unallocated.	-
0	11	01111	Unallocated.	-
1	-	00011	UADDLV	-
1	-	01010	UMAXV	-
1	-	11010	UMINV	-
1	-	11011	Unallocated.	-
1	0x	01100	FMAXNMV - <i>Single-precision and double-precision variant on page C7-1182</i>	-
1	0x	01111	FMAXV - <i>Single-precision and double-precision variant on page C7-1188</i>	-
1	1x	01100	FMINNMV - <i>Single-precision and double-precision variant on page C7-1202</i>	-
1	1x	01111	FMINV - <i>Single-precision and double-precision variant on page C7-1208</i>	-

Advanced SIMD three different

This section describes the encoding of the Advanced SIMD three different instruction class. This section is decoded from *Data Processing -- Scalar Floating-Point and Advanced SIMD on page C4-261*.

31 30 29 28 27 26 25 24 23 22 21 20										16 15		12 11 10 9			5 4		0
0	Q	U	0	1	1	1	0	size	1	Rm	opcode	0	0	Rn	Rd		

Decode fields		Instruction page
U	opcode	
-	1111	Unallocated.
0	0000	SADDL, SADDL2
0	0001	SADDW, SADDW2
0	0010	SSUBL, SSUBL2
0	0011	SSUBW, SSUBW2
0	0100	ADDHN, ADDHN2
0	0101	SABAL, SABAL2
0	0110	SUBHN, SUBHN2
0	0111	SABDL, SABDL2
0	1000	SMLAL, SMLAL2 (vector)
0	1001	SQDMLAL, SQDMLAL2 (vector)
0	1010	SMLSL, SMLSL2 (vector)
0	1011	SQDMLSL, SQDMLSL2 (vector)

Decode fields		Instruction page
U	opcode	
0	1100	SMULL, SMULL2 (vector)
0	1101	SQDMULL, SQDMULL2 (vector)
0	1110	PMULL, PMULL2
1	0000	UADDL, UADDL2
1	0001	UADDW, UADDW2
1	0010	USUBL, USUBL2
1	0011	USUBW, USUBW2
1	0100	RADDHN, RADDHN2
1	0101	UABAL, UABAL2
1	0110	RSUBHN, RSUBHN2
1	0111	UABDL, UABDL2
1	1000	UMLAL, UMLAL2 (vector)
1	1001	Unallocated.
1	1010	UMLSL, UMLSL2 (vector)
1	1011	Unallocated.
1	1100	UMULL, UMULL2 (vector)
1	1101	Unallocated.
1	1110	Unallocated.

Advanced SIMD three same

This section describes the encoding of the Advanced SIMD three same instruction class. This section is decoded from [Data Processing -- Scalar Floating-Point and Advanced SIMD on page C4-261](#).

31 30 29 28 27 26 25 24 23 22 21 20				16 15		11 10 9			5 4		0			
0	Q	U	0	1	1	1	0	size	1	Rm	opcode	1	Rn	Rd

Decode fields			Instruction page
U	size	opcode	
0	-	00000	SHADD
0	-	00001	SQADD
0	-	00010	SRHADD
0	-	00100	SHSUB
0	-	00101	SQSUB

Decode fields			Instruction page
U	size	opcode	
0	-	00110	CMGT (register)
0	-	00111	CMGE (register)
0	-	01000	SSHL
0	-	01001	SQSHL (register)
0	-	01010	SRSHL
0	-	01011	SQRSHL
0	-	01100	SMAX
0	-	01101	SMIN
0	-	01110	SABD
0	-	01111	SABA
0	-	10000	ADD (vector)
0	-	10001	CMTST
0	-	10010	MLA (vector)
0	-	10011	MUL (vector)
0	-	10100	SMAXP
0	-	10101	SMINP
0	-	10110	SQDMULH (vector)
0	-	10111	ADDP (vector)
0	0x	11000	FMAXNM (vector)
0	0x	11001	FMLA (vector)
0	0x	11010	FADD (vector)
0	0x	11011	FMULX
0	0x	11100	FCMEQ (register)
0	0x	11101	Unallocated.
0	0x	11110	FMAX (vector)
0	0x	11111	FRECPS
0	00	00011	AND (vector)
0	01	00011	BIC (vector, register)
0	1x	11000	FMINNM (vector)
0	1x	11001	FMLS (vector)
0	1x	11010	FSUB (vector)
0	1x	11011	Unallocated.

Decode fields			Instruction page
U	size	opcode	
0	1x	11100	Unallocated.
0	1x	11101	Unallocated.
0	1x	11110	FMIN (vector)
0	1x	11111	FRSQRTS
0	10	00011	ORR (vector, register)
0	11	00011	ORN (vector)
1	-	00000	UHADD
1	-	00001	UQADD
1	-	00010	URHADD
1	-	00100	UHSUB
1	-	00101	UQSUB
1	-	00110	CMHI (register)
1	-	00111	CMHS (register)
1	-	01000	USHL
1	-	01001	UQSHL (register)
1	-	01010	URSHL
1	-	01011	UQRSHL
1	-	01100	UMAX
1	-	01101	UMIN
1	-	01110	UABD
1	-	01111	UABA
1	-	10000	SUB (vector)
1	-	10001	CMEQ (register)
1	-	10010	MLS (vector)
1	-	10011	PMUL
1	-	10100	UMAXP
1	-	10101	UMINP
1	-	10110	SQRDMULH (vector)
1	-	10111	Unallocated.
1	0x	11000	FMAXNMP (vector)
1	0x	11001	Unallocated.
1	0x	11010	FADDP (vector)

Decode fields			Instruction page
U	size	opcode	
1	0x	11011	FMUL (vector)
1	0x	11100	FCMGE (register)
1	0x	11101	FACGE
1	0x	11110	FMAXP (vector)
1	0x	11111	FDIV (vector)
1	00	00011	EOR (vector)
1	01	00011	BSL
1	1x	11000	FMINNMP (vector)
1	1x	11001	Unallocated.
1	1x	11010	FABD
1	1x	11011	Unallocated.
1	1x	11100	FCMGT (register)
1	1x	11101	FACGT
1	1x	11110	FMINP (vector)
1	1x	11111	Unallocated.
1	10	00011	BIT
1	11	00011	BIF

Advanced SIMD modified immediate

This section describes the encoding of the Advanced SIMD modified immediate instruction class. This section is decoded from *Data Processing -- Scalar Floating-Point and Advanced SIMD* on page C4-261.

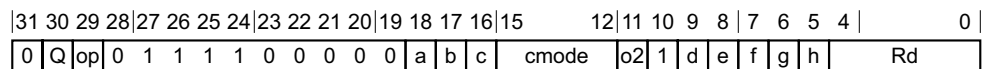

Decode fields				Instruction page	Architecture version
Q	op	cmode	o2		
-	0	0xxx	1	Unallocated.	-
-	0	0xx0	0	MOVI - 32-bit shifted immediate variant on page C7-1385	-
-	0	0xx1	0	ORR (vector, immediate) - 32-bit variant on page C7-1399	-
-	0	10xx	1	Unallocated.	-
-	0	10x0	0	MOVI - 16-bit shifted immediate variant on page C7-1385	-
-	0	10x1	0	ORR (vector, immediate) - 16-bit variant on page C7-1399	-

Decode fields				Instruction page	Architecture version
Q	op	cmode	o2		
-	0	110x	0	MOVI - 32-bit shifting ones variant on page C7-1385	-
-	0	110x	1	Unallocated.	-
-	0	1110	0	MOVI - 8-bit variant on page C7-1385	-
-	0	1110	1	Unallocated.	-
-	0	1111	0	FMOV (vector, immediate) - Single-precision variant on page C7-1222	-
-	0	1111	1	FMOV (vector, immediate) - Half-precision variant on page C7-1222	ARMv8.2
-	1	-	1	Unallocated.	-
-	1	0xx0	0	MVNI - 32-bit shifted immediate variant on page C7-1393	-
-	1	0xx1	0	BIC (vector, immediate) - 32-bit variant on page C7-995	-
-	1	10x0	0	MVNI - 16-bit shifted immediate variant on page C7-1393	-
-	1	10x1	0	BIC (vector, immediate) - 16-bit variant on page C7-995	-
-	1	110x	0	MVNI - 32-bit shifting ones variant on page C7-1393	-
0	1	1110	0	MOVI - 64-bit scalar variant on page C7-1385	-
0	1	1111	0	Unallocated.	-
1	1	1110	0	MOVI - 64-bit vector variant on page C7-1385	-
1	1	1111	0	FMOV (vector, immediate) - Double-precision variant on page C7-1222	-

Advanced SIMD shift by immediate

This section describes the encoding of the Advanced SIMD shift by immediate instruction class. This section is decoded from *Data Processing -- Scalar Floating-Point and Advanced SIMD* on page C4-261.

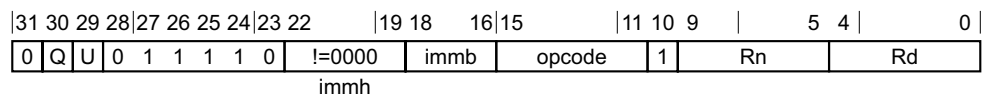

Decode fields		Instruction page
U	opcode	
-	00001	Unallocated.
-	00011	Unallocated.
-	00101	Unallocated.
-	00111	Unallocated.
-	01001	Unallocated.
-	01011	Unallocated.
-	01101	Unallocated.

Decode fields		Instruction page
U	opcode	
-	01111	Unallocated.
-	10101	Unallocated.
-	1011x	Unallocated.
-	110xx	Unallocated.
-	11101	Unallocated.
-	11110	Unallocated.
0	00000	SSHR
0	00010	SSRA
0	00100	SRSHR
0	00110	SRSRA
0	01000	Unallocated.
0	01010	SHL
0	01100	Unallocated.
0	01110	SQSHL (immediate)
0	10000	SHRN, SHRN2
0	10001	RSHRN, RSHRN2
0	10010	SQSHRN, SQSHRN2
0	10011	SQRSHRN, SQRSHRN2
0	10100	SSHLL, SSHLL2
0	11100	SCVTF (vector, fixed-point)
0	11111	FCVTZS (vector, fixed-point)
1	00000	USHR
1	00010	USRA
1	00100	URSHR
1	00110	URSRA
1	01000	SRI
1	01010	SLI
1	01100	SQSHLU
1	01110	UQSHL (immediate)
1	10000	SQSHRUN, SQSHRUN2
1	10001	SQRSHRUN, SQRSHRUN2
1	10010	UQSHRN, UQSHRN2

Decode fields		Instruction page
U	opcode	
1	10011	UQRSHRN, UQRSHRN2
1	10100	USHLL, USHLL2
1	11100	UCVTF (vector, fixed-point)
1	11111	FCVTZU (vector, fixed-point)

Advanced SIMD vector x indexed element

This section describes the encoding of the Advanced SIMD vector x indexed element instruction class. This section is decoded from *Data Processing -- Scalar Floating-Point and Advanced SIMD* on page C4-261.

31	30	29	28	27	26	25	24	23	22	21	20	19	16	15	12	11	10	9	5	4	0
0	Q	U	0	1	1	1	1	size	L	M	Rm	opcode	H	0	Rn	Rd					

Decode fields			Instruction page	Architecture version
U	size	opcode		
-	-	1110	Unallocated.	-
-	01	1001	Unallocated.	-
0	-	0000	Unallocated.	-
0	-	0010	SMLAL, SMLAL2 (by element)	-
0	-	0011	SQDMLAL, SQDMLAL2 (by element)	-
0	-	0100	Unallocated.	-
0	-	0110	SMLSL, SMLSL2 (by element)	-
0	-	0111	SQDMLSL, SQDMLSL2 (by element)	-
0	-	1000	MUL (by element)	-
0	-	1010	SMULL, SMULL2 (by element)	-
0	-	1011	SQDMULL, SQDMULL2 (by element)	-
0	-	1100	SQDMULH (by element)	-
0	-	1101	SQRDMULH (by element)	-
0	-	1111	Unallocated.	-
0	00	0001	FMLA (by element) - <i>Vector, half-precision variant on page C7-1211</i>	ARMv8.2
0	00	0101	FMLS (by element) - <i>Vector, half-precision variant on page C7-1217</i>	ARMv8.2
0	00	1001	FMUL (by element) - <i>Vector, half-precision variant on page C7-1234</i>	ARMv8.2
0	01	0001	Unallocated.	-
0	01	0101	Unallocated.	-

Decode fields			Instruction page	Architecture version
U	size	opcode		
0	1x	0001	FMLA (by element) - <i>Vector, single-precision and double-precision variant on page C7-1211</i>	-
0	1x	0101	FMLS (by element) - <i>Vector, single-precision and double-precision variant on page C7-1217</i>	-
0	1x	1001	FMUL (by element) - <i>Vector, single-precision and double-precision variant on page C7-1234</i>	-
1	-	0000	MLA (by element)	-
1	-	0010	UMLAL, UMLAL2 (by element)	-
1	-	0100	MLS (by element)	-
1	-	0110	UMLSL, UMLSL2 (by element)	-
1	-	1000	Unallocated.	-
1	-	1010	UMULL, UMULL2 (by element)	-
1	-	1011	Unallocated.	-
1	-	1100	Unallocated.	-
1	-	1101	SQRDMLAH (by element)	ARMv8.1
1	-	1111	SQRDMLSH (by element)	ARMv8.1
1	00	0001	Unallocated.	-
1	00	0011	Unallocated.	-
1	00	0101	Unallocated.	-
1	00	0111	Unallocated.	-
1	00	1001	FMULX (by element) - <i>Vector, half-precision variant on page C7-1242</i>	ARMv8.2
1	1x	0101	Unallocated.	-
1	1x	1001	FMULX (by element) - <i>Vector, single-precision and double-precision variant on page C7-1242</i>	-
1	11	0001	Unallocated.	-
1	11	0011	Unallocated.	-
1	11	0111	Unallocated.	-

Conversion between floating-point and fixed-point

This section describes the encoding of the Conversion between floating-point and fixed-point instruction class. This section is decoded from *Data Processing -- Scalar Floating-Point and Advanced SIMD* on page C4-261.

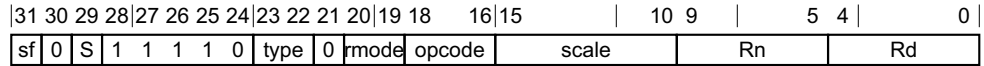

Decode fields						Instruction page	Architecture version
sf	S	type	rmode	opcode	scale		
-	-	-	-	1xx	-	Unallocated.	-
-	-	-	x0	00x	-	Unallocated.	-
-	-	-	x1	01x	-	Unallocated.	-
-	-	-	0x	00x	-	Unallocated.	-
-	-	-	1x	01x	-	Unallocated.	-
-	-	10	-	-	-	Unallocated.	-
-	1	-	-	-	-	Unallocated.	-
0	-	-	-	-	0xxxxx	Unallocated.	-
0	0	00	00	010	-	SCVTF (scalar, fixed-point) - 32-bit to single-precision variant on page C7-1443	-
0	0	00	00	011	-	UCVTF (scalar, fixed-point) - 32-bit to single-precision variant on page C7-1680	-
0	0	00	11	000	-	FCVTZS (scalar, fixed-point) - Single-precision to 32-bit variant on page C7-1150	-
0	0	00	11	001	-	FCVTZU (scalar, fixed-point) - Single-precision to 32-bit variant on page C7-1160	-
0	0	01	00	010	-	SCVTF (scalar, fixed-point) - 32-bit to double-precision variant on page C7-1443	-
0	0	01	00	011	-	UCVTF (scalar, fixed-point) - 32-bit to double-precision variant on page C7-1680	-
0	0	01	11	000	-	FCVTZS (scalar, fixed-point) - Double-precision to 32-bit variant on page C7-1150	-
0	0	01	11	001	-	FCVTZU (scalar, fixed-point) - Double-precision to 32-bit variant on page C7-1160	-
0	0	11	00	010	-	SCVTF (scalar, fixed-point) - 32-bit to half-precision variant on page C7-1443	ARMv8.2
0	0	11	00	011	-	UCVTF (scalar, fixed-point) - 32-bit to half-precision variant on page C7-1680	ARMv8.2
0	0	11	11	000	-	FCVTZS (scalar, fixed-point) - Half-precision to 32-bit variant on page C7-1150	ARMv8.2
0	0	11	11	001	-	FCVTZU (scalar, fixed-point) - Half-precision to 32-bit variant on page C7-1160	ARMv8.2
1	0	00	00	010	-	SCVTF (scalar, fixed-point) - 64-bit to single-precision variant on page C7-1443	-

Decode fields						Instruction page	Architecture version
sf	S	type	rmode	opcode	scale		
1	0	00	00	011	-	UCVTF (scalar, fixed-point) - <i>64-bit to single-precision variant on page C7-1680</i>	-
1	0	00	11	000	-	FCVTZS (scalar, fixed-point) - <i>Single-precision to 64-bit variant on page C7-1150</i>	-
1	0	00	11	001	-	FCVTZU (scalar, fixed-point) - <i>Single-precision to 64-bit variant on page C7-1160</i>	-
1	0	01	00	010	-	SCVTF (scalar, fixed-point) - <i>64-bit to double-precision variant on page C7-1443</i>	-
1	0	01	00	011	-	UCVTF (scalar, fixed-point) - <i>64-bit to double-precision variant on page C7-1680</i>	-
1	0	01	11	000	-	FCVTZS (scalar, fixed-point) - <i>Double-precision to 64-bit variant on page C7-1150</i>	-
1	0	01	11	001	-	FCVTZU (scalar, fixed-point) - <i>Double-precision to 64-bit variant on page C7-1160</i>	-
1	0	11	00	010	-	SCVTF (scalar, fixed-point) - <i>64-bit to half-precision variant on page C7-1443</i>	ARMv8.2
1	0	11	00	011	-	UCVTF (scalar, fixed-point) - <i>64-bit to half-precision variant on page C7-1680</i>	ARMv8.2
1	0	11	11	000	-	FCVTZS (scalar, fixed-point) - <i>Half-precision to 64-bit variant on page C7-1150</i>	ARMv8.2
1	0	11	11	001	-	FCVTZU (scalar, fixed-point) - <i>Half-precision to 64-bit variant on page C7-1160</i>	ARMv8.2

Conversion between floating-point and integer

This section describes the encoding of the Conversion between floating-point and integer instruction class. This section is decoded from *Data Processing -- Scalar Floating-Point and Advanced SIMD on page C4-261*.

31	30	29	28	27	26	25	24	23	22	21	20	19	18	16	15	14	13	12	11	10	9				5	4			0
sf	0	S	1	1	1	1	0	type	1	rmode	opcode	0	0	0	0	0	0	0	0	Rn			Rd						

Decode fields						Instruction page	Architecture version
sf	S	type	rmode	opcode			
-	-	-	x1	01x		Unallocated.	-
-	-	-	x1	10x		Unallocated.	-
-	-	-	1x	01x		Unallocated.	-
-	-	-	1x	10x		Unallocated.	-
-	0	10	-	0xx		Unallocated.	-

Decode fields					Instruction page	Architecture version
sf	S	type	rmode	opcode		
-	0	10	-	10x	Unallocated.	-
-	1	-	-	-	Unallocated.	-
0	0	00	x1	11x	Unallocated.	-
0	0	00	00	000	FCVTNS (scalar) - Single-precision to 32-bit variant on page C7-1125	-
0	0	00	00	001	FCVTNU (scalar) - Single-precision to 32-bit variant on page C7-1130	-
0	0	00	00	010	SCVTF (scalar, integer) - 32-bit to single-precision variant on page C7-1445	-
0	0	00	00	011	UCVTF (scalar, integer) - 32-bit to single-precision variant on page C7-1682	-
0	0	00	00	100	FCVTAS (scalar) - Single-precision to 32-bit variant on page C7-1101	-
0	0	00	00	101	FCVTAU (scalar) - Single-precision to 32-bit variant on page C7-1106	-
0	0	00	00	110	FMOV (general) - Single-precision to 32-bit variant on page C7-1226	-
0	0	00	00	111	FMOV (general) - 32-bit to single-precision variant on page C7-1226	-
0	0	00	01	000	FCVTPS (scalar) - Single-precision to 32-bit variant on page C7-1135	-
0	0	00	01	001	FCVTPU (scalar) - Single-precision to 32-bit variant on page C7-1140	-
0	0	00	1x	11x	Unallocated.	-
0	0	00	10	000	FCVTMS (scalar) - Single-precision to 32-bit variant on page C7-1113	-
0	0	00	10	001	FCVTMU (scalar) - Single-precision to 32-bit variant on page C7-1118	-
0	0	00	11	000	FCVTZS (scalar, integer) - Single-precision to 32-bit variant on page C7-1152	-
0	0	00	11	001	FCVTZU (scalar, integer) - Single-precision to 32-bit variant on page C7-1162	-
0	0	01	0x	11x	Unallocated.	-
0	0	01	00	000	FCVTNS (scalar) - Double-precision to 32-bit variant on page C7-1125	-
0	0	01	00	001	FCVTNU (scalar) - Double-precision to 32-bit variant on page C7-1130	-
0	0	01	00	010	SCVTF (scalar, integer) - 32-bit to double-precision variant on page C7-1445	-

Decode fields					Instruction page	Architecture version
sf	S	type	rmode	opcode		
0	0	01	00	011	UCVTF (scalar, integer) - <i>32-bit to double-precision variant on page C7-1682</i>	-
0	0	01	00	100	FCVTAS (scalar) - <i>Double-precision to 32-bit variant on page C7-1101</i>	-
0	0	01	00	101	FCVTAU (scalar) - <i>Double-precision to 32-bit variant on page C7-1106</i>	-
0	0	01	01	000	FCVTPS (scalar) - <i>Double-precision to 32-bit variant on page C7-1135</i>	-
0	0	01	01	001	FCVTPU (scalar) - <i>Double-precision to 32-bit variant on page C7-1140</i>	-
0	0	01	10	000	FCVTMS (scalar) - <i>Double-precision to 32-bit variant on page C7-1113</i>	-
0	0	01	10	001	FCVTMU (scalar) - <i>Double-precision to 32-bit variant on page C7-1118</i>	-
0	0	01	10	11x	Unallocated.	-
0	0	01	11	000	FCVTZS (scalar, integer) - <i>Double-precision to 32-bit variant on page C7-1152</i>	-
0	0	01	11	001	FCVTZU (scalar, integer) - <i>Double-precision to 32-bit variant on page C7-1162</i>	-
0	0	01	11	111	Unallocated.	-
0	0	10	-	11x	Unallocated.	-
0	0	11	00	000	FCVTNS (scalar) - <i>Half-precision to 32-bit variant on page C7-1125</i>	ARMv8.2
0	0	11	00	001	FCVTNU (scalar) - <i>Half-precision to 32-bit variant on page C7-1130</i>	ARMv8.2
0	0	11	00	010	SCVTF (scalar, integer) - <i>32-bit to half-precision variant on page C7-1445</i>	ARMv8.2
0	0	11	00	011	UCVTF (scalar, integer) - <i>32-bit to half-precision variant on page C7-1682</i>	ARMv8.2
0	0	11	00	100	FCVTAS (scalar) - <i>Half-precision to 32-bit variant on page C7-1101</i>	ARMv8.2
0	0	11	00	101	FCVTAU (scalar) - <i>Half-precision to 32-bit variant on page C7-1106</i>	ARMv8.2
0	0	11	00	110	FMOV (general) - <i>Half-precision to 32-bit variant on page C7-1226</i>	ARMv8.2
0	0	11	00	111	FMOV (general) - <i>32-bit to half-precision variant on page C7-1226</i>	ARMv8.2
0	0	11	01	000	FCVTPS (scalar) - <i>Half-precision to 32-bit variant on page C7-1135</i>	ARMv8.2

Decode fields					Instruction page	Architecture version
sf	S	type	rmode	opcode		
0	0	11	01	001	FCVTPU (scalar) - <i>Half-precision to 32-bit variant on page C7-1140</i>	ARMv8.2
0	0	11	10	000	FCVTMS (scalar) - <i>Half-precision to 32-bit variant on page C7-1113</i>	ARMv8.2
0	0	11	10	001	FCVTMU (scalar) - <i>Half-precision to 32-bit variant on page C7-1118</i>	ARMv8.2
0	0	11	11	000	FCVTZS (scalar, integer) - <i>Half-precision to 32-bit variant on page C7-1152</i>	ARMv8.2
0	0	11	11	001	FCVTZU (scalar, integer) - <i>Half-precision to 32-bit variant on page C7-1162</i>	ARMv8.2
1	0	00	-	11x	Unallocated.	-
1	0	00	00	000	FCVTNS (scalar) - <i>Single-precision to 64-bit variant on page C7-1125</i>	-
1	0	00	00	001	FCVTNU (scalar) - <i>Single-precision to 64-bit variant on page C7-1130</i>	-
1	0	00	00	010	SCVTF (scalar, integer) - <i>64-bit to single-precision variant on page C7-1445</i>	-
1	0	00	00	011	UCVTF (scalar, integer) - <i>64-bit to single-precision variant on page C7-1682</i>	-
1	0	00	00	100	FCVTAS (scalar) - <i>Single-precision to 64-bit variant on page C7-1101</i>	-
1	0	00	00	101	FCVTAU (scalar) - <i>Single-precision to 64-bit variant on page C7-1106</i>	-
1	0	00	01	000	FCVTPS (scalar) - <i>Single-precision to 64-bit variant on page C7-1135</i>	-
1	0	00	01	001	FCVTPU (scalar) - <i>Single-precision to 64-bit variant on page C7-1140</i>	-
1	0	00	10	000	FCVTMS (scalar) - <i>Single-precision to 64-bit variant on page C7-1113</i>	-
1	0	00	10	001	FCVTMU (scalar) - <i>Single-precision to 64-bit variant on page C7-1118</i>	-
1	0	00	11	000	FCVTZS (scalar, integer) - <i>Single-precision to 64-bit variant on page C7-1152</i>	-
1	0	00	11	001	FCVTZU (scalar, integer) - <i>Single-precision to 64-bit variant on page C7-1162</i>	-
1	0	01	x1	11x	Unallocated.	-
1	0	01	00	000	FCVTNS (scalar) - <i>Double-precision to 64-bit variant on page C7-1125</i>	-
1	0	01	00	001	FCVTNU (scalar) - <i>Double-precision to 64-bit variant on page C7-1130</i>	-

Decode fields					Instruction page	Architecture version
sf	S	type	rmode	opcode		
1	0	01	00	010	SCVTF (scalar, integer) - <i>64-bit to double-precision variant on page C7-1445</i>	-
1	0	01	00	011	UCVTF (scalar, integer) - <i>64-bit to double-precision variant on page C7-1682</i>	-
1	0	01	00	100	FCVTAS (scalar) - <i>Double-precision to 64-bit variant on page C7-1101</i>	-
1	0	01	00	101	FCVTAU (scalar) - <i>Double-precision to 64-bit variant on page C7-1106</i>	-
1	0	01	00	110	FMOV (general) - <i>Double-precision to 64-bit variant on page C7-1227</i>	-
1	0	01	00	111	FMOV (general) - <i>64-bit to double-precision variant on page C7-1226</i>	-
1	0	01	01	000	FCVTPS (scalar) - <i>Double-precision to 64-bit variant on page C7-1135</i>	-
1	0	01	01	001	FCVTPU (scalar) - <i>Double-precision to 64-bit variant on page C7-1140</i>	-
1	0	01	1x	11x	Unallocated.	-
1	0	01	10	000	FCVTMS (scalar) - <i>Double-precision to 64-bit variant on page C7-1113</i>	-
1	0	01	10	001	FCVTMU (scalar) - <i>Double-precision to 64-bit variant on page C7-1118</i>	-
1	0	01	11	000	FCVTZS (scalar, integer) - <i>Double-precision to 64-bit variant on page C7-1152</i>	-
1	0	01	11	001	FCVTZU (scalar, integer) - <i>Double-precision to 64-bit variant on page C7-1162</i>	-
1	0	10	x0	11x	Unallocated.	-
1	0	10	01	110	FMOV (general) - <i>Top half of 128-bit to 64-bit variant on page C7-1227</i>	-
1	0	10	01	111	FMOV (general) - <i>64-bit to top half of 128-bit variant on page C7-1226</i>	-
1	0	10	1x	11x	Unallocated.	-
1	0	11	00	000	FCVTNS (scalar) - <i>Half-precision to 64-bit variant on page C7-1125</i>	ARMv8.2
1	0	11	00	001	FCVTNU (scalar) - <i>Half-precision to 64-bit variant on page C7-1130</i>	ARMv8.2
1	0	11	00	010	SCVTF (scalar, integer) - <i>64-bit to half-precision variant on page C7-1445</i>	ARMv8.2
1	0	11	00	011	UCVTF (scalar, integer) - <i>64-bit to half-precision variant on page C7-1682</i>	ARMv8.2

Decode fields					Instruction page	Architecture version
sf	S	type	rmode	opcode		
1	0	11	00	100	FCVTAS (scalar) - Half-precision to 64-bit variant on page C7-1101	ARMv8.2
1	0	11	00	101	FCVTAU (scalar) - Half-precision to 64-bit variant on page C7-1106	ARMv8.2
1	0	11	00	110	FMOV (general) - Half-precision to 64-bit variant on page C7-1226	ARMv8.2
1	0	11	00	111	FMOV (general) - 64-bit to half-precision variant on page C7-1226	ARMv8.2
1	0	11	01	000	FCVTPS (scalar) - Half-precision to 64-bit variant on page C7-1135	ARMv8.2
1	0	11	01	001	FCVTPU (scalar) - Half-precision to 64-bit variant on page C7-1140	ARMv8.2
1	0	11	10	000	FCVTMS (scalar) - Half-precision to 64-bit variant on page C7-1113	ARMv8.2
1	0	11	10	001	FCVTMU (scalar) - Half-precision to 64-bit variant on page C7-1118	ARMv8.2
1	0	11	11	000	FCVTZS (scalar, integer) - Half-precision to 64-bit variant on page C7-1152	ARMv8.2
1	0	11	11	001	FCVTZU (scalar, integer) - Half-precision to 64-bit variant on page C7-1162	ARMv8.2

Floating-point data-processing (1 source)

This section describes the encoding of the Floating-point data-processing (1 source) instruction class. This section is decoded from [Data Processing -- Scalar Floating-Point and Advanced SIMD on page C4-261](#).

31 30 29 28		27 26 25 24		23 22 21 20		15 14 13 12 11 10 9				5 4		0							
M	0	S	1	1	1	1	0	type	1	opcode			1	0	0	0	0	Rn	Rd

Decode fields				Instruction page	Architecture version
M	S	type	opcode		
-	-	-	x1xxxx	Unallocated.	-
-	-	-	1xxxxx	Unallocated.	-
-	1	-	-	Unallocated.	-
0	0	00	000000	FMOV (register) - Single-precision variant on page C7-1224	-
0	0	00	000001	FABS (scalar) - Single-precision variant on page C7-1041	-
0	0	00	000010	FNEG (scalar) - Single-precision variant on page C7-1250	-
0	0	00	000011	FSQRT (scalar) - Single-precision variant on page C7-1302	-

Decode fields				Instruction page	Architecture version
M	S	type	opcode		
0	0	00	000100	Unallocated.	-
0	0	00	000101	FCVT - Single-precision to double-precision variant on page C7-1096	-
0	0	00	000110	Unallocated.	-
0	0	00	000111	FCVT - Single-precision to half-precision variant on page C7-1096	-
0	0	00	001000	FRINTN (scalar) - Single-precision variant on page C7-1280	-
0	0	00	001001	FRINTP (scalar) - Single-precision variant on page C7-1284	-
0	0	00	001010	FRINTM (scalar) - Single-precision variant on page C7-1276	-
0	0	00	001011	FRINTZ (scalar) - Single-precision variant on page C7-1292	-
0	0	00	001100	FRINTA (scalar) - Single-precision variant on page C7-1268	-
0	0	00	001101	Unallocated.	-
0	0	00	001110	FRINTX (scalar) - Single-precision variant on page C7-1288	-
0	0	00	001111	FRINTI (scalar) - Single-precision variant on page C7-1272	-
0	0	01	000000	FMOV (register) - Double-precision variant on page C7-1224	-
0	0	01	000001	FABS (scalar) - Double-precision variant on page C7-1041	-
0	0	01	000010	FNEG (scalar) - Double-precision variant on page C7-1250	-
0	0	01	000011	FSQRT (scalar) - Double-precision variant on page C7-1302	-
0	0	01	000100	FCVT - Double-precision to single-precision variant on page C7-1096	-
0	0	01	000101	Unallocated.	-
0	0	01	000110	Unallocated.	-
0	0	01	000111	FCVT - Double-precision to half-precision variant on page C7-1096	-
0	0	01	001000	FRINTN (scalar) - Double-precision variant on page C7-1280	-
0	0	01	001001	FRINTP (scalar) - Double-precision variant on page C7-1284	-
0	0	01	001010	FRINTM (scalar) - Double-precision variant on page C7-1276	-
0	0	01	001011	FRINTZ (scalar) - Double-precision variant on page C7-1292	-
0	0	01	001100	FRINTA (scalar) - Double-precision variant on page C7-1268	-
0	0	01	001101	Unallocated.	-
0	0	01	001110	FRINTX (scalar) - Double-precision variant on page C7-1288	-
0	0	01	001111	FRINTI (scalar) - Double-precision variant on page C7-1272	-
0	0	10	00xxxx	Unallocated.	-
0	0	11	000000	FMOV (register) - Half-precision variant on page C7-1224	ARMv8.2
0	0	11	000001	FABS (scalar) - Half-precision variant on page C7-1041	ARMv8.2
0	0	11	000010	FNEG (scalar) - Half-precision variant on page C7-1250	ARMv8.2

Decode fields				Instruction page	Architecture version
M	S	type	opcode		
0	0	11	000011	FSQRT (scalar) - <i>Half-precision variant on page C7-1302</i>	ARMv8.2
0	0	11	000100	FCVT - <i>Half-precision to single-precision variant on page C7-1096</i>	-
0	0	11	000101	FCVT - <i>Half-precision to double-precision variant on page C7-1096</i>	-
0	0	11	00011x	Unallocated.	-
0	0	11	001000	FRINTN (scalar) - <i>Half-precision variant on page C7-1280</i>	ARMv8.2
0	0	11	001001	FRINTP (scalar) - <i>Half-precision variant on page C7-1284</i>	ARMv8.2
0	0	11	001010	FRINTM (scalar) - <i>Half-precision variant on page C7-1276</i>	ARMv8.2
0	0	11	001011	FRINTZ (scalar) - <i>Half-precision variant on page C7-1292</i>	ARMv8.2
0	0	11	001100	FRINTA (scalar) - <i>Half-precision variant on page C7-1268</i>	ARMv8.2
0	0	11	001101	Unallocated.	-
0	0	11	001110	FRINTX (scalar) - <i>Half-precision variant on page C7-1288</i>	ARMv8.2
0	0	11	001111	FRINTI (scalar) - <i>Half-precision variant on page C7-1272</i>	ARMv8.2
1	-	-	-	Unallocated.	-

Floating-point compare

This section describes the encoding of the Floating-point compare instruction class. This section is decoded from *Data Processing -- Scalar Floating-Point and Advanced SIMD on page C4-261*.

31	30	29	28	27	26	25	24	23	22	21	20	16	15	14	13	12	11	10	9	5	4	0
M	0	S	1	1	1	1	0	type	1	Rm	op	1	0	0	0	Rn	opcode2					

Decode fields					Instruction page	Architecture version
M	S	type	op	opcode2		
-	-	-	-	xxxx1	Unallocated.	-
-	-	-	-	xxx1x	Unallocated.	-
-	-	-	-	xx1xx	Unallocated.	-
-	-	-	x1	-	Unallocated.	-
-	-	-	1x	-	Unallocated.	-
-	-	10	-	-	Unallocated.	-
-	1	-	-	-	Unallocated.	-
0	0	00	00	00000	FCMP	-
0	0	00	00	01000	FCMP	-
0	0	00	00	10000	FCMPE	-

Decode fields					Instruction page	Architecture version
M	S	type	op	opcode2		
0	0	00	00	11000	FCMPE	-
0	0	01	00	00000	FCMP	-
0	0	01	00	01000	FCMP	-
0	0	01	00	10000	FCMPE	-
0	0	01	00	11000	FCMPE	-
0	0	11	00	00000	FCMP	ARMv8.2
0	0	11	00	01000	FCMP	ARMv8.2
0	0	11	00	10000	FCMPE	ARMv8.2
0	0	11	00	11000	FCMPE	ARMv8.2
1	-	-	-	-	Unallocated.	-

Floating-point immediate

This section describes the encoding of the Floating-point immediate instruction class. This section is decoded from *Data Processing -- Scalar Floating-Point and Advanced SIMD* on page C4-261.

31 30 29 28 27 26 25 24 23 22 21 20										13 12 11 10 9				5 4		0				
M	0	S	1	1	1	1	0	type	1	imm8				1	0	0	imm5		Rd	

Decode fields				Instruction page	Architecture version
M	S	type	imm5		
-	-	-	xxxx1	Unallocated.	-
-	-	-	xxx1x	Unallocated.	-
-	-	-	xx1xx	Unallocated.	-
-	-	-	x1xxx	Unallocated.	-
-	-	-	1xxxx	Unallocated.	-
-	-	10	-	Unallocated.	-
-	1	-	-	Unallocated.	-
0	0	00	00000	FMOV (scalar, immediate) - <i>Single-precision variant</i> on page C7-1229	-
0	0	01	00000	FMOV (scalar, immediate) - <i>Double-precision variant</i> on page C7-1229	-
0	0	11	00000	FMOV (scalar, immediate) - <i>Half-precision variant</i> on page C7-1229	ARMv8.2
1	-	-	-	Unallocated.	-

Floating-point conditional compare

This section describes the encoding of the Floating-point conditional compare instruction class. This section is decoded from *Data Processing -- Scalar Floating-Point and Advanced SIMD* on page C4-261.

31 30 29 28		27 26 25 24				23 22 21 20				16 15		12 11 10 9			5 4		3		0	
M	0	S	1	1	1	1	0	type	1	Rm	cond	0	1	Rn	op	nzcv				

Decode fields				Instruction page	Architecture version
M	S	type	op		
-	-	10	-	Unallocated.	-
-	1	-	-	Unallocated.	-
0	0	00	0	FCCMP - Single-precision variant on page C7-1059	-
0	0	00	1	FCCMPE - Single-precision variant on page C7-1061	-
0	0	01	0	FCCMP - Double-precision variant on page C7-1059	-
0	0	01	1	FCCMPE - Double-precision variant on page C7-1061	-
0	0	11	0	FCCMP - Half-precision variant on page C7-1059	ARMv8.2
0	0	11	1	FCCMPE - Half-precision variant on page C7-1061	ARMv8.2
1	-	-	-	Unallocated.	-

Floating-point data-processing (2 source)

This section describes the encoding of the Floating-point data-processing (2 source) instruction class. This section is decoded from *Data Processing -- Scalar Floating-Point and Advanced SIMD* on page C4-261.

31 30 29 28		27 26 25 24				23 22 21 20				16 15		12 11 10 9			5 4		0	
M	0	S	1	1	1	1	0	type	1	Rm	opcode	1	0	Rn	Rd			

Decode fields				Instruction page	Architecture version
M	S	type	opcode		
-	-	-	1xx1	Unallocated.	-
-	-	-	1x1x	Unallocated.	-
-	-	-	11xx	Unallocated.	-
-	-	10	-	Unallocated.	-
-	1	-	-	Unallocated.	-
0	0	00	0000	FMUL (scalar) - Single-precision variant on page C7-1239	-
0	0	00	0001	FDIV (scalar) - Single-precision variant on page C7-1166	-
0	0	00	0010	FADD (scalar) - Single-precision variant on page C7-1053	-

Decode fields				Instruction page	Architecture version
M	S	type	opcode		
0	0	00	0011	FSUB (scalar) - <i>Single-precision variant on page C7-1306</i>	-
0	0	00	0100	FMAX (scalar) - <i>Single-precision variant on page C7-1172</i>	-
0	0	00	0101	FMIN (scalar) - <i>Single-precision variant on page C7-1192</i>	-
0	0	00	0110	FMAXNM (scalar) - <i>Single-precision variant on page C7-1176</i>	-
0	0	00	0111	FMINNM (scalar) - <i>Single-precision variant on page C7-1196</i>	-
0	0	00	1000	FNMUL (scalar) - <i>Single-precision variant on page C7-1256</i>	-
0	0	01	0000	FMUL (scalar) - <i>Double-precision variant on page C7-1239</i>	-
0	0	01	0001	FDIV (scalar) - <i>Double-precision variant on page C7-1166</i>	-
0	0	01	0010	FADD (scalar) - <i>Double-precision variant on page C7-1053</i>	-
0	0	01	0011	FSUB (scalar) - <i>Double-precision variant on page C7-1306</i>	-
0	0	01	0100	FMAX (scalar) - <i>Double-precision variant on page C7-1172</i>	-
0	0	01	0101	FMIN (scalar) - <i>Double-precision variant on page C7-1192</i>	-
0	0	01	0110	FMAXNM (scalar) - <i>Double-precision variant on page C7-1176</i>	-
0	0	01	0111	FMINNM (scalar) - <i>Double-precision variant on page C7-1196</i>	-
0	0	01	1000	FNMUL (scalar) - <i>Double-precision variant on page C7-1256</i>	-
0	0	11	0000	FMUL (scalar) - <i>Half-precision variant on page C7-1239</i>	ARMv8.2
0	0	11	0001	FDIV (scalar) - <i>Half-precision variant on page C7-1166</i>	ARMv8.2
0	0	11	0010	FADD (scalar) - <i>Half-precision variant on page C7-1053</i>	ARMv8.2
0	0	11	0011	FSUB (scalar) - <i>Half-precision variant on page C7-1306</i>	ARMv8.2
0	0	11	0100	FMAX (scalar) - <i>Half-precision variant on page C7-1172</i>	ARMv8.2
0	0	11	0101	FMIN (scalar) - <i>Half-precision variant on page C7-1192</i>	ARMv8.2
0	0	11	0110	FMAXNM (scalar) - <i>Half-precision variant on page C7-1176</i>	ARMv8.2
0	0	11	0111	FMINNM (scalar) - <i>Half-precision variant on page C7-1196</i>	ARMv8.2
0	0	11	1000	FNMUL (scalar) - <i>Half-precision variant on page C7-1256</i>	ARMv8.2
1	-	-	-	Unallocated.	-

Floating-point conditional select

This section describes the encoding of the Floating-point conditional select instruction class. This section is decoded from *Data Processing -- Scalar Floating-Point and Advanced SIMD* on page C4-261.

31	30	29	28	27	26	25	24	23	22	21	20	16	15	12	11	10	9	5	4	0
M	0	S	1	1	1	1	0	type	1	Rm	cond	1	1	Rn	Rd					

Decode fields					Instruction page	Architecture version
M	S	type				
-	-	10			Unallocated.	-
-	1	-			Unallocated.	-
0	0	00			FCSEL - Single-precision variant on page C7-1094	-
0	0	01			FCSEL - Double-precision variant on page C7-1094	-
0	0	11			FCSEL - Half-precision variant on page C7-1094	ARMv8.2
1	-	-			Unallocated.	-

Floating-point data-processing (3 source)

This section describes the encoding of the Floating-point data-processing (3 source) instruction class. This section is decoded from [Data Processing -- Scalar Floating-Point and Advanced SIMD on page C4-261](#).

31	30	29	28	27	26	25	24	23	22	21	20	16	15	14	10	9	5	4	0
M	0	S	1	1	1	1	1	type	o1	Rm	o0	Ra	Rn	Rd					

Decode fields						Instruction page	Architecture version
M	S	type	o1	o0			
-	-	10	-	-			Unallocated.
-	1	-	-	-			Unallocated.
0	0	00	0	0			FMADD - Single-precision variant on page C7-1168
0	0	00	0	1			FMSUB - Single-precision variant on page C7-1231
0	0	00	1	0			FNMADD - Single-precision variant on page C7-1252
0	0	00	1	1			FNMSUB - Single-precision variant on page C7-1254
0	0	01	0	0			FMADD - Double-precision variant on page C7-1168
0	0	01	0	1			FMSUB - Double-precision variant on page C7-1231
0	0	01	1	0			FNMADD - Double-precision variant on page C7-1252
0	0	01	1	1			FNMSUB - Double-precision variant on page C7-1254
0	0	11	0	0			FMADD - Half-precision variant on page C7-1168
0	0	11	0	1			FMSUB - Half-precision variant on page C7-1231

Decode fields					Instruction page	Architecture version
M	S	type	o1	o0		
0	0	11	1	0	FNMADD - Half-precision variant on page C7-1252	ARMv8.2
0	0	11	1	1	FNMSUB - Half-precision variant on page C7-1254	ARMv8.2
1	-	-	-	-	Unallocated.	-

Chapter C5

The A64 System Instruction Class

This chapter describes the A64 System instruction class, and the System instruction class encoding space, that is a subset of the System registers encoding space. It contains the following sections:

- *The System instruction class encoding space on page C5-312.*
- *Special-purpose registers on page C5-336.*
- *A64 system instructions for cache maintenance on page C5-405.*
- *A64 system instructions for address translation on page C5-427.*
- *A64 system instructions for TLB maintenance on page C5-454.*

See *General information about the A64 instruction descriptions on page C2-151* for information about entries used in the instruction encoding descriptions.

C5.1 The System instruction class encoding space

Part of the A64 instruction encoding space is assigned to instructions that access the System register encoding space. These instructions provide:

- Access to *System registers*, including the debug registers, that provide system control, and system status information.
- Access to Special-purpose registers such as [SPSR_ELx](#), [ELR_ELx](#), and the equivalent fields of the Process State.
- The cache and TLB maintenance instructions and address translation instructions.
- Barriers and the CLREX instruction.
- Architectural hint instructions.

This section describes the general model for accessing this functionality.

Note

- See [Fixed values in AArch64 instruction and System register descriptions on page C2-151](#) for information about abbreviations used in the System instruction descriptions.
- In AArch32 state much of this functionality is provided through the System register interface described in [The AArch32 System register interface on page G1-4408](#). In AArch64 state, the parameters used to characterize the System register encoding space are {op0, op1, CRn, CRm, op2}. These are based on the parameters that characterize the AArch32 System register encoding space, which reflect the original implementation of these registers, as described in [Background to the System register interface on page G1-4410](#). In ARMv8, there is no particular significance to the naming of these parameters, and no functional distinction between the op*n* parameters and the CR*x* parameters.

[Principles of the System instruction class encoding](#) describes some general properties of these encodings. [System instruction class encoding overview on page C5-313](#) then describes the top-level encoding of these instructions, and the following sections then describe the next level of the encoding hierarchy:

- [op0==0b00, architectural hints, barriers and CLREX, and PSTATE access on page C5-314](#).
- [op0==0b01, cache maintenance, TLB maintenance, and address translation instructions on page C5-317](#).
- [op0==0b10, Moves to and from debug and trace System registers on page C5-321](#).
- [op0==0b11, Moves to and from non-debug System registers and Special-purpose registers on page C5-323](#).
- [Reserved encodings for IMPLEMENTATION DEFINED registers on page C5-334](#).

C5.1.1 Principles of the System instruction class encoding

In ARMv8, an encoding in the System instruction space is identified by a set of arguments, {op0, op1, CRn, CRm, op2}. These form an encoding hierarchy, where:

op0	Defines the top-level division of the encoding space, see System instruction class encoding overview on page C5-313 .
op1	Identifies the lowest Exception level at which the encoding is accessible, as follows: Accessible at EL0 op1 has the value 3. Accessible at EL1 op1 has the value 0, 1, or 2. The value is the same as the op1 value used to access the equivalent AArch32 register. Accessible at EL2 op1 has the value 4. Accessible at EL3 op1 has the value 6.

ARM strongly recommends that implementers adopt this use of op1 when using the IMPLEMENTATION DEFINED regions of the encoding space described in [Reserved encodings for IMPLEMENTATION DEFINED registers on page C5-334](#).

System register width

In AArch64 state, each encoding in the System instruction space can provide access to a 64-bit register. An AArch64 System register is described as either a *32-bit register* or a *64-bit register*. For a 32-bit registers, the upper bits, bits[63:32], are RES0.

C5.1.2 System instruction class encoding overview

The encoding of the System instruction class describes each instruction as being either:

- A transfer to a System register. This is a System instruction with the semantics of a write.
- A transfer from a System register. This is a System instruction with the semantics of a read.

A System instruction that initiates an operation operates as if it was making a transfer to a register.

In the AArch64 instruction set, the decode structure for the System instruction class is:

31	30	29	28	27	26	25	24	23	22	21	20	19	18	16	15	12	11	8	7	5	4	0	
1	1	0	1	0	1	0	1	0	0	L	Op0	Op1	CRn	CRm	Op2	Rt							

The value of L indicates the transfer direction:

- 0** Transfer to System register.
- 1** Transfer from System register.

The op0 field is the top level encoding of the System instruction type. Its possible values are:

0b00 These encodings provide:

- Instructions with an immediate field for accessing [PSTATE](#), the current PE state.
- The architectural hint instructions.
- Barriers and the CLREX instruction.

For more information about these encodings, see [op0==0b00, architectural hints, barriers and CLREX, and PSTATE access on page C5-314](#).

0b01 These encodings provide the cache maintenance, TLB maintenance, and address translation instructions.

———— **Note** —————

These are equivalent to operations in the AArch32 (coproc==0b1111) encoding space.

For more information, see [op0==0b01, cache maintenance, TLB maintenance, and address translation instructions on page C5-317](#).

0b10 These encodings provide moves to and from:

- Legacy AArch32 System registers for execution environments, to provide access to these registers from higher Exception levels that are using AArch64.
- Debug and trace registers.

———— **Note** —————

These are equivalent to the registers in the AArch32 (coproc==0b1110) encoding space.

For more information, see [op0==0b10, Moves to and from debug and trace System registers on page C5-321](#).

0b11 These encodings provide:

- Moves to and from Non-debug System registers. The accessed registers provide system control, and system status information.

————— **Note** —————

The accessed registers are equivalent to the registers in the AArch32 (coproc==0b1111) encoding space.

- Access to Special-purpose registers.

For more information, see *Instructions for accessing Special-purpose registers* on page C5-333 and *Instructions for accessing non-debug System registers* on page C5-323.

UNDEFINED behaviors

In the System register instruction encoding space, the following principles apply:

- All unallocated encodings are treated as UNDEFINED.
- All encodings with L==1 and op0==0b0x are UNDEFINED, except for encodings in the area reserved for IMPLEMENTATION DEFINED use, see *Reserved encodings for IMPLEMENTATION DEFINED registers* on page C5-334.

For registers and operations that are accessible from a particular Exception level, any attempt to access those registers from a lower Exception level is UNDEFINED.

If a particular Exception level:

- Defines a register to be RO, then any attempt to write to that register, at that Exception level, is UNDEFINED. This means that any access to that register with L==0 is UNDEFINED.
- Defines a register to be WO, then any attempt to read from that register, at that Exception level, is UNDEFINED. This means that any access to that register with L==1 is UNDEFINED.

For IMPLEMENTATION DEFINED encoding spaces, the treatment of the encodings is IMPLEMENTATION DEFINED, but see the recommendation in *Principles of the System instruction class encoding* on page C5-312.

C5.1.3 op0==0b00, architectural hints, barriers and CLREX, and PSTATE access

The different groups of System register instructions with op0==0b00:

- Are identified by the value of CRn.
- Are always encoded with a value of 0b11111 in the Rt field.

The encoding of these instructions is:

31	30	29	28	27	26	25	24	23	22	21	20	19	18	16	15	12	11	8	7	5	4	0
1	1	0	1	0	1	0	1	0	0	L	0	0	op1	CRn	CRm	op2	1	1	1	1	1	1
														op0				Rt				

The encoding of the CRn field is as follows:

- 0b0010** See *Architectural hint instructions*.
- 0b0011** See *Barriers and CLREX* on page C5-315.
- 0b0100** See *Instructions for accessing the PSTATE fields* on page C5-316.

Architectural hint instructions

Within the op0==0b00 encodings, the architectural hint instructions are identified by CRn having the value 0b0010. The encoding of these instructions is:

31	30	29	28	27	26	25	24	23	22	21	20	19	18	16	15	12	11	5	4	0				
1	1	0	1	0	1	0	1	0	0	0	0	0	1	1	0	0	1	0	Op<6:0>	1	1	1	1	1
				Op0				Op1		CRn		CRm		Op2		Rt								

The value of op<6:0>, formed by concatenating the CRm and op2 fields, determines the hint instruction as follows:
 0b0000000 NOP instruction. This has no effect on architectural state other than to advance the PC.

0b0000001 YIELD instruction.
 0b0000010 WFE instruction.
 0b0000011 WFI instruction.
 0b0000100 SEV instruction.
 0b0000101 SEVL instruction.
 0b0000110-0b1111111
 Unallocated values. These encodings behave as NOPs.

———— **Note** —————

- Instruction encodings with bits[4:0] not set to 0b11111 are UNDEFINED.
- The operation of the A64 instructions for architectural hints are identical to the corresponding A32 and T32 instructions.

For more information about:

- The WFE, WFI, SEV, and SEVL instructions, see *Mechanisms for entering a low-power state* on page D1-1879.
- The YIELD instruction, see *Software control features and EL0* on page B1-76.

Barriers and CLREX

Within the $op0=0b00$ encodings, the barriers and CLREX instructions are identified by CRn having the value 0b0011. The encoding of these instructions is:

31	30	29	28	27	26	25	24	23	22	21	20	19	18	16	15	12	11	8	7	5	4	0		
1	1	0	1	0	1	0	1	0	0	0	0	0	1	1	0	0	1	1	CRm	op2	1	1	1	1
										op0			op1		CRn			Rt						

The value of op2 determines the instruction, as follows. For the DSB and DMB instructions, CRm controls the instruction options.

0b010 CLREX instruction. The value of CRm is ignored.
 0b100 DSB instruction. The value of CRm sets the option type, see [Table C5-1](#).
 0b101 DMB instruction. The value of CRm sets the option type, see [Table C5-1](#).
 0b110 ISB instruction. The value of CRm is ignored.
 0b000, 0b001, 0b011, 0b111
 UNDEFINED.

———— **Note** —————

Instruction encodings with bits[4:0] not set to 0b11111 are UNDEFINED.

[Table C5-1](#) shows the CRm encodings for the data barrier option types.

Table C5-1 CRm encoding for DMB and DSB instructions

CRm value	Option, for DMB and DSB	Meaning
0001	OSHL	Outer Shareable, load
0010	OSHS	Outer Shareable, store
0011	OSH	Outer Shareable, all
0101	NSHL	Non-shareable, load
0110	NSHS	Non-shareable, store
0111	NSH	Non-shareable, all

Table C5-1 CRm encoding for DMB and DSB instructions (continued)

CRm value	Option, for DMB and DSB	Meaning
1001	ISHLD	Inner Shareable, load
1010	ISHST	Inner Shareable, store
1011	ISH	Inner Shareable, all
1101	LD	Full system, load
1110	ST	Full system, store
0000, 0100, 1000, 1100	#<imm> ^a	Full system, all
1111	SY	Full system, all

a. #<imm> is a 4-bit unsigned immediate in the range 0-15, encoded in the CRm field.

Note

The operation of the A64 instructions for barriers and CLREX are identical to the corresponding A32 and T32 instructions.

For more information about:

- The barrier instructions, see [Memory barriers on page B2-92](#).
- The CLREX instruction, see [Synchronization and semaphores on page B2-121](#).

Instructions for accessing the PSTATE fields

Within the op0==0b00 encodings, the instructions that can be used to modify PSTATE fields directly are identified by CRn having the value 0b0100. The encoding of these instructions is:

31	30	29	28	27	26	25	24	23	22	21	20	19	18	16	15	12	11	8	7	5	4	0		
1	1	0	1	0	1	0	1	0	0	0	0	0	0	op1	0	1	0	0	Imm4	op2	1	1	1	1
												op0		CRn		CRm		Rt						

These instructions are:

- MSR DAIFSet, #Imm4 ; Used to set any or all of DAIF to 1
- MSR DAIFClr, #Imm4 ; Used to clear any or all of DAIF to 0
- MSR SPSEL, #Imm4 ; Used to select the Stack Pointer, between SP_EL0 and SP_ELx
- MSR UA0, #Imm4 ; Used to set UA0 to 1
- MSR PAN, #Imm4 ; Used to set PAN to 1

The value of op2 selects the instruction form, which defines the constraints on the values of the op1 and Imm4 arguments, as follows:

- op2==0b011 Selects the MSR UA0 instruction.
 op1 must be 0b000.
 This instruction is accessible at EL1 or higher.
- op2==0b100 Selects the MSR PAN instruction.
 op1 must be 0b000.
 This instruction is accessible at EL1 or higher.

- op2==0b101 Selects the MSR SPSEL instruction.
 op1 must be 0b000.
 This instruction is accessible at EL1 or higher.
 Imm4<0> selects the accessed stack pointer, as follows:
0 Selects SP_EL0.
1 Selects SP_ELx on page K11-6286, where x is the number of the current Exception level, 1, 2, or 3.
 Imm4<3:1> are SBZ.
- op2==0b110 Selects the MSR DAIFSET instruction, that sets the specified PSTATE.{D, A, I, F} bits to 1.
 op1 must be 0b011.
 This instruction is accessible at EL1 or higher, and when the value of the SCTLRL_EL1.UMA bit is 1 it is also accessible at EL0.
 Imm4 determines which of the PSTATE.{D, A, I, F} bits are set to 1, as follows:
 Imm4<3> If this bit is set to 1 then the D bit is set to 1, otherwise the D bit is not changed.
 Imm4<2> If this bit is set to 1 then the A bit is set to 1, otherwise the A bit is not changed.
 Imm4<1> If this bit is set to 1 then the I bit is set to 1, otherwise the I bit is not changed.
 Imm4<0> If this bit is set to 1 then the F bit is set to 1, otherwise the F bit is not changed.
- op2==0b111 Selects the MSR DAIFCLR instruction, that clears the specified PSTATE.{D, A, I, F} bits to 0.
 op1 must be 0b011.
 This instruction is accessible at EL1 or higher, and when the value of the SCTLRL_EL1.UMA bit is 1 it is also accessible at EL0.
 Imm4 determines which of the PSTATE.{D, A, I, F} bits is cleared to 0, as follows:
 Imm4<3> If this bit is set to 1 then the D bit is cleared to 0, otherwise the D bit is not changed.
 Imm4<2> If this bit is set to 1 then the A bit is cleared to 0, otherwise the A bit is not changed.
 Imm4<1> If this bit is set to 1 then the I bit is cleared to 0, otherwise the I bit is not changed.
 Imm4<0> If this bit is set to 1 then the F bit is cleared to 0, otherwise the F bit is not changed.

All other combinations of op1 and op2 are reserved, and the corresponding instructions are UNDEFINED.

———— **Note** —————

For PSTATE updates, instruction encodings with bits[4:0] not set to 0b11111 are UNDEFINED.

Writes to PSTATE.{D, A, I, F} occur in program order without the need for additional synchronization. Changing PSTATE.SPSEL to use EL0 synchronizes any updates to SP_EL0 that have been written by an MSR to SP_EL0, without the need for additional synchronization.

C5.1.4 op0==0b01, cache maintenance, TLB maintenance, and address translation instructions

The System instructions are encoded with op0==0b01. The different groups of System instructions are identified by the values of CRn and CRm, except that some of this encoding space is reserved for IMPLEMENTATION DEFINED functionality. The encoding of these instructions is:

31	30	29	28	27	26	25	24	23	22	21	20	19	18	16	15	12	11	8	7	5	4	0
1	1	0	1	0	1	0	1	0	0	0	0	1	op1	CRn	CRm	op2	Xt					

op0

The grouping of these instructions depending on the CRn and CRm fields is as follows:

- CRn==7 The instruction group is determined by the value of CRm, as follows:
 - CRm=={1, 5} Instruction cache maintenance instructions.
 - CRm==4 Data cache zero operation.
 - CRm=={6, 10, 11, 12, 14} Data cache maintenance instructions.
See *Cache maintenance instructions, and data cache zero*.
 - CRm==8 See *Address translation instructions* on page C5-319.
- CRn==8 See *TLB maintenance instructions* on page C5-320.
- CRn=={11, 15} See *Reserved encoding space for IMPLEMENTATION DEFINED instructions* on page C5-321.

Cache maintenance instructions, and data cache zero

Table C5-2 lists the Cache maintenance instructions and their encodings. Instructions that take an argument include Xt in the instruction syntax. For instructions that do not take an argument, the Xt field is encoded as 0b11111.

Table C5-2 Cache maintenance instructions

Instruction	Access instruction encoding					Notes
	op0	op1	CRn	CRm	op2	
Instruction cache maintenance instructions						
IC IALLUIS	1	0	7	1	0	Accessible from EL1 or higher.
IC IALLU				5	0	
IC IVAU, Xt		3	7	5	1	When SCTLR_EL1.UCI == 1, accessible from EL0 or higher. Otherwise, accessible from EL1 or higher.
Data cache maintenance instructions						
DC IVAC, Xt	1	0	7	6	1	Accessible from EL1 or higher.
DC ISW, Xt					2	
DC CSW, Xt				10	2	
DC CISW, Xt				14	2	
DC CVAC, Xt		3	7	10	1	When SCTLR_EL1.UCI == 1, accessible from EL0 or higher. Otherwise, accessible from EL1 or higher.
DC CVAU, Xt				11	1	
DC CVAP, Xt				12	1	
DC CIVAC, Xt				14	1	
Data cache zero operation						
DC ZVA, Xt	1	3	7	4	1	When SCTLR_EL1.DZE == 1, accessible from EL0 or higher. Otherwise, accessible from EL1 or higher.

For more information about these instructions, see *About cache maintenance in AArch64 state* on page D3-1981 and *A64 Cache maintenance instructions* on page D3-1985.

Address translation instructions

Table C5-3 lists the Address translation instructions and their encodings. The syntax of the instructions includes Xt, that provides the address to be translated.

Table C5-3 Address translation instructions

Instruction	Access instruction encoding					Notes
	op0	op1	CRn	CRm	op2	
AT S1E1R , Xt	1	0	7	8	0	Accessible from EL1 or higher.
AT S1E1W , Xt					1	
AT S1E0R , Xt					2	
AT S1E0W , Xt					3	
AT S1E2R , Xt		4	7	8	0	Accessible from EL2 or higher.
AT S1E2W , Xt					1	
AT S12E1R , Xt					4	
AT S12E1W , Xt					5	
AT S12E0R , Xt					6	
AT S12E0W , Xt					7	
AT S1E3R , Xt		6	7	8	0	
AT S1E3W , Xt					1	

For more information about these instructions, see [Address translation instructions](#) on page D4-2056.

TLB maintenance instructions

Table C5-4 lists the TLB maintenance instructions and their encodings. Instructions that take an argument include Xt in the instruction syntax. For instructions that do not take an argument, the Xt field is encoded as 0b11111.

Table C5-4 TLB maintenance instructions

Instruction	Access instruction encoding					Notes	
	op0	op1	CRn	CRm	op2		
TLBI VMALLE1IS	1	0	8	3	0	Accessible from EL1 or higher.	
TLBI VAE1IS, Xt					1		
TLBI ASIDE1IS, Xt					2		
TLBI VAAE1IS, Xt					3		
TLBI VALE1IS, Xt					5		
TLBI VAALE1IS, Xt					7		
TLBI VMALLE1				7	0		Accessible from EL1 or higher.
TLBI VAE1, Xt					1		
TLBI ASIDE1, Xt					2		
TLBI VAAE1, Xt					3		
TLBI VALE1, Xt					5		
TLBI VAALE1, Xt					7		
TLBI IPAS2E1IS, Xt	4	8	0		1	Accessible from EL2 or higher.	
TLBI IPAS2LE1IS, Xt					5		
TLBI ALLE2IS					3		0
TLBI VAE2IS, Xt							1
TLBI ALLE1IS							4
TLBI VALE2IS, Xt							5
TLBI VMALLS12E1IS							6
TLBI IPAS2E1, Xt	4				1		
TLBI IPAS2LE1, Xt					5		
TLBI ALLE2					7		0
TLBI VAE2, Xt							1
TLBI ALLE1							4
TLBI VALE2, Xt							5
TLBI VMALLS12E1							6

Table C5-4 TLB maintenance instructions (continued)

Instruction	Access instruction encoding					Notes
	op0	op1	CRn	CRm	op2	
TLBI ALLE3IS	1	6	8	3	0	Accessible only from EL3.
TLBI VAE3IS, Xt					1	
TLBI VALE3IS, Xt					5	
TLBI ALLE3				7	0	
TLBI VAE3, Xt					1	
TLBI VALE3, Xt					5	

For more information about these instructions, see [TLB maintenance instructions on page D4-2121](#).

Reserved encoding space for IMPLEMENTATION DEFINED instructions

The A64 instruction set reserves the following encoding space for IMPLEMENTATION DEFINED instructions:

31	30	29	28	27	26	25	24	23	22	21	20	19	18	16	15	12	11	8	7	5	4	0	
1	1	0	1	0	1	0	1	0	0	L	0	1	op1	1	x	1	1	CRm	op2			Rt	
												op0		CRn									

The value of L defines the use of Rt as follows:

- 0** Rt is an argument supplied to the instruction.
- 1** Rt is a result returned by the instruction.

IMPLEMENTATION DEFINED instructions in this encoding space are accessed using the SYS and SYSL instructions, see [SYS on page C6-950](#) and [SYSL on page C6-951](#).

See also [Reserved encodings for IMPLEMENTATION DEFINED registers on page C5-334](#).

C5.1.5 op0==0b10, Moves to and from debug and trace System registers

The instructions that move data to and from the debug, Execution environment, and trace System registers are encoded with op0==0b10. This means the encoding of these instructions is:

31	30	29	28	27	26	25	24	23	22	21	20	19	18	16	15	12	11	8	7	5	4	0	
1	1	0	1	0	1	0	1	0	0	L	1	0	op1		CRn		CRm	op2				Rt	
												op0											

———— **Note** —————

These encodings access the registers that are equivalent to the AArch32 System registers in the (coproc==0b1110) encoding space.

The value of op1 provides the next level of decode of these instructions, as follows:

op1 == {0, 3, 4}

Debug. See *Instructions for accessing debug System registers*

———— **Note** —————

The standard encoding of debug registers is op0==0b10, op1== {0, 3, 4}. The following sections describe registers in the op0==0b11 encoding space that are classified as debug registers, see *Instructions for accessing non-debug System registers* on page C5-323:

- *DLR_EL0, Debug Link Register* on page D7-2588.
- *DSPSR_EL0, Debug Saved Program Status Register* on page D7-2589.
- *MDCR_EL2, Monitor Debug Configuration Register (EL2)* on page D7-2599.
- *MDCR_EL3, Monitor Debug Configuration Register (EL3)* on page D7-2604.
- *SDER32_EL3, AArch32 Secure Debug Enable Register* on page D7-2627.

op1 == 1 Trace. See the appropriate trace architecture specification.

Instructions for accessing debug System registers

The instructions for accessing debug System registers are:

MSR <System register>, Xt ; Write to System register
MRS Xt, <System register> ; Read from System register

Where <System_register> is the register name, for example MDCCSR_EL0.

This section includes only the System register access encodings for which both:

- op0 is 0b10.
- The value of op1 is one of {0, 3, 4}.

———— **Note** —————

These encodings access the registers that are equivalent to the AArch32 System registers in the (coproc==0b1110) encoding space.

Table C5-5 shows the mapping of the System register encodings for debug System register access.

Table C5-5 System instruction encodings for debug System register access

Register	Access instruction encoding					Permitted accesses
	op0	op1	CRn	CRm	op2	
OSDTRRX_EL1	2	0	0	0	2	RW
MDCCINT_EL1				2	0	RW
MDSCR_EL1					2	RW
OSDTRTX_EL1				3	2	RW
OSECCR_EL1				6	2	RW
DBGBVR<n>_EL1				0-15 ^a	4	RW
DBGBCR<n>_EL1				0-15 ^a	5	RW
DBGWVR<n>_EL1				0-15 ^a	6	RW
DBGWCR<n>_EL1				0-15 ^a	7	RW

Table C5-5 System instruction encodings for debug System register access (continued)

Register	Access instruction encoding					Permitted accesses
	op0	op1	CRn	CRm	op2	
MDRAR_EL1	2	0	1	0	0	RO
OSLAR_EL1					4	WO
OSLSR_EL1				1	4	RO
OSDLR_EL1				3	4	RW
DBGPRCR_EL1				4	4	RW
DBGCLAIMSET_EL1			7	8	6	RW
DBGCLAIMCLR_EL1				9	6	RW
DBGAUTHSTATUS_EL1				14	6	RO
MDCCSR_EL0		3	0	1	0	RO
DBGDTR_EL0				4	0	RW
DBGDTRRX_EL0				5	0	RO
DBGDTRTX_EL0						WO
DBGVCR32_EL2		4	0	7	0	RW

a. Unimplemented breakpoint and watchpoint register access instructions are unallocated. CRm encodes <n>, the breakpoint or watchpoint number.

For more information see *Mapping of the System registers between the Execution states* on page D1-1890.

C5.1.6 op0==0b11, Moves to and from non-debug System registers and Special-purpose registers

The instructions that move data to and from non-debug System registers are encoded with op0==0b11, except that some of this encoding space is reserved for IMPLEMENTATION DEFINED functionality. The encoding of these instructions is:

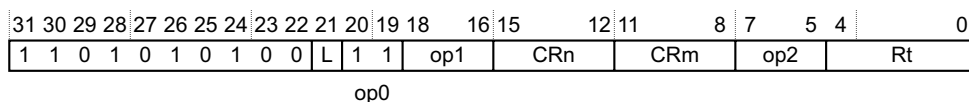

The value of CRn provides the next level of decode of these instructions, as follows:

CRn=={0, 1, 2, 3, 5, 6, 7, 9, 10, 12, 13, 14}

See *Instructions for accessing non-debug System registers*.

CRn==4

See *Instructions for accessing Special-purpose registers* on page C5-333.

CRn=={11, 15}

See *Reserved encodings for IMPLEMENTATION DEFINED registers* on page C5-334.

Instructions for accessing non-debug System registers

The A64 instructions for accessing System registers are:

MSR <System register>, Xt ; Write to System register
MRS Xt, <System register> ; Read from System register

Where <System_register> is the register name, for example MIDR_EL1.

This section includes only the System register access encodings for which both:

- `op0` is `0b11`.
- The value of `CRn` is one of {0, 1, 2, 3, 5, 6, 7, 9, 10, 12, 13, 14}.

Note

- These encodings access the registers that are equivalent to the AArch32 System registers in the (`coproc==0b1111`) encoding space.
- While this group is described as accessing the non-debug System registers, its correct characterization is by the {`op0`, `CRn`} values given in this subsection, and the group includes the debug registers described in the following sections:
 - [DLR_EL0, Debug Link Register](#) on page D7-2588.
 - [DSPSR_EL0, Debug Saved Program Status Register](#) on page D7-2589.
 - [MDCR_EL2, Monitor Debug Configuration Register \(EL2\)](#) on page D7-2599.
 - [MDCR_EL3, Monitor Debug Configuration Register \(EL3\)](#) on page D7-2604.
 - [SDER32_EL3, AArch32 Secure Debug Enable Register](#) on page D7-2627.

These registers are exceptions to the standard encoding of debug registers, that has `op0==0b10`, see [Instructions for accessing debug System registers](#) on page C5-322.

The instruction encoding for these accesses is:

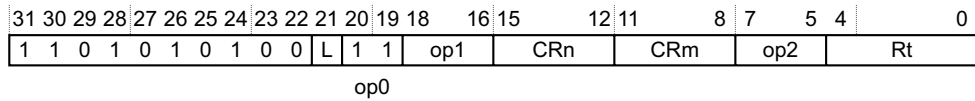

See text for permitted values of `CRn`

Table C5-6 shows the encodings of the register access instructions. In the *Notes* column of the table:

- Config-RO** Means it is configurable whether read accesses are permitted. Write accesses are UNDEFINED.
- Config-WO** Means it is configurable whether write accesses are permitted. Read accesses are UNDEFINED.
- Config-RW** Means it is configurable whether accesses are permitted. Either read and write accesses are permitted, or read and write accesses are UNDEFINED.

See the register descriptions for information about the control that determines whether these accesses are permitted.

Table C5-6 System instruction encodings for non-Debug System register accesses

Register accessed	Width (bits)	Access instruction encoding					Notes
		op0	op1	CRn	CRm	op2	
MIDR_EL1	32	3	0	0	0	0	RO.
MPIDR_EL1	64					5	RO.
REVIDR_EL1	32					6	RO.

Table C5-6 System instruction encodings for non-Debug System register accesses (continued)

Register accessed	Width (bits)	Access instruction encoding					Notes
		op0	op1	CRn	CRm	op2	
ID_PFR0_EL1	32	3	0	0	1	0	RO, but UNKNOWN if AArch32 is not implemented.
ID_PFR1_EL1	32					1	
ID_DFR0_EL1	32					2	
ID_AFR0_EL1	32					3	
ID_MMFR0_EL1	32					4	
ID_MMFR1_EL1	32					5	
ID_MMFR2_EL1	32					6	
ID_MMFR3_EL1	32					7	
ID_ISAR0_EL1	32				2	0	RO, but UNKNOWN if AArch32 is not implemented.
ID_ISAR1_EL1	32					1	
ID_ISAR2_EL1	32					2	
ID_ISAR3_EL1	32					3	
ID_ISAR4_EL1	32					4	
ID_ISAR5_EL1	32					5	
ID_MMFR4_EL1	32					6	
Reserved, RAZ	-					7	RO.
MVFR0_EL1	32				3	0	RO, but UNKNOWN if AArch32 is not implemented.
MVFR1_EL1	32					1	
MVFR2_EL1	32					2	
Reserved, RAZ	-					<i>n</i>	RO, for $n=3-7$.
ID_AA64PFR0_EL1	64				4	0	RO.
ID_AA64PFR1_EL1	64					1	RO.
ID_AA64ZFR0_EL1	64					4	RO. ^a
Reserved, RAZ	-					<i>n</i>	RO, for $n=\{2, 3, 5, 6, 7\}$.
ID_AA64DFR0_EL1	64				5	0	RO.
ID_AA64DFR1_EL1	64					1	RO.
ID_AA64AFR0_EL1	64					4	RO.
ID_AA64AFR1_EL1	64					5	RO.
Reserved, RAZ	-					<i>n</i>	RO, for $n=\{2, 3, 6, 7\}$.

Table C5-6 System instruction encodings for non-Debug System register accesses (continued)

Register accessed	Width (bits)	Access instruction encoding					Notes
		op0	op1	CRn	CRm	op2	
ID_AA64ISAR0_EL1	64	3	0	0	6	0	RO.
ID_AA64ISAR1_EL1	64					1	RO.
Reserved, RAZ	-					<i>n</i>	RO, for <i>n</i> =2-7.
ID_AA64MMFR0_EL1	64				7	0	RO.
ID_AA64MMFR1_EL1	64					1	RO.
ID_AA64MMFR2_EL1	64					2	RO.
Reserved, RAZ	-					<i>n</i>	RO, for <i>n</i> =3-7.
SCTLR_EL1	32			1	0	0	RW.
ACTLR_EL1	64					1	RW, contents IMPLEMENTATION DEFINED.
CPACR_EL1	32					2	RW.
ZCR_EL1	64				2	0	RW. ^a
TTBR0_EL1	64			2	0	0	RW.
TTBR1_EL1	64					1	RW.
TCR_EL1	64					2	RW.
ICC_PMR_EL1 ICV_PMR_EL1	32			4	6	0	RW. ^b
AFSR0_EL1	32			5	1	0	RW, contents IMPLEMENTATION DEFINED.
AFSR1_EL1	32					1	
ESR_EL1	32				2	0	RW.
RAS registers	64				3	0-1	RAS Extension. ^c
					4	0-3	
					5	0-1	
FAR_EL1	64			6	0	0	RW.
PAR_EL1	64			7	4	0	RW.
SPE registers	64			9	9	0, 2-7	Statistical Profiling Extension. ^d
					10	0, 1, 3, 7	
PMINTENSET_EL1	32				14	1	RW. ^e
PMINTENCLR_EL1	32					2	RW. ^e
MAIR_EL1	64			10	2	0	RW.
AMAIR_EL1	64				3	0	RW, contents IMPLEMENTATION DEFINED.

Table C5-6 System instruction encodings for non-Debug System register accesses (continued)

Register accessed	Width (bits)	Access instruction encoding					Notes	
		op0	op1	CRn	CRm	op2		
VBAR_EL1	64	3	0	12	0	0	RW.	
RVBAR_EL1	64					1	RO. Implemented only if EL2 and EL3 are not implemented.	
RMR_EL1	64					2	RW. Implemented only when both EL1 is the highest implemented Exception level and EL1 can use AArch32 and AArch64. Otherwise, it is IMPLEMENTATION DEFINED whether the register is implemented.	
ISR_EL1	32					1	0	RO.
RAS register	64						1	RAS Extension. ^c
ICC_IAR0_EL1 ICV_IAR0_EL1	32					8	0	RO. ^b
ICC_EOIR0_EL1 ICV_EOIR0_EL1	32						1	WO. ^b
ICC_HPPIR0_EL1 ICV_HPPIR0_EL1	32						2	RO. ^b
ICC_BPR0_EL1 ICV_BPR0_EL1	32						3	RW. ^b
ICC_AP0R<n>_EL1 ICV_AP0R<n>_EL1	32						4-7	RW, <n> = op2-4. ^b
ICC_APIR<n>_EL1 ICV_APIR<n>_EL1	32					9	0-3	RW, <n> = op2. ^b
ICC_DIR_EL1 ICV_DIR_EL1	32					11	1	WO. ^b
ICC_RPR_EL1 ICV_RPR_EL1	32						3	RO. ^b
ICC_SGI1R_EL1	64						5	WO. ^b
ICC_ASGI1R_EL1	64						6	WO. ^b
ICC_SGI0R_EL1	64						7	WO. ^b

Table C5-6 System instruction encodings for non-Debug System register accesses (continued)

Register accessed	Width (bits)	Access instruction encoding					Notes
		op0	op1	CRn	CRm	op2	
ICC_IAR1_EL1 ICV_IAR1_EL1	32	3	0	12	12	0	RO. ^b
ICC_EOIR1_EL1 ICV_EOIR1_EL1	32					1	WO. ^b
ICC_HPPIR1_EL1 ICV_HPPIR1_EL1	32					2	RO. ^b
ICC_BPR1_EL1 ICV_BPR1_EL1	32					3	RW. ^b
ICC_CTLR_EL1 ICV_CTLR_EL1	32					4	RW. ^b
ICC_SRE_EL1	32					5	RW. ^b
ICC_IGRPEN0_EL1	32					6	RW. ^b
ICC_IGRPEN1_EL1	32					7	RW. ^b
ICC_IGRPEN0_EL1 ICV_IGRPEN0_EL1	32					6	RW. ^b
ICC_IGRPEN1_EL1 ICV_IGRPEN1_EL1	32					7	RW. ^b
CONTEXTIDR_EL1	32			13	0	1	RW.
TPIDR_EL1	64					4	RW.
CNTKCTL_EL1	32			14	1	0	RW. ^f
CCSIDR_EL1	32	1	0	0	0	0	RO.
CLIDR_EL1	64					1	RO.
AIDR_EL1	32					7	RO.
CSSELR_EL1	32	2	0	0	0	0	RW.
CTR_EL0	32	3	0	0	0	1	Config-RO at EL0, otherwise RO.
DCZID_EL0	32					7	RO.

Table C5-6 System instruction encodings for non-Debug System register accesses (continued)

Register accessed	Width (bits)	Access instruction encoding					Notes
		op0	op1	CRn	CRm	op2	
PMCR_ELO	32	3	3	9	12	0	Config-RW at EL0, otherwise RW. ^e
PMCNTENSET_ELO	32					1	
PMCNTENCLR_ELO	32					2	
PMOVSCLR_ELO	32					3	
PMSWINC_ELO	32					4	Config-WO at EL0, otherwise WO. ^e
PMSELR_ELO	32					5	Config-RW at EL0, otherwise RW. ^e
PMCEID0_ELO	32					6	Config-RO at EL0, otherwise RO. ^e
PMCEID1_ELO	32					7	
PMCCNTR_ELO	64				13	0	Config-RW at EL0, otherwise RW. ^e
PMXEVTYPER_ELO	32					1	
PMXEVCNTR_ELO	32					2	
PMUSERENR_ELO	32				14	0	RO at EL0, RW at other Exception levels. ^e
PMOVSSET_ELO	32					3	Config-RW at EL0, otherwise RW. ^e
TPIDR_ELO	64			13	0	2	RW.
TPIDRRO_ELO	64					3	RW.
CNTFRQ_ELO	32			14	0	0	RO at EL1, RW at the highest Exception level implemented. Config-RO at EL0. ^f
CNTPCT_ELO	64					1	Config-RO at EL0, otherwise RO. ^f
CNTVCT_ELO	64					2	
CNTP_TVAL_ELO	32				2	0	Config-RW at EL0 and Non-secure EL1, otherwise RW. ^f
CNTP_CTL_ELO	32					1	
CNTP_CVAL_ELO	64					2	
CNTV_TVAL_ELO	32				3	0	Config-RW at EL0, otherwise RW. ^f
CNTV_CTL_ELO	32					1	
CNTV_CVAL_ELO	64					2	
PMEVCNTR<n>_ELO	32				{8-10}	{0-7}	RW. CRm and op2 encode <n>, the counter number ^e :
					11	{0-6}	• For CRm== {8, 12}, <n>=op2.
PMEVTYPER<n>_ELO	32				{12-14}	{0-7}	• For CRm== {9, 13}, <n>=op2+8.
							• For CRm== {10, 14}, <n>=op2+16.
					15	{0-6}	• For CRm== {11, 15}, <n>=op2+24.
							Config-RW at EL0, otherwise RW.
PMCCFILTR_ELO	32					7	Config-RW at EL0, otherwise RW. ^e

Table C5-6 System instruction encodings for non-Debug System register accesses (continued)

Register accessed	Width (bits)	Access instruction encoding					Notes
		op0	op1	CRn	CRm	op2	
VPIDR_EL2	32	3	4	0	0	0	RW.
VMPIDR_EL2	64					5	RW.
SCTLR_EL2	32			1	0	0	RW.
ACTLR_EL2	64					1	RW, contents IMPLEMENTATION DEFINED.
HCR_EL2	64				1	0	RW.
MDCR_EL2	32					1	RW. ^g
CPTR_EL2	32					2	RW.
HSTR_EL2	32					3	RW.
HACR_EL2	32					7	RW, contents IMPLEMENTATION DEFINED.
ZCR_EL2	64				2	0	RW. ^a
TTBR0_EL2	64			2	0	0	RW.
TCR_EL2	32					2	RW.
VTBR_EL2	64				1	0	RW.
VTCR_EL2	32					2	RW.
DACR32_EL2	32			3	0	0	RW. If EL1 cannot use AArch32, the register is UNDEFINED. ^h
IFSR32_EL2	32			5	0	1	RW. If EL1 cannot use AArch32, the register is UNDEFINED. ^h
AFSR0_EL2	32				1	0	RW, contents IMPLEMENTATION DEFINED.
AFSR1_EL2	32					1	RW, contents IMPLEMENTATION DEFINED.
ESR_EL2	32				2	0	RW.
RAS register	64					3	RAS Extension. ^c
FPEXC32_EL2	32				3	0	RW. If EL1 cannot use AArch32, the register is UNDEFINED. ^h
FAR_EL2	64			6	0	0	RW.
HPFAR_EL2	64					4	RW.
SPE register	64			9	9	0	Statistical Profiling Extension. ^d
MAIR_EL2	64			10	2	0	RW.
AMAIR_EL2	64				3	0	RW, contents IMPLEMENTATION DEFINED.

Table C5-6 System instruction encodings for non-Debug System register accesses (continued)

Register accessed	Width (bits)	Access instruction encoding					Notes
		op0	op1	CRn	CRm	op2	
VBAR_EL2	64	3	4	12	0	0	RW.
RVBAR_EL2	64					1	RO. Implemented only if EL3 is not implemented.
RMR_EL2	64					2	RW. Implemented only when both EL2 is the highest implemented Exception level and EL2 can use AArch32 and AArch64. Otherwise, it is IMPLEMENTATION DEFINED whether the register is implemented.
RAS register	64					1	1 RAS Extension. ^c
ICH_AP0R<n>_EL2	32					8	0-3 RW, <n>=op2. ^b
ICH_AP1R<n>_EL2	32					9	0-3 RW, <n>=op2. ^b
ICC_SRE_EL2	32					5	RW. ^b
ICH_HCR_EL2	32					11	0 RW. ^b
ICH_VTR_EL2	32					1	RO. ^b
ICH_MISR_EL2	32					2	RO. ^b
ICH_EISR_EL2	32					3	RO. ^b
ICH_ELRSR_EL2	32					5	RO. ^b
ICH_VMCR_EL2	32					7	RW. ^b
ICH_LR<n>_EL2	64					12, 13	0-7 RW. ^b : <ul style="list-style-type: none"> • For CRm==12, <n>=op2. • For CRm==13, <n>=op2+8.
TPIDR_EL2	64			13	0	2	RW.
CNTVOFF_EL2	64			14	0	3	RW. ^f
CNTHCTL_EL2	32				1	0	RW. ^f
CNTHP_TVAL_EL2	32				2	0	RW. ^f
CNTHP_CTL_EL2	32					1	RW. ^f
CNTHP_CVAL_EL2	64					2	RW. ^f
SPE register	64		5	9	9	0	Statistical Profiling Extension ^d

Table C5-6 System instruction encodings for non-Debug System register accesses (continued)

Register accessed	Width (bits)	Access instruction encoding					Notes
		op0	op1	CRn	CRm	op2	
SCTLR_EL3	32	3	6	1	0	0	RW.
ACTLR_EL3[63:0]	64					1	RW, contents IMPLEMENTATION DEFINED.
SCR_EL3	32				1	0	RW.
SDER32_EL3	32					1	RW. If EL1 cannot use AArch32, the register is UNDEFINED. ^{g, h}
CPTR_EL3	32					2	RW.
ZCR_EL3	64				2	0	RW. ^a
MDCR_EL3	32				3	1	RW. ^g
TTBR0_EL3	64			2	0	0	RW.
TCR_EL3	32					2	RW.
AFSR0_EL3	32			5	1	0	RW, contents IMPLEMENTATION DEFINED.
AFSR1_EL3	32					1	RW, contents IMPLEMENTATION DEFINED.
ESR_EL3	32				2	0	RW.
FAR_EL3	64			6	0	0	RW.
MAIR_EL3	64			10	2	0	RW.
AMAIR_EL3	64				3	0	RW, contents IMPLEMENTATION DEFINED.
VBAR_EL3	64			12	0	0	RW.
RVBAR_EL3	64					1	RO.
RMR_EL3	64					2	RW. Implemented only if EL3 can use both AArch32 and AArch64. Otherwise, it is IMPLEMENTATION DEFINED whether the register is implemented.
ICC_CTLR_EL3	32				12	4	RW. ^b
ICC_SRE_EL3	32					5	RW. ^b
ICC_IGRPEN1_EL3	32					7	RW. ^b
TPIDR_EL3	64			13	0	2	RW.

Table C5-6 System instruction encodings for non-Debug System register accesses (continued)

Register accessed	Width (bits)	Access instruction encoding					Notes
		op0	op1	CRn	CRm	op2	
CNTPS_TVAL_EL1	32	3	7	14	2	0	RW at EL3, Config-RW at Secure EL1. ^f
CNTPS_CTL_EL1	32					1	
CNTPS_CVAL_EL1	64					2	

- a. Scalable Vector Extension System register, see [SVE on page A1-66](#).
- b. GIC System register, see [About the GIC System registers](#). As that subsection describes, each ICV_* register uses the same encoding as the corresponding ICC_* register.
- c. RAS Extension System registers, see [The Reliability, Availability, and Serviceability \(RAS\) Extension on page A1-63](#).
- d. Statistical Profiling Extension System registers, see [The Statistical Profiling Extension on page A1-65](#).
- e. Performance Monitors Extension System register, see [Performance Monitors registers on page D7-2629](#).
- f. Generic Timer System register, see [Generic Timer registers on page D7-2672](#).
- g. Debug register in the op0==3 encoding space, see [Debug registers on page D7-2554](#).
- h. Defined to allow access from AArch64 state to registers that are only used in AArch32 state.

About the GIC System registers

From version 3.0 of the GIC architecture specification, the specification defines three groups of System registers, identified by the prefix of the register name:

- ICC_** GIC physical CPU interface System registers.
- ICH_** GIC virtual interface control System registers.
- ICV_** GIC Virtual CPU interface System registers.

———— Note —————

These registers are in addition to the GIC memory-mapped register groups GICC_, GICD_, GICH_, GICR_, GICV_, and GITS_.

When implemented, the GIC System registers form part of an ARM processor implementation, and therefore these registers are included in the register summaries. However, the registers are defined only in the GIC Architecture Specification.

As [Table C5-6 on page C5-324](#) shows, the ICV_* registers have the same {op0, op1, CRn, CRm, op2} encodings as the corresponding ICC_* registers. For these encodings, GIC register configuration fields determine which register is accessed.

For more information see the *ARM® Generic Interrupt Controller Architecture Specification, GIC architecture version 3.0 and version 4.0* (ARM IHI 0069).

Instructions for accessing Special-purpose registers

The A64 instructions for accessing Special-purpose registers are:

- MSR <Special-purpose register>, Xt ; Write to Special-purpose register
- MRS Xt, <Special-purpose register> ; Read from Special-purpose register

For these accesses, CRn has the value 4. The encoding for Special-purpose register accesses is:

31	30	29	28	27	26	25	24	23	22	21	20	19	18	16	15	12	11	8	7	5	4	0
1	1	0	1	0	1	0	1	0	0	L	1	1	Op1	0	1	0	0	CRm	Op2			Rt
												Op0				CRn						

Table C5-7 lists the encodings for op1, CRm, and op2 fields for accesses to the Special-purpose registers in AArch64.

Table C5-7 Special-purpose register accesses

Register	Access instruction encoding					Notes
	op0	op1	CRn	CRm	op2	
SPSR_EL1	3	0	4	0	0	Accessible from EL1 or higher
ELR_EL1					1	
SP_EL0				1	0	Accessible from EL1 or higher. If SP_EL0 is the current stack pointer then the access is UNDEFINED.
SPSel				2	0	Accessible from EL1 or higher.
CurrentEL					2	RO. Accessible from EL1 or higher.
UAO					4	Accessible from EL1 or higher.
DAIF		3	4	2	1	Configurable whether accesses at EL0 are permitted.
NZCV					0	Accessible from EL0 or higher.
FPCR				4	0	Accessible from EL0 or higher.
FPSR					1	
DSPSR_EL0				5	0	Accessible only in Debug state, from EL0 or higher.
DLR_EL0					1	
SPSR_EL2		4	4	0	0	Accessible from EL2 or higher.
ELR_EL2					1	
SP_EL1				1	0	
SPSR_irq				3	0	
SPSR_abt					1	
SPSR_und					2	
SPSR_fiq					3	
SPSR_EL3		6	4	0	0	Accessible from EL3 or higher.
ELR_EL3					1	
SP_EL2				1	0	

All direct and indirect reads and writes to Special-purpose registers appear to occur in program order relative to other instructions.

Reserved encodings for IMPLEMENTATION DEFINED registers

The System register encoding space with op0==0b11 reserves the following encodings for IMPLEMENTATION DEFINED registers:

31	30	29	28	27	26	25	24	23	22	21	20	19	18	16	15	12	11	8	7	5	4	0
1	1	0	1	0	1	0	1	0	0	L	1	1	op1	1	x	1	1	CRm	op2			Rt
												op0		CRn								

The value of L defines the access type and the use of Rt as follows:

- 0** Write the value in Rt to the IMPLEMENTATION DEFINED register.
- 1** Read the value of the IMPLEMENTATION DEFINED register to Rt.

For more information about these encodings see *S3_<op1>_<Cn>_<Cm>_<op2>*, *IMPLEMENTATION DEFINED registers* on page D7-2449. As that section describes, any IMPLEMENTATION DEFINED registers are accessed in a similar way to architecturally-defined System registers, using MRS and MSR instructions, see:

- *MRS* on page C6-772.
- *MSR (immediate)* on page C6-773.
- *MSR (register)* on page C6-775.

See also *Reserved encoding space for IMPLEMENTATION DEFINED instructions* on page C5-321.

The ARM architecture guarantees not to define any register name prefixed with *IMP_* as part of the standard ARM architecture.

———— **Note** —————

ARM strongly recommends that any register names created in the IMPLEMENTATION DEFINED register spaces be prefixed with *IMP_* and postfixed with *_ELx*, where appropriate.

C5.2 Special-purpose registers

The Special-purpose registers are:

- [CurrentEL](#), [DAIF](#), and [NZCV](#), that return [PSTATE](#) information.
- The ELRs, [DLR_EL0](#) and [ELR_ELx](#), that hold the return address for the return from Debug state, or for the exception return.
- [FPCR](#) and [FPSR](#), that provide floating-point status and control.
- The stack pointers, [SP_ELx](#), and stack pointer selector, [SPSel](#).
- The SPSRs, [DPSR_EL0](#) and [SPSR_ELx](#), that hold the PE state from immediately before entering Debug state or taking an exception. This means they hold the state required for the return from Debug state, or for the exception return.
- [SPSR_abt](#), [SPSR_fiq](#), [SPSR_irq](#), and [SPSR_und](#), that map to the corresponding AArch32 registers.

———— **Note** ————

The AArch32 SPSRs [SPSR_hyp](#), [SPSR_mon](#), and [SPSR_svc](#) are mapped to the AArch64 [SPSR_ELx](#) registers.

The characteristic of a Special-purpose register is that all direct and indirect reads and writes to the register appear to occur in program order relative to other instructions, without the need for any explicit synchronization.

This section describes the following registers:

- [CurrentEL](#), that software can read to determine the current Exception level.
- [DAIF](#), that specifies the current interrupt mask bits.
- [DLR_EL0](#), that holds the address to return to for a return from Debug state.
- [DPSR_EL0](#), that holds process state on entry to Debug state.
- [ELR_EL1](#), that holds the address to return to for an exception return from EL1.
- [ELR_EL2](#), that holds the address to return to for an exception return from EL2.
- [ELR_EL3](#), that holds the address to return to for an exception return from EL3.
- [FPCR](#), that provides control of floating-point operation.
- [FPSR](#), that provides floating-point status information.
- [NZCV](#), that holds the condition flags.
- [PAN](#), that holds access to the PAN bit.
- [SP_EL0](#), that holds the stack pointer for EL0.
- [SP_EL1](#), that holds the stack pointer for EL1.
- [SP_EL2](#), that holds the stack pointer for EL2.
- [SP_EL3](#), that holds the stack pointer for EL3.
- [SPSel](#), that at EL1 or higher selects between the SP for the current Exception level and [SP_EL0](#).
- [SPSR_abt](#), that holds process state on taking an exception to AArch32 Abort mode.
- [SPSR_EL1](#), that holds process state on taking an exception to AArch64 EL1.
- [SPSR_EL2](#), that holds process state on taking an exception to AArch64 EL2.
- [SPSR_EL3](#), that holds process state on taking an exception to AArch64 EL3.
- [SPSR_fiq](#), that holds process state on taking an exception to AArch32 FIQ mode.
- [SPSR_irq](#), that holds process state on taking an exception to AArch32 IRQ mode.
- [SPSR_und](#), that holds process state on taking an exception to AArch32 Undefined mode.
- [UAO](#), that holds access to the UAO bit.

C5.2.1 CurrentEL, Current Exception Level

The CurrentEL characteristics are:

Purpose

Holds the current Exception level.

Configurations

There are no configuration notes.

Attributes

CurrentEL is a 32-bit register.

Field descriptions

The CurrentEL bit assignments are:

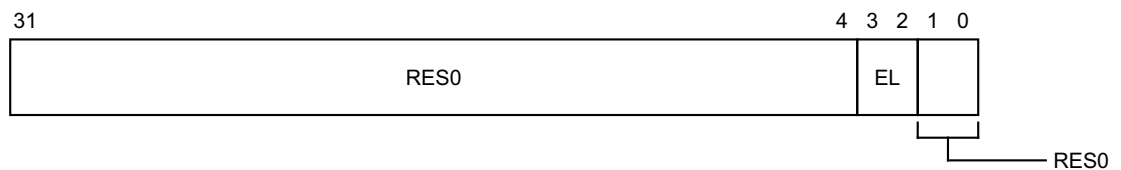

Bits [31:4]

Reserved, RES0.

EL, bits [3:2]

Current Exception level. Possible values of this field are:

00	EL0
01	EL1
10	EL2
11	EL3

This field resets to a value that is architecturally UNKNOWN.

Bits [1:0]

Reserved, RES0.

Accessing the CurrentEL

This register can be read using MRS with the following syntax:

MRS <Xt>, <systemreg>

This syntax is encoded with the following settings in the instruction encoding:

<systemreg>	op0	op1	CRn	CRm	op2
CurrentEL	11	000	0100	0010	010

Accessibility

The register is accessible in software as follows:

Control			Accessibility			
E2H	TGE	NS	EL0	EL1	EL2	EL3
x	x	0	-	RO	n/a	RO
x	0	1	-	RO	RO	RO
x	1	1	-	n/a	RO	RO

C5.2.2 DAIF, Interrupt Mask Bits

The DAIF characteristics are:

Purpose

Allows access to the interrupt mask bits.

Configurations

Some or all RW fields of this register have defined reset values. These apply only if the PE resets into an Exception level that is using AArch64. Otherwise, RW fields in this register reset to architecturally UNKNOWN values.

Attributes

DAIF is a 32-bit register.

Field descriptions

The DAIF bit assignments are:

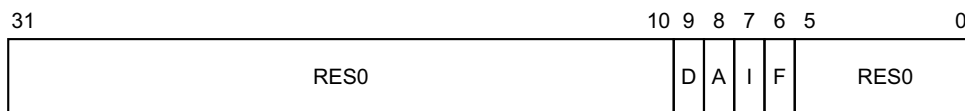

Bits [31:10]

Reserved, RES0.

D, bit [9]

Process state D mask. The possible values of this bit are:

- 0 Watchpoint, Breakpoint, and Software Step exceptions targeted at the current Exception level are not masked.
- 1 Watchpoint, Breakpoint, and Software Step exceptions targeted at the current Exception level are masked.

When the target Exception level of the debug exception is higher than the current Exception level, the exception is not masked by this bit.

When this register has an architecturally-defined reset value, this field resets to 1.

A, bit [8]

SError interrupt mask bit. The possible values of this bit are:

- 0 Exception not masked.
- 1 Exception masked.

When this register has an architecturally-defined reset value, this field resets to 1.

I, bit [7]

IRQ mask bit. The possible values of this bit are:

- 0 Exception not masked.
- 1 Exception masked.

When this register has an architecturally-defined reset value, this field resets to 1.

F, bit [6]

FIQ mask bit. The possible values of this bit are:

- 0 Exception not masked.
- 1 Exception masked.

When this register has an architecturally-defined reset value, this field resets to 1.

Bits [5:0]

Reserved, RES0.

Accessing the DAIF

This register can be read using MRS with the following syntax:

MRS <Xt>, <systemreg>

This register can be written using MSR (register) with the following syntax:

MSR <systemreg>, <Xt>

This syntax is encoded with the following settings in the instruction encoding:

<systemreg>	op0	op1	CRn	CRm	op2
DAIF	11	011	0100	0010	001

This register can be modified using MSR (immediate) with the following syntax:

MSR <pstatefield>, <imm>

This syntax is encoded with the following settings in the instruction encoding:

<pstatefield>	op0	op1	CRn	op2
DAIFSet	00	011	0100	110
DAIFClr	00	011	0100	111

Accessibility

The register is accessible in software as follows:

Control			Accessibility			
E2H	TGE	NS	EL0	EL1	EL2	EL3
x	x	0	RW	RW	n/a	RW
x	0	1	RW	RW	RW	RW
x	1	1	RW	n/a	RW	RW

Traps and Enables

For a description of the prioritization of any generated exceptions, see *Synchronous exception prioritization for exceptions taken to AArch64 on page D1-1827*. Subject to the prioritization rules:

- In both security states, and not dependent on other bits:
 - If `SCTLR_EL1.UMA==0`, accesses to this register from EL0 are trapped to EL1.

C5.2.3 DLR_EL0, Debug Link Register

The DLR_EL0 characteristics are:

Purpose

In Debug state, holds the address to restart from.

Configurations

AArch64 System register DLR_EL0[31:0] is architecturally mapped to AArch32 System register [DLR](#).

Attributes

DLR_EL0 is a 64-bit register.

Field descriptions

DLR_EL0 is a member of multiple register groups and is defined elsewhere. For the full definition, see [DLR_EL0](#).

Accessing the DLR_EL0

This register can be read using MRS with the following syntax:

MRS <Xt>, <systemreg>

This register can be written using MSR (register) with the following syntax:

MSR <systemreg>, <Xt>

This syntax is encoded with the following settings in the instruction encoding:

<systemreg>	op0	op1	CRn	CRm	op2
DLR_EL0	11	011	0100	0101	001

Accessibility

The register is accessible in software as follows:

Control			Accessibility			
E2H	TGE	NS	EL0	EL1	EL2	EL3
x	x	0	RW	RW	n/a	RW
x	0	1	RW	RW	RW	RW
x	1	1	RW	n/a	RW	RW

Access to this register is from Debug state only. During normal execution this register is unallocated.

C5.2.4 DSPSR_EL0, Debug Saved Program Status Register

The DSPSR_EL0 characteristics are:

Purpose

Holds the saved process state on entry to Debug state.

Configurations

AArch64 System register DSPSR_EL0 is architecturally mapped to AArch32 System register [DSPSR](#).

Attributes

DSPSR_EL0 is a 32-bit register.

Field descriptions

DSPSR_EL0 is a member of multiple register groups and is defined elsewhere. For the full definition, see [DSPSR_EL0](#).

Accessing the DSPSR_EL0

This register can be read using MRS with the following syntax:

MRS <Xt>, <systemreg>

This register can be written using MSR (register) with the following syntax:

MSR <systemreg>, <Xt>

This syntax is encoded with the following settings in the instruction encoding:

<systemreg>	op0	op1	CRn	CRm	op2
DSPSR_EL0	11	011	0100	0101	000

Accessibility

The register is accessible in software as follows:

Control			Accessibility			
E2H	TGE	NS	EL0	EL1	EL2	EL3
x	x	0	RW	RW	n/a	RW
x	0	1	RW	RW	RW	RW
x	1	1	RW	n/a	RW	RW

Access to this register is from Debug state only. During normal execution this register is unallocated.

C5.2.5 ELR_EL1, Exception Link Register (EL1)

The ELR_EL1 characteristics are:

Purpose

When taking an exception to EL1, holds the address to return to.

Configurations

There are no configuration notes.

Attributes

ELR_EL1 is a 64-bit register.

Field descriptions

The ELR_EL1 bit assignments are:

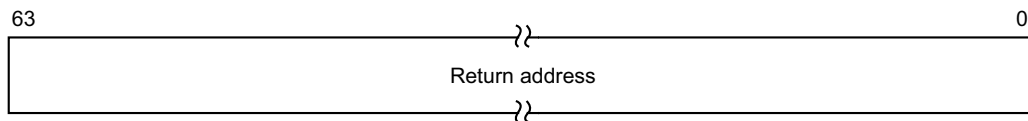

Bits [63:0]

Return address.

An exception return from EL1 using AArch64 makes ELR_EL1 become UNKNOWN.

Accessing the ELR_EL1

This register can be read using MRS with the following syntax:

MRS <Xt>, <systemreg>

This register can be written using MSR (register) with the following syntax:

MSR <systemreg>, <Xt>

This syntax is encoded with the following settings in the instruction encoding:

<systemreg>	op0	op1	CRn	CRm	op2
ELR_EL1	11	000	0100	0000	001
ELR_EL12	11	101	0100	0000	001

Accessibility

The register is accessible in software as follows:

<systemreg>	Control			Accessibility			
	E2H	TGE	NS	EL0	EL1	EL2	EL3
ELR_EL1	x	x	0	-	RW	n/a	RW
ELR_EL1	0	0	1	-	RW	RW	RW
ELR_EL1	0	1	1	-	n/a	RW	RW

<systemreg>	Control			Accessibility			
	E2H	TGE	NS	EL0	EL1	EL2	EL3
ELR_EL1	1	0	1	-	RW	ELR_EL2	RW
ELR_EL1	1	1	1	-	n/a	ELR_EL2	RW
ELR_EL12	x	x	0	-	-	n/a	-
ELR_EL12	0	0	1	-	-	-	-
ELR_EL12	0	1	1	-	n/a	-	-
ELR_EL12	1	0	1	-	-	RW	RW
ELR_EL12	1	1	1	-	n/a	RW	RW

This table applies to all instructions that can access this register.

When [HCR_EL2.E2H](#) is 1, without explicit synchronization, access from EL3 using the mnemonic ELR_EL1 or ELR_EL12 are not guaranteed to be ordered with respect to accesses using the other mnemonic.

C5.2.6 ELR_EL2, Exception Link Register (EL2)

The ELR_EL2 characteristics are:

Purpose

When taking an exception to EL2, holds the address to return to.

Configurations

AArch64 System register ELR_EL2 is architecturally mapped to AArch32 System register [ELR_hyp](#).

Attributes

ELR_EL2 is a 64-bit register.

Field descriptions

The ELR_EL2 bit assignments are:

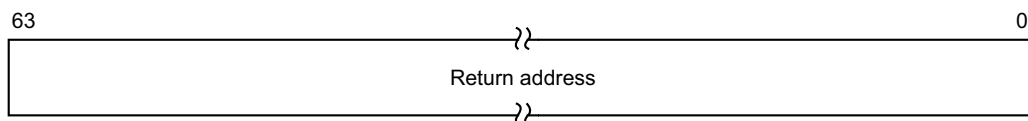

Bits [63:0]

Return address.

An exception return from EL2 using AArch64 makes ELR_EL2 become UNKNOWN.

When EL2 is in AArch32 Execution state and an exception is taken from EL0, EL1, or EL2 to EL3 and AArch64 execution, the upper 32-bits of ELR_EL2 are either set to 0 or hold the same value that they did before AArch32 execution. Which option is adopted is determined by an implementation, and might vary dynamically within an implementation. Correspondingly software must regard the value as being an UNKNOWN choice between the two values.

Accessing the ELR_EL2

This register can be read using MRS with the following syntax:

MRS <Xt>, <systemreg>

This register can be written using MSR (register) with the following syntax:

MSR <systemreg>, <Xt>

This syntax is encoded with the following settings in the instruction encoding:

<systemreg>	op0	op1	CRn	CRm	op2
ELR_EL2	11	100	0100	0000	001
ELR_EL1	11	000	0100	0000	001

Accessibility

The register is accessible in software as follows:

<systemreg>	Control			Accessibility			
	E2H	TGE	NS	EL0	EL1	EL2	EL3
ELR_EL2	x	x	0	-	-	n/a	RW
ELR_EL2	0	0	1	-	-	RW	RW
ELR_EL2	0	1	1	-	n/a	RW	RW
ELR_EL2	1	0	1	-	-	RW	RW
ELR_EL2	1	1	1	-	n/a	RW	RW
ELR_EL1	x	x	0	-	ELR_EL1	n/a	ELR_EL1
ELR_EL1	0	0	1	-	ELR_EL1	ELR_EL1	ELR_EL1
ELR_EL1	0	1	1	-	n/a	ELR_EL1	ELR_EL1
ELR_EL1	1	0	1	-	ELR_EL1	RW	ELR_EL1
ELR_EL1	1	1	1	-	n/a	RW	ELR_EL1

This table applies to all instructions that can access this register.

When [HCR_EL2.E2H](#) is 1, without explicit synchronization, access from EL2 using the mnemonic [ELR_EL2](#) or [ELR_EL1](#) are not guaranteed to be ordered with respect to accesses using the other mnemonic.

C5.2.7 ELR_EL3, Exception Link Register (EL3)

The ELR_EL3 characteristics are:

Purpose

When taking an exception to EL3, holds the address to return to.

Configurations

There are no configuration notes.

Attributes

ELR_EL3 is a 64-bit register.

Field descriptions

The ELR_EL3 bit assignments are:

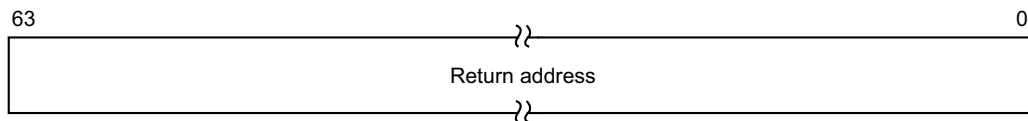

Bits [63:0]

Return address.

An exception return from EL3 using AArch64 makes ELR_EL3 become UNKNOWN.

Accessing the ELR_EL3

This register can be read using MRS with the following syntax:

MRS <Xt>, <systemreg>

This register can be written using MSR (register) with the following syntax:

MSR <systemreg>, <Xt>

This syntax is encoded with the following settings in the instruction encoding:

<systemreg>	op0	op1	CRn	CRm	op2
ELR_EL3	11	110	0100	0000	001

Accessibility

The register is accessible in software as follows:

Control			Accessibility			
E2H	TGE	NS	EL0	EL1	EL2	EL3
x	x	0	-	-	n/a	RW
x	0	1	-	-	-	RW
x	1	1	-	n/a	-	RW

C5.2.8 FPCR, Floating-point Control Register

The FPCR characteristics are:

Purpose

Controls floating-point behavior.

Configurations

The named fields in this register map to the equivalent fields in the AArch32 [FPSCR](#).

It is IMPLEMENTATION DEFINED whether the Len and Stride fields can be programmed to non-zero values, which will cause some AArch32 floating-point instruction encodings to be UNDEFINED, or whether these fields are RAZ.

RW fields in this register reset to architecturally UNKNOWN values.

Attributes

FPCR is a 32-bit register.

Field descriptions

The FPCR bit assignments are:

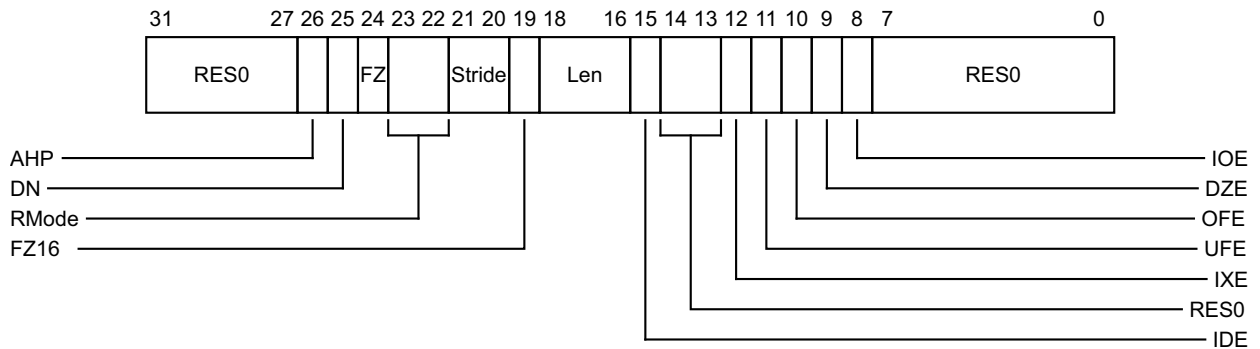

Bits [31:27]

Reserved, RES0.

AHP, bit [26]

Alternative half-precision control bit:

- 0 IEEE half-precision format selected.
- 1 Alternative half-precision format selected.

This bit is only used for conversions between half-precision floating-point and other floating-point formats.

The data-processing instructions added as part of the [ARMv8.2-FP16](#) extension always use the IEEE half-precision format, and ignore the value of this bit.

DN, bit [25]

Default NaN mode control bit:

- 0 NaN operands propagate through to the output of a floating-point operation.
- 1 Any operation involving one or more NaNs returns the Default NaN.

The value of this bit controls both scalar and Advanced SIMD floating-point arithmetic.

FZ, bit [24]

Flush-to-zero mode control bit:

- 0 Flush-to-zero mode disabled. Behavior of the floating-point system is fully compliant with the IEEE 754 standard.
- 1 Flush-to-zero mode enabled.

The value of this bit controls both scalar and Advanced SIMD floating-point arithmetic.

This bit has no effect on half-precision calculations.

RMode, bits [23:22]

Rounding Mode control field. The encoding of this field is:

- 00 Round to Nearest (RN) mode
- 01 Round towards Plus Infinity (RP) mode
- 10 Round towards Minus Infinity (RM) mode
- 11 Round towards Zero (RZ) mode.

The specified rounding mode is used by both scalar and Advanced SIMD floating-point instructions.

Stride, bits [21:20]

This field has no function in AArch64 state, and non-zero values are ignored during execution in AArch64 state. It is included only for context saving and restoration of the AArch32 [FPSCR.Stride](#) field.

FZ16, bit [19]

In ARMv8.2

When [ARMv8.2-FP16](#) is implemented, flush-to-zero mode control bit on half-precision data-processing instructions:

- 0 Flush-to-zero mode disabled. Behavior of the floating-point system is fully compliant with the IEEE 754 standard.
- 1 Flush-to-zero mode enabled.

The value of this bit applies to both scalar and Advanced SIMD floating-point half-precision calculations. A half-precision floating-point number that is flushed to zero as a result of the value of the FZ16 bit does not generate an Input Denormal exception.

When [ARMv8.2-FP16](#) is not implemented, this bit is RES0.

In ARMv8.1 and ARMv8.0.

Reserved, RES0.

Len, bits [18:16]

This field has no function in AArch64 state, and non-zero values are ignored during execution in AArch64 state. It is included only for context saving and restoration of the AArch32 [FPSCR.Len](#) field.

IDE, bit [15]

Input Denormal floating-point exception trap enable. Possible values are:

- 0 Untrapped exception handling selected. If the floating-point exception occurs then the [FPSR.IDC](#) bit is set to 1.
- 1 Trapped exception handling selected. If the floating-point exception occurs, the PE does not update the [FPSR.IDC](#) bit. The trap handling software can decide whether to set the [FPSR.IDC](#) bit to 1.

The value of this bit controls both scalar and Advanced SIMD floating-point arithmetic.

If the implementation does not support this exception, this bit is RES0.

Bits [14:13]

Reserved, RES0.

IXE, bit [12]

Inexact floating-point exception trap enable. Possible values are:

- 0 Untrapped exception handling selected. If the floating-point exception occurs then the [FPSR.IXC](#) bit is set to 1.
- 1 Trapped exception handling selected. If the floating-point exception occurs, the PE does not update the [FPSR.IXC](#) bit. The trap handling software can decide whether to set the [FPSR.IXC](#) bit to 1.

The value of this bit controls both scalar and Advanced SIMD floating-point arithmetic.

If the implementation does not support this exception, this bit is RES0.

UFE, bit [11]

Underflow floating-point exception trap enable. Possible values are:

- 0 Untrapped exception handling selected. If the floating-point exception occurs then the [FPSR.UFC](#) bit is set to 1.
- 1 Trapped exception handling selected. If the floating-point exception occurs, the PE does not update the [FPSR.UFC](#) bit. The trap handling software can decide whether to set the [FPSR.UFC](#) bit to 1.

The value of this bit controls both scalar and Advanced SIMD floating-point arithmetic.

If the implementation does not support this exception, this bit is RES0.

OFE, bit [10]

Overflow floating-point exception trap enable. Possible values are:

- 0 Untrapped exception handling selected. If the floating-point exception occurs then the [FPSR.OFC](#) bit is set to 1.
- 1 Trapped exception handling selected. If the floating-point exception occurs, the PE does not update the [FPSR.OFC](#) bit. The trap handling software can decide whether to set the [FPSR.OFC](#) bit to 1.

The value of this bit controls both scalar and Advanced SIMD floating-point arithmetic.

If the implementation does not support this exception, this bit is RES0.

DZE, bit [9]

Divide by Zero floating-point exception trap enable. Possible values are:

- 0 Untrapped exception handling selected. If the floating-point exception occurs then the [FPSR.DZC](#) bit is set to 1.
- 1 Trapped exception handling selected. If the floating-point exception occurs, the PE does not update the [FPSR.DZC](#) bit. The trap handling software can decide whether to set the [FPSR.DZC](#) bit to 1.

The value of this bit controls both scalar and Advanced SIMD floating-point arithmetic.

If the implementation does not support this exception, this bit is RES0.

IOE, bit [8]

Invalid Operation floating-point exception trap enable. Possible values are:

- 0 Untrapped exception handling selected. If the floating-point exception occurs then the [FPSR.IOC](#) bit is set to 1.
- 1 Trapped exception handling selected. If the floating-point exception occurs, the PE does not update the [FPSR.IOC](#) bit. The trap handling software can decide whether to set the [FPSR.IOC](#) bit to 1.

The value of this bit controls both scalar and Advanced SIMD floating-point arithmetic.

If the implementation does not support this exception, this bit is RES0.

Bits [7:0]

Reserved, RES0.

Accessing the FPCR

This register can be read using MRS with the following syntax:

MRS <Xt>, <systemreg>

This register can be written using MSR (register) with the following syntax:

MSR <systemreg>, <Xt>

This syntax is encoded with the following settings in the instruction encoding:

<systemreg>	op0	op1	CRn	CRm	op2
FPCR	11	011	0100	0100	000

Accessibility

The register is accessible in software as follows:

Control			Accessibility			
E2H	TGE	NS	EL0	EL1	EL2	EL3
x	x	0	RW	RW	n/a	RW
x	0	1	RW	RW	RW	RW
x	1	1	RW	n/a	RW	RW

Traps and Enables

For a description of the prioritization of any generated exceptions, see [Synchronous exception prioritization for exceptions taken to AArch64 on page D1-1827](#). Subject to the prioritization rules:

- When $HCR_EL2.E2H == 0$:
 - If $CPACR_EL1.FPEN == 00$, accesses to this register from EL0 and EL1 are trapped to EL1.
 - If $CPACR_EL1.FPEN == 01$, accesses to this register from EL0 are trapped to EL1.
 - If $CPACR_EL1.FPEN == 10$, accesses to this register from EL0 and EL1 are trapped to EL1.
- When EL2 is implemented and is using AArch64 and $(SCR_EL3.NS == 1) \&\& (HCR_EL2.E2H == 0)$:
 - If $CPTR_EL2.TFP == 1$, Non-secure accesses to this register from EL0, EL1, and EL2 are trapped to EL2.
- When EL2 is implemented and is using AArch64 and $(SCR_EL3.NS == 1) \&\& (HCR_EL2.E2H == 1) \&\& (HCR_EL2.TGE == 0)$:
 - If $CPACR_EL1.FPEN == 00$, Non-secure accesses to this register from EL0 and EL1 are trapped to EL1.
 - If $CPACR_EL1.FPEN == 01$, Non-secure accesses to this register from EL0 are trapped to EL1.
 - If $CPACR_EL1.FPEN == 10$, Non-secure accesses to this register from EL0 and EL1 are trapped to EL1.

- If `CPTR_EL2.FPEN==00`, Non-secure accesses to this register from EL0, EL1, and EL2 are trapped to EL2.
- If `CPTR_EL2.FPEN==10`, Non-secure accesses to this register from EL0, EL1, and EL2 are trapped to EL2.
- When EL2 is implemented and is using AArch64 and `(SCR_EL3.NS == 1) && (HCR_EL2.E2H == 1) && (HCR_EL2.TGE == 1)`:
 - If `CPTR_EL2.FPEN==00`, Non-secure accesses to this register from EL0 and EL2 are trapped to EL2.
 - If `CPTR_EL2.FPEN==01`, Non-secure accesses to this register from EL0 are trapped to EL2.
 - If `CPTR_EL2.FPEN==10`, Non-secure accesses to this register from EL0 and EL2 are trapped to EL2.
- When EL3 is implemented and is using AArch64:
 - If `CPTR_EL3.TFP==1`, accesses to this register from EL0, EL1, EL2, and EL3 are trapped to EL3.

C5.2.9 FPSR, Floating-point Status Register

The FPSR characteristics are:

Purpose

Provides floating-point system status information.

Configurations

The named fields in this register map to the equivalent fields in the AArch32 [FPSCR](#).

RW fields in this register reset to architecturally UNKNOWN values.

Attributes

FPSR is a 32-bit register.

Field descriptions

The FPSR bit assignments are:

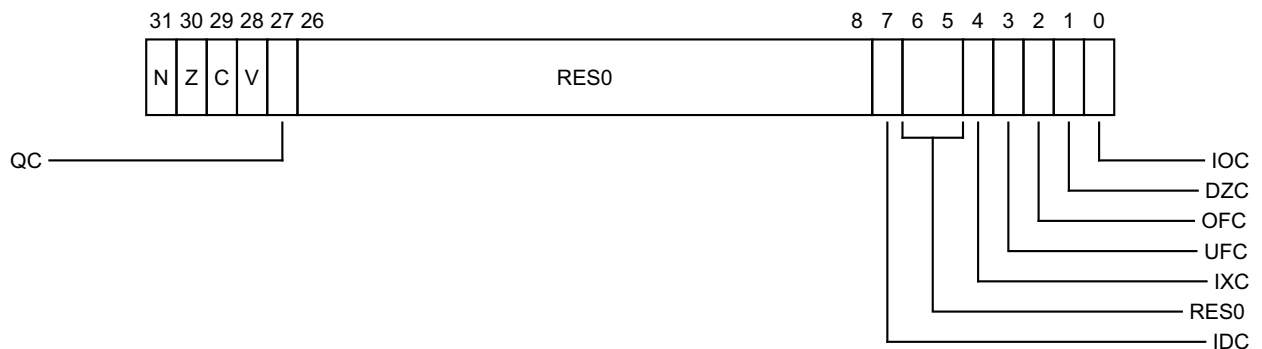

N, bit [31]

Negative condition flag for AArch32 floating-point comparison operations. AArch64 floating-point comparisons set the PSTATE.N flag instead.

Z, bit [30]

Zero condition flag for AArch32 floating-point comparison operations. AArch64 floating-point comparisons set the PSTATE.Z flag instead.

C, bit [29]

Carry condition flag for AArch32 floating-point comparison operations. AArch64 floating-point comparisons set the PSTATE.C flag instead.

V, bit [28]

Overflow condition flag for AArch32 floating-point comparison operations. AArch64 floating-point comparisons set the PSTATE.V flag instead.

QC, bit [27]

Cumulative saturation bit, Advanced SIMD only. This bit is set to 1 to indicate that an Advanced SIMD integer operation has saturated since 0 was last written to this bit.

Bits [26:8]

Reserved, RES0.

IDC, bit [7]

Input Denormal cumulative floating-point exception bit. This bit is set to 1 to indicate that the Input Denormal floating-point exception has occurred since 0 was last written to this bit.

How scalar and Advanced SIMD floating-point instructions update this bit depends on the value of the **FPCR.IDE** bit. This bit is only set to 1 to indicate a floating-point exception if **FPCR.IDE** is 0, or if trapping software sets it.

Bits [6:5]

Reserved, RES0.

IXC, bit [4]

Inexact cumulative floating-point exception bit. This bit is set to 1 to indicate that the Inexact exception floating-point has occurred since 0 was last written to this bit.

How scalar and Advanced SIMD floating-point instructions update this bit depends on the value of the **FPCR.IXE** bit. This bit is only set to 1 to indicate a floating-point exception if **FPCR.IXE** is 0, or if trapping software sets it.

UFC, bit [3]

Underflow cumulative floating-point exception bit. This bit is set to 1 to indicate that the Underflow floating-point exception has occurred since 0 was last written to this bit.

How scalar and Advanced SIMD floating-point instructions update this bit depends on the value of the **FPCR.UFE** bit. This bit is only set to 1 to indicate a floating-point exception if **FPCR.UFE** is 0, or if trapping software sets it.

OFC, bit [2]

Overflow cumulative floating-point exception bit. This bit is set to 1 to indicate that the Overflow floating-point exception has occurred since 0 was last written to this bit.

How scalar and Advanced SIMD floating-point instructions update this bit depends on the value of the **FPCR.OFE** bit. This bit is only set to 1 to indicate a floating-point exception if **FPCR.OFE** is 0, or if trapping software sets it.

DZC, bit [1]

Divide by Zero cumulative floating-point exception bit. This bit is set to 1 to indicate that the Divide by Zero floating-point exception has occurred since 0 was last written to this bit.

How scalar and Advanced SIMD floating-point instructions update this bit depends on the value of the **FPCR.DZE** bit. This bit is only set to 1 to indicate a floating-point exception if **FPCR.DZE** is 0, or if trapping software sets it.

IOC, bit [0]

Invalid Operation cumulative floating-point exception bit. This bit is set to 1 to indicate that the Invalid Operation floating-point exception has occurred since 0 was last written to this bit.

How scalar and Advanced SIMD floating-point instructions update this bit depends on the value of the **FPCR.IOE** bit. This bit is only set to 1 to indicate a floating-point exception if **FPCR.IOE** is 0, or if trapping software sets it.

Accessing the FPSR

This register can be read using MRS with the following syntax:

MRS <Xt>, <systemreg>

This register can be written using MSR (register) with the following syntax:

MSR <systemreg>, <Xt>

This syntax is encoded with the following settings in the instruction encoding:

<systemreg>	op0	op1	CRn	CRm	op2
FPSR	11	011	0100	0100	001

Accessibility

The register is accessible in software as follows:

Control			Accessibility			
E2H	TGE	NS	EL0	EL1	EL2	EL3
x	x	0	RW	RW	n/a	RW
x	0	1	RW	RW	RW	RW
x	1	1	RW	n/a	RW	RW

Traps and Enables

For a description of the prioritization of any generated exceptions, see [Synchronous exception prioritization for exceptions taken to AArch64 on page D1-1827](#). Subject to the prioritization rules:

- When `HCR_EL2.E2H == 0`:
 - If `CPACR_EL1.FPEN==00`, accesses to this register from EL0 and EL1 are trapped to EL1.
 - If `CPACR_EL1.FPEN==01`, accesses to this register from EL0 are trapped to EL1.
 - If `CPACR_EL1.FPEN==10`, accesses to this register from EL0 and EL1 are trapped to EL1.
- When EL2 is implemented and is using AArch64 and `(SCR_EL3.NS == 1) && (HCR_EL2.E2H == 0)`:
 - If `CPTR_EL2.TFP==1`, Non-secure accesses to this register from EL0, EL1, and EL2 are trapped to EL2.
- When EL2 is implemented and is using AArch64 and `(SCR_EL3.NS == 1) && (HCR_EL2.E2H == 1) && (HCR_EL2.TGE == 0)`:
 - If `CPACR_EL1.FPEN==00`, Non-secure accesses to this register from EL0 and EL1 are trapped to EL1.
 - If `CPACR_EL1.FPEN==01`, Non-secure accesses to this register from EL0 are trapped to EL1.
 - If `CPACR_EL1.FPEN==10`, Non-secure accesses to this register from EL0 and EL1 are trapped to EL1.
 - If `CPTR_EL2.FPEN==00`, Non-secure accesses to this register from EL0, EL1, and EL2 are trapped to EL2.
 - If `CPTR_EL2.FPEN==10`, Non-secure accesses to this register from EL0, EL1, and EL2 are trapped to EL2.
- When EL2 is implemented and is using AArch64 and `(SCR_EL3.NS == 1) && (HCR_EL2.E2H == 1) && (HCR_EL2.TGE == 1)`:
 - If `CPTR_EL2.FPEN==00`, Non-secure accesses to this register from EL0 and EL2 are trapped to EL2.
 - If `CPTR_EL2.FPEN==01`, Non-secure accesses to this register from EL0 are trapped to EL2.
 - If `CPTR_EL2.FPEN==10`, Non-secure accesses to this register from EL0 and EL2 are trapped to EL2.
- When EL3 is implemented and is using AArch64:
 - If `CPTR_EL3.TFP==1`, accesses to this register from EL0, EL1, EL2, and EL3 are trapped to EL3.

C5.2.10 NZCV, Condition Flags

The NZCV characteristics are:

Purpose

Allows access to the condition flags.

Configurations

There are no configuration notes.

Attributes

NZCV is a 32-bit register.

Field descriptions

The NZCV bit assignments are:

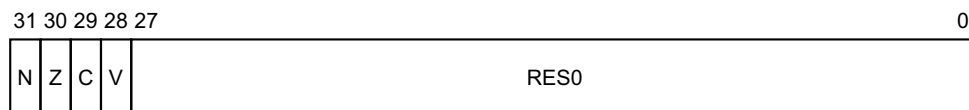

N, bit [31]

Negative condition flag. Set to 1 if the result of the last flag-setting instruction was negative.

Z, bit [30]

Zero condition flag. Set to 1 if the result of the last flag-setting instruction was zero, and to 0 otherwise. A result of zero often indicates an equal result from a comparison.

C, bit [29]

Carry condition flag. Set to 1 if the last flag-setting instruction resulted in a carry condition, for example an unsigned overflow on an addition.

V, bit [28]

Overflow condition flag. Set to 1 if the last flag-setting instruction resulted in an overflow condition, for example a signed overflow on an addition.

Bits [27:0]

Reserved, RES0.

Accessing the NZCV

This register can be read using MRS with the following syntax:

MRS <Xt>, <systemreg>

This register can be written using MSR (register) with the following syntax:

MSR <systemreg>, <Xt>

This syntax is encoded with the following settings in the instruction encoding:

<systemreg>	op0	op1	CRn	CRm	op2
NZCV	11	011	0100	0010	000

Accessibility

The register is accessible in software as follows:

Control			Accessibility			
E2H	TGE	NS	EL0	EL1	EL2	EL3
x	x	0	RW	RW	n/a	RW
x	0	1	RW	RW	RW	RW
x	1	1	RW	n/a	RW	RW

C5.2.11 PAN, Privileged Access Never

The PAN characteristics are:

Purpose

When [ARMv8.1-PAN](#) is implemented, allows access to the Privileged Access Never bit.
 When [ARMv8.1-PAN](#) is not implemented, this register is not implemented.

Configurations

This register is introduced in ARMv8.1.

Attributes

PAN is a 32-bit register.

Field descriptions

The PAN bit assignments are:

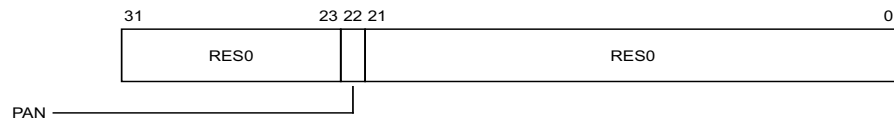

Bits [31:23]

Reserved, RES0.

PAN, bit [22]

Privileged Access Never. Defined values are:

- 0 The translation system is the same as ARMv8.0.
- 1 Disables privileged read and write accesses to addresses accessible at EL0.

The value of this bit is usually preserved on taking an exception, except in the following situations:

- When the target of the exception is EL1, and the value of the [SCTLR_EL1.SPAN](#) bit is 0, this bit is set to 1.
- When the target of the exception is EL2, [HCR_EL2](#).{E2H, TGE} is {1, 1}, and the value of the [SCTLR_EL2.SPAN](#) bit is 0, this bit is set to 1.

Bits [21:0]

Reserved, RES0.

Accessing the PAN

This register can be read using MRS with the following syntax:

MRS <Xt>, <systemreg>

This register can be written using MSR (register) with the following syntax:

MSR <systemreg>, <Xt>

This syntax is encoded with the following settings in the instruction encoding:

<systemreg>	op0	op1	CRn	CRm	op2
PAN	11	000	0100	0010	011

This register can be modified using MSR (immediate) with the following syntax:

MSR <pstatefield>, <imm>

This syntax is encoded with the following settings in the instruction encoding:

<pstatefield>	op0	op1	CRn	op2
PAN	00	000	0100	100

Accessibility

The register is accessible in software as follows:

Control			Accessibility			
E2H	TGE	NS	EL0	EL1	EL2	EL3
x	x	0	-	RW	n/a	RW
x	0	1	-	RW	RW	RW
x	1	1	-	n/a	RW	RW

C5.2.12 SP_EL0, Stack Pointer (EL0)

The SP_EL0 characteristics are:

Purpose

Holds the stack pointer associated with EL0. At higher Exception levels, this is used as the current stack pointer when the value of SPSel.SP is 0.

Configurations

There are no configuration notes.

Attributes

SP_EL0 is a 64-bit register.

Field descriptions

The SP_EL0 bit assignments are:

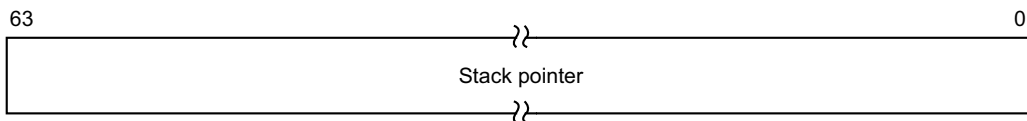

Bits [63:0]

Stack pointer.

Accessing the SP_EL0

This register can be read using MRS with the following syntax:

MRS <Xt>, <systemreg>

This register can be written using MSR (register) with the following syntax:

MSR <systemreg>, <Xt>

This syntax is encoded with the following settings in the instruction encoding:

<systemreg>	op0	op1	CRn	CRm	op2
SP_EL0	11	000	0100	0001	000

Accessibility

The register is accessible in software as follows:

Control			Accessibility			
E2H	TGE	NS	EL0	EL1	EL2	EL3
x	x	0	-	RW	n/a	RW
x	0	1	-	RW	RW	RW
x	1	1	-	n/a	RW	RW

This accessibility information only applies when the value of `SPSel.SP` is 1, and only for accesses using the MRS or MSR instructions. In addition, this register is accessible at EL0 as the current stack pointer.

When the value of `SPSel.SP` is 0:

- Any access to `SP_EL0` using the MRS or MSR instructions is UNDEFINED.
- This register is accessible at all Exception levels as the current stack pointer.

C5.2.13 SP_EL1, Stack Pointer (EL1)

The SP_EL1 characteristics are:

Purpose

Holds the stack pointer associated with EL1. When executing at EL1, the value of [SPSel.SP](#) determines the current stack pointer:

SPSel.SP	current stack pointer
0	SP_EL0
1	SP_EL1

Configurations

There are no configuration notes.

Attributes

SP_EL1 is a 64-bit register.

Field descriptions

The SP_EL1 bit assignments are:

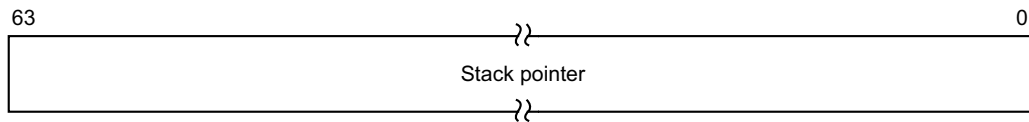

Bits [63:0]

Stack pointer.

Accessing the SP_EL1

This register can be read using MRS with the following syntax:

MRS <Xt>, <systemreg>

This register can be written using MSR (register) with the following syntax:

MSR <systemreg>, <Xt>

This syntax is encoded with the following settings in the instruction encoding:

<systemreg>	op0	op1	CRn	CRm	op2
SP_EL1	11	100	0100	0001	000

Accessibility

The register is accessible in software as follows:

Control			Accessibility			
E2H	TGE	NS	EL0	EL1	EL2	EL3
x	x	0	-	-	n/a	RW
x	0	1	-	-	RW	RW
x	1	1	-	n/a	RW	RW

This accessibility information only applies to accesses using the MRS or MSR instructions.

When the value of [SPSel.SP](#) is 1, this register is also accessible at EL1 as the current stack pointer.

———— **Note** —————

When the value of [SPSel.SP](#) is 0, [SP_ELO](#) is used as the current stack pointer at all Exception levels.

C5.2.14 SP_EL2, Stack Pointer (EL2)

The SP_EL2 characteristics are:

Purpose

Holds the stack pointer associated with EL2. When executing at EL2, the value of [SPSel.SP](#) determines the current stack pointer:

SPSel.SP	current stack pointer
0	SP_EL0
1	SP_EL2

Configurations

There are no configuration notes.

Attributes

SP_EL2 is a 64-bit register.

Field descriptions

The SP_EL2 bit assignments are:

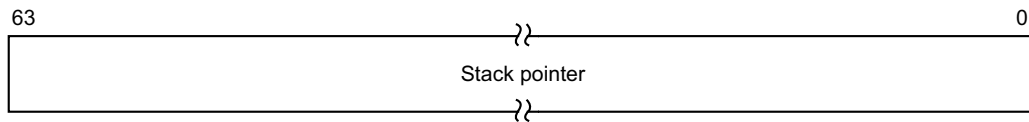

Bits [63:0]

Stack pointer.

Accessing the SP_EL2

This register can be read using MRS with the following syntax:

MRS <Xt>, <systemreg>

This register can be written using MSR (register) with the following syntax:

MSR <systemreg>, <Xt>

This syntax is encoded with the following settings in the instruction encoding:

<systemreg>	op0	op1	CRn	CRm	op2
SP_EL2	11	110	0100	0001	000

Accessibility

The register is accessible in software as follows:

Control			Accessibility			
E2H	TGE	NS	EL0	EL1	EL2	EL3
x	x	0	-	-	n/a	RW
x	0	1	-	-	-	RW
x	1	1	-	n/a	-	RW

This accessibility information only applies to accesses using the MRS or MSR instructions.

When the value of [SPSel.SP](#) is 1, this register is also accessible at EL2 as the current stack pointer.

———— **Note** ————

When the value of [SPSel.SP](#) is 0, [SP_ELO](#) is used as the current stack pointer at all Exception levels.

C5.2.15 SP_EL3, Stack Pointer (EL3)

The SP_EL3 characteristics are:

Purpose

Holds the stack pointer associated with EL3. When executing at EL3, the value of [SPSel.SP](#) determines the current stack pointer:

SPSel.SP	current stack pointer
0	SP_EL0
1	SP_EL3

Configurations

There are no configuration notes.

Attributes

SP_EL3 is a 64-bit register.

Field descriptions

The SP_EL3 bit assignments are:

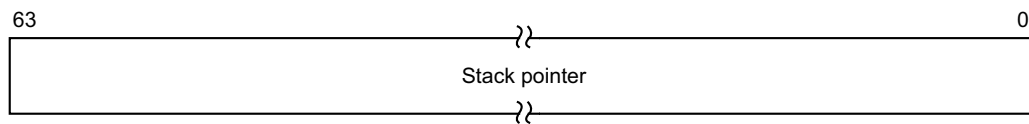

Bits [63:0]

Stack pointer.

C5.2.16 SPSel, Stack Pointer Select

The SPSel characteristics are:

Purpose

Allows the Stack Pointer to be selected between SP_EL0 and SP_ELx.

Configurations

Some or all RW fields of this register have defined reset values. These apply only if the PE resets into an Exception level that is using AArch64. Otherwise, RW fields in this register reset to architecturally UNKNOWN values.

Attributes

SPSel is a 32-bit register.

Field descriptions

The SPSel bit assignments are:

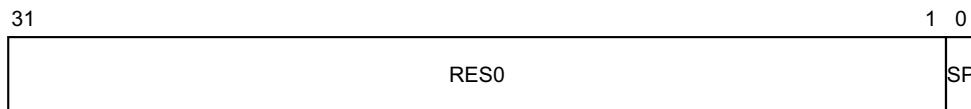

Bits [31:1]

Reserved, RES0.

SP, bit [0]

Stack pointer to use. Possible values of this bit are:

- 0 Use SP_EL0 at all Exception levels.
- 1 Use SP_ELx for Exception level ELx.

When this register has an architecturally-defined reset value, this field resets to 1.

Accessing the SPSel

This register can be read using MRS with the following syntax:

MRS <Xt>, <systemreg>

This register can be written using MSR (register) with the following syntax:

MSR <systemreg>, <Xt>

This syntax is encoded with the following settings in the instruction encoding:

<systemreg>	op0	op1	CRn	CRm	op2
SPSel	11	000	0100	0010	000

This register can be modified using MSR (immediate) with the following syntax:

MSR <pstatefield>, <imm>

This syntax is encoded with the following settings in the instruction encoding:

<pstatefield>	op0	op1	CRn	op2
SPSel	00	000	0100	101

Accessibility

The register is accessible in software as follows:

Control			Accessibility			
E2H	TGE	NS	EL0	EL1	EL2	EL3
x	x	0	-	RW	n/a	RW
x	0	1	-	RW	RW	RW
x	1	1	-	n/a	RW	RW

C5.2.17 SPSR_abt, Saved Program Status Register (Abort mode)

The SPSR_abt characteristics are:

Purpose

Holds the saved process state when an exception is taken to Abort mode.

Configurations

AArch64 System register SPSR_abt is architecturally mapped to AArch32 System register [SPSR_abt](#).

If EL1 does not support execution in AArch32 state, this register is RES0.

Attributes

SPSR_abt is a 32-bit register.

Field descriptions

The SPSR_abt bit assignments are:

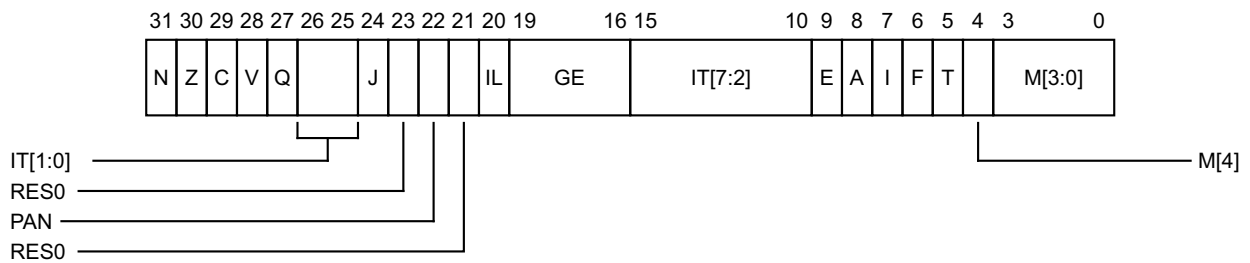

N, bit [31]

Set to the value of [CPSR.N](#) on taking an exception to Abort mode, and copied to [CPSR.N](#) on executing an exception return operation in Abort mode.

Z, bit [30]

Set to the value of [CPSR.Z](#) on taking an exception to Abort mode, and copied to [CPSR.Z](#) on executing an exception return operation in Abort mode.

C, bit [29]

Set to the value of [CPSR.C](#) on taking an exception to Abort mode, and copied to [CPSR.C](#) on executing an exception return operation in Abort mode.

V, bit [28]

Set to the value of [CPSR.V](#) on taking an exception to Abort mode, and copied to [CPSR.V](#) on executing an exception return operation in Abort mode.

Q, bit [27]

Cumulative saturation bit. Set to 1 to indicate that overflow or saturation occurred in some instructions.

IT[1:0], bits [26:25]

IT block state bits for the T32 IT (If-Then) instruction. See IT[7:2] for explanation of this field.

J, bit [24]

RES0.

In previous versions of the architecture, the {J, T} bits determined the AArch32 Instruction set state. ARMv8 does not support either Jazelle state or T32EE state, and the T bit determines the Instruction set state.

Bit [23]

Reserved, RES0.

PAN, bit [22]

In ARMv8.2 and ARMv8.1

When [ARMv8.1-PAN](#) is implemented, set to the value of [CPSR.PAN](#) on taking an exception to Abort mode, and copied to [CPSR.PAN](#) on executing an exception return operation in Abort mode.

When [ARMv8.1-PAN](#) is not implemented, this bit is RES0.

In ARMv8.0.

Reserved, RES0.

Bit [21]

Reserved, RES0.

IL, bit [20]

Illegal Execution state bit. Shows the value of [PSTATE.IL](#) immediately before the exception was taken.

GE, bits [19:16]

Greater than or Equal flags, for parallel addition and subtraction.

IT[7:2], bits [15:10]

IT block state bits for the T32 IT (If-Then) instruction. This field must be interpreted in two parts.

- IT[7:5] holds the base condition for the IT block. The base condition is the top 3 bits of the condition code specified by the first condition field of the IT instruction.
- IT[4:0] encodes the size of the IT block, which is the number of instructions that are to be conditionally executed, by the position of the least significant 1 in this field. It also encodes the value of the least significant bit of the condition code for each instruction in the block.

The IT field is `0b00000000` when no IT block is active.

E, bit [9]

Endianness state bit. Controls the load and store endianness for data accesses:

0 Little-endian operation

1 Big-endian operation.

Instruction fetches ignore this bit.

When the reset value of the [SCTLR.EE](#) bit is defined by a configuration input signal, that value also applies to the [CPSR.E](#) bit on reset, and therefore applies to software execution from reset.

If an implementation does not provide Big-endian support, this bit is RES0. If it does not provide Little-endian support, this bit is RES1.

If an implementation provides Big-endian support but only at EL0, this bit is RES0 for an exception return to any Exception level other than EL0.

Likewise, if it provides Little-endian support only at EL0, this bit is RES1 for an exception return to any Exception level other than EL0.

A, bit [8]

SError interrupt mask bit. The possible values of this bit are:

0 Exception not masked.

1 Exception masked.

I, bit [7]

IRQ mask bit. The possible values of this bit are:

- 0 Exception not masked.
- 1 Exception masked.

F, bit [6]

FIQ mask bit. The possible values of this bit are:

- 0 Exception not masked.
- 1 Exception masked.

T, bit [5]

T32 Instruction set state bit. Determines the AArch32 instruction set state that the exception was taken from. Possible values of this bit are:

- 0 Taken from A32 state.
- 1 Taken from T32 state.

M[4], bit [4]

Execution state that the exception was taken from. Possible values of this bit are:

- 1 Exception taken from AArch32.

M[3:0], bits [3:0]

AArch32 mode that an exception was taken from. The possible values are:

M[3:0]	Mode
0b0000	User
0b0001	FIQ
0b0010	IRQ
0b0011	Supervisor
0b0110	Monitor
0b0111	Abort
0b1010	Hyp
0b1011	Undefined
0b1111	System

Other values are reserved.

Accessing the SPSR_abt

This register can be read using MRS with the following syntax:

MRS <Xt>, <systemreg>

This register can be written using MSR (register) with the following syntax:

MSR <systemreg>, <Xt>

This syntax is encoded with the following settings in the instruction encoding:

<systemreg>	op0	op1	CRn	CRm	op2
SPSR_abt	11	100	0100	0011	001

Accessibility

The register is accessible in software as follows:

Control			Accessibility			
E2H	TGE	NS	EL0	EL1	EL2	EL3
x	x	0	-	-	n/a	RW
x	0	1	-	-	RW	RW
x	1	1	-	n/a	RW	RW

C5.2.18 SPSR_EL1, Saved Program Status Register (EL1)

The SPSR_EL1 characteristics are:

Purpose

Holds the saved process state when an exception is taken to EL1.

Configurations

AArch64 System register SPSR_EL1 is architecturally mapped to AArch32 System register [SPSR_svc](#).

Attributes

SPSR_EL1 is a 32-bit register.

Field descriptions

The SPSR_EL1 bit assignments are:

When exception taken from AArch32:

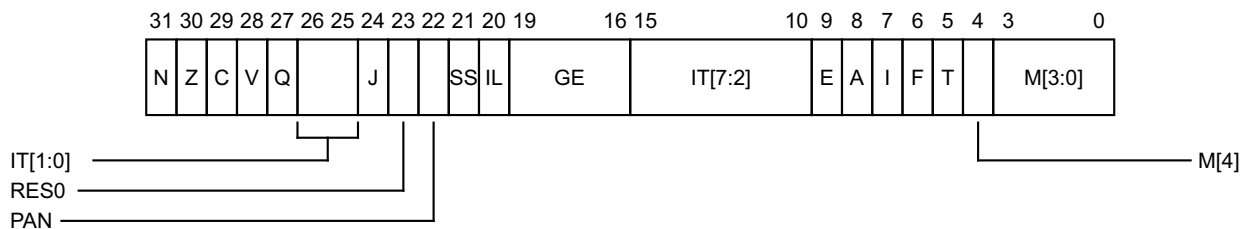

An exception return from EL1 using AArch64 makes SPSR_EL1 become UNKNOWN.

N, bit [31]

Set to the value of [CPSR.N](#) on taking an exception to Supervisor mode, and copied to [CPSR.N](#) on executing an exception return operation in Supervisor mode.

Z, bit [30]

Set to the value of [CPSR.Z](#) on taking an exception to Supervisor mode, and copied to [CPSR.Z](#) on executing an exception return operation in Supervisor mode.

C, bit [29]

Set to the value of [CPSR.C](#) on taking an exception to Supervisor mode, and copied to [CPSR.C](#) on executing an exception return operation in Supervisor mode.

V, bit [28]

Set to the value of [CPSR.V](#) on taking an exception to Supervisor mode, and copied to [CPSR.V](#) on executing an exception return operation in Supervisor mode.

Q, bit [27]

Cumulative saturation bit. Set to 1 to indicate that overflow or saturation occurred in some instructions.

IT[1:0], bits [26:25]

IT block state bits for the T32 IT (If-Then) instruction. See IT[7:2] for explanation of this field.

J, bit [24]

RES0.

In previous versions of the architecture, the {J, T} bits determined the AArch32 Instruction set state. ARMv8 does not support either Jazelle state or T32EE state, and the T bit determines the Instruction set state.

Bit [23]

Reserved, RES0.

PAN, bit [22]

In ARMv8.2 and ARMv8.1

When [ARMv8.1-PAN](#) is implemented, set to the value of [CPSR.PAN](#) on taking an exception to Supervisor mode, and copied to [CPSR.PAN](#) on executing an exception return operation in Supervisor mode.

When [ARMv8.1-PAN](#) is not implemented, this bit is RES0.

In ARMv8.0.

Reserved, RES0.

SS, bit [21]

Software step. Shows the value of [PSTATE.SS](#) immediately before the exception was taken.

IL, bit [20]

Illegal Execution state bit. Shows the value of [PSTATE.IL](#) immediately before the exception was taken.

GE, bits [19:16]

Greater than or Equal flags, for parallel addition and subtraction.

IT[7:2], bits [15:10]

IT block state bits for the T32 IT (If-Then) instruction. This field must be interpreted in two parts.

- IT[7:5] holds the base condition for the IT block. The base condition is the top 3 bits of the condition code specified by the first condition field of the IT instruction.
- IT[4:0] encodes the size of the IT block, which is the number of instructions that are to be conditionally executed, by the position of the least significant 1 in this field. It also encodes the value of the least significant bit of the condition code for each instruction in the block.

The IT field is 0b00000000 when no IT block is active.

E, bit [9]

Endianness state bit. Controls the load and store endianness for data accesses:

- | | |
|---|-------------------------|
| 0 | Little-endian operation |
| 1 | Big-endian operation. |

Instruction fetches ignore this bit.

When the reset value of the [SCTLR.EE](#) bit is defined by a configuration input signal, that value also applies to the [CPSR.E](#) bit on reset, and therefore applies to software execution from reset.

If an implementation does not provide Big-endian support, this bit is RES0. If it does not provide Little-endian support, this bit is RES1.

If an implementation provides Big-endian support but only at EL0, this bit is RES0 for an exception return to any Exception level other than EL0.

Likewise, if it provides Little-endian support only at EL0, this bit is RES1 for an exception return to any Exception level other than EL0.

A, bit [8]

SError interrupt mask bit. The possible values of this bit are:

- | | |
|---|-----------------------|
| 0 | Exception not masked. |
| 1 | Exception masked. |

I, bit [7]

IRQ mask bit. The possible values of this bit are:

- 0 Exception not masked.
- 1 Exception masked.

F, bit [6]

FIQ mask bit. The possible values of this bit are:

- 0 Exception not masked.
- 1 Exception masked.

T, bit [5]

T32 Instruction set state bit. Determines the AArch32 instruction set state that the exception was taken from. Possible values of this bit are:

- 0 Taken from A32 state.
- 1 Taken from T32 state.

M[4], bit [4]

Execution state that the exception was taken from. Possible values of this bit are:

- 1 Exception taken from AArch32.

M[3:0], bits [3:0]

AArch32 mode that an exception was taken from. The possible values are:

M[3:0]	Mode
0b0000	User
0b0001	FIQ
0b0010	IRQ
0b0011	Supervisor
0b0111	Abort
0b1011	Undefined
0b1111	System

Other values are reserved. The effect of programming this field to a Reserved value is that behavior is CONstrained UNPREDICTABLE, as described in *Reserved values in System and memory-mapped registers and translation table entries* on page K1-6133.

When exception taken from AArch64:

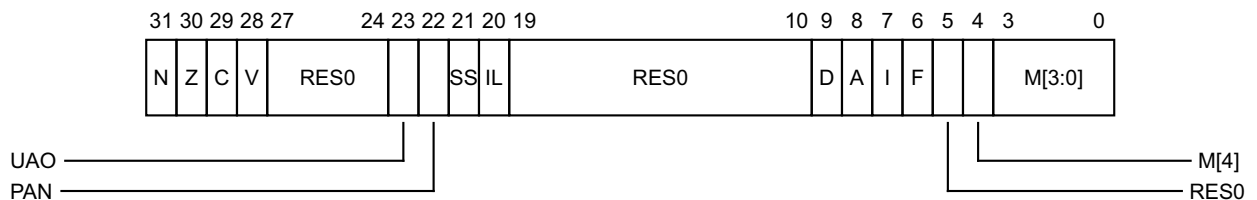

An exception return from EL1 using AArch64 makes SPSR_EL1 become UNKNOWN.

N, bit [31]

Set to the value of the N condition flag on taking an exception to EL1, and copied to the N condition flag on executing an exception return operation in EL1.

Z, bit [30]

Set to the value of the Z condition flag on taking an exception to EL1, and copied to the Z condition flag on executing an exception return operation in EL1.

C, bit [29]

Set to the value of the C condition flag on taking an exception to EL1, and copied to the C condition flag on executing an exception return operation in EL1.

V, bit [28]

Set to the value of the V condition flag on taking an exception to EL1, and copied to the V condition flag on executing an exception return operation in EL1.

Bits [27:24]

Reserved, RES0.

UAO, bit [23]

In ARMv8.2

When [ARMv8.2-UAO](#) is implemented, set to the value of PSTATE.UAO on taking an exception to EL1, and copied to PSTATE.UAO on executing an exception return operation in EL1.

When [ARMv8.2-UAO](#) is not implemented, this bit is RES0.

In ARMv8.1 and ARMv8.0.

Reserved, RES0.

PAN, bit [22]

In ARMv8.2 and ARMv8.1

When [ARMv8.1-PAN](#) is implemented, set to the value of PSTATE.PAN on taking an exception to EL1, and copied to PSTATE.PAN on executing an exception return operation in EL1.

When [ARMv8.1-PAN](#) is not implemented, this bit is RES0.

In ARMv8.0.

Reserved, RES0.

SS, bit [21]

Software step. Shows the value of PSTATE.SS immediately before the exception was taken.

IL, bit [20]

Illegal Execution state bit. Shows the value of PSTATE.IL immediately before the exception was taken.

Bits [19:10]

Reserved, RES0.

D, bit [9]

Process state D mask. The possible values of this bit are:

- | | |
|---|--|
| 0 | Watchpoint, Breakpoint, and Software Step exceptions targeted at the current Exception level are not masked. |
| 1 | Watchpoint, Breakpoint, and Software Step exceptions targeted at the current Exception level are masked. |

When the target Exception level of the debug exception is higher than the current Exception level, the exception is not masked by this bit.

A, bit [8]

SError interrupt mask bit. The possible values of this bit are:

- 0 Exception not masked.
- 1 Exception masked.

I, bit [7]

IRQ mask bit. The possible values of this bit are:

- 0 Exception not masked.
- 1 Exception masked.

F, bit [6]

FIQ mask bit. The possible values of this bit are:

- 0 Exception not masked.
- 1 Exception masked.

Bit [5]

Reserved, RES0.

M[4], bit [4]

Execution state that the exception was taken from. Possible values of this bit are:

- 0 Exception taken from AArch64.

M[3:0], bits [3:0]

AArch64 state (Exception level and selected SP) that an exception was taken from. The possible values are:

M[3:0]	State
0b0000	EL0t
0b0100	EL1t
0b0101	EL1h

Other values are reserved, and returning to an Exception level that is using AArch64 with a reserved value in this field is treated as an illegal exception return.

The bits in this field are interpreted as follows:

- M[3:2] holds the Exception Level.
- M[1] is unused and is RES0 for all non-reserved values.
- M[0] is used to select the SP:
 - 0 means the SP is always SP0.
 - 1 means the exception SP is determined by the EL.

Accessing the SPSR_EL1

This register can be read using MRS with the following syntax:

MRS <Xt>, <systemreg>

This register can be written using MSR (register) with the following syntax:

MSR <systemreg>, <Xt>

This syntax is encoded with the following settings in the instruction encoding:

<systemreg>	op0	op1	CRn	CRm	op2
SPSR_EL1	11	000	0100	0000	000
SPSR_EL12	11	101	0100	0000	000

Accessibility

The register is accessible in software as follows:

<systemreg>	Control			Accessibility			
	E2H	TGE	NS	EL0	EL1	EL2	EL3
SPSR_EL1	x	x	0	-	RW	n/a	RW
SPSR_EL1	0	0	1	-	RW	RW	RW
SPSR_EL1	0	1	1	-	n/a	RW	RW
SPSR_EL1	1	0	1	-	RW	SPSR_EL2	RW
SPSR_EL1	1	1	1	-	n/a	SPSR_EL2	RW
SPSR_EL12	x	x	0	-	-	n/a	-
SPSR_EL12	0	0	1	-	-	-	-
SPSR_EL12	0	1	1	-	n/a	-	-
SPSR_EL12	1	0	1	-	-	RW	RW
SPSR_EL12	1	1	1	-	n/a	RW	RW

This table applies to all instructions that can access this register.

When [HCR_EL2.E2H](#) is 1, without explicit synchronization, access from EL3 using the mnemonic SPSR_EL1 or SPSR_EL12 are not guaranteed to be ordered with respect to accesses using the other mnemonic.

C5.2.19 SPSR_EL2, Saved Program Status Register (EL2)

The SPSR_EL2 characteristics are:

Purpose

Holds the saved process state when an exception is taken to EL2.

Configurations

AArch64 System register SPSR_EL2 is architecturally mapped to AArch32 System register [SPSR_hyp](#).

Attributes

SPSR_EL2 is a 32-bit register.

Field descriptions

The SPSR_EL2 bit assignments are:

When exception taken from AArch32:

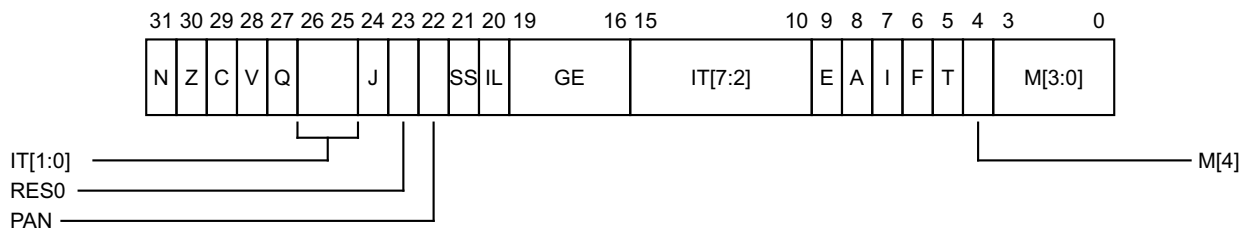

An exception return from EL2 using AArch64 makes SPSR_EL2 become UNKNOWN.

N, bit [31]

Set to the value of [CPSR.N](#) on taking an exception to Hyp mode, and copied to [CPSR.N](#) on executing an exception return operation in Hyp mode.

Z, bit [30]

Set to the value of [CPSR.Z](#) on taking an exception to Hyp mode, and copied to [CPSR.Z](#) on executing an exception return operation in Hyp mode.

C, bit [29]

Set to the value of [CPSR.C](#) on taking an exception to Hyp mode, and copied to [CPSR.C](#) on executing an exception return operation in Hyp mode.

V, bit [28]

Set to the value of [CPSR.V](#) on taking an exception to Hyp mode, and copied to [CPSR.V](#) on executing an exception return operation in Hyp mode.

Q, bit [27]

Cumulative saturation bit. Set to 1 to indicate that overflow or saturation occurred in some instructions.

IT[1:0], bits [26:25]

IT block state bits for the T32 IT (If-Then) instruction. See IT[7:2] for explanation of this field.

J, bit [24]

RES0.

In previous versions of the architecture, the {J, T} bits determined the AArch32 Instruction set state. ARMv8 does not support either Jazelle state or T32EE state, and the T bit determines the Instruction set state.

Bit [23]

Reserved, RES0.

PAN, bit [22]

In ARMv8.2 and ARMv8.1

When [ARMv8.1-PAN](#) is implemented, set to the value of [CPSR.PAN](#) on taking an exception to Hyp mode, and copied to [CPSR.PAN](#) on executing an exception return operation in Hyp mode.

When [ARMv8.1-PAN](#) is not implemented, this bit is RES0.

In ARMv8.0.

Reserved, RES0.

SS, bit [21]

Software step. Shows the value of [PSTATE.SS](#) immediately before the exception was taken.

IL, bit [20]

Illegal Execution state bit. Shows the value of [PSTATE.IL](#) immediately before the exception was taken.

GE, bits [19:16]

Greater than or Equal flags, for parallel addition and subtraction.

IT[7:2], bits [15:10]

IT block state bits for the T32 IT (If-Then) instruction. This field must be interpreted in two parts.

- IT[7:5] holds the base condition for the IT block. The base condition is the top 3 bits of the condition code specified by the first condition field of the IT instruction.
- IT[4:0] encodes the size of the IT block, which is the number of instructions that are to be conditionally executed, by the position of the least significant 1 in this field. It also encodes the value of the least significant bit of the condition code for each instruction in the block.

The IT field is `0b00000000` when no IT block is active.

E, bit [9]

Endianness state bit. Controls the load and store endianness for data accesses:

0 Little-endian operation

1 Big-endian operation.

Instruction fetches ignore this bit.

When the reset value of the [SCTLR.EE](#) bit is defined by a configuration input signal, that value also applies to the [CPSR.E](#) bit on reset, and therefore applies to software execution from reset.

If an implementation does not provide Big-endian support, this bit is RES0. If it does not provide Little-endian support, this bit is RES1.

If an implementation provides Big-endian support but only at EL0, this bit is RES0 for an exception return to any Exception level other than EL0.

Likewise, if it provides Little-endian support only at EL0, this bit is RES1 for an exception return to any Exception level other than EL0.

A, bit [8]

SError interrupt mask bit. The possible values of this bit are:

0 Exception not masked.

1 Exception masked.

I, bit [7]

IRQ mask bit. The possible values of this bit are:

- 0 Exception not masked.
- 1 Exception masked.

F, bit [6]

FIQ mask bit. The possible values of this bit are:

- 0 Exception not masked.
- 1 Exception masked.

T, bit [5]

T32 Instruction set state bit. Determines the AArch32 instruction set state that the exception was taken from. Possible values of this bit are:

- 0 Taken from A32 state.
- 1 Taken from T32 state.

M[4], bit [4]

Execution state that the exception was taken from. Possible values of this bit are:

- 1 Exception taken from AArch32.

M[3:0], bits [3:0]

AArch32 mode that an exception was taken from. The possible values are:

M[3:0]	Mode
0b0000	User
0b0001	FIQ
0b0010	IRQ
0b0011	Supervisor
0b0111	Abort
0b1010	Hyp
0b1011	Undefined
0b1111	System

Other values are reserved. The effect of programming this field to a Reserved value is that behavior is **CONSTRAINED UNPREDICTABLE**, as described in *Reserved values in System and memory-mapped registers and translation table entries* on page K1-6133.

When exception taken from AArch64:

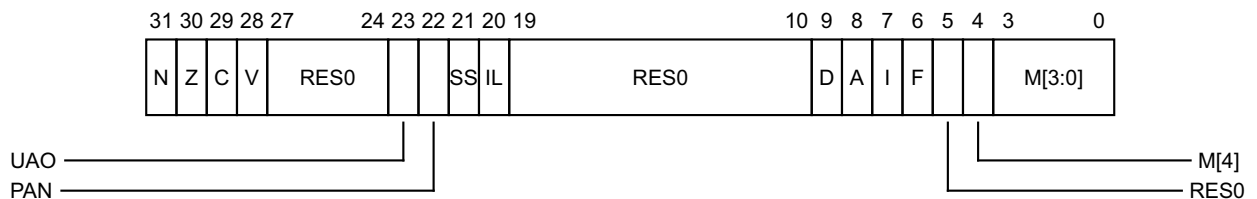

An exception return from EL2 using AArch64 makes SPSR_EL2 become UNKNOWN.

N, bit [31]

Set to the value of the N condition flag on taking an exception to EL2, and copied to the N condition flag on executing an exception return operation in EL2.

Z, bit [30]

Set to the value of the Z condition flag on taking an exception to EL2, and copied to the Z condition flag on executing an exception return operation in EL2.

C, bit [29]

Set to the value of the C condition flag on taking an exception to EL2, and copied to the C condition flag on executing an exception return operation in EL2.

V, bit [28]

Set to the value of the V condition flag on taking an exception to EL2, and copied to the V condition flag on executing an exception return operation in EL2.

Bits [27:24]

Reserved, RES0.

UAO, bit [23]

In ARMv8.2

When [ARMv8.2-UAO](#) is implemented, set to the value of PSTATE.UAO on taking an exception to EL2, and copied to PSTATE.UAO on executing an exception return operation in EL2.

When [ARMv8.2-UAO](#) is not implemented, this bit is RES0.

In ARMv8.1 and ARMv8.0.

Reserved, RES0.

PAN, bit [22]

In ARMv8.2 and ARMv8.1

When [ARMv8.1-PAN](#) is implemented, set to the value of PSTATE.PAN on taking an exception to EL2, and copied to PSTATE.PAN on executing an exception return operation in EL2.

When [ARMv8.1-PAN](#) is not implemented, this bit is RES0.

In ARMv8.0.

Reserved, RES0.

SS, bit [21]

Software step. Shows the value of PSTATE.SS immediately before the exception was taken.

IL, bit [20]

Illegal Execution state bit. Shows the value of PSTATE.IL immediately before the exception was taken.

Bits [19:10]

Reserved, RES0.

D, bit [9]

Process state D mask. The possible values of this bit are:

- | | |
|---|--|
| 0 | Watchpoint, Breakpoint, and Software Step exceptions targeted at the current Exception level are not masked. |
| 1 | Watchpoint, Breakpoint, and Software Step exceptions targeted at the current Exception level are masked. |

When the target Exception level of the debug exception is higher than the current Exception level, the exception is not masked by this bit.

A, bit [8]

SError interrupt mask bit. The possible values of this bit are:

- 0 Exception not masked.
- 1 Exception masked.

I, bit [7]

IRQ mask bit. The possible values of this bit are:

- 0 Exception not masked.
- 1 Exception masked.

F, bit [6]

FIQ mask bit. The possible values of this bit are:

- 0 Exception not masked.
- 1 Exception masked.

Bit [5]

Reserved, RES0.

M[4], bit [4]

Execution state that the exception was taken from. Possible values of this bit are:

- 0 Exception taken from AArch64.

M[3:0], bits [3:0]

AArch64 state (Exception level and selected SP) that an exception was taken from. The possible values are:

M[3:0]	State
0b0000	EL0t
0b0100	EL1t
0b0101	EL1h
0b1000	EL2t
0b1001	EL2h

Other values are reserved, and returning to an Exception level that is using AArch64 with a reserved value in this field is treated as an illegal exception return.

The bits in this field are interpreted as follows:

- M[3:2] holds the Exception Level.
- M[1] is unused and is RES0 for all non-reserved values.
- M[0] is used to select the SP:
 - 0 means the SP is always SP0.
 - 1 means the exception SP is determined by the EL.

Accessing the SPSR_EL2

This register can be read using MRS with the following syntax:

MRS <Xt>, <systemreg>

This register can be written using MSR (register) with the following syntax:

MSR <systemreg>, <Xt>

This syntax is encoded with the following settings in the instruction encoding:

<systemreg>	op0	op1	CRn	CRm	op2
SPSR_EL2	11	100	0100	0000	000
SPSR_EL1	11	000	0100	0000	000

Accessibility

The register is accessible in software as follows:

<systemreg>	Control			Accessibility			
	E2H	TGE	NS	EL0	EL1	EL2	EL3
SPSR_EL2	x	x	0	-	-	n/a	RW
SPSR_EL2	0	0	1	-	-	RW	RW
SPSR_EL2	0	1	1	-	n/a	RW	RW
SPSR_EL2	1	0	1	-	-	RW	RW
SPSR_EL2	1	1	1	-	n/a	RW	RW
SPSR_EL1	x	x	0	-	SPSR_EL1	n/a	SPSR_EL1
SPSR_EL1	0	0	1	-	SPSR_EL1	SPSR_EL1	SPSR_EL1
SPSR_EL1	0	1	1	-	n/a	SPSR_EL1	SPSR_EL1
SPSR_EL1	1	0	1	-	SPSR_EL1	RW	SPSR_EL1
SPSR_EL1	1	1	1	-	n/a	RW	SPSR_EL1

This table applies to all instructions that can access this register.

When [HCR_EL2.E2H](#) is 1, without explicit synchronization, access from EL2 using the mnemonic SPSR_EL2 or SPSR_EL1 are not guaranteed to be ordered with respect to accesses using the other mnemonic.

C5.2.20 SPSR_EL3, Saved Program Status Register (EL3)

The SPSR_EL3 characteristics are:

Purpose

Holds the saved process state when an exception is taken to EL3.

Configurations

AArch64 System register SPSR_EL3 can be mapped to AArch32 System register [SPSR_mon](#), but this is not architecturally mandated.

Attributes

SPSR_EL3 is a 32-bit register.

Field descriptions

The SPSR_EL3 bit assignments are:

When exception taken from AArch32:

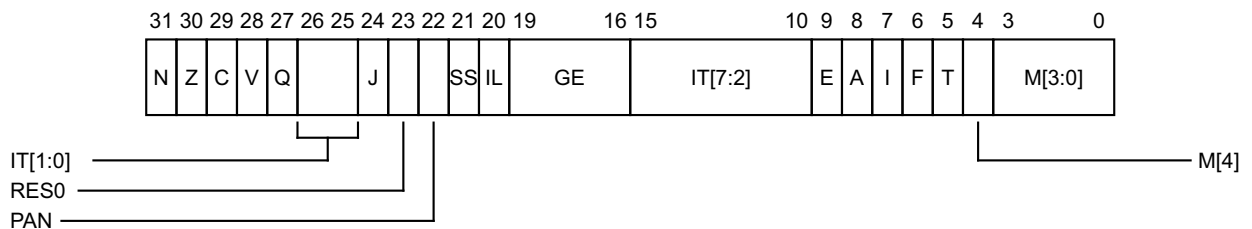

An exception return from EL3 using AArch64 makes SPSR_EL3 become UNKNOWN.

N, bit [31]

Set to the value of [CPSR.N](#) on taking an exception to Monitor mode, and copied to [CPSR.N](#) on executing an exception return operation in Monitor mode.

Z, bit [30]

Set to the value of [CPSR.Z](#) on taking an exception to Monitor mode, and copied to [CPSR.Z](#) on executing an exception return operation in Monitor mode.

C, bit [29]

Set to the value of [CPSR.C](#) on taking an exception to Monitor mode, and copied to [CPSR.C](#) on executing an exception return operation in Monitor mode.

V, bit [28]

Set to the value of [CPSR.V](#) on taking an exception to Monitor mode, and copied to [CPSR.V](#) on executing an exception return operation in Monitor mode.

Q, bit [27]

Cumulative saturation bit. Set to 1 to indicate that overflow or saturation occurred in some instructions.

IT[1:0], bits [26:25]

IT block state bits for the T32 IT (If-Then) instruction. See IT[7:2] for explanation of this field.

J, bit [24]

RES0.

In previous versions of the architecture, the {J, T} bits determined the AArch32 Instruction set state. ARMv8 does not support either Jazelle state or T32EE state, and the T bit determines the Instruction set state.

Bit [23]

Reserved, RES0.

PAN, bit [22]

In ARMv8.2 and ARMv8.1

When [ARMv8.1-PAN](#) is implemented, set to the value of [CPSR.PAN](#) on taking an exception to Monitor mode, and copied to [CPSR.PAN](#) on executing an exception return operation in Monitor mode.

When [ARMv8.1-PAN](#) is not implemented, this bit is RES0.

In ARMv8.0.

Reserved, RES0.

SS, bit [21]

Software step. Shows the value of [PSTATE.SS](#) immediately before the exception was taken.

IL, bit [20]

Illegal Execution state bit. Shows the value of [PSTATE.IL](#) immediately before the exception was taken.

GE, bits [19:16]

Greater than or Equal flags, for parallel addition and subtraction.

IT[7:2], bits [15:10]

IT block state bits for the T32 IT (If-Then) instruction. This field must be interpreted in two parts.

- IT[7:5] holds the base condition for the IT block. The base condition is the top 3 bits of the condition code specified by the first condition field of the IT instruction.
- IT[4:0] encodes the size of the IT block, which is the number of instructions that are to be conditionally executed, by the position of the least significant 1 in this field. It also encodes the value of the least significant bit of the condition code for each instruction in the block.

The IT field is 0b00000000 when no IT block is active.

E, bit [9]

Endianness state bit. Controls the load and store endianness for data accesses:

- | | |
|---|-------------------------|
| 0 | Little-endian operation |
| 1 | Big-endian operation. |

Instruction fetches ignore this bit.

When the reset value of the [SCTLR.EE](#) bit is defined by a configuration input signal, that value also applies to the [CPSR.E](#) bit on reset, and therefore applies to software execution from reset.

If an implementation does not provide Big-endian support, this bit is RES0. If it does not provide Little-endian support, this bit is RES1.

If an implementation provides Big-endian support but only at EL0, this bit is RES0 for an exception return to any Exception level other than EL0.

Likewise, if it provides Little-endian support only at EL0, this bit is RES1 for an exception return to any Exception level other than EL0.

A, bit [8]

SError interrupt mask bit. The possible values of this bit are:

- | | |
|---|-----------------------|
| 0 | Exception not masked. |
| 1 | Exception masked. |

I, bit [7]

IRQ mask bit. The possible values of this bit are:

- 0 Exception not masked.
- 1 Exception masked.

F, bit [6]

FIQ mask bit. The possible values of this bit are:

- 0 Exception not masked.
- 1 Exception masked.

T, bit [5]

T32 Instruction set state bit. Determines the AArch32 instruction set state that the exception was taken from. Possible values of this bit are:

- 0 Taken from A32 state.
- 1 Taken from T32 state.

M[4], bit [4]

Execution state that the exception was taken from. Possible values of this bit are:

- 1 Exception taken from AArch32.

M[3:0], bits [3:0]

AArch32 mode that an exception was taken from. The possible values are:

M[3:0]	Mode
0b0000	User
0b0001	FIQ
0b0010	IRQ
0b0011	Supervisor
0b0110	Monitor
0b0111	Abort
0b1010	Hyp
0b1011	Undefined
0b1111	System

Other values are reserved. The effect of programming this field to a Reserved value is that behavior is CONstrained UNPREDICTABLE, as described in [Reserved values in System and memory-mapped registers and translation table entries](#) on page K1-6133.

When exception taken from AArch64:

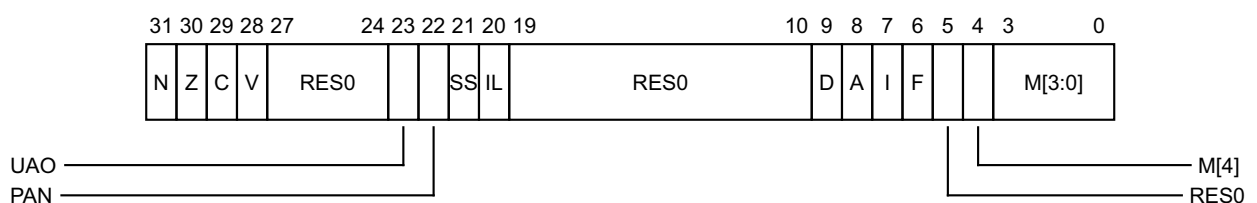

An exception return from EL3 using AArch64 makes SPSR_EL3 become UNKNOWN.

N, bit [31]

Set to the value of the N condition flag on taking an exception to EL3, and copied to the N condition flag on executing an exception return operation in EL3.

Z, bit [30]

Set to the value of the Z condition flag on taking an exception to EL3, and copied to the Z condition flag on executing an exception return operation in EL3.

C, bit [29]

Set to the value of the C condition flag on taking an exception to EL3, and copied to the C condition flag on executing an exception return operation in EL3.

V, bit [28]

Set to the value of the V condition flag on taking an exception to EL3, and copied to the V condition flag on executing an exception return operation in EL3.

Bits [27:24]

Reserved, RES0.

UAO, bit [23]

In ARMv8.2

When [ARMv8.2-UAO](#) is implemented, set to the value of PSTATE.UAO on taking an exception to EL3, and copied to PSTATE.UAO on executing an exception return operation in EL3.

When [ARMv8.2-UAO](#) is not implemented, this bit is RES0.

In ARMv8.1 and ARMv8.0.

Reserved, RES0.

PAN, bit [22]

In ARMv8.2 and ARMv8.1

When [ARMv8.1-PAN](#) is implemented, set to the value of PSTATE.PAN on taking an exception to EL3, and copied to PSTATE.PAN on executing an exception return operation in EL3.

When [ARMv8.1-PAN](#) is not implemented, this bit is RES0.

In ARMv8.0.

Reserved, RES0.

SS, bit [21]

Software step. Shows the value of PSTATE.SS immediately before the exception was taken.

IL, bit [20]

Illegal Execution state bit. Shows the value of PSTATE.IL immediately before the exception was taken.

Bits [19:10]

Reserved, RES0.

D, bit [9]

Process state D mask. The possible values of this bit are:

- | | |
|---|--|
| 0 | Watchpoint, Breakpoint, and Software Step exceptions targeted at the current Exception level are not masked. |
| 1 | Watchpoint, Breakpoint, and Software Step exceptions targeted at the current Exception level are masked. |

When the target Exception level of the debug exception is higher than the current Exception level, the exception is not masked by this bit.

A, bit [8]

SError interrupt mask bit. The possible values of this bit are:

- 0 Exception not masked.
- 1 Exception masked.

I, bit [7]

IRQ mask bit. The possible values of this bit are:

- 0 Exception not masked.
- 1 Exception masked.

F, bit [6]

FIQ mask bit. The possible values of this bit are:

- 0 Exception not masked.
- 1 Exception masked.

Bit [5]

Reserved, RES0.

M[4], bit [4]

Execution state that the exception was taken from. Possible values of this bit are:

- 0 Exception taken from AArch64.

M[3:0], bits [3:0]

AArch64 state (Exception level and selected SP) that an exception was taken from. The possible values are:

M[3:0]	State
0b0000	EL0t
0b0100	EL1t
0b0101	EL1h
0b1000	EL2t
0b1001	EL2h
0b1100	EL3t
0b1101	EL3h

Other values are reserved, and returning to an Exception level that is using AArch64 with a reserved value in this field is treated as an illegal exception return.

The bits in this field are interpreted as follows:

- M[3:2] holds the Exception Level.
- M[1] is unused and is RES0 for all non-reserved values.
- M[0] is used to select the SP:
 - 0 means the SP is always SP0.
 - 1 means the exception SP is determined by the EL.

Accessing the SPSR_EL3

This register can be read using MRS with the following syntax:

MRS <Xt>, <systemreg>

This register can be written using MSR (register) with the following syntax:

MSR <systemreg>, <Xt>

This syntax is encoded with the following settings in the instruction encoding:

<systemreg>	op0	op1	CRn	CRm	op2
SPSR_EL3	11	110	0100	0000	000

Accessibility

The register is accessible in software as follows:

Control			Accessibility			
E2H	TGE	NS	EL0	EL1	EL2	EL3
x	x	0	-	-	n/a	RW
x	0	1	-	-	-	RW
x	1	1	-	n/a	-	RW

C5.2.21 SPSR_fiq, Saved Program Status Register (FIQ mode)

The SPSR_fiq characteristics are:

Purpose

Holds the saved process state when an exception is taken to FIQ mode.

Configurations

AArch64 System register SPSR_fiq is architecturally mapped to AArch32 System register [SPSR_fiq](#).

If EL1 does not support execution in AArch32 state, this register is RES0.

Attributes

SPSR_fiq is a 32-bit register.

Field descriptions

The SPSR_fiq bit assignments are:

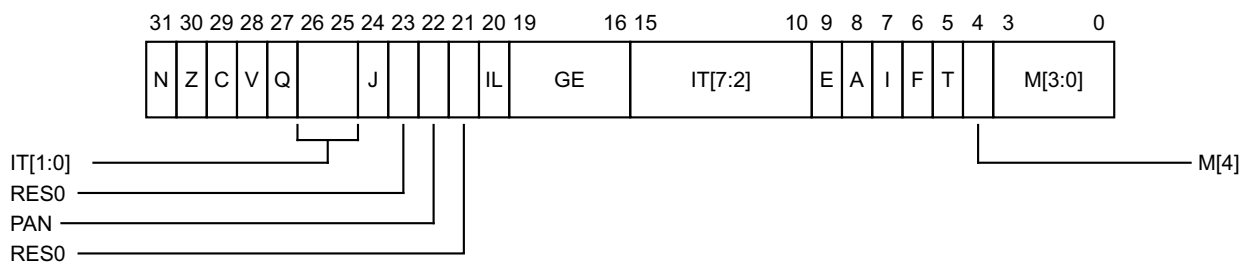

N, bit [31]

Set to the value of [CPSR.N](#) on taking an exception to FIQ mode, and copied to [CPSR.N](#) on executing an exception return operation in FIQ mode.

Z, bit [30]

Set to the value of [CPSR.Z](#) on taking an exception to FIQ mode, and copied to [CPSR.Z](#) on executing an exception return operation in FIQ mode.

C, bit [29]

Set to the value of [CPSR.C](#) on taking an exception to FIQ mode, and copied to [CPSR.C](#) on executing an exception return operation in FIQ mode.

V, bit [28]

Set to the value of [CPSR.V](#) on taking an exception to FIQ mode, and copied to [CPSR.V](#) on executing an exception return operation in FIQ mode.

Q, bit [27]

Cumulative saturation bit. Set to 1 to indicate that overflow or saturation occurred in some instructions.

IT[1:0], bits [26:25]

IT block state bits for the T32 IT (If-Then) instruction. See IT[7:2] for explanation of this field.

J, bit [24]

RES0.

In previous versions of the architecture, the {J, T} bits determined the AArch32 Instruction set state. ARMv8 does not support either Jazelle state or T32EE state, and the T bit determines the Instruction set state.

Bit [23]

Reserved, RES0.

PAN, bit [22]

In ARMv8.2 and ARMv8.1

When [ARMv8.1-PAN](#) is implemented, set to the value of [CPSR.PAN](#) on taking an exception to FIQ mode, and copied to [CPSR.PAN](#) on executing an exception return operation in FIQ mode.

When [ARMv8.1-PAN](#) is not implemented, this bit is RES0.

In ARMv8.0.

Reserved, RES0.

Bit [21]

Reserved, RES0.

IL, bit [20]

Illegal Execution state bit. Shows the value of [PSTATE.IL](#) immediately before the exception was taken.

GE, bits [19:16]

Greater than or Equal flags, for parallel addition and subtraction.

IT[7:2], bits [15:10]

IT block state bits for the T32 IT (If-Then) instruction. This field must be interpreted in two parts.

- IT[7:5] holds the base condition for the IT block. The base condition is the top 3 bits of the condition code specified by the first condition field of the IT instruction.
- IT[4:0] encodes the size of the IT block, which is the number of instructions that are to be conditionally executed, by the position of the least significant 1 in this field. It also encodes the value of the least significant bit of the condition code for each instruction in the block.

The IT field is `0b00000000` when no IT block is active.

E, bit [9]

Endianness state bit. Controls the load and store endianness for data accesses:

- | | |
|---|-------------------------|
| 0 | Little-endian operation |
| 1 | Big-endian operation. |

Instruction fetches ignore this bit.

When the reset value of the [SCTLR.EE](#) bit is defined by a configuration input signal, that value also applies to the [CPSR.E](#) bit on reset, and therefore applies to software execution from reset.

If an implementation does not provide Big-endian support, this bit is RES0. If it does not provide Little-endian support, this bit is RES1.

If an implementation provides Big-endian support but only at EL0, this bit is RES0 for an exception return to any Exception level other than EL0.

Likewise, if it provides Little-endian support only at EL0, this bit is RES1 for an exception return to any Exception level other than EL0.

A, bit [8]

SError interrupt mask bit. The possible values of this bit are:

- | | |
|---|-----------------------|
| 0 | Exception not masked. |
| 1 | Exception masked. |

I, bit [7]

IRQ mask bit. The possible values of this bit are:

- 0 Exception not masked.
- 1 Exception masked.

F, bit [6]

FIQ mask bit. The possible values of this bit are:

- 0 Exception not masked.
- 1 Exception masked.

T, bit [5]

T32 Instruction set state bit. Determines the AArch32 instruction set state that the exception was taken from. Possible values of this bit are:

- 0 Taken from A32 state.
- 1 Taken from T32 state.

M[4], bit [4]

Execution state that the exception was taken from. Possible values of this bit are:

- 1 Exception taken from AArch32.

M[3:0], bits [3:0]

AArch32 mode that an exception was taken from. The possible values are:

M[3:0]	Mode
0b0000	User
0b0001	FIQ
0b0010	IRQ
0b0011	Supervisor
0b0110	Monitor
0b0111	Abort
0b1010	Hyp
0b1011	Undefined
0b1111	System

Other values are reserved. The effect of programming this field to a Reserved value is that behavior is CONstrained UNPREDICTABLE, as described in [Reserved values in System and memory-mapped registers and translation table entries](#) on page K1-6133.

Accessing the SPSR_fiq

This register can be read using MRS with the following syntax:

MRS <Xt>, <systemreg>

This register can be written using MSR (register) with the following syntax:

MSR <systemreg>, <Xt>

This syntax is encoded with the following settings in the instruction encoding:

<systemreg>	op0	op1	CRn	CRm	op2
SPSR_fiq	11	100	0100	0011	011

Accessibility

The register is accessible in software as follows:

Control			Accessibility			
E2H	TGE	NS	EL0	EL1	EL2	EL3
x	x	0	-	-	n/a	RW
x	0	1	-	-	RW	RW
x	1	1	-	n/a	RW	RW

C5.2.22 SPSR_irq, Saved Program Status Register (IRQ mode)

The SPSR_irq characteristics are:

Purpose

Holds the saved process state when an exception is taken to IRQ mode.

Configurations

AArch64 System register SPSR_irq is architecturally mapped to AArch32 System register [SPSR_irq](#).

If EL1 does not support execution in AArch32 state, this register is RES0.

Attributes

SPSR_irq is a 32-bit register.

Field descriptions

The SPSR_irq bit assignments are:

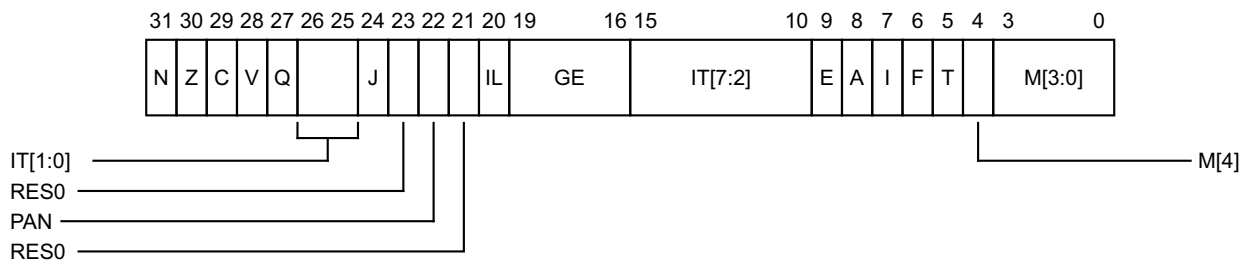

N, bit [31]

Set to the value of [CPSR.N](#) on taking an exception to IRQ mode, and copied to [CPSR.N](#) on executing an exception return operation in IRQ mode.

Z, bit [30]

Set to the value of [CPSR.Z](#) on taking an exception to IRQ mode, and copied to [CPSR.Z](#) on executing an exception return operation in IRQ mode.

C, bit [29]

Set to the value of [CPSR.C](#) on taking an exception to IRQ mode, and copied to [CPSR.C](#) on executing an exception return operation in IRQ mode.

V, bit [28]

Set to the value of [CPSR.V](#) on taking an exception to IRQ mode, and copied to [CPSR.V](#) on executing an exception return operation in IRQ mode.

Q, bit [27]

Cumulative saturation bit. Set to 1 to indicate that overflow or saturation occurred in some instructions.

IT[1:0], bits [26:25]

IT block state bits for the T32 IT (If-Then) instruction. See IT[7:2] for explanation of this field.

J, bit [24]

RES0.

In previous versions of the architecture, the {J, T} bits determined the AArch32 Instruction set state. ARMv8 does not support either Jazelle state or T32EE state, and the T bit determines the Instruction set state.

Bit [23]

Reserved, RES0.

PAN, bit [22]

In ARMv8.2 and ARMv8.1

When [ARMv8.1-PAN](#) is implemented, set to the value of [CPSR.PAN](#) on taking an exception to IRQ mode, and copied to [CPSR.PAN](#) on executing an exception return operation in IRQ mode.

When [ARMv8.1-PAN](#) is not implemented, this bit is RES0.

In ARMv8.0.

Reserved, RES0.

Bit [21]

Reserved, RES0.

IL, bit [20]

Illegal Execution state bit. Shows the value of [PSTATE.IL](#) immediately before the exception was taken.

GE, bits [19:16]

Greater than or Equal flags, for parallel addition and subtraction.

IT[7:2], bits [15:10]

IT block state bits for the T32 IT (If-Then) instruction. This field must be interpreted in two parts.

- IT[7:5] holds the base condition for the IT block. The base condition is the top 3 bits of the condition code specified by the first condition field of the IT instruction.
- IT[4:0] encodes the size of the IT block, which is the number of instructions that are to be conditionally executed, by the position of the least significant 1 in this field. It also encodes the value of the least significant bit of the condition code for each instruction in the block.

The IT field is `0b00000000` when no IT block is active.

E, bit [9]

Endianness state bit. Controls the load and store endianness for data accesses:

0 Little-endian operation

1 Big-endian operation.

Instruction fetches ignore this bit.

When the reset value of the [SCTLR.EE](#) bit is defined by a configuration input signal, that value also applies to the [CPSR.E](#) bit on reset, and therefore applies to software execution from reset.

If an implementation does not provide Big-endian support, this bit is RES0. If it does not provide Little-endian support, this bit is RES1.

If an implementation provides Big-endian support but only at EL0, this bit is RES0 for an exception return to any Exception level other than EL0.

Likewise, if it provides Little-endian support only at EL0, this bit is RES1 for an exception return to any Exception level other than EL0.

A, bit [8]

SError interrupt mask bit. The possible values of this bit are:

0 Exception not masked.

1 Exception masked.

I, bit [7]

IRQ mask bit. The possible values of this bit are:

- 0 Exception not masked.
- 1 Exception masked.

F, bit [6]

FIQ mask bit. The possible values of this bit are:

- 0 Exception not masked.
- 1 Exception masked.

T, bit [5]

T32 Instruction set state bit. Determines the AArch32 instruction set state that the exception was taken from. Possible values of this bit are:

- 0 Taken from A32 state.
- 1 Taken from T32 state.

M[4], bit [4]

Execution state that the exception was taken from. Possible values of this bit are:

- 1 Exception taken from AArch32.

M[3:0], bits [3:0]

AArch32 mode that an exception was taken from. The possible values are:

M[3:0]	Mode
0b0000	User
0b0001	FIQ
0b0010	IRQ
0b0011	Supervisor
0b0110	Monitor
0b0111	Abort
0b1010	Hyp
0b1011	Undefined
0b1111	System

Other values are reserved. The effect of programming this field to a Reserved value is that behavior is CONstrained UNPREDICTABLE, as described in [Reserved values in System and memory-mapped registers and translation table entries](#) on page K1-6133.

Accessing the SPSR_irq

This register can be read using MRS with the following syntax:

MRS <Xt>, <systemreg>

This register can be written using MSR (register) with the following syntax:

MSR <systemreg>, <Xt>

This syntax is encoded with the following settings in the instruction encoding:

<systemreg>	op0	op1	CRn	CRm	op2
SPSR_irq	11	100	0100	0011	000

Accessibility

The register is accessible in software as follows:

Control			Accessibility			
E2H	TGE	NS	EL0	EL1	EL2	EL3
x	x	0	-	-	n/a	RW
x	0	1	-	-	RW	RW
x	1	1	-	n/a	RW	RW

C5.2.23 SPSR_und, Saved Program Status Register (Undefined mode)

The SPSR_und characteristics are:

Purpose

Holds the saved process state when an exception is taken to Undefined mode.

Configurations

AArch64 System register SPSR_und is architecturally mapped to AArch32 System register [SPSR_und](#).

If EL1 does not support execution in AArch32 state, this register is RES0.

Attributes

SPSR_und is a 32-bit register.

Field descriptions

The SPSR_und bit assignments are:

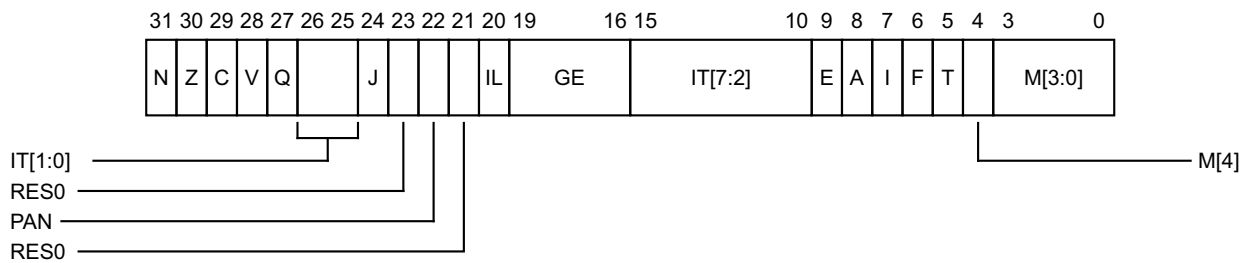

N, bit [31]

Set to the value of [CPSR.N](#) on taking an exception to Undefined mode, and copied to [CPSR.N](#) on executing an exception return operation in Undefined mode.

Z, bit [30]

Set to the value of [CPSR.Z](#) on taking an exception to Undefined mode, and copied to [CPSR.Z](#) on executing an exception return operation in Undefined mode.

C, bit [29]

Set to the value of [CPSR.C](#) on taking an exception to Undefined mode, and copied to [CPSR.C](#) on executing an exception return operation in Undefined mode.

V, bit [28]

Set to the value of [CPSR.V](#) on taking an exception to Undefined mode, and copied to [CPSR.V](#) on executing an exception return operation in Undefined mode.

Q, bit [27]

Cumulative saturation bit. Set to 1 to indicate that overflow or saturation occurred in some instructions.

IT[1:0], bits [26:25]

IT block state bits for the T32 IT (If-Then) instruction. See IT[7:2] for explanation of this field.

J, bit [24]

RES0.

In previous versions of the architecture, the {J, T} bits determined the AArch32 Instruction set state. ARMv8 does not support either Jazelle state or T32EE state, and the T bit determines the Instruction set state.

Bit [23]

Reserved, RES0.

PAN, bit [22]

In ARMv8.2 and ARMv8.1

When [ARMv8.1-PAN](#) is implemented, set to the value of [CPSR.PAN](#) on taking an exception to Undefined mode, and copied to [CPSR.PAN](#) on executing an exception return operation in Undefined mode.

When [ARMv8.1-PAN](#) is not implemented, this bit is RES0.

In ARMv8.0.

Reserved, RES0.

Bit [21]

Reserved, RES0.

IL, bit [20]

Illegal Execution state bit. Shows the value of [PSTATE.IL](#) immediately before the exception was taken.

GE, bits [19:16]

Greater than or Equal flags, for parallel addition and subtraction.

IT[7:2], bits [15:10]

IT block state bits for the T32 IT (If-Then) instruction. This field must be interpreted in two parts.

- IT[7:5] holds the base condition for the IT block. The base condition is the top 3 bits of the condition code specified by the first condition field of the IT instruction.
- IT[4:0] encodes the size of the IT block, which is the number of instructions that are to be conditionally executed, by the position of the least significant 1 in this field. It also encodes the value of the least significant bit of the condition code for each instruction in the block.

The IT field is 0b00000000 when no IT block is active.

E, bit [9]

Endianness state bit. Controls the load and store endianness for data accesses:

- | | |
|---|-------------------------|
| 0 | Little-endian operation |
| 1 | Big-endian operation. |

Instruction fetches ignore this bit.

When the reset value of the [SCTLR.EE](#) bit is defined by a configuration input signal, that value also applies to the [CPSR.E](#) bit on reset, and therefore applies to software execution from reset.

If an implementation does not provide Big-endian support, this bit is RES0. If it does not provide Little-endian support, this bit is RES1.

If an implementation provides Big-endian support but only at EL0, this bit is RES0 for an exception return to any Exception level other than EL0.

Likewise, if it provides Little-endian support only at EL0, this bit is RES1 for an exception return to any Exception level other than EL0.

A, bit [8]

SError interrupt mask bit. The possible values of this bit are:

- | | |
|---|-----------------------|
| 0 | Exception not masked. |
| 1 | Exception masked. |

I, bit [7]

IRQ mask bit. The possible values of this bit are:

- 0 Exception not masked.
- 1 Exception masked.

F, bit [6]

FIQ mask bit. The possible values of this bit are:

- 0 Exception not masked.
- 1 Exception masked.

T, bit [5]

T32 Instruction set state bit. Determines the AArch32 instruction set state that the exception was taken from. Possible values of this bit are:

- 0 Taken from A32 state.
- 1 Taken from T32 state.

M[4], bit [4]

Execution state that the exception was taken from. Possible values of this bit are:

- 1 Exception taken from AArch32.

M[3:0], bits [3:0]

AArch32 mode that an exception was taken from. The possible values are:

M[3:0]	Mode
0b0000	User
0b0001	FIQ
0b0010	IRQ
0b0011	Supervisor
0b0110	Monitor
0b0111	Abort
0b1010	Hyp
0b1011	Undefined
0b1111	System

Other values are reserved. The effect of programming this field to a Reserved value is that behavior is CONstrained UNPREDICTABLE, as described in [Reserved values in System and memory-mapped registers and translation table entries](#) on page K1-6133.

Accessing the SPSR_und

This register can be read using MRS with the following syntax:

MRS <Xt>, <systemreg>

This register can be written using MSR (register) with the following syntax:

MSR <systemreg>, <Xt>

This syntax is encoded with the following settings in the instruction encoding:

<systemreg>	op0	op1	CRn	CRm	op2
SPSR_und	11	100	0100	0011	010

Accessibility

The register is accessible in software as follows:

Control			Accessibility			
E2H	TGE	NS	EL0	EL1	EL2	EL3
x	x	0	-	-	n/a	RW
x	0	1	-	-	RW	RW
x	1	1	-	n/a	RW	RW

C5.2.24 UAO, User Access Override

The UAO characteristics are:

Purpose

When [ARMv8.2-UAO](#) is implemented, allows access to the User Access Override bit.
When [ARMv8.2-UAO](#) is not implemented, this register is not implemented.

Configurations

This register is introduced in ARMv8.2.

Attributes

UAO is a 32-bit register.

Field descriptions

The UAO bit assignments are:

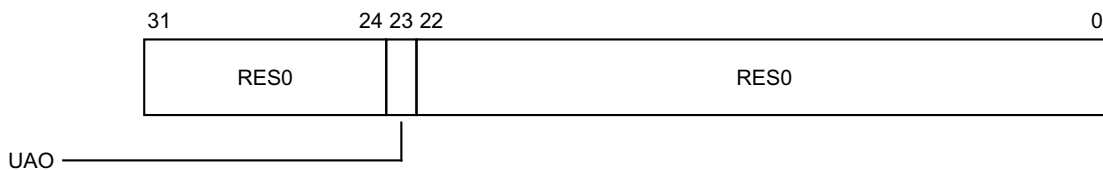

Bits [31:24]

Reserved, RES0.

UAO, bit [23]

User Access Override. Defined values are:

- 0 The behavior of LDTR* and STTR* instructions is as defined in the base ARMv8 architecture.
- 1 When executed at EL1, or at EL2 with [HCR_EL2](#).{E2H, TGE} == {1, 1}, LDTR* and STTR* instructions behave as the equivalent LDR* and STR* instructions.

When executed at EL3, or at EL2 with [HCR_EL2](#).E2H == 0 or [HCR_EL2](#).TGE == 0, the LDTR* and STTR* instructions behave as the equivalent LDR* and STR* instructions, regardless of the setting of the PSTATE.UAO bit.

Bits [22:0]

Reserved, RES0.

Accessing the UAO

This register can be read using MRS with the following syntax:

MRS <Xt>, <systemreg>

This register can be written using MSR (register) with the following syntax:

MSR <systemreg>, <Xt>

This syntax is encoded with the following settings in the instruction encoding:

<systemreg>	op0	op1	CRn	CRm	op2
UAO	11	000	0100	0010	100

This register can be modified using MSR (immediate) with the following syntax:

MSR <pstatefield>, <imm>

This syntax is encoded with the following settings in the instruction encoding:

<pstatefield>	op0	op1	CRn	op2
UAO	00	000	0100	011

Accessibility

The register is accessible in software as follows:

Control			Accessibility			
E2H	TGE	NS	EL0	EL1	EL2	EL3
x	x	0	-	RW	n/a	RW
x	0	1	-	RW	RW	RW
x	1	1	-	n/a	RW	RW

C5.3 A64 system instructions for cache maintenance

The following sections define the cache maintenance system instructions in A64:

- *DC CISW, Data or unified Cache line Clean and Invalidate by Set/Way* on page C5-406.
- *DC CIVAC, Data or unified Cache line Clean and Invalidate by VA to PoC* on page C5-408.
- *DC CSW, Data or unified Cache line Clean by Set/Way* on page C5-410.
- *DC CVAC, Data or unified Cache line Clean by VA to PoC* on page C5-412.
- *DC CVAU, Data or unified Cache line Clean by VA to PoU* on page C5-415.
- *DC ISW, Data or unified Cache line Invalidate by Set/Way* on page C5-417.
- *DC IVAC, Data or unified Cache line Invalidate by VA to PoC* on page C5-419.
- *DC ZVA, Data Cache Zero by VA* on page C5-421.
- *IC IALLU, Instruction Cache Invalidate All to PoU* on page C5-423.
- *IC IALLUIS, Instruction Cache Invalidate All to PoU, Inner Shareable* on page C5-424.
- *IC IVAU, Instruction Cache line Invalidate by VA to PoU* on page C5-425.

C5.3.1 DC CISW, Data or unified Cache line Clean and Invalidate by Set/Way

The DC CISW characteristics are:

Purpose

Clean and Invalidate data cache by set/way.

Configurations

AArch64 System instruction DC CISW performs the same function as AArch32 System instruction [DCCISW](#).

Attributes

DC CISW is a 64-bit System instruction.

Field descriptions

The DC CISW input value bit assignments are:

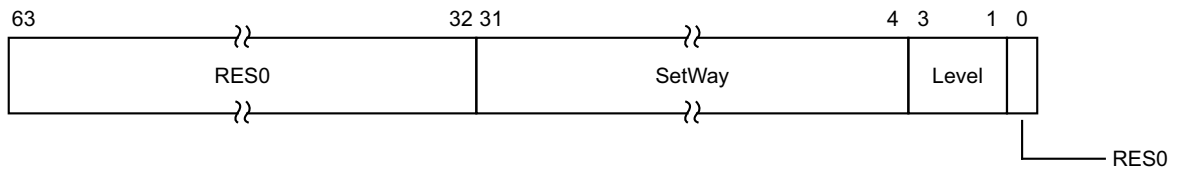

Bits [63:32]

Reserved, RES0.

SetWay, bits [31:4]

Contains two fields:

- Way, bits[31:32-A], the number of the way to operate on.
- Set, bits[B-1:L], the number of the set to operate on.

Bits[L-1:4] are RES0.

$A = \text{Log}_2(\text{ASSOCIATIVITY})$, $L = \text{Log}_2(\text{LINELEN})$, $B = (L + S)$, $S = \text{Log}_2(\text{NSETS})$.

ASSOCIATIVITY, LINELEN (line length, in bytes), and NSETS (number of sets) have their usual meanings and are the values for the cache level being operated on. The values of A and S are rounded up to the next integer.

Level, bits [3:1]

Cache level to operate on, minus 1. For example, this field is 0 for operations on L1 cache, or 1 for operations on L2 cache.

Bit [0]

Reserved, RES0.

Executing the DC CISW instruction

This instruction is executed using DC with the following syntax:

DC <dc_op>, <Xt>

This syntax uses the following encoding in the System instruction encoding space:

<dc_op>	op0	op1	CRn	CRm	op2
CISW	01	000	0111	1110	010

Accessibility

The instruction is executable as follows:

Control			Accessibility			
E2H	TGE	NS	EL0	EL1	EL2	EL3
x	x	0	-	WO	n/a	WO
x	0	1	-	WO	WO	WO
x	1	1	-	n/a	WO	WO

If this instruction is executed with a set, way or level argument that is larger than the value supported by the implementation then the behavior is CONstrained UNPREDICTABLE and one of the following occurs:

- The instruction is UNDEFINED
- The instruction performs cache maintenance on one of:
 - No cache lines.
 - A single arbitrary cache line.
 - Multiple arbitrary cache lines.

Traps and Enables

For a description of the prioritization of any generated exceptions, see [Synchronous exception prioritization for exceptions taken to AArch64 on page D1-1827](#). Subject to the prioritization rules:

- When EL2 is implemented and is using AArch64 and (SCR_EL3.NS == 1) && (HCR_EL2.E2H == 0):
 - If HCR_EL2.TSW==1, Non-secure execution of this instruction at EL1 is trapped to EL2.
- When EL2 is implemented and is using AArch64 and (SCR_EL3.NS == 1) && (HCR_EL2.E2H == 1) && (HCR_EL2.TGE == 0):
 - If HCR_EL2.TSW==1, Non-secure execution of this instruction at EL1 is trapped to EL2.

C5.3.2 DC CIVAC, Data or unified Cache line Clean and Invalidate by VA to PoC

The DC CIVAC characteristics are:

Purpose

Clean and Invalidate data cache by address to Point of Coherency.

Configurations

AArch64 System instruction DC CIVAC performs the same function as AArch32 System instruction [DCCIMVAC](#).

Attributes

DC CIVAC is a 64-bit System instruction.

Field descriptions

The DC CIVAC input value bit assignments are:

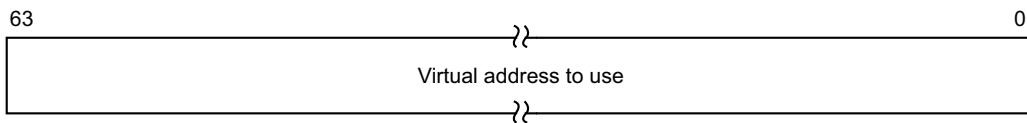

Bits [63:0]

Virtual address to use.

Executing the DC CIVAC instruction

This instruction is executed using DC with the following syntax:

DC <dc_op>, <Xt>

This syntax uses the following encoding in the System instruction encoding space:

<dc_op>	op0	op1	CRn	CRm	op2
CIVAC	01	011	0111	1110	001

Accessibility

The instruction is executable as follows:

Control			Accessibility			
E2H	TGE	NS	EL0	EL1	EL2	EL3
x	x	0	WO	WO	n/a	WO
x	0	1	WO	WO	WO	WO
x	1	1	WO	n/a	WO	WO

If EL0 access is enabled, when executing at EL0, this instruction requires read access permission to the VA, otherwise it causes a Permission Fault.

Traps and Enables

For a description of the prioritization of any generated exceptions, see *Synchronous exception prioritization for exceptions taken to AArch64* on page D1-1827. Subject to the prioritization rules:

- In both security states, and not dependent on other bits:
 - If `SCTLR_EL1.UCI==0`, execution of this instruction at EL0 is trapped to EL1.
- When EL2 is implemented and is using AArch64 and `(SCR_EL3.NS == 1) && (HCR_EL2.E2H == 0)`:
 - If `HCR_EL2.TPC==1`, Non-secure execution of this instruction at EL1 is trapped to EL2.
 - If `HCR_EL2.TPC==1`, and `SCTLR_EL1.UCI==1`, Non-secure execution of this instruction at EL0 is trapped to EL2.
- When EL2 is implemented and is using AArch64 and `(SCR_EL3.NS == 1) && (HCR_EL2.E2H == 1) && (HCR_EL2.TGE == 0)`:
 - If `HCR_EL2.TPC==1`, Non-secure execution of this instruction at EL0 is trapped to EL2.

C5.3.3 DC CSW, Data or unified Cache line Clean by Set/Way

The DC CSW characteristics are:

Purpose

Clean data cache by set/way.

Configurations

AArch64 System instruction DC CSW performs the same function as AArch32 System instruction [DCCSW](#).

Attributes

DC CSW is a 64-bit System instruction.

Field descriptions

The DC CSW input value bit assignments are:

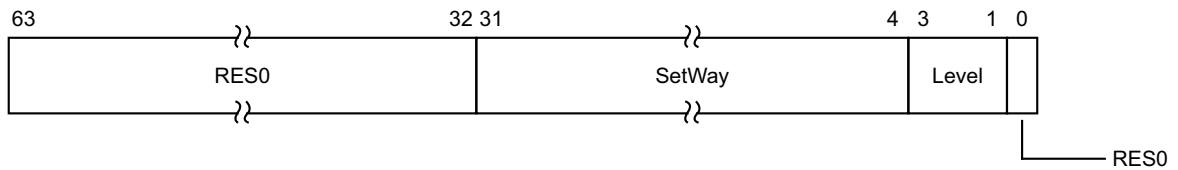

Bits [63:32]

Reserved, RES0.

SetWay, bits [31:4]

Contains two fields:

- Way, bits[31:32-A], the number of the way to operate on.
- Set, bits[B-1:L], the number of the set to operate on.

Bits[L-1:4] are RES0.

$A = \text{Log}_2(\text{ASSOCIATIVITY})$, $L = \text{Log}_2(\text{LINELEN})$, $B = (L + S)$, $S = \text{Log}_2(\text{NSETS})$.

ASSOCIATIVITY, LINELEN (line length, in bytes), and NSETS (number of sets) have their usual meanings and are the values for the cache level being operated on. The values of A and S are rounded up to the next integer.

Level, bits [3:1]

Cache level to operate on, minus 1. For example, this field is 0 for operations on L1 cache, or 1 for operations on L2 cache.

Bit [0]

Reserved, RES0.

Executing the DC CSW instruction

This instruction is executed using DC with the following syntax:

DC <dc_op>, <Xt>

This syntax uses the following encoding in the System instruction encoding space:

<dc_op>	op0	op1	CRn	CRm	op2
CSW	01	000	0111	1010	010

Accessibility

The instruction is executable as follows:

Control			Accessibility			
E2H	TGE	NS	EL0	EL1	EL2	EL3
x	x	0	-	WO	n/a	WO
x	0	1	-	WO	WO	WO
x	1	1	-	n/a	WO	WO

If this instruction is executed with a set, way or level argument that is larger than the value supported by the implementation then the behavior is CONstrained UNPREDICTABLE and one of the following occurs:

- The instruction is UNDEFINED
- The instruction performs cache maintenance on one of:
 - No cache lines.
 - A single arbitrary cache line.
 - Multiple arbitrary cache lines.

Traps and Enables

For a description of the prioritization of any generated exceptions, see [Synchronous exception prioritization for exceptions taken to AArch64 on page D1-1827](#). Subject to the prioritization rules:

- When EL2 is implemented and is using AArch64 and (SCR_EL3.NS == 1) && (HCR_EL2.E2H == 0):
 - If HCR_EL2.TSW==1, Non-secure execution of this instruction at EL1 is trapped to EL2.
- When EL2 is implemented and is using AArch64 and (SCR_EL3.NS == 1) && (HCR_EL2.E2H == 1) && (HCR_EL2.TGE == 0):
 - If HCR_EL2.TSW==1, Non-secure execution of this instruction at EL1 is trapped to EL2.

C5.3.4 DC CVAC, Data or unified Cache line Clean by VA to PoC

The DC CVAC characteristics are:

Purpose

Clean data cache by address to Point of Coherency.

Configurations

AArch64 System instruction DC CVAC performs the same function as AArch32 System instruction [DCCMVAC](#).

Attributes

DC CVAC is a 64-bit System instruction.

Field descriptions

The DC CVAC input value bit assignments are:

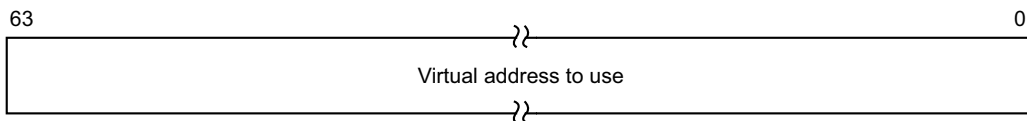

Bits [63:0]

Virtual address to use.

Executing the DC CVAC instruction

This instruction is executed using DC with the following syntax:

DC <dc_op>, <Xt>

This syntax uses the following encoding in the System instruction encoding space:

<dc_op>	op0	op1	CRn	CRm	op2
CVAC	01	011	0111	1010	001

Accessibility

The instruction is executable as follows:

Control			Accessibility			
E2H	TGE	NS	EL0	EL1	EL2	EL3
x	x	0	WO	WO	n/a	WO
x	0	1	WO	WO	WO	WO
x	1	1	WO	n/a	WO	WO

If EL0 access is enabled, when executing at EL0, this instruction requires read access permission to the VA, otherwise it causes a Permission Fault.

Traps and Enables

For a description of the prioritization of any generated exceptions, see *Synchronous exception prioritization for exceptions taken to AArch64* on page D1-1827. Subject to the prioritization rules:

- In both security states, and not dependent on other bits:
 - If `SCTLR_EL1.UCI==0`, execution of this instruction at EL0 is trapped to EL1.
- When EL2 is implemented and is using AArch64 and `(SCR_EL3.NS == 1) && (HCR_EL2.E2H == 0)`:
 - If `HCR_EL2.TPC==1`, Non-secure execution of this instruction at EL1 is trapped to EL2.
 - If `HCR_EL2.TPC==1`, and `SCTLR_EL1.UCI==1`, Non-secure execution of this instruction at EL0 is trapped to EL2.
- When EL2 is implemented and is using AArch64 and `(SCR_EL3.NS == 1) && (HCR_EL2.E2H == 1) && (HCR_EL2.TGE == 0)`:
 - If `HCR_EL2.TPC==1`, Non-secure execution of this instruction at EL0 is trapped to EL2.

C5.3.5 DC CVAP, Data or unified Cache line Clean by VA to PoP

The DC CVAP characteristics are:

Purpose

Clean data cache by address to Point of Persistence.

If the memory system does not identify a Point of Persistence, then this instruction behaves as a [DC CVAC](#).

Configurations

This instruction is introduced in ARMv8.2.

Attributes

DC CVAP is a 64-bit System instruction.

Field descriptions

The DC CVAP input value bit assignments are:

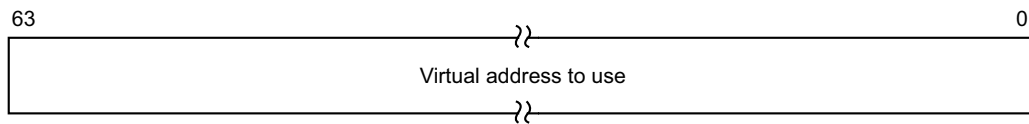

Bits [63:0]

Virtual address to use.

Executing the DC CVAP instruction

This instruction is executed using DC with the following syntax:

DC <dc_op>, <Xt>

This syntax uses the following encoding in the System instruction encoding space:

<dc_op>	op0	op1	CRn	CRm	op2
CVAP	01	011	0111	1100	001

Accessibility

The instruction is executable as follows:

Control			Accessibility			
E2H	TGE	NS	EL0	EL1	EL2	EL3
x	x	0	WO	WO	n/a	WO
x	0	1	WO	WO	WO	WO
x	1	1	WO	n/a	WO	WO

If EL0 access is enabled, when executing at EL0, this instruction requires read access permission to the VA, otherwise it causes a Permission Fault.

C5.3.6 DC CVAU, Data or unified Cache line Clean by VA to PoU

The DC CVAU characteristics are:

Purpose

Clean data cache by address to Point of Unification.

Configurations

AArch64 System instruction DC CVAU performs the same function as AArch32 System instruction [DCCMVAU](#).

Attributes

DC CVAU is a 64-bit System instruction.

Field descriptions

The DC CVAU input value bit assignments are:

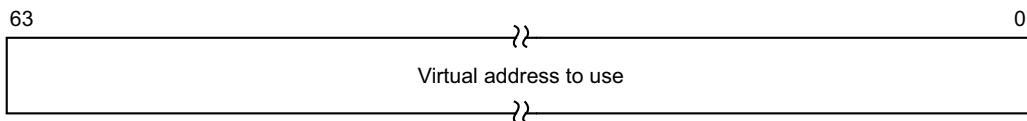

Bits [63:0]

Virtual address to use.

Executing the DC CVAU instruction

This instruction is executed using DC with the following syntax:

DC <dc_op>, <Xt>

This syntax uses the following encoding in the System instruction encoding space:

<dc_op>	op0	op1	CRn	CRm	op2
CVAU	01	011	0111	1011	001

Accessibility

The instruction is executable as follows:

Control			Accessibility			
E2H	TGE	NS	EL0	EL1	EL2	EL3
x	x	0	WO	WO	n/a	WO
x	0	1	WO	WO	WO	WO
x	1	1	WO	n/a	WO	WO

If EL0 access is enabled, when executing at EL0, this instruction requires read access permission to the VA, otherwise it causes a Permission Fault.

Traps and Enables

For a description of the prioritization of any generated exceptions, see *Synchronous exception prioritization for exceptions taken to AArch64* on page D1-1827. Subject to the prioritization rules:

- In both security states, and not dependent on other bits:
 - If `SCTLR_EL1.UCI==0`, execution of this instruction at EL0 is trapped to EL1.
- When EL2 is implemented and is using AArch64 and `(SCR_EL3.NS == 1) && (HCR_EL2.E2H == 0)`:
 - If `HCR_EL2.TPU==1`, Non-secure execution of this instruction at EL0 and EL1 is trapped to EL2.
- When EL2 is implemented and is using AArch64 and `(SCR_EL3.NS == 1) && (HCR_EL2.E2H == 1) && (HCR_EL2.TGE == 0)`:
 - If `HCR_EL2.TPU==1`, Non-secure execution of this instruction at EL0 and EL1 is trapped to EL2.

C5.3.7 DC ISW, Data or unified Cache line Invalidate by Set/Way

The DC ISW characteristics are:

Purpose

Invalidate data cache by set/way.

Configurations

AArch64 System instruction DC ISW performs the same function as AArch32 System instruction [DCISW](#).

Attributes

DC ISW is a 64-bit System instruction.

Field descriptions

The DC ISW input value bit assignments are:

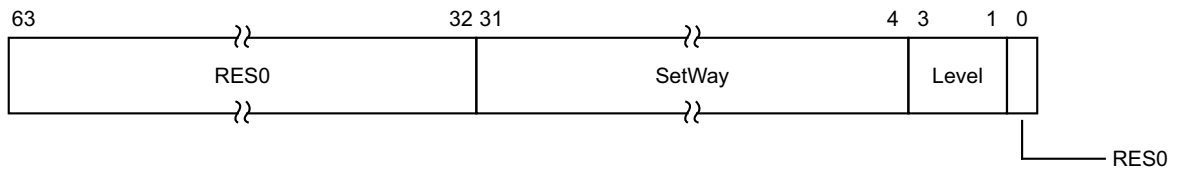

Bits [63:32]

Reserved, RES0.

SetWay, bits [31:4]

Contains two fields:

- Way, bits[31:32-A], the number of the way to operate on.
- Set, bits[B-1:L], the number of the set to operate on.

Bits[L-1:4] are RES0.

$A = \text{Log}_2(\text{ASSOCIATIVITY})$, $L = \text{Log}_2(\text{LINELEN})$, $B = (L + S)$, $S = \text{Log}_2(\text{NSETS})$.

ASSOCIATIVITY, LINELEN (line length, in bytes), and NSETS (number of sets) have their usual meanings and are the values for the cache level being operated on. The values of A and S are rounded up to the next integer.

Level, bits [3:1]

Cache level to operate on, minus 1. For example, this field is 0 for operations on L1 cache, or 1 for operations on L2 cache.

Bit [0]

Reserved, RES0.

Executing the DC ISW instruction

This instruction is executed using DC with the following syntax:

DC <dc_op>, <Xt>

This syntax uses the following encoding in the System instruction encoding space:

<dc_op>	op0	op1	CRn	CRm	op2
ISW	01	000	0111	0110	010

Accessibility

The instruction is executable as follows:

Control			Accessibility			
E2H	TGE	NS	EL0	EL1	EL2	EL3
x	x	0	-	WO	n/a	WO
x	0	1	-	WO	WO	WO
x	1	1	-	n/a	WO	WO

At EL1, this instruction performs a cache clean and invalidate, meaning it performs the same invalidation as a [DC CISCW](#) instruction, if all of the following apply:

- EL2 is implemented.
- The value of [HCR_EL2.SWIO](#) is 1 or the value of [HCR_EL2.VM](#) is 1.
- The value of [SCR_EL3.NS](#) is 1 or EL3 is not implemented.

If this instruction is executed with a set, way or level argument that is larger than the value supported by the implementation then the behavior is CONstrained UNPREDICTABLE and one of the following occurs:

- The instruction is UNDEFINED
- The instruction performs cache maintenance on one of:
 - No cache lines.
 - A single arbitrary cache line.
 - Multiple arbitrary cache lines.

Traps and Enables

For a description of the prioritization of any generated exceptions, see [Synchronous exception prioritization for exceptions taken to AArch64 on page D1-1827](#). Subject to the prioritization rules:

- When EL2 is implemented and is using AArch64 and ([SCR_EL3.NS](#) == 1) && ([HCR_EL2.E2H](#) == 0):
 - If [HCR_EL2.TSW](#)==1, Non-secure execution of this instruction at EL1 is trapped to EL2.
- When EL2 is implemented and is using AArch64 and ([SCR_EL3.NS](#) == 1) && ([HCR_EL2.E2H](#) == 1) && ([HCR_EL2.TGE](#) == 0):
 - If [HCR_EL2.TSW](#)==1, Non-secure execution of this instruction at EL1 is trapped to EL2.

C5.3.8 DC IVAC, Data or unified Cache line Invalidate by VA to PoC

The DC IVAC characteristics are:

Purpose

Invalidate data cache by address to Point of Coherency.

Configurations

AArch64 System instruction DC IVAC performs the same function as AArch32 System instruction [DCIMVAC](#).

Attributes

DC IVAC is a 64-bit System instruction.

Field descriptions

The DC IVAC input value bit assignments are:

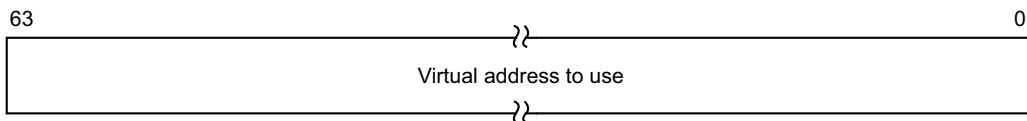

Bits [63:0]

Virtual address to use.

Executing the DC IVAC instruction

This instruction is executed using DC with the following syntax:

DC <dc_op>, <Xt>

This syntax uses the following encoding in the System instruction encoding space:

<dc_op>	op0	op1	CRn	CRm	op2
IVAC	01	000	0111	0110	001

When the instruction is executed, it can generate a watchpoint, which is prioritized in the same way as other watchpoints. If a watchpoint is generated, the CM bit in the [ESR_ELx.ISS](#) field is set to 1.

Accessibility

The instruction is executable as follows:

Control			Accessibility			
E2H	TGE	NS	EL0	EL1	EL2	EL3
x	x	0	-	WO	n/a	WO
x	0	1	-	WO	WO	WO
x	1	1	-	n/a	WO	WO

This instruction requires write access permission to the VA, otherwise it causes a Permission Fault.

At EL1, this instruction performs a cache clean and invalidate, meaning it performs the same invalidation as a [DC CIVAC](#) instruction, if all of the following apply:

- EL2 is implemented.
- [HCR_EL2.VM](#) is set to 1.
- [SCR_EL3.NS](#) is set to 1 or EL3 is not implemented.

Traps and Enables

For a description of the prioritization of any generated exceptions, see [Synchronous exception prioritization for exceptions taken to AArch64](#) on page D1-1827. Subject to the prioritization rules:

- When EL2 is implemented and is using AArch64 and $(SCR_EL3.NS == 1) \ \&\& \ (HCR_EL2.E2H == 0)$:
 - If [HCR_EL2.TPC](#)==1, Non-secure execution of this instruction at EL1 is trapped to EL2.

C5.3.9 DC ZVA, Data Cache Zero by VA

The DC ZVA characteristics are:

Purpose

Zero data cache by address. Zeroes a naturally aligned block of N bytes, where the size of N is identified in [DCZID_ELO](#).

Configurations

There are no configuration notes.

Attributes

DC ZVA is a 64-bit System instruction.

Field descriptions

The DC ZVA input value bit assignments are:

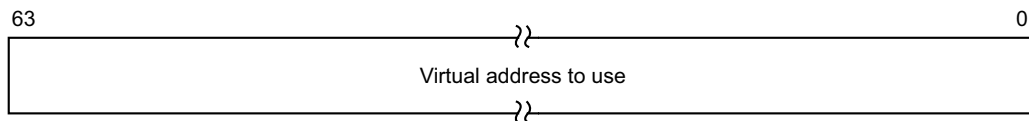

Bits [63:0]

Virtual address to use. There is no alignment restriction on the address within the block of N bytes that is used.

Executing the DC ZVA instruction

This instruction is executed using DC with the following syntax:

DC <dc_op>, <Xt>

This syntax uses the following encoding in the System instruction encoding space:

<dc_op>	op0	op1	CRn	CRm	op2
ZVA	01	011	0111	0100	001

When this instruction is executed, it can generate memory faults or watchpoints which are prioritized in the same way as other memory-related faults or watchpoints. If a synchronous data abort fault or a watchpoint is generated, the CM bit in the [ESR_ELx.ISS](#) field is not set.

If the memory region being zeroed is any type of Device memory, this instruction can give an alignment fault which is prioritized in the same way as other alignment faults that are determined by the memory type.

This instruction applies to Normal memory regardless of cacheability attributes.

This instruction behaves as a set of Stores to each byte within the block being accessed, and so it:

- Generates a Permission Fault if the translation system does not permit writes to the locations.
- Requires the same considerations for ordering and the management of coherency as any other store instructions.

Accessibility

The instruction is executable as follows:

Control			Accessibility			
E2H	TGE	NS	EL0	EL1	EL2	EL3
x	x	0	WO	WO	n/a	WO
x	0	1	WO	WO	WO	WO
x	1	1	WO	n/a	WO	WO

When EL0 access is disabled ([SCTLR_EL1.DZE](#) is set to 0) and [HCR_EL2.TDZ](#) is set to 1, execution of this instruction at EL0 is UNDEFINED.

Traps and Enables

For a description of the prioritization of any generated exceptions, see [Synchronous exception prioritization for exceptions taken to AArch64 on page D1-1827](#). Subject to the prioritization rules:

- In both security states, and not dependent on other bits:
 - If [SCTLR_EL1.DZE](#)==0, execution of this instruction at EL0 is trapped to EL1.
- When EL2 is implemented and is using AArch64 and ([SCR_EL3.NS](#) == 1) && ([HCR_EL2.E2H](#) == 0):
 - If [HCR_EL2.TDZ](#)==1, Non-secure execution of this instruction at EL0 and EL1 is trapped to EL2.
- When EL2 is implemented and is using AArch64 and ([SCR_EL3.NS](#) == 1) && ([HCR_EL2.E2H](#) == 1) && ([HCR_EL2.TGE](#) == 0):
 - If [HCR_EL2.TDZ](#)==1, Non-secure execution of this instruction at EL0 and EL1 is trapped to EL2.

C5.3.10 IC IALLU, Instruction Cache Invalidate All to PoU

The IC IALLU characteristics are:

Purpose

Invalidate all instruction caches to Point of Unification.

Configurations

AArch64 System instruction IC IALLU performs the same function as AArch32 System instruction [ICIALLU](#).

Attributes

IC IALLU is a 64-bit System instruction.

Field descriptions

IC IALLU ignores the value in the register specified by the instruction. Software does not have to write a value to the register before issuing this instruction.

Executing the IC IALLU instruction

This instruction is executed using IC with the following syntax:

IC <ic_op>

This syntax uses the following encoding in the System instruction encoding space:

<ic_op>	op0	op1	CRn	CRm	op2	Rt
IALLU	01	000	0111	0101	000	11111

Accessibility

The instruction is executable as follows:

Control			Accessibility			
E2H	TGE	NS	EL0	EL1	EL2	EL3
x	x	0	-	WO	n/a	WO
x	0	1	-	WO	WO	WO
x	1	1	-	n/a	WO	WO

When [HCR_EL2.FB](#) is 1, at Non-secure EL1 this instruction executes as a [IC IALLUIS](#).

Traps and Enables

For a description of the prioritization of any generated exceptions, see [Synchronous exception prioritization for exceptions taken to AArch64 on page D1-1827](#). Subject to the prioritization rules:

- When EL2 is implemented and is using AArch64 and (SCR_EL3.NS == 1) && (HCR_EL2.E2H == 0):
 - If [HCR_EL2.TPU](#)==1, Non-secure execution of this instruction at EL1 is trapped to EL2.
- When EL2 is implemented and is using AArch64 and (SCR_EL3.NS == 1) && (HCR_EL2.E2H == 1) && (HCR_EL2.TGE == 0):
 - If [HCR_EL2.TPU](#)==1, Non-secure execution of this instruction at EL1 is trapped to EL2.

C5.3.11 IC IALLUIS, Instruction Cache Invalidate All to PoU, Inner Shareable

The IC IALLUIS characteristics are:

Purpose

Invalidate all instruction caches in Inner Shareable domain to Point of Unification.

Configurations

AArch64 System instruction IC IALLUIS performs the same function as AArch32 System instruction [ICIALLUIS](#).

Attributes

IC IALLUIS is a 64-bit System instruction.

Field descriptions

IC IALLUIS ignores the value in the register specified by the instruction. Software does not have to write a value to the register before issuing this instruction.

Executing the IC IALLUIS instruction

This instruction is executed using IC with the following syntax:

IC <ic_op>

This syntax uses the following encoding in the System instruction encoding space:

<ic_op>	op0	op1	CRn	CRm	op2	Rt
IALLUIS	01	000	0111	0001	000	11111

Accessibility

The instruction is executable as follows:

Control			Accessibility			
E2H	TGE	NS	EL0	EL1	EL2	EL3
x	x	0	-	WO	n/a	WO
x	0	1	-	WO	WO	WO
x	1	1	-	n/a	WO	WO

Traps and Enables

For a description of the prioritization of any generated exceptions, see [Synchronous exception prioritization for exceptions taken to AArch64 on page D1-1827](#). Subject to the prioritization rules:

- When EL2 is implemented and is using AArch64 and (SCR_EL3.NS == 1) && (HCR_EL2.E2H == 0):
 - If HCR_EL2.TPU==1, Non-secure execution of this instruction at EL1 is trapped to EL2.
- When EL2 is implemented and is using AArch64 and (SCR_EL3.NS == 1) && (HCR_EL2.E2H == 1) && (HCR_EL2.TGE == 0):
 - If HCR_EL2.TPU==1, Non-secure execution of this instruction at EL1 is trapped to EL2.

C5.3.12 IC IVAU, Instruction Cache line Invalidate by VA to PoU

The IC IVAU characteristics are:

Purpose

Invalidate instruction cache by address to Point of Unification.

Configurations

AArch64 System instruction IC IVAU performs the same function as AArch32 System instruction [ICIMVAU](#).

Attributes

IC IVAU is a 64-bit System instruction.

Field descriptions

The IC IVAU input value bit assignments are:

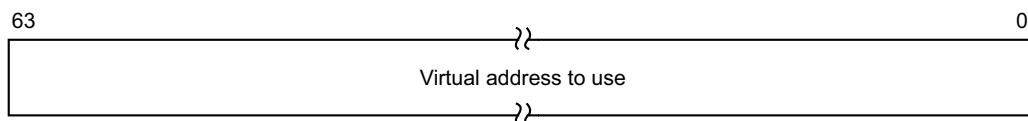

Bits [63:0]

Virtual address to use.

Executing the IC IVAU instruction

This instruction is executed using IC with the following syntax:

IC <ic_op>, <Xt>

This syntax uses the following encoding in the System instruction encoding space:

<ic_op>	op0	op1	CRn	CRm	op2
IVAU	01	011	0111	0101	001

Accessibility

The instruction is executable as follows:

Control			Accessibility			
E2H	TGE	NS	EL0	EL1	EL2	EL3
x	x	0	WO	WO	n/a	WO
x	0	1	WO	WO	WO	WO
x	1	1	WO	n/a	WO	WO

If EL0 access is enabled, when executing at EL0, this instruction requires read access permission to the VA, otherwise it is IMPLEMENTATION DEFINED whether it causes a Permission Fault.

Traps and Enables

For a description of the prioritization of any generated exceptions, see *Synchronous exception prioritization for exceptions taken to AArch64* on page D1-1827. Subject to the prioritization rules:

- In both security states, and not dependent on other bits:
 - If `SCTLR_EL1.UCI==0`, execution of this instruction at EL0 is trapped to EL1.
- When EL2 is implemented and is using AArch64 and `(SCR_EL3.NS == 1) && (HCR_EL2.E2H == 0)`:
 - If `HCR_EL2.TPU==1`, Non-secure execution of this instruction at EL0 and EL1 is trapped to EL2.
- When EL2 is implemented and is using AArch64 and `(SCR_EL3.NS == 1) && (HCR_EL2.E2H == 1) && (HCR_EL2.TGE == 0)`:
 - If `HCR_EL2.TPU==1`, Non-secure execution of this instruction at EL0 and EL1 is trapped to EL2.

C5.4 A64 system instructions for address translation

The following sections define the address translation system instructions in A64:

- *AT S12E0R, Address Translate Stages 1 and 2 EL0 Read* on page C5-428.
- *AT S12E0W, Address Translate Stages 1 and 2 EL0 Write* on page C5-430.
- *AT S12E1R, Address Translate Stages 1 and 2 EL1 Read* on page C5-432.
- *AT S12E1W, Address Translate Stages 1 and 2 EL1 Write* on page C5-434.
- *AT S1E0R, Address Translate Stage 1 EL0 Read* on page C5-436.
- *AT S1E0W, Address Translate Stage 1 EL0 Write* on page C5-438.
- *AT S1E1R, Address Translate Stage 1 EL1 Read* on page C5-440.
- *AT S1E1W, Address Translate Stage 1 EL1 Write* on page C5-444.
- *AT S1E2R, Address Translate Stage 1 EL2 Read* on page C5-448.
- *AT S1E2W, Address Translate Stage 1 EL2 Write* on page C5-450.
- *AT S1E3R, Address Translate Stage 1 EL3 Read* on page C5-452.
- *AT S1E3W, Address Translate Stage 1 EL3 Write* on page C5-453.

C5.4.1 AT S12E0R, Address Translate Stages 1 and 2 EL0 Read

The AT S12E0R characteristics are:

Purpose

Performs stage 1 and 2 address translations, with permissions as if reading from the given virtual address, using the following translation regime:

- In Secure state, and in Non-secure state when [HCR_EL2](#).{E2H, TGE} is not {1, 1}, the EL1&0 translation regime.
- In Non-secure state when [HCR_EL2](#).{E2H, TGE} is {1, 1}, the EL2&0 translation regime.

Configurations

There are no configuration notes.

Attributes

AT S12E0R is a 64-bit System instruction.

Field descriptions

The AT S12E0R input value bit assignments are:

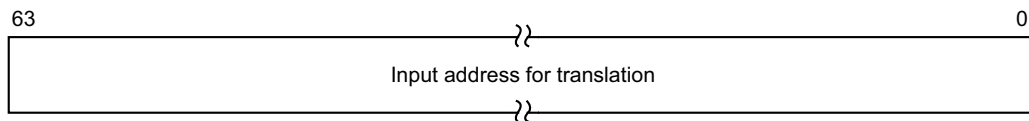

Bits [63:0]

Input address for translation. The resulting address can be read from the [PAR_EL1](#).

If the address translation instructions are targeting a translation regime that is using AArch32, and so has a VA of only 32 bits, then VA[63:32] is RES0.

Executing the AT S12E0R instruction

This instruction is executed using AT with the following syntax:

AT <at_op>, <Xt>

This syntax uses the following encoding in the System instruction encoding space:

<at_op>	op0	op1	CRn	CRm	op2
S12E0R	01	100	0111	1000	110

Accessibility

The instruction is executable as follows:

Control			Accessibility			
E2H	TGE	NS	EL0	EL1	EL2	EL3
x	x	0	-	-	n/a	WO
0	0	1	-	-	WO	WO

Control			Accessibility			
E2H	TGE	NS	EL0	EL1	EL2	EL3
0	1	1	-	n/a	WO	WO
1	0	1	-	-	WO	WO
1	1	1	-	n/a	WO	WO

If EL2 is not implemented, or stage 2 translation is disabled, or the instruction is executed at EL3 when the value of `SCR_EL3.NS` is 0, this instruction executes as [AT S1E0R](#).

C5.4.2 AT S12E0W, Address Translate Stages 1 and 2 EL0 Write

The AT S12E0W characteristics are:

Purpose

Performs stage 1 and 2 address translations, with permissions as if writing to the given virtual address, using the following translation regime:

- In Secure state, and in Non-secure state when [HCR_EL2](#).{E2H, TGE} is not {1, 1}, the EL1&0 translation regime.
- In Non-secure state when [HCR_EL2](#).{E2H, TGE} is {1, 1}, the EL2&0 translation regime.

Configurations

There are no configuration notes.

Attributes

AT S12E0W is a 64-bit System instruction.

Field descriptions

The AT S12E0W input value bit assignments are:

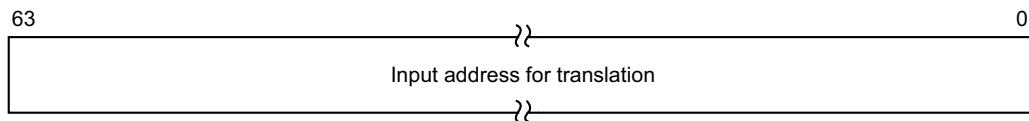

Bits [63:0]

Input address for translation. The resulting address can be read from the [PAR_EL1](#).

If the address translation instructions are targeting a translation regime that is using AArch32, and so has a VA of only 32 bits, then VA[63:32] is RES0.

Executing the AT S12E0W instruction

This instruction is executed using AT with the following syntax:

AT <at_op>, <Xt>

This syntax uses the following encoding in the System instruction encoding space:

<at_op>	op0	op1	CRn	CRm	op2
S12E0W	01	100	0111	1000	111

Accessibility

The instruction is executable as follows:

Control			Accessibility			
E2H	TGE	NS	EL0	EL1	EL2	EL3
x	x	0	-	-	n/a	WO
0	0	1	-	-	WO	WO

Control			Accessibility			
E2H	TGE	NS	EL0	EL1	EL2	EL3
0	1	1	-	n/a	WO	WO
1	0	1	-	-	WO	WO
1	1	1	-	n/a	WO	WO

If EL2 is not implemented, or stage 2 translation is disabled, or the instruction is executed at EL3 when the value of `SCR_EL3.NS` is 0, this instruction executes as [AT S1E0W](#).

C5.4.3 AT S12E1R, Address Translate Stages 1 and 2 EL1 Read

The AT S12E1R characteristics are:

Purpose

Performs stage 1 and 2 address translation, with permissions as if reading from the given virtual address, using the following translation regime:

- In Secure state, and in Non-secure state when [HCR_EL2](#).{E2H, TGE} is not {1, 1}, the EL1&0 translation regime.
- In Non-secure state when [HCR_EL2](#).{E2H, TGE} is {1, 1}, the EL2&0 translation regime.

Configurations

There are no configuration notes.

Attributes

AT S12E1R is a 64-bit System instruction.

Field descriptions

The AT S12E1R input value bit assignments are:

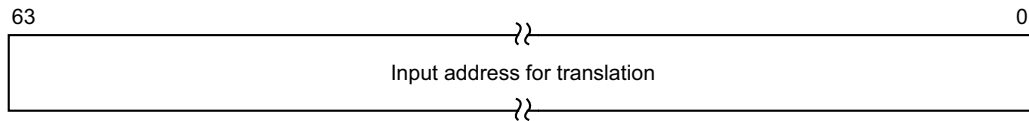

Bits [63:0]

Input address for translation. The resulting address can be read from the [PAR_EL1](#).

If the address translation instructions are targeting a translation regime that is using AArch32, and so has a VA of only 32 bits, then VA[63:32] is RES0.

Executing the AT S12E1R instruction

This instruction is executed using AT with the following syntax:

AT <at_op>, <Xt>

This syntax uses the following encoding in the System instruction encoding space:

<at_op>	op0	op1	CRn	CRm	op2
S12E1R	01	100	0111	1000	100

Accessibility

The instruction is executable as follows:

Control			Accessibility			
E2H	TGE	NS	EL0	EL1	EL2	EL3
x	x	0	-	-	n/a	WO
0	0	1	-	-	WO	WO

Control			Accessibility			
E2H	TGE	NS	EL0	EL1	EL2	EL3
0	1	1	-	n/a	WO	WO
1	0	1	-	-	WO	WO
1	1	1	-	n/a	WO	WO

If EL2 is not implemented, or stage 2 translation is disabled, or the instruction is executed at EL3 when the value of `SCR_EL3.NS` is 0, this instruction executes as [AT S1E1R](#).

C5.4.4 AT S12E1W, Address Translate Stages 1 and 2 EL1 Write

The AT S12E1W characteristics are:

Purpose

Performs stage 1 and 2 address translation, with permissions as if writing to the given virtual address, using the following translation regime:

- In Secure state, and in Non-secure state when [HCR_EL2](#).{E2H, TGE} is not {1, 1}, the EL1&0 translation regime.
- In Non-secure state when [HCR_EL2](#).{E2H, TGE} is {1, 1}, the EL2&0 translation regime.

Configurations

There are no configuration notes.

Attributes

AT S12E1W is a 64-bit System instruction.

Field descriptions

The AT S12E1W input value bit assignments are:

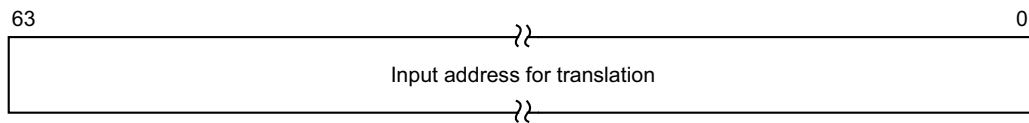

Bits [63:0]

Input address for translation. The resulting address can be read from the [PAR_EL1](#).

If the address translation instructions are targeting a translation regime that is using AArch32, and so has a VA of only 32 bits, then VA[63:32] is RES0.

Executing the AT S12E1W instruction

This instruction is executed using AT with the following syntax:

AT <at_op>, <Xt>

This syntax uses the following encoding in the System instruction encoding space:

<at_op>	op0	op1	CRn	CRm	op2
S12E1W	01	100	0111	1000	101

Accessibility

The instruction is executable as follows:

Control			Accessibility			
E2H	TGE	NS	EL0	EL1	EL2	EL3
x	x	0	-	-	n/a	WO
0	0	1	-	-	WO	WO
0	1	1	-	n/a	WO	WO
1	0	1	-	-	WO	WO
1	1	1	-	n/a	WO	WO

If EL2 is not implemented, or stage 2 translation is disabled, or the instruction is executed at EL3 when the value of [SCR_EL3.NS](#) is 0, this instruction executes as [AT S1E1W](#).

C5.4.5 AT S1E0R, Address Translate Stage 1 EL0 Read

The AT S1E0R characteristics are:

Purpose

Performs stage 1 address translation, with permissions as if reading from the given virtual address, using the following translation regime:

- In Secure state, and in Non-secure state when [HCR_EL2](#).{E2H, TGE} is not {1, 1}, the EL1&0 translation regime.
- In Non-secure state when [HCR_EL2](#).{E2H, TGE} is {1, 1}, the EL2&0 translation regime.

Configurations

There are no configuration notes.

Attributes

AT S1E0R is a 64-bit System instruction.

Field descriptions

The AT S1E0R input value bit assignments are:

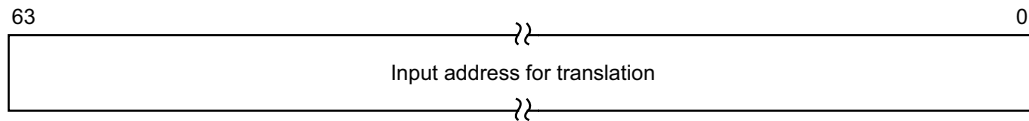

Bits [63:0]

Input address for translation. The resulting address can be read from the [PAR_EL1](#).

If the address translation instructions are targeting a translation regime that is using AArch32, and so has a VA of only 32 bits, then VA[63:32] is RES0.

Executing the AT S1E0R instruction

This instruction is executed using AT with the following syntax:

AT <at_op>, <Xt>

This syntax uses the following encoding in the System instruction encoding space:

<at_op>	op0	op1	CRn	CRm	op2
S1E0R	01	000	0111	1000	010

Accessibility

The instruction is executable as follows:

Control			Accessibility			
E2H	TGE	NS	EL0	EL1	EL2	EL3
x	x	0	-	WO	n/a	WO
0	0	1	-	WO	WO	WO

Control			Accessibility			
E2H	TGE	NS	EL0	EL1	EL2	EL3
0	1	1	-	n/a	WO	WO
1	0	1	-	WO	WO	WO
1	1	1	-	n/a	WO	WO

C5.4.6 AT S1E0W, Address Translate Stage 1 EL0 Write

The AT S1E0W characteristics are:

Purpose

Performs stage 1 address translation, with permissions as if writing to the given virtual address, using the following translation regime:

- In Secure state, and in Non-secure state when [HCR_EL2](#).{E2H, TGE} is not {1, 1}, the EL1&0 translation regime.
- In Non-secure state when [HCR_EL2](#).{E2H, TGE} is {1, 1}, the EL2&0 translation regime.

Configurations

There are no configuration notes.

Attributes

AT S1E0W is a 64-bit System instruction.

Field descriptions

The AT S1E0W input value bit assignments are:

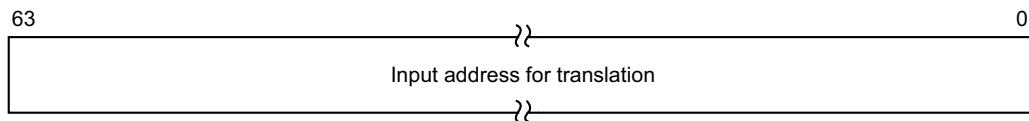

Bits [63:0]

Input address for translation. The resulting address can be read from the [PAR_EL1](#).

If the address translation instructions are targeting a translation regime that is using AArch32, and so has a VA of only 32 bits, then VA[63:32] is RES0.

Executing the AT S1E0W instruction

This instruction is executed using AT with the following syntax:

AT <at_op>, <Xt>

This syntax uses the following encoding in the System instruction encoding space:

<at_op>	op0	op1	CRn	CRm	op2
S1E0W	01	000	0111	1000	011

Accessibility

The instruction is executable as follows:

Control			Accessibility			
E2H	TGE	NS	EL0	EL1	EL2	EL3
x	x	0	-	WO	n/a	WO
0	0	1	-	WO	WO	WO

Control			Accessibility			
E2H	TGE	NS	EL0	EL1	EL2	EL3
0	1	1	-	n/a	WO	WO
1	0	1	-	WO	WO	WO
1	1	1	-	n/a	WO	WO

C5.4.7 AT S1E1R, Address Translate Stage 1 EL1 Read

The AT S1E1R characteristics are:

Purpose

Performs stage 1 address translation, with permissions as if reading from the given virtual address, using the following translation regime:

- In Secure state, and in Non-secure state when [HCR_EL2](#).{E2H, TGE} is not {1, 1}, the EL1&0 translation regime.
- In Non-secure state when [HCR_EL2](#).{E2H, TGE} is {1, 1}, the EL2&0 translation regime.

Configurations

There are no configuration notes.

Attributes

AT S1E1R is a 64-bit System instruction.

Field descriptions

The AT S1E1R input value bit assignments are:

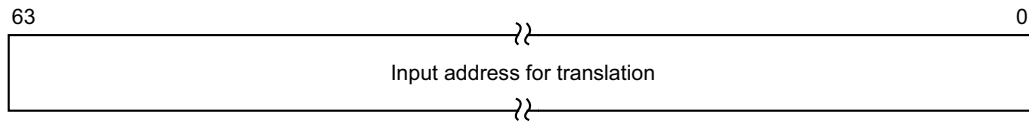

Bits [63:0]

Input address for translation. The resulting address can be read from the [PAR_EL1](#).

If the address translation instructions are targeting a translation regime that is using AArch32, and so has a VA of only 32 bits, then VA[63:32] is RES0.

Executing the AT S1E1R instruction

This instruction is executed using AT with the following syntax:

AT <at_op>, <Xt>

This syntax uses the following encoding in the System instruction encoding space:

<at_op>	op0	op1	CRn	CRm	op2
S1E1R	01	000	0111	1000	000

Accessibility

The instruction is executable as follows:

Control			Accessibility			
E2H	TGE	NS	EL0	EL1	EL2	EL3
x	x	0	-	WO	n/a	WO
0	0	1	-	WO	WO	WO
0	1	1	-	n/a	WO	WO
1	0	1	-	WO	WO	WO
1	1	1	-	n/a	WO	WO

C5.4.8 AT S1E1RP, Address Translate Stage 1 EL1 Read PAN

The AT S1E1RP characteristics are:

Purpose

When [ARMv8.2-ATS1E1](#) is implemented, performs a stage 1 address translation, where the value of `PSTATE.PAN` determines if a read from a location will generate a permission fault for a privileged access, using the following translation regime:

- In Secure state, and in Non-secure state when `HCR_EL2.{E2H, TGE}` is not `{1, 1}`, the EL1&0 translation regime.
- In Non-secure state when `HCR_EL2.{E2H, TGE}` is `{1, 1}`, the EL2&0 translation regime.

Configurations

This instruction is introduced in ARMv8.2.

Attributes

AT S1E1RP is a 64-bit System instruction.

Field descriptions

The AT S1E1RP input value bit assignments are:

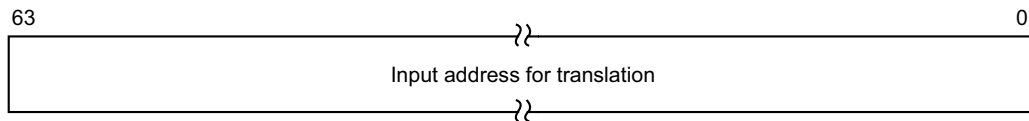

Bits [63:0]

Input address for translation. The resulting address can be read from the [PAR_EL1](#).

If the address translation instructions are targeting a translation regime that is using AArch32, and so has a VA of only 32 bits, then `VA[63:32]` is `RES0`.

Executing the AT S1E1RP instruction

This instruction is executed using AT with the following syntax:

AT <at_op>, <Xt>

This syntax uses the following encoding in the System instruction encoding space:

<at_op>	op0	op1	CRn	CRm	op2
S1E1RP	01	000	0111	1001	000

Accessibility

The instruction is executable as follows:

Control			Accessibility			
E2H	TGE	NS	EL0	EL1	EL2	EL3
x	x	0	-	WO	n/a	WO
0	0	1	-	WO	WO	WO
0	1	1	-	n/a	WO	WO
1	0	1	-	WO	WO	WO
1	1	1	-	n/a	WO	WO

C5.4.9 AT S1E1W, Address Translate Stage 1 EL1 Write

The AT S1E1W characteristics are:

Purpose

Performs stage 1 address translation, with permissions as if writing to the given virtual address, using the following translation regime:

- In Secure state, and in Non-secure state when [HCR_EL2](#).{E2H, TGE} is not {1, 1}, the EL1&0 translation regime.
- In Non-secure state when [HCR_EL2](#).{E2H, TGE} is {1, 1}, the EL2&0 translation regime.

Configurations

There are no configuration notes.

Attributes

AT S1E1W is a 64-bit System instruction.

Field descriptions

The AT S1E1W input value bit assignments are:

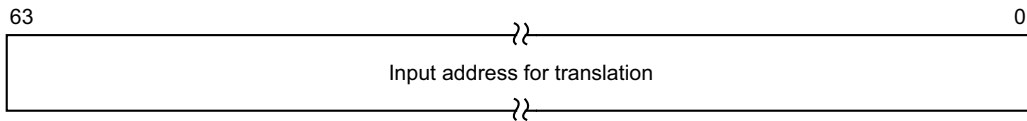

Bits [63:0]

Input address for translation. The resulting address can be read from the [PAR_EL1](#).

If the address translation instructions are targeting a translation regime that is using AArch32, and so has a VA of only 32 bits, then VA[63:32] is RES0.

Executing the AT S1E1W instruction

This instruction is executed using AT with the following syntax:

AT <at_op>, <Xt>

This syntax uses the following encoding in the System instruction encoding space:

<at_op>	op0	op1	CRn	CRm	op2
S1E1W	01	000	0111	1000	001

Accessibility

The instruction is executable as follows:

Control			Accessibility			
E2H	TGE	NS	EL0	EL1	EL2	EL3
x	x	0	-	WO	n/a	WO
0	0	1	-	WO	WO	WO

Control			Accessibility			
E2H	TGE	NS	EL0	EL1	EL2	EL3
0	1	1	-	n/a	WO	WO
1	0	1	-	WO	WO	WO
1	1	1	-	n/a	WO	WO

C5.4.10 AT S1E1WP, Address Translate Stage 1 EL1 Write PAN

The AT S1E1WP characteristics are:

Purpose

When [ARMv8.2-ATS1E1](#) is implemented, performs a stage 1 address translation, where the value of `PSTATE.PAN` determines if a write to a location will generate a permission fault for a privileged access, using the following translation regime:

- In Secure state, and in Non-secure state when [HCR_EL2](#).{E2H, TGE} is not {1, 1}, the EL1&0 translation regime.
- In Non-secure state when [HCR_EL2](#).{E2H, TGE} is {1, 1}, the EL2&0 translation regime.

Configurations

This instruction is introduced in ARMv8.2.

Attributes

AT S1E1WP is a 64-bit System instruction.

Field descriptions

The AT S1E1WP input value bit assignments are:

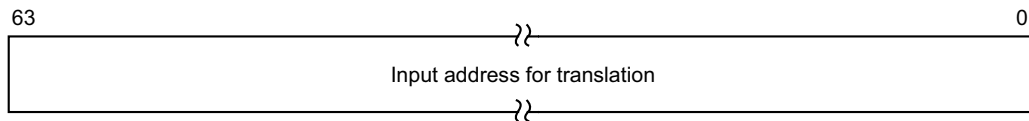

Bits [63:0]

Input address for translation. The resulting address can be read from the [PAR_EL1](#).

If the address translation instructions are targeting a translation regime that is using AArch32, and so has a VA of only 32 bits, then `VA[63:32]` is `RES0`.

Executing the AT S1E1WP instruction

This instruction is executed using AT with the following syntax:

AT <at_op>, <Xt>

This syntax uses the following encoding in the System instruction encoding space:

<at_op>	op0	op1	CRn	CRm	op2
S1E1WP	01	000	0111	1001	001

Accessibility

The instruction is executable as follows:

Control			Accessibility			
E2H	TGE	NS	EL0	EL1	EL2	EL3
x	x	0	-	WO	n/a	WO
0	0	1	-	WO	WO	WO
0	1	1	-	n/a	WO	WO
1	0	1	-	WO	WO	WO
1	1	1	-	n/a	WO	WO

C5.4.11 AT S1E2R, Address Translate Stage 1 EL2 Read

The AT S1E2R characteristics are:

Purpose

Performs stage 1 address translation as defined for EL2, with permissions as if reading from the given virtual address.

Configurations

There are no configuration notes.

Attributes

AT S1E2R is a 64-bit System instruction.

Field descriptions

The AT S1E2R input value bit assignments are:

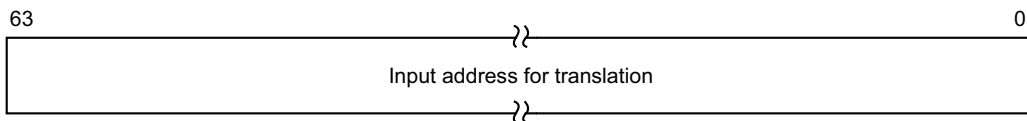

Bits [63:0]

Input address for translation. The resulting address can be read from the [PAR_EL1](#).

If the address translation instructions are targeting a translation regime that is using AArch32, and so has a VA of only 32 bits, then VA[63:32] is RES0.

Executing the AT S1E2R instruction

This instruction is executed using AT with the following syntax:

AT <at_op>, <Xt>

This syntax uses the following encoding in the System instruction encoding space:

<at_op>	op0	op1	CRn	CRm	op2
S1E2R	01	100	0111	1000	000

Accessibility

The instruction is executable as follows:

Control			Accessibility			
E2H	TGE	NS	EL0	EL1	EL2	EL3
x	x	0	-	-	n/a	-
0	0	1	-	-	WO	WO
0	1	1	-	n/a	WO	WO
1	0	1	-	-	WO	WO
1	1	1	-	n/a	WO	WO

If EL2 is not implemented, this instruction is UNDEFINED at EL3.

C5.4.12 AT S1E2W, Address Translate Stage 1 EL2 Write

The AT S1E2W characteristics are:

Purpose

Performs stage 1 address translation as defined for EL2, with permissions as if writing to the given virtual address.

Configurations

There are no configuration notes.

Attributes

AT S1E2W is a 64-bit System instruction.

Field descriptions

The AT S1E2W input value bit assignments are:

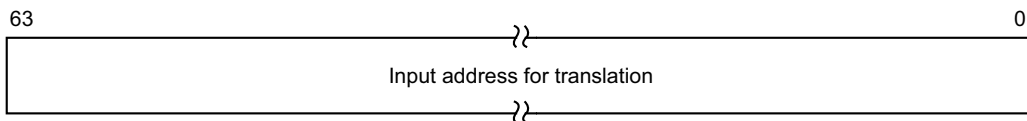

Bits [63:0]

Input address for translation. The resulting address can be read from the [PAR_EL1](#).

If the address translation instructions are targeting a translation regime that is using AArch32, and so has a VA of only 32 bits, then VA[63:32] is RES0.

Executing the AT S1E2W instruction

This instruction is executed using AT with the following syntax:

AT <at_op>, <Xt>

This syntax uses the following encoding in the System instruction encoding space:

<at_op>	op0	op1	CRn	CRm	op2
S1E2W	01	100	0111	1000	001

Accessibility

The instruction is executable as follows:

Control			Accessibility			
E2H	TGE	NS	EL0	EL1	EL2	EL3
x	x	0	-	-	n/a	-
0	0	1	-	-	WO	WO
0	1	1	-	n/a	WO	WO
1	0	1	-	-	WO	WO
1	1	1	-	n/a	WO	WO

If EL2 is not implemented, this instruction is UNDEFINED at EL3.

C5.4.13 AT S1E3R, Address Translate Stage 1 EL3 Read

The AT S1E3R characteristics are:

Purpose

Performs stage 1 address translation as defined for EL3, with permissions as if reading from the given virtual address.

Configurations

There are no configuration notes.

Attributes

AT S1E3R is a 64-bit System instruction.

Field descriptions

The AT S1E3R input value bit assignments are:

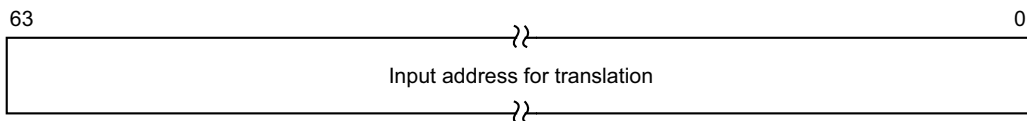

Bits [63:0]

Input address for translation. The resulting address can be read from the [PAR_EL1](#).

If the address translation instructions are targeting a translation regime that is using AArch32, and so has a VA of only 32 bits, then VA[63:32] is RES0.

Executing the AT S1E3R instruction

This instruction is executed using AT with the following syntax:

AT <at_op>, <Xt>

This syntax uses the following encoding in the System instruction encoding space:

<at_op>	op0	op1	CRn	CRm	op2
S1E3R	01	110	0111	1000	000

Accessibility

The instruction is executable as follows:

Control			Accessibility			
E2H	TGE	NS	EL0	EL1	EL2	EL3
x	x	0	-	-	n/a	WO
0	0	1	-	-	-	WO
0	1	1	-	n/a	-	WO
1	0	1	-	-	-	WO
1	1	1	-	n/a	-	WO

C5.4.14 AT S1E3W, Address Translate Stage 1 EL3 Write

The AT S1E3W characteristics are:

Purpose

Performs stage 1 address translation as defined for EL3, with permissions as if writing to the given virtual address.

Configurations

There are no configuration notes.

Attributes

AT S1E3W is a 64-bit System instruction.

Field descriptions

The AT S1E3W input value bit assignments are:

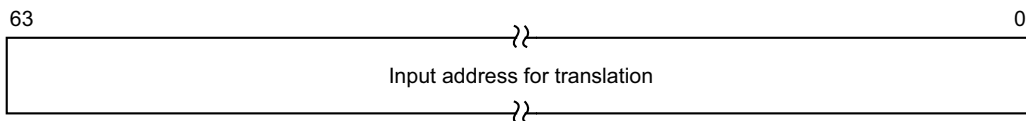

Bits [63:0]

Input address for translation. The resulting address can be read from the [PAR_EL1](#).

If the address translation instructions are targeting a translation regime that is using AArch32, and so has a VA of only 32 bits, then VA[63:32] is RES0.

Executing the AT S1E3W instruction

This instruction is executed using AT with the following syntax:

AT <at_op>, <Xt>

This syntax uses the following encoding in the System instruction encoding space:

<at_op>	op0	op1	CRn	CRm	op2
S1E3W	01	110	0111	1000	001

Accessibility

The instruction is executable as follows:

Control			Accessibility			
E2H	TGE	NS	EL0	EL1	EL2	EL3
x	x	0	-	-	n/a	WO
0	0	1	-	-	-	WO
0	1	1	-	n/a	-	WO
1	0	1	-	-	-	WO
1	1	1	-	n/a	-	WO

C5.5 A64 system instructions for TLB maintenance

The following sections define the TLB maintenance system instructions in A64:

- [TLBI ALLE1, TLB Invalidate All, EL1](#) on page C5-455.
- [TLBI ALLE1IS, TLB Invalidate All, EL1, Inner Shareable](#) on page C5-457.
- [TLBI ALLE2, TLB Invalidate All, EL2](#) on page C5-459.
- [TLBI ALLE2IS, TLB Invalidate All, EL2, Inner Shareable](#) on page C5-460.
- [TLBI ALLE3, TLB Invalidate All, EL3](#) on page C5-461.
- [TLBI ALLE3IS, TLB Invalidate All, EL3, Inner Shareable](#) on page C5-462.
- [TLBI ASIDE1, TLB Invalidate by ASID, EL1](#) on page C5-463.
- [TLBI ASIDE1IS, TLB Invalidate by ASID, EL1, Inner Shareable](#) on page C5-465.
- [TLBI IPAS2E1, TLB Invalidate by Intermediate Physical Address, Stage 2, EL1](#) on page C5-467.
- [TLBI IPAS2E1IS, TLB Invalidate by Intermediate Physical Address, Stage 2, EL1, Inner Shareable](#) on page C5-469.
- [TLBI IPAS2LE1, TLB Invalidate by Intermediate Physical Address, Stage 2, Last level, EL1](#) on page C5-471.
- [TLBI IPAS2LE1IS, TLB Invalidate by Intermediate Physical Address, Stage 2, Last level, EL1, Inner Shareable](#) on page C5-473.
- [TLBI VAAE1, TLB Invalidate by VA, All ASID, EL1](#) on page C5-475.
- [TLBI VAAE1IS, TLB Invalidate by VA, All ASID, EL1, Inner Shareable](#) on page C5-477.
- [TLBI VAALE1, TLB Invalidate by VA, All ASID, Last level, EL1](#) on page C5-479.
- [TLBI VAALE1IS, TLB Invalidate by VA, All ASID, EL1, Last Level, Inner Shareable](#) on page C5-481.
- [TLBI VAE1, TLB Invalidate by VA, EL1](#) on page C5-483.
- [TLBI VAE1IS, TLB Invalidate by VA, EL1, Inner Shareable](#) on page C5-486.
- [TLBI VAE2, TLB Invalidate by VA, EL2](#) on page C5-488.
- [TLBI VAE2IS, TLB Invalidate by VA, EL2, Inner Shareable](#) on page C5-490.
- [TLBI VAE3, TLB Invalidate by VA, EL3](#) on page C5-492.
- [TLBI VAE3IS, TLB Invalidate by VA, EL3, Inner Shareable](#) on page C5-494.
- [TLBI VALE1, TLB Invalidate by VA, Last level, EL1](#) on page C5-496.
- [TLBI VALE1IS, TLB Invalidate by VA, Last level, EL1, Inner Shareable](#) on page C5-499.
- [TLBI VALE2, TLB Invalidate by VA, Last level, EL2](#) on page C5-501.
- [TLBI VALE2IS, TLB Invalidate by VA, Last level, EL2, Inner Shareable](#) on page C5-503.
- [TLBI VALE3, TLB Invalidate by VA, Last level, EL3](#) on page C5-505.
- [TLBI VALE3IS, TLB Invalidate by VA, Last level, EL3, Inner Shareable](#) on page C5-507.
- [TLBI VMALLE1, TLB Invalidate by VMID, All at stage 1, EL1](#) on page C5-509.
- [TLBI VMALLE1IS, TLB Invalidate by VMID, All at stage 1, EL1, Inner Shareable](#) on page C5-511.
- [TLBI VMALLS12E1, TLB Invalidate by VMID, All at Stage 1 and 2, EL1](#) on page C5-513.
- [TLBI VMALLS12E1IS, TLB Invalidate by VMID, All at Stage 1 and 2, EL1, Inner Shareable](#) on page C5-515.

For more information about these instructions see [TLB maintenance instructions](#) on page D4-2121. In particular, for the full description of the scope of each instruction see [Scope of the A64 TLB maintenance instructions](#) on page D4-2124.

C5.5.1 TLBI ALLE1, TLB Invalidate All, EL1

The TLBI ALLE1 characteristics are:

Purpose

Invalidate cached copies of translation table entries from TLBs that meet all the following requirements:

- The entry is a stage 1 or stage 2 translation table entry, from any level of the translation table walk.
- If SCR_EL3.NS is 0, the entry would be required to translate an address using the Secure EL1&0 translation regime.
- If SCR_EL3.NS is 1, the entry would be required to translate an address using the Non-secure EL1&0 translation regime.

The invalidation applies to entries with any VMID.

The invalidation only applies to the PE that executes this instruction.

———— Note —————

For the EL1&0 translation regime, the invalidation applies to both:

- Global entries.
- Non-global entries with any ASID.

Configurations

There are no configuration notes.

Attributes

TLBI ALLE1 is a 64-bit System instruction.

Field descriptions

TLBI ALLE1 ignores the value in the register specified by the instruction. Software does not have to write a value to the register before issuing this instruction.

Executing the TLBI ALLE1 instruction

This instruction is executed using TLBI with the following syntax:

TLBI <tlbi_op>

This syntax uses the following encoding in the System instruction encoding space:

<tlbi_op>	op0	op1	CRn	CRm	op2	Rt
ALLE1	01	100	1000	0111	100	11111

Accessibility

The instruction is executable as follows:

Control			Accessibility			
E2H	TGE	NS	EL0	EL1	EL2	EL3
x	x	0	-	-	n/a	WO
0	0	1	-	-	WO	WO
0	1	1	-	n/a	WO	WO
1	0	1	-	-	WO	WO
1	1	1	-	n/a	WO	WO

C5.5.2 TLBI ALLE1IS, TLB Invalidate All, EL1, Inner Shareable

The TLBI ALLE1IS characteristics are:

Purpose

Invalidate cached copies of translation table entries from TLBs that meet all the following requirements:

- The entry is a stage 1 or stage 2 translation table entry, from any level of the translation table walk.
- If SCR_EL3.NS is 0, the entry would be required to translate an address using the Secure EL1&0 translation regime.
- If SCR_EL3.NS is 1, the entry would be required to translate an address using the Non-secure EL1&0 translation regime.

The invalidation applies to entries with any VMID.

The invalidation applies to all PEs in the same Inner Shareable shareability domain as the PE that executes this instructions.

———— Note —————

For the EL1&0 translation regime, the invalidation applies to both:

- Global entries.
- Non-global entries with any ASID.

Configurations

There are no configuration notes.

Attributes

TLBI ALLE1IS is a 64-bit System instruction.

Field descriptions

TLBI ALLE1IS ignores the value in the register specified by the instruction. Software does not have to write a value to the register before issuing this instruction.

Executing the TLBI ALLE1IS instruction

This instruction is executed using TLBI with the following syntax:

TLBI <tlbi_op>

This syntax uses the following encoding in the System instruction encoding space:

<tlbi_op>	op0	op1	CRn	CRm	op2	Rt
ALLE1IS	01	100	1000	0011	100	11111

Accessibility

The instruction is executable as follows:

Control			Accessibility			
E2H	TGE	NS	EL0	EL1	EL2	EL3
x	x	0	-	-	n/a	WO
0	0	1	-	-	WO	WO
0	1	1	-	n/a	WO	WO
1	0	1	-	-	WO	WO
1	1	1	-	n/a	WO	WO

C5.5.3 TLBI ALLE2, TLB Invalidate All, EL2

The TLBI ALLE2 characteristics are:

Purpose

If EL2 is implemented, invalidate cached copies of translation table entries from TLBs that meet all the following requirements:

- The entry is a stage 1 translation table entry, from any level of the translation table walk.
- SCR_EL3.NS is 1.
- The entry would be required to translate an address using the EL2 translation regime.

The invalidation only applies to the PE that executes this instruction.

Configurations

There are no configuration notes.

Attributes

TLBI ALLE2 is a 64-bit System instruction.

Field descriptions

TLBI ALLE2 ignores the value in the register specified by the instruction. Software does not have to write a value to the register before issuing this instruction.

Executing the TLBI ALLE2 instruction

This instruction is executed using TLBI with the following syntax:

TLBI <tlbi_op>

This syntax uses the following encoding in the System instruction encoding space:

<tlbi_op>	op0	op1	CRn	CRm	op2	Rt
ALLE2	01	100	1000	0111	000	11111

Accessibility

The instruction is executable as follows:

Control			Accessibility			
E2H	TGE	NS	EL0	EL1	EL2	EL3
x	x	0	-	-	n/a	-
0	0	1	-	-	WO	WO
0	1	1	-	n/a	WO	WO
1	0	1	-	-	WO	WO
1	1	1	-	n/a	WO	WO

If EL2 is not implemented, this instruction is UNDEFINED.

C5.5.4 TLBI ALLE2IS, TLB Invalidate All, EL2, Inner Shareable

The TLBI ALLE2IS characteristics are:

Purpose

If EL2 is implemented, invalidate cached copies of translation table entries from TLBs that meet all the following requirements:

- The entry is a stage 1 translation table entry, from any level of the translation table walk.
- SCR_EL3.NS is 1.
- The entry would be required to translate an address using the EL2 translation regime.

The invalidation applies to all PEs in the same Inner Shareable shareability domain as the PE that executes this instructions.

Configurations

There are no configuration notes.

Attributes

TLBI ALLE2IS is a 64-bit System instruction.

Field descriptions

TLBI ALLE2IS ignores the value in the register specified by the instruction. Software does not have to write a value to the register before issuing this instruction.

Executing the TLBI ALLE2IS instruction

This instruction is executed using TLBI with the following syntax:

TLBI <tlbi_op>

This syntax uses the following encoding in the System instruction encoding space:

<tlbi_op>	op0	op1	CRn	CRm	op2	Rt
ALLE2IS	01	100	1000	0011	000	11111

Accessibility

The instruction is executable as follows:

Control			Accessibility			
E2H	TGE	NS	EL0	EL1	EL2	EL3
x	x	0	-	-	n/a	-
0	0	1	-	-	WO	WO
0	1	1	-	n/a	WO	WO
1	0	1	-	-	WO	WO
1	1	1	-	n/a	WO	WO

If EL2 is not implemented, this instruction is UNDEFINED.

C5.5.5 TLBI ALLE3, TLB Invalidate All, EL3

The TLBI ALLE3 characteristics are:

Purpose

If EL3 is implemented, invalidate cached copies of translation table entries from TLBs that meet all the following requirements:

- The entry is a stage 1 translation table entry, from any level of the translation table walk.
- The entry would be required to translate an address using the EL3 translation regime.

The invalidation applies to all PEs in the same Inner Shareable shareability domain as the PE that executes this instructions.

Configurations

There are no configuration notes.

Attributes

TLBI ALLE3 is a 64-bit System instruction.

Field descriptions

TLBI ALLE3 ignores the value in the register specified by the instruction. Software does not have to write a value to the register before issuing this instruction.

Executing the TLBI ALLE3 instruction

This instruction is executed using TLBI with the following syntax:

TLBI <tlbi_op>

This syntax uses the following encoding in the System instruction encoding space:

<tlbi_op>	op0	op1	CRn	CRm	op2	Rt
ALLE3	01	110	1000	0111	000	11111

Accessibility

The instruction is executable as follows:

Control			Accessibility			
E2H	TGE	NS	EL0	EL1	EL2	EL3
x	x	0	-	-	n/a	WO
0	0	1	-	-	-	WO
0	1	1	-	n/a	-	WO
1	0	1	-	-	-	WO
1	1	1	-	n/a	-	WO

C5.5.6 TLBI ALLE3IS, TLB Invalidate All, EL3, Inner Shareable

The TLBI ALLE3IS characteristics are:

Purpose

If EL3 is implemented, invalidate cached copies of translation table entries from TLBs that meet all the following requirements:

- The entry is a stage 1 translation table entry, from any level of the translation table walk.
- The entry would be required to translate an address using the EL3 translation regime.

The invalidation applies to all PEs in the same Inner Shareable shareability domain as the PE that executes this instructions.

Configurations

There are no configuration notes.

Attributes

TLBI ALLE3IS is a 64-bit System instruction.

Field descriptions

TLBI ALLE3IS ignores the value in the register specified by the instruction. Software does not have to write a value to the register before issuing this instruction.

Executing the TLBI ALLE3IS instruction

This instruction is executed using TLBI with the following syntax:

TLBI <tlbi_op>

This syntax uses the following encoding in the System instruction encoding space:

<tlbi_op>	op0	op1	CRn	CRm	op2	Rt
ALLE3IS	01	110	1000	0011	000	11111

Accessibility

The instruction is executable as follows:

Control			Accessibility			
E2H	TGE	NS	EL0	EL1	EL2	EL3
x	x	0	-	-	n/a	WO
0	0	1	-	-	-	WO
0	1	1	-	n/a	-	WO
1	0	1	-	-	-	WO
1	1	1	-	n/a	-	WO

C5.5.7 TLBI ASIDE1, TLB Invalidate by ASID, EL1

The TLBI ASIDE1 characteristics are:

Purpose

Invalidate cached copies of translation table entries from TLBs that meet all the following requirements:

- The entry is a stage 1 translation table entry.
- The entry would be used for the specified ASID, and either:
 - Is from a level of lookup above the final level.
 - Is a non-global entry from the final level of lookup.
- If SCR_EL3.NS is 0, the entry would be required to translate an address using the Secure EL1&0 translation regime.
- If SCR_EL3.NS is 1, then:
 - If EL2 is not implemented, the entry would be required to translate an address using the Non-secure EL1&0 translation regime.
 - If EL2 is implemented and HCR_EL2.{E2H, TGE} is not {1, 1}, the entry would be used with the current VMID, and would be required to translate an address using the Non-secure EL1&0 translation regime.
 - If EL2 is implemented and HCR_EL2.{E2H, TGE} is {1, 1}, the entry would be required to translate an address using the EL2&0 translation regime.

The invalidation only applies to the PE that executes this instruction.

Configurations

There are no configuration notes.

Attributes

TLBI ASIDE1 is a 64-bit System instruction.

Field descriptions

The TLBI ASIDE1 input value bit assignments are:

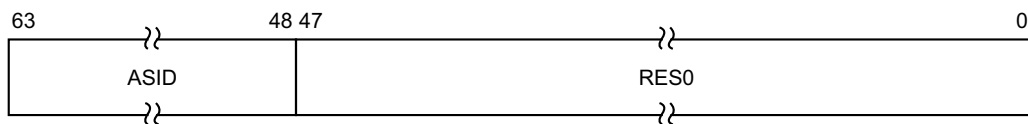

ASID, bits [63:48]

ASID value to match. Any appropriate TLB entries that match the ASID values will be affected by this operation.

If the implementation supports 16 bits of ASID, but only 8 bits are being used in the context being invalidated, the upper bits are RES0 and must be written to 0 by software performing the TLB maintenance.

Bits [47:0]

Reserved, RES0.

Executing the TLBI ASIDE1 instruction

This instruction is executed using TLBI with the following syntax:

TLBI <tlbi_op>, <Xt>

This syntax uses the following encoding in the System instruction encoding space:

<tlbi_op>	op0	op1	CRn	CRm	op2
ASIDE1	01	000	1000	0111	010

Accessibility

The instruction is executable as follows:

Control			Accessibility			
E2H	TGE	NS	EL0	EL1	EL2	EL3
x	x	0	-	WO	n/a	WO
0	0	1	-	WO	WO	WO
0	1	1	-	n/a	WO	WO
1	0	1	-	WO	WO	WO
1	1	1	-	n/a	WO	WO

When [HCR_EL2.FB](#) is 1, at Non-secure EL1 this instruction executes as a [TLBI ASIDE1IS](#).

Traps and Enables

For a description of the prioritization of any generated exceptions, see [Synchronous exception prioritization for exceptions taken to AArch64 on page D1-1827](#). Subject to the prioritization rules:

- When EL2 is implemented and is using AArch64 and (SCR_EL3.NS == 1) && (HCR_EL2.E2H == 0):
 - If [HCR_EL2.TTLB](#)==1, Non-secure execution of this instruction at EL1 is trapped to EL2.
- When EL2 is implemented and is using AArch64 and (SCR_EL3.NS == 1) && (HCR_EL2.E2H == 1) && (HCR_EL2.TGE == 0):
 - If [HCR_EL2.TTLB](#)==1, Non-secure execution of this instruction at EL1 is trapped to EL2.

C5.5.8 TLBI ASIDE1IS, TLB Invalidate by ASID, EL1, Inner Shareable

The TLBI ASIDE1IS characteristics are:

Purpose

Invalidate cached copies of translation table entries from TLBs that meet all the following requirements:

- The entry is a stage 1 translation table entry.
- The entry would be used for the specified ASID, and either:
 - Is from a level of lookup above the final level.
 - Is a non-global entry from the final level of lookup.
- If SCR_EL3.NS is 0, the entry would be required to translate an address using the Secure EL1&0 translation regime.
- If SCR_EL3.NS is 1, then:
 - If EL2 is not implemented, the entry would be required to translate an address using the Non-secure EL1&0 translation regime.
 - If EL2 is implemented and HCR_EL2.{E2H, TGE} is not {1, 1}, the entry would be used with the current VMID, and would be required to translate an address using the Non-secure EL1&0 translation regime.
 - If EL2 is implemented and HCR_EL2.{E2H, TGE} is {1, 1}, the entry would be required to translate an address using the EL2&0 translation regime.

The invalidation applies to all PEs in the same Inner Shareable shareability domain as the PE that executes this instructions.

Configurations

There are no configuration notes.

Attributes

TLBI ASIDE1IS is a 64-bit System instruction.

Field descriptions

The TLBI ASIDE1IS input value bit assignments are:

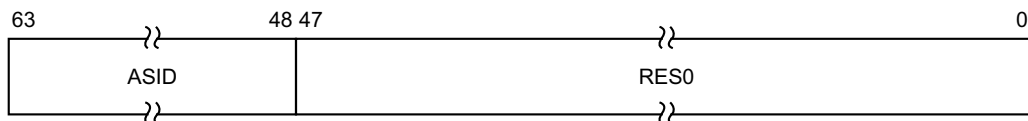

ASID, bits [63:48]

ASID value to match. Any appropriate TLB entries that match the ASID values will be affected by this operation.

If the implementation supports 16 bits of ASID, but only 8 bits are being used in the context being invalidated, the upper bits are RES0 and must be written to 0 by software performing the TLB maintenance.

Bits [47:0]

Reserved, RES0.

Executing the TLBI ASIDE1IS instruction

This instruction is executed using TLBI with the following syntax:

TLBI <tlbi_op>, <Xt>

This syntax uses the following encoding in the System instruction encoding space:

<tlbi_op>	op0	op1	CRn	CRm	op2
ASIDE1IS	01	000	1000	0011	010

Accessibility

The instruction is executable as follows:

Control			Accessibility			
E2H	TGE	NS	EL0	EL1	EL2	EL3
x	x	0	-	WO	n/a	WO
0	0	1	-	WO	WO	WO
0	1	1	-	n/a	WO	WO
1	0	1	-	WO	WO	WO
1	1	1	-	n/a	WO	WO

Traps and Enables

For a description of the prioritization of any generated exceptions, see [Synchronous exception prioritization for exceptions taken to AArch64 on page D1-1827](#). Subject to the prioritization rules:

- When EL2 is implemented and is using AArch64 and (SCR_EL3.NS == 1) && (HCR_EL2.E2H == 0):
 - If HCR_EL2.TTLB==1, Non-secure execution of this instruction at EL1 is trapped to EL2.
- When EL2 is implemented and is using AArch64 and (SCR_EL3.NS == 1) && (HCR_EL2.E2H == 1) && (HCR_EL2.TGE == 0):
 - If HCR_EL2.TTLB==1, Non-secure execution of this instruction at EL1 is trapped to EL2.

C5.5.9 TLBI IPAS2E1, TLB Invalidate by Intermediate Physical Address, Stage 2, EL1

The TLBI IPAS2E1 characteristics are:

Purpose

If EL2 is implemented, invalidate cached copies of translation table entries from TLBs that meet all the following requirements:

- The entry is a stage 2 only translation table entry, from any level of the translation table walk.
- SCR_EL3.NS is 1.
- The entry would be used with the current VMID.
- The entry would be required to translate the specified IPA using the Non-secure EL1&0 translation regime.

The invalidation is not required to apply to caching structures that combine stage 1 and stage 2 translation table entries.

The invalidation only applies to the PE that executes this instruction.

For more information about the architectural requirements for this instruction see [Invalidation of TLB entries from stage 2 translations on page D4-2128](#).

Configurations

There are no configuration notes.

Attributes

TLBI IPAS2E1 is a 64-bit System instruction.

Field descriptions

The TLBI IPAS2E1 input value bit assignments are:

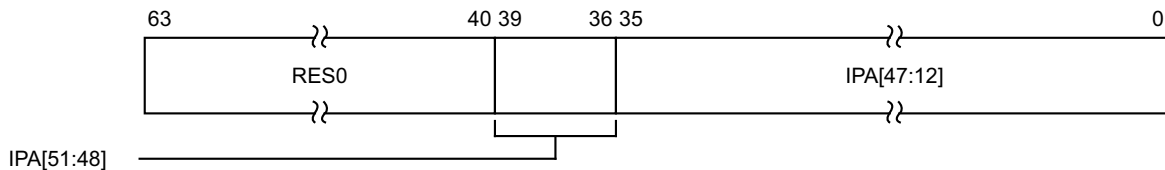

Bits [63:40]

Reserved, RES0.

IPA[51:48], bits [39:36]

In ARMv8.2

Extension to IPA[47:12]. See IPA[47:12] for more details.

In ARMv8.1 and ARMv8.0.

Reserved, RES0.

IPA[47:12], bits [35:0]

Bits[47:12] of the intermediate physical address to match.

When [ARMv8.2-LPA](#) is implemented, and 52-bit addresses and a 64KB translation granule are in use, IPA[51:48] form the upper part of the address value. Otherwise, IPA[51:48] are RES0.

Executing the TLBI IPAS2E1 instruction

This instruction is executed using TLBI with the following syntax:

TLBI <tlbi_op>, <Xt>

This syntax uses the following encoding in the System instruction encoding space:

<tlbi_op>	op0	op1	CRn	CRm	op2
IPAS2E1	01	100	1000	0100	001

Accessibility

The instruction is executable as follows:

Control			Accessibility			
E2H	TGE	NS	EL0	EL1	EL2	EL3
x	x	0	-	-	n/a	WO
x	0	1	-	-	WO	WO
x	1	1	-	n/a	WO	WO

If EL2 is not implemented, or SCR_EL3.NS is 0, this instruction is a NOP.

C5.5.10 TLBI IPAS2E1IS, TLB Invalidate by Intermediate Physical Address, Stage 2, EL1, Inner Shareable

The TLBI IPAS2E1IS characteristics are:

Purpose

If EL2 is implemented, invalidate cached copies of translation table entries from TLBs that meet all the following requirements:

- The entry is a stage 2 only translation table entry, from any level of the translation table walk.
- SCR_EL3.NS is 1.
- The entry would be used with the current VMID.
- The entry would be required to translate the specified IPA using the Non-secure EL1&0 translation regime.

The invalidation is not required to apply to caching structures that combine stage 1 and stage 2 translation table entries.

The invalidation applies to all PEs in the same Inner Shareable shareability domain as the PE that executes this instructions.

For more information about the architectural requirements for this instruction see [Invalidation of TLB entries from stage 2 translations on page D4-2128](#).

Configurations

There are no configuration notes.

Attributes

TLBI IPAS2E1IS is a 64-bit System instruction.

Field descriptions

The TLBI IPAS2E1IS input value bit assignments are:

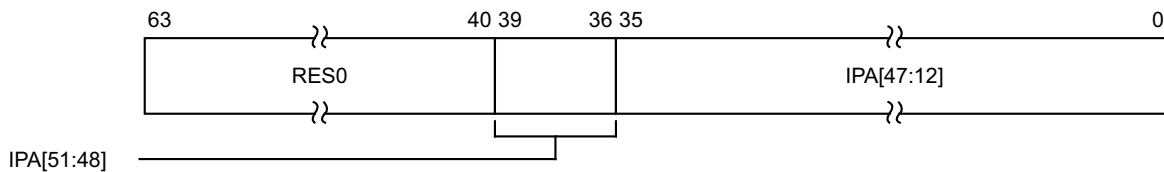

Bits [63:40]

Reserved, RES0.

IPA[51:48], bits [39:36]

In ARMv8.2

Extension to IPA[47:12]. See IPA[47:12] for more details.

In ARMv8.1 and ARMv8.0.

Reserved, RES0.

IPA[47:12], bits [35:0]

Bits[47:12] of the intermediate physical address to match.

When [ARMv8.2-LPA](#) is implemented, and 52-bit addresses and a 64KB translation granule are in use, IPA[51:48] form the upper part of the address value. Otherwise, IPA[51:48] are RES0.

Executing the TLBI IPAS2E1IS instruction

This instruction is executed using TLBI with the following syntax:

TLBI <tlbi_op>, <Xt>

This syntax uses the following encoding in the System instruction encoding space:

<tlbi_op>	op0	op1	CRn	CRm	op2
IPAS2E1IS	01	100	1000	0000	001

Accessibility

The instruction is executable as follows:

Control			Accessibility			
E2H	TGE	NS	EL0	EL1	EL2	EL3
x	x	0	-	-	n/a	WO
x	0	1	-	-	WO	WO
x	1	1	-	n/a	WO	WO

If EL2 is not implemented, or SCR_EL3.NS is 0, this instruction is a NOP.

C5.5.11 TLBI IPAS2LE1, TLB Invalidate by Intermediate Physical Address, Stage 2, Last level, EL1

The TLBI IPAS2LE1 characteristics are:

Purpose

If EL2 is implemented, invalidate cached copies of translation table entries from TLBs that meet all the following requirements:

- The entry is a stage 2 only translation table entry, from the final level of the translation table walk.
- SCR_EL3.NS is 1.
- The entry would be used with the current VMID.
- The entry would be required to translate the specified IPA using the Non-secure EL1&0 translation regime.

The invalidation is not required to apply to caching structures that combine stage 1 and stage 2 translation table entries.

The invalidation only applies to the PE that executes this instruction.

For more information about the architectural requirements for this instruction see [Invalidation of TLB entries from stage 2 translations on page D4-2128](#).

Configurations

There are no configuration notes.

Attributes

TLBI IPAS2LE1 is a 64-bit System instruction.

Field descriptions

The TLBI IPAS2LE1 input value bit assignments are:

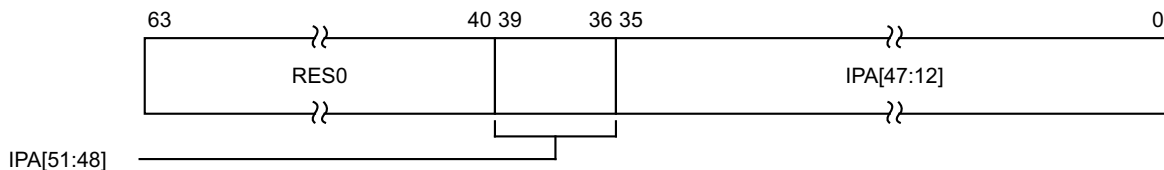

Bits [63:40]

Reserved, RES0.

IPA[51:48], bits [39:36]

In ARMv8.2

Extension to IPA[47:12]. See IPA[47:12] for more details.

In ARMv8.1 and ARMv8.0.

Reserved, RES0.

IPA[47:12], bits [35:0]

Bits[47:12] of the intermediate physical address to match.

When [ARMv8.2-LPA](#) is implemented, and 52-bit addresses and a 64KB translation granule are in use, IPA[51:48] form the upper part of the address value. Otherwise, IPA[51:48] are RES0.

Executing the TLBI IPAS2LE1 instruction

This instruction is executed using TLBI with the following syntax:

TLBI <tlbi_op>, <Xt>

This syntax uses the following encoding in the System instruction encoding space:

<tlbi_op>	op0	op1	CRn	CRm	op2
IPAS2LE1	01	100	1000	0100	101

Accessibility

The instruction is executable as follows:

Control			Accessibility			
E2H	TGE	NS	EL0	EL1	EL2	EL3
x	x	0	-	-	n/a	WO
x	0	1	-	-	WO	WO
x	1	1	-	n/a	WO	WO

If EL2 is not implemented, or SCR_EL3.NS is 0, this instruction is a NOP.

C5.5.12 TLBI IPAS2LE1IS, TLB Invalidate by Intermediate Physical Address, Stage 2, Last level, EL1, Inner Shareable

The TLBI IPAS2LE1IS characteristics are:

Purpose

If EL2 is implemented, invalidate cached copies of translation table entries from TLBs that meet all the following requirements:

- The entry is a stage 2 only translation table entry, from the final level of the translation table walk.
- SCR_EL3.NS is 1.
- The entry would be used with the current VMID.
- The entry would be required to translate the specified IPA using the Non-secure EL1&0 translation regime.

The invalidation is not required to apply to caching structures that combine stage 1 and stage 2 translation table entries.

The invalidation applies to all PEs in the same Inner Shareable shareability domain as the PE that executes this instructions.

For more information about the architectural requirements for this instruction see [Invalidation of TLB entries from stage 2 translations on page D4-2128](#).

Configurations

There are no configuration notes.

Attributes

TLBI IPAS2LE1IS is a 64-bit System instruction.

Field descriptions

The TLBI IPAS2LE1IS input value bit assignments are:

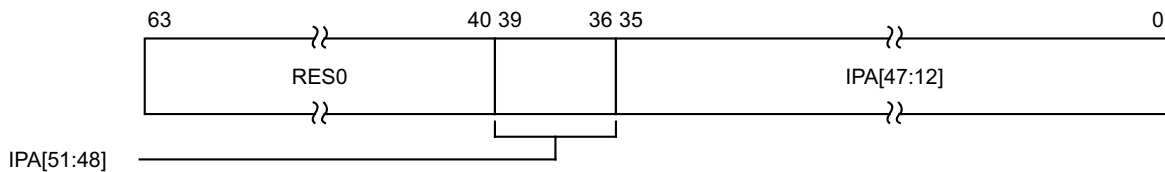

Bits [63:40]

Reserved, RES0.

IPA[51:48], bits [39:36]

In ARMv8.2

Extension to IPA[47:12]. See IPA[47:12] for more details.

In ARMv8.1 and ARMv8.0.

Reserved, RES0.

IPA[47:12], bits [35:0]

Bits[47:12] of the intermediate physical address to match.

When [ARMv8.2-LPA](#) is implemented, and 52-bit addresses and a 64KB translation granule are in use, IPA[51:48] form the upper part of the address value. Otherwise, IPA[51:48] are RES0.

Executing the TLBI IPAS2LE1IS instruction

This instruction is executed using TLBI with the following syntax:

TLBI <tlbi_op>, <Xt>

This syntax uses the following encoding in the System instruction encoding space:

<tlbi_op>	op0	op1	CRn	CRm	op2
IPAS2LE1IS	01	100	1000	0000	101

Accessibility

The instruction is executable as follows:

Control			Accessibility			
E2H	TGE	NS	EL0	EL1	EL2	EL3
x	x	0	-	-	n/a	WO
x	0	1	-	-	WO	WO
x	1	1	-	n/a	WO	WO

If EL2 is not implemented, or SCR_EL3.NS is 0, this instruction is a NOP.

C5.5.13 TLBI VAAE1, TLB Invalidate by VA, All ASID, EL1

The TLBI VAAE1 characteristics are:

Purpose

Invalidate cached copies of translation table entries from TLBs that meet all the following requirements:

- The entry is a stage 1 translation table entry, from any level of the translation table walk.
- The entry would be used to translate the specified address.
- If SCR_EL3.NS is 0, the entry would be required to translate using the Secure EL1&0 translation regime.
- If SCR_EL3.NS is 1, then:
 - If EL2 is not implemented, the entry would be required to translate using the Non-secure EL1&0 translation regime.
 - If EL2 is implemented and HCR_EL2.{E2H, TGE} is not {1, 1}, the entry would be used with the current VMID, and would be required to translate using the Non-secure EL1&0 translation regime.
 - If EL2 is implemented and HCR_EL2.{E2H, TGE} is {1, 1}, the entry would be required to translate using the EL2&0 translation regime.

The invalidation only applies to the PE that executes this instruction.

Note

For the EL1&0 translation regime, the invalidation applies to both:

- Global entries.
- Non-global entries with any ASID.

Configurations

There are no configuration notes.

Attributes

TLBI VAAE1 is a 64-bit System instruction.

Field descriptions

The TLBI VAAE1 input value bit assignments are:

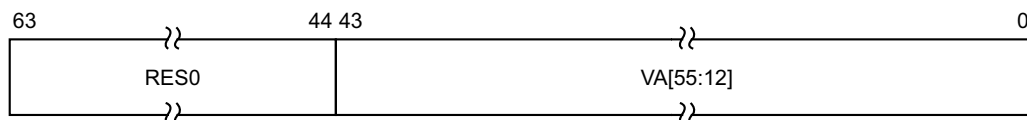

Bits [63:44]

Reserved, RES0.

VA[55:12], bits [43:0]

Bits[55:12] of the virtual address to match. Any appropriate TLB entries that match the VA will be affected by this operation, regardless of the ASID.

If the TLB maintenance instructions are targeting a translation regime that is using AArch32, and so has a VA of only 32 bits, then the software must treat bits[55:32] as RES0.

The treatment of the low-order bits of this field depends on the translation granule size, as follows:

- Where a 4KB translation granule is being used, all bits are valid and used for the invalidation.

- Where a 16KB translation granule is being used, bits [1:0] of this field are RES0 and ignored when the instruction is executed, because VA[13:12] have no effect on the operation of the instruction.
- Where a 64KB translation granule is being used, bits [3:0] of this field are RES0 and ignored when the instruction is executed, because VA[15:12] have no effect on the operation of the instruction.

Executing the TLBI VAAE1 instruction

This instruction is executed using TLBI with the following syntax:

TLBI <tlbi_op>, <Xt>

This syntax uses the following encoding in the System instruction encoding space:

<tlbi_op>	op0	op1	CRn	CRm	op2
VAAE1	01	000	1000	0111	011

Accessibility

The instruction is executable as follows:

Control			Accessibility			
E2H	TGE	NS	EL0	EL1	EL2	EL3
x	x	0	-	WO	n/a	WO
0	0	1	-	WO	WO	WO
0	1	1	-	n/a	WO	WO
1	0	1	-	WO	WO	WO
1	1	1	-	n/a	WO	WO

When [HCR_EL2.FB](#) is 1, at Non-secure EL1 this instruction executes as a [TLBI VAAE1IS](#).

Traps and Enables

For a description of the prioritization of any generated exceptions, see [Synchronous exception prioritization for exceptions taken to AArch64 on page D1-1827](#). Subject to the prioritization rules:

- When EL2 is implemented and is using AArch64 and (SCR_EL3.NS == 1) && (HCR_EL2.E2H == 0):
 - If [HCR_EL2.TTLB](#)==1, Non-secure execution of this instruction at EL1 is trapped to EL2.
- When EL2 is implemented and is using AArch64 and (SCR_EL3.NS == 1) && (HCR_EL2.E2H == 1) && (HCR_EL2.TGE == 0):
 - If [HCR_EL2.TTLB](#)==1, Non-secure execution of this instruction at EL1 is trapped to EL2.

C5.5.14 TLBI VAAE1IS, TLB Invalidate by VA, All ASID, EL1, Inner Shareable

The TLBI VAAE1IS characteristics are:

Purpose

Invalidate cached copies of translation table entries from TLBs that meet all the following requirements:

- The entry is a stage 1 translation table entry, from any level of the translation table walk.
- The entry would be used to translate the specified address.
- If SCR_EL3.NS is 0, the entry would be required to translate using the Secure EL1&0 translation regime.
- If SCR_EL3.NS is 1, then:
 - If EL2 is not implemented, the entry would be required to translate using the Non-secure EL1&0 translation regime.
 - If EL2 is implemented and HCR_EL2.{E2H, TGE} is not {1, 1}, the entry would be used with the current VMID, and would be required to translate using the Non-secure EL1&0 translation regime.
 - If EL2 is implemented and HCR_EL2.{E2H, TGE} is {1, 1}, the entry would be required to translate using the EL2&0 translation regime.

The invalidation applies to all PEs in the same Inner Shareable shareability domain as the PE that executes this instructions.

Note

For the EL1&0 translation regime, the invalidation applies to both:

- Global entries.
- Non-global entries with any ASID.

Configurations

There are no configuration notes.

Attributes

TLBI VAAE1IS is a 64-bit System instruction.

Field descriptions

The TLBI VAAE1IS input value bit assignments are:

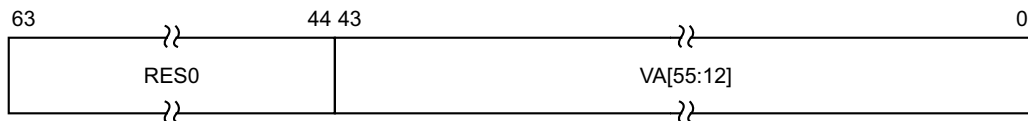

Bits [63:44]

Reserved, RES0.

VA[55:12], bits [43:0]

Bits[55:12] of the virtual address to match. Any appropriate TLB entries that match the VA will be affected by this operation, regardless of the ASID.

If the TLB maintenance instructions are targeting a translation regime that is using AArch32, and so has a VA of only 32 bits, then the software must treat bits[55:32] as RES0.

The treatment of the low-order bits of this field depends on the translation granule size, as follows:

- Where a 4KB translation granule is being used, all bits are valid and used for the invalidation.

- Where a 16KB translation granule is being used, bits [1:0] of this field are RES0 and ignored when the instruction is executed, because VA[13:12] have no effect on the operation of the instruction.
- Where a 64KB translation granule is being used, bits [3:0] of this field are RES0 and ignored when the instruction is executed, because VA[15:12] have no effect on the operation of the instruction.

Executing the TLBI VAAE1IS instruction

This instruction is executed using TLBI with the following syntax:

TLBI <tlbi_op>, <Xt>

This syntax uses the following encoding in the System instruction encoding space:

<tlbi_op>	op0	op1	CRn	CRm	op2
VAAE1IS	01	000	1000	0011	011

Accessibility

The instruction is executable as follows:

Control			Accessibility			
E2H	TGE	NS	EL0	EL1	EL2	EL3
x	x	0	-	WO	n/a	WO
0	0	1	-	WO	WO	WO
0	1	1	-	n/a	WO	WO
1	0	1	-	WO	WO	WO
1	1	1	-	n/a	WO	WO

Traps and Enables

For a description of the prioritization of any generated exceptions, see [Synchronous exception prioritization for exceptions taken to AArch64 on page D1-1827](#). Subject to the prioritization rules:

- When EL2 is implemented and is using AArch64 and (SCR_EL3.NS == 1) && (HCR_EL2.E2H == 0):
 - If HCR_EL2.TTLB==1, Non-secure execution of this instruction at EL1 is trapped to EL2.
- When EL2 is implemented and is using AArch64 and (SCR_EL3.NS == 1) && (HCR_EL2.E2H == 1) && (HCR_EL2.TGE == 0):
 - If HCR_EL2.TTLB==1, Non-secure execution of this instruction at EL1 is trapped to EL2.

C5.5.15 TLBI VAALE1, TLB Invalidate by VA, All ASID, Last level, EL1

The TLBI VAALE1 characteristics are:

Purpose

Invalidate cached copies of translation table entries from TLBs that meet all the following requirements:

- The entry is a stage 1 translation table entry, from the final level of the translation table walk.
- The entry would be used to translate the specified address.
- If SCR_EL3.NS is 0, the entry would be required to translate using the Secure EL1&0 translation regime.
- If SCR_EL3.NS is 1, then:
 - If EL2 is not implemented, the entry would be required to translate using the Non-secure EL1&0 translation regime.
 - If EL2 is implemented and HCR_EL2.{E2H, TGE} is not {1, 1}, the entry would be used with the current VMID, and would be required to translate using the Non-secure EL1&0 translation regime.
 - If EL2 is implemented and HCR_EL2.{E2H, TGE} is {1, 1}, the entry would be required to translate using the EL2&0 translation regime.

The invalidation only applies to the PE that executes this instruction.

Note

For the EL1&0 translation regime, the invalidation applies to both:

- Global entries.
- Non-global entries with any ASID.

Configurations

There are no configuration notes.

Attributes

TLBI VAALE1 is a 64-bit System instruction.

Field descriptions

The TLBI VAALE1 input value bit assignments are:

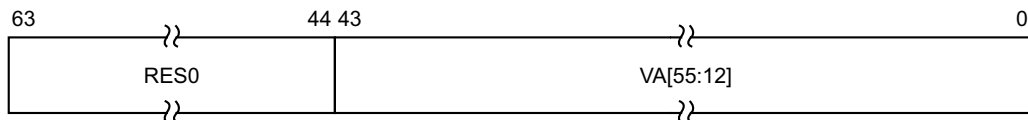

Bits [63:44]

Reserved, RES0.

VA[55:12], bits [43:0]

Bits[55:12] of the virtual address to match. Any appropriate TLB entries that match the VA will be affected by this operation, regardless of the ASID.

If the TLB maintenance instructions are targeting a translation regime that is using AArch32, and so has a VA of only 32 bits, then the software must treat bits[55:32] as RES0.

The treatment of the low-order bits of this field depends on the translation granule size, as follows:

- Where a 4KB translation granule is being used, all bits are valid and used for the invalidation.

- Where a 16KB translation granule is being used, bits [1:0] of this field are RES0 and ignored when the instruction is executed, because VA[13:12] have no effect on the operation of the instruction.
- Where a 64KB translation granule is being used, bits [3:0] of this field are RES0 and ignored when the instruction is executed, because VA[15:12] have no effect on the operation of the instruction.

Executing the TLBI VAALE1 instruction

This instruction is executed using TLBI with the following syntax:

TLBI <tlbi_op>, <Xt>

This syntax uses the following encoding in the System instruction encoding space:

<tlbi_op>	op0	op1	CRn	CRm	op2
VAALE1	01	000	1000	0111	111

Accessibility

The instruction is executable as follows:

Control			Accessibility			
E2H	TGE	NS	EL0	EL1	EL2	EL3
x	x	0	-	WO	n/a	WO
0	0	1	-	WO	WO	WO
0	1	1	-	n/a	WO	WO
1	0	1	-	WO	WO	WO
1	1	1	-	n/a	WO	WO

When [HCR_EL2.FB](#) is 1, at Non-secure EL1 this instruction executes as a [TLBI VAALE1IS](#).

Traps and Enables

For a description of the prioritization of any generated exceptions, see [Synchronous exception prioritization for exceptions taken to AArch64 on page D1-1827](#). Subject to the prioritization rules:

- When EL2 is implemented and is using AArch64 and (SCR_EL3.NS == 1) && (HCR_EL2.E2H == 0):
 - If [HCR_EL2.TTLB](#)==1, Non-secure execution of this instruction at EL1 is trapped to EL2.
- When EL2 is implemented and is using AArch64 and (SCR_EL3.NS == 1) && (HCR_EL2.E2H == 1) && (HCR_EL2.TGE == 0):
 - If [HCR_EL2.TTLB](#)==1, Non-secure execution of this instruction at EL1 is trapped to EL2.

C5.5.16 TLBI VAALE1IS, TLB Invalidate by VA, All ASID, EL1, Last Level, Inner Shareable

The TLBI VAALE1IS characteristics are:

Purpose

Invalidate cached copies of translation table entries from TLBs that meet all the following requirements:

- The entry is a stage 1 translation table entry, from the final level of the translation table walk.
- The entry would be used to translate the specified address.
- If SCR_EL3.NS is 0, the entry would be required to translate using the Secure EL1&0 translation regime.
- If SCR_EL3.NS is 1, then:
 - If EL2 is not implemented, the entry would be required to translate using the Non-secure EL1&0 translation regime.
 - If EL2 is implemented and HCR_EL2.{E2H, TGE} is not {1, 1}, the entry would be used with the current VMID, and would be required to translate using the Non-secure EL1&0 translation regime.
 - If EL2 is implemented and HCR_EL2.{E2H, TGE} is {1, 1}, the entry would be required to translate using the EL2&0 translation regime.

The invalidation applies to all PEs in the same Inner Shareable shareability domain as the PE that executes this instructions.

Note

For the EL1&0 translation regime, the invalidation applies to both:

- Global entries.
- Non-global entries with any ASID.

Configurations

There are no configuration notes.

Attributes

TLBI VAALE1IS is a 64-bit System instruction.

Field descriptions

The TLBI VAALE1IS input value bit assignments are:

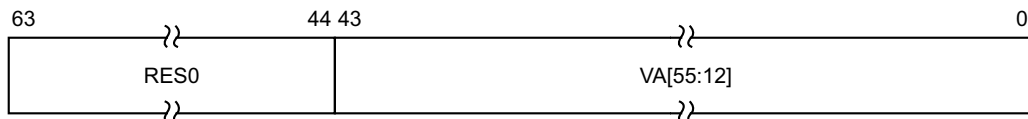

Bits [63:44]

Reserved, RES0.

VA[55:12], bits [43:0]

Bits[55:12] of the virtual address to match. Any appropriate TLB entries that match the VA will be affected by this operation, regardless of the ASID.

If the TLB maintenance instructions are targeting a translation regime that is using AArch32, and so has a VA of only 32 bits, then the software must treat bits[55:32] as RES0.

The treatment of the low-order bits of this field depends on the translation granule size, as follows:

- Where a 4KB translation granule is being used, all bits are valid and used for the invalidation.

- Where a 16KB translation granule is being used, bits [1:0] of this field are RES0 and ignored when the instruction is executed, because VA[13:12] have no effect on the operation of the instruction.
- Where a 64KB translation granule is being used, bits [3:0] of this field are RES0 and ignored when the instruction is executed, because VA[15:12] have no effect on the operation of the instruction.

Executing the TLBI VAALE1IS instruction

This instruction is executed using TLBI with the following syntax:

TLBI <tlbi_op>, <Xt>

This syntax uses the following encoding in the System instruction encoding space:

<tlbi_op>	op0	op1	CRn	CRm	op2
VAALE1IS	01	000	1000	0011	111

Accessibility

The instruction is executable as follows:

Control			Accessibility			
E2H	TGE	NS	EL0	EL1	EL2	EL3
x	x	0	-	WO	n/a	WO
0	0	1	-	WO	WO	WO
0	1	1	-	n/a	WO	WO
1	0	1	-	WO	WO	WO
1	1	1	-	n/a	WO	WO

Traps and Enables

For a description of the prioritization of any generated exceptions, see [Synchronous exception prioritization for exceptions taken to AArch64 on page D1-1827](#). Subject to the prioritization rules:

- When EL2 is implemented and is using AArch64 and (SCR_EL3.NS == 1) && (HCR_EL2.E2H == 0):
 - If HCR_EL2.TTLB==1, Non-secure execution of this instruction at EL1 is trapped to EL2.
- When EL2 is implemented and is using AArch64 and (SCR_EL3.NS == 1) && (HCR_EL2.E2H == 1) && (HCR_EL2.TGE == 0):
 - If HCR_EL2.TTLB==1, Non-secure execution of this instruction at EL1 is trapped to EL2.

C5.5.17 TLBI VAE1, TLB Invalidate by VA, EL1

The TLBI VAE1 characteristics are:

Purpose

Invalidate cached copies of translation table entries from TLBs that meet all the following requirements:

- The entry is a stage 1 translation table entry.
- The entry would be used to translate the specified address, and one of the following applies:
 - The entry is from a level of lookup above the final level and matches the specified ASID.
 - The entry is a global entry from the final level of lookup.
 - The entry is a non-global entry from the final level of lookup that matches the specified ASID.
- If SCR_EL3.NS is 0, the entry would be required to translate using the Secure EL1&0 translation regime.
- If SCR_EL3.NS is 1, then:
 - If EL2 is not implemented, the entry would be required to translate using the Non-secure EL1&0 translation regime.
 - If EL2 is implemented and HCR_EL2.{E2H, TGE} is not {1, 1}, the entry would be used with the current VMID, and would be required to translate using the Non-secure EL1&0 translation regime.
 - If EL2 is implemented and HCR_EL2.{E2H, TGE} is {1, 1}, the entry would be required to translate using the EL2&0 translation regime.

The invalidation only applies to the PE that executes this instruction.

Configurations

There are no configuration notes.

Attributes

TLBI VAE1 is a 64-bit System instruction.

Field descriptions

The TLBI VAE1 input value bit assignments are:

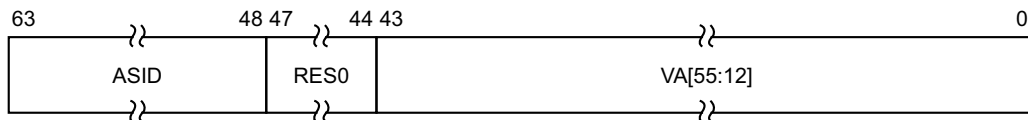

ASID, bits [63:48]

ASID value to match. Any TLB entries that match the ASID value and VA value will be affected by this operation.

Global TLB entries that match the VA value will be affected by this operation, regardless of the value of the ASID field.

If the implementation supports 16 bits of ASID, but only 8 bits are being used in the context being invalidated, the upper bits are RES0 and must be written to 0 by software performing the TLB maintenance.

Bits [47:44]

Reserved, RES0.

VA[55:12], bits [43:0]

Bits[55:12] of the virtual address to match. Any appropriate TLB entries that match the ASID value (if appropriate) and VA will be affected by this operation.

If the TLB maintenance instructions are targeting a translation regime that is using AArch32, and so has a VA of only 32 bits, then the software must treat bits[55:32] as RES0.

The treatment of the low-order bits of this field depends on the translation granule size, as follows:

- Where a 4KB translation granule is being used, all bits are valid and used for the invalidation.
- Where a 16KB translation granule is being used, bits [1:0] of this field are RES0 and ignored when the instruction is executed, because VA[13:12] have no effect on the operation of the instruction.
- Where a 64KB translation granule is being used, bits [3:0] of this field are RES0 and ignored when the instruction is executed, because VA[15:12] have no effect on the operation of the instruction.

Executing the TLBI VAE1 instruction

This instruction is executed using TLBI with the following syntax:

TLBI <tlbi_op>, <Xt>

This syntax uses the following encoding in the System instruction encoding space:

<tlbi_op>	op0	op1	CRn	CRm	op2
VAE1	01	000	1000	0111	001

Accessibility

The instruction is executable as follows:

Control			Accessibility			
E2H	TGE	NS	EL0	EL1	EL2	EL3
x	x	0	-	WO	n/a	WO
0	0	1	-	WO	WO	WO
0	1	1	-	n/a	WO	WO
1	0	1	-	WO	WO	WO
1	1	1	-	n/a	WO	WO

When HCR_EL2.FB is 1, at Non-secure EL1 this instruction executes as a [TLBI VAE1IS](#).

Traps and Enables

For a description of the prioritization of any generated exceptions, see [Synchronous exception prioritization for exceptions taken to AArch64 on page D1-1827](#). Subject to the prioritization rules:

- When EL2 is implemented and is using AArch64 and (SCR_EL3.NS == 1) && (HCR_EL2.E2H == 0):
 - If HCR_EL2.TTLB==1, Non-secure execution of this instruction at EL1 is trapped to EL2.

- When EL2 is implemented and is using AArch64 and (SCR_EL3.NS == 1) && (HCR_EL2.E2H == 1) && (HCR_EL2.TGE == 0):
 - If [HCR_EL2.TTLB](#)==1, Non-secure execution of this instruction at EL1 is trapped to EL2.

C5.5.18 TLBI VAE1IS, TLB Invalidate by VA, EL1, Inner Shareable

The TLBI VAE1IS characteristics are:

Purpose

Invalidate cached copies of translation table entries from TLBs that meet all the following requirements:

- The entry is a stage 1 translation table entry.
- The entry would be used to translate the specified address, and one of the following applies:
 - The entry is from a level of lookup above the final level and matches the specified ASID.
 - The entry is a global entry from the final level of lookup.
 - The entry is a non-global entry from the final level of lookup that matches the specified ASID.
- If SCR_EL3.NS is 0, the entry would be required to translate using the Secure EL1&0 translation regime.
- If SCR_EL3.NS is 1, then:
 - If EL2 is not implemented, the entry would be required to translate using the Non-secure EL1&0 translation regime.
 - If EL2 is implemented and HCR_EL2.{E2H, TGE} is not {1, 1}, the entry would be used with the current VMID, and would be required to translate using the Non-secure EL1&0 translation regime.
 - If EL2 is implemented and HCR_EL2.{E2H, TGE} is {1, 1}, the entry would be required to translate using the EL2&0 translation regime.

The invalidation applies to all PEs in the same Inner Shareable shareability domain as the PE that executes this instructions.

Configurations

There are no configuration notes.

Attributes

TLBI VAE1IS is a 64-bit System instruction.

Field descriptions

The TLBI VAE1IS input value bit assignments are:

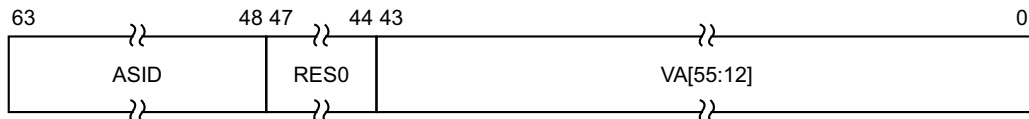

ASID, bits [63:48]

ASID value to match. Any TLB entries that match the ASID value and VA value will be affected by this operation.

Global TLB entries that match the VA value will be affected by this operation, regardless of the value of the ASID field.

If the implementation supports 16 bits of ASID, but only 8 bits are being used in the context being invalidated, the upper bits are RES0 and must be written to 0 by software performing the TLB maintenance.

Bits [47:44]

Reserved, RES0.

VA[55:12], bits [43:0]

Bits[55:12] of the virtual address to match. Any appropriate TLB entries that match the ASID value (if appropriate) and VA will be affected by this operation.

If the TLB maintenance instructions are targeting a translation regime that is using AArch32, and so has a VA of only 32 bits, then the software must treat bits[55:32] as RES0.

The treatment of the low-order bits of this field depends on the translation granule size, as follows:

- Where a 4KB translation granule is being used, all bits are valid and used for the invalidation.
- Where a 16KB translation granule is being used, bits [1:0] of this field are RES0 and ignored when the instruction is executed, because VA[13:12] have no effect on the operation of the instruction.
- Where a 64KB translation granule is being used, bits [3:0] of this field are RES0 and ignored when the instruction is executed, because VA[15:12] have no effect on the operation of the instruction.

Executing the TLBI VAE1IS instruction

This instruction is executed using TLBI with the following syntax:

TLBI <tlbi_op>, <Xt>

This syntax uses the following encoding in the System instruction encoding space:

<tlbi_op>	op0	op1	CRn	CRm	op2
VAE1IS	01	000	1000	0011	001

Accessibility

The instruction is executable as follows:

Control			Accessibility			
E2H	TGE	NS	EL0	EL1	EL2	EL3
x	x	0	-	WO	n/a	WO
0	0	1	-	WO	WO	WO
0	1	1	-	n/a	WO	WO
1	0	1	-	WO	WO	WO
1	1	1	-	n/a	WO	WO

Traps and Enables

For a description of the prioritization of any generated exceptions, see [Synchronous exception prioritization for exceptions taken to AArch64 on page D1-1827](#). Subject to the prioritization rules:

- When EL2 is implemented and is using AArch64 and (SCR_EL3.NS == 1) && (HCR_EL2.E2H == 0):
 - If HCR_EL2.TTLB==1, Non-secure execution of this instruction at EL1 is trapped to EL2.
- When EL2 is implemented and is using AArch64 and (SCR_EL3.NS == 1) && (HCR_EL2.E2H == 1) && (HCR_EL2.TGE == 0):
 - If HCR_EL2.TTLB==1, Non-secure execution of this instruction at EL1 is trapped to EL2.

C5.5.19 TLBI VAE2, TLB Invalidate by VA, EL2

The TLBI VAE2 characteristics are:

Purpose

If EL2 is implemented, invalidate cached copies of translation table entries from TLBs that meet all the following requirements:

- The entry is a stage 1 translation table entry, from any level of the translation table walk.
- The entry would be used to translate the specified address.
- SCR_EL3.NS is 1.
- The entry would be required to translate using the EL2 translation regime.

The invalidation only applies to the PE that executes this instruction.

Configurations

There are no configuration notes.

Attributes

TLBI VAE2 is a 64-bit System instruction.

Field descriptions

The TLBI VAE2 input value bit assignments are:

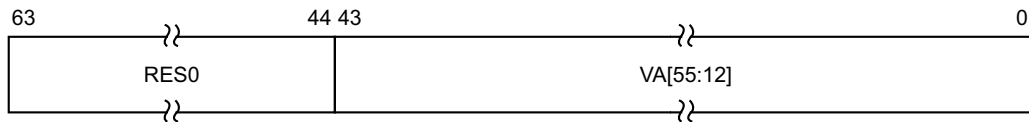

Bits [63:44]

Reserved, RES0.

VA[55:12], bits [43:0]

Bits[55:12] of the virtual address to match. Any appropriate TLB entries that match the ASID value (if appropriate) and VA will be affected by this operation.

If the TLB maintenance instructions are targeting a translation regime that is using AArch32, and so has a VA of only 32 bits, then the software must treat bits[55:32] as RES0.

The treatment of the low-order bits of this field depends on the translation granule size, as follows:

- Where a 4KB translation granule is being used, all bits are valid and used for the invalidation.
- Where a 16KB translation granule is being used, bits [1:0] of this field are RES0 and ignored when the instruction is executed, because VA[13:12] have no effect on the operation of the instruction.
- Where a 64KB translation granule is being used, bits [3:0] of this field are RES0 and ignored when the instruction is executed, because VA[15:12] have no effect on the operation of the instruction.

Executing the TLBI VAE2 instruction

This instruction is executed using TLBI with the following syntax:

TLBI <t\bi_op>, <Xt>

This syntax uses the following encoding in the System instruction encoding space:

<tlbi_op>	op0	op1	CRn	CRm	op2
VAE2	01	100	1000	0111	001

Accessibility

The instruction is executable as follows:

Control			Accessibility			
E2H	TGE	NS	EL0	EL1	EL2	EL3
x	x	0	-	-	n/a	-
0	0	1	-	-	WO	WO
0	1	1	-	n/a	WO	WO
1	0	1	-	-	WO	WO
1	1	1	-	n/a	WO	WO

If EL2 is not implemented, or SCR_EL3.NS is 0, this instruction is UNDEFINED.

C5.5.20 TLBI VAE2IS, TLB Invalidate by VA, EL2, Inner Shareable

The TLBI VAE2IS characteristics are:

Purpose

If EL2 is implemented, invalidate cached copies of translation table entries from TLBs that meet all the following requirements:

- The entry is a stage 1 translation table entry, from any level of the translation table walk.
- The entry would be used to translate the specified address.
- SCR_EL3.NS is 1.
- The entry would be required to translate using the EL2 translation regime.

The invalidation applies to all PEs in the same Inner Shareable shareability domain as the PE that executes this instructions.

Configurations

There are no configuration notes.

Attributes

TLBI VAE2IS is a 64-bit System instruction.

Field descriptions

The TLBI VAE2IS input value bit assignments are:

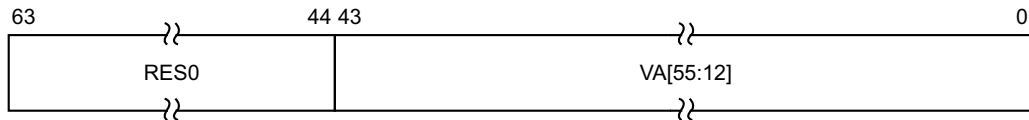

Bits [63:44]

Reserved, RES0.

VA[55:12], bits [43:0]

Bits[55:12] of the virtual address to match. Any appropriate TLB entries that match the ASID value (if appropriate) and VA will be affected by this operation.

If the TLB maintenance instructions are targeting a translation regime that is using AArch32, and so has a VA of only 32 bits, then the software must treat bits[55:32] as RES0.

The treatment of the low-order bits of this field depends on the translation granule size, as follows:

- Where a 4KB translation granule is being used, all bits are valid and used for the invalidation.
- Where a 16KB translation granule is being used, bits [1:0] of this field are RES0 and ignored when the instruction is executed, because VA[13:12] have no effect on the operation of the instruction.
- Where a 64KB translation granule is being used, bits [3:0] of this field are RES0 and ignored when the instruction is executed, because VA[15:12] have no effect on the operation of the instruction.

Executing the TLBI VAE2IS instruction

This instruction is executed using TLBI with the following syntax:

TLBI <tlbi_op>, <Xt>

This syntax uses the following encoding in the System instruction encoding space:

<tlbi_op>	op0	op1	CRn	CRm	op2
VAE2IS	01	100	1000	0011	001

Accessibility

The instruction is executable as follows:

Control			Accessibility			
E2H	TGE	NS	EL0	EL1	EL2	EL3
x	x	0	-	-	n/a	-
0	0	1	-	-	WO	WO
0	1	1	-	n/a	WO	WO
1	0	1	-	-	WO	WO
1	1	1	-	n/a	WO	WO

If EL2 is not implemented, or SCR_EL3.NS is 0, this instruction is UNDEFINED.

C5.5.21 TLBI VAE3, TLB Invalidate by VA, EL3

The TLBI VAE3 characteristics are:

Purpose

If EL3 is implemented, invalidate cached copies of translation table entries from TLBs that meet all the following requirements:

- The entry is a stage 1 translation table entry, from any level of the translation table walk.
- The entry would be used to translate the specified address.
- The entry would be required to translate using the EL3 translation regime.

The invalidation only applies to the PE that executes this instruction.

Configurations

There are no configuration notes.

Attributes

TLBI VAE3 is a 64-bit System instruction.

Field descriptions

The TLBI VAE3 input value bit assignments are:

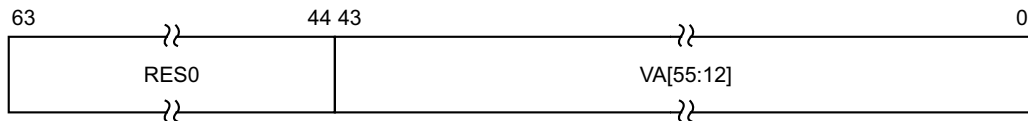

Bits [63:44]

Reserved, RES0.

VA[55:12], bits [43:0]

Bits[55:12] of the virtual address to match. Any appropriate TLB entries that match the ASID value (if appropriate) and VA will be affected by this operation.

If the TLB maintenance instructions are targeting a translation regime that is using AArch32, and so has a VA of only 32 bits, then the software must treat bits[55:32] as RES0.

The treatment of the low-order bits of this field depends on the translation granule size, as follows:

- Where a 4KB translation granule is being used, all bits are valid and used for the invalidation.
- Where a 16KB translation granule is being used, bits [1:0] of this field are RES0 and ignored when the instruction is executed, because VA[13:12] have no effect on the operation of the instruction.
- Where a 64KB translation granule is being used, bits [3:0] of this field are RES0 and ignored when the instruction is executed, because VA[15:12] have no effect on the operation of the instruction.

Executing the TLBI VAE3 instruction

This instruction is executed using TLBI with the following syntax:

TLBI <tlbi_op>, <Xt>

This syntax uses the following encoding in the System instruction encoding space:

<tlbi_op>	op0	op1	CRn	CRm	op2
VAE3	01	110	1000	0111	001

Accessibility

The instruction is executable as follows:

Control			Accessibility			
E2H	TGE	NS	EL0	EL1	EL2	EL3
x	x	0	-	-	n/a	WO
0	0	1	-	-	-	WO
0	1	1	-	n/a	-	WO
1	0	1	-	-	-	WO
1	1	1	-	n/a	-	WO

C5.5.22 TLBI VAE3IS, TLB Invalidate by VA, EL3, Inner Shareable

The TLBI VAE3IS characteristics are:

Purpose

If EL3 is implemented, invalidate cached copies of translation table entries from TLBs that meet all the following requirements:

- The entry is a stage 1 translation table entry, from any level of the translation table walk.
- The entry would be used to translate the specified address.
- The entry would be required to translate using the EL3 translation regime.

The invalidation applies to all PEs in the same Inner Shareable shareability domain as the PE that executes this instructions.

Configurations

There are no configuration notes.

Attributes

TLBI VAE3IS is a 64-bit System instruction.

Field descriptions

The TLBI VAE3IS input value bit assignments are:

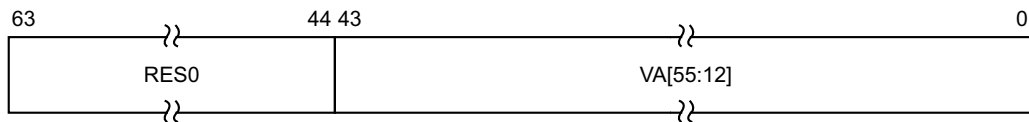

Bits [63:44]

Reserved, RES0.

VA[55:12], bits [43:0]

Bits[55:12] of the virtual address to match. Any appropriate TLB entries that match the ASID value (if appropriate) and VA will be affected by this operation.

If the TLB maintenance instructions are targeting a translation regime that is using AArch32, and so has a VA of only 32 bits, then the software must treat bits[55:32] as RES0.

The treatment of the low-order bits of this field depends on the translation granule size, as follows:

- Where a 4KB translation granule is being used, all bits are valid and used for the invalidation.
- Where a 16KB translation granule is being used, bits [1:0] of this field are RES0 and ignored when the instruction is executed, because VA[13:12] have no effect on the operation of the instruction.
- Where a 64KB translation granule is being used, bits [3:0] of this field are RES0 and ignored when the instruction is executed, because VA[15:12] have no effect on the operation of the instruction.

Executing the TLBI VAE3IS instruction

This instruction is executed using TLBI with the following syntax:

TLBI <tlbi_op>, <Xt>

This syntax uses the following encoding in the System instruction encoding space:

<tlbi_op>	op0	op1	CRn	CRm	op2
VAE3IS	01	110	1000	0011	001

Accessibility

The instruction is executable as follows:

Control			Accessibility			
E2H	TGE	NS	EL0	EL1	EL2	EL3
x	x	0	-	-	n/a	WO
0	0	1	-	-	-	WO
0	1	1	-	n/a	-	WO
1	0	1	-	-	-	WO
1	1	1	-	n/a	-	WO

C5.5.23 TLBI VALE1, TLB Invalidate by VA, Last level, EL1

The TLBI VALE1 characteristics are:

Purpose

Invalidate cached copies of translation table entries from TLBs that meet all the following requirements:

- The entry is a stage 1 translation table entry.
- The entry would be used to translate the specified address, and one of the following applies:
 - The entry is a global entry from the final level of lookup.
 - The entry is a non-global entry from the final level of lookup that matches the specified ASID.
- If SCR_EL3.NS is 0, the entry would be required to translate using the Secure EL1&0 translation regime.
- If SCR_EL3.NS is 1, then:
 - If EL2 is not implemented, the entry would be required to translate using the Non-secure EL1&0 translation regime.
 - If EL2 is implemented and HCR_EL2.{E2H, TGE} is not {1, 1}, the entry would be used with the current VMID, and would be required to translate using the Non-secure EL1&0 translation regime.
 - If EL2 is implemented and HCR_EL2.{E2H, TGE} is {1, 1}, the entry would be required to translate using the EL2&0 translation regime.

The invalidation only applies to the PE that executes this instruction.

Configurations

There are no configuration notes.

Attributes

TLBI VALE1 is a 64-bit System instruction.

Field descriptions

The TLBI VALE1 input value bit assignments are:

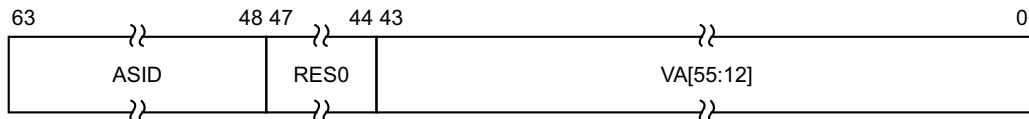

ASID, bits [63:48]

ASID value to match. Any TLB entries that match the ASID value and VA value will be affected by this operation.

Global TLB entries that match the VA value will be affected by this operation, regardless of the value of the ASID field.

If the implementation supports 16 bits of ASID, but only 8 bits are being used in the context being invalidated, the upper bits are RES0 and must be written to 0 by software performing the TLB maintenance.

Bits [47:44]

Reserved, RES0.

VA[55:12], bits [43:0]

Bits[55:12] of the virtual address to match. Any appropriate TLB entries that match the ASID value (if appropriate) and VA will be affected by this operation.

If the TLB maintenance instructions are targeting a translation regime that is using AArch32, and so has a VA of only 32 bits, then the software must treat bits[55:32] as RES0.

The treatment of the low-order bits of this field depends on the translation granule size, as follows:

- Where a 4KB translation granule is being used, all bits are valid and used for the invalidation.
- Where a 16KB translation granule is being used, bits [1:0] of this field are RES0 and ignored when the instruction is executed, because VA[13:12] have no effect on the operation of the instruction.
- Where a 64KB translation granule is being used, bits [3:0] of this field are RES0 and ignored when the instruction is executed, because VA[15:12] have no effect on the operation of the instruction.

Executing the TLBI VALE1 instruction

This instruction is executed using TLBI with the following syntax:

TLBI <tlbi_op>, <Xt>

This syntax uses the following encoding in the System instruction encoding space:

<tlbi_op>	op0	op1	CRn	CRm	op2
VALE1	01	000	1000	0111	101

Accessibility

The instruction is executable as follows:

Control			Accessibility			
E2H	TGE	NS	EL0	EL1	EL2	EL3
x	x	0	-	WO	n/a	WO
0	0	1	-	WO	WO	WO
0	1	1	-	n/a	WO	WO
1	0	1	-	WO	WO	WO
1	1	1	-	n/a	WO	WO

When [HCR_EL2.FB](#) is 1, at Non-secure EL1 this instruction executes as a [TLBI VALE1IS](#).

Traps and Enables

For a description of the prioritization of any generated exceptions, see [Synchronous exception prioritization for exceptions taken to AArch64 on page D1-1827](#). Subject to the prioritization rules:

- When EL2 is implemented and is using AArch64 and (SCR_EL3.NS == 1) && (HCR_EL2.E2H == 0):
 - If [HCR_EL2.TTLB](#)==1, Non-secure execution of this instruction at EL1 is trapped to EL2.

- When EL2 is implemented and is using AArch64 and (SCR_EL3.NS == 1) && (HCR_EL2.E2H == 1) && (HCR_EL2.TGE == 0):
 - If [HCR_EL2.TTLB](#)==1, Non-secure execution of this instruction at EL1 is trapped to EL2.

C5.5.24 TLBI VALE1IS, TLB Invalidate by VA, Last level, EL1, Inner Shareable

The TLBI VALE1IS characteristics are:

Purpose

Invalidate cached copies of translation table entries from TLBs that meet all the following requirements:

- The entry is a stage 1 translation table entry.
- The entry would be used to translate the specified address, and one of the following applies:
 - The entry is a global entry from the final level of lookup.
 - The entry is a non-global entry from the final level of lookup that matches the specified ASID.
- If SCR_EL3.NS is 0, the entry would be required to translate using the Secure EL1&0 translation regime.
- If SCR_EL3.NS is 1, then:
 - If EL2 is not implemented, the entry would be required to translate using the Non-secure EL1&0 translation regime.
 - If EL2 is implemented and HCR_EL2.{E2H, TGE} is not {1, 1}, the entry would be used with the current VMID, and would be required to translate using the Non-secure EL1&0 translation regime.
 - If EL2 is implemented and HCR_EL2.{E2H, TGE} is {1, 1}, the entry would be required to translate using the EL2&0 translation regime.

The invalidation applies to all PEs in the same Inner Shareable shareability domain as the PE that executes this instructions.

Configurations

There are no configuration notes.

Attributes

TLBI VALE1IS is a 64-bit System instruction.

Field descriptions

The TLBI VALE1IS input value bit assignments are:

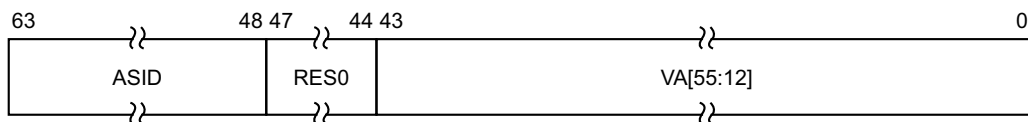

ASID, bits [63:48]

ASID value to match. Any TLB entries that match the ASID value and VA value will be affected by this operation.

Global TLB entries that match the VA value will be affected by this operation, regardless of the value of the ASID field.

If the implementation supports 16 bits of ASID, but only 8 bits are being used in the context being invalidated, the upper bits are RES0 and must be written to 0 by software performing the TLB maintenance.

Bits [47:44]

Reserved, RES0.

VA[55:12], bits [43:0]

Bits[55:12] of the virtual address to match. Any appropriate TLB entries that match the ASID value (if appropriate) and VA will be affected by this operation.

If the TLB maintenance instructions are targeting a translation regime that is using AArch32, and so has a VA of only 32 bits, then the software must treat bits[55:32] as RES0.

The treatment of the low-order bits of this field depends on the translation granule size, as follows:

- Where a 4KB translation granule is being used, all bits are valid and used for the invalidation.
- Where a 16KB translation granule is being used, bits [1:0] of this field are RES0 and ignored when the instruction is executed, because VA[13:12] have no effect on the operation of the instruction.
- Where a 64KB translation granule is being used, bits [3:0] of this field are RES0 and ignored when the instruction is executed, because VA[15:12] have no effect on the operation of the instruction.

Executing the TLBI VALE1IS instruction

This instruction is executed using TLBI with the following syntax:

TLBI <tlbi_op>, <Xt>

This syntax uses the following encoding in the System instruction encoding space:

<tlbi_op>	op0	op1	CRn	CRm	op2
VALE1IS	01	000	1000	0011	101

Accessibility

The instruction is executable as follows:

Control			Accessibility			
E2H	TGE	NS	EL0	EL1	EL2	EL3
x	x	0	-	WO	n/a	WO
0	0	1	-	WO	WO	WO
0	1	1	-	n/a	WO	WO
1	0	1	-	WO	WO	WO
1	1	1	-	n/a	WO	WO

Traps and Enables

For a description of the prioritization of any generated exceptions, see [Synchronous exception prioritization for exceptions taken to AArch64 on page D1-1827](#). Subject to the prioritization rules:

- When EL2 is implemented and is using AArch64 and (SCR_EL3.NS == 1) && (HCR_EL2.E2H == 0):
 - If HCR_EL2.TTLB==1, Non-secure execution of this instruction at EL1 is trapped to EL2.
- When EL2 is implemented and is using AArch64 and (SCR_EL3.NS == 1) && (HCR_EL2.E2H == 1) && (HCR_EL2.TGE == 0):
 - If HCR_EL2.TTLB==1, Non-secure execution of this instruction at EL1 is trapped to EL2.

C5.5.25 TLBI VALE2, TLB Invalidate by VA, Last level, EL2

The TLBI VALE2 characteristics are:

Purpose

If EL2 is implemented, invalidate cached copies of translation table entries from TLBs that meet all the following requirements:

- The entry is a stage 1 translation table entry, from the final level of the translation table walk.
- The entry would be used to translate the specified address.
- SCR_EL3.NS is 1.
- The entry would be required to translate using the EL2 translation regime.

The invalidation only applies to the PE that executes this instruction.

Configurations

There are no configuration notes.

Attributes

TLBI VALE2 is a 64-bit System instruction.

Field descriptions

The TLBI VALE2 input value bit assignments are:

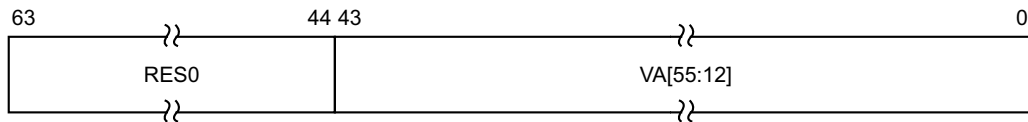

Bits [63:44]

Reserved, RES0.

VA[55:12], bits [43:0]

Bits[55:12] of the virtual address to match. Any appropriate TLB entries that match the ASID value (if appropriate) and VA will be affected by this operation.

If the TLB maintenance instructions are targeting a translation regime that is using AArch32, and so has a VA of only 32 bits, then the software must treat bits[55:32] as RES0.

The treatment of the low-order bits of this field depends on the translation granule size, as follows:

- Where a 4KB translation granule is being used, all bits are valid and used for the invalidation.
- Where a 16KB translation granule is being used, bits [1:0] of this field are RES0 and ignored when the instruction is executed, because VA[13:12] have no effect on the operation of the instruction.
- Where a 64KB translation granule is being used, bits [3:0] of this field are RES0 and ignored when the instruction is executed, because VA[15:12] have no effect on the operation of the instruction.

Executing the TLBI VALE2 instruction

This instruction is executed using TLBI with the following syntax:

TLBI <t\bi_op>, <Xt>

This syntax uses the following encoding in the System instruction encoding space:

<tlbi_op>	op0	op1	CRn	CRm	op2
VALE2	01	100	1000	0111	101

Accessibility

The instruction is executable as follows:

Control			Accessibility			
E2H	TGE	NS	EL0	EL1	EL2	EL3
x	x	0	-	-	n/a	-
0	0	1	-	-	WO	WO
0	1	1	-	n/a	WO	WO
1	0	1	-	-	WO	WO
1	1	1	-	n/a	WO	WO

If EL2 is not implemented, or SCR_EL3.NS is 0, this instruction is UNDEFINED.

C5.5.26 TLBI VALE2IS, TLB Invalidate by VA, Last level, EL2, Inner Shareable

The TLBI VALE2IS characteristics are:

Purpose

If EL2 is implemented, invalidate cached copies of translation table entries from TLBs that meet all the following requirements:

- The entry is a stage 1 translation table entry, from the final level of the translation table walk.
- The entry would be used to translate the specified address.
- SCR_EL3.NS is 1.
- The entry would be required to translate using the EL2 translation regime.

The invalidation applies to all PEs in the same Inner Shareable shareability domain as the PE that executes this instructions.

Configurations

There are no configuration notes.

Attributes

TLBI VALE2IS is a 64-bit System instruction.

Field descriptions

The TLBI VALE2IS input value bit assignments are:

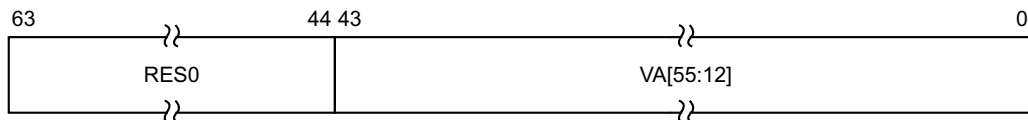

Bits [63:44]

Reserved, RES0.

VA[55:12], bits [43:0]

Bits[55:12] of the virtual address to match. Any appropriate TLB entries that match the ASID value (if appropriate) and VA will be affected by this operation.

If the TLB maintenance instructions are targeting a translation regime that is using AArch32, and so has a VA of only 32 bits, then the software must treat bits[55:32] as RES0.

The treatment of the low-order bits of this field depends on the translation granule size, as follows:

- Where a 4KB translation granule is being used, all bits are valid and used for the invalidation.
- Where a 16KB translation granule is being used, bits [1:0] of this field are RES0 and ignored when the instruction is executed, because VA[13:12] have no effect on the operation of the instruction.
- Where a 64KB translation granule is being used, bits [3:0] of this field are RES0 and ignored when the instruction is executed, because VA[15:12] have no effect on the operation of the instruction.

Executing the TLBI VALE2IS instruction

This instruction is executed using TLBI with the following syntax:

TLBI <tlbi_op>, <Xt>

This syntax uses the following encoding in the System instruction encoding space:

<tlbi_op>	op0	op1	CRn	CRm	op2
VALE2IS	01	100	1000	0011	101

Accessibility

The instruction is executable as follows:

Control			Accessibility			
E2H	TGE	NS	EL0	EL1	EL2	EL3
x	x	0	-	-	n/a	-
0	0	1	-	-	WO	WO
0	1	1	-	n/a	WO	WO
1	0	1	-	-	WO	WO
1	1	1	-	n/a	WO	WO

If EL2 is not implemented, or SCR_EL3.NS is 0, this instruction is UNDEFINED.

C5.5.27 TLBI VALE3, TLB Invalidate by VA, Last level, EL3

The TLBI VALE3 characteristics are:

Purpose

If EL3 is implemented, invalidate cached copies of translation table entries from TLBs that meet all the following requirements:

- The entry is a stage 1 translation table entry, from the final level of the translation table walk.
- The entry would be used to translate the specified address.
- The entry would be required to translate using the EL3 translation regime.

The invalidation only applies to the PE that executes this instruction.

Configurations

There are no configuration notes.

Attributes

TLBI VALE3 is a 64-bit System instruction.

Field descriptions

The TLBI VALE3 input value bit assignments are:

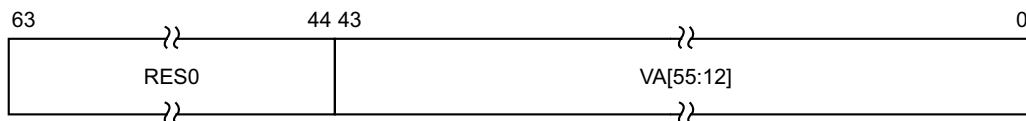

Bits [63:44]

Reserved, RES0.

VA[55:12], bits [43:0]

Bits[55:12] of the virtual address to match. Any appropriate TLB entries that match the ASID value (if appropriate) and VA will be affected by this operation.

If the TLB maintenance instructions are targeting a translation regime that is using AArch32, and so has a VA of only 32 bits, then the software must treat bits[55:32] as RES0.

The treatment of the low-order bits of this field depends on the translation granule size, as follows:

- Where a 4KB translation granule is being used, all bits are valid and used for the invalidation.
- Where a 16KB translation granule is being used, bits [1:0] of this field are RES0 and ignored when the instruction is executed, because VA[13:12] have no effect on the operation of the instruction.
- Where a 64KB translation granule is being used, bits [3:0] of this field are RES0 and ignored when the instruction is executed, because VA[15:12] have no effect on the operation of the instruction.

Executing the TLBI VALE3 instruction

This instruction is executed using TLBI with the following syntax:

TLBI <tlbi_op>, <Xt>

This syntax uses the following encoding in the System instruction encoding space:

<tlbi_op>	op0	op1	CRn	CRm	op2
VALE3	01	110	1000	0111	101

Accessibility

The instruction is executable as follows:

Control			Accessibility			
E2H	TGE	NS	EL0	EL1	EL2	EL3
x	x	0	-	-	n/a	WO
0	0	1	-	-	-	WO
0	1	1	-	n/a	-	WO
1	0	1	-	-	-	WO
1	1	1	-	n/a	-	WO

C5.5.28 TLBI VALE3IS, TLB Invalidate by VA, Last level, EL3, Inner Shareable

The TLBI VALE3IS characteristics are:

Purpose

If EL3 is implemented, invalidate cached copies of translation table entries from TLBs that meet all the following requirements:

- The entry is a stage 1 translation table entry, from the final level of the translation table walk.
- The entry would be used to translate the specified address.
- The entry would be required to translate using the EL3 translation regime.

The invalidation applies to all PEs in the same Inner Shareable shareability domain as the PE that executes this instructions.

Configurations

There are no configuration notes.

Attributes

TLBI VALE3IS is a 64-bit System instruction.

Field descriptions

The TLBI VALE3IS input value bit assignments are:

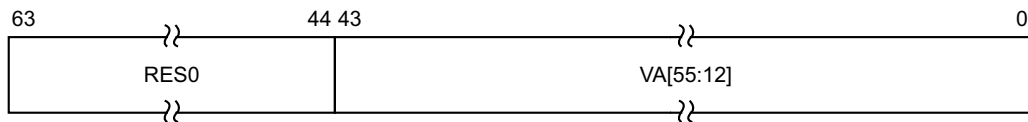

Bits [63:44]

Reserved, RES0.

VA[55:12], bits [43:0]

Bits[55:12] of the virtual address to match. Any appropriate TLB entries that match the ASID value (if appropriate) and VA will be affected by this operation.

If the TLB maintenance instructions are targeting a translation regime that is using AArch32, and so has a VA of only 32 bits, then the software must treat bits[55:32] as RES0.

The treatment of the low-order bits of this field depends on the translation granule size, as follows:

- Where a 4KB translation granule is being used, all bits are valid and used for the invalidation.
- Where a 16KB translation granule is being used, bits [1:0] of this field are RES0 and ignored when the instruction is executed, because VA[13:12] have no effect on the operation of the instruction.
- Where a 64KB translation granule is being used, bits [3:0] of this field are RES0 and ignored when the instruction is executed, because VA[15:12] have no effect on the operation of the instruction.

Executing the TLBI VALE3IS instruction

This instruction is executed using TLBI with the following syntax:

TLBI <tlbi_op>, <Xt>

This syntax uses the following encoding in the System instruction encoding space:

<tlbi_op>	op0	op1	CRn	CRm	op2
VALE3IS	01	110	1000	0011	101

Accessibility

The instruction is executable as follows:

Control			Accessibility			
E2H	TGE	NS	EL0	EL1	EL2	EL3
x	x	0	-	-	n/a	WO
0	0	1	-	-	-	WO
0	1	1	-	n/a	-	WO
1	0	1	-	-	-	WO
1	1	1	-	n/a	-	WO

C5.5.29 TLBI VMALLE1, TLB Invalidate by VMID, All at stage 1, EL1

The TLBI VMALLE1 characteristics are:

Purpose

Invalidate cached copies of translation table entries from TLBs that meet all the following requirements:

- The entry is a stage 1 translation table entry, from any level of the translation table walk.
- If SCR_EL3.NS is 0, the entry would be required to translate an address using the Secure EL1&0 translation regime.
- If SCR_EL3.NS is 1, then:
 - If EL2 is not implemented, the entry would be required to translate an address using the Non-secure EL1&0 translation regime.
 - If EL2 is implemented and HCR_EL2.{E2H, TGE} is not {1, 1}, the entry would be used with the current VMID, and would be required to translate an address using the Non-secure EL1&0 translation regime.
 - If EL2 is implemented and HCR_EL2.{E2H, TGE} is {1, 1}, the entry would be required to translate an address using the EL2&0 translation regime.

The invalidation only applies to the PE that executes this instruction.

———— Note —————

For the EL1&0 translation regime, the invalidation applies to both:

- Global entries.
- Non-global entries with any ASID.

Configurations

There are no configuration notes.

Attributes

TLBI VMALLE1 is a 64-bit System instruction.

Field descriptions

TLBI VMALLE1 ignores the value in the register specified by the instruction. Software does not have to write a value to the register before issuing this instruction.

Executing the TLBI VMALLE1 instruction

This instruction is executed using TLBI with the following syntax:

TLBI <tlbi_op>

This syntax uses the following encoding in the System instruction encoding space:

<tlbi_op>	op0	op1	CRn	CRm	op2	Rt
VMALLE1	01	000	1000	0111	000	11111

Accessibility

The instruction is executable as follows:

Control			Accessibility			
E2H	TGE	NS	EL0	EL1	EL2	EL3
x	x	0	-	WO	n/a	WO
0	0	1	-	WO	WO	WO
0	1	1	-	n/a	WO	WO
1	0	1	-	WO	WO	WO
1	1	1	-	n/a	WO	WO

When [HCR_EL2.FB](#) is 1, at Non-secure EL1 this instruction executes as a [TLBI VMALLE1IS](#).

Traps and Enables

For a description of the prioritization of any generated exceptions, see [Synchronous exception prioritization for exceptions taken to AArch64 on page D1-1827](#). Subject to the prioritization rules:

- When EL2 is implemented and is using AArch64 and $(SCR_EL3.NS == 1) \ \&\& \ (HCR_EL2.E2H == 0)$:
 - If [HCR_EL2.TTLB](#)==1, Non-secure execution of this instruction at EL1 is trapped to EL2.
- When EL2 is implemented and is using AArch64 and $(SCR_EL3.NS == 1) \ \&\& \ (HCR_EL2.E2H == 1) \ \&\& \ (HCR_EL2.TGE == 0)$:
 - If [HCR_EL2.TTLB](#)==1, Non-secure execution of this instruction at EL1 is trapped to EL2.

C5.5.30 TLBI VMALLE1IS, TLB Invalidate by VMID, All at stage 1, EL1, Inner Shareable

The TLBI VMALLE1IS characteristics are:

Purpose

Invalidate cached copies of translation table entries from TLBs that meet all the following requirements:

- The entry is a stage 1 translation table entry, from any level of the translation table walk.
- If SCR_EL3.NS is 0, the entry would be required to translate an address using the Secure EL1&0 translation regime.
- If SCR_EL3.NS is 1, then:
 - If EL2 is not implemented, the entry would be required to translate an address using the Non-secure EL1&0 translation regime.
 - If EL2 is implemented and HCR_EL2.{E2H, TGE} is not {1, 1}, the entry would be used with the current VMID, and would be required to translate an address using the Non-secure EL1&0 translation regime.
 - If EL2 is implemented and HCR_EL2.{E2H, TGE} is {1, 1}, the entry would be required to translate an address using the EL2&0 translation regime.

The invalidation applies to all PEs in the same Inner Shareable shareability domain as the PE that executes this instructions.

Note

For the EL1&0 translation regime, the invalidation applies to both:

- Global entries.
- Non-global entries with any ASID.

Configurations

There are no configuration notes.

Attributes

TLBI VMALLE1IS is a 64-bit System instruction.

Field descriptions

TLBI VMALLE1IS ignores the value in the register specified by the instruction. Software does not have to write a value to the register before issuing this instruction.

Executing the TLBI VMALLE1IS instruction

This instruction is executed using TLBI with the following syntax:

TLBI <tlbi_op>

This syntax uses the following encoding in the System instruction encoding space:

<tlbi_op>	op0	op1	CRn	CRm	op2	Rt
VMALLE1IS	01	000	1000	0011	000	11111

Accessibility

The instruction is executable as follows:

Control			Accessibility			
E2H	TGE	NS	EL0	EL1	EL2	EL3
x	x	0	-	WO	n/a	WO
0	0	1	-	WO	WO	WO
0	1	1	-	n/a	WO	WO
1	0	1	-	WO	WO	WO
1	1	1	-	n/a	WO	WO

Traps and Enables

For a description of the prioritization of any generated exceptions, see [Synchronous exception prioritization for exceptions taken to AArch64 on page D1-1827](#). Subject to the prioritization rules:

- When EL2 is implemented and is using AArch64 and (SCR_EL3.NS == 1) && (HCR_EL2.E2H == 0):
 - If HCR_EL2.TTLB==1, Non-secure execution of this instruction at EL1 is trapped to EL2.
- When EL2 is implemented and is using AArch64 and (SCR_EL3.NS == 1) && (HCR_EL2.E2H == 1) && (HCR_EL2.TGE == 0):
 - If HCR_EL2.TTLB==1, Non-secure execution of this instruction at EL1 is trapped to EL2.

C5.5.31 TLBI VMALLS12E1, TLB Invalidate by VMID, All at Stage 1 and 2, EL1

The TLBI VMALLS12E1 characteristics are:

Purpose

Invalidate cached copies of translation table entries from TLBs that meet all the following requirements:

- The entry is a stage 1 or stage 2 translation table entry, from any level of the translation table walk.
- If SCR_EL3.NS is 0, the entry would be required to translate an address using the Secure EL1&0 translation regime.
- If SCR_EL3.NS is 1, then:
 - The entry would be required to translate an address using the Non-secure EL1&0 translation regime.
 - If EL2 is implemented, the entry would be used with the current VMID.

The invalidation only applies to the PE that executes this instruction.

———— Note ————

For the EL1&0 translation regime, the invalidation applies to both:

- Global entries.
- Non-global entries with any ASID.

Configurations

There are no configuration notes.

Attributes

TLBI VMALLS12E1 is a 64-bit System instruction.

Field descriptions

TLBI VMALLS12E1 ignores the value in the register specified by the instruction. Software does not have to write a value to the register before issuing this instruction.

Executing the TLBI VMALLS12E1 instruction

This instruction is executed using TLBI with the following syntax:

TLBI <tlbi_op>

This syntax uses the following encoding in the System instruction encoding space:

<tlbi_op>	op0	op1	CRn	CRm	op2	Rt
VMALLS12E1	01	100	1000	0111	110	11111

Accessibility

The instruction is executable as follows:

Control			Accessibility			
E2H	TGE	NS	EL0	EL1	EL2	EL3
x	x	0	-	-	n/a	WO
0	0	1	-	-	WO	WO
0	1	1	-	n/a	WO	WO
1	0	1	-	-	WO	WO
1	1	1	-	n/a	WO	WO

If `SCR_EL3.NS=0`, or EL2 is not implemented, this instruction executes as a `TLBI VMALLE1`.

C5.5.32 TLBI VMALLS12E1IS, TLB Invalidate by VMID, All at Stage 1 and 2, EL1, Inner Shareable

The TLBI VMALLS12E1IS characteristics are:

Purpose

Invalidate cached copies of translation table entries from TLBs that meet all the following requirements:

- The entry is a stage 1 or stage 2 translation table entry, from any level of the translation table walk.
- If SCR_EL3.NS is 0, the entry would be required to translate an address using the Secure EL1&0 translation regime.
- If SCR_EL3.NS is 1, then:
 - The entry would be required to translate an address using the Non-secure EL1&0 translation regime.
 - If EL2 is implemented, the entry would be used with the current VMID.

The invalidation applies to all PEs in the same Inner Shareable shareability domain as the PE that executes this instructions.

———— Note ————

For the EL1&0 translation regime, the invalidation applies to both:

- Global entries.
- Non-global entries with any ASID.

Configurations

There are no configuration notes.

Attributes

TLBI VMALLS12E1IS is a 64-bit System instruction.

Field descriptions

TLBI VMALLS12E1IS ignores the value in the register specified by the instruction. Software does not have to write a value to the register before issuing this instruction.

Executing the TLBI VMALLS12E1IS instruction

This instruction is executed using TLBI with the following syntax:

TLBI <tlbi_op>

This syntax uses the following encoding in the System instruction encoding space:

<tlbi_op>	op0	op1	CRn	CRm	op2	Rt
VMALLS12E1IS	01	100	1000	0011	110	11111

Accessibility

The instruction is executable as follows:

Control			Accessibility			
E2H	TGE	NS	EL0	EL1	EL2	EL3
x	x	0	-	-	n/a	WO
0	0	1	-	-	WO	WO
0	1	1	-	n/a	WO	WO
1	0	1	-	-	WO	WO
1	1	1	-	n/a	WO	WO

If `SCR_EL3.NS`==0, or EL2 is not implemented, this instruction executes as a `TLBI VMALLE1IS`.

Chapter C6

A64 Base Instruction Descriptions

This chapter describes the A64 base instructions.

It contains the following sections:

- [About the A64 base instructions on page C6-518.](#)
- [Alphabetical list of A64 base instructions on page C6-520.](#)

C6.1 About the A64 base instructions

[Alphabetical list of A64 base instructions on page C6-520](#) gives full descriptions of the A64 instructions that are in the following instruction groups:

- Branch, Exception generation, and system instructions.
- Loads and stores associated with the general-purpose registers.
- Data processing (immediate).
- Data processing (register).

[A64 instruction set encoding on page C4-210](#) provides an overview of the instruction encodings as well as of the instruction classes within their functional groups.

The rest of this section is general description of the base instructions. It contains the following subsections:

- [Register size.](#)
- [Use of the PC.](#)
- [Use of the stack pointer on page C6-519.](#)
- [Condition flags and related instructions on page C6-519.](#)

C6.1.1 Register size

Most data processing, comparison, and conversion instructions that use the general-purpose registers as the source or destination operand have two instruction variants that operate on either a 32-bit or a 64-bit value.

Where a 32-bit instruction form is selected, the following holds:

- The upper 32 bits of the source registers are ignored.
- The upper 32 bits of the destination register are set to zero.
- Right shifts and right rotates inject at bit[31], not at bit[63].
- The Condition flags, where set by the instruction, are computed from the lower 32 bits.

This distinction applies even when the results of a 32-bit instruction form are indistinguishable from the lower 32 bits computed by the equivalent 64-bit instruction form. For example, a 32-bit bitwise ORR could be performed using a 64-bit ORR and simply ignoring the top 32 bits of the result. However, the A64 instruction set includes separate 32-bit and 64-bit forms of the ORR instruction.

As well as distinct sign-extend or zero-extend instructions, the A64 instruction set also provides the ability to extend and shift the final source register of an ADD, SUB, ADDS, or SUBS instruction and the index register of a Load/Store instruction. This enables array index calculations involving a 64-bit array pointer and a 32-bit array index to be implemented efficiently.

The assembly language notation enables the distinct identification of registers holding 32-bit values and registers holding 64-bit values. See [Register names on page C1-139](#) and [Register indexed addressing on page C1-143](#).

C6.1.2 Use of the PC

A64 instructions have limited access to the PC. The only instructions that can read the PC are those that generate a PC relative address:

- [ADR](#) and [ADRP](#).
- The Load register (literal) instruction class.
- Direct branches that use an immediate offset.
- The unconditional branch with link instructions, [BL](#) and [BLR](#), that use the PC to create the return link address.

Only explicit control flow instructions can modify the PC:

- Conditional and unconditional branch and return instructions.
- Exception generation and exception return instructions.

For more details of instructions that can modify the PC, see [Branches, Exception generating, and System instructions on page C3-156](#).

C6.1.3 Use of the stack pointer

A64 instructions can use the stack pointer only in a limited number of cases:

- Load/Store instructions use the current stack pointer as the base address:
 - When stack alignment checking is enabled by system software and the base register is SP, the current stack pointer must be initially quadword aligned. That is, it must be aligned to 16 bytes. Misalignment generates an SP alignment fault. See [SP alignment checking on page D1-1793](#) for more information.
- Add and subtract data processing instructions in their immediate and extended register forms, use the current stack pointer as a source register or the destination register or both.
- Logical data processing instructions in their immediate form use the current stack pointer as the destination register.

C6.1.4 Condition flags and related instructions

The A64 base instructions that use the Condition flags as an input are:

- Conditional branch. The conditional branch instruction is B.cond.
- Add or subtract with carry. These instruction types include instructions to perform multi-precision arithmetic and calculate checksums. The add or subtract with carry instructions are ADC, ADCS, SBC, and SBSC, or an architectural alias for these instructions.
- Conditional select with increment, negate, or invert. This instruction type conditionally selects between one source register and a second, incremented, negated, inverted, or unmodified source register. The conditional select with increment, negate, or invert instructions are CSINC, CSINV, and CSNEG.

These instructions also implement:

- Conditional select or move. The Condition flags select one of two source registers as the destination register. Short conditional sequences can be replaced by unconditional instructions followed by a conditional select, CSEL.
- Conditional set. Conditionally selects between 0 and 1, or 0 and -1. This can be used to convert the Condition flags to a Boolean value or mask in a general-purpose register, for example. These instructions include CSET and CSETM.
- Conditional compare. This instruction type sets the Condition flags to the result of a comparison if the original condition is true, otherwise it sets the Condition flags to an immediate value. It permits the flattening of nested conditional expressions without using conditional branches or performing Boolean arithmetic within the general-purpose registers. The conditional compare instructions are CCMP and CCMN.

The A64 base instructions that update the Condition flags as an output are:

- Flag-setting data processing instructions, such as ADCS, ADDS, ANDS, BICS, SBSC, and SUBS, and the aliases CMN, CMP, and TST.
- Conditional compare instructions such as CCMN, CCMP.

The flags can be directly accessed for a read/write using the [NZCV, Condition Flags on page C5-356](#).

The A64 base instructions also include conditional branch instructions that do not use the Condition flags as an input:

- Compare and branch if a register is zero or nonzero, CBZ and CBNZ.
- Test a single bit in a register and branch if the bit is zero or nonzero, TBZ and TBNZ.

C6.2 Alphabetical list of A64 base instructions

This section lists every instruction in the base category of the A64 instruction set. For details of the format used, see [Understanding the A64 instruction descriptions on page C2-148](#).

C6.2.1 ADC

Add with Carry adds two register values and the Carry flag value, and writes the result to the destination register.

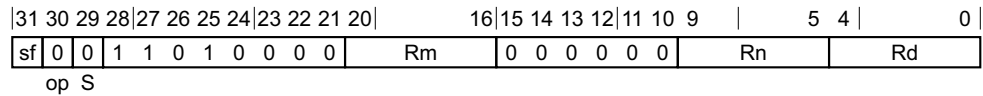

32-bit variant

Applies when `sf == 0`.

ADC <Wd>, <Wn>, <Wm>

64-bit variant

Applies when `sf == 1`.

ADC <Xd>, <Xn>, <Xm>

Decode for all variants of this encoding

```
integer d = UInt(Rd);
integer n = UInt(Rn);
integer m = UInt(Rm);
integer datasize = if sf == '1' then 64 else 32;
```

Assembler symbols

- <Wd> Is the 32-bit name of the general-purpose destination register, encoded in the "Rd" field.
- <Wn> Is the 32-bit name of the first general-purpose source register, encoded in the "Rn" field.
- <Wm> Is the 32-bit name of the second general-purpose source register, encoded in the "Rm" field.
- <Xd> Is the 64-bit name of the general-purpose destination register, encoded in the "Rd" field.
- <Xn> Is the 64-bit name of the first general-purpose source register, encoded in the "Rn" field.
- <Xm> Is the 64-bit name of the second general-purpose source register, encoded in the "Rm" field.

Operation

```
bits(datasize) result;
bits(datasize) operand1 = X[n];
bits(datasize) operand2 = X[m];

(result, -) = AddWithCarry(operand1, operand2, PSTATE.C);

X[d] = result;
```

C6.2.2 ADCS

Add with Carry, setting flags, adds two register values and the Carry flag value, and writes the result to the destination register. It updates the condition flags based on the result.

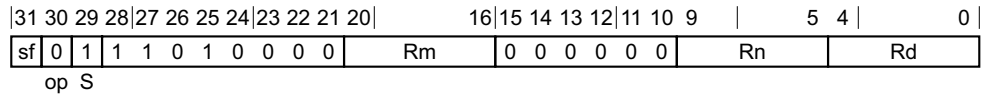

32-bit variant

Applies when sf == 0.

ADCS <Wd>, <Wn>, <Wm>

64-bit variant

Applies when sf == 1.

ADCS <Xd>, <Xn>, <Xm>

Decode for all variants of this encoding

```
integer d = UInt(Rd);
integer n = UInt(Rn);
integer m = UInt(Rm);
integer datasize = if sf == '1' then 64 else 32;
```

Assembler symbols

- <Wd> Is the 32-bit name of the general-purpose destination register, encoded in the "Rd" field.
- <Wn> Is the 32-bit name of the first general-purpose source register, encoded in the "Rn" field.
- <Wm> Is the 32-bit name of the second general-purpose source register, encoded in the "Rm" field.
- <Xd> Is the 64-bit name of the general-purpose destination register, encoded in the "Rd" field.
- <Xn> Is the 64-bit name of the first general-purpose source register, encoded in the "Rn" field.
- <Xm> Is the 64-bit name of the second general-purpose source register, encoded in the "Rm" field.

Operation

```
bits(datasize) result;
bits(datasize) operand1 = X[n];
bits(datasize) operand2 = X[m];
bits(4) nzcvc;

(result, nzcvc) = AddWithCarry(operand1, operand2, PSTATE.C);

PSTATE.<N,Z,C,V> = nzcvc;

X[d] = result;
```

C6.2.3 ADD (extended register)

Add (extended register) adds a register value and a sign or zero-extended register value, followed by an optional left shift amount, and writes the result to the destination register. The argument that is extended from the <Rm> register can be a byte, halfword, word, or doubleword.

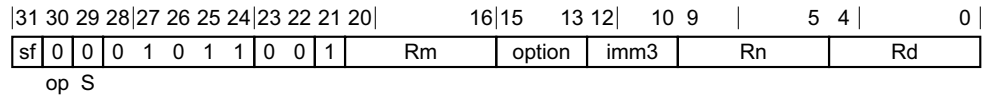

32-bit variant

Applies when sf == 0.

ADD <Wd|WSP>, <Wn|WSP>, <Wm>{, <extend> {#<amount>}}

64-bit variant

Applies when sf == 1.

ADD <Xd|SP>, <Xn|SP>, <R><m>{, <extend> {#<amount>}}

Decode for all variants of this encoding

```
integer d = UInt(Rd);
integer n = UInt(Rn);
integer m = UInt(Rm);
integer datasize = if sf == '1' then 64 else 32;
ExtendType extend_type = DecodeRegExtend(option);
integer shift = UInt(imm3);
if shift > 4 then ReservedValue();
```

Assembler symbols

- <Wd|WSP> Is the 32-bit name of the destination general-purpose register or stack pointer, encoded in the "Rd" field.
- <Wn|WSP> Is the 32-bit name of the first source general-purpose register or stack pointer, encoded in the "Rn" field.
- <Wm> Is the 32-bit name of the second general-purpose source register, encoded in the "Rm" field.
- <Xd|SP> Is the 64-bit name of the destination general-purpose register or stack pointer, encoded in the "Rd" field.
- <Xn|SP> Is the 64-bit name of the first source general-purpose register or stack pointer, encoded in the "Rn" field.
- <R> Is a width specifier, encoded in the "option" field. It can have the following values:
 - W when option = 00x
 - W when option = 010
 - X when option = x11
 - W when option = 10x
 - W when option = 110
- <m> Is the number [0-30] of the second general-purpose source register or the name ZR (31), encoded in the "Rm" field.

- <extend> For the 32-bit variant: is the extension to be applied to the second source operand, encoded in the "option" field. It can have the following values:
- | | |
|----------|-------------------|
| UXTB | when option = 000 |
| UXTH | when option = 001 |
| LSL UXTW | when option = 010 |
| UXTX | when option = 011 |
| SXTB | when option = 100 |
| SXTH | when option = 101 |
| SXTW | when option = 110 |
| SXTX | when option = 111 |
- If "Rd" or "Rn" is '11111' (WSP) and "option" is '010' then LSL is preferred, but may be omitted when "imm3" is '000'. In all other cases <extend> is required and must be UXTW when "option" is '010'.
- For the 64-bit variant: is the extension to be applied to the second source operand, encoded in the "option" field. It can have the following values:
- | | |
|----------|-------------------|
| UXTB | when option = 000 |
| UXTH | when option = 001 |
| UXTW | when option = 010 |
| LSL UXTX | when option = 011 |
| SXTB | when option = 100 |
| SXTH | when option = 101 |
| SXTW | when option = 110 |
| SXTX | when option = 111 |
- If "Rd" or "Rn" is '11111' (SP) and "option" is '011' then LSL is preferred, but may be omitted when "imm3" is '000'. In all other cases <extend> is required and must be UXTX when "option" is '011'.
- <amount> Is the left shift amount to be applied after extension in the range 0 to 4, defaulting to 0, encoded in the "imm3" field. It must be absent when <extend> is absent, is required when <extend> is LSL, and is optional when <extend> is present but not LSL.

Operation

```
bits(datasize) result;
bits(datasize) operand1 = if n == 31 then SP[] else X[n];
bits(datasize) operand2 = ExtendReg(m, extend_type, shift);

(result, -) = AddWithCarry(operand1, operand2, '0');

if d == 31 then
    SP[] = result;
else
    X[d] = result;
```

C6.2.4 ADD (immediate)

Add (immediate) adds a register value and an optionally-shifted immediate value, and writes the result to the destination register.

This instruction is used by the alias [MOV \(to/from SP\)](#). See [Alias conditions](#) for details of when each alias is preferred.



32-bit variant

Applies when `sf == 0`.

ADD <Wd|WSP>, <Wn|WSP>, #<imm>{, <shift>}

64-bit variant

Applies when `sf == 1`.

ADD <Xd|SP>, <Xn|SP>, #<imm>{, <shift>}

Decode for all variants of this encoding

```
integer d = UInt(Rd);
integer n = UInt(Rn);
integer datasize = if sf == '1' then 64 else 32;
bits(datasize) imm;

case shift of
  when '00' imm = ZeroExtend(imm12, datasize);
  when '01' imm = ZeroExtend(imm12:Zeros(12), datasize);
  when '1x' ReservedValue();
```

Alias conditions

Alias	is preferred when
MOV (to/from SP)	<code>shift == '00' && imm12 == '000000000000' && (Rd == '11111' Rn == '11111')</code>

Assembler symbols

<code><Wd WSP></code>	Is the 32-bit name of the destination general-purpose register or stack pointer, encoded in the "Rd" field.
<code><Wn WSP></code>	Is the 32-bit name of the source general-purpose register or stack pointer, encoded in the "Rn" field.
<code><Xd SP></code>	Is the 64-bit name of the destination general-purpose register or stack pointer, encoded in the "Rd" field.
<code><Xn SP></code>	Is the 64-bit name of the source general-purpose register or stack pointer, encoded in the "Rn" field.
<code><imm></code>	Is an unsigned immediate, in the range 0 to 4095, encoded in the "imm12" field.

<shift> Is the optional left shift to apply to the immediate, defaulting to LSL #0 and encoded in the "shift" field. It can have the following values:

LSL #0 when shift = 00

LSL #12 when shift = 01

The encoding shift = 1x is reserved.

Operation

```
bits(datasize) result;  
bits(datasize) operand1 = if n == 31 then SP[] else X[n];
```

```
(result, -) = AddWithCarry(operand1, imm, '0');
```

```
if d == 31 then  
    SP[] = result;  
else  
    X[d] = result;
```

C6.2.5 ADD (shifted register)

Add (shifted register) adds a register value and an optionally-shifted register value, and writes the result to the destination register.

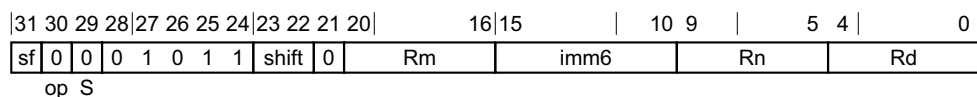

32-bit variant

Applies when sf == 0.

ADD <Wd>, <Wn>, <Wm>{, <shift> #<amount>}

64-bit variant

Applies when sf == 1.

ADD <Xd>, <Xn>, <Xm>{, <shift> #<amount>}

Decode for all variants of this encoding

```
integer d = UInt(Rd);
integer n = UInt(Rn);
integer m = UInt(Rm);
integer datasize = if sf == '1' then 64 else 32;

if shift == '11' then ReservedValue();
if sf == '0' && imm6<5> == '1' then ReservedValue();

ShiftType shift_type = DecodeShift(shift);
integer shift_amount = UInt(imm6);
```

Assembler symbols

- <Wd> Is the 32-bit name of the general-purpose destination register, encoded in the "Rd" field.
- <Wn> Is the 32-bit name of the first general-purpose source register, encoded in the "Rn" field.
- <Wm> Is the 32-bit name of the second general-purpose source register, encoded in the "Rm" field.
- <Xd> Is the 64-bit name of the general-purpose destination register, encoded in the "Rd" field.
- <Xn> Is the 64-bit name of the first general-purpose source register, encoded in the "Rn" field.
- <Xm> Is the 64-bit name of the second general-purpose source register, encoded in the "Rm" field.
- <shift> Is the optional shift type to be applied to the second source operand, defaulting to LSL and encoded in the "shift" field. It can have the following values:
 - LSL when shift = 00
 - LSR when shift = 01
 - ASR when shift = 10
 - The encoding shift = 11 is reserved.
- <amount> For the 32-bit variant: is the shift amount, in the range 0 to 31, defaulting to 0 and encoded in the "imm6" field.
For the 64-bit variant: is the shift amount, in the range 0 to 63, defaulting to 0 and encoded in the "imm6" field.

Operation

```
bits(datasize) result;  
bits(datasize) operand1 = X[n];  
bits(datasize) operand2 = ShiftReg(m, shift_type, shift_amount);  
  
(result, -) = AddWithCarry(operand1, operand2, '0');  
  
X[d] = result;
```

C6.2.6 ADDS (extended register)

Add (extended register), setting flags, adds a register value and a sign or zero-extended register value, followed by an optional left shift amount, and writes the result to the destination register. The argument that is extended from the <Rm> register can be a byte, halfword, word, or doubleword. It updates the condition flags based on the result.

This instruction is used by the alias [CMN \(extended register\)](#). See [Alias conditions](#) for details of when each alias is preferred.

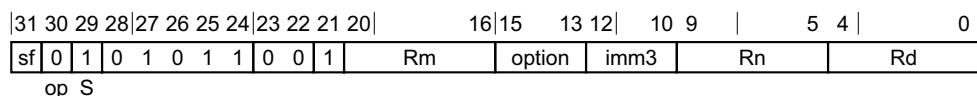

32-bit variant

Applies when sf == 0.

ADDS <Wd>, <Wn|WSP>, <Wm>{, <extend> {#<amount>}}

64-bit variant

Applies when sf == 1.

ADDS <Xd>, <Xn|SP>, <R><m>{, <extend> {#<amount>}}

Decode for all variants of this encoding

```
integer d = UInt(Rd);
integer n = UInt(Rn);
integer m = UInt(Rm);
integer datasize = if sf == '1' then 64 else 32;
ExtendType extend_type = DecodeRegExtend(option);
integer shift = UInt(imm3);
if shift > 4 then ReservedValue();
```

Alias conditions

Alias	is preferred when
CMN (extended register)	Rd == '11111'

Assembler symbols

<Wd>	Is the 32-bit name of the general-purpose destination register, encoded in the "Rd" field.
<Wn WSP>	Is the 32-bit name of the first source general-purpose register or stack pointer, encoded in the "Rn" field.
<Wm>	Is the 32-bit name of the second general-purpose source register, encoded in the "Rm" field.
<Xd>	Is the 64-bit name of the general-purpose destination register, encoded in the "Rd" field.
<Xn SP>	Is the 64-bit name of the first source general-purpose register or stack pointer, encoded in the "Rn" field.
<R>	Is a width specifier, encoded in the "option" field. It can have the following values:
W	when option = 00x
W	when option = 010

	X	when option = x11
	W	when option = 10x
	W	when option = 110
<m>		Is the number [0-30] of the second general-purpose source register or the name ZR (31), encoded in the "Rm" field.
<extend>		For the 32-bit variant: is the extension to be applied to the second source operand, encoded in the "option" field. It can have the following values:
	UXTB	when option = 000
	UXTH	when option = 001
	LSL UXTW	when option = 010
	UXTX	when option = 011
	SXTB	when option = 100
	SXTH	when option = 101
	SXTW	when option = 110
	SXTX	when option = 111
		If "Rn" is '11111' (WSP) and "option" is '010' then LSL is preferred, but may be omitted when "imm3" is '000'. In all other cases <extend> is required and must be UXTW when "option" is '010'.
		For the 64-bit variant: is the extension to be applied to the second source operand, encoded in the "option" field. It can have the following values:
	UXTB	when option = 000
	UXTH	when option = 001
	UXTW	when option = 010
	LSL UXTX	when option = 011
	SXTB	when option = 100
	SXTH	when option = 101
	SXTW	when option = 110
	SXTX	when option = 111
		If "Rn" is '11111' (SP) and "option" is '011' then LSL is preferred, but may be omitted when "imm3" is '000'. In all other cases <extend> is required and must be UXTX when "option" is '011'.
<amount>		Is the left shift amount to be applied after extension in the range 0 to 4, defaulting to 0, encoded in the "imm3" field. It must be absent when <extend> is absent, is required when <extend> is LSL, and is optional when <extend> is present but not LSL.

Operation

```

bits(datasize) result;
bits(datasize) operand1 = if n == 31 then SP[] else X[n];
bits(datasize) operand2 = ExtendReg(m, extend_type, shift);
bits(4) nzcvc;

(result, nzcvc) = AddWithCarry(operand1, operand2, '0');

PSTATE.<N,Z,C,V> = nzcvc;

X[d] = result;
  
```

C6.2.7 ADDS (immediate)

Add (immediate), setting flags, adds a register value and an optionally-shifted immediate value, and writes the result to the destination register. It updates the condition flags based on the result.

This instruction is used by the alias [CMN \(immediate\)](#). See [Alias conditions](#) for details of when each alias is preferred.



32-bit variant

Applies when sf == 0.

ADDS <Wd>, <Wn|WSP>, #<imm>{, <shift>}

64-bit variant

Applies when sf == 1.

ADDS <Xd>, <Xn|SP>, #<imm>{, <shift>}

Decode for all variants of this encoding

```
integer d = UInt(Rd);
integer n = UInt(Rn);
integer datasize = if sf == '1' then 64 else 32;
bits(datasize) imm;

case shift of
  when '00' imm = ZeroExtend(imm12, datasize);
  when '01' imm = ZeroExtend(imm12:Zeros(12), datasize);
  when '1x' ReservedValue();
```

Alias conditions

Alias	is preferred when
CMN (immediate)	Rd == '11111'

Assembler symbols

<Wd>	Is the 32-bit name of the general-purpose destination register, encoded in the "Rd" field.				
<Wn WSP>	Is the 32-bit name of the source general-purpose register or stack pointer, encoded in the "Rn" field.				
<Xd>	Is the 64-bit name of the general-purpose destination register, encoded in the "Rd" field.				
<Xn SP>	Is the 64-bit name of the source general-purpose register or stack pointer, encoded in the "Rn" field.				
<imm>	Is an unsigned immediate, in the range 0 to 4095, encoded in the "imm12" field.				
<shift>	Is the optional left shift to apply to the immediate, defaulting to LSL #0 and encoded in the "shift" field. It can have the following values: <table style="margin-left: 20px; border-collapse: collapse;"> <tr> <td style="padding-right: 10px;">LSL #0</td> <td>when shift = 00</td> </tr> <tr> <td style="padding-right: 10px;">LSL #12</td> <td>when shift = 01</td> </tr> </table>	LSL #0	when shift = 00	LSL #12	when shift = 01
LSL #0	when shift = 00				
LSL #12	when shift = 01				

The encoding shift = 1x is reserved.

Operation

```
bits(datasize) result;  
bits(datasize) operand1 = if n == 31 then SP[] else X[n];  
bits(4) nzcvc;  
  
(result, nzcvc) = AddWithCarry(operand1, imm, '0');  
  
PSTATE.<N,Z,C,V> = nzcvc;  
  
X[d] = result;
```

C6.2.8 ADDS (shifted register)

Add (shifted register), setting flags, adds a register value and an optionally-shifted register value, and writes the result to the destination register. It updates the condition flags based on the result.

This instruction is used by the alias [CMN \(shifted register\)](#). See [Alias conditions](#) for details of when each alias is preferred.

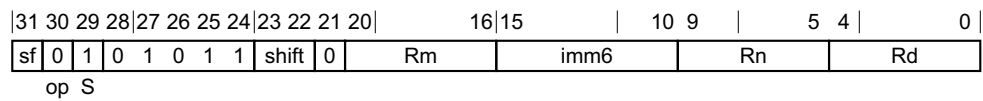

32-bit variant

Applies when `sf == 0`.

ADDS <Wd>, <Wn>, <Wm>{, <shift> #<amount>}

64-bit variant

Applies when `sf == 1`.

ADDS <Xd>, <Xn>, <Xm>{, <shift> #<amount>}

Decode for all variants of this encoding

```
integer d = UInt(Rd);
integer n = UInt(Rn);
integer m = UInt(Rm);
integer datasize = if sf == '1' then 64 else 32;

if shift == '11' then ReservedValue();
if sf == '0' && imm6<5> == '1' then ReservedValue();

ShiftType shift_type = DecodeShift(shift);
integer shift_amount = UInt(imm6);
```

Alias conditions

Alias	is preferred when
CMN (shifted register)	Rd == '11111'

Assembler symbols

<Wd>	Is the 32-bit name of the general-purpose destination register, encoded in the "Rd" field.
<Wn>	Is the 32-bit name of the first general-purpose source register, encoded in the "Rn" field.
<Wm>	Is the 32-bit name of the second general-purpose source register, encoded in the "Rm" field.
<Xd>	Is the 64-bit name of the general-purpose destination register, encoded in the "Rd" field.
<Xn>	Is the 64-bit name of the first general-purpose source register, encoded in the "Rn" field.
<Xm>	Is the 64-bit name of the second general-purpose source register, encoded in the "Rm" field.

- <shift> Is the optional shift type to be applied to the second source operand, defaulting to LSL and encoded in the "shift" field. It can have the following values:
- LSL when shift = 00
 - LSR when shift = 01
 - ASR when shift = 10
- The encoding shift = 11 is reserved.
- <amount> For the 32-bit variant: is the shift amount, in the range 0 to 31, defaulting to 0 and encoded in the "imm6" field.
- For the 64-bit variant: is the shift amount, in the range 0 to 63, defaulting to 0 and encoded in the "imm6" field.

Operation

```
bits(datasize) result;  
bits(datasize) operand1 = X[n];  
bits(datasize) operand2 = ShiftReg(m, shift_type, shift_amount);  
bits(4) nzcvc;  
  
(result, nzcvc) = AddWithCarry(operand1, operand2, '0');  
  
PSTATE.<N,Z,C,V> = nzcvc;  
  
X[d] = result;
```

C6.2.9 ADR

Form PC-relative address adds an immediate value to the PC value to form a PC-relative address, and writes the result to the destination register.

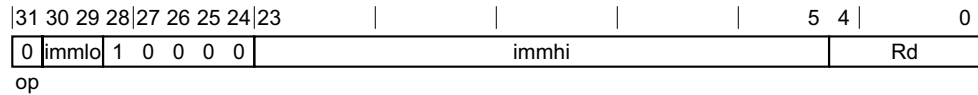

Literal variant

ADR <Xd>, <label>

Decode for this encoding

```
integer d = UInt(Rd);
bits(64) imm;

imm = SignExtend(immhi:immlo, 64);
```

Assembler symbols

- <Xd> Is the 64-bit name of the general-purpose destination register, encoded in the "Rd" field.
- <label> Is the program label whose address is to be calculated. Its offset from the address of this instruction, in the range +/-1MB, is encoded in "immhi:immlo".

Operation

```
bits(64) base = PC[];

X[d] = base + imm;
```

C6.2.10 ADRP

Form PC-relative address to 4KB page adds an immediate value that is shifted left by 12 bits, to the PC value to form a PC-relative address, with the bottom 12 bits masked out, and writes the result to the destination register.

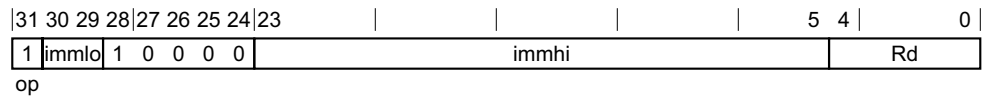

Literal variant

ADRP <Xd>, <label>

Decode for this encoding

```
integer d = UInt(Rd);
bits(64) imm;

imm = SignExtend(immhi:immlo:Zeros(12), 64);
```

Assembler symbols

- <Xd> Is the 64-bit name of the general-purpose destination register, encoded in the "Rd" field.
- <label> Is the program label whose 4KB page address is to be calculated. Its offset from the page address of this instruction, in the range +/-4GB, is encoded as "immhi:immlo" times 4096.

Operation

```
bits(64) base = PC[];
base<11:0> = Zeros(12);
X[d] = base + imm;
```

C6.2.11 AND (immediate)

Bitwise AND (immediate) performs a bitwise AND of a register value and an immediate value, and writes the result to the destination register.

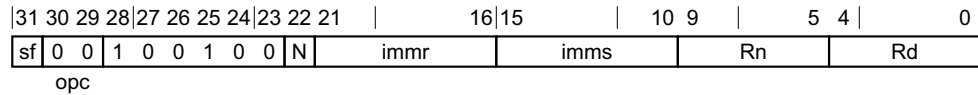

32-bit variant

Applies when `sf == 0` && `N == 0`.

AND <Wd|WSP>, <Wn>, #<imm>

64-bit variant

Applies when `sf == 1`.

AND <Xd|SP>, <Xn>, #<imm>

Decode for all variants of this encoding

```
integer d = UInt(Rd);
integer n = UInt(Rn);
integer datasize = if sf == '1' then 64 else 32;
bits(datasize) imm;
if sf == '0' && N != '0' then ReservedValue();
(imm, -) = DecodeBitMasks(N, imms, immr, TRUE);
```

Assembler symbols

<Wd WSP>	Is the 32-bit name of the destination general-purpose register or stack pointer, encoded in the "Rd" field.
<Wn>	Is the 32-bit name of the general-purpose source register, encoded in the "Rn" field.
<Xd SP>	Is the 64-bit name of the destination general-purpose register or stack pointer, encoded in the "Rd" field.
<Xn>	Is the 64-bit name of the general-purpose source register, encoded in the "Rn" field.
<imm>	For the 32-bit variant: is the bitmask immediate, encoded in "imms:immr". For the 64-bit variant: is the bitmask immediate, encoded in "N:imms:immr".

Operation

```
bits(datasize) result;
bits(datasize) operand1 = X[n];

result = operand1 AND imm;
if d == 31 then
  SP[] = result;
else
  X[d] = result;
```

C6.2.12 AND (shifted register)

Bitwise AND (shifted register) performs a bitwise AND of a register value and an optionally-shifted register value, and writes the result to the destination register.

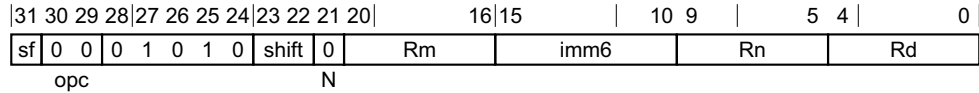

32-bit variant

Applies when `sf == 0`.

AND <Wd>, <Wn>, <Wm>{, <shift> #<amount>}

64-bit variant

Applies when `sf == 1`.

AND <Xd>, <Xn>, <Xm>{, <shift> #<amount>}

Decode for all variants of this encoding

```
integer d = UInt(Rd);
integer n = UInt(Rn);
integer m = UInt(Rm);
integer datasize = if sf == '1' then 64 else 32;
if sf == '0' && imm6<5> == '1' then ReservedValue();
```

```
ShiftType shift_type = DecodeShift(shift);
integer shift_amount = UInt(imm6);
```

Assembler symbols

- <Wd> Is the 32-bit name of the general-purpose destination register, encoded in the "Rd" field.
- <Wn> Is the 32-bit name of the first general-purpose source register, encoded in the "Rn" field.
- <Wm> Is the 32-bit name of the second general-purpose source register, encoded in the "Rm" field.
- <Xd> Is the 64-bit name of the general-purpose destination register, encoded in the "Rd" field.
- <Xn> Is the 64-bit name of the first general-purpose source register, encoded in the "Rn" field.
- <Xm> Is the 64-bit name of the second general-purpose source register, encoded in the "Rm" field.
- <shift> Is the optional shift to be applied to the final source, defaulting to LSL and encoded in the "shift" field. It can have the following values:
 - LSL when shift = 00
 - LSR when shift = 01
 - ASR when shift = 10
 - ROR when shift = 11
- <amount> For the 32-bit variant: is the shift amount, in the range 0 to 31, defaulting to 0 and encoded in the "imm6" field.
 For the 64-bit variant: is the shift amount, in the range 0 to 63, defaulting to 0 and encoded in the "imm6" field.

Operation

```
bits(datasize) operand1 = X[n];  
bits(datasize) operand2 = ShiftReg(m, shift_type, shift_amount);  
  
result = operand1 AND operand2;  
X[d] = result;
```

C6.2.13 ANDS (immediate)

Bitwise AND (immediate), setting flags, performs a bitwise AND of a register value and an immediate value, and writes the result to the destination register. It updates the condition flags based on the result.

This instruction is used by the alias [TST \(immediate\)](#). See *Alias conditions* for details of when each alias is preferred.

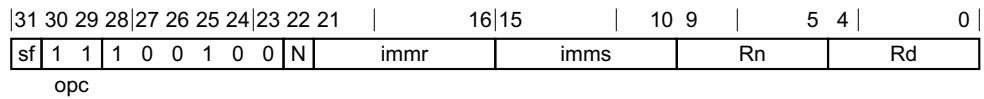

32-bit variant

Applies when `sf == 0 && N == 0`.

ANDS <Wd>, <Wn>, #<imm>

64-bit variant

Applies when `sf == 1`.

ANDS <Xd>, <Xn>, #<imm>

Decode for all variants of this encoding

```
integer d = UInt(Rd);
integer n = UInt(Rn);
integer datasize = if sf == '1' then 64 else 32;

bits(datasize) imm;
if sf == '0' && N != '0' then ReservedValue();
(imm, -) = DecodeBitMasks(N, imms, immr, TRUE);
```

Alias conditions

Alias	is preferred when
TST (immediate)	Rd == '11111'

Assembler symbols

- <Wd> Is the 32-bit name of the general-purpose destination register, encoded in the "Rd" field.
- <Wn> Is the 32-bit name of the general-purpose source register, encoded in the "Rn" field.
- <Xd> Is the 64-bit name of the general-purpose destination register, encoded in the "Rd" field.
- <Xn> Is the 64-bit name of the general-purpose source register, encoded in the "Rn" field.
- <imm> For the 32-bit variant: is the bitmask immediate, encoded in "imms:immr".
 For the 64-bit variant: is the bitmask immediate, encoded in "N:imms:immr".

Operation

```
bits(datasize) result;
bits(datasize) operand1 = X[n];
```

```
result = operand1 AND imm;  
PSTATE.<N,Z,C,V> = result<datasize-1>:IsZeroBit(result):'00';  
  
X[d] = result;
```

C6.2.14 ANDS (shifted register)

Bitwise AND (shifted register), setting flags, performs a bitwise AND of a register value and an optionally-shifted register value, and writes the result to the destination register. It updates the condition flags based on the result.

This instruction is used by the alias [TST \(shifted register\)](#). See [Alias conditions](#) for details of when each alias is preferred.

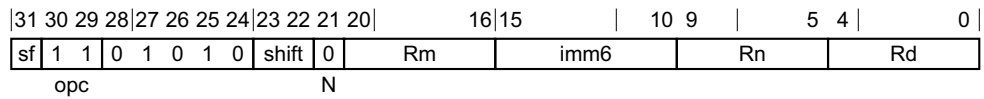

32-bit variant

Applies when sf == 0.

ANDS <Wd>, <Wn>, <Wm>{, <shift> #<amount>}

64-bit variant

Applies when sf == 1.

ANDS <Xd>, <Xn>, <Xm>{, <shift> #<amount>}

Decode for all variants of this encoding

```
integer d = UInt(Rd);
integer n = UInt(Rn);
integer m = UInt(Rm);
integer datasize = if sf == '1' then 64 else 32;

if sf == '0' && imm6<5> == '1' then ReservedValue();

ShiftType shift_type = DecodeShift(shift);
integer shift_amount = UInt(imm6);
```

Alias conditions

Alias	is preferred when
TST (shifted register)	Rd == '11111'

Assembler symbols

- <Wd> Is the 32-bit name of the general-purpose destination register, encoded in the "Rd" field.
- <Wn> Is the 32-bit name of the first general-purpose source register, encoded in the "Rn" field.
- <Wm> Is the 32-bit name of the second general-purpose source register, encoded in the "Rm" field.
- <Xd> Is the 64-bit name of the general-purpose destination register, encoded in the "Rd" field.
- <Xn> Is the 64-bit name of the first general-purpose source register, encoded in the "Rn" field.
- <Xm> Is the 64-bit name of the second general-purpose source register, encoded in the "Rm" field.
- <shift> Is the optional shift to be applied to the final source, defaulting to LSL and encoded in the "shift" field. It can have the following values:
 LSL when shift = 00

LSR when shift = 01
ASR when shift = 10
ROR when shift = 11

<amount> For the 32-bit variant: is the shift amount, in the range 0 to 31, defaulting to 0 and encoded in the "imm6" field.

 For the 64-bit variant: is the shift amount, in the range 0 to 63, defaulting to 0 and encoded in the "imm6" field,

Operation

```
bits(datasize) operand1 = X[n];  
bits(datasize) operand2 = ShiftReg(m, shift_type, shift_amount);  
  
result = operand1 AND operand2;  
PSTATE.<N,Z,C,V> = result<datasize-1>:IsZeroBit(result):'00';  
  
X[d] = result;
```

C6.2.15 ASR (register)

Arithmetic Shift Right (register) shifts a register value right by a variable number of bits, shifting in copies of its sign bit, and writes the result to the destination register. The remainder obtained by dividing the second source register by the data size defines the number of bits by which the first source register is right-shifted.

This instruction is an alias of the [ASRV](#) instruction. This means that:

- The encodings in this description are named to match the encodings of [ASRV](#).
- The description of [ASRV](#) gives the operational pseudocode for this instruction.

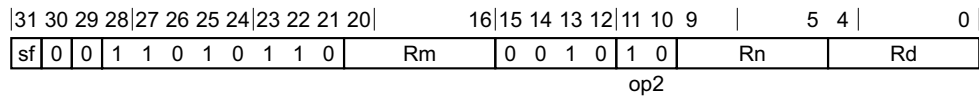

32-bit variant

Applies when `sf == 0`.

ASR <Wd>, <Wn>, <Wm>

is equivalent to

ASRV <Wd>, <Wn>, <Wm>

and is always the preferred disassembly.

64-bit variant

Applies when `sf == 1`.

ASR <Xd>, <Xn>, <Xm>

is equivalent to

ASRV <Xd>, <Xn>, <Xm>

and is always the preferred disassembly.

Assembler symbols

<Wd> Is the 32-bit name of the general-purpose destination register, encoded in the "Rd" field.

<Wn> Is the 32-bit name of the first general-purpose source register, encoded in the "Rn" field.

<Wm> Is the 32-bit name of the second general-purpose source register holding a shift amount from 0 to 31 in its bottom 5 bits, encoded in the "Rm" field.

<Xd> Is the 64-bit name of the general-purpose destination register, encoded in the "Rd" field.

<Xn> Is the 64-bit name of the first general-purpose source register, encoded in the "Rn" field.

<Xm> Is the 64-bit name of the second general-purpose source register holding a shift amount from 0 to 63 in its bottom 6 bits, encoded in the "Rm" field.

Operation

The description of [ASRV](#) gives the operational pseudocode for this instruction.

C6.2.16 ASR (immediate)

Arithmetic Shift Right (immediate) shifts a register value right by an immediate number of bits, shifting in copies of the sign bit in the upper bits and zeros in the lower bits, and writes the result to the destination register.

This instruction is an alias of the [SBFM](#) instruction. This means that:

- The encodings in this description are named to match the encodings of [SBFM](#).
- The description of [SBFM](#) gives the operational pseudocode for this instruction.

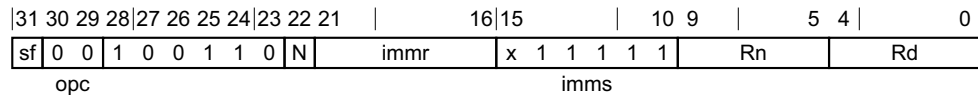

32-bit variant

Applies when $sf == 0 \ \&\& \ N == 0 \ \&\& \ imms == 011111$.

ASR <Wd>, <Wn>, #<shift>

is equivalent to

SBFM <Wd>, <Wn>, #<shift>, #31

and is always the preferred disassembly.

64-bit variant

Applies when $sf == 1 \ \&\& \ N == 1 \ \&\& \ imms == 111111$.

ASR <Xd>, <Xn>, #<shift>

is equivalent to

SBFM <Xd>, <Xn>, #<shift>, #63

and is always the preferred disassembly.

Assembler symbols

<Wd> Is the 32-bit name of the general-purpose destination register, encoded in the "Rd" field.

<Wn> Is the 32-bit name of the general-purpose source register, encoded in the "Rn" field.

<Xd> Is the 64-bit name of the general-purpose destination register, encoded in the "Rd" field.

<Xn> Is the 64-bit name of the general-purpose source register, encoded in the "Rn" field.

<shift> For the 32-bit variant: is the shift amount, in the range 0 to 31, encoded in the "immr" field.

For the 64-bit variant: is the shift amount, in the range 0 to 63, encoded in the "immr" field.

Operation

The description of [SBFM](#) gives the operational pseudocode for this instruction.

C6.2.17 ASRV

Arithmetic Shift Right Variable shifts a register value right by a variable number of bits, shifting in copies of its sign bit, and writes the result to the destination register. The remainder obtained by dividing the second source register by the data size defines the number of bits by which the first source register is right-shifted.

This instruction is used by the alias [ASR \(register\)](#). The alias is always the preferred disassembly.

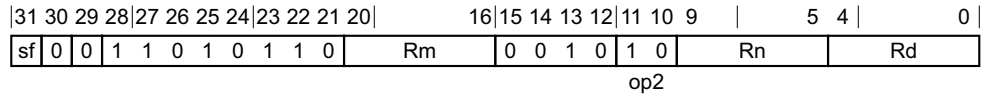

32-bit variant

Applies when sf == 0.

ASRV <Wd>, <Wn>, <Wm>

64-bit variant

Applies when sf == 1.

ASRV <Xd>, <Xn>, <Xm>

Decode for all variants of this encoding

```
integer d = UInt(Rd);
integer n = UInt(Rn);
integer m = UInt(Rm);
integer datasize = if sf == '1' then 64 else 32;
ShiftType shift_type = DecodeShift(op2);
```

Assembler symbols

- <Wd> Is the 32-bit name of the general-purpose destination register, encoded in the "Rd" field.
- <Wn> Is the 32-bit name of the first general-purpose source register, encoded in the "Rn" field.
- <Wm> Is the 32-bit name of the second general-purpose source register holding a shift amount from 0 to 31 in its bottom 5 bits, encoded in the "Rm" field.
- <Xd> Is the 64-bit name of the general-purpose destination register, encoded in the "Rd" field.
- <Xn> Is the 64-bit name of the first general-purpose source register, encoded in the "Rn" field.
- <Xm> Is the 64-bit name of the second general-purpose source register holding a shift amount from 0 to 63 in its bottom 6 bits, encoded in the "Rm" field.

Operation

```
bits(datasize) result;
bits(datasize) operand2 = X[m];

result = ShiftReg(n, shift_type, UInt(operand2) MOD datasize);
X[d] = result;
```

C6.2.18 AT

Address Translate. For more information, see [A64 system instructions for address translation](#).

This instruction is an alias of the [SYS](#) instruction. This means that:

- The encodings in this description are named to match the encodings of [SYS](#).
- The description of [SYS](#) gives the operational pseudocode for this instruction.

31	30	29	28	27	26	25	24	23	22	21	20	19	18	16	15	12	11	8	7	5	4	0	
1	1	0	1	0	1	0	1	0	0	0	0	1	op1	0	1	1	1	1	0	0	x	op2	Rt
L											CRn			CRm									

System variant

AT <at_op>, <Xt>

is equivalent to

SYS #<op1>, C7, <Cm>, #<op2>, <Xt>

and is the preferred disassembly when `SysOp(op1, '0111', CRm, op2) == Sys_AT`.

Assembler symbols

<at_op> Is an AT instruction name, as listed for the AT system instruction group, encoded in the "op1:CRm<0>:op2" field. It can have the following values:

S1E1R	when op1 = 000, CRm<0> = 0, op2 = 000
S1E1W	when op1 = 000, CRm<0> = 0, op2 = 001
S1E0R	when op1 = 000, CRm<0> = 0, op2 = 010
S1E0W	when op1 = 000, CRm<0> = 0, op2 = 011
S1E2R	when op1 = 100, CRm<0> = 0, op2 = 000
S1E2W	when op1 = 100, CRm<0> = 0, op2 = 001
S12E1R	when op1 = 100, CRm<0> = 0, op2 = 100
S12E1W	when op1 = 100, CRm<0> = 0, op2 = 101
S12E0R	when op1 = 100, CRm<0> = 0, op2 = 110
S12E0W	when op1 = 100, CRm<0> = 0, op2 = 111
S1E3R	when op1 = 110, CRm<0> = 0, op2 = 000
S1E3W	when op1 = 110, CRm<0> = 0, op2 = 001

When ARMv8.2-ATS1E1 is implemented, the following values are also valid:

S1E1RP	when op1 = 000, CRm<0> = 1, op2 = 000
S1E1WP	when op1 = 000, CRm<0> = 1, op2 = 001

<op1> Is a 3-bit unsigned immediate, in the range 0 to 7, encoded in the "op1" field.

<Cm> Is a name 'Cm', with 'm' in the range 0 to 15, encoded in the "CRm" field.

<op2> Is a 3-bit unsigned immediate, in the range 0 to 7, encoded in the "op2" field.

<Xt> Is the 64-bit name of the general-purpose source register, encoded in the "Rt" field.

Operation

The description of [SYS](#) gives the operational pseudocode for this instruction.

C6.2.19 B.cond

Branch conditionally to a label at a PC-relative offset, with a hint that this is not a subroutine call or return.

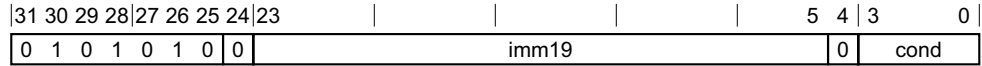

19-bit signed PC-relative branch offset variant

B.<cond> <label>

Decode for this encoding

```
bits(64) offset = SignExtend(imm19:'00', 64);
bits(4) condition = cond;
```

Assembler symbols

<cond> Is one of the standard conditions, encoded in the "cond" field in the standard way.

<label> Is the program label to be conditionally branched to. Its offset from the address of this instruction, in the range +/-1MB, is encoded as "imm19" times 4.

Operation

```
if ConditionHolds(condition) then
    BranchTo(PC[] + offset, BranchType_JMP);
```

C6.2.20 B

Branch causes an unconditional branch to a label at a PC-relative offset, with a hint that this is not a subroutine call or return.

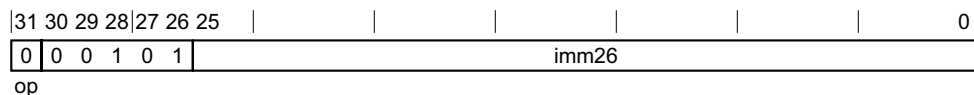

op

26-bit signed PC-relative branch offset variant

B <label>

Decode for this encoding

bits(64) offset = [SignExtend](#)(imm26:'00', 64);

Assembler symbols

<label> Is the program label to be unconditionally branched to. Its offset from the address of this instruction, in the range +/-128MB, is encoded as "imm26" times 4.

Operation

[BranchTo](#)(PC[] + offset, [BranchType_JMP](#));

C6.2.21 BFC

Bitfield Clear, leaving other bits unchanged

This instruction is an alias of the [BFM](#) instruction. This means that:

- The encodings in this description are named to match the encodings of [BFM](#).
- The description of [BFM](#) gives the operational pseudocode for this instruction.

ARMv8.2

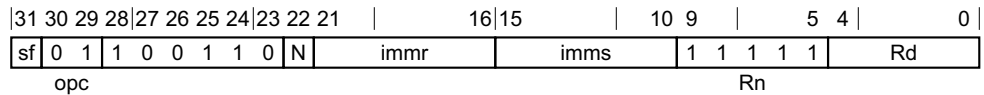

32-bit variant

Applies when $sf == 0 \ \&\& \ N == 0$.

BFC <wd>, #<lsb>, #<width>

is equivalent to

BFM <wd>, WZR, #(-<lsb> MOD 32), #(<width>-1)

and is the preferred disassembly when $UInt(imms) < UInt(immr)$.

64-bit variant

Applies when $sf == 1 \ \&\& \ N == 1$.

BFC <Xd>, #<lsb>, #<width>

is equivalent to

BFM <Xd>, XZR, #(-<lsb> MOD 64), #(<width>-1)

and is the preferred disassembly when $UInt(imms) < UInt(immr)$.

Assembler symbols

<wd> Is the 32-bit name of the general-purpose destination register, encoded in the "Rd" field.

<Xd> Is the 64-bit name of the general-purpose destination register, encoded in the "Rd" field.

<lsb> For the 32-bit variant: is the bit number of the lsb of the destination bitfield, in the range 0 to 31.
 For the 64-bit variant: is the bit number of the lsb of the destination bitfield, in the range 0 to 63.

<width> For the 32-bit variant: is the width of the bitfield, in the range 1 to 32-<lsb>.
 For the 64-bit variant: is the width of the bitfield, in the range 1 to 64-<lsb>.

Operation

The description of [BFM](#) gives the operational pseudocode for this instruction.

C6.2.22 BFI

Bitfield Insert copies any number of low-order bits from a source register into the same number of adjacent bits at any position in the destination register, leaving other bits unchanged.

This instruction is an alias of the [BFM](#) instruction. This means that:

- The encodings in this description are named to match the encodings of [BFM](#).
- The description of [BFM](#) gives the operational pseudocode for this instruction.

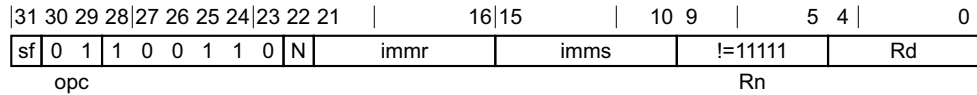

32-bit variant

Applies when $sf == 0 \ \&\& \ N == 0$.

BFI <Wd>, <Wn>, #<lsb>, #<width>

is equivalent to

BFM <Wd>, <Wn>, #(-<lsb> MOD 32), #(<width>-1)

and is the preferred disassembly when $UInt(imms) < UInt(immr)$.

64-bit variant

Applies when $sf == 1 \ \&\& \ N == 1$.

BFI <Xd>, <Xn>, #<lsb>, #<width>

is equivalent to

BFM <Xd>, <Xn>, #(-<lsb> MOD 64), #(<width>-1)

and is the preferred disassembly when $UInt(imms) < UInt(immr)$.

Assembler symbols

<Wd> Is the 32-bit name of the general-purpose destination register, encoded in the "Rd" field.

<Wn> Is the 32-bit name of the general-purpose source register, encoded in the "Rn" field.

<Xd> Is the 64-bit name of the general-purpose destination register, encoded in the "Rd" field.

<Xn> Is the 64-bit name of the general-purpose source register, encoded in the "Rn" field.

<lsb> For the 32-bit variant: is the bit number of the lsb of the destination bitfield, in the range 0 to 31.
 For the 64-bit variant: is the bit number of the lsb of the destination bitfield, in the range 0 to 63.

<width> For the 32-bit variant: is the width of the bitfield, in the range 1 to 32-<lsb>.
 For the 64-bit variant: is the width of the bitfield, in the range 1 to 64-<lsb>.

Operation

The description of [BFM](#) gives the operational pseudocode for this instruction.

C6.2.23 BFM

Bitfield Move copies any number of low-order bits from a source register into the same number of adjacent bits at any position in the destination register, leaving other bits unchanged.

This instruction is used by the aliases [BFC](#), [BFI](#), and [BFXIL](#). See *Alias conditions* for details of when each alias is preferred.

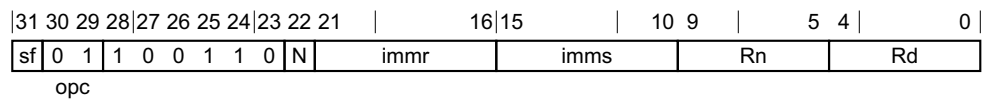

32-bit variant

Applies when `sf == 0 && N == 0`.

BFM <Wd>, <Wn>, #<immr>, #<imms>

64-bit variant

Applies when `sf == 1 && N == 1`.

BFM <Xd>, <Xn>, #<immr>, #<imms>

Decode for all variants of this encoding

```
integer d = UInt(Rd);
integer n = UInt(Rn);
integer datasize = if sf == '1' then 64 else 32;

integer R;
bits(datasize) wmask;
bits(datasize) tmask;

if sf == '1' && N != '1' then ReservedValue();
if sf == '0' && (N != '0' || immr<5> != '0' || imms<5> != '0') then ReservedValue();

R = UInt(immr);
(wmask, tmask) = DecodeBitMasks(N, imms, immr, FALSE);
```

Alias conditions

Alias	is preferred when
BFC	<code>Rn == '11111' && UInt(imms) < UInt(immr)</code>
BFI	<code>Rn != '11111' && UInt(imms) < UInt(immr)</code>
BFXIL	<code>UInt(imms) >= UInt(immr)</code>

Assembler symbols

<Wd>	Is the 32-bit name of the general-purpose destination register, encoded in the "Rd" field.
<Wn>	Is the 32-bit name of the general-purpose source register, encoded in the "Rn" field.
<Xd>	Is the 64-bit name of the general-purpose destination register, encoded in the "Rd" field.
<Xn>	Is the 64-bit name of the general-purpose source register, encoded in the "Rn" field.

- <immr> For the 32-bit variant: is the right rotate amount, in the range 0 to 31, encoded in the "immr" field.
For the 64-bit variant: is the right rotate amount, in the range 0 to 63, encoded in the "immr" field.
- <imms> For the 32-bit variant: is the leftmost bit number to be moved from the source, in the range 0 to 31, encoded in the "imms" field.
For the 64-bit variant: is the leftmost bit number to be moved from the source, in the range 0 to 63, encoded in the "imms" field.

Operation

```
bits(datasize) dst = X[d];
bits(datasize) src = X[n];

// perform bitfield move on low bits
bits(datasize) bot = (dst AND NOT(wmask)) OR (ROR(src, R) AND wmask);

// combine extension bits and result bits
X[d] = (dst AND NOT(tmask)) OR (bot AND tmask);
```

C6.2.24 BFXIL

Bitfield extract and insert at low end copies any number of low-order bits from a source register into the same number of adjacent bits at the low end in the destination register, leaving other bits unchanged.

This instruction is an alias of the [BFM](#) instruction. This means that:

- The encodings in this description are named to match the encodings of [BFM](#).
- The description of [BFM](#) gives the operational pseudocode for this instruction.

31	30	29	28	27	26	25	24	23	22	21	16	15	10	9	5	4	0
sf	0	1	1	0	0	1	1	0	N	immr		imms		Rn		Rd	
opc																	

32-bit variant

Applies when $sf == 0 \ \&\& \ N == 0$.

BFXIL <Wd>, <Wn>, #<lsb>, #<width>

is equivalent to

BFM <Wd>, <Wn>, #<lsb>, #(<lsb>+<width>-1)

and is the preferred disassembly when $UInt(imms) \geq UInt(immr)$.

64-bit variant

Applies when $sf == 1 \ \&\& \ N == 1$.

BFXIL <Xd>, <Xn>, #<lsb>, #<width>

is equivalent to

BFM <Xd>, <Xn>, #<lsb>, #(<lsb>+<width>-1)

and is the preferred disassembly when $UInt(imms) \geq UInt(immr)$.

Assembler symbols

<Wd> Is the 32-bit name of the general-purpose destination register, encoded in the "Rd" field.

<Wn> Is the 32-bit name of the general-purpose source register, encoded in the "Rn" field.

<Xd> Is the 64-bit name of the general-purpose destination register, encoded in the "Rd" field.

<Xn> Is the 64-bit name of the general-purpose source register, encoded in the "Rn" field.

<lsb> For the 32-bit variant: is the bit number of the lsb of the source bitfield, in the range 0 to 31.
For the 64-bit variant: is the bit number of the lsb of the source bitfield, in the range 0 to 63.

<width> For the 32-bit variant: is the width of the bitfield, in the range 1 to 32-<lsb>.
For the 64-bit variant: is the width of the bitfield, in the range 1 to 64-<lsb>.

Operation

The description of [BFM](#) gives the operational pseudocode for this instruction.

C6.2.25 BIC (shifted register)

Bitwise Bit Clear (shifted register) performs a bitwise AND of a register value and the complement of an optionally-shifted register value, and writes the result to the destination register.

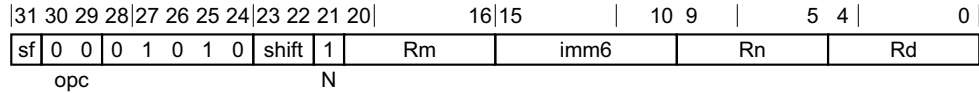

32-bit variant

Applies when `sf == 0`.

BIC <Wd>, <Wn>, <Wm>{, <shift> #<amount>}

64-bit variant

Applies when `sf == 1`.

BIC <Xd>, <Xn>, <Xm>{, <shift> #<amount>}

Decode for all variants of this encoding

```
integer d = UInt(Rd);
integer n = UInt(Rn);
integer m = UInt(Rm);
integer datasize = if sf == '1' then 64 else 32;
if sf == '0' && imm6<5> == '1' then ReservedValue();
```

```
ShiftType shift_type = DecodeShift(shift);
integer shift_amount = UInt(imm6);
```

Assembler symbols

- <Wd> Is the 32-bit name of the general-purpose destination register, encoded in the "Rd" field.
- <Wn> Is the 32-bit name of the first general-purpose source register, encoded in the "Rn" field.
- <Wm> Is the 32-bit name of the second general-purpose source register, encoded in the "Rm" field.
- <Xd> Is the 64-bit name of the general-purpose destination register, encoded in the "Rd" field.
- <Xn> Is the 64-bit name of the first general-purpose source register, encoded in the "Rn" field.
- <Xm> Is the 64-bit name of the second general-purpose source register, encoded in the "Rm" field.
- <shift> Is the optional shift to be applied to the final source, defaulting to LSL and encoded in the "shift" field. It can have the following values:
 - LSL when shift = 00
 - LSR when shift = 01
 - ASR when shift = 10
 - ROR when shift = 11
- <amount> For the 32-bit variant: is the shift amount, in the range 0 to 31, defaulting to 0 and encoded in the "imm6" field.
 For the 64-bit variant: is the shift amount, in the range 0 to 63, defaulting to 0 and encoded in the "imm6" field.

Operation

```
bits(datasize) operand1 = X[n];  
bits(datasize) operand2 = ShiftReg(m, shift_type, shift_amount);  
  
operand2 = NOT(operand2);  
  
result = operand1 AND operand2;  
X[d] = result;
```

C6.2.26 BICS (shifted register)

Bitwise Bit Clear (shifted register), setting flags, performs a bitwise AND of a register value and the complement of an optionally-shifted register value, and writes the result to the destination register. It updates the condition flags based on the result.

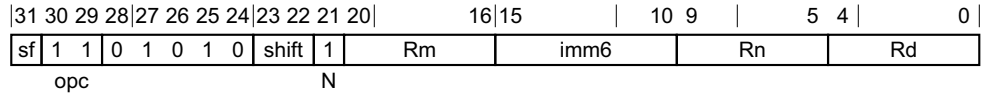

32-bit variant

Applies when `sf == 0`.

BICS <Wd>, <Wn>, <Wm>{, <shift> #<amount>}

64-bit variant

Applies when `sf == 1`.

BICS <Xd>, <Xn>, <Xm>{, <shift> #<amount>}

Decode for all variants of this encoding

```
integer d = UInt(Rd);
integer n = UInt(Rn);
integer m = UInt(Rm);
integer datasize = if sf == '1' then 64 else 32;

if sf == '0' && imm6<5> == '1' then ReservedValue();

ShiftType shift_type = DecodeShift(shift);
integer shift_amount = UInt(imm6);
```

Assembler symbols

- <Wd> Is the 32-bit name of the general-purpose destination register, encoded in the "Rd" field.
- <Wn> Is the 32-bit name of the first general-purpose source register, encoded in the "Rn" field.
- <Wm> Is the 32-bit name of the second general-purpose source register, encoded in the "Rm" field.
- <Xd> Is the 64-bit name of the general-purpose destination register, encoded in the "Rd" field.
- <Xn> Is the 64-bit name of the first general-purpose source register, encoded in the "Rn" field.
- <Xm> Is the 64-bit name of the second general-purpose source register, encoded in the "Rm" field.
- <shift> Is the optional shift to be applied to the final source, defaulting to LSL and encoded in the "shift" field. It can have the following values:
 - LSL when shift = 00
 - LSR when shift = 01
 - ASR when shift = 10
 - ROR when shift = 11
- <amount> For the 32-bit variant: is the shift amount, in the range 0 to 31, defaulting to 0 and encoded in the "imm6" field.
 For the 64-bit variant: is the shift amount, in the range 0 to 63, defaulting to 0 and encoded in the "imm6" field.

Operation

```
bits(datasize) operand1 = X[n];  
bits(datasize) operand2 = ShiftReg(m, shift_type, shift_amount);  
  
operand2 = NOT(operand2);  
  
result = operand1 AND operand2;  
PSTATE.<N,Z,C,V> = result<datasize-1>:IsZeroBit(result):'00';  
  
X[d] = result;
```

C6.2.27 BL

Branch with Link branches to a PC-relative offset, setting the register X30 to PC+4. It provides a hint that this is a subroutine call.

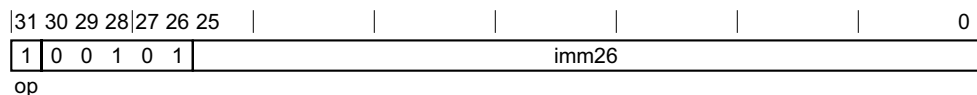

26-bit signed PC-relative branch offset variant

BL <label>

Decode for this encoding

bits(64) offset = [SignExtend](#)(imm26:'00', 64);

Assembler symbols

<label> Is the program label to be unconditionally branched to. Its offset from the address of this instruction, in the range +/-128MB, is encoded as "imm26" times 4.

Operation

$X[30] = PC[] + 4;$

[BranchTo](#)(PC[] + offset, [BranchType_CALL](#));

C6.2.28 BLR

Branch with Link to Register calls a subroutine at an address in a register, setting register X30 to PC+4.

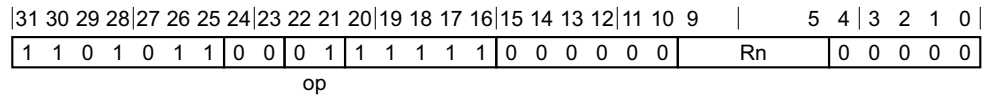

Integer variant

BLR <Xn>

Decode for this encoding

integer n = `UInt`(Rn);

Assembler symbols

<Xn> Is the 64-bit name of the general-purpose register holding the address to be branched to, encoded in the "Rn" field.

Operation

bits(64) target = X[n];

X[30] = PC[] + 4;
 BranchTo(target, BranchType_CALL);

C6.2.29 BR

Branch to Register branches unconditionally to an address in a register, with a hint that this is not a subroutine return.

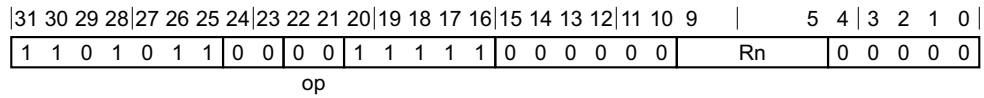

Integer variant

BR <Xn>

Decode for this encoding

integer n = `UInt`(Rn);

Assembler symbols

<Xn> Is the 64-bit name of the general-purpose register holding the address to be branched to, encoded in the "Rn" field.

Operation

bits(64) target = X[n];

`BranchTo`(target, `BranchType_JMP`);

C6.2.30 BRK

Breakpoint instruction generates a Breakpoint Instruction exception. The PE records the exception in [ESR_ELx](#), using the EC value 0x3c, and captures the value of the immediate argument in [ESR_ELx.ISS](#).

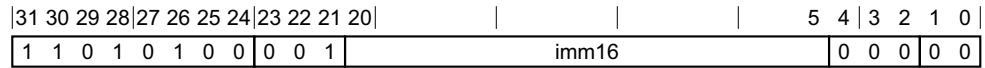

System variant

BRK #<imm>

Decode for this encoding

bits(16) comment = imm16;

Assembler symbols

<imm> Is a 16-bit unsigned immediate, in the range 0 to 65535, encoded in the "imm16" field.

Operation

[AArch64.SoftwareBreakpoint](#)(comment);

C6.2.31 CASB, CASAB, CASALB, CASLB

Compare and Swap byte in memory reads an 8-bit byte from memory, and compares it against the value held in a first register. If the comparison is equal, the value in a second register is written to memory. If the write is performed, the read and write occur atomically such that no other modification of the memory location can take place between the read and write.

- CASAB and CASALB load from memory with acquire semantics.
- CASLB and CASALB store to memory with release semantics.
- CASB has no memory ordering requirements.

For more information about memory ordering semantics see *Load-Acquire, Store-Release* on page B2-94.

For information about memory accesses see *Load/Store addressing modes* on page C1-143.

The architecture permits that the data read clears any exclusive monitors associated with that location, even if the compare subsequently fails.

If the instruction generates a synchronous Data Abort, the register which is compared and loaded, that is <Ws>, is restored to the values held in the register before the instruction was executed.

ARMv8.1

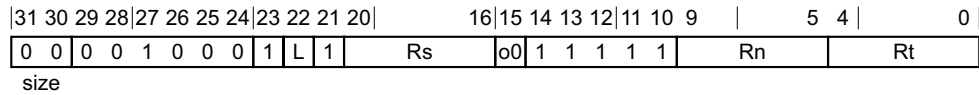

Acquire variant

Applies when L == 1 && o0 == 0.

CASAB <Ws>, <Wt>, [<Xn|SP>{,#0}]

Acquire and release variant

Applies when L == 1 && o0 == 1.

CASALB <Ws>, <Wt>, [<Xn|SP>{,#0}]

No memory ordering variant

Applies when L == 0 && o0 == 0.

CASB <Ws>, <Wt>, [<Xn|SP>{,#0}]

Release variant

Applies when L == 0 && o0 == 1.

CASLB <Ws>, <Wt>, [<Xn|SP>{,#0}]

Decode for all variants of this encoding

```

if !HaveAtomicExt() then UnallocatedEncoding();

integer n = UInt(Rn);
integer t = UInt(Rt);
integer s = UInt(Rs);

AccType ldacctype = if L == '1' then AccType_ORDEREDRW else AccType_ATOMICRW;
AccType stacctype = if o0 == '1' then AccType_ORDEREDRW else AccType_ATOMICRW;
    
```

Assembler symbols

- <Ws> Is the 32-bit name of the general-purpose register to be compared and loaded, encoded in the "Rs" field.
- <Wt> Is the 32-bit name of the general-purpose register to be conditionally stored, encoded in the "Rt" field.
- <Xn|SP> Is the 64-bit name of the general-purpose base register or stack pointer, encoded in the "Rn" field.

Operation

```
bits(64) address;
bits(8) comparevalue;
bits(8) newvalue;
bits(8) data;

comparevalue = X[s];
newvalue = X[t];
if n == 31 then
    CheckSPAlignment();
    address = SP[];
else
    address = X[n];
data = Mem[address, 1, ldacctype];
if data == comparevalue then
    // All observers in the shareability domain observe the
    // following load and store atomically.
    Mem[address, 1, stacctype] = newvalue;

X[s] = ZeroExtend(data, 32);
```

C6.2.32 CASH, CASAH, CASALH, CASLH

Compare and Swap halfword in memory reads a 16-bit halfword from memory, and compares it against the value held in a first register. If the comparison is equal, the value in a second register is written to memory. If the write is performed, the read and write occur atomically such that no other modification of the memory location can take place between the read and write.

- CASAH and CASALH load from memory with acquire semantics.
- CASLH and CASALH store to memory with release semantics.
- CAS has no memory ordering requirements.

For more information about memory ordering semantics see *Load-Acquire, Store-Release* on page B2-94.

For information about memory accesses see *Load/Store addressing modes* on page C1-143.

The architecture permits that the data read clears any exclusive monitors associated with that location, even if the compare subsequently fails.

If the instruction generates a synchronous Data Abort, the register which is compared and loaded, that is <Ws>, is restored to the values held in the register before the instruction was executed.

ARMv8.1

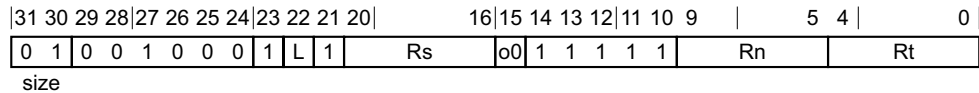

Acquire variant

Applies when L == 1 && o0 == 0.

CASAH <Ws>, <Wt>, [<Xn|SP>{,#0}]

Acquire and release variant

Applies when L == 1 && o0 == 1.

CASALH <Ws>, <Wt>, [<Xn|SP>{,#0}]

No memory ordering variant

Applies when L == 0 && o0 == 0.

CASH <Ws>, <Wt>, [<Xn|SP>{,#0}]

Release variant

Applies when L == 0 && o0 == 1.

CASLH <Ws>, <Wt>, [<Xn|SP>{,#0}]

Decode for all variants of this encoding

```

if !HaveAtomicExt() then UnallocatedEncoding();

integer n = UInt(Rn);
integer t = UInt(Rt);
integer s = UInt(Rs);

AccType ldacctype = if L == '1' then AccType_ORDEREDRW else AccType_ATOMICRW;
AccType stacctype = if o0 == '1' then AccType_ORDEREDRW else AccType_ATOMICRW;
    
```

Assembler symbols

- <Ws> Is the 32-bit name of the general-purpose register to be compared and loaded, encoded in the "Rs" field.
- <Wt> Is the 32-bit name of the general-purpose register to be conditionally stored, encoded in the "Rt" field.
- <Xn|SP> Is the 64-bit name of the general-purpose base register or stack pointer, encoded in the "Rn" field.

Operation

```
bits(64) address;
bits(16) comparevalue;
bits(16) newvalue;
bits(16) data;

comparevalue = X[s];
newvalue = X[t];
if n == 31 then
    CheckSPAlignment();
    address = SP[];
else
    address = X[n];
data = Mem[address, 2, ldacctype];
if data == comparevalue then
    // All observers in the shareability domain observe the
    // following load and store atomically.
    Mem[address, 2, stacctype] = newvalue;

X[s] = ZeroExtend(data, 32);
```

C6.2.33 CASP, CASPA, CASPAL, CASPL

Compare and Swap Pair of words or doublewords in memory reads a pair of 32-bit words or 64-bit doublewords from memory, and compares them against the values held in the first pair of registers. If the comparison is equal, the values in the second pair of registers are written to memory. If the writes are performed, the reads and writes occur atomically such that no other modification of the memory location can take place between the reads and writes.

- CASPA and CASPAL load from memory with acquire semantics.
- CASPL and CASPAL store to memory with release semantics.
- CAS has no memory ordering requirements.

For more information about memory ordering semantics see *Load-Acquire, Store-Release* on page B2-94.

For information about memory accesses see *Load/Store addressing modes* on page C1-143.

The architecture permits that the data read clears any exclusive monitors associated with that location, even if the compare subsequently fails.

If the instruction generates a synchronous Data Abort, the registers which are compared and loaded, that is <Ws> and <W(s+1)>, or <Xs> and <X(s+1)>, are restored to the values held in the registers before the instruction was executed.

ARMv8.1

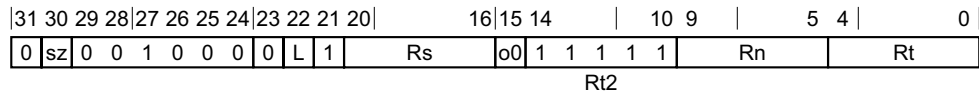

32-bit, acquire variant

Applies when $sz == 0 \ \&\& \ L == 1 \ \&\& \ o0 == 0$.
 CASPA <Ws>, <W(s+1)>, <Wt>, <W(t+1)>, [<Xn|SP>{,#0}]

32-bit, acquire and release variant

Applies when $sz == 0 \ \&\& \ L == 1 \ \&\& \ o0 == 1$.
 CASPAL <Ws>, <W(s+1)>, <Wt>, <W(t+1)>, [<Xn|SP>{,#0}]

32-bit, no memory ordering variant

Applies when $sz == 0 \ \&\& \ L == 0 \ \&\& \ o0 == 0$.
 CASP <Ws>, <W(s+1)>, <Wt>, <W(t+1)>, [<Xn|SP>{,#0}]

32-bit, release variant

Applies when $sz == 0 \ \&\& \ L == 0 \ \&\& \ o0 == 1$.
 CASPL <Ws>, <W(s+1)>, <Wt>, <W(t+1)>, [<Xn|SP>{,#0}]

64-bit, acquire variant

Applies when $sz == 1 \ \&\& \ L == 1 \ \&\& \ o0 == 0$.
 CASPA <Xs>, <X(s+1)>, <Xt>, <X(t+1)>, [<Xn|SP>{,#0}]

64-bit, acquire and release variant

Applies when $sz == 1 \ \&\& \ L == 1 \ \&\& \ o0 == 1$.

CASPAL <Xs>, <X(s+1)>, <Xt>, <X(t+1)>, [<Xn|SP>{,#0}]

64-bit, no memory ordering variant

Applies when sz == 1 && L == 0 && o0 == 0.

CASP <Xs>, <X(s+1)>, <Xt>, <X(t+1)>, [<Xn|SP>{,#0}]

64-bit, release variant

Applies when sz == 1 && L == 0 && o0 == 1.

CASPL <Xs>, <X(s+1)>, <Xt>, <X(t+1)>, [<Xn|SP>{,#0}]

Decode for all variants of this encoding

```
if !HaveAtomicExt() then UnallocatedEncoding();
if Rs<0> == '1' then UnallocatedEncoding();
if Rt<0> == '1' then UnallocatedEncoding();

integer n = UInt(Rn);
integer t = UInt(Rt);
integer s = UInt(Rs);

integer datasize = 32 << UInt(sz);
AccType ldacctype = if L == '1' then AccType_ORDEREDRW else AccType_ATOMICRW;
AccType stacctype = if o0 == '1' then AccType_ORDEREDRW else AccType_ATOMICRW;
```

Assembler symbols

- <Ws> Is the 32-bit name of the first general-purpose register to be compared and loaded, encoded in the "Rs" field.
- <W(s+1)> Is the 32-bit name of the second general-purpose register to be compared and loaded.
- <Wt> Is the 32-bit name of the first general-purpose register to be conditionally stored, encoded in the "Rt" field.
- <W(t+1)> Is the 32-bit name of the second general-purpose register to be conditionally stored.
- <Xs> Is the 64-bit name of the first general-purpose register to be compared and loaded, encoded in the "Rs" field.
- <X(s+1)> Is the 64-bit name of the second general-purpose register to be compared and loaded.
- <Xt> Is the 64-bit name of the first general-purpose register to be conditionally stored, encoded in the "Rt" field.
- <X(t+1)> Is the 64-bit name of the second general-purpose register to be conditionally stored.
- <Xn|SP> Is the 64-bit name of the general-purpose base register or stack pointer, encoded in the "Rn" field.

Operation

```
bits(64) address;
bits(2*datasize) comparevalue;
bits(2*datasize) newvalue;
bits(2*datasize) data;

bits(datasize) s1 = X[s];
bits(datasize) s2 = X[s+1];
bits(datasize) t1 = X[t];
bits(datasize) t2 = X[t+1];
comparevalue = if BigEndian() then s1:s2 else s2:s1;
newvalue = if BigEndian() then t1:t2 else t2:t1;
```

```
if n == 31 then
    CheckSPAlignment();
    address = SP[];
else
    address = X[n];
data = Mem[address, (2*datasize) DIV 8, 1dacctype];
if data == comparevalue then
    // All observers in the shareability domain observe the
    // following load and store atomically.
    Mem[address, (2*datasize) DIV 8, stacctype] = newvalue;

if BigEndian() then
    X[s] = ZeroExtend(data<2*datasize-1:datasize>, datasize);
    X[s+1] = ZeroExtend(data<datasize-1:0>, datasize);
else
    X[s] = ZeroExtend(data<datasize-1:0>, datasize);
    X[s+1] = ZeroExtend(data<2*datasize-1:datasize>, datasize);
```

C6.2.34 CAS, CASA, CASAL, CASL

Compare and Swap word or doubleword in memory reads a 32-bit word or 64-bit doubleword from memory, and compares it against the value held in a first register. If the comparison is equal, the value in a second register is written to memory. If the write is performed, the read and write occur atomically such that no other modification of the memory location can take place between the read and write.

- CASA and CASAL load from memory with acquire semantics.
- CASL and CASAL store to memory with release semantics.
- CAS has no memory ordering requirements.

For more information about memory ordering semantics see [Load-Acquire, Store-Release](#) on page B2-94.

For information about memory accesses see [Load/Store addressing modes](#) on page C1-143.

The architecture permits that the data read clears any exclusive monitors associated with that location, even if the compare subsequently fails.

If the instruction generates a synchronous Data Abort, the register which is compared and loaded, that is <Ws>, or <Xs>, is restored to the value held in the register before the instruction was executed.

ARMv8.1

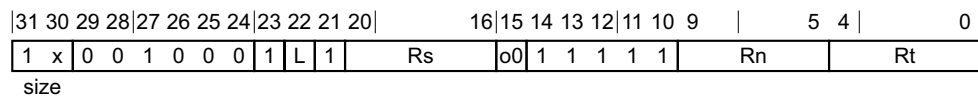

32-bit, acquire variant

Applies when size == 10 && L == 1 && o0 == 0.

CASA <Ws>, <Wt>, [<Xn|SP>{,#0}]

32-bit, acquire and release variant

Applies when size == 10 && L == 1 && o0 == 1.

CASAL <Ws>, <Wt>, [<Xn|SP>{,#0}]

32-bit, no memory ordering variant

Applies when size == 10 && L == 0 && o0 == 0.

CAS <Ws>, <Wt>, [<Xn|SP>{,#0}]

32-bit, release variant

Applies when size == 10 && L == 0 && o0 == 1.

CASL <Ws>, <Wt>, [<Xn|SP>{,#0}]

64-bit, acquire variant

Applies when size == 11 && L == 1 && o0 == 0.

CASA <Xs>, <Xt>, [<Xn|SP>{,#0}]

64-bit, acquire and release variant

Applies when size == 11 && L == 1 && o0 == 1.

CASAL <Xs>, <Xt>, [<Xn|SP>{,#0}]

64-bit, no memory ordering variant

Applies when size == 11 && L == 0 && o0 == 0.

CAS <Xs>, <Xt>, [<Xn|SP>{,#0}]

64-bit, release variant

Applies when size == 11 && L == 0 && o0 == 1.

CASL <Xs>, <Xt>, [<Xn|SP>{,#0}]

Decode for all variants of this encoding

```
if !HaveAtomicExt() then UnallocatedEncoding();

integer n = UInt(Rn);
integer t = UInt(Rt);
integer s = UInt(Rs);

integer datasize = 8 << UInt(size);
integer regsize = if datasize == 64 then 64 else 32;
AccType ldacctype = if L == '1' then AccType_ORDEREDRW else AccType_ATOMICRW;
AccType stacctype = if o0 == '1' then AccType_ORDEREDRW else AccType_ATOMICRW;
```

Assembler symbols

- <Ws> Is the 32-bit name of the general-purpose register to be compared and loaded, encoded in the "Rs" field.
- <Wt> Is the 32-bit name of the general-purpose register to be conditionally stored, encoded in the "Rt" field.
- <Xs> Is the 64-bit name of the general-purpose register to be compared and loaded, encoded in the "Rs" field.
- <Xt> Is the 64-bit name of the general-purpose register to be conditionally stored, encoded in the "Rt" field.
- <Xn|SP> Is the 64-bit name of the general-purpose base register or stack pointer, encoded in the "Rn" field.

Operation

```
bits(64) address;
bits(datasize) comparevalue;
bits(datasize) newvalue;
bits(datasize) data;

comparevalue = X[s];
newvalue = X[t];
if n == 31 then
  CheckSPAlignment();
  address = SP[];
else
  address = X[n];
data = Mem[address, datasize DIV 8, ldacctype];
if data == comparevalue then
  // All observers in the shareability domain observe the
  // following load and store atomically.
  Mem[address, datasize DIV 8, stacctype] = newvalue;

X[s] = ZeroExtend(data, regsize);
```

C6.2.35 CBNZ

Compare and Branch on Nonzero compares the value in a register with zero, and conditionally branches to a label at a PC-relative offset if the comparison is not equal. It provides a hint that this is not a subroutine call or return. This instruction does not affect the condition flags.



32-bit variant

Applies when sf == 0.

CBNZ <Wt>, <label>

64-bit variant

Applies when sf == 1.

CBNZ <Xt>, <label>

Decode for all variants of this encoding

```
integer t = UInt(Rt);
integer datasize = if sf == '1' then 64 else 32;
bits(64) offset = SignExtend(imm19:'00', 64);
```

Assembler symbols

- <Wt> Is the 32-bit name of the general-purpose register to be tested, encoded in the "Rt" field.
- <Xt> Is the 64-bit name of the general-purpose register to be tested, encoded in the "Rt" field.
- <label> Is the program label to be conditionally branched to. Its offset from the address of this instruction, in the range +/-1MB, is encoded as "imm19" times 4.

Operation

```
bits(datasize) operand1 = X[t];
if IsZero(operand1) == FALSE then
    BranchTo(PC[] + offset, BranchType_JMP);
```

C6.2.36 CBZ

Compare and Branch on Zero compares the value in a register with zero, and conditionally branches to a label at a PC-relative offset if the comparison is equal. It provides a hint that this is not a subroutine call or return. This instruction does not affect condition flags.

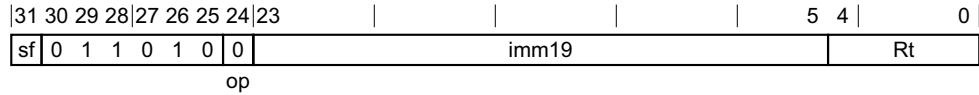

32-bit variant

Applies when `sf == 0`.

CBZ <Wt>, <label>

64-bit variant

Applies when `sf == 1`.

CBZ <Xt>, <label>

Decode for all variants of this encoding

```
integer t = UInt(Rt);
integer datasize = if sf == '1' then 64 else 32;
bits(64) offset = SignExtend(imm19:'00', 64);
```

Assembler symbols

- <Wt> Is the 32-bit name of the general-purpose register to be tested, encoded in the "Rt" field.
- <Xt> Is the 64-bit name of the general-purpose register to be tested, encoded in the "Rt" field.
- <label> Is the program label to be conditionally branched to. Its offset from the address of this instruction, in the range +/-1MB, is encoded as "imm19" times 4.

Operation

```
bits(datasize) operand1 = X[t];
if IsZero(operand1) == TRUE then
  BranchTo(PC[] + offset, BranchType_JMP);
```

C6.2.37 CCMN (immediate)

Conditional Compare Negative (immediate) sets the value of the condition flags to the result of the comparison of a register value and a negated immediate value if the condition is TRUE, and an immediate value otherwise.

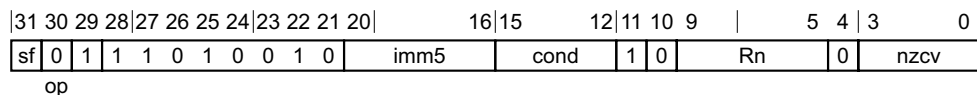

32-bit variant

Applies when sf == 0.

CCMN <Wn>, #<imm>, #<nzcw>, <cond>

64-bit variant

Applies when sf == 1.

CCMN <Xn>, #<imm>, #<nzcw>, <cond>

Decode for all variants of this encoding

```
integer n = UInt(Rn);
integer datasize = if sf == '1' then 64 else 32;
bits(4) flags = nzcw;
bits(datasize) imm = ZeroExtend(imm5, datasize);
```

Assembler symbols

- <Wn> Is the 32-bit name of the first general-purpose source register, encoded in the "Rn" field.
- <Xn> Is the 64-bit name of the first general-purpose source register, encoded in the "Rn" field.
- <imm> Is a five bit unsigned (positive) immediate encoded in the "imm5" field.
- <nzcw> Is the flag bit specifier, an immediate in the range 0 to 15, giving the alternative state for the 4-bit NZCV condition flags, encoded in the "nzcw" field.
- <cond> Is one of the standard conditions, encoded in the "cond" field in the standard way.

Operation

```
bits(datasize) operand1 = X[n];

if ConditionHolds(cond) then
  (-, flags) = AddWithCarry(operand1, imm, '0');
PSTATE.<N,Z,C,V> = flags;
```

C6.2.38 CCMN (register)

Conditional Compare Negative (register) sets the value of the condition flags to the result of the comparison of a register value and the inverse of another register value if the condition is TRUE, and an immediate value otherwise.

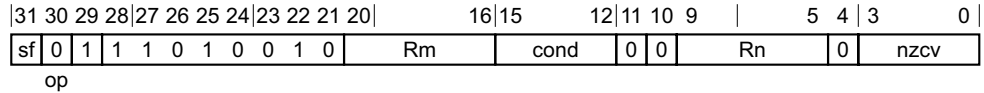

32-bit variant

Applies when sf == 0.

CCMN <Wn>, <Wm>, #<nzcv>, <cond>

64-bit variant

Applies when sf == 1.

CCMN <Xn>, <Xm>, #<nzcv>, <cond>

Decode for all variants of this encoding

```
integer n = UInt(Rn);
integer m = UInt(Rm);
integer datasize = if sf == '1' then 64 else 32;
bits(4) flags = nzcv;
```

Assembler symbols

- <Wn> Is the 32-bit name of the first general-purpose source register, encoded in the "Rn" field.
- <Wm> Is the 32-bit name of the second general-purpose source register, encoded in the "Rm" field.
- <Xn> Is the 64-bit name of the first general-purpose source register, encoded in the "Rn" field.
- <Xm> Is the 64-bit name of the second general-purpose source register, encoded in the "Rm" field.
- <nzcv> Is the flag bit specifier, an immediate in the range 0 to 15, giving the alternative state for the 4-bit NZCV condition flags, encoded in the "nzcv" field.
- <cond> Is one of the standard conditions, encoded in the "cond" field in the standard way.

Operation

```
bits(datasize) operand1 = X[n];
bits(datasize) operand2 = X[m];

if ConditionHolds(cond) then
  (-, flags) = AddWithCarry(operand1, operand2, '0');
PSTATE.<N,Z,C,V> = flags;
```

C6.2.39 CCMP (immediate)

Conditional Compare (immediate) sets the value of the condition flags to the result of the comparison of a register value and an immediate value if the condition is TRUE, and an immediate value otherwise.

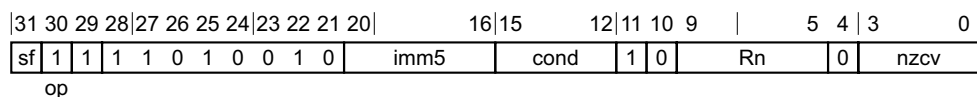

32-bit variant

Applies when sf == 0.

CCMP <Wn>, #<imm>, #<nzcvcv>, <cond>

64-bit variant

Applies when sf == 1.

CCMP <Xn>, #<imm>, #<nzcvcv>, <cond>

Decode for all variants of this encoding

```
integer n = UInt(Rn);
integer datasize = if sf == '1' then 64 else 32;
bits(4) flags = nzcvcv;
bits(datasize) imm = ZeroExtend(imm5, datasize);
```

Assembler symbols

- <Wn> Is the 32-bit name of the first general-purpose source register, encoded in the "Rn" field.
- <Xn> Is the 64-bit name of the first general-purpose source register, encoded in the "Rn" field.
- <imm> Is a five bit unsigned (positive) immediate encoded in the "imm5" field.
- <nzcvcv> Is the flag bit specifier, an immediate in the range 0 to 15, giving the alternative state for the 4-bit NZCV condition flags, encoded in the "nzcvcv" field.
- <cond> Is one of the standard conditions, encoded in the "cond" field in the standard way.

Operation

```
bits(datasize) operand1 = X[n];
bits(datasize) operand2;

if ConditionHolds(cond) then
    operand2 = NOT(imm);
    (-, flags) = AddWithCarry(operand1, operand2, '1');
PSTATE.<N,Z,C,V> = flags;
```

C6.2.40 CCMP (register)

Conditional Compare (register) sets the value of the condition flags to the result of the comparison of two registers if the condition is TRUE, and an immediate value otherwise.

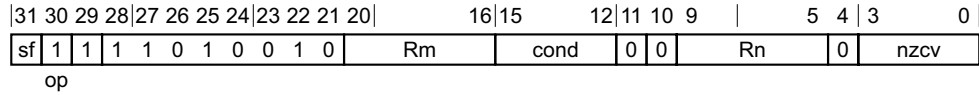

32-bit variant

Applies when sf == 0.

CCMP <Wn>, <Wm>, #<nzcv>, <cond>

64-bit variant

Applies when sf == 1.

CCMP <Xn>, <Xm>, #<nzcv>, <cond>

Decode for all variants of this encoding

```
integer n = UInt(Rn);
integer m = UInt(Rm);
integer datasize = if sf == '1' then 64 else 32;
bits(4) flags = nzcv;
```

Assembler symbols

- <Wn> Is the 32-bit name of the first general-purpose source register, encoded in the "Rn" field.
- <Wm> Is the 32-bit name of the second general-purpose source register, encoded in the "Rm" field.
- <Xn> Is the 64-bit name of the first general-purpose source register, encoded in the "Rn" field.
- <Xm> Is the 64-bit name of the second general-purpose source register, encoded in the "Rm" field.
- <nzcv> Is the flag bit specifier, an immediate in the range 0 to 15, giving the alternative state for the 4-bit NZCV condition flags, encoded in the "nzcv" field.
- <cond> Is one of the standard conditions, encoded in the "cond" field in the standard way.

Operation

```
bits(datasize) operand1 = X[n];
bits(datasize) operand2 = X[m];

if ConditionHolds(cond) then
  operand2 = NOT(operand2);
  (-, flags) = AddWithCarry(operand1, operand2, '1');
PSTATE.<N,Z,C,V> = flags;
```

C6.2.41 CINC

Conditional Increment returns, in the destination register, the value of the source register incremented by 1 if the condition is TRUE, and otherwise returns the value of the source register.

This instruction is an alias of the [CSINC](#) instruction. This means that:

- The encodings in this description are named to match the encodings of [CSINC](#).
- The description of [CSINC](#) gives the operational pseudocode for this instruction.

31 30 29 28		27 26 25 24				23 22 21 20				16 15		12 11 10 9			5 4		0
sf	0	0	1	1	0	1	0	1	0	0	!=11111	!=111x	0	1	!=11111	Rd	
op		Rm				cond			o2		Rn						

32-bit variant

Applies when `sf == 0`.

CINC <Wd>, <Wn>, <cond>

is equivalent to

CSINC <Wd>, <Wn>, <Wn>, invert(<cond>)

and is the preferred disassembly when `Rn == Rm`.

64-bit variant

Applies when `sf == 1`.

CINC <Xd>, <Xn>, <cond>

is equivalent to

CSINC <Xd>, <Xn>, <Xn>, invert(<cond>)

and is the preferred disassembly when `Rn == Rm`.

Assembler symbols

<Wd> Is the 32-bit name of the general-purpose destination register, encoded in the "Rd" field.

<Wn> Is the 32-bit name of the general-purpose source register, encoded in the "Rn" and "Rm" fields.

<Xd> Is the 64-bit name of the general-purpose destination register, encoded in the "Rd" field.

<Xn> Is the 64-bit name of the general-purpose source register, encoded in the "Rn" and "Rm" fields.

<cond> Is one of the standard conditions, excluding AL and NV, encoded in the "cond" field with its least significant bit inverted.

Operation

The description of [CSINC](#) gives the operational pseudocode for this instruction.

C6.2.42 CINV

Conditional Invert returns, in the destination register, the bitwise inversion of the value of the source register if the condition is TRUE, and otherwise returns the value of the source register.

This instruction is an alias of the [CSINV](#) instruction. This means that:

- The encodings in this description are named to match the encodings of [CSINV](#).
- The description of [CSINV](#) gives the operational pseudocode for this instruction.

31 30 29 28 27 26 25 24 23 22 21 20										16 15		12 11 10 9			5 4		0		
sf	1	0	1	1	0	1	0	1	0	0	!=11111		!=111x		0 0		!=11111		Rd
op										Rm		cond		o2		Rn			

32-bit variant

Applies when $sf == 0$.

CINV <Wd>, <Wn>, <cond>

is equivalent to

CSINV <Wd>, <Wn>, <Wn>, invert(<cond>)

and is the preferred disassembly when $Rn == Rm$.

64-bit variant

Applies when $sf == 1$.

CINV <Xd>, <Xn>, <cond>

is equivalent to

CSINV <Xd>, <Xn>, <Xn>, invert(<cond>)

and is the preferred disassembly when $Rn == Rm$.

Assembler symbols

- <Wd> Is the 32-bit name of the general-purpose destination register, encoded in the "Rd" field.
- <Wn> Is the 32-bit name of the general-purpose source register, encoded in the "Rn" and "Rm" fields.
- <Xd> Is the 64-bit name of the general-purpose destination register, encoded in the "Rd" field.
- <Xn> Is the 64-bit name of the general-purpose source register, encoded in the "Rn" and "Rm" fields.
- <cond> Is one of the standard conditions, excluding AL and NV, encoded in the "cond" field with its least significant bit inverted.

Operation

The description of [CSINV](#) gives the operational pseudocode for this instruction.

C6.2.43 CLREX

Clear Exclusive clears the local monitor of the executing PE.

31	30	29	28	27	26	25	24	23	22	21	20	19	18	17	16	15	14	13	12	11	8	7	6	5	4	3	2	1	0
1	1	0	1	0	1	0	1	0	0	0	0	0	0	1	1	0	0	1	1	CRm	0	1	0	1	1	1	1	1	1

System variant

CLREX {#<imm>}

Decode for this encoding

// CRm field is ignored

Assembler symbols

<imm> Is an optional 4-bit unsigned immediate, in the range 0 to 15, defaulting to 15 and encoded in the "CRm" field.

Operation

`ClearExclusiveLocal(ProcessorID());`

C6.2.44 CLS

Count leading sign bits : Rd = CLS(Rn)

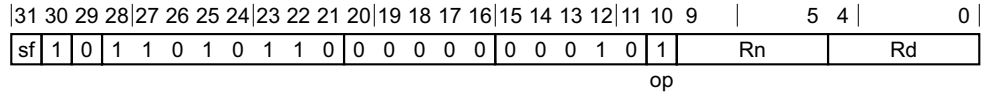

32-bit variant

Applies when sf == 0.

CLS <Wd>, <Wn>

64-bit variant

Applies when sf == 1.

CLS <Xd>, <Xn>

Decode for all variants of this encoding

```
integer d = UInt(Rd);
integer n = UInt(Rn);
integer datasize = if sf == '1' then 64 else 32;
```

Assembler symbols

- <Wd> Is the 32-bit name of the general-purpose destination register, encoded in the "Rd" field.
- <Wn> Is the 32-bit name of the general-purpose source register, encoded in the "Rn" field.
- <Xd> Is the 64-bit name of the general-purpose destination register, encoded in the "Rd" field.
- <Xn> Is the 64-bit name of the general-purpose source register, encoded in the "Rn" field.

Operation

```
integer result;
bits(datasize) operand1 = X[n];

result = CountLeadingSignBits(operand1);

X[d] = result<datasize-1:0>;
```

C6.2.45 CLZ

Count leading zero bits : Rd = CLZ(Rn)

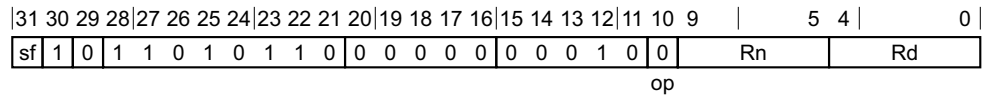

32-bit variant

Applies when sf == 0.

CLZ <Wd>, <Wn>

64-bit variant

Applies when sf == 1.

CLZ <Xd>, <Xn>

Decode for all variants of this encoding

```
integer d = UInt(Rd);
integer n = UInt(Rn);
integer datasize = if sf == '1' then 64 else 32;
```

Assembler symbols

- <Wd> Is the 32-bit name of the general-purpose destination register, encoded in the "Rd" field.
- <Wn> Is the 32-bit name of the general-purpose source register, encoded in the "Rn" field.
- <Xd> Is the 64-bit name of the general-purpose destination register, encoded in the "Rd" field.
- <Xn> Is the 64-bit name of the general-purpose source register, encoded in the "Rn" field.

Operation

```
integer result;
bits(datasize) operand1 = X[n];

result = CountLeadingZeroBits(operand1);
X[d] = result<datasize-1:0>;
```

C6.2.46 CMN (extended register)

Compare Negative (extended register) adds a register value and a sign or zero-extended register value, followed by an optional left shift amount. The argument that is extended from the <Rm> register can be a byte, halfword, word, or doubleword. It updates the condition flags based on the result, and discards the result.

This instruction is an alias of the [ADDS \(extended register\)](#) instruction. This means that:

- The encodings in this description are named to match the encodings of [ADDS \(extended register\)](#).
- The description of [ADDS \(extended register\)](#) gives the operational pseudocode for this instruction.

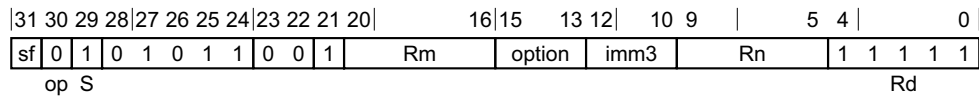

32-bit variant

Applies when sf == 0.

CMN <Wn|WSP>, <Wm>{, <extend> {#<amount>}}

is equivalent to

ADDS WZR, <Wn|WSP>, <Wm>{, <extend> {#<amount>}}

and is always the preferred disassembly.

64-bit variant

Applies when sf == 1.

CMN <Xn|SP>, <R><m>{, <extend> {#<amount>}}

is equivalent to

ADDS XZR, <Xn|SP>, <R><m>{, <extend> {#<amount>}}

and is always the preferred disassembly.

Assembler symbols

<Wn|WSP> Is the 32-bit name of the first source general-purpose register or stack pointer, encoded in the "Rn" field.

<Wm> Is the 32-bit name of the second general-purpose source register, encoded in the "Rm" field.

<Xn|SP> Is the 64-bit name of the first source general-purpose register or stack pointer, encoded in the "Rn" field.

<R> Is a width specifier, encoded in the "option" field. It can have the following values:

- W when option = 00x
- W when option = 010
- X when option = x11
- W when option = 10x
- W when option = 110

<m> Is the number [0-30] of the second general-purpose source register or the name ZR (31), encoded in the "Rm" field.

- <extend> For the 32-bit variant: is the extension to be applied to the second source operand, encoded in the "option" field. It can have the following values:
- UXTB when option = 000
 - UXTH when option = 001
 - LSL|UXTW when option = 010
 - UXTX when option = 011
 - SXTB when option = 100
 - SXTH when option = 101
 - SXTW when option = 110
 - SXTX when option = 111
- If "Rn" is '11111' (WSP) and "option" is '010' then LSL is preferred, but may be omitted when "imm3" is '000'. In all other cases <extend> is required and must be UXTW when "option" is '010'.
- For the 64-bit variant: is the extension to be applied to the second source operand, encoded in the "option" field. It can have the following values:
- UXTB when option = 000
 - UXTH when option = 001
 - UXTW when option = 010
 - LSL|UXTX when option = 011
 - SXTB when option = 100
 - SXTH when option = 101
 - SXTW when option = 110
 - SXTX when option = 111
- If "Rn" is '11111' (SP) and "option" is '011' then LSL is preferred, but may be omitted when "imm3" is '000'. In all other cases <extend> is required and must be UXTX when "option" is '011'.
- <amount> Is the left shift amount to be applied after extension in the range 0 to 4, defaulting to 0, encoded in the "imm3" field. It must be absent when <extend> is absent, is required when <extend> is LSL, and is optional when <extend> is present but not LSL.

Operation

The description of [ADDS \(extended register\)](#) gives the operational pseudocode for this instruction.

C6.2.47 CMN (immediate)

Compare Negative (immediate) adds a register value and an optionally-shifted immediate value. It updates the condition flags based on the result, and discards the result.

This instruction is an alias of the [ADDS \(immediate\)](#) instruction. This means that:

- The encodings in this description are named to match the encodings of [ADDS \(immediate\)](#).
- The description of [ADDS \(immediate\)](#) gives the operational pseudocode for this instruction.

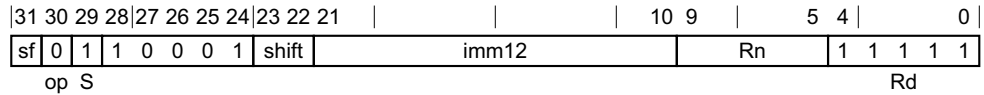

32-bit variant

Applies when `sf == 0`.

CMN <Wn|WSP>, #<imm>{, <shift>}

is equivalent to

ADDS WZR, <Wn|WSP>, #<imm> {, <shift>}

and is always the preferred disassembly.

64-bit variant

Applies when `sf == 1`.

CMN <Xn|SP>, #<imm>{, <shift>}

is equivalent to

ADDS XZR, <Xn|SP>, #<imm> {, <shift>}

and is always the preferred disassembly.

Assembler symbols

<Wn|WSP> Is the 32-bit name of the source general-purpose register or stack pointer, encoded in the "Rn" field.

<Xn|SP> Is the 64-bit name of the source general-purpose register or stack pointer, encoded in the "Rn" field.

<imm> Is an unsigned immediate, in the range 0 to 4095, encoded in the "imm12" field.

<shift> Is the optional left shift to apply to the immediate, defaulting to LSL #0 and encoded in the "shift" field. It can have the following values:

LSL #0 when shift = 00

LSL #12 when shift = 01

The encoding shift = 1x is reserved.

Operation

The description of [ADDS \(immediate\)](#) gives the operational pseudocode for this instruction.

C6.2.48 CMN (shifted register)

Compare Negative (shifted register) adds a register value and an optionally-shifted register value. It updates the condition flags based on the result, and discards the result.

This instruction is an alias of the [ADDS \(shifted register\)](#) instruction. This means that:

- The encodings in this description are named to match the encodings of [ADDS \(shifted register\)](#).
- The description of [ADDS \(shifted register\)](#) gives the operational pseudocode for this instruction.

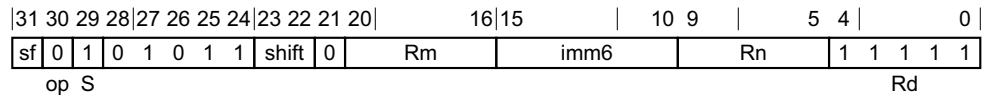

32-bit variant

Applies when `sf == 0`.

CMN <Wn>, <Wm>{, <shift> #<amount>}

is equivalent to

ADDS WZR, <Wn>, <Wm> {, <shift> #<amount>}

and is always the preferred disassembly.

64-bit variant

Applies when `sf == 1`.

CMN <Xn>, <Xm>{, <shift> #<amount>}

is equivalent to

ADDS XZR, <Xn>, <Xm> {, <shift> #<amount>}

and is always the preferred disassembly.

Assembler symbols

- | | | | | | | | | | |
|--------------------------------------|--|-----|-----------------|-----|-----------------|-----|-----------------|--------------------------------------|--|
| <Wn> | Is the 32-bit name of the first general-purpose source register, encoded in the "Rn" field. | | | | | | | | |
| <Wm> | Is the 32-bit name of the second general-purpose source register, encoded in the "Rm" field. | | | | | | | | |
| <Xn> | Is the 64-bit name of the first general-purpose source register, encoded in the "Rn" field. | | | | | | | | |
| <Xm> | Is the 64-bit name of the second general-purpose source register, encoded in the "Rm" field. | | | | | | | | |
| <shift> | Is the optional shift type to be applied to the second source operand, defaulting to LSL and encoded in the "shift" field. It can have the following values: <table style="margin-left: 20px; border: none;"> <tr> <td>LSL</td> <td>when shift = 00</td> </tr> <tr> <td>LSR</td> <td>when shift = 01</td> </tr> <tr> <td>ASR</td> <td>when shift = 10</td> </tr> <tr> <td colspan="2">The encoding shift = 11 is reserved.</td> </tr> </table> | LSL | when shift = 00 | LSR | when shift = 01 | ASR | when shift = 10 | The encoding shift = 11 is reserved. | |
| LSL | when shift = 00 | | | | | | | | |
| LSR | when shift = 01 | | | | | | | | |
| ASR | when shift = 10 | | | | | | | | |
| The encoding shift = 11 is reserved. | | | | | | | | | |
| <amount> | For the 32-bit variant: is the shift amount, in the range 0 to 31, defaulting to 0 and encoded in the "imm6" field.

For the 64-bit variant: is the shift amount, in the range 0 to 63, defaulting to 0 and encoded in the "imm6" field. | | | | | | | | |

Operation

The description of [ADDS \(shifted register\)](#) gives the operational pseudocode for this instruction.

C6.2.49 CMP (extended register)

Compare (extended register) subtracts a sign or zero-extended register value, followed by an optional left shift amount, from a register value. The argument that is extended from the <Rm> register can be a byte, halfword, word, or doubleword. It updates the condition flags based on the result, and discards the result.

This instruction is an alias of the [SUBS \(extended register\)](#) instruction. This means that:

- The encodings in this description are named to match the encodings of [SUBS \(extended register\)](#).
- The description of [SUBS \(extended register\)](#) gives the operational pseudocode for this instruction.

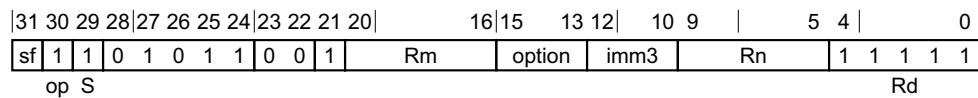

32-bit variant

Applies when `sf == 0`.

CMP <Wn|WSP>, <Wm>{, <extend> {#<amount>}}

is equivalent to

SUBS WZR, <Wn|WSP>, <Wm>{, <extend> {#<amount>}}

and is always the preferred disassembly.

64-bit variant

Applies when `sf == 1`.

CMP <Xn|SP>, <R><m>{, <extend> {#<amount>}}

is equivalent to

SUBS XZR, <Xn|SP>, <R><m>{, <extend> {#<amount>}}

and is always the preferred disassembly.

Assembler symbols

<Wn|WSP> Is the 32-bit name of the first source general-purpose register or stack pointer, encoded in the "Rn" field.

<Wm> Is the 32-bit name of the second general-purpose source register, encoded in the "Rm" field.

<Xn|SP> Is the 64-bit name of the first source general-purpose register or stack pointer, encoded in the "Rn" field.

<R> Is a width specifier, encoded in the "option" field. It can have the following values:

W	when option = 00x
W	when option = 010
X	when option = x11
W	when option = 10x
W	when option = 110

<m> Is the number [0-30] of the second general-purpose source register or the name ZR (31), encoded in the "Rm" field.

- <extend> For the 32-bit variant: is the extension to be applied to the second source operand, encoded in the "option" field. It can have the following values:
- | | |
|----------|-------------------|
| UXTB | when option = 000 |
| UXTH | when option = 001 |
| LSL UXTW | when option = 010 |
| UXTX | when option = 011 |
| SXTB | when option = 100 |
| SXTH | when option = 101 |
| SXTW | when option = 110 |
| SXTX | when option = 111 |
- If "Rn" is '11111' (WSP) and "option" is '010' then LSL is preferred, but may be omitted when "imm3" is '000'. In all other cases <extend> is required and must be UXTW when "option" is '010'.
- For the 64-bit variant: is the extension to be applied to the second source operand, encoded in the "option" field. It can have the following values:
- | | |
|----------|-------------------|
| UXTB | when option = 000 |
| UXTH | when option = 001 |
| UXTW | when option = 010 |
| LSL UXTX | when option = 011 |
| SXTB | when option = 100 |
| SXTH | when option = 101 |
| SXTW | when option = 110 |
| SXTX | when option = 111 |
- If "Rn" is '11111' (SP) and "option" is '011' then LSL is preferred, but may be omitted when "imm3" is '000'. In all other cases <extend> is required and must be UXTX when "option" is '011'.
- <amount> Is the left shift amount to be applied after extension in the range 0 to 4, defaulting to 0, encoded in the "imm3" field. It must be absent when <extend> is absent, is required when <extend> is LSL, and is optional when <extend> is present but not LSL.

Operation

The description of [SUBS \(extended register\)](#) gives the operational pseudocode for this instruction.

C6.2.50 CMP (immediate)

Compare (immediate) subtracts an optionally-shifted immediate value from a register value. It updates the condition flags based on the result, and discards the result.

This instruction is an alias of the [SUBS \(immediate\)](#) instruction. This means that:

- The encodings in this description are named to match the encodings of [SUBS \(immediate\)](#).
- The description of [SUBS \(immediate\)](#) gives the operational pseudocode for this instruction.

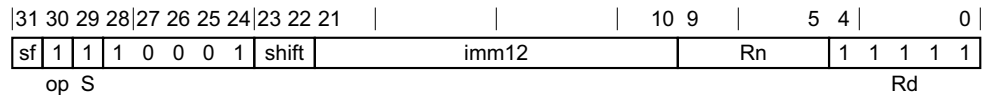

32-bit variant

Applies when `sf == 0`.

CMP <Wn|WSP>, #<imm>{, <shift>}

is equivalent to

SUBS WZR, <Wn|WSP>, #<imm> {, <shift>}

and is always the preferred disassembly.

64-bit variant

Applies when `sf == 1`.

CMP <Xn|SP>, #<imm>{, <shift>}

is equivalent to

SUBS XZR, <Xn|SP>, #<imm> {, <shift>}

and is always the preferred disassembly.

Assembler symbols

<Wn|WSP> Is the 32-bit name of the source general-purpose register or stack pointer, encoded in the "Rn" field.

<Xn|SP> Is the 64-bit name of the source general-purpose register or stack pointer, encoded in the "Rn" field.

<imm> Is an unsigned immediate, in the range 0 to 4095, encoded in the "imm12" field.

<shift> Is the optional left shift to apply to the immediate, defaulting to LSL #0 and encoded in the "shift" field. It can have the following values:

LSL #0 when shift = 00

LSL #12 when shift = 01

The encoding shift = 1x is reserved.

Operation

The description of [SUBS \(immediate\)](#) gives the operational pseudocode for this instruction.

C6.2.51 CMP (shifted register)

Compare (shifted register) subtracts an optionally-shifted register value from a register value. It updates the condition flags based on the result, and discards the result.

This instruction is an alias of the [SUBS \(shifted register\)](#) instruction. This means that:

- The encodings in this description are named to match the encodings of [SUBS \(shifted register\)](#).
- The description of [SUBS \(shifted register\)](#) gives the operational pseudocode for this instruction.

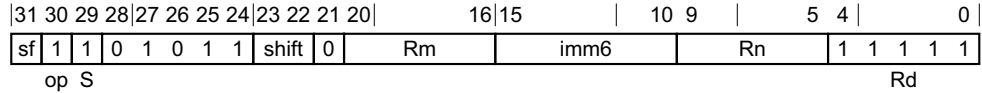

32-bit variant

Applies when `sf == 0`.

CMP <Wn>, <Wm>{, <shift> #<amount>}

is equivalent to

SUBS WZR, <Wn>, <Wm> {, <shift> #<amount>}

and is always the preferred disassembly.

64-bit variant

Applies when `sf == 1`.

CMP <Xn>, <Xm>{, <shift> #<amount>}

is equivalent to

SUBS XZR, <Xn>, <Xm> {, <shift> #<amount>}

and is always the preferred disassembly.

Assembler symbols

- <Wn> Is the 32-bit name of the first general-purpose source register, encoded in the "Rn" field.
- <Wm> Is the 32-bit name of the second general-purpose source register, encoded in the "Rm" field.
- <Xn> Is the 64-bit name of the first general-purpose source register, encoded in the "Rn" field.
- <Xm> Is the 64-bit name of the second general-purpose source register, encoded in the "Rm" field.
- <shift> Is the optional shift type to be applied to the second source operand, defaulting to LSL and encoded in the "shift" field. It can have the following values:
 - LSL when shift = 00
 - LSR when shift = 01
 - ASR when shift = 10
 - The encoding shift = 11 is reserved.
- <amount> For the 32-bit variant: is the shift amount, in the range 0 to 31, defaulting to 0 and encoded in the "imm6" field.
 For the 64-bit variant: is the shift amount, in the range 0 to 63, defaulting to 0 and encoded in the "imm6" field.

Operation

The description of [SUBS \(shifted register\)](#) gives the operational pseudocode for this instruction.

C6.2.52 CNEG

Conditional Negate returns, in the destination register, the negated value of the source register if the condition is TRUE, and otherwise returns the value of the source register.

This instruction is an alias of the CSNEG instruction. This means that:

- The encodings in this description are named to match the encodings of CSNEG.
- The description of CSNEG gives the operational pseudocode for this instruction.

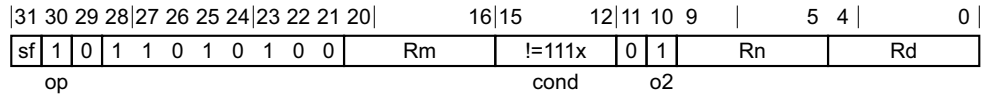

32-bit variant

Applies when sf == 0.

CNEG <Wd>, <Wn>, <cond>

is equivalent to

CSNEG <Wd>, <Wn>, <Wn>, invert(<cond>)

and is the preferred disassembly when Rn == Rm.

64-bit variant

Applies when sf == 1.

CNEG <Xd>, <Xn>, <cond>

is equivalent to

CSNEG <Xd>, <Xn>, <Xn>, invert(<cond>)

and is the preferred disassembly when Rn == Rm.

Assembler symbols

- <Wd> Is the 32-bit name of the general-purpose destination register, encoded in the "Rd" field.
- <Wn> Is the 32-bit name of the general-purpose source register, encoded in the "Rn" and "Rm" fields.
- <Xd> Is the 64-bit name of the general-purpose destination register, encoded in the "Rd" field.
- <Xn> Is the 64-bit name of the general-purpose source register, encoded in the "Rn" and "Rm" fields.
- <cond> Is one of the standard conditions, excluding AL and NV, encoded in the "cond" field with its least significant bit inverted.

Operation

The description of CSNEG gives the operational pseudocode for this instruction.

C6.2.53 CRC32B, CRC32H, CRC32W, CRC32X

CRC32 checksum performs a cyclic redundancy check (CRC) calculation on a value held in a general-purpose register. It takes an input CRC value in the first source operand, performs a CRC on the input value in the second source operand, and returns the output CRC value. The second source operand can be 8, 16, 32, or 64 bits. To align with common usage, the bit order of the values is reversed as part of the operation, and the polynomial 0x04C11DB7 is used for the CRC calculation.

In ARMv8-A, this is an OPTIONAL instruction, and in ARMv8.1 it is mandatory for all implementations to implement it.

———— Note ————

[ID_AA64ISAR0_EL1.CRC32](#) indicates whether this instruction is supported.

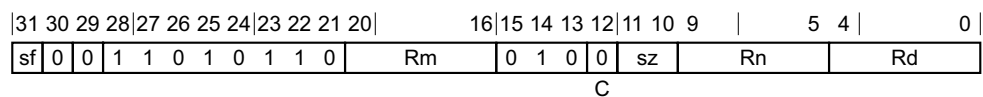

CRC32B variant

Applies when `sf == 0 && sz == 00`.

CRC32B <Wd>, <Wn>, <Wm>

CRC32H variant

Applies when `sf == 0 && sz == 01`.

CRC32H <Wd>, <Wn>, <Wm>

CRC32W variant

Applies when `sf == 0 && sz == 10`.

CRC32W <Wd>, <Wn>, <Wm>

CRC32X variant

Applies when `sf == 1 && sz == 11`.

CRC32X <Wd>, <Wn>, <Xm>

Decode for all variants of this encoding

```
integer d = UInt(Rd);
integer n = UInt(Rn);
integer m = UInt(Rm);
if sf == '1' && sz != '11' then UnallocatedEncoding();
if sf == '0' && sz == '11' then UnallocatedEncoding();
integer size = 8 << UInt(sz);
```

Assembler symbols

- <Wd> Is the 32-bit name of the general-purpose accumulator output register, encoded in the "Rd" field.
- <Wn> Is the 32-bit name of the general-purpose accumulator input register, encoded in the "Rn" field.
- <Xm> Is the 64-bit name of the general-purpose data source register, encoded in the "Rm" field.
- <Wm> Is the 32-bit name of the general-purpose data source register, encoded in the "Rm" field.

Operation

```
if !HaveCRCExt() then
    UnallocatedEncoding();

bits(32) acc = X[n];    // accumulator
bits(size) val = X[m]; // input value
bits(32) poly = 0x04C11DB7<31:0>;

bits(32+size) tempacc = BitReverse(acc):Zeros(size);
bits(size+32) tempval = BitReverse(val):Zeros(32);

// Poly32Mod2 on a bitstring does a polynomial Modulus over {0,1} operation
X[d] = BitReverse(Poly32Mod2(tempacc EOR tempval, poly));
```

C6.2.54 CRC32CB, CRC32CH, CRC32CW, CRC32CX

CRC32 checksum performs a cyclic redundancy check (CRC) calculation on a value held in a general-purpose register. It takes an input CRC value in the first source operand, performs a CRC on the input value in the second source operand, and returns the output CRC value. The second source operand can be 8, 16, 32, or 64 bits. To align with common usage, the bit order of the values is reversed as part of the operation, and the polynomial 0x1EDC6F41 is used for the CRC calculation.

In ARMv8-A, this is an OPTIONAL instruction, and in ARMv8.1 it is mandatory for all implementations to implement it.

———— **Note** ————

[ID_AA64ISAR0_EL1.CRC32](#) indicates whether this instruction is supported.

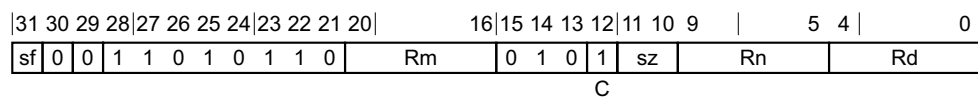

CRC32CB variant

Applies when `sf == 0` && `sz == 00`.

CRC32CB <Wd>, <Wn>, <Wm>

CRC32CH variant

Applies when `sf == 0` && `sz == 01`.

CRC32CH <Wd>, <Wn>, <Wm>

CRC32CW variant

Applies when `sf == 0` && `sz == 10`.

CRC32CW <Wd>, <Wn>, <Wm>

CRC32CX variant

Applies when `sf == 1` && `sz == 11`.

CRC32CX <Wd>, <Wn>, <Xm>

Decode for all variants of this encoding

```
integer d = UInt(Rd);
integer n = UInt(Rn);
integer m = UInt(Rm);
if sf == '1' && sz != '11' then UnallocatedEncoding();
if sf == '0' && sz == '11' then UnallocatedEncoding();
integer size = 8 << UInt(sz);
```

Assembler symbols

- <Wd> Is the 32-bit name of the general-purpose accumulator output register, encoded in the "Rd" field.
- <Wn> Is the 32-bit name of the general-purpose accumulator input register, encoded in the "Rn" field.
- <Xm> Is the 64-bit name of the general-purpose data source register, encoded in the "Rm" field.
- <Wm> Is the 32-bit name of the general-purpose data source register, encoded in the "Rm" field.

Operation

```
if !HaveCRCExt() then
    UnallocatedEncoding();

bits(32) acc = X[n];    // accumulator
bits(size) val = X[m]; // input value
bits(32) poly = 0x1EDC6F41<31:0>;

bits(32+size) tempacc = BitReverse(acc):Zeros(size);
bits(size+32) tempval = BitReverse(val):Zeros(32);

// Poly32Mod2 on a bitstring does a polynomial Modulus over {0,1} operation
X[d] = BitReverse(Poly32Mod2(tempacc EOR tempval, poly));
```

C6.2.55 CSEL

Conditional Select returns, in the destination register, the value of the first source register if the condition is TRUE, and otherwise returns the value of the second source register.

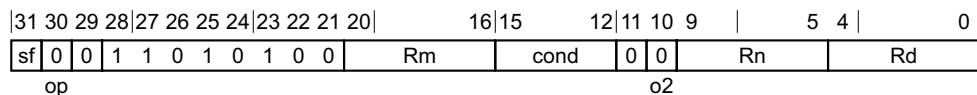

32-bit variant

Applies when sf == 0.

CSEL <Wd>, <Wn>, <Wm>, <cond>

64-bit variant

Applies when sf == 1.

CSEL <Xd>, <Xn>, <Xm>, <cond>

Decode for all variants of this encoding

```
integer d = UInt(Rd);
integer n = UInt(Rn);
integer m = UInt(Rm);
integer datasize = if sf == '1' then 64 else 32;
```

Assembler symbols

- <Wd> Is the 32-bit name of the general-purpose destination register, encoded in the "Rd" field.
- <Wn> Is the 32-bit name of the first general-purpose source register, encoded in the "Rn" field.
- <Wm> Is the 32-bit name of the second general-purpose source register, encoded in the "Rm" field.
- <Xd> Is the 64-bit name of the general-purpose destination register, encoded in the "Rd" field.
- <Xn> Is the 64-bit name of the first general-purpose source register, encoded in the "Rn" field.
- <Xm> Is the 64-bit name of the second general-purpose source register, encoded in the "Rm" field.
- <cond> Is one of the standard conditions, encoded in the "cond" field in the standard way.

Operation

```
bits(datasize) result;
bits(datasize) operand1 = X[n];
bits(datasize) operand2 = X[m];

if ConditionHolds(cond) then
    result = operand1;
else
    result = operand2;

X[d] = result;
```

C6.2.56 CSET

Conditional Set sets the destination register to 1 if the condition is TRUE, and otherwise sets it to 0.

This instruction is an alias of the CSINC instruction. This means that:

- The encodings in this description are named to match the encodings of CSINC.
- The description of CSINC gives the operational pseudocode for this instruction.

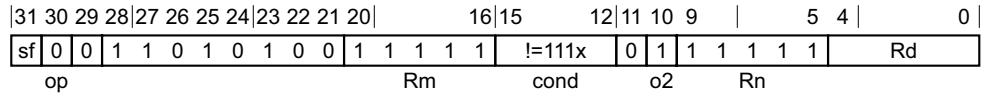

32-bit variant

Applies when `sf == 0`.

CSET <Wd>, <cond>

is equivalent to

CSINC <Wd>, WZR, WZR, invert(<cond>)

and is always the preferred disassembly.

64-bit variant

Applies when `sf == 1`.

CSET <Xd>, <cond>

is equivalent to

CSINC <Xd>, XZR, XZR, invert(<cond>)

and is always the preferred disassembly.

Assembler symbols

<Wd> Is the 32-bit name of the general-purpose destination register, encoded in the "Rd" field.

<Xd> Is the 64-bit name of the general-purpose destination register, encoded in the "Rd" field.

<cond> Is one of the standard conditions, excluding AL and NV, encoded in the "cond" field with its least significant bit inverted.

Operation

The description of CSINC gives the operational pseudocode for this instruction.

C6.2.57 CSETM

Conditional Set Mask sets all bits of the destination register to 1 if the condition is TRUE, and otherwise sets all bits to 0.

This instruction is an alias of the [CSINV](#) instruction. This means that:

- The encodings in this description are named to match the encodings of [CSINV](#).
- The description of [CSINV](#) gives the operational pseudocode for this instruction.

31 30 29 28 27 26 25 24 23 22 21 20		16 15		12 11 10 9		5 4		0	
sf 1 0 1 1 0 1 0 1 0 0 1 1 1 1 1		!=111x		0 0 1 1 1 1 1				Rd	
op		Rm		cond		o2		Rn	

32-bit variant

Applies when `sf == 0`.

CSETM <Wd>, <cond>

is equivalent to

CSINV <Wd>, WZR, WZR, invert(<cond>)

and is always the preferred disassembly.

64-bit variant

Applies when `sf == 1`.

CSETM <Xd>, <cond>

is equivalent to

CSINV <Xd>, XZR, XZR, invert(<cond>)

and is always the preferred disassembly.

Assembler symbols

<Wd> Is the 32-bit name of the general-purpose destination register, encoded in the "Rd" field.

<Xd> Is the 64-bit name of the general-purpose destination register, encoded in the "Rd" field.

<cond> Is one of the standard conditions, excluding AL and NV, encoded in the "cond" field with its least significant bit inverted.

Operation

The description of [CSINV](#) gives the operational pseudocode for this instruction.

C6.2.58 CSINC

Conditional Select Increment returns, in the destination register, the value of the first source register if the condition is TRUE, and otherwise returns the value of the second source register incremented by 1.

This instruction is used by the aliases **CINC** and **CSET**. See *Alias conditions* for details of when each alias is preferred.

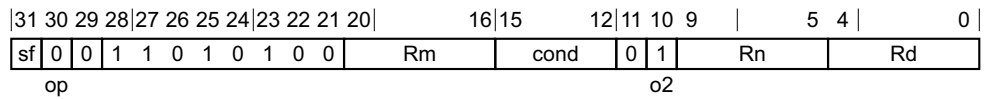

32-bit variant

Applies when sf == 0.

CSINC <Wd>, <Wn>, <Wm>, <cond>

64-bit variant

Applies when sf == 1.

CSINC <Xd>, <Xn>, <Xm>, <cond>

Decode for all variants of this encoding

```
integer d = UInt(Rd);
integer n = UInt(Rn);
integer m = UInt(Rm);
integer datasize = if sf == '1' then 64 else 32;
```

Alias conditions

Alias	is preferred when
CINC	Rm != '11111' && cond != '111x' && Rn != '11111' && Rn == Rm
CSET	Rm == '11111' && cond != '111x' && Rn == '11111'

Assembler symbols

<Wd>	Is the 32-bit name of the general-purpose destination register, encoded in the "Rd" field.
<Wn>	Is the 32-bit name of the first general-purpose source register, encoded in the "Rn" field.
<Wm>	Is the 32-bit name of the second general-purpose source register, encoded in the "Rm" field.
<Xd>	Is the 64-bit name of the general-purpose destination register, encoded in the "Rd" field.
<Xn>	Is the 64-bit name of the first general-purpose source register, encoded in the "Rn" field.
<Xm>	Is the 64-bit name of the second general-purpose source register, encoded in the "Rm" field.
<cond>	Is one of the standard conditions, encoded in the "cond" field in the standard way.

Operation

```
bits(datasize) result;  
bits(datasize) operand1 = X[n];  
bits(datasize) operand2 = X[m];  
  
if ConditionHolds(cond) then  
    result = operand1;  
else  
    result = operand2 + 1;  
  
X[d] = result;
```

C6.2.59 CSINV

Conditional Select Invert returns, in the destination register, the value of the first source register if the condition is TRUE, and otherwise returns the bitwise inversion value of the second source register.

This instruction is used by the aliases [CINV](#) and [CSETM](#). See [Alias conditions](#) for details of when each alias is preferred.

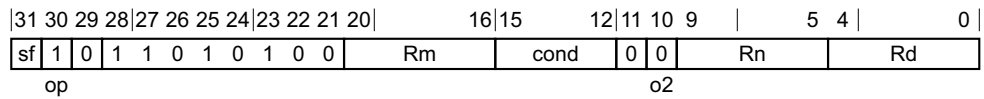

32-bit variant

Applies when sf == 0.

CSINV <Wd>, <Wn>, <Wm>, <cond>

64-bit variant

Applies when sf == 1.

CSINV <Xd>, <Xn>, <Xm>, <cond>

Decode for all variants of this encoding

```
integer d = UInt(Rd);
integer n = UInt(Rn);
integer m = UInt(Rm);
integer datasize = if sf == '1' then 64 else 32;
```

Alias conditions

Alias	is preferred when
CINV	Rm != '11111' && cond != '111x' && Rn != '11111' && Rn == Rm
CSETM	Rm == '11111' && cond != '111x' && Rn == '11111'

Assembler symbols

<code><Wd></code>	Is the 32-bit name of the general-purpose destination register, encoded in the "Rd" field.
<code><Wn></code>	Is the 32-bit name of the first general-purpose source register, encoded in the "Rn" field.
<code><Wm></code>	Is the 32-bit name of the second general-purpose source register, encoded in the "Rm" field.
<code><Xd></code>	Is the 64-bit name of the general-purpose destination register, encoded in the "Rd" field.
<code><Xn></code>	Is the 64-bit name of the first general-purpose source register, encoded in the "Rn" field.
<code><Xm></code>	Is the 64-bit name of the second general-purpose source register, encoded in the "Rm" field.
<code><cond></code>	Is one of the standard conditions, encoded in the "cond" field in the standard way.

Operation

```
bits(datasize) result;  
bits(datasize) operand1 = X[n];  
bits(datasize) operand2 = X[m];  
  
if ConditionHolds(cond) then  
    result = operand1;  
else  
    result = NOT(operand2);  
  
X[d] = result;
```

C6.2.60 CSNEG

Conditional Select Negation returns, in the destination register, the value of the first source register if the condition is TRUE, and otherwise returns the negated value of the second source register.

This instruction is used by the alias [CNEG](#). See [Alias conditions](#) for details of when each alias is preferred.

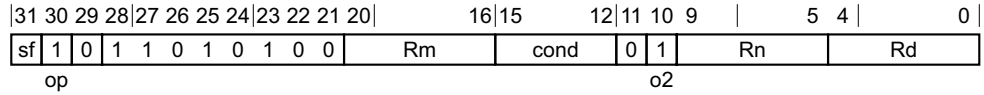

32-bit variant

Applies when `sf == 0`.

CSNEG <Wd>, <Wn>, <Wm>, <cond>

64-bit variant

Applies when `sf == 1`.

CSNEG <Xd>, <Xn>, <Xm>, <cond>

Decode for all variants of this encoding

```
integer d = UInt(Rd);
integer n = UInt(Rn);
integer m = UInt(Rm);
integer datasize = if sf == '1' then 64 else 32;
```

Alias conditions

Alias	is preferred when
CNEG	<code>cond != '111x' && Rn == Rm</code>

Assembler symbols

- <Wd> Is the 32-bit name of the general-purpose destination register, encoded in the "Rd" field.
- <Wn> Is the 32-bit name of the first general-purpose source register, encoded in the "Rn" field.
- <Wm> Is the 32-bit name of the second general-purpose source register, encoded in the "Rm" field.
- <Xd> Is the 64-bit name of the general-purpose destination register, encoded in the "Rd" field.
- <Xn> Is the 64-bit name of the first general-purpose source register, encoded in the "Rn" field.
- <Xm> Is the 64-bit name of the second general-purpose source register, encoded in the "Rm" field.
- <cond> Is one of the standard conditions, encoded in the "cond" field in the standard way.

Operation

```
bits(datasize) result;
bits(datasize) operand1 = X[n];
bits(datasize) operand2 = X[m];

if ConditionHolds(cond) then
```

```
    result = operand1;  
else  
    result = NOT(operand2);  
    result = result + 1;  
  
X[d] = result;
```

C6.2.61 DC

Data Cache operation. For more information, see [A64 system instructions for cache maintenance](#).

This instruction is an alias of the [SYS](#) instruction. This means that:

- The encodings in this description are named to match the encodings of [SYS](#).
- The description of [SYS](#) gives the operational pseudocode for this instruction.

31	30	29	28	27	26	25	24	23	22	21	20	19	18	16	15	12	11	8	7	5	4	0
1	1	0	1	0	1	0	1	0	0	0	0	1	op1	0	1	1	1	CRm	op2	Rt		
L											CRn											

System variant

DC <dc_op>, <Xt>

is equivalent to

SYS #<op1>, C7, <Cm>, #<op2>, <Xt>

and is the preferred disassembly when `SysOp(op1, '0111', CRm, op2) == Sys_DC`.

Assembler symbols

<dc_op> Is a DC instruction name, as listed for the DC system instruction group, encoded in the "op1:CRm:op2" field. It can have the following values:

IVAC	when op1 = 000, CRm = 0110, op2 = 001
ISW	when op1 = 000, CRm = 0110, op2 = 010
CSW	when op1 = 000, CRm = 1010, op2 = 010
CISW	when op1 = 000, CRm = 1110, op2 = 010
ZVA	when op1 = 011, CRm = 0100, op2 = 001
CVAC	when op1 = 011, CRm = 1010, op2 = 001
CVAU	when op1 = 011, CRm = 1011, op2 = 001
CIVAC	when op1 = 011, CRm = 1110, op2 = 001

When ARMv8.2-DCPoP is implemented, the following value is also valid:

CVAP	when op1 = 011, CRm = 1100, op2 = 001
------	---------------------------------------

<op1> Is a 3-bit unsigned immediate, in the range 0 to 7, encoded in the "op1" field.

<Cm> Is a name 'Cm', with 'm' in the range 0 to 15, encoded in the "CRm" field.

<op2> Is a 3-bit unsigned immediate, in the range 0 to 7, encoded in the "op2" field.

<Xt> Is the 64-bit name of the general-purpose source register, encoded in the "Rt" field.

Operation

The description of [SYS](#) gives the operational pseudocode for this instruction.

C6.2.62 DCPS1

Debug Change PE State to EL1, when executed in Debug state:

- If executed at EL0 changes the current Exception level and SP to EL1 using SP_EL1.
- Otherwise, if executed at EL_x, selects SP_EL_x.

The target exception level of a DCPS1 instruction is:

- EL1 if the instruction is executed at EL0.
- Otherwise, the Exception level at which the instruction is executed.

When the target Exception level of a DCPS1 instruction is EL_x, on executing this instruction:

- [ELR_EL_x](#) becomes UNKNOWN.
- [SPSR_EL_x](#) becomes UNKNOWN.
- [ESR_EL_x](#) becomes UNKNOWN.
- [DLR_EL0](#) and [DSPSR_EL0](#) become UNKNOWN.
- The endianness is set according to [SCTLR_EL_x.EE](#).

This instruction is UNDEFINED at EL0 in Non-secure state if EL2 is implemented and [HCR_EL2.TGE](#) == 1.

This instruction is always UNDEFINED in Non-debug state.

For more information on the operation of the DCPS_n instructions, see [DCPS<n> on page H2-5461](#).

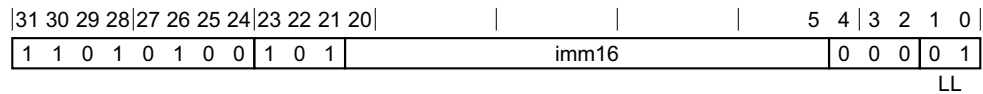

System variant

DCPS1 {#<imm>}

Decode for this encoding

if !Halted() then AArch64.UndefinedFault();

Assembler symbols

<imm> Is an optional 16-bit unsigned immediate, in the range 0 to 65535, defaulting to 0 and encoded in the "imm16" field.

Operation

[DCPSInstruction](#)(LL);

C6.2.63 DCPS2

Debug Change PE State to EL2, when executed in Debug state:

- If executed at EL0 or EL1 changes the current Exception level and SP to EL2 using SP_EL2.
- Otherwise, if executed at ELx, selects SP_ELx.

The target exception level of a DCPS2 instruction is:

- EL2 if the instruction is executed at an exception level that is not EL3.
- EL3 if the instruction is executed at EL3.

When the target Exception level of a DCPS2 instruction is ELx, on executing this instruction:

- [ELR_ELx](#) becomes UNKNOWN.
- [SPSR_ELx](#) becomes UNKNOWN.
- [ESR_ELx](#) becomes UNKNOWN.
- [DLR_EL0](#) and [DSPSR_EL0](#) become UNKNOWN.
- The endianness is set according to [SCTLR_ELx.EE](#).

This instruction is UNDEFINED at the following exception levels:

- All exception levels if EL2 is not implemented.
- At EL0 and EL1 in Secure state if EL2 is implemented.

This instruction is always UNDEFINED in Non-debug state.

For more information on the operation of the DCPSn instructions, see [DCPS<n>](#) on page H2-5461.

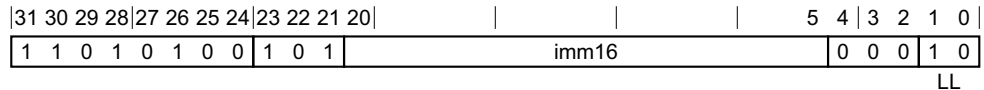

System variant

DCPS2 {#<imm>}

Decode for this encoding

```
if !Halted() then AArch64.UndefinedFault();
```

Assembler symbols

<imm> Is an optional 16-bit unsigned immediate, in the range 0 to 65535, defaulting to 0 and encoded in the "imm16" field.

Operation

```
DCPSInstruction(LL);
```

C6.2.64 DCPS3

Debug Change PE State to EL3, when executed in Debug state:

- If executed at EL3 selects SP_EL3.
- Otherwise, changes the current Exception level and SP to EL3 using SP_EL3.

The target exception level of a DCPS3 instruction is EL3.

On executing a DCPS3 instruction:

- `ELR_EL3` becomes UNKNOWN.
- `SPSR_EL3` becomes UNKNOWN.
- `ESR_EL3` becomes UNKNOWN.
- `DLR_EL0` and `DSPSR_EL0` become UNKNOWN.
- The endianness is set according to `SCTLR_EL3.EE`.

This instruction is UNDEFINED at all exception levels if either:

- `EDSCR == 1`.
- EL3 is not implemented.

This instruction is always UNDEFINED in Non-debug state.

For more information on the operation of the DCPSn instructions, see [DCPS<n> on page H2-5461](#).



System variant

DCPS3 {#<imm>}

Decode for this encoding

```
if !Halted() then AArch64.UndefinedFault();
```

Assembler symbols

<imm> Is an optional 16-bit unsigned immediate, in the range 0 to 65535, defaulting to 0 and encoded in the "imm16" field.

Operation

```
DCPSInstruction(LL);
```

C6.2.65 DMB

Data Memory Barrier is a memory barrier that ensures the ordering of observations of memory accesses, see [Data Memory Barrier \(DMB\) on page B2-92](#).

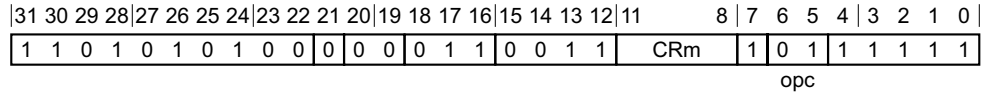

System variant

DMB <option>|<imm>

Decode for this encoding

```

MBReqDomain domain;
MBReqTypes types;

case CRm<3:2> of
    when '00' domain = MBReqDomain_OuterShareable;
    when '01' domain = MBReqDomain_Nonshareable;
    when '10' domain = MBReqDomain_InnerShareable;
    when '11' domain = MBReqDomain_FullSystem;

case CRm<1:0> of
    when '01' types = MBReqTypes_Reads;
    when '10' types = MBReqTypes_Writes;
    when '11' types = MBReqTypes_All;
    otherwise
        types = MBReqTypes_All;
        domain = MBReqDomain_FullSystem;
    
```

Assembler symbols

<option>	Specifies the limitation on the barrier operation. Values are:
SY	Full system is the required shareability domain, reads and writes are the required access types, both before and after the barrier instruction. This option is referred to as the full system barrier. Encoded as CRm = 0b1111.
ST	Full system is the required shareability domain, writes are the required access type, both before and after the barrier instruction. Encoded as CRm = 0b1110.
LD	Full system is the required shareability domain, reads are the required access type before the barrier instruction, and reads and writes are the required access types after the barrier instruction. Encoded as CRm = 0b1101.
ISH	Inner Shareable is the required shareability domain, reads and writes are the required access types, both before and after the barrier instruction. Encoded as CRm = 0b1011.
ISHST	Inner Shareable is the required shareability domain, writes are the required access type, both before and after the barrier instruction. Encoded as CRm = 0b1010.
ISHLD	Inner Shareable is the required shareability domain, reads are the required access type before the barrier instruction, and reads and writes are the required access types after the barrier instruction. Encoded as CRm = 0b1001.
NSH	Non-shareable is the required shareability domain, reads and writes are the required access, both before and after the barrier instruction. Encoded as CRm = 0b0111.
NSHST	Non-shareable is the required shareability domain, writes are the required access type before the barrier instruction, and reads and writes are the required type after the barrier instruction. Encoded as CRm = 0b0110.

NSHLD	Non-shareable is the required shareability domain, reads are the required access type before the barrier instruction, and reads and writes are the required access types after the barrier instruction. Encoded as CRm = 0b0101.
OSH	Outer Shareable is the required shareability domain, reads and writes are the required access types, both before and after the barrier instruction. Encoded as CRm = 0b0011.
OSHST	Outer Shareable is the required shareability domain, writes are the required access type, both before and after the barrier instruction. Encoded as CRm = 0b0010.
OSHLD	Outer Shareable is the required shareability domain, reads are the required access type before the barrier instruction, and reads and writes are the required access types after the barrier instruction. Encoded as CRm = 0b0001.

All other encodings of CRm that are not listed above are reserved, and can be encoded using the #<imm> syntax. It is IMPLEMENTATION DEFINED whether options other than SY are implemented. All unsupported and reserved options must execute as a full system barrier operation, but software must not rely on this behavior. For more information on whether an access is before or after a barrier instruction, see [Data Memory Barrier \(DMB\) on page B2-92](#) or see [Data Synchronization Barrier \(DSB\) on page B2-93](#).

<imm> Is a 4-bit unsigned immediate, in the range 0 to 15, encoded in the "CRm" field.

Operation

`DataMemoryBarrier(domain, types);`

C6.2.66 DRPS

Debug restore process state

31	30	29	28	27	26	25	24	23	22	21	20	19	18	17	16	15	14	13	12	11	10	9	8	7	6	5	4	3	2	1	0
1	1	0	1	0	1	1	0	1	1	1	1	1	1	1	0	0	0	0	0	0	0	1	1	1	1	1	0	0	0	0	0

System variant

DRPS

Decode for this encoding

```
if !Halted() || PSTATE.EL == EL0 then UnallocatedEncoding();
```

Operation

```
DRPSInstruction();
```

C6.2.67 DSB

Data Synchronization Barrier is a memory barrier that ensures the completion of memory accesses, see [Data Synchronization Barrier \(DSB\)](#) on page B2-93.

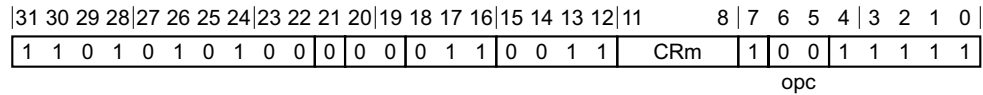

System variant

DSB <option>|<imm>

Decode for this encoding

```

MBReqDomain domain;
MBReqTypes types;

case CRm<3:2> of
    when '00' domain = MBReqDomain_OuterShareable;
    when '01' domain = MBReqDomain_Nonshareable;
    when '10' domain = MBReqDomain_InnerShareable;
    when '11' domain = MBReqDomain_FullSystem;

case CRm<1:0> of
    when '01' types = MBReqTypes_Reads;
    when '10' types = MBReqTypes_Writes;
    when '11' types = MBReqTypes_All;
    otherwise
        types = MBReqTypes_All;
        domain = MBReqDomain_FullSystem;

```

Assembler symbols

<option>	Specifies the limitation on the barrier operation. Values are:
SY	Full system is the required shareability domain, reads and writes are the required access types, both before and after the barrier instruction. This option is referred to as the full system barrier. Encoded as CRm = 0b1111.
ST	Full system is the required shareability domain, writes are the required access type, both before and after the barrier instruction. Encoded as CRm = 0b1110.
LD	Full system is the required shareability domain, reads are the required access type before the barrier instruction, and reads and writes are the required access types after the barrier instruction. Encoded as CRm = 0b1101.
ISH	Inner Shareable is the required shareability domain, reads and writes are the required access types, both before and after the barrier instruction. Encoded as CRm = 0b1011.
ISHST	Inner Shareable is the required shareability domain, writes are the required access type, both before and after the barrier instruction. Encoded as CRm = 0b1010.
ISHL	Inner Shareable is the required shareability domain, reads are the required access type before the barrier instruction, and reads and writes are the required access types after the barrier instruction. Encoded as CRm = 0b1001.
NSH	Non-shareable is the required shareability domain, reads and writes are the required access, both before and after the barrier instruction. Encoded as CRm = 0b0111.
NSHST	Non-shareable is the required shareability domain, writes are the required access type before the barrier instruction, and reads and writes are the required type after the barrier instruction. Encoded as CRm = 0b0110.

NSHLD	Non-shareable is the required shareability domain, reads are the required access type before the barrier instruction, and reads and writes are the required access types after the barrier instruction. Encoded as CRm = 0b0101.
OSH	Outer Shareable is the required shareability domain, reads and writes are the required access types, both before and after the barrier instruction. Encoded as CRm = 0b0011.
OSHST	Outer Shareable is the required shareability domain, writes are the required access type, both before and after the barrier instruction. Encoded as CRm = 0b0010.
OSHLD	Outer Shareable is the required shareability domain, reads are the required access type before the barrier instruction, and reads and writes are the required access types after the barrier instruction. Encoded as CRm = 0b0001.

All other encodings of CRm that are not listed above are reserved, and can be encoded using the #<imm> syntax. It is IMPLEMENTATION DEFINED whether options other than SY are implemented. All unsupported and reserved options must execute as a full system barrier operation, but software must not rely on this behavior. For more information on whether an access is before or after a barrier instruction, see [Data Memory Barrier \(DMB\) on page B2-92](#) or see [Data Synchronization Barrier \(DSB\) on page B2-93](#).

<imm> Is a 4-bit unsigned immediate, in the range 0 to 15, encoded in the "CRm" field.

Operation

`DataSynchronizationBarrier(domain, types);`

C6.2.68 EON (shifted register)

Bitwise Exclusive OR NOT (shifted register) performs a bitwise Exclusive OR NOT of a register value and an optionally-shifted register value, and writes the result to the destination register.

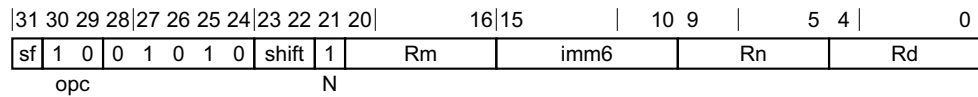

32-bit variant

Applies when `sf == 0`.

EON <Wd>, <Wn>, <Wm>{, <shift> #<amount>}

64-bit variant

Applies when `sf == 1`.

EON <Xd>, <Xn>, <Xm>{, <shift> #<amount>}

Decode for all variants of this encoding

```
integer d = UInt(Rd);
integer n = UInt(Rn);
integer m = UInt(Rm);
integer datasize = if sf == '1' then 64 else 32;
if sf == '0' && imm6<5> == '1' then ReservedValue();
```

```
ShiftType shift_type = DecodeShift(shift);
integer shift_amount = UInt(imm6);
```

Assembler symbols

- <Wd> Is the 32-bit name of the general-purpose destination register, encoded in the "Rd" field.
- <Wn> Is the 32-bit name of the first general-purpose source register, encoded in the "Rn" field.
- <Wm> Is the 32-bit name of the second general-purpose source register, encoded in the "Rm" field.
- <Xd> Is the 64-bit name of the general-purpose destination register, encoded in the "Rd" field.
- <Xn> Is the 64-bit name of the first general-purpose source register, encoded in the "Rn" field.
- <Xm> Is the 64-bit name of the second general-purpose source register, encoded in the "Rm" field.
- <shift> Is the optional shift to be applied to the final source, defaulting to LSL and encoded in the "shift" field. It can have the following values:
 - LSL when shift = 00
 - LSR when shift = 01
 - ASR when shift = 10
 - ROR when shift = 11
- <amount> For the 32-bit variant: is the shift amount, in the range 0 to 31, defaulting to 0 and encoded in the "imm6" field.
For the 64-bit variant: is the shift amount, in the range 0 to 63, defaulting to 0 and encoded in the "imm6" field.

Operation

```
bits(datasize) operand1 = X[n];  
bits(datasize) operand2 = ShiftReg(m, shift_type, shift_amount);  
  
operand2 = NOT(operand2);  
  
result = operand1 EOR operand2;  
  
X[d] = result;
```

C6.2.69 EOR (immediate)

Bitwise Exclusive OR (immediate) performs a bitwise Exclusive OR of a register value and an immediate value, and writes the result to the destination register.

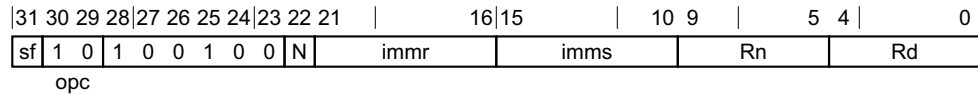

32-bit variant

Applies when `sf == 0` && `N == 0`.

EOR <Wd|WSP>, <Wn>, #<imm>

64-bit variant

Applies when `sf == 1`.

EOR <Xd|SP>, <Xn>, #<imm>

Decode for all variants of this encoding

```
integer d = UInt(Rd);
integer n = UInt(Rn);
integer datasize = if sf == '1' then 64 else 32;
bits(datasize) imm;
if sf == '0' && N != '0' then ReservedValue();
(imm, -) = DecodeBitMasks(N, imms, immr, TRUE);
```

Assembler symbols

<Wd WSP>	Is the 32-bit name of the destination general-purpose register or stack pointer, encoded in the "Rd" field.
<Wn>	Is the 32-bit name of the general-purpose source register, encoded in the "Rn" field.
<Xd SP>	Is the 64-bit name of the destination general-purpose register or stack pointer, encoded in the "Rd" field.
<Xn>	Is the 64-bit name of the general-purpose source register, encoded in the "Rn" field.
<imm>	For the 32-bit variant: is the bitmask immediate, encoded in "imms:immr". For the 64-bit variant: is the bitmask immediate, encoded in "N:imms:immr".

Operation

```
bits(datasize) result;
bits(datasize) operand1 = X[n];

result = operand1 EOR imm;

if d == 31 then
    SP[] = result;
else
    X[d] = result;
```

C6.2.70 EOR (shifted register)

Bitwise Exclusive OR (shifted register) performs a bitwise Exclusive OR of a register value and an optionally-shifted register value, and writes the result to the destination register.

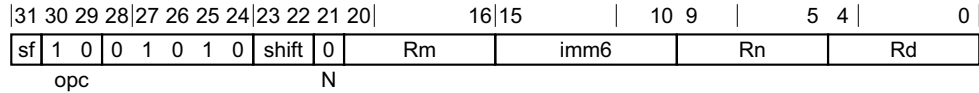

32-bit variant

Applies when `sf == 0`.

EOR <Wd>, <Wn>, <Wm>{, <shift> #<amount>}

64-bit variant

Applies when `sf == 1`.

EOR <Xd>, <Xn>, <Xm>{, <shift> #<amount>}

Decode for all variants of this encoding

```
integer d = UInt(Rd);
integer n = UInt(Rn);
integer m = UInt(Rm);
integer datasize = if sf == '1' then 64 else 32;
if sf == '0' && imm6<5> == '1' then ReservedValue();
```

```
ShiftType shift_type = DecodeShift(shift);
integer shift_amount = UInt(imm6);
```

Assembler symbols

- <Wd> Is the 32-bit name of the general-purpose destination register, encoded in the "Rd" field.
- <Wn> Is the 32-bit name of the first general-purpose source register, encoded in the "Rn" field.
- <Wm> Is the 32-bit name of the second general-purpose source register, encoded in the "Rm" field.
- <Xd> Is the 64-bit name of the general-purpose destination register, encoded in the "Rd" field.
- <Xn> Is the 64-bit name of the first general-purpose source register, encoded in the "Rn" field.
- <Xm> Is the 64-bit name of the second general-purpose source register, encoded in the "Rm" field.
- <shift> Is the optional shift to be applied to the final source, defaulting to LSL and encoded in the "shift" field. It can have the following values:
 - LSL when shift = 00
 - LSR when shift = 01
 - ASR when shift = 10
 - ROR when shift = 11
- <amount> For the 32-bit variant: is the shift amount, in the range 0 to 31, defaulting to 0 and encoded in the "imm6" field.
 For the 64-bit variant: is the shift amount, in the range 0 to 63, defaulting to 0 and encoded in the "imm6" field.

Operation

```
bits(datasize) operand1 = X[n];  
bits(datasize) operand2 = ShiftReg(m, shift_type, shift_amount);  
  
result = operand1 EOR operand2;  
  
X[d] = result;
```

C6.2.71 ERET

Exception Return using the ELR and SPSR for the current Exception level. When executed, the PE restores `PSTATE` from the SPSR, and branches to the address held in the ELR.

The PE checks the SPSR for the current Exception level for an illegal return event. See *Illegal return events from AArch64 state* on page D1-1816.

ERET is UNDEFINED at EL0.

31	30	29	28	27	26	25	24	23	22	21	20	19	18	17	16	15	14	13	12	11	10	9	8	7	6	5	4	3	2	1	0	
1	1	0	1	0	1	1	1	0	1	0	0	1	1	1	1	1	0	0	0	0	0	0	1	1	1	1	1	0	0	0	0	0

System variant

ERET

Decode for this encoding

```
if PSTATE.EL == EL0 then UnallocatedEncoding();
```

Operation

```
AArch64.ExceptionReturn(ELR[], SPSR[]);
```

C6.2.72 ESB

Error Synchronization Barrier is a synchronization barrier instruction to barrier between errors. This instruction can be used at all Exception levels and in Debug state. This instruction might update DISR_EL1 and VDISR_EL2.

In Debug state, this instruction behaves as if SError interrupts are masked at all Exception levels. See Error Synchronization Barrier in the *ARM® Reliability, Availability, and Serviceability (RAS) Specification, ARMv8, for ARMv8-A Architecture Profile*.

ARMv8.2

31	30	29	28	27	26	25	24	23	22	21	20	19	18	17	16	15	14	13	12	11	8	7	5	4	3	2	1	0			
1	1	0	1	0	1	0	1	0	0	0	0	0	0	1	1	0	0	1	0	0	0	1	0	0	0	0	1	1	1	1	1
																					CRm			op2							

System variant

ESB

Decode for this encoding

SystemHintOp op;

op = if HaveRASExt() then SystemHintOp_ESB else SystemHintOp_NOP;

Operation

```

case op of
  when SystemHintOp_YIELD
    Hint_Yield();

  when SystemHintOp_WFE
    if IsEventRegisterSet() then
      ClearEventRegister();
    else
      if PSTATE.EL == EL0 then
        // Check for traps described by the OS which may be EL1 or EL2.
        AArch64.CheckForWfxTrap(EL1, TRUE);
      if HaveEL(EL2) && !IsSecure() && PSTATE.EL IN {EL0, EL1} && !IsInHost() then
        // Check for traps described by the Hypervisor.
        AArch64.CheckForWfxTrap(EL2, TRUE);
      if HaveEL(EL3) && PSTATE.EL != EL3 then
        // Check for traps described by the Secure Monitor.
        AArch64.CheckForWfxTrap(EL3, TRUE);
        WaitForEvent();

  when SystemHintOp_WFI
    if !InterruptPending() then
      if PSTATE.EL == EL0 then
        // Check for traps described by the OS which may be EL1 or EL2.
        AArch64.CheckForWfxTrap(EL1, FALSE);
      if HaveEL(EL2) && !IsSecure() && PSTATE.EL IN {EL0, EL1} && !IsInHost() then
        // Check for traps described by the Hypervisor.
        AArch64.CheckForWfxTrap(EL2, FALSE);
      if HaveEL(EL3) && PSTATE.EL != EL3 then
        // Check for traps described by the Secure Monitor.
        AArch64.CheckForWfxTrap(EL3, FALSE);
        WaitForInterrupt();

  when SystemHintOp_SEV
    SendEvent();

```

```
when SystemHintOp_SEVL
    SendEventLocal();

when SystemHintOp_ESB
    ErrorSynchronizationBarrier(MBReqDomain_FullSystem, MBReqTypes_All);
    AArch64.ESB0peration();
    if HaveEL(EL2) && !IsSecure() && PSTATE.EL IN {EL0, EL1} then AArch64.vESB0peration();
    TakeUnmaskedSErrorInterrupts();

when SystemHintOp_PSB
    ProfilingSynchronizationBarrier();

otherwise // do nothing
```

C6.2.73 EXTR

Extract register extracts a register from a pair of registers.

This instruction is used by the alias [ROR \(immediate\)](#). See [Alias conditions](#) for details of when each alias is preferred.

31 30 29 28	27 26 25 24				23 22 21 20				16 15		10 9		5 4		0			
sf	0	0	1	0	0	1	1	1	N	0	Rm		imms		Rn		Rd	

32-bit variant

Applies when `sf == 0 && N == 0 && imms == 0xxxxx`.

EXTR <Wd>, <Wn>, <Wm>, #<lsb>

64-bit variant

Applies when `sf == 1 && N == 1`.

EXTR <Xd>, <Xn>, <Xm>, #<lsb>

Decode for all variants of this encoding

```
integer d = UInt(Rd);
integer n = UInt(Rn);
integer m = UInt(Rm);
integer datasize = if sf == '1' then 64 else 32;
integer lsb;

if N != sf then UnallocatedEncoding();
if sf == '0' && imms<5> == '1' then ReservedValue();
lsb = UInt(imms);
```

Alias conditions

Alias	is preferred when
ROR (immediate)	<code>Rn == Rm</code>

Assembler symbols

<Wd>	Is the 32-bit name of the general-purpose destination register, encoded in the "Rd" field.
<Wn>	Is the 32-bit name of the first general-purpose source register, encoded in the "Rn" field.
<Wm>	Is the 32-bit name of the second general-purpose source register, encoded in the "Rm" field.
<Xd>	Is the 64-bit name of the general-purpose destination register, encoded in the "Rd" field.
<Xn>	Is the 64-bit name of the first general-purpose source register, encoded in the "Rn" field.
<Xm>	Is the 64-bit name of the second general-purpose source register, encoded in the "Rm" field.
<lsb>	For the 32-bit variant: is the least significant bit position from which to extract, in the range 0 to 31, encoded in the "imms" field. For the 64-bit variant: is the least significant bit position from which to extract, in the range 0 to 63, encoded in the "imms" field.

Operation

```
bits(datasize) result;  
bits(datasize) operand1 = X[n];  
bits(datasize) operand2 = X[m];  
bits(2*datasize) concat = operand1:operand2;  
  
result = concat<lsb+datasize-1:lsb>;  
  
X[d] = result;
```

C6.2.74 HINT

Hint instruction is for the instruction set space that is reserved for architectural hint instructions.

Some encodings described here are unallocated in this revision of the architecture, and behave as NOPs. These encodings might be allocated to other hint functionality in future revisions of the architecture.

31	30	29	28	27	26	25	24	23	22	21	20	19	18	17	16	15	14	13	12	11	8	7	5	4	3	2	1	0	
1	1	0	1	0	1	0	1	0	0	0	0	0	0	1	1	0	0	1	0	CRm	op2	1	1	1	1	1	1	1	1

Hints 6 and 7 variant

Applies when CRm == 0000 && op2 == 11x.

HINT #<imm>

Hints 8 to 15, and 24 to 127 variant

Applies when CRm != 00x0.

HINT #<imm>

Hints 17 to 23 variant

Applies when CRm == 0010 && op2 != 00x.

HINT #<imm>

Assembler symbols

<imm> Is a 7-bit unsigned immediate, in the range 0 to 127, excluding the allocated encodings described below, encoded in "CRm:op2".

The following encodings of "CRm:op2" are allocated:

0000000	NOP
0000001	YIELD
0000010	WFE
0000011	WFI
0000100	SEV
0000101	SEVL

Note

For allocated encodings of "CRm:op2":

- A disassembler will disassemble the allocated instruction, rather than the HINT instruction.
- An assembler may support assembly of allocated encodings using HINT with the corresponding <imm> value, but it is not required to do so.

C6.2.75 HLT

Halt instruction generates a Halt Instruction debug event.

31	30	29	28	27	26	25	24	23	22	21	20					5	4	3	2	1	0	
1	1	0	1	0	1	0	0	0	1	0		imm16						0	0	0	0	0

System variant

HLT #<imm>

Decode for this encoding

```
if EDSCR.HDE == '0' || !HaltingAllowed() then UndefinedFault();
```

Assembler symbols

<imm> Is a 16-bit unsigned immediate, in the range 0 to 65535, encoded in the "imm16" field.

Operation

```
Halt(DebugHalt_HaltInstruction);
```

C6.2.76 HVC

Hypervisor Call causes an exception to EL2. Non-secure software executing at EL1 can use this instruction to call the hypervisor to request a service.

The HVC instruction is UNDEFINED:

- At EL0, and Secure EL1.
- When `SCR_EL3.HCE` is set to 0.

On executing an HVC instruction, the PE records the exception as a Hypervisor Call exception in `ESR_ELx`, using the EC value `0x16`, and the value of the immediate argument.

31	30	29	28	27	26	25	24	23	22	21	20							5	4	3	2	1	0
1	1	0	1	0	1	0	0	0	0	0		imm16						0	0	0	1	0	

System variant

HVC #<imm>

Decode for this encoding

bits(16) imm = imm16;

Assembler symbols

<imm> Is a 16-bit unsigned immediate, in the range 0 to 65535, encoded in the "imm16" field.

Operation

```
if !HaveEL(EL2) || PSTATE.EL == EL0 || (PSTATE.EL == EL1 && IsSecure()) then
    UnallocatedEncoding();
```

```
hvc_enable = if HaveEL(EL3) then SCR_EL3.HCE else NOT(HCR_EL2.HCD);
if hvc_enable == '0' then
    AArch64.UndefinedFault();
else
    AArch64.CallHypervisor(imm);
```

C6.2.77 IC

Instruction Cache operation. For more information, see [A64 system instructions for cache maintenance](#).

This instruction is an alias of the [SYS](#) instruction. This means that:

- The encodings in this description are named to match the encodings of [SYS](#).
- The description of [SYS](#) gives the operational pseudocode for this instruction.

31	30	29	28	27	26	25	24	23	22	21	20	19	18	16	15	12	11	8	7	5	4	0
1	1	0	1	0	1	0	1	0	0	0	0	1	op1	0	1	1	1	CRm	op2	Rt		
L											CRn											

System variant

IC <ic_op>{, <Xt>}

is equivalent to

SYS #<op1>, C7, <Cm>, #<op2>{, <Xt>}

and is the preferred disassembly when `SysOp(op1, '0111', CRm, op2) == Sys_IC`.

Assembler symbols

- <ic_op> Is an IC instruction name, as listed for the IC system instruction pages, encoded in the "op1:CRm:op2" field. It can have the following values:
- IALLUIS when op1 = 000, CRm = 0001, op2 = 000
 - IALLU when op1 = 000, CRm = 0101, op2 = 000
 - IVAU when op1 = 011, CRm = 0101, op2 = 001
- <op1> Is a 3-bit unsigned immediate, in the range 0 to 7, encoded in the "op1" field.
- <Cm> Is a name 'Cm', with 'm' in the range 0 to 15, encoded in the "CRm" field.
- <op2> Is a 3-bit unsigned immediate, in the range 0 to 7, encoded in the "op2" field.
- <Xt> Is the 64-bit name of the optional general-purpose source register, defaulting to '11111', encoded in the "Rt" field.

Operation

The description of [SYS](#) gives the operational pseudocode for this instruction.

C6.2.78 ISB

Instruction Synchronization Barrier flushes the pipeline in the PE and is a context synchronization event. For more information, see [Instruction Synchronization Barrier \(ISB\)](#) on page B2-92.

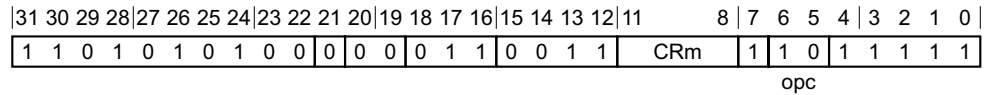

System variant

ISB {<option>|#<imm>}

Decode for this encoding

// Empty.

Assembler symbols

- <option> Specifies an optional limitation on the barrier operation. Values are:
- SY Full system barrier operation, encoded as CRm = 0b1111. Can be omitted.
- All other encodings of CRm are reserved. The corresponding instructions execute as full system barrier operations, but must not be relied upon by software.
- <imm> Is an optional 4-bit unsigned immediate, in the range 0 to 15, defaulting to 15 and encoded in the "CRm" field.

Operation

`InstructionSynchronizationBarrier();`

C6.2.79 LDADDB, LDADDAB, LDADDALB, LDADDLB

Atomic add on byte in memory atomically loads an 8-bit byte from memory, adds the value held in a register to it, and stores the result back to memory. The value initially loaded from memory is returned in the destination register.

- If the destination register is not WZR, LDADDAB and LDADDALB load from memory with acquire semantics.
- LDADDLB and LDADDALB store to memory with release semantics.
- LDADDB has no memory ordering requirements.

For more information about memory ordering semantics see [Load-Acquire, Store-Release on page B2-94](#).

For information about memory accesses see [Load/Store addressing modes on page C1-143](#).

ARMv8.1

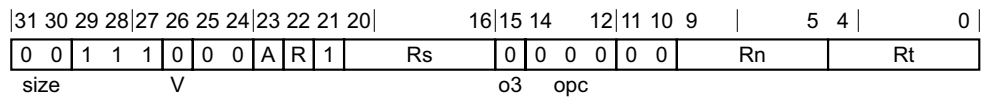

Acquire variant

Applies when A == 1 && R == 0.

LDADDAB <Ws>, <Wt>, [<Xn|SP>]

Acquire and release variant

Applies when A == 1 && R == 1.

LDADDALB <Ws>, <Wt>, [<Xn|SP>]

No memory ordering variant

Applies when A == 0 && R == 0 && Rt != 11111.

LDADDB <Ws>, <Wt>, [<Xn|SP>]

Release variant

Applies when A == 0 && R == 1 && Rt != 11111.

LDADDLB <Ws>, <Wt>, [<Xn|SP>]

Decode for all variants of this encoding

```
if !HaveAtomicExt() then UnallocatedEncoding();
integer t = UInt(Rt);
integer n = UInt(Rn);
integer s = UInt(Rs);
```

```
AccType ldacctype = if A == '1' && Rt != '11111' then AccType_ORDEREDRW else AccType_ATOMICRW;
AccType stacctype = if R == '1' then AccType_ORDEREDRW else AccType_ATOMICRW;
```

Assembler symbols

<Ws> Is the 32-bit name of the general-purpose register holding the data value to be operated on with the contents of the memory location, encoded in the "Rs" field.

<Wt> Is the 32-bit name of the general-purpose register to be loaded, encoded in the "Rt" field.

<Rn|SP> Is the 64-bit name of the general-purpose base register or stack pointer, encoded in the "Rn" field.

Operation

```
bits(64) address;
bits(8) value;
bits(8) data;
bits(8) result;

value = X[s];
if n == 31 then
    CheckSPAlignment();
    address = SP[];
else
    address = X[n];
data = Mem[address, 1, ldacctype];

result = data + value;
// All observers in the shareability domain observe the
// following load and store atomically.
Mem[address, 1, stacctype] = result;

X[t] = ZeroExtend(data, 32);
```

C6.2.80 LDADDH, LDADDAH, LDADDALH, LDADDLH

Atomic add on halfword in memory atomically loads a 16-bit halfword from memory, adds the value held in a register to it, and stores the result back to memory. The value initially loaded from memory is returned in the destination register.

- If the destination register is not WZR, LDADDAH and LDADDALH load from memory with acquire semantics.
- LDADDLH and LDADDALH store to memory with release semantics.
- LDADDH has no memory ordering requirements.

For more information about memory ordering semantics see [Load-Acquire, Store-Release](#) on page B2-94.

For information about memory accesses see [Load/Store addressing modes](#) on page C1-143.

ARMv8.1

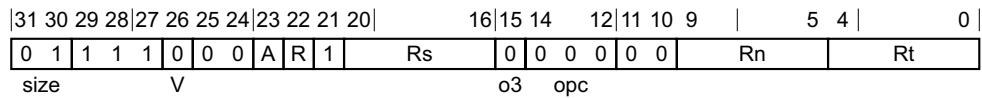

Acquire variant

Applies when A == 1 && R == 0.

LDADDAH <Ws>, <Wt>, [<Xn|SP>]

Acquire and release variant

Applies when A == 1 && R == 1.

LDADDALH <Ws>, <Wt>, [<Xn|SP>]

No memory ordering variant

Applies when A == 0 && R == 0 && Rt != 11111.

LDADDH <Ws>, <Wt>, [<Xn|SP>]

Release variant

Applies when A == 0 && R == 1 && Rt != 11111.

LDADDLH <Ws>, <Wt>, [<Xn|SP>]

Decode for all variants of this encoding

```
if !HaveAtomicExt() then UnallocatedEncoding();
integer t = UInt(Rt);
integer n = UInt(Rn);
integer s = UInt(Rs);
```

```
AccType ldacctype = if A == '1' && Rt != '11111' then AccType_ORDEREDRW else AccType_ATOMICRW;
AccType stacctype = if R == '1' then AccType_ORDEREDRW else AccType_ATOMICRW;
```

Assembler symbols

<Ws> Is the 32-bit name of the general-purpose register holding the data value to be operated on with the contents of the memory location, encoded in the "Rs" field.

<Wt> Is the 32-bit name of the general-purpose register to be loaded, encoded in the "Rt" field.

<Xn|SP> Is the 64-bit name of the general-purpose base register or stack pointer, encoded in the "Rn" field.

Operation

```
bits(64) address;
bits(16) value;
bits(16) data;
bits(16) result;

value = X[s];
if n == 31 then
    CheckSPAlignment();
    address = SP[];
else
    address = X[n];
data = Mem[address, 2, ldacctype];

result = data + value;
// All observers in the shareability domain observe the
// following load and store atomically.
Mem[address, 2, stacctype] = result;

X[t] = ZeroExtend(data, 32);
```

C6.2.81 LDADD, LDADDA, LDADDAL, LDADDL

Atomic add on word or doubleword in memory atomically loads a 32-bit word or 64-bit doubleword from memory, adds the value held in a register to it, and stores the result back to memory. The value initially loaded from memory is returned in the destination register.

- If the destination register is not one of WZR or XZR, LDADDA and LDADDAL load from memory with acquire semantics.
- LDADDL and LDADDAL store to memory with release semantics.
- LDADD has no memory ordering requirements.

For more information about memory ordering semantics see [Load-Acquire, Store-Release](#) on page B2-94.

For information about memory accesses see [Load/Store addressing modes](#) on page C1-143.

ARMv8.1

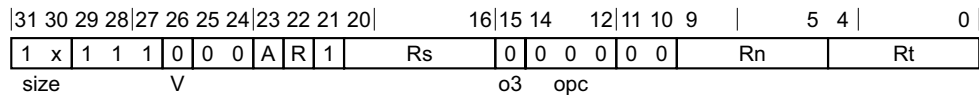

32-bit, acquire variant

Applies when size == 10 && A == 1 && R == 0.

LDADDA <Ws>, <Wt>, [<Xn|SP>]

32-bit, acquire and release variant

Applies when size == 10 && A == 1 && R == 1.

LDADDAL <Ws>, <Wt>, [<Xn|SP>]

32-bit, no memory ordering variant

Applies when size == 10 && A == 0 && R == 0 && Rt != 11111.

LDADD <Ws>, <Wt>, [<Xn|SP>]

32-bit, release variant

Applies when size == 10 && A == 0 && R == 1 && Rt != 11111.

LDADDL <Ws>, <Wt>, [<Xn|SP>]

64-bit, acquire variant

Applies when size == 11 && A == 1 && R == 0.

LDADDA <Xs>, <Xt>, [<Xn|SP>]

64-bit, acquire and release variant

Applies when size == 11 && A == 1 && R == 1.

LDADDAL <Xs>, <Xt>, [<Xn|SP>]

64-bit, no memory ordering variant

Applies when size == 11 && A == 0 && R == 0 && Rt != 11111.

LDADD <Xs>, <Xt>, [<Xn|SP>]

64-bit, release variant

Applies when size == 11 && A == 0 && R == 1 && Rt != 11111.

LDADDL <Xs>, <Xt>, [<Xn|SP>]

Decode for all variants of this encoding

```

if !HaveAtomicExt() then UnallocatedEncoding();
integer t = UInt(Rt);
integer n = UInt(Rn);
integer s = UInt(Rs);

integer datasize = 8 << UInt(size);
integer regsize = if datasize == 64 then 64 else 32;
AccType ldacctype = if A == '1' && Rt != '11111' then AccType_ORDEREDRW else AccType_ATOMICRW;
AccType stacctype = if R == '1' then AccType_ORDEREDRW else AccType_ATOMICRW;
  
```

Assembler symbols

- <Ws> Is the 32-bit name of the general-purpose register holding the data value to be operated on with the contents of the memory location, encoded in the "Rs" field.
- <Wt> Is the 32-bit name of the general-purpose register to be loaded, encoded in the "Rt" field.
- <Xs> Is the 64-bit name of the general-purpose register holding the data value to be operated on with the contents of the memory location, encoded in the "Rs" field.
- <Xt> Is the 64-bit name of the general-purpose register to be loaded, encoded in the "Rt" field.
- <Xn|SP> Is the 64-bit name of the general-purpose base register or stack pointer, encoded in the "Rn" field.

Operation

```

bits(64) address;
bits(datasize) value;
bits(datasize) data;
bits(datasize) result;

value = X[s];
if n == 31 then
  CheckSPAAlignment();
  address = SP[];
else
  address = X[n];
data = Mem[address, datasize DIV 8, ldacctype];

result = data + value;
// All observers in the shareability domain observe the
// following load and store atomically.
Mem[address, datasize DIV 8, stacctype] = result;

X[t] = ZeroExtend(data, regsize);
  
```

C6.2.82 LDAR

Load-Acquire Register derives an address from a base register value, loads a 32-bit word or 64-bit doubleword from memory, and writes it to a register. The instruction also has memory ordering semantics as described in [Load-Acquire, Store-Release](#) on page B2-94. For information about memory accesses, see [Load/Store addressing modes](#) on page C1-143.

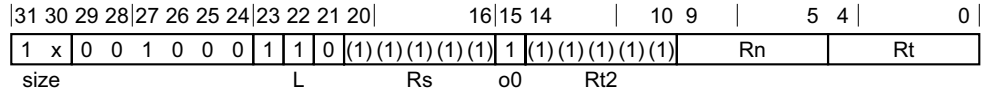

32-bit variant

Applies when size == 10.

LDAR <Wt>, [<Xn|SP>{,#0}]

64-bit variant

Applies when size == 11.

LDAR <Xt>, [<Xn|SP>{,#0}]

Decode for all variants of this encoding

```
integer n = UInt(Rn);
integer t = UInt(Rt);

integer elsize = 8 << UInt(size);
integer regsize = if elsize == 64 then 64 else 32;
```

Assembler symbols

- <Wt> Is the 32-bit name of the general-purpose register to be transferred, encoded in the "Rt" field.
- <Xt> Is the 64-bit name of the general-purpose register to be transferred, encoded in the "Rt" field.
- <Xn|SP> Is the 64-bit name of the general-purpose base register or stack pointer, encoded in the "Rn" field.

Operation

```
bits(64) address;
bits(elsize) data;
constant integer dbytes = elsize DIV 8;

if n == 31 then
  CheckSPAlignment();
  address = SP[];
else
  address = X[n];

data = Mem[address, dbytes, AccType_ORDERED];
X[t] = ZeroExtend(data, regsize);
```

C6.2.83 LDARB

Load-Acquire Register Byte derives an address from a base register value, loads a byte from memory, zero-extends it and writes it to a register. The instruction also has memory ordering semantics as described in [Load-Acquire, Store-Release](#) on page B2-94. For information about memory accesses, see [Load/Store addressing modes](#) on page C1-143.

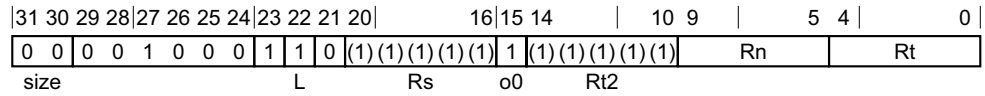

No offset variant

LDARB <Wt>, [<Xn|SP>{, #0}]

Decode for this encoding

```
integer n = UInt(Rn);
integer t = UInt(Rt);
```

Assembler symbols

<Wt> Is the 32-bit name of the general-purpose register to be transferred, encoded in the "Rt" field.

<Xn|SP> Is the 64-bit name of the general-purpose base register or stack pointer, encoded in the "Rn" field.

Operation

```
bits(64) address;
bits(8) data;

if n == 31 then
    CheckSPAlignment();
    address = SP[];
else
    address = X[n];

data = Mem[address, 1, AccType_ORDERED];
X[t] = ZeroExtend(data, 32);
```

C6.2.84 LDARH

Load-Acquire Register Halfword derives an address from a base register value, loads a halfword from memory, zero-extends it, and writes it to a register. The instruction also has memory ordering semantics as described in [Load-Acquire, Store-Release](#) on page B2-94. For information about memory accesses, see [Load/Store addressing modes](#) on page C1-143.

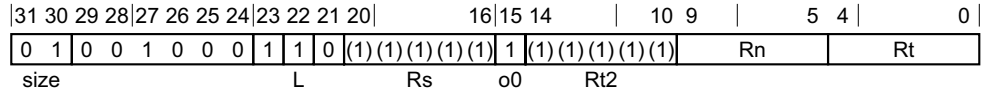

No offset variant

LDARH <Wt>, [<Xn|SP>{, #0}]

Decode for this encoding

```
integer n = UInt(Rn);
integer t = UInt(Rt);
```

Assembler symbols

- <Wt> Is the 32-bit name of the general-purpose register to be transferred, encoded in the "Rt" field.
- <Xn|SP> Is the 64-bit name of the general-purpose base register or stack pointer, encoded in the "Rn" field.

Operation

```
bits(64) address;
bits(16) data;

if n == 31 then
    CheckSPAAlignment();
    address = SP[];
else
    address = X[n];

data = Mem[address, 2, AccType_ORDERED];
X[t] = ZeroExtend(data, 32);
```

C6.2.85 LDAXP

Load-Acquire Exclusive Pair of Registers derives an address from a base register value, loads two 32-bit words or two 64-bit doublewords from memory, and writes them to two registers. A 32-bit pair requires the address to be doubleword aligned and is single-copy atomic at doubleword granularity. A 64-bit pair requires the address to be quadword aligned and is single-copy atomic for each doubleword at doubleword granularity. The PE marks the physical address being accessed as an exclusive access. This exclusive access mark is checked by Store Exclusive instructions. See [Synchronization and semaphores on page B2-121](#). The instruction also has memory ordering semantics as described in [Load-Acquire, Store-Release on page B2-94](#). For information about memory accesses see [Load/Store addressing modes on page C1-143](#).

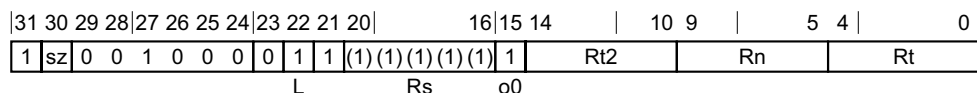

32-bit variant

Applies when `sz == 0`.

LDAXP <Wt1>, <Wt2>, [<Xn|SP>{,#0}]

64-bit variant

Applies when `sz == 1`.

LDAXP <Xt1>, <Xt2>, [<Xn|SP>{,#0}]

Decode for all variants of this encoding

```
integer n = UInt(Rn);
integer t = UInt(Rt);
integer t2 = UInt(Rt2);
```

```
integer elsize = 32 << UInt(sz);
integer datasize = elsize * 2;
```

Notes for all encodings

For information about the CONSTRAINED UNPREDICTABLE behavior of this instruction, see [Appendix K1 Architectural Constraints on UNPREDICTABLE behaviors](#), and particularly [LDAXP on page K1-6124](#).

Assembler symbols

- <Wt1> Is the 32-bit name of the first general-purpose register to be transferred, encoded in the "Rt" field.
- <Wt2> Is the 32-bit name of the second general-purpose register to be transferred, encoded in the "Rt2" field.
- <Xt1> Is the 64-bit name of the first general-purpose register to be transferred, encoded in the "Rt" field.
- <Xt2> Is the 64-bit name of the second general-purpose register to be transferred, encoded in the "Rt2" field.
- <Xn|SP> Is the 64-bit name of the general-purpose base register or stack pointer, encoded in the "Rn" field.

Operation

```

bits(64) address;
bits(datasize) data;
constant integer dbytes = datasize DIV 8;
boolean rt_unknown = FALSE;

if t == t2 then
  Constraint c = ConstrainUnpredictable();
  assert c IN {Constraint_UNKNOWN, Constraint_UNDEF, Constraint_NOP};
  case c of
    when Constraint_UNKNOWN rt_unknown = TRUE; // result is UNKNOWN
    when Constraint_UNDEF UnallocatedEncoding();
    when Constraint_NOP EndOfInstruction();

if n == 31 then
  CheckSPAlignment();
  address = SP[];
else
  address = X[n];

// Tell the Exclusive Monitors to record a sequence of one or more atomic
// memory reads from virtual address range [address, address+dbytes-1].
// The Exclusive Monitor will only be set if all the reads are from the
// same dbytes-aligned physical address, to allow for the possibility of
// an atomicity break if the translation is changed between reads.
AArch64.SetExclusiveMonitors(address, dbytes);

if rt_unknown then
  // ConstrainedUNPREDICTABLE case
  X[t] = bits(datasize) UNKNOWN;
elseif elsize == 32 then
  // 32-bit load exclusive pair (atomic)
  data = Mem[address, dbytes, AccType_ORDERED];
  if BigEndian() then
    X[t] = data<datasize-1:elsize>;
    X[t2] = data<elsize-1:0>;
  else
    X[t] = data<elsize-1:0>;
    X[t2] = data<datasize-1:elsize>;
else // elsize == 64
  // 64-bit load exclusive pair (not atomic),
  // but must be 128-bit aligned
  if address != Align(address, dbytes) then
    AArch64.Abort(address, AArch64.AlignmentFault(AccType_ORDERED, FALSE, FALSE));
  X[t] = Mem[address, 8, AccType_ORDERED];
  X[t2] = Mem[address+8, 8, AccType_ORDERED];

```

C6.2.86 LDAXR

Load-Acquire Exclusive Register derives an address from a base register value, loads a 32-bit word or 64-bit doubleword from memory, and writes it to a register. The memory access is atomic. The PE marks the physical address being accessed as an exclusive access. This exclusive access mark is checked by Store Exclusive instructions. See *Synchronization and semaphores* on page B2-121. The instruction also has memory ordering semantics as described in *Load-Acquire, Store-Release* on page B2-94. For information about memory accesses see *Load/Store addressing modes* on page C1-143.

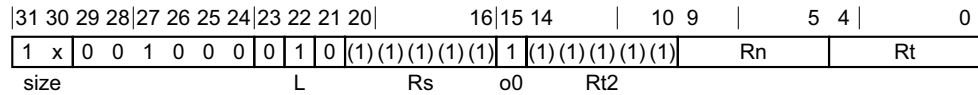

32-bit variant

Applies when size == 10.

LDAXR <Wt>, [<Xn|SP>{,#0}]

64-bit variant

Applies when size == 11.

LDAXR <Xt>, [<Xn|SP>{,#0}]

Decode for all variants of this encoding

```
integer n = UInt(Rn);
integer t = UInt(Rt);

integer ellsz = 8 << UInt(size);
integer regsize = if ellsz == 64 then 64 else 32;
```

Assembler symbols

<Wt> Is the 32-bit name of the general-purpose register to be transferred, encoded in the "Rt" field.

<Xt> Is the 64-bit name of the general-purpose register to be transferred, encoded in the "Rt" field.

<Xn|SP> Is the 64-bit name of the general-purpose base register or stack pointer, encoded in the "Rn" field.

Operation

```
bits(64) address;
bits(ellsz) data;
constant integer dbytes = ellsz DIV 8;

if n == 31 then
    CheckSPAlignment();
    address = SP[];
else
    address = X[n];

// Tell the Exclusive Monitors to record a sequence of one or more atomic
// memory reads from virtual address range [address, address+dbytes-1].
// The Exclusive Monitor will only be set if all the reads are from the
// same dbytes-aligned physical address, to allow for the possibility of
// an atomicity break if the translation is changed between reads.
AArch64.SetExclusiveMonitors(address, dbytes);
```

```
data = Mem[address, dbytes, AccType_ORDERED];  
X[t] = ZeroExtend(data, regsize);
```

C6.2.87 LDAXRB

Load-Acquire Exclusive Register Byte derives an address from a base register value, loads a byte from memory, zero-extends it and writes it to a register. The memory access is atomic. The PE marks the physical address being accessed as an exclusive access. This exclusive access mark is checked by Store Exclusive instructions. See [Synchronization and semaphores on page B2-121](#). The instruction also has memory ordering semantics as described in [Load-Acquire, Store-Release on page B2-94](#). For information about memory accesses see [Load/Store addressing modes on page C1-143](#).

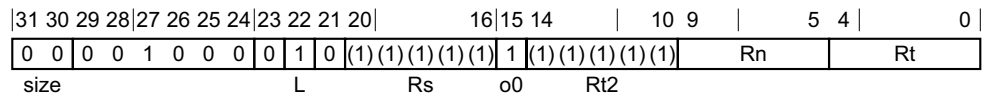

No offset variant

LDAXRB <wt>, [<Xn|SP>{,#0}]

Decode for this encoding

```
integer n = UInt(Rn);
integer t = UInt(Rt);
```

Assembler symbols

<wt> Is the 32-bit name of the general-purpose register to be transferred, encoded in the "Rt" field.

<Xn|SP> Is the 64-bit name of the general-purpose base register or stack pointer, encoded in the "Rn" field.

Operation

```
bits(64) address;
bits(8) data;
```

```
if n == 31 then
    CheckSPAlignment();
    address = SP[];
else
    address = X[n];
```

```
// Tell the Exclusive Monitors to record a sequence of one or more atomic
// memory reads from virtual address range [address, address+dbytes-1].
// The Exclusive Monitor will only be set if all the reads are from the
// same dbytes-aligned physical address, to allow for the possibility of
// an atomicity break if the translation is changed between reads.
AArch64.SetExclusiveMonitors(address, 1);
```

```
data = Mem[address, 1, AccType_ORDERED];
X[t] = ZeroExtend(data, 32);
```

C6.2.88 LDAXRH

Load-Acquire Exclusive Register Halfword derives an address from a base register value, loads a halfword from memory, zero-extends it and writes it to a register. The memory access is atomic. The PE marks the physical address being accessed as an exclusive access. This exclusive access mark is checked by Store Exclusive instructions. See *Synchronization and semaphores* on page B2-121. The instruction also has memory ordering semantics as described in *Load-Acquire, Store-Release* on page B2-94. For information about memory accesses see *Load/Store addressing modes* on page C1-143.

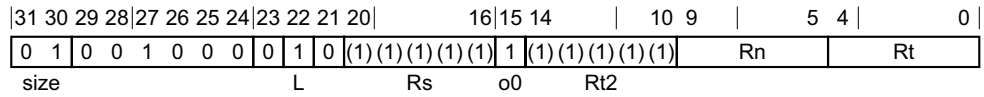

No offset variant

LDAXRH <wt>, [<Xn|SP>{,#0}]

Decode for this encoding

```
integer n = UInt(Rn);
integer t = UInt(Rt);
```

Assembler symbols

<wt> Is the 32-bit name of the general-purpose register to be transferred, encoded in the "Rt" field.

<Xn|SP> Is the 64-bit name of the general-purpose base register or stack pointer, encoded in the "Rn" field.

Operation

```
bits(64) address;
bits(16) data;
```

```
if n == 31 then
    CheckSPAlignment();
    address = SP[];
else
    address = X[n];
```

```
// Tell the Exclusive Monitors to record a sequence of one or more atomic
// memory reads from virtual address range [address, address+dbytes-1].
// The Exclusive Monitor will only be set if all the reads are from the
// same dbytes-aligned physical address, to allow for the possibility of
// an atomicity break if the translation is changed between reads.
AArch64.SetExclusiveMonitors(address, 2);
```

```
data = Mem[address, 2, AccType_ORDERED];
X[t] = ZeroExtend(data, 32);
```

C6.2.89 LDCLRB, LDCLRAB, LDCLRALB, LDCLRLB

Atomic bit clear on byte in memory atomically loads an 8-bit byte from memory, performs a bitwise AND with the complement of the value held in a register on it, and stores the result back to memory. The value initially loaded from memory is returned in the destination register.

- If the destination register is not WZR, LDCLRAB and LDCLRALB load from memory with acquire semantics.
- LDCLRLB and LDCLRALB store to memory with release semantics.
- LDCLRB has no memory ordering requirements.

For more information about memory ordering semantics see [Load-Acquire, Store-Release](#) on page B2-94.

For information about memory accesses see [Load/Store addressing modes](#) on page C1-143.

ARMv8.1

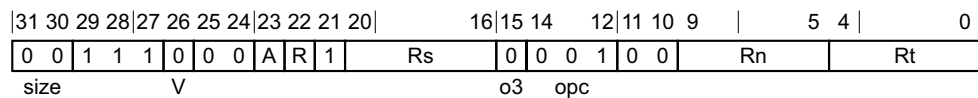

Acquire variant

Applies when A == 1 && R == 0.

LDCLRAB <Ws>, <Wt>, [<Xn|SP>]

Acquire and release variant

Applies when A == 1 && R == 1.

LDCLRALB <Ws>, <Wt>, [<Xn|SP>]

No memory ordering variant

Applies when A == 0 && R == 0 && Rt != 11111.

LDCLRB <Ws>, <Wt>, [<Xn|SP>]

Release variant

Applies when A == 0 && R == 1 && Rt != 11111.

LDCLRLB <Ws>, <Wt>, [<Xn|SP>]

Decode for all variants of this encoding

```
if !HaveAtomicExt() then UnallocatedEncoding();
integer t = UInt(Rt);
integer n = UInt(Rn);
integer s = UInt(Rs);
```

```
AccType ldacctype = if A == '1' && Rt != '11111' then AccType_ORDEREDRW else AccType_ATOMICRW;
AccType stacctype = if R == '1' then AccType_ORDEREDRW else AccType_ATOMICRW;
```

Assembler symbols

<Ws> Is the 32-bit name of the general-purpose register holding the data value to be operated on with the contents of the memory location, encoded in the "Rs" field.

<Wt> Is the 32-bit name of the general-purpose register to be loaded, encoded in the "Rt" field.

<Xn|SP> Is the 64-bit name of the general-purpose base register or stack pointer, encoded in the "Rn" field.

Operation

```
bits(64) address;
bits(8) value;
bits(8) data;
bits(8) result;

value = X[s];
if n == 31 then
    CheckSPAlignment();
    address = SP[];
else
    address = X[n];
data = Mem[address, 1, ldacctype];

result = data AND NOT(value);
// All observers in the shareability domain observe the
// following load and store atomically.
Mem[address, 1, stacctype] = result;

X[t] = ZeroExtend(data, 32);
```

C6.2.90 LDCLRH, LDCLRAH, LDCLRALH, LDCLRLH

Atomic bit clear on halfword in memory atomically loads a 16-bit halfword from memory, performs a bitwise AND with the complement of the value held in a register on it, and stores the result back to memory. The value initially loaded from memory is returned in the destination register.

- If the destination register is not WZR, LDCLRAH and LDCLRALH load from memory with acquire semantics.
- LDCLRLH and LDCLRALH store to memory with release semantics.
- LDCLRH has no memory ordering requirements.

For more information about memory ordering semantics see [Load-Acquire, Store-Release](#) on page B2-94.

For information about memory accesses see [Load/Store addressing modes](#) on page C1-143.

ARMv8.1

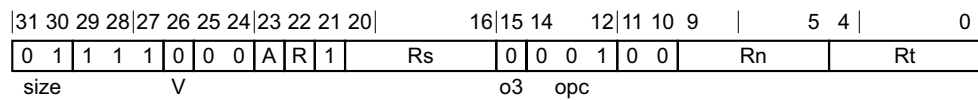

Acquire variant

Applies when A == 1 && R == 0.

LDCLRAH <Ws>, <Wt>, [<Xn|SP>]

Acquire and release variant

Applies when A == 1 && R == 1.

LDCLRALH <Ws>, <Wt>, [<Xn|SP>]

No memory ordering variant

Applies when A == 0 && R == 0 && Rt != 11111.

LDCLRH <Ws>, <Wt>, [<Xn|SP>]

Release variant

Applies when A == 0 && R == 1 && Rt != 11111.

LDCLRLH <Ws>, <Wt>, [<Xn|SP>]

Decode for all variants of this encoding

```
if !HaveAtomicExt() then UnallocatedEncoding();
integer t = UInt(Rt);
integer n = UInt(Rn);
integer s = UInt(Rs);
```

```
AccType ldacctype = if A == '1' && Rt != '11111' then AccType_ORDEREDRW else AccType_ATOMICRW;
AccType stacctype = if R == '1' then AccType_ORDEREDRW else AccType_ATOMICRW;
```

Assembler symbols

<Ws> Is the 32-bit name of the general-purpose register holding the data value to be operated on with the contents of the memory location, encoded in the "Rs" field.

<Wt> Is the 32-bit name of the general-purpose register to be loaded, encoded in the "Rt" field.

<Xn|SP> Is the 64-bit name of the general-purpose base register or stack pointer, encoded in the "Rn" field.

Operation

```
bits(64) address;
bits(16) value;
bits(16) data;
bits(16) result;

value = X[s];
if n == 31 then
    CheckSPAlignment();
    address = SP[];
else
    address = X[n];
data = Mem[address, 2, ldacctype];

result = data AND NOT(value);
// All observers in the shareability domain observe the
// following load and store atomically.
Mem[address, 2, stacctype] = result;

X[t] = ZeroExtend(data, 32);
```

C6.2.91 LDCLR, LDCLRA, LDCLRAL, LDCLRL

Atomic bit clear on word or doubleword in memory atomically loads a 32-bit word or 64-bit doubleword from memory, performs a bitwise AND with the complement of the value held in a register on it, and stores the result back to memory. The value initially loaded from memory is returned in the destination register.

- If the destination register is not one of WZR or XZR, LDCLRA and LDCLRAL load from memory with acquire semantics.
- LDCLRL and LDCLRAL store to memory with release semantics.
- LDCLR has no memory ordering requirements.

For more information about memory ordering semantics see [Load-Acquire, Store-Release](#) on page B2-94.

For information about memory accesses see [Load/Store addressing modes](#) on page C1-143.

ARMv8.1

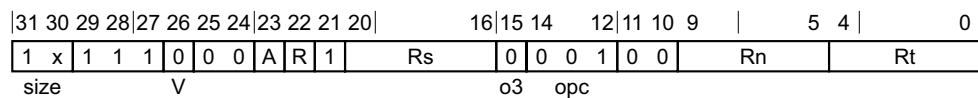

32-bit, acquire variant

Applies when size == 10 && A == 1 && R == 0.

LDCLRA <Ws>, <Wt>, [<Xn|SP>]

32-bit, acquire and release variant

Applies when size == 10 && A == 1 && R == 1.

LDCLRAL <Ws>, <Wt>, [<Xn|SP>]

32-bit, no memory ordering variant

Applies when size == 10 && A == 0 && R == 0 && Rt != 11111.

LDCLR <Ws>, <Wt>, [<Xn|SP>]

32-bit, release variant

Applies when size == 10 && A == 0 && R == 1 && Rt != 11111.

LDCLRL <Ws>, <Wt>, [<Xn|SP>]

64-bit, acquire variant

Applies when size == 11 && A == 1 && R == 0.

LDCLRA <Xs>, <Xt>, [<Xn|SP>]

64-bit, acquire and release variant

Applies when size == 11 && A == 1 && R == 1.

LDCLRAL <Xs>, <Xt>, [<Xn|SP>]

64-bit, no memory ordering variant

Applies when size == 11 && A == 0 && R == 0 && Rt != 11111.

LDCLR <Xs>, <Xt>, [<Xn|SP>]

64-bit, release variant

Applies when size == 11 && A == 0 && R == 1 && Rt != 11111.

LDCLR <Xs>, <Xt>, [<Xn|SP>]

Decode for all variants of this encoding

```
if !HaveAtomicExt() then UnallocatedEncoding();
integer t = UInt(Rt);
integer n = UInt(Rn);
integer s = UInt(Rs);

integer datasize = 8 << UInt(size);
integer regsize = if datasize == 64 then 64 else 32;
AccType ldacctype = if A == '1' && Rt != '11111' then AccType_ORDEREDRW else AccType_ATOMICRW;
AccType stacctype = if R == '1' then AccType_ORDEREDRW else AccType_ATOMICRW;
```

Assembler symbols

- <Ws> Is the 32-bit name of the general-purpose register holding the data value to be operated on with the contents of the memory location, encoded in the "Rs" field.
- <Wt> Is the 32-bit name of the general-purpose register to be loaded, encoded in the "Rt" field.
- <Xs> Is the 64-bit name of the general-purpose register holding the data value to be operated on with the contents of the memory location, encoded in the "Rs" field.
- <Xt> Is the 64-bit name of the general-purpose register to be loaded, encoded in the "Rt" field.
- <Xn|SP> Is the 64-bit name of the general-purpose base register or stack pointer, encoded in the "Rn" field.

Operation

```
bits(64) address;
bits(datasize) value;
bits(datasize) data;
bits(datasize) result;

value = X[s];
if n == 31 then
    CheckSPAlignment();
    address = SP[];
else
    address = X[n];
data = Mem[address, datasize DIV 8, ldacctype];

result = data AND NOT(value);
// All observers in the shareability domain observe the
// following load and store atomically.
Mem[address, datasize DIV 8, stacctype] = result;

X[t] = ZeroExtend(data, regsize);
```

C6.2.92 LDEORB, LDEORAB, LDEORALB, LDEORLB

Atomic exclusive OR on byte in memory atomically loads an 8-bit byte from memory, performs an exclusive OR with the value held in a register on it, and stores the result back to memory. The value initially loaded from memory is returned in the destination register.

- If the destination register is not WZR, LDEORAB and LDEORALB load from memory with acquire semantics.
- LDEORLB and LDEORALB store to memory with release semantics.
- LDEORB has no memory ordering requirements.

For more information about memory ordering semantics see [Load-Acquire, Store-Release](#) on page B2-94.

For information about memory accesses see [Load/Store addressing modes](#) on page C1-143.

ARMv8.1

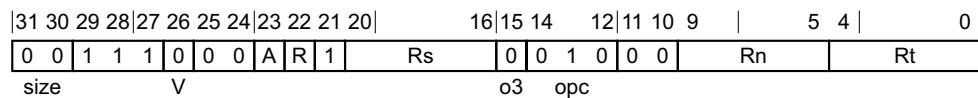

Acquire variant

Applies when A == 1 && R == 0.

LDEORAB <Ws>, <Wt>, [<Xn|SP>]

Acquire and release variant

Applies when A == 1 && R == 1.

LDEORALB <Ws>, <Wt>, [<Xn|SP>]

No memory ordering variant

Applies when A == 0 && R == 0 && Rt != 11111.

LDEORB <Ws>, <Wt>, [<Xn|SP>]

Release variant

Applies when A == 0 && R == 1 && Rt != 11111.

LDEORLB <Ws>, <Wt>, [<Xn|SP>]

Decode for all variants of this encoding

```
if !HaveAtomicExt() then UnallocatedEncoding();
integer t = UInt(Rt);
integer n = UInt(Rn);
integer s = UInt(Rs);
```

```
AccType ldacctype = if A == '1' && Rt != '11111' then AccType_ORDEREDRW else AccType_ATOMICRW;
AccType stacctype = if R == '1' then AccType_ORDEREDRW else AccType_ATOMICRW;
```

Assembler symbols

<Ws> Is the 32-bit name of the general-purpose register holding the data value to be operated on with the contents of the memory location, encoded in the "Rs" field.

<Wt> Is the 32-bit name of the general-purpose register to be loaded, encoded in the "Rt" field.

<Xn|SP> Is the 64-bit name of the general-purpose base register or stack pointer, encoded in the "Rn" field.

Operation

```
bits(64) address;
bits(8) value;
bits(8) data;
bits(8) result;

value = X[s];
if n == 31 then
    CheckSPAlignment();
    address = SP[];
else
    address = X[n];
data = Mem[address, 1, ldacctype];

result = data EOR value;
// All observers in the shareability domain observe the
// following load and store atomically.
Mem[address, 1, stacctype] = result;

X[t] = ZeroExtend(data, 32);
```

C6.2.93 LDEORH, LDEORAH, LDEORALH, LDEORLH

Atomic exclusive OR on halfword in memory atomically loads a 16-bit halfword from memory, performs an exclusive OR with the value held in a register on it, and stores the result back to memory. The value initially loaded from memory is returned in the destination register.

- If the destination register is not WZR, LDEORAH and LDEORALH load from memory with acquire semantics.
- LDEORLH and LDEORALH store to memory with release semantics.
- LDEORH has no memory ordering requirements.

For more information about memory ordering semantics see [Load-Acquire, Store-Release](#) on page B2-94.

For information about memory accesses see [Load/Store addressing modes](#) on page C1-143.

ARMv8.1

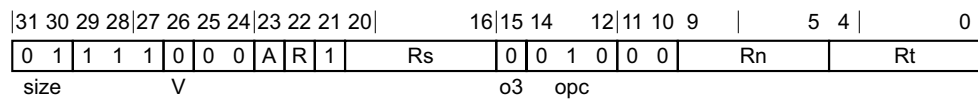

Acquire variant

Applies when A == 1 && R == 0.

LDEORAH <Ws>, <Wt>, [<Xn|SP>]

Acquire and release variant

Applies when A == 1 && R == 1.

LDEORALH <Ws>, <Wt>, [<Xn|SP>]

No memory ordering variant

Applies when A == 0 && R == 0 && Rt != 11111.

LDEORH <Ws>, <Wt>, [<Xn|SP>]

Release variant

Applies when A == 0 && R == 1 && Rt != 11111.

LDEORLH <Ws>, <Wt>, [<Xn|SP>]

Decode for all variants of this encoding

```
if !HaveAtomicExt() then UnallocatedEncoding();
integer t = UInt(Rt);
integer n = UInt(Rn);
integer s = UInt(Rs);
```

```
AccType ldacctype = if A == '1' && Rt != '11111' then AccType_ORDEREDRW else AccType_ATOMICRW;
AccType stacctype = if R == '1' then AccType_ORDEREDRW else AccType_ATOMICRW;
```

Assembler symbols

<Ws> Is the 32-bit name of the general-purpose register holding the data value to be operated on with the contents of the memory location, encoded in the "Rs" field.

<Wt> Is the 32-bit name of the general-purpose register to be loaded, encoded in the "Rt" field.

<Rn|SP> Is the 64-bit name of the general-purpose base register or stack pointer, encoded in the "Rn" field.

Operation

```
bits(64) address;
bits(16) value;
bits(16) data;
bits(16) result;

value = X[s];
if n == 31 then
    CheckSPAlignment();
    address = SP[];
else
    address = X[n];
data = Mem[address, 2, ldacctype];

result = data EOR value;
// All observers in the shareability domain observe the
// following load and store atomically.
Mem[address, 2, stacctype] = result;

X[t] = ZeroExtend(data, 32);
```

C6.2.94 LDEOR, LDEORA, LDEORAL, LDEORL

Atomic exclusive OR on word or doubleword in memory atomically loads a 32-bit word or 64-bit doubleword from memory, performs an exclusive OR with the value held in a register on it, and stores the result back to memory. The value initially loaded from memory is returned in the destination register.

- If the destination register is not one of WZR or XZR, LDEORA and LDEORAL load from memory with acquire semantics.
- LDEORL and LDEORAL store to memory with release semantics.
- LDEOR has no memory ordering requirements.

For more information about memory ordering semantics see [Load-Acquire, Store-Release](#) on page B2-94.

For information about memory accesses see [Load/Store addressing modes](#) on page C1-143.

ARMv8.1

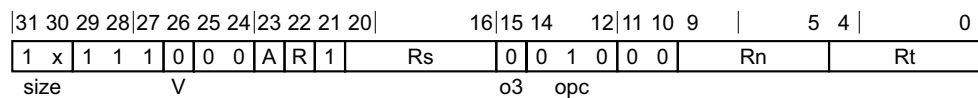

32-bit, acquire variant

Applies when size == 10 && A == 1 && R == 0.

LDEORA <Ws>, <Wt>, [<Xn|SP>]

32-bit, acquire and release variant

Applies when size == 10 && A == 1 && R == 1.

LDEORAL <Ws>, <Wt>, [<Xn|SP>]

32-bit, no memory ordering variant

Applies when size == 10 && A == 0 && R == 0 && Rt != 11111.

LDEOR <Ws>, <Wt>, [<Xn|SP>]

32-bit, release variant

Applies when size == 10 && A == 0 && R == 1 && Rt != 11111.

LDEORL <Ws>, <Wt>, [<Xn|SP>]

64-bit, acquire variant

Applies when size == 11 && A == 1 && R == 0.

LDEORA <Xs>, <Xt>, [<Xn|SP>]

64-bit, acquire and release variant

Applies when size == 11 && A == 1 && R == 1.

LDEORAL <Xs>, <Xt>, [<Xn|SP>]

64-bit, no memory ordering variant

Applies when size == 11 && A == 0 && R == 0 && Rt != 11111.

LDEOR <Xs>, <Xt>, [<Xn|SP>]

64-bit, release variant

Applies when size == 11 && A == 0 && R == 1 && Rt != 11111.

LDEORL <Xs>, <Xt>, [<Xn|SP>]

Decode for all variants of this encoding

```
if !HaveAtomicExt() then UnallocatedEncoding();
integer t = UInt(Rt);
integer n = UInt(Rn);
integer s = UInt(Rs);

integer datasize = 8 << UInt(size);
integer regsize = if datasize == 64 then 64 else 32;
AccType ldacctype = if A == '1' && Rt != '11111' then AccType_ORDEREDRW else AccType_ATOMICRW;
AccType stacctype = if R == '1' then AccType_ORDEREDRW else AccType_ATOMICRW;
```

Assembler symbols

- <Ws> Is the 32-bit name of the general-purpose register holding the data value to be operated on with the contents of the memory location, encoded in the "Rs" field.
- <Wt> Is the 32-bit name of the general-purpose register to be loaded, encoded in the "Rt" field.
- <Xs> Is the 64-bit name of the general-purpose register holding the data value to be operated on with the contents of the memory location, encoded in the "Rs" field.
- <Xt> Is the 64-bit name of the general-purpose register to be loaded, encoded in the "Rt" field.
- <Xn|SP> Is the 64-bit name of the general-purpose base register or stack pointer, encoded in the "Rn" field.

Operation

```
bits(64) address;
bits(datasize) value;
bits(datasize) data;
bits(datasize) result;

value = X[s];
if n == 31 then
    CheckSPAlignment();
    address = SP[];
else
    address = X[n];
data = Mem[address, datasize DIV 8, ldacctype];

result = data EOR value;
// All observers in the shareability domain observe the
// following load and store atomically.
Mem[address, datasize DIV 8, stacctype] = result;

X[t] = ZeroExtend(data, regsize);
```

C6.2.95 LDLARB

Load LOAcquire Register Byte loads a byte from memory, zero-extends it and writes it to a register. The instruction also has memory ordering semantics as described in *LoadLOAcquire, StoreLORelease* on page B2-95. For information about memory accesses, see *Load/Store addressing modes* on page C1-143.

ARMv8.1

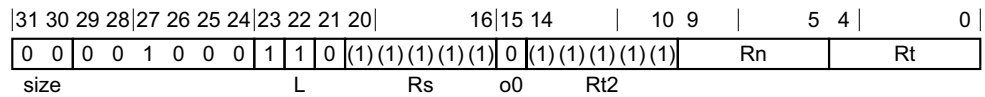

No offset variant

LDLARB <Wt>, [<Xn|SP>{, #0}]

Decode for this encoding

integer n = UInt(Rn);
 integer t = UInt(Rt);

Assembler symbols

<Wt> Is the 32-bit name of the general-purpose register to be transferred, encoded in the "Rt" field.

<Xn|SP> Is the 64-bit name of the general-purpose base register or stack pointer, encoded in the "Rn" field.

Operation

bits(64) address;
 bits(8) data;

```
if n == 31 then
    CheckSPAAlignment();
    address = SP[];
else
    address = X[n];
```

```
data = Mem[address, 1, AccType_LIMITEDORDERED];
X[t] = ZeroExtend(data, 32);
```

C6.2.96 LDLARH

Load LOAcquire Register Halfword loads a halfword from memory, zero-extends it, and writes it to a register. The instruction also has memory ordering semantics as described in *LoadLOAcquire, StoreLORelease* on page B2-95. For information about memory accesses, see *Load/Store addressing modes* on page C1-143.

ARMv8.1

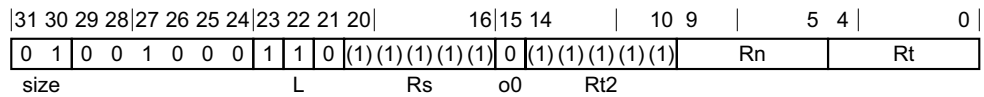

No offset variant

LDLARH <Wt>, [<Xn|SP>{, #0}]

Decode for this encoding

integer n = UInt(Rn);
 integer t = UInt(Rt);

Assembler symbols

<Wt> Is the 32-bit name of the general-purpose register to be transferred, encoded in the "Rt" field.

<Xn|SP> Is the 64-bit name of the general-purpose base register or stack pointer, encoded in the "Rn" field.

Operation

bits(64) address;
 bits(16) data;

```
if n == 31 then
    CheckSPAAlignment();
    address = SP[];
else
    address = X[n];
```

```
data = Mem[address, 2, AccType_LIMITEDORDERED];
X[t] = ZeroExtend(data, 32);
```

C6.2.97 LDLAR

Load LOAcquire Register loads a 32-bit word or 64-bit doubleword from memory, and writes it to a register. The instruction also has memory ordering semantics as described in *LoadLOAcquire, StoreLORelease* on page B2-95. For information about memory accesses, see *Load/Store addressing modes* on page C1-143.

ARMv8.1

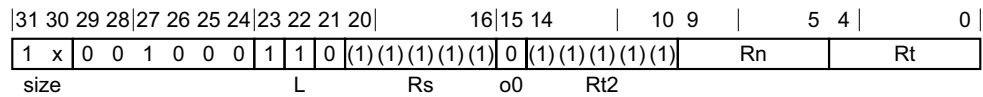

32-bit variant

Applies when size == 10.

LDLAR <Wt>, [<Xn|SP>{,#0}]

64-bit variant

Applies when size == 11.

LDLAR <Xt>, [<Xn|SP>{,#0}]

Decode for all variants of this encoding

```
integer n = UInt(Rn);
integer t = UInt(Rt);

integer elsize = 8 << UInt(size);
integer regsize = if elsize == 64 then 64 else 32;
```

Assembler symbols

<Wt> Is the 32-bit name of the general-purpose register to be transferred, encoded in the "Rt" field.

<Xt> Is the 64-bit name of the general-purpose register to be transferred, encoded in the "Rt" field.

<Xn|SP> Is the 64-bit name of the general-purpose base register or stack pointer, encoded in the "Rn" field.

Operation

```
bits(64) address;
bits(elsize) data;
constant integer dbytes = elsize DIV 8;

if n == 31 then
  CheckSPA1ignment();
  address = SP[];
else
  address = X[n];

data = Mem[address, dbytes, AccType_LIMITEDORDERED];
X[t] = ZeroExtend(data, regsize);
```

C6.2.98 LDNP

Load Pair of Registers, with non-temporal hint, calculates an address from a base register value and an immediate offset, loads two 32-bit words or two 64-bit doublewords from memory, and writes them to two registers.

For information about memory accesses, see [Load/Store addressing modes on page C1-143](#). For information about Non-temporal pair instructions, see [Load/Store Non-temporal Pair on page C3-163](#).

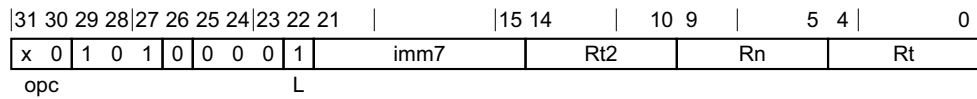

32-bit variant

Applies when `opc == 00`.

LDNP <Wt1>, <Wt2>, [<Xn|SP>{, #<imm>}]

64-bit variant

Applies when `opc == 10`.

LDNP <Xt1>, <Xt2>, [<Xn|SP>{, #<imm>}]

Decode for all variants of this encoding

// Empty.

Notes for all encodings

For information about the CONSTRAINED UNPREDICTABLE behavior of this instruction, see [Appendix K1 Architectural Constraints on UNPREDICTABLE behaviors](#), and particularly [LDNP on page K1-6125](#).

Assembler symbols

- <Wt1> Is the 32-bit name of the first general-purpose register to be transferred, encoded in the "Rt" field.
- <Wt2> Is the 32-bit name of the second general-purpose register to be transferred, encoded in the "Rt2" field.
- <Xt1> Is the 64-bit name of the first general-purpose register to be transferred, encoded in the "Rt" field.
- <Xt2> Is the 64-bit name of the second general-purpose register to be transferred, encoded in the "Rt2" field.
- <Xn|SP> Is the 64-bit name of the general-purpose base register or stack pointer, encoded in the "Rn" field.
- <imm> For the 32-bit variant: is the optional signed immediate byte offset, a multiple of 4 in the range -256 to 252, defaulting to 0 and encoded in the "imm7" field as <imm>/4.
 For the 64-bit variant: is the optional signed immediate byte offset, a multiple of 8 in the range -512 to 504, defaulting to 0 and encoded in the "imm7" field as <imm>/8.

Shared decode for all encodings

```
integer n = UInt(Rn);
integer t = UInt(Rt);
integer t2 = UInt(Rt2);
if opc<0> == '1' then UnallocatedEncoding();
```

```
integer scale = 2 + UInt(opc<1>);  
integer datasize = 8 << scale;  
bits(64) offset = LSL(SignExtend(imm7, 64), scale);
```

Operation

```
bits(64) address;  
bits(datasize) data1;  
bits(datasize) data2;  
constant integer dbytes = datasize DIV 8;  
boolean rt_unknown = FALSE;  
  
if t == t2 then  
    Constraint c = ConstrainUnpredictable();  
    assert c IN {Constraint_UNKNOWN, Constraint_UNDEF, Constraint_NOP};  
    case c of  
        when Constraint_UNKNOWN rt_unknown = TRUE;    // result is UNKNOWN  
        when Constraint_UNDEF   UnallocatedEncoding();  
        when Constraint_NOP     EndOfInstruction();  
  
if n == 31 then  
    CheckSPAlignment();  
    address = SP[];  
else  
    address = X[n];  
  
address = address + offset;  
  
data1 = Mem[address, dbytes, AccType_STREAM];  
data2 = Mem[address+dbytes, dbytes, AccType_STREAM];  
if rt_unknown then  
    data1 = bits(datasize) UNKNOWN;  
    data2 = bits(datasize) UNKNOWN;  
X[t] = data1;  
X[t2] = data2;
```

C6.2.99 LDP

Load Pair of Registers calculates an address from a base register value and an immediate offset, loads two 32-bit words or two 64-bit doublewords from memory, and writes them to two registers. For information about memory accesses, see [Load/Store addressing modes](#) on page C1-143.

Post-index

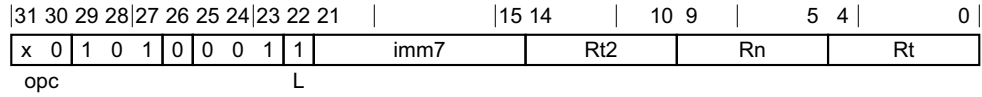

32-bit variant

Applies when `opc == 00`.

LDP <Wt1>, <Wt2>, [<Xn|SP>], #<imm>

64-bit variant

Applies when `opc == 10`.

LDP <Xt1>, <Xt2>, [<Xn|SP>], #<imm>

Decode for all variants of this encoding

```
boolean wback = TRUE;
boolean postindex = TRUE;
```

Pre-index

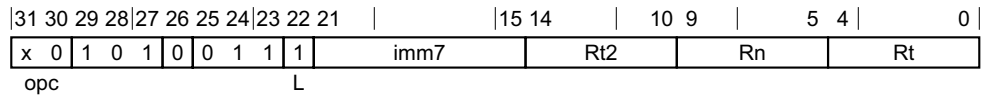

32-bit variant

Applies when `opc == 00`.

LDP <Wt1>, <Wt2>, [<Xn|SP>, #<imm>]!

64-bit variant

Applies when `opc == 10`.

LDP <Xt1>, <Xt2>, [<Xn|SP>, #<imm>]!

Decode for all variants of this encoding

```
boolean wback = TRUE;
boolean postindex = FALSE;
```

Signed offset

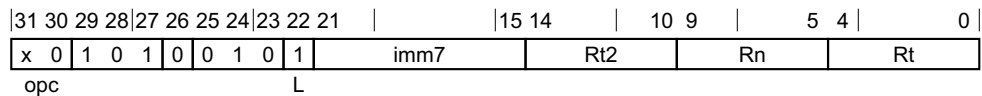

32-bit variant

Applies when `opc == 00`.

LDP <Wt1>, <Wt2>, [<Xn|SP>{, #<imm>}]

64-bit variant

Applies when `opc == 10`.

LDP <Xt1>, <Xt2>, [<Xn|SP>{, #<imm>}]

Decode for all variants of this encoding

```
boolean wback = FALSE;
boolean postindex = FALSE;
```

Notes for all encodings

For information about the CONSTRAINED UNPREDICTABLE behavior of this instruction, see [Appendix K1 Architectural Constraints on UNPREDICTABLE behaviors](#), and particularly [LDP on page K1-6125](#).

Assembler symbols

<Wt1>	Is the 32-bit name of the first general-purpose register to be transferred, encoded in the "Rt" field.
<Wt2>	Is the 32-bit name of the second general-purpose register to be transferred, encoded in the "Rt2" field.
<Xt1>	Is the 64-bit name of the first general-purpose register to be transferred, encoded in the "Rt" field.
<Xt2>	Is the 64-bit name of the second general-purpose register to be transferred, encoded in the "Rt2" field.
<Xn SP>	Is the 64-bit name of the general-purpose base register or stack pointer, encoded in the "Rn" field.
<imm>	For the 32-bit post-index and 32-bit pre-index variant: is the signed immediate byte offset, a multiple of 4 in the range -256 to 252, encoded in the "imm7" field as <imm>/4. For the 32-bit signed offset variant: is the optional signed immediate byte offset, a multiple of 4 in the range -256 to 252, defaulting to 0 and encoded in the "imm7" field as <imm>/4. For the 64-bit post-index and 64-bit pre-index variant: is the signed immediate byte offset, a multiple of 8 in the range -512 to 504, encoded in the "imm7" field as <imm>/8. For the 64-bit signed offset variant: is the optional signed immediate byte offset, a multiple of 8 in the range -512 to 504, defaulting to 0 and encoded in the "imm7" field as <imm>/8.

Shared decode for all encodings

```
integer n = UInt(Rn);
integer t = UInt(Rt);
integer t2 = UInt(Rt2);
if L:opc<0> == '01' || opc == '11' then UnallocatedEncoding();
boolean signed = (opc<0> != '0');
integer scale = 2 + UInt(opc<1>);
integer datasize = 8 << scale;
bits(64) offset = LSL(SignExtend(imm7, 64), scale);
```

Operation for all encodings

```
bits(64) address;
bits(datasize) data1;
bits(datasize) data2;
constant integer dbytes = datasize DIV 8;
```

```
boolean rt_unknown = FALSE;
boolean wb_unknown = FALSE;

if wback && (t == n || t2 == n) && n != 31 then
    Constraint c = ConstrainUnpredictable();
    assert c IN {Constraint_WBSUPPRESS, Constraint_UNKNOWN, Constraint_UNDEF, Constraint_NOP};
    case c of
        when Constraint_WBSUPPRESS wback = FALSE; // writeback is suppressed
        when Constraint_UNKNOWN wb_unknown = TRUE; // writeback is UNKNOWN
        when Constraint_UNDEF UnallocatedEncoding();
        when Constraint_NOP EndOfInstruction();

if t == t2 then
    Constraint c = ConstrainUnpredictable();
    assert c IN {Constraint_UNKNOWN, Constraint_UNDEF, Constraint_NOP};
    case c of
        when Constraint_UNKNOWN rt_unknown = TRUE; // result is UNKNOWN
        when Constraint_UNDEF UnallocatedEncoding();
        when Constraint_NOP EndOfInstruction();

if n == 31 then
    CheckSPAlignment();
    address = SP[];
else
    address = X[n];

if !postindex then
    address = address + offset;

data1 = Mem[address, dbytes, AccType_NORMAL];
data2 = Mem[address+dbytes, dbytes, AccType_NORMAL];
if rt_unknown then
    data1 = bits(datasize) UNKNOWN;
    data2 = bits(datasize) UNKNOWN;
if signed then
    X[t] = SignExtend(data1, 64);
    X[t2] = SignExtend(data2, 64);
else
    X[t] = data1;
    X[t2] = data2;

if wback then
    if wb_unknown then
        address = bits(64) UNKNOWN;
    elsif postindex then
        address = address + offset;
    if n == 31 then
        SP[] = address;
    else
        X[n] = address;
```

C6.2.100 LDPSW

Load Pair of Registers Signed Word calculates an address from a base register value and an immediate offset, loads two 32-bit words from memory, sign-extends them, and writes them to two registers. For information about memory accesses, see [Load/Store addressing modes](#) on page C1-143.

Post-index

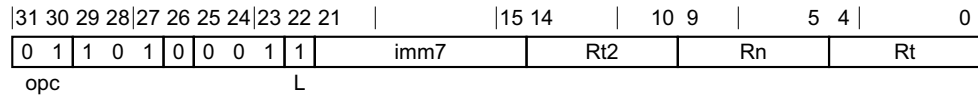

Post-index variant

LDPSW <Xt1>, <Xt2>, [<Xn|SP>], #<imm>

Decode for this encoding

boolean wback = TRUE;
 boolean postindex = TRUE;

Pre-index

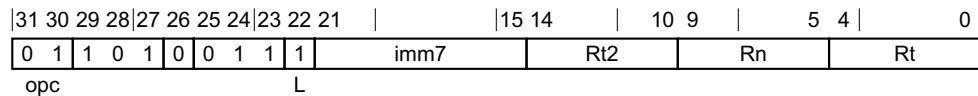

Pre-index variant

LDPSW <Xt1>, <Xt2>, [<Xn|SP>, #<imm>]!

Decode for this encoding

boolean wback = TRUE;
 boolean postindex = FALSE;

Signed offset

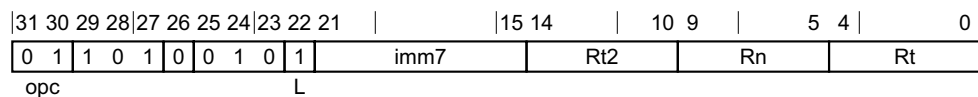

Signed offset variant

LDPSW <Xt1>, <Xt2>, [<Xn|SP>{, #<imm>}]

Decode for this encoding

boolean wback = FALSE;
 boolean postindex = FALSE;

Notes for all encodings

For information about the CONSTRAINED UNPREDICTABLE behavior of this instruction, see [Appendix K1 Architectural Constraints on UNPREDICTABLE behaviors](#), and particularly [LDPSW](#) on page K1-6126.

Assembler symbols

<Xt1>	Is the 64-bit name of the first general-purpose register to be transferred, encoded in the "Rt" field.
<Xt2>	Is the 64-bit name of the second general-purpose register to be transferred, encoded in the "Rt2" field.
<Xn SP>	Is the 64-bit name of the general-purpose base register or stack pointer, encoded in the "Rn" field.
<imm>	For the post-index and pre-index variant: is the signed immediate byte offset, a multiple of 4 in the range -256 to 252, encoded in the "imm7" field as <imm>/4. For the signed offset variant: is the optional signed immediate byte offset, a multiple of 4 in the range -256 to 252, defaulting to 0 and encoded in the "imm7" field as <imm>/4.

Shared decode for all encodings

```
integer n = UInt(Rn);
integer t = UInt(Rt);
integer t2 = UInt(Rt2);
bits(64) offset = LSL(SignExtend(imm7, 64), 2);
```

Operation for all encodings

```
bits(64) address;
bits(32) data1;
bits(32) data2;
boolean rt_unknown = FALSE;
boolean wb_unknown = FALSE;

if wback && (t == n || t2 == n) && n != 31 then
    Constraint c = ConstrainUnpredictable();
    assert c IN {Constraint_WBSUPPRESS, Constraint_UNKNOWN, Constraint_UNDEF, Constraint_NOP};
    case c of
        when Constraint_WBSUPPRESS wback = FALSE; // writeback is suppressed
        when Constraint_UNKNOWN wb_unknown = TRUE; // writeback is UNKNOWN
        when Constraint_UNDEF UnallocatedEncoding();
        when Constraint_NOP EndOfInstruction();

if t == t2 then
    Constraint c = ConstrainUnpredictable();
    assert c IN {Constraint_UNKNOWN, Constraint_UNDEF, Constraint_NOP};
    case c of
        when Constraint_UNKNOWN rt_unknown = TRUE; // result is UNKNOWN
        when Constraint_UNDEF UnallocatedEncoding();
        when Constraint_NOP EndOfInstruction();

if n == 31 then
    CheckSPAlignment();
    address = SP[];
else
    address = X[n];

if !postindex then
    address = address + offset;

data1 = Mem[address, 4, AccType_NORMAL];
data2 = Mem[address+4, 4, AccType_NORMAL];
if rt_unknown then
    data1 = bits(32) UNKNOWN;
    data2 = bits(32) UNKNOWN;
X[t] = SignExtend(data1, 64);
X[t2] = SignExtend(data2, 64);
if wback then
    if wb_unknown then
        address = bits(64) UNKNOWN;
```

```
elseif postindex then
    address = address + offset;
if n == 31 then
    SP[] = address;
else
    X[n] = address;
```

C6.2.101 LDR (immediate)

Load Register (immediate) loads a word or doubleword from memory and writes it to a register. The address that is used for the load is calculated from a base register and an immediate offset. For information about memory accesses, see [Load/Store addressing modes on page C1-143](#). The Unsigned offset variant scales the immediate offset value by the size of the value accessed before adding it to the base register value.

Post-index



32-bit variant

Applies when size == 10.

LDR <Wt>, [<Xn|SP>], #<sim>

64-bit variant

Applies when size == 11.

LDR <Xt>, [<Xn|SP>], #<sim>

Decode for all variants of this encoding

```
boolean wback = TRUE;
boolean postindex = TRUE;
integer scale = UInt(size);
bits(64) offset = SignExtend(imm9, 64);
```

Pre-index

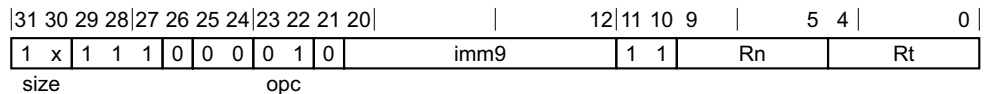

32-bit variant

Applies when size == 10.

LDR <Wt>, [<Xn|SP>, #<sim>]!

64-bit variant

Applies when size == 11.

LDR <Xt>, [<Xn|SP>, #<sim>]!

Decode for all variants of this encoding

```
boolean wback = TRUE;
boolean postindex = FALSE;
integer scale = UInt(size);
bits(64) offset = SignExtend(imm9, 64);
```

Unsigned offset



32-bit variant

Applies when size == 10.

LDR <Wt>, [<Xn|SP>{, #<pimm>}]

64-bit variant

Applies when size == 11.

LDR <Xt>, [<Xn|SP>{, #<pimm>}]

Decode for all variants of this encoding

```
boolean wback = FALSE;
boolean postindex = FALSE;
integer scale = UInt(size);
bits(64) offset = LSL(ZeroExtend(imm12, 64), scale);
```

Notes for all encodings

For information about the CONSTRAINED UNPREDICTABLE behavior of this instruction, see [Appendix K1 Architectural Constraints on UNPREDICTABLE behaviors](#), and particularly [LDR \(immediate\)](#) on page K1-6126.

Assembler symbols

<Wt>	Is the 32-bit name of the general-purpose register to be transferred, encoded in the "Rt" field.
<Xt>	Is the 64-bit name of the general-purpose register to be transferred, encoded in the "Rt" field.
<Xn SP>	Is the 64-bit name of the general-purpose base register or stack pointer, encoded in the "Rn" field.
<sim>	Is the signed immediate byte offset, in the range -256 to 255, encoded in the "imm9" field.
<pimm>	For the 32-bit variant: is the optional positive immediate byte offset, a multiple of 4 in the range 0 to 16380, defaulting to 0 and encoded in the "imm12" field as <pimm>/4. For the 64-bit variant: is the optional positive immediate byte offset, a multiple of 8 in the range 0 to 32760, defaulting to 0 and encoded in the "imm12" field as <pimm>/8.

Shared decode for all encodings

```
integer n = UInt(Rn);
integer t = UInt(Rt);
integer regsize;

regsize = if size == '11' then 64 else 32;
integer datasize = 8 << scale;
```

Operation for all encodings

```
bits(64) address;
bits(datasize) data;
boolean wb_unknown = FALSE;

if wback && n == t && n != 31 then
    c = ConstrainUnpredictable();
```

```
assert c IN {Constraint_WBSUPPRESS, Constraint_UNKNOWN, Constraint_UNDEF, Constraint_NOP};
case c of
  when Constraint_WBSUPPRESS wback = FALSE;    // writeback is suppressed
  when Constraint_UNKNOWN   wb_unknown = TRUE; // writeback is UNKNOWN
  when Constraint_UNDEF     UnallocatedEncoding();
  when Constraint_NOP       EndOfInstruction();

if n == 31 then
  CheckSPAlignment();
  address = SP[];
else
  address = X[n];

if !postindex then
  address = address + offset;

data = Mem[address, datasize DIV 8, AccType_NORMAL];
X[t] = ZeroExtend(data, regsize);

if wback then
  if wb_unknown then
    address = bits(64) UNKNOWN;
  elsif postindex then
    address = address + offset;
  if n == 31 then
    SP[] = address;
  else
    X[n] = address;
```

C6.2.102 LDR (literal)

Load Register (literal) calculates an address from the PC value and an immediate offset, loads a word from memory, and writes it to a register. For information about memory accesses, see [Load/Store addressing modes](#) on page C1-143.



32-bit variant

Applies when `opc == 00`.

LDR <Wt>, <label>

64-bit variant

Applies when `opc == 01`.

LDR <Xt>, <label>

Decode for all variants of this encoding

```
integer t = UInt(Rt);
MemOp memop = MemOp_LOAD;
boolean signed = FALSE;
integer size;
bits(64) offset;

case opc of
  when '00'
    size = 4;
  when '01'
    size = 8;
  when '10'
    size = 4;
    signed = TRUE;
  when '11'
    memop = MemOp_PREFETCH;

offset = SignExtend(imm19:'00', 64);
```

Assembler symbols

<Wt> Is the 32-bit name of the general-purpose register to be loaded, encoded in the "Rt" field.

<Xt> Is the 64-bit name of the general-purpose register to be loaded, encoded in the "Rt" field.

<label> Is the program label from which the data is to be loaded. Its offset from the address of this instruction, in the range +/-1MB, is encoded as "imm19" times 4.

Operation

```
bits(64) address = PC[] + offset;
bits(size*8) data;

case memop of
  when MemOp_LOAD
    data = Mem[address, size, AccType_NORMAL];
    if signed then
```

```
        X[t] = SignExtend(data, 64);  
    else  
        X[t] = data;  
when MemOp_PREFETCH  
    Prefetch(address, t<4:0>);
```

C6.2.103 LDR (register)

Load Register (register) calculates an address from a base register value and an offset register value, loads a word from memory, and writes it to a register. The offset register value can optionally be shifted and extended. For information about memory accesses, see [Load/Store addressing modes](#) on page C1-143.

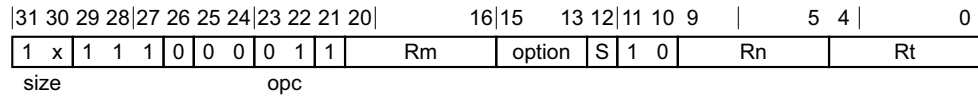

32-bit variant

Applies when size == 10.

```
LDR <Wt>, [<Xn|SP>, (<Wm>|<Xm>){, <extend> {<amount>}}]
```

64-bit variant

Applies when size == 11.

```
LDR <Xt>, [<Xn|SP>, (<Wm>|<Xm>){, <extend> {<amount>}}]
```

Decode for all variants of this encoding

```
integer scale = UInt(size);
if option<1> == '0' then UnallocatedEncoding(); // sub-word index
ExtendType extend_type = DecodeRegExtend(option);
integer shift = if S == '1' then scale else 0;
```

Assembler symbols

<Wt>	Is the 32-bit name of the general-purpose register to be transferred, encoded in the "Rt" field.								
<Xt>	Is the 64-bit name of the general-purpose register to be transferred, encoded in the "Rt" field.								
<Xn SP>	Is the 64-bit name of the general-purpose base register or stack pointer, encoded in the "Rn" field.								
<Wm>	When option<0> is set to 0, is the 32-bit name of the general-purpose index register, encoded in the "Rm" field.								
<Xm>	When option<0> is set to 1, is the 64-bit name of the general-purpose index register, encoded in the "Rm" field.								
<extend>	Is the index extend/shift specifier, defaulting to LSL, and which must be omitted for the LSL option when <amount> is omitted. encoded in the "option" field. It can have the following values: <table style="margin-left: 20px; border-collapse: collapse;"> <tr><td>UXTW</td><td>when option = 010</td></tr> <tr><td>LSL</td><td>when option = 011</td></tr> <tr><td>SXTW</td><td>when option = 110</td></tr> <tr><td>SXTX</td><td>when option = 111</td></tr> </table>	UXTW	when option = 010	LSL	when option = 011	SXTW	when option = 110	SXTX	when option = 111
UXTW	when option = 010								
LSL	when option = 011								
SXTW	when option = 110								
SXTX	when option = 111								
<amount>	For the 32-bit variant: is the index shift amount, optional only when <extend> is not LSL. Where it is permitted to be optional, it defaults to #0. It is encoded in the "S" field. It can have the following values: <table style="margin-left: 20px; border-collapse: collapse;"> <tr><td>#0</td><td>when S = 0</td></tr> <tr><td>#2</td><td>when S = 1</td></tr> </table>	#0	when S = 0	#2	when S = 1				
#0	when S = 0								
#2	when S = 1								

For the 64-bit variant: is the index shift amount, optional only when <extend> is not LSL. Where it is permitted to be optional, it defaults to #0. It is encoded in the "S" field. It can have the following values:

#0 when S = 0
#3 when S = 1

Shared decode for all encodings

```
integer n = UInt(Rn);  
integer t = UInt(Rt);  
integer m = UInt(Rm);  
integer regsize;  
  
regsize = if size == '11' then 64 else 32;  
integer datasize = 8 << scale;
```

Operation

```
bits(64) offset = ExtendReg(m, extend_type, shift);  
bits(64) address;  
bits(datasize) data;  
  
if n == 31 then  
    CheckSPAlignment();  
    address = SP[];  
else  
    address = X[n];  
  
address = address + offset;  
  
data = Mem[address, datasize DIV 8, AccType_NORMAL];  
X[t] = ZeroExtend(data, regsize);
```

C6.2.104 LDRB (immediate)

Load Register Byte (immediate) loads a byte from memory, zero-extends it, and writes the result to a register. The address that is used for the load is calculated from a base register and an immediate offset. For information about memory accesses, see [Load/Store addressing modes](#) on page C1-143.

Post-index

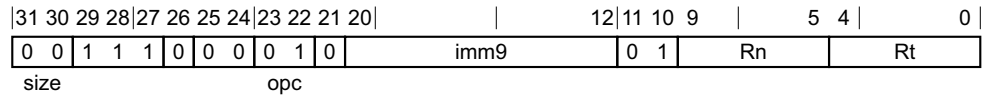

Post-index variant

LDRB <Wt>, [<Xn|SP>], #<imm>

Decode for this encoding

```
boolean wback = TRUE;
boolean postindex = TRUE;
bits(64) offset = SignExtend(imm9, 64);
```

Pre-index

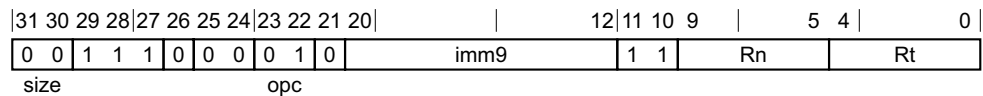

Pre-index variant

LDRB <Wt>, [<Xn|SP>, #<imm>]!

Decode for this encoding

```
boolean wback = TRUE;
boolean postindex = FALSE;
bits(64) offset = SignExtend(imm9, 64);
```

Unsigned offset

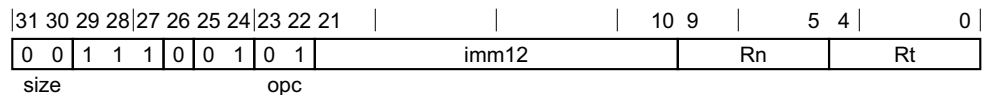

Unsigned offset variant

LDRB <Wt>, [<Xn|SP>{, #<pimm>}]

Decode for this encoding

```
boolean wback = FALSE;
boolean postindex = FALSE;
bits(64) offset = LSL(ZeroExtend(imm12, 64), 0);
```

Notes for all encodings

For information about the CONSTRAINED UNPREDICTABLE behavior of this instruction, see [Appendix K1 Architectural Constraints on UNPREDICTABLE behaviors](#), and particularly *LDRB (immediate)* on page K1-6127.

Assembler symbols

<Rt>	Is the 32-bit name of the general-purpose register to be transferred, encoded in the "Rt" field.
<Xn SP>	Is the 64-bit name of the general-purpose base register or stack pointer, encoded in the "Rn" field.
<sim>	Is the signed immediate byte offset, in the range -256 to 255, encoded in the "imm9" field.
<pi>	Is the optional positive immediate byte offset, in the range 0 to 4095, defaulting to 0 and encoded in the "imm12" field.

Shared decode for all encodings

```
integer n = UInt(Rn);  
integer t = UInt(Rt);
```

Operation for all encodings

```
bits(64) address;  
bits(8) data;  
boolean wb_unknown = FALSE;  
  
if wback && n == t && n != 31 then  
    c = ConstrainUnpredictable();  
    assert c IN {Constraint_WBSUPPRESS, Constraint_UNKNOWN, Constraint_UNDEF, Constraint_NOP};  
    case c of  
        when Constraint_WBSUPPRESS wback = FALSE; // writeback is suppressed  
        when Constraint_UNKNOWN wb_unknown = TRUE; // writeback is UNKNOWN  
        when Constraint_UNDEF UnallocatedEncoding();  
        when Constraint_NOP EndOfInstruction();  
  
if n == 31 then  
    CheckSPAlignment();  
    address = SP[];  
else  
    address = X[n];  
  
if !postindex then  
    address = address + offset;  
  
data = Mem[address, 1, AccType_NORMAL];  
X[t] = ZeroExtend(data, 32);  
  
if wback then  
    if wb_unknown then  
        address = bits(64) UNKNOWN;  
    elseif postindex then  
        address = address + offset;  
    if n == 31 then  
        SP[] = address;  
    else  
        X[n] = address;
```

C6.2.105 LDRB (register)

Load Register Byte (register) calculates an address from a base register value and an offset register value, loads a byte from memory, zero-extends it, and writes it to a register. For information about memory accesses, see [Load/Store addressing modes on page C1-143](#).

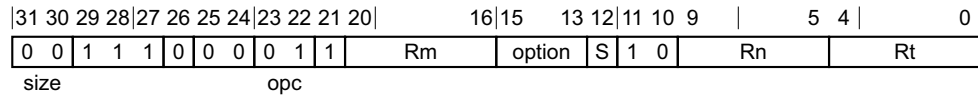

Extended register variant

Applies when option != 011.

LDRB <Wt>, [<Xn|SP>, (<Wm>|<Xm>), <extend> {<amount>}]

Shifted register variant

Applies when option == 011.

LDRB <Wt>, [<Xn|SP>, <Xm>{, LSL <amount>}]

Decode for all variants of this encoding

```
if option<1> == '0' then UnallocatedEncoding(); // sub-word index
ExtendType extend_type = DecodeRegExtend(option);
```

Assembler symbols

- <Wt> Is the 32-bit name of the general-purpose register to be transferred, encoded in the "Rt" field.
- <Xn|SP> Is the 64-bit name of the general-purpose base register or stack pointer, encoded in the "Rn" field.
- <Wm> When option<0> is set to 0, is the 32-bit name of the general-purpose index register, encoded in the "Rm" field.
- <Xm> When option<0> is set to 1, is the 64-bit name of the general-purpose index register, encoded in the "Rm" field.
- <extend> Is the index extend specifier, encoded in the "option" field. It can have the following values:
 - UXTW when option = 010
 - SXTW when option = 110
 - SXTX when option = 111
- <amount> Is the index shift amount, it must be #0, encoded in "S" as 0 if omitted, or as 1 if present.

Shared decode for all encodings

```
integer n = UInt(Rn);
integer t = UInt(Rt);
integer m = UInt(Rm);
```

Operation

```
bits(64) offset = ExtendReg(m, extend_type, 0);
bits(64) address;
bits(8) data;
```

```
if n == 31 then
    CheckSPAlignment();
    address = SP[];
else
    address = X[n];

address = address + offset;

data = Mem[address, 1, AccType_NORMAL];
X[t] = ZeroExtend(data, 32);
```

C6.2.106 LDRH (immediate)

Load Register Halfword (immediate) loads a halfword from memory, zero-extends it, and writes the result to a register. The address that is used for the load is calculated from a base register and an immediate offset. For information about memory accesses, see *Load/Store addressing modes* on page C1-143.

Post-index

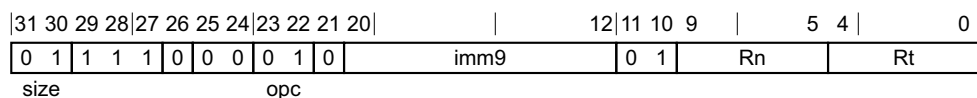

Post-index variant

LDRH <Wt>, [<Xn|SP>], #<imm>

Decode for this encoding

```
boolean wback = TRUE;
boolean postindex = TRUE;
bits(64) offset = SignExtend(imm9, 64);
```

Pre-index

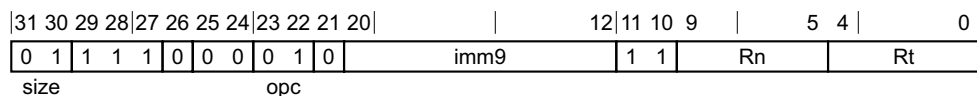

Pre-index variant

LDRH <Wt>, [<Xn|SP>, #<imm>]!

Decode for this encoding

```
boolean wback = TRUE;
boolean postindex = FALSE;
bits(64) offset = SignExtend(imm9, 64);
```

Unsigned offset

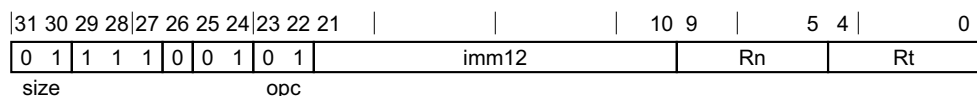

Unsigned offset variant

LDRH <Wt>, [<Xn|SP>{, #<pimm>}]

Decode for this encoding

```
boolean wback = FALSE;
boolean postindex = FALSE;
bits(64) offset = LSL(ZeroExtend(imm12, 64), 1);
```

Notes for all encodings

For information about the CONSTRAINED UNPREDICTABLE behavior of this instruction, see [Appendix K1 Architectural Constraints on UNPREDICTABLE behaviors](#), and particularly *LDRH (immediate)* on page K1-6127.

Assembler symbols

<Rt>	Is the 32-bit name of the general-purpose register to be transferred, encoded in the "Rt" field.
<Xn SP>	Is the 64-bit name of the general-purpose base register or stack pointer, encoded in the "Rn" field.
<sim>	Is the signed immediate byte offset, in the range -256 to 255, encoded in the "imm9" field.
<pimm>	Is the optional positive immediate byte offset, a multiple of 2 in the range 0 to 8190, defaulting to 0 and encoded in the "imm12" field as <pimm>/2.

Shared decode for all encodings

```
integer n = UInt(Rn);
integer t = UInt(Rt);
```

Operation for all encodings

```
bits(64) address;
bits(16) data;
boolean wb_unknown = FALSE;

if wback && n == t && n != 31 then
    c = ConstrainUnpredictable();
    assert c IN {Constraint_WBSUPPRESS, Constraint_UNKNOWN, Constraint_UNDEF, Constraint_NOP};
    case c of
        when Constraint_WBSUPPRESS wback = FALSE; // writeback is suppressed
        when Constraint_UNKNOWN wb_unknown = TRUE; // writeback is UNKNOWN
        when Constraint_UNDEF UnallocatedEncoding();
        when Constraint_NOP EndOfInstruction();

if n == 31 then
    CheckSPAlignment();
    address = SP[];
else
    address = X[n];

if !postindex then
    address = address + offset;

data = Mem[address, 2, AccType_NORMAL];
X[t] = ZeroExtend(data, 32);

if wback then
    if wb_unknown then
        address = bits(64) UNKNOWN;
    elseif postindex then
        address = address + offset;
    if n == 31 then
        SP[] = address;
    else
        X[n] = address;
```

C6.2.107 LDRH (register)

Load Register Halfword (register) calculates an address from a base register value and an offset register value, loads a halfword from memory, zero-extends it, and writes it to a register. For information about memory accesses, see [Load/Store addressing modes on page C1-143](#).

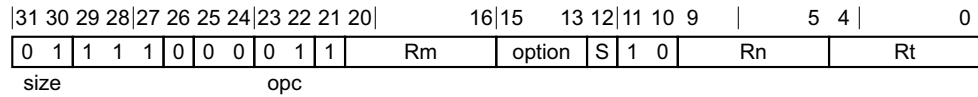

32-bit variant

LDRH <Wt>, [<Xn|SP>, (<Wm>|<Xm>){}, <extend> {<amount>}]

Decode for this encoding

```
if option<1> == '0' then UnallocatedEncoding(); // sub-word index
ExtendType extend_type = DecodeRegExtend(option);
integer shift = if S == '1' then 1 else 0;
```

Notes for all encodings

For information about the CONSTRAINED UNPREDICTABLE behavior of this instruction, see [Appendix K1 Architectural Constraints on UNPREDICTABLE behaviors](#).

Assembler symbols

<Wt>	Is the 32-bit name of the general-purpose register to be transferred, encoded in the "Rt" field.
<Xn SP>	Is the 64-bit name of the general-purpose base register or stack pointer, encoded in the "Rn" field.
<Wm>	When option<0> is set to 0, is the 32-bit name of the general-purpose index register, encoded in the "Rm" field.
<Xm>	When option<0> is set to 1, is the 64-bit name of the general-purpose index register, encoded in the "Rm" field.
<extend>	Is the index extend/shift specifier, defaulting to LSL, and which must be omitted for the LSL option when <amount> is omitted. encoded in the "option" field. It can have the following values:
UXTW	when option = 010
LSL	when option = 011
SXTW	when option = 110
SXTX	when option = 111
<amount>	Is the index shift amount, optional only when <extend> is not LSL. Where it is permitted to be optional, it defaults to #0. It is encoded in the "S" field. It can have the following values:
#0	when S = 0
#1	when S = 1

Shared decode for all encodings

```
integer n = UInt(Rn);
integer t = UInt(Rt);
integer m = UInt(Rm);
```

Operation

```
bits(64) offset = ExtendReg(m, extend_type, shift);
bits(64) address;
bits(16) data;

if n == 31 then
    CheckSPAlignment();
    address = SP[];
else
    address = X[n];

address = address + offset;

data = Mem[address, 2, AccType_NORMAL];
X[t] = ZeroExtend(data, 32);
```

C6.2.108 LDRSB (immediate)

Load Register Signed Byte (immediate) loads a byte from memory, sign-extends it to either 32 bits or 64 bits, and writes the result to a register. The address that is used for the load is calculated from a base register and an immediate offset. For information about memory accesses, see [Load/Store addressing modes](#) on page C1-143.

Post-index

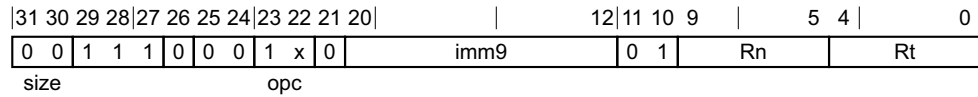

32-bit variant

Applies when `opc == 11`.

LDRSB <Wt>, [<Xn|SP>], #<sim>

64-bit variant

Applies when `opc == 10`.

LDRSB <Xt>, [<Xn|SP>], #<sim>

Decode for all variants of this encoding

```
boolean wback = TRUE;
boolean postindex = TRUE;
bits(64) offset = SignExtend(imm9, 64);
```

Pre-index

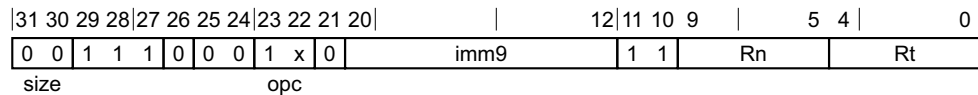

32-bit variant

Applies when `opc == 11`.

LDRSB <Wt>, [<Xn|SP>, #<sim>]!

64-bit variant

Applies when `opc == 10`.

LDRSB <Xt>, [<Xn|SP>, #<sim>]!

Decode for all variants of this encoding

```
boolean wback = TRUE;
boolean postindex = FALSE;
bits(64) offset = SignExtend(imm9, 64);
```

Unsigned offset



32-bit variant

Applies when `opc == 11`.

```
LDRSB <Wt>, [<Xn|SP>{, #<pimm>}]
```

64-bit variant

Applies when `opc == 10`.

```
LDRSB <Xt>, [<Xn|SP>{, #<pimm>}]
```

Decode for all variants of this encoding

```
boolean wback = FALSE;  
boolean postindex = FALSE;  
bits(64) offset = LSL(ZeroExtend(imm12, 64), 0);
```

Notes for all encodings

For information about the CONSTRAINED UNPREDICTABLE behavior of this instruction, see [Appendix K1 Architectural Constraints on UNPREDICTABLE behaviors](#), and particularly *LDRSB (immediate)* on page K1-6127.

Assembler symbols

<Wt> Is the 32-bit name of the general-purpose register to be transferred, encoded in the "Rt" field.

<Xt> Is the 64-bit name of the general-purpose register to be transferred, encoded in the "Rt" field.

<Xn|SP> Is the 64-bit name of the general-purpose base register or stack pointer, encoded in the "Rn" field.

<sim> Is the signed immediate byte offset, in the range -256 to 255, encoded in the "imm9" field.

<pimm> Is the optional positive immediate byte offset, in the range 0 to 4095, defaulting to 0 and encoded in the "imm12" field.

Shared decode for all encodings

```
integer n = UInt(Rn);  
integer t = UInt(Rt);  
MemOp memop;  
boolean signed;  
integer regsize;  
  
if opc<1> == '0' then  
    // store or zero-extending load  
    memop = if opc<0> == '1' then MemOp_LOAD else MemOp_STORE;  
    regsize = 32;  
    signed = FALSE;  
else  
    // sign-extending load  
    memop = MemOp_LOAD;  
    regsize = if opc<0> == '1' then 32 else 64;  
    signed = TRUE;
```

Operation for all encodings

```
bits(64) address;  
bits(8) data;  
boolean wb_unknown = FALSE;  
boolean rt_unknown = FALSE;  
  
if memop == MemOp_LOAD && wback && n == t && n != 31 then  
    c = ConstrainUnpredictable();  
    assert c IN {Constraint_WBSUPPRESS, Constraint_UNKNOWN, Constraint_UNDEF, Constraint_NOP};
```

```

case c of
  when Constraint_WBSUPPRESS wback = FALSE; // writeback is suppressed
  when Constraint_UNKNOWN wb_unknown = TRUE; // writeback is UNKNOWN
  when Constraint_UNDEF UnallocatedEncoding();
  when Constraint_NOP EndOfInstruction();

if memop == MemOp_STORE && wback && n == t && n != 31 then
  c = ConstrainUnpredictable();
  assert c IN {Constraint_NONE, Constraint_UNKNOWN, Constraint_UNDEF, Constraint_NOP};
  case c of
    when Constraint_NONE rt_unknown = FALSE; // value stored is original value
    when Constraint_UNKNOWN rt_unknown = TRUE; // value stored is UNKNOWN
    when Constraint_UNDEF UnallocatedEncoding();
    when Constraint_NOP EndOfInstruction();

if n == 31 then
  if memop != MemOp_PREFETCH then CheckSPAlignment();
  address = SP[];
else
  address = X[n];

if !postindex then
  address = address + offset;

case memop of
  when MemOp_STORE
    if rt_unknown then
      data = bits(8) UNKNOWN;
    else
      data = X[t];
      Mem[address, 1, AccType_NORMAL] = data;

  when MemOp_LOAD
    data = Mem[address, 1, AccType_NORMAL];
    if signed then
      X[t] = SignExtend(data, regsize);
    else
      X[t] = ZeroExtend(data, regsize);

  when MemOp_PREFETCH
    Prefetch(address, t<4:0>);

if wback then
  if wb_unknown then
    address = bits(64) UNKNOWN;
  elsif postindex then
    address = address + offset;
  if n == 31 then
    SP[] = address;
  else
    X[n] = address;

```

C6.2.109 LDRSB (register)

Load Register Signed Byte (register) calculates an address from a base register value and an offset register value, loads a byte from memory, sign-extends it, and writes it to a register. For information about memory accesses, see [Load/Store addressing modes on page C1-143](#).

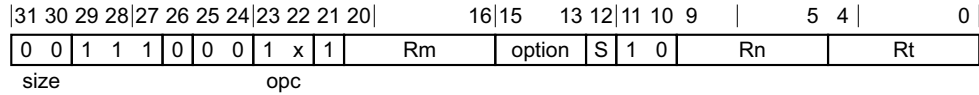

32-bit with extended register offset variant

Applies when `opc == 11` && `option != 011`.

LDRSB <Wt>, [<Xn|SP>, (<Wm>|<Xm>), <extend> {<amount>}]

32-bit with shifted register offset variant

Applies when `opc == 11` && `option == 011`.

LDRSB <Wt>, [<Xn|SP>, <Xm>{, LSL <amount>}]

64-bit with extended register offset variant

Applies when `opc == 10` && `option != 011`.

LDRSB <Xt>, [<Xn|SP>, (<Wm>|<Xm>), <extend> {<amount>}]

64-bit with shifted register offset variant

Applies when `opc == 10` && `option == 011`.

LDRSB <Xt>, [<Xn|SP>, <Xm>{, LSL <amount>}]

Decode for all variants of this encoding

```
if option<1> == '0' then UnallocatedEncoding(); // sub-word index
ExtendType extend_type = DecodeRegExtend(option);
```

Assembler symbols

- <Wt> Is the 32-bit name of the general-purpose register to be transferred, encoded in the "Rt" field.
- <Xt> Is the 64-bit name of the general-purpose register to be transferred, encoded in the "Rt" field.
- <Xn|SP> Is the 64-bit name of the general-purpose base register or stack pointer, encoded in the "Rn" field.
- <Wm> When `option<0>` is set to 0, is the 32-bit name of the general-purpose index register, encoded in the "Rm" field.
- <Xm> When `option<0>` is set to 1, is the 64-bit name of the general-purpose index register, encoded in the "Rm" field.
- <extend> Is the index extend specifier, encoded in the "option" field. It can have the following values:
 - UXTW when `option = 010`
 - SXTW when `option = 110`
 - SXTX when `option = 111`
- <amount> Is the index shift amount, it must be #0, encoded in "S" as 0 if omitted, or as 1 if present.

Shared decode for all encodings

```

integer n = UInt(Rn);
integer t = UInt(Rt);
integer m = UInt(Rm);
MemOp memop;
boolean signed;
integer regsize;

if opc<1> == '0' then
  // store or zero-extending load
  memop = if opc<0> == '1' then MemOp_LOAD else MemOp_STORE;
  regsize = 32;
  signed = FALSE;
else
  // sign-extending load
  memop = MemOp_LOAD;
  regsize = if opc<0> == '1' then 32 else 64;
  signed = TRUE;

```

Operation

```

bits(64) offset = ExtendReg(m, extend_type, 0);
bits(64) address;
bits(8) data;

if n == 31 then
  if memop != MemOp_PREFETCH then CheckSPAlignment();
  address = SP[];
else
  address = X[n];

address = address + offset;

case memop of
  when MemOp_STORE
    data = X[t];
    Mem[address, 1, AccType_NORMAL] = data;

  when MemOp_LOAD
    data = Mem[address, 1, AccType_NORMAL];
    if signed then
      X[t] = SignExtend(data, regsize);
    else
      X[t] = ZeroExtend(data, regsize);

  when MemOp_PREFETCH
    Prefetch(address, t<4:0>);

```

C6.2.110 LDRSH (immediate)

Load Register Signed Halfword (immediate) loads a halfword from memory, sign-extends it to 32 bits or 64 bits, and writes the result to a register. The address that is used for the load is calculated from a base register and an immediate offset. For information about memory accesses, see [Load/Store addressing modes](#) on page C1-143.

Post-index

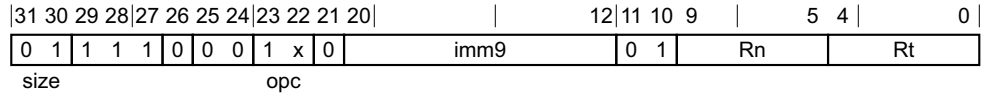

32-bit variant

Applies when `opc == 11`.

LDRSH <Wt>, [<Xn|SP>], #<sim>

64-bit variant

Applies when `opc == 10`.

LDRSH <Xt>, [<Xn|SP>], #<sim>

Decode for all variants of this encoding

```
boolean wback = TRUE;
boolean postindex = TRUE;
bits(64) offset = SignExtend(imm9, 64);
```

Pre-index



32-bit variant

Applies when `opc == 11`.

LDRSH <Wt>, [<Xn|SP>, #<sim>]!

64-bit variant

Applies when `opc == 10`.

LDRSH <Xt>, [<Xn|SP>, #<sim>]!

Decode for all variants of this encoding

```
boolean wback = TRUE;
boolean postindex = FALSE;
bits(64) offset = SignExtend(imm9, 64);
```

Unsigned offset

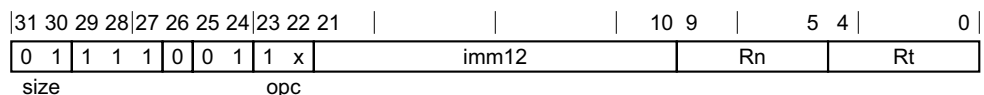

32-bit variant

Applies when `opc == 11`.

```
LDRSH <Wt>, [<Xn|SP>{, #<pimm>}]
```

64-bit variant

Applies when `opc == 10`.

```
LDRSH <Xt>, [<Xn|SP>{, #<pimm>}]
```

Decode for all variants of this encoding

```
boolean wback = FALSE;
boolean postindex = FALSE;
bits(64) offset = LSL(ZeroExtend(imm12, 64), 1);
```

Notes for all encodings

For information about the CONSTRAINED UNPREDICTABLE behavior of this instruction, see [Appendix K1 Architectural Constraints on UNPREDICTABLE behaviors](#), and particularly *LDRSH (immediate)* on [page K1-6128](#).

Assembler symbols

<Wt>	Is the 32-bit name of the general-purpose register to be transferred, encoded in the "Rt" field.
<Xt>	Is the 64-bit name of the general-purpose register to be transferred, encoded in the "Rt" field.
<Xn SP>	Is the 64-bit name of the general-purpose base register or stack pointer, encoded in the "Rn" field.
<sim>	Is the signed immediate byte offset, in the range -256 to 255, encoded in the "imm9" field.
<pimm>	Is the optional positive immediate byte offset, a multiple of 2 in the range 0 to 8190, defaulting to 0 and encoded in the "imm12" field as <pimm>/2.

Shared decode for all encodings

```
integer n = UInt(Rn);
integer t = UInt(Rt);
MemOp memop;
boolean signed;
integer regsize;

if opc<1> == '0' then
  // store or zero-extending load
  memop = if opc<0> == '1' then MemOp_LOAD else MemOp_STORE;
  regsize = 32;
  signed = FALSE;
else
  // sign-extending load
  memop = MemOp_LOAD;
  regsize = if opc<0> == '1' then 32 else 64;
  signed = TRUE;
```

Operation for all encodings

```
bits(64) address;
bits(16) data;
boolean wb_unknown = FALSE;
boolean rt_unknown = FALSE;

if memop == MemOp_LOAD && wback && n == t && n != 31 then
  c = ConstrainUnpredictable();
```

```
assert c IN {Constraint_WBSUPPRESS, Constraint_UNKNOWN, Constraint_UNDEF, Constraint_NOP};
case c of
  when Constraint_WBSUPPRESS wback = FALSE; // writeback is suppressed
  when Constraint_UNKNOWN wb_unknown = TRUE; // writeback is UNKNOWN
  when Constraint_UNDEF UnallocatedEncoding();
  when Constraint_NOP EndOfInstruction();

if memop == MemOp_STORE && wback && n == t && n != 31 then
  c = ConstrainUnpredictable();
  assert c IN {Constraint_NONE, Constraint_UNKNOWN, Constraint_UNDEF, Constraint_NOP};
  case c of
    when Constraint_NONE rt_unknown = FALSE; // value stored is original value
    when Constraint_UNKNOWN rt_unknown = TRUE; // value stored is UNKNOWN
    when Constraint_UNDEF UnallocatedEncoding();
    when Constraint_NOP EndOfInstruction();

if n == 31 then
  if memop != MemOp_PREFETCH then CheckSPAlignment();
  address = SP[];
else
  address = X[n];

if !postindex then
  address = address + offset;

case memop of
  when MemOp_STORE
    if rt_unknown then
      data = bits(16) UNKNOWN;
    else
      data = X[t];
      Mem[address, 2, AccType_NORMAL] = data;

  when MemOp_LOAD
    data = Mem[address, 2, AccType_NORMAL];
    if signed then
      X[t] = SignExtend(data, regsize);
    else
      X[t] = ZeroExtend(data, regsize);

  when MemOp_PREFETCH
    Prefetch(address, t<4:0>);

if wback then
  if wb_unknown then
    address = bits(64) UNKNOWN;
  elsif postindex then
    address = address + offset;
  if n == 31 then
    SP[] = address;
  else
    X[n] = address;
```

C6.2.111 LDRSH (register)

Load Register Signed Halfword (register) calculates an address from a base register value and an offset register value, loads a halfword from memory, sign-extends it, and writes it to a register. For information about memory accesses see [Load/Store addressing modes](#) on page C1-143.

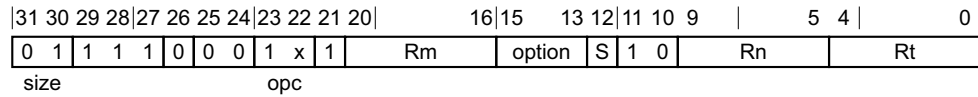

32-bit variant

Applies when `opc == 11`.

```
LDRSH <Wt>, [<Xn|SP>, (<Wm>|<Xm>){, <extend> {<amount>}}]
```

64-bit variant

Applies when `opc == 10`.

```
LDRSH <Xt>, [<Xn|SP>, (<Wm>|<Xm>){, <extend> {<amount>}}]
```

Decode for all variants of this encoding

```
if option<1> == '0' then UnallocatedEncoding(); // sub-word index
ExtendType extend_type = DecodeRegExtend(option);
integer shift = if S == '1' then 1 else 0;
```

Assembler symbols

<code><Wt></code>	Is the 32-bit name of the general-purpose register to be transferred, encoded in the "Rt" field.								
<code><Xt></code>	Is the 64-bit name of the general-purpose register to be transferred, encoded in the "Rt" field.								
<code><Xn SP></code>	Is the 64-bit name of the general-purpose base register or stack pointer, encoded in the "Rn" field.								
<code><Wm></code>	When <code>option<0></code> is set to 0, is the 32-bit name of the general-purpose index register, encoded in the "Rm" field.								
<code><Xm></code>	When <code>option<0></code> is set to 1, is the 64-bit name of the general-purpose index register, encoded in the "Rm" field.								
<code><extend></code>	Is the index extend/shift specifier, defaulting to LSL, and which must be omitted for the LSL option when <code><amount></code> is omitted. encoded in the "option" field. It can have the following values: <table style="margin-left: 20px; border-collapse: collapse;"> <tr><td>UXTW</td><td>when option = 010</td></tr> <tr><td>LSL</td><td>when option = 011</td></tr> <tr><td>SXTW</td><td>when option = 110</td></tr> <tr><td>SXTX</td><td>when option = 111</td></tr> </table>	UXTW	when option = 010	LSL	when option = 011	SXTW	when option = 110	SXTX	when option = 111
UXTW	when option = 010								
LSL	when option = 011								
SXTW	when option = 110								
SXTX	when option = 111								
<code><amount></code>	Is the index shift amount, optional only when <code><extend></code> is not LSL. Where it is permitted to be optional, it defaults to #0. It is encoded in the "S" field. It can have the following values: <table style="margin-left: 20px; border-collapse: collapse;"> <tr><td>#0</td><td>when S = 0</td></tr> <tr><td>#1</td><td>when S = 1</td></tr> </table>	#0	when S = 0	#1	when S = 1				
#0	when S = 0								
#1	when S = 1								

Shared decode for all encodings

```
integer n = UInt(Rn);
integer t = UInt(Rt);
integer m = UInt(Rm);
MemOp memop;
boolean signed;
integer regsize;

if opc<1> == '0' then
    // store or zero-extending load
    memop = if opc<0> == '1' then MemOp_LOAD else MemOp_STORE;
    regsize = 32;
    signed = FALSE;
else
    // sign-extending load
    memop = MemOp_LOAD;
    regsize = if opc<0> == '1' then 32 else 64;
    signed = TRUE;
```

Operation

```
bits(64) offset = ExtendReg(m, extend_type, shift);
bits(64) address;
bits(16) data;

if n == 31 then
    if memop != MemOp_PREFETCH then CheckSPAlignment();
    address = SP[];
else
    address = X[n];

address = address + offset;

case memop of
    when MemOp_STORE
        data = X[t];
        Mem[address, 2, AccType_NORMAL] = data;

    when MemOp_LOAD
        data = Mem[address, 2, AccType_NORMAL];
        if signed then
            X[t] = SignExtend(data, regsize);
        else
            X[t] = ZeroExtend(data, regsize);

    when MemOp_PREFETCH
        Prefetch(address, t<4:0>);
```

C6.2.112 LDRSW (immediate)

Load Register Signed Word (immediate) loads a word from memory, sign-extends it to 64 bits, and writes the result to a register. The address that is used for the load is calculated from a base register and an immediate offset. For information about memory accesses, see [Load/Store addressing modes](#) on page C1-143.

Post-index

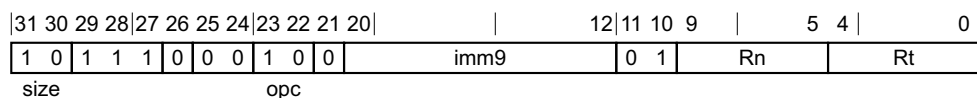

Post-index variant

LDRSW <Xt>, [<Xn|SP>], #<sim>

Decode for this encoding

```
boolean wback = TRUE;
boolean postindex = TRUE;
bits(64) offset = SignExtend(imm9, 64);
```

Pre-index



Pre-index variant

LDRSW <Xt>, [<Xn|SP>, #<sim>]!

Decode for this encoding

```
boolean wback = TRUE;
boolean postindex = FALSE;
bits(64) offset = SignExtend(imm9, 64);
```

Unsigned offset

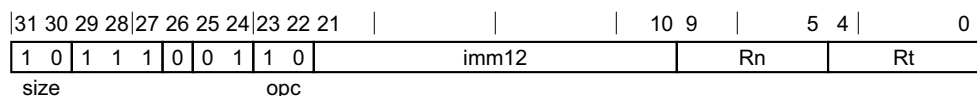

Unsigned offset variant

LDRSW <Xt>, [<Xn|SP>{, #<pimm>}]

Decode for this encoding

```
boolean wback = FALSE;
boolean postindex = FALSE;
bits(64) offset = LSL(ZeroExtend(imm12, 64), 2);
```

Notes for all encodings

For information about the CONSTRAINED UNPREDICTABLE behavior of this instruction, see [Appendix K1 Architectural Constraints on UNPREDICTABLE behaviors](#), and particularly *LDRSW (immediate)* on page K1-6128.

Assembler symbols

- <Xt> Is the 64-bit name of the general-purpose register to be transferred, encoded in the "Rt" field.
- <Xn|SP> Is the 64-bit name of the general-purpose base register or stack pointer, encoded in the "Rn" field.
- <sim> Is the signed immediate byte offset, in the range -256 to 255, encoded in the "imm9" field.
- <pimm> Is the optional positive immediate byte offset, a multiple of 4 in the range 0 to 16380, defaulting to 0 and encoded in the "imm12" field as <pimm>/4.

Shared decode for all encodings

```
integer n = UInt(Rn);  
integer t = UInt(Rt);
```

Operation for all encodings

```
bits(64) address;  
bits(32) data;  
boolean wb_unknown = FALSE;  
  
if wback && n == t && n != 31 then  
    c = ConstrainUnpredictable();  
    assert c IN {Constraint_WBSUPPRESS, Constraint_UNKNOWN, Constraint_UNDEF, Constraint_NOP};  
    case c of  
        when Constraint_WBSUPPRESS wbback = FALSE; // writeback is suppressed  
        when Constraint_UNKNOWN wb_unknown = TRUE; // writeback is UNKNOWN  
        when Constraint_UNDEF UnallocatedEncoding();  
        when Constraint_NOP EndOfInstruction();  
  
if n == 31 then  
    CheckSPAlignment();  
    address = SP[];  
else  
    address = X[n];  
  
if !postindex then  
    address = address + offset;  
  
data = Mem[address, 4, AccType_NORMAL];  
X[t] = SignExtend(data, 64);  
if wback then  
    if wb_unknown then  
        address = bits(64) UNKNOWN;  
    elsif postindex then  
        address = address + offset;  
    if n == 31 then  
        SP[] = address;  
    else  
        X[n] = address;
```

C6.2.113 LDRSW (literal)

Load Register Signed Word (literal) calculates an address from the PC value and an immediate offset, loads a word from memory, and writes it to a register. For information about memory accesses, see [Load/Store addressing modes](#) on page C1-143.

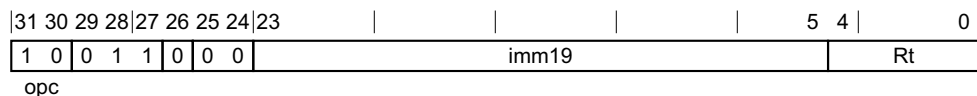

Literal variant

LDRSW <Xt>, <label>

Decode for this encoding

```
integer t = UInt(Rt);
bits(64) offset;

offset = SignExtend(imm19:'00', 64);
```

Assembler symbols

- <Xt> Is the 64-bit name of the general-purpose register to be loaded, encoded in the "Rt" field.
- <label> Is the program label from which the data is to be loaded. Its offset from the address of this instruction, in the range +/-1MB, is encoded as "imm19" times 4.

Operation

```
bits(64) address = PC[] + offset;
bits(32) data;

data = Mem[address, 4, AccType_NORMAL];
X[t] = SignExtend(data, 64);
```

C6.2.114 LDRSW (register)

Load Register Signed Word (register) calculates an address from a base register value and an offset register value, loads a word from memory, sign-extends it to form a 64-bit value, and writes it to a register. The offset register value can be shifted left by 0 or 2 bits. For information about memory accesses, see [Load/Store addressing modes on page C1-143](#).

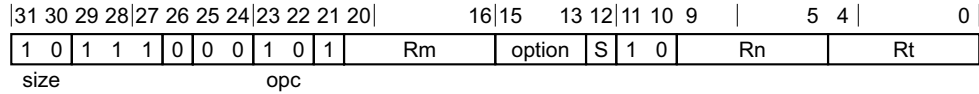

64-bit variant

LDRSW <Xt>, [<Xn|SP>, (<Wm>|<Xm>){, <extend> {<amount>}}]

Decode for this encoding

```
if option<1> == '0' then UnallocatedEncoding(); // sub-word index
ExtendType extend_type = DecodeRegExtend(option);
integer shift = if S == '1' then 2 else 0;
```

Assembler symbols

- <Xt> Is the 64-bit name of the general-purpose register to be transferred, encoded in the "Rt" field.
- <Xn|SP> Is the 64-bit name of the general-purpose base register or stack pointer, encoded in the "Rn" field.
- <Wm> When option<0> is set to 0, is the 32-bit name of the general-purpose index register, encoded in the "Rm" field.
- <Xm> When option<0> is set to 1, is the 64-bit name of the general-purpose index register, encoded in the "Rm" field.
- <extend> Is the index extend/shift specifier, defaulting to LSL, and which must be omitted for the LSL option when <amount> is omitted. encoded in the "option" field. It can have the following values:

UXTW	when option = 010
LSL	when option = 011
SXTW	when option = 110
SXTX	when option = 111
- <amount> Is the index shift amount, optional only when <extend> is not LSL. Where it is permitted to be optional, it defaults to #0. It is encoded in the "S" field. It can have the following values:

#0	when S = 0
#2	when S = 1

Shared decode for all encodings

```
integer n = UInt(Rn);
integer t = UInt(Rt);
integer m = UInt(Rm);
```

Operation

```
bits(64) offset = ExtendReg(m, extend_type, shift);
bits(64) address;
bits(32) data;
```



```
if n == 31 then
    CheckSPAlignment();
    address = SP[];
else
    address = X[n];

address = address + offset;

data = Mem[address, 4, AccType_NORMAL];
X[t] = SignExtend(data, 64);
```

C6.2.115 LDSETB, LDSETAB, LDSETALB, LDSETLB

Atomic bit set on byte in memory atomically loads an 8-bit byte from memory, performs a bitwise OR with the value held in a register on it, and stores the result back to memory. The value initially loaded from memory is returned in the destination register.

- If the destination register is not WZR, LDSETAB and LDSETALB load from memory with acquire semantics.
- LDSETLB and LDSETALB store to memory with release semantics.
- LDSETB has no memory ordering requirements.

For more information about memory ordering semantics see [Load-Acquire, Store-Release](#) on page B2-94.

For information about memory accesses see [Load/Store addressing modes](#) on page C1-143.

ARMv8.1

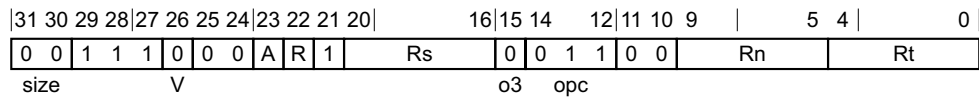

Acquire variant

Applies when A == 1 && R == 0.

LDSETAB <Ws>, <Wt>, [<Xn|SP>]

Acquire and release variant

Applies when A == 1 && R == 1.

LDSETALB <Ws>, <Wt>, [<Xn|SP>]

No memory ordering variant

Applies when A == 0 && R == 0 && Rt != 11111.

LDSETB <Ws>, <Wt>, [<Xn|SP>]

Release variant

Applies when A == 0 && R == 1 && Rt != 11111.

LDSETLB <Ws>, <Wt>, [<Xn|SP>]

Decode for all variants of this encoding

```
if !HaveAtomicExt() then UnallocatedEncoding();
integer t = UInt(Rt);
integer n = UInt(Rn);
integer s = UInt(Rs);
```

```
AccType ldacctype = if A == '1' && Rt != '11111' then AccType_ORDEREDRW else AccType_ATOMICRW;
AccType stacctype = if R == '1' then AccType_ORDEREDRW else AccType_ATOMICRW;
```

Assembler symbols

<Ws> Is the 32-bit name of the general-purpose register holding the data value to be operated on with the contents of the memory location, encoded in the "Rs" field.

<Wt> Is the 32-bit name of the general-purpose register to be loaded, encoded in the "Rt" field.

<Rn|SP> Is the 64-bit name of the general-purpose base register or stack pointer, encoded in the "Rn" field.

Operation

```
bits(64) address;
bits(8) value;
bits(8) data;
bits(8) result;

value = X[s];
if n == 31 then
    CheckSPAlignment();
    address = SP[];
else
    address = X[n];
data = Mem[address, 1, ldacctype];

result = data OR value;
// All observers in the shareability domain observe the
// following load and store atomically.
Mem[address, 1, stacctype] = result;

X[t] = ZeroExtend(data, 32);
```

C6.2.116 LDSETH, LDSETAH, LDSETALH, LDSETLH

Atomic bit set on halfword in memory atomically loads a 16-bit halfword from memory, performs a bitwise OR with the value held in a register on it, and stores the result back to memory. The value initially loaded from memory is returned in the destination register.

- If the destination register is not WZR, LDSETAH and LDSETALH load from memory with acquire semantics.
- LDSETLH and LDSETALH store to memory with release semantics.
- LDSETH has no memory ordering requirements.

For more information about memory ordering semantics see [Load-Acquire, Store-Release](#) on page B2-94.

For information about memory accesses see [Load/Store addressing modes](#) on page C1-143.

ARMv8.1

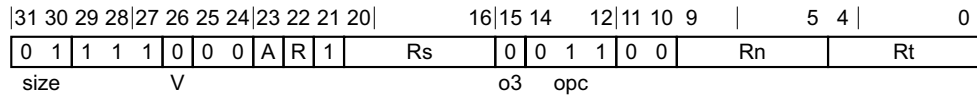

Acquire variant

Applies when A == 1 && R == 0.

LDSETAH <Ws>, <Wt>, [<Xn|SP>]

Acquire and release variant

Applies when A == 1 && R == 1.

LDSETALH <Ws>, <Wt>, [<Xn|SP>]

No memory ordering variant

Applies when A == 0 && R == 0 && Rt != 11111.

LDSETH <Ws>, <Wt>, [<Xn|SP>]

Release variant

Applies when A == 0 && R == 1 && Rt != 11111.

LDSETLH <Ws>, <Wt>, [<Xn|SP>]

Decode for all variants of this encoding

```
if !HaveAtomicExt() then UnallocatedEncoding();
integer t = UInt(Rt);
integer n = UInt(Rn);
integer s = UInt(Rs);
```

```
AccType ldacctype = if A == '1' && Rt != '11111' then AccType_ORDEREDRW else AccType_ATOMICRW;
AccType stacctype = if R == '1' then AccType_ORDEREDRW else AccType_ATOMICRW;
```

Assembler symbols

<Ws> Is the 32-bit name of the general-purpose register holding the data value to be operated on with the contents of the memory location, encoded in the "Rs" field.

<Wt> Is the 32-bit name of the general-purpose register to be loaded, encoded in the "Rt" field.

<Xn|SP> Is the 64-bit name of the general-purpose base register or stack pointer, encoded in the "Rn" field.

Operation

```
bits(64) address;
bits(16) value;
bits(16) data;
bits(16) result;

value = X[s];
if n == 31 then
    CheckSPAlignment();
    address = SP[];
else
    address = X[n];
data = Mem[address, 2, ldacctype];

result = data OR value;
// All observers in the shareability domain observe the
// following load and store atomically.
Mem[address, 2, stacctype] = result;

X[t] = ZeroExtend(data, 32);
```

C6.2.117 LDSET, LDSETA, LDSETAL, LDSETL

Atomic bit set on word or doubleword in memory atomically loads a 32-bit word or 64-bit doubleword from memory, performs a bitwise OR with the value held in a register on it, and stores the result back to memory. The value initially loaded from memory is returned in the destination register.

- If the destination register is not one of WZR or XZR, LDSETA and LDSETAL load from memory with acquire semantics.
- LDSETL and LDSETAL store to memory with release semantics.
- LDSET has no memory ordering requirements.

For more information about memory ordering semantics see [Load-Acquire, Store-Release](#) on page B2-94.

For information about memory accesses see [Load/Store addressing modes](#) on page C1-143.

ARMv8.1

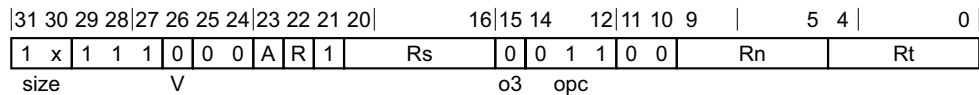

32-bit, acquire variant

Applies when size == 10 && A == 1 && R == 0.

LDSETA <Ws>, <Wt>, [<Xn|SP>]

32-bit, acquire and release variant

Applies when size == 10 && A == 1 && R == 1.

LDSETAL <Ws>, <Wt>, [<Xn|SP>]

32-bit, no memory ordering variant

Applies when size == 10 && A == 0 && R == 0 && Rt != 11111.

LDSET <Ws>, <Wt>, [<Xn|SP>]

32-bit, release variant

Applies when size == 10 && A == 0 && R == 1 && Rt != 11111.

LDSETL <Ws>, <Wt>, [<Xn|SP>]

64-bit, acquire variant

Applies when size == 11 && A == 1 && R == 0.

LDSETA <Xs>, <Xt>, [<Xn|SP>]

64-bit, acquire and release variant

Applies when size == 11 && A == 1 && R == 1.

LDSETAL <Xs>, <Xt>, [<Xn|SP>]

64-bit, no memory ordering variant

Applies when size == 11 && A == 0 && R == 0 && Rt != 11111.

LDSET <Xs>, <Xt>, [<Xn|SP>]

64-bit, release variant

Applies when size == 11 && A == 0 && R == 1 && Rt != 11111.

LDSETL <Xs>, <Xt>, [<Xn|SP>]

Decode for all variants of this encoding

```

if !HaveAtomicExt() then UnallocatedEncoding();
integer t = UInt(Rt);
integer n = UInt(Rn);
integer s = UInt(Rs);

integer datasize = 8 << UInt(size);
integer regsize = if datasize == 64 then 64 else 32;
AccType ldacctype = if A == '1' && Rt != '11111' then AccType_ORDEREDRW else AccType_ATOMICRW;
AccType stacctype = if R == '1' then AccType_ORDEREDRW else AccType_ATOMICRW;
  
```

Assembler symbols

- <Ws> Is the 32-bit name of the general-purpose register holding the data value to be operated on with the contents of the memory location, encoded in the "Rs" field.
- <Wt> Is the 32-bit name of the general-purpose register to be loaded, encoded in the "Rt" field.
- <Xs> Is the 64-bit name of the general-purpose register holding the data value to be operated on with the contents of the memory location, encoded in the "Rs" field.
- <Xt> Is the 64-bit name of the general-purpose register to be loaded, encoded in the "Rt" field.
- <Xn|SP> Is the 64-bit name of the general-purpose base register or stack pointer, encoded in the "Rn" field.

Operation

```

bits(64) address;
bits(datasize) value;
bits(datasize) data;
bits(datasize) result;

value = X[s];
if n == 31 then
  CheckSPAAlignment();
  address = SP[];
else
  address = X[n];
data = Mem[address, datasize DIV 8, ldacctype];

result = data OR value;
// All observers in the shareability domain observe the
// following load and store atomically.
Mem[address, datasize DIV 8, stacctype] = result;

X[t] = ZeroExtend(data, regsize);
  
```

C6.2.118 LDSMAXB, LDSMAXAB, LDSMAXALB, LDSMAXLB

Atomic signed maximum on byte in memory atomically loads an 8-bit byte from memory, compares it against the value held in a register, and stores the larger value back to memory, treating the values as signed numbers. The value initially loaded from memory is returned in the destination register.

- If the destination register is not WZR, LDSMAXAB and LDSMAXALB load from memory with acquire semantics.
- LDSMAXLB and LDSMAXALB store to memory with release semantics.
- LDSMAXB has no memory ordering requirements.

For more information about memory ordering semantics see [Load-Acquire, Store-Release on page B2-94](#).

For information about memory accesses see [Load/Store addressing modes on page C1-143](#).

ARMv8.1

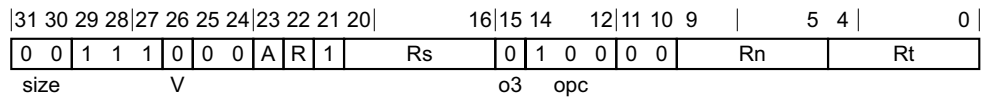

Acquire variant

Applies when A == 1 && R == 0.

LDSMAXAB <Ws>, <Wt>, [<Xn|SP>]

Acquire and release variant

Applies when A == 1 && R == 1.

LDSMAXALB <Ws>, <Wt>, [<Xn|SP>]

No memory ordering variant

Applies when A == 0 && R == 0 && Rt != 11111.

LDSMAXB <Ws>, <Wt>, [<Xn|SP>]

Release variant

Applies when A == 0 && R == 1 && Rt != 11111.

LDSMAXLB <Ws>, <Wt>, [<Xn|SP>]

Decode for all variants of this encoding

```
if !HaveAtomicExt() then UnallocatedEncoding();
integer t = UInt(Rt);
integer n = UInt(Rn);
integer s = UInt(Rs);
```

```
AccType ldacctype = if A == '1' && Rt != '11111' then AccType_ORDEREDRW else AccType_ATOMICRW;
AccType stacctype = if R == '1' then AccType_ORDEREDRW else AccType_ATOMICRW;
```

Assembler symbols

<Ws> Is the 32-bit name of the general-purpose register holding the data value to be operated on with the contents of the memory location, encoded in the "Rs" field.

<Wt> Is the 32-bit name of the general-purpose register to be loaded, encoded in the "Rt" field.

<Xn|SP> Is the 64-bit name of the general-purpose base register or stack pointer, encoded in the "Rn" field.

Operation

```
bits(64) address;
bits(8) value;
bits(8) data;
bits(8) result;

value = X[s];
if n == 31 then
    CheckSPAlignment();
    address = SP[];
else
    address = X[n];
data = Mem[address, 1, ldacctype];

result = if SInt(data) > SInt(value) then data else value;
// All observers in the shareability domain observe the
// following load and store atomically.
Mem[address, 1, stacctype] = result;

X[t] = ZeroExtend(data, 32);
```

C6.2.119 LDSMAXH, LDSMAXAH, LDSMAXALH, LDSMAXLH

Atomic signed maximum on halfword in memory atomically loads a 16-bit halfword from memory, compares it against the value held in a register, and stores the larger value back to memory, treating the values as signed numbers. The value initially loaded from memory is returned in the destination register.

- If the destination register is not WZR, LDSMAXAH and LDSMAXALH load from memory with acquire semantics.
- LDSMAXLH and LDSMAXALH store to memory with release semantics.
- LDSMAXH has no memory ordering requirements.

For more information about memory ordering semantics see [Load-Acquire, Store-Release](#) on page B2-94.

For information about memory accesses see [Load/Store addressing modes](#) on page C1-143.

ARMv8.1

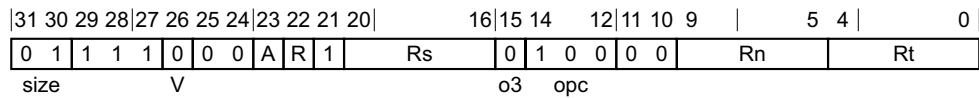

Acquire variant

Applies when A == 1 && R == 0.

LDSMAXAH <Ws>, <Wt>, [<Xn|SP>]

Acquire and release variant

Applies when A == 1 && R == 1.

LDSMAXALH <Ws>, <Wt>, [<Xn|SP>]

No memory ordering variant

Applies when A == 0 && R == 0 && Rt != 11111.

LDSMAXH <Ws>, <Wt>, [<Xn|SP>]

Release variant

Applies when A == 0 && R == 1 && Rt != 11111.

LDSMAXLH <Ws>, <Wt>, [<Xn|SP>]

Decode for all variants of this encoding

```
if !HaveAtomicExt() then UnallocatedEncoding();
integer t = UInt(Rt);
integer n = UInt(Rn);
integer s = UInt(Rs);
```

```
AccType ldacctype = if A == '1' && Rt != '11111' then AccType_ORDEREDRW else AccType_ATOMICRW;
AccType stacctype = if R == '1' then AccType_ORDEREDRW else AccType_ATOMICRW;
```

Assembler symbols

- <Ws> Is the 32-bit name of the general-purpose register holding the data value to be operated on with the contents of the memory location, encoded in the "Rs" field.
- <Wt> Is the 32-bit name of the general-purpose register to be loaded, encoded in the "Rt" field.

<Xn|SP> Is the 64-bit name of the general-purpose base register or stack pointer, encoded in the "Rn" field.

Operation

```
bits(64) address;
bits(16) value;
bits(16) data;
bits(16) result;

value = X[s];
if n == 31 then
    CheckSPAlignment();
    address = SP[];
else
    address = X[n];
data = Mem[address, 2, ldacctype];

result = if SInt(data) > SInt(value) then data else value;
// All observers in the shareability domain observe the
// following load and store atomically.
Mem[address, 2, stacctype] = result;

X[t] = ZeroExtend(data, 32);
```

C6.2.120 LDSMAX, LDSMAXA, LDSMAXAL, LDSMAXL

Atomic signed maximum on word or doubleword in memory atomically loads a 32-bit word or 64-bit doubleword from memory, compares it against the value held in a register, and stores the larger value back to memory, treating the values as signed numbers. The value initially loaded from memory is returned in the destination register.

- If the destination register is not one of WZR or XZR, LDSMAXA and LDSMAXAL load from memory with acquire semantics.
- LDSMAXL and LDSMAXAL store to memory with release semantics.
- LDSMAX has no memory ordering requirements.

For more information about memory ordering semantics see [Load-Acquire, Store-Release](#) on page B2-94.

For information about memory accesses see [Load/Store addressing modes](#) on page C1-143.

ARMv8.1

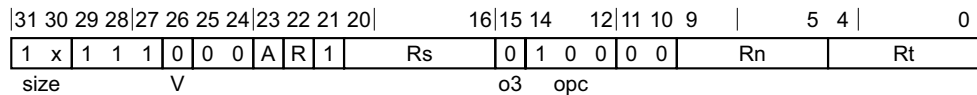

32-bit, acquire variant

Applies when size == 10 && A == 1 && R == 0.

LDSMAXA <Ws>, <Wt>, [<Xn|SP>]

32-bit, acquire and release variant

Applies when size == 10 && A == 1 && R == 1.

LDSMAXAL <Ws>, <Wt>, [<Xn|SP>]

32-bit, no memory ordering variant

Applies when size == 10 && A == 0 && R == 0 && Rt != 11111.

LDSMAX <Ws>, <Wt>, [<Xn|SP>]

32-bit, release variant

Applies when size == 10 && A == 0 && R == 1 && Rt != 11111.

LDSMAXL <Ws>, <Wt>, [<Xn|SP>]

64-bit, acquire variant

Applies when size == 11 && A == 1 && R == 0.

LDSMAXA <Xs>, <Xt>, [<Xn|SP>]

64-bit, acquire and release variant

Applies when size == 11 && A == 1 && R == 1.

LDSMAXAL <Xs>, <Xt>, [<Xn|SP>]

64-bit, no memory ordering variant

Applies when size == 11 && A == 0 && R == 0 && Rt != 11111.

LDSMAX <Xs>, <Xt>, [<Xn|SP>]

64-bit, release variant

Applies when size == 11 && A == 0 && R == 1 && Rt != 11111.

LDSMAXL <Xs>, <Xt>, [<Xn|SP>]

Decode for all variants of this encoding

```

if !HaveAtomicExt() then UnallocatedEncoding();
integer t = UInt(Rt);
integer n = UInt(Rn);
integer s = UInt(Rs);

integer datasize = 8 << UInt(size);
integer regsize = if datasize == 64 then 64 else 32;
AccType ldacctype = if A == '1' && Rt != '11111' then AccType_ORDEREDRW else AccType_ATOMICRW;
AccType stacctype = if R == '1' then AccType_ORDEREDRW else AccType_ATOMICRW;
  
```

Assembler symbols

- <Ws> Is the 32-bit name of the general-purpose register holding the data value to be operated on with the contents of the memory location, encoded in the "Rs" field.
- <Wt> Is the 32-bit name of the general-purpose register to be loaded, encoded in the "Rt" field.
- <Xs> Is the 64-bit name of the general-purpose register holding the data value to be operated on with the contents of the memory location, encoded in the "Rs" field.
- <Xt> Is the 64-bit name of the general-purpose register to be loaded, encoded in the "Rt" field.
- <Xn|SP> Is the 64-bit name of the general-purpose base register or stack pointer, encoded in the "Rn" field.

Operation

```

bits(64) address;
bits(datasize) value;
bits(datasize) data;
bits(datasize) result;

value = X[s];
if n == 31 then
    CheckSPAAlignment();
    address = SP[];
else
    address = X[n];
data = Mem[address, datasize DIV 8, ldacctype];

result = if SInt(data) > SInt(value) then data else value;
// All observers in the shareability domain observe the
// following load and store atomically.
Mem[address, datasize DIV 8, stacctype] = result;

X[t] = ZeroExtend(data, regsize);
  
```

C6.2.121 LDSMINB, LDSMINAB, LDSMINALB, LDSMINLB

Atomic signed minimum on byte in memory atomically loads an 8-bit byte from memory, compares it against the value held in a register, and stores the smaller value back to memory, treating the values as signed numbers. The value initially loaded from memory is returned in the destination register.

- If the destination register is not WZR, LDSMINAB and LDSMINALB load from memory with acquire semantics.
- LDSMINLB and LDSMINALB store to memory with release semantics.
- LDSMINB has no memory ordering requirements.

For more information about memory ordering semantics see [Load-Acquire, Store-Release on page B2-94](#).

For information about memory accesses see [Load/Store addressing modes on page C1-143](#).

ARMv8.1

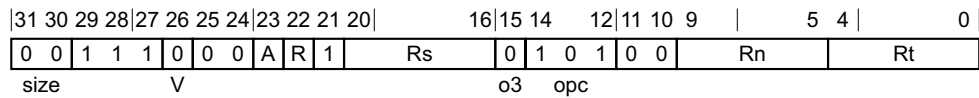

Acquire variant

Applies when A == 1 && R == 0.

LDSMINAB <Ws>, <Wt>, [<Xn|SP>]

Acquire and release variant

Applies when A == 1 && R == 1.

LDSMINALB <Ws>, <Wt>, [<Xn|SP>]

No memory ordering variant

Applies when A == 0 && R == 0 && Rt != 11111.

LDSMINB <Ws>, <Wt>, [<Xn|SP>]

Release variant

Applies when A == 0 && R == 1 && Rt != 11111.

LDSMINLB <Ws>, <Wt>, [<Xn|SP>]

Decode for all variants of this encoding

```
if !HaveAtomicExt() then UnallocatedEncoding();
integer t = UInt(Rt);
integer n = UInt(Rn);
integer s = UInt(Rs);
```

```
AccType ldacctype = if A == '1' && Rt != '11111' then AccType_ORDEREDRW else AccType_ATOMICRW;
AccType stacctype = if R == '1' then AccType_ORDEREDRW else AccType_ATOMICRW;
```

Assembler symbols

- <Ws> Is the 32-bit name of the general-purpose register holding the data value to be operated on with the contents of the memory location, encoded in the "Rs" field.
- <Wt> Is the 32-bit name of the general-purpose register to be loaded, encoded in the "Rt" field.

<Rn|SP> Is the 64-bit name of the general-purpose base register or stack pointer, encoded in the "Rn" field.

Operation

```
bits(64) address;
bits(8) value;
bits(8) data;
bits(8) result;

value = X[s];
if n == 31 then
    CheckSPAlignment();
    address = SP[];
else
    address = X[n];
data = Mem[address, 1, ldacctype];

result = if SInt(data) > SInt(value) then value else data;
// All observers in the shareability domain observe the
// following load and store atomically.
Mem[address, 1, stacctype] = result;

X[t] = ZeroExtend(data, 32);
```

C6.2.122 LDSMINH, LDSMINAH, LDSMINALH, LDSMINLH

Atomic signed minimum on halfword in memory atomically loads a 16-bit halfword from memory, compares it against the value held in a register, and stores the smaller value back to memory, treating the values as signed numbers. The value initially loaded from memory is returned in the destination register.

- If the destination register is not WZR, LDSMINAH and LDSMINALH load from memory with acquire semantics.
- LDSMINLH and LDSMINALH store to memory with release semantics.
- LDSMINH has no memory ordering requirements.

For more information about memory ordering semantics see [Load-Acquire, Store-Release on page B2-94](#).

For information about memory accesses see [Load/Store addressing modes on page C1-143](#).

ARMv8.1

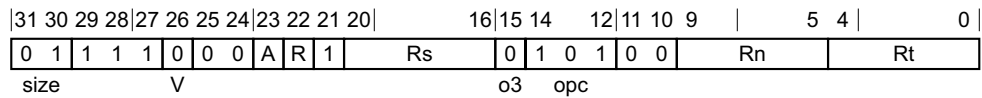

Acquire variant

Applies when A == 1 && R == 0.

LDSMINAH <Ws>, <Wt>, [<Xn|SP>]

Acquire and release variant

Applies when A == 1 && R == 1.

LDSMINALH <Ws>, <Wt>, [<Xn|SP>]

No memory ordering variant

Applies when A == 0 && R == 0 && Rt != 11111.

LDSMINH <Ws>, <Wt>, [<Xn|SP>]

Release variant

Applies when A == 0 && R == 1 && Rt != 11111.

LDSMINLH <Ws>, <Wt>, [<Xn|SP>]

Decode for all variants of this encoding

```
if !HaveAtomicExt() then UnallocatedEncoding();
integer t = UInt(Rt);
integer n = UInt(Rn);
integer s = UInt(Rs);
```

```
AccType ldacctype = if A == '1' && Rt != '11111' then AccType_ORDEREDRW else AccType_ATOMICRW;
AccType stacctype = if R == '1' then AccType_ORDEREDRW else AccType_ATOMICRW;
```

Assembler symbols

<Ws> Is the 32-bit name of the general-purpose register holding the data value to be operated on with the contents of the memory location, encoded in the "Rs" field.

<Wt> Is the 32-bit name of the general-purpose register to be loaded, encoded in the "Rt" field.

<Rn|SP> Is the 64-bit name of the general-purpose base register or stack pointer, encoded in the "Rn" field.

Operation

```
bits(64) address;
bits(16) value;
bits(16) data;
bits(16) result;

value = X[s];
if n == 31 then
    CheckSPAlignment();
    address = SP[];
else
    address = X[n];
data = Mem[address, 2, ldacctype];

result = if SInt(data) > SInt(value) then value else data;
// All observers in the shareability domain observe the
// following load and store atomically.
Mem[address, 2, stacctype] = result;

X[t] = ZeroExtend(data, 32);
```

C6.2.123 LDSMIN, LDSMINA, LDSMINAL, LDSMINL

Atomic signed minimum on word or doubleword in memory atomically loads a 32-bit word or 64-bit doubleword from memory, compares it against the value held in a register, and stores the smaller value back to memory, treating the values as signed numbers. The value initially loaded from memory is returned in the destination register.

- If the destination register is not one of WZR or XZR, LDSMINA and LDSMINAL load from memory with acquire semantics.
- LDSMINL and LDSMINAL store to memory with release semantics.
- LDSMIN has no memory ordering requirements.

For more information about memory ordering semantics see [Load-Acquire, Store-Release](#) on page B2-94.

For information about memory accesses see [Load/Store addressing modes](#) on page C1-143.

ARMv8.1

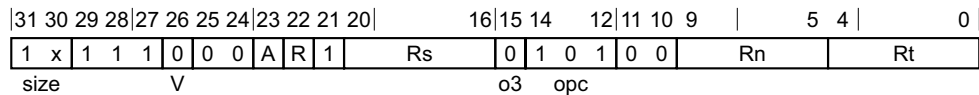

32-bit, acquire variant

Applies when size == 10 && A == 1 && R == 0.

LDSMINA <Ws>, <Wt>, [<Xn|SP>]

32-bit, acquire and release variant

Applies when size == 10 && A == 1 && R == 1.

LDSMINAL <Ws>, <Wt>, [<Xn|SP>]

32-bit, no memory ordering variant

Applies when size == 10 && A == 0 && R == 0 && Rt != 11111.

LDSMIN <Ws>, <Wt>, [<Xn|SP>]

32-bit, release variant

Applies when size == 10 && A == 0 && R == 1 && Rt != 11111.

LDSMINL <Ws>, <Wt>, [<Xn|SP>]

64-bit, acquire variant

Applies when size == 11 && A == 1 && R == 0.

LDSMINA <Xs>, <Xt>, [<Xn|SP>]

64-bit, acquire and release variant

Applies when size == 11 && A == 1 && R == 1.

LDSMINAL <Xs>, <Xt>, [<Xn|SP>]

64-bit, no memory ordering variant

Applies when size == 11 && A == 0 && R == 0 && Rt != 11111.

LDSMIN <Xs>, <Xt>, [<Xn|SP>]

64-bit, release variant

Applies when size == 11 && A == 0 && R == 1 && Rt != 11111.

LDSMINL <Xs>, <Xt>, [<Xn|SP>]

Decode for all variants of this encoding

```

if !HaveAtomicExt() then UnallocatedEncoding();
integer t = UInt(Rt);
integer n = UInt(Rn);
integer s = UInt(Rs);

integer datasize = 8 << UInt(size);
integer regsize = if datasize == 64 then 64 else 32;
AccType ldacctype = if A == '1' && Rt != '11111' then AccType_ORDEREDRW else AccType_ATOMICRW;
AccType stacctype = if R == '1' then AccType_ORDEREDRW else AccType_ATOMICRW;
  
```

Assembler symbols

- <Ws> Is the 32-bit name of the general-purpose register holding the data value to be operated on with the contents of the memory location, encoded in the "Rs" field.
- <Wt> Is the 32-bit name of the general-purpose register to be loaded, encoded in the "Rt" field.
- <Xs> Is the 64-bit name of the general-purpose register holding the data value to be operated on with the contents of the memory location, encoded in the "Rs" field.
- <Xt> Is the 64-bit name of the general-purpose register to be loaded, encoded in the "Rt" field.
- <Xn|SP> Is the 64-bit name of the general-purpose base register or stack pointer, encoded in the "Rn" field.

Operation

```

bits(64) address;
bits(datasize) value;
bits(datasize) data;
bits(datasize) result;

value = X[s];
if n == 31 then
  CheckSPAlignment();
  address = SP[];
else
  address = X[n];
data = Mem[address, datasize DIV 8, ldacctype];

result = if SInt(data) > SInt(value) then value else data;
// All observers in the shareability domain observe the
// following load and store atomically.
Mem[address, datasize DIV 8, stacctype] = result;

X[t] = ZeroExtend(data, regsize);
  
```

C6.2.124 LDTR

Load Register (unprivileged) loads a word or doubleword from memory, and writes it to a register. The address that is used for the load is calculated from a base register and an immediate offset.

The memory is restricted as if execution is at EL0 when:

- Executing at EL1.
- Executing at EL2, in ARMv8.1, with HCR_EL2.{E2H, TGE} set to {1, 1}.

Otherwise, the access permission is for the Exception level at which the instruction is executed. For information about memory accesses, see [Load/Store addressing modes](#) on page C1-143.

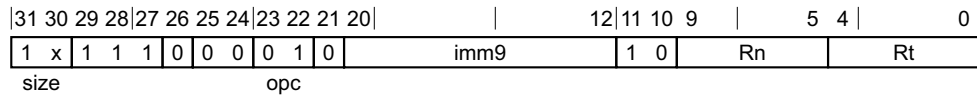

32-bit variant

Applies when size == 10.

LDTR <Wt>, [<Xn|SP>{, #<simmm>}]

64-bit variant

Applies when size == 11.

LDTR <Xt>, [<Xn|SP>{, #<simmm>}]

Decode for all variants of this encoding

```
integer scale = UInt(size);
bits(64) offset = SignExtend(imm9, 64);
```

Assembler symbols

- <Wt> Is the 32-bit name of the general-purpose register to be transferred, encoded in the "Rt" field.
- <Xt> Is the 64-bit name of the general-purpose register to be transferred, encoded in the "Rt" field.
- <Xn|SP> Is the 64-bit name of the general-purpose base register or stack pointer, encoded in the "Rn" field.
- <simmm> Is the optional signed immediate byte offset, in the range -256 to 255, defaulting to 0 and encoded in the "imm9" field.

Shared decode for all encodings

```
integer n = UInt(Rn);
integer t = UInt(Rt);
integer regsize;

regsize = if size == '11' then 64 else 32;
integer datasize = 8 << scale;
```

Operation

```
bits(64) address;
bits(datasize) data;
```

```
if n == 31 then
    CheckSPAlignment();
    address = SP[];
else
    address = X[n];

address = address + offset;

data = Mem[address, datasize DIV 8, AccType_UNPRIV];
X[t] = ZeroExtend(data, regsize);
```

C6.2.125 LDTRB

Load Register Byte (unprivileged) loads a byte from memory, zero-extends it, and writes the result to a register. The address that is used for the load is calculated from a base register and an immediate offset.

The memory is restricted as if execution is at EL0 when:

- Executing at EL1.
- Executing at EL2, in ARMv8.1, with HCR_EL2.{E2H, TGE} set to {1, 1}.

Otherwise, the access permission is for the Exception level at which the instruction is executed. For information about memory accesses, see [Load/Store addressing modes](#) on page C1-143.

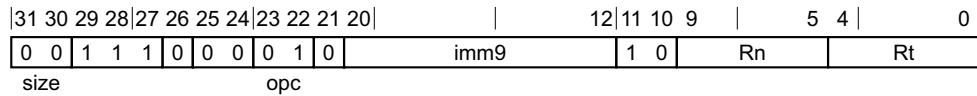

Unscaled offset variant

LDTRB <Wt>, [<Xn|SP>{, #<sim>}]

Decode for this encoding

bits(64) offset = [SignExtend](#)(imm9, 64);

Assembler symbols

- <Wt> Is the 32-bit name of the general-purpose register to be transferred, encoded in the "Rt" field.
- <Xn|SP> Is the 64-bit name of the general-purpose base register or stack pointer, encoded in the "Rn" field.
- <sim> Is the optional signed immediate byte offset, in the range -256 to 255, defaulting to 0 and encoded in the "imm9" field.

Shared decode for all encodings

```
integer n = UInt(Rn);
integer t = UInt(Rt);
```

Operation

```
bits(64) address;
bits(8) data;

if n == 31 then
    CheckSPAAlignment();
    address = SP[];
else
    address = X[n];

address = address + offset;

data = Mem[address, 1, AccType_UNPRIV];
X[t] = ZeroExtend(data, 32);
```

C6.2.126 LDTRH

Load Register Halfword (unprivileged) loads a halfword from memory, zero-extends it, and writes the result to a register. The address that is used for the load is calculated from a base register and an immediate offset.

The memory is restricted as if execution is at EL0 when:

- Executing at EL1.
- Executing at EL2, in ARMv8.1, with HCR_EL2.{E2H, TGE} set to {1, 1}.

Otherwise, the access permission is for the Exception level at which the instruction is executed. For information about memory accesses, see [Load/Store addressing modes](#) on page C1-143.

31	30	29	28	27	26	25	24	23	22	21	20					12	11	10	9			5	4			0
0	1	1	1	1	0	0	0	0	1	0	imm9				1	0	Rn		Rt							
size				opc																						

Unscaled offset variant

LDTRH <Wt>, [<Xn|SP>{, #<sim>}]

Decode for this encoding

bits(64) offset = [SignExtend](#)(imm9, 64);

Assembler symbols

- <Wt> Is the 32-bit name of the general-purpose register to be transferred, encoded in the "Rt" field.
- <Xn|SP> Is the 64-bit name of the general-purpose base register or stack pointer, encoded in the "Rn" field.
- <sim> Is the optional signed immediate byte offset, in the range -256 to 255, defaulting to 0 and encoded in the "imm9" field.

Shared decode for all encodings

```
integer n = UInt(Rn);
integer t = UInt(Rt);
```

Operation

```
bits(64) address;
bits(16) data;

if n == 31 then
    CheckSPAAlignment();
    address = SP[];
else
    address = X[n];

address = address + offset;

data = Mem[address, 2, AccType_UNPRIV];
X[t] = ZeroExtend(data, 32);
```

C6.2.127 LDTRSB

Load Register Signed Byte (unprivileged) loads a byte from memory, sign-extends it to 32 bits or 64 bits, and writes the result to a register. The address that is used for the load is calculated from a base register and an immediate offset.

The memory is restricted as if execution is at EL0 when:

- Executing at EL1.
- Executing at EL2, in ARMv8.1, with HCR_EL2.{E2H, TGE} set to {1, 1}.

Otherwise, the access permission is for the Exception level at which the instruction is executed. For information about memory accesses, see [Load/Store addressing modes](#) on page C1-143.



32-bit variant

Applies when `opc == 11`.

LDTRSB <Wt>, [<Xn|SP>{, #<sim>}]

64-bit variant

Applies when `opc == 10`.

LDTRSB <Xt>, [<Xn|SP>{, #<sim>}]

Decode for all variants of this encoding

bits(64) offset = [SignExtend](#)(imm9, 64);

Assembler symbols

- <Wt> Is the 32-bit name of the general-purpose register to be transferred, encoded in the "Rt" field.
- <Xt> Is the 64-bit name of the general-purpose register to be transferred, encoded in the "Rt" field.
- <Xn|SP> Is the 64-bit name of the general-purpose base register or stack pointer, encoded in the "Rn" field.
- <sim> Is the optional signed immediate byte offset, in the range -256 to 255, defaulting to 0 and encoded in the "imm9" field.

Shared decode for all encodings

```
integer n = UInt(Rn);
integer t = UInt(Rt);
MemOp memop;
boolean signed;
integer regsize;

if opc<1> == '0' then
  // store or zero-extending load
  memop = if opc<0> == '1' then MemOp_LOAD else MemOp_STORE;
  regsize = 32;
  signed = FALSE;
else
  // sign-extending load
```



```
memop = MemOp_LOAD;  
regsize = if opc<0> == '1' then 32 else 64;  
signed = TRUE;
```

Operation

```
bits(64) address;  
bits(8) data;  
  
if n == 31 then  
    if memop != MemOp_PREFETCH then CheckSPAlignment();  
    address = SP[];  
else  
    address = X[n];  
  
address = address + offset;  
  
case memop of  
    when MemOp_STORE  
        data = X[t];  
        Mem[address, 1, AccType_UNPRIV] = data;  
  
    when MemOp_LOAD  
        data = Mem[address, 1, AccType_UNPRIV];  
        if signed then  
            X[t] = SignExtend(data, regsize);  
        else  
            X[t] = ZeroExtend(data, regsize);  
  
    when MemOp_PREFETCH  
        Prefetch(address, t<4:0>);
```

C6.2.128 LDTRSH

Load Register Signed Halfword (unprivileged) loads a halfword from memory, sign-extends it to 32 bits or 64 bits, and writes the result to a register. The address that is used for the load is calculated from a base register and an immediate offset.

The memory is restricted as if execution is at EL0 when:

- Executing at EL1.
- Executing at EL2, in ARMv8.1, with HCR_EL2.{E2H, TGE} set to {1, 1}.

Otherwise, the access permission is for the Exception level at which the instruction is executed. For information about memory accesses, see [Load/Store addressing modes on page C1-143](#).

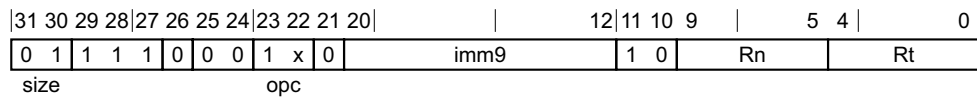

32-bit variant

Applies when `opc == 11`.

LDTRSH <Wt>, [<Xn|SP>{, #<sim>}]

64-bit variant

Applies when `opc == 10`.

LDTRSH <Xt>, [<Xn|SP>{, #<sim>}]

Decode for all variants of this encoding

bits(64) offset = [SignExtend](#)(imm9, 64);

Assembler symbols

- <Wt> Is the 32-bit name of the general-purpose register to be transferred, encoded in the "Rt" field.
- <Xt> Is the 64-bit name of the general-purpose register to be transferred, encoded in the "Rt" field.
- <Xn|SP> Is the 64-bit name of the general-purpose base register or stack pointer, encoded in the "Rn" field.
- <sim> Is the optional signed immediate byte offset, in the range -256 to 255, defaulting to 0 and encoded in the "imm9" field.

Shared decode for all encodings

```
integer n = UInt(Rn);
integer t = UInt(Rt);
MemOp memop;
boolean signed;
integer regsize;

if opc<1> == '0' then
  // store or zero-extending load
  memop = if opc<0> == '1' then MemOp_LOAD else MemOp_STORE;
  regsize = 32;
  signed = FALSE;
else
  // sign-extending load
```

```
memop = MemOp_LOAD;  
regsize = if opc<0> == '1' then 32 else 64;  
signed = TRUE;
```

Operation

```
bits(64) address;  
bits(16) data;  
  
if n == 31 then  
    if memop != MemOp_PREFETCH then CheckSPAlignment();  
    address = SP[];  
else  
    address = X[n];  
  
address = address + offset;  
  
case memop of  
    when MemOp_STORE  
        data = X[t];  
        Mem[address, 2, AccType_UNPRIV] = data;  
  
    when MemOp_LOAD  
        data = Mem[address, 2, AccType_UNPRIV];  
        if signed then  
            X[t] = SignExtend(data, regsize);  
        else  
            X[t] = ZeroExtend(data, regsize);  
  
    when MemOp_PREFETCH  
        Prefetch(address, t<4:0>);
```

C6.2.129 LDTRSW

Load Register Signed Word (unprivileged) loads a word from memory, sign-extends it to 64 bits, and writes the result to a register. The address that is used for the load is calculated from a base register and an immediate offset.

The memory is restricted as if execution is at EL0 when:

- Executing at EL1.
- Executing at EL2, in ARMv8.1, with HCR_EL2.{E2H, TGE} set to {1, 1}.

Otherwise, the access permission is for the Exception level at which the instruction is executed. For information about memory accesses, see [Load/Store addressing modes](#) on page C1-143.



Unscaled offset variant

LDTRSW <Xt>, [<Xn|SP>{, #<sim>}]

Decode for this encoding

bits(64) offset = `SignExtend`(imm9, 64);

Assembler symbols

- <Xt> Is the 64-bit name of the general-purpose register to be transferred, encoded in the "Rt" field.
- <Xn|SP> Is the 64-bit name of the general-purpose base register or stack pointer, encoded in the "Rn" field.
- <sim> Is the optional signed immediate byte offset, in the range -256 to 255, defaulting to 0 and encoded in the "imm9" field.

Shared decode for all encodings

```
integer n = UInt(Rn);
integer t = UInt(Rt);
```

Operation

```
bits(64) address;
bits(32) data;

if n == 31 then
    CheckSPAlignment();
    address = SP[];
else
    address = X[n];

address = address + offset;

data = Mem[address, 4, AccType_UNPRIV];
X[t] = SignExtend(data, 64);
```

C6.2.130 LDUMAXB, LDUMAXAB, LDUMAXALB, LDUMAXLB

Atomic unsigned maximum on byte in memory atomically loads an 8-bit byte from memory, compares it against the value held in a register, and stores the larger value back to memory, treating the values as unsigned numbers. The value initially loaded from memory is returned in the destination register.

- If the destination register is not WZR, LDUMAXB and LDUMAXALB load from memory with acquire semantics.
- LDUMAXLB and LDUMAXALB store to memory with release semantics.
- LDUMAXB has no memory ordering requirements.

For more information about memory ordering semantics see [Load-Acquire, Store-Release](#) on page B2-94.

For information about memory accesses see [Load/Store addressing modes](#) on page C1-143.

ARMv8.1

31	30	29	28	27	26	25	24	23	22	21	20	16			15	14	12			11	10	9	5		4	0
0	0	1	1	1	0	0	0	A	R	1	Rs			0	1	1	0	0	0	Rn			Rt			
size				V							o3			opc												

Acquire variant

Applies when A == 1 && R == 0.

LDUMAXAB <Ws>, <Wt>, [<Xn|SP>]

Acquire and release variant

Applies when A == 1 && R == 1.

LDUMAXALB <Ws>, <Wt>, [<Xn|SP>]

No memory ordering variant

Applies when A == 0 && R == 0 && Rt != 11111.

LDUMAXB <Ws>, <Wt>, [<Xn|SP>]

Release variant

Applies when A == 0 && R == 1 && Rt != 11111.

LDUMAXLB <Ws>, <Wt>, [<Xn|SP>]

Decode for all variants of this encoding

```
if !HaveAtomicExt() then UnallocatedEncoding();
integer t = UInt(Rt);
integer n = UInt(Rn);
integer s = UInt(Rs);
```

```
AccType ldacctype = if A == '1' && Rt != '11111' then AccType_ORDEREDRW else AccType_ATOMICRW;
AccType stacctype = if R == '1' then AccType_ORDEREDRW else AccType_ATOMICRW;
```

Assembler symbols

<Ws> Is the 32-bit name of the general-purpose register holding the data value to be operated on with the contents of the memory location, encoded in the "Rs" field.

<Wt> Is the 32-bit name of the general-purpose register to be loaded, encoded in the "Rt" field.

<Xn|SP> Is the 64-bit name of the general-purpose base register or stack pointer, encoded in the "Rn" field.

Operation

```
bits(64) address;
bits(8) value;
bits(8) data;
bits(8) result;

value = X[s];
if n == 31 then
    CheckSPAlignment();
    address = SP[];
else
    address = X[n];
data = Mem[address, 1, ldacctype];

result = if UInt(data) > UInt(value) then data else value;
// All observers in the shareability domain observe the
// following load and store atomically.
Mem[address, 1, stacctype] = result;

X[t] = ZeroExtend(data, 32);
```

C6.2.131 LDUMAXH, LDUMAXAH, LDUMAXALH, LDUMAXLH

Atomic unsigned maximum on halfword in memory atomically loads a 16-bit halfword from memory, compares it against the value held in a register, and stores the larger value back to memory, treating the values as unsigned numbers. The value initially loaded from memory is returned in the destination register.

- If the destination register is not WZR, LDUMAXAH and LDUMAXALH load from memory with acquire semantics.
- LDUMAXLH and LDUMAXALH store to memory with release semantics.
- LDUMAXH has no memory ordering requirements.

For more information about memory ordering semantics see [Load-Acquire, Store-Release](#) on page B2-94.

For information about memory accesses see [Load/Store addressing modes](#) on page C1-143.

ARMv8.1

31	30	29	28	27	26	25	24	23	22	21	20	16	15	14	12	11	10	9	5	4	0
0	1	1	1	1	0	0	0	A	R	1	Rs	0	1	1	0	0	0	Rn	Rt		
size					V					o3			opc								

Acquire variant

Applies when A == 1 && R == 0.

LDUMAXAH <Ws>, <Wt>, [<Xn|SP>]

Acquire and release variant

Applies when A == 1 && R == 1.

LDUMAXALH <Ws>, <Wt>, [<Xn|SP>]

No memory ordering variant

Applies when A == 0 && R == 0 && Rt != 11111.

LDUMAXH <Ws>, <Wt>, [<Xn|SP>]

Release variant

Applies when A == 0 && R == 1 && Rt != 11111.

LDUMAXLH <Ws>, <Wt>, [<Xn|SP>]

Decode for all variants of this encoding

```
if !HaveAtomicExt() then UnallocatedEncoding();
integer t = UInt(Rt);
integer n = UInt(Rn);
integer s = UInt(Rs);
```

```
AccType ldacctype = if A == '1' && Rt != '11111' then AccType_ORDEREDRW else AccType_ATOMICRW;
AccType stacctype = if R == '1' then AccType_ORDEREDRW else AccType_ATOMICRW;
```

Assembler symbols

<Ws> Is the 32-bit name of the general-purpose register holding the data value to be operated on with the contents of the memory location, encoded in the "Rs" field.

<Wt> Is the 32-bit name of the general-purpose register to be loaded, encoded in the "Rt" field.

<Xn|SP> Is the 64-bit name of the general-purpose base register or stack pointer, encoded in the "Rn" field.

Operation

```
bits(64) address;
bits(16) value;
bits(16) data;
bits(16) result;

value = X[s];
if n == 31 then
    CheckSPAlignment();
    address = SP[];
else
    address = X[n];
data = Mem[address, 2, ldacctype];

result = if UInt(data) > UInt(value) then data else value;
// All observers in the shareability domain observe the
// following load and store atomically.
Mem[address, 2, stacctype] = result;

X[t] = ZeroExtend(data, 32);
```

C6.2.132 LDUMAX, LDUMAXA, LDUMAXAL, LDUMAXL

Atomic unsigned maximum on word or doubleword in memory atomically loads a 32-bit word or 64-bit doubleword from memory, compares it against the value held in a register, and stores the larger value back to memory, treating the values as unsigned numbers. The value initially loaded from memory is returned in the destination register.

- If the destination register is not one of WZR or XZR, LDUMAXA and LDUMAXAL load from memory with acquire semantics.
- LDUMAXL and LDUMAXAL store to memory with release semantics.
- LDUMAX has no memory ordering requirements.

For more information about memory ordering semantics see [Load-Acquire, Store-Release](#) on page B2-94.

For information about memory accesses see [Load/Store addressing modes](#) on page C1-143.

ARMv8.1

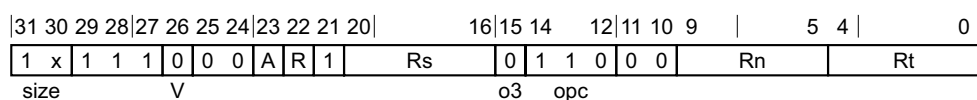

32-bit, acquire variant

Applies when size == 10 && A == 1 && R == 0.

LDUMAXA <Ws>, <Wt>, [<Xn|SP>]

32-bit, acquire and release variant

Applies when size == 10 && A == 1 && R == 1.

LDUMAXAL <Ws>, <Wt>, [<Xn|SP>]

32-bit, no memory ordering variant

Applies when size == 10 && A == 0 && R == 0 && Rt != 11111.

LDUMAX <Ws>, <Wt>, [<Xn|SP>]

32-bit, release variant

Applies when size == 10 && A == 0 && R == 1 && Rt != 11111.

LDUMAXL <Ws>, <Wt>, [<Xn|SP>]

64-bit, acquire variant

Applies when size == 11 && A == 1 && R == 0.

LDUMAXA <Xs>, <Xt>, [<Xn|SP>]

64-bit, acquire and release variant

Applies when size == 11 && A == 1 && R == 1.

LDUMAXAL <Xs>, <Xt>, [<Xn|SP>]

64-bit, no memory ordering variant

Applies when size == 11 && A == 0 && R == 0 && Rt != 11111.

LDUMAX <Xs>, <Xt>, [<Xn|SP>]

64-bit, release variant

Applies when size == 11 && A == 0 && R == 1 && Rt != 11111.

LDUMAXL <Xs>, <Xt>, [<Xn|SP>]

Decode for all variants of this encoding

```
if !HaveAtomicExt() then UnallocatedEncoding();
integer t = UInt(Rt);
integer n = UInt(Rn);
integer s = UInt(Rs);

integer datasize = 8 << UInt(size);
integer regsize = if datasize == 64 then 64 else 32;
AccType ldacctype = if A == '1' && Rt != '11111' then AccType_ORDEREDRW else AccType_ATOMICRW;
AccType stacctype = if R == '1' then AccType_ORDEREDRW else AccType_ATOMICRW;
```

Assembler symbols

- <Ws> Is the 32-bit name of the general-purpose register holding the data value to be operated on with the contents of the memory location, encoded in the "Rs" field.
- <Wt> Is the 32-bit name of the general-purpose register to be loaded, encoded in the "Rt" field.
- <Xs> Is the 64-bit name of the general-purpose register holding the data value to be operated on with the contents of the memory location, encoded in the "Rs" field.
- <Xt> Is the 64-bit name of the general-purpose register to be loaded, encoded in the "Rt" field.
- <Xn|SP> Is the 64-bit name of the general-purpose base register or stack pointer, encoded in the "Rn" field.

Operation

```
bits(64) address;
bits(datasize) value;
bits(datasize) data;
bits(datasize) result;

value = X[s];
if n == 31 then
    CheckSPAAlignment();
    address = SP[];
else
    address = X[n];
data = Mem[address, datasize DIV 8, ldacctype];

result = if UInt(data) > UInt(value) then data else value;
// All observers in the shareability domain observe the
// following load and store atomically.
Mem[address, datasize DIV 8, stacctype] = result;

X[t] = ZeroExtend(data, regsize);
```

C6.2.133 LDUMINB, LDUMINAB, LDUMINALB, LDUMINLB

Atomic unsigned minimum on byte in memory atomically loads an 8-bit byte from memory, compares it against the value held in a register, and stores the smaller value back to memory, treating the values as unsigned numbers. The value initially loaded from memory is returned in the destination register.

- If the destination register is not WZR, LDUMINAB and LDUMINALB load from memory with acquire semantics.
- LDUMINLB and LDUMINALB store to memory with release semantics.
- LDUMINB has no memory ordering requirements.

For more information about memory ordering semantics see [Load-Acquire, Store-Release](#) on page B2-94.

For information about memory accesses see [Load/Store addressing modes](#) on page C1-143.

ARMv8.1

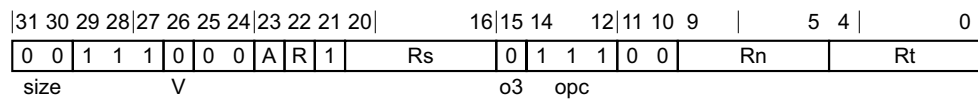

Acquire variant

Applies when A == 1 && R == 0.

LDUMINAB <Ws>, <Wt>, [<Xn|SP>]

Acquire and release variant

Applies when A == 1 && R == 1.

LDUMINALB <Ws>, <Wt>, [<Xn|SP>]

No memory ordering variant

Applies when A == 0 && R == 0 && Rt != 11111.

LDUMINB <Ws>, <Wt>, [<Xn|SP>]

Release variant

Applies when A == 0 && R == 1 && Rt != 11111.

LDUMINLB <Ws>, <Wt>, [<Xn|SP>]

Decode for all variants of this encoding

```
if !HaveAtomicExt() then UnallocatedEncoding();
integer t = UInt(Rt);
integer n = UInt(Rn);
integer s = UInt(Rs);
```

```
AccType ldacctype = if A == '1' && Rt != '11111' then AccType_ORDEREDRW else AccType_ATOMICRW;
AccType stacctype = if R == '1' then AccType_ORDEREDRW else AccType_ATOMICRW;
```

Assembler symbols

<Ws> Is the 32-bit name of the general-purpose register holding the data value to be operated on with the contents of the memory location, encoded in the "Rs" field.

<Wt> Is the 32-bit name of the general-purpose register to be loaded, encoded in the "Rt" field.

<Xn|SP> Is the 64-bit name of the general-purpose base register or stack pointer, encoded in the "Rn" field.

Operation

```
bits(64) address;
bits(8) value;
bits(8) data;
bits(8) result;

value = X[s];
if n == 31 then
    CheckSPAlignment();
    address = SP[];
else
    address = X[n];
data = Mem[address, 1, ldacctype];

result = if UInt(data) > UInt(value) then value else data;
// All observers in the shareability domain observe the
// following load and store atomically.
Mem[address, 1, stacctype] = result;

X[t] = ZeroExtend(data, 32);
```

C6.2.134 LDUMINH, LDUMINAH, LDUMINALH, LDUMINLH

Atomic unsigned minimum on halfword in memory atomically loads a 16-bit halfword from memory, compares it against the value held in a register, and stores the smaller value back to memory, treating the values as unsigned numbers. The value initially loaded from memory is returned in the destination register.

- If the destination register is not WZR, LDUMINAH and LDUMINALH load from memory with acquire semantics.
- LDUMINLH and LDUMINALH store to memory with release semantics.
- LDUMINH has no memory ordering requirements.

For more information about memory ordering semantics see [Load-Acquire, Store-Release](#) on page B2-94.

For information about memory accesses see [Load/Store addressing modes](#) on page C1-143.

ARMv8.1

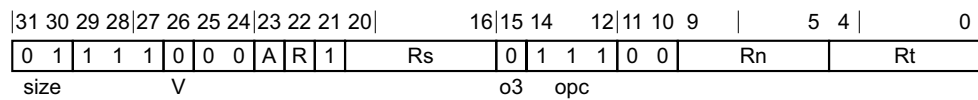

Acquire variant

Applies when A == 1 && R == 0.

LDUMINAH <Ws>, <Wt>, [<Xn|SP>]

Acquire and release variant

Applies when A == 1 && R == 1.

LDUMINALH <Ws>, <Wt>, [<Xn|SP>]

No memory ordering variant

Applies when A == 0 && R == 0 && Rt != 11111.

LDUMINH <Ws>, <Wt>, [<Xn|SP>]

Release variant

Applies when A == 0 && R == 1 && Rt != 11111.

LDUMINLH <Ws>, <Wt>, [<Xn|SP>]

Decode for all variants of this encoding

```
if !HaveAtomicExt() then UnallocatedEncoding();
integer t = UInt(Rt);
integer n = UInt(Rn);
integer s = UInt(Rs);
```

```
AccType ldacctype = if A == '1' && Rt != '11111' then AccType_ORDEREDRW else AccType_ATOMICRW;
AccType stacctype = if R == '1' then AccType_ORDEREDRW else AccType_ATOMICRW;
```

Assembler symbols

<Ws> Is the 32-bit name of the general-purpose register holding the data value to be operated on with the contents of the memory location, encoded in the "Rs" field.

<Wt> Is the 32-bit name of the general-purpose register to be loaded, encoded in the "Rt" field.

<Xn|SP> Is the 64-bit name of the general-purpose base register or stack pointer, encoded in the "Rn" field.

Operation

```
bits(64) address;
bits(16) value;
bits(16) data;
bits(16) result;

value = X[s];
if n == 31 then
    CheckSPAlignment();
    address = SP[];
else
    address = X[n];
data = Mem[address, 2, ldacctype];

result = if UInt(data) > UInt(value) then value else data;
// All observers in the shareability domain observe the
// following load and store atomically.
Mem[address, 2, stacctype] = result;

X[t] = ZeroExtend(data, 32);
```

C6.2.135 LDUMIN, LDUMINA, LDUMINAL, LDUMINL

Atomic unsigned minimum on word or doubleword in memory atomically loads a 32-bit word or 64-bit doubleword from memory, compares it against the value held in a register, and stores the smaller value back to memory, treating the values as unsigned numbers. The value initially loaded from memory is returned in the destination register.

- If the destination register is not one of WZR or XZR, LDUMINA and LDUMINAL load from memory with acquire semantics.
- LDUMINL and LDUMINAL store to memory with release semantics.
- LDUMIN has no memory ordering requirements.

For more information about memory ordering semantics see [Load-Acquire, Store-Release](#) on page B2-94.

For information about memory accesses see [Load/Store addressing modes](#) on page C1-143.

ARMv8.1

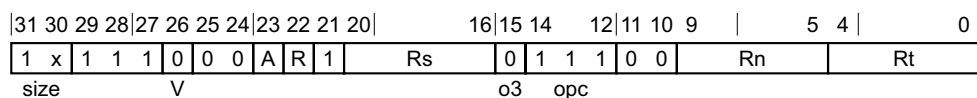

32-bit, acquire variant

Applies when $size == 10 \ \&\& \ A == 1 \ \&\& \ R == 0$.

LDUMINA <Ws>, <Wt>, [<Xn|SP>]

32-bit, acquire and release variant

Applies when $size == 10 \ \&\& \ A == 1 \ \&\& \ R == 1$.

LDUMINAL <Ws>, <Wt>, [<Xn|SP>]

32-bit, no memory ordering variant

Applies when $size == 10 \ \&\& \ A == 0 \ \&\& \ R == 0 \ \&\& \ Rt != 11111$.

LDUMIN <Ws>, <Wt>, [<Xn|SP>]

32-bit, release variant

Applies when $size == 10 \ \&\& \ A == 0 \ \&\& \ R == 1 \ \&\& \ Rt != 11111$.

LDUMINL <Ws>, <Wt>, [<Xn|SP>]

64-bit, acquire variant

Applies when $size == 11 \ \&\& \ A == 1 \ \&\& \ R == 0$.

LDUMINA <Xs>, <Xt>, [<Xn|SP>]

64-bit, acquire and release variant

Applies when $size == 11 \ \&\& \ A == 1 \ \&\& \ R == 1$.

LDUMINAL <Xs>, <Xt>, [<Xn|SP>]

64-bit, no memory ordering variant

Applies when $size == 11 \ \&\& \ A == 0 \ \&\& \ R == 0 \ \&\& \ Rt != 11111$.

LDUMIN <Xs>, <Xt>, [<Xn|SP>]

64-bit, release variant

Applies when size == 11 && A == 0 && R == 1 && Rt != 11111.

LDUMINL <Xs>, <Xt>, [<Xn|SP>]

Decode for all variants of this encoding

```
if !HaveAtomicExt() then UnallocatedEncoding();
integer t = UInt(Rt);
integer n = UInt(Rn);
integer s = UInt(Rs);

integer datasize = 8 << UInt(size);
integer regsize = if datasize == 64 then 64 else 32;
AccType ldacctype = if A == '1' && Rt != '11111' then AccType_ORDEREDRW else AccType_ATOMICRW;
AccType stacctype = if R == '1' then AccType_ORDEREDRW else AccType_ATOMICRW;
```

Assembler symbols

- <Ws> Is the 32-bit name of the general-purpose register holding the data value to be operated on with the contents of the memory location, encoded in the "Rs" field.
- <Wt> Is the 32-bit name of the general-purpose register to be loaded, encoded in the "Rt" field.
- <Xs> Is the 64-bit name of the general-purpose register holding the data value to be operated on with the contents of the memory location, encoded in the "Rs" field.
- <Xt> Is the 64-bit name of the general-purpose register to be loaded, encoded in the "Rt" field.
- <Xn|SP> Is the 64-bit name of the general-purpose base register or stack pointer, encoded in the "Rn" field.

Operation

```
bits(64) address;
bits(datasize) value;
bits(datasize) data;
bits(datasize) result;

value = X[s];
if n == 31 then
    CheckSPAAlignment();
    address = SP[];
else
    address = X[n];
data = Mem[address, datasize DIV 8, ldacctype];

result = if UInt(data) > UInt(value) then value else data;
// All observers in the shareability domain observe the
// following load and store atomically.
Mem[address, datasize DIV 8, stacctype] = result;

X[t] = ZeroExtend(data, regsize);
```

C6.2.136 LDUR

Load Register (unscaled) calculates an address from a base register and an immediate offset, loads a 32-bit word or 64-bit doubleword from memory, zero-extends it, and writes it to a register. For information about memory accesses, see [Load/Store addressing modes](#) on page C1-143.



32-bit variant

Applies when size == 10.

LDUR <Wt>, [<Xn|SP>{, #<sim>}]

64-bit variant

Applies when size == 11.

LDUR <Xt>, [<Xn|SP>{, #<sim>}]

Decode for all variants of this encoding

```
integer scale = UInt(size);
bits(64) offset = SignExtend(imm9, 64);
```

Assembler symbols

- <Wt> Is the 32-bit name of the general-purpose register to be transferred, encoded in the "Rt" field.
- <Xt> Is the 64-bit name of the general-purpose register to be transferred, encoded in the "Rt" field.
- <Xn|SP> Is the 64-bit name of the general-purpose base register or stack pointer, encoded in the "Rn" field.
- <sim> Is the optional signed immediate byte offset, in the range -256 to 255, defaulting to 0 and encoded in the "imm9" field.

Shared decode for all encodings

```
integer n = UInt(Rn);
integer t = UInt(Rt);
integer regsize;

regsize = if size == '11' then 64 else 32;
integer datasize = 8 << scale;
```

Operation

```
bits(64) address;
bits(datasize) data;

if n == 31 then
    CheckSPAlignment();
    address = SP[];
else
    address = X[n];

address = address + offset;
```

```
data = Mem[address, datasize DIV 8, AccType_NORMAL];  
X[t] = ZeroExtend(data, regsize);
```

C6.2.137 LDURB

Load Register Byte (unscaled) calculates an address from a base register and an immediate offset, loads a byte from memory, zero-extends it, and writes it to a register. For information about memory accesses, see [Load/Store addressing modes](#) on page C1-143.

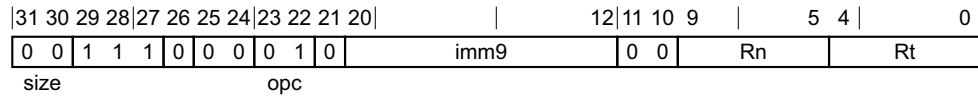

Unscaled offset variant

LDURB <Wt>, [<Xn|SP>{, #<sim>}]

Decode for this encoding

bits(64) offset = [SignExtend](#)(imm9, 64);

Assembler symbols

- <Wt> Is the 32-bit name of the general-purpose register to be transferred, encoded in the "Rt" field.
- <Xn|SP> Is the 64-bit name of the general-purpose base register or stack pointer, encoded in the "Rn" field.
- <sim> Is the optional signed immediate byte offset, in the range -256 to 255, defaulting to 0 and encoded in the "imm9" field.

Shared decode for all encodings

```
integer n = UInt(Rn);
integer t = UInt(Rt);
```

Operation

```
bits(64) address;
bits(8) data;

if n == 31 then
    CheckSPAlignment();
    address = SP[];
else
    address = X[n];

address = address + offset;

data = Mem[address, 1, AccType\_NORMAL];
X[t] = ZeroExtend(data, 32);
```

C6.2.138 LDURH

Load Register Halfword (unscaled) calculates an address from a base register and an immediate offset, loads a halfword from memory, zero-extends it, and writes it to a register. For information about memory accesses, see [Load/Store addressing modes on page C1-143](#).



Unscaled offset variant

LDURH <Wt>, [<Xn|SP>{, #<simmm>}]

Decode for this encoding

bits(64) offset = [SignExtend](#)(imm9, 64);

Assembler symbols

- <Wt> Is the 32-bit name of the general-purpose register to be transferred, encoded in the "Rt" field.
- <Xn|SP> Is the 64-bit name of the general-purpose base register or stack pointer, encoded in the "Rn" field.
- <simmm> Is the optional signed immediate byte offset, in the range -256 to 255, defaulting to 0 and encoded in the "imm9" field.

Shared decode for all encodings

```
integer n = UInt(Rn);
integer t = UInt(Rt);
```

Operation

```
bits(64) address;
bits(16) data;

if n == 31 then
    CheckSPAlignment();
    address = SP[];
else
    address = X[n];

address = address + offset;

data = Mem[address, 2, AccType_NORMAL];
X[t] = ZeroExtend(data, 32);
```

C6.2.139 LDURSB

Load Register Signed Byte (unscaled) calculates an address from a base register and an immediate offset, loads a signed byte from memory, sign-extends it, and writes it to a register. For information about memory accesses, see [Load/Store addressing modes on page C1-143](#).

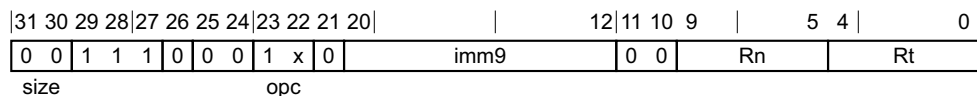

32-bit variant

Applies when `opc == 11`.

LDURSB <Wt>, [<Xn|SP>{, #<sim>}]

64-bit variant

Applies when `opc == 10`.

LDURSB <Xt>, [<Xn|SP>{, #<sim>}]

Decode for all variants of this encoding

bits(64) offset = [SignExtend](#)(imm9, 64);

Assembler symbols

- <Wt> Is the 32-bit name of the general-purpose register to be transferred, encoded in the "Rt" field.
- <Xt> Is the 64-bit name of the general-purpose register to be transferred, encoded in the "Rt" field.
- <Xn|SP> Is the 64-bit name of the general-purpose base register or stack pointer, encoded in the "Rn" field.
- <sim> Is the optional signed immediate byte offset, in the range -256 to 255, defaulting to 0 and encoded in the "imm9" field.

Shared decode for all encodings

```
integer n = UInt(Rn);
integer t = UInt(Rt);
MemOp memop;
boolean signed;
integer regsize;

if opc<1> == '0' then
  // store or zero-extending load
  memop = if opc<0> == '1' then MemOp_LOAD else MemOp_STORE;
  regsize = 32;
  signed = FALSE;
else
  // sign-extending load
  memop = MemOp_LOAD;
  regsize = if opc<0> == '1' then 32 else 64;
  signed = TRUE;
```

Operation

```
bits(64) address;
bits(8) data;

if n == 31 then
    if memop != MemOp_PREFETCH then CheckSPAlignment();
    address = SP[];
else
    address = X[n];

address = address + offset;

case memop of
    when MemOp_STORE
        data = X[t];
        Mem[address, 1, AccType_NORMAL] = data;

    when MemOp_LOAD
        data = Mem[address, 1, AccType_NORMAL];
        if signed then
            X[t] = SignExtend(data, regsize);
        else
            X[t] = ZeroExtend(data, regsize);

    when MemOp_PREFETCH
        Prefetch(address, t<4:0>);
```

C6.2.140 LDURSH

Load Register Signed Halfword (unscaled) calculates an address from a base register and an immediate offset, loads a signed halfword from memory, sign-extends it, and writes it to a register. For information about memory accesses, see *Load/Store addressing modes* on page C1-143.

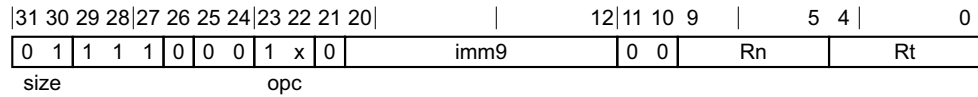

32-bit variant

Applies when `opc == 11`.

LDURSH <Wt>, [<Xn|SP>{, #<sim>}]

64-bit variant

Applies when `opc == 10`.

LDURSH <Xt>, [<Xn|SP>{, #<sim>}]

Decode for all variants of this encoding

bits(64) offset = `SignExtend`(imm9, 64);

Assembler symbols

- <Wt> Is the 32-bit name of the general-purpose register to be transferred, encoded in the "Rt" field.
- <Xt> Is the 64-bit name of the general-purpose register to be transferred, encoded in the "Rt" field.
- <Xn|SP> Is the 64-bit name of the general-purpose base register or stack pointer, encoded in the "Rn" field.
- <sim> Is the optional signed immediate byte offset, in the range -256 to 255, defaulting to 0 and encoded in the "imm9" field.

Shared decode for all encodings

```
integer n = UInt(Rn);
integer t = UInt(Rt);
MemOp memop;
boolean signed;
integer regsize;

if opc<1> == '0' then
    // store or zero-extending load
    memop = if opc<0> == '1' then MemOp_LOAD else MemOp_STORE;
    regsize = 32;
    signed = FALSE;
else
    // sign-extending load
    memop = MemOp_LOAD;
    regsize = if opc<0> == '1' then 32 else 64;
    signed = TRUE;
```

Operation

```
bits(64) address;
bits(16) data;

if n == 31 then
    if memop != MemOp_PREFETCH then CheckSPAlignment();
    address = SP[];
else
    address = X[n];

address = address + offset;

case memop of
    when MemOp_STORE
        data = X[t];
        Mem[address, 2, AccType_NORMAL] = data;

    when MemOp_LOAD
        data = Mem[address, 2, AccType_NORMAL];
        if signed then
            X[t] = SignExtend(data, regsize);
        else
            X[t] = ZeroExtend(data, regsize);

    when MemOp_PREFETCH
        Prefetch(address, t<4:0>);
```

C6.2.141 LDURSW

Load Register Signed Word (unscaled) calculates an address from a base register and an immediate offset, loads a signed word from memory, sign-extends it, and writes it to a register. For information about memory accesses, see [Load/Store addressing modes on page C1-143](#).

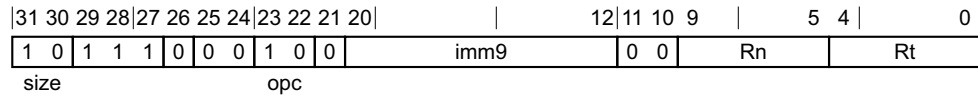

Unscaled offset variant

LDURSW <Xt>, [<Xn|SP>{, #<sim>}]

Decode for this encoding

bits(64) offset = [SignExtend](#)(imm9, 64);

Assembler symbols

- <Xt> Is the 64-bit name of the general-purpose register to be transferred, encoded in the "Rt" field.
- <Xn|SP> Is the 64-bit name of the general-purpose base register or stack pointer, encoded in the "Rn" field.
- <sim> Is the optional signed immediate byte offset, in the range -256 to 255, defaulting to 0 and encoded in the "imm9" field.

Shared decode for all encodings

```
integer n = UInt(Rn);
integer t = UInt(Rt);
```

Operation

```
bits(64) address;
bits(32) data;

if n == 31 then
    CheckSPAlignment();
    address = SP[];
else
    address = X[n];

address = address + offset;

data = Mem[address, 4, AccType\_NORMAL];
X[t] = SignExtend(data, 64);
```

C6.2.142 LDXP

Load Exclusive Pair of Registers derives an address from a base register value, loads two 32-bit words or two 64-bit doublewords from memory, and writes them to two registers. A 32-bit pair requires the address to be doubleword aligned and is single-copy atomic at doubleword granularity. A 64-bit pair requires the address to be quadword aligned and is single-copy atomic for each doubleword at doubleword granularity. The PE marks the physical address being accessed as an exclusive access. This exclusive access mark is checked by Store Exclusive instructions. See [Synchronization and semaphores on page B2-121](#). For information about memory accesses see [Load/Store addressing modes on page C1-143](#).

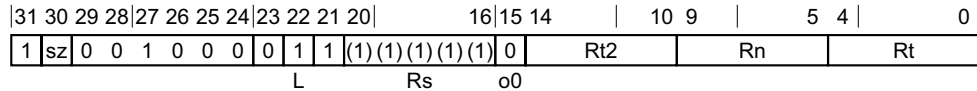

32-bit variant

Applies when `sz == 0`.

LDXP <Wt1>, <Wt2>, [<Xn|SP>{, #0}]

64-bit variant

Applies when `sz == 1`.

LDXP <Xt1>, <Xt2>, [<Xn|SP>{, #0}]

Decode for all variants of this encoding

```
integer n = UInt(Rn);
integer t = UInt(Rt);
integer t2 = UInt(Rt2);

integer elsize = 32 << UInt(sz);
integer datasize = elsize * 2;
```

Notes for all encodings

For information about the CONSTRAINED UNPREDICTABLE behavior of this instruction, see [Appendix K1 Architectural Constraints on UNPREDICTABLE behaviors](#), and particularly [LDXP on page K1-6128](#).

Assembler symbols

- <Wt1> Is the 32-bit name of the first general-purpose register to be transferred, encoded in the "Rt" field.
- <Wt2> Is the 32-bit name of the second general-purpose register to be transferred, encoded in the "Rt2" field.
- <Xt1> Is the 64-bit name of the first general-purpose register to be transferred, encoded in the "Rt" field.
- <Xt2> Is the 64-bit name of the second general-purpose register to be transferred, encoded in the "Rt2" field.
- <Xn|SP> Is the 64-bit name of the general-purpose base register or stack pointer, encoded in the "Rn" field.

Operation

```
bits(64) address;
bits(datasize) data;
constant integer dbytes = datasize DIV 8;
```

```

boolean rt_unknown = FALSE;

if t == t2 then
    Constraint c = ConstrainUnpredictable();
    assert c IN {Constraint_UNKNOWN, Constraint_UNDEF, Constraint_NOP};
    case c of
        when Constraint_UNKNOWN rt_unknown = TRUE; // result is UNKNOWN
        when Constraint_UNDEF UnallocatedEncoding();
        when Constraint_NOP EndOfInstruction();

if n == 31 then
    CheckSPAlignment();
    address = SP[];
else
    address = X[n];

// Tell the Exclusive Monitors to record a sequence of one or more atomic
// memory reads from virtual address range [address, address+dbytes-1].
// The Exclusive Monitor will only be set if all the reads are from the
// same dbytes-aligned physical address, to allow for the possibility of
// an atomicity break if the translation is changed between reads.
AArch64.SetExclusiveMonitors(address, dbytes);

if rt_unknown then
    // ConstrainedUNPREDICTABLE case
    X[t] = bits(datasize) UNKNOWN;
elseif e1size == 32 then
    // 32-bit load exclusive pair (atomic)
    data = Mem[address, dbytes, AccType_ATOMIC];
    if BigEndian() then
        X[t] = data<datasize-1:e1size>;
        X[t2] = data<e1size-1:0>;
    else
        X[t] = data<e1size-1:0>;
        X[t2] = data<datasize-1:e1size>;
else // e1size == 64
    // 64-bit load exclusive pair (not atomic),
    // but must be 128-bit aligned
    if address != Align(address, dbytes) then
        AArch64.Abort(address, AArch64.AlignmentFault(AccType_ATOMIC, FALSE, FALSE));
    X[t] = Mem[address, 8, AccType_ATOMIC];
    X[t2] = Mem[address+8, 8, AccType_ATOMIC];

```

C6.2.143 LDXR

Load Exclusive Register derives an address from a base register value, loads a 32-bit word or a 64-bit doubleword from memory, and writes it to a register. The memory access is atomic. The PE marks the physical address being accessed as an exclusive access. This exclusive access mark is checked by Store Exclusive instructions. See [Synchronization and semaphores on page B2-121](#). For information about memory accesses see [Load/Store addressing modes on page C1-143](#).

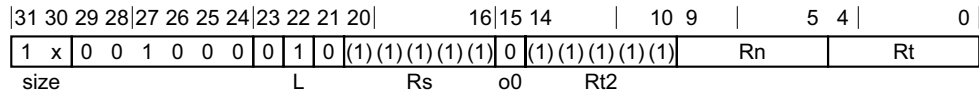

32-bit variant

Applies when size == 10.

LDXR <Wt>, [<Xn|SP>{,#0}]

64-bit variant

Applies when size == 11.

LDXR <Xt>, [<Xn|SP>{,#0}]

Decode for all variants of this encoding

```
integer n = UInt(Rn);
integer t = UInt(Rt);

integer elsize = 8 << UInt(size);
integer regsize = if elsize == 64 then 64 else 32;
```

Assembler symbols

- <Wt> Is the 32-bit name of the general-purpose register to be transferred, encoded in the "Rt" field.
- <Xt> Is the 64-bit name of the general-purpose register to be transferred, encoded in the "Rt" field.
- <Xn|SP> Is the 64-bit name of the general-purpose base register or stack pointer, encoded in the "Rn" field.

Operation

```
bits(64) address;
bits(elsize) data;
constant integer dbytes = elsize DIV 8;

if n == 31 then
    CheckSPAlignment();
    address = SP[];
else
    address = X[n];

// Tell the Exclusive Monitors to record a sequence of one or more atomic
// memory reads from virtual address range [address, address+dbytes-1].
// The Exclusive Monitor will only be set if all the reads are from the
// same dbytes-aligned physical address, to allow for the possibility of
// an atomicity break if the translation is changed between reads.
AArch64.SetExclusiveMonitors(address, dbytes);

data = Mem[address, dbytes, AccType_ATOMIC];
X[t] = ZeroExtend(data, regsize);
```

C6.2.144 LDXRB

Load Exclusive Register Byte derives an address from a base register value, loads a byte from memory, zero-extends it and writes it to a register. The memory access is atomic. The PE marks the physical address being accessed as an exclusive access. This exclusive access mark is checked by Store Exclusive instructions. See [Synchronization and semaphores on page B2-121](#). For information about memory accesses see [Load/Store addressing modes on page C1-143](#).

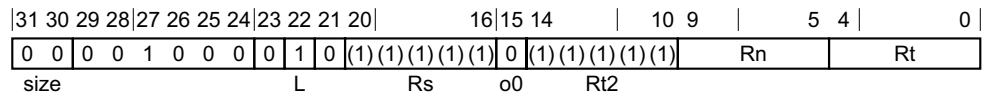

No offset variant

LDXRB <Wt>, [<Xn|SP>{,#0}]

Decode for this encoding

```
integer n = UInt(Rn);
integer t = UInt(Rt);
```

Assembler symbols

<Wt> Is the 32-bit name of the general-purpose register to be transferred, encoded in the "Rt" field.

<Xn|SP> Is the 64-bit name of the general-purpose base register or stack pointer, encoded in the "Rn" field.

Operation

```
bits(64) address;
bits(8) data;
```

```
if n == 31 then
    CheckSPAlignment();
    address = SP[];
else
    address = X[n];
```

```
// Tell the Exclusive Monitors to record a sequence of one or more atomic
// memory reads from virtual address range [address, address+dbytes-1].
// The Exclusive Monitor will only be set if all the reads are from the
// same dbytes-aligned physical address, to allow for the possibility of
// an atomicity break if the translation is changed between reads.
AArch64.SetExclusiveMonitors(address, 1);
```

```
data = Mem[address, 1, AccType_ATOMIC];
X[t] = ZeroExtend(data, 32);
```

C6.2.145 LDXRH

Load Exclusive Register Halfword derives an address from a base register value, loads a halfword from memory, zero-extends it and writes it to a register. The memory access is atomic. The PE marks the physical address being accessed as an exclusive access. This exclusive access mark is checked by Store Exclusive instructions. See [Synchronization and semaphores on page B2-121](#). For information about memory accesses see [Load/Store addressing modes on page C1-143](#).

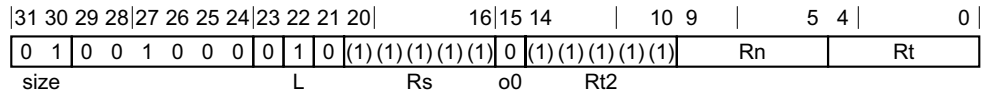

No offset variant

LDXRH <Wt>, [<Xn|SP>{,#0}]

Decode for this encoding

```
integer n = UInt(Rn);
integer t = UInt(Rt);
```

Assembler symbols

<Wt> Is the 32-bit name of the general-purpose register to be transferred, encoded in the "Rt" field.

<Xn|SP> Is the 64-bit name of the general-purpose base register or stack pointer, encoded in the "Rn" field.

Operation

```
bits(64) address;
bits(16) data;
```

```
if n == 31 then
    CheckSPAlignment();
    address = SP[];
else
    address = X[n];
```

```
// Tell the Exclusive Monitors to record a sequence of one or more atomic
// memory reads from virtual address range [address, address+dbytes-1].
// The Exclusive Monitor will only be set if all the reads are from the
// same dbytes-aligned physical address, to allow for the possibility of
// an atomicity break if the translation is changed between reads.
AArch64.SetExclusiveMonitors(address, 2);
```

```
data = Mem[address, 2, AccType_ATOMIC];
X[t] = ZeroExtend(data, 32);
```

C6.2.146 LSL (register)

Logical Shift Left (register) shifts a register value left by a variable number of bits, shifting in zeros, and writes the result to the destination register. The remainder obtained by dividing the second source register by the data size defines the number of bits by which the first source register is left-shifted.

This instruction is an alias of the [LSLV](#) instruction. This means that:

- The encodings in this description are named to match the encodings of [LSLV](#).
- The description of [LSLV](#) gives the operational pseudocode for this instruction.

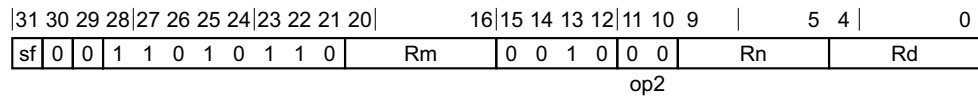

32-bit variant

Applies when `sf == 0`.

LSL <Wd>, <Wn>, <Wm>

is equivalent to

LSLV <Wd>, <Wn>, <Wm>

and is always the preferred disassembly.

64-bit variant

Applies when `sf == 1`.

LSL <Xd>, <Xn>, <Xm>

is equivalent to

LSLV <Xd>, <Xn>, <Xm>

and is always the preferred disassembly.

Assembler symbols

<Wd> Is the 32-bit name of the general-purpose destination register, encoded in the "Rd" field.

<Wn> Is the 32-bit name of the first general-purpose source register, encoded in the "Rn" field.

<Wm> Is the 32-bit name of the second general-purpose source register holding a shift amount from 0 to 31 in its bottom 5 bits, encoded in the "Rm" field.

<Xd> Is the 64-bit name of the general-purpose destination register, encoded in the "Rd" field.

<Xn> Is the 64-bit name of the first general-purpose source register, encoded in the "Rn" field.

<Xm> Is the 64-bit name of the second general-purpose source register holding a shift amount from 0 to 63 in its bottom 6 bits, encoded in the "Rm" field.

Operation

The description of [LSLV](#) gives the operational pseudocode for this instruction.

C6.2.147 LSL (immediate)

Logical Shift Left (immediate) shifts a register value left by an immediate number of bits, shifting in zeros, and writes the result to the destination register.

This instruction is an alias of the [UBFM](#) instruction. This means that:

- The encodings in this description are named to match the encodings of [UBFM](#).
- The description of [UBFM](#) gives the operational pseudocode for this instruction.

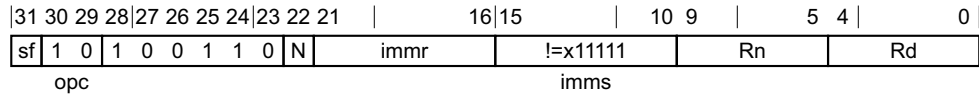

32-bit variant

Applies when $sf == 0 \ \&\& \ N == 0 \ \&\& \ imms \ != \ 011111$.

LSL <Wd>, <Wn>, #<shift>

is equivalent to

UBFM <Wd>, <Wn>, #(-<shift> MOD 32), #(31-<shift>)

and is the preferred disassembly when $imms + 1 == immr$.

64-bit variant

Applies when $sf == 1 \ \&\& \ N == 1 \ \&\& \ imms \ != \ 111111$.

LSL <Xd>, <Xn>, #<shift>

is equivalent to

UBFM <Xd>, <Xn>, #(-<shift> MOD 64), #(63-<shift>)

and is the preferred disassembly when $imms + 1 == immr$.

Assembler symbols

<Wd> Is the 32-bit name of the general-purpose destination register, encoded in the "Rd" field.

<Wn> Is the 32-bit name of the general-purpose source register, encoded in the "Rn" field.

<Xd> Is the 64-bit name of the general-purpose destination register, encoded in the "Rd" field.

<Xn> Is the 64-bit name of the general-purpose source register, encoded in the "Rn" field.

<shift> For the 32-bit variant: is the shift amount, in the range 0 to 31.

For the 64-bit variant: is the shift amount, in the range 0 to 63.

Operation

The description of [UBFM](#) gives the operational pseudocode for this instruction.

C6.2.148 LSLV

Logical Shift Left Variable shifts a register value left by a variable number of bits, shifting in zeros, and writes the result to the destination register. The remainder obtained by dividing the second source register by the data size defines the number of bits by which the first source register is left-shifted.

This instruction is used by the alias [LSL \(register\)](#). The alias is always the preferred disassembly.

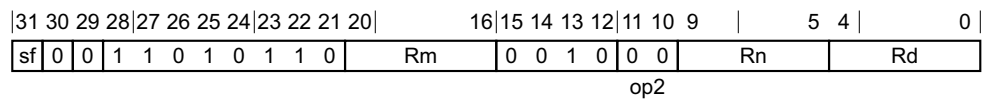

32-bit variant

Applies when `sf == 0`.

LSLV <Wd>, <Wn>, <Wm>

64-bit variant

Applies when `sf == 1`.

LSLV <Xd>, <Xn>, <Xm>

Decode for all variants of this encoding

```
integer d = UInt(Rd);
integer n = UInt(Rn);
integer m = UInt(Rm);
integer datasize = if sf == '1' then 64 else 32;
ShiftType shift_type = DecodeShift(op2);
```

Assembler symbols

<Wd>	Is the 32-bit name of the general-purpose destination register, encoded in the "Rd" field.
<Wn>	Is the 32-bit name of the first general-purpose source register, encoded in the "Rn" field.
<Wm>	Is the 32-bit name of the second general-purpose source register holding a shift amount from 0 to 31 in its bottom 5 bits, encoded in the "Rm" field.
<Xd>	Is the 64-bit name of the general-purpose destination register, encoded in the "Rd" field.
<Xn>	Is the 64-bit name of the first general-purpose source register, encoded in the "Rn" field.
<Xm>	Is the 64-bit name of the second general-purpose source register holding a shift amount from 0 to 63 in its bottom 6 bits, encoded in the "Rm" field.

Operation

```
bits(datasize) result;
bits(datasize) operand2 = X[m];

result = ShiftReg(n, shift_type, UInt(operand2) MOD datasize);
X[d] = result;
```

C6.2.149 LSR (register)

Logical Shift Right (register) shifts a register value right by a variable number of bits, shifting in zeros, and writes the result to the destination register. The remainder obtained by dividing the second source register by the data size defines the number of bits by which the first source register is right-shifted.

This instruction is an alias of the [LSRV](#) instruction. This means that:

- The encodings in this description are named to match the encodings of [LSRV](#).
- The description of [LSRV](#) gives the operational pseudocode for this instruction.

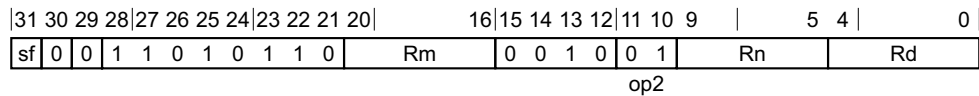

32-bit variant

Applies when `sf == 0`.

LSR <Wd>, <Wn>, <Wm>

is equivalent to

LSRV <Wd>, <Wn>, <Wm>

and is always the preferred disassembly.

64-bit variant

Applies when `sf == 1`.

LSR <Xd>, <Xn>, <Xm>

is equivalent to

LSRV <Xd>, <Xn>, <Xm>

and is always the preferred disassembly.

Assembler symbols

- <Wd> Is the 32-bit name of the general-purpose destination register, encoded in the "Rd" field.
- <Wn> Is the 32-bit name of the first general-purpose source register, encoded in the "Rn" field.
- <Wm> Is the 32-bit name of the second general-purpose source register holding a shift amount from 0 to 31 in its bottom 5 bits, encoded in the "Rm" field.
- <Xd> Is the 64-bit name of the general-purpose destination register, encoded in the "Rd" field.
- <Xn> Is the 64-bit name of the first general-purpose source register, encoded in the "Rn" field.
- <Xm> Is the 64-bit name of the second general-purpose source register holding a shift amount from 0 to 63 in its bottom 6 bits, encoded in the "Rm" field.

Operation

The description of [LSRV](#) gives the operational pseudocode for this instruction.

C6.2.150 LSR (immediate)

Logical Shift Right (immediate) shifts a register value right by an immediate number of bits, shifting in zeros, and writes the result to the destination register.

This instruction is an alias of the [UBFM](#) instruction. This means that:

- The encodings in this description are named to match the encodings of [UBFM](#).
- The description of [UBFM](#) gives the operational pseudocode for this instruction.

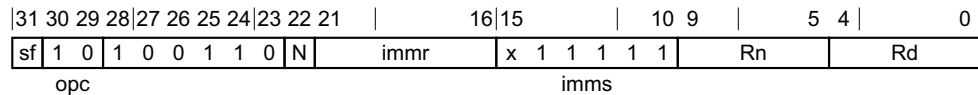

32-bit variant

Applies when $sf == 0 \ \&\& \ N == 0 \ \&\& \ imms == 011111$.

LSR <Wd>, <Wn>, #<shift>

is equivalent to

UBFM <Wd>, <Wn>, #<shift>, #31

and is always the preferred disassembly.

64-bit variant

Applies when $sf == 1 \ \&\& \ N == 1 \ \&\& \ imms == 111111$.

LSR <Xd>, <Xn>, #<shift>

is equivalent to

UBFM <Xd>, <Xn>, #<shift>, #63

and is always the preferred disassembly.

Assembler symbols

<Wd> Is the 32-bit name of the general-purpose destination register, encoded in the "Rd" field.

<Wn> Is the 32-bit name of the general-purpose source register, encoded in the "Rn" field.

<Xd> Is the 64-bit name of the general-purpose destination register, encoded in the "Rd" field.

<Xn> Is the 64-bit name of the general-purpose source register, encoded in the "Rn" field.

<shift> For the 32-bit variant: is the shift amount, in the range 0 to 31, encoded in the "immr" field.

For the 64-bit variant: is the shift amount, in the range 0 to 63, encoded in the "immr" field.

Operation

The description of [UBFM](#) gives the operational pseudocode for this instruction.

C6.2.151 LSRV

Logical Shift Right Variable shifts a register value right by a variable number of bits, shifting in zeros, and writes the result to the destination register. The remainder obtained by dividing the second source register by the data size defines the number of bits by which the first source register is right-shifted.

This instruction is used by the alias [LSR \(register\)](#). The alias is always the preferred disassembly.

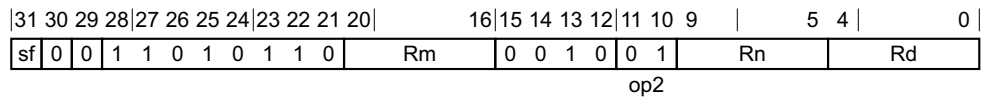

32-bit variant

Applies when sf == 0.

LSRV <Wd>, <Wn>, <Wm>

64-bit variant

Applies when sf == 1.

LSRV <Xd>, <Xn>, <Xm>

Decode for all variants of this encoding

```
integer d = UInt(Rd);
integer n = UInt(Rn);
integer m = UInt(Rm);
integer datasize = if sf == '1' then 64 else 32;
ShiftType shift_type = DecodeShift(op2);
```

Assembler symbols

- <Wd> Is the 32-bit name of the general-purpose destination register, encoded in the "Rd" field.
- <Wn> Is the 32-bit name of the first general-purpose source register, encoded in the "Rn" field.
- <Wm> Is the 32-bit name of the second general-purpose source register holding a shift amount from 0 to 31 in its bottom 5 bits, encoded in the "Rm" field.
- <Xd> Is the 64-bit name of the general-purpose destination register, encoded in the "Rd" field.
- <Xn> Is the 64-bit name of the first general-purpose source register, encoded in the "Rn" field.
- <Xm> Is the 64-bit name of the second general-purpose source register holding a shift amount from 0 to 63 in its bottom 6 bits, encoded in the "Rm" field.

Operation

```
bits(datasize) result;
bits(datasize) operand2 = X[m];

result = ShiftReg(n, shift_type, UInt(operand2) MOD datasize);
X[d] = result;
```

C6.2.152 MADD

Multiply-Add multiplies two register values, adds a third register value, and writes the result to the destination register.

This instruction is used by the alias [MUL](#). See [Alias conditions](#) for details of when each alias is preferred.

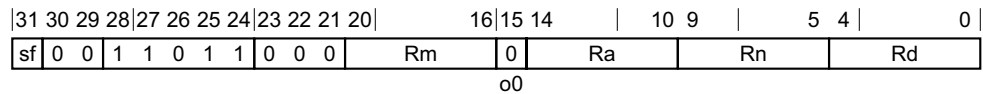

32-bit variant

Applies when sf == 0.

MADD <Wd>, <Wn>, <Wm>, <Wa>

64-bit variant

Applies when sf == 1.

MADD <Xd>, <Xn>, <Xm>, <Xa>

Decode for all variants of this encoding

```
integer d = UInt(Rd);
integer n = UInt(Rn);
integer m = UInt(Rm);
integer a = UInt(Ra);
integer destsize = if sf == '1' then 64 else 32;
```

Alias conditions

Alias	is preferred when
MUL	Ra == '11111'

Assembler symbols

<Wd>	Is the 32-bit name of the general-purpose destination register, encoded in the "Rd" field.
<Wn>	Is the 32-bit name of the first general-purpose source register holding the multiplicand, encoded in the "Rn" field.
<Wm>	Is the 32-bit name of the second general-purpose source register holding the multiplier, encoded in the "Rm" field.
<Wa>	Is the 32-bit name of the third general-purpose source register holding the addend, encoded in the "Ra" field.
<Xd>	Is the 64-bit name of the general-purpose destination register, encoded in the "Rd" field.
<Xn>	Is the 64-bit name of the first general-purpose source register holding the multiplicand, encoded in the "Rn" field.
<Xm>	Is the 64-bit name of the second general-purpose source register holding the multiplier, encoded in the "Rm" field.

<Xa> Is the 64-bit name of the third general-purpose source register holding the addend, encoded in the "Ra" field.

Operation

```
bits(destsize) operand1 = X[n];  
bits(destsize) operand2 = X[m];  
bits(destsize) operand3 = X[a];
```

```
integer result;
```

```
result = UInt(operand3) + (UInt(operand1) * UInt(operand2));
```

```
X[d] = result<destsize-1:0>;
```

C6.2.153 MNEG

Multiply-Negate multiplies two register values, negates the product, and writes the result to the destination register.

This instruction is an alias of the [MSUB](#) instruction. This means that:

- The encodings in this description are named to match the encodings of [MSUB](#).
- The description of [MSUB](#) gives the operational pseudocode for this instruction.

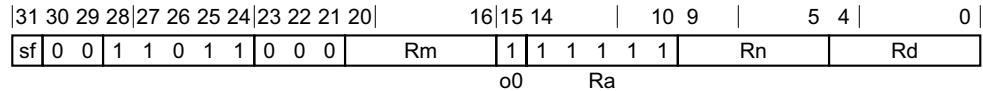

32-bit variant

Applies when `sf == 0`.

MNEG <Wd>, <Wn>, <Wm>

is equivalent to

MSUB <Wd>, <Wn>, <Wm>, WZR

and is always the preferred disassembly.

64-bit variant

Applies when `sf == 1`.

MNEG <Xd>, <Xn>, <Xm>

is equivalent to

MSUB <Xd>, <Xn>, <Xm>, XZR

and is always the preferred disassembly.

Assembler symbols

<Wd> Is the 32-bit name of the general-purpose destination register, encoded in the "Rd" field.

<Wn> Is the 32-bit name of the first general-purpose source register holding the multiplicand, encoded in the "Rn" field.

<Wm> Is the 32-bit name of the second general-purpose source register holding the multiplier, encoded in the "Rm" field.

<Xd> Is the 64-bit name of the general-purpose destination register, encoded in the "Rd" field.

<Xn> Is the 64-bit name of the first general-purpose source register holding the multiplicand, encoded in the "Rn" field.

<Xm> Is the 64-bit name of the second general-purpose source register holding the multiplier, encoded in the "Rm" field.

Operation

The description of [MSUB](#) gives the operational pseudocode for this instruction.

C6.2.154 MOV (to/from SP)

Move between register and stack pointer : Rd = Rn

This instruction is an alias of the [ADD \(immediate\)](#) instruction. This means that:

- The encodings in this description are named to match the encodings of [ADD \(immediate\)](#).
- The description of [ADD \(immediate\)](#) gives the operational pseudocode for this instruction.

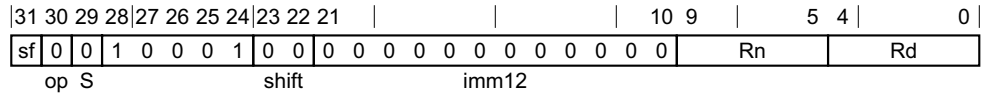

32-bit variant

Applies when sf == 0.

MOV <Wd|WSP>, <Wn|WSP>

is equivalent to

ADD <Wd|WSP>, <Wn|WSP>, #0

and is the preferred disassembly when (Rd == '11111' || Rn == '11111').

64-bit variant

Applies when sf == 1.

MOV <Xd|SP>, <Xn|SP>

is equivalent to

ADD <Xd|SP>, <Xn|SP>, #0

and is the preferred disassembly when (Rd == '11111' || Rn == '11111').

Assembler symbols

- <Wd|WSP> Is the 32-bit name of the destination general-purpose register or stack pointer, encoded in the "Rd" field.
- <Wn|WSP> Is the 32-bit name of the source general-purpose register or stack pointer, encoded in the "Rn" field.
- <Xd|SP> Is the 64-bit name of the destination general-purpose register or stack pointer, encoded in the "Rd" field.
- <Xn|SP> Is the 64-bit name of the source general-purpose register or stack pointer, encoded in the "Rn" field.

Operation

The description of [ADD \(immediate\)](#) gives the operational pseudocode for this instruction.

C6.2.155 MOV (inverted wide immediate)

Move (inverted wide immediate) moves an inverted 16-bit immediate value to a register.

This instruction is an alias of the [MOVN](#) instruction. This means that:

- The encodings in this description are named to match the encodings of [MOVN](#).
- The description of [MOVN](#) gives the operational pseudocode for this instruction.



32-bit variant

Applies when `sf == 0`.

MOV <Wd>, #<imm>

is equivalent to

MOVN <Wd>, #<imm16>, LSL #<shift>

and is the preferred disassembly when `!(IsZero(imm16) && hw != '00') && !IsOnes(imm16)`.

64-bit variant

Applies when `sf == 1`.

MOV <Xd>, #<imm>

is equivalent to

MOVN <Xd>, #<imm16>, LSL #<shift>

and is the preferred disassembly when `!(IsZero(imm16) && hw != '00')`.

Assembler symbols

<Wd> Is the 32-bit name of the general-purpose destination register, encoded in the "Rd" field.

<Xd> Is the 64-bit name of the general-purpose destination register, encoded in the "Rd" field.

<imm> For the 32-bit variant: is a 32-bit immediate, the bitwise inverse of which can be encoded in "imm16:hw", but excluding 0xffff0000 and 0x0000ffff
For the 64-bit variant: is a 64-bit immediate, the bitwise inverse of which can be encoded in "imm16:hw".

<shift> For the 32-bit variant: is the amount by which to shift the immediate left, either 0 (the default) or 16, encoded in the "hw" field as <shift>/16.
For the 64-bit variant: is the amount by which to shift the immediate left, either 0 (the default), 16, 32 or 48, encoded in the "hw" field as <shift>/16.

Operation

The description of [MOVN](#) gives the operational pseudocode for this instruction.

C6.2.156 MOV (wide immediate)

Move (wide immediate) moves a 16-bit immediate value to a register.

This instruction is an alias of the [MOVZ](#) instruction. This means that:

- The encodings in this description are named to match the encodings of [MOVZ](#).
- The description of [MOVZ](#) gives the operational pseudocode for this instruction.



32-bit variant

Applies when `sf == 0`.

MOV <Wd>, #<imm>

is equivalent to

MOVZ <Wd>, #<imm16>, LSL #<shift>

and is the preferred disassembly when `!(IsZero(imm16) && hw != '00')`.

64-bit variant

Applies when `sf == 1`.

MOV <Xd>, #<imm>

is equivalent to

MOVZ <Xd>, #<imm16>, LSL #<shift>

and is the preferred disassembly when `!(IsZero(imm16) && hw != '00')`.

Assembler symbols

<Wd> Is the 32-bit name of the general-purpose destination register, encoded in the "Rd" field.

<Xd> Is the 64-bit name of the general-purpose destination register, encoded in the "Rd" field.

<imm> For the 32-bit variant: is a 32-bit immediate which can be encoded in "imm16:hw".
 For the 64-bit variant: is a 64-bit immediate which can be encoded in "imm16:hw".

<shift> For the 32-bit variant: is the amount by which to shift the immediate left, either 0 (the default) or 16, encoded in the "hw" field as <shift>/16.
 For the 64-bit variant: is the amount by which to shift the immediate left, either 0 (the default), 16, 32 or 48, encoded in the "hw" field as <shift>/16.

Operation

The description of [MOVZ](#) gives the operational pseudocode for this instruction.

C6.2.157 MOV (bitmask immediate)

Move (bitmask immediate) writes a bitmask immediate value to a register.

This instruction is an alias of the [ORR \(immediate\)](#) instruction. This means that:

- The encodings in this description are named to match the encodings of [ORR \(immediate\)](#).
- The description of [ORR \(immediate\)](#) gives the operational pseudocode for this instruction.

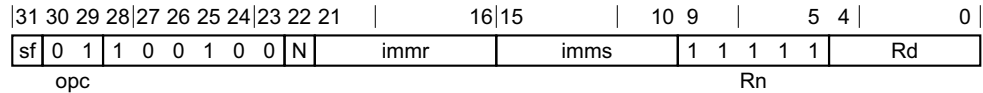

32-bit variant

Applies when $sf == 0 \ \&\& \ N == 0$.

MOV <Wd|WSP>, #<imm>

is equivalent to

ORR <Wd|WSP>, WZR, #<imm>

and is the preferred disassembly when $! \text{MoveWidePreferred}(sf, N, imms, immr)$.

64-bit variant

Applies when $sf == 1$.

MOV <Xd|SP>, #<imm>

is equivalent to

ORR <Xd|SP>, XZR, #<imm>

and is the preferred disassembly when $! \text{MoveWidePreferred}(sf, N, imms, immr)$.

Assembler symbols

<Wd|WSP> Is the 32-bit name of the destination general-purpose register or stack pointer, encoded in the "Rd" field.

<Xd|SP> Is the 64-bit name of the destination general-purpose register or stack pointer, encoded in the "Rd" field.

<imm> For the 32-bit variant: is the bitmask immediate, encoded in "imms:immr", but excluding values which could be encoded by MOVZ or MOVN.
For the 64-bit variant: is the bitmask immediate, encoded in "N:imms:immr", but excluding values which could be encoded by MOVZ or MOVN.

Operation

The description of [ORR \(immediate\)](#) gives the operational pseudocode for this instruction.

C6.2.158 MOV (register)

Move (register) copies the value in a source register to the destination register.

This instruction is an alias of the [ORR \(shifted register\)](#) instruction. This means that:

- The encodings in this description are named to match the encodings of [ORR \(shifted register\)](#).
- The description of [ORR \(shifted register\)](#) gives the operational pseudocode for this instruction.

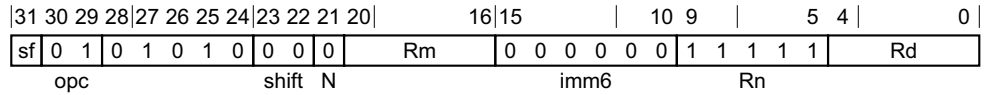

32-bit variant

Applies when `sf == 0`.

MOV <Wd>, <Wm>

is equivalent to

ORR <Wd>, WZR, <Wm>

and is always the preferred disassembly.

64-bit variant

Applies when `sf == 1`.

MOV <Xd>, <Xm>

is equivalent to

ORR <Xd>, XZR, <Xm>

and is always the preferred disassembly.

Assembler symbols

<Wd> Is the 32-bit name of the general-purpose destination register, encoded in the "Rd" field.

<Wm> Is the 32-bit name of the general-purpose source register, encoded in the "Rm" field.

<Xd> Is the 64-bit name of the general-purpose destination register, encoded in the "Rd" field.

<Xm> Is the 64-bit name of the general-purpose source register, encoded in the "Rm" field.

Operation

The description of [ORR \(shifted register\)](#) gives the operational pseudocode for this instruction.

C6.2.159 MOVK

Move wide with keep moves an optionally-shifted 16-bit immediate value into a register, keeping other bits unchanged.

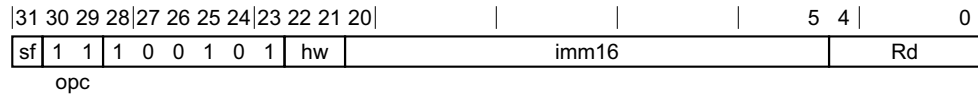

32-bit variant

Applies when `sf == 0`.

MOVK <Wd>, #<imm>{, LSL #<shift>}

64-bit variant

Applies when `sf == 1`.

MOVK <Xd>, #<imm>{, LSL #<shift>}

Decode for all variants of this encoding

```
integer d = UInt(Rd);
integer datasize = if sf == '1' then 64 else 32;
integer pos;

if sf == '0' && hw<1> == '1' then UnallocatedEncoding();
pos = UInt(hw:'0000');
```

Assembler symbols

- <Wd> Is the 32-bit name of the general-purpose destination register, encoded in the "Rd" field.
- <Xd> Is the 64-bit name of the general-purpose destination register, encoded in the "Rd" field.
- <imm> Is the 16-bit unsigned immediate, in the range 0 to 65535, encoded in the "imm16" field.
- <shift> For the 32-bit variant: is the amount by which to shift the immediate left, either 0 (the default) or 16, encoded in the "hw" field as <shift>/16.
 For the 64-bit variant: is the amount by which to shift the immediate left, either 0 (the default), 16, 32 or 48, encoded in the "hw" field as <shift>/16.

Operation

```
bits(datasize) result;

result = X[d];
result<pos+15:pos> = imm16;
X[d] = result;
```

C6.2.160 MOVN

Move wide with NOT moves the inverse of an optionally-shifted 16-bit immediate value to a register.

This instruction is used by the alias [MOV \(inverted wide immediate\)](#). See *Alias conditions* for details of when each alias is preferred.

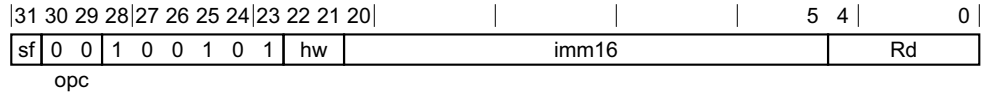

32-bit variant

Applies when sf == 0.

MOVN <Wd>, #<imm>{, LSL #<shift>}

64-bit variant

Applies when sf == 1.

MOVN <Xd>, #<imm>{, LSL #<shift>}

Decode for all variants of this encoding

```
integer d = UInt(Rd);
integer datasize = if sf == '1' then 64 else 32;
integer pos;

if sf == '0' && hw<1> == '1' then UnallocatedEncoding();
pos = UInt(hw:'0000');
```

Alias conditions

Alias	of variant	is preferred when
MOV (inverted wide immediate)	64-bit	! (IsZero(imm16) && hw != '00')
MOV (inverted wide immediate)	32-bit	! (IsZero(imm16) && hw != '00') && ! IsOnes(imm16)

Assembler symbols

- <Wd> Is the 32-bit name of the general-purpose destination register, encoded in the "Rd" field.
- <Xd> Is the 64-bit name of the general-purpose destination register, encoded in the "Rd" field.
- <imm> Is the 16-bit unsigned immediate, in the range 0 to 65535, encoded in the "imm16" field.
- <shift> For the 32-bit variant: is the amount by which to shift the immediate left, either 0 (the default) or 16, encoded in the "hw" field as <shift>/16.
 For the 64-bit variant: is the amount by which to shift the immediate left, either 0 (the default), 16, 32 or 48, encoded in the "hw" field as <shift>/16.

Operation

```
bits(datasize) result;
result = Zeros();
```

```
result<pos+15:pos> = imm16;  
result = NOT(result);  
X[d] = result;
```

C6.2.161 MOVZ

Move wide with zero moves an optionally-shifted 16-bit immediate value to a register.

This instruction is used by the alias [MOV \(wide immediate\)](#). See [Alias conditions](#) for details of when each alias is preferred.

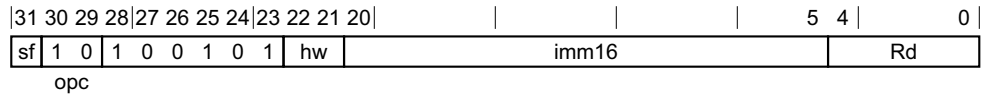

32-bit variant

Applies when `sf == 0`.

MOVZ <Wd>, #<imm>{, LSL #<shift>}

64-bit variant

Applies when `sf == 1`.

MOVZ <Xd>, #<imm>{, LSL #<shift>}

Decode for all variants of this encoding

```
integer d = UInt(Rd);
integer datasize = if sf == '1' then 64 else 32;
integer pos;

if sf == '0' && hw<1> == '1' then UnallocatedEncoding();
pos = UInt(hw:'0000');
```

Alias conditions

Alias	is preferred when
MOV (wide immediate)	! (IsZero(imm16) && hw != '00')

Assembler symbols

- <Wd> Is the 32-bit name of the general-purpose destination register, encoded in the "Rd" field.
- <Xd> Is the 64-bit name of the general-purpose destination register, encoded in the "Rd" field.
- <imm> Is the 16-bit unsigned immediate, in the range 0 to 65535, encoded in the "imm16" field.
- <shift> For the 32-bit variant: is the amount by which to shift the immediate left, either 0 (the default) or 16, encoded in the "hw" field as <shift>/16.
 For the 64-bit variant: is the amount by which to shift the immediate left, either 0 (the default), 16, 32 or 48, encoded in the "hw" field as <shift>/16.

Operation

bits(datasize) result;

result = Zeros();

```
result<pos+15:pos> = imm16;  
X[d] = result;
```

C6.2.162 MRS

Move System Register allows the PE to read an AArch64 System register into a general-purpose register.

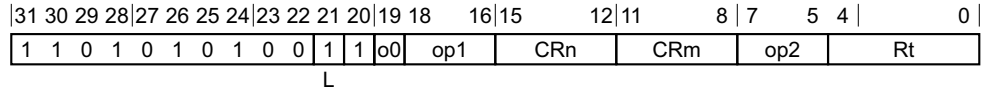

System variant

MRS <Xt>, (<systemreg>|S<op0>_<op1>_<Cn>_<Cm>_<op2>)

Decode for this encoding

[AArch64.CheckSystemAccess](#)('1':o0, op1, CRn, CRm, op2, Rt, L);

```
integer t = UInt(Rt);

integer sys_op0 = 2 + UInt(o0);
integer sys_op1 = UInt(op1);
integer sys_op2 = UInt(op2);
integer sys_crn = UInt(CRn);
integer sys_crm = UInt(CRm);
```

Assembler symbols

- <Xt> Is the 64-bit name of the general-purpose destination register, encoded in the "Rt" field.
- <systemreg> Is a System register name, encoded in the "o0:op1:CRn:CRm:op2".
The System register names are defined in [Chapter D7 AArch64 System Register Descriptions](#).
- <op0> Is an unsigned immediate, encoded in the "o0" field. It can have the following values:
 - 2 when o0 = 0
 - 3 when o0 = 1
- <op1> Is a 3-bit unsigned immediate, in the range 0 to 7, encoded in the "op1" field.
- <Cn> Is a name 'Cn', with 'n' in the range 0 to 15, encoded in the "CRn" field.
- <Cm> Is a name 'Cm', with 'm' in the range 0 to 15, encoded in the "CRm" field.
- <op2> Is a 3-bit unsigned immediate, in the range 0 to 7, encoded in the "op2" field.

Operation

$X[t] = \text{AArch64.SysRegRead}(\text{sys_op0}, \text{sys_op1}, \text{sys_crn}, \text{sys_crm}, \text{sys_op2});$

C6.2.163 MSR (immediate)

Move immediate value to Special Register moves an immediate value to selected bits of the PSTATE. For more information, see [PSTATE](#).

The bits that can be written are D, A, I, F, and SP. This set of bits is expanded in extensions to the architecture as follows:

- ARMv8.1 adds the PAN bit.
- ARMv8.2 adds the UAO bit.

31	30	29	28	27	26	25	24	23	22	21	20	19	18	16	15	14	13	12	11	8	7	5	4	3	2	1	0
1	1	0	1	0	1	0	1	0	0	0	0	0	0	op1	0	1	0	0	CRm	op2	1	1	1	1	1	1	1

System variant

MSR <pstatefield>, #<imm>

Decode for this encoding

```
AArch64.CheckSystemAccess('00', op1, '0100', CRm, op2, '11111', '0');
```

```
bits(4) operand = CRm;
PSTATEField field;
case op1:op2 of
    when '000 011'
        if !HaveUAOExt() then
            UnallocatedEncoding();
            field = PSTATEField_UAO;
        when '000 100'
            if !HavePANExt() then
                UnallocatedEncoding();
                field = PSTATEField_PAN;
            when '000 101' field = PSTATEField_SP;
            when '011 110' field = PSTATEField_DAIFFSet;
            when '011 111' field = PSTATEField_DAIFFClr;
            otherwise UnallocatedEncoding();
```

```
// Check that an AArch64 MSR/MRS access to the DAIF flags is permitted
if op1 == '011' && PSTATE.EL == EL0 && (IsInHost() || SCTLR_EL1.UMA == '0') then
    AArch64.SystemRegisterTrap(EL1, '00', op2, op1, '0100', '11111', CRm, '0');
```

Assembler symbols

<pstatefield> Is a PSTATE field name, encoded in the "op1:op2" field. It can have the following values:

SPSe1 when op1 = 000, op2 = 101

DAIFFSet when op1 = 011, op2 = 110

DAIFFClr when op1 = 011, op2 = 111

When ARMv8.2-UAO is implemented, the following value is also valid:

UAO when op1 = 000, op2 = 011

When ARMv8.1-PAN is implemented, the following value is also valid:

PAN when op1 = 000, op2 = 100

The following encodings are reserved:

- op1 = 000, op2 = 00x.

- op1 = 000, op2 = 010.
- op1 = 000, op2 = 11x.
- op1 = 001, op2 = xxx.
- op1 = 010, op2 = xxx.
- op1 = 011, op2 = 0xx.
- op1 = 011, op2 = 10x.
- op1 = 1xx, op2 = xxx.

<imm> Is a 4-bit unsigned immediate, in the range 0 to 15, encoded in the "CRm" field.

Operation

```
case field of
  when PSTATEField_SP
    PSTATE.SP = operand<0>;
  when PSTATEField_DAIFFSet
    PSTATE.D = PSTATE.D OR operand<3>;
    PSTATE.A = PSTATE.A OR operand<2>;
    PSTATE.I = PSTATE.I OR operand<1>;
    PSTATE.F = PSTATE.F OR operand<0>;
  when PSTATEField_DAIFFClr
    PSTATE.D = PSTATE.D AND NOT(operand<3>);
    PSTATE.A = PSTATE.A AND NOT(operand<2>);
    PSTATE.I = PSTATE.I AND NOT(operand<1>);
    PSTATE.F = PSTATE.F AND NOT(operand<0>);
  when PSTATEField_PAN
    PSTATE.PAN = operand<0>;
  when PSTATEField_UAO
    PSTATE.UAO = operand<0>;
```

C6.2.164 MSR (register)

Move general-purpose register to System Register allows the PE to write an AArch64 System register from a general-purpose register.

31	30	29	28	27	26	25	24	23	22	21	20	19	18	16	15	12	11	8	7	5	4	0
1	1	0	1	0	1	0	1	0	0	0	1	o0	op1	CRn	CRm	op2	Rt					

L

System variant

MSR (<systemreg>|S<op0>_<op1>_<Cn>_<Cm>_<op2>), <Xt>

Decode for this encoding

```
AArch64.CheckSystemAccess('1':o0, op1, CRn, CRm, op2, Rt, L);
```

```
integer t = UInt(Rt);
```

```
integer sys_op0 = 2 + UInt(o0);
integer sys_op1 = UInt(op1);
integer sys_op2 = UInt(op2);
integer sys_crn = UInt(CRn);
integer sys_crm = UInt(CRm);
```

Assembler symbols

- <systemreg> Is a System register name, encoded in the "o0:op1:CRn:CRm:op2".
The System register names are defined in [Chapter D7 AArch64 System Register Descriptions](#).
- <op0> Is an unsigned immediate, encoded in the "o0" field. It can have the following values:
 - 2 when o0 = 0
 - 3 when o0 = 1
- <op1> Is a 3-bit unsigned immediate, in the range 0 to 7, encoded in the "op1" field.
- <Cn> Is a name 'Cn', with 'n' in the range 0 to 15, encoded in the "CRn" field.
- <Cm> Is a name 'Cm', with 'm' in the range 0 to 15, encoded in the "CRm" field.
- <op2> Is a 3-bit unsigned immediate, in the range 0 to 7, encoded in the "op2" field.
- <Xt> Is the 64-bit name of the general-purpose source register, encoded in the "Rt" field.

Operation

```
AArch64.SysRegWrite(sys_op0, sys_op1, sys_crn, sys_crm, sys_op2, X[t]);
```

C6.2.165 MSUB

Multiply-Subtract multiplies two register values, subtracts the product from a third register value, and writes the result to the destination register.

This instruction is used by the alias **MNEG**. See *Alias conditions* for details of when each alias is preferred.

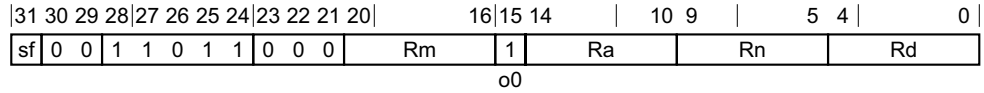

32-bit variant

Applies when sf == 0.

MSUB <Wd>, <Wn>, <Wm>, <Wa>

64-bit variant

Applies when sf == 1.

MSUB <Xd>, <Xn>, <Xm>, <Xa>

Decode for all variants of this encoding

```
integer d = UInt(Rd);
integer n = UInt(Rn);
integer m = UInt(Rm);
integer a = UInt(Ra);
integer destsize = if sf == '1' then 64 else 32;
```

Alias conditions

Alias	is preferred when
MNEG	Ra == '11111'

Assembler symbols

- <Wd> Is the 32-bit name of the general-purpose destination register, encoded in the "Rd" field.
- <Wn> Is the 32-bit name of the first general-purpose source register holding the multiplicand, encoded in the "Rn" field.
- <Wm> Is the 32-bit name of the second general-purpose source register holding the multiplier, encoded in the "Rm" field.
- <Wa> Is the 32-bit name of the third general-purpose source register holding the minuend, encoded in the "Ra" field.
- <Xd> Is the 64-bit name of the general-purpose destination register, encoded in the "Rd" field.
- <Xn> Is the 64-bit name of the first general-purpose source register holding the multiplicand, encoded in the "Rn" field.
- <Xm> Is the 64-bit name of the second general-purpose source register holding the multiplier, encoded in the "Rm" field.

<Xa> Is the 64-bit name of the third general-purpose source register holding the minuend, encoded in the "Ra" field.

Operation

```
bits(destsize) operand1 = X[n];  
bits(destsize) operand2 = X[m];  
bits(destsize) operand3 = X[a];
```

integer result;

```
result = UInt(operand3) - (UInt(operand1) * UInt(operand2));  
X[d] = result<destsize-1:0>;
```

C6.2.166 MUL

Multiply : $Rd = Rn * Rm$

This instruction is an alias of the [MADD](#) instruction. This means that:

- The encodings in this description are named to match the encodings of [MADD](#).
- The description of [MADD](#) gives the operational pseudocode for this instruction.

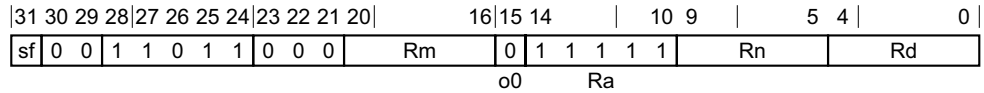

32-bit variant

Applies when $sf == 0$.

MUL <Wd>, <Wn>, <Wm>

is equivalent to

MADD <Wd>, <Wn>, <Wm>, WZR

and is always the preferred disassembly.

64-bit variant

Applies when $sf == 1$.

MUL <Xd>, <Xn>, <Xm>

is equivalent to

MADD <Xd>, <Xn>, <Xm>, XZR

and is always the preferred disassembly.

Assembler symbols

<Wd> Is the 32-bit name of the general-purpose destination register, encoded in the "Rd" field.

<Wn> Is the 32-bit name of the first general-purpose source register holding the multiplicand, encoded in the "Rn" field.

<Wm> Is the 32-bit name of the second general-purpose source register holding the multiplier, encoded in the "Rm" field.

<Xd> Is the 64-bit name of the general-purpose destination register, encoded in the "Rd" field.

<Xn> Is the 64-bit name of the first general-purpose source register holding the multiplicand, encoded in the "Rn" field.

<Xm> Is the 64-bit name of the second general-purpose source register holding the multiplier, encoded in the "Rm" field.

Operation

The description of [MADD](#) gives the operational pseudocode for this instruction.

C6.2.167 MVN

Bitwise NOT writes the bitwise inverse of a register value to the destination register.

This instruction is an alias of the [ORN \(shifted register\)](#) instruction. This means that:

- The encodings in this description are named to match the encodings of [ORN \(shifted register\)](#).
- The description of [ORN \(shifted register\)](#) gives the operational pseudocode for this instruction.

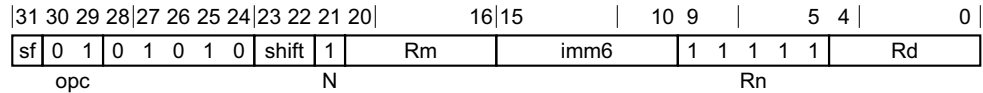

32-bit variant

Applies when `sf == 0`.

MVN <Wd>, <Wm>{, <shift> #<amount>}

is equivalent to

ORN <Wd>, WZR, <Wm>{, <shift> #<amount>}

and is always the preferred disassembly.

64-bit variant

Applies when `sf == 1`.

MVN <Xd>, <Xm>{, <shift> #<amount>}

is equivalent to

ORN <Xd>, XZR, <Xm>{, <shift> #<amount>}

and is always the preferred disassembly.

Assembler symbols

<Wd> Is the 32-bit name of the general-purpose destination register, encoded in the "Rd" field.

<Wm> Is the 32-bit name of the general-purpose source register, encoded in the "Rm" field.

<Xd> Is the 64-bit name of the general-purpose destination register, encoded in the "Rd" field.

<Xm> Is the 64-bit name of the general-purpose source register, encoded in the "Rm" field.

<shift> Is the optional shift to be applied to the final source, defaulting to LSL and encoded in the "shift" field. It can have the following values:

LSL when shift = 00

LSR when shift = 01

ASR when shift = 10

ROR when shift = 11

<amount> For the 32-bit variant: is the shift amount, in the range 0 to 31, defaulting to 0 and encoded in the "imm6" field.

For the 64-bit variant: is the shift amount, in the range 0 to 63, defaulting to 0 and encoded in the "imm6" field,

Operation

The description of [ORN \(shifted register\)](#) gives the operational pseudocode for this instruction.

C6.2.168 NEG (shifted register)

Negate (shifted register) negates an optionally-shifted register value, and writes the result to the destination register.

This instruction is an alias of the [SUB \(shifted register\)](#) instruction. This means that:

- The encodings in this description are named to match the encodings of [SUB \(shifted register\)](#).
- The description of [SUB \(shifted register\)](#) gives the operational pseudocode for this instruction.

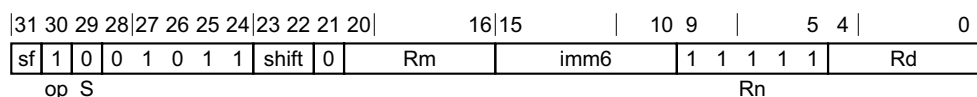

32-bit variant

Applies when `sf == 0`.

NEG <Wd>, <Wm>{, <shift> #<amount>}

is equivalent to

SUB <Wd>, WZR, <Wm> {, <shift> #<amount>}

and is always the preferred disassembly.

64-bit variant

Applies when `sf == 1`.

NEG <Xd>, <Xm>{, <shift> #<amount>}

is equivalent to

SUB <Xd>, XZR, <Xm> {, <shift> #<amount>}

and is always the preferred disassembly.

Assembler symbols

- <Wd> Is the 32-bit name of the general-purpose destination register, encoded in the "Rd" field.
- <Wm> Is the 32-bit name of the general-purpose source register, encoded in the "Rm" field.
- <Xd> Is the 64-bit name of the general-purpose destination register, encoded in the "Rd" field.
- <Xm> Is the 64-bit name of the general-purpose source register, encoded in the "Rm" field.
- <shift> Is the optional shift type to be applied to the second source operand, defaulting to LSL and encoded in the "shift" field. It can have the following values:
 - LSL when shift = 00
 - LSR when shift = 01
 - ASR when shift = 10
 - The encoding shift = 11 is reserved.
- <amount> For the 32-bit variant: is the shift amount, in the range 0 to 31, defaulting to 0 and encoded in the "imm6" field.
For the 64-bit variant: is the shift amount, in the range 0 to 63, defaulting to 0 and encoded in the "imm6" field.

Operation

The description of [SUB \(shifted register\)](#) gives the operational pseudocode for this instruction.

C6.2.169 NEGS

Negate, setting flags, negates an optionally-shifted register value, and writes the result to the destination register. It updates the condition flags based on the result.

This instruction is an alias of the [SUBS \(shifted register\)](#) instruction. This means that:

- The encodings in this description are named to match the encodings of [SUBS \(shifted register\)](#).
- The description of [SUBS \(shifted register\)](#) gives the operational pseudocode for this instruction.

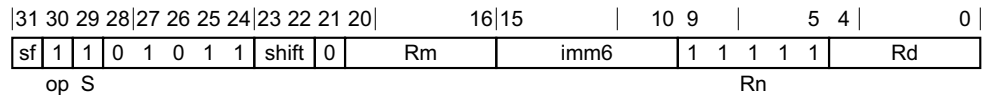

32-bit variant

Applies when `sf == 0`.

NEGS <Wd>, <Wm>{, <shift> #<amount>}

is equivalent to

SUBS <Wd>, WZR, <Wm> {, <shift> #<amount>}

and is always the preferred disassembly.

64-bit variant

Applies when `sf == 1`.

NEGS <Xd>, <Xm>{, <shift> #<amount>}

is equivalent to

SUBS <Xd>, XZR, <Xm> {, <shift> #<amount>}

and is always the preferred disassembly.

Assembler symbols

<Wd> Is the 32-bit name of the general-purpose destination register, encoded in the "Rd" field.

<Wm> Is the 32-bit name of the general-purpose source register, encoded in the "Rm" field.

<Xd> Is the 64-bit name of the general-purpose destination register, encoded in the "Rd" field.

<Xm> Is the 64-bit name of the general-purpose source register, encoded in the "Rm" field.

<shift> Is the optional shift type to be applied to the second source operand, defaulting to LSL and encoded in the "shift" field. It can have the following values:

LSL when shift = 00

LSR when shift = 01

ASR when shift = 10

The encoding shift = 11 is reserved.

<amount> For the 32-bit variant: is the shift amount, in the range 0 to 31, defaulting to 0 and encoded in the "imm6" field.

For the 64-bit variant: is the shift amount, in the range 0 to 63, defaulting to 0 and encoded in the "imm6" field.

Operation

The description of [SUBS \(shifted register\)](#) gives the operational pseudocode for this instruction.

C6.2.170 NGC

Negate with Carry negates the sum of a register value and the value of NOT (Carry flag), and writes the result to the destination register.

This instruction is an alias of the [SBC](#) instruction. This means that:

- The encodings in this description are named to match the encodings of [SBC](#).
- The description of [SBC](#) gives the operational pseudocode for this instruction.

31 30 29 28 27 26 25 24 23 22 21 20										16 15 14 13 12 11 10 9										5 4		0	
sf	1	0	1	1	0	1	0	0	0	0	Rm	0	0	0	0	0	0	1	1	1	1	1	Rd
op S											Rn												

32-bit variant

Applies when $sf == 0$.

NGC <Wd>, <Wm>

is equivalent to

SBC <Wd>, WZR, <Wm>

and is always the preferred disassembly.

64-bit variant

Applies when $sf == 1$.

NGC <Xd>, <Xm>

is equivalent to

SBC <Xd>, XZR, <Xm>

and is always the preferred disassembly.

Assembler symbols

<Wd> Is the 32-bit name of the general-purpose destination register, encoded in the "Rd" field.

<Wm> Is the 32-bit name of the general-purpose source register, encoded in the "Rm" field.

<Xd> Is the 64-bit name of the general-purpose destination register, encoded in the "Rd" field.

<Xm> Is the 64-bit name of the general-purpose source register, encoded in the "Rm" field.

Operation

The description of [SBC](#) gives the operational pseudocode for this instruction.

C6.2.171 NGCS

Negate with Carry, setting flags, negates the sum of a register value and the value of NOT (Carry flag), and writes the result to the destination register. It updates the condition flags based on the result.

This instruction is an alias of the [SBCS](#) instruction. This means that:

- The encodings in this description are named to match the encodings of [SBCS](#).
- The description of [SBCS](#) gives the operational pseudocode for this instruction.

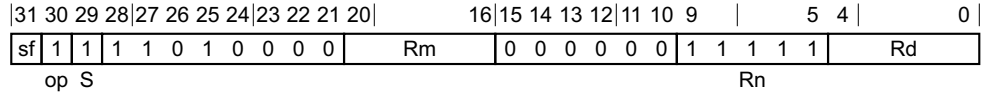

32-bit variant

Applies when `sf == 0`.

NGCS <Wd>, <Wm>

is equivalent to

SBCS <Wd>, WZR, <Wm>

and is always the preferred disassembly.

64-bit variant

Applies when `sf == 1`.

NGCS <Xd>, <Xm>

is equivalent to

SBCS <Xd>, XZR, <Xm>

and is always the preferred disassembly.

Assembler symbols

<Wd> Is the 32-bit name of the general-purpose destination register, encoded in the "Rd" field.

<Wm> Is the 32-bit name of the general-purpose source register, encoded in the "Rm" field.

<Xd> Is the 64-bit name of the general-purpose destination register, encoded in the "Rd" field.

<Xm> Is the 64-bit name of the general-purpose source register, encoded in the "Rm" field.

Operation

The description of [SBCS](#) gives the operational pseudocode for this instruction.

C6.2.172 NOP

No Operation does nothing, other than advance the value of the program counter by 4. This instruction can be used for instruction alignment purposes.

———— **Note** —————

The timing effects of including a NOP instruction in a program are not guaranteed. It can increase execution time, leave it unchanged, or even reduce it. Therefore, NOP instructions are not suitable for timing loops.

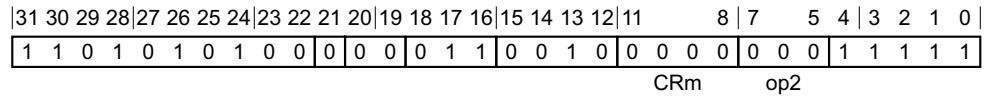

System variant

NOP

Decode for this encoding

// Empty.

Operation

// do nothing

C6.2.173 ORN (shifted register)

Bitwise OR NOT (shifted register) performs a bitwise (inclusive) OR of a register value and the complement of an optionally-shifted register value, and writes the result to the destination register.

This instruction is used by the alias [MVN](#). See [Alias conditions](#) for details of when each alias is preferred.

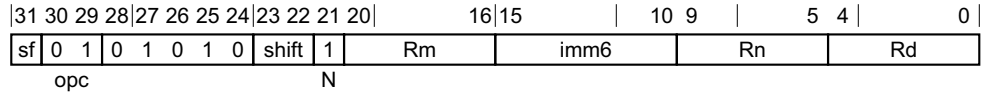

32-bit variant

Applies when sf == 0.

ORN <Wd>, <Wn>, <Wm>{, <shift> #<amount>}

64-bit variant

Applies when sf == 1.

ORN <Xd>, <Xn>, <Xm>{, <shift> #<amount>}

Decode for all variants of this encoding

```
integer d = UInt(Rd);
integer n = UInt(Rn);
integer m = UInt(Rm);
integer datasize = if sf == '1' then 64 else 32;
if sf == '0' && imm6<5> == '1' then ReservedValue();

ShiftType shift_type = DecodeShift(shift);
integer shift_amount = UInt(imm6);
```

Alias conditions

Alias	is preferred when
MVN	Rn == '11111'

Assembler symbols

- <Wd> Is the 32-bit name of the general-purpose destination register, encoded in the "Rd" field.
- <Wn> Is the 32-bit name of the first general-purpose source register, encoded in the "Rn" field.
- <Wm> Is the 32-bit name of the second general-purpose source register, encoded in the "Rm" field.
- <Xd> Is the 64-bit name of the general-purpose destination register, encoded in the "Rd" field.
- <Xn> Is the 64-bit name of the first general-purpose source register, encoded in the "Rn" field.
- <Xm> Is the 64-bit name of the second general-purpose source register, encoded in the "Rm" field.
- <shift> Is the optional shift to be applied to the final source, defaulting to LSL and encoded in the "shift" field. It can have the following values:
 - LSL when shift = 00
 - LSR when shift = 01

ASR when shift = 10

ROR when shift = 11

<amount> For the 32-bit variant: is the shift amount, in the range 0 to 31, defaulting to 0 and encoded in the "imm6" field.

For the 64-bit variant: is the shift amount, in the range 0 to 63, defaulting to 0 and encoded in the "imm6" field,

Operation

bits(datasize) operand1 = $X[n]$;

bits(datasize) operand2 = $\text{ShiftReg}(m, \text{shift_type}, \text{shift_amount})$;

operand2 = $\text{NOT}(\text{operand2})$;

result = operand1 OR operand2;

$X[d]$ = result;

C6.2.174 ORR (immediate)

Bitwise OR (immediate) performs a bitwise (inclusive) OR of a register value and an immediate register value, and writes the result to the destination register.

This instruction is used by the alias [MOV \(bitmask immediate\)](#). See *Alias conditions* for details of when each alias is preferred.

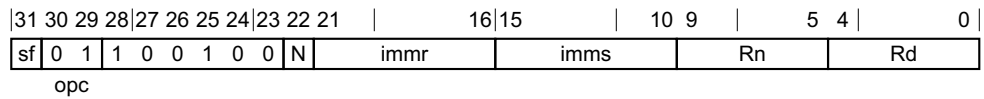

32-bit variant

Applies when `sf == 0 && N == 0`.

ORR <Wd|WSP>, <Wn>, #<imm>

64-bit variant

Applies when `sf == 1`.

ORR <Xd|SP>, <Xn>, #<imm>

Decode for all variants of this encoding

```
integer d = UInt(Rd);
integer n = UInt(Rn);
integer datasize = if sf == '1' then 64 else 32;
bits(datasize) imm;
if sf == '0' && N != '0' then ReservedValue();
(imm, -) = DecodeBitMasks(N, imms, immr, TRUE);
```

Alias conditions

Alias	is preferred when
MOV (bitmask immediate)	<code>Rn == '11111' && ! MoveWidePreferred(sf, N, imms, immr)</code>

Assembler symbols

- <Wd|WSP> Is the 32-bit name of the destination general-purpose register or stack pointer, encoded in the "Rd" field.
- <Wn> Is the 32-bit name of the general-purpose source register, encoded in the "Rn" field.
- <Xd|SP> Is the 64-bit name of the destination general-purpose register or stack pointer, encoded in the "Rd" field.
- <Xn> Is the 64-bit name of the general-purpose source register, encoded in the "Rn" field.
- <imm> For the 32-bit variant: is the bitmask immediate, encoded in "imms:immr".
 For the 64-bit variant: is the bitmask immediate, encoded in "N:imms:immr".

Operation

```
bits(datasize) result;  
bits(datasize) operand1 = X[n];
```

```
result = operand1 OR imm;  
if d == 31 then  
    SP[] = result;  
else  
    X[d] = result;
```

C6.2.175 ORR (shifted register)

Bitwise OR (shifted register) performs a bitwise (inclusive) OR of a register value and an optionally-shifted register value, and writes the result to the destination register.

This instruction is used by the alias [MOV \(register\)](#). See *Alias conditions* for details of when each alias is preferred.

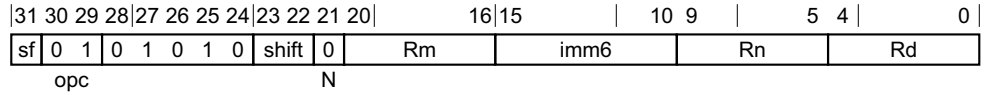

32-bit variant

Applies when sf == 0.

ORR <Wd>, <Wn>, <Wm>{, <shift> #<amount>}

64-bit variant

Applies when sf == 1.

ORR <Xd>, <Xn>, <Xm>{, <shift> #<amount>}

Decode for all variants of this encoding

```

integer d = UInt(Rd);
integer n = UInt(Rn);
integer m = UInt(Rm);
integer datasize = if sf == '1' then 64 else 32;
if sf == '0' && imm6<5> == '1' then ReservedValue();

ShiftType shift_type = DecodeShift(shift);
integer shift_amount = UInt(imm6);
    
```

Alias conditions

Alias	is preferred when
MOV (register)	shift == '00' && imm6 == '000000' && Rn == '11111'

Assembler symbols

<Wd>	Is the 32-bit name of the general-purpose destination register, encoded in the "Rd" field.
<Wn>	Is the 32-bit name of the first general-purpose source register, encoded in the "Rn" field.
<Wm>	Is the 32-bit name of the second general-purpose source register, encoded in the "Rm" field.
<Xd>	Is the 64-bit name of the general-purpose destination register, encoded in the "Rd" field.
<Xn>	Is the 64-bit name of the first general-purpose source register, encoded in the "Rn" field.
<Xm>	Is the 64-bit name of the second general-purpose source register, encoded in the "Rm" field.
<shift>	Is the optional shift to be applied to the final source, defaulting to LSL and encoded in the "shift" field. It can have the following values:
LSL	when shift = 00
LSR	when shift = 01

ASR when shift = 10

ROR when shift = 11

<amount> For the 32-bit variant: is the shift amount, in the range 0 to 31, defaulting to 0 and encoded in the "imm6" field.

For the 64-bit variant: is the shift amount, in the range 0 to 63, defaulting to 0 and encoded in the "imm6" field,

Operation

bits(datasize) operand1 = $X[n]$;

bits(datasize) operand2 = `ShiftReg`(m, shift_type, shift_amount);

result = operand1 OR operand2;

$X[d]$ = result;

C6.2.176 PRFM (immediate)

Prefetch Memory (immediate) signals the memory system that data memory accesses from a specified address are likely to occur in the near future. The memory system can respond by taking actions that are expected to speed up the memory accesses when they do occur, such as preloading the cache line containing the specified address into one or more caches.

The effect of an PRFM instruction is IMPLEMENTATION DEFINED. For more information, see [Prefetch memory on page C3-171](#).

For information about memory accesses, see [Load/Store addressing modes on page C1-143](#).



Unsigned offset variant

PRFM (<prfop>|<imm5>), [<Xn|SP>{, #<pimm>}]

Decode for this encoding

bits(64) offset = LSL(ZeroExtend(imm12, 64), 3);

Assembler symbols

- <prfop> Is the prefetch operation, defined as <type><target><policy>.
- <type> is one of:
- PLD Prefetch for load, encoded in the "Rt<4:3>" field as 0b00.
 - PLI Preload instructions, encoded in the "Rt<4:3>" field as 0b01.
 - PST Prefetch for store, encoded in the "Rt<4:3>" field as 0b10.
- <target> is one of:
- L1 Level 1 cache, encoded in the "Rt<2:1>" field as 0b00.
 - L2 Level 2 cache, encoded in the "Rt<2:1>" field as 0b01.
 - L3 Level 3 cache, encoded in the "Rt<2:1>" field as 0b10.
- <policy> is one of:
- KEEP Retained or temporal prefetch, allocated in the cache normally. Encoded in the "Rt<0>" field as 0.
 - STRM Streaming or non-temporal prefetch, for data that is used only once. Encoded in the "Rt<0>" field as 1.
- For more information on these prefetch operations, see [Prefetch memory on page C3-171](#).
- For other encodings of the "Rt" field, use <imm5>.
- <imm5> Is the prefetch operation encoding as an immediate, in the range 0 to 31, encoded in the "Rt" field. This syntax is only for encodings that are not accessible using <prfop>.
- <Xn|SP> Is the 64-bit name of the general-purpose base register or stack pointer, encoded in the "Rn" field.
- <pimm> Is the optional positive immediate byte offset, a multiple of 8 in the range 0 to 32760, defaulting to 0 and encoded in the "imm12" field as <pimm>/8.

Shared decode for all encodings

```
integer n = UInt(Rn);  
integer t = UInt(Rt);
```

Operation

```
bits(64) address;  
  
if n == 31 then  
    address = SP[];  
else  
    address = X[n];  
  
address = address + offset;  
  
Prefetch(address, t<4:0>);
```

C6.2.177 PRFM (literal)

Prefetch Memory (literal) signals the memory system that data memory accesses from a specified address are likely to occur in the near future. The memory system can respond by taking actions that are expected to speed up the memory accesses when they do occur, such as preloading the cache line containing the specified address into one or more caches.

The effect of an PRFM instruction is IMPLEMENTATION DEFINED. For more information, see [Prefetch memory on page C3-171](#).

For information about memory accesses, see [Load/Store addressing modes on page C1-143](#).

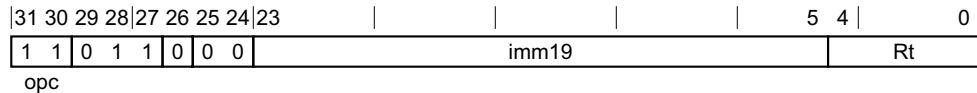

Literal variant

PRFM (<prfop>|#<imm5>), <label>

Decode for this encoding

```
integer t = UInt(Rt);
bits(64) offset;

offset = SignExtend(imm19:'00', 64);
```

Assembler symbols

- <prfop> Is the prefetch operation, defined as <type><target><policy>.
- <type> is one of:
- PLD Prefetch for load, encoded in the "Rt<4:3>" field as 0b00.
 - PLI Preload instructions, encoded in the "Rt<4:3>" field as 0b01.
 - PST Prefetch for store, encoded in the "Rt<4:3>" field as 0b10.
- <target> is one of:
- L1 Level 1 cache, encoded in the "Rt<2:1>" field as 0b00.
 - L2 Level 2 cache, encoded in the "Rt<2:1>" field as 0b01.
 - L3 Level 3 cache, encoded in the "Rt<2:1>" field as 0b10.
- <policy> is one of:
- KEEP Retained or temporal prefetch, allocated in the cache normally. Encoded in the "Rt<0>" field as 0.
 - STRM Streaming or non-temporal prefetch, for data that is used only once. Encoded in the "Rt<0>" field as 1.
- For more information on these prefetch operations, see [Prefetch memory on page C3-171](#).
- For other encodings of the "Rt" field, use <imm5>.
- <imm5> Is the prefetch operation encoding as an immediate, in the range 0 to 31, encoded in the "Rt" field. This syntax is only for encodings that are not accessible using <prfop>.
- <label> Is the program label from which the data is to be loaded. Its offset from the address of this instruction, in the range +/-1MB, is encoded as "imm19" times 4.

Operation

bits(64) address = PC[] + offset;

Prefetch(address, t<4:0>);

C6.2.178 PRFM (register)

Prefetch Memory (register) signals the memory system that data memory accesses from a specified address are likely to occur in the near future. The memory system can respond by taking actions that are expected to speed up the memory accesses when they do occur, such as preloading the cache line containing the specified address into one or more caches.

The effect of an PRFM instruction is IMPLEMENTATION DEFINED. For more information, see [Prefetch memory on page C3-171](#).

For information about memory accesses, see [Load/Store addressing modes on page C1-143](#).

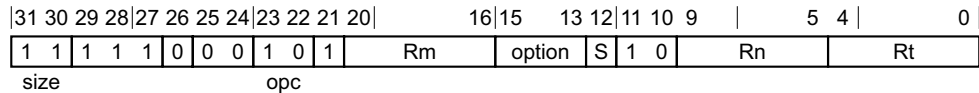

Integer variant

PRFM (<prfop>|<imm5>), [<Xn|SP>, (<Wm>|<Xm>){, <extend> {<amount>}}

Decode for this encoding

```
if option<1> == '0' then UnallocatedEncoding(); // sub-word index
ExtendType extend_type = DecodeRegExtend(option);
integer shift = if S == '1' then 3 else 0;
```

Assembler symbols

- <prfop> Is the prefetch operation, defined as <type><target><policy>.
- <type> is one of:
- PLD Prefetch for load, encoded in the "Rt<4:3>" field as 0b00.
 - PLI Preload instructions, encoded in the "Rt<4:3>" field as 0b01.
 - PST Prefetch for store, encoded in the "Rt<4:3>" field as 0b10.
- <target> is one of:
- L1 Level 1 cache, encoded in the "Rt<2:1>" field as 0b00.
 - L2 Level 2 cache, encoded in the "Rt<2:1>" field as 0b01.
 - L3 Level 3 cache, encoded in the "Rt<2:1>" field as 0b10.
- <policy> is one of:
- KEEP Retained or temporal prefetch, allocated in the cache normally. Encoded in the "Rt<0>" field as 0.
 - STRM Streaming or non-temporal prefetch, for data that is used only once. Encoded in the "Rt<0>" field as 1.
- For more information on these prefetch operations, see [Prefetch memory on page C3-171](#).
- For other encodings of the "Rt" field, use <imm5>.
- <imm5> Is the prefetch operation encoding as an immediate, in the range 0 to 31, encoded in the "Rt" field. This syntax is only for encodings that are not accessible using <prfop>.
- <Xn|SP> Is the 64-bit name of the general-purpose base register or stack pointer, encoded in the "Rn" field.
- <Wm> When option<0> is set to 0, is the 32-bit name of the general-purpose index register, encoded in the "Rm" field.

<Xm>	When option<0> is set to 1, is the 64-bit name of the general-purpose index register, encoded in the "Rm" field.
<extend>	Is the index extend/shift specifier, defaulting to LSL, and which must be omitted for the LSL option when <amount> is omitted. encoded in the "option" field. It can have the following values: UXTW when option = 010 LSL when option = 011 SXTW when option = 110 SXTX when option = 111
<amount>	Is the index shift amount, optional only when <extend> is not LSL. Where it is permitted to be optional, it defaults to #0. It is encoded in the "S" field. It can have the following values: #0 when S = 0 #3 when S = 1

Shared decode for all encodings

```
integer n = UInt(Rn);  
integer t = UInt(Rt);  
integer m = UInt(Rm);
```

Operation

```
bits(64) offset = ExtendReg(m, extend_type, shift);  
bits(64) address;
```

```
if n == 31 then  
    address = SP[];  
else  
    address = X[n];
```

```
address = address + offset;
```

```
Prefetch(address, t<4:0>);
```

C6.2.179 PRFM (unscaled offset)

Prefetch Memory (unscaled offset) signals the memory system that data memory accesses from a specified address are likely to occur in the near future. The memory system can respond by taking actions that are expected to speed up the memory accesses when they do occur, such as preloading the cache line containing the specified address into one or more caches.

The effect of an PRFUM instruction is IMPLEMENTATION DEFINED. For more information, see [Prefetch memory on page C3-171](#).

For information about memory accesses, see [Load/Store addressing modes on page C1-143](#).



Unscaled offset variant

PRFUM (<prfop>|#<imm5>), [<Xn|SP>{, #<simm>}]

Decode for this encoding

bits(64) offset = [SignExtend](#)(imm9, 64);

Assembler symbols

- <prfop> Is the prefetch operation, defined as <type><target><policy>.
- <type> is one of:
- PLD Prefetch for load, encoded in the "Rt<4:3>" field as 0b00.
 - PLI Preload instructions, encoded in the "Rt<4:3>" field as 0b01.
 - PST Prefetch for store, encoded in the "Rt<4:3>" field as 0b10.
- <target> is one of:
- L1 Level 1 cache, encoded in the "Rt<2:1>" field as 0b00.
 - L2 Level 2 cache, encoded in the "Rt<2:1>" field as 0b01.
 - L3 Level 3 cache, encoded in the "Rt<2:1>" field as 0b10.
- <policy> is one of:
- KEEP Retained or temporal prefetch, allocated in the cache normally. Encoded in the "Rt<0>" field as 0.
 - STRM Streaming or non-temporal prefetch, for data that is used only once. Encoded in the "Rt<0>" field as 1.
- For more information on these prefetch operations, see [Prefetch memory on page C3-171](#).
- For other encodings of the "Rt" field, use <imm5>.
- <imm5> Is the prefetch operation encoding as an immediate, in the range 0 to 31, encoded in the "Rt" field. This syntax is only for encodings that are not accessible using <prfop>.
- <Xn|SP> Is the 64-bit name of the general-purpose base register or stack pointer, encoded in the "Rn" field.
- <simm> Is the optional signed immediate byte offset, in the range -256 to 255, defaulting to 0 and encoded in the "imm9" field.

Shared decode for all encodings

```
integer n = UInt(Rn);  
integer t = UInt(Rt);
```

Operation

```
bits(64) address;  
  
if n == 31 then  
    address = SP[];  
else  
    address = X[n];  
  
address = address + offset;  
  
Prefetch(address, t<4:0>);
```

C6.2.180 PSB CSYNC

Profiling Synchronization Barrier. This instruction is a barrier that ensures that all existing profiling data for the current PE has been formatted, and profiling buffer addresses have been translated such that all writes to the profiling buffer have been initiated. A following DSB instruction completes when the writes to the profiling buffer have completed.

ARMv8.2

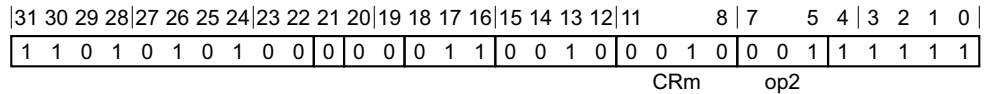

System variant

PSB CSYNC

Decode for this encoding

SystemHintOp op;

op = if HaveStatisticalProfiling() then SystemHintOp_PSB else SystemHintOp_NOP;

Operation

```

case op of
  when SystemHintOp_YIELD
    Hint_Yield();

  when SystemHintOp_WFE
    if IsEventRegisterSet() then
      ClearEventRegister();
    else
      if PSTATE.EL == EL0 then
        // Check for traps described by the OS which may be EL1 or EL2.
        AArch64.CheckForWfxTrap(EL1, TRUE);
      if HaveEL(EL2) && !IsSecure() && PSTATE.EL IN {EL0, EL1} && !IsInHost() then
        // Check for traps described by the Hypervisor.
        AArch64.CheckForWfxTrap(EL2, TRUE);
      if HaveEL(EL3) && PSTATE.EL != EL3 then
        // Check for traps described by the Secure Monitor.
        AArch64.CheckForWfxTrap(EL3, TRUE);
        WaitForEvent();

  when SystemHintOp_WFI
    if !InterruptPending() then
      if PSTATE.EL == EL0 then
        // Check for traps described by the OS which may be EL1 or EL2.
        AArch64.CheckForWfxTrap(EL1, FALSE);
      if HaveEL(EL2) && !IsSecure() && PSTATE.EL IN {EL0, EL1} && !IsInHost() then
        // Check for traps described by the Hypervisor.
        AArch64.CheckForWfxTrap(EL2, FALSE);
      if HaveEL(EL3) && PSTATE.EL != EL3 then
        // Check for traps described by the Secure Monitor.
        AArch64.CheckForWfxTrap(EL3, FALSE);
        WaitForInterrupt();

  when SystemHintOp_SEV
    SendEvent();

  when SystemHintOp_SEVL
    SendEventLocal();
    
```



```
when SystemHintOp_ESB
    ErrorSynchronizationBarrier(MBReqDomain_FullSystem, MBReqTypes_All);
    AArch64.ESB0peration();
    if HaveEL(EL2) && !IsSecure() && PSTATE.EL IN {EL0, EL1} then AArch64.vESB0peration();
    TakeUnmaskedSErrorInterrupts();

when SystemHintOp_PSB
    ProfilingSynchronizationBarrier();

otherwise // do nothing
```

C6.2.181 RBIT

Reverse Bits reverses the bit order in a register.

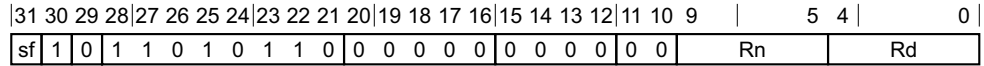

32-bit variant

Applies when sf == 0.

RBIT <Wd>, <Wn>

64-bit variant

Applies when sf == 1.

RBIT <Xd>, <Xn>

Decode for all variants of this encoding

```
integer d = UInt(Rd);
integer n = UInt(Rn);

integer datasize = if sf == '1' then 64 else 32;
```

Assembler symbols

- <Wd> Is the 32-bit name of the general-purpose destination register, encoded in the "Rd" field.
- <Wn> Is the 32-bit name of the general-purpose source register, encoded in the "Rn" field.
- <Xd> Is the 64-bit name of the general-purpose destination register, encoded in the "Rd" field.
- <Xn> Is the 64-bit name of the general-purpose source register, encoded in the "Rn" field.

Operation

```
bits(datasize) operand = X[n];
bits(datasize) result;

for i = 0 to datasize-1
    result<datasize-1-i> = operand<i>;

X[d] = result;
```

C6.2.182 RET

Return from subroutine branches unconditionally to an address in a register, with a hint that this is a subroutine return.

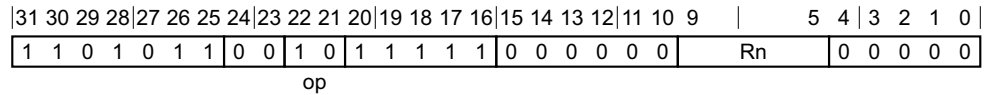

Integer variant

RET {<Xn>}

Decode for this encoding

integer n = `UInt(Rn)`;

Assembler symbols

<Xn> Is the 64-bit name of the general-purpose register holding the address to be branched to, encoded in the "Rn" field. Defaults to X30 if absent.

Operation

`bits(64) target = X[n]`;

`BranchTo(target, BranchType_RET)`;

C6.2.183 REV

Reverse Bytes reverses the byte order in a register.

This instruction is used by the pseudo-instruction [REV64](#). The pseudo-instruction is never the preferred disassembly.

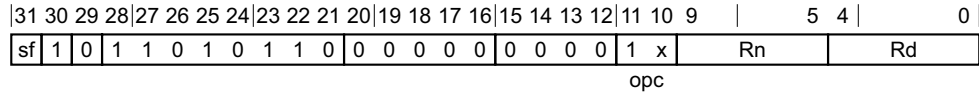

32-bit variant

Applies when `sf == 0` && `opc == 10`.

REV <Wd>, <Wn>

64-bit variant

Applies when `sf == 1` && `opc == 11`.

REV <Xd>, <Xn>

Decode for all variants of this encoding

```
integer d = UInt(Rd);
integer n = UInt(Rn);

integer datasize = if sf == '1' then 64 else 32;

integer container_size;
case opc of
    when '00'
        Unreachable();
    when '01'
        container_size = 16;
    when '10'
        container_size = 32;
    when '11'
        if sf == '0' then UnallocatedEncoding();
        container_size = 64;
```

Assembler symbols

- <Wd> Is the 32-bit name of the general-purpose destination register, encoded in the "Rd" field.
- <Wn> Is the 32-bit name of the general-purpose source register, encoded in the "Rn" field.
- <Xd> Is the 64-bit name of the general-purpose destination register, encoded in the "Rd" field.
- <Xn> Is the 64-bit name of the general-purpose source register, encoded in the "Rn" field.

Operation

```
bits(datasize) operand = X[n];
bits(datasize) result;

integer containers = datasize DIV container_size;
integer elements_per_container = container_size DIV 8;
integer index = 0;
integer rev_index;
```

```
for c = 0 to containers-1
  rev_index = index + ((elements_per_container - 1) * 8);
  for e = 0 to elements_per_container-1
    result<rev_index+7:rev_index> = operand<index+7:index>;
    index = index + 8;
    rev_index = rev_index - 8;

X[d] = result;
```

C6.2.184 REV16

Reverse bytes in 16-bit halfwords reverses the byte order in each 16-bit halfword of a register.

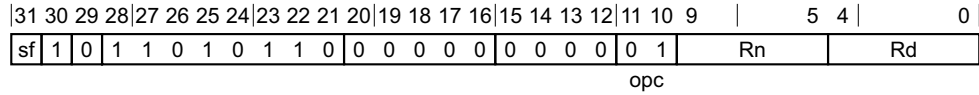

32-bit variant

Applies when sf == 0.

REV16 <Wd>, <Wn>

64-bit variant

Applies when sf == 1.

REV16 <Xd>, <Xn>

Decode for all variants of this encoding

```
integer d = UInt(Rd);
integer n = UInt(Rn);

integer datasize = if sf == '1' then 64 else 32;

integer container_size;
case opc of
  when '00'
    Unreachable();
  when '01'
    container_size = 16;
  when '10'
    container_size = 32;
  when '11'
    if sf == '0' then UnallocatedEncoding();
    container_size = 64;
```

Assembler symbols

- <Wd> Is the 32-bit name of the general-purpose destination register, encoded in the "Rd" field.
- <Wn> Is the 32-bit name of the general-purpose source register, encoded in the "Rn" field.
- <Xd> Is the 64-bit name of the general-purpose destination register, encoded in the "Rd" field.
- <Xn> Is the 64-bit name of the general-purpose source register, encoded in the "Rn" field.

Operation

```
bits(datasize) operand = X[n];
bits(datasize) result;

integer containers = datasize DIV container_size;
integer elements_per_container = container_size DIV 8;
integer index = 0;
integer rev_index;
for c = 0 to containers-1
  rev_index = index + ((elements_per_container - 1) * 8);
  for e = 0 to elements_per_container-1
```

```
result<rev_index+7:rev_index> = operand<index+7:index>;  
index = index + 8;  
rev_index = rev_index - 8;
```

X[d] = result;

C6.2.185 REV32

Reverse bytes in 32-bit words reverses the byte order in each 32-bit word of a register.

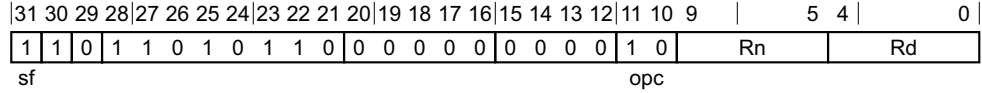

64-bit variant

REV32 <Xd>, <Xn>

Decode for this encoding

```
integer d = UInt(Rd);
integer n = UInt(Rn);

integer datasize = if sf == '1' then 64 else 32;

integer container_size;
case opc of
    when '00'
        Unreachable();
    when '01'
        container_size = 16;
    when '10'
        container_size = 32;
    when '11'
        if sf == '0' then UnallocatedEncoding();
        container_size = 64;
```

Assembler symbols

<Xd> Is the 64-bit name of the general-purpose destination register, encoded in the "Rd" field.

<Xn> Is the 64-bit name of the general-purpose source register, encoded in the "Rn" field.

Operation

```
bits(datasize) operand = X[n];
bits(datasize) result;

integer containers = datasize DIV container_size;
integer elements_per_container = container_size DIV 8;
integer index = 0;
integer rev_index;
for c = 0 to containers-1
    rev_index = index + ((elements_per_container - 1) * 8);
    for e = 0 to elements_per_container-1
        result<rev_index+7:rev_index> = operand<index+7:index>;
        index = index + 8;
        rev_index = rev_index - 8;

X[d] = result;
```



C6.2.186 REV64

Reverse Bytes reverses the byte order in a 64-bit general-purpose register.

When assembling for ARMv8.2, an assembler must support this pseudo-instruction. It is OPTIONAL whether an assembler supports this pseudo-instruction when assembling for an architecture earlier than ARMv8.2.

This instruction is a pseudo-instruction of the [REV](#) instruction. This means that:

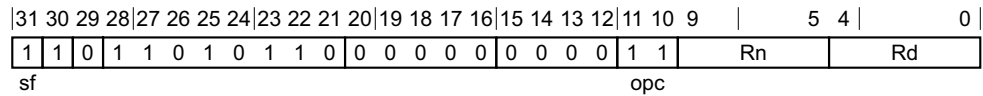
- The encodings in this description are named to match the encodings of [REV](#).
- The assembler syntax is used only for assembly, and is not used on disassembly.
- The description of [REV](#) gives the operational pseudocode for this instruction.



64-bit variant

REV64 <Xd>, <Xn>

is equivalent to

REV <Xd>, <Xn>

and is never the preferred disassembly.

Assembler symbols

<Xd> Is the 64-bit name of the general-purpose destination register, encoded in the "Rd" field.

<Xn> Is the 64-bit name of the general-purpose source register, encoded in the "Rn" field.

Operation

The description of [REV](#) gives the operational pseudocode for this instruction.

C6.2.187 ROR (immediate)

Rotate right (immediate) provides the value of the contents of a register rotated by a variable number of bits. The bits that are rotated off the right end are inserted into the vacated bit positions on the left.

This instruction is an alias of the [EXTR](#) instruction. This means that:

- The encodings in this description are named to match the encodings of [EXTR](#).
- The description of [EXTR](#) gives the operational pseudocode for this instruction.

31 30 29 28 27 26 25 24 23 22 21 20										16 15		10 9		5 4		0		
sf	0	0	1	0	0	1	1	1	N	0	Rm		imms		Rn		Rd	

32-bit variant

Applies when $sf == 0 \ \&\& \ N == 0 \ \&\& \ imms == 0xxxxx$.

ROR <Wd>, <Ws>, #<shift>

is equivalent to

EXTR <Wd>, <Ws>, <Ws>, #<shift>

and is the preferred disassembly when $Rn == Rm$.

64-bit variant

Applies when $sf == 1 \ \&\& \ N == 1$.

ROR <Xd>, <Xs>, #<shift>

is equivalent to

EXTR <Xd>, <Xs>, <Xs>, #<shift>

and is the preferred disassembly when $Rn == Rm$.

Assembler symbols

- <Wd> Is the 32-bit name of the general-purpose destination register, encoded in the "Rd" field.
- <Ws> Is the 32-bit name of the general-purpose source register, encoded in the "Rn" and "Rm" fields.
- <Xd> Is the 64-bit name of the general-purpose destination register, encoded in the "Rd" field.
- <Xs> Is the 64-bit name of the general-purpose source register, encoded in the "Rn" and "Rm" fields.
- <shift> For the 32-bit variant: is the amount by which to rotate, in the range 0 to 31, encoded in the "imms" field.
 For the 64-bit variant: is the amount by which to rotate, in the range 0 to 63, encoded in the "imms" field.

Operation

The description of [EXTR](#) gives the operational pseudocode for this instruction.

C6.2.188 ROR (register)

Rotate Right (register) provides the value of the contents of a register rotated by a variable number of bits. The bits that are rotated off the right end are inserted into the vacated bit positions on the left. The remainder obtained by dividing the second source register by the data size defines the number of bits by which the first source register is right-shifted.

This instruction is an alias of the [RORV](#) instruction. This means that:

- The encodings in this description are named to match the encodings of [RORV](#).
- The description of [RORV](#) gives the operational pseudocode for this instruction.

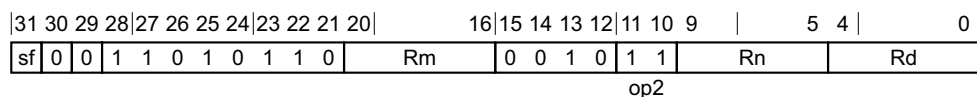

32-bit variant

Applies when `sf == 0`.

ROR <Wd>, <Wn>, <Wm>

is equivalent to

RORV <Wd>, <Wn>, <Wm>

and is always the preferred disassembly.

64-bit variant

Applies when `sf == 1`.

ROR <Xd>, <Xn>, <Xm>

is equivalent to

RORV <Xd>, <Xn>, <Xm>

and is always the preferred disassembly.

Assembler symbols

<Wd> Is the 32-bit name of the general-purpose destination register, encoded in the "Rd" field.

<Wn> Is the 32-bit name of the first general-purpose source register, encoded in the "Rn" field.

<Wm> Is the 32-bit name of the second general-purpose source register holding a shift amount from 0 to 31 in its bottom 5 bits, encoded in the "Rm" field.

<Xd> Is the 64-bit name of the general-purpose destination register, encoded in the "Rd" field.

<Xn> Is the 64-bit name of the first general-purpose source register, encoded in the "Rn" field.

<Xm> Is the 64-bit name of the second general-purpose source register holding a shift amount from 0 to 63 in its bottom 6 bits, encoded in the "Rm" field.

Operation

The description of [RORV](#) gives the operational pseudocode for this instruction.

C6.2.189 RORV

Rotate Right Variable provides the value of the contents of a register rotated by a variable number of bits. The bits that are rotated off the right end are inserted into the vacated bit positions on the left. The remainder obtained by dividing the second source register by the data size defines the number of bits by which the first source register is right-shifted.

This instruction is used by the alias [ROR \(register\)](#). The alias is always the preferred disassembly.

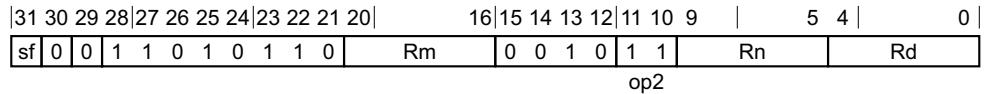

32-bit variant

Applies when `sf == 0`.

RORV <Wd>, <Wn>, <Wm>

64-bit variant

Applies when `sf == 1`.

RORV <Xd>, <Xn>, <Xm>

Decode for all variants of this encoding

```
integer d = UInt(Rd);
integer n = UInt(Rn);
integer m = UInt(Rm);
integer datasize = if sf == '1' then 64 else 32;
ShiftType shift_type = DecodeShift(op2);
```

Assembler symbols

- <Wd> Is the 32-bit name of the general-purpose destination register, encoded in the "Rd" field.
- <Wn> Is the 32-bit name of the first general-purpose source register, encoded in the "Rn" field.
- <Wm> Is the 32-bit name of the second general-purpose source register holding a shift amount from 0 to 31 in its bottom 5 bits, encoded in the "Rm" field.
- <Xd> Is the 64-bit name of the general-purpose destination register, encoded in the "Rd" field.
- <Xn> Is the 64-bit name of the first general-purpose source register, encoded in the "Rn" field.
- <Xm> Is the 64-bit name of the second general-purpose source register holding a shift amount from 0 to 63 in its bottom 6 bits, encoded in the "Rm" field.

Operation

```
bits(datasize) result;
bits(datasize) operand2 = X[m];

result = ShiftReg(n, shift_type, UInt(operand2) MOD datasize);
X[d] = result;
```

C6.2.190 SBC

Subtract with Carry subtracts a register value and the value of NOT (Carry flag) from a register value, and writes the result to the destination register.

This instruction is used by the alias [NGC](#). See [Alias conditions](#) for details of when each alias is preferred.

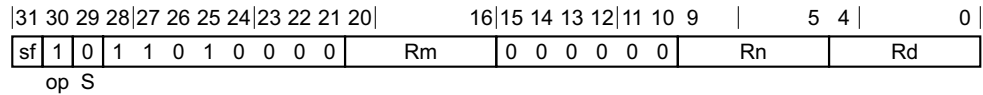

32-bit variant

Applies when `sf == 0`.

SBC <Wd>, <Wn>, <Wm>

64-bit variant

Applies when `sf == 1`.

SBC <Xd>, <Xn>, <Xm>

Decode for all variants of this encoding

```
integer d = UInt(Rd);
integer n = UInt(Rn);
integer m = UInt(Rm);
integer datasize = if sf == '1' then 64 else 32;
```

Alias conditions

Alias	is preferred when
NGC	Rn == '11111'

Assembler symbols

- <Wd> Is the 32-bit name of the general-purpose destination register, encoded in the "Rd" field.
- <Wn> Is the 32-bit name of the first general-purpose source register, encoded in the "Rn" field.
- <Wm> Is the 32-bit name of the second general-purpose source register, encoded in the "Rm" field.
- <Xd> Is the 64-bit name of the general-purpose destination register, encoded in the "Rd" field.
- <Xn> Is the 64-bit name of the first general-purpose source register, encoded in the "Rn" field.
- <Xm> Is the 64-bit name of the second general-purpose source register, encoded in the "Rm" field.

Operation

```
bits(datasize) result;
bits(datasize) operand1 = X[n];
bits(datasize) operand2 = X[m];

operand2 = NOT(operand2);
```

```
(result, -) = AddWithCarry(operand1, operand2, PSTATE.C);
```

```
X[d] = result;
```

C6.2.191 SBCS

Subtract with Carry, setting flags, subtracts a register value and the value of NOT (Carry flag) from a register value, and writes the result to the destination register. It updates the condition flags based on the result.

This instruction is used by the alias **NGCS**. See *Alias conditions* for details of when each alias is preferred.

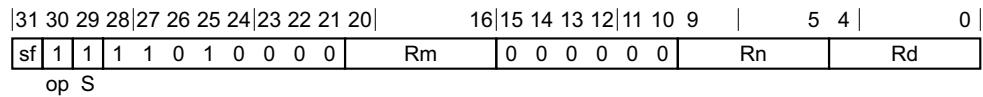

32-bit variant

Applies when sf == 0.

SBCS <Wd>, <Wn>, <Wm>

64-bit variant

Applies when sf == 1.

SBCS <Xd>, <Xn>, <Xm>

Decode for all variants of this encoding

```
integer d = UInt(Rd);
integer n = UInt(Rn);
integer m = UInt(Rm);
integer datasize = if sf == '1' then 64 else 32;
```

Alias conditions

Alias	is preferred when
NGCS	Rn == '11111'

Assembler symbols

<Wd>	Is the 32-bit name of the general-purpose destination register, encoded in the "Rd" field.
<Wn>	Is the 32-bit name of the first general-purpose source register, encoded in the "Rn" field.
<Wm>	Is the 32-bit name of the second general-purpose source register, encoded in the "Rm" field.
<Xd>	Is the 64-bit name of the general-purpose destination register, encoded in the "Rd" field.
<Xn>	Is the 64-bit name of the first general-purpose source register, encoded in the "Rn" field.
<Xm>	Is the 64-bit name of the second general-purpose source register, encoded in the "Rm" field.

Operation

```
bits(datasize) result;
bits(datasize) operand1 = X[n];
bits(datasize) operand2 = X[m];
bits(4) nzcvc;
```

```
operand2 = NOT(operand2);
```

```
(result, nzcvc) = AddWithCarry(operand1, operand2, PSTATE.C);
```

```
PSTATE.<N,Z,C,V> = nzcvc;
```

```
X[d] = result;
```

C6.2.192 SBFIZ

Signed Bitfield Insert in Zero zeroes the destination register and copies any number of contiguous bits from a source register into any position in the destination register, sign-extending the most significant bit of the transferred value.

This instruction is an alias of the [SBFM](#) instruction. This means that:

- The encodings in this description are named to match the encodings of [SBFM](#).
- The description of [SBFM](#) gives the operational pseudocode for this instruction.

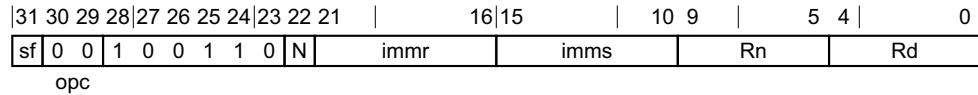

32-bit variant

Applies when $sf == 0 \ \&\& \ N == 0$.

SBFIZ <Wd>, <Wn>, #<lsb>, #<width>

is equivalent to

SBFM <Wd>, <Wn>, #(-<lsb> MOD 32), #(<width>-1)

and is the preferred disassembly when $UInt(imms) < UInt(immr)$.

64-bit variant

Applies when $sf == 1 \ \&\& \ N == 1$.

SBFIZ <Xd>, <Xn>, #<lsb>, #<width>

is equivalent to

SBFM <Xd>, <Xn>, #(-<lsb> MOD 64), #(<width>-1)

and is the preferred disassembly when $UInt(imms) < UInt(immr)$.

Assembler symbols

<Wd>	Is the 32-bit name of the general-purpose destination register, encoded in the "Rd" field.
<Wn>	Is the 32-bit name of the general-purpose source register, encoded in the "Rn" field.
<Xd>	Is the 64-bit name of the general-purpose destination register, encoded in the "Rd" field.
<Xn>	Is the 64-bit name of the general-purpose source register, encoded in the "Rn" field.
<lsb>	For the 32-bit variant: is the bit number of the lsb of the destination bitfield, in the range 0 to 31. For the 64-bit variant: is the bit number of the lsb of the destination bitfield, in the range 0 to 63.
<width>	For the 32-bit variant: is the width of the bitfield, in the range 1 to 32-<lsb>. For the 64-bit variant: is the width of the bitfield, in the range 1 to 64-<lsb>.

Operation

The description of [SBFM](#) gives the operational pseudocode for this instruction.

C6.2.193 SBFM

Signed Bitfield Move copies any number of low-order bits from a source register into the same number of adjacent bits at any position in the destination register, shifting in copies of the sign bit in the upper bits and zeros in the lower bits.

This instruction is used by the aliases [ASR \(immediate\)](#), [SBFIZ](#), [SBFX](#), [SXTB](#), [SXTH](#), and [SXTW](#). See *Alias conditions on page C6-821* for details of when each alias is preferred.

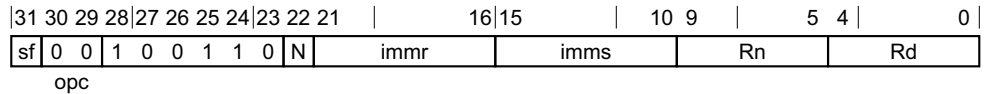

32-bit variant

Applies when `sf == 0 && N == 0`.

SBFM <Wd>, <Wn>, #<immr>, #<imms>

64-bit variant

Applies when `sf == 1 && N == 1`.

SBFM <Xd>, <Xn>, #<immr>, #<imms>

Decode for all variants of this encoding

```

integer d = UInt(Rd);
integer n = UInt(Rn);
integer datasize = if sf == '1' then 64 else 32;

integer R;
integer S;
bits(datasize) wmask;
bits(datasize) tmask;

if sf == '1' && N != '1' then ReservedValue();
if sf == '0' && (N != '0' || immr<5> != '0' || imms<5> != '0') then ReservedValue();

R = UInt(immr);
S = UInt(imms);
(wmask, tmask) = DecodeBitMasks(N, imms, immr, FALSE);
    
```

Alias conditions

Alias	of variant	is preferred when
ASR (immediate)	32-bit	<code>imms == '011111'</code>
ASR (immediate)	64-bit	<code>imms == '111111'</code>
SBFIZ	-	<code>UInt(imms) < UInt(immr)</code>
SBFX	-	<code>BFXPreferred(sf, opc<1>, imms, immr)</code>
SXTB	-	<code>immr == '000000' && imms == '000111'</code>
SXTH	-	<code>immr == '000000' && imms == '001111'</code>
SXTW	-	<code>immr == '000000' && imms == '011111'</code>

Assembler symbols

<Wd>	Is the 32-bit name of the general-purpose destination register, encoded in the "Rd" field.
<Wn>	Is the 32-bit name of the general-purpose source register, encoded in the "Rn" field.
<Xd>	Is the 64-bit name of the general-purpose destination register, encoded in the "Rd" field.
<Xn>	Is the 64-bit name of the general-purpose source register, encoded in the "Rn" field.
<immr>	For the 32-bit variant: is the right rotate amount, in the range 0 to 31, encoded in the "immr" field. For the 64-bit variant: is the right rotate amount, in the range 0 to 63, encoded in the "immr" field.
<imms>	For the 32-bit variant: is the leftmost bit number to be moved from the source, in the range 0 to 31, encoded in the "imms" field. For the 64-bit variant: is the leftmost bit number to be moved from the source, in the range 0 to 63, encoded in the "imms" field.

Operation

```
bits(datasize) src = X[n];

// perform bitfield move on low bits
bits(datasize) bot = ROR(src, R) AND wmask;

// determine extension bits (sign, zero or dest register)
bits(datasize) top = Replicate(src<S>);

// combine extension bits and result bits
X[d] = (top AND NOT(tmask)) OR (bot AND tmask);
```

C6.2.194 SBFX

Signed Bitfield Extract extracts any number of adjacent bits at any position from a register, sign-extends them to the size of the register, and writes the result to the destination register.

This instruction is an alias of the [SBFM](#) instruction. This means that:

- The encodings in this description are named to match the encodings of [SBFM](#).
- The description of [SBFM](#) gives the operational pseudocode for this instruction.

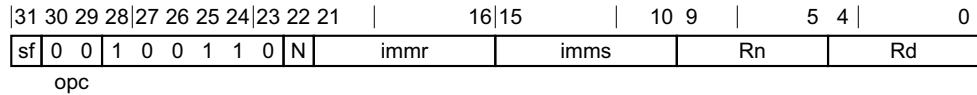

32-bit variant

Applies when $sf == 0 \ \&\& \ N == 0$.

SBFX <Wd>, <Wn>, #<lsb>, #<width>

is equivalent to

SBFM <Wd>, <Wn>, #<lsb>, #(<lsb>+<width>-1)

and is the preferred disassembly when $BFXPreferred(sf, opc<1>, imms, immr)$.

64-bit variant

Applies when $sf == 1 \ \&\& \ N == 1$.

SBFX <Xd>, <Xn>, #<lsb>, #<width>

is equivalent to

SBFM <Xd>, <Xn>, #<lsb>, #(<lsb>+<width>-1)

and is the preferred disassembly when $BFXPreferred(sf, opc<1>, imms, immr)$.

Assembler symbols

<Wd> Is the 32-bit name of the general-purpose destination register, encoded in the "Rd" field.

<Wn> Is the 32-bit name of the general-purpose source register, encoded in the "Rn" field.

<Xd> Is the 64-bit name of the general-purpose destination register, encoded in the "Rd" field.

<Xn> Is the 64-bit name of the general-purpose source register, encoded in the "Rn" field.

<lsb> For the 32-bit variant: is the bit number of the lsb of the source bitfield, in the range 0 to 31.

For the 64-bit variant: is the bit number of the lsb of the source bitfield, in the range 0 to 63.

<width> For the 32-bit variant: is the width of the bitfield, in the range 1 to 32-<lsb>.

For the 64-bit variant: is the width of the bitfield, in the range 1 to 64-<lsb>.

Operation

The description of [SBFM](#) gives the operational pseudocode for this instruction.

C6.2.195 SDIV

Signed Divide divides a signed integer register value by another signed integer register value, and writes the result to the destination register. The condition flags are not affected.

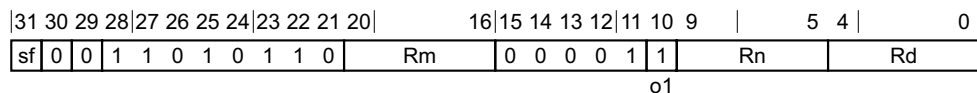

32-bit variant

Applies when `sf == 0`.

SDIV <Wd>, <Wn>, <Wm>

64-bit variant

Applies when `sf == 1`.

SDIV <Xd>, <Xn>, <Xm>

Decode for all variants of this encoding

```
integer d = UInt(Rd);
integer n = UInt(Rn);
integer m = UInt(Rm);
integer datasize = if sf == '1' then 64 else 32;
```

Assembler symbols

- <Wd> Is the 32-bit name of the general-purpose destination register, encoded in the "Rd" field.
- <Wn> Is the 32-bit name of the first general-purpose source register, encoded in the "Rn" field.
- <Wm> Is the 32-bit name of the second general-purpose source register, encoded in the "Rm" field.
- <Xd> Is the 64-bit name of the general-purpose destination register, encoded in the "Rd" field.
- <Xn> Is the 64-bit name of the first general-purpose source register, encoded in the "Rn" field.
- <Xm> Is the 64-bit name of the second general-purpose source register, encoded in the "Rm" field.

Operation

```
bits(datasize) operand1 = X[n];
bits(datasize) operand2 = X[m];
integer result;

if IsZero(operand2) then
  result = 0;
else
  result = RoundTowardsZero(Real(Int(operand1, FALSE)) / Real(Int(operand2, FALSE)));

X[d] = result<datasize-1:0>;
```

C6.2.196 SEV

Send Event is a hint instruction. It causes an event to be signaled to all PEs in the multiprocessor system. For more information, see [Wait for Event mechanism and Send event on page D1-1879](#).

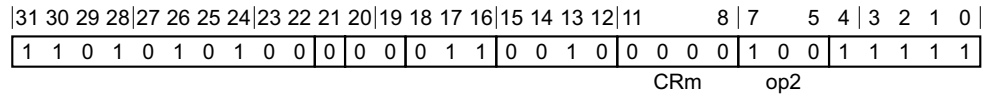

System variant

SEV

Decode for this encoding

// Empty.

Operation

`SendEvent();`

C6.2.197 SEVL

Send Event Local is a hint instruction that causes an event to be signaled locally without requiring the event to be signaled to other PEs in the multiprocessor system. It can prime a wait-loop which starts with a WFE instruction.

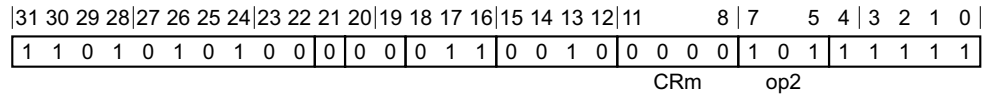

System variant

SEVL

Decode for this encoding

// Empty.

Operation

`SendEventLocal();`

C6.2.198 SMADDL

Signed Multiply-Add Long multiplies two 32-bit register values, adds a 64-bit register value, and writes the result to the 64-bit destination register.

This instruction is used by the alias *SMULL*. See *Alias conditions* for details of when each alias is preferred.

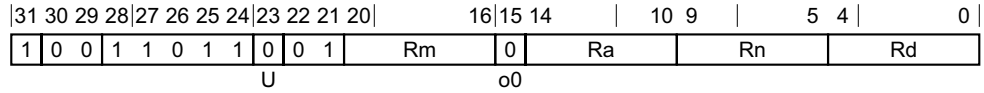

64-bit variant

SMADDL <Xd>, <Wn>, <Wm>, <Xa>

Decode for this encoding

```
integer d = UInt(Rd);
integer n = UInt(Rn);
integer m = UInt(Rm);
integer a = UInt(Ra);
```

Alias conditions

Alias	is preferred when
<i>SMULL</i>	Ra == '11111'

Assembler symbols

- <Xd> Is the 64-bit name of the general-purpose destination register, encoded in the "Rd" field.
- <Wn> Is the 32-bit name of the first general-purpose source register holding the multiplicand, encoded in the "Rn" field.
- <Wm> Is the 32-bit name of the second general-purpose source register holding the multiplier, encoded in the "Rm" field.
- <Xa> Is the 64-bit name of the third general-purpose source register holding the addend, encoded in the "Ra" field.

Operation

```
bits(32) operand1 = X[n];
bits(32) operand2 = X[m];
bits(64) operand3 = X[a];

integer result;

result = Int(operand3, FALSE) + (Int(operand1, FALSE) * Int(operand2, FALSE));

X[d] = result<63:0>;
```

C6.2.199 SMC

Secure Monitor Call causes an exception to EL3.

SMC is available only for software executing at EL1 or higher. It is UNDEFINED in EL0.

If the values of `HCR_EL2.TSC` and `SCR_EL3.SMD` are both 0, execution of an SMC instruction at EL1 or higher generates a Secure Monitor Call exception, recording it in `ESR_ELx`, using the EC value 0x17, that is taken to EL3.

If the value of `HCR_EL2.TSC` is 1, execution of an SMC instruction in a Non-secure EL1 state generates an exception that is taken to EL2, regardless of the value of `SCR_EL3.SMD`. For more information, see [Traps to EL2 of Non-secure EL1 execution of SMC instructions on page D1-1858](#).

If the value of `HCR_EL2.TSC` is 0 and the value of `SCR_EL3.SMD` is 1, the SMC instruction is UNDEFINED.

31	30	29	28	27	26	25	24	23	22	21	20							5	4	3	2	1	0	
1	1	0	1	0	1	0	0	0	0	0		imm16								0	0	0	1	1

System variant

SMC #<imm>

Decode for this encoding

```
bits(16) imm = imm16;
```

Assembler symbols

<imm> Is a 16-bit unsigned immediate, in the range 0 to 65535, encoded in the "imm16" field.

Operation

```
if !HaveEL(EL3) || PSTATE.EL == EL0 then
    UnallocatedEncoding();

AArch64.CheckForSMCTrap(imm);

if SCR_EL3.SMD == '1' then
    // SMC disabled
    AArch64.UndefinedFault();
else
    AArch64.CallSecureMonitor(imm);
```

C6.2.200 SMNEGL

Signed Multiply-Negate Long multiplies two 32-bit register values, negates the product, and writes the result to the 64-bit destination register.

This instruction is an alias of the [SMSUBL](#) instruction. This means that:

- The encodings in this description are named to match the encodings of [SMSUBL](#).
- The description of [SMSUBL](#) gives the operational pseudocode for this instruction.

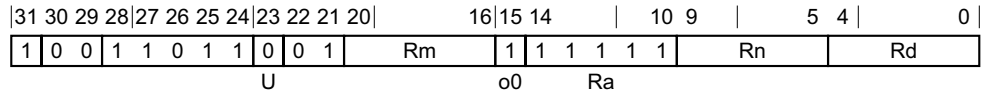

64-bit variant

SMNEGL <Xd>, <Wn>, <Wm>

is equivalent to

SMSUBL <Xd>, <Wn>, <Wm>, XZR

and is always the preferred disassembly.

Assembler symbols

<Xd> Is the 64-bit name of the general-purpose destination register, encoded in the "Rd" field.

<Wn> Is the 32-bit name of the first general-purpose source register holding the multiplicand, encoded in the "Rn" field.

<Wm> Is the 32-bit name of the second general-purpose source register holding the multiplier, encoded in the "Rm" field.

Operation

The description of [SMSUBL](#) gives the operational pseudocode for this instruction.

C6.2.201 SMSUBL

Signed Multiply-Subtract Long multiplies two 32-bit register values, subtracts the product from a 64-bit register value, and writes the result to the 64-bit destination register.

This instruction is used by the alias [SMNEGL](#). See *Alias conditions* for details of when each alias is preferred.

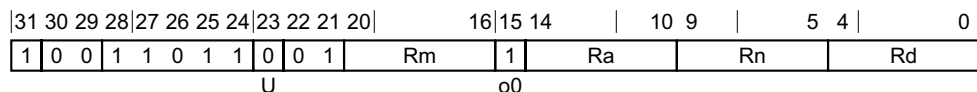

64-bit variant

SMSUBL <Xd>, <Wn>, <Wm>, <Xa>

Decode for this encoding

```
integer d = UInt(Rd);
integer n = UInt(Rn);
integer m = UInt(Rm);
integer a = UInt(Ra);
```

Alias conditions

Alias	is preferred when
SMNEGL	Ra == '11111'

Assembler symbols

- <Xd> Is the 64-bit name of the general-purpose destination register, encoded in the "Rd" field.
- <Wn> Is the 32-bit name of the first general-purpose source register holding the multiplicand, encoded in the "Rn" field.
- <Wm> Is the 32-bit name of the second general-purpose source register holding the multiplier, encoded in the "Rm" field.
- <Xa> Is the 64-bit name of the third general-purpose source register holding the minuend, encoded in the "Ra" field.

Operation

```
bits(32) operand1 = X[n];
bits(32) operand2 = X[m];
bits(64) operand3 = X[a];

integer result;

result = Int(operand3, FALSE) - (Int(operand1, FALSE) * Int(operand2, FALSE));
X[d] = result<63:0>;
```

C6.2.202 SMULH

Signed Multiply High multiplies two 64-bit register values, and writes bits[127:64] of the 128-bit result to the 64-bit destination register.

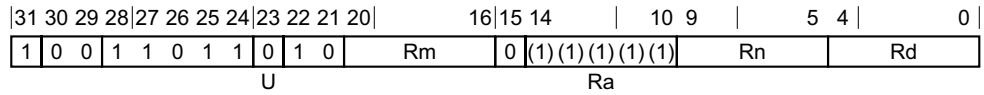

64-bit variant

SMULH <Xd>, <Xn>, <Xm>

Decode for this encoding

```
integer d = UInt(Rd);
integer n = UInt(Rn);
integer m = UInt(Rm);
```

Assembler symbols

- <Xd> Is the 64-bit name of the general-purpose destination register, encoded in the "Rd" field.
- <Xn> Is the 64-bit name of the first general-purpose source register holding the multiplicand, encoded in the "Rn" field.
- <Xm> Is the 64-bit name of the second general-purpose source register holding the multiplier, encoded in the "Rm" field.

Operation

```
bits(64) operand1 = X[n];
bits(64) operand2 = X[m];

integer result;

result = Int(operand1, FALSE) * Int(operand2, FALSE);

X[d] = result<127:64>;
```

C6.2.203 SMULL

Signed Multiply Long multiplies two 32-bit register values, and writes the result to the 64-bit destination register.

This instruction is an alias of the [SMADDL](#) instruction. This means that:

- The encodings in this description are named to match the encodings of [SMADDL](#).
- The description of [SMADDL](#) gives the operational pseudocode for this instruction.

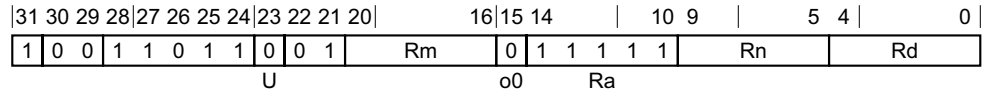

64-bit variant

SMULL <Xd>, <Wn>, <Wm>

is equivalent to

SMADDL <Xd>, <Wn>, <Wm>, XZR

and is always the preferred disassembly.

Assembler symbols

<Xd> Is the 64-bit name of the general-purpose destination register, encoded in the "Rd" field.

<Wn> Is the 32-bit name of the first general-purpose source register holding the multiplicand, encoded in the "Rn" field.

<Wm> Is the 32-bit name of the second general-purpose source register holding the multiplier, encoded in the "Rm" field.

Operation

The description of [SMADDL](#) gives the operational pseudocode for this instruction.

C6.2.204 STADDB, STADDLB

Atomic add on byte in memory, without return, atomically loads an 8-bit byte from memory, adds the value held in a register to it, and stores the result back to memory.

- STADDB has no memory ordering semantics.
- STADDLB stores to memory with release semantics, as described in [Load-Acquire, Store-Release on page B2-94](#).

For information about memory accesses see [Load/Store addressing modes on page C1-143](#).

ARMv8.1

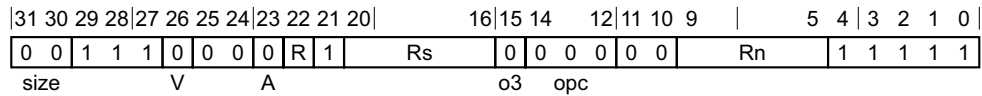

No memory ordering variant

Applies when R == 0.

STADDB <Ws>, [<Xn|SP>]

Release variant

Applies when R == 1.

STADDLB <Ws>, [<Xn|SP>]

Decode for all variants of this encoding

```

if !HaveAtomicExt() then UnallocatedEncoding();
integer n = UInt(Rn);
integer s = UInt(Rs);

AccType stacctype = if R == '1' then AccType_ORDEREDRW else AccType_ATOMICRW;
```

Assembler symbols

<Ws> Is the 32-bit name of the general-purpose register holding the data value to be operated on with the contents of the memory location, encoded in the "Rs" field.

<Xn|SP> Is the 64-bit name of the general-purpose base register or stack pointer, encoded in the "Rn" field.

Operation

```

bits(64) address;
bits(8) value;
bits(8) data;
bits(8) result;

value = X[s];
if n == 31 then
    CheckSPAlignment();
    address = SP[];
else
    address = X[n];
data = Mem[address, 1, AccType_ATOMICRW];

result = data + value;
```

```
// All observers in the shareability domain observe the  
// following load and store atomically.  
Mem[address, 1, stacctype] = result;
```

C6.2.205 STADDH, STADDLH

Atomic add on halfword in memory, without return, atomically loads a 16-bit halfword from memory, adds the value held in a register to it, and stores the result back to memory.

- STADDH has no memory ordering semantics.
- STADDLH stores to memory with release semantics, as described in [Load-Acquire, Store-Release on page B2-94](#).

For information about memory accesses see [Load/Store addressing modes on page C1-143](#).

ARMv8.1

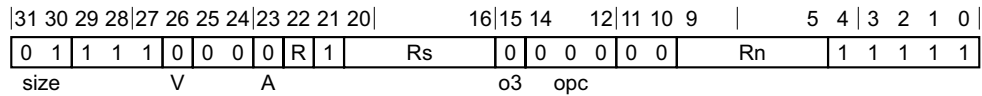

No memory ordering variant

Applies when R == 0.

STADDH <Ws>, [<Xn|SP>]

Release variant

Applies when R == 1.

STADDLH <Ws>, [<Xn|SP>]

Decode for all variants of this encoding

```
if !HaveAtomicExt() then UnallocatedEncoding();
integer n = UInt(Rn);
integer s = UInt(Rs);

AccType staccType = if R == '1' then AccType_ORDEREDRW else AccType_ATOMICRW;
```

Assembler symbols

<Ws> Is the 32-bit name of the general-purpose register holding the data value to be operated on with the contents of the memory location, encoded in the "Rs" field.

<Xn|SP> Is the 64-bit name of the general-purpose base register or stack pointer, encoded in the "Rn" field.

Operation

```
bits(64) address;
bits(16) value;
bits(16) data;
bits(16) result;

value = X[s];
if n == 31 then
    CheckSPAlignment();
    address = SP[];
else
    address = X[n];
data = Mem[address, 2, AccType_ATOMICRW];

result = data + value;
```



```
// All observers in the shareability domain observe the  
// following load and store atomically.  
Mem[address, 2, stacctype] = result;
```

C6.2.206 STADD, STADDL

Atomic add on word or doubleword in memory, without return, atomically loads a 32-bit word or 64-bit doubleword from memory, adds the value held in a register to it, and stores the result back to memory.

- STADD has no memory ordering semantics.
- STADDL stores to memory with release semantics, as described in [Load-Acquire, Store-Release](#) on page B2-94.

For information about memory accesses see [Load/Store addressing modes](#) on page C1-143.

ARMv8.1

31	30	29	28	27	26	25	24	23	22	21	20	16	15	14	12	11	10	9	5	4	3	2	1	0
1	x	1	1	1	0	0	0	0	R	1	Rs	0	0	0	0	0	0	Rn	1	1	1	1	1	1
size		V				A				o3				opc										

32-bit, no memory ordering variant

Applies when size == 10 && R == 0.

STADD <Ws>, [<Xn|SP>]

32-bit, release variant

Applies when size == 10 && R == 1.

STADDL <Ws>, [<Xn|SP>]

64-bit, no memory ordering variant

Applies when size == 11 && R == 0.

STADD <Xs>, [<Xn|SP>]

64-bit, release variant

Applies when size == 11 && R == 1.

STADDL <Xs>, [<Xn|SP>]

Decode for all variants of this encoding

```

if !HaveAtomicExt() then UnallocatedEncoding();
integer n = UInt(Rn);
integer s = UInt(Rs);

integer datasize = 8 << UInt(size);
AccType staccctype = if R == '1' then AccType_ORDEREDRW else AccType_ATOMICRW;
```

Assembler symbols

- <Ws> Is the 32-bit name of the general-purpose register holding the data value to be operated on with the contents of the memory location, encoded in the "Rs" field.
- <Xs> Is the 64-bit name of the general-purpose register holding the data value to be operated on with the contents of the memory location, encoded in the "Rs" field.
- <Xn|SP> Is the 64-bit name of the general-purpose base register or stack pointer, encoded in the "Rn" field.

Operation

```
bits(64) address;  
bits(datasize) value;  
bits(datasize) data;  
bits(datasize) result;  
  
value = X[s];  
if n == 31 then  
    CheckSPAlignment();  
    address = SP[];  
else  
    address = X[n];  
data = Mem[address, datasize DIV 8, AccType_ATOMICRW];  
  
result = data + value;  
// All observers in the shareability domain observe the  
// following load and store atomically.  
Mem[address, datasize DIV 8, stacctype] = result;
```

C6.2.207 STCLRB, STCLRLB

Atomic bit clear on byte in memory, without return, atomically loads an 8-bit byte from memory, performs a bitwise AND with the complement of the value held in a register on it, and stores the result back to memory.

- STCLRB has no memory ordering semantics.
- STCLRLB stores to memory with release semantics, as described in [Load-Acquire, Store-Release on page B2-94](#).

For information about memory accesses see [Load/Store addressing modes on page C1-143](#).

ARMv8.1

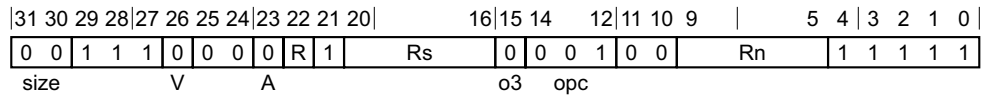

No memory ordering variant

Applies when R == 0.

STCLRB <Ws>, [<Xn|SP>]

Release variant

Applies when R == 1.

STCLRLB <Ws>, [<Xn|SP>]

Decode for all variants of this encoding

```

if !HaveAtomicExt() then UnallocatedEncoding();
integer n = UInt(Rn);
integer s = UInt(Rs);

AccType staccType = if R == '1' then AccType_ORDEREDRW else AccType_ATOMICRW;
    
```

Assembler symbols

<Ws> Is the 32-bit name of the general-purpose register holding the data value to be operated on with the contents of the memory location, encoded in the "Rs" field.

<Xn|SP> Is the 64-bit name of the general-purpose base register or stack pointer, encoded in the "Rn" field.

Operation

```

bits(64) address;
bits(8) value;
bits(8) data;
bits(8) result;

value = X[s];
if n == 31 then
    CheckSPAlignment();
    address = SP[];
else
    address = X[n];
data = Mem[address, 1, AccType_ATOMICRW];

result = data AND NOT(value);
    
```

```
// All observers in the shareability domain observe the  
// following load and store atomically.  
Mem[address, 1, stacctype] = result;
```

C6.2.208 STCLRH, STCLRLH

Atomic bit clear on halfword in memory, without return, atomically loads a 16-bit halfword from memory, performs a bitwise AND with the complement of the value held in a register on it, and stores the result back to memory.

- STCLRH has no memory ordering semantics.
- STCLRLH stores to memory with release semantics, as described in [Load-Acquire, Store-Release on page B2-94](#).

For information about memory accesses see [Load/Store addressing modes on page C1-143](#).

ARMv8.1

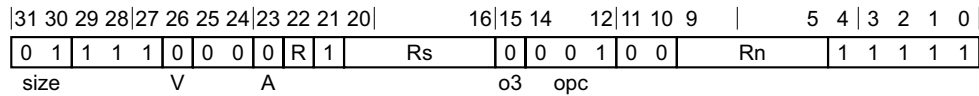

No memory ordering variant

Applies when R == 0.

STCLRH <Ws>, [<Xn|SP>]

Release variant

Applies when R == 1.

STCLRLH <Ws>, [<Xn|SP>]

Decode for all variants of this encoding

```
if !HaveAtomicExt() then UnallocatedEncoding();
integer n = UInt(Rn);
integer s = UInt(Rs);

AccType staccType = if R == '1' then AccType_ORDEREDRW else AccType_ATOMICRW;
```

Assembler symbols

<Ws> Is the 32-bit name of the general-purpose register holding the data value to be operated on with the contents of the memory location, encoded in the "Rs" field.

<Xn|SP> Is the 64-bit name of the general-purpose base register or stack pointer, encoded in the "Rn" field.

Operation

```
bits(64) address;
bits(16) value;
bits(16) data;
bits(16) result;

value = X[s];
if n == 31 then
    CheckSPAlignment();
    address = SP[];
else
    address = X[n];
data = Mem[address, 2, AccType_ATOMICRW];

result = data AND NOT(value);
```

```
// All observers in the shareability domain observe the  
// following load and store atomically.  
Mem[address, 2, stacctype] = result;
```

C6.2.209 STCLR, STCLRL

Atomic bit clear on word or doubleword in memory, without return, atomically loads a 32-bit word or 64-bit doubleword from memory, performs a bitwise AND with the complement of the value held in a register on it, and stores the result back to memory.

- STCLR has no memory ordering semantics.
- STCLRL stores to memory with release semantics, as described in [Load-Acquire, Store-Release on page B2-94](#).

For information about memory accesses see [Load/Store addressing modes on page C1-143](#).

ARMv8.1

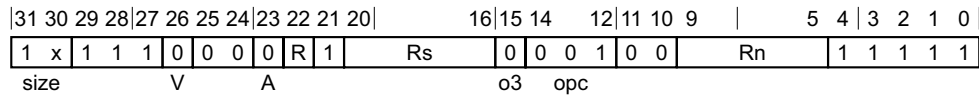

32-bit, no memory ordering variant

Applies when size == 10 && R == 0.

STCLR <Ws>, [<Xn|SP>]

32-bit, release variant

Applies when size == 10 && R == 1.

STCLRL <Ws>, [<Xn|SP>]

64-bit, no memory ordering variant

Applies when size == 11 && R == 0.

STCLR <Xs>, [<Xn|SP>]

64-bit, release variant

Applies when size == 11 && R == 1.

STCLRL <Xs>, [<Xn|SP>]

Decode for all variants of this encoding

```

if !HaveAtomicExt() then UnallocatedEncoding();
integer n = UInt(Rn);
integer s = UInt(Rs);

integer datasize = 8 << UInt(size);
AccType stacctype = if R == '1' then AccType_ORDEREDRW else AccType_ATOMICRW;
```

Assembler symbols

- <Ws> Is the 32-bit name of the general-purpose register holding the data value to be operated on with the contents of the memory location, encoded in the "Rs" field.
- <Xs> Is the 64-bit name of the general-purpose register holding the data value to be operated on with the contents of the memory location, encoded in the "Rs" field.
- <Xn|SP> Is the 64-bit name of the general-purpose base register or stack pointer, encoded in the "Rn" field.

Operation

```
bits(64) address;  
bits(datasize) value;  
bits(datasize) data;  
bits(datasize) result;  
  
value = X[s];  
if n == 31 then  
    CheckSPAlignment();  
    address = SP[];  
else  
    address = X[n];  
data = Mem[address, datasize DIV 8, AccType_ATOMICRW];  
  
result = data AND NOT(value);  
// All observers in the shareability domain observe the  
// following load and store atomically.  
Mem[address, datasize DIV 8, stacctype] = result;
```

C6.2.210 STEORB, STEORLB

Atomic exclusive OR on byte in memory, without return, atomically loads an 8-bit byte from memory, performs an exclusive OR with the value held in a register on it, and stores the result back to memory.

- STEORB has no memory ordering semantics.
- STEORLB stores to memory with release semantics, as described in [Load-Acquire, Store-Release on page B2-94](#).

For information about memory accesses see [Load/Store addressing modes on page C1-143](#).

ARMv8.1

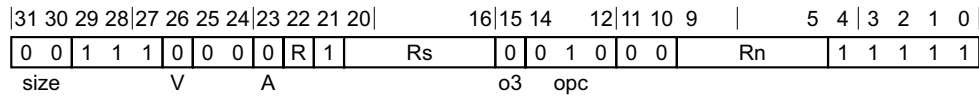

No memory ordering variant

Applies when R == 0.

STEORB <Ws>, [<Xn|SP>]

Release variant

Applies when R == 1.

STEORLB <Ws>, [<Xn|SP>]

Decode for all variants of this encoding

```
if !HaveAtomicExt() then UnallocatedEncoding();
integer n = UInt(Rn);
integer s = UInt(Rs);

AccType stacctype = if R == '1' then AccType_ORDEREDRW else AccType_ATOMICRW;
```

Assembler symbols

<Ws> Is the 32-bit name of the general-purpose register holding the data value to be operated on with the contents of the memory location, encoded in the "Rs" field.

<Xn|SP> Is the 64-bit name of the general-purpose base register or stack pointer, encoded in the "Rn" field.

Operation

```
bits(64) address;
bits(8) value;
bits(8) data;
bits(8) result;

value = X[s];
if n == 31 then
    CheckSPAlignment();
    address = SP[];
else
    address = X[n];
data = Mem[address, 1, AccType_ATOMICRW];

result = data EOR value;
```

```
// All observers in the shareability domain observe the  
// following load and store atomically.  
Mem[address, 1, stacctype] = result;
```

C6.2.211 STEORH, STEORLH

Atomic exclusive OR on halfword in memory, without return, atomically loads a 16-bit halfword from memory, performs an exclusive OR with the value held in a register on it, and stores the result back to memory.

- STEORH has no memory ordering semantics.
- STEORLH stores to memory with release semantics, as described in [Load-Acquire, Store-Release on page B2-94](#).

For information about memory accesses see [Load/Store addressing modes on page C1-143](#).

ARMv8.1

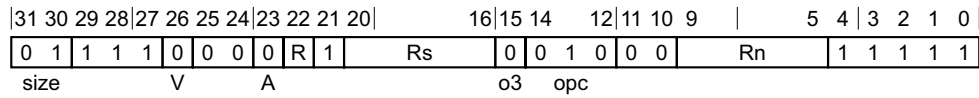

No memory ordering variant

Applies when R == 0.

STEORH <Ws>, [<Xn|SP>]

Release variant

Applies when R == 1.

STEORLH <Ws>, [<Xn|SP>]

Decode for all variants of this encoding

```
if !HaveAtomicExt() then UnallocatedEncoding();
integer n = UInt(Rn);
integer s = UInt(Rs);

AccType stacctype = if R == '1' then AccType_ORDEREDRW else AccType_ATOMICRW;
```

Assembler symbols

<Ws> Is the 32-bit name of the general-purpose register holding the data value to be operated on with the contents of the memory location, encoded in the "Rs" field.

<Xn|SP> Is the 64-bit name of the general-purpose base register or stack pointer, encoded in the "Rn" field.

Operation

```
bits(64) address;
bits(16) value;
bits(16) data;
bits(16) result;

value = X[s];
if n == 31 then
    CheckSPAlignment();
    address = SP[];
else
    address = X[n];
data = Mem[address, 2, AccType_ATOMICRW];

result = data EOR value;
```

```
// All observers in the shareability domain observe the  
// following load and store atomically.  
Mem[address, 2, stacctype] = result;
```

C6.2.212 STEOR, STEORL

Atomic exclusive OR on word or doubleword in memory, without return, atomically loads a 32-bit word or 64-bit doubleword from memory, performs an exclusive OR with the value held in a register on it, and stores the result back to memory.

- STEOR has no memory ordering semantics.
- STEORL stores to memory with release semantics, as described in [Load-Acquire, Store-Release](#) on page B2-94.

For information about memory accesses see [Load/Store addressing modes](#) on page C1-143.

ARMv8.1

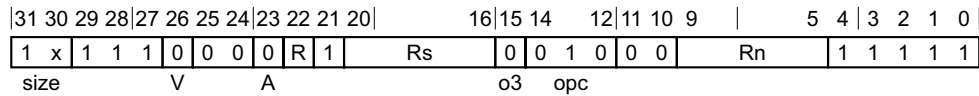

32-bit, no memory ordering variant

Applies when size == 10 && R == 0.

STEOR <Ws>, [<Xn|SP>]

32-bit, release variant

Applies when size == 10 && R == 1.

STEORL <Ws>, [<Xn|SP>]

64-bit, no memory ordering variant

Applies when size == 11 && R == 0.

STEOR <Xs>, [<Xn|SP>]

64-bit, release variant

Applies when size == 11 && R == 1.

STEORL <Xs>, [<Xn|SP>]

Decode for all variants of this encoding

```

if !HaveAtomicExt() then UnallocatedEncoding();
integer n = UInt(Rn);
integer s = UInt(Rs);

integer datasize = 8 << UInt(size);
AccType stacctype = if R == '1' then AccType_ORDEREDRW else AccType_ATOMICRW;
```

Assembler symbols

- <Ws> Is the 32-bit name of the general-purpose register holding the data value to be operated on with the contents of the memory location, encoded in the "Rs" field.
- <Xs> Is the 64-bit name of the general-purpose register holding the data value to be operated on with the contents of the memory location, encoded in the "Rs" field.
- <Xn|SP> Is the 64-bit name of the general-purpose base register or stack pointer, encoded in the "Rn" field.

Operation

```
bits(64) address;  
bits(datasize) value;  
bits(datasize) data;  
bits(datasize) result;  
  
value = X[s];  
if n == 31 then  
    CheckSPAlignment();  
    address = SP[];  
else  
    address = X[n];  
data = Mem[address, datasize DIV 8, AccType_ATOMICRW];  
  
result = data EOR value;  
// All observers in the shareability domain observe the  
// following load and store atomically.  
Mem[address, datasize DIV 8, stacctype] = result;
```

C6.2.213 STLLRB

Store LORelease Register Byte stores a byte from a 32-bit register to a memory location. The instruction also has memory ordering semantics as described in *LoadLOAcquire, StoreLORelease* on page B2-95. For information about memory accesses, see *Load/Store addressing modes* on page C1-143.

ARMv8.1

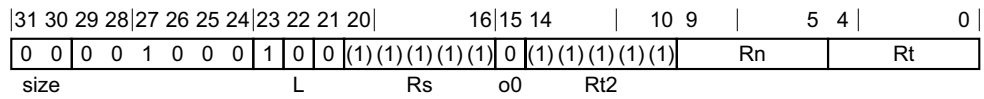

No offset variant

STLLRB <Wt>, [<Xn|SP>{, #0}]

Decode for this encoding

integer n = UInt(Rn);
 integer t = UInt(Rt);

Assembler symbols

- <Wt> Is the 32-bit name of the general-purpose register to be transferred, encoded in the "Rt" field.
- <Xn|SP> Is the 64-bit name of the general-purpose base register or stack pointer, encoded in the "Rn" field.

Operation

```

bits(64) address;
bits(8) data;

if n == 31 then
    CheckSPAAlignment();
    address = SP[];
else
    address = X[n];

data = X[t];
Mem[address, 1, AccType_LIMITEDORDERED] = data;
    
```

C6.2.214 STLLRH

Store LORelease Register Halfword stores a halfword from a 32-bit register to a memory location. The instruction also has memory ordering semantics as described in *LoadLOAcquire, StoreLORelease* on page B2-95. For information about memory accesses, see *Load/Store addressing modes* on page C1-143.

ARMv8.1

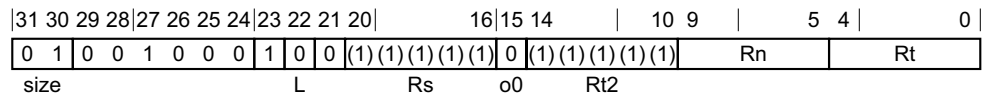

No offset variant

STLLRH <wt>, [<Xn|SP>{, #0}]

Decode for this encoding

integer n = UInt(Rn);
 integer t = UInt(Rt);

Assembler symbols

<wt> Is the 32-bit name of the general-purpose register to be transferred, encoded in the "Rt" field.

<Xn|SP> Is the 64-bit name of the general-purpose base register or stack pointer, encoded in the "Rn" field.

Operation

bits(64) address;
 bits(16) data;

if n == 31 then
 CheckSPAAlignment();
 address = SP[];
 else
 address = X[n];

data = X[t];
 Mem[address, 2, AccType_LIMITEDORDERED] = data;

C6.2.215 STLLR

Store LORelease Register stores a 32-bit word or a 64-bit doubleword to a memory location, from a register. The instruction also has memory ordering semantics as described in *LoadLOAcquire, StoreLORelease* on page B2-95. For information about memory accesses, see *Load/Store addressing modes* on page C1-143.

ARMv8.1

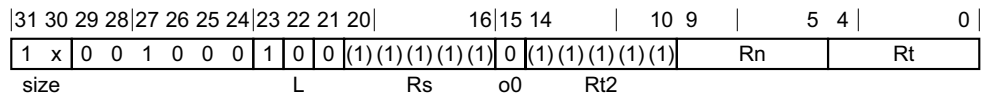

32-bit variant

Applies when size == 10.

STLLR <Wt>, [<Xn|SP>{, #0}]

64-bit variant

Applies when size == 11.

STLLR <Xt>, [<Xn|SP>{, #0}]

Decode for all variants of this encoding

```
integer n = UInt(Rn);
integer t = UInt(Rt);

integer  elsize = 8 << UInt(size);
```

Assembler symbols

- <Wt> Is the 32-bit name of the general-purpose register to be transferred, encoded in the "Rt" field.
- <Xt> Is the 64-bit name of the general-purpose register to be transferred, encoded in the "Rt" field.
- <Xn|SP> Is the 64-bit name of the general-purpose base register or stack pointer, encoded in the "Rn" field.

Operation

```
bits(64) address;
bits(elsize) data;
constant integer dbytes = elsize DIV 8;

if n == 31 then
    CheckSPAlignment();
    address = SP[];
else
    address = X[n];

data = X[t];
Mem[address, dbytes, AccType_LIMITEDORDERED] = data;
```

C6.2.216 STLR

Store-Release Register stores a 32-bit word or a 64-bit doubleword to a memory location, from a register. The instruction also has memory ordering semantics as described in *Load-Acquire, Store-Release* on page B2-94. For information about memory accesses, see *Load/Store addressing modes* on page C1-143.

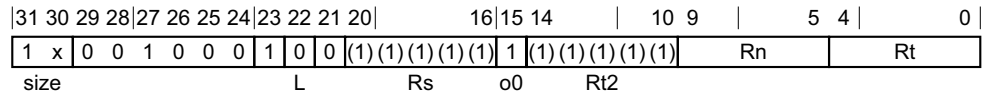

32-bit variant

Applies when size == 10.

STLR <Wt>, [<Xn|SP>{, #0}]

64-bit variant

Applies when size == 11.

STLR <Xt>, [<Xn|SP>{, #0}]

Decode for all variants of this encoding

```
integer n = UInt(Rn);
integer t = UInt(Rt);

integer elsize = 8 << UInt(size);
```

Assembler symbols

<Wt> Is the 32-bit name of the general-purpose register to be transferred, encoded in the "Rt" field.

<Xt> Is the 64-bit name of the general-purpose register to be transferred, encoded in the "Rt" field.

<Xn|SP> Is the 64-bit name of the general-purpose base register or stack pointer, encoded in the "Rn" field.

Operation

```
bits(64) address;
bits(elsize) data;
constant integer dbytes = elsize DIV 8;

if n == 31 then
    CheckSPAlignment();
    address = SP[];
else
    address = X[n];

data = X[t];
Mem[address, dbytes, AccType_ORDERED] = data;
```

C6.2.217 STLRB

Store-Release Register Byte stores a byte from a 32-bit register to a memory location. The instruction also has memory ordering semantics as described in *Load-Acquire, Store-Release* on page B2-94. For information about memory accesses, see *Load/Store addressing modes* on page C1-143.

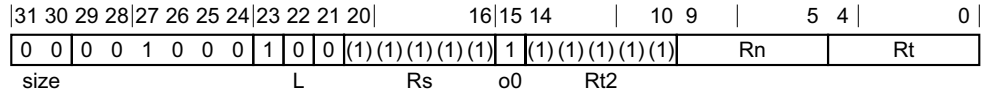

No offset variant

STLRB <Wt>, [<Xn|SP>{, #0}]

Decode for this encoding

```
integer n = UInt(Rn);
integer t = UInt(Rt);
```

Assembler symbols

- <Wt> Is the 32-bit name of the general-purpose register to be transferred, encoded in the "Rt" field.
- <Xn|SP> Is the 64-bit name of the general-purpose base register or stack pointer, encoded in the "Rn" field.

Operation

```
bits(64) address;
bits(8) data;

if n == 31 then
    CheckSPA1ignment();
    address = SP[];
else
    address = X[n];

data = X[t];
Mem[address, 1, AccType_ORDERED] = data;
```

C6.2.218 STLRH

Store-Release Register Halfword stores a halfword from a 32-bit register to a memory location. The instruction also has memory ordering semantics as described in *Load-Acquire, Store-Release* on page B2-94. For information about memory accesses, see *Load/Store addressing modes* on page C1-143.

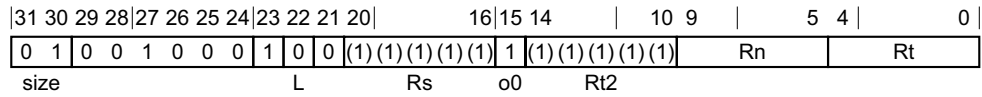

No offset variant

STLRH <Wt>, [<Xn|SP>{, #0}]

Decode for this encoding

```
integer n = UInt(Rn);
integer t = UInt(Rt);
```

Assembler symbols

<Wt> Is the 32-bit name of the general-purpose register to be transferred, encoded in the "Rt" field.

<Xn|SP> Is the 64-bit name of the general-purpose base register or stack pointer, encoded in the "Rn" field.

Operation

```
bits(64) address;
bits(16) data;

if n == 31 then
    CheckSPA1ignment();
    address = SP[];
else
    address = X[n];

data = X[t];
Mem[address, 2, AccType_ORDERED] = data;
```

C6.2.219 STLXP

Store-Release Exclusive Pair of registers stores two 32-bit words or two 64-bit doublewords to a memory location if the PE has exclusive access to the memory address, from two registers, and returns a status value of 0 if the store was successful, or of 1 if no store was performed. See [Synchronization and semaphores on page B2-121](#). A 32-bit pair requires the address to be doubleword aligned and is single-copy atomic at doubleword granularity. A 64-bit pair requires the address to be quadword aligned and, if the Store-Exclusive succeeds, it causes a single-copy atomic update of the 128-bit memory location being updated. The instruction also has memory ordering semantics as described in [Load-Acquire, Store-Release on page B2-94](#). For information about memory accesses see [Load/Store addressing modes on page C1-143](#).

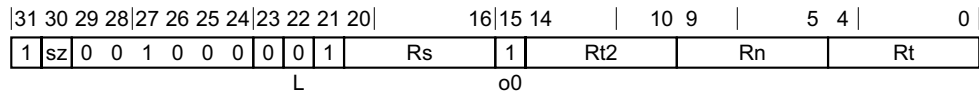

32-bit variant

Applies when `sz == 0`.

STLXP <Ws>, <Wt1>, <Wt2>, [<Xn|SP>{,#0}]

64-bit variant

Applies when `sz == 1`.

STLXP <Ws>, <Xt1>, <Xt2>, [<Xn|SP>{,#0}]

Decode for all variants of this encoding

```
integer n = UInt(Rn);
integer t = UInt(Rt);
integer t2 = UInt(Rt2); // ignored by load/store single register
integer s = UInt(Rs); // ignored by all loads and store-release
```

```
integer elsize = 32 << UInt(sz);
integer datasize = elsize * 2;
```

Notes for all encodings

For information about the **CONSTRAINED UNPREDICTABLE** behavior of this instruction, see [Appendix K1 Architectural Constraints on UNPREDICTABLE behaviors](#), and particularly [STLXP on page K1-6129](#).

Assembler symbols

- <Ws> Is the 32-bit name of the general-purpose register into which the status result of the store exclusive is written, encoded in the "Rs" field. The value returned is:
 - 0 If the operation updates memory.
 - 1 If the operation fails to update memory.
- <Xt1> Is the 64-bit name of the first general-purpose register to be transferred, encoded in the "Rt" field.
- <Xt2> Is the 64-bit name of the second general-purpose register to be transferred, encoded in the "Rt2" field.
- <Wt1> Is the 32-bit name of the first general-purpose register to be transferred, encoded in the "Rt" field.
- <Wt2> Is the 32-bit name of the second general-purpose register to be transferred, encoded in the "Rt2" field.

<Xn|SP> Is the 64-bit name of the general-purpose base register or stack pointer, encoded in the "Rn" field.

Aborts and alignment

If a synchronous Data Abort exception is generated by the execution of this instruction:

- Memory is not updated.
- <Ws> is not updated.

Accessing an address that is not aligned to the size of the data being accessed causes an Alignment fault Data Abort exception to be generated, subject to the following rules:

- If AArch64.ExclusiveMonitorsPass() returns TRUE, the exception is generated.
- Otherwise, it is IMPLEMENTATION DEFINED whether the exception is generated.

If AArch64.ExclusiveMonitorsPass() returns FALSE and the memory address, if accessed, would generate a synchronous Data Abort exception, it is IMPLEMENTATION DEFINED whether the exception is generated.

Operation

```

bits(64) address;
bits(datasize) data;
constant integer dbytes = datasize DIV 8;
boolean rt_unknown = FALSE;
boolean rn_unknown = FALSE;

if s == t || (s == t2) then
  Constraint c = ConstrainUnpredictable();
  assert c IN {Constraint_UNKNOWN, Constraint_NONE, Constraint_UNDEF, Constraint_NOP};
  case c of
    when Constraint_UNKNOWN rt_unknown = TRUE;    // store UNKNOWN value
    when Constraint_NONE    rt_unknown = FALSE;   // store original value
    when Constraint_UNDEF   UnallocatedEncoding();
    when Constraint_NOP     EndOfInstruction();
if s == n && n != 31 then
  Constraint c = ConstrainUnpredictable();
  assert c IN {Constraint_UNKNOWN, Constraint_NONE, Constraint_UNDEF, Constraint_NOP};
  case c of
    when Constraint_UNKNOWN rn_unknown = TRUE;    // address is UNKNOWN
    when Constraint_NONE    rn_unknown = FALSE;   // address is original base
    when Constraint_UNDEF   UnallocatedEncoding();
    when Constraint_NOP     EndOfInstruction();

if n == 31 then
  CheckSPAlignment();
  address = SP[];
elseif rn_unknown then
  address = bits(64) UNKNOWN;
else
  address = X[n];

if rt_unknown then
  data = bits(datasize) UNKNOWN;
else
  bits(datasize DIV 2) e1 = X[t];
  bits(datasize DIV 2) e2 = X[t2];
  data = if BigEndian() then e1:e2 else e2:e1;
bit status = '1';
// Check whether the Exclusive Monitors are set to include the
// physical memory locations corresponding to virtual address
// range [address, address+dbytes-1].
if AArch64.ExclusiveMonitorsPass(address, dbytes) then
  // This atomic write will be rejected if it does not refer
  // to the same physical locations after address translation.

```

```
Mem[address, dbytes, AccType_ORDERED] = data;  
status = ExclusiveMonitorsStatus();  
X[s] = ZeroExtend(status, 32);
```

C6.2.220 STLXR

Store-Release Exclusive Register stores a 32-bit word or a 64-bit doubleword to memory if the PE has exclusive access to the memory address, from two registers, and returns a status value of 0 if the store was successful, or of 1 if no store was performed. See [Synchronization and semaphores on page B2-121](#). The memory access is atomic. The instruction also has memory ordering semantics as described in [Load-Acquire, Store-Release on page B2-94](#). For information about memory accesses see [Load/Store addressing modes on page C1-143](#).

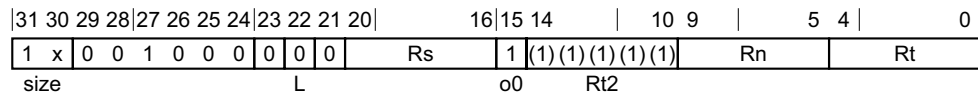

32-bit variant

Applies when size == 10.

STLXR <Ws>, <Wt>, [<Xn|SP>{,#0}]

64-bit variant

Applies when size == 11.

STLXR <Ws>, <Xt>, [<Xn|SP>{,#0}]

Decode for all variants of this encoding

```
integer n = UInt(Rn);
integer t = UInt(Rt);
integer s = UInt(Rs);    // ignored by all loads and store-release

integer elsize = 8 << UInt(size);
```

Notes for all encodings

For information about the CONSTRAINED UNPREDICTABLE behavior of this instruction, see [Appendix K1 Architectural Constraints on UNPREDICTABLE behaviors](#), and particularly [STLXR on page K1-6129](#).

Assembler symbols

<Ws> Is the 32-bit name of the general-purpose register into which the status result of the store exclusive is written, encoded in the "Rs" field. The value returned is:

- 0 If the operation updates memory.
- 1 If the operation fails to update memory.

<Xt> Is the 64-bit name of the general-purpose register to be transferred, encoded in the "Rt" field.

<Wt> Is the 32-bit name of the general-purpose register to be transferred, encoded in the "Rt" field.

<Xn|SP> Is the 64-bit name of the general-purpose base register or stack pointer, encoded in the "Rn" field.

Aborts and alignment

If a synchronous Data Abort exception is generated by the execution of this instruction:

- Memory is not updated.
- <Ws> is not updated.

Accessing an address that is not aligned to the size of the data being accessed causes an Alignment fault Data Abort exception to be generated, subject to the following rules:

- If `AArch64.ExclusiveMonitorsPass()` returns `TRUE`, the exception is generated.
- Otherwise, it is `IMPLEMENTATION DEFINED` whether the exception is generated.

If `AArch64.ExclusiveMonitorsPass()` returns `FALSE` and the memory address, if accessed, would generate a synchronous Data Abort exception, it is `IMPLEMENTATION DEFINED` whether the exception is generated.

Operation

```

bits(64) address;
bits(elsize) data;
constant integer dbytes = elsize DIV 8;
boolean rt_unknown = FALSE;
boolean rn_unknown = FALSE;

if s == t then
  Constraint c = ConstrainUnpredictable();
  assert c IN {Constraint_UNKNOWN, Constraint_NONE, Constraint_UNDEF, Constraint_NOP};
  case c of
    when Constraint_UNKNOWN rt_unknown = TRUE;    // store UNKNOWN value
    when Constraint_NONE    rt_unknown = FALSE;   // store original value
    when Constraint_UNDEF   UnallocatedEncoding();
    when Constraint_NOP     EndOfInstruction();
if s == n && n != 31 then
  Constraint c = ConstrainUnpredictable();
  assert c IN {Constraint_UNKNOWN, Constraint_NONE, Constraint_UNDEF, Constraint_NOP};
  case c of
    when Constraint_UNKNOWN rn_unknown = TRUE;    // address is UNKNOWN
    when Constraint_NONE    rn_unknown = FALSE;   // address is original base
    when Constraint_UNDEF   UnallocatedEncoding();
    when Constraint_NOP     EndOfInstruction();

if n == 31 then
  CheckSPAlignment();
  address = SP[];
elseif rn_unknown then
  address = bits(64) UNKNOWN;
else
  address = X[n];

if rt_unknown then
  data = bits(elsize) UNKNOWN;
else
  data = X[t];

bit status = '1';
// Check whether the Exclusive Monitors are set to include the
// physical memory locations corresponding to virtual address
// range [address, address+dbytes-1].
if AArch64.ExclusiveMonitorsPass(address, dbytes) then
  // This atomic write will be rejected if it does not refer
  // to the same physical locations after address translation.
  Mem[address, dbytes, AccType_ORDERED] = data;
  status = ExclusiveMonitorsStatus();
X[s] = ZeroExtend(status, 32);

```

C6.2.221 STLXRB

Store-Release Exclusive Register Byte stores a byte from a 32-bit register to memory if the PE has exclusive access to the memory address, and returns a status value of 0 if the store was successful, or of 1 if no store was performed. See [Synchronization and semaphores](#) on page B2-121. The memory access is atomic. The instruction also has memory ordering semantics as described in [Load-Acquire, Store-Release](#) on page B2-94. For information about memory accesses see [Load/Store addressing modes](#) on page C1-143.

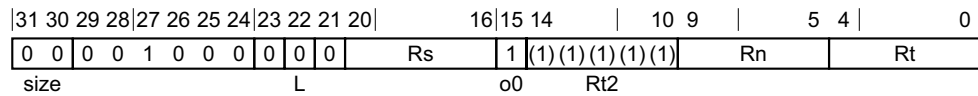

No offset variant

STLXRB <Ws>, <Wt>, [<Xn|SP>{,#0}]

Decode for this encoding

```
integer n = UInt(Rn);
integer t = UInt(Rt);
integer s = UInt(Rs); // ignored by all loads and store-release
```

Notes for all encodings

For information about the CONSTRAINED UNPREDICTABLE behavior of this instruction, see [Appendix K1 Architectural Constraints on UNPREDICTABLE behaviors](#), and particularly [STLXRB](#) on page K1-6130.

Assembler symbols

<Ws> Is the 32-bit name of the general-purpose register into which the status result of the store exclusive is written, encoded in the "Rs" field. The value returned is:

- 0 If the operation updates memory.
- 1 If the operation fails to update memory.

<Wt> Is the 32-bit name of the general-purpose register to be transferred, encoded in the "Rt" field.

<Xn|SP> Is the 64-bit name of the general-purpose base register or stack pointer, encoded in the "Rn" field.

Aborts

If a synchronous Data Abort exception is generated by the execution of this instruction:

- Memory is not updated.
- <Ws> is not updated.

If AAarch64.ExclusiveMonitorsPass() returns FALSE and the memory address, if accessed, would generate a synchronous Data Abort exception, it is IMPLEMENTATION DEFINED whether the exception is generated.

Operation

```
bits(64) address;
bits(8) data;
boolean rt_unknown = FALSE;
boolean rn_unknown = FALSE;

if s == t then
    Constraint c = ConstrainUnpredictable();
```

```
assert c IN {Constraint_UNKNOWN, Constraint_NONE, Constraint_UNDEF, Constraint_NOP};
case c of
  when Constraint_UNKNOWN rt_unknown = TRUE;    // store UNKNOWN value
  when Constraint_NONE    rt_unknown = FALSE;   // store original value
  when Constraint_UNDEF   UnallocatedEncoding();
  when Constraint_NOP     EndOfInstruction();
if s == n && n != 31 then
  Constraint c = ConstrainUnpredictable();
assert c IN {Constraint_UNKNOWN, Constraint_NONE, Constraint_UNDEF, Constraint_NOP};
case c of
  when Constraint_UNKNOWN rn_unknown = TRUE;    // address is UNKNOWN
  when Constraint_NONE    rn_unknown = FALSE;   // address is original base
  when Constraint_UNDEF   UnallocatedEncoding();
  when Constraint_NOP     EndOfInstruction();

if n == 31 then
  CheckSPAlignment();
  address = SP[];
elseif rn_unknown then
  address = bits(64) UNKNOWN;
else
  address = X[n];

if rt_unknown then
  data = bits(8) UNKNOWN;
else
  data = X[t];

bit status = '1';
// Check whether the Exclusive Monitors are set to include the
// physical memory locations corresponding to virtual address
// range [address, address+dbytes-1].
if AArch64.ExclusiveMonitorsPass(address, 1) then
  // This atomic write will be rejected if it does not refer
  // to the same physical locations after address translation.
  Mem[address, 1, AccType_ORDERED] = data;
  status = ExclusiveMonitorsStatus();
X[s] = ZeroExtend(status, 32);
```

C6.2.222 STLXRH

Store-Release Exclusive Register Halfword stores a halfword from a 32-bit register to memory if the PE has exclusive access to the memory address, and returns a status value of 0 if the store was successful, or of 1 if no store was performed. See [Synchronization and semaphores on page B2-121](#). The memory access is atomic. The instruction also has memory ordering semantics as described in [Load-Acquire, Store-Release on page B2-94](#). For information about memory accesses see [Load/Store addressing modes on page C1-143](#).

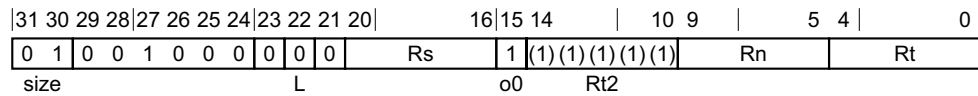

No offset variant

STLXRH <Ws>, <Wt>, [<Xn|SP>{,#0}]

Decode for this encoding

```
integer n = UInt(Rn);
integer t = UInt(Rt);
integer s = UInt(Rs); // ignored by all loads and store-release
```

Notes for all encodings

For information about the CONSTRAINED UNPREDICTABLE behavior of this instruction, see [Appendix K1 Architectural Constraints on UNPREDICTABLE behaviors](#), and particularly [STLXRH on page K1-6130](#).

Assembler symbols

<Ws> Is the 32-bit name of the general-purpose register into which the status result of the store exclusive is written, encoded in the "Rs" field. The value returned is:

- 0 If the operation updates memory.
- 1 If the operation fails to update memory.

<Wt> Is the 32-bit name of the general-purpose register to be transferred, encoded in the "Rt" field.

<Xn|SP> Is the 64-bit name of the general-purpose base register or stack pointer, encoded in the "Rn" field.

Aborts and alignment

If a synchronous Data Abort exception is generated by the execution of this instruction:

- Memory is not updated.
- <Ws> is not updated.

A non halfword-aligned memory address causes an Alignment fault Data Abort exception to be generated, subject to the following rules:

- If `AArch64.ExclusiveMonitorsPass()` returns TRUE, the exception is generated.
- Otherwise, it is IMPLEMENTATION DEFINED whether the exception is generated.

If `AArch64.ExclusiveMonitorsPass()` returns FALSE and the memory address, if accessed, would generate a synchronous Data Abort exception, it is IMPLEMENTATION DEFINED whether the exception is generated.

Operation

```
bits(64) address;
bits(16) data;
boolean rt_unknown = FALSE;
boolean rn_unknown = FALSE;

if s == t then
    Constraint c = ConstrainUnpredictable();
    assert c IN {Constraint_UNKNOWN, Constraint_NONE, Constraint_UNDEF, Constraint_NOP};
    case c of
        when Constraint_UNKNOWN rt_unknown = TRUE;    // store UNKNOWN value
        when Constraint_NONE     rt_unknown = FALSE;   // store original value
        when Constraint_UNDEF    UnallocatedEncoding();
        when Constraint_NOP      EndOfInstruction();
if s == n && n != 31 then
    Constraint c = ConstrainUnpredictable();
    assert c IN {Constraint_UNKNOWN, Constraint_NONE, Constraint_UNDEF, Constraint_NOP};
    case c of
        when Constraint_UNKNOWN rn_unknown = TRUE;    // address is UNKNOWN
        when Constraint_NONE     rn_unknown = FALSE;   // address is original base
        when Constraint_UNDEF    UnallocatedEncoding();
        when Constraint_NOP      EndOfInstruction();

if n == 31 then
    CheckSPAlignment();
    address = SP[];
elseif rn_unknown then
    address = bits(64) UNKNOWN;
else
    address = X[n];

if rt_unknown then
    data = bits(16) UNKNOWN;
else
    data = X[t];

bit status = '1';
// Check whether the Exclusive Monitors are set to include the
// physical memory locations corresponding to virtual address
// range [address, address+dbytes-1].
if AArch64.ExclusiveMonitorsPass(address, 2) then
    // This atomic write will be rejected if it does not refer
    // to the same physical locations after address translation.
    Mem[address, 2, AccType_ORDERED] = data;
    status = ExclusiveMonitorsStatus();
X[s] = ZeroExtend(status, 32);
```

C6.2.223 STNP

Store Pair of Registers, with non-temporal hint, calculates an address from a base register value and an immediate offset, and stores two 32-bit words or two 64-bit doublewords to the calculated address, from two registers. For information about memory accesses, see *Load/Store addressing modes* on page C1-143. For information about Non-temporal pair instructions, see *Load/Store Non-temporal Pair* on page C3-163.

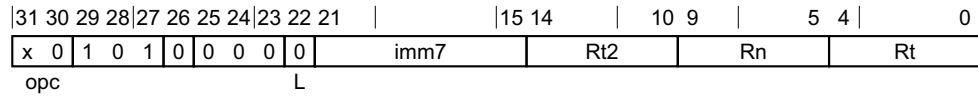

32-bit variant

Applies when `opc == 00`.

STNP <Wt1>, <Wt2>, [<Xn|SP>{, #<imm>}]

64-bit variant

Applies when `opc == 10`.

STNP <Xt1>, <Xt2>, [<Xn|SP>{, #<imm>}]

Decode for all variants of this encoding

// Empty.

Assembler symbols

- <Wt1> Is the 32-bit name of the first general-purpose register to be transferred, encoded in the "Rt" field.
- <Wt2> Is the 32-bit name of the second general-purpose register to be transferred, encoded in the "Rt2" field.
- <Xt1> Is the 64-bit name of the first general-purpose register to be transferred, encoded in the "Rt" field.
- <Xt2> Is the 64-bit name of the second general-purpose register to be transferred, encoded in the "Rt2" field.
- <Xn|SP> Is the 64-bit name of the general-purpose base register or stack pointer, encoded in the "Rn" field.
- <imm> For the 32-bit variant: is the optional signed immediate byte offset, a multiple of 4 in the range -256 to 252, defaulting to 0 and encoded in the "imm7" field as <imm>/4.
For the 64-bit variant: is the optional signed immediate byte offset, a multiple of 8 in the range -512 to 504, defaulting to 0 and encoded in the "imm7" field as <imm>/8.

Shared decode for all encodings

```
integer n = UInt(Rn);
integer t = UInt(Rt);
integer t2 = UInt(Rt2);
if opc<0> == '1' then UnallocatedEncoding();
integer scale = 2 + UInt(opc<1>);
integer datasize = 8 << scale;
bits(64) offset = LSL(SignExtend(imm7, 64), scale);
```

Operation

```
bits(64) address;
bits(datasize) data1;
bits(datasize) data2;
constant integer dbytes = datasize DIV 8;

if n == 31 then
    CheckSPAlignment();
    address = SP[];
else
    address = X[n];

address = address + offset;

data1 = X[t];
data2 = X[t2];
Mem[address, dbytes, AccType_STREAM] = data1;
Mem[address+dbytes, dbytes, AccType_STREAM] = data2;
```

C6.2.224 STP

Store Pair of Registers calculates an address from a base register value and an immediate offset, and stores two 32-bit words or two 64-bit doublewords to the calculated address, from two registers. For information about memory accesses, see [Load/Store addressing modes](#) on page C1-143.

Post-index

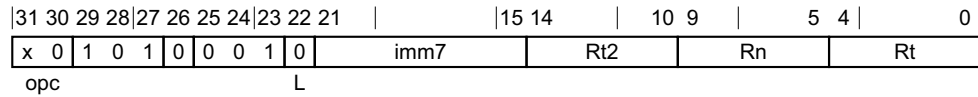

32-bit variant

Applies when `opc == 00`.

STP <Wt1>, <Wt2>, [<Xn|SP>], #<imm>

64-bit variant

Applies when `opc == 10`.

STP <Xt1>, <Xt2>, [<Xn|SP>], #<imm>

Decode for all variants of this encoding

```
boolean wback = TRUE;
boolean postindex = TRUE;
```

Pre-index

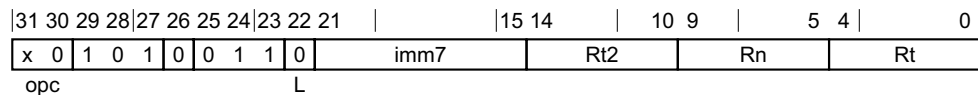

32-bit variant

Applies when `opc == 00`.

STP <Wt1>, <Wt2>, [<Xn|SP>, #<imm>]!

64-bit variant

Applies when `opc == 10`.

STP <Xt1>, <Xt2>, [<Xn|SP>, #<imm>]!

Decode for all variants of this encoding

```
boolean wback = TRUE;
boolean postindex = FALSE;
```

Signed offset

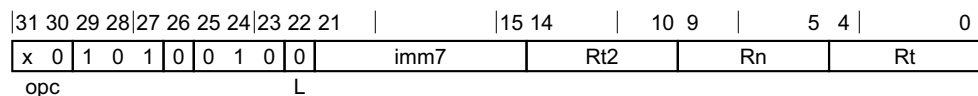

32-bit variant

Applies when `opc == 00`.

STP <Wt1>, <Wt2>, [<Xn|SP>{, #<imm>}]

64-bit variant

Applies when `opc == 10`.

STP <Xt1>, <Xt2>, [<Xn|SP>{, #<imm>}]

Decode for all variants of this encoding

```
boolean wback = FALSE;  
boolean postindex = FALSE;
```

Notes for all encodings

For information about the CONSTRAINED UNPREDICTABLE behavior of this instruction, see [Appendix K1 Architectural Constraints on UNPREDICTABLE behaviors](#), and particularly *STP* on page K1-6129.

Assembler symbols

<Wt1>	Is the 32-bit name of the first general-purpose register to be transferred, encoded in the "Rt" field.
<Wt2>	Is the 32-bit name of the second general-purpose register to be transferred, encoded in the "Rt2" field.
<Xt1>	Is the 64-bit name of the first general-purpose register to be transferred, encoded in the "Rt" field.
<Xt2>	Is the 64-bit name of the second general-purpose register to be transferred, encoded in the "Rt2" field.
<Xn SP>	Is the 64-bit name of the general-purpose base register or stack pointer, encoded in the "Rn" field.
<imm>	For the 32-bit post-index and 32-bit pre-index variant: is the signed immediate byte offset, a multiple of 4 in the range -256 to 252, encoded in the "imm7" field as <imm>/4. For the 32-bit signed offset variant: is the optional signed immediate byte offset, a multiple of 4 in the range -256 to 252, defaulting to 0 and encoded in the "imm7" field as <imm>/4. For the 64-bit post-index and 64-bit pre-index variant: is the signed immediate byte offset, a multiple of 8 in the range -512 to 504, encoded in the "imm7" field as <imm>/8. For the 64-bit signed offset variant: is the optional signed immediate byte offset, a multiple of 8 in the range -512 to 504, defaulting to 0 and encoded in the "imm7" field as <imm>/8.

Shared decode for all encodings

```
integer n = UInt(Rn);  
integer t = UInt(Rt);  
integer t2 = UInt(Rt2);  
if L:opc<0> == '01' || opc == '11' then UnallocatedEncoding();  
integer scale = 2 + UInt(opc<1>);  
integer datasize = 8 << scale;  
bits(64) offset = LSL(SignExtend(imm7, 64), scale);
```

Operation for all encodings

```
bits(64) address;  
bits(datasize) data1;  
bits(datasize) data2;  
constant integer dbytes = datasize DIV 8;  
boolean rt_unknown = FALSE;
```

```
if wback && (t == n || t2 == n) && n != 31 then
    Constraint c = ConstrainUnpredictable();
    assert c IN {Constraint_NONE, Constraint_UNKNOWN, Constraint_UNDEF, Constraint_NOP};
    case c of
        when Constraint_NONE    rt_unknown = FALSE; // value stored is pre-writeback
        when Constraint_UNKNOWN  rt_unknown = TRUE;  // value stored is UNKNOWN
        when Constraint_UNDEF    UnallocatedEncoding();
        when Constraint_NOP      EndOfInstruction();

if n == 31 then
    CheckSPAlignment();
    address = SP[];
else
    address = X[n];

if !postindex then
    address = address + offset;

if rt_unknown && t == n then
    data1 = bits(datasize) UNKNOWN;
else
    data1 = X[t];
if rt_unknown && t2 == n then
    data2 = bits(datasize) UNKNOWN;
else
    data2 = X[t2];
Mem[address, dbytes, AccType_NORMAL] = data1;
Mem[address+dbytes, dbytes, AccType_NORMAL] = data2;

if wback then
    if postindex then
        address = address + offset;
    if n == 31 then
        SP[] = address;
    else
        X[n] = address;
```

C6.2.225 STR (immediate)

Store Register (immediate) stores a word or a doubleword from a register to memory. The address that is used for the store is calculated from a base register and an immediate offset. For information about memory accesses, see [Load/Store addressing modes on page C1-143](#).

Post-index



32-bit variant

Applies when size == 10.

STR <Wt>, [<Xn|SP>], #<sim>

64-bit variant

Applies when size == 11.

STR <Xt>, [<Xn|SP>], #<sim>

Decode for all variants of this encoding

```
boolean wback = TRUE;
boolean postindex = TRUE;
integer scale = UInt(size);
bits(64) offset = SignExtend(imm9, 64);
```

Pre-index



32-bit variant

Applies when size == 10.

STR <Wt>, [<Xn|SP>, #<sim>]!

64-bit variant

Applies when size == 11.

STR <Xt>, [<Xn|SP>, #<sim>]!

Decode for all variants of this encoding

```
boolean wback = TRUE;
boolean postindex = FALSE;
integer scale = UInt(size);
bits(64) offset = SignExtend(imm9, 64);
```

Unsigned offset

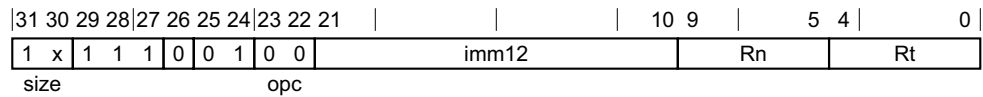

32-bit variant

Applies when size == 10.

STR <Wt>, [<Xn|SP>{, #<pimm>}]

64-bit variant

Applies when size == 11.

STR <Xt>, [<Xn|SP>{, #<pimm>}]

Decode for all variants of this encoding

```
boolean wback = FALSE;
boolean postindex = FALSE;
integer scale = UInt(size);
bits(64) offset = LSL(ZeroExtend(imm12, 64), scale);
```

Assembler symbols

- <Wt> Is the 32-bit name of the general-purpose register to be transferred, encoded in the "Rt" field.
- <Xt> Is the 64-bit name of the general-purpose register to be transferred, encoded in the "Rt" field.
- <Xn|SP> Is the 64-bit name of the general-purpose base register or stack pointer, encoded in the "Rn" field.
- <sim> Is the signed immediate byte offset, in the range -256 to 255, encoded in the "imm9" field.
- <pimm> For the 32-bit variant: is the optional positive immediate byte offset, a multiple of 4 in the range 0 to 16380, defaulting to 0 and encoded in the "imm12" field as <pimm>/4.
For the 64-bit variant: is the optional positive immediate byte offset, a multiple of 8 in the range 0 to 32760, defaulting to 0 and encoded in the "imm12" field as <pimm>/8.

Shared decode for all encodings

```
integer n = UInt(Rn);
integer t = UInt(Rt);

integer datasize = 8 << scale;
```

Operation for all encodings

```
bits(64) address;
bits(datasize) data;
boolean rt_unknown = FALSE;

if wback && n == t && n != 31 then
    c = ConstrainUnpredictable();
    assert c IN {Constraint_NONE, Constraint_UNKNOWN, Constraint_UNDEF, Constraint_NOP};
    case c of
        when Constraint_NONE    rt_unknown = FALSE; // value stored is original value
        when Constraint_UNKNOWN rt_unknown = TRUE; // value stored is UNKNOWN
        when Constraint_UNDEF    UnallocatedEncoding();
        when Constraint_NOP      EndOfInstruction();

if n == 31 then
```

```
    CheckSPAlignment();
    address = SP[];
else
    address = X[n];

if !postindex then
    address = address + offset;

if rt_unknown then
    data = bits(datasize) UNKNOWN;
else
    data = X[t];
Mem[address, datasize DIV 8, AccType_NORMAL] = data;

if wback then
    if postindex then
        address = address + offset;
    if n == 31 then
        SP[] = address;
    else
        X[n] = address;
```

C6.2.226 STR (register)

Store Register (register) calculates an address from a base register value and an offset register value, and stores a 32-bit word or a 64-bit doubleword to the calculated address, from a register. For information about memory accesses, see [Load/Store addressing modes on page C1-143](#).

The instruction uses an offset addressing mode, that calculates the address used for the memory access from a base register value and an offset register value. The offset can be optionally shifted and extended.

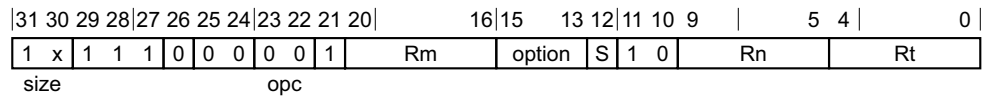

32-bit variant

Applies when size == 10.

STR <Wt>, [<Xn|SP>, (<Wm>|<Xm>){, <extend> {<amount>}}

64-bit variant

Applies when size == 11.

STR <Xt>, [<Xn|SP>, (<Wm>|<Xm>){, <extend> {<amount>}}

Decode for all variants of this encoding

```
integer scale = UInt(size);
if option<1> == '0' then UnallocatedEncoding(); // sub-word index
ExtendType extend_type = DecodeRegExtend(option);
integer shift = if S == '1' then scale else 0;
```

Assembler symbols

<Wt>	Is the 32-bit name of the general-purpose register to be transferred, encoded in the "Rt" field.								
<Xt>	Is the 64-bit name of the general-purpose register to be transferred, encoded in the "Rt" field.								
<Xn SP>	Is the 64-bit name of the general-purpose base register or stack pointer, encoded in the "Rn" field.								
<Wm>	When option<0> is set to 0, is the 32-bit name of the general-purpose index register, encoded in the "Rm" field.								
<Xm>	When option<0> is set to 1, is the 64-bit name of the general-purpose index register, encoded in the "Rm" field.								
<extend>	Is the index extend/shift specifier, defaulting to LSL, and which must be omitted for the LSL option when <amount> is omitted. encoded in the "option" field. It can have the following values: <table style="margin-left: 20px; border-collapse: collapse;"> <tr><td>UXTW</td><td>when option = 010</td></tr> <tr><td>LSL</td><td>when option = 011</td></tr> <tr><td>SXTW</td><td>when option = 110</td></tr> <tr><td>SXTX</td><td>when option = 111</td></tr> </table>	UXTW	when option = 010	LSL	when option = 011	SXTW	when option = 110	SXTX	when option = 111
UXTW	when option = 010								
LSL	when option = 011								
SXTW	when option = 110								
SXTX	when option = 111								
<amount>	For the 32-bit variant: is the index shift amount, optional only when <extend> is not LSL. Where it is permitted to be optional, it defaults to #0. It is encoded in the "S" field. It can have the following values: <table style="margin-left: 20px; border-collapse: collapse;"> <tr><td>#0</td><td>when S = 0</td></tr> <tr><td>#2</td><td>when S = 1</td></tr> </table>	#0	when S = 0	#2	when S = 1				
#0	when S = 0								
#2	when S = 1								

For the 64-bit variant: is the index shift amount, optional only when <extend> is not LSL. Where it is permitted to be optional, it defaults to #0. It is encoded in the "S" field. It can have the following values:

#0 when S = 0
#3 when S = 1

Shared decode for all encodings

```
integer n = UInt(Rn);  
integer t = UInt(Rt);  
integer m = UInt(Rm);  
  
integer datasize = 8 << scale;
```

Operation

```
bits(64) offset = ExtendReg(m, extend_type, shift);  
bits(64) address;  
bits(datasize) data;  
  
if n == 31 then  
    CheckSPAlignment();  
    address = SP[];  
else  
    address = X[n];  
  
address = address + offset;  
  
data = X[t];  
Mem[address, datasize DIV 8, AccType_NORMAL] = data;
```

C6.2.227 STRB (immediate)

Store Register Byte (immediate) stores the least significant byte of a 32-bit register to memory. The address that is used for the store is calculated from a base register and an immediate offset. For information about memory accesses, see [Load/Store addressing modes on page C1-143](#).

Post-index

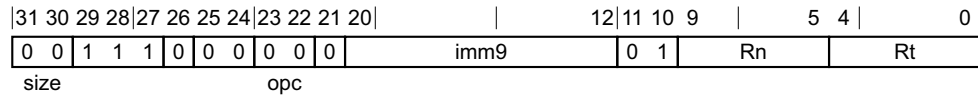

Post-index variant

STRB <Wt>, [<Xn|SP>], #<imm>

Decode for this encoding

```
boolean wback = TRUE;
boolean postindex = TRUE;
bits(64) offset = SignExtend(imm9, 64);
```

Pre-index

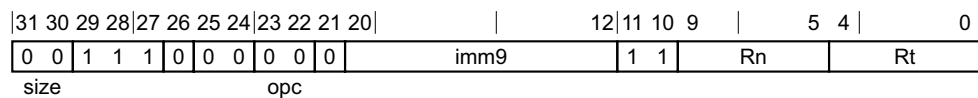

Pre-index variant

STRB <Wt>, [<Xn|SP>, #<imm>]!

Decode for this encoding

```
boolean wback = TRUE;
boolean postindex = FALSE;
bits(64) offset = SignExtend(imm9, 64);
```

Unsigned offset

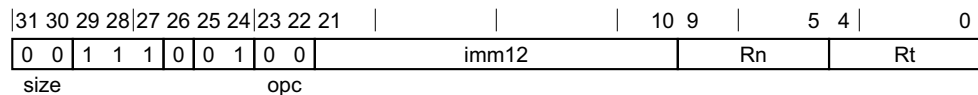

Unsigned offset variant

STRB <Wt>, [<Xn|SP>{, #<pimm>}]

Decode for this encoding

```
boolean wback = FALSE;
boolean postindex = FALSE;
bits(64) offset = LSL(ZeroExtend(imm12, 64), 0);
```

Notes for all encodings

For information about the CONSTRAINED UNPREDICTABLE behavior of this instruction, see [Appendix K1 Architectural Constraints on UNPREDICTABLE behaviors](#), and particularly *STRB (immediate)* on page K1-6131.

Assembler symbols

<wt>	Is the 32-bit name of the general-purpose register to be transferred, encoded in the "Rt" field.
<Xn SP>	Is the 64-bit name of the general-purpose base register or stack pointer, encoded in the "Rn" field.
<sim>	Is the signed immediate byte offset, in the range -256 to 255, encoded in the "imm9" field.
<pimm>	Is the optional positive immediate byte offset, in the range 0 to 4095, defaulting to 0 and encoded in the "imm12" field.

Shared decode for all encodings

```
integer n = UInt(Rn);  
integer t = UInt(Rt);
```

Operation for all encodings

```
bits(64) address;  
bits(8) data;  
boolean rt_unknown = FALSE;  
  
if wback && n == t && n != 31 then  
    c = ConstrainUnpredictable();  
    assert c IN {Constraint_NONE, Constraint_UNKNOWN, Constraint_UNDEF, Constraint_NOP};  
    case c of  
        when Constraint_NONE    rt_unknown = FALSE; // value stored is original value  
        when Constraint_UNKNOWN  rt_unknown = TRUE;  // value stored is UNKNOWN  
        when Constraint_UNDEF    UnallocatedEncoding();  
        when Constraint_NOP      EndOfInstruction();  
  
if n == 31 then  
    CheckSPAlignment();  
    address = SP[];  
else  
    address = X[n];  
  
if !postindex then  
    address = address + offset;  
  
if rt_unknown then  
    data = bits(8) UNKNOWN;  
else  
    data = X[t];  
Mem[address, 1, AccType_NORMAL] = data;  
  
if wback then  
    if postindex then  
        address = address + offset;  
    if n == 31 then  
        SP[] = address;  
    else  
        X[n] = address;
```

C6.2.228 STRB (register)

Store Register Byte (register) calculates an address from a base register value and an offset register value, and stores a byte from a 32-bit register to the calculated address. For information about memory accesses, see [Load/Store addressing modes on page C1-143](#).

The instruction uses an offset addressing mode, that calculates the address used for the memory access from a base register value and an offset register value. The offset can be optionally shifted and extended.

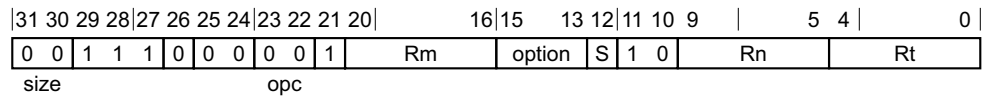

Extended register variant

Applies when option != 011.

STRB <Wt>, [<Xn|SP>, (<Wm>|<Xm>), <extend> {<amount>}]

Shifted register variant

Applies when option == 011.

STRB <Wt>, [<Xn|SP>, <Xm>{, LSL <amount>}]

Decode for all variants of this encoding

```
if option<1> == '0' then UnallocatedEncoding(); // sub-word index
ExtendType extend_type = DecodeRegExtend(option);
```

Assembler symbols

- <Wt> Is the 32-bit name of the general-purpose register to be transferred, encoded in the "Rt" field.
- <Xn|SP> Is the 64-bit name of the general-purpose base register or stack pointer, encoded in the "Rn" field.
- <Wm> When option<0> is set to 0, is the 32-bit name of the general-purpose index register, encoded in the "Rm" field.
- <Xm> When option<0> is set to 1, is the 64-bit name of the general-purpose index register, encoded in the "Rm" field.
- <extend> Is the index extend specifier, encoded in the "option" field. It can have the following values:
 - UXTW when option = 010
 - SXTW when option = 110
 - SXTX when option = 111
- <amount> Is the index shift amount, it must be #0, encoded in "S" as 0 if omitted, or as 1 if present.

Shared decode for all encodings

```
integer n = UInt(Rn);
integer t = UInt(Rt);
integer m = UInt(Rm);
```

Operation

```
bits(64) offset = ExtendReg(m, extend_type, 0);
bits(64) address;
bits(8) data;

if n == 31 then
    CheckSPAlignment();
    address = SP[];
else
    address = X[n];

address = address + offset;

data = X[t];
Mem[address, 1, AccType_NORMAL] = data;
```

C6.2.229 STRH (immediate)

Store Register Halfword (immediate) stores the least significant halfword of a 32-bit register to memory. The address that is used for the store is calculated from a base register and an immediate offset. For information about memory accesses, see [Load/Store addressing modes](#) on page C1-143.

Post-index

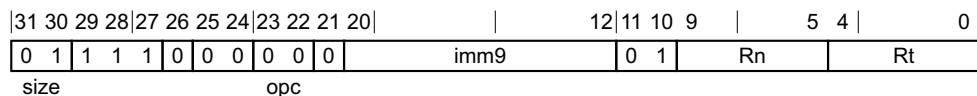

Post-index variant

STRH <Wt>, [<Xn|SP>], #<imm>

Decode for this encoding

```
boolean wback = TRUE;
boolean postindex = TRUE;
bits(64) offset = SignExtend(imm9, 64);
```

Pre-index



Pre-index variant

STRH <Wt>, [<Xn|SP>, #<imm>]!

Decode for this encoding

```
boolean wback = TRUE;
boolean postindex = FALSE;
bits(64) offset = SignExtend(imm9, 64);
```

Unsigned offset



Unsigned offset variant

STRH <Wt>, [<Xn|SP>{, #<pimm>}]

Decode for this encoding

```
boolean wback = FALSE;
boolean postindex = FALSE;
bits(64) offset = LSL(ZeroExtend(imm12, 64), 1);
```

Notes for all encodings

For information about the CONSTRAINED UNPREDICTABLE behavior of this instruction, see [Appendix K1 Architectural Constraints on UNPREDICTABLE behaviors](#), and particularly *STRH (immediate)* on page K1-6131.

Assembler symbols

<wt>	Is the 32-bit name of the general-purpose register to be transferred, encoded in the "Rt" field.
<Xn SP>	Is the 64-bit name of the general-purpose base register or stack pointer, encoded in the "Rn" field.
<sim>	Is the signed immediate byte offset, in the range -256 to 255, encoded in the "imm9" field.
<pimm>	Is the optional positive immediate byte offset, a multiple of 2 in the range 0 to 8190, defaulting to 0 and encoded in the "imm12" field as <pimm>/2.

Shared decode for all encodings

```
integer n = UInt(Rn);
integer t = UInt(Rt);
```

Operation for all encodings

```
bits(64) address;
bits(16) data;
boolean rt_unknown = FALSE;

if wback && n == t && n != 31 then
    c = ConstrainUnpredictable();
    assert c IN {Constraint_NONE, Constraint_UNKNOWN, Constraint_UNDEF, Constraint_NOP};
    case c of
        when Constraint_NONE    rt_unknown = FALSE; // value stored is original value
        when Constraint_UNKNOWN  rt_unknown = TRUE;  // value stored is UNKNOWN
        when Constraint_UNDEF    UnallocatedEncoding();
        when Constraint_NOP      EndOfInstruction();

if n == 31 then
    CheckSPAlignment();
    address = SP[];
else
    address = X[n];

if !postindex then
    address = address + offset;

if rt_unknown then
    data = bits(16) UNKNOWN;
else
    data = X[t];
Mem[address, 2, AccType_NORMAL] = data;

if wback then
    if postindex then
        address = address + offset;
    if n == 31 then
        SP[] = address;
    else
        X[n] = address;
```

C6.2.230 STRH (register)

Store Register Halfword (register) calculates an address from a base register value and an offset register value, and stores a halfword from a 32-bit register to the calculated address. For information about memory accesses, see [Load/Store addressing modes on page C1-143](#).

The instruction uses an offset addressing mode, that calculates the address used for the memory access from a base register value and an offset register value. The offset can be optionally shifted and extended.

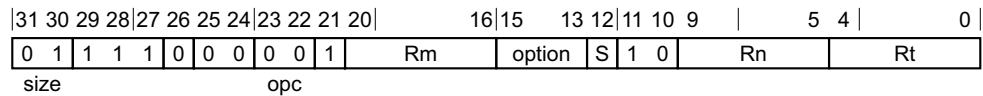

32-bit variant

STRH <Wt>, [<Xn|SP>, (<Wm>|<Xm>){, <extend> {<amount>}}

Decode for this encoding

```
if option<1> == '0' then UnallocatedEncoding(); // sub-word index
ExtendType extend_type = DecodeRegExtend(option);
integer shift = if S == '1' then 1 else 0;
```

Assembler symbols

<Wt>	Is the 32-bit name of the general-purpose register to be transferred, encoded in the "Rt" field.								
<Xn SP>	Is the 64-bit name of the general-purpose base register or stack pointer, encoded in the "Rn" field.								
<Wm>	When option<0> is set to 0, is the 32-bit name of the general-purpose index register, encoded in the "Rm" field.								
<Xm>	When option<0> is set to 1, is the 64-bit name of the general-purpose index register, encoded in the "Rm" field.								
<extend>	Is the index extend/shift specifier, defaulting to LSL, and which must be omitted for the LSL option when <amount> is omitted. encoded in the "option" field. It can have the following values: <table style="margin-left: 20px; border-collapse: collapse;"> <tr><td>UXTW</td><td>when option = 010</td></tr> <tr><td>LSL</td><td>when option = 011</td></tr> <tr><td>SXTW</td><td>when option = 110</td></tr> <tr><td>SXTX</td><td>when option = 111</td></tr> </table>	UXTW	when option = 010	LSL	when option = 011	SXTW	when option = 110	SXTX	when option = 111
UXTW	when option = 010								
LSL	when option = 011								
SXTW	when option = 110								
SXTX	when option = 111								
<amount>	Is the index shift amount, optional only when <extend> is not LSL. Where it is permitted to be optional, it defaults to #0. It is encoded in the "S" field. It can have the following values: <table style="margin-left: 20px; border-collapse: collapse;"> <tr><td>#0</td><td>when S = 0</td></tr> <tr><td>#1</td><td>when S = 1</td></tr> </table>	#0	when S = 0	#1	when S = 1				
#0	when S = 0								
#1	when S = 1								

Shared decode for all encodings

```
integer n = UInt(Rn);
integer t = UInt(Rt);
integer m = UInt(Rm);
```

Operation

```
bits(64) offset = ExtendReg(m, extend_type, shift);
bits(64) address;
bits(16) data;

if n == 31 then
    CheckSPAlignment();
    address = SP[];
else
    address = X[n];

address = address + offset;

data = X[t];
Mem[address, 2, AccType_NORMAL] = data;
```

C6.2.231 STSETB, STSETLB

Atomic bit set on byte in memory, without return, atomically loads an 8-bit byte from memory, performs a bitwise OR with the value held in a register on it, and stores the result back to memory.

- STSETB has no memory ordering semantics.
- STSETLB stores to memory with release semantics, as described in [Load-Acquire, Store-Release on page B2-94](#).

For information about memory accesses see [Load/Store addressing modes on page C1-143](#).

ARMv8.1

31	30	29	28	27	26	25	24	23	22	21	20	16	15	14	12	11	10	9	5	4	3	2	1	0
0	0	1	1	1	0	0	0	0	R	1	Rs	0	0	1	1	0	0	Rn	1	1	1	1	1	1
size				V			A		o3				opc											

No memory ordering variant

Applies when R == 0.

STSETB <Ws>, [<Xn|SP>]

Release variant

Applies when R == 1.

STSETLB <Ws>, [<Xn|SP>]

Decode for all variants of this encoding

```
if !HaveAtomicExt() then UnallocatedEncoding();
integer n = UInt(Rn);
integer s = UInt(Rs);

AccType staccType = if R == '1' then AccType_ORDEREDRW else AccType_ATOMICRW;
```

Assembler symbols

<Ws> Is the 32-bit name of the general-purpose register holding the data value to be operated on with the contents of the memory location, encoded in the "Rs" field.

<Xn|SP> Is the 64-bit name of the general-purpose base register or stack pointer, encoded in the "Rn" field.

Operation

```
bits(64) address;
bits(8) value;
bits(8) data;
bits(8) result;

value = X[s];
if n == 31 then
    CheckSPAlignment();
    address = SP[];
else
    address = X[n];
data = Mem[address, 1, AccType_ATOMICRW];

result = data OR value;
```

```
// All observers in the shareability domain observe the  
// following load and store atomically.  
Mem[address, 1, stacctype] = result;
```

C6.2.232 STSETH, STSETLH

Atomic bit set on halfword in memory, without return, atomically loads a 16-bit halfword from memory, performs a bitwise OR with the value held in a register on it, and stores the result back to memory.

- STSETH has no memory ordering semantics.
- STSETLH stores to memory with release semantics, as described in [Load-Acquire, Store-Release on page B2-94](#).

For information about memory accesses see [Load/Store addressing modes on page C1-143](#).

ARMv8.1

31	30	29	28	27	26	25	24	23	22	21	20	16	15	14	12	11	10	9	5	4	3	2	1	0
0	1	1	1	1	0	0	0	0	R	1	Rs	0	0	1	1	0	0	Rn	1	1	1	1	1	1
size				V				A				o3				opc								

No memory ordering variant

Applies when R == 0.

STSETH <Ws>, [<Xn|SP>]

Release variant

Applies when R == 1.

STSETLH <Ws>, [<Xn|SP>]

Decode for all variants of this encoding

```
if !HaveAtomicExt() then UnallocatedEncoding();
integer n = UInt(Rn);
integer s = UInt(Rs);

AccType staccType = if R == '1' then AccType_ORDEREDRW else AccType_ATOMICRW;
```

Assembler symbols

<Ws> Is the 32-bit name of the general-purpose register holding the data value to be operated on with the contents of the memory location, encoded in the "Rs" field.

<Xn|SP> Is the 64-bit name of the general-purpose base register or stack pointer, encoded in the "Rn" field.

Operation

```
bits(64) address;
bits(16) value;
bits(16) data;
bits(16) result;

value = X[s];
if n == 31 then
    CheckSPAlignment();
    address = SP[];
else
    address = X[n];
data = Mem[address, 2, AccType_ATOMICRW];

result = data OR value;
```

```
// All observers in the shareability domain observe the  
// following load and store atomically.  
Mem[address, 2, stacctype] = result;
```

C6.2.233 STSET, STSETL

Atomic bit set on word or doubleword in memory, without return, atomically loads a 32-bit word or 64-bit doubleword from memory, performs a bitwise OR with the value held in a register on it, and stores the result back to memory.

- STSET has no memory ordering semantics.
- STSETL stores to memory with release semantics, as described in *Load-Acquire, Store-Release* on page B2-94.

For information about memory accesses see *Load/Store addressing modes* on page C1-143.

ARMv8.1

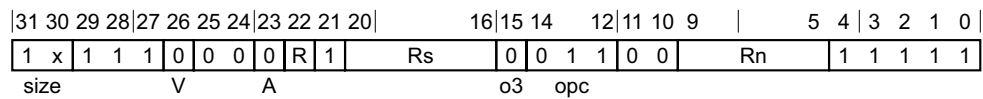

32-bit, no memory ordering variant

Applies when size == 10 && R == 0.

STSET <Ws>, [<Xn|SP>]

32-bit, release variant

Applies when size == 10 && R == 1.

STSETL <Ws>, [<Xn|SP>]

64-bit, no memory ordering variant

Applies when size == 11 && R == 0.

STSET <Xs>, [<Xn|SP>]

64-bit, release variant

Applies when size == 11 && R == 1.

STSETL <Xs>, [<Xn|SP>]

Decode for all variants of this encoding

```

if !HaveAtomicExt() then UnallocatedEncoding();
integer n = UInt(Rn);
integer s = UInt(Rs);

integer datasize = 8 << UInt(size);
AccType stacctype = if R == '1' then AccType_ORDEREDRW else AccType_ATOMICRW;

```

Assembler symbols

- <Ws> Is the 32-bit name of the general-purpose register holding the data value to be operated on with the contents of the memory location, encoded in the "Rs" field.
- <Xs> Is the 64-bit name of the general-purpose register holding the data value to be operated on with the contents of the memory location, encoded in the "Rs" field.
- <Xn|SP> Is the 64-bit name of the general-purpose base register or stack pointer, encoded in the "Rn" field.

Operation

```
bits(64) address;
bits(datasize) value;
bits(datasize) data;
bits(datasize) result;

value = X[s];
if n == 31 then
    CheckSPAlignment();
    address = SP[];
else
    address = X[n];
data = Mem[address, datasize DIV 8, AccType_ATOMICRW];

result = data OR value;
// All observers in the shareability domain observe the
// following load and store atomically.
Mem[address, datasize DIV 8, stacctype] = result;
```

C6.2.234 STSMAXB, STSMAXB

Atomic signed maximum on byte in memory, without return, atomically loads an 8-bit byte from memory, compares it against the value held in a register, and stores the larger value back to memory, treating the values as signed numbers.

- STSMAXB has no memory ordering semantics.
- STSMAXB stores to memory with release semantics, as described in [Load-Acquire, Store-Release](#) on page B2-94.

For information about memory accesses see [Load/Store addressing modes](#) on page C1-143.

ARMv8.1

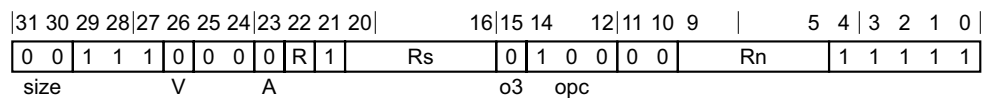

No memory ordering variant

Applies when R == 0.

STSMAXB <Ws>, [<Xn|SP>]

Release variant

Applies when R == 1.

STSMAXB <Ws>, [<Xn|SP>]

Decode for all variants of this encoding

```
if !HaveAtomicExt() then UnallocatedEncoding();
integer n = UInt(Rn);
integer s = UInt(Rs);
```

```
AccType staccType = if R == '1' then AccType_ORDEREDRW else AccType_ATOMICRW;
```

Assembler symbols

<Ws> Is the 32-bit name of the general-purpose register holding the data value to be operated on with the contents of the memory location, encoded in the "Rs" field.

<Xn|SP> Is the 64-bit name of the general-purpose base register or stack pointer, encoded in the "Rn" field.

Operation

```
bits(64) address;
bits(8) value;
bits(8) data;
bits(8) result;
```

```
value = X[s];
if n == 31 then
    CheckSPAignment();
    address = SP[];
else
    address = X[n];
data = Mem[address, 1, AccType_ATOMICRW];
```

```
result = if SInt(data) > SInt(value) then data else value;  
// All observers in the shareability domain observe the  
// following load and store atomically.  
Mem[address, 1, stacctype] = result;
```



C6.2.235 STSMAXH, STSMAXLH

Atomic signed maximum on halfword in memory, without return, atomically loads a 16-bit halfword from memory, compares it against the value held in a register, and stores the larger value back to memory, treating the values as signed numbers.

- STSMAXH has no memory ordering semantics.
- STSMAXLH stores to memory with release semantics, as described in [Load-Acquire, Store-Release](#) on page B2-94.

For information about memory accesses see [Load/Store addressing modes](#) on page C1-143.

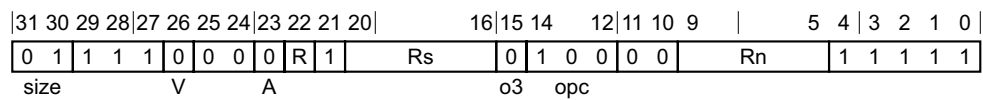
ARMv8.1



No memory ordering variant

Applies when R == 0.

STSMAXH <Ws>, [<Xn|SP>]

Release variant

Applies when R == 1.

STSMAXLH <Ws>, [<Xn|SP>]

Decode for all variants of this encoding

```
if !HaveAtomicExt() then UnallocatedEncoding();
integer n = UInt(Rn);
integer s = UInt(Rs);
```

```
AccType staccType = if R == '1' then AccType_ORDEREDRW else AccType_ATOMICRW;
```

Assembler symbols

<Ws> Is the 32-bit name of the general-purpose register holding the data value to be operated on with the contents of the memory location, encoded in the "Rs" field.

<Xn|SP> Is the 64-bit name of the general-purpose base register or stack pointer, encoded in the "Rn" field.

Operation

```
bits(64) address;
bits(16) value;
bits(16) data;
bits(16) result;

value = X[s];
if n == 31 then
    CheckSPAAlignment();
    address = SP[];
else
    address = X[n];
data = Mem[address, 2, AccType_ATOMICRW];
```

```
result = if SInt(data) > SInt(value) then data else value;  
// All observers in the shareability domain observe the  
// following load and store atomically.  
Mem[address, 2, stacctype] = result;
```

C6.2.236 STSMAX, STSMAXL

Atomic signed maximum on word or doubleword in memory, without return, atomically loads a 32-bit word or 64-bit doubleword from memory, compares it against the value held in a register, and stores the larger value back to memory, treating the values as signed numbers.

- STSMAX has no memory ordering semantics.
- STSMAXL stores to memory with release semantics, as described in [Load-Acquire, Store-Release on page B2-94](#).

For information about memory accesses see [Load/Store addressing modes on page C1-143](#).

ARMv8.1

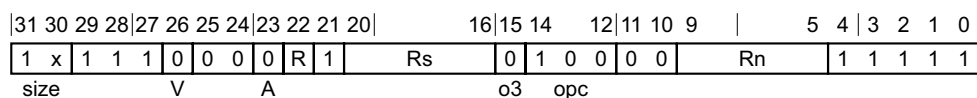

32-bit, no memory ordering variant

Applies when size == 10 && R == 0.

STSMAX <Ws>, [<Xn|SP>]

32-bit, release variant

Applies when size == 10 && R == 1.

STSMAXL <Ws>, [<Xn|SP>]

64-bit, no memory ordering variant

Applies when size == 11 && R == 0.

STSMAX <Xs>, [<Xn|SP>]

64-bit, release variant

Applies when size == 11 && R == 1.

STSMAXL <Xs>, [<Xn|SP>]

Decode for all variants of this encoding

```

if !HaveAtomicExt() then UnallocatedEncoding();
integer n = UInt(Rn);
integer s = UInt(Rs);

integer datasize = 8 << UInt(size);
AccType stacctype = if R == '1' then AccType_ORDEREDRW else AccType_ATOMICRW;
```

Assembler symbols

- <Ws> Is the 32-bit name of the general-purpose register holding the data value to be operated on with the contents of the memory location, encoded in the "Rs" field.
- <Xs> Is the 64-bit name of the general-purpose register holding the data value to be operated on with the contents of the memory location, encoded in the "Rs" field.
- <Xn|SP> Is the 64-bit name of the general-purpose base register or stack pointer, encoded in the "Rn" field.

Operation

```
bits(64) address;
bits(datasize) value;
bits(datasize) data;
bits(datasize) result;

value = X[s];
if n == 31 then
    CheckSPAlignment();
    address = SP[];
else
    address = X[n];
data = Mem[address, datasize DIV 8, AccType_ATOMICRW];

result = if SInt(data) > SInt(value) then data else value;
// All observers in the shareability domain observe the
// following load and store atomically.
Mem[address, datasize DIV 8, stacctype] = result;
```

C6.2.237 STSMINB, STSMINLB

Atomic signed minimum on byte in memory, without return, atomically loads an 8-bit byte from memory, compares it against the value held in a register, and stores the smaller value back to memory, treating the values as signed numbers.

- STSMINB has no memory ordering semantics.
- STSMINLB stores to memory with release semantics, as described in [Load-Acquire, Store-Release](#) on page B2-94.

For information about memory accesses see [Load/Store addressing modes](#) on page C1-143.

ARMv8.1

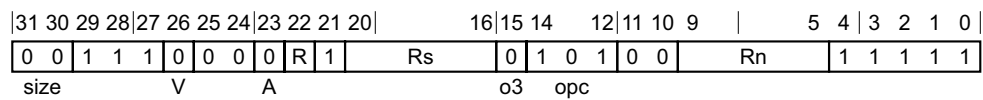

No memory ordering variant

Applies when R == 0.

STSMINB <Ws>, [<Xn|SP>]

Release variant

Applies when R == 1.

STSMINLB <Ws>, [<Xn|SP>]

Decode for all variants of this encoding

```
if !HaveAtomicExt() then UnallocatedEncoding();
integer n = UInt(Rn);
integer s = UInt(Rs);

AccType stacctype = if R == '1' then AccType_ORDEREDRW else AccType_ATOMICRW;
```

Assembler symbols

<Ws> Is the 32-bit name of the general-purpose register holding the data value to be operated on with the contents of the memory location, encoded in the "Rs" field.

<Xn|SP> Is the 64-bit name of the general-purpose base register or stack pointer, encoded in the "Rn" field.

Operation

```
bits(64) address;
bits(8) value;
bits(8) data;
bits(8) result;

value = X[s];
if n == 31 then
    CheckSPAignment();
    address = SP[];
else
    address = X[n];
data = Mem[address, 1, AccType_ATOMICRW];
```

```
result = if SInt(data) > SInt(value) then value else data;  
// All observers in the shareability domain observe the  
// following load and store atomically.  
Mem[address, 1, stacctype] = result;
```

C6.2.238 STSMINH, STSMINLH

Atomic signed minimum on halfword in memory, without return, atomically loads a 16-bit halfword from memory, compares it against the value held in a register, and stores the smaller value back to memory, treating the values as signed numbers.

- STSMINH has no memory ordering semantics.
- STSMINLH stores to memory with release semantics, as described in [Load-Acquire, Store-Release](#) on page B2-94.

For information about memory accesses see [Load/Store addressing modes](#) on page C1-143.

ARMv8.1

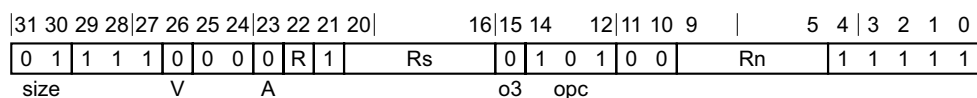

No memory ordering variant

Applies when R == 0.

STSMINH <Ws>, [<Xn|SP>]

Release variant

Applies when R == 1.

STSMINLH <Ws>, [<Xn|SP>]

Decode for all variants of this encoding

```
if !HaveAtomicExt() then UnallocatedEncoding();
integer n = UInt(Rn);
integer s = UInt(Rs);
```

```
AccType staccctype = if R == '1' then AccType_ORDEREDRW else AccType_ATOMICRW;
```

Assembler symbols

<Ws> Is the 32-bit name of the general-purpose register holding the data value to be operated on with the contents of the memory location, encoded in the "Rs" field.

<Xn|SP> Is the 64-bit name of the general-purpose base register or stack pointer, encoded in the "Rn" field.

Operation

```
bits(64) address;
bits(16) value;
bits(16) data;
bits(16) result;

value = X[s];
if n == 31 then
    CheckSPAignment();
    address = SP[];
else
    address = X[n];
data = Mem[address, 2, AccType_ATOMICRW];
```

```
result = if SInt(data) > SInt(value) then value else data;  
// All observers in the shareability domain observe the  
// following load and store atomically.  
Mem[address, 2, stacctype] = result;
```



C6.2.239 STSMIN, STSMINL

Atomic signed minimum on word or doubleword in memory, without return, atomically loads a 32-bit word or 64-bit doubleword from memory, compares it against the value held in a register, and stores the smaller value back to memory, treating the values as signed numbers.

- STSMIN has no memory ordering semantics.
- STSMINL stores to memory with release semantics, as described in [Load-Acquire, Store-Release on page B2-94](#).

For information about memory accesses see [Load/Store addressing modes on page C1-143](#).

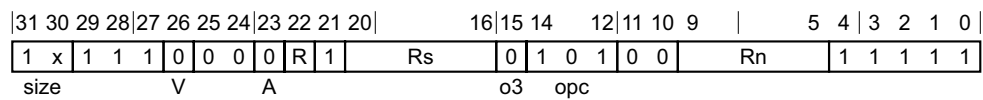
ARMv8.1



32-bit, no memory ordering variant

Applies when size == 10 && R == 0.

STSMIN <Ws>, [<Xn|SP>]

32-bit, release variant

Applies when size == 10 && R == 1.

STSMINL <Ws>, [<Xn|SP>]

64-bit, no memory ordering variant

Applies when size == 11 && R == 0.

STSMIN <Xs>, [<Xn|SP>]

64-bit, release variant

Applies when size == 11 && R == 1.

STSMINL <Xs>, [<Xn|SP>]

Decode for all variants of this encoding

```

if !HaveAtomicExt() then UnallocatedEncoding();
integer n = UInt(Rn);
integer s = UInt(Rs);

integer datasize = 8 << UInt(size);
AccType stacctype = if R == '1' then AccType_ORDEREDRW else AccType_ATOMICRW;
```

Assembler symbols

- <Ws> Is the 32-bit name of the general-purpose register holding the data value to be operated on with the contents of the memory location, encoded in the "Rs" field.
- <Xs> Is the 64-bit name of the general-purpose register holding the data value to be operated on with the contents of the memory location, encoded in the "Rs" field.
- <Xn|SP> Is the 64-bit name of the general-purpose base register or stack pointer, encoded in the "Rn" field.

Operation

```
bits(64) address;
bits(datasize) value;
bits(datasize) data;
bits(datasize) result;

value = X[s];
if n == 31 then
    CheckSPAlignment();
    address = SP[];
else
    address = X[n];
data = Mem[address, datasize DIV 8, AccType_ATOMICRW];

result = if SInt(data) > SInt(value) then value else data;
// All observers in the shareability domain observe the
// following load and store atomically.
Mem[address, datasize DIV 8, stacctype] = result;
```

C6.2.240 STTR

Store Register (unprivileged) stores a word or doubleword from a register to memory. The address that is used for the store is calculated from a base register and an immediate offset.

The memory is restricted as if execution is at EL0 when:

- Executing at EL1.
- Executing at EL2, in ARMv8.1, with HCR_EL2.{E2H, TGE} set to {1, 1}.

Otherwise, the access permission is for the Exception level at which the instruction is executed. For information about memory accesses, see [Load/Store addressing modes](#) on page C1-143.

31	30	29	28	27	26	25	24	23	22	21	20					12	11	10	9			5	4			0
1	x	1	1	1	0	0	0	0	0	0	imm9				1	0	Rn		Rt							
size				opc																						

32-bit variant

Applies when size == 10.

STTR <Wt>, [<Xn|SP>{, #<simmm>}]

64-bit variant

Applies when size == 11.

STTR <Xt>, [<Xn|SP>{, #<simmm>}]

Decode for all variants of this encoding

```
integer scale = UInt(size);
bits(64) offset = SignExtend(imm9, 64);
```

Assembler symbols

- <Wt> Is the 32-bit name of the general-purpose register to be transferred, encoded in the "Rt" field.
- <Xt> Is the 64-bit name of the general-purpose register to be transferred, encoded in the "Rt" field.
- <Xn|SP> Is the 64-bit name of the general-purpose base register or stack pointer, encoded in the "Rn" field.
- <simmm> Is the optional signed immediate byte offset, in the range -256 to 255, defaulting to 0 and encoded in the "imm9" field.

Shared decode for all encodings

```
integer n = UInt(Rn);
integer t = UInt(Rt);

integer datasize = 8 << scale;
```

Operation

```
bits(64) address;
bits(datasize) data;

if n == 31 then
    CheckSPAlignment();
```

```
        address = SP[];  
    else  
        address = X[n];  
  
    address = address + offset;  
  
    data = X[t];  
    Mem[address, datasize DIV 8, AccType_UNPRIV] = data;
```

C6.2.241 STTRB

Store Register Byte (unprivileged) stores a byte from a 32-bit register to memory. The address that is used for the store is calculated from a base register and an immediate offset.

The memory is restricted as if execution is at EL0 when:

- Executing at EL1.
- Executing at EL2, in ARMv8.1, with HCR_EL2.{E2H, TGE} set to {1, 1}.

Otherwise, the access permission is for the Exception level at which the instruction is executed. For information about memory accesses, see [Load/Store addressing modes](#) on page C1-143.

31	30	29	28	27	26	25	24	23	22	21	20					12	11	10	9			5	4			0
0	0	1	1	1	0	0	0	0	0	0	imm9				1	0	Rn		Rt							
size				opc																						

Unscaled offset variant

STTRB <Wt>, [<Xn|SP>{, #<sim>}]

Decode for this encoding

bits(64) offset = [SignExtend](#)(imm9, 64);

Assembler symbols

- <Wt> Is the 32-bit name of the general-purpose register to be transferred, encoded in the "Rt" field.
- <Xn|SP> Is the 64-bit name of the general-purpose base register or stack pointer, encoded in the "Rn" field.
- <sim> Is the optional signed immediate byte offset, in the range -256 to 255, defaulting to 0 and encoded in the "imm9" field.

Shared decode for all encodings

```
integer n = UInt(Rn);
integer t = UInt(Rt);
```

Operation

```
bits(64) address;
bits(8) data;

if n == 31 then
    CheckSPAAlignment();
    address = SP[];
else
    address = X[n];

address = address + offset;

data = X[t];
Mem[address, 1, AccType_UNPRIV] = data;
```

C6.2.242 STTRH

Store Register Halfword (unprivileged) stores a halfword from a 32-bit register to memory. The address that is used for the store is calculated from a base register and an immediate offset.

The memory is restricted as if execution is at EL0 when:

- Executing at EL1.
- Executing at EL2, in ARMv8.1, with HCR_EL2.{E2H, TGE} set to {1, 1}.

Otherwise, the access permission is for the Exception level at which the instruction is executed. For information about memory accesses, see [Load/Store addressing modes](#) on page C1-143.

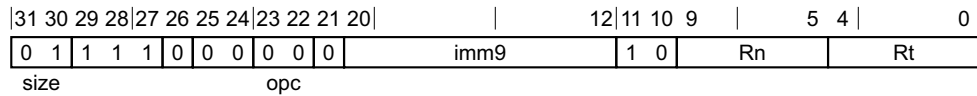

Unscaled offset variant

STTRH <Wt>, [<Xn|SP>{, #<sim>}]

Decode for this encoding

bits(64) offset = `SignExtend`(imm9, 64);

Assembler symbols

- <Wt> Is the 32-bit name of the general-purpose register to be transferred, encoded in the "Rt" field.
- <Xn|SP> Is the 64-bit name of the general-purpose base register or stack pointer, encoded in the "Rn" field.
- <sim> Is the optional signed immediate byte offset, in the range -256 to 255, defaulting to 0 and encoded in the "imm9" field.

Shared decode for all encodings

```
integer n = UInt(Rn);
integer t = UInt(Rt);
```

Operation

```
bits(64) address;
bits(16) data;

if n == 31 then
    CheckSPAAlignment();
    address = SP[];
else
    address = X[n];

address = address + offset;

data = X[t];
Mem[address, 2, AccType_UNPRIV] = data;
```

C6.2.243 STUMAXB, STUMAXB

Atomic unsigned maximum on byte in memory, without return, atomically loads an 8-bit byte from memory, compares it against the value held in a register, and stores the larger value back to memory, treating the values as unsigned numbers.

- STUMAXB has no memory ordering semantics.
- STUMAXB stores to memory with release semantics, as described in [Load-Acquire, Store-Release](#) on page B2-94.

For information about memory accesses see [Load/Store addressing modes](#) on page C1-143.

ARMv8.1

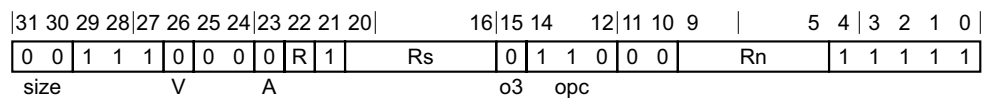

No memory ordering variant

Applies when R == 0.

STUMAXB <Ws>, [<Xn|SP>]

Release variant

Applies when R == 1.

STUMAXB <Ws>, [<Xn|SP>]

Decode for all variants of this encoding

```
if !HaveAtomicExt() then UnallocatedEncoding();
integer n = UInt(Rn);
integer s = UInt(Rs);
```

```
AccType staccType = if R == '1' then AccType_ORDEREDRW else AccType_ATOMICRW;
```

Assembler symbols

<Ws> Is the 32-bit name of the general-purpose register holding the data value to be operated on with the contents of the memory location, encoded in the "Rs" field.

<Xn|SP> Is the 64-bit name of the general-purpose base register or stack pointer, encoded in the "Rn" field.

Operation

```
bits(64) address;
bits(8) value;
bits(8) data;
bits(8) result;
```

```
value = X[s];
if n == 31 then
    CheckSPA1ignment();
    address = SP[];
else
    address = X[n];
data = Mem[address, 1, AccType_ATOMICRW];
```

```
result = if UInt(data) > UInt(value) then data else value;  
// All observers in the shareability domain observe the  
// following load and store atomically.  
Mem[address, 1, stacctype] = result;
```



C6.2.244 STUMAXH, STUMAXLH

Atomic unsigned maximum on halfword in memory, without return, atomically loads a 16-bit halfword from memory, compares it against the value held in a register, and stores the larger value back to memory, treating the values as unsigned numbers.

- STUMAXH has no memory ordering semantics.
- STUMAXLH stores to memory with release semantics, as described in [Load-Acquire, Store-Release](#) on page B2-94.

For information about memory accesses see [Load/Store addressing modes](#) on page C1-143.

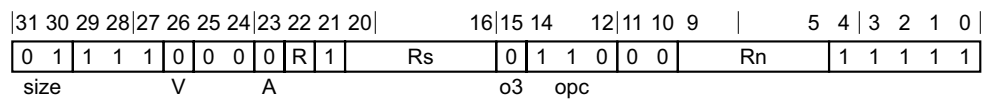
ARMv8.1



No memory ordering variant

Applies when R == 0.

STUMAXH <Ws>, [<Xn|SP>]

Release variant

Applies when R == 1.

STUMAXLH <Ws>, [<Xn|SP>]

Decode for all variants of this encoding

```
if !HaveAtomicExt() then UnallocatedEncoding();
integer n = UInt(Rn);
integer s = UInt(Rs);
```

```
AccType staccType = if R == '1' then AccType_ORDEREDRW else AccType_ATOMICRW;
```

Assembler symbols

<Ws> Is the 32-bit name of the general-purpose register holding the data value to be operated on with the contents of the memory location, encoded in the "Rs" field.

<Xn|SP> Is the 64-bit name of the general-purpose base register or stack pointer, encoded in the "Rn" field.

Operation

```
bits(64) address;
bits(16) value;
bits(16) data;
bits(16) result;

value = X[s];
if n == 31 then
    CheckSPAAlignment();
    address = SP[];
else
    address = X[n];
data = Mem[address, 2, AccType_ATOMICRW];
```

```
result = if UInt(data) > UInt(value) then data else value;  
// All observers in the shareability domain observe the  
// following load and store atomically.  
Mem[address, 2, stacctype] = result;
```

C6.2.245 STUMAX, STUMAXL

Atomic unsigned maximum on word or doubleword in memory, without return, atomically loads a 32-bit word or 64-bit doubleword from memory, compares it against the value held in a register, and stores the larger value back to memory, treating the values as unsigned numbers.

- STUMAX has no memory ordering semantics.
- STUMAXL stores to memory with release semantics, as described in [Load-Acquire, Store-Release on page B2-94](#).

For information about memory accesses see [Load/Store addressing modes on page C1-143](#).

ARMv8.1

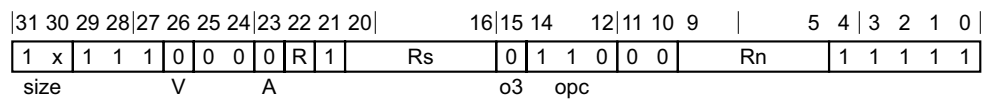

32-bit, no memory ordering variant

Applies when size == 10 && R == 0.

STUMAX <Ws>, [<Xn|SP>]

32-bit, release variant

Applies when size == 10 && R == 1.

STUMAXL <Ws>, [<Xn|SP>]

64-bit, no memory ordering variant

Applies when size == 11 && R == 0.

STUMAX <Xs>, [<Xn|SP>]

64-bit, release variant

Applies when size == 11 && R == 1.

STUMAXL <Xs>, [<Xn|SP>]

Decode for all variants of this encoding

```
if !HaveAtomicExt() then UnallocatedEncoding();
integer n = UInt(Rn);
integer s = UInt(Rs);

integer datasize = 8 << UInt(size);
AccType stacctype = if R == '1' then AccType_ORDEREDRW else AccType_ATOMICRW;
```

Assembler symbols

- | | |
|---------|--|
| <Ws> | Is the 32-bit name of the general-purpose register holding the data value to be operated on with the contents of the memory location, encoded in the "Rs" field. |
| <Xs> | Is the 64-bit name of the general-purpose register holding the data value to be operated on with the contents of the memory location, encoded in the "Rs" field. |
| <Xn SP> | Is the 64-bit name of the general-purpose base register or stack pointer, encoded in the "Rn" field. |

Operation

```
bits(64) address;
bits(datasize) value;
bits(datasize) data;
bits(datasize) result;

value = X[s];
if n == 31 then
    CheckSPAlignment();
    address = SP[];
else
    address = X[n];
data = Mem[address, datasize DIV 8, AccType_ATOMICRW];

result = if UInt(data) > UInt(value) then data else value;
// All observers in the shareability domain observe the
// following load and store atomically.
Mem[address, datasize DIV 8, stacctype] = result;
```

C6.2.246 STUMINB, STUMINLB

Atomic unsigned minimum on byte in memory, without return, atomically loads an 8-bit byte from memory, compares it against the value held in a register, and stores the smaller value back to memory, treating the values as unsigned numbers.

- STUMINB has no memory ordering semantics.
- STUMINLB stores to memory with release semantics, as described in [Load-Acquire, Store-Release](#) on page B2-94.

For information about memory accesses see [Load/Store addressing modes](#) on page C1-143.

ARMv8.1

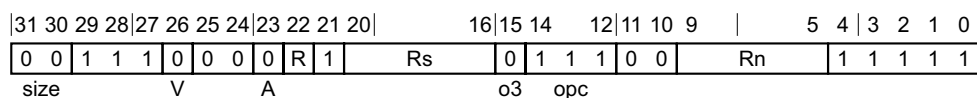

No memory ordering variant

Applies when R == 0.

STUMINB <Ws>, [<Xn|SP>]

Release variant

Applies when R == 1.

STUMINLB <Ws>, [<Xn|SP>]

Decode for all variants of this encoding

```
if !HaveAtomicExt() then UnallocatedEncoding();
integer n = UInt(Rn);
integer s = UInt(Rs);
```

```
AccType staccType = if R == '1' then AccType_ORDEREDRW else AccType_ATOMICRW;
```

Assembler symbols

<Ws> Is the 32-bit name of the general-purpose register holding the data value to be operated on with the contents of the memory location, encoded in the "Rs" field.

<Xn|SP> Is the 64-bit name of the general-purpose base register or stack pointer, encoded in the "Rn" field.

Operation

```
bits(64) address;
bits(8) value;
bits(8) data;
bits(8) result;
```

```
value = X[s];
if n == 31 then
    CheckSPAignment();
    address = SP[];
else
    address = X[n];
data = Mem[address, 1, AccType_ATOMICRW];
```

```
result = if UInt(data) > UInt(value) then value else data;  
// All observers in the shareability domain observe the  
// following load and store atomically.  
Mem[address, 1, stacctype] = result;
```

C6.2.247 STUMINH, STUMINLH

Atomic unsigned minimum on halfword in memory, without return, atomically loads a 16-bit halfword from memory, compares it against the value held in a register, and stores the smaller value back to memory, treating the values as unsigned numbers.

- STUMINH has no memory ordering semantics.
- STUMINLH stores to memory with release semantics, as described in [Load-Acquire, Store-Release](#) on page B2-94.

For information about memory accesses see [Load/Store addressing modes](#) on page C1-143.

ARMv8.1

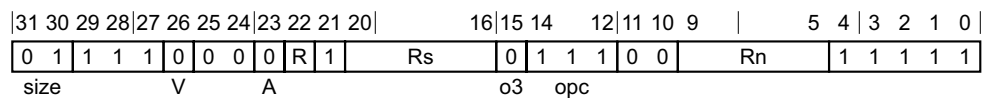

No memory ordering variant

Applies when R == 0.

STUMINH <Ws>, [<Xn|SP>]

Release variant

Applies when R == 1.

STUMINLH <Ws>, [<Xn|SP>]

Decode for all variants of this encoding

```
if !HaveAtomicExt() then UnallocatedEncoding();
integer n = UInt(Rn);
integer s = UInt(Rs);

AccType stacctype = if R == '1' then AccType_ORDEREDRW else AccType_ATOMICRW;
```

Assembler symbols

<Ws> Is the 32-bit name of the general-purpose register holding the data value to be operated on with the contents of the memory location, encoded in the "Rs" field.

<Xn|SP> Is the 64-bit name of the general-purpose base register or stack pointer, encoded in the "Rn" field.

Operation

```
bits(64) address;
bits(16) value;
bits(16) data;
bits(16) result;

value = X[s];
if n == 31 then
    CheckSPAAlignment();
    address = SP[];
else
    address = X[n];
data = Mem[address, 2, AccType_ATOMICRW];
```

```
result = if UInt(data) > UInt(value) then value else data;  
// All observers in the shareability domain observe the  
// following load and store atomically.  
Mem[address, 2, stacctype] = result;
```



C6.2.248 STUMIN, STUMINL

Atomic unsigned minimum on word or doubleword in memory, without return, atomically loads a 32-bit word or 64-bit doubleword from memory, compares it against the value held in a register, and stores the smaller value back to memory, treating the values as unsigned numbers.

- STUMIN has no memory ordering semantics.
- STUMINL stores to memory with release semantics, as described in [Load-Acquire, Store-Release on page B2-94](#).

For information about memory accesses see [Load/Store addressing modes on page C1-143](#).

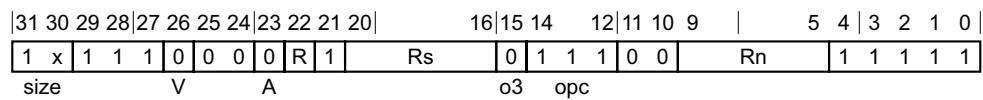
ARMv8.1



32-bit, no memory ordering variant

Applies when size == 10 && R == 0.

STUMIN <Ws>, [<Xn|SP>]

32-bit, release variant

Applies when size == 10 && R == 1.

STUMINL <Ws>, [<Xn|SP>]

64-bit, no memory ordering variant

Applies when size == 11 && R == 0.

STUMIN <Xs>, [<Xn|SP>]

64-bit, release variant

Applies when size == 11 && R == 1.

STUMINL <Xs>, [<Xn|SP>]

Decode for all variants of this encoding

```

if !HaveAtomicExt() then UnallocatedEncoding();
integer n = UInt(Rn);
integer s = UInt(Rs);

integer datasize = 8 << UInt(size);
AccType stacctype = if R == '1' then AccType_ORDEREDRW else AccType_ATOMICRW;
```

Assembler symbols

- <Ws> Is the 32-bit name of the general-purpose register holding the data value to be operated on with the contents of the memory location, encoded in the "Rs" field.
- <Xs> Is the 64-bit name of the general-purpose register holding the data value to be operated on with the contents of the memory location, encoded in the "Rs" field.
- <Xn|SP> Is the 64-bit name of the general-purpose base register or stack pointer, encoded in the "Rn" field.

Operation

```
bits(64) address;
bits(datasize) value;
bits(datasize) data;
bits(datasize) result;

value = X[s];
if n == 31 then
    CheckSPAlignment();
    address = SP[];
else
    address = X[n];
data = Mem[address, datasize DIV 8, AccType_ATOMICRW];

result = if UInt(data) > UInt(value) then value else data;
// All observers in the shareability domain observe the
// following load and store atomically.
Mem[address, datasize DIV 8, stacctype] = result;
```

C6.2.249 STUR

Store Register (unscaled) calculates an address from a base register value and an immediate offset, and stores a 32-bit word or a 64-bit doubleword to the calculated address, from a register. For information about memory accesses, see [Load/Store addressing modes](#) on page C1-143.

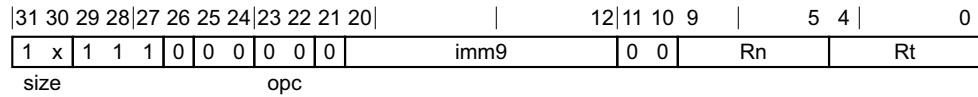

32-bit variant

Applies when size == 10.

STUR <Wt>, [<Xn|SP>{, #<sim>}]

64-bit variant

Applies when size == 11.

STUR <Xt>, [<Xn|SP>{, #<sim>}]

Decode for all variants of this encoding

```
integer scale = UInt(size);
bits(64) offset = SignExtend(imm9, 64);
```

Assembler symbols

- <Wt> Is the 32-bit name of the general-purpose register to be transferred, encoded in the "Rt" field.
- <Xt> Is the 64-bit name of the general-purpose register to be transferred, encoded in the "Rt" field.
- <Xn|SP> Is the 64-bit name of the general-purpose base register or stack pointer, encoded in the "Rn" field.
- <sim> Is the optional signed immediate byte offset, in the range -256 to 255, defaulting to 0 and encoded in the "imm9" field.

Shared decode for all encodings

```
integer n = UInt(Rn);
integer t = UInt(Rt);

integer datasize = 8 << scale;
```

Operation

```
bits(64) address;
bits(datasize) data;

if n == 31 then
    CheckSPAAlignment();
    address = SP[];
else
    address = X[n];

address = address + offset;

data = X[t];
Mem[address, datasize DIV 8, AccType_NORMAL] = data;
```

C6.2.250 STURB

Store Register Byte (unscaled) calculates an address from a base register value and an immediate offset, and stores a byte to the calculated address, from a 32-bit register. For information about memory accesses, see [Load/Store addressing modes](#) on page C1-143.



Unscaled offset variant

STURB <Wt>, [<Xn|SP>{, #<simmm>}]

Decode for this encoding

bits(64) offset = [SignExtend](#)(imm9, 64);

Assembler symbols

- <Wt> Is the 32-bit name of the general-purpose register to be transferred, encoded in the "Rt" field.
- <Xn|SP> Is the 64-bit name of the general-purpose base register or stack pointer, encoded in the "Rn" field.
- <simmm> Is the optional signed immediate byte offset, in the range -256 to 255, defaulting to 0 and encoded in the "imm9" field.

Shared decode for all encodings

```
integer n = UInt(Rn);
integer t = UInt(Rt);
```

Operation

```
bits(64) address;
bits(8) data;

if n == 31 then
    CheckSPAlignment();
    address = SP[];
else
    address = X[n];

address = address + offset;

data = X[t];
Mem[address, 1, AccType_NORMAL] = data;
```

C6.2.251 STURH

Store Register Halfword (unscaled) calculates an address from a base register value and an immediate offset, and stores a halfword to the calculated address, from a 32-bit register. For information about memory accesses, see [Load/Store addressing modes on page C1-143](#).

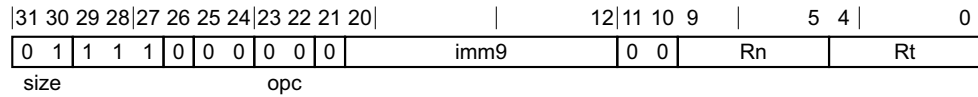

Unscaled offset variant

STURH <Wt>, [<Xn|SP>{, #<sim>}]

Decode for this encoding

bits(64) offset = [SignExtend](#)(imm9, 64);

Assembler symbols

- <Wt> Is the 32-bit name of the general-purpose register to be transferred, encoded in the "Rt" field.
- <Xn|SP> Is the 64-bit name of the general-purpose base register or stack pointer, encoded in the "Rn" field.
- <sim> Is the optional signed immediate byte offset, in the range -256 to 255, defaulting to 0 and encoded in the "imm9" field.

Shared decode for all encodings

```
integer n = UInt(Rn);
integer t = UInt(Rt);
```

Operation

```
bits(64) address;
bits(16) data;

if n == 31 then
    CheckSPAlignment();
    address = SP[];
else
    address = X[n];

address = address + offset;

data = X[t];
Mem[address, 2, AccType\_NORMAL] = data;
```

C6.2.252 STXP

Store Exclusive Pair of registers stores two 32-bit words or two 64-bit doublewords from two registers to a memory location if the PE has exclusive access to the memory address, and returns a status value of 0 if the store was successful, or of 1 if no store was performed. See [Synchronization and semaphores on page B2-121](#). A 32-bit pair requires the address to be doubleword aligned and is single-copy atomic at doubleword granularity. A 64-bit pair requires the address to be quadword aligned and, if the Store-Exclusive succeeds, it causes a single-copy atomic update of the 128-bit memory location being updated. For information about memory accesses see [Load/Store addressing modes on page C1-143](#).

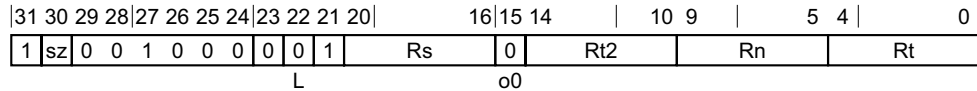

32-bit variant

Applies when `sz == 0`.

STXP <Ws>, <Wt1>, <Wt2>, [<Xn|SP>{, #0}]

64-bit variant

Applies when `sz == 1`.

STXP <Ws>, <Xt1>, <Xt2>, [<Xn|SP>{, #0}]

Decode for all variants of this encoding

```
integer n = UInt(Rn);
integer t = UInt(Rt);
integer t2 = UInt(Rt2); // ignored by load/store single register
integer s = UInt(Rs); // ignored by all loads and store-release

integer elsize = 32 << UInt(sz);
integer datasize = elsize * 2;
```

Notes for all encodings

For information about the CONSTRAINED UNPREDICTABLE behavior of this instruction, see [Appendix K1 Architectural Constraints on UNPREDICTABLE behaviors](#), and particularly [STXP on page K1-6131](#).

Assembler symbols

<Ws>	Is the 32-bit name of the general-purpose register into which the status result of the store exclusive is written, encoded in the "Rs" field. The value returned is: 0 If the operation updates memory. 1 If the operation fails to update memory.
<Xt1>	Is the 64-bit name of the first general-purpose register to be transferred, encoded in the "Rt" field.
<Xt2>	Is the 64-bit name of the second general-purpose register to be transferred, encoded in the "Rt2" field.
<Wt1>	Is the 32-bit name of the first general-purpose register to be transferred, encoded in the "Rt" field.
<Wt2>	Is the 32-bit name of the second general-purpose register to be transferred, encoded in the "Rt2" field.
<Xn SP>	Is the 64-bit name of the general-purpose base register or stack pointer, encoded in the "Rn" field.

Aborts and alignment

If a synchronous Data Abort exception is generated by the execution of this instruction:

- Memory is not updated.
- <Ws> is not updated.

Accessing an address that is not aligned to the size of the data being accessed causes an Alignment fault Data Abort exception to be generated, subject to the following rules:

- If AArch64.ExclusiveMonitorsPass() returns TRUE, the exception is generated.
- Otherwise, it is IMPLEMENTATION DEFINED whether the exception is generated.

If AArch64.ExclusiveMonitorsPass() returns FALSE and the memory address, if accessed, would generate a synchronous Data Abort exception, it is IMPLEMENTATION DEFINED whether the exception is generated.

Operation

```

bits(64) address;
bits(datasize) data;
constant integer dbytes = datasize DIV 8;
boolean rt_unknown = FALSE;
boolean rn_unknown = FALSE;

if s == t || (s == t2) then
    Constraint c = ConstrainUnpredictable();
    assert c IN {Constraint_UNKNOWN, Constraint_NONE, Constraint_UNDEF, Constraint_NOP};
    case c of
        when Constraint_UNKNOWN rt_unknown = TRUE;    // store UNKNOWN value
        when Constraint_NONE    rt_unknown = FALSE;   // store original value
        when Constraint_UNDEF    UnallocatedEncoding();
        when Constraint_NOP      EndOfInstruction();
if s == n && n != 31 then
    Constraint c = ConstrainUnpredictable();
    assert c IN {Constraint_UNKNOWN, Constraint_NONE, Constraint_UNDEF, Constraint_NOP};
    case c of
        when Constraint_UNKNOWN rn_unknown = TRUE;    // address is UNKNOWN
        when Constraint_NONE    rn_unknown = FALSE;   // address is original base
        when Constraint_UNDEF    UnallocatedEncoding();
        when Constraint_NOP      EndOfInstruction();

if n == 31 then
    CheckSPAlignment();
    address = SP[];
elseif rn_unknown then
    address = bits(64) UNKNOWN;
else
    address = X[n];

if rt_unknown then
    data = bits(datasize) UNKNOWN;
else
    bits(datasize DIV 2) e1 = X[t];
    bits(datasize DIV 2) e2 = X[t2];
    data = if BigEndian() then e1:e2 else e2:e1;
bit status = '1';
// Check whether the Exclusive Monitors are set to include the
// physical memory locations corresponding to virtual address
// range [address, address+dbytes-1].
if AArch64.ExclusiveMonitorsPass(address, dbytes) then
    // This atomic write will be rejected if it does not refer
    // to the same physical locations after address translation.
    Mem[address, dbytes, AccType_ATOMIC] = data;
    status = ExclusiveMonitorsStatus();
X[s] = ZeroExtend(status, 32);

```

C6.2.253 STXR

Store Exclusive Register stores a 32-bit word or a 64-bit doubleword from a register to memory if the PE has exclusive access to the memory address, and returns a status value of 0 if the store was successful, or of 1 if no store was performed. See [Synchronization and semaphores on page B2-121](#). For information about memory accesses see [Load/Store addressing modes on page C1-143](#).

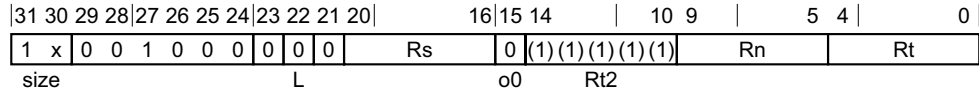

32-bit variant

Applies when size == 10.

STXR <Ws>, <Wt>, [<Xn|SP>{,#0}]

64-bit variant

Applies when size == 11.

STXR <Ws>, <Xt>, [<Xn|SP>{,#0}]

Decode for all variants of this encoding

```
integer n = UInt(Rn);
integer t = UInt(Rt);
integer s = UInt(Rs); // ignored by all loads and store-release

integer elsize = 8 << UInt(size);
```

Notes for all encodings

For information about the CONSTRAINED UNPREDICTABLE behavior of this instruction, see [Appendix K1 Architectural Constraints on UNPREDICTABLE behaviors](#), and particularly [STXR on page K1-6132](#).

Assembler symbols

- <Ws> Is the 32-bit name of the general-purpose register into which the status result of the store exclusive is written, encoded in the "Rs" field. The value returned is:
 - 0 If the operation updates memory.
 - 1 If the operation fails to update memory.
- <Xt> Is the 64-bit name of the general-purpose register to be transferred, encoded in the "Rt" field.
- <Wt> Is the 32-bit name of the general-purpose register to be transferred, encoded in the "Rt" field.
- <Xn|SP> Is the 64-bit name of the general-purpose base register or stack pointer, encoded in the "Rn" field.

Aborts and alignment

If a synchronous Data Abort exception is generated by the execution of this instruction:

- Memory is not updated.
- <Ws> is not updated.

Accessing an address that is not aligned to the size of the data being accessed causes an Alignment fault Data Abort exception to be generated, subject to the following rules:

- If AArch64.ExclusiveMonitorsPass() returns TRUE, the exception is generated.
- Otherwise, it is IMPLEMENTATION DEFINED whether the exception is generated.

If AArch64.ExclusiveMonitorsPass() returns FALSE and the memory address, if accessed, would generate a synchronous Data Abort exception, it is IMPLEMENTATION DEFINED whether the exception is generated.

Operation

```

bits(64) address;
bits(elsize) data;
constant integer dbytes = elsize DIV 8;
boolean rt_unknown = FALSE;
boolean rn_unknown = FALSE;

if s == t then
  Constraint c = ConstrainUnpredictable();
  assert c IN {Constraint_UNKNOWN, Constraint_NONE, Constraint_UNDEF, Constraint_NOP};
  case c of
    when Constraint_UNKNOWN rt_unknown = TRUE;    // store UNKNOWN value
    when Constraint_NONE    rt_unknown = FALSE;   // store original value
    when Constraint_UNDEF   UnallocatedEncoding();
    when Constraint_NOP     EndOfInstruction();
if s == n && n != 31 then
  Constraint c = ConstrainUnpredictable();
  assert c IN {Constraint_UNKNOWN, Constraint_NONE, Constraint_UNDEF, Constraint_NOP};
  case c of
    when Constraint_UNKNOWN rn_unknown = TRUE;    // address is UNKNOWN
    when Constraint_NONE    rn_unknown = FALSE;   // address is original base
    when Constraint_UNDEF   UnallocatedEncoding();
    when Constraint_NOP     EndOfInstruction();

if n == 31 then
  CheckSPAlignment();
  address = SP[];
elseif rn_unknown then
  address = bits(64) UNKNOWN;
else
  address = X[n];

if rt_unknown then
  data = bits(elsize) UNKNOWN;
else
  data = X[t];

bit status = '1';
// Check whether the Exclusive Monitors are set to include the
// physical memory locations corresponding to virtual address
// range [address, address+dbytes-1].
if AArch64.ExclusiveMonitorsPass(address, dbytes) then
  // This atomic write will be rejected if it does not refer
  // to the same physical locations after address translation.
  Mem[address, dbytes, AccType_ATOMIC] = data;
  status = ExclusiveMonitorsStatus();
X[s] = ZeroExtend(status, 32);

```

C6.2.254 STXRB

Store Exclusive Register Byte stores a byte from a register to memory if the PE has exclusive access to the memory address, and returns a status value of 0 if the store was successful, or of 1 if no store was performed. See [Synchronization and semaphores on page B2-121](#). The memory access is atomic.

For information about memory accesses see [Load/Store addressing modes on page C1-143](#).

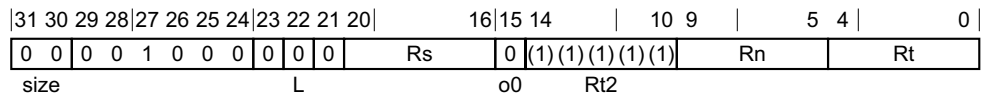

No offset variant

STXRB <Ws>, <Wt>, [<Xn|SP>{,#0}]

Decode for this encoding

```
integer n = UInt(Rn);
integer t = UInt(Rt);
integer s = UInt(Rs); // ignored by all loads and store-release
```

Notes for all encodings

For information about the CONSTRAINED UNPREDICTABLE behavior of this instruction, see [Appendix K1 Architectural Constraints on UNPREDICTABLE behaviors](#), and particularly [STXRB on page K1-6132](#).

Assembler symbols

- <Ws> Is the 32-bit name of the general-purpose register into which the status result of the store exclusive is written, encoded in the "Rs" field. The value returned is:
- 0 If the operation updates memory.
 - 1 If the operation fails to update memory.
- <Wt> Is the 32-bit name of the general-purpose register to be transferred, encoded in the "Rt" field.
- <Xn|SP> Is the 64-bit name of the general-purpose base register or stack pointer, encoded in the "Rn" field.

Aborts

If a synchronous Data Abort exception is generated by the execution of this instruction:

- Memory is not updated.
- <Ws> is not updated.

If AArch64.ExclusiveMonitorsPass() returns FALSE and the memory address, if accessed, would generate a synchronous Data Abort exception, it is IMPLEMENTATION DEFINED whether the exception is generated.

Operation

```
bits(64) address;
bits(8) data;
boolean rt_unknown = FALSE;
boolean rn_unknown = FALSE;

if s == t then
  Constraint c = ConstrainUnpredictable();
  assert c IN {Constraint_UNKNOWN, Constraint_NONE, Constraint_UNDEF, Constraint_NOP};
```

```

case c of
  when Constraint_UNKNOWN rt_unknown = TRUE;    // store UNKNOWN value
  when Constraint_NONE    rt_unknown = FALSE;   // store original value
  when Constraint_UNDEF   UnallocatedEncoding();
  when Constraint_NOP     EndOfInstruction();
if s == n && n != 31 then
  Constraint c = ConstrainUnpredictable();
  assert c IN {Constraint_UNKNOWN, Constraint_NONE, Constraint_UNDEF, Constraint_NOP};
  case c of
    when Constraint_UNKNOWN rn_unknown = TRUE;    // address is UNKNOWN
    when Constraint_NONE    rn_unknown = FALSE;   // address is original base
    when Constraint_UNDEF   UnallocatedEncoding();
    when Constraint_NOP     EndOfInstruction();

if n == 31 then
  CheckSPAlignment();
  address = SP[];
elseif rn_unknown then
  address = bits(64) UNKNOWN;
else
  address = X[n];

if rt_unknown then
  data = bits(8) UNKNOWN;
else
  data = X[t];

bit status = '1';
// Check whether the Exclusive Monitors are set to include the
// physical memory locations corresponding to virtual address
// range [address, address+dbytes-1].
if AArch64.ExclusiveMonitorsPass(address, 1) then
  // This atomic write will be rejected if it does not refer
  // to the same physical locations after address translation.
  Mem[address, 1, AccType_ATOMIC] = data;
  status = ExclusiveMonitorsStatus();
X[s] = ZeroExtend(status, 32);

```

C6.2.255 STXRH

Store Exclusive Register Halfword stores a halfword from a register to memory if the PE has exclusive access to the memory address, and returns a status value of 0 if the store was successful, or of 1 if no store was performed. See *Synchronization and semaphores* on page B2-121. The memory access is atomic.

For information about memory accesses see *Load/Store addressing modes* on page C1-143.

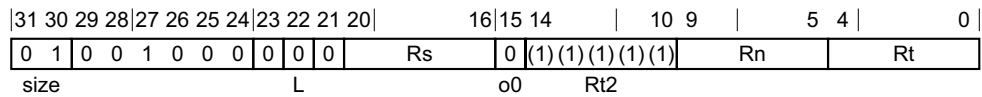

No offset variant

STXRH <Ws>, <Wt>, [<Xn|SP>{, #0}]

Decode for this encoding

```
integer n = UInt(Rn);
integer t = UInt(Rt);
integer s = UInt(Rs); // ignored by all loads and store-release
```

Assembler symbols

- <Ws> Is the 32-bit name of the general-purpose register into which the status result of the store exclusive is written, encoded in the "Rs" field. The value returned is:
- 0 If the operation updates memory.
 - 1 If the operation fails to update memory.
- <Wt> Is the 32-bit name of the general-purpose register to be transferred, encoded in the "Rt" field.
- <Xn|SP> Is the 64-bit name of the general-purpose base register or stack pointer, encoded in the "Rn" field.

Aborts and alignment

If a synchronous Data Abort exception is generated by the execution of this instruction:

- Memory is not updated.
- <Ws> is not updated.

A non halfword-aligned memory address causes an Alignment fault Data Abort exception to be generated, subject to the following rules:

- If AArch64.ExclusiveMonitorsPass() returns TRUE, the exception is generated.
- Otherwise, it is IMPLEMENTATION DEFINED whether the exception is generated.

If AArch64.ExclusiveMonitorsPass() returns FALSE and the memory address, if accessed, would generate a synchronous Data Abort exception, it is IMPLEMENTATION DEFINED whether the exception is generated.

Operation

```
bits(64) address;
bits(16) data;
boolean rt_unknown = FALSE;
boolean rn_unknown = FALSE;

if s == t then
    Constraint c = ConstrainUnpredictable();
```

```

assert c IN {Constraint_UNKNOWN, Constraint_NONE, Constraint_UNDEF, Constraint_NOP};
case c of
  when Constraint_UNKNOWN rt_unknown = TRUE;    // store UNKNOWN value
  when Constraint_NONE    rt_unknown = FALSE;   // store original value
  when Constraint_UNDEF   UnallocatedEncoding();
  when Constraint_NOP     EndOfInstruction();
if s == n && n != 31 then
  Constraint c = ConstrainUnpredictable();
assert c IN {Constraint_UNKNOWN, Constraint_NONE, Constraint_UNDEF, Constraint_NOP};
case c of
  when Constraint_UNKNOWN rn_unknown = TRUE;    // address is UNKNOWN
  when Constraint_NONE    rn_unknown = FALSE;   // address is original base
  when Constraint_UNDEF   UnallocatedEncoding();
  when Constraint_NOP     EndOfInstruction();

if n == 31 then
  CheckSPAlignment();
  address = SP[];
elseif rn_unknown then
  address = bits(64) UNKNOWN;
else
  address = X[n];

if rt_unknown then
  data = bits(16) UNKNOWN;
else
  data = X[t];

bit status = '1';
// Check whether the Exclusive Monitors are set to include the
// physical memory locations corresponding to virtual address
// range [address, address+dbytes-1].
if AArch64.ExclusiveMonitorsPass(address, 2) then
  // This atomic write will be rejected if it does not refer
  // to the same physical locations after address translation.
  Mem[address, 2, AccType_ATOMIC] = data;
  status = ExclusiveMonitorsStatus();
X[s] = ZeroExtend(status, 32);

```

C6.2.256 SUB (extended register)

Subtract (extended register) subtracts a sign or zero-extended register value, followed by an optional left shift amount, from a register value, and writes the result to the destination register. The argument that is extended from the <Rm> register can be a byte, halfword, word, or doubleword.

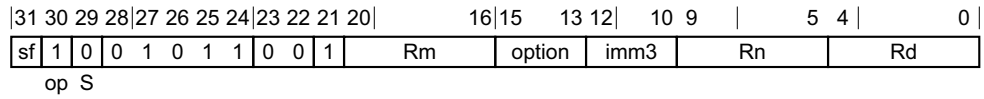

32-bit variant

Applies when sf == 0.

SUB <Wd|WSP>, <Wn|WSP>, <Wm>{, <extend> {#<amount>}}

64-bit variant

Applies when sf == 1.

SUB <Xd|SP>, <Xn|SP>, <R><m>{, <extend> {#<amount>}}

Decode for all variants of this encoding

```
integer d = UInt(Rd);
integer n = UInt(Rn);
integer m = UInt(Rm);
integer datasize = if sf == '1' then 64 else 32;
ExtendType extend_type = DecodeRegExtend(option);
integer shift = UInt(imm3);
if shift > 4 then ReservedValue();
```

Assembler symbols

- <Wd|WSP> Is the 32-bit name of the destination general-purpose register or stack pointer, encoded in the "Rd" field.
- <Wn|WSP> Is the 32-bit name of the first source general-purpose register or stack pointer, encoded in the "Rn" field.
- <Wm> Is the 32-bit name of the second general-purpose source register, encoded in the "Rm" field.
- <Xd|SP> Is the 64-bit name of the destination general-purpose register or stack pointer, encoded in the "Rd" field.
- <Xn|SP> Is the 64-bit name of the first source general-purpose register or stack pointer, encoded in the "Rn" field.
- <R> Is a width specifier, encoded in the "option" field. It can have the following values:
 - W when option = 00x
 - W when option = 010
 - X when option = x11
 - W when option = 10x
 - W when option = 110
- <m> Is the number [0-30] of the second general-purpose source register or the name ZR (31), encoded in the "Rm" field.

- <extend> For the 32-bit variant: is the extension to be applied to the second source operand, encoded in the "option" field. It can have the following values:
- | | |
|----------|-------------------|
| UXTB | when option = 000 |
| UXTH | when option = 001 |
| LSL UXTW | when option = 010 |
| UXTX | when option = 011 |
| SXTB | when option = 100 |
| SXTH | when option = 101 |
| SXTW | when option = 110 |
| SXTX | when option = 111 |
- If "Rd" or "Rn" is '11111' (WSP) and "option" is '010' then LSL is preferred, but may be omitted when "imm3" is '000'. In all other cases <extend> is required and must be UXTW when "option" is '010'.
- For the 64-bit variant: is the extension to be applied to the second source operand, encoded in the "option" field. It can have the following values:
- | | |
|----------|-------------------|
| UXTB | when option = 000 |
| UXTH | when option = 001 |
| UXTW | when option = 010 |
| LSL UXTX | when option = 011 |
| SXTB | when option = 100 |
| SXTH | when option = 101 |
| SXTW | when option = 110 |
| SXTX | when option = 111 |
- If "Rd" or "Rn" is '11111' (SP) and "option" is '011' then LSL is preferred, but may be omitted when "imm3" is '000'. In all other cases <extend> is required and must be UXTX when "option" is '011'.
- <amount> Is the left shift amount to be applied after extension in the range 0 to 4, defaulting to 0, encoded in the "imm3" field. It must be absent when <extend> is absent, is required when <extend> is LSL, and is optional when <extend> is present but not LSL.

Operation

```

bits(datasize) result;
bits(datasize) operand1 = if n == 31 then SP[] else X[n];
bits(datasize) operand2 = ExtendReg(m, extend_type, shift);

operand2 = NOT(operand2);
(result, -) = AddWithCarry(operand1, operand2, '1');

if d == 31 then
    SP[] = result;
else
    X[d] = result;
  
```

C6.2.257 SUB (immediate)

Subtract (immediate) subtracts an optionally-shifted immediate value from a register value, and writes the result to the destination register.

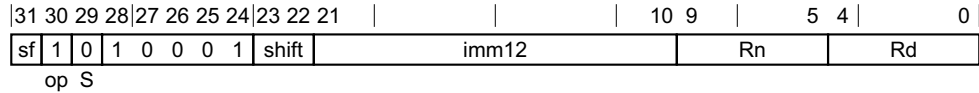

32-bit variant

Applies when sf == 0.

SUB <Wd|WSP>, <Wn|WSP>, #<imm>{, <shift>}

64-bit variant

Applies when sf == 1.

SUB <Xd|SP>, <Xn|SP>, #<imm>{, <shift>}

Decode for all variants of this encoding

```
integer d = UInt(Rd);
integer n = UInt(Rn);
integer datasize = if sf == '1' then 64 else 32;
bits(datasize) imm;

case shift of
  when '00' imm = ZeroExtend(imm12, datasize);
  when '01' imm = ZeroExtend(imm12:Zeros(12), datasize);
  when '1x' ReservedValue();
```

Assembler symbols

- <Wd|WSP> Is the 32-bit name of the destination general-purpose register or stack pointer, encoded in the "Rd" field.
- <Wn|WSP> Is the 32-bit name of the source general-purpose register or stack pointer, encoded in the "Rn" field.
- <Xd|SP> Is the 64-bit name of the destination general-purpose register or stack pointer, encoded in the "Rd" field.
- <Xn|SP> Is the 64-bit name of the source general-purpose register or stack pointer, encoded in the "Rn" field.
- <imm> Is an unsigned immediate, in the range 0 to 4095, encoded in the "imm12" field.
- <shift> Is the optional left shift to apply to the immediate, defaulting to LSL #0 and encoded in the "shift" field. It can have the following values:
 - LSL #0 when shift = 00
 - LSL #12 when shift = 01
 - The encoding shift = 1x is reserved.

Operation

```
bits(datasize) result;
bits(datasize) operand1 = if n == 31 then SP[] else X[n];
bits(datasize) operand2;
```



```
operand2 = NOT(imm);  
(result, -) = AddWithCarry(operand1, operand2, '1');  
  
if d == 31 then  
    SP[] = result;  
else  
    X[d] = result;
```

C6.2.258 SUB (shifted register)

Subtract (shifted register) subtracts an optionally-shifted register value from a register value, and writes the result to the destination register.

This instruction is used by the alias [NEG \(shifted register\)](#). See [Alias conditions](#) for details of when each alias is preferred.

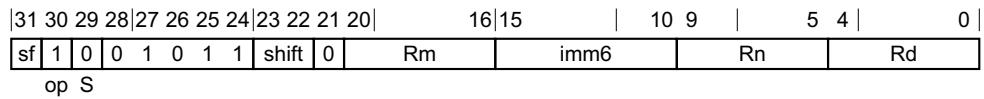

32-bit variant

Applies when sf == 0.

SUB <Wd>, <Wn>, <Wm>{, <shift> #<amount>}

64-bit variant

Applies when sf == 1.

SUB <Xd>, <Xn>, <Xm>{, <shift> #<amount>}

Decode for all variants of this encoding

```
integer d = UInt(Rd);
integer n = UInt(Rn);
integer m = UInt(Rm);
integer datasize = if sf == '1' then 64 else 32;

if shift == '11' then ReservedValue();
if sf == '0' && imm6<5> == '1' then ReservedValue();

ShiftType shift_type = DecodeShift(shift);
integer shift_amount = UInt(imm6);
```

Alias conditions

Alias	is preferred when
NEG (shifted register)	Rn == '11111'

Assembler symbols

- <Wd> Is the 32-bit name of the general-purpose destination register, encoded in the "Rd" field.
- <Wn> Is the 32-bit name of the first general-purpose source register, encoded in the "Rn" field.
- <Wm> Is the 32-bit name of the second general-purpose source register, encoded in the "Rm" field.
- <Xd> Is the 64-bit name of the general-purpose destination register, encoded in the "Rd" field.
- <Xn> Is the 64-bit name of the first general-purpose source register, encoded in the "Rn" field.
- <Xm> Is the 64-bit name of the second general-purpose source register, encoded in the "Rm" field.

- <shift> Is the optional shift type to be applied to the second source operand, defaulting to LSL and encoded in the "shift" field. It can have the following values:
- LSL when shift = 00
 - LSR when shift = 01
 - ASR when shift = 10
- The encoding shift = 11 is reserved.
- <amount> For the 32-bit variant: is the shift amount, in the range 0 to 31, defaulting to 0 and encoded in the "imm6" field.
- For the 64-bit variant: is the shift amount, in the range 0 to 63, defaulting to 0 and encoded in the "imm6" field.

Operation

```
bits(datasize) result;  
bits(datasize) operand1 = X[n];  
bits(datasize) operand2 = ShiftReg(m, shift_type, shift_amount);  
  
operand2 = NOT(operand2);  
(result, -) = AddWithCarry(operand1, operand2, '1');  
  
X[d] = result;
```

C6.2.259 SUBS (extended register)

Subtract (extended register), setting flags, subtracts a sign or zero-extended register value, followed by an optional left shift amount, from a register value, and writes the result to the destination register. The argument that is extended from the <Rm> register can be a byte, halfword, word, or doubleword. It updates the condition flags based on the result.

This instruction is used by the alias [CMP \(extended register\)](#). See [Alias conditions](#) for details of when each alias is preferred.

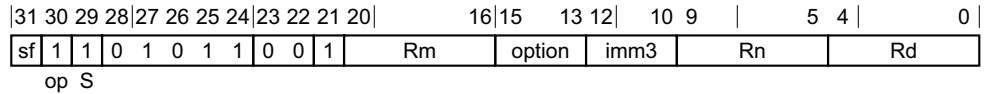

32-bit variant

Applies when sf == 0.

SUBS <Wd>, <Wn|WSP>, <Wm>{, <extend> {#<amount>}}

64-bit variant

Applies when sf == 1.

SUBS <Xd>, <Xn|SP>, <R><m>{, <extend> {#<amount>}}

Decode for all variants of this encoding

```
integer d = UInt(Rd);
integer n = UInt(Rn);
integer m = UInt(Rm);
integer datasize = if sf == '1' then 64 else 32;
ExtendType extend_type = DecodeRegExtend(option);
integer shift = UInt(imm3);
if shift > 4 then ReservedValue();
```

Alias conditions

Alias	is preferred when
CMP (extended register)	Rd == '11111'

Assembler symbols

- <Wd> Is the 32-bit name of the general-purpose destination register, encoded in the "Rd" field.
- <Wn|WSP> Is the 32-bit name of the first source general-purpose register or stack pointer, encoded in the "Rn" field.
- <Wm> Is the 32-bit name of the second general-purpose source register, encoded in the "Rm" field.
- <Xd> Is the 64-bit name of the general-purpose destination register, encoded in the "Rd" field.
- <Xn|SP> Is the 64-bit name of the first source general-purpose register or stack pointer, encoded in the "Rn" field.
- <R> Is a width specifier, encoded in the "option" field. It can have the following values:
 - W when option = 00x

	W	when option = 010
	X	when option = x11
	W	when option = 10x
	W	when option = 110
<m>		Is the number [0-30] of the second general-purpose source register or the name ZR (31), encoded in the "Rm" field.
<extend>		For the 32-bit variant: is the extension to be applied to the second source operand, encoded in the "option" field. It can have the following values: UXTB when option = 000 UXTH when option = 001 LSL UXTW when option = 010 UXTX when option = 011 SXTB when option = 100 SXTH when option = 101 SXTW when option = 110 SXTX when option = 111 If "Rn" is '11111' (WSP) and "option" is '010' then LSL is preferred, but may be omitted when "imm3" is '000'. In all other cases <extend> is required and must be UXTW when "option" is '010'. For the 64-bit variant: is the extension to be applied to the second source operand, encoded in the "option" field. It can have the following values: UXTB when option = 000 UXTH when option = 001 UXTW when option = 010 LSL UXTX when option = 011 SXTB when option = 100 SXTH when option = 101 SXTW when option = 110 SXTX when option = 111 If "Rn" is '11111' (SP) and "option" is '011' then LSL is preferred, but may be omitted when "imm3" is '000'. In all other cases <extend> is required and must be UXTX when "option" is '011'.
<amount>		Is the left shift amount to be applied after extension in the range 0 to 4, defaulting to 0, encoded in the "imm3" field. It must be absent when <extend> is absent, is required when <extend> is LSL, and is optional when <extend> is present but not LSL.

Operation

```

bits(datasize) result;
bits(datasize) operand1 = if n == 31 then SP[] else X[n];
bits(datasize) operand2 = ExtendReg(m, extend_type, shift);
bits(4) nzcvc;

operand2 = NOT(operand2);
(result, nzcvc) = AddWithCarry(operand1, operand2, '1');

PSTATE.<N,Z,C,V> = nzcvc;

X[d] = result;

```

C6.2.260 SUBS (immediate)

Subtract (immediate), setting flags, subtracts an optionally-shifted immediate value from a register value, and writes the result to the destination register. It updates the condition flags based on the result.

This instruction is used by the alias [CMP \(immediate\)](#). See [Alias conditions](#) for details of when each alias is preferred.

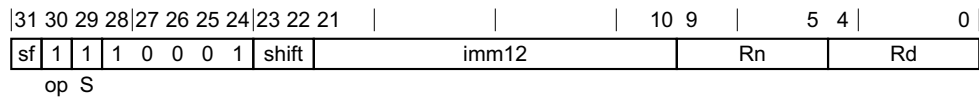

32-bit variant

Applies when sf == 0.

SUBS <Wd>, <Wn|WSP>, #<imm>{, <shift>}

64-bit variant

Applies when sf == 1.

SUBS <Xd>, <Xn|SP>, #<imm>{, <shift>}

Decode for all variants of this encoding

```
integer d = UInt(Rd);
integer n = UInt(Rn);
integer datasize = if sf == '1' then 64 else 32;
bits(datasize) imm;

case shift of
  when '00' imm = ZeroExtend(imm12, datasize);
  when '01' imm = ZeroExtend(imm12:Zeros(12), datasize);
  when '1x' ReservedValue();
```

Alias conditions

Alias	is preferred when
CMP (immediate)	Rd == '11111'

Assembler symbols

- <Wd> Is the 32-bit name of the general-purpose destination register, encoded in the "Rd" field.
- <Wn|WSP> Is the 32-bit name of the source general-purpose register or stack pointer, encoded in the "Rn" field.
- <Xd> Is the 64-bit name of the general-purpose destination register, encoded in the "Rd" field.
- <Xn|SP> Is the 64-bit name of the source general-purpose register or stack pointer, encoded in the "Rn" field.
- <imm> Is an unsigned immediate, in the range 0 to 4095, encoded in the "imm12" field.
- <shift> Is the optional left shift to apply to the immediate, defaulting to LSL #0 and encoded in the "shift" field. It can have the following values:
 - LSL #0 when shift = 00
 - LSL #12 when shift = 01

The encoding shift = 1x is reserved.

Operation

```
bits(datasize) result;  
bits(datasize) operand1 = if n == 31 then SP[] else X[n];  
bits(datasize) operand2;  
bits(4) nzcvc;  
  
operand2 = NOT(imm);  
(result, nzcvc) = AddWithCarry(operand1, operand2, '1');  
  
PSTATE.<N,Z,C,V> = nzcvc;  
  
X[d] = result;
```

C6.2.261 SUBS (shifted register)

Subtract (shifted register), setting flags, subtracts an optionally-shifted register value from a register value, and writes the result to the destination register. It updates the condition flags based on the result.

This instruction is used by the aliases [CMP \(shifted register\)](#) and [NEGS](#). See [Alias conditions](#) for details of when each alias is preferred.

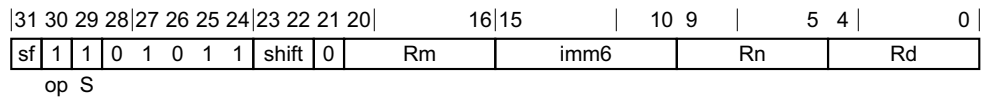

32-bit variant

Applies when sf == 0.

SUBS <Wd>, <Wn>, <Wm>{, <shift> #<amount>}

64-bit variant

Applies when sf == 1.

SUBS <Xd>, <Xn>, <Xm>{, <shift> #<amount>}

Decode for all variants of this encoding

```
integer d = UInt(Rd);
integer n = UInt(Rn);
integer m = UInt(Rm);
integer datasize = if sf == '1' then 64 else 32;

if shift == '11' then ReservedValue();
if sf == '0' && imm6<5> == '1' then ReservedValue();

ShiftType shift_type = DecodeShift(shift);
integer shift_amount = UInt(imm6);
```

Alias conditions

Alias	is preferred when
CMP (shifted register)	Rd == '11111'
NEGS	Rn == '11111'

Assembler symbols

- <Wd> Is the 32-bit name of the general-purpose destination register, encoded in the "Rd" field.
- <Wn> Is the 32-bit name of the first general-purpose source register, encoded in the "Rn" field.
- <Wm> Is the 32-bit name of the second general-purpose source register, encoded in the "Rm" field.
- <Xd> Is the 64-bit name of the general-purpose destination register, encoded in the "Rd" field.
- <Xn> Is the 64-bit name of the first general-purpose source register, encoded in the "Rn" field.
- <Xm> Is the 64-bit name of the second general-purpose source register, encoded in the "Rm" field.

- <shift> Is the optional shift type to be applied to the second source operand, defaulting to LSL and encoded in the "shift" field. It can have the following values:
- LSL when shift = 00
 - LSR when shift = 01
 - ASR when shift = 10
- The encoding shift = 11 is reserved.
- <amount> For the 32-bit variant: is the shift amount, in the range 0 to 31, defaulting to 0 and encoded in the "imm6" field.
- For the 64-bit variant: is the shift amount, in the range 0 to 63, defaulting to 0 and encoded in the "imm6" field.

Operation

```
bits(datasize) result;  
bits(datasize) operand1 = X[n];  
bits(datasize) operand2 = ShiftReg(m, shift_type, shift_amount);  
bits(4) nzcvc;  
  
operand2 = NOT(operand2);  
(result, nzcvc) = AddWithCarry(operand1, operand2, '1');  
  
PSTATE.<N,Z,C,V> = nzcvc;  
  
X[d] = result;
```

C6.2.262 SVC

Supervisor Call causes an exception to be taken to EL1.

On executing an SVC instruction, the PE records the exception as a Supervisor Call exception in [ESR_ELx](#), using the EC value 0x15, and the value of the immediate argument.

31	30	29	28	27	26	25	24	23	22	21	20					5	4	3	2	1	0	
1	1	0	1	0	1	0	0	0	0	0		imm16						0	0	0	0	1

System variant

SVC #<imm>

Decode for this encoding

bits(16) imm = imm16;

Assembler symbols

<imm> Is a 16-bit unsigned immediate, in the range 0 to 65535, encoded in the "imm16" field.

Operation

[AArch64.CallSupervisor](#)(imm);

C6.2.263 SWPB, SWPAB, SWPALB, SWPLB

Swap byte in memory atomically loads an 8-bit byte from a memory location, and stores the value held in a register back to the same memory location. The value initially loaded from memory is returned in the destination register.

- If the destination register is not WZR, SWPAB and SWPALB load from memory with acquire semantics.
- SWPLB and SWPALB store to memory with release semantics.
- SWPB has no memory ordering requirements.

For more information about memory ordering semantics see [Load-Acquire, Store-Release](#) on page B2-94.

For information about memory accesses see [Load/Store addressing modes](#) on page C1-143.

ARMv8.1

31	30	29	28	27	26	25	24	23	22	21	20	16	15	14	12	11	10	9	5	4	0
0	0	1	1	1	0	0	0	A	R	1	Rs	1	0	0	0	0	0	Rn	Rt		
size				V								o3		opc							

Acquire variant

Applies when A == 1 && R == 0.

SWPAB <Ws>, <Wt>, [<Xn|SP>]

Acquire and release variant

Applies when A == 1 && R == 1.

SWPALB <Ws>, <Wt>, [<Xn|SP>]

No memory ordering variant

Applies when A == 0 && R == 0.

SWPB <Ws>, <Wt>, [<Xn|SP>]

Release variant

Applies when A == 0 && R == 1.

SWPLB <Ws>, <Wt>, [<Xn|SP>]

Decode for all variants of this encoding

```
if !HaveAtomicExt() then UnallocatedEncoding();
integer t = UInt(Rt);
integer n = UInt(Rn);
integer s = UInt(Rs);
```

```
AccType ldacctype = if A == '1' && Rt != '11111' then AccType_ORDEREDRW else AccType_ATOMICRW;
AccType stacctype = if R == '1' then AccType_ORDEREDRW else AccType_ATOMICRW;
```

Assembler symbols

- <Ws> Is the 32-bit name of the general-purpose register to be stored, encoded in the "Rs" field.
- <Wt> Is the 32-bit name of the general-purpose register to be loaded, encoded in the "Rt" field.
- <Xn|SP> Is the 64-bit name of the general-purpose base register or stack pointer, encoded in the "Rn" field.

Operation

```
bits(64) address;
bits(8) value;
bits(8) data;

value = X[s];
if n == 31 then
    CheckSPAlignment();
    address = SP[];
else
    address = X[n];
data = Mem[address, 1, ldacctype];

// All observers in the shareability domain observe the
// following load and store atomically.
Mem[address, 1, stacctype] = value;

X[t] = ZeroExtend(data, 32);
```

C6.2.264 SWPH, SWPAH, SWPALH, SWPLH

Swap halfword in memory atomically loads a 16-bit halfword from a memory location, and stores the value held in a register back to the same memory location. The value initially loaded from memory is returned in the destination register.

- If the destination register is not WZR, SWPAH and SWPALH load from memory with acquire semantics.
- SWPLH and SWPALH store to memory with release semantics.
- SWPH has no memory ordering requirements.

For more information about memory ordering semantics see [Load-Acquire, Store-Release](#) on page B2-94.

For information about memory accesses see [Load/Store addressing modes](#) on page C1-143.

ARMv8.1

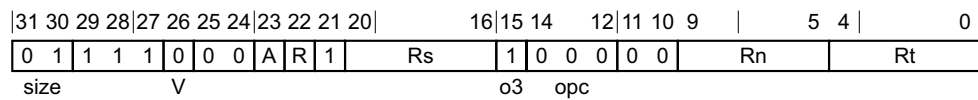

Acquire variant

Applies when A == 1 && R == 0.

SWPAH <Ws>, <Wt>, [<Xn|SP>]

Acquire and release variant

Applies when A == 1 && R == 1.

SWPALH <Ws>, <Wt>, [<Xn|SP>]

No memory ordering variant

Applies when A == 0 && R == 0.

SWPH <Ws>, <Wt>, [<Xn|SP>]

Release variant

Applies when A == 0 && R == 1.

SWPLH <Ws>, <Wt>, [<Xn|SP>]

Decode for all variants of this encoding

```
if !HaveAtomicExt() then UnallocatedEncoding();
integer t = UInt(Rt);
integer n = UInt(Rn);
integer s = UInt(Rs);
```

```
AccType ldacctype = if A == '1' && Rt != '11111' then AccType_ORDEREDRW else AccType_ATOMICRW;
AccType stacctype = if R == '1' then AccType_ORDEREDRW else AccType_ATOMICRW;
```

Assembler symbols

<Ws> Is the 32-bit name of the general-purpose register to be stored, encoded in the "Rs" field.

<Wt> Is the 32-bit name of the general-purpose register to be loaded, encoded in the "Rt" field.

<Xn|SP> Is the 64-bit name of the general-purpose base register or stack pointer, encoded in the "Rn" field.

Operation

```
bits(64) address;
bits(16) value;
bits(16) data;

value = X[s];
if n == 31 then
    CheckSPAlignment();
    address = SP[];
else
    address = X[n];
data = Mem[address, 2, 1dacctype];

// All observers in the shareability domain observe the
// following load and store atomically.
Mem[address, 2, stacctype] = value;

X[t] = ZeroExtend(data, 32);
```

C6.2.265 SWP, SWPA, SWPAL, SWPL

Swap word or doubleword in memory atomically loads a 32-bit word or 64-bit doubleword from a memory location, and stores the value held in a register back to the same memory location. The value initially loaded from memory is returned in the destination register.

- If the destination register is not one of WZR or XZR, SWPA and SWPAL load from memory with acquire semantics.
- SWPL and SWPAL store to memory with release semantics.
- SWP has no memory ordering requirements.

For more information about memory ordering semantics see [Load-Acquire, Store-Release](#) on page B2-94.

For information about memory accesses see [Load/Store addressing modes](#) on page C1-143.

ARMv8.1

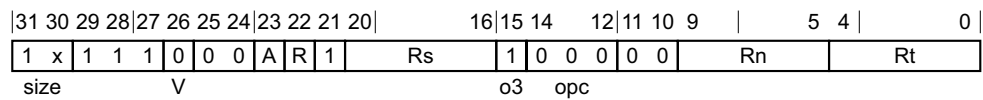

32-bit, acquire variant

Applies when size == 10 && A == 1 && R == 0.

SWPA <Ws>, <Wt>, [<Xn|SP>]

32-bit, acquire and release variant

Applies when size == 10 && A == 1 && R == 1.

SWPAL <Ws>, <Wt>, [<Xn|SP>]

32-bit, no memory ordering variant

Applies when size == 10 && A == 0 && R == 0.

SWP <Ws>, <Wt>, [<Xn|SP>]

32-bit, release variant

Applies when size == 10 && A == 0 && R == 1.

SWPL <Ws>, <Wt>, [<Xn|SP>]

64-bit, acquire variant

Applies when size == 11 && A == 1 && R == 0.

SWPA <Xs>, <Xt>, [<Xn|SP>]

64-bit, acquire and release variant

Applies when size == 11 && A == 1 && R == 1.

SWPAL <Xs>, <Xt>, [<Xn|SP>]

64-bit, no memory ordering variant

Applies when size == 11 && A == 0 && R == 0.

SWP <Xs>, <Xt>, [<Xn|SP>]

64-bit, release variant

Applies when size == 11 && A == 0 && R == 1.

SWPL <Xs>, <Xt>, [<Xn|SP>]

Decode for all variants of this encoding

```
if !HaveAtomicExt() then UnallocatedEncoding();
integer t = UInt(Rt);
integer n = UInt(Rn);
integer s = UInt(Rs);

integer datasize = 8 << UInt(size);
integer regsize = if datasize == 64 then 64 else 32;
AccType ldacctype = if A == '1' && Rt != '11111' then AccType_ORDEREDRW else AccType_ATOMICRW;
AccType stacctype = if R == '1' then AccType_ORDEREDRW else AccType_ATOMICRW;
```

Assembler symbols

<Ws> Is the 32-bit name of the general-purpose register to be stored, encoded in the "Rs" field.
<Wt> Is the 32-bit name of the general-purpose register to be loaded, encoded in the "Rt" field.
<Xs> Is the 64-bit name of the general-purpose register to be stored, encoded in the "Rs" field.
<Xt> Is the 64-bit name of the general-purpose register to be loaded, encoded in the "Rt" field.
<Xn|SP> Is the 64-bit name of the general-purpose base register or stack pointer, encoded in the "Rn" field.

Operation

```
bits(64) address;
bits(datasize) value;
bits(datasize) data;

value = X[s];
if n == 31 then
    CheckSPAAlignment();
    address = SP[];
else
    address = X[n];
data = Mem[address, datasize DIV 8, ldacctype];

// All observers in the shareability domain observe the
// following load and store atomically.
Mem[address, datasize DIV 8, stacctype] = value;

X[t] = ZeroExtend(data, regsize);
```

C6.2.266 SXTB

Signed Extend Byte extracts an 8-bit value from a register, sign-extends it to the size of the register, and writes the result to the destination register.

This instruction is an alias of the [SBFM](#) instruction. This means that:

- The encodings in this description are named to match the encodings of [SBFM](#).
- The description of [SBFM](#) gives the operational pseudocode for this instruction.

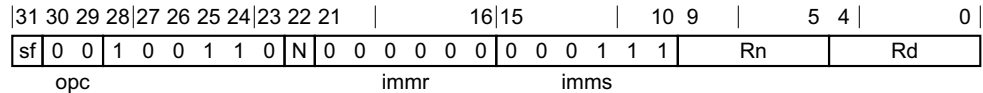

32-bit variant

Applies when $sf == 0 \ \&\& \ N == 0$.

SXTB <Wd>, <Wn>

is equivalent to

SBFM <Wd>, <Wn>, #0, #7

and is always the preferred disassembly.

64-bit variant

Applies when $sf == 1 \ \&\& \ N == 1$.

SXTB <Xd>, <Wn>

is equivalent to

SBFM <Xd>, <Xn>, #0, #7

and is always the preferred disassembly.

Assembler symbols

<Wd> Is the 32-bit name of the general-purpose destination register, encoded in the "Rd" field.

<Xd> Is the 64-bit name of the general-purpose destination register, encoded in the "Rd" field.

<Xn> Is the 64-bit name of the general-purpose source register, encoded in the "Rn" field.

<Wn> Is the 32-bit name of the general-purpose source register, encoded in the "Rn" field.

Operation

The description of [SBFM](#) gives the operational pseudocode for this instruction.

C6.2.267 SXTB

Sign Extend Halfword extracts a 16-bit value, sign-extends it to the size of the register, and writes the result to the destination register.

This instruction is an alias of the [SBFM](#) instruction. This means that:

- The encodings in this description are named to match the encodings of [SBFM](#).
- The description of [SBFM](#) gives the operational pseudocode for this instruction.

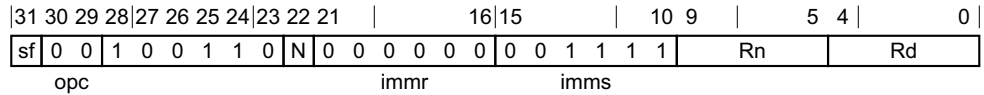

32-bit variant

Applies when $sf == 0 \ \&\& \ N == 0$.

SXTB <Wd>, <Wn>

is equivalent to

SBFM <Wd>, <Wn>, #0, #15

and is always the preferred disassembly.

64-bit variant

Applies when $sf == 1 \ \&\& \ N == 1$.

SXTB <Xd>, <Wn>

is equivalent to

SBFM <Xd>, <Xn>, #0, #15

and is always the preferred disassembly.

Assembler symbols

<Wd> Is the 32-bit name of the general-purpose destination register, encoded in the "Rd" field.

<Xd> Is the 64-bit name of the general-purpose destination register, encoded in the "Rd" field.

<Xn> Is the 64-bit name of the general-purpose source register, encoded in the "Rn" field.

<Wn> Is the 32-bit name of the general-purpose source register, encoded in the "Rn" field.

Operation

The description of [SBFM](#) gives the operational pseudocode for this instruction.

C6.2.268 SXTW

Sign Extend Word sign-extends a word to the size of the register, and writes the result to the destination register.

This instruction is an alias of the [SBFM](#) instruction. This means that:

- The encodings in this description are named to match the encodings of [SBFM](#).
- The description of [SBFM](#) gives the operational pseudocode for this instruction.

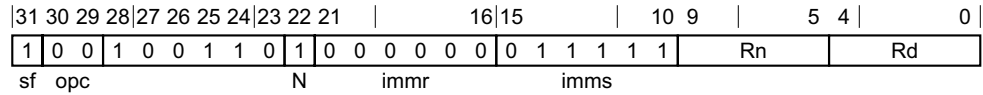

64-bit variant

SXTW <Xd>, <Wn>

is equivalent to

SBFM <Xd>, <Xn>, #0, #31

and is always the preferred disassembly.

Assembler symbols

<Xd> Is the 64-bit name of the general-purpose destination register, encoded in the "Rd" field.

<Xn> Is the 64-bit name of the general-purpose source register, encoded in the "Rn" field.

<Wn> Is the 32-bit name of the general-purpose source register, encoded in the "Rn" field.

Operation

The description of [SBFM](#) gives the operational pseudocode for this instruction.

C6.2.269 SYS

System instruction. For more information, see *op0==0b01, cache maintenance, TLB maintenance, and address translation instructions* on page C5-317 for the encodings of System instructions.

This instruction is used by the aliases *AT, DC, IC,* and *TLBI*. See *Alias conditions* for details of when each alias is preferred.

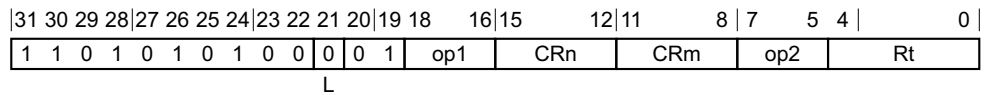

System variant

SYS #<op1>, <Cn>, <Cm>, #<op2>{, <Xt>}

Decode for this encoding

```
AArch64.CheckSystemAccess('01', op1, CRn, CRm, op2, Rt, L);
```

```
integer t = UInt(Rt);
```

```
integer sys_op1 = UInt(op1);
```

```
integer sys_op2 = UInt(op2);
```

```
integer sys_crn = UInt(CRn);
```

```
integer sys_crm = UInt(CRm);
```

Alias conditions

Alias	is preferred when
AT	CRn == '0111' && CRm == '100x' && SysOp(op1, '0111', CRm, op2) == Sys_AT
DC	CRn == '0111' && SysOp(op1, '0111', CRm, op2) == Sys_DC
IC	CRn == '0111' && SysOp(op1, '0111', CRm, op2) == Sys_IC
TLBI	CRn == '1000' && SysOp(op1, '1000', CRm, op2) == Sys_TLBI

Assembler symbols

<op1> Is a 3-bit unsigned immediate, in the range 0 to 7, encoded in the "op1" field.

<Cn> Is a name 'Cn', with 'n' in the range 0 to 15, encoded in the "CRn" field.

<Cm> Is a name 'Cm', with 'm' in the range 0 to 15, encoded in the "CRm" field.

<op2> Is a 3-bit unsigned immediate, in the range 0 to 7, encoded in the "op2" field.

<Xt> Is the 64-bit name of the optional general-purpose source register, defaulting to '11111', encoded in the "Rt" field.

Operation

```
AArch64.SysInstr(1, sys_op1, sys_crn, sys_crm, sys_op2, X[t]);
```

C6.2.270 SYSL

System instruction with result. For more information, see *op0==0b01, cache maintenance, TLB maintenance, and address translation instructions* on page C5-317 for the encodings of System instructions.

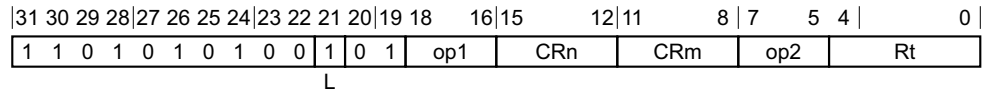

System variant

SYSL <Xt>, #<op1>, <Cn>, <Cm>, #<op2>

Decode for this encoding

```
AArch64.CheckSystemAccess('01', op1, CRn, CRm, op2, Rt, L);
```

```
integer t = UInt(Rt);
```

```
integer sys_op1 = UInt(op1);
```

```
integer sys_op2 = UInt(op2);
```

```
integer sys_crn = UInt(CRn);
```

```
integer sys_crm = UInt(CRm);
```

Assembler symbols

- <Xt> Is the 64-bit name of the general-purpose destination register, encoded in the "Rt" field.
- <op1> Is a 3-bit unsigned immediate, in the range 0 to 7, encoded in the "op1" field.
- <Cn> Is a name 'Cn', with 'n' in the range 0 to 15, encoded in the "CRn" field.
- <Cm> Is a name 'Cm', with 'm' in the range 0 to 15, encoded in the "CRm" field.
- <op2> Is a 3-bit unsigned immediate, in the range 0 to 7, encoded in the "op2" field.

Operation

```
X[t] = AArch64.SysInstrWithResult(1, sys_op1, sys_crn, sys_crm, sys_op2);
```

C6.2.271 TBNZ

Test bit and Branch if Nonzero compares the value of a bit in a general-purpose register with zero, and conditionally branches to a label at a PC-relative offset if the comparison is not equal. It provides a hint that this is not a subroutine call or return. This instruction does not affect condition flags.



14-bit signed PC-relative branch offset variant

TBNZ <R><t>, #<imm>, <label>

Decode for this encoding

```
integer t = UInt(Rt);

integer datasize = if b5 == '1' then 64 else 32;
integer bit_pos = UInt(b5:b40);
bits(64) offset = SignExtend(imm14:'00', 64);
```

Assembler symbols

- <R> Is a width specifier, encoded in the "b5" field. It can have the following values:
- | | |
|---|-------------|
| W | when b5 = 0 |
| X | when b5 = 1 |
- In assembler source code an 'X' specifier is always permitted, but a 'W' specifier is only permitted when the bit number is less than 32.
- <t> Is the number [0-30] of the general-purpose register to be tested or the name ZR (31), encoded in the "Rt" field.
- <imm> Is the bit number to be tested, in the range 0 to 63, encoded in "b5:b40".
- <label> Is the program label to be conditionally branched to. Its offset from the address of this instruction, in the range +/-32KB, is encoded as "imm14" times 4.

Operation

```
bits(datasize) operand = X[t];

if operand<bit_pos> == op then
  BranchTo(PC[] + offset, BranchType_JMP);
```

C6.2.272 TBZ

Test bit and Branch if Zero compares the value of a test bit with zero, and conditionally branches to a label at a PC-relative offset if the comparison is equal. It provides a hint that this is not a subroutine call or return. This instruction does not affect condition flags.

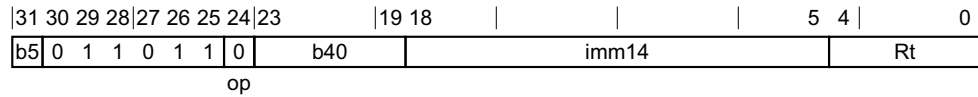

14-bit signed PC-relative branch offset variant

TBZ <R><t>, #<imm>, <label>

Decode for this encoding

```
integer t = UInt(Rt);
integer datasize = if b5 == '1' then 64 else 32;
integer bit_pos = UInt(b5:b40);
bits(64) offset = SignExtend(imm14:'00', 64);
```

Assembler symbols

- <R> Is a width specifier, encoded in the "b5" field. It can have the following values:
- | | |
|---|-------------|
| W | when b5 = 0 |
| X | when b5 = 1 |
- In assembler source code an 'X' specifier is always permitted, but a 'W' specifier is only permitted when the bit number is less than 32.
- <t> Is the number [0-30] of the general-purpose register to be tested or the name ZR (31), encoded in the "Rt" field.
- <imm> Is the bit number to be tested, in the range 0 to 63, encoded in "b5:b40".
- <label> Is the program label to be conditionally branched to. Its offset from the address of this instruction, in the range +/-32KB, is encoded as "imm14" times 4.

Operation

```
bits(datasize) operand = X[t];
if operand<bit_pos> == op then
    BranchTo(PC[] + offset, BranchType_JMP);
```

C6.2.273 TLBI

TLB Invalidate operation. For more information, see [A64 system instructions for TLB maintenance](#).

This instruction is an alias of the [SYS](#) instruction. This means that:

- The encodings in this description are named to match the encodings of [SYS](#).
- The description of [SYS](#) gives the operational pseudocode for this instruction.

31	30	29	28	27	26	25	24	23	22	21	20	19	18	16	15	12	11	8	7	5	4	0
1	1	0	1	0	1	0	1	0	0	0	0	1	op1	1	0	0	0	CRm	op2			Rt
L											CRn											

System variant

TLBI <t1bi_op>{, <Xt>}

is equivalent to

SYS #<op1>, C8, <Cm>, #<op2>{, <Xt>}

and is the preferred disassembly when `SysOp(op1, '1000', CRm, op2) == Sys_TLBI`.

Assembler symbols

<op1> Is a 3-bit unsigned immediate, in the range 0 to 7, encoded in the "op1" field.

<Cm> Is a name 'Cm', with 'm' in the range 0 to 15, encoded in the "CRm" field.

<op2> Is a 3-bit unsigned immediate, in the range 0 to 7, encoded in the "op2" field.

<t1bi_op> Is a TLBI instruction name, as listed for the TLBI system instruction group, encoded in the "op1:CRm:op2" field. It can have the following values:

VMALLE1IS	when op1 = 000, CRm = 0011, op2 = 000
VAE1IS	when op1 = 000, CRm = 0011, op2 = 001
ASIDE1IS	when op1 = 000, CRm = 0011, op2 = 010
VAAE1IS	when op1 = 000, CRm = 0011, op2 = 011
VALE1IS	when op1 = 000, CRm = 0011, op2 = 101
VAALE1IS	when op1 = 000, CRm = 0011, op2 = 111
VMALLE1	when op1 = 000, CRm = 0111, op2 = 000
VAE1	when op1 = 000, CRm = 0111, op2 = 001
ASIDE1	when op1 = 000, CRm = 0111, op2 = 010
VAAE1	when op1 = 000, CRm = 0111, op2 = 011
VALE1	when op1 = 000, CRm = 0111, op2 = 101
VAALE1	when op1 = 000, CRm = 0111, op2 = 111
IPAS2E1IS	when op1 = 100, CRm = 0000, op2 = 001
IPAS2LE1IS	when op1 = 100, CRm = 0000, op2 = 101
ALLE2IS	when op1 = 100, CRm = 0011, op2 = 000
VAE2IS	when op1 = 100, CRm = 0011, op2 = 001
ALLE1IS	when op1 = 100, CRm = 0011, op2 = 100
VALE2IS	when op1 = 100, CRm = 0011, op2 = 101

VMALLS12E1IS when op1 = 100, CRm = 0011, op2 = 110
IPAS2E1 when op1 = 100, CRm = 0100, op2 = 001
IPAS2LE1 when op1 = 100, CRm = 0100, op2 = 101
ALLE2 when op1 = 100, CRm = 0111, op2 = 000
VAE2 when op1 = 100, CRm = 0111, op2 = 001
ALLE1 when op1 = 100, CRm = 0111, op2 = 100
VALE2 when op1 = 100, CRm = 0111, op2 = 101
VMALLS12E1 when op1 = 100, CRm = 0111, op2 = 110
ALLE3IS when op1 = 110, CRm = 0011, op2 = 000
VAE3IS when op1 = 110, CRm = 0011, op2 = 001
VALE3IS when op1 = 110, CRm = 0011, op2 = 101
ALLE3 when op1 = 110, CRm = 0111, op2 = 000
VAE3 when op1 = 110, CRm = 0111, op2 = 001
VALE3 when op1 = 110, CRm = 0111, op2 = 101

<Xt> Is the 64-bit name of the optional general-purpose source register, defaulting to '11111', encoded in the "Rt" field.

Operation

The description of [SYS](#) gives the operational pseudocode for this instruction.

C6.2.274 TST (immediate)

Test bits (immediate) , setting the condition flags and discarding the result : Rn AND imm

This instruction is an alias of the [ANDS \(immediate\)](#) instruction. This means that:

- The encodings in this description are named to match the encodings of [ANDS \(immediate\)](#).
- The description of [ANDS \(immediate\)](#) gives the operational pseudocode for this instruction.

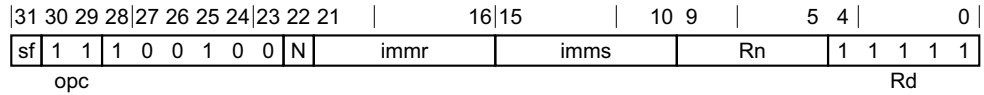

32-bit variant

Applies when sf == 0 && N == 0.

TST <Wn>, #<imm>

is equivalent to

ANDS WZR, <Wn>, #<imm>

and is always the preferred disassembly.

64-bit variant

Applies when sf == 1.

TST <Xn>, #<imm>

is equivalent to

ANDS XZR, <Xn>, #<imm>

and is always the preferred disassembly.

Assembler symbols

<Wn> Is the 32-bit name of the general-purpose source register, encoded in the "Rn" field.

<Xn> Is the 64-bit name of the general-purpose source register, encoded in the "Rn" field.

<imm> For the 32-bit variant: is the bitmask immediate, encoded in "imms:immr".
 For the 64-bit variant: is the bitmask immediate, encoded in "N:imms:immr".

Operation

The description of [ANDS \(immediate\)](#) gives the operational pseudocode for this instruction.

C6.2.275 TST (shifted register)

Test (shifted register) performs a bitwise AND operation on a register value and an optionally-shifted register value. It updates the condition flags based on the result, and discards the result.

This instruction is an alias of the [ANDS \(shifted register\)](#) instruction. This means that:

- The encodings in this description are named to match the encodings of [ANDS \(shifted register\)](#).
- The description of [ANDS \(shifted register\)](#) gives the operational pseudocode for this instruction.

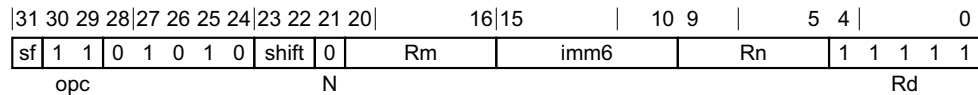

32-bit variant

Applies when `sf == 0`.

TST <Wn>, <Wm>{, <shift> #<amount>}

is equivalent to

ANDS WZR, <Wn>, <Wm>{, <shift> #<amount>}

and is always the preferred disassembly.

64-bit variant

Applies when `sf == 1`.

TST <Xn>, <Xm>{, <shift> #<amount>}

is equivalent to

ANDS XZR, <Xn>, <Xm>{, <shift> #<amount>}

and is always the preferred disassembly.

Assembler symbols

<Wn> Is the 32-bit name of the first general-purpose source register, encoded in the "Rn" field.

<Wm> Is the 32-bit name of the second general-purpose source register, encoded in the "Rm" field.

<Xn> Is the 64-bit name of the first general-purpose source register, encoded in the "Rn" field.

<Xm> Is the 64-bit name of the second general-purpose source register, encoded in the "Rm" field.

<shift> Is the optional shift to be applied to the final source, defaulting to LSL and encoded in the "shift" field. It can have the following values:

LSL when shift = 00

LSR when shift = 01

ASR when shift = 10

ROR when shift = 11

<amount> For the 32-bit variant: is the shift amount, in the range 0 to 31, defaulting to 0 and encoded in the "imm6" field.

For the 64-bit variant: is the shift amount, in the range 0 to 63, defaulting to 0 and encoded in the "imm6" field,

Operation

The description of [ANDS \(shifted register\)](#) gives the operational pseudocode for this instruction.

C6.2.276 UBFIZ

Unsigned Bitfield Insert in Zero zeroes the destination register and copies any number of contiguous bits from a source register into any position in the destination register.

This instruction is an alias of the [UBFM](#) instruction. This means that:

- The encodings in this description are named to match the encodings of [UBFM](#).
- The description of [UBFM](#) gives the operational pseudocode for this instruction.

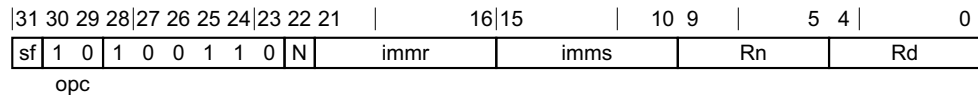

32-bit variant

Applies when $sf == 0 \ \&\& \ N == 0$.

UBFIZ <Wd>, <Wn>, #<lsb>, #<width>

is equivalent to

UBFM <Wd>, <Wn>, #(-<lsb> MOD 32), #(<width>-1)

and is the preferred disassembly when $UInt(imms) < UInt(immr)$.

64-bit variant

Applies when $sf == 1 \ \&\& \ N == 1$.

UBFIZ <Xd>, <Xn>, #<lsb>, #<width>

is equivalent to

UBFM <Xd>, <Xn>, #(-<lsb> MOD 64), #(<width>-1)

and is the preferred disassembly when $UInt(imms) < UInt(immr)$.

Assembler symbols

<Wd>	Is the 32-bit name of the general-purpose destination register, encoded in the "Rd" field.
<Wn>	Is the 32-bit name of the general-purpose source register, encoded in the "Rn" field.
<Xd>	Is the 64-bit name of the general-purpose destination register, encoded in the "Rd" field.
<Xn>	Is the 64-bit name of the general-purpose source register, encoded in the "Rn" field.
<lsb>	For the 32-bit variant: is the bit number of the lsb of the destination bitfield, in the range 0 to 31. For the 64-bit variant: is the bit number of the lsb of the destination bitfield, in the range 0 to 63.
<width>	For the 32-bit variant: is the width of the bitfield, in the range 1 to 32-<lsb>. For the 64-bit variant: is the width of the bitfield, in the range 1 to 64-<lsb>.

Operation

The description of [UBFM](#) gives the operational pseudocode for this instruction.

C6.2.277 UBFM

Unsigned Bitfield Move copies any number of low-order bits from a source register into the same number of adjacent bits at any position in the destination register, with zeros in the upper and lower bits.

This instruction is used by the aliases [LSL \(immediate\)](#), [LSR \(immediate\)](#), [UBFIZ](#), [UBFX](#), [UXTB](#), and [UXTH](#). See [Alias conditions on page C6-961](#) for details of when each alias is preferred.

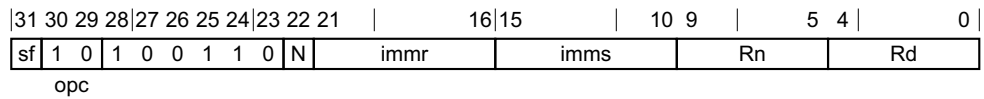

32-bit variant

Applies when `sf == 0 && N == 0`.

UBFM <Wd>, <Wn>, #<immr>, #<imms>

64-bit variant

Applies when `sf == 1 && N == 1`.

UBFM <Xd>, <Xn>, #<immr>, #<imms>

Decode for all variants of this encoding

```
integer d = UInt(Rd);
integer n = UInt(Rn);
integer datasize = if sf == '1' then 64 else 32;

integer R;
bits(datasize) wmask;
bits(datasize) tmask;

if sf == '1' && N != '1' then ReservedValue();
if sf == '0' && (N != '0' || immr<5> != '0' || imms<5> != '0') then ReservedValue();

R = UInt(immr);
(wmask, tmask) = DecodeBitMasks(N, imms, immr, FALSE);
```

Alias conditions

Alias	of variant	is preferred when
LSL (immediate)	32-bit	<code>imms != '011111' && imms + 1 == immr</code>
LSL (immediate)	64-bit	<code>imms != '111111' && imms + 1 == immr</code>
LSR (immediate)	32-bit	<code>imms == '011111'</code>
LSR (immediate)	64-bit	<code>imms == '111111'</code>
UBFIZ	-	<code>UInt(imms) < UInt(immr)</code>
UBFX	-	<code>BFXPreferred(sf, opc<1>, imms, immr)</code>
UXTB	-	<code>immr == '000000' && imms == '000111'</code>
UXTH	-	<code>immr == '000000' && imms == '001111'</code>

Assembler symbols

<Wd>	Is the 32-bit name of the general-purpose destination register, encoded in the "Rd" field.
<Wn>	Is the 32-bit name of the general-purpose source register, encoded in the "Rn" field.
<Xd>	Is the 64-bit name of the general-purpose destination register, encoded in the "Rd" field.
<Xn>	Is the 64-bit name of the general-purpose source register, encoded in the "Rn" field.
<immr>	For the 32-bit variant: is the right rotate amount, in the range 0 to 31, encoded in the "immr" field. For the 64-bit variant: is the right rotate amount, in the range 0 to 63, encoded in the "immr" field.
<imms>	For the 32-bit variant: is the leftmost bit number to be moved from the source, in the range 0 to 31, encoded in the "imms" field. For the 64-bit variant: is the leftmost bit number to be moved from the source, in the range 0 to 63, encoded in the "imms" field.

Operation

```
bits(datasize) src = X[n];

// perform bitfield move on low bits
bits(datasize) bot = ROR(src, R) AND wmask;

// combine extension bits and result bits
X[d] = bot AND tmask;
```

C6.2.278 UBFX

Unsigned Bitfield Extract extracts any number of adjacent bits at any position from a register, zero-extends them to the size of the register, and writes the result to the destination register.

This instruction is an alias of the [UBFM](#) instruction. This means that:

- The encodings in this description are named to match the encodings of [UBFM](#).
- The description of [UBFM](#) gives the operational pseudocode for this instruction.

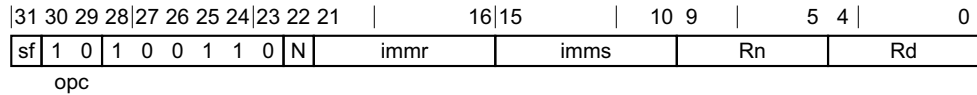

32-bit variant

Applies when $sf == 0 \ \&\& \ N == 0$.

UBFX <Wd>, <Wn>, #<lsb>, #<width>

is equivalent to

UBFM <Wd>, <Wn>, #<lsb>, #(<lsb>+<width>-1)

and is the preferred disassembly when $BFXPreferred(sf, \text{opc}<1>, \text{imms}, \text{immr})$.

64-bit variant

Applies when $sf == 1 \ \&\& \ N == 1$.

UBFX <Xd>, <Xn>, #<lsb>, #<width>

is equivalent to

UBFM <Xd>, <Xn>, #<lsb>, #(<lsb>+<width>-1)

and is the preferred disassembly when $BFXPreferred(sf, \text{opc}<1>, \text{imms}, \text{immr})$.

Assembler symbols

<Wd> Is the 32-bit name of the general-purpose destination register, encoded in the "Rd" field.

<Wn> Is the 32-bit name of the general-purpose source register, encoded in the "Rn" field.

<Xd> Is the 64-bit name of the general-purpose destination register, encoded in the "Rd" field.

<Xn> Is the 64-bit name of the general-purpose source register, encoded in the "Rn" field.

<lsb> For the 32-bit variant: is the bit number of the lsb of the source bitfield, in the range 0 to 31.
 For the 64-bit variant: is the bit number of the lsb of the source bitfield, in the range 0 to 63.

<width> For the 32-bit variant: is the width of the bitfield, in the range 1 to 32-<lsb>.
 For the 64-bit variant: is the width of the bitfield, in the range 1 to 64-<lsb>.

Operation

The description of [UBFM](#) gives the operational pseudocode for this instruction.

C6.2.279 UDIV

Unsigned Divide divides an unsigned integer register value by another unsigned integer register value, and writes the result to the destination register. The condition flags are not affected.

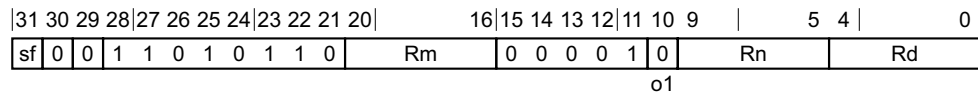

32-bit variant

Applies when `sf == 0`.

UDIV <Wd>, <Wn>, <Wm>

64-bit variant

Applies when `sf == 1`.

UDIV <Xd>, <Xn>, <Xm>

Decode for all variants of this encoding

```
integer d = UInt(Rd);
integer n = UInt(Rn);
integer m = UInt(Rm);
integer datasize = if sf == '1' then 64 else 32;
```

Assembler symbols

- <Wd> Is the 32-bit name of the general-purpose destination register, encoded in the "Rd" field.
- <Wn> Is the 32-bit name of the first general-purpose source register, encoded in the "Rn" field.
- <Wm> Is the 32-bit name of the second general-purpose source register, encoded in the "Rm" field.
- <Xd> Is the 64-bit name of the general-purpose destination register, encoded in the "Rd" field.
- <Xn> Is the 64-bit name of the first general-purpose source register, encoded in the "Rn" field.
- <Xm> Is the 64-bit name of the second general-purpose source register, encoded in the "Rm" field.

Operation

```
bits(datasize) operand1 = X[n];
bits(datasize) operand2 = X[m];
integer result;

if IsZero(operand2) then
  result = 0;
else
  result = RoundTowardsZero(Real(Int(operand1, TRUE)) / Real(Int(operand2, TRUE)));

X[d] = result<datasize-1:0>;
```

C6.2.280 UMADDL

Unsigned Multiply-Add Long multiplies two 32-bit register values, adds a 64-bit register value, and writes the result to the 64-bit destination register.

This instruction is used by the alias [UMULL](#). See *Alias conditions* for details of when each alias is preferred.

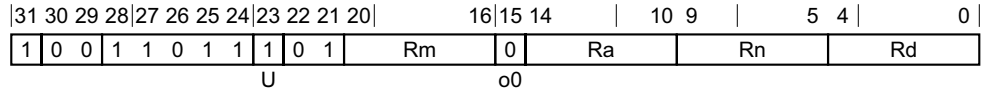

64-bit variant

UMADDL <Xd>, <Wn>, <Wm>, <Xa>

Decode for this encoding

```
integer d = UInt(Rd);
integer n = UInt(Rn);
integer m = UInt(Rm);
integer a = UInt(Ra);
```

Alias conditions

Alias	is preferred when
UMULL	Ra == '11111'

Assembler symbols

- <Xd> Is the 64-bit name of the general-purpose destination register, encoded in the "Rd" field.
- <Wn> Is the 32-bit name of the first general-purpose source register holding the multiplicand, encoded in the "Rn" field.
- <Wm> Is the 32-bit name of the second general-purpose source register holding the multiplier, encoded in the "Rm" field.
- <Xa> Is the 64-bit name of the third general-purpose source register holding the addend, encoded in the "Ra" field.

Operation

```
bits(32) operand1 = X[n];
bits(32) operand2 = X[m];
bits(64) operand3 = X[a];

integer result;

result = Int(operand3, TRUE) + (Int(operand1, TRUE) * Int(operand2, TRUE));

X[d] = result<63:0>;
```

C6.2.281 UMNEGL

Unsigned Multiply-Negate Long multiplies two 32-bit register values, negates the product, and writes the result to the 64-bit destination register.

This instruction is an alias of the [UMSUBL](#) instruction. This means that:

- The encodings in this description are named to match the encodings of [UMSUBL](#).
- The description of [UMSUBL](#) gives the operational pseudocode for this instruction.

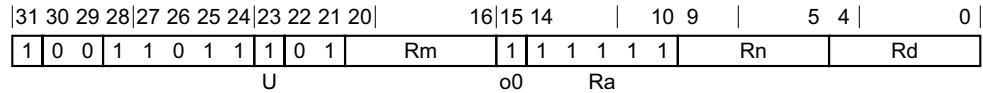

64-bit variant

UMNEGL <Xd>, <Wn>, <Wm>

is equivalent to

UMSUBL <Xd>, <Wn>, <Wm>, XZR

and is always the preferred disassembly.

Assembler symbols

<Xd> Is the 64-bit name of the general-purpose destination register, encoded in the "Rd" field.

<Wn> Is the 32-bit name of the first general-purpose source register holding the multiplicand, encoded in the "Rn" field.

<Wm> Is the 32-bit name of the second general-purpose source register holding the multiplier, encoded in the "Rm" field.

Operation

The description of [UMSUBL](#) gives the operational pseudocode for this instruction.

C6.2.282 UMSUBL

Unsigned Multiply-Subtract Long multiplies two 32-bit register values, subtracts the product from a 64-bit register value, and writes the result to the 64-bit destination register.

This instruction is used by the alias [UMNEGL](#). See [Alias conditions](#) for details of when each alias is preferred.

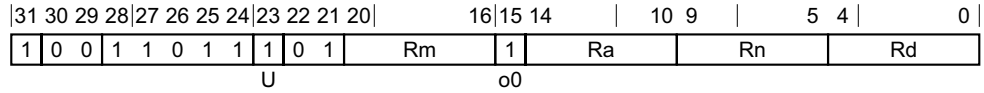

64-bit variant

UMSUBL <Xd>, <Wn>, <Wm>, <Xa>

Decode for this encoding

```
integer d = UInt(Rd);
integer n = UInt(Rn);
integer m = UInt(Rm);
integer a = UInt(Ra);
```

Alias conditions

Alias	is preferred when
UMNEGL	Ra == '11111'

Assembler symbols

- <Xd> Is the 64-bit name of the general-purpose destination register, encoded in the "Rd" field.
- <Wn> Is the 32-bit name of the first general-purpose source register holding the multiplicand, encoded in the "Rn" field.
- <Wm> Is the 32-bit name of the second general-purpose source register holding the multiplier, encoded in the "Rm" field.
- <Xa> Is the 64-bit name of the third general-purpose source register holding the minuend, encoded in the "Ra" field.

Operation

```
bits(32) operand1 = X[n];
bits(32) operand2 = X[m];
bits(64) operand3 = X[a];

integer result;

result = Int(operand3, TRUE) - (Int(operand1, TRUE) * Int(operand2, TRUE));
X[d] = result<63:0>;
```

C6.2.283 UMULH

Unsigned Multiply High multiplies two 64-bit register values, and writes bits[127:64] of the 128-bit result to the 64-bit destination register.

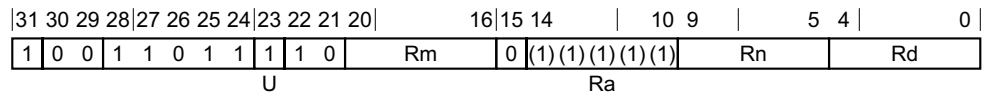

64-bit variant

UMULH <Xd>, <Xn>, <Xm>

Decode for this encoding

```
integer d = UInt(Rd);
integer n = UInt(Rn);
integer m = UInt(Rm);
```

Assembler symbols

- <Xd> Is the 64-bit name of the general-purpose destination register, encoded in the "Rd" field.
- <Xn> Is the 64-bit name of the first general-purpose source register holding the multiplicand, encoded in the "Rn" field.
- <Xm> Is the 64-bit name of the second general-purpose source register holding the multiplier, encoded in the "Rm" field.

Operation

```
bits(64) operand1 = X[n];
bits(64) operand2 = X[m];

integer result;

result = Int(operand1, TRUE) * Int(operand2, TRUE);

X[d] = result<127:64>;
```

C6.2.284 UMULL

Unsigned Multiply Long multiplies two 32-bit register values, and writes the result to the 64-bit destination register.

This instruction is an alias of the [UMADDL](#) instruction. This means that:

- The encodings in this description are named to match the encodings of [UMADDL](#).
- The description of [UMADDL](#) gives the operational pseudocode for this instruction.

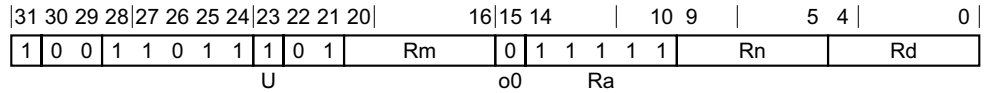

64-bit variant

UMULL <Xd>, <Wn>, <Wm>

is equivalent to

UMADDL <Xd>, <Wn>, <Wm>, XZR

and is always the preferred disassembly.

Assembler symbols

<Xd> Is the 64-bit name of the general-purpose destination register, encoded in the "Rd" field.

<Wn> Is the 32-bit name of the first general-purpose source register holding the multiplicand, encoded in the "Rn" field.

<Wm> Is the 32-bit name of the second general-purpose source register holding the multiplier, encoded in the "Rm" field.

Operation

The description of [UMADDL](#) gives the operational pseudocode for this instruction.

C6.2.285 UXTB

Unsigned Extend Byte extracts an 8-bit value from a register, zero-extends it to the size of the register, and writes the result to the destination register.

This instruction is an alias of the [UBFM](#) instruction. This means that:

- The encodings in this description are named to match the encodings of [UBFM](#).
- The description of [UBFM](#) gives the operational pseudocode for this instruction.

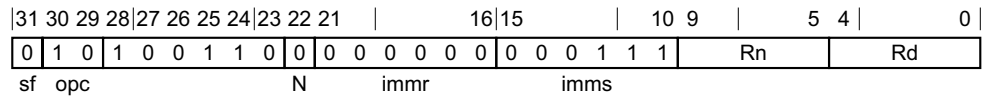

32-bit variant

UXTB <Wd>, <Wn>

is equivalent to

UBFM <Wd>, <Wn>, #0, #7

and is always the preferred disassembly.

Assembler symbols

<Wd> Is the 32-bit name of the general-purpose destination register, encoded in the "Rd" field.

<Wn> Is the 32-bit name of the general-purpose source register, encoded in the "Rn" field.

Operation

The description of [UBFM](#) gives the operational pseudocode for this instruction.

C6.2.286 UXTH

Unsigned Extend Halfword extracts a 16-bit value from a register, zero-extends it to the size of the register, and writes the result to the destination register.

This instruction is an alias of the [UBFM](#) instruction. This means that:

- The encodings in this description are named to match the encodings of [UBFM](#).
- The description of [UBFM](#) gives the operational pseudocode for this instruction.

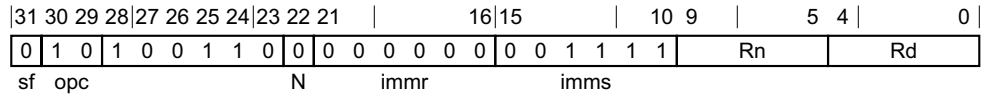

32-bit variant

UXTH <Wd>, <Wn>

is equivalent to

UBFM <Wd>, <Wn>, #0, #15

and is always the preferred disassembly.

Assembler symbols

<Wd> Is the 32-bit name of the general-purpose destination register, encoded in the "Rd" field.

<Wn> Is the 32-bit name of the general-purpose source register, encoded in the "Rn" field.

Operation

The description of [UBFM](#) gives the operational pseudocode for this instruction.

C6.2.287 WFE

Wait For Event is a hint instruction that indicates that the PE can enter a low-power state and remain there until a wakeup event occurs. Wakeup events include the event signaled as a result of executing the SEV instruction on any PE in the multiprocessor system. For more information, see [Wait for Event mechanism and Send event on page D1-1879](#).

As described in [Wait for Event mechanism and Send event on page D1-1879](#), the execution of a WFE instruction that would otherwise cause entry to a low-power state can be trapped to a higher Exception level. See:

- [Traps to EL1 of EL0 execution of WFE and WFI instructions on page D1-1845](#).
- [Traps to EL2 of Non-secure EL0 and EL1 execution of WFE and WFI instructions on page D1-1861](#).
- [Traps to EL3 of EL2, EL1, and EL0 execution of WFE and WFI instructions on page D1-1871](#).

31	30	29	28	27	26	25	24	23	22	21	20	19	18	17	16	15	14	13	12	11	8	7	5	4	3	2	1	0										
1	1	0	1	0	1	0	1	0	0	0	0	0	1	1	0	0	1	0	0	0	0	0	1	0	1	1	1	1	1									
																						CRm		op2														

System variant

WFE

Decode for this encoding

// Empty.

Operation

```

if IsEventRegisterSet() then
    ClearEventRegister();
else
    if PSTATE.EL == EL0 then
        // Check for traps described by the OS which may be EL1 or EL2.
        AArch64.CheckForWFXTrap(EL1, TRUE);
    if HaveEL(EL2) && !IsSecure() && PSTATE.EL IN {EL0, EL1} && !IsInHost() then
        // Check for traps described by the Hypervisor.
        AArch64.CheckForWFXTrap(EL2, TRUE);
    if HaveEL(EL3) && PSTATE.EL != EL3 then
        // Check for traps described by the Secure Monitor.
        AArch64.CheckForWFXTrap(EL3, TRUE);
    WaitForEvent();

```

C6.2.288 WFI

Wait For Interrupt is a hint instruction that indicates that the PE can enter a low-power state and remain there until a wakeup event occurs. For more information, see *Wait For Interrupt* on page D1-1882.

As described in *Wait For Interrupt* on page D1-1882, the execution of a WFI instruction that would otherwise cause entry to a low-power state can be trapped to a higher Exception level. See:

- *Traps to EL1 of EL0 execution of WFE and WFI instructions* on page D1-1845.
- *Traps to EL2 of Non-secure EL0 and EL1 execution of WFE and WFI instructions* on page D1-1861.
- *Traps to EL3 of EL2, EL1, and EL0 execution of WFE and WFI instructions* on page D1-1871.

31	30	29	28	27	26	25	24	23	22	21	20	19	18	17	16	15	14	13	12	11	8	7	5	4	3	2	1	0							
1	1	0	1	0	1	0	1	0	0	0	0	0	0	1	1	0	0	1	0	0	0	0	0	0	1	1	1	1	1						
																						CRm			op2										

System variant

WFI

Decode for this encoding

// Empty.

Operation

```

if !InterruptPending() then
    if PSTATE.EL == EL0 then
        // Check for traps described by the OS which may be EL1 or EL2.
        AArch64.CheckForWFXTrap(EL1, FALSE);
    if HaveEL(EL2) && !IsSecure() && PSTATE.EL IN {EL0, EL1} && !IsInHost() then
        // Check for traps described by the Hypervisor.
        AArch64.CheckForWFXTrap(EL2, FALSE);
    if HaveEL(EL3) && PSTATE.EL != EL3 then
        // Check for traps described by the Secure Monitor.
        AArch64.CheckForWFXTrap(EL3, FALSE);
    WaitForInterrupt();
    
```

C6.2.289 YIELD

YIELD is a hint instruction. Software with a multithreading capability can use a YIELD instruction to indicate to the PE that it is performing a task, for example a spin-lock, that could be swapped out to improve overall system performance. The PE can use this hint to suspend and resume multiple software threads if it supports the capability.

For more information about the recommended use of this instruction, see [The YIELD instruction on page B1-76](#).

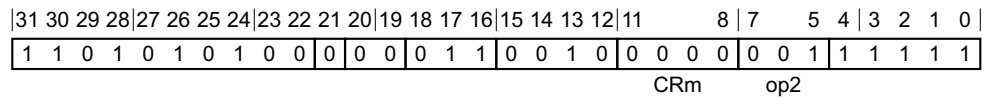

System variant

YIELD

Decode for this encoding

// Empty.

Operation

`Hint_Yield();`

Chapter C7

A64 Advanced SIMD and Floating-point Instruction Descriptions

This chapter describes the A64 SIMD and floating-point instructions.

It contains the following sections:

- *About the A64 SIMD and floating-point instructions on page C7-976.*
- *Alphabetical list of A64 floating-point and Advanced SIMD instructions on page C7-978.*

C7.1 About the A64 SIMD and floating-point instructions

[Alphabetical list of A64 floating-point and Advanced SIMD instructions on page C7-978](#) gives full descriptions of the A64 instructions that are in the following instruction groups:

- Loads and store instructions associated with the SIMD and floating-point registers.
- Data processing instructions with SIMD and floating-point registers.

[A64 instruction set encoding on page C4-210](#) in the A64 Instruction Encodings chapter provides an overview of the instruction encodings as part of an instruction class within a functional group.

The rest of this section is a general description of the SIMD and floating-point instructions. It contains the following subsections:

- [Register size](#).
- [Data types](#).
- [Condition flags and related instructions on page C7-977](#).
- [General capabilities on page C7-977](#).

C7.1.1 Register size

A64 provides a comprehensive set of packed Single Instruction Multiple Data (SIMD) and scalar operations using data held in the 32 entry 128-bit wide SIMD and floating-point register file.

Each SIMD and floating-point register can be used to hold:

- A single scalar value of the floating-point or integer type.
- A 64-bit wide vector containing one or more elements.
- A 128-bit wide vector containing two or more elements.

Where the entire 128-bit wide register is not fully utilized, the vector or scalar quantity is held in the least significant bits of the register, with the most significant bits being cleared to zero on a write, see [Vector formats on page A1-39](#).

The following instructions can insert data into individual elements within a SIMD and floating-point register without clearing the remaining bits to zero:

- Insert vector element from another vector element or general-purpose register, INS.
- Load structure into a single lane, for example LD3.
- All second-part narrowing operations, for example SHR2.

C7.1.2 Data types

The A64 instruction set provides support for arithmetic, conversion, and bitwise operations on:

- Half-precision, single-precision, and double-precision floating points.
- Signed and unsigned integers.
- Polynomials over $\{0, 1\}$.

For all AArch64 floating-point operations, including SIMD operations, the rounding mode and exception trap handling are controlled by the [FPCR](#).

———— **Note** —————

- AArch32 Advanced SIMD operations always use ARM standard floating-point arithmetic, regardless of the rounding mode specified by the AArch64 [FPCR](#) or the AArch32 [FPSCR](#).
- In AArch64 state, floating-point multiply-add operations are always performed as fused operations, but AArch32 state provides both fused and chained multiply-add instructions.

In addition to operations that consume and produce values of the same width and type, the A64 instruction set supports SIMD and scalar operations that produce a wider or narrower vector result:

- Where a SIMD operation narrows a 128-bit vector to a 64-bit vector, the A64 instruction set provides a second-part operation, for example SHRN2, that can pack the result of a second operation into the upper part of the same destination register.
- Where a SIMD operation widens a 64-bit vector to a 128-bit vector, the A64 instruction set provides a second-part operation, for example SMLAL2, that can extract the source from the upper 64 bits of the source registers.

All SIMD operations that could produce side-effects that are not limited to the destination SIMD and floating-point register, for example a potential update of FPSR.Q or FPSR.IDC, have a dedicated scalar variant to support the use of SIMD with loops requiring specialised head or tail handling, or both.

C7.1.3 Condition flags and related instructions

The A64 instruction set provides support for flag setting and conditional operations on the SIMD and floating-point register file:

- Floating-point FCSEL and FCCMP instructions are equivalent to the integer CSEL and CCMP instructions.
- Floating-point FCMP, FCMP, FCCMP, and FCCMP set the PSTATE.{N, Z, C, V} flags based on the result of the floating-point comparison.
- Floating-point and integer instructions provide a means of producing either a scalar or a vector mask based on a comparison in a SIMD and floating-point register, for example FCMEQ.

———— **Note** —————

FCMP and FCMP differ from the A32/T32 VCMP and VCMP instructions, which use the dedicated FPSCR.NZCV field for the result. A64 instructions store the result of an FCMP or FCMP operation in the PSTATE.{N, Z, C, V} field.

C7.1.4 General capabilities

A64 SIMD and floating-point instructions provide the following capabilities:

- General arithmetic on vector and scalar floating-point and integer values.
- Dedicated polynomial multiply over {0, 1}.
- Vector and scalar fused multiply-addition of single-precision and double-precision floating-points, **and for half-precision floating-points when ARMv8.2-FP16 is implemented.**
- Load and store of single and pairs of SIMD and floating-point registers.
- Load and store of structures and individual lanes of between one and four SIMD and floating-point registers.
- Direct conversion between 64-bit integers and floating-point values, with explicit rounding.
- Double-rounding free conversion between double-precision and half-precision floating-point values.
- Comprehensive SIMD with widening and narrowing support.
- Vector to scalar reduction returning the minimum or maximum value, or the sum.
- Floating-point to nearest integer in floating-point format.

C7.2 Alphabetical list of A64 floating-point and Advanced SIMD instructions

This section lists every section in the floating-point and Advanced SIMD categories of the A64 instruction set. For details of the format used, see [Structure of the A64 assembler language on page C1-137](#).

C7.2.1 ABS

Absolute value (vector). This instruction calculates the absolute value of each vector element in the source SIMD&FP register, puts the result into a vector, and writes the vector to the destination SIMD&FP register.

Depending on the settings in the CPACR_EL1, CPTR_EL2, and CPTR_EL3 registers, and the current Security state and Exception level, an attempt to execute the instruction might be trapped.

Scalar

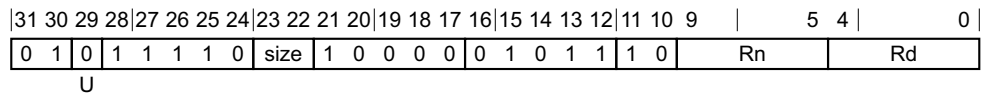

Scalar variant

ABS <V><d>, <V><n>

Decode for this encoding

```
integer d = UInt(Rd);
integer n = UInt(Rn);

if size != '11' then ReservedValue();
integer esize = 8 << UInt(size);
integer datasize = esize;
integer elements = 1;
boolean neg = (U == '1');
```

Vector

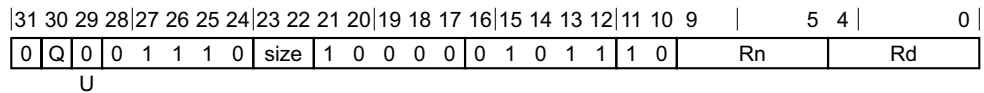

Vector variant

ABS <Vd>.<T>, <Vn>.<T>

Decode for this encoding

```
integer d = UInt(Rd);
integer n = UInt(Rn);

if size:Q == '110' then ReservedValue();
integer esize = 8 << UInt(size);
integer datasize = if Q == '1' then 128 else 64;
integer elements = datasize DIV esize;
boolean neg = (U == '1');
```

Assembler symbols

<V> Is a width specifier, encoded in the "size" field. It can have the following values:

- D when size = 11

The following encodings are reserved:

- size = 0x.
- size = 10.

- <d> Is the number of the SIMD&FP destination register, encoded in the "Rd" field.
- <n> Is the number of the SIMD&FP source register, encoded in the "Rn" field.
- <Vd> Is the name of the SIMD&FP destination register, encoded in the "Rd" field.
- <T> Is an arrangement specifier, encoded in the "size:Q" field. It can have the following values:
- | | |
|-----|-----------------------|
| 8B | when size = 00, Q = 0 |
| 16B | when size = 00, Q = 1 |
| 4H | when size = 01, Q = 0 |
| 8H | when size = 01, Q = 1 |
| 2S | when size = 10, Q = 0 |
| 4S | when size = 10, Q = 1 |
| 2D | when size = 11, Q = 1 |
- The encoding size = 11, Q = 0 is reserved.
- <Vn> Is the name of the SIMD&FP source register, encoded in the "Rn" field.

Operation for all encodings

```
CheckFPAdvSIMDEnabled64();
bits(datasize) operand = V[n];
bits(datasize) result;
integer element;

for e = 0 to elements-1
    element = SInt(Elem[operand, e, esize]);
    if neg then
        element = -element;
    else
        element = Abs(element);
    Elem[result, e, esize] = element<size-1:0>;

V[d] = result;
```

C7.2.2 ADD (vector)

Add (vector). This instruction adds corresponding elements in the two source SIMD&FP registers, places the results into a vector, and writes the vector to the destination SIMD&FP register.

Depending on the settings in the CPACR_EL1, CPTR_EL2, and CPTR_EL3 registers, and the current Security state and Exception level, an attempt to execute the instruction might be trapped.

Scalar

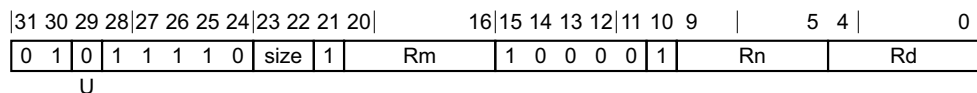

Scalar variant

ADD <V><d>, <V><n>, <V><m>

Decode for this encoding

```
integer d = UInt(Rd);
integer n = UInt(Rn);
integer m = UInt(Rm);
if size != '11' then ReservedValue();
integer esize = 8 << UInt(size);
integer datasize = esize;
integer elements = 1;
boolean sub_op = (U == '1');
```

Vector

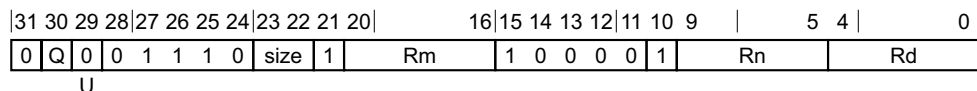

Vector variant

ADD <Vd>.<T>, <Vn>.<T>, <Vm>.<T>

Decode for this encoding

```
integer d = UInt(Rd);
integer n = UInt(Rn);
integer m = UInt(Rm);
if size:Q == '110' then ReservedValue();
integer esize = 8 << UInt(size);
integer datasize = if Q == '1' then 128 else 64;
integer elements = datasize DIV esize;
boolean sub_op = (U == '1');
```

Assembler symbols

<V> Is a width specifier, encoded in the "size" field. It can have the following values:

- D when size = 11

The following encodings are reserved:

- size = 0x.
- size = 10.

- <d> Is the number of the SIMD&FP destination register, in the "Rd" field.
- <n> Is the number of the first SIMD&FP source register, encoded in the "Rn" field.
- <m> Is the number of the second SIMD&FP source register, encoded in the "Rm" field.
- <Vd> Is the name of the SIMD&FP destination register, encoded in the "Rd" field.
- <T> Is an arrangement specifier, encoded in the "size:Q" field. It can have the following values:
- | | |
|-----|-----------------------|
| 8B | when size = 00, Q = 0 |
| 16B | when size = 00, Q = 1 |
| 4H | when size = 01, Q = 0 |
| 8H | when size = 01, Q = 1 |
| 2S | when size = 10, Q = 0 |
| 4S | when size = 10, Q = 1 |
| 2D | when size = 11, Q = 1 |
- The encoding size = 11, Q = 0 is reserved.
- <Vn> Is the name of the first SIMD&FP source register, encoded in the "Rn" field.
- <Vm> Is the name of the second SIMD&FP source register, encoded in the "Rm" field.

Operation for all encodings

```
CheckFPAdvSIMDEnabled64();
bits(datasize) operand1 = V[n];
bits(datasize) operand2 = V[m];
bits(datasize) result;
bits(esize) element1;
bits(esize) element2;

for e = 0 to elements-1
    element1 = Elem[operand1, e, esize];
    element2 = Elem[operand2, e, esize];
    if sub_op then
        Elem[result, e, esize] = element1 - element2;
    else
        Elem[result, e, esize] = element1 + element2;

V[d] = result;
```

C7.2.3 ADDHN, ADDHN2

Add returning High Narrow. This instruction adds each vector element in the first source SIMD&FP register to the corresponding vector element in the second source SIMD&FP register, places the most significant half of the result into a vector, and writes the vector to the lower or upper half of the destination SIMD&FP register.

The results are truncated. For rounded results, see [RADDHN](#), [RADDHN2](#).

The ADDHN instruction writes the vector to the lower half of the destination register and clears the upper half, while the ADDHN2 instruction writes the vector to the upper half of the destination register without affecting the other bits of the register.

Depending on the settings in the [CPACR_EL1](#), [CPTR_EL2](#), and [CPTR_EL3](#) registers, and the current Security state and Exception level, an attempt to execute the instruction might be trapped.

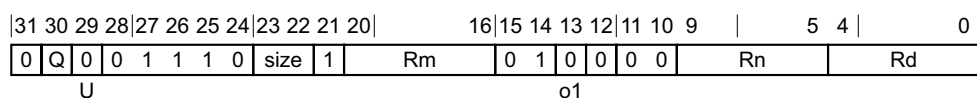

Three registers, not all the same type variant

ADDHN{2} <Vd>.<Tb>, <Vn>.<Ta>, <Vm>.<Ta>

Decode for this encoding

```
integer d = UInt(Rd);
integer n = UInt(Rn);
integer m = UInt(Rm);

if size == '11' then ReservedValue();
integer esize = 8 << UInt(size);
integer datasize = 64;
integer part = UInt(Q);
integer elements = datasize DIV esize;

boolean sub_op = (o1 == '1');
boolean round = (U == '1');
```

Assembler symbols

- 2 Is the second and upper half specifier. If present it causes the operation to be performed on the upper 64 bits of the registers holding the narrower elements, and is encoded in the "Q" field. It can have the following values:
 - [absent] when Q = 0
 - [present] when Q = 1
- <Vd> Is the name of the SIMD&FP destination register, encoded in the "Rd" field.
- <Tb> Is an arrangement specifier, encoded in the "size:Q" field. It can have the following values:
 - 8B when size = 00, Q = 0
 - 16B when size = 00, Q = 1
 - 4H when size = 01, Q = 0
 - 8H when size = 01, Q = 1
 - 2S when size = 10, Q = 0
 - 4S when size = 10, Q = 1

The encoding size = 11, Q = x is reserved.

- <Vn> Is the name of the first SIMD&FP source register, encoded in the "Rn" field.
- <Ta> Is an arrangement specifier, encoded in the "size" field. It can have the following values:
- | | |
|----|----------------|
| 8H | when size = 00 |
| 4S | when size = 01 |
| 2D | when size = 10 |
- The encoding size = 11 is reserved.
- <Vm> Is the name of the second SIMD&FP source register, encoded in the "Rm" field.

Operation

```
CheckFPAdvSIMDEnabled64();
bits(2*datasize) operand1 = V[n];
bits(2*datasize) operand2 = V[m];
bits(datasize) result;
integer round_const = if round then 1 << (esize - 1) else 0;
bits(2*esize) element1;
bits(2*esize) element2;
bits(2*esize) sum;

for e = 0 to elements-1
    element1 = Elem[operand1, e, 2*esize];
    element2 = Elem[operand2, e, 2*esize];
    if sub_op then
        sum = element1 - element2;
    else
        sum = element1 + element2;
    sum = sum + round_const;
    Elem[result, e, esize] = sum<2*esize-1:esize>;

Vpart[d, part] = result;
```

C7.2.4 ADDP (scalar)

Add Pair of elements (scalar). This instruction adds two vector elements in the source SIMD&FP register and writes the scalar result into the destination SIMD&FP register.

Depending on the settings in the CPACR_EL1, CPTR_EL2, and CPTR_EL3 registers, and the current Security state and Exception level, an attempt to execute the instruction might be trapped.

31	30	29	28	27	26	25	24	23	22	21	20	19	18	17	16	15	14	13	12	11	10	9				5	4				0				
0	1	0	1	1	1	1	0	size				1	1	0	0	0	1	1	0	1	1	1	0				Rn						Rd		

Advanced SIMD variant

ADDP <V><d>, <Vn>.<T>

Decode for this encoding

```
integer d = UInt(Rd);
integer n = UInt(Rn);

if size != '11' then ReservedValue();

integer esize = 8 << UInt(size);
integer datasize = esize * 2;
integer elements = 2;

ReduceOp op = ReduceOp_ADD;
```

Assembler symbols

- <V> Is the destination width specifier, encoded in the "size" field. It can have the following values:
- D when size = 11
- The following encodings are reserved:
- size = 0x.
 - size = 10.
- <d> Is the number of the SIMD&FP destination register, encoded in the "Rd" field.
- <Vn> Is the name of the SIMD&FP source register, encoded in the "Rn" field.
- <T> Is the source arrangement specifier, encoded in the "size" field. It can have the following values:
- 2D when size = 11
- The following encodings are reserved:
- size = 0x.
 - size = 10.

Operation

```
CheckFPAdvSIMDEnabled64();
bits(datasize) operand = V[n];
V[d] = Reduce(op, operand, esize);
```

C7.2.5 ADDP (vector)

Add Pairwise (vector). This instruction creates a vector by concatenating the vector elements of the first source SIMD&FP register after the vector elements of the second source SIMD&FP register, reads each pair of adjacent vector elements from the concatenated vector, adds each pair of values together, places the result into a vector, and writes the vector to the destination SIMD&FP register.

Depending on the settings in the CPACR_EL1, CPTR_EL2, and CPTR_EL3 registers, and the current Security state and Exception level, an attempt to execute the instruction might be trapped.

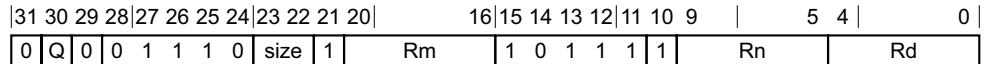

Three registers of the same type variant

ADDP <Vd>.<T>, <Vn>.<T>, <Vm>.<T>

Decode for this encoding

```
integer d = UInt(Rd);
integer n = UInt(Rn);
integer m = UInt(Rm);
if size:Q == '110' then ReservedValue();
integer esize = 8 << UInt(size);
integer datasize = if Q == '1' then 128 else 64;
integer elements = datasize DIV esize;
```

Assembler symbols

- <Vd> Is the name of the SIMD&FP destination register, encoded in the "Rd" field.
- <T> Is an arrangement specifier, encoded in the "size:Q" field. It can have the following values:
 - 8B when size = 00, Q = 0
 - 16B when size = 00, Q = 1
 - 4H when size = 01, Q = 0
 - 8H when size = 01, Q = 1
 - 2S when size = 10, Q = 0
 - 4S when size = 10, Q = 1
 - 2D when size = 11, Q = 1
 The encoding size = 11, Q = 0 is reserved.
- <Vn> Is the name of the first SIMD&FP source register, encoded in the "Rn" field.
- <Vm> Is the name of the second SIMD&FP source register, encoded in the "Rm" field.

Operation

```
CheckFPAdvSIMDEnabled64();
bits(datasize) operand1 = V[n];
bits(datasize) operand2 = V[m];
bits(datasize) result;
bits(2*datasize) concat = operand2:operand1;
bits(esize) element1;
bits(esize) element2;
```



```
for e = 0 to elements-1
  element1 = Elem[concat, 2*e, esize];
  element2 = Elem[concat, (2*e)+1, esize];
  Elem[result, e, esize] = element1 + element2;

V[d] = result;
```

C7.2.6 ADDV

Add across Vector. This instruction adds every vector element in the source SIMD&FP register together, and writes the scalar result to the destination SIMD&FP register.

Depending on the settings in the CPACR_EL1, CPTR_EL2, and CPTR_EL3 registers, and the current Security state and Exception level, an attempt to execute the instruction might be trapped.

31	30	29	28	27	26	25	24	23	22	21	20	19	18	17	16	15	14	13	12	11	10	9	5 4			0	
0	Q	0	0	1	1	1	0	size			1	1	0	0	0	1	1	0	1	1	1	0	Rn			Rd	

Advanced SIMD variant

ADDV <V><d>, <Vn>.<T>

Decode for this encoding

```
integer d = UInt(Rd);
integer n = UInt(Rn);

if size:Q == '100' then ReservedValue();
if size == '11' then ReservedValue();

integer esize = 8 << UInt(size);
integer datasize = if Q == '1' then 128 else 64;
integer elements = datasize DIV esize;

ReduceOp op = ReduceOp_ADD;
```

Assembler symbols

<V> Is the destination width specifier, encoded in the "size" field. It can have the following values:

B when size = 00
 H when size = 01
 S when size = 10

The encoding size = 11 is reserved.

<d> Is the number of the SIMD&FP destination register, encoded in the "Rd" field.

<Vn> Is the name of the SIMD&FP source register, encoded in the "Rn" field.

<T> Is an arrangement specifier, encoded in the "size:Q" field. It can have the following values:

8B when size = 00, Q = 0
 16B when size = 00, Q = 1
 4H when size = 01, Q = 0
 8H when size = 01, Q = 1
 4S when size = 10, Q = 1

The following encodings are reserved:

- size = 10, Q = 0.
- size = 11, Q = x.

Operation

```
CheckFPAdvSIMDEnabled64();  
bits(datasize) operand = V[n];  
V[d] = Reduce(op, operand, esize);
```

C7.2.7 AESD

AES single round decryption

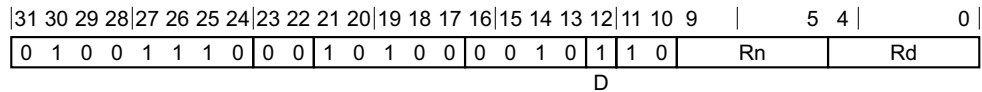

Advanced SIMD variant

AESD <Vd>.16B, <Vn>.16B

Decode for this encoding

```
integer d = UInt(Rd);
integer n = UInt(Rn);
if !HaveCryptoExt() then UnallocatedEncoding();
```

Assembler symbols

<Vd> Is the name of the SIMD&FP source and destination register, encoded in the "Rd" field.

<Vn> Is the name of the second SIMD&FP source register, encoded in the "Rn" field.

Operation

```
CheckCryptoEnabled64();

bits(128) operand1 = V[d];
bits(128) operand2 = V[n];
bits(128) result;
result = operand1 EOR operand2;
result = AESInvSubBytes(AESInvShiftRows(result));
V[d] = result;
```

C7.2.8 AESE

AES single round encryption

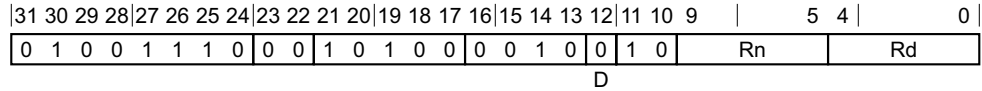

Advanced SIMD variant

AESE <Vd>.16B, <Vn>.16B

Decode for this encoding

```
integer d = UInt(Rd);
integer n = UInt(Rn);
if !HaveCryptoExt() then UnallocatedEncoding();
```

Assembler symbols

- <Vd> Is the name of the SIMD&FP source and destination register, encoded in the "Rd" field.
- <Vn> Is the name of the second SIMD&FP source register, encoded in the "Rn" field.

Operation

```
CheckCryptoEnabled64();

bits(128) operand1 = V[d];
bits(128) operand2 = V[n];
bits(128) result;
result = operand1 EOR operand2;
result = AESSubBytes(AESShiftRows(result));

V[d] = result;
```

C7.2.9 AESIMC

AES inverse mix columns

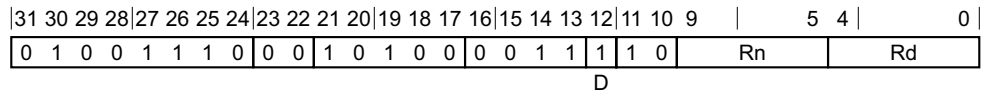

Advanced SIMD variant

AESIMC <Vd>.16B, <Vn>.16B

Decode for this encoding

```
integer d = UInt(Rd);
integer n = UInt(Rn);
if !HaveCryptoExt() then UnallocatedEncoding();
```

Assembler symbols

- <Vd> Is the name of the SIMD&FP destination register, encoded in the "Rd" field.
- <Vn> Is the name of the SIMD&FP source register, encoded in the "Rn" field.

Operation

```
CheckCryptoEnabled64();

bits(128) operand = V[n];
bits(128) result;
result = AESInvMixColumns(operand);
V[d] = result;
```

C7.2.10 AESMC

AES mix columns

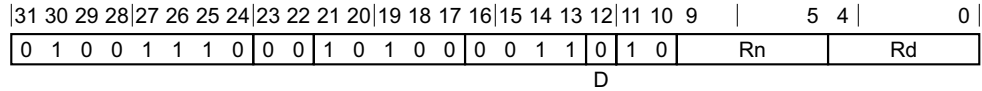

Advanced SIMD variant

AESMC <Vd>.16B, <Vn>.16B

Decode for this encoding

```
integer d = UInt(Rd);
integer n = UInt(Rn);
if !HaveCryptoExt() then UnallocatedEncoding();
```

Assembler symbols

<Vd> Is the name of the SIMD&FP destination register, encoded in the "Rd" field.
 <Vn> Is the name of the SIMD&FP source register, encoded in the "Rn" field.

Operation

```
CheckCryptoEnabled64();
bits(128) operand = V[n];
bits(128) result;
result = AESMixColumns(operand);
V[d] = result;
```

C7.2.11 AND (vector)

Bitwise AND (vector). This instruction performs a bitwise AND between the two source SIMD&FP registers, and writes the result to the destination SIMD&FP register.

Depending on the settings in the CPACR_EL1, CPTR_EL2, and CPTR_EL3 registers, and the current Security state and Exception level, an attempt to execute the instruction might be trapped.

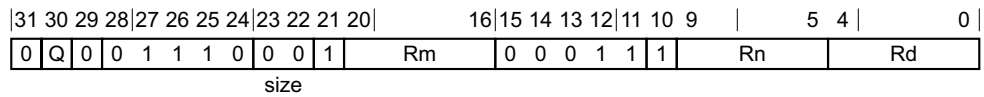

Three registers of the same type variant

AND <Vd>.<T>, <Vn>.<T>, <Vm>.<T>

Decode for this encoding

```
integer d = UInt(Rd);
integer n = UInt(Rn);
integer m = UInt(Rm);
integer datasize = if Q == '1' then 128 else 64;
```

Assembler symbols

- <Vd> Is the name of the SIMD&FP destination register, encoded in the "Rd" field.
- <T> Is an arrangement specifier, encoded in the "Q" field. It can have the following values:
 - 8B when Q = 0
 - 16B when Q = 1
- <Vn> Is the name of the first SIMD&FP source register, encoded in the "Rn" field.
- <Vm> Is the name of the second SIMD&FP source register, encoded in the "Rm" field.

Operation

```
CheckFPAdvSIMDEnabled64();
bits(datasize) operand1 = V[n];
bits(datasize) operand2 = V[m];
bits(datasize) result;

result = operand1 AND operand2;
V[d] = result;
```

C7.2.12 BIC (vector, immediate)

Bitwise bit Clear (vector, immediate). This instruction reads each vector element from the destination SIMD&FP register, performs a bitwise AND between each result and the complement of an immediate constant, places the result into a vector, and writes the vector to the destination SIMD&FP register.

Depending on the settings in the CPACR_EL1, CPTR_EL2, and CPTR_EL3 registers, and the current Security state and Exception level, an attempt to execute the instruction might be trapped.

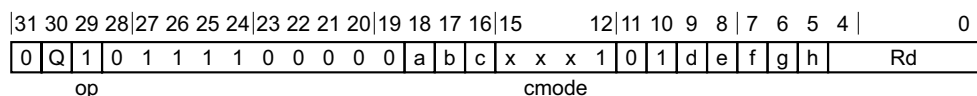

16-bit variant

Applies when cmode == 10x1.

BIC <Vd>.<T>, #<imm8>{, LSL #<amount>}

32-bit variant

Applies when cmode == 0xx1.

BIC <Vd>.<T>, #<imm8>{, LSL #<amount>}

Decode for all variants of this encoding

```
integer rd = UInt(Rd);

integer datasize = if Q == '1' then 128 else 64;
bits(datasize) imm;
bits(64) imm64;

ImmediateOp operation;
case cmode:op of
    when '0xx01' operation = ImmediateOp_MVNI;
    when '0xx11' operation = ImmediateOp_BIC;
    when '10x01' operation = ImmediateOp_MVNI;
    when '10x11' operation = ImmediateOp_BIC;
    when '110x1' operation = ImmediateOp_MVNI;
    when '1110x' operation = ImmediateOp_MOVI;
    when '11111'
        // FMOV Dn,#imm is in main FP instruction set
        if Q == '0' then UnallocatedEncoding();
        operation = ImmediateOp_MOVI;

imm64 = AdvSIMDExpandImm(op, cmode, a:b:c:d:e:f:g:h);
imm = Replicate(imm64, datasize DIV 64);
```

Assembler symbols

- <Vd> Is the name of the SIMD&FP register, encoded in the "Rd" field.
- <T> For the 16-bit variant: is an arrangement specifier, encoded in the "Q" field. It can have the following values:
 - 4H when Q = 0
 - 8H when Q = 1

For the 32-bit variant: is an arrangement specifier, encoded in the "Q" field. It can have the following values:

2S	when Q = 0
4S	when Q = 1

<imm8> Is an 8-bit immediate encoded in "a:b:c:d:e:f:g:h".

<amount> For the 16-bit variant: is the shift amount encoded in the "cmode<1>" field. It can have the following values:

0	when cmode<1> = 0
8	when cmode<1> = 1

defaulting to 0 if LSL is omitted.

For the 32-bit variant: is the shift amount encoded in the "cmode<2:1>" field. It can have the following values:

0	when cmode<2:1> = 00
8	when cmode<2:1> = 01
16	when cmode<2:1> = 10
24	when cmode<2:1> = 11

defaulting to 0 if LSL is omitted.

Operation

```
CheckFPAdvSIMDEnabled64();
bits(datasize) operand;
bits(datasize) result;

case operation of
  when ImmediateOp_MOVI
    result = imm;
  when ImmediateOp_MVNI
    result = NOT(imm);
  when ImmediateOp_ORR
    operand = V[rd];
    result = operand OR imm;
  when ImmediateOp_BIC
    operand = V[rd];
    result = operand AND NOT(imm);

V[rd] = result;
```

C7.2.13 BIC (vector, register)

Bitwise bit Clear (vector, register). This instruction performs a bitwise AND between the first source SIMD&FP register and the complement of the second source SIMD&FP register, and writes the result to the destination SIMD&FP register.

Depending on the settings in the CPACR_EL1, CPTR_EL2, and CPTR_EL3 registers, and the current Security state and Exception level, an attempt to execute the instruction might be trapped.

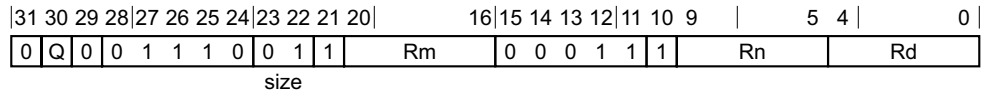

Three registers of the same type variant

BIC <Vd>.<T>, <Vn>.<T>, <Vm>.<T>

Decode for this encoding

```
integer d = UInt(Rd);
integer n = UInt(Rn);
integer m = UInt(Rm);
integer datasize = if Q == '1' then 128 else 64;
```

Assembler symbols

- <Vd> Is the name of the SIMD&FP destination register, encoded in the "Rd" field.
- <T> Is an arrangement specifier, encoded in the "Q" field. It can have the following values:
 - 8B when Q = 0
 - 16B when Q = 1
- <Vn> Is the name of the first SIMD&FP source register, encoded in the "Rn" field.
- <Vm> Is the name of the second SIMD&FP source register, encoded in the "Rm" field.

Operation

```
CheckFPAdvSIMDEnabled64();
bits(datasize) operand1 = V[n];
bits(datasize) operand2 = V[m];
bits(datasize) result;

operand2 = NOT(operand2);

result = operand1 AND operand2;
V[d] = result;
```

C7.2.14 BIF

Bitwise Insert if False. This instruction inserts each bit from the first source SIMD&FP register into the destination SIMD&FP register if the corresponding bit of the second source SIMD&FP register is 0, otherwise leaves the bit in the destination register unchanged.

Depending on the settings in the [CPACR_EL1](#), [CPTR_EL2](#), and [CPTR_EL3](#) registers, and the current Security state and Exception level, an attempt to execute the instruction might be trapped.

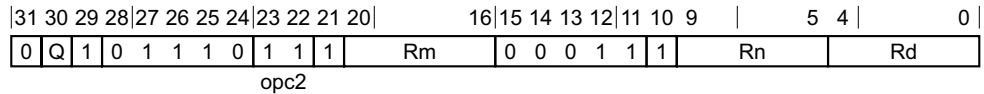

Three registers of the same type variant

BIF <Vd>.<T>, <Vn>.<T>, <Vm>.<T>

Decode for this encoding

```
integer d = UInt(Rd);
integer n = UInt(Rn);
integer m = UInt(Rm);
integer datasize = if Q == '1' then 128 else 64;
```

Assembler symbols

- <Vd> Is the name of the SIMD&FP destination register, encoded in the "Rd" field.
- <T> Is an arrangement specifier, encoded in the "Q" field. It can have the following values:
 - 8B when Q = 0
 - 16B when Q = 1
- <Vn> Is the name of the first SIMD&FP source register, encoded in the "Rn" field.
- <Vm> Is the name of the second SIMD&FP source register, encoded in the "Rm" field.

Operation

```
CheckFPAdvSIMDEnabled64();
bits(datasize) operand1;
bits(datasize) operand3;
bits(datasize) operand4 = V[n];

operand1 = V[d];
operand3 = NOT(V[m]);

V[d] = operand1 EOR ((operand1 EOR operand4) AND operand3);
```

C7.2.15 BIT

Bitwise Insert if True. This instruction inserts each bit from the first source SIMD&FP register into the SIMD&FP destination register if the corresponding bit of the second source SIMD&FP register is 1, otherwise leaves the bit in the destination register unchanged.

Depending on the settings in the [CPACR_EL1](#), [CPTR_EL2](#), and [CPTR_EL3](#) registers, and the current Security state and Exception level, an attempt to execute the instruction might be trapped.

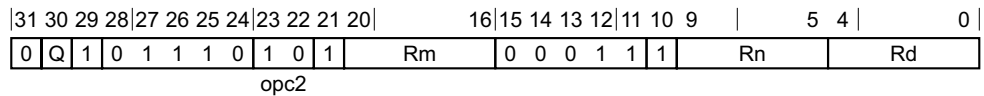

Three registers of the same type variant

BIT <Vd>.<T>, <Vn>.<T>, <Vm>.<T>

Decode for this encoding

```
integer d = UInt(Rd);
integer n = UInt(Rn);
integer m = UInt(Rm);
integer datasize = if Q == '1' then 128 else 64;
```

Assembler symbols

- <Vd> Is the name of the SIMD&FP destination register, encoded in the "Rd" field.
- <T> Is an arrangement specifier, encoded in the "Q" field. It can have the following values:
 - 8B when Q = 0
 - 16B when Q = 1
- <Vn> Is the name of the first SIMD&FP source register, encoded in the "Rn" field.
- <Vm> Is the name of the second SIMD&FP source register, encoded in the "Rm" field.

Operation

```
CheckFPAdvSIMDEnabled64();
bits(datasize) operand1;
bits(datasize) operand3;
bits(datasize) operand4 = V[n];

operand1 = V[d];
operand3 = V[m];
V[d] = operand1 EOR ((operand1 EOR operand4) AND operand3);
```

C7.2.16 BSL

Bitwise Select. This instruction sets each bit in the destination SIMD&FP register to the corresponding bit from the first source SIMD&FP register when the original destination bit was 1, otherwise from the second source SIMD&FP register.

Depending on the settings in the [CPACR_EL1](#), [CPTR_EL2](#), and [CPTR_EL3](#) registers, and the current Security state and Exception level, an attempt to execute the instruction might be trapped.

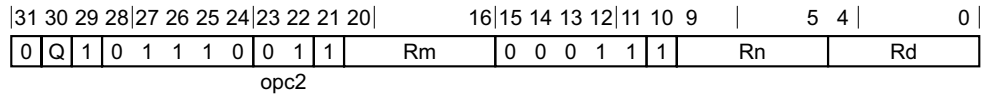

Three registers of the same type variant

BSL <Vd>.<T>, <Vn>.<T>, <Vm>.<T>

Decode for this encoding

```
integer d = UInt(Rd);
integer n = UInt(Rn);
integer m = UInt(Rm);
integer datasize = if Q == '1' then 128 else 64;
```

Assembler symbols

- <Vd> Is the name of the SIMD&FP destination register, encoded in the "Rd" field.
- <T> Is an arrangement specifier, encoded in the "Q" field. It can have the following values:
 - 8B when Q = 0
 - 16B when Q = 1
- <Vn> Is the name of the first SIMD&FP source register, encoded in the "Rn" field.
- <Vm> Is the name of the second SIMD&FP source register, encoded in the "Rm" field.

Operation

```
CheckFPAdvSIMDEnabled64();
bits(datasize) operand1;
bits(datasize) operand3;
bits(datasize) operand4 = V[n];

operand1 = V[m];
operand3 = V[d];
V[d] = operand1 EOR ((operand1 EOR operand4) AND operand3);
```

C7.2.17 CLS (vector)

Count Leading Sign bits (vector). This instruction counts the number of consecutive bits following the most significant bit that are the same as the most significant bit in each vector element in the source SIMD&FP register, places the result into a vector, and writes the vector to the destination SIMD&FP register. The count does not include the most significant bit itself.

Depending on the settings in the [CPACR_EL1](#), [CPTR_EL2](#), and [CPTR_EL3](#) registers, and the current Security state and Exception level, an attempt to execute the instruction might be trapped.

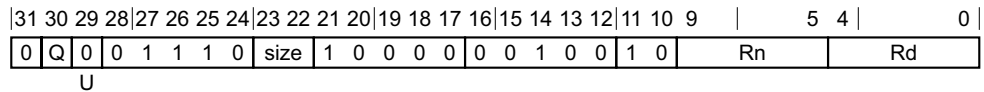

Vector variant

CLS <Vd>.<T>, <Vn>.<T>

Decode for this encoding

```
integer d = UInt(Rd);
integer n = UInt(Rn);

if size == '11' then ReservedValue();
integer esize = 8 << UInt(size);
integer datasize = if Q == '1' then 128 else 64;
integer elements = datasize DIV esize;

CountOp countop = if U == '1' then CountOp_CLZ else CountOp_CLS;
```

Assembler symbols

- <Vd> Is the name of the SIMD&FP destination register, encoded in the "Rd" field.
- <T> Is an arrangement specifier, encoded in the "size:Q" field. It can have the following values:
- | | |
|-----|-----------------------|
| 8B | when size = 00, Q = 0 |
| 16B | when size = 00, Q = 1 |
| 4H | when size = 01, Q = 0 |
| 8H | when size = 01, Q = 1 |
| 2S | when size = 10, Q = 0 |
| 4S | when size = 10, Q = 1 |
- The encoding size = 11, Q = x is reserved.
- <Vn> Is the name of the SIMD&FP source register, encoded in the "Rn" field.

Operation

```
CheckFPAdvSIMDEnabled64();
bits(datasize) operand = V[n];
bits(datasize) result;

integer count;
for e = 0 to elements-1
    if countop == CountOp_CLS then
        count = CountLeadingSignBits(Elem[operand, e, esize]);
    else
```

```
count = CountLeadingZeroBits(Elem[operand, e, esize]);  
Elem[result, e, esize] = count<esize-1:0>;  
V[d] = result;
```

C7.2.18 CLZ (vector)

Count Leading Zero bits (vector). This instruction counts the number of consecutive zeros, starting from the most significant bit, in each vector element in the source SIMD&FP register, places the result into a vector, and writes the vector to the destination SIMD&FP register.

Depending on the settings in the CPACR_EL1, CPTR_EL2, and CPTR_EL3 registers, and the current Security state and Exception level, an attempt to execute the instruction might be trapped.

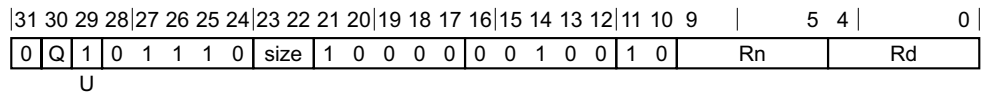

Vector variant

CLZ <Vd>.<T>, <Vn>.<T>

Decode for this encoding

```
integer d = UInt(Rd);
integer n = UInt(Rn);

if size == '11' then ReservedValue();
integer esize = 8 << UInt(size);
integer datasize = if Q == '1' then 128 else 64;
integer elements = datasize DIV esize;

CountOp countop = if U == '1' then CountOp_CLZ else CountOp_CLS;
```

Assembler symbols

- <Vd> Is the name of the SIMD&FP destination register, encoded in the "Rd" field.
- <T> Is an arrangement specifier, encoded in the "size:Q" field. It can have the following values:
- | | |
|-----|-----------------------|
| 8B | when size = 00, Q = 0 |
| 16B | when size = 00, Q = 1 |
| 4H | when size = 01, Q = 0 |
| 8H | when size = 01, Q = 1 |
| 2S | when size = 10, Q = 0 |
| 4S | when size = 10, Q = 1 |
- The encoding size = 11, Q = x is reserved.
- <Vn> Is the name of the SIMD&FP source register, encoded in the "Rn" field.

Operation

```
CheckFPAdvSIMDEnabled64();
bits(datasize) operand = V[n];
bits(datasize) result;

integer count;
for e = 0 to elements-1
    if countop == CountOp_CLS then
        count = CountLeadingSignBits(Elem[operand, e, esize]);
    else
```

```
count = CountLeadingZeroBits(Elem[operand, e, esize]);  
Elem[result, e, esize] = count<esize-1:0>;  
V[d] = result;
```

C7.2.19 CMEQ (register)

Compare bitwise Equal (vector). This instruction compares each vector element from the first source SIMD&FP register with the corresponding vector element from the second source SIMD&FP register, and if the comparison is equal sets every bit of the corresponding vector element in the destination SIMD&FP register to one, otherwise sets every bit of the corresponding vector element in the destination SIMD&FP register to zero.

Depending on the settings in the [CPACR_EL1](#), [CPTR_EL2](#), and [CPTR_EL3](#) registers, and the current Security state and Exception level, an attempt to execute the instruction might be trapped.

Scalar

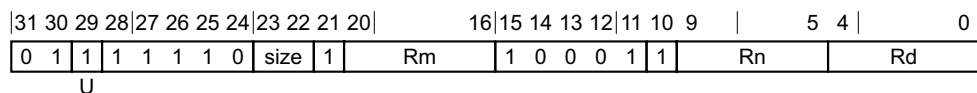

Scalar variant

CMEQ <V><d>, <V><n>, <V><m>

Decode for this encoding

```
integer d = UInt(Rd);
integer n = UInt(Rn);
integer m = UInt(Rm);
if size != '11' then ReservedValue();
integer esize = 8 << UInt(size);
integer datasize = esize;
integer elements = 1;
boolean and_test = (U == '0');
```

Vector

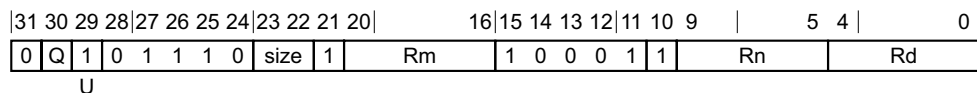

Vector variant

CMEQ <Vd>.<T>, <Vn>.<T>, <Vm>.<T>

Decode for this encoding

```
integer d = UInt(Rd);
integer n = UInt(Rn);
integer m = UInt(Rm);
if size:Q == '110' then ReservedValue();
integer esize = 8 << UInt(size);
integer datasize = if Q == '1' then 128 else 64;
integer elements = datasize DIV esize;
boolean and_test = (U == '0');
```

Assembler symbols

<V> Is a width specifier, encoded in the "size" field. It can have the following values:

D when size = 11

The following encodings are reserved:

- size = 0x.

- size = 10.
- <d> Is the number of the SIMD&FP destination register, in the "Rd" field.
- <n> Is the number of the first SIMD&FP source register, encoded in the "Rn" field.
- <m> Is the number of the second SIMD&FP source register, encoded in the "Rm" field.
- <Vd> Is the name of the SIMD&FP destination register, encoded in the "Rd" field.
- <T> Is an arrangement specifier, encoded in the "size:Q" field. It can have the following values:
- | | |
|-----|-----------------------|
| 8B | when size = 00, Q = 0 |
| 16B | when size = 00, Q = 1 |
| 4H | when size = 01, Q = 0 |
| 8H | when size = 01, Q = 1 |
| 2S | when size = 10, Q = 0 |
| 4S | when size = 10, Q = 1 |
| 2D | when size = 11, Q = 1 |
- The encoding size = 11, Q = 0 is reserved.
- <Vn> Is the name of the first SIMD&FP source register, encoded in the "Rn" field.
- <Vm> Is the name of the second SIMD&FP source register, encoded in the "Rm" field.

Operation for all encodings

```
CheckFPAdvSIMDEnabled64();
bits(datasize) operand1 = V[n];
bits(datasize) operand2 = V[m];
bits(datasize) result;
bits(esize) element1;
bits(esize) element2;
boolean test_passed;

for e = 0 to elements-1
    element1 = Elem[operand1, e, esize];
    element2 = Elem[operand2, e, esize];
    if and_test then
        test_passed = !IsZero(element1 AND element2);
    else
        test_passed = (element1 == element2);
    Elem[result, e, esize] = if test_passed then Ones() else Zeros();

V[d] = result;
```

C7.2.20 CMEQ (zero)

Compare bitwise Equal to zero (vector). This instruction reads each vector element in the source SIMD&FP register and if the value is equal to zero sets every bit of the corresponding vector element in the destination SIMD&FP register to one, otherwise sets every bit of the corresponding vector element in the destination SIMD&FP register to zero.

Depending on the settings in the [CPACR_EL1](#), [CPTR_EL2](#), and [CPTR_EL3](#) registers, and the current Security state and Exception level, an attempt to execute the instruction might be trapped.

Scalar

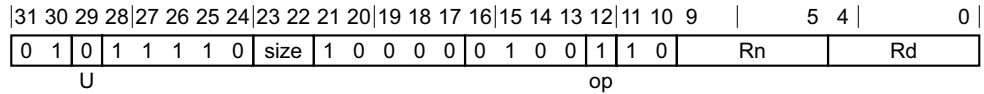

Scalar variant

CMEQ <V><d>, <V><n>, #0

Decode for this encoding

```
integer d = UInt(Rd);
integer n = UInt(Rn);

if size != '11' then ReservedValue();
integer esize = 8 << UInt(size);
integer datasize = esize;
integer elements = 1;

CompareOp comparison;
case op:U of
    when '00' comparison = CompareOp_GT;
    when '01' comparison = CompareOp_GE;
    when '10' comparison = CompareOp_EQ;
    when '11' comparison = CompareOp_LE;
```

Vector

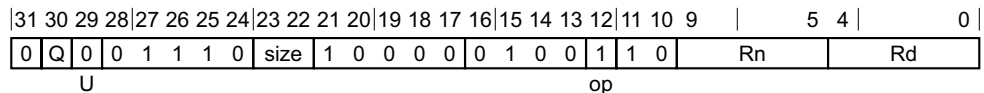

Vector variant

CMEQ <Vd>.<T>, <Vn>.<T>, #0

Decode for this encoding

```
integer d = UInt(Rd);
integer n = UInt(Rn);

if size:Q == '110' then ReservedValue();
integer esize = 8 << UInt(size);
integer datasize = if Q == '1' then 128 else 64;
integer elements = datasize DIV esize;

CompareOp comparison;
case op:U of
    when '00' comparison = CompareOp_GT;
```

```
when '01' comparison = CompareOp_GE;  
when '10' comparison = CompareOp_EQ;  
when '11' comparison = CompareOp_LE;
```

Assembler symbols

- <V> Is a width specifier, encoded in the "size" field. It can have the following values:
- D when size = 11
- The following encodings are reserved:
- size = 0x.
 - size = 10.
- <d> Is the number of the SIMD&FP destination register, encoded in the "Rd" field.
- <n> Is the number of the SIMD&FP source register, encoded in the "Rn" field.
- <Vd> Is the name of the SIMD&FP destination register, encoded in the "Rd" field.
- <T> Is an arrangement specifier, encoded in the "size:Q" field. It can have the following values:
- 8B when size = 00, Q = 0
 - 16B when size = 00, Q = 1
 - 4H when size = 01, Q = 0
 - 8H when size = 01, Q = 1
 - 2S when size = 10, Q = 0
 - 4S when size = 10, Q = 1
 - 2D when size = 11, Q = 1
- The encoding size = 11, Q = 0 is reserved.
- <Vn> Is the name of the SIMD&FP source register, encoded in the "Rn" field.

Operation for all encodings

```
CheckFPAdvSIMDEnabled64();  
bits(datasize) operand = V[n];  
bits(datasize) result;  
integer element;  
boolean test_passed;  
  
for e = 0 to elements-1  
  element = SInt(Elem[operand, e, esize]);  
  case comparison of  
    when CompareOp_GT test_passed = element > 0;  
    when CompareOp_GE test_passed = element >= 0;  
    when CompareOp_EQ test_passed = element == 0;  
    when CompareOp_LE test_passed = element <= 0;  
    when CompareOp_LT test_passed = element < 0;  
  Elem[result, e, esize] = if test_passed then Ones() else Zeros();  
  
V[d] = result;
```

C7.2.21 CMGE (register)

Compare signed Greater than or Equal (vector). This instruction compares each vector element in the first source SIMD&FP register with the corresponding vector element in the second source SIMD&FP register and if the first signed integer value is greater than or equal to the second signed integer value sets every bit of the corresponding vector element in the destination SIMD&FP register to one, otherwise sets every bit of the corresponding vector element in the destination SIMD&FP register to zero.

Depending on the settings in the [CPACR_EL1](#), [CPTR_EL2](#), and [CPTR_EL3](#) registers, and the current Security state and Exception level, an attempt to execute the instruction might be trapped.

Scalar

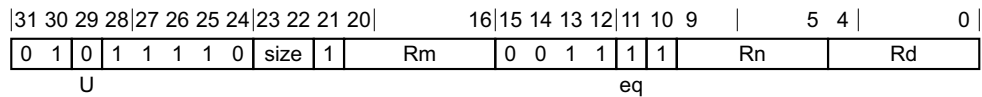

Scalar variant

CMGE <V><d>, <V><n>, <V><m>

Decode for this encoding

```
integer d = UInt(Rd);
integer n = UInt(Rn);
integer m = UInt(Rm);
if size != '11' then ReservedValue();
integer esize = 8 << UInt(size);
integer datasize = esize;
integer elements = 1;
boolean unsigned = (U == '1');
boolean cmp_eq = (eq == '1');
```

Vector

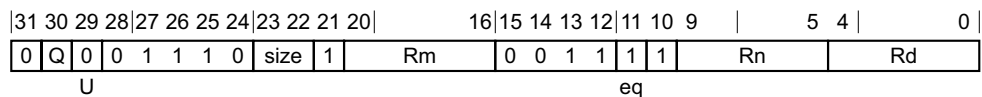

Vector variant

CMGE <Vd>.<T>, <Vn>.<T>, <Vm>.<T>

Decode for this encoding

```
integer d = UInt(Rd);
integer n = UInt(Rn);
integer m = UInt(Rm);
if size:Q == '110' then ReservedValue();
integer esize = 8 << UInt(size);
integer datasize = if Q == '1' then 128 else 64;
integer elements = datasize DIV esize;
boolean unsigned = (U == '1');
boolean cmp_eq = (eq == '1');
```

Assembler symbols

<V> Is a width specifier, encoded in the "size" field. It can have the following values:
 D when size = 11

The following encodings are reserved:

- size = 0x.
- size = 10.

<d>	Is the number of the SIMD&FP destination register, in the "Rd" field.
<n>	Is the number of the first SIMD&FP source register, encoded in the "Rn" field.
<m>	Is the number of the second SIMD&FP source register, encoded in the "Rm" field.
<Vd>	Is the name of the SIMD&FP destination register, encoded in the "Rd" field.
<T>	Is an arrangement specifier, encoded in the "size:Q" field. It can have the following values: 8B when size = 00, Q = 0 16B when size = 00, Q = 1 4H when size = 01, Q = 0 8H when size = 01, Q = 1 2S when size = 10, Q = 0 4S when size = 10, Q = 1 2D when size = 11, Q = 1 The encoding size = 11, Q = 0 is reserved.
<Vn>	Is the name of the first SIMD&FP source register, encoded in the "Rn" field.
<Vm>	Is the name of the second SIMD&FP source register, encoded in the "Rm" field.

Operation for all encodings

```
CheckFPAdvSIMDEnabled64();
bits(datasize) operand1 = V[n];
bits(datasize) operand2 = V[m];
bits(datasize) result;
integer element1;
integer element2;
boolean test_passed;

for e = 0 to elements-1
    element1 = Int(Elem[operand1, e, esize], unsigned);
    element2 = Int(Elem[operand2, e, esize], unsigned);
    test_passed = if cmp_eq then element1 >= element2 else element1 > element2;
    Elem[result, e, esize] = if test_passed then Ones() else Zeros();

V[d] = result;
```

C7.2.22 CMGE (zero)

Compare signed Greater than or Equal to zero (vector). This instruction reads each vector element in the source SIMD&FP register and if the signed integer value is greater than or equal to zero sets every bit of the corresponding vector element in the destination SIMD&FP register to one, otherwise sets every bit of the corresponding vector element in the destination SIMD&FP register to zero.

Depending on the settings in the CPACR_EL1, CPTR_EL2, and CPTR_EL3 registers, and the current Security state and Exception level, an attempt to execute the instruction might be trapped.

Scalar

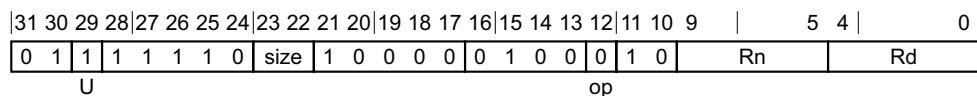

Scalar variant

CMGE <V><d>, <V><n>, #0

Decode for this encoding

```
integer d = UInt(Rd);
integer n = UInt(Rn);

if size != '11' then ReservedValue();
integer esize = 8 << UInt(size);
integer datasize = esize;
integer elements = 1;

CompareOp comparison;
case op:U of
    when '00' comparison = CompareOp_GT;
    when '01' comparison = CompareOp_GE;
    when '10' comparison = CompareOp_EQ;
    when '11' comparison = CompareOp_LE;
```

Vector

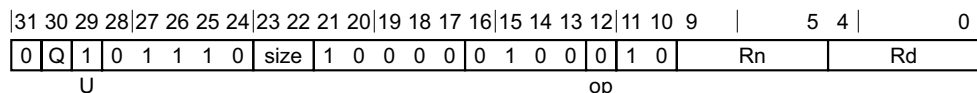

Vector variant

CMGE <Vd>.<T>, <Vn>.<T>, #0

Decode for this encoding

```
integer d = UInt(Rd);
integer n = UInt(Rn);

if size:Q == '110' then ReservedValue();
integer esize = 8 << UInt(size);
integer datasize = if Q == '1' then 128 else 64;
integer elements = datasize DIV esize;

CompareOp comparison;
case op:U of
    when '00' comparison = CompareOp_GT;
```

```
when '01' comparison = CompareOp_GE;  
when '10' comparison = CompareOp_EQ;  
when '11' comparison = CompareOp_LE;
```

Assembler symbols

- <V> Is a width specifier, encoded in the "size" field. It can have the following values:
- D when size = 11
- The following encodings are reserved:
- size = 0x.
 - size = 10.
- <d> Is the number of the SIMD&FP destination register, encoded in the "Rd" field.
- <n> Is the number of the SIMD&FP source register, encoded in the "Rn" field.
- <Vd> Is the name of the SIMD&FP destination register, encoded in the "Rd" field.
- <T> Is an arrangement specifier, encoded in the "size:Q" field. It can have the following values:
- 8B when size = 00, Q = 0
 - 16B when size = 00, Q = 1
 - 4H when size = 01, Q = 0
 - 8H when size = 01, Q = 1
 - 2S when size = 10, Q = 0
 - 4S when size = 10, Q = 1
 - 2D when size = 11, Q = 1
- The encoding size = 11, Q = 0 is reserved.
- <Vn> Is the name of the SIMD&FP source register, encoded in the "Rn" field.

Operation for all encodings

```
CheckFPAdvSIMDEnabled64();  
bits(datasize) operand = V[n];  
bits(datasize) result;  
integer element;  
boolean test_passed;  
  
for e = 0 to elements-1  
  element = SInt(Elem[operand, e, esize]);  
  case comparison of  
    when CompareOp_GT test_passed = element > 0;  
    when CompareOp_GE test_passed = element >= 0;  
    when CompareOp_EQ test_passed = element == 0;  
    when CompareOp_LE test_passed = element <= 0;  
    when CompareOp_LT test_passed = element < 0;  
  Elem[result, e, esize] = if test_passed then Ones() else Zeros();  
  
V[d] = result;
```

C7.2.23 CMGT (register)

Compare signed Greater than (vector). This instruction compares each vector element in the first source SIMD&FP register with the corresponding vector element in the second source SIMD&FP register and if the first signed integer value is greater than the second signed integer value sets every bit of the corresponding vector element in the destination SIMD&FP register to one, otherwise sets every bit of the corresponding vector element in the destination SIMD&FP register to zero.

Depending on the settings in the CPACR_EL1, CPTR_EL2, and CPTR_EL3 registers, and the current Security state and Exception level, an attempt to execute the instruction might be trapped.

Scalar

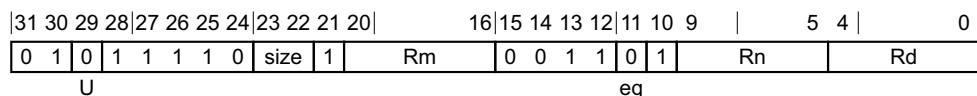

Scalar variant

CMGT <V><d>, <V><n>, <V><m>

Decode for this encoding

```
integer d = UInt(Rd);
integer n = UInt(Rn);
integer m = UInt(Rm);
if size != '11' then ReservedValue();
integer esize = 8 << UInt(size);
integer datasize = esize;
integer elements = 1;
boolean unsigned = (U == '1');
boolean cmp_eq = (eq == '1');
```

Vector

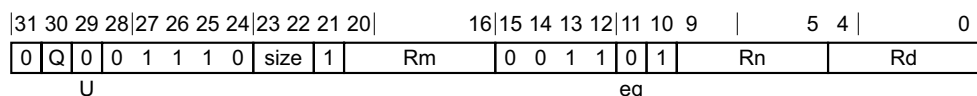

Vector variant

CMGT <Vd>.<T>, <Vn>.<T>, <Vm>.<T>

Decode for this encoding

```
integer d = UInt(Rd);
integer n = UInt(Rn);
integer m = UInt(Rm);
if size:Q == '110' then ReservedValue();
integer esize = 8 << UInt(size);
integer datasize = if Q == '1' then 128 else 64;
integer elements = datasize DIV esize;
boolean unsigned = (U == '1');
boolean cmp_eq = (eq == '1');
```

Assembler symbols

<V> Is a width specifier, encoded in the "size" field. It can have the following values:
 D when size = 11

The following encodings are reserved:

- size = 0x.
- size = 10.

<d>	Is the number of the SIMD&FP destination register, in the "Rd" field.
<n>	Is the number of the first SIMD&FP source register, encoded in the "Rn" field.
<m>	Is the number of the second SIMD&FP source register, encoded in the "Rm" field.
<Vd>	Is the name of the SIMD&FP destination register, encoded in the "Rd" field.
<T>	Is an arrangement specifier, encoded in the "size:Q" field. It can have the following values: 8B when size = 00, Q = 0 16B when size = 00, Q = 1 4H when size = 01, Q = 0 8H when size = 01, Q = 1 2S when size = 10, Q = 0 4S when size = 10, Q = 1 2D when size = 11, Q = 1 The encoding size = 11, Q = 0 is reserved.
<Vn>	Is the name of the first SIMD&FP source register, encoded in the "Rn" field.
<Vm>	Is the name of the second SIMD&FP source register, encoded in the "Rm" field.

Operation for all encodings

```
CheckFPAdvSIMDEnabled64();
bits(datasize) operand1 = V[n];
bits(datasize) operand2 = V[m];
bits(datasize) result;
integer element1;
integer element2;
boolean test_passed;

for e = 0 to elements-1
    element1 = Int(Elem[operand1, e, esize], unsigned);
    element2 = Int(Elem[operand2, e, esize], unsigned);
    test_passed = if cmp_eq then element1 >= element2 else element1 > element2;
    Elem[result, e, esize] = if test_passed then Ones() else Zeros();

V[d] = result;
```

C7.2.24 CMGT (zero)

Compare signed Greater than zero (vector). This instruction reads each vector element in the source SIMD&FP register and if the signed integer value is greater than zero sets every bit of the corresponding vector element in the destination SIMD&FP register to one, otherwise sets every bit of the corresponding vector element in the destination SIMD&FP register to zero.

Depending on the settings in the CPACR_EL1, CPTR_EL2, and CPTR_EL3 registers, and the current Security state and Exception level, an attempt to execute the instruction might be trapped.

Scalar

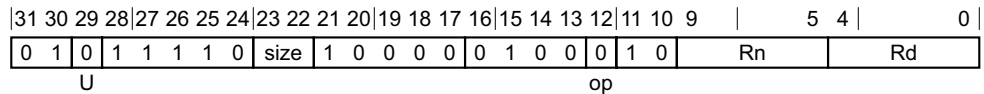

Scalar variant

CMGT <V><d>, <V><n>, #0

Decode for this encoding

```
integer d = UInt(Rd);
integer n = UInt(Rn);

if size != '11' then ReservedValue();
integer esize = 8 << UInt(size);
integer datasize = esize;
integer elements = 1;

CompareOp comparison;
case op:U of
    when '00' comparison = CompareOp_GT;
    when '01' comparison = CompareOp_GE;
    when '10' comparison = CompareOp_EQ;
    when '11' comparison = CompareOp_LE;
```

Vector

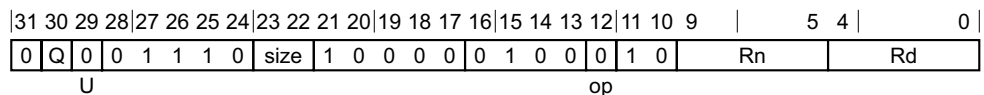

Vector variant

CMGT <Vd>.<T>, <Vn>.<T>, #0

Decode for this encoding

```
integer d = UInt(Rd);
integer n = UInt(Rn);

if size:Q == '110' then ReservedValue();
integer esize = 8 << UInt(size);
integer datasize = if Q == '1' then 128 else 64;
integer elements = datasize DIV esize;

CompareOp comparison;
case op:U of
    when '00' comparison = CompareOp_GT;
```

```
when '01' comparison = CompareOp_GE;  
when '10' comparison = CompareOp_EQ;  
when '11' comparison = CompareOp_LE;
```

Assembler symbols

- <V> Is a width specifier, encoded in the "size" field. It can have the following values:
- D when size = 11
- The following encodings are reserved:
- size = 0x.
 - size = 10.
- <d> Is the number of the SIMD&FP destination register, encoded in the "Rd" field.
- <n> Is the number of the SIMD&FP source register, encoded in the "Rn" field.
- <Vd> Is the name of the SIMD&FP destination register, encoded in the "Rd" field.
- <T> Is an arrangement specifier, encoded in the "size:Q" field. It can have the following values:
- 8B when size = 00, Q = 0
 - 16B when size = 00, Q = 1
 - 4H when size = 01, Q = 0
 - 8H when size = 01, Q = 1
 - 2S when size = 10, Q = 0
 - 4S when size = 10, Q = 1
 - 2D when size = 11, Q = 1
- The encoding size = 11, Q = 0 is reserved.
- <Vn> Is the name of the SIMD&FP source register, encoded in the "Rn" field.

Operation for all encodings

```
CheckFPAdvSIMDEnabled64();  
bits(datasize) operand = V[n];  
bits(datasize) result;  
integer element;  
boolean test_passed;  
  
for e = 0 to elements-1  
  element = SInt(Elem[operand, e, esize]);  
  case comparison of  
    when CompareOp_GT test_passed = element > 0;  
    when CompareOp_GE test_passed = element >= 0;  
    when CompareOp_EQ test_passed = element == 0;  
    when CompareOp_LE test_passed = element <= 0;  
    when CompareOp_LT test_passed = element < 0;  
  Elem[result, e, esize] = if test_passed then Ones() else Zeros();  
  
V[d] = result;
```

C7.2.25 CMHI (register)

Compare unsigned Higher (vector). This instruction compares each vector element in the first source SIMD&FP register with the corresponding vector element in the second source SIMD&FP register and if the first unsigned integer value is greater than the second unsigned integer value sets every bit of the corresponding vector element in the destination SIMD&FP register to one, otherwise sets every bit of the corresponding vector element in the destination SIMD&FP register to zero.

Depending on the settings in the CPACR_EL1, CPTR_EL2, and CPTR_EL3 registers, and the current Security state and Exception level, an attempt to execute the instruction might be trapped.

Scalar

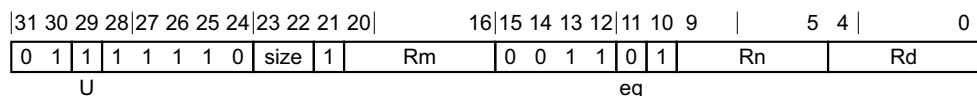

Scalar variant

CMHI <V><d>, <V><n>, <V><m>

Decode for this encoding

```
integer d = UInt(Rd);
integer n = UInt(Rn);
integer m = UInt(Rm);
if size != '11' then ReservedValue();
integer esize = 8 << UInt(size);
integer datasize = esize;
integer elements = 1;
boolean unsigned = (U == '1');
boolean cmp_eq = (eq == '1');
```

Vector

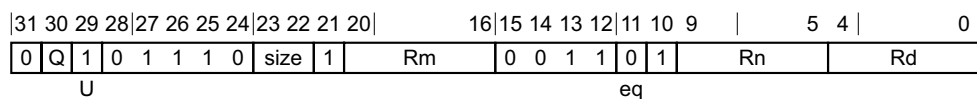

Vector variant

CMHI <Vd>.<T>, <Vn>.<T>, <Vm>.<T>

Decode for this encoding

```
integer d = UInt(Rd);
integer n = UInt(Rn);
integer m = UInt(Rm);
if size:Q == '110' then ReservedValue();
integer esize = 8 << UInt(size);
integer datasize = if Q == '1' then 128 else 64;
integer elements = datasize DIV esize;
boolean unsigned = (U == '1');
boolean cmp_eq = (eq == '1');
```

Assembler symbols

<V> Is a width specifier, encoded in the "size" field. It can have the following values:
 D when size = 11

The following encodings are reserved:

- size = 0x.
- size = 10.

<d>	Is the number of the SIMD&FP destination register, in the "Rd" field.
<n>	Is the number of the first SIMD&FP source register, encoded in the "Rn" field.
<m>	Is the number of the second SIMD&FP source register, encoded in the "Rm" field.
<Vd>	Is the name of the SIMD&FP destination register, encoded in the "Rd" field.
<T>	Is an arrangement specifier, encoded in the "size:Q" field. It can have the following values: 8B when size = 00, Q = 0 16B when size = 00, Q = 1 4H when size = 01, Q = 0 8H when size = 01, Q = 1 2S when size = 10, Q = 0 4S when size = 10, Q = 1 2D when size = 11, Q = 1 The encoding size = 11, Q = 0 is reserved.
<Vn>	Is the name of the first SIMD&FP source register, encoded in the "Rn" field.
<Vm>	Is the name of the second SIMD&FP source register, encoded in the "Rm" field.

Operation for all encodings

```
CheckFPAdvSIMDEnabled64();
bits(datasize) operand1 = V[n];
bits(datasize) operand2 = V[m];
bits(datasize) result;
integer element1;
integer element2;
boolean test_passed;

for e = 0 to elements-1
    element1 = Int(Elem[operand1, e, esize], unsigned);
    element2 = Int(Elem[operand2, e, esize], unsigned);
    test_passed = if cmp_eq then element1 >= element2 else element1 > element2;
    Elem[result, e, esize] = if test_passed then Ones() else Zeros();

V[d] = result;
```

C7.2.26 CMHS (register)

Compare unsigned Higher or Same (vector). This instruction compares each vector element in the first source SIMD&FP register with the corresponding vector element in the second source SIMD&FP register and if the first unsigned integer value is greater than or equal to the second unsigned integer value sets every bit of the corresponding vector element in the destination SIMD&FP register to one, otherwise sets every bit of the corresponding vector element in the destination SIMD&FP register to zero.

Depending on the settings in the [CPACR_EL1](#), [CPTR_EL2](#), and [CPTR_EL3](#) registers, and the current Security state and Exception level, an attempt to execute the instruction might be trapped.

Scalar

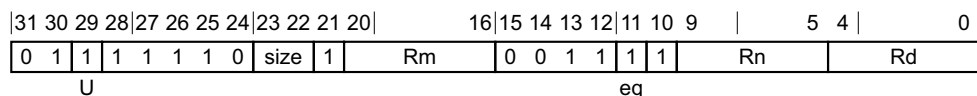

Scalar variant

CMHS <V><d>, <V><n>, <V><m>

Decode for this encoding

```
integer d = UInt(Rd);
integer n = UInt(Rn);
integer m = UInt(Rm);
if size != '11' then ReservedValue();
integer esize = 8 << UInt(size);
integer datasize = esize;
integer elements = 1;
boolean unsigned = (U == '1');
boolean cmp_eq = (eq == '1');
```

Vector

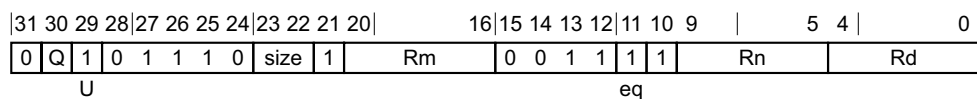

Vector variant

CMHS <Vd>.<T>, <Vn>.<T>, <Vm>.<T>

Decode for this encoding

```
integer d = UInt(Rd);
integer n = UInt(Rn);
integer m = UInt(Rm);
if size:Q == '110' then ReservedValue();
integer esize = 8 << UInt(size);
integer datasize = if Q == '1' then 128 else 64;
integer elements = datasize DIV esize;
boolean unsigned = (U == '1');
boolean cmp_eq = (eq == '1');
```

Assembler symbols

<V> Is a width specifier, encoded in the "size" field. It can have the following values:
 D when size = 11

The following encodings are reserved:

- size = 0x.
- size = 10.

<d>	Is the number of the SIMD&FP destination register, in the "Rd" field.
<n>	Is the number of the first SIMD&FP source register, encoded in the "Rn" field.
<m>	Is the number of the second SIMD&FP source register, encoded in the "Rm" field.
<Vd>	Is the name of the SIMD&FP destination register, encoded in the "Rd" field.
<T>	Is an arrangement specifier, encoded in the "size:Q" field. It can have the following values: 8B when size = 00, Q = 0 16B when size = 00, Q = 1 4H when size = 01, Q = 0 8H when size = 01, Q = 1 2S when size = 10, Q = 0 4S when size = 10, Q = 1 2D when size = 11, Q = 1 The encoding size = 11, Q = 0 is reserved.
<Vn>	Is the name of the first SIMD&FP source register, encoded in the "Rn" field.
<Vm>	Is the name of the second SIMD&FP source register, encoded in the "Rm" field.

Operation for all encodings

```
CheckFPAdvSIMDEnabled64();
bits(datasize) operand1 = V[n];
bits(datasize) operand2 = V[m];
bits(datasize) result;
integer element1;
integer element2;
boolean test_passed;

for e = 0 to elements-1
    element1 = Int(Elem[operand1, e, esize], unsigned);
    element2 = Int(Elem[operand2, e, esize], unsigned);
    test_passed = if cmp_eq then element1 >= element2 else element1 > element2;
    Elem[result, e, esize] = if test_passed then Ones() else Zeros();

V[d] = result;
```

C7.2.27 CMLE (zero)

Compare signed Less than or Equal to zero (vector). This instruction reads each vector element in the source SIMD&FP register and if the signed integer value is less than or equal to zero sets every bit of the corresponding vector element in the destination SIMD&FP register to one, otherwise sets every bit of the corresponding vector element in the destination SIMD&FP register to zero.

Depending on the settings in the [CPACR_EL1](#), [CPTR_EL2](#), and [CPTR_EL3](#) registers, and the current Security state and Exception level, an attempt to execute the instruction might be trapped.

Scalar

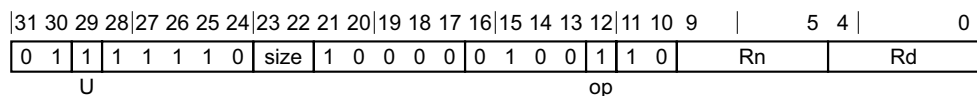

Scalar variant

CMLE <V><d>, <V><n>, #0

Decode for this encoding

```
integer d = UInt(Rd);
integer n = UInt(Rn);

if size != '11' then ReservedValue();
integer esize = 8 << UInt(size);
integer datasize = esize;
integer elements = 1;

CompareOp comparison;
case op:U of
    when '00' comparison = CompareOp_GT;
    when '01' comparison = CompareOp_GE;
    when '10' comparison = CompareOp_EQ;
    when '11' comparison = CompareOp_LE;
```

Vector

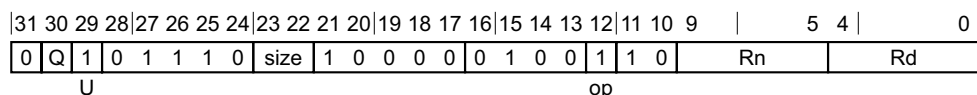

Vector variant

CMLE <Vd>.<T>, <Vn>.<T>, #0

Decode for this encoding

```
integer d = UInt(Rd);
integer n = UInt(Rn);

if size:Q == '110' then ReservedValue();
integer esize = 8 << UInt(size);
integer datasize = if Q == '1' then 128 else 64;
integer elements = datasize DIV esize;

CompareOp comparison;
case op:U of
    when '00' comparison = CompareOp_GT;
```

```
when '01' comparison = CompareOp_GE;  
when '10' comparison = CompareOp_EQ;  
when '11' comparison = CompareOp_LE;
```

Assembler symbols

- <V> Is a width specifier, encoded in the "size" field. It can have the following values:
- D when size = 11
- The following encodings are reserved:
- size = 0x.
 - size = 10.
- <d> Is the number of the SIMD&FP destination register, encoded in the "Rd" field.
- <n> Is the number of the SIMD&FP source register, encoded in the "Rn" field.
- <Vd> Is the name of the SIMD&FP destination register, encoded in the "Rd" field.
- <T> Is an arrangement specifier, encoded in the "size:Q" field. It can have the following values:
- 8B when size = 00, Q = 0
 - 16B when size = 00, Q = 1
 - 4H when size = 01, Q = 0
 - 8H when size = 01, Q = 1
 - 2S when size = 10, Q = 0
 - 4S when size = 10, Q = 1
 - 2D when size = 11, Q = 1
- The encoding size = 11, Q = 0 is reserved.
- <Vn> Is the name of the SIMD&FP source register, encoded in the "Rn" field.

Operation for all encodings

```
CheckFPAdvSIMDEnabled64();  
bits(datasize) operand = V[n];  
bits(datasize) result;  
integer element;  
boolean test_passed;  
  
for e = 0 to elements-1  
  element = SInt(Elem[operand, e, esize]);  
  case comparison of  
    when CompareOp_GT test_passed = element > 0;  
    when CompareOp_GE test_passed = element >= 0;  
    when CompareOp_EQ test_passed = element == 0;  
    when CompareOp_LE test_passed = element <= 0;  
    when CompareOp_LT test_passed = element < 0;  
  Elem[result, e, esize] = if test_passed then Ones() else Zeros();  
  
V[d] = result;
```

C7.2.28 CMLT (zero)

Compare signed Less than zero (vector). This instruction reads each vector element in the source SIMD&FP register and if the signed integer value is less than zero sets every bit of the corresponding vector element in the destination SIMD&FP register to one, otherwise sets every bit of the corresponding vector element in the destination SIMD&FP register to zero.

Depending on the settings in the [CPACR_EL1](#), [CPTR_EL2](#), and [CPTR_EL3](#) registers, and the current Security state and Exception level, an attempt to execute the instruction might be trapped.

Scalar

31	30	29	28	27	26	25	24	23	22	21	20	19	18	17	16	15	14	13	12	11	10	9	5 4			0
0	1	0	1	1	1	1	0	size	1	0	0	0	0	0	1	0	1	0	1	0	1	0	Rn			Rd

Scalar variant

CMLT <V><d>, <V><n>, #0

Decode for this encoding

```
integer d = UInt(Rd);
integer n = UInt(Rn);

if size != '11' then ReservedValue();
integer esize = 8 << UInt(size);
integer datasize = esize;
integer elements = 1;

CompareOp comparison = CompareOp_LT;
```

Vector

31	30	29	28	27	26	25	24	23	22	21	20	19	18	17	16	15	14	13	12	11	10	9	5 4			0
0	Q	0	0	1	1	1	0	size	1	0	0	0	0	0	1	0	1	0	1	0	1	0	Rn			Rd

Vector variant

CMLT <Vd>.<T>, <Vn>.<T>, #0

Decode for this encoding

```
integer d = UInt(Rd);
integer n = UInt(Rn);

if size:Q == '110' then ReservedValue();
integer esize = 8 << UInt(size);
integer datasize = if Q == '1' then 128 else 64;
integer elements = datasize DIV esize;

CompareOp comparison = CompareOp_LT;
```

Assembler symbols

<V> Is a width specifier, encoded in the "size" field. It can have the following values:
 D when size = 11

The following encodings are reserved:

- size = 0x.
- size = 10.

- <d> Is the number of the SIMD&FP destination register, encoded in the "Rd" field.
- <n> Is the number of the SIMD&FP source register, encoded in the "Rn" field.
- <Vd> Is the name of the SIMD&FP destination register, encoded in the "Rd" field.
- <T> Is an arrangement specifier, encoded in the "size:Q" field. It can have the following values:
- | | |
|-----|-----------------------|
| 8B | when size = 00, Q = 0 |
| 16B | when size = 00, Q = 1 |
| 4H | when size = 01, Q = 0 |
| 8H | when size = 01, Q = 1 |
| 2S | when size = 10, Q = 0 |
| 4S | when size = 10, Q = 1 |
| 2D | when size = 11, Q = 1 |
- The encoding size = 11, Q = 0 is reserved.
- <Vn> Is the name of the SIMD&FP source register, encoded in the "Rn" field.

Operation for all encodings

```
CheckFPAdvSIMDEnabled64();
bits(datasize) operand = V[n];
bits(datasize) result;
integer element;
boolean test_passed;

for e = 0 to elements-1
    element = SInt(Elem[operand, e, esize]);
    case comparison of
        when CompareOp_GT test_passed = element > 0;
        when CompareOp_GE test_passed = element >= 0;
        when CompareOp_EQ test_passed = element == 0;
        when CompareOp_LE test_passed = element <= 0;
        when CompareOp_LT test_passed = element < 0;
    Elem[result, e, esize] = if test_passed then Ones() else Zeros();

V[d] = result;
```

C7.2.29 CMTST

Compare bitwise Test bits nonzero (vector). This instruction reads each vector element in the first source SIMD&FP register, performs an AND with the corresponding vector element in the second source SIMD&FP register, and if the result is not zero, sets every bit of the corresponding vector element in the destination SIMD&FP register to one, otherwise sets every bit of the corresponding vector element in the destination SIMD&FP register to zero.

Depending on the settings in the [CPACR_EL1](#), [CPTR_EL2](#), and [CPTR_EL3](#) registers, and the current Security state and Exception level, an attempt to execute the instruction might be trapped.

Scalar

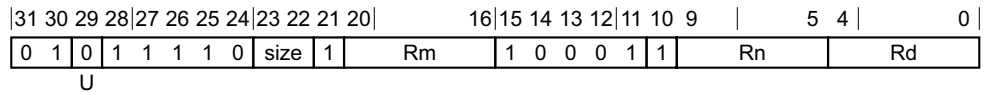

Scalar variant

CMTST <V><d>, <V><n>, <V><m>

Decode for this encoding

```
integer d = UInt(Rd);
integer n = UInt(Rn);
integer m = UInt(Rm);
if size != '11' then ReservedValue();
integer esize = 8 << UInt(size);
integer datasize = esize;
integer elements = 1;
boolean and_test = (U == '0');
```

Vector

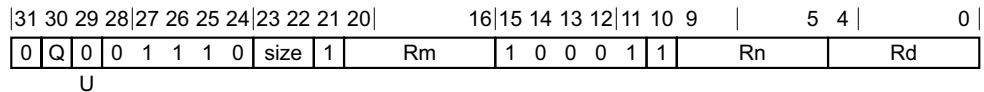

Vector variant

CMTST <Vd>.<T>, <Vn>.<T>, <Vm>.<T>

Decode for this encoding

```
integer d = UInt(Rd);
integer n = UInt(Rn);
integer m = UInt(Rm);
if size:Q == '110' then ReservedValue();
integer esize = 8 << UInt(size);
integer datasize = if Q == '1' then 128 else 64;
integer elements = datasize DIV esize;
boolean and_test = (U == '0');
```

Assembler symbols

<V> Is a width specifier, encoded in the "size" field. It can have the following values:

D when size = 11

The following encodings are reserved:

- size = 0x.

- size = 10.
- <d> Is the number of the SIMD&FP destination register, in the "Rd" field.
- <n> Is the number of the first SIMD&FP source register, encoded in the "Rn" field.
- <m> Is the number of the second SIMD&FP source register, encoded in the "Rm" field.
- <Vd> Is the name of the SIMD&FP destination register, encoded in the "Rd" field.
- <T> Is an arrangement specifier, encoded in the "size:Q" field. It can have the following values:
- | | |
|-----|-----------------------|
| 8B | when size = 00, Q = 0 |
| 16B | when size = 00, Q = 1 |
| 4H | when size = 01, Q = 0 |
| 8H | when size = 01, Q = 1 |
| 2S | when size = 10, Q = 0 |
| 4S | when size = 10, Q = 1 |
| 2D | when size = 11, Q = 1 |
- The encoding size = 11, Q = 0 is reserved.
- <Vn> Is the name of the first SIMD&FP source register, encoded in the "Rn" field.
- <Vm> Is the name of the second SIMD&FP source register, encoded in the "Rm" field.

Operation for all encodings

```
CheckFPAdvSIMDEnabled64();
bits(datasize) operand1 = V[n];
bits(datasize) operand2 = V[m];
bits(datasize) result;
bits(esize) element1;
bits(esize) element2;
boolean test_passed;

for e = 0 to elements-1
    element1 = Elem[operand1, e, esize];
    element2 = Elem[operand2, e, esize];
    if and_test then
        test_passed = !IsZero(element1 AND element2);
    else
        test_passed = (element1 == element2);
    Elem[result, e, esize] = if test_passed then Ones() else Zeros();

V[d] = result;
```

C7.2.30 CNT

Population Count per byte. This instruction counts the number of bits that have a value of one in each vector element in the source SIMD&FP register, places the result into a vector, and writes the vector to the destination SIMD&FP register.

Depending on the settings in the [CPACR_EL1](#), [CPTR_EL2](#), and [CPTR_EL3](#) registers, and the current Security state and Exception level, an attempt to execute the instruction might be trapped.

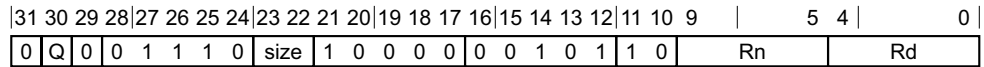

Vector variant

CNT <Vd>.<T>, <Vn>.<T>

Decode for this encoding

```
integer d = UInt(Rd);
integer n = UInt(Rn);

if size != '00' then ReservedValue();
integer esize = 8;
integer datasize = if Q == '1' then 128 else 64;
integer elements = datasize DIV 8;
```

Assembler symbols

- <Vd> Is the name of the SIMD&FP destination register, encoded in the "Rd" field.
- <T> Is an arrangement specifier, encoded in the "size:Q" field. It can have the following values:
- | | |
|-----|-----------------------|
| 8B | when size = 00, Q = 0 |
| 16B | when size = 00, Q = 1 |
- The following encodings are reserved:
- size = 01, Q = x.
 - size = 1x, Q = x.
- <Vn> Is the name of the SIMD&FP source register, encoded in the "Rn" field.

Operation

```
CheckFPAdvSIMDEnabled64();
bits(datasize) operand = V[n];
bits(datasize) result;

integer count;
for e = 0 to elements-1
    count = BitCount(Elem[operand, e, esize]);
    Elem[result, e, esize] = count<esize-1:0>;
V[d] = result;
```

C7.2.31 DUP (element)

Duplicate vector element to vector or scalar. This instruction duplicates the vector element at the specified element index in the source SIMD&FP register into a scalar or each element in a vector, and writes the result to the destination SIMD&FP register.

Depending on the settings in the CPACR_EL1, CPTR_EL2, and CPTR_EL3 registers, and the current Security state and Exception level, an attempt to execute the instruction might be trapped.

This instruction is used by the alias MOV (scalar). The alias is always the preferred disassembly.

Scalar

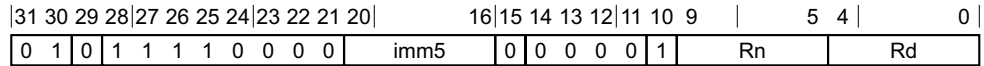

Scalar variant

DUP <V><d>, <Vn>.<T>[<index>]

Decode for this encoding

```
integer d = UInt(Rd);
integer n = UInt(Rn);

integer size = LowestSetBit(imm5);
if size > 3 then UnallocatedEncoding();

integer index = UInt(imm5<4:size+1>);
integer idxsize = if imm5<4> == '1' then 128 else 64;

integer esize = 8 << size;
integer datasize = esize;
integer elements = 1;
```

Vector

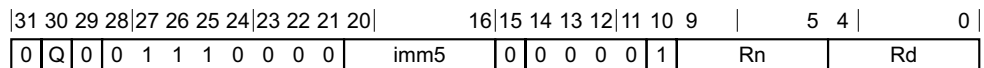

Vector variant

DUP <Vd>.<T>, <Vn>.<Ts>[<index>]

Decode for this encoding

```
integer d = UInt(Rd);
integer n = UInt(Rn);

integer size = LowestSetBit(imm5);
if size > 3 then UnallocatedEncoding();

integer index = UInt(imm5<4:size+1>);
integer idxsize = if imm5<4> == '1' then 128 else 64;

if size == 3 && Q == '0' then ReservedValue();
integer esize = 8 << size;
integer datasize = if Q == '1' then 128 else 64;
integer elements = datasize DIV esize;
```

Assembler symbols

<T> For the scalar variant: is the element width specifier, encoded in the "imm5" field. It can have the following values:

B when imm5 = xxxx1
H when imm5 = xxx10
S when imm5 = xx100
D when imm5 = x1000

The encoding imm5 = x0000 is reserved.

For the vector variant: is an arrangement specifier, encoded in the "imm5:Q" field. It can have the following values:

8B when imm5 = xxxx1, Q = 0
16B when imm5 = xxxx1, Q = 1
4H when imm5 = xxx10, Q = 0
8H when imm5 = xxx10, Q = 1
2S when imm5 = xx100, Q = 0
4S when imm5 = xx100, Q = 1
2D when imm5 = x1000, Q = 1

The following encodings are reserved:

- imm5 = x0000, Q = x.
- imm5 = x1000, Q = 0.

<Ts> Is an element size specifier, encoded in the "imm5" field. It can have the following values:

B when imm5 = xxxx1
H when imm5 = xxx10
S when imm5 = xx100
D when imm5 = x1000

The encoding imm5 = x0000 is reserved.

<V> Is the destination width specifier, encoded in the "imm5" field. It can have the following values:

B when imm5 = xxxx1
H when imm5 = xxx10
S when imm5 = xx100
D when imm5 = x1000

The encoding imm5 = x0000 is reserved.

<Vn> Is the name of the SIMD&FP source register, encoded in the "Rn" field.

<index> Is the element index encoded in the "imm5" field. It can have the following values:

imm5<4:1> when imm5 = xxxx1
imm5<4:2> when imm5 = xxx10
imm5<4:3> when imm5 = xx100
imm5<4> when imm5 = x1000

The encoding imm5 = x0000 is reserved.

<d> Is the number of the SIMD&FP destination register, encoded in the "Rd" field.

<Vd> Is the name of the SIMD&FP destination register, encoded in the "Rd" field.

Operation for all encodings

```
CheckFPAdvSIMDEnabled64();  
bits(idxsize) operand = V[n];  
bits(datasize) result;  
bits(esize) element;  
  
element = Elem[operand, index, esize];  
for e = 0 to elements-1  
    Elem[result, e, esize] = element;  
V[d] = result;
```

C7.2.32 DUP (general)

Duplicate general-purpose register to vector. This instruction duplicates the contents of the source general-purpose register into a scalar or each element in a vector, and writes the result to the SIMD&FP destination register.

Depending on the settings in the CPACR_EL1, CPTR_EL2, and CPTR_EL3 registers, and the current Security state and Exception level, an attempt to execute the instruction might be trapped.

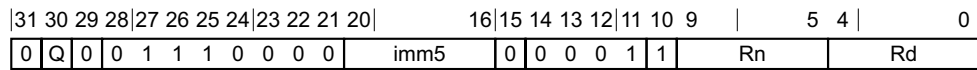

Advanced SIMD variant

DUP <Vd>.<T>, <R><n>

Decode for this encoding

```
integer d = UInt(Rd);
integer n = UInt(Rn);

integer size = LowestSetBit(imm5);
if size > 3 then UnallocatedEncoding();

// imm5<4:size+1> is IGNORED

if size == 3 && Q == '0' then ReservedValue();
integer esize = 8 << size;
integer datasize = if Q == '1' then 128 else 64;
integer elements = datasize DIV esize;
```

Assembler symbols

- <Vd> Is the name of the SIMD&FP destination register, encoded in the "Rd" field.
- <T> Is an arrangement specifier, encoded in the "imm5:Q" field. It can have the following values:
 - 8B when imm5 = xxxx1, Q = 0
 - 16B when imm5 = xxxx1, Q = 1
 - 4H when imm5 = xxx10, Q = 0
 - 8H when imm5 = xxx10, Q = 1
 - 2S when imm5 = xx100, Q = 0
 - 4S when imm5 = xx100, Q = 1
 - 2D when imm5 = x1000, Q = 1
 The following encodings are reserved:
 - imm5 = x0000, Q = x.
 - imm5 = x1000, Q = 0.
- <R> Is the width specifier for the general-purpose source register, encoded in the "imm5" field. It can have the following values:
 - W when imm5 = xxxx1
 - W when imm5 = xxx10
 - W when imm5 = xx100
 - X when imm5 = x1000

The encoding `imm5 = x0000` is reserved.

Unspecified bits in "imm5" are ignored but should be set to zero by an assembler.

<n> Is the number [0-30] of the general-purpose source register or ZR (31), encoded in the "Rn" field.

Operation

```
CheckFPAdvSIMDEnabled64();
bits(esize) element = X[n];
bits(datasize) result;

for e = 0 to elements-1
    Elem[result, e, esize] = element;
V[d] = result;
```

C7.2.33 EOR (vector)

Bitwise Exclusive OR (vector). This instruction performs a bitwise Exclusive OR operation between the two source SIMD&FP registers, and places the result in the destination SIMD&FP register.

Depending on the settings in the CPACR_EL1, CPTR_EL2, and CPTR_EL3 registers, and the current Security state and Exception level, an attempt to execute the instruction might be trapped.

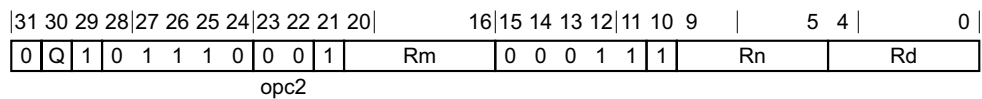

Three registers of the same type variant

EOR <Vd>.<T>, <Vn>.<T>, <Vm>.<T>

Decode for this encoding

```
integer d = UInt(Rd);
integer n = UInt(Rn);
integer m = UInt(Rm);
integer datasize = if Q == '1' then 128 else 64;
```

Assembler symbols

- <Vd> Is the name of the SIMD&FP destination register, encoded in the "Rd" field.
- <T> Is an arrangement specifier, encoded in the "Q" field. It can have the following values:
 - 8B when Q = 0
 - 16B when Q = 1
- <Vn> Is the name of the first SIMD&FP source register, encoded in the "Rn" field.
- <Vm> Is the name of the second SIMD&FP source register, encoded in the "Rm" field.

Operation

```
CheckFPAdvSIMDEnabled64();
bits(datasize) operand1;
bits(datasize) operand2;
bits(datasize) operand3;
bits(datasize) operand4 = V[n];

operand1 = V[m];
operand2 = Zeros();
operand3 = Ones();
V[d] = operand1 EOR ((operand2 EOR operand4) AND operand3);
```

C7.2.34 EXT

Extract vector from pair of vectors. This instruction extracts the lowest vector elements from the second source SIMD&FP register and the highest vector elements from the first source SIMD&FP register, concatenates the results into a vector, and writes the vector to the destination SIMD&FP register vector. The index value specifies the lowest vector element to extract from the first source register, and consecutive elements are extracted from the first, then second, source registers until the destination vector is filled.

The following figure shows the operation of EXT doubleword operation for $Q = 0$ and $\text{imm4}\langle 2:0 \rangle = 3$.

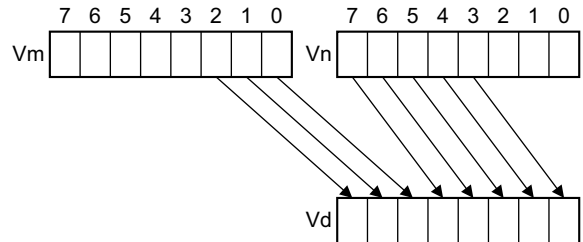

Depending on the settings in the CPACR_EL1, CPTR_EL2, and CPTR_EL3 registers, and the current Security state and Exception level, an attempt to execute the instruction might be trapped.

31 30 29 28			27 26 25 24			23 22 21 20			16 15 14			11 10 9			5 4		0	
0	Q	1	0	1	1	1	0	0	0	0	Rm	0	imm4	0	Rn	Rd		

Advanced SIMD variant

EXT <Vd>.<T>, <Vn>.<T>, <Vm>.<T>, #<index>

Decode for this encoding

```
integer d = UInt(Rd);
integer n = UInt(Rn);
integer m = UInt(Rm);
```

```
if Q == '0' && imm4<3> == '1' then UnallocatedEncoding();
```

```
integer datasize = if Q == '1' then 128 else 64;
integer position = UInt(imm4) << 3;
```

Assembler symbols

- <Vd> Is the name of the SIMD&FP destination register, encoded in the "Rd" field.
- <T> Is an arrangement specifier, encoded in the "Q" field. It can have the following values:
 - 8B when $Q = 0$
 - 16B when $Q = 1$
- <Vn> Is the name of the first SIMD&FP source register, encoded in the "Rn" field.
- <Vm> Is the name of the second SIMD&FP source register, encoded in the "Rm" field.
- <index> Is the lowest numbered byte element to be extracted, encoded in the "Q:imm4" field. It can have the following values:
 - $\text{imm4}\langle 2:0 \rangle$ when $Q = 0$, $\text{imm4}\langle 3 \rangle = 0$
 - imm4 when $Q = 1$, $\text{imm4}\langle 3 \rangle = x$
 The encoding $Q = 0$, $\text{imm4}\langle 3 \rangle = 1$ is reserved.

Operation

```
CheckFPAdvSIMDEnabled64();  
bits(datasize) hi = V[m];  
bits(datasize) lo = V[n];  
bits(datasize*2) concat = hi:lo;  
  
V[d] = concat<position+datasize-1:position>;
```

C7.2.35 FABD

Floating-point Absolute Difference (vector). This instruction subtracts the floating-point values in the elements of the second source SIMD&FP register, from the corresponding floating-point values in the elements of the first source SIMD&FP register, places the absolute value of each result in a vector, and writes the vector to the destination SIMD&FP register.

This instruction can generate a floating-point exception. Depending on the settings in [FPCR](#), the exception results in either a flag being set in [FPSR](#), or a synchronous exception being generated. For more information, see [Floating-point exceptions and exception traps on page D1-1831](#).

Depending on the settings in the [CPACR_EL1](#), [CPTR_EL2](#), and [CPTR_EL3](#) registers, and the current Security state and Exception level, an attempt to execute the instruction might be trapped.

Scalar half precision

ARMv8.2

31	30	29	28	27	26	25	24	23	22	21	20	16	15	14	13	12	11	10	9	5	4	0
0	1	1	1	1	1	1	0	1	1	0	Rm	0	0	0	1	0	1	Rn	Rd			

Scalar half precision variant

FABD <Hd>, <Hn>, <Hm>

Decode for this encoding

```
if !HaveFP16Ext() then UnallocatedEncoding();

integer d = UInt(Rd);
integer n = UInt(Rn);
integer m = UInt(Rm);
integer esize = 16;
integer datasize = esize;
integer elements = 1;
boolean abs = TRUE;
```

Scalar single-precision and double-precision

31	30	29	28	27	26	25	24	23	22	21	20	16	15	14	13	12	11	10	9	5	4	0
0	1	1	1	1	1	1	0	1	sz	1	Rm	1	1	0	1	0	1	Rn	Rd			

Scalar single-precision and double-precision variant

FABD <V><d>, <V><n>, <V><m>

Decode for this encoding

```
integer d = UInt(Rd);
integer n = UInt(Rn);
integer m = UInt(Rm);
integer esize = 32 << UInt(sz);
integer datasize = esize;
integer elements = 1;
boolean abs = TRUE;
```

Vector half precision

ARMv8.2

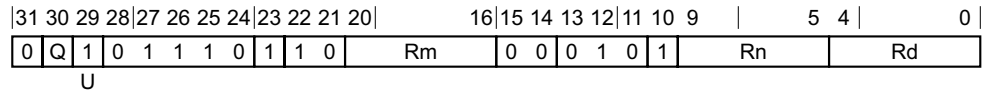

Vector half precision variant

FABD <Vd>.<T>, <Vn>.<T>, <Vm>.<T>

Decode for this encoding

```

if !HaveFP16Ext() then UnallocatedEncoding();

integer d = UInt(Rd);
integer n = UInt(Rn);
integer m = UInt(Rm);
integer esize = 16;
integer datasize = if Q == '1' then 128 else 64;
integer elements = datasize DIV esize;
boolean abs = (U == '1');
```

Vector single-precision and double-precision

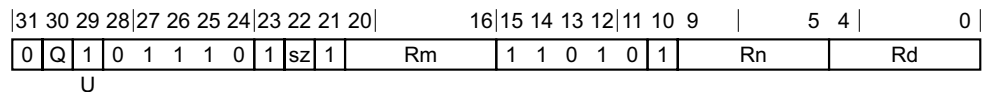

Vector single-precision and double-precision variant

FABD <Vd>.<T>, <Vn>.<T>, <Vm>.<T>

Decode for this encoding

```

integer d = UInt(Rd);
integer n = UInt(Rn);
integer m = UInt(Rm);
if sz:Q == '10' then ReservedValue();
integer esize = 32 << UInt(sz);
integer datasize = if Q == '1' then 128 else 64;
integer elements = datasize DIV esize;
boolean abs = (U == '1');
```

Assembler symbols

- <Hd> Is the 16-bit name of the SIMD&FP destination register, encoded in the "Rd" field.
- <Hn> Is the 16-bit name of the first SIMD&FP source register, encoded in the "Rn" field.
- <Hm> Is the 16-bit name of the second SIMD&FP source register, encoded in the "Rm" field.
- <V> Is a width specifier, encoded in the "sz" field. It can have the following values:
 - S when sz = 0
 - D when sz = 1
- <d> Is the number of the SIMD&FP destination register, in the "Rd" field.
- <n> Is the number of the first SIMD&FP source register, encoded in the "Rn" field.

- <m> Is the number of the second SIMD&FP source register, encoded in the "Rm" field.
- <Vd> Is the name of the SIMD&FP destination register, encoded in the "Rd" field.
- <T> For the vector half precision variant: is an arrangement specifier, encoded in the "Q" field. It can have the following values:
4H when Q = 0
8H when Q = 1
For the vector single-precision and double-precision variant: is an arrangement specifier, encoded in the "sz:Q" field. It can have the following values:
2S when sz = 0, Q = 0
4S when sz = 0, Q = 1
2D when sz = 1, Q = 1
The encoding sz = 1, Q = 0 is reserved.
- <Vn> Is the name of the first SIMD&FP source register, encoded in the "Rn" field.
- <Vm> Is the name of the second SIMD&FP source register, encoded in the "Rm" field.

Operation for all encodings

```
CheckFPAdvSIMDEnabled64();
bits(datasize) operand1 = V[n];
bits(datasize) operand2 = V[m];
bits(datasize) result;
bits(esize) element1;
bits(esize) element2;
bits(esize) diff;

for e = 0 to elements-1
    element1 = Elem[operand1, e, esize];
    element2 = Elem[operand2, e, esize];
    diff = FPSub(element1, element2, FPCR);
    Elem[result, e, esize] = if abs then FPAbs(diff) else diff;

V[d] = result;
```

C7.2.36 FABS (vector)

Floating-point Absolute value (vector). This instruction calculates the absolute value of each vector element in the source SIMD&FP register, writes the result to a vector, and writes the vector to the destination SIMD&FP register.

Depending on the settings in the CPACR_EL1, CPTR_EL2, and CPTR_EL3 registers, and the current Security state and Exception level, an attempt to execute the instruction might be trapped.

Half-precision

ARMv8.2

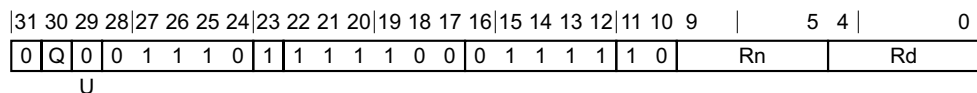

Half-precision variant

FABS <Vd>.<T>, <Vn>.<T>

Decode for this encoding

```
if !HaveFP16Ext() then UnallocatedEncoding();

integer d = UInt(Rd);
integer n = UInt(Rn);

integer esize = 16;
integer datasize = if Q == '1' then 128 else 64;
integer elements = datasize DIV esize;
boolean neg = (U == '1');
```

Single-precision and double-precision

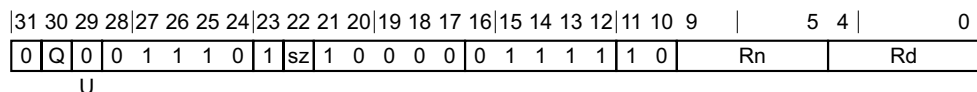

Single-precision and double-precision variant

FABS <Vd>.<T>, <Vn>.<T>

Decode for this encoding

```
integer d = UInt(Rd);
integer n = UInt(Rn);

if sz:Q == '10' then ReservedValue();
integer esize = 32 << UInt(sz);
integer datasize = if Q == '1' then 128 else 64;
integer elements = datasize DIV esize;
boolean neg = (U == '1');
```

Assembler symbols

- <Vd> Is the name of the SIMD&FP destination register, encoded in the "Rd" field.
- <T> For the half-precision variant: is an arrangement specifier, encoded in the "Q" field. It can have the following values:
 - 4H when Q = 0

8H when Q = 1

For the single-precision and double-precision variant: is an arrangement specifier, encoded in the "sz:Q" field. It can have the following values:

2S when sz = 0, Q = 0

4S when sz = 0, Q = 1

2D when sz = 1, Q = 1

The encoding sz = 1, Q = 0 is reserved.

<Vn> Is the name of the SIMD&FP source register, encoded in the "Rn" field.

Operation for all encodings

```
CheckFPAdvSIMDEnabled64();
bits(datasize) operand = V[n];
bits(datasize) result;
bits(esize) element;

for e = 0 to elements-1
    element = Elem[operand, e, esize];
    if neg then
        element = FPNeg(element);
    else
        element = FPAbs(element);
    Elem[result, e, esize] = element;

V[d] = result;
```

C7.2.37 FABS (scalar)

Floating-point Absolute value (scalar). This instruction calculates the absolute value in the SIMD&FP source register and writes the result to the SIMD&FP destination register.

Depending on the settings in the CPACR_EL1, CPTR_EL2, and CPTR_EL3 registers, and the current Security state and Exception level, an attempt to execute the instruction might be trapped.

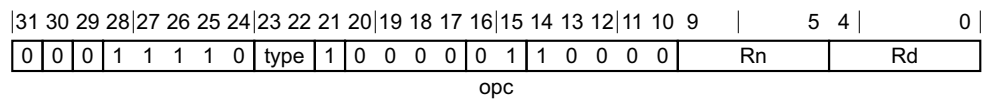

Half-precision variant

Applies when type == 11.

FABS <Hd>, <Hn>

Single-precision variant

Applies when type == 00.

FABS <Sd>, <Sn>

Double-precision variant

Applies when type == 01.

FABS <Dd>, <Dn>

Decode for all variants of this encoding

```
integer d = UInt(Rd);
integer n = UInt(Rn);

integer datasize;
case type of
    when '00' datasize = 32;
    when '01' datasize = 64;
    when '10' UnallocatedEncoding();
    when '11'
        if HaveFP16Ext() then
            datasize = 16;
        else
            UnallocatedEncoding();
```

Assembler symbols

- <Dd> Is the 64-bit name of the SIMD&FP destination register, encoded in the "Rd" field.
- <Dn> Is the 64-bit name of the SIMD&FP source register, encoded in the "Rn" field.
- <Hd> Is the 16-bit name of the SIMD&FP destination register, encoded in the "Rd" field.
- <Hn> Is the 16-bit name of the SIMD&FP source register, encoded in the "Rn" field.
- <Sd> Is the 32-bit name of the SIMD&FP destination register, encoded in the "Rd" field.
- <Sn> Is the 32-bit name of the SIMD&FP source register, encoded in the "Rn" field.

Operation

```
CheckFPAdvSIMDEnabled64();  
  
bits(datasize) result;  
bits(datasize) operand = V[n];  
  
result = FPAbs(operand);  
V[d] = result;
```

C7.2.38 FACGE

Floating-point Absolute Compare Greater than or Equal (vector). This instruction compares the absolute value of each floating-point value in the first source SIMD&FP register with the absolute value of the corresponding floating-point value in the second source SIMD&FP register and if the first value is greater than or equal to the second value sets every bit of the corresponding vector element in the destination SIMD&FP register to one, otherwise sets every bit of the corresponding vector element in the destination SIMD&FP register to zero.

This instruction can generate a floating-point exception. Depending on the settings in [FPCR](#), the exception results in either a flag being set in [FPSR](#), or a synchronous exception being generated. For more information, see [Floating-point exceptions and exception traps on page D1-1831](#).

Depending on the settings in the [CPACR_EL1](#), [CPTR_EL2](#), and [CPTR_EL3](#) registers, and the current Security state and Exception level, an attempt to execute the instruction might be trapped.

Scalar half precision

ARMv8.2

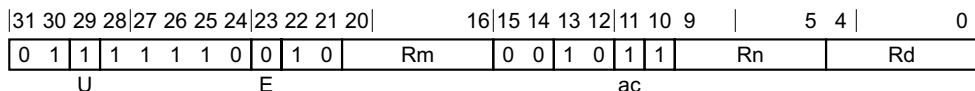

Scalar half precision variant

FACGE <Hd>, <Hn>, <Hm>

Decode for this encoding

```
if !HaveFP16Ext() then UnallocatedEncoding();
```

```
integer d = UInt(Rd);
integer n = UInt(Rn);
integer m = UInt(Rm);
integer esize = 16;
integer datasize = esize;
integer elements = 1;
CompareOp cmp;
boolean abs;
```

```
case E:U:ac of
  when '000' cmp = CompareOp_EQ; abs = FALSE;
  when '010' cmp = CompareOp_GE; abs = FALSE;
  when '011' cmp = CompareOp_GE; abs = TRUE;
  when '110' cmp = CompareOp_GT; abs = FALSE;
  when '111' cmp = CompareOp_GT; abs = TRUE;
  otherwise UnallocatedEncoding();
```

Scalar single-precision and double-precision

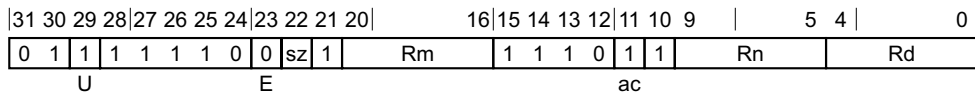

Scalar single-precision and double-precision variant

FACGE <V><d>, <V><n>, <V><m>

Decode for this encoding

```
integer d = UInt(Rd);
integer n = UInt(Rn);
integer m = UInt(Rm);
integer esize = 32 << UInt(sz);
integer datasize = esize;
integer elements = 1;
CompareOp cmp;
boolean abs;

case E:U:ac of
    when '000' cmp = CompareOp_EQ; abs = FALSE;
    when '010' cmp = CompareOp_GE; abs = FALSE;
    when '011' cmp = CompareOp_GE; abs = TRUE;
    when '110' cmp = CompareOp_GT; abs = FALSE;
    when '111' cmp = CompareOp_GT; abs = TRUE;
    otherwise UnallocatedEncoding();
```

Vector half precision

ARMv8.2

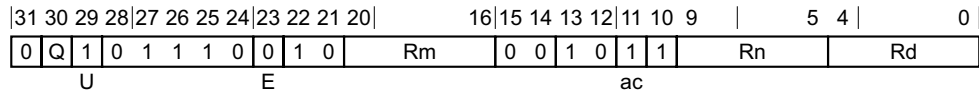

Vector half precision variant

FACGE <Vd>.<T>, <Vn>.<T>, <Vm>.<T>

Decode for this encoding

```
if !HaveFP16Ext() then UnallocatedEncoding();

integer d = UInt(Rd);
integer n = UInt(Rn);
integer m = UInt(Rm);
integer esize = 16;
integer datasize = if Q == '1' then 128 else 64;
integer elements = datasize DIV esize;
CompareOp cmp;
boolean abs;

case E:U:ac of
    when '000' cmp = CompareOp_EQ; abs = FALSE;
    when '010' cmp = CompareOp_GE; abs = FALSE;
    when '011' cmp = CompareOp_GE; abs = TRUE;
    when '110' cmp = CompareOp_GT; abs = FALSE;
    when '111' cmp = CompareOp_GT; abs = TRUE;
    otherwise UnallocatedEncoding();
```

Vector single-precision and double-precision

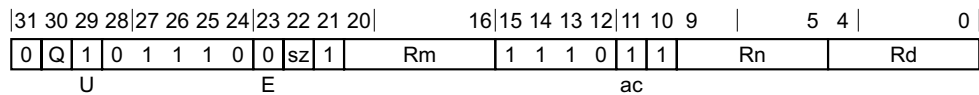

Vector single-precision and double-precision variant

FACGE <Vd>.<T>, <Vn>.<T>, <Vm>.<T>

Decode for this encoding

```

integer d = UInt(Rd);
integer n = UInt(Rn);
integer m = UInt(Rm);
if sz:Q == '10' then ReservedValue();
integer esize = 32 << UInt(sz);
integer datasize = if Q == '1' then 128 else 64;
integer elements = datasize DIV esize;
CompareOp cmp;
boolean abs;

case E:U:ac of
    when '000' cmp = CompareOp_EQ; abs = FALSE;
    when '010' cmp = CompareOp_GE; abs = FALSE;
    when '011' cmp = CompareOp_GE; abs = TRUE;
    when '110' cmp = CompareOp_GT; abs = FALSE;
    when '111' cmp = CompareOp_GT; abs = TRUE;
    otherwise UnallocatedEncoding();
    
```

Assembler symbols

- <Hd> Is the 16-bit name of the SIMD&FP destination register, encoded in the "Rd" field.
- <Hn> Is the 16-bit name of the first SIMD&FP source register, encoded in the "Rn" field.
- <Hm> Is the 16-bit name of the second SIMD&FP source register, encoded in the "Rm" field.
- <V> Is a width specifier, encoded in the "sz" field. It can have the following values:
 - S when sz = 0
 - D when sz = 1
- <d> Is the number of the SIMD&FP destination register, in the "Rd" field.
- <n> Is the number of the first SIMD&FP source register, encoded in the "Rn" field.
- <m> Is the number of the second SIMD&FP source register, encoded in the "Rm" field.
- <Vd> Is the name of the SIMD&FP destination register, encoded in the "Rd" field.
- <T> For the vector half precision variant: is an arrangement specifier, encoded in the "Q" field. It can have the following values:
 - 4H when Q = 0
 - 8H when Q = 1
 For the vector single-precision and double-precision variant: is an arrangement specifier, encoded in the "sz:Q" field. It can have the following values:
 - 2S when sz = 0, Q = 0
 - 4S when sz = 0, Q = 1
 - 2D when sz = 1, Q = 1
 The encoding sz = 1, Q = 0 is reserved.
- <Vn> Is the name of the first SIMD&FP source register, encoded in the "Rn" field.
- <Vm> Is the name of the second SIMD&FP source register, encoded in the "Rm" field.

Operation for all encodings

```

CheckFPAdvSIMDEnabled64();
bits(datasize) operand1 = V[n];
bits(datasize) operand2 = V[m];
bits(datasize) result;
    
```

```
bits(esize) element1;
bits(esize) element2;
boolean test_passed;

for e = 0 to elements-1
  element1 = Elem[operand1, e, esize];
  element2 = Elem[operand2, e, esize];
  if abs then
    element1 = FPAbs(element1);
    element2 = FPAbs(element2);
  case cmp of
    when CompareOp_EQ test_passed = FPCompareEQ(element1, element2, FPCR);
    when CompareOp_GE test_passed = FPCompareGE(element1, element2, FPCR);
    when CompareOp_GT test_passed = FPCompareGT(element1, element2, FPCR);
  Elem[result, e, esize] = if test_passed then Ones() else Zeros();

V[d] = result;
```

C7.2.39 FACGT

Floating-point Absolute Compare Greater than (vector). This instruction compares the absolute value of each vector element in the first source SIMD&FP register with the absolute value of the corresponding vector element in the second source SIMD&FP register and if the first value is greater than the second value sets every bit of the corresponding vector element in the destination SIMD&FP register to one, otherwise sets every bit of the corresponding vector element in the destination SIMD&FP register to zero.

This instruction can generate a floating-point exception. Depending on the settings in [FPCR](#), the exception results in either a flag being set in [FPSR](#), or a synchronous exception being generated. For more information, see [Floating-point exceptions and exception traps on page D1-1831](#).

Depending on the settings in the [CPACR_EL1](#), [CPTR_EL2](#), and [CPTR_EL3](#) registers, and the current Security state and Exception level, an attempt to execute the instruction might be trapped.

Scalar half precision

ARMv8.2

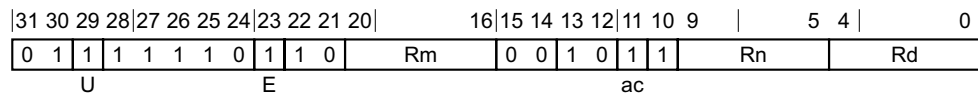

Scalar half precision variant

FACGT <Hd>, <Hn>, <Hm>

Decode for this encoding

```
if !HaveFP16Ext() then UnallocatedEncoding();
```

```
integer d = UInt(Rd);
integer n = UInt(Rn);
integer m = UInt(Rm);
integer esize = 16;
integer datasize = esize;
integer elements = 1;
CompareOp cmp;
boolean abs;
```

```
case E:U:ac of
  when '000' cmp = CompareOp_EQ; abs = FALSE;
  when '010' cmp = CompareOp_GE; abs = FALSE;
  when '011' cmp = CompareOp_GE; abs = TRUE;
  when '110' cmp = CompareOp_GT; abs = FALSE;
  when '111' cmp = CompareOp_GT; abs = TRUE;
  otherwise UnallocatedEncoding();
```

Scalar single-precision and double-precision

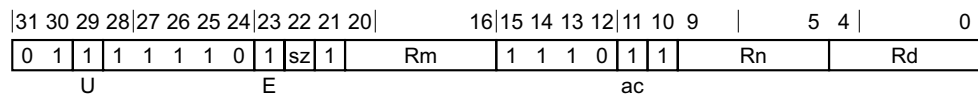

Scalar single-precision and double-precision variant

FACGT <V><d>, <V><n>, <V><m>

Decode for this encoding

```

integer d = UInt(Rd);
integer n = UInt(Rn);
integer m = UInt(Rm);
integer esize = 32 << UInt(sz);
integer datasize = esize;
integer elements = 1;
CompareOp cmp;
boolean abs;

case E:U:ac of
    when '000' cmp = CompareOp_EQ; abs = FALSE;
    when '010' cmp = CompareOp_GE; abs = FALSE;
    when '011' cmp = CompareOp_GE; abs = TRUE;
    when '110' cmp = CompareOp_GT; abs = FALSE;
    when '111' cmp = CompareOp_GT; abs = TRUE;
    otherwise UnallocatedEncoding();
    
```

Vector half precision

ARMv8.2

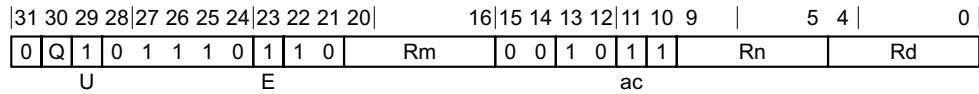

Vector half precision variant

FACGT <Vd>.<T>, <Vn>.<T>, <Vm>.<T>

Decode for this encoding

```

if !HaveFP16Ext() then UnallocatedEncoding();

integer d = UInt(Rd);
integer n = UInt(Rn);
integer m = UInt(Rm);
integer esize = 16;
integer datasize = if Q == '1' then 128 else 64;
integer elements = datasize DIV esize;
CompareOp cmp;
boolean abs;

case E:U:ac of
    when '000' cmp = CompareOp_EQ; abs = FALSE;
    when '010' cmp = CompareOp_GE; abs = FALSE;
    when '011' cmp = CompareOp_GE; abs = TRUE;
    when '110' cmp = CompareOp_GT; abs = FALSE;
    when '111' cmp = CompareOp_GT; abs = TRUE;
    otherwise UnallocatedEncoding();
    
```

Vector single-precision and double-precision

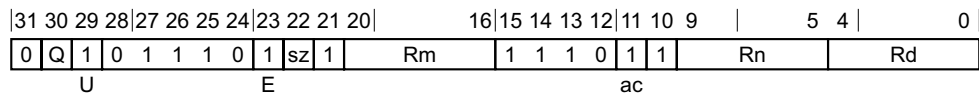

Vector single-precision and double-precision variant

FACGT <Vd>.<T>, <Vn>.<T>, <Vm>.<T>

Decode for this encoding

```

integer d = UInt(Rd);
integer n = UInt(Rn);
integer m = UInt(Rm);
if sz:Q == '10' then ReservedValue();
integer esize = 32 << UInt(sz);
integer datasize = if Q == '1' then 128 else 64;
integer elements = datasize DIV esize;
CompareOp cmp;
boolean abs;

case E:U:ac of
  when '000' cmp = CompareOp_EQ; abs = FALSE;
  when '010' cmp = CompareOp_GE; abs = FALSE;
  when '011' cmp = CompareOp_GE; abs = TRUE;
  when '110' cmp = CompareOp_GT; abs = FALSE;
  when '111' cmp = CompareOp_GT; abs = TRUE;
  otherwise UnallocatedEncoding();

```

Assembler symbols

- <Hd> Is the 16-bit name of the SIMD&FP destination register, encoded in the "Rd" field.
- <Hn> Is the 16-bit name of the first SIMD&FP source register, encoded in the "Rn" field.
- <Hm> Is the 16-bit name of the second SIMD&FP source register, encoded in the "Rm" field.
- <V> Is a width specifier, encoded in the "sz" field. It can have the following values:
 - S when sz = 0
 - D when sz = 1
- <d> Is the number of the SIMD&FP destination register, in the "Rd" field.
- <n> Is the number of the first SIMD&FP source register, encoded in the "Rn" field.
- <m> Is the number of the second SIMD&FP source register, encoded in the "Rm" field.
- <Vd> Is the name of the SIMD&FP destination register, encoded in the "Rd" field.
- <T> For the vector half precision variant: is an arrangement specifier, encoded in the "Q" field. It can have the following values:
 - 4H when Q = 0
 - 8H when Q = 1
 For the vector single-precision and double-precision variant: is an arrangement specifier, encoded in the "sz:Q" field. It can have the following values:
 - 2S when sz = 0, Q = 0
 - 4S when sz = 0, Q = 1
 - 2D when sz = 1, Q = 1
 The encoding sz = 1, Q = 0 is reserved.
- <Vn> Is the name of the first SIMD&FP source register, encoded in the "Rn" field.
- <Vm> Is the name of the second SIMD&FP source register, encoded in the "Rm" field.

Operation for all encodings

```

CheckFPAdvSIMDEnabled64();
bits(datasize) operand1 = V[n];
bits(datasize) operand2 = V[m];
bits(datasize) result;

```

```
bits(esize) element1;
bits(esize) element2;
boolean test_passed;

for e = 0 to elements-1
  element1 = Elem[operand1, e, esize];
  element2 = Elem[operand2, e, esize];
  if abs then
    element1 = FPAbs(element1);
    element2 = FPAbs(element2);
  case cmp of
    when CompareOp_EQ test_passed = FPCompareEQ(element1, element2, FPCR);
    when CompareOp_GE test_passed = FPCompareGE(element1, element2, FPCR);
    when CompareOp_GT test_passed = FPCompareGT(element1, element2, FPCR);
  Elem[result, e, esize] = if test_passed then Ones() else Zeros();

V[d] = result;
```

C7.2.40 FADD (vector)

Floating-point Add (vector). This instruction adds corresponding vector elements in the two source SIMD&FP registers, writes the result into a vector, and writes the vector to the destination SIMD&FP register. All the values in this instruction are floating-point values.

This instruction can generate a floating-point exception. Depending on the settings in [FPCR](#), the exception results in either a flag being set in [FPSR](#) or a synchronous exception being generated. For more information, see [Floating-point exceptions and exception traps on page D1-1831](#).

Depending on the settings in the [CPACR_EL1](#), [CPTR_EL2](#), and [CPTR_EL3](#) registers, and the current Security state and Exception level, an attempt to execute the instruction might be trapped.

Half-precision

ARMv8.2

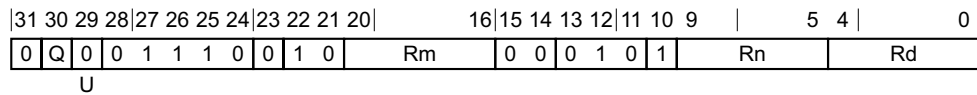

Half-precision variant

FADD <Vd>.<T>, <Vn>.<T>, <Vm>.<T>

Decode for this encoding

```
if !HaveFP16Ext() then UnallocatedEncoding();

integer d = UInt(Rd);
integer n = UInt(Rn);
integer m = UInt(Rm);
integer esize = 16;
integer datasize = if Q == '1' then 128 else 64;
integer elements = datasize DIV esize;

boolean pair = (U == '1');
```

Single-precision and double-precision

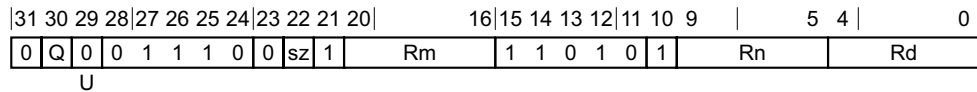

Single-precision and double-precision variant

FADD <Vd>.<T>, <Vn>.<T>, <Vm>.<T>

Decode for this encoding

```
integer d = UInt(Rd);
integer n = UInt(Rn);
integer m = UInt(Rm);
if sz:Q == '10' then ReservedValue();
integer esize = 32 << UInt(sz);
integer datasize = if Q == '1' then 128 else 64;
integer elements = datasize DIV esize;

boolean pair = (U == '1');
```

Assembler symbols

- <Vd> Is the name of the SIMD&FP destination register, encoded in the "Rd" field.
- <T> For the half-precision variant: is an arrangement specifier, encoded in the "Q" field. It can have the following values:
- 4H when Q = 0
 - 8H when Q = 1
- For the single-precision and double-precision variant: is an arrangement specifier, encoded in the "sz:Q" field. It can have the following values:
- 2S when sz = 0, Q = 0
 - 4S when sz = 0, Q = 1
 - 2D when sz = 1, Q = 1
- The encoding sz = 1, Q = 0 is reserved.
- <Vn> Is the name of the first SIMD&FP source register, encoded in the "Rn" field.
- <Vm> Is the name of the second SIMD&FP source register, encoded in the "Rm" field.

Operation for all encodings

```
CheckFPAdvSIMDEnabled64();
bits(datasize) operand1 = V[n];
bits(datasize) operand2 = V[m];
bits(datasize) result;
bits(2*datasize) concat = operand2:operand1;
bits(esize) element1;
bits(esize) element2;

for e = 0 to elements-1
  if pair then
    element1 = Elem[concat, 2*e, esize];
    element2 = Elem[concat, (2*e)+1, esize];
  else
    element1 = Elem[operand1, e, esize];
    element2 = Elem[operand2, e, esize];
  Elem[result, e, esize] = FPAdd(element1, element2, FPCR);

V[d] = result;
```

C7.2.41 FADD (scalar)

Floating-point Add (scalar). This instruction adds the floating-point values of the two source SIMD&FP registers, and writes the result to the destination SIMD&FP register.

This instruction can generate a floating-point exception. Depending on the settings in [FPCR](#), the exception results in either a flag being set in [FPSR](#), or a synchronous exception being generated. For more information, see [Floating-point exceptions and exception traps on page D1-1831](#).

Depending on the settings in the [CPACR_EL1](#), [CPTR_EL2](#), and [CPTR_EL3](#) registers, and the current Security state and Exception level, an attempt to execute the instruction might be trapped.

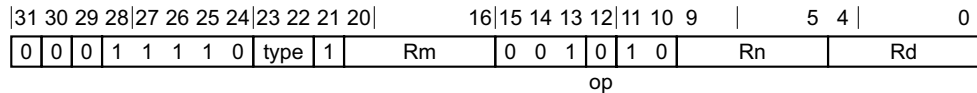

Half-precision variant

Applies when type == 11.

FADD <Hd>, <Hn>, <Hm>

Single-precision variant

Applies when type == 00.

FADD <Sd>, <Sn>, <Sm>

Double-precision variant

Applies when type == 01.

FADD <Dd>, <Dn>, <Dm>

Decode for all variants of this encoding

```
integer d = UInt(Rd);
integer n = UInt(Rn);
integer m = UInt(Rm);

integer datasize;
case type of
    when '00' datasize = 32;
    when '01' datasize = 64;
    when '10' UnallocatedEncoding();
    when '11'
        if HaveFP16Ext() then
            datasize = 16;
        else
            UnallocatedEncoding();
```

Assembler symbols

- <Dd> Is the 64-bit name of the SIMD&FP destination register, encoded in the "Rd" field.
- <Dn> Is the 64-bit name of the first SIMD&FP source register, encoded in the "Rn" field.
- <Dm> Is the 64-bit name of the second SIMD&FP source register, encoded in the "Rm" field.
- <Hd> Is the 16-bit name of the SIMD&FP destination register, encoded in the "Rd" field.
- <Hn> Is the 16-bit name of the first SIMD&FP source register, encoded in the "Rn" field.

- <Hm> Is the 16-bit name of the second SIMD&FP source register, encoded in the "Rm" field.
- <Sd> Is the 32-bit name of the SIMD&FP destination register, encoded in the "Rd" field.
- <Sn> Is the 32-bit name of the first SIMD&FP source register, encoded in the "Rn" field.
- <Sm> Is the 32-bit name of the second SIMD&FP source register, encoded in the "Rm" field.

Operation

```
CheckFPAdvSIMDEnabled64();  
bits(datasize) result;  
bits(datasize) operand1 = V[n];  
bits(datasize) operand2 = V[m];  
  
result = FPAdd(operand1, operand2, FPCR);  
  
V[d] = result;
```

C7.2.42 FADDP (scalar)

Floating-point Add Pair of elements (scalar). This instruction adds two floating-point vector elements in the source SIMD&FP register and writes the scalar result into the destination SIMD&FP register.

This instruction can generate a floating-point exception. Depending on the settings in [FPCR](#), the exception results in either a flag being set in [FPSR](#) or a synchronous exception being generated. For more information, see [Floating-point exceptions and exception traps on page D1-1831](#).

Depending on the settings in the [CPACR_EL1](#), [CPTR_EL2](#), and [CPTR_EL3](#) registers, and the current Security state and Exception level, an attempt to execute the instruction might be trapped.

Half-precision

ARMv8.2

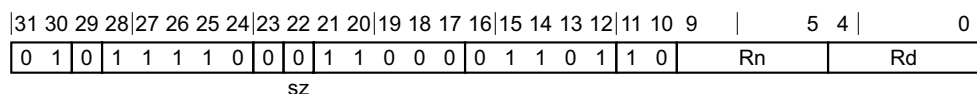

Half-precision variant

FADDP <V><d>, <Vn>.<T>

Decode for this encoding

```
if !HaveFP16Ext() then UnallocatedEncoding();

integer d = UInt(Rd);
integer n = UInt(Rn);
integer esize = 16;
integer datasize = 32;
```

Single-precision and double-precision

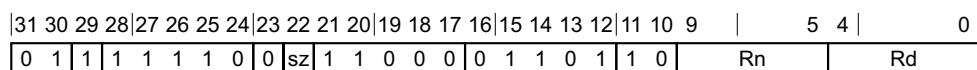

Single-precision and double-precision variant

FADDP <V><d>, <Vn>.<T>

Decode for this encoding

```
integer d = UInt(Rd);
integer n = UInt(Rn);

integer esize = 32;
integer datasize = 64;
```

Assembler symbols

<V> For the half-precision variant: is the destination width specifier, encoded in the "sz" field. It can have the following values:

H when sz = 0

The encoding sz = 1 is reserved.

For the single-precision and double-precision variant: is the destination width specifier, encoded in the "sz" field. It can have the following values:

S when sz = 0

D when sz = 1

<d> Is the number of the SIMD&FP destination register, encoded in the "Rd" field.

<Vn> Is the name of the SIMD&FP source register, encoded in the "Rn" field.

<T> For the half-precision variant: is the source arrangement specifier, encoded in the "sz" field. It can have the following values:

2H when sz = 0

The encoding sz = 1 is reserved.

For the single-precision and double-precision variant: is the source arrangement specifier, encoded in the "sz" field. It can have the following values:

2S when sz = 0

2D when sz = 1

Operation for all encodings

```
CheckFPAdvSIMDEnabled64();  
bits(datasize) operand = V[n];  
V[d] = Reduce(ReduceOp_FADD, operand, esize);
```

C7.2.43 FADDP (vector)

Floating-point Add Pairwise (vector). This instruction creates a vector by concatenating the vector elements of the first source SIMD&FP register after the vector elements of the second source SIMD&FP register, reads each pair of adjacent vector elements from the concatenated vector, adds each pair of values together, places the result into a vector, and writes the vector to the destination SIMD&FP register. All the values in this instruction are floating-point values.

This instruction can generate a floating-point exception. Depending on the settings in [FPCR](#), the exception results in either a flag being set in [FPSR](#) or a synchronous exception being generated. For more information, see [Floating-point exceptions and exception traps on page D1-1831](#).

Depending on the settings in the [CPACR_EL1](#), [CPTR_EL2](#), and [CPTR_EL3](#) registers, and the current Security state and Exception level, an attempt to execute the instruction might be trapped.

Half-precision

ARMv8.2

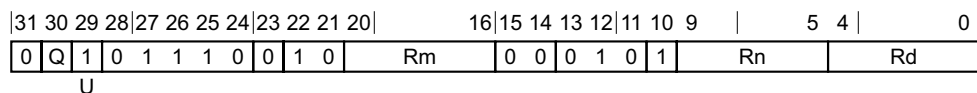

Half-precision variant

FADDP <Vd>.<T>, <Vn>.<T>, <Vm>.<T>

Decode for this encoding

```
if !HaveFP16Ext() then UnallocatedEncoding();

integer d = UInt(Rd);
integer n = UInt(Rn);
integer m = UInt(Rm);
integer esize = 16;
integer datasize = if Q == '1' then 128 else 64;
integer elements = datasize DIV esize;

boolean pair = (U == '1');
```

Single-precision and double-precision

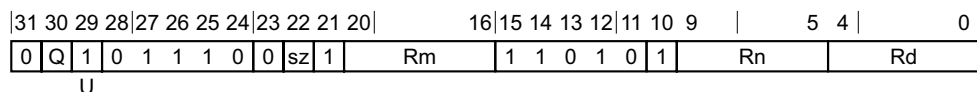

Single-precision and double-precision variant

FADDP <Vd>.<T>, <Vn>.<T>, <Vm>.<T>

Decode for this encoding

```
integer d = UInt(Rd);
integer n = UInt(Rn);
integer m = UInt(Rm);
if sz:Q == '10' then ReservedValue();
integer esize = 32 << UInt(sz);
integer datasize = if Q == '1' then 128 else 64;
integer elements = datasize DIV esize;

boolean pair = (U == '1');
```

Assembler symbols

- <Vd> Is the name of the SIMD&FP destination register, encoded in the "Rd" field.
- <T> For the half-precision variant: is an arrangement specifier, encoded in the "Q" field. It can have the following values:
- 4H when Q = 0
 - 8H when Q = 1
- For the single-precision and double-precision variant: is an arrangement specifier, encoded in the "sz:Q" field. It can have the following values:
- 2S when sz = 0, Q = 0
 - 4S when sz = 0, Q = 1
 - 2D when sz = 1, Q = 1
- The encoding sz = 1, Q = 0 is reserved.
- <Vn> Is the name of the first SIMD&FP source register, encoded in the "Rn" field.
- <Vm> Is the name of the second SIMD&FP source register, encoded in the "Rm" field.

Operation for all encodings

```
CheckFPAdvSIMDEnabled64();
bits(datasize) operand1 = V[n];
bits(datasize) operand2 = V[m];
bits(datasize) result;
bits(2*datasize) concat = operand2:operand1;
bits(esize) element1;
bits(esize) element2;

for e = 0 to elements-1
  if pair then
    element1 = Elem[concat, 2*e, esize];
    element2 = Elem[concat, (2*e)+1, esize];
  else
    element1 = Elem[operand1, e, esize];
    element2 = Elem[operand2, e, esize];
  Elem[result, e, esize] = FPAdd(element1, element2, FPCR);

V[d] = result;
```

C7.2.44 FCCMP

Floating-point Conditional quiet Compare (scalar). This instruction compares the two SIMD&FP source register values and writes the result to the `PSTATE`. {N, Z, C, V} flags. If the condition does not pass then the `PSTATE`. {N, Z, C, V} flags are set to the flag bit specifier.

It raises an Invalid Operation exception only if either operand is a signaling NaN.

A floating-point exception can be generated by this instruction. Depending on the settings in `FPCR`, the exception results in either a flag being set in `FPSR`, or a synchronous exception being generated. For more information, see *Floating-point exceptions and exception traps on page D1-1831*.

Depending on the settings in the `CPACR_EL1`, `CPTR_EL2`, and `CPTR_EL3` registers, and the current Security state and Exception level, an attempt to execute the instruction might be trapped.

31	30	29	28	27	26	25	24	23	22	21	20	16	15	12	11	10	9	5	4	3	0
0	0	0	1	1	1	1	0	type	1	Rm	cond	0	1	Rn	0	nzcw					
																			op		

Half-precision variant

Applies when `type == 11`.

FCCMP <Hn>, <Hm>, #<nzcw>, <cond>

Single-precision variant

Applies when `type == 00`.

FCCMP <Sn>, <Sm>, #<nzcw>, <cond>

Double-precision variant

Applies when `type == 01`.

FCCMP <Dn>, <Dm>, #<nzcw>, <cond>

Decode for all variants of this encoding

```
integer n = UInt(Rn);
integer m = UInt(Rm);

integer datasize;
case type of
    when '00' datasize = 32;
    when '01' datasize = 64;
    when '10' UnallocatedEncoding();
    when '11'
        if HaveFP16Ext() then
            datasize = 16;
        else
            UnallocatedEncoding();

bits(4) flags = nzcw;
```

Assembler symbols

- <Dn> Is the 64-bit name of the first SIMD&FP source register, encoded in the "Rn" field.
- <Dm> Is the 64-bit name of the second SIMD&FP source register, encoded in the "Rm" field.
- <Hn> Is the 16-bit name of the first SIMD&FP source register, encoded in the "Rn" field.

- <Hm> Is the 16-bit name of the second SIMD&FP source register, encoded in the "Rm" field.
- <Sn> Is the 32-bit name of the first SIMD&FP source register, encoded in the "Rn" field.
- <Sm> Is the 32-bit name of the second SIMD&FP source register, encoded in the "Rm" field.
- <nzcv> Is the flag bit specifier, an immediate in the range 0 to 15, giving the alternative state for the 4-bit NZCV condition flags, encoded in the "nzcv" field.
- <cond> Is one of the standard conditions, encoded in the "cond" field in the standard way.

NaNs

The IEEE 754 standard specifies that the result of a comparison is precisely one of <, ==, > or unordered. If either or both of the operands are NaNs, they are unordered, and all three of (Operand1 < Operand2), (Operand1 == Operand2) and (Operand1 > Operand2) are false. This case results in the **FPSCR** flags being set to N=0, Z=0, C=1, and V=1.

Operation

```
CheckFPAdvSIMDEnabled64();

bits(datasize) operand1 = V[n];
bits(datasize) operand2;

operand2 = V[m];

if ConditionHolds(cond) then
    flags = FPCompare(operand1, operand2, FALSE, FPCR);
PSTATE.<N,Z,C,V> = flags;
```

C7.2.45 FCCMPE

Floating-point Conditional signaling Compare (scalar). This instruction compares the two SIMD&FP source register values and writes the result to the **PSTATE**. {N, Z, C, V} flags. If the condition does not pass then the **PSTATE**. {N, Z, C, V} flags are set to the flag bit specifier.

If either operand is any type of NaN, or if either operand is a signaling NaN, the instruction raises an Invalid Operation exception.

A floating-point exception can be generated by this instruction. Depending on the settings in **FPCR**, the exception results in either a flag being set in **FPSR**, or a synchronous exception being generated. For more information, see *Floating-point exceptions and exception traps on page D1-1831*.

Depending on the settings in the **CPACR_EL1**, **CPTR_EL2**, and **CPTR_EL3** registers, and the current Security state and Exception level, an attempt to execute the instruction might be trapped.

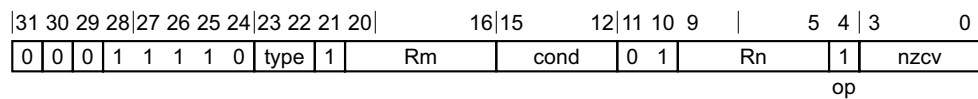

Half-precision variant

Applies when type == 11.

FCCMPE <Hn>, <Hm>, #<nzcvc>, <cond>

Single-precision variant

Applies when type == 00.

FCCMPE <Sn>, <Sm>, #<nzcvc>, <cond>

Double-precision variant

Applies when type == 01.

FCCMPE <Dn>, <Dm>, #<nzcvc>, <cond>

Decode for all variants of this encoding

```
integer n = UInt(Rn);
integer m = UInt(Rm);

integer datasize;
case type of
    when '00' datasize = 32;
    when '01' datasize = 64;
    when '10' UnallocatedEncoding();
    when '11'
        if HaveFP16Ext() then
            datasize = 16;
        else
            UnallocatedEncoding();

bits(4) flags = nzcvc;
```

Assembler symbols

<Dn> Is the 64-bit name of the first SIMD&FP source register, encoded in the "Rn" field.

<Dm> Is the 64-bit name of the second SIMD&FP source register, encoded in the "Rm" field.

<Hn>	Is the 16-bit name of the first SIMD&FP source register, encoded in the "Rn" field.
<Hm>	Is the 16-bit name of the second SIMD&FP source register, encoded in the "Rm" field.
<Sn>	Is the 32-bit name of the first SIMD&FP source register, encoded in the "Rn" field.
<Sm>	Is the 32-bit name of the second SIMD&FP source register, encoded in the "Rm" field.
<nzcv>	Is the flag bit specifier, an immediate in the range 0 to 15, giving the alternative state for the 4-bit NZCV condition flags, encoded in the "nzcv" field.
<cond>	Is one of the standard conditions, encoded in the "cond" field in the standard way.

NaNs

The IEEE 754 standard specifies that the result of a comparison is precisely one of <, ==, > or unordered. If either or both of the operands are NaNs, they are unordered, and all three of (Operand1 < Operand2), (Operand1 == Operand2) and (Operand1 > Operand2) are false. This case results in the **FPCR** flags being set to N=0, Z=0, C=1, and V=1.

FCCMPE raises an Invalid Operation exception if either operand is any type of NaN, and is suitable for testing for <, <=, >, >=, and other predicates that raise an exception when the operands are unordered.

Operation

```
CheckFPAdvSIMDEnabled64();

bits(datasize) operand1 = V[n];
bits(datasize) operand2;

operand2 = V[m];

if ConditionHolds(cond) then
    flags = FPCompare(operand1, operand2, TRUE, FPCR);
PSTATE.<N,Z,C,V> = flags;
```

C7.2.46 FCMEQ (register)

Floating-point Compare Equal (vector). This instruction compares each floating-point value from the first source SIMD&FP register, with the corresponding floating-point value from the second source SIMD&FP register, and if the comparison is equal sets every bit of the corresponding vector element in the destination SIMD&FP register to one, otherwise sets every bit of the corresponding vector element in the destination SIMD&FP register to zero.

This instruction can generate a floating-point exception. Depending on the settings in [FPCR](#), the exception results in either a flag being set in [FPSR](#), or a synchronous exception being generated. For more information, see [Floating-point exceptions and exception traps on page D1-1831](#).

Depending on the settings in the [CPACR_EL1](#), [CPTR_EL2](#), and [CPTR_EL3](#) registers, and the current Security state and Exception level, an attempt to execute the instruction might be trapped.

Scalar half precision

ARMv8.2

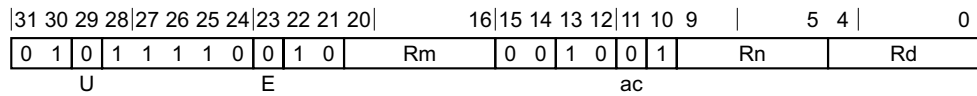

Scalar half precision variant

FCMEQ <Hd>, <Hn>, <Hm>

Decode for this encoding

```
if !HaveFP16Ext() then UnallocatedEncoding();
```

```
integer d = UInt(Rd);
integer n = UInt(Rn);
integer m = UInt(Rm);
integer esize = 16;
integer datasize = esize;
integer elements = 1;
CompareOp cmp;
boolean abs;
```

```
case E:U:ac of
  when '000' cmp = CompareOp_EQ; abs = FALSE;
  when '010' cmp = CompareOp_GE; abs = FALSE;
  when '011' cmp = CompareOp_GE; abs = TRUE;
  when '110' cmp = CompareOp_GT; abs = FALSE;
  when '111' cmp = CompareOp_GT; abs = TRUE;
  otherwise UnallocatedEncoding();
```

Scalar single-precision and double-precision

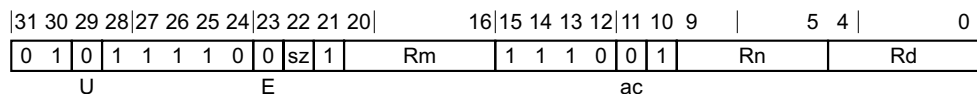

Scalar single-precision and double-precision variant

FCMEQ <V><d>, <V><n>, <V><m>

Decode for this encoding

```
integer d = UInt(Rd);
integer n = UInt(Rn);
integer m = UInt(Rm);
integer esize = 32 << UInt(sz);
integer datasize = esize;
integer elements = 1;
CompareOp cmp;
boolean abs;

case E:U:ac of
    when '000' cmp = CompareOp_EQ; abs = FALSE;
    when '010' cmp = CompareOp_GE; abs = FALSE;
    when '011' cmp = CompareOp_GE; abs = TRUE;
    when '110' cmp = CompareOp_GT; abs = FALSE;
    when '111' cmp = CompareOp_GT; abs = TRUE;
    otherwise UnallocatedEncoding();
```

Vector half precision

ARMv8.2

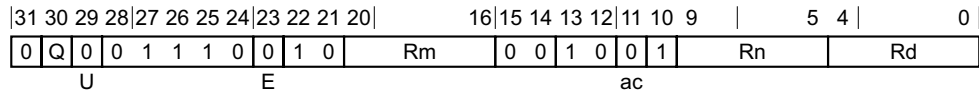

Vector half precision variant

FCMEQ <Vd>.<T>, <Vn>.<T>, <Vm>.<T>

Decode for this encoding

```
if !HaveFP16Ext() then UnallocatedEncoding();

integer d = UInt(Rd);
integer n = UInt(Rn);
integer m = UInt(Rm);
integer esize = 16;
integer datasize = if Q == '1' then 128 else 64;
integer elements = datasize DIV esize;
CompareOp cmp;
boolean abs;

case E:U:ac of
    when '000' cmp = CompareOp_EQ; abs = FALSE;
    when '010' cmp = CompareOp_GE; abs = FALSE;
    when '011' cmp = CompareOp_GE; abs = TRUE;
    when '110' cmp = CompareOp_GT; abs = FALSE;
    when '111' cmp = CompareOp_GT; abs = TRUE;
    otherwise UnallocatedEncoding();
```

Vector single-precision and double-precision

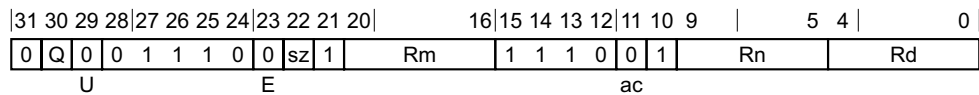

Vector single-precision and double-precision variant

FCMEQ <Vd>.<T>, <Vn>.<T>, <Vm>.<T>

Decode for this encoding

```
integer d = UInt(Rd);
integer n = UInt(Rn);
integer m = UInt(Rm);
if sz:Q == '10' then ReservedValue();
integer esize = 32 << UInt(sz);
integer datasize = if Q == '1' then 128 else 64;
integer elements = datasize DIV esize;
CompareOp cmp;
boolean abs;

case E:U:ac of
  when '000' cmp = CompareOp_EQ; abs = FALSE;
  when '010' cmp = CompareOp_GE; abs = FALSE;
  when '011' cmp = CompareOp_GE; abs = TRUE;
  when '110' cmp = CompareOp_GT; abs = FALSE;
  when '111' cmp = CompareOp_GT; abs = TRUE;
  otherwise UnallocatedEncoding();
```

Assembler symbols

- <Hd> Is the 16-bit name of the SIMD&FP destination register, encoded in the "Rd" field.
- <Hn> Is the 16-bit name of the first SIMD&FP source register, encoded in the "Rn" field.
- <Hm> Is the 16-bit name of the second SIMD&FP source register, encoded in the "Rm" field.
- <V> Is a width specifier, encoded in the "sz" field. It can have the following values:
 - S when sz = 0
 - D when sz = 1
- <d> Is the number of the SIMD&FP destination register, in the "Rd" field.
- <n> Is the number of the first SIMD&FP source register, encoded in the "Rn" field.
- <m> Is the number of the second SIMD&FP source register, encoded in the "Rm" field.
- <Vd> Is the name of the SIMD&FP destination register, encoded in the "Rd" field.
- <T> For the vector half precision variant: is an arrangement specifier, encoded in the "Q" field. It can have the following values:
 - 4H when Q = 0
 - 8H when Q = 1
 For the vector single-precision and double-precision variant: is an arrangement specifier, encoded in the "sz:Q" field. It can have the following values:
 - 2S when sz = 0, Q = 0
 - 4S when sz = 0, Q = 1
 - 2D when sz = 1, Q = 1
 The encoding sz = 1, Q = 0 is reserved.
- <Vn> Is the name of the first SIMD&FP source register, encoded in the "Rn" field.
- <Vm> Is the name of the second SIMD&FP source register, encoded in the "Rm" field.

Operation for all encodings

```
CheckFPAdvSIMDEnabled64();
bits(datasize) operand1 = V[n];
bits(datasize) operand2 = V[m];
bits(datasize) result;
```

```
bits(esize) element1;
bits(esize) element2;
boolean test_passed;

for e = 0 to elements-1
  element1 = Elem[operand1, e, esize];
  element2 = Elem[operand2, e, esize];
  if abs then
    element1 = FPAbs(element1);
    element2 = FPAbs(element2);
  case cmp of
    when CompareOp_EQ test_passed = FPCompareEQ(element1, element2, FPCR);
    when CompareOp_GE test_passed = FPCompareGE(element1, element2, FPCR);
    when CompareOp_GT test_passed = FPCompareGT(element1, element2, FPCR);
  Elem[result, e, esize] = if test_passed then Ones() else Zeros();

V[d] = result;
```

C7.2.47 FCMEQ (zero)

Floating-point Compare Equal to zero (vector). This instruction reads each floating-point value in the source SIMD&FP register and if the value is equal to zero sets every bit of the corresponding vector element in the destination SIMD&FP register to one, otherwise sets every bit of the corresponding vector element in the destination SIMD&FP register to zero.

This instruction can generate a floating-point exception. Depending on the settings in [FPCR](#), the exception results in either a flag being set in [FPSR](#), or a synchronous exception being generated. For more information, see [Floating-point exceptions and exception traps on page D1-1831](#).

Depending on the settings in the [CPACR_EL1](#), [CPTR_EL2](#), and [CPTR_EL3](#) registers, and the current Security state and Exception level, an attempt to execute the instruction might be trapped.

Scalar half precision

ARMv8.2

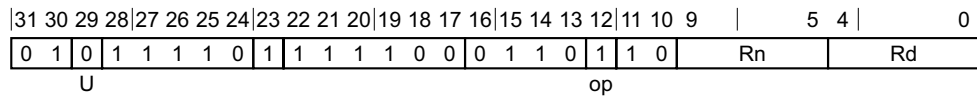

Scalar half precision variant

FCMEQ <Hd>, <Hn>, #0.0

Decode for this encoding

```
if !HaveFP16Ext() then UnallocatedEncoding();
```

```
integer d = UInt(Rd);
integer n = UInt(Rn);
```

```
integer esize = 16;
integer datasize = esize;
integer elements = 1;
```

```
CompareOp comparison;
case op:U of
    when '00' comparison = CompareOp_GT;
    when '01' comparison = CompareOp_GE;
    when '10' comparison = CompareOp_EQ;
    when '11' comparison = CompareOp_LE;
```

Scalar single-precision and double-precision

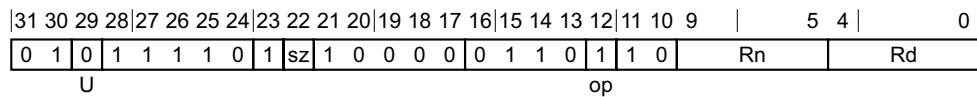

Scalar single-precision and double-precision variant

FCMEQ <V><d>, <V><n>, #0.0

Decode for this encoding

```
integer d = UInt(Rd);
integer n = UInt(Rn);
```

```
integer esize = 32 << UInt(sz);
integer datasize = esize;
```

```
integer elements = 1;

CompareOp comparison;
case op:U of
    when '00' comparison = CompareOp_GT;
    when '01' comparison = CompareOp_GE;
    when '10' comparison = CompareOp_EQ;
    when '11' comparison = CompareOp_LE;
```

Vector half precision

ARMv8.2

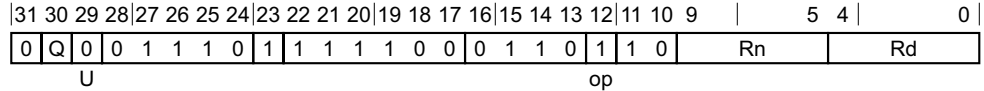

Vector half precision variant

FCMEQ <Vd>.<T>, <Vn>.<T>, #0.0

Decode for this encoding

```
if !HaveFP16Ext() then UnallocatedEncoding();

integer d = UInt(Rd);
integer n = UInt(Rn);

integer esize = 16;
integer datasize = if Q == '1' then 128 else 64;
integer elements = datasize DIV esize;

CompareOp comparison;
case op:U of
    when '00' comparison = CompareOp_GT;
    when '01' comparison = CompareOp_GE;
    when '10' comparison = CompareOp_EQ;
    when '11' comparison = CompareOp_LE;
```

Vector single-precision and double-precision

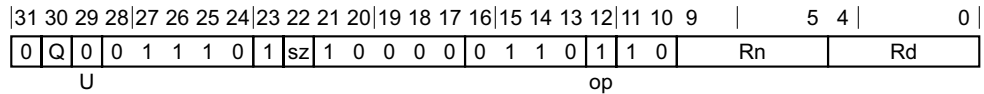

Vector single-precision and double-precision variant

FCMEQ <Vd>.<T>, <Vn>.<T>, #0.0

Decode for this encoding

```
integer d = UInt(Rd);
integer n = UInt(Rn);

if sz:Q == '10' then ReservedValue();
integer esize = 32 << UInt(sz);
integer datasize = if Q == '1' then 128 else 64;
integer elements = datasize DIV esize;

CompareOp comparison;
case op:U of
    when '00' comparison = CompareOp_GT;
```

```
when '01' comparison = CompareOp_GE;
when '10' comparison = CompareOp_EQ;
when '11' comparison = CompareOp_LE;
```

Assembler symbols

- <Hd> Is the 16-bit name of the SIMD&FP destination register, encoded in the "Rd" field.
- <Hn> Is the 16-bit name of the SIMD&FP source register, encoded in the "Rn" field.
- <V> Is a width specifier, encoded in the "sz" field. It can have the following values:
 - S when sz = 0
 - D when sz = 1
- <d> Is the number of the SIMD&FP destination register, encoded in the "Rd" field.
- <n> Is the number of the SIMD&FP source register, encoded in the "Rn" field.
- <Vd> Is the name of the SIMD&FP destination register, encoded in the "Rd" field.
- <T> For the vector half precision variant: is an arrangement specifier, encoded in the "Q" field. It can have the following values:
 - 4H when Q = 0
 - 8H when Q = 1
 For the vector single-precision and double-precision variant: is an arrangement specifier, encoded in the "sz:Q" field. It can have the following values:
 - 2S when sz = 0, Q = 0
 - 4S when sz = 0, Q = 1
 - 2D when sz = 1, Q = 1
 The encoding sz = 1, Q = 0 is reserved.
- <Vn> Is the name of the SIMD&FP source register, encoded in the "Rn" field.

Operation for all encodings

```
CheckFPAdvSIMDEnabled64();
bits(datasize) operand = V[n];
bits(datasize) result;
bits(esize) zero = FPZero('0');
bits(esize) element;
boolean test_passed;

for e = 0 to elements-1
  element = Elem[operand, e, esize];
  case comparison of
    when CompareOp_GT test_passed = FPCompareGT(element, zero, FPCR);
    when CompareOp_GE test_passed = FPCompareGE(element, zero, FPCR);
    when CompareOp_EQ test_passed = FPCompareEQ(element, zero, FPCR);
    when CompareOp_LE test_passed = FPCompareGE(zero, element, FPCR);
    when CompareOp_LT test_passed = FPCompareGT(zero, element, FPCR);
  Elem[result, e, esize] = if test_passed then Ones() else Zeros();

V[d] = result;
```

C7.2.48 FCMGE (register)

Floating-point Compare Greater than or Equal (vector). This instruction reads each floating-point value in the first source SIMD&FP register and if the value is greater than or equal to the corresponding floating-point value in the second source SIMD&FP register sets every bit of the corresponding vector element in the destination SIMD&FP register to one, otherwise sets every bit of the corresponding vector element in the destination SIMD&FP register to zero.

This instruction can generate a floating-point exception. Depending on the settings in [FPCR](#), the exception results in either a flag being set in [FPSR](#), or a synchronous exception being generated. For more information, see [Floating-point exceptions and exception traps on page D1-1831](#).

Depending on the settings in the [CPACR_EL1](#), [CPTR_EL2](#), and [CPTR_EL3](#) registers, and the current Security state and Exception level, an attempt to execute the instruction might be trapped.

Scalar half precision

ARMv8.2

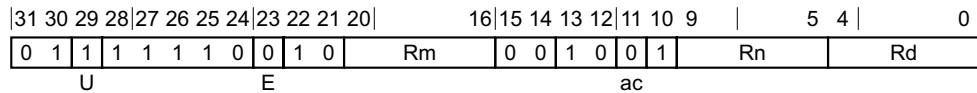

Scalar half precision variant

FCMGE <Hd>, <Hn>, <Hm>

Decode for this encoding

```

if !HaveFP16Ext() then UnallocatedEncoding();

integer d = UInt(Rd);
integer n = UInt(Rn);
integer m = UInt(Rm);
integer esize = 16;
integer datasize = esize;
integer elements = 1;
CompareOp cmp;
boolean abs;

case E:U:ac of
    when '000' cmp = CompareOp_EQ; abs = FALSE;
    when '010' cmp = CompareOp_GE; abs = FALSE;
    when '011' cmp = CompareOp_GE; abs = TRUE;
    when '110' cmp = CompareOp_GT; abs = FALSE;
    when '111' cmp = CompareOp_GT; abs = TRUE;
    otherwise UnallocatedEncoding();
    
```

Scalar single-precision and double-precision

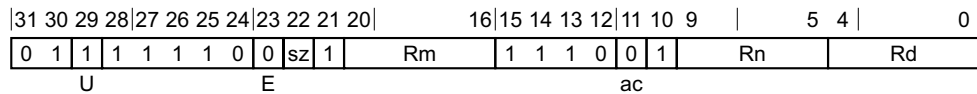

Scalar single-precision and double-precision variant

FCMGE <V><d>, <V><n>, <V><m>

Decode for this encoding

```
integer d = UInt(Rd);
integer n = UInt(Rn);
integer m = UInt(Rm);
integer esize = 32 << UInt(sz);
integer datasize = esize;
integer elements = 1;
CompareOp cmp;
boolean abs;

case E:U:ac of
    when '000' cmp = CompareOp_EQ; abs = FALSE;
    when '010' cmp = CompareOp_GE; abs = FALSE;
    when '011' cmp = CompareOp_GE; abs = TRUE;
    when '110' cmp = CompareOp_GT; abs = FALSE;
    when '111' cmp = CompareOp_GT; abs = TRUE;
    otherwise UnallocatedEncoding();
```

Vector half precision

ARMv8.2

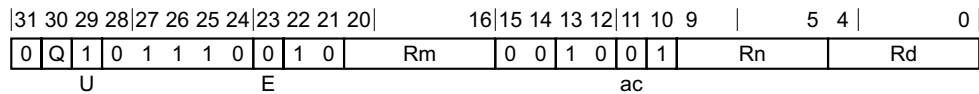

Vector half precision variant

FCMGE <Vd>.<T>, <Vn>.<T>, <Vm>.<T>

Decode for this encoding

```
if !HaveFP16Ext() then UnallocatedEncoding();

integer d = UInt(Rd);
integer n = UInt(Rn);
integer m = UInt(Rm);
integer esize = 16;
integer datasize = if Q == '1' then 128 else 64;
integer elements = datasize DIV esize;
CompareOp cmp;
boolean abs;

case E:U:ac of
    when '000' cmp = CompareOp_EQ; abs = FALSE;
    when '010' cmp = CompareOp_GE; abs = FALSE;
    when '011' cmp = CompareOp_GE; abs = TRUE;
    when '110' cmp = CompareOp_GT; abs = FALSE;
    when '111' cmp = CompareOp_GT; abs = TRUE;
    otherwise UnallocatedEncoding();
```

Vector single-precision and double-precision

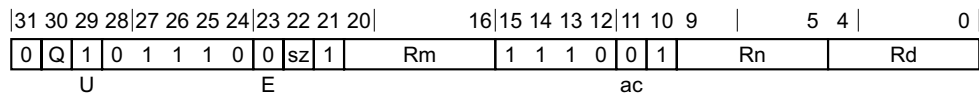

Vector single-precision and double-precision variant

FCMGE <Vd>.<T>, <Vn>.<T>, <Vm>.<T>

Decode for this encoding

```
integer d = UInt(Rd);
integer n = UInt(Rn);
integer m = UInt(Rm);
if sz:Q == '10' then ReservedValue();
integer esize = 32 << UInt(sz);
integer datasize = if Q == '1' then 128 else 64;
integer elements = datasize DIV esize;
CompareOp cmp;
boolean abs;

case E:U:ac of
    when '000' cmp = CompareOp_EQ; abs = FALSE;
    when '010' cmp = CompareOp_GE; abs = FALSE;
    when '011' cmp = CompareOp_GE; abs = TRUE;
    when '110' cmp = CompareOp_GT; abs = FALSE;
    when '111' cmp = CompareOp_GT; abs = TRUE;
    otherwise UnallocatedEncoding();
```

Assembler symbols

- <Hd> Is the 16-bit name of the SIMD&FP destination register, encoded in the "Rd" field.
- <Hn> Is the 16-bit name of the first SIMD&FP source register, encoded in the "Rn" field.
- <Hm> Is the 16-bit name of the second SIMD&FP source register, encoded in the "Rm" field.
- <V> Is a width specifier, encoded in the "sz" field. It can have the following values:
 - S when sz = 0
 - D when sz = 1
- <d> Is the number of the SIMD&FP destination register, in the "Rd" field.
- <n> Is the number of the first SIMD&FP source register, encoded in the "Rn" field.
- <m> Is the number of the second SIMD&FP source register, encoded in the "Rm" field.
- <Vd> Is the name of the SIMD&FP destination register, encoded in the "Rd" field.
- <T> For the vector half precision variant: is an arrangement specifier, encoded in the "Q" field. It can have the following values:
 - 4H when Q = 0
 - 8H when Q = 1
 For the vector single-precision and double-precision variant: is an arrangement specifier, encoded in the "sz:Q" field. It can have the following values:
 - 2S when sz = 0, Q = 0
 - 4S when sz = 0, Q = 1
 - 2D when sz = 1, Q = 1
 The encoding sz = 1, Q = 0 is reserved.
- <Vn> Is the name of the first SIMD&FP source register, encoded in the "Rn" field.
- <Vm> Is the name of the second SIMD&FP source register, encoded in the "Rm" field.

Operation for all encodings

```
CheckFPAdvSIMDEnabled64();
bits(datasize) operand1 = V[n];
bits(datasize) operand2 = V[m];
bits(datasize) result;
```

```
bits(esize) element1;
bits(esize) element2;
boolean test_passed;

for e = 0 to elements-1
  element1 = Elem[operand1, e, esize];
  element2 = Elem[operand2, e, esize];
  if abs then
    element1 = FPAbs(element1);
    element2 = FPAbs(element2);
  case cmp of
    when CompareOp_EQ test_passed = FPCompareEQ(element1, element2, FPCR);
    when CompareOp_GE test_passed = FPCompareGE(element1, element2, FPCR);
    when CompareOp_GT test_passed = FPCompareGT(element1, element2, FPCR);
  Elem[result, e, esize] = if test_passed then Ones() else Zeros();

V[d] = result;
```

C7.2.49 FCMGE (zero)

Floating-point Compare Greater than or Equal to zero (vector). This instruction reads each floating-point value in the source SIMD&FP register and if the value is greater than or equal to zero sets every bit of the corresponding vector element in the destination SIMD&FP register to one, otherwise sets every bit of the corresponding vector element in the destination SIMD&FP register to zero.

This instruction can generate a floating-point exception. Depending on the settings in [FPCR](#), the exception results in either a flag being set in [FPSR](#), or a synchronous exception being generated. For more information, see [Floating-point exceptions and exception traps on page D1-1831](#).

Depending on the settings in the [CPACR_EL1](#), [CPTR_EL2](#), and [CPTR_EL3](#) registers, and the current Security state and Exception level, an attempt to execute the instruction might be trapped.

Scalar half precision

ARMv8.2

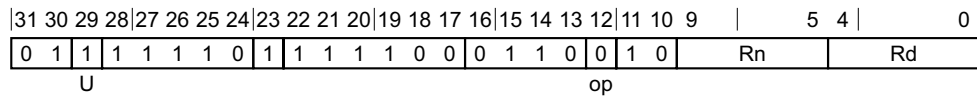

Scalar half precision variant

FCMGE <Hd>, <Hn>, #0.0

Decode for this encoding

```
if !HaveFP16Ext() then UnallocatedEncoding();
```

```
integer d = UInt(Rd);
integer n = UInt(Rn);
```

```
integer esize = 16;
integer datasize = esize;
integer elements = 1;
```

```
CompareOp comparison;
case op:U of
    when '00' comparison = CompareOp_GT;
    when '01' comparison = CompareOp_GE;
    when '10' comparison = CompareOp_EQ;
    when '11' comparison = CompareOp_LE;
```

Scalar single-precision and double-precision

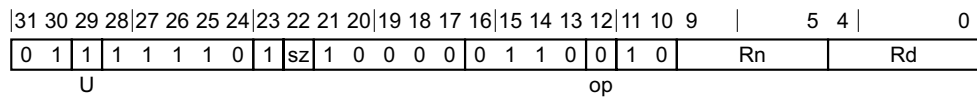

Scalar single-precision and double-precision variant

FCMGE <V><d>, <V><n>, #0.0

Decode for this encoding

```
integer d = UInt(Rd);
integer n = UInt(Rn);
```

```
integer esize = 32 << UInt(sz);
integer datasize = esize;
```



```
integer elements = 1;

CompareOp comparison;
case op:U of
    when '00' comparison = CompareOp_GT;
    when '01' comparison = CompareOp_GE;
    when '10' comparison = CompareOp_EQ;
    when '11' comparison = CompareOp_LE;
```

Vector half precision

ARMv8.2

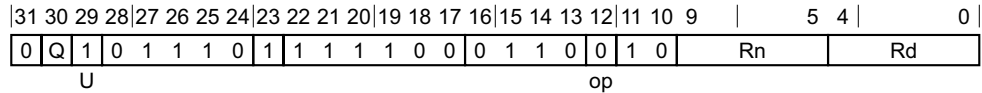

Vector half precision variant

FCMGE <Vd>.<T>, <Vn>.<T>, #0.0

Decode for this encoding

```
if !HaveFP16Ext() then UnallocatedEncoding();

integer d = UInt(Rd);
integer n = UInt(Rn);

integer esize = 16;
integer datasize = if Q == '1' then 128 else 64;
integer elements = datasize DIV esize;

CompareOp comparison;
case op:U of
    when '00' comparison = CompareOp_GT;
    when '01' comparison = CompareOp_GE;
    when '10' comparison = CompareOp_EQ;
    when '11' comparison = CompareOp_LE;
```

Vector single-precision and double-precision

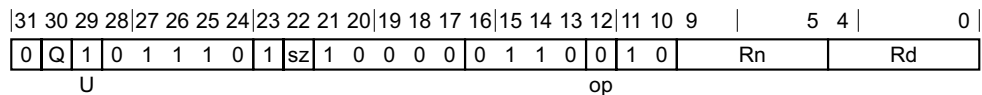

Vector single-precision and double-precision variant

FCMGE <Vd>.<T>, <Vn>.<T>, #0.0

Decode for this encoding

```
integer d = UInt(Rd);
integer n = UInt(Rn);

if sz:Q == '10' then ReservedValue();
integer esize = 32 << UInt(sz);
integer datasize = if Q == '1' then 128 else 64;
integer elements = datasize DIV esize;

CompareOp comparison;
case op:U of
    when '00' comparison = CompareOp_GT;
```

```
when '01' comparison = CompareOp_GE;  
when '10' comparison = CompareOp_EQ;  
when '11' comparison = CompareOp_LE;
```

Assembler symbols

<Hd>	Is the 16-bit name of the SIMD&FP destination register, encoded in the "Rd" field.
<Hn>	Is the 16-bit name of the SIMD&FP source register, encoded in the "Rn" field.
<V>	Is a width specifier, encoded in the "sz" field. It can have the following values: S when sz = 0 D when sz = 1
<d>	Is the number of the SIMD&FP destination register, encoded in the "Rd" field.
<n>	Is the number of the SIMD&FP source register, encoded in the "Rn" field.
<Vd>	Is the name of the SIMD&FP destination register, encoded in the "Rd" field.
<T>	For the vector half precision variant: is an arrangement specifier, encoded in the "Q" field. It can have the following values: 4H when Q = 0 8H when Q = 1 For the vector single-precision and double-precision variant: is an arrangement specifier, encoded in the "sz:Q" field. It can have the following values: 2S when sz = 0, Q = 0 4S when sz = 0, Q = 1 2D when sz = 1, Q = 1 The encoding sz = 1, Q = 0 is reserved.
<Vn>	Is the name of the SIMD&FP source register, encoded in the "Rn" field.

Operation for all encodings

```
CheckFPAdvSIMDEnabled64();  
bits(datasize) operand = V[n];  
bits(datasize) result;  
bits(esize) zero = FPZero('0');  
bits(esize) element;  
boolean test_passed;  
  
for e = 0 to elements-1  
  element = Elem[operand, e, esize];  
  case comparison of  
    when CompareOp_GT test_passed = FPCompareGT(element, zero, FPCR);  
    when CompareOp_GE test_passed = FPCompareGE(element, zero, FPCR);  
    when CompareOp_EQ test_passed = FPCompareEQ(element, zero, FPCR);  
    when CompareOp_LE test_passed = FPCompareGE(zero, element, FPCR);  
    when CompareOp_LT test_passed = FPCompareGT(zero, element, FPCR);  
  Elem[result, e, esize] = if test_passed then Ones() else Zeros();  
  
V[d] = result;
```

C7.2.50 FCMGT (register)

Floating-point Compare Greater than (vector). This instruction reads each floating-point value in the first source SIMD&FP register and if the value is greater than the corresponding floating-point value in the second source SIMD&FP register sets every bit of the corresponding vector element in the destination SIMD&FP register to one, otherwise sets every bit of the corresponding vector element in the destination SIMD&FP register to zero.

This instruction can generate a floating-point exception. Depending on the settings in [FPCR](#), the exception results in either a flag being set in [FPSR](#), or a synchronous exception being generated. For more information, see [Floating-point exceptions and exception traps on page D1-1831](#).

Depending on the settings in the [CPACR_EL1](#), [CPTR_EL2](#), and [CPTR_EL3](#) registers, and the current Security state and Exception level, an attempt to execute the instruction might be trapped.

Scalar half precision

ARMv8.2

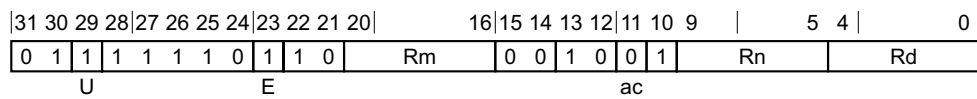

Scalar half precision variant

FCMGT <Hd>, <Hn>, <Hm>

Decode for this encoding

```
if !HaveFP16Ext() then UnallocatedEncoding();
```

```
integer d = UInt(Rd);
integer n = UInt(Rn);
integer m = UInt(Rm);
integer esize = 16;
integer datasize = esize;
integer elements = 1;
CompareOp cmp;
boolean abs;
```

```
case E:U:ac of
  when '000' cmp = CompareOp_EQ; abs = FALSE;
  when '010' cmp = CompareOp_GE; abs = FALSE;
  when '011' cmp = CompareOp_GE; abs = TRUE;
  when '110' cmp = CompareOp_GT; abs = FALSE;
  when '111' cmp = CompareOp_GT; abs = TRUE;
  otherwise UnallocatedEncoding();
```

Scalar single-precision and double-precision

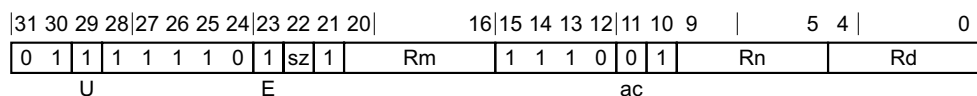

Scalar single-precision and double-precision variant

FCMGT <V><d>, <V><n>, <V><m>

Decode for this encoding

```
integer d = UInt(Rd);
integer n = UInt(Rn);
integer m = UInt(Rm);
integer esize = 32 << UInt(sz);
integer datasize = esize;
integer elements = 1;
CompareOp cmp;
boolean abs;

case E:U:ac of
    when '000' cmp = CompareOp_EQ; abs = FALSE;
    when '010' cmp = CompareOp_GE; abs = FALSE;
    when '011' cmp = CompareOp_GE; abs = TRUE;
    when '110' cmp = CompareOp_GT; abs = FALSE;
    when '111' cmp = CompareOp_GT; abs = TRUE;
    otherwise UnallocatedEncoding();
```

Vector half precision

ARMv8.2

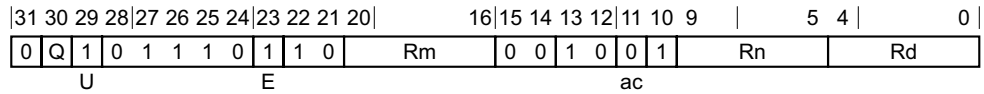

Vector half precision variant

FCMGT <Vd>.<T>, <Vn>.<T>, <Vm>.<T>

Decode for this encoding

```
if !HaveFP16Ext() then UnallocatedEncoding();

integer d = UInt(Rd);
integer n = UInt(Rn);
integer m = UInt(Rm);
integer esize = 16;
integer datasize = if Q == '1' then 128 else 64;
integer elements = datasize DIV esize;
CompareOp cmp;
boolean abs;

case E:U:ac of
    when '000' cmp = CompareOp_EQ; abs = FALSE;
    when '010' cmp = CompareOp_GE; abs = FALSE;
    when '011' cmp = CompareOp_GE; abs = TRUE;
    when '110' cmp = CompareOp_GT; abs = FALSE;
    when '111' cmp = CompareOp_GT; abs = TRUE;
    otherwise UnallocatedEncoding();
```

Vector single-precision and double-precision

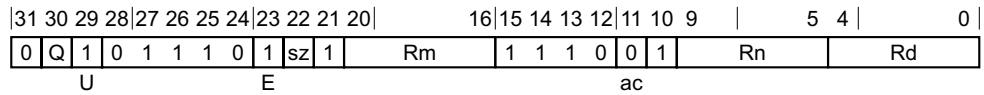

Vector single-precision and double-precision variant

FCMGT <Vd>.<T>, <Vn>.<T>, <Vm>.<T>

Decode for this encoding

```

integer d = UInt(Rd);
integer n = UInt(Rn);
integer m = UInt(Rm);
if sz:Q == '10' then ReservedValue();
integer esize = 32 << UInt(sz);
integer datasize = if Q == '1' then 128 else 64;
integer elements = datasize DIV esize;
CompareOp cmp;
boolean abs;

case E:U:ac of
    when '000' cmp = CompareOp_EQ; abs = FALSE;
    when '010' cmp = CompareOp_GE; abs = FALSE;
    when '011' cmp = CompareOp_GE; abs = TRUE;
    when '110' cmp = CompareOp_GT; abs = FALSE;
    when '111' cmp = CompareOp_GT; abs = TRUE;
    otherwise UnallocatedEncoding();
    
```

Assembler symbols

- <Hd> Is the 16-bit name of the SIMD&FP destination register, encoded in the "Rd" field.
- <Hn> Is the 16-bit name of the first SIMD&FP source register, encoded in the "Rn" field.
- <Hm> Is the 16-bit name of the second SIMD&FP source register, encoded in the "Rm" field.
- <V> Is a width specifier, encoded in the "sz" field. It can have the following values:
 - S when sz = 0
 - D when sz = 1
- <d> Is the number of the SIMD&FP destination register, in the "Rd" field.
- <n> Is the number of the first SIMD&FP source register, encoded in the "Rn" field.
- <m> Is the number of the second SIMD&FP source register, encoded in the "Rm" field.
- <Vd> Is the name of the SIMD&FP destination register, encoded in the "Rd" field.
- <T> For the vector half precision variant: is an arrangement specifier, encoded in the "Q" field. It can have the following values:
 - 4H when Q = 0
 - 8H when Q = 1
 For the vector single-precision and double-precision variant: is an arrangement specifier, encoded in the "sz:Q" field. It can have the following values:
 - 2S when sz = 0, Q = 0
 - 4S when sz = 0, Q = 1
 - 2D when sz = 1, Q = 1
 The encoding sz = 1, Q = 0 is reserved.
- <Vn> Is the name of the first SIMD&FP source register, encoded in the "Rn" field.
- <Vm> Is the name of the second SIMD&FP source register, encoded in the "Rm" field.

Operation for all encodings

```

CheckFPAdvSIMDEnabled64();
bits(datasize) operand1 = V[n];
bits(datasize) operand2 = V[m];
bits(datasize) result;
    
```

```
bits(esize) element1;
bits(esize) element2;
boolean test_passed;

for e = 0 to elements-1
  element1 = Elem[operand1, e, esize];
  element2 = Elem[operand2, e, esize];
  if abs then
    element1 = FPAbs(element1);
    element2 = FPAbs(element2);
  case cmp of
    when CompareOp_EQ test_passed = FPCompareEQ(element1, element2, FPCR);
    when CompareOp_GE test_passed = FPCompareGE(element1, element2, FPCR);
    when CompareOp_GT test_passed = FPCompareGT(element1, element2, FPCR);
  Elem[result, e, esize] = if test_passed then Ones() else Zeros();

V[d] = result;
```

C7.2.51 FCMGT (zero)

Floating-point Compare Greater than zero (vector). This instruction reads each floating-point value in the source SIMD&FP register and if the value is greater than zero sets every bit of the corresponding vector element in the destination SIMD&FP register to one, otherwise sets every bit of the corresponding vector element in the destination SIMD&FP register to zero.

This instruction can generate a floating-point exception. Depending on the settings in [FPCR](#), the exception results in either a flag being set in [FPSR](#), or a synchronous exception being generated. For more information, see [Floating-point exceptions and exception traps on page D1-1831](#).

Depending on the settings in the [CPACR_EL1](#), [CPTR_EL2](#), and [CPTR_EL3](#) registers, and the current Security state and Exception level, an attempt to execute the instruction might be trapped.

Scalar half precision

ARMv8.2

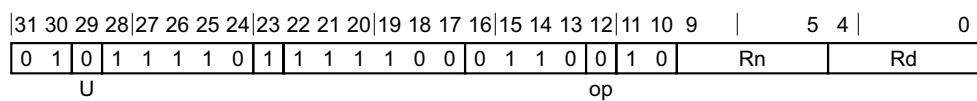

Scalar half precision variant

FCMGT <Hd>, <Hn>, #0.0

Decode for this encoding

```
if !HaveFP16Ext() then UnallocatedEncoding();
```

```
integer d = UInt(Rd);
integer n = UInt(Rn);
```

```
integer esize = 16;
integer datasize = esize;
integer elements = 1;
```

```
CompareOp comparison;
case op:U of
    when '00' comparison = CompareOp_GT;
    when '01' comparison = CompareOp_GE;
    when '10' comparison = CompareOp_EQ;
    when '11' comparison = CompareOp_LE;
```

Scalar single-precision and double-precision

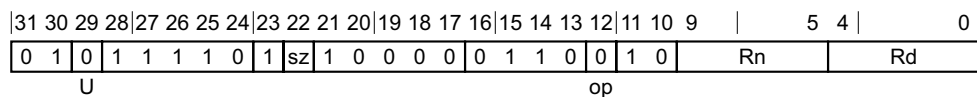

Scalar single-precision and double-precision variant

FCMGT <V><d>, <V><n>, #0.0

Decode for this encoding

```
integer d = UInt(Rd);
integer n = UInt(Rn);
```

```
integer esize = 32 << UInt(sz);
integer datasize = esize;
```

```
integer elements = 1;

CompareOp comparison;
case op:U of
    when '00' comparison = CompareOp_GT;
    when '01' comparison = CompareOp_GE;
    when '10' comparison = CompareOp_EQ;
    when '11' comparison = CompareOp_LE;
```

Vector half precision

ARMv8.2

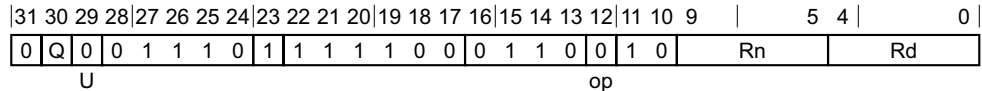

Vector half precision variant

FCMGT <Vd>.<T>, <Vn>.<T>, #0.0

Decode for this encoding

```
if !HaveFP16Ext() then UnallocatedEncoding();

integer d = UInt(Rd);
integer n = UInt(Rn);

integer esize = 16;
integer datasize = if Q == '1' then 128 else 64;
integer elements = datasize DIV esize;

CompareOp comparison;
case op:U of
    when '00' comparison = CompareOp_GT;
    when '01' comparison = CompareOp_GE;
    when '10' comparison = CompareOp_EQ;
    when '11' comparison = CompareOp_LE;
```

Vector single-precision and double-precision

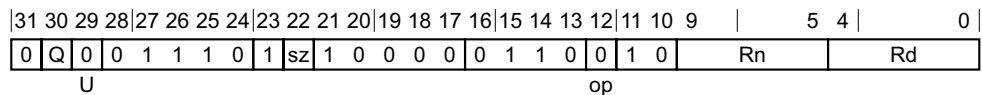

Vector single-precision and double-precision variant

FCMGT <Vd>.<T>, <Vn>.<T>, #0.0

Decode for this encoding

```
integer d = UInt(Rd);
integer n = UInt(Rn);

if sz:Q == '10' then ReservedValue();
integer esize = 32 << UInt(sz);
integer datasize = if Q == '1' then 128 else 64;
integer elements = datasize DIV esize;

CompareOp comparison;
case op:U of
    when '00' comparison = CompareOp_GT;
```



```
when '01' comparison = CompareOp_GE;
when '10' comparison = CompareOp_EQ;
when '11' comparison = CompareOp_LE;
```

Assembler symbols

- <Hd> Is the 16-bit name of the SIMD&FP destination register, encoded in the "Rd" field.
- <Hn> Is the 16-bit name of the SIMD&FP source register, encoded in the "Rn" field.
- <V> Is a width specifier, encoded in the "sz" field. It can have the following values:
- | | |
|---|-------------|
| S | when sz = 0 |
| D | when sz = 1 |
- <d> Is the number of the SIMD&FP destination register, encoded in the "Rd" field.
- <n> Is the number of the SIMD&FP source register, encoded in the "Rn" field.
- <Vd> Is the name of the SIMD&FP destination register, encoded in the "Rd" field.
- <T> For the vector half precision variant: is an arrangement specifier, encoded in the "Q" field. It can have the following values:
- | | |
|----|------------|
| 4H | when Q = 0 |
| 8H | when Q = 1 |
- For the vector single-precision and double-precision variant: is an arrangement specifier, encoded in the "sz:Q" field. It can have the following values:
- | | |
|----|--------------------|
| 2S | when sz = 0, Q = 0 |
| 4S | when sz = 0, Q = 1 |
| 2D | when sz = 1, Q = 1 |
- The encoding sz = 1, Q = 0 is reserved.
- <Vn> Is the name of the SIMD&FP source register, encoded in the "Rn" field.

Operation for all encodings

```
CheckFPAdvSIMDEnabled64();
bits(datasize) operand = V[n];
bits(datasize) result;
bits(esize) zero = FPZero('0');
bits(esize) element;
boolean test_passed;

for e = 0 to elements-1
  element = Elem[operand, e, esize];
  case comparison of
    when CompareOp_GT test_passed = FPCompareGT(element, zero, FPCR);
    when CompareOp_GE test_passed = FPCompareGE(element, zero, FPCR);
    when CompareOp_EQ test_passed = FPCompareEQ(element, zero, FPCR);
    when CompareOp_LE test_passed = FPCompareGE(zero, element, FPCR);
    when CompareOp_LT test_passed = FPCompareGT(zero, element, FPCR);
  Elem[result, e, esize] = if test_passed then Ones() else Zeros();

V[d] = result;
```

C7.2.52 FCMLE (zero)

Floating-point Compare Less than or Equal to zero (vector). This instruction reads each floating-point value in the source SIMD&FP register and if the value is less than or equal to zero sets every bit of the corresponding vector element in the destination SIMD&FP register to one, otherwise sets every bit of the corresponding vector element in the destination SIMD&FP register to zero.

This instruction can generate a floating-point exception. Depending on the settings in [FPCR](#), the exception results in either a flag being set in [FPSR](#), or a synchronous exception being generated. For more information, see [Floating-point exceptions and exception traps on page D1-1831](#).

Depending on the settings in the [CPACR_EL1](#), [CPTR_EL2](#), and [CPTR_EL3](#) registers, and the current Security state and Exception level, an attempt to execute the instruction might be trapped.

Scalar half precision

ARMv8.2

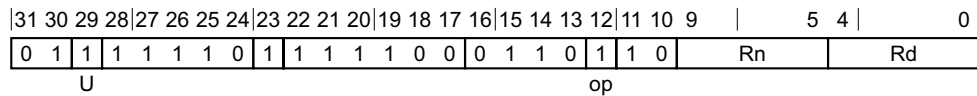

Scalar half precision variant

FCMLE <Hd>, <Hn>, #0.0

Decode for this encoding

```
if !HaveFP16Ext() then UnallocatedEncoding();

integer d = UInt(Rd);
integer n = UInt(Rn);

integer esize = 16;
integer datasize = esize;
integer elements = 1;

CompareOp comparison;
case op:U of
    when '00' comparison = CompareOp_GT;
    when '01' comparison = CompareOp_GE;
    when '10' comparison = CompareOp_EQ;
    when '11' comparison = CompareOp_LE;
```

Scalar single-precision and double-precision

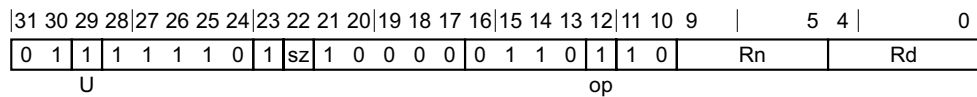

Scalar single-precision and double-precision variant

FCMLE <V><d>, <V><n>, #0.0

Decode for this encoding

```
integer d = UInt(Rd);
integer n = UInt(Rn);

integer esize = 32 << UInt(sz);
integer datasize = esize;
```

```
integer elements = 1;

CompareOp comparison;
case op:U of
    when '00' comparison = CompareOp_GT;
    when '01' comparison = CompareOp_GE;
    when '10' comparison = CompareOp_EQ;
    when '11' comparison = CompareOp_LE;
```

Vector half precision

ARMv8.2

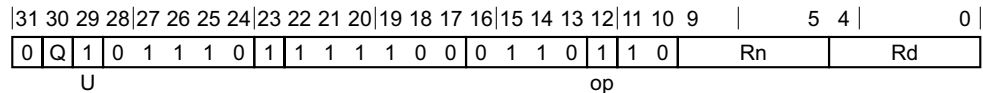

Vector half precision variant

FCMLE <Vd>.<T>, <Vn>.<T>, #0.0

Decode for this encoding

```
if !HaveFP16Ext() then UnallocatedEncoding();

integer d = UInt(Rd);
integer n = UInt(Rn);

integer esize = 16;
integer datasize = if Q == '1' then 128 else 64;
integer elements = datasize DIV esize;

CompareOp comparison;
case op:U of
    when '00' comparison = CompareOp_GT;
    when '01' comparison = CompareOp_GE;
    when '10' comparison = CompareOp_EQ;
    when '11' comparison = CompareOp_LE;
```

Vector single-precision and double-precision

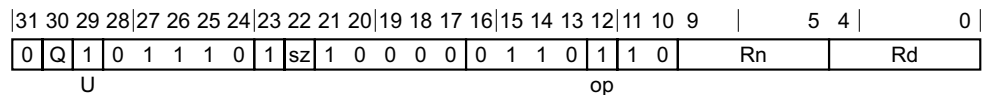

Vector single-precision and double-precision variant

FCMLE <Vd>.<T>, <Vn>.<T>, #0.0

Decode for this encoding

```
integer d = UInt(Rd);
integer n = UInt(Rn);

if sz:Q == '10' then ReservedValue();
integer esize = 32 << UInt(sz);
integer datasize = if Q == '1' then 128 else 64;
integer elements = datasize DIV esize;

CompareOp comparison;
case op:U of
    when '00' comparison = CompareOp_GT;
```

```
when '01' comparison = CompareOp_GE;  
when '10' comparison = CompareOp_EQ;  
when '11' comparison = CompareOp_LE;
```

Assembler symbols

- <Hd> Is the 16-bit name of the SIMD&FP destination register, encoded in the "Rd" field.
- <Hn> Is the 16-bit name of the SIMD&FP source register, encoded in the "Rn" field.
- <V> Is a width specifier, encoded in the "sz" field. It can have the following values:
- S when sz = 0
 - D when sz = 1
- <d> Is the number of the SIMD&FP destination register, encoded in the "Rd" field.
- <n> Is the number of the SIMD&FP source register, encoded in the "Rn" field.
- <Vd> Is the name of the SIMD&FP destination register, encoded in the "Rd" field.
- <T> For the vector half precision variant: is an arrangement specifier, encoded in the "Q" field. It can have the following values:
- 4H when Q = 0
 - 8H when Q = 1
- For the vector single-precision and double-precision variant: is an arrangement specifier, encoded in the "sz:Q" field. It can have the following values:
- 2S when sz = 0, Q = 0
 - 4S when sz = 0, Q = 1
 - 2D when sz = 1, Q = 1
- The encoding sz = 1, Q = 0 is reserved.
- <Vn> Is the name of the SIMD&FP source register, encoded in the "Rn" field.

Operation for all encodings

```
CheckFPAdvSIMDEnabled64();  
bits(datasize) operand = V[n];  
bits(datasize) result;  
bits(esize) zero = FPZero('0');  
bits(esize) element;  
boolean test_passed;  
  
for e = 0 to elements-1  
  element = Elem[operand, e, esize];  
  case comparison of  
    when CompareOp_GT test_passed = FPCompareGT(element, zero, FPCR);  
    when CompareOp_GE test_passed = FPCompareGE(element, zero, FPCR);  
    when CompareOp_EQ test_passed = FPCompareEQ(element, zero, FPCR);  
    when CompareOp_LE test_passed = FPCompareLE(zero, element, FPCR);  
    when CompareOp_LT test_passed = FPCompareLT(zero, element, FPCR);  
  Elem[result, e, esize] = if test_passed then Ones() else Zeros();  
  
V[d] = result;
```

C7.2.53 FCMLT (zero)

Floating-point Compare Less than zero (vector). This instruction reads each floating-point value in the source SIMD&FP register and if the value is less than zero sets every bit of the corresponding vector element in the destination SIMD&FP register to one, otherwise sets every bit of the corresponding vector element in the destination SIMD&FP register to zero.

This instruction can generate a floating-point exception. Depending on the settings in [FPCR](#), the exception results in either a flag being set in [FPSR](#), or a synchronous exception being generated. For more information, see [Floating-point exceptions and exception traps on page D1-1831](#).

Depending on the settings in the [CPACR_EL1](#), [CPTR_EL2](#), and [CPTR_EL3](#) registers, and the current Security state and Exception level, an attempt to execute the instruction might be trapped.

Scalar half precision

ARMv8.2

31	30	29	28	27	26	25	24	23	22	21	20	19	18	17	16	15	14	13	12	11	10	9	5 4			0
0	1	0	1	1	1	1	0	1	1	1	1	0	0	0	0	1	1	1	0	1	0	Rn			Rd	

Scalar half precision variant

FCMLT <Hd>, <Hn>, #0.0

Decode for this encoding

```
if !HaveFP16Ext() then UnallocatedEncoding();
```

```
integer d = UInt(Rd);
integer n = UInt(Rn);
```

```
integer esize = 16;
integer datasize = esize;
integer elements = 1;
```

```
CompareOp comparison = CompareOp_LT;
```

Scalar single-precision and double-precision

31	30	29	28	27	26	25	24	23	22	21	20	19	18	17	16	15	14	13	12	11	10	9	5 4			0
0	1	0	1	1	1	1	0	1	sz	1	0	0	0	0	0	0	1	1	1	0	1	0	Rn			Rd

Scalar single-precision and double-precision variant

FCMLT <V><d>, <V><n>, #0.0

Decode for this encoding

```
integer d = UInt(Rd);
integer n = UInt(Rn);
```

```
integer esize = 32 << UInt(sz);
integer datasize = esize;
integer elements = 1;
```

```
CompareOp comparison = CompareOp_LT;
```

Vector half precision

ARMv8.2

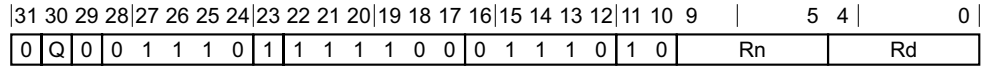

Vector half precision variant

FCMLT <Vd>.<T>, <Vn>.<T>, #0.0

Decode for this encoding

```

if !HaveFP16Ext() then UnallocatedEncoding();

integer d = UInt(Rd);
integer n = UInt(Rn);

integer esize = 16;
integer datasize = if Q == '1' then 128 else 64;
integer elements = datasize DIV esize;

CompareOp comparison = CompareOp_LT;
    
```

Vector single-precision and double-precision

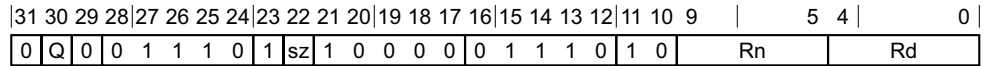

Vector single-precision and double-precision variant

FCMLT <Vd>.<T>, <Vn>.<T>, #0.0

Decode for this encoding

```

integer d = UInt(Rd);
integer n = UInt(Rn);

if sz:Q == '10' then ReservedValue();
integer esize = 32 << UInt(sz);
integer datasize = if Q == '1' then 128 else 64;
integer elements = datasize DIV esize;

CompareOp comparison = CompareOp_LT;
    
```

Assembler symbols

- <Hd> Is the 16-bit name of the SIMD&FP destination register, encoded in the "Rd" field.
- <Hn> Is the 16-bit name of the SIMD&FP source register, encoded in the "Rn" field.
- <V> Is a width specifier, encoded in the "sz" field. It can have the following values:
 - S when sz = 0
 - D when sz = 1
- <d> Is the number of the SIMD&FP destination register, encoded in the "Rd" field.
- <n> Is the number of the SIMD&FP source register, encoded in the "Rn" field.

- <Vd> Is the name of the SIMD&FP destination register, encoded in the "Rd" field.
- <T> For the vector half precision variant: is an arrangement specifier, encoded in the "Q" field. It can have the following values:
- 4H when Q = 0
 - 8H when Q = 1
- For the vector single-precision and double-precision variant: is an arrangement specifier, encoded in the "sz:Q" field. It can have the following values:
- 2S when sz = 0, Q = 0
 - 4S when sz = 0, Q = 1
 - 2D when sz = 1, Q = 1
- The encoding sz = 1, Q = 0 is reserved.
- <Vn> Is the name of the SIMD&FP source register, encoded in the "Rn" field.

Operation for all encodings

```
CheckFPAdvSIMDEnabled64();
bits(datasize) operand = V[n];
bits(datasize) result;
bits(esize) zero = FPZero('0');
bits(esize) element;
boolean test_passed;

for e = 0 to elements-1
    element = Elem[operand, e, esize];
    case comparison of
        when CompareOp_GT test_passed = FPCompareGT(element, zero, FPCR);
        when CompareOp_GE test_passed = FPCompareGE(element, zero, FPCR);
        when CompareOp_EQ test_passed = FPCompareEQ(element, zero, FPCR);
        when CompareOp_LE test_passed = FPCompareLE(zero, element, FPCR);
        when CompareOp_LT test_passed = FPCompareLT(zero, element, FPCR);
    Elem[result, e, esize] = if test_passed then Ones() else Zeros();

V[d] = result;
```

C7.2.54 FCMP

Floating-point quiet Compare (scalar). This instruction compares the two SIMD&FP source register values, or the first SIMD&FP source register value and zero. It writes the result to the `PSTATE`.{N, Z, C, V} flags.

It raises an Invalid Operation exception only if either operand is a signaling NaN.

A floating-point exception can be generated by this instruction. Depending on the settings in `FPCR`, the exception results in either a flag being set in `FPSR`, or a synchronous exception being generated. For more information, see [Floating-point exceptions and exception traps on page D1-1831](#).

Depending on the settings in the `CPACR_EL1`, `CPTR_EL2`, and `CPTR_EL3` registers, and the current Security state and Exception level, an attempt to execute the instruction might be trapped.

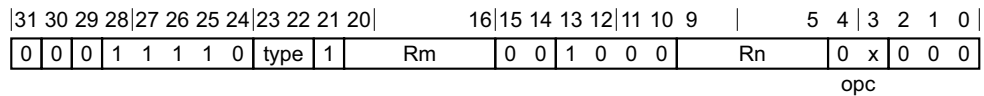

Half-precision variant

Applies when `type == 11` && `opc == 00`.

FCMP <Hn>, <Hm>

Half-precision, zero variant

Applies when `type == 11` && `Rm == (00000)` && `opc == 01`.

FCMP <Hn>, #0.0

Single-precision variant

Applies when `type == 00` && `opc == 00`.

FCMP <Sn>, <Sm>

Single-precision, zero variant

Applies when `type == 00` && `Rm == (00000)` && `opc == 01`.

FCMP <Sn>, #0.0

Double-precision variant

Applies when `type == 01` && `opc == 00`.

FCMP <Dn>, <Dm>

Double-precision, zero variant

Applies when `type == 01` && `Rm == (00000)` && `opc == 01`.

FCMP <Dn>, #0.0

Decode for all variants of this encoding

```
integer n = UInt(Rn);
integer m = UInt(Rm);    // ignored when opc<0> == '1'

integer datasize;
case type of
    when '00' datasize = 32;
    when '01' datasize = 64;
```



```
when '10' UnallocatedEncoding();
when '11'
  if HaveFP16Ext() then
    datasize = 16;
  else
    UnallocatedEncoding();

boolean signal_all_nans = (opc<1> == '1');
boolean cmp_with_zero = (opc<0> == '1');
```

Assembler symbols

- <Dn> For the double-precision variant: is the 64-bit name of the first SIMD&FP source register, encoded in the "Rn" field.
For the double-precision, zero variant: is the 64-bit name of the SIMD&FP source register, encoded in the "Rn" field.
- <Dm> Is the 64-bit name of the second SIMD&FP source register, encoded in the "Rm" field.
- <Hn> For the half-precision variant: is the 16-bit name of the first SIMD&FP source register, encoded in the "Rn" field.
For the half-precision, zero variant: is the 16-bit name of the SIMD&FP source register, encoded in the "Rn" field.
- <Hm> Is the 16-bit name of the second SIMD&FP source register, encoded in the "Rm" field.
- <Sn> For the single-precision variant: is the 32-bit name of the first SIMD&FP source register, encoded in the "Rn" field.
For the single-precision, zero variant: is the 32-bit name of the SIMD&FP source register, encoded in the "Rn" field.
- <Sm> Is the 32-bit name of the second SIMD&FP source register, encoded in the "Rm" field.

NaNs

The IEEE 754 standard specifies that the result of a comparison is precisely one of <, ==, > or unordered. If either or both of the operands are NaNs, they are unordered, and all three of (Operand1 < Operand2), (Operand1 == Operand2) and (Operand1 > Operand2) are false. This case results in the **FPSCR** flags being set to N=0, Z=0, C=1, and V=1.

Operation

```
CheckFPAdvSIMDEnabled64();

bits(datasize) operand1 = V[n];
bits(datasize) operand2;

operand2 = if cmp_with_zero then FPZero('0') else V[m];

PSTATE.<N,Z,C,V> = FPCompare(operand1, operand2, signal_all_nans, FPCR);
```

C7.2.55 FCMPE

Floating-point signaling Compare (scalar). This instruction compares the two SIMD&FP source register values, or the first SIMD&FP source register value and zero. It writes the result to the `PSTATE`.{N, Z, C, V} flags.

If either operand is any type of NaN, or if either operand is a signaling NaN, the instruction raises an Invalid Operation exception.

A floating-point exception can be generated by this instruction. Depending on the settings in `FPCR`, the exception results in either a flag being set in `FPSR`, or a synchronous exception being generated. For more information, see *Floating-point exceptions and exception traps on page D1-1831*.

Depending on the settings in the `CPACR_EL1`, `CPTR_EL2`, and `CPTR_EL3` registers, and the current Security state and Exception level, an attempt to execute the instruction might be trapped.

31	30	29	28	27	26	25	24	23	22	21	20	16	15	14	13	12	11	10	9	5	4	3	2	1	0
0	0	0	1	1	1	1	0	type	1	Rm	0	0	1	0	0	0	Rn	1	x	0	0	0			
opc																									

Half-precision variant

Applies when `type == 11` && `opc == 10`.

FCMPE <Hn>, <Hm>

Half-precision, zero variant

Applies when `type == 11` && `Rm == (00000)` && `opc == 11`.

FCMPE <Hn>, #0.0

Single-precision variant

Applies when `type == 00` && `opc == 10`.

FCMPE <Sn>, <Sm>

Single-precision, zero variant

Applies when `type == 00` && `Rm == (00000)` && `opc == 11`.

FCMPE <Sn>, #0.0

Double-precision variant

Applies when `type == 01` && `opc == 10`.

FCMPE <Dn>, <Dm>

Double-precision, zero variant

Applies when `type == 01` && `Rm == (00000)` && `opc == 11`.

FCMPE <Dn>, #0.0

Decode for all variants of this encoding

```
integer n = UInt(Rn);
integer m = UInt(Rm);    // ignored when opc<0> == '1'

integer datasize;
case type of
    when '00' datasize = 32;
```

```

when '01' datasize = 64;
when '10' UnallocatedEncoding();
when '11'
  if HaveFP16Ext() then
    datasize = 16;
  else
    UnallocatedEncoding();

boolean signal_all_nans = (opc<1> == '1');
boolean cmp_with_zero = (opc<0> == '1');
  
```

Assembler symbols

- <Dn> For the double-precision variant: is the 64-bit name of the first SIMD&FP source register, encoded in the "Rn" field.
 For the double-precision, zero variant: is the 64-bit name of the SIMD&FP source register, encoded in the "Rn" field.
- <Dm> Is the 64-bit name of the second SIMD&FP source register, encoded in the "Rm" field.
- <Hn> For the half-precision variant: is the 16-bit name of the first SIMD&FP source register, encoded in the "Rn" field.
 For the half-precision, zero variant: is the 16-bit name of the SIMD&FP source register, encoded in the "Rn" field.
- <Hm> Is the 16-bit name of the second SIMD&FP source register, encoded in the "Rm" field.
- <Sn> For the single-precision variant: is the 32-bit name of the first SIMD&FP source register, encoded in the "Rn" field.
 For the single-precision, zero variant: is the 32-bit name of the SIMD&FP source register, encoded in the "Rn" field.
- <Sm> Is the 32-bit name of the second SIMD&FP source register, encoded in the "Rm" field.

NaNs

The IEEE 754 standard specifies that the result of a comparison is precisely one of <, ==, > or unordered. If either or both of the operands are NaNs, they are unordered, and all three of (Operand1 < Operand2), (Operand1 == Operand2) and (Operand1 > Operand2) are false. This case results in the **FPSCR** flags being set to N=0, Z=0, C=1, and V=1.

FCMPE raises an Invalid Operation exception if either operand is any type of NaN, and is suitable for testing for <, <=, >, >=, and other predicates that raise an exception when the operands are unordered.

Operation

```

CheckFPAdvSIMDEnabled64();

bits(datasize) operand1 = V[n];
bits(datasize) operand2;

operand2 = if cmp_with_zero then FPZero('0') else V[m];

PSTATE.<N,Z,C,V> = FPCompare(operand1, operand2, signal_all_nans, FPCR);
  
```

C7.2.56 FCSEL

Floating-point Conditional Select (scalar). This instruction allows the SIMD&FP destination register to take the value from either one or the other of two SIMD&FP source registers. If the condition passes, the first SIMD&FP source register value is taken, otherwise the second SIMD&FP source register value is taken.

Depending on the settings in the CPACR_EL1, CPTR_EL2, and CPTR_EL3 registers, and the current Security state and Exception level, an attempt to execute the instruction might be trapped.

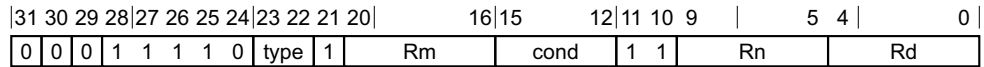

Half-precision variant

Applies when type == 11.

FCSEL <Hd>, <Hn>, <Hm>, <cond>

Single-precision variant

Applies when type == 00.

FCSEL <Sd>, <Sn>, <Sm>, <cond>

Double-precision variant

Applies when type == 01.

FCSEL <Dd>, <Dn>, <Dm>, <cond>

Decode for all variants of this encoding

```
integer d = UInt(Rd);
integer n = UInt(Rn);
integer m = UInt(Rm);

integer datasize;
case type of
    when '00' datasize = 32;
    when '01' datasize = 64;
    when '10' UnallocatedEncoding();
    when '11'
        if HaveFP16Ext() then
            datasize = 16;
        else
            UnallocatedEncoding();

bits(4) condition = cond;
```

Assembler symbols

- <Dd> Is the 64-bit name of the SIMD&FP destination register, encoded in the "Rd" field.
- <Dn> Is the 64-bit name of the first SIMD&FP source register, encoded in the "Rn" field.
- <Dm> Is the 64-bit name of the second SIMD&FP source register, encoded in the "Rm" field.
- <Hd> Is the 16-bit name of the SIMD&FP destination register, encoded in the "Rd" field.
- <Hn> Is the 16-bit name of the first SIMD&FP source register, encoded in the "Rn" field.

- <Hm> Is the 16-bit name of the second SIMD&FP source register, encoded in the "Rm" field.
- <Sd> Is the 32-bit name of the SIMD&FP destination register, encoded in the "Rd" field.
- <Sn> Is the 32-bit name of the first SIMD&FP source register, encoded in the "Rn" field.
- <Sm> Is the 32-bit name of the second SIMD&FP source register, encoded in the "Rm" field.
- <cond> Is one of the standard conditions, encoded in the "cond" field in the standard way.

Operation

```
CheckFPAdvSIMDEnabled64();  
bits(datasize) result;  
  
result = if ConditionHolds(condition) then V[n] else V[m];  
  
V[d] = result;
```

C7.2.57 FCVT

Floating-point Convert precision (scalar). This instruction converts the floating-point value in the SIMD&FP source register to the precision for the destination register data type using the rounding mode that is determined by the [FPCR](#) and writes the result to the SIMD&FP destination register.

Depending on the settings in the [CPACR_EL1](#), [CPTR_EL2](#), and [CPTR_EL3](#) registers, and the current Security state and Exception level, an attempt to execute the instruction might be trapped.

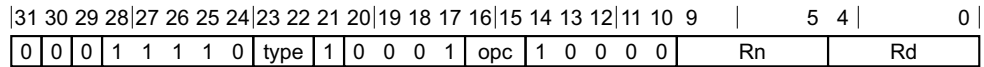

Half-precision to single-precision variant

Applies when type == 11 && opc == 00.

FCVT <Sd>, <Hn>

Half-precision to double-precision variant

Applies when type == 11 && opc == 01.

FCVT <Dd>, <Hn>

Single-precision to half-precision variant

Applies when type == 00 && opc == 11.

FCVT <Hd>, <Sn>

Single-precision to double-precision variant

Applies when type == 00 && opc == 01.

FCVT <Dd>, <Sn>

Double-precision to half-precision variant

Applies when type == 01 && opc == 11.

FCVT <Hd>, <Dn>

Double-precision to single-precision variant

Applies when type == 01 && opc == 00.

FCVT <Sd>, <Dn>

Decode for all variants of this encoding

```
integer d = UInt(Rd);
integer n = UInt(Rn);

if type == opc then UnallocatedEncoding();

integer srcsize;
case type of
    when '00' srcsize = 32;
    when '01' srcsize = 64;
    when '10' UnallocatedEncoding();
    when '11' srcsize = 16;
integer dstsize;
```

```
case opc of
  when '00' dstsize = 32;
  when '01' dstsize = 64;
  when '10' UnallocatedEncoding();
  when '11' dstsize = 16;
```

Assembler symbols

<Dd> Is the 64-bit name of the SIMD&FP destination register, encoded in the "Rd" field.

<Hd> Is the 16-bit name of the SIMD&FP destination register, encoded in the "Rd" field.

<Sn> Is the 32-bit name of the SIMD&FP source register, encoded in the "Rn" field.

<Sd> Is the 32-bit name of the SIMD&FP destination register, encoded in the "Rd" field.

<Hn> Is the 16-bit name of the SIMD&FP source register, encoded in the "Rn" field.

<Dn> Is the 64-bit name of the SIMD&FP source register, encoded in the "Rn" field.

Operation

```
CheckFPAdvSIMDEnabled64();

bits(dstsize) result;
bits(srcsize) operand = V[n];

result = FPConvert(operand, FPCR);
V[d] = result;
```

C7.2.58 FCVTAS (vector)

Floating-point Convert to Signed integer, rounding to nearest with ties to Away (vector). This instruction converts each element in a vector from a floating-point value to a signed integer value using the Round to Nearest with Ties to Away rounding mode and writes the result to the SIMD&FP destination register.

A floating-point exception can be generated by this instruction. Depending on the settings in [FPCR](#), the exception results in either a flag being set in [FPSR](#), or a synchronous exception being generated. For more information, see [Floating-point exceptions and exception traps on page D1-1831](#).

Depending on the settings in the [CPACR_EL1](#), [CPTR_EL2](#), and [CPTR_EL3](#) registers, and the current Security state and Exception level, an attempt to execute the instruction might be trapped.

Scalar half precision

ARMv8.2

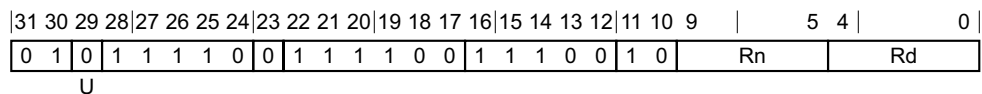

Scalar half precision variant

FCVTAS <Hd>, <Hn>

Decode for this encoding

```
if !HaveFP16Ext() then UnallocatedEncoding();
```

```
integer d = UInt(Rd);
integer n = UInt(Rn);
```

```
integer esize = 16;
integer datasize = esize;
integer elements = 1;
```

```
FPRounding rounding = FPRounding_TIEAWAY;
boolean unsigned = (U == '1');
```

Scalar single-precision and double-precision

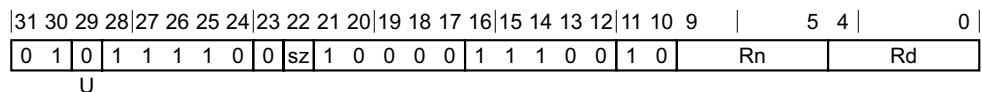

Scalar single-precision and double-precision variant

FCVTAS <V><d>, <V><n>

Decode for this encoding

```
integer d = UInt(Rd);
integer n = UInt(Rn);
```

```
integer esize = 32 << UInt(sz);
integer datasize = esize;
integer elements = 1;
```

```
FPRounding rounding = FPRounding_TIEAWAY;
boolean unsigned = (U == '1');
```

Vector half precision

ARMv8.2

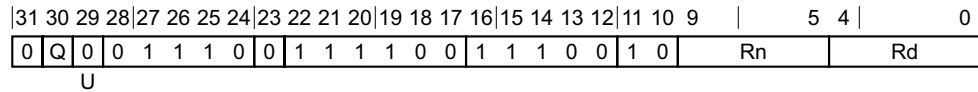

Vector half precision variant

FCVTAS <Vd>.<T>, <Vn>.<T>

Decode for this encoding

```

if !HaveFP16Ext() then UnallocatedEncoding();

integer d = UInt(Rd);
integer n = UInt(Rn);

integer esize = 16;
integer datasize = if Q == '1' then 128 else 64;
integer elements = datasize DIV esize;

FPRounding rounding = FPRounding_TIEAWAY;
boolean unsigned = (U == '1');
```

Vector single-precision and double-precision

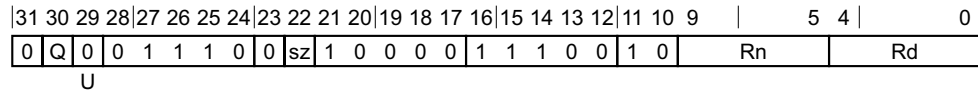

Vector single-precision and double-precision variant

FCVTAS <Vd>.<T>, <Vn>.<T>

Decode for this encoding

```

integer d = UInt(Rd);
integer n = UInt(Rn);

if sz:Q == '10' then ReservedValue();
integer esize = 32 << UInt(sz);
integer datasize = if Q == '1' then 128 else 64;
integer elements = datasize DIV esize;

FPRounding rounding = FPRounding_TIEAWAY;
boolean unsigned = (U == '1');
```

Assembler symbols

- <Hd> Is the 16-bit name of the SIMD&FP destination register, encoded in the "Rd" field.
- <Hn> Is the 16-bit name of the SIMD&FP source register, encoded in the "Rn" field.
- <V> Is a width specifier, encoded in the "sz" field. It can have the following values:
 - S when sz = 0
 - D when sz = 1
- <d> Is the number of the SIMD&FP destination register, encoded in the "Rd" field.

- <n> Is the number of the SIMD&FP source register, encoded in the "Rn" field.
- <Vd> Is the name of the SIMD&FP destination register, encoded in the "Rd" field.
- <T> For the vector half precision variant: is an arrangement specifier, encoded in the "Q" field. It can have the following values:
4H when Q = 0
8H when Q = 1
For the vector single-precision and double-precision variant: is an arrangement specifier, encoded in the "sz:Q" field. It can have the following values:
2S when sz = 0, Q = 0
4S when sz = 0, Q = 1
2D when sz = 1, Q = 1
The encoding sz = 1, Q = 0 is reserved.
- <Vn> Is the name of the SIMD&FP source register, encoded in the "Rn" field.

Operation for all encodings

```
CheckFPAdvSIMDEnabled64();
bits(datasize) operand = V[n];
bits(datasize) result;
bits(esize) element;

for e = 0 to elements-1
    element = Elem[operand, e, esize];
    Elem[result, e, esize] = FPToFixed(element, 0, unsigned, FPCR, rounding);

V[d] = result;
```

C7.2.59 FCVTAS (scalar)

Floating-point Convert to Signed integer, rounding to nearest with ties to Away (scalar). This instruction converts the floating-point value in the SIMD&FP source register to a 32-bit or 64-bit signed integer using the Round to Nearest with Ties to Away rounding mode, and writes the result to the general-purpose destination register.

A floating-point exception can be generated by this instruction. Depending on the settings in [FPCR](#), the exception results in either a flag being set in [FPSR](#), or a synchronous exception being generated. For more information, see [Floating-point exceptions and exception traps on page D1-1831](#).

Depending on the settings in the [CPACR_EL1](#), [CPTR_EL2](#), and [CPTR_EL3](#) registers, and the current Security state and Exception level, an attempt to execute the instruction might be trapped.

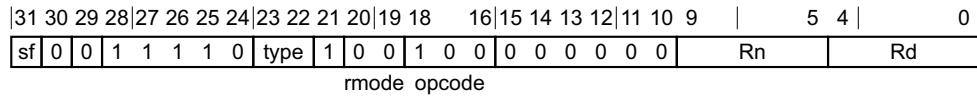

Half-precision to 32-bit variant

Applies when sf == 0 && type == 11.

FCVTAS <Wd>, <Hn>

Half-precision to 64-bit variant

Applies when sf == 1 && type == 11.

FCVTAS <Xd>, <Hn>

Single-precision to 32-bit variant

Applies when sf == 0 && type == 00.

FCVTAS <Wd>, <Sn>

Single-precision to 64-bit variant

Applies when sf == 1 && type == 00.

FCVTAS <Xd>, <Sn>

Double-precision to 32-bit variant

Applies when sf == 0 && type == 01.

FCVTAS <Wd>, <Dn>

Double-precision to 64-bit variant

Applies when sf == 1 && type == 01.

FCVTAS <Xd>, <Dn>

Decode for all variants of this encoding

```
integer d = UInt(Rd);
integer n = UInt(Rn);

integer intsize = if sf == '1' then 64 else 32;
integer fltsize;

case type of
```

```
when '00'  
    fltsize = 32;  
when '01'  
    fltsize = 64;  
when '10'  
    UnallocatedEncoding();  
when '11'  
    if HaveFP16Ext() then  
        fltsize = 16;  
    else  
        UnallocatedEncoding();
```

Assembler symbols

- <Wd> Is the 32-bit name of the general-purpose destination register, encoded in the "Rd" field.
- <Xd> Is the 64-bit name of the general-purpose destination register, encoded in the "Rd" field.
- <Sn> Is the 32-bit name of the SIMD&FP source register, encoded in the "Rn" field.
- <Hn> Is the 16-bit name of the SIMD&FP source register, encoded in the "Rn" field.
- <Dn> Is the 64-bit name of the SIMD&FP source register, encoded in the "Rn" field.

Operation

```
CheckFPAdvSIMDEnabled64();  
  
bits(fltsize) fltval;  
bits(intsize) intval;  
  
fltval = V[n];  
intval = FPToFixed(fltval, 0, FALSE, FPCR, FPRounding_TIEAWAY);  
X[d] = intval;
```

C7.2.60 FCVTAU (vector)

Floating-point Convert to Unsigned integer, rounding to nearest with ties to Away (vector). This instruction converts each element in a vector from a floating-point value to an unsigned integer value using the Round to Nearest with Ties to Away rounding mode and writes the result to the SIMD&FP destination register.

A floating-point exception can be generated by this instruction. Depending on the settings in [FPCR](#), the exception results in either a flag being set in [FPSR](#), or a synchronous exception being generated. For more information, see [Floating-point exceptions and exception traps on page D1-1831](#).

Depending on the settings in the [CPACR_EL1](#), [CPTR_EL2](#), and [CPTR_EL3](#) registers, and the current Security state and Exception level, an attempt to execute the instruction might be trapped.

Scalar half precision

ARMv8.2

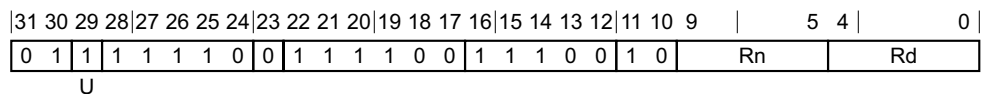

Scalar half precision variant

FCVTAU <Hd>, <Hn>

Decode for this encoding

```
if !HaveFP16Ext() then UnallocatedEncoding();
```

```
integer d = UInt(Rd);
integer n = UInt(Rn);
```

```
integer esize = 16;
integer datasize = esize;
integer elements = 1;
```

```
FPRounding rounding = FPRounding_TIEAWAY;
boolean unsigned = (U == '1');
```

Scalar single-precision and double-precision

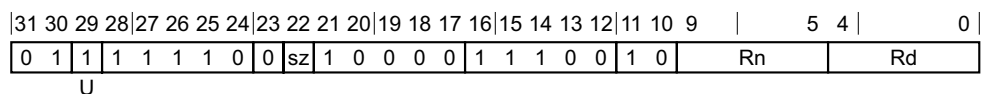

Scalar single-precision and double-precision variant

FCVTAU <V><d>, <V><n>

Decode for this encoding

```
integer d = UInt(Rd);
integer n = UInt(Rn);
```

```
integer esize = 32 << UInt(sz);
integer datasize = esize;
integer elements = 1;
```

```
FPRounding rounding = FPRounding_TIEAWAY;
boolean unsigned = (U == '1');
```

Vector half precision

ARMv8.2

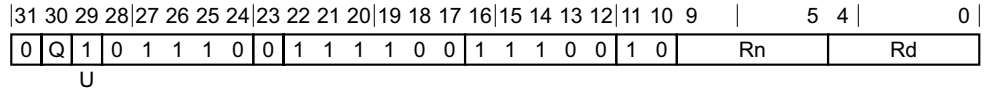

Vector half precision variant

FCVTAU <Vd>.<T>, <Vn>.<T>

Decode for this encoding

```

if !HaveFP16Ext() then UnallocatedEncoding();

integer d = UInt(Rd);
integer n = UInt(Rn);

integer esize = 16;
integer datasize = if Q == '1' then 128 else 64;
integer elements = datasize DIV esize;

FPRounding rounding = FPRounding_TIEAWAY;
boolean unsigned = (U == '1');
```

Vector single-precision and double-precision

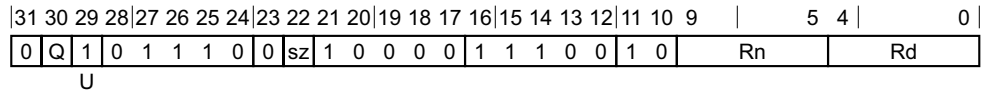

Vector single-precision and double-precision variant

FCVTAU <Vd>.<T>, <Vn>.<T>

Decode for this encoding

```

integer d = UInt(Rd);
integer n = UInt(Rn);

if sz:Q == '10' then ReservedValue();
integer esize = 32 << UInt(sz);
integer datasize = if Q == '1' then 128 else 64;
integer elements = datasize DIV esize;

FPRounding rounding = FPRounding_TIEAWAY;
boolean unsigned = (U == '1');
```

Assembler symbols

- <Hd> Is the 16-bit name of the SIMD&FP destination register, encoded in the "Rd" field.
- <Hn> Is the 16-bit name of the SIMD&FP source register, encoded in the "Rn" field.
- <V> Is a width specifier, encoded in the "sz" field. It can have the following values:
 - S when sz = 0
 - D when sz = 1
- <d> Is the number of the SIMD&FP destination register, encoded in the "Rd" field.

- <n> Is the number of the SIMD&FP source register, encoded in the "Rn" field.
- <Vd> Is the name of the SIMD&FP destination register, encoded in the "Rd" field.
- <T> For the vector half precision variant: is an arrangement specifier, encoded in the "Q" field. It can have the following values:
- 4H when Q = 0
 - 8H when Q = 1
- For the vector single-precision and double-precision variant: is an arrangement specifier, encoded in the "sz:Q" field. It can have the following values:
- 2S when sz = 0, Q = 0
 - 4S when sz = 0, Q = 1
 - 2D when sz = 1, Q = 1
- The encoding sz = 1, Q = 0 is reserved.
- <Vn> Is the name of the SIMD&FP source register, encoded in the "Rn" field.

Operation for all encodings

```
CheckFPAdvSIMDEnabled64();
bits(datasize) operand = V[n];
bits(datasize) result;
bits(esize) element;

for e = 0 to elements-1
    element = Elem[operand, e, esize];
    Elem[result, e, esize] = FPToFixed(element, 0, unsigned, FPCR, rounding);

V[d] = result;
```

C7.2.61 FCVTAU (scalar)

Floating-point Convert to Unsigned integer, rounding to nearest with ties to Away (scalar). This instruction converts the floating-point value in the SIMD&FP source register to a 32-bit or 64-bit unsigned integer using the Round to Nearest with Ties to Away rounding mode, and writes the result to the general-purpose destination register.

A floating-point exception can be generated by this instruction. Depending on the settings in [FPCR](#), the exception results in either a flag being set in [FPSR](#), or a synchronous exception being generated. For more information, see [Floating-point exceptions and exception traps on page D1-1831](#).

Depending on the settings in the [CPACR_EL1](#), [CPTR_EL2](#), and [CPTR_EL3](#) registers, and the current Security state and Exception level, an attempt to execute the instruction might be trapped.

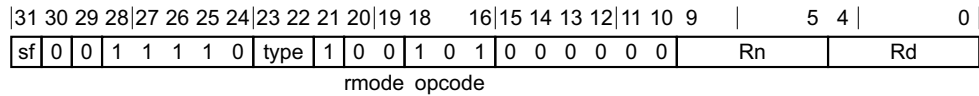

Half-precision to 32-bit variant

Applies when sf == 0 && type == 11.

FCVTAU <Wd>, <Hn>

Half-precision to 64-bit variant

Applies when sf == 1 && type == 11.

FCVTAU <Xd>, <Hn>

Single-precision to 32-bit variant

Applies when sf == 0 && type == 00.

FCVTAU <Wd>, <Sn>

Single-precision to 64-bit variant

Applies when sf == 1 && type == 00.

FCVTAU <Xd>, <Sn>

Double-precision to 32-bit variant

Applies when sf == 0 && type == 01.

FCVTAU <Wd>, <Dn>

Double-precision to 64-bit variant

Applies when sf == 1 && type == 01.

FCVTAU <Xd>, <Dn>

Decode for all variants of this encoding

```
integer d = UInt(Rd);
integer n = UInt(Rn);

integer intsize = if sf == '1' then 64 else 32;
integer fltsize;

case type of
```



```
when '00'  
    fltsize = 32;  
when '01'  
    fltsize = 64;  
when '10'  
    UnallocatedEncoding();  
when '11'  
    if HaveFP16Ext() then  
        fltsize = 16;  
    else  
        UnallocatedEncoding();
```

Assembler symbols

- <Wd> Is the 32-bit name of the general-purpose destination register, encoded in the "Rd" field.
- <Xd> Is the 64-bit name of the general-purpose destination register, encoded in the "Rd" field.
- <Sn> Is the 32-bit name of the SIMD&FP source register, encoded in the "Rn" field.
- <Hn> Is the 16-bit name of the SIMD&FP source register, encoded in the "Rn" field.
- <Dn> Is the 64-bit name of the SIMD&FP source register, encoded in the "Rn" field.

Operation

```
CheckFPAdvSIMDEnabled64();  
  
bits(fltsize) fltval;  
bits(intsize) intval;  
  
fltval = V[n];  
intval = FPToFixed(fltval, 0, TRUE, FPCR, FPRounding_TIEAWAY);  
X[d] = intval;
```

C7.2.62 FCVTL, FCVTL2

Floating-point Convert to higher precision Long (vector). This instruction reads each element in a vector in the SIMD&FP source register, converts each value to double the precision of the source element using the rounding mode that is determined by the [FPCR](#), and writes each result to the equivalent element of the vector in the SIMD&FP destination register.

Where the operation lengthens a 64-bit vector to a 128-bit vector, the FCVTL2 variant operates on the elements in the top 64 bits of the source register.

A floating-point exception can be generated by this instruction. Depending on the settings in [FPCR](#), the exception results in either a flag being set in [FPSR](#), or a synchronous exception being generated. For more information, see [Floating-point exceptions and exception traps on page D1-1831](#).

Depending on the settings in the [CPACR_EL1](#), [CPTR_EL2](#), and [CPTR_EL3](#) registers, and the current Security state and Exception level, an attempt to execute the instruction might be trapped.

31	30	29	28	27	26	25	24	23	22	21	20	19	18	17	16	15	14	13	12	11	10	9	5 4			0
0	Q	0	0	1	1	1	0	0	sz	1	0	0	0	0	1	0	1	1	1	1	0	Rn			Rd	

Vector single-precision and double-precision variant

FCVTL{2} <Vd>.<Ta>, <Vn>.<Tb>

Decode for this encoding

```
integer d = UInt(Rd);
integer n = UInt(Rn);

integer esize = 16 << UInt(sz);
integer datasize = 64;
integer part = UInt(Q);
integer elements = datasize DIV esize;
```

Assembler symbols

- 2 Is the second and upper half specifier. If present it causes the operation to be performed on the upper 64 bits of the registers holding the narrower elements, and is encoded in the "Q" field. It can have the following values:
 - [absent] when Q = 0
 - [present] when Q = 1
- <Vd> Is the name of the SIMD&FP destination register, encoded in the "Rd" field.
- <Ta> Is an arrangement specifier, encoded in the "sz" field. It can have the following values:
 - 4S when sz = 0
 - 2D when sz = 1
- <Vn> Is the name of the SIMD&FP source register, encoded in the "Rn" field.
- <Tb> Is an arrangement specifier, encoded in the "sz:Q" field. It can have the following values:
 - 4H when sz = 0, Q = 0
 - 8H when sz = 0, Q = 1
 - 2S when sz = 1, Q = 0
 - 4S when sz = 1, Q = 1

Operation

```
CheckFPAdvSIMDEnabled64();  
bits(datasize) operand = Vpart[n, part];  
bits(2*datasize) result;  
  
for e = 0 to elements-1  
    Elem[result, e, 2*esize] = FPConvert(Elem[operand, e, esize], FPCR);  
  
V[d] = result;
```

C7.2.63 FCVTMS (vector)

Floating-point Convert to Signed integer, rounding toward Minus infinity (vector). This instruction converts a scalar or each element in a vector from a floating-point value to a signed integer value using the Round towards Minus Infinity rounding mode, and writes the result to the SIMD&FP destination register.

A floating-point exception can be generated by this instruction. Depending on the settings in [FPCR](#), the exception results in either a flag being set in [FPSR](#), or a synchronous exception being generated. For more information, see [Floating-point exceptions and exception traps on page D1-1831](#).

Depending on the settings in the [CPACR_EL1](#), [CPTR_EL2](#), and [CPTR_EL3](#) registers, and the Security state and Exception level in which the instruction is executed, an attempt to execute the instruction might be trapped.

Scalar half precision

ARMv8.2

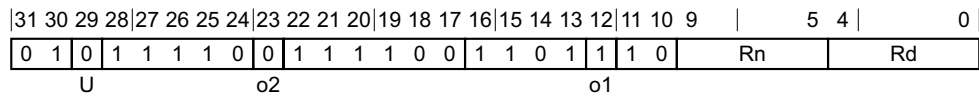

Scalar half precision variant

FCVTMS <Hd>, <Hn>

Decode for this encoding

```
if !HaveFP16Ext() then UnallocatedEncoding();
```

```
integer d = UInt(Rd);
integer n = UInt(Rn);
```

```
integer esize = 16;
integer datasize = esize;
integer elements = 1;
```

```
FPRounding rounding = FPDecodeRounding(o1:o2);
boolean unsigned = (U == '1');
```

Scalar single-precision and double-precision

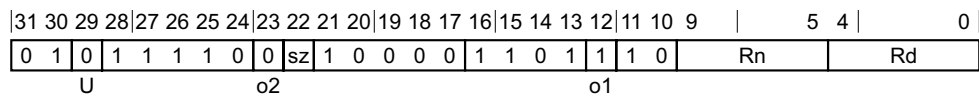

Scalar single-precision and double-precision variant

FCVTMS <V><d>, <V><n>

Decode for this encoding

```
integer d = UInt(Rd);
integer n = UInt(Rn);
```

```
integer esize = 32 << UInt(sz);
integer datasize = esize;
integer elements = 1;
```

```
FPRounding rounding = FPDecodeRounding(o1:o2);
boolean unsigned = (U == '1');
```

Vector half precision

ARMv8.2

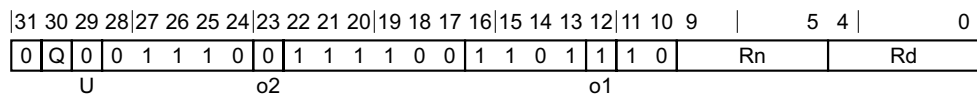

Vector half precision variant

FCVTMS <Vd>.<T>, <Vn>.<T>

Decode for this encoding

```

if !HaveFP16Ext() then UnallocatedEncoding();

integer d = UInt(Rd);
integer n = UInt(Rn);

integer esize = 16;
integer datasize = if Q == '1' then 128 else 64;
integer elements = datasize DIV esize;

FPRounding rounding = FPDecodeRounding(o1:o2);
boolean unsigned = (U == '1');
```

Vector single-precision and double-precision

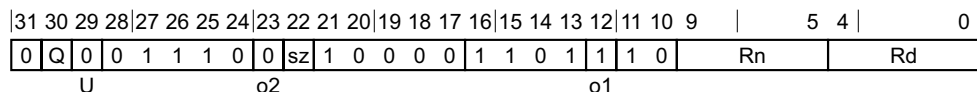

Vector single-precision and double-precision variant

FCVTMS <Vd>.<T>, <Vn>.<T>

Decode for this encoding

```

integer d = UInt(Rd);
integer n = UInt(Rn);

if sz:Q == '10' then ReservedValue();
integer esize = 32 << UInt(sz);
integer datasize = if Q == '1' then 128 else 64;
integer elements = datasize DIV esize;

FPRounding rounding = FPDecodeRounding(o1:o2);
boolean unsigned = (U == '1');
```

Assembler symbols

- <Hd> Is the 16-bit name of the SIMD&FP destination register, encoded in the "Rd" field.
- <Hn> Is the 16-bit name of the SIMD&FP source register, encoded in the "Rn" field.
- <V> Is a width specifier, encoded in the "sz" field. It can have the following values:
 - S when sz = 0
 - D when sz = 1
- <d> Is the number of the SIMD&FP destination register, encoded in the "Rd" field.

- <n> Is the number of the SIMD&FP source register, encoded in the "Rn" field.
- <Vd> Is the name of the SIMD&FP destination register, encoded in the "Rd" field.
- <T> For the vector half precision variant: is an arrangement specifier, encoded in the "Q" field. It can have the following values:
- 4H when Q = 0
 - 8H when Q = 1
- For the vector single-precision and double-precision variant: is an arrangement specifier, encoded in the "sz:Q" field. It can have the following values:
- 2S when sz = 0, Q = 0
 - 4S when sz = 0, Q = 1
 - 2D when sz = 1, Q = 1
- The encoding sz = 1, Q = 0 is reserved.
- <Vn> Is the name of the SIMD&FP source register, encoded in the "Rn" field.

Operation for all encodings

```
CheckFPAdvSIMDEnabled64();
bits(datasize) operand = V[n];
bits(datasize) result;
bits(esize) element;

for e = 0 to elements-1
    element = Elem[operand, e, esize];
    Elem[result, e, esize] = FPToFixed(element, 0, unsigned, FPCR, rounding);

V[d] = result;
```

C7.2.64 FCVTMS (scalar)

Floating-point Convert to Signed integer, rounding toward Minus infinity (scalar). This instruction converts the floating-point value in the SIMD&FP source register to a 32-bit or 64-bit signed integer using the Round towards Minus Infinity rounding mode, and writes the result to the general-purpose destination register.

A floating-point exception can be generated by this instruction. Depending on the settings in [FPCR](#), the exception results in either a flag being set in [FPSR](#), or a synchronous exception being generated. For more information, see [Floating-point exceptions and exception traps on page D1-1831](#).

Depending on the settings in the [CPACR_EL1](#), [CPTR_EL2](#), and [CPTR_EL3](#) registers, and the current Security state and Exception level, an attempt to execute the instruction might be trapped.

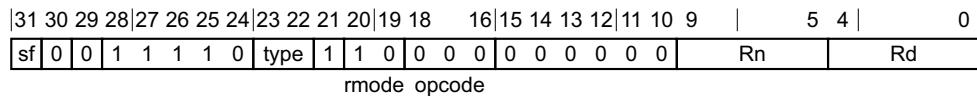

Half-precision to 32-bit variant

Applies when `sf == 0 && type == 11`.

FCVTMS <Wd>, <Hn>

Half-precision to 64-bit variant

Applies when `sf == 1 && type == 11`.

FCVTMS <Xd>, <Hn>

Single-precision to 32-bit variant

Applies when `sf == 0 && type == 00`.

FCVTMS <Wd>, <Sn>

Single-precision to 64-bit variant

Applies when `sf == 1 && type == 00`.

FCVTMS <Xd>, <Sn>

Double-precision to 32-bit variant

Applies when `sf == 0 && type == 01`.

FCVTMS <Wd>, <Dn>

Double-precision to 64-bit variant

Applies when `sf == 1 && type == 01`.

FCVTMS <Xd>, <Dn>

Decode for all variants of this encoding

```
integer d = UInt(Rd);
integer n = UInt(Rn);

integer intsize = if sf == '1' then 64 else 32;
integer fltsize;
FPRounding rounding;
```

```
case type of
  when '00'
    fltsize = 32;
  when '01'
    fltsize = 64;
  when '10'
    UnallocatedEncoding();
  when '11'
    if HaveFP16Ext() then
      fltsize = 16;
    else
      UnallocatedEncoding();

rounding = FPDecodeRounding(rmode);
```

Assembler symbols

- <Wd> Is the 32-bit name of the general-purpose destination register, encoded in the "Rd" field.
- <Xd> Is the 64-bit name of the general-purpose destination register, encoded in the "Rd" field.
- <Sn> Is the 32-bit name of the SIMD&FP source register, encoded in the "Rn" field.
- <Hn> Is the 16-bit name of the SIMD&FP source register, encoded in the "Rn" field.
- <Dn> Is the 64-bit name of the SIMD&FP source register, encoded in the "Rn" field.

Operation

```
CheckFPAdvSIMDEnabled64();

bits(fltsize) fltval;
bits(intsize) intval;

fltval = V[n];
intval = FPToFixed(fltval, 0, FALSE, FPCR, rounding);
X[d] = intval;
```

C7.2.65 FCVTMU (vector)

Floating-point Convert to Unsigned integer, rounding toward Minus infinity (vector). This instruction converts a scalar or each element in a vector from a floating-point value to an unsigned integer value using the Round towards Minus Infinity rounding mode, and writes the result to the SIMD&FP destination register.

A floating-point exception can be generated by this instruction. Depending on the settings in [FPCR](#), the exception results in either a flag being set in [FPSR](#), or a synchronous exception being generated. For more information, see [Floating-point exceptions and exception traps on page D1-1831](#).

Depending on the settings in the [CPACR_EL1](#), [CPTR_EL2](#), and [CPTR_EL3](#) registers, and the Security state and Exception level in which the instruction is executed, an attempt to execute the instruction might be trapped.

Scalar half precision

ARMv8.2

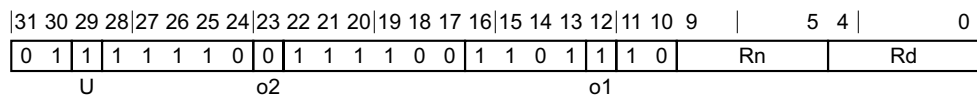

Scalar half precision variant

FCVTMU <Hd>, <Hn>

Decode for this encoding

```
if !HaveFP16Ext() then UnallocatedEncoding();

integer d = UInt(Rd);
integer n = UInt(Rn);

integer esize = 16;
integer datasize = esize;
integer elements = 1;

FPRounding rounding = FPDecodeRounding(o1:o2);
boolean unsigned = (U == '1');
```

Scalar single-precision and double-precision

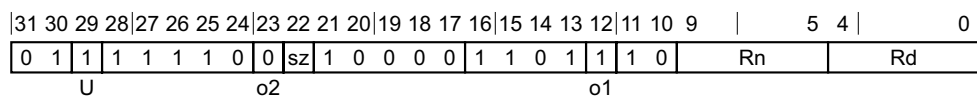

Scalar single-precision and double-precision variant

FCVTMU <V><d>, <V><n>

Decode for this encoding

```
integer d = UInt(Rd);
integer n = UInt(Rn);

integer esize = 32 << UInt(sz);
integer datasize = esize;
integer elements = 1;

FPRounding rounding = FPDecodeRounding(o1:o2);
boolean unsigned = (U == '1');
```

Vector half precision

ARMv8.2

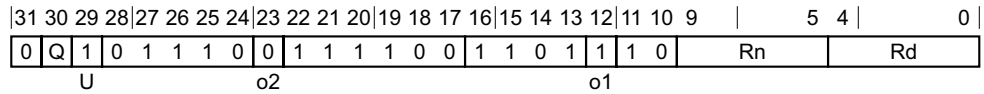

Vector half precision variant

FCVTMU <Vd>.<T>, <Vn>.<T>

Decode for this encoding

```

if !HaveFP16Ext() then UnallocatedEncoding();

integer d = UInt(Rd);
integer n = UInt(Rn);

integer esize = 16;
integer datasize = if Q == '1' then 128 else 64;
integer elements = datasize DIV esize;

FPRounding rounding = FPDecodeRounding(o1:o2);
boolean unsigned = (U == '1');
```

Vector single-precision and double-precision

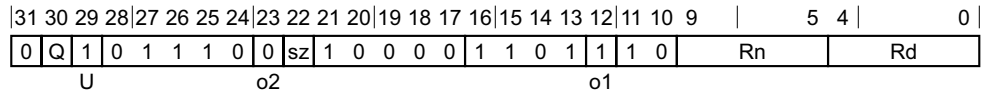

Vector single-precision and double-precision variant

FCVTMU <Vd>.<T>, <Vn>.<T>

Decode for this encoding

```

integer d = UInt(Rd);
integer n = UInt(Rn);

if sz:Q == '10' then ReservedValue();
integer esize = 32 << UInt(sz);
integer datasize = if Q == '1' then 128 else 64;
integer elements = datasize DIV esize;

FPRounding rounding = FPDecodeRounding(o1:o2);
boolean unsigned = (U == '1');
```

Assembler symbols

- <Hd> Is the 16-bit name of the SIMD&FP destination register, encoded in the "Rd" field.
- <Hn> Is the 16-bit name of the SIMD&FP source register, encoded in the "Rn" field.
- <V> Is a width specifier, encoded in the "sz" field. It can have the following values:
 - S when sz = 0
 - D when sz = 1
- <d> Is the number of the SIMD&FP destination register, encoded in the "Rd" field.

- <n> Is the number of the SIMD&FP source register, encoded in the "Rn" field.
- <Vd> Is the name of the SIMD&FP destination register, encoded in the "Rd" field.
- <T> For the vector half precision variant: is an arrangement specifier, encoded in the "Q" field. It can have the following values:
- 4H when Q = 0
 - 8H when Q = 1
- For the vector single-precision and double-precision variant: is an arrangement specifier, encoded in the "sz:Q" field. It can have the following values:
- 2S when sz = 0, Q = 0
 - 4S when sz = 0, Q = 1
 - 2D when sz = 1, Q = 1
- The encoding sz = 1, Q = 0 is reserved.
- <Vn> Is the name of the SIMD&FP source register, encoded in the "Rn" field.

Operation for all encodings

```
CheckFPAdvSIMDEnabled64();
bits(datasize) operand = V[n];
bits(datasize) result;
bits(esize) element;

for e = 0 to elements-1
    element = Elem[operand, e, esize];
    Elem[result, e, esize] = FPToFixed(element, 0, unsigned, FPCR, rounding);

V[d] = result;
```

C7.2.66 FCVTMU (scalar)

Floating-point Convert to Unsigned integer, rounding toward Minus infinity (scalar). This instruction converts the floating-point value in the SIMD&FP source register to a 32-bit or 64-bit unsigned integer using the Round towards Minus Infinity rounding mode, and writes the result to the general-purpose destination register.

A floating-point exception can be generated by this instruction. Depending on the settings in [FPCR](#), the exception results in either a flag being set in [FPSR](#), or a synchronous exception being generated. For more information, see [Floating-point exceptions and exception traps on page D1-1831](#).

Depending on the settings in the [CPACR_EL1](#), [CPTR_EL2](#), and [CPTR_EL3](#) registers, and the current Security state and Exception level, an attempt to execute the instruction might be trapped.

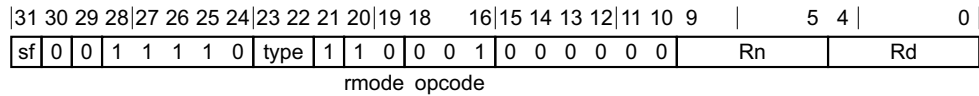

Half-precision to 32-bit variant

Applies when sf == 0 && type == 11.

FCVTMU <Wd>, <Hn>

Half-precision to 64-bit variant

Applies when sf == 1 && type == 11.

FCVTMU <Xd>, <Hn>

Single-precision to 32-bit variant

Applies when sf == 0 && type == 00.

FCVTMU <Wd>, <Sn>

Single-precision to 64-bit variant

Applies when sf == 1 && type == 00.

FCVTMU <Xd>, <Sn>

Double-precision to 32-bit variant

Applies when sf == 0 && type == 01.

FCVTMU <Wd>, <Dn>

Double-precision to 64-bit variant

Applies when sf == 1 && type == 01.

FCVTMU <Xd>, <Dn>

Decode for all variants of this encoding

```
integer d = UInt(Rd);
integer n = UInt(Rn);

integer intsize = if sf == '1' then 64 else 32;
integer fltsize;
FPRounding rounding;
```

```
case type of
  when '00'
    fltsize = 32;
  when '01'
    fltsize = 64;
  when '10'
    UnallocatedEncoding();
  when '11'
    if HaveFP16Ext() then
      fltsize = 16;
    else
      UnallocatedEncoding();

rounding = FPDecodeRounding(rmode);
```

Assembler symbols

- <Wd> Is the 32-bit name of the general-purpose destination register, encoded in the "Rd" field.
- <Xd> Is the 64-bit name of the general-purpose destination register, encoded in the "Rd" field.
- <Sn> Is the 32-bit name of the SIMD&FP source register, encoded in the "Rn" field.
- <Hn> Is the 16-bit name of the SIMD&FP source register, encoded in the "Rn" field.
- <Dn> Is the 64-bit name of the SIMD&FP source register, encoded in the "Rn" field.

Operation

```
CheckFPAdvSIMDEnabled64();

bits(fltsize) fltval;
bits(intsize) intval;

fltval = V[n];
intval = FPToFixed(fltval, 0, TRUE, FPCR, rounding);
X[d] = intval;
```

C7.2.67 FCVTN, FCVTN2

Floating-point Convert to lower precision Narrow (vector). This instruction reads each vector element in the SIMD&FP source register, converts each result to half the precision of the source element, writes the final result to a vector, and writes the vector to the lower or upper half of the destination SIMD&FP register. The destination vector elements are half as long as the source vector elements. The rounding mode is determined by the [FPCR](#).

The FCVTN instruction writes the vector to the lower half of the destination register and clears the upper half, while the FCVTN2 instruction writes the vector to the upper half of the destination register without affecting the other bits of the register.

A floating-point exception can be generated by this instruction. Depending on the settings in [FPCR](#), the exception results in either a flag being set in [FPSR](#) or a synchronous exception being generated. For more information, see [Floating-point exceptions and exception traps on page D1-1831](#).

Depending on the settings in the [CPACR_EL1](#), [CPTR_EL2](#), and [CPTR_EL3](#) registers, and the Security state and Exception level in which the instruction is executed, an attempt to execute the instruction might be trapped.

31	30	29	28	27	26	25	24	23	22	21	20	19	18	17	16	15	14	13	12	11	10	9	5		4	0	
0	Q	0	0	1	1	1	0	0	sz	1	0	0	0	0	1	0	1	1	0	1	0	Rn		Rd			

Vector single-precision and double-precision variant

FCVTN{2} <Vd>.<Tb>, <Vn>.<Ta>

Decode for this encoding

```
integer d = UInt(Rd);
integer n = UInt(Rn);

integer esize = 16 << UInt(sz);
integer datasize = 64;
integer part = UInt(Q);
integer elements = datasize DIV esize;
```

Assembler symbols

2 Is the second and upper half specifier. If present it causes the operation to be performed on the upper 64 bits of the registers holding the narrower elements, and is encoded in the "Q" field. It can have the following values:

[absent] when Q = 0
 [present] when Q = 1

<Vd> Is the name of the SIMD&FP destination register, encoded in the "Rd" field.

<Tb> Is an arrangement specifier, encoded in the "sz:Q" field. It can have the following values:

4H when sz = 0, Q = 0
 8H when sz = 0, Q = 1
 2S when sz = 1, Q = 0
 4S when sz = 1, Q = 1

<Vn> Is the name of the SIMD&FP source register, encoded in the "Rn" field.

<Ta> Is an arrangement specifier, encoded in the "sz" field. It can have the following values:

4S when sz = 0

2D when sz = 1

Operation

```
CheckFPAdvSIMDEnabled64();  
bits(2*datasize) operand = V[n];  
bits(datasize) result;  
  
for e = 0 to elements-1  
    Elem[result, e, esize] = FPConvert(Elem[operand, e, 2*esize], FPCR);  
  
Vpart[d, part] = result;
```

C7.2.68 FCVTNS (vector)

Floating-point Convert to Signed integer, rounding to nearest with ties to even (vector). This instruction converts a scalar or each element in a vector from a floating-point value to a signed integer value using the Round to Nearest rounding mode, and writes the result to the SIMD&FP destination register.

A floating-point exception can be generated by this instruction. Depending on the settings in [FPCR](#), the exception results in either a flag being set in [FPSR](#), or a synchronous exception being generated. For more information, see [Floating-point exceptions and exception traps on page D1-1831](#).

Depending on the settings in the [CPACR_EL1](#), [CPTR_EL2](#), and [CPTR_EL3](#) registers, and the Security state and Exception level in which the instruction is executed, an attempt to execute the instruction might be trapped.

Scalar half precision

ARMv8.2

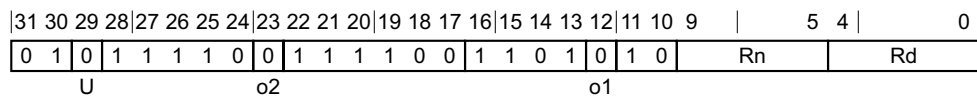

Scalar half precision variant

FCVTNS <Hd>, <Hn>

Decode for this encoding

```
if !HaveFP16Ext() then UnallocatedEncoding();

integer d = UInt(Rd);
integer n = UInt(Rn);

integer esize = 16;
integer datasize = esize;
integer elements = 1;

FPRounding rounding = FPDecodeRounding(o1:o2);
boolean unsigned = (U == '1');
```

Scalar single-precision and double-precision

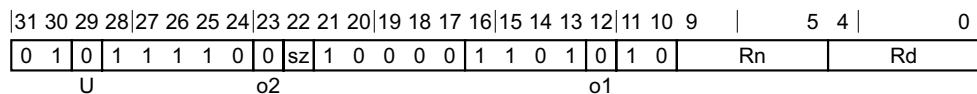

Scalar single-precision and double-precision variant

FCVTNS <V><d>, <V><n>

Decode for this encoding

```
integer d = UInt(Rd);
integer n = UInt(Rn);

integer esize = 32 << UInt(sz);
integer datasize = esize;
integer elements = 1;

FPRounding rounding = FPDecodeRounding(o1:o2);
boolean unsigned = (U == '1');
```

Vector half precision

ARMv8.2

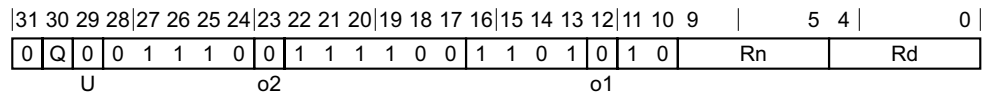

Vector half precision variant

FCVTNS <Vd>.<T>, <Vn>.<T>

Decode for this encoding

```

if !HaveFP16Ext() then UnallocatedEncoding();

integer d = UInt(Rd);
integer n = UInt(Rn);

integer esize = 16;
integer datasize = if Q == '1' then 128 else 64;
integer elements = datasize DIV esize;

FPRounding rounding = FPDecodeRounding(o1:o2);
boolean unsigned = (U == '1');
```

Vector single-precision and double-precision

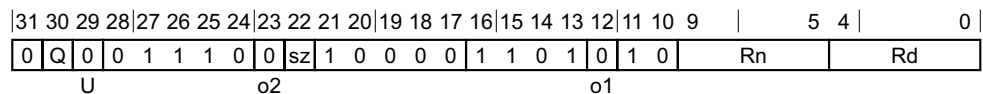

Vector single-precision and double-precision variant

FCVTNS <Vd>.<T>, <Vn>.<T>

Decode for this encoding

```

integer d = UInt(Rd);
integer n = UInt(Rn);

if sz:Q == '10' then ReservedValue();
integer esize = 32 << UInt(sz);
integer datasize = if Q == '1' then 128 else 64;
integer elements = datasize DIV esize;

FPRounding rounding = FPDecodeRounding(o1:o2);
boolean unsigned = (U == '1');
```

Assembler symbols

- <Hd> Is the 16-bit name of the SIMD&FP destination register, encoded in the "Rd" field.
- <Hn> Is the 16-bit name of the SIMD&FP source register, encoded in the "Rn" field.
- <V> Is a width specifier, encoded in the "sz" field. It can have the following values:
 - S when sz = 0
 - D when sz = 1
- <d> Is the number of the SIMD&FP destination register, encoded in the "Rd" field.

- <n> Is the number of the SIMD&FP source register, encoded in the "Rn" field.
- <Vd> Is the name of the SIMD&FP destination register, encoded in the "Rd" field.
- <T> For the vector half precision variant: is an arrangement specifier, encoded in the "Q" field. It can have the following values:
- 4H when Q = 0
 - 8H when Q = 1
- For the vector single-precision and double-precision variant: is an arrangement specifier, encoded in the "sz:Q" field. It can have the following values:
- 2S when sz = 0, Q = 0
 - 4S when sz = 0, Q = 1
 - 2D when sz = 1, Q = 1
- The encoding sz = 1, Q = 0 is reserved.
- <Vn> Is the name of the SIMD&FP source register, encoded in the "Rn" field.

Operation for all encodings

```
CheckFPAdvSIMDEnabled64();
bits(datasize) operand = V[n];
bits(datasize) result;
bits(esize) element;

for e = 0 to elements-1
    element = Elem[operand, e, esize];
    Elem[result, e, esize] = FPToFixed(element, 0, unsigned, FPCR, rounding);

V[d] = result;
```

C7.2.69 FCVTNS (scalar)

Floating-point Convert to Signed integer, rounding to nearest with ties to even (scalar). This instruction converts the floating-point value in the SIMD&FP source register to a 32-bit or 64-bit signed integer using the Round to Nearest rounding mode, and writes the result to the general-purpose destination register.

A floating-point exception can be generated by this instruction. Depending on the settings in [FPCR](#), the exception results in either a flag being set in [FPSR](#), or a synchronous exception being generated. For more information, see [Floating-point exceptions and exception traps on page D1-1831](#).

Depending on the settings in the [CPACR_EL1](#), [CPTR_EL2](#), and [CPTR_EL3](#) registers, and the current Security state and Exception level, an attempt to execute the instruction might be trapped.

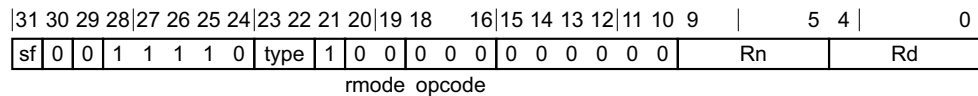

Half-precision to 32-bit variant

Applies when `sf == 0 && type == 11`.

FCVTNS <Wd>, <Hn>

Half-precision to 64-bit variant

Applies when `sf == 1 && type == 11`.

FCVTNS <Xd>, <Hn>

Single-precision to 32-bit variant

Applies when `sf == 0 && type == 00`.

FCVTNS <Wd>, <Sn>

Single-precision to 64-bit variant

Applies when `sf == 1 && type == 00`.

FCVTNS <Xd>, <Sn>

Double-precision to 32-bit variant

Applies when `sf == 0 && type == 01`.

FCVTNS <Wd>, <Dn>

Double-precision to 64-bit variant

Applies when `sf == 1 && type == 01`.

FCVTNS <Xd>, <Dn>

Decode for all variants of this encoding

```
integer d = UInt(Rd);
integer n = UInt(Rn);

integer intsize = if sf == '1' then 64 else 32;
integer fltsize;
FPRounding rounding;
```

```
case type of
  when '00'
    fltsize = 32;
  when '01'
    fltsize = 64;
  when '10'
    UnallocatedEncoding();
  when '11'
    if HaveFP16Ext() then
      fltsize = 16;
    else
      UnallocatedEncoding();

rounding = FPDecodeRounding(rmode);
```

Assembler symbols

- <Wd> Is the 32-bit name of the general-purpose destination register, encoded in the "Rd" field.
- <Xd> Is the 64-bit name of the general-purpose destination register, encoded in the "Rd" field.
- <Sn> Is the 32-bit name of the SIMD&FP source register, encoded in the "Rn" field.
- <Hn> Is the 16-bit name of the SIMD&FP source register, encoded in the "Rn" field.
- <Dn> Is the 64-bit name of the SIMD&FP source register, encoded in the "Rn" field.

Operation

```
CheckFPAdvSIMDEnabled64();

bits(fltsize) fltval;
bits(intsize) intval;

fltval = V[n];
intval = FPToFixed(fltval, 0, FALSE, FPCR, rounding);
X[d] = intval;
```

C7.2.70 FCVTNU (vector)

Floating-point Convert to Unsigned integer, rounding to nearest with ties to even (vector). This instruction converts a scalar or each element in a vector from a floating-point value to an unsigned integer value using the Round to Nearest rounding mode, and writes the result to the SIMD&FP destination register.

A floating-point exception can be generated by this instruction. Depending on the settings in [FPCR](#), the exception results in either a flag being set in [FPSR](#), or a synchronous exception being generated. For more information, see [Floating-point exceptions and exception traps on page D1-1831](#).

Depending on the settings in the [CPACR_EL1](#), [CPTR_EL2](#), and [CPTR_EL3](#) registers, and the Security state and Exception level in which the instruction is executed, an attempt to execute the instruction might be trapped.

Scalar half precision

ARMv8.2

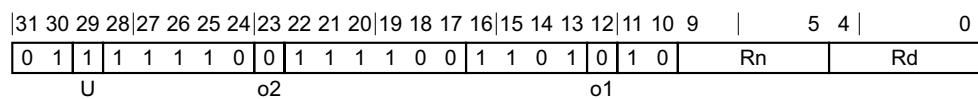

Scalar half precision variant

FCVTNU <Hd>, <Hn>

Decode for this encoding

```
if !HaveFP16Ext() then UnallocatedEncoding();

integer d = UInt(Rd);
integer n = UInt(Rn);

integer esize = 16;
integer datasize = esize;
integer elements = 1;

FPRounding rounding = FPDecodeRounding(o1:o2);
boolean unsigned = (U == '1');
```

Scalar single-precision and double-precision

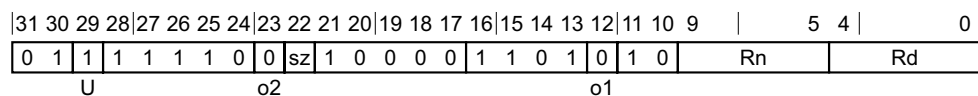

Scalar single-precision and double-precision variant

FCVTNU <V><d>, <V><n>

Decode for this encoding

```
integer d = UInt(Rd);
integer n = UInt(Rn);

integer esize = 32 << UInt(sz);
integer datasize = esize;
integer elements = 1;

FPRounding rounding = FPDecodeRounding(o1:o2);
boolean unsigned = (U == '1');
```

Vector half precision

ARMv8.2

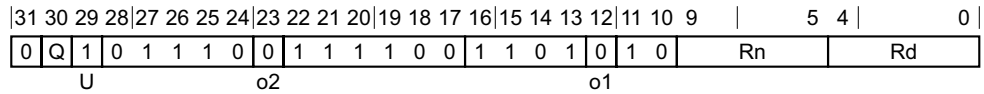

Vector half precision variant

FCVTNU <Vd>.<T>, <Vn>.<T>

Decode for this encoding

```

if !HaveFP16Ext() then UnallocatedEncoding();

integer d = UInt(Rd);
integer n = UInt(Rn);

integer esize = 16;
integer datasize = if Q == '1' then 128 else 64;
integer elements = datasize DIV esize;

FPRounding rounding = FPDecodeRounding(o1:o2);
boolean unsigned = (U == '1');
```

Vector single-precision and double-precision

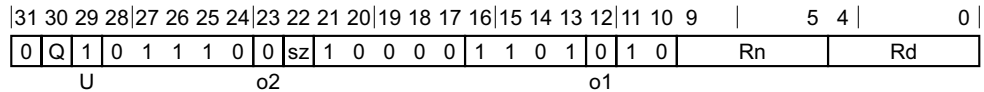

Vector single-precision and double-precision variant

FCVTNU <Vd>.<T>, <Vn>.<T>

Decode for this encoding

```

integer d = UInt(Rd);
integer n = UInt(Rn);

if sz:Q == '10' then ReservedValue();
integer esize = 32 << UInt(sz);
integer datasize = if Q == '1' then 128 else 64;
integer elements = datasize DIV esize;

FPRounding rounding = FPDecodeRounding(o1:o2);
boolean unsigned = (U == '1');
```

Assembler symbols

- <Hd> Is the 16-bit name of the SIMD&FP destination register, encoded in the "Rd" field.
- <Hn> Is the 16-bit name of the SIMD&FP source register, encoded in the "Rn" field.
- <V> Is a width specifier, encoded in the "sz" field. It can have the following values:
 - S when sz = 0
 - D when sz = 1
- <d> Is the number of the SIMD&FP destination register, encoded in the "Rd" field.

- <n> Is the number of the SIMD&FP source register, encoded in the "Rn" field.
- <Vd> Is the name of the SIMD&FP destination register, encoded in the "Rd" field.
- <T> For the vector half precision variant: is an arrangement specifier, encoded in the "Q" field. It can have the following values:
- 4H when Q = 0
 - 8H when Q = 1
- For the vector single-precision and double-precision variant: is an arrangement specifier, encoded in the "sz:Q" field. It can have the following values:
- 2S when sz = 0, Q = 0
 - 4S when sz = 0, Q = 1
 - 2D when sz = 1, Q = 1
- The encoding sz = 1, Q = 0 is reserved.
- <Vn> Is the name of the SIMD&FP source register, encoded in the "Rn" field.

Operation for all encodings

```
CheckFPAdvSIMDEnabled64();
bits(datasize) operand = V[n];
bits(datasize) result;
bits(esize) element;

for e = 0 to elements-1
    element = Elem[operand, e, esize];
    Elem[result, e, esize] = FPToFixed(element, 0, unsigned, FPCR, rounding);

V[d] = result;
```

C7.2.71 FCVTNU (scalar)

Floating-point Convert to Unsigned integer, rounding to nearest with ties to even (scalar). This instruction converts the floating-point value in the SIMD&FP source register to a 32-bit or 64-bit unsigned integer using the Round to Nearest rounding mode, and writes the result to the general-purpose destination register.

A floating-point exception can be generated by this instruction. Depending on the settings in [FPCR](#), the exception results in either a flag being set in [FPSR](#), or a synchronous exception being generated. For more information, see [Floating-point exceptions and exception traps on page D1-1831](#).

Depending on the settings in the [CPACR_EL1](#), [CPTR_EL2](#), and [CPTR_EL3](#) registers, and the current Security state and Exception level, an attempt to execute the instruction might be trapped.

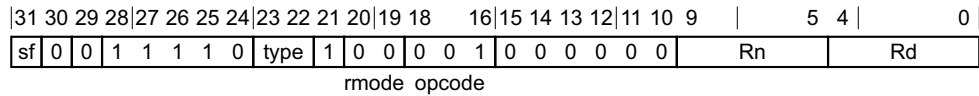

Half-precision to 32-bit variant

Applies when sf == 0 && type == 11.

FCVTNU <Wd>, <Hn>

Half-precision to 64-bit variant

Applies when sf == 1 && type == 11.

FCVTNU <Xd>, <Hn>

Single-precision to 32-bit variant

Applies when sf == 0 && type == 00.

FCVTNU <Wd>, <Sn>

Single-precision to 64-bit variant

Applies when sf == 1 && type == 00.

FCVTNU <Xd>, <Sn>

Double-precision to 32-bit variant

Applies when sf == 0 && type == 01.

FCVTNU <Wd>, <Dn>

Double-precision to 64-bit variant

Applies when sf == 1 && type == 01.

FCVTNU <Xd>, <Dn>

Decode for all variants of this encoding

```
integer d = UInt(Rd);
integer n = UInt(Rn);

integer intsize = if sf == '1' then 64 else 32;
integer fltsize;
FPRounding rounding;
```



```
case type of
  when '00'
    fltsize = 32;
  when '01'
    fltsize = 64;
  when '10'
    UnallocatedEncoding();
  when '11'
    if HaveFP16Ext() then
      fltsize = 16;
    else
      UnallocatedEncoding();

rounding = FPDecodeRounding(rmode);
```

Assembler symbols

- <Wd> Is the 32-bit name of the general-purpose destination register, encoded in the "Rd" field.
- <Xd> Is the 64-bit name of the general-purpose destination register, encoded in the "Rd" field.
- <Sn> Is the 32-bit name of the SIMD&FP source register, encoded in the "Rn" field.
- <Hn> Is the 16-bit name of the SIMD&FP source register, encoded in the "Rn" field.
- <Dn> Is the 64-bit name of the SIMD&FP source register, encoded in the "Rn" field.

Operation

```
CheckFPAdvSIMDEnabled64();

bits(fltsize) fltval;
bits(intsize) intval;

fltval = V[n];
intval = FPToFixed(fltval, 0, TRUE, FPCR, rounding);
X[d] = intval;
```

C7.2.72 FCVTPS (vector)

Floating-point Convert to Signed integer, rounding toward Plus infinity (vector). This instruction converts a scalar or each element in a vector from a floating-point value to a signed integer value using the Round towards Plus Infinity rounding mode, and writes the result to the SIMD&FP destination register.

A floating-point exception can be generated by this instruction. Depending on the settings in [FPCR](#), the exception results in either a flag being set in [FPSR](#), or a synchronous exception being generated. For more information, see [Floating-point exceptions and exception traps on page D1-1831](#).

Depending on the settings in the [CPACR_EL1](#), [CPTR_EL2](#), and [CPTR_EL3](#) registers, and the Security state and Exception level in which the instruction is executed, an attempt to execute the instruction might be trapped.

Scalar half precision

ARMv8.2

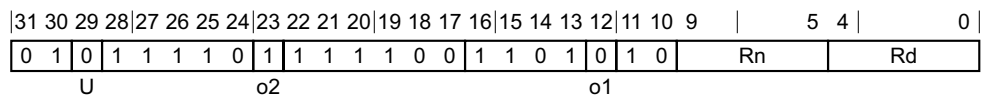

Scalar half precision variant

FCVTPS <Hd>, <Hn>

Decode for this encoding

```

if !HaveFP16Ext() then UnallocatedEncoding();

integer d = UInt(Rd);
integer n = UInt(Rn);

integer esize = 16;
integer datasize = esize;
integer elements = 1;

FPRounding rounding = FPDecodeRounding(o1:o2);
boolean unsigned = (U == '1');
```

Scalar single-precision and double-precision

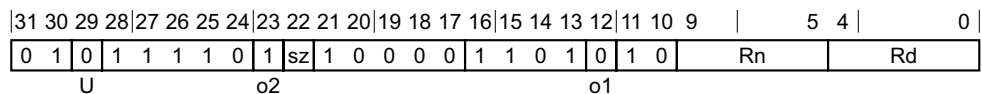

Scalar single-precision and double-precision variant

FCVTPS <V><d>, <V><n>

Decode for this encoding

```

integer d = UInt(Rd);
integer n = UInt(Rn);

integer esize = 32 << UInt(sz);
integer datasize = esize;
integer elements = 1;

FPRounding rounding = FPDecodeRounding(o1:o2);
boolean unsigned = (U == '1');
```

Vector half precision

ARMv8.2

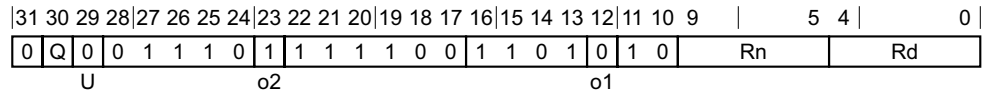

Vector half precision variant

FCVTPS <Vd>.<T>, <Vn>.<T>

Decode for this encoding

```
if !HaveFP16Ext() then UnallocatedEncoding();

integer d = UInt(Rd);
integer n = UInt(Rn);

integer esize = 16;
integer datasize = if Q == '1' then 128 else 64;
integer elements = datasize DIV esize;

FPRounding rounding = FPDecodeRounding(o1:o2);
boolean unsigned = (U == '1');
```

Vector single-precision and double-precision

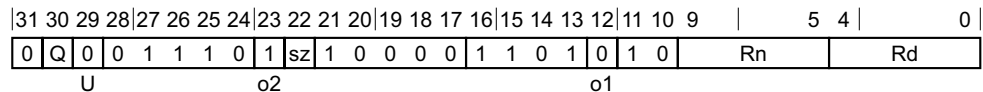

Vector single-precision and double-precision variant

FCVTPS <Vd>.<T>, <Vn>.<T>

Decode for this encoding

```
integer d = UInt(Rd);
integer n = UInt(Rn);

if sz:Q == '10' then ReservedValue();
integer esize = 32 << UInt(sz);
integer datasize = if Q == '1' then 128 else 64;
integer elements = datasize DIV esize;

FPRounding rounding = FPDecodeRounding(o1:o2);
boolean unsigned = (U == '1');
```

Assembler symbols

- <Hd> Is the 16-bit name of the SIMD&FP destination register, encoded in the "Rd" field.
- <Hn> Is the 16-bit name of the SIMD&FP source register, encoded in the "Rn" field.
- <V> Is a width specifier, encoded in the "sz" field. It can have the following values:
 - S when sz = 0
 - D when sz = 1
- <d> Is the number of the SIMD&FP destination register, encoded in the "Rd" field.

- <n> Is the number of the SIMD&FP source register, encoded in the "Rn" field.
- <Vd> Is the name of the SIMD&FP destination register, encoded in the "Rd" field.
- <T> For the vector half precision variant: is an arrangement specifier, encoded in the "Q" field. It can have the following values:
- 4H when Q = 0
 - 8H when Q = 1
- For the vector single-precision and double-precision variant: is an arrangement specifier, encoded in the "sz:Q" field. It can have the following values:
- 2S when sz = 0, Q = 0
 - 4S when sz = 0, Q = 1
 - 2D when sz = 1, Q = 1
- The encoding sz = 1, Q = 0 is reserved.
- <Vn> Is the name of the SIMD&FP source register, encoded in the "Rn" field.

Operation for all encodings

```
CheckFPAdvSIMDEnabled64();
bits(datasize) operand = V[n];
bits(datasize) result;
bits(esize) element;

for e = 0 to elements-1
    element = Elem[operand, e, esize];
    Elem[result, e, esize] = FPToFixed(element, 0, unsigned, FPCR, rounding);

V[d] = result;
```

C7.2.73 FCVTPS (scalar)

Floating-point Convert to Signed integer, rounding toward Plus infinity (scalar). This instruction converts the floating-point value in the SIMD&FP source register to a 32-bit or 64-bit signed integer using the Round towards Plus Infinity rounding mode, and writes the result to the general-purpose destination register.

A floating-point exception can be generated by this instruction. Depending on the settings in [FPCR](#), the exception results in either a flag being set in [FPSR](#), or a synchronous exception being generated. For more information, see [Floating-point exceptions and exception traps on page D1-1831](#).

Depending on the settings in the [CPACR_EL1](#), [CPTR_EL2](#), and [CPTR_EL3](#) registers, and the current Security state and Exception level, an attempt to execute the instruction might be trapped.

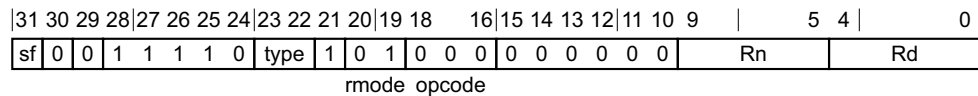

Half-precision to 32-bit variant

Applies when `sf == 0 && type == 11`.

FCVTPS <Wd>, <Hn>

Half-precision to 64-bit variant

Applies when `sf == 1 && type == 11`.

FCVTPS <Xd>, <Hn>

Single-precision to 32-bit variant

Applies when `sf == 0 && type == 00`.

FCVTPS <Wd>, <Sn>

Single-precision to 64-bit variant

Applies when `sf == 1 && type == 00`.

FCVTPS <Xd>, <Sn>

Double-precision to 32-bit variant

Applies when `sf == 0 && type == 01`.

FCVTPS <Wd>, <Dn>

Double-precision to 64-bit variant

Applies when `sf == 1 && type == 01`.

FCVTPS <Xd>, <Dn>

Decode for all variants of this encoding

```
integer d = UInt(Rd);
integer n = UInt(Rn);

integer intsize = if sf == '1' then 64 else 32;
integer fltsize;
FPRounding rounding;
```

```
case type of
  when '00'
    fltsize = 32;
  when '01'
    fltsize = 64;
  when '10'
    UnallocatedEncoding();
  when '11'
    if HaveFP16Ext() then
      fltsize = 16;
    else
      UnallocatedEncoding();

rounding = FPDecodeRounding(rmode);
```

Assembler symbols

- <Wd> Is the 32-bit name of the general-purpose destination register, encoded in the "Rd" field.
- <Xd> Is the 64-bit name of the general-purpose destination register, encoded in the "Rd" field.
- <Sn> Is the 32-bit name of the SIMD&FP source register, encoded in the "Rn" field.
- <Hn> Is the 16-bit name of the SIMD&FP source register, encoded in the "Rn" field.
- <Dn> Is the 64-bit name of the SIMD&FP source register, encoded in the "Rn" field.

Operation

```
CheckFPAdvSIMDEnabled64();

bits(fltsize) fltval;
bits(intsize) intval;

fltval = V[n];
intval = FPToFixed(fltval, 0, FALSE, FPCR, rounding);
X[d] = intval;
```

C7.2.74 FCVTPU (vector)

Floating-point Convert to Unsigned integer, rounding toward Plus infinity (vector). This instruction converts a scalar or each element in a vector from a floating-point value to an unsigned integer value using the Round towards Plus Infinity rounding mode, and writes the result to the SIMD&FP destination register.

A floating-point exception can be generated by this instruction. Depending on the settings in [FPCR](#), the exception results in either a flag being set in [FPSR](#), or a synchronous exception being generated. For more information, see [Floating-point exceptions and exception traps on page D1-1831](#).

Depending on the settings in the [CPACR_EL1](#), [CPTR_EL2](#), and [CPTR_EL3](#) registers, and the Security state and Exception level in which the instruction is executed, an attempt to execute the instruction might be trapped.

Scalar half precision

ARMv8.2

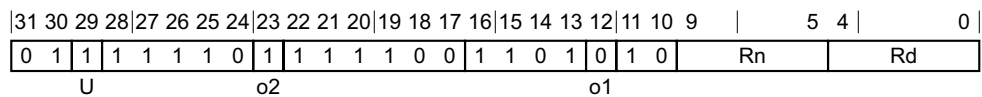

Scalar half precision variant

FCVTPU <Hd>, <Hn>

Decode for this encoding

```
if !HaveFP16Ext() then UnallocatedEncoding();

integer d = UInt(Rd);
integer n = UInt(Rn);

integer esize = 16;
integer datasize = esize;
integer elements = 1;

FPRounding rounding = FPDecodeRounding(o1:o2);
boolean unsigned = (U == '1');
```

Scalar single-precision and double-precision

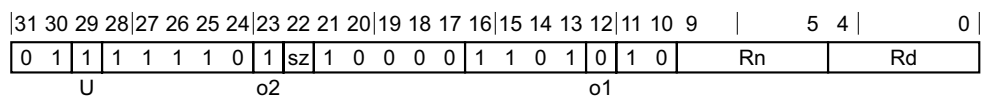

Scalar single-precision and double-precision variant

FCVTPU <V><d>, <V><n>

Decode for this encoding

```
integer d = UInt(Rd);
integer n = UInt(Rn);

integer esize = 32 << UInt(sz);
integer datasize = esize;
integer elements = 1;

FPRounding rounding = FPDecodeRounding(o1:o2);
boolean unsigned = (U == '1');
```

Vector half precision

ARMv8.2

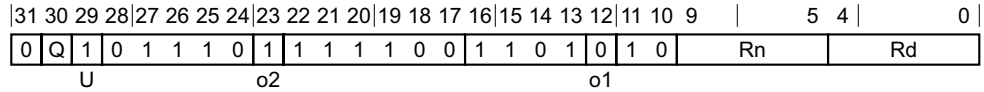

Vector half precision variant

FCVTPU <Vd>.<T>, <Vn>.<T>

Decode for this encoding

```

if !HaveFP16Ext() then UnallocatedEncoding();

integer d = UInt(Rd);
integer n = UInt(Rn);

integer esize = 16;
integer datasize = if Q == '1' then 128 else 64;
integer elements = datasize DIV esize;

FPRounding rounding = FPDecodeRounding(o1:o2);
boolean unsigned = (U == '1');
```

Vector single-precision and double-precision

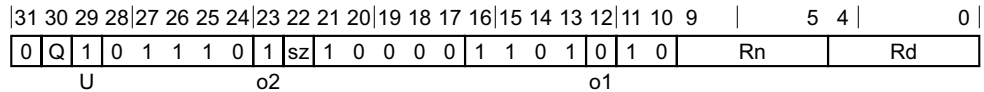

Vector single-precision and double-precision variant

FCVTPU <Vd>.<T>, <Vn>.<T>

Decode for this encoding

```

integer d = UInt(Rd);
integer n = UInt(Rn);

if sz:Q == '10' then ReservedValue();
integer esize = 32 << UInt(sz);
integer datasize = if Q == '1' then 128 else 64;
integer elements = datasize DIV esize;

FPRounding rounding = FPDecodeRounding(o1:o2);
boolean unsigned = (U == '1');
```

Assembler symbols

- <Hd> Is the 16-bit name of the SIMD&FP destination register, encoded in the "Rd" field.
- <Hn> Is the 16-bit name of the SIMD&FP source register, encoded in the "Rn" field.
- <V> Is a width specifier, encoded in the "sz" field. It can have the following values:
 - S when sz = 0
 - D when sz = 1
- <d> Is the number of the SIMD&FP destination register, encoded in the "Rd" field.

- <n> Is the number of the SIMD&FP source register, encoded in the "Rn" field.
- <Vd> Is the name of the SIMD&FP destination register, encoded in the "Rd" field.
- <T> For the vector half precision variant: is an arrangement specifier, encoded in the "Q" field. It can have the following values:
- 4H when Q = 0
 - 8H when Q = 1
- For the vector single-precision and double-precision variant: is an arrangement specifier, encoded in the "sz:Q" field. It can have the following values:
- 2S when sz = 0, Q = 0
 - 4S when sz = 0, Q = 1
 - 2D when sz = 1, Q = 1
- The encoding sz = 1, Q = 0 is reserved.
- <Vn> Is the name of the SIMD&FP source register, encoded in the "Rn" field.

Operation for all encodings

```
CheckFPAdvSIMDEnabled64();
bits(datasize) operand = V[n];
bits(datasize) result;
bits(esize) element;

for e = 0 to elements-1
    element = Elem[operand, e, esize];
    Elem[result, e, esize] = FPToFixed(element, 0, unsigned, FPCR, rounding);

V[d] = result;
```

C7.2.75 FCVTPU (scalar)

Floating-point Convert to Unsigned integer, rounding toward Plus infinity (scalar). This instruction converts the floating-point value in the SIMD&FP source register to a 32-bit or 64-bit unsigned integer using the Round towards Plus Infinity rounding mode, and writes the result to the general-purpose destination register.

A floating-point exception can be generated by this instruction. Depending on the settings in [FPCR](#), the exception results in either a flag being set in [FPSR](#), or a synchronous exception being generated. For more information, see [Floating-point exceptions and exception traps on page D1-1831](#).

Depending on the settings in the [CPACR_EL1](#), [CPTR_EL2](#), and [CPTR_EL3](#) registers, and the current Security state and Exception level, an attempt to execute the instruction might be trapped.

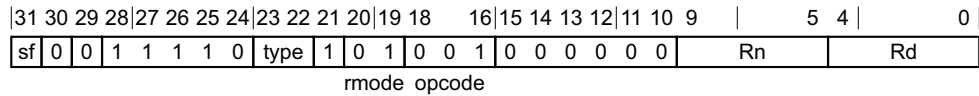

Half-precision to 32-bit variant

Applies when sf == 0 && type == 11.

FCVTPU <Wd>, <Hn>

Half-precision to 64-bit variant

Applies when sf == 1 && type == 11.

FCVTPU <Xd>, <Hn>

Single-precision to 32-bit variant

Applies when sf == 0 && type == 00.

FCVTPU <Wd>, <Sn>

Single-precision to 64-bit variant

Applies when sf == 1 && type == 00.

FCVTPU <Xd>, <Sn>

Double-precision to 32-bit variant

Applies when sf == 0 && type == 01.

FCVTPU <Wd>, <Dn>

Double-precision to 64-bit variant

Applies when sf == 1 && type == 01.

FCVTPU <Xd>, <Dn>

Decode for all variants of this encoding

```
integer d = UInt(Rd);
integer n = UInt(Rn);

integer intsize = if sf == '1' then 64 else 32;
integer fltsize;
FPRounding rounding;
```

```
case type of
  when '00'
    fltsize = 32;
  when '01'
    fltsize = 64;
  when '10'
    UnallocatedEncoding();
  when '11'
    if HaveFP16Ext() then
      fltsize = 16;
    else
      UnallocatedEncoding();

rounding = FPDecodeRounding(rmode);
```

Assembler symbols

- <Wd> Is the 32-bit name of the general-purpose destination register, encoded in the "Rd" field.
- <Xd> Is the 64-bit name of the general-purpose destination register, encoded in the "Rd" field.
- <Sn> Is the 32-bit name of the SIMD&FP source register, encoded in the "Rn" field.
- <Hn> Is the 16-bit name of the SIMD&FP source register, encoded in the "Rn" field.
- <Dn> Is the 64-bit name of the SIMD&FP source register, encoded in the "Rn" field.

Operation

```
CheckFPAdvSIMDEnabled64();

bits(fltsize) fltval;
bits(intsize) intval;

fltval = V[n];
intval = FPToFixed(fltval, 0, TRUE, FPCR, rounding);
X[d] = intval;
```

C7.2.76 FCVTXN, FCVTXN2

Floating-point Convert to lower precision Narrow, rounding to odd (vector). This instruction reads each vector element in the source SIMD&FP register, narrows each value to half the precision of the source element using the Round to Odd rounding mode, writes the result to a vector, and writes the vector to the destination SIMD&FP register.

———— **Note** —————

This instruction uses the Round to Odd rounding mode which is not defined by the IEEE 754-2008 standard. This rounding mode ensures that if the result of the conversion is inexact the least significant bit of the mantissa is forced to 1. This rounding mode enables a floating-point value to be converted to a lower precision format via an intermediate precision format while avoiding double rounding errors. For example, a 64-bit floating-point value can be converted to a correctly rounded 16-bit floating-point value by first using this instruction to produce a 32-bit value and then using another instruction with the wanted rounding mode to convert the 32-bit value to the final 16-bit floating-point value.

The FCVTXN instruction writes the vector to the lower half of the destination register and clears the upper half, while the FCVTXN2 instruction writes the vector to the upper half of the destination register without affecting the other bits of the register.

This instruction can generate a floating-point exception. Depending on the settings in [FPCR](#), the exception results in either a flag being set in [FPSR](#) or a synchronous exception being generated. For more information, see [Floating-point exceptions and exception traps on page D1-1831](#).

Depending on the settings in the [CPACR_EL1](#), [CPTR_EL2](#), and [CPTR_EL3](#) registers, and the current Security state and Exception level, an attempt to execute the instruction might be trapped.

Scalar

31	30	29	28	27	26	25	24	23	22	21	20	19	18	17	16	15	14	13	12	11	10	9	5		4	0	
0	1	1	1	1	1	1	0	0	sz	1	0	0	0	0	1	0	1	1	0	1	0	Rn		Rd			

Scalar variant

FCVTXN <Vb><d>, <Va><n>

Decode for this encoding

```
integer d = UInt(Rd);
integer n = UInt(Rn);

if sz == '0' then ReservedValue();
integer esize = 32;
integer datasize = esize;
integer elements = 1;
integer part = 0;
```

Vector

31	30	29	28	27	26	25	24	23	22	21	20	19	18	17	16	15	14	13	12	11	10	9	5		4	0	
0	Q	1	0	1	1	1	0	0	sz	1	0	0	0	0	1	0	1	1	0	1	0	Rn		Rd			

Vector variant

FCVTXN{2} <Vd>.<Tb>, <Vn>.<Ta>

Decode for this encoding

```
integer d = UInt(Rd);
integer n = UInt(Rn);

if sz == '0' then ReservedValue();
integer esize = 32;
integer datasize = 64;
integer elements = 2;
integer part = UInt(Q);
```

Assembler symbols

- 2 Is the second and upper half specifier. If present it causes the operation to be performed on the upper 64 bits of the registers holding the narrower elements, and is encoded in the "Q" field. It can have the following values:
- [absent] when Q = 0
 - [present] when Q = 1
- <Vd> Is the name of the SIMD&FP destination register, encoded in the "Rd" field.
- <Tb> Is an arrangement specifier, encoded in the "sz:Q" field. It can have the following values:
- 2S when sz = 1, Q = 0
 - 4S when sz = 1, Q = 1
- The encoding sz = 0, Q = x is reserved.
- <Vn> Is the name of the SIMD&FP source register, encoded in the "Rn" field.
- <Ta> Is an arrangement specifier, encoded in the "sz" field. It can have the following values:
- 2D when sz = 1
- The encoding sz = 0 is reserved.
- <Vb> Is the destination width specifier, encoded in the "sz" field. It can have the following values:
- S when sz = 1
- The encoding sz = 0 is reserved.
- <d> Is the number of the SIMD&FP destination register, encoded in the "Rd" field.
- <Va> Is the source width specifier, encoded in the "sz" field. It can have the following values:
- D when sz = 1
- The encoding sz = 0 is reserved.
- <n> Is the number of the SIMD&FP source register, encoded in the "Rn" field.

Operation for all encodings

```
CheckFPAdvSIMDEnabled64();
bits(2*datasize) operand = V[n];
bits(datasize) result;

for e = 0 to elements-1
  Elem[result, e, esize] = FPConvert(Elem[operand, e, 2*esize], FPCR, FPRounding_ODD);

Vpart[d, part] = result;
```

C7.2.77 FCVTZS (vector, fixed-point)

Floating-point Convert to Signed fixed-point, rounding toward Zero (vector). This instruction converts a scalar or each element in a vector from floating-point to fixed-point signed integer using the Round towards Zero rounding mode, and writes the result to the SIMD&FP destination register.

A floating-point exception can be generated by this instruction. Depending on the settings in [FPCR](#), the exception results in either a flag being set in [FPSR](#), or a synchronous exception being generated. For more information, see [Floating-point exceptions and exception traps on page D1-1831](#).

Depending on the settings in the [CPACR_EL1](#), [CPTR_EL2](#), and [CPTR_EL3](#) registers, and the Security state and Exception level in which the instruction is executed, an attempt to execute the instruction might be trapped.

Scalar

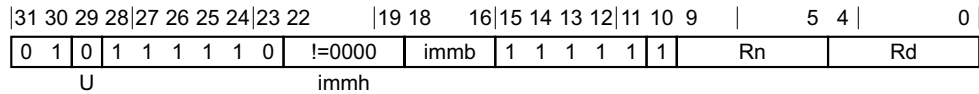

Scalar variant

FCVTZS <V><d>, <V><n>, #<fbits>

Decode for this encoding

```
integer d = UInt(Rd);
integer n = UInt(Rn);

if immh == '000x' || (immh == '001x' && !HaveFP16Ext()) then ReservedValue();
integer esize = if immh == '1xxx' then 64 else if immh == '01xx' then 32 else 16;
integer datasize = esize;
integer elements = 1;

integer fracbits = (esize * 2) - UInt(immh:immb);
boolean unsigned = (U == '1');
FPRounding rounding = FPRounding_ZERO;
```

Vector

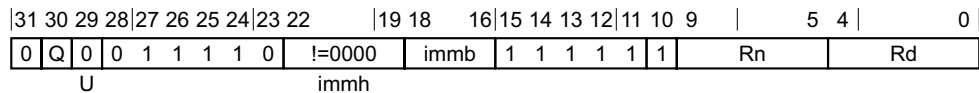

Vector variant

FCVTZS <Vd>.<T>, <Vn>.<T>, #<fbits>

Decode for this encoding

```
integer d = UInt(Rd);
integer n = UInt(Rn);

if immh == '0000' then SEE "Advanced SIMD modified immediate";
if immh == '000x' || (immh == '001x' && !HaveFP16Ext()) then ReservedValue();
if immh<3>:Q == '10' then ReservedValue();
integer esize = if immh == '1xxx' then 64 else if immh == '01xx' then 32 else 16;
integer datasize = if Q == '1' then 128 else 64;
integer elements = datasize DIV esize;
```

```
integer fracbits = (esize * 2) - UInt(immh:immb);
boolean unsigned = (U == '1');
FPRounding rounding = FPRounding_ZERO;
```

Assembler symbols

- <V> Is a width specifier, encoded in the "immh" field. It can have the following values:
- H when immh = 001x
 - S when immh = 01xx
 - D when immh = 1xxx
- The encoding immh = 000x is reserved.
- <d> Is the number of the SIMD&FP destination register, in the "Rd" field.
- <n> Is the number of the first SIMD&FP source register, encoded in the "Rn" field.
- <Vd> Is the name of the SIMD&FP destination register, encoded in the "Rd" field.
- <T> Is an arrangement specifier, encoded in the "immh:Q" field. It can have the following values:
- 4H when immh = 001x, Q = 0
 - 8H when immh = 001x, Q = 1
 - 2S when immh = 01xx, Q = 0
 - 4S when immh = 01xx, Q = 1
 - 2D when immh = 1xxx, Q = 1
- See [Advanced SIMD modified immediate on page C4-291](#) when immh = 0000, Q = x.
- The following encodings are reserved:
- immh = 0001, Q = x.
 - immh = 1xxx, Q = 0.
- <Vn> Is the name of the SIMD&FP source register, encoded in the "Rn" field.
- <fbits> For the scalar variant: is the number of fractional bits, in the range 1 to the operand width, encoded in the "immh:immb" field. It can have the following values:
- (32-UInt(immh:immb)) when immh = 001x
 - (64-UInt(immh:immb)) when immh = 01xx
 - (128-UInt(immh:immb)) when immh = 1xxx
- The encoding immh = 000x is reserved.
- For the vector variant: is the number of fractional bits, in the range 1 to the element width, encoded in the "immh:immb" field. It can have the following values:
- (32-UInt(immh:immb)) when immh = 001x
 - (64-UInt(immh:immb)) when immh = 01xx
 - (128-UInt(immh:immb)) when immh = 1xxx
- See [Advanced SIMD modified immediate on page C4-291](#) when immh = 0000.
- The encoding immh = 0001 is reserved.

Operation for all encodings

```
CheckFPAdvSIMDEnabled64();
bits(datasize) operand = V[n];
bits(datasize) result;
bits(esize) element;
```

for e = 0 to elements-1

```
element = Elem[operand, e, esize];  
Elem[result, e, esize] = FPToFixed(element, fracbits, unsigned, FPCR, rounding);  
V[d] = result;
```

C7.2.78 FCVTZS (vector, integer)

Floating-point Convert to Signed integer, rounding toward Zero (vector). This instruction converts a scalar or each element in a vector from a floating-point value to a signed integer value using the Round towards Zero rounding mode, and writes the result to the SIMD&FP destination register.

A floating-point exception can be generated by this instruction. Depending on the settings in [FPCR](#), the exception results in either a flag being set in [FPSR](#), or a synchronous exception being generated. For more information, see [Floating-point exceptions and exception traps on page D1-1831](#).

Depending on the settings in the [CPACR_EL1](#), [CPTR_EL2](#), and [CPTR_EL3](#) registers, and the Security state and Exception level in which the instruction is executed, an attempt to execute the instruction might be trapped.

Scalar half precision

ARMv8.2

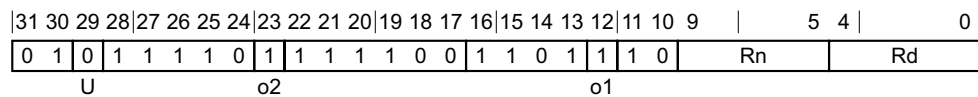

Scalar half precision variant

FCVTZS <Hd>, <Hn>

Decode for this encoding

```
if !HaveFP16Ext() then UnallocatedEncoding();

integer d = UInt(Rd);
integer n = UInt(Rn);

integer esize = 16;
integer datasize = esize;
integer elements = 1;

FPRounding rounding = FPDecodeRounding(o1:o2);
boolean unsigned = (U == '1');
```

Scalar single-precision and double-precision

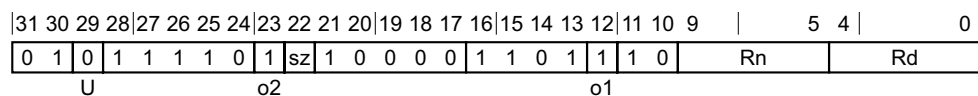

Scalar single-precision and double-precision variant

FCVTZS <V><d>, <V><n>

Decode for this encoding

```
integer d = UInt(Rd);
integer n = UInt(Rn);

integer esize = 32 << UInt(sz);
integer datasize = esize;
integer elements = 1;

FPRounding rounding = FPDecodeRounding(o1:o2);
boolean unsigned = (U == '1');
```

Vector half precision

ARMv8.2

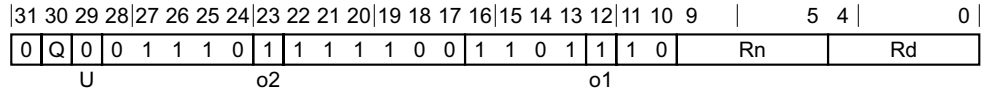

Vector half precision variant

FCVTZS <Vd>.<T>, <Vn>.<T>

Decode for this encoding

```

if !HaveFP16Ext() then UnallocatedEncoding();

integer d = UInt(Rd);
integer n = UInt(Rn);

integer esize = 16;
integer datasize = if Q == '1' then 128 else 64;
integer elements = datasize DIV esize;

FPRounding rounding = FPDecodeRounding(o1:o2);
boolean unsigned = (U == '1');
```

Vector single-precision and double-precision

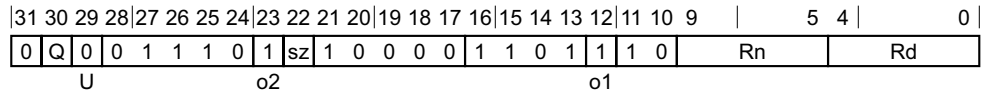

Vector single-precision and double-precision variant

FCVTZS <Vd>.<T>, <Vn>.<T>

Decode for this encoding

```

integer d = UInt(Rd);
integer n = UInt(Rn);

if sz:Q == '10' then ReservedValue();
integer esize = 32 << UInt(sz);
integer datasize = if Q == '1' then 128 else 64;
integer elements = datasize DIV esize;

FPRounding rounding = FPDecodeRounding(o1:o2);
boolean unsigned = (U == '1');
```

Assembler symbols

- <Hd> Is the 16-bit name of the SIMD&FP destination register, encoded in the "Rd" field.
- <Hn> Is the 16-bit name of the SIMD&FP source register, encoded in the "Rn" field.
- <V> Is a width specifier, encoded in the "sz" field. It can have the following values:
 - S when sz = 0
 - D when sz = 1
- <d> Is the number of the SIMD&FP destination register, encoded in the "Rd" field.

- <n> Is the number of the SIMD&FP source register, encoded in the "Rn" field.
- <Vd> Is the name of the SIMD&FP destination register, encoded in the "Rd" field.
- <T> For the vector half precision variant: is an arrangement specifier, encoded in the "Q" field. It can have the following values:
- 4H when Q = 0
 - 8H when Q = 1
- For the vector single-precision and double-precision variant: is an arrangement specifier, encoded in the "sz:Q" field. It can have the following values:
- 2S when sz = 0, Q = 0
 - 4S when sz = 0, Q = 1
 - 2D when sz = 1, Q = 1
- The encoding sz = 1, Q = 0 is reserved.
- <Vn> Is the name of the SIMD&FP source register, encoded in the "Rn" field.

Operation for all encodings

```
CheckFPAdvSIMDEnabled64();
bits(datasize) operand = V[n];
bits(datasize) result;
bits(esize) element;

for e = 0 to elements-1
    element = Elem[operand, e, esize];
    Elem[result, e, esize] = FPToFixed(element, 0, unsigned, FPCR, rounding);

V[d] = result;
```

C7.2.79 FCVTZS (scalar, fixed-point)

Floating-point Convert to Signed fixed-point, rounding toward Zero (scalar). This instruction converts the floating-point value in the SIMD&FP source register to a 32-bit or 64-bit fixed-point signed integer using the Round towards Zero rounding mode, and writes the result to the general-purpose destination register.

A floating-point exception can be generated by this instruction. Depending on the settings in [FPCR](#), the exception results in either a flag being set in [FPSR](#), or a synchronous exception being generated. For more information, see [Floating-point exceptions and exception traps on page D1-1831](#).

Depending on the settings in the [CPACR_EL1](#), [CPTR_EL2](#), and [CPTR_EL3](#) registers, and the Security state and Exception level in which the instruction is executed, an attempt to execute the instruction might be trapped.

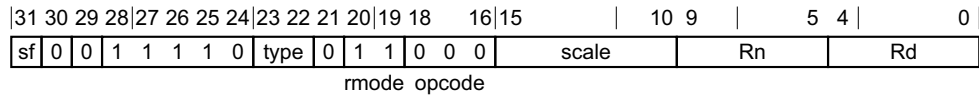

Half-precision to 32-bit variant

Applies when sf == 0 && type == 11.

FCVTZS <Wd>, <Hn>, #<fbits>

Half-precision to 64-bit variant

Applies when sf == 1 && type == 11.

FCVTZS <Xd>, <Hn>, #<fbits>

Single-precision to 32-bit variant

Applies when sf == 0 && type == 00.

FCVTZS <Wd>, <Sn>, #<fbits>

Single-precision to 64-bit variant

Applies when sf == 1 && type == 00.

FCVTZS <Xd>, <Sn>, #<fbits>

Double-precision to 32-bit variant

Applies when sf == 0 && type == 01.

FCVTZS <Wd>, <Dn>, #<fbits>

Double-precision to 64-bit variant

Applies when sf == 1 && type == 01.

FCVTZS <Xd>, <Dn>, #<fbits>

Decode for all variants of this encoding

```
integer d = UInt(Rd);
integer n = UInt(Rn);

integer intsize = if sf == '1' then 64 else 32;
integer fltsize;

case type of
```

```
when '00' fltsize = 32;
when '01' fltsize = 64;
when '10' UnallocatedEncoding();
when '11'
    if HaveFP16Ext() then
        // Empty block.
    else
        UnallocatedEncoding();

if sf == '0' && scale<5> == '0' then UnallocatedEncoding();
integer fracbits = 64 - UInt(scale);
```

Assembler symbols

- <Wd> Is the 32-bit name of the general-purpose destination register, encoded in the "Rd" field.
- <Xd> Is the 64-bit name of the general-purpose destination register, encoded in the "Rd" field.
- <Sn> Is the 32-bit name of the SIMD&FP source register, encoded in the "Rn" field.
- <Hn> Is the 16-bit name of the SIMD&FP source register, encoded in the "Rn" field.
- <Dn> Is the 64-bit name of the SIMD&FP source register, encoded in the "Rn" field.
- <fbits> For the double-precision to 32-bit, half-precision to 32-bit and single-precision to 32-bit variant: is the number of bits after the binary point in the fixed-point destination, in the range 1 to 32, encoded as 64 minus "scale".
- For the double-precision to 64-bit, half-precision to 64-bit and single-precision to 64-bit variant: is the number of bits after the binary point in the fixed-point destination, in the range 1 to 64, encoded as 64 minus "scale".

Operation

```
CheckFPAdvSIMDEnabled64();

bits(fltsize) fltval;
bits(intsize) intval;

fltval = V[n];
intval = FPToFixed(fltval, fracbits, FALSE, FPCR, FPRounding_ZERO);
X[d] = intval;
```

C7.2.80 FCVTZS (scalar, integer)

Floating-point Convert to Signed integer, rounding toward Zero (scalar). This instruction converts the floating-point value in the SIMD&FP source register to a 32-bit or 64-bit signed integer using the Round towards Zero rounding mode, and writes the result to the general-purpose destination register.

A floating-point exception can be generated by this instruction. Depending on the settings in [FPCR](#), the exception results in either a flag being set in [FPSR](#), or a synchronous exception being generated. For more information, see [Floating-point exceptions and exception traps on page D1-1831](#).

Depending on the settings in the [CPACR_EL1](#), [CPTR_EL2](#), and [CPTR_EL3](#) registers, and the current Security state and Exception level, an attempt to execute the instruction might be trapped.

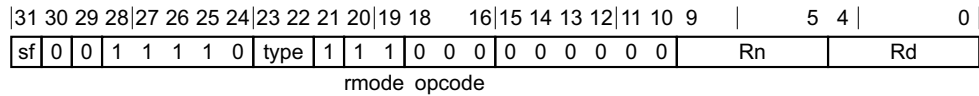

Half-precision to 32-bit variant

Applies when `sf == 0 && type == 11`.

FCVTZS <Wd>, <Hn>

Half-precision to 64-bit variant

Applies when `sf == 1 && type == 11`.

FCVTZS <Xd>, <Hn>

Single-precision to 32-bit variant

Applies when `sf == 0 && type == 00`.

FCVTZS <Wd>, <Sn>

Single-precision to 64-bit variant

Applies when `sf == 1 && type == 00`.

FCVTZS <Xd>, <Sn>

Double-precision to 32-bit variant

Applies when `sf == 0 && type == 01`.

FCVTZS <Wd>, <Dn>

Double-precision to 64-bit variant

Applies when `sf == 1 && type == 01`.

FCVTZS <Xd>, <Dn>

Decode for all variants of this encoding

```
integer d = UInt(Rd);
integer n = UInt(Rn);

integer intsize = if sf == '1' then 64 else 32;
integer fltsize;
FPRounding rounding;
```

```
case type of
  when '00'
    fltsize = 32;
  when '01'
    fltsize = 64;
  when '10'
    UnallocatedEncoding();
  when '11'
    if HaveFP16Ext() then
      fltsize = 16;
    else
      UnallocatedEncoding();

rounding = FPDecodeRounding(rmode);
```

Assembler symbols

- <Wd> Is the 32-bit name of the general-purpose destination register, encoded in the "Rd" field.
- <Xd> Is the 64-bit name of the general-purpose destination register, encoded in the "Rd" field.
- <Sn> Is the 32-bit name of the SIMD&FP source register, encoded in the "Rn" field.
- <Hn> Is the 16-bit name of the SIMD&FP source register, encoded in the "Rn" field.
- <Dn> Is the 64-bit name of the SIMD&FP source register, encoded in the "Rn" field.

Operation

```
CheckFPAdvSIMDEnabled64();

bits(fltsize) fltval;
bits(intsize) intval;

fltval = V[n];
intval = FPToFixed(fltval, 0, FALSE, FPCR, rounding);
X[d] = intval;
```

C7.2.81 FCVTZU (vector, fixed-point)

Floating-point Convert to Unsigned fixed-point, rounding toward Zero (vector). This instruction converts a scalar or each element in a vector from floating-point to fixed-point unsigned integer using the Round towards Zero rounding mode, and writes the result to the general-purpose destination register.

A floating-point exception can be generated by this instruction. Depending on the settings in [FPCR](#), the exception results in either a flag being set in [FPSR](#), or a synchronous exception being generated. For more information, see [Floating-point exceptions and exception traps on page D1-1831](#).

Depending on the settings in the [CPACR_EL1](#), [CPTR_EL2](#), and [CPTR_EL3](#) registers, and the Security state and Exception level in which the instruction is executed, an attempt to execute the instruction might be trapped.

Scalar

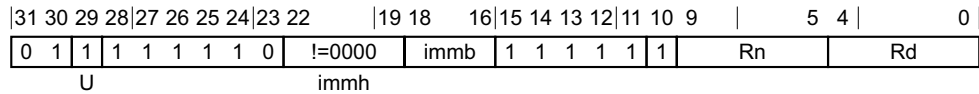

Scalar variant

FCVTZU <V><d>, <V><n>, #<fbits>

Decode for this encoding

```
integer d = UInt(Rd);
integer n = UInt(Rn);

if immh == '000x' || (immh == '001x' && !HaveFP16Ext()) then ReservedValue();
integer esize = if immh == '1xxx' then 64 else if immh == '01xx' then 32 else 16;
integer datasize = esize;
integer elements = 1;

integer fracbits = (esize * 2) - UInt(immh:immb);
boolean unsigned = (U == '1');
FPRounding rounding = FPRounding_ZERO;
```

Vector

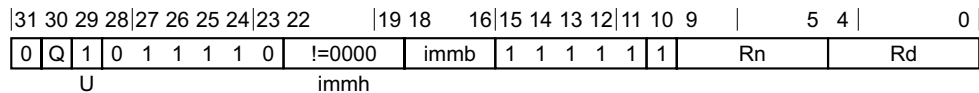

Vector variant

FCVTZU <Vd>.<T>, <Vn>.<T>, #<fbits>

Decode for this encoding

```
integer d = UInt(Rd);
integer n = UInt(Rn);

if immh == '0000' then SEE "Advanced SIMD modified immediate";
if immh == '000x' || (immh == '001x' && !HaveFP16Ext()) then ReservedValue();
if immh<3>:Q == '10' then ReservedValue();
integer esize = if immh == '1xxx' then 64 else if immh == '01xx' then 32 else 16;
integer datasize = if Q == '1' then 128 else 64;
integer elements = datasize DIV esize;
```



```
integer fracbits = (esize * 2) - UInt(immh:immb);
boolean unsigned = (U == '1');
FPRounding rounding = FPRounding_ZERO;
```

Assembler symbols

- <V> Is a width specifier, encoded in the "immh" field. It can have the following values:
- H when immh = 001x
 - S when immh = 01xx
 - D when immh = 1xxx
- The encoding immh = 000x is reserved.
- <d> Is the number of the SIMD&FP destination register, in the "Rd" field.
- <n> Is the number of the first SIMD&FP source register, encoded in the "Rn" field.
- <Vd> Is the name of the SIMD&FP destination register, encoded in the "Rd" field.
- <T> Is an arrangement specifier, encoded in the "immh:Q" field. It can have the following values:
- 4H when immh = 001x, Q = 0
 - 8H when immh = 001x, Q = 1
 - 2S when immh = 01xx, Q = 0
 - 4S when immh = 01xx, Q = 1
 - 2D when immh = 1xxx, Q = 1
- See [Advanced SIMD modified immediate on page C4-291](#) when immh = 0000, Q = x.
- The following encodings are reserved:
- immh = 0001, Q = x.
 - immh = 1xxx, Q = 0.
- <Vn> Is the name of the SIMD&FP source register, encoded in the "Rn" field.
- <fbits> For the scalar variant: is the number of fractional bits, in the range 1 to the operand width, encoded in the "immh:immb" field. It can have the following values:
- (32-UInt(immh:immb)) when immh = 001x
 - (64-UInt(immh:immb)) when immh = 01xx
 - (128-UInt(immh:immb)) when immh = 1xxx
- The encoding immh = 000x is reserved.
- For the vector variant: is the number of fractional bits, in the range 1 to the element width, encoded in the "immh:immb" field. It can have the following values:
- (32-UInt(immh:immb)) when immh = 001x
 - (64-UInt(immh:immb)) when immh = 01xx
 - (128-UInt(immh:immb)) when immh = 1xxx
- See [Advanced SIMD modified immediate on page C4-291](#) when immh = 0000.
- The encoding immh = 0001 is reserved.

Operation for all encodings

```
CheckFPAdvSIMDEnabled64();
bits(datasize) operand = V[n];
bits(datasize) result;
bits(esize) element;
```

for e = 0 to elements-1

```
element = Elem[operand, e, esize];  
Elem[result, e, esize] = FPToFixed(element, fracbits, unsigned, FPCR, rounding);  
V[d] = result;
```

C7.2.82 FCVTZU (vector, integer)

Floating-point Convert to Unsigned integer, rounding toward Zero (vector). This instruction converts a scalar or each element in a vector from a floating-point value to an unsigned integer value using the Round towards Zero rounding mode, and writes the result to the SIMD&FP destination register.

A floating-point exception can be generated by this instruction. Depending on the settings in [FPCR](#), the exception results in either a flag being set in [FPSR](#), or a synchronous exception being generated. For more information, see [Floating-point exceptions and exception traps on page D1-1831](#).

Depending on the settings in the [CPACR_EL1](#), [CPTR_EL2](#), and [CPTR_EL3](#) registers, and the Security state and Exception level in which the instruction is executed, an attempt to execute the instruction might be trapped.

Scalar half precision

ARMv8.2

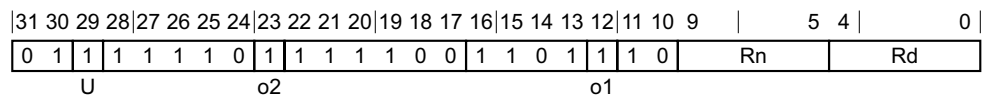

Scalar half precision variant

FCVTZU <Hd>, <Hn>

Decode for this encoding

```

if !HaveFP16Ext() then UnallocatedEncoding();

integer d = UInt(Rd);
integer n = UInt(Rn);

integer esize = 16;
integer datasize = esize;
integer elements = 1;

FPRounding rounding = FPDecodeRounding(o1:o2);
boolean unsigned = (U == '1');
```

Scalar single-precision and double-precision

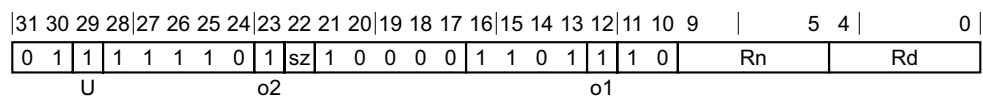

Scalar single-precision and double-precision variant

FCVTZU <V><d>, <V><n>

Decode for this encoding

```

integer d = UInt(Rd);
integer n = UInt(Rn);

integer esize = 32 << UInt(sz);
integer datasize = esize;
integer elements = 1;

FPRounding rounding = FPDecodeRounding(o1:o2);
boolean unsigned = (U == '1');
```

Vector half precision

ARMv8.2

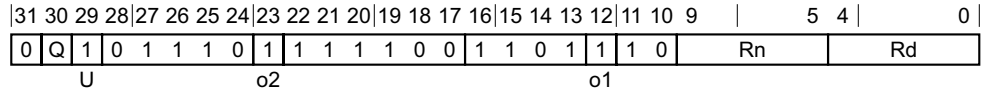

Vector half precision variant

FCVTZU <Vd>.<T>, <Vn>.<T>

Decode for this encoding

```

if !HaveFP16Ext() then UnallocatedEncoding();

integer d = UInt(Rd);
integer n = UInt(Rn);

integer esize = 16;
integer datasize = if Q == '1' then 128 else 64;
integer elements = datasize DIV esize;

FPRounding rounding = FPDecodeRounding(o1:o2);
boolean unsigned = (U == '1');
```

Vector single-precision and double-precision

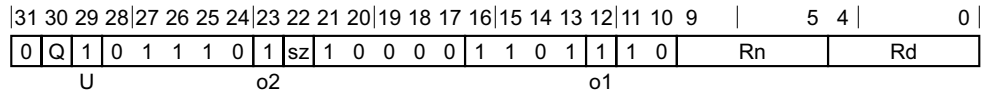

Vector single-precision and double-precision variant

FCVTZU <Vd>.<T>, <Vn>.<T>

Decode for this encoding

```

integer d = UInt(Rd);
integer n = UInt(Rn);

if sz:Q == '10' then ReservedValue();
integer esize = 32 << UInt(sz);
integer datasize = if Q == '1' then 128 else 64;
integer elements = datasize DIV esize;

FPRounding rounding = FPDecodeRounding(o1:o2);
boolean unsigned = (U == '1');
```

Assembler symbols

- <Hd> Is the 16-bit name of the SIMD&FP destination register, encoded in the "Rd" field.
- <Hn> Is the 16-bit name of the SIMD&FP source register, encoded in the "Rn" field.
- <V> Is a width specifier, encoded in the "sz" field. It can have the following values:
 - S when sz = 0
 - D when sz = 1
- <d> Is the number of the SIMD&FP destination register, encoded in the "Rd" field.

- <n> Is the number of the SIMD&FP source register, encoded in the "Rn" field.
- <Vd> Is the name of the SIMD&FP destination register, encoded in the "Rd" field.
- <T> For the vector half precision variant: is an arrangement specifier, encoded in the "Q" field. It can have the following values:
- 4H when Q = 0
 - 8H when Q = 1
- For the vector single-precision and double-precision variant: is an arrangement specifier, encoded in the "sz:Q" field. It can have the following values:
- 2S when sz = 0, Q = 0
 - 4S when sz = 0, Q = 1
 - 2D when sz = 1, Q = 1
- The encoding sz = 1, Q = 0 is reserved.
- <Vn> Is the name of the SIMD&FP source register, encoded in the "Rn" field.

Operation for all encodings

```
CheckFPAdvSIMDEnabled64();
bits(datasize) operand = V[n];
bits(datasize) result;
bits(esize) element;

for e = 0 to elements-1
    element = Elem[operand, e, esize];
    Elem[result, e, esize] = FPToFixed(element, 0, unsigned, FPCR, rounding);

V[d] = result;
```

C7.2.83 FCVTZU (scalar, fixed-point)

Floating-point Convert to Unsigned fixed-point, rounding toward Zero (scalar). This instruction converts the floating-point value in the SIMD&FP source register to a 32-bit or 64-bit fixed-point unsigned integer using the Round towards Zero rounding mode, and writes the result to the general-purpose destination register.

A floating-point exception can be generated by this instruction. Depending on the settings in [FPCR](#), the exception results in either a flag being set in [FPSR](#), or a synchronous exception being generated. For more information, see [Floating-point exceptions and exception traps on page D1-1831](#).

Depending on the settings in the [CPACR_EL1](#), [CPTR_EL2](#), and [CPTR_EL3](#) registers, and the Security state and Exception level in which the instruction is executed, an attempt to execute the instruction might be trapped.

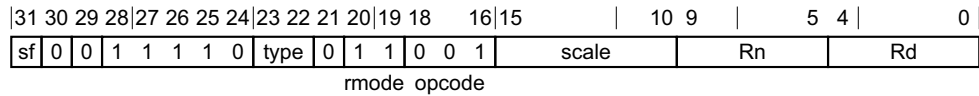

Half-precision to 32-bit variant

Applies when sf == 0 && type == 11.

FCVTZU <Wd>, <Hn>, #<fbits>

Half-precision to 64-bit variant

Applies when sf == 1 && type == 11.

FCVTZU <Xd>, <Hn>, #<fbits>

Single-precision to 32-bit variant

Applies when sf == 0 && type == 00.

FCVTZU <Wd>, <Sn>, #<fbits>

Single-precision to 64-bit variant

Applies when sf == 1 && type == 00.

FCVTZU <Xd>, <Sn>, #<fbits>

Double-precision to 32-bit variant

Applies when sf == 0 && type == 01.

FCVTZU <Wd>, <Dn>, #<fbits>

Double-precision to 64-bit variant

Applies when sf == 1 && type == 01.

FCVTZU <Xd>, <Dn>, #<fbits>

Decode for all variants of this encoding

```
integer d = UInt(Rd);
integer n = UInt(Rn);

integer intsize = if sf == '1' then 64 else 32;
integer fltsize;

case type of
```

```
when '00' fltsize = 32;
when '01' fltsize = 64;
when '10' UnallocatedEncoding();
when '11'
    if HaveFP16Ext() then
        // Empty block.
    else
        UnallocatedEncoding();

if sf == '0' && scale<5> == '0' then UnallocatedEncoding();
integer fracbits = 64 - UInt(scale);
```

Assembler symbols

- <Wd> Is the 32-bit name of the general-purpose destination register, encoded in the "Rd" field.
- <Xd> Is the 64-bit name of the general-purpose destination register, encoded in the "Rd" field.
- <Sn> Is the 32-bit name of the SIMD&FP source register, encoded in the "Rn" field.
- <Hn> Is the 16-bit name of the SIMD&FP source register, encoded in the "Rn" field.
- <Dn> Is the 64-bit name of the SIMD&FP source register, encoded in the "Rn" field.
- <fbits> For the double-precision to 32-bit, half-precision to 32-bit and single-precision to 32-bit variant: is the number of bits after the binary point in the fixed-point destination, in the range 1 to 32, encoded as 64 minus "scale".
- For the double-precision to 64-bit, half-precision to 64-bit and single-precision to 64-bit variant: is the number of bits after the binary point in the fixed-point destination, in the range 1 to 64, encoded as 64 minus "scale".

Operation

```
CheckFPAdvSIMDEnabled64();

bits(fltsize) fltval;
bits(intsize) intval;

fltval = V[n];
intval = FPToFixed(fltval, fracbits, TRUE, FPCR, FPRounding_ZERO);
X[d] = intval;
```

C7.2.84 FCVTZU (scalar, integer)

Floating-point Convert to Unsigned integer, rounding toward Zero (scalar). This instruction converts the floating-point value in the SIMD&FP source register to a 32-bit or 64-bit unsigned integer using the Round towards Zero rounding mode, and writes the result to the general-purpose destination register.

A floating-point exception can be generated by this instruction. Depending on the settings in [FPCR](#), the exception results in either a flag being set in [FPSR](#), or a synchronous exception being generated. For more information, see [Floating-point exceptions and exception traps on page D1-1831](#).

Depending on the settings in the [CPACR_EL1](#), [CPTR_EL2](#), and [CPTR_EL3](#) registers, and the current Security state and Exception level, an attempt to execute the instruction might be trapped.

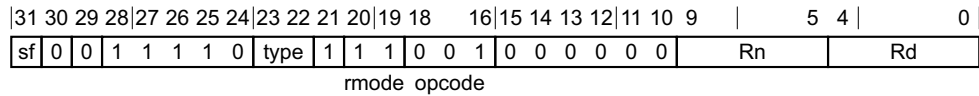

Half-precision to 32-bit variant

Applies when `sf == 0 && type == 11`.

FCVTZU <Wd>, <Hn>

Half-precision to 64-bit variant

Applies when `sf == 1 && type == 11`.

FCVTZU <Xd>, <Hn>

Single-precision to 32-bit variant

Applies when `sf == 0 && type == 00`.

FCVTZU <Wd>, <Sn>

Single-precision to 64-bit variant

Applies when `sf == 1 && type == 00`.

FCVTZU <Xd>, <Sn>

Double-precision to 32-bit variant

Applies when `sf == 0 && type == 01`.

FCVTZU <Wd>, <Dn>

Double-precision to 64-bit variant

Applies when `sf == 1 && type == 01`.

FCVTZU <Xd>, <Dn>

Decode for all variants of this encoding

```
integer d = UInt(Rd);
integer n = UInt(Rn);

integer intsize = if sf == '1' then 64 else 32;
integer fltsize;
FPRounding rounding;
```



```
case type of
  when '00'
    fltsize = 32;
  when '01'
    fltsize = 64;
  when '10'
    UnallocatedEncoding();
  when '11'
    if HaveFP16Ext() then
      fltsize = 16;
    else
      UnallocatedEncoding();

rounding = FPDecodeRounding(rmode);
```

Assembler symbols

- <Wd> Is the 32-bit name of the general-purpose destination register, encoded in the "Rd" field.
- <Xd> Is the 64-bit name of the general-purpose destination register, encoded in the "Rd" field.
- <Sn> Is the 32-bit name of the SIMD&FP source register, encoded in the "Rn" field.
- <Hn> Is the 16-bit name of the SIMD&FP source register, encoded in the "Rn" field.
- <Dn> Is the 64-bit name of the SIMD&FP source register, encoded in the "Rn" field.

Operation

```
CheckFPAdvSIMDEnabled64();

bits(fltsize) fltval;
bits(intsize) intval;

fltval = V[n];
intval = FPToFixed(fltval, 0, TRUE, FPCR, rounding);
X[d] = intval;
```

C7.2.85 FDIV (vector)

Floating-point Divide (vector). This instruction divides the floating-point values in the elements in the first source SIMD&FP register, by the floating-point values in the corresponding elements in the second source SIMD&FP register, places the results in a vector, and writes the vector to the destination SIMD&FP register.

This instruction can generate a floating-point exception. Depending on the settings in [FPCR](#), the exception results in either a flag being set in [FPSR](#), or a synchronous exception being generated. For more information, see [Floating-point exceptions and exception traps on page D1-1831](#).

Depending on the settings in the [CPACR_EL1](#), [CPTR_EL2](#), and [CPTR_EL3](#) registers, and the current Security state and Exception level, an attempt to execute the instruction might be trapped.

Half-precision

ARMv8.2

31	30	29	28	27	26	25	24	23	22	21	20	16	15	14	13	12	11	10	9	5	4	0
0	Q	1	0	1	1	1	0	0	1	0	Rm	0	0	1	1	1	1	Rn	Rd			

Half-precision variant

FDIV <Vd>.<T>, <Vn>.<T>, <Vm>.<T>

Decode for this encoding

```
if !HaveFP16Ext() then UnallocatedEncoding();

integer d = UInt(Rd);
integer n = UInt(Rn);
integer m = UInt(Rm);
integer esize = 16;
integer datasize = if Q == '1' then 128 else 64;
integer elements = datasize DIV esize;
```

Single-precision and double-precision

31	30	29	28	27	26	25	24	23	22	21	20	16	15	14	13	12	11	10	9	5	4	0
0	Q	1	0	1	1	1	0	0	sz	1	Rm	1	1	1	1	1	1	Rn	Rd			

Single-precision and double-precision variant

FDIV <Vd>.<T>, <Vn>.<T>, <Vm>.<T>

Decode for this encoding

```
integer d = UInt(Rd);
integer n = UInt(Rn);
integer m = UInt(Rm);
if sz:Q == '10' then ReservedValue();
integer esize = 32 << UInt(sz);
integer datasize = if Q == '1' then 128 else 64;
integer elements = datasize DIV esize;
```

Assembler symbols

<Vd> Is the name of the SIMD&FP destination register, encoded in the "Rd" field.

- <T> For the half-precision variant: is an arrangement specifier, encoded in the "Q" field. It can have the following values:
- 4H when Q = 0
 - 8H when Q = 1
- For the single-precision and double-precision variant: is an arrangement specifier, encoded in the "sz:Q" field. It can have the following values:
- 2S when sz = 0, Q = 0
 - 4S when sz = 0, Q = 1
 - 2D when sz = 1, Q = 1
- The encoding sz = 1, Q = 0 is reserved.
- <Vn> Is the name of the first SIMD&FP source register, encoded in the "Rn" field.
- <Vm> Is the name of the second SIMD&FP source register, encoded in the "Rm" field.

Operation for all encodings

```
CheckFPAdvSIMDEnabled64();
bits(datasize) operand1 = V[n];
bits(datasize) operand2 = V[m];
bits(datasize) result;
bits(esize) element1;
bits(esize) element2;

for e = 0 to elements-1
    element1 = Elem[operand1, e, esize];
    element2 = Elem[operand2, e, esize];
    Elem[result, e, esize] = FPDiv(element1, element2, FPCR);

V[d] = result;
```

C7.2.86 FDIV (scalar)

Floating-point Divide (scalar). This instruction divides the floating-point value of the first source SIMD&FP register by the floating-point value of the second source SIMD&FP register, and writes the result to the destination SIMD&FP register.

This instruction can generate a floating-point exception. Depending on the settings in [FPCR](#), the exception results in either a flag being set in [FPSR](#), or a synchronous exception being generated. For more information, see [Floating-point exceptions and exception traps on page D1-1831](#).

Depending on the settings in the [CPACR_EL1](#), [CPTR_EL2](#), and [CPTR_EL3](#) registers, and the current Security state and Exception level, an attempt to execute the instruction might be trapped.

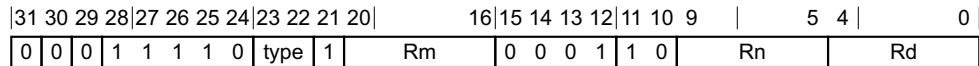

Half-precision variant

Applies when type == 11.

FDIV <Hd>, <Hn>, <Hm>

Single-precision variant

Applies when type == 00.

FDIV <Sd>, <Sn>, <Sm>

Double-precision variant

Applies when type == 01.

FDIV <Dd>, <Dn>, <Dm>

Decode for all variants of this encoding

```
integer d = UInt(Rd);
integer n = UInt(Rn);
integer m = UInt(Rm);

integer datasize;
case type of
    when '00' datasize = 32;
    when '01' datasize = 64;
    when '10' UnallocatedEncoding();
    when '11'
        if HaveFP16Ext() then
            datasize = 16;
        else
            UnallocatedEncoding();
```

Assembler symbols

- <Dd> Is the 64-bit name of the SIMD&FP destination register, encoded in the "Rd" field.
- <Dn> Is the 64-bit name of the first SIMD&FP source register, encoded in the "Rn" field.
- <Dm> Is the 64-bit name of the second SIMD&FP source register, encoded in the "Rm" field.
- <Hd> Is the 16-bit name of the SIMD&FP destination register, encoded in the "Rd" field.

- <Hn> Is the 16-bit name of the first SIMD&FP source register, encoded in the "Rn" field.
- <Hm> Is the 16-bit name of the second SIMD&FP source register, encoded in the "Rm" field.
- <Sd> Is the 32-bit name of the SIMD&FP destination register, encoded in the "Rd" field.
- <Sn> Is the 32-bit name of the first SIMD&FP source register, encoded in the "Rn" field.
- <Sm> Is the 32-bit name of the second SIMD&FP source register, encoded in the "Rm" field.

Operation

```
CheckFPAdvSIMDEnabled64();  
bits(datasize) result;  
bits(datasize) operand1 = V[n];  
bits(datasize) operand2 = V[m];  
  
result = FPDiv(operand1, operand2, FPCR);  
  
V[d] = result;
```

C7.2.87 FMADD

Floating-point fused Multiply-Add (scalar). This instruction multiplies the values of the first two SIMD&FP source registers, adds the product to the value of the third SIMD&FP source register, and writes the result to the SIMD&FP destination register.

A floating-point exception can be generated by this instruction. Depending on the settings in [FPCR](#), the exception results in either a flag being set in [FPSR](#), or a synchronous exception being generated. For more information, see [Floating-point exceptions and exception traps on page D1-1831](#).

Depending on the settings in the [CPACR_EL1](#), [CPTR_EL2](#), and [CPTR_EL3](#) registers, and the current Security state and Exception level, an attempt to execute the instruction might be trapped.

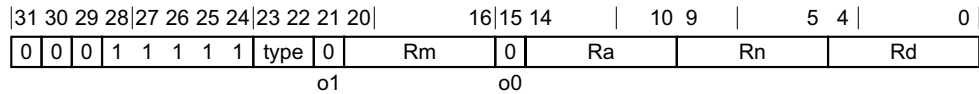

Half-precision variant

Applies when type == 11.

FMADD <Hd>, <Hn>, <Hm>, <Ha>

Single-precision variant

Applies when type == 00.

FMADD <Sd>, <Sn>, <Sm>, <Sa>

Double-precision variant

Applies when type == 01.

FMADD <Dd>, <Dn>, <Dm>, <Da>

Decode for all variants of this encoding

```
integer d = UInt(Rd);
integer a = UInt(Ra);
integer n = UInt(Rn);
integer m = UInt(Rm);

integer datasize;
case type of
    when '00' datasize = 32;
    when '01' datasize = 64;
    when '10' UnallocatedEncoding();
    when '11'
        if HaveFP16Ext() then
            datasize = 16;
        else
            UnallocatedEncoding();
```

Assembler symbols

<Dd> Is the 64-bit name of the SIMD&FP destination register, encoded in the "Rd" field.

<Dn> Is the 64-bit name of the first SIMD&FP source register holding the multiplicand, encoded in the "Rn" field.

- <Dm> Is the 64-bit name of the second SIMD&FP source register holding the multiplier, encoded in the "Rm" field.
- <Da> Is the 64-bit name of the third SIMD&FP source register holding the addend, encoded in the "Ra" field.
- <Hd> Is the 16-bit name of the SIMD&FP destination register, encoded in the "Rd" field.
- <Hn> Is the 16-bit name of the first SIMD&FP source register holding the multiplicand, encoded in the "Rn" field.
- <Hm> Is the 16-bit name of the second SIMD&FP source register holding the multiplier, encoded in the "Rm" field.
- <Ha> Is the 16-bit name of the third SIMD&FP source register holding the addend, encoded in the "Ra" field.
- <Sd> Is the 32-bit name of the SIMD&FP destination register, encoded in the "Rd" field.
- <Sn> Is the 32-bit name of the first SIMD&FP source register holding the multiplicand, encoded in the "Rn" field.
- <Sm> Is the 32-bit name of the second SIMD&FP source register holding the multiplier, encoded in the "Rm" field.
- <Sa> Is the 32-bit name of the third SIMD&FP source register holding the addend, encoded in the "Ra" field.

Operation

```
CheckFPAdvSIMDEnabled64();  
bits(datasize) result;  
bits(datasize) operandA = V[a];  
bits(datasize) operand1 = V[n];  
bits(datasize) operand2 = V[m];  
  
result = FPMu1Add(operandA, operand1, operand2, FPCR);  
  
V[d] = result;
```

C7.2.88 FMAX (vector)

Floating-point Maximum (vector). This instruction compares corresponding vector elements in the two source SIMD&FP registers, places the larger of each of the two floating-point values into a vector, and writes the vector to the destination SIMD&FP register.

This instruction can generate a floating-point exception. Depending on the settings in [FPCR](#), the exception results in either a flag being set in [FPSR](#), or a synchronous exception being generated. For more information, see [Floating-point exceptions and exception traps on page D1-1831](#).

Depending on the settings in the [CPACR_EL1](#), [CPTR_EL2](#), and [CPTR_EL3](#) registers, and the current Security state and Exception level, an attempt to execute the instruction might be trapped.

Half-precision

ARMv8.2

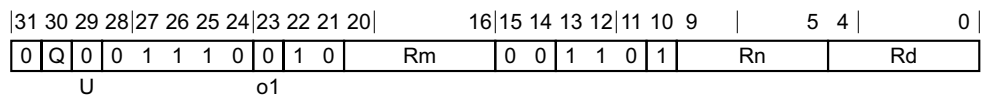

Half-precision variant

FMAX <Vd>.<T>, <Vn>.<T>, <Vm>.<T>

Decode for this encoding

```

if !HaveFP16Ext() then UnallocatedEncoding();

integer d = UInt(Rd);
integer n = UInt(Rn);
integer m = UInt(Rm);
integer esize = 16;
integer datasize = if Q == '1' then 128 else 64;
integer elements = datasize DIV esize;

boolean pair = (U == '1');
boolean minimum = (o1 == '1');
```

Single-precision and double-precision

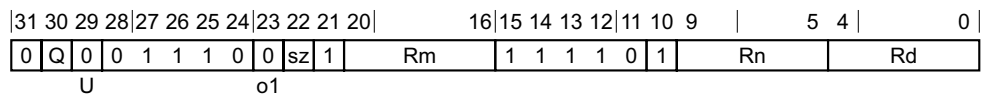

Single-precision and double-precision variant

FMAX <Vd>.<T>, <Vn>.<T>, <Vm>.<T>

Decode for this encoding

```

integer d = UInt(Rd);
integer n = UInt(Rn);
integer m = UInt(Rm);
if sz:Q == '10' then ReservedValue();
integer esize = 32 << UInt(sz);
integer datasize = if Q == '1' then 128 else 64;
integer elements = datasize DIV esize;

boolean pair = (U == '1');
boolean minimum = (o1 == '1');
```

Assembler symbols

- <Vd> Is the name of the SIMD&FP destination register, encoded in the "Rd" field.
- <T> For the half-precision variant: is an arrangement specifier, encoded in the "Q" field. It can have the following values:
- 4H when Q = 0
 - 8H when Q = 1
- For the single-precision and double-precision variant: is an arrangement specifier, encoded in the "sz:Q" field. It can have the following values:
- 2S when sz = 0, Q = 0
 - 4S when sz = 0, Q = 1
 - 2D when sz = 1, Q = 1
- The encoding sz = 1, Q = 0 is reserved.
- <Vn> Is the name of the first SIMD&FP source register, encoded in the "Rn" field.
- <Vm> Is the name of the second SIMD&FP source register, encoded in the "Rm" field.

Operation for all encodings

```
CheckFPAdvSIMDEnabled64();
bits(datasize) operand1 = V[n];
bits(datasize) operand2 = V[m];
bits(datasize) result;
bits(2*datasize) concat = operand2:operand1;
bits(esize) element1;
bits(esize) element2;

for e = 0 to elements-1
  if pair then
    element1 = Elem[concat, 2*e, esize];
    element2 = Elem[concat, (2*e)+1, esize];
  else
    element1 = Elem[operand1, e, esize];
    element2 = Elem[operand2, e, esize];

  if minimum then
    Elem[result, e, esize] = FPMIn(element1, element2, FPCR);
  else
    Elem[result, e, esize] = FPMMax(element1, element2, FPCR);

V[d] = result;
```

C7.2.89 FMAX (scalar)

Floating-point Maximum (scalar). This instruction compares the two source SIMD&FP registers, and writes the larger of the two floating-point values to the destination SIMD&FP register.

This instruction can generate a floating-point exception. Depending on the settings in [FPCR](#), the exception results in either a flag being set in [FPSR](#), or a synchronous exception being generated. For more information, see [Floating-point exceptions and exception traps on page D1-1831](#).

Depending on the settings in the [CPACR_EL1](#), [CPTR_EL2](#), and [CPTR_EL3](#) registers, and the current Security state and Exception level, an attempt to execute the instruction might be trapped.

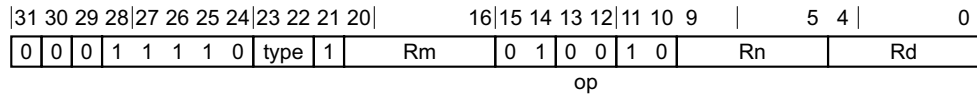

Half-precision variant

Applies when type == 11.

FMAX <Hd>, <Hn>, <Hm>

Single-precision variant

Applies when type == 00.

FMAX <Sd>, <Sn>, <Sm>

Double-precision variant

Applies when type == 01.

FMAX <Dd>, <Dn>, <Dm>

Decode for all variants of this encoding

```
integer d = UInt(Rd);
integer n = UInt(Rn);
integer m = UInt(Rm);

integer datasize;
case type of
    when '00' datasize = 32;
    when '01' datasize = 64;
    when '10' UnallocatedEncoding();
    when '11'
        if HaveFP16Ext() then
            datasize = 16;
        else
            UnallocatedEncoding();
```

Assembler symbols

- <Dd> Is the 64-bit name of the SIMD&FP destination register, encoded in the "Rd" field.
- <Dn> Is the 64-bit name of the first SIMD&FP source register, encoded in the "Rn" field.
- <Dm> Is the 64-bit name of the second SIMD&FP source register, encoded in the "Rm" field.
- <Hd> Is the 16-bit name of the SIMD&FP destination register, encoded in the "Rd" field.
- <Hn> Is the 16-bit name of the first SIMD&FP source register, encoded in the "Rn" field.

- <Hm> Is the 16-bit name of the second SIMD&FP source register, encoded in the "Rm" field.
- <Sd> Is the 32-bit name of the SIMD&FP destination register, encoded in the "Rd" field.
- <Sn> Is the 32-bit name of the first SIMD&FP source register, encoded in the "Rn" field.
- <Sm> Is the 32-bit name of the second SIMD&FP source register, encoded in the "Rm" field.

Operation

```
CheckFPAdvSIMDEnabled64();  
bits(datasize) result;  
bits(datasize) operand1 = V[n];  
bits(datasize) operand2 = V[m];  
  
result = FPMax(operand1, operand2, FPCR);  
V[d] = result;
```

C7.2.90 FMAXNM (vector)

Floating-point Maximum Number (vector). This instruction compares corresponding vector elements in the two source SIMD&FP registers, writes the larger of the two floating-point values into a vector, and writes the vector to the destination SIMD&FP register.

NaNs are handled according to the IEEE 754-2008 standard. If one vector element is numeric and the other is a quiet NaN, the result placed in the vector is the numerical value, otherwise the result is identical to [FMAX \(scalar\)](#).

This instruction can generate a floating-point exception. Depending on the settings in [FPCR](#), the exception results in either a flag being set in [FPSR](#), or a synchronous exception being generated. For more information, see [Floating-point exceptions and exception traps on page D1-1831](#).

Depending on the settings in the [CPACR_EL1](#), [CPTR_EL2](#), and [CPTR_EL3](#) registers, and the current Security state and Exception level, an attempt to execute the instruction might be trapped.

Half-precision

ARMv8.2

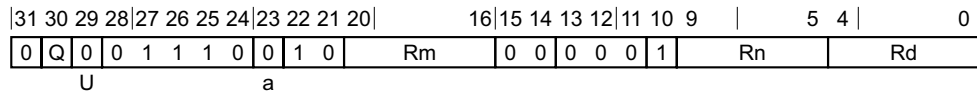

Half-precision variant

FMAXNM <Vd>.<T>, <Vn>.<T>, <Vm>.<T>

Decode for this encoding

```

if !HaveFP16Ext() then UnallocatedEncoding();

integer d = UInt(Rd);
integer n = UInt(Rn);
integer m = UInt(Rm);
integer esize = 16;
integer datasize = if Q == '1' then 128 else 64;
integer elements = datasize DIV esize;

boolean pair = (U == '1');
boolean minimum = (a == '1');
```

Single-precision and double-precision

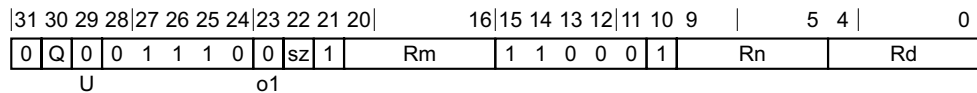

Single-precision and double-precision variant

FMAXNM <Vd>.<T>, <Vn>.<T>, <Vm>.<T>

Decode for this encoding

```

integer d = UInt(Rd);
integer n = UInt(Rn);
integer m = UInt(Rm);
if sz:Q == '10' then ReservedValue();
integer esize = 32 << UInt(sz);
integer datasize = if Q == '1' then 128 else 64;
integer elements = datasize DIV esize;
```

```
boolean pair = (U == '1');
boolean minimum = (o1 == '1');
```

Assembler symbols

- <Vd> Is the name of the SIMD&FP destination register, encoded in the "Rd" field.
- <T> For the half-precision variant: is an arrangement specifier, encoded in the "Q" field. It can have the following values:
- 4H when Q = 0
 - 8H when Q = 1
- For the single-precision and double-precision variant: is an arrangement specifier, encoded in the "sz:Q" field. It can have the following values:
- 2S when sz = 0, Q = 0
 - 4S when sz = 0, Q = 1
 - 2D when sz = 1, Q = 1
- The encoding sz = 1, Q = 0 is reserved.
- <Vn> Is the name of the first SIMD&FP source register, encoded in the "Rn" field.
- <Vm> Is the name of the second SIMD&FP source register, encoded in the "Rm" field.

Operation for all encodings

```
CheckFPAdvSIMDEnabled64();
bits(datasize) operand1 = V[n];
bits(datasize) operand2 = V[m];
bits(datasize) result;
bits(2*datasize) concat = operand2:operand1;
bits(esize) element1;
bits(esize) element2;

for e = 0 to elements-1
    if pair then
        element1 = Elem[concat, 2*e, esize];
        element2 = Elem[concat, (2*e)+1, esize];
    else
        element1 = Elem[operand1, e, esize];
        element2 = Elem[operand2, e, esize];

    if minimum then
        Elem[result, e, esize] = FPMinNum(element1, element2, FPCR);
    else
        Elem[result, e, esize] = FPMaxNum(element1, element2, FPCR);

V[d] = result;
```

C7.2.91 FMAXNM (scalar)

Floating-point Maximum Number (scalar). This instruction compares the first and second source SIMD&FP register values, and writes the larger of the two floating-point values to the destination SIMD&FP register.

NaNs are handled according to the IEEE 754-2008 standard. If one vector element is numeric and the other is a quiet NaN, the result that is placed in the vector is the numerical value, otherwise the result is identical to [FMAX \(scalar\)](#).

This instruction can generate a floating-point exception. Depending on the settings in [FPCR](#), the exception results in either a flag being set in [FPSR](#), or a synchronous exception being generated. For more information, see [Floating-point exceptions and exception traps on page D1-1831](#).

Depending on the settings in the [CPACR_EL1](#), [CPTR_EL2](#), and [CPTR_EL3](#) registers, and the current Security state and Exception level, an attempt to execute the instruction might be trapped.

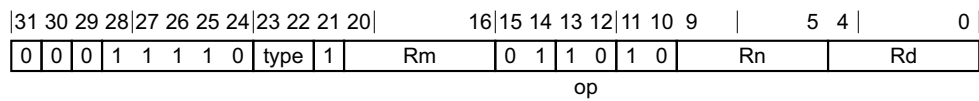

Half-precision variant

Applies when type == 11.

FMAXNM <Hd>, <Hn>, <Hm>

Single-precision variant

Applies when type == 00.

FMAXNM <Sd>, <Sn>, <Sm>

Double-precision variant

Applies when type == 01.

FMAXNM <Dd>, <Dn>, <Dm>

Decode for all variants of this encoding

```
integer d = UInt(Rd);
integer n = UInt(Rn);
integer m = UInt(Rm);

integer datasize;
case type of
    when '00' datasize = 32;
    when '01' datasize = 64;
    when '10' UnallocatedEncoding();
    when '11'
        if HaveFP16Ext() then
            datasize = 16;
        else
            UnallocatedEncoding();
```

Assembler symbols

- <Dd> Is the 64-bit name of the SIMD&FP destination register, encoded in the "Rd" field.
- <Dn> Is the 64-bit name of the first SIMD&FP source register, encoded in the "Rn" field.
- <Dm> Is the 64-bit name of the second SIMD&FP source register, encoded in the "Rm" field.

- <Hd> Is the 16-bit name of the SIMD&FP destination register, encoded in the "Rd" field.
- <Hn> Is the 16-bit name of the first SIMD&FP source register, encoded in the "Rn" field.
- <Hm> Is the 16-bit name of the second SIMD&FP source register, encoded in the "Rm" field.
- <Sd> Is the 32-bit name of the SIMD&FP destination register, encoded in the "Rd" field.
- <Sn> Is the 32-bit name of the first SIMD&FP source register, encoded in the "Rn" field.
- <Sm> Is the 32-bit name of the second SIMD&FP source register, encoded in the "Rm" field.

Operation

```
CheckFPAdvSIMDEnabled64();  
bits(datasize) result;  
bits(datasize) operand1 = V[n];  
bits(datasize) operand2 = V[m];  
  
result = FPMaxNum(operand1, operand2, FPCR);  
V[d] = result;
```

C7.2.92 FMAXNMP (scalar)

Floating-point Maximum Number of Pair of elements (scalar). This instruction compares two vector elements in the source SIMD&FP register and writes the largest of the floating-point values as a scalar to the destination SIMD&FP register.

This instruction can generate a floating-point exception. Depending on the settings in [FPCR](#), the exception results in either a flag being set in [FPSR](#) or a synchronous exception being generated. For more information, see [Floating-point exceptions and exception traps on page D1-1831](#).

Depending on the settings in the [CPACR_EL1](#), [CPTR_EL2](#), and [CPTR_EL3](#) registers, and the current Security state and Exception level, an attempt to execute the instruction might be trapped.

Half-precision

ARMv8.2

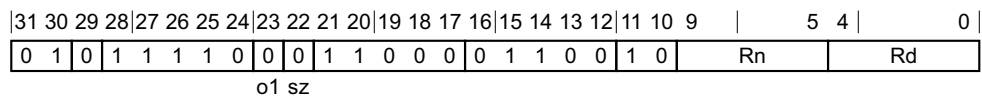

Half-precision variant

FMAXNMP <V><d>, <Vn>.<T>

Decode for this encoding

```
if !HaveFP16Ext() then UnallocatedEncoding();

integer d = UInt(Rd);
integer n = UInt(Rn);

integer esize = 16;
integer datasize = 32;
```

Single-precision and double-precision

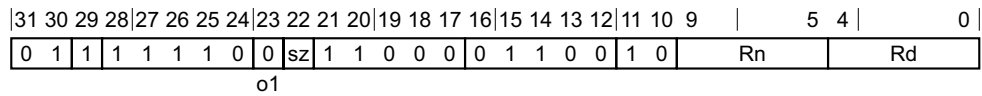

Single-precision and double-precision variant

FMAXNMP <V><d>, <Vn>.<T>

Decode for this encoding

```
integer d = UInt(Rd);
integer n = UInt(Rn);

integer esize = 32;
integer datasize = 64;
```

Assembler symbols

<V> For the half-precision variant: is the destination width specifier, encoded in the "sz" field. It can have the following values:

H when sz = 0

The encoding sz = 1 is reserved.

For the single-precision and double-precision variant: is the destination width specifier, encoded in the "sz" field. It can have the following values:

S when sz = 0

D when sz = 1

<d> Is the number of the SIMD&FP destination register, encoded in the "Rd" field.

<Vn> Is the name of the SIMD&FP source register, encoded in the "Rn" field.

<T> For the half-precision variant: is the source arrangement specifier, encoded in the "sz" field. It can have the following values:

2H when sz = 0

The encoding sz = 1 is reserved.

For the single-precision and double-precision variant: is the source arrangement specifier, encoded in the "sz" field. It can have the following values:

2S when sz = 0

2D when sz = 1

Operation for all encodings

```
CheckFPAdvSIMDEnabled64();  
bits(datasize) operand = V[n];  
V[d] = Reduce(ReduceOp_FMAXNUM, operand, esize);
```

C7.2.93 FMAXNMP (vector)

Floating-point Maximum Number Pairwise (vector). This instruction creates a vector by concatenating the vector elements of the first source SIMD&FP register after the vector elements of the second source SIMD&FP register, reads each pair of adjacent vector elements in the two source SIMD&FP registers, writes the largest of each pair of values into a vector, and writes the vector to the destination SIMD&FP register. All the values in this instruction are floating-point values.

NaNs are handled according to the IEEE 754-2008 standard. If one vector element is numeric and the other is a quiet NaN, the result is the numerical value, otherwise the result is identical to [FMAX \(scalar\)](#).

This instruction can generate a floating-point exception. Depending on the settings in [FPCR](#), the exception results in either a flag being set in [FPSR](#) or a synchronous exception being generated. For more information, see [Floating-point exceptions and exception traps on page D1-1831](#).

Depending on the settings in the [CPACR_EL1](#), [CPTR_EL2](#), and [CPTR_EL3](#) registers, and the current Security state and Exception level, an attempt to execute the instruction might be trapped.

Half-precision

ARMv8.2

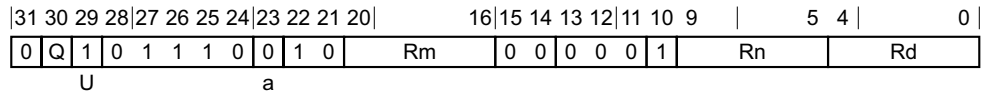

Half-precision variant

FMAXNMP <Vd>.<T>, <Vn>.<T>, <Vm>.<T>

Decode for this encoding

```

if !HaveFP16Ext() then UnallocatedEncoding();

integer d = UInt(Rd);
integer n = UInt(Rn);
integer m = UInt(Rm);
integer esize = 16;
integer datasize = if Q == '1' then 128 else 64;
integer elements = datasize DIV esize;

boolean pair = (U == '1');
boolean minimum = (a == '1');
```

Single-precision and double-precision

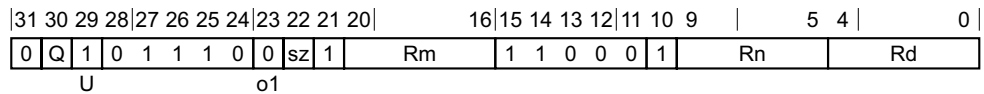

Single-precision and double-precision variant

FMAXNMP <Vd>.<T>, <Vn>.<T>, <Vm>.<T>

Decode for this encoding

```

integer d = UInt(Rd);
integer n = UInt(Rn);
integer m = UInt(Rm);
if sz:Q == '10' then ReservedValue();
integer esize = 32 << UInt(sz);
```

```
integer datasize = if Q == '1' then 128 else 64;
integer elements = datasize DIV esize;
```

```
boolean pair = (U == '1');
boolean minimum = (o1 == '1');
```

Assembler symbols

- <Vd> Is the name of the SIMD&FP destination register, encoded in the "Rd" field.
- <T> For the half-precision variant: is an arrangement specifier, encoded in the "Q" field. It can have the following values:
- | | |
|----|------------|
| 4H | when Q = 0 |
| 8H | when Q = 1 |
- For the single-precision and double-precision variant: is an arrangement specifier, encoded in the "sz:Q" field. It can have the following values:
- | | |
|----|--------------------|
| 2S | when sz = 0, Q = 0 |
| 4S | when sz = 0, Q = 1 |
| 2D | when sz = 1, Q = 1 |
- The encoding sz = 1, Q = 0 is reserved.
- <Vn> Is the name of the first SIMD&FP source register, encoded in the "Rn" field.
- <Vm> Is the name of the second SIMD&FP source register, encoded in the "Rm" field.

Operation for all encodings

```
CheckFPAdvSIMDEnabled64();
bits(datasize) operand1 = V[n];
bits(datasize) operand2 = V[m];
bits(datasize) result;
bits(2*datasize) concat = operand2:operand1;
bits(esize) element1;
bits(esize) element2;

for e = 0 to elements-1
  if pair then
    element1 = Elem[concat, 2*e, esize];
    element2 = Elem[concat, (2*e)+1, esize];
  else
    element1 = Elem[operand1, e, esize];
    element2 = Elem[operand2, e, esize];

  if minimum then
    Elem[result, e, esize] = FPMinNum(element1, element2, FPCR);
  else
    Elem[result, e, esize] = FPMaxNum(element1, element2, FPCR);

V[d] = result;
```

C7.2.94 FMAXNMV

Floating-point Maximum Number across Vector. This instruction compares all the vector elements in the source SIMD&FP register, and writes the largest of the values as a scalar to the destination SIMD&FP register. All the values in this instruction are floating-point values.

NaNs are handled according to the IEEE 754-2008 standard. If one vector element is numeric and the other is a quiet NaN, the result of the comparison is the numerical value, otherwise the result is identical to [FMAX \(scalar\)](#).

This instruction can generate a floating-point exception. Depending on the settings in [FPCR](#), the exception results in either a flag being set in [FPSR](#) or a synchronous exception being generated. For more information, see [Floating-point exceptions and exception traps on page D1-1831](#).

Depending on the settings in the [CPACR_EL1](#), [CPTR_EL2](#), and [CPTR_EL3](#) registers, and the current Security state and Exception level, an attempt to execute the instruction might be trapped.

Half-precision

ARMv8.2

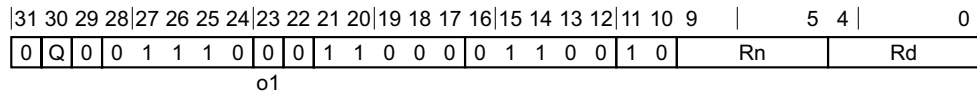

Half-precision variant

FMAXNMV <V><d>, <Vn>.<T>

Decode for this encoding

```
if !HaveFP16Ext() then UnallocatedEncoding();

integer d = UInt(Rd);
integer n = UInt(Rn);

integer esize = 16;
integer datasize = if Q == '1' then 128 else 64;
```

Single-precision and double-precision

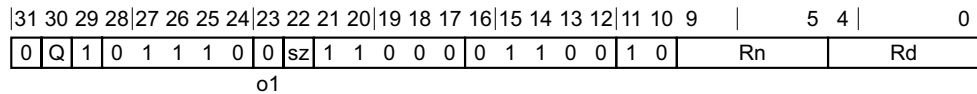

Single-precision and double-precision variant

FMAXNMV <V><d>, <Vn>.<T>

Decode for this encoding

```
integer d = UInt(Rd);
integer n = UInt(Rn);

if sz:Q != '01' then ReservedValue(); // .4S only

integer esize = 32 << UInt(sz);
integer datasize = if Q == '1' then 128 else 64;
```

Assembler symbols

- <V> For the half-precision variant: is the destination width specifier, H.
For the single-precision and double-precision variant: is the destination width specifier, encoded in the "sz" field. It can have the following values:
S when sz = 0
The encoding sz = 1 is reserved.
- <d> Is the number of the SIMD&FP destination register, encoded in the "Rd" field.
- <Vn> Is the name of the SIMD&FP source register, encoded in the "Rn" field.
- <T> For the half-precision variant: is an arrangement specifier, encoded in the "Q" field. It can have the following values:
4H when Q = 0
8H when Q = 1
For the single-precision and double-precision variant: is an arrangement specifier, encoded in the "Q:sz" field. It can have the following values:
4S when Q = 1, sz = 0
The following encodings are reserved:
- Q = 0, sz = x.
 - Q = 1, sz = 1.

Operation for all encodings

```
CheckFPAdvSIMDEnabled64();  
bits(datasize) operand = V[n];  
V[d] = Reduce(ReduceOp_FMAXNUM, operand, esize);
```

C7.2.95 FMAXP (scalar)

Floating-point Maximum of Pair of elements (scalar). This instruction compares two vector elements in the source SIMD&FP register and writes the largest of the floating-point values as a scalar to the destination SIMD&FP register.

This instruction can generate a floating-point exception. Depending on the settings in [FPCR](#), the exception results in either a flag being set in [FPSR](#) or a synchronous exception being generated. For more information, see [Floating-point exceptions and exception traps on page D1-1831](#).

Depending on the settings in the [CPACR_EL1](#), [CPTR_EL2](#), and [CPTR_EL3](#) registers, and the current Security state and Exception level, an attempt to execute the instruction might be trapped.

Half-precision

ARMv8.2

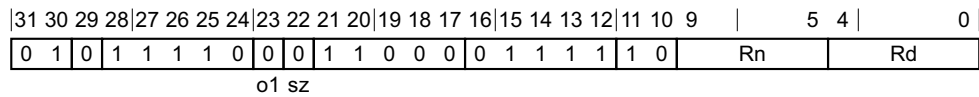

Half-precision variant

FMAXP <V><d>, <Vn>.<T>

Decode for this encoding

```
if !HaveFP16Ext() then UnallocatedEncoding();
```

```
integer d = UInt(Rd);
integer n = UInt(Rn);
```

```
integer esize = 16;
integer datasize = 32;
```

Single-precision and double-precision

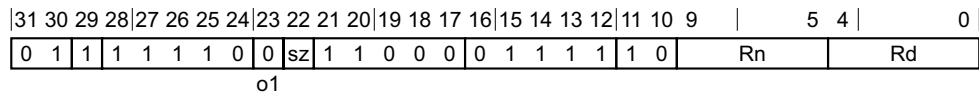

Single-precision and double-precision variant

FMAXP <V><d>, <Vn>.<T>

Decode for this encoding

```
integer d = UInt(Rd);
integer n = UInt(Rn);
```

```
integer esize = 32;
integer datasize = 64;
```

Assembler symbols

<V> For the half-precision variant: is the destination width specifier, encoded in the "sz" field. It can have the following values:

H when sz = 0

The encoding sz = 1 is reserved.

For the single-precision and double-precision variant: is the destination width specifier, encoded in the "sz" field. It can have the following values:

S when sz = 0

D when sz = 1

<d> Is the number of the SIMD&FP destination register, encoded in the "Rd" field.

<Vn> Is the name of the SIMD&FP source register, encoded in the "Rn" field.

<T> For the half-precision variant: is the source arrangement specifier, encoded in the "sz" field. It can have the following values:

2H when sz = 0

The encoding sz = 1 is reserved.

For the single-precision and double-precision variant: is the source arrangement specifier, encoded in the "sz" field. It can have the following values:

2S when sz = 0

2D when sz = 1

Operation for all encodings

```
CheckFPAdvSIMDEnabled64();  
bits(datasize) operand = V[n];  
V[d] = Reduce(ReduceOp_FMAX, operand, esize);
```

C7.2.96 FMAXP (vector)

Floating-point Maximum Pairwise (vector). This instruction creates a vector by concatenating the vector elements of the first source SIMD&FP register after the vector elements of the second source SIMD&FP register, reads each pair of adjacent vector elements from the concatenated vector, writes the larger of each pair of values into a vector, and writes the vector to the destination SIMD&FP register. All the values in this instruction are floating-point values.

This instruction can generate a floating-point exception. Depending on the settings in [FPCR](#), the exception results in either a flag being set in [FPSR](#) or a synchronous exception being generated. For more information, see [Floating-point exceptions and exception traps on page D1-1831](#).

Depending on the settings in the [CPACR_EL1](#), [CPTR_EL2](#), and [CPTR_EL3](#) registers, and the current Security state and Exception level, an attempt to execute the instruction might be trapped.

Half-precision

ARMv8.2

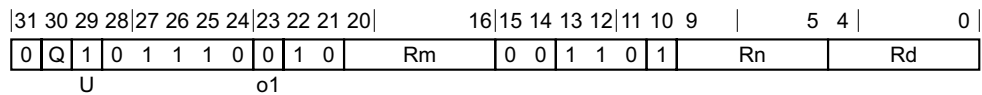

Half-precision variant

FMAXP <Vd>.<T>, <Vn>.<T>, <Vm>.<T>

Decode for this encoding

```

if !HaveFP16Ext() then UnallocatedEncoding();

integer d = UInt(Rd);
integer n = UInt(Rn);
integer m = UInt(Rm);
integer esize = 16;
integer datasize = if Q == '1' then 128 else 64;
integer elements = datasize DIV esize;

boolean pair = (U == '1');
boolean minimum = (o1 == '1');
```

Single-precision and double-precision

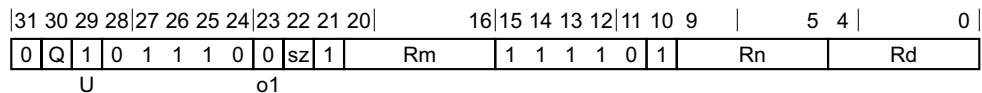

Single-precision and double-precision variant

FMAXP <Vd>.<T>, <Vn>.<T>, <Vm>.<T>

Decode for this encoding

```

integer d = UInt(Rd);
integer n = UInt(Rn);
integer m = UInt(Rm);
if sz:Q == '10' then ReservedValue();
integer esize = 32 << UInt(sz);
integer datasize = if Q == '1' then 128 else 64;
integer elements = datasize DIV esize;
```



```
boolean pair = (U == '1');
boolean minimum = (o1 == '1');
```

Assembler symbols

- <Vd> Is the name of the SIMD&FP destination register, encoded in the "Rd" field.
- <T> For the half-precision variant: is an arrangement specifier, encoded in the "Q" field. It can have the following values:
- 4H when Q = 0
 - 8H when Q = 1
- For the single-precision and double-precision variant: is an arrangement specifier, encoded in the "sz:Q" field. It can have the following values:
- 2S when sz = 0, Q = 0
 - 4S when sz = 0, Q = 1
 - 2D when sz = 1, Q = 1
- The encoding sz = 1, Q = 0 is reserved.
- <Vn> Is the name of the first SIMD&FP source register, encoded in the "Rn" field.
- <Vm> Is the name of the second SIMD&FP source register, encoded in the "Rm" field.

Operation for all encodings

```
CheckFPAdvSIMDEnabled64();
bits(datasize) operand1 = V[n];
bits(datasize) operand2 = V[m];
bits(datasize) result;
bits(2*datasize) concat = operand2:operand1;
bits(esize) element1;
bits(esize) element2;

for e = 0 to elements-1
  if pair then
    element1 = Elem[concat, 2*e, esize];
    element2 = Elem[concat, (2*e)+1, esize];
  else
    element1 = Elem[operand1, e, esize];
    element2 = Elem[operand2, e, esize];

  if minimum then
    Elem[result, e, esize] = FPMIn(element1, element2, FPCR);
  else
    Elem[result, e, esize] = FPMaX(element1, element2, FPCR);

V[d] = result;
```

C7.2.97 FMAXV

Floating-point Maximum across Vector. This instruction compares all the vector elements in the source SIMD&FP register, and writes the largest of the values as a scalar to the destination SIMD&FP register. All the values in this instruction are floating-point values.

This instruction can generate a floating-point exception. Depending on the settings in [FPCR](#), the exception results in either a flag being set in [FPSR](#) or a synchronous exception being generated. For more information, see [Floating-point exceptions and exception traps on page D1-1831](#).

Depending on the settings in the [CPACR_EL1](#), [CPTR_EL2](#), and [CPTR_EL3](#) registers, and the current Security state and Exception level, an attempt to execute the instruction might be trapped.

Half-precision

ARMv8.2

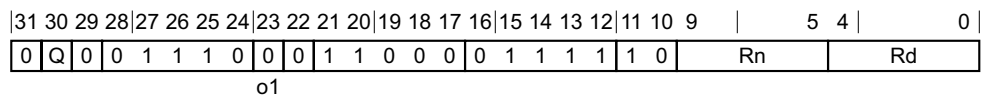

Half-precision variant

FMAXV <V><d>, <Vn>.<T>

Decode for this encoding

```
if !HaveFP16Ext() then UnallocatedEncoding();

integer d = UInt(Rd);
integer n = UInt(Rn);

integer esize = 16;
integer datasize = if Q == '1' then 128 else 64;
```

Single-precision and double-precision

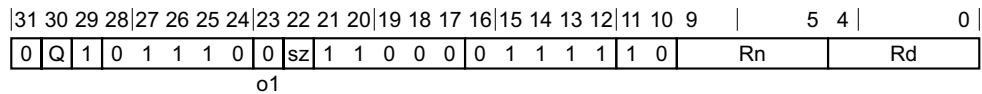

Single-precision and double-precision variant

FMAXV <V><d>, <Vn>.<T>

Decode for this encoding

```
integer d = UInt(Rd);
integer n = UInt(Rn);

if sz:Q != '01' then ReservedValue();

integer esize = 32 << UInt(sz);
integer datasize = if Q == '1' then 128 else 64;
```

Assembler symbols

<V> For the half-precision variant: is the destination width specifier, H.

For the single-precision and double-precision variant: is the destination width specifier, encoded in the "sz" field. It can have the following values:

S when sz = 0

The encoding sz = 1 is reserved.

<d> Is the number of the SIMD&FP destination register, encoded in the "Rd" field.

<Vn> Is the name of the SIMD&FP source register, encoded in the "Rn" field.

<T> For the half-precision variant: is an arrangement specifier, encoded in the "Q" field. It can have the following values:

4H when Q = 0

8H when Q = 1

For the single-precision and double-precision variant: is an arrangement specifier, encoded in the "Q:sz" field. It can have the following values:

4S when Q = 1, sz = 0

The following encodings are reserved:

- Q = 0, sz = x.
- Q = 1, sz = 1.

Operation for all encodings

```
CheckFPAdvSIMDEnabled64();  
bits(datasize) operand = V[n];  
V[d] = Reduce(ReduceOp_FMAX, operand, esize);
```

C7.2.98 FMIN (vector)

Floating-point minimum (vector). This instruction compares corresponding elements in the vectors in the two source SIMD&FP registers, places the smaller of each of the two floating-point values into a vector, and writes the vector to the destination SIMD&FP register.

This instruction can generate a floating-point exception. Depending on the settings in [FPCR](#), the exception results in either a flag being set in [FPSR](#), or a synchronous exception being generated. For more information, see [Floating-point exceptions and exception traps on page D1-1831](#).

Depending on the settings in the [CPACR_EL1](#), [CPTR_EL2](#), and [CPTR_EL3](#) registers, and the current Security state and Exception level, an attempt to execute the instruction might be trapped.

Half-precision

ARMv8.2

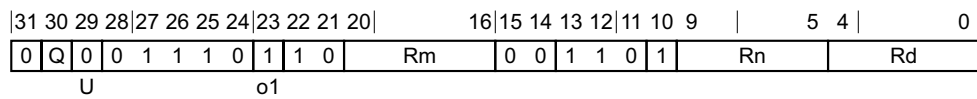

Half-precision variant

FMIN <Vd>.<T>, <Vn>.<T>, <Vm>.<T>

Decode for this encoding

```
if !HaveFP16Ext() then UnallocatedEncoding();

integer d = UInt(Rd);
integer n = UInt(Rn);
integer m = UInt(Rm);
integer esize = 16;
integer datasize = if Q == '1' then 128 else 64;
integer elements = datasize DIV esize;

boolean pair = (U == '1');
boolean minimum = (o1 == '1');
```

Single-precision and double-precision

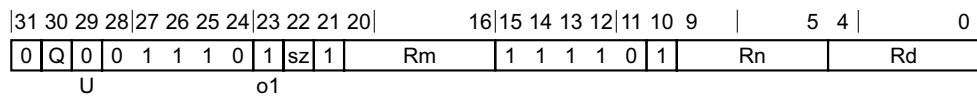

Single-precision and double-precision variant

FMIN <Vd>.<T>, <Vn>.<T>, <Vm>.<T>

Decode for this encoding

```
integer d = UInt(Rd);
integer n = UInt(Rn);
integer m = UInt(Rm);
if sz:Q == '10' then ReservedValue();
integer esize = 32 << UInt(sz);
integer datasize = if Q == '1' then 128 else 64;
integer elements = datasize DIV esize;

boolean pair = (U == '1');
boolean minimum = (o1 == '1');
```

Assembler symbols

- <Vd> Is the name of the SIMD&FP destination register, encoded in the "Rd" field.
- <T> For the half-precision variant: is an arrangement specifier, encoded in the "Q" field. It can have the following values:
- 4H when Q = 0
 - 8H when Q = 1
- For the single-precision and double-precision variant: is an arrangement specifier, encoded in the "sz:Q" field. It can have the following values:
- 2S when sz = 0, Q = 0
 - 4S when sz = 0, Q = 1
 - 2D when sz = 1, Q = 1
- The encoding sz = 1, Q = 0 is reserved.
- <Vn> Is the name of the first SIMD&FP source register, encoded in the "Rn" field.
- <Vm> Is the name of the second SIMD&FP source register, encoded in the "Rm" field.

Operation for all encodings

```
CheckFPAdvSIMDEnabled64();
bits(datasize) operand1 = V[n];
bits(datasize) operand2 = V[m];
bits(datasize) result;
bits(2*datasize) concat = operand2:operand1;
bits(esize) element1;
bits(esize) element2;

for e = 0 to elements-1
  if pair then
    element1 = Elem[concat, 2*e, esize];
    element2 = Elem[concat, (2*e)+1, esize];
  else
    element1 = Elem[operand1, e, esize];
    element2 = Elem[operand2, e, esize];

  if minimum then
    Elem[result, e, esize] = FPMIn(element1, element2, FPCR);
  else
    Elem[result, e, esize] = FPMMax(element1, element2, FPCR);

V[d] = result;
```

C7.2.99 FMIN (scalar)

Floating-point Minimum (scalar). This instruction compares the first and second source SIMD&FP register values, and writes the smaller of the two floating-point values to the destination SIMD&FP register.

This instruction can generate a floating-point exception. Depending on the settings in [FPCR](#), the exception results in either a flag being set in [FPSR](#), or a synchronous exception being generated. For more information, see [Floating-point exceptions and exception traps on page D1-1831](#).

Depending on the settings in the [CPACR_EL1](#), [CPTR_EL2](#), and [CPTR_EL3](#) registers, and the current Security state and Exception level, an attempt to execute the instruction might be trapped.

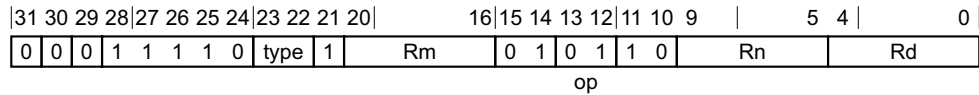

Half-precision variant

Applies when type == 11.

FMIN <Hd>, <Hn>, <Hm>

Single-precision variant

Applies when type == 00.

FMIN <Sd>, <Sn>, <Sm>

Double-precision variant

Applies when type == 01.

FMIN <Dd>, <Dn>, <Dm>

Decode for all variants of this encoding

```
integer d = UInt(Rd);
integer n = UInt(Rn);
integer m = UInt(Rm);

integer datasize;
case type of
    when '00' datasize = 32;
    when '01' datasize = 64;
    when '10' UnallocatedEncoding();
    when '11'
        if HaveFP16Ext() then
            datasize = 16;
        else
            UnallocatedEncoding();
```

Assembler symbols

- <Dd> Is the 64-bit name of the SIMD&FP destination register, encoded in the "Rd" field.
- <Dn> Is the 64-bit name of the first SIMD&FP source register, encoded in the "Rn" field.
- <Dm> Is the 64-bit name of the second SIMD&FP source register, encoded in the "Rm" field.
- <Hd> Is the 16-bit name of the SIMD&FP destination register, encoded in the "Rd" field.
- <Hn> Is the 16-bit name of the first SIMD&FP source register, encoded in the "Rn" field.

- <Hm> Is the 16-bit name of the second SIMD&FP source register, encoded in the "Rm" field.
- <Sd> Is the 32-bit name of the SIMD&FP destination register, encoded in the "Rd" field.
- <Sn> Is the 32-bit name of the first SIMD&FP source register, encoded in the "Rn" field.
- <Sm> Is the 32-bit name of the second SIMD&FP source register, encoded in the "Rm" field.

Operation

```
CheckFPAdvSIMDEnabled64();  
bits(datasize) result;  
bits(datasize) operand1 = V[n];  
bits(datasize) operand2 = V[m];  
  
result = FPMIn(operand1, operand2, FPCR);  
V[d] = result;
```

C7.2.100 FMINNM (vector)

Floating-point Minimum Number (vector). This instruction compares corresponding vector elements in the two source SIMD&FP registers, writes the smaller of the two floating-point values into a vector, and writes the vector to the destination SIMD&FP register.

NaNs are handled according to the IEEE 754-2008 standard. If one vector element is numeric and the other is a quiet NaN, the result placed in the vector is the numerical value, otherwise the result is identical to [FMIN \(scalar\)](#).

This instruction can generate a floating-point exception. Depending on the settings in [FPCR](#), the exception results in either a flag being set in [FPSR](#) or a synchronous exception being generated. For more information, see [Floating-point exceptions and exception traps on page D1-1831](#).

Depending on the settings in the [CPACR_EL1](#), [CPTR_EL2](#), and [CPTR_EL3](#) registers, and the current Security state and Exception level, an attempt to execute the instruction might be trapped.

Half-precision

ARMv8.2

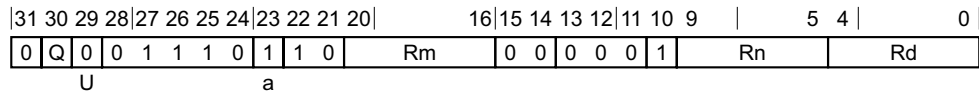

Half-precision variant

FMINNM <Vd>.<T>, <Vn>.<T>, <Vm>.<T>

Decode for this encoding

```
if !HaveFP16Ext() then UnallocatedEncoding();

integer d = UInt(Rd);
integer n = UInt(Rn);
integer m = UInt(Rm);
integer esize = 16;
integer datasize = if Q == '1' then 128 else 64;
integer elements = datasize DIV esize;

boolean pair = (U == '1');
boolean minimum = (a == '1');
```

Single-precision and double-precision

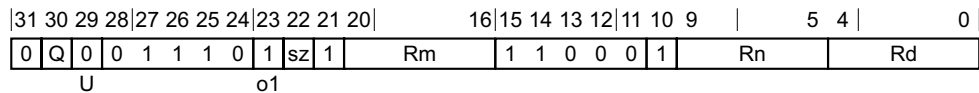

Single-precision and double-precision variant

FMINNM <Vd>.<T>, <Vn>.<T>, <Vm>.<T>

Decode for this encoding

```
integer d = UInt(Rd);
integer n = UInt(Rn);
integer m = UInt(Rm);
if sz:Q == '10' then ReservedValue();
integer esize = 32 << UInt(sz);
integer datasize = if Q == '1' then 128 else 64;
integer elements = datasize DIV esize;
```



```
boolean pair = (U == '1');
boolean minimum = (o1 == '1');
```

Assembler symbols

- <Vd> Is the name of the SIMD&FP destination register, encoded in the "Rd" field.
- <T> For the half-precision variant: is an arrangement specifier, encoded in the "Q" field. It can have the following values:
- 4H when Q = 0
 - 8H when Q = 1
- For the single-precision and double-precision variant: is an arrangement specifier, encoded in the "sz:Q" field. It can have the following values:
- 2S when sz = 0, Q = 0
 - 4S when sz = 0, Q = 1
 - 2D when sz = 1, Q = 1
- The encoding sz = 1, Q = 0 is reserved.
- <Vn> Is the name of the first SIMD&FP source register, encoded in the "Rn" field.
- <Vm> Is the name of the second SIMD&FP source register, encoded in the "Rm" field.

Operation for all encodings

```
CheckFPAdvSIMDEnabled64();
bits(datasize) operand1 = V[n];
bits(datasize) operand2 = V[m];
bits(datasize) result;
bits(2*datasize) concat = operand2:operand1;
bits(esize) element1;
bits(esize) element2;

for e = 0 to elements-1
    if pair then
        element1 = Elem[concat, 2*e, esize];
        element2 = Elem[concat, (2*e)+1, esize];
    else
        element1 = Elem[operand1, e, esize];
        element2 = Elem[operand2, e, esize];

    if minimum then
        Elem[result, e, esize] = FPMinNum(element1, element2, FPCR);
    else
        Elem[result, e, esize] = FPMaxNum(element1, element2, FPCR);

V[d] = result;
```

C7.2.101 FMINNM (scalar)

Floating-point Minimum Number (scalar). This instruction compares the first and second source SIMD&FP register values, and writes the smaller of the two floating-point values to the destination SIMD&FP register.

NaNs are handled according to the IEEE 754-2008 standard. If one vector element is numeric and the other is a quiet NaN, the result that is placed in the vector is the numerical value, otherwise the result is identical to [FMIN \(scalar\)](#).

This instruction can generate a floating-point exception. Depending on the settings in [FPCR](#), the exception results in either a flag being set in [FPSR](#) or a synchronous exception being generated. For more information, see [Floating-point exceptions and exception traps on page D1-1831](#).

Depending on the settings in the [CPACR_EL1](#), [CPTR_EL2](#), and [CPTR_EL3](#) registers, and the current Security state and Exception level, an attempt to execute the instruction might be trapped.

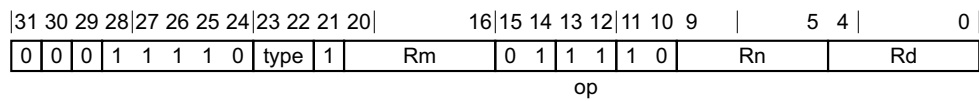

Half-precision variant

Applies when type == 11.

FMINNM <Hd>, <Hn>, <Hm>

Single-precision variant

Applies when type == 00.

FMINNM <Sd>, <Sn>, <Sm>

Double-precision variant

Applies when type == 01.

FMINNM <Dd>, <Dn>, <Dm>

Decode for all variants of this encoding

```
integer d = UInt(Rd);
integer n = UInt(Rn);
integer m = UInt(Rm);

integer datasize;
case type of
    when '00' datasize = 32;
    when '01' datasize = 64;
    when '10' UnallocatedEncoding();
    when '11'
        if HaveFP16Ext() then
            datasize = 16;
        else
            UnallocatedEncoding();
```

Assembler symbols

- <Dd> Is the 64-bit name of the SIMD&FP destination register, encoded in the "Rd" field.
- <Dn> Is the 64-bit name of the first SIMD&FP source register, encoded in the "Rn" field.
- <Dm> Is the 64-bit name of the second SIMD&FP source register, encoded in the "Rm" field.

- <Hd> Is the 16-bit name of the SIMD&FP destination register, encoded in the "Rd" field.
- <Hn> Is the 16-bit name of the first SIMD&FP source register, encoded in the "Rn" field.
- <Hm> Is the 16-bit name of the second SIMD&FP source register, encoded in the "Rm" field.
- <Sd> Is the 32-bit name of the SIMD&FP destination register, encoded in the "Rd" field.
- <Sn> Is the 32-bit name of the first SIMD&FP source register, encoded in the "Rn" field.
- <Sm> Is the 32-bit name of the second SIMD&FP source register, encoded in the "Rm" field.

Operation

```
CheckFPAdvSIMDEnabled64();  
bits(datasize) result;  
bits(datasize) operand1 = V[n];  
bits(datasize) operand2 = V[m];  
  
result = FPMinNum(operand1, operand2, FPCR);  
  
V[d] = result;
```

C7.2.102 FMINNMP (scalar)

Floating-point Minimum Number of Pair of elements (scalar). This instruction compares two vector elements in the source SIMD&FP register and writes the smallest of the floating-point values as a scalar to the destination SIMD&FP register.

This instruction can generate a floating-point exception. Depending on the settings in [FPCR](#), the exception results in either a flag being set in [FPSR](#) or a synchronous exception being generated. For more information, see [Floating-point exceptions and exception traps on page D1-1831](#).

Depending on the settings in the [CPACR_EL1](#), [CPTR_EL2](#), and [CPTR_EL3](#) registers, and the current Security state and Exception level, an attempt to execute the instruction might be trapped.

Half-precision

ARMv8.2

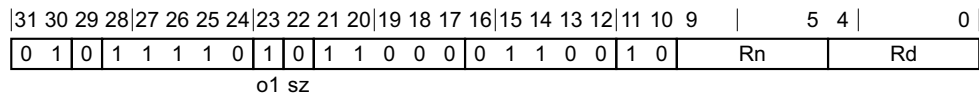

Half-precision variant

FMINNMP <V><d>, <Vn>.<T>

Decode for this encoding

```
if !HaveFP16Ext() then UnallocatedEncoding();

integer d = UInt(Rd);
integer n = UInt(Rn);

integer esize = 16;
integer datasize = 32;
```

Single-precision and double-precision

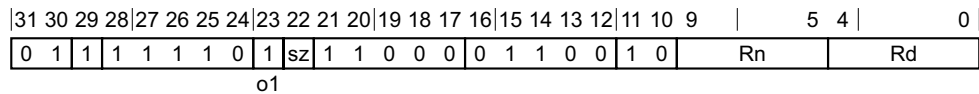

Single-precision and double-precision variant

FMINNMP <V><d>, <Vn>.<T>

Decode for this encoding

```
integer d = UInt(Rd);
integer n = UInt(Rn);

integer esize = 32;
integer datasize = 64;
```

Assembler symbols

<V> For the half-precision variant: is the destination width specifier, encoded in the "sz" field. It can have the following values:

H when sz = 0

The encoding sz = 1 is reserved.

For the single-precision and double-precision variant: is the destination width specifier, encoded in the "sz" field. It can have the following values:

S when sz = 0

D when sz = 1

<d> Is the number of the SIMD&FP destination register, encoded in the "Rd" field.

<Vn> Is the name of the SIMD&FP source register, encoded in the "Rn" field.

<T> For the half-precision variant: is the source arrangement specifier, encoded in the "sz" field. It can have the following values:

2H when sz = 0

The encoding sz = 1 is reserved.

For the single-precision and double-precision variant: is the source arrangement specifier, encoded in the "sz" field. It can have the following values:

2S when sz = 0

2D when sz = 1

Operation for all encodings

```
CheckFPAdvSIMDEnabled64();  
bits(datasize) operand = V[n];  
V[d] = Reduce(ReduceOp_FMNUM, operand, esize);
```

C7.2.103 FMINNMP (vector)

Floating-point Minimum Number Pairwise (vector). This instruction creates a vector by concatenating the vector elements of the first source SIMD&FP register after the vector elements of the second source SIMD&FP register, reads each pair of adjacent vector elements in the two source SIMD&FP registers, writes the smallest of each pair of floating-point values into a vector, and writes the vector to the destination SIMD&FP register. All the values in this instruction are floating-point values.

NaNs are handled according to the IEEE 754-2008 standard. If one vector element is numeric and the other is a quiet NaN, the result is the numerical value, otherwise the result is identical to [FMIN \(scalar\)](#).

This instruction can generate a floating-point exception. Depending on the settings in [FPCR](#), the exception results in either a flag being set in [FPSR](#) or a synchronous exception being generated. For more information, see [Floating-point exceptions and exception traps on page D1-1831](#).

Depending on the settings in the [CPACR_EL1](#), [CPTR_EL2](#), and [CPTR_EL3](#) registers, and the current Security state and Exception level, an attempt to execute the instruction might be trapped.

Half-precision

ARMv8.2

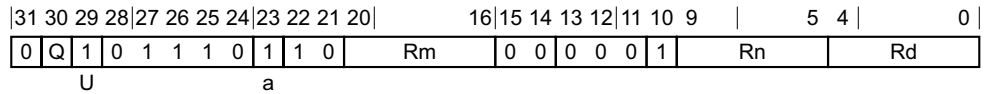

Half-precision variant

FMINNMP <Vd>.<T>, <Vn>.<T>, <Vm>.<T>

Decode for this encoding

```
if !HaveFP16Ext() then UnallocatedEncoding();

integer d = UInt(Rd);
integer n = UInt(Rn);
integer m = UInt(Rm);
integer esize = 16;
integer datasize = if Q == '1' then 128 else 64;
integer elements = datasize DIV esize;

boolean pair = (U == '1');
boolean minimum = (a == '1');
```

Single-precision and double-precision

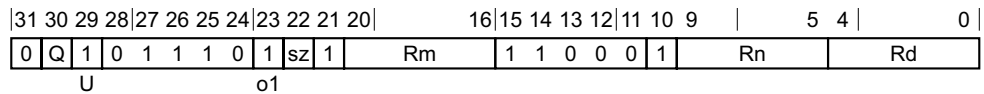

Single-precision and double-precision variant

FMINNMP <Vd>.<T>, <Vn>.<T>, <Vm>.<T>

Decode for this encoding

```
integer d = UInt(Rd);
integer n = UInt(Rn);
integer m = UInt(Rm);
if sz:Q == '10' then ReservedValue();
integer esize = 32 << UInt(sz);
```

```
integer datasize = if Q == '1' then 128 else 64;
integer elements = datasize DIV esize;
```

```
boolean pair = (U == '1');
boolean minimum = (o1 == '1');
```

Assembler symbols

- <Vd> Is the name of the SIMD&FP destination register, encoded in the "Rd" field.
- <T> For the half-precision variant: is an arrangement specifier, encoded in the "Q" field. It can have the following values:
- | | |
|----|------------|
| 4H | when Q = 0 |
| 8H | when Q = 1 |
- For the single-precision and double-precision variant: is an arrangement specifier, encoded in the "sz:Q" field. It can have the following values:
- | | |
|----|--------------------|
| 2S | when sz = 0, Q = 0 |
| 4S | when sz = 0, Q = 1 |
| 2D | when sz = 1, Q = 1 |
- The encoding sz = 1, Q = 0 is reserved.
- <Vn> Is the name of the first SIMD&FP source register, encoded in the "Rn" field.
- <Vm> Is the name of the second SIMD&FP source register, encoded in the "Rm" field.

Operation for all encodings

```
CheckFPAdvSIMDEnabled64();
bits(datasize) operand1 = V[n];
bits(datasize) operand2 = V[m];
bits(datasize) result;
bits(2*datasize) concat = operand2:operand1;
bits(esize) element1;
bits(esize) element2;

for e = 0 to elements-1
    if pair then
        element1 = Elem[concat, 2*e, esize];
        element2 = Elem[concat, (2*e)+1, esize];
    else
        element1 = Elem[operand1, e, esize];
        element2 = Elem[operand2, e, esize];

    if minimum then
        Elem[result, e, esize] = FPMinNum(element1, element2, FPCR);
    else
        Elem[result, e, esize] = FPMaxNum(element1, element2, FPCR);

V[d] = result;
```

C7.2.104 FMINNMV

Floating-point Minimum Number across Vector. This instruction compares all the vector elements in the source SIMD&FP register, and writes the smallest of the values as a scalar to the destination SIMD&FP register. All the values in this instruction are floating-point values.

NaNs are handled according to the IEEE 754-2008 standard. If one vector element is numeric and the other is a quiet NaN, the result of the comparison is the numerical value, otherwise the result is identical to [FMIN \(scalar\)](#).

This instruction can generate a floating-point exception. Depending on the settings in [FPCR](#), the exception results in either a flag being set in [FPSR](#) or a synchronous exception being generated. For more information, see [Floating-point exceptions and exception traps on page D1-1831](#).

Depending on the settings in the [CPACR_EL1](#), [CPTR_EL2](#), and [CPTR_EL3](#) registers, and the current Security state and Exception level, an attempt to execute the instruction might be trapped.

Half-precision

ARMv8.2

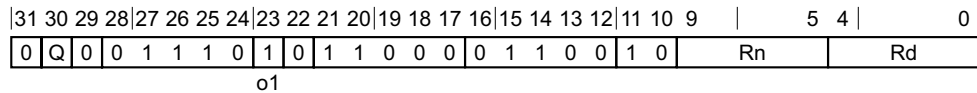

Half-precision variant

FMINNMV <V><d>, <Vn>.<T>

Decode for this encoding

```
if !HaveFP16Ext() then UnallocatedEncoding();

integer d = UInt(Rd);
integer n = UInt(Rn);

integer esize = 16;
integer datasize = if Q == '1' then 128 else 64;
```

Single-precision and double-precision

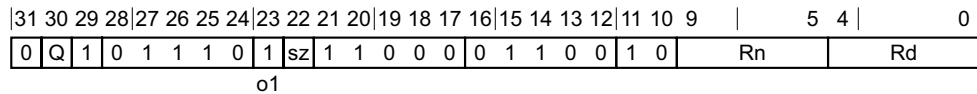

Single-precision and double-precision variant

FMINNMV <V><d>, <Vn>.<T>

Decode for this encoding

```
integer d = UInt(Rd);
integer n = UInt(Rn);

if sz:Q != '01' then ReservedValue(); // .4S only

integer esize = 32 << UInt(sz);
integer datasize = if Q == '1' then 128 else 64;
```

Assembler symbols

- <V> For the half-precision variant: is the destination width specifier, H.
For the single-precision and double-precision variant: is the destination width specifier, encoded in the "sz" field. It can have the following values:
S when sz = 0
The encoding sz = 1 is reserved.
- <d> Is the number of the SIMD&FP destination register, encoded in the "Rd" field.
- <Vn> Is the name of the SIMD&FP source register, encoded in the "Rn" field.
- <T> For the half-precision variant: is an arrangement specifier, encoded in the "Q" field. It can have the following values:
4H when Q = 0
8H when Q = 1
For the single-precision and double-precision variant: is an arrangement specifier, encoded in the "Q:sz" field. It can have the following values:
4S when Q = 1, sz = 0
The following encodings are reserved:
- Q = 0, sz = x.
 - Q = 1, sz = 1.

Operation for all encodings

```
CheckFPAdvSIMDEnabled64();  
bits(datasize) operand = V[n];  
V[d] = Reduce(ReduceOp_FMINNUM, operand, esize);
```

C7.2.105 FMINP (scalar)

Floating-point Minimum of Pair of elements (scalar). This instruction compares two vector elements in the source SIMD&FP register and writes the smallest of the floating-point values as a scalar to the destination SIMD&FP register.

This instruction can generate a floating-point exception. Depending on the settings in [FPCR](#), the exception results in either a flag being set in [FPSR](#) or a synchronous exception being generated. For more information, see [Floating-point exceptions and exception traps on page D1-1831](#).

Depending on the settings in the [CPACR_EL1](#), [CPTR_EL2](#), and [CPTR_EL3](#) registers, and the current Security state and Exception level, an attempt to execute the instruction might be trapped.

Half-precision

ARMv8.2

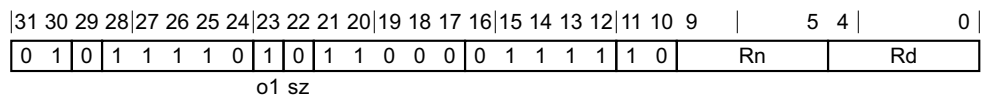

Half-precision variant

FMINP <V><d>, <Vn>.<T>

Decode for this encoding

```
if !HaveFP16Ext() then UnallocatedEncoding();
```

```
integer d = UInt(Rd);
integer n = UInt(Rn);
```

```
integer esize = 16;
integer datasize = 32;
```

Single-precision and double-precision

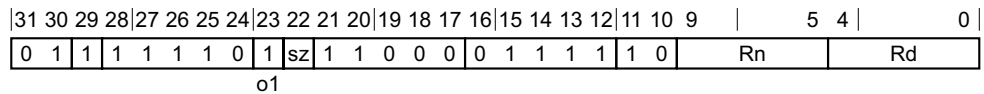

Single-precision and double-precision variant

FMINP <V><d>, <Vn>.<T>

Decode for this encoding

```
integer d = UInt(Rd);
integer n = UInt(Rn);
```

```
integer esize = 32;
integer datasize = 64;
```

Assembler symbols

<V> For the half-precision variant: is the destination width specifier, encoded in the "sz" field. It can have the following values:

H when sz = 0

The encoding sz = 1 is reserved.

For the single-precision and double-precision variant: is the destination width specifier, encoded in the "sz" field. It can have the following values:

S when sz = 0

D when sz = 1

<d> Is the number of the SIMD&FP destination register, encoded in the "Rd" field.

<Vn> Is the name of the SIMD&FP source register, encoded in the "Rn" field.

<T> For the half-precision variant: is the source arrangement specifier, encoded in the "sz" field. It can have the following values:

2H when sz = 0

The encoding sz = 1 is reserved.

For the single-precision and double-precision variant: is the source arrangement specifier, encoded in the "sz" field. It can have the following values:

2S when sz = 0

2D when sz = 1

Operation for all encodings

```
CheckFPAdvSIMDEnabled64();  
bits(datasize) operand = V[n];  
V[d] = Reduce(ReduceOp_FMIN, operand, esize);
```

C7.2.106 FMINP (vector)

Floating-point Minimum Pairwise (vector). This instruction creates a vector by concatenating the vector elements of the first source SIMD&FP register after the vector elements of the second source SIMD&FP register, reads each pair of adjacent vector elements from the concatenated vector, writes the smaller of each pair of values into a vector, and writes the vector to the destination SIMD&FP register. All the values in this instruction are floating-point values.

This instruction can generate a floating-point exception. Depending on the settings in [FPCR](#), the exception results in either a flag being set in [FPSR](#) or a synchronous exception being generated. For more information, see [Floating-point exceptions and exception traps on page D1-1831](#).

Depending on the settings in the [CPACR_EL1](#), [CPTR_EL2](#), and [CPTR_EL3](#) registers, and the current Security state and Exception level, an attempt to execute the instruction might be trapped.

Half-precision

ARMv8.2

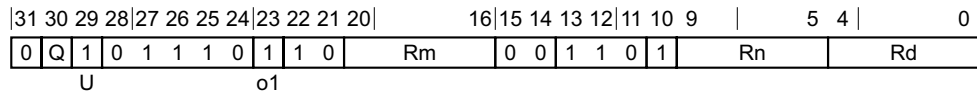

Half-precision variant

FMINP <Vd>.<T>, <Vn>.<T>, <Vm>.<T>

Decode for this encoding

```

if !HaveFP16Ext() then UnallocatedEncoding();

integer d = UInt(Rd);
integer n = UInt(Rn);
integer m = UInt(Rm);
integer esize = 16;
integer datasize = if Q == '1' then 128 else 64;
integer elements = datasize DIV esize;

boolean pair = (U == '1');
boolean minimum = (o1 == '1');
```

Single-precision and double-precision

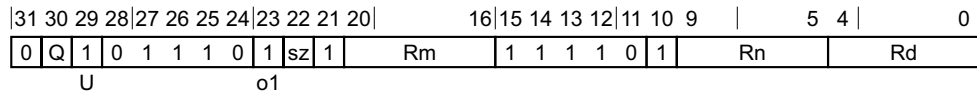

Single-precision and double-precision variant

FMINP <Vd>.<T>, <Vn>.<T>, <Vm>.<T>

Decode for this encoding

```

integer d = UInt(Rd);
integer n = UInt(Rn);
integer m = UInt(Rm);
if sz:Q == '10' then ReservedValue();
integer esize = 32 << UInt(sz);
integer datasize = if Q == '1' then 128 else 64;
integer elements = datasize DIV esize;
```

```
boolean pair = (U == '1');
boolean minimum = (o1 == '1');
```

Assembler symbols

- <Vd> Is the name of the SIMD&FP destination register, encoded in the "Rd" field.
- <T> For the half-precision variant: is an arrangement specifier, encoded in the "Q" field. It can have the following values:
- 4H when Q = 0
 - 8H when Q = 1
- For the single-precision and double-precision variant: is an arrangement specifier, encoded in the "sz:Q" field. It can have the following values:
- 2S when sz = 0, Q = 0
 - 4S when sz = 0, Q = 1
 - 2D when sz = 1, Q = 1
- The encoding sz = 1, Q = 0 is reserved.
- <Vn> Is the name of the first SIMD&FP source register, encoded in the "Rn" field.
- <Vm> Is the name of the second SIMD&FP source register, encoded in the "Rm" field.

Operation for all encodings

```
CheckFPAdvSIMDEnabled64();
bits(datasize) operand1 = V[n];
bits(datasize) operand2 = V[m];
bits(datasize) result;
bits(2*datasize) concat = operand2:operand1;
bits(esize) element1;
bits(esize) element2;

for e = 0 to elements-1
    if pair then
        element1 = Elem[concat, 2*e, esize];
        element2 = Elem[concat, (2*e)+1, esize];
    else
        element1 = Elem[operand1, e, esize];
        element2 = Elem[operand2, e, esize];

    if minimum then
        Elem[result, e, esize] = FPMIn(element1, element2, FPCR);
    else
        Elem[result, e, esize] = FPMax(element1, element2, FPCR);

V[d] = result;
```

C7.2.107 FMINV

Floating-point Minimum across Vector. This instruction compares all the vector elements in the source SIMD&FP register, and writes the smallest of the values as a scalar to the destination SIMD&FP register. All the values in this instruction are floating-point values.

This instruction can generate a floating-point exception. Depending on the settings in [FPCR](#), the exception results in either a flag being set in [FPSR](#) or a synchronous exception being generated. For more information, see [Floating-point exceptions and exception traps on page D1-1831](#).

Depending on the settings in the [CPACR_EL1](#), [CPTR_EL2](#), and [CPTR_EL3](#) registers, and the current Security state and Exception level, an attempt to execute the instruction might be trapped.

Half-precision

ARMv8.2

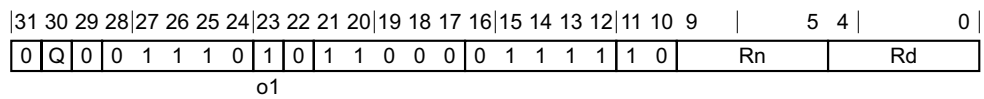

Half-precision variant

FMINV <V><d>, <Vn>.<T>

Decode for this encoding

```
if !HaveFP16Ext() then UnallocatedEncoding();

integer d = UInt(Rd);
integer n = UInt(Rn);

integer esize = 16;
integer datasize = if Q == '1' then 128 else 64;
```

Single-precision and double-precision

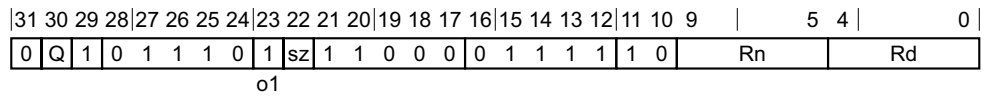

Single-precision and double-precision variant

FMINV <V><d>, <Vn>.<T>

Decode for this encoding

```
integer d = UInt(Rd);
integer n = UInt(Rn);

if sz:Q != '01' then ReservedValue();

integer esize = 32 << UInt(sz);
integer datasize = if Q == '1' then 128 else 64;
```

Assembler symbols

<V> For the half-precision variant: is the destination width specifier, H.

For the single-precision and double-precision variant: is the destination width specifier, encoded in the "sz" field. It can have the following values:

S when sz = 0

The encoding sz = 1 is reserved.

<d> Is the number of the SIMD&FP destination register, encoded in the "Rd" field.

<Vn> Is the name of the SIMD&FP source register, encoded in the "Rn" field.

<T> For the half-precision variant: is an arrangement specifier, encoded in the "Q" field. It can have the following values:

4H when Q = 0

8H when Q = 1

For the single-precision and double-precision variant: is an arrangement specifier, encoded in the "Q:sz" field. It can have the following values:

4S when Q = 1, sz = 0

The following encodings are reserved:

- Q = 0, sz = x.
- Q = 1, sz = 1.

Operation for all encodings

```
CheckFPAdvSIMDEnabled64();  
bits(datasize) operand = V[n];  
V[d] = Reduce(ReduceOp_FMIN, operand, esize);
```

C7.2.108 FMLA (by element)

Floating-point fused Multiply-Add to accumulator (by element). This instruction multiplies the vector elements in the first source SIMD&FP register by the specified value in the second source SIMD&FP register, and accumulates the results in the vector elements of the destination SIMD&FP register. All the values in this instruction are floating-point values.

This instruction can generate a floating-point exception. Depending on the settings in [FPCR](#), the exception results in either a flag being set in [FPSR](#) or a synchronous exception being generated. For more information, see [Floating-point exceptions and exception traps on page D1-1831](#).

Depending on the settings in the [CPACR_EL1](#), [CPTR_EL2](#), and [CPTR_EL3](#) registers, and the current Security state and Exception level, an attempt to execute the instruction might be trapped.

Scalar, half-precision

ARMv8.2

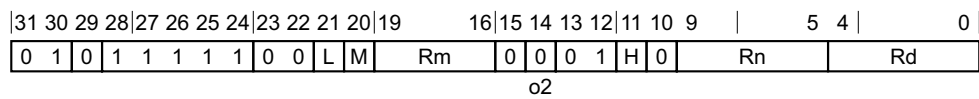

Scalar, half-precision variant

FMLA <Hd>, <Hn>, <Vm>.H[<index>]

Decode for this encoding

```

if !HaveFP16Ext() then UnallocatedEncoding();

integer idxsize = if H == '1' then 128 else 64;
integer index;
index = UInt(H:L:M);

integer d = UInt(Rd);
integer n = UInt(Rn);
integer m = UInt(Rm);

integer esize = 16;
integer datasize = esize;
integer elements = 1;
boolean sub_op = (o2 == '1');
```

Scalar, single-precision and double-precision

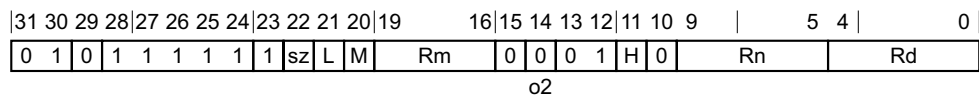

Scalar, single-precision and double-precision variant

FMLA <V><d>, <V><n>, <Vm>.<Ts>[<index>]

Decode for this encoding

```

integer idxsize = if H == '1' then 128 else 64;
integer index;
bit Rmhi = M;
case sz:L of
    when '0x' index = UInt(H:L);
    when '10' index = UInt(H);
```



```

    when '11' UnallocatedEncoding();

    integer d = UInt(Rd);
    integer n = UInt(Rn);
    integer m = UInt(Rmhi:Rm);

    integer esize = 32 << UInt(sz);
    integer datasize = esize;
    integer elements = 1;
    boolean sub_op = (o2 == '1');
    
```

Vector, half-precision

ARMv8.2

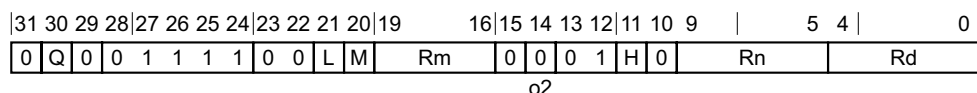

Vector, half-precision variant

FMLA <Vd>.<T>, <Vn>.<T>, <Vm>.<H>[<index>]

Decode for this encoding

```

    if !HaveFP16Ext() then UnallocatedEncoding();

    integer idxdsize = if H == '1' then 128 else 64;
    integer index;
    index = UInt(H:L:M);

    integer d = UInt(Rd);
    integer n = UInt(Rn);
    integer m = UInt(Rm);

    integer esize = 16;
    integer datasize = if Q == '1' then 128 else 64;
    integer elements = datasize DIV esize;
    boolean sub_op = (o2 == '1');
    
```

Vector, single-precision and double-precision

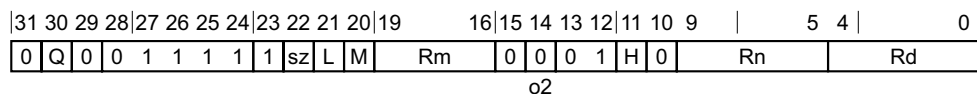

Vector, single-precision and double-precision variant

FMLA <Vd>.<T>, <Vn>.<T>, <Vm>.<Ts>[<index>]

Decode for this encoding

```

    integer idxdsize = if H == '1' then 128 else 64;
    integer index;
    bit Rmhi = M;
    case sz:L of
        when '0x' index = UInt(H:L);
        when '10' index = UInt(H);
        when '11' UnallocatedEncoding();

    integer d = UInt(Rd);
    integer n = UInt(Rn);
    
```

```
integer m = UInt(Rmhi:Rm);

if sz:Q == '10' then ReservedValue();
integer esize = 32 << UInt(sz);
integer datasize = if Q == '1' then 128 else 64;
integer elements = datasize DIV esize;
boolean sub_op = (o2 == '1');
```

Assembler symbols

- <Hd> Is the 16-bit name of the SIMD&FP destination register, encoded in the "Rd" field.
- <Hn> Is the 16-bit name of the first SIMD&FP source register, encoded in the "Rn" field.
- <V> Is a width specifier, encoded in the "sz" field. It can have the following values:
- | | |
|---|-------------|
| S | when sz = 0 |
| D | when sz = 1 |
- <d> Is the number of the SIMD&FP destination register, encoded in the "Rd" field.
- <n> Is the number of the first SIMD&FP source register, encoded in the "Rn" field.
- <Vd> Is the name of the SIMD&FP destination register, encoded in the "Rd" field.
- <T> For the vector, half-precision variant: is an arrangement specifier, encoded in the "Q" field. It can have the following values:
- | | |
|----|------------|
| 4H | when Q = 0 |
| 8H | when Q = 1 |
- For the vector, single-precision and double-precision variant: is an arrangement specifier, encoded in the "Q:sz" field. It can have the following values:
- | | |
|----|--------------------|
| 2S | when Q = 0, sz = 0 |
| 4S | when Q = 1, sz = 0 |
| 2D | when Q = 1, sz = 1 |
- The encoding Q = 0, sz = 1 is reserved.
- <Vn> Is the name of the first SIMD&FP source register, encoded in the "Rn" field.
- <Vm> For the half-precision variant: is the name of the second SIMD&FP source register, in the range V0 to V15, encoded in the "Rm" field.
- For the single-precision and double-precision variant: is the name of the second SIMD&FP source register, encoded in the "M:Rm" fields.
- <Ts> Is an element size specifier, encoded in the "sz" field. It can have the following values:
- | | |
|---|-------------|
| S | when sz = 0 |
| D | when sz = 1 |
- <index> For the half-precision variant: is the element index, in the range 0 to 7, encoded in the "H:L:M" fields.
- For the single-precision and double-precision variant: is the element index, encoded in the "sz:L:H" field. It can have the following values:
- | | |
|-----|--------------------|
| H:L | when sz = 0, L = x |
| H | when sz = 1, L = 0 |
- The encoding sz = 1, L = 1 is reserved.

Operation for all encodings

```
CheckFPAdvSIMDEnabled64();
bits(datasize) operand1 = V[n];
bits(idxsized) operand2 = V[m];
bits(datasize) operand3 = V[d];
bits(datasize) result;
bits(esize) element1;
bits(esize) element2 = Elem[operand2, index, esize];

for e = 0 to elements-1
    element1 = Elem[operand1, e, esize];
    if sub_op then element1 = FPNeg(element1);
    Elem[result, e, esize] = FPMu1Add(Elem[operand3, e, esize], element1, element2, FPCR);
V[d] = result;
```

C7.2.109 FMLA (vector)

Floating-point fused Multiply-Add to accumulator (vector). This instruction multiplies corresponding floating-point values in the vectors in the two source SIMD&FP registers, adds the product to the corresponding vector element of the destination SIMD&FP register, and writes the result to the destination SIMD&FP register.

A floating-point exception can be generated by this instruction. Depending on the settings in [FPCR](#), the exception results in either a flag being set in [FPSR](#), or a synchronous exception being generated. For more information, see [Floating-point exceptions and exception traps on page D1-1831](#).

Depending on the settings in the [CPACR_EL1](#), [CPTR_EL2](#), and [CPTR_EL3](#) registers, and the current Security state and Exception level, an attempt to execute the instruction might be trapped.

Half-precision

ARMv8.2

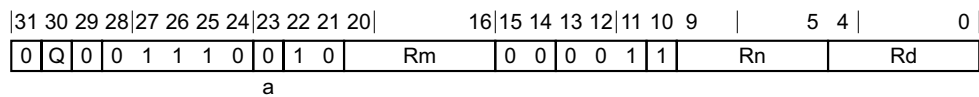

Half-precision variant

FMLA <Vd>.<T>, <Vn>.<T>, <Vm>.<T>

Decode for this encoding

```

if !HaveFP16Ext() then UnallocatedEncoding();

integer d = UInt(Rd);
integer n = UInt(Rn);
integer m = UInt(Rm);
integer esize = 16;
integer datasize = if Q == '1' then 128 else 64;
integer elements = datasize DIV esize;

boolean sub_op = (a == '1');
```

Single-precision and double-precision

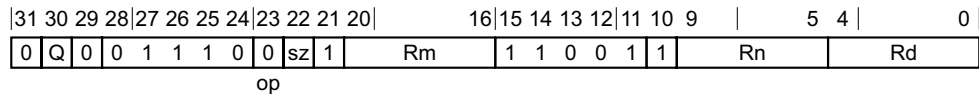

Single-precision and double-precision variant

FMLA <Vd>.<T>, <Vn>.<T>, <Vm>.<T>

Decode for this encoding

```

integer d = UInt(Rd);
integer n = UInt(Rn);
integer m = UInt(Rm);
if sz:Q == '10' then ReservedValue();
integer esize = 32 << UInt(sz);
integer datasize = if Q == '1' then 128 else 64;
integer elements = datasize DIV esize;

boolean sub_op = (op == '1');
```

Assembler symbols

- <Vd> Is the name of the SIMD&FP destination register, encoded in the "Rd" field.
- <T> For the half-precision variant: is an arrangement specifier, encoded in the "Q" field. It can have the following values:
- 4H when Q = 0
 - 8H when Q = 1
- For the single-precision and double-precision variant: is an arrangement specifier, encoded in the "sz:Q" field. It can have the following values:
- 2S when sz = 0, Q = 0
 - 4S when sz = 0, Q = 1
 - 2D when sz = 1, Q = 1
- The encoding sz = 1, Q = 0 is reserved.
- <Vn> Is the name of the first SIMD&FP source register, encoded in the "Rn" field.
- <Vm> Is the name of the second SIMD&FP source register, encoded in the "Rm" field.

Operation for all encodings

```
CheckFPAdvSIMDEnabled64();
bits(datasize) operand1 = V[n];
bits(datasize) operand2 = V[m];
bits(datasize) operand3 = V[d];
bits(datasize) result;
bits(esize) element1;
bits(esize) element2;

for e = 0 to elements-1
    element1 = Elem[operand1, e, esize];
    element2 = Elem[operand2, e, esize];
    if sub_op then element1 = FPNeg(element1);
    Elem[result, e, esize] = FPMu1Add(Elem[operand3, e, esize], element1, element2, FPCR);

V[d] = result;
```

C7.2.110 FMLS (by element)

Floating-point fused Multiply-Subtract from accumulator (by element). This instruction multiplies the vector elements in the first source SIMD&FP register by the specified value in the second source SIMD&FP register, and subtracts the results from the vector elements of the destination SIMD&FP register. All the values in this instruction are floating-point values.

This instruction can generate a floating-point exception. Depending on the settings in [FPCR](#), the exception results in either a flag being set in [FPSR](#) or a synchronous exception being generated. For more information, see [Floating-point exceptions and exception traps on page D1-1831](#).

Depending on the settings in the [CPACR_EL1](#), [CPTR_EL2](#), and [CPTR_EL3](#) registers, and the current Security state and Exception level, an attempt to execute the instruction might be trapped.

Scalar, half-precision

ARMv8.2

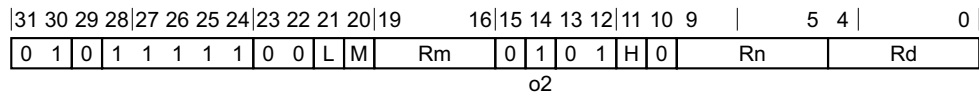

Scalar, half-precision variant

FMLS <Hd>, <Hn>, <Vm>.H[<index>]

Decode for this encoding

```

if !HaveFP16Ext() then UnallocatedEncoding();

integer idxdsize = if H == '1' then 128 else 64;
integer index;
index = UInt(H:L:M);

integer d = UInt(Rd);
integer n = UInt(Rn);
integer m = UInt(Rm);

integer esize = 16;
integer datasize = esize;
integer elements = 1;
boolean sub_op = (o2 == '1');
```

Scalar, single-precision and double-precision

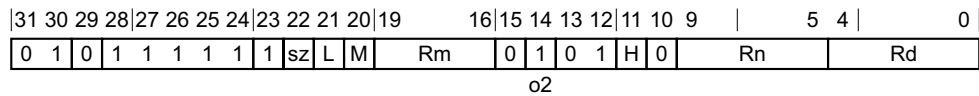

Scalar, single-precision and double-precision variant

FMLS <V><d>, <V><n>, <Vm>.<Ts>[<index>]

Decode for this encoding

```

integer idxdsize = if H == '1' then 128 else 64;
integer index;
bit Rmhi = M;
case sz:L of
    when '0x' index = UInt(H:L);
    when '10' index = UInt(H);
```

```

    when '11' UnallocatedEncoding();

    integer d = UInt(Rd);
    integer n = UInt(Rn);
    integer m = UInt(Rmhi:Rm);

    integer esize = 32 << UInt(sz);
    integer datasize = esize;
    integer elements = 1;
    boolean sub_op = (o2 == '1');
    
```

Vector, half-precision

ARMv8.2

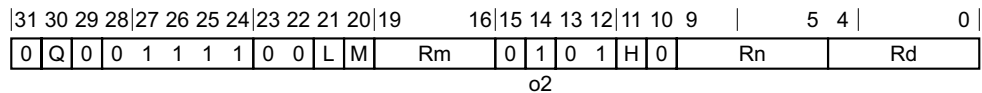

Vector, half-precision variant

FMLS <Vd>.<T>, <Vn>.<T>, <Vm>.<H>[<index>]

Decode for this encoding

```

    if !HaveFP16Ext() then UnallocatedEncoding();

    integer idxdsize = if H == '1' then 128 else 64;
    integer index;
    index = UInt(H:L:M);

    integer d = UInt(Rd);
    integer n = UInt(Rn);
    integer m = UInt(Rm);

    integer esize = 16;
    integer datasize = if Q == '1' then 128 else 64;
    integer elements = datasize DIV esize;
    boolean sub_op = (o2 == '1');
    
```

Vector, single-precision and double-precision

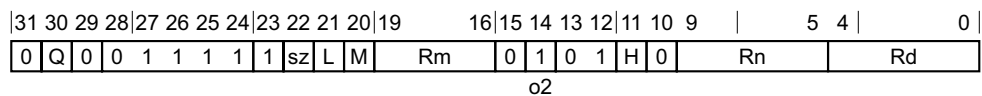

Vector, single-precision and double-precision variant

FMLS <Vd>.<T>, <Vn>.<T>, <Vm>.<Ts>[<index>]

Decode for this encoding

```

    integer idxdsize = if H == '1' then 128 else 64;
    integer index;
    bit Rmhi = M;
    case sz:L of
        when '0x' index = UInt(H:L);
        when '10' index = UInt(H);
        when '11' UnallocatedEncoding();

    integer d = UInt(Rd);
    integer n = UInt(Rn);
    
```

```
integer m = UInt(Rmhi:Rm);  
  
if sz:Q == '10' then ReservedValue();  
integer esize = 32 << UInt(sz);  
integer datasize = if Q == '1' then 128 else 64;  
integer elements = datasize DIV esize;  
boolean sub_op = (o2 == '1');
```

Assembler symbols

- <Hd> Is the 16-bit name of the SIMD&FP destination register, encoded in the "Rd" field.
- <Hn> Is the 16-bit name of the first SIMD&FP source register, encoded in the "Rn" field.
- <V> Is a width specifier, encoded in the "sz" field. It can have the following values:
- S when sz = 0
 - D when sz = 1
- <d> Is the number of the SIMD&FP destination register, encoded in the "Rd" field.
- <n> Is the number of the first SIMD&FP source register, encoded in the "Rn" field.
- <Vd> Is the name of the SIMD&FP destination register, encoded in the "Rd" field.
- <T> For the vector, half-precision variant: is an arrangement specifier, encoded in the "Q" field. It can have the following values:
- 4H when Q = 0
 - 8H when Q = 1
- For the vector, single-precision and double-precision variant: is an arrangement specifier, encoded in the "Q:sz" field. It can have the following values:
- 2S when Q = 0, sz = 0
 - 4S when Q = 1, sz = 0
 - 2D when Q = 1, sz = 1
- The encoding Q = 0, sz = 1 is reserved.
- <Vn> Is the name of the first SIMD&FP source register, encoded in the "Rn" field.
- <Vm> For the half-precision variant: is the name of the second SIMD&FP source register, in the range V0 to V15, encoded in the "Rm" field.
- For the single-precision and double-precision variant: is the name of the second SIMD&FP source register, encoded in the "M:Rm" fields.
- <Ts> Is an element size specifier, encoded in the "sz" field. It can have the following values:
- S when sz = 0
 - D when sz = 1
- <index> For the half-precision variant: is the element index, in the range 0 to 7, encoded in the "H:L:M" fields.
- For the single-precision and double-precision variant: is the element index, encoded in the "sz:L:H" field. It can have the following values:
- H:L when sz = 0, L = x
 - H when sz = 1, L = 0
- The encoding sz = 1, L = 1 is reserved.

Operation for all encodings

```
CheckFPAdvSIMDEnabled64();
bits(datasize) operand1 = V[n];
bits(idxsized) operand2 = V[m];
bits(datasize) operand3 = V[d];
bits(datasize) result;
bits(esize) element1;
bits(esize) element2 = Elem[operand2, index, esize];

for e = 0 to elements-1
    element1 = Elem[operand1, e, esize];
    if sub_op then element1 = FPNeg(element1);
    Elem[result, e, esize] = FPMu1Add(Elem[operand3, e, esize], element1, element2, FPCR);
V[d] = result;
```

C7.2.111 FMLS (vector)

Floating-point fused Multiply-Subtract from accumulator (vector). This instruction multiplies corresponding floating-point values in the vectors in the two source SIMD&FP registers, negates the product, adds the result to the corresponding vector element of the destination SIMD&FP register, and writes the result to the destination SIMD&FP register.

A floating-point exception can be generated by this instruction. Depending on the settings in [FPCR](#), the exception results in either a flag being set in [FPSR](#), or a synchronous exception being generated. For more information, see [Floating-point exceptions and exception traps on page D1-1831](#).

Depending on the settings in the [CPACR_EL1](#), [CPTR_EL2](#), and [CPTR_EL3](#) registers, and the current Security state and Exception level, an attempt to execute the instruction might be trapped.

Half-precision

ARMv8.2

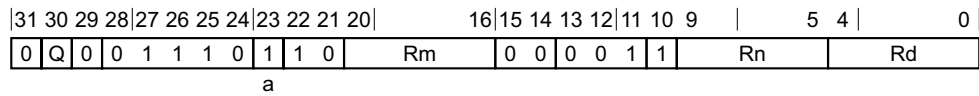

Half-precision variant

FMLS <Vd>.<T>, <Vn>.<T>, <Vm>.<T>

Decode for this encoding

```

if !HaveFP16Ext() then UnallocatedEncoding();

integer d = UInt(Rd);
integer n = UInt(Rn);
integer m = UInt(Rm);
integer esize = 16;
integer datasize = if Q == '1' then 128 else 64;
integer elements = datasize DIV esize;

boolean sub_op = (a == '1');
```

Single-precision and double-precision

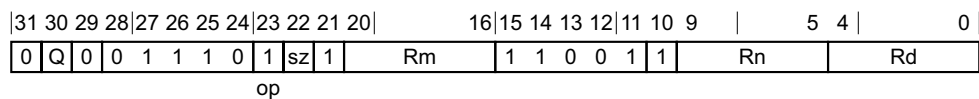

Single-precision and double-precision variant

FMLS <Vd>.<T>, <Vn>.<T>, <Vm>.<T>

Decode for this encoding

```

integer d = UInt(Rd);
integer n = UInt(Rn);
integer m = UInt(Rm);
if sz:Q == '10' then ReservedValue();
integer esize = 32 << UInt(sz);
integer datasize = if Q == '1' then 128 else 64;
integer elements = datasize DIV esize;

boolean sub_op = (op == '1');
```

Assembler symbols

- <Vd> Is the name of the SIMD&FP destination register, encoded in the "Rd" field.
- <T> For the half-precision variant: is an arrangement specifier, encoded in the "Q" field. It can have the following values:
- 4H when Q = 0
 - 8H when Q = 1
- For the single-precision and double-precision variant: is an arrangement specifier, encoded in the "sz:Q" field. It can have the following values:
- 2S when sz = 0, Q = 0
 - 4S when sz = 0, Q = 1
 - 2D when sz = 1, Q = 1
- The encoding sz = 1, Q = 0 is reserved.
- <Vn> Is the name of the first SIMD&FP source register, encoded in the "Rn" field.
- <Vm> Is the name of the second SIMD&FP source register, encoded in the "Rm" field.

Operation for all encodings

```
CheckFPAdvSIMDEnabled64();
bits(datasize) operand1 = V[n];
bits(datasize) operand2 = V[m];
bits(datasize) operand3 = V[d];
bits(datasize) result;
bits(esize) element1;
bits(esize) element2;

for e = 0 to elements-1
    element1 = Elem[operand1, e, esize];
    element2 = Elem[operand2, e, esize];
    if sub_op then element1 = FPNeg(element1);
    Elem[result, e, esize] = FPMu1Add(Elem[operand3, e, esize], element1, element2, FPCR);

V[d] = result;
```

C7.2.112 FMOV (vector, immediate)

Floating-point move immediate (vector). This instruction copies an immediate floating-point constant into every element of the SIMD&FP destination register.

Depending on the settings in the CPACR_EL1, CPTR_EL2, and CPTR_EL3 registers, and the current Security state and Exception level, an attempt to execute the instruction might be trapped.

Half-precision

ARMv8.2

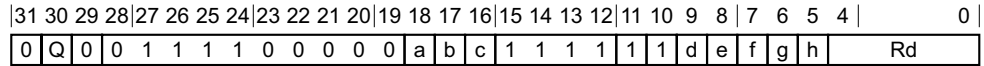

Half-precision variant

FMOV <Vd>.<T>, #<imm>

Decode for this encoding

```

if !HaveFP16Ext() then UnallocatedEncoding();

integer rd = UInt(Rd);

integer datasize = if Q == '1' then 128 else 64;
bits(datasize) imm;

imm8 = a:b:c:d:e:f:g:h;
imm16 = imm8<7>:NOT(imm8<6>):Replicate(imm8<6>, 2):imm8<5:0>:Zeros(6);

imm = Replicate(imm16, datasize DIV 16);
    
```

Single-precision and double-precision

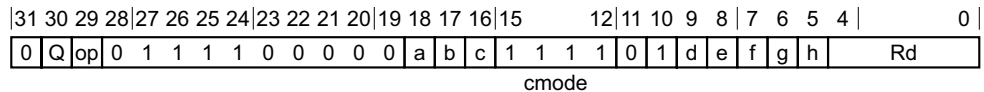

Single-precision variant

Applies when op == 0.

FMOV <Vd>.<T>, #<imm>

Double-precision variant

Applies when Q == 1 && op == 1.

FMOV <Vd>.2D, #<imm>

Decode for all variants of this encoding

```

integer rd = UInt(Rd);

integer datasize = if Q == '1' then 128 else 64;
bits(datasize) imm;
bits(64) imm64;

if cmode:op == '11111' then
    // FMOV Dn,#imm is in main FP instruction set
    
```

```
if Q == '0' then UnallocatedEncoding();  
  
imm64 = AdvSIMDExpandImm(op, cmode, a:b:c:d:e:f:g:h);  
imm = Replicate(imm64, datasize DIV 64);
```

Assembler symbols

- <Vd> Is the name of the SIMD&FP destination register, encoded in the "Rd" field.
- <T> For the half-precision variant: is an arrangement specifier, encoded in the "Q" field. It can have the following values:
4H when Q = 0
8H when Q = 1
For the single-precision variant: is an arrangement specifier, encoded in the "Q" field. It can have the following values:
2S when Q = 0
4S when Q = 1
- <imm> Is a signed floating-point constant with 3-bit exponent and normalized 4 bits of precision, encoded in "a:b:c:d:e:f:g:h". For details of the range of constants available and the encoding of <imm>, see [Modified immediate constants in A64 floating-point instructions on page C2-152](#).

Operation for all encodings

```
CheckFPAdvSIMDEnabled64();
```

```
V[rd] = imm;
```

C7.2.113 FMOV (register)

Floating-point Move register without conversion. This instruction copies the floating-point value in the SIMD&FP source register to the SIMD&FP destination register.

Depending on the settings in the CPACR_EL1, CPTR_EL2, and CPTR_EL3 registers, and the current Security state and Exception level, an attempt to execute the instruction might be trapped.

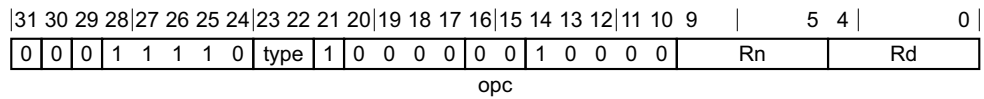

Half-precision variant

Applies when type == 11.

FMOV <Hd>, <Hn>

Single-precision variant

Applies when type == 00.

FMOV <Sd>, <Sn>

Double-precision variant

Applies when type == 01.

FMOV <Dd>, <Dn>

Decode for all variants of this encoding

```
integer d = UInt(Rd);
integer n = UInt(Rn);

integer datasize;
case type of
    when '00' datasize = 32;
    when '01' datasize = 64;
    when '10' UnallocatedEncoding();
    when '11'
        if HaveFP16Ext() then
            datasize = 16;
        else
            UnallocatedEncoding();
```

Assembler symbols

- <Dd> Is the 64-bit name of the SIMD&FP destination register, encoded in the "Rd" field.
- <Dn> Is the 64-bit name of the SIMD&FP source register, encoded in the "Rn" field.
- <Hd> Is the 16-bit name of the SIMD&FP destination register, encoded in the "Rd" field.
- <Hn> Is the 16-bit name of the SIMD&FP source register, encoded in the "Rn" field.
- <Sd> Is the 32-bit name of the SIMD&FP destination register, encoded in the "Rd" field.
- <Sn> Is the 32-bit name of the SIMD&FP source register, encoded in the "Rn" field.

Operation

```
CheckFPAdvSIMDEnabled64();
```

```
bits(datasize) operand = V[n];
```

```
V[d] = operand;
```

C7.2.114 FMOV (general)

Floating-point Move to or from general-purpose register without conversion. This instruction transfers the contents of a SIMD&FP register to a general-purpose register, or the contents of a general-purpose register to a SIMD&FP register.

Depending on the settings in the CPACR_EL1, CPTR_EL2, and CPTR_EL3 registers, and the current Security state and Exception level, an attempt to execute the instruction might be trapped.

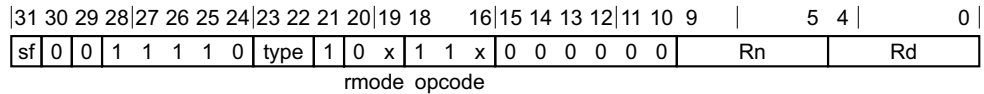

Half-precision to 32-bit variant

Applies when sf == 0 && type == 11 && rmode == 00 && opcode == 110.

FMOV <Wd>, <Hn>

Half-precision to 64-bit variant

Applies when sf == 1 && type == 11 && rmode == 00 && opcode == 110.

FMOV <Xd>, <Hn>

32-bit to half-precision variant

Applies when sf == 0 && type == 11 && rmode == 00 && opcode == 111.

FMOV <Hd>, <Wn>

32-bit to single-precision variant

Applies when sf == 0 && type == 00 && rmode == 00 && opcode == 111.

FMOV <Sd>, <Wn>

Single-precision to 32-bit variant

Applies when sf == 0 && type == 00 && rmode == 00 && opcode == 110.

FMOV <Wd>, <Sn>

64-bit to half-precision variant

Applies when sf == 1 && type == 11 && rmode == 00 && opcode == 111.

FMOV <Hd>, <Xn>

64-bit to double-precision variant

Applies when sf == 1 && type == 01 && rmode == 00 && opcode == 111.

FMOV <Dd>, <Xn>

64-bit to top half of 128-bit variant

Applies when sf == 1 && type == 10 && rmode == 01 && opcode == 111.

FMOV <Vd>.D[1], <Xn>

Double-precision to 64-bit variant

Applies when `sf == 1` && `type == 01` && `rmode == 00` && `opcode == 110`.

FMOV <Xd>, <Dn>

Top half of 128-bit to 64-bit variant

Applies when `sf == 1` && `type == 10` && `rmode == 01` && `opcode == 110`.

FMOV <Xd>, <Vn>.D[1]

Decode for all variants of this encoding

```
integer d = UInt(Rd);
integer n = UInt(Rn);

integer intsize = if sf == '1' then 64 else 32;
integer fltsize;
FPCConvOp op;
FPRounding rounding;
boolean unsigned;
integer part;

case type of
    when '00'
        fltsize = 32;
    when '01'
        fltsize = 64;
    when '10'
        if opcode<2:1>:rmode != '11 01' then UnallocatedEncoding();
        fltsize = 128;
    when '11'
        if HaveFP16Ext() then
            fltsize = 16;
        else
            UnallocatedEncoding();

case opcode<2:1>:rmode of
    when '00 xx' // FCVT[NPMZ][US]
        rounding = FPDecodeRounding(rmode);
        unsigned = (opcode<0> == '1');
        op = FPCConvOp_CVT_FtoI;
    when '01 00' // [US]CVTF
        rounding = FPRoundingMode(FPCR);
        unsigned = (opcode<0> == '1');
        op = FPCConvOp_CVT_ItoF;
    when '10 00' // FCVTA[US]
        rounding = FPRounding_TIEAWAY;
        unsigned = (opcode<0> == '1');
        op = FPCConvOp_CVT_FtoI;
    when '11 00' // FMOV
        if fltsize != 16 && fltsize != intsize then UnallocatedEncoding();
        op = if opcode<0> == '1' then FPCConvOp_MOV_ItoF else FPCConvOp_MOV_FtoI;
        part = 0;
    when '11 01' // FMOV D[1]
        if intsize != 64 || fltsize != 128 then UnallocatedEncoding();
        op = if opcode<0> == '1' then FPCConvOp_MOV_ItoF else FPCConvOp_MOV_FtoI;
        part = 1;
        fltsize = 64; // size of D[1] is 64
    otherwise
        UnallocatedEncoding();
```

Assembler symbols

<Dd> Is the 64-bit name of the SIMD&FP destination register, encoded in the "Rd" field.

<Hd>	Is the 16-bit name of the SIMD&FP destination register, encoded in the "Rd" field.
<Sd>	Is the 32-bit name of the SIMD&FP destination register, encoded in the "Rd" field.
<Wn>	Is the 32-bit name of the general-purpose source register, encoded in the "Rn" field.
<Vd>	Is the name of the SIMD&FP destination register, encoded in the "Rd" field.
<Xn>	Is the 64-bit name of the general-purpose source register, encoded in the "Rn" field.
<Wd>	Is the 32-bit name of the general-purpose destination register, encoded in the "Rd" field.
<Sn>	Is the 32-bit name of the SIMD&FP source register, encoded in the "Rn" field.
<Xd>	Is the 64-bit name of the general-purpose destination register, encoded in the "Rd" field.
<Vn>	Is the name of the SIMD&FP source register, encoded in the "Rn" field.
<Hn>	Is the 16-bit name of the SIMD&FP source register, encoded in the "Rn" field.
<Dn>	Is the 64-bit name of the SIMD&FP source register, encoded in the "Rn" field.

Operation

```
CheckFPAdvSIMDEnabled64();

bits(floatsize) fltval;
bits(intsize) intval;

case op of
  when FPConvOp_CVT_FtoI
    fltval = V[n];
    intval = FPToFixed(fltval, 0, unsigned, FPCR, rounding);
    X[d] = intval;
  when FPConvOp_CVT_ItoF
    intval = X[n];
    fltval = FixedToFP(intval, 0, unsigned, FPCR, rounding);
    V[d] = fltval;
  when FPConvOp_MOV_FtoI
    fltval = Vpart[n, part];
    intval = ZeroExtend(fltval, intsize);
    X[d] = intval;
  when FPConvOp_MOV_ItoF
    intval = X[n];
    fltval = intval<floatsize-1:0>;
    Vpart[d, part] = fltval;
```

C7.2.115 FMOV (scalar, immediate)

Floating-point move immediate (scalar). This instruction copies a floating-point immediate constant into the SIMD&FP destination register.

Depending on the settings in the CPACR_EL1, CPTR_EL2, and CPTR_EL3 registers, and the current Security state and Exception level, an attempt to execute the instruction might be trapped.

31	30	29	28	27	26	25	24	23	22	21	20					13	12	11	10	9	8	7	6	5	4	0
0	0	0	1	1	1	1	0	type	1	imm8				1	0	0	0	0	0	0	0	0	Rd			

Half-precision variant

Applies when type == 11.

FMOV <Hd>, #<imm>

Single-precision variant

Applies when type == 00.

FMOV <Sd>, #<imm>

Double-precision variant

Applies when type == 01.

FMOV <Dd>, #<imm>

Decode for all variants of this encoding

```
integer d = UInt(Rd);

integer datasize;
case type of
    when '00' datasize = 32;
    when '01' datasize = 64;
    when '10' UnallocatedEncoding();
    when '11'
        if HaveFP16Ext() then
            datasize = 16;
        else
            UnallocatedEncoding();

bits(datasize) imm = VFPEExpandImm(imm8);
```

Assembler symbols

- <Dd> Is the 64-bit name of the SIMD&FP destination register, encoded in the "Rd" field.
- <Hd> Is the 16-bit name of the SIMD&FP destination register, encoded in the "Rd" field.
- <Sd> Is the 32-bit name of the SIMD&FP destination register, encoded in the "Rd" field.
- <imm> Is a signed floating-point constant with 3-bit exponent and normalized 4 bits of precision, encoded in the "imm8" field. For details of the range of constants available and the encoding of <imm>, see [Modified immediate constants in A64 floating-point instructions on page C2-152](#).

Operation

```
CheckFPAdvSIMDEnabled64();
```

```
V[d] = imm;
```

C7.2.116 FMSUB

Floating-point Fused Multiply-Subtract (scalar). This instruction multiplies the values of the first two SIMD&FP source registers, negates the product, adds that to the value of the third SIMD&FP source register, and writes the result to the SIMD&FP destination register.

A floating-point exception can be generated by this instruction. Depending on the settings in [FPCR](#), the exception results in either a flag being set in [FPSR](#), or a synchronous exception being generated. For more information, see [Floating-point exceptions and exception traps on page D1-1831](#).

Depending on the settings in the [CPACR_EL1](#), [CPTR_EL2](#), and [CPTR_EL3](#) registers, and the current Security state and Exception level, an attempt to execute the instruction might be trapped.

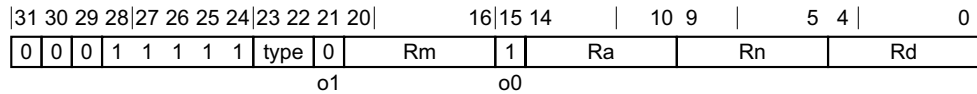

Half-precision variant

Applies when type == 11.

FMSUB <Hd>, <Hn>, <Hm>, <Ha>

Single-precision variant

Applies when type == 00.

FMSUB <Sd>, <Sn>, <Sm>, <Sa>

Double-precision variant

Applies when type == 01.

FMSUB <Dd>, <Dn>, <Dm>, <Da>

Decode for all variants of this encoding

```
integer d = UInt(Rd);
integer a = UInt(Ra);
integer n = UInt(Rn);
integer m = UInt(Rm);

integer datasize;
case type of
    when '00' datasize = 32;
    when '01' datasize = 64;
    when '10' UnallocatedEncoding();
    when '11'
        if HaveFP16Ext() then
            datasize = 16;
        else
            UnallocatedEncoding();
```

Assembler symbols

<Dd> Is the 64-bit name of the SIMD&FP destination register, encoded in the "Rd" field.

<Dn> Is the 64-bit name of the first SIMD&FP source register holding the multiplicand, encoded in the "Rn" field.

<Dm>	Is the 64-bit name of the second SIMD&FP source register holding the multiplier, encoded in the "Rm" field.
<Da>	Is the 64-bit name of the third SIMD&FP source register holding the minuend, encoded in the "Ra" field.
<Hd>	Is the 16-bit name of the SIMD&FP destination register, encoded in the "Rd" field.
<Hn>	Is the 16-bit name of the first SIMD&FP source register holding the multiplicand, encoded in the "Rn" field.
<Hm>	Is the 16-bit name of the second SIMD&FP source register holding the multiplier, encoded in the "Rm" field.
<Ha>	Is the 16-bit name of the third SIMD&FP source register holding the minuend, encoded in the "Ra" field.
<Sd>	Is the 32-bit name of the SIMD&FP destination register, encoded in the "Rd" field.
<Sn>	Is the 32-bit name of the first SIMD&FP source register holding the multiplicand, encoded in the "Rn" field.
<Sm>	Is the 32-bit name of the second SIMD&FP source register holding the multiplier, encoded in the "Rm" field.
<Sa>	Is the 32-bit name of the third SIMD&FP source register holding the minuend, encoded in the "Ra" field.

Operation

```
CheckFPAdvSIMDEnabled64();  
bits(datasize) result;  
bits(datasize) operandA = V[a];  
bits(datasize) operand1 = V[n];  
bits(datasize) operand2 = V[m];  
  
operand1 = FPNeg(operand1);  
result = FPMu1Add(operandA, operand1, operand2, FPCR);  
  
V[d] = result;
```

C7.2.117 FMUL (by element)

Floating-point Multiply (by element). This instruction multiplies the vector elements in the first source SIMD&FP register by the specified value in the second source SIMD&FP register, places the results in a vector, and writes the vector to the destination SIMD&FP register. All the values in this instruction are floating-point values.

This instruction can generate a floating-point exception. Depending on the settings in [FPCR](#), the exception results in either a flag being set in [FPSR](#) or a synchronous exception being generated. For more information, see [Floating-point exceptions and exception traps on page D1-1831](#).

Depending on the settings in the [CPACR_EL1](#), [CPTR_EL2](#), and [CPTR_EL3](#) registers, and the current Security state and Exception level, an attempt to execute the instruction might be trapped.

Scalar, half-precision

ARMv8.2

31	30	29	28	27	26	25	24	23	22	21	20	19	16	15	14	13	12	11	10	9	5	4	0
0	1	0	1	1	1	1	1	0	0	L	M	Rm	1	0	0	1	H	0	Rn	Rd			

U

Scalar, half-precision variant

FMUL <Hd>, <Hn>, <Vm>.H[<index>]

Decode for this encoding

```
if !HaveFP16Ext() then UnallocatedEncoding();

integer idxdsize = if H == '1' then 128 else 64;
integer index;
index = UInt(H:L:M);

integer d = UInt(Rd);
integer n = UInt(Rn);
integer m = UInt(Rm);

integer esize = 16;
integer datasize = esize;
integer elements = 1;
boolean mulx_op = (U == '1');
```

Scalar, single-precision and double-precision

31	30	29	28	27	26	25	24	23	22	21	20	19	16	15	14	13	12	11	10	9	5	4	0
0	1	0	1	1	1	1	1	1	sz	L	M	Rm	1	0	0	1	H	0	Rn	Rd			

U

Scalar, single-precision and double-precision variant

FMUL <V><d>, <V><n>, <Vm>.<Ts>[<index>]

Decode for this encoding

```
integer idxdsize = if H == '1' then 128 else 64;
integer index;
bit Rmhi = M;
case sz:L of
    when '0x' index = UInt(H:L);
    when '10' index = UInt(H);
    when '11' UnallocatedEncoding();
```

```
integer d = UInt(Rd);
integer n = UInt(Rn);
integer m = UInt(Rmhi:Rm);

integer esize = 32 << UInt(sz);
integer datasize = esize;
integer elements = 1;
boolean mulx_op = (U == '1');
```

Vector, half-precision

ARMv8.2

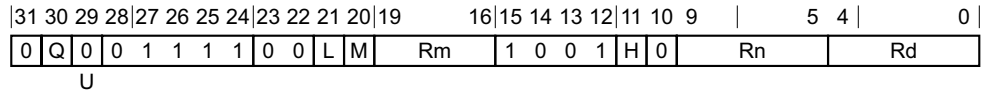

Vector, half-precision variant

FMUL <Vd>.<T>, <Vn>.<T>, <Vm>.<H>[<index>]

Decode for this encoding

```
if !HaveFP16Ext() then UnallocatedEncoding();

integer idxsize = if H == '1' then 128 else 64;
integer index;
index = UInt(H:L:M);

integer d = UInt(Rd);
integer n = UInt(Rn);
integer m = UInt(Rm);

integer esize = 16;
integer datasize = if Q == '1' then 128 else 64;
integer elements = datasize DIV esize;
boolean mulx_op = (U == '1');
```

Vector, single-precision and double-precision

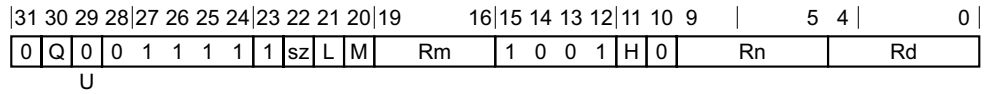

Vector, single-precision and double-precision variant

FMUL <Vd>.<T>, <Vn>.<T>, <Vm>.<Ts>[<index>]

Decode for this encoding

```
integer idxsize = if H == '1' then 128 else 64;
integer index;
bit Rmhi = M;
case sz:L of
    when '0x' index = UInt(H:L);
    when '10' index = UInt(H);
    when '11' UnallocatedEncoding();

integer d = UInt(Rd);
integer n = UInt(Rn);
integer m = UInt(Rmhi:Rm);
```



```

if sz:Q == '10' then ReservedValue();
integer esize = 32 << UInt(sz);
integer datasize = if Q == '1' then 128 else 64;
integer elements = datasize DIV esize;
boolean mulx_op = (U == '1');
  
```

Assembler symbols

- <Hd> Is the 16-bit name of the SIMD&FP destination register, encoded in the "Rd" field.
- <Hn> Is the 16-bit name of the first SIMD&FP source register, encoded in the "Rn" field.
- <V> Is a width specifier, encoded in the "sz" field. It can have the following values:
- S when sz = 0
 - D when sz = 1
- <d> Is the number of the SIMD&FP destination register, encoded in the "Rd" field.
- <n> Is the number of the first SIMD&FP source register, encoded in the "Rn" field.
- <Vd> Is the name of the SIMD&FP destination register, encoded in the "Rd" field.
- <T> For the vector, half-precision variant: is an arrangement specifier, encoded in the "Q" field. It can have the following values:
- 4H when Q = 0
 - 8H when Q = 1
- For the vector, single-precision and double-precision variant: is an arrangement specifier, encoded in the "Q:sz" field. It can have the following values:
- 2S when Q = 0, sz = 0
 - 4S when Q = 1, sz = 0
 - 2D when Q = 1, sz = 1
- The encoding Q = 0, sz = 1 is reserved.
- <Vn> Is the name of the first SIMD&FP source register, encoded in the "Rn" field.
- <Vm> For the half-precision variant: is the name of the second SIMD&FP source register, in the range V0 to V15, encoded in the "Rm" field.
- For the single-precision and double-precision variant: is the name of the second SIMD&FP source register, encoded in the "M:Rm" fields.
- <Ts> Is an element size specifier, encoded in the "sz" field. It can have the following values:
- S when sz = 0
 - D when sz = 1
- <index> For the half-precision variant: is the element index, in the range 0 to 7, encoded in the "H:L:M" fields.
- For the single-precision and double-precision variant: is the element index, encoded in the "sz:L:H" field. It can have the following values:
- H:L when sz = 0, L = x
 - H when sz = 1, L = 0
- The encoding sz = 1, L = 1 is reserved.

Operation for all encodings

```
CheckFPAdvSIMDEnabled64();
bits(datasize) operand1 = V[n];
bits(idxsized) operand2 = V[m];
bits(datasize) result;
bits(esize) element1;
bits(esize) element2 = Elem[operand2, index, esize];

for e = 0 to elements-1
    element1 = Elem[operand1, e, esize];
    if mulx_op then
        Elem[result, e, esize] = FPMu1X(element1, element2, FPCR);
    else
        Elem[result, e, esize] = FPMu1(element1, element2, FPCR);

V[d] = result;
```

C7.2.118 FMUL (vector)

Floating-point Multiply (vector). This instruction multiplies corresponding floating-point values in the vectors in the two source SIMD&FP registers, places the result in a vector, and writes the vector to the destination SIMD&FP register.

This instruction can generate a floating-point exception. Depending on the settings in [FPCR](#), the exception results in either a flag being set in [FPSR](#), or a synchronous exception being generated. For more information, see [Floating-point exceptions and exception traps on page D1-1831](#).

Depending on the settings in the [CPACR_EL1](#), [CPTR_EL2](#), and [CPTR_EL3](#) registers, and the current Security state and Exception level, an attempt to execute the instruction might be trapped.

Half-precision

ARMv8.2

31	30	29	28	27	26	25	24	23	22	21	20	16	15	14	13	12	11	10	9	5	4	0
0	Q	1	0	1	1	1	0	0	1	0	Rm	0	0	0	1	1	1	Rn	Rd			

Half-precision variant

FMUL <Vd>.<T>, <Vn>.<T>, <Vm>.<T>

Decode for this encoding

```
if !HaveFP16Ext() then UnallocatedEncoding();

integer d = UInt(Rd);
integer n = UInt(Rn);
integer m = UInt(Rm);
integer esize = 16;
integer datasize = if Q == '1' then 128 else 64;
integer elements = datasize DIV esize;
```

Single-precision and double-precision

31	30	29	28	27	26	25	24	23	22	21	20	16	15	14	13	12	11	10	9	5	4	0
0	Q	1	0	1	1	1	0	0	sz	1	Rm	1	1	0	1	1	1	Rn	Rd			

Single-precision and double-precision variant

FMUL <Vd>.<T>, <Vn>.<T>, <Vm>.<T>

Decode for this encoding

```
integer d = UInt(Rd);
integer n = UInt(Rn);
integer m = UInt(Rm);
if sz:Q == '10' then ReservedValue();
integer esize = 32 << UInt(sz);
integer datasize = if Q == '1' then 128 else 64;
integer elements = datasize DIV esize;
```

Assembler symbols

<Vd> Is the name of the SIMD&FP destination register, encoded in the "Rd" field.

- <T> For the half-precision variant: is an arrangement specifier, encoded in the "Q" field. It can have the following values:
- 4H when Q = 0
 - 8H when Q = 1
- For the single-precision and double-precision variant: is an arrangement specifier, encoded in the "sz:Q" field. It can have the following values:
- 2S when sz = 0, Q = 0
 - 4S when sz = 0, Q = 1
 - 2D when sz = 1, Q = 1
- The encoding sz = 1, Q = 0 is reserved.
- <Vn> Is the name of the first SIMD&FP source register, encoded in the "Rn" field.
- <Vm> Is the name of the second SIMD&FP source register, encoded in the "Rm" field.

Operation for all encodings

```
CheckFPAdvSIMDEnabled64();
bits(datasize) operand1 = V[n];
bits(datasize) operand2 = V[m];
bits(datasize) result;
bits(esize) element1;
bits(esize) element2;

for e = 0 to elements-1
    element1 = Elem[operand1, e, esize];
    element2 = Elem[operand2, e, esize];
    Elem[result, e, esize] = FPMu1(element1, element2, FPCR);

V[d] = result;
```

C7.2.119 FMUL (scalar)

Floating-point Multiply (scalar). This instruction multiplies the floating-point values of the two source SIMD&FP registers, and writes the result to the destination SIMD&FP register.

This instruction can generate a floating-point exception. Depending on the settings in [FPCR](#), the exception results in either a flag being set in [FPSR](#), or a synchronous exception being generated. For more information, see [Floating-point exceptions and exception traps on page D1-1831](#).

Depending on the settings in the [CPACR_EL1](#), [CPTR_EL2](#), and [CPTR_EL3](#) registers, and the current Security state and Exception level, an attempt to execute the instruction might be trapped.

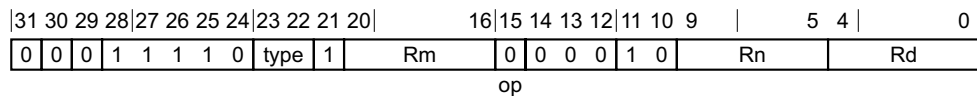

Half-precision variant

Applies when type == 11.

FMUL <Hd>, <Hn>, <Hm>

Single-precision variant

Applies when type == 00.

FMUL <Sd>, <Sn>, <Sm>

Double-precision variant

Applies when type == 01.

FMUL <Dd>, <Dn>, <Dm>

Decode for all variants of this encoding

```
integer d = UInt(Rd);
integer n = UInt(Rn);
integer m = UInt(Rm);

integer datasize;
case type of
    when '00' datasize = 32;
    when '01' datasize = 64;
    when '10' UnallocatedEncoding();
    when '11'
        if HaveFP16Ext() then
            datasize = 16;
        else
            UnallocatedEncoding();
```

Assembler symbols

- <Dd> Is the 64-bit name of the SIMD&FP destination register, encoded in the "Rd" field.
- <Dn> Is the 64-bit name of the first SIMD&FP source register, encoded in the "Rn" field.
- <Dm> Is the 64-bit name of the second SIMD&FP source register, encoded in the "Rm" field.
- <Hd> Is the 16-bit name of the SIMD&FP destination register, encoded in the "Rd" field.
- <Hn> Is the 16-bit name of the first SIMD&FP source register, encoded in the "Rn" field.

- <Hm> Is the 16-bit name of the second SIMD&FP source register, encoded in the "Rm" field.
- <Sd> Is the 32-bit name of the SIMD&FP destination register, encoded in the "Rd" field.
- <Sn> Is the 32-bit name of the first SIMD&FP source register, encoded in the "Rn" field.
- <Sm> Is the 32-bit name of the second SIMD&FP source register, encoded in the "Rm" field.

Operation

```
CheckFPAdvSIMDEnabled64();  
bits(datasize) result;  
bits(datasize) operand1 = V[n];  
bits(datasize) operand2 = V[m];  
  
result = FPMu1(operand1, operand2, FPCR);  
  
V[d] = result;
```

C7.2.120 FMULX (by element)

Floating-point Multiply extended (by element). This instruction multiplies the floating-point values in the vector elements in the first source SIMD&FP register by the specified floating-point value in the second source SIMD&FP register, places the results in a vector, and writes the vector to the destination SIMD&FP register.

If one value is zero and the other value is infinite, the result is 2.0. In this case, the result is negative if only one of the values is negative, otherwise the result is positive.

This instruction can generate a floating-point exception. Depending on the settings in [FPCR](#), the exception results in either a flag being set in [FPSR](#) or a synchronous exception being generated. For more information, see [Floating-point exceptions and exception traps on page D1-1831](#).

Depending on the settings in the [CPACR_EL1](#), [CPTR_EL2](#), and [CPTR_EL3](#) registers, and the current Security state and Exception level, an attempt to execute the instruction might be trapped.

Scalar, half-precision

ARMv8.2

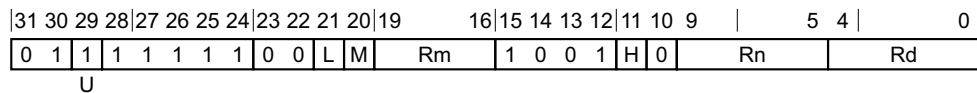

Scalar, half-precision variant

FMULX <Hd>, <Hn>, <Vm>.H[<index>]

Decode for this encoding

```

if !HaveFP16Ext() then UnallocatedEncoding();

integer idxdsize = if H == '1' then 128 else 64;
integer index;
index = UInt(H:L:M);

integer d = UInt(Rd);
integer n = UInt(Rn);
integer m = UInt(Rm);

integer esize = 16;
integer datasize = esize;
integer elements = 1;
boolean mulx_op = (U == '1');
```

Scalar, single-precision and double-precision

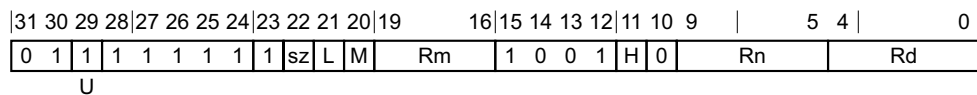

Scalar, single-precision and double-precision variant

FMULX <V><d>, <V><n>, <Vm>.<Ts>[<index>]

Decode for this encoding

```

integer idxdsize = if H == '1' then 128 else 64;
integer index;
bit Rmhi = M;
case sz:L of
```

```

    when '0x' index = UInt(H:L);
    when '10' index = UInt(H);
    when '11' UnallocatedEncoding();

    integer d = UInt(Rd);
    integer n = UInt(Rn);
    integer m = UInt(Rmhi:Rm);

    integer esize = 32 << UInt(sz);
    integer datasize = esize;
    integer elements = 1;
    boolean mulx_op = (U == '1');
    
```

Vector, half-precision

ARMv8.2

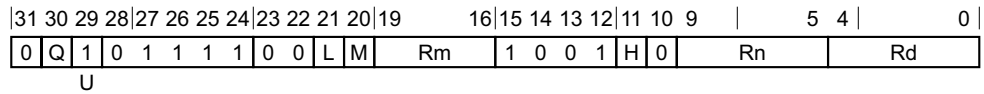

Vector, half-precision variant

FMULX <Vd>.<T>, <Vn>.<T>, <Vm>.H[<index>]

Decode for this encoding

```

    if !HaveFP16Ext() then UnallocatedEncoding();

    integer idxdsize = if H == '1' then 128 else 64;
    integer index;
    index = UInt(H:L:M);

    integer d = UInt(Rd);
    integer n = UInt(Rn);
    integer m = UInt(Rm);

    integer esize = 16;
    integer datasize = if Q == '1' then 128 else 64;
    integer elements = datasize DIV esize;
    boolean mulx_op = (U == '1');
    
```

Vector, single-precision and double-precision

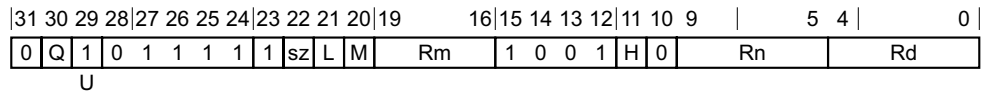

Vector, single-precision and double-precision variant

FMULX <Vd>.<T>, <Vn>.<T>, <Vm>.<Ts>[<index>]

Decode for this encoding

```

    integer idxdsize = if H == '1' then 128 else 64;
    integer index;
    bit Rmhi = M;
    case sz:L of
        when '0x' index = UInt(H:L);
        when '10' index = UInt(H);
        when '11' UnallocatedEncoding();
    
```



```
integer d = UInt(Rd);
integer n = UInt(Rn);
integer m = UInt(Rmhi:Rm);

if sz:Q == '10' then ReservedValue();
integer esize = 32 << UInt(sz);
integer datasize = if Q == '1' then 128 else 64;
integer elements = datasize DIV esize;
boolean mulx_op = (U == '1');
```

Assembler symbols

- <Hd> Is the 16-bit name of the SIMD&FP destination register, encoded in the "Rd" field.
- <Hn> Is the 16-bit name of the first SIMD&FP source register, encoded in the "Rn" field.
- <V> Is a width specifier, encoded in the "sz" field. It can have the following values:
 - S when sz = 0
 - D when sz = 1
- <d> Is the number of the SIMD&FP destination register, encoded in the "Rd" field.
- <n> Is the number of the first SIMD&FP source register, encoded in the "Rn" field.
- <Vd> Is the name of the SIMD&FP destination register, encoded in the "Rd" field.
- <T> For the vector, half-precision variant: is an arrangement specifier, encoded in the "Q" field. It can have the following values:
 - 4H when Q = 0
 - 8H when Q = 1
 For the vector, single-precision and double-precision variant: is an arrangement specifier, encoded in the "Q:sz" field. It can have the following values:
 - 2S when Q = 0, sz = 0
 - 4S when Q = 1, sz = 0
 - 2D when Q = 1, sz = 1
 The encoding Q = 0, sz = 1 is reserved.
- <Vn> Is the name of the first SIMD&FP source register, encoded in the "Rn" field.
- <Vm> For the half-precision variant: is the name of the second SIMD&FP source register, in the range V0 to V15, encoded in the "Rm" field.
 For the single-precision and double-precision variant: is the name of the second SIMD&FP source register, encoded in the "M:Rm" fields.
- <Ts> Is an element size specifier, encoded in the "sz" field. It can have the following values:
 - S when sz = 0
 - D when sz = 1
- <index> For the half-precision variant: is the element index, in the range 0 to 7, encoded in the "H:L:M" fields.
 For the single-precision and double-precision variant: is the element index, encoded in the "sz:L:H" field. It can have the following values:
 - H:L when sz = 0, L = x
 - H when sz = 1, L = 0
 The encoding sz = 1, L = 1 is reserved.

Operation for all encodings

```
CheckFPAdvSIMDEnabled64();
bits(datasize) operand1 = V[n];
bits(idxsizesize) operand2 = V[m];
bits(datasize) result;
bits(esize) element1;
bits(esize) element2 = Elem[operand2, index, esize];

for e = 0 to elements-1
    element1 = Elem[operand1, e, esize];
    if mulx_op then
        Elem[result, e, esize] = FPMu1X(element1, element2, FPCR);
    else
        Elem[result, e, esize] = FPMu1(element1, element2, FPCR);

V[d] = result;
```

C7.2.121 FMULX

Floating-point Multiply extended. This instruction multiplies corresponding floating-point values in the vectors of the two source SIMD&FP registers, places the resulting floating-point values in a vector, and writes the vector to the destination SIMD&FP register.

If one value is zero and the other value is infinite, the result is 2.0. In this case, the result is negative if only one of the values is negative, otherwise the result is positive.

This instruction can generate a floating-point exception. Depending on the settings in [FPCR](#), the exception results in either a flag being set in [FPSR](#), or a synchronous exception being generated. For more information, see [Floating-point exceptions and exception traps on page D1-1831](#).

Depending on the settings in the [CPACR_EL1](#), [CPTR_EL2](#), and [CPTR_EL3](#) registers, and the current Security state and Exception level, an attempt to execute the instruction might be trapped.

Scalar half precision

ARMv8.2

31	30	29	28	27	26	25	24	23	22	21	20	16	15	14	13	12	11	10	9	5	4	0
0	1	0	1	1	1	1	0	0	1	0	Rm	0	0	0	1	1	1	Rn	Rd			

Scalar half precision variant

FMULX <Hd>, <Hn>, <Hm>

Decode for this encoding

```
if !HaveFP16Ext() then UnallocatedEncoding();
```

```
integer d = UInt(Rd);
integer n = UInt(Rn);
integer m = UInt(Rm);
integer esize = 16;
integer datasize = esize;
integer elements = 1;
```

Scalar single-precision and double-precision

31	30	29	28	27	26	25	24	23	22	21	20	16	15	14	13	12	11	10	9	5	4	0
0	1	0	1	1	1	1	0	0	sz	1	Rm	1	1	0	1	1	1	Rn	Rd			

Scalar single-precision and double-precision variant

FMULX <V><d>, <V><n>, <V><m>

Decode for this encoding

```
integer d = UInt(Rd);
integer n = UInt(Rn);
integer m = UInt(Rm);
integer esize = 32 << UInt(sz);
integer datasize = esize;
integer elements = 1;
```

Vector half precision

ARMv8.2

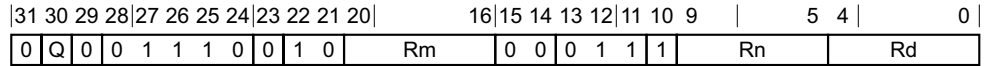

Vector half precision variant

FMULX <Vd>.<T>, <Vn>.<T>, <Vm>.<T>

Decode for this encoding

```

if !HaveFP16Ext() then UnallocatedEncoding();

integer d = UInt(Rd);
integer n = UInt(Rn);
integer m = UInt(Rm);
integer esize = 16;
integer datasize = if Q == '1' then 128 else 64;
integer elements = datasize DIV esize;
    
```

Vector single-precision and double-precision

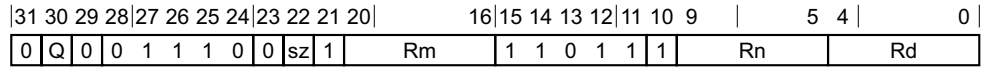

Vector single-precision and double-precision variant

FMULX <Vd>.<T>, <Vn>.<T>, <Vm>.<T>

Decode for this encoding

```

integer d = UInt(Rd);
integer n = UInt(Rn);
integer m = UInt(Rm);
if sz:Q == '10' then ReservedValue();
integer esize = 32 << UInt(sz);
integer datasize = if Q == '1' then 128 else 64;
integer elements = datasize DIV esize;
    
```

Assembler symbols

- <Hd> Is the 16-bit name of the SIMD&FP destination register, encoded in the "Rd" field.
- <Hn> Is the 16-bit name of the first SIMD&FP source register, encoded in the "Rn" field.
- <Hm> Is the 16-bit name of the second SIMD&FP source register, encoded in the "Rm" field.
- <V> Is a width specifier, encoded in the "sz" field. It can have the following values:
 - S when sz = 0
 - D when sz = 1
- <d> Is the number of the SIMD&FP destination register, in the "Rd" field.
- <n> Is the number of the first SIMD&FP source register, encoded in the "Rn" field.
- <m> Is the number of the second SIMD&FP source register, encoded in the "Rm" field.
- <Vd> Is the name of the SIMD&FP destination register, encoded in the "Rd" field.

- <T> For the vector half precision variant: is an arrangement specifier, encoded in the "Q" field. It can have the following values:
- 4H when Q = 0
 - 8H when Q = 1
- For the vector single-precision and double-precision variant: is an arrangement specifier, encoded in the "sz:Q" field. It can have the following values:
- 2S when sz = 0, Q = 0
 - 4S when sz = 0, Q = 1
 - 2D when sz = 1, Q = 1
- The encoding sz = 1, Q = 0 is reserved.
- <Vn> Is the name of the first SIMD&FP source register, encoded in the "Rn" field.
- <Vm> Is the name of the second SIMD&FP source register, encoded in the "Rm" field.

Operation for all encodings

```
CheckFPAdvSIMDEnabled64();
bits(datasize) operand1 = V[n];
bits(datasize) operand2 = V[m];
bits(datasize) result;
bits(esize) element1;
bits(esize) element2;

for e = 0 to elements-1
    element1 = Elem[operand1, e, esize];
    element2 = Elem[operand2, e, esize];
    Elem[result, e, esize] = FPMu1X(element1, element2, FPCR);
V[d] = result;
```

C7.2.122 FNEG (vector)

Floating-point Negate (vector). This instruction negates the value of each vector element in the source SIMD&FP register, writes the result to a vector, and writes the vector to the destination SIMD&FP register.

Depending on the settings in the CPACR_EL1, CPTR_EL2, and CPTR_EL3 registers, and the current Security state and Exception level, an attempt to execute the instruction might be trapped.

Half-precision

ARMv8.2

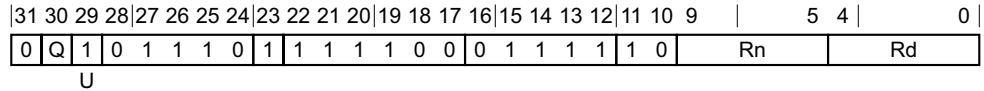

Half-precision variant

FNEG <Vd>.<T>, <Vn>.<T>

Decode for this encoding

```

if !HaveFP16Ext() then UnallocatedEncoding();

integer d = UInt(Rd);
integer n = UInt(Rn);

integer esize = 16;
integer datasize = if Q == '1' then 128 else 64;
integer elements = datasize DIV esize;
boolean neg = (U == '1');
```

Single-precision and double-precision

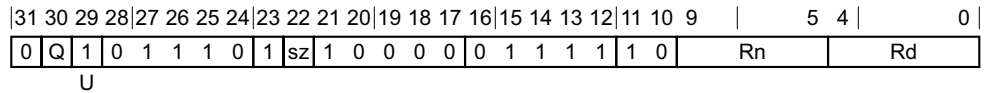

Single-precision and double-precision variant

FNEG <Vd>.<T>, <Vn>.<T>

Decode for this encoding

```

integer d = UInt(Rd);
integer n = UInt(Rn);

if sz:Q == '10' then ReservedValue();
integer esize = 32 << UInt(sz);
integer datasize = if Q == '1' then 128 else 64;
integer elements = datasize DIV esize;
boolean neg = (U == '1');
```

Assembler symbols

- <Vd> Is the name of the SIMD&FP destination register, encoded in the "Rd" field.
- <T> For the half-precision variant: is an arrangement specifier, encoded in the "Q" field. It can have the following values:
 - 4H when Q = 0

8H when Q = 1

For the single-precision and double-precision variant: is an arrangement specifier, encoded in the "sz:Q" field. It can have the following values:

2S when sz = 0, Q = 0

4S when sz = 0, Q = 1

2D when sz = 1, Q = 1

The encoding sz = 1, Q = 0 is reserved.

<Vn> Is the name of the SIMD&FP source register, encoded in the "Rn" field.

Operation for all encodings

```
CheckFPAdvSIMDEnabled64();
bits(datasize) operand = V[n];
bits(datasize) result;
bits(esize) element;

for e = 0 to elements-1
    element = Elem[operand, e, esize];
    if neg then
        element = FPNeg(element);
    else
        element = FPAbs(element);
    Elem[result, e, esize] = element;

V[d] = result;
```

C7.2.123 FNEG (scalar)

Floating-point Negate (scalar). This instruction negates the value in the SIMD&FP source register and writes the result to the SIMD&FP destination register.

Depending on the settings in the CPACR_EL1, CPTR_EL2, and CPTR_EL3 registers, and the current Security state and Exception level, an attempt to execute the instruction might be trapped.

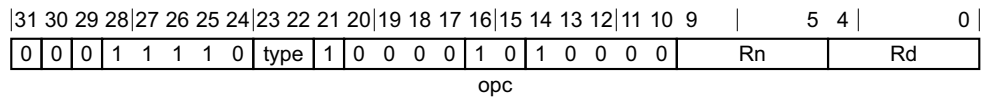

Half-precision variant

Applies when type == 11.

FNEG <Hd>, <Hn>

Single-precision variant

Applies when type == 00.

FNEG <Sd>, <Sn>

Double-precision variant

Applies when type == 01.

FNEG <Dd>, <Dn>

Decode for all variants of this encoding

```
integer d = UInt(Rd);
integer n = UInt(Rn);

integer datasize;
case type of
    when '00' datasize = 32;
    when '01' datasize = 64;
    when '10' UnallocatedEncoding();
    when '11'
        if HaveFP16Ext() then
            datasize = 16;
        else
            UnallocatedEncoding();
```

Assembler symbols

- <Dd> Is the 64-bit name of the SIMD&FP destination register, encoded in the "Rd" field.
- <Dn> Is the 64-bit name of the SIMD&FP source register, encoded in the "Rn" field.
- <Hd> Is the 16-bit name of the SIMD&FP destination register, encoded in the "Rd" field.
- <Hn> Is the 16-bit name of the SIMD&FP source register, encoded in the "Rn" field.
- <Sd> Is the 32-bit name of the SIMD&FP destination register, encoded in the "Rd" field.
- <Sn> Is the 32-bit name of the SIMD&FP source register, encoded in the "Rn" field.

Operation

```
CheckFPAdvSIMDEnabled64();  
  
bits(datasize) result;  
bits(datasize) operand = V[n];  
  
result = FPNeg(operand);  
V[d] = result;
```

C7.2.124 FNMADD

Floating-point Negated fused Multiply-Add (scalar). This instruction multiplies the values of the first two SIMD&FP source registers, negates the product, subtracts the value of the third SIMD&FP source register, and writes the result to the destination SIMD&FP register.

This instruction can generate a floating-point exception. Depending on the settings in [FPCR](#), the exception results in either a flag being set in [FPSR](#), or a synchronous exception being generated. For more information, see [Floating-point exceptions and exception traps on page D1-1831](#).

Depending on the settings in the [CPACR_EL1](#), [CPTR_EL2](#), and [CPTR_EL3](#) registers, and the current Security state and Exception level, an attempt to execute the instruction might be trapped.

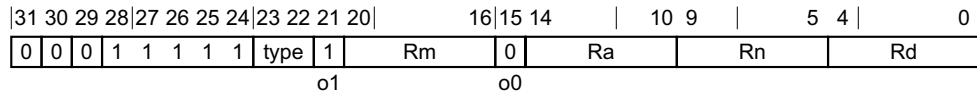

Half-precision variant

Applies when type == 11.

FNMADD <Hd>, <Hn>, <Hm>, <Ha>

Single-precision variant

Applies when type == 00.

FNMADD <Sd>, <Sn>, <Sm>, <Sa>

Double-precision variant

Applies when type == 01.

FNMADD <Dd>, <Dn>, <Dm>, <Da>

Decode for all variants of this encoding

```
integer d = UInt(Rd);
integer a = UInt(Ra);
integer n = UInt(Rn);
integer m = UInt(Rm);

integer datasize;
case type of
    when '00' datasize = 32;
    when '01' datasize = 64;
    when '10' UnallocatedEncoding();
    when '11'
        if HaveFP16Ext() then
            datasize = 16;
        else
            UnallocatedEncoding();
```

Assembler symbols

<Dd> Is the 64-bit name of the SIMD&FP destination register, encoded in the "Rd" field.

<Dn> Is the 64-bit name of the first SIMD&FP source register holding the multiplicand, encoded in the "Rn" field.

- <Dm> Is the 64-bit name of the second SIMD&FP source register holding the multiplier, encoded in the "Rm" field.
- <Da> Is the 64-bit name of the third SIMD&FP source register holding the addend, encoded in the "Ra" field.
- <Hd> Is the 16-bit name of the SIMD&FP destination register, encoded in the "Rd" field.
- <Hn> Is the 16-bit name of the first SIMD&FP source register holding the multiplicand, encoded in the "Rn" field.
- <Hm> Is the 16-bit name of the second SIMD&FP source register holding the multiplier, encoded in the "Rm" field.
- <Ha> Is the 16-bit name of the third SIMD&FP source register holding the addend, encoded in the "Ra" field.
- <Sd> Is the 32-bit name of the SIMD&FP destination register, encoded in the "Rd" field.
- <Sn> Is the 32-bit name of the first SIMD&FP source register holding the multiplicand, encoded in the "Rn" field.
- <Sm> Is the 32-bit name of the second SIMD&FP source register holding the multiplier, encoded in the "Rm" field.
- <Sa> Is the 32-bit name of the third SIMD&FP source register holding the addend, encoded in the "Ra" field.

Operation

```
CheckFPAdvSIMDEnabled64();
bits(datasize) result;
bits(datasize) operandA = V[a];
bits(datasize) operand1 = V[n];
bits(datasize) operand2 = V[m];

operandA = FPNeg(operandA);
operand1 = FPNeg(operand1);
result = FPMu1Add(operandA, operand1, operand2, FPCR);

V[d] = result;
```

C7.2.125 FNMSUB

Floating-point Negated fused Multiply-Subtract (scalar). This instruction multiplies the values of the first two SIMD&FP source registers, subtracts the value of the third SIMD&FP source register, and writes the result to the destination SIMD&FP register.

A floating-point exception can be generated by this instruction. Depending on the settings in [FPCR](#), the exception results in either a flag being set in [FPSR](#), or a synchronous exception being generated. For more information, see [Floating-point exceptions and exception traps on page D1-1831](#).

Depending on the settings in the [CPACR_EL1](#), [CPTR_EL2](#), and [CPTR_EL3](#) registers, and the current Security state and Exception level, an attempt to execute the instruction might be trapped.

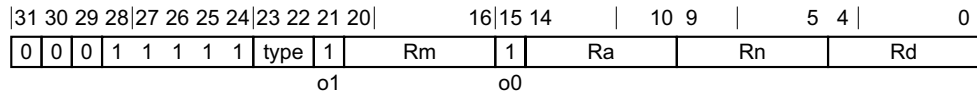

Half-precision variant

Applies when type == 11.

FNMSUB <Hd>, <Hn>, <Hm>, <Ha>

Single-precision variant

Applies when type == 00.

FNMSUB <Sd>, <Sn>, <Sm>, <Sa>

Double-precision variant

Applies when type == 01.

FNMSUB <Dd>, <Dn>, <Dm>, <Da>

Decode for all variants of this encoding

```
integer d = UInt(Rd);
integer a = UInt(Ra);
integer n = UInt(Rn);
integer m = UInt(Rm);

integer datasize;
case type of
    when '00' datasize = 32;
    when '01' datasize = 64;
    when '10' UnallocatedEncoding();
    when '11'
        if HaveFP16Ext() then
            datasize = 16;
        else
            UnallocatedEncoding();
```

Assembler symbols

<Dd> Is the 64-bit name of the SIMD&FP destination register, encoded in the "Rd" field.

<Dn> Is the 64-bit name of the first SIMD&FP source register holding the multiplicand, encoded in the "Rn" field.

- <Dm> Is the 64-bit name of the second SIMD&FP source register holding the multiplier, encoded in the "Rm" field.
- <Da> Is the 64-bit name of the third SIMD&FP source register holding the minuend, encoded in the "Ra" field.
- <Hd> Is the 16-bit name of the SIMD&FP destination register, encoded in the "Rd" field.
- <Hn> Is the 16-bit name of the first SIMD&FP source register holding the multiplicand, encoded in the "Rn" field.
- <Hm> Is the 16-bit name of the second SIMD&FP source register holding the multiplier, encoded in the "Rm" field.
- <Ha> Is the 16-bit name of the third SIMD&FP source register holding the minuend, encoded in the "Ra" field.
- <Sd> Is the 32-bit name of the SIMD&FP destination register, encoded in the "Rd" field.
- <Sn> Is the 32-bit name of the first SIMD&FP source register holding the multiplicand, encoded in the "Rn" field.
- <Sm> Is the 32-bit name of the second SIMD&FP source register holding the multiplier, encoded in the "Rm" field.
- <Sa> Is the 32-bit name of the third SIMD&FP source register holding the minuend, encoded in the "Ra" field.

Operation

```
CheckFPAdvSIMDEnabled64();
bits(datasize) result;
bits(datasize) operanda = V[a];
bits(datasize) operand1 = V[n];
bits(datasize) operand2 = V[m];

operanda = FPNeg(operanda);
result = FPMu1Add(operanda, operand1, operand2, FPCR);

V[d] = result;
```

C7.2.126 FNMUL (scalar)

Floating-point Multiply-Negate (scalar). This instruction multiplies the floating-point values of the two source SIMD&FP registers, and writes the negation of the result to the destination SIMD&FP register.

This instruction can generate a floating-point exception. Depending on the settings in [FPCR](#), the exception results in either a flag being set in [FPSR](#), or a synchronous exception being generated. For more information, see [Floating-point exceptions and exception traps on page D1-1831](#).

Depending on the settings in the [CPACR_EL1](#), [CPTR_EL2](#), and [CPTR_EL3](#) registers, and the current Security state and Exception level, an attempt to execute the instruction might be trapped.

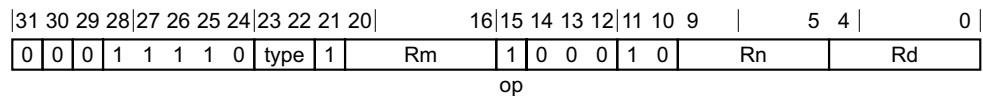

Half-precision variant

Applies when type == 11.

FNMUL <Hd>, <Hn>, <Hm>

Single-precision variant

Applies when type == 00.

FNMUL <Sd>, <Sn>, <Sm>

Double-precision variant

Applies when type == 01.

FNMUL <Dd>, <Dn>, <Dm>

Decode for all variants of this encoding

```
integer d = UInt(Rd);
integer n = UInt(Rn);
integer m = UInt(Rm);

integer datasize;
case type of
    when '00' datasize = 32;
    when '01' datasize = 64;
    when '10' UnallocatedEncoding();
    when '11'
        if HaveFP16Ext() then
            datasize = 16;
        else
            UnallocatedEncoding();
```

Assembler symbols

- <Dd> Is the 64-bit name of the SIMD&FP destination register, encoded in the "Rd" field.
- <Dn> Is the 64-bit name of the first SIMD&FP source register, encoded in the "Rn" field.
- <Dm> Is the 64-bit name of the second SIMD&FP source register, encoded in the "Rm" field.
- <Hd> Is the 16-bit name of the SIMD&FP destination register, encoded in the "Rd" field.
- <Hn> Is the 16-bit name of the first SIMD&FP source register, encoded in the "Rn" field.

- <Hm> Is the 16-bit name of the second SIMD&FP source register, encoded in the "Rm" field.
- <Sd> Is the 32-bit name of the SIMD&FP destination register, encoded in the "Rd" field.
- <Sn> Is the 32-bit name of the first SIMD&FP source register, encoded in the "Rn" field.
- <Sm> Is the 32-bit name of the second SIMD&FP source register, encoded in the "Rm" field.

Operation

```
CheckFPAdvSIMDEnabled64();
bits(datasize) result;
bits(datasize) operand1 = V[n];
bits(datasize) operand2 = V[m];

result = FPMu1(operand1, operand2, FPCR);

result = FPNeg(result);

V[d] = result;
```

C7.2.127 FRECPE

Floating-point Reciprocal Estimate. This instruction finds an approximate reciprocal estimate for each vector element in the source SIMD&FP register, places the result in a vector, and writes the vector to the destination SIMD&FP register.

This instruction can generate a floating-point exception. Depending on the settings in [FPCR](#), the exception results in either a flag being set in [FPSR](#) or a synchronous exception being generated. For more information, see [Floating-point exceptions and exception traps on page D1-1831](#).

Depending on the settings in the [CPACR_EL1](#), [CPTR_EL2](#), and [CPTR_EL3](#) registers, and the current Security state and Exception level, an attempt to execute the instruction might be trapped.

Scalar half precision

ARMv8.2

31	30	29	28	27	26	25	24	23	22	21	20	19	18	17	16	15	14	13	12	11	10	9			5	4			0	
0	1	0	1	1	1	1	0	1	1	1	1	0	0	1	1	1	0	1	1	0										
																							Rn			Rd				

Scalar half precision variant

FRECPE <Hd>, <Hn>

Decode for this encoding

```
if !HaveFP16Ext() then UnallocatedEncoding();
```

```
integer d = UInt(Rd);
integer n = UInt(Rn);
```

```
integer esize = 16;
integer datasize = esize;
integer elements = 1;
```

Scalar single-precision and double-precision

31	30	29	28	27	26	25	24	23	22	21	20	19	18	17	16	15	14	13	12	11	10	9			5	4			0
0	1	0	1	1	1	1	0	1	sz	1	0	0	0	0	1	1	1	0	1	1	0								
																							Rn			Rd			

Scalar single-precision and double-precision variant

FRECPE <V><d>, <V><n>

Decode for this encoding

```
integer d = UInt(Rd);
integer n = UInt(Rn);
```

```
integer esize = 32 << UInt(sz);
integer datasize = esize;
integer elements = 1;
```

Vector half precision

ARMv8.2

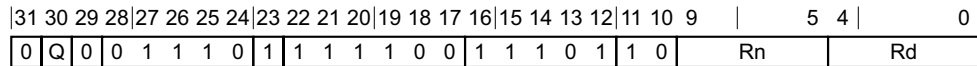

Vector half precision variant

FRECPE <Vd>.<T>, <Vn>.<T>

Decode for this encoding

```
if !HaveFP16Ext() then UnallocatedEncoding();

integer d = UInt(Rd);
integer n = UInt(Rn);

integer esize = 16;
integer datasize = if Q == '1' then 128 else 64;
integer elements = datasize DIV esize;
```

Vector single-precision and double-precision

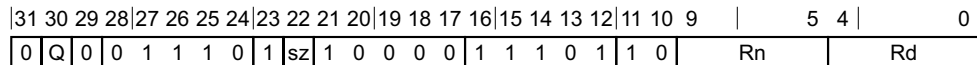

Vector single-precision and double-precision variant

FRECPE <Vd>.<T>, <Vn>.<T>

Decode for this encoding

```
integer d = UInt(Rd);
integer n = UInt(Rn);

if sz:Q == '10' then ReservedValue();
integer esize = 32 << UInt(sz);
integer datasize = if Q == '1' then 128 else 64;
integer elements = datasize DIV esize;
```

Assembler symbols

- <Hd> Is the 16-bit name of the SIMD&FP destination register, encoded in the "Rd" field.
- <Hn> Is the 16-bit name of the SIMD&FP source register, encoded in the "Rn" field.
- <V> Is a width specifier, encoded in the "sz" field. It can have the following values:
 - S when sz = 0
 - D when sz = 1
- <d> Is the number of the SIMD&FP destination register, encoded in the "Rd" field.
- <n> Is the number of the SIMD&FP source register, encoded in the "Rn" field.
- <Vd> Is the name of the SIMD&FP destination register, encoded in the "Rd" field.
- <T> For the vector half precision variant: is an arrangement specifier, encoded in the "Q" field. It can have the following values:
 - 4H when Q = 0
 - 8H when Q = 1

For the vector single-precision and double-precision variant: is an arrangement specifier, encoded in the "sz:Q" field. It can have the following values:

2S when sz = 0, Q = 0

4S when sz = 0, Q = 1

2D when sz = 1, Q = 1

The encoding sz = 1, Q = 0 is reserved.

<Vn> Is the name of the SIMD&FP source register, encoded in the "Rn" field.

Operation for all encodings

```
CheckFPAdvSIMDEnabled64();
bits(datasize) operand = V[n];
bits(datasize) result;
bits(esize) element;

for e = 0 to elements-1
    element = Elem[operand, e, esize];
    Elem[result, e, esize] = FPrecipEstimate(element, FPCR);

V[d] = result;
```

C7.2.128 FRECPS

Floating-point Reciprocal Step. This instruction multiplies the corresponding floating-point values in the vectors of the two source SIMD&FP registers, subtracts each of the products from 2.0, places the resulting floating-point values in a vector, and writes the vector to the destination SIMD&FP register.

This instruction can generate a floating-point exception. Depending on the settings in [FPCR](#), the exception results in either a flag being set in [FPSR](#), or a synchronous exception being generated. For more information, see [Floating-point exceptions and exception traps on page D1-1831](#).

Depending on the settings in the [CPACR_EL1](#), [CPTR_EL2](#), and [CPTR_EL3](#) registers, and the current Security state and Exception level, an attempt to execute the instruction might be trapped.

Scalar half precision

ARMv8.2

31	30	29	28	27	26	25	24	23	22	21	20	16	15	14	13	12	11	10	9	5	4	0
0	1	0	1	1	1	1	0	0	1	0	Rm	0	0	1	1	1	1	Rn	Rd			

Scalar half precision variant

FRECPS <Hd>, <Hn>, <Hm>

Decode for this encoding

```
if !HaveFP16Ext() then UnallocatedEncoding();
```

```
integer d = UInt(Rd);
integer n = UInt(Rn);
integer m = UInt(Rm);
integer esize = 16;
integer datasize = esize;
integer elements = 1;
```

Scalar single-precision and double-precision

31	30	29	28	27	26	25	24	23	22	21	20	16	15	14	13	12	11	10	9	5	4	0
0	1	0	1	1	1	1	0	0	sz	1	Rm	1	1	1	1	1	1	Rn	Rd			

Scalar single-precision and double-precision variant

FRECPS <V><d>, <V><n>, <V><m>

Decode for this encoding

```
integer d = UInt(Rd);
integer n = UInt(Rn);
integer m = UInt(Rm);
integer esize = 32 << UInt(sz);
integer datasize = esize;
integer elements = 1;
```

Vector half precision

ARMv8.2

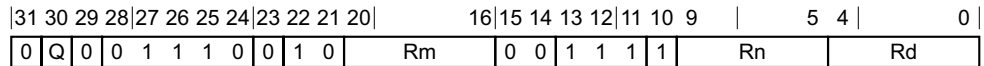

Vector half precision variant

FRECPS <Vd>.<T>, <Vn>.<T>, <Vm>.<T>

Decode for this encoding

```
if !HaveFP16Ext() then UnallocatedEncoding();

integer d = UInt(Rd);
integer n = UInt(Rn);
integer m = UInt(Rm);
integer esize = 16;
integer datasize = if Q == '1' then 128 else 64;
integer elements = datasize DIV esize;
```

Vector single-precision and double-precision

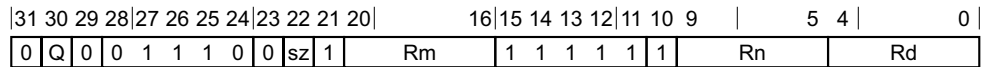

Vector single-precision and double-precision variant

FRECPS <Vd>.<T>, <Vn>.<T>, <Vm>.<T>

Decode for this encoding

```
integer d = UInt(Rd);
integer n = UInt(Rn);
integer m = UInt(Rm);
if sz:Q == '10' then ReservedValue();
integer esize = 32 << UInt(sz);
integer datasize = if Q == '1' then 128 else 64;
integer elements = datasize DIV esize;
```

Assembler symbols

- <Hd> Is the 16-bit name of the SIMD&FP destination register, encoded in the "Rd" field.
- <Hn> Is the 16-bit name of the first SIMD&FP source register, encoded in the "Rn" field.
- <Hm> Is the 16-bit name of the second SIMD&FP source register, encoded in the "Rm" field.
- <V> Is a width specifier, encoded in the "sz" field. It can have the following values:
 - S when sz = 0
 - D when sz = 1
- <d> Is the number of the SIMD&FP destination register, in the "Rd" field.
- <n> Is the number of the first SIMD&FP source register, encoded in the "Rn" field.
- <m> Is the number of the second SIMD&FP source register, encoded in the "Rm" field.
- <Vd> Is the name of the SIMD&FP destination register, encoded in the "Rd" field.

- <T> For the vector half precision variant: is an arrangement specifier, encoded in the "Q" field. It can have the following values:
- 4H when Q = 0
 - 8H when Q = 1
- For the vector single-precision and double-precision variant: is an arrangement specifier, encoded in the "sz:Q" field. It can have the following values:
- 2S when sz = 0, Q = 0
 - 4S when sz = 0, Q = 1
 - 2D when sz = 1, Q = 1
- The encoding sz = 1, Q = 0 is reserved.
- <Vn> Is the name of the first SIMD&FP source register, encoded in the "Rn" field.
- <Vm> Is the name of the second SIMD&FP source register, encoded in the "Rm" field.

Operation for all encodings

```
CheckFPAdvSIMDEnabled64();
bits(datasize) operand1 = V[n];
bits(datasize) operand2 = V[m];
bits(datasize) result;
bits(esize) element1;
bits(esize) element2;

for e = 0 to elements-1
    element1 = Elem[operand1, e, esize];
    element2 = Elem[operand2, e, esize];
    Elem[result, e, esize] = FPRecipStepFused(element1, element2);

V[d] = result;
```

C7.2.129 FRECPX

Floating-point Reciprocal exponent (scalar). This instruction finds an approximate reciprocal exponent for each vector element in the source SIMD&FP register, places the result in a vector, and writes the vector to the destination SIMD&FP register.

This instruction can generate a floating-point exception. Depending on the settings in [FPCR](#), the exception results in either a flag being set in [FPSR](#) or a synchronous exception being generated. For more information, see [Floating-point exceptions and exception traps on page D1-1831](#).

Depending on the settings in the [CPACR_EL1](#), [CPTR_EL2](#), and [CPTR_EL3](#) registers, and the current Security state and Exception level, an attempt to execute the instruction might be trapped.

Half-precision

ARMv8.2

31	30	29	28	27	26	25	24	23	22	21	20	19	18	17	16	15	14	13	12	11	10	9			5	4			0	
0	1	0	1	1	1	1	0	1	1	1	1	0	0	1	1	1	1	1	1	1	0									
																							Rn			Rd				

Half-precision variant

FRECPX <Hd>, <Hn>

Decode for this encoding

```
if !HaveFP16Ext() then UnallocatedEncoding();

integer d = UInt(Rd);
integer n = UInt(Rn);

integer esize = 16;
integer datasize = esize;
integer elements = 1;
```

Single-precision and double-precision

31	30	29	28	27	26	25	24	23	22	21	20	19	18	17	16	15	14	13	12	11	10	9			5	4			0	
0	1	0	1	1	1	1	0	1	sz	1	0	0	0	0	1	1	1	1	1	1	0									
																							Rn			Rd				

Single-precision and double-precision variant

FRECPX <V><d>, <V><n>

Decode for this encoding

```
integer d = UInt(Rd);
integer n = UInt(Rn);

integer esize = 32 << UInt(sz);
integer datasize = esize;
integer elements = 1;
```

Assembler symbols

- <Hd> Is the 16-bit name of the SIMD&FP destination register, encoded in the "Rd" field.
- <Hn> Is the 16-bit name of the SIMD&FP source register, encoded in the "Rn" field.

- <V> Is a width specifier, encoded in the "sz" field. It can have the following values:
- S when sz = 0
 - D when sz = 1
- <d> Is the number of the SIMD&FP destination register, encoded in the "Rd" field.
- <n> Is the number of the SIMD&FP source register, encoded in the "Rn" field.

Operation for all encodings

```
CheckFPAdvSIMDEnabled64();
bits(datasize) operand = V[n];
bits(datasize) result;
bits(esize) element;

for e = 0 to elements-1
    element = Elem[operand, e, esize];
    Elem[result, e, esize] = FPRecpX(element, FPCR);

V[d] = result;
```

C7.2.130 FRINTA (vector)

Floating-point Round to Integral, to nearest with ties to Away (vector). This instruction rounds a vector of floating-point values in the SIMD&FP source register to integral floating-point values of the same size using the Round to Nearest with Ties to Away rounding mode, and writes the result to the SIMD&FP destination register.

A zero input gives a zero result with the same sign, an infinite input gives an infinite result with the same sign, and a NaN is propagated as for normal arithmetic.

A floating-point exception can be generated by this instruction. Depending on the settings in [FPCR](#), the exception results in either a flag being set in [FPSR](#), or a synchronous exception being generated. For more information, see [Floating-point exceptions and exception traps on page D1-1831](#).

Depending on the settings in the [CPACR_EL1](#), [CPTR_EL2](#), and [CPTR_EL3](#) registers, and the current Security state and Exception level, an attempt to execute the instruction might be trapped.

Half-precision

ARMv8.2

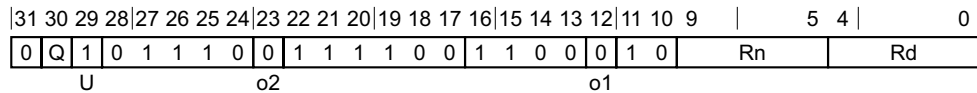

Half-precision variant

FRINTA <Vd>.<T>, <Vn>.<T>

Decode for this encoding

```

if !HaveFP16Ext() then UnallocatedEncoding();

integer d = UInt(Rd);
integer n = UInt(Rn);

integer esize = 16;
integer datasize = if Q == '1' then 128 else 64;
integer elements = datasize DIV esize;

boolean exact = FALSE;
FPRounding rounding;
case U:o1:o2 of
    when '0xx' rounding = FPDecodeRounding(o1:o2);
    when '100' rounding = FPRounding_TIEAWAY;
    when '101' UnallocatedEncoding();
    when '110' rounding = FPRoundingMode(FPCR); exact = TRUE;
    when '111' rounding = FPRoundingMode(FPCR);
    
```

Single-precision and double-precision

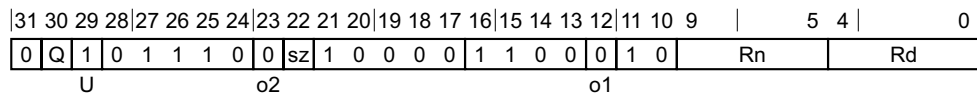

Single-precision and double-precision variant

FRINTA <Vd>.<T>, <Vn>.<T>

Decode for this encoding

```
integer d = UInt(Rd);
integer n = UInt(Rn);

if sz:Q == '10' then ReservedValue();
integer esize = 32 << UInt(sz);
integer datasize = if Q == '1' then 128 else 64;
integer elements = datasize DIV esize;

boolean exact = FALSE;
FPRounding rounding;
case U:o1:o2 of
    when '0xx' rounding = FPDecodeRounding(o1:o2);
    when '100' rounding = FPRounding_TIEAWAY;
    when '101' UnallocatedEncoding();
    when '110' rounding = FPRoundingMode(FPCR); exact = TRUE;
    when '111' rounding = FPRoundingMode(FPCR);
```

Assembler symbols

- <Vd> Is the name of the SIMD&FP destination register, encoded in the "Rd" field.
- <T> For the half-precision variant: is an arrangement specifier, encoded in the "Q" field. It can have the following values:
- | | |
|----|------------|
| 4H | when Q = 0 |
| 8H | when Q = 1 |
- For the single-precision and double-precision variant: is an arrangement specifier, encoded in the "sz:Q" field. It can have the following values:
- | | |
|----|--------------------|
| 2S | when sz = 0, Q = 0 |
| 4S | when sz = 0, Q = 1 |
| 2D | when sz = 1, Q = 1 |
- The encoding sz = 1, Q = 0 is reserved.
- <Vn> Is the name of the SIMD&FP source register, encoded in the "Rn" field.

Operation for all encodings

```
CheckFPAdvSIMDEnabled64();
bits(datasize) operand = V[n];
bits(datasize) result;
bits(esize) element;

for e = 0 to elements-1
    element = Elem[operand, e, esize];
    Elem[result, e, esize] = FPRoundInt(element, FPCR, rounding, exact);

V[d] = result;
```

C7.2.131 FRINTA (scalar)

Floating-point Round to Integral, to nearest with ties to Away (scalar). This instruction rounds a floating-point value in the SIMD&FP source register to an integral floating-point value of the same size using the Round to Nearest with Ties to Away rounding mode, and writes the result to the SIMD&FP destination register.

A zero input gives a zero result with the same sign, an infinite input gives an infinite result with the same sign, and a NaN is propagated as for normal arithmetic.

A floating-point exception can be generated by this instruction. Depending on the settings in [FPCR](#), the exception results in either a flag being set in [FPSR](#), or a synchronous exception being generated. For more information, see [Floating-point exceptions and exception traps on page D1-1831](#).

Depending on the settings in the [CPACR_EL1](#), [CPTR_EL2](#), and [CPTR_EL3](#) registers, and the current Security state and Exception level, an attempt to execute the instruction might be trapped.

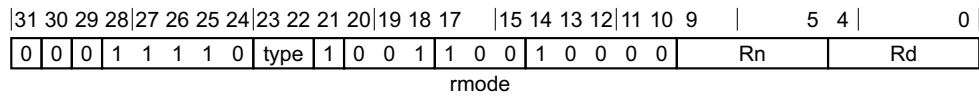

Half-precision variant

Applies when type == 11.

FRINTA <Hd>, <Hn>

Single-precision variant

Applies when type == 00.

FRINTA <Sd>, <Sn>

Double-precision variant

Applies when type == 01.

FRINTA <Dd>, <Dn>

Decode for all variants of this encoding

```
integer d = UInt(Rd);
integer n = UInt(Rn);

integer datasize;
case type of
    when '00' datasize = 32;
    when '01' datasize = 64;
    when '10' UnallocatedEncoding();
    when '11'
        if HaveFP16Ext() then
            datasize = 16;
        else
            UnallocatedEncoding();
```

Assembler symbols

- <Dd> Is the 64-bit name of the SIMD&FP destination register, encoded in the "Rd" field.
- <Dn> Is the 64-bit name of the SIMD&FP source register, encoded in the "Rn" field.
- <Hd> Is the 16-bit name of the SIMD&FP destination register, encoded in the "Rd" field.

- <Hn> Is the 16-bit name of the SIMD&FP source register, encoded in the "Rn" field.
- <Sd> Is the 32-bit name of the SIMD&FP destination register, encoded in the "Rd" field.
- <Sn> Is the 32-bit name of the SIMD&FP source register, encoded in the "Rn" field.

Operation

```
CheckFPAdvSIMDEnabled64();  
  
bits(datasize) result;  
bits(datasize) operand = V[n];  
  
result = FPRoundInt(operand, FPCR, FPRounding_TIEAWAY, FALSE);  
  
V[d] = result;
```

C7.2.132 FRINTI (vector)

Floating-point Round to Integral, using current rounding mode (vector). This instruction rounds a vector of floating-point values in the SIMD&FP source register to integral floating-point values of the same size using the rounding mode that is determined by the [FPCR](#), and writes the result to the SIMD&FP destination register.

A zero input gives a zero result with the same sign, an infinite input gives an infinite result with the same sign, and a NaN is propagated as for normal arithmetic.

A floating-point exception can be generated by this instruction. Depending on the settings in [FPCR](#), the exception results in either a flag being set in [FPSR](#), or a synchronous exception being generated. For more information, see [Floating-point exceptions and exception traps on page D1-1831](#).

Depending on the settings in the [CPACR_EL1](#), [CPTR_EL2](#), and [CPTR_EL3](#) registers, and the current Security state and Exception level, an attempt to execute the instruction might be trapped.

Half-precision

ARMv8.2

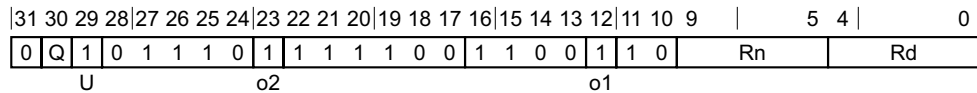

Half-precision variant

FRINTI <Vd>.<T>, <Vn>.<T>

Decode for this encoding

```

if !HaveFP16Ext() then UnallocatedEncoding();

integer d = UInt(Rd);
integer n = UInt(Rn);

integer esize = 16;
integer datasize = if Q == '1' then 128 else 64;
integer elements = datasize DIV esize;

boolean exact = FALSE;
FPRounding rounding;
case U:o1:o2 of
    when '0xx' rounding = FPDecodeRounding(o1:o2);
    when '100' rounding = FPRounding_TIEAWAY;
    when '101' UnallocatedEncoding();
    when '110' rounding = FPRoundingMode(FPCR); exact = TRUE;
    when '111' rounding = FPRoundingMode(FPCR);
    
```

Single-precision and double-precision

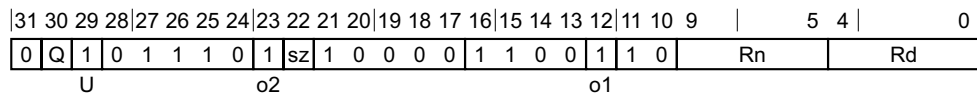

Single-precision and double-precision variant

FRINTI <Vd>.<T>, <Vn>.<T>

Decode for this encoding

```
integer d = UInt(Rd);
integer n = UInt(Rn);

if sz:Q == '10' then ReservedValue();
integer esize = 32 << UInt(sz);
integer datasize = if Q == '1' then 128 else 64;
integer elements = datasize DIV esize;

boolean exact = FALSE;
FPRounding rounding;
case U:o1:o2 of
    when '0xx' rounding = FPDecodeRounding(o1:o2);
    when '100' rounding = FPRounding_TIEAWAY;
    when '101' UnallocatedEncoding();
    when '110' rounding = FPRoundingMode(FPCR); exact = TRUE;
    when '111' rounding = FPRoundingMode(FPCR);
```

Assembler symbols

- <Vd> Is the name of the SIMD&FP destination register, encoded in the "Rd" field.
- <T> For the half-precision variant: is an arrangement specifier, encoded in the "Q" field. It can have the following values:
- | | |
|----|------------|
| 4H | when Q = 0 |
| 8H | when Q = 1 |
- For the single-precision and double-precision variant: is an arrangement specifier, encoded in the "sz:Q" field. It can have the following values:
- | | |
|----|--------------------|
| 2S | when sz = 0, Q = 0 |
| 4S | when sz = 0, Q = 1 |
| 2D | when sz = 1, Q = 1 |
- The encoding sz = 1, Q = 0 is reserved.
- <Vn> Is the name of the SIMD&FP source register, encoded in the "Rn" field.

Operation for all encodings

```
CheckFPAdvSIMDEnabled64();
bits(datasize) operand = V[n];
bits(datasize) result;
bits(esome) element;

for e = 0 to elements-1
    element = Elem[operand, e, esize];
    Elem[result, e, esize] = FPRoundInt(element, FPCR, rounding, exact);

V[d] = result;
```

C7.2.133 FRINTI (scalar)

Floating-point Round to Integral, using current rounding mode (scalar). This instruction rounds a floating-point value in the SIMD&FP source register to an integral floating-point value of the same size using the rounding mode that is determined by the [FPCR](#), and writes the result to the SIMD&FP destination register.

A zero input gives a zero result with the same sign, an infinite input gives an infinite result with the same sign, and a NaN is propagated as for normal arithmetic.

A floating-point exception can be generated by this instruction. Depending on the settings in [FPCR](#), the exception results in either a flag being set in [FPSR](#), or a synchronous exception being generated. For more information, see [Floating-point exceptions and exception traps on page D1-1831](#).

Depending on the settings in the [CPACR_EL1](#), [CPTR_EL2](#), and [CPTR_EL3](#) registers, and the current Security state and Exception level, an attempt to execute the instruction might be trapped.

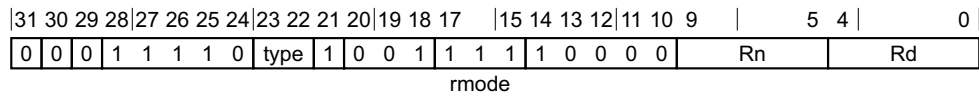

Half-precision variant

Applies when type == 11.

FRINTI <Hd>, <Hn>

Single-precision variant

Applies when type == 00.

FRINTI <Sd>, <Sn>

Double-precision variant

Applies when type == 01.

FRINTI <Dd>, <Dn>

Decode for all variants of this encoding

```
integer d = UInt(Rd);
integer n = UInt(Rn);

integer datasize;
case type of
    when '00' datasize = 32;
    when '01' datasize = 64;
    when '10' UnallocatedEncoding();
    when '11'
        if HaveFP16Ext() then
            datasize = 16;
        else
            UnallocatedEncoding();

FPRounding rounding;
rounding = FPRoundingMode(FPCR);
```

Assembler symbols

- <Dd> Is the 64-bit name of the SIMD&FP destination register, encoded in the "Rd" field.
- <Dn> Is the 64-bit name of the SIMD&FP source register, encoded in the "Rn" field.

- <Hd> Is the 16-bit name of the SIMD&FP destination register, encoded in the "Rd" field.
- <Hn> Is the 16-bit name of the SIMD&FP source register, encoded in the "Rn" field.
- <Sd> Is the 32-bit name of the SIMD&FP destination register, encoded in the "Rd" field.
- <Sn> Is the 32-bit name of the SIMD&FP source register, encoded in the "Rn" field.

Operation

```
CheckFPAdvSIMDEnabled64();  
  
bits(datasize) result;  
bits(datasize) operand = V[n];  
  
result = FPRoundInt(operand, FPCR, rounding, FALSE);  
  
V[d] = result;
```

C7.2.134 FRINTM (vector)

Floating-point Round to Integral, toward Minus infinity (vector). This instruction rounds a vector of floating-point values in the SIMD&FP source register to integral floating-point values of the same size using the Round towards Minus Infinity rounding mode, and writes the result to the SIMD&FP destination register.

A zero input gives a zero result with the same sign, an infinite input gives an infinite result with the same sign, and a NaN is propagated as for normal arithmetic.

A floating-point exception can be generated by this instruction. Depending on the settings in [FPCR](#), the exception results in either a flag being set in [FPSR](#), or a synchronous exception being generated. For more information, see [Floating-point exceptions and exception traps on page D1-1831](#).

Depending on the settings in the [CPACR_EL1](#), [CPTR_EL2](#), and [CPTR_EL3](#) registers, and the current Security state and Exception level, an attempt to execute the instruction might be trapped.

Half-precision

ARMv8.2

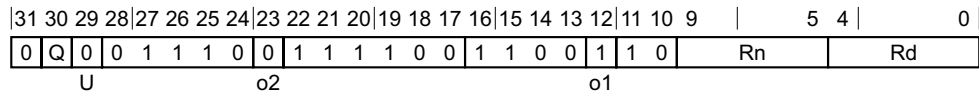

Half-precision variant

FRINTM <Vd>.<T>, <Vn>.<T>

Decode for this encoding

```

if !HaveFP16Ext() then UnallocatedEncoding();

integer d = UInt(Rd);
integer n = UInt(Rn);

integer esize = 16;
integer datasize = if Q == '1' then 128 else 64;
integer elements = datasize DIV esize;

boolean exact = FALSE;
FPRounding rounding;
case U:o1:o2 of
    when '0xx' rounding = FPDecodeRounding(o1:o2);
    when '100' rounding = FPRounding_TIEAWAY;
    when '101' UnallocatedEncoding();
    when '110' rounding = FPRoundingMode(FPCR); exact = TRUE;
    when '111' rounding = FPRoundingMode(FPCR);
    
```

Single-precision and double-precision

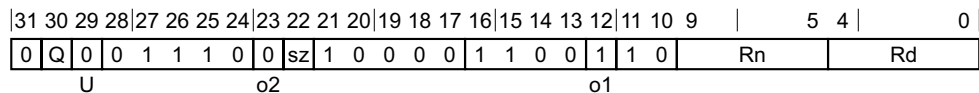

Single-precision and double-precision variant

FRINTM <Vd>.<T>, <Vn>.<T>

Decode for this encoding

```
integer d = UInt(Rd);
integer n = UInt(Rn);

if sz:Q == '10' then ReservedValue();
integer esize = 32 << UInt(sz);
integer datasize = if Q == '1' then 128 else 64;
integer elements = datasize DIV esize;

boolean exact = FALSE;
FPRounding rounding;
case U:o1:o2 of
    when '0xx' rounding = FPDecodeRounding(o1:o2);
    when '100' rounding = FPRounding_TIEAWAY;
    when '101' UnallocatedEncoding();
    when '110' rounding = FPRoundingMode(FPCR); exact = TRUE;
    when '111' rounding = FPRoundingMode(FPCR);
```

Assembler symbols

- <Vd> Is the name of the SIMD&FP destination register, encoded in the "Rd" field.
- <T> For the half-precision variant: is an arrangement specifier, encoded in the "Q" field. It can have the following values:
- | | |
|----|------------|
| 4H | when Q = 0 |
| 8H | when Q = 1 |
- For the single-precision and double-precision variant: is an arrangement specifier, encoded in the "sz:Q" field. It can have the following values:
- | | |
|----|--------------------|
| 2S | when sz = 0, Q = 0 |
| 4S | when sz = 0, Q = 1 |
| 2D | when sz = 1, Q = 1 |
- The encoding sz = 1, Q = 0 is reserved.
- <Vn> Is the name of the SIMD&FP source register, encoded in the "Rn" field.

Operation for all encodings

```
CheckFPAdvSIMDEnabled64();
bits(datasize) operand = V[n];
bits(datasize) result;
bits(esize) element;

for e = 0 to elements-1
    element = Elem[operand, e, esize];
    Elem[result, e, esize] = FPRoundInt(element, FPCR, rounding, exact);

V[d] = result;
```

C7.2.135 FRINTM (scalar)

Floating-point Round to Integral, toward Minus infinity (scalar). This instruction rounds a floating-point value in the SIMD&FP source register to an integral floating-point value of the same size using the Round towards Minus Infinity rounding mode, and writes the result to the SIMD&FP destination register.

A zero input gives a zero result with the same sign, an infinite input gives an infinite result with the same sign, and a NaN is propagated as for normal arithmetic.

A floating-point exception can be generated by this instruction. Depending on the settings in [FPCR](#), the exception results in either a flag being set in [FPSR](#), or a synchronous exception being generated. For more information, see [Floating-point exceptions and exception traps on page D1-1831](#).

Depending on the settings in the [CPACR_EL1](#), [CPTR_EL2](#), and [CPTR_EL3](#) registers, and the current Security state and Exception level, an attempt to execute the instruction might be trapped.

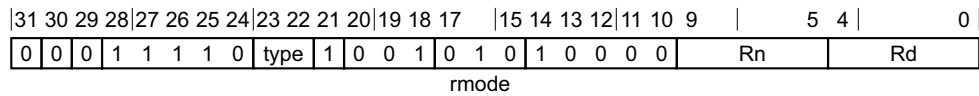

Half-precision variant

Applies when type == 11.

FRINTM <Hd>, <Hn>

Single-precision variant

Applies when type == 00.

FRINTM <Sd>, <Sn>

Double-precision variant

Applies when type == 01.

FRINTM <Dd>, <Dn>

Decode for all variants of this encoding

```
integer d = UInt(Rd);
integer n = UInt(Rn);

integer datasize;
case type of
    when '00' datasize = 32;
    when '01' datasize = 64;
    when '10' UnallocatedEncoding();
    when '11'
        if HaveFP16Ext() then
            datasize = 16;
        else
            UnallocatedEncoding();

FPRounding rounding;
rounding = FPDecodeRounding('10');
```

Assembler symbols

- <Dd> Is the 64-bit name of the SIMD&FP destination register, encoded in the "Rd" field.
- <Dn> Is the 64-bit name of the SIMD&FP source register, encoded in the "Rn" field.

- <Hd> Is the 16-bit name of the SIMD&FP destination register, encoded in the "Rd" field.
- <Hn> Is the 16-bit name of the SIMD&FP source register, encoded in the "Rn" field.
- <Sd> Is the 32-bit name of the SIMD&FP destination register, encoded in the "Rd" field.
- <Sn> Is the 32-bit name of the SIMD&FP source register, encoded in the "Rn" field.

Operation

```
CheckFPAdvSIMDEnabled64();  
  
bits(datasize) result;  
bits(datasize) operand = V[n];  
  
result = FPRoundInt(operand, FPCR, rounding, FALSE);  
  
V[d] = result;
```

C7.2.136 FRINTN (vector)

Floating-point Round to Integral, to nearest with ties to even (vector). This instruction rounds a vector of floating-point values in the SIMD&FP source register to integral floating-point values of the same size using the Round to Nearest rounding mode, and writes the result to the SIMD&FP destination register.

A zero input gives a zero result with the same sign, an infinite input gives an infinite result with the same sign, and a NaN is propagated as for normal arithmetic.

A floating-point exception can be generated by this instruction. Depending on the settings in [FPCR](#), the exception results in either a flag being set in [FPSR](#), or a synchronous exception being generated. For more information, see [Floating-point exceptions and exception traps on page D1-1831](#).

Depending on the settings in the [CPACR_EL1](#), [CPTR_EL2](#), and [CPTR_EL3](#) registers, and the current Security state and Exception level, an attempt to execute the instruction might be trapped.

Half-precision

ARMv8.2

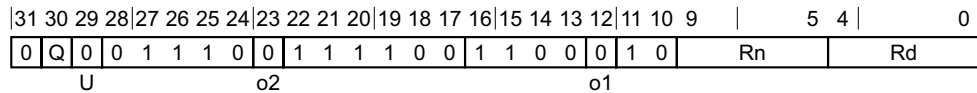

Half-precision variant

FRINTN <Vd>.<T>, <Vn>.<T>

Decode for this encoding

```

if !HaveFP16Ext() then UnallocatedEncoding();

integer d = UInt(Rd);
integer n = UInt(Rn);

integer esize = 16;
integer datasize = if Q == '1' then 128 else 64;
integer elements = datasize DIV esize;

boolean exact = FALSE;
FPRounding rounding;
case U:o1:o2 of
    when '0xx' rounding = FPDecodeRounding(o1:o2);
    when '100' rounding = FPRounding_TIEAWAY;
    when '101' UnallocatedEncoding();
    when '110' rounding = FPRoundingMode(FPCR); exact = TRUE;
    when '111' rounding = FPRoundingMode(FPCR);
    
```

Single-precision and double-precision

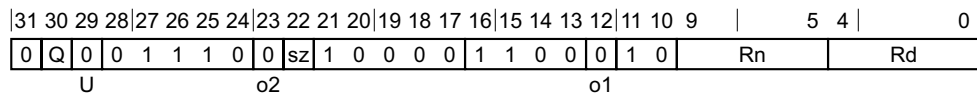

Single-precision and double-precision variant

FRINTN <Vd>.<T>, <Vn>.<T>

Decode for this encoding

```
integer d = UInt(Rd);
integer n = UInt(Rn);

if sz:Q == '10' then ReservedValue();
integer esize = 32 << UInt(sz);
integer datasize = if Q == '1' then 128 else 64;
integer elements = datasize DIV esize;

boolean exact = FALSE;
FPRounding rounding;
case U:o1:o2 of
    when '0xx' rounding = FPDecodeRounding(o1:o2);
    when '100' rounding = FPRounding_TIEAWAY;
    when '101' UnallocatedEncoding();
    when '110' rounding = FPRoundingMode(FPCR); exact = TRUE;
    when '111' rounding = FPRoundingMode(FPCR);
```

Assembler symbols

- <Vd> Is the name of the SIMD&FP destination register, encoded in the "Rd" field.
- <T> For the half-precision variant: is an arrangement specifier, encoded in the "Q" field. It can have the following values:
- | | |
|----|------------|
| 4H | when Q = 0 |
| 8H | when Q = 1 |
- For the single-precision and double-precision variant: is an arrangement specifier, encoded in the "sz:Q" field. It can have the following values:
- | | |
|----|--------------------|
| 2S | when sz = 0, Q = 0 |
| 4S | when sz = 0, Q = 1 |
| 2D | when sz = 1, Q = 1 |
- The encoding sz = 1, Q = 0 is reserved.
- <Vn> Is the name of the SIMD&FP source register, encoded in the "Rn" field.

Operation for all encodings

```
CheckFPAdvSIMDEnabled64();
bits(datasize) operand = V[n];
bits(datasize) result;
bits(esize) element;

for e = 0 to elements-1
    element = Elem[operand, e, esize];
    Elem[result, e, esize] = FPRoundInt(element, FPCR, rounding, exact);

V[d] = result;
```

C7.2.137 FRINTN (scalar)

Floating-point Round to Integral, to nearest with ties to even (scalar). This instruction rounds a floating-point value in the SIMD&FP source register to an integral floating-point value of the same size using the Round to Nearest rounding mode, and writes the result to the SIMD&FP destination register.

A zero input gives a zero result with the same sign, an infinite input gives an infinite result with the same sign, and a NaN is propagated as for normal arithmetic.

A floating-point exception can be generated by this instruction. Depending on the settings in [FPCR](#), the exception results in either a flag being set in [FPSR](#), or a synchronous exception being generated. For more information, see [Floating-point exceptions and exception traps on page D1-1831](#).

Depending on the settings in the [CPACR_EL1](#), [CPTR_EL2](#), and [CPTR_EL3](#) registers, and the current Security state and Exception level, an attempt to execute the instruction might be trapped.

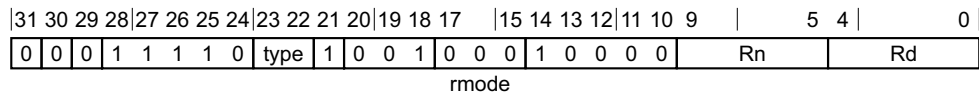

Half-precision variant

Applies when type == 11.

FRINTN <Hd>, <Hn>

Single-precision variant

Applies when type == 00.

FRINTN <Sd>, <Sn>

Double-precision variant

Applies when type == 01.

FRINTN <Dd>, <Dn>

Decode for all variants of this encoding

```
integer d = UInt(Rd);
integer n = UInt(Rn);

integer datasize;
case type of
    when '00' datasize = 32;
    when '01' datasize = 64;
    when '10' UnallocatedEncoding();
    when '11'
        if HaveFP16Ext() then
            datasize = 16;
        else
            UnallocatedEncoding();

FPRounding rounding;
rounding = FPDecodeRounding('00');
```

Assembler symbols

- <Dd> Is the 64-bit name of the SIMD&FP destination register, encoded in the "Rd" field.
- <Dn> Is the 64-bit name of the SIMD&FP source register, encoded in the "Rn" field.

- <Hd> Is the 16-bit name of the SIMD&FP destination register, encoded in the "Rd" field.
- <Hn> Is the 16-bit name of the SIMD&FP source register, encoded in the "Rn" field.
- <Sd> Is the 32-bit name of the SIMD&FP destination register, encoded in the "Rd" field.
- <Sn> Is the 32-bit name of the SIMD&FP source register, encoded in the "Rn" field.

Operation

```
CheckFPAdvSIMDEnabled64();  
  
bits(datasize) result;  
bits(datasize) operand = V[n];  
  
result = FPRoundInt(operand, FPCR, rounding, FALSE);  
  
V[d] = result;
```

C7.2.138 FRINTP (vector)

Floating-point Round to Integral, toward Plus infinity (vector). This instruction rounds a vector of floating-point values in the SIMD&FP source register to integral floating-point values of the same size using the Round towards Plus Infinity rounding mode, and writes the result to the SIMD&FP destination register.

A zero input gives a zero result with the same sign, an infinite input gives an infinite result with the same sign, and a NaN is propagated as for normal arithmetic.

A floating-point exception can be generated by this instruction. Depending on the settings in [FPCR](#), the exception results in either a flag being set in [FPSR](#), or a synchronous exception being generated. For more information, see [Floating-point exceptions and exception traps on page D1-1831](#).

Depending on the settings in the [CPACR_EL1](#), [CPTR_EL2](#), and [CPTR_EL3](#) registers, and the current Security state and Exception level, an attempt to execute the instruction might be trapped.

Half-precision

ARMv8.2

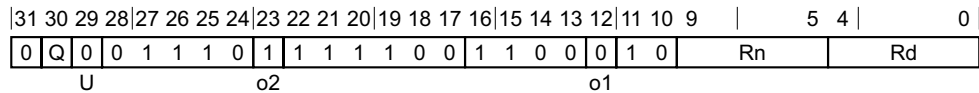

Half-precision variant

FRINTP <Vd>.<T>, <Vn>.<T>

Decode for this encoding

```

if !HaveFP16Ext() then UnallocatedEncoding();

integer d = UInt(Rd);
integer n = UInt(Rn);

integer esize = 16;
integer datasize = if Q == '1' then 128 else 64;
integer elements = datasize DIV esize;

boolean exact = FALSE;
FPRounding rounding;
case U:o1:o2 of
    when '0xx' rounding = FPDecodeRounding(o1:o2);
    when '100' rounding = FPRounding_TIEAWAY;
    when '101' UnallocatedEncoding();
    when '110' rounding = FPRoundingMode(FPCR); exact = TRUE;
    when '111' rounding = FPRoundingMode(FPCR);
    
```

Single-precision and double-precision

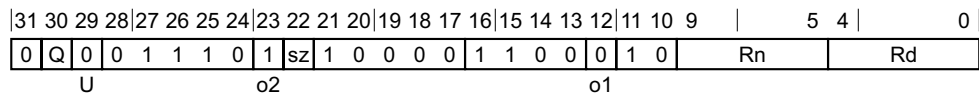

Single-precision and double-precision variant

FRINTP <Vd>.<T>, <Vn>.<T>

Decode for this encoding

```
integer d = UInt(Rd);
integer n = UInt(Rn);

if sz:Q == '10' then ReservedValue();
integer esize = 32 << UInt(sz);
integer datasize = if Q == '1' then 128 else 64;
integer elements = datasize DIV esize;

boolean exact = FALSE;
FPRounding rounding;
case U:o1:o2 of
    when '0xx' rounding = FPDecodeRounding(o1:o2);
    when '100' rounding = FPRounding_TIEAWAY;
    when '101' UnallocatedEncoding();
    when '110' rounding = FPRoundingMode(FPCR); exact = TRUE;
    when '111' rounding = FPRoundingMode(FPCR);
```

Assembler symbols

- <Vd> Is the name of the SIMD&FP destination register, encoded in the "Rd" field.
- <T> For the half-precision variant: is an arrangement specifier, encoded in the "Q" field. It can have the following values:
- | | |
|----|------------|
| 4H | when Q = 0 |
| 8H | when Q = 1 |
- For the single-precision and double-precision variant: is an arrangement specifier, encoded in the "sz:Q" field. It can have the following values:
- | | |
|----|--------------------|
| 2S | when sz = 0, Q = 0 |
| 4S | when sz = 0, Q = 1 |
| 2D | when sz = 1, Q = 1 |
- The encoding sz = 1, Q = 0 is reserved.
- <Vn> Is the name of the SIMD&FP source register, encoded in the "Rn" field.

Operation for all encodings

```
CheckFPAdvSIMDEnabled64();
bits(datasize) operand = V[n];
bits(datasize) result;
bits(esize) element;

for e = 0 to elements-1
    element = Elem[operand, e, esize];
    Elem[result, e, esize] = FPRoundInt(element, FPCR, rounding, exact);

V[d] = result;
```

C7.2.139 FRINTP (scalar)

Floating-point Round to Integral, toward Plus infinity (scalar). This instruction rounds a floating-point value in the SIMD&FP source register to an integral floating-point value of the same size using the Round towards Plus Infinity rounding mode, and writes the result to the SIMD&FP destination register.

A zero input gives a zero result with the same sign, an infinite input gives an infinite result with the same sign, and a NaN is propagated as for normal arithmetic.

A floating-point exception can be generated by this instruction. Depending on the settings in [FPCR](#), the exception results in either a flag being set in [FPSR](#), or a synchronous exception being generated. For more information, see [Floating-point exceptions and exception traps on page D1-1831](#).

Depending on the settings in the [CPACR_EL1](#), [CPTR_EL2](#), and [CPTR_EL3](#) registers, and the current Security state and Exception level, an attempt to execute the instruction might be trapped.

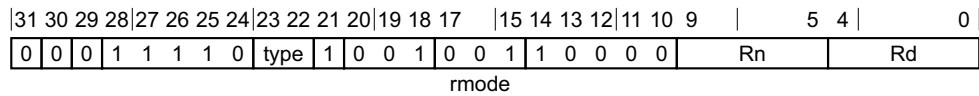

Half-precision variant

Applies when type == 11.

FRINTP <Hd>, <Hn>

Single-precision variant

Applies when type == 00.

FRINTP <Sd>, <Sn>

Double-precision variant

Applies when type == 01.

FRINTP <Dd>, <Dn>

Decode for all variants of this encoding

```
integer d = UInt(Rd);
integer n = UInt(Rn);

integer datasize;
case type of
    when '00' datasize = 32;
    when '01' datasize = 64;
    when '10' UnallocatedEncoding();
    when '11'
        if HaveFP16Ext() then
            datasize = 16;
        else
            UnallocatedEncoding();

FPRounding rounding;
rounding = FPDecodeRounding('01');
```

Assembler symbols

- <Dd> Is the 64-bit name of the SIMD&FP destination register, encoded in the "Rd" field.
- <Dn> Is the 64-bit name of the SIMD&FP source register, encoded in the "Rn" field.

- <Hd> Is the 16-bit name of the SIMD&FP destination register, encoded in the "Rd" field.
- <Hn> Is the 16-bit name of the SIMD&FP source register, encoded in the "Rn" field.
- <Sd> Is the 32-bit name of the SIMD&FP destination register, encoded in the "Rd" field.
- <Sn> Is the 32-bit name of the SIMD&FP source register, encoded in the "Rn" field.

Operation

```
CheckFPAdvSIMDEnabled64();  
  
bits(datasize) result;  
bits(datasize) operand = V[n];  
  
result = FPRoundInt(operand, FPCR, rounding, FALSE);  
  
V[d] = result;
```

C7.2.140 FRINTX (vector)

Floating-point Round to Integral exact, using current rounding mode (vector). This instruction rounds a vector of floating-point values in the SIMD&FP source register to integral floating-point values of the same size using the rounding mode that is determined by the [FPCR](#), and writes the result to the SIMD&FP destination register.

An Inexact exception is raised when the result value is not numerically equal to the input value. A zero input gives a zero result with the same sign, an infinite input gives an infinite result with the same sign, and a NaN is propagated as for normal arithmetic.

A floating-point exception can be generated by this instruction. Depending on the settings in [FPCR](#), the exception results in either a flag being set in [FPSR](#), or a synchronous exception being generated. For more information, see [Floating-point exceptions and exception traps on page D1-1831](#).

Depending on the settings in the [CPACR_EL1](#), [CPTR_EL2](#), and [CPTR_EL3](#) registers, and the current Security state and Exception level, an attempt to execute the instruction might be trapped.

Half-precision

ARMv8.2

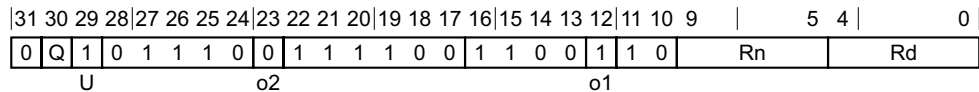

Half-precision variant

FRINTX <Vd>.<T>, <Vn>.<T>

Decode for this encoding

```

if !HaveFP16Ext() then UnallocatedEncoding();

integer d = UInt(Rd);
integer n = UInt(Rn);

integer esize = 16;
integer datasize = if Q == '1' then 128 else 64;
integer elements = datasize DIV esize;

boolean exact = FALSE;
FPRounding rounding;
case U:o1:o2 of
    when '0xx' rounding = FPDecodeRounding(o1:o2);
    when '100' rounding = FPRounding_TIEAWAY;
    when '101' UnallocatedEncoding();
    when '110' rounding = FPRoundingMode(FPCR); exact = TRUE;
    when '111' rounding = FPRoundingMode(FPCR);
    
```

Single-precision and double-precision

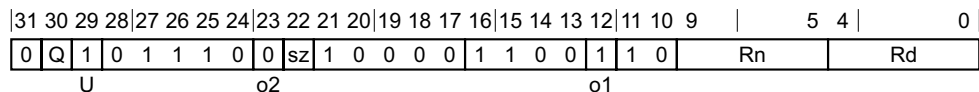

Single-precision and double-precision variant

FRINTX <Vd>.<T>, <Vn>.<T>

Decode for this encoding

```
integer d = UInt(Rd);
integer n = UInt(Rn);

if sz:Q == '10' then ReservedValue();
integer esize = 32 << UInt(sz);
integer datasize = if Q == '1' then 128 else 64;
integer elements = datasize DIV esize;

boolean exact = FALSE;
FPRounding rounding;
case U:o1:o2 of
    when '0xx' rounding = FPDecodeRounding(o1:o2);
    when '100' rounding = FPRounding_TIEAWAY;
    when '101' UnallocatedEncoding();
    when '110' rounding = FPRoundingMode(FPCR); exact = TRUE;
    when '111' rounding = FPRoundingMode(FPCR);
```

Assembler symbols

- <Vd> Is the name of the SIMD&FP destination register, encoded in the "Rd" field.
- <T> For the half-precision variant: is an arrangement specifier, encoded in the "Q" field. It can have the following values:
- | | |
|----|------------|
| 4H | when Q = 0 |
| 8H | when Q = 1 |
- For the single-precision and double-precision variant: is an arrangement specifier, encoded in the "sz:Q" field. It can have the following values:
- | | |
|----|--------------------|
| 2S | when sz = 0, Q = 0 |
| 4S | when sz = 0, Q = 1 |
| 2D | when sz = 1, Q = 1 |
- The encoding sz = 1, Q = 0 is reserved.
- <Vn> Is the name of the SIMD&FP source register, encoded in the "Rn" field.

Operation for all encodings

```
CheckFPAdvSIMDEnabled64();
bits(datasize) operand = V[n];
bits(datasize) result;
bits(esize) element;

for e = 0 to elements-1
    element = Elem[operand, e, esize];
    Elem[result, e, esize] = FPRoundInt(element, FPCR, rounding, exact);

V[d] = result;
```

C7.2.141 FRINTX (scalar)

Floating-point Round to Integral exact, using current rounding mode (scalar). This instruction rounds a floating-point value in the SIMD&FP source register to an integral floating-point value of the same size using the rounding mode that is determined by the [FPCR](#), and writes the result to the SIMD&FP destination register.

An Inexact exception is raised when the result value is not numerically equal to the input value. A zero input gives a zero result with the same sign, an infinite input gives an infinite result with the same sign, and a NaN is propagated as for normal arithmetic.

A floating-point exception can be generated by this instruction. Depending on the settings in [FPCR](#), the exception results in either a flag being set in [FPSR](#), or a synchronous exception being generated. For more information, see [Floating-point exceptions and exception traps on page D1-1831](#).

Depending on the settings in the [CPACR_EL1](#), [CPTR_EL2](#), and [CPTR_EL3](#) registers, and the current Security state and Exception level, an attempt to execute the instruction might be trapped.

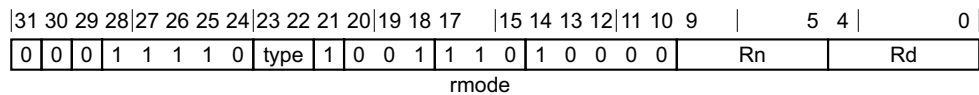

Half-precision variant

Applies when type == 11.

FRINTX <Hd>, <Hn>

Single-precision variant

Applies when type == 00.

FRINTX <Sd>, <Sn>

Double-precision variant

Applies when type == 01.

FRINTX <Dd>, <Dn>

Decode for all variants of this encoding

```
integer d = UInt(Rd);
integer n = UInt(Rn);

integer datasize;
case type of
    when '00' datasize = 32;
    when '01' datasize = 64;
    when '10' UnallocatedEncoding();
    when '11'
        if HaveFP16Ext() then
            datasize = 16;
        else
            UnallocatedEncoding();

FPRounding rounding;
rounding = FPRoundingMode(FPCR);
```

Assembler symbols

<Dd> Is the 64-bit name of the SIMD&FP destination register, encoded in the "Rd" field.

- <Dn> Is the 64-bit name of the SIMD&FP source register, encoded in the "Rn" field.
- <Hd> Is the 16-bit name of the SIMD&FP destination register, encoded in the "Rd" field.
- <Hn> Is the 16-bit name of the SIMD&FP source register, encoded in the "Rn" field.
- <Sd> Is the 32-bit name of the SIMD&FP destination register, encoded in the "Rd" field.
- <Sn> Is the 32-bit name of the SIMD&FP source register, encoded in the "Rn" field.

Operation

```
CheckFPAdvSIMDEnabled64();  
  
bits(datasize) result;  
bits(datasize) operand = V[n];  
  
result = FPRoundInt(operand, FPCR, rounding, TRUE);  
  
V[d] = result;
```

C7.2.142 FRINTZ (vector)

Floating-point Round to Integral, toward Zero (vector). This instruction rounds a vector of floating-point values in the SIMD&FP source register to integral floating-point values of the same size using the Round towards Zero rounding mode, and writes the result to the SIMD&FP destination register.

A zero input gives a zero result with the same sign, an infinite input gives an infinite result with the same sign, and a NaN is propagated as for normal arithmetic.

A floating-point exception can be generated by this instruction. Depending on the settings in [FPCR](#), the exception results in either a flag being set in [FPSR](#), or a synchronous exception being generated. For more information, see [Floating-point exceptions and exception traps on page D1-1831](#).

Depending on the settings in the [CPACR_EL1](#), [CPTR_EL2](#), and [CPTR_EL3](#) registers, and the current Security state and Exception level, an attempt to execute the instruction might be trapped.

Half-precision

ARMv8.2

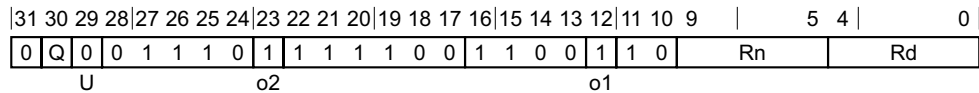

Half-precision variant

FRINTZ <Vd>.<T>, <Vn>.<T>

Decode for this encoding

```

if !HaveFP16Ext() then UnallocatedEncoding();

integer d = UInt(Rd);
integer n = UInt(Rn);

integer esize = 16;
integer datasize = if Q == '1' then 128 else 64;
integer elements = datasize DIV esize;

boolean exact = FALSE;
FPRounding rounding;
case U:o1:o2 of
    when '0xx' rounding = FPDecodeRounding(o1:o2);
    when '100' rounding = FPRounding_TIEAWAY;
    when '101' UnallocatedEncoding();
    when '110' rounding = FPRoundingMode(FPCR); exact = TRUE;
    when '111' rounding = FPRoundingMode(FPCR);
    
```

Single-precision and double-precision

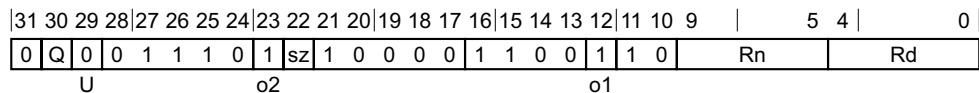

Single-precision and double-precision variant

FRINTZ <Vd>.<T>, <Vn>.<T>

Decode for this encoding

```
integer d = UInt(Rd);
integer n = UInt(Rn);

if sz:Q == '10' then ReservedValue();
integer esize = 32 << UInt(sz);
integer datasize = if Q == '1' then 128 else 64;
integer elements = datasize DIV esize;

boolean exact = FALSE;
FPRounding rounding;
case U:o1:o2 of
  when '0xx' rounding = FPDecodeRounding(o1:o2);
  when '100' rounding = FPRounding_TIEAWAY;
  when '101' UnallocatedEncoding();
  when '110' rounding = FPRoundingMode(FPCR); exact = TRUE;
  when '111' rounding = FPRoundingMode(FPCR);
```

Assembler symbols

- <Vd> Is the name of the SIMD&FP destination register, encoded in the "Rd" field.
- <T> For the half-precision variant: is an arrangement specifier, encoded in the "Q" field. It can have the following values:
- | | |
|----|------------|
| 4H | when Q = 0 |
| 8H | when Q = 1 |
- For the single-precision and double-precision variant: is an arrangement specifier, encoded in the "sz:Q" field. It can have the following values:
- | | |
|----|--------------------|
| 2S | when sz = 0, Q = 0 |
| 4S | when sz = 0, Q = 1 |
| 2D | when sz = 1, Q = 1 |
- The encoding sz = 1, Q = 0 is reserved.
- <Vn> Is the name of the SIMD&FP source register, encoded in the "Rn" field.

Operation for all encodings

```
CheckFPAdvSIMDEnabled64();
bits(datasize) operand = V[n];
bits(datasize) result;
bits(esize) element;

for e = 0 to elements-1
  element = Elem[operand, e, esize];
  Elem[result, e, esize] = FPRoundInt(element, FPCR, rounding, exact);

V[d] = result;
```

C7.2.143 FRINTZ (scalar)

Floating-point Round to Integral, toward Zero (scalar). This instruction rounds a floating-point value in the SIMD&FP source register to an integral floating-point value of the same size using the Round towards Zero rounding mode, and writes the result to the SIMD&FP destination register.

A zero input gives a zero result with the same sign, an infinite input gives an infinite result with the same sign, and a NaN is propagated as for normal arithmetic.

A floating-point exception can be generated by this instruction. Depending on the settings in [FPCR](#), the exception results in either a flag being set in [FPSR](#), or a synchronous exception being generated. For more information, see [Floating-point exceptions and exception traps on page D1-1831](#).

Depending on the settings in the [CPACR_EL1](#), [CPTR_EL2](#), and [CPTR_EL3](#) registers, and the current Security state and Exception level, an attempt to execute the instruction might be trapped.

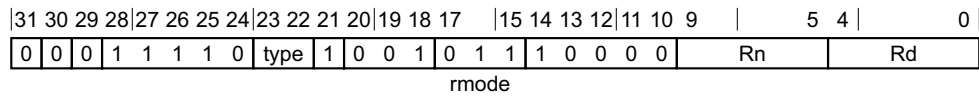

Half-precision variant

Applies when type == 11.

FRINTZ <Hd>, <Hn>

Single-precision variant

Applies when type == 00.

FRINTZ <Sd>, <Sn>

Double-precision variant

Applies when type == 01.

FRINTZ <Dd>, <Dn>

Decode for all variants of this encoding

```
integer d = UInt(Rd);
integer n = UInt(Rn);

integer datasize;
case type of
    when '00' datasize = 32;
    when '01' datasize = 64;
    when '10' UnallocatedEncoding();
    when '11'
        if HaveFP16Ext() then
            datasize = 16;
        else
            UnallocatedEncoding();

FPRounding rounding;
rounding = FPDecodeRounding('11');
```

Assembler symbols

- <Dd> Is the 64-bit name of the SIMD&FP destination register, encoded in the "Rd" field.
- <Dn> Is the 64-bit name of the SIMD&FP source register, encoded in the "Rn" field.

- <Hd> Is the 16-bit name of the SIMD&FP destination register, encoded in the "Rd" field.
- <Hn> Is the 16-bit name of the SIMD&FP source register, encoded in the "Rn" field.
- <Sd> Is the 32-bit name of the SIMD&FP destination register, encoded in the "Rd" field.
- <Sn> Is the 32-bit name of the SIMD&FP source register, encoded in the "Rn" field.

Operation

```
CheckFPAdvSIMDEnabled64();  
  
bits(datasize) result;  
bits(datasize) operand = V[n];  
  
result = FPRoundInt(operand, FPCR, rounding, FALSE);  
  
V[d] = result;
```

C7.2.144 FRSQRTE

Floating-point Reciprocal Square Root Estimate. This instruction calculates an approximate square root for each vector element in the source SIMD&FP register, places the result in a vector, and writes the vector to the destination SIMD&FP register.

This instruction can generate a floating-point exception. Depending on the settings in [FPCR](#), the exception results in either a flag being set in [FPSR](#) or a synchronous exception being generated. For more information, see [Floating-point exceptions and exception traps on page D1-1831](#).

Depending on the settings in the [CPACR_EL1](#), [CPTR_EL2](#), and [CPTR_EL3](#) registers, and the current Security state and Exception level, an attempt to execute the instruction might be trapped.

Scalar half precision

ARMv8.2

31	30	29	28	27	26	25	24	23	22	21	20	19	18	17	16	15	14	13	12	11	10	9			5	4			0	
0	1	1	1	1	1	1	0	1	1	1	1	0	0	1	1	1	0	1	1	0										
																							Rn			Rd				

Scalar half precision variant

FRSQRTE <Hd>, <Hn>

Decode for this encoding

```
if !HaveFP16Ext() then UnallocatedEncoding();

integer d = UInt(Rd);
integer n = UInt(Rn);

integer esize = 16;
integer datasize = esize;
integer elements = 1;
```

Scalar single-precision and double-precision

31	30	29	28	27	26	25	24	23	22	21	20	19	18	17	16	15	14	13	12	11	10	9			5	4			0
0	1	1	1	1	1	1	0	1	sz	1	0	0	0	0	1	1	1	0	1	1	0								
																							Rn			Rd			

Scalar single-precision and double-precision variant

FRSQRTE <V><d>, <V><n>

Decode for this encoding

```
integer d = UInt(Rd);
integer n = UInt(Rn);

integer esize = 32 << UInt(sz);
integer datasize = esize;
integer elements = 1;
```

Vector half precision

ARMv8.2

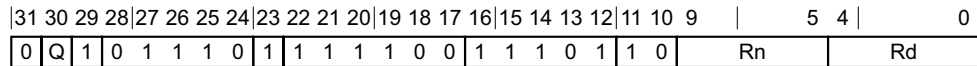

Vector half precision variant

FRSQRTE <Vd>.<T>, <Vn>.<T>

Decode for this encoding

```

if !HaveFP16Ext() then UnallocatedEncoding();

integer d = UInt(Rd);
integer n = UInt(Rn);

integer esize = 16;
integer datasize = if Q == '1' then 128 else 64;
integer elements = datasize DIV esize;
    
```

Vector single-precision and double-precision

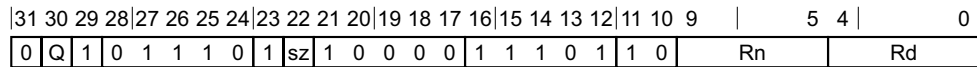

Vector single-precision and double-precision variant

FRSQRTE <Vd>.<T>, <Vn>.<T>

Decode for this encoding

```

integer d = UInt(Rd);
integer n = UInt(Rn);

if sz:Q == '10' then ReservedValue();
integer esize = 32 << UInt(sz);
integer datasize = if Q == '1' then 128 else 64;
integer elements = datasize DIV esize;
    
```

Assembler symbols

- <Hd> Is the 16-bit name of the SIMD&FP destination register, encoded in the "Rd" field.
- <Hn> Is the 16-bit name of the SIMD&FP source register, encoded in the "Rn" field.
- <V> Is a width specifier, encoded in the "sz" field. It can have the following values:
 - S when sz = 0
 - D when sz = 1
- <d> Is the number of the SIMD&FP destination register, encoded in the "Rd" field.
- <n> Is the number of the SIMD&FP source register, encoded in the "Rn" field.
- <Vd> Is the name of the SIMD&FP destination register, encoded in the "Rd" field.
- <T> For the vector half precision variant: is an arrangement specifier, encoded in the "Q" field. It can have the following values:
 - 4H when Q = 0
 - 8H when Q = 1

For the vector single-precision and double-precision variant: is an arrangement specifier, encoded in the "sz:Q" field. It can have the following values:

2S when sz = 0, Q = 0

4S when sz = 0, Q = 1

2D when sz = 1, Q = 1

The encoding sz = 1, Q = 0 is reserved.

<Vn> Is the name of the SIMD&FP source register, encoded in the "Rn" field.

Operation for all encodings

```
CheckFPAdvSIMDEnabled64();
bits(datasize) operand = V[n];
bits(datasize) result;
bits(esize) element;

for e = 0 to elements-1
    element = Elem[operand, e, esize];
    Elem[result, e, esize] = FPRSqrtEstimate(element, FPCR);

V[d] = result;
```

C7.2.145 FRSQRTS

Floating-point Reciprocal Square Root Step. This instruction multiplies corresponding floating-point values in the vectors of the two source SIMD&FP registers, subtracts each of the products from 3.0, divides these results by 2.0, places the results into a vector, and writes the vector to the destination SIMD&FP register.

This instruction can generate a floating-point exception. Depending on the settings in [FPCR](#), the exception results in either a flag being set in [FPSR](#), or a synchronous exception being generated. For more information, see [Floating-point exceptions and exception traps on page D1-1831](#).

Depending on the settings in the [CPACR_EL1](#), [CPTR_EL2](#), and [CPTR_EL3](#) registers, and the current Security state and Exception level, an attempt to execute the instruction might be trapped.

Scalar half precision

ARMv8.2

31	30	29	28	27	26	25	24	23	22	21	20	16	15	14	13	12	11	10	9	5	4	0
0	1	0	1	1	1	1	0	1	1	0	Rm	0	0	1	1	1	1	Rn	Rd			

Scalar half precision variant

FRSQRTS <Hd>, <Hn>, <Hm>

Decode for this encoding

```
if !HaveFP16Ext() then UnallocatedEncoding();
```

```
integer d = UInt(Rd);
integer n = UInt(Rn);
integer m = UInt(Rm);
integer esize = 16;
integer datasize = esize;
integer elements = 1;
```

Scalar single-precision and double-precision

31	30	29	28	27	26	25	24	23	22	21	20	16	15	14	13	12	11	10	9	5	4	0
0	1	0	1	1	1	1	0	1	sz	1	Rm	1	1	1	1	1	1	Rn	Rd			

Scalar single-precision and double-precision variant

FRSQRTS <V><d>, <V><n>, <V><m>

Decode for this encoding

```
integer d = UInt(Rd);
integer n = UInt(Rn);
integer m = UInt(Rm);
integer esize = 32 << UInt(sz);
integer datasize = esize;
integer elements = 1;
```

Vector half precision

ARMv8.2

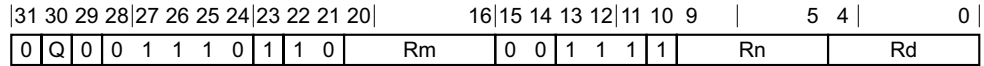

Vector half precision variant

FRSQRTS <Vd>.<T>, <Vn>.<T>, <Vm>.<T>

Decode for this encoding

```
if !HaveFP16Ext() then UnallocatedEncoding();

integer d = UInt(Rd);
integer n = UInt(Rn);
integer m = UInt(Rm);
integer esize = 16;
integer datasize = if Q == '1' then 128 else 64;
integer elements = datasize DIV esize;
```

Vector single-precision and double-precision

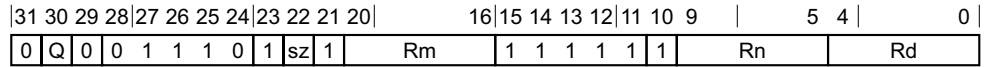

Vector single-precision and double-precision variant

FRSQRTS <Vd>.<T>, <Vn>.<T>, <Vm>.<T>

Decode for this encoding

```
integer d = UInt(Rd);
integer n = UInt(Rn);
integer m = UInt(Rm);
if sz:Q == '10' then ReservedValue();
integer esize = 32 << UInt(sz);
integer datasize = if Q == '1' then 128 else 64;
integer elements = datasize DIV esize;
```

Assembler symbols

- <Hd> Is the 16-bit name of the SIMD&FP destination register, encoded in the "Rd" field.
- <Hn> Is the 16-bit name of the first SIMD&FP source register, encoded in the "Rn" field.
- <Hm> Is the 16-bit name of the second SIMD&FP source register, encoded in the "Rm" field.
- <V> Is a width specifier, encoded in the "sz" field. It can have the following values:
 - S when sz = 0
 - D when sz = 1
- <d> Is the number of the SIMD&FP destination register, in the "Rd" field.
- <n> Is the number of the first SIMD&FP source register, encoded in the "Rn" field.
- <m> Is the number of the second SIMD&FP source register, encoded in the "Rm" field.
- <Vd> Is the name of the SIMD&FP destination register, encoded in the "Rd" field.

- <T> For the vector half precision variant: is an arrangement specifier, encoded in the "Q" field. It can have the following values:
- 4H when Q = 0
 - 8H when Q = 1
- For the vector single-precision and double-precision variant: is an arrangement specifier, encoded in the "sz:Q" field. It can have the following values:
- 2S when sz = 0, Q = 0
 - 4S when sz = 0, Q = 1
 - 2D when sz = 1, Q = 1
- The encoding sz = 1, Q = 0 is reserved.
- <Vn> Is the name of the first SIMD&FP source register, encoded in the "Rn" field.
- <Vm> Is the name of the second SIMD&FP source register, encoded in the "Rm" field.

Operation for all encodings

```
CheckFPAdvSIMDEnabled64();
bits(datasize) operand1 = V[n];
bits(datasize) operand2 = V[m];
bits(datasize) result;
bits(esize) element1;
bits(esize) element2;

for e = 0 to elements-1
    element1 = Elem[operand1, e, esize];
    element2 = Elem[operand2, e, esize];
    Elem[result, e, esize] = FPRSqrtStepFused(element1, element2);

V[d] = result;
```

C7.2.146 FSQRT (vector)

Floating-point Square Root (vector). This instruction calculates the square root for each vector element in the source SIMD&FP register, places the result in a vector, and writes the vector to the destination SIMD&FP register.

This instruction can generate a floating-point exception. Depending on the settings in [FPCR](#), the exception results in either a flag being set in [FPSR](#) or a synchronous exception being generated. For more information, see [Floating-point exceptions and exception traps on page D1-1831](#).

Depending on the settings in the [CPACR_EL1](#), [CPTR_EL2](#), and [CPTR_EL3](#) registers, and the current Security state and Exception level, an attempt to execute the instruction might be trapped.

Half-precision

ARMv8.2

31	30	29	28	27	26	25	24	23	22	21	20	19	18	17	16	15	14	13	12	11	10	9				5	4				0
0	Q	1	0	1	1	1	0	1	1	1	1	0	0	1	1	1	1	1	1	0	Rn			Rd							

Half-precision variant

FSQRT <Vd>.<T>, <Vn>.<T>

Decode for this encoding

```
if !HaveFP16Ext() then UnallocatedEncoding();
integer d = UInt(Rd);
integer n = UInt(Rn);

integer esize = 16;
integer datasize = if Q == '1' then 128 else 64;
integer elements = datasize DIV esize;
```

Single-precision and double-precision

31	30	29	28	27	26	25	24	23	22	21	20	19	18	17	16	15	14	13	12	11	10	9				5	4				0
0	Q	1	0	1	1	1	0	1	sz	1	0	0	0	0	1	1	1	1	1	1	0	Rn			Rd						

Single-precision and double-precision variant

FSQRT <Vd>.<T>, <Vn>.<T>

Decode for this encoding

```
integer d = UInt(Rd);
integer n = UInt(Rn);

if sz:Q == '10' then ReservedValue();
integer esize = 32 << UInt(sz);
integer datasize = if Q == '1' then 128 else 64;
integer elements = datasize DIV esize;
```

Assembler symbols

<Vd> Is the name of the SIMD&FP destination register, encoded in the "Rd" field.

<T> For the half-precision variant: is an arrangement specifier, encoded in the "Q" field. It can have the following values:

4H when Q = 0

8H when Q = 1

For the single-precision and double-precision variant: is an arrangement specifier, encoded in the "sz:Q" field. It can have the following values:

2S when sz = 0, Q = 0

4S when sz = 0, Q = 1

2D when sz = 1, Q = 1

The encoding sz = 1, Q = 0 is reserved.

<Vn> Is the name of the SIMD&FP source register, encoded in the "Rn" field.

Operation for all encodings

```
CheckFPAdvSIMDEnabled64();
bits(datasize) operand = V[n];
bits(datasize) result;
bits(esize) element;

for e = 0 to elements-1
    element = Elem[operand, e, esize];
    Elem[result, e, esize] = FPSqrt(element, FPCR);

V[d] = result;
```

C7.2.147 FSQRT (scalar)

Floating-point Square Root (scalar). This instruction calculates the square root of the value in the SIMD&FP source register and writes the result to the SIMD&FP destination register.

A floating-point exception can be generated by this instruction. Depending on the settings in [FPCR](#), the exception results in either a flag being set in [FPSR](#), or a synchronous exception being generated. For more information, see [Floating-point exceptions and exception traps on page D1-1831](#).

Depending on the settings in the [CPACR_EL1](#), [CPTR_EL2](#), and [CPTR_EL3](#) registers, and the current Security state and Exception level, an attempt to execute the instruction might be trapped.

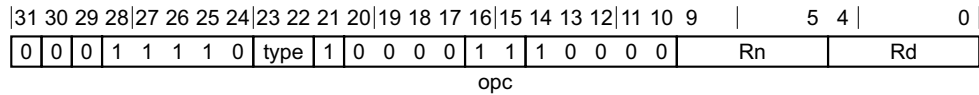

Half-precision variant

Applies when type == 11.

FSQRT <Hd>, <Hn>

Single-precision variant

Applies when type == 00.

FSQRT <Sd>, <Sn>

Double-precision variant

Applies when type == 01.

FSQRT <Dd>, <Dn>

Decode for all variants of this encoding

```
integer d = UInt(Rd);
integer n = UInt(Rn);

integer datasize;
case type of
    when '00' datasize = 32;
    when '01' datasize = 64;
    when '10' UnallocatedEncoding();
    when '11'
        if HaveFP16Ext() then
            datasize = 16;
        else
            UnallocatedEncoding();
```

Assembler symbols

- <Dd> Is the 64-bit name of the SIMD&FP destination register, encoded in the "Rd" field.
- <Dn> Is the 64-bit name of the SIMD&FP source register, encoded in the "Rn" field.
- <Hd> Is the 16-bit name of the SIMD&FP destination register, encoded in the "Rd" field.
- <Hn> Is the 16-bit name of the SIMD&FP source register, encoded in the "Rn" field.
- <Sd> Is the 32-bit name of the SIMD&FP destination register, encoded in the "Rd" field.

<Sn> Is the 32-bit name of the SIMD&FP source register, encoded in the "Rn" field.

Operation

```
CheckFPAdvSIMDEnabled64();  
  
bits(datasize) result;  
bits(datasize) operand = V[n];  
  
result = FPSqrt(operand, FPCR);  
  
V[d] = result;
```

C7.2.148 FSUB (vector)

Floating-point Subtract (vector). This instruction subtracts the elements in the vector in the second source SIMD&FP register, from the corresponding elements in the vector in the first source SIMD&FP register, places each result into elements of a vector, and writes the vector to the destination SIMD&FP register.

This instruction can generate a floating-point exception. Depending on the settings in [FPCR](#), the exception results in either a flag being set in [FPSR](#), or a synchronous exception being generated. For more information, see [Floating-point exceptions and exception traps on page D1-1831](#).

Depending on the settings in the [CPACR_EL1](#), [CPTR_EL2](#), and [CPTR_EL3](#) registers, and the current Security state and Exception level, an attempt to execute the instruction might be trapped.

Half-precision

ARMv8.2

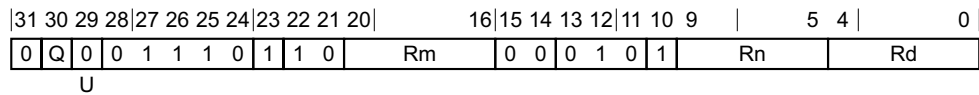

Half-precision variant

FSUB <Vd>.<T>, <Vn>.<T>, <Vm>.<T>

Decode for this encoding

```
if !HaveFP16Ext() then UnallocatedEncoding();

integer d = UInt(Rd);
integer n = UInt(Rn);
integer m = UInt(Rm);
integer esize = 16;
integer datasize = if Q == '1' then 128 else 64;
integer elements = datasize DIV esize;
boolean abs = (U == '1');
```

Single-precision and double-precision

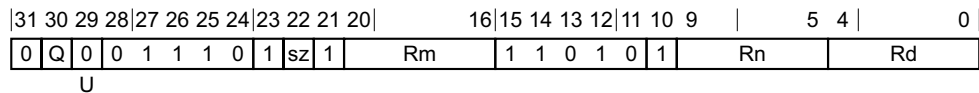

Single-precision and double-precision variant

FSUB <Vd>.<T>, <Vn>.<T>, <Vm>.<T>

Decode for this encoding

```
integer d = UInt(Rd);
integer n = UInt(Rn);
integer m = UInt(Rm);
if sz:Q == '10' then ReservedValue();
integer esize = 32 << UInt(sz);
integer datasize = if Q == '1' then 128 else 64;
integer elements = datasize DIV esize;
boolean abs = (U == '1');
```

Assembler symbols

- <Vd> Is the name of the SIMD&FP destination register, encoded in the "Rd" field.
- <T> For the half-precision variant: is an arrangement specifier, encoded in the "Q" field. It can have the following values:
- 4H when Q = 0
 - 8H when Q = 1
- For the single-precision and double-precision variant: is an arrangement specifier, encoded in the "sz:Q" field. It can have the following values:
- 2S when sz = 0, Q = 0
 - 4S when sz = 0, Q = 1
 - 2D when sz = 1, Q = 1
- The encoding sz = 1, Q = 0 is reserved.
- <Vn> Is the name of the first SIMD&FP source register, encoded in the "Rn" field.
- <Vm> Is the name of the second SIMD&FP source register, encoded in the "Rm" field.

Operation for all encodings

```
CheckFPAdvSIMDEnabled64();
bits(datasize) operand1 = V[n];
bits(datasize) operand2 = V[m];
bits(datasize) result;
bits(esize) element1;
bits(esize) element2;
bits(esize) diff;

for e = 0 to elements-1
    element1 = Elem[operand1, e, esize];
    element2 = Elem[operand2, e, esize];
    diff = FPSub(element1, element2, FPCR);
    Elem[result, e, esize] = if abs then FPAbs(diff) else diff;

V[d] = result;
```

C7.2.149 FSUB (scalar)

Floating-point Subtract (scalar). This instruction subtracts the floating-point value of the second source SIMD&FP register from the floating-point value of the first source SIMD&FP register, and writes the result to the destination SIMD&FP register.

This instruction can generate a floating-point exception. Depending on the settings in [FPCR](#), the exception results in either a flag being set in [FPSR](#), or a synchronous exception being generated. For more information, see [Floating-point exceptions and exception traps on page D1-1831](#).

Depending on the settings in the [CPACR_EL1](#), [CPTR_EL2](#), and [CPTR_EL3](#) registers, and the current Security state and Exception level, an attempt to execute the instruction might be trapped.

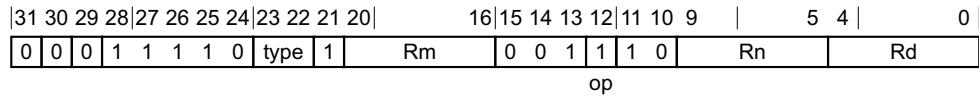

Half-precision variant

Applies when type == 11.

FSUB <Hd>, <Hn>, <Hm>

Single-precision variant

Applies when type == 00.

FSUB <Sd>, <Sn>, <Sm>

Double-precision variant

Applies when type == 01.

FSUB <Dd>, <Dn>, <Dm>

Decode for all variants of this encoding

```
integer d = UInt(Rd);
integer n = UInt(Rn);
integer m = UInt(Rm);

integer datasize;
case type of
    when '00' datasize = 32;
    when '01' datasize = 64;
    when '10' UnallocatedEncoding();
    when '11'
        if HaveFP16Ext() then
            datasize = 16;
        else
            UnallocatedEncoding();
```

Assembler symbols

- <Dd> Is the 64-bit name of the SIMD&FP destination register, encoded in the "Rd" field.
- <Dn> Is the 64-bit name of the first SIMD&FP source register, encoded in the "Rn" field.
- <Dm> Is the 64-bit name of the second SIMD&FP source register, encoded in the "Rm" field.
- <Hd> Is the 16-bit name of the SIMD&FP destination register, encoded in the "Rd" field.

- <Hn> Is the 16-bit name of the first SIMD&FP source register, encoded in the "Rn" field.
- <Hm> Is the 16-bit name of the second SIMD&FP source register, encoded in the "Rm" field.
- <Sd> Is the 32-bit name of the SIMD&FP destination register, encoded in the "Rd" field.
- <Sn> Is the 32-bit name of the first SIMD&FP source register, encoded in the "Rn" field.
- <Sm> Is the 32-bit name of the second SIMD&FP source register, encoded in the "Rm" field.

Operation

```
CheckFPAdvSIMDEnabled64();
bits(datasize) result;
bits(datasize) operand1 = V[n];
bits(datasize) operand2 = V[m];

result = FPSub(operand1, operand2, FPCR);
V[d] = result;
```

C7.2.150 INS (element)

Insert vector element from another vector element. This instruction copies the vector element of the source SIMD&FP register to the specified vector element of the destination SIMD&FP register.

This instruction can insert data into individual elements within a SIMD&FP register without clearing the remaining bits to zero.

Depending on the settings in the CPACR_EL1, CPTR_EL2, and CPTR_EL3 registers, and the current Security state and Exception level, an attempt to execute the instruction might be trapped.

This instruction is used by the alias MOV (element). The alias is always the preferred disassembly.

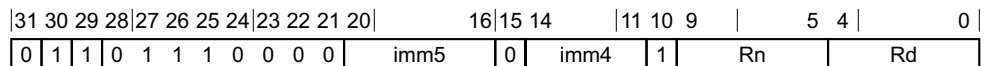

Advanced SIMD variant

INS <Vd>.<Ts>[<index1>], <Vn>.<Ts>[<index2>]

Decode for this encoding

```
integer d = UInt(Rd);
integer n = UInt(Rn);

integer size = LowestSetBit(imm5);
if size > 3 then UnallocatedEncoding();

integer dst_index = UInt(imm5<4:size+1>);
integer src_index = UInt(imm4<3:size>);
integer idxdsize = if imm4<3> == '1' then 128 else 64;
// imm4<size-1:0> is IGNORED

integer esize = 8 << size;
```

Assembler symbols

- <Vd> Is the name of the SIMD&FP destination register, encoded in the "Rd" field.
- <Ts> Is an element size specifier, encoded in the "imm5" field. It can have the following values:
 - B when imm5 = xxxx1
 - H when imm5 = xxx10
 - S when imm5 = xx100
 - D when imm5 = x1000
 The encoding imm5 = x0000 is reserved.
- <index1> Is the destination element index encoded in the "imm5" field. It can have the following values:
 - imm5<4:1> when imm5 = xxxx1
 - imm5<4:2> when imm5 = xxx10
 - imm5<4:3> when imm5 = xx100
 - imm5<4> when imm5 = x1000
 The encoding imm5 = x0000 is reserved.
- <Vn> Is the name of the SIMD&FP source register, encoded in the "Rn" field.

<index2> Is the source element index encoded in the "imm5:imm4" field. It can have the following values:

- imm4<3:0> when imm5 = xxxx1
- imm4<3:1> when imm5 = xxx10
- imm4<3:2> when imm5 = xx100
- imm4<3> when imm5 = x1000

The encoding imm5 = x0000 is reserved.

Unspecified bits in "imm4" are ignored but should be set to zero by an assembler.

Operation

```
CheckFPAdvSIMDEnabled64();
bits(idxsize) operand = V[n];
bits(128) result;

result = V[d];
Elem[result, dst_index, esize] = Elem[operand, src_index, esize];
V[d] = result;
```

C7.2.151 INS (general)

Insert vector element from general-purpose register. This instruction copies the contents of the source general-purpose register to the specified vector element in the destination SIMD&FP register.

This instruction can insert data into individual elements within a SIMD&FP register without clearing the remaining bits to zero.

Depending on the settings in the CPACR_EL1, CPTR_EL2, and CPTR_EL3 registers, and the current Security state and Exception level, an attempt to execute the instruction might be trapped.

This instruction is used by the alias MOV (from general). The alias is always the preferred disassembly.

31	30	29	28	27	26	25	24	23	22	21	20	16	15	14	13	12	11	10	9	5	4	0
0	1	0	0	1	1	1	0	0	0	0	imm5	0	0	0	1	1	1	Rn	Rd			

Advanced SIMD variant

INS <Vd>.<Ts>[<index>], <R><n>

Decode for this encoding

```
integer d = UInt(Rd);
integer n = UInt(Rn);

integer size = LowestSetBit(imm5);

if size > 3 then UnallocatedEncoding();
integer index = UInt(imm5<4:size+1>);

integer esize = 8 << size;
integer datasize = 128;
```

Assembler symbols

- <Vd> Is the name of the SIMD&FP destination register, encoded in the "Rd" field.
- <Ts> Is an element size specifier, encoded in the "imm5" field. It can have the following values:
 - B when imm5 = xxxx1
 - H when imm5 = xxx10
 - S when imm5 = xx100
 - D when imm5 = x1000
 The encoding imm5 = x0000 is reserved.
- <index> Is the element index encoded in the "imm5" field. It can have the following values:
 - imm5<4:1> when imm5 = xxxx1
 - imm5<4:2> when imm5 = xxx10
 - imm5<4:3> when imm5 = xx100
 - imm5<4> when imm5 = x1000
 The encoding imm5 = x0000 is reserved.
- <R> Is the width specifier for the general-purpose source register, encoded in the "imm5" field. It can have the following values:
 - W when imm5 = xxxx1

W when imm5 = xxx10

W when imm5 = xx100

X when imm5 = x1000

The encoding imm5 = x0000 is reserved.

<n> Is the number [0-30] of the general-purpose source register or ZR (31), encoded in the "Rn" field.

Operation

```
CheckFPAdvSIMDEnabled64();
bits(esize) element = X[n];
bits(datasize) result;

result = V[d];
Elem[result, index, esize] = element;
V[d] = result;
```

C7.2.152 LD1 (multiple structures)

Load multiple single-element structures to one, two, three, or four registers. This instruction loads multiple single-element structures from memory and writes the result to one, two, three, or four SIMD&FP registers.

Depending on the settings in the CPACR_EL1, CPTR_EL2, and CPTR_EL3 registers, and the current Security state and Exception level, an attempt to execute the instruction might be trapped.

No offset

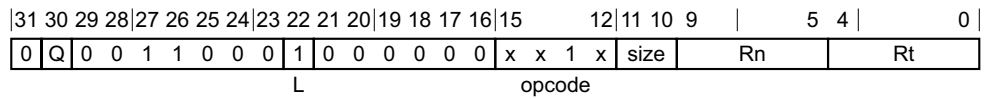

One register variant

Applies when opcode == 0111.

LD1 { <Vt>.<T> }, [<Xn|SP>]

Two registers variant

Applies when opcode == 1010.

LD1 { <Vt>.<T>, <Vt2>.<T> }, [<Xn|SP>]

Three registers variant

Applies when opcode == 0110.

LD1 { <Vt>.<T>, <Vt2>.<T>, <Vt3>.<T> }, [<Xn|SP>]

Four registers variant

Applies when opcode == 0010.

LD1 { <Vt>.<T>, <Vt2>.<T>, <Vt3>.<T>, <Vt4>.<T> }, [<Xn|SP>]

Decode for all variants of this encoding

```
integer t = UInt(Rt);
integer n = UInt(Rn);
integer m = integer UNKNOWN;
boolean wback = FALSE;
```

Post-index

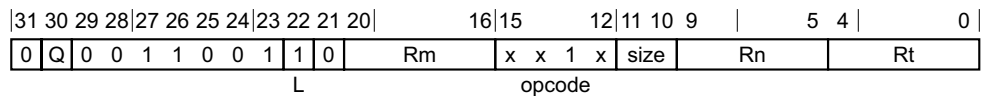

One register, immediate offset variant

Applies when Rm == 11111 && opcode == 0111.

LD1 { <Vt>.<T> }, [<Xn|SP>], <imm>

One register, register offset variant

Applies when Rm != 11111 && opcode == 0111.

LD1 { <Vt>.<T> }, [<Xn|SP>], <Xm>

Two registers, immediate offset variant

Applies when $Rm == 11111$ && opcode == 1010.
 LD1 { <Vt>.<T>, <Vt2>.<T> }, [<Xn|SP>], <imm>

Two registers, register offset variant

Applies when $Rm != 11111$ && opcode == 1010.
 LD1 { <Vt>.<T>, <Vt2>.<T> }, [<Xn|SP>], <Xm>

Three registers, immediate offset variant

Applies when $Rm == 11111$ && opcode == 0110.
 LD1 { <Vt>.<T>, <Vt2>.<T>, <Vt3>.<T> }, [<Xn|SP>], <imm>

Three registers, register offset variant

Applies when $Rm != 11111$ && opcode == 0110.
 LD1 { <Vt>.<T>, <Vt2>.<T>, <Vt3>.<T> }, [<Xn|SP>], <Xm>

Four registers, immediate offset variant

Applies when $Rm == 11111$ && opcode == 0010.
 LD1 { <Vt>.<T>, <Vt2>.<T>, <Vt3>.<T>, <Vt4>.<T> }, [<Xn|SP>], <imm>

Four registers, register offset variant

Applies when $Rm != 11111$ && opcode == 0010.
 LD1 { <Vt>.<T>, <Vt2>.<T>, <Vt3>.<T>, <Vt4>.<T> }, [<Xn|SP>], <Xm>

Decode for all variants of this encoding

```
integer t = UInt(Rt);
integer n = UInt(Rn);
integer m = UInt(Rm);
boolean wback = TRUE;
```

Assembler symbols

- <Vt> Is the name of the first or only SIMD&FP register to be transferred, encoded in the "Rt" field.
- <T> Is an arrangement specifier, encoded in the "size:Q" field. It can have the following values:
 - 8B when size = 00, Q = 0
 - 16B when size = 00, Q = 1
 - 4H when size = 01, Q = 0
 - 8H when size = 01, Q = 1
 - 2S when size = 10, Q = 0
 - 4S when size = 10, Q = 1
 - 1D when size = 11, Q = 0
 - 2D when size = 11, Q = 1
- <Vt2> Is the name of the second SIMD&FP register to be transferred, encoded as "Rt" plus 1 modulo 32.
- <Vt3> Is the name of the third SIMD&FP register to be transferred, encoded as "Rt" plus 2 modulo 32.
- <Vt4> Is the name of the fourth SIMD&FP register to be transferred, encoded as "Rt" plus 3 modulo 32.

<Xn|SP> Is the 64-bit name of the general-purpose base register or stack pointer, encoded in the "Rn" field.

<imm> For the one register, immediate offset variant: is the post-index immediate offset, encoded in the "Q" field. It can have the following values:
 #8 when Q = 0
 #16 when Q = 1
 For the two registers, immediate offset variant: is the post-index immediate offset, encoded in the "Q" field. It can have the following values:
 #16 when Q = 0
 #32 when Q = 1
 For the three registers, immediate offset variant: is the post-index immediate offset, encoded in the "Q" field. It can have the following values:
 #24 when Q = 0
 #48 when Q = 1
 For the four registers, immediate offset variant: is the post-index immediate offset, encoded in the "Q" field. It can have the following values:
 #32 when Q = 0
 #64 when Q = 1

<Xm> Is the 64-bit name of the general-purpose post-index register, excluding XZR, encoded in the "Rm" field.

Shared decode for all encodings

```
MemOp memop = if L == '1' then MemOp_LOAD else MemOp_STORE;
integer datasize = if Q == '1' then 128 else 64;
integer esize = 8 << UInt(size);
integer elements = datasize DIV esize;

integer rpt; // number of iterations
integer selem; // structure elements

case opcode of
  when '0000' rpt = 1; selem = 4; // LD/ST4 (4 registers)
  when '0010' rpt = 4; selem = 1; // LD/ST1 (4 registers)
  when '0100' rpt = 1; selem = 3; // LD/ST3 (3 registers)
  when '0110' rpt = 3; selem = 1; // LD/ST1 (3 registers)
  when '0111' rpt = 1; selem = 1; // LD/ST1 (1 register)
  when '1000' rpt = 1; selem = 2; // LD/ST2 (2 registers)
  when '1010' rpt = 2; selem = 1; // LD/ST1 (2 registers)
  otherwise UnallocatedEncoding();

// .1D format only permitted with LD1 & ST1
if size:Q == '110' && selem != 1 then ReservedValue();
```

Operation for all encodings

```
CheckFPAdvSIMDEnabled64();

bits(64) address;
bits(64) offs;
bits(datasize) rval;
integer e, r, s, tt;
constant integer ebytes = esize DIV 8;

if n == 31 then
  CheckSPAlignment();
  address = SP[];
else
```



```
address = X[n];

offs = Zeros();
for r = 0 to rpt-1
  for e = 0 to elements-1
    tt = (t + r) MOD 32;
    for s = 0 to selem-1
      rval = V[tt];
      if memop == MemOp_LOAD then
        Elem[rval, e, esize] = Mem[address+offs, ebytes, AccType_VEC];
        V[tt] = rval;
      else // memop == MemOp_STORE
        Mem[address+offs, ebytes, AccType_VEC] = Elem[rval, e, esize];
        offs = offs + ebytes;
        tt = (tt + 1) MOD 32;

if wback then
  if m != 31 then
    offs = X[m];
  if n == 31 then
    SP[] = address + offs;
  else
    X[n] = address + offs;
```

C7.2.153 LD1 (single structure)

Load one single-element structure to one lane of one register. This instruction loads a single-element structure from memory and writes the result to the specified lane of the SIMD&FP register without affecting the other bits of the register.

Depending on the settings in the CPACR_EL1, CPTR_EL2, and CPTR_EL3 registers, and the current Security state and Exception level, an attempt to execute the instruction might be trapped.

No offset

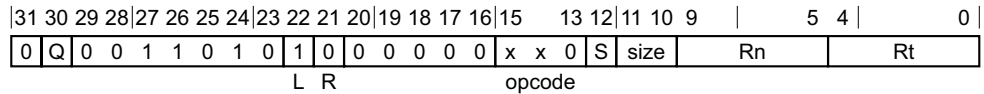

8-bit variant

Applies when opcode == 000.

LD1 { <Vt>.B }[<index>], [<Xn|SP>]

16-bit variant

Applies when opcode == 010 && size == x0.

LD1 { <Vt>.H }[<index>], [<Xn|SP>]

32-bit variant

Applies when opcode == 100 && size == 00.

LD1 { <Vt>.S }[<index>], [<Xn|SP>]

64-bit variant

Applies when opcode == 100 && S == 0 && size == 01.

LD1 { <Vt>.D }[<index>], [<Xn|SP>]

Decode for all variants of this encoding

```
integer t = UInt(Rt);
integer n = UInt(Rn);
integer m = integer UNKNOWN;
boolean wback = FALSE;
```

Post-index

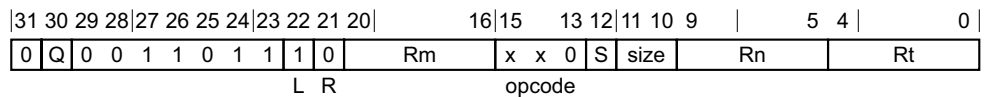

8-bit, immediate offset variant

Applies when Rm == 11111 && opcode == 000.

LD1 { <Vt>.B }[<index>], [<Xn|SP>], #1

8-bit, register offset variant

Applies when Rm != 11111 && opcode == 000.

LD1 { <Vt>.B }[<index>], [<Xn|SP>], <Xm>

16-bit, immediate offset variant

Applies when Rm == 11111 && opcode == 010 && size == x0.

LD1 { <Vt>.H }[<index>], [<Xn|SP>], #2

16-bit, register offset variant

Applies when Rm != 11111 && opcode == 010 && size == x0.

LD1 { <Vt>.H }[<index>], [<Xn|SP>], <Xm>

32-bit, immediate offset variant

Applies when Rm == 11111 && opcode == 100 && size == 00.

LD1 { <Vt>.S }[<index>], [<Xn|SP>], #4

32-bit, register offset variant

Applies when Rm != 11111 && opcode == 100 && size == 00.

LD1 { <Vt>.S }[<index>], [<Xn|SP>], <Xm>

64-bit, immediate offset variant

Applies when Rm == 11111 && opcode == 100 && S == 0 && size == 01.

LD1 { <Vt>.D }[<index>], [<Xn|SP>], #8

64-bit, register offset variant

Applies when Rm != 11111 && opcode == 100 && S == 0 && size == 01.

LD1 { <Vt>.D }[<index>], [<Xn|SP>], <Xm>

Decode for all variants of this encoding

```
integer t = UInt(Rt);
integer n = UInt(Rn);
integer m = UInt(Rm);
boolean wback = TRUE;
```

Assembler symbols

- <Vt> Is the name of the first or only SIMD&FP register to be transferred, encoded in the "Rt" field.
- <index> For the 8-bit variant: is the element index, encoded in "Q:S:size".
 For the 16-bit variant: is the element index, encoded in "Q:S:size<I>".
 For the 32-bit variant: is the element index, encoded in "Q:S".
 For the 64-bit variant: is the element index, encoded in "Q".
- <Xn|SP> Is the 64-bit name of the general-purpose base register or stack pointer, encoded in the "Rn" field.
- <Xm> Is the 64-bit name of the general-purpose post-index register, excluding XZR, encoded in the "Rm" field.

Shared decode for all encodings

```
integer scale = UInt(opcode<2:1>);
integer selem = UInt(opcode<0>:R) + 1;
boolean replicate = FALSE;
integer index;
```

```

case scale of
when 3
    // load and replicate
    if L == '0' || S == '1' then UnallocatedEncoding();
    scale = UInt(size);
    replicate = TRUE;
when 0
    index = UInt(Q:S:size); // B[0-15]
when 1
    if size<0> == '1' then UnallocatedEncoding();
    index = UInt(Q:S:size<1>); // H[0-7]
when 2
    if size<1> == '1' then UnallocatedEncoding();
    if size<0> == '0' then
        index = UInt(Q:S); // S[0-3]
    else
        if S == '1' then UnallocatedEncoding();
        index = UInt(Q); // D[0-1]
        scale = 3;

MemOp memop = if L == '1' then MemOp_LOAD else MemOp_STORE;
integer datasize = if Q == '1' then 128 else 64;
integer esize = 8 << scale;
    
```

Operation for all encodings

```

CheckFPAdvSIMDEnabled64();

bits(64) address;
bits(64) offs;
bits(128) rval;
bits(esize) element;
integer s;
constant integer ebytes = esize DIV 8;

if n == 31 then
    CheckSPAlignment();
    address = SP[];
else
    address = X[n];

offs = Zeros();
if replicate then
    // load and replicate to all elements
    for s = 0 to selem-1
        element = Mem[address+offs, ebytes, AccType_VEC];
        // replicate to fill 128- or 64-bit register
        V[t] = Replicate(element, datasize DIV esize);
        offs = offs + ebytes;
        t = (t + 1) MOD 32;
else
    // load/store one element per register
    for s = 0 to selem-1
        rval = V[t];
        if memop == MemOp_LOAD then
            // insert into one lane of 128-bit register
            Elem[rval, index, esize] = Mem[address+offs, ebytes, AccType_VEC];
            V[t] = rval;
        else // memop == MemOp_STORE
            // extract from one lane of 128-bit register
            Mem[address+offs, ebytes, AccType_VEC] = Elem[rval, index, esize];
            offs = offs + ebytes;
            t = (t + 1) MOD 32;

if wback then
    if m != 31 then
    
```

```
    offs = X[m];  
if n == 31 then  
    SP[] = address + offs;  
else  
    X[n] = address + offs;
```

C7.2.154 LD1R

Load one single-element structure and Replicate to all lanes (of one register). This instruction loads a single-element structure from memory and replicates the structure to all the lanes of the SIMD&FP register.

Depending on the settings in the CPACR_EL1, CPTR_EL2, and CPTR_EL3 registers, and the current Security state and Exception level, an attempt to execute the instruction might be trapped.

No offset

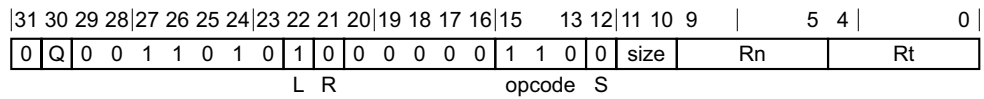

No offset variant

LD1R { <Vt>.<T> }, [<Xn|SP>]

Decode for this encoding

```
integer t = UInt(Rt);
integer n = UInt(Rn);
integer m = integer UNKNOWN;
boolean wback = FALSE;
```

Post-index

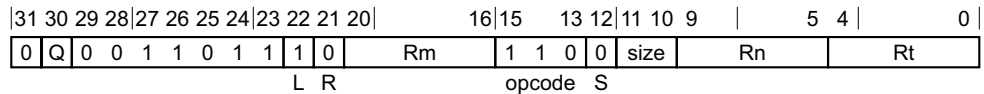

Immediate offset variant

Applies when Rm == 11111.

LD1R { <Vt>.<T> }, [<Xn|SP>], <imm>

Register offset variant

Applies when Rm != 11111.

LD1R { <Vt>.<T> }, [<Xn|SP>], <Xm>

Decode for all variants of this encoding

```
integer t = UInt(Rt);
integer n = UInt(Rn);
integer m = UInt(Rm);
boolean wback = TRUE;
```

Assembler symbols

- <Vt> Is the name of the first or only SIMD&FP register to be transferred, encoded in the "Rt" field.
- <T> Is an arrangement specifier, encoded in the "size:Q" field. It can have the following values:
 - 8B when size = 00, Q = 0
 - 16B when size = 00, Q = 1
 - 4H when size = 01, Q = 0
 - 8H when size = 01, Q = 1

2S	when size = 10, Q = 0
4S	when size = 10, Q = 1
1D	when size = 11, Q = 0
2D	when size = 11, Q = 1
<Xn SP>	Is the 64-bit name of the general-purpose base register or stack pointer, encoded in the "Rn" field.
<imm>	Is the post-index immediate offset, encoded in the "size" field. It can have the following values:
#1	when size = 00
#2	when size = 01
#4	when size = 10
#8	when size = 11
<Xm>	Is the 64-bit name of the general-purpose post-index register, excluding XZR, encoded in the "Rm" field.

Shared decode for all encodings

```

integer scale = UInt(opcode<2:1>);
integer selem = UInt(opcode<0>:R) + 1;
boolean replicate = FALSE;
integer index;

case scale of
    when 3
        // load and replicate
        if L == '0' || S == '1' then UnallocatedEncoding();
        scale = UInt(size);
        replicate = TRUE;
    when 0
        index = UInt(Q:S:size); // B[0-15]
    when 1
        if size<0> == '1' then UnallocatedEncoding();
        index = UInt(Q:S:size<1>); // H[0-7]
    when 2
        if size<1> == '1' then UnallocatedEncoding();
        if size<0> == '0' then
            index = UInt(Q:S); // S[0-3]
        else
            if S == '1' then UnallocatedEncoding();
            index = UInt(Q); // D[0-1]
            scale = 3;

MemOp memop = if L == '1' then MemOp_LOAD else MemOp_STORE;
integer datasize = if Q == '1' then 128 else 64;
integer esize = 8 << scale;
    
```

Operation for all encodings

```

CheckFPAdvSIMDEnabled64();

bits(64) address;
bits(64) offs;
bits(128) rval;
bits(esize) element;
integer s;
constant integer ebytes = esize DIV 8;

if n == 31 then
    CheckSPAlignment();
    address = SP[];
else
    
```

```
    address = X[n];

offs = Zeros();
if replicate then
    // load and replicate to all elements
    for s = 0 to selem-1
        element = Mem[address+offs, ebytes, AccType_VEC];
        // replicate to fill 128- or 64-bit register
        V[t] = Replicate(element, datasize DIV esize);
        offs = offs + ebytes;
        t = (t + 1) MOD 32;
else
    // load/store one element per register
    for s = 0 to selem-1
        rval = V[t];
        if memop == MemOp_LOAD then
            // insert into one lane of 128-bit register
            Elem[rval, index, esize] = Mem[address+offs, ebytes, AccType_VEC];
            V[t] = rval;
        else // memop == MemOp_STORE
            // extract from one lane of 128-bit register
            Mem[address+offs, ebytes, AccType_VEC] = Elem[rval, index, esize];
            offs = offs + ebytes;
            t = (t + 1) MOD 32;

if wback then
    if m != 31 then
        offs = X[m];
    if n == 31 then
        SP[] = address + offs;
    else
        X[n] = address + offs;
```



C7.2.155 LD2 (multiple structures)

Load multiple 2-element structures to two registers. This instruction loads multiple 2-element structures from memory and writes the result to the two SIMD&FP registers, with de-interleaving.

For an example of de-interleaving, see LD3 (multiple structures).

Depending on the settings in the CPACR_EL1, CPTR_EL2, and CPTR_EL3 registers, and the current Security state and Exception level, an attempt to execute the instruction might be trapped.

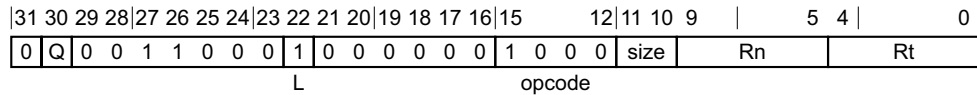
No offset



No offset variant

LD2 { <Vt>.<T>, <Vt2>.<T> }, [<Xn|SP>]

Decode for this encoding

```
integer t = UInt(Rt);
integer n = UInt(Rn);
integer m = integer UNKNOWN;
boolean wback = FALSE;
```

Post-index

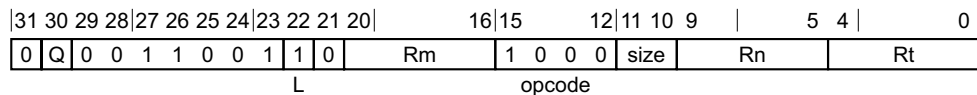

Immediate offset variant

Applies when Rm == 11111.

LD2 { <Vt>.<T>, <Vt2>.<T> }, [<Xn|SP>], <imm>

Register offset variant

Applies when Rm != 11111.

LD2 { <Vt>.<T>, <Vt2>.<T> }, [<Xn|SP>], <Xm>

Decode for all variants of this encoding

```
integer t = UInt(Rt);
integer n = UInt(Rn);
integer m = UInt(Rm);
boolean wback = TRUE;
```

Assembler symbols

<Vt> Is the name of the first or only SIMD&FP register to be transferred, encoded in the "Rt" field.

<T> Is an arrangement specifier, encoded in the "size:Q" field. It can have the following values:

8B	when size = 00, Q = 0
16B	when size = 00, Q = 1

4H when size = 01, Q = 0
 8H when size = 01, Q = 1
 2S when size = 10, Q = 0
 4S when size = 10, Q = 1
 2D when size = 11, Q = 1
 The encoding size = 11, Q = 0 is reserved.

- <Vt2> Is the name of the second SIMD&FP register to be transferred, encoded as "Rt" plus 1 modulo 32.
- <Xn|SP> Is the 64-bit name of the general-purpose base register or stack pointer, encoded in the "Rn" field.
- <imm> Is the post-index immediate offset, encoded in the "Q" field. It can have the following values:
- #16 when Q = 0
 #32 when Q = 1
- <Xm> Is the 64-bit name of the general-purpose post-index register, excluding XZR, encoded in the "Rm" field.

Shared decode for all encodings

```
MemOp memop = if L == '1' then MemOp_LOAD else MemOp_STORE;
integer datasize = if Q == '1' then 128 else 64;
integer esize = 8 << UInt(size);
integer elements = datasize DIV esize;

integer rpt; // number of iterations
integer selem; // structure elements

case opcode of
  when '0000' rpt = 1; selem = 4; // LD/ST4 (4 registers)
  when '0010' rpt = 4; selem = 1; // LD/ST1 (4 registers)
  when '0100' rpt = 1; selem = 3; // LD/ST3 (3 registers)
  when '0110' rpt = 3; selem = 1; // LD/ST1 (3 registers)
  when '0111' rpt = 1; selem = 1; // LD/ST1 (1 register)
  when '1000' rpt = 1; selem = 2; // LD/ST2 (2 registers)
  when '1010' rpt = 2; selem = 1; // LD/ST1 (2 registers)
  otherwise UnallocatedEncoding();

// .1D format only permitted with LD1 & ST1
if size:Q == '110' && selem != 1 then ReservedValue();
```

Operation for all encodings

```
CheckFPAdvSIMDEnabled64();

bits(64) address;
bits(64) offs;
bits(datasize) rval;
integer e, r, s, tt;
constant integer ebytes = esize DIV 8;

if n == 31 then
  CheckSPAlignment();
  address = SP[];
else
  address = X[n];

offs = Zeros();
for r = 0 to rpt-1
  for e = 0 to elements-1
    tt = (t + r) MOD 32;
    for s = 0 to selem-1
```

```
rval = V[tt];
if memop == MemOp_LOAD then
    Elem[rval, e, esize] = Mem[address+offs, ebytes, AccType_VEC];
    V[tt] = rval;
else // memop == MemOp_STORE
    Mem[address+offs, ebytes, AccType_VEC] = Elem[rval, e, esize];
offs = offs + ebytes;
tt = (tt + 1) MOD 32;

if wback then
    if m != 31 then
        offs = X[m];
    if n == 31 then
        SP[] = address + offs;
    else
        X[n] = address + offs;
```

C7.2.156 LD2 (single structure)

Load single 2-element structure to one lane of two registers. This instruction loads a 2-element structure from memory and writes the result to the corresponding elements of the two SIMD&FP registers without affecting the other bits of the registers.

Depending on the settings in the CPACR_EL1, CPTR_EL2, and CPTR_EL3 registers, and the current Security state and Exception level, an attempt to execute the instruction might be trapped.

No offset

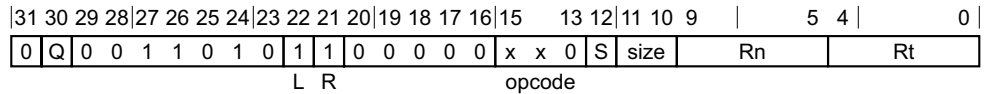

8-bit variant

Applies when opcode == 000.

LD2 { <Vt>.B, <Vt2>.B }[<index>], [<Xn|SP>]

16-bit variant

Applies when opcode == 010 && size == x0.

LD2 { <Vt>.H, <Vt2>.H }[<index>], [<Xn|SP>]

32-bit variant

Applies when opcode == 100 && size == 00.

LD2 { <Vt>.S, <Vt2>.S }[<index>], [<Xn|SP>]

64-bit variant

Applies when opcode == 100 && S == 0 && size == 01.

LD2 { <Vt>.D, <Vt2>.D }[<index>], [<Xn|SP>]

Decode for all variants of this encoding

```
integer t = UInt(Rt);
integer n = UInt(Rn);
integer m = integer UNKNOWN;
boolean wback = FALSE;
```

Post-index

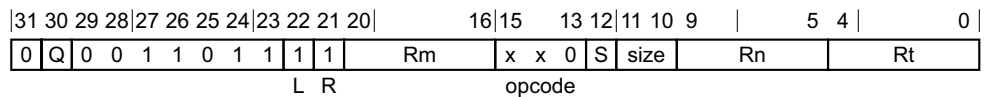

8-bit, immediate offset variant

Applies when Rm == 11111 && opcode == 000.

LD2 { <Vt>.B, <Vt2>.B }[<index>], [<Xn|SP>], #2

8-bit, register offset variant

Applies when Rm != 11111 && opcode == 000.

LD2 { <Vt>.B, <Vt2>.B }[<index>], [<Xn|SP>], <Xm>

16-bit, immediate offset variant

Applies when Rm == 11111 && opcode == 010 && size == x0.

LD2 { <Vt>.H, <Vt2>.H }[<index>], [<Xn|SP>], #4

16-bit, register offset variant

Applies when Rm != 11111 && opcode == 010 && size == x0.

LD2 { <Vt>.H, <Vt2>.H }[<index>], [<Xn|SP>], <Xm>

32-bit, immediate offset variant

Applies when Rm == 11111 && opcode == 100 && size == 00.

LD2 { <Vt>.S, <Vt2>.S }[<index>], [<Xn|SP>], #8

32-bit, register offset variant

Applies when Rm != 11111 && opcode == 100 && size == 00.

LD2 { <Vt>.S, <Vt2>.S }[<index>], [<Xn|SP>], <Xm>

64-bit, immediate offset variant

Applies when Rm == 11111 && opcode == 100 && S == 0 && size == 01.

LD2 { <Vt>.D, <Vt2>.D }[<index>], [<Xn|SP>], #16

64-bit, register offset variant

Applies when Rm != 11111 && opcode == 100 && S == 0 && size == 01.

LD2 { <Vt>.D, <Vt2>.D }[<index>], [<Xn|SP>], <Xm>

Decode for all variants of this encoding

```
integer t = UInt(Rt);
integer n = UInt(Rn);
integer m = UInt(Rm);
boolean wback = TRUE;
```

Assembler symbols

- <Vt> Is the name of the first or only SIMD&FP register to be transferred, encoded in the "Rt" field.
- <Vt2> Is the name of the second SIMD&FP register to be transferred, encoded as "Rt" plus 1 modulo 32.
- <index> For the 8-bit variant: is the element index, encoded in "Q:S:size".
 For the 16-bit variant: is the element index, encoded in "Q:S:size<1>".
 For the 32-bit variant: is the element index, encoded in "Q:S".
 For the 64-bit variant: is the element index, encoded in "Q".
- <Xn|SP> Is the 64-bit name of the general-purpose base register or stack pointer, encoded in the "Rn" field.
- <Xm> Is the 64-bit name of the general-purpose post-index register, excluding XZR, encoded in the "Rm" field.

Shared decode for all encodings

```

integer scale = UInt(opcode<2:1>);
integer selem = UInt(opcode<0>:R) + 1;
boolean replicate = FALSE;
integer index;

case scale of
    when 3
        // load and replicate
        if L == '0' || S == '1' then UnallocatedEncoding();
        scale = UInt(size);
        replicate = TRUE;
    when 0
        index = UInt(Q:S:size); // B[0-15]
    when 1
        if size<0> == '1' then UnallocatedEncoding();
        index = UInt(Q:S:size<1>); // H[0-7]
    when 2
        if size<1> == '1' then UnallocatedEncoding();
        if size<0> == '0' then
            index = UInt(Q:S); // S[0-3]
        else
            if S == '1' then UnallocatedEncoding();
            index = UInt(Q); // D[0-1]
            scale = 3;

MemOp memop = if L == '1' then MemOp_LOAD else MemOp_STORE;
integer datasize = if Q == '1' then 128 else 64;
integer esize = 8 << scale;
    
```

Operation for all encodings

```

CheckFPAdvSIMDEnabled64();

bits(64) address;
bits(64) offs;
bits(128) rval;
bits(esize) element;
integer s;
constant integer ebytes = esize DIV 8;

if n == 31 then
    CheckSPAlignment();
    address = SP[];
else
    address = X[n];

offs = Zeros();
if replicate then
    // load and replicate to all elements
    for s = 0 to selem-1
        element = Mem[address+offs, ebytes, AccType_VEC];
        // replicate to fill 128- or 64-bit register
        V[t] = Replicate(element, datasize DIV esize);
        offs = offs + ebytes;
        t = (t + 1) MOD 32;
else
    // load/store one element per register
    for s = 0 to selem-1
        rval = V[t];
        if memop == MemOp_LOAD then
            // insert into one lane of 128-bit register
            Elem[rval, index, esize] = Mem[address+offs, ebytes, AccType_VEC];
            V[t] = rval;
        else // memop == MemOp_STORE
            // extract from one lane of 128-bit register
    
```

```
    Mem[address+offs, ebytes, AccType_VEC] = Elem[rval, index, esize];  
    offs = offs + ebytes;  
    t = (t + 1) MOD 32;  
  
if wback then  
    if m != 31 then  
        offs = X[m];  
    if n == 31 then  
        SP[] = address + offs;  
    else  
        X[n] = address + offs;
```

C7.2.157 LD2R

Load single 2-element structure and Replicate to all lanes of two registers. This instruction loads a 2-element structure from memory and replicates the structure to all the lanes of the two SIMD&FP registers.

Depending on the settings in the CPACR_EL1, CPTR_EL2, and CPTR_EL3 registers, and the current Security state and Exception level, an attempt to execute the instruction might be trapped.

No offset

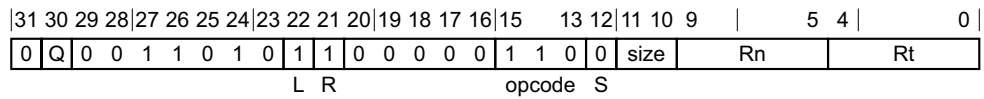

No offset variant

LD2R { <Vt>.<T>, <Vt2>.<T> }, [<Xn|SP>]

Decode for this encoding

```
integer t = UInt(Rt);
integer n = UInt(Rn);
integer m = integer UNKNOWN;
boolean wback = FALSE;
```

Post-index

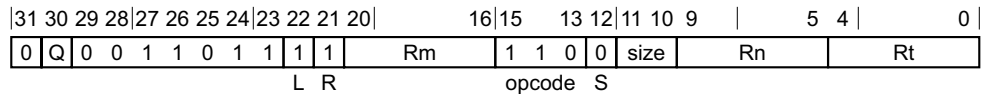

Immediate offset variant

Applies when Rm == 11111.

LD2R { <Vt>.<T>, <Vt2>.<T> }, [<Xn|SP>], <imm>

Register offset variant

Applies when Rm != 11111.

LD2R { <Vt>.<T>, <Vt2>.<T> }, [<Xn|SP>], <Xm>

Decode for all variants of this encoding

```
integer t = UInt(Rt);
integer n = UInt(Rn);
integer m = UInt(Rm);
boolean wback = TRUE;
```

Assembler symbols

- <Vt> Is the name of the first or only SIMD&FP register to be transferred, encoded in the "Rt" field.
- <T> Is an arrangement specifier, encoded in the "size:Q" field. It can have the following values:
 - 8B when size = 00, Q = 0
 - 16B when size = 00, Q = 1
 - 4H when size = 01, Q = 0
 - 8H when size = 01, Q = 1

- 2S when size = 10, Q = 0
 4S when size = 10, Q = 1
 1D when size = 11, Q = 0
 2D when size = 11, Q = 1
- <Vt2> Is the name of the second SIMD&FP register to be transferred, encoded as "Rt" plus 1 modulo 32.
- <Xn|SP> Is the 64-bit name of the general-purpose base register or stack pointer, encoded in the "Rn" field.
- <imm> Is the post-index immediate offset, encoded in the "size" field. It can have the following values:
- #2 when size = 00
 #4 when size = 01
 #8 when size = 10
 #16 when size = 11
- <Xm> Is the 64-bit name of the general-purpose post-index register, excluding XZR, encoded in the "Rm" field.

Shared decode for all encodings

```
integer scale = UInt(opcode<2:1>);
integer selem = UInt(opcode<0>:R) + 1;
boolean replicate = FALSE;
integer index;

case scale of
  when 3
    // load and replicate
    if L == '0' || S == '1' then UnallocatedEncoding();
    scale = UInt(size);
    replicate = TRUE;
  when 0
    index = UInt(Q:S:size); // B[0-15]
  when 1
    if size<0> == '1' then UnallocatedEncoding();
    index = UInt(Q:S:size<1>); // H[0-7]
  when 2
    if size<1> == '1' then UnallocatedEncoding();
    if size<0> == '0' then
      index = UInt(Q:S); // S[0-3]
    else
      if S == '1' then UnallocatedEncoding();
      index = UInt(Q); // D[0-1]
      scale = 3;

MemOp memop = if L == '1' then MemOp_LOAD else MemOp_STORE;
integer datasize = if Q == '1' then 128 else 64;
integer esize = 8 << scale;
```

Operation for all encodings

```
CheckFPAdvSIMDEnabled64();

bits(64) address;
bits(64) offs;
bits(128) rval;
bits(esize) element;
integer s;
constant integer ebytes = esize DIV 8;

if n == 31 then
  CheckSPAAlignment();
```

```
        address = SP[];
    else
        address = X[n];

    offs = Zeros();
    if replicate then
        // load and replicate to all elements
        for s = 0 to selem-1
            element = Mem[address+offs, ebytes, AccType_VEC];
            // replicate to fill 128- or 64-bit register
            V[t] = Replicate(element, datasize DIV esize);
            offs = offs + ebytes;
            t = (t + 1) MOD 32;
    else
        // load/store one element per register
        for s = 0 to selem-1
            rval = V[t];
            if memop == MemOp_LOAD then
                // insert into one lane of 128-bit register
                Elem[rval, index, esize] = Mem[address+offs, ebytes, AccType_VEC];
                V[t] = rval;
            else // memop == MemOp_STORE
                // extract from one lane of 128-bit register
                Mem[address+offs, ebytes, AccType_VEC] = Elem[rval, index, esize];
            offs = offs + ebytes;
            t = (t + 1) MOD 32;

    if wback then
        if m != 31 then
            offs = X[m];
        if n == 31 then
            SP[] = address + offs;
        else
            X[n] = address + offs;
```

C7.2.158 LD3 (multiple structures)

Load multiple 3-element structures to three registers. This instruction loads multiple 3-element structures from memory and writes the result to the three SIMD&FP registers, with de-interleaving.

The following figure shows the operation of de-interleaving of a LD3.16 (multiple 3-element structures) instruction:

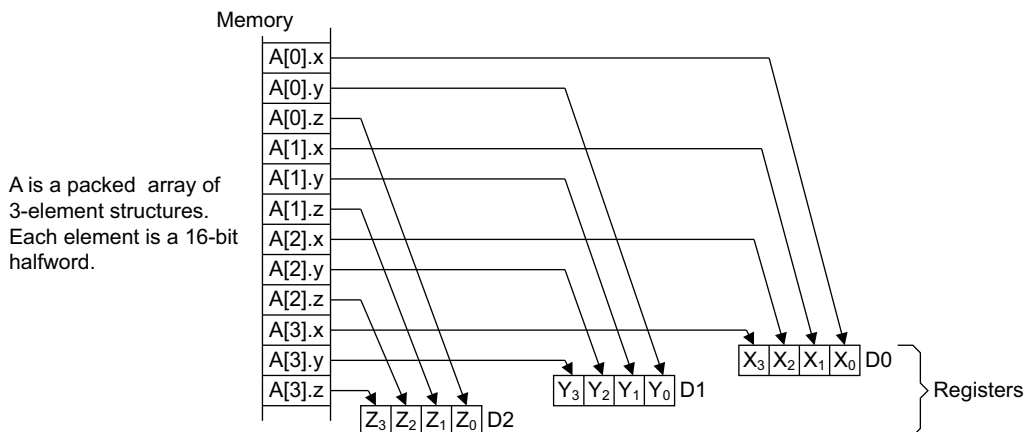

Depending on the settings in the CPACR_EL1, CPTR_EL2, and CPTR_EL3 registers, and the current Security state and Exception level, an attempt to execute the instruction might be trapped.

No offset

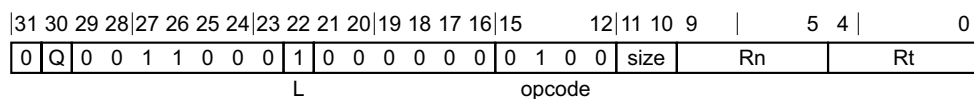

No offset variant

LD3 { <Vt>.<T>, <Vt2>.<T>, <Vt3>.<T> }, [<Xn|SP>]

Decode for this encoding

```
integer t = UInt(Rt);
integer n = UInt(Rn);
integer m = integer UNKNOWN;
boolean wback = FALSE;
```

Post-index

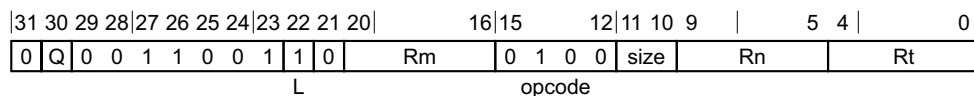

Immediate offset variant

Applies when Rm == 11111.

LD3 { <Vt>.<T>, <Vt2>.<T>, <Vt3>.<T> }, [<Xn|SP>], <imm>

Register offset variant

Applies when Rm != 11111.

LD3 { <Vt>.<T>, <Vt2>.<T>, <Vt3>.<T> }, [<Xn|SP>], <Xm>

Decode for all variants of this encoding

```
integer t = UInt(Rt);
integer n = UInt(Rn);
integer m = UInt(Rm);
boolean wback = TRUE;
```

Assembler symbols

- <Vt> Is the name of the first or only SIMD&FP register to be transferred, encoded in the "Rt" field.
- <T> Is an arrangement specifier, encoded in the "size:Q" field. It can have the following values:
 - 8B when size = 00, Q = 0
 - 16B when size = 00, Q = 1
 - 4H when size = 01, Q = 0
 - 8H when size = 01, Q = 1
 - 2S when size = 10, Q = 0
 - 4S when size = 10, Q = 1
 - 2D when size = 11, Q = 1
 The encoding size = 11, Q = 0 is reserved.
- <Vt2> Is the name of the second SIMD&FP register to be transferred, encoded as "Rt" plus 1 modulo 32.
- <Vt3> Is the name of the third SIMD&FP register to be transferred, encoded as "Rt" plus 2 modulo 32.
- <Xn|SP> Is the 64-bit name of the general-purpose base register or stack pointer, encoded in the "Rn" field.
- <imm> Is the post-index immediate offset, encoded in the "Q" field. It can have the following values:
 - #24 when Q = 0
 - #48 when Q = 1
- <Xm> Is the 64-bit name of the general-purpose post-index register, excluding XZR, encoded in the "Rm" field.

Shared decode for all encodings

```
MemOp memop = if L == '1' then MemOp_LOAD else MemOp_STORE;
integer datasize = if Q == '1' then 128 else 64;
integer esize = 8 << UInt(size);
integer elements = datasize DIV esize;

integer rpt; // number of iterations
integer selem; // structure elements

case opcode of
  when '0000' rpt = 1; selem = 4; // LD/ST4 (4 registers)
  when '0010' rpt = 4; selem = 1; // LD/ST1 (4 registers)
  when '0100' rpt = 1; selem = 3; // LD/ST3 (3 registers)
  when '0110' rpt = 3; selem = 1; // LD/ST1 (3 registers)
  when '0111' rpt = 1; selem = 1; // LD/ST1 (1 register)
  when '1000' rpt = 1; selem = 2; // LD/ST2 (2 registers)
  when '1010' rpt = 2; selem = 1; // LD/ST1 (2 registers)
  otherwise UnallocatedEncoding();

// .1D format only permitted with LD1 & ST1
if size:Q == '110' && selem != 1 then ReservedValue();
```

Operation for all encodings

```
CheckFPAdvSIMDEnabled64();

bits(64) address;
bits(64) offs;
bits(datasize) rval;
integer e, r, s, tt;
constant integer ebytes = esize DIV 8;

if n == 31 then
    CheckSPAlignment();
    address = SP[];
else
    address = X[n];

offs = Zeros();
for r = 0 to rpt-1
    for e = 0 to elements-1
        tt = (t + r) MOD 32;
        for s = 0 to selem-1
            rval = V[tt];
            if memop == MemOp_LOAD then
                Elem[rval, e, esize] = Mem[address+offs, ebytes, AccType_VEC];
                V[tt] = rval;
            else // memop == MemOp_STORE
                Mem[address+offs, ebytes, AccType_VEC] = Elem[rval, e, esize];
            offs = offs + ebytes;
            tt = (tt + 1) MOD 32;

if wback then
    if m != 31 then
        offs = X[m];
    if n == 31 then
        SP[] = address + offs;
    else
        X[n] = address + offs;
```

C7.2.159 LD3 (single structure)

Load single 3-element structure to one lane of three registers). This instruction loads a 3-element structure from memory and writes the result to the corresponding elements of the three SIMD&FP registers without affecting the other bits of the registers.

Depending on the settings in the CPACR_EL1, CPTR_EL2, and CPTR_EL3 registers, and the current Security state and Exception level, an attempt to execute the instruction might be trapped.

No offset

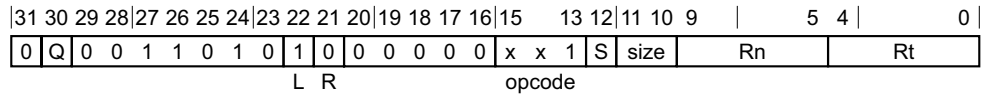

8-bit variant

Applies when opcode == 001.

LD3 { <Vt>.B, <Vt2>.B, <Vt3>.B } [<index>], [<Xn|SP>]

16-bit variant

Applies when opcode == 011 && size == x0.

LD3 { <Vt>.H, <Vt2>.H, <Vt3>.H } [<index>], [<Xn|SP>]

32-bit variant

Applies when opcode == 101 && size == 00.

LD3 { <Vt>.S, <Vt2>.S, <Vt3>.S } [<index>], [<Xn|SP>]

64-bit variant

Applies when opcode == 101 && S == 0 && size == 01.

LD3 { <Vt>.D, <Vt2>.D, <Vt3>.D } [<index>], [<Xn|SP>]

Decode for all variants of this encoding

```
integer t = UInt(Rt);
integer n = UInt(Rn);
integer m = integer UNKNOWN;
boolean wback = FALSE;
```

Post-index

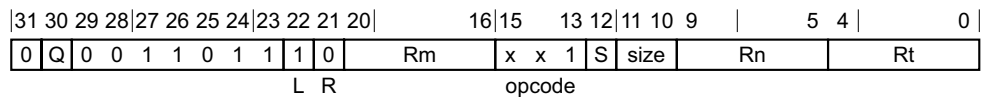

8-bit, immediate offset variant

Applies when Rm == 11111 && opcode == 001.

LD3 { <Vt>.B, <Vt2>.B, <Vt3>.B } [<index>], [<Xn|SP>], #3

8-bit, register offset variant

Applies when Rm != 11111 && opcode == 001.

LD3 { <Vt>.B, <Vt2>.B, <Vt3>.B } [<index>], [<Xn|SP>], <Xm>

16-bit, immediate offset variant

Applies when Rm == 11111 && opcode == 011 && size == x0.

LD3 { <Vt>.H, <Vt2>.H, <Vt3>.H } [<index>], [<Xn|SP>], #6

16-bit, register offset variant

Applies when Rm != 11111 && opcode == 011 && size == x0.

LD3 { <Vt>.H, <Vt2>.H, <Vt3>.H } [<index>], [<Xn|SP>], <Xm>

32-bit, immediate offset variant

Applies when Rm == 11111 && opcode == 101 && size == 00.

LD3 { <Vt>.S, <Vt2>.S, <Vt3>.S } [<index>], [<Xn|SP>], #12

32-bit, register offset variant

Applies when Rm != 11111 && opcode == 101 && size == 00.

LD3 { <Vt>.S, <Vt2>.S, <Vt3>.S } [<index>], [<Xn|SP>], <Xm>

64-bit, immediate offset variant

Applies when Rm == 11111 && opcode == 101 && S == 0 && size == 01.

LD3 { <Vt>.D, <Vt2>.D, <Vt3>.D } [<index>], [<Xn|SP>], #24

64-bit, register offset variant

Applies when Rm != 11111 && opcode == 101 && S == 0 && size == 01.

LD3 { <Vt>.D, <Vt2>.D, <Vt3>.D } [<index>], [<Xn|SP>], <Xm>

Decode for all variants of this encoding

```
integer t = UInt(Rt);
integer n = UInt(Rn);
integer m = UInt(Rm);
boolean wback = TRUE;
```

Assembler symbols

- <Vt> Is the name of the first or only SIMD&FP register to be transferred, encoded in the "Rt" field.
- <Vt2> Is the name of the second SIMD&FP register to be transferred, encoded as "Rt" plus 1 modulo 32.
- <Vt3> Is the name of the third SIMD&FP register to be transferred, encoded as "Rt" plus 2 modulo 32.
- <index> For the 8-bit variant: is the element index, encoded in "Q:S:size".
 For the 16-bit variant: is the element index, encoded in "Q:S:size<1>".
 For the 32-bit variant: is the element index, encoded in "Q:S".
 For the 64-bit variant: is the element index, encoded in "Q".
- <Xn|SP> Is the 64-bit name of the general-purpose base register or stack pointer, encoded in the "Rn" field.
- <Xm> Is the 64-bit name of the general-purpose post-index register, excluding XZR, encoded in the "Rm" field.

Shared decode for all encodings

```

integer scale = UInt(opcode<2:1>);
integer selem = UInt(opcode<0>:R) + 1;
boolean replicate = FALSE;
integer index;

case scale of
    when 3
        // load and replicate
        if L == '0' || S == '1' then UnallocatedEncoding();
        scale = UInt(size);
        replicate = TRUE;
    when 0
        index = UInt(Q:S:size); // B[0-15]
    when 1
        if size<0> == '1' then UnallocatedEncoding();
        index = UInt(Q:S:size<1>); // H[0-7]
    when 2
        if size<1> == '1' then UnallocatedEncoding();
        if size<0> == '0' then
            index = UInt(Q:S); // S[0-3]
        else
            if S == '1' then UnallocatedEncoding();
            index = UInt(Q); // D[0-1]
            scale = 3;

MemOp memop = if L == '1' then MemOp_LOAD else MemOp_STORE;
integer datasize = if Q == '1' then 128 else 64;
integer esize = 8 << scale;
    
```

Operation for all encodings

```

CheckFPAdvSIMDEnabled64();

bits(64) address;
bits(64) offs;
bits(128) rval;
bits(esize) element;
integer s;
constant integer ebytes = esize DIV 8;

if n == 31 then
    CheckSPAlignment();
    address = SP[];
else
    address = X[n];

offs = Zeros();
if replicate then
    // load and replicate to all elements
    for s = 0 to selem-1
        element = Mem[address+offs, ebytes, AccType_VEC];
        // replicate to fill 128- or 64-bit register
        V[t] = Replicate(element, datasize DIV esize);
        offs = offs + ebytes;
        t = (t + 1) MOD 32;
else
    // load/store one element per register
    for s = 0 to selem-1
        rval = V[t];
        if memop == MemOp_LOAD then
            // insert into one lane of 128-bit register
            Elem[rval, index, esize] = Mem[address+offs, ebytes, AccType_VEC];
            V[t] = rval;
        else // memop == MemOp_STORE
            // extract from one lane of 128-bit register
    
```



```
    Mem[address+offs, ebytes, AccType_VEC] = Elem[rval, index, esize];
    offs = offs + ebytes;
    t = (t + 1) MOD 32;

if wback then
    if m != 31 then
        offs = X[m];
    if n == 31 then
        SP[] = address + offs;
    else
        X[n] = address + offs;
```

C7.2.160 LD3R

Load single 3-element structure and Replicate to all lanes of three registers. This instruction loads a 3-element structure from memory and replicates the structure to all the lanes of the three SIMD&FP registers.

Depending on the settings in the CPACR_EL1, CPTR_EL2, and CPTR_EL3 registers, and the current Security state and Exception level, an attempt to execute the instruction might be trapped.

No offset

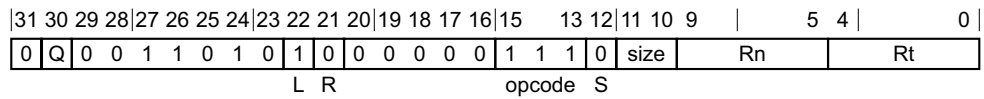

No offset variant

LD3R { <Vt>.<T>, <Vt2>.<T>, <Vt3>.<T> }, [<Xn|SP>]

Decode for this encoding

```
integer t = UInt(Rt);
integer n = UInt(Rn);
integer m = integer UNKNOWN;
boolean wback = FALSE;
```

Post-index

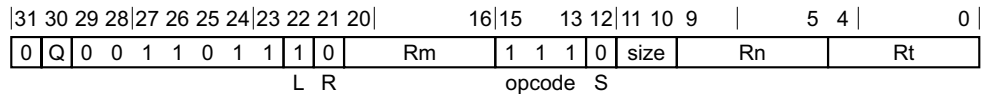

Immediate offset variant

Applies when Rm == 11111.

LD3R { <Vt>.<T>, <Vt2>.<T>, <Vt3>.<T> }, [<Xn|SP>], <imm>

Register offset variant

Applies when Rm != 11111.

LD3R { <Vt>.<T>, <Vt2>.<T>, <Vt3>.<T> }, [<Xn|SP>], <Xm>

Decode for all variants of this encoding

```
integer t = UInt(Rt);
integer n = UInt(Rn);
integer m = UInt(Rm);
boolean wback = TRUE;
```

Assembler symbols

- <Vt> Is the name of the first or only SIMD&FP register to be transferred, encoded in the "Rt" field.
- <T> Is an arrangement specifier, encoded in the "size:Q" field. It can have the following values:
 - 8B when size = 00, Q = 0
 - 16B when size = 00, Q = 1
 - 4H when size = 01, Q = 0
 - 8H when size = 01, Q = 1

2S	when size = 10, Q = 0
4S	when size = 10, Q = 1
1D	when size = 11, Q = 0
2D	when size = 11, Q = 1
<Vt2>	Is the name of the second SIMD&FP register to be transferred, encoded as "Rt" plus 1 modulo 32.
<Vt3>	Is the name of the third SIMD&FP register to be transferred, encoded as "Rt" plus 2 modulo 32.
<Xn SP>	Is the 64-bit name of the general-purpose base register or stack pointer, encoded in the "Rn" field.
<imm>	Is the post-index immediate offset, encoded in the "size" field. It can have the following values:
#3	when size = 00
#6	when size = 01
#12	when size = 10
#24	when size = 11
<Xm>	Is the 64-bit name of the general-purpose post-index register, excluding XZR, encoded in the "Rm" field.

Shared decode for all encodings

```

integer scale = UInt(opcode<2:1>);
integer selem = UInt(opcode<0>:R) + 1;
boolean replicate = FALSE;
integer index;

case scale of
    when 3
        // load and replicate
        if L == '0' || S == '1' then UnallocatedEncoding();
        scale = UInt(size);
        replicate = TRUE;
    when 0
        index = UInt(Q:S:size); // B[0-15]
    when 1
        if size<0> == '1' then UnallocatedEncoding();
        index = UInt(Q:S:size<1>); // H[0-7]
    when 2
        if size<1> == '1' then UnallocatedEncoding();
        if size<0> == '0' then
            index = UInt(Q:S); // S[0-3]
        else
            if S == '1' then UnallocatedEncoding();
            index = UInt(Q); // D[0-1]
            scale = 3;

MemOp memop = if L == '1' then MemOp_LOAD else MemOp_STORE;
integer datasize = if Q == '1' then 128 else 64;
integer esize = 8 << scale;
    
```

Operation for all encodings

```

CheckFPAdvSIMDEnabled64();

bits(64) address;
bits(64) offs;
bits(128) rval;
bits(esize) element;
integer s;
constant integer ebytes = esize DIV 8;
    
```

```
if n == 31 then
    CheckSPAlignment();
    address = SP[];
else
    address = X[n];

offs = Zeros();
if replicate then
    // load and replicate to all elements
    for s = 0 to selem-1
        element = Mem[address+offs, ebytes, AccType_VEC];
        // replicate to fill 128- or 64-bit register
        V[t] = Replicate(element, datasize DIV esize);
        offs = offs + ebytes;
        t = (t + 1) MOD 32;
else
    // load/store one element per register
    for s = 0 to selem-1
        rval = V[t];
        if memop == MemOp_LOAD then
            // insert into one lane of 128-bit register
            Elem[rval, index, esize] = Mem[address+offs, ebytes, AccType_VEC];
            V[t] = rval;
        else // memop == MemOp_STORE
            // extract from one lane of 128-bit register
            Mem[address+offs, ebytes, AccType_VEC] = Elem[rval, index, esize];
            offs = offs + ebytes;
            t = (t + 1) MOD 32;

if wback then
    if m != 31 then
        offs = X[m];
    if n == 31 then
        SP[] = address + offs;
    else
        X[n] = address + offs;
```

C7.2.161 LD4 (multiple structures)

Load multiple 4-element structures to four registers. This instruction loads multiple 4-element structures from memory and writes the result to the four SIMD&FP registers, with de-interleaving.

For an example of de-interleaving, see LD3 (multiple structures).

Depending on the settings in the CPACR_EL1, CPTR_EL2, and CPTR_EL3 registers, and the current Security state and Exception level, an attempt to execute the instruction might be trapped.

No offset

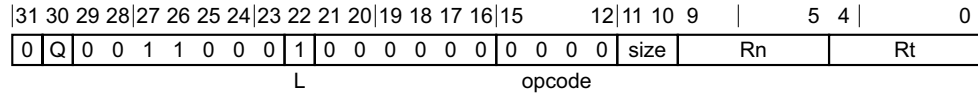

No offset variant

LD4 { <Vt>.<T>, <Vt2>.<T>, <Vt3>.<T>, <Vt4>.<T> }, [<Xn|SP>]

Decode for this encoding

```
integer t = UInt(Rt);
integer n = UInt(Rn);
integer m = integer UNKNOWN;
boolean wback = FALSE;
```

Post-index

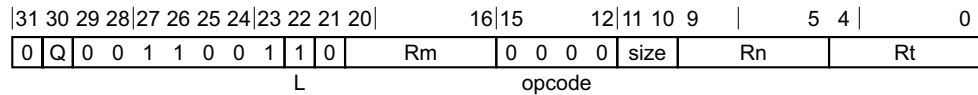

Immediate offset variant

Applies when Rm == 11111.

LD4 { <Vt>.<T>, <Vt2>.<T>, <Vt3>.<T>, <Vt4>.<T> }, [<Xn|SP>], <imm>

Register offset variant

Applies when Rm != 11111.

LD4 { <Vt>.<T>, <Vt2>.<T>, <Vt3>.<T>, <Vt4>.<T> }, [<Xn|SP>], <Xm>

Decode for all variants of this encoding

```
integer t = UInt(Rt);
integer n = UInt(Rn);
integer m = UInt(Rm);
boolean wback = TRUE;
```

Assembler symbols

- <Vt> Is the name of the first or only SIMD&FP register to be transferred, encoded in the "Rt" field.
- <T> Is an arrangement specifier, encoded in the "size:Q" field. It can have the following values:
 - 8B when size = 00, Q = 0
 - 16B when size = 00, Q = 1

4H when size = 01, Q = 0

8H when size = 01, Q = 1

2S when size = 10, Q = 0

4S when size = 10, Q = 1

2D when size = 11, Q = 1

The encoding size = 11, Q = 0 is reserved.

<Vt2> Is the name of the second SIMD&FP register to be transferred, encoded as "Rt" plus 1 modulo 32.

<Vt3> Is the name of the third SIMD&FP register to be transferred, encoded as "Rt" plus 2 modulo 32.

<Vt4> Is the name of the fourth SIMD&FP register to be transferred, encoded as "Rt" plus 3 modulo 32.

<Xn|SP> Is the 64-bit name of the general-purpose base register or stack pointer, encoded in the "Rn" field.

<imm> Is the post-index immediate offset, encoded in the "Q" field. It can have the following values:

#32 when Q = 0

#64 when Q = 1

<Xm> Is the 64-bit name of the general-purpose post-index register, excluding XZR, encoded in the "Rm" field.

Shared decode for all encodings

```
MemOp memop = if L == '1' then MemOp_LOAD else MemOp_STORE;
integer datasize = if Q == '1' then 128 else 64;
integer esize = 8 << UInt(size);
integer elements = datasize DIV esize;

integer rpt; // number of iterations
integer selem; // structure elements

case opcode of
  when '0000' rpt = 1; selem = 4; // LD/ST4 (4 registers)
  when '0010' rpt = 4; selem = 1; // LD/ST1 (4 registers)
  when '0100' rpt = 1; selem = 3; // LD/ST3 (3 registers)
  when '0110' rpt = 3; selem = 1; // LD/ST1 (3 registers)
  when '0111' rpt = 1; selem = 1; // LD/ST1 (1 register)
  when '1000' rpt = 1; selem = 2; // LD/ST2 (2 registers)
  when '1010' rpt = 2; selem = 1; // LD/ST1 (2 registers)
  otherwise UnallocatedEncoding();

// .1D format only permitted with LD1 & ST1
if size:Q == '110' && selem != 1 then ReservedValue();
```

Operation for all encodings

```
CheckFPAdvSIMDEnabled64();

bits(64) address;
bits(64) offs;
bits(datasize) rval;
integer e, r, s, tt;
constant integer ebytes = esize DIV 8;

if n == 31 then
  CheckSPAlignment();
  address = SP[];
else
  address = X[n];

offs = Zeros();
```

```
for r = 0 to rpt-1
  for e = 0 to elements-1
    tt = (t + r) MOD 32;
    for s = 0 to selem-1
      rval = V[tt];
      if memop == MemOp_LOAD then
        Elem[rval, e, esize] = Mem[address+offs, ebytes, AccType_VEC];
        V[tt] = rval;
      else // memop == MemOp_STORE
        Mem[address+offs, ebytes, AccType_VEC] = Elem[rval, e, esize];
      offs = offs + ebytes;
      tt = (tt + 1) MOD 32;

if wback then
  if m != 31 then
    offs = X[m];
  if n == 31 then
    SP[] = address + offs;
  else
    X[n] = address + offs;
```

C7.2.162 LD4 (single structure)

Load single 4-element structure to one lane of four registers. This instruction loads a 4-element structure from memory and writes the result to the corresponding elements of the four SIMD&FP registers without affecting the other bits of the registers.

Depending on the settings in the CPACR_EL1, CPTR_EL2, and CPTR_EL3 registers, and the current Security state and Exception level, an attempt to execute the instruction might be trapped.

No offset

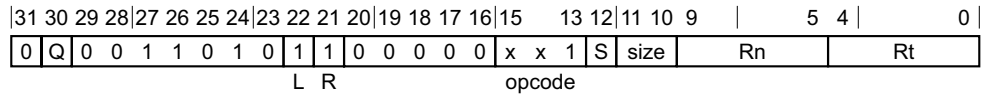

8-bit variant

Applies when opcode == 001.

LD4 { <Vt>.B, <Vt2>.B, <Vt3>.B, <Vt4>.B }[<index>], [<Xn|SP>]

16-bit variant

Applies when opcode == 011 && size == x0.

LD4 { <Vt>.H, <Vt2>.H, <Vt3>.H, <Vt4>.H }[<index>], [<Xn|SP>]

32-bit variant

Applies when opcode == 101 && size == 00.

LD4 { <Vt>.S, <Vt2>.S, <Vt3>.S, <Vt4>.S }[<index>], [<Xn|SP>]

64-bit variant

Applies when opcode == 101 && S == 0 && size == 01.

LD4 { <Vt>.D, <Vt2>.D, <Vt3>.D, <Vt4>.D }[<index>], [<Xn|SP>]

Decode for all variants of this encoding

```
integer t = UInt(Rt);
integer n = UInt(Rn);
integer m = integer UNKNOWN;
boolean wback = FALSE;
```

Post-index

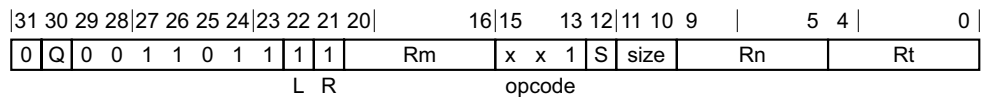

8-bit, immediate offset variant

Applies when Rm == 11111 && opcode == 001.

LD4 { <Vt>.B, <Vt2>.B, <Vt3>.B, <Vt4>.B }[<index>], [<Xn|SP>], #4

8-bit, register offset variant

Applies when Rm != 11111 && opcode == 001.

LD4 { <Vt>.B, <Vt2>.B, <Vt3>.B, <Vt4>.B }[<index>], [<Xn|SP>], <Xm>

16-bit, immediate offset variant

Applies when Rm == 11111 && opcode == 011 && size == x0.

LD4 { <Vt>.H, <Vt2>.H, <Vt3>.H, <Vt4>.H }[<index>], [<Xn|SP>], #8

16-bit, register offset variant

Applies when Rm != 11111 && opcode == 011 && size == x0.

LD4 { <Vt>.H, <Vt2>.H, <Vt3>.H, <Vt4>.H }[<index>], [<Xn|SP>], <Xm>

32-bit, immediate offset variant

Applies when Rm == 11111 && opcode == 101 && size == 00.

LD4 { <Vt>.S, <Vt2>.S, <Vt3>.S, <Vt4>.S }[<index>], [<Xn|SP>], #16

32-bit, register offset variant

Applies when Rm != 11111 && opcode == 101 && size == 00.

LD4 { <Vt>.S, <Vt2>.S, <Vt3>.S, <Vt4>.S }[<index>], [<Xn|SP>], <Xm>

64-bit, immediate offset variant

Applies when Rm == 11111 && opcode == 101 && S == 0 && size == 01.

LD4 { <Vt>.D, <Vt2>.D, <Vt3>.D, <Vt4>.D }[<index>], [<Xn|SP>], #32

64-bit, register offset variant

Applies when Rm != 11111 && opcode == 101 && S == 0 && size == 01.

LD4 { <Vt>.D, <Vt2>.D, <Vt3>.D, <Vt4>.D }[<index>], [<Xn|SP>], <Xm>

Decode for all variants of this encoding

```
integer t = UInt(Rt);
integer n = UInt(Rn);
integer m = UInt(Rm);
boolean wback = TRUE;
```

Assembler symbols

- <Vt> Is the name of the first or only SIMD&FP register to be transferred, encoded in the "Rt" field.
- <Vt2> Is the name of the second SIMD&FP register to be transferred, encoded as "Rt" plus 1 modulo 32.
- <Vt3> Is the name of the third SIMD&FP register to be transferred, encoded as "Rt" plus 2 modulo 32.
- <Vt4> Is the name of the fourth SIMD&FP register to be transferred, encoded as "Rt" plus 3 modulo 32.
- <index> For the 8-bit variant: is the element index, encoded in "Q:S:size".
 For the 16-bit variant: is the element index, encoded in "Q:S:size<1>".
 For the 32-bit variant: is the element index, encoded in "Q:S".
 For the 64-bit variant: is the element index, encoded in "Q".
- <Xn|SP> Is the 64-bit name of the general-purpose base register or stack pointer, encoded in the "Rn" field.
- <Xm> Is the 64-bit name of the general-purpose post-index register, excluding XZR, encoded in the "Rm" field.

Shared decode for all encodings

```

integer scale = UInt(opcode<2:1>);
integer selem = UInt(opcode<0>:R) + 1;
boolean replicate = FALSE;
integer index;

case scale of
    when 3
        // load and replicate
        if L == '0' || S == '1' then UnallocatedEncoding();
        scale = UInt(size);
        replicate = TRUE;
    when 0
        index = UInt(Q:S:size); // B[0-15]
    when 1
        if size<0> == '1' then UnallocatedEncoding();
        index = UInt(Q:S:size<1>); // H[0-7]
    when 2
        if size<1> == '1' then UnallocatedEncoding();
        if size<0> == '0' then
            index = UInt(Q:S); // S[0-3]
        else
            if S == '1' then UnallocatedEncoding();
            index = UInt(Q); // D[0-1]
            scale = 3;

MemOp memop = if L == '1' then MemOp_LOAD else MemOp_STORE;
integer datasize = if Q == '1' then 128 else 64;
integer esize = 8 << scale;
    
```

Operation for all encodings

```

CheckFPAdvSIMDEnabled64();

bits(64) address;
bits(64) offs;
bits(128) rval;
bits(esize) element;
integer s;
constant integer ebytes = esize DIV 8;

if n == 31 then
    CheckSPAlignment();
    address = SP[];
else
    address = X[n];

offs = Zeros();
if replicate then
    // load and replicate to all elements
    for s = 0 to selem-1
        element = Mem[address+offs, ebytes, AccType_VEC];
        // replicate to fill 128- or 64-bit register
        V[t] = Replicate(element, datasize DIV esize);
        offs = offs + ebytes;
        t = (t + 1) MOD 32;
else
    // load/store one element per register
    for s = 0 to selem-1
        rval = V[t];
        if memop == MemOp_LOAD then
            // insert into one lane of 128-bit register
            Elem[rval, index, esize] = Mem[address+offs, ebytes, AccType_VEC];
            V[t] = rval;
        else // memop == MemOp_STORE
            // extract from one lane of 128-bit register
    
```

```
    Mem[address+offs, ebytes, AccType_VEC] = Elem[rval, index, esize];  
    offs = offs + ebytes;  
    t = (t + 1) MOD 32;  
  
if wback then  
    if m != 31 then  
        offs = X[m];  
    if n == 31 then  
        SP[] = address + offs;  
    else  
        X[n] = address + offs;
```

C7.2.163 LD4R

Load single 4-element structure and Replicate to all lanes of four registers. This instruction loads a 4-element structure from memory and replicates the structure to all the lanes of the four SIMD&FP registers.

Depending on the settings in the CPACR_EL1, CPTR_EL2, and CPTR_EL3 registers, and the current Security state and Exception level, an attempt to execute the instruction might be trapped.

No offset

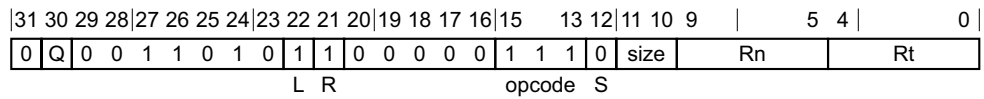

No offset variant

LD4R { <Vt>.<T>, <Vt2>.<T>, <Vt3>.<T>, <Vt4>.<T> }, [<Xn|SP>]

Decode for this encoding

```
integer t = UInt(Rt);
integer n = UInt(Rn);
integer m = integer UNKNOWN;
boolean wback = FALSE;
```

Post-index

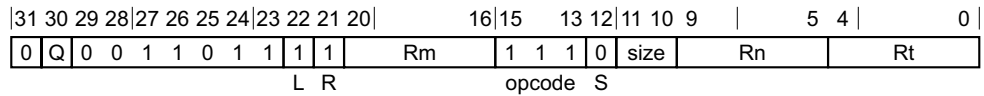

Immediate offset variant

Applies when Rm == 11111.

LD4R { <Vt>.<T>, <Vt2>.<T>, <Vt3>.<T>, <Vt4>.<T> }, [<Xn|SP>], <imm>

Register offset variant

Applies when Rm != 11111.

LD4R { <Vt>.<T>, <Vt2>.<T>, <Vt3>.<T>, <Vt4>.<T> }, [<Xn|SP>], <Xm>

Decode for all variants of this encoding

```
integer t = UInt(Rt);
integer n = UInt(Rn);
integer m = UInt(Rm);
boolean wback = TRUE;
```

Assembler symbols

- <Vt> Is the name of the first or only SIMD&FP register to be transferred, encoded in the "Rt" field.
- <T> Is an arrangement specifier, encoded in the "size:Q" field. It can have the following values:
 - 8B when size = 00, Q = 0
 - 16B when size = 00, Q = 1
 - 4H when size = 01, Q = 0
 - 8H when size = 01, Q = 1

- 2S when size = 10, Q = 0
 4S when size = 10, Q = 1
 1D when size = 11, Q = 0
 2D when size = 11, Q = 1
- <Vt2> Is the name of the second SIMD&FP register to be transferred, encoded as "Rt" plus 1 modulo 32.
- <Vt3> Is the name of the third SIMD&FP register to be transferred, encoded as "Rt" plus 2 modulo 32.
- <Vt4> Is the name of the fourth SIMD&FP register to be transferred, encoded as "Rt" plus 3 modulo 32.
- <Xn|SP> Is the 64-bit name of the general-purpose base register or stack pointer, encoded in the "Rn" field.
- <imm> Is the post-index immediate offset, encoded in the "size" field. It can have the following values:
- #4 when size = 00
 #8 when size = 01
 #16 when size = 10
 #32 when size = 11
- <Xm> Is the 64-bit name of the general-purpose post-index register, excluding XZR, encoded in the "Rm" field.

Shared decode for all encodings

```
integer scale = UInt(opcode<2:1>);
integer selem = UInt(opcode<0>:R) + 1;
boolean replicate = FALSE;
integer index;

case scale of
    when 3
        // load and replicate
        if L == '0' || S == '1' then UnallocatedEncoding();
        scale = UInt(size);
        replicate = TRUE;
    when 0
        index = UInt(Q:S:size); // B[0-15]
    when 1
        if size<0> == '1' then UnallocatedEncoding();
        index = UInt(Q:S:size<1>); // H[0-7]
    when 2
        if size<1> == '1' then UnallocatedEncoding();
        if size<0> == '0' then
            index = UInt(Q:S); // S[0-3]
        else
            if S == '1' then UnallocatedEncoding();
            index = UInt(Q); // D[0-1]
            scale = 3;

MemOp memop = if L == '1' then MemOp_LOAD else MemOp_STORE;
integer datasize = if Q == '1' then 128 else 64;
integer esize = 8 << scale;
```

Operation for all encodings

```
CheckFPAdvSIMDEnabled64();

bits(64) address;
bits(64) offs;
bits(128) rval;
bits(esize) element;
integer s;
```

```
constant integer ebytes = esize DIV 8;

if n == 31 then
    CheckSPAlignment();
    address = SP[];
else
    address = X[n];

offs = Zeros();
if replicate then
    // load and replicate to all elements
    for s = 0 to selem-1
        element = Mem[address+offs, ebytes, AccType_VEC];
        // replicate to fill 128- or 64-bit register
        V[t] = Replicate(element, datasize DIV esize);
        offs = offs + ebytes;
        t = (t + 1) MOD 32;
else
    // load/store one element per register
    for s = 0 to selem-1
        rval = V[t];
        if memop == MemOp_LOAD then
            // insert into one lane of 128-bit register
            Elem[rval, index, esize] = Mem[address+offs, ebytes, AccType_VEC];
            V[t] = rval;
        else // memop == MemOp_STORE
            // extract from one lane of 128-bit register
            Mem[address+offs, ebytes, AccType_VEC] = Elem[rval, index, esize];
            offs = offs + ebytes;
            t = (t + 1) MOD 32;

if wback then
    if m != 31 then
        offs = X[m];
    if n == 31 then
        SP[] = address + offs;
    else
        X[n] = address + offs;
```

C7.2.164 LDNP (SIMD&FP)

Load Pair of SIMD&FP registers, with Non-temporal hint. This instruction loads a pair of SIMD&FP registers from memory, issuing a hint to the memory system that the access is non-temporal. The address that is used for the load is calculated from a base register value and an optional immediate offset.

For information about non-temporal pair instructions, see [Load/Store SIMD and Floating-point Non-temporal pair on page C3-168](#).

Depending on the settings in the [CPACR_EL1](#), [CPTR_EL2](#), and [CPTR_EL3](#) registers, and the current Security state and Exception level, an attempt to execute the instruction might be trapped.

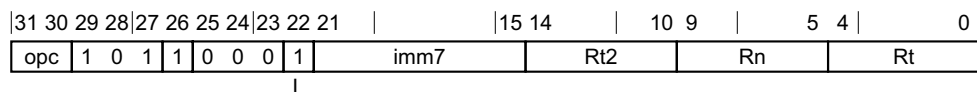

32-bit variant

Applies when `opc == 00`.

LDNP <St1>, <St2>, [<Xn|SP>{, #<imm>}]

64-bit variant

Applies when `opc == 01`.

LDNP <Dt1>, <Dt2>, [<Xn|SP>{, #<imm>}]

128-bit variant

Applies when `opc == 10`.

LDNP <Qt1>, <Qt2>, [<Xn|SP>{, #<imm>}]

Decode for all variants of this encoding

// Empty.

Notes for all encodings

For information about the CONSTRAINED UNPREDICTABLE behavior of this instruction, see [Appendix K1 Architectural Constraints on UNPREDICTABLE behaviors](#), and particularly [LDNP \(SIMD&FP\) on page K1-6125](#).

Assembler symbols

- <Dt1> Is the 64-bit name of the first SIMD&FP register to be transferred, encoded in the "Rt" field.
- <Dt2> Is the 64-bit name of the second SIMD&FP register to be transferred, encoded in the "Rt2" field.
- <Qt1> Is the 128-bit name of the first SIMD&FP register to be transferred, encoded in the "Rt" field.
- <Qt2> Is the 128-bit name of the second SIMD&FP register to be transferred, encoded in the "Rt2" field.
- <St1> Is the 32-bit name of the first SIMD&FP register to be transferred, encoded in the "Rt" field.
- <St2> Is the 32-bit name of the second SIMD&FP register to be transferred, encoded in the "Rt2" field.
- <Xn|SP> Is the 64-bit name of the general-purpose base register or stack pointer, encoded in the "Rn" field.
- <imm> For the 32-bit variant: is the optional signed immediate byte offset, a multiple of 4 in the range -256 to 252, defaulting to 0 and encoded in the "imm7" field as <imm>/4.

For the 64-bit variant: is the optional signed immediate byte offset, a multiple of 8 in the range -512 to 504, defaulting to 0 and encoded in the "imm7" field as <imm>/8.

For the 128-bit variant: is the optional signed immediate byte offset, a multiple of 16 in the range -1024 to 1008, defaulting to 0 and encoded in the "imm7" field as <imm>/16.

Shared decode for all encodings

```
integer n = UInt(Rn);
integer t = UInt(Rt);
integer t2 = UInt(Rt2);
if opc == '11' then UnallocatedEncoding();
integer scale = 2 + UInt(opc);
integer datasize = 8 << scale;
bits(64) offset = LSL(SignExtend(imm7, 64), scale);
```

Operation

```
CheckFPAdvSIMDEnabled64();

bits(64) address;
bits(datasize) data1;
bits(datasize) data2;
constant integer dbytes = datasize DIV 8;
boolean rt_unknown = FALSE;

if t == t2 then
    Constraint c = ConstrainUnpredictable();
    assert c IN {Constraint_UNKNOWN, Constraint_UNDEF, Constraint_NOP};
    case c of
        when Constraint_UNKNOWN rt_unknown = TRUE; // result is UNKNOWN
        when Constraint_UNDEF UnallocatedEncoding();
        when Constraint_NOP EndOfInstruction();

if n == 31 then
    CheckSPAlignment();
    address = SP[];
else
    address = X[n];

address = address + offset;

data1 = Mem[address, dbytes, AccType_VECSTREAM];
data2 = Mem[address+dbytes, dbytes, AccType_VECSTREAM];
if rt_unknown then
    data1 = bits(datasize) UNKNOWN;
    data2 = bits(datasize) UNKNOWN;
V[t] = data1;
V[t2] = data2;
```

C7.2.165 LDP (SIMD&FP)

Load Pair of SIMD&FP registers. This instruction loads a pair of SIMD&FP registers from memory. The address that is used for the load is calculated from a base register value and an optional immediate offset.

Depending on the settings in the CPACR_EL1, CPTR_EL2, and CPTR_EL3 registers, and the current Security state and Exception level, an attempt to execute the instruction might be trapped.

Post-index

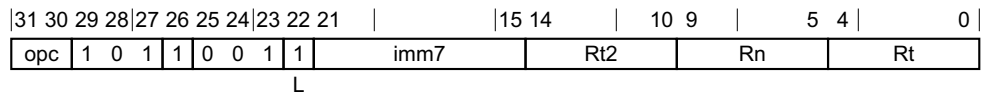

32-bit variant

Applies when `opc == 00`.

LDP <St1>, <St2>, [<Xn|SP>], #<imm>

64-bit variant

Applies when `opc == 01`.

LDP <Dt1>, <Dt2>, [<Xn|SP>], #<imm>

128-bit variant

Applies when `opc == 10`.

LDP <Qt1>, <Qt2>, [<Xn|SP>], #<imm>

Decode for all variants of this encoding

```
boolean wback = TRUE;
boolean postindex = TRUE;
```

Pre-index

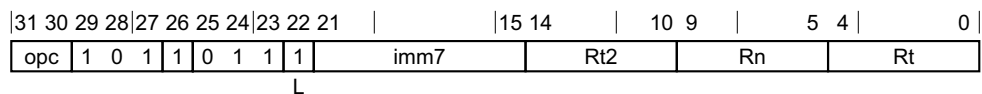

32-bit variant

Applies when `opc == 00`.

LDP <St1>, <St2>, [<Xn|SP>, #<imm>]!

64-bit variant

Applies when `opc == 01`.

LDP <Dt1>, <Dt2>, [<Xn|SP>, #<imm>]!

128-bit variant

Applies when `opc == 10`.

LDP <Qt1>, <Qt2>, [<Xn|SP>, #<imm>]!

Decode for all variants of this encoding

boolean wback = TRUE;
 boolean postindex = FALSE;

Signed offset

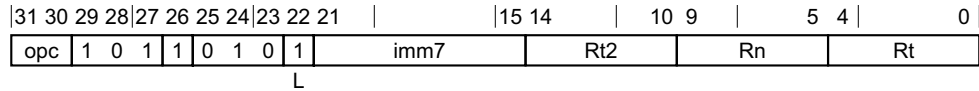

32-bit variant

Applies when `opc == 00`.
 LDP <St1>, <St2>, [<Xn|SP>{, #<imm>}]

64-bit variant

Applies when `opc == 01`.
 LDP <Dt1>, <Dt2>, [<Xn|SP>{, #<imm>}]

128-bit variant

Applies when `opc == 10`.
 LDP <Qt1>, <Qt2>, [<Xn|SP>{, #<imm>}]

Decode for all variants of this encoding

boolean wback = FALSE;
 boolean postindex = FALSE;

Notes for all encodings

For information about the CONSTRAINED UNPREDICTABLE behavior of this instruction, see [LDP \(SIMD&FP\) on page K1-6125](#), and particularly [LDNP \(SIMD&FP\) on page K1-6125](#).

Assembler symbols

- <Dt1> Is the 64-bit name of the first SIMD&FP register to be transferred, encoded in the "Rt" field.
- <Dt2> Is the 64-bit name of the second SIMD&FP register to be transferred, encoded in the "Rt2" field.
- <Qt1> Is the 128-bit name of the first SIMD&FP register to be transferred, encoded in the "Rt" field.
- <Qt2> Is the 128-bit name of the second SIMD&FP register to be transferred, encoded in the "Rt2" field.
- <St1> Is the 32-bit name of the first SIMD&FP register to be transferred, encoded in the "Rt" field.
- <St2> Is the 32-bit name of the second SIMD&FP register to be transferred, encoded in the "Rt2" field.
- <Xn|SP> Is the 64-bit name of the general-purpose base register or stack pointer, encoded in the "Rn" field.
- <imm> For the 32-bit post-index and 32-bit pre-index variant: is the signed immediate byte offset, a multiple of 4 in the range -256 to 252, encoded in the "imm7" field as <imm>/4.
 For the 32-bit signed offset variant: is the optional signed immediate byte offset, a multiple of 4 in the range -256 to 252, defaulting to 0 and encoded in the "imm7" field as <imm>/4.
 For the 64-bit post-index and 64-bit pre-index variant: is the signed immediate byte offset, a multiple of 8 in the range -512 to 504, encoded in the "imm7" field as <imm>/8.

For the 64-bit signed offset variant: is the optional signed immediate byte offset, a multiple of 8 in the range -512 to 504, defaulting to 0 and encoded in the "imm7" field as <imm>/8.

For the 128-bit post-index and 128-bit pre-index variant: is the signed immediate byte offset, a multiple of 16 in the range -1024 to 1008, encoded in the "imm7" field as <imm>/16.

For the 128-bit signed offset variant: is the optional signed immediate byte offset, a multiple of 16 in the range -1024 to 1008, defaulting to 0 and encoded in the "imm7" field as <imm>/16.

Shared decode for all encodings

```
integer n = UInt(Rn);
integer t = UInt(Rt);
integer t2 = UInt(Rt2);
if opc == '11' then UnallocatedEncoding();
integer scale = 2 + UInt(opc);
integer datasize = 8 << scale;
bits(64) offset = LSL(SignExtend(imm7, 64), scale);
```

Operation for all encodings

```
CheckFPAdvSIMDEnabled64();

bits(64) address;
bits(datasize) data1;
bits(datasize) data2;
constant integer dbytes = datasize DIV 8;
boolean rt_unknown = FALSE;

if t == t2 then
    Constraint c = ConstrainUnpredictable();
    assert c IN {Constraint_UNKNOWN, Constraint_UNDEF, Constraint_NOP};
    case c of
        when Constraint_UNKNOWN rt_unknown = TRUE; // result is UNKNOWN
        when Constraint_UNDEF UnallocatedEncoding();
        when Constraint_NOP EndOfInstruction();

if n == 31 then
    CheckSPAlignment();
    address = SP[];
else
    address = X[n];

if !postindex then
    address = address + offset;

data1 = Mem[address, dbytes, AccType_VEC];
data2 = Mem[address+dbytes, dbytes, AccType_VEC];
if rt_unknown then
    data1 = bits(datasize) UNKNOWN;
    data2 = bits(datasize) UNKNOWN;
V[t] = data1;
V[t2] = data2;

if wback then
    if postindex then
        address = address + offset;
    if n == 31 then
        SP[] = address;
    else
        X[n] = address;
```

C7.2.166 LDR (immediate, SIMD&FP)

Load SIMD&FP Register (immediate offset). This instruction loads an element from memory, and writes the result as a scalar to the SIMD&FP register. The address that is used for the load is calculated from a base register value, a signed immediate offset, and an optional offset that is a multiple of the element size.

Depending on the settings in the CPACR_EL1, CPTR_EL2, and CPTR_EL3 registers, and the current Security state and Exception level, an attempt to execute the instruction might be trapped.

Post-index



8-bit variant

Applies when size == 00 && opc == 01.

LDR <Bt>, [<Xn|SP>], #<sim>

16-bit variant

Applies when size == 01 && opc == 01.

LDR <Ht>, [<Xn|SP>], #<sim>

32-bit variant

Applies when size == 10 && opc == 01.

LDR <St>, [<Xn|SP>], #<sim>

64-bit variant

Applies when size == 11 && opc == 01.

LDR <Dt>, [<Xn|SP>], #<sim>

128-bit variant

Applies when size == 00 && opc == 11.

LDR <Qt>, [<Xn|SP>], #<sim>

Decode for all variants of this encoding

```
boolean wback = TRUE;
boolean postindex = TRUE;
integer scale = UInt(opc<1>:size);
if scale > 4 then UnallocatedEncoding();
bits(64) offset = SignExtend(imm9, 64);
```

Pre-index



8-bit variant

Applies when size == 00 && opc == 01.

LDR <Bt>, [<Xn|SP>, #<sim>]!

16-bit variant

Applies when size == 01 && opc == 01.

LDR <Ht>, [<Xn|SP>, #<sim>]!

32-bit variant

Applies when size == 10 && opc == 01.

LDR <St>, [<Xn|SP>, #<sim>]!

64-bit variant

Applies when size == 11 && opc == 01.

LDR <Dt>, [<Xn|SP>, #<sim>]!

128-bit variant

Applies when size == 00 && opc == 11.

LDR <Qt>, [<Xn|SP>, #<sim>]!

Decode for all variants of this encoding

```
boolean wback = TRUE;
boolean postindex = FALSE;
integer scale = UInt(opc<1>:size);
if scale > 4 then UnallocatedEncoding();
bits(64) offset = SignExtend(imm9, 64);
```

Unsigned offset



8-bit variant

Applies when size == 00 && opc == 01.

LDR <Bt>, [<Xn|SP>{, #<pimm>}]

16-bit variant

Applies when size == 01 && opc == 01.

LDR <Ht>, [<Xn|SP>{, #<pimm>}]

32-bit variant

Applies when size == 10 && opc == 01.

LDR <St>, [<Xn|SP>{, #<pimm>}]

64-bit variant

Applies when size == 11 && opc == 01.

LDR <Dt>, [<Xn|SP>{, #<pimm>}]

128-bit variant

Applies when size == 00 && opc == 11.

```
LDR <Qt>, [<Xn|SP>{, #<pimm>}]
```

Decode for all variants of this encoding

```
boolean wback = FALSE;  
boolean postindex = FALSE;  
integer scale = UInt(opc<1>:size);  
if scale > 4 then UnallocatedEncoding();  
bits(64) offset = LSL(ZeroExtend(imm12, 64), scale);
```

Assembler symbols

<Bt>	Is the 8-bit name of the SIMD&FP register to be transferred, encoded in the "Rt" field.
<Dt>	Is the 64-bit name of the SIMD&FP register to be transferred, encoded in the "Rt" field.
<Ht>	Is the 16-bit name of the SIMD&FP register to be transferred, encoded in the "Rt" field.
<Qt>	Is the 128-bit name of the SIMD&FP register to be transferred, encoded in the "Rt" field.
<St>	Is the 32-bit name of the SIMD&FP register to be transferred, encoded in the "Rt" field.
<Xn SP>	Is the 64-bit name of the general-purpose base register or stack pointer, encoded in the "Rn" field.
<sim>	Is the signed immediate byte offset, in the range -256 to 255, encoded in the "imm9" field.
<pimm>	For the 8-bit variant: is the optional positive immediate byte offset, in the range 0 to 4095, defaulting to 0 and encoded in the "imm12" field. For the 16-bit variant: is the optional positive immediate byte offset, a multiple of 2 in the range 0 to 8190, defaulting to 0 and encoded in the "imm12" field as <pimm>/2. For the 32-bit variant: is the optional positive immediate byte offset, a multiple of 4 in the range 0 to 16380, defaulting to 0 and encoded in the "imm12" field as <pimm>/4. For the 64-bit variant: is the optional positive immediate byte offset, a multiple of 8 in the range 0 to 32760, defaulting to 0 and encoded in the "imm12" field as <pimm>/8. For the 128-bit variant: is the optional positive immediate byte offset, a multiple of 16 in the range 0 to 65520, defaulting to 0 and encoded in the "imm12" field as <pimm>/16.

Shared decode for all encodings

```
integer n = UInt(Rn);  
integer t = UInt(Rt);  
AccType acctype = AccType_VEC;  
MemOp memop = if opc<0> == '1' then MemOp_LOAD else MemOp_STORE;  
integer datasize = 8 << scale;
```

Operation for all encodings

```
CheckFPAdvSIMDEnabled64();  
  
bits(64) address;  
bits(datasize) data;  
  
if n == 31 then  
    CheckSPAlignment();  
    address = SP[];  
else  
    address = X[n];  
  
if !postindex then
```

```
address = address + offset;

case memop of
  when MemOp_STORE
    data = V[t];
    Mem[address, datasize DIV 8, acctype] = data;

  when MemOp_LOAD
    data = Mem[address, datasize DIV 8, acctype];
    V[t] = data;

if wback then
  if postindex then
    address = address + offset;
  if n == 31 then
    SP[] = address;
  else
    X[n] = address;
```

C7.2.167 LDR (literal, SIMD&FP)

Load SIMD&FP Register (PC-relative literal). This instruction loads a SIMD&FP register from memory. The address that is used for the load is calculated from the PC value and an immediate offset.

Depending on the settings in the [CPACR_EL1](#), [CPTR_EL2](#), and [CPTR_EL3](#) registers, and the current Security state and Exception level, an attempt to execute the instruction might be trapped.

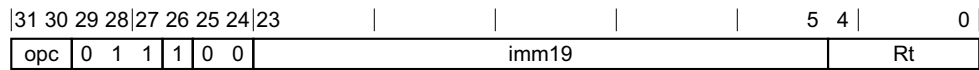

32-bit variant

Applies when `opc == 00`.

LDR <St>, <label>

64-bit variant

Applies when `opc == 01`.

LDR <Dt>, <label>

128-bit variant

Applies when `opc == 10`.

LDR <Qt>, <label>

Decode for all variants of this encoding

```
integer t = UInt(Rt);
integer size;
bits(64) offset;

case opc of
  when '00'
    size = 4;
  when '01'
    size = 8;
  when '10'
    size = 16;
  when '11'
    UnallocatedEncoding();

offset = SignExtend(imm19:'00', 64);
```

Assembler symbols

- <Dt> Is the 64-bit name of the SIMD&FP register to be loaded, encoded in the "Rt" field.
- <Qt> Is the 128-bit name of the SIMD&FP register to be loaded, encoded in the "Rt" field.
- <St> Is the 32-bit name of the SIMD&FP register to be loaded, encoded in the "Rt" field.
- <label> Is the program label from which the data is to be loaded. Its offset from the address of this instruction, in the range +/-1MB, is encoded as "imm19" times 4.

Operation

```
bits(64) address = PC[] + offset;  
bits(size*8) data;
```

```
CheckFPAdvSIMDEnabled64();
```

```
data = Mem[address, size, AccType_VEC];  
V[t] = data;
```

C7.2.168 LDR (register, SIMD&FP)

Load SIMD&FP Register (register offset). This instruction loads a SIMD&FP register from memory. The address that is used for the load is calculated from a base register value and an offset register value. The offset can be optionally shifted and extended.

Depending on the settings in the CPACR_EL1, CPTR_EL2, and CPTR_EL3 registers, and the current Security state and Exception level, an attempt to execute the instruction might be trapped.

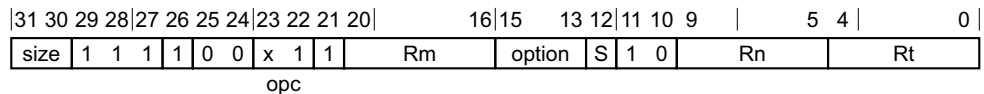

8-bit variant

Applies when size == 00 && opc == 01 && option != 011.

LDR <Bt>, [<Xn|SP>, (<Wm>|<Xm>), <extend> {<amount>}]

8-bit variant

Applies when size == 00 && opc == 01 && option == 011.

LDR <Bt>, [<Xn|SP>, <Xm>{, LSL <amount>}]

16-bit variant

Applies when size == 01 && opc == 01.

LDR <Ht>, [<Xn|SP>, (<Wm>|<Xm>){, <extend> {<amount>}}]

32-bit variant

Applies when size == 10 && opc == 01.

LDR <St>, [<Xn|SP>, (<Wm>|<Xm>){, <extend> {<amount>}}]

64-bit variant

Applies when size == 11 && opc == 01.

LDR <Dt>, [<Xn|SP>, (<Wm>|<Xm>){, <extend> {<amount>}}]

128-bit variant

Applies when size == 00 && opc == 11.

LDR <Qt>, [<Xn|SP>, (<Wm>|<Xm>){, <extend> {<amount>}}]

Decode for all variants of this encoding

```
boolean wback = FALSE;
boolean postindex = FALSE;
integer scale = UInt(opc<1>:size);
if scale > 4 then UnallocatedEncoding();
if option<1> == '0' then UnallocatedEncoding(); // sub-word index
ExtendType extend_type = DecodeRegExtend(option);
integer shift = if S == '1' then scale else 0;
```

Assembler symbols

<Bt> Is the 8-bit name of the SIMD&FP register to be transferred, encoded in the "Rt" field.

<Dt>	Is the 64-bit name of the SIMD&FP register to be transferred, encoded in the "Rt" field.																
<Ht>	Is the 16-bit name of the SIMD&FP register to be transferred, encoded in the "Rt" field.																
<Qt>	Is the 128-bit name of the SIMD&FP register to be transferred, encoded in the "Rt" field.																
<St>	Is the 32-bit name of the SIMD&FP register to be transferred, encoded in the "Rt" field.																
<Xn SP>	Is the 64-bit name of the general-purpose base register or stack pointer, encoded in the "Rn" field.																
<Wm>	When option<0> is set to 0, is the 32-bit name of the general-purpose index register, encoded in the "Rm" field.																
<Xm>	When option<0> is set to 1, is the 64-bit name of the general-purpose index register, encoded in the "Rm" field.																
<extend>	<p>For the 8-bit variant: is the index extend specifier, encoded in the "option" field. It can have the following values:</p> <table><tr><td>UXTW</td><td>when option = 010</td></tr><tr><td>SXTW</td><td>when option = 110</td></tr><tr><td>SXTX</td><td>when option = 111</td></tr></table> <p>For the 128-bit, 16-bit, 32-bit and 64-bit variant: is the index extend/shift specifier, defaulting to LSL, and which must be omitted for the LSL option when <amount> is omitted. encoded in the "option" field. It can have the following values:</p> <table><tr><td>UXTW</td><td>when option = 010</td></tr><tr><td>LSL</td><td>when option = 011</td></tr><tr><td>SXTW</td><td>when option = 110</td></tr><tr><td>SXTX</td><td>when option = 111</td></tr></table>	UXTW	when option = 010	SXTW	when option = 110	SXTX	when option = 111	UXTW	when option = 010	LSL	when option = 011	SXTW	when option = 110	SXTX	when option = 111		
UXTW	when option = 010																
SXTW	when option = 110																
SXTX	when option = 111																
UXTW	when option = 010																
LSL	when option = 011																
SXTW	when option = 110																
SXTX	when option = 111																
<amount>	<p>For the 8-bit variant: is the index shift amount, it must be #0, encoded in "S" as 0 if omitted, or as 1 if present.</p> <p>For the 16-bit variant: is the index shift amount, optional only when <extend> is not LSL. Where it is permitted to be optional, it defaults to #0. It is encoded in the "S" field. It can have the following values:</p> <table><tr><td>#0</td><td>when S = 0</td></tr><tr><td>#1</td><td>when S = 1</td></tr></table> <p>For the 32-bit variant: is the index shift amount, optional only when <extend> is not LSL. Where it is permitted to be optional, it defaults to #0. It is encoded in the "S" field. It can have the following values:</p> <table><tr><td>#0</td><td>when S = 0</td></tr><tr><td>#2</td><td>when S = 1</td></tr></table> <p>For the 64-bit variant: is the index shift amount, optional only when <extend> is not LSL. Where it is permitted to be optional, it defaults to #0. It is encoded in the "S" field. It can have the following values:</p> <table><tr><td>#0</td><td>when S = 0</td></tr><tr><td>#3</td><td>when S = 1</td></tr></table> <p>For the 128-bit variant: is the index shift amount, optional only when <extend> is not LSL. Where it is permitted to be optional, it defaults to #0. It is encoded in the "S" field. It can have the following values:</p> <table><tr><td>#0</td><td>when S = 0</td></tr><tr><td>#4</td><td>when S = 1</td></tr></table>	#0	when S = 0	#1	when S = 1	#0	when S = 0	#2	when S = 1	#0	when S = 0	#3	when S = 1	#0	when S = 0	#4	when S = 1
#0	when S = 0																
#1	when S = 1																
#0	when S = 0																
#2	when S = 1																
#0	when S = 0																
#3	when S = 1																
#0	when S = 0																
#4	when S = 1																

Shared decode for all encodings

```
integer n = UInt(Rn);
integer t = UInt(Rt);
integer m = UInt(Rm);
AccType acctype = AccType_VEC;
MemOp memop = if opc<0> == '1' then MemOp_LOAD else MemOp_STORE;
integer datasize = 8 << scale;
```

Operation

```
bits(64) offset = ExtendReg(m, extend_type, shift);
CheckFPAdvSIMDEnabled64();

bits(64) address;
bits(datasize) data;

if n == 31 then
    CheckSPAlignment();
    address = SP[];
else
    address = X[n];

if !postindex then
    address = address + offset;

case memop of
    when MemOp_STORE
        data = V[t];
        Mem[address, datasize DIV 8, acctype] = data;

    when MemOp_LOAD
        data = Mem[address, datasize DIV 8, acctype];
        V[t] = data;

if wback then
    if postindex then
        address = address + offset;
    if n == 31 then
        SP[] = address;
    else
        X[n] = address;
```

C7.2.169 LDUR (SIMD&FP)

Load SIMD&FP Register (unscaled offset). This instruction loads a SIMD&FP register from memory. The address that is used for the load is calculated from a base register value and an optional immediate offset.

Depending on the settings in the CPACR_EL1, CPTR_EL2, and CPTR_EL3 registers, and the current Security state and Exception level, an attempt to execute the instruction might be trapped.

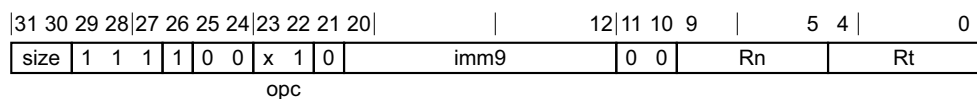

8-bit variant

Applies when size == 00 && opc == 01.

LDUR <Bt>, [<Xn|SP>{, #<imm>}]

16-bit variant

Applies when size == 01 && opc == 01.

LDUR <Ht>, [<Xn|SP>{, #<imm>}]

32-bit variant

Applies when size == 10 && opc == 01.

LDUR <St>, [<Xn|SP>{, #<imm>}]

64-bit variant

Applies when size == 11 && opc == 01.

LDUR <Dt>, [<Xn|SP>{, #<imm>}]

128-bit variant

Applies when size == 00 && opc == 11.

LDUR <Qt>, [<Xn|SP>{, #<imm>}]

Decode for all variants of this encoding

```
boolean wback = FALSE;
boolean postindex = FALSE;
integer scale = UInt(opc<1>:size);
if scale > 4 then UnallocatedEncoding();
bits(64) offset = SignExtend(imm9, 64);
```

Assembler symbols

- <Bt> Is the 8-bit name of the SIMD&FP register to be transferred, encoded in the "Rt" field.
- <Dt> Is the 64-bit name of the SIMD&FP register to be transferred, encoded in the "Rt" field.
- <Ht> Is the 16-bit name of the SIMD&FP register to be transferred, encoded in the "Rt" field.
- <Qt> Is the 128-bit name of the SIMD&FP register to be transferred, encoded in the "Rt" field.
- <St> Is the 32-bit name of the SIMD&FP register to be transferred, encoded in the "Rt" field.

<Xn|SP> Is the 64-bit name of the general-purpose base register or stack pointer, encoded in the "Rn" field.

<imm> Is the optional signed immediate byte offset, in the range -256 to 255, defaulting to 0 and encoded in the "imm9" field.

Shared decode for all encodings

```
integer n = UInt(Rn);
integer t = UInt(Rt);
AccType acctype = AccType_VEC;
MemOp memop = if opc<0> == '1' then MemOp_LOAD else MemOp_STORE;
integer datasize = 8 << scale;
```

Operation

```
CheckFPAdvSIMDEnabled64();

bits(64) address;
bits(datasize) data;

if n == 31 then
    CheckSPAlignment();
    address = SP[];
else
    address = X[n];

if !postindex then
    address = address + offset;

case memop of
    when MemOp_STORE
        data = V[t];
        Mem[address, datasize DIV 8, acctype] = data;

    when MemOp_LOAD
        data = Mem[address, datasize DIV 8, acctype];
        V[t] = data;

if wback then
    if postindex then
        address = address + offset;
    if n == 31 then
        SP[] = address;
    else
        X[n] = address;
```

C7.2.170 MLA (by element)

Multiply-Add to accumulator (vector, by element). This instruction multiplies the vector elements in the first source SIMD&FP register by the specified value in the second source SIMD&FP register, and accumulates the results with the vector elements of the destination SIMD&FP register. All the values in this instruction are unsigned integer values.

Depending on the settings in the [CPACR_EL1](#), [CPTR_EL2](#), and [CPTR_EL3](#) registers, and the current Security state and Exception level, an attempt to execute the instruction might be trapped.

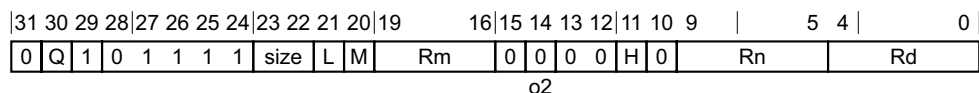

Vector variant

MLA <Vd>.<T>, <Vn>.<T>, <Vm>.<Ts>[<index>]

Decode for this encoding

```
integer idxsize = if H == '1' then 128 else 64;
integer index;
bit Rmhi;
case size of
    when '01' index = UInt(H:L:M); Rmhi = '0';
    when '10' index = UInt(H:L); Rmhi = M;
    otherwise UnallocatedEncoding();
```

```
integer d = UInt(Rd);
integer n = UInt(Rn);
integer m = UInt(Rmhi:Rm);
```

```
integer esize = 8 << UInt(size);
integer datasize = if Q == '1' then 128 else 64;
integer elements = datasize DIV esize;
```

```
boolean sub_op = (o2 == '1');
```

Assembler symbols

<Vd> Is the name of the SIMD&FP destination register, encoded in the "Rd" field.

<T> Is an arrangement specifier, encoded in the "size:Q" field. It can have the following values:

- | | | |
|----|--|-----------------------|
| 4H | | when size = 01, Q = 0 |
| 8H | | when size = 01, Q = 1 |
| 2S | | when size = 10, Q = 0 |
| 4S | | when size = 10, Q = 1 |

The following encodings are reserved:

- size = 00, Q = x.
- size = 11, Q = x.

<Vn> Is the name of the first SIMD&FP source register, encoded in the "Rn" field.

<Vm> Is the name of the second SIMD&FP source register, encoded in the "size:M:Rm" field. It can have the following values:

- | | | |
|------|--|----------------|
| 0:Rm | | when size = 01 |
|------|--|----------------|

M:Rm when size = 10

The following encodings are reserved:

- size = 00.
- size = 11.

Restricted to V0-V15 when element size <Ts> is H.

<Ts> Is an element size specifier, encoded in the "size" field. It can have the following values:

H when size = 01

S when size = 10

The following encodings are reserved:

- size = 00.
- size = 11.

<index> Is the element index, encoded in the "size:L:H:M" field. It can have the following values:

H:L:M when size = 01

H:L when size = 10

The following encodings are reserved:

- size = 00.
- size = 11.

Operation

```
CheckFPAdvSIMDEnabled64();
bits(datasize) operand1 = V[n];
bits(idxs size) operand2 = V[m];
bits(datasize) operand3 = V[d];
bits(datasize) result;
integer element1;
integer element2;
bits(esize) product;

element2 = UInt(Elem[operand2, index, esize]);
for e = 0 to elements-1
    element1 = UInt(Elem[operand1, e, esize]);
    product = (element1*element2)<esize-1:0>;
    if sub_op then
        Elem[result, e, esize] = Elem[operand3, e, esize] - product;
    else
        Elem[result, e, esize] = Elem[operand3, e, esize] + product;
V[d] = result;
```

C7.2.171 MLA (vector)

Multiply-Add to accumulator (vector). This instruction multiplies corresponding elements in the vectors of the two source SIMD&FP registers, and accumulates the results with the vector elements of the destination SIMD&FP register.

Depending on the settings in the CPACR_EL1, CPTR_EL2, and CPTR_EL3 registers, and the current Security state and Exception level, an attempt to execute the instruction might be trapped.

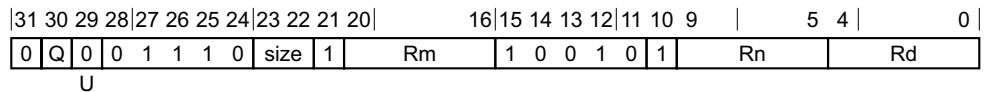

Three registers of the same type variant

MLA <Vd>.<T>, <Vn>.<T>, <Vm>.<T>

Decode for this encoding

```
integer d = UInt(Rd);
integer n = UInt(Rn);
integer m = UInt(Rm);
if size == '11' then ReservedValue();
integer esize = 8 << UInt(size);
integer datasize = if Q == '1' then 128 else 64;
integer elements = datasize DIV esize;

boolean sub_op = (U == '1');
```

Assembler symbols

- <Vd> Is the name of the SIMD&FP destination register, encoded in the "Rd" field.
- <T> Is an arrangement specifier, encoded in the "size:Q" field. It can have the following values:
- | | |
|-----|-----------------------|
| 8B | when size = 00, Q = 0 |
| 16B | when size = 00, Q = 1 |
| 4H | when size = 01, Q = 0 |
| 8H | when size = 01, Q = 1 |
| 2S | when size = 10, Q = 0 |
| 4S | when size = 10, Q = 1 |
- The encoding size = 11, Q = x is reserved.
- <Vn> Is the name of the first SIMD&FP source register, encoded in the "Rn" field.
- <Vm> Is the name of the second SIMD&FP source register, encoded in the "Rm" field.

Operation

```
CheckFPAdvSIMDEnabled64();
bits(datasize) operand1 = V[n];
bits(datasize) operand2 = V[m];
bits(datasize) operand3 = V[d];
bits(datasize) result;
bits(esize) element1;
bits(esize) element2;
bits(esize) product;
```

```
for e = 0 to elements-1
  element1 = Elem[operand1, e, esize];
  element2 = Elem[operand2, e, esize];
  product = (UInt(element1)*UInt(element2))<size-1:0>;
  if sub_op then
    Elem[result, e, esize] = Elem[operand3, e, esize] - product;
  else
    Elem[result, e, esize] = Elem[operand3, e, esize] + product;
V[d] = result;
```

C7.2.172 MLS (by element)

Multiply-Subtract from accumulator (vector, by element). This instruction multiplies the vector elements in the first source SIMD&FP register by the specified value in the second source SIMD&FP register, and subtracts the results from the vector elements of the destination SIMD&FP register. All the values in this instruction are unsigned integer values.

Depending on the settings in the [CPACR_EL1](#), [CPTR_EL2](#), and [CPTR_EL3](#) registers, and the current Security state and Exception level, an attempt to execute the instruction might be trapped.

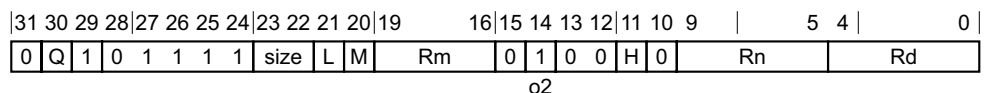

Vector variant

MLS <Vd>.<T>, <Vn>.<T>, <Vm>.<Ts>[<index>]

Decode for this encoding

```

integer idxsize = if H == '1' then 128 else 64;
integer index;
bit Rmhi;
case size of
    when '01' index = UInt(H:L:M); Rmhi = '0';
    when '10' index = UInt(H:L); Rmhi = M;
    otherwise UnallocatedEncoding();

integer d = UInt(Rd);
integer n = UInt(Rn);
integer m = UInt(Rmhi:Rm);

integer esize = 8 << UInt(size);
integer datasize = if Q == '1' then 128 else 64;
integer elements = datasize DIV esize;

boolean sub_op = (o2 == '1');
```

Assembler symbols

- <Vd> Is the name of the SIMD&FP destination register, encoded in the "Rd" field.
- <T> Is an arrangement specifier, encoded in the "size:Q" field. It can have the following values:
- | | |
|----|-----------------------|
| 4H | when size = 01, Q = 0 |
| 8H | when size = 01, Q = 1 |
| 2S | when size = 10, Q = 0 |
| 4S | when size = 10, Q = 1 |
- The following encodings are reserved:
- size = 00, Q = x.
 - size = 11, Q = x.
- <Vn> Is the name of the first SIMD&FP source register, encoded in the "Rn" field.
- <Vm> Is the name of the second SIMD&FP source register, encoded in the "size:M:Rm" field. It can have the following values:
- | | |
|------|----------------|
| 0:Rm | when size = 01 |
|------|----------------|

M:Rm when size = 10

The following encodings are reserved:

- size = 00.
- size = 11.

Restricted to V0-V15 when element size <Ts> is H.

<Ts> Is an element size specifier, encoded in the "size" field. It can have the following values:

H when size = 01

S when size = 10

The following encodings are reserved:

- size = 00.
- size = 11.

<index> Is the element index, encoded in the "size:L:H:M" field. It can have the following values:

H:L:M when size = 01

H:L when size = 10

The following encodings are reserved:

- size = 00.
- size = 11.

Operation

```

CheckFPAdvSIMDEnabled64();
bits(datasize) operand1 = V[n];
bits(idxsized) operand2 = V[m];
bits(datasize) operand3 = V[d];
bits(datasize) result;
integer element1;
integer element2;
bits(esize) product;

element2 = UInt(Elem[operand2, index, esize]);
for e = 0 to elements-1
    element1 = UInt(Elem[operand1, e, esize]);
    product = (element1*element2)<esize-1:0>;
    if sub_op then
        Elem[result, e, esize] = Elem[operand3, e, esize] - product;
    else
        Elem[result, e, esize] = Elem[operand3, e, esize] + product;
V[d] = result;
    
```

C7.2.173 MLS (vector)

Multiply-Subtract from accumulator (vector). This instruction multiplies corresponding elements in the vectors of the two source SIMD&FP registers, and subtracts the results from the vector elements of the destination SIMD&FP register.

Depending on the settings in the CPACR_EL1, CPTR_EL2, and CPTR_EL3 registers, and the current Security state and Exception level, an attempt to execute the instruction might be trapped.

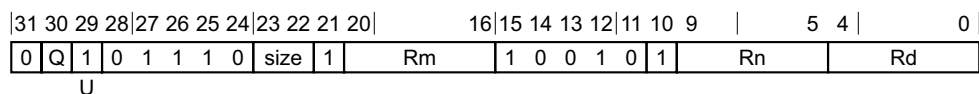

Three registers of the same type variant

MLS <Vd>.<T>, <Vn>.<T>, <Vm>.<T>

Decode for this encoding

```
integer d = UInt(Rd);
integer n = UInt(Rn);
integer m = UInt(Rm);
if size == '11' then ReservedValue();
integer esize = 8 << UInt(size);
integer datasize = if Q == '1' then 128 else 64;
integer elements = datasize DIV esize;

boolean sub_op = (U == '1');
```

Assembler symbols

- <Vd> Is the name of the SIMD&FP destination register, encoded in the "Rd" field.
- <T> Is an arrangement specifier, encoded in the "size:Q" field. It can have the following values:
 - 8B when size = 00, Q = 0
 - 16B when size = 00, Q = 1
 - 4H when size = 01, Q = 0
 - 8H when size = 01, Q = 1
 - 2S when size = 10, Q = 0
 - 4S when size = 10, Q = 1
 The encoding size = 11, Q = x is reserved.
- <Vn> Is the name of the first SIMD&FP source register, encoded in the "Rn" field.
- <Vm> Is the name of the second SIMD&FP source register, encoded in the "Rm" field.

Operation

```
CheckFPAdvSIMDEnabled64();
bits(datasize) operand1 = V[n];
bits(datasize) operand2 = V[m];
bits(datasize) operand3 = V[d];
bits(datasize) result;
bits(esize) element1;
bits(esize) element2;
bits(esize) product;
```

```
for e = 0 to elements-1
  element1 = Elem[operand1, e, esize];
  element2 = Elem[operand2, e, esize];
  product = (UInt(element1)*UInt(element2))<size-1:0>;
  if sub_op then
    Elem[result, e, esize] = Elem[operand3, e, esize] - product;
  else
    Elem[result, e, esize] = Elem[operand3, e, esize] + product;
V[d] = result;
```

C7.2.174 MOV (scalar)

Move vector element to scalar. This instruction duplicates the specified vector element in the SIMD&FP source register into a scalar, and writes the result to the SIMD&FP destination register.

Depending on the settings in the CPACR_EL1, CPTR_EL2, and CPTR_EL3 registers, and the current Security state and Exception level, an attempt to execute the instruction might be trapped.

This instruction is an alias of the DUP (element) instruction. This means that:

- The encodings in this description are named to match the encodings of DUP (element).
- The description of DUP (element) gives the operational pseudocode for this instruction.

31	30	29	28	27	26	25	24	23	22	21	20	16	15	14	13	12	11	10	9	5	4	0
0	1	0	1	1	1	1	0	0	0	0	imm5	0	0	0	0	0	1	Rn	Rd			

Scalar variant

MOV <V><d>, <Vn>.<T>[<index>]

is equivalent to

DUP <V><d>, <Vn>.<T>[<index>]

and is always the preferred disassembly.

Assembler symbols

<V> Is the destination width specifier, encoded in the "imm5" field. It can have the following values:

- B when imm5 = xxxx1
- H when imm5 = xxx10
- S when imm5 = xx100
- D when imm5 = x1000

The encoding imm5 = x0000 is reserved.

<d> Is the number of the SIMD&FP destination register, encoded in the "Rd" field.

<Vn> Is the name of the SIMD&FP source register, encoded in the "Rn" field.

<T> Is the element width specifier, encoded in the "imm5" field. It can have the following values:

- B when imm5 = xxxx1
- H when imm5 = xxx10
- S when imm5 = xx100
- D when imm5 = x1000

The encoding imm5 = x0000 is reserved.

<index> Is the element index encoded in the "imm5" field. It can have the following values:

- imm5<4:1> when imm5 = xxxx1
- imm5<4:2> when imm5 = xxx10
- imm5<4:3> when imm5 = xx100
- imm5<4> when imm5 = x1000

The encoding imm5 = x0000 is reserved.

Operation

The description of [DUP \(element\)](#) gives the operational pseudocode for this instruction.

C7.2.175 MOV (element)

Move vector element to another vector element. This instruction copies the vector element of the source SIMD&FP register to the specified vector element of the destination SIMD&FP register.

This instruction can insert data into individual elements within a SIMD&FP register without clearing the remaining bits to zero.

Depending on the settings in the CPACR_EL1, CPTR_EL2, and CPTR_EL3 registers, and the current Security state and Exception level, an attempt to execute the instruction might be trapped.

This instruction is an alias of the [INS \(element\)](#) instruction. This means that:

- The encodings in this description are named to match the encodings of [INS \(element\)](#).
- The description of [INS \(element\)](#) gives the operational pseudocode for this instruction.

31	30	29	28	27	26	25	24	23	22	21	20	16	15	14	11	10	9	5	4	0
0	1	1	0	1	1	1	0	0	0	0	0	imm5	0	imm4	1	Rn			Rd	

Advanced SIMD variant

MOV <Vd>.<Ts>[<index1>], <Vn>.<Ts>[<index2>]

is equivalent to

INS <Vd>.<Ts>[<index1>], <Vn>.<Ts>[<index2>]

and is always the preferred disassembly.

Assembler symbols

<Vd> Is the name of the SIMD&FP destination register, encoded in the "Rd" field.

<Ts> Is an element size specifier, encoded in the "imm5" field. It can have the following values:

B	when imm5 = xxxx1
H	when imm5 = xxx10
S	when imm5 = xx100
D	when imm5 = x1000

The encoding imm5 = x0000 is reserved.

<index1> Is the destination element index encoded in the "imm5" field. It can have the following values:

imm5<4:1>	when imm5 = xxxx1
imm5<4:2>	when imm5 = xxx10
imm5<4:3>	when imm5 = xx100
imm5<4>	when imm5 = x1000

The encoding imm5 = x0000 is reserved.

<Vn> Is the name of the SIMD&FP source register, encoded in the "Rn" field.

<index2> Is the source element index encoded in the "imm5:imm4" field. It can have the following values:

imm4<3:0>	when imm5 = xxxx1
imm4<3:1>	when imm5 = xxx10
imm4<3:2>	when imm5 = xx100

$\text{imm4}\langle 3 \rangle$ when $\text{imm5} = \text{x1000}$

The encoding $\text{imm5} = \text{x0000}$ is reserved.

Unspecified bits in "imm4" are ignored but should be set to zero by an assembler.

Operation

The description of [INS \(element\)](#) gives the operational pseudocode for this instruction.

C7.2.176 MOV (from general)

Move general-purpose register to a vector element. This instruction copies the contents of the source general-purpose register to the specified vector element in the destination SIMD&FP register.

This instruction can insert data into individual elements within a SIMD&FP register without clearing the remaining bits to zero.

Depending on the settings in the CPACR_EL1, CPTR_EL2, and CPTR_EL3 registers, and the current Security state and Exception level, an attempt to execute the instruction might be trapped.

This instruction is an alias of the [INS \(general\)](#) instruction. This means that:

- The encodings in this description are named to match the encodings of [INS \(general\)](#).
- The description of [INS \(general\)](#) gives the operational pseudocode for this instruction.

31	30	29	28	27	26	25	24	23	22	21	20	16	15	14	13	12	11	10	9	5	4	0
0	1	0	0	1	1	1	0	0	0	0	imm5	0	0	0	1	1	1	Rn	Rd			

Advanced SIMD variant

MOV <Vd>.<Ts>[<index>], <R><n>

is equivalent to

INS <Vd>.<Ts>[<index>], <R><n>

and is always the preferred disassembly.

Assembler symbols

<Vd> Is the name of the SIMD&FP destination register, encoded in the "Rd" field.

<Ts> Is an element size specifier, encoded in the "imm5" field. It can have the following values:

- B when imm5 = xxxx1
- H when imm5 = xxx10
- S when imm5 = xx100
- D when imm5 = x1000

The encoding imm5 = x0000 is reserved.

<index> Is the element index encoded in the "imm5" field. It can have the following values:

- imm5<4:1> when imm5 = xxxx1
- imm5<4:2> when imm5 = xxx10
- imm5<4:3> when imm5 = xx100
- imm5<4> when imm5 = x1000

The encoding imm5 = x0000 is reserved.

<R> Is the width specifier for the general-purpose source register, encoded in the "imm5" field. It can have the following values:

- W when imm5 = xxxx1
- W when imm5 = xxx10
- W when imm5 = xx100
- X when imm5 = x1000

The encoding `imm5 = x0000` is reserved.

<n> Is the number [0-30] of the general-purpose source register or ZR (31), encoded in the "Rn" field.

Operation

The description of [INS \(general\)](#) gives the operational pseudocode for this instruction.

C7.2.177 MOV (vector)

Move vector. This instruction copies the vector in the source SIMD&FP register into the destination SIMD&FP register.

Depending on the settings in the CPACR_EL1, CPTR_EL2, and CPTR_EL3 registers, and the current Security state and Exception level, an attempt to execute the instruction might be trapped.

This instruction is an alias of the [ORR \(vector, register\)](#) instruction. This means that:

- The encodings in this description are named to match the encodings of [ORR \(vector, register\)](#).
- The description of [ORR \(vector, register\)](#) gives the operational pseudocode for this instruction.

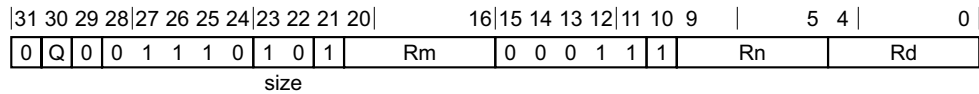

Three registers of the same type variant

MOV <Vd>.<T>, <Vn>.<T>

is equivalent to

ORR <Vd>.<T>, <Vn>.<T>, <Vn>.<T>

and is the preferred disassembly when Rm == Rn.

Assembler symbols

<Vd> Is the name of the SIMD&FP destination register, encoded in the "Rd" field.

<T> Is an arrangement specifier, encoded in the "Q" field. It can have the following values:

- 8B when Q = 0
- 16B when Q = 1

<Vn> Is the name of the first SIMD&FP source register, encoded in the "Rn" field.

Operation

The description of [ORR \(vector, register\)](#) gives the operational pseudocode for this instruction.

C7.2.178 MOV (to general)

Move vector element to general-purpose register. This instruction reads the unsigned integer from the source SIMD&FP register, zero-extends it to form a 32-bit or 64-bit value, and writes the result to the destination general-purpose register.

Depending on the settings in the CPACR_EL1, CPTR_EL2, and CPTR_EL3 registers, and the current Security state and Exception level, an attempt to execute the instruction might be trapped.

This instruction is an alias of the UMOV instruction. This means that:

- The encodings in this description are named to match the encodings of UMOV.
- The description of UMOV gives the operational pseudocode for this instruction.

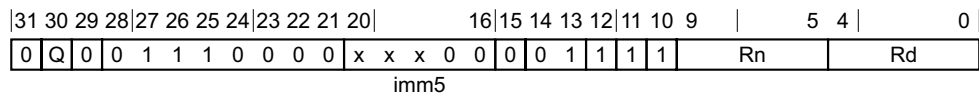

32-bit variant

Applies when Q == 0 && imm5 == xx100.

MOV <Wd>, <Vn>.S[<index>]

is equivalent to

UMOV <Wd>, <Vn>.S[<index>]

and is always the preferred disassembly.

64-bit variant

Applies when Q == 1 && imm5 == x1000.

MOV <Xd>, <Vn>.D[<index>]

is equivalent to

UMOV <Xd>, <Vn>.D[<index>]

and is always the preferred disassembly.

Assembler symbols

<Wd> Is the 32-bit name of the general-purpose destination register, encoded in the "Rd" field.

<Xd> Is the 64-bit name of the general-purpose destination register, encoded in the "Rd" field.

<Vn> Is the name of the SIMD&FP source register, encoded in the "Rn" field.

<index> For the 32-bit variant: is the element index encoded in "imm5<4:3>".

For the 64-bit variant: is the element index encoded in "imm5<4>".

Operation

The description of UMOV gives the operational pseudocode for this instruction.

C7.2.179 MOVI

Move Immediate (vector). This instruction places an immediate constant into every vector element of the destination SIMD&FP register.

Depending on the settings in the CPACR_EL1, CPTR_EL2, and CPTR_EL3 registers, and the current Security state and Exception level, an attempt to execute the instruction might be trapped.

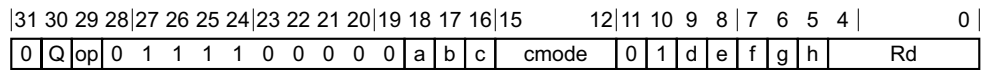

8-bit variant

Applies when op == 0 && cmode == 1110.

MOVI <Vd>.<T>, #<imm8>{, LSL #0}

16-bit shifted immediate variant

Applies when op == 0 && cmode == 10x0.

MOVI <Vd>.<T>, #<imm8>{, LSL #<amount>}

32-bit shifted immediate variant

Applies when op == 0 && cmode == 0xx0.

MOVI <Vd>.<T>, #<imm8>{, LSL #<amount>}

32-bit shifting ones variant

Applies when op == 0 && cmode == 110x.

MOVI <Vd>.<T>, #<imm8>, MSL #<amount>

64-bit scalar variant

Applies when Q == 0 && op == 1 && cmode == 1110.

MOVI <Dd>, #<imm>

64-bit vector variant

Applies when Q == 1 && op == 1 && cmode == 1110.

MOVI <Vd>.2D, #<imm>

Decode for all variants of this encoding

```
integer rd = UInt(Rd);

integer datasize = if Q == '1' then 128 else 64;
bits(datasize) imm;
bits(64) imm64;

ImmediateOp operation;
case cmode:op of
    when '0xx00' operation = ImmediateOp_MOVI;
    when '0xx01' operation = ImmediateOp_MVNI;
    when '0xx10' operation = ImmediateOp_ORR;
    when '0xx11' operation = ImmediateOp_BIC;
    when '10x00' operation = ImmediateOp_MOVI;
```

```

when '10x01' operation = ImmediateOp_MVNI;
when '10x10' operation = ImmediateOp_ORR;
when '10x11' operation = ImmediateOp_BIC;
when '110x0' operation = ImmediateOp_MOVI;
when '110x1' operation = ImmediateOp_MVNI;
when '1110x' operation = ImmediateOp_MOVI;
when '11110' operation = ImmediateOp_MOVI;
when '11111'
    // FMOV Dn,#imm is in main FP instruction set
    if Q == '0' then UnallocatedEncoding();
    operation = ImmediateOp_MOVI;

imm64 = AdvSIMDExpandImm(op, cmode, a:b:c:d:e:f:g:h);
imm = Replicate(imm64, datasize DIV 64);
    
```

Assembler symbols

- <Dd> Is the 64-bit name of the SIMD&FP destination register, encoded in the "Rd" field.
- <Vd> Is the name of the SIMD&FP destination register, encoded in the "Rd" field.
- <imm> Is a 64-bit immediate 'aaaaaaaaabbbbbbbccccccddddddeeeeeeffffffffggggggghhhhhhh', encoded in "a:b:c:d:e:f:g:h".
- <T> For the 8-bit variant: is an arrangement specifier, encoded in the "Q" field. It can have the following values:
 - 8B when Q = 0
 - 16B when Q = 1
 For the 16-bit variant: is an arrangement specifier, encoded in the "Q" field. It can have the following values:
 - 4H when Q = 0
 - 8H when Q = 1
 For the 32-bit variant: is an arrangement specifier, encoded in the "Q" field. It can have the following values:
 - 2S when Q = 0
 - 4S when Q = 1
- <imm8> Is an 8-bit immediate encoded in "a:b:c:d:e:f:g:h".
- <amount> For the 16-bit shifted immediate variant: is the shift amount encoded in the "cmode<1>" field. It can have the following values:
 - 0 when cmode<1> = 0
 - 8 when cmode<1> = 1
 defaulting to 0 if LSL is omitted.
 For the 32-bit shifted immediate variant: is the shift amount encoded in the "cmode<2:1>" field. It can have the following values:
 - 0 when cmode<2:1> = 00
 - 8 when cmode<2:1> = 01
 - 16 when cmode<2:1> = 10
 - 24 when cmode<2:1> = 11
 defaulting to 0 if LSL is omitted.
 For the 32-bit shifting ones variant: is the shift amount encoded in the "cmode<0>" field. It can have the following values:
 - 8 when cmode<0> = 0
 - 16 when cmode<0> = 1

Operation

```
CheckFPAdvSIMDEnabled64();
bits(datasize) operand;
bits(datasize) result;

case operation of
  when ImmediateOp_MOVI
    result = imm;
  when ImmediateOp_MVNI
    result = NOT(imm);
  when ImmediateOp_ORR
    operand = V[rd];
    result = operand OR imm;
  when ImmediateOp_BIC
    operand = V[rd];
    result = operand AND NOT(imm);

V[rd] = result;
```

C7.2.180 MUL (by element)

Multiply (vector, by element). This instruction multiplies the vector elements in the first source SIMD&FP register by the specified value in the second source SIMD&FP register, places the results in a vector, and writes the vector to the destination SIMD&FP register. All the values in this instruction are unsigned integer values.

Depending on the settings in the CPACR_EL1, CPTR_EL2, and CPTR_EL3 registers, and the current Security state and Exception level, an attempt to execute the instruction might be trapped.

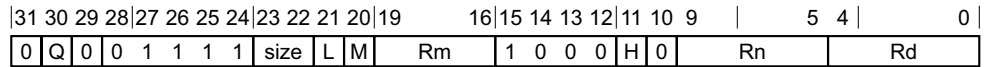

Vector variant

MUL <Vd>.<T>, <Vn>.<T>, <Vm>.<Ts>[<index>]

Decode for this encoding

```

integer idxsize = if H == '1' then 128 else 64;
integer index;
bit Rmhi;
case size of
    when '01' index = UInt(H:L:M); Rmhi = '0';
    when '10' index = UInt(H:L); Rmhi = M;
    otherwise UnallocatedEncoding();

integer d = UInt(Rd);
integer n = UInt(Rn);
integer m = UInt(Rmhi:Rm);

integer esize = 8 << UInt(size);
integer datasize = if Q == '1' then 128 else 64;
integer elements = datasize DIV esize;
    
```

Assembler symbols

- <Vd> Is the name of the SIMD&FP destination register, encoded in the "Rd" field.
- <T> Is an arrangement specifier, encoded in the "size:Q" field. It can have the following values:
- | | |
|----|-----------------------|
| 4H | when size = 01, Q = 0 |
| 8H | when size = 01, Q = 1 |
| 2S | when size = 10, Q = 0 |
| 4S | when size = 10, Q = 1 |
- The following encodings are reserved:
- size = 00, Q = x.
 - size = 11, Q = x.
- <Vn> Is the name of the first SIMD&FP source register, encoded in the "Rn" field.
- <Vm> Is the name of the second SIMD&FP source register, encoded in the "size:M:Rm" field. It can have the following values:
- | | |
|------|----------------|
| 0:Rm | when size = 01 |
| M:Rm | when size = 10 |

The following encodings are reserved:

- size = 00.
- size = 11.

Restricted to V0-V15 when element size <Ts> is H.

<Ts> Is an element size specifier, encoded in the "size" field. It can have the following values:

H when size = 01

S when size = 10

The following encodings are reserved:

- size = 00.
- size = 11.

<index> Is the element index, encoded in the "size:L:H:M" field. It can have the following values:

H:L:M when size = 01

H:L when size = 10

The following encodings are reserved:

- size = 00.
- size = 11.

Operation

```
CheckFPAdvSIMDEnabled64();
bits(datasize) operand1 = V[n];
bits(idxsized) operand2 = V[m];
bits(datasize) result;
integer element1;
integer element2;
bits(esize) product;

element2 = UInt(Elem[operand2, index, esize]);
for e = 0 to elements-1
    element1 = UInt(Elem[operand1, e, esize]);
    product = (element1*element2)<esize-1:0>;
    Elem[result, e, esize] = product;

V[d] = result;
```

C7.2.181 MUL (vector)

Multiply (vector). This instruction multiplies corresponding elements in the vectors of the two source SIMD&FP registers, places the results in a vector, and writes the vector to the destination SIMD&FP register.

Depending on the settings in the CPACR_EL1, CPTR_EL2, and CPTR_EL3 registers, and the current Security state and Exception level, an attempt to execute the instruction might be trapped.

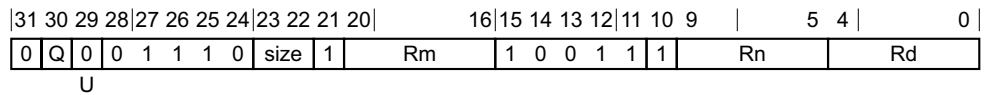

Three registers of the same type variant

MUL <Vd>.<T>, <Vn>.<T>, <Vm>.<T>

Decode for this encoding

```

integer d = UInt(Rd);
integer n = UInt(Rn);
integer m = UInt(Rm);
if U == '1' && size != '00' then ReservedValue();
if size == '11' then ReservedValue();
integer esize = 8 << UInt(size);
integer datasize = if Q == '1' then 128 else 64;
integer elements = datasize DIV esize;

boolean poly = (U == '1');
```

Assembler symbols

- <Vd> Is the name of the SIMD&FP destination register, encoded in the "Rd" field.
- <T> Is an arrangement specifier, encoded in the "size:Q" field. It can have the following values:
 - 8B when size = 00, Q = 0
 - 16B when size = 00, Q = 1
 - 4H when size = 01, Q = 0
 - 8H when size = 01, Q = 1
 - 2S when size = 10, Q = 0
 - 4S when size = 10, Q = 1
 The encoding size = 11, Q = x is reserved.
- <Vn> Is the name of the first SIMD&FP source register, encoded in the "Rn" field.
- <Vm> Is the name of the second SIMD&FP source register, encoded in the "Rm" field.

Operation

```

CheckFPAdvSIMDEnabled64();
bits(datasize) operand1 = V[n];
bits(datasize) operand2 = V[m];
bits(datasize) result;
bits(esize) element1;
bits(esize) element2;
bits(esize) product;

for e = 0 to elements-1
```

```
element1 = Elem[operand1, e, esize];  
element2 = Elem[operand2, e, esize];  
if poly then  
    product = PolynomialMult(element1, element2)<esize-1:0>;  
else  
    product = (UInt(element1)*UInt(element2))<esize-1:0>;  
Elem[result, e, esize] = product;  
  
V[d] = result;
```

C7.2.182 MVN

Bitwise NOT (vector). This instruction reads each vector element from the source SIMD&FP register, places the inverse of each value into a vector, and writes the vector to the destination SIMD&FP register.

Depending on the settings in the CPACR_EL1, CPTR_EL2, and CPTR_EL3 registers, and the current Security state and Exception level, an attempt to execute the instruction might be trapped.

This instruction is an alias of the NOT instruction. This means that:

- The encodings in this description are named to match the encodings of NOT.
- The description of NOT gives the operational pseudocode for this instruction.

31	30	29	28	27	26	25	24	23	22	21	20	19	18	17	16	15	14	13	12	11	10	9	5		4	0	
0	Q	1	0	1	1	1	0	0	0	1	0	0	0	0	0	0	1	0	1	1	0	Rn		Rd			

Vector variant

MVN <Vd>.<T>, <Vn>.<T>

is equivalent to

NOT <Vd>.<T>, <Vn>.<T>

and is always the preferred disassembly.

Assembler symbols

<Vd> Is the name of the SIMD&FP destination register, encoded in the "Rd" field.

<T> Is an arrangement specifier, encoded in the "Q" field. It can have the following values:

8B when Q = 0

16B when Q = 1

<Vn> Is the name of the SIMD&FP source register, encoded in the "Rn" field.

Operation

The description of NOT gives the operational pseudocode for this instruction.

C7.2.183 MVNI

Move inverted Immediate (vector). This instruction places the inverse of an immediate constant into every vector element of the destination SIMD&FP register.

Depending on the settings in the CPACR_EL1, CPTR_EL2, and CPTR_EL3 registers, and the current Security state and Exception level, an attempt to execute the instruction might be trapped.

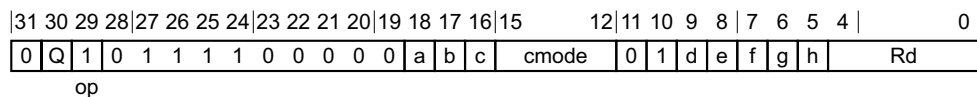

16-bit shifted immediate variant

Applies when cmode == 10x0.

MVNI <Vd>.<T>, #<imm8>{, LSL #<amount>}

32-bit shifted immediate variant

Applies when cmode == 0xx0.

MVNI <Vd>.<T>, #<imm8>{, LSL #<amount>}

32-bit shifting ones variant

Applies when cmode == 110x.

MVNI <Vd>.<T>, #<imm8>, MSL #<amount>

Decode for all variants of this encoding

```
integer rd = UInt(Rd);

integer datasize = if Q == '1' then 128 else 64;
bits(datasize) imm;
bits(64) imm64;

ImmediateOp operation;
case cmode:op of
    when '0xx01' operation = ImmediateOp_MVNI;
    when '0xx11' operation = ImmediateOp_BIC;
    when '10x01' operation = ImmediateOp_MVNI;
    when '10x11' operation = ImmediateOp_BIC;
    when '110x1' operation = ImmediateOp_MVNI;
    when '1110x' operation = ImmediateOp_MOVI;
    when '11111'
        // FMOV Dn,#imm is in main FP instruction set
        if Q == '0' then UnallocatedEncoding();
        operation = ImmediateOp_MOVI;

imm64 = AdvSIMDExpandImm(op, cmode, a:b:c:d:e:f:g:h);
imm = Replicate(imm64, datasize DIV 64);
```

Assembler symbols

- <Vd> Is the name of the SIMD&FP destination register, encoded in the "Rd" field.
- <T> For the 16-bit variant: is an arrangement specifier, encoded in the "Q" field. It can have the following values:
 - 4H when Q = 0

8H when Q = 1

For the 32-bit variant: is an arrangement specifier, encoded in the "Q" field. It can have the following values:

2S when Q = 0

4S when Q = 1

<imm8> Is an 8-bit immediate encoded in "a:b:c:d:e:f:g:h".

<amount> For the 16-bit shifted immediate variant: is the shift amount encoded in the "cmode<1>" field. It can have the following values:

0 when cmode<1> = 0

8 when cmode<1> = 1

defaulting to 0 if LSL is omitted.

For the 32-bit shifted immediate variant: is the shift amount encoded in the "cmode<2:1>" field. It can have the following values:

0 when cmode<2:1> = 00

8 when cmode<2:1> = 01

16 when cmode<2:1> = 10

24 when cmode<2:1> = 11

defaulting to 0 if LSL is omitted.

For the 32-bit shifting ones variant: is the shift amount encoded in the "cmode<0>" field. It can have the following values:

8 when cmode<0> = 0

16 when cmode<0> = 1

Operation

```
CheckFPAdvSIMDEnabled64();
bits(datasize) operand;
bits(datasize) result;

case operation of
  when ImmediateOp_MOVI
    result = imm;
  when ImmediateOp_MVNI
    result = NOT(imm);
  when ImmediateOp_ORR
    operand = V[rd];
    result = operand OR imm;
  when ImmediateOp_BIC
    operand = V[rd];
    result = operand AND NOT(imm);

V[rd] = result;
```

C7.2.184 NEG (vector)

Negate (vector). This instruction reads each vector element from the source SIMD&FP register, negates each value, puts the result into a vector, and writes the vector to the destination SIMD&FP register.

Depending on the settings in the CPACR_EL1, CPTR_EL2, and CPTR_EL3 registers, and the current Security state and Exception level, an attempt to execute the instruction might be trapped.

Scalar

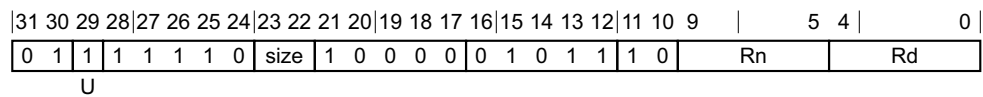

Scalar variant

NEG <V><d>, <V><n>

Decode for this encoding

```
integer d = UInt(Rd);
integer n = UInt(Rn);

if size != '11' then ReservedValue();
integer esize = 8 << UInt(size);
integer datasize = esize;
integer elements = 1;
boolean neg = (U == '1');
```

Vector

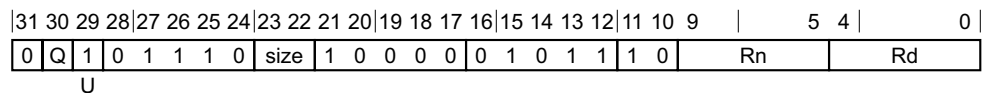

Vector variant

NEG <Vd>.<T>, <Vn>.<T>

Decode for this encoding

```
integer d = UInt(Rd);
integer n = UInt(Rn);

if size:Q == '110' then ReservedValue();
integer esize = 8 << UInt(size);
integer datasize = if Q == '1' then 128 else 64;
integer elements = datasize DIV esize;
boolean neg = (U == '1');
```

Assembler symbols

<V> Is a width specifier, encoded in the "size" field. It can have the following values:

D when size = 11

The following encodings are reserved:

- size = 0x.
- size = 10.

- <d> Is the number of the SIMD&FP destination register, encoded in the "Rd" field.
- <n> Is the number of the SIMD&FP source register, encoded in the "Rn" field.
- <Vd> Is the name of the SIMD&FP destination register, encoded in the "Rd" field.
- <T> Is an arrangement specifier, encoded in the "size:Q" field. It can have the following values:
- | | |
|-----|-----------------------|
| 8B | when size = 00, Q = 0 |
| 16B | when size = 00, Q = 1 |
| 4H | when size = 01, Q = 0 |
| 8H | when size = 01, Q = 1 |
| 2S | when size = 10, Q = 0 |
| 4S | when size = 10, Q = 1 |
| 2D | when size = 11, Q = 1 |
- The encoding size = 11, Q = 0 is reserved.
- <Vn> Is the name of the SIMD&FP source register, encoded in the "Rn" field.

Operation for all encodings

```
CheckFPAdvSIMDEnabled64();
bits(datasize) operand = V[n];
bits(datasize) result;
integer element;

for e = 0 to elements-1
    element = SInt(Elem[operand, e, esize]);
    if neg then
        element = -element;
    else
        element = Abs(element);
    Elem[result, e, esize] = element<size-1:0>;

V[d] = result;
```

C7.2.185 NOT

Bitwise NOT (vector). This instruction reads each vector element from the source SIMD&FP register, places the inverse of each value into a vector, and writes the vector to the destination SIMD&FP register.

Depending on the settings in the [CPACR_EL1](#), [CPTR_EL2](#), and [CPTR_EL3](#) registers, and the current Security state and Exception level, an attempt to execute the instruction might be trapped.

This instruction is used by the alias [MVN](#). The alias is always the preferred disassembly.

31	30	29	28	27	26	25	24	23	22	21	20	19	18	17	16	15	14	13	12	11	10	9	5 4			0
0	Q	1	0	1	1	1	0	0	0	1	0	0	0	0	0	0	1	0	1	1	0	Rn			Rd	

Vector variant

NOT <Vd>.<T>, <Vn>.<T>

Decode for this encoding

```
integer d = UInt(Rd);
integer n = UInt(Rn);

integer esize = 8;
integer datasize = if Q == '1' then 128 else 64;
integer elements = datasize DIV 8;
```

Assembler symbols

- <Vd> Is the name of the SIMD&FP destination register, encoded in the "Rd" field.
- <T> Is an arrangement specifier, encoded in the "Q" field. It can have the following values:
- | | |
|-----|------------|
| 8B | when Q = 0 |
| 16B | when Q = 1 |
- <Vn> Is the name of the SIMD&FP source register, encoded in the "Rn" field.

Operation

```
CheckFPAdvSIMDEnabled64();
bits(datasize) operand = V[n];
bits(datasize) result;
bits(esize) element;

for e = 0 to elements-1
    element = Elem[operand, e, esize];
    Elem[result, e, esize] = NOT(element);

V[d] = result;
```

C7.2.186 ORN (vector)

Bitwise inclusive OR NOT (vector). This instruction performs a bitwise OR NOT between the two source SIMD&FP registers, and writes the result to the destination SIMD&FP register.

Depending on the settings in the CPACR_EL1, CPTR_EL2, and CPTR_EL3 registers, and the current Security state and Exception level, an attempt to execute the instruction might be trapped.

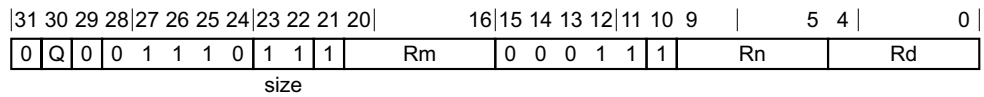

Three registers of the same type variant

ORN <Vd>.<T>, <Vn>.<T>, <Vm>.<T>

Decode for this encoding

```
integer d = UInt(Rd);
integer n = UInt(Rn);
integer m = UInt(Rm);
integer datasize = if Q == '1' then 128 else 64;
```

Assembler symbols

- <Vd> Is the name of the SIMD&FP destination register, encoded in the "Rd" field.
- <T> Is an arrangement specifier, encoded in the "Q" field. It can have the following values:
 - 8B when Q = 0
 - 16B when Q = 1
- <Vn> Is the name of the first SIMD&FP source register, encoded in the "Rn" field.
- <Vm> Is the name of the second SIMD&FP source register, encoded in the "Rm" field.

Operation

```
CheckFPAdvSIMDEnabled64();
bits(datasize) operand1 = V[n];
bits(datasize) operand2 = V[m];
bits(datasize) result;

operand2 = NOT(operand2);

result = operand1 OR operand2;

V[d] = result;
```

C7.2.187 ORR (vector, immediate)

Bitwise inclusive OR (vector, immediate). This instruction reads each vector element from the destination SIMD&FP register, performs a bitwise OR between each result and an immediate constant, places the result into a vector, and writes the vector to the destination SIMD&FP register.

Depending on the settings in the CPACR_EL1, CPTR_EL2, and CPTR_EL3 registers, and the current Security state and Exception level, an attempt to execute the instruction might be trapped.

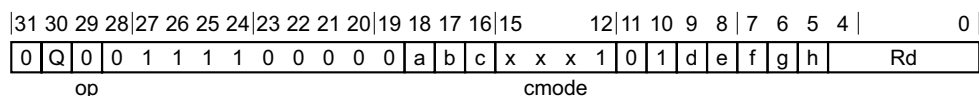

16-bit variant

Applies when cmode == 10x1.

ORR <Vd>.<T>, #<imm8>{, LSL #<amount>}

32-bit variant

Applies when cmode == 0xx1.

ORR <Vd>.<T>, #<imm8>{, LSL #<amount>}

Decode for all variants of this encoding

```
integer rd = UInt(Rd);

integer datasize = if Q == '1' then 128 else 64;
bits(datasize) imm;
bits(64) imm64;

ImmediateOp operation;
case cmode:op of
    when '0xx00' operation = ImmediateOp_MOVI;
    when '0xx10' operation = ImmediateOp_ORR;
    when '10x00' operation = ImmediateOp_MOVI;
    when '10x10' operation = ImmediateOp_ORR;
    when '110x0' operation = ImmediateOp_MOVI;
    when '1110x' operation = ImmediateOp_MOVI;
    when '11110' operation = ImmediateOp_MOVI;
imm64 = AdvSIMDExpandImm(op, cmode, a:b:c:d:e:f:g:h);
imm = Replicate(imm64, datasize DIV 64);
```

Assembler symbols

- <Vd> Is the name of the SIMD&FP register, encoded in the "Rd" field.
- <T> For the 16-bit variant: is an arrangement specifier, encoded in the "Q" field. It can have the following values:
- 4H when Q = 0
 - 8H when Q = 1
- For the 32-bit variant: is an arrangement specifier, encoded in the "Q" field. It can have the following values:
- 2S when Q = 0
 - 4S when Q = 1
- <imm8> Is an 8-bit immediate encoded in "a:b:c:d:e:f:g:h".

<amount> For the 16-bit variant: is the shift amount encoded in the "cmode<1>" field. It can have the following values:

- 0 when cmode<1> = 0
- 8 when cmode<1> = 1

defaulting to 0 if LSL is omitted.

For the 32-bit variant: is the shift amount encoded in the "cmode<2:1>" field. It can have the following values:

- 0 when cmode<2:1> = 00
- 8 when cmode<2:1> = 01
- 16 when cmode<2:1> = 10
- 24 when cmode<2:1> = 11

defaulting to 0 if LSL is omitted.

Operation

```
CheckFPAdvSIMDEnabled64();
bits(datasize) operand;
bits(datasize) result;

case operation of
  when ImmediateOp_MOVI
    result = imm;
  when ImmediateOp_MVNI
    result = NOT(imm);
  when ImmediateOp_ORR
    operand = V[rd];
    result = operand OR imm;
  when ImmediateOp_BIC
    operand = V[rd];
    result = operand AND NOT(imm);

V[rd] = result;
```

C7.2.188 ORR (vector, register)

Bitwise inclusive OR (vector, register). This instruction performs a bitwise OR between the two source SIMD&FP registers, and writes the result to the destination SIMD&FP register.

Depending on the settings in the CPACR_EL1, CPTR_EL2, and CPTR_EL3 registers, and the current Security state and Exception level, an attempt to execute the instruction might be trapped.

This instruction is used by the alias MOV (vector). See *Alias conditions* for details of when each alias is preferred.

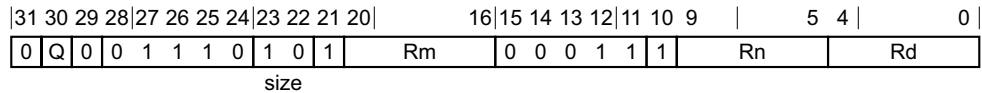

Three registers of the same type variant

ORR <Vd>.<T>, <Vn>.<T>, <Vm>.<T>

Decode for this encoding

```
integer d = UInt(Rd);
integer n = UInt(Rn);
integer m = UInt(Rm);
integer datasize = if Q == '1' then 128 else 64;
```

Alias conditions

Alias	is preferred when
MOV (vector)	Rm == Rn

Assembler symbols

- <Vd> Is the name of the SIMD&FP destination register, encoded in the "Rd" field.
- <T> Is an arrangement specifier, encoded in the "Q" field. It can have the following values:
 - 8B when Q = 0
 - 16B when Q = 1
- <Vn> Is the name of the first SIMD&FP source register, encoded in the "Rn" field.
- <Vm> Is the name of the second SIMD&FP source register, encoded in the "Rm" field.

Operation

```
CheckFPAdvSIMDEnabled64();
bits(datasize) operand1 = V[n];
bits(datasize) operand2 = V[m];
bits(datasize) result;

result = operand1 OR operand2;

V[d] = result;
```

C7.2.189 PMUL

Polynomial Multiply. This instruction multiplies corresponding elements in the vectors of the two source SIMD&FP registers, places the results in a vector, and writes the vector to the destination SIMD&FP register.

For information about multiplying polynomials see *Polynomial arithmetic over {0, 1}* on page A1-47.

Depending on the settings in the CPACR_EL1, CPTR_EL2, and CPTR_EL3 registers, and the current Security state and Exception level, an attempt to execute the instruction might be trapped.

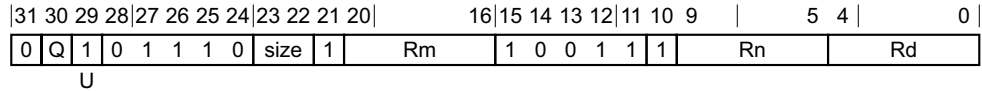

Three registers of the same type variant

PMUL <Vd>.<T>, <Vn>.<T>, <Vm>.<T>

Decode for this encoding

```
integer d = UInt(Rd);
integer n = UInt(Rn);
integer m = UInt(Rm);
if U == '1' && size != '00' then ReservedValue();
if size == '11' then ReservedValue();
integer esize = 8 << UInt(size);
integer datasize = if Q == '1' then 128 else 64;
integer elements = datasize DIV esize;

boolean poly = (U == '1');
```

Assembler symbols

- <Vd> Is the name of the SIMD&FP destination register, encoded in the "Rd" field.
- <T> Is an arrangement specifier, encoded in the "size:Q" field. It can have the following values:
- | | |
|-----|-----------------------|
| 8B | when size = 00, Q = 0 |
| 16B | when size = 00, Q = 1 |
- The following encodings are reserved:
- size = 01, Q = x.
 - size = 1x, Q = x.
- <Vn> Is the name of the first SIMD&FP source register, encoded in the "Rn" field.
- <Vm> Is the name of the second SIMD&FP source register, encoded in the "Rm" field.

Operation

```
CheckFPAdvSIMDEnabled64();
bits(datasize) operand1 = V[n];
bits(datasize) operand2 = V[m];
bits(datasize) result;
bits(esize) element1;
bits(esize) element2;
bits(esize) product;

for e = 0 to elements-1
    element1 = Elem[operand1, e, esize];
```



```
element2 = Elem[operand2, e, esize];  
if poly then  
    product = PolynomialMult(element1, element2)<esize-1:0>;  
else  
    product = (UInt(element1)*UInt(element2))<esize-1:0>;  
Elem[result, e, esize] = product;  
  
V[d] = result;
```

C7.2.190 PMULL, PMULL2

Polynomial Multiply Long. This instruction multiplies corresponding elements in the lower or upper half of the vectors of the two source SIMD&FP registers, places the results in a vector, and writes the vector to the destination SIMD&FP register. The destination vector elements are twice as long as the elements that are multiplied.

For information about multiplying polynomials see *Polynomial arithmetic over {0, 1}* on page A1-47.

The PMULL instruction extracts each source vector from the lower half of each source register, while the PMULL2 instruction extracts each source vector from the upper half of each source register.

Depending on the settings in the CPACR_EL1, CPTR_EL2, and CPTR_EL3 registers, and the current Security state and Exception level, an attempt to execute the instruction might be trapped.

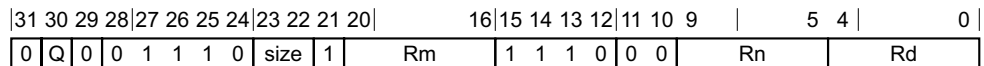

Three registers, not all the same type variant

PMULL{2} <Vd>.<Ta>, <Vn>.<Tb>, <Vm>.<Tb>

Decode for this encoding

```
integer d = UInt(Rd);
integer n = UInt(Rn);
integer m = UInt(Rm);

if size == '01' || size == '10' then ReservedValue();
if size == '11' && !HaveCryptoExt() then UnallocatedEncoding();
integer esize = 8 << UInt(size);
integer datasize = 64;
integer part = UInt(Q);
integer elements = datasize DIV esize;
```

Assembler symbols

2 Is the second and upper half specifier. If present it causes the operation to be performed on the upper 64 bits of the registers holding the narrower elements, and is encoded in the "Q" field. It can have the following values:

[absent] when Q = 0
 [present] when Q = 1

<Vd> Is the name of the SIMD&FP destination register, encoded in the "Rd" field.

<Ta> Is an arrangement specifier, encoded in the "size" field. It can have the following values:

8H when size = 00
 1Q when size = 11

The following encodings are reserved:

- size = 01.
- size = 10.

The '1Q' arrangement is only allocated in an implementation that includes the Cryptographic Extension, and is otherwise RESERVED.

<Vn> Is the name of the first SIMD&FP source register, encoded in the "Rn" field.

<Tb> Is an arrangement specifier, encoded in the "size:Q" field. It can have the following values:

8B when size = 00, Q = 0

16B when size = 00, Q = 1

1D when size = 11, Q = 0

2D when size = 11, Q = 1

The following encodings are reserved:

- size = 01, Q = x.
- size = 10, Q = x.

<Vm> Is the name of the second SIMD&FP source register, encoded in the "Rm" field.

Operation

```
CheckFPAdvSIMDEnabled64();
bits(datasize) operand1 = Vpart[n, part];
bits(datasize) operand2 = Vpart[m, part];
bits(2*datasize) result;
bits(esize) element1;
bits(esize) element2;

for e = 0 to elements-1
    element1 = Elem[operand1, e, esize];
    element2 = Elem[operand2, e, esize];
    Elem[result, e, 2*esize] = PolynomialMult(element1, element2);

V[d] = result;
```

C7.2.191 RADDHN, RADDHN2

Rounding Add returning High Narrow. This instruction adds each vector element in the first source SIMD&FP register to the corresponding vector element in the second source SIMD&FP register, places the most significant half of the result into a vector, and writes the vector to the lower or upper half of the destination SIMD&FP register.

The results are rounded. For truncated results, see [ADDHN](#), [ADDHN2](#).

The RADDHN instruction writes the vector to the lower half of the destination register and clears the upper half, while the RADDHN2 instruction writes the vector to the upper half of the destination register without affecting the other bits of the register.

Depending on the settings in the [CPACR_EL1](#), [CPTR_EL2](#), and [CPTR_EL3](#) registers, and the current Security state and Exception level, an attempt to execute the instruction might be trapped.

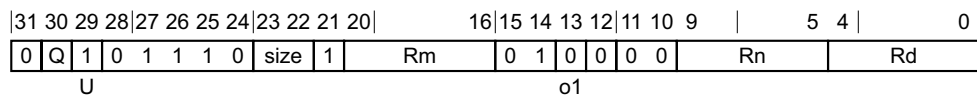

Three registers, not all the same type variant

RADDHN{2} <Vd>.<Tb>, <Vn>.<Ta>, <Vm>.<Ta>

Decode for this encoding

```
integer d = UInt(Rd);
integer n = UInt(Rn);
integer m = UInt(Rm);

if size == '11' then ReservedValue();
integer esize = 8 << UInt(size);
integer datasize = 64;
integer part = UInt(Q);
integer elements = datasize DIV esize;

boolean sub_op = (o1 == '1');
boolean round = (U == '1');
```

Assembler symbols

- 2 Is the second and upper half specifier. If present it causes the operation to be performed on the upper 64 bits of the registers holding the narrower elements, and is encoded in the "Q" field. It can have the following values:
 - [absent] when Q = 0
 - [present] when Q = 1
- <Vd> Is the name of the SIMD&FP destination register, encoded in the "Rd" field.
- <Tb> Is an arrangement specifier, encoded in the "size:Q" field. It can have the following values:
 - 8B when size = 00, Q = 0
 - 16B when size = 00, Q = 1
 - 4H when size = 01, Q = 0
 - 8H when size = 01, Q = 1
 - 2S when size = 10, Q = 0
 - 4S when size = 10, Q = 1

The encoding size = 11, Q = x is reserved.

- <Vn> Is the name of the first SIMD&FP source register, encoded in the "Rn" field.
- <Ta> Is an arrangement specifier, encoded in the "size" field. It can have the following values:
- | | |
|----|----------------|
| 8H | when size = 00 |
| 4S | when size = 01 |
| 2D | when size = 10 |
- The encoding size = 11 is reserved.
- <Vm> Is the name of the second SIMD&FP source register, encoded in the "Rm" field.

Operation

```
CheckFPAdvSIMDEnabled64();
bits(2*datasize) operand1 = V[n];
bits(2*datasize) operand2 = V[m];
bits(datasize) result;
integer round_const = if round then 1 << (esize - 1) else 0;
bits(2*esize) element1;
bits(2*esize) element2;
bits(2*esize) sum;

for e = 0 to elements-1
    element1 = Elem[operand1, e, 2*esize];
    element2 = Elem[operand2, e, 2*esize];
    if sub_op then
        sum = element1 - element2;
    else
        sum = element1 + element2;
    sum = sum + round_const;
    Elem[result, e, esize] = sum<2*esize-1:esize>;

Vpart[d, part] = result;
```

C7.2.192 RBIT (vector)

Reverse Bit order (vector). This instruction reads each vector element from the source SIMD&FP register, reverses the bits of the element, places the results into a vector, and writes the vector to the destination SIMD&FP register.

Depending on the settings in the CPACR_EL1, CPTR_EL2, and CPTR_EL3 registers, and the current Security state and Exception level, an attempt to execute the instruction might be trapped.

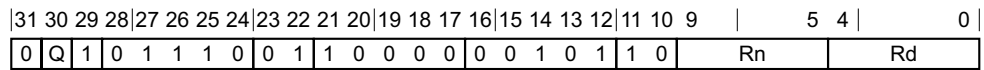

Vector variant

RBIT <Vd>.<T>, <Vn>.<T>

Decode for this encoding

```
integer d = UInt(Rd);
integer n = UInt(Rn);

integer esize = 8;
integer datasize = if Q == '1' then 128 else 64;
integer elements = datasize DIV 8;
```

Assembler symbols

- <Vd> Is the name of the SIMD&FP destination register, encoded in the "Rd" field.
- <T> Is an arrangement specifier, encoded in the "Q" field. It can have the following values:
 - 8B when Q = 0
 - 16B when Q = 1
- <Vn> Is the name of the SIMD&FP source register, encoded in the "Rn" field.

Operation

```
CheckFPAdvSIMDEnabled64();
bits(datasize) operand = V[n];
bits(datasize) result;
bits(esize) element;
bits(esize) rev;

for e = 0 to elements-1
    element = Elem[operand, e, esize];
    for i = 0 to esize-1
        rev<esize-1-i> = element<i>;
    Elem[result, e, esize] = rev;

V[d] = result;
```

C7.2.193 REV16 (vector)

Reverse elements in 16-bit halfwords (vector). This instruction reverses the order of 8-bit elements in each halfword of the vector in the source SIMD&FP register, places the results into a vector, and writes the vector to the destination SIMD&FP register.

Depending on the settings in the CPACR_EL1, CPTR_EL2, and CPTR_EL3 registers, and the current Security state and Exception level, an attempt to execute the instruction might be trapped.

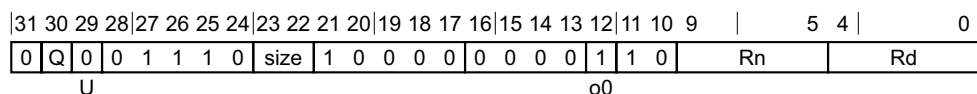

Vector variant

REV16 <Vd>.<T>, <Vn>.<T>

Decode for this encoding

```
integer d = UInt(Rd);
integer n = UInt(Rn);

// size=esize:  B(0), H(1), S(1), D(S)
integer esize = 8 << UInt(size);
integer datasize = if Q == '1' then 128 else 64;

// op=REVx: 64(0), 32(1), 16(2)
bits(2) op = o0:U;

// => op+size:
// 64+B = 0, 64+H = 1, 64+S = 2, 64+D = X
// 32+B = 1, 32+H = 2, 32+S = X, 32+D = X
// 16+B = 2, 16+H = X, 16+S = X, 16+D = X
// 8+B = X, 8+H = X, 8+S = X, 8+D = X
// => 3-(op+size) (index bits in group)
// 64/B = 3, 64+H = 2, 64+S = 1, 64+D = X
// 32+B = 2, 32+H = 1, 32+S = X, 32+D = X
// 16+B = 1, 16+H = X, 16+S = X, 16+D = X
// 8+B = X, 8+H = X, 8+S = X, 8+D = X

// index bits within group: 1, 2, 3
if UInt(op) + UInt(size) >= 3 then UnallocatedEncoding();

integer container_size;
case op of
    when '10' container_size = 16;
    when '01' container_size = 32;
    when '00' container_size = 64;

integer containers = datasize DIV container_size;
integer elements_per_container = container_size DIV esize;
```

Assembler symbols

- <Vd> Is the name of the SIMD&FP destination register, encoded in the "Rd" field.
- <T> Is an arrangement specifier, encoded in the "size:Q" field. It can have the following values:
- | | |
|-----|-----------------------|
| 8B | when size = 00, Q = 0 |
| 16B | when size = 00, Q = 1 |

The following encodings are reserved:

- size = 01, Q = x.
- size = 1x, Q = x.

<Vn> Is the name of the SIMD&FP source register, encoded in the "Rn" field.

Operation

```
CheckFPAdvSIMDEnabled64();
bits(datasize) operand = V[n];
bits(datasize) result;
integer element = 0;
integer rev_element;
for c = 0 to containers-1
    rev_element = element + elements_per_container - 1;
    for e = 0 to elements_per_container-1
        Elem[result, rev_element, esize] = Elem[operand, element, esize];
        element = element + 1;
        rev_element = rev_element - 1;

V[d] = result;
```

C7.2.194 REV32 (vector)

Reverse elements in 32-bit words (vector). This instruction reverses the order of 8-bit or 16-bit elements in each word of the vector in the source SIMD&FP register, places the results into a vector, and writes the vector to the destination SIMD&FP register.

Depending on the settings in the [CPACR_EL1](#), [CPTR_EL2](#), and [CPTR_EL3](#) registers, and the current Security state and Exception level, an attempt to execute the instruction might be trapped.

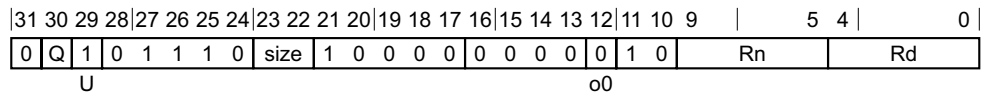

Vector variant

REV32 <Vd>.<T>, <Vn>.<T>

Decode for this encoding

```
integer d = UInt(Rd);
integer n = UInt(Rn);

// size=esize:  B(0), H(1), S(1), D(S)
integer esize = 8 << UInt(size);
integer datasize = if Q == '1' then 128 else 64;

// op=REVx: 64(0), 32(1), 16(2)
bits(2) op = o0:U;

// => op+size:
// 64+B = 0, 64+H = 1, 64+S = 2, 64+D = X
// 32+B = 1, 32+H = 2, 32+S = X, 32+D = X
// 16+B = 2, 16+H = X, 16+S = X, 16+D = X
// 8+B = X, 8+H = X, 8+S = X, 8+D = X
// => 3-(op+size) (index bits in group)
// 64/B = 3, 64+H = 2, 64+S = 1, 64+D = X
// 32+B = 2, 32+H = 1, 32+S = X, 32+D = X
// 16+B = 1, 16+H = X, 16+S = X, 16+D = X
// 8+B = X, 8+H = X, 8+S = X, 8+D = X

// index bits within group: 1, 2, 3
if UInt(op) + UInt(size) >= 3 then UnallocatedEncoding();

integer container_size;
case op of
    when '10' container_size = 16;
    when '01' container_size = 32;
    when '00' container_size = 64;

integer containers = datasize DIV container_size;
integer elements_per_container = container_size DIV esize;
```

Assembler symbols

- <Vd> Is the name of the SIMD&FP destination register, encoded in the "Rd" field.
- <T> Is an arrangement specifier, encoded in the "size:Q" field. It can have the following values:
- | | |
|-----|-----------------------|
| 8B | when size = 00, Q = 0 |
| 16B | when size = 00, Q = 1 |
| 4H | when size = 01, Q = 0 |

8H when size = 01, Q = 1
The encoding size = 1x, Q = x is reserved.

<Vn> Is the name of the SIMD&FP source register, encoded in the "Rn" field.

Operation

```
CheckFPAdvSIMDEnabled64();
bits(datasize) operand = V[n];
bits(datasize) result;
integer element = 0;
integer rev_element;
for c = 0 to containers-1
    rev_element = element + elements_per_container - 1;
    for e = 0 to elements_per_container-1
        Elem[result, rev_element, esize] = Elem[operand, element, esize];
        element = element + 1;
        rev_element = rev_element - 1;

V[d] = result;
```

C7.2.195 REV64

Reverse elements in 64-bit doublewords (vector). This instruction reverses the order of 8-bit, 16-bit, or 32-bit elements in each doubleword of the vector in the source SIMD&FP register, places the results into a vector, and writes the vector to the destination SIMD&FP register.

Depending on the settings in the CPACR_EL1, CPTR_EL2, and CPTR_EL3 registers, and the current Security state and Exception level, an attempt to execute the instruction might be trapped.

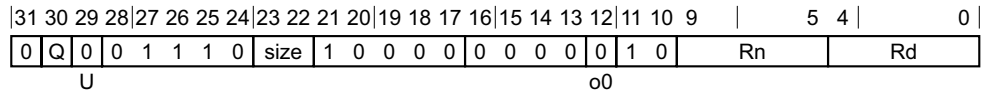

Vector variant

REV64 <Vd>.<T>, <Vn>.<T>

Decode for this encoding

```
integer d = UInt(Rd);
integer n = UInt(Rn);

// size=esize:  B(0), H(1), S(1), D(S)
integer esize = 8 << UInt(size);
integer datasize = if Q == '1' then 128 else 64;

// op=REVx: 64(0), 32(1), 16(2)
bits(2) op = o0:U;

// => op+size:
// 64+B = 0, 64+H = 1, 64+S = 2, 64+D = X
// 32+B = 1, 32+H = 2, 32+S = X, 32+D = X
// 16+B = 2, 16+H = X, 16+S = X, 16+D = X
// 8+B = X, 8+H = X, 8+S = X, 8+D = X
// => 3-(op+size) (index bits in group)
// 64/B = 3, 64+H = 2, 64+S = 1, 64+D = X
// 32+B = 2, 32+H = 1, 32+S = X, 32+D = X
// 16+B = 1, 16+H = X, 16+S = X, 16+D = X
// 8+B = X, 8+H = X, 8+S = X, 8+D = X

// index bits within group: 1, 2, 3
if UInt(op) + UInt(size) >= 3 then UnallocatedEncoding();

integer container_size;
case op of
    when '10' container_size = 16;
    when '01' container_size = 32;
    when '00' container_size = 64;

integer containers = datasize DIV container_size;
integer elements_per_container = container_size DIV esize;
```

Assembler symbols

- <Vd> Is the name of the SIMD&FP destination register, encoded in the "Rd" field.
- <T> Is an arrangement specifier, encoded in the "size:Q" field. It can have the following values:
- | | |
|-----|-----------------------|
| 8B | when size = 00, Q = 0 |
| 16B | when size = 00, Q = 1 |
| 4H | when size = 01, Q = 0 |

8H when size = 01, Q = 1

2S when size = 10, Q = 0

4S when size = 10, Q = 1

The encoding size = 11, Q = x is reserved.

<Vn> Is the name of the SIMD&FP source register, encoded in the "Rn" field.

Operation

```
CheckFPAdvSIMDEnabled64();
bits(datasize) operand = V[n];
bits(datasize) result;
integer element = 0;
integer rev_element;
for c = 0 to containers-1
    rev_element = element + elements_per_container - 1;
    for e = 0 to elements_per_container-1
        Elem[result, rev_element, esize] = Elem[operand, element, esize];
        element = element + 1;
        rev_element = rev_element - 1;

V[d] = result;
```

C7.2.196 RSHRN, RSHRN2

Rounding Shift Right Narrow (immediate). This instruction reads each unsigned integer value from the vector in the source SIMD&FP register, right shifts each result by an immediate value, writes the final result to a vector, and writes the vector to the lower or upper half of the destination SIMD&FP register. The destination vector elements are half as long as the source vector elements. The results are rounded. For truncated results, see [SHRN](#), [SHRN2](#).

The RSHRN instruction writes the vector to the lower half of the destination register and clears the upper half, while the RSHRN2 instruction writes the vector to the upper half of the destination register without affecting the other bits of the register.

Depending on the settings in the [CPACR_EL1](#), [CPTR_EL2](#), and [CPTR_EL3](#) registers, and the current Security state and Exception level, an attempt to execute the instruction might be trapped.

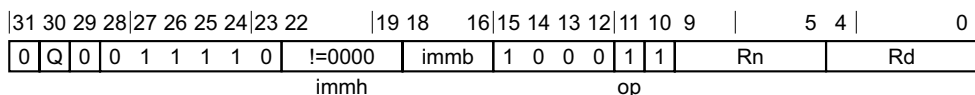

Vector variant

RSHRN{2} <Vd>.<Tb>, <Vn>.<Ta>, #<shift>

Decode for this encoding

```
integer d = UInt(Rd);
integer n = UInt(Rn);

if immh == '0000' then SEE "Advanced SIMD modified immediate";
if immh<3> == '1' then ReservedValue();
integer esize = 8 << HighestSetBit(immh);
integer datasize = 64;
integer part = UInt(Q);
integer elements = datasize DIV esize;

integer shift = (2 * esize) - UInt(immh:immb);
boolean round = (op == '1');
```

Assembler symbols

2 Is the second and upper half specifier. If present it causes the operation to be performed on the upper 64 bits of the registers holding the narrower elements, and is encoded in the "Q" field. It can have the following values:

[absent] when Q = 0
 [present] when Q = 1

<Vd> Is the name of the SIMD&FP destination register, encoded in the "Rd" field.

<Tb> Is an arrangement specifier, encoded in the "immh:Q" field. It can have the following values:

8B when immh = 0001, Q = 0
 16B when immh = 0001, Q = 1
 4H when immh = 001x, Q = 0
 8H when immh = 001x, Q = 1
 2S when immh = 01xx, Q = 0
 4S when immh = 01xx, Q = 1

See [Advanced SIMD modified immediate on page C4-291](#) when immh = 0000, Q = x.

- The encoding `immh = 1xxx`, `Q = x` is reserved.
- <Vn> Is the name of the SIMD&FP source register, encoded in the "Rn" field.
- <Ta> Is an arrangement specifier, encoded in the "immh" field. It can have the following values:
- | | |
|----|-------------------------------|
| 8H | when <code>immh = 0001</code> |
| 4S | when <code>immh = 001x</code> |
| 2D | when <code>immh = 01xx</code> |
- See [Advanced SIMD modified immediate on page C4-291](#) when `immh = 0000`.
- The encoding `immh = 1xxx` is reserved.
- <shift> Is the right shift amount, in the range 1 to the destination element width in bits, encoded in the "immh:immb" field. It can have the following values:
- | | |
|-----------------------------------|-------------------------------|
| <code>(16-UInt(immh:immb))</code> | when <code>immh = 0001</code> |
| <code>(32-UInt(immh:immb))</code> | when <code>immh = 001x</code> |
| <code>(64-UInt(immh:immb))</code> | when <code>immh = 01xx</code> |
- See [Advanced SIMD modified immediate on page C4-291](#) when `immh = 0000`.
- The encoding `immh = 1xxx` is reserved.

Operation

```
CheckFPAdvSIMDEnabled64();
bits(datasize*2) operand = V[n];
bits(datasize) result;
integer round_const = if round then (1 << (shift - 1)) else 0;
integer element;

for e = 0 to elements-1
    element = (UInt(Elem[operand, e, 2*esize]) + round_const) >> shift;
    Elem[result, e, esize] = element<esize-1:0>;

Vpart[d, part] = result;
```

C7.2.197 RSUBHN, RSUBHN2

Rounding Subtract returning High Narrow. This instruction subtracts each vector element of the second source SIMD&FP register from the corresponding vector element of the first source SIMD&FP register, places the most significant half of the result into a vector, and writes the vector to the lower or upper half of the destination SIMD&FP register.

The results are rounded. For truncated results, see [SUBHN](#), [SUBHN2](#).

The RSUBHN instruction writes the vector to the lower half of the destination register and clears the upper half, while the RSUBHN2 instruction writes the vector to the upper half of the destination register without affecting the other bits of the register.

Depending on the settings in the [CPACR_EL1](#), [CPTR_EL2](#), and [CPTR_EL3](#) registers, and the current Security state and Exception level, an attempt to execute the instruction might be trapped.

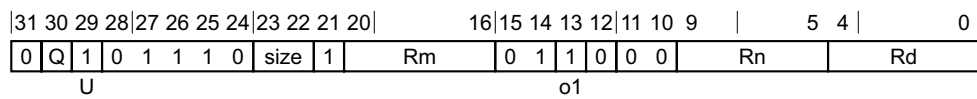

Three registers, not all the same type variant

RSUBHN{2} <Vd>.<Tb>, <Vn>.<Ta>, <Vm>.<Ta>

Decode for this encoding

```
integer d = UInt(Rd);
integer n = UInt(Rn);
integer m = UInt(Rm);

if size == '11' then ReservedValue();
integer esize = 8 << UInt(size);
integer datasize = 64;
integer part = UInt(Q);
integer elements = datasize DIV esize;

boolean sub_op = (o1 == '1');
boolean round = (U == '1');
```

Assembler symbols

- 2 Is the second and upper half specifier. If present it causes the operation to be performed on the upper 64 bits of the registers holding the narrower elements, and is encoded in the "Q" field. It can have the following values:
 - [absent] when Q = 0
 - [present] when Q = 1
- <Vd> Is the name of the SIMD&FP destination register, encoded in the "Rd" field.
- <Tb> Is an arrangement specifier, encoded in the "size:Q" field. It can have the following values:
 - 8B when size = 00, Q = 0
 - 16B when size = 00, Q = 1
 - 4H when size = 01, Q = 0
 - 8H when size = 01, Q = 1
 - 2S when size = 10, Q = 0
 - 4S when size = 10, Q = 1

The encoding size = 11, Q = x is reserved.

- <Vn> Is the name of the first SIMD&FP source register, encoded in the "Rn" field.
- <Ta> Is an arrangement specifier, encoded in the "size" field. It can have the following values:
- | | |
|----|----------------|
| 8H | when size = 00 |
| 4S | when size = 01 |
| 2D | when size = 10 |
- The encoding size = 11 is reserved.
- <Vm> Is the name of the second SIMD&FP source register, encoded in the "Rm" field.

Operation

```
CheckFPAdvSIMDEnabled64();
bits(2*datasize) operand1 = V[n];
bits(2*datasize) operand2 = V[m];
bits(datasize) result;
integer round_const = if round then 1 << (esize - 1) else 0;
bits(2*esize) element1;
bits(2*esize) element2;
bits(2*esize) sum;

for e = 0 to elements-1
    element1 = Elem[operand1, e, 2*esize];
    element2 = Elem[operand2, e, 2*esize];
    if sub_op then
        sum = element1 - element2;
    else
        sum = element1 + element2;
    sum = sum + round_const;
    Elem[result, e, esize] = sum<2*esize-1:esize>;

Vpart[d, part] = result;
```

C7.2.198 SABA

Signed Absolute difference and Accumulate. This instruction subtracts the elements of the vector of the second source SIMD&FP register from the corresponding elements of the first source SIMD&FP register, and accumulates the absolute values of the results into the elements of the vector of the destination SIMD&FP register.

Depending on the settings in the [CPACR_EL1](#), [CPTR_EL2](#), and [CPTR_EL3](#) registers, and the current Security state and Exception level, an attempt to execute the instruction might be trapped.

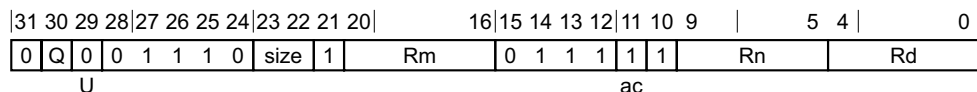

Three registers of the same type variant

SABA <Vd>.<T>, <Vn>.<T>, <Vm>.<T>

Decode for this encoding

```
integer d = UInt(Rd);
integer n = UInt(Rn);
integer m = UInt(Rm);
if size == '11' then ReservedValue();
integer esize = 8 << UInt(size);
integer datasize = if Q == '1' then 128 else 64;
integer elements = datasize DIV esize;
```

```
boolean unsigned = (U == '1');
boolean accumulate = (ac == '1');
```

Assembler symbols

- <Vd> Is the name of the SIMD&FP destination register, encoded in the "Rd" field.
- <T> Is an arrangement specifier, encoded in the "size:Q" field. It can have the following values:
- | | |
|-----|-----------------------|
| 8B | when size = 00, Q = 0 |
| 16B | when size = 00, Q = 1 |
| 4H | when size = 01, Q = 0 |
| 8H | when size = 01, Q = 1 |
| 2S | when size = 10, Q = 0 |
| 4S | when size = 10, Q = 1 |
- The encoding size = 11, Q = x is reserved.
- <Vn> Is the name of the first SIMD&FP source register, encoded in the "Rn" field.
- <Vm> Is the name of the second SIMD&FP source register, encoded in the "Rm" field.

Operation

```
CheckFPAdvSIMDEnabled64();
bits(datasize) operand1 = V[n];
bits(datasize) operand2 = V[m];
bits(datasize) result;
integer element1;
integer element2;
bits(esize) absdiff;
```

```
result = if accumulate then V[d] else Zeros();
for e = 0 to elements-1
    element1 = Int(Elem[operand1, e, esize], unsigned);
    element2 = Int(Elem[operand2, e, esize], unsigned);
    absdiff = Abs(element1-element2)<esize-1:0>;
    Elem[result, e, esize] = Elem[result, e, esize] + absdiff;
V[d] = result;
```

C7.2.199 SABAL, SABAL2

Signed Absolute difference and Accumulate Long. This instruction subtracts the vector elements in the lower or upper half of the second source SIMD&FP register from the corresponding vector elements of the first source SIMD&FP register, and accumulates the absolute values of the results into the vector elements of the destination SIMD&FP register. The destination vector elements are twice as long as the source vector elements.

The SABAL instruction extracts each source vector from the lower half of each source register, while the SABAL2 instruction extracts each source vector from the upper half of each source register.

Depending on the settings in the CPACR_EL1, CPTR_EL2, and CPTR_EL3 registers, and the current Security state and Exception level, an attempt to execute the instruction might be trapped.

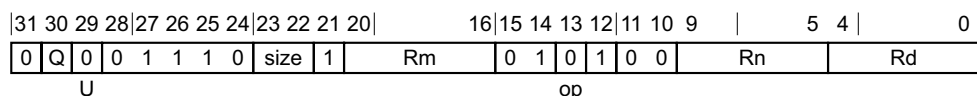

Three registers, not all the same type variant

SABAL{2} <Vd>.<Ta>, <Vn>.<Tb>, <Vm>.<Tb>

Decode for this encoding

```
integer d = UInt(Rd);
integer n = UInt(Rn);
integer m = UInt(Rm);

if size == '11' then ReservedValue();
integer esize = 8 << UInt(size);
integer datasize = 64;
integer part = UInt(Q);
integer elements = datasize DIV esize;

boolean accumulate = (op == '0');
boolean unsigned = (U == '1');
```

Assembler symbols

- 2 Is the second and upper half specifier. If present it causes the operation to be performed on the upper 64 bits of the registers holding the narrower elements, and is encoded in the "Q" field. It can have the following values:
- | | |
|-----------|------------|
| [absent] | when Q = 0 |
| [present] | when Q = 1 |
- <Vd> Is the name of the SIMD&FP destination register, encoded in the "Rd" field.
- <Ta> Is an arrangement specifier, encoded in the "size" field. It can have the following values:
- | | |
|----|----------------|
| 8H | when size = 00 |
| 4S | when size = 01 |
| 2D | when size = 10 |
- The encoding size = 11 is reserved.
- <Vn> Is the name of the first SIMD&FP source register, encoded in the "Rn" field.
- <Tb> Is an arrangement specifier, encoded in the "size:Q" field. It can have the following values:
- | | |
|-----|-----------------------|
| 8B | when size = 00, Q = 0 |
| 16B | when size = 00, Q = 1 |

4H when size = 01, Q = 0
8H when size = 01, Q = 1
2S when size = 10, Q = 0
4S when size = 10, Q = 1
The encoding size = 11, Q = x is reserved.

<Vm> Is the name of the second SIMD&FP source register, encoded in the "Rm" field.

Operation

```
CheckFPAdvSIMDEnabled64();
bits(datasize) operand1 = Vpart[n, part];
bits(datasize) operand2 = Vpart[m, part];
bits(2*datasize) result;
integer element1;
integer element2;
bits(2*esize) absdiff;

result = if accumulate then V[d] else Zeros();
for e = 0 to elements-1
    element1 = Int(Elem[operand1, e, esize], unsigned);
    element2 = Int(Elem[operand2, e, esize], unsigned);
    absdiff = Abs(element1-element2)<2*esize-1:0>;
    Elem[result, e, 2*esize] = Elem[result, e, 2*esize] + absdiff;
V[d] = result;
```

C7.2.200 SABD

Signed Absolute Difference. This instruction subtracts the elements of the vector of the second source SIMD&FP register from the corresponding elements of the first source SIMD&FP register, places the absolute values of the results into a vector, and writes the vector to the destination SIMD&FP register.

Depending on the settings in the [CPACR_EL1](#), [CPTR_EL2](#), and [CPTR_EL3](#) registers, and the current Security state and Exception level, an attempt to execute the instruction might be trapped.

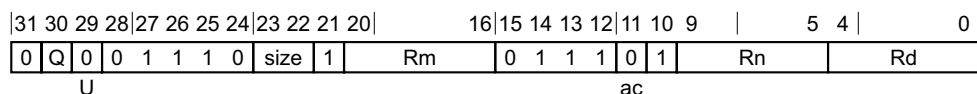

Three registers of the same type variant

SABD <Vd>.<T>, <Vn>.<T>, <Vm>.<T>

Decode for this encoding

```
integer d = UInt(Rd);
integer n = UInt(Rn);
integer m = UInt(Rm);
if size == '11' then ReservedValue();
integer esize = 8 << UInt(size);
integer datasize = if Q == '1' then 128 else 64;
integer elements = datasize DIV esize;
```

```
boolean unsigned = (U == '1');
boolean accumulate = (ac == '1');
```

Assembler symbols

- <Vd> Is the name of the SIMD&FP destination register, encoded in the "Rd" field.
- <T> Is an arrangement specifier, encoded in the "size:Q" field. It can have the following values:
- | | |
|-----|-----------------------|
| 8B | when size = 00, Q = 0 |
| 16B | when size = 00, Q = 1 |
| 4H | when size = 01, Q = 0 |
| 8H | when size = 01, Q = 1 |
| 2S | when size = 10, Q = 0 |
| 4S | when size = 10, Q = 1 |
- The encoding size = 11, Q = x is reserved.
- <Vn> Is the name of the first SIMD&FP source register, encoded in the "Rn" field.
- <Vm> Is the name of the second SIMD&FP source register, encoded in the "Rm" field.

Operation

```
CheckFPAdvSIMDEnabled64();
bits(datasize) operand1 = V[n];
bits(datasize) operand2 = V[m];
bits(datasize) result;
integer element1;
integer element2;
bits(esize) absdiff;
```

```
result = if accumulate then V[d] else Zeros();  
for e = 0 to elements-1  
    element1 = Int(Elem[operand1, e, esize], unsigned);  
    element2 = Int(Elem[operand2, e, esize], unsigned);  
    absdiff = Abs(element1-element2)<esize-1:0>;  
    Elem[result, e, esize] = Elem[result, e, esize] + absdiff;  
V[d] = result;
```

C7.2.201 SABDL, SABDL2

Signed Absolute Difference Long. This instruction subtracts the vector elements of the second source SIMD&FP register from the corresponding vector elements of the first source SIMD&FP register, places the absolute value of the results into a vector, and writes the vector to the lower or upper half of the destination SIMD&FP register. The destination vector elements are twice as long as the source vector elements.

The SABDL instruction writes the vector to the lower half of the destination register and clears the upper half, while the SABDL2 instruction writes the vector to the upper half of the destination register without affecting the other bits of the register.

Depending on the settings in the CPACR_EL1, CPTR_EL2, and CPTR_EL3 registers, and the current Security state and Exception level, an attempt to execute the instruction might be trapped.

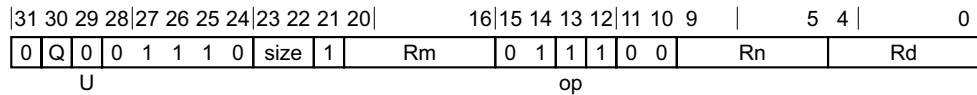

Three registers, not all the same type variant

SABDL{2} <Vd>.<Ta>, <Vn>.<Tb>, <Vm>.<Tb>

Decode for this encoding

```
integer d = UInt(Rd);
integer n = UInt(Rn);
integer m = UInt(Rm);

if size == '11' then ReservedValue();
integer esize = 8 << UInt(size);
integer datasize = 64;
integer part = UInt(Q);
integer elements = datasize DIV esize;

boolean accumulate = (op == '0');
boolean unsigned = (U == '1');
```

Assembler symbols

- 2 Is the second and upper half specifier. If present it causes the operation to be performed on the upper 64 bits of the registers holding the narrower elements, and is encoded in the "Q" field. It can have the following values:
- [absent] when Q = 0
 - [present] when Q = 1
- <Vd> Is the name of the SIMD&FP destination register, encoded in the "Rd" field.
- <Ta> Is an arrangement specifier, encoded in the "size" field. It can have the following values:
- 8H when size = 00
 - 4S when size = 01
 - 2D when size = 10
- The encoding size = 11 is reserved.
- <Vn> Is the name of the first SIMD&FP source register, encoded in the "Rn" field.
- <Tb> Is an arrangement specifier, encoded in the "size:Q" field. It can have the following values:
- 8B when size = 00, Q = 0

16B when size = 00, Q = 1
4H when size = 01, Q = 0
8H when size = 01, Q = 1
2S when size = 10, Q = 0
4S when size = 10, Q = 1
The encoding size = 11, Q = x is reserved.

<Vm> Is the name of the second SIMD&FP source register, encoded in the "Rm" field.

Operation

```
CheckFPAdvSIMDEnabled64();
bits(datasize) operand1 = Vpart[n, part];
bits(datasize) operand2 = Vpart[m, part];
bits(2*datasize) result;
integer element1;
integer element2;
bits(2*esize) absdiff;

result = if accumulate then V[d] else Zeros();
for e = 0 to elements-1
    element1 = Int(Elem[operand1, e, esize], unsigned);
    element2 = Int(Elem[operand2, e, esize], unsigned);
    absdiff = Abs(element1-element2)<2*esize-1:0>;
    Elem[result, e, 2*esize] = Elem[result, e, 2*esize] + absdiff;
V[d] = result;
```

C7.2.202 SADALP

Signed Add and Accumulate Long Pairwise. This instruction adds pairs of adjacent signed integer values from the vector in the source SIMD&FP register and accumulates the results into the vector elements of the destination SIMD&FP register. The destination vector elements are twice as long as the source vector elements.

Depending on the settings in the CPACR_EL1, CPTR_EL2, and CPTR_EL3 registers, and the current Security state and Exception level, an attempt to execute the instruction might be trapped.

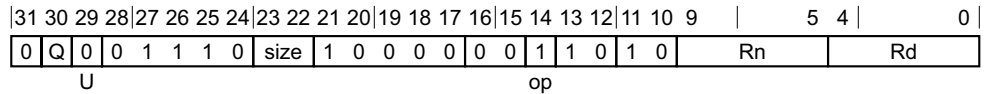

Vector variant

SADALP <Vd>.<Ta>, <Vn>.<Tb>

Decode for this encoding

```
integer d = UInt(Rd);
integer n = UInt(Rn);

if size == '11' then ReservedValue();
integer esize = 8 << UInt(size);
integer datasize = if Q == '1' then 128 else 64;
integer elements = datasize DIV (2 * esize);
boolean acc = (op == '1');
boolean unsigned = (U == '1');
```

Assembler symbols

- <Vd> Is the name of the SIMD&FP destination register, encoded in the "Rd" field.
- <Ta> Is an arrangement specifier, encoded in the "size:Q" field. It can have the following values:
 - 4H when size = 00, Q = 0
 - 8H when size = 00, Q = 1
 - 2S when size = 01, Q = 0
 - 4S when size = 01, Q = 1
 - 1D when size = 10, Q = 0
 - 2D when size = 10, Q = 1
 The encoding size = 11, Q = x is reserved.
- <Vn> Is the name of the SIMD&FP source register, encoded in the "Rn" field.
- <Tb> Is an arrangement specifier, encoded in the "size:Q" field. It can have the following values:
 - 8B when size = 00, Q = 0
 - 16B when size = 00, Q = 1
 - 4H when size = 01, Q = 0
 - 8H when size = 01, Q = 1
 - 2S when size = 10, Q = 0
 - 4S when size = 10, Q = 1
 The encoding size = 11, Q = x is reserved.

Operation

```
CheckFPAdvSIMDEnabled64();
bits(datasize) operand = V[n];
bits(datasize) result;

bits(2*esize) sum;
integer op1;
integer op2;

result = if acc then V[d] else Zeros();
for e = 0 to elements-1
    op1 = Int(Elem[operand, 2*e+0, esize], unsigned);
    op2 = Int(Elem[operand, 2*e+1, esize], unsigned);
    sum = (op1+op2)<2*esize-1:0>;
    Elem[result, e, 2*esize] = Elem[result, e, 2*esize] + sum;

V[d] = result;
```

C7.2.203 SADDL, SADDL2

Signed Add Long (vector). This instruction adds each vector element in the lower or upper half of the first source SIMD&FP register to the corresponding vector element of the second source SIMD&FP register, places the results into a vector, and writes the vector to the destination SIMD&FP register. The destination vector elements are twice as long as the source vector elements. All the values in this instruction are signed integer values.

The SADDL instruction extracts each source vector from the lower half of each source register, while the SADDL2 instruction extracts each source vector from the upper half of each source register.

Depending on the settings in the CPACR_EL1, CPTR_EL2, and CPTR_EL3 registers, and the current Security state and Exception level, an attempt to execute the instruction might be trapped.

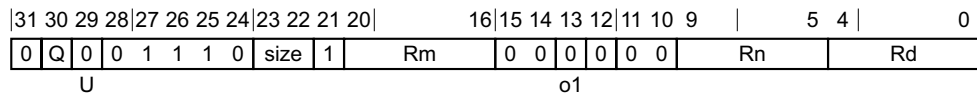

Three registers, not all the same type variant

SADDL{2} <Vd>.<Ta>, <Vn>.<Tb>, <Vm>.<Tb>

Decode for this encoding

```
integer d = UInt(Rd);
integer n = UInt(Rn);
integer m = UInt(Rm);

if size == '11' then ReservedValue();
integer esize = 8 << UInt(size);
integer datasize = 64;
integer part = UInt(Q);
integer elements = datasize DIV esize;

boolean sub_op = (o1 == '1');
boolean unsigned = (U == '1');
```

Assembler symbols

- 2 Is the second and upper half specifier. If present it causes the operation to be performed on the upper 64 bits of the registers holding the narrower elements, and is encoded in the "Q" field. It can have the following values:
- | | |
|-----------|------------|
| [absent] | when Q = 0 |
| [present] | when Q = 1 |
- <Vd> Is the name of the SIMD&FP destination register, encoded in the "Rd" field.
- <Ta> Is an arrangement specifier, encoded in the "size" field. It can have the following values:
- | | |
|----|----------------|
| 8H | when size = 00 |
| 4S | when size = 01 |
| 2D | when size = 10 |
- The encoding size = 11 is reserved.
- <Vn> Is the name of the first SIMD&FP source register, encoded in the "Rn" field.
- <Tb> Is an arrangement specifier, encoded in the "size:Q" field. It can have the following values:
- | | |
|-----|-----------------------|
| 8B | when size = 00, Q = 0 |
| 16B | when size = 00, Q = 1 |

4H when size = 01, Q = 0
8H when size = 01, Q = 1
2S when size = 10, Q = 0
4S when size = 10, Q = 1
The encoding size = 11, Q = x is reserved.

<Vm> Is the name of the second SIMD&FP source register, encoded in the "Rm" field.

Operation

```
CheckFPAdvSIMDEnabled64();
bits(datasize) operand1 = Vpart[n, part];
bits(datasize) operand2 = Vpart[m, part];
bits(2*datasize) result;
integer element1;
integer element2;
integer sum;

for e = 0 to elements-1
    element1 = Int(Elem[operand1, e, esize], unsigned);
    element2 = Int(Elem[operand2, e, esize], unsigned);
    if sub_op then
        sum = element1 - element2;
    else
        sum = element1 + element2;
    Elem[result, e, 2*esize] = sum<2*esize-1:0>;

V[d] = result;
```

C7.2.204 SADDLP

Signed Add Long Pairwise. This instruction adds pairs of adjacent signed integer values from the vector in the source SIMD&FP register, places the result into a vector, and writes the vector to the destination SIMD&FP register. The destination vector elements are twice as long as the source vector elements.

Depending on the settings in the CPACR_EL1, CPTR_EL2, and CPTR_EL3 registers, and the current Security state and Exception level, an attempt to execute the instruction might be trapped.

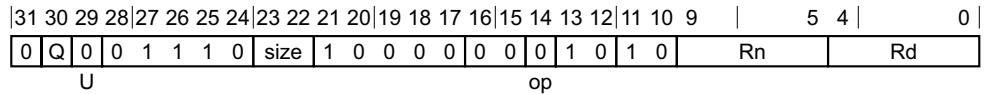

Vector variant

SADDLP <Vd>.<Ta>, <Vn>.<Tb>

Decode for this encoding

```
integer d = UInt(Rd);
integer n = UInt(Rn);

if size == '11' then ReservedValue();
integer esize = 8 << UInt(size);
integer datasize = if Q == '1' then 128 else 64;
integer elements = datasize DIV (2 * esize);
boolean acc = (op == '1');
boolean unsigned = (U == '1');
```

Assembler symbols

- <Vd> Is the name of the SIMD&FP destination register, encoded in the "Rd" field.
- <Ta> Is an arrangement specifier, encoded in the "size:Q" field. It can have the following values:
- | | |
|----|-----------------------|
| 4H | when size = 00, Q = 0 |
| 8H | when size = 00, Q = 1 |
| 2S | when size = 01, Q = 0 |
| 4S | when size = 01, Q = 1 |
| 1D | when size = 10, Q = 0 |
| 2D | when size = 10, Q = 1 |
- The encoding size = 11, Q = x is reserved.
- <Vn> Is the name of the SIMD&FP source register, encoded in the "Rn" field.
- <Tb> Is an arrangement specifier, encoded in the "size:Q" field. It can have the following values:
- | | |
|-----|-----------------------|
| 8B | when size = 00, Q = 0 |
| 16B | when size = 00, Q = 1 |
| 4H | when size = 01, Q = 0 |
| 8H | when size = 01, Q = 1 |
| 2S | when size = 10, Q = 0 |
| 4S | when size = 10, Q = 1 |
- The encoding size = 11, Q = x is reserved.

Operation

```
CheckFPAdvSIMDEnabled64();
bits(datasize) operand = V[n];
bits(datasize) result;

bits(2*esize) sum;
integer op1;
integer op2;

result = if acc then V[d] else Zeros();
for e = 0 to elements-1
    op1 = Int(Elem[operand, 2*e+0, esize], unsigned);
    op2 = Int(Elem[operand, 2*e+1, esize], unsigned);
    sum = (op1+op2)<2*esize-1:0>;
    Elem[result, e, 2*esize] = Elem[result, e, 2*esize] + sum;

V[d] = result;
```

C7.2.205 SADDLV

Signed Add Long across Vector. This instruction adds every vector element in the source SIMD&FP register together, and writes the scalar result to the destination SIMD&FP register. The destination scalar is twice as long as the source vector elements. All the values in this instruction are signed integer values.

Depending on the settings in the CPACR_EL1, CPTR_EL2, and CPTR_EL3 registers, and the current Security state and Exception level, an attempt to execute the instruction might be trapped.

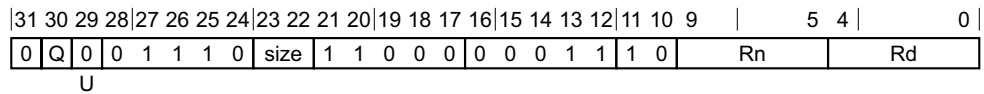

Advanced SIMD variant

SADDLV <V><d>, <Vn>.<T>

Decode for this encoding

```
integer d = UInt(Rd);
integer n = UInt(Rn);

if size:Q == '100' then ReservedValue();
if size == '11' then ReservedValue();
integer esize = 8 << UInt(size);
integer datasize = if Q == '1' then 128 else 64;
integer elements = datasize DIV esize;

boolean unsigned = (U == '1');
```

Assembler symbols

<V> Is the destination width specifier, encoded in the "size" field. It can have the following values:

H when size = 00
 S when size = 01
 D when size = 10

The encoding size = 11 is reserved.

<d> Is the number of the SIMD&FP destination register, encoded in the "Rd" field.

<Vn> Is the name of the SIMD&FP source register, encoded in the "Rn" field.

<T> Is an arrangement specifier, encoded in the "size:Q" field. It can have the following values:

8B when size = 00, Q = 0
 16B when size = 00, Q = 1
 4H when size = 01, Q = 0
 8H when size = 01, Q = 1
 4S when size = 10, Q = 1

The following encodings are reserved:

- size = 10, Q = 0.
- size = 11, Q = x.

Operation

```
CheckFPAdvSIMDEnabled64();
bits(datasize) operand = V[n];
integer sum;

sum = Int(Elem[operand, 0, esize], unsigned);
for e = 1 to elements-1
    sum = sum + Int(Elem[operand, e, esize], unsigned);

V[d] = sum<2*esize-1:0>;
```

C7.2.206 SADDW, SADDW2

Signed Add Wide. This instruction adds vector elements of the first source SIMD&FP register to the corresponding vector elements in the lower or upper half of the second source SIMD&FP register, places the results in a vector, and writes the vector to the SIMD&FP destination register.

The SADDW instruction extracts the second source vector from the lower half of the second source register, while the SADDW2 instruction extracts the second source vector from the upper half of the second source register.

Depending on the settings in the CPACR_EL1, CPTR_EL2, and CPTR_EL3 registers, and the current Security state and Exception level, an attempt to execute the instruction might be trapped.

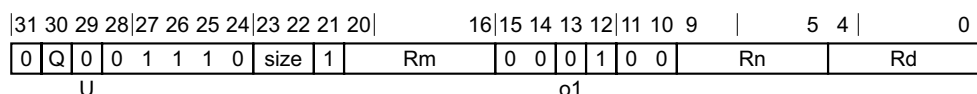

Three registers, not all the same type variant

SADDW{2} <Vd>.<Ta>, <Vn>.<Ta>, <Vm>.<Tb>

Decode for this encoding

```
integer d = UInt(Rd);
integer n = UInt(Rn);
integer m = UInt(Rm);

if size == '11' then ReservedValue();
integer esize = 8 << UInt(size);
integer datasize = 64;
integer part = UInt(Q);
integer elements = datasize DIV esize;

boolean sub_op = (o1 == '1');
boolean unsigned = (U == '1');
```

Assembler symbols

- 2 Is the second and upper half specifier. If present it causes the operation to be performed on the upper 64 bits of the registers holding the narrower elements, and is encoded in the "Q" field. It can have the following values:
 - [absent] when Q = 0
 - [present] when Q = 1
- <Vd> Is the name of the SIMD&FP destination register, encoded in the "Rd" field.
- <Ta> Is an arrangement specifier, encoded in the "size" field. It can have the following values:
 - 8H when size = 00
 - 4S when size = 01
 - 2D when size = 10
 The encoding size = 11 is reserved.
- <Vn> Is the name of the first SIMD&FP source register, encoded in the "Rn" field.
- <Vm> Is the name of the second SIMD&FP source register, encoded in the "Rm" field.
- <Tb> Is an arrangement specifier, encoded in the "size:Q" field. It can have the following values:
 - 8B when size = 00, Q = 0

16B when size = 00, Q = 1
4H when size = 01, Q = 0
8H when size = 01, Q = 1
2S when size = 10, Q = 0
4S when size = 10, Q = 1
The encoding size = 11, Q = x is reserved.

Operation

```
CheckFPAdvSIMDEnabled64();
bits(2*datasize) operand1 = V[n];
bits(datasize) operand2 = Vpart[m, part];
bits(2*datasize) result;
integer element1;
integer element2;
integer sum;

for e = 0 to elements-1
    element1 = Int(Elem[operand1, e, 2*esize], unsigned);
    element2 = Int(Elem[operand2, e, esize], unsigned);
    if sub_op then
        sum = element1 - element2;
    else
        sum = element1 + element2;
    Elem[result, e, 2*esize] = sum<2*esize-1:0>;

V[d] = result;
```

C7.2.207 SCVTF (vector, fixed-point)

Signed fixed-point Convert to Floating-point (vector). This instruction converts each element in a vector from fixed-point to floating-point using the rounding mode that is specified by the **FPCR**, and writes the result to the SIMD&FP destination register.

A floating-point exception can be generated by this instruction. Depending on the settings in **FPCR**, the exception results in either a flag being set in **FPSR**, or a synchronous exception being generated. For more information, see [Floating-point exceptions and exception traps on page D1-1831](#).

Depending on the settings in the **CPACR_EL1**, **CPTR_EL2**, and **CPTR_EL3** registers, and the Security state and Exception level in which the instruction is executed, an attempt to execute the instruction might be trapped.

Scalar

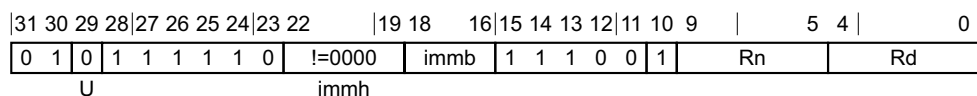

Scalar variant

SCVTF <V><d>, <V><n>, #<fbits>

Decode for this encoding

```
integer d = UInt(Rd);
integer n = UInt(Rn);

if immh == '000x' || (immh == '001x' && !HaveFP16Ext()) then ReservedValue();
integer esize = if immh == '1xxx' then 64 else if immh == '01xx' then 32 else 16;
integer datasize = esize;
integer elements = 1;

integer fracbits = (esize * 2) - UInt(immh:immb);
boolean unsigned = (U == '1');
FPRounding rounding = FPRoundingMode(FPCR);
```

Vector

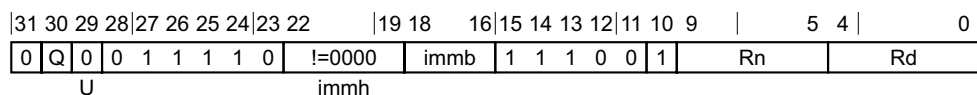

Vector variant

SCVTF <Vd>.<T>, <Vn>.<T>, #<fbits>

Decode for this encoding

```
integer d = UInt(Rd);
integer n = UInt(Rn);

if immh == '0000' then SEE "Advanced SIMD modified immediate";
if immh == '000x' || (immh == '001x' && !HaveFP16Ext()) then ReservedValue();
if immh<3>:Q == '10' then ReservedValue();
integer esize = if immh == '1xxx' then 64 else if immh == '01xx' then 32 else 16;
integer datasize = if Q == '1' then 128 else 64;
integer elements = datasize DIV esize;
```

```
integer fracbits = (esize * 2) - UInt(immh:immb);  
boolean unsigned = (U == '1');  
FPRounding rounding = FPRoundingMode(FPCR);
```

Assembler symbols

- <V> Is a width specifier, encoded in the "immh" field. It can have the following values:
- H when immh = 001x
 - S when immh = 01xx
 - D when immh = 1xxx
- The encoding immh = 000x is reserved.
- <d> Is the number of the SIMD&FP destination register, in the "Rd" field.
- <n> Is the number of the first SIMD&FP source register, encoded in the "Rn" field.
- <Vd> Is the name of the SIMD&FP destination register, encoded in the "Rd" field.
- <T> Is an arrangement specifier, encoded in the "immh:Q" field. It can have the following values:
- 4H when immh = 001x, Q = 0
 - 8H when immh = 001x, Q = 1
 - 2S when immh = 01xx, Q = 0
 - 4S when immh = 01xx, Q = 1
 - 2D when immh = 1xxx, Q = 1
- See [Advanced SIMD modified immediate on page C4-291](#) when immh = 0000, Q = x.
- The following encodings are reserved:
- immh = 0001, Q = x.
 - immh = 1xxx, Q = 0.
- <Vn> Is the name of the SIMD&FP source register, encoded in the "Rn" field.
- <fbits> For the scalar variant: is the number of fractional bits, in the range 1 to the operand width, encoded in the "immh:immb" field. It can have the following values:
- (32-UInt(immh:immb)) when immh = 001x
 - (64-UInt(immh:immb)) when immh = 01xx
 - (128-UInt(immh:immb)) when immh = 1xxx
- The encoding immh = 000x is reserved.
- For the vector variant: is the number of fractional bits, in the range 1 to the element width, encoded in the "immh:immb" field. It can have the following values:
- (32-UInt(immh:immb)) when immh = 001x
 - (64-UInt(immh:immb)) when immh = 01xx
 - (128-UInt(immh:immb)) when immh = 1xxx
- See [Advanced SIMD modified immediate on page C4-291](#) when immh = 0000.
- The encoding immh = 0001 is reserved.

Operation for all encodings

```
CheckFPAdvSIMDEnabled64();  
bits(datasize) operand = V[n];  
bits(datasize) result;  
bits(esize) element;  
  
for e = 0 to elements-1
```

```
element = Elem[operand, e, esize];  
Elem[result, e, esize] = FixedToFP(element, fracbits, unsigned, FPCR, rounding);  
V[d] = result;
```

C7.2.208 SCVTF (vector, integer)

Signed integer Convert to Floating-point (vector). This instruction converts each element in a vector from signed integer to floating-point using the rounding mode that is specified by the [FPCR](#), and writes the result to the SIMD&FP destination register.

A floating-point exception can be generated by this instruction. Depending on the settings in [FPCR](#), the exception results in either a flag being set in [FPSR](#), or a synchronous exception being generated. For more information, see [Floating-point exceptions and exception traps on page D1-1831](#).

Depending on the settings in the [CPACR_EL1](#), [CPTR_EL2](#), and [CPTR_EL3](#) registers, and the Security state and Exception level in which the instruction is executed, an attempt to execute the instruction might be trapped.

Scalar half precision

ARMv8.2

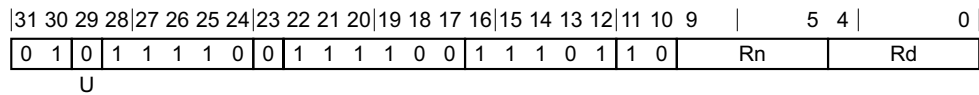

Scalar half precision variant

SCVTF <Hd>, <Hn>

Decode for this encoding

```
if !HaveFP16Ext() then UnallocatedEncoding();
```

```
integer d = UInt(Rd);
integer n = UInt(Rn);
```

```
integer esize = 16;
integer datasize = esize;
integer elements = 1;
boolean unsigned = (U == '1');
```

Scalar single-precision and double-precision

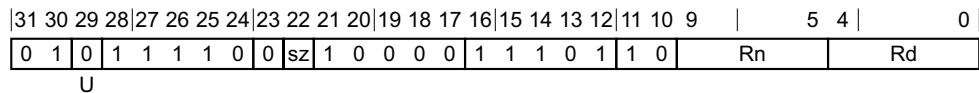

Scalar single-precision and double-precision variant

SCVTF <V><d>, <V><n>

Decode for this encoding

```
integer d = UInt(Rd);
integer n = UInt(Rn);
```

```
integer esize = 32 << UInt(sz);
integer datasize = esize;
integer elements = 1;
boolean unsigned = (U == '1');
```

Vector half precision

ARMv8.2

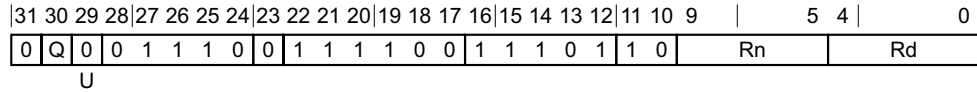

Vector half precision variant

SCVTF <Vd>.<T>, <Vn>.<T>

Decode for this encoding

```

if !HaveFP16Ext() then UnallocatedEncoding();

integer d = UInt(Rd);
integer n = UInt(Rn);

integer esize = 16;
integer datasize = if Q == '1' then 128 else 64;
integer elements = datasize DIV esize;
boolean unsigned = (U == '1');
```

Vector single-precision and double-precision

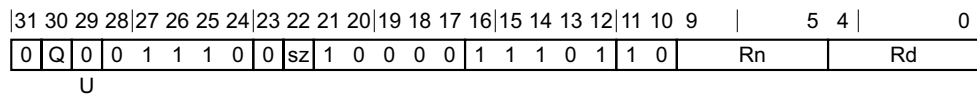

Vector single-precision and double-precision variant

SCVTF <Vd>.<T>, <Vn>.<T>

Decode for this encoding

```

integer d = UInt(Rd);
integer n = UInt(Rn);

if sz:Q == '10' then ReservedValue();
integer esize = 32 << UInt(sz);
integer datasize = if Q == '1' then 128 else 64;
integer elements = datasize DIV esize;
boolean unsigned = (U == '1');
```

Assembler symbols

- <Hd> Is the 16-bit name of the SIMD&FP destination register, encoded in the "Rd" field.
- <Hn> Is the 16-bit name of the SIMD&FP source register, encoded in the "Rn" field.
- <V> Is a width specifier, encoded in the "sz" field. It can have the following values:
 - S when sz = 0
 - D when sz = 1
- <d> Is the number of the SIMD&FP destination register, encoded in the "Rd" field.
- <n> Is the number of the SIMD&FP source register, encoded in the "Rn" field.
- <Vd> Is the name of the SIMD&FP destination register, encoded in the "Rd" field.
- <T> For the vector half precision variant: is an arrangement specifier, encoded in the "Q" field. It can have the following values:
 - 4H when Q = 0

8H when $Q = 1$

For the vector single-precision and double-precision variant: is an arrangement specifier, encoded in the "sz:Q" field. It can have the following values:

2S when $sz = 0, Q = 0$

4S when $sz = 0, Q = 1$

2D when $sz = 1, Q = 1$

The encoding $sz = 1, Q = 0$ is reserved.

<Vn> Is the name of the SIMD&FP source register, encoded in the "Rn" field.

Operation for all encodings

```
CheckFPAdvSIMDEnabled64();
bits(datasize) operand = V[n];
bits(datasize) result;
FPRounding rounding = FPRoundingMode(FPCR);
bits(esize) element;
for e = 0 to elements-1
    element = Elem[operand, e, esize];
    Elem[result, e, esize] = FixedToFP(element, 0, unsigned, FPCR, rounding);

V[d] = result;
```

C7.2.209 SCVTF (scalar, fixed-point)

Signed fixed-point Convert to Floating-point (scalar). This instruction converts the signed value in the 32-bit or 64-bit general-purpose source register to a floating-point value using the rounding mode that is specified by the [FPCR](#), and writes the result to the SIMD&FP destination register.

A floating-point exception can be generated by this instruction. Depending on the settings in [FPCR](#), the exception results in either a flag being set in [FPSR](#), or a synchronous exception being generated. For more information, see [Floating-point exceptions and exception traps on page D1-1831](#).

Depending on the settings in the [CPACR_EL1](#), [CPTR_EL2](#), and [CPTR_EL3](#) registers, and the Security state and Exception level in which the instruction is executed, an attempt to execute the instruction might be trapped.

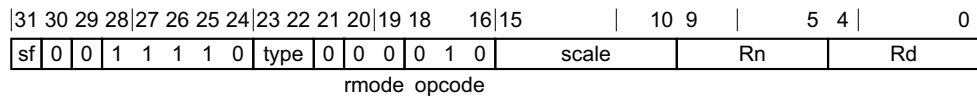

32-bit to half-precision variant

Applies when `sf == 0 && type == 11`.

SCVTF <Hd>, <Wn>, #<fbits>

32-bit to single-precision variant

Applies when `sf == 0 && type == 00`.

SCVTF <Sd>, <Wn>, #<fbits>

32-bit to double-precision variant

Applies when `sf == 0 && type == 01`.

SCVTF <Dd>, <Wn>, #<fbits>

64-bit to half-precision variant

Applies when `sf == 1 && type == 11`.

SCVTF <Hd>, <Xn>, #<fbits>

64-bit to single-precision variant

Applies when `sf == 1 && type == 00`.

SCVTF <Sd>, <Xn>, #<fbits>

64-bit to double-precision variant

Applies when `sf == 1 && type == 01`.

SCVTF <Dd>, <Xn>, #<fbits>

Decode for all variants of this encoding

```
integer d = UInt(Rd);
integer n = UInt(Rn);

integer intsize = if sf == '1' then 64 else 32;
integer fltsize;
FPRounding rounding;
```

```
case type of
  when '00' fltsize = 32;
  when '01' fltsize = 64;
  when '10' UnallocatedEncoding();
  when '11'
    if HaveFP16Ext() then
      // Empty block.
    else
      UnallocatedEncoding();

if sf == '0' && scale<5> == '0' then UnallocatedEncoding();
integer fracbits = 64 - UInt(scale);

rounding = FPRoundingMode(FPCR);
```

Assembler symbols

- <Dd> Is the 64-bit name of the SIMD&FP destination register, encoded in the "Rd" field.
- <Hd> Is the 16-bit name of the SIMD&FP destination register, encoded in the "Rd" field.
- <Sd> Is the 32-bit name of the SIMD&FP destination register, encoded in the "Rd" field.
- <Xn> Is the 64-bit name of the general-purpose source register, encoded in the "Rn" field.
- <Wn> Is the 32-bit name of the general-purpose source register, encoded in the "Rn" field.
- <fbits> For the 32-bit to double-precision, 32-bit to half-precision and 32-bit to single-precision variant: is the number of bits after the binary point in the fixed-point source, in the range 1 to 32, encoded as 64 minus "scale".
For the 64-bit to double-precision, 64-bit to half-precision and 64-bit to single-precision variant: is the number of bits after the binary point in the fixed-point source, in the range 1 to 64, encoded as 64 minus "scale".

Operation

```
CheckFPAdvSIMDEnabled64();

bits(fltsize) fltval;
bits(intsize) intval;

intval = X[n];
fltval = FixedToFP(intval, fracbits, FALSE, FPCR, rounding);
V[d] = fltval;
```

C7.2.210 SCVTF (scalar, integer)

Signed integer Convert to Floating-point (scalar). This instruction converts the signed integer value in the general-purpose source register to a floating-point value using the rounding mode that is specified by the [FPCR](#), and writes the result to the SIMD&FP destination register.

A floating-point exception can be generated by this instruction. Depending on the settings in [FPCR](#), the exception results in either a flag being set in [FPSR](#), or a synchronous exception being generated. For more information, see [Floating-point exceptions and exception traps on page D1-1831](#).

Depending on the settings in the [CPACR_EL1](#), [CPTR_EL2](#), and [CPTR_EL3](#) registers, and the current Security state and Exception level, an attempt to execute the instruction might be trapped.

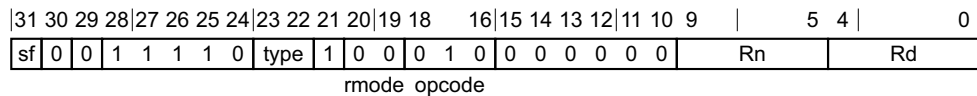

32-bit to half-precision variant

Applies when `sf == 0 && type == 11`.

SCVTF <Hd>, <Wn>

32-bit to single-precision variant

Applies when `sf == 0 && type == 00`.

SCVTF <Sd>, <Wn>

32-bit to double-precision variant

Applies when `sf == 0 && type == 01`.

SCVTF <Dd>, <Wn>

64-bit to half-precision variant

Applies when `sf == 1 && type == 11`.

SCVTF <Hd>, <Xn>

64-bit to single-precision variant

Applies when `sf == 1 && type == 00`.

SCVTF <Sd>, <Xn>

64-bit to double-precision variant

Applies when `sf == 1 && type == 01`.

SCVTF <Dd>, <Xn>

Decode for all variants of this encoding

```
integer d = UInt(Rd);
integer n = UInt(Rn);
```

```
integer intsize = if sf == '1' then 64 else 32;
integer fltsize;
FPRounding rounding;
```

```
case type of
  when '00'
    fltsize = 32;
  when '01'
    fltsize = 64;
  when '10'
    UnallocatedEncoding();
  when '11'
    if HaveFP16Ext() then
      fltsize = 16;
    else
      UnallocatedEncoding();

rounding = FPRoundingMode(FPCR);
```

Assembler symbols

- <Dd> Is the 64-bit name of the SIMD&FP destination register, encoded in the "Rd" field.
- <Hd> Is the 16-bit name of the SIMD&FP destination register, encoded in the "Rd" field.
- <Sd> Is the 32-bit name of the SIMD&FP destination register, encoded in the "Rd" field.
- <Xn> Is the 64-bit name of the general-purpose source register, encoded in the "Rn" field.
- <Wn> Is the 32-bit name of the general-purpose source register, encoded in the "Rn" field.

Operation

```
CheckFPAdvSIMDEnabled64();

bits(fltsize) fltval;
bits(intsize) intval;

intval = X[n];
fltval = FixedToFP(intval, 0, FALSE, FPCR, rounding);
V[d] = fltval;
```

C7.2.211 SHA1C

SHA1 hash update (choose)

31	30	29	28	27	26	25	24	23	22	21	20	16	15	14	13	12	11	10	9	5	4	0
0	1	0	1	1	1	1	0	0	0	0	Rm	0	0	0	0	0	0	0	Rn	Rd		

Advanced SIMD variant

SHA1C <Qd>, <Sn>, <Vm>.4S

Decode for this encoding

```
integer d = UInt(Rd);
integer n = UInt(Rn);
integer m = UInt(Rm);
if !HaveCryptoExt() then UnallocatedEncoding();
```

Assembler symbols

- <Qd> Is the 128-bit name of the SIMD&FP source and destination, encoded in the "Rd" field.
- <Sn> Is the 32-bit name of the second SIMD&FP source register, encoded in the "Rn" field.
- <Vm> Is the name of the third SIMD&FP source register, encoded in the "Rm" field.

Operation

```
CheckCryptoEnabled64();

bits(128) X = V[d];
bits(32) Y = V[n]; // Note: 32 not 128 bits wide
bits(128) W = V[m];
bits(32) t;

for e = 0 to 3
    t = SHAchoose(X<63:32>, X<95:64>, X<127:96>);
    Y = Y + ROL(X<31:0>, 5) + t + Elem[W, e, 32];
    X<63:32> = ROL(X<63:32>, 30);
    <Y, X> = ROL(Y:X, 32);
V[d] = X;
```

C7.2.212 SHA1H

SHA1 fixed rotate

31	30	29	28	27	26	25	24	23	22	21	20	19	18	17	16	15	14	13	12	11	10	9			5	4			0
0	1	0	1	1	1	1	0	0	0	1	0	1	0	0	0	0	0	0	0	1	0			Rn				Rd	

Advanced SIMD variant

SHA1H <Sd>, <Sn>

Decode for this encoding

```
integer d = UInt(Rd);
integer n = UInt(Rn);
if !HaveCryptoExt() then UnallocatedEncoding();
```

Assembler symbols

<Sd> Is the 32-bit name of the SIMD&FP destination register, encoded in the "Rd" field.

<Sn> Is the 32-bit name of the SIMD&FP source register, encoded in the "Rn" field.

Operation

```
CheckCryptoEnabled64();

bits(32) operand = V[n]; // read element [0] only, [1-3] zeroed
V[d] = ROL(operand, 30);
```

C7.2.213 SHA1M

SHA1 hash update (majority)

31	30	29	28	27	26	25	24	23	22	21	20	16	15	14	13	12	11	10	9	5	4	0
0	1	0	1	1	1	1	0	0	0	0	Rm	0	0	1	0	0	0	Rn	Rd			

Advanced SIMD variant

SHA1M <Qd>, <Sn>, <Vm>.4S

Decode for this encoding

```
integer d = UInt(Rd);
integer n = UInt(Rn);
integer m = UInt(Rm);
if !HaveCryptoExt() then UnallocatedEncoding();
```

Assembler symbols

<Qd> Is the 128-bit name of the SIMD&FP source and destination, encoded in the "Rd" field.
 <Sn> Is the 32-bit name of the second SIMD&FP source register, encoded in the "Rn" field.
 <Vm> Is the name of the third SIMD&FP source register, encoded in the "Rm" field.

Operation

```
CheckCryptoEnabled64();

bits(128) X = V[d];
bits(32) Y = V[n]; // Note: 32 not 128 bits wide
bits(128) W = V[m];
bits(32) t;

for e = 0 to 3
    t = SHAMajority(X<63:32>, X<95:64>, X<127:96>);
    Y = Y + ROL(X<31:0>, 5) + t + Elem[W, e, 32];
    X<63:32> = ROL(X<63:32>, 30);
    <Y, X> = ROL(Y:X, 32);
V[d] = X;
```

C7.2.214 SHA1P

SHA1 hash update (parity)

31	30	29	28	27	26	25	24	23	22	21	20	16	15	14	13	12	11	10	9	5	4	0
0	1	0	1	1	1	1	0	0	0	0	Rm	0	0	0	1	0	0	Rn	Rd			

Advanced SIMD variant

SHA1P <Qd>, <Sn>, <Vm>.4S

Decode for this encoding

```
integer d = UInt(Rd);
integer n = UInt(Rn);
integer m = UInt(Rm);
if !HaveCryptoExt() then UnallocatedEncoding();
```

Assembler symbols

<Qd> Is the 128-bit name of the SIMD&FP source and destination, encoded in the "Rd" field.
 <Sn> Is the 32-bit name of the second SIMD&FP source register, encoded in the "Rn" field.
 <Vm> Is the name of the third SIMD&FP source register, encoded in the "Rm" field.

Operation

```
CheckCryptoEnabled64();

bits(128) X = V[d];
bits(32) Y = V[n]; // Note: 32 not 128 bits wide
bits(128) W = V[m];
bits(32) t;

for e = 0 to 3
    t = SHAParity(X<63:32>, X<95:64>, X<127:96>);
    Y = Y + ROL(X<31:0>, 5) + t + Elem[W, e, 32];
    X<63:32> = ROL(X<63:32>, 30);
    <Y, X> = ROL(Y:X, 32);
V[d] = X;
```

C7.2.215 SHA1SU0

SHA1 schedule update 0

31	30	29	28	27	26	25	24	23	22	21	20	16	15	14	13	12	11	10	9	5	4	0
0	1	0	1	1	1	1	0	0	0	0	Rm	0	0	1	1	0	0	Rn	Rd			

Advanced SIMD variant

SHA1SU0 <Vd>.4S, <Vn>.4S, <Vm>.4S

Decode for this encoding

```
integer d = UInt(Rd);
integer n = UInt(Rn);
integer m = UInt(Rm);
if !HaveCryptoExt() then UnallocatedEncoding();
```

Assembler symbols

<Vd> Is the name of the SIMD&FP source and destination register, encoded in the "Rd" field.
 <Vn> Is the name of the second SIMD&FP source register, encoded in the "Rn" field.
 <Vm> Is the name of the third SIMD&FP source register, encoded in the "Rm" field.

Operation

```
CheckCryptoEnabled64();

bits(128) operand1 = V[d];
bits(128) operand2 = V[n];
bits(128) operand3 = V[m];
bits(128) result;

result = operand2<63:0>:operand1<127:64>;
result = result EOR operand1 EOR operand3;
V[d] = result;
```

C7.2.216 SHA1SU1

SHA1 schedule update 1

31	30	29	28	27	26	25	24	23	22	21	20	19	18	17	16	15	14	13	12	11	10	9				5	4				0
0	1	0	1	1	1	1	0	0	0	1	0	1	0	0	0	0	0	1	1	0	Rn			Rd							

Advanced SIMD variant

SHA1SU1 <Vd>.4S, <Vn>.4S

Decode for this encoding

```
integer d = UInt(Rd);
integer n = UInt(Rn);
if !HaveCryptoExt() then UnallocatedEncoding();
```

Assembler symbols

- <Vd> Is the name of the SIMD&FP source and destination register, encoded in the "Rd" field.
- <Vn> Is the name of the second SIMD&FP source register, encoded in the "Rn" field.

Operation

```
CheckCryptoEnabled64();

bits(128) operand1 = V[d];
bits(128) operand2 = V[n];
bits(128) result;
bits(128) T = operand1 EOR LSR(operand2, 32);
result<31:0> = ROL(T<31:0>, 1);
result<63:32> = ROL(T<63:32>, 1);
result<95:64> = ROL(T<95:64>, 1);
result<127:96> = ROL(T<127:96>, 1) EOR ROL(T<31:0>, 2);
V[d] = result;
```

C7.2.217 SHA256H2

SHA256 hash update (part 2)

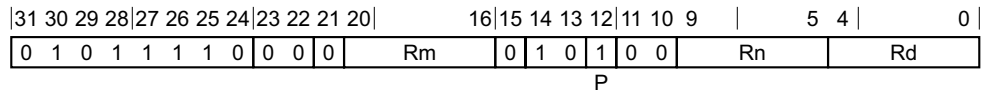

Advanced SIMD variant

SHA256H2 <Qd>, <Qn>, <Vm>.4S

Decode for this encoding

```
integer d = UInt(Rd);
integer n = UInt(Rn);
integer m = UInt(Rm);
if !HaveCryptoExt() then UnallocatedEncoding();
```

Assembler symbols

- <Qd> Is the 128-bit name of the SIMD&FP source and destination, encoded in the "Rd" field.
- <Qn> Is the 128-bit name of the second SIMD&FP source register, encoded in the "Rn" field.
- <Vm> Is the name of the third SIMD&FP source register, encoded in the "Rm" field.

Operation

```
CheckCryptoEnabled64();
bits(128) result;
result = SHA256hash(V[n], V[d], V[m], FALSE);
V[d] = result;
```

C7.2.218 SHA256H

SHA256 hash update (part 1)

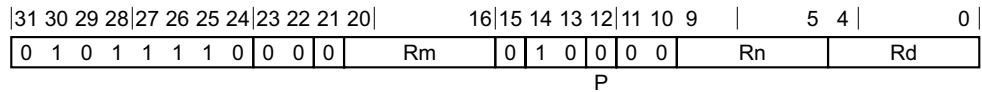

Advanced SIMD variant

SHA256H <Qd>, <Qn>, <Vm>.4S

Decode for this encoding

```
integer d = UInt(Rd);
integer n = UInt(Rn);
integer m = UInt(Rm);
if !HaveCryptoExt() then UnallocatedEncoding();
```

Assembler symbols

- <Qd> Is the 128-bit name of the SIMD&FP source and destination, encoded in the "Rd" field.
- <Qn> Is the 128-bit name of the second SIMD&FP source register, encoded in the "Rn" field.
- <Vm> Is the name of the third SIMD&FP source register, encoded in the "Rm" field.

Operation

```
CheckCryptoEnabled64();
bits(128) result;
result = SHA256hash(V[d], V[n], V[m], TRUE);
V[d] = result;
```

C7.2.219 SHA256SU0

SHA256 schedule update 0

31	30	29	28	27	26	25	24	23	22	21	20	19	18	17	16	15	14	13	12	11	10	9				5	4				0
0	1	0	1	1	1	1	0	0	0	1	0	1	0	0	0	0	0	1	0	1	0				Rn			Rd			

Advanced SIMD variant

SHA256SU0 <Vd>.4S, <Vn>.4S

Decode for this encoding

```
integer d = UInt(Rd);
integer n = UInt(Rn);
if !HaveCryptoExt() then UnallocatedEncoding();
```

Assembler symbols

<Vd> Is the name of the SIMD&FP source and destination register, encoded in the "Rd" field.
 <Vn> Is the name of the second SIMD&FP source register, encoded in the "Rn" field.

Operation

```
CheckCryptoEnabled64();

bits(128) operand1 = V[d];
bits(128) operand2 = V[n];
bits(128) result;
bits(128) T = operand2<31:0>:operand1<127:32>;
bits(32) elt;

for e = 0 to 3
  elt = Elem[T, e, 32];
  elt = ROR(elt, 7) EOR ROR(elt, 18) EOR LSR(elt, 3);
  Elem[result, e, 32] = elt + Elem[operand1, e, 32];
V[d] = result;
```

C7.2.220 SHA256SU1

SHA256 schedule update 1

31	30	29	28	27	26	25	24	23	22	21	20	16	15	14	13	12	11	10	9	5	4	0
0	1	0	1	1	1	1	0	0	0	0	Rm	0	1	1	0	0	0	Rn	Rd			

Advanced SIMD variant

SHA256SU1 <Vd>.4S, <Vn>.4S, <Vm>.4S

Decode for this encoding

```
integer d = UInt(Rd);
integer n = UInt(Rn);
integer m = UInt(Rm);
if !HaveCryptoExt() then UnallocatedEncoding();
```

Assembler symbols

- <Vd> Is the name of the SIMD&FP source and destination register, encoded in the "Rd" field.
- <Vn> Is the name of the second SIMD&FP source register, encoded in the "Rn" field.
- <Vm> Is the name of the third SIMD&FP source register, encoded in the "Rm" field.

Operation

```
CheckCryptoEnabled64();

bits(128) operand1 = V[d];
bits(128) operand2 = V[n];
bits(128) operand3 = V[m];
bits(128) result;
bits(128) T0 = operand3<31:0>:operand2<127:32>;
bits(64) T1;
bits(32) elt;

T1 = operand3<127:64>;
for e = 0 to 1
    elt = Elem[T1, e, 32];
    elt = ROR(elt, 17) EOR ROR(elt, 19) EOR LSR(elt, 10);
    elt = elt + Elem[operand1, e, 32] + Elem[T0, e, 32];
    Elem[result, e, 32] = elt;

T1 = result<63:0>;
for e = 2 to 3
    elt = Elem[T1, e-2, 32];
    elt = ROR(elt, 17) EOR ROR(elt, 19) EOR LSR(elt, 10);
    elt = elt + Elem[operand1, e, 32] + Elem[T0, e, 32];
    Elem[result, e, 32] = elt;

V[d] = result;
```

C7.2.221 SHADD

Signed Halving Add. This instruction adds corresponding signed integer values from the two source SIMD&FP registers, shifts each result right one bit, places the results into a vector, and writes the vector to the destination SIMD&FP register.

The results are truncated. For rounded results, see [SRHADD](#).

Depending on the settings in the [CPACR_EL1](#), [CPTR_EL2](#), and [CPTR_EL3](#) registers, and the current Security state and Exception level, an attempt to execute the instruction might be trapped.

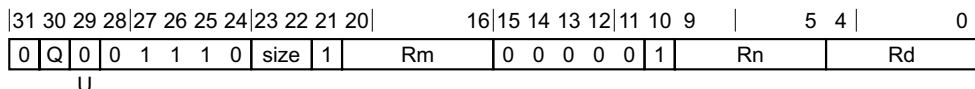

Three registers of the same type variant

SHADD <Vd>.<T>, <Vn>.<T>, <Vm>.<T>

Decode for this encoding

```
integer d = UInt(Rd);
integer n = UInt(Rn);
integer m = UInt(Rm);
if size == '11' then ReservedValue();
integer esize = 8 << UInt(size);
integer datasize = if Q == '1' then 128 else 64;
integer elements = datasize DIV esize;
boolean unsigned = (U == '1');
```

Assembler symbols

- <Vd> Is the name of the SIMD&FP destination register, encoded in the "Rd" field.
- <T> Is an arrangement specifier, encoded in the "size:Q" field. It can have the following values:
- | | |
|-----|-----------------------|
| 8B | when size = 00, Q = 0 |
| 16B | when size = 00, Q = 1 |
| 4H | when size = 01, Q = 0 |
| 8H | when size = 01, Q = 1 |
| 2S | when size = 10, Q = 0 |
| 4S | when size = 10, Q = 1 |
- The encoding size = 11, Q = x is reserved.
- <Vn> Is the name of the first SIMD&FP source register, encoded in the "Rn" field.
- <Vm> Is the name of the second SIMD&FP source register, encoded in the "Rm" field.

Operation

```
CheckFPAdvSIMDEnabled64();
bits(datasize) operand1 = V[n];
bits(datasize) operand2 = V[m];
bits(datasize) result;
integer element1;
integer element2;
integer sum;
```

```
for e = 0 to elements-1
    element1 = Int(Elem[operand1, e, esize], unsigned);
    element2 = Int(Elem[operand2, e, esize], unsigned);
    sum = element1 + element2;
    Elem[result, e, esize] = sum<esize:1>;

V[d] = result;
```

C7.2.222 SHL

Shift Left (immediate). This instruction reads each value from a vector, left shifts each result by an immediate value, writes the final result to a vector, and writes the vector to the destination SIMD&FP register.

Depending on the settings in the CPACR_EL1, CPTR_EL2, and CPTR_EL3 registers, and the current Security state and Exception level, an attempt to execute the instruction might be trapped.

Scalar

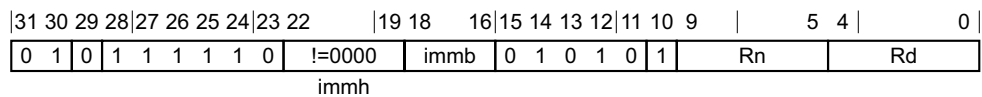

Scalar variant

SHL <V><d>, <V><n>, #<shift>

Decode for this encoding

```
integer d = UInt(Rd);
integer n = UInt(Rn);

if immh<3> != '1' then ReservedValue();
integer esize = 8 << 3;
integer datasize = esize;
integer elements = 1;

integer shift = UInt(immh:immb) - esize;
```

Vector

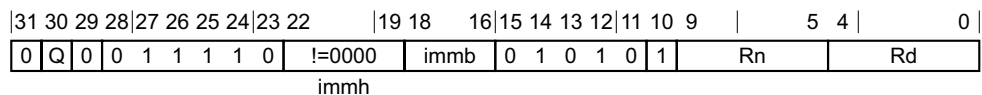

Vector variant

SHL <Vd>.<T>, <Vn>.<T>, #<shift>

Decode for this encoding

```
integer d = UInt(Rd);
integer n = UInt(Rn);

if immh == '0000' then SEE "Advanced SIMD modified immediate";
if immh<3>:Q == '10' then ReservedValue();
integer esize = 8 << HighestSetBit(immh);
integer datasize = if Q == '1' then 128 else 64;
integer elements = datasize DIV esize;

integer shift = UInt(immh:immb) - esize;
```

Assembler symbols

<V> Is a width specifier, encoded in the "immh" field. It can have the following values:

- D when immh = 1xxx

The encoding immh = 0xxx is reserved.

- <d> Is the number of the SIMD&FP destination register, in the "Rd" field.
- <n> Is the number of the first SIMD&FP source register, encoded in the "Rn" field.
- <Vd> Is the name of the SIMD&FP destination register, encoded in the "Rd" field.
- <T> Is an arrangement specifier, encoded in the "immh:Q" field. It can have the following values:
- | | |
|-----|-------------------------|
| 8B | when immh = 0001, Q = 0 |
| 16B | when immh = 0001, Q = 1 |
| 4H | when immh = 001x, Q = 0 |
| 8H | when immh = 001x, Q = 1 |
| 2S | when immh = 01xx, Q = 0 |
| 4S | when immh = 01xx, Q = 1 |
| 2D | when immh = 1xxx, Q = 1 |
- See [Advanced SIMD modified immediate on page C4-291](#) when immh = 0000, Q = x.
The encoding immh = 1xxx, Q = 0 is reserved.
- <Vn> Is the name of the SIMD&FP source register, encoded in the "Rn" field.
- <shift> For the scalar variant: is the left shift amount, in the range 0 to 63, encoded in the "immh:immb" field. It can have the following values:
- | | |
|----------------------|------------------|
| (UInt(immh:immb)-64) | when immh = 1xxx |
|----------------------|------------------|
- The encoding immh = 0xxx is reserved.
- For the vector variant: is the left shift amount, in the range 0 to the element width in bits minus 1, encoded in the "immh:immb" field. It can have the following values:
- | | |
|----------------------|------------------|
| (UInt(immh:immb)-8) | when immh = 0001 |
| (UInt(immh:immb)-16) | when immh = 001x |
| (UInt(immh:immb)-32) | when immh = 01xx |
| (UInt(immh:immb)-64) | when immh = 1xxx |
- See [Advanced SIMD modified immediate on page C4-291](#) when immh = 0000.

Operation for all encodings

```
CheckFPAdvSIMDEnabled64();
bits(datasize) operand = V[n];
bits(datasize) result;

for e = 0 to elements-1
    Elem[result, e, esize] = LSL(Elem[operand, e, esize], shift);

V[d] = result;
```

C7.2.223 SHLL, SHLL2

Shift Left Long (by element size). This instruction reads each vector element in the lower or upper half of the source SIMD&FP register, left shifts each result by the element size, writes the final result to a vector, and writes the vector to the destination SIMD&FP register. The destination vector elements are twice as long as the source vector elements.

The SHLL instruction extracts vector elements from the lower half of the source register, while the SHLL2 instruction extracts vector elements from the upper half of the source register.

Depending on the settings in the CPACR_EL1, CPTR_EL2, and CPTR_EL3 registers, and the current Security state and Exception level, an attempt to execute the instruction might be trapped.

31	30	29	28	27	26	25	24	23	22	21	20	19	18	17	16	15	14	13	12	11	10	9	5 4			0
0	Q	1	0	1	1	1	0	size	1	0	0	0	0	1	0	0	1	1	1	0	Rn				Rd	

Vector variant

SHLL{2} <Vd>.<Ta>, <Vn>.<Tb>, #<shift>

Decode for this encoding

```
integer d = UInt(Rd);
integer n = UInt(Rn);

if size == '11' then ReservedValue();
integer esize = 8 << UInt(size);
integer datasize = 64;
integer part = UInt(Q);
integer elements = datasize DIV esize;

integer shift = esize;
boolean unsigned = FALSE; // Or TRUE without change of functionality
```

Assembler symbols

- 2 Is the second and upper half specifier. If present it causes the operation to be performed on the upper 64 bits of the registers holding the narrower elements, and is encoded in the "Q" field. It can have the following values:
- [absent] when Q = 0
 - [present] when Q = 1
- <Vd> Is the name of the SIMD&FP destination register, encoded in the "Rd" field.
- <Ta> Is an arrangement specifier, encoded in the "size" field. It can have the following values:
- 8H when size = 00
 - 4S when size = 01
 - 2D when size = 10
- The encoding size = 11 is reserved.
- <Vn> Is the name of the SIMD&FP source register, encoded in the "Rn" field.
- <Tb> Is an arrangement specifier, encoded in the "size:Q" field. It can have the following values:
- 8B when size = 00, Q = 0
 - 16B when size = 00, Q = 1

4H when size = 01, Q = 0

8H when size = 01, Q = 1

2S when size = 10, Q = 0

4S when size = 10, Q = 1

The encoding size = 11, Q = x is reserved.

<shift> Is the left shift amount, which must be equal to the source element width in bits, encoded in the "size" field. It can have the following values:

8 when size = 00

16 when size = 01

32 when size = 10

The encoding size = 11 is reserved.

Operation

```
CheckFPAdvSIMDEnabled64();
bits(datasize) operand = Vpart[n, part];
bits(2*datasize) result;
integer element;

for e = 0 to elements-1
    element = Int(Elem[operand, e, esize], unsigned) << shift;
    Elem[result, e, 2*esize] = element<2*esize-1:0>;

V[d] = result;
```

C7.2.224 SHRN, SHRN2

Shift Right Narrow (immediate). This instruction reads each unsigned integer value from the source SIMD&FP register, right shifts each result by an immediate value, puts the final result into a vector, and writes the vector to the lower or upper half of the destination SIMD&FP register. The destination vector elements are half as long as the source vector elements. The results are truncated. For rounded results, see [RSHRN](#), [RSHRN2](#).

The RSHRN instruction writes the vector to the lower half of the destination register and clears the upper half, while the RSHRN2 instruction writes the vector to the upper half of the destination register without affecting the other bits of the register.

Depending on the settings in the [CPACR_EL1](#), [CPTR_EL2](#), and [CPTR_EL3](#) registers, and the current Security state and Exception level, an attempt to execute the instruction might be trapped.

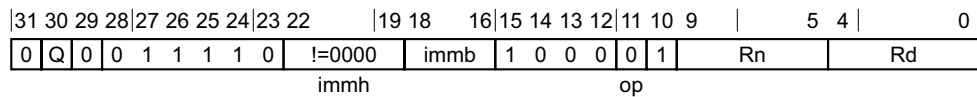

Vector variant

SHRN{2} <Vd>.<Tb>, <Vn>.<Ta>, #<shift>

Decode for this encoding

```
integer d = UInt(Rd);
integer n = UInt(Rn);

if immh == '0000' then SEE "Advanced SIMD modified immediate";
if immh<3> == '1' then ReservedValue();
integer esize = 8 << HighestSetBit(immh);
integer datasize = 64;
integer part = UInt(Q);
integer elements = datasize DIV esize;

integer shift = (2 * esize) - UInt(immh:immb);
boolean round = (op == '1');
```

Assembler symbols

2 Is the second and upper half specifier. If present it causes the operation to be performed on the upper 64 bits of the registers holding the narrower elements, and is encoded in the "Q" field. It can have the following values:

[absent] when Q = 0
 [present] when Q = 1

<Vd> Is the name of the SIMD&FP destination register, encoded in the "Rd" field.

<Tb> Is an arrangement specifier, encoded in the "immh:Q" field. It can have the following values:

8B when immh = 0001, Q = 0
 16B when immh = 0001, Q = 1
 4H when immh = 001x, Q = 0
 8H when immh = 001x, Q = 1
 2S when immh = 01xx, Q = 0
 4S when immh = 01xx, Q = 1

See [Advanced SIMD modified immediate on page C4-291](#) when immh = 0000, Q = x.

- The encoding `immh = 1xxx`, `Q = x` is reserved.
- <Vn> Is the name of the SIMD&FP source register, encoded in the "Rn" field.
- <Ta> Is an arrangement specifier, encoded in the "immh" field. It can have the following values:
- | | |
|----|-------------------------------|
| 8H | when <code>immh = 0001</code> |
| 4S | when <code>immh = 001x</code> |
| 2D | when <code>immh = 01xx</code> |
- See [Advanced SIMD modified immediate on page C4-291](#) when `immh = 0000`.
- The encoding `immh = 1xxx` is reserved.
- <shift> Is the right shift amount, in the range 1 to the destination element width in bits, encoded in the "immh:immb" field. It can have the following values:
- | | |
|-----------------------------------|-------------------------------|
| <code>(16-UInt(immh:immb))</code> | when <code>immh = 0001</code> |
| <code>(32-UInt(immh:immb))</code> | when <code>immh = 001x</code> |
| <code>(64-UInt(immh:immb))</code> | when <code>immh = 01xx</code> |
- See [Advanced SIMD modified immediate on page C4-291](#) when `immh = 0000`.
- The encoding `immh = 1xxx` is reserved.

Operation

```
CheckFPAdvSIMDEnabled64();
bits(datasize*2) operand = V[n];
bits(datasize) result;
integer round_const = if round then (1 << (shift - 1)) else 0;
integer element;

for e = 0 to elements-1
    element = (UInt(Elem[operand, e, 2*esize]) + round_const) >> shift;
    Elem[result, e, esize] = element<esize-1:0>;

Vpart[d, part] = result;
```

C7.2.225 SHSUB

Signed Halving Subtract. This instruction subtracts the elements in the vector in the second source SIMD&FP register from the corresponding elements in the vector in the first source SIMD&FP register, shifts each result right one bit, places each result into elements of a vector, and writes the vector to the destination SIMD&FP register.

Depending on the settings in the CPACR_EL1, CPTR_EL2, and CPTR_EL3 registers, and the current Security state and Exception level, an attempt to execute the instruction might be trapped.

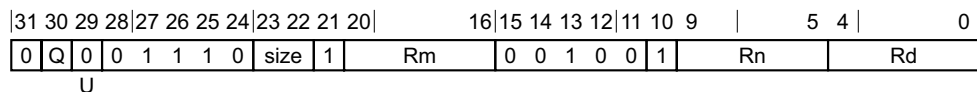

Three registers of the same type variant

SHSUB <Vd>.<T>, <Vn>.<T>, <Vm>.<T>

Decode for this encoding

```
integer d = UInt(Rd);
integer n = UInt(Rn);
integer m = UInt(Rm);
if size == '11' then ReservedValue();
integer esize = 8 << UInt(size);
integer datasize = if Q == '1' then 128 else 64;
integer elements = datasize DIV esize;
boolean unsigned = (U == '1');
```

Assembler symbols

- <Vd> Is the name of the SIMD&FP destination register, encoded in the "Rd" field.
- <T> Is an arrangement specifier, encoded in the "size:Q" field. It can have the following values:
- | | |
|-----|-----------------------|
| 8B | when size = 00, Q = 0 |
| 16B | when size = 00, Q = 1 |
| 4H | when size = 01, Q = 0 |
| 8H | when size = 01, Q = 1 |
| 2S | when size = 10, Q = 0 |
| 4S | when size = 10, Q = 1 |
- The encoding size = 11, Q = x is reserved.
- <Vn> Is the name of the first SIMD&FP source register, encoded in the "Rn" field.
- <Vm> Is the name of the second SIMD&FP source register, encoded in the "Rm" field.

Operation

```
CheckFPAdvSIMDEnabled64();
bits(datasize) operand1 = V[n];
bits(datasize) operand2 = V[m];
bits(datasize) result;
integer element1;
integer element2;
integer diff;

for e = 0 to elements-1
    element1 = Int(Elem[operand1, e, esize], unsigned);
```

```
element2 = Int(Elem[operand2, e, esize], unsigned);  
diff = element1 - element2;  
Elem[result, e, esize] = diff<esize:1>;  
  
V[d] = result;
```

C7.2.226 SLI

Shift Left and Insert (immediate). This instruction reads each vector element in the source SIMD&FP register, left shifts each vector element by an immediate value, and inserts the result into the corresponding vector element in the destination SIMD&FP register such that the new zero bits created by the shift are not inserted but retain their existing value. Bits shifted out of the left of each vector element in the source register are lost.

The following figure shows the operation of shift left by 3 for an 8-bit vector element.

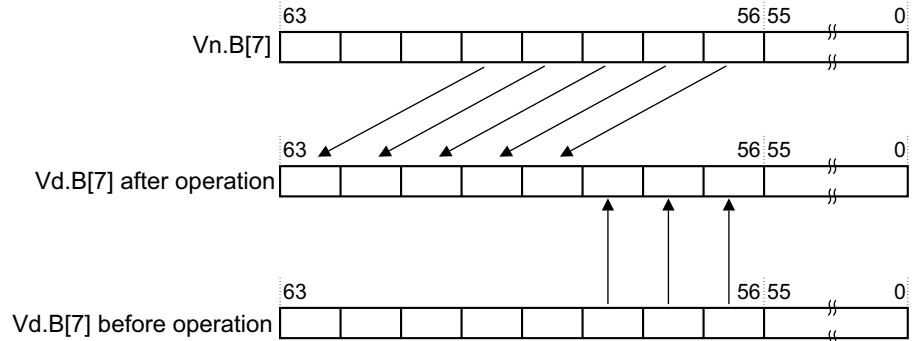

Depending on the settings in the CPACR_EL1, CPTR_EL2, and CPTR_EL3 registers, and the current Security state and Exception level, an attempt to execute the instruction might be trapped.

Scalar

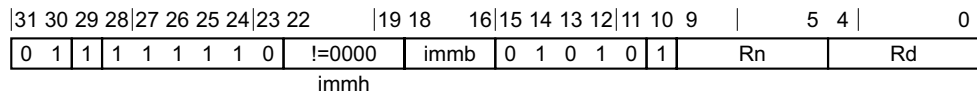

Scalar variant

SLI <V><d>, <V><n>, #<shift>

Decode for this encoding

```
integer d = UInt(Rd);
integer n = UInt(Rn);

if immh<3> != '1' then ReservedValue();
integer esize = 8 << 3;
integer datasize = esize;
integer elements = 1;

integer shift = UInt(immh:immb) - esize;
```

Vector

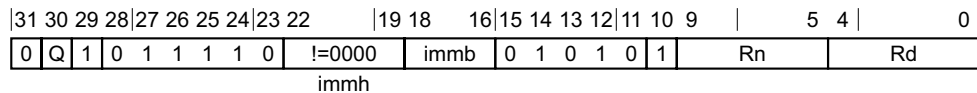

Vector variant

SLI <Vd>.<T>, <Vn>.<T>, #<shift>

Decode for this encoding

```
integer d = UInt(Rd);
integer n = UInt(Rn);

if immh == '0000' then SEE "Advanced SIMD modified immediate";
if immh<3>:Q == '10' then ReservedValue();
integer esize = 8 << HighestSetBit(immh);
integer datasize = if Q == '1' then 128 else 64;
integer elements = datasize DIV esize;

integer shift = UInt(immh:immb) - esize;
```

Assembler symbols

- <V> Is a width specifier, encoded in the "immh" field. It can have the following values:
- D when immh = 1xxx
- The encoding immh = 0xxx is reserved.
- <d> Is the number of the SIMD&FP destination register, in the "Rd" field.
- <n> Is the number of the first SIMD&FP source register, encoded in the "Rn" field.
- <Vd> Is the name of the SIMD&FP destination register, encoded in the "Rd" field.
- <T> Is an arrangement specifier, encoded in the "immh:Q" field. It can have the following values:
- 8B when immh = 0001, Q = 0
 - 16B when immh = 0001, Q = 1
 - 4H when immh = 001x, Q = 0
 - 8H when immh = 001x, Q = 1
 - 2S when immh = 01xx, Q = 0
 - 4S when immh = 01xx, Q = 1
 - 2D when immh = 1xxx, Q = 1
- See [Advanced SIMD modified immediate on page C4-291](#) when immh = 0000, Q = x.
- The encoding immh = 1xxx, Q = 0 is reserved.
- <Vn> Is the name of the SIMD&FP source register, encoded in the "Rn" field.
- <shift> For the scalar variant: is the left shift amount, in the range 0 to 63, encoded in the "immh:immb" field. It can have the following values:
- (UInt(immh:immb)-64) when immh = 1xxx
- The encoding immh = 0xxx is reserved.
- For the vector variant: is the left shift amount, in the range 0 to the element width in bits minus 1, encoded in the "immh:immb" field. It can have the following values:
- (UInt(immh:immb)-8) when immh = 0001
 - (UInt(immh:immb)-16) when immh = 001x
 - (UInt(immh:immb)-32) when immh = 01xx
 - (UInt(immh:immb)-64) when immh = 1xxx
- See [Advanced SIMD modified immediate on page C4-291](#) when immh = 0000.

Operation for all encodings

```
CheckFPAdvSIMDEnabled64();
bits(datasize) operand = V[n];
bits(datasize) operand2 = V[d];
bits(datasize) result;
```

```
bits(size) mask = LSL(Ones(size), shift);
bits(size) shifted;

for e = 0 to elements-1
    shifted = LSL(Elem[operand, e, size], shift);
    Elem[result, e, size] = (Elem[operand2, e, size] AND NOT(mask)) OR shifted;
V[d] = result;
```

C7.2.227 SMAX

Signed Maximum (vector). This instruction compares corresponding elements in the vectors in the two source SIMD&FP registers, places the larger of each pair of signed integer values into a vector, and writes the vector to the destination SIMD&FP register.

Depending on the settings in the CPACR_EL1, CPTR_EL2, and CPTR_EL3 registers, and the current Security state and Exception level, an attempt to execute the instruction might be trapped.

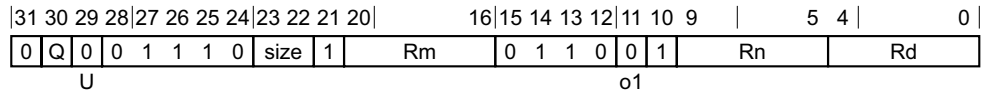

Three registers of the same type variant

SMAX <Vd>.<T>, <Vn>.<T>, <Vm>.<T>

Decode for this encoding

```
integer d = UInt(Rd);
integer n = UInt(Rn);
integer m = UInt(Rm);
if size == '11' then ReservedValue();
integer esize = 8 << UInt(size);
integer datasize = if Q == '1' then 128 else 64;
integer elements = datasize DIV esize;

boolean unsigned = (U == '1');
boolean minimum = (o1 == '1');
```

Assembler symbols

- <Vd> Is the name of the SIMD&FP destination register, encoded in the "Rd" field.
- <T> Is an arrangement specifier, encoded in the "size:Q" field. It can have the following values:
 - 8B when size = 00, Q = 0
 - 16B when size = 00, Q = 1
 - 4H when size = 01, Q = 0
 - 8H when size = 01, Q = 1
 - 2S when size = 10, Q = 0
 - 4S when size = 10, Q = 1
 The encoding size = 11, Q = x is reserved.
- <Vn> Is the name of the first SIMD&FP source register, encoded in the "Rn" field.
- <Vm> Is the name of the second SIMD&FP source register, encoded in the "Rm" field.

Operation

```
CheckFPAdvSIMDEnabled64();
bits(datasize) operand1 = V[n];
bits(datasize) operand2 = V[m];
bits(datasize) result;
integer element1;
integer element2;
integer maxmin;
```

```
for e = 0 to elements-1
    element1 = Int(Elem[operand1, e, esize], unsigned);
    element2 = Int(Elem[operand2, e, esize], unsigned);
    maxmin = if minimum then Min(element1, element2) else Max(element1, element2);
    Elem[result, e, esize] = maxmin<esize-1:0>;

V[d] = result;
```

C7.2.228 SMAXP

Signed Maximum Pairwise. This instruction creates a vector by concatenating the vector elements of the first source SIMD&FP register after the vector elements of the second source SIMD&FP register, reads each pair of adjacent vector elements in the two source SIMD&FP registers, writes the largest of each pair of signed integer values into a vector, and writes the vector to the destination SIMD&FP register.

Depending on the settings in the CPACR_EL1, CPTR_EL2, and CPTR_EL3 registers, and the current Security state and Exception level, an attempt to execute the instruction might be trapped.

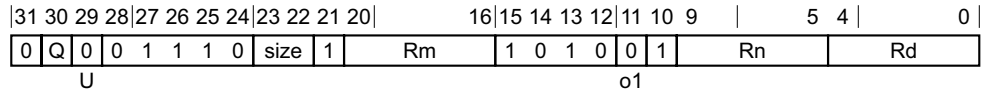

Three registers of the same type variant

SMAXP <Vd>.<T>, <Vn>.<T>, <Vm>.<T>

Decode for this encoding

```
integer d = UInt(Rd);
integer n = UInt(Rn);
integer m = UInt(Rm);
if size == '11' then ReservedValue();
integer esize = 8 << UInt(size);
integer datasize = if Q == '1' then 128 else 64;
integer elements = datasize DIV esize;

boolean unsigned = (U == '1');
boolean minimum = (o1 == '1');
```

Assembler symbols

- <Vd> Is the name of the SIMD&FP destination register, encoded in the "Rd" field.
- <T> Is an arrangement specifier, encoded in the "size:Q" field. It can have the following values:
 - 8B when size = 00, Q = 0
 - 16B when size = 00, Q = 1
 - 4H when size = 01, Q = 0
 - 8H when size = 01, Q = 1
 - 2S when size = 10, Q = 0
 - 4S when size = 10, Q = 1
 The encoding size = 11, Q = x is reserved.
- <Vn> Is the name of the first SIMD&FP source register, encoded in the "Rn" field.
- <Vm> Is the name of the second SIMD&FP source register, encoded in the "Rm" field.

Operation

```
CheckFPAdvSIMDEnabled64();
bits(datasize) operand1 = V[n];
bits(datasize) operand2 = V[m];
bits(datasize) result;
bits(2*datasize) concat = operand2:operand1;
integer element1;
integer element2;
```

```
integer maxmin;  
  
for e = 0 to elements-1  
    element1 = Int(Elem[concat, 2*e, esize], unsigned);  
    element2 = Int(Elem[concat, (2*e)+1, esize], unsigned);  
    maxmin = if minimum then Min(element1, element2) else Max(element1, element2);  
    Elem[result, e, esize] = maxmin<esize-1:0>;  
  
V[d] = result;
```

C7.2.229 SMAXV

Signed Maximum across Vector. This instruction compares all the vector elements in the source SIMD&FP register, and writes the largest of the values as a scalar to the destination SIMD&FP register. All the values in this instruction are signed integer values.

Depending on the settings in the CPACR_EL1, CPTR_EL2, and CPTR_EL3 registers, and the current Security state and Exception level, an attempt to execute the instruction might be trapped.

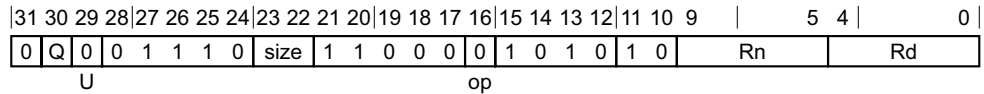

Advanced SIMD variant

SMAXV <V><d>, <Vn>.<T>

Decode for this encoding

```
integer d = UInt(Rd);
integer n = UInt(Rn);

if size:Q == '100' then ReservedValue();
if size == '11' then ReservedValue();
integer esize = 8 << UInt(size);
integer datasize = if Q == '1' then 128 else 64;
integer elements = datasize DIV esize;

boolean unsigned = (U == '1');
boolean min = (op == '1');
```

Assembler symbols

<V> Is the destination width specifier, encoded in the "size" field. It can have the following values:

- B when size = 00
- H when size = 01
- S when size = 10

The encoding size = 11 is reserved.

<d> Is the number of the SIMD&FP destination register, encoded in the "Rd" field.

<Vn> Is the name of the SIMD&FP source register, encoded in the "Rn" field.

<T> Is an arrangement specifier, encoded in the "size:Q" field. It can have the following values:

- 8B when size = 00, Q = 0
- 16B when size = 00, Q = 1
- 4H when size = 01, Q = 0
- 8H when size = 01, Q = 1
- 4S when size = 10, Q = 1

The following encodings are reserved:

- size = 10, Q = 0.
- size = 11, Q = x.

Operation

```
CheckFPAdvSIMDEnabled64();
bits(datasize) operand = V[n];
integer maxmin;
integer element;

maxmin = Int(Elem[operand, 0, esize], unsigned);
for e = 1 to elements-1
    element = Int(Elem[operand, e, esize], unsigned);
    maxmin = if min then Min(maxmin, element) else Max(maxmin, element);

V[d] = maxmin<esize-1:0>;
```

C7.2.230 SMIN

Signed Minimum (vector). This instruction compares corresponding elements in the vectors in the two source SIMD&FP registers, places the smaller of each of the two signed integer values into a vector, and writes the vector to the destination SIMD&FP register.

Depending on the settings in the CPACR_EL1, CPTR_EL2, and CPTR_EL3 registers, and the current Security state and Exception level, an attempt to execute the instruction might be trapped.

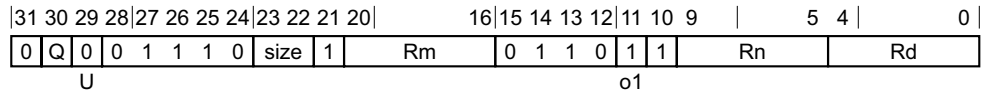

Three registers of the same type variant

SMIN <Vd>.<T>, <Vn>.<T>, <Vm>.<T>

Decode for this encoding

```
integer d = UInt(Rd);
integer n = UInt(Rn);
integer m = UInt(Rm);
if size == '11' then ReservedValue();
integer esize = 8 << UInt(size);
integer datasize = if Q == '1' then 128 else 64;
integer elements = datasize DIV esize;

boolean unsigned = (U == '1');
boolean minimum = (o1 == '1');
```

Assembler symbols

- <Vd> Is the name of the SIMD&FP destination register, encoded in the "Rd" field.
- <T> Is an arrangement specifier, encoded in the "size:Q" field. It can have the following values:
 - 8B when size = 00, Q = 0
 - 16B when size = 00, Q = 1
 - 4H when size = 01, Q = 0
 - 8H when size = 01, Q = 1
 - 2S when size = 10, Q = 0
 - 4S when size = 10, Q = 1
 The encoding size = 11, Q = x is reserved.
- <Vn> Is the name of the first SIMD&FP source register, encoded in the "Rn" field.
- <Vm> Is the name of the second SIMD&FP source register, encoded in the "Rm" field.

Operation

```
CheckFPAdvSIMDEnabled64();
bits(datasize) operand1 = V[n];
bits(datasize) operand2 = V[m];
bits(datasize) result;
integer element1;
integer element2;
integer maxmin;
```

```
for e = 0 to elements-1
    element1 = Int(Elem[operand1, e, esize], unsigned);
    element2 = Int(Elem[operand2, e, esize], unsigned);
    maxmin = if minimum then Min(element1, element2) else Max(element1, element2);
    Elem[result, e, esize] = maxmin<esize-1:0>;

V[d] = result;
```

C7.2.231 SMINP

Signed Minimum Pairwise. This instruction creates a vector by concatenating the vector elements of the first source SIMD&FP register after the vector elements of the second source SIMD&FP register, reads each pair of adjacent vector elements in the two source SIMD&FP registers, writes the smallest of each pair of signed integer values into a vector, and writes the vector to the destination SIMD&FP register.

Depending on the settings in the CPACR_EL1, CPTR_EL2, and CPTR_EL3 registers, and the current Security state and Exception level, an attempt to execute the instruction might be trapped.

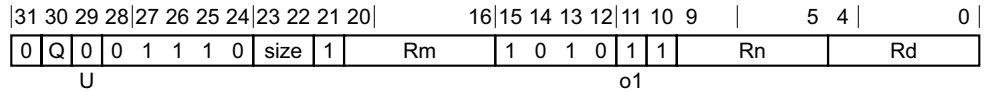

Three registers of the same type variant

SMINP <Vd>.<T>, <Vn>.<T>, <Vm>.<T>

Decode for this encoding

```
integer d = UInt(Rd);
integer n = UInt(Rn);
integer m = UInt(Rm);
if size == '11' then ReservedValue();
integer esize = 8 << UInt(size);
integer datasize = if Q == '1' then 128 else 64;
integer elements = datasize DIV esize;

boolean unsigned = (U == '1');
boolean minimum = (o1 == '1');
```

Assembler symbols

- <Vd> Is the name of the SIMD&FP destination register, encoded in the "Rd" field.
- <T> Is an arrangement specifier, encoded in the "size:Q" field. It can have the following values:
 - 8B when size = 00, Q = 0
 - 16B when size = 00, Q = 1
 - 4H when size = 01, Q = 0
 - 8H when size = 01, Q = 1
 - 2S when size = 10, Q = 0
 - 4S when size = 10, Q = 1
 The encoding size = 11, Q = x is reserved.
- <Vn> Is the name of the first SIMD&FP source register, encoded in the "Rn" field.
- <Vm> Is the name of the second SIMD&FP source register, encoded in the "Rm" field.

Operation

```
CheckFPAdvSIMDEnabled64();
bits(datasize) operand1 = V[n];
bits(datasize) operand2 = V[m];
bits(datasize) result;
bits(2*datasize) concat = operand2:operand1;
integer element1;
integer element2;
```

```
integer maxmin;  
  
for e = 0 to elements-1  
    element1 = Int(Elem[concat, 2*e, esize], unsigned);  
    element2 = Int(Elem[concat, (2*e)+1, esize], unsigned);  
    maxmin = if minimum then Min(element1, element2) else Max(element1, element2);  
    Elem[result, e, esize] = maxmin<esize-1:0>;  
  
V[d] = result;
```

C7.2.232 SMINV

Signed Minimum across Vector. This instruction compares all the vector elements in the source SIMD&FP register, and writes the smallest of the values as a scalar to the destination SIMD&FP register. All the values in this instruction are signed integer values.

Depending on the settings in the CPACR_EL1, CPTR_EL2, and CPTR_EL3 registers, and the current Security state and Exception level, an attempt to execute the instruction might be trapped.

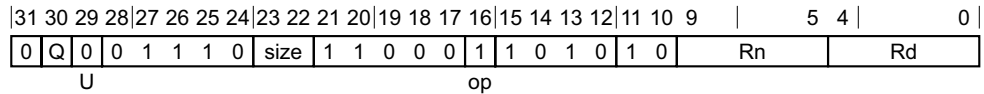

Advanced SIMD variant

SMINV <V><d>, <Vn>.<T>

Decode for this encoding

```
integer d = UInt(Rd);
integer n = UInt(Rn);

if size:Q == '100' then ReservedValue();
if size == '11' then ReservedValue();
integer esize = 8 << UInt(size);
integer datasize = if Q == '1' then 128 else 64;
integer elements = datasize DIV esize;

boolean unsigned = (U == '1');
boolean min = (op == '1');
```

Assembler symbols

<V> Is the destination width specifier, encoded in the "size" field. It can have the following values:

- B when size = 00
- H when size = 01
- S when size = 10

The encoding size = 11 is reserved.

<d> Is the number of the SIMD&FP destination register, encoded in the "Rd" field.

<Vn> Is the name of the SIMD&FP source register, encoded in the "Rn" field.

<T> Is an arrangement specifier, encoded in the "size:Q" field. It can have the following values:

- 8B when size = 00, Q = 0
- 16B when size = 00, Q = 1
- 4H when size = 01, Q = 0
- 8H when size = 01, Q = 1
- 4S when size = 10, Q = 1

The following encodings are reserved:

- size = 10, Q = 0.
- size = 11, Q = x.

Operation

```
CheckFPAdvSIMDEnabled64();
bits(datasize) operand = V[n];
integer maxmin;
integer element;

maxmin = Int(Elem[operand, 0, esize], unsigned);
for e = 1 to elements-1
    element = Int(Elem[operand, e, esize], unsigned);
    maxmin = if min then Min(maxmin, element) else Max(maxmin, element);

V[d] = maxmin<esize-1:0>;
```

C7.2.233 SMLAL, SMLAL2 (by element)

Signed Multiply-Add Long (vector, by element). This instruction multiplies each vector element in the lower or upper half of the first source SIMD&FP register by the specified vector element in the second source SIMD&FP register, and accumulates the results with the vector elements of the destination SIMD&FP register. The destination vector elements are twice as long as the elements that are multiplied. All the values in this instruction are signed integer values.

The SMLAL instruction extracts vector elements from the lower half of the first source register, while the SMLAL2 instruction extracts vector elements from the upper half of the first source register.

Depending on the settings in the CPACR_EL1, CPTR_EL2, and CPTR_EL3 registers, and the current Security state and Exception level, an attempt to execute the instruction might be trapped.

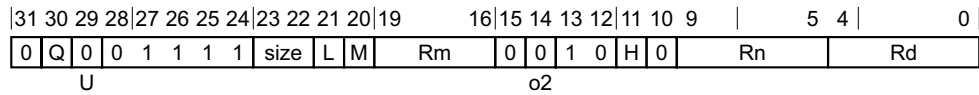

Vector variant

SMLAL{2} <Vd>.<Ta>, <Vn>.<Tb>, <Vm>.<Ts>[<index>]

Decode for this encoding

```

integer idxsize = if H == '1' then 128 else 64;
integer index;
bit Rmhi;
case size of
    when '01' index = UInt(H:L:M); Rmhi = '0';
    when '10' index = UInt(H:L); Rmhi = M;
    otherwise UnallocatedEncoding();

integer d = UInt(Rd);
integer n = UInt(Rn);
integer m = UInt(Rmhi:Rm);

integer esize = 8 << UInt(size);
integer datasize = 64;
integer part = UInt(Q);
integer elements = datasize DIV esize;

boolean unsigned = (U == '1');
boolean sub_op = (o2 == '1');
```

Assembler symbols

- 2 Is the second and upper half specifier. If present it causes the operation to be performed on the upper 64 bits of the registers holding the narrower elements, and is encoded in the "Q" field. It can have the following values:
 - [absent] when Q = 0
 - [present] when Q = 1
- <Vd> Is the name of the SIMD&FP destination register, encoded in the "Rd" field.
- <Ta> Is an arrangement specifier, encoded in the "size" field. It can have the following values:
 - 4S when size = 01
 - 2D when size = 10

The following encodings are reserved:

- size = 00.
- size = 11.

<Vn> Is the name of the first SIMD&FP source register, encoded in the "Rn" field.

<Tb> Is an arrangement specifier, encoded in the "size:Q" field. It can have the following values:

- 4H when size = 01, Q = 0
- 8H when size = 01, Q = 1
- 2S when size = 10, Q = 0
- 4S when size = 10, Q = 1

The following encodings are reserved:

- size = 00, Q = x.
- size = 11, Q = x.

<Vm> Is the name of the second SIMD&FP source register, encoded in the "size:M:Rm" field. It can have the following values:

- 0:Rm when size = 01
- M:Rm when size = 10

The following encodings are reserved:

- size = 00.
- size = 11.

Restricted to V0-V15 when element size <Ts> is H.

<Ts> Is an element size specifier, encoded in the "size" field. It can have the following values:

- H when size = 01
- S when size = 10

The following encodings are reserved:

- size = 00.
- size = 11.

<index> Is the element index, encoded in the "size:L:H:M" field. It can have the following values:

- H:L:M when size = 01
- H:L when size = 10

The following encodings are reserved:

- size = 00.
- size = 11.

Operation

```

CheckFPAdvSIMDEnabled64();
bits(datasize) operand1 = Vpart[n, part];
bits(idxszie) operand2 = V[m];
bits(2*datasize) operand3 = V[d];
bits(2*datasize) result;
integer element1;
integer element2;
bits(2*esize) product;

element2 = Int(Elem[operand2, index, esize], unsigned);
for e = 0 to elements-1
    element1 = Int(Elem[operand1, e, esize], unsigned);
    product = (element1*element2)<2*esize-1:0>;
    
```

```
if sub_op then
    Elem[result, e, 2*esize] = Elem[operand3, e, 2*esize] - product;
else
    Elem[result, e, 2*esize] = Elem[operand3, e, 2*esize] + product;
V[d] = result;
```

C7.2.234 SMLAL, SMLAL2 (vector)

Signed Multiply-Add Long (vector). This instruction multiplies corresponding signed integer values in the lower or upper half of the vectors of the two source SIMD&FP registers, and accumulates the results with the vector elements of the destination SIMD&FP register. The destination vector elements are twice as long as the elements that are multiplied.

The SMLAL instruction extracts each source vector from the lower half of each source register, while the SMLAL2 instruction extracts each source vector from the upper half of each source register.

Depending on the settings in the CPACR_EL1, CPTR_EL2, and CPTR_EL3 registers, and the current Security state and Exception level, an attempt to execute the instruction might be trapped.

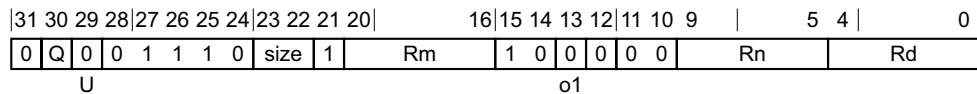

Three registers, not all the same type variant

SMLAL{2} <Vd>.<Ta>, <Vn>.<Tb>, <Vm>.<Tb>

Decode for this encoding

```
integer d = UInt(Rd);
integer n = UInt(Rn);
integer m = UInt(Rm);

if size == '11' then ReservedValue();
integer esize = 8 << UInt(size);
integer datasize = 64;
integer part = UInt(Q);
integer elements = datasize DIV esize;
boolean sub_op = (o1 == '1');
boolean unsigned = (U == '1');
```

Assembler symbols

- 2 Is the second and upper half specifier. If present it causes the operation to be performed on the upper 64 bits of the registers holding the narrower elements, and is encoded in the "Q" field. It can have the following values:
- [absent] when Q = 0
 - [present] when Q = 1
- <Vd> Is the name of the SIMD&FP destination register, encoded in the "Rd" field.
- <Ta> Is an arrangement specifier, encoded in the "size" field. It can have the following values:
- 8H when size = 00
 - 4S when size = 01
 - 2D when size = 10
- The encoding size = 11 is reserved.
- <Vn> Is the name of the first SIMD&FP source register, encoded in the "Rn" field.
- <Tb> Is an arrangement specifier, encoded in the "size:Q" field. It can have the following values:
- 8B when size = 00, Q = 0
 - 16B when size = 00, Q = 1

4H when size = 01, Q = 0
8H when size = 01, Q = 1
2S when size = 10, Q = 0
4S when size = 10, Q = 1
The encoding size = 11, Q = x is reserved.

<Vm> Is the name of the second SIMD&FP source register, encoded in the "Rm" field.

Operation

```
CheckFPAdvSIMDEnabled64();
bits(datasize) operand1 = Vpart[n, part];
bits(datasize) operand2 = Vpart[m, part];
bits(2*datasize) operand3 = V[d];
bits(2*datasize) result;
integer element1;
integer element2;
bits(2*esize) product;
bits(2*esize) accum;

for e = 0 to elements-1
    element1 = Int(Elem[operand1, e, esize], unsigned);
    element2 = Int(Elem[operand2, e, esize], unsigned);
    product = (element1*element2)<2*esize-1:0>;
    if sub_op then
        accum = Elem[operand3, e, 2*esize] - product;
    else
        accum = Elem[operand3, e, 2*esize] + product;
    Elem[result, e, 2*esize] = accum;

V[d] = result;
```

C7.2.235 SMLSL, SMLSL2 (by element)

Signed Multiply-Subtract Long (vector, by element). This instruction multiplies each vector element in the lower or upper half of the first source SIMD&FP register by the specified vector element of the second source SIMD&FP register and subtracts the results from the vector elements of the destination SIMD&FP register. The destination vector elements are twice as long as the elements that are multiplied.

The SMLSL instruction extracts vector elements from the lower half of the first source register, while the SMLSL2 instruction extracts vector elements from the upper half of the first source register.

Depending on the settings in the CPACR_EL1, CPTR_EL2, and CPTR_EL3 registers, and the current Security state and Exception level, an attempt to execute the instruction might be trapped.

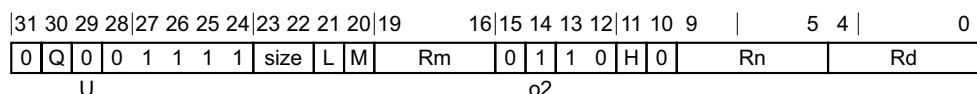

Vector variant

SMLSL{2} <Vd>.<Ta>, <Vn>.<Tb>, <Vm>.<Ts>[<index>]

Decode for this encoding

```

integer idxdsize = if H == '1' then 128 else 64;
integer index;
bit Rmhi;
case size of
    when '01' index = UInt(H:L:M); Rmhi = '0';
    when '10' index = UInt(H:L); Rmhi = M;
    otherwise UnallocatedEncoding();

integer d = UInt(Rd);
integer n = UInt(Rn);
integer m = UInt(Rmhi:Rm);

integer esize = 8 << UInt(size);
integer datasize = 64;
integer part = UInt(Q);
integer elements = datasize DIV esize;

boolean unsigned = (U == '1');
boolean sub_op = (o2 == '1');
    
```

Assembler symbols

- 2 Is the second and upper half specifier. If present it causes the operation to be performed on the upper 64 bits of the registers holding the narrower elements, and is encoded in the "Q" field. It can have the following values:
- [absent] when Q = 0
 - [present] when Q = 1
- <Vd> Is the name of the SIMD&FP destination register, encoded in the "Rd" field.
- <Ta> Is an arrangement specifier, encoded in the "size" field. It can have the following values:
- 4S when size = 01
 - 2D when size = 10
- The following encodings are reserved:
- size = 00.

- size = 11.
- <Vn> Is the name of the first SIMD&FP source register, encoded in the "Rn" field.
- <Tb> Is an arrangement specifier, encoded in the "size:Q" field. It can have the following values:
- | | |
|----|-----------------------|
| 4H | when size = 01, Q = 0 |
| 8H | when size = 01, Q = 1 |
| 2S | when size = 10, Q = 0 |
| 4S | when size = 10, Q = 1 |
- The following encodings are reserved:
- size = 00, Q = x.
 - size = 11, Q = x.
- <Vm> Is the name of the second SIMD&FP source register, encoded in the "size:M:Rm" field. It can have the following values:
- | | |
|------|----------------|
| 0:Rm | when size = 01 |
| M:Rm | when size = 10 |
- The following encodings are reserved:
- size = 00.
 - size = 11.
- Restricted to V0-V15 when element size <Ts> is H.
- <Ts> Is an element size specifier, encoded in the "size" field. It can have the following values:
- | | |
|---|----------------|
| H | when size = 01 |
| S | when size = 10 |
- The following encodings are reserved:
- size = 00.
 - size = 11.
- <index> Is the element index, encoded in the "size:L:H:M" field. It can have the following values:
- | | |
|-------|----------------|
| H:L:M | when size = 01 |
| H:L | when size = 10 |
- The following encodings are reserved:
- size = 00.
 - size = 11.

Operation

```

CheckFPAdvSIMDEnabled64();
bits(datasize) operand1 = Vpart[n, part];
bits(idxsizesize) operand2 = V[m];
bits(2*datasize) operand3 = V[d];
bits(2*datasize) result;
integer element1;
integer element2;
bits(2*esize) product;

element2 = Int(Elem[operand2, index, esize], unsigned);
for e = 0 to elements-1
    element1 = Int(Elem[operand1, e, esize], unsigned);
    product = (element1*element2)<2*esize-1:0>;
    if sub_op then
        Elem[result, e, 2*esize] = Elem[operand3, e, 2*esize] - product;
    else

```

```
Elem[result, e, 2*esize] = Elem[operand3, e, 2*esize] + product;  
V[d] = result;
```

C7.2.236 SMLSL, SMLSL2 (vector)

Signed Multiply-Subtract Long (vector). This instruction multiplies corresponding signed integer values in the lower or upper half of the vectors of the two source SIMD&FP registers, and subtracts the results from the vector elements of the destination SIMD&FP register. The destination vector elements are twice as long as the elements that are multiplied.

The SMLSL instruction extracts each source vector from the lower half of each source register, while the SMLSL2 instruction extracts each source vector from the upper half of each source register.

Depending on the settings in the CPACR_EL1, CPTR_EL2, and CPTR_EL3 registers, and the current Security state and Exception level, an attempt to execute the instruction might be trapped.

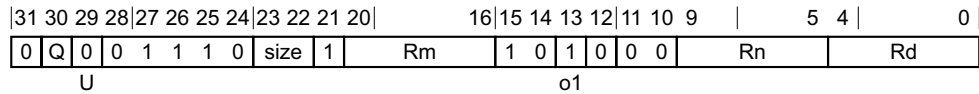

Three registers, not all the same type variant

SMLSL{2} <Vd>.<Ta>, <Vn>.<Tb>, <Vm>.<Tb>

Decode for this encoding

```
integer d = UInt(Rd);
integer n = UInt(Rn);
integer m = UInt(Rm);

if size == '11' then ReservedValue();
integer esize = 8 << UInt(size);
integer datasize = 64;
integer part = UInt(Q);
integer elements = datasize DIV esize;
boolean sub_op = (o1 == '1');
boolean unsigned = (U == '1');
```

Assembler symbols

- 2 Is the second and upper half specifier. If present it causes the operation to be performed on the upper 64 bits of the registers holding the narrower elements, and is encoded in the "Q" field. It can have the following values:
 - [absent] when Q = 0
 - [present] when Q = 1
- <Vd> Is the name of the SIMD&FP destination register, encoded in the "Rd" field.
- <Ta> Is an arrangement specifier, encoded in the "size" field. It can have the following values:
 - 8H when size = 00
 - 4S when size = 01
 - 2D when size = 10
 The encoding size = 11 is reserved.
- <Vn> Is the name of the first SIMD&FP source register, encoded in the "Rn" field.
- <Tb> Is an arrangement specifier, encoded in the "size:Q" field. It can have the following values:
 - 8B when size = 00, Q = 0
 - 16B when size = 00, Q = 1

4H when size = 01, Q = 0
8H when size = 01, Q = 1
2S when size = 10, Q = 0
4S when size = 10, Q = 1
The encoding size = 11, Q = x is reserved.

<Vm> Is the name of the second SIMD&FP source register, encoded in the "Rm" field.

Operation

```
CheckFPAdvSIMDEnabled64();
bits(datasize) operand1 = Vpart[n, part];
bits(datasize) operand2 = Vpart[m, part];
bits(2*datasize) operand3 = V[d];
bits(2*datasize) result;
integer element1;
integer element2;
bits(2*esize) product;
bits(2*esize) accum;

for e = 0 to elements-1
    element1 = Int(Elem[operand1, e, esize], unsigned);
    element2 = Int(Elem[operand2, e, esize], unsigned);
    product = (element1*element2)<2*esize-1:0>;
    if sub_op then
        accum = Elem[operand3, e, 2*esize] - product;
    else
        accum = Elem[operand3, e, 2*esize] + product;
    Elem[result, e, 2*esize] = accum;

V[d] = result;
```

C7.2.237 SMOV

Signed Move vector element to general-purpose register. This instruction reads the signed integer from the source SIMD&FP register, sign-extends it to form a 32-bit or 64-bit value, and writes the result to destination general-purpose register.

Depending on the settings in the CPACR_EL1, CPTR_EL2, and CPTR_EL3 registers, and the current Security state and Exception level, an attempt to execute the instruction might be trapped.

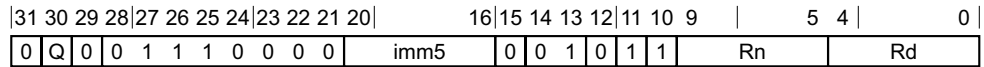

32-bit variant

Applies when Q == 0.

SMOV <Wd>, <Vn>.<Ts>[<index>]

64-bit variant

Applies when Q == 1.

SMOV <Xd>, <Vn>.<Ts>[<index>]

Decode for all variants of this encoding

```
integer d = UInt(Rd);
integer n = UInt(Rn);

integer size;
case Q:imm5 of
    when 'xxxxx1' size = 0; // SMOV [WX]d, Vn.B
    when 'xxxx10' size = 1; // SMOV [WX]d, Vn.H
    when '1xx100' size = 2; // SMOV Xd, Vn.S
    otherwise UnallocatedEncoding();

integer idxsize = if imm5<4> == '1' then 128 else 64;
integer index = UInt(imm5<4:size+1>);
integer esize = 8 << size;
integer datasize = if Q == '1' then 64 else 32;
```

Assembler symbols

- <Wd> Is the 32-bit name of the general-purpose destination register, encoded in the "Rd" field.
- <Xd> Is the 64-bit name of the general-purpose destination register, encoded in the "Rd" field.
- <Vn> Is the name of the SIMD&FP source register, encoded in the "Rn" field.
- <Ts> For the 32-bit variant: is an element size specifier, encoded in the "imm5" field. It can have the following values:
 - B when imm5 = xxxx1
 - H when imm5 = xxx10
 The encoding imm5 = xxx00 is reserved.

 For the 64-bit variant: is an element size specifier, encoded in the "imm5" field. It can have the following values:
 - B when imm5 = xxxx1

H when imm5 = xxx10

S when imm5 = xx100

The encoding imm5 = xx000 is reserved.

<index> For the 32-bit variant: is the element index encoded in the "imm5" field. It can have the following values:

imm5<4:1> when imm5 = xxxx1

imm5<4:2> when imm5 = xxx10

The encoding imm5 = xxx00 is reserved.

For the 64-bit variant: is the element index encoded in the "imm5" field. It can have the following values:

imm5<4:1> when imm5 = xxxx1

imm5<4:2> when imm5 = xxx10

imm5<4:3> when imm5 = xx100

The encoding imm5 = xx000 is reserved.

Operation

```
CheckFPAdvSIMDEnabled64();  
bits(idxsize) operand = V[n];
```

```
X[d] = SignExtend(Elem[operand, index, esize], datasize);
```

C7.2.238 SMULL, SMULL2 (by element)

Signed Multiply Long (vector, by element). This instruction multiplies each vector element in the lower or upper half of the first source SIMD&FP register by the specified vector element of the second source SIMD&FP register, places the result in a vector, and writes the vector to the destination SIMD&FP register. The destination vector elements are twice as long as the elements that are multiplied.

The SMULL instruction extracts vector elements from the lower half of the first source register, while the SMULL2 instruction extracts vector elements from the upper half of the first source register.

Depending on the settings in the CPACR_EL1, CPTR_EL2, and CPTR_EL3 registers, and the current Security state and Exception level, an attempt to execute the instruction might be trapped.

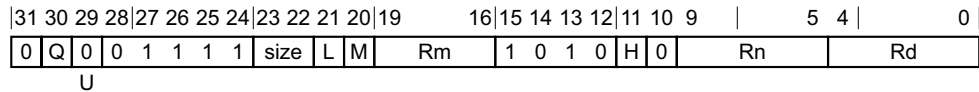

Vector variant

SMULL{2} <Vd>.<Ta>, <Vn>.<Tb>, <Vm>.<Ts>[<index>]

Decode for this encoding

```

integer idxsize = if H == '1' then 128 else 64;
integer index;
bit Rmhi;
case size of
    when '01' index = UInt(H:L:M); Rmhi = '0';
    when '10' index = UInt(H:L); Rmhi = M;
    otherwise UnallocatedEncoding();

integer d = UInt(Rd);
integer n = UInt(Rn);
integer m = UInt(Rmhi:Rm);

integer esize = 8 << UInt(size);
integer datasize = 64;
integer part = UInt(Q);
integer elements = datasize DIV esize;
boolean unsigned = (U == '1');
```

Assembler symbols

2 Is the second and upper half specifier. If present it causes the operation to be performed on the upper 64 bits of the registers holding the narrower elements, and is encoded in the "Q" field. It can have the following values:

[absent] when Q = 0
 [present] when Q = 1

<Vd> Is the name of the SIMD&FP destination register, encoded in the "Rd" field.

<Ta> Is an arrangement specifier, encoded in the "size" field. It can have the following values:

4S when size = 01
 2D when size = 10

The following encodings are reserved:

- size = 00.
- size = 11.

- <Vn> Is the name of the first SIMD&FP source register, encoded in the "Rn" field.
- <Tb> Is an arrangement specifier, encoded in the "size:Q" field. It can have the following values:
- | | |
|----|-----------------------|
| 4H | when size = 01, Q = 0 |
| 8H | when size = 01, Q = 1 |
| 2S | when size = 10, Q = 0 |
| 4S | when size = 10, Q = 1 |
- The following encodings are reserved:
- size = 00, Q = x.
 - size = 11, Q = x.
- <Vm> Is the name of the second SIMD&FP source register, encoded in the "size:M:Rm" field. It can have the following values:
- | | |
|------|----------------|
| 0:Rm | when size = 01 |
| M:Rm | when size = 10 |
- The following encodings are reserved:
- size = 00.
 - size = 11.
- Restricted to V0-V15 when element size <Ts> is H.
- <Ts> Is an element size specifier, encoded in the "size" field. It can have the following values:
- | | |
|---|----------------|
| H | when size = 01 |
| S | when size = 10 |
- The following encodings are reserved:
- size = 00.
 - size = 11.
- <index> Is the element index, encoded in the "size:L:H:M" field. It can have the following values:
- | | |
|-------|----------------|
| H:L:M | when size = 01 |
| H:L | when size = 10 |
- The following encodings are reserved:
- size = 00.
 - size = 11.

Operation

```

CheckFPAdvSIMDEnabled64();
bits(datasize) operand1 = Vpart[n, part];
bits(idxsize) operand2 = V[m];
bits(2*datasize) result;
integer element1;
integer element2;
bits(2*esize) product;

element2 = Int(Elem[operand2, index, esize], unsigned);
for e = 0 to elements-1
    element1 = Int(Elem[operand1, e, esize], unsigned);
    product = (element1*element2)<2*esize-1:0>;
    Elem[result, e, 2*esize] = product;

V[d] = result;
    
```

C7.2.239 SMULL, SMULL2 (vector)

Signed Multiply Long (vector). This instruction multiplies corresponding signed integer values in the lower or upper half of the vectors of the two source SIMD&FP registers, places the results in a vector, and writes the vector to the destination SIMD&FP register.

The destination vector elements are twice as long as the elements that are multiplied.

The SMULL instruction extracts each source vector from the lower half of each source register, while the SMULL2 instruction extracts each source vector from the upper half of each source register.

Depending on the settings in the CPACR_EL1, CPTR_EL2, and CPTR_EL3 registers, and the current Security state and Exception level, an attempt to execute the instruction might be trapped.

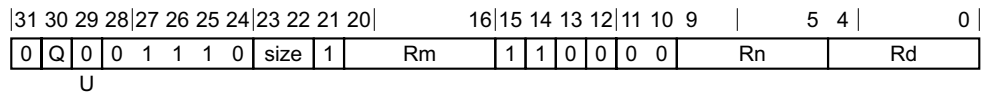

Three registers, not all the same type variant

SMULL{2} <Vd>.<Ta>, <Vn>.<Tb>, <Vm>.<Tb>

Decode for this encoding

```
integer d = UInt(Rd);
integer n = UInt(Rn);
integer m = UInt(Rm);

if size == '11' then ReservedValue();
integer esize = 8 << UInt(size);
integer datasize = 64;
integer part = UInt(Q);
integer elements = datasize DIV esize;

boolean unsigned = (U == '1');
```

Assembler symbols

- 2 Is the second and upper half specifier. If present it causes the operation to be performed on the upper 64 bits of the registers holding the narrower elements, and is encoded in the "Q" field. It can have the following values:
 - [absent] when Q = 0
 - [present] when Q = 1
- <Vd> Is the name of the SIMD&FP destination register, encoded in the "Rd" field.
- <Ta> Is an arrangement specifier, encoded in the "size" field. It can have the following values:
 - 8H when size = 00
 - 4S when size = 01
 - 2D when size = 10
 The encoding size = 11 is reserved.
- <Vn> Is the name of the first SIMD&FP source register, encoded in the "Rn" field.
- <Tb> Is an arrangement specifier, encoded in the "size:Q" field. It can have the following values:
 - 8B when size = 00, Q = 0
 - 16B when size = 00, Q = 1

4H when size = 01, Q = 0

8H when size = 01, Q = 1

2S when size = 10, Q = 0

4S when size = 10, Q = 1

The encoding size = 11, Q = x is reserved.

<Vm> Is the name of the second SIMD&FP source register, encoded in the "Rm" field.

Operation

```
CheckFPAdvSIMDEnabled64();
bits(datasize) operand1 = Vpart[n, part];
bits(datasize) operand2 = Vpart[m, part];
bits(2*datasize) result;
integer element1;
integer element2;

for e = 0 to elements-1
    element1 = Int(Elem[operand1, e, esize], unsigned);
    element2 = Int(Elem[operand2, e, esize], unsigned);
    Elem[result, e, 2*esize] = (element1*element2)<2*esize-1:0>;

V[d] = result;
```

C7.2.240 SQABS

Signed saturating Absolute value. This instruction reads each vector element from the source SIMD&FP register, puts the absolute value of the result into a vector, and writes the vector to the destination SIMD&FP register. All the values in this instruction are signed integer values.

If overflow occurs with any of the results, those results are saturated. If saturation occurs, the cumulative saturation bit [FPSR.QC](#) is set.

Depending on the settings in the [CPACR_EL1](#), [CPTR_EL2](#), and [CPTR_EL3](#) registers, and the current Security state and Exception level, an attempt to execute the instruction might be trapped.

Scalar

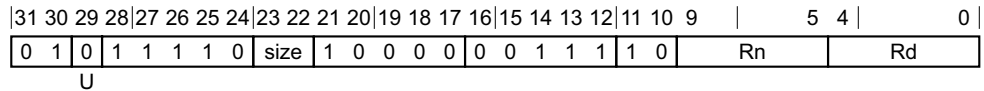

Scalar variant

SQABS <V><d>, <V><n>

Decode for this encoding

```
integer d = UInt(Rd);
integer n = UInt(Rn);

integer esize = 8 << UInt(size);
integer datasize = esize;
integer elements = 1;
boolean neg = (U == '1');
```

Vector

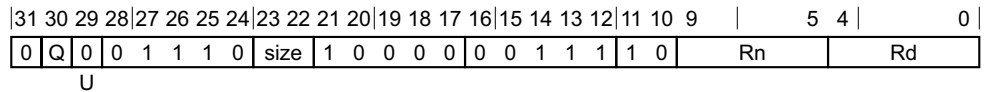

Vector variant

SQABS <Vd>.<T>, <Vn>.<T>

Decode for this encoding

```
integer d = UInt(Rd);
integer n = UInt(Rn);

if size:Q == '110' then ReservedValue();
integer esize = 8 << UInt(size);
integer datasize = if Q == '1' then 128 else 64;
integer elements = datasize DIV esize;
boolean neg = (U == '1');
```

Assembler symbols

- <V> Is a width specifier, encoded in the "size" field. It can have the following values:
- B when size = 00
 - H when size = 01
 - S when size = 10

- D when size = 11
- <d> Is the number of the SIMD&FP destination register, encoded in the "Rd" field.
- <n> Is the number of the SIMD&FP source register, encoded in the "Rn" field.
- <Vd> Is the name of the SIMD&FP destination register, encoded in the "Rd" field.
- <T> Is an arrangement specifier, encoded in the "size:Q" field. It can have the following values:
- 8B when size = 00, Q = 0
- 16B when size = 00, Q = 1
- 4H when size = 01, Q = 0
- 8H when size = 01, Q = 1
- 2S when size = 10, Q = 0
- 4S when size = 10, Q = 1
- 2D when size = 11, Q = 1
- The encoding size = 11, Q = 0 is reserved.
- <Vn> Is the name of the SIMD&FP source register, encoded in the "Rn" field.

Operation for all encodings

```
CheckFPAdvSIMDEnabled64();
bits(datasize) operand = V[n];
bits(datasize) result;
integer element;
boolean sat;

for e = 0 to elements-1
    element = SInt(Elem[operand, e, esize]);
    if neg then
        element = -element;
    else
        element = Abs(element);
    (Elem[result, e, esize], sat) = SignedSatQ(element, esize);
    if sat then FPSR.QC = '1';

V[d] = result;
```

C7.2.241 SQADD

Signed saturating Add. This instruction adds the values of corresponding elements of the two source SIMD&FP registers, places the results into a vector, and writes the vector to the destination SIMD&FP register.

If overflow occurs with any of the results, those results are saturated. If saturation occurs, the cumulative saturation bit [FPSR.QC](#) is set.

Depending on the settings in the [CPACR_EL1](#), [CPTR_EL2](#), and [CPTR_EL3](#) registers, and the current Security state and Exception level, an attempt to execute the instruction might be trapped.

Scalar

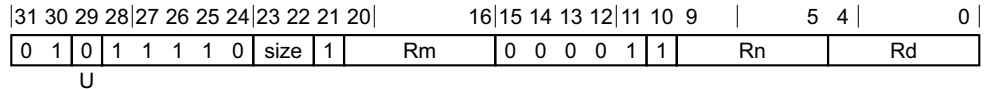

Scalar variant

SQADD <V><d>, <V><n>, <V><m>

Decode for this encoding

```
integer d = UInt(Rd);
integer n = UInt(Rn);
integer m = UInt(Rm);
integer esize = 8 << UInt(size);
integer datasize = esize;
integer elements = 1;
boolean unsigned = (U == '1');
```

Vector

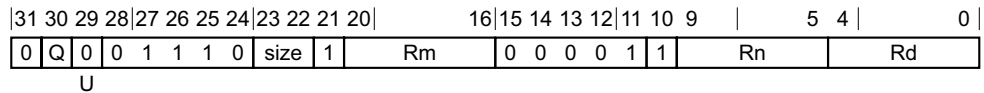

Vector variant

SQADD <Vd>.<T>, <Vn>.<T>, <Vm>.<T>

Decode for this encoding

```
integer d = UInt(Rd);
integer n = UInt(Rn);
integer m = UInt(Rm);
if size:Q == '110' then ReservedValue();
integer esize = 8 << UInt(size);
integer datasize = if Q == '1' then 128 else 64;
integer elements = datasize DIV esize;
boolean unsigned = (U == '1');
```

Assembler symbols

<V> Is a width specifier, encoded in the "size" field. It can have the following values:

B	when size = 00
H	when size = 01
S	when size = 10

- D when size = 11
- <d> Is the number of the SIMD&FP destination register, in the "Rd" field.
- <n> Is the number of the first SIMD&FP source register, encoded in the "Rn" field.
- <m> Is the number of the second SIMD&FP source register, encoded in the "Rm" field.
- <Vd> Is the name of the SIMD&FP destination register, encoded in the "Rd" field.
- <T> Is an arrangement specifier, encoded in the "size:Q" field. It can have the following values:
- 8B when size = 00, Q = 0
- 16B when size = 00, Q = 1
- 4H when size = 01, Q = 0
- 8H when size = 01, Q = 1
- 2S when size = 10, Q = 0
- 4S when size = 10, Q = 1
- 2D when size = 11, Q = 1
- The encoding size = 11, Q = 0 is reserved.
- <Vn> Is the name of the first SIMD&FP source register, encoded in the "Rn" field.
- <Vm> Is the name of the second SIMD&FP source register, encoded in the "Rm" field.

Operation for all encodings

```

CheckFPAdvSIMDEnabled64();
bits(datasize) operand1 = V[n];
bits(datasize) operand2 = V[m];
bits(datasize) result;
integer element1;
integer element2;
integer sum;
boolean sat;

for e = 0 to elements-1
    element1 = Int(Elem[operand1, e, esize], unsigned);
    element2 = Int(Elem[operand2, e, esize], unsigned);
    sum = element1 + element2;
    (Elem[result, e, esize], sat) = SatQ(sum, esize, unsigned);
    if sat then FPSR.QC = '1';

V[d] = result;
    
```

C7.2.242 SQDMLAL, SQDMLAL2 (by element)

Signed saturating Doubling Multiply-Add Long (by element). This instruction multiplies each vector element in the lower or upper half of the first source SIMD&FP register by the specified vector element of the second source SIMD&FP register, doubles the results, and accumulates the final results with the vector elements of the destination SIMD&FP register. The destination vector elements are twice as long as the elements that are multiplied.

If overflow occurs with any of the results, those results are saturated. If saturation occurs, the cumulative saturation bit `FPSR.QC` is set.

The `SQDMLAL` instruction extracts vector elements from the lower half of the first source register, while the `SQDMLAL2` instruction extracts vector elements from the upper half of the first source register.

Depending on the settings in the `CPACR_EL1`, `CPTR_EL2`, and `CPTR_EL3` registers, and the current Security state and Exception level, an attempt to execute the instruction might be trapped.

Scalar

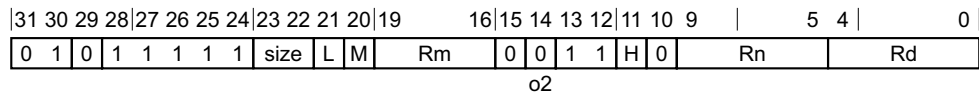

Scalar variant

`SQDMLAL <Va><d>, <Vb><n>, <Vm>.<Ts>[<index>]`

Decode for this encoding

```

integer idxsize = if H == '1' then 128 else 64;
integer index;
bit Rmhi;
case size of
    when '01' index = UInt(H:L:M); Rmhi = '0';
    when '10' index = UInt(H:L); Rmhi = M;
    otherwise UnallocatedEncoding();

integer d = UInt(Rd);
integer n = UInt(Rn);
integer m = UInt(Rmhi:Rm);

integer esize = 8 << UInt(size);
integer datasize = esize;
integer elements = 1;
integer part = 0;

boolean sub_op = (o2 == '1');
```

Vector

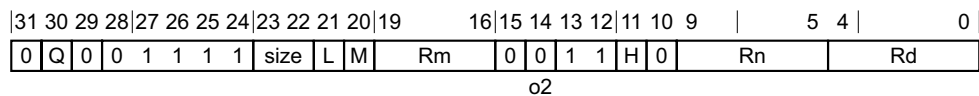

Vector variant

`SQDMLAL{2} <Vd>.<Ta>, <Vn>.<Tb>, <Vm>.<Ts>[<index>]`

Decode for this encoding

```

integer idxsize = if H == '1' then 128 else 64;
integer index;
bit Rmhi;
case size of
    when '01' index = UInt(H:L:M); Rmhi = '0';
    when '10' index = UInt(H:L); Rmhi = M;
    otherwise UnallocatedEncoding();

integer d = UInt(Rd);
integer n = UInt(Rn);
integer m = UInt(Rmhi:Rm);

integer esize = 8 << UInt(size);
integer datasize = 64;
integer part = UInt(Q);
integer elements = datasize DIV esize;

boolean sub_op = (o2 == '1');
    
```

Assembler symbols

- 2 Is the second and upper half specifier. If present it causes the operation to be performed on the upper 64 bits of the registers holding the narrower elements, and is encoded in the "Q" field. It can have the following values:
- [absent] when Q = 0
 [present] when Q = 1
- <Vd> Is the name of the SIMD&FP destination register, encoded in the "Rd" field.
- <Ta> Is an arrangement specifier, encoded in the "size" field. It can have the following values:
- 4S when size = 01
 2D when size = 10
- The following encodings are reserved:
- size = 00.
 - size = 11.
- <Vn> Is the name of the first SIMD&FP source register, encoded in the "Rn" field.
- <Tb> Is an arrangement specifier, encoded in the "size:Q" field. It can have the following values:
- 4H when size = 01, Q = 0
 8H when size = 01, Q = 1
 2S when size = 10, Q = 0
 4S when size = 10, Q = 1
- The following encodings are reserved:
- size = 00, Q = x.
 - size = 11, Q = x.
- <Va> Is the destination width specifier, encoded in the "size" field. It can have the following values:
- S when size = 01
 D when size = 10
- The following encodings are reserved:
- size = 00.
 - size = 11.

- <d> Is the number of the SIMD&FP destination register, encoded in the "Rd" field.
- <Vb> Is the source width specifier, encoded in the "size" field. It can have the following values:
 H when size = 01
 S when size = 10
 The following encodings are reserved:
 • size = 00.
 • size = 11.
- <n> Is the number of the first SIMD&FP source register, encoded in the "Rn" field.
- <Vm> Is the name of the second SIMD&FP source register, encoded in the "size:M:Rm" field. It can have the following values:
 0:Rm when size = 01
 M:Rm when size = 10
 The following encodings are reserved:
 • size = 00.
 • size = 11.
 Restricted to V0-V15 when element size <Ts> is H.
- <Ts> Is an element size specifier, encoded in the "size" field. It can have the following values:
 H when size = 01
 S when size = 10
 The following encodings are reserved:
 • size = 00.
 • size = 11.
- <index> Is the element index, encoded in the "size:L:H:M" field. It can have the following values:
 H:L:M when size = 01
 H:L when size = 10
 The following encodings are reserved:
 • size = 00.
 • size = 11.

Operation for all encodings

```

CheckFPAdvSIMDEnabled64();
bits(datasize) operand1 = Vpart[n, part];
bits(idxsizesize) operand2 = V[m];
bits(2*datasize) operand3 = V[d];
bits(2*datasize) result;
integer element1;
integer element2;
bits(2*esize) product;
integer accum;
boolean sat1;
boolean sat2;

element2 = SInt(EMem[operand2, index, esize]);
for e = 0 to elements-1
    element1 = SInt(EMem[operand1, e, esize]);
    (product, sat1) = SignedSatQ(2 * element1 * element2, 2 * esize);
    if sub_op then
        accum = SInt(EMem[operand3, e, 2*esize]) - SInt(product);
    else

```

```
    accum = SInt(Elem[operand3, e, 2*esize]) + SInt(product);  
    (Elem[result, e, 2*esize], sat2) = SignedSatQ(accum, 2 * esize);  
    if sat1 || sat2 then FPSR.QC = '1';  
  
V[d] = result;
```

C7.2.243 SQDMLAL, SQDMLAL2 (vector)

Signed saturating Doubling Multiply-Add Long. This instruction multiplies corresponding signed integer values in the lower or upper half of the vectors of the two source SIMD&FP registers, doubles the results, and accumulates the final results with the vector elements of the destination SIMD&FP register. The destination vector elements are twice as long as the elements that are multiplied.

If overflow occurs with any of the results, those results are saturated. If saturation occurs, the cumulative saturation bit `FPSR.QC` is set.

The `SQDMLAL` instruction extracts each source vector from the lower half of each source register, while the `SQDMLAL2` instruction extracts each source vector from the upper half of each source register.

Depending on the settings in the `CPACR_EL1`, `CPTR_EL2`, and `CPTR_EL3` registers, and the current Security state and Exception level, an attempt to execute the instruction might be trapped.

Scalar

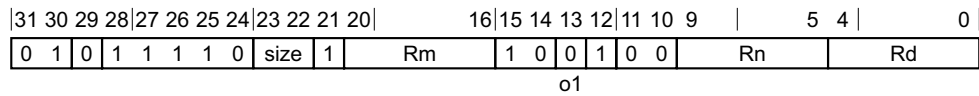

Scalar variant

`SQDMLAL <Va><d>, <Vb><n>, <Vb><m>`

Decode for this encoding

```
integer d = UInt(Rd);
integer n = UInt(Rn);
integer m = UInt(Rm);

if size == '00' || size == '11' then ReservedValue();
integer esize = 8 << UInt(size);
integer datasize = esize;
integer elements = 1;
integer part = 0;

boolean sub_op = (o1 == '1');
```

Vector

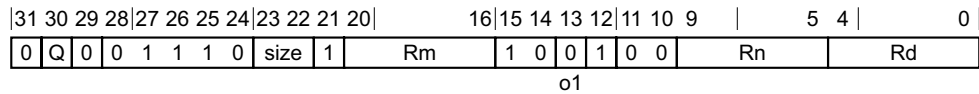

Vector variant

`SQDMLAL{2} <Vd>.<Ta>, <Vn>.<Tb>, <Vm>.<Tb>`

Decode for this encoding

```
integer d = UInt(Rd);
integer n = UInt(Rn);
integer m = UInt(Rm);

if size == '00' || size == '11' then ReservedValue();
integer esize = 8 << UInt(size);
integer datasize = 64;
integer part = UInt(Q);
```

integer elements = datasize DIV esize;

boolean sub_op = (o1 == '1');

Assembler symbols

2 Is the second and upper half specifier. If present it causes the operation to be performed on the upper 64 bits of the registers holding the narrower elements, and is encoded in the "Q" field. It can have the following values:

[absent] when Q = 0

[present] when Q = 1

<Vd> Is the name of the SIMD&FP destination register, encoded in the "Rd" field.

<Ta> Is an arrangement specifier, encoded in the "size" field. It can have the following values:

4S when size = 01

2D when size = 10

The following encodings are reserved:

- size = 00.
- size = 11.

<Vn> Is the name of the first SIMD&FP source register, encoded in the "Rn" field.

<Tb> Is an arrangement specifier, encoded in the "size:Q" field. It can have the following values:

4H when size = 01, Q = 0

8H when size = 01, Q = 1

2S when size = 10, Q = 0

4S when size = 10, Q = 1

The following encodings are reserved:

- size = 00, Q = x.
- size = 11, Q = x.

<Vm> Is the name of the second SIMD&FP source register, encoded in the "Rm" field.

<Va> Is the destination width specifier, encoded in the "size" field. It can have the following values:

S when size = 01

D when size = 10

The following encodings are reserved:

- size = 00.
- size = 11.

<d> Is the number of the SIMD&FP destination register, encoded in the "Rd" field.

<Vb> Is the source width specifier, encoded in the "size" field. It can have the following values:

H when size = 01

S when size = 10

The following encodings are reserved:

- size = 00.
- size = 11.

<n> Is the number of the first SIMD&FP source register, encoded in the "Rn" field.

<m> Is the number of the second SIMD&FP source register, encoded in the "Rm" field.

Operation for all encodings

```
CheckFPAdvSIMDEnabled64();
bits(datasize) operand1 = Vpart[n, part];
bits(datasize) operand2 = Vpart[m, part];
bits(2*datasize) operand3 = V[d];
bits(2*datasize) result;
integer element1;
integer element2;
bits(2*esize) product;
integer accum;
boolean sat1;
boolean sat2;

for e = 0 to elements-1
    element1 = SInt(Elem[operand1, e, esize]);
    element2 = SInt(Elem[operand2, e, esize]);
    (product, sat1) = SignedSatQ(2 * element1 * element2, 2 * esize);
    if sub_op then
        accum = SInt(Elem[operand3, e, 2*esize]) - SInt(product);
    else
        accum = SInt(Elem[operand3, e, 2*esize]) + SInt(product);
    (Elem[result, e, 2*esize], sat2) = SignedSatQ(accum, 2 * esize);
    if sat1 || sat2 then FPSR.QC = '1';

V[d] = result;
```

C7.2.244 SQDMLSL, SQDMLSL2 (by element)

Signed saturating Doubling Multiply-Subtract Long (by element). This instruction multiplies each vector element in the lower or upper half of the first source SIMD&FP register by the specified vector element of the second source SIMD&FP register, doubles the results, and subtracts the final results from the vector elements of the destination SIMD&FP register. The destination vector elements are twice as long as the elements that are multiplied. All the values in this instruction are signed integer values.

If overflow occurs with any of the results, those results are saturated. If saturation occurs, the cumulative saturation bit [FPSR.QC](#) is set.

The SQDMLSL instruction extracts vector elements from the lower half of the first source register, while the SQDMLSL2 instruction extracts vector elements from the upper half of the first source register.

Depending on the settings in the [CPACR_EL1](#), [CPTR_EL2](#), and [CPTR_EL3](#) registers, and the current Security state and Exception level, an attempt to execute the instruction might be trapped.

Scalar

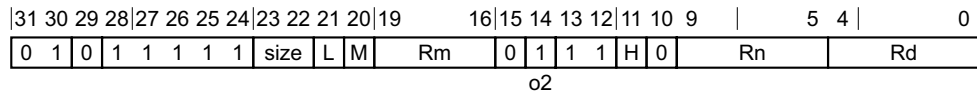

Scalar variant

SQDMLSL <Va><d>, <Vb><n>, <Vm>.<Ts>[<index>]

Decode for this encoding

```

integer idxsize = if H == '1' then 128 else 64;
integer index;
bit Rmhi;
case size of
    when '01' index = UInt(H:L:M); Rmhi = '0';
    when '10' index = UInt(H:L); Rmhi = M;
    otherwise UnallocatedEncoding();

integer d = UInt(Rd);
integer n = UInt(Rn);
integer m = UInt(Rmhi:Rm);

integer esize = 8 << UInt(size);
integer datasize = esize;
integer elements = 1;
integer part = 0;

boolean sub_op = (o2 == '1');
```

Vector

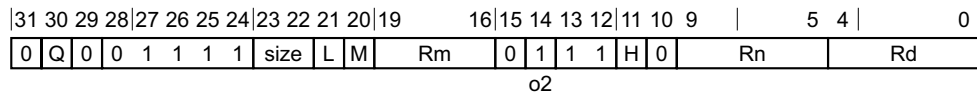

Vector variant

SQDMLSL{2} <Vd>.<Ta>, <Vn>.<Tb>, <Vm>.<Ts>[<index>]

Decode for this encoding

```
integer idxdsize = if H == '1' then 128 else 64;
integer index;
bit Rmhi;
case size of
  when '01' index = UInt(H:L:M); Rmhi = '0';
  when '10' index = UInt(H:L); Rmhi = M;
  otherwise UnallocatedEncoding();

integer d = UInt(Rd);
integer n = UInt(Rn);
integer m = UInt(Rmhi:Rm);

integer esize = 8 << UInt(size);
integer datasize = 64;
integer part = UInt(Q);
integer elements = datasize DIV esize;

boolean sub_op = (o2 == '1');
```

Assembler symbols

- 2 Is the second and upper half specifier. If present it causes the operation to be performed on the upper 64 bits of the registers holding the narrower elements, and is encoded in the "Q" field. It can have the following values:
- [absent] when Q = 0
 - [present] when Q = 1
- <Vd> Is the name of the SIMD&FP destination register, encoded in the "Rd" field.
- <Ta> Is an arrangement specifier, encoded in the "size" field. It can have the following values:
- 4S when size = 01
 - 2D when size = 10
- The following encodings are reserved:
- size = 00.
 - size = 11.
- <Vn> Is the name of the first SIMD&FP source register, encoded in the "Rn" field.
- <Tb> Is an arrangement specifier, encoded in the "size:Q" field. It can have the following values:
- 4H when size = 01, Q = 0
 - 8H when size = 01, Q = 1
 - 2S when size = 10, Q = 0
 - 4S when size = 10, Q = 1
- The following encodings are reserved:
- size = 00, Q = x.
 - size = 11, Q = x.
- <Va> Is the destination width specifier, encoded in the "size" field. It can have the following values:
- S when size = 01
 - D when size = 10
- The following encodings are reserved:
- size = 00.
 - size = 11.

- <d> Is the number of the SIMD&FP destination register, encoded in the "Rd" field.
- <Vb> Is the source width specifier, encoded in the "size" field. It can have the following values:
 H when size = 01
 S when size = 10
 The following encodings are reserved:
 • size = 00.
 • size = 11.
- <n> Is the number of the first SIMD&FP source register, encoded in the "Rn" field.
- <Vm> Is the name of the second SIMD&FP source register, encoded in the "size:M:Rm" field. It can have the following values:
 0:Rm when size = 01
 M:Rm when size = 10
 The following encodings are reserved:
 • size = 00.
 • size = 11.
 Restricted to V0-V15 when element size <Ts> is H.
- <Ts> Is an element size specifier, encoded in the "size" field. It can have the following values:
 H when size = 01
 S when size = 10
 The following encodings are reserved:
 • size = 00.
 • size = 11.
- <index> Is the element index, encoded in the "size:L:H:M" field. It can have the following values:
 H:L:M when size = 01
 H:L when size = 10
 The following encodings are reserved:
 • size = 00.
 • size = 11.

Operation for all encodings

```

CheckFPAdvSIMDEnabled64();
bits(datasize) operand1 = Vpart[n, part];
bits(idxsizesize) operand2 = V[m];
bits(2*datasize) operand3 = V[d];
bits(2*datasize) result;
integer element1;
integer element2;
bits(2*esize) product;
integer accum;
boolean sat1;
boolean sat2;

element2 = SInt(EMem[operand2, index, esize]);
for e = 0 to elements-1
  element1 = SInt(EMem[operand1, e, esize]);
  (product, sat1) = SignedSatQ(2 * element1 * element2, 2 * esize);
  if sub_op then
    accum = SInt(EMem[operand3, e, 2*esize]) - SInt(product);
  else

```

```
    accum = SInt(Elem[operand3, e, 2*esize]) + SInt(product);  
    (Elem[result, e, 2*esize], sat2) = SignedSatQ(accum, 2 * esize);  
    if sat1 || sat2 then FPSR.QC = '1';  
  
V[d] = result;
```

C7.2.245 SQDMLSL, SQDMLSL2 (vector)

Signed saturating Doubling Multiply-Subtract Long. This instruction multiplies corresponding signed integer values in the lower or upper half of the vectors of the two source SIMD&FP registers, doubles the results, and subtracts the final results from the vector elements of the destination SIMD&FP register. The destination vector elements are twice as long as the elements that are multiplied.

If overflow occurs with any of the results, those results are saturated. If saturation occurs, the cumulative saturation bit `FPSR.QC` is set.

The `SQDMLSL` instruction extracts each source vector from the lower half of each source register, while the `SQDMLSL2` instruction extracts each source vector from the upper half of each source register.

Depending on the settings in the `CPACR_EL1`, `CPTR_EL2`, and `CPTR_EL3` registers, and the current Security state and Exception level, an attempt to execute the instruction might be trapped.

Scalar

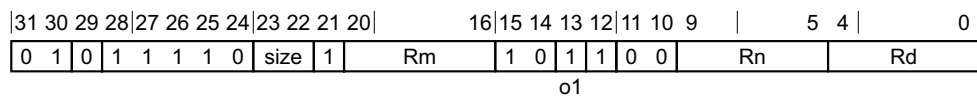

Scalar variant

`SQDMLSL <Va><d>, <Vb><n>, <Vb><m>`

Decode for this encoding

```
integer d = UInt(Rd);
integer n = UInt(Rn);
integer m = UInt(Rm);

if size == '00' || size == '11' then ReservedValue();
integer esize = 8 << UInt(size);
integer datasize = esize;
integer elements = 1;
integer part = 0;

boolean sub_op = (o1 == '1');
```

Vector

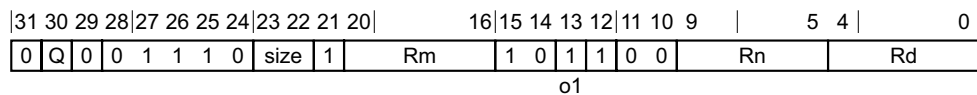

Vector variant

`SQDMLSL{2} <Vd>.<Ta>, <Vn>.<Tb>, <Vm>.<Tb>`

Decode for this encoding

```
integer d = UInt(Rd);
integer n = UInt(Rn);
integer m = UInt(Rm);

if size == '00' || size == '11' then ReservedValue();
integer esize = 8 << UInt(size);
integer datasize = 64;
integer part = UInt(Q);
```

```
integer elements = datasize DIV esize;
```

```
boolean sub_op = (o1 == '1');
```

Assembler symbols

2 Is the second and upper half specifier. If present it causes the operation to be performed on the upper 64 bits of the registers holding the narrower elements, and is encoded in the "Q" field. It can have the following values:

[absent] when Q = 0

[present] when Q = 1

<Vd> Is the name of the SIMD&FP destination register, encoded in the "Rd" field.

<Ta> Is an arrangement specifier, encoded in the "size" field. It can have the following values:

4S when size = 01

2D when size = 10

The following encodings are reserved:

- size = 00.
- size = 11.

<Vn> Is the name of the first SIMD&FP source register, encoded in the "Rn" field.

<Tb> Is an arrangement specifier, encoded in the "size:Q" field. It can have the following values:

4H when size = 01, Q = 0

8H when size = 01, Q = 1

2S when size = 10, Q = 0

4S when size = 10, Q = 1

The following encodings are reserved:

- size = 00, Q = x.
- size = 11, Q = x.

<Vm> Is the name of the second SIMD&FP source register, encoded in the "Rm" field.

<Va> Is the destination width specifier, encoded in the "size" field. It can have the following values:

S when size = 01

D when size = 10

The following encodings are reserved:

- size = 00.
- size = 11.

<d> Is the number of the SIMD&FP destination register, encoded in the "Rd" field.

<Vb> Is the source width specifier, encoded in the "size" field. It can have the following values:

H when size = 01

S when size = 10

The following encodings are reserved:

- size = 00.
- size = 11.

<n> Is the number of the first SIMD&FP source register, encoded in the "Rn" field.

<m> Is the number of the second SIMD&FP source register, encoded in the "Rm" field.

Operation for all encodings

```
CheckFPAdvSIMDEnabled64();
bits(datasize) operand1 = Vpart[n, part];
bits(datasize) operand2 = Vpart[m, part];
bits(2*datasize) operand3 = V[d];
bits(2*datasize) result;
integer element1;
integer element2;
bits(2*esize) product;
integer accum;
boolean sat1;
boolean sat2;

for e = 0 to elements-1
    element1 = SInt(Elem[operand1, e, esize]);
    element2 = SInt(Elem[operand2, e, esize]);
    (product, sat1) = SignedSatQ(2 * element1 * element2, 2 * esize);
    if sub_op then
        accum = SInt(Elem[operand3, e, 2*esize]) - SInt(product);
    else
        accum = SInt(Elem[operand3, e, 2*esize]) + SInt(product);
    (Elem[result, e, 2*esize], sat2) = SignedSatQ(accum, 2 * esize);
    if sat1 || sat2 then FPSR.QC = '1';

V[d] = result;
```

C7.2.246 SQDMULH (by element)

Signed saturating Doubling Multiply returning High half (by element). This instruction multiplies each vector element in the first source SIMD&FP register by the specified vector element of the second source SIMD&FP register, doubles the results, places the most significant half of the final results into a vector, and writes the vector to the destination SIMD&FP register.

The results are truncated. For rounded results, see [SQRDMULH \(by element\)](#).

Depending on the settings in the [CPACR_EL1](#), [CPTR_EL2](#), and [CPTR_EL3](#) registers, and the current Security state and Exception level, an attempt to execute the instruction might be trapped.

Scalar

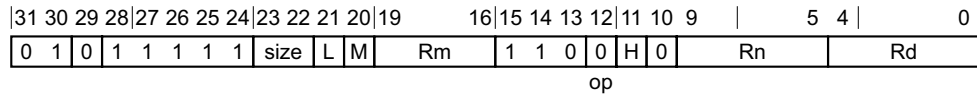

Scalar variant

SQDMULH <V><d>, <V><n>, <Vm>.<Ts>[<index>]

Decode for this encoding

```

integer idxdsize = if H == '1' then 128 else 64;
integer index;
bit Rmhi;
case size of
    when '01' index = UInt(H:L:M); Rmhi = '0';
    when '10' index = UInt(H:L); Rmhi = M;
    otherwise UnallocatedEncoding();

integer d = UInt(Rd);
integer n = UInt(Rn);
integer m = UInt(Rmhi:Rm);

integer esize = 8 << UInt(size);
integer datasize = esize;
integer elements = 1;

boolean round = (op == '1');
```

Vector

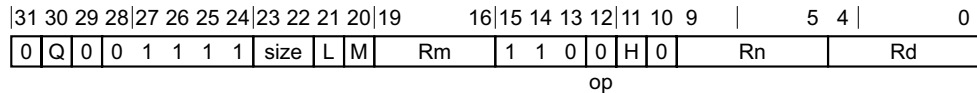

Vector variant

SQDMULH <Vd>.<T>, <Vn>.<T>, <Vm>.<Ts>[<index>]

Decode for this encoding

```

integer idxdsize = if H == '1' then 128 else 64;
integer index;
bit Rmhi;
case size of
    when '01' index = UInt(H:L:M); Rmhi = '0';
    when '10' index = UInt(H:L); Rmhi = M;
    otherwise UnallocatedEncoding();
```

```
integer d = UInt(Rd);
integer n = UInt(Rn);
integer m = UInt(Rmhi:Rm);

integer esize = 8 << UInt(size);
integer datasize = if Q == '1' then 128 else 64;
integer elements = datasize DIV esize;

boolean round = (op == '1');
```

Assembler symbols

- <V> Is a width specifier, encoded in the "size" field. It can have the following values:
- H when size = 01
 - S when size = 10
- The following encodings are reserved:
- size = 00.
 - size = 11.
- <d> Is the number of the SIMD&FP destination register, encoded in the "Rd" field.
- <n> Is the number of the first SIMD&FP source register, encoded in the "Rn" field.
- <Vd> Is the name of the SIMD&FP destination register, encoded in the "Rd" field.
- <T> Is an arrangement specifier, encoded in the "size:Q" field. It can have the following values:
- 4H when size = 01, Q = 0
 - 8H when size = 01, Q = 1
 - 2S when size = 10, Q = 0
 - 4S when size = 10, Q = 1
- The following encodings are reserved:
- size = 00, Q = x.
 - size = 11, Q = x.
- <Vn> Is the name of the first SIMD&FP source register, encoded in the "Rn" field.
- <Vm> Is the name of the second SIMD&FP source register, encoded in the "size:M:Rm" field. It can have the following values:
- 0:Rm when size = 01
 - M:Rm when size = 10
- The following encodings are reserved:
- size = 00.
 - size = 11.
- Restricted to V0-V15 when element size <Ts> is H.
- <Ts> Is an element size specifier, encoded in the "size" field. It can have the following values:
- H when size = 01
 - S when size = 10
- The following encodings are reserved:
- size = 00.
 - size = 11.

<index> Is the element index, encoded in the "size:L:H:M" field. It can have the following values:

H:L:M when size = 01
H:L when size = 10

The following encodings are reserved:

- size = 00.
- size = 11.

Operation for all encodings

```
CheckFPAdvSIMDEnabled64();
bits(datasize) operand1 = V[n];
bits(idxszie) operand2 = V[m];
bits(datasize) result;
integer round_const = if round then 1 << (esize - 1) else 0;
integer element1;
integer element2;
integer product;
boolean sat;

element2 = SInt(Elem[operand2, index, esize]);
for e = 0 to elements-1
    element1 = SInt(Elem[operand1, e, esize]);
    product = (2 * element1 * element2) + round_const;
    // The following only saturates if element1 and element2 equal -(2^(esize-1))
    (Elem[result, e, esize], sat) = SignedSatQ(product >> esize, esize);
    if sat then FPSR.QC = '1';

V[d] = result;
```

C7.2.247 SQDMULH (vector)

Signed saturating Doubling Multiply returning High half. This instruction multiplies the values of corresponding elements of the two source SIMD&FP registers, doubles the results, places the most significant half of the final results into a vector, and writes the vector to the destination SIMD&FP register.

The results are truncated. For rounded results, see [SQRDMULH \(vector\)](#).

If overflow occurs with any of the results, those results are saturated. If saturation occurs, the cumulative saturation bit [FPSR.QC](#) is set.

Depending on the settings in the [CPACR_EL1](#), [CPTR_EL2](#), and [CPTR_EL3](#) registers, and the current Security state and Exception level, an attempt to execute the instruction might be trapped.

Scalar

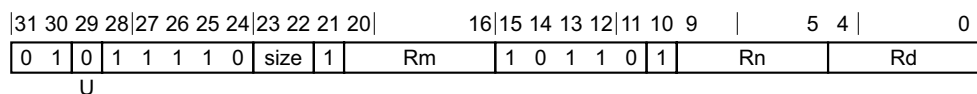

Scalar variant

SQDMULH <V><d>, <V><n>, <V><m>

Decode for this encoding

```
integer d = UInt(Rd);
integer n = UInt(Rn);
integer m = UInt(Rm);
if size == '11' || size == '00' then ReservedValue();
integer esize = 8 << UInt(size);
integer datasize = esize;
integer elements = 1;
boolean rounding = (U == '1');
```

Vector

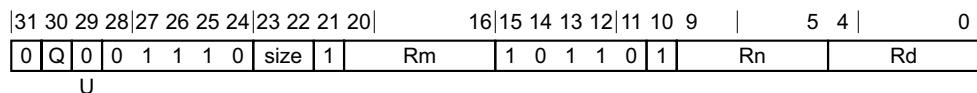

Vector variant

SQDMULH <Vd>.<T>, <Vn>.<T>, <Vm>.<T>

Decode for this encoding

```
integer d = UInt(Rd);
integer n = UInt(Rn);
integer m = UInt(Rm);
if size == '11' || size == '00' then ReservedValue();
integer esize = 8 << UInt(size);
integer datasize = if Q == '1' then 128 else 64;
integer elements = datasize DIV esize;
boolean rounding = (U == '1');
```

Assembler symbols

<V> Is a width specifier, encoded in the "size" field. It can have the following values:

H	when size = 01
---	----------------

S when size = 10

The following encodings are reserved:

- size = 00.
- size = 11.

<d> Is the number of the SIMD&FP destination register, in the "Rd" field.

<n> Is the number of the first SIMD&FP source register, encoded in the "Rn" field.

<m> Is the number of the second SIMD&FP source register, encoded in the "Rm" field.

<Vd> Is the name of the SIMD&FP destination register, encoded in the "Rd" field.

<T> Is an arrangement specifier, encoded in the "size:Q" field. It can have the following values:

4H when size = 01, Q = 0

8H when size = 01, Q = 1

2S when size = 10, Q = 0

4S when size = 10, Q = 1

The following encodings are reserved:

- size = 00, Q = x.
- size = 11, Q = x.

<Vn> Is the name of the first SIMD&FP source register, encoded in the "Rn" field.

<Vm> Is the name of the second SIMD&FP source register, encoded in the "Rm" field.

Operation for all encodings

```
CheckFPAdvSIMDEnabled64();
bits(datasize) operand1 = V[n];
bits(datasize) operand2 = V[m];
bits(datasize) result;
integer round_const = if rounding then 1 << (esize - 1) else 0;
integer element1;
integer element2;
integer product;
boolean sat;

for e = 0 to elements-1
    element1 = SInt(Elem[operand1, e, esize]);
    element2 = SInt(Elem[operand2, e, esize]);
    product = (2 * element1 * element2) + round_const;
    (Elem[result, e, esize], sat) = SignedSatQ(product >> esize, esize);
    if sat then FPSR.QC = '1';

V[d] = result;
```

C7.2.248 SQDMULL, SQDMULL2 (by element)

Signed saturating Doubling Multiply Long (by element). This instruction multiplies each vector element in the lower or upper half of the first source SIMD&FP register by the specified vector element of the second source SIMD&FP register, doubles the results, places the final results in a vector, and writes the vector to the destination SIMD&FP register. All the values in this instruction are signed integer values.

If overflow occurs with any of the results, those results are saturated. If saturation occurs, the cumulative saturation bit [FPSR.QC](#) is set.

The SQDMULL instruction extracts the first source vector from the lower half of the first source register, while the SQDMULL2 instruction extracts the first source vector from the upper half of the first source register.

Depending on the settings in the [CPACR_EL1](#), [CPTR_EL2](#), and [CPTR_EL3](#) registers, and the current Security state and Exception level, an attempt to execute the instruction might be trapped.

Scalar

31	30	29	28	27	26	25	24	23	22	21	20	19	16	15	14	13	12	11	10	9	5	4	0
0	1	0	1	1	1	1	1	size	L	M		Rm	1	0	1	1	H	0		Rn			Rd

Scalar variant

SQDMULL <Va><d>, <Vb><n>, <Vm>.<Ts>[<index>]

Decode for this encoding

```
integer idxdsize = if H == '1' then 128 else 64;
integer index;
bit Rmhi;
case size of
    when '01' index = UInt(H:L:M); Rmhi = '0';
    when '10' index = UInt(H:L); Rmhi = M;
    otherwise UnallocatedEncoding();
```

```
integer d = UInt(Rd);
integer n = UInt(Rn);
integer m = UInt(Rmhi:Rm);
```

```
integer esize = 8 << UInt(size);
integer datasize = esize;
integer elements = 1;
integer part = 0;
```

Vector

31	30	29	28	27	26	25	24	23	22	21	20	19	16	15	14	13	12	11	10	9	5	4	0
0	Q	0	0	1	1	1	1	size	L	M		Rm	1	0	1	1	H	0		Rn			Rd

Vector variant

SQDMULL{2} <Vd>.<Ta>, <Vn>.<Tb>, <Vm>.<Ts>[<index>]

Decode for this encoding

```
integer idxdsize = if H == '1' then 128 else 64;
integer index;
bit Rmhi;
case size of
```

```
when '01' index = UInt(H:L:M); Rmhi = '0';  
when '10' index = UInt(H:L); Rmhi = M;  
otherwise UnallocatedEncoding();  
  
integer d = UInt(Rd);  
integer n = UInt(Rn);  
integer m = UInt(Rmhi:Rm);  
  
integer esize = 8 << UInt(size);  
integer datasize = 64;  
integer part = UInt(Q);  
integer elements = datasize DIV esize;
```

Assembler symbols

- 2 Is the second and upper half specifier. If present it causes the operation to be performed on the upper 64 bits of the registers holding the narrower elements, and is encoded in the "Q" field. It can have the following values:
- [absent] when Q = 0
[present] when Q = 1
- <Vd> Is the name of the SIMD&FP destination register, encoded in the "Rd" field.
- <Ta> Is an arrangement specifier, encoded in the "size" field. It can have the following values:
- 4S when size = 01
2D when size = 10
- The following encodings are reserved:
- size = 00.
 - size = 11.
- <Vn> Is the name of the first SIMD&FP source register, encoded in the "Rn" field.
- <Tb> Is an arrangement specifier, encoded in the "size:Q" field. It can have the following values:
- 4H when size = 01, Q = 0
8H when size = 01, Q = 1
2S when size = 10, Q = 0
4S when size = 10, Q = 1
- The following encodings are reserved:
- size = 00, Q = x.
 - size = 11, Q = x.
- <Va> Is the destination width specifier, encoded in the "size" field. It can have the following values:
- S when size = 01
D when size = 10
- The following encodings are reserved:
- size = 00.
 - size = 11.
- <d> Is the number of the SIMD&FP destination register, encoded in the "Rd" field.
- <Vb> Is the source width specifier, encoded in the "size" field. It can have the following values:
- H when size = 01
S when size = 10

The following encodings are reserved:

- size = 00.
- size = 11.

<n> Is the number of the first SIMD&FP source register, encoded in the "Rn" field.

<Vm> Is the name of the second SIMD&FP source register, encoded in the "size:M:Rm" field. It can have the following values:

0:Rm when size = 01

M:Rm when size = 10

The following encodings are reserved:

- size = 00.
- size = 11.

Restricted to V0-V15 when element size <Ts> is H.

<Ts> Is an element size specifier, encoded in the "size" field. It can have the following values:

H when size = 01

S when size = 10

The following encodings are reserved:

- size = 00.
- size = 11.

<index> Is the element index, encoded in the "size:L:H:M" field. It can have the following values:

H:L:M when size = 01

H:L when size = 10

The following encodings are reserved:

- size = 00.
- size = 11.

Operation for all encodings

```
CheckFPAdvSIMDEnabled64();
```

```
bits(datasize) operand1 = Vpart[n, part];
```

```
bits(idxsize) operand2 = V[m];
```

```
bits(2*datasize) result;
```

```
integer element1;
```

```
integer element2;
```

```
bits(2*esize) product;
```

```
boolean sat;
```

```
element2 = SInt(EMem[operand2, index, esize]);
```

```
for e = 0 to elements-1
```

```
    element1 = SInt(EMem[operand1, e, esize]);
```

```
    (product, sat) = SignedSatQ(2 * element1 * element2, 2 * esize);
```

```
    EMem[result, e, 2*esize] = product;
```

```
    if sat then FPSR.QC = '1';
```

```
V[d] = result;
```

C7.2.249 SQDMULL, SQDMULL2 (vector)

Signed saturating Doubling Multiply Long. This instruction multiplies corresponding vector elements in the lower or upper half of the two source SIMD&FP registers, doubles the results, places the final results in a vector, and writes the vector to the destination SIMD&FP register.

If overflow occurs with any of the results, those results are saturated. If saturation occurs, the cumulative saturation bit [FPSR.QC](#) is set.

The SQDMULL instruction extracts each source vector from the lower half of each source register, while the SQDMULL2 instruction extracts each source vector from the upper half of each source register.

Depending on the settings in the [CPACR_EL1](#), [CPTR_EL2](#), and [CPTR_EL3](#) registers, and the current Security state and Exception level, an attempt to execute the instruction might be trapped.

Scalar

31 30 29 28 27 26 25 24 23 22 21 20										16 15 14 13 12 11 10 9					5 4			0		
0	1	0	1	1	1	1	0	size	1	Rm		1	1	0	1	0	0	Rn		Rd

Scalar variant

SQDMULL <Va><d>, <Vb><n>, <Vb><m>

Decode for this encoding

```
integer d = UInt(Rd);
integer n = UInt(Rn);
integer m = UInt(Rm);

if size == '00' || size == '11' then ReservedValue();
integer esize = 8 << UInt(size);
integer datasize = esize;
integer elements = 1;
integer part = 0;
```

Vector

31 30 29 28 27 26 25 24 23 22 21 20										16 15 14 13 12 11 10 9					5 4			0		
0	Q	0	0	1	1	1	0	size	1	Rm		1	1	0	1	0	0	Rn		Rd

Vector variant

SQDMULL{2} <Vd>.<Ta>, <Vn>.<Tb>, <Vm>.<Tb>

Decode for this encoding

```
integer d = UInt(Rd);
integer n = UInt(Rn);
integer m = UInt(Rm);

if size == '00' || size == '11' then ReservedValue();
integer esize = 8 << UInt(size);
integer datasize = 64;
integer part = UInt(Q);
integer elements = datasize DIV esize;
```

Assembler symbols

- 2 Is the second and upper half specifier. If present it causes the operation to be performed on the upper 64 bits of the registers holding the narrower elements, and is encoded in the "Q" field. It can have the following values:
- [absent] when Q = 0
 - [present] when Q = 1
- <Vd> Is the name of the SIMD&FP destination register, encoded in the "Rd" field.
- <Ta> Is an arrangement specifier, encoded in the "size" field. It can have the following values:
- 4S when size = 01
 - 2D when size = 10
- The following encodings are reserved:
- size = 00.
 - size = 11.
- <Vn> Is the name of the first SIMD&FP source register, encoded in the "Rn" field.
- <Tb> Is an arrangement specifier, encoded in the "size:Q" field. It can have the following values:
- 4H when size = 01, Q = 0
 - 8H when size = 01, Q = 1
 - 2S when size = 10, Q = 0
 - 4S when size = 10, Q = 1
- The following encodings are reserved:
- size = 00, Q = x.
 - size = 11, Q = x.
- <Vm> Is the name of the second SIMD&FP source register, encoded in the "Rm" field.
- <Va> Is the destination width specifier, encoded in the "size" field. It can have the following values:
- S when size = 01
 - D when size = 10
- The following encodings are reserved:
- size = 00.
 - size = 11.
- <d> Is the number of the SIMD&FP destination register, encoded in the "Rd" field.
- <Vb> Is the source width specifier, encoded in the "size" field. It can have the following values:
- H when size = 01
 - S when size = 10
- The following encodings are reserved:
- size = 00.
 - size = 11.
- <n> Is the number of the first SIMD&FP source register, encoded in the "Rn" field.
- <m> Is the number of the second SIMD&FP source register, encoded in the "Rm" field.

Operation for all encodings

```
CheckFPAdvSIMDEnabled64();
bits(datasize) operand1 = Vpart[n, part];
bits(datasize) operand2 = Vpart[m, part];
bits(2*datasize) result;
integer element1;
integer element2;
bits(2*esize) product;
boolean sat;

for e = 0 to elements-1
    element1 = SInt(Elem[operand1, e, esize]);
    element2 = SInt(Elem[operand2, e, esize]);
    (product, sat) = SignedSatQ(2 * element1 * element2, 2 * esize);
    Elem[result, e, 2*esize] = product;
    if sat then FPSR.QC = '1';

V[d] = result;
```

C7.2.250 SQNEG

Signed saturating Negate. This instruction reads each vector element from the source SIMD&FP register, negates each value, places the result into a vector, and writes the vector to the destination SIMD&FP register. All the values in this instruction are signed integer values.

If overflow occurs with any of the results, those results are saturated. If saturation occurs, the cumulative saturation bit [FPSR.QC](#) is set.

Depending on the settings in the [CPACR_EL1](#), [CPTR_EL2](#), and [CPTR_EL3](#) registers, and the current Security state and Exception level, an attempt to execute the instruction might be trapped.

Scalar

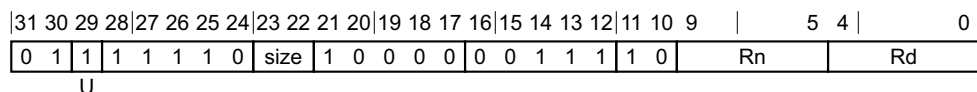

Scalar variant

SQNEG <V><d>, <V><n>

Decode for this encoding

```
integer d = UInt(Rd);
integer n = UInt(Rn);

integer esize = 8 << UInt(size);
integer datasize = esize;
integer elements = 1;
boolean neg = (U == '1');
```

Vector

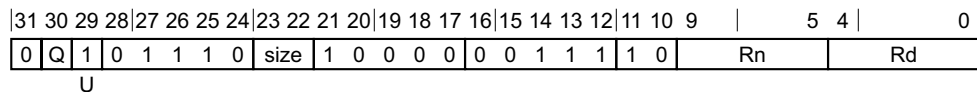

Vector variant

SQNEG <Vd>.<T>, <Vn>.<T>

Decode for this encoding

```
integer d = UInt(Rd);
integer n = UInt(Rn);

if size:Q == '110' then ReservedValue();
integer esize = 8 << UInt(size);
integer datasize = if Q == '1' then 128 else 64;
integer elements = datasize DIV esize;
boolean neg = (U == '1');
```

Assembler symbols

<V> Is a width specifier, encoded in the "size" field. It can have the following values:

B	when size = 00
H	when size = 01
S	when size = 10

- D when size = 11
- <d> Is the number of the SIMD&FP destination register, encoded in the "Rd" field.
- <n> Is the number of the SIMD&FP source register, encoded in the "Rn" field.
- <Vd> Is the name of the SIMD&FP destination register, encoded in the "Rd" field.
- <T> Is an arrangement specifier, encoded in the "size:Q" field. It can have the following values:
- 8B when size = 00, Q = 0
- 16B when size = 00, Q = 1
- 4H when size = 01, Q = 0
- 8H when size = 01, Q = 1
- 2S when size = 10, Q = 0
- 4S when size = 10, Q = 1
- 2D when size = 11, Q = 1
- The encoding size = 11, Q = 0 is reserved.
- <Vn> Is the name of the SIMD&FP source register, encoded in the "Rn" field.

Operation for all encodings

```
CheckFPAdvSIMDEnabled64();
bits(datasize) operand = V[n];
bits(datasize) result;
integer element;
boolean sat;

for e = 0 to elements-1
    element = SInt(Elem[operand, e, esize]);
    if neg then
        element = -element;
    else
        element = Abs(element);
    (Elem[result, e, esize], sat) = SignedSatQ(element, esize);
    if sat then FPSR.QC = '1';

V[d] = result;
```

C7.2.251 SQRDMLAH (by element)

Signed Saturating Rounding Doubling Multiply Accumulate returning High Half (by element). This instruction multiplies the vector elements of the first source SIMD&FP register with the value of a vector element of the second source SIMD&FP register without saturating the multiply results, doubles the results, and accumulates the most significant half of the final results with the vector elements of the destination SIMD&FP register. The results are rounded.

If any of the results overflow, they are saturated. The cumulative saturation bit, `FPSR.QC`, is set if saturation occurs.

Depending on the settings in the `CPACR_EL1`, `CPTR_EL2`, and `CPTR_EL3` registers, and the current Security state and Exception level, an attempt to execute the instruction might be trapped.

Scalar

ARMv8.1

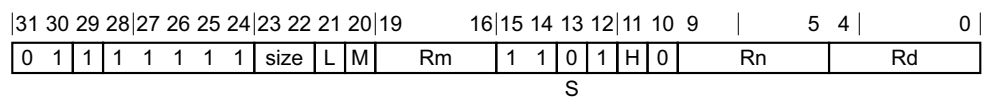

Scalar variant

`SQRDMLAH <V><d>, <V><n>, <Vm>.<Ts>[<i>index</i>]`

Decode for this encoding

```

if !HaveQRDMLAHExt() then UnallocatedEncoding();

integer idxsize = if H == '1' then 128 else 64;
integer index;
bit Rmhi;
case size of
    when '01' index = UInt(H:L:M); Rmhi = '0';
    when '10' index = UInt(H:L); Rmhi = M;
    otherwise UnallocatedEncoding();

integer d = UInt(Rd);
integer n = UInt(Rn);
integer m = UInt(Rmhi:Rm);

integer esize = 8 << UInt(size);
integer datasize = esize;
integer elements = 1;

boolean rounding = TRUE;
boolean sub_op = (S == '1');
    
```

Vector

ARMv8.1

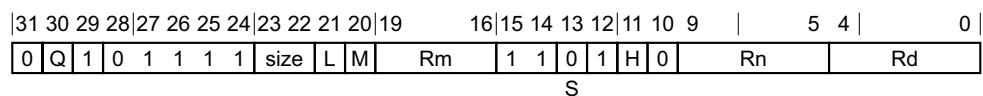

Vector variant

`SQRDMLAH <Vd>.<T>, <Vn>.<T>, <Vm>.<Ts>[<i>index</i>]`

Decode for this encoding

```

if !HaveQRDMLAExt() then UnallocatedEncoding();

integer idxdsize = if H == '1' then 128 else 64;
integer index;
bit Rmhi;
case size of
    when '01' index = UInt(H:L:M); Rmhi = '0';
    when '10' index = UInt(H:L); Rmhi = M;
    otherwise UnallocatedEncoding();

integer d = UInt(Rd);
integer n = UInt(Rn);
integer m = UInt(Rmhi:Rm);

integer esize = 8 << UInt(size);
integer datasize = if Q == '1' then 128 else 64;
integer elements = datasize DIV esize;

boolean rounding = TRUE;
boolean sub_op = (S == '1');
    
```

Assembler symbols

- <V> Is a width specifier, encoded in the "size" field. It can have the following values:
- | | |
|---|----------------|
| H | when size = 01 |
| S | when size = 10 |
- The following encodings are reserved:
- size = 00.
 - size = 11.
- <d> Is the number of the SIMD&FP destination register, encoded in the "Rd" field.
- <n> Is the number of the first SIMD&FP source register, encoded in the "Rn" field.
- <Vd> Is the name of the SIMD&FP destination register, encoded in the "Rd" field.
- <T> Is an arrangement specifier, encoded in the "size:Q" field. It can have the following values:
- | | |
|----|-----------------------|
| 4H | when size = 01, Q = 0 |
| 8H | when size = 01, Q = 1 |
| 2S | when size = 10, Q = 0 |
| 4S | when size = 10, Q = 1 |
- The following encodings are reserved:
- size = 00, Q = x.
 - size = 11, Q = x.
- <Vn> Is the name of the first SIMD&FP source register, encoded in the "Rn" field.
- <Vm> Is the name of the second SIMD&FP source register, encoded in the "size:M:Rm" field. It can have the following values:
- | | |
|------|----------------|
| 0:Rm | when size = 01 |
| M:Rm | when size = 10 |
- The following encodings are reserved:
- size = 00.
 - size = 11.
- Restricted to V0-V15 when element size <Ts> is H.

<Ts> Is an element size specifier, encoded in the "size" field. It can have the following values:

H when size = 01

S when size = 10

The following encodings are reserved:

- size = 00.
- size = 11.

<index> Is the element index, encoded in the "size:L:H:M" field. It can have the following values:

H:L:M when size = 01

H:L when size = 10

The following encodings are reserved:

- size = 00.
- size = 11.

Operation for all encodings

```

CheckFPAdvSIMDEnabled64();
bits(datasize) operand1 = V[n];
bits(idxsizesize) operand2 = V[m];
bits(datasize) operand3 = V[d];
bits(datasize) result;
integer rounding_const = if rounding then 1 << (esize - 1) else 0;
integer element1;
integer element2;
integer element3;
integer product;
boolean sat;

element2 = SInt(EMem[operand2, index, esize]);
for e = 0 to elements-1
    element1 = SInt(EMem[operand1, e, esize]);
    element3 = SInt(EMem[operand3, e, esize]);
    if sub_op then
        accum = ((element3 << esize) - 2 * (element1 * element2) + rounding_const);
    else
        accum = ((element3 << esize) + 2 * (element1 * element2) + rounding_const);
    (EMem[result, e, esize], sat) = SignedSatQ(accum >> esize, esize);
    if sat then FPSR.QC = '1';

V[d] = result;
    
```

C7.2.252 SQRDMLAH (vector)

Signed Saturating Rounding Doubling Multiply Accumulate returning High Half (vector). This instruction multiplies the vector elements of the first source SIMD&FP register with the corresponding vector elements of the second source SIMD&FP register without saturating the multiply results, doubles the results, and accumulates the most significant half of the final results with the vector elements of the destination SIMD&FP register. The results are rounded.

If any of the results overflow, they are saturated. The cumulative saturation bit, `FPSR.QC`, is set if saturation occurs.

Depending on the settings in the `CPACR_EL1`, `CPTR_EL2`, and `CPTR_EL3` registers, and the current Security state and Exception level, an attempt to execute the instruction might be trapped.

Scalar

ARMv8.1

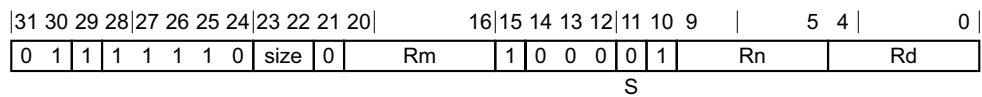

Scalar variant

SQRDMLAH <V><d>, <V><n>, <V><m>

Decode for this encoding

```

if !HaveQRDMLAHExt() then UnallocatedEncoding();

integer d = UInt(Rd);
integer n = UInt(Rn);
integer m = UInt(Rm);
if size == '11' || size == '00' then ReservedValue();
integer esize = 8 << UInt(size);
integer datasize = esize;
integer elements = 1;
boolean rounding = TRUE;
boolean sub_op = (S == '1');
```

Vector

ARMv8.1

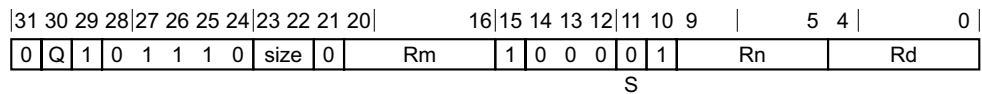

Vector variant

SQRDMLAH <Vd>.<T>, <Vn>.<T>, <Vm>.<T>

Decode for this encoding

```

if !HaveQRDMLAHExt() then UnallocatedEncoding();

integer d = UInt(Rd);
integer n = UInt(Rn);
integer m = UInt(Rm);
if size == '11' || size == '00' then ReservedValue();
integer esize = 8 << UInt(size);
integer datasize = if Q == '1' then 128 else 64;
```

```
integer elements = datasize DIV esize;
boolean rounding = TRUE;
boolean sub_op = (S == '1');
```

Assembler symbols

- <V> Is a width specifier, encoded in the "size" field. It can have the following values:
- H when size = 01
 - S when size = 10
- The following encodings are reserved:
- size = 00.
 - size = 11.
- <d> Is the number of the SIMD&FP destination register, in the "Rd" field.
- <n> Is the number of the first SIMD&FP source register, encoded in the "Rn" field.
- <m> Is the number of the second SIMD&FP source register, encoded in the "Rm" field.
- <Vd> Is the name of the SIMD&FP destination register, encoded in the "Rd" field.
- <T> Is an arrangement specifier, encoded in the "size:Q" field. It can have the following values:
- 4H when size = 01, Q = 0
 - 8H when size = 01, Q = 1
 - 2S when size = 10, Q = 0
 - 4S when size = 10, Q = 1
- The following encodings are reserved:
- size = 00, Q = x.
 - size = 11, Q = x.
- <Vn> Is the name of the first SIMD&FP source register, encoded in the "Rn" field.
- <Vm> Is the name of the second SIMD&FP source register, encoded in the "Rm" field.

Operation for all encodings

```
CheckFPAdvSIMDEnabled64();
bits(datasize) operand1 = V[n];
bits(datasize) operand2 = V[m];
bits(datasize) operand3 = V[d];
bits(datasize) result;
integer rounding_const = if rounding then 1 << (esize - 1) else 0;
integer element1;
integer element2;
integer element3;
integer product;
boolean sat;

for e = 0 to elements-1
    element1 = SInt(Elem[operand1, e, esize]);
    element2 = SInt(Elem[operand2, e, esize]);
    element3 = SInt(Elem[operand3, e, esize]);
    if sub_op then
        accum = ((element3 << esize) - 2 * (element1 * element2) + rounding_const);
    else
        accum = ((element3 << esize) + 2 * (element1 * element2) + rounding_const);
    (Elem[result, e, esize], sat) = SignedSatQ(accum >> esize, esize);
    if sat then FPSR.QC = '1';

V[d] = result;
```

C7.2.253 SQRDMLSH (by element)

Signed Saturating Rounding Doubling Multiply Subtract returning High Half (by element). This instruction multiplies the vector elements of the first source SIMD&FP register with the value of a vector element of the second source SIMD&FP register without saturating the multiply results, doubles the results, and subtracts the most significant half of the final results from the vector elements of the destination SIMD&FP register. The results are rounded.

If any of the results overflow, they are saturated. The cumulative saturation bit, `FPSR.QC`, is set if saturation occurs.

Depending on the settings in the `CPACR_EL1`, `CPTR_EL2`, and `CPTR_EL3` registers, and the current Security state and Exception level, an attempt to execute the instruction might be trapped.

Scalar

ARMv8.1

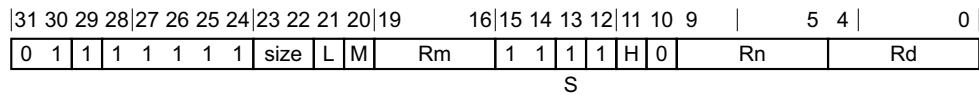

Scalar variant

SQRDMLSH <V><d>, <V><n>, <Vm>.<Ts>[<i>index</i>]

Decode for this encoding

```

if !HaveQRDMLAExt() then UnallocatedEncoding();

integer idxsize = if H == '1' then 128 else 64;
integer index;
bit Rmhi;
case size of
    when '01' index = UInt(H:L:M); Rmhi = '0';
    when '10' index = UInt(H:L); Rmhi = M;
    otherwise UnallocatedEncoding();

integer d = UInt(Rd);
integer n = UInt(Rn);
integer m = UInt(Rmhi:Rm);

integer esize = 8 << UInt(size);
integer datasize = esize;
integer elements = 1;

boolean rounding = TRUE;
boolean sub_op = (S == '1');
```

Vector

ARMv8.1

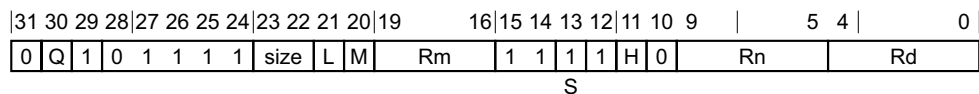

Vector variant

SQRDMLSH <Vd>.<T>, <Vn>.<T>, <Vm>.<Ts>[<i>index</i>]

Decode for this encoding

```

if !HaveQRDMLAExt() then UnallocatedEncoding();

integer idxdsize = if H == '1' then 128 else 64;
integer index;
bit Rmhi;
case size of
    when '01' index = UInt(H:L:M); Rmhi = '0';
    when '10' index = UInt(H:L); Rmhi = M;
    otherwise UnallocatedEncoding();

integer d = UInt(Rd);
integer n = UInt(Rn);
integer m = UInt(Rmhi:Rm);

integer esize = 8 << UInt(size);
integer datasize = if Q == '1' then 128 else 64;
integer elements = datasize DIV esize;

boolean rounding = TRUE;
boolean sub_op = (S == '1');
    
```

Assembler symbols

- <V> Is a width specifier, encoded in the "size" field. It can have the following values:
- | | |
|---|----------------|
| H | when size = 01 |
| S | when size = 10 |
- The following encodings are reserved:
- size = 00.
 - size = 11.
- <d> Is the number of the SIMD&FP destination register, encoded in the "Rd" field.
- <n> Is the number of the first SIMD&FP source register, encoded in the "Rn" field.
- <Vd> Is the name of the SIMD&FP destination register, encoded in the "Rd" field.
- <T> Is an arrangement specifier, encoded in the "size:Q" field. It can have the following values:
- | | |
|----|-----------------------|
| 4H | when size = 01, Q = 0 |
| 8H | when size = 01, Q = 1 |
| 2S | when size = 10, Q = 0 |
| 4S | when size = 10, Q = 1 |
- The following encodings are reserved:
- size = 00, Q = x.
 - size = 11, Q = x.
- <Vn> Is the name of the first SIMD&FP source register, encoded in the "Rn" field.
- <Vm> Is the name of the second SIMD&FP source register, encoded in the "size:M:Rm" field. It can have the following values:
- | | |
|------|----------------|
| 0:Rm | when size = 01 |
| M:Rm | when size = 10 |
- The following encodings are reserved:
- size = 00.
 - size = 11.
- Restricted to V0-V15 when element size <Ts> is H.

<Ts> Is an element size specifier, encoded in the "size" field. It can have the following values:

H when size = 01

S when size = 10

The following encodings are reserved:

- size = 00.
- size = 11.

<index> Is the element index, encoded in the "size:L:H:M" field. It can have the following values:

H:L:M when size = 01

H:L when size = 10

The following encodings are reserved:

- size = 00.
- size = 11.

Operation for all encodings

```
CheckFPAdvSIMDEnabled64();
bits(datasize) operand1 = V[n];
bits(idxszie) operand2 = V[m];
bits(datasize) operand3 = V[d];
bits(datasize) result;
integer rounding_const = if rounding then 1 << (esize - 1) else 0;
integer element1;
integer element2;
integer element3;
integer product;
boolean sat;

element2 = SInt(Elem[operand2, index, esize]);
for e = 0 to elements-1
    element1 = SInt(Elem[operand1, e, esize]);
    element3 = SInt(Elem[operand3, e, esize]);
    if sub_op then
        accum = ((element3 << esize) - 2 * (element1 * element2) + rounding_const);
    else
        accum = ((element3 << esize) + 2 * (element1 * element2) + rounding_const);
    (Elem[result, e, esize], sat) = SignedSatQ(accum >> esize, esize);
    if sat then FPSR.QC = '1';

V[d] = result;
```

C7.2.254 SQRDMLSH (vector)

Signed Saturating Rounding Doubling Multiply Subtract returning High Half (vector). This instruction multiplies the vector elements of the first source SIMD&FP register with the corresponding vector elements of the second source SIMD&FP register without saturating the multiply results, doubles the results, and subtracts the most significant half of the final results from the vector elements of the destination SIMD&FP register. The results are rounded.

If any of the results overflow, they are saturated. The cumulative saturation bit, `FPSR.QC`, is set if saturation occurs.

Depending on the settings in the `CPACR_EL1`, `CPTR_EL2`, and `CPTR_EL3` registers, and the current Security state and Exception level, an attempt to execute the instruction might be trapped.

Scalar

ARMv8.1

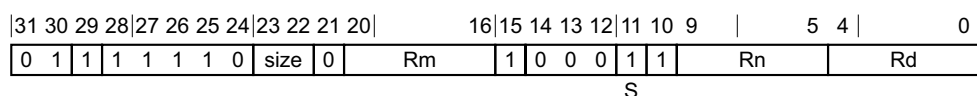

Scalar variant

SQRDMLSH <V><d>, <V><n>, <V><m>

Decode for this encoding

```

if !HaveQRDMLAExt() then UnallocatedEncoding();

integer d = UInt(Rd);
integer n = UInt(Rn);
integer m = UInt(Rm);
if size == '11' || size == '00' then ReservedValue();
integer esize = 8 << UInt(size);
integer datasize = esize;
integer elements = 1;
boolean rounding = TRUE;
boolean sub_op = (S == '1');
```

Vector

ARMv8.1

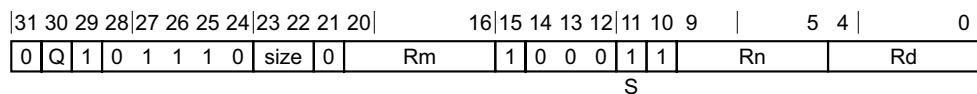

Vector variant

SQRDMLSH <Vd>.<T>, <Vn>.<T>, <Vm>.<T>

Decode for this encoding

```

if !HaveQRDMLAExt() then UnallocatedEncoding();

integer d = UInt(Rd);
integer n = UInt(Rn);
integer m = UInt(Rm);
if size == '11' || size == '00' then ReservedValue();
integer esize = 8 << UInt(size);
integer datasize = if Q == '1' then 128 else 64;
```

```
integer elements = datasize DIV esize;
boolean rounding = TRUE;
boolean sub_op = (S == '1');
```

Assembler symbols

- <V> Is a width specifier, encoded in the "size" field. It can have the following values:
- H when size = 01
 - S when size = 10
- The following encodings are reserved:
- size = 00.
 - size = 11.
- <d> Is the number of the SIMD&FP destination register, in the "Rd" field.
- <n> Is the number of the first SIMD&FP source register, encoded in the "Rn" field.
- <m> Is the number of the second SIMD&FP source register, encoded in the "Rm" field.
- <Vd> Is the name of the SIMD&FP destination register, encoded in the "Rd" field.
- <T> Is an arrangement specifier, encoded in the "size:Q" field. It can have the following values:
- 4H when size = 01, Q = 0
 - 8H when size = 01, Q = 1
 - 2S when size = 10, Q = 0
 - 4S when size = 10, Q = 1
- The following encodings are reserved:
- size = 00, Q = x.
 - size = 11, Q = x.
- <Vn> Is the name of the first SIMD&FP source register, encoded in the "Rn" field.
- <Vm> Is the name of the second SIMD&FP source register, encoded in the "Rm" field.

Operation for all encodings

```
CheckFPAdvSIMDEnabled64();
bits(datasize) operand1 = V[n];
bits(datasize) operand2 = V[m];
bits(datasize) operand3 = V[d];
bits(datasize) result;
integer rounding_const = if rounding then 1 << (esize - 1) else 0;
integer element1;
integer element2;
integer element3;
integer product;
boolean sat;

for e = 0 to elements-1
    element1 = SInt(Elem[operand1, e, esize]);
    element2 = SInt(Elem[operand2, e, esize]);
    element3 = SInt(Elem[operand3, e, esize]);
    if sub_op then
        accum = ((element3 << esize) - 2 * (element1 * element2) + rounding_const);
    else
        accum = ((element3 << esize) + 2 * (element1 * element2) + rounding_const);
    (Elem[result, e, esize], sat) = SignedSatQ(accum >> esize, esize);
    if sat then FPSR.QC = '1';

V[d] = result;
```

C7.2.255 SQRDMULH (by element)

Signed saturating Rounding Doubling Multiply returning High half (by element). This instruction multiplies each vector element in the first source SIMD&FP register by the specified vector element of the second source SIMD&FP register, doubles the results, places the most significant half of the final results into a vector, and writes the vector to the destination SIMD&FP register.

The results are rounded. For truncated results, see [SQDMULH \(by element\)](#).

If any of the results overflows, they are saturated. If saturation occurs, the cumulative saturation bit [FPSR.QC](#) is set.

Depending on the settings in the [CPACR_EL1](#), [CPTR_EL2](#), and [CPTR_EL3](#) registers, and the current Security state and Exception level, an attempt to execute the instruction might be trapped.

Scalar

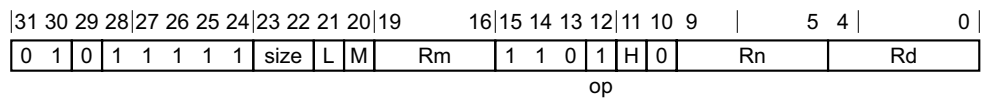

Scalar variant

SQRDMULH <V><d>, <V><n>, <Vm>.<Ts>[<index>]

Decode for this encoding

```

integer idxdsize = if H == '1' then 128 else 64;
integer index;
bit Rmhi;
case size of
    when '01' index = UInt(H:L:M); Rmhi = '0';
    when '10' index = UInt(H:L); Rmhi = M;
    otherwise UnallocatedEncoding();

integer d = UInt(Rd);
integer n = UInt(Rn);
integer m = UInt(Rmhi:Rm);

integer esize = 8 << UInt(size);
integer datasize = esize;
integer elements = 1;

boolean round = (op == '1');
```

Vector

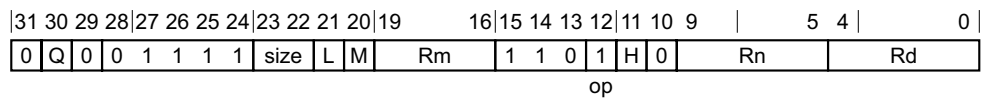

Vector variant

SQRDMULH <Vd>.<T>, <Vn>.<T>, <Vm>.<Ts>[<index>]

Decode for this encoding

```

integer idxdsize = if H == '1' then 128 else 64;
integer index;
bit Rmhi;
case size of
    when '01' index = UInt(H:L:M); Rmhi = '0';
```

```

when '10' index = UInt(H:L); Rmhi = M;
otherwise UnallocatedEncoding();

integer d = UInt(Rd);
integer n = UInt(Rn);
integer m = UInt(Rmhi:Rm);

integer esize = 8 << UInt(size);
integer datasize = if Q == '1' then 128 else 64;
integer elements = datasize DIV esize;

boolean round = (op == '1');
    
```

Assembler symbols

- <V> Is a width specifier, encoded in the "size" field. It can have the following values:
- | | |
|---|----------------|
| H | when size = 01 |
| S | when size = 10 |
- The following encodings are reserved:
- size = 00.
 - size = 11.
- <d> Is the number of the SIMD&FP destination register, encoded in the "Rd" field.
- <n> Is the number of the first SIMD&FP source register, encoded in the "Rn" field.
- <Vd> Is the name of the SIMD&FP destination register, encoded in the "Rd" field.
- <T> Is an arrangement specifier, encoded in the "size:Q" field. It can have the following values:
- | | |
|----|-----------------------|
| 4H | when size = 01, Q = 0 |
| 8H | when size = 01, Q = 1 |
| 2S | when size = 10, Q = 0 |
| 4S | when size = 10, Q = 1 |
- The following encodings are reserved:
- size = 00, Q = x.
 - size = 11, Q = x.
- <Vn> Is the name of the first SIMD&FP source register, encoded in the "Rn" field.
- <Vm> Is the name of the second SIMD&FP source register, encoded in the "size:M:Rm" field. It can have the following values:
- | | |
|------|----------------|
| 0:Rm | when size = 01 |
| M:Rm | when size = 10 |
- The following encodings are reserved:
- size = 00.
 - size = 11.
- Restricted to V0-V15 when element size <Ts> is H.
- <Ts> Is an element size specifier, encoded in the "size" field. It can have the following values:
- | | |
|---|----------------|
| H | when size = 01 |
| S | when size = 10 |
- The following encodings are reserved:
- size = 00.
 - size = 11.

<index> Is the element index, encoded in the "size:L:H:M" field. It can have the following values:

H:L:M when size = 01
H:L when size = 10

The following encodings are reserved:

- size = 00.
- size = 11.

Operation for all encodings

```
CheckFPAdvSIMDEnabled64();
bits(datasize) operand1 = V[n];
bits(idxsizesize) operand2 = V[m];
bits(datasize) result;
integer round_const = if round then 1 << (esize - 1) else 0;
integer element1;
integer element2;
integer product;
boolean sat;

element2 = SInt(Elem[operand2, index, esize]);
for e = 0 to elements-1
    element1 = SInt(Elem[operand1, e, esize]);
    product = (2 * element1 * element2) + round_const;
    // The following only saturates if element1 and element2 equal -(2^(esize-1))
    (Elem[result, e, esize], sat) = SignedSatQ(product >> esize, esize);
    if sat then FPSR.QC = '1';

V[d] = result;
```

C7.2.256 SQRDMULH (vector)

Signed saturating Rounding Doubling Multiply returning High half. This instruction multiplies the values of corresponding elements of the two source SIMD&FP registers, doubles the results, places the most significant half of the final results into a vector, and writes the vector to the destination SIMD&FP register.

The results are rounded. For truncated results, see [SQDMULH \(vector\)](#).

If overflow occurs with any of the results, those results are saturated. If saturation occurs, the cumulative saturation bit [FPSR.QC](#) is set.

Depending on the settings in the [CPACR_EL1](#), [CPTR_EL2](#), and [CPTR_EL3](#) registers, and the current Security state and Exception level, an attempt to execute the instruction might be trapped.

Scalar

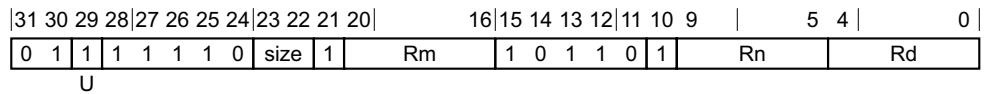

Scalar variant

SQRDMULH <V><d>, <V><n>, <V><m>

Decode for this encoding

```
integer d = UInt(Rd);
integer n = UInt(Rn);
integer m = UInt(Rm);
if size == '11' || size == '00' then ReservedValue();
integer esize = 8 << UInt(size);
integer datasize = esize;
integer elements = 1;
boolean rounding = (U == '1');
```

Vector

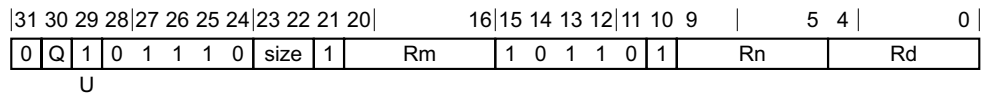

Vector variant

SQRDMULH <Vd>.<T>, <Vn>.<T>, <Vm>.<T>

Decode for this encoding

```
integer d = UInt(Rd);
integer n = UInt(Rn);
integer m = UInt(Rm);
if size == '11' || size == '00' then ReservedValue();
integer esize = 8 << UInt(size);
integer datasize = if Q == '1' then 128 else 64;
integer elements = datasize DIV esize;
boolean rounding = (U == '1');
```

Assembler symbols

<V> Is a width specifier, encoded in the "size" field. It can have the following values:

H	when size = 01
---	----------------

S when size = 10

The following encodings are reserved:

- size = 00.
- size = 11.

- <d> Is the number of the SIMD&FP destination register, in the "Rd" field.
- <n> Is the number of the first SIMD&FP source register, encoded in the "Rn" field.
- <m> Is the number of the second SIMD&FP source register, encoded in the "Rm" field.
- <Vd> Is the name of the SIMD&FP destination register, encoded in the "Rd" field.
- <T> Is an arrangement specifier, encoded in the "size:Q" field. It can have the following values:
- 4H when size = 01, Q = 0
- 8H when size = 01, Q = 1
- 2S when size = 10, Q = 0
- 4S when size = 10, Q = 1
- The following encodings are reserved:
- size = 00, Q = x.
 - size = 11, Q = x.
- <Vn> Is the name of the first SIMD&FP source register, encoded in the "Rn" field.
- <Vm> Is the name of the second SIMD&FP source register, encoded in the "Rm" field.

Operation for all encodings

```

CheckFPAdvSIMDEnabled64();
bits(datasize) operand1 = V[n];
bits(datasize) operand2 = V[m];
bits(datasize) result;
integer round_const = if rounding then 1 << (esize - 1) else 0;
integer element1;
integer element2;
integer product;
boolean sat;

for e = 0 to elements-1
    element1 = SInt(Elem[operand1, e, esize]);
    element2 = SInt(Elem[operand2, e, esize]);
    product = (2 * element1 * element2) + round_const;
    (Elem[result, e, esize], sat) = SignedSatQ(product >> esize, esize);
    if sat then FPSR.QC = '1';

V[d] = result;
    
```

C7.2.257 SQRSHL

Signed saturating Rounding Shift Left (register). This instruction takes each vector element in the first source SIMD&FP register, shifts it by a value from the least significant byte of the corresponding vector element of the second source SIMD&FP register, places the results into a vector, and writes the vector to the destination SIMD&FP register.

If the shift value is positive, the operation is a left shift. Otherwise, it is a right shift. The results are rounded. For truncated results, see [SQSHL \(register\)](#).

If overflow occurs with any of the results, those results are saturated. If saturation occurs, the cumulative saturation bit [FPSR.QC](#) is set.

Depending on the settings in the [CPACR_EL1](#), [CPTR_EL2](#), and [CPTR_EL3](#) registers, and the current Security state and Exception level, an attempt to execute the instruction might be trapped.

Scalar

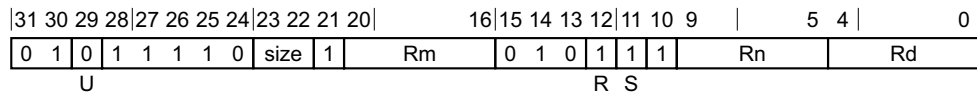

Scalar variant

SQRSHL <V><d>, <V><n>, <V><m>

Decode for this encoding

```
integer d = UInt(Rd);
integer n = UInt(Rn);
integer m = UInt(Rm);
integer esize = 8 << UInt(size);
integer datasize = esize;
integer elements = 1;
boolean unsigned = (U == '1');
boolean rounding = (R == '1');
boolean saturating = (S == '1');
if S == '0' && size != '11' then ReservedValue();
```

Vector

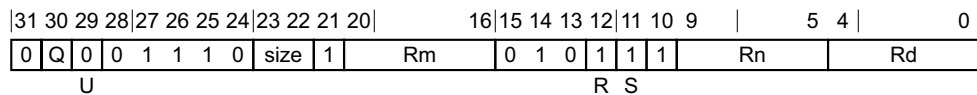

Vector variant

SQRSHL <Vd>.<T>, <Vn>.<T>, <Vm>.<T>

Decode for this encoding

```
integer d = UInt(Rd);
integer n = UInt(Rn);
integer m = UInt(Rm);
if size:Q == '110' then ReservedValue();
integer esize = 8 << UInt(size);
integer datasize = if Q == '1' then 128 else 64;
integer elements = datasize DIV esize;
boolean unsigned = (U == '1');
boolean rounding = (R == '1');
boolean saturating = (S == '1');
```

Assembler symbols

<V>	Is a width specifier, encoded in the "size" field. It can have the following values:
B	when size = 00
H	when size = 01
S	when size = 10
D	when size = 11
<d>	Is the number of the SIMD&FP destination register, in the "Rd" field.
<n>	Is the number of the first SIMD&FP source register, encoded in the "Rn" field.
<m>	Is the number of the second SIMD&FP source register, encoded in the "Rm" field.
<Vd>	Is the name of the SIMD&FP destination register, encoded in the "Rd" field.
<T>	Is an arrangement specifier, encoded in the "size:Q" field. It can have the following values:
8B	when size = 00, Q = 0
16B	when size = 00, Q = 1
4H	when size = 01, Q = 0
8H	when size = 01, Q = 1
2S	when size = 10, Q = 0
4S	when size = 10, Q = 1
2D	when size = 11, Q = 1
	The encoding size = 11, Q = 0 is reserved.
<Vn>	Is the name of the first SIMD&FP source register, encoded in the "Rn" field.
<Vm>	Is the name of the second SIMD&FP source register, encoded in the "Rm" field.

Operation for all encodings

```

CheckFPAdvSIMDEnabled64();
bits(datasize) operand1 = V[n];
bits(datasize) operand2 = V[m];
bits(datasize) result;

integer round_const = 0;
integer shift;
integer element;
boolean sat;

for e = 0 to elements-1
  shift = SInt(Elem[operand2, e, esize]<7:0>);
  if rounding then
    round_const = 1 << (-shift - 1); // 0 for left shift, 2^(n-1) for right shift
  element = (Int(Elem[operand1, e, esize], unsigned) + round_const) << shift;
  if saturating then
    (Elem[result, e, esize], sat) = SatQ(element, esize, unsigned);
    if sat then FPSR.QC = '1';
  else
    Elem[result, e, esize] = element<esize-1:0>;

V[d] = result;

```

C7.2.258 SQRSHRN, SQRSHRN2

Signed saturating Rounded Shift Right Narrow (immediate). This instruction reads each vector element in the source SIMD&FP register, right shifts each result by an immediate value, saturates each shifted result to a value that is half the original width, puts the final result into a vector, and writes the vector to the lower or upper half of the destination SIMD&FP register. All the values in this instruction are signed integer values. The destination vector elements are half as long as the source vector elements. The results are rounded. For truncated results, see [SQSHRN](#), [SQSHRN2](#).

The SQRSHRN instruction writes the vector to the lower half of the destination register and clears the upper half, while the SQRSHRN2 instruction writes the vector to the upper half of the destination register without affecting the other bits of the register.

If saturation occurs, the cumulative saturation bit [FPSR.QC](#) is set.

Depending on the settings in the [CPACR_EL1](#), [CPTR_EL2](#), and [CPTR_EL3](#) registers, and the current Security state and Exception level, an attempt to execute the instruction might be trapped.

Scalar

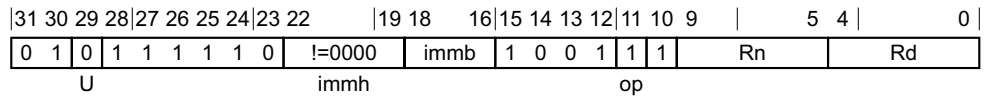

Scalar variant

SQRSHRN <Vb><d>, <Va><n>, #<shift>

Decode for this encoding

```
integer d = UInt(Rd);
integer n = UInt(Rn);

if immh == '0000' then ReservedValue();
if immh<3> == '1' then ReservedValue();
integer esize = 8 << HighestSetBit(immh);
integer datasize = esize;
integer elements = 1;
integer part = 0;

integer shift = (2 * esize) - UInt(immh:immb);
boolean round = (op == '1');
boolean unsigned = (U == '1');
```

Vector

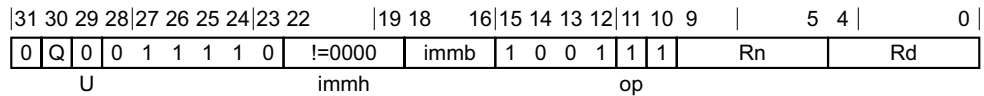

Vector variant

SQRSHRN{2} <Vd>.<Tb>, <Vn>.<Ta>, #<shift>

Decode for this encoding

```
integer d = UInt(Rd);
integer n = UInt(Rn);

if immh == '0000' then SEE "Advanced SIMD modified immediate";
if immh<3> == '1' then ReservedValue();
```



```
integer esize = 8 << HighestSetBit(immh);
integer datasize = 64;
integer part = UInt(Q);
integer elements = datasize DIV esize;

integer shift = (2 * esize) - UInt(immh:immb);
boolean round = (op == '1');
boolean unsigned = (U == '1');
```

Assembler symbols

2 Is the second and upper half specifier. If present it causes the operation to be performed on the upper 64 bits of the registers holding the narrower elements, and is encoded in the "Q" field. It can have the following values:

[absent] when Q = 0
 [present] when Q = 1

<Vd> Is the name of the SIMD&FP destination register, encoded in the "Rd" field.

<Tb> Is an arrangement specifier, encoded in the "immh:Q" field. It can have the following values:

8B when immh = 0001, Q = 0
 16B when immh = 0001, Q = 1
 4H when immh = 001x, Q = 0
 8H when immh = 001x, Q = 1
 2S when immh = 01xx, Q = 0
 4S when immh = 01xx, Q = 1

See [Advanced SIMD modified immediate on page C4-291](#) when immh = 0000, Q = x.

The encoding immh = 1xxx, Q = x is reserved.

<Vn> Is the name of the SIMD&FP source register, encoded in the "Rn" field.

<Ta> Is an arrangement specifier, encoded in the "immh" field. It can have the following values:

8H when immh = 0001
 4S when immh = 001x
 2D when immh = 01xx

See [Advanced SIMD modified immediate on page C4-291](#) when immh = 0000.

The encoding immh = 1xxx is reserved.

<Vb> Is the destination width specifier, encoded in the "immh" field. It can have the following values:

B when immh = 0001
 H when immh = 001x
 S when immh = 01xx

The following encodings are reserved:

- immh = 0000.
- immh = 1xxx.

<d> Is the number of the SIMD&FP destination register, in the "Rd" field.

<Va> Is the source width specifier, encoded in the "immh" field. It can have the following values:

H when immh = 0001
 S when immh = 001x
 D when immh = 01xx

The following encodings are reserved:

- `immh = 0000`.
- `immh = 1xxx`.

<n> Is the number of the first SIMD&FP source register, encoded in the "Rn" field.

<shift> For the scalar variant: is the right shift amount, in the range 1 to the destination operand width in bits, encoded in the "immh:immb" field. It can have the following values:

`(16-UInt(immh:immb))` when `immh = 0001`

`(32-UInt(immh:immb))` when `immh = 001x`

`(64-UInt(immh:immb))` when `immh = 01xx`

The following encodings are reserved:

- `immh = 0000`.
- `immh = 1xxx`.

For the vector variant: is the right shift amount, in the range 1 to the destination element width in bits, encoded in the "immh:immb" field. It can have the following values:

`(16-UInt(immh:immb))` when `immh = 0001`

`(32-UInt(immh:immb))` when `immh = 001x`

`(64-UInt(immh:immb))` when `immh = 01xx`

See [Advanced SIMD modified immediate on page C4-291](#) when `immh = 0000`.

The encoding `immh = 1xxx` is reserved.

Operation for all encodings

```
CheckFPAdvSIMDEnabled64();
bits(datasize*2) operand = V[n];
bits(datasize) result;
integer round_const = if round then (1 << (shift - 1)) else 0;
integer element;
boolean sat;

for e = 0 to elements-1
    element = (Int(Elem[operand, e, 2*esize], unsigned) + round_const) >> shift;
    (Elem[result, e, esize], sat) = SatQ(element, esize, unsigned);
    if sat then FPSR.QC = '1';

Vpart[d, part] = result;
```

C7.2.259 SQRSHRUN, SQRSHRUN2

Signed saturating Rounded Shift Right Unsigned Narrow (immediate). This instruction reads each signed integer value in the vector of the source SIMD&FP register, right shifts each value by an immediate value, saturates the result to an unsigned integer value that is half the original width, places the final result into a vector, and writes the vector to the destination SIMD&FP register. The results are rounded. For truncated results, see [SQSHRUN](#), [SQSHRUN2](#).

The SQRSHRUN instruction writes the vector to the lower half of the destination register and clears the upper half, while the SQRSHRUN2 instruction writes the vector to the upper half of the destination register without affecting the other bits of the register.

If saturation occurs, the cumulative saturation bit [FPSR.QC](#) is set.

Depending on the settings in the [CPACR_EL1](#), [CPTR_EL2](#), and [CPTR_EL3](#) registers, and the current Security state and Exception level, an attempt to execute the instruction might be trapped.

Scalar

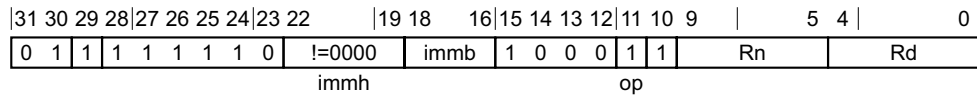

Scalar variant

SQRSHRUN <Vb><d>, <Va><n>, #<shift>

Decode for this encoding

```
integer d = UInt(Rd);
integer n = UInt(Rn);

if immh == '0000' then ReservedValue();
if immh<3> == '1' then ReservedValue();
integer esize = 8 << HighestSetBit(immh);
integer datasize = esize;
integer elements = 1;
integer part = 0;

integer shift = (2 * esize) - UInt(immh:immb);
boolean round = (op == '1');
```

Vector

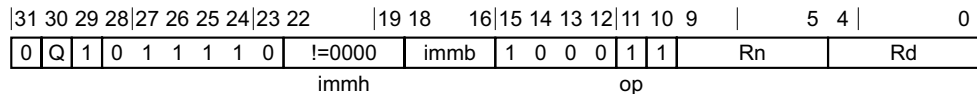

Vector variant

SQRSHRUN{2} <Vd>.<Tb>, <Vn>.<Ta>, #<shift>

Decode for this encoding

```
integer d = UInt(Rd);
integer n = UInt(Rn);

if immh == '0000' then SEE "Advanced SIMD modified immediate";
if immh<3> == '1' then ReservedValue();
integer esize = 8 << HighestSetBit(immh);
integer datasize = 64;
```

```
integer part = UInt(Q);  
integer elements = datasize DIV esize;  
  
integer shift = (2 * esize) - UInt(immh:immb);  
boolean round = (op == '1');
```

Assembler symbols

- 2 Is the second and upper half specifier. If present it causes the operation to be performed on the upper 64 bits of the registers holding the narrower elements, and is encoded in the "Q" field. It can have the following values:
- | | |
|-----------|------------|
| [absent] | when Q = 0 |
| [present] | when Q = 1 |
- <Vd> Is the name of the SIMD&FP destination register, encoded in the "Rd" field.
- <Tb> Is an arrangement specifier, encoded in the "immh:Q" field. It can have the following values:
- | | |
|-----|-------------------------|
| 8B | when immh = 0001, Q = 0 |
| 16B | when immh = 0001, Q = 1 |
| 4H | when immh = 001x, Q = 0 |
| 8H | when immh = 001x, Q = 1 |
| 2S | when immh = 01xx, Q = 0 |
| 4S | when immh = 01xx, Q = 1 |
- See [Advanced SIMD modified immediate on page C4-291](#) when immh = 0000, Q = x.
The encoding immh = 1xxx, Q = x is reserved.
- <Vn> Is the name of the SIMD&FP source register, encoded in the "Rn" field.
- <Ta> Is an arrangement specifier, encoded in the "immh" field. It can have the following values:
- | | |
|----|------------------|
| 8H | when immh = 0001 |
| 4S | when immh = 001x |
| 2D | when immh = 01xx |
- See [Advanced SIMD modified immediate on page C4-291](#) when immh = 0000.
The encoding immh = 1xxx is reserved.
- <Vb> Is the destination width specifier, encoded in the "immh" field. It can have the following values:
- | | |
|---|------------------|
| B | when immh = 0001 |
| H | when immh = 001x |
| S | when immh = 01xx |
- The following encodings are reserved:
- immh = 0000.
 - immh = 1xxx.
- <d> Is the number of the SIMD&FP destination register, in the "Rd" field.
- <Va> Is the source width specifier, encoded in the "immh" field. It can have the following values:
- | | |
|---|------------------|
| H | when immh = 0001 |
| S | when immh = 001x |
| D | when immh = 01xx |
- The following encodings are reserved:
- immh = 0000.
 - immh = 1xxx.

<n> Is the number of the first SIMD&FP source register, encoded in the "Rn" field.

<shift> For the scalar variant: is the right shift amount, in the range 1 to the destination operand width in bits, encoded in the "immh:immb" field. It can have the following values:

(16-UInt(immh:immb)) when immh = 0001
(32-UInt(immh:immb)) when immh = 001x
(64-UInt(immh:immb)) when immh = 01xx

The following encodings are reserved:

- immh = 0000.
- immh = 1xxx.

For the vector variant: is the right shift amount, in the range 1 to the destination element width in bits, encoded in the "immh:immb" field. It can have the following values:

(16-UInt(immh:immb)) when immh = 0001
(32-UInt(immh:immb)) when immh = 001x
(64-UInt(immh:immb)) when immh = 01xx

See [Advanced SIMD modified immediate on page C4-291](#) when immh = 0000.

The encoding immh = 1xxx is reserved.

Operation for all encodings

```
CheckFPAdvSIMDEnabled64();
bits(datasize*2) operand = V[n];
bits(datasize) result;
integer round_const = if round then (1 << (shift - 1)) else 0;
integer element;
boolean sat;

for e = 0 to elements-1
    element = (SInt(Elem[operand, e, 2*esize]) + round_const) >> shift;
    (Elem[result, e, esize], sat) = UnsignedSatQ(element, esize);
    if sat then FPSR.QC = '1';

Vpart[d, part] = result;
```

C7.2.260 SQSHL (immediate)

Signed saturating Shift Left (immediate). This instruction reads each vector element in the source SIMD&FP register, shifts each result by an immediate value, places the final result in a vector, and writes the vector to the destination SIMD&FP register. The results are truncated. For rounded results, see [UQRSHL](#).

If overflow occurs with any of the results, those results are saturated. If saturation occurs, the cumulative saturation bit [FPSR.QC](#) is set.

Depending on the settings in the [CPACR_EL1](#), [CPTR_EL2](#), and [CPTR_EL3](#) registers, and the current Security state and Exception level, an attempt to execute the instruction might be trapped.

Scalar

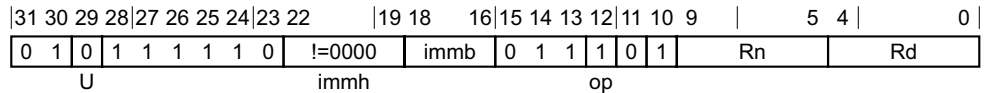

Scalar variant

SQSHL <V><d>, <V><n>, #<shift>

Decode for this encoding

```
integer d = UInt(Rd);
integer n = UInt(Rn);

if immh == '0000' then ReservedValue();
integer esize = 8 << HighestSetBit(immh);
integer datasize = esize;
integer elements = 1;

integer shift = UInt(immh:immb) - esize;

boolean src_unsigned;
boolean dst_unsigned;
case op:U of
    when '00' UnallocatedEncoding();
    when '01' src_unsigned = FALSE; dst_unsigned = TRUE;
    when '10' src_unsigned = FALSE; dst_unsigned = FALSE;
    when '11' src_unsigned = TRUE; dst_unsigned = TRUE;
```

Vector

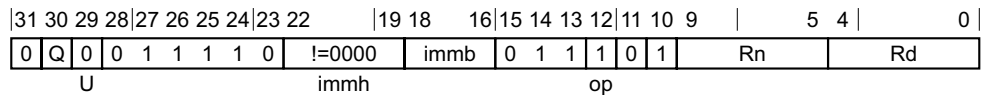

Vector variant

SQSHL <Vd>.<T>, <Vn>.<T>, #<shift>

Decode for this encoding

```
integer d = UInt(Rd);
integer n = UInt(Rn);

if immh == '0000' then SEE "Advanced SIMD modified immediate";
if immh<3>:Q == '10' then ReservedValue();
integer esize = 8 << HighestSetBit(immh);
integer datasize = if Q == '1' then 128 else 64;
```

```
integer elements = datasize DIV esize;

integer shift = UInt(immh:immb) - esize;

boolean src_unsigned;
boolean dst_unsigned;
case op:U of
  when '00' UnallocatedEncoding();
  when '01' src_unsigned = FALSE; dst_unsigned = TRUE;
  when '10' src_unsigned = FALSE; dst_unsigned = FALSE;
  when '11' src_unsigned = TRUE; dst_unsigned = TRUE;
```

Assembler symbols

- <V> Is a width specifier, encoded in the "immh" field. It can have the following values:
- | | |
|---|------------------|
| B | when immh = 0001 |
| H | when immh = 001x |
| S | when immh = 01xx |
| D | when immh = 1xxx |
- The encoding immh = 0000 is reserved.
- <d> Is the number of the SIMD&FP destination register, in the "Rd" field.
- <n> Is the number of the first SIMD&FP source register, encoded in the "Rn" field.
- <Vd> Is the name of the SIMD&FP destination register, encoded in the "Rd" field.
- <T> Is an arrangement specifier, encoded in the "immh:Q" field. It can have the following values:
- | | |
|-----|-------------------------|
| 8B | when immh = 0001, Q = 0 |
| 16B | when immh = 0001, Q = 1 |
| 4H | when immh = 001x, Q = 0 |
| 8H | when immh = 001x, Q = 1 |
| 2S | when immh = 01xx, Q = 0 |
| 4S | when immh = 01xx, Q = 1 |
| 2D | when immh = 1xxx, Q = 1 |
- See [Advanced SIMD modified immediate on page C4-291](#) when immh = 0000, Q = x.
- The encoding immh = 1xxx, Q = 0 is reserved.
- <Vn> Is the name of the SIMD&FP source register, encoded in the "Rn" field.
- <shift> For the scalar variant: is the left shift amount, in the range 0 to the operand width in bits minus 1, encoded in the "immh:immb" field. It can have the following values:
- | | |
|----------------------|------------------|
| (UInt(immh:immb)-8) | when immh = 0001 |
| (UInt(immh:immb)-16) | when immh = 001x |
| (UInt(immh:immb)-32) | when immh = 01xx |
| (UInt(immh:immb)-64) | when immh = 1xxx |
- The encoding immh = 0000 is reserved.
- For the vector variant: is the left shift amount, in the range 0 to the element width in bits minus 1, encoded in the "immh:immb" field. It can have the following values:
- | | |
|----------------------|------------------|
| (UInt(immh:immb)-8) | when immh = 0001 |
| (UInt(immh:immb)-16) | when immh = 001x |
| (UInt(immh:immb)-32) | when immh = 01xx |
| (UInt(immh:immb)-64) | when immh = 1xxx |

See [Advanced SIMD modified immediate on page C4-291](#) when immh = 0000.

Operation for all encodings

```
CheckFPAdvSIMDEnabled64();
bits(datasize) operand = V[n];
bits(datasize) result;
integer element;
boolean sat;

for e = 0 to elements-1
    element = Int(Elem[operand, e, esize], src_unsigned) << shift;
    (Elem[result, e, esize], sat) = SatQ(element, esize, dst_unsigned);
    if sat then FPSR.QC = '1';

V[d] = result;
```

C7.2.261 SQSHL (register)

Signed saturating Shift Left (register). This instruction takes each element in the vector of the first source SIMD&FP register, shifts each element by a value from the least significant byte of the corresponding element of the second source SIMD&FP register, places the results in a vector, and writes the vector to the destination SIMD&FP register.

If the shift value is positive, the operation is a left shift. Otherwise, it is a right shift. The results are truncated. For rounded results, see [SQRSHL](#).

If overflow occurs with any of the results, those results are saturated. If saturation occurs, the cumulative saturation bit [FPSR.QC](#) is set.

Depending on the settings in the [CPACR_EL1](#), [CPTR_EL2](#), and [CPTR_EL3](#) registers, and the current Security state and Exception level, an attempt to execute the instruction might be trapped.

Scalar

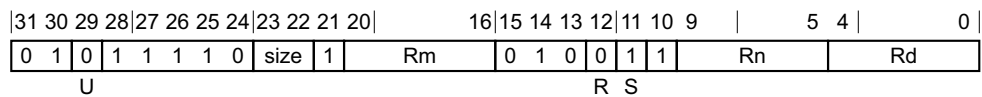

Scalar variant

SQSHL <V><d>, <V><n>, <V><m>

Decode for this encoding

```
integer d = UInt(Rd);
integer n = UInt(Rn);
integer m = UInt(Rm);
integer esize = 8 << UInt(size);
integer datasize = esize;
integer elements = 1;
boolean unsigned = (U == '1');
boolean rounding = (R == '1');
boolean saturating = (S == '1');
if S == '0' && size != '11' then ReservedValue();
```

Vector

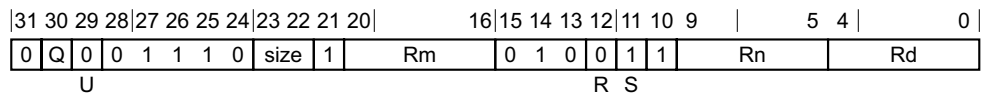

Vector variant

SQSHL <Vd>.<T>, <Vn>.<T>, <Vm>.<T>

Decode for this encoding

```
integer d = UInt(Rd);
integer n = UInt(Rn);
integer m = UInt(Rm);
if size:Q == '110' then ReservedValue();
integer esize = 8 << UInt(size);
integer datasize = if Q == '1' then 128 else 64;
integer elements = datasize DIV esize;
boolean unsigned = (U == '1');
boolean rounding = (R == '1');
boolean saturating = (S == '1');
```

Assembler symbols

<V>	Is a width specifier, encoded in the "size" field. It can have the following values:
B	when size = 00
H	when size = 01
S	when size = 10
D	when size = 11
<d>	Is the number of the SIMD&FP destination register, in the "Rd" field.
<n>	Is the number of the first SIMD&FP source register, encoded in the "Rn" field.
<m>	Is the number of the second SIMD&FP source register, encoded in the "Rm" field.
<Vd>	Is the name of the SIMD&FP destination register, encoded in the "Rd" field.
<T>	Is an arrangement specifier, encoded in the "size:Q" field. It can have the following values:
8B	when size = 00, Q = 0
16B	when size = 00, Q = 1
4H	when size = 01, Q = 0
8H	when size = 01, Q = 1
2S	when size = 10, Q = 0
4S	when size = 10, Q = 1
2D	when size = 11, Q = 1
	The encoding size = 11, Q = 0 is reserved.
<Vn>	Is the name of the first SIMD&FP source register, encoded in the "Rn" field.
<Vm>	Is the name of the second SIMD&FP source register, encoded in the "Rm" field.

Operation for all encodings

```

CheckFPAdvSIMDEnabled64();
bits(datasize) operand1 = V[n];
bits(datasize) operand2 = V[m];
bits(datasize) result;

integer round_const = 0;
integer shift;
integer element;
boolean sat;

for e = 0 to elements-1
  shift = SInt(Elem[operand2, e, esize]<7:0>);
  if rounding then
    round_const = 1 << (-shift - 1); // 0 for left shift, 2^(n-1) for right shift
  element = (Int(Elem[operand1, e, esize], unsigned) + round_const) << shift;
  if saturating then
    (Elem[result, e, esize], sat) = SatQ(element, esize, unsigned);
    if sat then FPSR.QC = '1';
  else
    Elem[result, e, esize] = element<esize-1:0>;

V[d] = result;

```

C7.2.262 SQSHLU

Signed saturating Shift Left Unsigned (immediate). This instruction reads each signed integer value in the vector of the source SIMD&FP register, shifts each value by an immediate value, saturates the shifted result to an unsigned integer value, places the result in a vector, and writes the vector to the destination SIMD&FP register. The results are truncated. For rounded results, see [UQRSHL](#).

If saturation occurs, the cumulative saturation bit [FPSR.QC](#) is set.

Depending on the settings in the [CPACR_EL1](#), [CPTR_EL2](#), and [CPTR_EL3](#) registers, and the current Security state and Exception level, an attempt to execute the instruction might be trapped.

Scalar

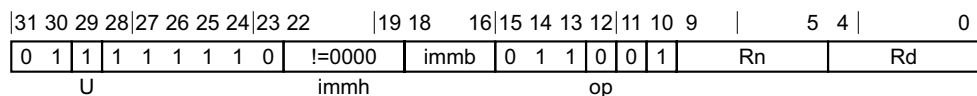

Scalar variant

SQSHLU <V><d>, <V><n>, #<shift>

Decode for this encoding

```
integer d = UInt(Rd);
integer n = UInt(Rn);

if immh == '0000' then ReservedValue();
integer esize = 8 << HighestSetBit(immh);
integer datasize = esize;
integer elements = 1;

integer shift = UInt(immh:immb) - esize;

boolean src_unsigned;
boolean dst_unsigned;
case op:U of
    when '00' UnallocatedEncoding();
    when '01' src_unsigned = FALSE; dst_unsigned = TRUE;
    when '10' src_unsigned = FALSE; dst_unsigned = FALSE;
    when '11' src_unsigned = TRUE; dst_unsigned = TRUE;
```

Vector

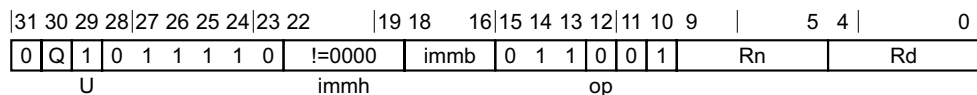

Vector variant

SQSHLU <Vd>.<T>, <Vn>.<T>, #<shift>

Decode for this encoding

```
integer d = UInt(Rd);
integer n = UInt(Rn);

if immh == '0000' then SEE "Advanced SIMD modified immediate";
if immh<3>:Q == '10' then ReservedValue();
integer esize = 8 << HighestSetBit(immh);
integer datasize = if Q == '1' then 128 else 64;
```

```
integer elements = datasize DIV esize;

integer shift = UInt(immh:immb) - esize;

boolean src_unsigned;
boolean dst_unsigned;
case op:U of
  when '00' UnallocatedEncoding();
  when '01' src_unsigned = FALSE; dst_unsigned = TRUE;
  when '10' src_unsigned = FALSE; dst_unsigned = FALSE;
  when '11' src_unsigned = TRUE; dst_unsigned = TRUE;
```

Assembler symbols

- <V> Is a width specifier, encoded in the "immh" field. It can have the following values:
- | | |
|---|------------------|
| B | when immh = 0001 |
| H | when immh = 001x |
| S | when immh = 01xx |
| D | when immh = 1xxx |
- The encoding immh = 0000 is reserved.
- <d> Is the number of the SIMD&FP destination register, in the "Rd" field.
- <n> Is the number of the first SIMD&FP source register, encoded in the "Rn" field.
- <Vd> Is the name of the SIMD&FP destination register, encoded in the "Rd" field.
- <T> Is an arrangement specifier, encoded in the "immh:Q" field. It can have the following values:
- | | |
|-----|-------------------------|
| 8B | when immh = 0001, Q = 0 |
| 16B | when immh = 0001, Q = 1 |
| 4H | when immh = 001x, Q = 0 |
| 8H | when immh = 001x, Q = 1 |
| 2S | when immh = 01xx, Q = 0 |
| 4S | when immh = 01xx, Q = 1 |
| 2D | when immh = 1xxx, Q = 1 |
- See [Advanced SIMD modified immediate on page C4-291](#) when immh = 0000, Q = x.
- The encoding immh = 1xxx, Q = 0 is reserved.
- <Vn> Is the name of the SIMD&FP source register, encoded in the "Rn" field.
- <shift> For the scalar variant: is the left shift amount, in the range 0 to the operand width in bits minus 1, encoded in the "immh:immb" field. It can have the following values:
- | | |
|----------------------|------------------|
| (UInt(immh:immb)-8) | when immh = 0001 |
| (UInt(immh:immb)-16) | when immh = 001x |
| (UInt(immh:immb)-32) | when immh = 01xx |
| (UInt(immh:immb)-64) | when immh = 1xxx |
- The encoding immh = 0000 is reserved.
- For the vector variant: is the left shift amount, in the range 0 to the element width in bits minus 1, encoded in the "immh:immb" field. It can have the following values:
- | | |
|----------------------|------------------|
| (UInt(immh:immb)-8) | when immh = 0001 |
| (UInt(immh:immb)-16) | when immh = 001x |
| (UInt(immh:immb)-32) | when immh = 01xx |
| (UInt(immh:immb)-64) | when immh = 1xxx |

See [Advanced SIMD modified immediate on page C4-291](#) when immh = 0000.

Operation for all encodings

```
CheckFPAdvSIMDEnabled64();
bits(datasize) operand = V[n];
bits(datasize) result;
integer element;
boolean sat;

for e = 0 to elements-1
    element = Int(Elem[operand, e, esize], src_unsigned) << shift;
    (Elem[result, e, esize], sat) = SatQ(element, esize, dst_unsigned);
    if sat then FPSR.QC = '1';

V[d] = result;
```

C7.2.263 SQSHRN, SQSHRN2

Signed saturating Shift Right Narrow (immediate). This instruction reads each vector element in the source SIMD&FP register, right shifts and truncates each result by an immediate value, saturates each shifted result to a value that is half the original width, puts the final result into a vector, and writes the vector to the lower or upper half of the destination SIMD&FP register. All the values in this instruction are signed integer values. The destination vector elements are half as long as the source vector elements. For rounded results, see [SQRSHRN](#), [SQRSHRN2](#).

The SQSHRN instruction writes the vector to the lower half of the destination register and clears the upper half, while the SQSHRN2 instruction writes the vector to the upper half of the destination register without affecting the other bits of the register.

If saturation occurs, the cumulative saturation bit [FPSR.QC](#) is set.

Depending on the settings in the [CPACR_EL1](#), [CPTR_EL2](#), and [CPTR_EL3](#) registers, and the current Security state and Exception level, an attempt to execute the instruction might be trapped.

Scalar

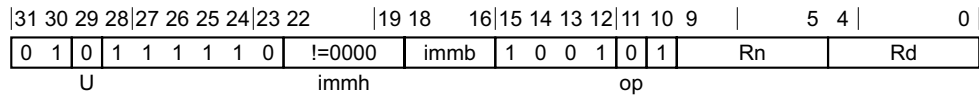

Scalar variant

SQSHRN <Vb><d>, <Va><n>, #<shift>

Decode for this encoding

```
integer d = UInt(Rd);
integer n = UInt(Rn);

if immh == '0000' then ReservedValue();
if immh<3> == '1' then ReservedValue();
integer esize = 8 << HighestSetBit(immh);
integer datasize = esize;
integer elements = 1;
integer part = 0;

integer shift = (2 * esize) - UInt(immh:immb);
boolean round = (op == '1');
boolean unsigned = (U == '1');
```

Vector

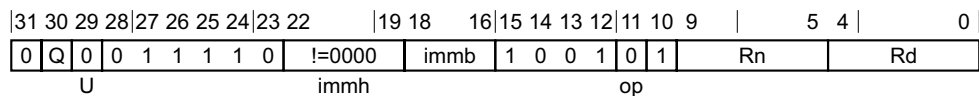

Vector variant

SQSHRN{2} <Vd>.<Tb>, <Vn>.<Ta>, #<shift>

Decode for this encoding

```
integer d = UInt(Rd);
integer n = UInt(Rn);

if immh == '0000' then SEE "Advanced SIMD modified immediate";
if immh<3> == '1' then ReservedValue();
integer esize = 8 << HighestSetBit(immh);
```

```
integer datasize = 64;  
integer part = UInt(Q);  
integer elements = datasize DIV esize;  
  
integer shift = (2 * esize) - UInt(immh:immb);  
boolean round = (op == '1');  
boolean unsigned = (U == '1');
```

Assembler symbols

2 Is the second and upper half specifier. If present it causes the operation to be performed on the upper 64 bits of the registers holding the narrower elements, and is encoded in the "Q" field. It can have the following values:

[absent] when Q = 0
[present] when Q = 1

<Vd> Is the name of the SIMD&FP destination register, encoded in the "Rd" field.

<Tb> Is an arrangement specifier, encoded in the "immh:Q" field. It can have the following values:

8B when immh = 0001, Q = 0
16B when immh = 0001, Q = 1
4H when immh = 001x, Q = 0
8H when immh = 001x, Q = 1
2S when immh = 01xx, Q = 0
4S when immh = 01xx, Q = 1

See [Advanced SIMD modified immediate on page C4-291](#) when immh = 0000, Q = x.

The encoding immh = 1xxx, Q = x is reserved.

<Vn> Is the name of the SIMD&FP source register, encoded in the "Rn" field.

<Ta> Is an arrangement specifier, encoded in the "immh" field. It can have the following values:

8H when immh = 0001
4S when immh = 001x
2D when immh = 01xx

See [Advanced SIMD modified immediate on page C4-291](#) when immh = 0000.

The encoding immh = 1xxx is reserved.

<Vb> Is the destination width specifier, encoded in the "immh" field. It can have the following values:

B when immh = 0001
H when immh = 001x
S when immh = 01xx

The following encodings are reserved:

- immh = 0000.
- immh = 1xxx.

<d> Is the number of the SIMD&FP destination register, in the "Rd" field.

<Va> Is the source width specifier, encoded in the "immh" field. It can have the following values:

H when immh = 0001
S when immh = 001x
D when immh = 01xx

The following encodings are reserved:

- `immh = 0000`.
- `immh = 1xxx`.

<n> Is the number of the first SIMD&FP source register, encoded in the "Rn" field.

<shift> For the scalar variant: is the right shift amount, in the range 1 to the destination operand width in bits, encoded in the "immh:immb" field. It can have the following values:

(16-UInt(immh:immb)) when `immh = 0001`

(32-UInt(immh:immb)) when `immh = 001x`

(64-UInt(immh:immb)) when `immh = 01xx`

The following encodings are reserved:

- `immh = 0000`.
- `immh = 1xxx`.

For the vector variant: is the right shift amount, in the range 1 to the destination element width in bits, encoded in the "immh:immb" field. It can have the following values:

(16-UInt(immh:immb)) when `immh = 0001`

(32-UInt(immh:immb)) when `immh = 001x`

(64-UInt(immh:immb)) when `immh = 01xx`

See [Advanced SIMD modified immediate on page C4-291](#) when `immh = 0000`.

The encoding `immh = 1xxx` is reserved.

Operation for all encodings

```
CheckFPAdvSIMDEnabled64();
bits(datasize*2) operand = V[n];
bits(datasize) result;
integer round_const = if round then (1 << (shift - 1)) else 0;
integer element;
boolean sat;

for e = 0 to elements-1
    element = (Int(Elem[operand, e, 2*esize], unsigned) + round_const) >> shift;
    (Elem[result, e, esize], sat) = SatQ(element, esize, unsigned);
    if sat then FPSR.QC = '1';

Vpart[d, part] = result;
```

C7.2.264 SQSHRUN, SQSHRUN2

Signed saturating Shift Right Unsigned Narrow (immediate). This instruction reads each signed integer value in the vector of the source SIMD&FP register, right shifts each value by an immediate value, saturates the result to an unsigned integer value that is half the original width, places the final result into a vector, and writes the vector to the destination SIMD&FP register. The results are truncated. For rounded results, see [SQRSHRUN](#), [SQRSHRUN2](#).

The SQSHRUN instruction writes the vector to the lower half of the destination register and clears the upper half, while the SQSHRUN2 instruction writes the vector to the upper half of the destination register without affecting the other bits of the register.

If saturation occurs, the cumulative saturation bit [FPSR.QC](#) is set.

Depending on the settings in the [CPACR_EL1](#), [CPTR_EL2](#), and [CPTR_EL3](#) registers, and the current Security state and Exception level, an attempt to execute the instruction might be trapped.

Scalar

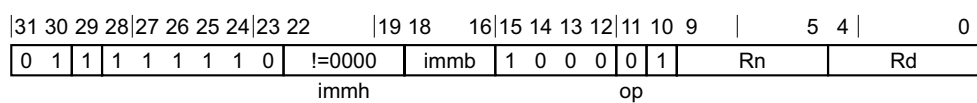

Scalar variant

SQSHRUN <Vb><d>, <Va><n>, #<shift>

Decode for this encoding

```
integer d = UInt(Rd);
integer n = UInt(Rn);

if immh == '0000' then ReservedValue();
if immh<3> == '1' then ReservedValue();
integer esize = 8 << HighestSetBit(immh);
integer datasize = esize;
integer elements = 1;
integer part = 0;

integer shift = (2 * esize) - UInt(immh:immb);
boolean round = (op == '1');
```

Vector

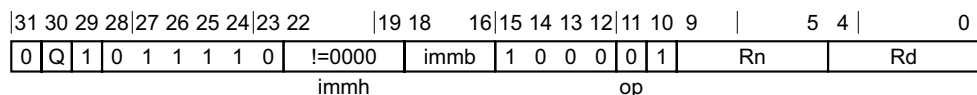

Vector variant

SQSHRUN{2} <Vd>.<Tb>, <Vn>.<Ta>, #<shift>

Decode for this encoding

```
integer d = UInt(Rd);
integer n = UInt(Rn);

if immh == '0000' then SEE "Advanced SIMD modified immediate";
if immh<3> == '1' then ReservedValue();
integer esize = 8 << HighestSetBit(immh);
integer datasize = 64;
integer part = UInt(Q);
```

```
integer elements = datasize DIV esize;  
  
integer shift = (2 * esize) - UInt(immh:immb);  
boolean round = (op == '1');
```

Assembler symbols

2 Is the second and upper half specifier. If present it causes the operation to be performed on the upper 64 bits of the registers holding the narrower elements, and is encoded in the "Q" field. It can have the following values:

[absent] when Q = 0

[present] when Q = 1

<Vd> Is the name of the SIMD&FP destination register, encoded in the "Rd" field.

<Tb> Is an arrangement specifier, encoded in the "immh:Q" field. It can have the following values:

8B when immh = 0001, Q = 0

16B when immh = 0001, Q = 1

4H when immh = 001x, Q = 0

8H when immh = 001x, Q = 1

2S when immh = 01xx, Q = 0

4S when immh = 01xx, Q = 1

See [Advanced SIMD modified immediate on page C4-291](#) when immh = 0000, Q = x.

The encoding immh = 1xxx, Q = x is reserved.

<Vn> Is the name of the SIMD&FP source register, encoded in the "Rn" field.

<Ta> Is an arrangement specifier, encoded in the "immh" field. It can have the following values:

8H when immh = 0001

4S when immh = 001x

2D when immh = 01xx

See [Advanced SIMD modified immediate on page C4-291](#) when immh = 0000.

The encoding immh = 1xxx is reserved.

<Vb> Is the destination width specifier, encoded in the "immh" field. It can have the following values:

B when immh = 0001

H when immh = 001x

S when immh = 01xx

The following encodings are reserved:

- immh = 0000.

- immh = 1xxx.

<d> Is the number of the SIMD&FP destination register, in the "Rd" field.

<Va> Is the source width specifier, encoded in the "immh" field. It can have the following values:

H when immh = 0001

S when immh = 001x

D when immh = 01xx

The following encodings are reserved:

- immh = 0000.

- immh = 1xxx.

<n> Is the number of the first SIMD&FP source register, encoded in the "Rn" field.

<shift> For the scalar variant: is the right shift amount, in the range 1 to the destination operand width in bits, encoded in the "immh:immb" field. It can have the following values:

(16-UInt(immh:immb)) when immh = 0001
(32-UInt(immh:immb)) when immh = 001x
(64-UInt(immh:immb)) when immh = 01xx

The following encodings are reserved:

- immh = 0000.
- immh = 1xxx.

For the vector variant: is the right shift amount, in the range 1 to the destination element width in bits, encoded in the "immh:immb" field. It can have the following values:

(16-UInt(immh:immb)) when immh = 0001
(32-UInt(immh:immb)) when immh = 001x
(64-UInt(immh:immb)) when immh = 01xx

See [Advanced SIMD modified immediate on page C4-291](#) when immh = 0000.

The encoding immh = 1xxx is reserved.

Operation for all encodings

```
CheckFPAdvSIMDEnabled64();
bits(datasize*2) operand = V[n];
bits(datasize) result;
integer round_const = if round then (1 << (shift - 1)) else 0;
integer element;
boolean sat;

for e = 0 to elements-1
    element = (SInt(Elem[operand, e, 2*esize]) + round_const) >> shift;
    (Elem[result, e, esize], sat) = UnsignedSatQ(element, esize);
    if sat then FPSR.QC = '1';

Vpart[d, part] = result;
```

C7.2.265 SQSUB

Signed saturating Subtract. This instruction subtracts the element values of the second source SIMD&FP register from the corresponding element values of the first source SIMD&FP register, places the results into a vector, and writes the vector to the destination SIMD&FP register.

If overflow occurs with any of the results, those results are saturated. If saturation occurs, the cumulative saturation bit [FPSR.QC](#) is set.

Depending on the settings in the [CPACR_EL1](#), [CPTR_EL2](#), and [CPTR_EL3](#) registers, and the current Security state and Exception level, an attempt to execute the instruction might be trapped.

Scalar

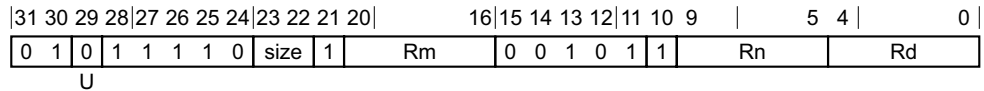

Scalar variant

SQSUB <V><d>, <V><n>, <V><m>

Decode for this encoding

```
integer d = UInt(Rd);
integer n = UInt(Rn);
integer m = UInt(Rm);
integer esize = 8 << UInt(size);
integer datasize = esize;
integer elements = 1;
boolean unsigned = (U == '1');
```

Vector

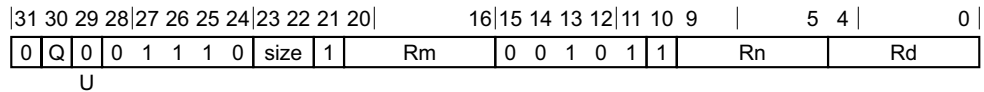

Vector variant

SQSUB <Vd>.<T>, <Vn>.<T>, <Vm>.<T>

Decode for this encoding

```
integer d = UInt(Rd);
integer n = UInt(Rn);
integer m = UInt(Rm);
if size:Q == '110' then ReservedValue();
integer esize = 8 << UInt(size);
integer datasize = if Q == '1' then 128 else 64;
integer elements = datasize DIV esize;
boolean unsigned = (U == '1');
```

Assembler symbols

<V> Is a width specifier, encoded in the "size" field. It can have the following values:

B	when size = 00
H	when size = 01
S	when size = 10

- D when size = 11
- <d> Is the number of the SIMD&FP destination register, in the "Rd" field.
- <n> Is the number of the first SIMD&FP source register, encoded in the "Rn" field.
- <m> Is the number of the second SIMD&FP source register, encoded in the "Rm" field.
- <Vd> Is the name of the SIMD&FP destination register, encoded in the "Rd" field.
- <T> Is an arrangement specifier, encoded in the "size:Q" field. It can have the following values:
- 8B when size = 00, Q = 0
- 16B when size = 00, Q = 1
- 4H when size = 01, Q = 0
- 8H when size = 01, Q = 1
- 2S when size = 10, Q = 0
- 4S when size = 10, Q = 1
- 2D when size = 11, Q = 1
- The encoding size = 11, Q = 0 is reserved.
- <Vn> Is the name of the first SIMD&FP source register, encoded in the "Rn" field.
- <Vm> Is the name of the second SIMD&FP source register, encoded in the "Rm" field.

Operation for all encodings

```

CheckFPAdvSIMDEnabled64();
bits(datasize) operand1 = V[n];
bits(datasize) operand2 = V[m];
bits(datasize) result;
integer element1;
integer element2;
integer diff;
boolean sat;

for e = 0 to elements-1
  element1 = Int(Elem[operand1, e, esize], unsigned);
  element2 = Int(Elem[operand2, e, esize], unsigned);
  diff = element1 - element2;
  (Elem[result, e, esize], sat) = SatQ(diff, esize, unsigned);
  if sat then FPSR.QC = '1';

V[d] = result;

```

C7.2.266 SQXTN, SQXTN2

Signed saturating extract Narrow. This instruction reads each vector element from the source SIMD&FP register, saturates the value to half the original width, places the result into a vector, and writes the vector to the lower or upper half of the destination SIMD&FP register. The destination vector elements are half as long as the source vector elements. All the values in this instruction are signed integer values.

If overflow occurs with any of the results, those results are saturated. If saturation occurs, the cumulative saturation bit [FPSR.QC](#) is set.

The SQXTN instruction writes the vector to the lower half of the destination register and clears the upper half, while the SQXTN2 instruction writes the vector to the upper half of the destination register without affecting the other bits of the register.

Depending on the settings in the [CPACR_EL1](#), [CPTR_EL2](#), and [CPTR_EL3](#) registers, and the current Security state and Exception level, an attempt to execute the instruction might be trapped.

Scalar

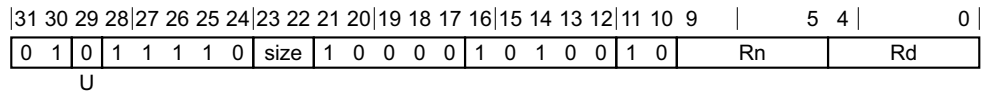

Scalar variant

SQXTN <Vb><d>, <Va><n>

Decode for this encoding

```
integer d = UInt(Rd);
integer n = UInt(Rn);

if size == '11' then ReservedValue();
integer esize = 8 << UInt(size);
integer datasize = esize;
integer part = 0;
integer elements = 1;

boolean unsigned = (U == '1');
```

Vector

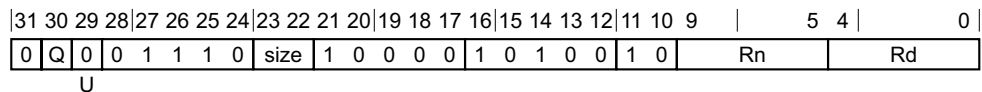

Vector variant

SQXTN{2} <Vd>.<Tb>, <Vn>.<Ta>

Decode for this encoding

```
integer d = UInt(Rd);
integer n = UInt(Rn);

if size == '11' then ReservedValue();
integer esize = 8 << UInt(size);
integer datasize = 64;
integer part = UInt(Q);
```

integer elements = datasize DIV esize;

boolean unsigned = (U == '1');

Assembler symbols

2 Is the second and upper half specifier. If present it causes the operation to be performed on the upper 64 bits of the registers holding the narrower elements, and is encoded in the "Q" field. It can have the following values:

[absent] when Q = 0

[present] when Q = 1

<Vd> Is the name of the SIMD&FP destination register, encoded in the "Rd" field.

<Tb> Is an arrangement specifier, encoded in the "size:Q" field. It can have the following values:

8B when size = 00, Q = 0

16B when size = 00, Q = 1

4H when size = 01, Q = 0

8H when size = 01, Q = 1

2S when size = 10, Q = 0

4S when size = 10, Q = 1

The encoding size = 11, Q = x is reserved.

<Vn> Is the name of the SIMD&FP source register, encoded in the "Rn" field.

<Ta> Is an arrangement specifier, encoded in the "size" field. It can have the following values:

8H when size = 00

4S when size = 01

2D when size = 10

The encoding size = 11 is reserved.

<Vb> Is the destination width specifier, encoded in the "size" field. It can have the following values:

B when size = 00

H when size = 01

S when size = 10

The encoding size = 11 is reserved.

<d> Is the number of the SIMD&FP destination register, encoded in the "Rd" field.

<Va> Is the source width specifier, encoded in the "size" field. It can have the following values:

H when size = 00

S when size = 01

D when size = 10

The encoding size = 11 is reserved.

<n> Is the number of the SIMD&FP source register, encoded in the "Rn" field.

Operation for all encodings

```
CheckFPAdvSIMDEnabled64();
bits(2*datasize) operand = V[n];
bits(datasize) result;
bits(2*esize) element;
boolean sat;
```

```
for e = 0 to elements-1
  element = Elem[operand, e, 2*esize];
  (Elem[result, e, esize], sat) = SatQ(Int(element, unsigned), esize, unsigned);
  if sat then FPSR.QC = '1';

Vpart[d, part] = result;
```

C7.2.267 SQXTUN, SQXTUN2

Signed saturating extract Unsigned Narrow. This instruction reads each signed integer value in the vector of the source SIMD&FP register, saturates the value to an unsigned integer value that is half the original width, places the result into a vector, and writes the vector to the lower or upper half of the destination SIMD&FP register. The destination vector elements are half as long as the source vector elements.

If saturation occurs, the cumulative saturation bit [FPSR.QC](#) is set.

The SQXTUN instruction writes the vector to the lower half of the destination register and clears the upper half, while the SQXTUN2 instruction writes the vector to the upper half of the destination register without affecting the other bits of the register.

Depending on the settings in the [CPACR_EL1](#), [CPTR_EL2](#), and [CPTR_EL3](#) registers, and the current Security state and Exception level, an attempt to execute the instruction might be trapped.

Scalar

31	30	29	28	27	26	25	24	23	22	21	20	19	18	17	16	15	14	13	12	11	10	9				5	4				0
0	1	1	1	1	1	1	0	size	1	0	0	0	0	1	0	0	1	0	1	0				Rn						Rd	

Scalar variant

SQXTUN <Vb><d>, <Va><n>

Decode for this encoding

```
integer d = UInt(Rd);
integer n = UInt(Rn);

if size == '11' then ReservedValue();
integer esize = 8 << UInt(size);
integer datasize = esize;
integer part = 0;
integer elements = 1;
```

Vector

31	30	29	28	27	26	25	24	23	22	21	20	19	18	17	16	15	14	13	12	11	10	9				5	4				0
0	Q	1	0	1	1	1	0	size	1	0	0	0	0	1	0	0	1	0	1	0				Rn						Rd	

Vector variant

SQXTUN{2} <Vd>.<Tb>, <Vn>.<Ta>

Decode for this encoding

```
integer d = UInt(Rd);
integer n = UInt(Rn);

if size == '11' then ReservedValue();
integer esize = 8 << UInt(size);
integer datasize = 64;
integer part = UInt(Q);
integer elements = datasize DIV esize;
```

Assembler symbols

- 2 Is the second and upper half specifier. If present it causes the operation to be performed on the upper 64 bits of the registers holding the narrower elements, and is encoded in the "Q" field. It can have the following values:
- [absent] when Q = 0
 - [present] when Q = 1
- <Vd> Is the name of the SIMD&FP destination register, encoded in the "Rd" field.
- <Tb> Is an arrangement specifier, encoded in the "size:Q" field. It can have the following values:
- 8B when size = 00, Q = 0
 - 16B when size = 00, Q = 1
 - 4H when size = 01, Q = 0
 - 8H when size = 01, Q = 1
 - 2S when size = 10, Q = 0
 - 4S when size = 10, Q = 1
- The encoding size = 11, Q = x is reserved.
- <Vn> Is the name of the SIMD&FP source register, encoded in the "Rn" field.
- <Ta> Is an arrangement specifier, encoded in the "size" field. It can have the following values:
- 8H when size = 00
 - 4S when size = 01
 - 2D when size = 10
- The encoding size = 11 is reserved.
- <Vb> Is the destination width specifier, encoded in the "size" field. It can have the following values:
- B when size = 00
 - H when size = 01
 - S when size = 10
- The encoding size = 11 is reserved.
- <d> Is the number of the SIMD&FP destination register, encoded in the "Rd" field.
- <Va> Is the source width specifier, encoded in the "size" field. It can have the following values:
- H when size = 00
 - S when size = 01
 - D when size = 10
- The encoding size = 11 is reserved.
- <n> Is the number of the SIMD&FP source register, encoded in the "Rn" field.

Operation for all encodings

```
CheckFPAdvSIMDEnabled64();
bits(2*datasize) operand = V[n];
bits(datasize) result;
bits(2*esize) element;
boolean sat;

for e = 0 to elements-1
    element = Elem[operand, e, 2*esize];
    (Elem[result, e, esize], sat) = UnsignedSatQ(SInt(element), esize);
```

```
if sat then FPSR.QC = '1';  
Vpart[d, part] = result;
```

C7.2.268 SRHADD

Signed Rounding Halving Add. This instruction adds corresponding signed integer values from the two source SIMD&FP registers, shifts each result right one bit, places the results into a vector, and writes the vector to the destination SIMD&FP register.

The results are rounded. For truncated results, see [SHADD](#).

Depending on the settings in the [CPACR_EL1](#), [CPTR_EL2](#), and [CPTR_EL3](#) registers, and the current Security state and Exception level, an attempt to execute the instruction might be trapped.

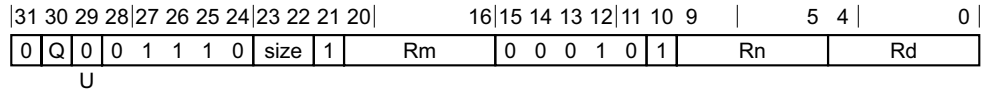

Three registers of the same type variant

SRHADD <Vd>.<T>, <Vn>.<T>, <Vm>.<T>

Decode for this encoding

```
integer d = UInt(Rd);
integer n = UInt(Rn);
integer m = UInt(Rm);
if size == '11' then ReservedValue();
integer esize = 8 << UInt(size);
integer datasize = if Q == '1' then 128 else 64;
integer elements = datasize DIV esize;

boolean unsigned = (U == '1');
```

Assembler symbols

- <Vd> Is the name of the SIMD&FP destination register, encoded in the "Rd" field.
- <T> Is an arrangement specifier, encoded in the "size:Q" field. It can have the following values:
 - 8B when size = 00, Q = 0
 - 16B when size = 00, Q = 1
 - 4H when size = 01, Q = 0
 - 8H when size = 01, Q = 1
 - 2S when size = 10, Q = 0
 - 4S when size = 10, Q = 1
 The encoding size = 11, Q = x is reserved.
- <Vn> Is the name of the first SIMD&FP source register, encoded in the "Rn" field.
- <Vm> Is the name of the second SIMD&FP source register, encoded in the "Rm" field.

Operation

```
CheckFPAdvSIMDEnabled64();
bits(datasize) operand1 = V[n];
bits(datasize) operand2 = V[m];
bits(datasize) result;
integer element1;
integer element2;
```

```
for e = 0 to elements-1
    element1 = Int(Elem[operand1, e, esize], unsigned);
    element2 = Int(Elem[operand2, e, esize], unsigned);
    Elem[result, e, esize] = (element1+element2+1)<esize:1>;

V[d] = result;
```

C7.2.269 SRI

Shift Right and Insert (immediate). This instruction reads each vector element in the source SIMD&FP register, right shifts each vector element by an immediate value, and inserts the result into the corresponding vector element in the destination SIMD&FP register such that the new zero bits created by the shift are not inserted but retain their existing value. Bits shifted out of the right of each vector element of the source register are lost.

The following figure shows the operation of shift right by 3 for an 8-bit vector element.

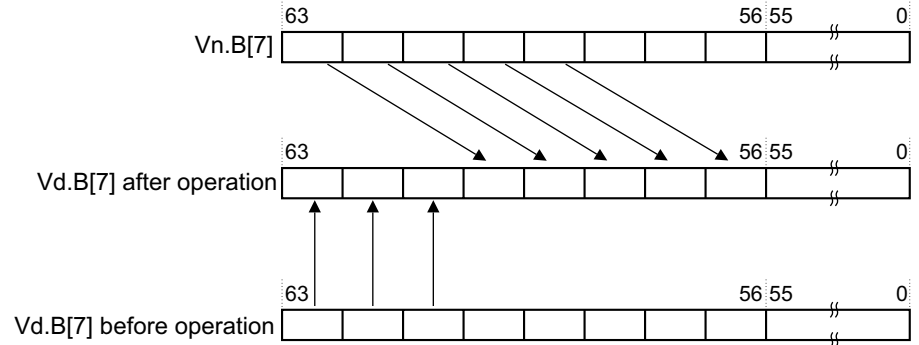

Depending on the settings in the [CPACR_EL1](#), [CPTR_EL2](#), and [CPTR_EL3](#) registers, and the current Security state and Exception level, an attempt to execute the instruction might be trapped.

Scalar

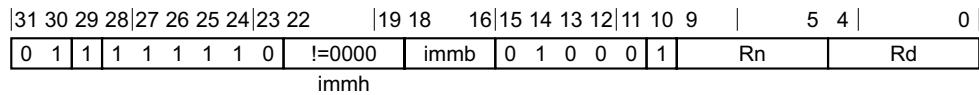

Scalar variant

SRI <V><d>, <V><n>, #<shift>

Decode for this encoding

```
integer d = UInt(Rd);
integer n = UInt(Rn);

if immh<3> != '1' then ReservedValue();
integer esize = 8 << 3;
integer datasize = esize;
integer elements = 1;

integer shift = (esize * 2) - UInt(immh:immb);
```

Vector

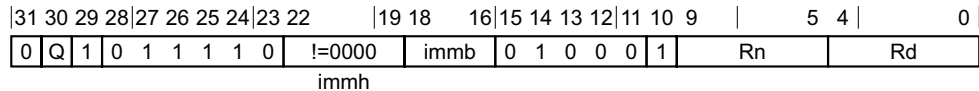

Vector variant

SRI <Vd>.<T>, <Vn>.<T>, #<shift>

Decode for this encoding

```
integer d = UInt(Rd);
integer n = UInt(Rn);

if immh == '0000' then SEE "Advanced SIMD modified immediate";
if immh<3>:Q == '10' then ReservedValue();
integer esize = 8 << HighestSetBit(immh);
integer datasize = if Q == '1' then 128 else 64;
integer elements = datasize DIV esize;

integer shift = (esize * 2) - UInt(immh:immb);
```

Assembler symbols

- <V> Is a width specifier, encoded in the "immh" field. It can have the following values:
- D when immh = 1xxx
- The encoding immh = 0xxx is reserved.
- <d> Is the number of the SIMD&FP destination register, in the "Rd" field.
- <n> Is the number of the first SIMD&FP source register, encoded in the "Rn" field.
- <Vd> Is the name of the SIMD&FP destination register, encoded in the "Rd" field.
- <T> Is an arrangement specifier, encoded in the "immh:Q" field. It can have the following values:
- 8B when immh = 0001, Q = 0
 - 16B when immh = 0001, Q = 1
 - 4H when immh = 001x, Q = 0
 - 8H when immh = 001x, Q = 1
 - 2S when immh = 01xx, Q = 0
 - 4S when immh = 01xx, Q = 1
 - 2D when immh = 1xxx, Q = 1
- See [Advanced SIMD modified immediate on page C4-291](#) when immh = 0000, Q = x.
- The encoding immh = 1xxx, Q = 0 is reserved.
- <Vn> Is the name of the SIMD&FP source register, encoded in the "Rn" field.
- <shift> For the scalar variant: is the right shift amount, in the range 1 to 64, encoded in the "immh:immb" field. It can have the following values:
- (128-UInt(immh:immb)) when immh = 1xxx
- The encoding immh = 0xxx is reserved.
- For the vector variant: is the right shift amount, in the range 1 to the element width in bits, encoded in the "immh:immb" field. It can have the following values:
- (16-UInt(immh:immb)) when immh = 0001
 - (32-UInt(immh:immb)) when immh = 001x
 - (64-UInt(immh:immb)) when immh = 01xx
 - (128-UInt(immh:immb)) when immh = 1xxx
- See [Advanced SIMD modified immediate on page C4-291](#) when immh = 0000.

Operation for all encodings

```
CheckFPAdvSIMDEnabled64();
bits(datasize) operand = V[n];
bits(datasize) operand2 = V[d];
bits(datasize) result;
```

```
bits(size) mask = LSR(Ones(size), shift);
bits(size) shifted;

for e = 0 to elements-1
    shifted = LSR(Elem[operand, e, esize], shift);
    Elem[result, e, esize] = (Elem[operand2, e, esize] AND NOT(mask)) OR shifted;
V[d] = result;
```



C7.2.270 SRSHL

Signed Rounding Shift Left (register). This instruction takes each signed integer value in the vector of the first source SIMD&FP register, shifts it by a value from the least significant byte of the corresponding element of the second source SIMD&FP register, places the results in a vector, and writes the vector to the destination SIMD&FP register.

If the shift value is positive, the operation is a left shift. If the shift value is negative, it is a rounding right shift. For a truncating shift, see [SSHL](#).

Depending on the settings in the [CPACR_EL1](#), [CPTR_EL2](#), and [CPTR_EL3](#) registers, and the current Security state and Exception level, an attempt to execute the instruction might be trapped.

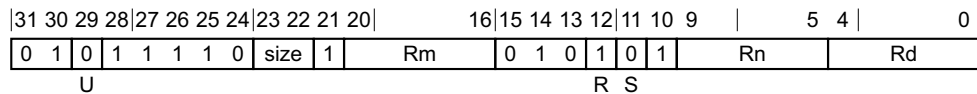
Scalar



Scalar variant

SRSHL <V><d>, <V><n>, <V><m>

Decode for this encoding

```
integer d = UInt(Rd);
integer n = UInt(Rn);
integer m = UInt(Rm);
integer esize = 8 << UInt(size);
integer datasize = esize;
integer elements = 1;
boolean unsigned = (U == '1');
boolean rounding = (R == '1');
boolean saturating = (S == '1');
if S == '0' && size != '11' then ReservedValue();
```

Vector

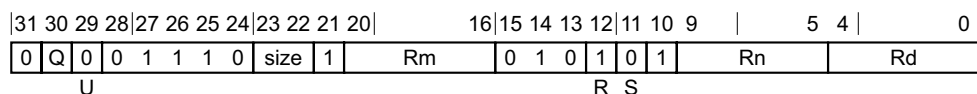

Vector variant

SRSHL <Vd>.<T>, <Vn>.<T>, <Vm>.<T>

Decode for this encoding

```
integer d = UInt(Rd);
integer n = UInt(Rn);
integer m = UInt(Rm);
if size:Q == '110' then ReservedValue();
integer esize = 8 << UInt(size);
integer datasize = if Q == '1' then 128 else 64;
integer elements = datasize DIV esize;
boolean unsigned = (U == '1');
boolean rounding = (R == '1');
boolean saturating = (S == '1');
```

Assembler symbols

- <V> Is a width specifier, encoded in the "size" field. It can have the following values:
- D when size = 11
- The following encodings are reserved:
- size = 0x.
 - size = 10.
- <d> Is the number of the SIMD&FP destination register, in the "Rd" field.
- <n> Is the number of the first SIMD&FP source register, encoded in the "Rn" field.
- <m> Is the number of the second SIMD&FP source register, encoded in the "Rm" field.
- <Vd> Is the name of the SIMD&FP destination register, encoded in the "Rd" field.
- <T> Is an arrangement specifier, encoded in the "size:Q" field. It can have the following values:
- 8B when size = 00, Q = 0
 - 16B when size = 00, Q = 1
 - 4H when size = 01, Q = 0
 - 8H when size = 01, Q = 1
 - 2S when size = 10, Q = 0
 - 4S when size = 10, Q = 1
 - 2D when size = 11, Q = 1
- The encoding size = 11, Q = 0 is reserved.
- <Vn> Is the name of the first SIMD&FP source register, encoded in the "Rn" field.
- <Vm> Is the name of the second SIMD&FP source register, encoded in the "Rm" field.

Operation for all encodings

```
CheckFPAdvSIMDEnabled64();
bits(datasize) operand1 = V[n];
bits(datasize) operand2 = V[m];
bits(datasize) result;

integer round_const = 0;
integer shift;
integer element;
boolean sat;

for e = 0 to elements-1
    shift = SInt(Elem[operand2, e, esize]<7:0>);
    if rounding then
        round_const = 1 << (-shift - 1); // 0 for left shift, 2^(n-1) for right shift
    element = (Int(Elem[operand1, e, esize], unsigned) + round_const) << shift;
    if saturating then
        (Elem[result, e, esize], sat) = SatQ(element, esize, unsigned);
        if sat then FPSR.QC = '1';
    else
        Elem[result, e, esize] = element<esize-1:0>;

V[d] = result;
```

C7.2.271 SRSHR

Signed Rounding Shift Right (immediate). This instruction reads each vector element in the source SIMD&FP register, right shifts each result by an immediate value, places the final result into a vector, and writes the vector to the destination SIMD&FP register. All the values in this instruction are signed integer values. The results are rounded. For truncated results, see [SSHR](#).

Depending on the settings in the [CPACR_EL1](#), [CPTR_EL2](#), and [CPTR_EL3](#) registers, and the current Security state and Exception level, an attempt to execute the instruction might be trapped.

Scalar

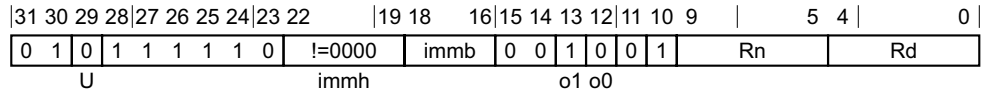

Scalar variant

SRSHR <V><d>, <V><n>, #<shift>

Decode for this encoding

```
integer d = UInt(Rd);
integer n = UInt(Rn);

if immh<3> != '1' then ReservedValue();
integer esize = 8 << 3;
integer datasize = esize;
integer elements = 1;

integer shift = (esize * 2) - UInt(immh:immh);
boolean unsigned = (U == '1');
boolean round = (o1 == '1');
boolean accumulate = (o0 == '1');
```

Vector

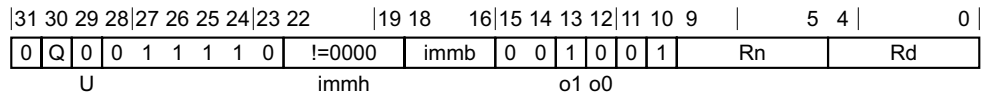

Vector variant

SRSHR <Vd>.<T>, <Vn>.<T>, #<shift>

Decode for this encoding

```
integer d = UInt(Rd);
integer n = UInt(Rn);

if immh == '0000' then SEE "Advanced SIMD modified immediate";
if immh<3>:Q == '10' then ReservedValue();
integer esize = 8 << HighestSetBit(immh);
integer datasize = if Q == '1' then 128 else 64;
integer elements = datasize DIV esize;

integer shift = (esize * 2) - UInt(immh:immh);
boolean unsigned = (U == '1');
boolean round = (o1 == '1');
boolean accumulate = (o0 == '1');
```

Assembler symbols

- <V> Is a width specifier, encoded in the "immh" field. It can have the following values:
 D when immh = 1xxx
 The encoding immh = 0xxx is reserved.
- <d> Is the number of the SIMD&FP destination register, in the "Rd" field.
- <n> Is the number of the first SIMD&FP source register, encoded in the "Rn" field.
- <Vd> Is the name of the SIMD&FP destination register, encoded in the "Rd" field.
- <T> Is an arrangement specifier, encoded in the "immh:Q" field. It can have the following values:
 8B when immh = 0001, Q = 0
 16B when immh = 0001, Q = 1
 4H when immh = 001x, Q = 0
 8H when immh = 001x, Q = 1
 2S when immh = 01xx, Q = 0
 4S when immh = 01xx, Q = 1
 2D when immh = 1xxx, Q = 1
 See [Advanced SIMD modified immediate on page C4-291](#) when immh = 0000, Q = x.
 The encoding immh = 1xxx, Q = 0 is reserved.
- <Vn> Is the name of the SIMD&FP source register, encoded in the "Rn" field.
- <shift> For the scalar variant: is the right shift amount, in the range 1 to 64, encoded in the "immh:immb" field. It can have the following values:
 (128-UInt(immh:immb)) when immh = 1xxx
 The encoding immh = 0xxx is reserved.
 For the vector variant: is the right shift amount, in the range 1 to the element width in bits, encoded in the "immh:immb" field. It can have the following values:
 (16-UInt(immh:immb)) when immh = 0001
 (32-UInt(immh:immb)) when immh = 001x
 (64-UInt(immh:immb)) when immh = 01xx
 (128-UInt(immh:immb)) when immh = 1xxx
 See [Advanced SIMD modified immediate on page C4-291](#) when immh = 0000.

Operation for all encodings

```

CheckFPAdvSIMDEnabled64();
bits(datasize) operand = V[n];
bits(datasize) operand2;
bits(datasize) result;
integer round_const = if round then (1 << (shift - 1)) else 0;
integer element;

operand2 = if accumulate then V[d] else Zeros();
for e = 0 to elements-1
    element = (Int(Elem[operand, e, esize], unsigned) + round_const) >> shift;
    Elem[result, e, esize] = Elem[operand2, e, esize] + element<esize-1:0>;

V[d] = result;

```

C7.2.272 SRSRA

Signed Rounding Shift Right and Accumulate (immediate). This instruction reads each vector element in the source SIMD&FP register, right shifts each result by an immediate value, and accumulates the final results with the vector elements of the destination SIMD&FP register. All the values in this instruction are signed integer values. The results are rounded. For truncated results, see [SSRA](#).

Depending on the settings in the [CPACR_EL1](#), [CPTR_EL2](#), and [CPTR_EL3](#) registers, and the current Security state and Exception level, an attempt to execute the instruction might be trapped.

Scalar

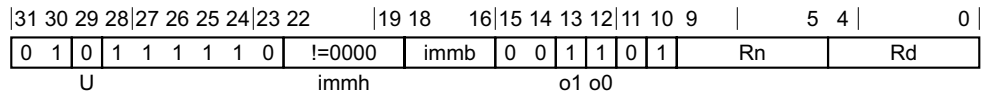

Scalar variant

SRSRA <V><d>, <V><n>, #<shift>

Decode for this encoding

```
integer d = UInt(Rd);
integer n = UInt(Rn);

if immh<3> != '1' then ReservedValue();
integer esize = 8 << 3;
integer datasize = esize;
integer elements = 1;

integer shift = (esize * 2) - UInt(immh:immh);
boolean unsigned = (U == '1');
boolean round = (o1 == '1');
boolean accumulate = (o0 == '1');
```

Vector

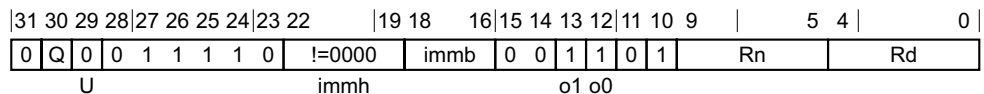

Vector variant

SRSRA <Vd>.<T>, <Vn>.<T>, #<shift>

Decode for this encoding

```
integer d = UInt(Rd);
integer n = UInt(Rn);

if immh == '0000' then SEE "Advanced SIMD modified immediate";
if immh<3>:Q == '10' then ReservedValue();
integer esize = 8 << HighestSetBit(immh);
integer datasize = if Q == '1' then 128 else 64;
integer elements = datasize DIV esize;

integer shift = (esize * 2) - UInt(immh:immh);
boolean unsigned = (U == '1');
boolean round = (o1 == '1');
boolean accumulate = (o0 == '1');
```

Assembler symbols

- <V> Is a width specifier, encoded in the "immh" field. It can have the following values:
D when immh = 1xxx
The encoding immh = 0xxx is reserved.
- <d> Is the number of the SIMD&FP destination register, in the "Rd" field.
- <n> Is the number of the first SIMD&FP source register, encoded in the "Rn" field.
- <Vd> Is the name of the SIMD&FP destination register, encoded in the "Rd" field.
- <T> Is an arrangement specifier, encoded in the "immh:Q" field. It can have the following values:
8B when immh = 0001, Q = 0
16B when immh = 0001, Q = 1
4H when immh = 001x, Q = 0
8H when immh = 001x, Q = 1
2S when immh = 01xx, Q = 0
4S when immh = 01xx, Q = 1
2D when immh = 1xxx, Q = 1
See [Advanced SIMD modified immediate on page C4-291](#) when immh = 0000, Q = x.
The encoding immh = 1xxx, Q = 0 is reserved.
- <Vn> Is the name of the SIMD&FP source register, encoded in the "Rn" field.
- <shift> For the scalar variant: is the right shift amount, in the range 1 to 64, encoded in the "immh:immb" field. It can have the following values:
(128-UInt(immh:immb)) when immh = 1xxx
The encoding immh = 0xxx is reserved.
For the vector variant: is the right shift amount, in the range 1 to the element width in bits, encoded in the "immh:immb" field. It can have the following values:
(16-UInt(immh:immb)) when immh = 0001
(32-UInt(immh:immb)) when immh = 001x
(64-UInt(immh:immb)) when immh = 01xx
(128-UInt(immh:immb)) when immh = 1xxx
See [Advanced SIMD modified immediate on page C4-291](#) when immh = 0000.

Operation for all encodings

```
CheckFPAdvSIMDEnabled64();
bits(datasize) operand = V[n];
bits(datasize) operand2;
bits(datasize) result;
integer round_const = if round then (1 << (shift - 1)) else 0;
integer element;

operand2 = if accumulate then V[d] else Zeros();
for e = 0 to elements-1
    element = (Int(Elem[operand, e, esize], unsigned) + round_const) >> shift;
    Elem[result, e, esize] = Elem[operand2, e, esize] + element<esize-1:0>;

V[d] = result;
```

C7.2.273 SSSL

Signed Shift Left (register). This instruction takes each signed integer value in the vector of the first source SIMD&FP register, shifts each value by a value from the least significant byte of the corresponding element of the second source SIMD&FP register, places the results in a vector, and writes the vector to the destination SIMD&FP register.

If the shift value is positive, the operation is a left shift. If the shift value is negative, it is a truncating right shift. For a rounding shift, see [SRSHL](#).

Depending on the settings in the [CPACR_EL1](#), [CPTR_EL2](#), and [CPTR_EL3](#) registers, and the current Security state and Exception level, an attempt to execute the instruction might be trapped.

Scalar

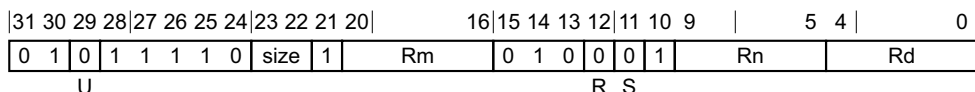

Scalar variant

SSHL <V><d>, <V><n>, <V><m>

Decode for this encoding

```
integer d = UInt(Rd);
integer n = UInt(Rn);
integer m = UInt(Rm);
integer esize = 8 << UInt(size);
integer datasize = esize;
integer elements = 1;
boolean unsigned = (U == '1');
boolean rounding = (R == '1');
boolean saturating = (S == '1');
if S == '0' && size != '11' then ReservedValue();
```

Vector

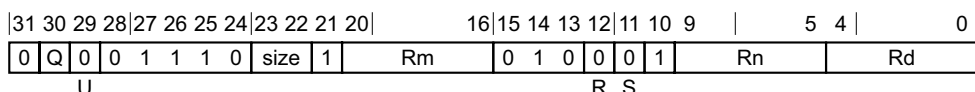

Vector variant

SSHL <Vd>.<T>, <Vn>.<T>, <Vm>.<T>

Decode for this encoding

```
integer d = UInt(Rd);
integer n = UInt(Rn);
integer m = UInt(Rm);
if size:Q == '110' then ReservedValue();
integer esize = 8 << UInt(size);
integer datasize = if Q == '1' then 128 else 64;
integer elements = datasize DIV esize;
boolean unsigned = (U == '1');
boolean rounding = (R == '1');
boolean saturating = (S == '1');
```

Assembler symbols

- <V> Is a width specifier, encoded in the "size" field. It can have the following values:
- D when size = 11
- The following encodings are reserved:
- size = 0x.
 - size = 10.
- <d> Is the number of the SIMD&FP destination register, in the "Rd" field.
- <n> Is the number of the first SIMD&FP source register, encoded in the "Rn" field.
- <m> Is the number of the second SIMD&FP source register, encoded in the "Rm" field.
- <Vd> Is the name of the SIMD&FP destination register, encoded in the "Rd" field.
- <T> Is an arrangement specifier, encoded in the "size:Q" field. It can have the following values:
- 8B when size = 00, Q = 0
 - 16B when size = 00, Q = 1
 - 4H when size = 01, Q = 0
 - 8H when size = 01, Q = 1
 - 2S when size = 10, Q = 0
 - 4S when size = 10, Q = 1
 - 2D when size = 11, Q = 1
- The encoding size = 11, Q = 0 is reserved.
- <Vn> Is the name of the first SIMD&FP source register, encoded in the "Rn" field.
- <Vm> Is the name of the second SIMD&FP source register, encoded in the "Rm" field.

Operation for all encodings

```
CheckFPAdvSIMDEnabled64();
bits(datasize) operand1 = V[n];
bits(datasize) operand2 = V[m];
bits(datasize) result;

integer round_const = 0;
integer shift;
integer element;
boolean sat;

for e = 0 to elements-1
    shift = SInt(Elem[operand2, e, esize]<7:0>);
    if rounding then
        round_const = 1 << (-shift - 1); // 0 for left shift, 2^(n-1) for right shift
    element = (Int(Elem[operand1, e, esize], unsigned) + round_const) << shift;
    if saturating then
        (Elem[result, e, esize], sat) = SatQ(element, esize, unsigned);
        if sat then FPSR.QC = '1';
    else
        Elem[result, e, esize] = element<esize-1:0>;

V[d] = result;
```



C7.2.274 SSHLL, SSHLL2

Signed Shift Left Long (immediate). This instruction reads each vector element from the source SIMD&FP register, left shifts each vector element by the specified shift amount, places the result into a vector, and writes the vector to the destination SIMD&FP register. The destination vector elements are twice as long as the source vector elements. All the values in this instruction are signed integer values.

The SSHLL instruction extracts vector elements from the lower half of the source register, while the SSHLL2 instruction extracts vector elements from the upper half of the source register.

Depending on the settings in the CPACR_EL1, CPTR_EL2, and CPTR_EL3 registers, and the current Security state and Exception level, an attempt to execute the instruction might be trapped.

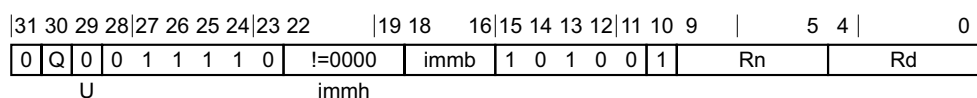
This instruction is used by the alias SXTL, SXTL2. See *Alias conditions* for details of when each alias is preferred.



Vector variant

SSHLL{2} <Vd>.<Ta>, <Vn>.<Tb>, #<shift>

Decode for this encoding

```
integer d = UInt(Rd);
integer n = UInt(Rn);

if immh == '0000' then SEE "Advanced SIMD modified immediate";
if immh<3> == '1' then ReservedValue();
integer esize = 8 << HighestSetBit(immh);
integer datasize = 64;
integer part = UInt(Q);
integer elements = datasize DIV esize;

integer shift = UInt(immh:immb) - esize;
boolean unsigned = (U == '1');
```

Alias conditions

Alias	is preferred when
SXTL, SXTL2	immb == '000' && BitCount(immh) == 1

Assembler symbols

- 2 Is the second and upper half specifier. If present it causes the operation to be performed on the upper 64 bits of the registers holding the narrower elements, and is encoded in the "Q" field. It can have the following values:
 - [absent] when Q = 0
 - [present] when Q = 1
- <Vd> Is the name of the SIMD&FP destination register, encoded in the "Rd" field.
- <Ta> Is an arrangement specifier, encoded in the "immh" field. It can have the following values:
 - 8H when immh = 0001
 - 4S when immh = 001x

2D when immh = 01xx

See [Advanced SIMD modified immediate on page C4-291](#) when immh = 0000.

The encoding immh = 1xxx is reserved.

<Vn> Is the name of the SIMD&FP source register, encoded in the "Rn" field.

<Tb> Is an arrangement specifier, encoded in the "immh:Q" field. It can have the following values:

8B when immh = 0001, Q = 0

16B when immh = 0001, Q = 1

4H when immh = 001x, Q = 0

8H when immh = 001x, Q = 1

2S when immh = 01xx, Q = 0

4S when immh = 01xx, Q = 1

See [Advanced SIMD modified immediate on page C4-291](#) when immh = 0000, Q = x.

The encoding immh = 1xxx, Q = x is reserved.

<shift> Is the left shift amount, in the range 0 to the source element width in bits minus 1, encoded in the "immh:immb" field. It can have the following values:

(UInt(immh:immb)-8) when immh = 0001

(UInt(immh:immb)-16) when immh = 001x

(UInt(immh:immb)-32) when immh = 01xx

See [Advanced SIMD modified immediate on page C4-291](#) when immh = 0000.

The encoding immh = 1xxx is reserved.

Operation

```
CheckFPAdvSIMDEnabled64();
bits(datasize) operand = Vpart[n, part];
bits(datasize*2) result;
integer element;

for e = 0 to elements-1
    element = Int(Elem[operand, e, esize], unsigned) << shift;
    Elem[result, e, 2*esize] = element<2*esize-1:0>;

V[d] = result;
```

C7.2.275 SSHR

Signed Shift Right (immediate). This instruction reads each vector element in the source SIMD&FP register, right shifts each result by an immediate value, places the final result into a vector, and writes the vector to the destination SIMD&FP register. All the values in this instruction are signed integer values. The results are truncated. For rounded results, see [SRSHR](#).

Depending on the settings in the [CPACR_EL1](#), [CPTR_EL2](#), and [CPTR_EL3](#) registers, and the current Security state and Exception level, an attempt to execute the instruction might be trapped.

Scalar

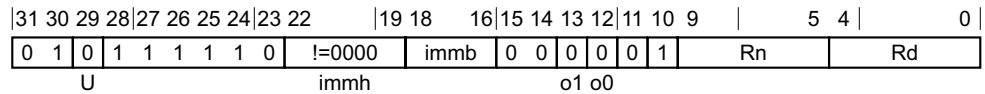

Scalar variant

SSHR <V><d>, <V><n>, #<shift>

Decode for this encoding

```
integer d = UInt(Rd);
integer n = UInt(Rn);

if immh<3> != '1' then ReservedValue();
integer esize = 8 << 3;
integer datasize = esize;
integer elements = 1;

integer shift = (esize * 2) - UInt(immh:immh);
boolean unsigned = (U == '1');
boolean round = (o1 == '1');
boolean accumulate = (o0 == '1');
```

Vector

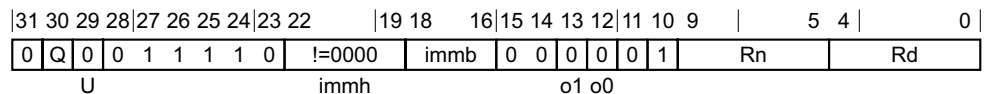

Vector variant

SSHR <Vd>.<T>, <Vn>.<T>, #<shift>

Decode for this encoding

```
integer d = UInt(Rd);
integer n = UInt(Rn);

if immh == '0000' then SEE "Advanced SIMD modified immediate";
if immh<3>:Q == '10' then ReservedValue();
integer esize = 8 << HighestSetBit(immh);
integer datasize = if Q == '1' then 128 else 64;
integer elements = datasize DIV esize;

integer shift = (esize * 2) - UInt(immh:immh);
boolean unsigned = (U == '1');
boolean round = (o1 == '1');
boolean accumulate = (o0 == '1');
```

Assembler symbols

- <V> Is a width specifier, encoded in the "immh" field. It can have the following values:
D when immh = 1xxx
The encoding immh = 0xxx is reserved.
- <d> Is the number of the SIMD&FP destination register, in the "Rd" field.
- <n> Is the number of the first SIMD&FP source register, encoded in the "Rn" field.
- <Vd> Is the name of the SIMD&FP destination register, encoded in the "Rd" field.
- <T> Is an arrangement specifier, encoded in the "immh:Q" field. It can have the following values:
8B when immh = 0001, Q = 0
16B when immh = 0001, Q = 1
4H when immh = 001x, Q = 0
8H when immh = 001x, Q = 1
2S when immh = 01xx, Q = 0
4S when immh = 01xx, Q = 1
2D when immh = 1xxx, Q = 1
See [Advanced SIMD modified immediate on page C4-291](#) when immh = 0000, Q = x.
The encoding immh = 1xxx, Q = 0 is reserved.
- <Vn> Is the name of the SIMD&FP source register, encoded in the "Rn" field.
- <shift> For the scalar variant: is the right shift amount, in the range 1 to 64, encoded in the "immh:immb" field. It can have the following values:
(128-UInt(immh:immb)) when immh = 1xxx
The encoding immh = 0xxx is reserved.
For the vector variant: is the right shift amount, in the range 1 to the element width in bits, encoded in the "immh:immb" field. It can have the following values:
(16-UInt(immh:immb)) when immh = 0001
(32-UInt(immh:immb)) when immh = 001x
(64-UInt(immh:immb)) when immh = 01xx
(128-UInt(immh:immb)) when immh = 1xxx
See [Advanced SIMD modified immediate on page C4-291](#) when immh = 0000.

Operation for all encodings

```
CheckFPAdvSIMDEnabled64();
bits(datasize) operand = V[n];
bits(datasize) operand2;
bits(datasize) result;
integer round_const = if round then (1 << (shift - 1)) else 0;
integer element;

operand2 = if accumulate then V[d] else Zeros();
for e = 0 to elements-1
    element = (Int(Elem[operand, e, esize], unsigned) + round_const) >> shift;
    Elem[result, e, esize] = Elem[operand2, e, esize] + element<esize-1:0>;

V[d] = result;
```

C7.2.276 SSRA

Signed Shift Right and Accumulate (immediate). This instruction reads each vector element in the source SIMD&FP register, right shifts each result by an immediate value, and accumulates the final results with the vector elements of the destination SIMD&FP register. All the values in this instruction are signed integer values. The results are truncated. For rounded results, see [SRSRA](#).

Depending on the settings in the [CPACR_EL1](#), [CPTR_EL2](#), and [CPTR_EL3](#) registers, and the current Security state and Exception level, an attempt to execute the instruction might be trapped.

Scalar

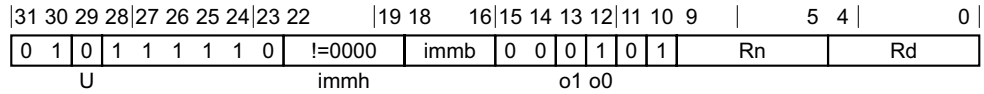

Scalar variant

SSRA <V><d>, <V><n>, #<shift>

Decode for this encoding

```
integer d = UInt(Rd);
integer n = UInt(Rn);

if immh<3> != '1' then ReservedValue();
integer esize = 8 << 3;
integer datasize = esize;
integer elements = 1;

integer shift = (esize * 2) - UInt(immh:immh);
boolean unsigned = (U == '1');
boolean round = (o1 == '1');
boolean accumulate = (o0 == '1');
```

Vector

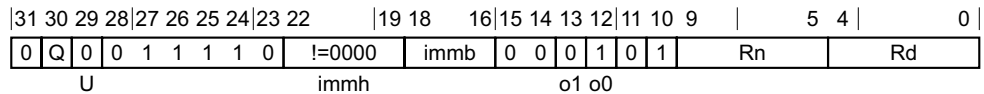

Vector variant

SSRA <Vd>.<T>, <Vn>.<T>, #<shift>

Decode for this encoding

```
integer d = UInt(Rd);
integer n = UInt(Rn);

if immh == '0000' then SEE "Advanced SIMD modified immediate";
if immh<3>:Q == '10' then ReservedValue();
integer esize = 8 << HighestSetBit(immh);
integer datasize = if Q == '1' then 128 else 64;
integer elements = datasize DIV esize;

integer shift = (esize * 2) - UInt(immh:immh);
boolean unsigned = (U == '1');
boolean round = (o1 == '1');
boolean accumulate = (o0 == '1');
```

Assembler symbols

- <V> Is a width specifier, encoded in the "immh" field. It can have the following values:
 D when immh = 1xxx
 The encoding immh = 0xxx is reserved.
- <d> Is the number of the SIMD&FP destination register, in the "Rd" field.
- <n> Is the number of the first SIMD&FP source register, encoded in the "Rn" field.
- <Vd> Is the name of the SIMD&FP destination register, encoded in the "Rd" field.
- <T> Is an arrangement specifier, encoded in the "immh:Q" field. It can have the following values:
 8B when immh = 0001, Q = 0
 16B when immh = 0001, Q = 1
 4H when immh = 001x, Q = 0
 8H when immh = 001x, Q = 1
 2S when immh = 01xx, Q = 0
 4S when immh = 01xx, Q = 1
 2D when immh = 1xxx, Q = 1
 See [Advanced SIMD modified immediate on page C4-291](#) when immh = 0000, Q = x.
 The encoding immh = 1xxx, Q = 0 is reserved.
- <Vn> Is the name of the SIMD&FP source register, encoded in the "Rn" field.
- <shift> For the scalar variant: is the right shift amount, in the range 1 to 64, encoded in the "immh:immb" field. It can have the following values:
 (128-UInt(immh:immb)) when immh = 1xxx
 The encoding immh = 0xxx is reserved.
 For the vector variant: is the right shift amount, in the range 1 to the element width in bits, encoded in the "immh:immb" field. It can have the following values:
 (16-UInt(immh:immb)) when immh = 0001
 (32-UInt(immh:immb)) when immh = 001x
 (64-UInt(immh:immb)) when immh = 01xx
 (128-UInt(immh:immb)) when immh = 1xxx
 See [Advanced SIMD modified immediate on page C4-291](#) when immh = 0000.

Operation for all encodings

```

CheckFPAdvSIMDEnabled64();
bits(datasize) operand = V[n];
bits(datasize) operand2;
bits(datasize) result;
integer round_const = if round then (1 << (shift - 1)) else 0;
integer element;

operand2 = if accumulate then V[d] else Zeros();
for e = 0 to elements-1
    element = (Int(Elem[operand, e, esize], unsigned) + round_const) >> shift;
    Elem[result, e, esize] = Elem[operand2, e, esize] + element<esize-1:0>;

V[d] = result;

```

C7.2.277 SSUBL, SSUBL2

Signed Subtract Long. This instruction subtracts each vector element in the lower or upper half of the second source SIMD&FP register from the corresponding vector element of the first source SIMD&FP register, places the results into a vector, and writes the vector to the destination SIMD&FP register. All the values in this instruction are signed integer values. The destination vector elements are twice as long as the source vector elements.

The SSUBL instruction extracts each source vector from the lower half of each source register, while the SSUBL2 instruction extracts each source vector from the upper half of each source register.

Depending on the settings in the CPACR_EL1, CPTR_EL2, and CPTR_EL3 registers, and the current Security state and Exception level, an attempt to execute the instruction might be trapped.

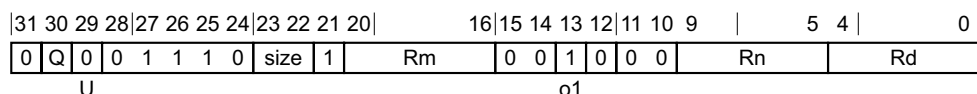

Three registers, not all the same type variant

SSUBL{2} <Vd>.<Ta>, <Vn>.<Tb>, <Vm>.<Tb>

Decode for this encoding

```
integer d = UInt(Rd);
integer n = UInt(Rn);
integer m = UInt(Rm);

if size == '11' then ReservedValue();
integer esize = 8 << UInt(size);
integer datasize = 64;
integer part = UInt(Q);
integer elements = datasize DIV esize;

boolean sub_op = (o1 == '1');
boolean unsigned = (U == '1');
```

Assembler symbols

- 2 Is the second and upper half specifier. If present it causes the operation to be performed on the upper 64 bits of the registers holding the narrower elements, and is encoded in the "Q" field. It can have the following values:
 - [absent] when Q = 0
 - [present] when Q = 1
- <Vd> Is the name of the SIMD&FP destination register, encoded in the "Rd" field.
- <Ta> Is an arrangement specifier, encoded in the "size" field. It can have the following values:
 - 8H when size = 00
 - 4S when size = 01
 - 2D when size = 10
 The encoding size = 11 is reserved.
- <Vn> Is the name of the first SIMD&FP source register, encoded in the "Rn" field.
- <Tb> Is an arrangement specifier, encoded in the "size:Q" field. It can have the following values:
 - 8B when size = 00, Q = 0
 - 16B when size = 00, Q = 1

4H when size = 01, Q = 0
8H when size = 01, Q = 1
2S when size = 10, Q = 0
4S when size = 10, Q = 1
The encoding size = 11, Q = x is reserved.

<Vm> Is the name of the second SIMD&FP source register, encoded in the "Rm" field.

Operation

```
CheckFPAdvSIMDEnabled64();
bits(datasize) operand1 = Vpart[n, part];
bits(datasize) operand2 = Vpart[m, part];
bits(2*datasize) result;
integer element1;
integer element2;
integer sum;

for e = 0 to elements-1
    element1 = Int(Elem[operand1, e, esize], unsigned);
    element2 = Int(Elem[operand2, e, esize], unsigned);
    if sub_op then
        sum = element1 - element2;
    else
        sum = element1 + element2;
    Elem[result, e, 2*esize] = sum<2*esize-1:0>;

V[d] = result;
```

C7.2.278 SSUBW, SSUBW2

Signed Subtract Wide. This instruction subtracts each vector element in the lower or upper half of the second source SIMD&FP register from the corresponding vector element in the first source SIMD&FP register, places the result in a vector, and writes the vector to the SIMD&FP destination register. All the values in this instruction are signed integer values.

The SSUBW instruction extracts the second source vector from the lower half of the second source register, while the SSUBW2 instruction extracts the second source vector from the upper half of the second source register.

Depending on the settings in the CPACR_EL1, CPTR_EL2, and CPTR_EL3 registers, and the current Security state and Exception level, an attempt to execute the instruction might be trapped.

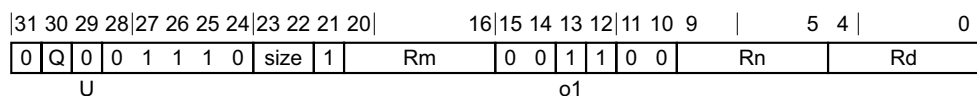

Three registers, not all the same type variant

SSUBW{2} <Vd>.<Ta>, <Vn>.<Ta>, <Vm>.<Tb>

Decode for this encoding

```
integer d = UInt(Rd);
integer n = UInt(Rn);
integer m = UInt(Rm);

if size == '11' then ReservedValue();
integer esize = 8 << UInt(size);
integer datasize = 64;
integer part = UInt(Q);
integer elements = datasize DIV esize;

boolean sub_op = (o1 == '1');
boolean unsigned = (U == '1');
```

Assembler symbols

- 2 Is the second and upper half specifier. If present it causes the operation to be performed on the upper 64 bits of the registers holding the narrower elements, and is encoded in the "Q" field. It can have the following values:
 - [absent] when Q = 0
 - [present] when Q = 1
- <Vd> Is the name of the SIMD&FP destination register, encoded in the "Rd" field.
- <Ta> Is an arrangement specifier, encoded in the "size" field. It can have the following values:
 - 8H when size = 00
 - 4S when size = 01
 - 2D when size = 10
 The encoding size = 11 is reserved.
- <Vn> Is the name of the first SIMD&FP source register, encoded in the "Rn" field.
- <Vm> Is the name of the second SIMD&FP source register, encoded in the "Rm" field.

<Tb> Is an arrangement specifier, encoded in the "size:Q" field. It can have the following values:

8B	when size = 00, Q = 0
16B	when size = 00, Q = 1
4H	when size = 01, Q = 0
8H	when size = 01, Q = 1
2S	when size = 10, Q = 0
4S	when size = 10, Q = 1

The encoding size = 11, Q = x is reserved.

Operation

```
CheckFPAdvSIMDEnabled64();
bits(2*datasize) operand1 = V[n];
bits(datasize) operand2 = Vpart[m, part];
bits(2*datasize) result;
integer element1;
integer element2;
integer sum;

for e = 0 to elements-1
    element1 = Int(Elem[operand1, e, 2*esize], unsigned);
    element2 = Int(Elem[operand2, e, esize], unsigned);
    if sub_op then
        sum = element1 - element2;
    else
        sum = element1 + element2;
    Elem[result, e, 2*esize] = sum<2*esize-1:0>;

V[d] = result;
```

C7.2.279 ST1 (multiple structures)

Store multiple single-element structures from one, two, three, or four registers. This instruction stores elements to memory from one, two, three, or four SIMD&FP registers, without interleaving. Every element of each register is stored.

Depending on the settings in the CPACR_EL1, CPTR_EL2, and CPTR_EL3 registers, and the current Security state and Exception level, an attempt to execute the instruction might be trapped.

No offset

31	30	29	28	27	26	25	24	23	22	21	20	19	18	17	16	15	12	11	10	9	5	4	0
0	Q	0	0	1	1	0	0	0	0	0	0	0	0	0	0	0	x	x	1	x	size	Rn	Rt
L												opcode											

One register variant

Applies when opcode == 0111.

ST1 { <Vt>.<T> }, [<Xn|SP>]

Two registers variant

Applies when opcode == 1010.

ST1 { <Vt>.<T>, <Vt2>.<T> }, [<Xn|SP>]

Three registers variant

Applies when opcode == 0110.

ST1 { <Vt>.<T>, <Vt2>.<T>, <Vt3>.<T> }, [<Xn|SP>]

Four registers variant

Applies when opcode == 0010.

ST1 { <Vt>.<T>, <Vt2>.<T>, <Vt3>.<T>, <Vt4>.<T> }, [<Xn|SP>]

Decode for all variants of this encoding

```
integer t = UInt(Rt);
integer n = UInt(Rn);
integer m = integer UNKNOWN;
boolean wback = FALSE;
```

Post-index

31	30	29	28	27	26	25	24	23	22	21	20	16	15	12	11	10	9	5	4	0		
0	Q	0	0	1	1	0	0	1	0	0	Rm	x	x	1	x	size	Rn	Rt				
L												opcode										

One register, immediate offset variant

Applies when Rm == 11111 && opcode == 0111.

ST1 { <Vt>.<T> }, [<Xn|SP>], <imm>

One register, register offset variant

Applies when Rm != 11111 && opcode == 0111.

ST1 { <Vt>.<T> }, [<Xn|SP>], <Xm>

Two registers, immediate offset variant

Applies when Rm == 11111 && opcode == 1010.

ST1 { <Vt>.<T>, <Vt2>.<T> }, [<Xn|SP>], <imm>

Two registers, register offset variant

Applies when Rm != 11111 && opcode == 1010.

ST1 { <Vt>.<T>, <Vt2>.<T> }, [<Xn|SP>], <Xm>

Three registers, immediate offset variant

Applies when Rm == 11111 && opcode == 0110.

ST1 { <Vt>.<T>, <Vt2>.<T>, <Vt3>.<T> }, [<Xn|SP>], <imm>

Three registers, register offset variant

Applies when Rm != 11111 && opcode == 0110.

ST1 { <Vt>.<T>, <Vt2>.<T>, <Vt3>.<T> }, [<Xn|SP>], <Xm>

Four registers, immediate offset variant

Applies when Rm == 11111 && opcode == 0010.

ST1 { <Vt>.<T>, <Vt2>.<T>, <Vt3>.<T>, <Vt4>.<T> }, [<Xn|SP>], <imm>

Four registers, register offset variant

Applies when Rm != 11111 && opcode == 0010.

ST1 { <Vt>.<T>, <Vt2>.<T>, <Vt3>.<T>, <Vt4>.<T> }, [<Xn|SP>], <Xm>

Decode for all variants of this encoding

```
integer t = UInt(Rt);
integer n = UInt(Rn);
integer m = UInt(Rm);
boolean wback = TRUE;
```

Assembler symbols

<Vt> Is the name of the first or only SIMD&FP register to be transferred, encoded in the "Rt" field.

<T> Is an arrangement specifier, encoded in the "size:Q" field. It can have the following values:

- 8B when size = 00, Q = 0
- 16B when size = 00, Q = 1
- 4H when size = 01, Q = 0
- 8H when size = 01, Q = 1
- 2S when size = 10, Q = 0
- 4S when size = 10, Q = 1
- 1D when size = 11, Q = 0
- 2D when size = 11, Q = 1

<Vt2> Is the name of the second SIMD&FP register to be transferred, encoded as "Rt" plus 1 modulo 32.

<Vt3> Is the name of the third SIMD&FP register to be transferred, encoded as "Rt" plus 2 modulo 32.

- <Vt4> Is the name of the fourth SIMD&FP register to be transferred, encoded as "Rt" plus 3 modulo 32.
- <Xn|SP> Is the 64-bit name of the general-purpose base register or stack pointer, encoded in the "Rn" field.
- <imm> For the one register, immediate offset variant: is the post-index immediate offset, encoded in the "Q" field. It can have the following values:
 #8 when Q = 0
 #16 when Q = 1
 For the two registers, immediate offset variant: is the post-index immediate offset, encoded in the "Q" field. It can have the following values:
 #16 when Q = 0
 #32 when Q = 1
 For the three registers, immediate offset variant: is the post-index immediate offset, encoded in the "Q" field. It can have the following values:
 #24 when Q = 0
 #48 when Q = 1
 For the four registers, immediate offset variant: is the post-index immediate offset, encoded in the "Q" field. It can have the following values:
 #32 when Q = 0
 #64 when Q = 1
- <Xm> Is the 64-bit name of the general-purpose post-index register, excluding XZR, encoded in the "Rm" field.

Shared decode for all encodings

```
MemOp memop = if L == '1' then MemOp_LOAD else MemOp_STORE;
integer datasize = if Q == '1' then 128 else 64;
integer esize = 8 << UInt(size);
integer elements = datasize DIV esize;

integer rpt; // number of iterations
integer selem; // structure elements

case opcode of
  when '0000' rpt = 1; selem = 4; // LD/ST4 (4 registers)
  when '0010' rpt = 4; selem = 1; // LD/ST1 (4 registers)
  when '0100' rpt = 1; selem = 3; // LD/ST3 (3 registers)
  when '0110' rpt = 3; selem = 1; // LD/ST1 (3 registers)
  when '0111' rpt = 1; selem = 1; // LD/ST1 (1 register)
  when '1000' rpt = 1; selem = 2; // LD/ST2 (2 registers)
  when '1010' rpt = 2; selem = 1; // LD/ST1 (2 registers)
  otherwise UnallocatedEncoding();

// .1D format only permitted with LD1 & ST1
if size:Q == '110' && selem != 1 then ReservedValue();
```

Operation for all encodings

```
CheckFPAdvSIMDEnabled64();

bits(64) address;
bits(64) offs;
bits(datasize) rval;
integer e, r, s, tt;
constant integer ebytes = esize DIV 8;

if n == 31 then
  CheckSPAlignment();
  address = SP[];
```

```
else
    address = X[n];

offs = Zeros();
for r = 0 to rpt-1
    for e = 0 to elements-1
        tt = (t + r) MOD 32;
        for s = 0 to selem-1
            rval = V[tt];
            if memop == MemOp_LOAD then
                Elem[rval, e, esize] = Mem[address+offs, ebytes, AccType_VEC];
                V[tt] = rval;
            else // memop == MemOp_STORE
                Mem[address+offs, ebytes, AccType_VEC] = Elem[rval, e, esize];
            offs = offs + ebytes;
            tt = (tt + 1) MOD 32;

if wback then
    if m != 31 then
        offs = X[m];
    if n == 31 then
        SP[] = address + offs;
    else
        X[n] = address + offs;
```

C7.2.280 ST1 (single structure)

Store a single-element structure from one lane of one register. This instruction stores the specified element of a SIMD&FP register to memory.

Depending on the settings in the CPACR_EL1, CPTR_EL2, and CPTR_EL3 registers, and the current Security state and Exception level, an attempt to execute the instruction might be trapped.

No offset

31	30	29	28	27	26	25	24	23	22	21	20	19	18	17	16	15	13	12	11	10	9	5	4	0
0	Q	0	0	1	1	0	1	0	0	0	0	0	0	0	0	x	x	0	S	size	Rn	Rt		
L R										opcode														

8-bit variant

Applies when opcode == 000.

ST1 { <Vt>.B }[<index>], [<Xn|SP>]

16-bit variant

Applies when opcode == 010 && size == x0.

ST1 { <Vt>.H }[<index>], [<Xn|SP>]

32-bit variant

Applies when opcode == 100 && size == 00.

ST1 { <Vt>.S }[<index>], [<Xn|SP>]

64-bit variant

Applies when opcode == 100 && S == 0 && size == 01.

ST1 { <Vt>.D }[<index>], [<Xn|SP>]

Decode for all variants of this encoding

```
integer t = UInt(Rt);
integer n = UInt(Rn);
integer m = integer UNKNOWN;
boolean wback = FALSE;
```

Post-index

31	30	29	28	27	26	25	24	23	22	21	20	16	15	13	12	11	10	9	5	4	0	
0	Q	0	0	1	1	0	1	1	0	0	Rm	x	x	0	S	size	Rn	Rt				
L R												opcode										

8-bit, immediate offset variant

Applies when Rm == 11111 && opcode == 000.

ST1 { <Vt>.B }[<index>], [<Xn|SP>], #1

8-bit, register offset variant

Applies when Rm != 11111 && opcode == 000.

ST1 { <Vt>.B }[<index>], [<Xn|SP>], <Xm>

16-bit, immediate offset variant

Applies when $Rm == 11111$ && $opcode == 010$ && $size == x0$.

ST1 { <Vt>.H }[<index>], [<Xn|SP>], #2

16-bit, register offset variant

Applies when $Rm != 11111$ && $opcode == 010$ && $size == x0$.

ST1 { <Vt>.H }[<index>], [<Xn|SP>], <Xm>

32-bit, immediate offset variant

Applies when $Rm == 11111$ && $opcode == 100$ && $size == 00$.

ST1 { <Vt>.S }[<index>], [<Xn|SP>], #4

32-bit, register offset variant

Applies when $Rm != 11111$ && $opcode == 100$ && $size == 00$.

ST1 { <Vt>.S }[<index>], [<Xn|SP>], <Xm>

64-bit, immediate offset variant

Applies when $Rm == 11111$ && $opcode == 100$ && $S == 0$ && $size == 01$.

ST1 { <Vt>.D }[<index>], [<Xn|SP>], #8

64-bit, register offset variant

Applies when $Rm != 11111$ && $opcode == 100$ && $S == 0$ && $size == 01$.

ST1 { <Vt>.D }[<index>], [<Xn|SP>], <Xm>

Decode for all variants of this encoding

```
integer t = UInt(Rt);
integer n = UInt(Rn);
integer m = UInt(Rm);
boolean wback = TRUE;
```

Assembler symbols

<Vt>	Is the name of the first or only SIMD&FP register to be transferred, encoded in the "Rt" field.
<index>	For the 8-bit variant: is the element index, encoded in "Q:S:size". For the 16-bit variant: is the element index, encoded in "Q:S:size<1>". For the 32-bit variant: is the element index, encoded in "Q:S". For the 64-bit variant: is the element index, encoded in "Q".
<Xn SP>	Is the 64-bit name of the general-purpose base register or stack pointer, encoded in the "Rn" field.
<Xm>	Is the 64-bit name of the general-purpose post-index register, excluding XZR, encoded in the "Rm" field.

Shared decode for all encodings

```
integer scale = UInt(opcode<2:1>);
integer selem = UInt(opcode<0>:R) + 1;
boolean replicate = FALSE;
integer index;
```

case scale of

```

when 3
    // load and replicate
    if L == '0' || S == '1' then UnallocatedEncoding();
    scale = UInt(size);
    replicate = TRUE;
when 0
    index = UInt(Q:S:size);    // B[0-15]
when 1
    if size<0> == '1' then UnallocatedEncoding();
    index = UInt(Q:S:size<1>); // H[0-7]
when 2
    if size<1> == '1' then UnallocatedEncoding();
    if size<0> == '0' then
        index = UInt(Q:S);    // S[0-3]
    else
        if S == '1' then UnallocatedEncoding();
        index = UInt(Q);    // D[0-1]
        scale = 3;

MemOp memop = if L == '1' then MemOp_LOAD else MemOp_STORE;
integer datasize = if Q == '1' then 128 else 64;
integer esize = 8 << scale;

```

Operation for all encodings

```

CheckFPAdvSIMDEnabled64();

bits(64) address;
bits(64) offs;
bits(128) rval;
bits(esize) element;
integer s;
constant integer ebytes = esize DIV 8;

if n == 31 then
    CheckSPAlignment();
    address = SP[];
else
    address = X[n];

offs = Zeros();
if replicate then
    // load and replicate to all elements
    for s = 0 to selem-1
        element = Mem[address+offs, ebytes, AccType_VEC];
        // replicate to fill 128- or 64-bit register
        V[t] = Replicate(element, datasize DIV esize);
        offs = offs + ebytes;
        t = (t + 1) MOD 32;
else
    // load/store one element per register
    for s = 0 to selem-1
        rval = V[t];
        if memop == MemOp_LOAD then
            // insert into one lane of 128-bit register
            Elem[rval, index, esize] = Mem[address+offs, ebytes, AccType_VEC];
            V[t] = rval;
        else // memop == MemOp_STORE
            // extract from one lane of 128-bit register
            Mem[address+offs, ebytes, AccType_VEC] = Elem[rval, index, esize];
            offs = offs + ebytes;
            t = (t + 1) MOD 32;

if wback then
    if m != 31 then
        offs = X[m];
    if n == 31 then

```

```
    SP[] = address + offs;  
else  
    X[n] = address + offs;
```

C7.2.281 ST2 (multiple structures)

Store multiple 2-element structures from two registers. This instruction stores multiple 2-element structures from two SIMD&FP registers to memory, with interleaving. Every element of each register is stored.

Depending on the settings in the CPACR_EL1, CPTR_EL2, and CPTR_EL3 registers, and the current Security state and Exception level, an attempt to execute the instruction might be trapped.

No offset

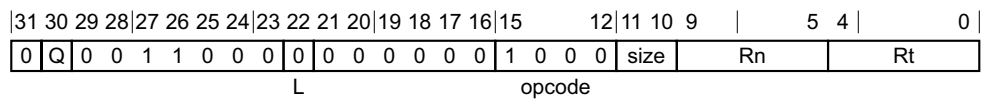

No offset variant

ST2 { <Vt>.<T>, <Vt2>.<T> }, [<Xn|SP>]

Decode for this encoding

```
integer t = UInt(Rt);
integer n = UInt(Rn);
integer m = integer UNKNOWN;
boolean wback = FALSE;
```

Post-index

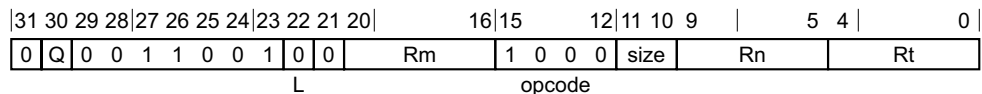

Immediate offset variant

Applies when Rm == 11111.

ST2 { <Vt>.<T>, <Vt2>.<T> }, [<Xn|SP>], <imm>

Register offset variant

Applies when Rm != 11111.

ST2 { <Vt>.<T>, <Vt2>.<T> }, [<Xn|SP>], <Xm>

Decode for all variants of this encoding

```
integer t = UInt(Rt);
integer n = UInt(Rn);
integer m = UInt(Rm);
boolean wback = TRUE;
```

Assembler symbols

- <Vt> Is the name of the first or only SIMD&FP register to be transferred, encoded in the "Rt" field.
- <T> Is an arrangement specifier, encoded in the "size:Q" field. It can have the following values:
- | | |
|-----|-----------------------|
| 8B | when size = 00, Q = 0 |
| 16B | when size = 00, Q = 1 |
| 4H | when size = 01, Q = 0 |
| 8H | when size = 01, Q = 1 |

2S when size = 10, Q = 0
 4S when size = 10, Q = 1
 2D when size = 11, Q = 1

The encoding size = 11, Q = 0 is reserved.

<Vt2> Is the name of the second SIMD&FP register to be transferred, encoded as "Rt" plus 1 modulo 32.
 <Xn|SP> Is the 64-bit name of the general-purpose base register or stack pointer, encoded in the "Rn" field.
 <imm> Is the post-index immediate offset, encoded in the "Q" field. It can have the following values:
 #16 when Q = 0
 #32 when Q = 1
 <Xm> Is the 64-bit name of the general-purpose post-index register, excluding XZR, encoded in the "Rm" field.

Shared decode for all encodings

```
MemOp memop = if L == '1' then MemOp_LOAD else MemOp_STORE;
integer datasize = if Q == '1' then 128 else 64;
integer esize = 8 << UInt(size);
integer elements = datasize DIV esize;

integer rpt;    // number of iterations
integer selem;   // structure elements

case opcode of
    when '0000' rpt = 1; selem = 4;    // LD/ST4 (4 registers)
    when '0010' rpt = 4; selem = 1;    // LD/ST1 (4 registers)
    when '0100' rpt = 1; selem = 3;    // LD/ST3 (3 registers)
    when '0110' rpt = 3; selem = 1;    // LD/ST1 (3 registers)
    when '0111' rpt = 1; selem = 1;    // LD/ST1 (1 register)
    when '1000' rpt = 1; selem = 2;    // LD/ST2 (2 registers)
    when '1010' rpt = 2; selem = 1;    // LD/ST1 (2 registers)
    otherwise UnallocatedEncoding();

// .1D format only permitted with LD1 & ST1
if size:Q == '110' && selem != 1 then ReservedValue();
```

Operation for all encodings

```
CheckFPAdvSIMDEnabled64();

bits(64) address;
bits(64) offs;
bits(datasize) rval;
integer e, r, s, tt;
constant integer ebytes = esize DIV 8;

if n == 31 then
    CheckSPAlignment();
    address = SP[];
else
    address = X[n];

offs = Zeros();
for r = 0 to rpt-1
    for e = 0 to elements-1
        tt = (t + r) MOD 32;
        for s = 0 to selem-1
            rval = V[tt];
            if memop == MemOp_LOAD then
                Elem[rval, e, esize] = Mem[address+offs, ebytes, AccType_VEC];
```

```
        V[tt] = rval;
    else // memop == MemOp_STORE
        Mem[address+offs, ebytes, AccType_VEC] = Elem[rval, e, esize];
    offs = offs + ebytes;
    tt = (tt + 1) MOD 32;

if wback then
    if m != 31 then
        offs = X[m];
    if n == 31 then
        SP[] = address + offs;
    else
        X[n] = address + offs;
```

C7.2.282 ST2 (single structure)

Store single 2-element structure from one lane of two registers. This instruction stores a 2-element structure to memory from corresponding elements of two SIMD&FP registers.

Depending on the settings in the CPACR_EL1, CPTR_EL2, and CPTR_EL3 registers, and the current Security state and Exception level, an attempt to execute the instruction might be trapped.

No offset

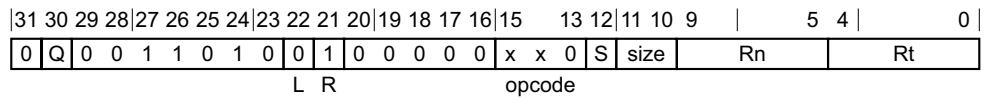

8-bit variant

Applies when opcode == 000.

ST2 { <Vt>.B, <Vt2>.B }[<index>], [<Xn|SP>]

16-bit variant

Applies when opcode == 010 && size == x0.

ST2 { <Vt>.H, <Vt2>.H }[<index>], [<Xn|SP>]

32-bit variant

Applies when opcode == 100 && size == 00.

ST2 { <Vt>.S, <Vt2>.S }[<index>], [<Xn|SP>]

64-bit variant

Applies when opcode == 100 && S == 0 && size == 01.

ST2 { <Vt>.D, <Vt2>.D }[<index>], [<Xn|SP>]

Decode for all variants of this encoding

```
integer t = UInt(Rt);
integer n = UInt(Rn);
integer m = integer UNKNOWN;
boolean wback = FALSE;
```

Post-index

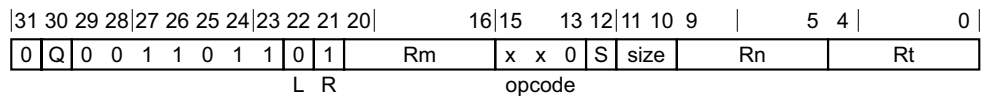

8-bit, immediate offset variant

Applies when Rm == 11111 && opcode == 000.

ST2 { <Vt>.B, <Vt2>.B }[<index>], [<Xn|SP>], #2

8-bit, register offset variant

Applies when Rm != 11111 && opcode == 000.

ST2 { <Vt>.B, <Vt2>.B }[<index>], [<Xn|SP>], <Xm>

16-bit, immediate offset variant

Applies when $Rm == 11111$ && $opcode == 010$ && $size == x0$.

ST2 { <Vt>.H, <Vt2>.H }[<index>], [<Xn|SP>], #4

16-bit, register offset variant

Applies when $Rm != 11111$ && $opcode == 010$ && $size == x0$.

ST2 { <Vt>.H, <Vt2>.H }[<index>], [<Xn|SP>], <Xm>

32-bit, immediate offset variant

Applies when $Rm == 11111$ && $opcode == 100$ && $size == 00$.

ST2 { <Vt>.S, <Vt2>.S }[<index>], [<Xn|SP>], #8

32-bit, register offset variant

Applies when $Rm != 11111$ && $opcode == 100$ && $size == 00$.

ST2 { <Vt>.S, <Vt2>.S }[<index>], [<Xn|SP>], <Xm>

64-bit, immediate offset variant

Applies when $Rm == 11111$ && $opcode == 100$ && $S == 0$ && $size == 01$.

ST2 { <Vt>.D, <Vt2>.D }[<index>], [<Xn|SP>], #16

64-bit, register offset variant

Applies when $Rm != 11111$ && $opcode == 100$ && $S == 0$ && $size == 01$.

ST2 { <Vt>.D, <Vt2>.D }[<index>], [<Xn|SP>], <Xm>

Decode for all variants of this encoding

```
integer t = UInt(Rt);
integer n = UInt(Rn);
integer m = UInt(Rm);
boolean wback = TRUE;
```

Assembler symbols

- <Vt> Is the name of the first or only SIMD&FP register to be transferred, encoded in the "Rt" field.
- <Vt2> Is the name of the second SIMD&FP register to be transferred, encoded as "Rt" plus 1 modulo 32.
- <index> For the 8-bit variant: is the element index, encoded in "Q:S:size".
 For the 16-bit variant: is the element index, encoded in "Q:S:size<1>".
 For the 32-bit variant: is the element index, encoded in "Q:S".
 For the 64-bit variant: is the element index, encoded in "Q".
- <Xn|SP> Is the 64-bit name of the general-purpose base register or stack pointer, encoded in the "Rn" field.
- <Xm> Is the 64-bit name of the general-purpose post-index register, excluding XZR, encoded in the "Rm" field.

Shared decode for all encodings

```
integer scale = UInt(opcode<2:1>);
integer selem = UInt(opcode<0>:R) + 1;
boolean replicate = FALSE;
integer index;
```

```

case scale of
when 3
    // load and replicate
    if L == '0' || S == '1' then UnallocatedEncoding();
    scale = UInt(size);
    replicate = TRUE;
when 0
    index = UInt(Q:S:size); // B[0-15]
when 1
    if size<0> == '1' then UnallocatedEncoding();
    index = UInt(Q:S:size<1>); // H[0-7]
when 2
    if size<1> == '1' then UnallocatedEncoding();
    if size<0> == '0' then
        index = UInt(Q:S); // S[0-3]
    else
        if S == '1' then UnallocatedEncoding();
        index = UInt(Q); // D[0-1]
        scale = 3;

MemOp memop = if L == '1' then MemOp_LOAD else MemOp_STORE;
integer datasize = if Q == '1' then 128 else 64;
integer esize = 8 << scale;
    
```

Operation for all encodings

```

CheckFPAdvSIMDEnabled64();

bits(64) address;
bits(64) offs;
bits(128) rval;
bits(esize) element;
integer s;
constant integer ebytes = esize DIV 8;

if n == 31 then
    CheckSPAlignment();
    address = SP[];
else
    address = X[n];

offs = Zeros();
if replicate then
    // load and replicate to all elements
    for s = 0 to selem-1
        element = Mem[address+offs, ebytes, AccType_VEC];
        // replicate to fill 128- or 64-bit register
        V[t] = Replicate(element, datasize DIV esize);
        offs = offs + ebytes;
        t = (t + 1) MOD 32;
else
    // load/store one element per register
    for s = 0 to selem-1
        rval = V[t];
        if memop == MemOp_LOAD then
            // insert into one lane of 128-bit register
            Elem[rval, index, esize] = Mem[address+offs, ebytes, AccType_VEC];
            V[t] = rval;
        else // memop == MemOp_STORE
            // extract from one lane of 128-bit register
            Mem[address+offs, ebytes, AccType_VEC] = Elem[rval, index, esize];
            offs = offs + ebytes;
            t = (t + 1) MOD 32;

if wback then
    if m != 31 then
    
```



```
    offs = X[m];  
if n == 31 then  
    SP[] = address + offs;  
else  
    X[n] = address + offs;
```

C7.2.283 ST3 (multiple structures)

Store multiple 3-element structures from three registers. This instruction stores multiple 3-element structures to memory from three SIMD&FP registers, with interleaving. Every element of each register is stored.

Depending on the settings in the CPACR_EL1, CPTR_EL2, and CPTR_EL3 registers, and the current Security state and Exception level, an attempt to execute the instruction might be trapped.

No offset

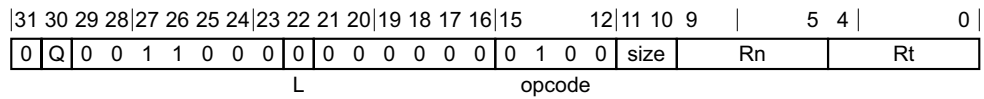

No offset variant

ST3 { <Vt>.<T>, <Vt2>.<T>, <Vt3>.<T> }, [<Xn|SP>]

Decode for this encoding

```
integer t = UInt(Rt);
integer n = UInt(Rn);
integer m = integer UNKNOWN;
boolean wback = FALSE;
```

Post-index

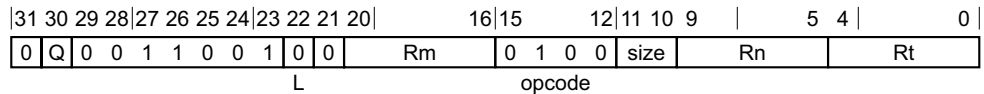

Immediate offset variant

Applies when Rm == 11111.

ST3 { <Vt>.<T>, <Vt2>.<T>, <Vt3>.<T> }, [<Xn|SP>], <imm>

Register offset variant

Applies when Rm != 11111.

ST3 { <Vt>.<T>, <Vt2>.<T>, <Vt3>.<T> }, [<Xn|SP>], <Xm>

Decode for all variants of this encoding

```
integer t = UInt(Rt);
integer n = UInt(Rn);
integer m = UInt(Rm);
boolean wback = TRUE;
```

Assembler symbols

- <Vt> Is the name of the first or only SIMD&FP register to be transferred, encoded in the "Rt" field.
- <T> Is an arrangement specifier, encoded in the "size:Q" field. It can have the following values:
 - 8B when size = 00, Q = 0
 - 16B when size = 00, Q = 1
 - 4H when size = 01, Q = 0
 - 8H when size = 01, Q = 1

2S when size = 10, Q = 0
 4S when size = 10, Q = 1
 2D when size = 11, Q = 1

The encoding size = 11, Q = 0 is reserved.

<Vt2> Is the name of the second SIMD&FP register to be transferred, encoded as "Rt" plus 1 modulo 32.
 <Vt3> Is the name of the third SIMD&FP register to be transferred, encoded as "Rt" plus 2 modulo 32.
 <Xn|SP> Is the 64-bit name of the general-purpose base register or stack pointer, encoded in the "Rn" field.
 <imm> Is the post-index immediate offset, encoded in the "Q" field. It can have the following values:
 #24 when Q = 0
 #48 when Q = 1
 <Xm> Is the 64-bit name of the general-purpose post-index register, excluding XZR, encoded in the "Rm" field.

Shared decode for all encodings

```
MemOp memop = if L == '1' then MemOp_LOAD else MemOp_STORE;
integer datasize = if Q == '1' then 128 else 64;
integer esize = 8 << UInt(size);
integer elements = datasize DIV esize;

integer rpt;    // number of iterations
integer selem; // structure elements

case opcode of
    when '0000' rpt = 1; selem = 4;    // LD/ST4 (4 registers)
    when '0010' rpt = 4; selem = 1;    // LD/ST1 (4 registers)
    when '0100' rpt = 1; selem = 3;    // LD/ST3 (3 registers)
    when '0110' rpt = 3; selem = 1;    // LD/ST1 (3 registers)
    when '0111' rpt = 1; selem = 1;    // LD/ST1 (1 register)
    when '1000' rpt = 1; selem = 2;    // LD/ST2 (2 registers)
    when '1010' rpt = 2; selem = 1;    // LD/ST1 (2 registers)
    otherwise UnallocatedEncoding();

// .LD format only permitted with LD1 & ST1
if size:Q == '110' && selem != 1 then ReservedValue();
```

Operation for all encodings

```
CheckFPAdvSIMDEnabled64();

bits(64) address;
bits(64) offs;
bits(datasize) rval;
integer e, r, s, tt;
constant integer ebytes = esize DIV 8;

if n == 31 then
    CheckSPAlignment();
    address = SP[];
else
    address = X[n];

offs = Zeros();
for r = 0 to rpt-1
    for e = 0 to elements-1
        tt = (t + r) MOD 32;
        for s = 0 to selem-1
            rval = V[tt];
```

```
    if memop == MemOp_LOAD then
        Elem[rval, e, esize] = Mem[address+offs, ebytes, AccType_VEC];
        V[tt] = rval;
    else // memop == MemOp_STORE
        Mem[address+offs, ebytes, AccType_VEC] = Elem[rval, e, esize];
        offs = offs + ebytes;
        tt = (tt + 1) MOD 32;

if wback then
    if m != 31 then
        offs = X[m];
    if n == 31 then
        SP[] = address + offs;
    else
        X[n] = address + offs;
```

C7.2.284 ST3 (single structure)

Store single 3-element structure from one lane of three registers. This instruction stores a 3-element structure to memory from corresponding elements of three SIMD&FP registers.

Depending on the settings in the CPACR_EL1, CPTR_EL2, and CPTR_EL3 registers, and the current Security state and Exception level, an attempt to execute the instruction might be trapped.

No offset

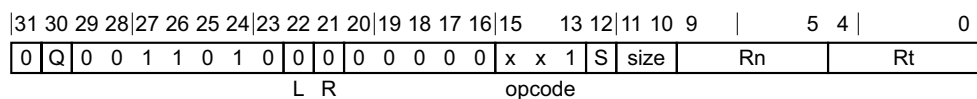

8-bit variant

Applies when opcode == 001.

ST3 { <Vt>.B, <Vt2>.B, <Vt3>.B }[<index>], [<Xn|SP>]

16-bit variant

Applies when opcode == 011 && size == x0.

ST3 { <Vt>.H, <Vt2>.H, <Vt3>.H }[<index>], [<Xn|SP>]

32-bit variant

Applies when opcode == 101 && size == 00.

ST3 { <Vt>.S, <Vt2>.S, <Vt3>.S }[<index>], [<Xn|SP>]

64-bit variant

Applies when opcode == 101 && S == 0 && size == 01.

ST3 { <Vt>.D, <Vt2>.D, <Vt3>.D }[<index>], [<Xn|SP>]

Decode for all variants of this encoding

```
integer t = UInt(Rt);
integer n = UInt(Rn);
integer m = integer UNKNOWN;
boolean wback = FALSE;
```

Post-index

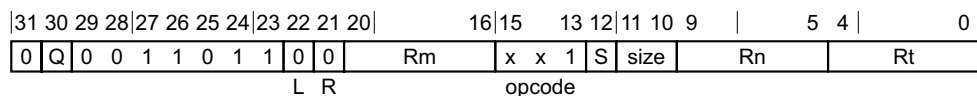

8-bit, immediate offset variant

Applies when Rm == 11111 && opcode == 001.

ST3 { <Vt>.B, <Vt2>.B, <Vt3>.B }[<index>], [<Xn|SP>], #3

8-bit, register offset variant

Applies when Rm != 11111 && opcode == 001.

ST3 { <Vt>.B, <Vt2>.B, <Vt3>.B }[<index>], [<Xn|SP>], <Xm>

16-bit, immediate offset variant

Applies when $R_m == 11111$ && opcode == 011 && size == x0.

ST3 { <Vt>.H, <Vt2>.H, <Vt3>.H } [<index>], [<Xn|SP>], #6

16-bit, register offset variant

Applies when $R_m != 11111$ && opcode == 011 && size == x0.

ST3 { <Vt>.H, <Vt2>.H, <Vt3>.H } [<index>], [<Xn|SP>], <Xm>

32-bit, immediate offset variant

Applies when $R_m == 11111$ && opcode == 101 && size == 00.

ST3 { <Vt>.S, <Vt2>.S, <Vt3>.S } [<index>], [<Xn|SP>], #12

32-bit, register offset variant

Applies when $R_m != 11111$ && opcode == 101 && size == 00.

ST3 { <Vt>.S, <Vt2>.S, <Vt3>.S } [<index>], [<Xn|SP>], <Xm>

64-bit, immediate offset variant

Applies when $R_m == 11111$ && opcode == 101 && S == 0 && size == 01.

ST3 { <Vt>.D, <Vt2>.D, <Vt3>.D } [<index>], [<Xn|SP>], #24

64-bit, register offset variant

Applies when $R_m != 11111$ && opcode == 101 && S == 0 && size == 01.

ST3 { <Vt>.D, <Vt2>.D, <Vt3>.D } [<index>], [<Xn|SP>], <Xm>

Decode for all variants of this encoding

```
integer t = UInt(Rt);
integer n = UInt(Rn);
integer m = UInt(Rm);
boolean wback = TRUE;
```

Assembler symbols

<Vt>	Is the name of the first or only SIMD&FP register to be transferred, encoded in the "Rt" field.
<Vt2>	Is the name of the second SIMD&FP register to be transferred, encoded as "Rt" plus 1 modulo 32.
<Vt3>	Is the name of the third SIMD&FP register to be transferred, encoded as "Rt" plus 2 modulo 32.
<index>	For the 8-bit variant: is the element index, encoded in "Q:S:size". For the 16-bit variant: is the element index, encoded in "Q:S:size<1>". For the 32-bit variant: is the element index, encoded in "Q:S". For the 64-bit variant: is the element index, encoded in "Q".
<Xn SP>	Is the 64-bit name of the general-purpose base register or stack pointer, encoded in the "Rn" field.
<Xm>	Is the 64-bit name of the general-purpose post-index register, excluding XZR, encoded in the "Rm" field.

Shared decode for all encodings

```

integer scale = UInt(opcode<2:1>);
integer selem = UInt(opcode<0>:R) + 1;
boolean replicate = FALSE;
integer index;

case scale of
    when 3
        // load and replicate
        if L == '0' || S == '1' then UnallocatedEncoding();
        scale = UInt(size);
        replicate = TRUE;
    when 0
        index = UInt(Q:S:size); // B[0-15]
    when 1
        if size<0> == '1' then UnallocatedEncoding();
        index = UInt(Q:S:size<1>); // H[0-7]
    when 2
        if size<1> == '1' then UnallocatedEncoding();
        if size<0> == '0' then
            index = UInt(Q:S); // S[0-3]
        else
            if S == '1' then UnallocatedEncoding();
            index = UInt(Q); // D[0-1]
            scale = 3;

MemOp memop = if L == '1' then MemOp_LOAD else MemOp_STORE;
integer datasize = if Q == '1' then 128 else 64;
integer esize = 8 << scale;
    
```

Operation for all encodings

```

CheckFPAdvSIMDEnabled64();

bits(64) address;
bits(64) offs;
bits(128) rval;
bits(esize) element;
integer s;
constant integer ebytes = esize DIV 8;

if n == 31 then
    CheckSPAlignment();
    address = SP[];
else
    address = X[n];

offs = Zeros();
if replicate then
    // load and replicate to all elements
    for s = 0 to selem-1
        element = Mem[address+offs, ebytes, AccType_VEC];
        // replicate to fill 128- or 64-bit register
        V[t] = Replicate(element, datasize DIV esize);
        offs = offs + ebytes;
        t = (t + 1) MOD 32;
else
    // load/store one element per register
    for s = 0 to selem-1
        rval = V[t];
        if memop == MemOp_LOAD then
            // insert into one lane of 128-bit register
            Elem[rval, index, esize] = Mem[address+offs, ebytes, AccType_VEC];
            V[t] = rval;
        else // memop == MemOp_STORE
            // extract from one lane of 128-bit register
    
```

```
        Mem[address+offs, ebytes, AccType_VEC] = Elem[rval, index, esize];
        offs = offs + ebytes;
        t = (t + 1) MOD 32;

if wback then
    if m != 31 then
        offs = X[m];
    if n == 31 then
        SP[] = address + offs;
    else
        X[n] = address + offs;
```

C7.2.285 ST4 (multiple structures)

Store multiple 4-element structures from four registers. This instruction stores multiple 4-element structures to memory from four SIMD&FP registers, with interleaving. Every element of each register is stored.

Depending on the settings in the CPACR_EL1, CPTR_EL2, and CPTR_EL3 registers, and the current Security state and Exception level, an attempt to execute the instruction might be trapped.

No offset

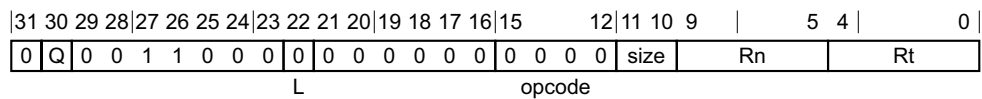

No offset variant

ST4 { <Vt>.<T>, <Vt2>.<T>, <Vt3>.<T>, <Vt4>.<T> }, [<Xn|SP>]

Decode for this encoding

```
integer t = UInt(Rt);
integer n = UInt(Rn);
integer m = integer UNKNOWN;
boolean wback = FALSE;
```

Post-index

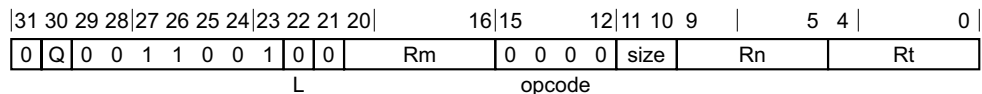

Immediate offset variant

Applies when Rm == 11111.

ST4 { <Vt>.<T>, <Vt2>.<T>, <Vt3>.<T>, <Vt4>.<T> }, [<Xn|SP>], <imm>

Register offset variant

Applies when Rm != 11111.

ST4 { <Vt>.<T>, <Vt2>.<T>, <Vt3>.<T>, <Vt4>.<T> }, [<Xn|SP>], <Xm>

Decode for all variants of this encoding

```
integer t = UInt(Rt);
integer n = UInt(Rn);
integer m = UInt(Rm);
boolean wback = TRUE;
```

Assembler symbols

- <Vt> Is the name of the first or only SIMD&FP register to be transferred, encoded in the "Rt" field.
- <T> Is an arrangement specifier, encoded in the "size:Q" field. It can have the following values:
 - 8B when size = 00, Q = 0
 - 16B when size = 00, Q = 1
 - 4H when size = 01, Q = 0
 - 8H when size = 01, Q = 1

2S when size = 10, Q = 0
 4S when size = 10, Q = 1
 2D when size = 11, Q = 1

The encoding size = 11, Q = 0 is reserved.

- <Vt2> Is the name of the second SIMD&FP register to be transferred, encoded as "Rt" plus 1 modulo 32.
- <Vt3> Is the name of the third SIMD&FP register to be transferred, encoded as "Rt" plus 2 modulo 32.
- <Vt4> Is the name of the fourth SIMD&FP register to be transferred, encoded as "Rt" plus 3 modulo 32.
- <Xn|SP> Is the 64-bit name of the general-purpose base register or stack pointer, encoded in the "Rn" field.
- <imm> Is the post-index immediate offset, encoded in the "Q" field. It can have the following values:
 - #32 when Q = 0
 - #64 when Q = 1
- <Xm> Is the 64-bit name of the general-purpose post-index register, excluding XZR, encoded in the "Rm" field.

Shared decode for all encodings

```
MemOp memop = if L == '1' then MemOp_LOAD else MemOp_STORE;
integer datasize = if Q == '1' then 128 else 64;
integer esize = 8 << UInt(size);
integer elements = datasize DIV esize;

integer rpt;    // number of iterations
integer selem;   // structure elements

case opcode of
    when '0000' rpt = 1; selem = 4;    // LD/ST4 (4 registers)
    when '0010' rpt = 4; selem = 1;    // LD/ST1 (4 registers)
    when '0100' rpt = 1; selem = 3;    // LD/ST3 (3 registers)
    when '0110' rpt = 3; selem = 1;    // LD/ST1 (3 registers)
    when '0111' rpt = 1; selem = 1;    // LD/ST1 (1 register)
    when '1000' rpt = 1; selem = 2;    // LD/ST2 (2 registers)
    when '1010' rpt = 2; selem = 1;    // LD/ST1 (2 registers)
    otherwise UnallocatedEncoding();

// .LD format only permitted with LD1 & ST1
if size:Q == '110' && selem != 1 then ReservedValue();
```

Operation for all encodings

```
CheckFPAdvSIMDEnabled64();

bits(64) address;
bits(64) offs;
bits(datasize) rval;
integer e, r, s, tt;
constant integer ebytes = esize DIV 8;

if n == 31 then
    CheckSPAlignment();
    address = SP[];
else
    address = X[n];

offs = Zeros();
for r = 0 to rpt-1
    for e = 0 to elements-1
        tt = (t + r) MOD 32;
        for s = 0 to selem-1
```

```
rval = V[tt];
if memop == MemOp_LOAD then
    Elem[rval, e, esize] = Mem[address+offs, ebytes, AccType_VEC];
    V[tt] = rval;
else // memop == MemOp_STORE
    Mem[address+offs, ebytes, AccType_VEC] = Elem[rval, e, esize];
offs = offs + ebytes;
tt = (tt + 1) MOD 32;

if wback then
    if m != 31 then
        offs = X[m];
    if n == 31 then
        SP[] = address + offs;
    else
        X[n] = address + offs;
```

C7.2.286 ST4 (single structure)

Store single 4-element structure from one lane of four registers. This instruction stores a 4-element structure to memory from corresponding elements of four SIMD&FP registers.

Depending on the settings in the CPACR_EL1, CPTR_EL2, and CPTR_EL3 registers, and the current Security state and Exception level, an attempt to execute the instruction might be trapped.

No offset

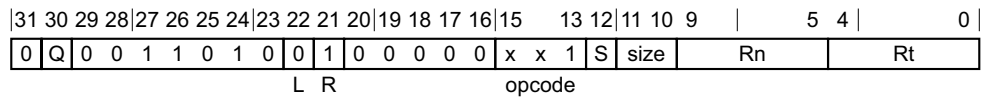

8-bit variant

Applies when opcode == 001.

ST4 { <Vt>.B, <Vt2>.B, <Vt3>.B, <Vt4>.B }[<index>], [<Xn|SP>]

16-bit variant

Applies when opcode == 011 && size == x0.

ST4 { <Vt>.H, <Vt2>.H, <Vt3>.H, <Vt4>.H }[<index>], [<Xn|SP>]

32-bit variant

Applies when opcode == 101 && size == 00.

ST4 { <Vt>.S, <Vt2>.S, <Vt3>.S, <Vt4>.S }[<index>], [<Xn|SP>]

64-bit variant

Applies when opcode == 101 && S == 0 && size == 01.

ST4 { <Vt>.D, <Vt2>.D, <Vt3>.D, <Vt4>.D }[<index>], [<Xn|SP>]

Decode for all variants of this encoding

```
integer t = UInt(Rt);
integer n = UInt(Rn);
integer m = integer UNKNOWN;
boolean wback = FALSE;
```

Post-index

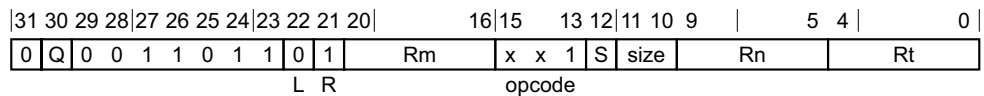

8-bit, immediate offset variant

Applies when Rm == 11111 && opcode == 001.

ST4 { <Vt>.B, <Vt2>.B, <Vt3>.B, <Vt4>.B }[<index>], [<Xn|SP>], #4

8-bit, register offset variant

Applies when Rm != 11111 && opcode == 001.

ST4 { <Vt>.B, <Vt2>.B, <Vt3>.B, <Vt4>.B }[<index>], [<Xn|SP>], <Xm>

16-bit, immediate offset variant

Applies when $Rm == 11111$ && $opcode == 011$ && $size == x0$.

ST4 { <Vt>.H, <Vt2>.H, <Vt3>.H, <Vt4>.H }[<index>], [<Xn|SP>], #8

16-bit, register offset variant

Applies when $Rm != 11111$ && $opcode == 011$ && $size == x0$.

ST4 { <Vt>.H, <Vt2>.H, <Vt3>.H, <Vt4>.H }[<index>], [<Xn|SP>], <Xm>

32-bit, immediate offset variant

Applies when $Rm == 11111$ && $opcode == 101$ && $size == 00$.

ST4 { <Vt>.S, <Vt2>.S, <Vt3>.S, <Vt4>.S }[<index>], [<Xn|SP>], #16

32-bit, register offset variant

Applies when $Rm != 11111$ && $opcode == 101$ && $size == 00$.

ST4 { <Vt>.S, <Vt2>.S, <Vt3>.S, <Vt4>.S }[<index>], [<Xn|SP>], <Xm>

64-bit, immediate offset variant

Applies when $Rm == 11111$ && $opcode == 101$ && $S == 0$ && $size == 01$.

ST4 { <Vt>.D, <Vt2>.D, <Vt3>.D, <Vt4>.D }[<index>], [<Xn|SP>], #32

64-bit, register offset variant

Applies when $Rm != 11111$ && $opcode == 101$ && $S == 0$ && $size == 01$.

ST4 { <Vt>.D, <Vt2>.D, <Vt3>.D, <Vt4>.D }[<index>], [<Xn|SP>], <Xm>

Decode for all variants of this encoding

```
integer t = UInt(Rt);
integer n = UInt(Rn);
integer m = UInt(Rm);
boolean wback = TRUE;
```

Assembler symbols

- <Vt> Is the name of the first or only SIMD&FP register to be transferred, encoded in the "Rt" field.
- <Vt2> Is the name of the second SIMD&FP register to be transferred, encoded as "Rt" plus 1 modulo 32.
- <Vt3> Is the name of the third SIMD&FP register to be transferred, encoded as "Rt" plus 2 modulo 32.
- <Vt4> Is the name of the fourth SIMD&FP register to be transferred, encoded as "Rt" plus 3 modulo 32.
- <index> For the 8-bit variant: is the element index, encoded in "Q:S:size".
 For the 16-bit variant: is the element index, encoded in "Q:S:size<1>".
 For the 32-bit variant: is the element index, encoded in "Q:S".
 For the 64-bit variant: is the element index, encoded in "Q".
- <Xn|SP> Is the 64-bit name of the general-purpose base register or stack pointer, encoded in the "Rn" field.
- <Xm> Is the 64-bit name of the general-purpose post-index register, excluding XZR, encoded in the "Rm" field.

Shared decode for all encodings

```

integer scale = UInt(opcode<2:1>);
integer selem = UInt(opcode<0>:R) + 1;
boolean replicate = FALSE;
integer index;

case scale of
  when 3
    // load and replicate
    if L == '0' || S == '1' then UnallocatedEncoding();
    scale = UInt(size);
    replicate = TRUE;
  when 0
    index = UInt(Q:S:size); // B[0-15]
  when 1
    if size<0> == '1' then UnallocatedEncoding();
    index = UInt(Q:S:size<1>); // H[0-7]
  when 2
    if size<1> == '1' then UnallocatedEncoding();
    if size<0> == '0' then
      index = UInt(Q:S); // S[0-3]
    else
      if S == '1' then UnallocatedEncoding();
      index = UInt(Q); // D[0-1]
      scale = 3;

MemOp memop = if L == '1' then MemOp_LOAD else MemOp_STORE;
integer datasize = if Q == '1' then 128 else 64;
integer esize = 8 << scale;
  
```

Operation for all encodings

```

CheckFPAdvSIMDEnabled64();

bits(64) address;
bits(64) offs;
bits(128) rval;
bits(esize) element;
integer s;
constant integer ebytes = esize DIV 8;

if n == 31 then
  CheckSPAlignment();
  address = SP[];
else
  address = X[n];

offs = Zeros();
if replicate then
  // load and replicate to all elements
  for s = 0 to selem-1
    element = Mem[address+offs, ebytes, AccType_VEC];
    // replicate to fill 128- or 64-bit register
    V[t] = Replicate(element, datasize DIV esize);
    offs = offs + ebytes;
    t = (t + 1) MOD 32;
else
  // load/store one element per register
  for s = 0 to selem-1
    rval = V[t];
    if memop == MemOp_LOAD then
      // insert into one lane of 128-bit register
      Elem[rval, index, esize] = Mem[address+offs, ebytes, AccType_VEC];
      V[t] = rval;
    else // memop == MemOp_STORE
      // extract from one lane of 128-bit register
  
```

```
    Mem[address+offs, ebytes, AccType_VEC] = Elem[rval, index, esize];  
    offs = offs + ebytes;  
    t = (t + 1) MOD 32;  
  
if wback then  
    if m != 31 then  
        offs = X[m];  
    if n == 31 then  
        SP[] = address + offs;  
    else  
        X[n] = address + offs;
```

C7.2.287 STNP (SIMD&FP)

Store Pair of SIMD&FP registers, with Non-temporal hint. This instruction stores a pair of SIMD&FP registers to memory, issuing a hint to the memory system that the access is non-temporal. The address used for the store is calculated from an address from a base register value and an immediate offset. For information about non-temporal pair instructions, see *Load/Store SIMD and Floating-point Non-temporal pair* on page C3-168.

Depending on the settings in the CPACR_EL1, CPTR_EL2, and CPTR_EL3 registers, and the current Security state and Exception level, an attempt to execute the instruction might be trapped.

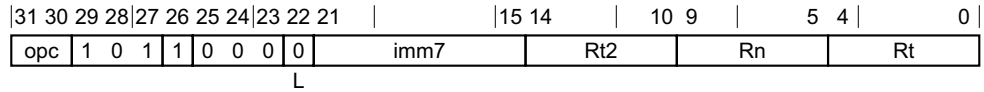

32-bit variant

Applies when `opc == 00`.

STNP <St1>, <St2>, [<Xn|SP>{, #<imm>}]

64-bit variant

Applies when `opc == 01`.

STNP <Dt1>, <Dt2>, [<Xn|SP>{, #<imm>}]

128-bit variant

Applies when `opc == 10`.

STNP <Qt1>, <Qt2>, [<Xn|SP>{, #<imm>}]

Decode for all variants of this encoding

// Empty.

Assembler symbols

- <Dt1> Is the 64-bit name of the first SIMD&FP register to be transferred, encoded in the "Rt" field.
- <Dt2> Is the 64-bit name of the second SIMD&FP register to be transferred, encoded in the "Rt2" field.
- <Qt1> Is the 128-bit name of the first SIMD&FP register to be transferred, encoded in the "Rt" field.
- <Qt2> Is the 128-bit name of the second SIMD&FP register to be transferred, encoded in the "Rt2" field.
- <St1> Is the 32-bit name of the first SIMD&FP register to be transferred, encoded in the "Rt" field.
- <St2> Is the 32-bit name of the second SIMD&FP register to be transferred, encoded in the "Rt2" field.
- <Xn|SP> Is the 64-bit name of the general-purpose base register or stack pointer, encoded in the "Rn" field.
- <imm> For the 32-bit variant: is the optional signed immediate byte offset, a multiple of 4 in the range -256 to 252, defaulting to 0 and encoded in the "imm7" field as <imm>/4.
For the 64-bit variant: is the optional signed immediate byte offset, a multiple of 8 in the range -512 to 504, defaulting to 0 and encoded in the "imm7" field as <imm>/8.
For the 128-bit variant: is the optional signed immediate byte offset, a multiple of 16 in the range -1024 to 1008, defaulting to 0 and encoded in the "imm7" field as <imm>/16.

Shared decode for all encodings

```
integer n = UInt(Rn);  
integer t = UInt(Rt);  
integer t2 = UInt(Rt2);  
if opc == '11' then UnallocatedEncoding();  
integer scale = 2 + UInt(opc);  
integer datasize = 8 << scale;  
bits(64) offset = LSL(SignExtend(imm7, 64), scale);
```

Operation

```
CheckFPAdvSIMDEnabled64();  
  
bits(64) address;  
bits(datasize) data1;  
bits(datasize) data2;  
constant integer dbytes = datasize DIV 8;  
  
if n == 31 then  
    CheckSPAlignment();  
    address = SP[];  
else  
    address = X[n];  
  
address = address + offset;  
  
data1 = V[t];  
data2 = V[t2];  
Mem[address, dbytes, AccType_VECSTREAM] = data1;  
Mem[address+dbytes, dbytes, AccType_VECSTREAM] = data2;
```

C7.2.288 STP (SIMD&FP)

Store Pair of SIMD&FP registers. This instruction stores a pair of SIMD&FP registers to memory. The address used for the store is calculated from a base register value and an immediate offset.

Depending on the settings in the CPACR_EL1, CPTR_EL2, and CPTR_EL3 registers, and the current Security state and Exception level, an attempt to execute the instruction might be trapped.

Post-index

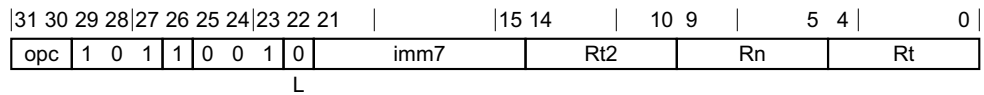

32-bit variant

Applies when `opc == 00`.

STP <St1>, <St2>, [<Xn|SP>], #<imm>

64-bit variant

Applies when `opc == 01`.

STP <Dt1>, <Dt2>, [<Xn|SP>], #<imm>

128-bit variant

Applies when `opc == 10`.

STP <Qt1>, <Qt2>, [<Xn|SP>], #<imm>

Decode for all variants of this encoding

```
boolean wback = TRUE;
boolean postindex = TRUE;
```

Pre-index

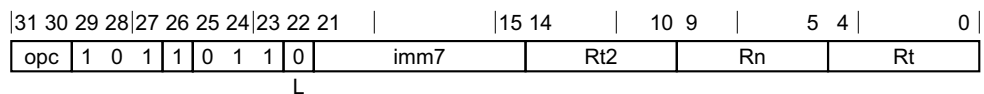

32-bit variant

Applies when `opc == 00`.

STP <St1>, <St2>, [<Xn|SP>], #<imm>!

64-bit variant

Applies when `opc == 01`.

STP <Dt1>, <Dt2>, [<Xn|SP>], #<imm>!

128-bit variant

Applies when `opc == 10`.

STP <Qt1>, <Qt2>, [<Xn|SP>], #<imm>!

Decode for all variants of this encoding

boolean wback = TRUE;
 boolean postindex = FALSE;

Signed offset

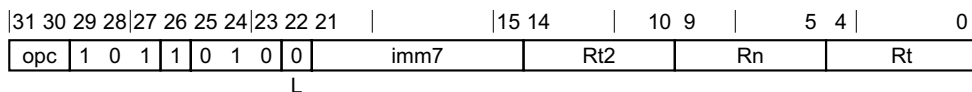

32-bit variant

Applies when opc == 00.
 STP <St1>, <St2>, [<Xn|SP>{, #<imm>}]

64-bit variant

Applies when opc == 01.
 STP <Dt1>, <Dt2>, [<Xn|SP>{, #<imm>}]

128-bit variant

Applies when opc == 10.
 STP <Qt1>, <Qt2>, [<Xn|SP>{, #<imm>}]

Decode for all variants of this encoding

boolean wback = FALSE;
 boolean postindex = FALSE;

Assembler symbols

- <Dt1> Is the 64-bit name of the first SIMD&FP register to be transferred, encoded in the "Rt" field.
- <Dt2> Is the 64-bit name of the second SIMD&FP register to be transferred, encoded in the "Rt2" field.
- <Qt1> Is the 128-bit name of the first SIMD&FP register to be transferred, encoded in the "Rt" field.
- <Qt2> Is the 128-bit name of the second SIMD&FP register to be transferred, encoded in the "Rt2" field.
- <St1> Is the 32-bit name of the first SIMD&FP register to be transferred, encoded in the "Rt" field.
- <St2> Is the 32-bit name of the second SIMD&FP register to be transferred, encoded in the "Rt2" field.
- <Xn|SP> Is the 64-bit name of the general-purpose base register or stack pointer, encoded in the "Rn" field.
- <imm> For the 32-bit post-index and 32-bit pre-index variant: is the signed immediate byte offset, a multiple of 4 in the range -256 to 252, encoded in the "imm7" field as <imm>/4.
 For the 32-bit signed offset variant: is the optional signed immediate byte offset, a multiple of 4 in the range -256 to 252, defaulting to 0 and encoded in the "imm7" field as <imm>/4.
 For the 64-bit post-index and 64-bit pre-index variant: is the signed immediate byte offset, a multiple of 8 in the range -512 to 504, encoded in the "imm7" field as <imm>/8.
 For the 64-bit signed offset variant: is the optional signed immediate byte offset, a multiple of 8 in the range -512 to 504, defaulting to 0 and encoded in the "imm7" field as <imm>/8.
 For the 128-bit post-index and 128-bit pre-index variant: is the signed immediate byte offset, a multiple of 16 in the range -1024 to 1008, encoded in the "imm7" field as <imm>/16.

For the 128-bit signed offset variant: is the optional signed immediate byte offset, a multiple of 16 in the range -1024 to 1008, defaulting to 0 and encoded in the "imm7" field as <imm>/16.

Shared decode for all encodings

```
integer n = UInt(Rn);
integer t = UInt(Rt);
integer t2 = UInt(Rt2);
if opc == '11' then UnallocatedEncoding();
integer scale = 2 + UInt(opc);
integer datasize = 8 << scale;
bits(64) offset = LSL(SignExtend(imm7, 64), scale);
```

Operation for all encodings

```
CheckFPAdvSIMDEnabled64();

bits(64) address;
bits(datasize) data1;
bits(datasize) data2;
constant integer dbytes = datasize DIV 8;

if n == 31 then
    CheckSPAlignment();
    address = SP[];
else
    address = X[n];

if !postindex then
    address = address + offset;

data1 = V[t];
data2 = V[t2];
Mem[address, dbytes, AccType_VEC] = data1;
Mem[address+dbytes, dbytes, AccType_VEC] = data2;

if wback then
    if postindex then
        address = address + offset;
    if n == 31 then
        SP[] = address;
    else
        X[n] = address;
```

C7.2.289 STR (immediate, SIMD&FP)

Store SIMD&FP register (immediate offset). This instruction stores a single SIMD&FP register to memory. The address that is used for the store is calculated from a base register value and an immediate offset.

Depending on the settings in the CPACR_EL1, CPTR_EL2, and CPTR_EL3 registers, and the current Security state and Exception level, an attempt to execute the instruction might be trapped.

Post-index

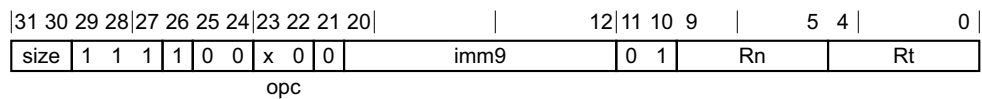

8-bit variant

Applies when size == 00 && opc == 00.

STR <Bt>, [<Xn|SP>], #<sim>

16-bit variant

Applies when size == 01 && opc == 00.

STR <Ht>, [<Xn|SP>], #<sim>

32-bit variant

Applies when size == 10 && opc == 00.

STR <St>, [<Xn|SP>], #<sim>

64-bit variant

Applies when size == 11 && opc == 00.

STR <Dt>, [<Xn|SP>], #<sim>

128-bit variant

Applies when size == 00 && opc == 10.

STR <Qt>, [<Xn|SP>], #<sim>

Decode for all variants of this encoding

```
boolean wback = TRUE;
boolean postindex = TRUE;
integer scale = UInt(opc<1>:size);
if scale > 4 then UnallocatedEncoding();
bits(64) offset = SignExtend(imm9, 64);
```

Pre-index

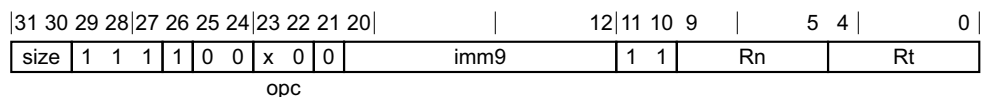

8-bit variant

Applies when size == 00 && opc == 00.

STR <Bt>, [<Xn|SP>, #<sim>]!

16-bit variant

Applies when size == 01 && opc == 00.

STR <Ht>, [<Xn|SP>, #<sim>]!

32-bit variant

Applies when size == 10 && opc == 00.

STR <St>, [<Xn|SP>, #<sim>]!

64-bit variant

Applies when size == 11 && opc == 00.

STR <Dt>, [<Xn|SP>, #<sim>]!

128-bit variant

Applies when size == 00 && opc == 10.

STR <Qt>, [<Xn|SP>, #<sim>]!

Decode for all variants of this encoding

```
boolean wback = TRUE;
boolean postindex = FALSE;
integer scale = UInt(opc<1>:size);
if scale > 4 then UnallocatedEncoding();
bits(64) offset = SignExtend(imm9, 64);
```

Unsigned offset

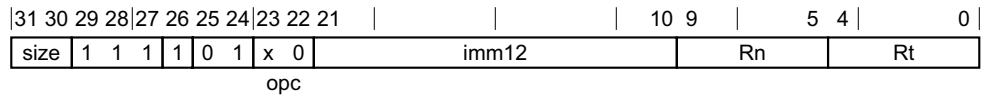

8-bit variant

Applies when size == 00 && opc == 00.

STR <Bt>, [<Xn|SP>{, #<pimm>}]

16-bit variant

Applies when size == 01 && opc == 00.

STR <Ht>, [<Xn|SP>{, #<pimm>}]

32-bit variant

Applies when size == 10 && opc == 00.

STR <St>, [<Xn|SP>{, #<pimm>}]

64-bit variant

Applies when size == 11 && opc == 00.

STR <Dt>, [<Xn|SP>{, #<pimm>}]

128-bit variant

Applies when size == 00 && opc == 10.

STR <Qt>, [<Xn|SP>{, #<pimm>}]

Decode for all variants of this encoding

```
boolean wback = FALSE;
boolean postindex = FALSE;
integer scale = UInt(opc<1>:size);
if scale > 4 then UnallocatedEncoding();
bits(64) offset = LSL(ZeroExtend(imm12, 64), scale);
```

Assembler symbols

<Bt>	Is the 8-bit name of the SIMD&FP register to be transferred, encoded in the "Rt" field.
<Dt>	Is the 64-bit name of the SIMD&FP register to be transferred, encoded in the "Rt" field.
<Ht>	Is the 16-bit name of the SIMD&FP register to be transferred, encoded in the "Rt" field.
<Qt>	Is the 128-bit name of the SIMD&FP register to be transferred, encoded in the "Rt" field.
<St>	Is the 32-bit name of the SIMD&FP register to be transferred, encoded in the "Rt" field.
<Xn SP>	Is the 64-bit name of the general-purpose base register or stack pointer, encoded in the "Rn" field.
<sim9>	Is the signed immediate byte offset, in the range -256 to 255, encoded in the "imm9" field.
<pimm>	For the 8-bit variant: is the optional positive immediate byte offset, in the range 0 to 4095, defaulting to 0 and encoded in the "imm12" field. For the 16-bit variant: is the optional positive immediate byte offset, a multiple of 2 in the range 0 to 8190, defaulting to 0 and encoded in the "imm12" field as <pimm>/2. For the 32-bit variant: is the optional positive immediate byte offset, a multiple of 4 in the range 0 to 16380, defaulting to 0 and encoded in the "imm12" field as <pimm>/4. For the 64-bit variant: is the optional positive immediate byte offset, a multiple of 8 in the range 0 to 32760, defaulting to 0 and encoded in the "imm12" field as <pimm>/8. For the 128-bit variant: is the optional positive immediate byte offset, a multiple of 16 in the range 0 to 65520, defaulting to 0 and encoded in the "imm12" field as <pimm>/16.

Shared decode for all encodings

```
integer n = UInt(Rn);
integer t = UInt(Rt);
AccType acctype = AccType_VEC;
MemOp memop = if opc<0> == '1' then MemOp_LOAD else MemOp_STORE;
integer datasize = 8 << scale;
```

Operation for all encodings

```
CheckFPAdvSIMDEnabled64();

bits(64) address;
bits(datasize) data;

if n == 31 then
  CheckSPAlignment();
  address = SP[];
else
  address = X[n];

if !postindex then
```

```
    address = address + offset;

case memop of
  when MemOp_STORE
    data = V[t];
    Mem[address, datasize DIV 8, acctype] = data;

  when MemOp_LOAD
    data = Mem[address, datasize DIV 8, acctype];
    V[t] = data;

if wback then
  if postindex then
    address = address + offset;
  if n == 31 then
    SP[] = address;
  else
    X[n] = address;
```

C7.2.290 STR (register, SIMD&FP)

Store SIMD&FP register (register offset). This instruction stores a single SIMD&FP register to memory. The address that is used for the store is calculated from a base register value and an offset register value. The offset can be optionally shifted and extended.

Depending on the settings in the CPACR_EL1, CPTR_EL2, and CPTR_EL3 registers, and the current Security state and Exception level, an attempt to execute the instruction might be trapped.

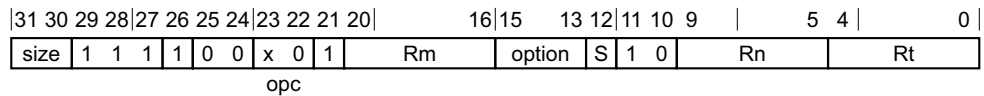

8-bit variant

Applies when size == 00 && opc == 00 && option != 011.

STR <Bt>, [<Xn|SP>, (<Wm>|<Xm>), <extend> {<amount>}]

8-bit variant

Applies when size == 00 && opc == 00 && option == 011.

STR <Bt>, [<Xn|SP>, <Xm>{, LSL <amount>}]

16-bit variant

Applies when size == 01 && opc == 00.

STR <Ht>, [<Xn|SP>, (<Wm>|<Xm>){, <extend> {<amount>}}]

32-bit variant

Applies when size == 10 && opc == 00.

STR <St>, [<Xn|SP>, (<Wm>|<Xm>){, <extend> {<amount>}}]

64-bit variant

Applies when size == 11 && opc == 00.

STR <Dt>, [<Xn|SP>, (<Wm>|<Xm>){, <extend> {<amount>}}]

128-bit variant

Applies when size == 00 && opc == 10.

STR <Qt>, [<Xn|SP>, (<Wm>|<Xm>){, <extend> {<amount>}}]

Decode for all variants of this encoding

```
boolean wback = FALSE;
boolean postindex = FALSE;
integer scale = UInt(opc<1>:size);
if scale > 4 then UnallocatedEncoding();
if option<1> == '0' then UnallocatedEncoding(); // sub-word index
ExtendType extend_type = DecodeRegExtend(option);
integer shift = if S == '1' then scale else 0;
```

Assembler symbols

<Bt> Is the 8-bit name of the SIMD&FP register to be transferred, encoded in the "Rt" field.

<Dt>	Is the 64-bit name of the SIMD&FP register to be transferred, encoded in the "Rt" field.
<Ht>	Is the 16-bit name of the SIMD&FP register to be transferred, encoded in the "Rt" field.
<Qt>	Is the 128-bit name of the SIMD&FP register to be transferred, encoded in the "Rt" field.
<St>	Is the 32-bit name of the SIMD&FP register to be transferred, encoded in the "Rt" field.
<Xn SP>	Is the 64-bit name of the general-purpose base register or stack pointer, encoded in the "Rn" field.
<Wm>	When option<0> is set to 0, is the 32-bit name of the general-purpose index register, encoded in the "Rm" field.
<Xm>	When option<0> is set to 1, is the 64-bit name of the general-purpose index register, encoded in the "Rm" field.
<extend>	<p>For the 8-bit variant: is the index extend specifier, encoded in the "option" field. It can have the following values:</p> <p>UXTW when option = 010</p> <p>SXTW when option = 110</p> <p>SXTX when option = 111</p> <p>For the 128-bit, 16-bit, 32-bit and 64-bit variant: is the index extend/shift specifier, defaulting to LSL, and which must be omitted for the LSL option when <amount> is omitted. encoded in the "option" field. It can have the following values:</p> <p>UXTW when option = 010</p> <p>LSL when option = 011</p> <p>SXTW when option = 110</p> <p>SXTX when option = 111</p>
<amount>	<p>For the 8-bit variant: is the index shift amount, it must be #0, encoded in "S" as 0 if omitted, or as 1 if present.</p> <p>For the 16-bit variant: is the index shift amount, optional only when <extend> is not LSL. Where it is permitted to be optional, it defaults to #0. It is encoded in the "S" field. It can have the following values:</p> <p>#0 when S = 0</p> <p>#1 when S = 1</p> <p>For the 32-bit variant: is the index shift amount, optional only when <extend> is not LSL. Where it is permitted to be optional, it defaults to #0. It is encoded in the "S" field. It can have the following values:</p> <p>#0 when S = 0</p> <p>#2 when S = 1</p> <p>For the 64-bit variant: is the index shift amount, optional only when <extend> is not LSL. Where it is permitted to be optional, it defaults to #0. It is encoded in the "S" field. It can have the following values:</p> <p>#0 when S = 0</p> <p>#3 when S = 1</p> <p>For the 128-bit variant: is the index shift amount, optional only when <extend> is not LSL. Where it is permitted to be optional, it defaults to #0. It is encoded in the "S" field. It can have the following values:</p> <p>#0 when S = 0</p> <p>#4 when S = 1</p>

Shared decode for all encodings

```
integer n = UInt(Rn);
integer t = UInt(Rt);
integer m = UInt(Rm);
AccType acctype = AccType_VEC;
MemOp memop = if opc<0> == '1' then MemOp_LOAD else MemOp_STORE;
integer datasize = 8 << scale;
```

Operation

```
bits(64) offset = ExtendReg(m, extend_type, shift);
CheckFPAdvSIMDEnabled64();

bits(64) address;
bits(datasize) data;

if n == 31 then
    CheckSPAlignment();
    address = SP[];
else
    address = X[n];

if !postindex then
    address = address + offset;

case memop of
    when MemOp_STORE
        data = V[t];
        Mem[address, datasize DIV 8, acctype] = data;

    when MemOp_LOAD
        data = Mem[address, datasize DIV 8, acctype];
        V[t] = data;

if wback then
    if postindex then
        address = address + offset;
    if n == 31 then
        SP[] = address;
    else
        X[n] = address;
```

C7.2.291 STUR (SIMD&FP)

Store SIMD&FP register (unscaled offset). This instruction stores a single SIMD&FP register to memory. The address that is used for the store is calculated from a base register value and an optional immediate offset.

Depending on the settings in the CPACR_EL1, CPTR_EL2, and CPTR_EL3 registers, and the current Security state and Exception level, an attempt to execute the instruction might be trapped.

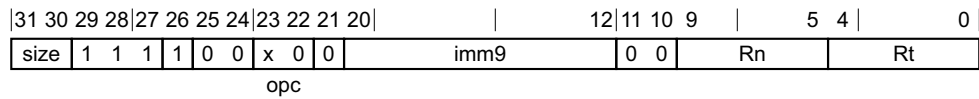

8-bit variant

Applies when size == 00 && opc == 00.

STUR <Bt>, [<Xn|SP>{, #<sim>}]

16-bit variant

Applies when size == 01 && opc == 00.

STUR <Ht>, [<Xn|SP>{, #<sim>}]

32-bit variant

Applies when size == 10 && opc == 00.

STUR <St>, [<Xn|SP>{, #<sim>}]

64-bit variant

Applies when size == 11 && opc == 00.

STUR <Dt>, [<Xn|SP>{, #<sim>}]

128-bit variant

Applies when size == 00 && opc == 10.

STUR <Qt>, [<Xn|SP>{, #<sim>}]

Decode for all variants of this encoding

```
boolean wback = FALSE;
boolean postindex = FALSE;
integer scale = UInt(opc<1>:size);
if scale > 4 then UnallocatedEncoding();
bits(64) offset = SignExtend(imm9, 64);
```

Assembler symbols

- <Bt> Is the 8-bit name of the SIMD&FP register to be transferred, encoded in the "Rt" field.
- <Dt> Is the 64-bit name of the SIMD&FP register to be transferred, encoded in the "Rt" field.
- <Ht> Is the 16-bit name of the SIMD&FP register to be transferred, encoded in the "Rt" field.
- <Qt> Is the 128-bit name of the SIMD&FP register to be transferred, encoded in the "Rt" field.
- <St> Is the 32-bit name of the SIMD&FP register to be transferred, encoded in the "Rt" field.

<Xn|SP> Is the 64-bit name of the general-purpose base register or stack pointer, encoded in the "Rn" field.

<imm> Is the optional signed immediate byte offset, in the range -256 to 255, defaulting to 0 and encoded in the "imm9" field.

Shared decode for all encodings

```
integer n = UInt(Rn);
integer t = UInt(Rt);
AccType acctype = AccType_VEC;
MemOp memop = if opc<0> == '1' then MemOp_LOAD else MemOp_STORE;
integer datasize = 8 << scale;
```

Operation

```
CheckFPAdvSIMDEnabled64();

bits(64) address;
bits(datasize) data;

if n == 31 then
    CheckSPAlignment();
    address = SP[];
else
    address = X[n];

if !postindex then
    address = address + offset;

case memop of
    when MemOp_STORE
        data = V[t];
        Mem[address, datasize DIV 8, acctype] = data;

    when MemOp_LOAD
        data = Mem[address, datasize DIV 8, acctype];
        V[t] = data;

if wback then
    if postindex then
        address = address + offset;
    if n == 31 then
        SP[] = address;
    else
        X[n] = address;
```

C7.2.292 SUB (vector)

Subtract (vector). This instruction subtracts each vector element in the second source SIMD&FP register from the corresponding vector element in the first source SIMD&FP register, places the result into a vector, and writes the vector to the destination SIMD&FP register.

Depending on the settings in the CPACR_EL1, CPTR_EL2, and CPTR_EL3 registers, and the current Security state and Exception level, an attempt to execute the instruction might be trapped.

Scalar

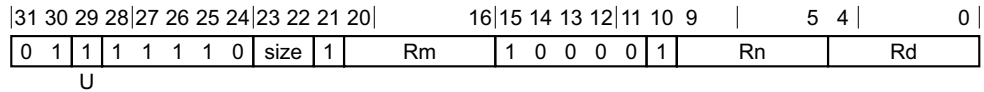

Scalar variant

SUB <V><d>, <V><n>, <V><m>

Decode for this encoding

```
integer d = UInt(Rd);
integer n = UInt(Rn);
integer m = UInt(Rm);
if size != '11' then ReservedValue();
integer esize = 8 << UInt(size);
integer datasize = esize;
integer elements = 1;
boolean sub_op = (U == '1');
```

Vector

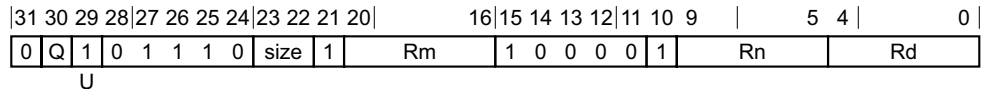

Vector variant

SUB <Vd>.<T>, <Vn>.<T>, <Vm>.<T>

Decode for this encoding

```
integer d = UInt(Rd);
integer n = UInt(Rn);
integer m = UInt(Rm);
if size:Q == '110' then ReservedValue();
integer esize = 8 << UInt(size);
integer datasize = if Q == '1' then 128 else 64;
integer elements = datasize DIV esize;
boolean sub_op = (U == '1');
```

Assembler symbols

<V> Is a width specifier, encoded in the "size" field. It can have the following values:

D when size = 11

The following encodings are reserved:

- size = 0x.
- size = 10.

- <d> Is the number of the SIMD&FP destination register, in the "Rd" field.
- <n> Is the number of the first SIMD&FP source register, encoded in the "Rn" field.
- <m> Is the number of the second SIMD&FP source register, encoded in the "Rm" field.
- <Vd> Is the name of the SIMD&FP destination register, encoded in the "Rd" field.
- <T> Is an arrangement specifier, encoded in the "size:Q" field. It can have the following values:
- | | |
|-----|-----------------------|
| 8B | when size = 00, Q = 0 |
| 16B | when size = 00, Q = 1 |
| 4H | when size = 01, Q = 0 |
| 8H | when size = 01, Q = 1 |
| 2S | when size = 10, Q = 0 |
| 4S | when size = 10, Q = 1 |
| 2D | when size = 11, Q = 1 |
- The encoding size = 11, Q = 0 is reserved.
- <Vn> Is the name of the first SIMD&FP source register, encoded in the "Rn" field.
- <Vm> Is the name of the second SIMD&FP source register, encoded in the "Rm" field.

Operation for all encodings

```
CheckFPAdvSIMDEnabled64();
bits(datasize) operand1 = V[n];
bits(datasize) operand2 = V[m];
bits(datasize) result;
bits(esize) element1;
bits(esize) element2;

for e = 0 to elements-1
    element1 = Elem[operand1, e, esize];
    element2 = Elem[operand2, e, esize];
    if sub_op then
        Elem[result, e, esize] = element1 - element2;
    else
        Elem[result, e, esize] = element1 + element2;

V[d] = result;
```

C7.2.293 SUBHN, SUBHN2

Subtract returning High Narrow. This instruction subtracts each vector element in the second source SIMD&FP register from the corresponding vector element in the first source SIMD&FP register, places the most significant half of the result into a vector, and writes the vector to the lower or upper half of the destination SIMD&FP register. All the values in this instruction are signed integer values.

The results are truncated. For rounded results, see [RSubHN](#), [RSubHN2](#).

The SUBHN instruction writes the vector to the lower half of the destination register and clears the upper half, while the SUBHN2 instruction writes the vector to the upper half of the destination register without affecting the other bits of the register.

Depending on the settings in the [CPACR_EL1](#), [CPTR_EL2](#), and [CPTR_EL3](#) registers, and the current Security state and Exception level, an attempt to execute the instruction might be trapped.

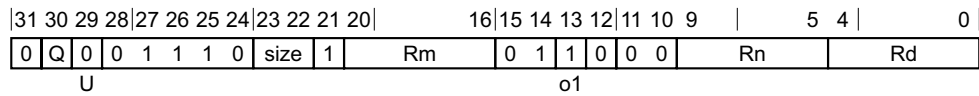

Three registers, not all the same type variant

SUBHN{2} <Vd>.<Tb>, <Vn>.<Ta>, <Vm>.<Ta>

Decode for this encoding

```
integer d = UInt(Rd);
integer n = UInt(Rn);
integer m = UInt(Rm);

if size == '11' then ReservedValue();
integer esize = 8 << UInt(size);
integer datasize = 64;
integer part = UInt(Q);
integer elements = datasize DIV esize;

boolean sub_op = (o1 == '1');
boolean round = (U == '1');
```

Assembler symbols

- 2 Is the second and upper half specifier. If present it causes the operation to be performed on the upper 64 bits of the registers holding the narrower elements, and is encoded in the "Q" field. It can have the following values:
 - [absent] when Q = 0
 - [present] when Q = 1
- <Vd> Is the name of the SIMD&FP destination register, encoded in the "Rd" field.
- <Tb> Is an arrangement specifier, encoded in the "size:Q" field. It can have the following values:
 - 8B when size = 00, Q = 0
 - 16B when size = 00, Q = 1
 - 4H when size = 01, Q = 0
 - 8H when size = 01, Q = 1
 - 2S when size = 10, Q = 0
 - 4S when size = 10, Q = 1

The encoding size = 11, Q = x is reserved.

<Vn> Is the name of the first SIMD&FP source register, encoded in the "Rn" field.

<Ta> Is an arrangement specifier, encoded in the "size" field. It can have the following values:

8H when size = 00

4S when size = 01

2D when size = 10

The encoding size = 11 is reserved.

<Vm> Is the name of the second SIMD&FP source register, encoded in the "Rm" field.

Operation

```
CheckFPAdvSIMDEnabled64();
bits(2*datasize) operand1 = V[n];
bits(2*datasize) operand2 = V[m];
bits(datasize) result;
integer round_const = if round then 1 << (esize - 1) else 0;
bits(2*esize) element1;
bits(2*esize) element2;
bits(2*esize) sum;

for e = 0 to elements-1
    element1 = Elem[operand1, e, 2*esize];
    element2 = Elem[operand2, e, 2*esize];
    if sub_op then
        sum = element1 - element2;
    else
        sum = element1 + element2;
    sum = sum + round_const;
    Elem[result, e, esize] = sum<2*esize-1:esize>;

Vpart[d, part] = result;
```

C7.2.294 SUQADD

Signed saturating Accumulate of Unsigned value. This instruction adds the unsigned integer values of the vector elements in the source SIMD&FP register to corresponding signed integer values of the vector elements in the destination SIMD&FP register, and writes the resulting signed integer values to the destination SIMD&FP register.

If overflow occurs with any of the results, those results are saturated. If saturation occurs, the cumulative saturation bit [FPSR.QC](#) is set.

Depending on the settings in the [CPACR_EL1](#), [CPTR_EL2](#), and [CPTR_EL3](#) registers, and the current Security state and Exception level, an attempt to execute the instruction might be trapped.

Scalar

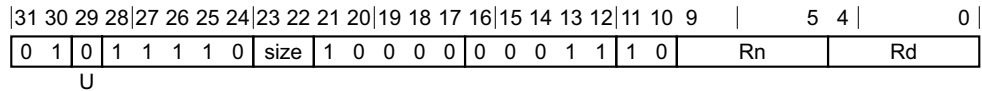

Scalar variant

SUQADD <V><d>, <V><n>

Decode for this encoding

```
integer d = UInt(Rd);
integer n = UInt(Rn);

integer esize = 8 << UInt(size);
integer datasize = esize;
integer elements = 1;

boolean unsigned = (U == '1');
```

Vector

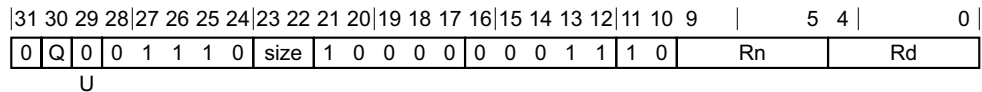

Vector variant

SUQADD <Vd>.<T>, <Vn>.<T>

Decode for this encoding

```
integer d = UInt(Rd);
integer n = UInt(Rn);

if size:Q == '110' then ReservedValue();
integer esize = 8 << UInt(size);
integer datasize = if Q == '1' then 128 else 64;
integer elements = datasize DIV esize;

boolean unsigned = (U == '1');
```

Assembler symbols

<V> Is a width specifier, encoded in the "size" field. It can have the following values:

B	when size = 00
---	----------------

- H when size = 01
S when size = 10
D when size = 11
- <d> Is the number of the SIMD&FP destination register, encoded in the "Rd" field.
- <n> Is the number of the SIMD&FP source register, encoded in the "Rn" field.
- <Vd> Is the name of the SIMD&FP destination register, encoded in the "Rd" field.
- <T> Is an arrangement specifier, encoded in the "size:Q" field. It can have the following values:
- 8B when size = 00, Q = 0
16B when size = 00, Q = 1
4H when size = 01, Q = 0
8H when size = 01, Q = 1
2S when size = 10, Q = 0
4S when size = 10, Q = 1
2D when size = 11, Q = 1
The encoding size = 11, Q = 0 is reserved.
- <Vn> Is the name of the SIMD&FP source register, encoded in the "Rn" field.

Operation for all encodings

```
CheckFPAdvSIMDEnabled64();
bits(datasize) operand = V[n];
bits(datasize) result;

bits(datasize) operand2 = V[d];
integer op1;
integer op2;
boolean sat;

for e = 0 to elements-1
    op1 = Int(Elem[operand, e, esize], !unsigned);
    op2 = Int(Elem[operand2, e, esize], unsigned);
    (Elem[result, e, esize], sat) = SatQ(op1 + op2, esize, unsigned);
    if sat then FPSR.QC = '1';
V[d] = result;
```

C7.2.295 SXTL, SXTL2

Signed extend Long. This instruction duplicates each vector element in the lower or upper half of the source SIMD&FP register into a vector, and writes the vector to the destination SIMD&FP register. The destination vector elements are twice as long as the source vector elements. All the values in this instruction are signed integer values.

The SXTL instruction extracts the source vector from the lower half of the source register, while the SXTL2 instruction extracts the source vector from the upper half of the source register.

Depending on the settings in the CPACR_EL1, CPTR_EL2, and CPTR_EL3 registers, and the current Security state and Exception level, an attempt to execute the instruction might be trapped.

This instruction is an alias of the SSHLL, SSHLL2 instruction. This means that:

- The encodings in this description are named to match the encodings of SSHLL, SSHLL2.
- The description of SSHLL, SSHLL2 gives the operational pseudocode for this instruction.

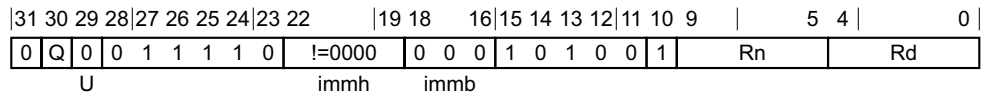

Vector variant

SXTL{2} <Vd>.<Ta>, <Vn>.<Tb>

is equivalent to

SSHLL{2} <Vd>.<Ta>, <Vn>.<Tb>, #0

and is the preferred disassembly when BitCount(immh) == 1.

Assembler symbols

2 Is the second and upper half specifier. If present it causes the operation to be performed on the upper 64 bits of the registers holding the narrower elements, and is encoded in the "Q" field. It can have the following values:

- [absent] when Q = 0
- [present] when Q = 1

<Vd> Is the name of the SIMD&FP destination register, encoded in the "Rd" field.

<Ta> Is an arrangement specifier, encoded in the "immh" field. It can have the following values:

- 8H when immh = 0001
- 4S when immh = 001x
- 2D when immh = 01xx

See [Advanced SIMD modified immediate on page C4-291](#) when immh = 0000.

The encoding immh = 1xxx is reserved.

<Vn> Is the name of the SIMD&FP source register, encoded in the "Rn" field.

<Tb> Is an arrangement specifier, encoded in the "immh:Q" field. It can have the following values:

- 8B when immh = 0001, Q = 0
- 16B when immh = 0001, Q = 1
- 4H when immh = 001x, Q = 0
- 8H when immh = 001x, Q = 1

2S when $\text{immh} = 01xx$, $Q = 0$

4S when $\text{immh} = 01xx$, $Q = 1$

See [Advanced SIMD modified immediate on page C4-291](#) when $\text{immh} = 0000$, $Q = x$.

The encoding $\text{immh} = 1xxx$, $Q = x$ is reserved.

Operation

The description of [SSHLL](#), [SSHLL2](#) gives the operational pseudocode for this instruction.

C7.2.296 TBL

Table vector Lookup. This instruction reads each value from the vector elements in the index source SIMD&FP register, uses each result as an index to perform a lookup in a table of bytes that is described by one to four source table SIMD&FP registers, places the lookup result in a vector, and writes the vector to the destination SIMD&FP register. If an index is out of range for the table, the result for that lookup is 0. If more than one source register is used to describe the table, the first source register describes the lowest bytes of the table.

Depending on the settings in the CPACR_EL1, CPTR_EL2, and CPTR_EL3 registers, and the current Security state and Exception level, an attempt to execute the instruction might be trapped.

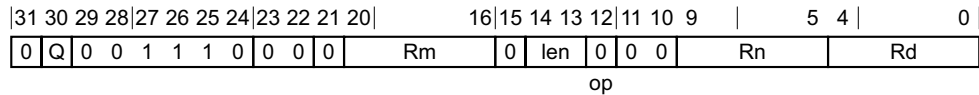

Two register table variant

Applies when len == 01.

TBL <Vd>.<Ta>, { <Vn>.16B, <Vn+1>.16B }, <Vm>.<Ta>

Three register table variant

Applies when len == 10.

TBL <Vd>.<Ta>, { <Vn>.16B, <Vn+1>.16B, <Vn+2>.16B }, <Vm>.<Ta>

Four register table variant

Applies when len == 11.

TBL <Vd>.<Ta>, { <Vn>.16B, <Vn+1>.16B, <Vn+2>.16B, <Vn+3>.16B }, <Vm>.<Ta>

Single register table variant

Applies when len == 00.

TBL <Vd>.<Ta>, { <Vn>.16B }, <Vm>.<Ta>

Decode for all variants of this encoding

```
integer d = UInt(Rd);
integer n = UInt(Rn);
integer m = UInt(Rm);

integer datasize = if Q == '1' then 128 else 64;
integer elements = datasize DIV 8;
integer regs = UInt(len) + 1;
boolean is_tbl = (op == '0');
```

Assembler symbols

- <Vd> Is the name of the SIMD&FP destination register, encoded in the "Rd" field.
- <Ta> Is an arrangement specifier, encoded in the "Q" field. It can have the following values:
 - 8B when Q = 0
 - 16B when Q = 1
- <Vn> For the four register table, three register table and two register table variant: is the name of the first SIMD&FP table register, encoded in the "Rn" field.

For the single register table variant: is the name of the SIMD&FP table register, encoded in the "Rn" field.

- <Vn+1> Is the name of the second SIMD&FP table register, encoded as "Rn" plus 1 modulo 32.
- <Vn+2> Is the name of the third SIMD&FP table register, encoded as "Rn" plus 2 modulo 32.
- <Vn+3> Is the name of the fourth SIMD&FP table register, encoded as "Rn" plus 3 modulo 32.
- <Vm> Is the name of the SIMD&FP index register, encoded in the "Rm" field.

Operation

```
CheckFPAdvSIMDEnabled64();
bits(datasize) indices = V[m];
bits(128*regs) table = Zeros();
bits(datasize) result;
integer index;
integer i;

// Create table from registers
for i = 0 to regs-1
    table<128*i+127:128*i> = V[n];
    n = (n + 1) MOD 32;

result = if is_tbl then Zeros() else V[d];
for i = 0 to elements-1
    index = UInt(Elem[indices, i, 8]);
    if index < 16 * regs then
        Elem[result, i, 8] = Elem[table, index, 8];

V[d] = result;
```

C7.2.297 TBX

Table vector lookup extension. This instruction reads each value from the vector elements in the index source SIMD&FP register, uses each result as an index to perform a lookup in a table of bytes that is described by one to four source table SIMD&FP registers, places the lookup result in a vector, and writes the vector to the destination SIMD&FP register. If an index is out of range for the table, the existing value in the vector element of the destination register is left unchanged. If more than one source register is used to describe the table, the first source register describes the lowest bytes of the table.

Depending on the settings in the CPACR_EL1, CPTR_EL2, and CPTR_EL3 registers, and the current Security state and Exception level, an attempt to execute the instruction might be trapped.

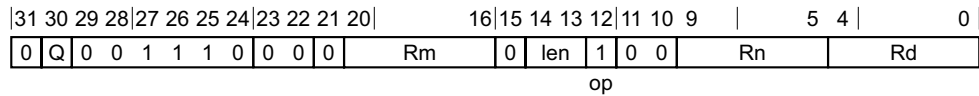

Two register table variant

Applies when len == 01.

TBX <Vd>.<Ta>, { <Vn>.16B, <Vn+1>.16B }, <Vm>.<Ta>

Three register table variant

Applies when len == 10.

TBX <Vd>.<Ta>, { <Vn>.16B, <Vn+1>.16B, <Vn+2>.16B }, <Vm>.<Ta>

Four register table variant

Applies when len == 11.

TBX <Vd>.<Ta>, { <Vn>.16B, <Vn+1>.16B, <Vn+2>.16B, <Vn+3>.16B }, <Vm>.<Ta>

Single register table variant

Applies when len == 00.

TBX <Vd>.<Ta>, { <Vn>.16B }, <Vm>.<Ta>

Decode for all variants of this encoding

```
integer d = UInt(Rd);
integer n = UInt(Rn);
integer m = UInt(Rm);

integer datasize = if Q == '1' then 128 else 64;
integer elements = datasize DIV 8;
integer regs = UInt(len) + 1;
boolean is_tbl = (op == '0');
```

Assembler symbols

- <Vd> Is the name of the SIMD&FP destination register, encoded in the "Rd" field.
- <Ta> Is an arrangement specifier, encoded in the "Q" field. It can have the following values:
 - 8B when Q = 0
 - 16B when Q = 1

- <Vn> For the four register table, three register table and two register table variant: is the name of the first SIMD&FP table register, encoded in the "Rn" field.
For the single register table variant: is the name of the SIMD&FP table register, encoded in the "Rn" field.
- <Vn+1> Is the name of the second SIMD&FP table register, encoded as "Rn" plus 1 modulo 32.
- <Vn+2> Is the name of the third SIMD&FP table register, encoded as "Rn" plus 2 modulo 32.
- <Vn+3> Is the name of the fourth SIMD&FP table register, encoded as "Rn" plus 3 modulo 32.
- <Vm> Is the name of the SIMD&FP index register, encoded in the "Rm" field.

Operation

```
CheckFPAdvSIMDEnabled64();
bits(datasize) indices = V[m];
bits(128*regs) table = Zeros();
bits(datasize) result;
integer index;
integer i;

// Create table from registers
for i = 0 to regs-1
    table<128*i+127:128*i> = V[n];
    n = (n + 1) MOD 32;

result = if is_tbl then Zeros() else V[d];
for i = 0 to elements-1
    index = UInt(Elem[indices, i, 8]);
    if index < 16 * regs then
        Elem[result, i, 8] = Elem[table, index, 8];

V[d] = result;
```

C7.2.298 TRN1

Transpose vectors (primary). This instruction reads corresponding even-numbered vector elements from the two source SIMD&FP registers, starting at zero, places each result into consecutive elements of a vector, and writes the vector to the destination SIMD&FP register. Vector elements from the first source register are placed into even-numbered elements of the destination vector, starting at zero, while vector elements from the second source register are placed into odd-numbered elements of the destination vector.

———— **Note** ————

By using this instruction with TRN2, a 2 x 2 matrix can be transposed.

The following figure shows the operation of TRN1 and TRN2 halfword operations where Q = 0.

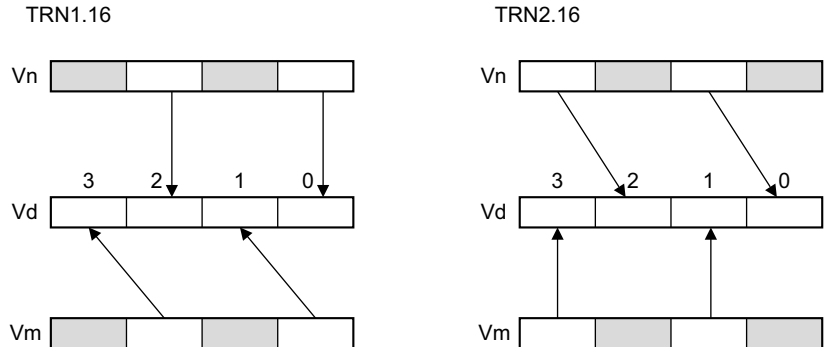

Depending on the settings in the CPACR_EL1, CPTR_EL2, and CPTR_EL3 registers, and the current Security state and Exception level, an attempt to execute the instruction might be trapped.

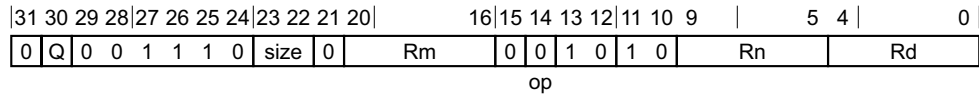

Advanced SIMD variant

TRN1 <Vd>.<T>, <Vn>.<T>, <Vm>.<T>

Decode for this encoding

```
integer d = UInt(Rd);
integer n = UInt(Rn);
integer m = UInt(Rm);

if size:Q == '110' then ReservedValue();
integer esize = 8 << UInt(size);
integer datasize = if Q == '1' then 128 else 64;
integer elements = datasize DIV esize;
integer part = UInt(op);
integer pairs = elements DIV 2;
```

Assembler symbols

- <Vd> Is the name of the SIMD&FP destination register, encoded in the "Rd" field.
- <T> Is an arrangement specifier, encoded in the "size:Q" field. It can have the following values:
 - 8B when size = 00, Q = 0
 - 16B when size = 00, Q = 1

4H when size = 01, Q = 0

8H when size = 01, Q = 1

2S when size = 10, Q = 0

4S when size = 10, Q = 1

2D when size = 11, Q = 1

The encoding size = 11, Q = 0 is reserved.

<Vn> Is the name of the first SIMD&FP source register, encoded in the "Rn" field.

<Vm> Is the name of the second SIMD&FP source register, encoded in the "Rm" field.

Operation

```
CheckFPAdvSIMDEnabled64();
bits(datasize) operand1 = V[n];
bits(datasize) operand2 = V[m];
bits(datasize) result;
integer p;

for p = 0 to pairs-1
    Elem[result, 2*p+0, esize] = Elem[operand1, 2*p+part, esize];
    Elem[result, 2*p+1, esize] = Elem[operand2, 2*p+part, esize];

V[d] = result;
```

C7.2.299 TRN2

Transpose vectors (secondary). This instruction reads corresponding odd-numbered vector elements from the two source SIMD&FP registers, places each result into consecutive elements of a vector, and writes the vector to the destination SIMD&FP register. Vector elements from the first source register are placed into even-numbered elements of the destination vector, starting at zero, while vector elements from the second source register are placed into odd-numbered elements of the destination vector.

———— **Note** ————

By using this instruction with TRN1, a 2 x 2 matrix can be transposed.

The following figure shows the operation of TRN1 and TRN2 halfword operations where Q = 0.

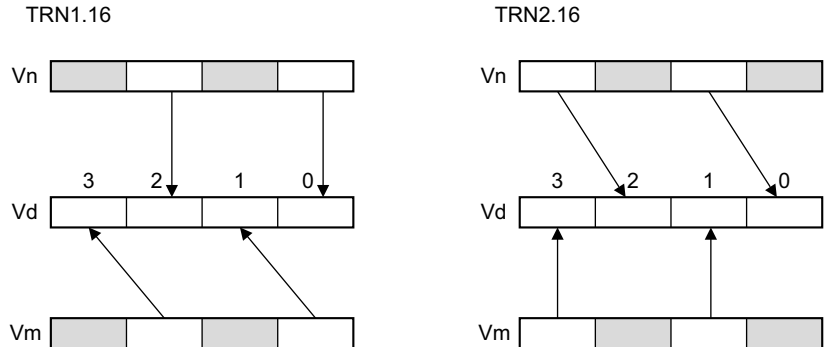

Depending on the settings in the CPACR_EL1, CPTR_EL2, and CPTR_EL3 registers, and the current Security state and Exception level, an attempt to execute the instruction might be trapped.

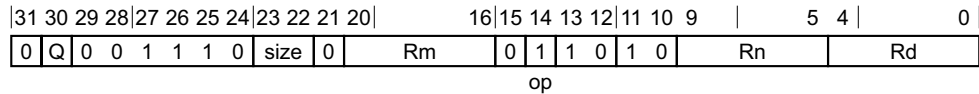

Advanced SIMD variant

TRN2 <Vd>.<T>, <Vn>.<T>, <Vm>.<T>

Decode for this encoding

```

integer d = UInt(Rd);
integer n = UInt(Rn);
integer m = UInt(Rm);

if size:Q == '110' then ReservedValue();
integer esize = 8 << UInt(size);
integer datasize = if Q == '1' then 128 else 64;
integer elements = datasize DIV esize;
integer part = UInt(op);
integer pairs = elements DIV 2;
    
```

Assembler symbols

- <Vd> Is the name of the SIMD&FP destination register, encoded in the "Rd" field.
- <T> Is an arrangement specifier, encoded in the "size:Q" field. It can have the following values:
 - 8B when size = 00, Q = 0
 - 16B when size = 00, Q = 1

4H when size = 01, Q = 0

8H when size = 01, Q = 1

2S when size = 10, Q = 0

4S when size = 10, Q = 1

2D when size = 11, Q = 1

The encoding size = 11, Q = 0 is reserved.

<Vn> Is the name of the first SIMD&FP source register, encoded in the "Rn" field.

<Vm> Is the name of the second SIMD&FP source register, encoded in the "Rm" field.

Operation

```
CheckFPAdvSIMDEnabled64();
bits(datasize) operand1 = V[n];
bits(datasize) operand2 = V[m];
bits(datasize) result;
integer p;

for p = 0 to pairs-1
    Elem[result, 2*p+0, esize] = Elem[operand1, 2*p+part, esize];
    Elem[result, 2*p+1, esize] = Elem[operand2, 2*p+part, esize];

V[d] = result;
```

C7.2.300 UABA

Unsigned Absolute difference and Accumulate. This instruction subtracts the elements of the vector of the second source SIMD&FP register from the corresponding elements of the first source SIMD&FP register, and accumulates the absolute values of the results into the elements of the vector of the destination SIMD&FP register.

Depending on the settings in the CPACR_EL1, CPTR_EL2, and CPTR_EL3 registers, and the current Security state and Exception level, an attempt to execute the instruction might be trapped.

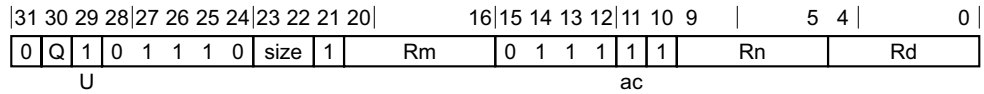

Three registers of the same type variant

UABA <Vd>.<T>, <Vn>.<T>, <Vm>.<T>

Decode for this encoding

```
integer d = UInt(Rd);
integer n = UInt(Rn);
integer m = UInt(Rm);
if size == '11' then ReservedValue();
integer esize = 8 << UInt(size);
integer datasize = if Q == '1' then 128 else 64;
integer elements = datasize DIV esize;
```

```
boolean unsigned = (U == '1');
boolean accumulate = (ac == '1');
```

Assembler symbols

- <Vd> Is the name of the SIMD&FP destination register, encoded in the "Rd" field.
- <T> Is an arrangement specifier, encoded in the "size:Q" field. It can have the following values:
 - 8B when size = 00, Q = 0
 - 16B when size = 00, Q = 1
 - 4H when size = 01, Q = 0
 - 8H when size = 01, Q = 1
 - 2S when size = 10, Q = 0
 - 4S when size = 10, Q = 1
 The encoding size = 11, Q = x is reserved.
- <Vn> Is the name of the first SIMD&FP source register, encoded in the "Rn" field.
- <Vm> Is the name of the second SIMD&FP source register, encoded in the "Rm" field.

Operation

```
CheckFPAdvSIMDEnabled64();
bits(datasize) operand1 = V[n];
bits(datasize) operand2 = V[m];
bits(datasize) result;
integer element1;
integer element2;
bits(esize) absdiff;
```

```
result = if accumulate then V[d] else Zeros();  
for e = 0 to elements-1  
    element1 = Int(Elem[operand1, e, esize], unsigned);  
    element2 = Int(Elem[operand2, e, esize], unsigned);  
    absdiff = Abs(element1-element2)<esize-1:0>;  
    Elem[result, e, esize] = Elem[result, e, esize] + absdiff;  
V[d] = result;
```

C7.2.301 UABAL, UABAL2

Unsigned Absolute difference and Accumulate Long. This instruction subtracts the vector elements in the lower or upper half of the second source SIMD&FP register from the corresponding vector elements of the first source SIMD&FP register, and accumulates the absolute values of the results into the vector elements of the destination SIMD&FP register. The destination vector elements are twice as long as the source vector elements. All the values in this instruction are unsigned integer values.

The UABAL instruction extracts each source vector from the lower half of each source register, while the UABAL2 instruction extracts each source vector from the upper half of each source register.

Depending on the settings in the CPACR_EL1, CPTR_EL2, and CPTR_EL3 registers, and the current Security state and Exception level, an attempt to execute the instruction might be trapped.

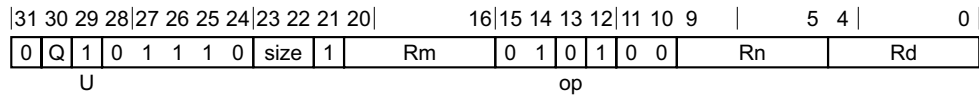

Three registers, not all the same type variant

UABAL{2} <Vd>.<Ta>, <Vn>.<Tb>, <Vm>.<Tb>

Decode for this encoding

```
integer d = UInt(Rd);
integer n = UInt(Rn);
integer m = UInt(Rm);

if size == '11' then ReservedValue();
integer esize = 8 << UInt(size);
integer datasize = 64;
integer part = UInt(Q);
integer elements = datasize DIV esize;

boolean accumulate = (op == '0');
boolean unsigned = (U == '1');
```

Assembler symbols

- 2 Is the second and upper half specifier. If present it causes the operation to be performed on the upper 64 bits of the registers holding the narrower elements, and is encoded in the "Q" field. It can have the following values:
 - [absent] when Q = 0
 - [present] when Q = 1
- <Vd> Is the name of the SIMD&FP destination register, encoded in the "Rd" field.
- <Ta> Is an arrangement specifier, encoded in the "size" field. It can have the following values:
 - 8H when size = 00
 - 4S when size = 01
 - 2D when size = 10
 The encoding size = 11 is reserved.
- <Vn> Is the name of the first SIMD&FP source register, encoded in the "Rn" field.
- <Tb> Is an arrangement specifier, encoded in the "size:Q" field. It can have the following values:
 - 8B when size = 00, Q = 0

16B when size = 00, Q = 1
4H when size = 01, Q = 0
8H when size = 01, Q = 1
2S when size = 10, Q = 0
4S when size = 10, Q = 1
The encoding size = 11, Q = x is reserved.

<Vm> Is the name of the second SIMD&FP source register, encoded in the "Rm" field.

Operation

```
CheckFPAdvSIMDEnabled64();
bits(datasize) operand1 = Vpart[n, part];
bits(datasize) operand2 = Vpart[m, part];
bits(2*datasize) result;
integer element1;
integer element2;
bits(2*esize) absdiff;

result = if accumulate then V[d] else Zeros();
for e = 0 to elements-1
    element1 = Int(Elem[operand1, e, esize], unsigned);
    element2 = Int(Elem[operand2, e, esize], unsigned);
    absdiff = Abs(element1-element2)<2*esize-1:0>;
    Elem[result, e, 2*esize] = Elem[result, e, 2*esize] + absdiff;
V[d] = result;
```

C7.2.302 UABD

Unsigned Absolute Difference (vector). This instruction subtracts the elements of the vector of the second source SIMD&FP register from the corresponding elements of the first source SIMD&FP register, places the absolute values of the results into a vector, and writes the vector to the destination SIMD&FP register.

Depending on the settings in the CPACR_EL1, CPTR_EL2, and CPTR_EL3 registers, and the current Security state and Exception level, an attempt to execute the instruction might be trapped.

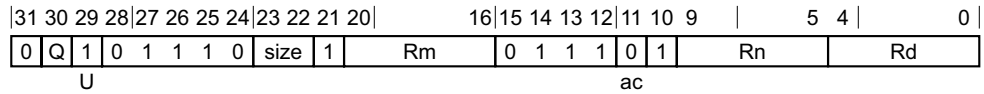

Three registers of the same type variant

UABD <Vd>.<T>, <Vn>.<T>, <Vm>.<T>

Decode for this encoding

```
integer d = UInt(Rd);
integer n = UInt(Rn);
integer m = UInt(Rm);
if size == '11' then ReservedValue();
integer esize = 8 << UInt(size);
integer datasize = if Q == '1' then 128 else 64;
integer elements = datasize DIV esize;
```

```
boolean unsigned = (U == '1');
boolean accumulate = (ac == '1');
```

Assembler symbols

- <Vd> Is the name of the SIMD&FP destination register, encoded in the "Rd" field.
- <T> Is an arrangement specifier, encoded in the "size:Q" field. It can have the following values:
 - 8B when size = 00, Q = 0
 - 16B when size = 00, Q = 1
 - 4H when size = 01, Q = 0
 - 8H when size = 01, Q = 1
 - 2S when size = 10, Q = 0
 - 4S when size = 10, Q = 1
 The encoding size = 11, Q = x is reserved.
- <Vn> Is the name of the first SIMD&FP source register, encoded in the "Rn" field.
- <Vm> Is the name of the second SIMD&FP source register, encoded in the "Rm" field.

Operation

```
CheckFPAdvSIMDEnabled64();
bits(datasize) operand1 = V[n];
bits(datasize) operand2 = V[m];
bits(datasize) result;
integer element1;
integer element2;
bits(esize) absdiff;
```

```
result = if accumulate then V[d] else Zeros();
for e = 0 to elements-1
    element1 = Int(Elem[operand1, e, esize], unsigned);
    element2 = Int(Elem[operand2, e, esize], unsigned);
    absdiff = Abs(element1-element2)<esize-1:0>;
    Elem[result, e, esize] = Elem[result, e, esize] + absdiff;
V[d] = result;
```

C7.2.303 UABDL, UABDL2

Unsigned Absolute Difference Long. This instruction subtracts the vector elements in the lower or upper half of the second source SIMD&FP register from the corresponding vector elements of the first source SIMD&FP register, places the absolute value of the result into a vector, and writes the vector to the destination SIMD&FP register. The destination vector elements are twice as long as the source vector elements. All the values in this instruction are unsigned integer values.

The UABDL instruction extracts each source vector from the lower half of each source register, while the UABDL2 instruction extracts each source vector from the upper half of each source register.

Depending on the settings in the CPACR_EL1, CPTR_EL2, and CPTR_EL3 registers, and the current Security state and Exception level, an attempt to execute the instruction might be trapped.

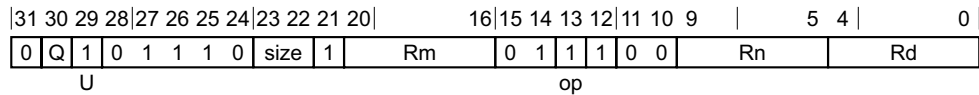

Three registers, not all the same type variant

UABDL{2} <Vd>.<Ta>, <Vn>.<Tb>, <Vm>.<Tb>

Decode for this encoding

```
integer d = UInt(Rd);
integer n = UInt(Rn);
integer m = UInt(Rm);

if size == '11' then ReservedValue();
integer esize = 8 << UInt(size);
integer datasize = 64;
integer part = UInt(Q);
integer elements = datasize DIV esize;

boolean accumulate = (op == '0');
boolean unsigned = (U == '1');
```

Assembler symbols

- 2 Is the second and upper half specifier. If present it causes the operation to be performed on the upper 64 bits of the registers holding the narrower elements, and is encoded in the "Q" field. It can have the following values:
 - [absent] when Q = 0
 - [present] when Q = 1
- <Vd> Is the name of the SIMD&FP destination register, encoded in the "Rd" field.
- <Ta> Is an arrangement specifier, encoded in the "size" field. It can have the following values:
 - 8H when size = 00
 - 4S when size = 01
 - 2D when size = 10
 The encoding size = 11 is reserved.
- <Vn> Is the name of the first SIMD&FP source register, encoded in the "Rn" field.
- <Tb> Is an arrangement specifier, encoded in the "size:Q" field. It can have the following values:
 - 8B when size = 00, Q = 0

16B when size = 00, Q = 1
4H when size = 01, Q = 0
8H when size = 01, Q = 1
2S when size = 10, Q = 0
4S when size = 10, Q = 1
The encoding size = 11, Q = x is reserved.

<Vm> Is the name of the second SIMD&FP source register, encoded in the "Rm" field.

Operation

```
CheckFPAdvSIMDEnabled64();
bits(datasize) operand1 = Vpart[n, part];
bits(datasize) operand2 = Vpart[m, part];
bits(2*datasize) result;
integer element1;
integer element2;
bits(2*esize) absdiff;

result = if accumulate then V[d] else Zeros();
for e = 0 to elements-1
    element1 = Int(Elem[operand1, e, esize], unsigned);
    element2 = Int(Elem[operand2, e, esize], unsigned);
    absdiff = Abs(element1-element2)<2*esize-1:0>;
    Elem[result, e, 2*esize] = Elem[result, e, 2*esize] + absdiff;
V[d] = result;
```

C7.2.304 UADALP

Unsigned Add and Accumulate Long Pairwise. This instruction adds pairs of adjacent unsigned integer values from the vector in the source SIMD&FP register and accumulates the results with the vector elements of the destination SIMD&FP register. The destination vector elements are twice as long as the source vector elements.

Depending on the settings in the CPACR_EL1, CPTR_EL2, and CPTR_EL3 registers, and the current Security state and Exception level, an attempt to execute the instruction might be trapped.

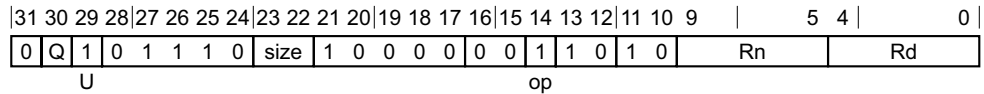

Vector variant

UADALP <Vd>.<Ta>, <Vn>.<Tb>

Decode for this encoding

```
integer d = UInt(Rd);
integer n = UInt(Rn);

if size == '11' then ReservedValue();
integer esize = 8 << UInt(size);
integer datasize = if Q == '1' then 128 else 64;
integer elements = datasize DIV (2 * esize);
boolean acc = (op == '1');
boolean unsigned = (U == '1');
```

Assembler symbols

- <Vd> Is the name of the SIMD&FP destination register, encoded in the "Rd" field.
- <Ta> Is an arrangement specifier, encoded in the "size:Q" field. It can have the following values:
 - 4H when size = 00, Q = 0
 - 8H when size = 00, Q = 1
 - 2S when size = 01, Q = 0
 - 4S when size = 01, Q = 1
 - 1D when size = 10, Q = 0
 - 2D when size = 10, Q = 1
 The encoding size = 11, Q = x is reserved.
- <Vn> Is the name of the SIMD&FP source register, encoded in the "Rn" field.
- <Tb> Is an arrangement specifier, encoded in the "size:Q" field. It can have the following values:
 - 8B when size = 00, Q = 0
 - 16B when size = 00, Q = 1
 - 4H when size = 01, Q = 0
 - 8H when size = 01, Q = 1
 - 2S when size = 10, Q = 0
 - 4S when size = 10, Q = 1
 The encoding size = 11, Q = x is reserved.

Operation

```
CheckFPAdvSIMDEnabled64();
bits(datasize) operand = V[n];
bits(datasize) result;

bits(2*esize) sum;
integer op1;
integer op2;

result = if acc then V[d] else Zeros();
for e = 0 to elements-1
    op1 = Int(Elem[operand, 2*e+0, esize], unsigned);
    op2 = Int(Elem[operand, 2*e+1, esize], unsigned);
    sum = (op1+op2)<2*esize-1:0>;
    Elem[result, e, 2*esize] = Elem[result, e, 2*esize] + sum;

V[d] = result;
```

C7.2.305 UADDL, UADDL2

Unsigned Add Long (vector). This instruction adds each vector element in the lower or upper half of the first source SIMD&FP register to the corresponding vector element of the second source SIMD&FP register, places the result into a vector, and writes the vector to the destination SIMD&FP register. The destination vector elements are twice as long as the source vector elements. All the values in this instruction are unsigned integer values.

The UADDL instruction extracts each source vector from the lower half of each source register, while the UADDL2 instruction extracts each source vector from the upper half of each source register.

Depending on the settings in the CPACR_EL1, CPTR_EL2, and CPTR_EL3 registers, and the current Security state and Exception level, an attempt to execute the instruction might be trapped.

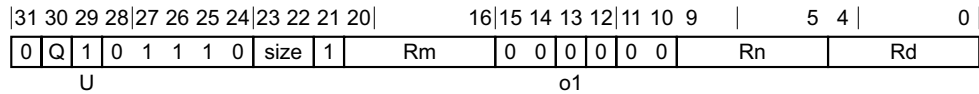

Three registers, not all the same type variant

UADDL{2} <Vd>.<Ta>, <Vn>.<Tb>, <Vm>.<Tb>

Decode for this encoding

```
integer d = UInt(Rd);
integer n = UInt(Rn);
integer m = UInt(Rm);

if size == '11' then ReservedValue();
integer esize = 8 << UInt(size);
integer datasize = 64;
integer part = UInt(Q);
integer elements = datasize DIV esize;

boolean sub_op = (o1 == '1');
boolean unsigned = (U == '1');
```

Assembler symbols

- 2 Is the second and upper half specifier. If present it causes the operation to be performed on the upper 64 bits of the registers holding the narrower elements, and is encoded in the "Q" field. It can have the following values:
 - [absent] when Q = 0
 - [present] when Q = 1
- <Vd> Is the name of the SIMD&FP destination register, encoded in the "Rd" field.
- <Ta> Is an arrangement specifier, encoded in the "size" field. It can have the following values:
 - 8H when size = 00
 - 4S when size = 01
 - 2D when size = 10
 The encoding size = 11 is reserved.
- <Vn> Is the name of the first SIMD&FP source register, encoded in the "Rn" field.
- <Tb> Is an arrangement specifier, encoded in the "size:Q" field. It can have the following values:
 - 8B when size = 00, Q = 0
 - 16B when size = 00, Q = 1

4H when size = 01, Q = 0

8H when size = 01, Q = 1

2S when size = 10, Q = 0

4S when size = 10, Q = 1

The encoding size = 11, Q = x is reserved.

<Vm> Is the name of the second SIMD&FP source register, encoded in the "Rm" field.

Operation

```
CheckFPAdvSIMDEnabled64();
bits(datasize) operand1 = Vpart[n, part];
bits(datasize) operand2 = Vpart[m, part];
bits(2*datasize) result;
integer element1;
integer element2;
integer sum;

for e = 0 to elements-1
    element1 = Int(Elem[operand1, e, esize], unsigned);
    element2 = Int(Elem[operand2, e, esize], unsigned);
    if sub_op then
        sum = element1 - element2;
    else
        sum = element1 + element2;
    Elem[result, e, 2*esize] = sum<2*esize-1:0>;

V[d] = result;
```

C7.2.306 UADDLP

Unsigned Add Long Pairwise. This instruction adds pairs of adjacent unsigned integer values from the vector in the source SIMD&FP register, places the result into a vector, and writes the vector to the destination SIMD&FP register. The destination vector elements are twice as long as the source vector elements.

Depending on the settings in the CPACR_EL1, CPTR_EL2, and CPTR_EL3 registers, and the current Security state and Exception level, an attempt to execute the instruction might be trapped.

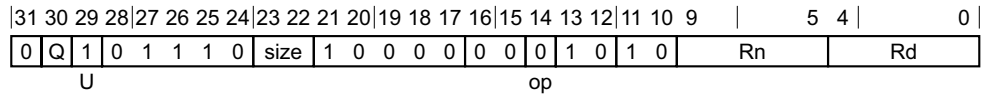

Vector variant

UADDLP <Vd>.<Ta>, <Vn>.<Tb>

Decode for this encoding

```
integer d = UInt(Rd);
integer n = UInt(Rn);

if size == '11' then ReservedValue();
integer esize = 8 << UInt(size);
integer datasize = if Q == '1' then 128 else 64;
integer elements = datasize DIV (2 * esize);
boolean acc = (op == '1');
boolean unsigned = (U == '1');
```

Assembler symbols

- <Vd> Is the name of the SIMD&FP destination register, encoded in the "Rd" field.
- <Ta> Is an arrangement specifier, encoded in the "size:Q" field. It can have the following values:
 - 4H when size = 00, Q = 0
 - 8H when size = 00, Q = 1
 - 2S when size = 01, Q = 0
 - 4S when size = 01, Q = 1
 - 1D when size = 10, Q = 0
 - 2D when size = 10, Q = 1
 The encoding size = 11, Q = x is reserved.
- <Vn> Is the name of the SIMD&FP source register, encoded in the "Rn" field.
- <Tb> Is an arrangement specifier, encoded in the "size:Q" field. It can have the following values:
 - 8B when size = 00, Q = 0
 - 16B when size = 00, Q = 1
 - 4H when size = 01, Q = 0
 - 8H when size = 01, Q = 1
 - 2S when size = 10, Q = 0
 - 4S when size = 10, Q = 1
 The encoding size = 11, Q = x is reserved.

Operation

```
CheckFPAdvSIMDEnabled64();
bits(datasize) operand = V[n];
bits(datasize) result;

bits(2*esize) sum;
integer op1;
integer op2;

result = if acc then V[d] else Zeros();
for e = 0 to elements-1
    op1 = Int(Elem[operand, 2*e+0, esize], unsigned);
    op2 = Int(Elem[operand, 2*e+1, esize], unsigned);
    sum = (op1+op2)<2*esize-1:0>;
    Elem[result, e, 2*esize] = Elem[result, e, 2*esize] + sum;

V[d] = result;
```

C7.2.307 UADDLV

Unsigned sum Long across Vector. This instruction adds every vector element in the source SIMD&FP register together, and writes the scalar result to the destination SIMD&FP register. The destination scalar is twice as long as the source vector elements. All the values in this instruction are unsigned integer values.

Depending on the settings in the CPACR_EL1, CPTR_EL2, and CPTR_EL3 registers, and the current Security state and Exception level, an attempt to execute the instruction might be trapped.

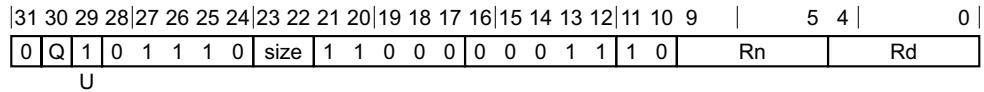

Advanced SIMD variant

UADDLV <V><d>, <Vn>.<T>

Decode for this encoding

```
integer d = UInt(Rd);
integer n = UInt(Rn);

if size:Q == '100' then ReservedValue();
if size == '11' then ReservedValue();
integer esize = 8 << UInt(size);
integer datasize = if Q == '1' then 128 else 64;
integer elements = datasize DIV esize;

boolean unsigned = (U == '1');
```

Assembler symbols

- <V> Is the destination width specifier, encoded in the "size" field. It can have the following values:
 - H when size = 00
 - S when size = 01
 - D when size = 10
 The encoding size = 11 is reserved.
- <d> Is the number of the SIMD&FP destination register, encoded in the "Rd" field.
- <Vn> Is the name of the SIMD&FP source register, encoded in the "Rn" field.
- <T> Is an arrangement specifier, encoded in the "size:Q" field. It can have the following values:
 - 8B when size = 00, Q = 0
 - 16B when size = 00, Q = 1
 - 4H when size = 01, Q = 0
 - 8H when size = 01, Q = 1
 - 4S when size = 10, Q = 1
 The following encodings are reserved:
 - size = 10, Q = 0.
 - size = 11, Q = x.

Operation

```
CheckFPAdvSIMDEnabled64();  
bits(datasize) operand = V[n];  
integer sum;  
  
sum = Int(Elem[operand, 0, esize], unsigned);  
for e = 1 to elements-1  
    sum = sum + Int(Elem[operand, e, esize], unsigned);  
  
V[d] = sum<2*esize-1:0>;
```

C7.2.308 UADDW, UADDW2

Unsigned Add Wide. This instruction adds the vector elements of the first source SIMD&FP register to the corresponding vector elements in the lower or upper half of the second source SIMD&FP register, places the result in a vector, and writes the vector to the SIMD&FP destination register. The vector elements of the destination register and the first source register are twice as long as the vector elements of the second source register. All the values in this instruction are unsigned integer values.

The UADDW instruction extracts vector elements from the lower half of the second source register, while the UADDW2 instruction extracts vector elements from the upper half of the second source register.

Depending on the settings in the CPACR_EL1, CPTR_EL2, and CPTR_EL3 registers, and the current Security state and Exception level, an attempt to execute the instruction might be trapped.

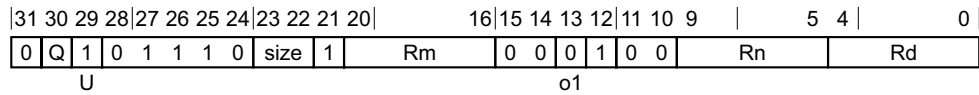

Three registers, not all the same type variant

UADDW{2} <Vd>.<Ta>, <Vn>.<Ta>, <Vm>.<Tb>

Decode for this encoding

```
integer d = UInt(Rd);
integer n = UInt(Rn);
integer m = UInt(Rm);

if size == '11' then ReservedValue();
integer esize = 8 << UInt(size);
integer datasize = 64;
integer part = UInt(Q);
integer elements = datasize DIV esize;

boolean sub_op = (o1 == '1');
boolean unsigned = (U == '1');
```

Assembler symbols

- 2 Is the second and upper half specifier. If present it causes the operation to be performed on the upper 64 bits of the registers holding the narrower elements, and is encoded in the "Q" field. It can have the following values:
 - [absent] when Q = 0
 - [present] when Q = 1
- <Vd> Is the name of the SIMD&FP destination register, encoded in the "Rd" field.
- <Ta> Is an arrangement specifier, encoded in the "size" field. It can have the following values:
 - 8H when size = 00
 - 4S when size = 01
 - 2D when size = 10
 The encoding size = 11 is reserved.
- <Vn> Is the name of the first SIMD&FP source register, encoded in the "Rn" field.
- <Vm> Is the name of the second SIMD&FP source register, encoded in the "Rm" field.

<Tb> Is an arrangement specifier, encoded in the "size:Q" field. It can have the following values:

8B when size = 00, Q = 0

16B when size = 00, Q = 1

4H when size = 01, Q = 0

8H when size = 01, Q = 1

2S when size = 10, Q = 0

4S when size = 10, Q = 1

The encoding size = 11, Q = x is reserved.

Operation

```
CheckFPAdvSIMDEnabled64();
bits(2*datasize) operand1 = V[n];
bits(datasize) operand2 = Vpart[m, part];
bits(2*datasize) result;
integer element1;
integer element2;
integer sum;

for e = 0 to elements-1
    element1 = Int(Elem[operand1, e, 2*esize], unsigned);
    element2 = Int(Elem[operand2, e, esize], unsigned);
    if sub_op then
        sum = element1 - element2;
    else
        sum = element1 + element2;
    Elem[result, e, 2*esize] = sum<2*esize-1:0>;

V[d] = result;
```

C7.2.309 UCVTF (vector, fixed-point)

Unsigned fixed-point Convert to Floating-point (vector). This instruction converts each element in a vector from fixed-point to floating-point using the rounding mode that is specified by the **FPCR**, and writes the result to the SIMD&FP destination register.

A floating-point exception can be generated by this instruction. Depending on the settings in **FPCR**, the exception results in either a flag being set in **FPSR**, or a synchronous exception being generated. For more information, see [Floating-point exceptions and exception traps on page D1-1831](#).

Depending on the settings in the **CPACR_EL1**, **CPTR_EL2**, and **CPTR_EL3** registers, and the Security state and Exception level in which the instruction is executed, an attempt to execute the instruction might be trapped.

Scalar

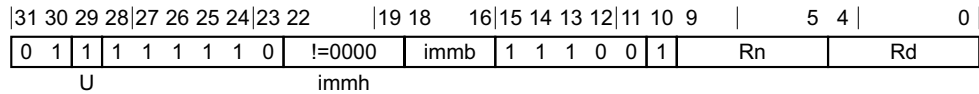

Scalar variant

UCVTF <V><d>, <V><n>, #<fbits>

Decode for this encoding

```
integer d = UInt(Rd);
integer n = UInt(Rn);

if immh == '000x' || (immh == '001x' && !HaveFP16Ext()) then ReservedValue();
integer esize = if immh == '1xxx' then 64 else if immh == '01xx' then 32 else 16;
integer datasize = esize;
integer elements = 1;

integer fracbits = (esize * 2) - UInt(immh:immb);
boolean unsigned = (U == '1');
FPRounding rounding = FPRoundingMode(FPCR);
```

Vector

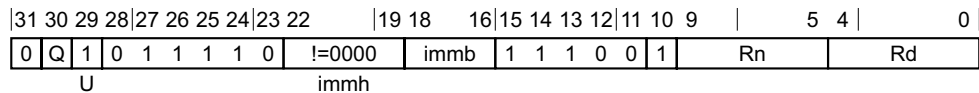

Vector variant

UCVTF <Vd>.<T>, <Vn>.<T>, #<fbits>

Decode for this encoding

```
integer d = UInt(Rd);
integer n = UInt(Rn);

if immh == '0000' then SEE "Advanced SIMD modified immediate";
if immh == '000x' || (immh == '001x' && !HaveFP16Ext()) then ReservedValue();
if immh<3>:Q == '10' then ReservedValue();
integer esize = if immh == '1xxx' then 64 else if immh == '01xx' then 32 else 16;
integer datasize = if Q == '1' then 128 else 64;
integer elements = datasize DIV esize;
```



```
integer fracbits = (esize * 2) - UInt(immh:immb);
boolean unsigned = (U == '1');
FPRounding rounding = FPRoundingMode(FPCR);
```

Assembler symbols

- <V> Is a width specifier, encoded in the "immh" field. It can have the following values:
- | | |
|---|------------------|
| H | when immh = 001x |
| S | when immh = 01xx |
| D | when immh = 1xxx |
- The encoding immh = 000x is reserved.
- <d> Is the number of the SIMD&FP destination register, in the "Rd" field.
- <n> Is the number of the first SIMD&FP source register, encoded in the "Rn" field.
- <Vd> Is the name of the SIMD&FP destination register, encoded in the "Rd" field.
- <T> Is an arrangement specifier, encoded in the "immh:Q" field. It can have the following values:
- | | |
|----|-------------------------|
| 4H | when immh = 001x, Q = 0 |
| 8H | when immh = 001x, Q = 1 |
| 2S | when immh = 01xx, Q = 0 |
| 4S | when immh = 01xx, Q = 1 |
| 2D | when immh = 1xxx, Q = 1 |
- See [Advanced SIMD modified immediate on page C4-291](#) when immh = 0000, Q = x.
- The following encodings are reserved:
- immh = 0001, Q = x.
 - immh = 1xxx, Q = 0.
- <Vn> Is the name of the SIMD&FP source register, encoded in the "Rn" field.
- <fbits> For the scalar variant: is the number of fractional bits, in the range 1 to the operand width, encoded in the "immh:immb" field. It can have the following values:
- | | |
|-----------------------|------------------|
| (32-UInt(immh:immb)) | when immh = 001x |
| (64-UInt(immh:immb)) | when immh = 01xx |
| (128-UInt(immh:immb)) | when immh = 1xxx |
- The encoding immh = 000x is reserved.
- For the vector variant: is the number of fractional bits, in the range 1 to the element width, encoded in the "immh:immb" field. It can have the following values:
- | | |
|-----------------------|------------------|
| (32-UInt(immh:immb)) | when immh = 001x |
| (64-UInt(immh:immb)) | when immh = 01xx |
| (128-UInt(immh:immb)) | when immh = 1xxx |
- See [Advanced SIMD modified immediate on page C4-291](#) when immh = 0000.
- The encoding immh = 0001 is reserved.

Operation for all encodings

```
CheckFPAdvSIMDEnabled64();
bits(datasize) operand = V[n];
bits(datasize) result;
bits(esize) element;
```

for e = 0 to elements-1

```
element = Elem[operand, e, esize];  
Elem[result, e, esize] = FixedToFP(element, fracbits, unsigned, FPCR, rounding);  
V[d] = result;
```

C7.2.310 UCVTF (vector, integer)

Unsigned integer Convert to Floating-point (vector). This instruction converts each element in a vector from an unsigned integer value to a floating-point value using the rounding mode that is specified by the [FPCR](#), and writes the result to the SIMD&FP destination register.

A floating-point exception can be generated by this instruction. Depending on the settings in [FPCR](#), the exception results in either a flag being set in [FPSR](#), or a synchronous exception being generated. For more information, see [Floating-point exceptions and exception traps on page D1-1831](#).

Depending on the settings in the [CPACR_EL1](#), [CPTR_EL2](#), and [CPTR_EL3](#) registers, and the Security state and Exception level in which the instruction is executed, an attempt to execute the instruction might be trapped.

Scalar half precision

ARMv8.2

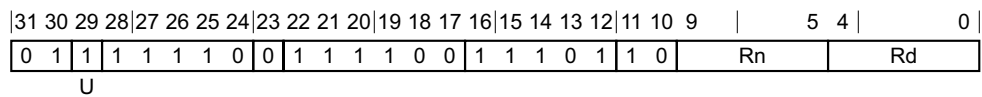

Scalar half precision variant

UCVTF <Hd>, <Hn>

Decode for this encoding

```
if !HaveFP16Ext() then UnallocatedEncoding();
```

```
integer d = UInt(Rd);
integer n = UInt(Rn);
```

```
integer esize = 16;
integer datasize = esize;
integer elements = 1;
boolean unsigned = (U == '1');
```

Scalar single-precision and double-precision

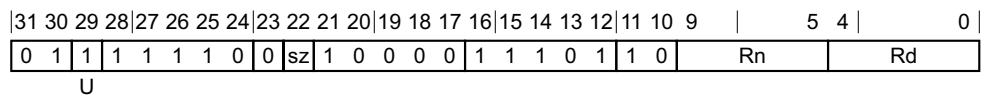

Scalar single-precision and double-precision variant

UCVTF <V><d>, <V><n>

Decode for this encoding

```
integer d = UInt(Rd);
integer n = UInt(Rn);
```

```
integer esize = 32 << UInt(sz);
integer datasize = esize;
integer elements = 1;
boolean unsigned = (U == '1');
```

Vector half precision

ARMv8.2

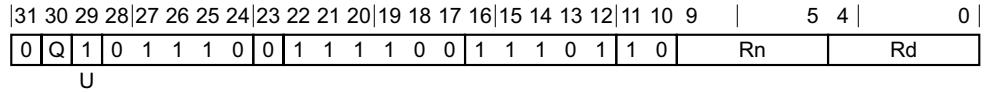

Vector half precision variant

UCVTF <Vd>.<T>, <Vn>.<T>

Decode for this encoding

```

if !HaveFP16Ext() then UnallocatedEncoding();

integer d = UInt(Rd);
integer n = UInt(Rn);

integer esize = 16;
integer datasize = if Q == '1' then 128 else 64;
integer elements = datasize DIV esize;
boolean unsigned = (U == '1');
```

Vector single-precision and double-precision

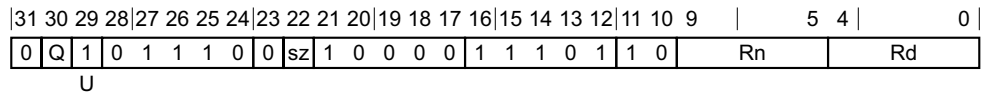

Vector single-precision and double-precision variant

UCVTF <Vd>.<T>, <Vn>.<T>

Decode for this encoding

```

integer d = UInt(Rd);
integer n = UInt(Rn);

if sz:Q == '10' then ReservedValue();
integer esize = 32 << UInt(sz);
integer datasize = if Q == '1' then 128 else 64;
integer elements = datasize DIV esize;
boolean unsigned = (U == '1');
```

Assembler symbols

- <Hd> Is the 16-bit name of the SIMD&FP destination register, encoded in the "Rd" field.
- <Hn> Is the 16-bit name of the SIMD&FP source register, encoded in the "Rn" field.
- <V> Is a width specifier, encoded in the "sz" field. It can have the following values:
 - S when sz = 0
 - D when sz = 1
- <d> Is the number of the SIMD&FP destination register, encoded in the "Rd" field.
- <n> Is the number of the SIMD&FP source register, encoded in the "Rn" field.
- <Vd> Is the name of the SIMD&FP destination register, encoded in the "Rd" field.
- <T> For the vector half precision variant: is an arrangement specifier, encoded in the "Q" field. It can have the following values:
 - 4H when Q = 0

8H when Q = 1

For the vector single-precision and double-precision variant: is an arrangement specifier, encoded in the "sz:Q" field. It can have the following values:

2S when sz = 0, Q = 0

4S when sz = 0, Q = 1

2D when sz = 1, Q = 1

The encoding sz = 1, Q = 0 is reserved.

<Vn> Is the name of the SIMD&FP source register, encoded in the "Rn" field.

Operation for all encodings

```
CheckFPAdvSIMDEnabled64();
bits(datasize) operand = V[n];
bits(datasize) result;
FPRounding rounding = FPRoundingMode(FPCR);
bits(esize) element;
for e = 0 to elements-1
    element = Elem[operand, e, esize];
    Elem[result, e, esize] = FixedToFP(element, 0, unsigned, FPCR, rounding);

V[d] = result;
```

C7.2.311 UCVTF (scalar, fixed-point)

Unsigned fixed-point Convert to Floating-point (scalar). This instruction converts the unsigned value in the 32-bit or 64-bit general-purpose source register to a floating-point value using the rounding mode that is specified by the [FPCR](#), and writes the result to the SIMD&FP destination register.

A floating-point exception can be generated by this instruction. Depending on the settings in [FPCR](#), the exception results in either a flag being set in [FPSR](#), or a synchronous exception being generated. For more information, see [Floating-point exceptions and exception traps on page D1-1831](#).

Depending on the settings in the [CPACR_EL1](#), [CPTR_EL2](#), and [CPTR_EL3](#) registers, and the Security state and Exception level in which the instruction is executed, an attempt to execute the instruction might be trapped.

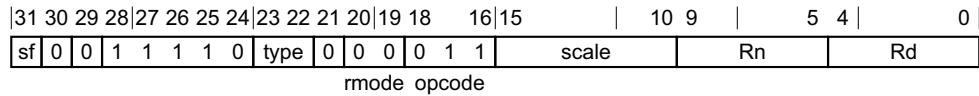

32-bit to half-precision variant

Applies when sf == 0 && type == 11.

UCVTF <Hd>, <Wn>, #<fbits>

32-bit to single-precision variant

Applies when sf == 0 && type == 00.

UCVTF <Sd>, <Wn>, #<fbits>

32-bit to double-precision variant

Applies when sf == 0 && type == 01.

UCVTF <Dd>, <Wn>, #<fbits>

64-bit to half-precision variant

Applies when sf == 1 && type == 11.

UCVTF <Hd>, <Xn>, #<fbits>

64-bit to single-precision variant

Applies when sf == 1 && type == 00.

UCVTF <Sd>, <Xn>, #<fbits>

64-bit to double-precision variant

Applies when sf == 1 && type == 01.

UCVTF <Dd>, <Xn>, #<fbits>

Decode for all variants of this encoding

```
integer d = UInt(Rd);
integer n = UInt(Rn);

integer intsize = if sf == '1' then 64 else 32;
integer fltsize;
FPRounding rounding;
```

```
case type of
  when '00' fltsize = 32;
  when '01' fltsize = 64;
  when '10' UnallocatedEncoding();
  when '11'
    if HaveFP16Ext() then
      // Empty block.
    else
      UnallocatedEncoding();

if sf == '0' && scale<5> == '0' then UnallocatedEncoding();
integer fracbits = 64 - UInt(scale);

rounding = FPRoundingMode(FPCR);
```

Assembler symbols

- <Dd> Is the 64-bit name of the SIMD&FP destination register, encoded in the "Rd" field.
- <Hd> Is the 16-bit name of the SIMD&FP destination register, encoded in the "Rd" field.
- <Sd> Is the 32-bit name of the SIMD&FP destination register, encoded in the "Rd" field.
- <Xn> Is the 64-bit name of the general-purpose source register, encoded in the "Rn" field.
- <Wn> Is the 32-bit name of the general-purpose source register, encoded in the "Rn" field.
- <fbits> For the 32-bit to double-precision, 32-bit to half-precision and 32-bit to single-precision variant: is the number of bits after the binary point in the fixed-point source, in the range 1 to 32, encoded as 64 minus "scale".
- For the 64-bit to double-precision, 64-bit to half-precision and 64-bit to single-precision variant: is the number of bits after the binary point in the fixed-point source, in the range 1 to 64, encoded as 64 minus "scale".

Operation

```
CheckFPAdvSIMDEnabled64();

bits(fltsize) fltval;
bits(intsize) intval;

intval = X[n];
fltval = FixedToFP(intval, fracbits, TRUE, FPCR, rounding);
V[d] = fltval;
```

C7.2.312 UCVTF (scalar, integer)

Unsigned integer Convert to Floating-point (scalar). This instruction converts the unsigned integer value in the general-purpose source register to a floating-point value using the rounding mode that is specified by the **FPCR**, and writes the result to the SIMD&FP destination register.

A floating-point exception can be generated by this instruction. Depending on the settings in **FPCR**, the exception results in either a flag being set in **FPSR**, or a synchronous exception being generated. For more information, see *Floating-point exceptions and exception traps on page D1-1831*.

Depending on the settings in the **CPACR_EL1**, **CPTR_EL2**, and **CPTR_EL3** registers, and the current Security state and Exception level, an attempt to execute the instruction might be trapped.

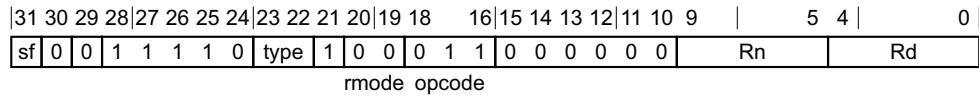

32-bit to half-precision variant

Applies when sf == 0 && type == 11.

UCVTF <Hd>, <Wn>

32-bit to single-precision variant

Applies when sf == 0 && type == 00.

UCVTF <Sd>, <Wn>

32-bit to double-precision variant

Applies when sf == 0 && type == 01.

UCVTF <Dd>, <Wn>

64-bit to half-precision variant

Applies when sf == 1 && type == 11.

UCVTF <Hd>, <Xn>

64-bit to single-precision variant

Applies when sf == 1 && type == 00.

UCVTF <Sd>, <Xn>

64-bit to double-precision variant

Applies when sf == 1 && type == 01.

UCVTF <Dd>, <Xn>

Decode for all variants of this encoding

```
integer d = UInt(Rd);
integer n = UInt(Rn);

integer intsize = if sf == '1' then 64 else 32;
integer fltsize;
FPRounding rounding;
```



```
case type of
  when '00'
    fltsize = 32;
  when '01'
    fltsize = 64;
  when '10'
    UnallocatedEncoding();
  when '11'
    if HaveFP16Ext() then
      fltsize = 16;
    else
      UnallocatedEncoding();

rounding = FPRoundingMode(FPCR);
```

Assembler symbols

- <Dd> Is the 64-bit name of the SIMD&FP destination register, encoded in the "Rd" field.
- <Hd> Is the 16-bit name of the SIMD&FP destination register, encoded in the "Rd" field.
- <Sd> Is the 32-bit name of the SIMD&FP destination register, encoded in the "Rd" field.
- <Xn> Is the 64-bit name of the general-purpose source register, encoded in the "Rn" field.
- <Wn> Is the 32-bit name of the general-purpose source register, encoded in the "Rn" field.

Operation

```
CheckFPAdvSIMDEnabled64();

bits(fltsize) fltval;
bits(intsize) intval;

intval = X[n];
fltval = FixedToFP(intval, 0, TRUE, FPCR, rounding);
V[d] = fltval;
```

C7.2.313 UHADD

Unsigned Halving Add. This instruction adds corresponding unsigned integer values from the two source SIMD&FP registers, shifts each result right one bit, places the results into a vector, and writes the vector to the destination SIMD&FP register.

The results are truncated. For rounded results, see [URHADD](#).

Depending on the settings in the [CPACR_EL1](#), [CPTR_EL2](#), and [CPTR_EL3](#) registers, and the current Security state and Exception level, an attempt to execute the instruction might be trapped.

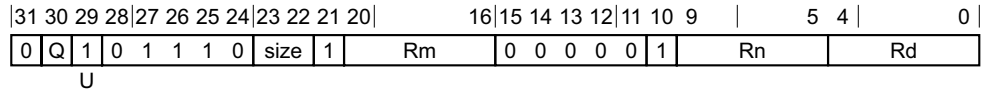

Three registers of the same type variant

UHADD <Vd>.<T>, <Vn>.<T>, <Vm>.<T>

Decode for this encoding

```
integer d = UInt(Rd);
integer n = UInt(Rn);
integer m = UInt(Rm);
if size == '11' then ReservedValue();
integer esize = 8 << UInt(size);
integer datasize = if Q == '1' then 128 else 64;
integer elements = datasize DIV esize;
boolean unsigned = (U == '1');
```

Assembler symbols

- <Vd> Is the name of the SIMD&FP destination register, encoded in the "Rd" field.
- <T> Is an arrangement specifier, encoded in the "size:Q" field. It can have the following values:
 - 8B when size = 00, Q = 0
 - 16B when size = 00, Q = 1
 - 4H when size = 01, Q = 0
 - 8H when size = 01, Q = 1
 - 2S when size = 10, Q = 0
 - 4S when size = 10, Q = 1
 The encoding size = 11, Q = x is reserved.
- <Vn> Is the name of the first SIMD&FP source register, encoded in the "Rn" field.
- <Vm> Is the name of the second SIMD&FP source register, encoded in the "Rm" field.

Operation

```
CheckFPAdvSIMDEnabled64();
bits(datasize) operand1 = V[n];
bits(datasize) operand2 = V[m];
bits(datasize) result;
integer element1;
integer element2;
integer sum;
```

```
for e = 0 to elements-1
    element1 = Int(Elem[operand1, e, esize], unsigned);
    element2 = Int(Elem[operand2, e, esize], unsigned);
    sum = element1 + element2;
    Elem[result, e, esize] = sum<esize:1>;

V[d] = result;
```

C7.2.314 UHSUB

Unsigned Halving Subtract. This instruction subtracts the vector elements in the second source SIMD&FP register from the corresponding vector elements in the first source SIMD&FP register, shifts each result right one bit, places each result into a vector, and writes the vector to the destination SIMD&FP register.

Depending on the settings in the CPACR_EL1, CPTR_EL2, and CPTR_EL3 registers, and the current Security state and Exception level, an attempt to execute the instruction might be trapped.

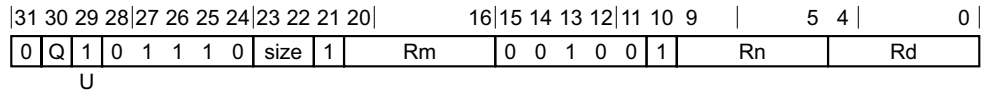

Three registers of the same type variant

UHSUB <Vd>.<T>, <Vn>.<T>, <Vm>.<T>

Decode for this encoding

```
integer d = UInt(Rd);
integer n = UInt(Rn);
integer m = UInt(Rm);
if size == '11' then ReservedValue();
integer esize = 8 << UInt(size);
integer datasize = if Q == '1' then 128 else 64;
integer elements = datasize DIV esize;
boolean unsigned = (U == '1');
```

Assembler symbols

- <Vd> Is the name of the SIMD&FP destination register, encoded in the "Rd" field.
- <T> Is an arrangement specifier, encoded in the "size:Q" field. It can have the following values:
 - 8B when size = 00, Q = 0
 - 16B when size = 00, Q = 1
 - 4H when size = 01, Q = 0
 - 8H when size = 01, Q = 1
 - 2S when size = 10, Q = 0
 - 4S when size = 10, Q = 1
 The encoding size = 11, Q = x is reserved.
- <Vn> Is the name of the first SIMD&FP source register, encoded in the "Rn" field.
- <Vm> Is the name of the second SIMD&FP source register, encoded in the "Rm" field.

Operation

```
CheckFPAdvSIMDEnabled64();
bits(datasize) operand1 = V[n];
bits(datasize) operand2 = V[m];
bits(datasize) result;
integer element1;
integer element2;
integer diff;

for e = 0 to elements-1
    element1 = Int(Elem[operand1, e, esize], unsigned);
```

```
element2 = Int(Elem[operand2, e, esize], unsigned);  
diff = element1 - element2;  
Elem[result, e, esize] = diff<esize:1>;  
  
V[d] = result;
```

C7.2.315 UMAX

Unsigned Maximum (vector). This instruction compares corresponding elements in the vectors in the two source SIMD&FP registers, places the larger of each pair of unsigned integer values into a vector, and writes the vector to the destination SIMD&FP register.

Depending on the settings in the CPACR_EL1, CPTR_EL2, and CPTR_EL3 registers, and the current Security state and Exception level, an attempt to execute the instruction might be trapped.

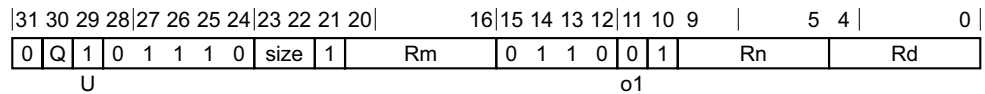

Three registers of the same type variant

UMAX <Vd>.<T>, <Vn>.<T>, <Vm>.<T>

Decode for this encoding

```
integer d = UInt(Rd);
integer n = UInt(Rn);
integer m = UInt(Rm);
if size == '11' then ReservedValue();
integer esize = 8 << UInt(size);
integer datasize = if Q == '1' then 128 else 64;
integer elements = datasize DIV esize;
```

```
boolean unsigned = (U == '1');
boolean minimum = (o1 == '1');
```

Assembler symbols

- <Vd> Is the name of the SIMD&FP destination register, encoded in the "Rd" field.
- <T> Is an arrangement specifier, encoded in the "size:Q" field. It can have the following values:
- | | |
|-----|-----------------------|
| 8B | when size = 00, Q = 0 |
| 16B | when size = 00, Q = 1 |
| 4H | when size = 01, Q = 0 |
| 8H | when size = 01, Q = 1 |
| 2S | when size = 10, Q = 0 |
| 4S | when size = 10, Q = 1 |
- The encoding size = 11, Q = x is reserved.
- <Vn> Is the name of the first SIMD&FP source register, encoded in the "Rn" field.
- <Vm> Is the name of the second SIMD&FP source register, encoded in the "Rm" field.

Operation

```
CheckFPAdvSIMDEnabled64();
bits(datasize) operand1 = V[n];
bits(datasize) operand2 = V[m];
bits(datasize) result;
integer element1;
integer element2;
integer maxmin;
```

```
for e = 0 to elements-1
    element1 = Int(Elem[operand1, e, esize], unsigned);
    element2 = Int(Elem[operand2, e, esize], unsigned);
    maxmin = if minimum then Min(element1, element2) else Max(element1, element2);
    Elem[result, e, esize] = maxmin<esize-1:0>;

V[d] = result;
```

C7.2.316 UMAXP

Unsigned Maximum Pairwise. This instruction creates a vector by concatenating the vector elements of the first source SIMD&FP register after the vector elements of the second source SIMD&FP register, reads each pair of adjacent vector elements in the two source SIMD&FP registers, writes the largest of each pair of unsigned integer values into a vector, and writes the vector to the destination SIMD&FP register.

Depending on the settings in the CPACR_EL1, CPTR_EL2, and CPTR_EL3 registers, and the current Security state and Exception level, an attempt to execute the instruction might be trapped.

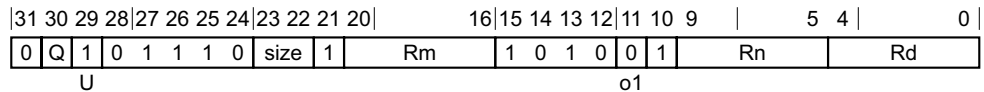

Three registers of the same type variant

UMAXP <Vd>.<T>, <Vn>.<T>, <Vm>.<T>

Decode for this encoding

```
integer d = UInt(Rd);
integer n = UInt(Rn);
integer m = UInt(Rm);
if size == '11' then ReservedValue();
integer esize = 8 << UInt(size);
integer datasize = if Q == '1' then 128 else 64;
integer elements = datasize DIV esize;

boolean unsigned = (U == '1');
boolean minimum = (o1 == '1');
```

Assembler symbols

- <Vd> Is the name of the SIMD&FP destination register, encoded in the "Rd" field.
- <T> Is an arrangement specifier, encoded in the "size:Q" field. It can have the following values:
- | | |
|-----|-----------------------|
| 8B | when size = 00, Q = 0 |
| 16B | when size = 00, Q = 1 |
| 4H | when size = 01, Q = 0 |
| 8H | when size = 01, Q = 1 |
| 2S | when size = 10, Q = 0 |
| 4S | when size = 10, Q = 1 |
- The encoding size = 11, Q = x is reserved.
- <Vn> Is the name of the first SIMD&FP source register, encoded in the "Rn" field.
- <Vm> Is the name of the second SIMD&FP source register, encoded in the "Rm" field.

Operation

```
CheckFPAdvSIMDEnabled64();
bits(datasize) operand1 = V[n];
bits(datasize) operand2 = V[m];
bits(datasize) result;
bits(2*datasize) concat = operand2:operand1;
integer element1;
integer element2;
```



```
integer maxmin;  
  
for e = 0 to elements-1  
    element1 = Int(Elem[concat, 2*e, esize], unsigned);  
    element2 = Int(Elem[concat, (2*e)+1, esize], unsigned);  
    maxmin = if minimum then Min(element1, element2) else Max(element1, element2);  
    Elem[result, e, esize] = maxmin<esize-1:0>;  
  
V[d] = result;
```

C7.2.317 UMAXV

Unsigned Maximum across Vector. This instruction compares all the vector elements in the source SIMD&FP register, and writes the largest of the values as a scalar to the destination SIMD&FP register. All the values in this instruction are unsigned integer values.

Depending on the settings in the CPACR_EL1, CPTR_EL2, and CPTR_EL3 registers, and the current Security state and Exception level, an attempt to execute the instruction might be trapped.

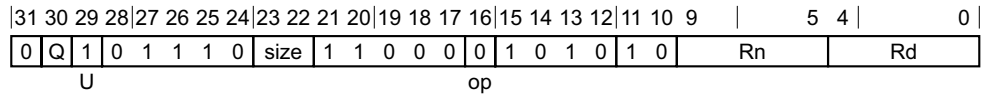

Advanced SIMD variant

UMAXV <V><d>, <Vn>.<T>

Decode for this encoding

```
integer d = UInt(Rd);
integer n = UInt(Rn);

if size:Q == '100' then ReservedValue();
if size == '11' then ReservedValue();
integer esize = 8 << UInt(size);
integer datasize = if Q == '1' then 128 else 64;
integer elements = datasize DIV esize;

boolean unsigned = (U == '1');
boolean min = (op == '1');
```

Assembler symbols

<V> Is the destination width specifier, encoded in the "size" field. It can have the following values:

- B when size = 00
- H when size = 01
- S when size = 10

The encoding size = 11 is reserved.

<d> Is the number of the SIMD&FP destination register, encoded in the "Rd" field.

<Vn> Is the name of the SIMD&FP source register, encoded in the "Rn" field.

<T> Is an arrangement specifier, encoded in the "size:Q" field. It can have the following values:

- 8B when size = 00, Q = 0
- 16B when size = 00, Q = 1
- 4H when size = 01, Q = 0
- 8H when size = 01, Q = 1
- 4S when size = 10, Q = 1

The following encodings are reserved:

- size = 10, Q = 0.
- size = 11, Q = x.

Operation

```
CheckFPAdvSIMDEnabled64();
bits(datasize) operand = V[n];
integer maxmin;
integer element;

maxmin = Int(Elem[operand, 0, esize], unsigned);
for e = 1 to elements-1
    element = Int(Elem[operand, e, esize], unsigned);
    maxmin = if min then Min(maxmin, element) else Max(maxmin, element);

V[d] = maxmin<esize-1:0>;
```

C7.2.318 UMIN

Unsigned Minimum (vector). This instruction compares corresponding vector elements in the two source SIMD&FP registers, places the smaller of each of the two unsigned integer values into a vector, and writes the vector to the destination SIMD&FP register.

Depending on the settings in the CPACR_EL1, CPTR_EL2, and CPTR_EL3 registers, and the current Security state and Exception level, an attempt to execute the instruction might be trapped.

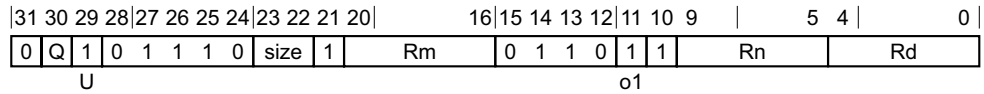

Three registers of the same type variant

UMIN <Vd>.<T>, <Vn>.<T>, <Vm>.<T>

Decode for this encoding

```
integer d = UInt(Rd);
integer n = UInt(Rn);
integer m = UInt(Rm);
if size == '11' then ReservedValue();
integer esize = 8 << UInt(size);
integer datasize = if Q == '1' then 128 else 64;
integer elements = datasize DIV esize;

boolean unsigned = (U == '1');
boolean minimum = (o1 == '1');
```

Assembler symbols

- <Vd> Is the name of the SIMD&FP destination register, encoded in the "Rd" field.
- <T> Is an arrangement specifier, encoded in the "size:Q" field. It can have the following values:
 - 8B when size = 00, Q = 0
 - 16B when size = 00, Q = 1
 - 4H when size = 01, Q = 0
 - 8H when size = 01, Q = 1
 - 2S when size = 10, Q = 0
 - 4S when size = 10, Q = 1
 The encoding size = 11, Q = x is reserved.
- <Vn> Is the name of the first SIMD&FP source register, encoded in the "Rn" field.
- <Vm> Is the name of the second SIMD&FP source register, encoded in the "Rm" field.

Operation

```
CheckFPAdvSIMDEnabled64();
bits(datasize) operand1 = V[n];
bits(datasize) operand2 = V[m];
bits(datasize) result;
integer element1;
integer element2;
integer maxmin;
```

```
for e = 0 to elements-1
    element1 = Int(Elem[operand1, e, esize], unsigned);
    element2 = Int(Elem[operand2, e, esize], unsigned);
    maxmin = if minimum then Min(element1, element2) else Max(element1, element2);
    Elem[result, e, esize] = maxmin<esize-1:0>;

V[d] = result;
```

C7.2.319 UMINP

Unsigned Minimum Pairwise. This instruction creates a vector by concatenating the vector elements of the first source SIMD&FP register after the vector elements of the second source SIMD&FP register, reads each pair of adjacent vector elements in the two source SIMD&FP registers, writes the smallest of each pair of unsigned integer values into a vector, and writes the vector to the destination SIMD&FP register.

Depending on the settings in the CPACR_EL1, CPTR_EL2, and CPTR_EL3 registers, and the current Security state and Exception level, an attempt to execute the instruction might be trapped.

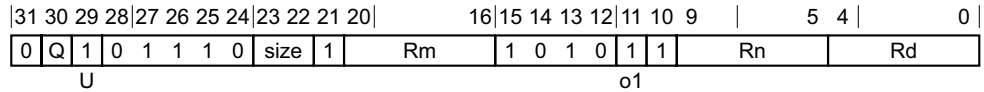

Three registers of the same type variant

UMINP <Vd>.<T>, <Vn>.<T>, <Vm>.<T>

Decode for this encoding

```
integer d = UInt(Rd);
integer n = UInt(Rn);
integer m = UInt(Rm);
if size == '11' then ReservedValue();
integer esize = 8 << UInt(size);
integer datasize = if Q == '1' then 128 else 64;
integer elements = datasize DIV esize;

boolean unsigned = (U == '1');
boolean minimum = (o1 == '1');
```

Assembler symbols

- <Vd> Is the name of the SIMD&FP destination register, encoded in the "Rd" field.
- <T> Is an arrangement specifier, encoded in the "size:Q" field. It can have the following values:
 - 8B when size = 00, Q = 0
 - 16B when size = 00, Q = 1
 - 4H when size = 01, Q = 0
 - 8H when size = 01, Q = 1
 - 2S when size = 10, Q = 0
 - 4S when size = 10, Q = 1
 The encoding size = 11, Q = x is reserved.
- <Vn> Is the name of the first SIMD&FP source register, encoded in the "Rn" field.
- <Vm> Is the name of the second SIMD&FP source register, encoded in the "Rm" field.

Operation

```
CheckFPAdvSIMDEnabled64();
bits(datasize) operand1 = V[n];
bits(datasize) operand2 = V[m];
bits(datasize) result;
bits(2*datasize) concat = operand2:operand1;
integer element1;
integer element2;
```

```
integer maxmin;  
  
for e = 0 to elements-1  
    element1 = Int(Elem[concat, 2*e, esize], unsigned);  
    element2 = Int(Elem[concat, (2*e)+1, esize], unsigned);  
    maxmin = if minimum then Min(element1, element2) else Max(element1, element2);  
    Elem[result, e, esize] = maxmin<esize-1:0>;  
  
V[d] = result;
```

C7.2.320 UMINV

Unsigned Minimum across Vector. This instruction compares all the vector elements in the source SIMD&FP register, and writes the smallest of the values as a scalar to the destination SIMD&FP register. All the values in this instruction are unsigned integer values.

Depending on the settings in the CPACR_EL1, CPTR_EL2, and CPTR_EL3 registers, and the current Security state and Exception level, an attempt to execute the instruction might be trapped.

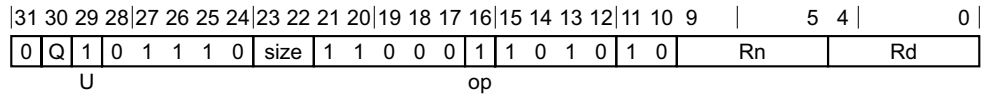

Advanced SIMD variant

UMINV <V><d>, <Vn>.<T>

Decode for this encoding

```
integer d = UInt(Rd);
integer n = UInt(Rn);

if size:Q == '100' then ReservedValue();
if size == '11' then ReservedValue();
integer esize = 8 << UInt(size);
integer datasize = if Q == '1' then 128 else 64;
integer elements = datasize DIV esize;

boolean unsigned = (U == '1');
boolean min = (op == '1');
```

Assembler symbols

- <V> Is the destination width specifier, encoded in the "size" field. It can have the following values:
- | | |
|---|----------------|
| B | when size = 00 |
| H | when size = 01 |
| S | when size = 10 |
- The encoding size = 11 is reserved.
- <d> Is the number of the SIMD&FP destination register, encoded in the "Rd" field.
- <Vn> Is the name of the SIMD&FP source register, encoded in the "Rn" field.
- <T> Is an arrangement specifier, encoded in the "size:Q" field. It can have the following values:
- | | |
|-----|-----------------------|
| 8B | when size = 00, Q = 0 |
| 16B | when size = 00, Q = 1 |
| 4H | when size = 01, Q = 0 |
| 8H | when size = 01, Q = 1 |
| 4S | when size = 10, Q = 1 |
- The following encodings are reserved:
- size = 10, Q = 0.
 - size = 11, Q = x.

Operation

```
CheckFPAdvSIMDEnabled64();
bits(datasize) operand = V[n];
integer maxmin;
integer element;

maxmin = Int(Elem[operand, 0, esize], unsigned);
for e = 1 to elements-1
    element = Int(Elem[operand, e, esize], unsigned);
    maxmin = if min then Min(maxmin, element) else Max(maxmin, element);

V[d] = maxmin<esize-1:0>;
```

C7.2.321 UMLAL, UMLAL2 (by element)

Unsigned Multiply-Add Long (vector, by element). This instruction multiplies each vector element in the lower or upper half of the first source SIMD&FP register by the specified vector element of the second source SIMD&FP register and accumulates the results with the vector elements of the destination SIMD&FP register. The destination vector elements are twice as long as the elements that are multiplied.

The UMLAL instruction extracts vector elements from the lower half of the first source register, while the UMLAL2 instruction extracts vector elements from the upper half of the first source register.

Depending on the settings in the CPACR_EL1, CPTR_EL2, and CPTR_EL3 registers, and the current Security state and Exception level, an attempt to execute the instruction might be trapped.

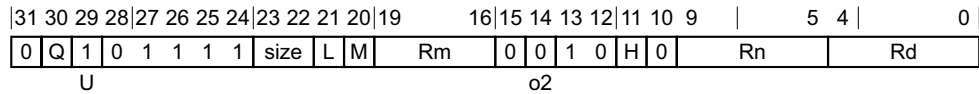

Vector variant

UMLAL{2} <Vd>.<Ta>, <Vn>.<Tb>, <Vm>.<Ts>[<index>]

Decode for this encoding

```

integer idxsize = if H == '1' then 128 else 64;
integer index;
bit Rmhi;
case size of
    when '01' index = UInt(H:L:M); Rmhi = '0';
    when '10' index = UInt(H:L); Rmhi = M;
    otherwise UnallocatedEncoding();

integer d = UInt(Rd);
integer n = UInt(Rn);
integer m = UInt(Rmhi:Rm);

integer esize = 8 << UInt(size);
integer datasize = 64;
integer part = UInt(Q);
integer elements = datasize DIV esize;

boolean unsigned = (U == '1');
boolean sub_op = (o2 == '1');
    
```

Assembler symbols

- 2 Is the second and upper half specifier. If present it causes the operation to be performed on the upper 64 bits of the registers holding the narrower elements, and is encoded in the "Q" field. It can have the following values:
 - [absent] when Q = 0
 - [present] when Q = 1
- <Vd> Is the name of the SIMD&FP destination register, encoded in the "Rd" field.
- <Ta> Is an arrangement specifier, encoded in the "size" field. It can have the following values:
 - 4S when size = 01
 - 2D when size = 10
 The following encodings are reserved:
 - size = 00.

- size = 11.
- <Vn> Is the name of the first SIMD&FP source register, encoded in the "Rn" field.
- <Tb> Is an arrangement specifier, encoded in the "size:Q" field. It can have the following values:
- | | |
|----|-----------------------|
| 4H | when size = 01, Q = 0 |
| 8H | when size = 01, Q = 1 |
| 2S | when size = 10, Q = 0 |
| 4S | when size = 10, Q = 1 |
- The following encodings are reserved:
- size = 00, Q = x.
 - size = 11, Q = x.
- <Vm> Is the name of the second SIMD&FP source register, encoded in the "size:M:Rm" field. It can have the following values:
- | | |
|------|----------------|
| 0:Rm | when size = 01 |
| M:Rm | when size = 10 |
- The following encodings are reserved:
- size = 00.
 - size = 11.
- Restricted to V0-V15 when element size <Ts> is H.
- <Ts> Is an element size specifier, encoded in the "size" field. It can have the following values:
- | | |
|---|----------------|
| H | when size = 01 |
| S | when size = 10 |
- The following encodings are reserved:
- size = 00.
 - size = 11.
- <index> Is the element index, encoded in the "size:L:H:M" field. It can have the following values:
- | | |
|-------|----------------|
| H:L:M | when size = 01 |
| H:L | when size = 10 |
- The following encodings are reserved:
- size = 00.
 - size = 11.

Operation

```

CheckFPAdvSIMDEnabled64();
bits(datasize) operand1 = Vpart[n, part];
bits(idxsizesize) operand2 = V[m];
bits(2*datasize) operand3 = V[d];
bits(2*datasize) result;
integer element1;
integer element2;
bits(2*esize) product;

element2 = Int(Elem[operand2, index, esize], unsigned);
for e = 0 to elements-1
    element1 = Int(Elem[operand1, e, esize], unsigned);
    product = (element1*element2)<2*esize-1:0>;
    if sub_op then
        Elem[result, e, 2*esize] = Elem[operand3, e, 2*esize] - product;
    else

```

```
Elem[result, e, 2*esize] = Elem[operand3, e, 2*esize] + product;  
V[d] = result;
```

C7.2.322 UMLAL, UMLAL2 (vector)

Unsigned Multiply-Add Long (vector). This instruction multiplies the vector elements in the lower or upper half of the first source SIMD&FP register by the corresponding vector elements of the second source SIMD&FP register, and accumulates the results with the vector elements of the destination SIMD&FP register. The destination vector elements are twice as long as the elements that are multiplied.

The UMLAL instruction extracts vector elements from the lower half of the first source register, while the UMLAL2 instruction extracts vector elements from the upper half of the first source register.

Depending on the settings in the CPACR_EL1, CPTR_EL2, and CPTR_EL3 registers, and the current Security state and Exception level, an attempt to execute the instruction might be trapped.

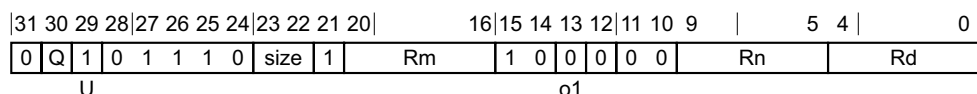

Three registers, not all the same type variant

UMLAL{2} <Vd>.<Ta>, <Vn>.<Tb>, <Vm>.<Tb>

Decode for this encoding

```
integer d = UInt(Rd);
integer n = UInt(Rn);
integer m = UInt(Rm);

if size == '11' then ReservedValue();
integer esize = 8 << UInt(size);
integer datasize = 64;
integer part = UInt(Q);
integer elements = datasize DIV esize;
boolean sub_op = (o1 == '1');
boolean unsigned = (U == '1');
```

Assembler symbols

- 2 Is the second and upper half specifier. If present it causes the operation to be performed on the upper 64 bits of the registers holding the narrower elements, and is encoded in the "Q" field. It can have the following values:
- [absent] when Q = 0
 - [present] when Q = 1
- <Vd> Is the name of the SIMD&FP destination register, encoded in the "Rd" field.
- <Ta> Is an arrangement specifier, encoded in the "size" field. It can have the following values:
- 8H when size = 00
 - 4S when size = 01
 - 2D when size = 10
- The encoding size = 11 is reserved.
- <Vn> Is the name of the first SIMD&FP source register, encoded in the "Rn" field.
- <Tb> Is an arrangement specifier, encoded in the "size:Q" field. It can have the following values:
- 8B when size = 00, Q = 0
 - 16B when size = 00, Q = 1

4H when size = 01, Q = 0
8H when size = 01, Q = 1
2S when size = 10, Q = 0
4S when size = 10, Q = 1
The encoding size = 11, Q = x is reserved.

<Vm> Is the name of the second SIMD&FP source register, encoded in the "Rm" field.

Operation

```
CheckFPAdvSIMDEnabled64();
bits(datasize) operand1 = Vpart[n, part];
bits(datasize) operand2 = Vpart[m, part];
bits(2*datasize) operand3 = V[d];
bits(2*datasize) result;
integer element1;
integer element2;
bits(2*esize) product;
bits(2*esize) accum;

for e = 0 to elements-1
    element1 = Int(Elem[operand1, e, esize], unsigned);
    element2 = Int(Elem[operand2, e, esize], unsigned);
    product = (element1*element2)<2*esize-1:0>;
    if sub_op then
        accum = Elem[operand3, e, 2*esize] - product;
    else
        accum = Elem[operand3, e, 2*esize] + product;
    Elem[result, e, 2*esize] = accum;

V[d] = result;
```

C7.2.323 UMLSL, UMLSL2 (by element)

Unsigned Multiply-Subtract Long (vector, by element). This instruction multiplies each vector element in the lower or upper half of the first source SIMD&FP register by the specified vector element of the second source SIMD&FP register and subtracts the results from the vector elements of the destination SIMD&FP register. The destination vector elements are twice as long as the elements that are multiplied.

The UMLSL instruction extracts vector elements from the lower half of the first source register, while the UMLSL2 instruction extracts vector elements from the upper half of the first source register.

Depending on the settings in the CPACR_EL1, CPTR_EL2, and CPTR_EL3 registers, and the current Security state and Exception level, an attempt to execute the instruction might be trapped.

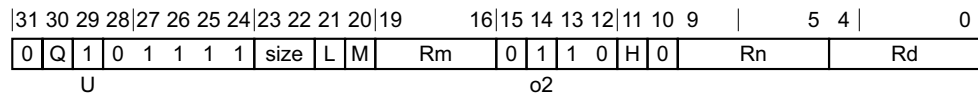

Vector variant

UMLSL{2} <Vd>.<Ta>, <Vn>.<Tb>, <Vm>.<Ts>[<index>]

Decode for this encoding

```

integer idxdsize = if H == '1' then 128 else 64;
integer index;
bit Rmhi;
case size of
    when '01' index = UInt(H:L:M); Rmhi = '0';
    when '10' index = UInt(H:L); Rmhi = M;
    otherwise UnallocatedEncoding();

integer d = UInt(Rd);
integer n = UInt(Rn);
integer m = UInt(Rmhi:Rm);

integer esize = 8 << UInt(size);
integer datasize = 64;
integer part = UInt(Q);
integer elements = datasize DIV esize;

boolean unsigned = (U == '1');
boolean sub_op = (o2 == '1');
```

Assembler symbols

- 2 Is the second and upper half specifier. If present it causes the operation to be performed on the upper 64 bits of the registers holding the narrower elements, and is encoded in the "Q" field. It can have the following values:
- [absent] when Q = 0
 - [present] when Q = 1
- <Vd> Is the name of the SIMD&FP destination register, encoded in the "Rd" field.
- <Ta> Is an arrangement specifier, encoded in the "size" field. It can have the following values:
- 4S when size = 01
 - 2D when size = 10
- The following encodings are reserved:
- size = 00.

- size = 11.
- <Vn> Is the name of the first SIMD&FP source register, encoded in the "Rn" field.
- <Tb> Is an arrangement specifier, encoded in the "size:Q" field. It can have the following values:
- | | |
|----|-----------------------|
| 4H | when size = 01, Q = 0 |
| 8H | when size = 01, Q = 1 |
| 2S | when size = 10, Q = 0 |
| 4S | when size = 10, Q = 1 |
- The following encodings are reserved:
- size = 00, Q = x.
 - size = 11, Q = x.
- <Vm> Is the name of the second SIMD&FP source register, encoded in the "size:M:Rm" field. It can have the following values:
- | | |
|------|----------------|
| 0:Rm | when size = 01 |
| M:Rm | when size = 10 |
- The following encodings are reserved:
- size = 00.
 - size = 11.
- Restricted to V0-V15 when element size <Ts> is H.
- <Ts> Is an element size specifier, encoded in the "size" field. It can have the following values:
- | | |
|---|----------------|
| H | when size = 01 |
| S | when size = 10 |
- The following encodings are reserved:
- size = 00.
 - size = 11.
- <index> Is the element index, encoded in the "size:L:H:M" field. It can have the following values:
- | | |
|-------|----------------|
| H:L:M | when size = 01 |
| H:L | when size = 10 |
- The following encodings are reserved:
- size = 00.
 - size = 11.

Operation

```

CheckFPAdvSIMDEnabled64();
bits(datasize) operand1 = Vpart[n, part];
bits(idxsizesize) operand2 = V[m];
bits(2*datasize) operand3 = V[d];
bits(2*datasize) result;
integer element1;
integer element2;
bits(2*esize) product;

element2 = Int(Elem[operand2, index, esize], unsigned);
for e = 0 to elements-1
    element1 = Int(Elem[operand1, e, esize], unsigned);
    product = (element1*element2)<2*esize-1:0>;
    if sub_op then
        Elem[result, e, 2*esize] = Elem[operand3, e, 2*esize] - product;
    else

```



```
Elem[result, e, 2*esize] = Elem[operand3, e, 2*esize] + product;  
V[d] = result;
```

C7.2.324 UMLSL, UMLSL2 (vector)

Unsigned Multiply-Subtract Long (vector). This instruction multiplies corresponding vector elements in the lower or upper half of the two source SIMD&FP registers, and subtracts the results from the vector elements of the destination SIMD&FP register. The destination vector elements are twice as long as the elements that are multiplied. All the values in this instruction are unsigned integer values.

The UMLSL instruction extracts each source vector from the lower half of each source register, while the UMLSL2 instruction extracts each source vector from the upper half of each source register.

Depending on the settings in the CPACR_EL1, CPTR_EL2, and CPTR_EL3 registers, and the current Security state and Exception level, an attempt to execute the instruction might be trapped.

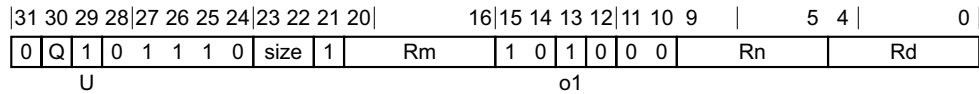

Three registers, not all the same type variant

UMLSL{2} <Vd>.<Ta>, <Vn>.<Tb>, <Vm>.<Tb>

Decode for this encoding

```
integer d = UInt(Rd);
integer n = UInt(Rn);
integer m = UInt(Rm);

if size == '11' then ReservedValue();
integer esize = 8 << UInt(size);
integer datasize = 64;
integer part = UInt(Q);
integer elements = datasize DIV esize;
boolean sub_op = (o1 == '1');
boolean unsigned = (U == '1');
```

Assembler symbols

- 2 Is the second and upper half specifier. If present it causes the operation to be performed on the upper 64 bits of the registers holding the narrower elements, and is encoded in the "Q" field. It can have the following values:
 - [absent] when Q = 0
 - [present] when Q = 1
- <Vd> Is the name of the SIMD&FP destination register, encoded in the "Rd" field.
- <Ta> Is an arrangement specifier, encoded in the "size" field. It can have the following values:
 - 8H when size = 00
 - 4S when size = 01
 - 2D when size = 10
 The encoding size = 11 is reserved.
- <Vn> Is the name of the first SIMD&FP source register, encoded in the "Rn" field.
- <Tb> Is an arrangement specifier, encoded in the "size:Q" field. It can have the following values:
 - 8B when size = 00, Q = 0
 - 16B when size = 00, Q = 1

4H when size = 01, Q = 0
8H when size = 01, Q = 1
2S when size = 10, Q = 0
4S when size = 10, Q = 1
The encoding size = 11, Q = x is reserved.

<Vm> Is the name of the second SIMD&FP source register, encoded in the "Rm" field.

Operation

```
CheckFPAdvSIMDEnabled64();
bits(datasize) operand1 = Vpart[n, part];
bits(datasize) operand2 = Vpart[m, part];
bits(2*datasize) operand3 = V[d];
bits(2*datasize) result;
integer element1;
integer element2;
bits(2*esize) product;
bits(2*esize) accum;

for e = 0 to elements-1
    element1 = Int(Elem[operand1, e, esize], unsigned);
    element2 = Int(Elem[operand2, e, esize], unsigned);
    product = (element1*element2)<2*esize-1:0>;
    if sub_op then
        accum = Elem[operand3, e, 2*esize] - product;
    else
        accum = Elem[operand3, e, 2*esize] + product;
    Elem[result, e, 2*esize] = accum;

V[d] = result;
```

C7.2.325 UMOV

Unsigned Move vector element to general-purpose register. This instruction reads the unsigned integer from the source SIMD&FP register, zero-extends it to form a 32-bit or 64-bit value, and writes the result to the destination general-purpose register.

Depending on the settings in the CPACR_EL1, CPTR_EL2, and CPTR_EL3 registers, and the current Security state and Exception level, an attempt to execute the instruction might be trapped.

This instruction is used by the alias MOV (to general). See *Alias conditions* for details of when each alias is preferred.

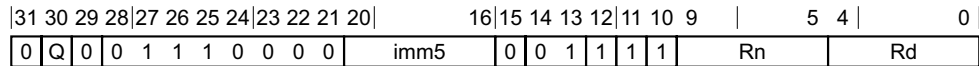

32-bit variant

Applies when Q == 0.

UMOV <Wd>, <Vn>.<Ts>[<index>]

64-bit variant

Applies when Q == 1 && imm5 == x1000.

UMOV <Xd>, <Vn>.<Ts>[<index>]

Decode for all variants of this encoding

```
integer d = UInt(Rd);
integer n = UInt(Rn);

integer size;
case Q:imm5 of
    when '0xxx1' size = 0; // UMOV Wd, Vn.B
    when '0xxx10' size = 1; // UMOV Wd, Vn.H
    when '0xx100' size = 2; // UMOV Wd, Vn.S
    when '1x1000' size = 3; // UMOV Xd, Vn.D
    otherwise UnallocatedEncoding();

integer idxsize = if imm5<4> == '1' then 128 else 64;
integer index = UInt(imm5<4:size+1>);
integer esize = 8 << size;
integer datasize = if Q == '1' then 64 else 32;
```

Alias conditions

Alias	is preferred when
MOV (to general)	imm5 == 'x1000'
MOV (to general)	imm5 == 'xx100'

Assembler symbols

- <Wd> Is the 32-bit name of the general-purpose destination register, encoded in the "Rd" field.
- <Xd> Is the 64-bit name of the general-purpose destination register, encoded in the "Rd" field.

- <Vn> Is the name of the SIMD&FP source register, encoded in the "Rn" field.
- <Ts> For the 32-bit variant: is an element size specifier, encoded in the "imm5" field. It can have the following values:
- B when imm5 = xxxx1
 - H when imm5 = xxx10
 - S when imm5 = xx100
- The encoding imm5 = xx000 is reserved.
- For the 64-bit variant: is an element size specifier, encoded in the "imm5" field. It can have the following values:
- D when imm5 = x1000
- The following encodings are reserved:
- imm5 = x0000.
 - imm5 = xxxx1.
 - imm5 = xxx10.
 - imm5 = xx100.
- <index> For the 32-bit variant: is the element index encoded in the "imm5" field. It can have the following values:
- imm5<4:1> when imm5 = xxxx1
 - imm5<4:2> when imm5 = xxx10
 - imm5<4:3> when imm5 = xx100
- The encoding imm5 = xx000 is reserved.
- For the 64-bit variant: is the element index encoded in "imm5<4>".

Operation

```
CheckFPAdvSIMDEnabled64();  
bits(idxsize) operand = V[n];  
  
X[d] = ZeroExtend(Elem[operand, index, esize], datasize);
```

C7.2.326 UMULL, UMULL2 (by element)

Unsigned Multiply Long (vector, by element). This instruction multiplies each vector element in the lower or upper half of the first source SIMD&FP register by the specified vector element of the second source SIMD&FP register, places the results in a vector, and writes the vector to the destination SIMD&FP register. The destination vector elements are twice as long as the elements that are multiplied.

The UMULL instruction extracts vector elements from the lower half of the first source register, while the UMULL2 instruction extracts vector elements from the upper half of the first source register.

Depending on the settings in the CPACR_EL1, CPTR_EL2, and CPTR_EL3 registers, and the current Security state and Exception level, an attempt to execute the instruction might be trapped.

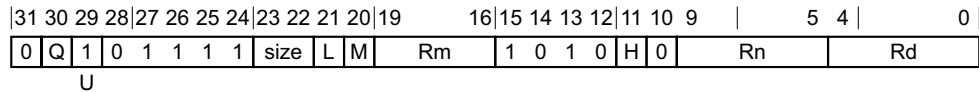

Vector variant

UMULL{2} <Vd>.<Ta>, <Vn>.<Tb>, <Vm>.<Ts>[<index>]

Decode for this encoding

```

integer idxsize = if H == '1' then 128 else 64;
integer index;
bit Rmhi;
case size of
    when '01' index = UInt(H:L:M); Rmhi = '0';
    when '10' index = UInt(H:L); Rmhi = M;
    otherwise UnallocatedEncoding();

integer d = UInt(Rd);
integer n = UInt(Rn);
integer m = UInt(Rmhi:Rm);

integer esize = 8 << UInt(size);
integer datasize = 64;
integer part = UInt(Q);
integer elements = datasize DIV esize;
boolean unsigned = (U == '1');
```

Assembler symbols

2 Is the second and upper half specifier. If present it causes the operation to be performed on the upper 64 bits of the registers holding the narrower elements, and is encoded in the "Q" field. It can have the following values:

[absent] when Q = 0
 [present] when Q = 1

<Vd> Is the name of the SIMD&FP destination register, encoded in the "Rd" field.

<Ta> Is an arrangement specifier, encoded in the "size" field. It can have the following values:

4S when size = 01
 2D when size = 10

The following encodings are reserved:

- size = 00.
- size = 11.

- <Vn> Is the name of the first SIMD&FP source register, encoded in the "Rn" field.
- <Tb> Is an arrangement specifier, encoded in the "size:Q" field. It can have the following values:
- | | |
|----|-----------------------|
| 4H | when size = 01, Q = 0 |
| 8H | when size = 01, Q = 1 |
| 2S | when size = 10, Q = 0 |
| 4S | when size = 10, Q = 1 |
- The following encodings are reserved:
- size = 00, Q = x.
 - size = 11, Q = x.
- <Vm> Is the name of the second SIMD&FP source register, encoded in the "size:M:Rm" field. It can have the following values:
- | | |
|------|----------------|
| 0:Rm | when size = 01 |
| M:Rm | when size = 10 |
- The following encodings are reserved:
- size = 00.
 - size = 11.
- Restricted to V0-V15 when element size <Ts> is H.
- <Ts> Is an element size specifier, encoded in the "size" field. It can have the following values:
- | | |
|---|----------------|
| H | when size = 01 |
| S | when size = 10 |
- The following encodings are reserved:
- size = 00.
 - size = 11.
- <index> Is the element index, encoded in the "size:L:H:M" field. It can have the following values:
- | | |
|-------|----------------|
| H:L:M | when size = 01 |
| H:L | when size = 10 |
- The following encodings are reserved:
- size = 00.
 - size = 11.

Operation

```

CheckFPAdvSIMDEnabled64();
bits(datasize) operand1 = Vpart[n, part];
bits(idxsizesize) operand2 = V[m];
bits(2*datasize) result;
integer element1;
integer element2;
bits(2*esize) product;

element2 = Int(Elem[operand2, index, esize], unsigned);
for e = 0 to elements-1
    element1 = Int(Elem[operand1, e, esize], unsigned);
    product = (element1*element2)<2*esize-1:0>;
    Elem[result, e, 2*esize] = product;

V[d] = result;
    
```

C7.2.327 UMULL, UMULL2 (vector)

Unsigned Multiply long (vector). This instruction multiplies corresponding vector elements in the lower or upper half of the two source SIMD&FP registers, places the result in a vector, and writes the vector to the destination SIMD&FP register. The destination vector elements are twice as long as the elements that are multiplied. All the values in this instruction are unsigned integer values.

The UMULL instruction extracts each source vector from the lower half of each source register, while the UMULL2 instruction extracts each source vector from the upper half of each source register.

Depending on the settings in the CPACR_EL1, CPTR_EL2, and CPTR_EL3 registers, and the current Security state and Exception level, an attempt to execute the instruction might be trapped.

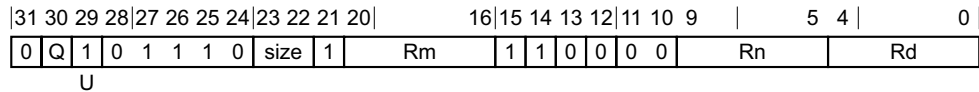

Three registers, not all the same type variant

UMULL{2} <Vd>.<Ta>, <Vn>.<Tb>, <Vm>.<Tb>

Decode for this encoding

```
integer d = UInt(Rd);
integer n = UInt(Rn);
integer m = UInt(Rm);

if size == '11' then ReservedValue();
integer esize = 8 << UInt(size);
integer datasize = 64;
integer part = UInt(Q);
integer elements = datasize DIV esize;

boolean unsigned = (U == '1');
```

Assembler symbols

- 2 Is the second and upper half specifier. If present it causes the operation to be performed on the upper 64 bits of the registers holding the narrower elements, and is encoded in the "Q" field. It can have the following values:
 - [absent] when Q = 0
 - [present] when Q = 1
- <Vd> Is the name of the SIMD&FP destination register, encoded in the "Rd" field.
- <Ta> Is an arrangement specifier, encoded in the "size" field. It can have the following values:
 - 8H when size = 00
 - 4S when size = 01
 - 2D when size = 10
 The encoding size = 11 is reserved.
- <Vn> Is the name of the first SIMD&FP source register, encoded in the "Rn" field.
- <Tb> Is an arrangement specifier, encoded in the "size:Q" field. It can have the following values:
 - 8B when size = 00, Q = 0
 - 16B when size = 00, Q = 1

4H when size = 01, Q = 0

8H when size = 01, Q = 1

2S when size = 10, Q = 0

4S when size = 10, Q = 1

The encoding size = 11, Q = x is reserved.

<Vm> Is the name of the second SIMD&FP source register, encoded in the "Rm" field.

Operation

```
CheckFPAdvSIMDEnabled64();
bits(datasize) operand1 = Vpart[n, part];
bits(datasize) operand2 = Vpart[m, part];
bits(2*datasize) result;
integer element1;
integer element2;

for e = 0 to elements-1
    element1 = Int(Elem[operand1, e, esize], unsigned);
    element2 = Int(Elem[operand2, e, esize], unsigned);
    Elem[result, e, 2*esize] = (element1*element2)<2*esize-1:0>;

V[d] = result;
```

C7.2.328 UQADD

Unsigned saturating Add. This instruction adds the values of corresponding elements of the two source SIMD&FP registers, places the results into a vector, and writes the vector to the destination SIMD&FP register.

If overflow occurs with any of the results, those results are saturated. If saturation occurs, the cumulative saturation bit [FPSR.QC](#) is set.

Depending on the settings in the [CPACR_EL1](#), [CPTR_EL2](#), and [CPTR_EL3](#) registers, and the current Security state and Exception level, an attempt to execute the instruction might be trapped.

Scalar

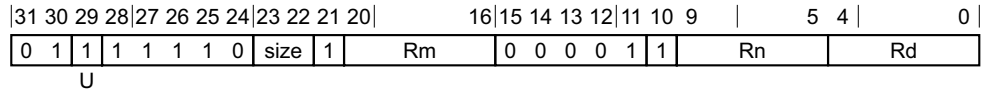

Scalar variant

UQADD <V><d>, <V><n>, <V><m>

Decode for this encoding

```
integer d = UInt(Rd);
integer n = UInt(Rn);
integer m = UInt(Rm);
integer esize = 8 << UInt(size);
integer datasize = esize;
integer elements = 1;
boolean unsigned = (U == '1');
```

Vector

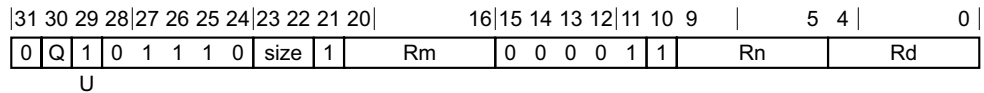

Vector variant

UQADD <Vd>.<T>, <Vn>.<T>, <Vm>.<T>

Decode for this encoding

```
integer d = UInt(Rd);
integer n = UInt(Rn);
integer m = UInt(Rm);
if size:Q == '110' then ReservedValue();
integer esize = 8 << UInt(size);
integer datasize = if Q == '1' then 128 else 64;
integer elements = datasize DIV esize;
boolean unsigned = (U == '1');
```

Assembler symbols

<V> Is a width specifier, encoded in the "size" field. It can have the following values:

B	when size = 00
H	when size = 01
S	when size = 10

- D when size = 11
- <d> Is the number of the SIMD&FP destination register, in the "Rd" field.
- <n> Is the number of the first SIMD&FP source register, encoded in the "Rn" field.
- <m> Is the number of the second SIMD&FP source register, encoded in the "Rm" field.
- <Vd> Is the name of the SIMD&FP destination register, encoded in the "Rd" field.
- <T> Is an arrangement specifier, encoded in the "size:Q" field. It can have the following values:
- 8B when size = 00, Q = 0
- 16B when size = 00, Q = 1
- 4H when size = 01, Q = 0
- 8H when size = 01, Q = 1
- 2S when size = 10, Q = 0
- 4S when size = 10, Q = 1
- 2D when size = 11, Q = 1
- The encoding size = 11, Q = 0 is reserved.
- <Vn> Is the name of the first SIMD&FP source register, encoded in the "Rn" field.
- <Vm> Is the name of the second SIMD&FP source register, encoded in the "Rm" field.

Operation for all encodings

```

CheckFPAdvSIMDEnabled64();
bits(datasize) operand1 = V[n];
bits(datasize) operand2 = V[m];
bits(datasize) result;
integer element1;
integer element2;
integer sum;
boolean sat;

for e = 0 to elements-1
    element1 = Int(Elem[operand1, e, esize], unsigned);
    element2 = Int(Elem[operand2, e, esize], unsigned);
    sum = element1 + element2;
    (Elem[result, e, esize], sat) = SatQ(sum, esize, unsigned);
    if sat then FPSR.QC = '1';

V[d] = result;
    
```

C7.2.329 UQRSHL

Unsigned saturating Rounding Shift Left (register). This instruction takes each vector element of the first source SIMD&FP register, shifts the vector element by a value from the least significant byte of the corresponding vector element of the second source SIMD&FP register, places the results into a vector, and writes the vector to the destination SIMD&FP register.

If the shift value is positive, the operation is a left shift. Otherwise, it is a right shift. The results are rounded. For truncated results, see [UQSHL \(immediate\)](#).

If overflow occurs with any of the results, those results are saturated. If saturation occurs, the cumulative saturation bit [FPSR.QC](#) is set.

Depending on the settings in the [CPACR_EL1](#), [CPTR_EL2](#), and [CPTR_EL3](#) registers, and the current Security state and Exception level, an attempt to execute the instruction might be trapped.

Scalar

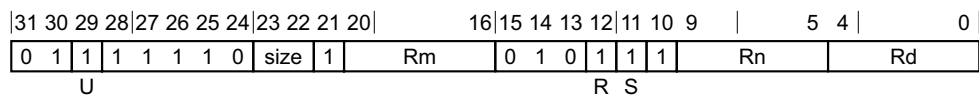

Scalar variant

UQRSHL <V><d>, <V><n>, <V><m>

Decode for this encoding

```
integer d = UInt(Rd);
integer n = UInt(Rn);
integer m = UInt(Rm);
integer esize = 8 << UInt(size);
integer datasize = esize;
integer elements = 1;
boolean unsigned = (U == '1');
boolean rounding = (R == '1');
boolean saturating = (S == '1');
if S == '0' && size != '11' then ReservedValue();
```

Vector

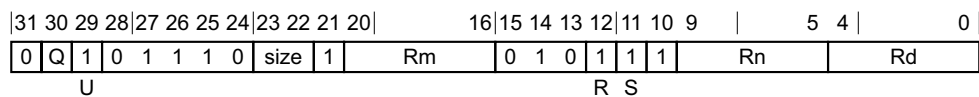

Vector variant

UQRSHL <Vd>.<T>, <Vn>.<T>, <Vm>.<T>

Decode for this encoding

```
integer d = UInt(Rd);
integer n = UInt(Rn);
integer m = UInt(Rm);
if size:Q == '110' then ReservedValue();
integer esize = 8 << UInt(size);
integer datasize = if Q == '1' then 128 else 64;
integer elements = datasize DIV esize;
boolean unsigned = (U == '1');
boolean rounding = (R == '1');
boolean saturating = (S == '1');
```

Assembler symbols

<V>	Is a width specifier, encoded in the "size" field. It can have the following values:
B	when size = 00
H	when size = 01
S	when size = 10
D	when size = 11
<d>	Is the number of the SIMD&FP destination register, in the "Rd" field.
<n>	Is the number of the first SIMD&FP source register, encoded in the "Rn" field.
<m>	Is the number of the second SIMD&FP source register, encoded in the "Rm" field.
<Vd>	Is the name of the SIMD&FP destination register, encoded in the "Rd" field.
<T>	Is an arrangement specifier, encoded in the "size:Q" field. It can have the following values:
8B	when size = 00, Q = 0
16B	when size = 00, Q = 1
4H	when size = 01, Q = 0
8H	when size = 01, Q = 1
2S	when size = 10, Q = 0
4S	when size = 10, Q = 1
2D	when size = 11, Q = 1
	The encoding size = 11, Q = 0 is reserved.
<Vn>	Is the name of the first SIMD&FP source register, encoded in the "Rn" field.
<Vm>	Is the name of the second SIMD&FP source register, encoded in the "Rm" field.

Operation for all encodings

```

CheckFPAdvSIMDEnabled64();
bits(datasize) operand1 = V[n];
bits(datasize) operand2 = V[m];
bits(datasize) result;

integer round_const = 0;
integer shift;
integer element;
boolean sat;

for e = 0 to elements-1
  shift = SInt(Elem[operand2, e, esize]<7:0>);
  if rounding then
    round_const = 1 << (-shift - 1); // 0 for left shift, 2^(n-1) for right shift
  element = (Int(Elem[operand1, e, esize], unsigned) + round_const) << shift;
  if saturating then
    (Elem[result, e, esize], sat) = SatQ(element, esize, unsigned);
    if sat then FPSR.QC = '1';
  else
    Elem[result, e, esize] = element<esize-1:0>;

V[d] = result;

```

C7.2.330 UQRSHRN, UQRSHRN2

Unsigned saturating Rounded Shift Right Narrow (immediate). This instruction reads each vector element in the source SIMD&FP register, right shifts each result by an immediate value, puts the final result into a vector, and writes the vector to the lower or upper half of the destination SIMD&FP register. All the values in this instruction are unsigned integer values. The results are rounded. For truncated results, see [UQSHRN](#), [UQSHRN2](#).

The UQRSHRN instruction writes the vector to the lower half of the destination register and clears the upper half, while the UQRSHRN2 instruction writes the vector to the upper half of the destination register without affecting the other bits of the register.

If overflow occurs with any of the results, those results are saturated. If saturation occurs, the cumulative saturation bit [FPSR.QC](#) is set.

Depending on the settings in the [CPACR_EL1](#), [CPTR_EL2](#), and [CPTR_EL3](#) registers, and the current Security state and Exception level, an attempt to execute the instruction might be trapped.

Scalar

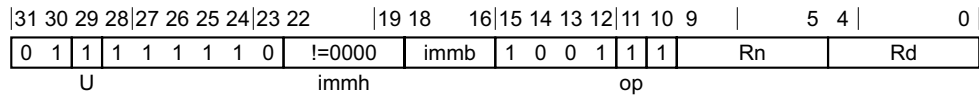

Scalar variant

UQRSHRN <Vb><d>, <Va><n>, #<shift>

Decode for this encoding

```
integer d = UInt(Rd);
integer n = UInt(Rn);

if immh == '0000' then ReservedValue();
if immh<3> == '1' then ReservedValue();
integer esize = 8 << HighestSetBit(immh);
integer datasize = esize;
integer elements = 1;
integer part = 0;

integer shift = (2 * esize) - UInt(immh:immb);
boolean round = (op == '1');
boolean unsigned = (U == '1');
```

Vector

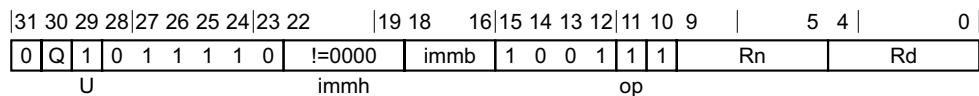

Vector variant

UQRSHRN{2} <Vd>.<Tb>, <Vn>.<Ta>, #<shift>

Decode for this encoding

```
integer d = UInt(Rd);
integer n = UInt(Rn);

if immh == '0000' then SEE "Advanced SIMD modified immediate";
if immh<3> == '1' then ReservedValue();
integer esize = 8 << HighestSetBit(immh);
```

```
integer datasize = 64;  
integer part = UInt(Q);  
integer elements = datasize DIV esize;  
  
integer shift = (2 * esize) - UInt(immh:immb);  
boolean round = (op == '1');  
boolean unsigned = (U == '1');
```

Assembler symbols

2 Is the second and upper half specifier. If present it causes the operation to be performed on the upper 64 bits of the registers holding the narrower elements, and is encoded in the "Q" field. It can have the following values:

[absent] when Q = 0
[present] when Q = 1

<Vd> Is the name of the SIMD&FP destination register, encoded in the "Rd" field.

<Tb> Is an arrangement specifier, encoded in the "immh:Q" field. It can have the following values:

8B when immh = 0001, Q = 0
16B when immh = 0001, Q = 1
4H when immh = 001x, Q = 0
8H when immh = 001x, Q = 1
2S when immh = 01xx, Q = 0
4S when immh = 01xx, Q = 1

See [Advanced SIMD modified immediate on page C4-291](#) when immh = 0000, Q = x.

The encoding immh = 1xxx, Q = x is reserved.

<Vn> Is the name of the SIMD&FP source register, encoded in the "Rn" field.

<Ta> Is an arrangement specifier, encoded in the "immh" field. It can have the following values:

8H when immh = 0001
4S when immh = 001x
2D when immh = 01xx

See [Advanced SIMD modified immediate on page C4-291](#) when immh = 0000.

The encoding immh = 1xxx is reserved.

<Vb> Is the destination width specifier, encoded in the "immh" field. It can have the following values:

B when immh = 0001
H when immh = 001x
S when immh = 01xx

The following encodings are reserved:

- immh = 0000.
- immh = 1xxx.

<d> Is the number of the SIMD&FP destination register, in the "Rd" field.

<Va> Is the source width specifier, encoded in the "immh" field. It can have the following values:

H when immh = 0001
S when immh = 001x
D when immh = 01xx

The following encodings are reserved:

- immh = 0000.
- immh = 1xxx.

<n> Is the number of the first SIMD&FP source register, encoded in the "Rn" field.

<shift> For the scalar variant: is the right shift amount, in the range 1 to the destination operand width in bits, encoded in the "immh:immb" field. It can have the following values:

(16-UInt(immh:immb)) when immh = 0001

(32-UInt(immh:immb)) when immh = 001x

(64-UInt(immh:immb)) when immh = 01xx

The following encodings are reserved:

- immh = 0000.
- immh = 1xxx.

For the vector variant: is the right shift amount, in the range 1 to the destination element width in bits, encoded in the "immh:immb" field. It can have the following values:

(16-UInt(immh:immb)) when immh = 0001

(32-UInt(immh:immb)) when immh = 001x

(64-UInt(immh:immb)) when immh = 01xx

See [Advanced SIMD modified immediate on page C4-291](#) when immh = 0000.

The encoding immh = 1xxx is reserved.

Operation for all encodings

```
CheckFPAdvSIMDEnabled64();
bits(datasize*2) operand = V[n];
bits(datasize) result;
integer round_const = if round then (1 << (shift - 1)) else 0;
integer element;
boolean sat;

for e = 0 to elements-1
    element = (Int(Elem[operand, e, 2*esize], unsigned) + round_const) >> shift;
    (Elem[result, e, esize], sat) = SatQ(element, esize, unsigned);
    if sat then FPSR.QC = '1';

Vpart[d, part] = result;
```



C7.2.331 UQSHL (immediate)

Unsigned saturating Shift Left (immediate). This instruction takes each vector element in the source SIMD&FP register, shifts it by an immediate value, places the results in a vector, and writes the vector to the destination SIMD&FP register. The results are truncated. For rounded results, see [UQRSHL](#).

If overflow occurs with any of the results, those results are saturated. If saturation occurs, the cumulative saturation bit [FPSR.QC](#) is set.

Depending on the settings in the [CPACR_EL1](#), [CPTR_EL2](#), and [CPTR_EL3](#) registers, and the current Security state and Exception level, an attempt to execute the instruction might be trapped.

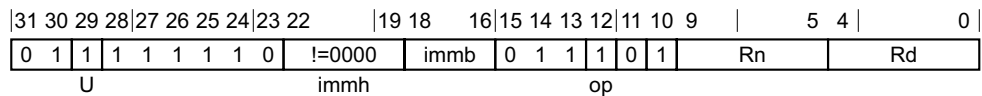
Scalar



Scalar variant

UQSHL <V><d>, <V><n>, #<shift>

Decode for this encoding

```
integer d = UInt(Rd);
integer n = UInt(Rn);

if immh == '0000' then ReservedValue();
integer esize = 8 << HighestSetBit(immh);
integer datasize = esize;
integer elements = 1;

integer shift = UInt(immh:immh) - esize;

boolean src_unsigned;
boolean dst_unsigned;
case op:U of
    when '00' UnallocatedEncoding();
    when '01' src_unsigned = FALSE; dst_unsigned = TRUE;
    when '10' src_unsigned = FALSE; dst_unsigned = FALSE;
    when '11' src_unsigned = TRUE; dst_unsigned = TRUE;
```

Vector

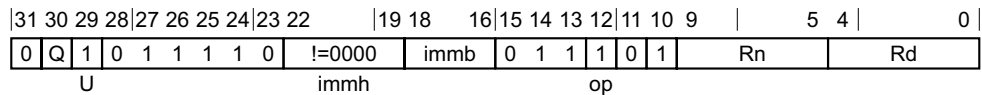

Vector variant

UQSHL <Vd>.<T>, <Vn>.<T>, #<shift>

Decode for this encoding

```
integer d = UInt(Rd);
integer n = UInt(Rn);

if immh == '0000' then SEE "Advanced SIMD modified immediate";
if immh<3>:Q == '10' then ReservedValue();
integer esize = 8 << HighestSetBit(immh);
integer datasize = if Q == '1' then 128 else 64;
```

```
integer elements = datasize DIV esize;

integer shift = UInt(immh:immb) - esize;

boolean src_unsigned;
boolean dst_unsigned;
case op:U of
  when '00' UnallocatedEncoding();
  when '01' src_unsigned = FALSE; dst_unsigned = TRUE;
  when '10' src_unsigned = FALSE; dst_unsigned = FALSE;
  when '11' src_unsigned = TRUE; dst_unsigned = TRUE;
```

Assembler symbols

- <V> Is a width specifier, encoded in the "immh" field. It can have the following values:
- | | |
|---|------------------|
| B | when immh = 0001 |
| H | when immh = 001x |
| S | when immh = 01xx |
| D | when immh = 1xxx |
- The encoding immh = 0000 is reserved.
- <d> Is the number of the SIMD&FP destination register, in the "Rd" field.
- <n> Is the number of the first SIMD&FP source register, encoded in the "Rn" field.
- <Vd> Is the name of the SIMD&FP destination register, encoded in the "Rd" field.
- <T> Is an arrangement specifier, encoded in the "immh:Q" field. It can have the following values:
- | | |
|-----|-------------------------|
| 8B | when immh = 0001, Q = 0 |
| 16B | when immh = 0001, Q = 1 |
| 4H | when immh = 001x, Q = 0 |
| 8H | when immh = 001x, Q = 1 |
| 2S | when immh = 01xx, Q = 0 |
| 4S | when immh = 01xx, Q = 1 |
| 2D | when immh = 1xxx, Q = 1 |
- See [Advanced SIMD modified immediate on page C4-291](#) when immh = 0000, Q = x.
- The encoding immh = 1xxx, Q = 0 is reserved.
- <Vn> Is the name of the SIMD&FP source register, encoded in the "Rn" field.
- <shift> For the scalar variant: is the left shift amount, in the range 0 to the operand width in bits minus 1, encoded in the "immh:immb" field. It can have the following values:
- | | |
|----------------------|------------------|
| (UInt(immh:immb)-8) | when immh = 0001 |
| (UInt(immh:immb)-16) | when immh = 001x |
| (UInt(immh:immb)-32) | when immh = 01xx |
| (UInt(immh:immb)-64) | when immh = 1xxx |
- The encoding immh = 0000 is reserved.
- For the vector variant: is the left shift amount, in the range 0 to the element width in bits minus 1, encoded in the "immh:immb" field. It can have the following values:
- | | |
|----------------------|------------------|
| (UInt(immh:immb)-8) | when immh = 0001 |
| (UInt(immh:immb)-16) | when immh = 001x |
| (UInt(immh:immb)-32) | when immh = 01xx |
| (UInt(immh:immb)-64) | when immh = 1xxx |

See [Advanced SIMD modified immediate on page C4-291](#) when immh = 0000.

Operation for all encodings

```
CheckFPAdvSIMDEnabled64();
bits(datasize) operand = V[n];
bits(datasize) result;
integer element;
boolean sat;

for e = 0 to elements-1
    element = Int(Elm[operand, e, esize], src_unsigned) << shift;
    (Elm[result, e, esize], sat) = SatQ(element, esize, dst_unsigned);
    if sat then FPSR.QC = '1';

V[d] = result;
```

C7.2.332 UQSHL (register)

Unsigned saturating Shift Left (register). This instruction takes each element in the vector of the first source SIMD&FP register, shifts the element by a value from the least significant byte of the corresponding element of the second source SIMD&FP register, places the results in a vector, and writes the vector to the destination SIMD&FP register.

If the shift value is positive, the operation is a left shift. Otherwise, it is a right shift. The results are truncated. For rounded results, see [UQRSHL](#).

If overflow occurs with any of the results, those results are saturated. If saturation occurs, the cumulative saturation bit [FPSR.QC](#) is set.

Depending on the settings in the [CPACR_EL1](#), [CPTR_EL2](#), and [CPTR_EL3](#) registers, and the current Security state and Exception level, an attempt to execute the instruction might be trapped.

Scalar

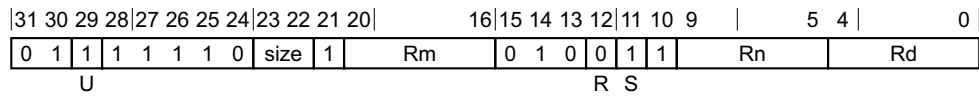

Scalar variant

UQSHL <V><d>, <V><n>, <V><m>

Decode for this encoding

```
integer d = UInt(Rd);
integer n = UInt(Rn);
integer m = UInt(Rm);
integer esize = 8 << UInt(size);
integer datasize = esize;
integer elements = 1;
boolean unsigned = (U == '1');
boolean rounding = (R == '1');
boolean saturating = (S == '1');
if S == '0' && size != '11' then ReservedValue();
```

Vector

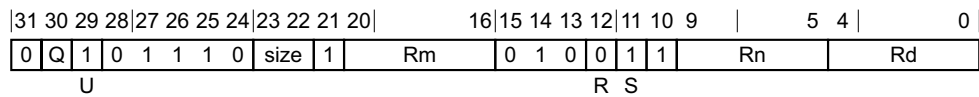

Vector variant

UQSHL <Vd>.<T>, <Vn>.<T>, <Vm>.<T>

Decode for this encoding

```
integer d = UInt(Rd);
integer n = UInt(Rn);
integer m = UInt(Rm);
if size:Q == '110' then ReservedValue();
integer esize = 8 << UInt(size);
integer datasize = if Q == '1' then 128 else 64;
integer elements = datasize DIV esize;
boolean unsigned = (U == '1');
boolean rounding = (R == '1');
boolean saturating = (S == '1');
```

Assembler symbols

<V>	Is a width specifier, encoded in the "size" field. It can have the following values:
B	when size = 00
H	when size = 01
S	when size = 10
D	when size = 11
<d>	Is the number of the SIMD&FP destination register, in the "Rd" field.
<n>	Is the number of the first SIMD&FP source register, encoded in the "Rn" field.
<m>	Is the number of the second SIMD&FP source register, encoded in the "Rm" field.
<Vd>	Is the name of the SIMD&FP destination register, encoded in the "Rd" field.
<T>	Is an arrangement specifier, encoded in the "size:Q" field. It can have the following values:
8B	when size = 00, Q = 0
16B	when size = 00, Q = 1
4H	when size = 01, Q = 0
8H	when size = 01, Q = 1
2S	when size = 10, Q = 0
4S	when size = 10, Q = 1
2D	when size = 11, Q = 1
	The encoding size = 11, Q = 0 is reserved.
<Vn>	Is the name of the first SIMD&FP source register, encoded in the "Rn" field.
<Vm>	Is the name of the second SIMD&FP source register, encoded in the "Rm" field.

Operation for all encodings

```

CheckFPAdvSIMDEnabled64();
bits(datasize) operand1 = V[n];
bits(datasize) operand2 = V[m];
bits(datasize) result;

integer round_const = 0;
integer shift;
integer element;
boolean sat;

for e = 0 to elements-1
  shift = SInt(Elem[operand2, e, esize]<7:0>);
  if rounding then
    round_const = 1 << (-shift - 1); // 0 for left shift, 2^(n-1) for right shift
  element = (Int(Elem[operand1, e, esize], unsigned) + round_const) << shift;
  if saturating then
    (Elem[result, e, esize], sat) = SatQ(element, esize, unsigned);
    if sat then FPSR.QC = '1';
  else
    Elem[result, e, esize] = element<esize-1:0>;

V[d] = result;

```

C7.2.333 UQSHRN, UQSHRN2

Unsigned saturating Shift Right Narrow (immediate). This instruction reads each vector element in the source SIMD&FP register, right shifts each result by an immediate value, saturates each shifted result to a value that is half the original width, puts the final result into a vector, and writes the vector to the lower or upper half of the destination SIMD&FP register. All the values in this instruction are unsigned integer values. The results are truncated. For rounded results, see [UQRSHRN](#), [UQRSHRN2](#).

The UQSHRN instruction writes the vector to the lower half of the destination register and clears the upper half, while the UQSHRN2 instruction writes the vector to the upper half of the destination register without affecting the other bits of the register.

If overflow occurs with any of the results, those results are saturated. If saturation occurs, the cumulative saturation bit [FPSR.QC](#) is set.

Depending on the settings in the [CPACR_EL1](#), [CPTR_EL2](#), and [CPTR_EL3](#) registers, and the current Security state and Exception level, an attempt to execute the instruction might be trapped.

Scalar

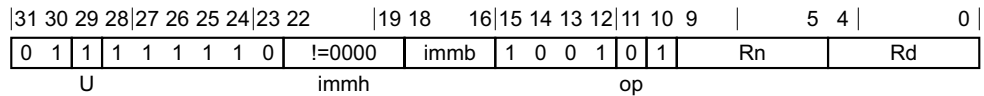

Scalar variant

UQSHRN <Vb><d>, <Va><n>, #<shift>

Decode for this encoding

```
integer d = UInt(Rd);
integer n = UInt(Rn);

if immh == '0000' then ReservedValue();
if immh<3> == '1' then ReservedValue();
integer esize = 8 << HighestSetBit(immh);
integer datasize = esize;
integer elements = 1;
integer part = 0;

integer shift = (2 * esize) - UInt(immh:immb);
boolean round = (op == '1');
boolean unsigned = (U == '1');
```

Vector

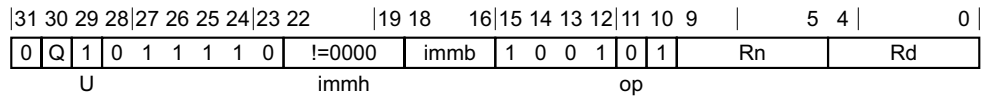

Vector variant

UQSHRN{2} <Vd>.<Tb>, <Vn>.<Ta>, #<shift>

Decode for this encoding

```
integer d = UInt(Rd);
integer n = UInt(Rn);

if immh == '0000' then SEE "Advanced SIMD modified immediate";
if immh<3> == '1' then ReservedValue();
```

```
integer esize = 8 << HighestSetBit(immh);
integer datasize = 64;
integer part = UInt(Q);
integer elements = datasize DIV esize;

integer shift = (2 * esize) - UInt(immh:immb);
boolean round = (op == '1');
boolean unsigned = (U == '1');
```

Assembler symbols

2 Is the second and upper half specifier. If present it causes the operation to be performed on the upper 64 bits of the registers holding the narrower elements, and is encoded in the "Q" field. It can have the following values:

[absent] when Q = 0
 [present] when Q = 1

<Vd> Is the name of the SIMD&FP destination register, encoded in the "Rd" field.

<Tb> Is an arrangement specifier, encoded in the "immh:Q" field. It can have the following values:

8B when immh = 0001, Q = 0
 16B when immh = 0001, Q = 1
 4H when immh = 001x, Q = 0
 8H when immh = 001x, Q = 1
 2S when immh = 01xx, Q = 0
 4S when immh = 01xx, Q = 1

See [Advanced SIMD modified immediate on page C4-291](#) when immh = 0000, Q = x.

The encoding immh = 1xxx, Q = x is reserved.

<Vn> Is the name of the SIMD&FP source register, encoded in the "Rn" field.

<Ta> Is an arrangement specifier, encoded in the "immh" field. It can have the following values:

8H when immh = 0001
 4S when immh = 001x
 2D when immh = 01xx

See [Advanced SIMD modified immediate on page C4-291](#) when immh = 0000.

The encoding immh = 1xxx is reserved.

<Vb> Is the destination width specifier, encoded in the "immh" field. It can have the following values:

B when immh = 0001
 H when immh = 001x
 S when immh = 01xx

The following encodings are reserved:

- immh = 0000.
- immh = 1xxx.

<d> Is the number of the SIMD&FP destination register, in the "Rd" field.

<Va> Is the source width specifier, encoded in the "immh" field. It can have the following values:

H when immh = 0001
 S when immh = 001x
 D when immh = 01xx

The following encodings are reserved:

- immh = 0000.
- immh = 1xxx.

<n> Is the number of the first SIMD&FP source register, encoded in the "Rn" field.

<shift> For the scalar variant: is the right shift amount, in the range 1 to the destination operand width in bits, encoded in the "immh:immb" field. It can have the following values:

(16-UInt(immh:immb)) when immh = 0001

(32-UInt(immh:immb)) when immh = 001x

(64-UInt(immh:immb)) when immh = 01xx

The following encodings are reserved:

- immh = 0000.
- immh = 1xxx.

For the vector variant: is the right shift amount, in the range 1 to the destination element width in bits, encoded in the "immh:immb" field. It can have the following values:

(16-UInt(immh:immb)) when immh = 0001

(32-UInt(immh:immb)) when immh = 001x

(64-UInt(immh:immb)) when immh = 01xx

See [Advanced SIMD modified immediate on page C4-291](#) when immh = 0000.

The encoding immh = 1xxx is reserved.

Operation for all encodings

```
CheckFPAdvSIMDEnabled64();
bits(datasize*2) operand = V[n];
bits(datasize) result;
integer round_const = if round then (1 << (shift - 1)) else 0;
integer element;
boolean sat;

for e = 0 to elements-1
    element = (Int(Elem[operand, e, 2*esize], unsigned) + round_const) >> shift;
    (Elem[result, e, esize], sat) = SatQ(element, esize, unsigned);
    if sat then FPSR.QC = '1';

Vpart[d, part] = result;
```



C7.2.334 UQSUB

Unsigned saturating Subtract. This instruction subtracts the element values of the second source SIMD&FP register from the corresponding element values of the first source SIMD&FP register, places the results into a vector, and writes the vector to the destination SIMD&FP register.

If overflow occurs with any of the results, those results are saturated. If saturation occurs, the cumulative saturation bit [FPSR.QC](#) is set.

Depending on the settings in the [CPACR_EL1](#), [CPTR_EL2](#), and [CPTR_EL3](#) registers, and the current Security state and Exception level, an attempt to execute the instruction might be trapped.

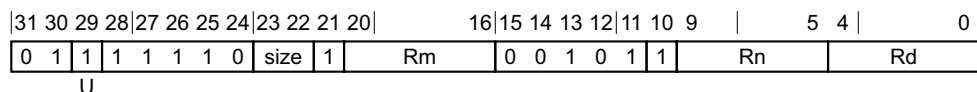
Scalar



Scalar variant

UQSUB <V><d>, <V><n>, <V><m>

Decode for this encoding

```
integer d = UInt(Rd);
integer n = UInt(Rn);
integer m = UInt(Rm);
integer esize = 8 << UInt(size);
integer datasize = esize;
integer elements = 1;
boolean unsigned = (U == '1');
```

Vector

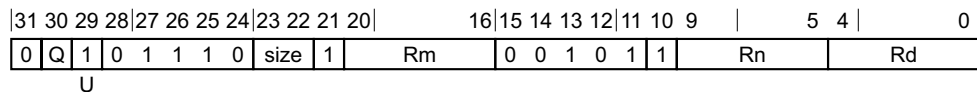

Vector variant

UQSUB <Vd>.<T>, <Vn>.<T>, <Vm>.<T>

Decode for this encoding

```
integer d = UInt(Rd);
integer n = UInt(Rn);
integer m = UInt(Rm);
if size:Q == '110' then ReservedValue();
integer esize = 8 << UInt(size);
integer datasize = if Q == '1' then 128 else 64;
integer elements = datasize DIV esize;
boolean unsigned = (U == '1');
```

Assembler symbols

<V> Is a width specifier, encoded in the "size" field. It can have the following values:

B	when size = 00
H	when size = 01
S	when size = 10

- D when size = 11
- <d> Is the number of the SIMD&FP destination register, in the "Rd" field.
- <n> Is the number of the first SIMD&FP source register, encoded in the "Rn" field.
- <m> Is the number of the second SIMD&FP source register, encoded in the "Rm" field.
- <Vd> Is the name of the SIMD&FP destination register, encoded in the "Rd" field.
- <T> Is an arrangement specifier, encoded in the "size:Q" field. It can have the following values:
- 8B when size = 00, Q = 0
- 16B when size = 00, Q = 1
- 4H when size = 01, Q = 0
- 8H when size = 01, Q = 1
- 2S when size = 10, Q = 0
- 4S when size = 10, Q = 1
- 2D when size = 11, Q = 1
- The encoding size = 11, Q = 0 is reserved.
- <Vn> Is the name of the first SIMD&FP source register, encoded in the "Rn" field.
- <Vm> Is the name of the second SIMD&FP source register, encoded in the "Rm" field.

Operation for all encodings

```

CheckFPAdvSIMDEnabled64();
bits(datasize) operand1 = V[n];
bits(datasize) operand2 = V[m];
bits(datasize) result;
integer element1;
integer element2;
integer diff;
boolean sat;

for e = 0 to elements-1
    element1 = Int(Elem[operand1, e, esize], unsigned);
    element2 = Int(Elem[operand2, e, esize], unsigned);
    diff = element1 - element2;
    (Elem[result, e, esize], sat) = SatQ(diff, esize, unsigned);
    if sat then FPSR.QC = '1';

V[d] = result;
    
```

C7.2.335 UQXTN, UQXTN2

Unsigned saturating extract Narrow. This instruction reads each vector element from the source SIMD&FP register, saturates each value to half the original width, places the result into a vector, and writes the vector to the destination SIMD&FP register. All the values in this instruction are unsigned integer values.

If saturation occurs, the cumulative saturation bit `FPSR.QC` is set.

The `UQXTN` instruction writes the vector to the lower half of the destination register and clears the upper half, while the `UQXTN2` instruction writes the vector to the upper half of the destination register without affecting the other bits of the register.

Depending on the settings in the `CPACR_EL1`, `CPTR_EL2`, and `CPTR_EL3` registers, and the current Security state and Exception level, an attempt to execute the instruction might be trapped.

Scalar

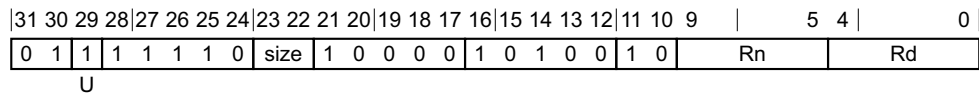

Scalar variant

`UQXTN <Vb><d>, <Va><n>`

Decode for this encoding

```
integer d = UInt(Rd);
integer n = UInt(Rn);

if size == '11' then ReservedValue();
integer esize = 8 << UInt(size);
integer datasize = esize;
integer part = 0;
integer elements = 1;

boolean unsigned = (U == '1');
```

Vector

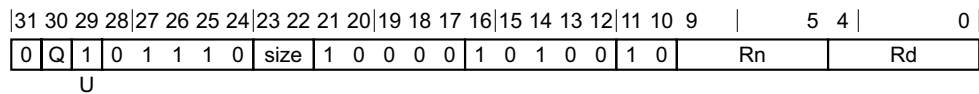

Vector variant

`UQXTN{2} <Vd>.<Tb>, <Vn>.<Ta>`

Decode for this encoding

```
integer d = UInt(Rd);
integer n = UInt(Rn);

if size == '11' then ReservedValue();
integer esize = 8 << UInt(size);
integer datasize = 64;
integer part = UInt(Q);
integer elements = datasize DIV esize;

boolean unsigned = (U == '1');
```

Assembler symbols

- 2 Is the second and upper half specifier. If present it causes the operation to be performed on the upper 64 bits of the registers holding the narrower elements, and is encoded in the "Q" field. It can have the following values:
- [absent] when Q = 0
 - [present] when Q = 1
- <Vd> Is the name of the SIMD&FP destination register, encoded in the "Rd" field.
- <Tb> Is an arrangement specifier, encoded in the "size:Q" field. It can have the following values:
- 8B when size = 00, Q = 0
 - 16B when size = 00, Q = 1
 - 4H when size = 01, Q = 0
 - 8H when size = 01, Q = 1
 - 2S when size = 10, Q = 0
 - 4S when size = 10, Q = 1
- The encoding size = 11, Q = x is reserved.
- <Vn> Is the name of the SIMD&FP source register, encoded in the "Rn" field.
- <Ta> Is an arrangement specifier, encoded in the "size" field. It can have the following values:
- 8H when size = 00
 - 4S when size = 01
 - 2D when size = 10
- The encoding size = 11 is reserved.
- <Vb> Is the destination width specifier, encoded in the "size" field. It can have the following values:
- B when size = 00
 - H when size = 01
 - S when size = 10
- The encoding size = 11 is reserved.
- <d> Is the number of the SIMD&FP destination register, encoded in the "Rd" field.
- <Va> Is the source width specifier, encoded in the "size" field. It can have the following values:
- H when size = 00
 - S when size = 01
 - D when size = 10
- The encoding size = 11 is reserved.
- <n> Is the number of the SIMD&FP source register, encoded in the "Rn" field.

Operation for all encodings

```
CheckFPAdvSIMDEnabled64();
bits(2*datasize) operand = V[n];
bits(datasize) result;
bits(2*esize) element;
boolean sat;

for e = 0 to elements-1
    element = Elem[operand, e, 2*esize];
    (Elem[result, e, esize], sat) = SatQ(Int(element, unsigned), esize, unsigned);
```

```
if sat then FPSR.QC = '1';  
Vpart[d, part] = result;
```

C7.2.336 URECPE

Unsigned Reciprocal Estimate. This instruction reads each vector element from the source SIMD&FP register, calculates an approximate inverse for the unsigned integer value, places the result into a vector, and writes the vector to the destination SIMD&FP register.

Depending on the settings in the CPACR_EL1, CPTR_EL2, and CPTR_EL3 registers, and the current Security state and Exception level, an attempt to execute the instruction might be trapped.

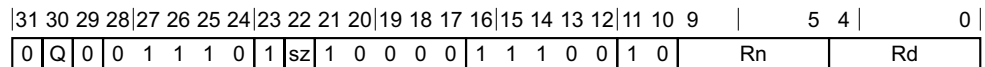

Vector variant

URECPE <Vd>.<T>, <Vn>.<T>

Decode for this encoding

```
integer d = UInt(Rd);
integer n = UInt(Rn);

if sz == '1' then ReservedValue();
integer esize = 32;
integer datasize = if Q == '1' then 128 else 64;
integer elements = datasize DIV esize;
```

Assembler symbols

- <Vd> Is the name of the SIMD&FP destination register, encoded in the "Rd" field.
- <T> Is an arrangement specifier, encoded in the "sz:Q" field. It can have the following values:
 - 2S when sz = 0, Q = 0
 - 4S when sz = 0, Q = 1
 The encoding sz = 1, Q = x is reserved.
- <Vn> Is the name of the SIMD&FP source register, encoded in the "Rn" field.

Operation

```
CheckFPAdvSIMDEnabled64();
bits(datasize) operand = V[n];
bits(datasize) result;
bits(32) element;

for e = 0 to elements-1
    element = Elem[operand, e, 32];
    Elem[result, e, 32] = UnsignedRecipEstimate(element);

V[d] = result;
```

C7.2.337 URHADD

Unsigned Rounding Halving Add. This instruction adds corresponding unsigned integer values from the two source SIMD&FP registers, shifts each result right one bit, places the results into a vector, and writes the vector to the destination SIMD&FP register.

The results are rounded. For truncated results, see [UHADD](#).

Depending on the settings in the [CPACR_EL1](#), [CPTR_EL2](#), and [CPTR_EL3](#) registers, and the current Security state and Exception level, an attempt to execute the instruction might be trapped.

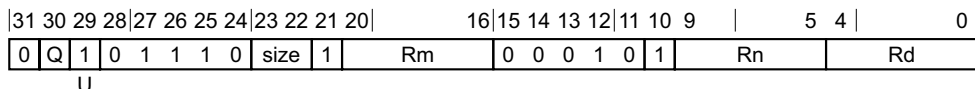

Three registers of the same type variant

URHADD <Vd>.<T>, <Vn>.<T>, <Vm>.<T>

Decode for this encoding

```
integer d = UInt(Rd);
integer n = UInt(Rn);
integer m = UInt(Rm);
if size == '11' then ReservedValue();
integer esize = 8 << UInt(size);
integer datasize = if Q == '1' then 128 else 64;
integer elements = datasize DIV esize;

boolean unsigned = (U == '1');
```

Assembler symbols

- <Vd> Is the name of the SIMD&FP destination register, encoded in the "Rd" field.
- <T> Is an arrangement specifier, encoded in the "size:Q" field. It can have the following values:
- | | |
|-----|-----------------------|
| 8B | when size = 00, Q = 0 |
| 16B | when size = 00, Q = 1 |
| 4H | when size = 01, Q = 0 |
| 8H | when size = 01, Q = 1 |
| 2S | when size = 10, Q = 0 |
| 4S | when size = 10, Q = 1 |
- The encoding size = 11, Q = x is reserved.
- <Vn> Is the name of the first SIMD&FP source register, encoded in the "Rn" field.
- <Vm> Is the name of the second SIMD&FP source register, encoded in the "Rm" field.

Operation

```
CheckFPAdvSIMDEnabled64();
bits(datasize) operand1 = V[n];
bits(datasize) operand2 = V[m];
bits(datasize) result;
integer element1;
integer element2;
```

```
for e = 0 to elements-1
    element1 = Int(Elem[operand1, e, esize], unsigned);
    element2 = Int(Elem[operand2, e, esize], unsigned);
    Elem[result, e, esize] = (element1+element2+1)<esize:1>;

V[d] = result;
```



C7.2.338 URSHL

Unsigned Rounding Shift Left (register). This instruction takes each element in the vector of the first source SIMD&FP register, shifts the vector element by a value from the least significant byte of the corresponding element of the second source SIMD&FP register, places the results in a vector, and writes the vector to the destination SIMD&FP register.

If the shift value is positive, the operation is a left shift. If the shift value is negative, it is a rounding right shift.

Depending on the settings in the CPACR_EL1, CPTR_EL2, and CPTR_EL3 registers, and the current Security state and Exception level, an attempt to execute the instruction might be trapped.

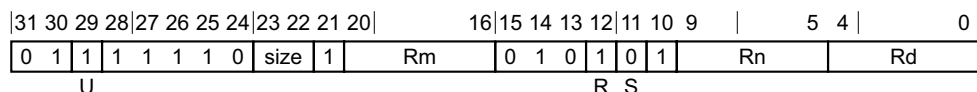
Scalar



Scalar variant

URSHL <V><d>, <V><n>, <V><m>

Decode for this encoding

```
integer d = UInt(Rd);
integer n = UInt(Rn);
integer m = UInt(Rm);
integer esize = 8 << UInt(size);
integer datasize = esize;
integer elements = 1;
boolean unsigned = (U == '1');
boolean rounding = (R == '1');
boolean saturating = (S == '1');
if S == '0' && size != '11' then ReservedValue();
```

Vector

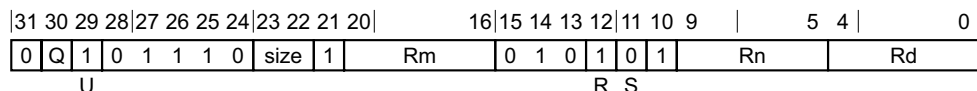

Vector variant

URSHL <Vd>.<T>, <Vn>.<T>, <Vm>.<T>

Decode for this encoding

```
integer d = UInt(Rd);
integer n = UInt(Rn);
integer m = UInt(Rm);
if size:Q == '110' then ReservedValue();
integer esize = 8 << UInt(size);
integer datasize = if Q == '1' then 128 else 64;
integer elements = datasize DIV esize;
boolean unsigned = (U == '1');
boolean rounding = (R == '1');
boolean saturating = (S == '1');
```

Assembler symbols

- <V> Is a width specifier, encoded in the "size" field. It can have the following values:
- D when size = 11
- The following encodings are reserved:
- size = 0x.
 - size = 10.
- <d> Is the number of the SIMD&FP destination register, in the "Rd" field.
- <n> Is the number of the first SIMD&FP source register, encoded in the "Rn" field.
- <m> Is the number of the second SIMD&FP source register, encoded in the "Rm" field.
- <Vd> Is the name of the SIMD&FP destination register, encoded in the "Rd" field.
- <T> Is an arrangement specifier, encoded in the "size:Q" field. It can have the following values:
- 8B when size = 00, Q = 0
 - 16B when size = 00, Q = 1
 - 4H when size = 01, Q = 0
 - 8H when size = 01, Q = 1
 - 2S when size = 10, Q = 0
 - 4S when size = 10, Q = 1
 - 2D when size = 11, Q = 1
- The encoding size = 11, Q = 0 is reserved.
- <Vn> Is the name of the first SIMD&FP source register, encoded in the "Rn" field.
- <Vm> Is the name of the second SIMD&FP source register, encoded in the "Rm" field.

Operation for all encodings

```
CheckFPAdvSIMDEnabled64();
bits(datasize) operand1 = V[n];
bits(datasize) operand2 = V[m];
bits(datasize) result;

integer round_const = 0;
integer shift;
integer element;
boolean sat;

for e = 0 to elements-1
    shift = SInt(ELem[operand2, e, esize]<7:0>);
    if rounding then
        round_const = 1 << (-shift - 1); // 0 for left shift, 2^(n-1) for right shift
    element = (Int(ELem[operand1, e, esize], unsigned) + round_const) << shift;
    if saturating then
        (ELem[result, e, esize], sat) = SatQ(element, esize, unsigned);
        if sat then FPSR.QC = '1';
    else
        ELem[result, e, esize] = element<esize-1:0>;

V[d] = result;
```

C7.2.339 URSHR

Unsigned Rounding Shift Right (immediate). This instruction reads each vector element in the source SIMD&FP register, right shifts each result by an immediate value, writes the final result to a vector, and writes the vector to the destination SIMD&FP register. All the values in this instruction are unsigned integer values. The results are rounded. For truncated results, see [USHR](#).

Depending on the settings in the [CPACR_EL1](#), [CPTR_EL2](#), and [CPTR_EL3](#) registers, and the current Security state and Exception level, an attempt to execute the instruction might be trapped.

Scalar

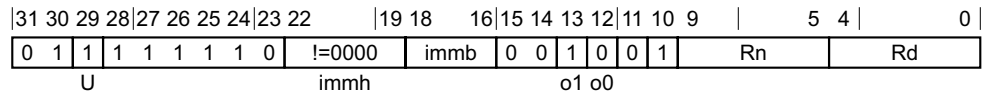

Scalar variant

URSHR <V><d>, <V><n>, #<shift>

Decode for this encoding

```
integer d = UInt(Rd);
integer n = UInt(Rn);

if immh<3> != '1' then ReservedValue();
integer esize = 8 << 3;
integer datasize = esize;
integer elements = 1;

integer shift = (esize * 2) - UInt(immh:immh);
boolean unsigned = (U == '1');
boolean round = (o1 == '1');
boolean accumulate = (o0 == '1');
```

Vector

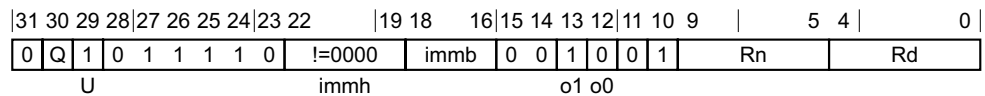

Vector variant

URSHR <Vd>.<T>, <Vn>.<T>, #<shift>

Decode for this encoding

```
integer d = UInt(Rd);
integer n = UInt(Rn);

if immh == '0000' then SEE "Advanced SIMD modified immediate";
if immh<3>:Q == '10' then ReservedValue();
integer esize = 8 << HighestSetBit(immh);
integer datasize = if Q == '1' then 128 else 64;
integer elements = datasize DIV esize;

integer shift = (esize * 2) - UInt(immh:immh);
boolean unsigned = (U == '1');
boolean round = (o1 == '1');
boolean accumulate = (o0 == '1');
```

Assembler symbols

- <V> Is a width specifier, encoded in the "immh" field. It can have the following values:
D when immh = 1xxx
The encoding immh = 0xxx is reserved.
- <d> Is the number of the SIMD&FP destination register, in the "Rd" field.
- <n> Is the number of the first SIMD&FP source register, encoded in the "Rn" field.
- <Vd> Is the name of the SIMD&FP destination register, encoded in the "Rd" field.
- <T> Is an arrangement specifier, encoded in the "immh:Q" field. It can have the following values:
8B when immh = 0001, Q = 0
16B when immh = 0001, Q = 1
4H when immh = 001x, Q = 0
8H when immh = 001x, Q = 1
2S when immh = 01xx, Q = 0
4S when immh = 01xx, Q = 1
2D when immh = 1xxx, Q = 1
See [Advanced SIMD modified immediate on page C4-291](#) when immh = 0000, Q = x.
The encoding immh = 1xxx, Q = 0 is reserved.
- <Vn> Is the name of the SIMD&FP source register, encoded in the "Rn" field.
- <shift> For the scalar variant: is the right shift amount, in the range 1 to 64, encoded in the "immh:immb" field. It can have the following values:
(128-UInt(immh:immb)) when immh = 1xxx
The encoding immh = 0xxx is reserved.
For the vector variant: is the right shift amount, in the range 1 to the element width in bits, encoded in the "immh:immb" field. It can have the following values:
(16-UInt(immh:immb)) when immh = 0001
(32-UInt(immh:immb)) when immh = 001x
(64-UInt(immh:immb)) when immh = 01xx
(128-UInt(immh:immb)) when immh = 1xxx
See [Advanced SIMD modified immediate on page C4-291](#) when immh = 0000.

Operation for all encodings

```
CheckFPAdvSIMDEnabled64();
bits(datasize) operand = V[n];
bits(datasize) operand2;
bits(datasize) result;
integer round_const = if round then (1 << (shift - 1)) else 0;
integer element;

operand2 = if accumulate then V[d] else Zeros();
for e = 0 to elements-1
    element = (Int(Elem[operand, e, esize], unsigned) + round_const) >> shift;
    Elem[result, e, esize] = Elem[operand2, e, esize] + element<esize-1:0>;

V[d] = result;
```

C7.2.340 URSQRTE

Unsigned Reciprocal Square Root Estimate. This instruction reads each vector element from the source SIMD&FP register, calculates an approximate inverse square root for each value, places the result into a vector, and writes the vector to the destination SIMD&FP register. All the values in this instruction are unsigned integer values.

Depending on the settings in the CPACR_EL1, CPTR_EL2, and CPTR_EL3 registers, and the current Security state and Exception level, an attempt to execute the instruction might be trapped.

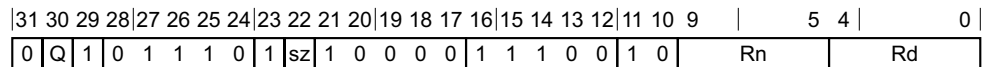

Vector variant

URSQRTE <Vd>.<T>, <Vn>.<T>

Decode for this encoding

```
integer d = UInt(Rd);
integer n = UInt(Rn);

if sz == '1' then ReservedValue();
integer esize = 32;
integer datasize = if Q == '1' then 128 else 64;
integer elements = datasize DIV esize;
```

Assembler symbols

- <Vd> Is the name of the SIMD&FP destination register, encoded in the "Rd" field.
- <T> Is an arrangement specifier, encoded in the "sz:Q" field. It can have the following values:
 - 2S when sz = 0, Q = 0
 - 4S when sz = 0, Q = 1
 - The encoding sz = 1, Q = x is reserved.
- <Vn> Is the name of the SIMD&FP source register, encoded in the "Rn" field.

Operation

```
CheckFPAdvSIMDEnabled64();
bits(datasize) operand = V[n];
bits(datasize) result;
bits(32) element;

for e = 0 to elements-1
    element = Elem[operand, e, 32];
    Elem[result, e, 32] = UnsignedRSqrtEstimate(element);

V[d] = result;
```

C7.2.341 URSRA

Unsigned Rounding Shift Right and Accumulate (immediate). This instruction reads each vector element in the source SIMD&FP register, right shifts each result by an immediate value, and accumulates the final results with the vector elements of the destination SIMD&FP register. All the values in this instruction are unsigned integer values. The results are rounded. For truncated results, see [USRA](#).

Depending on the settings in the [CPACR_EL1](#), [CPTR_EL2](#), and [CPTR_EL3](#) registers, and the current Security state and Exception level, an attempt to execute the instruction might be trapped.

Scalar

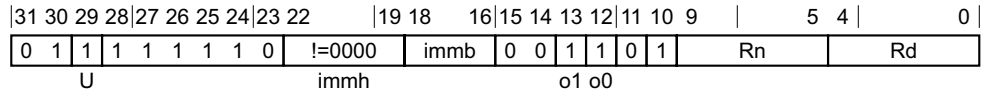

Scalar variant

URSRA <V><d>, <V><n>, #<shift>

Decode for this encoding

```
integer d = UInt(Rd);
integer n = UInt(Rn);

if immh<3> != '1' then ReservedValue();
integer esize = 8 << 3;
integer datasize = esize;
integer elements = 1;

integer shift = (esize * 2) - UInt(immh:immb);
boolean unsigned = (U == '1');
boolean round = (o1 == '1');
boolean accumulate = (o0 == '1');
```

Vector

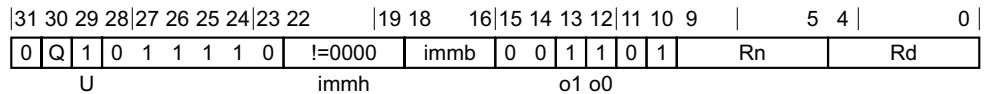

Vector variant

URSRA <Vd>.<T>, <Vn>.<T>, #<shift>

Decode for this encoding

```
integer d = UInt(Rd);
integer n = UInt(Rn);

if immh == '0000' then SEE "Advanced SIMD modified immediate";
if immh<3>:Q == '10' then ReservedValue();
integer esize = 8 << HighestSetBit(immh);
integer datasize = if Q == '1' then 128 else 64;
integer elements = datasize DIV esize;

integer shift = (esize * 2) - UInt(immh:immb);
boolean unsigned = (U == '1');
boolean round = (o1 == '1');
boolean accumulate = (o0 == '1');
```

Assembler symbols

- <V> Is a width specifier, encoded in the "immh" field. It can have the following values:
 D when immh = 1xxx
 The encoding immh = 0xxx is reserved.
- <d> Is the number of the SIMD&FP destination register, in the "Rd" field.
- <n> Is the number of the first SIMD&FP source register, encoded in the "Rn" field.
- <Vd> Is the name of the SIMD&FP destination register, encoded in the "Rd" field.
- <T> Is an arrangement specifier, encoded in the "immh:Q" field. It can have the following values:
 8B when immh = 0001, Q = 0
 16B when immh = 0001, Q = 1
 4H when immh = 001x, Q = 0
 8H when immh = 001x, Q = 1
 2S when immh = 01xx, Q = 0
 4S when immh = 01xx, Q = 1
 2D when immh = 1xxx, Q = 1
 See [Advanced SIMD modified immediate on page C4-291](#) when immh = 0000, Q = x.
 The encoding immh = 1xxx, Q = 0 is reserved.
- <Vn> Is the name of the SIMD&FP source register, encoded in the "Rn" field.
- <shift> For the scalar variant: is the right shift amount, in the range 1 to 64, encoded in the "immh:immb" field. It can have the following values:
 (128-UInt(immh:immb)) when immh = 1xxx
 The encoding immh = 0xxx is reserved.
 For the vector variant: is the right shift amount, in the range 1 to the element width in bits, encoded in the "immh:immb" field. It can have the following values:
 (16-UInt(immh:immb)) when immh = 0001
 (32-UInt(immh:immb)) when immh = 001x
 (64-UInt(immh:immb)) when immh = 01xx
 (128-UInt(immh:immb)) when immh = 1xxx
 See [Advanced SIMD modified immediate on page C4-291](#) when immh = 0000.

Operation for all encodings

```

CheckFPAdvSIMDEnabled64();
bits(datasize) operand = V[n];
bits(datasize) operand2;
bits(datasize) result;
integer round_const = if round then (1 << (shift - 1)) else 0;
integer element;

operand2 = if accumulate then V[d] else Zeros();
for e = 0 to elements-1
    element = (Int(Elem[operand, e, esize], unsigned) + round_const) >> shift;
    Elem[result, e, esize] = Elem[operand2, e, esize] + element<esize-1:0>;

V[d] = result;
  
```

C7.2.342 USHL

Unsigned Shift Left (register). This instruction takes each element in the vector of the first source SIMD&FP register, shifts each element by a value from the least significant byte of the corresponding element of the second source SIMD&FP register, places the results in a vector, and writes the vector to the destination SIMD&FP register.

If the shift value is positive, the operation is a left shift. If the shift value is negative, it is a truncating right shift. For a rounding shift, see [URSHL](#).

Depending on the settings in the [CPACR_EL1](#), [CPTR_EL2](#), and [CPTR_EL3](#) registers, and the current Security state and Exception level, an attempt to execute the instruction might be trapped.

Scalar

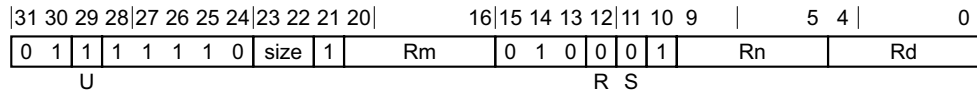

Scalar variant

USHL <V><d>, <V><n>, <V><m>

Decode for this encoding

```
integer d = UInt(Rd);
integer n = UInt(Rn);
integer m = UInt(Rm);
integer esize = 8 << UInt(size);
integer datasize = esize;
integer elements = 1;
boolean unsigned = (U == '1');
boolean rounding = (R == '1');
boolean saturating = (S == '1');
if S == '0' && size != '11' then ReservedValue();
```

Vector

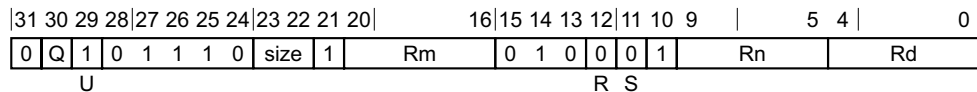

Vector variant

USHL <Vd>.<T>, <Vn>.<T>, <Vm>.<T>

Decode for this encoding

```
integer d = UInt(Rd);
integer n = UInt(Rn);
integer m = UInt(Rm);
if size:Q == '110' then ReservedValue();
integer esize = 8 << UInt(size);
integer datasize = if Q == '1' then 128 else 64;
integer elements = datasize DIV esize;
boolean unsigned = (U == '1');
boolean rounding = (R == '1');
boolean saturating = (S == '1');
```

Assembler symbols

<V>	Is a width specifier, encoded in the "size" field. It can have the following values: D when size = 11 The following encodings are reserved: • size = 0x. • size = 10.
<d>	Is the number of the SIMD&FP destination register, in the "Rd" field.
<n>	Is the number of the first SIMD&FP source register, encoded in the "Rn" field.
<m>	Is the number of the second SIMD&FP source register, encoded in the "Rm" field.
<Vd>	Is the name of the SIMD&FP destination register, encoded in the "Rd" field.
<T>	Is an arrangement specifier, encoded in the "size:Q" field. It can have the following values: 8B when size = 00, Q = 0 16B when size = 00, Q = 1 4H when size = 01, Q = 0 8H when size = 01, Q = 1 2S when size = 10, Q = 0 4S when size = 10, Q = 1 2D when size = 11, Q = 1 The encoding size = 11, Q = 0 is reserved.
<Vn>	Is the name of the first SIMD&FP source register, encoded in the "Rn" field.
<Vm>	Is the name of the second SIMD&FP source register, encoded in the "Rm" field.

Operation for all encodings

```

CheckFPAdvSIMDEnabled64();
bits(datasize) operand1 = V[n];
bits(datasize) operand2 = V[m];
bits(datasize) result;

integer round_const = 0;
integer shift;
integer element;
boolean sat;

for e = 0 to elements-1
    shift = SInt(Elem[operand2, e, esize]<7:0>);
    if rounding then
        round_const = 1 << (-shift - 1);    // 0 for left shift, 2^(n-1) for right shift
    element = (Int(Elem[operand1, e, esize], unsigned) + round_const) << shift;
    if saturating then
        (Elem[result, e, esize], sat) = SatQ(element, esize, unsigned);
        if sat then FPSR.QC = '1';
    else
        Elem[result, e, esize] = element<esize-1:0>;

V[d] = result;
    
```

C7.2.343 USHLL, USHLL2

Unsigned Shift Left Long (immediate). This instruction reads each vector element in the lower or upper half of the source SIMD&FP register, shifts the unsigned integer value left by the specified number of bits, places the result into a vector, and writes the vector to the destination SIMD&FP register. The destination vector elements are twice as long as the source vector elements.

The USHLL instruction extracts vector elements from the lower half of the source register, while the USHLL2 instruction extracts vector elements from the upper half of the source register.

Depending on the settings in the CPACR_EL1, CPTR_EL2, and CPTR_EL3 registers, and the current Security state and Exception level, an attempt to execute the instruction might be trapped.

This instruction is used by the alias UXTL, UXTL2. See *Alias conditions* for details of when each alias is preferred.

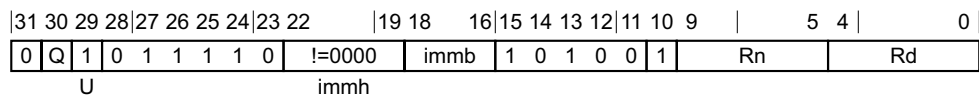

Vector variant

USHLL{2} <Vd>.<Ta>, <Vn>.<Tb>, #<shift>

Decode for this encoding

```
integer d = UInt(Rd);
integer n = UInt(Rn);

if immh == '0000' then SEE "Advanced SIMD modified immediate";
if immh<3> == '1' then ReservedValue();
integer esize = 8 << HighestSetBit(immh);
integer datasize = 64;
integer part = UInt(Q);
integer elements = datasize DIV esize;

integer shift = UInt(immh:immb) - esize;
boolean unsigned = (U == '1');
```

Alias conditions

Alias	is preferred when
UXTL, UXTL2	immb == '000' && BitCount(immh) == 1

Assembler symbols

- 2 Is the second and upper half specifier. If present it causes the operation to be performed on the upper 64 bits of the registers holding the narrower elements, and is encoded in the "Q" field. It can have the following values:
 - [absent] when Q = 0
 - [present] when Q = 1
- <Vd> Is the name of the SIMD&FP destination register, encoded in the "Rd" field.
- <Ta> Is an arrangement specifier, encoded in the "immh" field. It can have the following values:
 - 8H when immh = 0001
 - 4S when immh = 001x

2D when immh = 01xx

See [Advanced SIMD modified immediate on page C4-291](#) when immh = 0000.

The encoding immh = 1xxx is reserved.

<Vn> Is the name of the SIMD&FP source register, encoded in the "Rn" field.

<Tb> Is an arrangement specifier, encoded in the "immh:Q" field. It can have the following values:

8B when immh = 0001, Q = 0

16B when immh = 0001, Q = 1

4H when immh = 001x, Q = 0

8H when immh = 001x, Q = 1

2S when immh = 01xx, Q = 0

4S when immh = 01xx, Q = 1

See [Advanced SIMD modified immediate on page C4-291](#) when immh = 0000, Q = x.

The encoding immh = 1xxx, Q = x is reserved.

<shift> Is the left shift amount, in the range 0 to the source element width in bits minus 1, encoded in the "immh:immb" field. It can have the following values:

(UInt(immh:immb)-8) when immh = 0001

(UInt(immh:immb)-16) when immh = 001x

(UInt(immh:immb)-32) when immh = 01xx

See [Advanced SIMD modified immediate on page C4-291](#) when immh = 0000.

The encoding immh = 1xxx is reserved.

Operation

```

CheckFPAdvSIMDEnabled64();
bits(datasize) operand = Vpart[n, part];
bits(datasize*2) result;
integer element;

for e = 0 to elements-1
  element = Int(Elem[operand, e, esize], unsigned) << shift;
  Elem[result, e, 2*esize] = element<2*esize-1:0>;

V[d] = result;
  
```

C7.2.344 USHR

Unsigned Shift Right (immediate). This instruction reads each vector element in the source SIMD&FP register, right shifts each result by an immediate value, writes the final result to a vector, and writes the vector to the destination SIMD&FP register. All the values in this instruction are unsigned integer values. The results are truncated. For rounded results, see [URSHR](#).

Depending on the settings in the [CPACR_EL1](#), [CPTR_EL2](#), and [CPTR_EL3](#) registers, and the current Security state and Exception level, an attempt to execute the instruction might be trapped.

Scalar

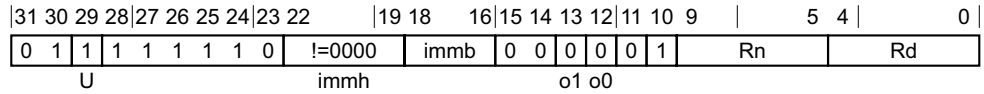

Scalar variant

USHR <V><d>, <V><n>, #<shift>

Decode for this encoding

```
integer d = UInt(Rd);
integer n = UInt(Rn);

if immh<3> != '1' then ReservedValue();
integer esize = 8 << 3;
integer datasize = esize;
integer elements = 1;

integer shift = (esize * 2) - UInt(immh:immb);
boolean unsigned = (U == '1');
boolean round = (o1 == '1');
boolean accumulate = (o0 == '1');
```

Vector

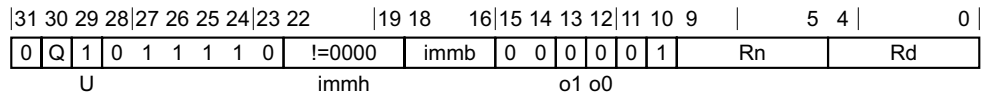

Vector variant

USHR <Vd>.<T>, <Vn>.<T>, #<shift>

Decode for this encoding

```
integer d = UInt(Rd);
integer n = UInt(Rn);

if immh == '0000' then SEE "Advanced SIMD modified immediate";
if immh<3>:Q == '10' then ReservedValue();
integer esize = 8 << HighestSetBit(immh);
integer datasize = if Q == '1' then 128 else 64;
integer elements = datasize DIV esize;

integer shift = (esize * 2) - UInt(immh:immb);
boolean unsigned = (U == '1');
boolean round = (o1 == '1');
boolean accumulate = (o0 == '1');
```

Assembler symbols

- <V> Is a width specifier, encoded in the "immh" field. It can have the following values:
 D when immh = 1xxx
 The encoding immh = 0xxx is reserved.
- <d> Is the number of the SIMD&FP destination register, in the "Rd" field.
- <n> Is the number of the first SIMD&FP source register, encoded in the "Rn" field.
- <Vd> Is the name of the SIMD&FP destination register, encoded in the "Rd" field.
- <T> Is an arrangement specifier, encoded in the "immh:Q" field. It can have the following values:
 8B when immh = 0001, Q = 0
 16B when immh = 0001, Q = 1
 4H when immh = 001x, Q = 0
 8H when immh = 001x, Q = 1
 2S when immh = 01xx, Q = 0
 4S when immh = 01xx, Q = 1
 2D when immh = 1xxx, Q = 1
 See [Advanced SIMD modified immediate on page C4-291](#) when immh = 0000, Q = x.
 The encoding immh = 1xxx, Q = 0 is reserved.
- <Vn> Is the name of the SIMD&FP source register, encoded in the "Rn" field.
- <shift> For the scalar variant: is the right shift amount, in the range 1 to 64, encoded in the "immh:immb" field. It can have the following values:
 (128-UInt(immh:immb)) when immh = 1xxx
 The encoding immh = 0xxx is reserved.
 For the vector variant: is the right shift amount, in the range 1 to the element width in bits, encoded in the "immh:immb" field. It can have the following values:
 (16-UInt(immh:immb)) when immh = 0001
 (32-UInt(immh:immb)) when immh = 001x
 (64-UInt(immh:immb)) when immh = 01xx
 (128-UInt(immh:immb)) when immh = 1xxx
 See [Advanced SIMD modified immediate on page C4-291](#) when immh = 0000.

Operation for all encodings

```

CheckFPAdvSIMDEnabled64();
bits(datasize) operand = V[n];
bits(datasize) operand2;
bits(datasize) result;
integer round_const = if round then (1 << (shift - 1)) else 0;
integer element;

operand2 = if accumulate then V[d] else Zeros();
for e = 0 to elements-1
    element = (Int(Elem[operand, e, esize], unsigned) + round_const) >> shift;
    Elem[result, e, esize] = Elem[operand2, e, esize] + element<esize-1:0>;

V[d] = result;
    
```

C7.2.345 USQADD

Unsigned saturating Accumulate of Signed value. This instruction adds the signed integer values of the vector elements in the source SIMD&FP register to corresponding unsigned integer values of the vector elements in the destination SIMD&FP register, and accumulates the resulting unsigned integer values with the vector elements of the destination SIMD&FP register.

If overflow occurs with any of the results, those results are saturated. If saturation occurs, the cumulative saturation bit [FPSR.QC](#) is set.

Depending on the settings in the [CPACR_EL1](#), [CPTR_EL2](#), and [CPTR_EL3](#) registers, and the current Security state and Exception level, an attempt to execute the instruction might be trapped.

Scalar

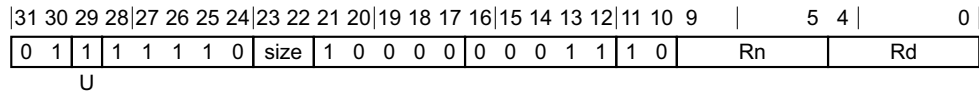

Scalar variant

USQADD <V><d>, <V><n>

Decode for this encoding

```
integer d = UInt(Rd);
integer n = UInt(Rn);

integer esize = 8 << UInt(size);
integer datasize = esize;
integer elements = 1;

boolean unsigned = (U == '1');
```

Vector

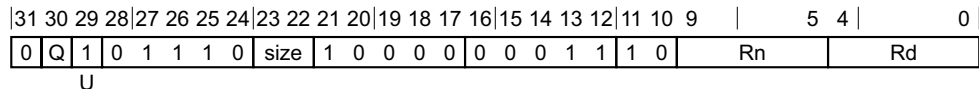

Vector variant

USQADD <Vd>.<T>, <Vn>.<T>

Decode for this encoding

```
integer d = UInt(Rd);
integer n = UInt(Rn);

if size:Q == '110' then ReservedValue();
integer esize = 8 << UInt(size);
integer datasize = if Q == '1' then 128 else 64;
integer elements = datasize DIV esize;

boolean unsigned = (U == '1');
```

Assembler symbols

<V> Is a width specifier, encoded in the "size" field. It can have the following values:

B when size = 00

- H when size = 01
S when size = 10
D when size = 11
- <d> Is the number of the SIMD&FP destination register, encoded in the "Rd" field.
- <n> Is the number of the SIMD&FP source register, encoded in the "Rn" field.
- <Vd> Is the name of the SIMD&FP destination register, encoded in the "Rd" field.
- <T> Is an arrangement specifier, encoded in the "size:Q" field. It can have the following values:
- 8B when size = 00, Q = 0
16B when size = 00, Q = 1
4H when size = 01, Q = 0
8H when size = 01, Q = 1
2S when size = 10, Q = 0
4S when size = 10, Q = 1
2D when size = 11, Q = 1
The encoding size = 11, Q = 0 is reserved.
- <Vn> Is the name of the SIMD&FP source register, encoded in the "Rn" field.

Operation for all encodings

```
CheckFPAdvSIMDEnabled64();
bits(datasize) operand = V[n];
bits(datasize) result;

bits(datasize) operand2 = V[d];
integer op1;
integer op2;
boolean sat;

for e = 0 to elements-1
    op1 = Int(Elem[operand, e, esize], !unsigned);
    op2 = Int(Elem[operand2, e, esize], unsigned);
    (Elem[result, e, esize], sat) = SatQ(op1 + op2, esize, unsigned);
    if sat then FPSR.QC = '1';
V[d] = result;
```

C7.2.346 USRA

Unsigned Shift Right and Accumulate (immediate). This instruction reads each vector element in the source SIMD&FP register, right shifts each result by an immediate value, and accumulates the final results with the vector elements of the destination SIMD&FP register. All the values in this instruction are unsigned integer values. The results are truncated. For rounded results, see [URSRA](#).

Depending on the settings in the [CPACR_EL1](#), [CPTR_EL2](#), and [CPTR_EL3](#) registers, and the current Security state and Exception level, an attempt to execute the instruction might be trapped.

Scalar

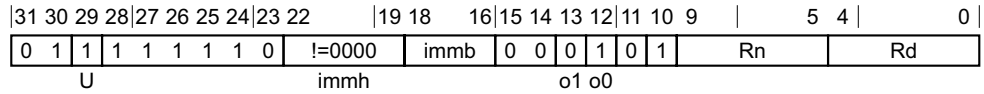

Scalar variant

USRA <V><d>, <V><n>, #<shift>

Decode for this encoding

```
integer d = UInt(Rd);
integer n = UInt(Rn);

if immh<3> != '1' then ReservedValue();
integer esize = 8 << 3;
integer datasize = esize;
integer elements = 1;

integer shift = (esize * 2) - UInt(immh:immb);
boolean unsigned = (U == '1');
boolean round = (o1 == '1');
boolean accumulate = (o0 == '1');
```

Vector

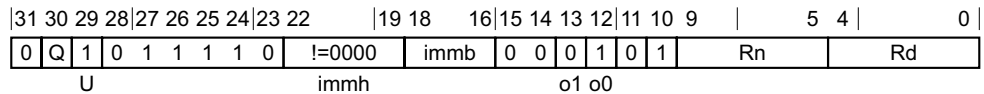

Vector variant

USRA <Vd>.<T>, <Vn>.<T>, #<shift>

Decode for this encoding

```
integer d = UInt(Rd);
integer n = UInt(Rn);

if immh == '0000' then SEE "Advanced SIMD modified immediate";
if immh<3>:Q == '10' then ReservedValue();
integer esize = 8 << HighestSetBit(immh);
integer datasize = if Q == '1' then 128 else 64;
integer elements = datasize DIV esize;

integer shift = (esize * 2) - UInt(immh:immb);
boolean unsigned = (U == '1');
boolean round = (o1 == '1');
boolean accumulate = (o0 == '1');
```

Assembler symbols

- <V> Is a width specifier, encoded in the "immh" field. It can have the following values:
 D when immh = 1xxx
 The encoding immh = 0xxx is reserved.
- <d> Is the number of the SIMD&FP destination register, in the "Rd" field.
- <n> Is the number of the first SIMD&FP source register, encoded in the "Rn" field.
- <Vd> Is the name of the SIMD&FP destination register, encoded in the "Rd" field.
- <T> Is an arrangement specifier, encoded in the "immh:Q" field. It can have the following values:
 8B when immh = 0001, Q = 0
 16B when immh = 0001, Q = 1
 4H when immh = 001x, Q = 0
 8H when immh = 001x, Q = 1
 2S when immh = 01xx, Q = 0
 4S when immh = 01xx, Q = 1
 2D when immh = 1xxx, Q = 1
 See [Advanced SIMD modified immediate on page C4-291](#) when immh = 0000, Q = x.
 The encoding immh = 1xxx, Q = 0 is reserved.
- <Vn> Is the name of the SIMD&FP source register, encoded in the "Rn" field.
- <shift> For the scalar variant: is the right shift amount, in the range 1 to 64, encoded in the "immh:immb" field. It can have the following values:
 (128-UInt(immh:immb)) when immh = 1xxx
 The encoding immh = 0xxx is reserved.
 For the vector variant: is the right shift amount, in the range 1 to the element width in bits, encoded in the "immh:immb" field. It can have the following values:
 (16-UInt(immh:immb)) when immh = 0001
 (32-UInt(immh:immb)) when immh = 001x
 (64-UInt(immh:immb)) when immh = 01xx
 (128-UInt(immh:immb)) when immh = 1xxx
 See [Advanced SIMD modified immediate on page C4-291](#) when immh = 0000.

Operation for all encodings

```

CheckFPAdvSIMDEnabled64();
bits(datasize) operand = V[n];
bits(datasize) operand2;
bits(datasize) result;
integer round_const = if round then (1 << (shift - 1)) else 0;
integer element;

operand2 = if accumulate then V[d] else Zeros();
for e = 0 to elements-1
  element = (Int(Elem[operand, e, esize], unsigned) + round_const) >> shift;
  Elem[result, e, esize] = Elem[operand2, e, esize] + element<esize-1:0>;

V[d] = result;
  
```

C7.2.347 USUBL, USUBL2

Unsigned Subtract Long. This instruction subtracts each vector element in the lower or upper half of the second source SIMD&FP register from the corresponding vector element of the first source SIMD&FP register, places the result into a vector, and writes the vector to the destination SIMD&FP register. All the values in this instruction are unsigned integer values. The destination vector elements are twice as long as the source vector elements.

The USUBL instruction extracts each source vector from the lower half of each source register, while the USUBL2 instruction extracts each source vector from the upper half of each source register.

Depending on the settings in the CPACR_EL1, CPTR_EL2, and CPTR_EL3 registers, and the current Security state and Exception level, an attempt to execute the instruction might be trapped.

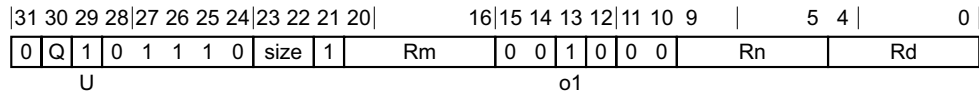

Three registers, not all the same type variant

USUBL{2} <Vd>.<Ta>, <Vn>.<Tb>, <Vm>.<Tb>

Decode for this encoding

```
integer d = UInt(Rd);
integer n = UInt(Rn);
integer m = UInt(Rm);

if size == '11' then ReservedValue();
integer esize = 8 << UInt(size);
integer datasize = 64;
integer part = UInt(Q);
integer elements = datasize DIV esize;

boolean sub_op = (o1 == '1');
boolean unsigned = (U == '1');
```

Assembler symbols

- 2 Is the second and upper half specifier. If present it causes the operation to be performed on the upper 64 bits of the registers holding the narrower elements, and is encoded in the "Q" field. It can have the following values:
 - [absent] when Q = 0
 - [present] when Q = 1
- <Vd> Is the name of the SIMD&FP destination register, encoded in the "Rd" field.
- <Ta> Is an arrangement specifier, encoded in the "size" field. It can have the following values:
 - 8H when size = 00
 - 4S when size = 01
 - 2D when size = 10
 The encoding size = 11 is reserved.
- <Vn> Is the name of the first SIMD&FP source register, encoded in the "Rn" field.
- <Tb> Is an arrangement specifier, encoded in the "size:Q" field. It can have the following values:
 - 8B when size = 00, Q = 0
 - 16B when size = 00, Q = 1

4H when size = 01, Q = 0

8H when size = 01, Q = 1

2S when size = 10, Q = 0

4S when size = 10, Q = 1

The encoding size = 11, Q = x is reserved.

<Vm> Is the name of the second SIMD&FP source register, encoded in the "Rm" field.

Operation

```
CheckFPAdvSIMDEnabled64();
bits(datasize) operand1 = Vpart[n, part];
bits(datasize) operand2 = Vpart[m, part];
bits(2*datasize) result;
integer element1;
integer element2;
integer sum;

for e = 0 to elements-1
    element1 = Int(Elem[operand1, e, esize], unsigned);
    element2 = Int(Elem[operand2, e, esize], unsigned);
    if sub_op then
        sum = element1 - element2;
    else
        sum = element1 + element2;
    Elem[result, e, 2*esize] = sum<2*esize-1:0>;

V[d] = result;
```

C7.2.348 USUBW, USUBW2

Unsigned Subtract Wide. This instruction subtracts each vector element of the second source SIMD&FP register from the corresponding vector element in the lower or upper half of the first source SIMD&FP register, places the result in a vector, and writes the vector to the SIMD&FP destination register. All the values in this instruction are signed integer values.

The vector elements of the destination register and the first source register are twice as long as the vector elements of the second source register.

The USUBW instruction extracts vector elements from the lower half of the first source register, while the USUBW2 instruction extracts vector elements from the upper half of the first source register.

Depending on the settings in the CPACR_EL1, CPTR_EL2, and CPTR_EL3 registers, and the current Security state and Exception level, an attempt to execute the instruction might be trapped.

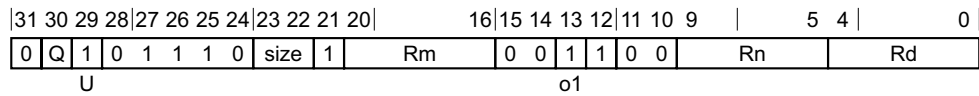

Three registers, not all the same type variant

USUBW{2} <Vd>.<Ta>, <Vn>.<Ta>, <Vm>.<Tb>

Decode for this encoding

```
integer d = UInt(Rd);
integer n = UInt(Rn);
integer m = UInt(Rm);

if size == '11' then ReservedValue();
integer esize = 8 << UInt(size);
integer datasize = 64;
integer part = UInt(Q);
integer elements = datasize DIV esize;

boolean sub_op = (o1 == '1');
boolean unsigned = (U == '1');
```

Assembler symbols

- 2 Is the second and upper half specifier. If present it causes the operation to be performed on the upper 64 bits of the registers holding the narrower elements, and is encoded in the "Q" field. It can have the following values:
 - [absent] when Q = 0
 - [present] when Q = 1
- <Vd> Is the name of the SIMD&FP destination register, encoded in the "Rd" field.
- <Ta> Is an arrangement specifier, encoded in the "size" field. It can have the following values:
 - 8H when size = 00
 - 4S when size = 01
 - 2D when size = 10
 The encoding size = 11 is reserved.
- <Vn> Is the name of the first SIMD&FP source register, encoded in the "Rn" field.
- <Vm> Is the name of the second SIMD&FP source register, encoded in the "Rm" field.

<Tb> Is an arrangement specifier, encoded in the "size:Q" field. It can have the following values:

8B when size = 00, Q = 0

16B when size = 00, Q = 1

4H when size = 01, Q = 0

8H when size = 01, Q = 1

2S when size = 10, Q = 0

4S when size = 10, Q = 1

The encoding size = 11, Q = x is reserved.

Operation

```
CheckFPAdvSIMDEnabled64();
bits(2*datasize) operand1 = V[n];
bits(datasize) operand2 = Vpart[m, part];
bits(2*datasize) result;
integer element1;
integer element2;
integer sum;

for e = 0 to elements-1
    element1 = Int(Elem[operand1, e, 2*esize], unsigned);
    element2 = Int(Elem[operand2, e, esize], unsigned);
    if sub_op then
        sum = element1 - element2;
    else
        sum = element1 + element2;
    Elem[result, e, 2*esize] = sum<2*esize-1:0>;

V[d] = result;
```

C7.2.349 UXTL, UXTL2

Unsigned extend Long. This instruction copies each vector element from the lower or upper half of the source SIMD&FP register into a vector, and writes the vector to the destination SIMD&FP register. The destination vector elements are twice as long as the source vector elements.

The UXTL instruction extracts vector elements from the lower half of the source register, while the UXTL2 instruction extracts vector elements from the upper half of the source register.

Depending on the settings in the CPACR_EL1, CPTR_EL2, and CPTR_EL3 registers, and the current Security state and Exception level, an attempt to execute the instruction might be trapped.

This instruction is an alias of the USHLL, USHLL2 instruction. This means that:

- The encodings in this description are named to match the encodings of USHLL, USHLL2.
- The description of USHLL, USHLL2 gives the operational pseudocode for this instruction.

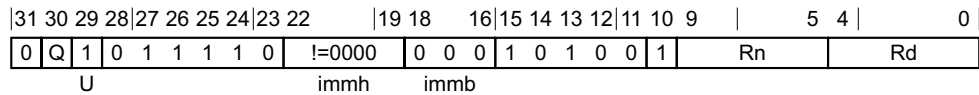

Vector variant

UXTL{2} <Vd>.<Ta>, <Vn>.<Tb>

is equivalent to

USHLL{2} <Vd>.<Ta>, <Vn>.<Tb>, #0

and is the preferred disassembly when BitCount(immh) == 1.

Assembler symbols

2 Is the second and upper half specifier. If present it causes the operation to be performed on the upper 64 bits of the registers holding the narrower elements, and is encoded in the "Q" field. It can have the following values:

[absent] when Q = 0

[present] when Q = 1

<Vd> Is the name of the SIMD&FP destination register, encoded in the "Rd" field.

<Ta> Is an arrangement specifier, encoded in the "immh" field. It can have the following values:

8H when immh = 0001

4S when immh = 001x

2D when immh = 01xx

See [Advanced SIMD modified immediate on page C4-291](#) when immh = 0000.

The encoding immh = 1xxx is reserved.

<Vn> Is the name of the SIMD&FP source register, encoded in the "Rn" field.

<Tb> Is an arrangement specifier, encoded in the "immh:Q" field. It can have the following values:

8B when immh = 0001, Q = 0

16B when immh = 0001, Q = 1

4H when immh = 001x, Q = 0

8H when immh = 001x, Q = 1

2S when immh = 01xx, Q = 0

4S when immh = 01xx, Q = 1

See [Advanced SIMD modified immediate on page C4-291](#) when immh = 0000, Q = x.

The encoding immh = 1xxx, Q = x is reserved.

Operation

The description of [USHLL](#), [USHLL2](#) gives the operational pseudocode for this instruction.

C7.2.350 UZP1

Unzip vectors (primary). This instruction reads corresponding even-numbered vector elements from the two source SIMD&FP registers, starting at zero, places the result from the first source register into consecutive elements in the lower half of a vector, and the result from the second source register into consecutive elements in the upper half of a vector, and writes the vector to the destination SIMD&FP register.

———— **Note** ————

This instruction can be used with UZP2 to de-interleave two vectors.

The following figure shows the operation of UZP1 and UZP2 with the arrangement specifier 8B.

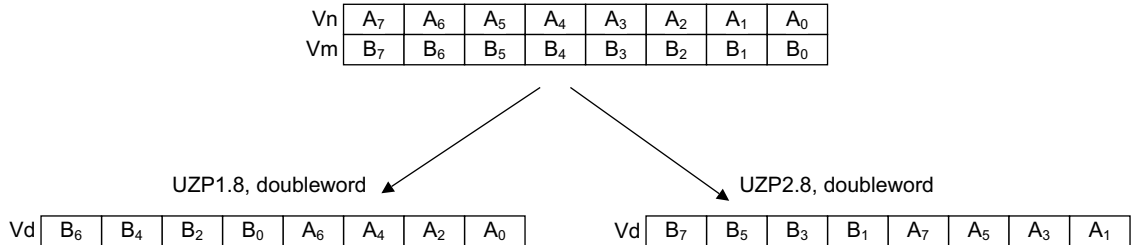

Depending on the settings in the CPACR_EL1, CPTR_EL2, and CPTR_EL3 registers, and the current Security state and Exception level, an attempt to execute the instruction might be trapped.

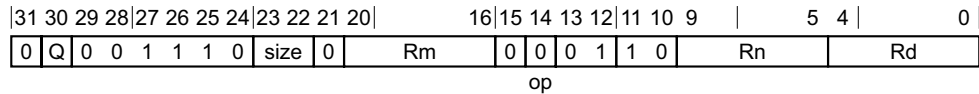

Advanced SIMD variant

UZP1 <Vd>.<T>, <Vn>.<T>, <Vm>.<T>

Decode for this encoding

```

integer d = UInt(Rd);
integer n = UInt(Rn);
integer m = UInt(Rm);

if size:Q == '110' then ReservedValue();
integer esize = 8 << UInt(size);
integer datasize = if Q == '1' then 128 else 64;
integer elements = datasize DIV esize;
integer part = UInt(op);
    
```

Assembler symbols

- <Vd> Is the name of the SIMD&FP destination register, encoded in the "Rd" field.
- <T> Is an arrangement specifier, encoded in the "size:Q" field. It can have the following values:
 - 8B when size = 00, Q = 0
 - 16B when size = 00, Q = 1
 - 4H when size = 01, Q = 0
 - 8H when size = 01, Q = 1
 - 2S when size = 10, Q = 0
 - 4S when size = 10, Q = 1

2D when size = 11, Q = 1

The encoding size = 11, Q = 0 is reserved.

<Vn> Is the name of the first SIMD&FP source register, encoded in the "Rn" field.

<Vm> Is the name of the second SIMD&FP source register, encoded in the "Rm" field.

Operation

```
CheckFPAdvSIMDEnabled64();
bits(datasize) operandl = V[n];
bits(datasize) operandh = V[m];
bits(datasize) result;
integer e;

bits(datasize*2) zipped = operandh:operandl;
for e = 0 to elements-1
    Elem[result, e, esize] = Elem[zipped, 2*e+part, esize];

V[d] = result;
```

C7.2.351 UZP2

Unzip vectors (secondary). This instruction reads corresponding odd-numbered vector elements from the two source SIMD&FP registers, places the result from the first source register into consecutive elements in the lower half of a vector, and the result from the second source register into consecutive elements in the upper half of a vector, and writes the vector to the destination SIMD&FP register.

———— **Note** ————

This instruction can be used with UZP1 to de-interleave two vectors.

The following figure shows the operation of UZP1 and UZP2 with the arrangement specifier 8B.

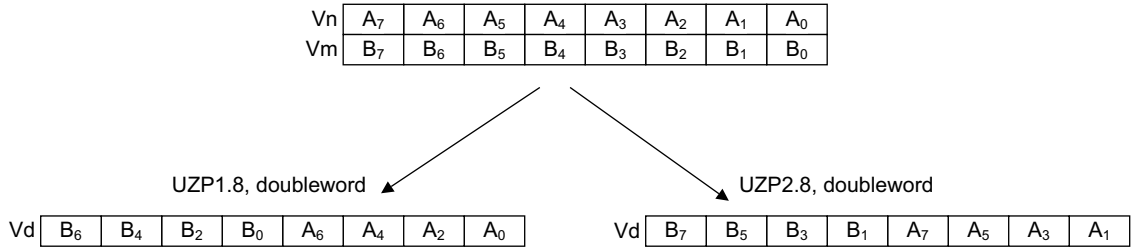

Depending on the settings in the CPACR_EL1, CPTR_EL2, and CPTR_EL3 registers, and the current Security state and Exception level, an attempt to execute the instruction might be trapped.

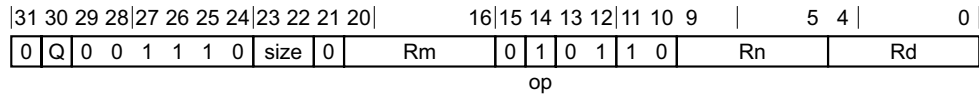

Advanced SIMD variant

UZP2 <Vd>.<T>, <Vn>.<T>, <Vm>.<T>

Decode for this encoding

```
integer d = UInt(Rd);
integer n = UInt(Rn);
integer m = UInt(Rm);

if size:Q == '110' then ReservedValue();
integer esize = 8 << UInt(size);
integer datasize = if Q == '1' then 128 else 64;
integer elements = datasize DIV esize;
integer part = UInt(op);
```

Assembler symbols

- <Vd> Is the name of the SIMD&FP destination register, encoded in the "Rd" field.
- <T> Is an arrangement specifier, encoded in the "size:Q" field. It can have the following values:
 - 8B when size = 00, Q = 0
 - 16B when size = 00, Q = 1
 - 4H when size = 01, Q = 0
 - 8H when size = 01, Q = 1
 - 2S when size = 10, Q = 0
 - 4S when size = 10, Q = 1

2D when size = 11, Q = 1

The encoding size = 11, Q = 0 is reserved.

<Vn> Is the name of the first SIMD&FP source register, encoded in the "Rn" field.

<Vm> Is the name of the second SIMD&FP source register, encoded in the "Rm" field.

Operation

```
CheckFPAdvSIMDEnabled64();
bits(datasize) operandl = V[n];
bits(datasize) operandh = V[m];
bits(datasize) result;
integer e;

bits(datasize*2) zipped = operandh:operandl;
for e = 0 to elements-1
    Elem[result, e, esize] = Elem[zipped, 2*e+part, esize];

V[d] = result;
```

C7.2.352 XTN, XTN2

Extract Narrow. This instruction reads each vector element from the source SIMD&FP register, narrows each value to half the original width, places the result into a vector, and writes the vector to the lower or upper half of the destination SIMD&FP register. The destination vector elements are half as long as the source vector elements.

The XTN instruction writes the vector to the lower half of the destination register and clears the upper half, while the XTN2 instruction writes the vector to the upper half of the destination register without affecting the other bits of the register.

Depending on the settings in the CPACR_EL1, CPTR_EL2, and CPTR_EL3 registers, and the current Security state and Exception level, an attempt to execute the instruction might be trapped.

31	30	29	28	27	26	25	24	23	22	21	20	19	18	17	16	15	14	13	12	11	10	9				5	4			0
0	Q	0	0	1	1	1	0	size	1	0	0	0	0	1	0	0	1	0	1	0	Rn						Rd			

Vector variant

XTN{2} <Vd>.<Tb>, <Vn>.<Ta>

Decode for this encoding

```
integer d = UInt(Rd);
integer n = UInt(Rn);

if size == '11' then ReservedValue();
integer esize = 8 << UInt(size);
integer datasize = 64;
integer part = UInt(Q);
integer elements = datasize DIV esize;
```

Assembler symbols

2 Is the second and upper half specifier. If present it causes the operation to be performed on the upper 64 bits of the registers holding the narrower elements, and is encoded in the "Q" field. It can have the following values:

[absent] when Q = 0
 [present] when Q = 1

<Vd> Is the name of the SIMD&FP destination register, encoded in the "Rd" field.

<Tb> Is an arrangement specifier, encoded in the "size:Q" field. It can have the following values:

8B when size = 00, Q = 0
 16B when size = 00, Q = 1
 4H when size = 01, Q = 0
 8H when size = 01, Q = 1
 2S when size = 10, Q = 0
 4S when size = 10, Q = 1

The encoding size = 11, Q = x is reserved.

<Vn> Is the name of the SIMD&FP source register, encoded in the "Rn" field.

<Ta> Is an arrangement specifier, encoded in the "size" field. It can have the following values:

8H when size = 00

4S when size = 01
2D when size = 10
The encoding size = 11 is reserved.

Operation

```
CheckFPAdvSIMDEnabled64();  
bits(2*datasize) operand = V[n];  
bits(datasize) result;  
bits(2*esize) element;  
  
for e = 0 to elements-1  
  element = Elem[operand, e, 2*esize];  
  Elem[result, e, esize] = element<esize-1:0>;  
Vpart[d, part] = result;
```

C7.2.353 ZIP1

Zip vectors (primary). This instruction reads adjacent vector elements from the upper half of two source SIMD&FP registers as pairs, interleaves the pairs and places them into a vector, and writes the vector to the destination SIMD&FP register. The first pair from the first source register is placed into the two lowest vector elements, with subsequent pairs taken alternately from each source register.

———— **Note** ————

This instruction can be used with ZIP2 to interleave two vectors.

The following figure shows the operation of ZIP1 and ZIP2 with the arrangement specifier 8B.

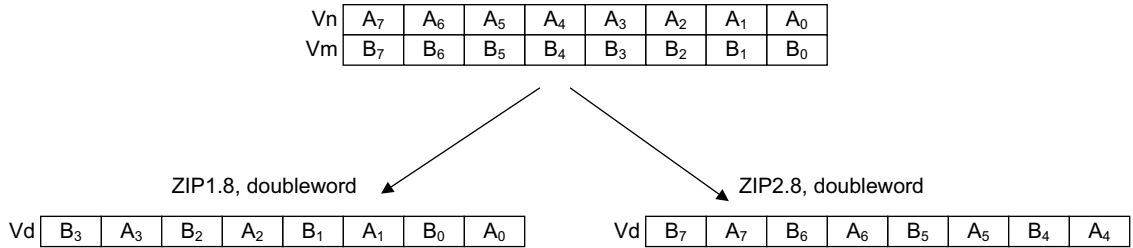

Depending on the settings in the CPACR_EL1, CPTR_EL2, and CPTR_EL3 registers, and the current Security state and Exception level, an attempt to execute the instruction might be trapped.

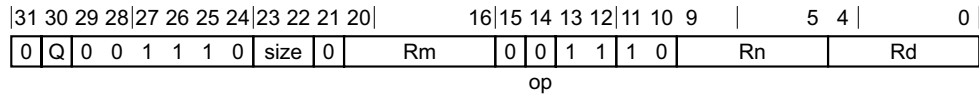

Advanced SIMD variant

ZIP1 <Vd>.<T>, <Vn>.<T>, <Vm>.<T>

Decode for this encoding

```
integer d = UInt(Rd);
integer n = UInt(Rn);
integer m = UInt(Rm);

if size:Q == '110' then ReservedValue();
integer esize = 8 << UInt(size);
integer datasize = if Q == '1' then 128 else 64;
integer elements = datasize DIV esize;
integer part = UInt(op);
integer pairs = elements DIV 2;
```

Assembler symbols

- <Vd> Is the name of the SIMD&FP destination register, encoded in the "Rd" field.
- <T> Is an arrangement specifier, encoded in the "size:Q" field. It can have the following values:
 - 8B when size = 00, Q = 0
 - 16B when size = 00, Q = 1
 - 4H when size = 01, Q = 0
 - 8H when size = 01, Q = 1
 - 2S when size = 10, Q = 0

4S when size = 10, Q = 1

2D when size = 11, Q = 1

The encoding size = 11, Q = 0 is reserved.

<Vn> Is the name of the first SIMD&FP source register, encoded in the "Rn" field.

<Vm> Is the name of the second SIMD&FP source register, encoded in the "Rm" field.

Operation

```
CheckFPAdvSIMDEnabled64();
bits(datasize) operand1 = V[n];
bits(datasize) operand2 = V[m];
bits(datasize) result;

integer base = part * pairs;
integer p;

for p = 0 to pairs-1
    Elem[result, 2*p+0, esize] = Elem[operand1, base+p, esize];
    Elem[result, 2*p+1, esize] = Elem[operand2, base+p, esize];

V[d] = result;
```

C7.2.354 ZIP2

Zip vectors (secondary). This instruction reads adjacent vector elements from the lower half of two source SIMD&FP registers as pairs, interleaves the pairs and places them into a vector, and writes the vector to the destination SIMD&FP register. The first pair from the first source register is placed into the two lowest vector elements, with subsequent pairs taken alternately from each source register.

———— **Note** ————

This instruction can be used with ZIP1 to interleave two vectors.

The following figure shows the operation of ZIP1 and ZIP2 with the arrangement specifier 8B.

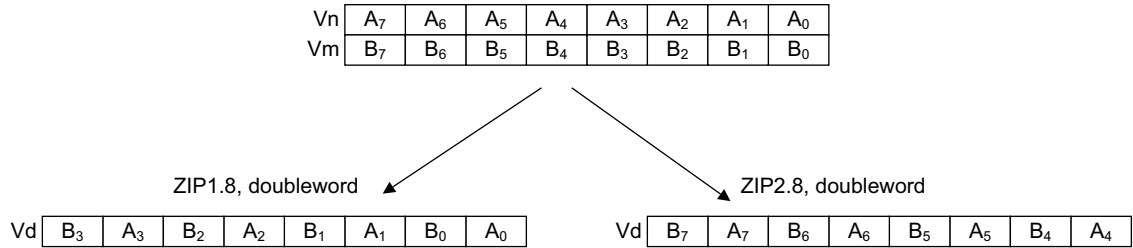

Depending on the settings in the CPACR_EL1, CPTR_EL2, and CPTR_EL3 registers, and the current Security state and Exception level, an attempt to execute the instruction might be trapped.

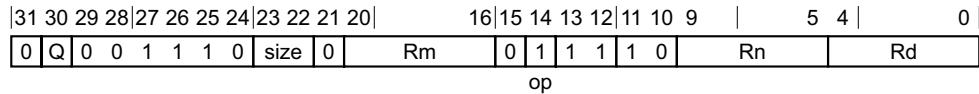

Advanced SIMD variant

ZIP2 <Vd>.<T>, <Vn>.<T>, <Vm>.<T>

Decode for this encoding

```
integer d = UInt(Rd);
integer n = UInt(Rn);
integer m = UInt(Rm);

if size:Q == '110' then ReservedValue();
integer esize = 8 << UInt(size);
integer datasize = if Q == '1' then 128 else 64;
integer elements = datasize DIV esize;
integer part = UInt(op);
integer pairs = elements DIV 2;
```

Assembler symbols

- <Vd> Is the name of the SIMD&FP destination register, encoded in the "Rd" field.
- <T> Is an arrangement specifier, encoded in the "size:Q" field. It can have the following values:
 - 8B when size = 00, Q = 0
 - 16B when size = 00, Q = 1
 - 4H when size = 01, Q = 0
 - 8H when size = 01, Q = 1
 - 2S when size = 10, Q = 0

4S when size = 10, Q = 1

2D when size = 11, Q = 1

The encoding size = 11, Q = 0 is reserved.

<Vn> Is the name of the first SIMD&FP source register, encoded in the "Rn" field.

<Vm> Is the name of the second SIMD&FP source register, encoded in the "Rm" field.

Operation

```
CheckFPAdvSIMDEnabled64();
bits(datasize) operand1 = V[n];
bits(datasize) operand2 = V[m];
bits(datasize) result;

integer base = part * pairs;
integer p;

for p = 0 to pairs-1
    Elem[result, 2*p+0, esize] = Elem[operand1, base+p, esize];
    Elem[result, 2*p+1, esize] = Elem[operand2, base+p, esize];

V[d] = result;
```

Part D

The AArch64 System Level Architecture

Chapter D1

The AArch64 System Level Programmers' Model

This chapter describes the AArch64 system level programmers' model. It contains the following sections:

- *Exception levels* on page D1-1776.
- *Exception terminology* on page D1-1777.
- *Execution state* on page D1-1779.
- *Security state* on page D1-1780.
- *Virtualization* on page D1-1782.
- *Registers for instruction processing and exception handling* on page D1-1785.
- *Process state, PSTATE* on page D1-1791.
- *Program counter and stack pointer alignment* on page D1-1793.
- *Reset* on page D1-1795.
- *Exception entry* on page D1-1799.
- *Exception return* on page D1-1815.
- *The Exception level hierarchy* on page D1-1819.
- *Synchronous exception types, routing and priorities* on page D1-1826.
- *Asynchronous exception types, routing, masking and priorities* on page D1-1834.
- *Configurable instruction enables and disables, and trap controls* on page D1-1842.
- *System calls* on page D1-1878.
- *Mechanisms for entering a low-power state* on page D1-1879.
- *Self-hosted debug* on page D1-1884.
- *The Performance Monitors Extension* on page D1-1886.
- *Interprocessing* on page D1-1887.
- *The effect of implementation choices on the programmers' model* on page D1-1899.

D1.1 Exception levels

The ARMv8-A architecture defines a set of Exception levels, EL0 to EL3, where:

- If EL n is the Exception level, increased values of n indicate increased software execution privilege.
- Execution at EL0 is called *unprivileged execution*.
- EL2 provides support for virtualization of Non-secure operation.
- EL3 provides support for switching between two Security states, Secure state and Non-secure state.

An implementation might not include all of the Exception levels. All implementations must include EL0 and EL1. EL2 and EL3 are optional.

———— Note —————

A PE is not required to implement a contiguous set of Exception levels. For example, it is permissible for an implementation to include only EL0, EL1, and EL3.

The effect of implementation choices on the programmers' model on page D1-1899 shows some example implementations.

When executing in AArch64 state, execution can move between Exception levels only on taking an exception or on returning from an exception:

- On taking an exception, the Exception level can only increase or remain the same.
- On returning from an exception, the Exception level can only decrease or remain the same.

The Exception level that execution changes to or remains in on taking an exception is called the *target Exception level* of the exception.

Each exception type has a target Exception level that is either:

- Implicit in the nature of the exception.
- Defined by configuration bits in the System registers.

An exception cannot target EL0.

Exception levels exist within a particular Security state. *The ARMv8-A security model on page D1-1780* describes this. When executing at an Exception level, the PE can access both of the following:

- The resources that are available for the combination of the current Exception level and the current Security state.
- The resources that are available at all lower Exception levels, provided that those resources are available to the current Security state.

This means that if the implementation includes EL3, then when execution is at EL3, the PE can access all resources available at all Exception levels, for both Security states.

Each Exception level other than EL0 has its own translation regime and associated control registers. For information on the translation regimes, see *Chapter D4 The AArch64 Virtual Memory System Architecture*.

D1.1.1 Typical Exception level usage model

The architecture does not specify what software uses which Exception level. Such choices are outside the scope of the architecture. However, the following is a common usage model for the Exception levels:

EL0	Applications.
EL1	OS kernel and associated functions that are typically described as <i>privileged</i> .
EL2	Hypervisor.
EL3	Secure monitor.

D1.2 Exception terminology

The following subsections define the terms used when describing exceptions:

- [Terminology for taking an exception.](#)
- [Terminology for returning from an exception.](#)
- [Exception levels.](#)
- [Definition of a precise exception.](#)
- [Definitions of synchronous and asynchronous exceptions on page D1-1778.](#)

D1.2.1 Terminology for taking an exception

An exception is *generated* when the PE first responds to an exceptional condition. The PE state at this time is the state the exception is *taken from*. The PE state immediately after taking the exception is the state the exception is *taken to*.

D1.2.2 Terminology for returning from an exception

To return from an exception, the PE must execute an exception return instruction. The PE state when an exception return instruction is committed for execution is the state the exception *returns from*. The PE state immediately after the execution of that instruction is the state the exception *returns to*.

D1.2.3 Exception levels

An Exception level, EL_n , with a larger value of n than another Exception level, is described as being a *higher* Exception level than the other Exception level. For example, EL_3 is a higher Exception level than EL_1 .

An Exception level with a smaller value of n than another Exception level is described as being a *lower* Exception level than the other Exception level. For example, EL_0 is a lower Exception level than EL_1 .

An Exception level is described as:

- *Using AArch64* when execution in that Exception level is in the AArch64 Execution state.
- *Using AArch32* when execution in that Exception level is in the AArch32 Execution state.

D1.2.4 Definition of a precise exception

An exception is described as *precise* when the exception handler receives the PE state and memory system state that is consistent with the PE having executed all of the instructions up to but not including the point in the instruction stream where the exception was taken, and none afterwards.

Other than the *SError interrupt*, all exceptions taken to AArch64 state are required to be precise. For each occurrence of an SError interrupt, whether the interrupt is precise or imprecise is IMPLEMENTATION DEFINED.

Where a synchronous exception that is taken to AArch64 state is generated as part of an instruction that performs more than one single-copy atomic memory access, the definition of precise permits that the values in registers or memory affected by the instructions can be UNKNOWN, provided that:

- The accesses affecting those registers or memory locations do not, themselves, generate exceptions.
- The registers are not involved in the calculation of the memory address used by the instruction.

Also, for Data Aborts from load or store instructions executed in AArch64 state, where the Data Abort is taken synchronously:

- If the load or store instruction specifies writeback of a new base address, the base address is restored to the original value on taking the exception.
- If the instruction was a load to either the base address register or the offset register, that register is restored to the original value. Any other destination registers become UNKNOWN.
- If the instruction was a load that does not load the base address register or the offset register, then the destination registers become UNKNOWN.

Examples of instructions that perform more than one single-copy atomic memory access are the AArch32 LDM and STM instructions and the AArch64 LDP and STP instructions.

———— **Note** —————

For the definition of a single-copy atomic access, see [Properties of single-copy atomic accesses on page B2-83](#).

D1.2.5 Definitions of synchronous and asynchronous exceptions

An exception is described as *synchronous* if all of the following apply:

- The exception is generated as a result of direct execution or attempted execution of an instruction.
- The return address presented to the exception handler is guaranteed to indicate the instruction that caused the exception.
- The exception is precise.

For more information about synchronous exceptions, see [Synchronous exception types, routing and priorities on page D1-1826](#).

An exception is described as *asynchronous* if any of the following apply:

- The exception is not generated as a result of direct execution or attempted execution of the instruction stream.
- The return address presented to the exception handler is not guaranteed to indicate the instruction that caused the exception.
- The exception is imprecise.

For more information about asynchronous exceptions, see [Asynchronous exception types, routing, masking and priorities on page D1-1834](#).

D1.3 Execution state

The Execution states are:

AArch64 The 64-bit Execution state.

AArch32 The 32-bit Execution state. Operation in this state is compatible with ARMv7-A operation.

[Execution state on page A1-34](#) gives more information about them.

Exception levels *use* Execution states. For example, EL0, EL1 and EL2 might all be using AArch32, under EL3 using AArch64.

This means that:

- Different software layers, such as an application, an operating system kernel, and a hypervisor, executing at different Exception levels, can execute in different Execution states.
- The PE can change Execution states only either:
 - At reset.
 - On a change of Exception level.

Note

- [Typical Exception level usage model on page D1-1776](#) shows which Exception levels different software layers might typically use.
 - [The effect of implementation choices on the programmers' model on page D1-1899](#) gives information on supported configurations of Exception levels and Execution states.
-

The interaction between the AArch64 and AArch32 Execution states is called *interprocessing*. [Interprocessing on page D1-1887](#) describes this.

D1.4 Security state

The ARMv8-A architecture provides two Security states, each with an associated physical memory address space, as follows:

- | | |
|-------------------------|---|
| Secure state | When in this state, the PE can access both the Secure physical address space and the Non-secure physical address space. |
| Non-secure state | When in this state, the PE: <ul style="list-style-type: none">• Can access only the Non-secure physical address space.• Cannot access the Secure system control resources. |

For information on how virtual addresses translate onto Secure physical and Non-secure addresses, see [About the Virtual Memory System Architecture \(VMSA\)](#) on page D4-2004.

D1.4.1 The ARMv8-A security model

The general principles of the ARMv8-A security model are:

- If the implementation includes EL3 then it has two Security states, Secure and Non-secure, and:
 - EL3 exists only in Secure state.
 - A change from Non-secure state to Secure state can only occur on taking an exception to EL3.
 - A change from Secure state to Non-secure state can only occur on an exception return from EL3.
 - If EL2 is implemented, it exists only in Non-secure state.
- If the implementation does not include EL3 it has one Security state, that is:
 - IMPLEMENTATION DEFINED, if the implementation does not include EL2.
 - Non-secure state if the implementation includes EL2.

Security model when EL3 is using AArch64

[Figure D1-1 on page D1-1781](#) shows the security model when EL3 is using AArch64. The figure shows how instances of EL0 and EL1 are present in both Security states. It also shows the expected software usage of the different Exception levels.

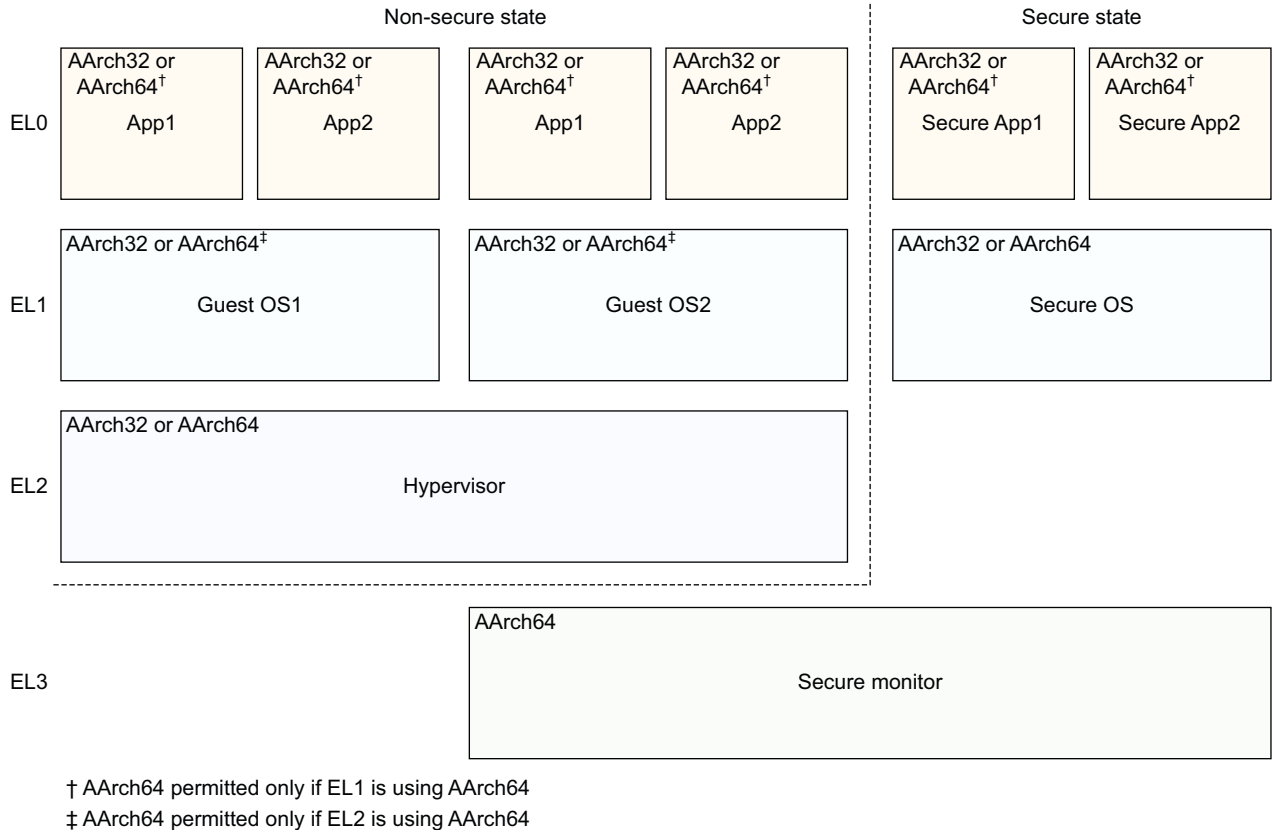

Figure D1-1 ARMv8-A security model when EL3 is using AArch64

For an overview of the Security model when EL3 is using AArch32, see [Figure G1-1 on page G1-4316](#).

D1.5 Virtualization

The support for virtualization described in this section applies only to an implementation that includes EL2.

EL2 provides a set of features that support virtualizing the Non-secure state of an ARMv8-A implementation. The basic model of a virtualized system involves:

- A hypervisor, running in EL2, that is responsible for switching between *virtual machines*. A virtual machine comprises Non-secure EL1 and Non-secure EL0.
- A number of Guest operating systems. A Guest OS runs on a virtual machine in Non-secure EL1.
- For each Guest operating system, applications, that run on the virtual machine of that Guest OS, usually in Non-secure EL0.

Note

In some systems, a Guest OS is unaware that it is running on a virtual machine, and is unaware of any other Guest OS. In other systems, a hypervisor makes the Guest OS aware of these facts. The ARMv8-A architecture supports both of these models.

The hypervisor assigns a *virtual machine identifier (VMID)* to each virtual machine.

EL2 is implemented only in Non-secure state, to support Guest OS management. EL2 provides controls to:

- Provide virtual values for the contents of a small number of identification registers. A read of one of these registers by a Guest OS or the applications for a Guest OS returns the virtual value.
- *Trap* various operations, including memory management operations and accesses to many other registers. A trapped operation generates an exception that is taken to EL2. See [Configurable instruction enables and disables, and trap controls on page D1-1842](#).
- Route interrupts to the appropriate one of:
 - The current Guest OS.
 - A Guest OS that is not currently running.
 - The hypervisor.

ARMv8.1 introduces the Virtualization Host Extensions (VHE) that provide enhanced support for Type 2 hypervisors in Non-secure state. For more information, see [Virtualization Host Extensions on page D4-2098](#).

In Non-secure state, in an implementation that includes EL2:

- The implementation provides an independent translation regime for memory accesses from EL2, the EL2 translation regime. An implementation that includes [ARMv8.1-VHE](#) also supports an alternative EL2&0 translation regime.

Note

An implementation that includes [ARMv8.1-VHE](#) can be configured so that the EL2&0 translation regime is used both for accesses from EL2 and for accesses from Non-secure EL0.

- For the EL1&0 translation regime, address translation occurs in two stages:
 - Stage 1 maps the *virtual address (VA)* to an *intermediate physical address (IPA)*. This is managed at EL1, usually by a Guest OS. The Guest OS believes that the IPA is the *physical address (PA)*.
 - Stage 2 maps the IPA to the PA. This is managed at EL2. The Guest OS might be completely unaware of this stage.

For more information on the translation regimes, see [Chapter D4 The AArch64 Virtual Memory System Architecture](#).

D1.5.1 The effect of implementing EL2 on the Exception model

An implementation that includes EL2 implements the following exceptions:

- Hypervisor Call (HVC) exception.
- Traps to EL2. [EL2 configurable controls on page D1-1851](#), describes these.
- All of the virtual interrupts:
 - Virtual SError.
 - Virtual IRQ.
 - Virtual FIQ.

Hypervisor call exceptions taken from EL3 are taken to EL3. Otherwise, Hypervisor call exceptions are taken from Non-secure state to EL2.

All virtual interrupts are always taken to Non-secure EL1, and can only be taken from Non-secure EL1 or EL0.

Each of the virtual interrupts can be independently enabled using controls at EL2.

Each of the virtual interrupts has a corresponding physical interrupt. See [Virtual interrupts](#).

When a virtual interrupt is enabled, in Non-secure state its corresponding physical exception is taken to EL2, unless EL3 has configured that physical exception to be taken to EL3.

For more information, see [Asynchronous exception types, routing, masking and priorities on page D1-1834](#).

An implementation that includes EL2 also:

- Provides controls that can be used to route some synchronous exceptions, taken from Non-secure state, to EL2. For more information, see:
 - [Routing exceptions from Non-secure EL0 to EL2 on page D1-1827](#).
 - [Routing debug exceptions on page D2-1911](#).
- Provides mechanisms to trap Non-secure PE operations to EL2. See [EL2 configurable controls on page D1-1851](#).
 - When an operation is trapped to EL2, the hypervisor typically either:
 - Emulates the required operation. The application running in the Guest OS is unaware of the trap.
 - Returns an error to the Guest OS.

Virtual interrupts

The virtual interrupts have names that correspond to the physical interrupts, as shown in [Table D1-1](#).

Table D1-1 The virtual interrupt

Physical interrupt	Corresponding virtual interrupt
SError	Virtual SError
IRQ	Virtual IRQ
FIQ	Virtual FIQ

Software executing in EL2 can use virtual interrupts to signal physical interrupts to Non-secure EL1 and Non-secure EL0. [Example D1-1](#) shows a usage model for virtual interrupts.

Example D1-1 Virtual interrupt usage model

A virtual interrupt usage model is as follows:

1. Software executing at EL2 routes a physical interrupt to EL2.

2. When a physical interrupt of that type occurs, the exception handler executing in EL2 determines whether the interrupt can be handled in EL2 or requires routing to a Guest OS in EL1. If the interrupt requires routing to a Guest OS:
 - If the Guest OS is currently running, the hypervisor uses the appropriate virtual interrupt type to signal the physical interrupt to the Guest OS.
 - If the Guest OS is not currently running, the physical interrupt is marked as pending for the guest OS. When the hypervisor next switches to the virtual machine that is running that Guest OS, the hypervisor uses the appropriate virtual interrupt type to signal the physical interrupt to the Guest OS.
-

A hypervisor can prevent Non-secure EL1 and Non-secure EL0 from distinguishing a virtual interrupt from a physical interrupt.

- [Asynchronous exception types, routing, masking and priorities on page D1-1834.](#)
- [Virtual interrupts on page D1-1839.](#)

D1.6 Registers for instruction processing and exception handling

In the ARM architecture, registers fall into two main categories:

- Registers that provide system control or status reporting. These are described in [Chapter D7 AArch64 System Register Descriptions](#).
- Registers that are used in instruction processing, for example to accumulate a result, and in handling exceptions. This section introduces these registers, for execution in AArch64 state.

This section contains the following subsections:

- [The general purpose registers, R0-R30](#).
- [The stack pointer registers](#).
- [The SIMD and floating-point registers, V0-V31 on page D1-1786](#).
- [Saved Program Status Registers \(SPSRs\) on page D1-1786](#).
- [Exception Link Registers \(ELRs\) on page D1-1790](#).

D1.6.1 The general purpose registers, R0-R30

The general purpose register bank is used when processing instructions in the base instruction set. It comprises 31 general purpose registers, R0-R30.

These registers can be accessed as 31 64-bit registers, X0-X30, or 31 32-bit registers, W0-W30. See [Register size on page C6-518](#).

For information on the format of these registers, see [Registers in AArch64 state on page B1-71](#).

D1.6.2 The stack pointer registers

In AArch64 state, in addition to the general purpose registers, a dedicated stack pointer register is implemented for each implemented Exception level. The stack pointer registers are:

- [SP_ELO](#) and [SP_EL1](#).
- If the implementation includes EL2, [SP_EL2](#).
- If the implementation includes EL3, [SP_EL3](#).

———— Note —————

The four stack pointer register names define an architecture state requirement for four registers. For information on how to access these registers, and access restrictions, see [Special-purpose registers on page C5-336](#).

For information on stack pointer alignment restrictions, see [SP alignment checking on page D1-1793](#).

Stack pointer register selection

When executing at EL0, the PE uses the EL0 stack pointer, [SP_ELO](#).

When executing at any other Exception level, the PE can be configured to use either [SP_ELO](#) or the stack pointer for that Exception level, [SP_ELx](#).

By default, taking an exception selects the stack pointer for the target Exception level, [SP_ELx](#). For example, taking an exception to EL1 selects [SP_EL1](#). Software executing at the target Exception level can then choose to change the stack pointer to [SP_ELO](#) by updating [PSTATE.SP](#).

This applies even if taking the exception does not change the Exception level. For example, if the PE is executing at EL1 and the PE is using the [SP_ELO](#) stack pointer, then on taking an exception that targets EL1, the stack pointer changes to [SP_EL1](#).

The selected stack pointer can be indicated by a suffix to the Exception level:

- t** Indicates use of the [SP_ELO](#) stack pointer.
- h** Indicates use of the [SP_ELx](#) stack pointer.

———— **Note** —————

The t and h suffixes are based on the terminology of *thread* and *handler*, introduced in ARMv7-M.

Table D1-2 shows the set of stack pointer options.

Table D1-2 AArch64 stack pointer options

Exception level	AArch64 stack pointer options
EL0	EL0t
EL1	EL1t, EL1h
EL2	EL2t, EL2h
EL3	EL3t, EL3h

D1.6.3 The SIMD and floating-point registers, V0-V31

The SIMD and floating-point instructions share a common bank of registers for floating-point, vector, and other SIMD-related scalar operations.

The SIMD and floating-point register bank comprises 32 quadword (128-bit) registers, V0-V31.

These registers can be accessed as:

- 32 doubleword (64-bit) registers, D0-D31.
- 32 word (32-bit) registers, S0-S31.
- 32 halfword (16-bit) registers, H0-H31.
- 32 byte (8-bit) registers, B0-B31.

For information on the format of these registers, see *Registers in AArch64 state* on page B1-71.

D1.6.4 Saved Program Status Registers (SPSRs)

The *Saved Program Status Registers* (SPSRs) are used to save PE state on taking exceptions.

In AArch64 state, there is an SPSR at each Exception level exceptions can be taken to, as follows:

- [SPSR_EL1](#), for exceptions taken to EL1 using AArch64.
- If EL2 is implemented, [SPSR_EL2](#), for exceptions taken to EL2 using AArch64.
- If EL3 is implemented, [SPSR_EL3](#), for exceptions taken to EL3 using AArch64.

———— **Note** —————

Exceptions cannot be taken to EL0.

When the PE takes an exception, the PE state is saved from PSTATE in the [SPSR](#) at the Exception level the exception is taken to. For example, if the PE takes an exception to EL1, the PE state is saved in [SPSR_EL1](#). For more information on [PSTATE](#), see *Process state, PSTATE* on page D1-1791.

Saving the PE state means the exception handler can:

- On return from the exception, restore the PE state to the state stored in the [SPSR](#) at the Exception level the exception is returning from. For example, on returning from EL1, the PE state is restored to the state stored in [SPSR_EL1](#).
- Examine the value that PSTATE had when the exception was taken, for example to determine the Execution state and Exception level in which the instruction that caused an exception was executed.

Note

- All PSTATE fields are saved, including those which have no direct read and write access, and those that are meaningful only in AArch32 state.
- Those PSTATE fields that are meaningful only in AArch32 state are saved when an exception is taken from AArch32 state to AArch64 state.

The SPSRs are UNKNOWN on reset.

SPSR format for exceptions taken to AArch64 state

Exceptions can be taken to AArch64 state from AArch64 state or AArch32 state:

- For an exception taken to AArch64 state from AArch64 state, the SPSR bit assignments are:

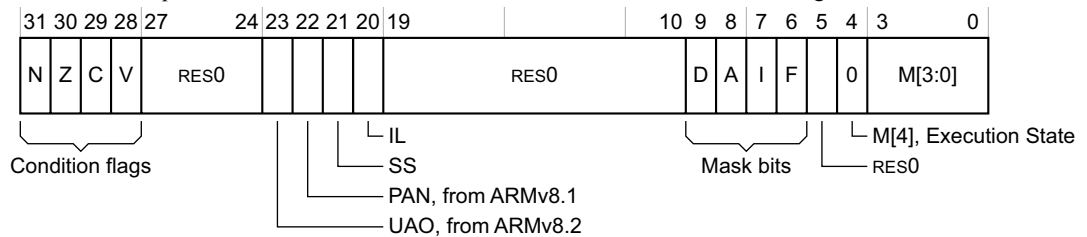

- For an exception taken to AArch64 state from AArch32 state, the SPSR bit assignments are:

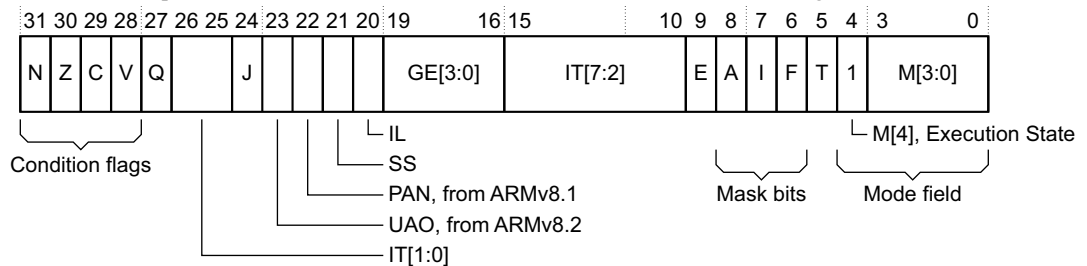

The following list describes the bit assignments:

N, Z, C, V, bits[31:28]

Shows the values of the **PSTATE**.{N, Z, C, V} Condition flags immediately before the exception was taken.

Bits[27:24], for exceptions taken from AArch64 state

Reserved, RES0.

Q, bit[27], for exceptions taken from AArch32 state

Shows the value of **PSTATE**.Q immediately before the exception was taken.

IT[1:0], bits[26:25], for exceptions taken from AArch32 state

See **IT[7:2]** on page D1-1788.

J, bit[24], for exceptions taken from AArch32 state

Shows the value of **PSTATE**.J immediately before the exception was taken. This bit is RES0.

UAO, bit[23], from ARMv8.2

Shows the value of **PSTATE**.UAO immediately before the exception was taken.

This bit is RES0 in ARMv8.0 and in ARMv8.1 when ARMv8.2-UAO is not implemented.

PAN, bit[22], from ARMv8.1

Shows the value of **PSTATE**.PAN immediately before the exception was taken.

This bit is RES0 in ARMv8.0.

SS, bit[21] The Software Step bit.
[SPSR_ELx.SS](#) is used by a debugger to initiate a Software Step exception. The SS bit also indicates which software step state machine state the PE was in. See [Software Step exceptions on page D2-1956](#).

IL, bit[20] Illegal Execution state bit. Shows the value of [PSTATE.IL](#) immediately before the exception was taken. See [Illegal return events from AArch64 state on page D1-1816](#).

Bits[19:10], for exceptions taken from AArch64 state

Reserved, RES0.

GE[3:0], bits [19:16], for exceptions taken from AArch32 state

Shows the value of [PSTATE.GE](#) immediately before the exception was taken.

IT[7:2], bits [15:10], for exceptions taken from AArch32 state

With [IT\[1:0\]](#) on page D1-1787, shows the value of [PSTATE.IT](#) before the exception was taken.

D, bit[9], for exceptions taken from AArch64 state

The debug exception mask bit. Shows the value of [PSTATE.D](#) immediately before the exception was taken. See [The PSTATE debug mask bit, D on page D1-1884](#).

E, bit[9], for exceptions taken from AArch32 state

Endianness of data accesses. Shows the value of [PSTATE.E](#) immediately before the exception was taken.

A, I, F, bits[8:6]

Shows the values of the [PSTATE](#). {A, I, F} exception mask bits immediately before the exception was taken:

A, bit[8] Error interrupt mask bit.

I, bit[7] IRQ mask bit.

F, bit[6] FIQ mask bit.

See [Asynchronous exception masking on page D1-1836](#).

Bit[5], for exceptions taken from AArch64 state

Reserved, RES0.

T, bit[5], for exceptions taken from AArch32 state

Shows the value of [PSTATE.T](#) immediately before the exception was taken.

M[4:0], bits[4:0], for exceptions taken from AArch64 state

———— **Note** —————

The name of this field is inherited from ARMv7, where the M field specified the *PE mode*.

M[4] The value of this is 0. M[4] encodes the value of [PSTATE.nRW](#), that indicates the Execution state from which the exception was taken.

M[3:0] Encodes the Exception level and the stack pointer register selection, as shown in [Table D1-3](#).

Table D1-3 M[3:0] encodings, for exceptions taken from AArch64 state

M[3:0] ^a	Exception level and stack pointer
0b1101	EL3h
0b1100	EL3t
0b1001	EL2h
0b1000	EL2t
0b0101	EL1h
0b0100	EL1t
0b0000	EL0t

a. All M[3:0] encodings not shown in the table are reserved.

The M[3:0] encoding comprises:

M[3:2] Encodes the Exception level, 0-3.

M[1] Reserved, RES0. If set to 1 at the time of an exception return, then that exception return is treated as an Illegal Execution state exception return.

M[0] Selects the SP:

0 [SP_EL0](#). Indicated by a t suffix on the Exception level.

1 [SP_ELx](#), where *x* is the value of M[3:2]. Indicated by an h suffix on the Exception level.

See [Stack pointer register selection on page D1-1785](#).

M[4:0], bits[4:0], for exceptions taken from AArch32 state

The Mode field. Specifies the AArch32 PE mode.

M[4] The value of this is 1. M[4] encodes the value of [PSTATE.nRW](#), that indicates the Execution state from which the exception was taken.

M[3:0] Encodes the AArch32 PE mode that the PE was in immediately before the exception was taken, as shown in [Table D1-4](#).

Table D1-4 M[3:0] encodings, for exceptions taken from AArch32 state

M[3:0]	AArch32 PE mode
0b0000	User
0b0001	FIQ
0b0010	IRQ
0b0011	Supervisor
0b0111	Abort
0b1010	Hyp
0b1011	Undefined
0b1111	System

———— **Note** ————

In this description of SPSR:

- For exceptions taken from AArch64 state, [PSTATE](#) links to the AArch64 system level description.
- For exceptions taken from AArch32 state, [PSTATE](#) links to the AArch32 system level description.

SPSR bits:

- That are defined as RES0 on an exception taken from AArch32 state are ignored on any exception return to AArch32 state.
- That are defined as RES0 on an exception taken from AArch64 state are ignored on any exception return to AArch64 state.

Pseudocode description of SPSR operations

The [SPSR\[\]](#) pseudocode function accesses the current SPSR, and is common to AArch32 and AArch64 operations.

The [SetPSTATEFromPSR\(\)](#) pseudocode function updates [PSTATE](#) from an SPSR.

D1.6.5 Exception Link Registers (ELRs)

Exception Link Registers hold preferred exception return addresses.

Whenever the PE takes an exception, the preferred return address is saved in the ELR at the Exception level the exception is taken to. For example, whenever the PE takes an exception to EL1, the preferred return address is saved in [ELR_EL1](#).

On an exception return, the PC is restored to the address stored in the ELR. For example, on returning from EL1, the PC is restored to the address stored in [ELR_EL1](#).

AArch64 state provides an ELR for each Exception level exceptions can be taken to. The ELRs that AArch64 state provides are:

- [ELR_EL1](#), for exceptions taken to EL1.
- If EL2 is implemented, [ELR_EL2](#), for exceptions taken to EL2.
- If EL3 is implemented, [ELR_EL3](#), for exceptions taken to EL3.

On taking an exception from AArch32 state to AArch64 state, bits[63:32] of the ELR are set to zero.

The preferred return address depends on the nature of the exception. For more information, see [Preferred exception return address on page D1-1799](#).

D1.7 Process state, PSTATE

In the ARMv8-A architecture, Process state or PSTATE is an abstraction of process state information. All of the instruction sets provide instructions that operate on elements of PSTATE.

PSTATE includes all of the following:

- Fields that are meaningful only in AArch32 state.
- Fields that are meaningful only in AArch64 state.
- Fields that are meaningful in both Execution states.

PSTATE is defined in pseudocode as the PSTATE structure, of type `ProcState`. `ProcState` is defined in [Chapter J1 ARMv8 Pseudocode](#).

The PSTATE fields that are meaningful in AArch64 state are:

The Condition flags

N	Negative Condition flag.
Z	Zero Condition flag.
C	Carry Condition flag.
V	Overflow Condition flag.

[Process state, PSTATE on page B1-73](#) gives more information about these flags.

The Execution state controls

SS	Software Step bit, see Software Step exceptions on page D2-1956 . On a reset or taking an exception to AArch64 state, this bit is set to 0.
IL	Illegal Execution state bit, see The Illegal Execution state exception on page D1-1818 . On a reset or taking an exception to AArch64 state, this bit is set to 0.
nRW	Current Execution state, see Execution state on page D1-1779 . This bit is 0 when the current Execution state is AArch64. This bit is set to 0: <ul style="list-style-type: none"> • On reset into an Exception level that is using AArch64. • On taking an exception to an Exception level that is using AArch64.
EL	Current Exception level, see Exception levels on page D1-1776 . On a reset to AArch64 state, this field holds the encoding for the highest implemented Exception level.

———— Note ————

The ARM architecture requires that a PE resets into the highest implemented Exception level.

SP	Stack pointer register selection bit, see Stack pointer register selection on page D1-1785 . On a reset or taking an exception to AArch64 state, this bit is set to 1, meaning that SP_ELx is selected.
-----------	---

The exception mask bits

D	Debug exception mask bit, see The PSTATE debug mask bit, D on page D1-1884 . On a reset or taking an exception to AArch64 state, this bit is set to 1.						
A, I, F	Asynchronous exception mask bits: <table> <tr> <td>A</td> <td>SError interrupt mask bit.</td> </tr> <tr> <td>I</td> <td>IRQ interrupt mask bit.</td> </tr> <tr> <td>F</td> <td>FIQ interrupt mask bit.</td> </tr> </table>	A	SError interrupt mask bit.	I	IRQ interrupt mask bit.	F	FIQ interrupt mask bit.
A	SError interrupt mask bit.						
I	IRQ interrupt mask bit.						
F	FIQ interrupt mask bit.						

See [Asynchronous exception types, routing, masking and priorities on page D1-1834](#). On a reset or taking an exception to AArch64 state, each of these bits is set to 1.

Access control bits

PAN	<i>Privileged Access Never</i> (PAN) state bit. For more information, see About the PAN bit on page D4-2072 .
------------	---

UAO *User Access Override (UAO) bit. For more information, see [About the UAO bit on page D4-2072](#).*

D1.7.1 Accessing PSTATE fields

In AArch64 state, PSTATE fields can be accessed using Special-purpose registers that can be directly read using the [MRS](#) instruction, and directly written using the [MSR \(register\)](#) instructions. [Table D1-5](#) shows the Special-purpose registers that access the PSTATE fields that hold AArch64 state, when the PE is in AArch64 state. All other PSTATE fields do not have direct read and write access.

Table D1-5 Accessing PSTATE fields using MRS and MSR (register)

Special-purpose register	PSTATE fields
NZCV	N, Z, C, V
DAIF	D, A, I, F
CurrentEL	EL
SPSel	SP
PAN	PAN
UAO	UAO

Software can also use the [MSR \(immediate\)](#) instruction to directly write to PSTATE. {D, A, I, F, SP, PAN, **UAO**}. [Table D1-6](#) shows the [MSR \(immediate\)](#) operands that can directly write to these PSTATE fields when the PE is in AArch64 state.

Table D1-6 Accessing PSTATE.{D, A, I, F, SP} using MSR (immediate)

Operand	PSTATE fields	Notes
DAIFSet	D, A, I, F	Directly sets any of the PSTATE. {D,A, I, F} bits to 1
DAIFClr	D, A, I, F	Directly clears any of the PSTATE. {D, A, I, F} bits to 0
SPSel	SP	Directly sets PSTATE.SP to either 1 or 0
PAN	PAN	Directly sets PSTATE.PAN to either 1 or 0
UAO	UAO	Directly sets PSTATE.UAO to either 1 or 0

PSTATE. {N, Z, C, V} can be accessed at EL0. Access to PSTATE. {D, A, I, F} at EL0 using AArch64 depends on [SCTLR_EL1.UMA](#), see [Traps to EL1 of EL0 accesses to the PSTATE. {D, A, I, F} interrupt masks on page D1-1846](#). All other PSTATE access instructions can be executed at EL1 or higher and are UNDEFINED at EL0.

Writes to the PSTATE fields have side-effects on various aspects of the PE operation. All of these side-effects are guaranteed:

- Not to be visible to earlier instructions in the execution stream.
- To be visible to later instructions in the execution stream.

D1.7.2 The Saved Program Status Registers (SPSRs)

On taking an exception, PSTATE is preserved in the SPSR of the Exception level the exception is taken to. The SPSRs are described in [Saved Program Status Registers \(SPSRs\) on page D1-1786](#).

D1.8 Program counter and stack pointer alignment

This section contains the following:

- [PC alignment checking](#).
- [SP alignment checking](#).

D1.8.1 PC alignment checking

PC alignment checking generates a PC alignment fault exception associated with the instruction fetch if, in AArch64 state, there is an attempt to architecturally execute an instruction that was fetched with a misaligned PC. A misaligned PC is when bits[1:0] of the PC are not 0b00.

———— **Note** ————

As with Instruction Aborts, speculative fetching of an instruction does not generate an exception. An exception occurs only on an attempt to architecturally execute the instruction.

If an exception is generated as a result of an instruction fetch at EL0, it is taken to EL1, unless the exception occurs in Non-secure state and [HCR_EL2.TGE](#) bit is 1, when it is taken to EL2 instead. If an exception is generated as a result of an instruction fetch at any other Exception level, the Exception level is unchanged.

A PC misalignment sets the EC field in the *Exception Syndrome Register* (ESR) to 0x22, for the ESR associated with the target Exception level.

When the exception is taken to an Exception level using AArch64, the associated Exception Link Register holds the entire PC in its misaligned form, as does the [FAR_ELx](#) for the Exception level that the exception is taken to.

[Exception return and PC alignment on page D1-1816](#) gives more information on PC alignment checking associated with exception returns.

———— **Note** ————

A misalignment of the PC is a common indication of a serious error, for example software corruption of an address.

The pseudocode function [AArch64.CheckPCAlignment\(\)](#) performs PC alignment checking in AArch64 state. When necessary it calls [AArch64.PCAlignmentFault\(\)](#) to generate an exception.

D1.8.2 SP alignment checking

A *misaligned stack pointer* is where bits[3:0] of the stack pointer are not 0b0000, when the stack pointer is used as the base address of the calculation, regardless of any offset applied by the instruction.

The PE can be configured so that if a load or store instruction uses a misaligned stack pointer, the PE generates an SP alignment fault exception on the attempt to execute the instruction. In this configuration, [CheckSPAlignment\(\)](#) performs the stack pointer check, and calls [AArch64.SPAlignmentFault\(\)](#) if a misaligned stack pointer is found.

———— **Note** ————

- As with Data Aborts, a speculative data access to memory using the stack pointer does not generate the exception. The exception occurs only on an attempt to architecturally execute the instruction.
- Prefetch memory abort instructions do not cause synchronous exceptions. See [Prefetch memory on page C3-171](#).

Stack pointer alignment checking is only performed in AArch64 state, and can be enabled for each Exception level as follows:

- [SCTLR_EL1](#).{SA0, SA} controls EL0 and EL1, respectively
- [SCTLR_EL2](#).SA controls EL2
- [SCTLR_EL3](#).SA controls EL3.

If an exception is generated as a result of a load or store at EL0, it is taken as an exception to EL1 unless the [HCR_EL2.TGE](#) bit is set in the Non-secure state, when it is taken to EL2. If an exception is generated as a result of a load or store at any other Exception level, the Exception level is unchanged.

A stack pointer misalignment sets the EC field to 0x26, in the ESR associated with the target Exception level. If memory alignment checking and stack pointer alignment checking are enabled, then an SP alignment fault has priority in setting the value of the EC field, in the ESR associated with the target Exception level.

The pseudocode function [CheckSPAlignment\(\)](#) performs the stack pointer alignment check. When necessary it calls [AArch64.SPAlignmentFault\(\)](#) to generate an exception.

D1.9 Reset

The ARMv8-A architecture supports the following resets:

- | | |
|-------------------|---|
| Cold reset | Resets all of the logic on which the PE executes, including the integrated debug functionality.

In some contexts, this logic is described as belonging to the <i>Cold reset domain</i> . |
| Warm reset | Resets the logic on which the PE executes, but does not reset the integrated debug functionality.

In some contexts, this logic is described as belonging to the <i>Warm reset domain</i> . |

Note

The ARMv8-A architecture also supports an *external debug reset*. See [External debug register resets on page H8-5572](#).

The difference between a Cold reset and a Warm reset is relevant only to the debug functionality and the [RMR_ELx](#) register, if an [RMR_ELx](#) register is implemented:

- A Warm reset permits debugging across a reset of the PE logic.
- Writing 1 to [RMR_ELx.RR](#) requests a Warm reset.

The mechanisms, other than [RMR_ELx.RR](#), to assert these resets are IMPLEMENTATION DEFINED. It is IMPLEMENTATION DEFINED whether:

- It is possible to independently assert an External Debug reset and a Cold reset.
- It is possible to assert a Warm reset, as opposed to asserting a Cold reset, other than by the use of [RMR_ELx.RR](#).

Note

ARM recommends that:

- If separate Core and Debug power domains are implemented, as described in [Reset and debug on page H6-5545](#), then a Cold reset can be asserted independently of External Debug reset.
 - A Warm reset can be asserted to permit debugging across a reset of the PE logic.
-

This means that an implementation can define other resets according to the requirements the implementation or system must fulfil. These other resets are outside the scope of the ARMv8-A architecture. However, they can be mapped onto the resets described here.

In the description that follows, the term *reset* is used in contexts where there is no difference between the effect of a Cold reset and the effect of a Warm reset.

On a reset, the PE enters the highest implemented Exception level.

If the highest implemented Exception level can use either Execution state, then:

- The implementation must include a *Reset Management Register* (RMR). Only one RMR is implemented. The RMR implemented is the RMR is associated with the highest Exception level.
- On a Cold reset, the Execution state entered is determined by a configuration input signal.
- On a Warm reset, the Execution state entered is determined by [RMR_ELx.AA64](#).

If the highest implemented Exception level is configured to use AArch64 state, then on reset:

- The stack pointer for the highest implemented Exception level, [SP_ELx](#), is selected.
- Execution starts at an IMPLEMENTATION DEFINED address, anywhere in the physical address range. The RVBAR associated with the highest implemented Exception level, [RVBAR_EL1](#), [RVBAR_EL2](#), or [RVBAR_EL3](#), holds this address.

The remainder of this section contains the following:

- [PE state on reset to AArch64 state.](#)
- [Code sequence to use RMR_ELx.RR to request a Warm reset on page D1-1797.](#)

For more information about reset see:

- [Behavior of caches at reset on page D3-1980.](#)
- [TLB behavior at reset on page D4-2117.](#)
- [Reset and debug on page H6-5545.](#)

D1.9.1 PE state on reset to AArch64 state

———— Note ————

See the *ARM® Generic Interrupt Controller Architecture Specification, GIC architecture version 3.0 and version 4.0* for the reset requirements for GIC System registers.

Immediately after a reset, much of the PE state is UNKNOWN. However, some of the PE state is defined. If the PE resets to AArch64 state using either a Cold or a Warm reset, the PE state that is defined is as follows:

- Each of the `PSTATE`.{D, A, I, F} interrupt masks is set to 1.
- The Software step control bit, `PSTATE.SS`, is set to 0.
- The IL process state bit, `PSTATE.IL`, is set to 0.
- All general-purpose, and SIMD and floating-point registers are UNKNOWN.
- The ELR and SPSR for each Exception level are UNKNOWN.
- The stack pointer register for each Exception level is UNKNOWN.
- Unless explicitly defined in this subsection, each System register at each Exception level is in an architecturally UNKNOWN state.
- The TLBs and caches are in an IMPLEMENTATION DEFINED state. This means that the TLBs, the caches, or both, might require invalidation using IMPLEMENTATION DEFINED invalidation sequences before the memory management system is enabled or Normal memory accesses are permitted to be Cacheable.

———— Note ————

- On reset, System register Cacheability control fields force all Normal memory accesses to be treated as Non-cacheable. This applies only for the translation regime used by the Exception level and Security state entered on reset. For information about these controls see [Enabling and disabling the caching of memory accesses on page D3-1978.](#)
 - The implementation might include IMPLEMENTATION DEFINED resets. If it does, each of these resets might treat the cache and TLB state differently. The ARMv8-A architecture permits this.
 - Different IMPLEMENTATION DEFINED invalidation sequences might be required for different IMPLEMENTATION DEFINED resets.
 - In some implementations, the IMPLEMENTATION DEFINED invalidation sequence might be a NOP.
-
- In the `SCTLR_ELx` for the highest implemented Exception level:
 - Each of the {M, C, I} bits is set to 0
 - The EE bit is set to an IMPLEMENTATION DEFINED value, typically defined by a configuration input.
 - If an RMR is implemented, `RMR_ELx.RR` is set to 0. ELx in this context is the highest implemented Exception level.
 - The enables for the counter event stream are set to 0. This means that the following bits are set to 0:
 - `CNTKCTL_EL1.EVNTEN`.
 - If the implementation includes EL2, `CNTHCTL_EL2.EVNTEN`.

- `PMCR_EL0.E` is set to 0.

———— **Note** ————

This means the Performance Monitors cannot assert interrupts at reset.

- `OSDLR_EL1.DLK` bit is set to 0.
- Each of `MDCCINT_EL1`.{TX, RX} is set to 0.
- `EDPRCR.CWRR` is set to 0.
- `EDPRSR.SR` is set to 1.
- If the implementation includes EL3, then each of `MDCR_EL3`.{EPMAD, EDAD, SPME} is set to 0.
- If the implementation includes EL2, then `MDCR_EL2.HPMN` is set to the value of `PMCR_EL0.N`.
- `EDES.R.OSUC` is set to 0, and `EDES`.{SS, RC} are set to the values of `EDEC.R`.{SS, RCE}.

———— **Note** ————

On an External debug reset, `EDEC.R`.{SS, RCE} are set to 0.

Additionally, for a Cold reset into AArch64 state:

- If an RMR is implemented, `RMR_ELx.AA64` is set to 1. ELx in this context is the highest implemented Exception level.
- Each of `MDCCSR_EL0`.{TXfull, RXfull} is set to 0.
- The `DBGPRCR_EL1.CORENPRDRQ` is set to the value of `EDPRCR.COREPURQ`.
An External Debug reset sets `EDPRCR.COREPURQ` to 0, see [External debug register resets on page H8-5572](#). If an External Debug reset and a Cold reset coincide, both `DBGPRCR_EL1.CORENPRDRQ` and `EDPRCR.COREPURQ` are reset to 0.
- The debug CLAIM bits are reset to 0.

———— **Note** ————

These are the bits that are set to 1 by writing to `DBGCLAIMSET_EL1.CLAIM`, and cleared to 0 by writing to `DBGCLAIMCLR_EL1.CLAIM`.

- Each of `EDSCR`.{RXO, TXU, INTdis, TDA, MA, HDE, ERR, RXfull, TXfull} is set to 0.

———— **Note** ————

`MDCCSR_EL0`.{RXfull, TXfull} reflect the values in `EDSCR`.{RXfull, TXfull}.

- Each of `EDECCR`.{NSE, SE} is set to 0.
- `OSLSR_EL1.OSLK` is set to 1.
- In the `EDPRSR`:
 - The SPMAD, SDAD fields are set to 0.
 - The SPD field is set to 1.

D1.9.2 Code sequence to use `RMR_ELx.RR` to request a Warm reset

The following assembler sequence uses `RMR_ELx.RR` to request a Warm reset:

```
; in addition, interrupts and debug requests for this PE should be disabled
; in the system before running this sequence to ensure the WFI suspends execution
MOV Wy, #3 ; for AArch64, #2 for AArch32; y is any register
```

```
    DSB                ; ensure all stores etc are complete
    MSR RMR_ELx, Wy   ; request the reset
    ISB                ; synchronise change to the RMR
Loop
    WFI                ; enter a quiescent state
    B Loop
```

D1.9.3 Pseudocode description of reset

The `AArch64.TakeReset()` pseudocode function performs a reset into AArch64 state.

`AArch64.TakeReset()` calls the functions `AArch64.ResetGeneralRegisters()`, `AArch64.ResetSIMDFPRegisters()`, `AArch64.ResetSpecialRegisters()`, `AArch64.ResetSystemRegisters()`, and `ResetExternalDebugRegisters()`.

`AArch64.ResetSystemRegisters()` resets all System registers to their reset state as defined in the register descriptions in *PE state on reset to AArch64 state* on page D1-1796 and *Chapter D7 AArch64 System Register Descriptions*.

———— **Note** —————

The `AArch64.ResetSystemRegisters()` function only resets the System registers.

`ResetExternalDebugRegisters()` resets all external debug registers to their reset state as defined in the register descriptions in *Chapter H9 External Debug Register Descriptions*.

D1.10 Exception entry

Exceptions are targeted at particular Exception levels. The Exception level that an exception targets is either programmed by software, or is determined by the nature of the exception.

Under no circumstances do exceptions cause execution to move to a lower Exception level.

If an asynchronous exception targets a lower Exception level, the exception is not taken and remains pending. See [Asynchronous exception routing](#) on page D1-1834 and [Asynchronous exception masking](#) on page D1-1836.

———— Note —————

The construction of the architecture means that usually, it is impossible for an exception to target a lower Exception level.

The Security state can only change on taking an exception if the exception is taken from Non-secure state to EL3.

———— Note —————

Taking an exception to EL3 from any Exception level has no effect on the value of the [SCR_EL3.NS](#) bit.

On taking an exception to AArch64 state:

- The PE state is saved in the [SPSR_ELx](#) at the Exception level the exception is taken to. See [Saved Program Status Registers \(SPSRs\)](#) on page D1-1786.
- The preferred return address is saved in the [ELR_ELx](#) at the Exception level the exception is taken to. See [Exception Link Registers \(ELRs\)](#) on page D1-1790.
- All of [PSTATE](#). {D, A, I, F} are set to 1. See [Process state, PSTATE](#) on page D1-1791.
- [PSTATE.UAO](#) is set to 0. See [Process state, PSTATE](#) on page D1-1791.
- If the exception is a synchronous exception or an SError interrupt, information characterizing the reason for the exception is saved in the [ESR_ELx](#) at the Exception level the exception is taken to. See [Use of the ESR_EL1, ESR_EL2, and ESR_EL3](#) on page D1-1801.
- Execution moves to the target Exception level, and starts at the address defined by the exception vector. Which exception vector is used is also an indicator of whether the exception came from a lower Exception level or the current Exception level. See [Exception vectors](#) on page D1-1800.
- The stack pointer register selected is the dedicated stack pointer register for the target Exception level. See [The stack pointer registers](#) on page D1-1785.

The remainder of this section contains the following:

- [Preferred exception return address](#).
- [Exception vectors](#) on page D1-1800.
- [Pseudocode description of exception entry to AArch64 state](#) on page D1-1801.
- [Exception classes and the ESR_ELx syndrome registers](#) on page D1-1801.
- [Summary of register updates on faults taken to an Exception level that is using AArch64](#) on page D1-1813.

D1.10.1 Preferred exception return address

For an exception taken to an Exception level using AArch64, the Exception Link Register for that Exception level, [ELR_ELx](#), holds the preferred exception return address. The preferred exception return address depends on the nature of the exception, as follows:

- For asynchronous exceptions, it is the address of the instruction following the instruction boundary at which the interrupt occurs. Therefore, it is the address of the first instruction that did not execute, or did not complete execution, as a result of taking the interrupt.

- For synchronous exceptions other than system calls, it is the address of the instruction that generates the exception.
- For exception generating instructions, it is the address of the instruction that follows the exception generating instruction.

———— **Note** —————

If an exception generating instruction is trapped, disabled, or is UNDEFINED because the Exception level has insufficient privilege to execute the instruction, the preferred exception return address is the address of the exception generating instruction.

When an exception is taken from an Exception level using AArch32 to an Exception level using AArch64, the top 32 bits of the modified `ELR_ELx` are 0.

D1.10.2 Exception vectors

When the PE takes an exception to an Exception level that is using AArch64, execution is forced to an address that is the *exception vector* for the exception. The exception vector exists in a *vector table* at the Exception level the exception is taken to.

A vector table occupies a number of consecutive word-aligned addresses in memory, starting at the *vector base address*.

Each Exception level has an associated *Vector Base Address Register* (VBAR), that defines the exception base address for the table at that Exception level.

For exceptions taken to AArch64 state, the vector table provides the following information:

- Whether the exception is one of the following:
 - Synchronous exception.
 - SError.
 - IRQ.
 - FIQ.
- Information about the Exception level that the exception came from, combined with information about the stack pointer in use, and the state of the register file.

Table D1-7 shows this.

Table D1-7 Vector offsets from vector table base address

Exception taken from	Offset for exception type			
	Synchronous	IRQ or vIRQ	FIQ or vFIQ	SError or vSError
Current Exception level with <code>SP_ELO</code> .	0x000	0x080	0x100	0x180
Current Exception level with <code>SP_ELx</code> , $x > 0$.	0x200	0x280	0x300	0x380
Lower Exception level, where the implemented level immediately lower than the target level is using AArch64. ^a	0x400	0x480	0x500	0x580
Lower Exception level, where the implemented level immediately lower than the target level is using AArch32. ^a	0x600	0x680	0x700	0x780

a. For exceptions taken to EL3, if EL2 is implemented, the level immediately lower than the target level is EL2 if the exception was taken from Non-secure state, but EL1 if the exception was taken from Secure EL1 or EL0.

Reset is treated as a special vector for the highest implemented Exception level. This special vector uses an IMPLEMENTATION DEFINED address that is typically set either by a hardwired configuration of the PE or by configuration input signals. The `RVBAR_ELx` register contains this reset vector address, where *x* is the number of the highest implemented Exception level.

D1.10.3 Pseudocode description of exception entry to AArch64 state

The `AArch64.TakeException()` pseudocode function describes the behavior when the PE takes an exception to an Exception level that is using AArch64. The `AArch64.ExceptionClass()` function determines the EC (Exception class) and IL (Instruction length) values required to report the exception, and `AArch64.ReportException()` reports the exception.

The pseudocode functions `AArch64.TakeException()`, `AArch64.ExceptionClass()`, and `AArch64.ReportException()` are described in [Chapter J1 ARMv8 Pseudocode](#).

D1.10.4 Exception classes and the ESR_ELx syndrome registers

If the exception is a synchronous exception or an SError interrupt, information characterizing the reason for the exception is saved in the `ESR_ELx` at the Exception level the exception is taken to. The information saved is determined at the time the exception is taken, and is not changed as a result of the explicit synchronization that takes place at the start of taking the exception. See [Synchronization requirements for AArch64 System registers on page D7-2191](#). The following sections give more information:

- [Use of the ESR_EL1, ESR_EL2, and ESR_EL3](#).
- [The EC used to report an exception routed to EL2 because HCR_EL2.TGE is 1 on page D1-1813](#).

Use of the ESR_EL1, ESR_EL2, and ESR_EL3

An `ESR_ELx` holds the syndrome information for an exception that is taken to AArch64 state.

———— **Note** ————

This use of a syndrome is also the reporting model used for exceptions taken to Hyp mode when they are taken to EL2 using AArch32.

[Figure D1-2](#) shows the general format of the `ESR_ELx` registers.

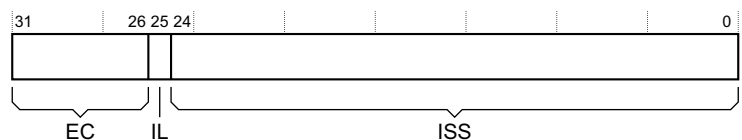

Figure D1-2 Overall format of the `ESR_ELx` registers

The `ESR_ELx` fields are:

- EC, bits[31:26]** The Exception class field, that indicates the cause of the exception.
- IL, bit[25]** The Instruction length bit, for synchronous exceptions, that indicates whether a trapped instruction was a 16-bit or a 32-bit instruction.
- ISS, bits[24:0]** The Instruction specific syndrome field. Architecturally, this field can be defined independently for each defined Exception class. However, in practice, some ISS encodings are used for more than one Exception class.

[ESR_ELx, Exception Syndrome Register \(ELx\) on page D7-2254](#) describes the register in full, including:

- Listing the valid EC field values.
- Describing the ISS for each Exception class.
- Giving a full description of the use of the IL field.

Table D1-8 shows the encoding of the `ESR_ELx.EC` field, the Exception class field. For each EC value, the table references a subsection of the `ESR_ELx` register definition that describes the ISS format, with links to descriptions of possible causes of the exception, for example the configuration required to enable a trap.

Table D1-8 ESR_ELx.EC field encoding

EC	Exception class	From, state		To, Exception level			ISS encoding description
		AArch32 ^a	AArch64	EL1	EL2	EL3	
000000	Unknown reason	Yes	Yes	Yes	Yes	Yes	<i>ISS encoding for exceptions with an unknown reason on page D7-2259</i>
000001	Trapped WFI or WFE instruction execution ^b	Yes	Yes	Yes	Yes	Yes	<i>ISS encoding for an exception from a WFI or WFE instruction on page D7-2260</i>
000011	Trapped MCR or MRC access with (coproc==0b1111) ^b that is not reported using EC 0b000000	Yes	No	Yes	Yes	Yes ^c	<i>ISS encoding for an exception from an MCR or MRC access on page D7-2262</i>
000100	Trapped MCRR or MRRC access with (coproc==0b1111) ^b that is not reported using EC 0b000000	Yes	No	Yes	Yes	Yes ^d	<i>ISS encoding for an exception from an MCRR or MRRC access on page D7-2264</i>
000101	Trapped MCR or MRC access with (coproc==0b1110) ^b	Yes	No	Yes	Yes	Yes	<i>ISS encoding for an exception from an MCR or MRC access on page D7-2262</i>
000110	Trapped LDC or STC access ^b	Yes	No	Yes	Yes	Yes	<i>ISS encoding for an exception from an LDC or STC instruction on page D7-2266</i>
000111	Access to Advanced SIMD or floating-point functionality trapped by CPACR_EL1.FPEN or CPTR_ELx.TFP control ^e	Yes	Yes	Yes	Yes	Yes	<i>ISS encoding for an exception from an access to an Advanced SIMD or floating-point register, resulting from CPACR_EL1.FPEN or CPTR_ELx.TFP on page D7-2268</i>
001000	Trapped VMRS access, from ID group traps, that is not reported using EC 0b000111 ^f	Yes	No	No	Yes	No	<i>ISS encoding for an exception from an MCR or MRC access on page D7-2262</i>
001100	Trapped MRRC access with (coproc==0b1110) ^b	Yes	No	Yes	Yes	Yes	<i>ISS encoding for an exception from an MCRR or MRRC access on page D7-2264</i>
001110	Illegal Execution state	Yes	Yes	Yes	Yes	Yes	<i>ISS encoding for an exception from an Illegal Execution state, or a PC or SP alignment fault on page D7-2270</i>
010001	SVC instruction execution in AArch32 state	Yes	No	Yes	Yes ^g	No	<i>ISS encoding for an exception from HVC or SVC instruction execution on page D7-2270</i>
010010	HVC instruction execution in AArch32 state, when HVC is not disabled	Yes	No	No	Yes	No	

Table D1-8 **ESR_ELx.EC** field encoding (continued)

EC	Exception class	From, state		To, Exception level			ISS encoding description
		AArch32 ^a	AArch64	EL1	EL2	EL3	
010011	SMC instruction execution in AArch32 state, when SMC is not disabled	Yes	No	No	Yes ^h	Yes	<i>ISS encoding for an exception from SMC instruction execution in AArch32 state on page D7-2271</i>
010101	SVC instruction execution in AArch64 state	No	Yes	Yes	Yes	Yes	<i>ISS encoding for an exception from HVC or SVC instruction execution on page D7-2270</i>
010110	HVC instruction execution in AArch64 state, when HVC is not disabled	No	Yes	No	Yes	Yes	
010111	SMC instruction execution in AArch64 state, when SMC is not disabled	No	Yes	No	Yes ^h	Yes	<i>ISS encoding for an exception from SMC instruction execution in AArch64 state on page D7-2272</i>
011000	Trapped MSR, MRS, or System instruction execution, that is not reported using EC 0x00, 0x01, or 0x07	No	Yes	Yes	Yes	Yes	<i>ISS encoding for an exception from MSR, MRS, or System instruction execution in AArch64 state on page D7-2273</i>
011111	IMPLEMENTATION DEFINED exception taken to EL3	Yes	Yes	No	No	Yes	<i>ISS encoding for a IMPLEMENTATION DEFINED exception to EL3 on page D7-2274</i>
100000	Instruction Abort from a lower Exception level ⁱ	Yes	Yes	Yes	Yes	Yes	<i>ISS encoding for an exception from an Instruction Abort on page D7-2275</i>
100001	Instruction Abort taken without a change in Exception level ⁱ	Yes	Yes	Yes	Yes	Yes	
100010	PC alignment fault	Yes	Yes	Yes	Yes	Yes	<i>ISS encoding for an exception from an Illegal Execution state, or a PC or SP alignment fault on page D7-2270</i>
100100	Data Abort from a lower Exception level ^j	Yes	Yes	Yes	Yes	Yes	<i>ISS encoding for an exception from a Data Abort on page D7-2277</i>
100101	Data Abort taken without a change in Exception level ^j	Yes	Yes	Yes	Yes	Yes	
100110	SP alignment fault	No	Yes	Yes	Yes	Yes	<i>ISS encoding for an exception from an Illegal Execution state, or a PC or SP alignment fault on page D7-2270</i>
101000	Trapped floating-point exception taken from AArch32 state	Yes	No	Yes	Yes	No	<i>ISS encoding for an exception from a trapped floating-point exception on page D7-2281</i>
101100	Trapped floating-point exception taken from AArch64 state	No	Yes	Yes	Yes	Yes	

Table D1-8 ESR_ELx.EC field encoding (continued)

EC	Exception class	From, state		To, Exception level			ISS encoding description
		AArch32 ^a	AArch64	EL1	EL2	EL3	
101111	SError interrupt	Yes	Yes	Yes	Yes	Yes	<i>ISS encoding for an SError interrupt on page D7-2283</i>
110000	Breakpoint exception from a lower Exception level	Yes	Yes	Yes	Yes ^k	No	<i>ISS encoding for an exception from a Breakpoint or Vector Catch debug exception on page D7-2285</i>
110001	Breakpoint exception taken without a change in Exception level	Yes	Yes	Yes	Yes ^k	No	
110010	Software Step exception from a lower Exception level	Yes	Yes	Yes	Yes ^k	No	<i>ISS encoding for an exception from a Software Step exception on page D7-2285</i>
110011	Software Step exception taken without a change in Exception level	Yes	Yes	Yes	Yes ^k	No	
110100	Watchpoint exception from a lower Exception level	Yes	Yes	Yes	Yes ^k	No	<i>ISS encoding for an exception from a Watchpoint exception on page D7-2286</i>
110101	Watchpoint exception taken without a change in Exception level	Yes	Yes	Yes	Yes ^k	No	
111000	BKPT instruction execution in AArch32 state	Yes	No	Yes	Yes ^k	No	<i>ISS encoding for an exception from execution of a Breakpoint instruction on page D7-2287</i>
111010	Vector Catch exception from AArch32 state	Yes	No	No	Yes ^k	No	<i>ISS encoding for an exception from a Breakpoint or Vector Catch debug exception on page D7-2285</i>
111100	BRK instruction execution in AArch64 state	No	Yes	Yes	Yes ^k	Yes ^l	<i>ISS encoding for an exception from execution of a Breakpoint instruction on page D7-2287</i>

- See also *Reporting AArch32 synchronous exceptions taken to an Exception level using AArch64* on page D1-1813.
- Exceptions caused by configurable traps, enables, or disables.
- See *Traps to EL3 of Secure monitor functionality from Secure EL1 using AArch32* on page D1-1870.
- Only for MRRR or MRRC accesses to the `PMCCNTR_EL0` or `PMCCNTR`.
- Excludes exceptions that are generated because the value of `HCR_EL2.TGE` is 1, see *The EC used to report an exception routed to EL2 because HCR_EL2.TGE is 1* on page D1-1813.
- Applies only to traps of accesses to `MVFR0`, `MVFR1`, `MVFR2`, or `FPSID`. Includes traps of VMRS accesses. Because the `MVFRn` registers are read-only and a VMRS access to the `FPSID` is ignored and not trapped, there are no MCR or VMSR accesses that can be trapped with this EC value.
- Only as a result of `HCR_EL2.TGE`.
- Only as a result of `HCR_EL2.TSC`.
- Used for MMU faults generated by instruction accesses, and for synchronous external aborts, including synchronous parity or ECC errors. Not used for debug-related exceptions.
- Used for MMU faults generated by data accesses, Alignment faults other than SP alignment faults and PC alignment faults, and for synchronous external aborts, including synchronous parity or ECC errors. Not used for debug-related exceptions.
- Only as a result of `HCR_EL2.TGE == 1` or `MDCR_EL2.TDE == 1`.
- Only if the BRK instruction is executed in EL3. This is the only debug exception that can be taken to EL3 when EL3 is using AArch64.

Reserved EC values

For EC values not shown in [Table D1-8 on page D1-1802](#):

- Unused EC values in the range 0b000000-0b101100 (0x00-0x2C) are reserved by ARM for future use for synchronous exceptions.
- Unused EC values in the range 0b101101-0b111111 (0x2D-0x3F) are reserved by ARM for future use, and might be used for synchronous or asynchronous exceptions.

Exceptions with an unknown reason

These are the exceptions reported with an [ESR_ELx](#).EC value of 0b000000

This encoding reports an exception with an unknown reason.

When [ESR_ELx](#).EC returns a value of 0x00, all other fields of [ESR_ELx](#) are invalid, and defined as follows:

- IL is set to 1.
- ISS[24:0] is RES0.

An exception with an unknown reason occurs for the following reasons:

- The attempted execution of an instruction bit pattern that has no allocated instruction at the current Exception level and Security state, including:
 - A read access using a System register pattern that is not allocated for reads at the current Exception level and Security state.
 - A write access using a System register pattern that is not allocated for writes at the current Exception level and Security state.
 - Instruction encodings for instructions that are not implemented.
- In Debug state, the attempted execution of an instruction bit pattern that is unallocated in Debug state.
- In Non-debug state, the attempted execution of an instruction bit pattern that is unallocated in Non-debug state.
- In AArch32 state, attempted execution of a short vector floating-point instruction.
- An exception generated by any of the [SCTLR_EL1](#).{ITD, SED, CP15BEN} control bits.
- Attempted execution of:
 - An HVC instruction when disabled by [HCR_EL2](#).HCD or [SCR_EL3](#).HCE.
 - An SMC instruction when disabled by [SCR_EL3](#).SMD.
 - An HLT instruction when disabled by [EDSCR](#).HDE.
- Attempted execution of an MSR or MRS to [SP_EL0](#) when the value of [SPSel.SP](#) is 0.
- Attempted execution, in Debug state, of:
 - A DCPS1 instruction in Non-secure state from EL0 when the value of [HCR_EL2](#).TGE is 1.
 - A DCPS2 instruction from EL1 or EL0 when the value of [SCR_EL3](#).NS is 0, or when EL2 is not implemented.
 - A DCPS3 instruction when the value of [EDSCR](#).SDD is 1, or when EL3 is not implemented.
- When EL3 is using AArch64, attempted execution of an SRS instruction using R13_mon from Secure EL1. See [Traps to EL3 of Secure monitor functionality from Secure EL1 using AArch32 on page D1-1870](#).
- In Debug state when the value of [EDSCR](#).SDD is 1, the attempted execution at EL2, EL1, or EL0 of an instruction that is configured to trap to EL3.

- In AArch32 state, the attempted execution of an MRS (Banked register) or an MSR (Banked register) instruction to SPSR_mon, SP_mon, or LR_mon.
- An exception that is taken to EL2 because the value of HCR_EL2.TGE is 1 that, if the value of HCR_EL2.TGE was 0 would have been reported with an ESR_ELx.EC value of 0x07.

Exception from a WFI or WFE instruction, from AArch32 or AArch64 state

This is the exception syndrome with EC value 0b000001.

This reports exceptions from WFI or WFE instructions executed in either Execution state that result from configurable traps, enables, or disables.

The returned syndrome indicates whether the trapped instruction was a WFI or a WFE. *ISS encoding for an exception from a WFI or WFE instruction on page D7-2260* describes the format of this syndrome.

The following sections describe configuration settings for generating these exceptions:

- *Traps to EL1 of EL0 execution of WFE and WFI instructions on page D1-1845.*
- *Traps to EL2 of Non-secure EL0 and EL1 execution of WFE and WFI instructions on page D1-1861.*
- *Traps to EL3 of Secure monitor functionality from Secure EL1 using AArch32 on page D1-1870.*

Exception from an MCR or MRC access from AArch32 state

These are the exception syndromes with the following EC values:

- 0b000011, MRC or MCR access to a System register in the (coproc==0b1111) encoding space.
- 0b000101, MRC or MCR access to a System register in the (coproc==0b1110) encoding space.
- 0b001000, VMRS System register access.

These report exceptions from MRC, MCR, or VMRS instructions executed in AArch32 state that result from configurable traps, enables, or disables and are not reported using the EC code of 0b000000.

The returned syndrome indicates whether the instruction was an MRC or an MCR, and the instruction arguments. *ISS encoding for an exception from an MCR or MRC access on page D7-2262* describes the format of this syndrome.

The following sections describe configuration settings for generating exceptions that are reported using EC value 0b000011:

- *Traps to EL1 of EL0 accesses to the Generic Timer registers on page D1-1849.*
- *Traps to EL1 of EL0 accesses to Performance Monitors registers on page D1-1850.*
- *Traps to EL2 of Non-secure EL1 accesses to virtual memory control registers on page D1-1853.*
- *Traps to EL2 of Non-secure EL1 execution of TLB maintenance instructions on page D1-1854.*
- *Traps to EL2 of Non-secure EL0 and EL1 execution of cache maintenance instructions on page D1-1855.*
- *Traps to EL2 of Non-secure EL1 accesses to the Auxiliary Control Register on page D1-1856.*
- *Traps to EL2 of Non-secure EL0 and EL1 accesses to lockdown, DMA, and TCM operations on page D1-1857.*
- *Traps to EL2 of Non-secure EL0 and EL1 accesses to the ID registers on page D1-1858.*
- *Trapping to EL2 of Non-secure EL1 accesses to the CPACR_EL1 or CPACR on page D1-1862.*
- *General trapping to EL2 of Non-secure EL0 and EL1 accesses to System registers, from AArch32 state only on page D1-1864.*
- *Traps to EL2 of Non-secure EL0 and EL1 accesses to the Generic Timer registers on page D1-1867.*
- *Traps to EL2 of Non-secure EL0 and EL1 accesses to Performance Monitors registers on page D1-1868.*
- *Traps to EL3 of Secure monitor functionality from Secure EL1 using AArch32 on page D1-1870.*

- [Trapping to EL3 of EL2 accesses to the CPTR_EL2 or HCPTR, and EL2 and EL1 accesses to the CPACR_EL1 or CPACR on page D1-1873.](#)
- [Traps to EL3 of EL2, EL1, and EL0 accesses to Performance Monitors registers on page D1-1877.](#)

The following sections describe configuration settings for generating exceptions that are reported using EC value 0b000101:

- [Traps to EL1 of EL0 and EL1 System register accesses to the trace registers on page D1-1847.](#)
- [Traps to EL1 of EL0 accesses to the Debug Communications Channel \(DCC\) registers on page D1-1848.](#)
- [Traps to EL2 of Non-secure EL0 and EL1 accesses to the ID registers on page D1-1858, for trapped accesses to the JIDR.](#)
- [Traps to EL2 of Non-secure System register accesses to the trace registers on page D1-1863.](#)
- [Trapping System register accesses to Debug ROM registers to EL2 on page D1-1865.](#)
- [Trapping System register accesses to powerdown debug registers to EL2 on page D1-1866.](#)
- [Trapping general System register accesses to debug registers to EL2 on page D1-1866.](#)
- [Traps to EL3 of all System register accesses to the trace registers on page D1-1874.](#)
- [Trapping System register accesses to powerdown debug registers to EL3 on page D1-1875.](#)
- [Trapping general System register accesses to debug registers to EL3 on page D1-1876.](#)

[Traps to EL2 of Non-secure EL0 and EL1 accesses to the ID registers on page D1-1858](#) describes configuration settings for generating exceptions that are reported using EC value 0b001000.

Exception from an MCRR or MRRC access from AArch32 state

These are the exception syndromes with the following EC values:

- 0b000100, MRRC or MCRR access to a System register in the (coproc==0b1111) encoding space.
- 0b001100, MRRC access to a System register in the (coproc==0b1110) encoding space.

These report exceptions from MCRR or MRRC instructions executed in AArch32 state that result from configurable traps, enables, or disables and are not reported using the EC code of 0x00.

The returned syndrome indicates whether the instruction was an MCRR or an MRRC, and the instruction arguments. [ISS encoding for an exception from an MCRR or MRRC access on page D7-2264](#) describes the format of this syndrome.

The following sections describe configuration settings for generating exceptions that are reported using EC value 0b000100:

- [Traps to EL1 of EL0 accesses to the Generic Timer registers on page D1-1849.](#)
- [Traps to EL1 of EL0 accesses to Performance Monitors registers on page D1-1850.](#)
- [Traps to EL2 of Non-secure EL1 accesses to virtual memory control registers on page D1-1853.](#)
- [General trapping to EL2 of Non-secure EL0 and EL1 accesses to System registers, from AArch32 state only on page D1-1864.](#)
- [Traps to EL2 of Non-secure EL0 and EL1 accesses to the Generic Timer registers on page D1-1867.](#)
- [Traps to EL2 of Non-secure EL0 and EL1 accesses to Performance Monitors registers on page D1-1868.](#)
- [Traps to EL3 of EL2, EL1, and EL0 accesses to Performance Monitors registers on page D1-1877.](#)

The following sections describe configuration settings for generating exceptions that are reported using EC value 0b001100:

- [Traps to EL1 of EL0 and EL1 System register accesses to the trace registers on page D1-1847.](#)
- [Traps to EL1 of EL0 accesses to the Debug Communications Channel \(DCC\) registers on page D1-1848.](#)

- [Traps to EL2 of Non-secure System register accesses to the trace registers](#) on page D1-1863.
- [Trapping System register accesses to Debug ROM registers to EL2](#) on page D1-1865.
- [Traps to EL3 of all System register accesses to the trace registers](#) on page D1-1874.
- [Trapping System register accesses to powerdown debug registers to EL3](#) on page D1-1875.

Exception from an LDC or STC access to a System register

This is the exception syndrome with EC value 0b000110.

This reports exceptions from LDC or STC instructions executed in AArch32 state that result from configurable traps, enables, or disables.

The returned syndrome indicates whether the instruction was an MCRR or an MRRC, and the instruction arguments. [ISS encoding for an exception from an LDC or STC instruction](#) on page D7-2266 describes the format of this syndrome.

———— Note —————

The only architected uses of these instructions are:

- An STC to write to memory from [DBGDTRRXint](#).
- An LDC to read from memory to [DBGDTRTXint](#).

The following sections describe configuration settings for generating exceptions that are reported using EC value 0b000110:

- [Traps to EL1 of EL0 accesses to the Debug Communications Channel \(DCC\) registers](#) on page D1-1848.
- [Trapping general System register accesses to debug registers to EL2](#) on page D1-1866
- [Trapping general System register accesses to debug registers to EL3](#) on page D1-1876.

Exception from an access to an Advanced SIMD or floating-point register, from either Execution state, resulting from CPACR_EL1.FPEN or CPTR_ELx.TFP

This is the exception syndrome with EC value 0b000111.

———— Note —————

If [HCR_EL2.TGE](#) is 1, these exceptions are reported with EC value 0b000000 instead of 0b000111. [The EC used to report an exception routed to EL2 because HCR_EL2.TGE is 1](#) on page D1-1813 describes this.

It reports exceptions from accesses to the Advanced SIMD and floating-point register bank, or to SIMD and floating-point System registers, when [CPACR_EL1.FPEN](#) != 0b11 or [CPTR_ELx.TFP](#) == 1.

These are taken from either Execution state.

[ISS encoding for an exception from an access to an Advanced SIMD or floating-point register, resulting from CPACR_EL1.FPEN or CPTR_ELx.TFP](#) on page D7-2268 describes the format of the returned syndrome.

The following sections describe configuration settings for generating exceptions that are reported using EC value 0b000111:

- [Traps to EL1 of EL0 and EL1 accesses to SIMD and floating-point functionality](#) on page D1-1848.
- [General trapping to EL2 of Non-secure accesses to the SIMD and floating-point registers](#) on page D1-1863
- [Traps to EL3 of all System register accesses to the trace registers](#) on page D1-1874.

Exception from an Illegal Execution state, PC alignment fault, or SP alignment fault

These are the exception syndromes with the following EC values:

- 0b001110, Illegal Execution state.
- 0b100010, PC alignment fault.
- 0b100110, SP alignment fault.

When [ESR_ELx.EC](#) returns one of these values, the ISS field does not return any syndrome information and the ISS field is RES0.

There are no configuration settings for generating Illegal Execution state exceptions and PC alignment fault exceptions. See [The Illegal Execution state exception on page D1-1818](#) and [PC alignment checking on page D1-1793](#). [SP alignment checking on page D1-1793](#) describes the configuration settings for generating SP alignment fault exceptions.

Exception from HVC or SVC instruction execution

These are the exception syndromes with the following EC values:

- 0b010001, SVC instruction executed in AArch32 state.
- 0b010010, HVC instruction executed, when not disabled, in AArch32 state.
- 0b010101, SVC instruction executed in AArch64 state.
- 0b010110, HVC instruction executed, when not disabled, in AArch64 state.

The returned syndrome indicates the immediate value given as an instruction argument. [ISS encoding for an exception from HVC or SVC instruction execution on page D7-2270](#) describes the format of this syndrome.

———— **Note** ————

In AArch32 state, the HVC instruction is unconditional, and a conditional SVC instruction generates an exception only if it passes its Condition code check. Therefore, the syndrome information for these exceptions does not include conditionality information.

See [System calls on page D1-1878](#).

Exception from SMC instruction execution in AArch32 state

This is the exception syndrome with EC value 0b010011.

This reports the exception from an SMC that is not disabled and is executed in AArch32 state.

[ISS encoding for an exception from SMC instruction execution in AArch32 state on page D7-2271](#) describes the format of this syndrome.

———— **Note** ————

[ISS encoding for an exception from SMC instruction execution in AArch32 state on page D7-2271](#) describes ISS[24:0] for each of the following cases:

- When an SMC instruction completes normally and generates an exception that is taken to EL3.
- When an SMC instruction is trapped to EL2 from Non-secure EL1 because [HCR_EL2.TSC](#) is set to 1.

[Traps to EL2 of Non-secure EL1 execution of SMC instructions on page D1-1858](#) describes the configuration settings for trapping SMC instructions to EL2.

Exception from SMC instruction execution in AArch64 state

This is the exception syndrome with EC value 0b010111.

This reports the exception from an SMC that is not disabled and is executed in AArch64 state.

The returned syndrome indicates the immediate value given as an instruction argument. [ISS encoding for an exception from SMC instruction execution in AArch64 state on page D7-2272](#) describes the format of this syndrome.

———— **Note** ————

The value of ISS[24:0] described here is used both:

- When an SMC instruction is trapped from Non-secure EL1.
- When an SMC instruction is not trapped, so completes normally and generates an exception that is taken to EL3.

[Traps to EL2 of Non-secure EL1 execution of SMC instructions on page D1-1858](#) describes the configuration settings for trapping SMC instructions to EL2.

Exception from MSR, MRS, or System instruction execution in AArch64 state

This is the exception syndrome with the EC value 0b011000.

These report exceptions from MSR, MRS, or System instructions executed in AArch64 state that result from configurable traps, enables, or disables and are not reported using the EC codes of 0b000000, 0b000001, or 0b000111.

Note

[The System instruction class encoding space on page C5-312](#) identifies the System instructions referred to in this description.

The returned syndrome indicates whether the instruction was an MSR or an MRS, and the instruction arguments. [ISS encoding for an exception from MSR, MRS, or System instruction execution in AArch64 state on page D7-2273](#) describes the format of this syndrome.

For exceptions caused by System instructions, see [System on page C4-215](#) for the instruction arguments returned in the syndrome.

The following sections describe configuration settings for generating the exception that is reported using EC value 0b011000:

- In [EL1 configurable controls on page D1-1843](#):
 - [Traps to EL1 of EL0 execution of cache maintenance instructions on page D1-1844](#).
 - [Traps to EL1 of EL0 accesses to the CTR_EL0 on page D1-1845](#).
 - [Traps to EL1 of EL0 execution of DC ZVA instructions on page D1-1846](#).
 - [Traps to EL1 of EL0 accesses to the PSTATE.{D, A, I, F} interrupt masks on page D1-1846](#).
 - [Traps to EL1 of EL0 and EL1 System register accesses to the trace registers on page D1-1847](#).
 - [Traps to EL1 of EL0 accesses to the Debug Communications Channel \(DCC\) registers on page D1-1848](#).
 - [Traps to EL1 of EL0 accesses to the Generic Timer registers on page D1-1849](#).
 - [Traps to EL1 of EL0 accesses to Performance Monitors registers on page D1-1850](#).
- In [EL2 configurable controls on page D1-1851](#):
 - [Traps to EL2 of Non-secure EL1 accesses to virtual memory control registers on page D1-1853](#).
 - [Traps to EL2 of Non-secure EL0 and EL1 execution of DC ZVA instructions on page D1-1854](#).
 - [Traps to EL2 of Non-secure EL1 execution of TLB maintenance instructions on page D1-1854](#).
 - [Traps to EL2 of Non-secure EL0 and EL1 execution of cache maintenance instructions on page D1-1855](#).
 - [Traps to EL2 of Non-secure EL1 accesses to the Auxiliary Control Register on page D1-1856](#).
 - [Traps to EL2 of Non-secure EL0 and EL1 accesses to lockdown, DMA, and TCM operations on page D1-1857](#).
 - [Traps to EL2 of Non-secure EL0 and EL1 accesses to the ID registers on page D1-1858](#).
 - [Trapping to EL2 of Non-secure EL1 accesses to the CPACR_EL1 or CPACR on page D1-1862](#).
 - [Traps to EL2 of Non-secure System register accesses to the trace registers on page D1-1863](#).
 - [Trapping System register accesses to Debug ROM registers to EL2 on page D1-1865](#).
 - [Trapping System register accesses to powerdown debug registers to EL2 on page D1-1866](#).
 - [Trapping general System register accesses to debug registers to EL2 on page D1-1866](#).
 - [Traps to EL2 of Non-secure EL0 and EL1 accesses to the Generic Timer registers on page D1-1867](#).
 - [Traps to EL2 of Non-secure EL0 and EL1 accesses to Performance Monitors registers on page D1-1868](#).

- In *EL3 configurable controls* on page D1-1869:
 - *Traps to EL3 of Secure EL1 accesses to the Counter-timer Physical Secure timer registers* on page D1-1872.
 - *Trapping to EL3 of EL2 accesses to the CPTR_EL2 or HCPTR, and EL2 and EL1 accesses to the CPACR_EL1 or CPACR* on page D1-1873.
 - *Traps to EL3 of all System register accesses to the trace registers* on page D1-1874.
 - *Trapping System register accesses to powerdown debug registers to EL3* on page D1-1875.
 - *Trapping general System register accesses to debug registers to EL3* on page D1-1876.
 - *Traps to EL3 of EL2, EL1, and EL0 accesses to Performance Monitors registers* on page D1-1877.

Exception from an Instruction abort

These are the exception syndromes with the following EC values:

- 0100000, for an Instruction abort exception taken from a lower Exception level, that could be using AArch64 or AArch32.
- 0b100001, for an Instruction abort exception taken without a change in Exception level, meaning it is taken from an Exception level that is using AArch64.

These EC values are used for MMU faults and synchronous external aborts, including synchronous parity or ECC errors, that are generated by instruction accesses. They are not used for Debug exceptions.

The returned syndrome provides more information about the exception, including a fault code that indicates the cause of the exception. *ISS encoding for an exception from an Instruction Abort* on page D7-2275 describes the format of this syndrome.

Exception from a Data abort

These are the exception syndromes with the following EC values:

- 0b100100, for a Data abort exception taken from a lower Exception level, that could be using AArch64 or AArch32.
- 0b100101, for a Data abort exception taken without a change in Exception level, meaning it is taken from an Exception level that is using AArch64.

These EC values are used for the following exceptions if the exception is generated by a data access:

- MMU faults.
- Alignment faults other than SP alignment faults and PC alignment faults.
- Synchronous external aborts, including synchronous parity or ECC errors.

They are not used for Debug exceptions.

The returned syndrome provides more information about the exception, including a fault code that indicates the cause of the exception. *ISS encoding for an exception from a Data Abort* on page D7-2277 describes the format of this syndrome.

Floating-point exceptions

These are the exception syndromes with the following EC values:

- 0b101000, trapped floating-point exception from AArch32.
- 0b101100, trapped floating-point exception from AArch64.

These Exception classes are supported only when the SIMD and floating-point implementation supports the trapping of floating-point exceptions. Otherwise, the 0x28 and 0x2C EC values are reserved. That is, these EC values are used to report the floating-point exceptions defined by IEEE 754, and the Input Denormal floating-point exception.

The returned syndrome identifies the trapped floating-point exception or exceptions. *ISS encoding for an exception from a trapped floating-point exception* on page D7-2281 describes the format of this syndrome.

In an implementation where the SIMD and floating-point implementation supports the trapping of floating-point exceptions:

- From an Exception level using AArch64, the **FPCR**.{IDE, IXE, UFE, OFE, DZE, IOE} bits enable each of the floating-point exception traps.
- From an Exception level using AArch32, the **FPSCR**.{IDE, IXE, UFE, OFE, DZE, IOE} bits enable each of the floating-point exception traps.

SError interrupt

This is the exception syndrome with EC value 0b101111.

It is used to report the exception caused by an SError interrupt.

The returned syndrome is implementation specific. *ISS encoding for an SError interrupt on page D7-2283* describes the format of this syndrome. See also *Asynchronous exception types, routing, masking and priorities on page D1-1834*.

Breakpoint exception or Vector Catch exception

These are the exception syndromes with the following EC values:

- 0b110000, Breakpoint exception taken from a lower Exception level.
- 0b110001, Breakpoint exception taken without a change of Exception level.
- 0b111010, AArch32 Vector Catch exception.

The returned syndrome provides a fault code that indicates the cause of the exception. *ISS encoding for an exception from a Breakpoint or Vector Catch debug exception on page D7-2285* describes the format of this syndrome.

For more information about generating these exceptions, see:

- *Breakpoint exceptions on page D2-1921*.
- *Vector Catch exceptions on page D2-1955*.

Watchpoint exception

These are the exception syndromes with the following EC values:

- 0b110100, Watchpoint exception taken from a lower Exception level.
- 0b110101, Watchpoint exception taken without a change of Exception level.

The returned syndrome provides more information about the watchpoint, including a fault code that indicates the cause of the exception. *ISS encoding for an exception from a Watchpoint exception on page D7-2286* describes the format of this syndrome.

For more information about generating these exceptions, see *Watchpoint exceptions on page D2-1940*.

Software Step exception

These are the exception syndromes with the following EC values:

- 0b110010, Software Step exception taken from a lower Exception level.
- 0b110011, Software Step exception taken without a change of Exception level.

The returned syndrome provides more information about the exception, including a fault code that indicates its cause. *ISS encoding for an exception from a Software Step exception on page D7-2285* describes the format of this syndrome.

For more information about generating these exceptions, see *Software Step exceptions on page D2-1956*.

Breakpoint Instruction exception

These are the exception syndromes with the following EC values:

- 0b111000, BKPT instruction executed in AArch32 state.
- 0b111100, BRK instruction executed in AArch64 state.

The returned syndrome provides the comment that was provided as an argument to the Breakpoint Instruction. *ISS encoding for an exception from execution of a Breakpoint instruction on page D7-2287* describes the format of this syndrome.

For more information about generating these exceptions, see *Breakpoint Instruction exceptions on page D2-1919*.

The EC used to report an exception routed to EL2 because HCR_EL2.TGE is 1

When an exception is taken from EL0 to EL2 because the value of HCR_EL2.TGE is 1, the exception is reported in ESR_EL2. The EC value and corresponding ISS encoding used to report the exception in ESR_EL2 depend on how an exception of the same class would be reported in ESR_EL1 when the value of HCR_EL2.{TGE, RW} is {0, 1}:

- If the exception would have been reported in ESR_EL1 using the EC value 0x07 then it is reported in ESR_EL2 using the EC value 0x00 and corresponding ISS encoding.
- Otherwise, the exception is reported in ESR_EL2 using the EC value and ISS encoding that would have been used to report the exception ESR_EL1.

Reporting AArch32 synchronous exceptions taken to an Exception level using AArch64

Although possible exception causes are generally similar for AArch32 state and AArch64 state, AArch32 state has additional exception taxonomy that is not present in AArch64 state. The following sections described named AArch32 exceptions that can, in some contexts, be taken to an Exception level that is using AArch64:

- *Undefined Instruction exception on page G1-4376.*
- *Supervisor Call (SVC) exception on page G1-4380.*
- *Secure Monitor Call (SMC) exception on page G1-4382.*
- *Hypervisor Call (HVC) exception on page G1-4383.*
- *Prefetch Abort exception on page G1-4384.*
- *Data Abort exception on page G1-4387.*

When EL2 is using AArch64 and the value of HCR_EL2.TGE is 1, these exceptions are routed to EL2, and reported in the ESR_EL2. Table D1-9 shows how they are reported.

Table D1-9 Syndrome reporting in ESR_EL2 of HCR_EL2 routing of exceptions

AArch32 exception	Pseudocode	EC value used to report exception in ESR_ELx
Undefined Instruction	<code>AArch32.UndefinedFault()</code>	0x00, Exception for an unknown reason
Supervisor Call	<code>AArch32.CallSupervisor()</code>	0x11, Exception from SVC instruction executed in AArch32 state
Secure Monitor Call	See <i>SMC on page F5-3429</i> ^a	0x13, Exception from SMC instruction executed in AArch32 state
Hypervisor Call	<code>AArch32.CallHypervisor()</code>	0x12, Exception from HVC instruction executed in AArch32 state
Prefetch Abort	<code>AArch32.Abort()</code>	0x20, Exception from an Instruction abort at a lower Exception level
Data Abort	<code>AArch32.Abort()</code>	0x24, Exception from a Data abort at a lower Exception level

- a. The pseudocode in *Operation for all encodings on page F5-3430* identifies when the execution of an SMC instruction in AArch32 state generates an exception that is taken to EL3 using AArch64.

D1.10.5 Summary of register updates on faults taken to an Exception level that is using AArch64

For all exceptions taken to an Exception level using AArch64 that are not listed in *Validity of FAR_ELx on page D1-1814*, the FAR_ELx for the Exception level the exception is taken to is UNKNOWN.

For all exceptions taken to EL2 using AArch64 that are not listed in *Validity of HPFAR_EL2 on page D1-1814*, the HPFAR_EL2 is UNKNOWN.

Validity of FAR_ELx

The faulting virtual address is saved in FAR_ELx for the Exception level the exception is taken to if an exception is one of:

- An Instruction Abort exception.
- A Data Abort exception.
- A PC alignment fault exception.
- A Watchpoint exception.

The architecture permits that the FAR_ELx is UNKNOWN for Synchronous External Aborts other than Synchronous External Aborts on Translation Table Walks. In this case, the ISS.FnV bit returned in ESR_ELx indicates whether FAR_ELx is valid.

If an exception is taken from an Exception level using AArch32 into an Exception level using AArch64, and that exception writes the FAR_ELx at the Exception level the exception is taken to, the most significant 32 bits of the FAR_ELx are all zero, unless both:

- The faulting address was generated by a load or store that sequentially incremented from address 0xFFFFFFFF. Such a load or store instruction is CONSTRAINED UNPREDICTABLE, see [Out of range virtual address on page K1-6105](#).
- The implementation treats such incrementing as setting bit[32] of the virtual address.

The FAR_ELx for an Exception level is made UNKNOWN as a result of an exception return from that Exception level.

Validity of HPFAR_EL2

The faulting IPA is saved in HPFAR_EL2 if the exception is an Instruction Abort or Data Abort taken to EL2 and the fault is one of:

- A Translation or Access Flag fault on a stage 2 translation.
- A stage 2 Address Size fault.
- A fault on the stage 2 translation of an address accessed in a stage 1 translation table walk.

HPFAR_EL2 is made UNKNOWN as a result of an exception return from EL2.

D1.11 Exception return

In the ARMv8-A architecture, an exception return is always to the same Exception level or a lower Exception level. An exception return is used for:

- A return to a previously executing thread.
- Entry to a new execution thread. For example:
 - The initialization of a hypervisor by a Secure monitor.
 - The initialization of an operating system by a hypervisor.
 - Application entry from an operating system or hypervisor.

An exception return requires the simultaneous restoration of the PC and `PSTATE` to values that are consistent with the desired state of execution on returning from the exception.

In AArch64 state, an ERET instruction causes an exception return, see [ERET on page C6-622](#). On executing an ERET instruction at ELx:

- The PC is restored with the value held in `ELR_ELx`.
- `PSTATE` is restored by using the contents of `SPSR_ELx`.

`ELR_ELx` and `SPSR_ELx` are the `ELR_ELx` and `SPSR_ELx` at the Exception level the exception is returning from. The exception return makes this `ELR_ELx` and `SPSR_ELx` UNKNOWN.

See [Address tagging in AArch64 state on page D4-2006](#) for details of how tagged addresses are handled in an Exception return from an Exception level using AArch64 to an Exception level using AArch64.

———— **Note** —————

When returning from an Exception level using AArch64 to an Exception level using AArch32, the top 32 bits of the `ELR_ELx` are ignored.

An ERET instruction also:

- Sets the Event Register for the PE executing the ERET instruction. See [Mechanisms for entering a low-power state on page D1-1879](#).
- Resets the local Exclusives monitor for the PE executing the ERET instruction. This removes the risk of errors that might be caused when a path to an exception return fails to include a CLREX instruction.

———— **Note** —————

This behavior prevents self-hosted debug from software stepping through an LDREX/STREX pair. However, when self-hosted debug is using software step, it is highly probable that the Exclusives monitor state would be lost anyway, for other reasons. [Stepping code that uses Exclusives monitors on page D2-1968](#) describes this.

It is IMPLEMENTATION DEFINED whether the resetting of the local Exclusives monitor also resets the global Exclusives monitor.

The ERET instruction is UNDEFINED in EL0.

When returning from an Exception level using AArch64 to an Exception level using AArch32, the AArch32 context is restored. The ARMv8-A architecture defines the relationship between AArch64 state and AArch32 state, for:

- General-purpose registers.
- Special-purpose registers.
- System registers.

In an implementation that includes EL3, the Security state can only change on returning from an exception if the return is from EL3 to a lower Exception level.

The following sections give more information:

- [Exception return and PC alignment.](#)
- [Illegal return events from AArch64 state.](#)
- [Legal returns that set PSTATE.IL to 1 on page D1-1818.](#)
- [The Illegal Execution state exception on page D1-1818.](#)
- [Pseudocode description of exception return on page D1-1818.](#)

D1.11.1 Exception return and PC alignment

When `SPSR_ELx.M[4] == 0`, indicating an Exception return to AArch64 state, the value of `ELR_ELx` is transferred to the PC. If this value is misaligned, subsequent execution results in a PC alignment fault exception.

When `SPSR_ELx.M[4] == 1`, indicating an Exception return to AArch32 state, the value of `ELR_ELx` is transferred to the PC except that, for a legal exception return:

- If `SPSR_ELx.T` is 0, `ELR_ELx[1:0]` are treated as being 0 for restoring the PC.
- If `SPSR_ELx.T` is 1, `ELR_ELx[0]` is treated as being 0 for restoring the PC.

This means that a PC alignment fault exception cannot occur following a legal exception return from AArch64 state to AArch32 state. However, where the Exception return with `SPSR_ELx.M[4] == 1` is an illegal exception return then it is IMPLEMENTATION DEFINED whether a misaligned value in `ELR_ELx` is aligned when it is restored to the PC.

———— Note —————

In an implementation that forces the alignment of the PC value restored from `SPSR_ELx` on an illegal exception return with `SPSR_ELx.M[4] == 1`, if `SPSR_ELx.T == 1` the restored PC value might give rise to a PC alignment fault exception, because the PE remains in AArch64 state and only `ELR_ELx[0]` is treated as being 0 for restoring the PC.

For more information about the illegal exception return cases see [Illegal return events from AArch64 state](#).

D1.11.2 Illegal return events from AArch64 state

In this section:

Return In AArch64 state, refers to any of:

- Execution of an ERET instruction.
- Execution of a DRPS instruction in Debug state.
- Exit from Debug state.

Saved process state value In AArch64 state, refers to any of:

- The value held in the `SPSR_ELx` for an ERET instruction.
- The value held in the `SPSR_ELx` for a DRPS instruction executed in Debug state.
- The value held in the `DSPSR_ELO` for a Debug state exit.

Link address In AArch64 state, refers to any of:

- The address held in `ELR_ELx` for an ERET instruction.
- The address held in `DLR_ELO` for a Debug state exit.

Configured from reset Indicates the state determined on powerup or reset by a configuration input signal, or by another IMPLEMENTATION DEFINED mechanism.

The ARMv8 architecture has a generic mechanism for handling returns to a mode or state that is illegal. In AArch64 state, this can occur as the result of any of the following situations:

- A return where the Exception level being returned to is higher than the current Exception level.
- A return where the Exception level being returned to is not implemented. For example a return to EL2 when EL2 is not implemented.

- A return to EL2 when EL3 is implemented and the value of the [SCR_EL3.NS](#) bit is 0.
- A return to Non-secure EL1 when EL2 is implemented and the value of the [HCR_EL2.TGE](#) bit is 1.
- A return where the value of the saved process state M[4] bit is 0, indicating a return to AArch64 state, and one of the following is true:
 - The M[1] bit is 1.
 - The M[3:0] bits are 0b0001.
 - The Exception level being returned to is using AArch32 state, as programmed by the [SCR_EL3.RW](#) or [HCR_EL2.RW](#) bits, or as configured from reset.
- A return where the value of the saved process state M[4] bit is 1, indicating a return to AArch32 state, and one of the following is true:
 - The M field value is not a valid AArch32 state PE mode. [Table D1-4 on page D1-1789](#) shows the valid M[3:0] values for AArch32 state PE modes. This includes the case where M[3:0] is 0b0000, indicating User mode, and EL0 does not support AArch32 state.
 - The Exception level being returned to is using AArch64 state as determined by the [SCR_EL3.RW](#) or [HCR_EL2.RW](#) field or the configuration from reset. This includes the case where the Exception level being returned to does not support AArch32 state.

———— **Note** —————

This means that, in an implementation that supports only AArch64 state, any attempt to return to AArch32 state is an illegal exception return.

- A Debug state exit from EL0 using AArch64 state, to EL0 using AArch32 state.

In these cases:

- [PSTATE.IL](#) is set to 1, to indicate an illegal return.
- [PSTATE](#).{EL, nRW, SP} are unchanged. This means the Exception level, Execution state, and stack pointer selection do not change as a result of the return.
- The following [PSTATE](#) bits are restored from the saved process state value:
 - The N, Z, C, V Condition flags.
 - The D, A, I, F exception mask bits.
- If the illegal return is an illegal exception return, the [PSTATE.SS](#) bit is handled as normal for a return. That is, the SS bit is handled in the same way as an exception return that is not an illegal exception return. See [Software Step exceptions on page D2-1956](#).
In all these cases the [PSTATE.SS](#) bit is handled as it would be for a normal return, as described in [Entering the active-not-pending state on page D2-1958](#) and [Exiting Debug state on page H2-5471](#). DRPS never sets the SS bit. This is indicated in [Entering the active-not-pending state on page D2-1958](#).
- If the illegal return is not a DRPS instruction executed in Debug state, the PC is restored from the link address. However, if the value of the M[4] bit of the saved process state is 1, indicating a return to AArch32 state, then:
 - Bits[31:2] of the PC are restored from the link address.
 - Bits[63:32, 1:0] of the PC are UNKNOWN.

When the value of the [PSTATE.IL](#) bit is 1, any attempt to execute any instruction results in an Illegal Execution state exception. See [The Illegal Execution state exception on page D1-1818](#).

All aspects of the illegal return, other than the effects described in this section, occur as they do for a legal return.

D1.11.3 Legal returns that set PSTATE.IL to 1

In this section, *return*, *saved process state value*, and *link address* have the same meaning as defined in *Illegal return events from AArch64 state on page D1-1816*.

If the value of the IL bit in the saved process state is 1, then it is copied to PSTATE by a return, meaning that PSTATE.IL is set to 1. In this case, if the return is not an illegal return, and targets AArch32 state, then the PSTATE.{IT, T} bits are either:

- Set to 0.
- Copied from the saved process state value.

The choice between these two options is determined by an implementation, and might vary dynamically within the implementation. Correspondingly software must regard the value as being an UNKNOWN choice between the two values.

The PSTATE.{IT, T} bits are only valid in AArch32 state, see *Process state, PSTATE on page G1-4332*.

When the PSTATE.IL bit is 1, any attempt to execute any instruction results in an Illegal Execution state exception. See *The Illegal Execution state exception*.

D1.11.4 The Illegal Execution state exception

When the value of the PSTATE.IL bit is 1, any attempt to execute any instruction results in an Illegal Execution state exception. In AArch64 state, the PSTATE.IL bit can be set to 1 by any of:

- An illegal return, as described in *Illegal return events from AArch64 state on page D1-1816*.
- A legal return that sets PSTATE.IL to 1, as described in *Legal returns that set PSTATE.IL to 1*.

An Illegal Execution state exception sets ESR_ELx.EC for the target Exception level to the value of 0x0E.

On taking any exception to an Exception level that is using AArch64 state:

1. The value of the PSTATE.IL bit is copied into the SPSR_ELx.IL bit for the Exception level to which the exception is taken.
2. The PSTATE.IL bit is cleared to 0.

———— **Note** —————

This means that it is not possible for software to observe the value of PSTATE.IL.

For the priority of this exception class, see *Synchronous exception prioritization for exceptions taken to AArch64 on page D1-1827*.

D1.11.5 Pseudocode description of exception return

The `AArch64.ExceptionReturn()` pseudocode function transfers the return address to the PC, and restores PSTATE to its saved value by calling `SetPSTATEFromPSR()`.

The `IllegalExceptionReturn()` function checks for an Illegal Execution state exception.

D1.12 The Exception level hierarchy

The System registers provide controls that control PE behavior through the Exception level hierarchy.

If EL3 and EL2 are implemented, System registers at EL3 and EL2 provide controls that control the Execution state of lower Exception levels.

Table D1-10 shows the principal System registers.

Table D1-10 Principal System registers

EL3	EL2	EL1	Notes
SCTLR_EL3	SCTLR_EL2	SCTLR_EL1	Controls execution for its own Exception level.
SCR_EL3	HCR_EL2	-	Controls execution at lower Exception levels.
-	HSTR_EL2	-	Used only if at least one of EL1 and EL0 is using AArch32.

The prioritization of exceptions generated as a result of controls in these registers is described in *Synchronous exception prioritization for exceptions taken to AArch64* on page D1-1827.

The following sections describe the Exception level hierarchy:

- *The hierarchy of configuration and routing control.*
- *Control of SIMD, floating-point and trace functionality* on page D1-1825.
- *Control of IMPLEMENTATION DEFINED features* on page D1-1825.
- *Routing exceptions from Non-secure EL0 to EL2* on page D1-1827.

D1.12.1 The hierarchy of configuration and routing control

The following subsections give a summary of the controls available at each Exception level for controlling execution at that Exception level and all lower Exception levels:

- *Controls provided at EL3.*
- *Controls provided at EL2* on page D1-1821.
- *Controls provided at EL1* on page D1-1823.

For information on how the controls summarized in these subsections affect PE behavior, see the definitions of the control bits in the register descriptions.

Controls provided at EL3

See:

- *Controls provided by the SCR_EL3.*
- *Controls provided by the SCTLR_EL3* on page D1-1820.
- *Controls provided by the MDCR_EL3* on page D1-1820.

Controls provided by the SCR_EL3

SCR_EL3.NS Determines the Security state of execution at EL1 and EL0.

SCR_EL3.RW Determines the Execution state of the next-lower Exception level.

SCR_EL3.{EA, FIQ, IRQ}

Route:

EA Physical SError interrupts and synchronous External Aborts to EL3.

FIQ Physical FIQ interrupts to EL3.

IRQ Physical IRQ interrupts to EL3.

SCR_EL3.SMD Disables the Secure Monitor Call exception.

SCR_EL3.HCE	Enables the Hypervisor Call exception.
SCR_EL3.ST	Enables Secure EL1 access to the Secure timer.
SCR_EL3.SIF	Secure Instruction Fetch. When in Secure state, disables instruction fetches from Non-secure memory.
SCR_EL3.TWI	Trap Wait-For-Interrupt.
SCR_EL3.TWE	Trap Wait-For-Event.

Controls provided by the SCTLR_EL3

SCTLR_EL3.{A, SA} Enable alignment checking:

A	On data accesses from EL3.
SA	On the SP, when executing at EL3.

SCTLR_EL3.{M, C, I, WXN}

Memory system control bits:

M	Enables EL3 stage 1 address translation.
C	When set to 0, makes data accesses to Normal memory from EL3, and Normal memory accesses to the EL3 translation tables, Non-cacheable.
I	When set to 0, makes instruction accesses to Normal memory from EL3 Non-cacheable.
WXN	For accesses from EL3, enables treating all writable memory regions as XN, execute-never.

SCTLR_EL3.EE Defines the endianness of data accesses from EL3, including stage 1 translation table walks at EL3.

———— **Note** —————

Instruction fetches are always little-endian.

Controls provided by the MDCR_EL3

MDCR_EL3.{EPMAD, EDAD}

Enable external debugger accesses to:

EPMAD	Performance Monitors registers.
EDAD	Breakpoint and Watchpoint registers.

MDCR_EL3.{SPME, SDD, SPD32}

Secure debug controls:

SPME	Secure Performance Monitors enable. Enables event counting in Secure state.
SDD	Disables all debug exceptions taken from Secure state, if the <i>debug target Exception level</i> , EL _D , is using AArch64.
SPD32	Enables debug exceptions from Secure EL1 using AArch32.

MDCR_EL3.{TDOSA, TDA, TPM}

These are trap controls, that control traps to EL3 of EL2, EL1, and EL0 accesses to the following:

TDOSA	The OS-related debug registers.
TDA	Those debug registers not included in the MDCR_EL3 .TDOSA trap.
TPM	The Performance Monitors registers.

For EL1 and EL0, these traps apply to accesses from both Security states.

Controls provided at EL2

EL2 is implemented only in Non-secure state, and its controls apply only to execution in Non-secure EL2, Non-secure EL1, and Non-secure EL0. See:

- [Controls provided by SCTLR_EL2.](#)
- [Controls provided by HCR_EL2.](#)
- [Controls provided by the HSTR_EL2 on page D1-1823.](#)
- [Controls provided by the MDCR_EL2 on page D1-1823.](#)

Controls provided by SCTLR_EL2

SCTLR_EL2.{A, SA} Enable alignment checking:

A	On data accesses from EL2.
SA	On the SP, when executing at EL2.

SCTLR_EL2.{M, C, I, WXN}

Memory system control bits:

M	Enables EL2 stage 1 address translation.
C	When set to 0, makes data accesses to Normal memory from EL2, and Normal memory accesses to the EL2 translation tables, Non-cacheable.
I	When set to 0, makes instruction accesses to Normal memory from EL2 Non-cacheable.
WXN	For accesses from EL2, enables treating all writable memory regions as XN, execute-never.

SCTLR_EL2.EE Defines the endianness of data accesses from EL2, including stage 1 translation table walks at EL2.

Also defines the endianness of stage 2 translation table walks at Non-secure EL1 and EL0.

———— **Note** —————

Instruction fetches are always little-endian.

Controls provided by HCR_EL2

HCR_EL2.RW Determines the Execution state of the next-lower Exception level.

HCR_EL2.{AMO, IMO, FMO}

Route physical interrupts to EL2, and if the value of **HCR_EL2.TGE** is 0, enable virtual interrupts:

AMO	Route physical SError interrupts to EL2 and enable virtual SError interrupts
IMO	Route physical IRQ interrupts to EL2 and enable virtual IRQ interrupts.
FMO	Route physical FIQ interrupts to EL2 and enable virtual FIQ interrupts.

———— **Note** —————

- If a physical interrupt is routed to both EL3 and EL2, routing to EL3 takes precedence over routing to EL2.
- When the value of **HCR_EL2.TGE** is 0, the virtual interrupt enables apply regardless of whether the corresponding physical interrupt is routed to EL2 or to EL3.
- In ARMv8.0, when the value of **HCR_EL2.TGE** is 1 the virtual interrupts are disabled.
- From ARMv8.1, when the value of **HCR_EL2.TGE** is 1:
 - If **ARMv8.1-VHE** is not implemented, or if **HCR_EL2.E2H** is 0, these fields behave as 1 for all purposes other than a direct read of the value of the fields.

- If [ARMv8.1-VHE](#) is implemented and [HCR_EL2.E2H](#) is 1, these fields behave as 0 for all purposes other than a direct read of the value of the fields.
-

[HCR_EL2](#).{VSE, VI, VF}

Cause a virtual interrupt to be pending:

- VSE** Virtual SError interrupt.
- VI** Virtual IRQ interrupt.
- VF** Virtual FIQ interrupt.

[HCR_EL2.VM](#) Enable bit for Non-secure EL1&0 stage 2 address translations.

[HCR_EL2](#).{SWIO, PTW, FB, BSU, DC, CD, ID}

Controls for memory system behavior for accesses made from Non-secure EL1 and EL0:

- SWIO** Set/Way Invalidate Override.
- PTW** Protect Table Walk.
- FB** Force broadcast of TLB and instruction cache maintenance instructions.
- BSU** Barrier Shareability Upgrade.
- DC** Default Cacheability control for the EL1&0 translation regime.
- CD** For the Non-secure EL1&0 translation regime, when set to 1, forces stage 2 translation table walks to Normal memory, and stage 2 translations for data accesses to Normal memory, to be Non-cacheable.
- ID** For the Non-secure EL1&0 translation regime, when set to 1, forces stage 2 translations for instruction accesses to Normal memory be Non-cacheable.

[HCR_EL2.HCD](#) Hypervisor Call Disable.

———— **Note** —————

If an implementation includes EL3, this bit is RES0.

[HCR_EL2](#).{TRVM, TDZ, TVM, TTLB, TPU, TPC, TSW, TACR, TIDCP, TSC, TID1, TID2, TID3, TWE, TWI}

Trap operations performed at Non-secure EL1 or EL0 to EL2, as follows:

- TRVM** Trap Read of Virtual Memory controls.
- TDZ** Trap Data Cache Zero.
- TVM** Trap Virtual Memory controls.
- TTLB** Trap TLB maintenance instructions.
- TPU** Trap cache maintenance to the Point of Unification instructions.
- TPC** Trap data cache maintenance to the Point of Coherency instructions.
- TSW** Trap data cache maintenance by Set/Way instructions.
- TACR** Trap Auxiliary Control Register accesses.
- TIDCP** Trap Implementation-Dependent functionality.
- TSC** Trap Secure Monitor Call.
- TID0** Trap ID Group 0 register accesses.
- TID1** Trap ID Group 1 register accesses.
- TID2** Trap ID Group 2 register accesses.
- TID3** Trap ID Group 3 register accesses.
- TWI** Trap Wait-For-Interrupt.
- TWE** Trap Wait-For-Event.

———— **Note** ————

There are no AArch64 System registers in ID Group 0, therefore the TID0 trap is only relevant when Non-secure EL1 is using AArch32.

HCR_EL2.TGE Trap General Exceptions.

Controls provided by the HSTR_EL2

When EL2 is using AArch64 and at least one of Non-secure EL1 or EL0 is using AArch32, **HSTR_EL2** provides the following trap of Non-secure AArch32 operation to EL2:

HSTR_EL2.Tn, for values of n in the set {0-3, 5-13, 15}

Trap accesses to System registers in the AArch32 (coproc==0b1111) encoding space, by the value of *n*, where *n* is:

- The numeric value of the CRn argument used when accessing the register using an MCR or MRC instruction.
- The numeric value of the CRm argument used when accessing the register using an MCRR or MRRC instruction.

Controls provided by the MDCR_EL2

MDCR_EL2.{TDRA, TDOSA, TDA}

Trap controls, that control traps to EL2 of Non-secure EL1 and EL0 System register accesses to the following:

TDRA The Debug ROM registers.

TDOSA The OS-related debug registers.

TDA Those debug registers not included in either of the **MDCR_EL2.TDRA** or **MDCR_EL2.TDOSA** traps.

MDCR_EL2.TDE Routes all debug exceptions taken from Non-secure EL1 and EL0 to EL2.

MDCR_EL2.{TPM, TPMCR}

These are trap controls, that control traps to EL2 of Non-secure EL1 and EL0 accesses to the following registers:

TPM All Performance Monitors registers.

TPMCR The Performance Monitors Control Registers.

MDCR_EL2.HPMN Defines the number of Performance Monitors counters that are accessible from Non-secure EL1 and EL0.

Controls provided at EL1

See:

- [Controls provided by the SCTLR_EL1](#).
- [Controls provided by the MDSCR_EL1](#) on page D1-1824.

Controls provided by the SCTLR_EL1

SCTLR_EL1.{A, SA} Enable alignment checking:

A On data accesses from EL1 and EL0.

SA On the SP, when executing at EL1.

SCTLR_EL1.SA0 Enable alignment checking on the SP when executing at EL0.

SCTLR_EL1.{M, C, I, WXN}

Memory system control bits:

- M** Enables EL1&0 stage 1 address translation.
- C** When set to 0, makes data accesses to Normal memory from EL0 and EL1, and Normal memory accesses to the EL1&0 stage 1 translation tables, Non-cacheable.
- I** When set to 0, makes instruction accesses to Normal memory from EL1 and EL0 Non-cacheable.
- WXN** For accesses from EL1 and EL0, enables treating all writable memory regions as XN, execute-never.

SCTLR_EL1.EE Defines the endianness of data accesses from EL1, including stage 1 translation table walks at EL1 and EL0.

———— **Note** —————

Instruction fetches are always little-endian.

SCTLR_EL1.E0E EL0 Endianness. Defines the endianness used for explicit data accesses made from EL0.

SCTLR_EL1.{UCI, UCT, DZE, nTWI, nTWE}

Trap enables:

- UCI** Unprivileged Cache maintenance Instruction enable.
- UCT** Unprivileged Cache Type access enable.
- DZE** Data cache Zero Enable.
- nTWI** Not Trap Wait-For-Interrupt.
- nTWE** Not Trap Wait-For-Event.

SCTLR_EL1.UMA Unprivileged Mask Access.

SCTLR_EL1.{SED, ITD, CP15BEN}

These bits control the use, at EL0, of AArch32 functionality that is deprecated, or OPTIONAL and deprecated:

- SED** Disables use of the SETEND instruction.
- ITD** If supported, disables some uses of the IT instruction. The register field description identifies the uses that are disabled.
- CP15BEN** If supported, enables use of the CP15DMB, CP15DSB, and CP15ISB memory barrier instructions.

The deprecated uses of the IT instruction, and use of the CP15DMB, CP15DSB, and CP15ISB instructions, are deprecated for performance reasons. Implementation of the ITD and CP15BEN controls is optional, and if a control is not implemented then the associated AArch32 functionality cannot be disabled.

Controls provided by the MDSCR_EL1

MDSCR_EL1.{MDE, SS}

Enable controls for the debug exceptions:

- MDE** Enables Breakpoint exceptions, Watchpoint exceptions, and Vector Catch exceptions.
- SS** Enables Software Step exceptions.

There is no enable control for Breakpoint Instruction exceptions. Breakpoint Instruction exceptions are always enabled.

MDSCR_EL1.KDE Enables debug exceptions from EL_D when EL_D is using AArch64.

MDSCR_EL1.TDCC Enables a trap to EL1 of EL0 accesses to the Debug Communications Channel registers.

D1.12.2 Control of SIMD, floating-point and trace functionality

In addition to the controls described in *The hierarchy of configuration and routing control* on page D1-1819, the following registers provide a hierarchy of control of access to SIMD and floating-point functionality, and to trace functionality that is accessible using the System registers:

CPTR_EL3 Traps operation at lower Exception levels to EL3, if the operation is not trapped to EL2 by **CPTR_EL2** and is not trapped to EL1 by **CPACR_EL1**.

CPTR_EL2 Traps operation in Non-secure EL1 or EL0 to EL2, if the operation is not trapped to EL1 by **CPACR_EL1**. **CPTR_EL2**.{TTA, TFP} also trap operation in EL2.

The trap bits in the **CPTR_EL3** and **CPTR_EL2** are as follows:

- TCPAC** Traps accesses to the registers that control access to SIMD, floating-point, and trace functionality.
- TTA** Traps any System register access to trace functionality, unless that access is otherwise trapped to a lower Exception level.
- TFP** Traps any execution of an instruction that uses the SIMD and floating-point register bank, unless that access is otherwise trapped to a lower Exception level.

CPACR_EL1 Traps operation from EL1 or EL0 to EL1. Traps set in the **CPACR_EL1** take precedence over any traps set in the **CPTR_EL2** or **CPTR_EL3**. The trap fields are as follows:

- TTA** Traps to EL1 any System register access from EL0 or EL1 to trace functionality.
- FPEN** Traps to EL1 execution of instructions that uses the SIMD and floating-point register bank.

D1.12.3 Control of IMPLEMENTATION DEFINED features

The hierarchy of configuration and routing control on page D1-1819 and *Control of SIMD, floating-point and trace functionality* describe the controls of the trapping of architecturally-defined functionality. However, the architecture also defines registers that can be used to provide IMPLEMENTATION DEFINED traps of IMPLEMENTATION DEFINED functionality to the different Exception levels. [Table D1-11](#) shows these control registers, for AArch64 state controls.

Table D1-11 Control of traps of IMPLEMENTATION DEFINED functionality

Traps to EL3	Traps to EL2	Traps to EL1	Notes
ACTLR_EL3	ACTLR_EL2	ACTLR_EL1	Registers also provide IMPLEMENTATION DEFINED configuration controls for the appropriate Exception level.
-	HACR_EL2	-	Provides traps of IMPLEMENTATION DEFINED Non-secure EL1 and EL0 functionality to EL2.

D1.13 Synchronous exception types, routing and priorities

Synchronous exceptions are:

- Any exception generated by attempting to execute an instruction that is UNDEFINED, including:
 - Attempts to execute instructions at an inappropriate Exception level.
 - Attempts to execute instructions when they are disabled.
 - Attempts to execute instruction bit patterns that have not been allocated.
- Illegal Execution state exceptions. These are caused by attempts to execute an instruction when the value of `PSTATE.IL` is 1, see [Illegal return events from AArch64 state on page D1-1816](#).
- Exceptions caused by the use of a misaligned SP.
- Exceptions caused by attempting to execute an instruction with a misaligned PC.
- Exceptions caused by the exception-generating instructions SVC, HVC, or SMC.
- Traps on attempts to execute instructions that the System registers define as instructions that are trapped to a higher Exception level. See [Configurable instruction enables and disables, and trap controls on page D1-1842](#).
- Instruction Aborts generated by the memory address translation system that are associated with attempts to execute instructions from areas of memory that generate faults.
- Data Aborts generated by the memory address translation system that are associated with attempts to read or write memory that generate faults.
- Data Aborts caused by a misaligned address.
- All of the debug exceptions:
 - Breakpoint Instruction exceptions.
 - Breakpoint exceptions.
 - Watchpoint exceptions.
 - Vector Catch exceptions.
 - Software Step exceptions.
- In an implementation that supports the trapping of floating-point exceptions, exceptions caused by trapped IEEE floating-point exceptions, see [Floating-point exceptions and exception traps on page D1-1831](#).
- In some implementations, External aborts. External aborts are failed memory accesses, and include accesses to those parts of the memory system that occur during the address translation. The ARMv8 architecture permits, but does not require, implementations to treat such exceptions synchronously. See [External aborts on page D3-1997](#).

This remainder of this section contains the following:

- [Routing exceptions from Non-secure EL0 to EL2 on page D1-1827](#).
- [Routing debug exceptions in Non-secure state to EL2 on page D1-1827](#).
- [Synchronous exception prioritization for exceptions taken to AArch64 on page D1-1827](#).
- [Effect of Data Aborts on page D1-1830](#).
- [Floating-point exceptions and exception traps on page D1-1831](#).

D1.13.1 Routing exceptions from Non-secure EL0 to EL2

When the value of [HCR_EL2.TGE](#) is 1, any exception taken from Non-secure EL0 that would otherwise be taken to Non-secure EL1 is, instead, routed to EL2. This means that an application can execute at Non-secure EL0 without using any functionality at Non-secure EL1.

———— **Note** —————

- When EL2 is using AArch64, the [HCR_EL2.TGE](#) control applies regardless of whether Non-secure EL0 is using AArch32 or AArch64.
- Implementations typically use the following Exception level and software hierarchy in Non-secure state:
EL2 Hypervisor.
EL1 Operating system.
EL0 Application.

In such an implementation, setting [HCR_EL2.TGE](#) to 1 means that an application can run at Non-secure EL0 under the direct control of a hypervisor executing at EL2, with no operating system involvement.

D1.13.2 Routing debug exceptions in Non-secure state to EL2

When the value of [MDCR_EL2.TDE](#) is 1, debug exceptions taken from Non-secure state are routed to EL2. For more information see [Routing debug exceptions on page D2-1911](#).

When the value of [MDCR_EL2.TDE](#) is 1, each of the [MDCR_EL2](#).{TDRA, TDOSA, TDA} bits is treated as 1 for all purposes other than direct reads of the [MDCR_EL2](#).

D1.13.3 Synchronous exception prioritization for exceptions taken to AArch64

In principle, any single instruction can generate a number of different synchronous exceptions, between the fetching of the instruction, its decode, and eventual execution. For exceptions taken to an Exception level that is using AArch64, these are prioritized as follows, where 1 is the highest priority.

———— **Note** —————

The priority numbering in this list only shows the relative priorities of exceptions taken to an Exception level that is using AArch64. This numbering has no global significance and, for example, does not correlate with the equivalent AArch32 list in [Synchronous exception prioritization for exceptions taken to AArch32 state on page G1-4344](#).

1. Software Step exceptions. See [Software Step exceptions on page D2-1956](#).
2. PC alignment fault exceptions. See [PC alignment checking on page D1-1793](#).
3. Instruction Abort exceptions. See [Exception from an Instruction abort on page D1-1811](#) and [AArch64 state prioritization of synchronous aborts from a single stage of address translation on page D4-2110](#).
4. Breakpoint exceptions or Address Matching Vector Catch exceptions. See:
 - [Breakpoint exceptions on page D2-1921](#).
 - [Vector Catch exceptions on page D2-1955](#).

Vector Catch exceptions are only taken from AArch32 state.

———— **Note** —————

An Exception Trapping Vector Catch exception is generated on exception entry for an exception that has been prioritized as described in [Synchronous exception prioritization for exceptions taken to AArch32 state on page G1-4344](#). This means that it is outside the scope of the description of this section.

5. Illegal Execution state exceptions. See [Illegal return events from AArch64 state on page D1-1816](#).

6. Exceptions taken from EL1 to EL2 because of one of the following configuration settings:
- [HSTR_EL2.Tn](#).
 - [HCR_EL2.TIDCP](#).

———— **Note** —————

These are the controls for exceptions taken to AArch64 state. For exceptions taken to AArch32 state the equivalent controls are [HSTR.Tn](#) and [HCR.TIDCP](#).

7. Exceptions that occur as a result of attempting to execute an instruction that is UNDEFINED for one or more of the following reasons:
- Attempting to execute an unallocated instruction encoding, including an encoding for an instruction that is not implemented in the PE implementation.
 - Attempting to execute an instruction that is defined never to be accessible at the current Exception level regardless of any enables or traps.
 - Debug state execution of an instruction encoding that is unallocated in Debug state.
 - Non-debug state execution of an instruction encoding that is unallocated in Non-debug state.
 - Execution of an HVC instruction, when HVC instructions are disabled by [SCR_EL3.HCE](#) or [HCR_EL2.HCD](#).
 - Execution of an MSR or MRS instruction to [SP_EL0](#) when the value of [SPSel](#) is 0.
 - Execution of an HLT instruction when HLT instructions are disabled by [EDSCR.HDE](#).
 - In Debug state:
 - Execution of a DCP51 instruction in Non-secure EL0 when [HCR_EL2.TGE](#) is 1.
 - Execution of a DCP52 instruction in EL1 or EL0 when [SCR_EL3.NS](#) is 0 or when EL2 is not implemented.
 - Execution of a DCP53 instruction when [EDSCR.SDD](#) is 1 or when EL3 is not implemented.
 - When the value of [EDSCR.SDD](#) is 1, execution in EL2, EL1, or EL0 of an instruction that is trapped to EL3.
 - When executing in AArch32 state, execution of an instruction that is UNDEFINED as a result of any of:
 - Being in an IT block when [SCTLR_EL1.ITD](#) is 1.
 - Executing a SETEND instruction executed [SCTLR_EL1.SED](#).
 - Executing a [CP15DMB](#), [CP15DSB](#), or [CP15ISB](#) barrier instruction when [SCTLR_EL1.CP15BEN](#) is 0.

———— **Note** —————

These are the controls for exceptions taken to AArch64 state. For exceptions taken to AArch32 state the equivalent controls are [SCTLR](#).{ITD, SED, CP15BEN}, with additional controls [HSCTLR](#).{ITD, SED, CP15BEN}.

See [Disabling or enabling EL0 use of AArch32 deprecated functionality on page D1-1847](#)

- When executing in AArch32 state, execution of an instruction that is UNDEFINED because at least one of [FPCR](#).{Stride, Len} is nonzero, when programming these bits to nonzero values is supported. See [Floating-point exception traps on page G1-4416](#).

———— **Note** —————

- This case applies only when EL0 is using AArch32 and EL1 is using AArch64. The exception generated by the attempted execution at EL0 of the UNDEFINED instruction is taken to EL1 using AArch64.
- When EL1 is using AArch32, the corresponding controls are [FPSCR](#).{Stride, Len}, and any exception generated by the attempted execution at EL0 or EL1 of an instruction that is UNDEFINED because of a nonzero {Stride, Len} value is taken to EL1 using AArch32.

8. Exceptions taken to EL1, or taken to EL2 because the value of [HCR_EL2.TGE](#) is 1, that are generated because of configurable access to instructions, and that are not covered by any of priorities 1-7.

———— **Note** —————

When EL2 is using AArch32, the equivalent control for routing exceptions to EL2 is [HCR.TGE](#).

9. Exceptions taken from EL0 to EL2 because of one of the following configuration settings:
- [HSTR_EL2.Tn](#).
 - [HCR_EL2.TIDCP](#).

———— **Note** —————

These are the controls for exceptions taken to AArch64 state. For exceptions taken to AArch32 state the equivalent controls are [HSTR.Tn](#) and [HCR.TIDCP](#).

10. Exceptions taken to EL2 because of configuration settings in the [CPTR_EL2](#).

———— **Note** —————

These are the controls for exceptions taken to AArch64 state. For exceptions taken to AArch32 state, the equivalent controls are in the [HCPTR](#).

11. Exceptions taken to EL2 because of one of the following configuration settings:

- Any setting in [HCR_EL2](#), other than the TIDCP bit.
- Any setting in [CNTHCTL_EL2](#).
- Any setting in [MDCR_EL2](#).

———— **Note** —————

These are the controls for exceptions taken to AArch64 state. For exceptions taken to AArch32 state, the equivalent controls are:

- Any setting in [HCR](#), other than the TIDCP bit.
- Any setting in [CNTHCTL](#) or [HDCR](#).

12. Exceptions taken to EL2 because of configurable access to instructions, and that are not covered by any of priorities 1-11.
13. Exceptions caused by the SMC instruction being UNDEFINED because the value of [SCR_EL3.SMD](#) is 1.
14. Exceptions caused by the execution of an Exception generating instruction:
- For exceptions taken from AArch64 state, [Branches, Exception generating, and System instructions on page C3-156](#) defines these instructions.
 - When executing in AArch32 state, the exception-generating instructions are SVC, HVC, SMC, and BKPT.
15. Exceptions taken to EL3 because of configuration settings in the [CPTR_EL3](#).
16. Exceptions taken to EL3 from Secure EL1 using AArch32, because of execution of the instructions listed in [Traps to EL3 of Secure monitor functionality from Secure EL1 using AArch32 on page D1-1870](#).
17. Exceptions taken to EL3 from EL0, EL1, or EL2 because of configuration settings in the [MDCR_EL3](#).
18. Exceptions taken to EL3 because of configurable access to instructions, and that are not covered by any of priorities 1-17.
19. Trapped floating-point exceptions, if supported. See [Floating-point exceptions and exception traps on page D1-1831](#).
20. SP alignment faults. See [SP alignment checking on page D1-1793](#).

21. Data Abort exceptions other than a Data Abort exception generated by a Synchronous external abort that was not generated by a translation table walk. That is, any Data Abort exception that is not covered by item 23. See [Exception from a Data abort on page D1-1811](#) and [AArch64 state prioritization of synchronous aborts from a single stage of address translation on page D4-2110](#). It is IMPLEMENTATION DEFINED whether Synchronous external aborts are prioritized here or as item 23.
22. Watchpoint exceptions. See [Watchpoint exceptions on page D2-1940](#).
23. Data Abort exception generated by a Synchronous external abort that was not generated by a translation table walk, see [External aborts on page D3-1997](#). It is IMPLEMENTATION DEFINED whether Synchronous external aborts are prioritized here or as item 21.

For items 21-23, if an instruction results in more than one single-copy atomic memory access, the prioritization between synchronous exceptions generated on each of those different memory accesses is not defined by the architecture.

———— **Note** —————

Exceptions generated by a translation table walk are reported and prioritized as either an Instruction Abort exception, priority 3 in this list, or a Data Abort exception, priority 21 in this list. See also [AArch64 state prioritization of synchronous aborts from a single stage of address translation on page D4-2110](#).

D1.13.4 Effect of Data Aborts

If an instruction that stores to memory generates a Data Abort, the value of each memory location that instruction stores to is either:

- Unchanged, if one of the following applies:
 - An MMU fault is generated.
 - A Watchpoint exception is generated.
 - An external abort is generated, if that external abort is taken synchronously.

———— **Note** —————

If an external abort is taken asynchronously, using the SError interrupt, it is outside the scope of the architecture to define the effect of the store on the memory location, because it depends on the system-specific nature of the external abort. However, in general, ARM recommends that such memory locations are not updated.

- UNKNOWN for any location for which no exception and no debug event is generated.

For external aborts and Watchpoint exceptions, the size of a memory location is defined as being the size for which a memory access is single-copy atomic.

———— **Note** —————

For the definition of a single-copy atomic access, see [Properties of single-copy atomic accesses on page B2-83](#).

For Data Aborts from load or store instructions executed in AArch64 state, if the:

Data Abort is taken synchronously

- If the load or store instruction specifies writeback of a new base address, the base address is restored to the original value on taking the exception.
- If the instruction was a load to either the base address register or the offset register, that register is restored to the original value. Any other destination registers become UNKNOWN.
- If the instruction was a load that does not load the base address register or the offset register, then the destination registers become UNKNOWN.

Data Abort is taken asynchronously, using the SError interrupt

If the instruction was a load, the destination registers of the load take an UNKNOWN value if the SError interrupt is taken at a point in the instruction stream after the load.

D1.13.5 Floating-point exceptions and exception traps

Execution of a floating-point instruction, or an Advanced SIMD instruction that performs floating-point operations, can generate an exceptional condition, called a *floating-point exception*.

———— Note ————

In AArch64 state, a floating-point instruction performs only a single floating-point operation. However, an Advanced SIMD instruction that operates on floating-point values can perform multiple floating-point operations. Therefore, this section describes the handling of a floating-point exception on an *operation*, rather than on an *instruction*.

The ARMv8-A architecture supports synchronous exception generation in the event of any or all of the following floating-point exceptions:

- Input Denormal.
- Inexact.
- Underflow.
- Overflow.
- Divide by Zero.
- Invalid Operation.

Whether an implementation includes synchronous exception generation for these floating-point exceptions is IMPLEMENTATION DEFINED:

- For an implementation that does provide this capability, **FPCR**.{IDE, IXE, UFE, OFE, DZE, IOE} are the control bits that enable synchronous exception generation for each of the different floating-point exceptions.
- For an implementation that does not provide this capability, the **FPCR**.{IDE, IXE, UFE, OFE, DZE, IOE} bits are RAZ/WI.

———— Note ————

The ARMv8-A architecture does not support asynchronous reporting of floating-point exceptions.

When generating synchronous exceptions for one or more floating-point exceptions is enabled, the synchronous exceptions generated by the floating-point exception traps are taken to the lowest Exception level that can handle such an exception, while adhering to the rule that an exception can never be taken to a lower Exception level. This means that trapped floating-point exceptions taken:

- From EL0 are taken to EL1, unless they are taken from Non-secure state when the value of **HCR_EL2.TGE** is 1, when they are taken to EL2 instead.
- From EL1 are taken to EL1.
- From EL2 are taken to EL2.
- From EL3 are taken to EL3.

The exception is reported in the **ESR_ELx** for the Exception level to which it is taken.

In an implementation that includes synchronous exception generation for floating-point exceptions in AArch64 state:

- The registers that are presented to the exception handler are consistent with the state of the PE immediately before the instruction that caused the exception. An implementation is permitted not to restore the cumulative exception bits in the event of such an exception. For more information see *Combinations of floating-point exceptions on page D1-1832*.
- When the execution of separate operations in separate SIMD elements causes multiple floating-point exceptions, the **ESR_ELx** reports one exception associated with one element that the instruction uses. The architecture does not specify which element is reported, however the element that is reported is identified in the **ESR_ELx**.

The `AArch64.FPTrappedException()` and `FPProcessException()` pseudocode functions describe the handling of trapped floating-point exceptions generated in AArch64 state.

Combinations of floating-point exceptions

Many pseudocode functions perform *floating-point operations*, including `FixedToFP()`, `FAdd()`, `FPCompare()`, `FPCompareEQ()`, `FPCompareGE()`, `FPCompareGT()`, `FPDiv()`, `FMax()`, `FMin()`, `FMul()`, `FMulAdd()`, `FRecipEstimate()`, `FRecipStepFused()`, `FPSqrtEstimate()`, `FPSqrtStepFused()`, `FPSqrt()`, `FSub()`, and `FToFixed()`. All of these operations can generate floating-point exceptions.

Note

`FPAbs()` and `FPNeg()` are not classified as *floating-point operations* because:

- They cannot generate floating-point exceptions.
- The floating-point operation behavior described in the following sections does not apply to them:
 - [Flush-to-zero on page A1-51](#).
 - [NaN handling and the Default NaN on page A1-52](#).

More than one floating-point exception can occur on the same operation. The only combinations of floating-point exceptions that can occur are:

- Overflow with Inexact.
- Underflow with Inexact.
- Input Denormal with other floating-point exceptions.

The priority order of these floating-point exceptions is that the Inexact exception is treated as lowest priority, and the Input Denormal exception is treated as highest priority.

Some floating-point instructions specify more than one floating-point operation, as indicated by the pseudocode descriptions of the instruction. In such cases, a floating-point exception on one operation is treated as higher priority than a floating-point exception on another operation if the occurrence of the second floating-point exception depends on the result of the first operation. Otherwise, it is CONstrained UNPREDICTABLE which floating-point exception is treated as higher priority, where the exception prioritized might differ between different instances of the same two floating-point exceptions being generated on the same operation during execution of the instruction.

When none of the floating-point exceptions caused by an operation is trapped, any floating-point exception that occurs causes the associated cumulative bit in the `FPSR` to be set to 1.

When a floating-point exception is trapped:

- It is IMPLEMENTATION DEFINED whether the `FPSR` is restored when the trapped floating-point exception is taken. If the `FPSR` is not restored then, then it is CONstrained UNPREDICTABLE which untrapped floating-point exception, if any, are indicated by the corresponding `FPSR` cumulative exception bits having the value 1.
- In the `ESR_ELx` for the Exception level to which the trapped exception is taken, the value of the floating-point exception trapped bit for the highest priority trapped floating-point exception must be 1.
In this `ESR_ELx`:
 - The value of the floating-point exception trapped bit for any other untrapped floating-point exception generated by the same operation must be 0. This applies to both higher priority and lower priority untrapped floating point exceptions.
 - The value of the floating-point exception trapped bit for any lower priority trapped floating-point exception generated by the same operation might be 1, but the architecture does not require this.

For trapped floating-point exceptions from Advanced SIMD instructions, the architecture does not define the floating-point exception prioritization between different elements of the instruction. The architectural requirements for floating-point exception prioritization apply only to multiple floating-point exceptions generated on the same element of an Advanced SIMD operation.

———— **Note** —————

An implementation might provide information about a lower priority or untrapped floating-point exceptions in an IMPLEMENTATION DEFINED way, for example using an IMPLEMENTATION DEFINED register.

D1.14 Asynchronous exception types, routing, masking and priorities

In the ARMv8-A architecture, asynchronous exceptions that are taken to AArch64 state are also known as *interrupts*.

There are two types of interrupts:

Physical interrupts Are signals sent to the PE from outside the PE. They are:

- SError. System Error.
- IRQ.
- FIQ.

Virtual interrupts Are interrupts that software executing at EL2 can enable and make pending. A virtual interrupt is taken from Non-secure EL0 or Non-secure EL1 to Non-secure EL1.

Virtual interrupts have names that correspond to the physical interrupts:

- vSError.
- vIRQ.
- vFIQ.

Note

- For information about how virtual interrupts might be used see [Virtual interrupt usage model on page D1-1783](#).
- The SError interrupt replaces the ARMv7 asynchronous abort. The new name better describes the nature of the exception, and means that, in AArch64 state, it is categorized as a unique exception class, with EC encoding 0x2F.

An external abort generated by the memory system might be taken asynchronously using the SError interrupt. The effect of a failed memory access is described in [Effect of Data Aborts on page D1-1830](#).

Each physical interrupt type can be assigned a target Exception level of EL1, EL2 or EL3, as shown in [Asynchronous exception routing](#).

When an interrupt occurs:

- On taking an SError or a vSError interrupt to an Exception level using AArch64, the Exception Syndrome register for that Exception level is updated with the encoding for an SError interrupt. See [Exception classes and the ESR_ELx syndrome registers on page D1-1801](#).
- On taking an IRQ, vIRQ, FIQ or vFIQ interrupt to an Exception level using AArch64, the Exception Syndrome register for that Exception level is not updated.

The remainder of this section contains the following:

- [Asynchronous exception routing](#).
- [Asynchronous exception masking on page D1-1836](#).
- [Virtual interrupts on page D1-1839](#).
- [Prioritization and recognition of interrupts on page D1-1841](#).
- [Taking an interrupt or other exception during a multiple-register load or store on page D1-1841](#).

D1.14.1 Asynchronous exception routing

The following tables show the routing of physical interrupts when the highest implemented Exception level is using AArch64:

- For implementations that include both EL2 and EL3, see [Table D1-12 on page D1-1835](#).
- For implementations that include EL3 but not EL2, see [Table D1-13 on page D1-1836](#).
- For implementations that include EL2 but not EL3, see [Table D1-14 on page D1-1836](#).

In the tables:

C Indicates that the interrupt is not taken, regardless of the Process state interrupt mask.

n/a Not applicable:

- In an implementation that includes EL3:
 - The PE cannot be executing at EL2 when the value of `SCR_EL3.NS` is 0.
 - The PE cannot be executing at EL3 when the value of `SCR_EL3.NS` is 1.
- In an implementation that includes EL2, the PE cannot be executing at Non-secure EL1 when the value of `HCR.TGE` is 1.

HCR In Table D1-12, including in the table footnote:

- When EL2 is using AArch64 `HCR` refers to the AArch64 register `HCR_EL2`.
- When EL2 is using AArch32 `HCR` refers to the AArch32 register `HCR`.

When the *Effective value* of `HCR`.{E2H, TGE} is:

- {0, 1}** The *Effective value* of each of the `HCR`.{AMO, IMO, FMO} fields is 1. The virtual exceptions are disabled.
- {1, 1}** The *Effective value* of each of the `HCR`.{AMO, IMO, FMO} fields is 0.

Table D1-12 Routing when both EL3 and EL2 are implemented

SCR_EL3			HCR			Target Exception level when executing at:				
NS	EA IRQ FIQ	RW	E2H^a	TGE	AMO IMO FMO	EL0	EL1	EL2	EL3	
0	0	x	x	x	x	EL1	EL1	n/a	C	
	1	x	x	x	x	EL3	EL3	n/a	EL3	
1	0	x	x	0	1	EL2	EL2	EL2	n/a	
			0	1	1	EL2	n/a	EL2	n/a	
	0	x	x	0	0	EL1	EL1	EL2	n/a	
			1	1	0	EL1	n/a	EL2	n/a	
	1	x	x	x	0	0	EL1	EL1	C	n/a
				1	1	0	EL1	n/a	C	n/a
	1	x	x	x	x	x	EL3	EL3	EL3	n/a

a. When the implementation does not include `ARMv8.1-VHE`, the `HCR_EL2.E2H` field is not implemented and behavior is as if the value of E2H is 0.

Table D1-13 Routing when EL3 is implemented and EL2 is not implemented

SCR_EL3		Target Exception level when executing at		
NS	EA IRQ FIQ	EL0	EL1	EL3
0	0	EL1	EL1	C
	1	EL3	EL3	EL3
1	0	EL1	EL1	n/a
	1	EL3	EL3	n/a

Table D1-14 Routing when EL3 is not implemented and EL2 is implemented

HCR_EL2			Target Exception level when executing at		
E2H^a	TGE	AMO IMO FMO	EL0	EL1	EL2
0	1	1	EL2	n/a	EL2
x	0	0	EL1	EL1	C
		1	EL2	EL2	EL2
1	1	0	EL1	n/a	C

a. When the implementation does not include [ARMv8.1-VHE](#), the `HCR_EL2.E2H` field is not implemented and behavior is as if the value of E2H is 0.

D1.14.2 Asynchronous exception masking

When an interrupt is masked, it means that it cannot be taken. Instead, it remains pending.

When executing in AArch64 state, interrupts are masked implicitly when the target Exception level of the interrupt is lower than the current Exception level.

In addition, interrupts can be masked when the target Exception level is the current Exception level. The controls for this are:

Serror [PSTATE.A](#)

IRQ [PSTATE.I](#)

FIQ [PSTATE.F](#)

When the target Exception level is higher than the current Exception level:

- If the target Exception level is EL2 or EL3, the interrupt cannot be masked by the `PSTATE.{A, I, F}` bits.
- If the target Exception level is EL1, the interrupt can be masked by the `PSTATE.{A, I, F}` bits.

————— **Note** —————

- The ability to execute in EL0 with interrupts to EL1 masked is required by some user level driver code.
- The `PSTATE.{A, I, F}` bits can mask both physical interrupts and virtual interrupts.

- The ARMv8-A architecture does not support *Non-maskable FIQ* (NMFI) operations. This means that it does not provide a configuration option to override the masking of FIQs by `PSTATE.F`.

On taking any exception to an Exception level using AArch64, all of `PSTATE.{A, I, F}` are set to 1, masking all interrupts that target that Exception level.

The following tables show the masking of physical interrupts when the highest implemented Exception level is using AArch64:

- For implementations that include both EL2 and EL3, see [Table D1-15](#).
- For implementations that include EL3 but not EL2, see [Table D1-16 on page D1-1838](#).
- For implementations that include EL2 but not EL3, see [Table D1-17 on page D1-1839](#).

For the masking of virtual interrupts, see [Virtual interrupts on page D1-1839](#).

In the tables:

- A** When the interrupt is asserted it is taken regardless of the value of the Process state interrupt mask.
- B** When the interrupt is asserted it is subject to the corresponding Process state mask. If the value of the mask is 1 then the interrupt is not taken. If the value of the mask is 0 the interrupt is taken.
- C** When the interrupt is asserted it is not taken, regardless of the value of the Process state interrupt mask.
- When the value of `SCR_EL3.RW` is 0, EL2 is using AArch32, and there is no `HCR.E2H` bit.
- n/a** Not applicable:

- In an implementation that includes EL3, the PE cannot be executing at EL2 when the value of `SCR_EL3.NS` is 0.

The PE cannot be executing at Non-secure EL1 when the value of `HCR.TGE` is 1.

HCR In [Table D1-15](#), including in the table footnote:

- When EL2 is using AArch64 `HCR` refers to the AArch64 register `HCR_EL2`.
- When EL2 is using AArch32 `HCR` refers to the AArch32 register `HCR`.

When the *Effective value* of `HCR.{E2H, TGE}` is:

- {0, 1}** The *Effective value* of each of the `HCR.{AMO, IMO, FMO}` fields is 1. The virtual exceptions are disabled.
- {1, 1}** The *Effective value* of each of the `HCR.{AMO, IMO, FMO}` fields is 0.

Table D1-15 Physical interrupt target and masking when both EL3 and EL2 are implemented

SCR_EL3			HCR			Target Exception level	Effect of the interrupt mask when executing at:			
NS	EA IRQ FIQ	RW	E2H^a	TGE	AMO IMO FMO		EL0	EL1	EL2	EL3
0	0	x	x	x	x	EL1	B	B	n/a	C
	1	x	x	x	x	EL3	A	A	n/a	B

Table D1-15 Physical interrupt target and masking when both EL3 and EL2 are implemented (continued)

SCR_EL3			HCR			Target Exception level	Effect of the interrupt mask when executing at:					
NS	EA IRQ FIQ	RW	E2H ^a	TGE	AMO IMO FMO		EL0	EL1	EL2	EL3		
1	0	0	-	0	0	EL1	B ^b	B ^b	B ^b	C		
					1	EL2	A ^b	A ^b	B ^b	C		
			1	x	1	x	EL2	A ^b	n/a	B ^b	C	
					x	0	0	EL1	B	B	C	C
	1	x	x	x	1	EL2	A	A	B	C		
					0	1	x	EL2	A	n/a	B	C
					1	1	x	EL2	B	n/a	B	C
	1	x				EL3	A	A	A	B		

- When the implementation does not include [ARMv8.1-VHE](#), the `HCR_EL2.E2H` field is not implemented and behavior is as if the value of E2H is 0.
- In these cases, the exception is taken from an Exception level using AArch32 to an Exception level using AArch32, and therefore the masking rules defined in [Asynchronous exception masking controls on page G1-4368](#) apply.

Table D1-16 Physical interrupt target and masking when EL3 is implemented and EL2 is not implemented

SCR_EL3		Target Exception level	Effect of the interrupt mask when executing at:		
NS	EA IRQ FIQ		EL0	EL1	EL3
x	0	EL1	B	B	C
	1	EL3	A	A	B

Table D1-17 Physical interrupt target and masking when EL3 is not implemented and EL2 is implemented

HCR_EL2			Target Exception level	Effect of the interrupt mask when executing at:		
E2H ^a	TGE	AMO IMO FMO		EL0	EL1	EL2
x	0	0	EL1	B	B	C
		1	EL2	A	A	B
0	1	x	EL2	A	n/a	B
1	1	x	EL2	B	n/a	B

a. If the implementation does not include [ARMv8.1-VHE](#), the HCR.E2H field is not implemented and behavior is as if the value of E2H is 0.

D1.14.3 Virtual interrupts

When the value of HCR_EL2.TGE is 0, setting an HCR_EL2.{FMO, IMO, AMO} routing control bit to 1 enables the corresponding virtual interrupt. When the value of HCR_EL2.TGE is 1 all virtual interrupts are disabled.

Virtual interrupts can only be taken from Non-secure EL0 or Non-secure EL1 to Non-secure EL1. When a virtual interrupt type is enabled, that type of interrupt can be generated by:

- Software setting the corresponding virtual interrupt pending bit, HCR_EL2.{VSE, VI, VF}, to 1.
- For a vIRQ or a vFIQ, by an IMPLEMENTATION DEFINED mechanism. This might be a signal from an interrupt controller. See, for example, the *ARM Generic Interrupt Controller Architecture Specification*.

———— **Note** —————

For a usage model for virtual interrupts, see [Virtual interrupt usage model](#) on page D1-1783.

When a virtual interrupt is disabled:

- It cannot be taken.
- It cannot be seen in the [ISR_EL1](#).

Each virtual interrupt type can be masked when execution is in Non-secure EL1 or EL0, by using the same Process State mask bits that mask the physical interrupts, [PSTATE](#).{A, I, F}.

When execution is in Secure state, or at EL2, all types of virtual interrupt are always masked.

[Table D1-18](#) summarizes the bits that enable virtual interrupts and the bits that cause virtual interrupts to be pending.

Table D1-18 HCR_EL2 interrupt control bits

Virtual interrupt type	Enable control ^a	Cause a virtual interrupt to be pending
vSError	HCR_EL2.AMO	HCR_EL2.VSE
vIRQ	HCR_EL2.IMO	HCR_EL2.VI
vFIQ	HCR_EL2.FMO	HCR_EL2.VF

a. Applies only when the value of HCR_EL2.TGE is 0, otherwise the virtual interrupts are disabled.

On taking a vIRQ or a vFIQ interrupt, the corresponding virtual interrupt pending bit in the [HCR_EL2](#) retains its state.

On taking a vSError interrupt, [HCR_EL2.VSE](#) is cleared to 0.

———— **Note** ————

This means that if the virtual interrupt pending bits are used, the vIRQ or vFIQ exception handler must cause software executing at EL2 or EL3 to set their corresponding virtual interrupt pending bits to 0.

As with physical interrupts:

- Taking a vSError interrupt to an Exception level using AArch64 updates [ESR_EL1](#) with the dedicated encoding for an SError interrupt. For the encoding, see [Exception classes and the ESR_ELx syndrome registers on page D1-1801](#).
- Taking a vIRQ or a vFIQ interrupt to an Exception level using AArch64 does not update the [ESR_EL1](#).

The following table shows the masking of virtual interrupts when the highest implemented Exception level is using AArch64. In the table:

- B** When the interrupt is asserted it is subject to the corresponding Process state mask. If the value of the mask is 1 then the interrupt is not taken. If the value of the mask is 0 the interrupt is taken.
- C** When the interrupt is asserted it is not taken, regardless of the value of the Process state mask.
- n/a** Not applicable:

- In an implementation that includes EL3, the PE cannot be executing at EL2 when the value of [SCR_EL3.NS](#) is 0.
- The PE cannot be executing at Non-secure EL1 when the value of [HCR.TGE](#) is 1.

HCR In [Table D1-19](#), including in the table footnote:

- When EL2 is using AArch64 [HCR](#) refers to the AArch64 register [HCR_EL2](#).
- When EL2 is using AArch32 [HCR](#) refers to the AArch32 register [HCR](#).

When the *Effective value* of [HCR](#).{E2H, TGE} is:

- {0, 1}** The *Effective value* of each of the [HCR](#).{AMO, IMO, FMO} fields is 1. The virtual exceptions are disabled.
- {1, 1}** The *Effective value* of each of the [HCR](#).{AMO, IMO, FMO} fields is 0.

Table D1-19 Virtual interrupt masking

SCR_EL3		HCR			Effect of the interrupt mask when executing at:			
NS	EA IRQ FIQ	E2H^a	TGE	AMO IMO FMO	EL0	EL1	EL2	EL3
0	x	x	x	x	C	C	n/a	C
1	x	x	0	0	C	C	C	C
				1	B	B	C	C
			1	x	C	n/a	C	C

a. If EL2 is using AArch32 or the implementation does not include [ARMv8.1-VHE](#), the [HCR.E2H](#) field is not implemented and behavior is as if the value of E2H is 0.

D1.14.4 Prioritization and recognition of interrupts

The ARMv8-A architecture does not define when interrupts are taken. The prioritization of interrupts, including virtual interrupts, is IMPLEMENTATION DEFINED.

———— **Note** —————

As indicated at the start of *Asynchronous exception types, routing, masking and priorities* on page D1-1834, in AArch64 state all possible asynchronous exceptions are defined as *interrupts*.

Any interrupt that is pending before one of the following context synchronizing events is taken before the first instruction after the context synchronizing event, provided that the pending interrupt is not masked:

- Execution of an ISB instruction.
- Exception entry.
- Exception return.
- Exit from Debug state.

———— **Note** —————

- If the first instruction after the context synchronizing event generates a synchronous exception, then the architecture does not define whether the PE takes the interrupt or the synchronous exception first.
 - The *ISR_EL1* identifies any pending interrupts.
 - Interrupts are masked when the PE is in Debug state, and therefore this list of context synchronizing events does not include the DCPS and DRPS instructions.
-

In the absence of a specific requirement to take an interrupt, the architecture only requires that unmasked pending interrupts are taken in finite time.

If an unmasked interrupt was pending but is changed to not pending before it is taken, then the architecture permits the interrupt to be taken, but does not require this to happen. If the interrupt is taken then it must be taken before the first *Context synchronization event* after the interrupt was changed to not pending.

D1.14.5 Taking an interrupt or other exception during a multiple-register load or store

In AArch64 state, interrupts can be taken during a sequence of memory accesses caused by a single load or store instruction. This is true regardless of the memory type being accessed.

If an interrupt, or another exception, is taken from AArch64 during the execution of an instruction that performs a sequence of memory accesses, rather than a single single-copy atomic access, then:

- For a load, any register being loaded by the instruction other than ones used in the generation of the address by the instruction, can contain an UNKNOWN value. Registers used in the generation of the address are restored to their initial value.
- For a store, any data location being stored to by the instruction can contain an UNKNOWN value.
- For either a load or a store, if the instruction specifies writeback of the base address, then that register is restored to its initial value.

———— **Note** —————

- This interrupt behavior is in contrast to behavior in AArch32 state, when interrupts cannot be taken during a sequence of memory accesses caused by a single load or store instruction.
 - In both Execution states, synchronous data abort exceptions can be taken during the execution of an instruction that performs a sequence of memory accesses.
 - Software must avoid using multiple-register load and store instructions for accesses to Device memory, particularly to Device memory with the non-Gathering attribute, because an exception taken during the load or store can result in repeated accesses.
-

D1.15 Configurable instruction enables and disables, and trap controls

This section describes the controls provided by AArch64 state for enabling, disabling, and trapping particular instructions. Each control is categorized as an *instruction enable*, an *instruction disable*, or a *trap control*:

Instruction enables and instruction disables

Enable or disable the use of one or more particular instructions at a particular Exception level and Security state.

When an instruction is disabled as a result of an instruction enable or disable, it is UNDEFINED.

Trap controls A trap control determines whether one or more particular instructions, whenever executed at a particular Exception level, are *trapped*.

A trapped instruction generates a *Trap exception*.

For trap controls provided by:

EL1 Trap exceptions are taken to EL1, unless routed from Non-secure EL0 to EL2 because [HCR_EL2.TGE](#) is 1 as described in [Routing exceptions from Non-secure EL0 to EL2 on page D1-1827](#).

For descriptions of these controls see [EL1 configurable controls on page D1-1843](#).

EL2 Trap exceptions are taken to EL2.

For descriptions of these controls see [EL2 configurable controls on page D1-1851](#).

EL3 Trap exceptions are taken to EL3.

For descriptions of these controls see [EL3 configurable controls on page D1-1869](#).

Note

The definitions of *traps* and *enables and disables* overlap, and the classification of some controls is historical. In AArch64 state, the most significant characteristic of an exception report is the [ESR_ELx.EC](#) value with which it is reported. Describing a register control field as an instruction enable, an instruction disable, or a trap control, gives no indication of how an exception that is generated as a consequence of the value of that field is handled or reported.

An exception generated as a result of an instruction enable or disable, or a trap control, is only taken if both of the following apply:

- The instruction generating the exception does not also generate a higher priority exception. [Synchronous exception prioritization for exceptions taken to AArch64 on page D1-1827](#) defines the prioritization of different exceptions on the same instruction.
- The instruction is not UNPREDICTABLE or CONSTRAINED UNPREDICTABLE in the PE state it is executed in. UNPREDICTABLE and CONSTRAINED UNPREDICTABLE instructions can generate exceptions as a result of these controls, but the architecture does not require them to do so.

Exceptions generated as a result of these controls are synchronous exceptions.

Exceptions are reported in the [ESR_ELx](#), with an EC value that indicates the Exception class, and:

- Many cases, including all traps, are reported with a non-zero EC value and an associated syndrome.
- Some cases where an instruction is UNDEFINED are reported with an EC value `0x00`, the value for an exception for an unknown or uncategorized reason, and in these cases no syndrome is provided. [ISS encoding for exceptions with an unknown reason on page D7-2259](#) identifies the cases that are reported with EC value `0x00`.

Table D1-8 on page D1-1802 lists the EC values that are used for exceptions that result from traps, enables, and disables.

Note

- A particular control might have a mnemonic that suggests it is different type of control to the control type it is categorized as. For example, SCTLR_EL1.DZE is a trap control even though DZE means DC ZVA Enable.
- In addition to the controls described in this section, a *routing control*, HCR_EL2.TGE, can be used to route exceptions from EL0 to EL2. See *Routing exceptions from Non-secure EL0 to EL2* on page D1-1827.
- An implementation might provide additional controls, in IMPLEMENTATION DEFINED registers, to provide control of trapping of IMPLEMENTATION DEFINED features.

This section is organized as follows:

- *Register access instructions.*
- *EL1 configurable controls.*
- *EL2 configurable controls* on page D1-1851.
- *EL3 configurable controls* on page D1-1869.

D1.15.1 Register access instructions

When an instruction is disabled or trapped, the exception is taken before execution of the instruction. This means that if the instruction is a register access instruction:

- No access is made before the exception is taken.
- Side-effects that are normally associated with the access do not occur before the exception is taken.

D1.15.2 EL1 configurable controls

These controls are in _EL1 System registers. The resulting exceptions might be taken from either Execution state. SPSR_EL1.M[4] indicates which Execution state the exception was taken from.

Table D1-20 shows the _EL1 System registers that contain these controls.

Table D1-20 _EL1 registers that contain instruction enables and disables, and trap controls

Register name	Register description
SCTLR_EL1	System Control Register, EL1
CPACR_EL1	Architectural Feature Access Control Register
MDSCR_EL1	Monitor System Debug Control Register
PMUSERENR_EL0	Performance Monitors User Enable Register

Table D1-21 summarizes the controls.

Table D1-21 Instruction enables and disables, and trap controls, provided by EL1

Control	Control type ^a	Description
SCTLR_EL1.UCI	T	Traps to EL1 of EL0 execution of cache maintenance instructions on page D1-1844
SCTLR_EL1.UCT	T	Traps to EL1 of EL0 accesses to the CTR_EL0 on page D1-1845
SCTLR_EL1.{nTWE, nTWI}	T	Traps to EL1 of EL0 execution of WFE and WFI instructions on page D1-1845

Table D1-21 Instruction enables and disables, and trap controls, provided by EL1 (continued)

Control	Control type ^a	Description
SCTLR_EL1.DZE	T	Traps to EL1 of EL0 execution of DC ZVA instructions on page D1-1846
SCTLR_EL1.UMA	T	Traps to EL1 of EL0 accesses to the PSTATE.{D, A, I, F} interrupt masks on page D1-1846
SCTLR_EL1.{SED, ITD}	D	Disabling or enabling EL0 use of AArch32 deprecated functionality on page D1-1847
SCTLR_EL1.CP15BEN	E	
CPACR_EL1.TTA	T	Traps to EL1 of EL0 and EL1 System register accesses to the trace registers on page D1-1847
CPACR_EL1.FPEN	T	Traps to EL1 of EL0 and EL1 accesses to SIMD and floating-point functionality on page D1-1848
MDSR_EL1.TDCC	T	Traps to EL1 of EL0 accesses to the Debug Communications Channel (DCC) registers on page D1-1848
CNTKCTL_EL1.{ELOPTEN, EL0VTEN, EL0PCTEN, EL0VCTEN}	T	Traps to EL1 of EL0 accesses to the Generic Timer registers on page D1-1849
PMUSERENR_EL0.{ER, CR, SW, EN}	T	Traps to EL1 of EL0 accesses to Performance Monitors registers on page D1-1850

a. See Table D1-22.

Table D1-22 Control types, for exceptions taken to EL1

Abbreviation	Type	See
D	Disable	Instruction enables and instruction disables on page D1-1842
E	Enable	Instruction enables and instruction disables on page D1-1842
T	Trap	Trap controls on page D1-1842

Traps to EL1 of EL0 execution of cache maintenance instructions

SCTLR_EL1.UCI traps EL0 execution of cache maintenance instructions to EL1:

- 1** EL0 execution of cache maintenance instructions is not trapped to EL1.
- 0** Any attempt to execute a cache maintenance instruction at EL0 is trapped to EL1.

Table D1-23 shows the instructions that are trapped to EL1, and how the exceptions are reported in ESR_EL1:

Table D1-23 Instructions trapped to EL1 when SCTLR_EL1.UCI is 0

Traps from	Trapped instructions	Syndrome reporting in ESR_EL1
AArch64 state	DC CVAU, DC CIVAC, DC CVAC, DC CVAP, IC IVAU	Trapped AArch64 MSR, MRS, or system instruction, using EC value 0x18 ^a
AArch32 state	n/a	n/a

a. If HCR_EL2.TGE is 1 and the PE is in Non-secure state, these Trap exceptions are routed to EL2 and are reported in ESR_EL2 using the same EC values as shown in the table.

Traps to EL1 of EL0 accesses to the CTR_ELO

SCTLR_EL1.UCT traps EL0 accesses to the CTR_ELO to EL1:

- 1** EL0 accesses to the CTR_ELO are not trapped to EL1.
- 0** EL0 accesses to the CTR_ELO are trapped to EL1.

Table D1-24 shows how the exceptions are reported in ESR_EL1:

Table D1-24 Register accesses trapped to EL1 when SCTLR_EL1.UCT is 0

Traps from	Register	Syndrome reporting in ESR_EL1
AArch64	CTR_ELO	Trapped AArch64 MSR, MRS, or system instruction, using EC value 0x18 ^a
AArch32	n/a	n/a

- a. If HCR_EL2.TGE is 1 and the PE is in Non-secure state, these Trap exceptions are routed to EL2 and are reported in ESR_EL2 using the same EC values as shown in the table.

Traps to EL1 of EL0 execution of WFE and WFI instructions

SCTLR_EL1.{nTWE, nTWI} trap EL0 execution of WFE and WFI instructions to EL1:

SCTLR_EL1.nTWE

- 1** EL0 execution of WFE instructions is not trapped to EL1.
- 0** Any attempt to execute a WFE instruction at EL0 is trapped to EL1, if the instruction would otherwise have caused the PE to enter a low-power state.

SCTLR_EL1.nTWI

- 1** EL0 execution of WFI instructions is not trapped to EL1.
- 0** Any attempt to execute a WFI instruction at EL0 is trapped EL1, if the instruction would otherwise have caused the PE to enter a low-power state.

Table D1-25 shows how the exceptions are reported in ESR_EL1:

Table D1-25 Instructions trapped to EL1 when SCTLR_EL1.{nTWE, nTWI} are 0

Trap control	Traps from	Trapped instructions	Syndrome reporting in ESR_EL1
SCTLR_EL1.nTWE	Both Execution states	WFE	Trapped WFI or WFE instruction, using EC value 0x01 ^a
SCTLR_EL1.nTWI		WFI	

- a. If HCR_EL2.TGE is 1 and the PE is in Non-secure state, these Trap exceptions are routed to EL2 and are reported in ESR_EL2 using the same EC values as shown in the table.

In AArch32 state, the attempted execution of a conditional WFE or WFI instruction is only trapped if the instruction passes its Condition code check.

————— Note —————

Since a WFE or WFI can complete at any time, even without a Wakeup event, the traps on WFE or WFI are not guaranteed to be taken, even if the WFE or WFI is executed when there is no Wakeup event. The only guarantee is that if the instruction does not complete in finite time in the absence of a Wakeup event, the trap will be taken.

For more information about these instructions, and when they can cause the PE to enter a low-power state, see:

- [Wait for Event mechanism and Send event on page D1-1879.](#)
- [Wait For Interrupt on page D1-1882.](#)

Traps to EL1 of EL0 execution of DC ZVA instructions

[SCTLR_EL1.DZE](#) traps EL0 execution of DC ZVA instructions to EL1:

- 1** EL0 execution of DC ZVA instructions is not trapped to EL1.
- 0** Any attempt to execute a DC ZVA instruction at EL0 is trapped to EL1. Reading the [DCZID_EL0](#) returns a value that indicates that DC ZVA instructions are not implemented.

[Table D1-26](#) shows how the exceptions are reported in [ESR_EL1](#):

Table D1-26 Instruction trapped to EL1 when [SCTLR_EL1.DZE](#) is 0

Traps from	Trapped instruction	Syndrome reporting in ESR_EL1
AArch64 state	DC ZVA	Trapped AArch64 MSR, MRS, or system instruction, using EC value 0x18 ^a
AArch32 state	n/a	n/a

- a. If [HCR_EL2.TGE](#) is 1 and the PE is in Non-secure state, these Trap exceptions are routed to EL2 and are reported in [ESR_EL2](#) using the same EC values as shown in the table.

Traps to EL1 of EL0 accesses to the PSTATE.{D, A, I, F} interrupt masks

[SCTLR_EL1.UMA](#) traps EL0 execution of MSR and MRS instructions that access the [PSTATE.{D, A, I, F}](#) masks to EL1:

- 1** EL0 execution of MSR or MRS instructions that access the [DAIF](#) is not trapped to EL1.
- 0** Any attempt at EL0 to execute an MSR or an MRS instruction that accesses the [DAIF](#) is trapped to EL1.

[Table D1-27](#) shows how the exceptions are reported in [ESR_EL1](#):

Table D1-27 Instructions trapped to EL1 when [SCTLR_EL1.UMA](#) is 0

Taken from	Disabled instructions	Syndrome reporting in ESR_EL1
AArch64 state	MRS , MSR (register) , MSR (immediate) , that access the DAIF	Trapped AArch64 MSR, MRS, or system instruction, using EC value 0x18 ^a
AArch32 state	n/a	n/a

- a. If [HCR_EL2.TGE](#) is 1 and the PE is in Non-secure state, these Trap exceptions are routed to EL2 and are reported in [ESR_EL2](#) using the same EC values as shown in the table.

Disabling or enabling EL0 use of AArch32 deprecated functionality

Table D1-28 shows the deprecated AArch32 functionality that might have disable controls in the `SCTLR_EL1`:

- The SED control is always implemented.
- Whether each of the ITD, CP15BEN controls is implemented is IMPLEMENTATION DEFINED. If a control is not implemented then the associated functionality cannot be disabled.

These `SCTLR_EL1` controls apply only to execution at EL0 using AArch32. When an instruction is disabled by one of these controls, it is UNDEFINED at EL0 using AArch32. Table D1-28 shows how the exceptions are reported in `ESR_EL1`:

Table D1-28 EL1 controls for disabling and enabling EL0 use of AArch32 deprecated functionality

Deprecated AArch32 functionality	Instruction enable or disable in the <code>SCTLR_EL1</code>	Disabled instructions	Syndrome reporting in <code>ESR_EL1</code> ^a
SETEND instructions	SED ^b	SETEND instructions	Exception for an unknown reason, using EC value 0x00
Some uses of IT instructions	ITD ^c	See the <code>SCTLR_EL1.IT</code> description	
Accesses to the <code>CP15DMB</code> , <code>CP15DSB</code> , and <code>CP15ISB</code> barrier instructions	CP15BEN ^d	MCR accesses to the <code>CP15DMB</code> , <code>CP15DSB</code> , and <code>CP15ISB</code> instructions	

- If `HCR_EL2.TGE` is 1 and the PE is in Non-secure state, the exception is routed to EL2 and reported in `ESR_EL2` using the EC value shown in the table.
- SETEND instruction disable. SETEND instructions are disabled when the value of this field is 1.
- IT instruction disable. If this control is implemented, some uses of IT instructions are disabled when the value of this field is 1.
- System register (coproc==0b1111) memory barrier enable. If this control is implemented, the specified register accesses are disabled when the value of CP15BEN is 0.

Note

- The uses of the IT instruction, and use of the `CP15DMB`, `CP15DSB`, and `CP15ISB` barrier instructions, are deprecated for performance reasons.
- The `SCTLR` provides similar controls that apply when EL1 is using AArch32, and the `HSCTLR` provides similar controls that apply when EL2 is using AArch32.

Traps to EL1 of EL0 and EL1 System register accesses to the trace registers

`CPACR_EL1.TTA` traps EL0 and EL1 System register accesses to the trace registers to EL1.

- | | |
|----------|---|
| 1 | EL0 and EL1 System register accesses to the trace registers are trapped to EL1. |
| 0 | EL0 and EL1 System register accesses to the trace registers are not trapped to EL1. |

Note

- The ETMv4 architecture does not permit EL0 to access the trace registers. If the ARMv8-A architecture is implemented with an ETMv4 implementation, EL0 accesses to the trace registers are UNDEFINED, and the resulting exception is higher priority than a `CPACR_EL1.TTA` Trap exception.
- The ARMv8-A architecture does not provide traps on trace register accesses through the optional Memory-mapped interface.

System register accesses to the trace registers can have side-effects. When a System register access is trapped, no side-effects occur before the exception is taken, see *Register access instructions on page D1-1843*.

Table D1-29 shows the registers for which accesses are trapped to EL1 when `CPACR_EL1.TTA` is 1, and how the exceptions are reported in `ESR_EL1`:

Table D1-29 Register accesses trapped to EL1 when `CPACR_EL1.TTA` is 1

Traps from	Registers	Syndrome reporting in <code>ESR_EL1</code>
AArch64 state	All implemented trace registers	Trapped AArch64 MSR, MRS, or system instruction, using EC value <code>0x18</code> . ^a
AArch32 state	All implemented trace registers	For accesses using: <ul style="list-style-type: none"> MCR or MRC instructions, trapped MCR or MRC access (<code>coproc==0b1110</code>), using EC value <code>0x05</code>.^a MCRR or MRRC instructions, trapped MCRR or MRRC access (<code>coproc==0b1110</code>), using EC value <code>0x0C</code>.^a

a. If `HCR_EL2.TGE` is 1 and the PE is in Non-secure state, these Trap exceptions are routed to EL2 and are reported in `ESR_EL2` using the same EC values as shown in the table.

Traps to EL1 of EL0 and EL1 accesses to SIMD and floating-point functionality

When EL1 is using AArch64, `CPACR_EL1.FPEN` traps EL0 and EL1 accesses to the SIMD and floating-point registers to EL1:

00	Causes any instructions in EL0 or EL1 that use the registers that are associated with Advanced SIMD and floating-point execution to be trapped.
01	Causes any instructions in EL0 that use the registers that are associated with Advanced SIMD and floating-point execution to be trapped, but does not cause any instruction in EL1 to be trapped.
10	Causes any instructions in EL0 or EL1 that use the registers that are associated with Advanced SIMD and floating-point execution to be trapped.
11	Does not cause any instruction to be trapped.

Table D1-30 shows the registers for which accesses are trapped, and how the exceptions are reported in `ESR_EL1`:

Table D1-30 Register accesses trapped to EL1 by `CPACR_EL1.FPEN`

Traps from	Registers	Syndrome reporting in <code>ESR_EL1</code>
EL0 and EL1 using AArch64, or EL0 using AArch64 only ^a .	<code>FPCR</code> , <code>FPSR</code> , and any of the SIMD and floating-point registers V0-V31, including their views as D0-D31 registers or S0-S31 registers. See <i>The SIMD and floating-point registers, V0-V31</i> on page D1-1786.	Trapped access to a SIMD or floating-point register, resulting from <code>CPACR_EL1.FPEN</code> or <code>CPTR_ELx.TFP</code> , using EC value <code>0x07</code> ^b
EL0 using AArch32	<code>FPSCR</code> , and any of the SIMD and floating-point registers Q0-Q15, including their views as D0-D31 registers or S0-S31 registers. See <i>Advanced SIMD and floating-point System registers</i> on page G1-4415.	Trapped access to a SIMD or floating-point register, resulting from <code>CPACR_EL1.FPEN</code> or <code>CPTR_ELx.TFP</code> , using EC value <code>0x07</code> ^b

a. As described at the start of this subsection, the value of `CPACR_EL1.FPEN` determines whether the trap applies only to accesses from EL0, or applies to both accesses from EL1 and accesses from EL0.

b. If `HCR_EL2.TGE` is 1 and the PE is in Non-secure state, these Trap exceptions are routed to EL2 and are reported in `ESR_EL2` using EC value `0x00`.

Traps to EL1 of EL0 accesses to the Debug Communications Channel (DCC) registers

`MDSCR_EL1.TDCC` traps EL0 accesses to the DCC registers to EL1:

1	EL0 accesses to the DCC registers are trapped to EL1.
0	EL0 accesses to the DCC registers are not trapped to EL1.

Traps of AArch32 accesses to [DBGDTRRXint](#) and [DBGDTRTXint](#) are ignored in Debug state.

Traps of AArch64 accesses to [DBGDTR_EL0](#), [DBGDTRRX_EL0](#), and [DBGDTRTX_EL0](#) are ignored in Debug state.

[Table D1-31](#) shows the accesses that are trapped, and how the exceptions are reported in [ESR_EL1](#):

Table D1-31 Accesses trapped to EL1 when [MDSCR_EL1.TDCC](#) is 1

Traps from	Trapped accesses	Syndrome reporting in ESR_EL1
AArch64 state	Accesses to the MDCCSR_EL0 , DBGDTR_EL0 , DBGDTRTX_EL0 and DBGDTRRX_EL0	Trapped AArch64 MSR, MRS, or system instruction, using EC value 0x18 ^a
AArch32 state	<ul style="list-style-type: none"> MCR of DBGDSCRint, DBGDTRRXint, and, if implemented, DBGDIDR, DBGDSAR and DBGDRAR. MCR to DBGDTRTXint. 	Trapped MCR or MRC access (coproc==0b1110), using EC value 0x05 ^a
	<ul style="list-style-type: none"> LDC access to DBGDTRTXint. STC access to DBGDTRRXint. 	Trapped LDC or STC access, using EC value 0x06 ^a
	If implemented, MRRC of DBGDSAR and DBGDRAR .	Trapped MCRR or MRRC access (coproc==0b1110), using EC value 0x0C ^a

- a. If [HCR_EL2.TGE](#) is 1 and the PE is in Non-secure state, these Trap exceptions are routed to EL2 and are reported in [ESR_EL2](#) using the same EC values as shown in the table.

Traps to EL1 of EL0 accesses to the Generic Timer registers

[CNTKCTL_EL1](#).{[ELOPTEN](#), [ELOVTEN](#), [EL0PCTEN](#), [EL0VCTEN](#)} trap EL0 accesses to the Generic Timer registers to EL1, as follows:

- [CNTKCTL_EL1.ELOPTEN](#) traps EL0 accesses to the physical timer registers.
- [CNTKCTL_EL1.ELOVTEN](#) traps EL0 accesses to the virtual timer registers.
- [CNTKCTL_EL1.EL0PCTEN](#) traps EL0 accesses to the frequency register and physical counter register.
- [CNTKCTL_EL1.EL0VCTEN](#) traps EL0 accesses to the frequency register and virtual counter register.

For all of these controls:

- 1 EL0 accesses are not trapped to EL1.
0 EL0 accesses are trapped to EL1.

Accesses to the frequency register, [CNTFRQ_EL0](#) or [CNTFRQ](#), are only trapped if [CNTKCTL_EL1.EL0PCTEN](#) and [CNTKCTL_EL1.EL0VCTEN](#) are both 0.

[Table D1-32](#) shows the registers for which accesses are trapped, and how the exceptions are reported in [ESR_EL1](#):

Table D1-32 Register accesses trapped from EL0 to EL1 by [CNTKCTL_EL1](#) trap controls

Traps from	Trap control	Registers	Syndrome reporting in ESR_EL1
AArch64 state	ELOPTEN	CNTP_CTL_EL0 , CNTP_CVAL_EL0 , CNTP_TVAL_EL0	Trapped AArch64 MSR, MRS, or system instruction, using EC value 0x18 ^a
	ELOVTEN	CNTV_CTL_EL0 , CNTV_CVAL_EL0 , CNTV_TVAL_EL0	
	EL0PCTEN	CNTFRQ_EL0 , CNTPCT_EL0	
	EL0VCTEN	CNTFRQ_EL0 , CNTVCT_EL0	

Table D1-32 Register accesses trapped from EL0 to EL1 by CNTKCTL_EL1 trap controls (continued)

Traps from	Trap control	Registers	Syndrome reporting in ESR_EL1
AArch32 state	ELOPTEN	CNTP_CTL, CNTP_CVAL, CNTP_TVAL	For accesses using: <ul style="list-style-type: none"> MCR or MRC instructions, trapped MCR or MRC access (coproc==0b1111), using EC value 0x03^a MCR or MRRC instructions, trapped MCRR or MRRC access (coproc==0b1111), using EC value 0x04^a
	ELOVTEN	CNTV_CTL, CNTV_CVAL, CNTV_TVAL	
	ELOPCTEN	CNTPFRQ, CNTPCT	
	ELOVCTEN	CNTPFRQ, CNTVCT	

- a. If HCR_EL2.TGE is 1 and the PE is in Non-secure state, these Trap exceptions are routed to EL2 and are reported in ESR_EL2 using the same EC values as shown in the table.

Traps to EL1 of EL0 accesses to Performance Monitors registers

PMUSERENR_EL0.{ER, CR, SW, EN} trap EL0 accesses to the Performance Monitors registers to EL1. For each of these controls:

- 1** EL0 accesses are not trapped to EL1.
- 0** EL0 accesses are trapped to EL1.

For those Performance Monitors registers that more than one PMUSERENR_EL0.{ER, CR, SW, EN} control applies to, accesses are only trapped if all controls that apply are set to 0.

The accesses that these trap controls trap might be reads, writes, or both.

Table D1-33 shows:

- The registers for which EL0 accesses are trapped. For each register, the table shows the type of access trapped.
- How the exceptions are reported in ESR_EL1.

Table D1-33 Register accesses trapped to EL1 when disabled from EL0

Traps from	Trap control	Registers	Access type	Syndrome reporting in ESR_EL1
AArch64 state	ER	PMXEVNTR_EL0, PMEVCNTR<n>_EL0	R	Trapped AArch64 MSR, MRS, or system instruction, using EC value 0x18 ^a
		PMSELR_EL0	RW	
	CR	PMCCNTR_EL0	R	
	SW	PMSWINC_EL0	W	
	EN	PMCNTENSET_EL0, PMCNTENCLR_EL0, PMCR_EL0, PMOVSCLR_EL0, PMSWINC_EL0, PMSELR_EL0, PMCEID0_EL0, PMCEID1_EL0, PMCCNTR_EL0, PMXEVTYPER_EL0, PMXEVNTR_EL0, PMOVSSET_EL0, PMEVCNTR<n>_EL0, PMEVTYPER<n>_EL0, PMCCFILTR_EL0.	RW	

Table D1-33 Register accesses trapped to EL1 when disabled from EL0 (continued)

Traps from	Trap control	Registers	Access type	Syndrome reporting in ESR_EL1
AArch32 state	ER	PMXVCNTR , PMEVCNTR<n>	R	Trapped MCR or MRC access (coproc==0b1111), using EC value 0x03 ^a
		PMSELR	RW	
	CR	PMCCNTR , accessed using an MRC	R	
	CR	PMCCNTR , accessed using an MRRC	R	Trapped MCRR or MRRC access (coproc==0b1111), using EC value 0x04 ^a
	SW	PMSWINC	W	Trapped MCR or MRC access (coproc==0b1111), using EC value 0x03 ^a
	EN	PMCNTENSET , PMCNTENCLR , PMCR , PMOVS , PMSWINC , PMSELR , PMCEID0 , PMCEID1 , PMCCNTR , PMXEVTYPER , PMXVCNTR , PMOVSSET , PMEVCNTR<n> , PMEVTYPER<n> , PMCCFILTR , accessed using an MCR or MRC	RW	
	EN	PMCCNTR , accessed using an MCRR or MRRC	RW	Trapped MCRR or MRRC access (coproc==0b1111), using EC value 0x04 ^a

a. If [HCR_EL2.TGE](#) is 1 and the PE is in Non-secure state, these Trap exceptions are routed to EL2 and are reported in [ESR_EL2](#) using the same EC values as shown in the table.

D1.15.3 EL2 configurable controls

These controls are in [_EL2](#) System registers. The resulting exceptions might be taken from either Execution state. [SPSR_EL2.M\[4\]](#) indicates which Execution state the exception was taken from.

These controls are ignored in Secure state.

[Table D1-34](#) shows the [_EL2](#) System registers that contain these controls.

Table D1-34 [_EL2](#) registers that contain instruction disables and trap controls

Register name	Register description
HCR_EL2	Hypervisor Configuration Register
HSTR_EL2	Hypervisor System Trap Register
CPTR_EL2	Architectural Feature Trap Register, EL2
MDCR_EL2	Monitor Debug Configuration Register, EL2

[Table D1-35](#) on page D1-1852 summarizes the controls.

Note

- There are no instruction enables at EL2.
- For completeness, [Table D1-35](#) on page D1-1852 includes the routing control described in [Routing exceptions from Non-secure EL0 to EL2](#) on page D1-1827.

Table D1-35 Instruction disables and trap controls provided by EL2

Control	Control type^a	Description
HCR_EL2.{TRVM, TVM}	T	Traps to EL2 of Non-secure EL1 accesses to virtual memory control registers on page D1-1853
HCR_EL2.HCD	D	Disabling Non-secure state execution of HVC instructions on page D1-1854
HCR_EL2.TDZ	T	Traps to EL2 of Non-secure EL0 and EL1 execution of DC ZVA instructions on page D1-1854
HCR_EL2.TGE	R	Routing exceptions from Non-secure EL0 to EL2 on page D1-1827
HCR_EL2.TTLB	T	Traps to EL2 of Non-secure EL1 execution of TLB maintenance instructions on page D1-1854
HCR_EL2.{TSW, TPC, TPU}	T	Traps to EL2 of Non-secure EL0 and EL1 execution of cache maintenance instructions on page D1-1855
HCR_EL2.TACR	T	Traps to EL2 of Non-secure EL1 accesses to the Auxiliary Control Register on page D1-1856
HCR_EL2.TIDCP	T	Traps to EL2 of Non-secure EL0 and EL1 accesses to lockdown, DMA, and TCM operations on page D1-1857
HCR_EL2.TSC	T	Traps to EL2 of Non-secure EL1 execution of SMC instructions on page D1-1858
HCR_EL2.{TID0, TID1, TID2, TID3}	T	Traps to EL2 of Non-secure EL0 and EL1 accesses to the ID registers on page D1-1858
HCR_EL2.{TWI, TWE}	T	Traps to EL2 of Non-secure EL0 and EL1 execution of WFE and WFI instructions on page D1-1861
CPTR_EL2.TCPAC	T	Trapping to EL2 of Non-secure EL1 accesses to the CPACR_EL1 or CPACR on page D1-1862
CPTR_EL2.TFP	T	General trapping to EL2 of Non-secure accesses to the SIMD and floating-point registers on page D1-1863
CPTR_EL2.TTA	T	Traps to EL2 of Non-secure System register accesses to the trace registers on page D1-1863
HSTR_EL2.{T0-T3, T5-T13, T15}	T	General trapping to EL2 of Non-secure EL0 and EL1 accesses to System registers, from AArch32 state only on page D1-1864
MDCR_EL2.{TDRA, TDOSA, TDA}	T	Traps to EL2 of Non-secure EL0 and EL1 System register accesses to debug registers on page D1-1865
CNTHCTL_EL2.{EL1PCEN, EL1PCTEN}	T	Traps to EL2 of Non-secure EL0 and EL1 accesses to the Generic Timer registers on page D1-1867
MDCR_EL2.{TPM, TPMCR}	T	Traps to EL2 of Non-secure EL0 and EL1 accesses to Performance Monitors registers on page D1-1868

a. See Table D1-36 on page D1-1853.

Table D1-36 Control types, for exceptions taken to EL1

Abbreviation	Type	See
D	Disable	<i>Instruction enables and instruction disables on page D1-1842</i>
R	Routing control	<i>Routing exceptions from Non-secure EL0 to EL2 on page D1-1827</i>
T	Trap	<i>Trap controls on page D1-1842</i>

Also see the following for more general information about traps to EL2:

- *Register access instructions on page D1-1843.*
- For traps from an Exception level using AArch32:
 - *Instructions that fail their Condition code check on page G1-4429.*
 - *Trapping to EL2 of instructions that are UNPREDICTABLE on page G1-4429.*

Traps to EL2 of Non-secure EL1 accesses to virtual memory control registers

HCR_EL2.{TRVM, TVM} trap Non-secure EL1 accesses to the virtual memory control registers to EL2:

HCR_EL2.TRVM, for read accesses:

- 1** Non-secure EL1 reads of the virtual memory control registers are trapped to EL2.
- 0** Non-secure EL1 reads of the virtual memory control registers are not trapped to EL2.

HCR_EL2.TVM, for write access:

- 1** Non-secure EL1 writes to the virtual memory control registers are trapped to EL2.
- 0** Non-secure writes to the virtual memory control registers are not trapped to EL2.

Table D1-37 shows:

- The registers for which reads are trapped to EL2 when **HCR_EL2**.TRVM is 1.
- The registers for which writes are trapped to EL2 when **HCR_EL2**.TVM is 1.
- How the exceptions are reported in **ESR_EL2**.

Table D1-37 Register read and write accesses trapped when **HCR_EL2.{TRVM, TVM} are 1**

Traps from	Registers	Syndrome reporting in ESR_EL2
AArch64 state	SCTLR_EL1 , TTBR0_EL1 , TTBR1_EL1 , TCR_EL1 , ESR_EL1 , FAR_EL1 , AFSR0_EL1 , AFSR1_EL1 , MAIR_EL1 , AMAIR_EL1 , CONTEXTIDR_EL1 .	Trapped AArch64 MSR, MRS, or system instruction, using EC value 0x18.
AArch32 state	SCTLR , TTBR0 , TTBR1 , TTBCR , TTBCR2 , DACR , DFSR , IFSR , DFAR , IFAR , ADFSR , AIFSR , PRRR , NMRR , MAIR0 , MAIR1 , AMAIR0 , AMAIR1 , CONTEXTIDR .	Trapped MCR or MRC access (coproc==0b1111), using EC value 0x03. Trapped MCRR or MRRC access (coproc==0b1111), using EC value 0x04.

———— **Note** —————

EL2 provides a second stage of address translation, that a hypervisor can use to remap the address map defined by a Guest OS. In addition, a hypervisor can trap attempts by a Guest OS to write to the registers that control the Non-secure memory system. A hypervisor might use this trap as part of its virtualization of memory management.

Disabling Non-secure state execution of HVC instructions

[HCR_EL2.HCD](#) disables Non-secure state execution of HVC instructions:

- 1** HVC instructions are UNDEFINED at EL2 and Non-secure EL1, and any resulting exception is taken from the current Exception level to the current Exception level.
- 0** HVC instruction execution is enabled at EL2 and Non-secure EL1.

———— **Note** ————

HVC instructions are always UNDEFINED at EL0.

[HCR_EL2.HCD](#) is only implemented if EL3 is not implemented. Otherwise, it is RES0.

[Table D1-38](#) shows how the exceptions are reported in [ESR_ELx](#):

Table D1-38 Instruction disabled when [HCR_EL2.HCD](#) is 1

Taken from	Disabled instruction	Syndrome reporting in ESR_ELx
AArch64 state	HVC	Exception for an unknown reason, using EC value 0x00
AArch32 state	HVC	

Traps to EL2 of Non-secure EL0 and EL1 execution of DC ZVA instructions

[HCR_EL2.TDZ](#) traps Non-secure EL0 and EL1 execution of DC ZVA instructions to EL2:

- 1** Any attempt to execute a DC ZVA instruction at Non-secure EL0 or EL1 is trapped to EL2. Reading the [DCZID_EL0](#) returns a value that indicates that DC ZVA instructions are not implemented.
- 0** Non-secure EL0 and EL1 execution of DC ZVA instructions is not trapped to EL2.

[Table D1-39](#) shows how the exceptions are reported in [ESR_EL2](#):

Table D1-39 Instruction trapped to EL1 when [HCR_EL2.TDZ](#) is 0

Traps from	Trapped instruction	Syndrome reporting in ESR_EL2
AArch64 state	DC ZVA	Trapped AArch64 MSR, MRS, or system instruction, using EC value 0x18
AArch32 state	n/a	n/a

Traps to EL2 of Non-secure EL1 execution of TLB maintenance instructions

In the ARMv8-A architecture, the system instruction encoding space includes TLB maintenance instructions.

[HCR_EL2.TTLB](#) traps Non-secure EL1 execution of TLB maintenance instructions to EL2:

- 1** Any attempt to execute a TLBI instruction at Non-secure EL1 is trapped to EL2.
- 0** Non-secure EL1 execution of TLBI instructions is not trapped to EL2.

Table D1-40 shows the instructions that are trapped, and how the exceptions are reported in [ESR_EL2](#):

Table D1-40 Instructions trapped to EL2 when [HCR_EL2.TTLB](#) is 1

Traps from	Trapped instructions	Syndrome reporting in ESR_EL2
AArch64 state	TLBI VMALLE1IS , TLBI VAE1IS , TLBI ASIDE1IS , TLBI VAAE1IS , TLBI VALE1IS , TLBI VAALE1IS , TLBI VMALLE1 , TLBI VAE1 , TLBI ASIDE1 , TLBI VAAE1 , TLBI VALE1 , TLBI VAALE1	Trapped AArch64 MSR, MRS, or system instruction, using EC value 0x18
AArch32 state	TLBIALLIS , TLBIMVAIS , TLBIASIDIS , TLBIMVA AIS , TLBIMVALIS , TLBIMVAALIS , ITLBIALL , ITLBIMVA , ITLBIASID , DTLBIALL , DTLBIMVA , DTLBIASID , TLBIALL , TLBIMVA , TLBIASID , TLBIMVAA , TLBIMVAL , TLBIMVAAL .	Trapped MCR or MRC access (coproc==0b1111), using EC value 0x03

———— **Note** —————

These instructions are always UNDEFINED at EL0.

For more information about these instructions, see:

- [TLB maintenance instructions](#) on page D4-2121, for the AArch64 state instructions.
- [The scope of TLB maintenance instructions](#) on page G4-4641, for the AArch32 state instructions.

Traps to EL2 of Non-secure EL0 and EL1 execution of cache maintenance instructions

[HCR_EL2](#).{TSW, TPC, TPU} trap cache maintenance instructions to EL2 as follows:

- 0** The control has no effect on the execution of cache maintenance instructions.
- 1** Any attempt to execute a corresponding cache maintenance instruction at Non-secure EL1, or at Non-secure EL0 if permitted by [SCTLR_EL1.UCI](#), is trapped to EL2.

Table D1-41 Controls for trapping cache maintenance instructions to EL2

Trap control	Trapped instructions
HCR_EL2.TSW	Data or unified cache maintenance by set/way
HCR_EL2.TPC	Data or unified cache maintenance to point of coherency
HCR_EL2.TPU	Cache maintenance to point of unification

For:

- [HCR_EL2.TSW](#) == 1, [Table D1-42](#) on page D1-1856 shows the instructions that are trapped, and how the exceptions are reported in [ESR_EL2](#).
- [HCR_EL2.TPC](#) == 1, [Table D1-43](#) on page D1-1856 shows the instructions that are trapped, and how the exceptions are reported in [ESR_EL2](#).
- [HCR_EL2.TPU](#) == 1, [Table D1-44](#) on page D1-1856 shows the instructions that are trapped, and how the exceptions are reported in [ESR_EL2](#).

Table D1-42 Instructions trapped to EL2 when `HCR_EL2.TSW` is 1

Traps from	Trapped instructions	Syndrome reporting in <code>ESR_EL2</code>
AArch64 state	<code>DC ISW</code> , <code>DC CSW</code> , <code>DC CISW</code>	Trapped AArch64 MSR, MRS, or system instruction, using EC value 0x18
AArch32 state	<code>DCISW</code> , <code>DCCSW</code> , <code>DCCISW</code>	Trapped MCR or MRC access (coproc==0b1111), using EC value 0x03

———— **Note** —————
These instructions are always UNDEFINED at EL0.

Table D1-43 Instructions trapped to EL2 when `HCR_EL2.TPC` is 1

Traps from	Trapped instructions	Syndrome reporting in <code>ESR_EL2</code>
AArch64 state	<code>DC IVAC</code> , <code>DC CVAC</code> , <code>DC CIVAC</code>	Trapped AArch64 MSR, MRS, or system instruction, using EC value 0x18
AArch32 state	<code>DCIMVAC</code> , <code>DCCIMVAC</code> , <code>DCCMVAC</code>	Trapped MCR or MRC access, (coproc==0b1111) using EC value 0x03

———— **Note** —————
`DC IVAC` is always UNDEFINED at EL0 using AArch64.
`DCIMVAC`, `DCCIMVAC`, and `DCCMVAC` are always UNDEFINED at EL0 using AArch32.

Table D1-44 Instructions trapped to EL2 when `HCR_EL2.TPU` is 1

Traps from	Trapped instructions	Syndrome reporting in <code>ESR_EL2</code>
AArch64 state	<code>IC IVAU</code> , <code>IC IALLU</code> , <code>IC IALLUIS</code> , <code>DC CVAU</code>	Trapped AArch64 MSR, MRS, or system instruction, using EC value 0x18
AArch32 state	<code>ICIMVAU</code> , <code>ICIALLU</code> , <code>ICIALLUIS</code> , <code>DCCMVAU</code>	Trapped MCR or MRC access (coproc==0b1111), using EC value 0x03

———— **Note** —————
`IC IALLUIS` and `IC IALLU` are always UNDEFINED at EL0 using AArch64.
`ICIMVAU`, `ICIALLU`, `ICIALLUIS`, and `DCCMVAU` are always UNDEFINED at EL0 using AArch32.

For more information about these instructions, see:

- [Cache maintenance instructions, and data cache zero on page C5-318](#) for the AArch64 instructions.
- [Cache maintenance instructions, functional group on page G4-4734](#) for the AArch32 instructions.

Traps to EL2 of Non-secure EL1 accesses to the Auxiliary Control Register

`HCR_EL2.TACR` traps Non-secure EL1 accesses to the Auxiliary Control Registers to EL2:

- 1** Non-secure EL1 accesses to the Auxiliary Control Registers are trapped to EL2.
- 0** Non-secure EL1 accesses to the Auxiliary Control Registers are not trapped to EL2.

Table D1-45 shows the registers for which accesses are trapped, and how the exceptions are reported in [ESR_EL2](#):

Table D1-45 Register accesses trapped to EL2 when [HCR_EL2.TACR](#) is 1

Traps from	Registers	Syndrome reporting in ESR_EL2
AArch64 state	ACTLR_EL1	Trapped AArch64 MSR, MRS, or system instruction, using EC value 0x18
AArch32 state	ACTLR and, if implemented, ACTLR2 .	Trapped MCR or MRC access (coproc==0b1111), using EC value 0x03

———— **Note** —————

- The [ACTLR_EL1](#), [ACTLR](#), and [ACTLR2](#) are not accessible at EL0.
- The Auxiliary Control Registers are IMPLEMENTATION DEFINED registers that might implement global control bits for the PE.

Traps to EL2 of Non-secure EL0 and EL1 accesses to lockdown, DMA, and TCM operations

The lockdown, DMA, and TCM features of the ARMv8-A architecture are IMPLEMENTATION DEFINED. The architecture reserves the encodings of a number of System registers for control of these features.

[HCR_EL2.TIDCP](#) traps the execution of System register access instructions that access these registers, as follows:

- 1** At Non-secure EL1, any attempt to execute a System register access instruction with a reserved register encoding is trapped to EL2.
- At Non-secure EL0, it is IMPLEMENTATION DEFINED whether attempts to execute System register access instructions with reserved register encodings are:
- Trapped to EL2.
 - UNDEFINED, and any resulting exception is taken to EL1.
- 0** Non-secure EL0 and EL1 System register access instructions with reserved register encodings are not trapped to EL2.

[Table D1-46](#) shows the register encodings for which accesses are trapped, and how the exceptions are reported in [ESR_EL2](#):

Table D1-46 Encodings trapped to EL2 when [HCR_EL2.TIDCP](#) is 1

Traps from	Register encodings	Syndrome reporting in ESR_EL2
AArch64 state	Any access to any of the encodings described in <i>Reserved encodings for IMPLEMENTATION DEFINED registers</i> on page C5-334.	Trapped AArch64 MSR, MRS, or system instruction, using EC value 0x18
AArch32 state	An access to any of the following encodings: <ul style="list-style-type: none"> • CRn==c9, opc1=={0-7}, CRm=={c0-c2, c5-c8}, opc2=={0-7}. • CRn==c10, opc1=={0-7}, CRm=={c0, c1, c4, c8}, opc2=={0-7}. • CRn==c11, opc1=={0-7}, CRm=={c0-c8, c15}, opc2=={0-7}. 	Trapped MCR or MRC access (coproc==0b1111), using EC value 0x03

An implementation can also include IMPLEMENTATION DEFINED registers that provide additional controls, to give finer-grained control of the trapping of IMPLEMENTATION DEFINED features.

———— **Note** —————

- ARM expects the trapping of Non-secure EL0 accesses to these functions to EL2 to be unusual, and used only when the hypervisor is virtualizing EL0 operation. ARM strongly recommends that unless the hypervisor must virtualize EL0 operation, a Non-secure EL0 access to any of these functions is UNDEFINED, as it would be if the implementation did not include EL2. The PE then takes any resulting exception to Non-secure EL1.

- The trapping of accesses to these registers from Non-secure EL1 is higher priority than an exception resulting from the register access being UNDEFINED.

Traps to EL2 of Non-secure EL1 execution of SMC instructions

[HCR_EL2.TSC](#) traps Non-secure EL1 execution of SMC instructions to EL2:

- 1** Any attempt to execute an SMC instruction at Non-secure EL1 is trapped to EL2, regardless of the value of [SCR_EL3.SMD](#).
- 0** Non-secure EL1 execution of SMC instructions is not trapped to EL2.

If EL3 is not implemented, [HCR_EL2.TSC](#) is RES0.

[Table D1-47](#) shows how the exceptions are reported in [ESR_EL2](#):

Table D1-47 SMC Instruction trapped to EL2 when [HCR_EL2.TSC](#) is 1

Traps from	Trapped instruction	Syndrome reporting in ESR_EL2
AArch64 state	SMC on page C6-827	Trapped SMC instruction execution in AArch64 state, using EC value 0x17
AArch32 state	SMC on page F5-3429	Trapped SMC instruction execution in AArch32 state, using EC value 0x13

In AArch32 state, the ARMv8-A architecture permits, but does not require, this trap to apply to conditional SMC instructions that fail their Condition code check, in the same way as with traps on other conditional instructions.

For more information about SMC instructions, see [SMC on page C6-827](#).

———— Note ————

- This trap is implemented only if the implementation includes EL3.
- SMC instructions are UNDEFINED at EL0.
- [HCR_EL2.TSC](#) traps execution of the SMC instruction. It is not a routing control for the SMC exception. Trap exceptions and SMC exceptions have different preferred return addresses.

Traps to EL2 of Non-secure EL0 and EL1 accesses to the ID registers

Other than the [MIDR_EL1](#), [MPIDR_EL1](#), and [PMCR_EL0.N](#), the ID registers are divided into groups, with a trap control in the [HCR_EL2](#) for each group.

Table D1-48 ID register groups

Trap control	Register group
HCR_EL2.TID0	<i>ID group 0, Primary device identification registers on page D1-1859</i>
HCR_EL2.TID1	<i>ID group 1, Implementation identification registers on page D1-1860</i>
HCR_EL2.TID2	<i>ID group 2, Cache identification registers on page D1-1860</i>
HCR_EL2.TID3	<i>ID group 3, Detailed feature identification registers on page D1-1860</i>

These controls trap register accesses to EL2, as follows:

[HCR_EL2.TID0](#)

- 0** This control has no effect on Non-secure EL1 reads of the ID group 0 registers.

1 Any attempt at Non-secure EL0 or EL1 to read any register in ID group 0 is trapped to EL2.

HCR_EL2.TID1

0 This control has no effect on Non-secure EL1 reads of the ID group 1 registers.

1 Any attempt at Non-secure EL1 to read any register in ID group 1 is trapped to EL2.

HCR_EL2.TID2

0 This control has no effect on Non-secure EL1 and EL0 accesses to the ID group 2 registers.

1 Any attempt at Non-secure EL0 or EL1 to read any register in ID group 2, and any attempt at Non-secure EL0 or EL1 to write to the [CSSELR](#) or [CSSELR_EL1](#), is trapped to EL2.

HCR_EL2.TID3

0 This control has no effect on Non-secure EL1 reads of the ID group 3 registers.

1 Any attempt at Non-secure EL1 to read any register in ID group 3 is trapped to EL2.

For the [MIDR_EL1](#) and [MPIDR_EL1](#), and for [PMCR_EL0.N](#), the architecture provides read/write aliases. The original register becomes accessible only from EL2 or Secure state, and a Non-secure EL0 or EL1 read of the original register returns the value of the read/write alias. This substitution is invisible to the EL0 or EL1 software reading the register.

Table D1-49 ID register substitution

Register	Original	Alias, EL2 using AArch64
Main ID	MIDR_EL1	VPIDR_EL2
Multiprocessor Affinity	MPIDR_EL1	VMPIDR_EL2
Performance Monitors Control Register	PMCR_EL0.N	MDCR_EL2.HPMN

Reads of the [MIDR_EL1](#), [MPIDR_EL1](#) or [PMCR_EL0.N](#) from EL2 or Secure state are unchanged by the implementation of EL2, and access the physical registers.

Note

- If the optional Performance Monitors Extension is not implemented, [MDCR_EL2.HPMN](#) is RES0 and [PMCR_EL0](#) is reserved.
- [MDCR_EL2.HPMN](#) also affects whether a Performance Monitors counter can be accessed from Non-secure EL0 or EL1. See the register description of [MDCR_EL2](#) for more information.
- [PMCR_EL0](#) contains other fields that identify the implementation. For more information about trapping accesses to the [PMCR_EL0](#), see *Traps to EL2 of Non-secure EL0 and EL1 accesses to Performance Monitors registers* on page D1-1868.

ID group 0, Primary device identification registers

In:

- AArch64 state, there are no ID group 0 registers.
- AArch32 state, these registers identify some top-level implementation choices.

Table D1-50 shows the registers that are in ID group 0 for traps to EL2, and how the exceptions are reported in ESR_EL2:

Table D1-50 ID group 0 registers

Traps from	Group 0 registers	Syndrome reporting in ESR_EL2
AArch64 state	n/a	n/a
AArch32 state	FPSID	Trapped VMRS System register access, using EC value 0x08
	JIDR	Trapped MRC System register access (coproc==0b1110), using EC value 0x05

———— **Note** —————

The FPSID is not accessible from EL0 using AArch32.

When the FPSID is accessible, a T32 or A32 VMRS FPSID, <Rt> instruction is permitted but is ignored. The execution of this VMRS instruction execution is not trapped by the ID group 0 trap.

ID group 1, Implementation identification registers

These registers often provide coarse-grained identification mechanisms for implementation-specific features.

Table D1-51 shows the registers that are in ID group 1 for traps to EL2, and how the exceptions are reported in ESR_EL2:

Table D1-51 ID group 1 registers

Traps from	Group 1 registers	Syndrome reporting in ESR_EL2
AArch64 state	REVIDR_EL1, AIDR_EL1	Trapped AArch64 MSR, MRS, or system instruction, using EC value 0x18
AArch32 state	TCMTR, TLBTR, REVIDR, AIDR	Trapped MCR or MRC System register access (coproc==0b1111), using EC value 0x03

ID group 2, Cache identification registers

These registers describe and control the cache implementation.

Table D1-52 shows the registers that are in ID group 2 for traps to EL2, and how the exceptions are reported in ESR_EL2:

Table D1-52 ID group 2 registers

Traps from	Group 2 registers	Syndrome reporting in ESR_EL2
AArch64 state	CTR_EL0, CCSIDR_EL1, CLIDR_EL1, CSSELR_EL1	Trapped AArch64 MSR, MRS, or system instruction, using EC value 0x18
AArch32 state	CTR, CCSIDR, CLIDR, CSSELR	Trapped MCR or MRC System register access (coproc==0b1111), using EC value 0x03

ID group 3, Detailed feature identification registers

These registers provide detailed information about the features of the implementation.

Note

In AArch32 state, these registers are called the CPUID registers. There is no requirement for this trap to apply to those registers that the CPUID Identification Scheme defines as reserved. See *The CPUID identification scheme on page G4-4728*.

Table D1-53 shows the registers that are in ID group 3 for traps to EL2, and how the exceptions are reported in ESR_EL2:

Table D1-53 ID group 3 registers

Traps from	Group 3 registers	Syndrome reporting in ESR_EL2
AArch64 state	<p>ID_PFR0_EL1, ID_PFR1_EL1, ID_DFR0_EL1, ID_AFR0_EL1, ID_MMFR0_EL1, ID_MMFR1_EL1, ID_MMFR2_EL1, ID_MMFR3_EL1, and ID_MMFR4_EL1, except that if ID_MMFR4_EL1 is implemented as RAZ/WI then it is IMPLEMENTATION DEFINED whether reads of the register are trapped.</p> <p>ID_ISAR0_EL1, ID_ISAR1_EL1, ID_ISAR2_EL1, ID_ISAR3_EL1, ID_ISAR4_EL1, ID_ISAR5_EL1.</p> <p>MVFR0_EL1, MVFR1_EL1, MVFR2_EL1.</p> <p>ID_AA64PFR0_EL1, ID_AA64PFR1_EL1, ID_AA64DFR0_EL1, ID_AA64DFR1_EL1, ID_AA64ISAR0_EL1, ID_AA64ISAR1_EL1, ID_AA64MMFR0_EL1, ID_AA64MMFR1_EL1, ID_AA64MMFR2_EL1, ID_AA64AFR0_EL1, ID_AA64AFR1_EL1.</p> <p>It is IMPLEMENTATION DEFINED whether HCR_EL2.TID3 traps MRS accesses to registers in the following range that are not already mentioned in this table:</p> <ul style="list-style-type: none"> Op0 == 3, CRn == c0, op1 == 0, CRm == {c2-c7}, op2 == {0-7}. 	Trapped AArch64 MSR, MRS, or system instruction, using EC value 0x18
AArch32 state	<p>MVFR0, MVFR1, MVFR2.</p> <hr/> <p>ID_PFR0, ID_PFR1, ID_DFR0, ID_AFR0, ID_MMFR0, ID_MMFR1, ID_MMFR2, ID_MMFR3 and, ID_MMFR4, except that if ID_MMFR4 is implemented as RAZ/WI then it is IMPLEMENTATION DEFINED whether reads of the register are trapped.</p> <p>ID_ISAR0, ID_ISAR1, ID_ISAR2, ID_ISAR3, ID_ISAR4, ID_ISAR5.</p> <p>Any MRC access to any of the following encodings in the (coproc==0b1111) encoding space:</p> <ul style="list-style-type: none"> CRn == c0, opc1 == 0, CRm == {c3-c7}, opc2 == {0, 1}. CRn == c0, opc1 == 0, CRm == c3, opc2 == 2. CRn == c0, opc1 == 0, CRm == c5, opc2 == {4, 5}. <p>It is IMPLEMENTATION DEFINED whether HCR_EL2.TID3 traps MRC accesses to in the (coproc==0b1111) encoding space in the following range that are not already mentioned in this table:</p> <ul style="list-style-type: none"> CRn == c0, opc1 == 0, CRm == {c2-c7}, opc2 == {0-7}. 	<p>Trapped VMRS System register access, using EC value 0x08</p> <hr/> <p>Trapped MCR or MRC System register access (coproc==0b1111), using EC value 0x03</p>

Traps to EL2 of Non-secure EL0 and EL1 execution of WFE and WFI instructions

HCR_EL2.{TWE, TWI} trap Non-secure EL0 and EL1 execution of WFE and WFI instructions to EL2:

HCR_EL2.TWE

- | | |
|----------|--|
| 1 | Any attempt to execute a WFE instruction at Non-secure EL0 or EL1 is trapped to EL2, if the instruction would otherwise have caused the PE to enter a low-power state. |
| 0 | Non-secure EL0 or EL1 execution of WFE instructions is not trapped to EL2. |

HCR_EL2.TWI

- 1** Any attempt to execute a WFI instruction at Non-secure EL0 or EL1 is trapped to EL2, if the instruction would otherwise have caused the PE to enter a low-power state.
- 0** Non-secure EL0 or EL1 execution of WFI instructions is not trapped to EL2.

Table D1-54 shows how the exceptions are reported in [ESR_EL2](#):

Table D1-54 Instructions trapped to EL2 when HCR_EL2.{TWE, TWI} are 1

Trap control	Traps from	Trapped instructions	Syndrome reporting in ESR_EL2
HCR_EL2.TWE	Both Execution states	WFE	Trapped WFI or WFE instruction, using EC value 0x01
HCR_EL2.TWI		WFI	

In AArch32 state, the attempted execution of a conditional WFE or WFI instruction is only trapped if the instruction passes its Condition code check.

———— Note ————

Since a WFE or WFI can complete at any time, even without a Wakeup event, the traps on WFE or WFI are not guaranteed to be taken, even if the WFE or WFI is executed when there is no Wakeup event. The only guarantee is that if the instruction does not complete in finite time in the absence of a Wakeup event, the trap will be taken.

For more information about these instructions, and when they can cause the PE to enter a low-power state, see:

- [Wait for Event mechanism and Send event on page D1-1879](#).
- [Wait For Interrupt on page D1-1882](#).

Trapping to EL2 of Non-secure EL1 accesses to the CPACR_EL1 or CPACR

[CPTR_EL2.TCPAC](#) traps Non-secure EL1 accesses to the [CPACR_EL1](#) or [CPACR](#) to EL2:

- 1** Non-secure EL1 accesses to the [CPACR_EL1](#) or [CPACR](#) are trapped to EL2.
- 0** Non-secure EL1 accesses to the [CPACR_EL1](#) or [CPACR](#) are not trapped to EL2.

Table D1-55 shows how the exceptions are reported in [ESR_EL2](#):

Table D1-55 Register accesses trapped to EL2 when CPTTR_EL2.TCPAC is 1

Traps from	Registers	Syndrome reporting in ESR_EL2
AArch64 state	CPACR_EL1	Trapped AArch64 MSR, MRS, or system instruction, using EC value 0x18
AArch32 state	CPACR	Trapped MCR or MRC System register access (coproc==0b1111), using EC value 0x03

———— Note ————

- The [CPACR_EL1](#) or [CPACR](#) is not accessible at EL0.
- In ARMv7 and earlier versions of the ARM architecture, one function of the [CPACR](#) is as an ID register that identifies what coprocessor or conceptual coprocessor functionality is implemented. Legacy software might use this identification mechanism, and a hypervisor can use this trap to emulate this mechanism. For more information about this coprocessor model see [Background to the System register interface on page G1-4410](#).

General trapping to EL2 of Non-secure accesses to the SIMD and floating-point registers

[CPTR_EL2](#).TFP traps Non-secure accesses to SIMD and floating-point registers to EL2:

- 1 . Any attempt at EL2, or Non-secure EL0 or EL1, to execute an instruction that accesses the SIMD or floating-point registers is trapped to EL2.
- 0 . Non-secure execution of instructions that access the SIMD or floating-point registers is not trapped to EL2.

[Table D1-56](#) shows the registers for which accesses are trapped, and how the exceptions are reported in [ESR_EL2](#):

Table D1-56 Register accesses trapped to EL2 when [CPTR_EL2](#).TFP is 1

Traps from	Registers	Syndrome reporting in ESR_EL2
AArch64 state	FPCR , FPSR , FPEXC32_EL2 , and any of the SIMD and floating-point registers V0-V31, including their views as D0-D31 registers or S0-S31 registers. See <i>The SIMD and floating-point registers, V0-V31</i> on page D1-1786.	Trapped access to a SIMD or floating-point register, resulting from CPACR_EL1 .FPEN or CPTR_ELx .TFP, using EC value 0x07
AArch32 state	FPSID , MVFR0 , MVFR1 , MVFR2 , FPSCR , FPEXC , and any of the SIMD and floating-point registers Q0-Q15, including their views as D0-D31 registers or S0-S31 registers. See <i>Advanced SIMD and floating-point System registers</i> on page G1-4415.	Trapped access to a SIMD or floating-point register, resulting from CPACR_EL1 .FPEN or CPTR_ELx .TFP, using EC value 0x07 ^a

- a. Permitted VMSR accesses to the [FPSID](#) are ignored, but for the purposes of this trap the architecture defines a VMSR access to the [FPSID](#) from EL1 or higher as an access to a SIMD and floating-point register.

Traps to EL2 of Non-secure System register accesses to the trace registers

[CPTR_EL2](#).TTA traps System register accesses to the trace registers to EL2. These traps are from Non-secure state, so are from all of:

- EL2.
- Non-secure EL0 and EL1.

When [CPTR_EL2](#).TTA is:

- 1 Non-secure System register accesses to the trace registers are trapped to EL2.
- 0 Non-secure System register accesses to the trace registers are not trapped to EL2.

Note

- The ETMv4 architecture does not permit EL0 to access the trace registers. If the ARMv8-A architecture is implemented with an ETMv4 implementation, EL0 accesses to the trace registers are UNDEFINED, and any resulting exception is higher priority than a [CPTR_EL2](#).TTA Trap exception.
- EL2 does not provide traps on trace register accesses through the Memory-mapped interface.

System register accesses to the trace registers can have side-effects. When a System register access is trapped, no side-effects occur before the exception is taken, see *Register access instructions* on page D1-1843.

Table D1-57 shows the registers for which accesses are trapped to EL2 when `CPTR_EL2.TTA` is 1, and how the exceptions are reported in `ESR_EL2`:

Table D1-57 Register accesses trapped to EL2 when `CPTR_EL2.TTA` is 1

Traps from	Registers	Syndrome reporting in <code>ESR_EL2</code>
AArch64 state	All implemented trace registers	Trapped AArch64 MSR, MRS, or system instruction, using EC value 0x18.
AArch32 state	All implemented trace registers	<ul style="list-style-type: none"> Trapped MCR or MRC System register access (<code>coproc==0b1110</code>), using EC value 0x05. Trapped MCRR or MRRC System register access (<code>coproc==0b1110</code>), using EC value 0x0C.

General trapping to EL2 of Non-secure EL0 and EL1 accesses to System registers, from AArch32 state only

`HSTR_EL2`.{T0-T3, T5-T13, T15} trap accesses to the AArch32 System registers in the `coproc==0b1111` encoding space, by the register number, {c0-c3, c5-c13, c15} used for:

- The CRn argument used when accessing the register using an MCR or MRC instruction.
- The CRm argument used when accessing the register using an MCRR or MRRC instruction.

These traps are from AArch32 state only. They are from both:

- Non-secure EL1 using AArch32.
- Non-secure EL0 using AArch32.

When an `HSTR_EL2.Tx` trap control is:

- 1** Any AArch32 state Non-secure EL1 or EL0 access to the corresponding register is trapped to EL2.
- 0** AArch32 state Non-secure EL1 or EL0 accesses to the corresponding register are not trapped to EL2.

Table D1-58 shows the accesses that are trapped, and how the exceptions are reported in `ESR_EL2`:

Table D1-58 Accesses trapped to EL2 when an `HSTR_EL2.Tx` trap is enabled

Traps from	Trapped accesses	Syndrome reporting in <code>ESR_EL2</code>
AArch64 state	n/a	n/a
AArch32 state	MCR and MRC instructions, where CRn in the instruction identifies the trapped encodings in the (<code>coproc==0b1111</code>) encoding space	Trapped MCR or MRC access (<code>coproc==0b1111</code>), using EC value 0x03
	MCRR and MRRC instructions, where CRm in the instruction identifies the trapped encodings in the (<code>coproc==0b1111</code>) encoding space	Trapped MCRR or MRRC access (<code>coproc==0b1111</code>), using EC value 0x04

————— Note —————

`HSTR_EL2`[4, 14] is reserved, RES0. Although the Generic Timer AArch32 System registers are implemented in the `coproc==0b1111` encoding space and accessed using a CRn or CRm value of c14, EL2 does not provide a trap on accesses to the Generic Timer System registers.

System registers in the (coproc==0b1111) encoding space with IMPLEMENTATION DEFINED access permission from EL0

For an AArch32 System register in the (coproc==0b1111) encoding space, that is accessed using a CRn or CRm value that can be trapped by a HSTR_EL2.Tn control, if an access to the register from EL0 is UNDEFINED when the value of the corresponding HSTR_EL2.Tn trap control is 0, then when that HSTR_EL2.Tn trap control is 1, it is IMPLEMENTATION DEFINED whether an access from Non-secure EL0 using AArch32:

- Generates a Trap exception that is taken to EL2.
- Is UNDEFINED and generates an exception that is taken to Non-secure EL1.

If the instruction is treated as UNDEFINED and generates an exception that is taken to Non-secure EL1, and Non-secure EL1 is using AArch64, the exception is reported in ESR_EL1 as an exception for an unknown reason, using EC value 0x00.

———— **Note** ————

ARM expects that trapping to EL2 of Non-secure EL0 accesses to AArch32 System register in the (coproc==0b1111) encoding space will be unusual, and used only when the hypervisor must virtualize EL0 operation. ARM recommends that, whenever possible, Non-secure EL0 accesses to the System registers behave as they would if the implementation did not include EL2. This means that, if the architecture does not support the Non-secure EL0 access, then the register access instruction is treated as UNDEFINED and generates an exception that is taken to Non-secure EL1.

Traps to EL2 of Non-secure EL0 and EL1 System register accesses to debug registers

MDCR_EL2.{TDRA, TDOSA, TDA} trap Non-secure System register accesses to the debug registers to EL2, as follows:

- MDCR_EL2.(TDRA, TDA) trap Non-secure EL0 and EL1 accesses.
- MDCR_EL2.TDOSA traps Non-secure EL1 accesses.

———— **Note** ————

EL2 does not provide traps on debug register accesses through the optional memory-mapped external debug interfaces.

System register accesses to the debug registers can have side-effects. When a System register access is trapped to EL2, no side-effects occur before the exception is taken to EL2. See *Register access instructions on page D1-1843*.

Table D1-59 shows the subsections that list the accesses trapped. The subsections describe how the traps are reported in ESR_EL2:

Table D1-59 Traps of Non-secure EL0 and EL1 accesses to debug registers

Trap control	Subsection
MDCR_EL2.TDRA	<i>Traps to EL2 of Non-secure EL0 and EL1 System register accesses to debug registers</i>
MDCR_EL2.TDOSA	<i>Trapping System register accesses to powerdown debug registers to EL2 on page D1-1866</i>
MDCR_EL2.TDA	<i>Trapping general System register accesses to debug registers to EL2 on page D1-1866</i>

Trapping System register accesses to Debug ROM registers to EL2

MDCR_EL2.TDRA traps Non-secure EL0 and EL1 System register accesses to the Debug ROM registers to EL2:

- 1** Non-secure EL0 and EL1 System register accesses to the Debug ROM registers are trapped to EL2.
- 0** Non-secure EL0 and EL1 System register accesses to the Debug ROM registers are not trapped to EL2.

This trap applies to Non-secure EL0 only if it is using AArch32.

Table D1-60 shows the register accesses that are trapped, and how the exceptions are reported in [ESR_EL2](#):

Table D1-60 Register accesses trapped to EL2 when [MDCR_EL2.TDRA](#) is 1

Traps from	Registers	Syndrome reporting in ESR_EL2
AArch64 state	MDRAR_EL1	Trapped AArch64 MSR, MRS, or system instruction, using EC value 0x18.
AArch32 state	DBGDRAR , DBGDSAR	For accesses using: <ul style="list-style-type: none"> MCR or MRC instructions, trapped MCR or MRC access (coproc==0b1110), using EC value 0x05. MCRR or MRRC instructions, trapped MCRR or MRRC access (coproc==0b1110), using EC value 0x0C.

If [MDCR_EL2.TDE](#) or [HCR_EL2.TGE](#) is 1, behavior is as if [MDCR_EL2.TDRA](#) is 1 other than for the purpose of a direct read.

Trapping System register accesses to powerdown debug registers to EL2

[MDCR_EL2.TDOSA](#) traps Non-secure EL1 System register accesses to the powerdown debug registers to EL2:

- 1 . Non-secure EL1 System register accesses to the powerdown debug registers are trapped to EL2.
- 0 . Non-secure EL1 System register accesses to the powerdown debug registers are not trapped to EL2.

Table D1-61 shows the register accesses that are trapped, and how the exceptions are reported in [ESR_EL2](#):

Table D1-61 Register accesses trapped to EL2 when [MDCR_EL2.TDOSA](#) is 1

Traps from	Registers	Syndrome reporting in ESR_EL2
AArch64 state	OSLAR_EL1 , OSLSR_EL1 , OSDLR_EL1 , DBGPRCR_EL1 . Any IMPLEMENTATION DEFINED integration registers. Any IMPLEMENTATION DEFINED register with similar functionality that the implementation specifies as trapped by MDCR_EL2.TDOSA	Trapped AArch64 MSR, MRS, or system instruction, using EC value 0x18.
AArch32 state	DBGOSLSR , DBGOSLAR , DBGOSDLR , DBGPRCR . Any IMPLEMENTATION DEFINED integration registers. Any IMPLEMENTATION DEFINED register with similar functionality that the implementation specifies as trapped by HDCR.TDOSA	Trapped MCR or MRC access (coproc==0b1110), using EC value 0x05.

Note

These registers are not accessible at EL0.

If [MDCR_EL2.TDE](#) or [HCR_EL2.TGE](#) is 1, behavior is as if [MDCR_EL2.TDOSA](#) is 1 other than for the purpose of a direct read.

Trapping general System register accesses to debug registers to EL2

[MDCR_EL2.TDA](#) traps Non-secure EL0 and EL1 System register accesses to those debug System registers that are not mentioned in either of the following:

- [Traps to EL2 of Non-secure EL0 and EL1 System register accesses to debug registers](#) on page D1-1865.
- [Trapping System register accesses to powerdown debug registers to EL2](#).

This means that [MDCR_EL2.TDA](#) traps Non-secure EL0 and EL1 System register accesses to all debug System registers to EL2, except the following:

- Any access from:
 - AArch64 state to the [MDRAR_EL1](#).
 - AArch32 state to the [DBGDRAR](#) or [DBGDSAR](#).

MDCR_EL2.TDRA traps these accesses.

- Any access from:
 - AArch64 state to the **OSLAR_EL1**, **OSLSR_EL1**, **OSDLR_EL1** or **DBGPRCR_EL1**.
 - AArch32 state to the **DBGOSLSR**, **DBGOSLAR**, **OSDLR_EL1** or **DBGPRCR**.

MDCR_EL2.TDOSA traps these accesses.

When the PE is in Debug state, **MDCR_EL2.TDA** does not trap any access from:

- AArch32 state to **DBGDTRRXint** and **DBGDTRTXint**.
- AArch64 state to **DBGDTR_EL0**, **DBGDTRRX_EL0**, and **DBGDTRTX_EL0**.

When **MDCR_EL2.TDA** is:

- | | |
|----------|---|
| 1 | Non-secure EL0 or EL1 System register accesses to any of the registers shown in Table D1-62 are trapped to EL2. |
| 0 | Non-secure EL0 or EL1 System register accesses to the registers shown in Table D1-62 are not trapped to EL2. |

[Table D1-62](#) shows how the exceptions are reported in **ESR_EL2**:

Table D1-62 Accesses trapped to EL2 when **MDCR_EL2.TDA** is 1

Traps from	Trapped accesses	Syndrome reporting in ESR_EL2
AArch64 state	Accesses to the MDCCSR_EL0 , MDCCINT_EL1 , DBGDTR_EL0 , DBGDTRRX_EL0 , DBGDTRTX_EL0 , OSDTRRX_EL1 , MDSCR_EL1 , OSDTRTX_EL1 , OSECCR_EL1 , DBGBVR<n>_EL1 , DBGBCR<n>_EL1 , DBGWVR<n>_EL1 , DBGWCR<n>_EL1 , DBGCLAIMSET_EL1 , DBGCLAIMCLR_EL1 , and DBGAUTHSTATUS_EL1 .	Trapped AArch64 MSR, MRS, or system instruction, using EC value 0x18
AArch32 state	Accesses to the DBGDIDR , DBGDSCRint , DBGDCCINT , DBGDTRRXint , DBGDTRTXint , DBGWFAR , DBGVCR , DBGDSCRExt , DBGDTRTXext , DBGDTRRXext , DBGBVR<n> , DBGBCR<n> , DBGBXVR<n> , DBGWCR<n> , DBGWVR<n> , DBGCLAIMSET , DBGCLAIMCLR , DBGAUTHSTATUS , DBGDEVID , DBGDEVID1 , DBGDEVID2 , and DBGOSECCR .	For accesses using MCR or MRC instructions, trapped MCR or MRC access (coproc==0b1110), using EC value 0x05
	STC accesses to DBGDTRRXint . LDC accesses to DBGDTRTXint .	Trapped LDC or STC access, using EC value 0x06

If **MDCR_EL2.TDE** or **HCR_EL2.TGE** is 1, behavior is as if **MDCR_EL2.TDA** is 1 other than for the purpose of a direct read.

Traps to EL2 of Non-secure EL0 and EL1 accesses to the Generic Timer registers

CNTHCTL_EL2.{EL1PCEN, EL1PCTEN} trap Non-secure EL0 and EL1 accesses to the Generic Timer registers to EL2, as follows:

- **CNTHCTL_EL2.EL1PCEN** traps Non-secure EL0 and EL1 accesses to the physical timer registers.
- **CNTHCTL_EL2.EL1PCTEN** traps Non-secure EL0 and EL1 accesses to the physical counter register.

For each of these controls:

- | | |
|----------|---|
| 1 | Non-secure EL0 and EL1 accesses are not trapped to EL2. |
| 0 | Non-secure EL0 and EL1 accesses are trapped to EL2. |

Table D1-63 shows the registers for which accesses are trapped, and how the exceptions are reported in [ESR_EL2](#).

Table D1-63 Register accesses trapped to EL2 by [CNTHCTL_EL2](#) trap controls

Traps from	Trap control	Registers	Syndrome reporting in ESR_EL2
AArch64 state	EL1PCEN	CNTP_CTL_EL0 , CNTP_CVAL_EL0 , CNTP_TVAL_EL0	Trapped AArch64 MSR, MRS, or system instruction, using EC value 0x18
	EL1PCTEN	CNTPCT_EL0	
AArch32 state	EL1PCEN	CNTP_CTL , CNTP_CVAL , CNTP_TVAL	For accesses using: <ul style="list-style-type: none"> MCR or MRC instructions, trapped MCR or MRC access (coproc==0b1111), using EC value 0x03 MCR or MRRC instructions, trapped MCR or MRRC access (coproc==0b1111), using EC value 0x04
	EL1PCTEN	CNTPCT	Trapped MCRR or MRRC access (coproc==0b1111), using EC value 0x04

Traps to EL2 of Non-secure EL0 and EL1 accesses to Performance Monitors registers

[MDCR_EL2](#).{TPM, TPMCR} trap Non-secure EL0 and EL1 accesses to the Performance Monitors registers to EL2:

[MDCR_EL2.TPM](#)

- 1** Non-secure EL0 and EL1 accesses to the Performance Monitors registers are trapped to EL2.
- 0** Non-secure EL0 and EL1 accesses to the Performance Monitors registers are not trapped to EL2.

[MDCR_EL2.TPMCR](#)

- 1** Non-secure EL0 and EL1 accesses to the Performance Monitors Control Registers are trapped to EL2.
- 0** Non-secure EL0 and EL1 accesses to the Performance Monitors Control Registers are not trapped to EL2.

———— **Note** ————

EL2 does not provide traps on Performance Monitor register accesses through the optional memory-mapped external debug interface.

For:

- [MDCR_EL2.TPM](#) == 1, [Table D1-64 on page D1-1869](#) shows the registers for which accesses are trapped, and how the exceptions are reported in [ESR_EL2](#).

- [MDCR_EL2.TPMCR](#) == 1, [Table D1-65](#) shows the registers for which accesses are trapped, and how the exceptions are reported in [ESR_EL2](#).

Table D1-64 Register accesses trapped to EL2 when [MDCR_EL2.TPM](#) is 1

Traps from	Registers	Syndrome reporting in ESR_EL2
AArch64 state	PMCR_EL0 , PMCNTENSET_EL0 , PMCNTENCLR_EL0 , PMOVSCLR_EL0 , PMSWINC_EL0 , PMSELR_EL0 , PMCEID0_EL0 , PMCEID1_EL0 , PMCCNTR_EL0 , PMXEVTYPER_EL0 , PMXEVCNTR_EL0 , PMUSERENR_EL0 , PMINTENSET_EL1 , PMINTENCLR_EL1 , PMOVSSET_EL0 , PMEVCNTR<n>_EL0 , PMEVTYPER<n>_EL0 , PMCCFILTR_EL0 .	Trapped AArch64 MSR, MRS, or system instruction, using EC value 0x18
AArch32 state	PMCR , PMCNTENSET , PMCNTENCLR , PMOVS , PMSWINC , PMSELR , PMCEID0 , PMCEID1 , PMCCNTR , PMXEVTYPER , PMXEVCNTR , PMUSERENR , PMINTENSET , PMINTENCLR , PMOVSSET , PMEVCNTR<n> , PMEVTYPER<n> , PMCCFILTR .	For accesses using: <ul style="list-style-type: none"> • MCR or MRC instructions, trapped MCR or MRC access (coproc==0b1111), using EC value 0x03 • MCRR or MRRC instructions, trapped MCRR or MRRC access, (coproc==0b1111) using EC value 0x04

Table D1-65 Register accesses trapped to EL2 when [MDCR_EL2.TPMCR](#) is 1

Traps from	Registers	Syndrome reporting in ESR_EL2
AArch64 state	PMCR_EL0	Trapped AArch64 MSR, MRS, or system instruction, using EC value 0x18
AArch32 state	PMCR	Trapped MCR or MRC access (coproc==0b1111), using EC value 0x03

———— **Note** —————

[MDCR_EL2.HPMN](#) affects whether a counter can be accessed from Non-secure EL0 or EL1. See the register description of [MDCR_EL2](#) for more information.

D1.15.4 EL3 configurable controls

These controls are in [_EL3](#) System registers. The resulting exceptions might be taken from either Execution state. [SPSR_EL3.M\[4\]](#) indicates which Execution state the exception was taken from.

[Table D1-66](#) shows the [_EL3](#) System registers that contain these controls.

Table D1-66 [_EL3](#) registers that contain instruction enables and disables, and trap controls

Register description	Register name
Secure Configuration Register	SCR_EL3
Architectural Feature Trap Register, EL3	CPTR_EL3
Monitor Debug Configuration Register, EL3	MDCR_EL3

Table D1-67 summarizes the controls.

Table D1-67 Instruction enables and disables, and trap controls, provided by EL3

Control	Control type ^a	Description
SCR_EL3.{TWE, TWI}	T	Traps to EL3 of EL2, EL1, and EL0 execution of WFE and WFI instructions on page D1-1871
SCR_EL3.ST	T	Traps to EL3 of Secure EL1 accesses to the Counter-timer Physical Secure timer registers on page D1-1872
SCR_EL3.HCE	E	Enabling EL3, EL2, and Non-secure EL1 execution of HVC instructions on page D1-1872
SCR_EL3.SMD	D	Disabling EL3, EL2, and EL1 execution of SMC instructions on page D1-1873
CPTR_EL3.TCPAC	T	Trapping to EL3 of EL2 accesses to the CPTR_EL2 or HCPTR, and EL2 and EL1 accesses to the CPACR_EL1 or CPACR on page D1-1873
CPTR_EL3.TTA	T	Traps to EL3 of all System register accesses to the trace registers on page D1-1874
CPTR_EL3.TFP	T	Traps to EL3 of all accesses to the SIMD and floating-point registers on page D1-1874
MDCR_EL3.{TDOSA, TDA}	T	Traps to EL3 of EL2, EL1, and EL0 System register accesses to debug registers on page D1-1875
MDCR_EL3.TPM	T	Traps to EL3 of EL2, EL1, and EL0 accesses to Performance Monitors registers on page D1-1877

a. See Table D1-68.

Table D1-68 Control types, for exceptions taken to EL1

Abbreviation	Type	See
D	Disable	Instruction enables and instruction disables on page D1-1842
E	Enable	Instruction enables and instruction disables on page D1-1842
T	Trap	Trap controls on page D1-1842

Also see the following for more general information about traps to EL3:

- [Register access instructions on page D1-1843.](#)
- [Traps to EL3 of Secure monitor functionality from Secure EL1 using AArch32.](#)

Traps to EL3 of Secure monitor functionality from Secure EL1 using AArch32

If EL1 is using AArch32, all of the following are trapped to EL3:

- Secure EL1 reads and writes to any of the [SCR](#), [NSACR](#), [MVBAR](#) or [SDCR](#).
- Any attempt at Secure EL1 to execute any of the following:
 - [ATS12NSO**](#) instructions.
 - SRS instructions that use the R13_mon banked register.
 - MRS or MSR instructions that access any of the SPSR_mon, R13_mon or R14_mon banked registers.

In addition, if EL1 is using AArch32:

- Secure EL1 write accesses to the [CNTFRQ](#) register are UNDEFINED. They are not trapped to EL3.

- Any attempt at Secure EL1 to change the PE mode to Monitor mode, by using a CPS or an MSR instruction, or by performing an exception return, is treated as an illegal change of the `CPSR.M` field. See *Illegal changes to PSTATE.M* on page G1-4336.

Table D1-69 shows the accesses that are trapped to EL3, and how the exceptions are reported in `ESR_EL3`.

Table D1-69 Accesses trapped to EL3 from Secure EL1 using AArch32

Taken from	Trapped instructions, or trapped accesses	Syndrome reporting in <code>ESR_EL3</code>
Secure EL1 using AArch32	Reads and writes to any of the <code>SCR</code> , <code>NSACR</code> , <code>MVBAR</code> or <code>SDCR</code> <code>ATS12NSO**</code> instructions	Trapped MCR or MRC access (coproc==0b1111), using EC value 0x03
	SRS instructions that use the <code>R13_mon</code> banked register	Exception for an unknown reason, using EC value 0x00
	MRS or MSR instructions that accesses any of the <code>SPSR_mon</code> , <code>R13_mon</code> or <code>R14_mon</code> banked registers	

Note

- Reads of the `NSACR` from either Non-secure EL1 using AArch32 or Non-secure EL2 using AArch32 return the value 0x00000C00. See *Restricted access System registers* on page G4-4694.
- These operations are not available at EL0.

Traps to EL3 of EL2, EL1, and EL0 execution of WFE and WFI instructions

`SCR_EL3`.{TWE, TWI} trap EL2, EL1, and EL0 execution of WFE and WFI instructions to EL3:

`SCR_EL3.TWE`

- 1** Any attempt to execute a WFE instruction at any Exception level lower than EL3 is trapped to EL3, if the instruction would otherwise have caused the PE to enter a low-power state.
- 0** EL2, EL1, and EL0 execution of WFE instructions is not trapped to EL3.

`SCR_EL3.TWI`

- 1** Any attempt to execute a WFI instruction at any Exception level lower than EL3 is trapped to EL3, if the instruction would otherwise have caused the PE to enter a low-power state.
- 0** EL2, EL1, and EL0 execution of WFI instructions is not trapped.

For EL0 and EL1, these traps apply to WFE and WFI execution in both Security states.

Table D1-70 shows how the exceptions are reported in `ESR_EL3`.

Table D1-70 Instructions trapped to EL3 when `SCR_EL3`.{TWE, TWI} are 1

Trap control	Traps from	Trapped instructions	Syndrome reporting in <code>ESR_EL3</code>
<code>SCR_EL3.TWE</code>	Both Execution states	WFE	Trapped WFI or WFE instruction, using EC value 0x01
<code>SCR_EL3.TWI</code>		WFI	

In AArch32 state, the attempted execution of a conditional WFE or WFI instruction is only trapped if the instruction passes its Condition code check.

———— **Note** —————

Since a WFE or WFI can complete at any time, even without a Wakeup event, the traps on WFE or WFI are not guaranteed to be taken, even if the WFE or WFI is executed when there is no Wakeup event. The only guarantee is that if the instruction does not complete in finite time in the absence of a Wakeup event, the trap will be taken.

For more information about these instructions, and when they can cause the PE to enter a low-power state, see:

- [Wait for Event mechanism and Send event on page D1-1879.](#)
- [Wait For Interrupt on page D1-1882.](#)

Traps to EL3 of Secure EL1 accesses to the Counter-timer Physical Secure timer registers

[SCR_EL3.ST](#) traps Secure EL1 accesses to the Counter-timer Physical Secure timer registers to EL3:

- 1** Secure EL1 accesses to the Counter-timer Physical Secure timer registers are not trapped to EL3.
- 0** Secure EL1 accesses to the Counter-timer Physical Secure timer registers are trapped to EL3.

———— **Note** —————

Accesses to the Counter-timer Physical Secure timer registers are always enabled at EL3.

[Table D1-71](#) shows the registers for which accesses are trapped to EL3, and how the exceptions are reported in [ESR_EL3](#).

Table D1-71 Register accesses trapped to EL3 when [SCR_EL3.ST](#) is 0

Traps from	Registers	Syndrome reporting in ESR_EL3
AArch64 state	CNTPS_TVAL_EL1 CNTPS_CTL_EL1 CNTPS_CVAL_EL1	Trapped AArch64 MSR, MRS, or system instruction, using EC value 0x18
AArch32 state	n/a	n/a

———— **Note** —————

These registers are not accessible at EL0.

Enabling EL3, EL2, and Non-secure EL1 execution of HVC instructions

[SCR_EL3.HCE](#) enables HVC instruction execution at EL1 and above:

- 1** HVC instruction execution is enabled at EL1 and above.
- 0** HVC instructions are UNDEFINED at EL1, EL2, and EL3, and any resulting exception is taken from the current Exception level to the current Exception level.

For EL1, this enable control applies to HVC instructions in Non-secure state only.

If EL2 is not implemented, this bit is RES0.

———— **Note** —————

HVC instructions are always UNDEFINED at EL0.

Table D1-72 shows how the exceptions are reported in [ESR_ELx](#):

Table D1-72 Instruction disabled when [SCR_EL3.HCE](#) is 0

Taken from	Disabled instruction	Syndrome reporting in ESR_ELx
AArch64 state	HVC	Exception for an unknown reason, using EC value 0x00
AArch32 state		

Disabling EL3, EL2, and EL1 execution of SMC instructions

[SCR_EL3.SMD](#) disables SMC instruction execution at EL1 and above:

- 1** SMC instructions are UNDEFINED at EL1 and above, and any resulting exception is taken from the current Exception level to the current Exception level.
- 0** SMC instruction execution is enabled at EL1 and above.

For EL1, this disable control applies to SMC instructions in both Security states.

———— **Note** ————

SMC instructions are always UNDEFINED at EL0.

Table D1-73 shows how the exceptions are reported in [ESR_ELx](#):

Table D1-73 Exceptions generated when [SCR_EL3.SMD](#) is 1

Taken from	Disabled Instruction	Syndrome reporting in ESR_ELx
AArch64 state	SMC	Exception for an unknown reason, using EC value 0x00
AArch32 state		

———— **Note** ————

If [HCR_EL2.TSC](#) or [HCR.TSC](#) traps attempted EL1 execution of SMC instructions to EL2, that trap has priority over this disable.

Trapping to EL3 of EL2 accesses to the [CPTR_EL2](#) or [HCPTR](#), and EL2 and EL1 accesses to the [CPACR_EL1](#) or [CPACR](#)

[CPTR_EL3.TCPAC](#) traps all of the following to EL3:

- EL2 accesses to the [CPTR_EL2](#) or [HCPTR](#).
- EL2 and EL1 accesses to the [CPACR_EL1](#) or [CPACR](#).

When [CPTR_EL3.TCPAC](#) is:

- 1** EL2 accesses to the [CPTR_EL2](#) or [HCPTR](#), and EL2 and EL1 accesses to the [CPACR_EL1](#) or [CPACR](#), are trapped to EL3.
- 0** EL2 accesses to the [CPTR_EL2](#) or [HCPTR](#), and EL2 and EL1 accesses to the [CPACR_EL1](#) or [CPACR](#), are not trapped to EL3.

For EL1, this trap control applies to accesses from both Security states.

Table D1-74 shows how the exceptions are reported in [ESR_EL3](#).

Table D1-74 Register accesses trapped to EL3 when [CPTR_EL3.TCPAC](#) is 1

Traps from	Registers	Syndrome reporting in ESR_EL3
AArch64 state	CPTR_EL2 CPACR_EL1	Trapped AArch64 MSR, MRS, or system instruction, using EC value 0x18
AArch32 state	HCPTR CPACR	Trapped MCR or MRC access (coproc==0b1111), using EC value 0x03

Traps to EL3 of all System register accesses to the trace registers

[CPTR_EL3.TTA](#) traps System register accesses to the trace registers, from all Exception levels, to EL3:

- 1** All System register accesses to the trace registers are trapped to EL3.
- 0** System register accesses to the trace registers are not trapped to EL3.

———— **Note** ————

- The ETMv4 architecture does not permit EL0 to access the trace registers. If the ARMv8-A architecture is implemented with an ETMv4 implementation, EL0 accesses to the trace registers are UNDEFINED, and any resulting exception is higher priority than a [CPTR_EL3.TTA](#) Trap exception.
- EL3 does not provide traps on trace register accesses through the Memory-mapped interface.

System register accesses to the trace registers can have side-effects. When a System register access is trapped, no side-effects occur before the exception is taken, see [Register access instructions on page D1-1843](#).

For EL0 and EL1, this trap control applies to accesses from both Security states.

[Table D1-75](#) shows the registers for which accesses are trapped to EL3, and how the exceptions are reported in [ESR_EL3](#).

Table D1-75 Register accesses trapped to EL3 when [CPTR_EL3.TTA](#) is 1

Traps from	Registers	Syndrome reporting in ESR_EL3
AArch64 state	All implemented trace registers	Trapped AArch64 MSR, MRS, or system instruction, using EC value 0x18
AArch32 state	All implemented trace registers	For accesses using: <ul style="list-style-type: none"> • MCR or MRC instructions, trapped MCR or MRC access (coproc==0b1110), using EC value 0x05. • MCRR or MRRC instructions, trapped MCRR or MRRC access (coproc==0b1110), using EC value 0x0C.

Traps to EL3 of all accesses to the SIMD and floating-point registers

[CPTR_EL3.TFP](#) traps all accesses to SIMD and floating-point registers, from all Exception levels, to EL3:

- 1** Any attempt at any Exception level to execute an instruction that accesses the SIMD or floating-point registers is trapped to EL3
- 0** Execution of instructions that access the SIMD or floating-point registers is not trapped to EL3.

For EL0 and EL1, this trap control applies to accesses from both Security states.

Table D1-76 shows the registers for which accesses are trapped to EL3, and how the exceptions are reported in ESR_EL3.

Table D1-76 Register accesses trapped to EL3 when CPTR_EL3.TFP is 1

Traps from	Registers	Syndrome reporting in ESR_EL3
AArch64 state	FPCR, FPSR, FPEXC32_EL2, and any of the SIMD and floating-point registers V0-V31, including their views as D0-D31 registers or S0-S31 registers. See <i>The SIMD and floating-point registers, V0-V31</i> on page D1-1786.	Trapped access to a SIMD or floating-point register, resulting from CPACR_EL1.FPEN or CPTR_ELx.TFP, using EC value 0x07
AArch32 state	FPSID, MVFR0, MVFR1, MVFR2, FPSCR, FPEXC, and any of the SIMD and floating-point registers Q0-Q15, including their views as D0-D31 registers or S0-S31 registers. See <i>Advanced SIMD and floating-point System registers</i> on page G1-4415.	Trapped access to a SIMD or floating-point register, resulting from CPACR_EL1.FPEN or CPTR_ELx.TFP, using EC value 0x07 ^a

- a. Permitted VMSR accesses to the FPSID are ignored, but for the purposes of this trap the architecture defines a VMSR access to the FPSID from EL1 or higher is an access to a SIMD and floating-point register.

———— **Note** —————

- FPEXC32_EL2 is not accessible from EL0 using AArch64.
- FPSID, MVFR0, MVFR1, and FPEXC are not accessible from EL0 using AArch32.

Traps to EL3 of EL2, EL1, and EL0 System register accesses to debug registers

MDCR_EL3.{TDOSA, TDA} trap EL2, EL1, and EL0 System register accesses to the debug registers to EL3, from both Security states.

———— **Note** —————

EL3 does not provide traps on debug register accesses through the Memory-mapped or External debug interfaces.

System register accesses to the debug registers can have side-effects. When a System register access is trapped to EL3, no side-effects occur before the exception is taken to EL3. See *Register access instructions* on page D1-1843.

Table D1-77 shows the subsections that list the accesses trapped.

Table D1-77 Traps of EL2, EL1, and EL0 accesses to debug registers

Trap control	Subsection
MDCR_EL3.TDOSA	<i>Trapping System register accesses to powerdown debug registers to EL3</i>
MDCR_EL3.TDA	<i>Trapping general System register accesses to debug registers to EL3 on page D1-1876</i>

Trapping System register accesses to powerdown debug registers to EL3

MDCR_EL3.TDOSA traps EL2 and EL1 accesses to the powerdown debug registers to EL3:

- 1** EL2 and EL1 System register accesses to the powerdown debug registers are trapped to EL3.
0 EL2 and EL1 System register accesses to the powerdown debug registers are not trapped to EL3.

For EL1, this trap control applies to accesses from both Security states.

Table D1-78 shows the registers for which accesses are trapped, and how the exceptions are reported in [ESR_EL3](#).

Table D1-78 Register accesses trapped to EL3 when [MDCR_EL3.TDOSA](#) is 1

Traps from	Registers	Syndrome reporting in ESR_EL3
AArch64 state	OSLAR_EL1 , OSLSR_EL1 , OSDLR_EL1 , DBGPRCR_EL1 . Any IMPLEMENTATION DEFINED integration registers. Any IMPLEMENTATION DEFINED register with similar functionality that the implementation specifies as trapped by MDCR_EL3.TDOSA .	Trapped AArch64 MSR, MRS, or system instruction, using EC value 0x18.
AArch32 state	DBGOSLSR , DBGOSLAR , DBGOSDLR , DBGPRCR .	For accesses using: <ul style="list-style-type: none"> MCR or MRC instructions, trapped MCR or MRC access (coproc==0b1110), using EC value 0x05. MCRR or MRRC instructions, trapped MCRR or MRRC access (coproc==0b1110), using EC value 0x0C.

———— **Note** —————

These registers are not accessible at EL0.

Trapping general System register accesses to debug registers to EL3

[MDCR_EL3.TDA](#) traps EL2, EL1, and EL0 System register accesses to the debug System registers that are not mentioned in [Trapping System register accesses to powerdown debug registers to EL3](#) on page D1-1875.

This means that [MDCR_EL3.TDA](#) traps EL2, EL1, and EL0 System register accesses to all debug System registers, except the following:

- Accesses from AArch64 state to the [OSLAR_EL1](#), [OSLSR_EL1](#), [OSDLR_EL1](#) or [DBGPRCR_EL1](#).
- Accesses from AArch32 state to the [DBGOSLSR](#), [DBGOSLAR](#), [OSDLR_EL1](#) or [DBGPRCR](#).

When [MDCR_EL3.TDA](#) is:

- 1** EL2, EL1, and EL0 System register accesses to any of the registers shown in [Table D1-79 on page D1-1877](#) are trapped to EL3.
- 0** EL2, EL1, and EL0 System register accesses to the registers shown in [Table D1-79 on page D1-1877](#) are not trapped to EL3.

For EL0 and EL1, this trap control applies to accesses from both Security states.

When the PE is in Debug state, [MDCR_EL3.TDA](#) does not trap any access from:

- AArch32 state to [DBGDTRRXint](#) and [DBGDTRTXint](#).
- AArch64 state to [DBGDTR_EL0](#), [DBGDTRRX_EL0](#), and [DBGDTRTX_EL0](#).

Table D1-79 shows the registers for which accesses are trapped, and how the exceptions are reported in [ESR_EL3](#).

Table D1-79 Accesses trapped to EL3 when [MDCR_EL3.TDA](#) is 1

Traps from	Trapped accesses	Syndrome reporting in ESR_EL3
AArch64 state	Accesses to the MDCR_EL2 , MDRAR_EL1 , MDCCSR_EL0 , MDCCINT_EL1 , DBGDTR_EL0 , DBGDTRRX_EL0 , DBGDTRTX_EL0 , OSDTRRX_EL1 , MDSR_EL1 , OSDTRTX_EL1 , OSECCR_EL1 , DBGBVR<n>_EL1 , DBGBCR<n>_EL1 , DBGWVR<n>_EL1 , DBGWCR<n>_EL1 , DBGCLAIMSET_EL1 , DBGCLAIMCLR_EL1 , and DBGAUTHSTATUS_EL1 .	Trapped AArch64 MSR, MRS, or system instruction, using EC value 0x18
AArch32 state	Accesses to the HDCR , DBGDRAR , DBGDSAR , DBGDIDR , DBGDSCRint , DBGDCCINT , DBGDTRRXint , DBGDTRTXint , DBGWFAR , DBGVCR , DBGDSCRExt , DBGDTRTXext , DBGDTRRXext , DBGBVR<n> , DBGBCR<n> , DBGBXVR<n> , DBGWCR<n> , DBGWVR<n> , DBGCLAIMSET , DBGCLAIMCLR , DBGAUTHSTATUS , DBGDEVID , DBGDEVID1 , DBGDEVID2 , and DBGOSECCR .	For accesses using: <ul style="list-style-type: none"> MCR or MRC instructions, trapped MCR or MRC access (coproc==0b1110), using EC value 0x05. MRRC instructions, trapped MCRR or MRRC access (coproc==0b1110), using EC value 0x0C.
	STC accesses to DBGDTRRXint . LDC accesses to DBGDTRTXint .	LDC or STC, trapped LDC or STC access, using EC value 0x06

Traps to EL3 of EL2, EL1, and EL0 accesses to Performance Monitors registers

[MDCR_EL3.TPM](#) traps EL2, EL1, and EL0 accesses to the Performance Monitors registers to EL3:

- 1** EL2, EL1, and EL0 System register accesses to all Performance Monitors registers are trapped to EL3.
- 0** EL2, EL1, and EL0 System register accesses to Performance Monitors registers are not trapped to EL3.

For EL0 and EL1, this trap control applies to accesses from both Security states.

Table D1-80 shows the registers for which accesses are trapped, and how the exceptions are reported in [ESR_EL3](#).

Table D1-80 Register accesses trapped to EL3 when [MDCR_EL3.TPM](#) is 1

Traps from	Registers	Syndrome reporting in ESR_EL3
AArch64 state	PMCR_EL0 , PMCNTENSET_EL0 , PMCNTENCLR_EL0 , PMOVSCLR_EL0 , PMSWINC_EL0 , PMSELR_EL0 , PMCEID0_EL0 , PMCEID1_EL0 , PMCCNTR_EL0 , PMXEVTYPER_EL0 , PMXEVNTR_EL0 , PMUSERENR_EL0 , PMINTENSET_EL1 , PMINTENCLR_EL1 , PMOVSSET_EL0 , PMEVCNTR<n>_EL0 , PMEVTYPER<n>_EL0 , PMCCFILTR_EL0 .	Trapped AArch64 MSR, MRS, or system instruction, using EC value 0x18
AArch32 state	PMCR , PMCNTENSET , PMCNTENCLR , PMOVS , PMSWINC , PMSELR , PMCEID0 , PMCEID1 , PMCCNTR , PMXEVTYPER , PMXEVNTR , PMUSERENR , PMINTENSET , PMINTENCLR , PMOVSSET , PMEVCNTR<n> , PMEVTYPER<n> , PMCCFILTR .	For accesses using: <ul style="list-style-type: none"> MCR or MRC instructions, trapped MCR or MRC access (coproc==0b1111), using EC value 0x03 MCRR or MRRC instructions, trapped MCRR or MRRC access (coproc==0b1111), using EC value 0x04

D1.16 System calls

A system call is generated by the execution of an SVC, HVC, or SMC instruction:

- By default, the execution of an SVC instruction generates a Supervisor Call, a synchronous exception that targets EL1. This provides a mechanism for software executing at EL0 to make a call to an operating system or other software executing at EL1.
- In an implementation that includes EL2, the execution of an HVC instruction generates a Hypervisor Call, a synchronous exception that targets EL2 by default.

The HVC instruction is UNDEFINED:

- At EL0.
- At EL1 in Secure state.

———— **Note** —————

Software executing at EL0 cannot directly generate a Hypervisor Call.

- In an implementation that includes EL3, by default the execution of an SMC instruction generates a Secure Monitor Call, a synchronous exception that targets EL3.

The SMC instruction is UNDEFINED at EL0, meaning software executing at EL0 cannot directly generate a Secure Monitor Call.

The default behavior applies when the instruction is not UNDEFINED and both of the following are true:

- The instruction is executed at an Exception level that is the same as or lower than the target Exception level.
- The instruction is not trapped to a different Exception level.

If an SVC or HVC instruction is executed at an Exception level that is higher than the target Exception then it generates a synchronous exception that is taken to the current Exception level.

EL2 and EL3 can disable Hypervisor Call exceptions, see:

- [Disabling Non-secure state execution of HVC instructions on page D1-1854.](#)
- [Enabling EL3, EL2, and Non-secure EL1 execution of HVC instructions on page D1-1872.](#)

EL2 can trap use of the SMC instruction, see [Traps to EL2 of Non-secure EL1 execution of SMC instructions on page D1-1858.](#)

EL3 can disable Secure Monitor Call exceptions, see [Disabling EL3, EL2, and EL1 execution of SMC instructions on page D1-1873.](#)

D1.16.1 Pseudocode description of system calls

The `AArch64.CallSupervisor()` pseudocode function performs an SVC call in AArch64 state.

The `AArch64.CallHypervisor()` pseudocode function performs an HVC call in AArch64 state.

The `AArch64.CallSecureMonitor()` pseudocode function performs an SMC call in AArch64 state.

The `AArch64.CallSupervisor()`, `AArch64.CallHypervisor()`, and `AArch64.CallSecureMonitor()` functions are described in [Chapter J1 ARMv8 Pseudocode.](#)

D1.17 Mechanisms for entering a low-power state

The ARM architecture provides mechanisms that software can use to indicate that the PE can enter a low-power state, if it supports that state. The following sections describe those mechanisms:

- [Wait for Event mechanism and Send event](#).
- [Wait For Interrupt](#) on page D1-1882.

D1.17.1 Wait for Event mechanism and Send event

A PE can use the *Wait for Event* (WFE) mechanism to enter a low-power state, depending on the value of the Event Register for that PE. To enter the low-power state, the PE executes a Wait For Event instruction, WFE, and if the Event Register is clear, the PE can enter the low-power state.

If the PE does enter the low-power state, it remains in that low-power state until it receives a *WFE wake-up event*.

The architecture does not define the exact nature of the low-power state, except that the execution of a WFE instruction must not cause a loss of memory coherency.

WFE mechanism behavior depends on the interaction of all of the following, that are described in the subsections that follow:

- The Event Register for the PE. See subsection [The Event Register](#) on page D1-1880.
- The Wait For Event instruction, WFE. See subsection [The Wait For Event instruction](#) on page D1-1880.
- *WFE wake-up events*. See subsection [WFE wake-up events in AArch64 state](#) on page D1-1881
- The Send Event instructions, SEV and SEVL that can cause WFE wake-up events. See subsection [The Send Event instructions](#) on page D1-1881.

———— Note —————

Because the Wait for Event mechanism is associated with suspending execution on a PE for the purpose of power saving, ARM recommends that the Event Register is set only infrequently. However, software must only use the setting of the Event Register as a hint, and must not assume that any particular message is sent as a result of the setting of the Event Register.

[Example D1-2](#) describes how a spinlock implementation might use the WFE mechanism to save energy.

Example D1-2 Spinlock as an example of using Wait For Event and Send Event

A multiprocessor operating system requires locking mechanisms to protect data structures from being accessed simultaneously by multiple PEs. These mechanisms prevent the data structures becoming inconsistent or corrupted if different PEs try to make conflicting changes. If a lock is busy, because a data structure is being used by one PE, it might not be practical for another PE to do anything except wait for the lock to be released. For example, if a PE is handling an interrupt from a device, it might need to add data received from the device to a queue. If another PE is removing data from the same queue, it will have locked the memory area that holds the queue. The first PE cannot add the new data until the queue is in a consistent state and the second PE has released the lock. The first PE cannot return from the interrupt handler until the data has been added to the queue, so it must wait.

Typically, a spin-lock mechanism is used in these circumstances:

- A PE requiring access to the protected data attempts to obtain the lock using single-copy atomic synchronization primitives such as the Load-Exclusive and Store-Exclusive operations described in [Synchronization and semaphores](#) on page B2-121.
- If the PE obtains the lock it performs its memory operation and then releases the lock.
- If the PE cannot obtain the lock, it reads the lock value repeatedly in a tight loop until the lock becomes available. When the lock becomes available, the PE again attempts to obtain it.

A spin-lock mechanism is not ideal for all situations:

- In a low-power system the tight read loop is undesirable because it uses energy to no effect.
- In a multiprocessor system the execution of spin-locks by multiple waiting PEs can degrade overall performance.

Using the Wait For Event and Send Event mechanism can improve the energy efficiency of a spinlock:

- A PE that fails to obtain a lock executes a WFE instruction to request entry to a low-power state, at the time when the Exclusives monitor is set holding the address of the location holding the lock.
- When a PE releases a lock, the write to the lock location causes the Exclusives monitor of any PE monitoring the lock location to be cleared. This clearing of the Exclusives monitors generates a WFE wake-up event for each of those PEs. Then, these PEs can attempt to obtain the lock again.

For large systems, more advanced locking systems, such as ticket locks, can avoid unfairness caused by having multiple PEs simultaneously reading the lock. In such systems, the WFE mechanism can be used in a similar way to monitor the next ticket value.

The Event Register

The Event Register is a single bit register for each PE. When set, an Event Register indicates that an event has occurred since the register was last cleared, that might require some action by the PE. Therefore, when the Event Register is set, the PE must not suspend operation on executing a WFE instruction.

The reset value of the Event Register is UNKNOWN.

The Event Register for a PE is set by any of the following:

- A Send Event instruction, SEV, executed by any PE in the system.
- A Send Event Local instruction, SEVL, executed by the PE.
- An exception return.
- The clearing of the global monitor for the PE.
- An event from a Generic Timer event stream, see [Event streams on page D6-2186](#).
- An event sent by some IMPLEMENTATION DEFINED mechanism.

The Event Register is cleared only by a Wait For Event instruction.

Note

Software cannot read or write the value of the Event Register directly.

The Wait For Event instruction

The action of the Wait For Event instruction, WFE, depends on the state of the Event Register:

- If the Event Register is set, the instruction clears the register and completes immediately.
- If the Event Register is clear the PE can suspend execution and enter a low-power state. It remains in that state until the PE detects a WFE wake-up event, or earlier if the implementation chooses, or until a reset. When the PE detects a WFE wake-up event, or earlier if chosen, the WFE instruction completes. If the wake-up event sets the Event Register, it is IMPLEMENTATION DEFINED whether on restarting execution, the Event Register is cleared.

The WFE instruction is available at all Exception levels. Attempts to enter a low-power state made by software executing at EL0, EL1, or EL2 might be trapped to a higher Exception level. See:

- [Traps to EL1 of EL0 execution of WFE and WFI instructions on page D1-1845](#).
- [Traps to EL2 of Non-secure EL0 and EL1 execution of WFE and WFI instructions on page D1-1861](#).
- [Traps to EL3 of EL2, EL1, and EL0 execution of WFE and WFI instructions on page D1-1871](#).

———— **Note** —————

Software using the Wait For Event mechanism must tolerate spurious wake-up events, including multiple wake-ups.

WFE wake-up events in AArch64 state

The following are *WFE wake-up events*:

- The execution of an SEV instruction on any PE in the multiprocessor system.
- Any physical SError interrupt, IRQ interrupt, or FIQ interrupt received by the PE, that is not disabled by `EDSCR.INTdis` and:
 - Is marked as **A** in the tables in *Asynchronous exception masking* on page D1-1836, regardless of the value of the corresponding `PSTATE.{A, I, F}` mask bit.
 - Is marked as **B** in the tables in *Asynchronous exception masking* on page D1-1836, if the value of the corresponding `PSTATE.{A, I, F}` mask bit is 0.
- In Non-secure EL1 or EL0, any virtual SError interrupt, IRQ interrupt, or FIQ interrupt received by the PE, that is not disabled by `EDSCR.INTdis` and is marked as **B** in Table D1-19 on page D1-1840 in *Virtual interrupts* on page D1-1839, if the value of the corresponding `PSTATE.{A, I, F}` mask bit is 0.
- An asynchronous External Debug Request debug event, if halting is allowed. For the definition of *halting is allowed* see *Halting allowed and halting prohibited* on page H2-5435.
See also *External Debug Request debug event* on page H3-5490.
- An event sent by the timer event stream for the PE. See *Event streams* on page D6-2186.
- An event caused by the clearing of the global monitor for the PE.
- An event sent by some IMPLEMENTATION DEFINED mechanism.

Not all of these wake-up events set the Event Register.

———— **Note** —————

The disabling of interrupts, and WFE wake-up events, by `EDSCR.INTdis` is possible only when external debug is enabled.

The Send Event instructions

The Send Event instructions are:

SEV, Send Event This causes an event to be signaled to all PEs in the multiprocessor system.

SEVL, Send Event Local

This must set the local Event Register.

———— **Note** —————

It might signal an event to other PEs by some IMPLEMENTATION DEFINED mechanism, but is not required to do so.

The mechanism that signals an event to other PEs is IMPLEMENTATION DEFINED. The PE is not required to guarantee the ordering of this event with respect to the completion of memory accesses by instructions before the SEV instruction. Therefore, ARM recommends that software includes a DSB instruction before any SEV instruction.

Note

A DSB instruction ensures that no instructions, including any SEV instructions, that appear in program order after the DSB instruction, can execute until the DSB instruction has completed. See [Data Synchronization Barrier \(DSB\) on page B2-93](#).

The SEVL instruction appears to execute in program order relative to any subsequent WFE instruction executed on the same PE, without the need for any explicit insertion of barrier instructions.

The receipt of a signaled SEV or SEVL event by a PE sets the Event Register on that PE.

The SEV and SEVL instructions are available at all Exception levels.

Pseudocode description of the Wait For Event mechanism

This section identifies pseudocode functions that describe the behavior of the Wait For Event mechanism.

The [ClearEventRegister\(\)](#) pseudocode function clears the Event Register of the current PE.

The [IsEventRegisterSet\(\)](#) pseudocode function returns TRUE if the Event Register of the current PE is set and FALSE if it is clear.

The [WaitForEvent\(\)](#) pseudocode function optionally suspends execution until a WFE wake-up event or reset occurs, or until some earlier time if the implementation chooses. It is IMPLEMENTATION DEFINED whether restarting execution after the period of suspension causes [ClearEventRegister\(\)](#) to be called.

The [SendEvent\(\)](#) pseudocode function sets the Event Register of every PE in the multiprocessor system.

The [SendEventLocal\(\)](#) pseudocode function sets the event register for the local PE.

D1.17.2 Wait For Interrupt

Software can use the *Wait for Interrupt (WFI)* instruction to cause the PE to enter a low-power state. The PE then remains in that low-power state until it receives a *WFI wake-up event*, or until some other IMPLEMENTATION DEFINED reason causes it to leave the low-power state. The architecture permits a PE to leave the low-power state for any reason, but requires that it must leave the low-power state on receipt of any architected WFI wake-up event.

Note

Because the architecture permits a PE to leave the low-power state for any reason, it is permissible for a PE to treat WFI as a NOP, but this is not recommended for lowest power operation.

When the PE leaves a low-power state that was entered as a result of a WFI instruction, that WFI instruction completes.

The architecture does not define the exact nature of the low-power state, except that the execution of a WFI instruction must not cause a loss of memory coherency.

Attempts to enter a low-power state made by software executing at EL0, EL1, or EL2 might be trapped to a higher Exception level. See:

- [Traps to EL1 of EL0 execution of WFE and WFI instructions on page D1-1845](#).
- [Traps to EL2 of Non-secure EL0 and EL1 execution of WFE and WFI instructions on page D1-1861](#).
- [Traps to EL3 of EL2, EL1, and EL0 execution of WFE and WFI instructions on page D1-1871](#).

WFI wake-up events

The following are *WFI wake-up events*:

- Any physical SError interrupt, IRQ interrupt, or FIQ interrupt received by the PE, that is marked as **A** as **B** in the tables in [Asynchronous exception masking on page D1-1836](#), regardless of the value of the corresponding `PSTATE.{A, I, F}` mask bit.

- In Non-secure EL1 or EL0, any virtual SError interrupt, IRQ interrupt, or FIQ interrupt received by the PE, that is marked as B in Table D1-19 on page D1-1840 in *Virtual interrupts on page D1-1839*, regardless of the value of the corresponding PSTATE.{A, I, F} mask bit.
- An asynchronous External Debug Request debug event, if halting is allowed. For the definition of *halting is allowed* see *Halting allowed and halting prohibited on page H2-5435*.
See also *External Debug Request debug event on page H3-5490*.
- An event sent by some IMPLEMENTATION DEFINED mechanism.

Note

- WFI wake-up events are never disabled by EDSCR.INTdis, and are never masked by the PSTATE.{A, I, F} mask bits. If wake-up is invoked by an interrupt that is disabled or masked the interrupt is not taken.
- Because debug events are WFI wake-up events, ARM recommends that Wait For Interrupt is used as part of an idle loop rather than waiting for a single specific interrupt event to occur and then moving forward. This ensures that the intervention of debug while waiting does not significantly change the function of the program being debugged.
- Some implementations of the WFI mechanism drain down any pending memory activity before suspending execution. This increases power saving, by increasing the area over which clocks can be stopped. The architecture does not require this operation, therefore software must not rely on the WFI mechanism operating in this way.

Using WFI to indicate an idle state on bus interfaces

Software can use the WFI mechanism to force quiescence on a PE, and, combined with preventing any possible WFI wakeup events, this can be used to complete an entry into a powerdown state.

Because mechanisms for entering powerdown states are inherently IMPLEMENTATION DEFINED, whether an implementation uses the WFI mechanism is IMPLEMENTATION DEFINED. If it does, the WFI instruction forces the suspension of execution, and of all associated bus activity.

The control logic that does this also tracks the activity on the bus interfaces of the PE, so that when the PE has completed all current operations and any associated bus activity has completed, it can signal to an external power controller that there is no ongoing bus activity.

However, the PE must continue to process memory-mapped and external debug interface accesses to debug registers when in the WFI state. The indication of idle state to the system normally only applies to the non-debug functional interfaces used by the PE, not the debug interfaces.

When the OS Double Lock control, OSDLR_EL1.DLK, is 1, the PE must not signal this idle state to the control logic unless it can also guarantee that the debug interface is idle. For more information about the OS Double Lock, see *Debug behavior when the OS Double Lock is locked on page H6-5543*.

Note

In a PE that implements separate core and debug power domains, the debug interface referred to in this section is the interface between the core and debug power domains, since the signal to the power controller indicates that the core power domain is idle. For more information about the power domains see *Power domains and debug on page H6-5535*.

The exact nature of this interface is IMPLEMENTATION DEFINED, but the use of Wait For Interrupt as the only architecturally-defined mechanism that completely suspends execution makes it very suitable as the preferred powerdown entry mechanism.

Pseudocode description of Wait For Interrupt

The `WaitForInterrupt()` pseudocode function optionally suspends execution until a WFI wake-up event or reset occurs, or until some earlier time if the implementation chooses.

D1.18 Self-hosted debug

The ARMv8-A architecture supports both of the following:

Self-hosted debug

The PE itself hosts a debugger. The debugger programs the PE to generate *debug exceptions*. Debug exceptions are accommodated in the ARMv8-A Exception model.

External debug

The PE is controlled by an external debugger. The debugger programs the PE to generate *Debug events*, that cause the PE to enter *Debug state*. In Debug state, the PE is halted.

This section describes self-hosted debug. It includes:

- [Debug exceptions](#).
- [The PSTATE debug mask bit, D](#).

For external debug, see part E.

D1.18.1 Debug exceptions

Debug exceptions occur during normal program flow, if a debugger has programmed the PE to generate them.

For example, a software developer might use a debugger contained in an operating system to debug an application. To do this, the debugger might enable one or more debug exceptions.

The possible debug exceptions are:

- Breakpoint Instruction exceptions.
- Breakpoint exceptions.
- Watchpoint exceptions.
- Vector Catch exceptions.
- Software Step exceptions.

[Chapter D2 AArch64 Self-hosted Debug](#) describes these in detail for AArch64.

For the PE to generate a debug exception requires that:

- The debug exception is enabled. [The debug exception enable controls on page D2-1910](#) gives the controls for the different debug exceptions.
- Debug exceptions are enabled from the current Exception level and Security state. See [Enabling debug exceptions from the current Exception level and Security state on page D2-1913](#).

Debug exceptions are synchronous exceptions, and are accommodated in the ARMv8 Exception model.

———— **Note** —————

Breakpoints and Watchpoints can cause entry to Debug state instead of causing debug exceptions. See [Chapter H1 About External Debug](#).

D1.18.2 The PSTATE debug mask bit, D

As with all other exceptions, when a debug exception is taken, software must take care to avoid generating another instance of an exception within the exception handler, to avoid recursive entry into the exception handler and loss of return state.

To help avoid this, the ARMv8 architecture provides a debug exception mask bit, [PSTATE.D](#), that can mask Watchpoint, Breakpoint, and Software Step exceptions when the target Exception level is the current Exception level.

`PSTATE.D` is set to 1 on taking an exception. This means that while handling an exception in AArch64 state, Watchpoint, Breakpoint, and Software Step exceptions are masked. This prevents recursive entry at the Exception level that debug exceptions are targeted to.

When execution is in AArch64 state, debug exceptions are also masked implicitly when the target Exception level is lower than the current Exception level.

When the target Exception level is higher than the current Exception level, debug exceptions cannot be masked by `PSTATE.D`.

Because debug exceptions are synchronous, the architecture requires that debug exceptions are not generated when `PSTATE.D` is 1. By preventing debug exception generation, debug exceptions cannot be taken at a subsequent time when the Process state D mask bit is cleared to 0.

———— **Note** —————

This differs from the behavior for interrupts, where the `PSTATE.{A, I, F}` mask has the effect of preventing the interrupt from being taken, but instead the interrupt remains pending.

D1.19 The Performance Monitors Extension

The System registers provide access to a Performance Monitors Unit (PMU), defined as the OPTIONAL Performance Monitors Extension to the architecture, a non-invasive debug resource that provides information about the operation of the PE. The PMU provides:

- A 64-bit cycle counter.
- An IMPLEMENTATION DEFINED number of 32-bit event counters. Each event counter can be configured to count occurrences of a specified event. The events that can be counted are:
 - Architectural and microarchitectural events that are likely to be consistent across many microarchitectures. The PMU architecture uses event numbers to identify an event, and the PMU specification defines which event number must be used for each of these architectural and microarchitectural events.
 - Implementation-specific events. The PMU specification reserves event numbers for implementation-specific events. See [Appendix K3 Recommendations for Performance Monitors Event Numbers for IMPLEMENTATION DEFINED Events](#).

For more information, see [Chapter D5 The Performance Monitors Extension](#).

D1.20 Interprocessing

Interprocessing is the term used to describe moving between the AArch64 and AArch32 Execution states.

The Execution state can change only on a change of Exception level. This means that the Execution state can change only on taking an exception to a higher Exception level, or returning from an exception to a lower Exception level.

On taking an exception to a higher Exception level, the Execution state either:

- Remains unchanged.
- Changes from AArch32 state to AArch64 state.

On returning from an exception to a lower Exception level, the Execution state either:

- Remains unchanged.
- Changes from AArch64 state to AArch32 state.

Note

If, on taking or returning from an exception, the Exception level remains the same, the Execution state cannot change.

For the description of:

- Exception entry to an Exception level using AArch64, see [Exception entry on page D1-1799](#).
- Exception return from an Exception level using AArch64 state, see [Exception return on page D1-1815](#).
- Exception return to AArch32 state, see [Exception return to an Exception level using AArch32 on page G1-4360](#).

Note

The description in [Handling exceptions that are taken to an Exception level using AArch32 on page G1-4340](#) is outside the scope of interprocessing, because such exceptions must have been taken from an Exception level that is using AArch32, and therefore there is no change of Execution state.

The following sections describe the behavior associated with interprocessing.

- [Register mappings between AArch32 state and AArch64 state](#).
- [State of the general-purpose registers on taking an exception to AArch64 state on page D1-1896](#).
- [SPSR, ELR, and AArch64 SP relationships on changing Execution state on page D1-1897](#).

D1.20.1 Register mappings between AArch32 state and AArch64 state

This section defines the architectural mappings between AArch32 state registers and AArch64 state registers.

The mappings describe:

- For exceptions taken from AArch32 state to AArch64 state, where the AArch32 register content is found.
- For exception returns from AArch64 state to AArch32 state, how the AArch32 register content is derived.

The general model is:

- The AArch32 register contents are situated in the bottom 32 bits of the AArch64 registers.
- In AArch32 state, the upper 32 bits of AArch64 registers are inaccessible and are ignored.

Note

System software that executes in AArch64 state, such as an OS or Hypervisor, can use these mappings for context save and restore, or to interpret and modify the AArch32 registers of an application or virtual machine.

For more information see the following subsections:

- [Mapping of the general-purpose registers between the Execution states.](#)
- [Mapping of the SIMD and floating-point registers between the Execution states on page D1-1889.](#)
- [Mapping of the System registers between the Execution states on page D1-1890.](#)

Mapping of the general-purpose registers between the Execution states

Table D1-81 shows how each of the AArch32 general-purpose registers, R0-R12, SP, and LR, including the banked copies of these registers, maps to an AArch64 general-purpose register. A register in the *AArch64 register* column of the table provides the AArch64 view of the corresponding register in the *AArch32 register* column.

———— **Note** —————

For some exceptions, the exception syndrome given in the `ESR_ELx` identifies one or more register numbers from the issued instruction that generated the exception. Where the exception is taken from an Exception level using AArch32 these register numbers give the AArch64 view of the register. For example, if an exception is taken from AArch32 Abort mode, and the faulting instruction specified R14, the `ESR_ELx.ISS` field would report this using the EC value `0b10100`, because register X20 provides the AArch64 view of LR_abt, which is the copy of R14 used in Abort mode.

Table D1-81 General-purpose register mapping between AArch32 state and AArch64 state

AArch32 register	AArch64 register
R0	X0
R1	X1
R2	X2
R3	X3
R4	X4
R5	X5
R6	X6
R7	X7
R8_usr	X8
R9_usr	X9
R10_usr	X10
R11_usr	X11
R12_usr	X12
SP_usr	X13
LR_usr	X14
SP_hyp	X15
LR_irq	X16
SP_irq	X17
LR_svc	X18

Table D1-81 General-purpose register mapping between AArch32 state and AArch64 state

AArch32 register	AArch64 register
SP_svc	X19
LR_abt	X20
SP_abt	X21
LR_und	X22
SP_und	X23
R8_fiq	X24
R9_fiq	X25
R10_fiq	X26
R11_fiq	X27
R12_fiq	X28
SP_fiq	X29
LR_fiq	X30

———— **Note** ————

For a description of the banking of AArch32 general-purpose registers R8-R12, SP, and LR, see [AArch32 general-purpose registers, the PC, and the Special-purpose registers](#) on page G1-4327.

Mapping of the SIMD and floating-point registers between the Execution states

Table D1-82 shows the mapping between the AArch64 V registers and the AArch32 Q registers.

Table D1-82 SIMD and floating-point register mapping between AArch64 state and AArch32 state

AArch64 register	AArch32 register
V0	Q0
V1	Q1
V2	Q2
.	.
.	.
.	.
V15	Q15

The AArch64 registers V16-V31 are not accessible from AArch32 state.

The mapping between the V, D, and S registers in AArch64 state is not the same as the mapping between the Q, D, and S registers in AArch32 state:

- In AArch64 state, there are:
 - 32 128-bit V registers, V0-V31.
 - 32 64-bit D registers, D0-D31.
 - 32 32-bit S registers, S0-S31.

A smaller register occupies the least-significant bytes of the corresponding larger register. For example, S5 is the least-significant word of D5 and V5. [Figure D1-3](#) shows this mapping.

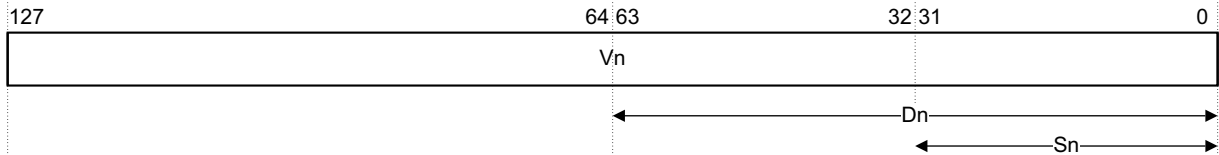

Figure D1-3 AArch64 state SIMD and floating-point register mappings

- In AArch32 state, there are:
 - 16 128-bit Q registers, Q0-Q15.
 - 32 64-bit D registers, D0-D31.
 - 32 32-bit S registers, S0-S31.

Smaller registers are packed into larger registers. [Figure D1-4](#) shows this mapping.

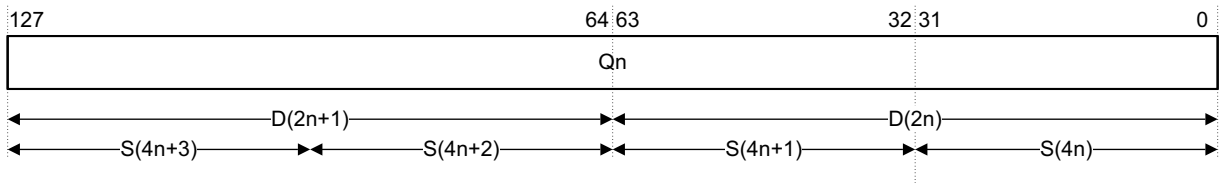

Figure D1-4 AArch32 state SIMD and floating-point register mappings

In AArch32 state:

- There are no S registers that correspond to Q8-Q15.
- D16-D31 pack into Q8-Q15. For example, D16 and D17 pack into Q8.

Note

A consequence of this mapping is that if software executing in AArch64 state interprets D or S registers from AArch32 state, it must unpack the D or S registers from the V registers before it uses them.

Mapping of the System registers between the Execution states

ARMv8 architecturally defines the relationship between the AArch64 System registers and the AArch32 System registers, to allow supervisory code such as a hypervisor, that is executing in AArch64 state, to save, restore, and interpret the System registers belonging to a lower Exception level that is using AArch32.

Any modifications made to AArch32 System registers affects only those parts of those AArch64 registers that are mapped to the AArch32 System registers. Bits[63:32] of AArch64 registers, where they are not mapped to AArch32 registers, are unchanged by AArch32 state execution.

Note

This model is different to the model for the general-purpose registers described in [Mapping of the general-purpose registers between the Execution states on page D1-1888](#). In this model, there are several cases where two AArch32 System registers are packed into a single AArch64 System register.

When EL3 is implemented and is using AArch32, some System registers are banked between the two Security states. When a register is banked in this way, there is an instance of the register in Secure state, and another instance of the register in Non-secure state. In [Table D1-83 on page D1-1891](#) these banked registers are identified by footnote^a. This banking is not supported when EL3 is using AArch64 or if EL3 is not implemented. This means that when EL3 is implemented and is using AArch64, exactly the same registers are accessed in the following states:

- Secure EL1 with EL1 using AArch32.
- Non-secure EL1 with EL1 using AArch32.

This means that, architecturally, it is not possible to determine whether an AArch64 register is mapped onto the Secure instance of the corresponding AArch32 register, or onto the Non-secure instance of that register. When EL3 is using AArch64, the interrupt asserted by the AArch64 CNTP_* timer is the same interrupt as is asserted by the Non-secure AArch32 CNTP_* timer when EL3 is using AArch32.

———— **Note** ————

Although the architecture does not require this, because it is not architecturally visible, ARM expects that implementations will map many of the AArch64 registers for use by EL3 to the Secure instances of the banked AArch32 registers, and will map many of the AArch64 registers for use by EL1 to the Non-secure instances of the banked AArch32 registers. However, if EL2 and EL3 are implemented and both support use of AArch32, this is not possible for the following registers:

IFAR This is because when EL3 is using AArch32, **HIFAR** is an alias of the Secure **IFAR**.

DFAR This is because when EL3 is using AArch32, **HDFAR** is an alias of the Secure **DFAR**.

Table D1-83 shows the mappings between the writable AArch64 System registers and the AArch32 System registers.

Table D1-83 Mapping of writable AArch64 System registers to the AArch32 System registers

AArch64 register	AArch32 register
ACTLR_EL1	ACTLR ^a , and, if implemented, ACTLR2 ^a .
AFSR0_EL1	ADFSR ^a
AFSR1_EL1	AIFSR ^a
AMAIR_EL1[31:0]	AMAIRO ^a
AMAIR_EL1[63:32]	AMAIR1 ^a
CONTEXTIDR_EL1	CONTEXTIDR ^a
CPACR_EL1	CPACR
CSSELR_EL1	CSSELR ^a
DACR32_EL2	DACR ^a
FAR_EL1[31:0]	DFAR ^a
ESR_EL1	DFSR ^a
HACR_EL2	HACR
ACTLR_EL2	HACTLR and, if implemented, HACTLR2 .
AFSR0_EL2	HADFSR
AFSR1_EL2	HAIFSR
AMAIR_EL2[31:0]	HAMAIRO
AMAIR_EL2[63:32]	HAMAIR1
CPTR_EL2	HCPTR
HCR_EL2[31:0]	HCR
HCR_EL2[63:32]	HCR2
MDCR_EL2	HDCR

Table D1-83 Mapping of writable AArch64 System registers to the AArch32 System registers

AArch64 register	AArch32 register
FAR_EL2[31:0]	HDFAR
FAR_EL2[63:32]	HIFAR
MAIR_EL2[31:0]	HMAIR0
MAIR_EL2[63:32]	HMAIR1
HPFAR_EL2[31:0]	HPFAR
SCTLR_EL2	HSCTLR
ESR_EL2	HSR
HSTR_EL2	HSTR
TCR_EL2	HTCR
TPIDR_EL2[31:0]	HTPIDR
TTBR0_EL2	HTTBR
VBAR_EL2[31:0]	HVBAR
FAR_EL1[63:32]	IFAR ^a
IFSR32_EL2	IFSR ^a
MAIR_EL1[63:32]	NMRR or MAIR1 ^a
PAR_EL1	PAR ^a
MAIR_EL1[31:0]	PRRR or MAIR0 ^a
RMR_EL1	RMR (at EL1)
RMR_EL2	HRMR
RMR_EL3	RMR (at EL3)
SCTLR_EL1	SCTLR ^a
SDER32_EL3	SDER
TPIDR_EL1[31:0]	TPIDRPRW ^a
TPIDRRO_EL0[31:0]	TPIDRURO ^a
TPIDR_EL0[31:0]	TPIDRURW ^a
TCR_EL1[31:0]	TTBCR ^a
TCR_EL1[63:32]	TTBCR2 ^a
TTBR0_EL1	TTBR0 ^a
TTBR1_EL1	TTBR1 ^a
VBAR_EL1[31:0]	VBAR ^a
VMPIDR_EL2[31:0]	VMPIDR
VPIDR_EL2	VPIDR

Table D1-83 Mapping of writable AArch64 System registers to the AArch32 System registers

AArch64 register	AArch32 register
VTCR_EL2	VTCR
VTTBR_EL2	VTTBR
Timer registers	
CNTRQ_EL0	CNTRQ
CNTHCTL_EL2	CNTHCTL
CNTHP_CTL_EL2	CNTHP_CTL
CNTHP_CVAL_EL2[63:0]	CNTHP_CVAL
CNTHP_TVAL_EL2	CNTHP_TVAL
CNTKCTL_EL1	CNTKCTL
CNTP_CTL_EL0	CNTP_CTL ^a
CNTP_CVAL_EL0[63:0]	CNTP_CVAL ^a
CNTP_TVAL_EL0	CNTP_TVAL ^a
CNTPCT_EL0[63:0]	CNTPCT
CNTV_CTL_EL0	CNTV_CTL
CNTV_CVAL_EL0[63:0]	CNTV_CVAL
CNTV_TVAL_EL0	CNTV_TVAL
CNTVCT_EL0[63:0]	CNTVCT
CNTVOFF_EL2[63:0]	CNTVOFF
Debug System registers	
DBGAUTHSTATUS_EL1	DBGAUTHSTATUS
DBGBCR<n>_EL1	DBGBCR<n>
DBGBVR<n>_EL1[31:0]	DBGBVR<n>
DBGBVR<n>_EL1[63:32]	DBGBXVR<n>
DBGCLAIMCLR_EL1	DBGCLAIMCLR
DBGCLAIMSET_EL1	DBGCLAIMSET
DBGDTR_EL0	DBGDTRRXint or the DBGDTRTXint
DBGDTRRX_EL0	DBGDTRRXint
DBGDTRTX_EL0	DBGDTRRXint
DBGPRCR_EL1	DBGPRCR
DBGVCR32_EL2	DBGVCR
DBGWCR<n>_EL1	DBGWCR<n>
DBGWVR<n>_EL1[31:0]	DBGWVR<n>

Table D1-83 Mapping of writable AArch64 System registers to the AArch32 System registers

AArch64 register	AArch32 register
ID_DFR0_EL1	ID_DFR0
MDCCSR_EL0 ^b	DBGDSCRint ^b
MDCR_EL2	HDCR
MDRAR_EL1	DBGDRAR
MDSCR_EL1 ^b	DBGDSCRExt ^b
OSDLR_EL1	DBGOSDLR
OSDTRRX_EL1 ^b	DBGDTRRXExt ^b
OSDTRTX_EL1 ^b	DBGDTRTXExt ^b
OSECCR_EL1	DBGOSECCR
OSLAR_EL1	DBGOSLAR
OSLSR_EL1	DBGOSLSR
SDER32_EL3	SDER
Performance Monitors System registers	
PMCCNTR_EL0[31:0]	PMCCNTR (MRC/MCR)
PMCEID0_EL0	PMCEID0
PMCEID1_EL0	PMCEID1
PMCNTENCLR_EL0	PMCNTENCLR
PMCNTENSET_EL0	PMCNTENSET
PMCR_EL0	PMCR
PMEVCNTR<n>_EL0	PMEVCNTR<n>
PMEVTYPER<n>_EL0	PMEVTYPER<n>
PMINTENCLR_EL1	PMINTENCLR
PMINTENSET_EL1	PMINTENSET
PMOVSCLR_EL0	PMOVS
PMOVSSET_EL0	PMOVSSET
PMSELR_EL0	PMSELR
PMSWINC_EL0	PMSWINC
PMUSERENR_EL0	PMUSERENR
PMXEVCNTR_EL0	PMXEVCNTR
PMXEVTYPER_EL0	PMXEVTYPER

- a. AArch32 registers that are banked if EL3 is using AArch32.
b. These registers have overlapping register content. One or more bits of one register appear in the other register.

There are a small number of AArch32 System registers that are not mapped to any AArch64 System registers. The AArch64 registers listed in Table D1-84 can be used to access these from a higher Exception level that is using AArch64. The registers shown in the table are UNDEFINED if EL1 cannot use AArch32.

Table D1-84 AArch64 registers for accessing registers that are only used in AArch32 state

AArch32 register	AArch64 register for accessing the AArch32 register	Short description
DACR	DACR32_EL2	Domain Access Control Register
DBGVCR	DBGVCR32_EL2	Debug Vector Catch Register
FPEXC	FPEXC32_EL2	Floating-Point Exception Control Register
IFSR	IFSR32_EL2	Instruction Fault Status Register
SDER	SDER32_EL3	AArch32 Secure Debug Enable Register

Table D1-85 shows the AArch64 System registers that allow access from AArch64 state to the AArch32 ID registers. These AArch64 registers are UNKNOWN if no Exception level can use AArch32.

Table D1-85 AArch64 registers that access the AArch32 ID registers

AArch32 register	AArch64 register for accessing the AArch32 register	Short description
ID_AFR0	ID_AFR0_EL1	AArch32 Auxiliary Feature Register 0
ID_DFR0	ID_DFR0_EL1	AArch32 Debug Feature Register 0
ID_ISAR0	ID_ISAR0_EL1	EL1, AArch32 Instruction Set Attribute Register 0
ID_ISAR1	ID_ISAR1_EL1	EL1, AArch32 Instruction Set Attribute Register 1
ID_ISAR2	ID_ISAR2_EL1	EL1, AArch32 Instruction Set Attribute Register 2
ID_ISAR3	ID_ISAR3_EL1	EL1, AArch32 Instruction Set Attribute Register 3
ID_ISAR4	ID_ISAR4_EL1	EL1, AArch32 Instruction Set Attribute Register 4
ID_ISAR5	ID_ISAR5_EL1	EL1, AArch32 Instruction Set Attribute Register 5
ID_MMFR0	ID_MMFR0_EL1	AArch32 Memory Model Feature Register 0
ID_MMFR1	ID_MMFR1_EL1	AArch32 Memory Model Feature Register 1
ID_MMFR2	ID_MMFR2_EL1	AArch32 Memory Model Feature Register 2
ID_MMFR3	ID_MMFR3_EL1	AArch32 Memory Model Feature Register 3
ID_MMFR4	ID_MMFR4_EL1	AArch32 Memory Model Feature Register 4
ID_PFR0	ID_PFR0_EL1	AArch32 PE Feature Register 0
ID_PFR1	ID_PFR1_EL1	AArch32 PE Feature Register 1

D1.20.2 State of the general-purpose registers on taking an exception to AArch64 state

When an exception is taken from AArch32 state to AArch64 state, the state of a general-purpose register depends on whether, immediately before the exception, the register was accessible from AArch32 state, as follows:

If the general-purpose register was accessible from AArch32 state

The upper 32 bits either become zero, or hold the value that the same architectural register held before any AArch32 execution. The choice between these two options is IMPLEMENTATION DEFINED, and might vary dynamically within an implementation. Correspondingly, software must regard the value as being a CONSTRAINED UNPREDICTABLE choice between these two values.

This behavior applies regardless of whether any execution occurred at the Exception level that was using AArch32. That is, this behavior applies even if AArch32 state was entered by an exception return from AArch64 state, and another exception was immediately taken to AArch64 state without any instruction execution in AArch32 state.

Which general-purpose registers have their upper 32 bits affected in this way depends on both:

- The AArch64 state target Exception level.
- The values of both:
 - `SCR_EL3.RW`.
 - `HCR_EL2.RW` or `HCR.RW`, where `HCR.RW` is a notional bit that is RES0.

Table D1-86 shows which general-purpose registers can have their upper 32 bits set to zero.

Table D1-86 General-purpose registers that can have their upper 32 bits set to zero on taking an exception to AArch64 state from AArch32 state

<code>SCR_EL3.RW</code>	<code>HCR_EL2.RW</code> or <code>HCR.RW</code> ^a	Registers when the target Exception level is:		
		EL3	EL2	EL1
0	0	X0-X30	_b	_b
0	1	_c	_c	_c
1	0	X0-X14, X16-X30	X0-X14, X16-X30	_b
1	1	X0-X14	X0-X14	X0-X14

- a. `HCR.RW` is a notional bit that is RES0.
- b. The RW bit values are not valid for the targeted Exception level.
- c. Not valid because the RW bit values would imply that EL2 is AArch32 and EL1 is AArch64.

Note

If EL2 is not implemented, or the `SCR_EL3.NS` or `SCR.NS` bit prevents its use, then as described in *The effects of supporting fewer than four Exception levels on page D1-1901*, the behavior is consistent with `HCR_EL2.RW` taking the value of `SCR_EL3.RW`.

If the general-purpose register was not accessible from AArch32 state

The general rule is that the register retains the state it had before any AArch32 execution.

There is one exception to this rule, that is when taking an exception to EL3 using AArch64 when either EL2 is not implemented or EL1 is in Secure state. In these cases, the X15 register must be treated as if it is accessible when the value of `SCR_EL3.RW` is 0, and therefore the upper bits of X15 might either be set to zero or retain their previous value.

Which general-purpose registers retain their state depends on both:

- The AArch64 state target Exception level.
- The values of both:
 - `SCR_EL3.RW`.

— `HCR_EL2.RW` or `HCR.RW`, where `HCR.RW` is a notional bit that is RES0.

Table D1-87 shows which general-purpose registers can retain their state.

Table D1-87 General-purpose registers that can retain their state on taking an exception to AArch64 from AArch32

<code>SCR_EL3.RW</code>	<code>HCR_EL2.RW</code> or <code>HCR.RW</code> ^a	Registers when the target Exception level is:		
		EL3	EL2	EL1
0	0	None	_b	_b
0	1	_c	_c	_c
1	0	X15	X15	_b
1	1	X15-X30	X15-X30	X15-X30

- a. `HCR.RW` is a notional bit that is RES0.
- b. The RW bit values are not valid for the targeted Exception level.
- c. Not valid because the RW bit values would imply that EL2 is AArch32 and EL1 is AArch64.

Note

If EL2 is not implemented, or the `SCR_EL3.NS` bit prevents its use, then as described in *The effects of supporting fewer than four Exception levels on page D1-1901*, the behavior is consistent with `HCR_EL2.RW` taking the value of `SCR_EL3.RW`.

D1.20.3 SPSR, ELR, and AArch64 SP relationships on changing Execution state

Table D1-88 shows the SPSR and ELR registers that are architecturally mapped between AArch32 state and AArch64 state.

Table D1-88 SPSR and ELR mappings between AArch32 state and AArch64 state

AArch32 register	AArch64 register
<code>SPSR_svc</code>	<code>SPSR_EL1</code>
<code>SPSR_hyp</code>	<code>SPSR_EL2</code>
<code>ELR_hyp</code>	<code>ELR_EL2</code>

On exception entry to EL3 using AArch64 state from an Exception level using AArch32 state, when EL2 has been using AArch32 state, the upper 32-bits of `ELR_EL2` are either set to zero or they retain the value before the AArch32 state execution. The implementation determines the choice between these two options, and the choice might vary dynamically within an implementation. Therefore, software must regard the upper 32-bits as being UNKNOWN.

On exception entry to an Exception level using AArch64 state from an Exception level using AArch32 state, the AArch64 Stack Pointers and Exception Link Registers associated with an Exception level that are not accessible during execution in AArch32 state at that Exception level, retain the state that they had before the execution in AArch32 state.

The following AArch32 registers are used only during execution in AArch32 state. However, they retain their state when there is execution at EL1 with EL1 using AArch64 state:

- `SPSR_abt`.
- `SPSR_und`.
- `SPSR_irq`.

- [SPSR_fiq](#).

———— **Note** —————

- These registers are accessible during execution in AArch64 state at Exception levels higher than EL1, for context switching.
- If EL1 does not support execution in AArch32 state then these registers are RES0.

On exception entry to an Exception level using AArch64 from an Exception level using AArch32, the AArch64 Stack Pointers and Exception Link Registers associated with an Exception level that are not accessible during AArch32 execution at that Exception level retain the state that they had before AArch32 execution. This applies to the following registers:

- [SP_EL0](#).
- [SP_EL1](#).
- [SP_EL2](#).
- [ELR_EL1](#).

D1.21 The effect of implementation choices on the programmers' model

Three of the implementation choices in ARMv8 are:

- The number of Exception levels implemented.
- Which Exception levels support AArch32 and which Exception levels support AArch64.
- Whether SIMD and floating-point support is implemented.

The following subsections give more information about how these choices affect the programmers' model:

- [Implication of Exception levels implemented.](#)
- [Support for Exception levels and Execution states on page D1-1900.](#)
- [Implementations not including Advanced SIMD and floating-point instructions on page D1-1901.](#)
- [The effects of supporting fewer than four Exception levels on page D1-1901.](#)

D1.21.1 Implication of Exception levels implemented

All implementations must include EL0 and EL1.

EL2 and EL3 are optional. The architecture permits all combinations of EL2 and EL3.

See also [Implementations not including Advanced SIMD and floating-point instructions on page D1-1901](#) and [The effects of supporting fewer than four Exception levels on page D1-1901](#).

For an implementation that includes all of the Exception levels [Figure D1-5](#) shows the implemented Exception levels and the possible Execution states at lower Exception levels when EL3 is using AArch64. [Figure D1-5](#) applies regardless of whether EL3 also supports use of AArch32.

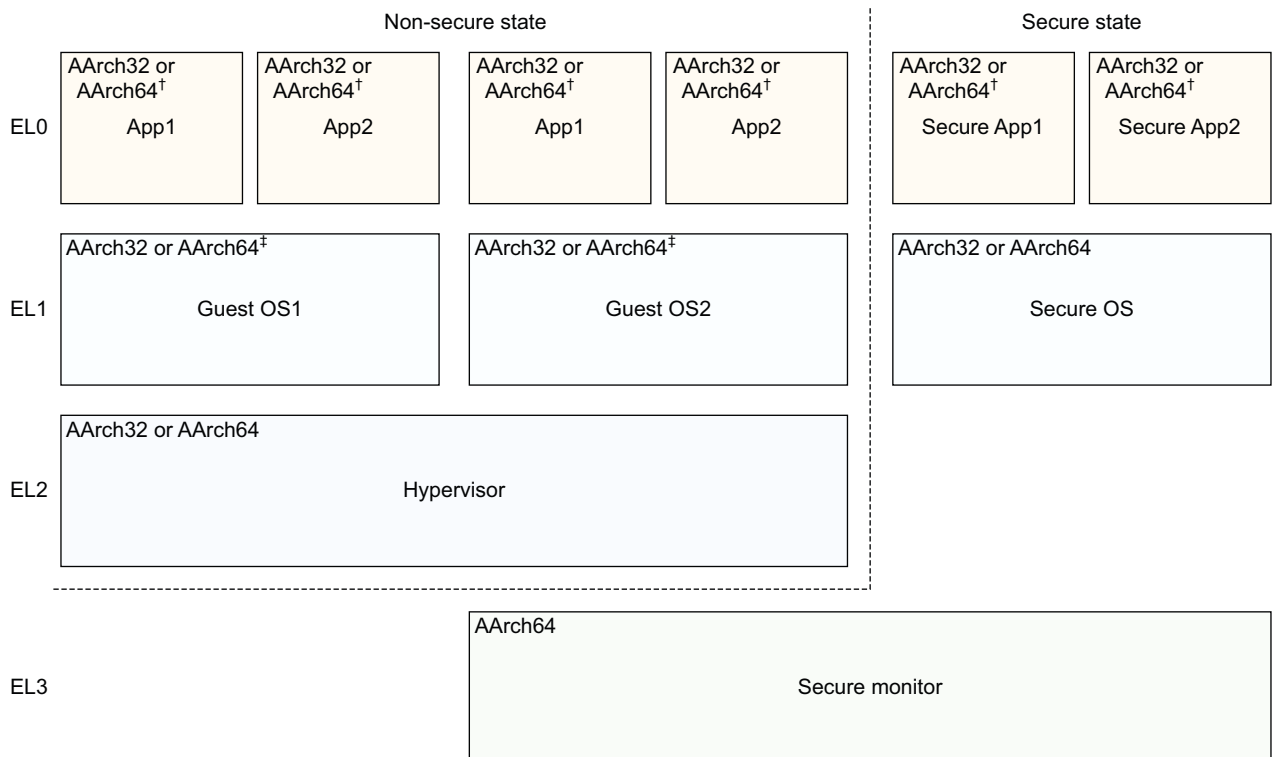

† AArch64 permitted only if EL1 is using AArch64

‡ AArch64 permitted only if EL2 is using AArch64

Figure D1-5 ARMv8-A security model when EL3 is using AArch64

The possible combinations of Exception levels are as follows:

- EL0, EL1, and EL2. The implementation supports only Non-secure state.

- EL0, EL1, and EL3. The implementation does not support Virtualization. The Exception levels and Execution states depend on whether EL3 is using AArch64 state or AArch32 state, as follows:
 - If EL3 is using AArch64, the Exception levels and Execution states are as shown in [Figure D1-5 on page D1-1899](#) with EL2 removed and no Non-secure state virtualization of EL1 and EL0.
 - If EL3 is using AArch32, the Exception levels and Execution states are as shown in [Figure G1-1 on page G1-4316](#) with EL2 removed and no Non-secure state virtualization of EL1 and EL0.
- EL0 and EL1 only. The implementation supports only a single Security state. This might be either Secure state or Non-secure state, see [Behavior when only EL1 and EL0 are implemented on page D1-1902](#).
- EL0, EL1, EL2, and EL3, as described in this section.

For more information, see [The effects of supporting fewer than four Exception levels on page D1-1901](#).

D1.21.2 Support for Exception levels and Execution states

Subject to the interprocessing rules defined in [Interprocessing on page D1-1887](#), an implementation of the ARM architecture could support:

- AArch64 state only.
- AArch64 and AArch32 states.
- AArch32 state only.

This means the ARMv8-A architecture can, potentially, support implementations with very large number of combinations of Execution state and Exception level. ARM intends to license only a subset of the possible combinations. [Table D1-89](#) shows the combinations of Exception levels and Execution states that are currently licensed.

Table D1-89 Supported combinations of Exception levels and Execution state

Number of Exception levels	Supported Security states	Exception levels, AArch64 state				Exception levels, AArch32 state			
		EL3	EL2	EL1	EL0	EL3	EL2	EL1	EL0
Four	Both	Yes	Yes	Yes	Yes	Yes	Yes	Yes	Yes
		Yes	Yes	Yes	Yes	No	No	Yes	Yes
		Yes	Yes	Yes	Yes	No	No	No	Yes
		Yes	Yes	Yes	Yes	No	No	No	No
		No	No	No	No	Yes	Yes	Yes	Yes
Three	Both	Yes	No	Yes	Yes	No	No	Yes	Yes
		Yes	No	Yes	Yes	No	No	No	Yes
		Yes	No	Yes	Yes	No	No	No	No
		No	No	No	No	Yes	No	Yes	Yes
	Non-secure only	No	Yes	Yes	Yes	No	No	Yes	Yes
		No	Yes	Yes	Yes	No	No	No	No
Two	Either	No	No	Yes	Yes	No	No	No	Yes
		No	No	Yes	Yes	No	No	No	No
		No	No	No	No	No	No	Yes	Yes

D1.21.3 Implementations not including Advanced SIMD and floating-point instructions

In general, ARMv8-A requires the inclusion of the Advanced SIMD and floating-point instructions in all instruction sets. Exceptionally, for implementations targeting specialized markets that do not require support for floating-point or use of Advanced SIMD, ARM might produce or license an ARMv8-A implementation that does not provide any support for Advanced SIMD and floating-point instructions. In such an implementation:

In AArch64 state

- The `CPACR_EL1.FPEN` field is RES0.
- The `CPTR_EL2.TFP` bit is RES1.
- The `CPTR_EL3.TFP` bit is RES1.
- Each of the `ID_AA64PFR0_EL1`.{AdvSIMD, FP} fields is 0b1111.
- The `FPEXC32_EL2`, `FPCR`, and `FPSR` registers are not implemented, and their encodings are UNDEFINED.
- Attempted accesses to Advanced SIMD and floating-point functionality are UNDEFINED. This means:
 - All Advanced SIMD and floating-point instructions are UNDEFINED.
 - Attempts to access the Advanced SIMD and floating-point System registers are UNDEFINED.
- If at least one Exception level supports execution in AArch32 state, the `MVFR0_EL1`, `MVFR1_EL1` and `MVFR2_EL1` registers are RAZ. When no Exception level supports execution in AArch32 state these registers are UNKNOWN.

In AArch32 state

See [AArch32 implications of not including support for Advanced SIMD and floating-point on page G1-4412](#).

D1.21.4 The effects of supporting fewer than four Exception levels

[The effect of implementation choices on the programmers' model on page D1-1899](#) defines the permitted combinations of Exception levels in an ARMv8-A implementation.

In every implementation that supports the highest Exception level using either AArch64 state or AArch32 state, an IMPLEMENTATION DEFINED mechanism determines whether the highest implemented Exception level uses AArch64 state or AArch32 state from a Cold reset. Typically, this mechanism is a configuration input. When the highest level is configured to be AArch64 state, then after a Cold reset execution starts at the reset vector in that Exception level.

The unimplemented Exception levels have no effect on execution:

- No interrupts are routed to these Exception levels.
- No traps that target these Exception levels are active
- All systems calls to unimplemented Exception levels from lower Exception levels are treated as UNDEFINED.
- There is no support for address translation from these Exception levels.
- Any exception return that targets an unimplemented Exception level is treated as an illegal exception return as described in [Illegal return events from AArch64 state on page D1-1816](#).
- Every accessible register associated with an unimplemented Exception level is RES0 unless the register is associated with the Exception level only to provide the ability to transfer execution to a lower Exception level.

————— Note —————

If, for example, EL3 is not implemented and EL2 is the highest implemented Exception level, then because none of the EL3 registers are accessible from EL2, the content of those registers is not architecturally visible.

The following subsections give more information about each of the permitted combinations of Exception levels that do not include all Exception levels.

Behavior when EL2 is not implemented

If EL2 is not implemented and EL3 is implemented:

- If EL1 can use AArch32 then the following registers are not RES0:
 - [DACR32_EL2](#).
 - [IFSR32_EL2](#).
 - [FPEXC32_EL2](#).
 - [DBGVCR32_EL2](#).
 - The [VMPIDR_EL2](#) and [VPIDR_EL2](#) behave as follows:
 - Reads of [VMPIDR_EL2](#) return the value of [MPIDR_EL1](#), writes to [VMPIDR_EL2](#) are ignored.
 - Reads of [VPIDR_EL2](#) return the value of [MIDR_EL1](#), writes to [VPIDR_EL2](#) are ignored.
 - Behavior is consistent with the [HCR_EL2.RW](#) bit taking the value of the [SCR_EL3.RW](#) bit for all purposes other than reading the [HCR_EL2](#).
 - Virtual interrupts are disabled.
 - The following address translation and TLB invalidation instructions are UNDEFINED:
 - [AT S1E2R](#) and [AT S1E2W](#).
 - [TLBI VAE2](#), [TLBI VALE2](#), [TLBI VAE2IS](#), [TLBI VALE2IS](#), [TLBI ALLE2](#), [TLBI ALLE2IS](#).
- Note**
- No other TLB or address translation instructions become UNDEFINED with this combination of Exception levels.
- The [SCR_EL3.HCE](#) bit is RES0.

If EL2 is not implemented, regardless of whether EL3 is implemented:

- The [CNTHCTL_EL2](#)[1:0] bits are treated as if they have the value 0b11 for all purposes other than reading the [CNTHCTL_EL2](#) register.
- The [MDCR_EL2.HPMN](#) bit taking the value of the [PMCR_EL0.N](#) bit for all purposes other than reading the value of [MDCR_EL2.HPMN](#)

Behavior when EL3 is not implemented and EL2 is implemented

If EL3 is not implemented and EL2 is implemented, then:

- All memory transactions can only access a single physical memory address space.
- The PE behaves as if the value of the [SCR_EL3.NS](#) bit is 1, even though the [SCR_EL3](#) is not accessible.

This means that if the PE is part of a system that supports two Security states, it behaves as if it is in Non-secure state, and can only access Non-secure memory.

Behavior when only EL1 and EL0 are implemented

If EL3 and EL2 are not implemented, it is IMPLEMENTATION DEFINED whether the PE behaves as if the value of the [SCR_EL3.NS](#) bit is 1 or the PE behaves as if the value of the [SCR_EL3.NS](#) bit is 0.

This means that if the PE is part of a system that supports two Security states:

- If it behaves as if the value of the [SCR_EL3.NS](#) bit is 1, it can only access Non-secure memory.
- If it behaves as if the value of the [SCR_EL3.NS](#) bit is 0, it can access both Secure memory and Non-secure memory.

If the PE behaves as if the value of the [SCR_EL3.NS](#) bit is 0, then:

- The [MDCR_EL3](#).{EPMAD, EDAD, SPME} bits behave as if they have the value 1.

- The `MDCR_EL3.SPD32` field behaves as if it has the value `0b11`.

———— **Note** —————

- The behavior described in this subsection still applies if EL1 is configured to use AArch32.
 - The implementation can provide a configuration input that determines, from reset, whether the it behaves as if the value of the `SCR_EL3.NS` bit is 1, or as if the value of the `SCR_EL3.NS` bit is 0.
-

Chapter D2

AArch64 Self-hosted Debug

When the PE is using self-hosted debug, it generates *debug exceptions*. This chapter describes the AArch64 self-hosted debug exception model. It is organized as follows:

Introductory information

- [About self-hosted debug](#) on page D2-1906.
- [The debug exception enable controls](#) on page D2-1910.

The debug Exception model

- [Routing debug exceptions](#) on page D2-1911.
- [Enabling debug exceptions from the current Exception level and Security state](#) on page D2-1913.
- [The effect of powerdown on debug exceptions](#) on page D2-1915.
- [Summary of the routing and enabling of debug exceptions](#) on page D2-1916.
- [Pseudocode description of debug exceptions](#) on page D2-1918.

The debug exceptions

- [Breakpoint Instruction exceptions](#) on page D2-1919.
- [Breakpoint exceptions](#) on page D2-1921.
- [Watchpoint exceptions](#) on page D2-1940.
- [Vector Catch exceptions](#) on page D2-1955.
- [Software Step exceptions](#) on page D2-1956.

Synchronization requirements

The behavior of self-hosted debug after changes to System registers, or after changes to the authentication interface, but before a *Context synchronization event* guarantees the effects of the changes:

- [Synchronization and debug exceptions](#) on page D2-1970.

D2.1 About self-hosted debug

Self-hosted debug supports debugging through the generation and handling of *debug exceptions*, that are taken using the exception model described in [Chapter D1 The AArch64 System Level Programmers' Model](#). This section introduces some terms that are used in describing self-hosted debug, and then introduces the debug exceptions. See:

- [Definition of a debugger in the context of self-hosted debug](#).
- [Context ID and Process ID](#).
- [About debug exceptions](#).

D2.1.1 Definition of a debugger in the context of self-hosted debug

Within this chapter, *debugger* means that part of an operating system, or higher level of system software, that handles debug exceptions and programs the debug System registers. An operating system with rich application environments might provide debug services that support a debugger user interface executing at EL0. From the architectural perspective, the debug services are the debugger.

D2.1.2 Context ID and Process ID

A `CONTEXTIDR_ELx` identifies the current *Context ID*, that is used by:

- The debug logic, for breakpoint and watchpoint matching.
- Implemented trace logic, to identify the current process.

In AArch64 state, the `CONTEXTIDR_ELx` has a single field, `PROCID`, that is defined as the *Process Identifier* (Process ID). Therefore, in AArch64 state, the Context ID and Process ID are identical.

D2.1.3 About debug exceptions

Debug exceptions occur during normal program flow if a debugger has programmed the PE to generate them. For example, a software developer might use a debugger contained in an operating system to debug an application. To do this, the debugger enables one or more debug exceptions. The debug exceptions that can be generated in stage 1 of an AArch64 translation regime are:

- [Breakpoint Instruction exceptions on page D2-1907](#).
- [Breakpoint exceptions on page D2-1907](#), generated by hardware breakpoints.
- [Watchpoint exceptions on page D2-1907](#), generated by hardware watchpoints.
- [Software Step exceptions on page D2-1908](#).

In addition, debug exceptions generated in an AArch32 translation regime might be routed to EL2 using AArch64. See [Routing debug exceptions on page D2-1911](#). [Chapter G2](#) describes the debug exceptions that can be generated in an AArch32 translation regime.

Vector Catch exceptions are exceptions that cannot be generated in an AArch64 translation regime but can be generated in stage 1 of an AArch32 translation regime and routed to EL2 using AArch64. [Vector Catch exceptions on page D2-1955](#) describes the behavior for this case.

The PE can only generate a particular debug exception when both:

1. Debug exceptions are enabled from the current Exception level and Security state.
See [Enabling debug exceptions from the current Exception level and Security state on page D2-1913](#).
Breakpoint Instruction exceptions are always enabled from the current Exception level and Security state.
2. A debugger has enabled that particular debug exception.
All of the debug exceptions except for Breakpoint Instruction exceptions have an enable control contained in the `MDSCR_EL1`. See [The debug exception enable controls on page D2-1910](#).

Note

If *halting is allowed* and `EDSCR.HDE` is 1, hardware breakpoints and watchpoints cause entry to Debug state instead of causing debug exceptions. In Debug state, the PE is halted.

For the definition of *halting is allowed*, see [Halting allowed and halting prohibited on page H2-5435](#).

The following list summarizes each of the debug exceptions:

Breakpoint Instruction exceptions

Breakpoint instructions generate these. Breakpoint instructions are instructions that software developers can use to cause exceptions at particular points in the program flow.

The breakpoint instruction in the A64 instruction set is `BRK #<immediate>`. Whenever one of these is committed for execution, the PE takes a Breakpoint Instruction exception.

PE behavior

Breakpoint Instruction exceptions cannot be masked. The PE takes Breakpoint Instruction exceptions regardless of both of the following:

- The current Exception level.
- The current Security state.

For more information, see [Breakpoint Instruction exceptions on page D2-1919](#).

Breakpoint exceptions

The ARMv8-A architecture provides 2-16 hardware breakpoints. These can be programmed to generate Breakpoint exceptions based on particular instruction addresses, or based on particular PE contexts, or both.

For example, a software developer might program a hardware breakpoint to generate a Breakpoint exception whenever the instruction with address `0x1000` is committed for execution.

The ARMv8-A architecture supports the following types of hardware breakpoint for use in stage 1 of an AArch64 translation regime:

- Address.
 - Comparisons are made with the virtual address of each instruction in the program flow.
- Context:
 - Context ID Match. Matches with the Context ID held in the `CONTEXTIDR_EL1`.
 - VMID Match. Matches with the VMID value held in the `VTTBR_EL2`.
 - Context ID and VMID Match. Matches with both the Context ID and the VMID value.

An Address breakpoint can link to a Context breakpoint, so that the Address breakpoint only generates a Breakpoint exception if the PE is in a particular context when the address match occurs.

A breakpoint generates a Breakpoint exception whenever an instruction that causes a match is committed for execution.

PE behavior

If *halting is allowed* and `EDSCR.HDE` is 1, hardware breakpoints cause entry to Debug state. That is, they halt the PE. See [Chapter H2 Debug State](#).

Otherwise:

- If debug exceptions are enabled, hardware breakpoints cause Breakpoint exceptions.
- If debug exceptions are disabled, hardware breakpoints are ignored.

For more information, see [Breakpoint exceptions on page D2-1921](#).

Watchpoint exceptions

The ARMv8-A architecture provides 2-16 hardware watchpoints. These can be programmed to generate Watchpoint exceptions based on accesses to particular data addresses, or based on accesses to any address in a data address range.

For example, a software developer might program a hardware watchpoint to generate a Watchpoint exception on an access to any address in the data address range 0x1000 - 0x101F.

A hardware watchpoint can link to a hardware breakpoint if the hardware breakpoint is a *Linked Context* type. In this case, the watchpoint only generates a Watchpoint exception if the PE is in a particular context when the data address match occurs.

The smallest data address size that a watchpoint can be programmed to match on is a byte. A single watchpoint can be programmed to match on one or more bytes.

A watchpoint generates a Watchpoint exception whenever an instruction that initiates an access that causes a match is committed for execution.

PE behavior

If halting is allowed and `EDSCR.HDE` is 1, hardware watchpoints cause entry to Debug state. That is, they halt the PE. See [Chapter H2 Debug State](#).

Otherwise:

- If debug exceptions are enabled, hardware watchpoints cause Watchpoint exceptions.
- If debug exceptions are disabled, hardware watchpoints are ignored.

For more information, see [Watchpoint exceptions on page D2-1940](#).

Vector Catch exceptions

These are not generated in an AArch64 translation regime. They can only be generated in an AArch32 translation regime. See [Vector Catch exceptions on page D2-1955](#).

Software Step exceptions

Software step is a resource that a debugger can use to make the PE single-step instructions.

For example, by using software step, debugger software executing at a higher Exception level can debug software executing at a lower Exception level, by making it single-step instructions.

After the software being debugged has single-stepped an instruction, the PE takes a Software Step exception.

PE behavior

Software step can only be used by a debugger executing in an Exception level that is using AArch64. However, the instruction stepped might be executed in either Execution state, and therefore Software Step exceptions can be taken from either Execution state.

If debug exceptions are enabled, Software Step exceptions can be generated.

If debug exceptions are disabled, software step is inactive.

For more information, see [Software Step exceptions on page D2-1956](#).

[Table D2-1](#) summarizes PE behavior and shows the location of the pseudocode for each of the debug exceptions.

Table D2-1 PE behavior and pseudocode for each of the debug exceptions

Debug exception	PE behavior if debug exceptions are:		Pseudocode
	Enabled	Disabled	
Breakpoint Instruction exceptions	Takes the exception	Takes the exception	Pseudocode description of Breakpoint Instruction exceptions on page D2-1920
Breakpoint exceptions	Takes the exception ^a	Ignored	Pseudocode description of Breakpoint exceptions taken from AArch64 state on page D2-1939

Table D2-1 PE behavior and pseudocode for each of the debug exceptions (continued)

Debug exception	PE behavior if debug exceptions are:		Pseudocode
	Enabled	Disabled	
Watchpoint exceptions	Takes the exception ^a	Ignored	<i>Pseudocode description of Watchpoint exceptions taken from AArch64 state on page D2-1953</i>
Vector Catch exceptions	Takes the exception	Ignored	<i>Pseudocode description of Vector Catch exceptions on page G2-4517</i>
Software Step exceptions	Takes the exception	Not applicable ^b	<i>Pseudocode description of Software Step exceptions on page D2-1969</i>

- a. If halting is allowed and `EDSCR.HDE` is 1, hardware breakpoints and watchpoints cause the PE to enter Debug state instead of causing debug exceptions. See [Chapter H2 Debug State](#).
- b. Software Step is inactive if debug exceptions are disabled. No Software Step exceptions can be generated.

D2.2 The debug exception enable controls

The enable controls for each debug exception are as follows:

Breakpoint Instruction exceptions

None. Breakpoint Instruction exceptions are always enabled.

Breakpoint exceptions

[MDSR_EL1.MDE](#), plus an enable control for each breakpoint, [DBGBCR<n>_EL1.E](#).

Watchpoint exceptions

[MDSR_EL1.MDE](#), plus an enable control for each watchpoint, [DBGWCR<n>_EL1.E](#).

Vector Catch exceptions

[MDSR_EL1.MDE](#).

Software Step exceptions

[MDSR_EL1.SS](#).

In addition, for all debug exceptions other than Breakpoint Instruction exceptions, software must configure the controls that enable debug exceptions from the current Exception level and Security state. See [Enabling debug exceptions from the current Exception level and Security state on page D2-1913](#).

The PE cannot take a debug exception if debug exceptions are disabled from either the current Exception level or the current Security state.

Breakpoint Instruction exceptions are always enabled from the current Exception level and Security state.

D2.3 Routing debug exceptions

The routing of debug exceptions is as follows:

Debug exceptions taken from Non-secure state when EL2 is implemented

The routing of debug exceptions taken from Non-secure state depends on the values of [MDCR_EL2.TDE](#) and [HCR_EL2.TGE](#):

If the value of {[MDCR_EL2.TDE](#), [HCR_EL2.TGE](#)} is not {0, 0}

Debug exceptions taken from Non-secure state are routed to EL2.

Otherwise

In Non-secure state, debug exceptions behave as follows:

- Debug exceptions taken from Non-secure EL1 and Non-secure EL0 are routed to Non-secure EL1.
- Breakpoint Instruction exceptions taken from EL2 are routed to EL2.
- All other debug exceptions are disabled from EL2 using AArch64.

Note

If EL2 is not implemented, the *Effective value* of [HCR_EL2.TGE](#) is 0 and the *Effective value* of [MDCR_EL2.TDE](#) is 0. Throughout this section, references to the values of these fields are to the *Effective values* of the fields.

When EL3 is implemented

Breakpoint Instruction exceptions taken from EL3 are routed to EL3.

All other debug exceptions are disabled from EL3 using AArch64.

Otherwise Debug exceptions are routed to EL1.

This means that, for all debug exceptions, the *Debug target Exception level*, EL_D , is either EL1 or EL2:

- EL_D is EL2 if all of the following apply:
 - EL2 is implemented.
 - The *Effective value* of [SCR_EL3.NS](#) is 1.
 - The value of {[MDCR_EL2.TDE](#), [HCR_EL2.TGE](#)} is not {0, 0}.
- Otherwise EL_D is EL1.

[Table D2-2 on page D2-1912](#), [Table D2-3 on page D2-1912](#), and [Table D2-4 on page D2-1912](#) show the routing of debug exceptions. In these tables:

TDE Means the logical OR of [MDCR_EL2.TDE](#) and [HCR_EL2.TGE](#).

NS Means the *Effective value* of [SCR_EL3.NS](#).

(EL x) Means EL_D is EL x . However:

- All debug exceptions other than Breakpoint Instruction exceptions are disabled from this Exception level.
- Breakpoint Instruction exceptions taken from this Exception level are routed to this Exception level.

EL x Means EL_D is EL x .

Table D2-2 Routing when both EL3 and EL2 are implemented

NS	TDE	EL _D when executing in:			
		EL0	EL1	EL2	EL3
0	x	EL1	EL1	(EL1)	(EL1)
1	0	EL1	EL1	(EL1)	(EL1)
1	1	EL2	EL2	EL2	(EL2)

Table D2-3 Routing when EL3 is implemented and EL2 is not implemented

EL _D when executing in:		
EL0	EL1	EL3
EL1	EL1	(EL1)

Table D2-4 Routing when EL3 is not implemented and EL2 is implemented

TDE	EL _D when executing in:		
	EL0	EL1	EL2
0	EL1	EL1	(EL1)
1	EL2	EL2	EL2

D2.3.1 Pseudocode description of routing debug exceptions

[DebugTarget\(\)](#) returns the current debug target Exception level.

[DebugTargetFrom\(\)](#) returns the debug target Exception level for the specified Security state.

These functions are described in [Chapter J1 ARMv8 Pseudocode](#).

D2.4 Enabling debug exceptions from the current Exception level and Security state

A debug exception can only be taken if all of the following are true:

- The OS lock is unlocked.
- `DoubleLockStatus() == FALSE`.
- The debug exception is enabled from the current Exception level.
- The debug exception is enabled from the current Security state.

Table D2-5 shows when debug exceptions are enabled from the current Exception level. In the table, `ELD` is the Exception level that Table D2-2 on page D2-1912 defines.

Table D2-5 Whether debug exceptions are enabled from the current Exception level

Current Exception level	Breakpoint Instruction exceptions	All other debug exceptions
Any Exception level that is higher than <code>EL_D</code> ^a	Enabled	Disabled
<code>EL_D</code>	Enabled	Disabled if either of the following is true: <ul style="list-style-type: none"> • The Local (kernel) Debug Enable bit, <code>MDCR_EL1.KDE</code>, is 0. • The Debug exception mask bit, <code>PSTATE.D</code>, is 1. Otherwise enabled. This means that a debugger must explicitly enable these debug exceptions from <code>EL_D</code> by setting <code>MDCR_EL1.KDE</code> to 1 and <code>PSTATE.D</code> to 0.
Any Exception level that is lower than <code>EL_D</code>	Enabled	Enabled

a. This includes `EL3`. `EL3` is always higher than `ELD`.

———— **Note** ————

`PSTATE.D` is set to 1 at reset and on exception entry.

Table D2-6 shows when debug exceptions are enabled from the current Security state.

Table D2-6 Whether debug exceptions are enabled from the current Security state

Current Security state	Breakpoint Instruction exceptions	All other debug exceptions
Non-secure	Enabled	Enabled
Secure	Enabled	Disabled if <code>MDCR_EL3.SDD</code> is 1. See <i>Disabling debug exceptions from Secure state</i> on page D2-1914. Otherwise enabled.

D2.4.1 Disabling debug exceptions from Secure state

If EL3 is implemented, software executing at EL3 can set the *Secure Debug Disable* bit, `MDCR_EL3.SDD`, to 1 to disable all debug exceptions taken from AArch64 Secure state other than Breakpoint Instruction exceptions.

The ARMv8-A architecture does not support disabling debug in Non-secure state.

———— **Note** —————

- If the boot software executed when reset is deasserted sets `MDCR_EL3.SDD` to 1, software operating at EL3 never has to switch the debug registers between Secure state and Non-secure state.
- The PE cannot take a debug exception unless it is enabled from the current Exception level. See [Table D2-5 on page D2-1913](#).
- If either the OS lock or the OS double-lock is locked, debug exceptions other than Breakpoint Instruction exceptions are disabled.
- If EL3 and EL2 are not implemented, and the implementation is a Secure state only implementation, the PE behaves as if `MDCR_EL3.SDD` is 0.

D2.4.2 Pseudocode description of enabling debug exceptions

`AArch64.GenerateDebugExceptions()` determines whether debug exceptions other than Breakpoint Instruction exceptions are enabled from the current Exception level and Security state.

`AArch64.GenerateDebugExceptionsFrom()` determines whether debug exceptions other than Breakpoint Instruction exceptions are enabled from the specified Exception level and Security state.

These functions are described in [Chapter J1 ARMv8 Pseudocode](#).

D2.5 The effect of powerdown on debug exceptions

Debug OS Save and Restore sequences on page H6-5541 describes the *powerdown save routine* and the *restore routine*.

When executing either routine, software must use the OS Lock to disable generation of all of the following:

- Breakpoint exceptions.
- Watchpoint exceptions.
- Vector Catch exceptions.
- Software Step exceptions.

This is because the generation of these exceptions depends on the state of the debug registers, and the state of the debug registers might be lost over these routines.

Debug exceptions other than Breakpoint Instruction exceptions are enabled only if both the OS Lock is unlocked and `DoubleLockStatus() == FALSE`.

Breakpoint Instruction exceptions are enabled regardless of the state of the OS Lock and the OS Double Lock.

D2.6 Summary of the routing and enabling of debug exceptions

Behavior is as follows:

Breakpoint Instruction exceptions

These are always enabled, regardless of the current Exception level and Security state. [Table D2-7](#) shows the routing of these. In the table, n/a means not applicable.

Table D2-7 Routing of Breakpoint Instruction exceptions

Current Security state	MDCR_EL2.TDE ^a	EL _D when enabled from:			
		EL0	EL1	EL2	EL3
Secure	X	Secure EL1	Secure EL1	n/a	EL3
Non-secure	0	Non-secure EL1	Non-secure EL1	EL2	n/a
	1	EL2	EL2	EL2	n/a

a. If EL2 is not implemented, behavior is as if this is 0. Otherwise, if the value of [HCR_EL2.TGE](#) is 1, [MDCR_EL2.TDE](#) is treated as being 1 other than for a direct read of [MDCR_EL2](#).

All other debug exceptions

[Table D2-8](#) shows the valid combinations of [MDCR_EL3.SDD](#), [MDCR_EL2.TDE](#), [MDSR_EL1.KDE](#), and [PSTATE.D](#), and for each combination shows where these exceptions are enabled from and where they are taken to.

In the table, n/a means not applicable and a dash, -, means that debug exceptions are disabled from that Exception level.

Table D2-8 Routing of Breakpoint, Watchpoint, Software Step, and Vector Catch exceptions

Debug state	Lock ^a	Current Security state	SDD ^b	TDE ^c	KDE	D	EL _D when enabled from:			
							EL0	EL1	EL2	EL3
Yes	X	X	X	X	X	X	-	-	-	-
No	TRUE	X	X	X	X	X	-	-	-	-
No	FALSE	Secure	1	X	X	X	-	-	n/a	-
No	FALSE	Secure	0	X	0	X	Secure EL1	-	n/a	-
No	FALSE	Secure	0	X	1	1	Secure EL1	-	n/a	-
No	FALSE	Secure	0	X	1	0	Secure EL1	Secure EL1	n/a	-
No	FALSE	Non-secure	X	0	0	X	Non-secure EL1	-	-	n/a
No	FALSE	Non-secure	X	0	1	1	Non-secure EL1	-	-	n/a
No	FALSE	Non-secure	X	0	1	0	Non-secure EL1	Non-secure EL1	-	n/a
No	FALSE	Non-secure	X	1	0	X	EL2	EL2	-	n/a
No	FALSE	Non-secure	X	1	1	1	EL2	EL2	-	n/a
No	FALSE	Non-secure	X	1	1	0	EL2	EL2	EL2	n/a

a. The value of [\(OSLSR_EL1.OSLK == '1' || DoubleLockStatus\(\)\)](#).

b. If EL3 is not implemented, behavior is as if this is 0.

- c. If `HCR_EL2.TGE` is 1, this bit is treated as being 1 other than for a direct read of `MDCR_EL2`. If EL2 is not implemented, behavior is as if TDE is 0.

D2.7 Pseudocode description of debug exceptions

`AArch64.DebugFault()` returns a `FaultRecord` object that indicates that a memory access has generated a debug exception:

The `AArch64.Abort()` function processes `FaultRecord` objects, as described in *Abort exceptions* on page D3-2002, and generates a debug exception.

`AArch64.Abort()` calls one of the following:

- `AArch64.BreakpointException()`.
- `AArch64.WatchpointException()`.
- `AArch64.VectorCatchException()`.
- `AArch64.SoftwareStepException()`.

These functions are defined in *Chapter J1 ARMv8 Pseudocode*.

D2.8 Breakpoint Instruction exceptions

This section describes Breakpoint Instruction exceptions in an AArch64 translation regime.

The PE is using an AArch64 translation regime when it is executing either:

- In an Exception level that is using AArch64.
- At EL0 using AArch32 when EL1 is using AArch64.

For software executing in an Exception level that is using AArch64, a Breakpoint Instruction exception results from the execution of an A64 BRK instruction. However, within the AArch64 EL1&0 translation regime, executing a T32 or A32 BKPT instruction at EL0 using AArch32 generates a Breakpoint Instruction exception.

For more information about the T32 and A32 BKPT instructions, see:

- [Breakpoint instruction in the A32 and T32 instruction sets on page G2-4467.](#)
- [BKPT instructions as the first instruction in an IT block on page G2-4468.](#)

The following subsections describe Breakpoint Instruction exceptions in an AArch64 translation regime:

- [About Breakpoint Instruction exceptions.](#)
- [Breakpoint instructions.](#)
- [Exception syndrome information and preferred return address on page D2-1920.](#)
- [Pseudocode description of Breakpoint Instruction exceptions on page D2-1920.](#)

D2.8.1 About Breakpoint Instruction exceptions

A *breakpoint* is an event that results from the execution of an instruction, which is based on either:

- The instruction address, the PE context, or both. This type of breakpoint is called a *hardware breakpoint*.
- The instruction itself. That is, the instruction is a *breakpoint instruction*. These can be included in the program that the PE executes. This type of breakpoint is called a *software breakpoint*.

Breakpoint Instruction exceptions, that this section describes, are software breakpoints. [Breakpoint exceptions on page D2-1921](#) describes hardware breakpoints.

There is no enable control for Breakpoint Instruction exceptions. They are always enabled, and cannot be masked.

A Breakpoint Instruction exception is generated whenever a breakpoint instruction is committed for execution, regardless of all of the following:

- The current Exception level.
- The current Security state.
- Whether the *debug target Exception level*, EL_D , is using AArch64 or AArch32.

Note

- The debug target Exception level, EL_D , is the Exception level that debug exceptions are targeting. [Routing debug exceptions on page D2-1911](#) describes how EL_D is derived.
 - Debuggers using breakpoint instructions must be aware of the ARMv8 rules for concurrent modification and execution of instructions. See [Concurrent modification and execution of instructions on page B2-84](#).
-

D2.8.2 Breakpoint instructions

The breakpoint instruction in the A64 instruction set is BRK #<immediate>. It is unconditional.

For details of the instruction encoding, see [BRK on page C6-563](#).

The breakpoint instruction in the A32 and T32 instruction sets is BKPT #<immediate>.

For more information about the A32 and T32 breakpoint instruction, see [Breakpoint instruction in the A32 and T32 instruction sets on page G2-4467](#).

D2.8.3 Exception syndrome information and preferred return address

See the following:

- [Exception syndrome information](#).
- [Preferred return address](#).

Exception syndrome information

On taking a Breakpoint Instruction exception, the PE records information about the exception in the *Exception Syndrome Register* (ESR) at the Exception level the exception is taken to. The ESR used is one of:

- [ESR_EL1](#).
- [ESR_EL2](#).
- [ESR_EL3](#).

———— **Note** ————

Breakpoint Instruction exceptions are the only debug exception that can be taken to EL3 using AArch64.

[Table D2-9](#) shows the information that the PE records.

Table D2-9 Information recorded in the [ESR_ELx](#)

ESR_ELx field	Information recorded in ESR_EL1, ESR_EL2, or ESR_EL3.	
<i>Exception Class</i> , EC	Whether the breakpoint instruction was executed in AArch64 state or AArch32 state. The PE sets this to: <ul style="list-style-type: none"> • 0x3C for an A64 BRK instruction. • 0x38 for an A32 or T32 BKPT instruction. 	
<i>Instruction Length</i> , IL	The PE sets this to: <ul style="list-style-type: none"> • 0 for a 16-bit T32 BKPT instruction. • 1 for an A64 BRK instruction, or an A32 BKPT instruction. 	
<i>Instruction Specific Syndrome</i> , ISS	ISS[24:16]	RES0.
	ISS[15:0]	The PE copies the instruction Comment field value into here, zero extended as necessary.

———— **Note** ————

- If debug exceptions are routed to EL2, it is the exception that is routed, not the instruction that is trapped. Therefore, if a Breakpoint Instruction exception is routed to EL2, [ESR_EL2.EC](#) is set to the same value as if the exception was taken to EL1.
- For information about how debug exceptions can be routed to EL2, see [Routing debug exceptions on page D2-1911](#).

Preferred return address

The preferred return address is the address of the breakpoint instruction, not the next instruction. This is different to the behavior of other exception-generating instructions, like SVC.

D2.8.4 Pseudocode description of Breakpoint Instruction exceptions

[AArch64.SoftwareBreakpoint\(\)](#) generates a Breakpoint Instruction exception that is taken to AArch64 state.

This function is defined in [Chapter J1 ARMv8 Pseudocode](#).

D2.9 Breakpoint exceptions

This section describes Breakpoint exceptions in stage 1 of an AArch64 translation regime.

The PE is using an AArch64 translation regime when it is executing either:

- In an Exception level that is using AArch64.
- At EL0 using AArch32 when EL1 is using AArch64.

This section contains the following subsections:

- [About Breakpoint exceptions.](#)
- [Breakpoint types and linking of breakpoints on page D2-1922.](#)
- [Execution conditions for which a breakpoint generates Breakpoint exceptions on page D2-1931.](#)
- [Breakpoint instruction address comparisons on page D2-1932.](#)
- [Breakpoint context comparisons on page D2-1934.](#)
- [Breakpoint usage constraints on page D2-1935.](#)
- [Exception syndrome information and preferred return address on page D2-1938.](#)
- [Pseudocode description of Breakpoint exceptions taken from AArch64 state on page D2-1939.](#)

D2.9.1 About Breakpoint exceptions

A *breakpoint* is an event that results from the execution of an instruction, which is based on either:

- The instruction address, the PE context, or both. This type of breakpoint is called a *hardware breakpoint*.
- The instruction itself. That is, the instruction is a *breakpoint instruction*. These can be included in the program that the PE executes. This type of breakpoint is called a *software breakpoint*.

Breakpoint exceptions are generated by *Breakpoint debug events*. Breakpoint debug events are generated by hardware breakpoints. Software breakpoints are described in [Breakpoint Instruction exceptions on page D2-1919](#).

An implementation can include between 2-16 hardware breakpoints. [ID_AA64DFR0_EL1.BRPs](#) shows how many are implemented.

To use an implemented hardware breakpoint, a debugger programs the following registers for the breakpoint:

- The *Breakpoint Control Register*, [DBGBCR<n>_EL1](#). This contains controls for the breakpoint, for example an enable control.
- The *Breakpoint Value Register*, [DBGBVR<n>_EL1](#). This holds the value used for breakpoint matching, that is one of:
 - An instruction virtual address.
 - A Context ID.
 - A [VMID](#) value.
 - A concatenation of both a Context ID value and a [VMID](#) value.

These registers are numbered, so that:

- [DBGBCR1_EL1](#) and [DBGBVR1_EL1](#) are for breakpoint number one.
- [DBGBCR2_EL1](#) and [DBGBVR2_EL1](#) are for breakpoint number two.
- ...
- ...
- [DBGBCR<n>_EL1](#) and [DBGBVR<n>_EL1](#) are for breakpoint number n.

A debugger can link a breakpoint that is programmed with an address and a breakpoint that is programmed with anything other than an address together, so that a Breakpoint debug event is only generated if both breakpoints match.

For each instruction in the program flow, all of the breakpoints are tested. When a breakpoint is tested, it generates a Breakpoint debug event if all of the following are true:

- The breakpoint is enabled. That is, the breakpoint enable control for it, `DBGBCR<n>_EL1.E`, is 1.
- The conditions specified in the `DBGBCR<n>_EL1` are met.
- The comparison with the value held in the `DBGBVR<n>_EL1` is successful.
- If the breakpoint is linked to another breakpoint, the comparisons made by that other breakpoint are also successful.
- The instruction is committed for execution.

If all of these conditions are met, the breakpoint generates the Breakpoint debug event regardless of the following:

- Whether the instruction passes its Condition code check.
- The instruction type.

If halting is allowed and `EDSCR.HDE` is 1, Breakpoint debug events cause entry to Debug state.

Otherwise, if debug exceptions are:

- Enabled, Breakpoint debug events generate Breakpoint exceptions.
- Disabled, Breakpoint debug events are ignored.

———— **Note** —————

The remainder of this Breakpoint exceptions section, including all subsections, describes breakpoints as generating Breakpoint exceptions.

However, the behavior described also applies if breakpoints are causing entry to Debug state.

The debug exception enable controls on page D2-1910 describes the enable controls for Breakpoint debug events.

D2.9.2 Breakpoint types and linking of breakpoints

Each implemented breakpoint is one of the following:

- A *context-aware* breakpoint. This is a breakpoint that can be programmed to generate a Breakpoint exception on any one of the following:
 - An instruction address match.
 - A Context ID match, with the value held in the `CONTEXTIDR_EL1`.
 - A `VMID` match, with the `VMID` value held in the `VTTBR_EL2`.
 - Both a Context ID match and a `VMID` match.
- A breakpoint that is not context-aware. These can only be programmed to generate a Breakpoint exception on an instruction address match.

`ID_AA64DFR0_EL1.CTX_CMPs` shows how many of the implemented breakpoints are context-aware breakpoints. At least one implemented breakpoint must be context-aware. The context-aware breakpoints are the highest numbered breakpoints.

Any breakpoint that is programmed to generate a Breakpoint exception on an instruction address match is categorized as an *Address breakpoint*. Breakpoints that are programmed to match on anything else are categorized as *Context breakpoints*.

When a debugger programs a breakpoint to be an Address or a Context breakpoint, it must also program that breakpoint so that it is either:

- Used in isolation. In this case, the breakpoint is called an *Unlinked breakpoint*.
- Enabled for linking to another breakpoint. In this case, the breakpoint is called a *Linked breakpoint*.

By linking an Address breakpoint and a Context breakpoint together, the debugger can create a breakpoint pair that only generates a Breakpoint exception if the PE is in a particular context when an instruction address match occurs. For example, a debugger might:

1. Program breakpoint number one to be a *Linked Address Match breakpoint*.
2. Program breakpoint number five to be a *Linked Context ID Match breakpoint*.
3. Link these two breakpoints together. A Breakpoint exception is only generated if both the instruction address matches and the Context ID matches.

The *Breakpoint Type* field for a breakpoint, `DBGBCR<n>_EL1.BT`, controls the breakpoint type and whether the breakpoint is enabled for linking. If `BT[0]` is 1, the breakpoint is enabled for linking.

Figure D2-1 shows all of the possible breakpoint types that stage 1 of an AArch64 translation regime supports, and their associated BT field values.

		Unlinked	Linked
Address breakpoints	Address Match	BT == 0b0000 Unlinked Address Match	BT == 0b0001 Linked Address Match
Context breakpoints	Context ID Match	BT == 0b0010 Unlinked Context ID Match	BT == 0b0011 Linked Context ID Match
	VMID Match	BT == 0b1000 Unlinked VMID Match	BT == 0b1001 Linked VMID Match
	VMID and context ID Match	BT == 0b1010 Unlinked VMID and Context ID Match	BT == 0b1011 Linked VMID and Context ID Match

Figure D2-1 Breakpoint types and their associated BT field values

If AArch32 state is implemented, Address breakpoints can be programmed to generate Breakpoint exceptions on addresses that are halfword-aligned but not word-aligned. This makes it possible to breakpoint on T32 instructions. See [Specifying the halfword-aligned address that an Address breakpoint matches on on page D2-1933](#).

Note

Stage 1 of an AArch32 translation regimes supports two additional breakpoint types, Unlinked and Linked Address Mismatch breakpoints, `BT == 0b0100` and `BT == 0b0101`. For information about these, see [Chapter G2 AArch32 Self-hosted Debug](#). These types are reserved in stage 1 of an AArch64 translation regime. See [Reserved BT values on page D2-1935](#).

Rules for linking breakpoints

The rules for breakpoint linking are as follows:

- Only Linked breakpoint types can be linked.
- Any type of Linked Address breakpoint can link to any type of Linked Context breakpoint. The *Linked Breakpoint Number* field, `DBGBCR<n>_EL1.LBN`, for the Linked Address breakpoint specifies the particular Linked Context breakpoint that the Linked Address breakpoint links to, and:
 - `DBGBCR<n>_EL1.{SSC, HMC, PMC}` for the Linked Address breakpoint define the execution conditions that the breakpoint pair generates Breakpoint exceptions for. See [Execution conditions for which a breakpoint generates Breakpoint exceptions on page D2-1931](#).
 - `DBGBCR<n>_EL1.{SSC, HMC, PMC}` for the Linked Context breakpoint are ignored.
- Linked Context breakpoint types can only be linked to. The LBN field for Context breakpoints is therefore ignored.
- Linked Address breakpoints cannot link to watchpoints. The LBN field can therefore only specify another breakpoint.
- If a Linked Address breakpoint links to a breakpoint that is not context-aware, the behavior of the Linked Address breakpoint is CONstrained UNPREDICTABLE. See [Other usage constraints for Address breakpoints on page D2-1938](#).
- If a Linked Address breakpoint links to an Unlinked Context breakpoint, the Linked Address breakpoint never generates any Breakpoint exceptions.
- Multiple Linked Address breakpoints can link to a single Linked Context breakpoint.

———— **Note** —————

Multiple Linked watchpoints can also link to a single Linked Context breakpoint. [Watchpoint exceptions on page D2-1940](#) describes watchpoints.

These rules mean that a single Linked Context breakpoint might be linked to by all, or any combination of, the following:

- Multiple Linked Address Match breakpoints.
- Multiple Linked watchpoints.

It is also possible that a Linked Context breakpoint might have no breakpoints or watchpoints linked to it.

[Figure D2-2 on page D2-1925](#) shows an example of permitted breakpoint and watchpoint linking.

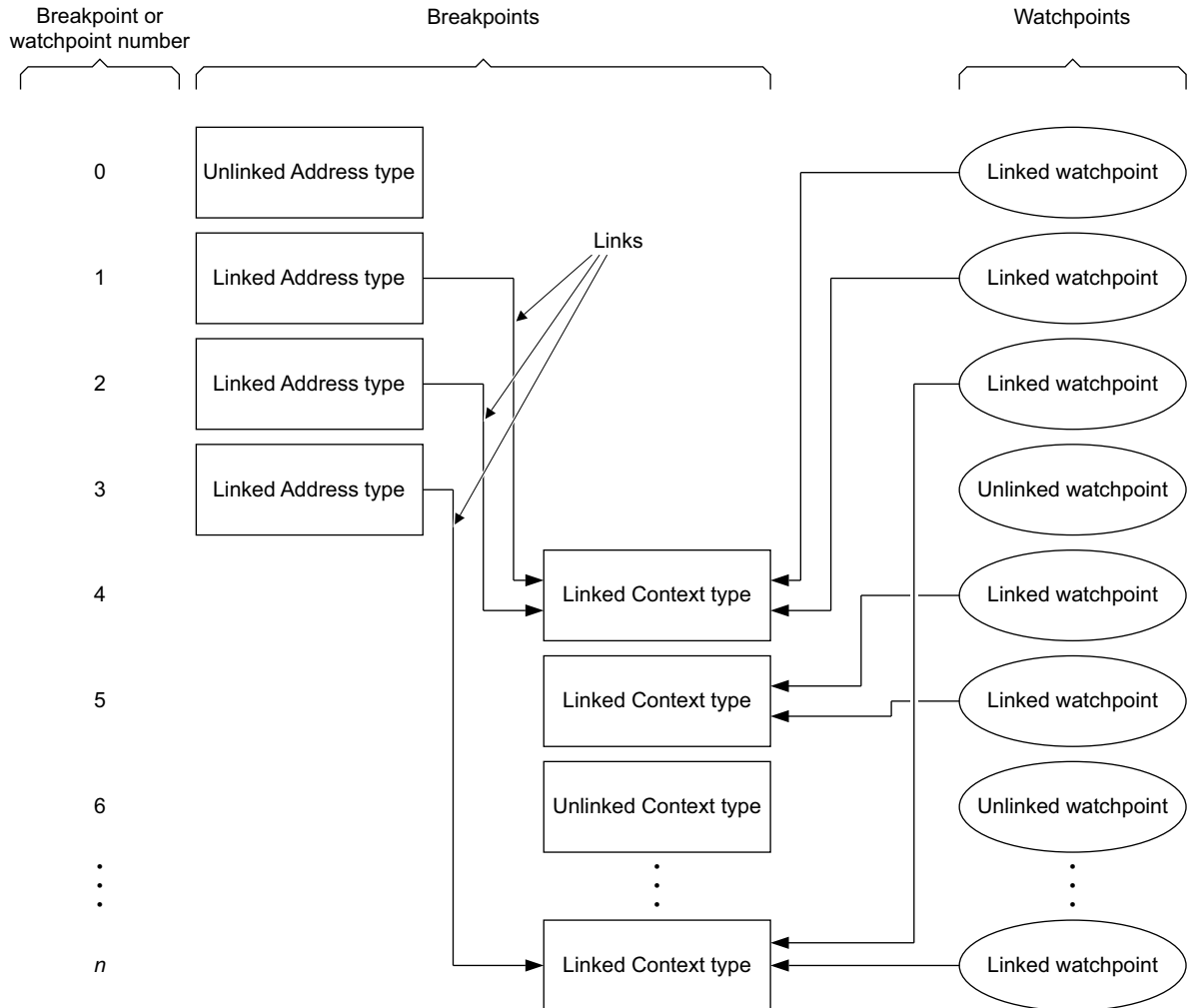

Figure D2-2 The role of linking in Breakpoint and Watchpoint exception generation

In [Figure D2-2](#), each Linked Address breakpoint can only generate a Breakpoint exception if the comparisons made by both it, and the Linked Context breakpoint that it links, to are successful. Similarly, each Linked watchpoint can only generate a Watchpoint exception if the comparisons made by both it, and the Linked Context breakpoint that it links to, are successful.

Breakpoint types defined by DBGBCR_n_EL1.BT

The following list provides more detail about each breakpoint type:

0b0000, Unlinked Address Match breakpoint

Generation of a Breakpoint exception depends on both:

- [DBGBCR<n>_EL1](#).{SSC, HMC, PMC}. These define the execution conditions for which the breakpoint generates Breakpoint exceptions. See *Execution conditions for which a breakpoint generates Breakpoint exceptions* on page D2-1931.
- A successful address match, as described in *Breakpoint instruction address comparisons* on page D2-1932.

[DBGBCR<n>_EL1.LBN](#) for this breakpoint is ignored.

0b0001, Linked Address Match breakpoint

Generation of a Breakpoint exception depends on all of the following:

- [DBGBCR<n>_EL1](#). {SSC, HMC, PMC} for this breakpoint. These define the execution conditions that the breakpoint generates Breakpoint exceptions for. See [Execution conditions for which a breakpoint generates Breakpoint exceptions](#) on page D2-1931.
- A successful address match defined by this breakpoint, as described in [Breakpoint instruction address comparisons](#) on page D2-1932.
- A successful context match defined by the Linked Context breakpoint that this breakpoint links to.

[DBGBCR<n>_EL1.LBN](#) for this breakpoint selects the Linked Context breakpoint that this breakpoint links to.

0b0010, Unlinked Context ID Match breakpoint

BT == 0b0010 is a reserved value if the breakpoint is not a context-aware breakpoint.

For context-aware breakpoints, generation of a Breakpoint exception depends on both:

- [DBGBCR<n>_EL1](#). {SSC, HMC, PMC}. These define the execution conditions for which the breakpoint generates Breakpoint exceptions. See [Execution conditions for which a breakpoint generates Breakpoint exceptions](#) on page D2-1931.
- A successful Context ID match, as described in [Breakpoint context comparisons](#) on page D2-1934.

The value of [DBGBVR<n>_EL1.ContextID](#) is compared with the current Context ID.

[CONTEXTIDR_EL2](#) holds the current Context ID when all of:

- The implementation includes [ARMv8.1-VHE](#).
- The PE is in Non-secure state.
- EL2 using AArch64 and [HCR_EL2.E2H](#) is set to 1.
- The PE is executing at EL0 and [HCR_EL2.TGE](#) is 1, or the PE is executing at EL2.

Otherwise, [CONTEXTIDR_EL1](#) holds the current Context ID.

[DBGBCR<n>_EL1](#). {LBN, BAS} for this breakpoint are ignored

0b0011, Linked Context ID Match breakpoint

BT == 0b0011 is a reserved value if the breakpoint is not a context-aware breakpoint.

For context-aware breakpoints, one of the following applies:

- If no Linked breakpoints or Linked watchpoints link to this breakpoint, then the breakpoint does not generate any Breakpoint exceptions.
- Generation of a Breakpoint exception depends on both:
 - A successful instruction address match, defined by a Linked Address breakpoint that links to this breakpoint, see [Breakpoint instruction address comparisons](#) on page D2-1932.
 - A successful Context ID match defined by this breakpoint, as described in [Breakpoint context comparisons](#) on page D2-1934.
- Generation of a Watchpoint exception depends on both:
 - A successful data address match, defined by a Linked watchpoint that links to this breakpoint, see [Watchpoint data address comparisons](#) on page D2-1944.
 - A successful Context ID match defined by this breakpoint, as described in [Breakpoint context comparisons](#) on page D2-1934.

The value of [DBGBVR<n>_EL1.ContextID](#) is compared with the current Context ID.

[CONTEXTIDR_EL2](#) holds the current Context ID when all of:

- The implementation includes [ARMv8.1-VHE](#).
- The PE is in Non-secure state.
- EL2 using AArch64 and [HCR_EL2.E2H](#) is set to 1.

- The PE is executing at EL0 and `HCR_EL2.TGE` is 1, or the PE is executing at EL2.

Otherwise, `CONTEXTIDR_EL1` holds the current Context ID.

`DBGBCR<n>_EL1`. {LBN, SSC, HMC, BAS, PMC} for this breakpoint are ignored.

0b0100, Unlinked Address Mismatch breakpoint

BT == 0b0100 is a reserved value in stage 1 of an AArch64 translation regime. See *Reserved BT values* on page D2-1935.

0b0100, Unlinked Address Mismatch breakpoint on page G2-4476 describes the behavior of Address Mismatch breakpoints in stage 1 of an AArch32 translation regime.

0b0101, Linked Address Mismatch breakpoint

BT == 0b0101 is a reserved value in stage 1 of an AArch64 translation regime. See *Reserved BT values* on page D2-1935.

0b0101, Linked Address Mismatch breakpoint on page G2-4476 describes the behavior of Address Mismatch breakpoints in stage 1 of an AArch32 translation regime.

0b0110, Unlinked CONTEXTIDR_EL1 Match

BT == 0b0110 is a reserved value if either:

- The breakpoint is not a context-aware breakpoint.
- The implementation does not include [ARMv8.1-VHE](#).

For context-aware breakpoints, generation of a Breakpoint exception depends on both:

- `DBGBCR<n>_EL1`. {SSC, HMC, PMC}. These define the execution conditions for which the breakpoint generates Breakpoint exceptions.
- A successful Context ID match defined by this breakpoint, as described in *Breakpoint context comparisons* on page D2-1934.

The Context ID check is made against the value in `CONTEXTIDR_EL1`. The value of `DBGBVR<n>_EL1.ContextID` is compared with the Context ID value held in `CONTEXTIDR_EL1`.

`DBGBCR<n>_EL1`. {LBN, BAS} for this breakpoint are ignored.

0b0111, Linked CONTEXTIDR_EL1 Match

BT == 0b0111 is a reserved value if either:

- The breakpoint is not a context-aware breakpoint.
- The implementation does not include [ARMv8.1-VHE](#).

For context-aware breakpoints, one of the following applies:

- If no Linked breakpoints or Linked watchpoints link to this breakpoint, then the breakpoint does not generate any Breakpoint exceptions.
- Generation of a Breakpoint exception depends on both:
 - A successful instruction address match, defined by a Linked Address match breakpoint that links to this breakpoint, see *Breakpoint instruction address comparisons* on page D2-1932.
 - A successful Context ID match defined by this breakpoint, as described in *Breakpoint context comparisons* on page D2-1934.
- Generation of a Watchpoint exception depends on both:
 - A successful data address match, defined by a Linked watchpoint that links to this breakpoint, see *Watchpoint data address comparisons* on page D2-1944.
 - A successful Context ID match defined by this breakpoint, as described in *Breakpoint context comparisons* on page D2-1934.

The Context ID check is made against the value in `CONTEXTIDR_EL1`. The value of `DBGBVR<n>_EL1.ContextID` is compared with the Context ID value held in `CONTEXTIDR_EL1`.

`DBGBCR<n>_EL1`. {LBN, SSC, HMC, BAS, PMC} for this breakpoint are ignored.

0b1000, Unlinked VMID Match breakpoint

BT == 0b1000 is a reserved value if either:

- The breakpoint is not a context-aware breakpoint.
- EL2 is not implemented.

For context-aware breakpoints, generation of a Breakpoint exception depends on both:

- `DBGBCR<n>_EL1`. {SSC, HMC, PMC}. These define the execution conditions for which the breakpoint generates Breakpoint exceptions. See *Execution conditions for which a breakpoint generates Breakpoint exceptions* on page D2-1931.
- A successful VMID match, as described in *Breakpoint context comparisons* on page D2-1934.

`DBGBCR<n>_EL1`. {LBN, BAS} for this breakpoint are ignored.

0b1001, Linked VMID Match breakpoint

BT == 0b1001 is a reserved value if either:

- The breakpoint is not a context-matching breakpoint.
- EL2 is not implemented.

For context-aware breakpoints, one of the following applies:

- If no Linked breakpoints or Linked watchpoints link to this breakpoint, then the breakpoint does not generate any Breakpoint exceptions.
- Generation of a Breakpoint exception depends on both:
 - A successful instruction address match, defined by a Linked Address Match breakpoint that links to this breakpoint. See *Breakpoint instruction address comparisons* on page D2-1932.
 - A successful VMID match defined by this breakpoint, as described in *Breakpoint context comparisons* on page D2-1934.
- Generation of a Watchpoint exception depends on both:
 - A successful data address match, defined by a Linked watchpoint that links to this breakpoint, see *Watchpoint data address comparisons* on page D2-1944.
 - A successful VMID match defined by this breakpoint, as described in *Breakpoint context comparisons* on page D2-1934.

`DBGBCR<n>_EL1`. {LBN, SSC, HMC, BAS, PMC} for this breakpoint are ignored.

0b1010, Unlinked Context ID and VMID Match breakpoint

BT == 0b1010 is a reserved value if either:

- The breakpoint is not a context-aware breakpoint.
- EL2 is not implemented.

For context-aware breakpoints, generation of a Breakpoint exception depends on all of the following:

- `DBGBCR<n>_EL1`. {SSC, HMC, PMC}. These define the execution conditions that the breakpoint generates a Breakpoint exception for. See *Execution conditions for which a breakpoint generates Breakpoint exceptions* on page D2-1931.
- A successful Context ID match, as described in *Breakpoint context comparisons* on page D2-1934.
- A successful VMID match.

The value of `DBGBCR<n>_EL1.ContextID` is compared with the current Context ID.

`CONTEXTIDR_EL2` holds the current Context ID when all of:

- The implementation includes [ARMv8.1-VHE](#).
- The PE is in Non-secure state.
- EL2 using AArch64 and `HCR_EL2.E2H` is set to 1.

- The PE is executing at EL0 and `HCR_EL2.TGE` is 1, or the PE is executing at EL2.

Otherwise, `CONTEXTIDR_EL1` holds the current Context ID.

[Breakpoint context comparisons on page D2-1934](#) describes the requirements for a successful Context ID match and a successful VMID match.

`DBGBCR<n>_EL1`.{LBN, BAS} for this breakpoint are ignored.

0b1011, Linked Context ID and VMID Match breakpoint

BT == 0b1011 is a reserved value if either:

- The breakpoint is not a context-aware breakpoint.
- EL2 is not implemented.

For context-aware breakpoints, one of the following applies:

- If no Linked breakpoints or Linked watchpoints link to this breakpoint, then the breakpoint does not generate any Breakpoint exceptions.
- Generation of a Breakpoint exception depends on all of the following:
 - A successful instruction address match, defined by a Linked Address breakpoint that links to this breakpoint, see [Breakpoint instruction address comparisons on page D2-1932](#).
 - A successful Context ID match defined by this breakpoint, as described in [Breakpoint context comparisons on page D2-1934](#).
 - A successful VMID match defined by this breakpoint.
- Generation of a Watchpoint exception depends on all of the following:
 - A successful data address match, defined by a Linked watchpoint that links to this breakpoint, see [Watchpoint data address comparisons on page D2-1944](#).
 - A successful Context ID match defined by this breakpoint, as described in [Breakpoint context comparisons on page D2-1934](#).
 - A successful VMID match defined by this breakpoint.

The value of `DBGBVR<n>_EL1.ContextID` is compared with the current Context ID.

`CONTEXTIDR_EL2` holds the current Context ID when all of:

- The implementation includes [ARMv8.1-VHE](#).
- The PE is in Non-secure state.
- EL2 using AArch64 and `HCR_EL2.E2H` is set to 1.
- The PE is executing at EL0 and `HCR_EL2.TGE` is 1, or the PE is executing at EL2.

Otherwise, `CONTEXTIDR_EL1` holds the current Context ID.

[Breakpoint context comparisons on page D2-1934](#) describes the requirements for a successful Context ID match and a successful VMID match by this breakpoint.

`DBGBCR<n>_EL1`.{LBN, SSC, HMC, BAS, PMC} for this breakpoint are ignored.

0b1100, Unlinked CONTEXTIDR_EL2 Match

BT == 0b1100 is a reserved value if either:

- The breakpoint is not a context-aware breakpoint.
- The implementation does not include [ARMv8.1-VHE](#).

For context-aware breakpoints, generation of a Breakpoint exception depends on both:

- `DBGBCR<n>_EL1`.{SSC, HMC, PMC}. These define the execution conditions for which the breakpoint generates Breakpoint exceptions.
- A successful `CONTEXTIDR_EL2` match, as described in [Breakpoint context comparisons on page D2-1934](#).

The Context ID check is made against the value in `CONTEXTIDR_EL2`. The value of `DBGBVR<n>_EL1` is compared with the Context ID value held in `CONTEXTIDR_EL2`.

`DBGBCR<n>_EL1`.{LBN, BAS} for this breakpoint are ignored.

0b1101, Linked CONTEXTIDR_EL2 Match

BT == 0b1101 is a reserved value if either:

- The breakpoint is not a context-aware breakpoint.
- The implementation does not include [ARMv8.1-VHE](#).

For context-aware breakpoints, either:

- If no Linked breakpoints or Linked watchpoints link to this breakpoint, then the breakpoint does not generate any Breakpoint exceptions.
- Generation of a Breakpoint exception depends on both:
 - A successful instruction address match, defined by a Linked Address match breakpoint that links to this breakpoint, see [Breakpoint instruction address comparisons](#) on page D2-1932.
 - A successful [CONTEXTIDR_EL2](#) match, as described in [Breakpoint context comparisons](#) on page D2-1934.
- Generation of a Watchpoint exception depends on both:
 - A successful data address match, defined by a Linked watchpoint that links to this breakpoint, see [Watchpoint data address comparisons](#) on page D2-1944.
 - A successful [CONTEXTIDR_EL2](#) match, as described in [Breakpoint context comparisons](#) on page D2-1934.

The Context ID check is made against the value in [CONTEXTIDR_EL2](#). The value of [DBGBVR<n>_EL1](#) is compared with the Context ID value held in [CONTEXTIDR_EL2](#). [DBGBCR<n>_EL1](#).{LBN, SSC, HMC, BAS, PMC} for this breakpoint are ignored.

0b1110, Unlinked Full Context ID Match

BT == 0b1110 is a reserved value if either:

- The breakpoint is not a context-aware breakpoint.
- The implementation does not include [ARMv8.1-VHE](#).

For context-aware breakpoints, generation of a Breakpoint exception depends on both:

- [DBGBCR<n>_EL1](#).{SSC, HMC, PMC}. These define the execution conditions for which the breakpoint generates Breakpoint exceptions.
- A successful Context ID match, as described in [Breakpoint context comparisons](#) on page D2-1934.

The Context ID check is made against the values in both [CONTEXTIDR_EL1](#) and [CONTEXTIDR_EL2](#). The value of [DBGBVR<n>_EL1](#)[31:0] is compared with the Context ID value held in [CONTEXTIDR_EL1](#), and the value of [DBGBVR<n>_EL1](#)[63:32] is compared with the Context ID value held in [CONTEXTIDR_EL2](#). Both comparisons must match for the Context ID check.

[DBGBCR<n>_EL1](#).{LBN, BAS} for this breakpoint are ignored.

0b1111, Linked Full Context ID Match

BT == 0b1111 is a reserved value if either:

- The breakpoint is not a context-aware breakpoint.
- The implementation does not include [ARMv8.1-VHE](#).

For context-aware breakpoints, one of the following applies:

- If no Linked breakpoints or Linked watchpoints link to this breakpoint, then the breakpoint does not generate any Breakpoint exceptions.
- Generation of a Breakpoint exception depends on both:
 - A successful instruction address match, defined by a Linked Address match breakpoint that links to this breakpoint, see [Breakpoint instruction address comparisons](#) on page D2-1932.
 - A successful Context ID match, as described in [Breakpoint context comparisons](#) on page D2-1934.

- Generation of a Watchpoint exception depends on both:
 - A successful data address match, defined by a Linked watchpoint that links to this breakpoint, see [Watchpoint data address comparisons on page D2-1944](#).
 - A successful Context ID match, as described in [Breakpoint context comparisons on page D2-1934](#).

The Context ID check is made against the values in both `CONTEXTIDR_EL1` and `CONTEXTIDR_EL2`. The value of `DBGBVR<n>_EL1[31:0]` is compared with the Context ID value held in `CONTEXTIDR_EL1`, and the value of `DBGBVR<n>_EL1[63:32]` is compared with the Context ID value held in `CONTEXTIDR_EL2`. Both comparisons must match for the Context ID check.

`DBGBCR<n>_EL1`. {LBN, SSC, HMC, BAS, PMC} for this breakpoint are ignored.

———— **Note** —————

See [Reserved `DBGBCR<n>_EL1.BT` values on page D2-1935](#) for the behavior of breakpoints programmed with reserved BT values.

D2.9.3 Execution conditions for which a breakpoint generates Breakpoint exceptions

Each breakpoint can be programmed so that it only generates Breakpoint exceptions for certain execution conditions. For example, a breakpoint might be programmed to generate Breakpoint exceptions only when the PE is executing at EL0 in Secure state.

`DBGBCR<n>_EL1`. {SSC, HMC, PMC} defines the execution conditions the breakpoint generates Breakpoint exceptions for, as follows:

Security State Control, SSC

Controls whether the breakpoint generates Breakpoint exceptions only in Secure state, only in Non-secure state, or in both Security states.

———— **Note** —————

This is determined by the Security state of the PE, not from the NS attribute returned by the translation of the virtual address on which the breakpoint is set.

Higher Mode Control, HMC, and Privileged Mode Control, PMC

HMC and PMC together control which Exception levels the breakpoint generates Breakpoint exceptions in.

[Table D2-10 on page D2-1932](#) shows the valid combinations of the values of HMC, SSC, and PMC, and for each combination shows which Exception levels breakpoints generate Breakpoint exceptions in.

In the table:

Y or - Means that a breakpoint programmed with the values of HMC, SSC, and PMC shown in that row:
Y Can generate Breakpoint exceptions in that Exception level.
- Cannot generate Breakpoint exceptions in that Exception level.

Res Means that the combination of HMC, SSC, and PMC is reserved. See [Reserved `DBGBCR<n>_EL1`. {SSC, HMC, PMC} values on page D2-1936](#).

Table D2-10 Summary of breakpoint HMC, SSC, and PMC encodings

HMC	SSC	PMC	Security state the breakpoint is programmed to match in	EL3 ^a	EL2	EL1	EL0	Implementation	
								No EL3	No EL3 and no EL2
0	00	01	Both	-	-	Y	-	-	-
0	00	10		-	-	-	Y	-	-
0	00	11		-	-	Y	Y	-	-
0	01	01	Non-secure	-	-	Y	-	Res	Res
0	01	10		-	-	-	Y	Res	Res
0	01	11		-	-	Y	Y	Res	Res
0	10	01	Secure	-	-	Y	-	Res	Res
0	10	10		-	-	-	Y	Res	Res
0	10	11		-	-	Y	Y	Res	Res
1	00	01	Both	Y	Y	Y	-	-	Res
1	00	11		Y	Y	Y	Y	-	Res
1	01	01	Non-secure	-	Y	Y	-	Res	Res
1	01	11		-	Y	Y	Y	Res	Res
1	10	00	Secure	Y	-	-	-	Res	Res
1	10	01		Y	-	Y	-	Res	Res
1	10	11		Y	-	Y	Y	Res	Res
1	11	00	Non-secure	-	Y	-	-	-	Res if no EL2 ^b

a. Debug exceptions are not generated at EL3 using AArch64. This means that these combinations of HMC, SSC, and PMC are only relevant if breakpoints cause entry to Debug state. Self-hosted debuggers must avoid combinations of HMC, SSC, and PMC that generate Breakpoint exceptions at EL3 using AArch64.

b. This encoding is only reserved when EL2 is not implemented, regardless of whether EL3 is implemented.

All combinations of HMC, SSC, and PMC that this table does not show are reserved. See *Reserved DBGBCR<n>_EL1.{SSC, HMC, PMC} values on page D2-1936*.

D2.9.4 Breakpoint instruction address comparisons

In this subsection, the term `maxAddressSize` represents the maximum supported virtual address size, which is **52 bits in an implementation that includes ARMv8.2-LVA and uses the 64KB translation granule and 48 bits otherwise**.

An address comparison is successful if bits `[maxAddressSize:2]` of the current instruction virtual address are equal to `DBGBVR<n>_EL1[maxAddressSize:2]`.

———— **Note** —————

`DBGBVR<n>_EL1` is a 64-bit register. The most significant bits of this register are sign-extension bits. `DBGBVR<n>_EL1[1:0]` are RES0 and are ignored.

If EL1 is using AArch64 and EL0 is using AArch32, A32 and T32 instructions can be executed in stage 1 of an AArch64 translation regime. In this case, the instruction addresses are zero-extended before comparison with the breakpoint.

Specifying the halfword-aligned address that an Address breakpoint matches on

For Address Match breakpoints, if the implementation supports AArch32 state, a debugger must program the *Byte Address Selection* field, `DBGBCR<n>_EL1.BAS`.

Table D2-11 Programmable BAS values

BAS	Match instruction at	Constraint for debuggers
0b0011	DBGBCR<n>_EL1	Use for T32 instructions.
0b1100	DBGBCR<n>_EL1 + 2	Use for T32 instructions.
0b1111	DBGBCR<n>_EL1	Use for A64 and A32 instructions.

If the implementation is an AArch64-only implementation, all instructions are word-aligned and `DBGBCR<n>_EL1.BAS` is RES1.

Figure D2-3 on page D2-1934 shows a summary of when Address Match breakpoints programmed with particular BAS values generate Breakpoint exceptions. The figure contains four parts:

- A column showing the row number, on the left.
- An instruction set and instruction size table.
- A location of instruction figure.
- A BAS field values table, on the right.

To use the figure, read across the rows. For example, row 7 shows that a breakpoint with `DBGBCR<n>_EL1.BAS` programmed as either 0b0011 or 0b1111 generates Breakpoint exceptions for A64 instructions. A64 instructions are always at word-aligned addresses.

———— Note —————

To breakpoint on an A64 instruction, ARM recommends that the debugger programs `DBGBCR<n>_EL1.BAS` as 0b1111.

In the figure:

- Yes** Means that the breakpoint generates a Breakpoint exception.
- No** Means that the breakpoint does not generate a Breakpoint exception.
- UNP** Means that it is CONstrained UNPREDICTABLE whether the breakpoint generates a Breakpoint exception. See *Other usage constraints for Address breakpoints on page D2-1938*.

	Instruction set	Size	Location of instruction ^a								BAS[3:0]			
			-2	-1	0	+1	+2	+3	+4	+5	0b0011	0b1100	0b1111	
Row 1	T32	16-bit			■							Yes	No	Yes
Row 2		16-bit					■					No	Yes	UNP
Row 3	T32	32-bit	■	■	■							UNP	No	UNP
Row 4		32-bit			■	■	■					Yes	UNP	Yes
Row 5		32-bit					■	■	■	■		No	Yes	UNP
Row 6	A32	32-bit			■	■	■					Yes	UNP	Yes
Row 7	A64	32-bit			■	■	■					Yes	UNP	Yes

- a. 0 means the word-aligned address held in the `DBGVCR<n>_EL1`[maxAddressSize:2]:00. The other locations are:
- -2 means $((\text{DBGVCR}\langle n \rangle_EL1[\text{maxAddressSize}:2]:00) - 2)$.
 - -1 means $((\text{DBGVCR}\langle n \rangle_EL1[\text{maxAddressSize}:2]:00) - 1)$.
 - ...
 - ...
 - +5 means $((\text{DBGVCR}\langle n \rangle_EL1[\text{maxAddressSize}:2]:00) + 5)$.

The solid areas show the location of the instruction.

Figure D2-3 Summary of BAS field meanings for Address Match breakpoints

D2.9.5 Breakpoint context comparisons

The breakpoint type defined by `DBGVCR<n>_EL1.BT` determines what context comparison is required, if any. [Table D2-12](#) shows the BT values that require a comparison, and the match required for the comparison to be successful.

Table D2-12 Breakpoint context comparison tests

<code>DBGVCR<n>.BT</code>	Test required for successful context comparison
0b001x	When ARMv8.1-VHE is not implemented, <code>CONTEXTIDR_EL1</code> value matches <code>DBGVCR<n>_EL1.ContextID</code> value When ARMv8.1-VHE is implemented, <code>CONTEXTIDR_EL2</code> matches <code>DBGVCR<n>_EL1.ContextID</code> value
0b011x	<code>CONTEXTIDR_EL1</code> value matches <code>DBGVCR<n>_EL1.ContextID</code> value
0b100x	<code>VTTBR_EL2.VMID</code> value matches <code>DBGVCR<n>_EL1.VMID</code> value
0b101x	When ARMv8.1-VHE is not implemented, <code>CONTEXTIDR_EL1</code> value matches <code>DBGVCR<n>_EL1.ContextID</code> value and <code>VTTBR_EL2.VMID</code> value matches <code>DBGVCR<n>_EL1.VMID</code> value When ARMv8.1-VHE is implemented, <code>CONTEXTIDR_EL2</code> matches <code>DBGVCR<n>_EL1.ContextID</code> value and <code>VTTBR_EL2.VMID</code> value matches <code>DBGVCR<n>_EL1.VMID</code> value
0b110x	<code>CONTEXTIDR_EL2</code> value matches <code>DBGVCR<n>_EL1.ContextID</code> value
0b111x	<code>CONTEXTIDR_EL1</code> value matches <code>DBGVCR<n>_EL1[63:32]</code> and <code>CONTEXTIDR_EL2</code> value matches <code>DBGVCR<n>_EL1[31:0]</code>

No context comparison is required for other valid `DBGVCR<n>.BT` values.

In ARMv8.0, context breakpoints do not generate Breakpoint exceptions when execution is in EL2 using either Execution state, or when execution is in EL3 using AArch64.

Context breakpoints do not generate Breakpoint exceptions when any of:

- The comparison uses the value of `CONTEXTIDR_EL1` and any of:
 - The PE is executing at EL3 using AArch64.
 - The PE is executing at EL2.
 - [ARMv8.1-VHE](#) is implemented, EL2 is using AArch64, the PE is executing in Non-secure state, and `HCR_EL2.{E2H, TGE} == {1, 1}`.
- The comparison uses the value of `CONTEXTIDR_EL2` and any of:
 - [ARMv8.1-VHE](#) is not implemented.
 - The PE is in Secure state.
 - EL2 is using AArch32.
- The comparison uses the current `VMID` value and any of:
 - EL2 is not implemented.
 - The PE is in Secure state.
 - The PE is executing at EL2.
 - [ARMv8.1-VHE](#) is implemented, EL2 is using AArch64, the PE is executing in Non-secure state, and `HCR_EL2.{E2H, TGE} == {1, 1}`.

The following Context breakpoint types do not generate Breakpoint exceptions in Secure state:

- `VMID` Match breakpoints.
- `VMID` and Context ID Match breakpoints.

———— **Note** —————

- For all Context breakpoints, `DBGBCR<n>_EL1.BAS` is RES1 and is ignored.
- For Linked Context breakpoints, `DBGBCR<n>_EL1.{LBN, SSC, HMC, PMC}` are RES0 and are ignored.

D2.9.6 Breakpoint usage constraints

See the following sections:

- [Reserved `DBGBCR<n>_EL1.BT` values.](#)
- [Reserved `DBGBCR<n>_EL1.{SSC, HMC, PMC}` values on page D2-1936.](#)
- [Reserved `DBGBCR<n>_EL1.BAS` values on page D2-1937.](#)
- [Reserved `DBGBCR<n>_EL1.LBN` values on page D2-1937.](#)
- [Other usage constraints for Address breakpoints on page D2-1938.](#)
- [Other usage constraints for Context breakpoints on page D2-1938.](#)

Reserved `DBGBCR<n>_EL1.BT` values

Table D2-13 shows when particular `DBGBCR<n>_EL1.BT` values are reserved.

Table D2-13 Reserved BT values

BT value	Breakpoint type	Reserved
0b001x	Context ID Match	For non context-aware breakpoints
0b010x	Address Mismatch	In stage 1 of an AArch64 translation regime, or if <code>EDSCR.HDE</code> is 1 and halting is allowed
0b011x	-	In ARMv8.0, always
	CONTEXTIDR_EL1 Match	For non context-aware breakpoints, or if ARMv8.1-VHE is not implemented

Table D2-13 Reserved BT values (continued)

BT value	Breakpoint type	Reserved
0b100x	VMID Match	For non context-aware breakpoints, or if EL2 is not implemented
0b101x	Context ID and VMID Match	For non context-aware breakpoints, or if EL2 is not implemented, or if ARMv8.1-VHE is not implemented
0b11xx	-	In ARMv8.0, always
	CONTEXTIDR_EL2 Match	For non context-aware breakpoints, or if ARMv8.1-VHE is not implemented
0b111x	Full Context ID Match	For non context-aware breakpoints, or if ARMv8.1-VHE is not implemented

If a breakpoint is programmed with one of these reserved BT values:

- The breakpoint must behave as if it is either:
 - Disabled.
 - Programmed with a BT value that is not reserved, other than for a direct or external read of [DBGBCR<n>_EL1](#).
- For a direct or external read of [DBGBCR<n>_EL1](#), if the reserved BT value:
 - Has no function for any execution conditions, the value read back is UNKNOWN.
 - Has a function for execution conditions other than the current execution conditions, the value read back is the value written. This permits software to save and restore the BT value so that the breakpoint functions for the other execution conditions.

The behavior of breakpoints with reserved BT values might change in future revisions of the architecture. For this reason, software must not rely on the behavior described here.

Reserved [DBGBCR<n>_EL1](#).{SSC, HMC, PMC} values

[Table D2-14](#) shows when particular combinations of [DBGBCR<n>_EL1](#).{SSC, HMC, PMC} are reserved in stage 1 of an AArch64 translation regime.

Table D2-14 Reserved HMC, SSC, and PMC combinations

HMC, SSC, and PMC combination	Reserved
All combinations with SSC set to 0b01 or 0b10	When EL3 is not implemented and EL2 is implemented
Any combination where HMC or SSC is nonzero, except for the combination with HMC set to 1, SSC set to 0b11, and PMC set to 0b00	When both of EL2 and EL3 are not implemented
The combination with HMC set to 1, SSC set to 0b11, and PMC set to 0b00	When EL2 is not implemented
Combinations not included in Table D2-10 on page D2-1932	Always

For all breakpoints except Linked Context breakpoints, if a breakpoint is programmed with one of these reserved combinations:

- If the reserved combination has a function for other execution conditions:
 - The breakpoint must behave as if it is disabled.

- A direct or external read of `DBGBCR<n>_EL1`. {SSC, HMC, PMC} returns the values written. This means that software can save and restore the combination so that the breakpoint can function for the other execution conditions.
- If the reserved combination does not have a function for other execution conditions:
 - It must behave either as if it is programmed with a combination that is not reserved or as if it is disabled.
 - A direct or external read of `DBGBCR<n>_EL1`. {SSC, HMC, PMC} returns UNKNOWN values.

If the breakpoint is a Linked Context breakpoint, then:

- The values of HMC, SSC, and PMC are ignored.
- A direct or external read of `DBGBCR<n>_EL1`. {SSC, HMC, PMC} returns UNKNOWN values

The behavior of breakpoints with reserved combinations of HMC, SSC, and PMC might change in future revisions of the architecture. For this reason, software must not rely on the behavior described here.

Reserved `DBGBCR<n>_EL1.BAS` values

In an AArch64-only implementation, `DBGBCR<n>_EL1.BAS` for all breakpoints is RES1.

Otherwise:

For all Context breakpoints

`DBGBCR<n>_EL1.BAS` is RES1 and is ignored.

For all Address breakpoints

[Table D2-11 on page D2-1933](#) gives the valid values of the `DBGBCR<n>_EL1.BAS` field.

If a breakpoint is programmed with a reserved BAS value:

- The breakpoint must behave as if it is either:
 - Disabled.
 - Programmed with a BAS value that is not reserved, other than for a direct or external read of `DBGBCR<n>_EL1`.
- A direct or external read of `DBGBCR<n>_EL1.BAS` returns an UNKNOWN value.

Software must not rely on these properties as the behavior of reserved values might change in a future revision of the architecture.

Reserved `DBGBCR<n>_EL1.LBN` values

For all Context breakpoints

`DBGBCR<n>_EL1.LBN` reads UNKNOWN and its value is ignored.

For Linked Address breakpoints

A Linked Address breakpoint must link to a context-aware breakpoint. For a Linked Address breakpoint, any `DBGBCR<n>_EL1.LBN` value that is not for a context-aware breakpoint is reserved.

If a Linked Address breakpoint links to a breakpoint that is not implemented, or that is not context-aware, then reads of `DBGBCR<n>_EL1.LBN` return an UNKNOWN value and behavior is CONSTRAINED UNPREDICTABLE. The Linked Address breakpoint behaves as if it is either:

- Disabled.
- Linked to an UNKNOWN context-aware breakpoint.

If a Linked Address breakpoint links to a breakpoint that is implemented and that is context-aware, but that is either not enabled or not programmed as a Linked Context breakpoint, it behaves as if it is disabled.

For Unlinked Address breakpoints

[DBGBCR<n>_EL1.LBN](#) reads UNKNOWN and its value is ignored.

Other usage constraints for Address breakpoints

For all Address breakpoints

- [DBGBVR<n>_EL1\[1:0\]](#) are RES0 and are ignored.
- If the implementation supports AArch32 state:
 - For 32-bit instructions, if a breakpoint matches on the address of the second halfword but not the address of the first halfword, it is CONSTRAINED UNPREDICTABLE whether the breakpoint generates a Breakpoint exception.
 - If [DBGBCR<n>.BAS](#) is 0b1111, it is CONSTRAINED UNPREDICTABLE whether the breakpoint generates a Breakpoint exception for a T32 instruction starting at address $((\text{DBGBVR}\langle n \rangle[48:2]:00) + 2)$. For T32 instructions, ARM recommends that the debugger programs the BAS field with either 0b0011 or 0b1100.

Other usage constraints for Context breakpoints

For all Context breakpoints

Any bits of [DBGBVR<n>_EL1](#) that are not used to specify Context ID or [VMID](#) are RES0 and are ignored.

For Linked Context breakpoints

If no Linked Address breakpoints or Linked watchpoints link to a Linked Context breakpoint, the Linked Context breakpoint does not generate any Breakpoint exceptions.

D2.9.7 Exception syndrome information and preferred return address

See the following:

- [Exception syndrome information](#).
- [Preferred return address on page D2-1939](#).

Exception syndrome information

On taking a Breakpoint exception, the PE records information about the exception in the *Exception Syndrome Register* (ESR) at the Exception level the exception is taken to. The ESR used is one of:

- [ESR_EL1](#).
- [ESR_EL2](#).

———— Note —————

Breakpoint exceptions cannot be taken to EL3 using AArch64.

Table D2-15 shows the information that the PE records.

Table D2-15 Information recorded in the ESR_ELx

ESR_ELx field	Information recorded in ESR_EL1 or ESR_EL2.
<i>Exception Class</i> , EC	The PE sets this to: <ul style="list-style-type: none"> • 0x30, if the exception was taken from a lower Exception level. • 0x31, if the exception was taken without a change of Exception level.
<i>Instruction Length</i> , IL	The PE sets this to 1.
<i>Instruction Specific Syndrome</i> , ISS	ISS[24:6] RES0. ISS[5:0] <i>Instruction Fault Status Code</i> (IFSC). The PE sets this to the code for a debug exception, 0b100010.

Preferred return address

The preferred return address of a Breakpoint exception is the address of the instruction that was not executed because the PE took the Breakpoint exception instead.

This means that the preferred return address is the address of the instruction that caused the exception.

D2.9.8 Pseudocode description of Breakpoint exceptions taken from AArch64 state

`AArch64.BreakpointValueMatch()` tests the value in `DBGBVR<n>_EL1`.

`AArch64.StateMatch()` tests the values in `DBGBCR<n>_EL1`. {SSC, HMC, PMC} and, if the breakpoint links to a Linked Context breakpoint, also tests the Linked Context breakpoint.

For a watchpoint, `AArch64.StateMatch()` tests the values in `DBGWCR<n>_EL1`. {SSC, HMC, PAC} and, if the watchpoint links to a Linked Context breakpoint, also tests the Linked Context breakpoint.

`AArch64.BreakpointMatch()` tests a committed instruction against all breakpoints.

`AArch64.CheckBreakpoint()` generates a Breakpoint exception if all of the following are true:

- `MDSCR_EL1.MDE` is 1.
- Debug exceptions are enabled from the current Exception level and Security state. See *Enabling debug exceptions from the current Exception level and Security state* on page D2-1913.
- All of the conditions required for Breakpoint exception generation are met. See *About Breakpoint exceptions* on page D2-1921.

———— **Note** —————

`AArch64.CheckBreakpoint()` might halt the PE and cause it to enter Debug state. External debug uses Debug state.

`AArch64.BreakpointException()` is called to generate a Breakpoint exception.

These functions are defined in *Chapter J1 ARMv8 Pseudocode*.

D2.10 Watchpoint exceptions

This section describes Watchpoint exceptions in stage 1 of an AArch64 translation regime.

The PE is using an AArch64 translation regime when it is executing either:

- In an Exception level that is using AArch64.
- At EL0 using AArch32 when EL1 is using AArch64.

This section contains the following subsections:

- [About Watchpoint exceptions.](#)
- [Watchpoint types and linking of watchpoints on page D2-1942.](#)
- [Execution conditions for which a watchpoint generates Watchpoint exceptions on page D2-1943.](#)
- [Watchpoint data address comparisons on page D2-1944.](#)
- [Determining the memory location that caused a Watchpoint exception on page D2-1948.](#)
- [Watchpoint behavior on other instructions on page D2-1949.](#)
- [Watchpoint usage constraints on page D2-1950.](#)
- [Exception syndrome information and preferred return address on page D2-1952.](#)
- [Pseudocode description of Watchpoint exceptions taken from AArch64 state on page D2-1953.](#)

D2.10.1 About Watchpoint exceptions

A *watchpoint* is an event that results from the execution of an instruction, based on a data address. Watchpoints are also known as *data breakpoints*.

A watchpoint operates as follows:

1. A debugger programs the watchpoint with a data address, or a data address range.
2. The watchpoint generates a *Watchpoint debug event* on an access to the address, or any address in the address range.

A watchpoint never generates a Watchpoint debug event on an instruction fetch.

An implementation can include between 2-16 watchpoints. In an implementation, `ID_AA64DFR0_EL1.WRPs` shows how many are implemented.

To use an implemented watchpoint, a debugger programs the following registers for the watchpoint:

- The *Watchpoint Control Register*, `DBGWCR<n>_EL1`. This contains controls for the watchpoint, for example an enable control.
- The *Watchpoint Value Register*, `DBGWVR<n>_EL1`. This holds the data virtual address used for watchpoint matching.

These registers are numbered, so that:

- `DBGWCR1_EL1` and `DBGWVR1_EL1` are for watchpoint number one.
- `DBGWCR2_EL2` and `DBGWVR2_EL1` are for watchpoint number two.
- ...
- ...
- `DBGWCR<n>_EL1` and `DBGWVR<n>_EL1` are for watchpoint number n.

A watchpoint can:

- Be programmed to generate Watchpoint debug events on read accesses only, on write accesses only, or on both types of access.
- Link to a *Linked Context breakpoint*, so that a Watchpoint debug event is only generated if the PE is in a particular context when the address match occurs.

A single watchpoint can be programmed to match on one or more address bytes. A watchpoint generates a Watchpoint debug event on an access to any byte that it is watching. The number of bytes a watchpoint is watching is either:

- One to eight bytes, provided that these bytes are contiguous and that they are all in the same naturally-aligned doubleword. A debugger uses the *Byte Address Select* field, `DBGWCR<n>_EL1.BAS`, to select the bytes. See [Programming a watchpoint with eight bytes or fewer on page D2-1946](#).
- Eight bytes to 2GB, provided that both of the following are true:
 - The number of bytes is a power-of-two.
 - The range starts at an address that is aligned to the range size.
 A debugger uses the *MASK* field, `DBGWCR<n>_EL1.MASK`, to program a watchpoint with eight bytes to 2GB. See [Programming a watchpoint with eight or more bytes on page D2-1947](#).

A debugger must use either the *BAS* field or the *MASK* field. If it uses both, whether the watchpoint generates Watchpoint debug events is `CONSTRAINED UNPREDICTABLE`. See [Programming dependencies of the *BAS* and *MASK* fields on page D2-1951](#).

For each memory access, all of the watchpoints are tested. When a watchpoint is tested, it generates a Watchpoint debug event if all of the following are true:

- The watchpoint is enabled. That is, the watchpoint enable control for it, `DBGWCR<n>_EL1.E`, is 1.
- The conditions specified in the `DBGWCR<n>_EL1` are met.
- The comparison with the address held in the `DBGWVR<n>_EL1` is successful.
- If the watchpoint links to a Linked Context breakpoint, the comparison or comparisons made by the Linked Context breakpoint also are successful. See [Figure D2-2 on page D2-1925](#). See also [Breakpoint context comparisons on page D2-1934](#).
- The instruction that initiates the memory access is committed for execution.
- The instruction that initiates the memory access passes its Condition code check.

If halting is allowed and `EDSCR.HDE` is 1, Watchpoint debug events cause entry to Debug state.

Otherwise, if debug exceptions are:

- Enabled, Watchpoint debug events generate Watchpoint exceptions.
- Disabled, Watchpoint debug events are ignored.

———— **Note** —————

The remainder of this Watchpoint Exceptions section, including all subsections, describes watchpoints as generating Watchpoint exceptions.

However, the behavior described also applies if watchpoints are causing entry to Debug state.

[The debug exception enable controls on page D2-1910](#) describes the enable controls for Watchpoint debug events.

D2.10.2 Watchpoint types and linking of watchpoints

When a debugger programs a watchpoint, it must program that watchpoint so that it is either:

- Used in isolation. In this case, the watchpoint is called an *Unlinked watchpoint*.
- Enabled for linking to a Linked Context breakpoint. In this case, the watchpoint is called a *Linked watchpoint*.

When a Linked watchpoint links to a Linked Context breakpoint, the Linked watchpoint only generates a Watchpoint exception if the PE is in a particular context when the data address match occurs. For example, a debugger might:

1. Program watchpoint number one with a data address.
2. Program breakpoint number five to be a *Linked VMID Match breakpoint*.
3. Link the watchpoint and the breakpoint together. A Watchpoint exception is only generated if both the data address matches and the **VMID** matches.

The *Watchpoint Type* field for a watchpoint, `DBGWCR<n>_EL1.WT`, controls whether the watchpoint is enabled for linking. If `DBGWCR<n>_EL1.WT` is 1, the watchpoint is enabled for linking.

Rules for linking watchpoints

The rules for watchpoint linking are as follows:

- Only Linked watchpoints can be linked.
- A Linked watchpoint can link to any type of Linked Context breakpoint. The *Linked Breakpoint Number* field, `DBGWCR<n>_EL1.LBN`, for the Linked watchpoint specifies the particular Linked Context breakpoint that the Linked watchpoint links to, and:
 - `DBGWCR<n>_EL1.WT.{SSC, HMC, PAC}` for the Linked watchpoint defines the execution conditions that the watchpoint generates Watchpoint exceptions for. See [Execution conditions for which a watchpoint generates Watchpoint exceptions on page D2-1943](#).
 - `DBGBCR<n>_EL1.{SSC, HMC, PMC}` for the Linked Context breakpoint are ignored.
- A Linked watchpoint cannot link to another watchpoint. The LBN field can therefore only specify a breakpoint.
- If a Linked watchpoint links to a breakpoint that is not context-aware, the behavior of the Linked watchpoint is **CONSTRAINED UNPREDICTABLE**. See [Watchpoint usage constraints on page D2-1950](#).
- If a Linked watchpoint links to an Unlinked Context breakpoint, the Linked watchpoint never generates any Watchpoint exceptions.
- Multiple Linked watchpoints can link to a single Linked Context breakpoint.

———— **Note** —————

Multiple Address breakpoints can also link to a single Linked Context breakpoint. [Breakpoint exceptions on page D2-1921](#) describes breakpoints.

Figure D2-2 on page D2-1925 shows an example of permitted watchpoint linking.

D2.10.3 Execution conditions for which a watchpoint generates Watchpoint exceptions

Each watchpoint can be programmed so that it only generates Watchpoint exceptions for certain execution conditions. For example, a watchpoint might be programmed to generate Watchpoint exceptions only when the PE is executing at EL2 in Non-secure state.

`DBGWCR<n>_EL1.{SSC, HMC, PAC}` define the execution conditions a watchpoint generates Watchpoint exceptions for, as follows:

Security State Control, SSC

Controls whether the watchpoint generates Watchpoint exceptions only in Secure state, only in Non-secure state, or in both Security states.

———— **Note** —————

This is determined by the Security state of the PE, not from the NS attribute returned by the translation of the virtual address on which the watchpoint is set.

Higher Mode Control, HMC, and Privileged Access Control, PAC

HMC and PAC together control which Exception levels the watchpoint generates Watchpoint exceptions in.

The PAC control relates to the privilege of the memory access, not to the Exception level at which the access was made.

———— **Note** —————

This means that, if the PE executes a Load unprivileged or Store unprivileged instruction at EL1, the resulting data access triggers a watchpoint only if both:

- PAC is programmed to a value that generates watchpoints on EL0 accesses.
- All other conditions for generating the watchpoint are met.

Example A64 Load unprivileged and Store unprivileged instructions are LDTR and STTR.

Table D2-16 on page D2-1944 shows the valid combinations of HMC, SSC, and PAC, and for each combination shows which Exception levels watchpoints generate Watchpoint exceptions in.

In the table:

- Y or -** Means that a watchpoint programmed with the values of HMC, SSC, and PAC shown in that row:
- Y** Can generate Watchpoint exceptions in that Exception level.
 - Cannot generate Watchpoint exceptions in that Exception level.
- Res** Means that the combination of HMC, SSC, and PAC is reserved. See *Reserved DBGWCR<n>_EL1.{SSC, HMC, PAC} values on page D2-1950*.

Table D2-16 Summary of watchpoint HMC, SSC, and PAC encodings

HMC	SSC	PAC	Security state the watchpoint is programmed to match in	EL3 ^a	EL2	EL1	EL0	Implementation	
								No EL3	No EL3 and no EL2
0	00	01	Both	-	-	Y	-	-	-
0	00	10		-	-	-	Y	-	-
0	00	11		-	-	Y	Y	-	-
0	01	01	Non-secure	-	-	Y	-	Res	Res
0	01	10		-	-	-	Y	Res	Res
0	01	11		-	-	Y	Y	Res	Res
0	10	01	Secure	-	-	Y	-	Res	Res
0	10	10		-	-	-	Y	Res	Res
0	10	11		-	-	Y	Y	Res	Res
1	00	01	Both	Y	Y	Y	-	-	Res
1	00	11		Y	Y	Y	Y	-	Res
1	01	01	Non-secure	-	Y	Y	-	Res	Res
1	01	11		-	Y	Y	Y	Res	Res
1	10	00	Secure	Y	-	-	-	Res	Res
1	10	01		Y	-	Y	-	Res	Res
1	10	11		Y	-	Y	Y	Res	Res
1	11	00	Non-secure	-	Y	-	-	-	Res if no EL2 ^b

a. Debug exceptions are not generated at EL3 using AArch64. This means that these combinations of HMC, SSC, and PAC are only relevant if watchpoints cause entry to Debug state. Self-hosted debuggers must avoid combinations of HMC, SSC, and PAC that generate Watchpoint exceptions at EL3 using AArch64.

b. This encoding is only reserved when EL2 is not implemented, regardless of whether EL3 is implemented.

All combinations of HMC, SSC, and PAC that this table does not show are reserved. See [Reserved DBGWCR<n>_EL1.{SSC, HMC, PAC} values on page D2-1950](#).

D2.10.4 Watchpoint data address comparisons

In this subsection, the term `maxAddressSize` represents the maximum supported virtual address size, which is **52 bits in an implementation that includes ARMv8.2-LVA and uses the 64KB translation granule and 48 bits otherwise**.

An address comparison is successful if bits [maxAddressSize:2] of the current data virtual address are equal to `DBGWVR<n>_EL1`[maxAddressSize:2], taking into account all of the following:

- The size of the access. See *Size of the data access*.
If EL1 is using AArch64 and EL0 is using AArch32, AArch32 instructions can be executed in stage 1 of an AArch64 translation regime. In this case, data addresses are zero-extended before comparison with the watchpoint.
- The bytes selected by `DBGWVR<n>_EL1.BAS`. See *Programming a watchpoint with eight bytes or fewer* on page D2-1946.
- Any address ranges indicated by `DBGWVR<n>_EL1.MASK`. See *Programming a watchpoint with eight or more bytes* on page D2-1947.

Note

- `DBGWVR<n>_EL1` is a 64-bit register. The most significant bits of this register are sign-extension bits.
 - `DBGWVR<n>_EL1`[1:0] are RES0 and are ignored
-

Size of the data access

Because watchpoints can be programmed to generate Watchpoint exceptions on individual bytes, the size of each data access must be taken into account. See [Example D2-1](#).

Example D2-1

1. A debugger programs a watchpoint to generate Watchpoint exceptions only when the byte at address 0x1009 is accessed.
2. The PE accesses the unaligned doubleword starting at address 0x1003.

In this scenario, the watchpoint must generate a Watchpoint exception.

The size of data accesses initiated by DC ZVA instructions is the DC ZVA block size that `DCZID_EL0.BS` defines.

The size of data accesses initiated by DC IVAC instructions is an IMPLEMENTATION DEFINED size that is both:

- From the inclusive range between:
 - The size that `CTR_EL0.DminLine` defines.
 - 2KB.
- A power-of-two.

For both of these instructions:

- The lowest address accessed by the instruction is the address supplied to the instruction, rounded down to the nearest multiple of the access size initiated by that instruction.
- The highest address accessed is (size - 1) bytes above the lowest address accessed.

See also, *Watchpoint behavior on accesses by the DC IVAC instruction and the DC ZVA instruction* on page D2-1950.

Programming a watchpoint with eight bytes or fewer

The Byte Address Select field, `DBGWCR<n>_EL1.BAS`, selects which bytes in the doubleword starting at the address contained in the `DBGWVR<n>_EL1` the watchpoint generates Watchpoint exceptions for.

If the address programmed into the `DBGWVR<n>_EL1` is:

- Doubleword-aligned:
 - All eight bits of `DBGWCR<n>_EL1.BAS` are used, and the descriptions given in [Table D2-17](#) apply.
- Word-aligned but not doubleword-aligned:
 - Only `DBGWCR<n>_EL1.BAS[3:0]` are used, and the descriptions given in [Table D2-18](#) apply. In this case, `DBGWCR<n>_EL1.BAS[7:4]` are RES0.

Table D2-17 Supported BAS values when the `DBGWVRn_EL1` address alignment is doubleword

BAS value	Description
0b00000000	Watchpoint never generates a Watchpoint exception.
<code>BAS[0] == 1</code>	Generates a Watchpoint exception if the byte at address <code>DBGWVR<n>_EL1[maxAddressSize^a:3]:000</code> is accessed.
<code>BAS[1] == 1</code>	Generates a Watchpoint exception if the byte at address <code>DBGWVR<n>_EL1[maxAddressSize^a:3]:001</code> is accessed.
<code>BAS[2] == 1</code>	Generates a Watchpoint exception if the byte at address <code>DBGWVR<n>_EL1[maxAddressSize^a:3]:010</code> is accessed.
<code>BAS[3] == 1</code>	Generates a Watchpoint exception if the byte at address <code>DBGWVR<n>_EL1[maxAddressSize^a:3]:011</code> is accessed.
<code>BAS[4] == 1</code>	Generates a Watchpoint exception if the byte at address <code>DBGWVR<n>_EL1[maxAddressSize^a:3]:100</code> is accessed.
<code>BAS[5] == 1</code>	Generates a Watchpoint exception if the byte at address <code>DBGWVR<n>_EL1[maxAddressSize^a:3]:101</code> is accessed.
<code>BAS[6] == 1</code>	Generates a Watchpoint exception if the byte at address <code>DBGWVR<n>_EL1[maxAddressSize^a:3]:110</code> is accessed.
<code>BAS[7] == 1</code>	Generates a Watchpoint exception if the byte at address <code>DBGWVR<n>_EL1[maxAddressSize^a:3]:111</code> is accessed.

a. The value of `maxAddressSize` is 48 unless a 52 bit address size is implemented, when the value of `maxAddressSize` is 52.

Table D2-18 Supported BAS values when the `DBGWVRn_EL1` address alignment is word

BAS value ^a	Description
0b00000000	Watchpoint never generates a Watchpoint exception
<code>BAS[0] == 1</code>	Generates a Watchpoint exception if byte at address <code>DBGWVR<n>_EL1[maxAddressSize^b:2]:00</code> is accessed.

Table D2-18 Supported BAS values when the DBGWVRn_EL1 address alignment is word

BAS value ^a	Description
BAS[1] == 1	Generates a Watchpoint exception if byte at address <code>DBGWVR<n>_EL1[maxAddressSize^b:2]:01</code> is accessed.
BAS[2] == 1	Generates a Watchpoint exception if byte at address <code>DBGWVR<n>_EL1[maxAddressSize^b:2]:10</code> is accessed.
BAS[3] == 1	Generates a Watchpoint exception if byte at address <code>DBGWVR<n>_EL1[maxAddressSize^b:2]:11</code> is accessed.

- a. `DBGWCR<n>_EL1.BAS[7:4]` are RES0.
- b. The value of `maxAddressSize` is 48 **unless a 52 bit address size is implemented, when the value of `maxAddressSize` is 52.**

If the BAS field is programmed with more than one byte, the bytes that it is programmed with must be contiguous. For watchpoint behavior when its BAS field is programmed with non-contiguous bytes, see [Other usage constraints on page D2-1952](#).

When programming the BAS field with anything other than `0b11111111`, a debugger must program `DBGWCR<n>_EL1.MASK` to be `0b000000`. See [Programming dependencies of the BAS and MASK fields on page D2-1951](#).

A watchpoint generates a Watchpoint exception whenever a watched byte is accessed, even if:

- The access size is smaller or larger than the address region being watched.
- The access is misaligned, and the base address of the access is not in the doubleword or word of memory addressed by the `DBGWVR<n>_EL1[maxAddressSize:3]`. See [Example D2-1 on page D2-1945](#).

The following are some example configurations of the BAS field:

- To program a watchpoint to generate a Watchpoint exception on the byte at address `0x1003`, program:
 - `DBGWVR<n>_EL1` with `0x1000`.
 - `DBGWCR<n>_EL1.BAS` to be `0b00001000`.
- To program a watchpoint to generate a Watchpoint exception on the bytes at addresses `0x2003`, `0x2004` and `0x2005`, program:
 - `DBGWVR<n>_EL1` with `0x2000`.
 - `DBGWCR<n>_EL1.BAS` to be `0b00111000`.
- If the address programmed into the `DBGWVR<n>_EL1` is doubleword-aligned:
 - To generate a Watchpoint exception when any byte in the word starting at the doubleword-aligned address is accessed, program `DBGWCR<n>_EL1.BAS` to be `0b00001111`.
 - To generate a Watchpoint exception when any byte in the word starting at address `DBGWVR<n>_EL1[31:3]:100` is accessed, program `DBGWCR<n>_EL1.BAS` to be `0b11110000`.

Note

ARM deprecates programming a `DBGWVR<n>_EL1` with an address that is not doubleword-aligned.

Programming a watchpoint with eight or more bytes

A debugger can use the `MASK` field, `DBGWCR<n>_EL1.MASK`, to program a single watchpoint with a data address range. The range must meet all of the following criteria:

- It is a size that is:
 - A power-of-two.

- A minimum of eight bytes.
 - A maximum of 2GB.
- It starts at an address that is aligned to the size.

The MASK field specifies the number of least significant data address bits that must be masked. Up to 31 least significant bits can be masked:

MASK	0b00000	No bits are masked.
	0b00001	Reserved.
	0b00010	Reserved.
	0b00011	Three least significant bits are masked.
	0b00100	Four least significant bits are masked.
	0b00101	Five least significant bits are masked.

	0b11111	31 least significant bits are masked.

If n least significant address bits are masked, the watchpoint generates a Watchpoint exception on all of the following:

- Address `DBGWVR<n>_EL1[maxAddressSize:n]:000...`
- Address `DBGWVR<n>_EL1[maxAddressSize:n]:111...`
- Any address between these two addresses.

For example, if the four least significant address bits are masked, Watchpoint exceptions are generated for all addresses between `DBGWVR<n>_EL1[maxAddressSize:4]:0000` and `DBGWVR<n>_EL1[maxAddressSize:4]:1111`, including these addresses.

———— **Note** —————

- The 17 most significant bits cannot be masked. This means that the full address cannot be masked.
- For watchpoint behavior when its MASK field is programmed with a reserved value, see [Reserved DBGWCR<n>_EL1.MASK values on page D2-1952](#).

When masking address bits, a debugger must both:

- Program `DBGWCR<n>_EL1.BAS` to be `0b11111111`. See [Programming dependencies of the BAS and MASK fields on page D2-1951](#).
- In the `DBGWVR<n>_EL1`, set the masked address bits to 0. For watchpoint behavior when any of the masked address bits are not 0, see [Other usage constraints on page D2-1952](#).

D2.10.5 Determining the memory location that caused a Watchpoint exception

On taking a Watchpoint exception, the PE records an address in a *Fault Address Register* that the debugger can use to determine the memory location that triggered the watchpoint.

The Fault Address Register (FAR) used is either:

- `FAR_EL1`, if the exception is taken to EL1.
- `FAR_EL2`, if the exception is taken to EL2.

In cases where one instruction triggers multiple watchpoints, only one address is recorded.

On entering Debug state on a Watchpoint debug event, the PE records the address in the `EDWAR`.

For more information, see the subsections that follow. These are:

- [Address recorded for Watchpoint exceptions generated by instructions other than Data Cache instructions on page D2-1949](#)
- [Address recorded for Watchpoint exceptions generated by Data Cache instructions on page D2-1949](#)

Address recorded for Watchpoint exceptions generated by instructions other than Data Cache instructions

The address recorded must be both:

- From the inclusive range between:
 - The lowest address accessed by the memory access that triggered the watchpoint.
 - The highest *watchpointed address* accessed by the memory access. A watchpointed address is an address that the watchpoint is watching.
- Within a naturally-aligned block of memory that is all of the following:
 - A power-of-two size.
 - No larger than the DC ZVA block size.
 - Contains a watchpointed address accessed by the memory access.

The size of the block is IMPLEMENTATION DEFINED. There is no architectural means of discovering the size.

Example D2-2 Address recorded for a watchpoint programmed on 0x8019

A debugger programs a watchpoint to generate a Watchpoint exception on any access to the byte 0x8019.

An A32 load multiple instruction then loads nine registers starting from address 0x8004 upwards. This triggers the watchpoint.

If the DC ZVA block size is:

- 32 bytes, the address that the PE records must be between 0x8004 and 0x8019 inclusive.
 - 16 bytes, the address that the PE records must be between 0x8010 and 0x8019 inclusive.
-

Address recorded for Watchpoint exceptions generated by Data Cache instructions

The address recorded is the address passed to the instruction. This means that the address recorded might be higher than the address of the location that triggered the watchpoint.

D2.10.6 Watchpoint behavior on other instructions

Under normal operating conditions, the following do not generate Watchpoint exceptions:

- Instruction cache maintenance instructions.
- Address translation instructions.
- TLB maintenance instructions.
- Prefetch memory instructions.
- All data cache maintenance instructions except DC IVAC.

However, the debug architecture allows for IMPLEMENTATION DEFINED controls, such as those in ACTLR registers, to enable watchpoints on an IMPLEMENTATION DEFINED subset of these instructions. Whether a watchpoint treats the instruction as a load or a store, and the access size of instruction cache, address translation, and TLB operations are IMPLEMENTATION DEFINED.

The access size of the IMPLEMENTATION DEFINED instruction cache, address translation, and TLB operations which generate Watchpoint exceptions are IMPLEMENTATION DEFINED.

———— Note —————

The DC ZVA instruction is not a data cache maintenance instruction.

See also the following subsections:

- [Watchpoint behavior on accesses by Store-Exclusive instructions on page D2-1950.](#)
- [Watchpoint behavior on accesses by the DC IVAC instruction and the DC ZVA instruction on page D2-1950.](#)

Watchpoint behavior on accesses by Store-Exclusive instructions

If a watchpoint matches on a data access caused by a Store-Exclusive instruction, then:

- If the store fails because an Exclusives monitor does not permit it, it is IMPLEMENTATION DEFINED whether the watchpoint generates a Watchpoint exception.
- Otherwise, the watchpoint generates a Watchpoint exception.

Watchpoint behavior on accesses by the DC IVAC instruction and the DC ZVA instruction

DC IVAC and DC ZVA operations are treated as data stores. This means that for a watchpoint to match on an access caused by one of these instructions, the debugger must program `DBGWCR<n>_EL1.LSC` to be one of the following:

- 10** Match on data stores.
- 11** Match on data stores and data loads.

———— **Note** —————

For the size of data accesses performed by the DC IVAC instruction and the DC ZVA instruction, see [Watchpoint data address comparisons on page D2-1944](#). The size of all data accesses must be considered because watchpoints can be programmed to match on individual bytes.

D2.10.7 Watchpoint usage constraints

See the following:

- [Reserved `DBGWCR<n>_EL1.{SSC, HMC, PAC}` values.](#)
- [Reserved `DBGWCR<n>_EL1.LBN` values on page D2-1951.](#)
- [Programming dependencies of the `BAS` and `MASK` fields on page D2-1951.](#)
- [Reserved `DBGWCR<n>_EL1.BAS` values on page D2-1951.](#)
- [Reserved `DBGWCR<n>_EL1.MASK` values on page D2-1952.](#)
- [Other usage constraints on page D2-1952.](#)

Reserved `DBGWCR<n>_EL1.{SSC, HMC, PAC}` values

[Table D2-19](#) shows when particular combinations of `DBGWCR<n>_EL1.{SSC, HMC, PAC}` are reserved.

Table D2-19 Reserved SSC, HMC, and PAC combinations

HMC, SSC, and PMC combination	Reserved
All combinations with SSC set to <code>0b01</code> or <code>0b10</code> .	When EL3 is not implemented and EL2 is implemented.
All combinations where HMC or SSC is nonzero, except for the combination with HMC set to 1, SSC set to <code>0b11</code> , and PMC set to <code>0b00</code> .	When both of EL2 and EL3 are not implemented
The combination with HMC set to 1, SSC set to <code>0b11</code> , and PMC set to <code>0b00</code> .	When EL2 is not implemented
Combinations not included in Table D2-16 on page D2-1944 .	Always

If a watchpoint is programmed with one of these reserved combinations:

- The watchpoint must behave as if it is either:
 - Disabled.
 - Programmed with a combination that is not reserved, other than for a direct or external read of `DBGWCR<n>_EL1`.

- For a direct or external read of `DBGWCR<n>_EL1`, if the reserved combination:
 - Has no function for any execution conditions, the value read back for each of SSC, HMC, and PMC is UNKNOWN.
 - Has a function for execution conditions other than the current execution conditions, the value read back is the value written. This permits software to save and restore the combination so that the watchpoint functions for the other execution conditions.

The behavior of watchpoints with reserved combinations of SSC, HMC, and PAC might change in future revisions of the architecture. For this reason, software must not rely on the behavior described here.

Reserved `DBGWCR<n>_EL1.LBN` values

For Linked Watchpoints

A Linked watchpoint must link to a context-aware breakpoint. For a Linked watchpoint, any `DBGWCR<n>_EL1.LBN` value that is not for a context-aware breakpoint is reserved.

If a Linked watchpoint links to a breakpoint that is not implemented, or that is not context-aware, then reads of `DBGWCR<n>_EL1.LBN` return an UNKNOWN value and the behavior is CONSTRAINED UNPREDICTABLE. The Linked watchpoint behaves as if it is either:

- Disabled
- Linked to an UNKNOWN context-aware breakpoint.

If a Linked watchpoint links to a breakpoint that is implemented and is context-aware, but that is either not enabled or not programmed as a Linked Context breakpoint, it behaves as if it is disabled.

For Unlinked Watchpoints For Unlinked watchpoints, `DBGWCR<n>_EL1.LBN` reads UNKNOWN and its value is ignored.

Programming dependencies of the BAS and MASK fields

When programming a watchpoint, a debugger must use either:

- The MASK field, to program the watchpoint with an address range that can be eight bytes to 2GB.
- The BAS field, to select which bytes in the doubleword or word starting at the address contained in the `DBGWVR<n>_EL1` the watchpoint must generate Watchpoint exceptions for.

If the debugger uses the:

- MASK field, it must program BAS to be `0b11111111`, so that all bytes in the doubleword or word are selected.
- BAS field, it must program MASK to be `0b000000`, so that the MASK field does not indicate any address ranges.

If an enabled watchpoint has a MASK field that is non-zero and a BAS field that is not set to `0b11111111`, then for each byte in the address range, it is CONSTRAINED UNPREDICTABLE whether or not a Watchpoint exception is generated.

Reserved `DBGWCR<n>_EL1.BAS` values

The BAS field must be programmed with a value `Zeros(8-n-m):Ones(n):Zeros(m)`, where:

- `n` is a non-zero positive integer less-than-or-equal-to 8.
- `m` is a positive integer less-than 8.
- `n+m` is less-than-or-equal-to 8.

All other values are reserved.

———— **Note** —————

If `x` is zero, then `Zeros(x)` is an empty bitstring.

If `DBGWVR<n>_EL1[2]` is 1, `DBGWCR<n>_EL1.BAS[7:4]` are RES0 and are ignored.

If a watchpoint is programmed with a reserved BAS value:

- It is CONSTRAINED UNPREDICTABLE whether the watchpoint generates a Watchpoint exception for each byte in the doubleword or word of memory addressed by the `DBGWVR<n>_EL1`.
- A direct or external read of `DBGWCR<n>_EL1.BAS` returns an UNKNOWN value.

Software must not rely on these properties as the behavior of reserved values might change in a future revision of the architecture.

Reserved `DBGWCR<n>_EL1.MASK` values

If a watchpoint is programmed with a reserved MASK value:

- The watchpoint must behave as if it is either:
 - Disabled.
 - Programmed with an UNKNOWN value that is not reserved, that might be `0b00000`, other than for a direct or external read of `DBGWCR<n>_EL1`.
- A direct or external read of `DBGWCR<n>_EL1.MASK` returns an UNKNOWN value.

Other usage constraints

For all watchpoints:

- `DBGWVR<n>_EL1[1:0]` are RES0 and are ignored.
- If `DBGWCR<n>_EL1.MASK` is nonzero, and any masked bits of `DBGWVR<n>_EL1` are not 0, it is CONSTRAINED UNPREDICTABLE whether the watchpoint generates a Watchpoint exception when the unmasked bits match.
- A watchpoint never generates any Watchpoint exceptions if `DBGWCR<n>_EL1.LSC` is `0b00`.

D2.10.8 Exception syndrome information and preferred return address

See the following:

- [Exception syndrome information](#).
- [Preferred return address on page D2-1953](#).

Exception syndrome information

On taking a Watchpoint exception, the PE records all of the following:

- Information about the exception in the *Exception Syndrome Register* (ESR) at the Exception level the exception is taken to.
- An address that the debugger can use to determine the memory location that caused the exception. The PE records this in a *Fault Address Register* (FAR).

The ESR and FAR used is either:

- `ESR_EL1` and `FAR_EL1`, if the exception is taken to EL1.
- `ESR_EL2` and `FAR_EL2`, if the exception is taken to EL2.

———— **Note** —————

Watchpoint exceptions cannot be taken to EL3 using AArch64.

Table D2-20 shows the recorded information.

Table D2-20 Information recorded in the ESR_ELx

ESR_ELx field	Information recorded in ESR_EL1 or ESR_EL2	
Exception Class, EC	This is set to: <ul style="list-style-type: none"> 0x34, if the exception was taken from a lower Exception level. 0x35, if the exception was taken without a change of Exception level. 	
Instruction Length, IL	This is set to 1.	
Instruction Specific Syndrome, ISS	ISS[24]	<i>Instruction Syndrome Valid</i> (ISV). This is 0, because Watchpoint exceptions are not stage 2 aborts.
	ISS[23:9]	RES0.
	ISS[8]	<i>Cache Maintenance</i> (CM). This indicates whether a cache maintenance instruction generated the exception: <ul style="list-style-type: none"> 0 Not generated by a cache maintenance instruction. 1 Generated by a cache maintenance instruction. If a DC ZVA instruction generated the exception, CM is 0.
	ISS[7]	RES0.
	ISS[6]	<i>Write-not-Read</i> (WnR). This indicates whether the access was by a read instruction or a write instruction: <ul style="list-style-type: none"> 0 Read instruction. 1 Write instruction.
	ISS[5:0]	<i>Data Fault Status Code</i> (DFSC). The PE sets this to the code for a debug exception, 0b100010.

Preferred return address

The preferred return address of a Watchpoint exception is the address of the instruction that was not executed because the PE took the Watchpoint exception instead.

This means that the preferred return address is the address of the instruction that caused the exception.

D2.10.9 Pseudocode description of Watchpoint exceptions taken from AArch64 state

`AArch64.WatchpointByteMatch()` tests an individual byte accessed by an operation.

`AArch64.StateMatch()` tests the values in `DBGWCR<n>_EL1`. {HMC, SSC, PAC}, and if the watchpoint is Linked, also tests the Linked Context breakpoint that the watchpoint links to.

`AArch64.WatchpointMatch()` tests the value in `DBGWVR<n>_EL1`.

`AArch64.CheckWatchpoint()` generates a `FaultRecord` that `AArch64.Abort()` raises a Watchpoint exception for if all of the following are true:

- `MDSCR_EL1.MDE` is 1.
- Debug exceptions are enabled from the current Exception level and Security state. See *Enabling debug exceptions from the current Exception level and Security state* on page D2-1913.
- All of the conditions required for Watchpoint exception generation are met. See *About Watchpoint exceptions* on page D2-1940.

———— **Note** ————

`AArch64.CheckWatchpoint()` might halt the PE and cause it to enter Debug state. External debug uses Debug state.

[AArch64.WatchpointException\(\)](#) is called to generate a Watchpoint exception.

These functions are defined in [Chapter J1 ARMv8 Pseudocode](#).

D2.11 Vector Catch exceptions

Vector Catch exceptions are not generated in AArch64 translation regimes.

———— **Note** —————

This means that they are never taken to EL1 using AArch64 and are only supported if at least EL1 using AArch32 is supported.

A debugger that is executing in EL2 using AArch64 can route Vector Catch exceptions to EL2 using AArch64. See [Routing debug exceptions on page D2-1911](#).

`AArch64.VectorCatchException()` is called to generate a Vector Catch exception.

[Vector Catch exceptions on page G2-4510](#) describes Vector Catch exceptions.

D2.12 Software Step exceptions

The following subsections describe Software Step exceptions:

- [About Software Step exceptions](#).
- [Rules for setting MDSCR_EL1.SS to 1](#).
- [The software step state machine](#) on page D2-1957.
- [Entering the active-not-pending state](#) on page D2-1958.
- [Behavior in the active-not-pending state](#) on page D2-1962.
- [Entering the active-pending state](#) on page D2-1964.
- [Behavior in the active-pending state](#) on page D2-1964.
- [Stepping T32 IT instructions](#) on page D2-1965.
- [Exception syndrome information and preferred return address](#) on page D2-1965.
- [Additional considerations](#) on page D2-1967.
- [Pseudocode description of Software Step exceptions](#) on page D2-1969.

D2.12.1 About Software Step exceptions

Software step is an ARMv8-A resource that a debugger can use to make the PE single-step instructions.

For example, by using software step, debugger software executing at a higher Exception level can single-step instructions at a lower Exception level.

Operation is as follows:

1. A debugger:
 - a. Enables software step by setting `MDSCR_EL1.SS` to 1. See [The debug exception enable controls](#) on page D2-1910.
 - b. Executes an exception return instruction, ERET, to branch to the instruction to be single-stepped in the software being debugged.
2. The PE then:
 - a. Executes the instruction to be single-stepped.
 - b. Takes a Software Step exception on the next instruction, returning control to the debugger.

However, another exception might be generated while the instruction is being stepped. This exception is either:

- A synchronous exception that is generated by the instruction being stepped.
- An asynchronous exception that is taken before or after the instruction being stepped.

The PE can only take a Software Step exception if debug exceptions are enabled from the current Exception level and Security state. See [Enabling debug exceptions from the current Exception level and Security state](#) on page D2-1913.

A state machine describes the behavior of software step, shown in [The software step state machine](#) on page D2-1957.

Throughout this [Software Step exceptions](#) section, including in all subsections, EL_D means the Exception level that Software Step exceptions are targeting. [Routing debug exceptions](#) on page D2-1911 defines EL_D as the *debug target Exception level*.

D2.12.2 Rules for setting MDSCR_EL1.SS to 1

Debugger software must be executing in an Exception level and Security state that debug exceptions are disabled from when it sets `MDSCR_EL1.SS` to 1.

The Exception level that hosts the debugger software must be using AArch64.

D2.12.3 The software step state machine

In Figure D2-4:

- The OS Lock is unlocked and `DoubleLockStatus() == FALSE`.
- The PE is not in Secure state with `MDCR_EL3.SDD` set to 1. That is, the PE is in Non-secure state, or is in Secure state with `MDCR_EL3.SDD` set to 0, or the implementation does not include EL3.

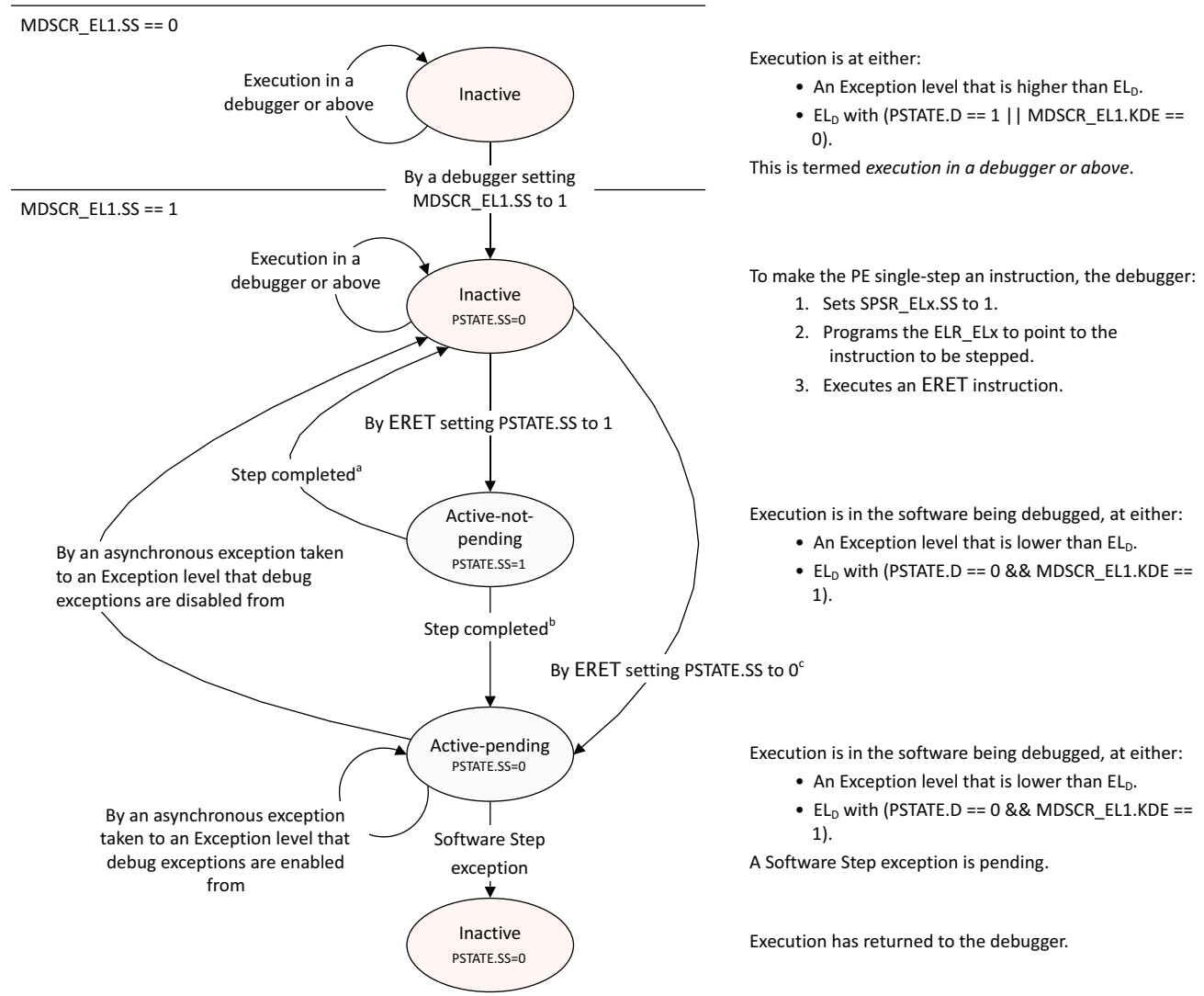

a. The step is the PE either:

- Taking an exception to an Exception level that debug exceptions are disabled from.
- If execution is at `ELD` with `MDCR_EL1.KDE == 1`, executing an instruction that sets `PSTATE.D` to 1.

Software step is inactive when debug exceptions are disabled from the current Exception level, and debug exceptions are disabled from `ELD` when `PSTATE.D` is 1.

b. The step is the PE either:

- Executing the instruction to be stepped without taking an exception.
- Taking an exception to an Exception level that debug exceptions are enabled from. The Exception level might be using AArch64 or AArch32.

c. Or, if execution is at `ELD` with `MDCR_EL1.KDE == 1`, by software setting `PSTATE.D` to 0.

Figure D2-4 Software step state machine

For a description of when debug exceptions are enabled or disabled from an Exception level, see [Enabling debug exceptions from the current Exception level and Security state on page D2-1913](#).

For more information about how a step is completed, see [Behavior in the active-not-pending state on page D2-1962](#).

The software step states are:

Inactive Software step is inactive. It cannot generate any Software Step exceptions or affect PE execution. Software step is inactive whenever any of the following are true:

- [MDSCR_EL1.SS](#) is 0.
- EL_D is using AArch32.
- Debug exceptions are disabled from the current Exception level or Security state.

Active-not-pending

None of the conditions mentioned in *Inactive* are true, therefore software step is active.
The current instruction is the instruction to be stepped.

Active-pending

None of the conditions mentioned in *Inactive* are true, therefore software step is active.
A Software Step exception is pending on the current instruction.

Whenever software step is active, whether the state machine is in the active-not pending state or the active-pending state depends on [PSTATE.SS](#). [Table D2-21](#) shows this.

Table D2-21 State machine states

EL_D using:	Debug exception enable status in the current Exception level and Security state	MDSCR_EL1.SS	PSTATE.SS	State machine state
AArch32	X	X	X	Inactive
AArch64	Disabled	X	X	Inactive
AArch64	Enabled	0	X	Inactive
AArch64	Enabled	1	1	Active-not-pending
AArch64	Enabled	1	0	Active-pending

D2.12.4 Entering the active-not-pending state

Software step can only enter the active-not-pending state from the inactive state.

Software step:

- Enters the active-not-pending state when an ERET instruction writes 1 to [PSTATE.SS](#), by copying from [SPSR_ELx.SS](#) when it restores [PSTATE](#).
- Might enter the active-not-pending state on exiting Debug state when [DSPSR_EL0.SS](#) or [DSPSR.SS](#) is 1. See [Exiting Debug state on page H2-5471](#).

An ERET instruction only copies 1 from [SPSR_ELx.SS](#) to [PSTATE.SS](#) if all of the following are true:

- [MDSCR_EL1.SS](#) is 1.
- EL_D is using AArch64.
- Debug exceptions are disabled from the current Exception level.
- Debug exceptions are enabled from the Exception level that the ERET instruction targets.

Otherwise, ERET instructions set [PSTATE.SS](#) to 0, regardless of the value of [SPSR_ELx.SS](#).

[Table D2-22 on page D2-1959](#) shows this. In the table:

Lock Means the value of ([OSLSR_EL1.OSLK](#) == '1' || DoubleLockStatus()).

NS Is [SCR_EL3.NS](#).

SDD Is [MDCR_EL3.SDD](#). See [Disabling debug exceptions from Secure state on page D2-1914](#).

TDE Is `MDCR_EL2.TDE`. See *Routing debug exceptions on page D2-1911*.

Table D2-22 Value an ERET writes to `PSTATE.SS`

<code>MDSCR_EL1.SS</code>	Lock	NS	SDD	TDE	EL1 is using	EL2 is using	Value an ERET writes to <code>PSTATE.SS</code>
0	X	X	X	X	X	X	0
1	TRUE	X	X	X	X	X	0
	FALSE	0	1	X	X	n/a	0
			0	X	AArch32	n/a	0
	1	X	0	0	AArch32	X	0
				0	AArch64	n/a	See Table D2-23 on page D2-1960
				1	AArch64	AArch64	See Table D2-23 on page D2-1960
1	X	0	1	AArch32	AArch32	0	
			1	X	AArch64	See Table D2-24 on page D2-1961	

For:

- `SCR_EL3.NS == 0` or `MDCR_EL2.TDE == 0`, and EL1 using AArch64, so that `EL_D` is EL1 using AArch64, [Table D2-23 on page D2-1960](#) shows the value an ERET writes to `PSTATE.SS`.
- `SCR_EL3.NS == 1` and `MDCR_EL2.TDE == 1` and EL2 using AArch64, so that `EL_D` is EL2 using AArch64, [Table D2-24 on page D2-1961](#) shows the value an ERET writes to `PSTATE.SS`.

In both tables:

From EL Means the Exception level at which the PE executes the ERET instruction.

Target EL Is the target Exception level of the ERET.

Note

If the ERET is an illegal exception return, the target Exception level of the ERET is the current Exception level. See *Illegal return events from AArch64 state on page D1-1816*.

KDE Is `MDSCR_EL1.KDE`. See *Enabling debug exceptions from the current Exception level and Security state on page D2-1913*.

Table D2-23 Value an ERET writes to **PSTATE.SS** if **EL_D** is **EL1** using **AArch64**

From EL	Target EL	KDE	PSTATE.D	SPSR_ELx.D	Software step enable status at:		Value an ERET writes to PSTATE.SS	
					From EL	Target EL		
EL3	EL3	X	X	X	Disabled	Disabled	0	
	EL2	X	X	X	Disabled	Disabled	0	
	EL1	0	X	X	Disabled	Disabled	0	
			1	X	1	Disabled	Disabled	0
					0	Disabled	Enabled	SPSR_EL3.SS
	EL0	X	X	X	Disabled	Enabled	SPSR_EL3.SS	
EL2	EL2	X	X	X	Disabled	Disabled	0	
	EL1	0	X	X	Disabled	Disabled	0	
			1	X	1	Disabled	Disabled	0
					0	Disabled	Enabled	SPSR_EL2.SS
	EL0	X	X	X	Disabled	Enabled	SPSR_EL2.SS	
EL1	EL1	0	X	X	Disabled	Disabled	0	
		1	0	X	Enabled ^a	_ ^b	0	
			1	1	Disabled	Disabled	0	
				0	Disabled	Enabled	SPSR_EL1.SS	
	EL0	0	X	X	Disabled	Enabled	SPSR_EL1.SS	
			1	0	X	Enabled ^a	Enabled	0
				1	X	Disabled	Enabled	SPSR_EL1.SS

a. Because [MDSCR_EL1.SS](#) == 1, it means that the ERET is itself being stepped.

b. Depends on [SPSR_EL1.D](#).

Table D2-24 Value an ERET writes to **PSTATE.SS** if **EL_D** is **EL2** using **AArch64**

From EL	Target EL	KDE	PSTATE.D	SPSR_ELx.D	Software step enable status at:		Value an ERET writes to PSTATE.SS
					From EL	Target EL	
EL3	EL3	X	X	X	Disabled	Disabled	0
	EL2	0	X	X	Disabled	Disabled	0
		1	X	1	Disabled	Disabled	0
		0		0	Disabled	Enabled	SPSR_EL3.SS
	EL1	X	X	X	Disabled	Enabled	SPSR_EL3.SS
	EL0	X	X	X	Disabled	Enabled	SPSR_EL3.SS
EL2	EL2	0	X	X	Disabled	Disabled	0
		1	0	X	Enabled ^a	_b	0
			1	1	Disabled	Disabled	0
		0		0	Disabled	Enabled	SPSR_EL2.SS
	EL1	0	X	X	Disabled	Enabled	SPSR_EL2.SS
		1	0	X	Enabled ^a	Enabled	0
			1	X	Disabled	Enabled	SPSR_EL2.SS
	EL0	0	X	X	Disabled	Enabled	SPSR_EL2.SS
		1	0	X	Enabled ^a	Enabled	0
			1	X	Disabled	Enabled	SPSR_EL2.SS
EL1	EL1	X	X	X	Enabled ^a	Enabled	0
	EL0	X	X	X	Enabled ^a	Enabled	0

a. Because **MDSR_EL1.SS** == 1, it means that the ERET is itself being stepped.

b. Depends on **SPSR_EL2.D**.

———— **Note** ————

No AArch32 instruction can set **PSTATE.SS** to 1.

D2.12.5 Behavior in the active-not-pending state

In this state, the PE does one of the following:

- Executes the instruction to be stepped and either:
 - Completes it without taking a synchronous exception.
 - Takes a synchronous exception if the instruction generates one.
- Takes an asynchronous exception without executing any instructions.
- Enters Debug state because of a *Halting debug event*.

If the PE executes the instruction without taking any exceptions, then the PE sets `PSTATE.SS` to 0, meaning that after the instruction has been executed:

- If the instruction has disabled debug by setting `PSTATE.D` to 1 then software step advances to the inactive state.
- If the instruction disables software step by a direct write to a System register, for example a write to `MDSCR_ELI.KDE` or `MDSCR_ELI.SS`, then software step might advance to the inactive state. These writes require explicit synchronization to guarantee their effect. See *Synchronization and the software step state machine* on page D2-1968.
- Otherwise, software step advances to the active-pending state. See *Behavior in the active-pending state* on page D2-1964.

If the PE takes either a synchronous or an asynchronous exception, behavior is as described in one of the following:

- *If the PE takes an exception to an Exception level that is using AArch64.*
- *If the PE takes an exception to an Exception level that is using AArch32* on page D2-1963.

If the PE enters Debug state because of a Halting debug event, behavior is as described in *Entering Debug state and Software Step* on page H2-5444.

If the PE takes an exception to an Exception level that is using AArch64

As part of exception entry, the PE does all of the following:

- Sets `SPSR_ELx.SS` to 0 or 1, depending on the exception. See [Table D2-25](#).
- Sets `PSTATE.SS` to 0. This causes software step to enter either the active-pending state or the inactive state, depending on whether debug exceptions are enabled or disabled from the Exception level that the exception is taken to:
 - Enabled** Software step enters the active-pending state.
 - Disabled** Software step enters the inactive state.

In either case, on taking the exception, a step is complete.
- Sets `PSTATE.D` to 1.

Table D2-25 Categorization of exceptions, for setting `SPSR_ELx.SS` to 0 or 1

Exception description	Exceptions	<code>SPSR_ELx.SS</code>
Exceptions whose preferred return address is for the instruction that follows the instruction to be stepped.	Supervisor Call (SVC) exceptions. Hypervisor Call (HVC) exceptions. Secure Monitor Call (SMC) exceptions.	0
Exceptions whose preferred return address is the address of the instruction to be stepped.	All other synchronous exceptions, and asynchronous exceptions that are taken before the instruction to be stepped.	1

———— **Note** —————

If an SMC instruction executed at Non-secure EL1 is trapped to EL2 because [HCR_EL2.TSC](#) is 1, the exception is a Trap exception, not a Secure Monitor Call exception, and so [SPSR_ELx.SS](#) is set to 1, not 0.

If the PE takes an exception to an Exception level that is using AArch32

This can only happen when all of the following is true:

- EL2 is implemented and is using AArch64, the PE is executing in Non-secure state, and [MDCR_EL2.TDE](#) is 1. Because [MDCR_EL2.TDE](#) is 1, EL_D is EL2.
- The exception is taken to Non-secure EL1 using AArch32.

As part of exception entry, the PE sets [PSTATE.SS](#) to 0. This causes software step to enter the active-pending state.

———— **Note** —————

- Software step always enters the active-pending state because the exception is taken to an Exception level that debug exceptions are enabled from, EL1. Debug exceptions are enabled from EL1 because EL_D is EL2, and debug exceptions are always enabled from Exception levels that are lower than EL_D .
- AArch32 SPSRs have no SS bit. Where an [SPSR_ELx](#) register architecturally maps to an AArch32 [SPSR_<mode>](#) register, [SPSR_ELx.SS](#) maps to [SPSR_<mode>\[21\]](#).
[SPSR_<mode>\[21\]](#) is always RES0. The PE always sets [SPSR_<mode>\[21\]](#) to 0 on taking an exception to an Exception level that is using AArch32.

Summary of behavior in the active-not-pending state

[Table D2-26](#) summarizes behavior in the active-not-pending state.

Table D2-26 Summary of behavior in the active-not-pending state

Event	Value written to PSTATE.SS	Target Exception level is using:	Details ^a	Value written to SPSR_ELx.SS	Next state
No exception	0	n/a	Disables Software step	n/a	Inactive
			Otherwise	n/a	Active-pending
Exception	0	AArch64	Supervisor Call (SVC)	0	Active-pending or inactive ^b
			Hypervisor Call (HVC)		
		Secure Monitor Call (SMC)	1	Active-pending	
Other					
		AArch32	All	0 ^c	Active-pending

a. For the *No exception* rows, this column shows the effect of the event.

For the *Exception* rows, this column shows the exception taken.

b. Which state software step enters depends on whether debug exceptions are enabled or disabled from the target Exception level. See [Figure D2-4 on page D2-1957](#).

c. [SPSR_<mode>\[21\]](#) is RES0.

D2.12.6 Entering the active-pending state

Software step enters the active-pending state after any of the following operations, provided that both:

- [MDSCR_EL1.SS](#) is 1.
- Debug exceptions are enabled from the Exception level and Security state that execution is in after the operation.

The operations are:

While software step is in the active-not-pending state

The PE either:

- Executing the instruction to be stepped without taking any exceptions.
- Taking an exception.

While software step is in the active-pending state

The PE takes an asynchronous exception.

While software step is in the inactive state

The PE executes either:

- An ERET instruction when [SPSR_ELx.SS](#) is 0.
- An instruction that enables debug by setting [PSTATE.D](#) to 0.

———— Note ————

If entry to the active-pending state is because of the PE taking an exception, it means that the exception is one that is taken to Non-secure EL1 when [MDCR_EL2.TDE](#) is 1. Otherwise, debug exceptions are masked by [PSTATE.D](#), therefore they would be disabled from the target Exception level of the exception.

In addition, software step might enter the active-pending state either:

- After a direct write to a System register, for example a write to [MDSCR_EL1.KDE](#) or [MDSCR_EL1.SS](#). These writes require explicit synchronization to guarantee their effect. See *Synchronization and the software step state machine* on page D2-1968.
- On exiting Debug state when [DPSR_EL0.SS](#) or [DPSR.SS](#) is 0. See *Exiting Debug state* on page H2-5471.

D2.12.7 Behavior in the active-pending state

When the PE is in the active-pending state, a Software Step exception is taken before the PE executes an instruction.

The Software Step exception has higher priority than all other types of synchronous exception. However, the prioritization of this exception with respect to any unmasked pending asynchronous exception is not defined by the architecture.

For more information, see the following:

- *Synchronous exception prioritization for exceptions taken to AArch64* on page D1-1827.
- *Prioritization and recognition of interrupts* on page D1-1841.
- *Architectural requirements for taking asynchronous exceptions* on page G1-4346.

D2.12.8 Stepping T32 IT instructions

The ARMv8-A architecture permits a combination of an IT instruction and another 16-bit T32 instruction to comprise one 32-bit instruction.

For the purpose of stepping an item, it is IMPLEMENTATION DEFINED whether:

- The PE considers this combination to be one instruction.
- The PE considers this combination to be two instructions.

In an implementation that supports the ITD control, that can disable some uses of the IT instruction, it is then IMPLEMENTATION DEFINED whether this behavior depends on the value of the applicable ITD field. For example:

- The PE might consider this combination to be one instruction, regardless of the state of the applicable ITD field.
- The PE might consider this combination to be two instructions, regardless of the state of the applicable ITD field.
- The PE might consider this combination to be one instruction when the applicable ITD field is 1, and two instructions when it is 0.

The applicable ITD field is one of:

- [SCTLR_EL1.ITD](#) if execution is at EL0 using AArch32 when EL1 is using AArch64.
- [SCTLR.ITD](#) if execution is at Non-secure EL0 or EL1 using AArch32.
- [HSCTLR.ITD](#) if execution is at Non-secure EL2 using AArch32.

D2.12.9 Exception syndrome information and preferred return address

See the following:

- [Exception syndrome information](#).
- [Preferred return address on page D2-1967](#).

Exception syndrome information

On taking a Software Step exception, the PE records information about the exception in the Exception Syndrome Register (ESR) at the Exception level the exception is taken to. The ESR used is one of:

- [ESR_EL1](#).
- [ESR_EL2](#).

———— **Note** —————

Software Step exceptions cannot be taken to EL3.

[Table D2-27 on page D2-1966](#) shows the information that the PE records.

Table D2-27 Information recorded in the ESR_ELx

ESR_ELx field	Information recorded in ESR_EL1 or ESR_EL2
Exception Class, EC	The PE sets this to: <ul style="list-style-type: none"> • 0x32, if the exception was taken from a lower Exception level. • 0x33, if the exception was taken from the current Exception level.
Instruction Length, IL	The PE sets this to 1.
Instruction Specific Syndrome, ISS	<p>ISS[24] <i>Instruction Syndrome Valid (ISV)</i>. This indicates whether the EX bit, ISS[6], is valid. The PE sets this to:</p> <p>0 Not valid.</p> <p>1 Valid.</p> <p>ISS[23:7] RES0.</p> <p>ISS[6] <i>Exclusive operation (EX)</i>. The PE sets this to indicate whether the instruction stepped was a Load-Exclusive instruction:</p> <p>0 The stepped instruction was not a Load-Exclusive instruction.</p> <p>1 The stepped instruction was a Load-Exclusive instruction.</p> <p>A debugger can use this information when stepping code that uses Exclusives monitors. See Stepping code that uses Exclusives monitors on page D2-1968</p> <p>ISS[5:0] <i>Instruction Fault Status Code (IFSC)</i>. The PE sets this to the code for a debug exception, 0b100010.</p>

When an instruction has been stepped, the PE sets:

- The value of ISS.ISV to 1, to indicate that the EX bit is valid.
- The value of EX to indicate whether the instruction stepped was a Load-Exclusive instruction, using the ISS.EX values shown in [Table D2-27](#).

If no instruction was stepped because software step entered the active-pending state from the inactive state without passing through the active-not-pending state, the PE sets both ESR_ELx.{ISV, EX} to 0.

———— **Note** —————

An implementation that always sets ISV to 0 and never sets EX is not compliant.

ESR_ELx.ISV is UNKNOWN if, in the active-not-pending state, either:

- The instruction stepped was an ERET or an ISB. In these cases, ESR_ELx.EX is set to 0.
- MDCR_EL2.TDE was set to 1 and either:
 - The instruction to be stepped generated a synchronous exception that was taken to Non-secure EL1. In this case, the instruction to be stepped never completed.
 - The PE took an asynchronous exception to Non-secure EL1 before it could execute the instruction to be stepped. In this case, the instruction to be stepped was never executed.

In both of these cases, ESR_ELx.EX is set to the correct value for the instruction.

Table D2-28 shows the permitted scenarios.

Table D2-28 Values that the PE can record in ESR_ELx.{ISV, EX}

Description	ESR_ELx.ISV	ESR_ELx.EX
Syndrome data is not available because no instruction was stepped.	0	0
Syndrome data is available because an instruction was stepped. The instruction stepped was an instruction other than a Load-Exclusive instruction.	1	0
Syndrome data is available because an instruction was stepped. The instruction stepped was a Load-Exclusive instruction.	1	1
The instruction stepped was an ERET or an ISB.	UNKNOWN	0
The instruction to be stepped generated a synchronous exception that was taken to Non-secure EL1.	UNKNOWN	Set to the correct value for the instruction.
The PE took an asynchronous exception before it could execute the instruction to be stepped.	UNKNOWN	Set to the correct value for the instruction.

ESR_ELx.EX is UNKNOWN if the stepped instruction was a conditional Load-Exclusive instruction that failed its Condition code test.

———— **Note** —————

A Load-Exclusive instruction is any one of the following:

- In the A64 instruction set, any instruction that has a mnemonic starting with either LDX or LDAX.
- In the A32 and T32 instruction sets, any instruction that has a mnemonic starting with either LDREX or LDAEX.

Preferred return address

The preferred return of a Software Step exception is the address of the instruction that was not executed because the PE took the Software Step exception instead.

D2.12.10 Additional considerations

This section contains the following:

- [Behavior when an ERET instruction is an illegal exception return.](#)
- [Behavior when the instruction stepped writes a misaligned PC value on page D2-1968.](#)
- [Stepping code that uses Exclusives monitors on page D2-1968.](#)
- [Synchronization and the software step state machine on page D2-1968.](#)

Behavior when an ERET instruction is an illegal exception return

If the conditions for entering the active-not-pending state in [Entering the active-not-pending state on page D2-1958](#) are met, but the PE executes an ERET instruction that is an illegal exception return, the exception return must be taken to the same Exception level that it was taken from. In this scenario, even though the Exception level remains the same before and after the ERET, software step can advance from the inactive state to one of the active states. Consider the following case:

1. **MDCR_EL1.SS** is 1 and software step is inactive. The current Exception level is EL1 using AArch64, the OS Lock and OS Double Lock are unlocked, and **MDCR_EL2.TDE** is 0, **MDCR_EL1.KDE** is 1, and **PSTATE.D** is 1.
PSTATE.D == 1 is the reason why software step is inactive, because **PSTATE.D == 1** means that debug exceptions are disabled from the current Exception level.
2. The PE executes an ERET instruction.

- The intended target of the ERET is EL2. This means that the ERET is an illegal exception return because the intended target is higher than the Exception level the ERET it is executed at. In this case, the ERET must target EL1 instead of EL2.
If `SPSR_EL1.D` is 0, then on the ERET `PSTATE.D` becomes 0 and debug exceptions become enabled from the current Exception level. Software step therefore advances from the inactive state to one of the active states.

Which active state software step advances to depends on whether `SPSR_ELx.SS` is 1 or 0:

- If `SPSR_ELx.SS` is 1, software step advances to the active-not-pending state.
In this case, an Illegal Execution state exception is pending on the instruction to be stepped, and the PE takes the Illegal Execution state exception instead of executing the instruction to be stepped.
- If `SPSR_ELx.SS` is 0, software step advances to the active-pending state.
In this case, a Software Step exception and an Illegal Execution state exception are both pending. The Software Step exception has higher priority. On taking the Software Step exception, the PE sets `SPSR_ELx.IL` to 1.

Note

[Synchronous exception prioritization for exceptions taken to AArch64 on page D1-1827](#) shows the relative priorities of synchronous exceptions.

Behavior when the instruction stepped writes a misaligned PC value

An indirect branch that writes a misaligned PC value might generate a PC alignment fault exception at the target of the branch. However, if the indirect branch is stepped using software step, the PE takes a Software Step exception instead, because the Software Step exception has higher priority. Behavior on returning from the Software Step exception depends on which Execution state the Exception level being returned to is using:

- AArch64** A PC alignment fault exception is generated.
- AArch32** The return from the Software Step exception forces the PC to the correct alignment, and no PC alignment fault exception is generated.

Debugger software must therefore take care when using software step to single-step an indirect branch instruction executed in AArch32 state, that it does not hide a PC alignment fault exception.

Stepping code that uses Exclusives monitors

The ARMv8-A architecture provides no mechanism for preserving the state of the Exclusives monitors when a Load-Exclusive or a Store-Exclusive instruction is stepped.

However, for certain progressions through the software step state machine, on taking a Software Step exception, the PE provides an indication of whether the instruction stepped was a Load-Exclusive instruction.

Debugger software can use this to detect the state of the Exclusives monitors. For example, if the PE reports that the instruction stepped was a Load-Exclusive instruction, the debugger is aware that the next Store-Exclusive operation will fail, because all Exclusives monitors are cleared on returning from the Software Step exception. The debugger must then take action to ensure that the code being stepped makes forwards progress.

For more information on how the PE reports whether the instruction stepped was a Load-Exclusive instruction, see [Exception syndrome information and preferred return address on page D2-1965](#).

Synchronization and the software step state machine

Any of the following can cause transitions between software step states:

- A direct write to a System register.
- A direct write to a Special-purpose register.
- A write to an external debug register that affects the routing of debug exceptions.

Because the software step state machine indirectly reads these registers, it is not guaranteed to observe any new values until after a *Context synchronization event* has occurred.

In the time between a write to one of these registers and the next *Context synchronization event*, it is CONSTRAINED UNPREDICTABLE whether software step uses the state of the PE before the write, or the state of the PE after the write.

After a *Context synchronization event*, the state machine must use the state of the PE after the write.

Example D2-3

-
1. Software changes `MDSCR_EL1.SS` from 0 to 1 when debug exceptions are enabled.
 2. The PE executes some instructions.
 3. A *Context synchronization event* occurs.

During step 2, it is CONSTRAINED UNPREDICTABLE whether software step remains in the inactive state, as if `MDSCR_EL1.SS` is 0, or enters the active-pending state because `MDSCR_EL1.SS` is 1. If it is in the:

- Inactive state, then after the *Context synchronization event*, it must enter the active-pending state.
- Active-pending state, the PE might take a Software Step exception before the *Context synchronization event*.

———— Note —————

A direct write to a Special-purpose register does not require explicit synchronization.

D2.12.11 Pseudocode description of Software Step exceptions

`SSAdvance()` advances software step from the active-not-pending state to the active-pending state, by setting `PSTATE.SS` to 0. It is called on completing execution of each instruction.

`CheckSoftwareStep()` checks whether software step is in the active-pending state, and if it is, generates a Software Step exception. It is called before each instruction executed, regardless of Execution state, before checking for any other synchronous exceptions.

`DebugExceptionReturnSS()` returns the value to write to `PSTATE.SS` on an exception return or an exit from Debug state. See *Entering the active-not-pending state* on page D2-1958.

These functions are defined in *Chapter J1 ARMv8 Pseudocode*.

D2.13 Synchronization and debug exceptions

The behavior of debug depends on all of the following:

- The state of the external debug authentication interface.
- Indirect reads of:
 - External debug registers.
 - System registers, including system debug registers.
 - Special-purpose registers.

If a change is made to any of these, the effect of that change on debug exception generation cannot be relied on until after a *Context synchronization event* has occurred. Similarly, the effect of the change on the software step state machine cannot be relied on until after a *Context synchronization event* has occurred.

For any instructions executed between the time when the change is made and the time when the next *Context synchronization event* occurs, it is CONSTRAINED UNPREDICTABLE whether debug uses the state of the PE before the change, or the state of the PE after the change.

Example D2-4

-
1. Software changes `MDSR_EL1.MDE` from 0 to 1.
 2. An instruction is executed, that would cause a Breakpoint exception if self-hosted debug uses the state of the PE after the change.
 3. A *Context synchronization event* occurs.

In this case, it is CONSTRAINED UNPREDICTABLE whether the instruction generates a Breakpoint exception.

Example D2-5

-
1. Software unlocks the OS lock.
 2. The PE executes some instructions.
 3. A *Context synchronization event* occurs.

During the time when the PE is executing some instructions, step 2, it is CONSTRAINED UNPREDICTABLE whether debug exceptions other than Breakpoint Instruction exceptions can be generated.

Note

- Some register updates are self-synchronizing. Others require an explicit *Context synchronization event*. For more information, see:
 - *Accessing PSTATE fields* on page D1-1792.
 - *Synchronization requirements for AArch64 System registers* on page D7-2191.
 - *Synchronization of changes to the external debug registers* on page H8-5554.
-

Chapter D3

The AArch64 System Level Memory Model

This chapter provides a system level view of the general features of the memory system. It contains the following sections:

- *About the memory system architecture* on page D3-1972.
- *Address space* on page D3-1973.
- *Mixed-endian support* on page D3-1974.
- *Cache support* on page D3-1975.
- *External aborts* on page D3-1997.
- *Memory barrier instructions* on page D3-1999.
- *Pseudocode description of general memory system instructions* on page D3-2000.

D3.1 About the memory system architecture

The ARM architecture supports different implementation choices for the memory system microarchitecture and memory hierarchy, depending on the requirements of the system being implemented. In this respect, the memory system architecture describes a design space in which an implementation is made. The architecture does not prescribe a particular form for the memory systems. Key concepts are abstracted in a way that permits implementation choices to be made while enabling the development of common software routines that do not have to be specific to a particular microarchitectural form of the memory system. For more information about the concept of a hierarchical memory system see [Memory hierarchy on page B2-98](#).

D3.1.1 Form of the memory system architecture

The ARMv8 A-profile architecture includes a *Virtual Memory System Architecture* (VMSA). [Chapter D4 The AArch64 Virtual Memory System Architecture](#) describes the AArch64 view of the VMSA.

D3.1.2 Memory attributes

[Memory types and attributes on page B2-107](#) describes the memory attributes, including how different memory types have different attributes. Each location in memory has a set of memory attributes, and the translation tables define the virtual memory locations, and the attributes for each location.

[Table D3-1](#) shows the memory attributes that are visible at the system level.

Table D3-1 Memory attribute summary

Memory type	Shareability	Cacheability
Device ^a	Outer Shareable	Non-cacheable.
Normal	One of: <ul style="list-style-type: none">Non-shareable.Inner Shareable.Outer Shareable.	One of ^b : <ul style="list-style-type: none">Non-cacheable.Write-Through Cacheable.Write-Back Cacheable.

a. Takes additional attributes, see [Device memory on page B2-111](#).

b. See also [Cacheability, cache allocation hints, and cache transient hints on page D3-1977](#).

For more information on cacheability and shareability see [Shareable Normal memory on page B2-108](#), [Non-shareable Normal memory on page B2-109](#), and [Caches and memory hierarchy on page B2-97](#).

D3.2 Address space

The ARMv8 architecture is designed to support a wide range of applications with different memory requirements. It supports a range of *physical address* (PA) sizes, and provides associated control and identification mechanisms. For more information, see [Address size configuration](#) on page D4-2014.

D3.2.1 Instruction address space overflow

When a PE performs a *Simple sequential execution* of instructions, it calculates:

$$(\text{address_of_current_instruction}) + (\text{size_of_executed_instruction})$$

This calculation is performed after each instruction to determine which instruction to execute next.

If the address calculation performed after executing an instruction overflows `0xFFFF_FFFF_FFFF_FFFF`, the program counter becomes UNKNOWN.

———— **Note** —————

Address tags are not propagated to the program counter, so the tag does not affect the address calculation.

Where an instruction accesses a sequential set of bytes that crosses the `0xFFFF_FFFF_FFFF_FFFF` boundary when tagged addresses are not used, or the `0xxxFF_FFFF_FFFF_FFFF` boundary when tagged addresses are used, then the virtual address accessed for the bytes above this boundary is UNKNOWN. When tagged addresses are used, the value of the tag associated with the address also becomes UNKNOWN.

D3.3 Mixed-endian support

A control bit, [SCTLR_EL1.E0E](#) is provided to allow the endianness of explicit data accesses made while executing at EL0 to be controlled independently of those made while executing at EL1. [Table D3-2](#) shows the endianness of explicit data accesses and translation table walks.

Table D3-2 Endianness support

Exception level	Explicit data accesses	Stage 1 translation table walks	Stage 2 translation table walks
EL0	SCTLR_EL1.E0E	SCTLR_EL1.EE	SCTLR_EL2.EE
EL1	SCTLR_EL1.EE	SCTLR_EL1.EE	SCTLR_EL2.EE
EL2	SCTLR_EL2.EE	SCTLR_EL2.EE	N/A
EL3	SCTLR_EL3.EE	SCTLR_EL3.EE	N/A

———— **Note** —————

[SCTLR_EL1.E0E](#) has no effect on the endianness of the [LDTR](#), [LDTRH](#), [LDTRSH](#), and [LDTRSW](#) instructions, or on the endianness of the [STTR](#) and [STTRH](#) instructions, when these are executed at EL1.

AArch64 state provides the following options for endianness support:

- All Exception levels support mixed-endianness:
 - [SCTLR_ELx.EE](#) is RW and [SCTLR_EL1.E0E](#) is RW.
- Only EL0 supports mixed-endianness and EL1, EL2, and EL3 support only little-endianness:
 - [SCTLR_ELx](#) is RES0 and [SCTLR_EL1.E0E](#) is RW.
- Only EL0 supports mixed-endianness and EL1, EL2, and EL3 support only big-endianness:
 - [SCTLR_ELx](#) is RES1 and [SCTLR_EL1.E0E](#) is RW.
- All Exception levels support only little-endianness:
 - [SCTLR_ELx](#) is RES0 and [SCTLR_EL1.E0E](#) is RES0.
- All Exception levels support only big-endianness:
 - [SCTLR_ELx](#) is RES1 and [SCTLR_EL1.E0E](#) is RES1.

If mixed endian support is implemented for an Exception level using AArch32, endianness is controlled by [PSTATE.E](#). For exception returns to AArch32 state, [PSTATE.E](#) is copied from [SPSR_ELx.E](#). If the target Exception level supports only little-endian accesses, [SPSR_ELx.E](#) is RES0. If the target Exception level supports only big-endian accesses, [SPSR_ELx.E](#) is RES1. [PSTATE.E](#) is ignored in AArch64 state.

The [BigEndian\(\)](#) function determines whether the current Exception level and Execution state are using big-endian data. This function is defined in [Chapter J1 ARMv8 Pseudocode](#).

For more information about endianness in the ARM architecture see [Endian support on page B2-104](#).

D3.4 Cache support

This section describes the ARMv8 cache identification and control mechanisms, and the A64 cache maintenance instructions, in the following sections:

- [General behavior of the caches.](#)
- [Cache identification on page D3-1976.](#)
- [Cacheability, cache allocation hints, and cache transient hints on page D3-1977.](#)
- [Enabling and disabling the caching of memory accesses on page D3-1978.](#)
- [Behavior of caches at reset on page D3-1980](#)
- [Non-cacheable accesses and instruction caches on page D3-1981.](#)
- [About cache maintenance in AArch64 state on page D3-1981.](#)
- [A64 Cache maintenance instructions on page D3-1985](#)
- [Data cache zero instruction on page D3-1994.](#)
- [Cache lockdown on page D3-1995.](#)
- [System level caches on page D3-1996.](#)
- [Branch prediction on page D3-1996.](#)

See also [Caches in a VMSAv8-64 implementation on page D4-2133.](#)

D3.4.1 General behavior of the caches

When a memory location has a Normal Cacheable memory attribute, determining whether a copy of the memory location is held in a cache still depends on many aspects of the implementation. The following non-exhaustive list of factors might be involved:

- The size, line length, and associativity of the cache.
- The cache allocation algorithm.
- Activity by other elements of the system that can access the memory.
- Speculative instruction fetching algorithms.
- Speculative data fetching algorithms.
- Interrupt behaviors.

Given this range of factors, and the large variety of cache systems that might be implemented, the architecture cannot guarantee whether:

- A memory location present in the cache remains in the cache.
- A memory location not present in the cache is brought into the cache.

Instead, the following principles apply to the behavior of caches:

- The architecture has a concept of an entry locked down in the cache. How lockdown is achieved is IMPLEMENTATION DEFINED, and lockdown might not be supported by:
 - A particular implementation.
 - Some memory attributes.
- An unlocked entry in a cache might not remain in that cache. The architecture does not guarantee that an unlocked cache entry remains in the cache or remains incoherent with the rest of memory. Software must not assume that an unlocked item that remains in the cache remains dirty.
- A locked entry in a cache is guaranteed to remain in that cache. The architecture does not guarantee that a locked cache entry remains incoherent with the rest of memory, that is, it might not remain dirty.

———— **Note** —————

For more information, see [The interaction of cache lockdown with cache maintenance instructions on page D3-1995.](#)

- Any memory location that has a Normal Cacheable attribute at either the current Exception level or at a higher Exception level can be allocated to a cache at any time.

- It is guaranteed that no memory location that does not have a Normal Cacheable attribute is allocated into the cache.
- It is guaranteed that no memory location is allocated to the cache if it has a Normal Non-cacheable attribute or any type of Device memory attribute in both:
 - The translation regime at the current Exception level.
 - The translation regime at any higher Exception level.
- For data accesses, any memory location with a Normal Inner Shareable or Normal Outer Shareable attribute is guaranteed to be coherent with all masters in its shareability domain.
- Any memory location is not guaranteed to remain incoherent with the rest of memory.
- The eviction of a cache entry from a cache level can overwrite memory that has been written by another observer only if the entry contains a memory location that has been written to by an observer in the shareability domain of that memory location. The maximum size of the memory that can be overwritten is called the *Cache Write-back Granule*. In some implementations the `CTR_ELO` identifies the Cache Write-back Granule.
- The allocation of a memory location into a cache cannot cause the most recent value of that memory location to become invisible to an observer if it was previously visible to that observer.

———— **Note** —————

The Cacheability attribute of an address is determined by the applicable translation table entry for that address, as modified by any applicable System register Cacheability controls, such as the `SCTLR_EL1`. {I, C} controls.

For the purpose of these principles, a cache entry covers at least 16 bytes and no more than 2KB of contiguous address space, aligned to the size of the cache entry.

D3.4.2 Cache identification

The ARMv8 cache identification registers describe the implemented caches that are affected by cache maintenance instructions executed on the PE. This includes the cache maintenance instructions that:

- Affect the entire cache, for example `IC IALLU`.
- Operate by VA, for example `IC IVAU`.
- Operate by set/way, for example `DC ISW`.

The cache identification registers are:

- The Cache Type Register, `CTR_ELO`, that defines:
 - The minimum line length of any of the instruction caches affected by the instruction cache maintenance instructions.
 - The minimum line length of any of the data or unified caches, affected by the data cache maintenance instructions.
 - The cache indexing and tagging policy of the Level 1 instruction cache.

———— **Note** —————

It is IMPLEMENTATION DEFINED whether caches beyond the PoC will be reported by this mechanism, and because of the possible existence of system caches some caches before the PoC might not be reported. For more information about system caches see *System level caches on page D3-1996*.

- A single Cache Level ID Register, `CLIDR_EL1`, that defines:
 - The type of cache that is implemented and can be maintained using the architected cache maintenance instructions that operate by set/way or operate on the entire cache at each cache level, up to the maximum of seven levels.
 - The *Level of Coherence* (LoC) for the caches. See *Terms used in describing the cache maintenance instructions on page D3-1981* for the definition of LoC.

- The *Level of Unification Uniprocessor* (LoUU) for the caches. See *Terms used in describing the cache maintenance instructions* on page D3-1981 for the definition of LoUU.
- An optional ICB field to indicate the boundary between the caches use for caching Inner Cacheable memory regions and those used only for caching Outer Cacheable regions.
- A single Cache Size Selection Register, `CSSELR_EL1`, that selects the cache level and cache type of the current Cache Size Identification Register.
- For each implemented cache that is identifiable by this mechanism, across all the levels of caching, a Cache Size Identification Register, `CCSIDR_EL1`, that defines:
 - Whether the cache supports Write-Through, Write-Back, Read-Allocate and Write-Allocate.
 - The number of sets, associativity and line length of the cache. See *Terms used in describing the cache maintenance instructions* on page D3-1981 for a definition of these terms.

To determine the cache topology associated with a PE:

1. Read the Cache Type Register to find the indexing and tagging policy used for the Level 1 instruction cache. This register also provides the size of the smallest cache lines used for the instruction caches, and for the data and unified caches. These values are used in cache maintenance instructions.
2. Read the Cache Level ID Register to find what caches are implemented. The register includes seven Cache type fields, for cache levels 1 to 7. Scanning these fields, starting from Level 1, identifies the instruction, data or unified caches implemented at each level. This scan ends when it reaches a level at which no caches are defined. The Cache Level ID Register also specifies the Level of Unification (LoU) and the Level of Coherence (LoC) for the cache implementation.
3. For each cache identified at stage 2:
 - Write to the Cache Size Selection Register to select the required cache. A cache is identified by its level, and whether it is:
 - An instruction cache.
 - A data or unified cache.
 - Read the Cache Size ID Register to find details of the cache.

D3.4.3 Cacheability, cache allocation hints, and cache transient hints

Cacheability only applies to Normal memory, and can be defined independently for Inner and Outer cache locations. All types of Device memory are always treated as Non-cacheable.

As described in *Memory types and attributes* on page B2-107, the memory attributes include a cacheability attribute that is one of:

- Non-cacheable.
- Write-Through cacheable.
- Write-Back cacheable.

In ARMv8, Cacheability attributes other than Non-cacheable can be complemented by a *cache allocation hint*. This is an indication to the memory system of whether allocating a value to a cache is likely to improve performance. In addition, it is IMPLEMENTATION DEFINED whether a *cache transient hint* is supported, see *Transient cacheability hint* on page D3-1978.

The cache allocation hints are assigned independently for read and write accesses, and therefore when the Transient hit is supported the following cache allocation hints can be assigned:

For read accesses: Read-Allocate, Transient Read-Allocate, or No Read-Allocate.

For write accesses: Write-Allocate, Transient Write-Allocate, or No Write-Allocate.

Note

- A Cacheable location with both No Read-Allocate and No Write-Allocate hints is not the same as a Non-cacheable location. A Non-cacheable location has coherency guarantees for all observers within the system that do not apply for a location that is Cacheable, No Read-Allocate, No Write-Allocate.
- Implementations can use the cache allocation hints to limit cache pollution to a part of a cache, such as to a subset of ways.
- For VMSAv8-64 translation table walks, the [TCR_ELx](#).{IRGNn, ORGNn} fields define the memory attributes of the translation tables, including the cacheability. However, this assignment supports only a subset of the cacheability attributes described in this section.

The architecture does not require an implementation to make any use of cache allocation hints. This means an implementation might not make any distinction between memory locations with attributes that differ only in their cache allocation hint.

Transient cacheability hint

In ARMv8, it is IMPLEMENTATION DEFINED whether a Transient hint is supported. In an implementation that supports the Transient hint, the Transient hint is a qualifier of the cache allocation hints, and indicates that the benefit of caching is for a relatively short period. It indicates that it might be better to restrict allocation of transient entries, to avoid possibly casting-out other, less transient, entries.

Note

The architecture does not specify what is meant by a *relatively short period*.

The description of the AArch64 [MAIR_EL1](#), [MAIR_EL2](#), and [MAIR_EL3](#) registers, and the AArch32 [MAIR0](#), [MAIR1](#), [HMAIR0](#), and [HMAIR1](#) registers, includes the assignment of the Transient hint in an implementation that supports this option. In this assignment:

- The Transient hint is defined independently for Inner Cacheable and Outer Cacheable memory regions.
- A single Transient hint applies to both read and write accesses to a memory region.

D3.4.4 Enabling and disabling the caching of memory accesses

In ARMv8, Cacheability control fields can force all memory locations with the Normal memory type to be treated as Non-cacheable, regardless of their assigned Cacheability attribute. Independent controls are provided for each stage of address translation, with separate controls for:

- Data accesses. These controls also apply to accesses to the translation tables.
- Instruction accesses.

Note

These Cacheability controls replace the cache enable controls provided in previous versions of the ARM architecture.

The Cacheability control fields and their effects are as follows:

For the EL1&0 translation regime

- When the value of [SCTLR_EL1.C](#) is 0:
 - All stage 1 translations for data accesses to Normal memory are Non-cacheable.
 - All accesses to the EL1&0 stage 1 translation tables are Non-cacheable.
- When the value of [SCTLR_EL1.I](#) is 0:
 - All stage 1 translations for instruction accesses to Normal memory are Non-cacheable.
- When the value of [HCR_EL2.CD](#) is 1:
 - All stage 2 translations for data accesses to Normal memory are Non-cacheable.

- All accesses to the EL1&0 stage 2 translation tables are Non-cacheable.
- When the value of `HCR_EL2.ID` is 1:
 - All stage 2 translations for instruction accesses to Normal memory are Non-cacheable.
- When the value of `HCR_EL2.DC` is 1, all Non-secure stage 1 translations and all accesses to the Non-secure EL1&0 stage 1 translation tables, are treated as accesses to Normal Non-shareable Inner Write-Back Cacheable Read-Allocate Write-Allocate, Outer Write-Back Cacheable Read-Allocate Write-Allocate memory, regardless of the value of `SCTLR_EL1.{I, C}`. This applies to translations for both data and instruction accesses.

Note

- In Non-secure state, the stage 1 and stage 2 cacheability attributes are combined as described in [Combining the stage 1 and stage 2 cacheability attributes for Normal memory on page D4-2097](#).
- The `SCTLR_EL1.{C, I}` and `HCR_EL2.DC` fields have no effect on the EL2, EL2&0, and EL3 translation regimes.
- The `HCR_EL2.{ID, CD}` fields affect only stage 2 of the Non-secure EL1&0 translation regime.
- In Non-secure state, when EL2 is using AArch64 and EL1 is using AArch32, the `HCR_EL2.{ID, CD, DC}` controls apply as described here, but the EL1 controls are `SCTLR.{C, I}`.

For the EL2 translation regime

- When the value of `SCTLR_EL2.C` is 0:
 - All data accesses to Normal memory using the EL2 translation regime are Non-cacheable.
 - All accesses to the EL2 translation tables are Non-cacheable.
- When the value of `SCTLR_EL2.I` is 0:
 - All instruction accesses to Normal memory using the EL2 translation regime are Non-cacheable.

Note

The `SCTLR_EL2.{I, C}` fields have no effect on the EL1&0 and EL3 translation regimes.

For the EL2&0 translation regime

When the value of `SCTLR_EL2.C` is 1:

- All stage 2 translations for data accesses to Normal memory from EL2, and from EL0 when those accesses are using the EL2&0 translation regime, are Non-cacheable.
- All accesses to the EL2&0 translation tables are Non-cacheable.

For the EL3 translation regime

- When the value of `SCTLR_EL3.C` is 0:
 - All data accesses to Normal memory using the EL3 translation regime are Non-cacheable.
 - All accesses to the EL3 translation tables are Non-cacheable.
- When the value of `SCTLR_EL3.I` is 0:
 - All instruction accesses to Normal memory using the EL3 translation regime are Non-cacheable.

Note

The `SCTLR_EL3.{I, C}` fields have no effect on the EL1&0, EL2, and EL2&0 translation regimes.

In addition:

- For translation regimes other than the Non-secure EL1&0 translation regime, if the value of `SCTLR_ELx.M` is 0, indicating that stage 1 translations are disabled for that translation regime, then:
 - If the value of `SCTLR_ELx.I` is 0, instruction accesses to Normal memory from stage 1 of the translation regime are Outer Shareable, Inner Non-cacheable, Outer Non-cacheable.
 - If the value of `SCTLR_ELx.I` is 1, instruction accesses to Normal memory from stage 1 of the translation regime are Outer Shareable, Inner Write-Through cacheable, Outer Write-Through cacheable.
- For the Non-secure EL1&0 translation regime, if the value of `SCTLR_EL1.M` is 0, indicating that stage 1 translations are disabled for that translation regime, and the value of `HCR_EL2.DC` is 0:
 - If the value of `SCTLR_EL1.I` is 0, instruction accesses to Normal memory from stage 1 of the translation regime are Outer Shareable, Inner Non-cacheable, Outer Non-cacheable.
 - If the value of `SCTLR_EL1.I` is 1, instruction accesses to Normal memory from stage 1 of the translation regime are Outer Shareable, Inner Write-Through Cacheable, Outer Write-Through Cacheable.

The effect of `SCTLR_ELx.C`, `HCR_EL2.DC` and `HCR_EL2.CD` is reflected in the result of the address translation instructions in the PAR when these bits have an effect on the stages of translation being reported in the PAR.

———— **Note** —————

- In conjunction with the requirements in *Non-cacheable accesses and instruction caches on page D3-1981*, the requirements in this section mean the architecturally required effect of `SCTLR_ELx.I` is limited to its effect on caching instruction accesses in unified caches.
- This specification can give rise to different cacheability attributes between instruction and data accesses to the same location. Where this occurs, the measures for mismatch memory attributes described in *Mismatched memory attributes on page B2-118* must be followed to manage the corresponding loss of coherency.

D3.4.5 Behavior of caches at reset

In ARMv8:

- All caches reset to IMPLEMENTATION DEFINED states that might be UNKNOWN.
- The Cacheability control fields described in *Enabling and disabling the caching of memory accesses on page D3-1978* reset to values that force all memory locations to be treated as Non-cacheable.

———— **Note** —————

This applies only to the controls that apply to the Translation regime that is used by the Exception level and Security state entered on reset.

- An implementation can require the use of a specific cache initialization routine to invalidate its storage array before caching is enabled. The exact form of any required initialization routine is IMPLEMENTATION DEFINED, and the routine must be documented clearly as part of the documentation of the device.
- If an implementation permits cache hits when the Cacheability control fields force all memory locations to be treated as Non-cacheable then the cache initialization routine must:
 - Provide a mechanism to ensure the correct initialization of the caches.
 - Be documented clearly as part of the documentation of the device.

In particular, if an implementation permits cache hits when the Cacheability controls force all memory locations to be treated as Non-cacheable, and the cache contents are not invalidated at reset, the initialization routine must avoid any possibility of running from an uninitialized cache. It is acceptable for an initialization routine to require a fixed instruction sequence to be placed in a restricted range of memory.

- ARM recommends that whenever an invalidation routine is required, it is based on the ARMv8 cache maintenance instructions.

See also [TLB behavior at reset on page D4-2117](#).

D3.4.6 Non-cacheable accesses and instruction caches

In AArch64 state, instruction accesses to Non-cacheable Normal memory can be held in instruction caches.

Correspondingly, the sequence for ensuring that modifications to instructions are available for execution must include invalidation of the modified locations from the instruction cache, even if the instructions are held in Normal Non-cacheable memory. This includes cases where System register Cacheability control fields force instruction accesses to memory to be Non-cacheable.

Therefore when using self-modified code in non-cacheable space in a uniprocessor system, the following sequence is required:

```
; Enter this code with <Wt> containing the new 32-bit instruction
; to be held at a location pointed to by <Xn> in Normal Non-cacheable memory.
STR <Wt>, [Xn]
DSB ISH; Ensure visibility of the data stored
IC IVAU, [Xn] ; Invalidate instruction cache by VA to PoU
DSB ISH; Ensure completion of the invalidations
ISB ;
```

In a multiprocessor system, the **IC IVAU** is broadcast to all PEs within the Inner Shareable domain of the PE running this sequence, but additional software steps might be required to synchronize the threads with other PEs. This might be necessary so that the PEs executing the modified instructions can execute an ISB after completing the invalidation, and to avoid issues associated with concurrent modification and execution of instruction sequences.

Larger blocks of instructions can be modified using the **IC IALLU** instruction for a uniprocessor system, or a **IC IALLUIS** for a multiprocessor system.

———— Note ————

This section applies even when the Cacheability control fields force instruction accesses to memory in AArch64 state to be Non-cacheable, as described in [Enabling and disabling the caching of memory accesses on page D3-1978](#).

D3.4.7 About cache maintenance in AArch64 state

The following sections give general information about cache maintenance:

- [Terms used in describing the cache maintenance instructions](#).
- [The ARMv8 abstraction of the cache hierarchy on page D3-1984](#).

The following sections describe the A64 cache maintenance instructions:

- [The instruction cache maintenance instruction \(IC\) on page D3-1986](#).
- [The data cache maintenance instruction \(DC\) on page D3-1987](#).

———— Note ————

Some descriptions of the cache maintenance instructions refer to the cacheability of the address on which the instruction operates. The Cacheability of an address is determined by the applicable translation table entry for that address, as modified by any applicable System register Cacheability controls, such as the **SCTLR_EL1**.{I, C} controls.

Terms used in describing the cache maintenance instructions

Cache maintenance instructions are defined to act on particular memory locations. Instruction scope can be defined:

- By the virtual address of the memory location to be maintained, referred to as operating *by VA*.
- By a mechanism that describes the location in the hardware of the cache, referred to as operating *by set/way*.

In addition, for instruction caches, there are instructions that invalidate all entries.

The following subsections define the terms used in the descriptions of the cache maintenance instructions:

- [Terminology for cache maintenance instructions operating by set/way.](#)
- [Terminology for Clean, Invalidate, and Clean and Invalidate instructions.](#)

Note

There is no terminology specific to cache maintenance instructions that operate by VA. When all applicable stages of translation are disabled, the VA used is identical to the PA. For more information about memory system behavior when address translation is disabled, see [The effects of disabling a stage of address translation on page D4-2053.](#)

Terminology for cache maintenance instructions operating by set/way

Cache maintenance instruction that operate by set/way refer to the particular structures in a cache. Three parameters describe the location in a cache hierarchy that an instruction works on. These parameters are:

- Level** The cache level of the hierarchy. The number of levels of cache is IMPLEMENTATION DEFINED. The cache levels that can be managed using the architected cache maintenance instructions that operate by set/way can be determined from the [CLIDR_EL1](#).
- In the ARM architecture, the lower numbered cache levels are those closest to the PE. See [Memory hierarchy on page B2-98.](#)
- Set** Each level of a cache is split up into a number of *sets*. Each set is a set of locations in a cache level to which an address can be assigned. Usually, the set number is an IMPLEMENTATION DEFINED function of an address.
- In the ARM architecture, sets are numbered from 0.
- Way** The associativity of a cache is the number of locations in a set to which a specific address can be assigned. The *way* number specifies one of these locations.
- In the ARM architecture, ways are numbered from 0.

Note

Because the allocation of a memory address to a cache location is entirely IMPLEMENTATION DEFINED, ARM expects that most portable software will use only the cache maintenance instructions by set/way as single steps in a routine to perform maintenance on the entire cache.

Terminology for Clean, Invalidate, and Clean and Invalidate instructions

Caches introduce coherency problems in two possible directions:

1. An update to a memory location by a PE that accesses a cache might not be visible to other observers that can access memory. This can occur because new updates are still in the cache and are not visible yet to the other observers that do not access that cache.
2. Updates to memory locations by other observers that can access memory might not be visible to a PE that accesses a cache. This can occur when the cache contains an old, or *stale*, copy of the memory location that has been updated.

The *Clean* and *Invalidate* instructions address these two issues. The definitions of these instructions are:

- Clean** A cache clean instruction ensures that updates made by an observer that controls the cache are made visible to other observers that can access memory at the point to which the instruction is performed. Once the Clean has completed, the new memory values are guaranteed to be visible to the point to which the instruction is performed, for example to the Point of Unification.
- The cleaning of a cache entry from a cache can overwrite memory that has been written by another observer only if the entry contains a location that has been written to by an observer in the shareability domain of that memory location.

Invalidate A cache invalidate instruction ensures that updates made visible by observers that access memory at the point to which the invalidate is defined, are made visible to an observer that controls the cache. This might result in the loss of updates to the locations affected by the invalidate instruction that have been written by observers that access the cache, if those updates have not been cleaned from the cache since they were made.

If the address of an entry on which the invalidate instruction operates is Normal, Non-cacheable or any type of Device memory then an invalidate instruction also ensures that this address is not present in the cache.

———— **Note** —————

Entries for addresses that are Normal Cacheable can be allocated to the cache at any time, and so the cache invalidate instruction cannot ensure that the address is not present in a cache.

Clean and Invalidate

A cache *clean and invalidate* instruction behaves as the execution of a clean instruction followed immediately by an invalidate instruction. Both instructions are performed to the same location.

The points to which a cache maintenance instruction can be defined differ depending on whether the instruction operates by VA or by set/way:

- For instructions operating by set/way, the point is defined to be to the next level of caching. For the All operations, the point is defined as the Point of Unification for each location held in the cache.
- For instructions operating by VA, two conceptual points are defined:

Point of Coherency (PoC)

The point at which all agents that can access memory are guaranteed to see the same copy of a memory location for accesses of any memory type or cacheability attribute. In many cases this is effectively the main system memory, although the architecture does not prohibit the implementation of caches beyond the PoC that have no effect on the coherency between memory system agents.

———— **Note** —————

The presence of system caches can affect the determination of the point of coherency as described in [System level caches on page D3-1996](#).

Point of Unification (PoU)

The PoU for a PE is the point by which the instruction and data caches and the translation table walks of that PE are guaranteed to see the same copy of a memory location. In many cases, the Point of Unification is the point in a uniprocessor memory system by which the instruction and data caches and the translation table walks have merged.

The PoU for an Inner Shareable shareability domain is the point by which the instruction and data caches and the translation table walks of all the PEs in that Inner Shareable shareability domain are guaranteed to see the same copy of a memory location. Defining this point permits self-modifying software to ensure future instruction fetches are associated with the modified version of the software by using the standard correctness policy of:

1. Clean data cache entry by address.
2. Invalidate instruction cache entry by address.

The following fields in the [CLIDR_EL1](#) relate to these conceptual points:

LoC, Level of Coherence

This field defines the last level of cache that must be cleaned or invalidated when cleaning or invalidating to the Point of Coherency. The LoC value is a cache level, so, for example, if LoC contains the value 3:

- A clean to the Point of Coherency operation requires the level 1, level 2 and level 3 caches to be cleaned.
- Level 4 cache is the first level that does not have to be maintained.

If the LoC field value is 0x0, this means that no levels of cache need to be cleaned or invalidated when cleaning or invalidating to the Point of Coherency.

If the LoC field value is a nonzero value that corresponds to a level that is not implemented, this indicates that all implemented caches are before the Point of Coherency.

LoUU, Level of Unification, uniprocessor

This field defines the last level of data cache that must be cleaned or invalidated when cleaning or invalidating to the Point of Unification for the PE. As with LoC, the LoUU value is a cache level.

If the LoUU field value is 0x0, this means that no levels of data cache need to be cleaned or invalidated when cleaning or invalidating to the Point of Unification.

If the LoUU field value is a nonzero value that corresponds to a level that is not implemented, this indicates that all implemented caches are before the Point of Unification.

LoUIS, Level of Unification, Inner Shareable

In any implementation:

- This field defines the last level of data or unified cache that must be cleaned or invalidated when cleaning or invalidating to the Point of Unification for the Inner Shareable shareability domain. As with LoC, the LoUIS value is a cache level.
- If the LoUIS field value is 0x0, this means that no levels of data or unified cache need to be cleaned or invalidated when cleaning or invalidating to the Point of Unification for the Inner Shareable shareability domain.
- If the LoUIS field value is a nonzero value that corresponds to a level that is not implemented, this indicates that all implemented caches are before the Point of Unification.

For more information, see [CLIDR_EL1, Cache Level ID Register](#) on page D7-2223.

- **For instructions operating by VA, an additional conceptual point is defined in ARMv8.2:**

Point of Persistence (PoP)

The point in a memory system, should it exist, at or beyond the Point of Coherency, where a write to memory is maintained when system power is removed, and reliably recovered when power is restored to the affected locations in memory.

Where the Point of Persistence is not supported, a data cache clean to the Point of Persistence behaves as a data cache clean to the Point of Coherency. For more information, see DC CVAP.

Support for the Point of Persistence does not change the definition or behavior of the CLIDR_EL1 System register.

The ARMv8 abstraction of the cache hierarchy

The following subsections describe the ARMv8 abstraction of the cache hierarchy:

- [Cache maintenance instructions that operate by VA.](#)
- [Cache maintenance instructions that operate by set/way](#) on page D3-1985.

Cache maintenance instructions that operate by VA

The VA-based cache maintenance instructions are described as operating by VA. Each of these instructions is always qualified as being one of:

- Performed to the Point of Coherency.
- Performed to the Point of Unification.
- **Performed to the Point of Persistence.**

See [Terms used in describing the cache maintenance instructions](#) on page D3-1981 for definitions of Point of Coherency, Point of Unification, and **Point of Persistence**, and more information about possible meanings of VA.

[A64 Cache maintenance instructions](#) on page D3-1985 lists the VA-based maintenance instructions.

The CTR_EL0 holds minimum line length values for:

- The instruction caches.

- The data and unified caches.

These values support efficient invalidation of a range of VAs, because this value is the most efficient address stride to use to apply a sequence of VA-based maintenance instructions to a range of VAs.

For the Invalidate data or unified cache line by VA instruction, the Cache Write-back Granule field of the `CTR_EL0` defines the maximum granule that a single invalidate instruction can invalidate. This meaning of the Cache Write-back Granule is in addition to its defining the maximum size that can be written back.

Cache maintenance instructions that operate by set/way

A64 Cache maintenance instructions lists the set/way-based maintenance instructions. Some encodings of these instructions include a required field that specifies the cache level for the instruction:

- A clean instruction cleans from the level of cache specified through to at least the next level of cache, moving further from the PE.
- An invalidate instruction invalidates only at the level specified.

D3.4.8 A64 Cache maintenance instructions

The A64 cache maintenance instructions are part of the A64 system instruction class in the register encoding space. For encoding details and other general information on these system instructions, see *System instructions on page C3-158*, *SYS on page C6-950* and *Cache maintenance instructions, and data cache zero on page C5-318*.

In general, the instruction and data cache maintenance instructions have the same functionality in AArch32 state and in AArch64 state. **The exception to this is the data cache clean operation to the Point of Persistence, introduced in ARMv8.2, which is supported in AArch64 state only.** [Table D3-3](#) shows these system instructions. Instructions that take an argument include Xt in the instruction description.

———— Note —————

In [Table D3-3](#) the Point of Unification is the Point of Unification of the PE executing the cache maintenance instruction.

Table D3-3 System instructions for cache maintenance

System instructions	Instruction	Notes
Instruction cache maintenance instructions, see <i>System instructions on page C3-158</i>		
IC IALLUIS	Invalidate all to Point of Unification, Inner Shareable	EL1 or higher access.
IC IALLU	Invalidate all to Point of Unification	EL1 or higher access.
IC IVAU, Xt	Invalidate by virtual address to Point of Unification	When <code>SCTLR_EL1.UCI == 1</code> , EL0 access. Otherwise, EL1 or higher access.
Data cache maintenance instructions, see <i>System instructions on page C3-158</i>		
DC IVAC, Xt	Invalidate by virtual address to Point of Coherency	EL1 or higher access.
DC ISW, Xt	Invalidate by set/way	EL1 or higher access.
DC CVAC, Xt	Clean by virtual address to Point of Coherency	When <code>SCTLR_EL1.UCI == 1</code> , EL0 access. Otherwise EL1 or higher access.
DC CVAP, Xt	Clean by virtual address to Point of Persistence	When <code>SCTLR_EL1.UCI == 1</code> , EL0 access. Otherwise EL1 or higher access.
DC CSW, Xt	Clean by set/way	EL1 or higher access.

Table D3-3 System instructions for cache maintenance (continued)

System instructions	Instruction	Notes
DC CVAU, Xt	Clean by virtual address to Point of Unification	When SCTLR_EL1.UCI == 1, EL0 access. Otherwise EL1 or higher access.
DC CIVAC, Xt	Clean and invalidate by virtual address to Point of Coherency	When SCTLR_EL1.UCI == 1, EL0 access. Otherwise EL1 or higher access.
DC CISW, Xt	Clean and invalidate by set/way	EL1 or higher access.

A DSB or DMB instruction intended to ensure the completion of cache or branch predictor maintenance instructions must have an access type of both loads and stores.

The following subsections give more information about these instructions:

- [The instruction cache maintenance instruction \(IC\)](#).
- [The data cache maintenance instruction \(DC\) on page D3-1987](#).
- [EL0 accessibility to cache maintenance instructions on page D3-1988](#).
- [General requirements for the scope of maintenance instructions on page D3-1988](#).
- [Effects of instructions that operate by VA to the Point of Coherency on page D3-1988](#).
- [Effects of instructions operate by VA but not to the Point of Coherency on page D3-1989](#).
- [Effects of All and set/way maintenance instructions on page D3-1989](#).
- [Effects of virtualization and security on the cache maintenance instructions on page D3-1990](#).
- [Boundary conditions for cache maintenance instructions on page D3-1991](#).
- [Ordering and completion of data and instruction cache instructions on page D3-1992](#).
- [Performing cache maintenance instructions on page D3-1993](#).

The instruction cache maintenance instruction (IC)

[System instructions on page C3-158](#) describes the A64 assembly syntax for this instruction.

When an IC instruction requires an address argument this takes the form of a 64-bit register that holds the virtual address argument. No restrictions apply for this address.

Any cache maintenance instruction operating by VA includes as part of any required VA to PA translation:

- For an instruction executed at EL1, the current [ASID \(Address Space Identifier\)](#).
- The current Security state.
- Whether the instruction was executed at EL2, or in Non-secure EL1 state.
- For an instruction executed in Non-secure EL1 state, the current [VMID \(Virtual Machine Identifier\)](#).

For an instruction cache maintenance instruction that operates by VA:

- It is IMPLEMENTATION DEFINED whether the instruction can generate a Translation fault or an Access flag fault.
- The instruction cannot generate a Permission fault, except for the Permission fault case described in [Stage 2 fault on a stage 1 translation table walk on page D4-2109](#).

For more information about these possible faults on an instruction that operates by VA see [MMU faults on page D4-2103](#).

See also [EL0 accessibility to cache maintenance instructions on page D3-1988](#) and [Ordering and completion of data and instruction cache instructions on page D3-1992](#).

The data cache maintenance instruction (DC)

[System instructions on page C3-158](#) describes the A64 assembly syntax for this instruction.

When a DC instruction requires a set/way/level argument this takes the form of a 64-bit register, the upper 32 bits of which are RES0.

When executed at EL1, a **DC ISW** instruction performs a clean and invalidate, meaning it performs the same maintenance as a **DC CISW** instruction, if all of the following apply:

- EL2 is implemented.
- The value of **HCR_EL2.SWIO** is 1.
- Either EL3 is not implemented, or EL3 is implemented and the value of **SCR_EL3.NS** is 1

If a data cache maintenance by set/way instruction specifies a set, way, or level argument that is larger than the value supported by the implementation then the instruction is CONstrained UNPREDICTABLE, see [Out of range values of the Set/Way/Index fields in cache maintenance instructions on page K1-6133](#) or the instruction description.

When a DC instruction requires an address argument this takes the form of a 64-bit register that holds the virtual address argument. No alignment restrictions apply for this address.

Any cache maintenance instruction operating by VA includes as part of any required VA to PA translation:

- For an instruction executed at EL1, the current **ASID**.
- The current Security state.
- Whether the instruction was executed at EL2, or in Non-secure EL1 state.
- For an instruction executed in Non-secure EL1 state, the current **VMID**.

A data or unified cache maintenance instruction that operates by VA cannot generate a Permission fault except in the following cases:

- **DC IVAC** requires write permission or else a Permission fault is generated.
- The Permission fault described in [Stage 2 fault on a stage 1 translation table walk on page D4-2109](#).

For more information about these possible faults on an instruction that operates by VA see [MMU faults on page D4-2103](#).

When executed at EL1, a **DC IVAC** or **DC ISW** instruction performs a clean and invalidate, meaning a **DC IVAC** instruction performs the same maintenance as a **DC CIVAC** instruction and a **DC ISW** instruction performs the same maintenance as a **DC CISW** instruction, if all of the following apply:

- EL2 is implemented.
- The value of **HCR_EL2.VM** is 1, meaning EL1&0 stage two address translation is enabled.
- Either EL3 is not implemented, or EL3 is implemented and the value of **SCR_EL3.NS** is 1

———— Note ————

This also applies to the AArch32 cache maintenance instructions **DCIMVAC** and **DCISW**. See [AArch32 data cache maintenance instructions \(DC*\) on page G3-4537](#).

Where DC CVAP is supported:

- The operation is ordered in the same way as DC CVAC.
- A DSB SY instruction will wait until completion of all previous DC CVAP instructions.

To complete a store to the Point of Persistence where the store might be to Non-cacheable memory, the following sequence should be used:

```

DMB
DC CVAP, Xt
DSB
    
```

Note

If caches, that are invisible to the programmer, exist beyond the Point of Coherency but before the Point of Persistence and hold data that is marked as Non-cacheable, the DC CVAP operation causes the non-cacheable locations to be cleaned from those caches.

If a memory fault that sets the FAR for the translation regime applicable for the cache maintenance instruction is generated from a data cache maintenance instruction, the FAR holds the address specified in the register argument of the instruction.

Note

Despite its mnemonic, DC ZVA is not a cache maintenance instruction. For more information, see *DC ZVA, Data Cache Zero by VA* on page C5-421.

See also *EL0 accessibility to cache maintenance instructions* and *Ordering and completion of data and instruction cache instructions* on page D3-1992.

EL0 accessibility to cache maintenance instructions

The SCTLR_EL1.UCI bit enables EL0 access for the DC CVAU, DC CVAC, DC CVAP, DC CIVAC, and IC IVAU instructions. When EL0 use of these instructions is disabled because SCTLR_EL1.UCI == 0, executing one of these instructions at EL0 generates a trap to EL1, that is reported using EC = 0x18.

For these instructions read access permission is required. When the value of SCTLR_EL1.UCI is 1:

- For the DC CVAU, DC CVAC, DC CVAP, and DC CIVAC instructions, if the instruction is executed at EL0 and the address specified in the argument cannot be read at EL0, a Permission fault is generated.
- For the IC IVAU instruction, if the instruction is executed at EL0 and the address specified in the argument cannot be read at EL0, it is IMPLEMENTATION DEFINED whether a Permission fault is generated.

Software can read the CTR_EL0 to discover the stride needed for cache maintenance instructions. The SCTLR_EL1.UCT bit enables EL0 access to the CTR_EL0. When EL0 access to the Cache Type register is disabled, a register access instruction executed at EL0 is trapped to EL1 using EC = 0x18.

General requirements for the scope of maintenance instructions

The ARMv8 specification of the cache maintenance instructions describes what each instruction is guaranteed to do in a system. It does not limit other behaviors that might occur, provided they are consistent with the requirements described in *General behavior of the caches* on page D3-1975, *Behavior of caches at reset* on page D3-1980, and *Preloading caches* on page B2-101.

This means that as a side-effect of a cache maintenance instruction:

- Any location in the cache might be cleaned.
- Any unlocked location in the cache might be cleaned and invalidated.

Note

ARM recommends that, for best performance, such side-effects are kept to a minimum. ARM strongly recommends that the side-effects of operations performed in Non-secure state do not have a significant performance impact on execution in Secure state.

Effects of instructions that operate by VA to the Point of Coherency

For Normal memory that is not Inner Non-cacheable, Outer Non-cacheable, these instructions must affect the caches of other PEs in the shareability domain described by the shareability attributes of the VA supplied with the instruction.

For Device memory and Normal memory that is Inner Non-cacheable, Outer Non-cacheable, these instructions must affect the caches of all PEs in the Outer Shareable shareability domain of the PE on which the instruction is operating.

In all cases, for any affected PE, these instructions affect all data and unified caches to the Point of Coherency.

Table D3-4 shows the scope of the Data and unified cache maintenance instructions.

Table D3-4 PEs affected by cache maintenance instructions to the Point of Coherency

Shareability	PEs affected	Effective to
Non-shareable	The PE performing the operation	The Point of Coherency of the entire system
Inner Shareable	All PEs in the same Inner Shareable shareability domain as the PE performing the operation	The Point of Coherency of the entire system
Outer Shareable	All PEs in the same Outer Shareable shareability domain as the PE performing the operation	The Point of Coherency of the entire system

Effects of instructions operate by VA but not to the Point of Coherency

For these instructions, Table D3-5 shows how, for a VA in a Normal or Device memory location, the shareability attribute of the VA determines the minimum set of PEs affected, and the point to which the instruction must be effective.

Table D3-5 PEs affected by cache maintenance instructions to the Point of Unification

Shareability	PEs affected	Effective to
Non-shareable	The PE executing the instruction	The point of unification of instruction cache fills, data cache fills and write-backs, and translation table walks, on the PE executing the instruction
Inner Shareable or Outer Shareable	All PEs in the same Inner Shareable shareability domain as the PE executing the instruction	The Point of Unification of instruction cache fills, data cache fills and write-backs, and translation table walks, of all PEs in the same Inner Shareable shareability domain as the PE executing the instruction

———— Note —————

The set of PEs guaranteed to be affected is never greater than the PEs in the Inner Shareable shareability domain containing the PE executing the instruction.

Effects of All and set/way maintenance instructions

The IC IALLU and DC set/way instructions apply only to the caches of the PE that performs the instruction.

The IC IALLUIS instruction can affect the caches of all PEs in the same Inner Shareable shareability domain as the PE that performs the instruction. This instruction has an effect to the Point of Unification of instruction cache fills, data cache fills, and write-backs, and translation table walks, of all PEs in the same Inner Shareable shareability domain.

———— Note —————

The possible presence of system caches, as described in *System level caches on page D3-1996*, means architecture does not guarantee that all levels of the cache can be maintained using set/way instructions.

Effects of virtualization and security on the cache maintenance instructions

Each Security state has its own physical address (PA) space, therefore cache entries are associated with PA space.

Table D3-6 shows the effects of virtualization and security on the cache maintenance instructions. In the table, the *Specified entries* are entries that the architecture requires the instruction to affect. The rules described in *General behavior of the caches* on page D3-1975 mean that an instruction might also affect other entries.

Table D3-6 Effects of virtualization and security on the maintenance instructions

Cache maintenance instructions	Security state	Specified entries
Data or unified cache maintenance instructions		
Invalidate, Clean, or Clean and Invalidate by VA: IVAC, CVAC, DC CVAP, CVAU, CIVAC	Both	All lines that hold the PA that, in the current Security state, is mapped to by the combination of all of: <ul style="list-style-type: none"> The specified VA. For an instruction executed at EL1 or EL0, the current ASID if the location is mapped to by a non-global page. For an instruction executed at Non-secure EL1 or Non-secure EL0, the current VMID^a.
Invalidate, Clean, or Clean and Invalidate by set/way: ISW, CSW, CISW	Non-secure	Line specified by set/way provided that the entry comes from the Non-secure PA space.
	Secure	Line specified by set/way regardless of the PA space that the entry has come from.
Instruction cache maintenance instructions		
Invalidate by VA: IVAU	Both	All lines corresponding to the specified VA ^b in the current translation regime and: <ul style="list-style-type: none"> For an instruction executed at EL1 or EL0, the current ASID. For an instruction executed at Non-secure EL1 or Non-secure EL0, the current VMID^a.
Invalidate All: IALLU, IALLUIS	Both	For an instruction executed at: <ul style="list-style-type: none"> Non-secure EL1, all instruction cache lines containing entries associated with the current VMID^a. EL2, all instruction cache lines containing Non-secure entries. EL3 or Secure EL1, all instruction cache lines.

- a. Dependencies on the VMID apply even when HCR_EL2.VM is set to 0. The architecture does not define a reset value for VTTBR_EL2.VMID, and therefore, in any implementation that includes EL2, the boot software executed when reset is deasserted must initialize VTTBR_EL2.VMID.
- b. The type of instruction cache used affects the interpretation of the specified entries in this table such that:
- For a PIPT instruction cache, the cache maintenance applies to all entries whose physical address corresponds to the specified address.
 - For a VIPT instruction cache, the cache maintenance applies to entries whose virtual index and physical tag corresponds to the specified address.
- For information on types of instruction cache see *Instruction caches* on page D4-2133.

For locked entries and entries that might be locked, the behavior of cache maintenance instructions described in *The interaction of cache lockdown with cache maintenance instructions* on page D3-1995 applies.

With an implementation that generates aborts if entries are locked or might be locked in the cache, when the use of lockdown aborts is enabled, these aborts can occur on any cache maintenance instructions.

In an implementation that includes EL2:

- The architecture does not require cache cleaning when switching between virtual machines. Cache invalidation by set/way must not present an opportunity for one virtual machine to corrupt state associated with a second virtual machine. To ensure this requirement is met, Non-secure clean by set/way instructions can, instead, perform a clean and invalidate by set/way.
- The AArch64 Data cache invalidate instructions, [DC IVAC](#) and [DC ISW](#), at EL1 and EL0, and the AArch32 Data cache invalidate instructions [DCIMVAC](#) and [DCISW](#), at EL1, perform a cache clean as well as a cache invalidation if both of the following apply:
 - The value of [HCR.VM](#) is 1.
 - The instruction is executed in Non-secure state, or EL3 is not implemented.

The means that, in Non-secure state:

- At EL1 using AArch64 or EL0 using AArch64, a [DC IVAC](#) instruction performs the same maintenance as a [DC CIVAC](#) instruction, and a [DC ISW](#) instruction performs the same maintenance as a [DC CISW](#) instruction.
- At EL1 using AArch32, a [DCIMVAC](#) instruction performs the same maintenance as a [DCCIMVAC](#) instruction, and a [DCISW](#) instruction performs the same maintenance as a [DCCISW](#) instruction.
- The AArch64 Data cache invalidate by set/way instruction [DC ISW](#), at EL1 and EL0, and the AArch32 Data cache invalidate by set/way instruction [DCISW](#), at EL1, perform a cache clean as well as a cache invalidation if both of the following apply:
 - The value of [HCR_EL2.SWIO](#) is 1.
 - The instruction is executed in Non-secure state, or EL3 is not implemented.

This means that, in Non-secure state:

- At EL1 using AArch64 or EL0 using AArch64, a [DC ISW](#) instruction performs the same maintenance as a [DC CISW](#) instruction.
- At EL1 using AArch32, a [DCISW](#) instruction performs the same maintenance as a [DCCISW](#) instruction.
- When the value of [HCR_EL2.FB](#) is 1, TLB and instruction cache invalidate instructions executed in the Non-secure EL1 Exception level are broadcast across the Inner Shareable domain. When Non-secure EL1 is using AArch64, this applies to the [TLBI VMALLE1](#), [TLBI VAE1](#), [TLBI ASIDE1](#), [TLBI VAAE1](#), [TLBI VALE1](#), [TLBI VAALE1](#), and [IC IALLU](#) instructions. This means the instruction performs the invalidation that would be performed by the corresponding Inner Shareable instruction, for example [IC IALLU](#) performs the invalidation that would be performed by [IC IALLUIS](#).

For more information about the cache maintenance instructions, see [About cache maintenance in AArch64 state on page D3-1981](#), [A64 Cache maintenance instructions on page D3-1985](#), and [Chapter D4 The AArch64 Virtual Memory System Architecture](#).

Boundary conditions for cache maintenance instructions

Cache maintenance instructions operate on the caches regardless of whether the System register Cacheability controls force all memory accesses to be Non-cacheable.

For VA-based cache maintenance instructions, the instruction operates on the caches regardless of the memory type and cacheability attributes marked for the memory address in the VMSA translation table entries. This means that the effects of the cache maintenance instructions can apply regardless of:

- Whether the address accessed:
 - Is Normal memory or Device memory.
 - Has the Cacheable attribute or the Non-cacheable attribute.
- Any applicable domain control of the address accessed.
- The access permissions for the address accessed, other than the effect of the stage two write permission on data or unified cache invalidation instructions.

Ordering and completion of data and instruction cache instructions

All data cache instructions, other than [DC ZVA](#), that specify an address:

- Execute in program order relative to loads or stores that access an address in Normal memory with either Inner Write Through or Inner Write Back attributes within the same cache line of minimum size, as indicated by [CTR_EL0.DMinLine](#).
- Can execute in any order relative to loads or stores that access any address with the Device memory attribute, or with Normal memory with Inner Non-cacheable attribute unless a DMB or DSB is executed between the instructions.
- Execute in program order relative to other data cache maintenance instructions, other than [DC ZVA](#), that specify an address within the same cache line of minimum size, as indicated by [CTR_EL0.DMinLine](#).
- Can execute in any order relative to loads or stores that access an address in a different cache line of minimum size, as indicated by [CTR_EL0.DMinLine](#), unless a DMB or DSB is executed between the instructions.
- Can execute in any order relative to other data cache maintenance instructions, other than [DC ZVA](#), that specify an address in a different cache line of minimum size, as indicated by [CTR_EL0.DMinLine](#), unless a DMB or DSB is executed between the instructions.
- Can execute in any order relative to data cache maintenance instructions that do not specify an address unless a DMB or DSB is executed between the instructions.
- Can execute in any order relative to instruction cache maintenance instructions unless a DSB is executed between the instructions.

Note

- Data cache ordering rules by address are consistent with physically indexed physically tagged caches. See [Data and unified caches on page D4-2133](#).
- [Data cache zero instruction on page D3-1994](#) describes the ordering and completion rules for Data Cache Zero.

All data cache maintenance instructions that do not specify an address:

- Can execute in any order relative to data cache maintenance instructions that do not specify an address unless a DMB or DSB is executed between the instructions.
- Can execute in any order relative to data cache maintenance instructions that specify an address, other than Data Cache Zero, unless a DMB or DSB is executed between the instructions.
- Can execute in any order relative to loads or stores unless a DMB or DSB is executed between the instructions.
- Can execute in any order relative to instruction cache maintenance instructions unless a DSB is executed between the instructions.

All instruction cache instructions can execute in any order relative to other instruction cache instructions, data cache instructions, loads, and stores unless a DSB is executed between the instructions.

A cache maintenance instruction can complete at any time after it is executed, but is only guaranteed to be complete, and its effects visible to other observers, following a DSB instruction executed by the PE that executed the cache maintenance instruction.

In all cases, where the text in this section refers to a DMB or a DSB, this means a DMB or DSB whose required access type is both loads and stores.

Note

These ordering requirements are extended from the requirements in AArch32 state given:

- [Ordering of cache and branch predictor maintenance instructions on page G3-4543](#).
- [AArch32 instruction cache maintenance instructions \(IC*\) on page G3-4536](#).

Performing cache maintenance instructions

To ensure all cache lines in a block of address space are maintained through all levels of cache ARM strongly recommends that software:

- For data or unified cache maintenance, uses the `CTR_EL0.DMinLine` value to determine the loop increment size for a loop of data cache maintenance by VA instructions.
- For instruction cache maintenance, uses the `CTR_EL0.IMinLine` value to determine the loop increment size for a loop of instruction cache maintenance by VA instructions.

Example code for cache maintenance instructions

The cache maintenance instructions by set/way can clean or invalidate, or both, the entirety of one or more levels of cache attached to a PE. However, unless all PEs attached to the caches regard all memory locations as Non-cacheable, it is not possible to prevent locations being allocated into the cache during such a sequence of the cache maintenance instructions.

———— Note ————

Since the set/way instructions are performed only locally, there is no guarantee of the atomicity of cache maintenance between different PEs, even if those different PEs are each executing the same cache maintenance instructions at the same time. Since any cacheable line can be allocated into the cache at any time, it is possible for a cache line to migrate from an entry in the cache of one PE to the cache of a different PE in a way that means the line is not affected by set/way based cache maintenance. Therefore, ARM strongly discourages the use of set/way instructions to manage coherency in coherent systems. The expected use of the cache maintenance instructions that operate by set/way is limited to the cache maintenance associated with the powerdown and powerup of caches, if this is required by the implementation.

The limitations of cache maintenance by set/way mean maintenance by set/way does not happen on multiple PEs, and cannot be made to happen atomically for each address on each PE. Therefore in multiprocessor or multithreaded systems, the use of cache maintenance by set/way to clean, or clean and invalidate, the entire cache for coherency management with very large buffers or with buffers with unknown address can fail to provide the expected coherency results because of speculation by other PEs, or possibly by other threads. The only way that these instructions can be used in this way is to first ensure that all PEs that might cause speculative accesses to caches that need to be maintained are not capable of generating speculative accesses. This can be achieved by ensuring that those PEs have no memory locations with a Normal Cacheable attribute. Such an approach can have very large system performance effects, and ARM advises implementers to use hardware coherency mechanisms in systems where this will be an issue.

[System level caches on page D3-1996](#) refers to other limitations of cache maintenance by set/way.

The following example code for cleaning a data or unified cache to the Point of Coherency illustrates a generic mechanism for cleaning the entire data or unified cache to the Point of Coherency.

```

MRS    X0, CLIDR_EL1
AND    W3, W0, #0x07000000    // Get 2 x Level of Coherence
LSR    W3, W3, #23
CBZ    W3, Finished
MOV    W10, #0                // W10 = 2 x cache level
MOV    W8, #1                 // W8 = constant 0b1
Loop1: ADD  W2, W10, W10, LSR #1 // Calculate 3 x cache level
LSR    W1, W0, W2             // extract 3-bit cache type for this level
AND    W1, W1, #0x7
CMP    W1, #2
B.LT  Skip                   // No data or unified cache at this level
MSR    CSSELR_EL1, X10       // Select this cache level
ISB                               // Synchronize change of CSSELR
MRS    X1, CCSIDR_EL1        // Read CCSIDR
AND    W2, W1, #7            // W2 = log2(lineLen)-4
ADD    W2, W2, #4            // W2 = log2(lineLen)
UBFX  W4, W1, #3, #10        // W4 = max way number, right aligned
CLZ   W5, W4                 // W5 = 32-log2(ways), bit position of way in DC operand
LSL   W9, W4, W5            // W9 = max way number, aligned to position in DC operand

```



```

    LSL    W16, W8, W5           // W16 = amount to decrement way number per iteration
Loop2:  UBFX   W7, W1, #13, #15 // W7 = max set number, right aligned
    LSL    W7, W7, W2           // W7 = max set number, aligned to position in DC operand
    LSL    W17, W8, W2         // W17 = amount to decrement set number per iteration
Loop3:  ORR    W11, W10, W9      // W11 = combine way number and cache number ...
    ORR    W11, W11, W7        // ... and set number for DC operand
    DC     CSW, X11            // Do data cache clean by set and way
    SUBS   W7, W7, W17         // Decrement set number
    B.GE   Loop3
    SUBS   X9, X9, X16         // Decrement way number
    B.GE   Loop2
Skip:   ADD    W10, W10, #2     // Increment 2 x cache level
    CMP    W3, W10
    DSB                                // Ensure completion of previous cache maintenance instruction
    B.GT   Loop1
Finished:
```

Similar approaches can be used for all cache maintenance instructions.

D3.4.9 Data cache zero instruction

The Data Cache Zero by Address instruction, [DC ZVA](#), writes 0b00 to each of a block of N bytes, aligned in memory to N bytes in size, where the block in memory is identified by the address passed. There are no alignment restrictions on the address supplied. The [DCZID_EL0](#) register indicates the block size that is written with byte values of zero.

Software can restrict access to this instruction. See [Configurable instruction enables and disables, and trap controls on page D1-1842](#).

If disabled, the operation at EL0 is trapped to EL1.

The DC ZVA instruction behaves as a set of stores to the location being accessed, and:

- Generates a Permission fault if the translation regime being used when the instruction is executed does not permit writes to the locations.
- Requires the same considerations for ordering and the management of coherency as any other store instruction.

In addition:

- When the instruction is executed, it can generate memory faults or watchpoints that are prioritized in the same way as other memory related faults or watchpoints. Where a synchronous Data Abort fault or a watchpoint is generated, the CM bit in the syndrome field is not set to 1, which would be the case for all other cache maintenance instructions. See [Exception from a Data abort on page D1-1811](#) for more information about the encoding of [ESR_ELx](#) and the associated ISS field.
- If the memory region being zeroed is any type of Device memory, then DC ZVA generates an Alignment fault which is prioritized in the same way as other alignment faults that are determined by the memory type.

Note

The architecture makes no statements about whether or not a [DC ZVA](#) instruction causes allocation to any particular level of the cache, for addresses that have a cacheable attribute for those levels of cache.

D3.4.10 Cache lockdown

The concept of an entry locked in a cache is allowed, but not architecturally defined. How lockdown is achieved is IMPLEMENTATION DEFINED and might not be supported by:

- An implementation.
- Some memory attributes.

An unlocked entry in a cache might not remain in that cache. The architecture does not guarantee that an unlocked cache entry remains in the cache or remains incoherent with the rest of memory. Software must not assume that an unlocked item that remains in the cache remains dirty.

A locked entry in a cache is guaranteed to remain in that cache. The architecture does not guarantee that a locked cache entry remains incoherent with the rest of memory, that is, it might not remain dirty.

The interaction of cache lockdown with cache maintenance instructions

The interaction of cache lockdown and cache maintenance instructions is IMPLEMENTATION DEFINED. However, an architecturally-defined cache maintenance instruction on a locked cache line must comply with the following general rules:

- The effect of the following instructions on locked cache entries is IMPLEMENTATION DEFINED:
 - Cache clean by set/way, [DC CSW](#).
 - Cache invalidate by set/way, [DC ISW](#).
 - Cache clean and invalidate by set/way, [DC CISW](#).
 - Instruction cache invalidate all, [IC IALLU](#) and [IC IALLUIS](#).

However, one of the following approaches must be adopted in all these cases:

1. If the instruction specified an invalidation, a locked entry is not invalidated from the cache.
2. If the instruction specified a clean it is IMPLEMENTATION DEFINED whether locked entries are cleaned.
3. If an entry is locked down, or could be locked down, an IMPLEMENTATION DEFINED Data Abort exception is generated, using DFSC value defined for this purpose. See [Exception from a Data abort on page D1-1811](#).

This permits a usage model for cache invalidate routines to operate on a large range of addresses by performing the required operation on the entire cache, without having to consider whether any cache entries are locked.

The effect of the following instructions is IMPLEMENTATION DEFINED:

- Cache clean by virtual address, [DC CVAC](#), [DC CVAP](#), and [DC CVAU](#).
- Cache invalidate by virtual address, [DC IVAC](#).
- Cache clean and invalidate by virtual address, [DC CIVAC](#).

However, one of the following approaches must be adopted in all these cases:

1. If the instruction specified an invalidation, a locked entry is invalidated from the cache. For the clean and invalidate instructions, the entry must be cleaned before it is invalidated.
2. If the instruction specified an invalidation, a locked entry is not invalidated from the cache. If the instruction specified a clean it is IMPLEMENTATION DEFINED whether locked entries are cleaned.
3. If an entry is locked down, or could be locked down, an IMPLEMENTATION DEFINED Data Abort exception is generated, using the DFSC value defined for this purpose. See [ESR_ELx on page K11-6285](#).

In an implementation that includes EL2, if [HCR_EL2.TIDCP](#) is set to 1, any exception relating to lockdown of an entry associated with Non-secure memory is routed to EL2.

———— **Note** ————

An implementation that uses an abort mechanism for entries that can be locked down but are not actually locked down must:

- Document the IMPLEMENTATION DEFINED instruction sequences that perform the required operations on entries that are not locked down.
- Implement one of the other permitted alternatives for the locked entries.

ARM recommends that, when possible, such IMPLEMENTATION DEFINED instruction sequences use architecturally-defined instructions. This minimizes the number of customized instructions required.

In addition, an implementation that uses an abort to handle cache maintenance instructions for entries that might be locked must provide a mechanism that ensures that no entries are locked in the cache.

The reset setting of the cache must be that no cache entries are locked.

Additional cache functions for the implementation of lockdown

An implementation can add additional cache maintenance functions for the handling of lockdown in the IMPLEMENTATION DEFINED spaces reserved for Cache Lockdown, see [Reserved encodings for IMPLEMENTATION DEFINED registers on page C5-334](#).

D3.4.11 System level caches

The ARM Architecture defines a *system cache* as a cache that is not described in the PE Cache Identification registers, [CCSIDR_EL1](#) and [CLIDR_EL1](#), and for which the set/way cache maintenance instructions do not apply.

Conceptually, three classes of system cache can be envisaged:

1. System caches which lie before the point of coherency and cannot be managed by any cache maintenance instructions. Such systems fundamentally undermine the concept of cache maintenance instructions operating to the point of coherency, as they imply the use of non-architecture mechanisms to manage coherency. The use of such systems in the ARM architecture is explicitly prohibited.
2. System caches which lie before the point of coherency and can be managed by cache maintenance by address instructions that apply to the point of coherency, but cannot be managed by cache maintenance by set/way instructions. Where maintenance of the entirety of such a cache must be performed, as in the case for power management, it must be performed using non-architectural mechanisms.
3. System caches which lie beyond the point of coherency and so are invisible to the software. The management of such caches is outside the scope of the architecture.

D3.4.12 Branch prediction

ARMv8 does not define any branch predictor maintenance instructions for AArch64 state.

If branch prediction is architecturally visible, cache maintenance must also apply to branch prediction.

D3.5 External aborts

The ARM architecture defines external aborts as errors that occur in the memory system, other than those that are detected by the MMU or debug logic. External aborts include parity or ECC errors detected by the caches or other parts of the memory system. For example, an uncorrectable parity or ECC failure on a Level 2 memory structure might generate an external abort.

An external abort is one of the following:

- Synchronous.
- Precise asynchronous.
- Imprecise asynchronous.

For more information, see [Exception terminology on page D1-1777](#).

The ARM architecture does not provide any method to distinguish between precise asynchronous and imprecise asynchronous external aborts.

VMSAv8-64 permits external aborts on data accesses, translation table walks, and instruction fetches to be either synchronous or asynchronous.

It is IMPLEMENTATION DEFINED which external aborts, if any, are supported. Asynchronous aborts are taken as SError interrupt exceptions. See [Asynchronous exception types, routing, masking and priorities on page D1-1834](#).

Synchronous external aborts are reported using the Instruction Abort and Data Abort exceptions. See [Synchronous exception types, routing and priorities on page D1-1826](#).

Normally, external aborts are rare. An imprecise asynchronous external abort is likely to be fatal to the process that is running, ARM recommends that implementations make external aborts precise wherever possible.

The following subsections give more information about possible external aborts:

- [External abort on an instruction fetch](#).
- [External abort on data read or write](#).
- [Provision for the classification of external aborts](#).
- [Parity or ECC error reporting on page D3-1998](#).

D3.5.1 External abort on an instruction fetch

An external abort on an instruction fetch can be either synchronous or asynchronous.

A synchronous external abort on an instruction fetch is taken precisely using the Instruction Abort exception.

An implementation can report the external abort asynchronously from the instruction that it applies to. In such an implementation the abort is taken using the SError interrupt exception.

D3.5.2 External abort on data read or write

Externally-generated errors that occur during a data read or write can be either synchronous or asynchronous.

A synchronous external abort on a data read or write is taken precisely using the Data Abort exception.

An implementation can report the external abort asynchronously from the instruction that generated the access. In such an implementation the abort is taken using the SError interrupt exception.

D3.5.3 Provision for the classification of external aborts

In AArch64 state, an implementation can use `ESR_ELx.EA, ISS[9]`, to provide more information about synchronous external aborts. For more information, see [Exception from an Instruction abort on page D1-1811](#) and [Exception from a Data abort on page D1-1811](#).

For all aborts other than synchronous external aborts reported using the EC values `0x20`, `0x21`, `0x24`, and `0x25`, `ESR_ELx.EA, ISS[9]`, returns a value of 0.

D3.5.4 Parity or ECC error reporting

The ARM architecture supports the reporting of both synchronous and asynchronous parity or ECC errors from the cache system. It is IMPLEMENTATION DEFINED what parity or ECC errors in the cache systems, if any, result in synchronous or asynchronous parity or ECC errors.

A fault code is defined for reporting parity or ECC errors, see [Use of the ESR_EL1, ESR_EL2, and ESR_EL3 on page D1-1801](#). However, when parity or ECC error reporting is implemented, it is IMPLEMENTATION DEFINED whether a parity or ECC error is reported using the assigned fault code or using another appropriate encoding.

For all purposes other than the Fault status encoding, parity or ECC errors are treated as external aborts.

D3.6 Memory barrier instructions

[Memory barriers on page B2-92](#) describes the memory barrier instructions. This section describes the system level controls of those instructions.

D3.6.1 EL2 control of the shareability of data barrier instructions executed at Non-secure EL0 or EL1

In an implementation that includes EL2 and supports shareability limitations on the data barrier instructions, the [HCR_EL2.BSU](#) field can modify the required shareability of an instruction that is executed at EL0 or EL1 in Non-secure state. [Table D3-7](#) shows the encoding of this field.

Table D3-7 EL2 control of shareability of barrier instructions executed at Non-secure EL0 or EL1

HCR_EL2.BSU	Minimum shareability of barrier instructions
00	No effect, shareability is as specified by the instruction
01	Inner Shareable
10	Outer Shareable
11	Full system

For an instruction executed at EL0 or EL1 in Non-secure state, [Table D3-8](#) shows how the [HCR_EL2.BSU](#) is combined with the shareability specified by the argument of the DMB or DSB instruction to give the scope of the instruction.

Table D3-8 Effect of HCR_EL2.BSU on barrier instructions executed at Non-secure EL1 or EL0

Shareability specified by the DMB or DSB argument	HCR_EL2.BSU	Resultant shareability
Full system	Any	Full system
	00, 01, or 10	Outer Shareable
Outer Shareable	11, Full system	Full system
	00 or 01	Inner Shareable
	10, Outer Shareable	Outer Shareable
Inner Shareable	11, Full system	Full system
	00, No effect	Non-shareable
	01, Inner Shareable	Inner Shareable
	10, Outer Shareable	Outer Shareable
Non-shareable	11, Full system	Full system

D3.7 Pseudocode description of general memory system instructions

This section lists the pseudocode describing general memory operations:

- [Memory data type definitions](#).
- [Basic memory access](#).
- [Aligned memory access](#).
- [Unaligned memory access](#) on page D3-2001.
- [Exclusives monitors operations](#) on page D3-2001.
- [Access permission checking](#) on page D3-2002.
- [Abort exceptions](#) on page D3-2002.
- [Memory barriers](#) on page D3-2002.

D3.7.1 Memory data type definitions

This section lists the memory data types.

The memory data types are:

- Address descriptor, defined by the [AddressDescriptor](#) type.
- Full address, defined by the [FullAddress](#) type.
- Memory attributes, defined by the [MemoryAttributes](#) type.
- Memory type, defined by the [MemType](#) enumeration.
- Device memory type, defined by the [DeviceType](#) enumeration.
- Normal memory attributes, defined by the [MemAttrHints](#) type.
- Cacheability attributes, defined by the [MemAttr_NC](#), [MemAttr_WT](#), and [MemAttr_WB](#) constants.
- Allocation hints, defined by the [MemHint_No](#), [MemHint_WA](#), [MemHint_RA](#), and [MemHint_RWA](#) constants.
- Access permissions, defined by the [Permissions](#) type.

These types are defined in [Chapter J1 ARMv8 Pseudocode](#).

D3.7.2 Basic memory access

The two forms of the `_Mem[]` accessor, non-assignment (memory read) `_Mem[]` and assignment (memory write) `_Mem[]`, are the operations that perform single-copy atomic, aligned, little-endian memory accesses of size bytes to or from the underlying physical memory array of bytes.

The functions address the array using `desc.paddress`, that supplies:

- The physical address.
- An NS bit that selects between the Secure and Non-secure parts of the array.

The attributes in `desc.memattrs` are used by the memory system to determine caching and ordering behaviors as described in [Memory types and attributes](#) on page B2-107, [Ordering and observability](#) on page B2-87, and [Atomicity in the ARM architecture](#) on page B2-82.

An additional parameter to the `_Mem[]` accessor defines the access type, for example normal, exclusive, ordered, or streaming, and whether the access is made as part of a translation table walk.

The actual implemented array of memory might be smaller than the permitted 2^{48} bytes **or, in an implementation that includes ARMv8.2-LPA, 2^{52} bytes**. In this case the scheme for aliasing is IMPLEMENTATION DEFINED, or some parts of the address space might give rise to external aborts or a System Error.

`PAMax()` returns the IMPLEMENTATION DEFINED size of the physical address.

D3.7.3 Aligned memory access

The two `MemSingle[]` accessors, non-assignment (memory read) `AArch64.MemSingle[]` and assignment (memory write) `AArch64.MemSingle[]`, make atomic, little-endian accesses of size bytes. These functions are defined in [Chapter J1 ARMv8 Pseudocode](#).

D3.7.4 Unaligned memory access

The two `Mem[]` accessors, Non-assignment (memory read) `Mem[]` and Assignment (memory write) `Mem[]`, make accesses of the required type. If an access is not architecturally defined to be atomic, `Mem[]` synthesizes accesses from multiple calls to `AArch64.MemSingle[]`. It also reverses the byte order if the access is big-endian.

The `AArch64.CheckAlignment()` function checks the alignment of memory accesses.

D3.7.5 Exclusives monitors operations

The `AArch64.SetExclusiveMonitors()` function sets the Exclusives monitors for a block of bytes, the size of which is determined by `size`, at the virtual address defined by `address`.

The `AArch64.ExclusiveMonitorsPass()` function checks whether the Exclusives monitors are set to include the location of a number of bytes specified by `size`, at the virtual address defined by `address`. The atomic write that follows after the Exclusives monitors have been set must be to the same physical address. It is permitted, but not required, for this function to return `FALSE` if the virtual address is not the same as that used in the previous call to `AArch64.SetExclusiveMonitors()`.

The `ExclusiveMonitorsStatus()` function returns 0 if the previous atomic write was to the same physical memory locations selected by `AArch64.ExclusiveMonitorsPass()` and therefore succeeded. Otherwise the function returns 1, indicating that the address translation delivered a different physical address.

The `MarkExclusiveGlobal()` procedure takes as arguments a `FullAddress` `address`, the PE identifier `processorid` and the size of the transfer. The procedure records that the PE `processorid` has requested exclusive access covering at least `size` bytes from `address`. The size of the location marked as exclusive is IMPLEMENTATION DEFINED, up to a limit of 2KB and no smaller than two words, and aligned in the address space to the size of the location. It is CONSTRAINED UNPREDICTABLE whether this causes any previous request for exclusive access to any other address by the same PE to be cleared.

The `MarkExclusiveLocal()` procedure takes as arguments a `FullAddress` `address`, the PE identifier `processorid` and the size of the transfer. The procedure records in a local record that PE `processorid` has requested exclusive access to an address covering at least `size` bytes from `address`. The size of the location marked as exclusive is IMPLEMENTATION DEFINED, and can at its largest cover the whole of memory but is no smaller than two words, and is aligned in the address space to the size of the location. It is IMPLEMENTATION DEFINED whether this procedure also performs a `MarkExclusiveGlobal()` using the same parameters.

The `IsExclusiveGlobal()` function takes as arguments a `FullAddress` `address`, the PE identifier `processorid` and the size of the transfer. The function returns `TRUE` if the PE `processorid` has marked in a global record an address range as exclusive access requested that covers at least `size` bytes from `address`. It is IMPLEMENTATION DEFINED whether it returns `TRUE` or `FALSE` if a global record has marked a different address as exclusive access requested. If no address is marked in a global record as exclusive access, `IsExclusiveGlobal()` returns `FALSE`.

The `IsExclusiveLocal()` function takes as arguments a `FullAddress` `address`, the PE identifier `processorid` and the size of the transfer. The function returns `TRUE` if the PE `processorid` has marked an address range as exclusive access requested that covers at least the `size` bytes from `address`. It is IMPLEMENTATION DEFINED whether this function returns `TRUE` or `FALSE` if the address marked as exclusive access requested does not cover all of `size` bytes from `address`. If no address is marked as exclusive access requested, then this function returns `FALSE`. It is IMPLEMENTATION DEFINED whether this result is ANDed with the result of `IsExclusiveGlobal()` with the same parameters.

The `ClearExclusiveByAddress()` procedure takes as arguments a `FullAddress` `address`, the PE identifier `processorid` and the size of the transfer. The procedure clears the global records of all PEs, other than `processorid`, for which an address region including any of `size` bytes starting from `address` has had a request for an exclusive access. It is IMPLEMENTATION DEFINED whether the equivalent global record of the PE `processorid` is also cleared if any of `size` bytes starting from `address` has had a request for an exclusive access, or if any other address has had a request for an exclusive access.

The `ClearExclusiveLocal()` procedure takes as arguments the PE identifier `processorid`. The procedure clears the local record of PE `processorid` for which an address has had a request for an exclusive access. It is IMPLEMENTATION DEFINED whether this operation also clears the global record of PE `processorid` that an address has had a request for an exclusive access.

These functions are defined in [Chapter J1 ARMv8 Pseudocode](#).

D3.7.6 Access permission checking

The function [AArch64.CheckPermission\(\)](#) is used by the architecture to perform access permission checking based on attributes derived from the translation tables or location descriptors. It returns the result of the call to [AArch64.NoFault\(\)](#).

These functions are defined in [Chapter J1 ARMv8 Pseudocode](#).

The interpretation of access permission is shown in [Memory access control on page D4-2071](#).

D3.7.7 Abort exceptions

The function [AArch64.Abort\(\)](#) generates either a Data Abort or an Instruction Abort exception by calling [AArch64.DataAbort\(\)](#) or [AArch64.InstructionAbort\(\)](#). It also can generate a debug exception for debug related faults, see [Chapter D2 AArch64 Self-hosted Debug](#).

The function [AArch64.DataAbort\(\)](#) generates a Data Abort exception, routes the exception to EL2 or EL3, and records the information required for the Exception Syndrome registers, [ESR_ELx](#). See [Exception from a Data abort on page D1-1811](#). A second stage abort might also record the intermediate physical address, IPA, but this depends on the type of the abort.

For a synchronous abort, [AArch64.DataAbort\(\)](#) also sets the FAR to the VA of the abort.

The function [AArch64.InstructionAbort\(\)](#) generates an Instruction Abort exception, routes the exception to EL2 or EL3, and records the information required for the Exception Syndrome registers, [ESR_ELx](#). See [Exception from an Instruction abort on page D1-1811](#). A second stage abort might also record the intermediate physical address, IPA, but this depends on the type of the abort.

For a synchronous abort, [AArch64.InstructionAbort\(\)](#) also sets the FAR to the VA of the abort.

The [FaultRecord](#) type describes a fault. Functions that check for faults return a record of this type appropriate to the type of fault. [Pseudocode description of the MMU faults on page D4-2112](#) provides a number of wrappers to generate [FaultRecords](#).

The function [AArch64.NoFault\(\)](#) returns a null record that indicates no fault. The [IsFault\(\)](#) function tests whether a [FaultRecord](#) contains a fault.

D3.7.8 Memory barriers

The definition for the memory barrier functions is given by the enumerations [MBReqDomain](#) and [MBReqTypes](#).

These enumerations define the required shareability domains and required access types used as arguments for DMB and DSB instructions.

The procedures [DataMemoryBarrier](#), [DataSynchronizationBarrier](#), and [InstructionSynchronizationBarrier](#) perform the memory barriers.

Chapter D4

The AArch64 Virtual Memory System Architecture

This chapter provides a system level view of the AArch64 *Virtual Memory System Architecture* (VMSAv8-64), the memory system architecture of an ARMv8 implementation that is executing in AArch64 state. It contains the following sections:

- *About the Virtual Memory System Architecture (VMSA)* on page D4-2004.
- *The VMSAv8-64 address translation system* on page D4-2008.
- *VMSAv8-64 translation table format descriptors* on page D4-2060.
- *Memory access control* on page D4-2071.
- *Memory region attributes* on page D4-2090.
- *Virtualization Host Extensions* on page D4-2098.
- *MMU faults* on page D4-2103.
- *Translation Lookaside Buffers (TLBs)* on page D4-2113.
- *TLB maintenance requirements and the TLB maintenance instructions* on page D4-2119.
- *Caches in a VMSAv8-64 implementation* on page D4-2133.

D4.1 About the Virtual Memory System Architecture (VMSA)

This chapter describes the ARMv8 *Virtual Memory System Architecture* (VMSA), and in particular how it applies to a PE that is executing in AArch64 state. In this state the PE is using VMSAv8-64, as defined in [ARMv8 VMSA naming](#). See [The ARMv8 VMSA when some Exception levels are using AArch32](#) for information about the VMSA in other contexts.

A VMSA provides a *Memory Management Unit* (MMU), that controls address translation, access permissions, and memory attribute determination and checking, for memory accesses made by the PE. The process of address translation maps the *virtual addresses* (VAs) used by the PE onto the *physical addresses* (PAs) of the physical memory system. The mapping of a VA to a PA requires either a single stage of translation, or two sequential stages of translation.

The translations are defined independently for different Exception levels and Security states, as described in [The VMSAv8-64 address translation system on page D4-2008](#).

VMSAv8-64 supports tagging of VAs, as described in [Address tagging in AArch64 state on page D4-2006](#). As that section describes, this address tagging has no effect on the address translation process.

The remainder of this chapter gives a full description of VMSAv8-64 for an implementation that includes all of the Exception levels. [The implemented Exception levels and the resulting translation stages and regimes on page D4-2012](#) describes the differences in the VMSA if some Exception levels are not implemented.

D4.1.1 ARMv8 VMSA naming

The ARMv8 VMSA naming model reflects the possible stages of address translation, as follows:

- VMSAv8** The overall translation scheme, within which an address translation has one or two stages.
- VMSAv8-32** The translation scheme for a single stage of address translation that is managed from an Exception level that is using AArch32.
VMSAv8-32 is sometimes used to refer to the two stages of translation used to map a VA to a PA, where each stage is managed from an Exception level that is using AArch32.
- VMSAv8-64** The translation scheme for a single stage of address translation that is managed from an Exception level that is using AArch64.
VMSAv8-64 is sometimes used to refer to the two stages of translation used to map a VA to a PA, where each stage is managed from an Exception level that is using AArch64.

D4.1.2 The ARMv8 VMSA when some Exception levels are using AArch32

As stated at the start of the chapter, this chapter describes VMSAv8-64, the ARMv8 VMSA that applies to an Exception level that is using AArch64. However, when a higher Exception level is using AArch64, and therefore using VMSAv8-64, lower Exception levels can be using AArch32. [Chapter G4 The AArch32 Virtual Memory System Architecture](#) describes VMSAv8-32, meaning it describes:

- The translation stages and translation regimes when EL3 is using AArch32.
- Any stages of address translation that are using VMSAv8-32 when EL3 is using AArch64.

However, a PE can be executing at EL0 using AArch32 when the next higher Exception level is using AArch64, for example when EL0 is using AArch32 and EL1 is using AArch64. When this is the case execution at EL0 uses a VMSAv8-64 translation regime as described in [Constraints on accesses from EL0 when EL0 is using AArch32 on page D4-2010](#).

D4.1.3 VMSA address types and address spaces

A description of the VMSA refers to the following address types.

———— **Note** —————

These descriptions relate to the VMSAv8 description and therefore give more detail than the generic definitions given in the glossary.

———— **Virtual address (VA)** ————

An address used in an instruction, as a data or instruction address, is a Virtual Address (VA).

———— **Note** —————

This means that an address held in the PC, LR, SP, or an ELR, is a VA.

In AArch64 state, the VA has a maximum address width of either 48 bits or, when ARMv8.2-LVA is implemented and the 64KB translation granule is used, 52 bits. As *About address translation and supported input address ranges* on page D4-2011 describes, a stage of address translation can support one or two VA ranges:

Translation stage with a single VA range

For a translation stage that supports a single VA range, a 48-bit VA width gives a VA range of 0x0000000000000000 to 0x000FFFFFFFFFFFFF.

If ARMv8.2-LVA is implemented and the 64KB translation granule is used, for a translation regime that supports a single VA range, the 52-bit VA width gives a VA range of 0x0000000000000000 to 0x000FFFFFFFFFFFFF.

Translation stage with two VA ranges

For a translation stage that supports two VA subranges, one at the bottom of the full 64-bit address range, and one at the top, as follows:

- The bottom VA range runs up from address 0x0000000000000000. With a maximum VA width of 48 bits this gives a VA range of 0x0000000000000000 to 0x000FFFFFFFFFFFFF. With a maximum VA width of 52 bits this gives a VA range of 0x0000000000000000 to 0x000FFFFFFFFFFFFF.
- The top VA subrange runs up to address 0xFFFFFFFFFFFFFFFF. With a maximum VA width of 48 bits this gives a VA range of 0xFFFF000000000000 to 0xFFFFFFFFFFFFFFFF. With a maximum VA width of 52 bits this gives a VA range of 0xFFFF000000000000 to 0xFFFFFFFFFFFFFFFF.

Reducing the VA width for this subrange increases the bottom address of the range.

A 48-bit VA range corresponds to an address space of 256TB. A 52-bit VA range corresponds to an address space of 4PB.

Each translation regime that takes a VA as an input address can be configured to support fewer than the maximum number of bits of VA space, see *Address size configuration* on page D4-2014.

———— **Intermediate physical address (IPA)** ————

In a translation regime that provides two stages of address translation, the IPA is:

- The OA from the stage 1 translation.
- The IA for the stage 2 translation.

In a translation regime that provides only one stage of address translation, the IPA is identical to the PA. Alternatively, the translation regime can be considered as having no concept of IPAs.

For more information about maximum address widths, see *Address size configuration* on page D4-2014.

Physical address (PA)

The address of a location in a physical memory map. That is, an output address from the PE to the memory system.

The EL3 and Secure EL1 Exception levels provide independent definitions of the PA spaces for Secure and Non-secure operation. This means they provide two independent address spaces, where:

- A VA accessed in Secure state can be translated to either the Secure or the Non-secure PA space.
- When in Non-secure state, a VA is always mapped to the Non-secure PA space.

For more information about maximum address widths, see [Address size configuration on page D4-2014](#).

D4.1.4 Address tagging in AArch64 state

In AArch64 state, the ARMv8 architecture supports the tagging of addresses. In these cases the top eight bits of the VA are ignored when determining:

- If the translation system is enabled, whether the address is out of range and therefore causes a Translation fault.
- If the translation system is not enabled, whether the address is out of range and therefore causes an Address size fault.
- Whether the address requires invalidation when performing a TLB invalidation instruction by address.

The use of address tags is controlled as follows:

For addresses using a stage 1 translation that supports two VA ranges

The value of bit[55] of the VA determines the register bit that controls the use of address tags, as follows:

VA[55]==0 TCR_ELx.TBI0 determines whether address tags are used. If stage 1 translation is enabled, TTBR0_ELx holds the base address of the translation tables used to translate the address.

VA[55]==1 TCR_ELx.TBI1 determines whether address tags are used. If stage 1 translation is enabled, TTBR1_ELx holds the base address of the translation tables used to translate the address.

For addresses using a stage 1 translation that supports a single VA range

TCR_ELx.TBI determines whether address tags are used. If stage 1 translation is enabled, TTBR0_ELx holds the base address of the translation tables used to translate the address.

———— Note —————

The TCR_ELx.TBI{n} bit determines whether address tags are used regardless of whether the corresponding translation regime is enabled.

An address tag enable bit also has an effect on the PC value in the following cases:

- On taking an exception to the controlled Exception level, regardless of whether this is also the Exception level from which the exception was taken.
- Any branch within the controlled Exception level, unless that branch generates an Illegal exception return.
- On performing an exception return that is not an Illegal exception return to the controlled Exception level, regardless of whether this is also the Exception level from which the exception return was performed.

———— Note —————

On an Illegal exception return, bits[63:32] of the PC become UNKNOWN.

- Exiting from debug state to the controlled Exception level.

Note

As an example of what is meant by the *controlled Exception level*, [TCR_EL3](#).TBI controls this effect for:

- A branch or procedure return within EL3.
 - Taking an exception to EL3.
 - Performing an exception return or a debug state exit to EL3.
-

The effect of the controlling TBI{n} bit is:

For a translation regime where the stage 1 translation supports two VA ranges

If the controlling TBI{n} bit for the address being loaded into the PC is set to 1, then bits[63:56] of the PC are forced to be a sign-extension of bit[55] of that address.

For a translation regime where the stage 1 translation supports a single VA range

If the controlling TBI bit for the address being loaded into the PC is set to 1, then bits[63:56] of the PC are forced to be 0x00.

The [AddrTop\(\)](#) pseudocode function shows the algorithm determining the most significant bit of the VA, and therefore whether the VA is using tagging. For a translation regime where the stage 1 translation supports two VA ranges, this pseudocode includes the selection between [TTBR0_ELx](#) and [TTBR1_ELx](#) described in [Selection between TTBR0_ELx and TTBR1_ELx when two VA ranges are supported on page D4-2045](#).

Note

The required behavior prevents a tagged address being propagated to the program counter.

When address tagging is enabled for an address that causes a Data Abort or a Watchpoint, the address tag is included in the VA returned in the [FAR](#).

D4.2 The VMSAv8-64 address translation system

The following subsections describe the VMSAv8-64 address translation system, that maps VAs to PAs:

- [About the VMSAv8-64 address translation system.](#)
- [Controlling address translation stages on page D4-2012.](#)
- [Memory translation granule size on page D4-2021.](#)
- [Translation tables and the translation process on page D4-2026.](#)
- [Overview of the VMSAv8-64 address translation stages on page D4-2030.](#)
- [The VMSAv8-64 translation table format on page D4-2042.](#)
- [The algorithm for finding the translation table descriptors on page D4-2049.](#)
- [The effects of disabling a stage of address translation on page D4-2053.](#)
- [The implemented Exception levels and the resulting translation stages and regimes on page D4-2012.](#)
- [Pseudocode description of VMSAv8-64 address translation on page D4-2055.](#)
- [Address translation instructions on page D4-2056.](#)

Related to this:

- [VMSAv8-64 translation table format descriptors on page D4-2060](#) describes the translation table entries.
- [Memory region attributes on page D4-2090](#) describes the attributes that are held in the translation table entries, including how different attributes can interact.
- [Translation Lookaside Buffers \(TLBs\) on page D4-2113](#) describes the caching of translation table lookups in TLBs, and the architected instructions for maintaining TLBs.
- [AArch64 Address translation examples on page K6-6180](#) gives detailed descriptions of typical examples of translating a VA to a final PA, and obtaining the memory attributes of that PA.

D4.2.1 About the VMSAv8-64 address translation system

The *Memory Management Unit* (MMU) controls address translation, memory access permissions, and memory attribute determination and checking, for memory accesses made by the PE.

The general model of MMU operation is that the MMU takes information about a required memory access, including an *input address* (IA), and either:

- Returns an associated *output address* (OA), and the *memory attributes* for that address.
- Is unable to perform the translation for one of a number of reasons, and therefore causes an exception to be generated. This exception is called an MMU fault. System registers are used to report any MMU faults that occur.

The process of mapping an IA to an OA is an *address translation*, or more precisely a single stage of address translation.

When using a VMSA, a *translation regime* maps a VA to a PA using one or two stages of translation, and:

- [The AArch64 translation regimes on page D4-2009](#) defines the translation regimes.
- [VMSA address types and address spaces on page D4-2005](#) give more information about VAs and PAs.

The *translation granule* specifies the granularity of the mapping from IA to OA. That is, it defines both:

- The *page size* for a stage of address translation, where a page is the smallest block of memory for which an IA to OA mapping can be specified.
- The size of a complete translation table for that stage of address translation.

The MMU is controlled by System registers, that provide independent control of each address translation stage, including a control to disable the stage of address translation. [The effects of disabling a stage of address translation on page D4-2053](#) defines how the MMU handles an access for which a required address translation stage is disabled.

This section describes the address translation system for an implementation that includes all of the Exception levels, and gives a complete description of translations that are controlled by an Exception level that is using AArch64. In addition:

- [The ARMv8 VMSA when some Exception levels are using AArch32 on page D4-2004](#) gives information about the VMSA when some Exception levels are using AArch32.
- [The implemented Exception levels and the resulting translation stages and regimes on page D4-2012](#) describes the effect on the address translation model when some Exception levels are not implemented.

Each enabled stage of address translation uses a set of address translations and associated memory properties held in memory mapped tables called *translation tables*. A single translation table lookup can resolve only a limited number of bits of the IA, and therefore a single address translation can require multiple lookups. These are described as different *levels* of lookup.

Translation table entries can be cached in a *Translation Lookaside Buffer* (TLB).

As well as defining the OA that corresponds to the IA, the translation table entries define the following properties:

- For accesses made from Secure state, whether the access is to the Secure or Non-secure address map.
- Memory access permissions.
- Memory region attributes.

For more information, see [Memory attribute fields in the VMSAv8-64 translation table format descriptors on page D4-2064](#).

The following subsections give more information:

- [The AArch64 translation regimes](#).
- [About address translation and supported input address ranges on page D4-2011](#).
- [The VMSAv8-64 translation table format on page D4-2011](#).

The AArch64 translation regimes

The architecture defines a number of *translation regimes*, where a translation regime comprises either:

- A single stage of address translation.
This maps an input VA to an output PA.
- Two, sequential, stages of address translation, where:
 - Stage 1 maps an input VA to an output IPA.
 - Stage 2 maps an input IPA to an output PA.

[Figure D4-1](#) shows these translation stages and translation regimes when EL3 is using AArch64.

Translation regimes, when EL3 is using AArch64

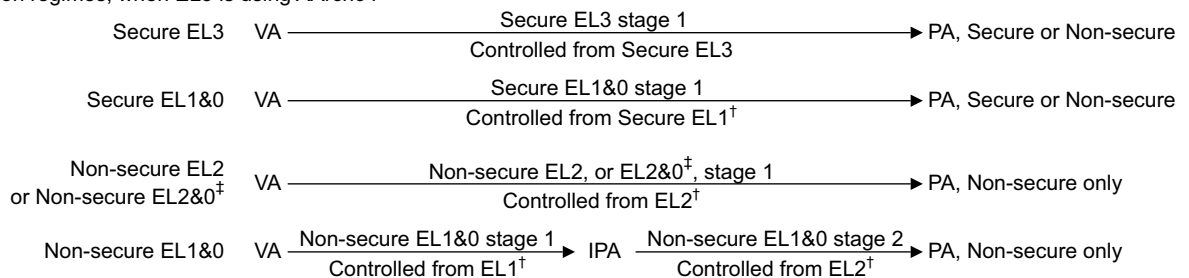

[†] Typically controlled from this Exception level, but also accessible from higher Exception levels

[‡] Non-secure EL2&0 when the implementation includes ARMv8.1-VHE and the value of HCR_EL2.E2H is 1, otherwise Non-secure EL2.

Figure D4-1 VMSAv8 AArch64 translation regimes, translation stages, and associated controls

This means that in VMSAv8-64 the set of translation regimes is:

The Secure EL3 translation regime

This has a single stage of translation, stage 1, that maps VAs to PAs and supports a single VA range.

The Non-secure EL2 translation regime

This has a single stage of translation, stage 1, that maps VAs to PAs and supports a single VA range.

In an implementation that:

- Does not include [ARMv8.1-VHE](#) this regime is used for all memory accesses from EL2.
- Includes [ARMv8.1-VHE](#), this regime is used for memory accesses from EL2 only when the value of [HCR_EL2.E2H](#) is 0.

The Non-secure EL2&0 translation regime

This has a single stage of translation, stage 1, that maps VAs to PAs and supports two VA ranges and the use of [ASIDs](#). It is supported only by implementations that include [ARMv8.1-VHE](#), and is used:

- For memory accesses from EL2 when the value of [HCR_EL2.E2H](#) is 1.
- For memory accesses from EL0 when the value of [HCR_EL2](#).{E2H, TGE} is {1, 1}.

The Secure EL1&0 translation regime

This has a single stage of translation, stage 1, that maps VAs to PAs and supports two VA ranges and the use of [ASIDs](#).

The Non-secure EL1&0 translation regime

If cached in a TLB, a translation table lookup for this regime is associated with the [VMID](#) that identifies the current *virtual machine*. This regime has two stages of lookup:

Stage 1 Maps VAs to IPAs. This stage supports two VA ranges and the use of [ASIDs](#).

Stage 2 Maps IPAs to PAs. This stage supports a single IPA range.

An MMU fault might be generated by a particular stage of translation. An MMU fault is described as either a stage 1 MMU fault or a stage 2 MMU fault.

Note

- In the ARM architecture, a software agent, such as an operating system, that uses or defines stage 1 memory translations, might be unaware of the second stage of translation, and of the distinction between [IPA](#) and [PA](#).
- A more generalized description of the translation regimes is that a regime always comprises two sequential stages of translation, but in some regimes the stage 2 translation both:
 - Returns an OA that equals the IA. This is called a *flat mapping* of the IA to the OA.
 - Does not change the memory attributes returned by the stage 1 address translation.

Constraints on accesses from EL0 when EL0 is using AArch32

ARMv8 permits execution with EL0 using AArch32 when the next higher Exception level is using AArch64. This happens in the following situations:

- EL1 is using AArch64. Execution at EL0 using AArch32 uses the VMSAv8-64 EL1&0 translation regime.
- EL2 is using AArch64 and the *Effective value* of [HCR_EL2](#).{E2H, TGE} is {0, 1} or {1, 0}. Execution at EL0 using AArch32 uses the VMSAv8-64 EL1&0 translation regime.
- In an implementation that includes [ARMv8.1-VHE](#), EL2 is using AArch64 and the value of [HCR_EL2](#).{E2H, TGE} is {1, 1}. Execution at EL0 using AArch32 uses the VMSAv8-64 EL2&0 translation regime.

In this case, accesses from EL0 using AArch32 are using:

- The stated VMSAv8-64 translation regime, EL1&0 or EL2&0.
- The AArch32 memory model.

In particular, this means the accesses from EL0 are limited to a 32-bit VA range.

About address translation and supported input address ranges

For a single stage of address translation, a *Translation table base register (TTBR_ELx)* indicates the start of the first translation table required for a mapping from input address (IA) to output address (OA). For a stage of address translation that supports two VA ranges each VA range is an independent mapping from IA to OA. This means that each implemented translation stage shown in *VMSAv8 AArch64 translation regimes, translation stages, and associated controls* on page D4-2009 requires:

- Two associated sets of translation tables if it supports two IA ranges.
- One associated set of translation tables if it supports a single IA range.

Note

- Stage 2 translations never support two IA ranges. This means that, for the translation stages that support two IA ranges the IA is always a VA.
- *Example use of the split VA range, and the TTBR0_ELx and TTBR1_ELx controls* on page D4-2046 shows how two supported VA ranges might be used.

Controlling address translation stages on page D4-2012 summarizes the System registers that control address translation by the MMU, and *Selection between TTBR0_ELx and TTBR1_ELx when two VA ranges are supported* on page D4-2045 gives more information about the address translation stages that support two VA ranges.

A full translation table lookup is called a *translation table walk*. It is performed automatically by hardware, and can have a significant cost in execution time. To support fine granularity of the VA to PA mapping, a single IA to OA translation can require multiple accesses to the translation tables, with each access giving finer granularity. Each access is described as a *level* of address lookup. The final level of the lookup defines:

- The high bits of the required output address.
- The *attributes* and *access permissions* of the addressed memory.

Translation table entries can be cached in a *Translation Lookaside Buffer*, see *Translation Lookaside Buffers (TLBs)* on page D4-2113.

The VMSAv8-64 translation table format

Stages of address translation that are controlled by an Exception level that is using AArch64 use the VMSAv8-64 translation table format. This format uses 64-bit descriptor entries in the translation tables.

Note

This format is an extension of the VMSAv8-32 Long-descriptor translation table format originally defined by the ARMv7 Large Physical Address Extension, and extended slightly by ARMv8. VMSAv8-32 also supports a Short-descriptor translation table format. *Chapter G4 The AArch32 Virtual Memory System Architecture* describes both of these formats.

The VMSAv8-64 translation table format provides:

- Up to four levels of address lookup.
- A translation granule size of 4KB, 16KB, or 64KB.
- **Input addresses of:**
 - Up to 52 bits if ARMv8.2-LVA is implemented and the 64KB translation granule is used.
 - Otherwise, up to 48 bits.
- **Output addresses of:**
 - Up to 52 bits if ARMv8.2-LPA is implemented and the 64KB translation granule is used.
 - Otherwise, up to 48 bits.

For more information about input address and output address sizes see *Address size configuration* on page D4-2014.

D4.2.2 The implemented Exception levels and the resulting translation stages and regimes

About the VMSAv8-64 address translation system on page D4-2008 describes an implementation that includes all Exception levels. *Controlling address translation stages* describes the control of address translation by Exception levels that are using AArch64. This subsection describes how the address translation scheme changes if an implementation does not include all of the Exception levels.

If an implementation does not include EL3, it has only a single Security state, with MMU controls equivalent to the Secure state MMU controls.

If an implementation does not include EL2 then:

- If it also does not include EL3, the MMU provides only a single EL1&0 stage 1 translation regime.
- If it includes EL3, the MMU provides an EL1&0 stage 1 translation regime in each Security state.

[Figure D4-1 on page D4-2009](#) shows the set of translation regimes for an implementation that implements all of the Exception levels. [Table D4-1](#) shows how the supported translation stages depend on the implemented Exception levels, and in some cases on the Execution state being used by the highest implemented Exception level.

Table D4-1 The relation between the implemented translation stages and Exception levels for AArch64

Translation stage	Requires
Secure EL3 stage 1	EL3 implemented and using AArch64.
Secure EL1&0 stage 1	Either: <ul style="list-style-type: none"> • EL3 implemented and using AArch64. • Only EL1 and EL0 implemented, all operation is in Secure state, and EL1 is using AArch64.
Non-secure EL2 stage 1 or Non-secure EL2&0 ^a stage 1	EL2 implemented.
Non-secure EL1&0 stage 2	EL2 implemented.
Non-secure EL1&0 stage 1	Any implementation except: <ul style="list-style-type: none"> • Only EL1 and EL0 implemented, with all operation in the Secure state.

a. The Non-secure EL2&0 translation regime is supported only if an implementation includes [ARMv8.1-VHE](#). When supported, it is used when the value of [HCR_EL2.E2H](#) is 1.

D4.2.3 Controlling address translation stages

The implemented Exception levels and the resulting translation stages and regimes defines the translation regimes and stages. For each supported address translation stage:

- A System register bit enables the stage of address translation.
- A System register bit determines the endianness of the translation table lookups.
- A *Translation Control Register (TCR_ELx)* controls the stage of address translation.
- If a stage of address translation supports two VA ranges then that stage of translation provides a [TTBR_ELx](#) for each VA range, and the stage of address translation has:
 - A single [TCR_ELx](#).
 - A [TTBR_ELx](#) for each VA range. [TTBR0_ELx](#) points to the translation tables for the address range that starts at `0x0000000000000000`, and [TTBR1_ELx](#) points to the translation tables for the address range that ends at `0xFFFFFFFFFFFFFFFF`.

Otherwise, a single [TTBR_ELx](#) holds the address of the translation table that must be used for the first lookup for the stage of address translation.

For address translation stages controlled from AArch64:

- [Table D4-2](#) shows the endianness bit (EE) and the enable bit (M or VM) for each stage of address translation. Each register entry in the table gives the endianness bit followed by the enable bit.

Table D4-2 Enable and endianness bits for the AArch64 translation stages

Translation stage	Controlled from	Controlling register
Secure EL3 stage 1	EL3	SCTLR_EL3.{EE, M}
Secure EL1&0 stage 1	Secure EL1	SCTLR_EL1.{EE, M}
Non-secure EL2 stage 1 or Non-secure EL2&0 ^a stage 1	EL2	SCTLR_EL2.{EE, M}
Non-secure EL1&0 stage 2	EL2	SCTLR_EL2.EE, HCR_EL2.VM
Non-secure EL1&0 stage 1	Non-secure EL1	SCTLR_EL1.{EE, M}

- a. The Non-secure EL2&0 translation regime is supported only if an implementation includes [ARMv8.1-VHE](#). When supported, it is used when the value of [HCR_EL2.E2H](#) is 1.

Note

If the [PA](#) of the software that enables or disables a particular stage of address translation differs from its [VA](#), speculative instruction fetching can cause complications. ARM strongly recommends that the [PA](#) and [VA](#) of any software that enables or disables a stage of address translation are identical if that stage of translation controls translations that apply to the software currently being executed.

- [Table D4-3](#) shows the [TCR_ELx](#) and [TTBR_ELx](#), or [TTBR_ELxs](#), for each stage of address translation. In the table, each *Controlling registers* entry gives the [TCR_ELx](#) followed by the [TTBR_ELx](#) or [TTBR_ELxs](#).

Table D4-3 TCR_ELx and TTBR_ELx for the AArch64 translation stages

Translation stage	Controlled from	Controlling registers
Secure EL3 stage 1	EL3	TCR_EL3, TTBR0_EL3
Secure EL1&0 stage 1	Secure EL1	TCR_EL1, TTBR0_EL1, TTBR1_EL1
Non-secure EL2 stage 1	EL2	TCR_EL2, TTBR0_EL2
Non-secure EL2&0 ^a stage 1	EL2	TCR_EL2, TTBR0_EL2, TTBR1_EL2
Non-secure EL1&0 stage 2	EL2	VTCR_EL2, VTTBR_EL2
Non-secure EL1&0 stage 1	Non-secure EL1	TCR_EL1, TTBR0_EL1, TTBR1_EL1

- a. The Non-secure EL2&0 translation regime is supported only if an implementation includes [ARMv8.1-VHE](#). When supported, it is used when the value of [HCR_EL2.E2H](#) is 1.

The following subsections give more information about controlling address translation:

- [System registers relevant to MMU operation on page D4-2014.](#)
- [Address size configuration on page D4-2014.](#)
- [Atomicity of register changes on changing virtual machine on page D4-2020.](#)
- [Use of out-of-context translation regimes on page D4-2020.](#)

System registers relevant to MMU operation

In AArch64 state, System registers have a suffix, that indicates the lowest Exception level from which they can be accessed. In some general descriptions of MMU control and address translation, this chapter uses a *Common abbreviation* for each of the System registers that affects MMU operation, as Table D4-4 shows. The common abbreviation is used when describing features that apply to multiple translation regimes or stages.

———— **Note** ————

The only translation regime that supports a stage 2 translation is the Non-secure EL1&0 translation regime.

Table D4-4 Abbreviations for System registers used in this chapter

Common abbreviation	Translation stage	Exception level		
		EL1	EL2	EL3
HCR_ELx	-	-	HCR_EL2	-
SCTLR_ELx	-	SCTLR_EL1	SCTLR_EL2	SCTLR_EL3
TCR_ELx	Stage 1	TCR_EL1	TCR_EL2	TCR_EL3
	Stage 2	-	VTCR_EL2	-
TTBR_ELx	Stage 1	TTBR0_EL1, TTBR1_EL1	TTBR0_EL2	TTBR0_EL3
	Stage 2	-	VTTBR_EL2	-
TTBR0_ELx	Stage 1	TTBR0_EL1	TTBR0_EL2	TTBR0_EL3
TTBR1_ELx	Stage 1	TTBR1_EL1	TTBR1_EL2 ^a	-

a. Only when both the implementation includes ARMv8.1-VHE and the value of HCR_EL2.E2H is 1.

Address size configuration

The following subsections specify the configuration of the PA size and of the input and output address sizes for each of the stages of address translation:

- *Physical address size.*
- *Output address size on page D4-2015.*
- *Input address size on page D4-2016.*
- *Supported IPA size on page D4-2017.*

Physical address size

The ID_AA64MMFR0_EL1.PARange field indicates the implemented PA size, as Table D4-5 shows.

Table D4-5 Physical address size implementation options

ID_AA64MMFR0_EL1.PARange	Total PA size	PA address size
0000	4 GB	32 bits, PA[31:0]
0001	64 GB	36 bits, PA[35:0]
0010	1 TB	40 bits, PA[39:0]
0011	4 TB	42 bits, PA[41:0]

Table D4-5 Physical address size implementation options (continued)

ID_AA64MMFR0_EL1.PARange	Total PA size	PA address size
0100	16 TB	44 bits, PA[43:0]
0101	256 TB	48 bits, PA[47:0]
0110	4PB	52 bits, PA[51:0] ^a

a. Only when an implementation includes ARMv8.2-LPA and the 64KB translation granule is used, see *Extending addressing above 48 bits* on page D4-2018.

All other PARange values are reserved.

Output address size

For each enabled stage of address translation, TCR_ELx.{I}PS must be programmed to maximum output address size for that stage of translation, using the encodings as shown in Table D4-6.

Table D4-6 Output address size implementation options

TCR_ELx.{I}PS	Total output size	Output address size
000	4 GB	32 bits, PA[31:0]
001	64 GB	36 bits, PA[35:0]
010	1 TB	40 bits, PA[39:0]
011	4 TB	42 bits, PA[41:0]
100	16 TB	44 bits, PA[43:0]
101	256 TB	48 bits, PA[47:0]
110	4PB	52 bits, PA[51:0] ^a

a. Only when an implementation includes ARMv8.2-LPA and is using the 64KB translation granule, see *Extending addressing above 48 bits* on page D4-2018.

Note

- The naming of this field is as follows:
 - IPS**
 - In TCR_EL1.
 - In an implementation that includes ARMv8.1-VHE, in TCR_EL2 when the value of HCR_EL2.E2H is 1.
 - PS** Otherwise.
- The {I}PS fields are 3-bit fields, corresponding to the least-significant PARange bits shown in Table D4-5 on page D4-2014.

If {I}PS is programmed to a value larger than the implemented PA size, then the PE behaves as if programmed with the implemented PA size, but software must not rely on this behavior. That is, the output address size is never larger than the implemented PA size. Table D4-5 on page D4-2014 shows the implemented PA size.

The PE checks that the TTBR_ELx, translation table entries, and the output address for the stage of address translation have the address bits above the output address size set to zero. If this is not the case, an Address size fault is generated for the level and stage of translation that caused the fault. An Address size fault from the TTBR_ELx is always reported as a level 0 fault. When ARMv8.2-LPA is implemented and a translation granule of 4KB or 16KB is in use, all output addresses are treated as having bits[51:48] set to 0b0000.

If stage 1 translation is disabled and the input address is larger than the implemented PA size, then a stage 1 level 0 Address size fault is generated.

———— **Note** —————

These faults are reported as level 0 faults even if they occur in a translation stage that does not perform level 0 lookups.

When using two stages of translation:

- If stage 2 translation is disabled and the output address from the stage 1 translation is larger than the implemented PA size, then a stage 1 Address size fault is generated for the level of the stage 1 translation that generated the output address.
- If stage 2 translation is enabled and the output address from the stage 1 translation does not generate a stage 1 Address Size fault, but is larger than the input address size specified for the stage 2 translation, then a stage 2 Translation fault is generated.

Input address size

For each enabled stage of address translation, the TCR_ELx.TxSZ fields specify the input address size:

For a stage of translation that supports two VA ranges

The TCR_ELx has two TxSZ fields, corresponding to the two VA ranges:

- TCR_ELx.T0SZ specifies the size for the lower VA range, translated using TTBR0_ELx.
- TCR_ELx.T1SZ specifies the size for the upper VA range, translated using TTBR1_ELx.

For a stage of translation that supports a single input address (IA) range

The TCR_ELx has a single T0SZ field, and IAs are translated using TTBR0_ELx.

Attempting to translate an address that is larger than the configured input address size generates a Translation fault. This means:

- For a TCR_ELx with a single T0SZ field and a 48-bit address size, Figure D4-2 shows the input address map:

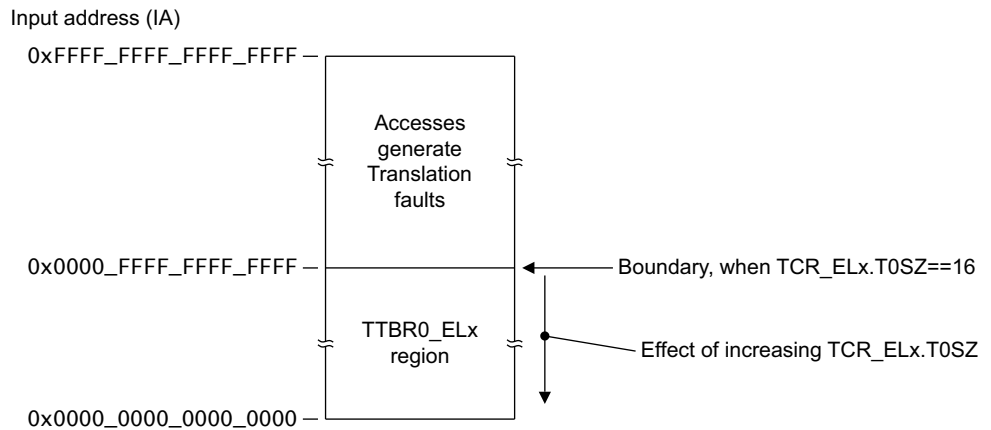

Figure D4-2 AArch64 input address map when using a single TTBR and 48-bit input address size

- For a TCR_ELx with two TxSZ fields, the input address is always a VA, and *Selection between TTBR0_ELx and TTBR1_ELx when two VA ranges are supported* on page D4-2045 describes the VA address map.

For the Non-secure EL1&0 translation regime, when both stages of translation are enabled, if the output address from the stage 1 translation does not generate a stage 1 address size fault, and is larger than the input address size specified by VTCR_EL2.T0SZ, then the input address size check for the stage 2 translation generates a Translation fault.

Although software can configure the input address size to be smaller than 48 bits, all implemented AArch64 TTBR_ELx must support input address sizes of up to 48 bits, and in an implementation that includes ARMv8.2-LVA, all TTBR_ELx must support input address sizes of up to 52 bits.

Overview of the VMSAv8-64 address translation stages on page D4-2030 gives more information about the relationship between the required input address size, the value of TxSZ, and the required initial lookup level, and how these are affected by the translation granule size. However:

For all translation stages

The maximum TxSZ value is 39. If TxSZ is programmed to a value larger than 39 then it is IMPLEMENTATION DEFINED whether:

- The implementation behaves as if the field is programmed to 39 for all purposes other than reading back the value of the field.
- Any use of the TxSZ value generates a Level 0 Translation fault for the stage of translation at which TxSZ is used.

For a stage 1 translation

The effective minimum value of TxSZ is 16 if ARMv8.2-LVA is not supported or if the translation granule that is in use is 4KB or 16KB in size. When ARMv8.2-LVA is supported, for the 64KB translation granule size only, the effective minimum value of TxSZ is 12.

If TxSZ is programmed to a value smaller than the effective minimum value, and if ARMv8.2-LVA is not supported, then it IMPLEMENTATION DEFINED whether:

- The implementation behaves as if the field were programmed to 16 for all purposes other than reading back the value of the field.
- Any use of the TxSZ value generates a stage 1 level 0 Translation fault.

If TxSZ is programmed to a value smaller than the effective minimum value when ARMv8.2-LVA is supported, then any use of the TxSZ value generates a stage 1 level 0 Translation fault.

For more information, see *Extending addressing above 48 bits on page D4-2018*.

For a stage 2 translation

Supported IPA size defines the effective minimum value of T0SZ, that depends on the supported PA size, and also describes the possible effects of programming T0SZ to a value that is smaller than this effective minimum value.

Supported IPA size

For the Non-secure EL1&0 translation regime, the maximum IPA size is the maximum input address size for the second stage of translation, that must be specified by VTCR_EL2.T0SZ, see *Input address size on page D4-2016*. This value is constrained by the implemented PA size that is specified by ID_AA64MMFR0_EL1.PARange, see *Physical address size on page D4-2014*. This implemented PA size also constrains the maximum value of VTCR_EL2.SL0, that specifies the level of the initial lookup. SL0 also depends on the translation granule, as described in *Overview of the VMSAv8-64 address translation stages on page D4-2030*.

Table D4-7 PA size implications for the VTCR_EL2.{T0SZ, SL0} fields

Supported PA size	Effective minimum T0SZ value	Maximum SL0 value		
		4KB granule	16KB granule	64KB granule
32 bits	32 if EL1 is using AArch64 24 if EL1 is using AArch32	1	1	1
36 bits	28 if EL1 is using AArch64 24 if EL1 is using AArch32	1	1	1
40 bits	24	1	1	1

Table D4-7 PA size implications for the **VTCCR_EL2.T0SZ, SL0** fields (continued)

Supported PA size	Effective minimum T0SZ value	Maximum SL0 value		
		4KB granule	16KB granule	64KB granule
42 bits	22	1	2	1
44 bits	20	2	2	2
48 bits	16	2	2	2
52 bits	12	<i>-a</i>	<i>-a</i>	2

a. Only supported in an implementation that includes ARMv8.2-LPA and is using the 64KB translation granule size.

If **VTCCR_EL2.SL0** is programmed to a value larger than the maximum value shown in [Table D4-7 on page D4-2017](#), or is programmed to a reserved value, then any memory access that uses the second stage of translation generates a stage 2 level 0 Translation fault.

If **VTCCR_EL2.T0SZ** is programmed to a value smaller than the effective minimum value shown in [Table D4-7 on page D4-2017](#), and if **ARMv8.2-LPA** is not implemented, then the implementation consistently does one of the following:

- Treats the **VTCCR_EL2.T0SZ** field as being programmed to the effective minimum value for all purposes other than reading back the value of the field.
- Treats the **VTCCR_EL2.T0SZ** field as being programmed to the effective minimum value for all purposes other than:
 - Reading back the value of the field.
 - Checking whether the value of **VTCCR_EL2.T0SZ** is consistent with the value of **VTCCR_EL2.SL0**.
- Generates a stage 2 level 0 Translation fault on any memory access that uses the second stage of translation.

If **T0SZ** is programmed to a value smaller than the effective minimum value when **ARMv8.2-LPA** is supported, then any use of the **T0SZ** value generates a stage 2 level 0 Translation fault.

For more information, see *Extending addressing above 48 bits*.

———— **Note** ————

Programming **VTCCR_EL2.T0SZ** to a value smaller than the effective minimum value shown in [Table D4-7 on page D4-2017](#) can never provide support for a larger address range than the range given by the effective minimum value, because the stage 1 output address will give an Address size fault if it is larger than either:

- The **PA** size, for a VMSAv8-64 stage 1 translation.
- 40 bits, for a VMSAv8-32 stage 1 translation.

Extending addressing above 48 bits

ARMv8.2 defines the following options for supporting 52-bit addressing:

ARMv8.2-LVA Supports 52-bit VAs. The maximum IPA and PA sizes remain 48-bit.

ARMv8.2-LPA Supports 52-bit IPAs and PAs. The maximum VA size remains 48-bit.

ARMv8.2-LPA and ARMv8.2-LVA can be implemented independently of each other.

When using the 64KB translation granule, ARMv8.2-LPA supports Block descriptors in level 1 translation tables. In this case, a block covers a 4TB address range.

In all cases, 52-bit address ranges are supported only when using the 64KB translation granule. Maximum address sizes when using the other translation granules remain 48-bit.

See *Address size configuration* on page D4-2014 for how to configure use of 52-bit VAs when an implementation includes ARMv8.2-LVA.

When using the 64KB translation granule, the 52-bit input address size is supported as follows:

- In an implementation that includes ARMv8.2-LVA, for stage 1 translations the minimum value of TCR_ELx.TnSZ field is 12.
If TCR_ELx.TnSZ is programmed to a value less than 12, any use of the TCR_ELx.TnSZ bit generates a stage 1 level 0 translation fault.
- In an implementation that includes ARMv8.2-LVA, for a stage 2 translation the effective minimum value of VTCR_EL2.T0SZ is 12.
If VTCR_EL2.T0SZ is programmed to a smaller value than the effective minimum size, then any use of a stage 2 translation generates a stage 2 level 0 translation fault.

Table D4-28 on page D4-2052 shows the translation table descriptor addressing for each level of lookup when using the 64KB translation granule.

In an implementation that includes ARMv8.2-LPA and is using the 64KB translation granule:

- Bits[15:12] of each valid translation table descriptor hold bits[51:48] of the output address, or of the address of the translation table to be used for the initial lookup at the next level of translation. If the implementation does not support 52-bit physical addresses, then non-zero values for these bits generate an Address Size fault.
- For a stage 1 translation, bits[5:2] of TTBR0_ELx or TTBR1_ELx holds bits[51:48] of the address of the translation table to be used for the initial lookup of that translation regime.
- For a stage 2 translation, bits[5:2] of VTTBR_EL2 holds bits[51:48] of the address of the translation table to be used for the initial lookup of the stage 2 translation.
- The minimum alignment of a translation table containing fewer than eight entries is 64 bytes.

———— **Note** ————

This is because, when the OA space is more than 48 bits, TTBR_ELx[5:2] specifies bits[51:48] of the translation table base address, and a translation table of fewer than eight entries would require one or more bits of TTBR_ELx[5:2] to be RES0 if the table was aligned to its size.

For more information, see *VMSAv8-64 translation table level 0, level 1, and level 2 descriptor formats* on page D4-2060 and *ARMv8 translation table level 3 descriptor formats* on page D4-2063.

The ID_AA64MMFR2_EL1.VA field indicates the supported VA size. This field has the value 0x1 if the implementation includes ARMv8.2-LVA.

The ID_AA64MMFR0_EL1.PArange field indicates the supported PA and IPA size. This field has the value 0x6 if the implementation supports 52-bit PAs.

In addition to the System registers discussed in this subsection, the ARMv8.2-LPA and ARMv8.2-LVA features affect the following System registers that contain addresses:

- HPFAR_EL2.
- PAR_EL1.
- VBAR_EL1, VBAR_EL2, VBAR_EL3.
- DBGBVR<n>_EL1.
- DBGWVR<n>_EL1.
- MDRAR_EL1.
- LOREA_EL1.
- LORSA_EL1.

The larger VA, IPA, and PA addresses also affect the following system instructions for TLB maintenance:

- TLBI IPAS2E1.
- TLBI IPAS2E1IS.

- [TLBI IPAS2LE1](#).
- [TLBI IPAS2LE1IS](#).

Atomicity of register changes on changing virtual machine

From the viewpoint of software executing at Non-secure EL1 or EL0, when there is a switch from one virtual machine to another, the registers that control or affect address translation must be changed atomically. This applies to the registers for the Non-secure EL1&0 translation regime. This means that all of the following registers must change atomically:

- The registers associated with the stage 1 translations:
 - [MAIR_EL1](#) and [AMAIR_EL1](#).
 - [TTBR0_EL1](#), [TTBR1_EL1](#), [TCR_EL1](#), and [CONTEXTIDR_EL1](#).
 - [SCTLR_EL1](#).
- The registers associated with the stage 2 translations:
 - [VTTBR_EL2](#) and [VTTCR_EL2](#).
 - [SCTLR_EL2](#).

Note

Only some bits of [SCTLR_EL1](#) affect the stage 1 translation, and only some bits of [SCTLR_EL2](#) affect the stage 2 translation. However, in each case, changing these bits requires a write to the register, and that write must be atomic with the other register updates.

These registers apply to execution using the Non-secure EL1&0 translation regime. However, when updated as part of a switch of virtual machines they are updated by software executing at EL2. This means the registers are *out of context* when they are updated, and no synchronization precautions are required.

Similar considerations apply when [ARMv8.1-VHE](#) is implemented.

Use of out-of-context translation regimes

The architecture requires that:

- When executing at EL3, EL2, or Secure EL1, the PE must not use the registers associated with the Non-secure EL1&0 translation regime for speculative memory accesses.
- When executing at EL3 or Secure EL1, the PE must not use the registers associated with the EL2, or EL2&0 translation regime for speculative memory accesses.
- When executing at EL3, EL2, or Non-secure EL1, the PE must not use the registers associated with the Secure EL1&0 translation regime for speculative memory accesses.

When entering an Exception level, on completion of a DSB instruction, no new memory accesses using any translation table entries from a translation regime of an Exception level lower than the Exception level that has been entered will be observed by any observers, to the extent that those accesses are required to be observed as determined by the shareability and cacheability of those translation table entries.

Note

- This does not require that speculative memory accesses cannot be performed using those entries if it is impossible to tell that those memory accesses have been observed by the observers.
- This requirement does not imply that, on taking an exception to a higher Exception level, any translation table walks started before the exception was taken will be completed by the time the higher Exception level is entered, and therefore memory accesses required for such a translation table walk might, in effect, be performed speculatively. However, the execution of a DSB on entry to the higher Exception level ensures that these accesses are complete.

D4.2.4 Memory translation granule size

The memory translation granule size defines both:

- The maximum size of a single translation table.
- The memory *page* size. That is, the granularity of a translation table lookup.

VMSAv8-64 supports translation granule sizes of 4KB, 16KB, and 64KB. Support for each granule size is optional, and is indicated as shown in [Table D4-8](#):

Table D4-8 Identifying supported granule sizes

Granule size	Support indicated by:		Values
	Field		
4KB	ID_AA64MMFR0_EL1.TGRAN4	0b0000	4KB granule size supported.
		0b1111	4KB granule size not supported.
16KB	ID_AA64MMFR0_EL1.TGRAN16	0b0000	16KB granule size not supported.
		0b0001	16KB granule size supported.
64KB	ID_AA64MMFR0_EL1.TGRAN64	0b0000	64KB granule size supported.
		0b1111	64KB granule size not supported.

In VMSAv8-64, each address translation stage is configured, independently, to use one of the supported granule sizes.

———— **Note** —————

- Using a larger granule size can reduce the maximum required number of levels of address lookup because:
 - The increased translation table size means the translation table holds more entries. This means a single lookup can resolve more bits of the input address.
 - The increased page size means more of the least-significant address bits are required to address a page. These address bits are flat mapped from the input address to the output address, and therefore do not require translation.
- ARM recommends that memory-mapped peripherals are separated by an integer multiple of the largest granule size supported by the operating system or hypervisor, to allow each peripheral to be managed independently.

[Table D4-9](#) summarizes the effects of the different granule sizes.

Table D4-9 Effect of granule size on a stage of address translation

Property	4KB granule	16KB granule	64KB granule	Notes
Maximum number of entries in a translation table	512	2048 (2K)	8192 (8K)	-
Address bits resolved in one level of lookup	9	11	13	$2^9=512$, $2^{11}=2K$, $2^{13}=8K$
Page size	4KB	16KB	64KB	-
Page address range	VA[11:0]= PA[11:0]	VA[13:0]= PA[13:0]	VA[15:0]= PA[15:0]	$2^{12}=4K$, $2^{14}=16K$, $2^{16}=64K$

How the granule size affects the address translation process

As Table D4-9 on page D4-2021 shows, the translation granule determines the number of address bits:

- Required to address a memory page.
- That can be resolved in a single translation table lookup.

This means the translation granule determines how the *input address* (IA) is resolved to an *output address* (OA) by the translation process.

Because a single translation table lookup can resolve only a limited number of address bits, the IA to OA resolution requires multiple *levels* of lookup.

Considering the resolution of an IA range of 48 bits, with a translation granule size of 2^n bytes:

- The least-significant n bits of the IA address the memory page. This means $OA[(n-1):0]=IA[(n-1):0]$.
- The remaining $(48-n)$ bits of the IA, $IA[47:n]$, must be resolved by the address translation.
- A translation table descriptor is 8 bytes. Therefore:
 - A complete translation table holds $2^{(n-3)}$ descriptors.
 - A single level of translation can resolve a maximum of $(n-3)$ bits of address.

Consider the translation process, working back from the final level of lookup, that resolves the least significant of the address bits that require translation. Because the translation needs to resolve $IA[47:n]$ and a level of lookup can resolve $(n-3)$ bits of address:

- The final level of lookup resolves $IA[(2n-4):n]$.
- The previous level of lookup resolves $IA[(3n-7):(2n-3)]$.

However, the level of lookup that resolves the most significant bits of the IA might not require a full-sized translation table. Therefore, in general, for a 48-bit IA the address bits resolved in a level of lookup are:

$$IA[\text{Min}(47, ((m-3)(n-3)+2n-4):(n+(x-3)(n-3))], \text{ where:}$$

Min(a, b) Is a function that returns the minimum of a and b .

m Indicates the level of lookup. This is defined so that the level that resolves the least significant bit of the translated IA bits is level 3.

The following diagrams show this model, for each of the permitted granule sizes.

Figure D4-3 shows how a 48-bit IA is resolved when using the 4KB translation granule.

Using the 4KB translation granule

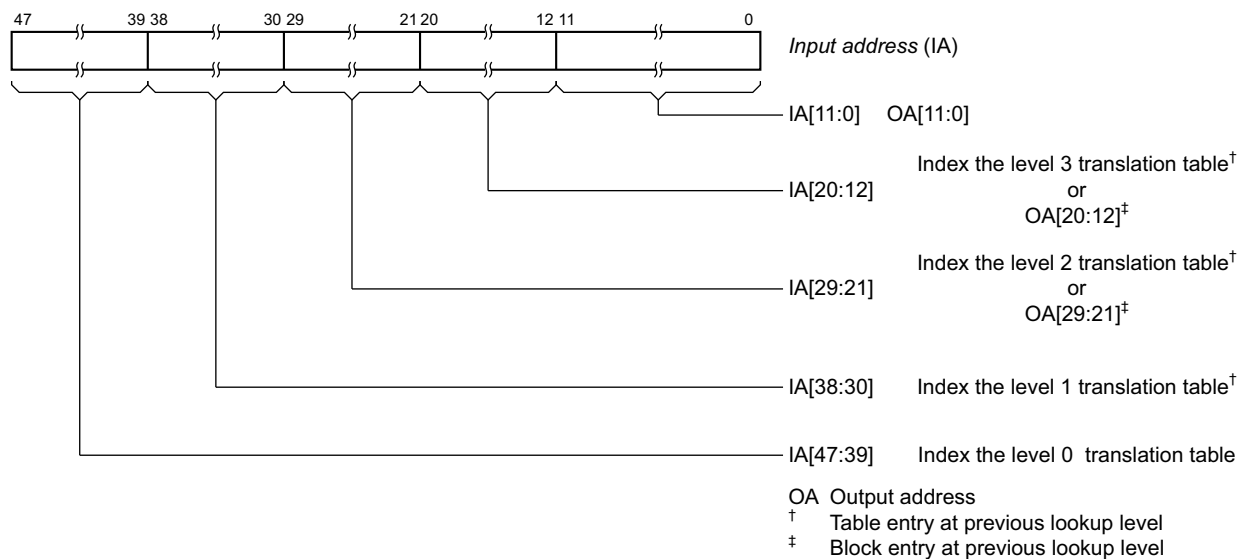

Figure D4-3 How a 48-bit IA is resolved when using the 4KB translation granule

Figure D4-4 shows how a 48-bit IA is resolved when using the 16KB translation granule.

Using the 16KB translation granule

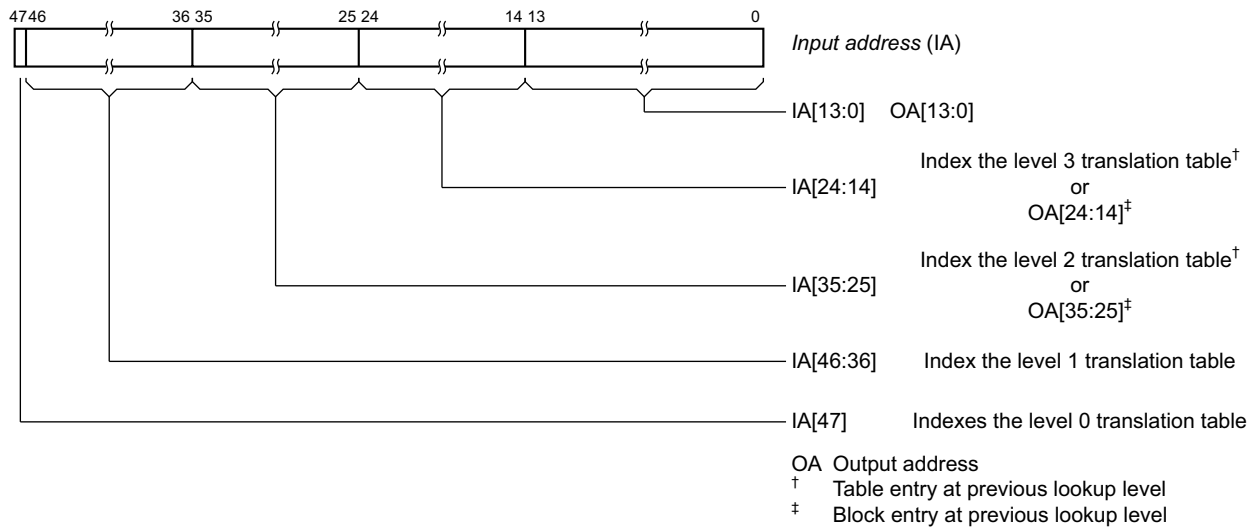

Figure D4-4 How a 48-bit IA is resolved when using the 16KB translation granule

Figure D4-5 shows how a 48-bit IA is resolved when using the 64KB translation granule.

Using the 64KB translation granule

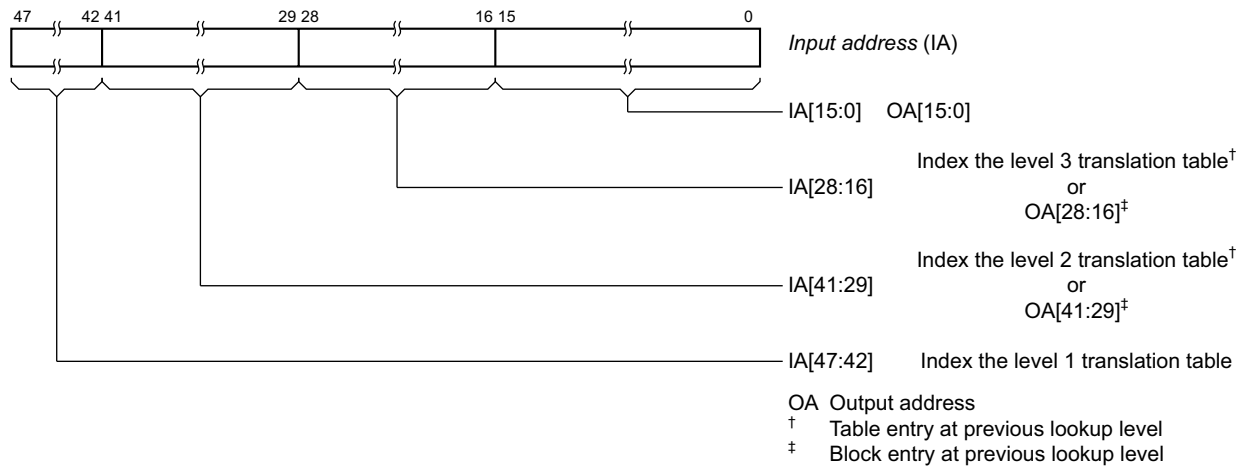

Figure D4-5 How a 48-bit IA is resolved when using the 64KB translation granule

In an implementation that includes ARMv8.2-LVA and is using the 64KB translation granule:

- The IA range that can be addressed by the level 1 lookup is IA[51:42].
- The level 1 lookup can directly address a block of memory, returning OA[51:42].

———— **Note** ————

The increased IA range means the size of the indexed level 1 translation table is increased.

Later sections of this chapter give more information about the translation process, and explain the terminology used in these figures.

Effect of granule size on translation table addressing and indexing

Table D4-10 shows the effect of the translation granule size on the addressing and indexing of the `TTBR_ELx`, and on the input address range that must be resolved.

Table D4-10 The effect of translation granule size on the translation tables

Granule size	Translation table		Translation resolves ^a	Notes
	Addressed by	Indexed by ^b		
4KB	<code>TTBR_ELx[47:12]</code>	<code>IA[(x + 8):x]</code>	<code>IA[47:12]</code>	One level of lookup resolves up to ^c 9 bits of IA
16KB	<code>TTBR_ELx[47:14]</code>	<code>IA[(x + 10):x]</code>	<code>IA[47:14]</code>	One level of lookup resolves up to ^c 11 bits of IA
64KB	<code>TTBR_ELx[47:16]</code> ^d <code>TTBR_ELx[5:2, 47:16]</code>	<code>IA[(x + 12):x]</code>	<code>IA[47:16]</code> ^d <code>IA[51:16]</code>	One level of lookup resolves up to ^c 13 bits of IA

- a. When translating a maximum-sized input address, and accessing a page of memory.
- b. Where the value of x depends on the lookup level, see Table D4-11.
- c. Depending on the IA size, the initial lookup might resolve fewer bits of the IA.
- d. For the 64KB granule entries in the *Addressed by* and *Translation resolves* columns, the second entry applies to an implementation that includes ARMv8.2-LVA and has selected an IA space larger than 47 bits, see *Extending addressing above 48 bits* on page D4-2018. The first entry applies otherwise.

Table D4-11 shows the IA bits resolved at each level of lookup, and how these correspond to the possible values of x in Table D4-10.

Table D4-11 IA bits resolved at different levels of lookup

Lookup level	4KB granule size	16KB granule size	64KB granule size
Zero	<code>IA[47:39]</code> , $x = 39$	<code>IA[47^a]</code> , $x = 47$	- ^b
First	<code>IA[38:30]</code> , $x = 30$	<code>IA[46:36]</code> , $x = 36$	<code>IA[47^a:42]</code> , $x = 42$ ^c <code>IA[51^a:42]</code> , $x = 42$
Second	<code>IA[29:21]</code> , $x = 21$	<code>IA[35:25]</code> , $x = 25$	<code>IA[41:29]</code> , $x = 29$
Third	<code>IA[20:12]</code> , $x = 12$	<code>IA[24:14]</code> , $x = 14$	<code>IA[28:16]</code> , $x = 16$

- a. Smaller value than indicated in Table D4-10, as explained in this section.
- b. Level 0 lookup not possible with 64KB granule size
- c. The second entry applies to an implementation that includes ARMv8.2-LVA and has selected an IA space larger than 47 bits, see *Extending addressing above 48 bits* on page D4-2018, The first entry applies otherwise.

Table D4-10 on page D4-2024 refers to accessing a complete translation table, of 4KB, 16KB, or 64KB. However, the ARMv8 translation system supports the following possible variations from the information in Table D4-10 on page D4-2024:

Reduced IA width

Depending on the configuration and implementation choices, the required input address width for the initial level of lookup might be smaller than the number of address bits that can be resolved at that level. This means that, for this initial level of lookup:

- The translation table size is reduced. For each 1 bit reduction in the input address size the size of the translation table is halved.

Note

- This has no effect on the translation table size for subsequent levels of lookup, for which the lookups always use full-sized translation tables.
 - For a stage 2 translation, it might be possible to start the translation at a lower level, see *Concatenated translation tables*.
-

- More low-order `TTBR_ELx` bits are needed to hold the translation table base address.

Example D4-1 shows how this applies to translating a 35-bit input address range using the 4KB granule.

Example D4-1 Effect of an IA width of 35 bits when using the 4KB granule size

With a 4KB granule size, a single level of lookup can resolve up to 9 bits of IA. If an implementation has a 35-bit input address range, `IA[34:0]`, Table D4-11 on page D4-2024 shows that lookup must start at level 1, and that the initial lookup must resolve `IA[34:30]`, meaning it resolves 5 bits of address: This 4-bit reduction in the required resolution means:

- The translation table size is divided by 2^4 , giving a size of 256B.
 - The `TTBR_ELx` requires 4 more bits for the translation table base address, which becomes `TTBR_ELx[47:8]`.
-

When using the 64KB translation granule to translate the maximum IA size of 48 bits, Table D4-11 on page D4-2024 shows that a level 1 lookup must resolve only `IA[47:42]`. This is 6 bits of address, compared to the 13 bits that can be resolved at a single level of lookup. This 7-bit reduction in the required resolution means:

- The translation table size is divided by 2^7 , giving a size of 512B.
- The `TTBR_ELx` requires 7 more bits for the translation table base address, which becomes `TTBR_ELx[47:9]`.

Concatenated translation tables

For stage 2 address translations, for the initial lookup, up to 16 translation tables can be concatenated. This means additional IA bits can be resolved at that lookup level. The block of concatenated translation tables must be aligned to the size of the block of translation tables.

This means that each additional IA bit resolved:

- Doubles the number of translation tables required. Resolving an additional n bits requires 2^n concatenated translation tables at the initial lookup level.
- Reduces by 1 bit the width of the translation table base address held in the `TTBR_ELx`.

This means that, for the initial lookup of a stage 2 translation table, the IA ranges shown in Table D4-11 on page D4-2024 can be extended by up to 4 bits. Example D4-2 on page D4-2026 shows how concatenation can be used to resolve a 40-bit IA when using the 4KB translation granule.

Example D4-2 Concatenating translation tables to resolve a 40-bit IA range, with the 4K granule

Table D4-11 on page D4-2024 shows that, when using the 4KB translation granule, a level 1 lookup can resolve a 39-bit IA, with the first lookup resolving IA[38:30]. For a stage 2 translation, to extend the IA width to 40 bits and resolve IA[39:30] with the first lookup:

- Two translation tables are concatenated, giving a total size of 8KB.
- The `TTBR_ELx` requires 1 fewer bit for the translation table base address, which becomes `TTBR_ELx[47:13]`.

For more information, see *Use of concatenated translation tables for the initial stage 2 lookup* on page D4-2047.

In all cases, the translation table, or block of concatenated translation tables, must be aligned to the actual size of the table or block of concatenated tables.

The translation table base address held in the `TTBR_ELx` is defined in the OA map for that stage of address translation. The information given in this section assumes this stage of translation has the maximum OA size, meaning the translation table base address is:

- `TTBR_ELx[47:12]` if using the 4KB translation granule.
- `TTBR_ELx[47:14]` if using the 16KB translation granule.
- `TTBR_ELx[47:16]` if using the 64KB translation granule with an OA of 48 bits.
- In an implementation that includes ARMv8.2-LPA and is using the 64KB translation granule, OA[51:16], where:
 - `TTBR_ELx[5:2]` holds OA[51:48].
 - `TTBR_ELx[47:16]` holds OA[47:16].

If the OA address is smaller than 48 bits then the upper bits of this field must be written as zero. For example, for a 40-bit OA range:

- If using the 4KB translation granule:
 - `TTBR_ELx[47:40]` must be set to zero.
 - `TTBR_ELx[39:12]` holds the translation table base address.
- If using the 16KB translation granule:
 - `TTBR_ELx[47:40]` must be set to zero.
 - `TTBR_ELx[39:14]` holds the translation table base address.
- If using the 64KB translation granule:
 - `TTBR_ELx[47:40]` must be set to zero.
 - `TTBR_ELx[39:16]` holds the translation table base address.

In all cases, if `TTBR_ELx[47:40]` is not zero, any attempt to access the translation table generates an Address size fault.

D4.2.5 Translation tables and the translation process

The following subsections describe general properties of the translation tables and translation table walks, that are largely independent of the translation table format:

- *Translation table walks* on page D4-2027.
- *Ordering of memory accesses from translation table walks* on page D4-2029.
- *Security state of translation table lookups* on page D4-2029.
- *Control of translation table walks* on page D4-2029.

See also *Selection between `TTBR0_ELx` and `TTBR1_ELx` when two VA ranges are supported* on page D4-2045.

Translation table walks

A *translation table walk* comprises one or more *translation table lookups*. The translation table walk is the set of lookups that are required to translate the VA to the PA. For the Non-secure EL1&0 translation regime, this set includes lookups for both the stage 1 translation and the stage 2 translation, but *translation table walk* can also be used to refer to either:

- The set of lookups required for the stage 1 translation, that translates the VA to the IPA. This is the *stage 1 translation table walk*.
- The set of lookups required for the stage 2 translation, that translates the IPA to the PA. This is the *stage 2 translation table walk*.

The information returned by a successful translation table walk is:

- The required PA. If the access is from Secure state this includes identifying whether the access is to the Secure PA space or the Non-secure PA space, see [Security state of translation table lookups on page D4-2029](#).
- The memory attributes for the target memory region, as described in [Memory types and attributes on page B2-107](#). For more information about how the translation table descriptors specify these attributes see [Memory region attributes on page D4-2090](#).
- The access permissions for the target memory regions. For more information about how the translation table descriptors specify these permissions see [Memory access control on page D4-2071](#).

The translation table walk starts with a read of the translation table for the initial lookup. The TTBR_ELx for the stage of translation holds the base address of this table. Each translation table lookup returns a descriptor, that indicates one of the following:

- The entry is the final entry of the walk. In this case, the entry contains the OA, and the permissions and attributes for the access.
- An additional level of lookup is required. In this case, the entry contains the translation table base address for that lookup. In addition:
 - The descriptor provides hierarchical attributes that are applied to the final translation, see [Hierarchical control of Secure or Non-secure memory accesses on page D4-2070](#) and [Hierarchical control of data access permissions on page D4-2074](#).
 - If the translation is in a Secure translation regime, the descriptor indicates whether that base address is in the Secure or Non-secure address space, unless a hierarchical control at a previous level of lookup has indicated that it must be in the Non-secure address space.
- The descriptor is invalid. In this case, the memory access generates a Translation fault.

[Figure D4-6 on page D4-2028](#) gives a generalized view of a single stage of address translation where three levels of lookup are required.

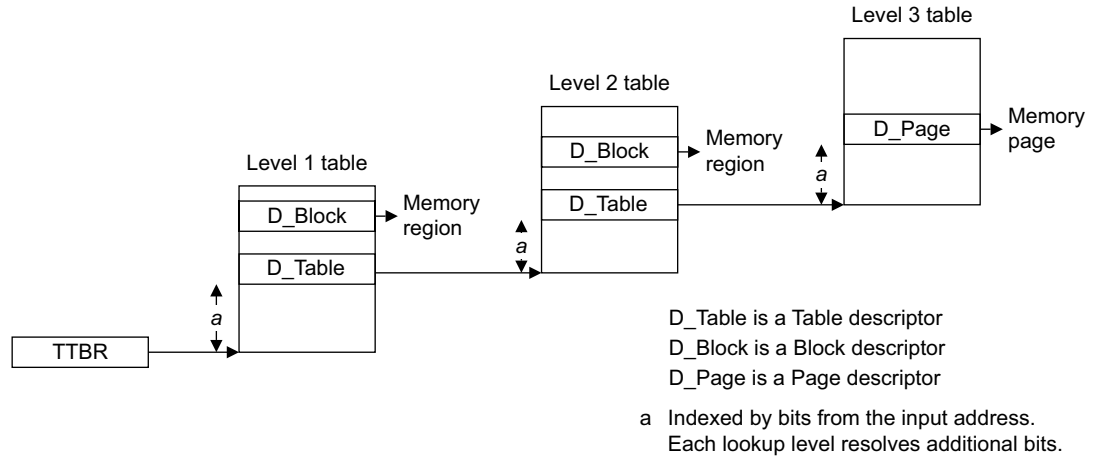

Figure D4-6 Generalized view of a stage of address translation

A translation table lookup from VMSAv8-64 performs a single-copy atomic 64-bit access to the translation table entry. This means the translation table entry is treated as a 64-bit object for the purpose of endianness.

[SCTLR_ELx.EE](#) determines the endianness of the translation table lookups.

———— **Note** —————

Dynamically changing translation table endianness

Because any change to an [SCTLR_ELx.EE](#) bit requires synchronization before it is visible to subsequent operations, ARM strongly recommends that any EE bit is changed only when either:

- Executing at an Exception level that does not use the translation tables affected by the EE bit being changed.
- Executing with address translation disabled for any stage of translation affected by the EE bit being changed.

Address translation stages are disabled by setting an [SCTLR_ELx.M](#) bit or the [HCR_EL2.VM](#) bit to 0. See the appropriate register description for more information.

The appropriate [TTBR_ELx](#) holds the output address of the base of the translation table used for the initial lookup, and:

- For all address translation stages other than Non-secure EL1&0 stage 1 translations, the output address held in the [TTBR_ELx](#), and any translation table base address returned by a translation table descriptor, is the **PA** of the base of the translation table.
- For Non-secure EL1&0 stage 1 translations, the output address held in the [TTBR_ELx](#), and any translation table base address returned by a translation table descriptor, is the **IPA** of the base of the translation table. This means that if stage 2 address translation is enabled, each of these OAs is subject to second stage translation.

———— **Note** —————

TLB caching can be used to minimize the number of translation table lookups that must be performed. For the Non-secure EL1&0 translation regime, because each stage 1 OA generated during a translation table walk is subject to a stage 2 translation, if the caching of translation table entries is ineffective, a **VA** to **PA** address translation with two stages of translation can give rise to multiple translation table lookups. The number of lookups required is given by the following equation:

$$(S1+1)*(S2+1) - 1$$

Where, for this translation regime, S1 is the number of levels of lookup required for a stage 1 translation, and S2 is the number of levels of lookup required for a stage 2 translation.

The `TTBR_ELx` also determines the memory cacheability and shareability attributes that apply, for the corresponding stage of translation, to all translation table lookups generated by that stage of translation.

The Normal memory type is the memory type defined for a translation table lookup for a stage of translation.

———— **Note** ————

- In a two stage translation regime, a translation table lookup from stage 1, that has the Normal memory type defined at stage 1 by this rule, can still be given the Device memory type as part of the stage 2 translation of that address. ARM strongly recommends against such a remapping of the memory type, and the architecture includes a trap of this behavior to EL2. For more information, see [Stage 2 fault on a stage 1 translation table walk on page D4-2109](#).
- The rules about mismatched attributes given in [Mismatched memory attributes on page B2-118](#) apply to the relationship between translation table walks and explicit memory accesses to the translation tables in the same way that they apply to the relationship between different explicit memory accesses to the same location. For this reason, ARM strongly recommends that the attributes that the `TCR_ELx` applies to the translation tables are the same as the attributes that are applied for explicit accesses to the memory that holds the translation tables.

For more information see [Overview of the VMSAv8-64 address translation stages on page D4-2030](#).

See also [Selection between `TTBR0_ELx` and `TTBR1_ELx` when two VA ranges are supported on page D4-2045](#).

Ordering of memory accesses from translation table walks

A translation table walk is considered to be a separate observer, and:

- A write to the translation tables can be observed by that separate observer at any time after the execution of the instruction that performed that write, but is only guaranteed to be observable after the execution of a DSB instruction by the PE that executed the instruction that performed that write to the translation tables.
- Any writes to the translation tables are not seen by any explicit memory access generated by a load or store that occurs in program order before the instruction that performs the write to the translation tables.

Security state of translation table lookups

For a Non-secure translation regime, all translation table lookups are performed to Non-secure output addresses.

For a Secure translation regimes, the initial translation table lookup is performed to a Secure output address.

If the translation table descriptor returned as a result of that initial lookup points to a second translation table, then the NSTable bit in that descriptor determines whether that translation table lookup is made to Secure or to Non-secure output addresses.

This applies for all subsequent translation table lookups as part of that translation table walk, with the additional rule that any translation table descriptor that is returned from Non-secure memory is treated as if the NSTable bit in that descriptor indicates that the subsequent translation table lookup is to Non-secure memory.

Control of translation table walks

For a stage 1 translation that supports two VA ranges the `TCR_ELx`.{EPD0, EPD1} bits determine whether the translation tables for the stage are valid. EPD0 indicates whether the table that `TTBR0_ELx` points to is valid, and EPD1 indicates whether the table that `TTBR1_ELx` points to is valid. The effect of these bits is:

EPD n == 0 The translation table is valid, and can be used for a translation table lookup.

EPD n == 1 If a TLB miss occurs based on `TTBR_ELx`, a Translation fault is returned, and no translation table walk is performed. The fault is reported as a level 0 fault.

D4.2.6 Overview of the VMSAv8-64 address translation stages

As shown in *Memory translation granule size* on page D4-2021, the granule size determines significant aspects of the address translation process. *Effect of granule size on translation table addressing and indexing* on page D4-2024 shows, for each granule size:

- How the required input address range determines the required initial lookup levels.
- For stage 2 translations, the possible effect described in *Concatenated translation tables* on page D4-2025.
- The `TTBR_ELx` addressing and indexing for the initial lookup.

The following subsections summarize the multiple levels of lookup that can be required for a single stage of address translation that might require the maximum number of lookups:

- *Overview of VMSAv8-64 address translation using the 4KB translation granule.*
- *Overview of VMSAv8-64 address translation using the 16KB translation granule* on page D4-2034.
- *Overview of VMSAv8-64 address translation using the 64KB translation granule* on page D4-2038.

Overview of VMSAv8-64 address translation using the 4KB translation granule

The requirements for the level of the initial lookup are different for stage 1 and stage 2 translations.

Overview of stage 1 translations, 4KB granule

For a stage 1 translation, the required initial lookup level is determined only by the required input address range specified by the corresponding `TCR_ELx.TnSZ` field. When using the 4KB translation granule, [Table D4-12](#) shows this requirement.

Table D4-12 `TCR_ELx.TnSZ` values and IA ranges, 4K granule with no concatenation of tables

Initial lookup level	TnSZ values for and input address ranges ^a for starting at this level			
	TnSZ _{min}	IA _{max}	TnSZ _{max}	IA _{min}
0	16	IA[47:12]	24	IA[39:12]
1	25	IA[38:12]	33	IA[30:12]
2	34	IA[29:12]	39	IA[24:12]

a. The IAs show the address bits to be resolved when addressing a page of memory, see the *Note* that follows.

These configuration options are also permitted for stage 2 translations.

Note

- When using the 4KB translation granule, the initial lookup cannot be at level 3.
- Some bits of the IA do not require resolution by the translation table lookup, because they always map directly to the OA. When using the 4KB translation granule, `IA[11:0] = OA[11:0]` for all translations.

Figure D4-7 shows the stage 1 address translation, for an address translation using the 4KB granule with an input address size greater than 39 bits.

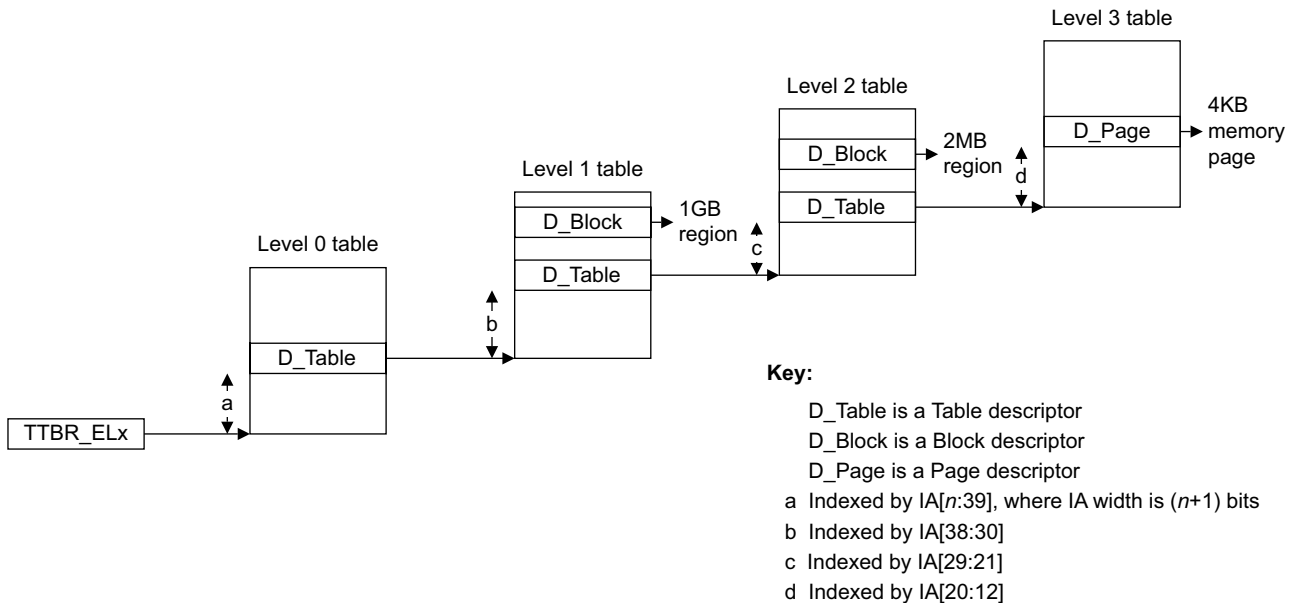

Figure D4-7 General view of VMSAv8-64 stage 1 address translation, 4KB granule

Overview of stage 2 translations, 4KB granule

For a stage 2 translation, up to 16 translation tables can be concatenated at the initial lookup level. For certain input address sizes, concatenating tables in this way means that the lookup starts at a lower level than would otherwise be the case. For more information see [Use of concatenated translation tables for the initial stage 2 lookup on page D4-2047](#).

When using the 4KB translation granule, [Table D4-13](#) shows all possibilities for the initial lookup for a stage 2 translation.

Table D4-13 VTCR_EL2.T0SZ values and IA ranges, 4K granule with possible concatenation of translation tables

Tables ^a	1	2		4		8		16		
Initial lookup level	T0SZ values and input address ranges ^b for starting at this level									
	T0SZ	IA	T0SZ	IA	T0SZ	IA	T0SZ	IA	T0SZ	IA
0	16-24	IA[47:12]-IA[39:12]	-	-	-	-	-	-	-	-
1	25-33	IA[38:12]-IA[30:12]	24	IA[39:12]	23	IA[40:12]	22	IA[41:12]	21	IA[42:12]
2	34-39	IA[29:12]-IA[24:12]	33	IA[30:12]	32	IA[31:12]	31	IA[32:12]	30	IA[33:12]

a. Number of concatenated translation tables at the initial lookup level. 1 table corresponds to no concatenation, also shown in [Table D4-12 on page D4-2030](#).
b. The IAs shown in the table indicate the address bits to be resolved by an address translation addressing a page of memory, see the Note that follows.

———— **Note** ————

- When using the 4KB translation granule, the initial lookup cannot be at level 3.
- Because concatenating translation tables reduces the number of levels of lookup required, when using the 4KB translation granule, tables cannot be concatenated at level 0.
- Some bits of the IA do not require resolution by the translation table lookup, because they always map directly to the OA. When using the 4KB translation granule, IA[11:0] = OA[11:0] for all translations.

In addition, [VTCR_EL2.SL0](#) indicates the required initial lookup level, as [Table D4-14](#) shows.

Table D4-14 [VTCR_EL2.SL0](#) values, 4KB granule

Initial lookup level	VTCR_EL2.SL0
0	0b10
1	0b01
2	0b00

The [VTCR_EL2.SL0](#) value 0b11 is reserved.

Because the maximum number of concatenated translation tables is 16, there is a relationship between the permitted [VTCR_EL2.{T0SZ, SL0}](#) values. [Table D4-13 on page D4-2031](#) shows the permitted T0SZ values for each initial lookup level.

If, when a translation table walk is started, the T0SZ value is not consistent with the SL0 value, or [VTCR_EL2.SL0](#) is programmed to a reserved value, a stage 2 level 0 Translation fault is generated.

Figure D4-8 shows the stage 2 address translation, for an input address size of between 40 and 43 bits. For an input address size in this range, the lookup can start at either level 0 or level 1.

VTCR_EL2.SL0 defines the start level.

Starting at level 0

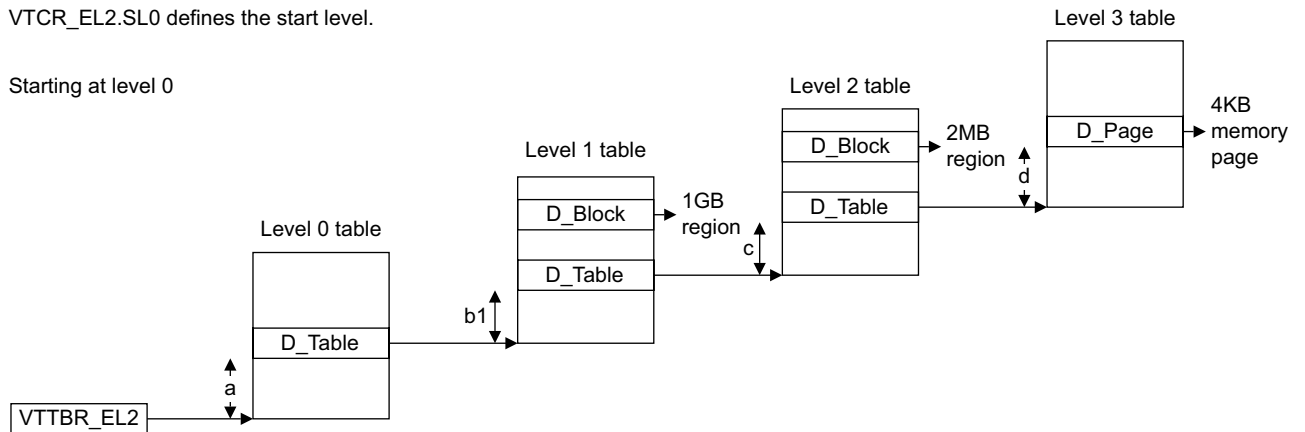

Starting at level 1

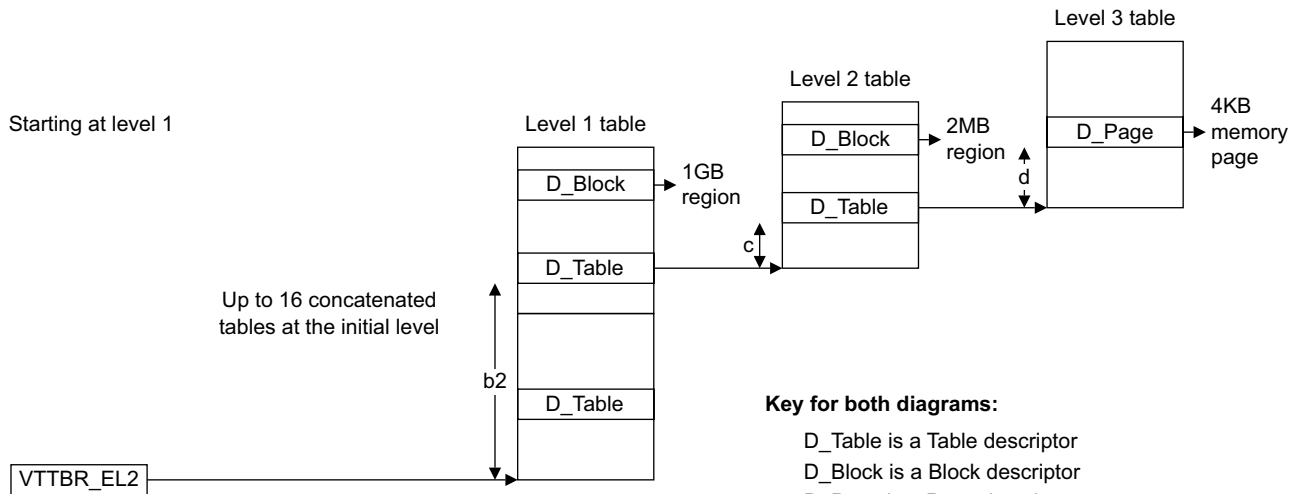

Key for both diagrams:

- D_Table is a Table descriptor
- D_Block is a Block descriptor
- D_Page is a Page descriptor
- a Indexed by IA[n:39], where IA width is (n+1) bits
- b1 Indexed by IA[38:30]
- b2 Indexed by IA[n:30], where IA width is (n+1) bits
- c Indexed by IA[29:21]
- d Indexed by IA[20:12]

Figure D4-8 General view of VMSAv8-64 stage 2 address translation, 4KB granule

Overview of VMSAv8-64 address translation using the 16KB translation granule

The requirements for the level of the initial lookup are different for stage 1 and stage 2 translations.

Overview of stage 1 translations, 16KB granule

For a stage 1 translation, the required initial lookup level is determined only by the required input address range specified by the corresponding `TCR_ELx.TnSZ` field. When using the 16KB translation granule, Table D4-15 shows this requirement.

Table D4-15 `TCR_ELx.TnSZ` values and IA ranges, 16K granule with no concatenation of tables

Initial lookup level	TnSZ values for and input address ranges ^a for starting at this level			
	TnSZ _{min}	IA _{max}	TnSZ _{max}	IA _{min}
0	16	IA[47:14]	-	-
1	17	IA[46:14]	27	IA[36:14]
2	28	IA[35:14]	38	IA[25:14]
3	39	IA[24:14]	-	-

a. The IAs show the address bits to be resolved when addressing a page of memory, see the *Note* that follows.

The configuration options for an initial lookup at level 1, level 2, or level 3 are also permitted for stage 2 translations, but stage 2 translation does not permit an initial lookup at level 0.

Note

- When using the 16KB translation granule, a maximum of 1 bit of IA is resolved by a level 0 lookup.
- Some bits of the IA do not require resolution by the translation table lookup, because they always map directly to the OA. When using the 16KB translation granule, $IA[13:0] = OA[13:0]$ for all translations.

Figure D4-9 shows the stage 1 address translation, for an address translation using the 16KB granule with an input address size of 48 bits.

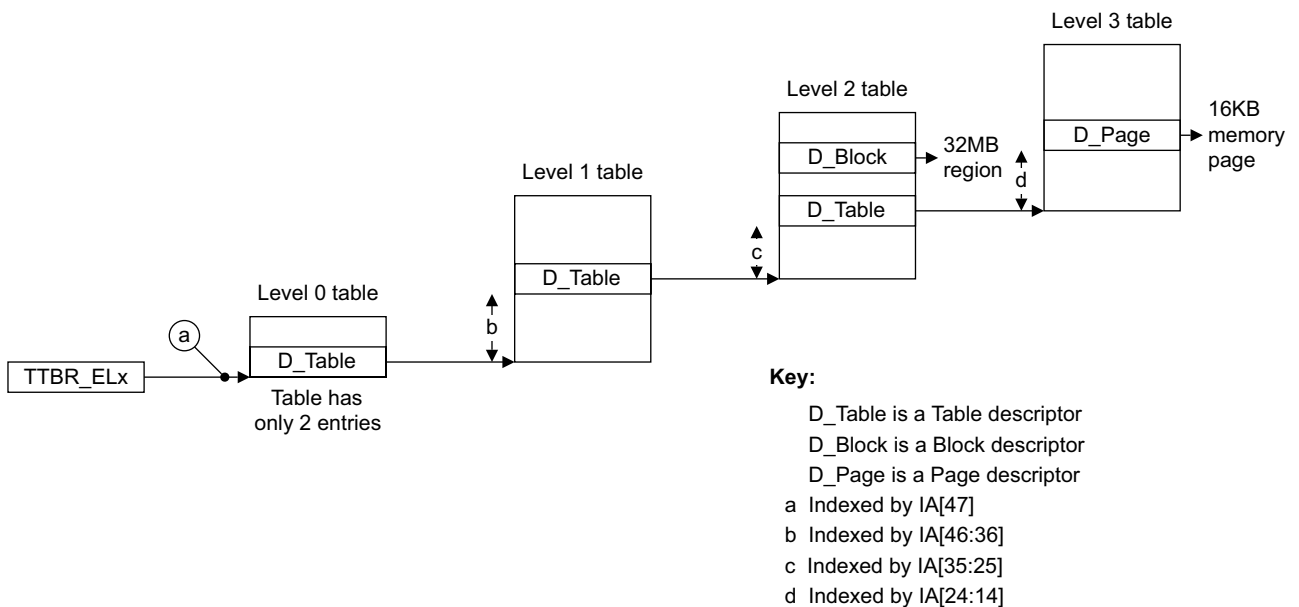

Figure D4-9 General view of VMSAv8-64 stage 1 address translation, 16KB granule

Overview of stage 2 translations, 16KB granule

For a stage 2 translation, up to 16 translation tables can be concatenated at the initial lookup level. For certain input address sizes, concatenating tables in this way means that the lookup starts at a lower level than would otherwise be the case. For more information see [Use of concatenated translation tables for the initial stage 2 lookup on page D4-2047](#).

When using the 16KB granule, for a stage 2 translation with an input address sized of 48 bits, the initial lookup must be at level 1, with two concatenated translation tables at this level.

When using the 16KB translation granule, [Table D4-16](#) shows all possibilities for the initial lookup for a stage 2 translation.

Table D4-16 VTCR_EL2.T0SZ values and IA ranges, 16K granule with possible concatenation of translation tables

Tables ^a	1		2		4		8		16	
Initial lookup level	T0SZ values and input address ranges ^b for starting at this level									
	T0SZ	IA	T0SZ	IA	T0SZ	IA	T0SZ	IA	T0SZ	IA
1	17-27	IA[46:14]-IA[36:14]	16	IA[47:14]	-	-	-	-	-	-
2	28-38	IA[35:14]-IA[25:14]	27	IA[36:14]	26	IA[37:14]	25	IA[38:14]	24	IA[39:14]
3	39	IA[24:14]	38	IA[25:14]	37	IA[26:14]	36	IA[27:14]	35	IA[28:14]

- a. Number of concatenated translation tables at the initial lookup level. *1 table* corresponds to no concatenation, also shown in [Table D4-15 on page D4-2034](#).
- b. The IAs shown in the table indicate the address bits to be resolved by an address translation addressing a page of memory, see the *Note* that follows.

Note

- When using the 16KB translation granule for a stage 2 translation, the initial lookup cannot be at level 0. When a 48-bit input address is required, translation must start with a level 1 lookup using two concatenated translation tables.
- Some bits of the IA do not require resolution by the translation table lookup, because they always map directly to the OA. When using the 16KB translation granule, IA[13:0] = OA[13:0] for all translations.

In addition, VTCR_EL2.SL0 indicates the required initial lookup level, as [Table D4-17](#) shows.

Table D4-17 VTCR_EL2.SL0 values, 16KB granule

Initial lookup level	VTCR_EL2.SL0
1	0b10
2	0b01
3	0b00

The VTCR_EL2.SL0 value 0b11 is reserved.

Because the maximum number of concatenated translation tables is 16, there is a relationship between the permitted VTCR_EL2.{T0SZ, SL0} values. [Table D4-16](#) shows the permitted values of T0SZ for each initial lookup level.

If, when a translation table walk is started, the T0SZ value is not consistent with the SL0 value, or VTCR_EL2.SL0 is programmed to a reserved value, a stage 2 level 0 Translation fault is generated.

When stage 2 translation supports a 48-bit input address range, translation must start with a level 1 lookup using two concatenated translation tables. Figure D4-10 shows the translation for this case.

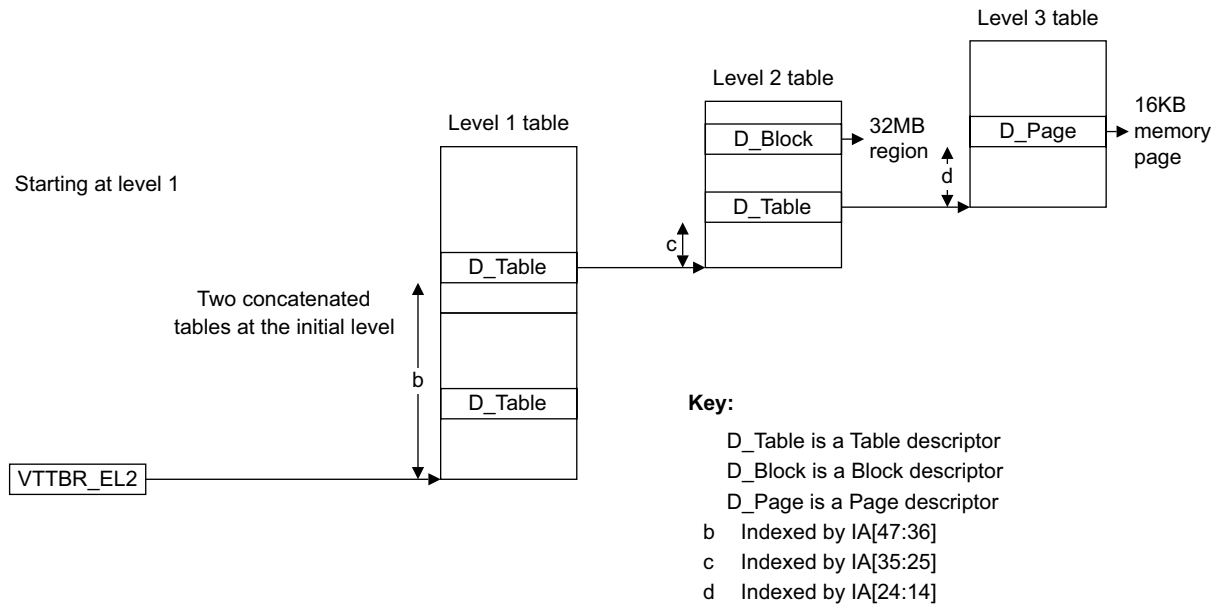
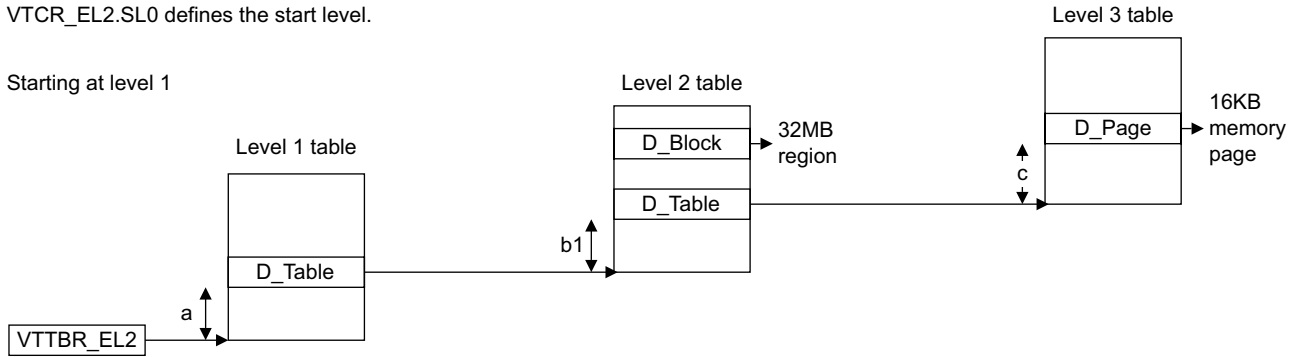

Figure D4-10 VMSAv8-64 stage 2 address translation, 16KB granule, 48 bit input address

However, for an input address size of between 37 and 40 bits, Table D4-16 on page D4-2035 shows that translation can start with either a level 1 lookup or a level 2 lookup, and Figure D4-11 shows these options.

VTCR_EL2.SL0 defines the start level.

Starting at level 1



Starting at level 2

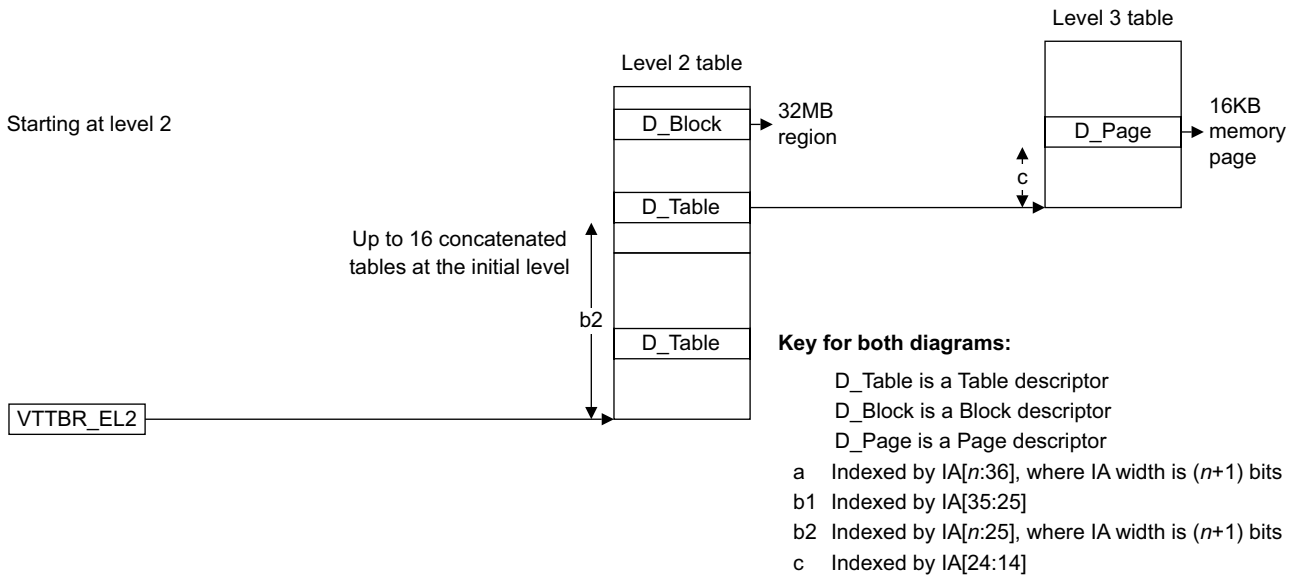

Figure D4-11 General view of VMSAv8-64 stage 2 address translation, 16KB granule

Overview of VMSAv8-64 address translation using the 64KB translation granule

The requirements for the level of the initial lookup are different for stage 1 and stage 2 translations.

Overview of stage 1 translations, 64KB granule

For a stage 1 translation, the required initial lookup level is determined only by the required input address range specified by the corresponding `TCR_ELx.TxSZ` field. When using the 64KB translation granule, [Table D4-18](#) shows this requirement.

Table D4-18 `TCR_ELx.TnSZ` values and IA ranges, 64K granule with no concatenation of tables

Lookup level	TnSZ values for and input address ranges ^a for starting at this level			
	TnSZ _{min}	IA _{max}	TnSZ _{max}	IA _{min}
1 ^b	12	IA[51:16]	21	IA[42:16]
1	16	IA[47:16]	21	IA[42:16]
2	22	IA[41:16]	34	IA[29:16]
3	35	IA[28:16]	39	IA[24:16]

- a. The IAs show the address bits to be resolved when addressing a page of memory, see the *Note* that follows.
- b. Supported only if ARMv8.2-LVA is implemented and the 64KB translation granule is used, see [Extending addressing above 48 bits](#) on page D4-2018.

These configuration options are also permitted for stage 2 translations.

————— Note —————

- When using the 64KB translation granule, there are no level 0 lookups.
- Some bits of the IA do not require resolution by the translation table lookup, because they always map directly to the OA. When using the 64KB translation granule, IA[15:0] = OA[15:0] for all translations.
- **When ARMv8.2-LPA is implemented, a level 1 block attribute is supported when using the 64KB granule.**

[Figure D4-12 on page D4-2039](#) shows the stage 1 address translation, for an address translation using the 64KB granule with an input address size greater than 42 bits.

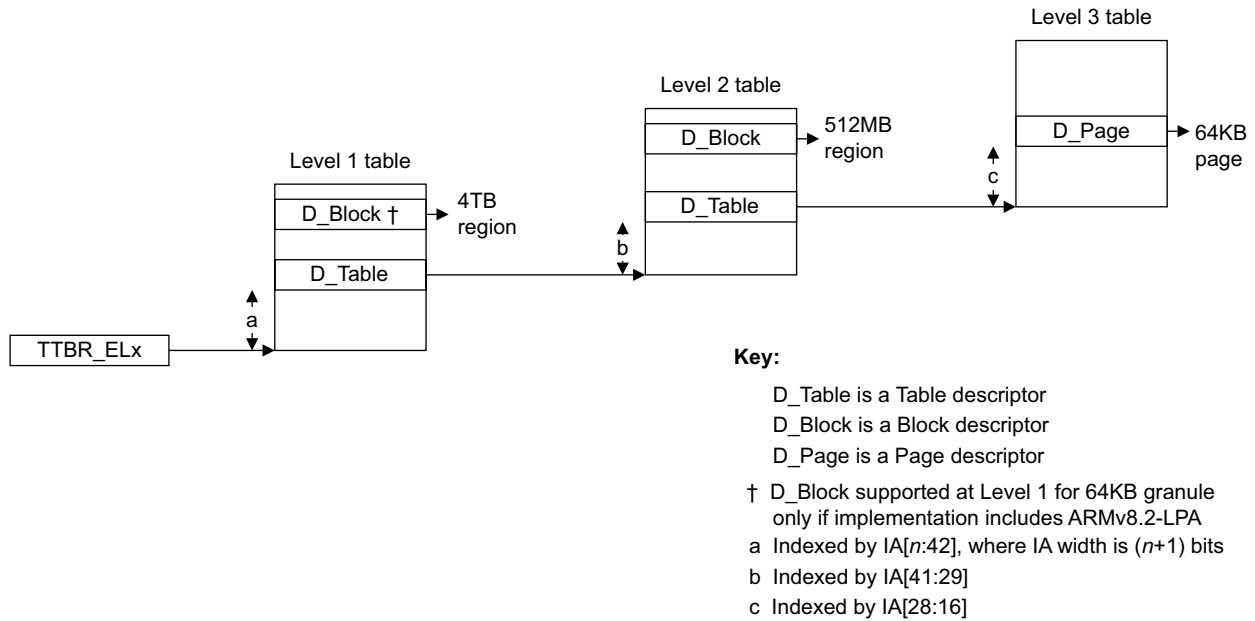

Figure D4-12 General view of VMSAv8-64 stage 1 address translation, 64KB granule with 52-bit VA support

Overview of stage 2 translations, 64KB granule

For a stage 2 translation, up to 16 translation tables can be concatenated at the initial lookup level. For certain input address sizes, concatenating tables in this way means that the lookup starts at a lower level than would otherwise be the case. For more information see [Use of concatenated translation tables for the initial stage 2 lookup on page D4-2047](#).

When using the 64KB translation granule, [Table D4-19](#) shows all possibilities for the initial lookup for a stage 2 translation.

Table D4-19 VTCR_EL2.T0SZ values and IA ranges, 64K granule with possible concatenation of translation tables

Tables ^a	1	2	4	8	16					
Initial lookup level	T0SZ values and input address ranges ^b for starting at this level									
	T0SZ	IA	T0SZ	IA	T0SZ	IA	T0SZ	IA	T0SZ	IA
1 ^c	12-21	IA[51:16]- IA[48:16]	-	-	-	-	-	-	-	-
1	16-21	IA[47:16]- IA[42:16]	-	-	-	-	-	-	-	-
2	22-34	IA[41:16]- IA[29:16]	21	IA[42:16]	20	IA[43:16]	19	IA[44:16]	18	IA[45:16]
3	35-39	IA[28:16]- IA[24:16]	34	IA[29:16]	33	IA[30:16]	32	IA[31:16]	31	IA[32:16]

- a. Number of concatenated translation tables at the initial lookup level. 1 table corresponds to no concatenation, also shown in [Table D4-18 on page D4-2038](#).
- b. The IAs shown in the table indicate the address bits to be resolved by an address translation addressing a page of memory, see the *Note* that follows.
- c. Only supported if the PA size is 52 bits, see [Extending addressing above 48 bits on page D4-2018](#).

———— **Note** ————

- When using the 64KB translation granule, there are no level 0 lookups.
- Because concatenating translation tables reduces the number of levels of lookup required, when using the 64KB translation granule, tables cannot be concatenated at level 1.
- Some bits of the IA do not require resolution by the translation table lookup, because they always map directly to the OA. When using the 64KB translation granule, IA[15:0] = OA[15:0] for all translations.

VTCCR_EL2.SL0 indicates the required initial lookup level, as [Table D4-20](#) shows.

Table D4-20 VTCCR_EL2.SL0 values, 64K granule

Initial lookup level	VTCCR_EL2.SL0
1	0b10
2	0b01
3	0b00

The VTCCR_EL2.SL0 value 0b11 is reserved.

Because the maximum number of concatenated translation tables is 16, there is a relationship between the permitted VTCCR_EL2.{T0SZ, SL0} values. [Table D4-19 on page D4-2039](#) shows the permitted values of T0SZ for each initial lookup level.

If, when a translation table walk is started, the T0SZ value is not consistent with the SL0 value, or VTCCR_EL2.SL0 is programmed to a reserved value, a stage 2 level 0 Translation fault is generated.

Figure D4-13 shows the stage 2 address translation, for an input address size of between 43 and 46 bits. This means the lookup can start at either level 1 or level 2.

VTCR_EL2.SL0 defines the start level.

Starting at level 1

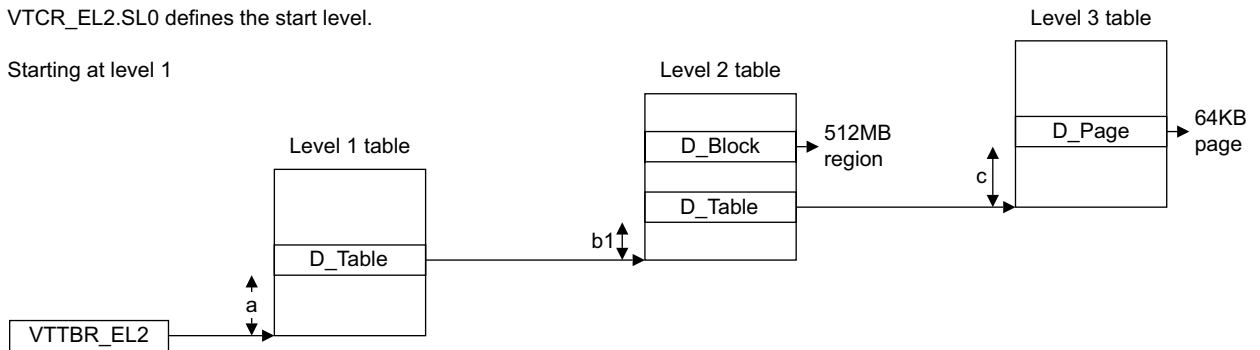

Starting at level 2

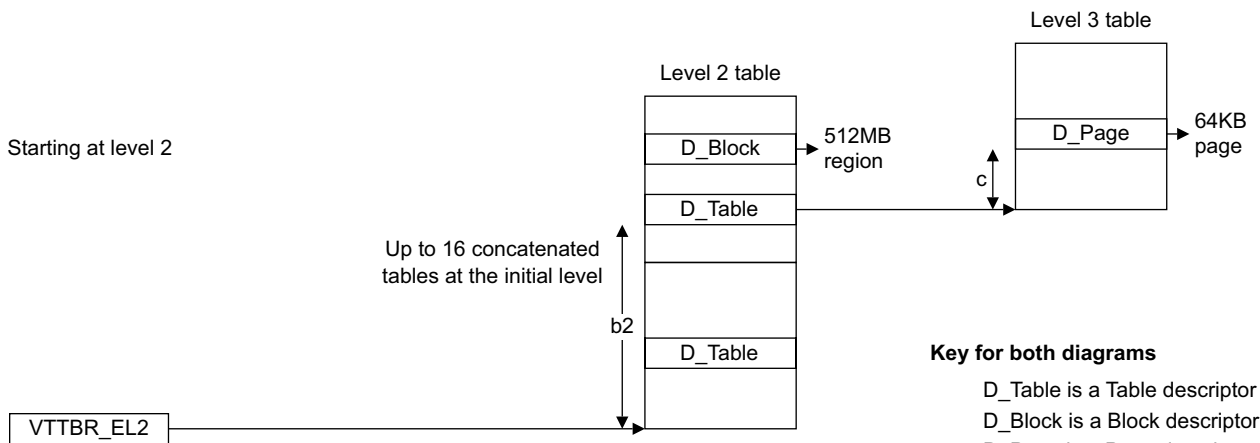

Key for both diagrams

- D_Table is a Table descriptor
- D_Block is a Block descriptor
- D_Page is a Page descriptor
- a Indexed by IA[n:42], where IA width is (n+1) bits
- b1 Indexed by IA[41:29]
- b2 Indexed by IA[n:29], where IA width is (n+1) bits
- c Indexed by IA[28:16]

Figure D4-13 General view of VMSAv8-64 stage 2 address translation, 64KB granule

D4.2.7 The VMSAv8-64 translation table format

This section provides the full description of the VMSAv8-64 translation table format, its use for address translations that are controlled by an Exception level using AArch64. For these translation regimes:

For a stage 1 translation that supports two VA ranges

- For the lower VA range, that uses [TTBR0_ELx](#):
 - The [TCR_ELx](#).{SH0, ORGN0, IRGN0} fields define memory region attributes for the translation table walks.
 - The [TCR_ELx](#).TG0 field defines the Translation granule size.
- For the upper VA range, that uses [TTBR1_ELx](#):
 - The [TCR_ELx](#).{SH1, ORGN1, IRGN1} fields define memory region attributes for the translation table walks.
 - The [TCR_ELx](#).TG1 field defines the Translation granule size.
- Each of [TTBR0_ELx](#) and [TTBR1_ELx](#) contains an ASID field, and the [TCR_ELx](#).A1 field selects which of these specifies the [ASID](#) to use.

For a stage 1 translation that supports one VA range

The translation table walks use [TTBR0_ELx](#), and:

- The [TCR_ELx](#).{SH0, ORGN0, IRGN0} fields define memory region attributes for the translation table walks.
- The [TCR_ELx](#).TG0 field defines the Translation granule size.

For a stage 2 translation

The translation table walks use [VTTBR_EL2](#), and:

- The [VTCR_EL2](#).{SH0, ORGN0, IRGN0} fields define memory region attributes for the translation table walks.
- The [VTCR_EL2](#).TG0 field defines the Translation granule size.

For the VMSAv8-64 translation table format, [Overview of the VMSAv8-64 address translation stages](#) on page D4-2030 summarizes the lookup levels, and [Descriptor encodings, ARMv8 level 0, level 1, and level 2 formats](#) on page D4-2061 describes the translation table entries.

The following subsections describe the use of this translation table format:

- [Translation granule size and associated block and page sizes](#) on page D4-2043.
- [Selection between TTBR0_ELx and TTBR1_ELx when two VA ranges are supported](#) on page D4-2045.
- [Use of concatenated translation tables for the initial stage 2 lookup](#) on page D4-2047.
- [Possible errors in programming the translation table registers](#) on page D4-2048.

Translation granule size and associated block and page sizes

Table D4-21 shows the supported granule sizes, block sizes and page sizes, for the different granule sizes. For completeness, this table includes information for AArch32 state. In the table, the OA bit ranges are the OA bits that the translation table descriptor specifies to address the block or page of memory, in an implementation that supports a 48-bit OA range.

Table D4-21 Translation granule sizes, with block and page sizes, and output address ranges

Granule size	Table level	Block size and OA bit range	Page size and OA bit range
4KB	Zero	-	-
	One	1GB, OA[47:30]	-
	Two	2MB, OA[47:21]	-
	Three	-	4KB, OA[47:12]
16KB	Zero	-	-
	One	-	-
	Two	32MB, OA[47:25]	-
	Three	-	16KB, OA[47:14]
64KB	One	4TB, OA[51:42] ^a	-
	Two	512MB, OA[47:29]	-
	Three	-	64KB, OA[47:16]

a. Only available when ARMv8.2-LPA is implemented, see *Extending addressing above 48 bits* on page D4-2018.

Bit[1] of a translation table descriptor identifies whether the descriptor is a block descriptor, and:

- The 4KB granule size supports block descriptors only in level 1 and level 2 translation tables.
- The 16KB granule size supports block descriptors only in level 2 translation tables.
- The 64KB granule size supports block descriptors in level 2 translation tables, and in level 1 translation tables when ARMv8.2-LPA is implemented and the implementation supports 52 bits of physical address. If the implementation does not support 52 bits of physical address, then encoding a block descriptor in a level 1 translation table generates a level 1 Translation fault.

If bit[1] of a descriptor is 0 in a translation table that does not support block descriptors then a translation table walk that accesses that descriptor generates a Translation fault.

For translations managed from AArch64 state, the following tables expand the information for each granule size, showing for an access to a single translation table at each lookup level:

- The maximum IA size, and the address bits that are resolved for that maximum size.
- The maximum OA range resolved by the translation table descriptors at this level, and the corresponding memory region size.
- The maximum size of the translation table. This is the size required for the maximum IA size.

Table D4-22 on page D4-2044 shows this information for the 4KB translation granule size, Table D4-23 on page D4-2044 shows this information for the 16KB translation granule size, and Table D4-24 on page D4-2044 shows this information for the 64KB translation granule size.

Table D4-22 Properties of the address lookup levels, 4KB granule size

Level	Maximum input address		Maximum output address		Number of entries	Block entries supported?
	Size	Address range	Address range	Size of addressed region ^a		
Zero	256TB	Address[47:39]	Address[47:39]	512GB	Up to 512	No
One	512GB	Address[38:30]	Address[47:30]	1GB	Up to 512	Yes
Two	1GB	Address[29:21]	Address[47:21]	2MB	Up to 512	Yes
Three	2MB	Address[20:12]	Address[47:12]	4KB	512	Page only

a. That is, the size of the region either addressed by descriptors at this level or to be resolved at this and the subsequent levels of lookup.

Table D4-23 Properties of the address lookup levels, 16KB granule size

Level	Maximum input address		Maximum output address		Number of entries	Block entries supported?
	Size	Address range	Address range	Size of addressed region ^a		
Zero	256TB	Address[47]	Address[47]	128TB	2 ^b	No
One	128TB	Address[46:36]	Address[47:36]	64GB	Up to 2048	No
Two	64GB	Address[35:25]	Address[47:25]	32MB	Up to 2048	Yes
Three	32MB	Address[24:14]	Address[47:14]	16KB	2048	Page only

a. That is, the size of the region either addressed by descriptors at this level or to be resolved at this and the subsequent levels of lookup.

b. The translation table size is less than the maximum for this granule size, and therefore the number of entries is reduced.

Table D4-24 Properties of the address lookup levels, 64KB granule size

Level	Maximum input address		Maximum output address		Number of entries	Block entries supported?
	Size	Address range	Address range	Size of addressed region ^a		
One	4PB	Address[51:42]	Address[51:42]	4TB	Up to 64^b	Yes
One	256TB	Address[47:42]	Address[47:42]	4TB	Up to 64 ^b	No
Two	4TB	Address[41:29]	Address[47:29]	512MB	Up to 8192	Yes
Three	512MB	Address[28:16]	Address[47:16]	64KB	8192	Page only

a. That is, the size of the region either addressed by descriptors at this level or to be resolved at this and the subsequent levels of lookup.

b. The translation table size is less than the maximum for this granule size, and therefore the number of entries is reduced.

For the initial lookup level:

- If the IA range specified by the `TCR_ELx.TxSZ` field is smaller than the maximum size shown in these table then this reduces the number of addresses in the table and therefore reduces the table size. The smaller translation table is aligned to its table size.
- For stage 2 translations, multiple translation tables can be concatenated to extend the maximum IA size beyond that shown in these tables. For more information see the stage 2 translation overviews in *Overview of the VMSEA8-64 address translation stages* on page D4-2030 and *Use of concatenated translation tables for the initial stage 2 lookup* on page D4-2047.

If a supplied input address is larger than the configured input address size, a Translation fault is generated.

———— **Note** ————

Larger translation granule sizes typically requires fewer levels of translation tables to translate a particular size of VA.

For the `TCR_ELx` programming requirements for the initial lookup, see *Overview of the VMSEA8-64 address translation stages* on page D4-2030.

Selection between `TTBR0_ELx` and `TTBR1_ELx` when two VA ranges are supported

Every translation table walk starts by accessing the translation table addressed by the `TTBR_ELx` for the stage 1 translation for the required translation regime.

For a stage 1 translation that supports two VA ranges, [Figure D4-14](#) shows this VA range split when using 48-bit VAs, and:

- `TTBR0_ELx` points to the initial translation table for the lower VA range, that starts at address `0x0000_0000_0000_0000`,
- `TTBR1_ELx` points to the initial translation table for the upper VA range, that runs up to address `0xFFFFFFFFFFFFFFFF`.

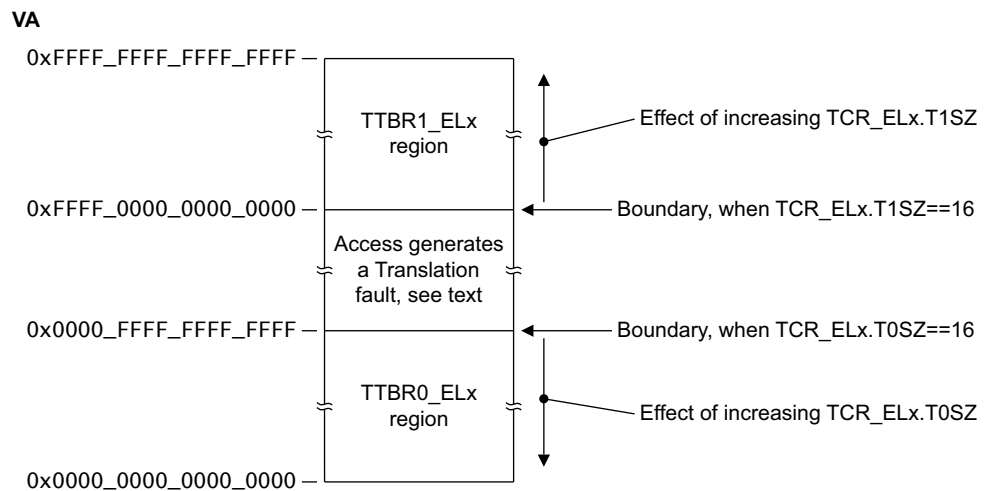

Figure D4-14 AArch64 `TTBRn` boundaries and VA ranges for 48-bit VAs

As [Figure D4-14](#) shows, for 48-bit VAs:

- The address range translated using `TTBR0_ELx` is `0x0000_0000_0000_0000` to `0x0000_FFFFFFFF`.
- The address range translated using `TTBR1_ELx` is `0xFFFF_0000_0000_0000` to `0xFFFFFFFF`.

In an implementation that includes ARMv8.2-LVA and is using the 64KB translation granule, for 52-bit VAs:

- The address range translated using `TTBR0_ELx` is `0x0000_0000_0000_0000` to `0x000_FFFFFFFF`.
- The address range translated using `TTBR1_ELx` is `0xFFF0_0000_0000_0000` to `0xFFFFFFFF`.

Which `TTBR_ELx` is used depends only on the `VA` presented for translation. The most significant bits of the `VA` must all be the same value and:

- If the most significant bits of the `VA` are zero, then `TTBR0_ELx` is used.
- If the most significant bits of the `VA` are one, then `TTBR1_ELx` is used.

However, it is configurable whether `VA[63:56]` are considered when determining which `TTBR_ELx` is used, that is:

- In an implementation that includes ARMv8.2-LVA and is using the 64KB translation granule, whether the determination depends on `VA[63:52]` or on `VA[55:52]`.
- Otherwise, whether the determination depends on `VA[63:48]` or on `VA[55:48]`.

For more information about whether `VA[63:56]` are considered for this determination see [Address tagging in AArch64 state on page D4-2006](#).

Note

The handling of the Contiguous bit can mean that the boundary between the translation regions defined by the `TCR_ELx.TnSZ` values and the region for which an access generates a Translation fault is wider than shown in [Figure D4-14 on page D4-2045](#). That is, if the descriptor for an access to the region shown as generating a fault has the Contiguous bit set to 1, the access might not generate a fault. [Possible errors in programming the translation table registers on page D4-2048](#) describes this possibility.

[Example D4-3](#) shows a typical application of this `VA` split.

Example D4-3 Example use of the split `VA` range, and the `TTBR0_ELx` and `TTBR1_ELx` controls

An example of using the split `VA` range is:

TTBR0_ELx Used for process-specific addresses.

Each process maintains a separate level 1 translation table. On a context switch:

- `TTBR0_ELx` is updated to point to the level 1 translation table for the new context
- `TCR_ELx` is updated if this change changes the size of the translation table
- `CONTEXTIDR_ELx` is updated.

TTBR1_ELx Used for operating system and I/O addresses, that do not change on a context switch.

For each `VA` subrange, the input address size is $2^{(64-TnSZ)}$, where `TnSZ` is one of `TCR_ELx`. {`T0SZ`, `T1SZ`}.

This means the two `VA` subranges are:

Lower `VA` subrange `0x0000_0000_0000_0000` to $(2^{(64-T0SZ)} - 1)$.

Upper `VA` subrange $(2^{64} - 2^{(64-T1SZ)})$ to `0xFFFF_FFFF_FFFF_FFFF`.

For the situation where the minimum `TnSZ` value is 16, corresponding to a maximum input address range of 48 bits, [Example D4-4](#) shows the two `VA` subranges when `T0SZ` and `T1SZ` are both set to this minimum value.

Example D4-4 Maximum `VA` ranges when a stage of translation supports two ranges

The maximum `VA` subranges correspond to `T0SZ` and `T1SZ` each having a minimum value of 16. In this case the subranges are:

Lower `VA` subrange `0x0000_0000_0000_0000` to `0x0000_FFFF_FFFF_FFFF`.

Upper `VA` subrange `0xFFFF_0000_0000_0000` to `0xFFFF_FFFF_FFFF_FFFF`.

[Figure D4-14 on page D4-2045](#) indicates the effect of varying the `TnSZ` values.

As described in [Overview of the VMSAv8-64 address translation stages on page D4-2030](#), the $TnSZ$ values also determine the initial lookup level for the translation.

Use of concatenated translation tables for the initial stage 2 lookup

[Overview of the VMSAv8-64 address translation stages on page D4-2030](#) introduced the ability to concatenate translation tables for the initial stage 2 translation lookup. This section gives more information about that concatenation.

If a stage 2 translation would require 16 entries or fewer in its top-level translation table, that stage of translation can, instead, be configured so that:

- It requires the corresponding number of concatenated translation tables at the next translation level, aligned to the size of the block of concatenated translation tables.
- The stage 2 translation starts at that next translation level.

When using the 16KB translation granule, if a 48-bit input address size is required for the stage 2 translations, lookup must start with two concatenated translation tables at level 1.

The use of concatenated translation tables requires the software that is defining the translation to:

- Define the concatenated translation tables with the required overall alignment.
- Program `VTTBR_EL2` to hold the address of the first of the concatenated translation tables.
- Program `VTCR_EL2` to indicate the required input address range and initial lookup level.

Note

The use of concatenated translation tables avoids the overhead of an additional level of translation.

Concatenating additional translation tables at the initial level of look up resolves additional address bits at that level. To resolve n additional address bits requires 2^n concatenated translation tables. [Example D4-5](#) shows how, for level 1 lookups using the 4KB translation granule, translation tables can be concatenated to resolve three additional address bits.

Example D4-5 Adding three bits of address resolution at level 1 lookup, using the 4KB granule

When using the 4KB translation granule, a level 1 lookup with a single translation table resolves address bits[38:30]. To add three more address bits requires 2^3 translation tables, that is, eight translation tables. This means:

- The total size of the concatenated translation tables is $8 \times 4\text{KB} = 32\text{KB}$.
 - This block of concatenated translation tables must be aligned to 32KB.
 - The address range resolved at this lookup level is $A[41:30]$, of which:
 - Bits $A[41:39]$ select the 4KB translation table.
 - Bits $A[38:30]$ index a descriptor within that translation table.
-

As an example of the concatenation of translation tables at the initial lookup level, when using the 4KB translation granule, [Table D4-25](#) shows the possible uses of concatenated translation tables to permit lookup to start at level 1 rather than at level 0. For completeness, the table starts with the case where the required IPA range means lookup starts at level 1 with a single translation table at that level.

Table D4-25 Possible uses of concatenated translation tables for level 1 lookup, 4KB granule

Configured stage 2 IA size		Lookup starts at level 0	Lookup starts at level 1	
IPA range	Size	Required level 0 entries	Number of concatenated tables	Required alignment ^a
IPA[38:0]	2 ³⁶ bytes	-	1	4KB
IPA[39:0]	2 ³⁷ bytes	2	2	8KB
IPA[40:0]	2 ³⁸ bytes	4	4	16KB
IPA[41:0]	2 ³⁹ bytes	8	8	32KB
IPA[42:0]	2 ⁴⁰ bytes	16	16	64KB

a. Required alignment of the set of concatenated level 2 tables.

Note

Because concatenation is permitted only for a stage 2 translation, the input addresses in the table are IPAs.

[Overview of the VMSAv8-64 address translation stages on page D4-2030](#) identifies all of the possible uses of concatenation. In all cases, the block of concatenated translation tables must be aligned to the block size.

Possible errors in programming the translation table registers

This subsection describes possible errors in programming the translation table registers.

Misprogramming the VTCR_EL2.{T0SZ, SL0} fields

For a stage 2 translation, the programming of the VTCR_EL2.{T0SZ, SL0} fields must be consistent. If these fields are not consistent, or if SL0 is programmed to a reserved value, any translation table walk that uses stage 2 translation generates a stage 2 level 0 Translation fault. For more information see [Overview of the VMSAv8-64 address translation stages on page D4-2030](#).

Misprogramming of the Contiguous bit

For more information about the Contiguous bit, and the range of translation table entries that must have the bit set to 1 to mark the entries as contiguous, see [The Contiguous bit on page D4-2094](#).

If one or more of the following errors is made in programming the translation tables, the TLB might contain overlapping entries:

- One or more of the contiguous translation table entries does not have the Contiguous bit set to 1.
- One or more of the contiguous translation table entries holds an output address that is not consistent with all of the entries pointing to the same aligned contiguous address range.
- The attributes and permissions of the contiguous entries are not all the same.

Such misprogramming of the translation tables means the output address, memory permissions, or attributes for a lookup might be corrupted, and might be equal to values that are not consistent with any of the programmed translation table values.

In some implementations, such misprogramming might also give rise to a TLB Conflict abort.

The architecture guarantees that misprogramming of the Contiguous bit cannot provide a mechanism for any of the following to occur:

- Software executing at EL1 or EL0 accessing regions of physical memory that are not accessible by programming the translation tables, from EL1, with arbitrary chosen values that do not misprogram the Contiguous bit.
- Software executing at EL1 or EL0 accessing regions of physical memory with attributes or permissions that are not possible by programming the translation tables, from EL1, with arbitrary chosen values that do not misprogram the Contiguous bit.
- Software executing in Non-secure state accessing Secure physical memory.

———— **Note** ————

Hardware implementations must ensure that use of the Contiguous bit cannot provide a mechanism for avoiding output address range checking. This might occur if a Contiguous bit block size of 0.5GB or 1GB is used in a system with the output address size configured to 4GB. The architecture permits the implemented mechanism for preventing any avoidance of output address range checking to suppress the use of the Contiguous bit for such entries in such a system.

Where the Contiguous bit is used to mark a set of blocks as contiguous, if the address range translated by a set of blocks marked as contiguous is larger than the size of the input address supported at a stage of translation used to translate that address at that stage of translation, as defined by the `TCR_ELx.TxSZ` field, then this is a programming error. An implementation is permitted, but not required, to:

- Treat such a block within a contiguous set of blocks as causing a Translation fault, even though the block is valid, and the address accessed within that block is within the size of the input address supported at a stage of translation, as defined by the `TCR_ELx.TxSZ` field.
- Treat such a block within a contiguous set of blocks as not causing a Translation fault, even though the address accessed within that block is outside the size of the input address supported at a stage of translation, as defined by the `TCR_ELx.TxSZ` field, provided that both of the following apply:
 - The block is valid.
 - At least one address within the block, or contiguous set of blocks, is within the size of the input address supported at a stage of translation.

When ARMv8.2-LVA is implemented, level 1 block descriptors for the 64KB granule do not support the Contiguous bit, and that field is RES0.

D4.2.8 The algorithm for finding the translation table descriptors

This subsection gives the algorithms for finding the translation table descriptor that corresponds to a given IA, for each required level of lookup. The algorithms encode the descriptions of address translation given earlier in this section. The algorithm details depend on the translation granule size for the stage of address translation, see:

- [Finding the translation table descriptor when using the 4KB translation granule on page D4-2050.](#)
- [Finding the translation table descriptor when using the 16KB translation granule on page D4-2051.](#)
- [Finding the translation table descriptor when using the 64KB translation granule on page D4-2052.](#)

Each subsection uses the following terms:

- BaseAddr** The base address for the level of lookup, as defined by:
- For the initial lookup level, the value of the appropriate `TTBR_ELx.BADDR` field.
 - Otherwise, the translation table address returned by the previous level of lookup.
- PAMax** The supported `PA` width, in bits.
- IA** The supplied IA for this stage of translation.

- TnSZ** The translation table size for this stage of translation:
For EL1&0 stage 1 [TCR_EL1.T0SZ](#) or [TCR_EL1.T1SZ](#), as appropriate.
For EL1&0 stage 2 [VTCR_EL2.T0SZ](#).
For EL2 stage 1 [TCR_EL2.T0SZ](#).
For EL2&0 stage 1 [TCR_EL2.T0SZ](#) or [TCR_EL2.T1SZ](#), as appropriate.
For EL3 stage 1 [TCR_EL3.T0SZ](#).
- SL0** [VTCR_EL2.SL0](#). Applies to the Non-secure EL1&0 stage 2 translation only.

These subsections show only architecturally-valid programming of the [TCR_ELx](#). See also *Possible errors in programming the translation table registers* on page D4-2048.

Finding the translation table descriptor when using the 4KB translation granule

[Table D4-26](#) shows the translation table descriptor address, for each level of lookup, when using the 4KB translation granule. See the start of *The algorithm for finding the translation table descriptors* on page D4-2049 for more information about terms used in the table.

Table D4-26 Translation table entry addresses when using the 4KB translation granule

Lookup level	Entry address and conditions		General conditions
	Stage 1 translation	Stage 2 translation	
Zero	BaseAddr[PAMax-1:x]:IA[y:39]:0b000 if ^a $z \leq TnSZ \leq 24$ then $x = (28 - TnSZ)$	BaseAddr[PAMax-1:x]:IA[y:39]:0b000 if $SL0^b == 2$ then if ^a $z \leq T0SZ \leq 24$ then $x = (28 - T0SZ)$	$y = (x + 35)$ $z = 16$
One	BaseAddr[PAMax-1:x]:IA[y:30]:0b000 if ^a $25 \leq TnSZ \leq 33$ then $x = (37 - TnSZ)$ else ^c $x = 12$	BaseAddr[PAMax-1:x]:IA[y:30]:0b000 if $SL0^b == 1$ then if ^a $21 \leq T0SZ \leq 33$ then $x = (37 - T0SZ)$ elseif $SL0^{b,c} == 2$ then $x = 12$	$y = (x + 26)$
Two	BaseAddr[PAMax-1:x]:IA[y:21]:0b000 if ^a $34 \leq TnSZ \leq 39$ then $x = (46 - TnSZ)$ else ^c $x = 12$	BaseAddr[PAMax-1:x]:IA[y:21]:0b000 if $SL0^b == 0$ then if ^a $30 \leq T0SZ \leq 39$ then $x = (46 - T0SZ)$ elseif $SL0^{b,c} > 0$ then $x = 12$	$y = (x + 17)$
Three	BaseAddr[PAMax-1:12]:IA[20:12]:0b000	BaseAddr[PAMax-1:12]:IA[20:12]:0b000	-

- This line indicates the range of permitted values for TnSZ, for a lookup that starts at this level, see *Overview of VMSAv8-64 address translation using the 4KB translation granule* on page D4-2030.
- $SL0 == 0$ if the initial lookup is level 2, $SL0 == 1$ if the initial lookup is level 1, and $SL0 == 2$ if the initial lookup level is level 0.
- This is the case where this level of lookup is not the initial level of lookup.

[Table D4-8](#) on page D4-2021 shows how software can determine whether an implementation supports the 4KB granule size.

Finding the translation table descriptor when using the 16KB translation granule

Table D4-27 shows the translation table descriptor address, for each level of lookup, when using the 16KB translation granule. See the start of *The algorithm for finding the translation table descriptors* on page D4-2049 for more information about terms used in the table.

Table D4-27 Translation table entry addresses when using the 16KB translation granule

Lookup level	Entry address and conditions		General conditions
	Stage 1 translation	Stage 2 translation	
Zero	BaseAddr[PAMax-1:4]:IA[47]:0b000 ^a $16 \leq TnSZ$	-	Only applies to stage 1
One	BaseAddr[PAMax-1:x]:IA[y:36]:0b000 if ^a $17 \leq TnSZ \leq 27$ then $x = (31 - TnSZ)$ else ^c $x = 14$	BaseAddr[PAMax-1:x]:IA[y:36]:0b000 if $SL0^b == 2$ then if ^a $16 \leq T0SZ \leq 27$ then $x = (31 - T0SZ)$	$y = (x + 32)$
Two	BaseAddr[PAMax-1:x]:IA[y:25]:0b000 if ^a $28 \leq TnSZ \leq 38$ then $x = (42 - TnSZ)$ else ^c $x = 14$	BaseAddr[PAMax-1:x]:IA[y:25]:0b000 if $SL0^b == 1$ then if ^a $24 \leq T0SZ \leq 38$ then $x = (42 - T0SZ)$ elsif $SL0^b, ^c == 2$ then $x = 14$	$y = (x + 21)$
Three	BaseAddr[PAMax-1:14]:IA[24:14]:0b000	BaseAddr[PAMax-1:x]:IA[y:14]:0b000 if $SL0^b == 0$ then if ^a $35 \leq T0SZ \leq 39$ then $x = (53 - T0SZ)$ elsif $SL0^b, ^c > 0$ then $x = 14$	$y = (x + 10)$

- a. This line indicates the range of permitted values for $TnSZ$, for a lookup that starts at this level, see *Overview of VMSAv8-64 address translation using the 16KB translation granule* on page D4-2034.
- b. $SL0 == 0$ if the initial lookup is level 3, $SL0 == 1$ if the initial lookup is level 2, and $SL0 == 2$ if the initial lookup level is level 1.
- c. This is the case where this level of lookup is not the initial level of lookup.

Table D4-8 on page D4-2021 shows how software can determine whether an implementation supports the 16KB granule size.

Finding the translation table descriptor when using the 64KB translation granule

Table D4-28 shows the translation table descriptor address, for each level of lookup, when using the 64KB translation granule. See the start of *The algorithm for finding the translation table descriptors* on page D4-2049 for more information about terms used in the table.

Table D4-28 Translation table entry addresses when using the 64KB translation granule

Lookup level	Entry address and conditions		General conditions
	Stage 1 translation	Stage 2 translation	
One	BaseAddr[PAMax-1:x]:IA[y:42]:0b000 if ^a $z^b \leq TnSZ \leq 21$ then $x = (25 - TnSZ)$	BaseAddr[PAMax-1:x]:IA[y:42]:0b000 if $SL0^c == 2$ then if ^a $z^b \leq T0SZ \leq 21$ then $x = (25 - T0SZ)$	$y = (x + 38)$ $z = 16$ or 12^b
Two	BaseAddr[PAMax-1:x]:IA[y:29]:0b000 if ^a $22 \leq TnSZ \leq 34$ then $x = (38 - TnSZ)$ else ^d $x = 16$	BaseAddr[PAMax-1:x]:IA[y:29]:0b000 if $SL0^c == 1$ then if ^a $18 \leq T0SZ \leq 34$ then $x = (38 - T0SZ)$ elseif $SL0^{c,d} == 2$ then $x = 16$	$y = (x + 25)$
Three	BaseAddr[PAMax-1:x]:IA[y:16]:0b000 if ^a $35 \leq TnSZ \leq 39$ then $x = (51 - TnSZ)$ else ^d $x = 16$	BaseAddr[PAMax-1:x]:IA[y:16]:0b000 if $SL0^c == 0$ then if ^a $31 \leq T0SZ \leq 39$ then $x = (51 - T0SZ)$ elseif $SL0^{c,d} > 0$ then $x = 16$	$y = (x + 12)$

a. This line indicates the range of permitted values for $TnSZ$, for a lookup that starts at this level, see *Overview of VMSAv8-64 address translation using the 64KB translation granule* on page D4-2038.

b. If ARMv8.2-LVA is implemented, the value of z is 12, see *Extending addressing above 48 bits* on page D4-2018. Otherwise, the value of z is 16.

c. $SL0 == 0$ if the initial lookup is level 3, $SL0 == 1$ if the initial lookup is level 2, and $SL0 == 2$ if the initial lookup level is at level 1.

d. This is the case where this level of lookup is not the initial level of lookup.

Table D4-8 on page D4-2021 shows how software can determine whether an implementation supports the 64KB granule size.

D4.2.9 The effects of disabling a stage of address translation

The following sections describe the effect on MMU behavior of disabling each stage of translation:

- [Behavior when stage 1 address translation is disabled.](#)
- [Behavior when stage 2 address translation is disabled on page D4-2054.](#)
- [Behavior of instruction fetches when all associated stages of translation are disabled on page D4-2054.](#)

Behavior when stage 1 address translation is disabled

When a stage 1 address translation is disabled, memory accesses that would otherwise be translated by that stage of translation are treated as follows:

Non-secure EL1 and EL0 accesses if the [HCR_EL2.DC](#) bit is set to 1

For the Non-secure EL1&0 translation regime, when the value of [HCR_EL2.DC](#) is 1, the stage 1 translation assigns the Normal Non-shareable, Inner Write-Back Read-Allocate Write-Allocate, Outer Write-Back Read-Allocate Write-Allocate memory attributes.

———— **Note** —————

This applies for both instruction and data accesses.

—————

All other accesses

For all other accesses, when stage 1 address translation is disabled, the assigned attributes depend on whether the access is a data access or an instruction access, as follows:

Data access

The stage 1 translation assigns the Device-nGnRnE memory type.

Instruction access

The stage 1 translation assigns the Normal memory attribute, with the cacheability and shareability attributes determined by the value of the [SCTLR_ELx.I](#) bit for the translation regime, as follows:

When the value of I is 0

The stage 1 translation assigns the Non-cacheable and Outer Shareable attributes.

When the value of I is 1

The stage 1 translation assigns the Cacheable, Inner Write-Through Read-Allocate No Write-Allocate, Outer Write-Through Read-Allocate No Write-Allocate Outer Shareable attribute.

For this stage of translation, no memory access permission checks are performed. Therefore no MMU faults can be generated for this stage of address translation.

———— **Note** —————

Alignment checking is performed, and therefore Alignment faults can occur.

—————

For every access, the input address of the stage 1 translation is flat-mapped to the output address.

For a Non-secure EL1 or EL0 access, if EL1&0 stage 2 address translation is enabled, the stage 1 memory attribute assignments and output address can be modified by the stage 2 translation.

When the value of [HCR_EL2.DC](#) is 1, in Non-secure state:

- The [SCTLR_EL1.M](#) bit behaves as if it is 0, for all purposes other than reading the value of the bit. This means Non-secure EL1&0 stage 1 address translation is disabled.
- The [HCR_EL2.VM](#) bit behaves as if it is 1, for all purposes other than reading the value of the bit. This means that Non-secure EL1&0 stage 2 address translation is enabled.

See also [Behavior of instruction fetches when all associated stages of translation are disabled on page D4-2054.](#)

Effect of disabling address translation on maintenance and address translation instruction instructions

Cache maintenance instructions act on the target cache regardless of whether any stages of address translation are disabled, and regardless of the values of the memory attributes. However, if a stage of address translation is disabled, they use the flat address mapping for that translation stage.

TLB invalidate operations act on the target TLB regardless of whether any stage of address translation is disabled.

The value of `HCR_EL2.DC` affect some address translation instructions, see [Address translation instructions, AT*](#) on page D4-2056.

Behavior when stage 2 address translation is disabled

When stage 2 address translation is disabled:

- The IPA output from the stage 1 translation maps flat to the PA.
- The memory attributes and permissions from the stage 1 translation apply to the PA.

When both stages of address translation are disabled, see also [Behavior of instruction fetches when all associated stages of translation are disabled](#).

Behavior of instruction fetches when all associated stages of translation are disabled

When EL3 is using AArch64, this section applies to:

- The Secure EL1&0 translation regime when stage 1 address translation is disabled in that regime.
- The Secure EL3 translation regime when stage 1 address translation is disabled in that regime.
- The Non-secure EL2, or EL2&0, translation regime when stage 1 address translation is disabled in that regime
- The Non-secure EL1&0 translation regime, when both stages of address translation are disabled.

Note

- The behaviors in Non-secure state apply regardless of the Execution state that EL3 is using.
- When the value of `HCR_EL2.DC` is 1, then the behavior of the Non-secure EL1&0 translation regime is as if stage 1 translation is disabled and stage 2 translation is enabled, as described in [Behavior when stage 1 address translation is disabled on page D4-2053](#).

In these cases, when execution is in AArch64 state, a memory location might be accessed as a result of an instruction fetch if either:

- The memory location is in the same block of memory as, or in the next contiguous block of memory to, an instruction that a simple sequential execution of the program either requires to be fetched now or has required to be fetched since the last reset.
- The memory location is the target of a direct branch that a simple sequential execution of the program would have taken since the most recent of:
 - The last reset.
 - The last synchronization of instruction cache maintenance targeting the address of the branch instruction.

In this description, the blocks of memory referred to are of the size of the minimum implemented translation granule and are aligned to that size.

These accesses can be caused by speculative instruction fetches, regardless of whether the prefetched instruction is committed for execution.

Note

To ensure architectural compliance, software must ensure that both of the following apply:

- Instructions that will be executed when all associated stages of address translation are disabled are located in blocks of the address space, of the translation granule size, that contain only memory that is tolerant to speculative accesses.
 - Each block of the address space, of the translation granule size, that immediately follows a similar block that holds instructions that will be executed when all associated stages address translation are disabled, contains only memory that is tolerant to speculative accesses.
-

D4.2.10 Pseudocode description of VMSAv8-64 address translation

The following subsections outline a pseudocode description of the translation table walk:

- [Definitions required for address translation.](#)
- [Performing the full address translation.](#)
- [Stage 1 translation.](#)
- [Stage 2 translation.](#)
- [Translation table walk.](#)
- [Support functions on page D4-2056.](#)

Definitions required for address translation

In pseudocode, the result of a translation table lookup, in either Execution state, is returned in a [TLBRecord](#) structure.

[Memory data type definitions on page D3-2000](#) includes definitions of the Permissions and AddressDescriptor parameters.

Performing the full address translation

The function [AArch64.FullTranslate\(\)](#) performs a full translation table walk. For any translation regime it performs a stage 1 translation for the supplied VA, and for the Non-secure EL1&0 translation regime it then performs a stage 2 translation of the returned address.

Stage 1 translation

The function [AArch64.FirstStageTranslate\(\)](#) performs a stage 1 translation, calling the function [AArch64.TranslationTableWalk\(\)](#), described in [Translation table walk](#), to perform the required translation table walk. However, if stage 1 translation is disabled, it calls the function [AArch64.TranslateAddressS10ff\(\)](#) to set the memory attributes.

Stage 2 translation

In the Non-secure EL1&0 translation regime, a descriptor address returned by stage 1 lookup is in the IPA address space, and must be mapped to a PA by a stage 2 translation. Function [AArch64.SecondStageWalk\(\)](#) performs this translation, by calling the [AArch64.SecondStageTranslate\(\)](#) function. When called from [AArch64.SecondStageWalk\(\)](#), the [AArch64.SecondStageTranslate\(\)](#) function performs a second stage translation, from IPA to PA, of the supplied address, including checking that the access has read permission at the second stage. If the access does not have second stage read permission it generates a second stage Permission fault on the first stage translation table walk. The second stage translation might hit in a TLB, or might involve a translation table walk, which will use the algorithm described in this section.

Translation table walk

The function [AArch64.TranslationTableWalk\(\)](#) returns the result, in the form of a [TLBRecord](#), of a translation table walk made for a memory access from an Exception level that is using AArch64.

Support functions

In the translation table walk functions, the `WalkAttrDecode()` function determines the attributes for a translation table lookup.

The function `AArch64.S1AttrDecode()` decodes the attributes from a stage 1 translation table lookup.

The function `AArch64.CheckPermission()` checks the access permissions returned by a stage 1 translation table lookup, see *Access permission checking on page D3-2002*.

The function `AArch64.CheckS2Permission()` checks the access permissions returned by a stage 2 translation table lookup.

The function `AddrTop()` returns the bit number of the most significant valid bit of a VA in the current translation regime. If EL1 is using AArch64 and EL0 is using AArch32 then an address from EL0 is zero-extended to 64 bits.

D4.2.11 Address translation instructions

Each of the ARMv8 instruction sets provides instructions that return the result of translating an input address, supplied as an argument to the instruction, using a specified translation stage or regime.

The available instructions only perform translations that are accessible from the Security state and Exception level at which the instruction is executed. That is:

- No instruction executed in Non-secure state can return the result of a Secure address translation stage.
- No instruction can return the result of an address translation stage that is controlled by an Exception level that is higher than the Exception level at which the instruction is executed.

*Address translation instructions, AT** summarizes the A64 address translation instructions.

See also *A64 system instructions for address translation on page C5-427*.

Address translation instructions, AT*

The A64 assembly language syntax for address translation instructions is:

AT <operation>, <Xt>

Where:

<operation> Is one of S1E1R, S1E1RP, S1E1W, S1E1WP, S1E0R, S1E0W, S12E1R, S12E1W, S12E0R, S12E0W, S1E2R, S1E2W, S1E3R, or S1E3W.

<operation> has a structure of <stages><level><read|write><pan>, where:

<stages> Is one of:

S1 Stage 1 translation.

S12 Stage 1 translation followed by stage 2 translation.

<level> Describes the Exception Level that the translation applies to. Is one of:

E0 EL0.

E1 EL1.

E2 EL2.

E3 EL3.

If <level> is higher than the current Exception Level, the instruction is UNDEFINED.

<read|write>

Is one of:

R Read.

W Write.

<pan>

Only available when ARMv8.2-ATS1E1 is implemented. Optional, but if present:

P Determines action based on value of PSTATE.PAN.

Only permitted for <stages>=S1 and <level>=E1.

<Xt> The address to be translated. No alignment restrictions apply for the address.

If EL2 is not implemented, the AT S1E2R and AT S1E2W instructions are UNDEFINED.

Note

If EL2 is not implemented but EL3 is implemented, the AT S1E** instructions are not UNDEFINED, but behave the same way as the equivalent AT S1E** instructions. This is consistent with the behavior if EL2 is implemented but stage 2 translation is disabled.

In each case, the address being translated is held in the 64-bit address argument register, Xt. If the address translation instruction uses a translation regime that is using AArch32, meaning it requires a VA of only 32 bits, then VA[63:32] is RES0.

If the address translation is successful, the resulting PA is returned in PAR_EL1.PA, and PAR_EL1.F is set to 0 to indicate that the translation was successful. Otherwise, see *Synchronous faults generated by address translation instructions*.

Note

The architecture provides a single PAR, PAR_EL1, that is used regardless of:

- The Exception level at which the instruction was executed.
- The Exception level that controls the stage or stages of translation used by the instruction.

For all of these instructions, the current context information determines which entries in TLB caching structures are used, and how the translation table walk is performed. However, it is IMPLEMENTATION DEFINED whether the Address translation instructions return the values held in a TLB or the result of a translation table walk. Therefore, ARM recommends that these instructions are not used at a time when the TLB entries might be different from the underlying translation tables held in memory.

If EL3 is implemented, then for instructions that apply to the EL1 or EL0 Exception level, SCR_EL3.NS determines the translation regime to which the instruction applies, as follows:

SCR_EL3.NS == 0 Secure EL1&0 translation regime.

SCR_EL3.NS == 1 Non-secure EL1&0 translation regime.

All relevant context information used for the translation depends on this determination.

When Non-secure EL1&0 stage 1 address translation is disabled, any AT S1E0*, AT S1E1*, AT S1E0*, or AT S1E1* address translation instruction that accesses the Non-secure state translation reflects the effect of the HCR_EL2.DC bit as described in *Behavior when stage 1 address translation is disabled on page D4-2053*.

Executing AT S1E2R or AT S1E2W at EL3 with SCR_EL3.NS==0 is UNDEFINED.

Note

AT S1E** instructions at EL3 with SCR_EL3.NS==0 are not UNDEFINED but behave the same way as the equivalent AT S1E** instructions.

Synchronous faults generated by address translation instructions

The address translation instructions use the translation mechanism, and that mechanism can generate the following synchronous faults:

- Translation fault.
- Access flag fault.
- Permission fault.
- Domain fault, when translating using the AArch32 translation systems.
- Address size fault.
- TLB conflict fault.
- Synchronous external aborts during a translation table walk.

In addition:

- If the address translation instruction requires two stages of translation then these faults could arise from either stage 1 or stage 2.
- For a stage 1 translation for the Non-secure EL1&0 translation regime, the fault might be generated on the stage 2 translation of an address accessed as part of the stage 1 translation table walk, see [Stage 2 fault on a stage 1 translation table walk on page D4-2109](#).

Except as described in this section, these faults are not taken as an exception for the address translation instructions, but instead the `PAR_EL1.FST` field holds the Fault status information. In these cases the `PAR_EL1.PA` field does not hold the output address of the translation.

The exceptions to this reporting the fault in `PAR_EL1` are:

- Synchronous external aborts during a translation table walk are taken as a Data Abort exception.
For an address translation instruction executed at a particular Exception level, if the synchronous external abort is generated on a stage 1 translation table walk, the Data Abort exception is taken to the Exception level to which a synchronous external abort on a stage 1 translation table walk for a memory access from that Exception level would be taken.

If the synchronous external abort is generated on a stage 2 translation table walk then:

- If the address translation instruction was executed at EL3, the synchronous Data Abort exception is taken to EL3.
- If the address translation instruction was executed at EL2 or EL1, the Data Abort exception is taken to the Exception level to which a synchronous external abort on a stage 2 translation table walk for a memory access from that Exception level would be taken.

In any case where the address translation instruction causes a synchronous Data Abort exception to be taken:

- The `PAR_EL1` is UNKNOWN.
- The `ESR_ELx` of the target Exception Level of the exception indicates that the fault was due to a translation table walk for a cache maintenance instruction.
- The `FAR_ELx` of the target Exception Level holds the `VA` for the translation request.
- For the AT S1E0* and AT S1E1* instructions executed from the Non-secure EL1 Exception level, if there is a synchronous stage 2 fault on a memory access made as part of the translation table walk then if the value of `SCR_EL3.EA` is 1 then a synchronous external abort on a stage 2 translation table walk is taken to EL3. In all other cases of a synchronous stage 2 fault on a memory access made as part of the translation table walk, the fault is taken as an exception to EL2, and:
 - `PAR_EL1` is UNKNOWN
 - `ESR_EL2` indicates that the fault occurred on a translation table walk, and that the operation that faulted was a cache maintenance instruction.
 - `HPFAR_EL2` holds the `IPA` that faulted
 - `FAR_EL2` holds the `VA` that the executing software supplied to the address translation instruction.

This fault can occur for any of the following reasons:

- Stage 2 Translation fault.
- Stage 2 Access fault.
- Stage 2 Permission fault.
- Stage 2 Address size fault.
- Synchronous external abort on a stage 2 translation table walk.

Synchronization requirements of the address translation instructions

Where an instruction results in an update to a System register, as is the case with the AT * address translation instructions, explicit synchronization must be performed before the result is guaranteed to be visible to subsequent direct reads of the [PAR_EL1](#).

———— **Note** —————

This is consistent with the AArch32 requirement, where the [VA](#) to [PA](#) translation instructions are executed as writes to the (coproc==0b1111) System register encoding space, and the effect of those writes to other registers require explicit synchronization before the result is guaranteed to be visible to subsequent instructions.

D4.3 VMSAv8-64 translation table format descriptors

In general, a descriptor is one of:

- An invalid or fault entry.
- A table entry, that points to the next-level translation table.
- A block entry, that defines the memory properties for the access.
- A reserved format.

Bit[1] of the descriptor indicates the descriptor type, and bit[0] indicates whether the descriptor is valid.

The following sections describe the ARMv8 translation table descriptor formats:

- [VMSAv8-64 translation table level 0, level 1, and level 2 descriptor formats](#).
- [ARMv8 translation table level 3 descriptor formats on page D4-2063](#).

[Memory attribute fields in the VMSAv8-64 translation table format descriptors on page D4-2064](#) then gives more information about the descriptor attribute fields, and [Control of Secure or Non-secure memory access on page D4-2070](#) describe how the NS and NSTable together control whether a memory access from Secure state accesses the Secure memory map or the Non-secure memory map.

D4.3.1 VMSAv8-64 translation table level 0, level 1, and level 2 descriptor formats

In the VMSAv8-64 translation table format, the difference in the formats of the level 0, level 1 and level 2 descriptors is:

- Whether a block entry is permitted.
- If a block entry is permitted, the size of the memory region described by that entry.

These differences depend on the translation granule, as follows:

4KB granule A level 0 descriptor does not support block translation.

A block entry:

- In a level 1 table describes the mapping of the associated 1GB input address range.
- In a level 2 table describes the mapping of the associated 2MB input address range.

16KB granule Level 0 and level 1 descriptors do not support block translation.

A block entry in a level 2 table describes the mapping of the associated 32MB input address range.

64KB granule Level 0 lookup is not supported.

If ARMv8.2-LPA is implemented with 52 bits of physical address space, a block entry in a level 1 table describes the mapping of the associated 4TB input address range. A level 1 descriptor does not support block translation if ARMv8.2-LPA is not implemented.

A block entry in a level 2 table describes the mapping of the associated 512MB input address range.

Figure D4-15 on page D4-2061 shows the ARMv8 level 0, level 1, and level 2 descriptor formats:

In an implementation that includes ARMv8.2-LPA, when the 64KB granule is used, the Block and Table descriptors are redefined as Figure D4-15 on page D4-2061 shows:

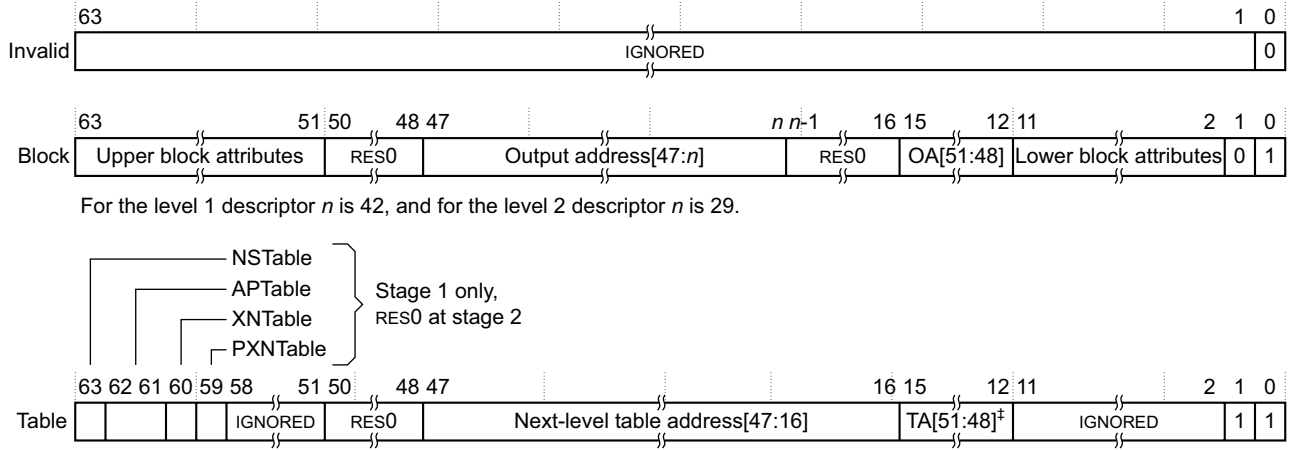

A level 1 Table descriptor returns the address of the level 2 table.
A level 2 Table descriptor returns the address of the level 3 table.

[‡] TA[51:48] indicates bits[51:48] of the next-level table address.

Figure D4-15 VMSAv8-64 level 1 and level 2 descriptor formats, 64KB granule

Descriptor encodings, ARMv8 level 0, level 1, and level 2 formats

Descriptor bit[0] identifies whether the descriptor is valid, and is 1 for a valid descriptor. If a lookup returns an invalid descriptor, the associated input address is unmapped, and any attempt to access it generates a Translation fault.

Descriptor bit[1] identifies the descriptor type, and is encoded as:

- 0, Block** The descriptor gives the base address of a block of memory, and the attributes for that memory region.
- 1, Table** The descriptor gives the address of the next level of translation table, and for a stage 1 translation, some attributes for that translation.

The other fields in the valid descriptors are:

Block descriptor

Gives the base address and attributes of a block of memory, as follows:

4KB translation granule

- For a level 1 Block descriptor, bits[47:30] are bits[47:30] of the output address. This output address specifies a 1GB block of memory.
- For a level 2 descriptor, bits[47:21] are bits[47:21] of the output address. This output address specifies a 2MB block of memory.

16KB translation granule

For a level 2 Block descriptor, bits[47:25] are bits[47:25] of the output address. This output address specifies a 32MB block of memory.

64KB translation granule

For a level 1 Block descriptor:

- If ARMv8.2-LPA is implemented, bits[15:12] are bits[51:48] of the output address and bits[47:42] are bits [47:42] of the output address. This output address specifies a 4TB block of memory.
- If ARMv8.2-LPA is not implemented, there is no level 1 Block descriptor.

For a level 2 Block descriptor:

- If ARMv8.2-LPA is implemented, bits[15:12] are bits[51:48] of the output address, and bits[47:29] are bits [47:29] of the output address. This output address specifies a 512MB block of memory.
- If ARMv8.2-LPA is not implemented, bits[47:29] are bits[47:29] of the output address. This output address specifies a 512MB block of memory.

In ARMv8.0, bits[63:52, 11:2] provide attributes for the target memory block. When ARMv8.1-TTHM is implemented, bits[63:51, 11:2] provide the attributes for the target memory block. For more information, see *Memory attribute fields in the VMSAv8-64 translation table format descriptors* on page D4-2064. The position and contents of these bits are identical in the level 2 block descriptor and in the level 3 page descriptor.

Table descriptor

Gives the translation table address for the next-level lookup, as follows:

4KB translation granule

- Bits[47:12] are bits[47:12] of the address of the required next-level table, which is:
 - For a level 0 Table descriptor, the address of a level 1 table.
 - For a level 1 Table descriptor, the address of a level 2 table.
 - For a level 2 Table descriptor, the address of a level 3 table.
- Bits[11:0] of the table address are zero.

16KB translation granule

- Bits[47:14] are bits[47:14] of the address of the required next-level table, which is:
 - For a level 0 Table descriptor, the address of a level 1 table.
 - For a level 1 Table descriptor, the address of a level 2 table.
 - For a level 2 Table descriptor, the address of a level 3 table.
- Bits[13:0] of the table address are zero.

64KB translation granule

- Bits[47:16] are bits[47:16] of the address of the required next-level table, which is:
 - For a level 1 Table descriptor, the address of a level 2 table.
 - For a level 2 Table descriptor, the address of a level 3 table.

When ARMv8.2-LPA is implemented, bits[15:12] are bits[51:48] of the required next-level table.
- Bits[15:0] of the table address are zero.

For a stage 1 translation only, bits[63:59] provide attributes for the next-level lookup, see *Memory attribute fields in the VMSAv8-64 translation table format descriptors* on page D4-2064.

If the translation table defines the Non-secure EL1&0 stage 1 translations, then the output address in the descriptor is the IPA of the target block or table. Otherwise, it is the PA of the target block or table.

D4.3.2 ARMv8 translation table level 3 descriptor formats

For the 4KB granule size, each entry in a level 3 table describes the mapping of the associated 4KB input address range.

For the 16KB granule size, each entry in a level 3 table describes the mapping of the associated 16KB input address range.

For the 64KB granule size, each entry in a level 3 table describes the mapping of the associated 64KB input address range.

Figure D4-16 shows the ARMv8 level 3 descriptor formats.

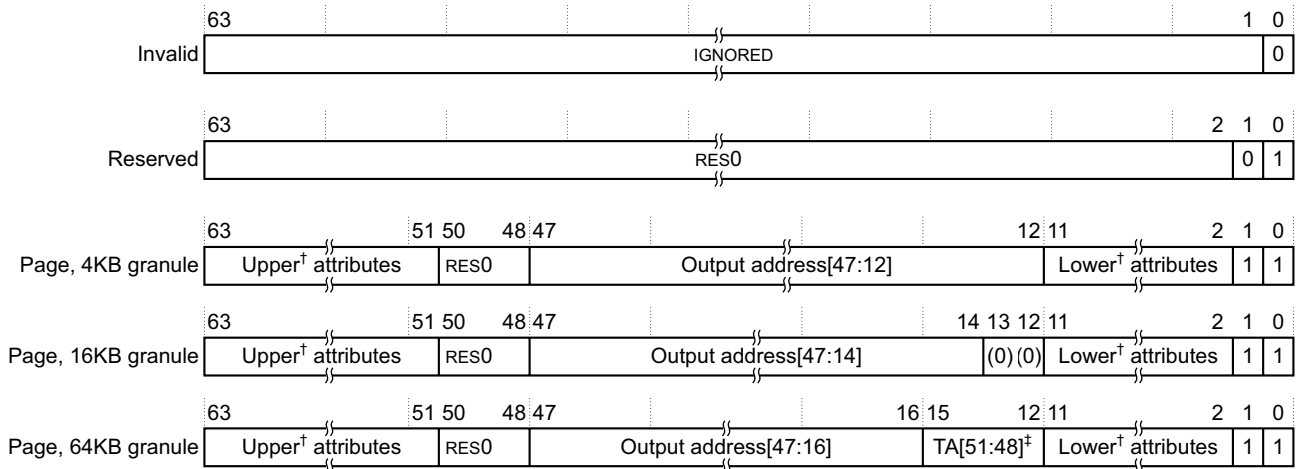

[†] Upper page attributes and Lower page attributes
[‡] TA[51:48] indicates bits[51:48] of the page address.

Figure D4-16 VMSAv8-64 level 3 descriptor format

Descriptor bit[0] identifies whether the descriptor is valid, and is 1 for a valid descriptor. If a lookup returns an invalid descriptor, the associated input address is unmapped, and any attempt to access it generates a Translation fault.

Descriptor bit[1] identifies the descriptor type, and is encoded as:

0, Reserved, invalid

Behaves identically to encodings with bit[0] set to 0.

This encoding must not be used in level 3 translation tables.

1, Page Gives the address and attributes of a 4KB, 16KB, or 64KB page of memory.

At this level, the only valid format is the Page descriptor. The other fields in the Page descriptor are:

Page descriptor

Gives the output address of a page of memory, as follows:

4KB translation granule

Bits[47:12] are bits[47:12] of the output address for a page of memory.

16KB translation granule

Bits[47:14] are bits[47:14] of the output address for a page of memory.

64KB translation granule

If ARMv8.2-LPA is implemented, bits[15:12] are bits[51:48] and bits[47:16] are bits[47:16] of the output address for a page of memory.

If [ARMv8.2-LPA](#) is not implemented, bits[47:16] are bits[47:16] of the output address for a page of memory.

Bits[63:52, 11:2] provide attributes for the target memory page, see [Memory attribute fields in the VMSAv8-64 translation table format descriptors](#).

————— **Note** —————

- In ARMv8.0, the position and contents of bits[63:52, 11:2] are identical to bits[63:52, 11:2] in the level 0, level 1, and level 2 block descriptors.
- When [ARMv8.1-TTHM](#) is implemented, the position and contents of bits[63:51, 11:2] are identical to bits[63:51, 11:2] in the level 0, level 1, and level 2 block descriptors.
- **When ARMv8.2-TTPBHA is implemented, hardware can use bits[62:59] of the level 3 descriptor for an IMPLEMENTATION DEFINED purpose. See [Memory attribute fields in the VMSAv8-64 translation table format descriptors](#).**

For the Non-secure EL1&0 stage 1 translations, the output address in the descriptor is the [IPA](#) of the target page. Otherwise, it is the [PA](#) of the target page.

D4.3.3 Memory attribute fields in the VMSAv8-64 translation table format descriptors

[Memory region attributes on page D4-2090](#) describes the region attribute fields. The following subsections summarize the descriptor attributes as follows:

Table descriptor

Table descriptors for stage 2 translations do not include any attribute field. For a summary of the attribute fields in a stage 1 table descriptor, that define the attributes for the next lookup level, see [Next-level attributes in stage 1 VMSAv8-64 Table descriptors](#).

Block and page descriptors

These descriptors define memory attributes for the target block or page of memory. Stage 1 and stage 2 translations have some differences in these attributes, see:

- [Attribute fields in stage 1 VMSAv8-64 Block and Page descriptors on page D4-2066](#)
- [Attribute fields in stage 2 VMSAv8-64 Block and Page descriptors on page D4-2068](#).

Next-level attributes in stage 1 VMSAv8-64 Table descriptors

In a Table descriptor for a stage 1 translation, bits[63:59] of the descriptor define the attributes for the next-level translation table access, and bits[58:51] are IGNORED:

Next-level descriptor attributes, stage 1 only

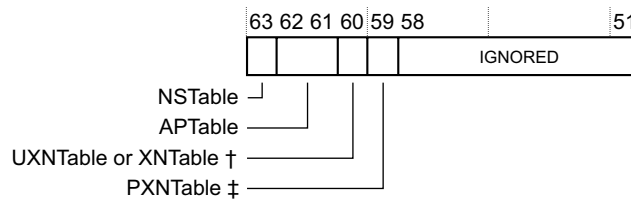

† UXN for a translation regime that applies to execution at EL0, XN for the other regimes.
‡ RES0 for a translation regime that does not apply to execution at EL0.

These attributes are:

NSTable, bit[63]

For memory accesses from Secure state, specifies the Security state for subsequent levels of lookup, see [Hierarchical control of Secure or Non-secure memory accesses on page D4-2070](#).

For memory accesses from Non-secure state, including all accesses in the EL2 or EL2&0 translation regime, this bit is RES0 and is ignored by the PE.

APTable, bits[62:61]

Access permissions limit for subsequent levels of lookup, see [Hierarchical control of data access permissions on page D4-2074](#).

APTable[0] is RES0:

- In the EL2 translation regime.

———— **Note** —————

In an implementation that includes [ARMv8.1-VHE](#), when the value of `HCR_EL2.E2H` is 1 the translation regime for memory accesses from EL2 is the EL2&0 translation regime. APTable[0] can be valid (not RES0) in the EL2&0 translation regime.

- In the EL3 translation regime.

From ARMv8.1, when [ARMv8.1-HPD](#) is implemented, this field can be disabled. When the value of `TCR_ELx.HPD{0}` or `TCR_ELx.HPD1` is 1:

- The value of the corresponding APTable field is IGNORED by hardware, allowing the field to be used by software.
- The behavior of the system is as if the value of the corresponding APTable field is 0.

UXNTable or XNTable, bit[60]

XN limit for subsequent levels of lookup, see [Hierarchical control of instruction fetching on page D4-2079](#).

The naming of this field depends on whether the stage 1 translation supports two VA ranges:

Two VA ranges supported

This field is UXNTable, and determines whether execution at EL0 of instructions fetched from the region identified at a lower level of lookup permitted.

———— **Note** —————

PXNTable is the equivalent control of execution at a higher Exception level.

One VA range supported

This field is XNTable.

From ARMv8.1, when [ARMv8.1-HPD](#) is implemented, this field can be disabled. When the value of `TCR_ELx.HPD{0}` or `TCR_ELx.HPD1` is 1:

- The value of the corresponding UXNTable field is IGNORED by hardware, allowing the field to be used by software.
- The behavior of the system is as if the value of the corresponding UXNTable field is 0.

PXNTable, bit[59]

PXN limit for subsequent levels of lookup, see [Hierarchical control of instruction fetching on page D4-2079](#).

This field is valid only for a stage 1 translation that supports two VA ranges. It is RES0 for stage 1 translations that support only one VA range.

From ARMv8.1, when [ARMv8.1-HPD](#) is implemented, this field can be disabled. When the value of `TCR_ELx.HPD{0}` or `TCR_EL1.HPD1` is 1:

- The value of the corresponding PXNTable field is IGNORED by hardware, allowing the field to be used by software.
- The behavior of the system is as if the value of the corresponding PXNTable field is 0.

The definition of IGNORED means the architecture guarantees that the PE makes no use of the field, see [IGNORED on page Glossary-6341](#). For more information about these fields see [Other fields in the VMSAv8-64 translation table format descriptors on page D4-2093](#).

Attribute fields in stage 1 VMSAv8-64 Block and Page descriptors

In Block and Page descriptors, the memory attributes are split into an upper block and a lower block, as shown for a stage 1 translation:

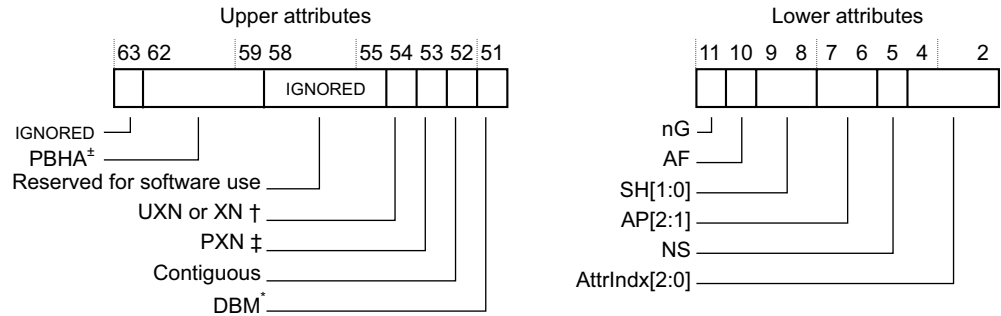

[‡] IGNORED in ARMv8.0 and ARMv8.1.

[†] UXN for a translation regime that applies to execution at EL0, XN for the other regimes.

[‡] RES0 for a translation regime that does not apply to execution at EL0.

* RES0 in ARMv8.0.

For a stage 1 descriptor, the attributes are:

PBHA, bits[62:59]

Page based hardware attributes bits.

These bits are IGNORED in descriptors at any level above level 3, and are IGNORED in level 3 descriptors in an implementation that does not include ARMv8.2-TTPBHA.

In an implementation that includes ARMv8.2-TTPBHA, each TCR_ELx has a control bit for each PBHA bit in the translation tables that it controls. When the value of that control bit is 1, and the value of the corresponding Hierarchical permission disables bit, TCR_ELx.HPD{n} is 1, hardware can use that PBHA bit for IMPLEMENTATION DEFINED purposes.

The TCR_ELx control bits for this feature are:

For a translation regime that supports only a single VA range

HWU0nn Controls whether level 3 descriptor bit[nn] can be used by hardware. These controls apply only when the value of TCR_ELx.HPD0 is 1.

For a translation regime that supports two VA ranges

HWU0nn For the translation tables indicated by TTBR0_ELx, controls whether descriptor bit[nn] can be used by hardware. These controls apply only when the value of TCR_ELx.HPD0 is 1.

HWU1nn For the translation tables indicated by TTBR1_ELx, controls whether descriptor bit[nn] can be used by hardware. These controls apply only when the value of TCR_ELx.HPD1 is 1.

If ARMv8.2-TTPBHA is not implemented, then the TCR_ELx control bits are RAZ/WI.

UXN or XN, bit[54]

The Execute-never bit. Determines whether the region is executable, see [Access permissions for instruction execution on page D4-2075](#).

The naming of this field depends on whether the stage 1 translation supports two VA ranges:

Two VA ranges supported

This field is UXN (Unprivileged execute-never), and determines whether execution at EL0 of instructions fetched from the region is permitted.

Note

PXN is the equivalent control of execution at a higher Exception level.

One VA range supported

This field is XN (Execute-never).

PXN, bit[53] The Privileged execute-never bit. Determines whether the region is executable at EL1, see [Access permissions for instruction execution on page D4-2075](#).

This field is valid only for a stage 1 translation that supports two VA ranges. It is RES0 for stage 1 translations that support only one VA range.

Contiguous, bit[52]

A hint bit indicating that the translation table entry is one of a contiguous set or entries, that might be cached in a single TLB entry, see [The Contiguous bit on page D4-2094](#).

DBM, bit[51] Dirty Bit Modifier, see [The dirty state bit on page D4-2081](#).

nG, bit[11] The not global bit. If a lookup using this descriptor is cached in a TLB, determines whether the TLB entry applies to all ASID values, or only to the current ASID value. See [Global and process-specific translation table entries on page D4-2116](#).

This field is valid only for a stage 1 translation that supports two VA ranges. It is RES0 for stage 1 translations that support only one VA range.

AF, bit[10] The Access flag, see [The Access flag on page D4-2081](#).

SH, bits[9:8] Shareability field, see [Memory region attributes on page D4-2090](#).

AP[2:1], bits[7:6]

Data Access Permissions bits, see [Memory access control on page D4-2071](#).

———— Note —————

The ARMv8 translation table descriptor format defines AP[2:1] as the Access Permissions bits, and does not define an AP[0] bit.

AP[1] is valid only for a stage 1 translation that supports two VA ranges. It is RES0 for stage 1 translations that support only one VA range.

NS, bit[5] Non-secure bit. For memory accesses from Secure state, specifies whether the output address is in the Secure or Non-secure address map, see [Control of Secure or Non-secure memory access on page D4-2070](#).

For memory accesses from Non-secure state, including all accesses in the EL2, or EL2&0, translation regime, this bit is RES0 and is ignored by the PE.

AttrIndx[2:0], bits[4:2]

Stage 1 memory attributes index field, for the MAIR_ELx, see [Stage 1 memory region type and Cacheability attributes on page D4-2090](#).

The definition of IGNORED means the architecture guarantees that the PE makes no use of the field, see [IGNORED on page Glossary-6341](#). For more information about these fields see [Other fields in the VMSAv8-64 translation table format descriptors on page D4-2093](#).

Attribute fields in stage 2 VMSAv8-64 Block and Page descriptors

In Block and Page descriptors, the memory attributes are split into an upper block and a lower block, as shown for a stage 2 translation:

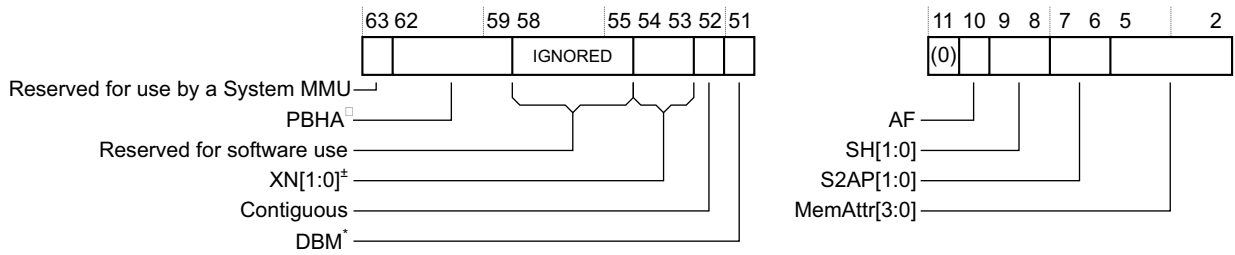

[‡] Bit[53] is RES0 before ARMv8.2.

^{*} RES0 in ARMv8.0.

[‡] Reserved for use by System MMU in ARMv8.0 and ARMv8.1.

For a stage 2 descriptor, the attributes are:

PBHA, bits[62:59]

Page based hardware attributes bits.

These bits are IGNORED in descriptors at any level above level 3, and are IGNORED in level 3 descriptors in an implementation that does not include ARMv8.2-TTPBHA.

In an implementation that includes ARMv8.2-TTPBHA, VTCR_EL2 has a control bit for each PBHA bit in the EL1&0 stage 2 translation tables. When the value of that control bit is 1, hardware can use that PBHA bit for IMPLEMENTATION DEFINED purposes.

For each PBHA bit, VTCR_EL2.HWUnn controls whether descriptor bit[nn] can be used by hardware.

If ARMv8.2-TTPBHA is not implemented, then the control bits are RAZ/WI.

XN[1:0], bits[54:53]

The Execute-never field. Determines whether the region is executable.

For more information, see *Access permissions for instruction execution* on page D4-2075.

In an implementation that does not support ARMv8.2-TTS2UXN, bit[53] is RES0.

Contiguous, bit[52]

A hint bit indicating that the translation table entry is one of a contiguous set or entries, that might be cached in a single TLB entry, see *The Contiguous bit* on page D4-2094.

DBM, bit[51] Dirty Bit Modifier, see *The dirty state bit* on page D4-2081.

AF, bit[10] The Access flag, see *The Access flag* on page D4-2081.

SH, bits[9:8] Shareability field, see *The stage 2 memory region attributes, EL1&0 translation regime* on page D4-2092.

S2AP, bits[7:6]

Stage 2 data Access Permissions bits, see *The S2AP data access permissions, Non-secure EL1&0 translation regime* on page D4-2074.

Note

In the original VMSAv7-32 Long-descriptor attribute definition, this field was called HAP[2:1], for consistency with the AP[2:1] field in the stage 1 descriptors and despite there being no HAP[0] bit. ARMv8 renames the field for greater clarity.

MemAttr, bits[5:2]

Stage 2 memory attributes, see *The stage 2 memory region attributes, EL1&0 translation regime* on page D4-2092.

The definition of IGNORED means the architecture guarantees that the PE makes no use of the field, see *IGNORED* on page Glossary-6341. For more information about these fields see *Other fields in the VMsAv8-64 translation table format descriptors* on page D4-2093.

D4.3.4 Control of Secure or Non-secure memory access

As this section describes, the NS bit in the translation table entries:

- For accesses from Secure state, if the translation table entry was held in secure memory, determines whether the access is to Secure or Non-secure memory.
- Is ignored by:
 - Accesses from Non-secure state.
 - Accesses from Secure state if the translation table entry was held in Non-secure memory.

In the VMSAv8-64 translation table format:

- The NS bit relates only to the memory block or page at the output address defined by the descriptor.
- The descriptors also include an NSTable bit, that affects accesses at lower levels of lookup, see [Hierarchical control of Secure or Non-secure memory accesses](#).

The NS and NSTable bits are valid only for memory accesses from Secure state described by translation table descriptors that are fetched from Secure memory, and:

- In the translation table descriptors in a Non-secure translation table, the NS and NSTable bits are SBZ.
- Memory accesses from Non-secure state, including all accesses from EL2, ignore the values of these bits.

In the Secure translation regimes, for translation table descriptors that are fetched from Secure memory, the NS bit in a descriptor indicates whether the descriptor refers to the Secure or the Non-secure address map, as follows:

- NS == 0 Access the Secure PA space.
- NS == 1 Access the Non-secure PA space.

For Non-secure translation regimes, and for translation table descriptors fetched from Non-secure memory, the corresponding bit is RES0 and is ignored by the PE. The access is made to Non-secure memory, regardless of the value of the bit.

Hierarchical control of Secure or Non-secure memory accesses

For VMSAv8-64 table descriptors for stage 1 translations, the descriptor includes an NSTable bit, that indicates whether the table identified in the descriptor is in Secure or Non-secure memory. For accesses from Secure state, the meaning of the NSTable bit is:

NSTable == 0 The defined table address is in the Secure PA space. In the descriptors in that translation table, NS bits and NSTable bits have their defined meanings.

NSTable == 1 The defined table address is in the Non-secure PA space. Because this table is fetched from the Non-secure address space, the NS and NSTable bits in the descriptors in this table must be ignored. This means that, for this table:

- The value of the NS bit in any block or page descriptor is ignored. The block or page address refers to Non-secure memory.
- The value of the NSTable bit in any table descriptor is ignored, and the table address refers to Non-secure memory. When this table is accessed, the NS bit in any block or page descriptor is ignored, and all descriptors in the table refer to Non-secure memory.

In addition, an entry fetched in Secure state is treated as non-global if it is read from Non-secure memory. That is, these entries must be treated as if nG==1, regardless of the value of the nG bit. For more information about the nG bit, see [Global and process-specific translation table entries on page D4-2116](#).

The effect of NSTable applies to later entries in the translation table walk, and so its effects can be held in one or more TLB entries. Therefore a change to NSTable requires coarse-grained invalidation of the TLB to ensure that the effect of the change is visible to subsequent memory transactions.

D4.4 Memory access control

The access control fields in the translation table descriptors determine whether the PE, in its current state, is permitted to perform the required access to the output address given in the translation table descriptor. If a translation stage does not permit the access then an MMU fault is generated for that translation stage, and no memory access is performed.

The following sections describe the memory access controls:

- [About access permissions](#).
- [About the PAN bit on page D4-2072](#).
- [About the UAO bit on page D4-2072](#).
- [Data access permission controls on page D4-2073](#).
- [Access permissions for instruction execution on page D4-2075](#).
- [The Access flag on page D4-2081](#).
- [The dirty state bit on page D4-2081](#).
- [Software management of the Access flag on page D4-2081](#).
- [Hardware management of the Access flag and dirty state on page D4-2081](#).
- [Ordering of hardware updates to the translation tables on page D4-2087](#).
- [Restriction on memory types for hardware updates on page tables on page D4-2088](#).
- [Use of the Contiguous bit with hardware updates of the translation table entries on page D4-2089](#).

Note

This section describes the access controls for each of the translation regimes, and for each stage of translation in the Non-secure EL1&0 translation regime.

A translation applies to memory accesses from either:

- Only a single Exception level, for example the EL3 translation regime.
- EL0 and one higher Exception level, for example the EL1&0 translation regime.

In addition to an output address, a translation table entry that refers to a page or region of memory includes fields that define properties of the target memory region. These fields can be classified as address map control, access control, and region attribute fields. [Control of Secure or Non-secure memory access on page D4-2070](#) describes the address map control, and [Memory region attributes on page D4-2090](#) describes the other fields.

D4.4.1 About access permissions

The translation table descriptors include fields that define access permissions for data accesses and for instruction fetches. This section introduces those fields. In addition:

- System register controls can prevent execution from writable locations, see [Preventing execution from writable locations on page D4-2080](#).
- For the effect of disabling a stage of address translation on the access permissions see [The effects of disabling a stage of address translation on page D4-2053](#).
- From ARMv8.1, the `PSTATE.PAN` bit can affect the access permissions for privileged data accesses, see [About the PAN bit on page D4-2072](#).
- From ARMv8.2, the `PSTATE.UAO` bit can affect the access permissions for unprivileged instructions, see [About the UAO bit on page D4-2072](#).

Note

This section gives a general description of memory access permissions. In an implementation that includes EL2, software executing at EL1 in Non-secure state can see only the access permissions defined by the Non-secure EL1&0 stage 1 translations. However, software executing at EL2 can modify these permissions. This modification is invisible to the Non-secure software executing at EL1 or EL0.

The access permission bits control access to the corresponding memory region. The VMSAv8-64 translation table format:

- In stage 1 translations, uses AP[2:1] to define the data access permissions, see *The AP[2:1] data access permissions, for stage 1 translations* on page D4-2073.

———— **Note** ————

The description of the access permission field as AP[2:1] is for consistency with the VMSAv8-32 Short-descriptor translation table format, see *The VMSAv8-32 Short-descriptor translation table format* on page G4-4576. The VMSAv8-64 translation table format does not define an AP[0] bit.

- In stage 2 translations, uses S2AP[1:0] to define the data access permissions, see *The S2AP data access permissions, Non-secure EL1&0 translation regime* on page D4-2074.
- Uses the UXN, XN and PXN fields to define access controls for instruction fetches, see *Access permissions for instruction execution* on page D4-2075.

An attempt to perform a memory access that the translation table access permission bits do not permit generates a Permission fault, for the corresponding stage of translation.

———— **Note** ————

In an implementation that includes EL2, each stage of the translation of a memory access made using the Non-secure EL1&0 translation regime has its own, independent, permission check.

D4.4.2 About the PAN bit

When the value of `PSTATE.PAN` is 1, any privileged data access from EL1 or EL2 to a virtual memory address that is accessible at EL0 generates a Permission fault.

When the value of `PSTATE.PAN` is 0, the translation system is the same as in ARMv8.0.

A corresponding PAN bit is added to `SPSR_EL1`, `SPSR_EL2`, and `SPSR_EL3` for exception returns, and `DSPSR_EL0` for entry to or exit from Debug state.

A new SPAN bit is added to `SCTLR_EL1` and `SCTLR_EL2`, and applies when `HCR_EL2.{E2H, TGE} == {1, 1}`. The bit is used to control whether the PAN bit is set on an exception to EL1 or EL2.

The PAN bit has no effect on:

- Data Cache instructions other than DC ZVA.
- Address translation instructions, other than `ATS1E1RP` and `ATS1E1WP` when `ARMv8.2-ATS1E1` is implemented.
- Unprivileged instructions, `LDTR`, `LDTRB`, `LDTRH`, `LDTRSB`, `LDTRSH`, `LDTRSW`, `STTR`, `STTRB`, and `STTRH`, unless `HCR_EL2.{E2H, TGE} == {1, 0}`.
- Instruction accesses.

If access is disabled, then the access will give rise to a stage 1 Permission fault.

On an exception that is taken from AArch64 to AArch64, `PSTATE.PAN` is copied to `SPSR_ELx.PAN`.

On an exception return from AArch64:

- `SPSR_ELx.PAN` is copied to `PSTATE.PAN`, when the target Exception level is in AArch64.
- `SPSR_ELx.PAN` is copied to `CPSR.PAN`, when the target Exception level is in AArch32.

D4.4.3 About the UAO bit

When the value of `PSTATE.UAO` is 1, and when executed at EL1 or at EL2 with `HCR_EL2.{E2H, TGE} == {1, 1}`, the memory accesses made by the Load/Store unprivileged instructions behave as if they were made by the Load/Store register instructions. See *Load/Store unprivileged* on page C3-164 and *Load/Store register* on page C3-160.

When ARMv8.2-UAO is implemented and PSTATE.UAO is 0, it has no effect on the described behavior of any Load/Store unprivileged instruction.

A corresponding UAO bit is added to SPSR_EL1, SPSR_EL2, and SPSR_EL3 for exception returns, and DSPSR_EL0 for entry to or exit from Debug state.

On an exception that is taken from AArch64 to AArch64, PSTATE.UAO is copied to SPSR_ELx.UAO and then set to 0.

On an exception that is taken from AArch32 to AArch64:

- PSTATE.UAO is set to 0.
- SPSR_ELx.UAO is set to 0.

On an exception return from AArch64 to AArch64, SPSR_ELx.UAO is copied to PSTATE.UAO.

D4.4.4 Data access permission controls

The following subsections describe the data access permission controls:

- *The AP[2:1] data access permissions, for stage 1 translations.*
- *The S2AP data access permissions, Non-secure EL1&0 translation regime on page D4-2074.*
- *Hierarchical control of data access permissions on page D4-2074.*

The AP[2:1] data access permissions, for stage 1 translations

In VMSAv8-64, for a translation regime that applies to both EL0 and a higher Exception level, the AP[2:1] bits control the stage 1 data access permissions, and:

AP[2] Selects between read-only and read/write access.

AP[1] Selects between Application level (EL0) control and the higher Exception level control.

This provides four permission settings for data accesses:

- Read-only at all levels.
- Read/write at all levels.
- Read-only at the higher Exception level, no access by software executing at EL0.
- Read/write at the higher Exception level, no access by software executing at EL0.

————— Note —————

In an implementation that does not include ARMv8.1-VHE, the only translation regime that applies to EL0 and a higher Exception level is the EL1&0 translation regime. In an implementation that includes ARMv8.1-VHE, the EL2&0 translation regime applies to both Non-secure EL0 and EL2 when the value of HCR_EL2.{E2H, TGE} is {1, 1}.

For translation regimes that apply only to accesses from a single Exception level, AP[2] determines the stage 1 data access permissions, and AP[1] is RES1, meaning it is ignored by hardware and is treated as if it is 1.

Table D4-29 shows the meaning of the AP[2:1] field for stage 1 of a translation regime that applies to both EL0 and a higher Exception level. In this table, an entry of None indicates that any access from that Exception level faults.

Table D4-29 Data access permissions for stage 1 translations that applies to EL0 and a higher Exception level

AP[2:1]	Access from higher Exception level	Access from EL0
00	Read/write	None
01	Read/write	Read/write
10	Read-only	None
11	Read-only	Read-only

For the Non-secure EL1&0 translation regime:

- The stage 2 translation also defines data access permissions, see [The S2AP data access permissions, Non-secure EL1&0 translation regime](#).
- When both stages of translation are enabled, [Combining the stage 1 and stage 2 data access permissions on page D4-2095](#) describes how these permissions are combined.

[Table D4-30](#) shows the effect of the AP[2] field for stage 1 of a translation regime that applies to only a single Exception level.

Table D4-30 Data access permissions for stage 1 translations that apply to only a single Exception level

AP[2]	Access permission
0	Read/write
1	Read-only

The S2AP data access permissions, Non-secure EL1&0 translation regime

In the Non-secure EL1&0 translation regime, when stage 2 address translation is enabled, the S2AP field in the stage 2 translation table descriptors define the data access permissions as [Table D4-31](#) shows. In this table, an entry of None indicates that any access generates a Permission fault.

Table D4-31 Data access permissions for stage 2 of the Non-secure EL1&0 translation regime

S2AP	Access from Non-secure EL1 or Non-secure EL0
00	None
01	Read-only
10	Write-only
11	Read/write

The S2AP access permissions make no distinction between Non-secure accesses from EL1 and Non-secure accesses from EL0. However, when both stages of address translation are enabled, these permissions are combined with the stage 1 access permissions defined by AP[2:1], see [Combining the stage 1 and stage 2 data access permissions on page D4-2095](#).

[Combining the stage 1 and stage 2 attributes, Non-secure EL1&0 translation regime on page D4-2095](#) gives more information about the use of the stage 1 and stage 2 access permissions in an implementation of virtualization.

Hierarchical control of data access permissions

The VMSAv8-64 translation table format includes mechanisms by which entries at one level of translation table lookup can set limits on the permitted entries at subsequent levels of lookup. This subsection describes how these controls apply to the data access permissions.

———— **Note** —————

Similar hierarchical controls apply to instruction fetching, see [Hierarchical control of instruction fetching on page D4-2079](#).

However, in an implementation that includes [ARMv8.1-HPD](#), when the value of a `TCR_ELx.HPD{0}` field is 1, or the value of the `TCR_ELx.HPD1` field is 1, the hierarchical control of data access permissions is disabled for the translation stage controlled by that `TCR_ELx`, and the information in this subsection does not apply.

The restrictions apply only to subsequent levels of lookup for the same stage of translation. The APTable[1:0] field restricts the access permissions, as Table D4-32 shows. As stated in the table footnote, for a translation regime that applies to only a single Exception level, APTable[0] is RES0, meaning it is ignored by the hardware.

Table D4-32 Effect of APTable[1:0] on subsequent levels of lookup

APTable[1:0]	Effect
00	No effect on permissions in subsequent levels of lookup.
01 ^a	Access at EL0 not permitted, regardless of permissions in subsequent levels of lookup.
10	Write access not permitted, at any Exception level, regardless of permissions in subsequent levels of lookup.
11 ^a	Regardless of permissions in subsequent levels of lookup: <ul style="list-style-type: none"> • Write access not permitted, at any Exception level. • Read access not permitted at EL0.

a. Not valid any translation regime that applies to only a single Exception level. In the translation tables for such a regime, APTable[0] is RES0.

———— **Note** —————

The APTable[1:0] settings are combined with the translation table access permissions in the translation table descriptors accessed in subsequent levels of lookup. They do not restrict or change the values entered in those descriptors.

The VMSAv8-64 provides APTable[1:0] control only for stage 1 translations. The corresponding bits are RES0 in the stage 2 translation table descriptors.

The effect of APTable applies to later entries in the translation table walk, and so its effects can be held in one or more TLB entries. Therefore, a change to APTable requires coarse-grained invalidation of the TLB to ensure that the effect of the change is visible to subsequent memory transactions.

D4.4.5 Access permissions for instruction execution

Execute-never controls determine whether instructions can be executed from a memory region. These controls are:

UXN, Unprivileged execute-never

Descriptor bit[54], defined as UXN only for stage 1 of any translation regime that applies to EL0 and a higher Exception level.

XN, Execute-never

Descriptor bit[54], defined as XN for:

- Stage 1 of any translation regime that applies to only a single Exception level.
- Stage 2 of the Non-secure EL1&0 translation regime when ARMv8.2-TTS2UXN is not implemented.

———— **Note** —————

XN[1:0], Execute-never, for stage 2 control describes the stage 2 control when ARMv8.2-TTS2UXN is implemented.

A value of 0 indicates that this control permits execution.

PXN, Privileged execute-never

Descriptor bit[53], used only for stage 1 of any translation regime that applies to EL0 and a higher Exception level:

- For stage 1 of a translation regime that applies to only a single Exception level the descriptors define a PXN field that is RES0, meaning it is ignored by hardware.

———— **Note** ————

For stage 2 of the Non-secure EL1&0 translation regime in an implementation where ARMv8.2-TTS2UXN is not supported, descriptor bit[53] is RES0, meaning it is ignored by hardware.

A value of 0 indicates that this control permits execution.

XN[1:0], Execute-never, for stage 2 control

Descriptor bits[54:53], defined as XN[1:0] for:

- Stage 2 of the Non-secure EL1&0 translation regime in an implementation where ARMv8.2-TTS2UXN is supported.

Table D4-33 shows the operation of this control.

Table D4-33 XN[1:0] stage 2 access permissions model

XN[1]	XN[0]	Access
0	0	The stage 2 control permits execution at EL1 and EL0
0	1	The stage 2 control does not permit execution at EL1, but permits execution at EL0
1	0	The stage 2 control does not permit execution at EL1 or EL0
1	1	The stage 2 control permits execution at EL1, but does not permit execution at EL0

———— **Note** ————

In an implementation that does not include ARMv8.1-VHE, the only translation regime that applies to EL0 and a higher Exception level is the EL1&0 translation regime. In an implementation that includes ARMv8.1-VHE:

- When the value of HCR_EL2.E2H is 1, TCR_EL2 controls the EL2&0 translation regime, and this regime:
 - Supports two VA ranges, corresponding to TTBR0_EL2 and TTBR1_EL2.
 - Always supports both UXN and PXN fields.
- Memory accesses from Non-secure EL0 are translated using the EL2&0 translation regime only when the value of HCR_EL2.{E2H, TGE} is {1, 1}.

Table D4-33 shows the operation of the stage 2 XN[1:0] control, and for each single-bit execute-never field a value of 1 indicates that instructions cannot be executed from the target memory region. In addition:

- For a translation regime that applies to EL0 and a higher Exception level, if the value of the AP[2:1] bits is 0b01, permitting write access from EL0, then the PXN field is treated as if it has the value 1, regardless of its actual value.
- In a translation regime with two stages of translation, a region is execute-never if execution is not permitted by the value of the applicable execute-never field in one or both of:
 - The stage 1 translation table descriptor.
 - The stage 2 translation table descriptor.
- For each translation regime, if the value of the corresponding SCTLR_ELx.WXN field is 1 then any memory region that is writable is treated as XN, regardless of the value of the corresponding UXN, XN, or PXN field. For more information, see *Preventing execution from writable locations* on page D4-2080.
- The SCR_EL3.SIF bit prevents execution in Secure state of any instruction fetched from Non-secure memory, see *Restriction on Secure instruction fetch* on page D4-2080.

The execute-never controls apply to speculative instruction fetching, meaning speculative instruction fetch from a memory region that is execute-never at the current Exception level is prohibited.

Note

- Although the execute-never controls apply to speculative fetching, on a speculative instruction fetch from an execute-never location, no Permission fault is generated unless the PE attempts to execute the instruction that would have been fetched from that location. This means that, if a speculative fetch from an execute-never location is attempted, but there is no attempt to execute the corresponding instruction, a Permission fault is not generated.
- The software that defines a translation table must mark any region of memory that is read-sensitive as execute-never, to avoid the possibility of a speculative fetch accessing the memory region. This means it must mark any memory region that corresponds to a read-sensitive peripheral as execute-never. Hardware does not prevent speculative accesses to a region of any Device memory type unless that region is also marked as execute-never for all Exception levels from which it can be accessed.
- When no stage of address translation for the translation regime is enabled, memory regions cannot have UXN, XN, or PXN attributes assigned. *Behavior of instruction fetches when all associated stages of translation are disabled on page D4-2054* describes how disabling all stages of address translation affects instruction fetching.

The following subsections describe the data access permission controls:

- *Stage 1 instruction access and execution permissions.*
- *Stage 2 instruction execution permissions on page D4-2079.*
- *Hierarchical control of instruction fetching on page D4-2079.*
- *Preventing execution from writable locations on page D4-2080.*
- *Restriction on Secure instruction fetch on page D4-2080.*

Stage 1 instruction access and execution permissions

Table D4-34 and Table D4-35 on page D4-2078 include the AP[2:1] read and write permissions shown in Table D4-29 on page D4-2073 and Table D4-30 on page D4-2074. These permissions are shown as:

- R** . Indicates Read permission granted.
- W** . Indicates Write permission granted.

Table D4-34 shows the stage 1 access permissions for instruction execution when using a translation regime that applies to EL0 and a higher Exception level.

Table D4-34 Stage 1 access permissions for instruction execution for a translation regime that applies to EL0 and a higher Exception level

UXN	PXN	AP[2:1]	SCTLR_ELx.WXN ^a	Access from higher Exception level	Access from EL0
0	0	00	0	R, W, Executable	Executable
			1	R, W, Not executable ^b	Executable
		01	0	R, W, Not executable ^c	R, W, Executable
			1	R, W, Not executable	R, W, Not executable ^d
		10	x	R, Executable	Executable
		11	x	R, Executable	R, Executable

Table D4-34 Stage 1 access permissions for instruction execution for a translation regime that applies to EL0 and a higher Exception level (continued)

UXN	PXN	AP[2:1]	SCTLR_ELx.WXN ^a	Access from higher Exception level	Access from EL0	
0	1	00	x	R, W, Not executable	Executable	
		01	0	R, W, Not executable	R, W, Executable	
			1	R, W, Not executable	R, W, Not executable ^d	
		10	x	R, Not executable	Executable	
		11	x	R, Not executable	R, Executable	
1	0	00	0	R, W, Executable	Not executable	
			1	R, W, Not executable ^b	Not executable	
		01	x	R, W, Not executable ^c	R, W, Not executable	
		10	x	R, Executable	Not executable	
		11	x	R, Executable	R, Not executable	
	1	1	00	x	R, W, Not executable	Not executable
			01	x	R, W, Not executable	R, W, Not executable
			10	x	R, Not executable	Not executable
			11	x	R, Not executable	R, Not executable

- a. Where ELx is the higher Exception level to which the translation regime applies.
- b. Not executable because of SCTLR_ELx.WXN control, because region is writable at ELx.
- c. Not executable, because AArch64 execution treats all regions writable at EL0 as being PXN.
- d. Not executable because of SCTLR_ELx.WXN control, because region is writable at EL0.

Table D4-35 shows the stage 1 access permissions for instruction execution when using a translation regime that applies to only a single Exception level.

Table D4-35 Access permissions for instruction execution for a translation regime that applies to only a single Exception level

XN	AP[2]	SCTLR_ELx.WXN ^a	Access permission
0	0	0	R, W, Executable
		1	R, W, Not executable ^b
		1	R, Executable
1	0	x	R, W, Not executable
		1	R, Not executable

- a. Where ELx is the higher Exception level to which the translation regime applies.
- b. Not executable because of the SCTLR_ELx.WXN control, because region is writable at ELx.

Note

The Access permissions for an AArch64 translation regime that applies to only a single Exception level are consistent with the following fields in the translation table entries being treated as shown:

- AP treated as RES1.

- [APTable\[0\]](#) treated as RES0.
- [PXN](#) treated as RES0.
- [PXNTable](#) treated as RES0.

Stage 2 instruction execution permissions

For the Non-secure EL1&0 stage 2 translation, the XN fields in the stage 2 translation table descriptors control the execution permission, and this control is completely independent of the S2AP access permissions.

Table D4-36 Access permissions for instruction execution for stage 2 of the Non-secure EL1&0 translation regime

XN	Access from Non-secure EL1 or Non-secure EL0
0	Executable
1	Not executable

The stage 2 XN access permissions make no distinction between Non-secure accesses from EL1 and Non-secure accesses from EL0. However, when both stages of address translation are enabled, these permissions are combined with the stage 1 access permissions defined at stage 1 of the translation, see [Combining the stage 1 and stage 2 instruction execution permissions](#) on page D4-2096.

Hierarchical control of instruction fetching

The VMSAv8-64 translation table format includes mechanisms by which entries at one level of translation table lookup can set limits on the permitted entries at subsequent levels of lookup. This subsection describes how these controls apply to the instruction fetching controls.

Note

Similar hierarchical controls apply to data accesses, see [Hierarchical control of data access permissions](#) on page D4-2074.

However, in an implementation that includes [ARMv8.1-HPD](#), when the value of a [TCR_ELx.HPD{0}](#) field is 1, or the value of the [TCR_ELx.HPD1](#) field is 1, the hierarchical control of instruction fetching is disabled for the translation stage controlled by that [TCR_ELx](#), and the information in this subsection does not apply.

The restrictions apply only to subsequent levels of lookup at the same stage of translation, and:

- [UXNTable](#) or [XNTable](#) restricts the execute-never control:
 - When the value of the [XNTable](#) bit is 1, the [XN](#) bit is treated as 1 in all subsequent levels of lookup, regardless of its actual value.
 - When the value of the [UXNTable](#) bit is 1, the [UXN](#) bit is treated as 1 in all subsequent levels of lookup, regardless of its actual value.
 - When the value of a [UXNTable](#) or [XNTable](#) bit is 0 the bit has no effect.
- For a translation regime that applies to EL0 and a higher Exception level, [PXNTable](#) restricts the [PXN](#) control:
 - When the value of [PXNTable](#) is 1, the [PXN](#) bit is treated as 1 in all subsequent levels of lookup, regardless of the actual value of the bit.
 - When the value of [PXNTable](#) is 0 it has no effect.

Note

The [UXNTable](#), [XNTable](#), and [PXNTable](#) settings are combined with the [UXN](#), [XN](#), and [PXN](#) bits in the translation table descriptors accessed at subsequent levels of lookup. They do not restrict or change the values entered in those descriptors.

The [UXNTable](#), [XNTable](#), and [PXNTable](#) controls are provided only for stage 1 translations. The corresponding bits are RES0 in the stage 2 translation table descriptors.

The effect of [UXNTable](#), [XNTable](#), or [PXNTable](#) applies to later entries in the translation table walk, and so its effects can be held in one or more TLB entries. Therefore, a change to [UXNTable](#), [XNTable](#), or [PXNTable](#) requires coarse-grained invalidation of the TLB to ensure that the effect of the change is visible to subsequent memory transactions.

Preventing execution from writable locations

ARMv8 provides control bits that, when corresponding stage 1 address translation is enabled, force writable memory to be treated as [UXN](#), [PXN](#), or [XN](#), regardless of the value of the [UXN](#), [PXN](#), or [XN](#) bit:

- For a translation regime that applies to EL0 and a higher Exception value, when the value of the applicable [SCTLR_ELx.WXN](#) field is 1:
 - All regions that are writable from EL0 at stage 1 of the address translation are treated as [UXN](#).
 - All regions that are writable from EL1 at stage 1 of the address translation are treated as [PXN](#).
- For a translation regime that applies to only a single Exception level, when the value of the applicable [SCTLR_ELx.WXN](#) field is 1, all regions that are writable at stage 1 of the address translation are treated as [XN](#).

Note

- The [SCTLR_ELx.WXN](#) controls are intended to be used in systems with very high security requirements.
 - Setting a [WXN](#) field to 1 changes the interpretation of the translation table entry, overriding a zero value of a [UXN](#), [XN](#), or [PXN](#) field. It does not cause any change to the translation table entry.
-

For any given virtual machine, ARM expects [WXN](#) to remain static in normal operation. In particular, it is IMPLEMENTATION DEFINED whether TLB entries associated with a particular [VMID](#) reflect the effect of the values of these fields. This means that any change of these fields without a corresponding change of [VMID](#) might require synchronization and TLB invalidation, as described in [TLB maintenance requirements and the TLB maintenance instructions](#) on page D4-2119.

Restriction on Secure instruction fetch

EL3 provides a Secure instruction fetch bit, [SCR_EL3.SIF](#). When the value of this bit is 1, and execution is using the EL3 translation regime or the Secure EL1&0 translation regime, any attempt to execute an instruction fetched from Non-secure physical memory causes a Permission fault. TLB entries might reflect the value of this bit, and therefore any change to the value of this bit requires synchronization and TLB invalidation, as described in [TLB maintenance requirements and the TLB maintenance instructions](#) on page D4-2119.

D4.4.6 The Access flag

The Access flag indicates when a page or section of memory is accessed for the first time since the Access flag in the corresponding translation table descriptor was set to 0.

The AF bit in the translation table descriptors is the Access flag.

In ARMv8.0, the Access flag is managed by software as described in [Software management of the Access flag](#).

From ARMv8.1, the Access flag can be managed by hardware as described in [Hardware management of the Access flag on page D4-2082](#).

———— **Note** —————

The support for hardware management of the Access flag is in AArch64 state only.

D4.4.7 The dirty state bit

The dirty state bit indicates whether a page or section of memory is modified.

The DBM bit in the translation table descriptors is the dirty state bit.

The dirty state bit can be managed by hardware as described in [Hardware management of dirty state on page D4-2083](#).

D4.4.8 Software management of the Access flag

ARMv8.0 requires that software manages the Access flag. This means an Access flag fault is generated whenever an attempt is made to read into the TLB a translation table descriptor entry for which the value of Access flag is 0.

The Access flag mechanism expects that, when an Access flag fault occurs, software resets the Access flag to 1 in the translation table entry that caused the fault. This prevents the fault occurring the next time that memory location is accessed. Entries with the Access flag set to 0 are never held in the TLB, meaning software does not have to flush the entry from the TLB after setting the flag.

———— **Note** —————

If a system incorporates components that can autonomously update translation table entries that are shared with the ARM PE, then the software must be aware of the possibility that such components can update the access flag autonomously.

In such a system, system software should perform any changes of translation table entries with an Access flag of 0, other than changes to the Access flag value, by using an Load-Exclusive/Store-Exclusive loop, to allow for the possibility of simultaneous updates.

D4.4.9 Hardware management of the Access flag and dirty state

ARMv8.1 introduces the following optional features that perform hardware updates to the translation tables:

- [Hardware management of the Access flag on page D4-2082](#).
- [Hardware management of dirty state on page D4-2083](#).

The support for hardware management of the Access flag and dirty state is identified by the feature [ARMv8.1-TTHM](#).

When the hardware management of the Access flag is enabled, in situations where, without this feature, an Access flag fault would be generated, the hardware instead performs an atomic read-modify-write of the appropriate translation table descriptor to update the Access flag from 0 to 1.

When the hardware management of dirty state is enabled, if the Block or Page descriptor in a translation table indicates that a data access does not have write permission, then in situations where, without this feature, a data access would generate a Permission fault only because of this lack of write permission, the hardware checks the

value of the DBM field in the Block or Page descriptor. If this field is 1, then instead of generating a Permission fault, the hardware performs an atomic read-modify-write of the translation table descriptor, to change the value of the bit that prohibits the write access.

Hardware management of the Access flag

Hardware management of the Access flag is enabled, for the corresponding stage of address translation, by the following configuration fields:

For stage 1 translations

- [TCR_EL1.HA](#).
- [TCR_EL2.HA](#).
- [TCR_EL3.HA](#).

For stage 2 translations

- [VTCR_EL2.HA](#).

Implementations are not required to support the hardware management of the Access flag. If [ARMv8.1-TTHM](#) is not supported, then the HA bit in [TCR_EL1](#), [TCR_EL2](#), [TCR_EL3](#), and [VTCR_EL2](#) is RES0.

When the value of a configuration bit, HA, is 1, then when a memory access is made using a translation table Block or Page descriptor from the corresponding stage of address translation:

- The PE sets the value of the Access flag to 1 in the translation table descriptor in memory, in a coherent manner, by an atomic read-modify-write of the translation table descriptor, if both of the following conditions are true:
 - The descriptor does not generate a Permission fault or an Alignment fault based on the memory type.
 - If the hardware update mechanism was disabled or not implemented, the access would have generated an Access flag fault.

When the PE updates the Access flag in this way no Access flag fault is generated.

- It is CONSTRAINED UNPREDICTABLE whether the PE sets the value of the Access flag in the translation table entry in memory to 1, in a coherent manner, by an atomic read-modify-write of the translation table descriptor, if both of the following conditions are true:
 - The descriptor generates a Permission fault or an Alignment fault based on the memory type.
 - If the hardware update mechanism was disabled or not implemented, the access would have generated an Access flag fault.

This means that the value of the Access flag becomes UNKNOWN if the above conditions are all true.

The Access flag might be set to 1 as a result of speculative accesses by the PE.

———— Note —————

A consequence of the architectural rules for translation table accesses is that the architecture requires that for any translation to which an architecturally executed memory access occurs, the Access flag is set to 1, except as indicated in [Using break-before-make when updating translation table entries on page D4-2120](#). However, because the architecture permits speculative accesses, the Access flag is permitted to be set to 1, even if there is no architecturally executed memory accesses by the processor.

When hardware updating of the Access flag is enabled, each stage of translation is treated independently. This means that a single memory access can cause a hardware update to either or both:

- The stage 1 Access flag.
- The stage 2 Access flag.

Note

Since speculative accesses are permitted to update the Access flags, it is permissible for:

- The stage 1 Access flag for a translation of a virtual address to be updated in situations where the stage 2 translation of the associated intermediate physical address that is returned by the stage 1 of the virtual address does not permit access.
- The stage 2 Access flag for a translation of an intermediate physical address to be updated in situations where the stage 1 translation of the associated virtual address which returned that intermediate physical address does not permit access.

An address translation instruction for an address is permitted, but not required, to set the Access flag in the translation table entries for that address. Correspondingly, it is IMPLEMENTATION DEFINED whether such an instruction can generate a Data Abort if the Access flag for a stage of translation is updated to be set.

When hardware updates of the Access flag are enabled for a stage of translation an address translation instruction that uses that stage of translation will not report that the address will give rise to an Access flag fault in the PAR, and the result in PAR will be as if the value of the Access flag in the translation table entries for that address was 1.

Hardware management of dirty state

The hardware management of dirty state mechanism can only be enabled if hardware management of the Access flag is enabled. For information on the hardware management of the Access flag, see [Hardware management of the Access flag on page D4-2082](#).

Note

The hardware management of dirty state mechanism uses:

- In a stage 1 translation table access, the AP[2] bit in conjunction with the DBM bit in the translation table descriptors.
- In a stage 2 translation table access, the S2AP[1] bit in conjunction with the DBM bit in the translation table descriptors.

Hardware management of dirty state is enabled, for the corresponding stage of address translation, by the following configuration fields:

For stage 1 translations

- [TCR_EL1.HD](#).
- [TCR_EL2.HD](#).
- [TCR_EL3.HD](#).

For stage 2 translations

- [VTCR_EL2.HD](#).

Implementations are not required to support the dirty state mechanism. If this mechanism is not supported, then the HD bit in [TCR_EL1](#), [TCR_EL2](#), [TCR_EL3](#), and [VTCR_EL2](#) is RES0.

When hardware management of dirty state is enabled, and a memory access is made using a translation table Block or Page descriptor:

- For a stage 1 address translation, if the value of the TCR_ELx.HD field corresponding to the address translation is 1, then the PE sets AP[2] to 0 in the translation descriptor in memory, in a coherent manner by an atomic read-modify-write of the translation table descriptor, if both of the following conditions are true:
 - The value of the DBM field in the descriptor is 1.
 - If the hardware update mechanism was disabled or not implemented, the access using this descriptor would have generated a Permission fault only because the value of the AP[2] field is 1, indicating that the access does not have write permission.

When the PE updates AP[2] in this way no Permission fault is generated because of the value of the AP[2] field.

- For a stage 2 address translation, if the value of the VTCR_EL2.HD field is 1, then the PE sets S2AP[1] to 1 in the translation descriptor in memory, in a coherent manner by an atomic read-modify-write of the translation table descriptor, if both of the following conditions are true:
 - The value of the DBM field in the descriptor is 1.
 - If the hardware update mechanism was disabled or not implemented, the access using this descriptor would have generated a Permission fault only because the value of the S2AP[1] field is 0, indicating that the access does not have write permission.

When the PE updates S2AP[1] in this way no Permission fault is generated because of the value of the S2AP[1] field.

Note

The PE that does the atomic update of the translation table descriptor is expected to ensure that any cached copy of that translation table descriptor for that PE is similarly updated, or removed from the TLB, so that multiple writes from the same thread on the same PE do not lead to multiple updates to the table. This is only a performance expectation.

If, for a write access, the PE finds that a cached copy of the descriptor in a TLB had the DBM bit set to 1 and the AP[2] or S2AP[1] bit set to the value that forbids writes, then the PE must check that the cached copy is not stale with regard to the descriptor entry in memory, and if necessary perform an atomic read-modify-write update of the descriptor in memory. This applies if the cached copy of the descriptor in a TLB is either:

- A stage 1 descriptor in which DBM has the value 1 and AP[2] has the value 1.
- A stage 2 descriptor in which DBM has the value 1 and S2AP[1] has the value 0.

Note

ARM expects that, in many implementations, any atomic update of a translation table entry required by the dirty state management mechanism will cause a translation table walk.

For the hardware updating of the AP[2] and S2AP[1] bits, each translation stage is treated independently. This means a single memory access can update either or both of:

- The stage 1 AP[2] bit.
- The stage 2 S2AP[1] bit.

The architecture does not permit updates to AP[2] and S2AP[1] by the hardware management of dirty state mechanism to occur as a result of speculative accesses by the PE that are not performed architecturally, except that:

- A non-speculative access that passes its stage 1 permissions check can update AP[2] and subsequently encounter a stage 2 fault.

Note

This update of AP[2] is permitted even if the transaction subsequently encounters a stage 2 Translation fault or a Permission fault. This avoids a need to update both AP[2] and S2AP[1] as a single atomic update.

- A non-speculative access that generates an Alignment fault only because the memory type accessed is Device memory by a stage of translation can update AP[2] or S2AP[1] of that stage of translation if the memory access would have updated that translation table bit had the memory access not generated the Alignment fault.
- If the stage 2 hardware management of dirty state mechanism is enabled, the S2AP[1] field of a stage 2 translation table entry that is translating a stage 1 translation table without generating a stage 2 MMU fault:
 - Is updated from 0 to 1 as a result of a speculative update of the Access flag in an entry of that stage 1 translation table.
 - Is permitted to be updated speculatively from 0 to 1 as a result of performing a translation table walk using that stage 1 translation table, even if the entry in the stage 1 translation table is not updated.

———— **Note** —————

This applies even if the stage 1 translation table contains entries that are not the final level entries and therefore would not be updated. This relaxation avoids the hardware complexity of having to detect whether the stage 1 entry is a final level entry before deciding to set the stage 2 dirty state information.

- If an instruction that generates more than one single-copy atomic memory access has a fault on some, but not all, of those memory accesses, then AP[2] and S2AP[1] bits associated with accesses from that instruction, which do not fault are permitted to be updated if the associated hardware update of dirty state mechanism is enabled.

For a Block or Page translation table descriptor for which the AF bit is 0, the DBM bit is 1, and either the value of the stage 1 AP[2] bit is 1 or the value of the stage 2 S2AP[1] bit is 0, both AF can be set to 1, and either AP[2] set to 0 or S2AP[1] set to 1, in a single atomic read-modify-write operation, as a result of an attempted write to a memory location that uses the translation table entry.

Implications of enabling the dirty state management mechanism

This subsection describes behaviors that result from having the dirty state management mechanism enabled for a particular stage of address translation.

For the final level of lookup in a stage 1 translation:

In the EL3 translation regime

The OA of the lookup is treated as writable if all of the following conditions apply:

- In the descriptor for the final level of lookup, the value of DBM is 1 and the value of AP[2] is 1.
- In the descriptor for every higher level of lookup, the value of APTable[1] is 0.

In this case, if the value of SCTLR_EL3.WXN is 1 then the OA is treated as Execute-never.

In the EL2 or EL2&0 translation regime, when the value of HCR_EL2.{E2H, TGE} is not {1, 1}

———— **Note** —————

When the value of HCR_EL2.E2H is 1, TCR_EL2 controls the EL2&0 translation regime, and otherwise it controls the EL2 translation regime.

The OA of the lookup is treated as writable if all of the following conditions apply:

- In the descriptor for the final level of lookup, the value of DBM is 1 and the value of AP[2] is 1.
- In the descriptor for every higher level of lookup the value of APTable[1] is 0.

In this the value of SCTLR_EL2.WXN is 1 then the OA is treated as Execute-never.

In addition, if the value of HCR_EL2.E2H is 1, the OA is treated as Privileged execute-never if all of the following conditions apply:

- In the descriptor for the final level of lookup, the value of DBM is 1 and the value of AP[2:1] is 0b11.
- In the descriptor for every higher level of lookup, the value of APTable[1:0] is 0b00.

———— **Note** —————

When the value of HCR_EL2.{E2H, TGE} is not {1, 1}, memory accesses from EL0 do not use the EL2, or EL2&0, translation regime.

In the EL2&0 translation regime, when the value of HCR_EL2.{E2H, TGE} is {1, 1}

The OA of the lookup is treated as writable at EL2 and EL0, Privileged execute-never, if all of the following conditions apply:

- In the descriptor for the final level of lookup, the value of DBM is 1 and the value of AP[2:1] is 0b11.
- In the descriptor for every higher level of lookup the value of APTable[1:0] is 0b00.

In this case, if the value of SCTLR_EL2.WXN is 1 then the OA is also treated as Unprivileged execute-never.

The OA of the lookup is treated as writable at EL2 but not writable at EL0 if either:

- Both:
 - In the descriptor for the final level of lookup, the value of DBM is 1 and the value of AP[2:1] is 0b10.
 - In the descriptor for every higher level of lookup the value of APTable[1:0] is 0b0x.

In this case, if the value of SCTLR_EL2.WXN is 1 then the OA is treated as Privileged execute-never.

- Both:
 - In the descriptor for the final level of lookup, the value of DBM is 1 and the value of AP[2:1] is 0b11.
 - In at least one of the descriptors for higher levels of lookup the value of APTable[1:0] is 0b01.

In this case, if the value of SCTLR_EL2.WXN is 1 then the OA is treated as Privileged execute-never.

In the EL1&0 translation regime

The OA of the lookup is treated as writable at EL1 and EL0, Privileged execute-never, if all of the following conditions apply:

- In the descriptor for the final level of lookup, the value of DBM is 1 and the value of AP[2:1] is 0b11.
- In the descriptor for every higher level of lookup the value of APTable[1:0] is 0b00.

In this case, if the value of SCTLR_EL1.WXN is 1 then the OA is treated as Unprivileged execute-never.

The OA of the lookup is treated as writable at EL1 but not writable at EL0 if either:

- Both:
 - In the descriptor for the final level of lookup, the value of DBM is 1 and the value of AP[2:1] is 0b11.
 - In at least one of the descriptors for higher levels of lookup the value of APTable[1:0] is 0b01.

In this case, if the value of SCTLR_EL1.WXN is 1 then the OA is treated as Privileged execute-never.

- Both:
 - In the descriptor for the final level of lookup, the value of DBM is 1 and the value of AP[2:1] is 0b10.
 - In the descriptor for every higher level of lookup the value of APTable[1:0] is 0b0x.

In this case, if the value of SCTLR_EL1.WXN is 1 then the OA is treated as Privileged execute-never.

The OA of a translation table entry where the DBM bit is 1, and the stage 1 AP[2] bit is 1 or the stage 2 S2AP[1] bit is 0, is treated as writable:

- For data cache invalidation instructions that require write permission, that is for the DC IVAC instruction.
- For address translation instructions that require write permission, that is for the AT S12E0W, AT S12E1W, AT S1E0W, AT S1E1W, AT S1E2W, and AT S1E3W instructions.

Cache invalidation and address translation instructions never cause the stage 1 AP[2] bit or the stage 2 S2AP[1] bit in the translation table entry to be updated.

For a Store-Exclusive instruction to a memory location for which the DBM bit is 1 and the stage 1 AP[2] bit is 1, if the Store-Exclusive fails because the Exclusives monitor is not in the exclusive state, it is IMPLEMENTATION DEFINED whether the AP[2] bit in the translation table is updated.

For a Store-Exclusive instruction to a memory location for which the DBM bit is 1, and the stage 2 S2AP[1] bit is 0, if the Store-Exclusive fails because the Exclusives monitor is not in the Exclusive access state, it is IMPLEMENTATION DEFINED whether the S2AP[1] bit in the translation table is updated.

For a store to a memory location for which the DBM bit is 1, and the stage 1 AP[2] bit is 1, it is IMPLEMENTATION DEFINED whether the AP[2] bit in the translation table is updated:

- If the memory location generates a synchronous external abort on a write for a store to a memory location.
- If the memory location generates a watchpoint on a write.

For a store to a memory location for which the DBM bit is 1, and the stage 2 S2AP[1] bit is 0, it is IMPLEMENTATION DEFINED whether the S2AP[1] bit in the translation table is updated:

- If the memory location generates a synchronous external abort on a write for a store to a memory location.
- If the memory location generates a watchpoint on a write.

In the event of a PE setting the stage 1 AP[2] bit to 0, it is not required that all associated entries are removed from the TLBs of other PEs in the system.

In the event of a PE setting the stage 2 S2AP[1] bit to 1, it is not required that all associated entries are removed from the TLBs of other PEs in the system.

For the stage 2 translation tables, it is CONSTRAINED UNPREDICTABLE whether the stage 2 S2AP[1] entry is updated in response to a stage 1 translation table walk where the stage 1 translation system is configured to perform hardware updates to the Access flag or stage 1 AP[2] bit, but the values of the Access flag and AP[2] bit are such that a hardware update to the stage 1 translation table entry being accessed is not required.

In the event of a PE encountering a situation for a data write for which the DBM bit is 1 and the stage 1 AP[2] bit is 1 in a TLB, it is required that the hardware checks that the cached copy is not stale with regards to the translation table entry in memory and performs the atomic read-modify-write update with respect to table entry in memory.

In the event of a PE encountering a situation for a data write for which the DBM bit is 1 and stage 2 S2AP[1] bit is 0 in a TLB, it is required that the hardware checks that the cached copy is not stale with regards to the translation table entry in memory and performs the atomic read-modify-write update with respect to table entry in memory.

For a CAS or CASP instruction to a memory location for which the DBM bit is 1, and the stage 1 AP[2] bit is 1, if the compare fails, and the location is not updated, it is CONSTRAINED UNPREDICTABLE whether the AP[2] bit in the translation table is updated.

For a CAS or CASP instruction to a memory location for which the DBM bit is 1, and the stage 2 S2AP[1] bit is 0, if the compare fails, and the location is not updated, it is CONSTRAINED UNPREDICTABLE whether the S2AP[1] bit in the translation table is updated.

For an atomic instruction to a memory location for which the DMB bit is 1, and the stage 2 S2AP[0:1] is 00, if the instruction generates a stage 2 Permission fault as a result of not having read permission, it is CONSTRAINED UNPREDICTABLE whether the S2AP[1] bit in the translation table is updated.

D4.4.10 Ordering of hardware updates to the translation tables

A hardware update to the translation table that is caused by a load or a store, including an atomic instruction, is guaranteed to be observed, to the extent required by the shareability attributes:

- Before a load or store, including an atomic instruction, to an arbitrary address, other than the address of the translation table entry, that appears in program order after the load or store, including an atomic instruction, causing the update to the translation table entry only if a DSB with the appropriate shareability attributes, where the DSB applies to both loads and stores, is executed between the load or store, including an atomic instruction, that caused the update to the translation table and the subsequent load or store.

- Before a load to the translation table entry that is being updated that appears in program order after the load or store, including an atomic instruction, causing the update to the translation table entry only if a DSB with the appropriate shareability attributes, where the DSB applies to both loads and stores, is executed between the load or store, including an atomic instruction, that caused the update to the translation table and the subsequent load.
- Before a store or atomic access to the translation table entry that is being updated that appears in program order after the load or store, including an atomic instruction, causing the update to the translation table entry.
- Before a cache maintenance instruction to an arbitrary address appearing in program order after the load or store, including an atomic instruction, causing the update to the translation table entry only if a DSB with the appropriate shareability attributes, where the DSB applies to both loads and stores, is executed between the load or store, including an atomic instruction that caused the update to the translation table entry and the subsequent cache maintenance instruction.

An update to the translation table that is caused by a load is not ordered with respect to the load itself.

An update to the translation table that is caused by a store or an atomic access is observed by all observers, to the extent required by the shareability attributes, before the store itself in the case that the store is to the same location as the translation table update.

An update to the translation table that is caused by a store or an atomic access is not ordered with respect to the store itself in the case that the store is not the same location as the translation table update.

D4.4.11 Restriction on memory types for hardware updates on page tables

Translation tables can be placed in Normal memory with any cacheability, but the hardware updates to the translation tables require an atomic update of memory. The properties of the atomicity can be met only by functionality outside the PE. Some system implementations might not implement this functionality for all regions of memory. This can apply to:

- Any type of memory in the system that does not support hardware cache coherency.
- Non-cacheable memory, or memory that is treated as Non-cacheable, in an implementation that does not support hardware cache coherency.

An implementation can choose which memory type is treated as Non-cacheable.

The memory types for which it is architecturally guaranteed that the hardware updates of the translation tables will be atomic are:

- Inner Shareable, Inner Write-Back, Outer Write-Back Normal memory with Read allocation hints and Write allocation hints and not transient.
- Outer Shareable, Inner Write-Back, Outer Write-Back Normal memory with Read allocation hints and Write allocation hints and not transient.

If the hardware updates of the translation tables are not atomic in regard to other agents that access memory, then performing a hardware update to such a location can have one or more of the following effects:

- The hardware update generates a Synchronous external abort, which is presented as an external abort on a translation table walk.
- The instruction generates a SError interrupt.
- The hardware update generates an Unsupported atomic hardware update MMU fault reported using the Fault status code of:

— `ESR_ELx.DFSC = 110001` for Data Aborts.

— `ESR_ELx.IFSC = 110001` for Instruction Aborts.

For the Non-secure EL1&0 translation regime, if atomic hardware update is not supported because of the memory type that is defined in the first stage of translation, or the second stage of translation is not enabled, then this exception is a first stage abort and is taken to EL1. Otherwise, the exception is a second stage abort and is taken to EL2.

The priority of this MMU fault for a stage of the translation is immediately before or immediately after the priority of a Permission fault generated by the same stage of translation as the stage of this MMU fault, as determined by an IMPLEMENTATION DEFINED choice.

- The hardware updates are performed, but there is no guarantee that the memory accesses were performed atomically in regard to other agents that access memory. In this case, the instruction might also generate a SError interrupt.

D4.4.12 Use of the Contiguous bit with hardware updates of the translation table entries

The hardware update of the Access flag, and the AP[2]/S2AP[1] bit only apply to a single translation table entry. An update to one of these bits in a translation table entry that also has the Contiguous bit set to 1 can give rise to translation table entries that have different Access flag, or different AP[2] and S2AP[1] bits within the members of a group of contiguous translation table entries.

This is acceptable under the architecture when using hardware updates of the translation table entries. In addition, an access or a write to a location translated by an entry that has the Contiguous bit set might not result in a hardware update of the Access flag or the AP[2]/S2AP[1] bit, if at least one entry in the set of contiguous translation table entries has the Access flag set to 1, or the AP[2]/S2AP[1] bit indicating that the entry is dirty.

———— **Note** —————

- The provision of the Contiguous bit permits, but does not require, the hardware to hold a single entry in a TLB for the set of translation table entries in the group, and to have updated only one or more of the Access flags and the AP[2] bit or S2AP[1] bit for the single translation table entry that gave rise to the TLB entry.
- A consequence of this is that software must combine the Access flag values, and AP[2] or S2AP[1] values, across all translation table entries in a contiguous group to determine whether any of the entries have been accessed or written to.

For more information on the Contiguous bit, see [The Contiguous bit on page D4-2094](#).

D4.5 Memory region attributes

The memory region attribute fields control the memory type, accesses to the caches, and whether the memory region is Shareable and therefore is coherent. This section also describes some additional translation table fields, that this manual groups with the memory region attributes.

In the EL1&0 translation regime, each enabled stage of address translation assigns memory region attributes, as described in this section. When both stages of translation are enabled, [Combining the stage 1 and stage 2 attributes](#), [Non-secure EL1&0 translation regime on page D4-2095](#) describes how the assignments from the two stages are combined.

Note

In a virtualization implementation, a hypervisor, executing at EL2, might usefully:

- Reduce the permitted cacheability of a region.
- Increase the required shareability of a region.

The combining of attributes from stage 1 and stage 2 translations supports both of these options.

The following sections describe these attributes:

- [The stage 1 memory region attributes](#).
- [The stage 2 memory region attributes, EL1&0 translation regime on page D4-2092](#).
- [Other fields in the VMSEA8-64 translation table format descriptors on page D4-2093](#).

Note

- This section describes the memory region attributes for each of the translation regimes, and for each stage of translation in the Non-secure EL1&0 translation regime.
 - A translation applies to memory accesses from either:
 - Only a single Exception level, for example the EL3 translation regime.
 - EL0 and one higher Exception level, for example the EL1&0 translation regime.
 - In general, attribute assignment is simpler in a regime that applies to only a single Exception level, and in these regimes behavior is consistent with fields in the translation tables being treated as follows:
 - `AP[1]` is RES1, meaning the PE ignores the value of the bit and behaves as if it is 1.
 - `APTable[0]` is RES0, meaning the PE ignores the value of the bit and behaves as if it is 0.
 - The `PXN` field is RES0, meaning the PE ignores the value of the bit and behaves as if it is 0.
 - The `PXNTable` bit is RES0, meaning the PE ignores the value of the bit and behaves as if it is 0.
-

D4.5.1 The stage 1 memory region attributes

The description of the memory region attributes in a translation descriptor divides into:

Memory type and Cacheability

These are described indirectly, by registers referenced by bits in the table descriptor. This is described as *remapping* the memory type and attribute description. [Stage 1 memory region type and Cacheability attributes](#) describes this encoding.

Shareability The SH[1:0] field in the translation table descriptor encodes shareability information. [Stage 1 Shareability attribute, for Normal memory on page D4-2091](#) describes this encoding.

Stage 1 memory region type and Cacheability attributes

In the VMSEA8-64 translation table format, the AttrIdx[2:0] field in a block or page translation table descriptor for a stage 1 translation indicates the 8-bit field in the MAIR_ELx that specifies the attributes for the corresponding memory region. The required field is Attrn, where n = AttrIdx[2:0]. For more information about AttrIdx[2:0] see [Attribute fields in stage 1 VMSEA8-64 Block and Page descriptors on page D4-2066](#)

———— **Note** —————

Each MAIR_ELx is a 64-bit register that is architecturally mapped to a pair of AArch32 registers. See the MAIR_ELx register descriptions for more information.

Each MAIR_ELx.Attrn field defines, for the corresponding memory region:

- The memory type, Device or Normal.
- For Device memory, the Device memory type, one of:
 - Device-nGnRnE.
 - Device-nGnRE.
 - Device-nGRE.
 - Device-GRE.
- For Normal memory:
 - The inner and outer cacheability, Non-cacheable, Write-Through, or Write-Back
 - For Write-Through Cacheable and Write-Back Cacheable regions, the Read-Allocate and Write-Allocate policy hints, each of which is *Allocate* or *No Allocate*, and the Transient allocation hints, if supported.

For more information about the memory type and attributes, see *Memory types and attributes* on page B2-107 and *Cacheability, cache allocation hints, and cache transient hints* on page D3-1977.

Stage 1 Shareability attribute, for Normal memory

When using the VMSAv8-64 translation table format, the SH[1:0] field in a block or page translation table descriptor specifies the Shareability attributes of the corresponding memory region. Table D4-37 shows the encoding of this field.

Table D4-37 SH[1:0] field encoding for Normal memory, VMSAv8-64 translation table format

SH[1:0]	Normal memory
00	Non-shareable
01	Reserved, CONSTRAINED UNPREDICTABLE ^a
10	Outer Shareable
11	Inner Shareable

a. See *Reserved values in System and memory-mapped registers and translation table entries* on page K1-6133 for the permitted CONSTRAINED UNPREDICTABLE behavior.

———— **Note** —————

The shareability field is only relevant if the memory is a Normal Cacheable memory type. All Device and Normal Non-cacheable memory regions are always treated as Outer Shareable, regardless of the translation table shareability attributes

See *Combining the stage 1 and stage 2 shareability attributes for Normal memory* on page D4-2097 for constraints on the Shareability attributes of a Normal memory region that is Inner Non-cacheable, Outer Non-cacheable.

D4.5.2 The stage 2 memory region attributes, EL1&0 translation regime

In the stage 2 translation table descriptors for memory regions and pages, the MemAttr[3:0] and SH[1:0] fields describe the stage 2 memory region attributes:

- [Stage 2 memory region type and Cacheability attributes](#) describes how the MemAttr[3:0] field defines these attributes.
- The SH[1:0] field in the translation table descriptor encodes shareability information. [Stage 2 Shareability attribute, for Normal memory on page D4-2093](#) describes this encoding.

The following sections describe how, when both stages of address translation are enabled, the memory region attributes assigned at stage 2 of the translation are combined with those assigned at stage 1:

- [Combining the stage 1 and stage 2 memory type attributes on page D4-2096](#).
- [Combining the stage 1 and stage 2 cacheability attributes for Normal memory on page D4-2097](#).
- [Combining the stage 1 and stage 2 shareability attributes for Normal memory on page D4-2097](#).

Stage 2 memory region type and Cacheability attributes

[Table D4-38](#) shows how MemAttr[3:2] gives a top-level definition of the memory type, and of the Outer cacheability of a Normal memory region.

Table D4-38 VMSAv8-64 MemAttr[3:2] encoding, stage 2 translation

MemAttr[3:2]	Memory type	Outer cacheability
00	Device. MemAttr[1:0] encodes the Device memory type.	Not applicable
01	Normal. MemAttr[1:0] encodes the Inner Cacheability.	Outer Non-cacheable
10		Outer Write-Through Cacheable
11		Outer Write-Back Cacheable

The encoding of MemAttr[1:0] depends on the Memory type indicated by MemAttr[3:2]:

- When MemAttr[3:2]==0b00, indicating Device memory, [Table D4-39](#) shows the encoding of MemAttr[1:0].

Table D4-39 MemAttr[1:0] encoding for Device memory

MemAttr[1:0]	Meaning when MemAttr[3:2] == 0b00
00	Region is Device-nGnRnE memory
01	Region is Device-nGnRE memory
10	Region is Device-nGRE memory
11	Region is Device-GRE memory

- When MemAttr[3:2]!=0b00, indicating Normal memory, [Table D4-40](#) shows the encoding of MemAttr[1:0].

Table D4-40 MemAttr[1:0] encoding for Normal memory

MemAttr[1:0]	Meaning when MemAttr[3:2] != 0b00
00	Reserved, CONSTRAINED UNPREDICTABLE ^a

Table D4-40 MemAttr[1:0] encoding for Normal memory (continued)

MemAttr[1:0]	Meaning when MemAttr[3:2] != 0b00
01	Inner Non-cacheable
10	Inner Write-Through Cacheable
11	Inner Write-Back Cacheable

a. See *Reserved values in System and memory-mapped registers and translation table entries* on page K1-6133 for the permitted CONSTRAINED UNPREDICTABLE behavior.

Note

- The stage 2 translation does not assign any allocation hints.
- The following stage 2 translation table attribute settings leave the stage 1 settings unchanged:
 - MemAttr[3:2] == 0b11, Normal memory, Outer Write-Back Cacheable.
 - MemAttr[1:0] == 0b11, Inner Write-Back Cacheable.

Stage 2 Shareability attribute, for Normal memory

When using the VMSAv8-64 translation table format, the SH[1:0] field in a block or page translation table descriptor specifies the Shareability attributes of the corresponding memory region. Table D4-41 shows the encoding of this field.

Table D4-41 SH[1:0] field encoding for Normal memory, VMSAv8-64 translation table format

SH[1:0]	Normal memory
00	Non-shareable
01	Reserved, CONSTRAINED UNPREDICTABLE ^a
10	Outer Shareable
11	Inner Shareable

a. See *Reserved values in System and memory-mapped registers and translation table entries* on page K1-6133 for the permitted CONSTRAINED UNPREDICTABLE behavior.

Note

- This encoding is the same as the shareability encoding described in *Stage 1 Shareability attribute, for Normal memory* on page D4-2091.
- The shareability field is only relevant if the memory is a Normal Cacheable memory type. All Device and Normal Non-cacheable memory regions are always treated as Outer Shareable, regardless of the translation table shareability attributes.

See *Combining the stage 1 and stage 2 shareability attributes for Normal memory* on page D4-2097 for constraints on the Shareability attributes of a Normal memory region that is Inner Non-cacheable, Outer Non-cacheable.

D4.5.3 Other fields in the VMSAv8-64 translation table format descriptors

The following subsections describe the other fields in the translation table block and page descriptors:

- *The Contiguous bit* on page D4-2094.
- *IGNORED fields* on page D4-2095.
- *Field reserved for software use* on page D4-2095.

The Contiguous bit

When the value of the Contiguous bit is 1, it indicates that the entry is one of a number of adjacent translation table entries that point to a *contiguous output address range*. The required number of adjacent entries depends on the current translation granule size, as follows:

4KB granule 16 adjacent translation table entries point to a contiguous output address range that has the same permissions and attributes. These 16 entries must be aligned in the translation table. If accessing a full-sized 4KB translation table, this means that the top 5 of the 9 input addresses bits that index the descriptor positions in the translation table are the same for all of the entries.

The contiguous output address range must be aligned to size of 16 translation table entries at the same translation table level.

16KB granule This bit indicates that adjacent translation table entries point to contiguous output address range that has the same permissions and attributes. With the 16KB granule, the number of contiguous entries indicated by setting this bit to 1 depends on the lookup level of the translation table:

Level 2 lookup The bit indicates 32 contiguous entries, giving a 1GB block of memory. These entries must be aligned in the translation table. When accessing a full-sized 16KB translation table, this means the top 6 of the 11 input addresses bits that index the descriptor positions in the translation table are the same for all of the entries.

The contiguous output address range must be aligned to size of 32 translation table entries at the same translation table level.

Level 3 lookup The bit indicates 128 contiguous entries, giving a 2MB block of memory. These entries must be aligned in the translation table. When accessing a full-sized 16KB translation table, this means the top 4 of the 11 input addresses bits that index the descriptor positions in the translation table are the same for all of the entries.

The contiguous output address range must be aligned to size of 128 translation table entries at the same translation table level.

64KB granule 32 adjacent translation table entries point to a contiguous output address range that has the same permissions and attributes. These 32 entries must be aligned in the translation table. If accessing a full-sized 64KB translation table, this means that the top 8 of the 13 input addresses bits that index the descriptor positions in the translation table are the same for all of the entries.

The contiguous output address range must be aligned to size of 32 translation table entries at the same translation table level.

Setting this bit to 1 means that the TLB can cache a single entry to cover the contiguous translation table entries.

This section defines the requirements for programming the Contiguous bit. [Possible errors in programming the translation table registers on page D4-2048](#) describes the effect of not meeting these requirements.

The architecture does not require a PE to cache TLB entries in this way. To avoid TLB coherency issues, any TLB maintenance by address must not assume any optimization of the TLB tables that might result from use of the Contiguous bit.

TLB maintenance must be performed based on the size of the underlying translation table entries, to avoid TLB coherency issues.

[Use of the Contiguous bit with hardware updates of the translation table entries on page D4-2089](#) describes the effect of hardware management of the Access flag and dirty state on the Contiguous bit.

Note

When ARMv8.2-LVA is implemented, the level 1 block size for the 64KB granule does not support the Contiguous bit, and that field is RES0.

IGNORED fields

In the VMSAv8-64 translation table descriptors, the following fields are identified as IGNORED, meaning the architecture guarantees that a PE makes no use of these fields:

- In the stage 1 table descriptors, bits[58:52].
- In the stage 1 and stage 2 block and page descriptors, bit[63] and bits[58:55].
- **In the stage 1 and stage 2 block and page descriptors at any level above level 3, and in level 3 descriptors in an implementation that does not include ARMv8.2-TTPBHA, bits[62:59].**

Of these fields:

- In the stage 1 and stage 2 block and page descriptors, bits[58:55] are reserved for software use, see [Field reserved for software use](#).
- In the stage 2 block and page descriptors, bit[63] is reserved for use by a System MMU.

Field reserved for software use

The architecture reserves a 4-bit IGNORED field in the Block and Page table descriptors, bits[58:55], for software use. The definition of IGNORED means the architecture guarantees that hardware makes no use of this field.

———— Note —————

This means there is no need to invalidate the TLB if these bits are changed.

D4.5.4 Combining the stage 1 and stage 2 attributes, Non-secure EL1&0 translation regime

The Non-secure EL1&0 translation regime comprises two stage of translation, each of which can be enabled independently:

- Stage 1 translation is configured and controlled from EL1. When enabled, stage 1 translation can define access permissions independently for access from EL0 and for accesses from EL1.
Stage 1 MMU faults are taken to EL1.
- When stage 2 translation is enabled, the stage 2 access controls defined at EL2:
 - Affect only the Non-secure stage 1 access permissions settings.
 - Take no account of whether the accesses are at EL1 or EL0.
 - Permit software executing at EL2 to assign a write-only attribute to a memory region.Stage 2 MMU faults are taken to EL2.

———— Note —————

In an implementation of virtualization, the attributes defined in the stage 2 translation tables mean a hypervisor can define additional access restrictions to those defined by a Guest OS in the stage 1 translation tables. For a particular access, the actual access permission is the more restrictive of the permissions defined by:

- The Guest OS, in the stage 1 translation tables.
- The hypervisor, in the stage 2 translation tables.

The effects of the combination of attributes defined by the Hypervisor are functionally transparent to the Guest OS.

Combining the stage 1 and stage 2 data access permissions

When both stages of translation are enabled, the following access permissions are combined:

- The stage 1 permissions described in [The AP\[2:1\] data access permissions, for stage 1 translations on page D4-2073](#).
- The stage 2 permissions described in [The S2AP data access permissions, Non-secure EL1&0 translation regime on page D4-2074](#).

The stage 1 and stage 2 permissions are combined as follows:

1. If an access is not permitted by the stage 1 permissions, then it generates a Stage 1 Permission fault, regardless of the stage 2 permissions.
2. If an access is permitted by the stage 1 permissions, but is not permitted by the stage 2 Permissions, then it generates a Stage 2 Permission fault.
3. If an access is permitted by both the stage 1 permissions and the stage 2 permissions, then it does not generate a Permission fault.

Combining the stage 1 and stage 2 instruction execution permissions

When both stages of translation are enabled, the following access permissions are combined:

- The stage 1 permissions described in [Stage 1 instruction access and execution permissions on page D4-2077](#).
- The stage 2 permissions described in [Stage 2 instruction execution permissions on page D4-2079](#).

The stage 1 and stage 2 permissions are combined as follows:

1. If an instruction fetch is not permitted by the stage 1 permissions, then it generates a Stage 1 Permission fault, regardless of the stage 2 permissions.
2. If an instruction fetch is permitted by the stage 1 permissions, but is not permitted by the stage 2 Permissions, then it generates a Stage 2 Permission fault.
3. If an instruction fetch is permitted by both the stage 1 permissions and the stage 2 permissions, then it does not generate a Permission fault.

Combining the stage 1 and stage 2 memory type attributes

[Table D4-42](#) shows the rules for combining the stage 1 and stage 2 memory type assignments.

Table D4-42 Combining the stage 1 and stage 2 memory type assignments

Rule	If either stage of translation assigns:	The resultant memory type is:
Device has precedence over Normal	Any Device memory type	A Device memory type
Non-Gathering has precedence over Gathering	A Device-nGxx memory type	A Device-nGxx memory type
Non-Reordering has precedence over Reordering	A Device-nGnRx memory type	A Device-nGnRx memory type
No Early write acknowledge has precedence over Early write acknowledge	The Device-nGnRnE memory type	The Device-nGnRnE memory type

Regardless of any shareability attribute obtained as described in [Combining the stage 1 and stage 2 shareability attributes for Normal memory on page D4-2097](#):

- Any location for which the resultant memory type is any type of Device memory is always treated as Outer Shareable.
- Any location for which the resultant memory type is Normal Inner Non-cacheable, Outer Non-cacheable is always treated as Outer Shareable.

For information about how the cacheability attribute is obtained from the attributes assigned at each stage of translation see [Combining the stage 1 and stage 2 cacheability attributes for Normal memory on page D4-2097](#).

The combining of the memory type attributes from the two stages of translation means a translation table walk for stage 1 translation can be made to a type of Device memory. If this occurs then:

- If the value of `HCR_EL2.PTW` is 0, then the translation table walk occurs as if it is to Normal Non-cacheable memory. This means it can be done speculatively.
- If the value of `HCR_EL2.PTW` is 1, then the memory access generates a stage 2 Permission fault.

Combining the stage 1 and stage 2 cacheability attributes for Normal memory

For a Normal memory region, [Table D4-43](#) shows how the stage 1 and stage 2 cacheability assignments are combined. This combination applies, independently, for the Inner cacheability and Outer cacheability attributes.

Table D4-43 Combining the stage 1 and stage 2 cacheability assignments for Normal memory

Assignment in stage 1	Assignment in stage 2	Resultant cacheability
Non-cacheable	Any	Non-cacheable
Any	Non-cacheable	Non-cacheable
Write-Through Cacheable	Write-Through or Write-Back Cacheable	Write-Through Cacheable
Write-Through or Write-Back Cacheable	Write-Through Cacheable	Write-Through Cacheable
Write-Back Cacheable	Write-Back Cacheable	Write-Back Cacheable

Combining the stage 1 and stage 2 shareability attributes for Normal memory

A memory region is treated as Outer Shareable, regardless of any shareability assignments at either stage of translation, if either:

- The resultant memory type attribute, described in [Combining the stage 1 and stage 2 memory type attributes on page D4-2096](#), is any type of Device memory.
- The resultant memory type attribute, described in [Combining the stage 1 and stage 2 memory type attributes on page D4-2096](#), is Normal memory, and the resultant cacheability, described in [Combining the stage 1 and stage 2 cacheability attributes for Normal memory](#), is Inner Non-cacheable, Outer Non-cacheable.

For a memory region with a resultant memory type attribute of Normal, that is not Inner Non-cacheable, Outer Non-cacheable, [Table D4-44](#) shows how the stage 1 and stage 2 shareability assignments are combined.

Table D4-44 Combining the stage 1 and stage 2 Shareability assignments for Normal memory^a

Assignment in stage 1	Assignment in stage 2	Resultant shareability
Outer Shareable	Any	Outer Shareable
Inner Shareable	Outer Shareable	Outer Shareable
Inner Shareable	Inner Shareable	Inner Shareable
Inner Shareable	Non-shareable	Inner Shareable
Non-shareable	Outer Shareable	Outer Shareable
Non-shareable	Inner Shareable	Inner Shareable
Non-shareable	Non-shareable	Non-shareable

a. Applies only if the Normal memory is not Inner Non-cacheable, Outer Non-cacheable, see text.

D4.6 Virtualization Host Extensions

ARMv8.1 introduces the Virtualization Host Extensions that provide enhanced support for a Type 2 virtualization solution, where there is a Host OS, which is either more privileged than the hypervisor, or is a peer of the hypervisor.

The Virtualization Host Extensions only apply to an implementation that includes EL2 using AArch64.

D4.6.1 State added by the Virtualization Host Extensions

The following state is added as part of the Virtualization Host Extensions:

- A new configuration bit, EL2 host (E2H), is added to [HCR_EL2](#). This only applies to execution in Non-secure state. When [SCR_EL3.NS](#)==0, [HCR_EL2.E2H](#) is treated as 0 for all purposes other than reading or writing the value of the register
- New registers added:
 - [TTBR1_EL2](#), which has the same format and contents as the [TTBR1_EL1](#).
 - [CONTEXTIDR_EL2](#), which has the same format and contents as [CONTEXTIDR_EL1](#).
- A new virtual timer is added to EL2 and is accessed using the registers: [CNTHV_CTL_EL2](#), [CNTHV_CVAL_EL2](#), and [CNTHV_TVAL_EL2](#). The registers take the same format as [CNTV_CTL_EL0](#), [CNTV_CVAL_EL0](#), and [CNTV_TVAL_EL0](#) respectively. The virtual offset is treated as 0 for this timer.

D4.6.2 Behavior of HCR_EL2.E2H

When the value of [HCR_EL2.E2H](#) is 0:

- There are no changes to the ARMv8 functionality other than the new state described in *State added by the Virtualization Host Extensions*.
- **Note** —————
- This means the translation regime controlled by [TCR_EL2](#) is called the EL2 translation regime.
- The contents of [TTBR1_EL2](#) are ignored by hardware, other than reads by an MRS instruction and writes by an MSR instruction.
 - The Context ID matching breakpoint is disabled at EL2, and uses the value of [CONTEXTIDR_EL1](#) at EL0 and EL1.

When the value of [HCR_EL2.E2H](#) is 1:

- The translation regime controlled by [TCR_EL2](#) is the EL2&0 translation regime, and the behaviors of this translation regime differ from those of the EL2 translation regime.
- The EL2&0 translation regime behaves in the same way as stage 1 of the EL1&0 translation regime, with an upper address range translated by tables pointed to by [TTBR1_EL2](#). The existing [TTBR0_EL2](#) translates the lower address range of the EL2&0 translation regime and is extended to have the same contents and format as the [TTBR0_EL1](#).
- The translation tables used in the EL2&0 translation regime take the same format as the EL1&0 translation regime. EL2 accesses are treated as privileged in this format.
- Context ID matching can occur at EL2. When executing at EL2, a Context ID matching breakpoint uses [CONTEXTIDR_EL2](#).
- [VMID](#) and [VMID](#) + Context ID matching breakpoints do not match at EL2.
- The virtual offset is treated as 0 when [CNTVCT_EL0](#) is read from EL2.
- The Privileged Access Never mechanism applies to accesses from EL2 to a virtual address which has access permitted in the EL2&0 translation regime.

- The following registers are redefined:
 - CNTHCTL_EL2.
 - CPTR_EL2.
 - TCR_EL2.

If $\text{HCR_EL2}\{E2H, TGE\} = \{1, 0\}$, then all accesses from EL1 and EL0 are not included in the EL2&0 translation regime.

If $\text{HCR_EL2}\{E2H, TGE\} = \{1, 1\}$:

- The EL2&0 translation regime is used when executing at Non-secure EL0 as well as when executing at EL2, where Non-secure EL0 accesses are treated as unprivileged.

———— **Note** —————

Accesses from Non-secure EL1 are not possible under this configuration.

- In EL2, the unprivileged instructions LDTR, LDTRB, LDTRH, LDTRSB, LDTRSH, LDTRSW, STTR, STTRB, and STTRH act as if they are executing at Non-secure EL0 for permission and watchpoint checking.
- Except for the purpose of reading the value held in the register, some fields in [HCR_EL2](#) and all fields in [HSTR_EL2](#) are treated as having a specific value.
- [SCTLR_EL2](#) is redefined to include additional fields from [SCTLR_EL1](#), and to apply to execution at Non-secure EL0.
- The following timer registers, and their equivalent AArch32 registers, are redefined to access the associated [_EL2](#) register, rather than accessing the [_EL0](#) register when in EL0:
 - CNTP_CTL_EL0.
 - CNTP_CVAL_EL0.
 - CNTP_TVAL_EL0.
 - CNTV_CTL_EL0.
 - CNTV_CVAL_EL0.
 - CNTV_TVAL_EL0.

For some information on registers that are redirected, see [System and Special-purpose register redirection on page D4-2100](#).

- When executing at Non-secure EL0, a Context ID matching breakpoint uses [CONTEXTIDR_EL2](#).
- [VMID](#) and [VMID](#) + Context ID matching breakpoints do not match at Non-secure EL0.
- The [CPACR_EL1](#) register does not cause any instructions to be trapped to EL1, regardless of the contents of [CPACR_EL1](#).
- The [CNTKCTL_EL1](#) register does not cause any instructions to be trapped to EL1, and the event stream event caused by the [CNTKCTL_EL1](#) is disabled, regardless of the contents of [CNTKCTL_EL1](#).
- The virtual offset is treated as 0 when [CNTVCT_EL0](#) is read from EL0 or EL2.
- The TLB maintenance and address translation instructions that apply to the EL1&0 translation regime are redefined to apply to the EL2&0 translation regime. See [A64 system instructions for address translation on page C5-427](#) and [A64 system instructions for TLB maintenance on page C5-454](#).
- When executing at EL2 or Non-secure EL0, any physical interrupt that is configured to be taken at EL2 is subject to the Process state interrupt mask. If the mask bit is set, then the corresponding interrupt will not be taken. If the mask bit is not set, then the corresponding interrupt will be taken. See [Asynchronous exception masking on page D1-1836](#).
- When an exception is taken from EL0 to EL2, the value of the [HCR_EL2.RW](#) bit is not considered when determining the exception vector offset to use. [Table D1-7 on page D1-1800](#) lists the vector offsets used when an exception is taken from EL0.

D4.6.3 System and Special-purpose register redirection

When [ARMv8.1-VHE](#) is implemented, and [HCR_EL2.E2H](#) is set to 1, when executing at EL2, some EL1 System register access instructions are redefined to access the equivalent EL2 register. Register access behavior is unchanged when executing at EL3, EL1, or EL0.

[Table D4-45](#) shows the System register access instruction encodings that are redirected to the equivalent EL2 register when the named mnemonic is used.

Table D4-45 System register redirection

System register access instruction encoding					Mnemonic	Equivalent register accessed at EL2	
op0	op1	CRn	CRm	op2			
3	0	1	0	0	SCTLR_EL1	SCTLR_EL2	
				2	CPACR_EL1	CPTR_EL2	
		2	0	0	0	TTBR0_EL1	TTBR0_EL2
					1	TTBR1_EL1	TTBR1_EL2
					2	TCR_EL1	TCR_EL2
						5	1
		1	AFSR1_EL1	AFSR1_EL2			
		2	0	ESR_EL1	ESR_EL2		
		6	0	0	FAR_EL1	FAR_EL2	
		10	2	0	0	MAIR_EL1	MAIR_EL2
					3	0	AMAIR_EL1
		12	0	0	VBAR_EL1	VBAR_EL2	
		13	0	1	CONTEXTIDR_EL1	CONTEXTIDR_EL2	
		14	1	0	CNTKCTL_EL1	CNTHCTL_EL2	
3	14	2	0	CNTP_TVAL_EL0	CNTHP_TVAL_EL2		
				1	CNTP_CTL_EL0	CNTHP_CTL_EL2	
				2	CNTP_CVAL_EL0	CNTHP_CVAL_EL2	
3	3	14	3	0	CNTV_TVAL_EL0	CNTHV_TVAL_EL2	
				1	CNTV_CTL_EL0	CNTHV_CTL_EL2	
				2	CNTV_CVAL_EL0	CNTHV_CVAL_EL2	

Table D4-46 shows the Special-purpose register access instruction encodings that are redirected to the equivalent EL2 register when the named mnemonic is used.

Table D4-46 Special-purpose register redirection

Special-purpose register access instruction encoding			Mnemonic	Equivalent register accessed at EL2
op1	CRm	op2		
0	0	0	SPSR_EL1	SPSR_EL2
		1	ELR_EL1	ELR_EL2

D4.6.4 System and Special-purpose register aliasing

New register encodings, and aliases, are provided so that software executing at EL2 can access the EL1 registers for which accesses from EL2 are redirected as described in *System and Special-purpose register redirection* on page D4-2100. These aliases can also be used at EL3, but are UNDEFINED at EL1 and EL0.

Table D4-47 shows the System register access instruction encodings that are aliased.

Table D4-47 System register aliases

System register access instruction encoding					Mnemonic	Register accessed	
op0	op1	CRn	CRm	op2			
3	5	1	0	0	SCTLR_EL12	SCTLR_EL1	
				2	CPACR_EL12	CPACR_EL1	
		2	0	0	0	TTBR0_EL12	TTBR0_EL1
					1	TTBR1_EL12	TTBR1_EL1
		5	1	0	0	AFSR0_EL12	AFSR0_EL1
					1	AFSR1_EL12	AFSR1_EL1
6	0	0	0	ESR_EL12	ESR_EL1		
			2	FAR_EL12	FAR_EL1		
10	2	0	0	MAIR_EL12	MAIR_EL1		
			3	AMAIR_EL12	AMAIR_EL1		
12	0	0	0	VBAR_EL12	VBAR_EL1		
13	0	1	0	CONTEXTIDR_EL12	CONTEXTIDR_EL1		
14	1	0	0	CNTKCTL_EL12	CNTKCTL_EL1		
			2	0	CNTP_TVAL_EL02	CNTP_TVAL_EL0	
				1	CNTP_CTL_EL02	CNTP_CTL_EL0	
			2	CNTP_CVAL_EL02	CNTP_CVAL_EL0		

Table D4-47 System register aliases (continued)

System register access instruction encoding					Mnemonic	Register accessed
op0	op1	CRn	CRm	op2		
3	5	14	3	0	CNTV_TVAL_EL02	CNTV_TVAL_EL0
				1	CNTV_CTL_EL02	CNTV_CTL_EL0
				2	CNTV_CVAL_EL02	CNTV_CVAL_EL0

Table D4-48 shows the Special-purpose register aliasing.

Table D4-48 Special-purpose register aliases

Special-purpose register access instruction encoding			Register name	Register accessed
op1	CRm	op2		
5	0	0	SPSR_EL12	SPSR_EL1
		1	ELR_EL12	ELR_EL1

D4.7 MMU faults

In a VMSAv8-64 implementation, the following mechanisms cause a PE to take an exception on a failed memory access:

Debug exception	An exception caused by the debug configuration, see Chapter D2 AArch64 Self-hosted Debug .
Alignment fault	An Alignment fault is generated if the address used for a memory access does not have the required alignment for the operation. For more information, see Alignment support on page B2-102 .
MMU fault	An MMU fault is a fault generated by the fault checking sequence for the current translation regime. The remainder of this section describes MMU faults.
External abort	Any memory system fault other than a Debug exception, an Alignment fault, or an MMU fault.

Collectively, these mechanisms are called *aborts*.

In AArch64 state MMU faults are synchronous exceptions that are reported as either:

- Data Aborts.
- Instruction Aborts

Note

Instruction Aborts report any synchronous memory abort on an instruction fetch.

External aborts can be reported synchronously or asynchronously. Asynchronous external aborts are reported using the SError interrupt. For more information, see [External aborts on page D3-1997](#).

An access that causes an abort is said to be aborted, and uses the *Fault Address Registers* (FARs) and *Exception Syndrome Registers* (ESRs) to record context information.

For more information, see [Synchronous exception types, routing and priorities on page D1-1826](#).

The Exception level that the MMU fault is taken to depends on the translation regime that generated the fault. The fault context saved in the appropriate `ESR_ELx`, where ELx is the Exception level that the fault is taken to, is dependent on whether:

- The MMU fault is due to an Instruction or Data Abort.
- The exception is taken from the same or a lower Exception level.

Software stepping, which is a debug feature, and a PC alignment fault exception are the only exceptions that are higher priority than an Instruction Abort. Only watchpoints are at a lower priority than Data Aborts in the exception priority hierarchy. For more information, see [Synchronous exception prioritization for exceptions taken to AArch64 on page D1-1827](#).

The following sections describe the abort mechanisms:

- [Types of MMU faults on page D4-2104](#).
- [The MMU fault-checking sequence on page D4-2106](#).
- [AArch64 state prioritization of synchronous aborts from a single stage of address translation on page D4-2110](#).
- [Pseudocode description of the MMU faults on page D4-2112](#).

D4.7.1 Types of MMU faults

This section describes the faults that might be detected during one of the fault-checking sequences described in *The MMU fault-checking sequence* on page D4-2106. The following list includes all the types of exceptions that can occur:

- Alignment fault on a data access, see *Alignment support* on page B2-102.
- Permission fault, see *Permission fault*.
- Translation fault, see *Translation fault* on page D4-2105.
- Address size fault, see *Address size fault* on page D4-2105.
- Synchronous external abort on a translation table walk, see *External abort on a translation table walk* on page D4-2105.
- Access flag fault, see *Access flag fault* on page D4-2106.
- TLB conflict abort, see *TLB conflict aborts* on page D4-2118.

When an MMU fault generates an abort for a region of memory, no memory access is made if that region is or could be marked as Device.

The following subsections describe the MMU faults that are not described elsewhere in this Manual.

Permission fault

A Permission fault can be generated at any level of lookup, and the reported fault code identifies the lookup level. See *About access permissions* on page D4-2071 for information about conditions that cause a Permission fault.

A TLB might hold a translation table entry that causes a Permission fault. Therefore, if the handling of a Permission fault results in an update to the associated translation tables, the software that updates the translation tables must invalidate the appropriate TLB entry, to prevent the stale information in the TLB being used on a subsequent memory access.

This maintenance requirement applies to Permission faults in both stage 1 and stage 2 translations.

Cache maintenance instructions cannot generate Permission faults, except that:

- A stage 1 translation table walk performed as part of a cache maintenance instruction can generate a stage 2 Permission fault as described in *Stage 2 fault on a stage 1 translation table walk* on page D4-2109.
- When the value of `SCTLR_EL1.UCI` is 1, enabling EL0 execution of the `DC CVAU`, `DC CVAC`, `DC CVAP`, `DC CIVAC`, and `IC IVAU` instructions:
 - Executing a `DC CVAU`, `DC CVAC`, `DC CVAP`, or `DC CIVAC` instruction at EL0 to a location that does not have read permission at EL0 generates a Permission fault.
 - It is IMPLEMENTATION DEFINED whether executing a `IC IVAU` instruction at EL0 to a location that does not have read permission at EL0 generates a Permission fault.
- A `DC IVAC` instruction requires write permission to the address it invalidates, otherwise it generates a Permission fault.

————— Note —————

- Execution of the `DCIMVAC` instruction in AArch32 state does not have this write permission requirement.
- When Non-secure EL1&0 stage 2 address translation is enabled, a `DC IVAC` instruction executed in Non-secure state performs a cache clean and invalidate, meaning it performs the same invalidation as a `DC CIVAC` instruction, as described in *Effects of virtualization and security on the cache maintenance instructions* on page D3-1990.

The Data Cache Zero instruction, `DC ZVA`, operates as set of stores to each byte within the block being accessed, and therefore it generates a Permission fault if the translation system does not permit writes to these locations.

Translation fault

A Translation fault can be generated at any level of lookup, and the reported fault code identifies the lookup level. A Translation fault is generated if bits[1:0] of a translation table descriptor identify the descriptor as either a Fault encoding or a reserved encoding. For more information, see *VMSAv8-64 translation table format descriptors* on page D4-2060.

In addition, a Translation fault is generated if the input address for a translation either does not map onto an address range of a `TTBR_ELx`, or the `TTBR_ELx` range that it maps onto is disabled. In these cases, the fault is reported as a level 0 Translation fault on the translation stage at which the mapping to a region described by a `TTBR_ELx` failed.

A data or unified cache maintenance by `VA` instruction can generate a Translation fault. If the Point of Coherency is before any level of cache, it is IMPLEMENTATION DEFINED whether a data or unified cache maintenance by `VA` instruction can generate a Translation fault. It is IMPLEMENTATION DEFINED whether an instruction cache invalidate by `VA` operation can generate a Translation fault.

If the Point of Unification is before any level of data cache, it is IMPLEMENTATION DEFINED whether a data or unified cache clean by `VA` to the Point of Unification instruction can generate a Translation fault.

The architecture guarantees that any translation table entry that causes a Translation fault is not cached, meaning the TLB never holds such an entry. Therefore, when a Translation fault occurs, the fault handler does not have to perform any TLB maintenance instructions to remove the faulting entry.

Address size fault

An Address size fault can be generated at any level of lookup.

An Address size fault is generated if one of the following has nonzero address bits above the output address size, for the current stage of translation:

- The `TTBR_ELx` used for the translation.
- A translation table entry.
- The output address of the translation.

For an Address size fault generated because the `TTBR_ELx` used for the translation has nonzero address bits above the output address size, the reported fault code indicates a fault at level 0. Otherwise, the reported fault code indicates the lookup level at which the fault occurred.

A data or unified cache maintenance by `VA` instruction can generate an Address size fault. If the Point of Coherency is before any level of cache, it is IMPLEMENTATION DEFINED whether a data or unified cache maintenance by `VA` instruction can generate an Address size fault. It is IMPLEMENTATION DEFINED whether an instruction cache invalidate by `VA` operation can generate an Address size fault.

If the Point of Unification is before any level of data cache, it is IMPLEMENTATION DEFINED whether a data or unified cache clean by `VA` to the Point of Unification instruction can generate an Address size fault.

The architecture guarantees that any translation table entry that causes an Address size fault is not cached, meaning the TLB never holds such an entry. Therefore, when an Address size fault occurs, the fault handler does not have to perform any TLB maintenance instructions to remove the faulting entry.

For more information on Address size faults, see *Output address size* on page D4-2015.

External abort on a translation table walk

An external abort on a translation table walk can be either synchronous or asynchronous. An external abort on a translation table walk is reported:

- If the external abort is synchronous, using:
 - A synchronous Instruction Abort exception if the translation table walk is for an instruction fetch.
 - A synchronous Data Abort exception if the translation table walk is for a data access.
- If the external abort is asynchronous, using the SError interrupt exception.

Behavior of external aborts on a translation table walk caused by address translation instructions

The address translation instructions summarized in [Address translation instructions, functional group on page G4-4737](#) require translation table walks. An external abort can occur in the translation table walk. This is reported as follows:

- If the external abort is synchronous, using a synchronous Data Abort exception.
- If the external abort is asynchronous, using the SError interrupt exception.

For more information, see [Synchronous faults generated by address translation instructions on page D4-2057](#).

Access flag fault

An Access flag fault can be generated at any level of lookup, and the reported fault code identifies the lookup level. An Access flag fault is generated only if a translation table descriptor with the Access flag bit set to 0 is used.

For more information about the Access flag bit, see [VMSAv8-64 translation table format descriptors on page D4-2060](#).

The architecture guarantees that any translation table entry that causes an Access flag fault is not cached, meaning the TLB never holds such an entry. Therefore, when an Access flag fault occurs, the fault handler does not have to execute any TLB maintenance instructions to remove the faulting entry.

Whether any cache maintenance by VA instructions can generate Access flag faults is IMPLEMENTATION DEFINED.

For more information, see [The Access flag on page D4-2081](#).

D4.7.2 The MMU fault-checking sequence

This section describes the MMU checks made for the memory accesses required for instruction fetches and for explicit memory accesses:

- If an instruction fetch faults, it generates an Instruction Abort.
- If a data memory access faults, it generates a Data Abort.

MMU fault checking is performed for each stage of address translation.

The fault-checking sequence shows a translation from an Input address to an Output address. For more information about this terminology, see [About address translation and supported input address ranges on page D4-2011](#).

———— Note —————

The descriptions in this section do not include the possibility that the attempted address translation generates a TLB conflict abort, as described in [TLB conflict aborts on page D4-2118](#).

[Types of MMU faults on page D4-2104](#) describes the faults that an MMU fault-checking sequence can report.

[Figure D4-17 on page D4-2107](#) shows the process of fetching a descriptor from the translation table. For the top-level fetch for any translation, the descriptor is fetched only if the input address passes any required alignment check. As the figure shows, if the translation is stage 1 of the Non-secure EL1&0 translation regime, then the descriptor address is in the IPA address space, and is subject to a stage 2 translation to obtain the required PA. This stage 2 translation requires a recursive entry to the fault checking sequence.

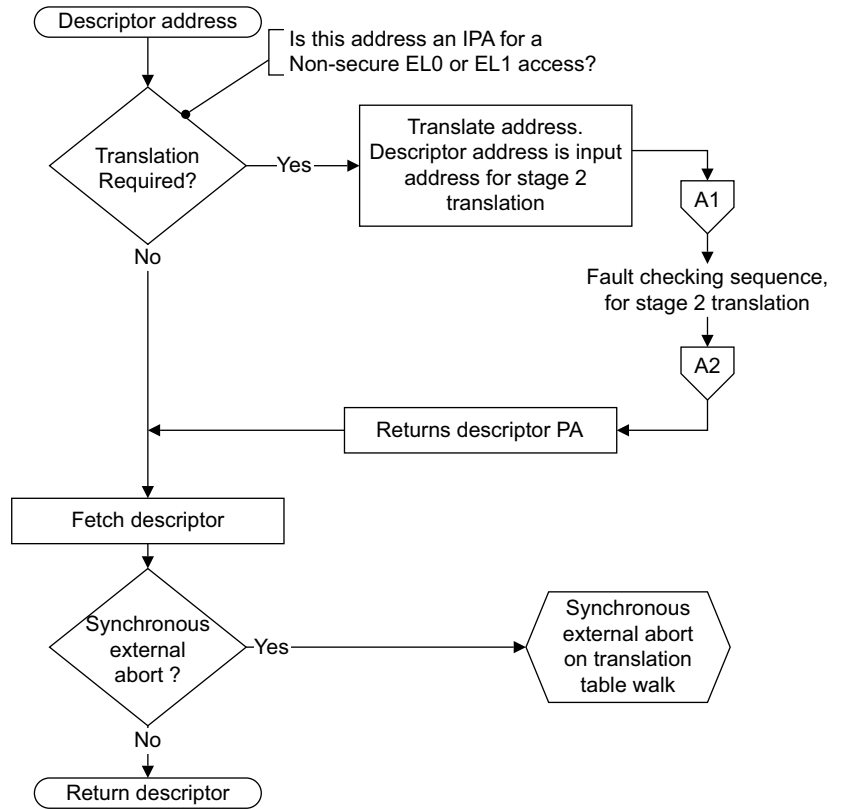
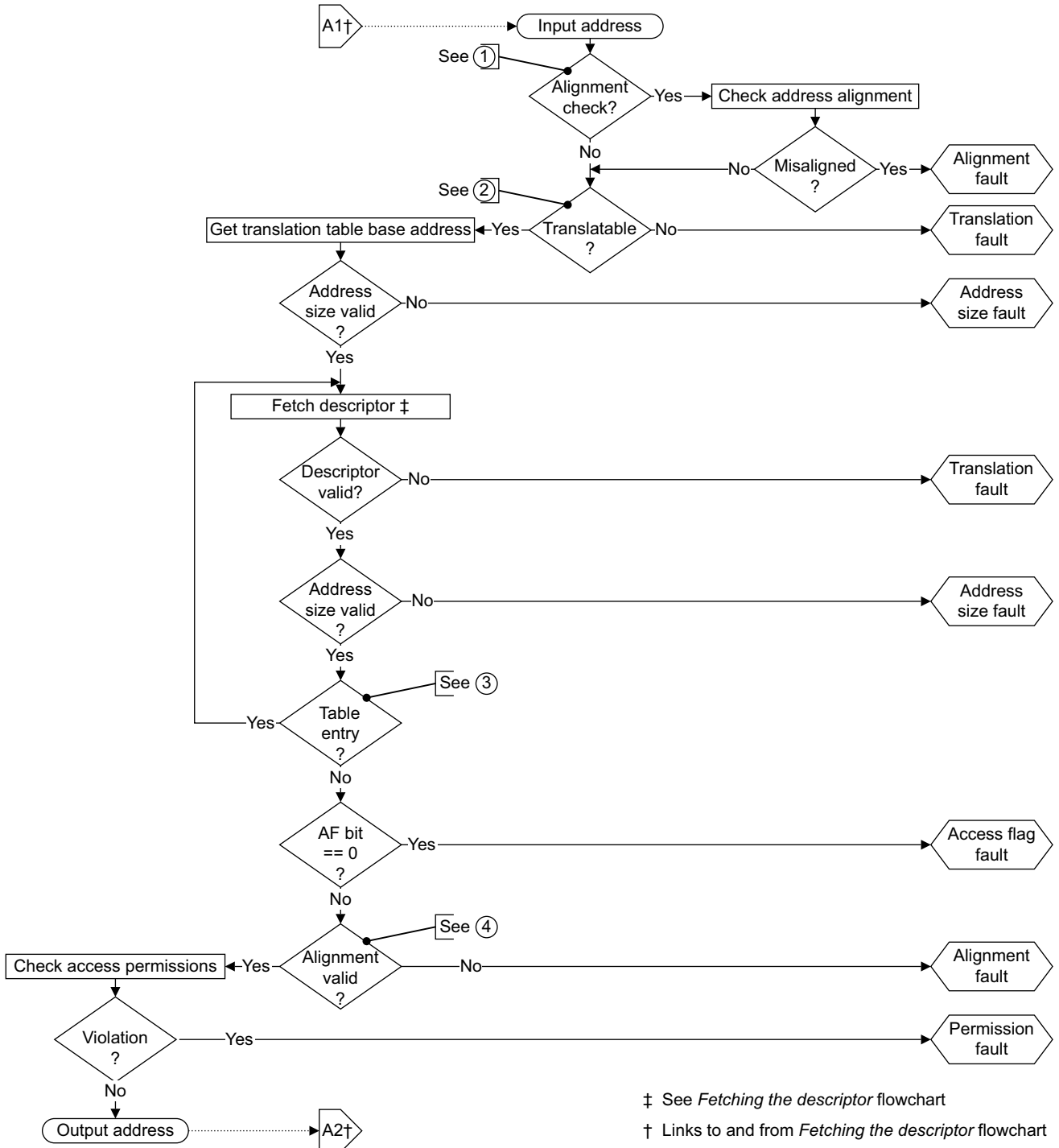

Figure D4-17 Fetching the descriptor in a VMSAv8-64 translation table walk

Figure D4-18 on page D4-2108 shows the full VMSA fault checking sequence, including the alignment check on the initial access.



‡ See *Fetching the descriptor* flowchart
† Links to and from *Fetching the descriptor* flowchart
① Is the access subject to an alignment check?
② Does the address map to a TTBR?
③ Not permitted at the lowest lookup level
④ Fault any unaligned access to Device memory

Figure D4-18 VMSAv8-64 fault checking sequence

Stage 2 fault on a stage 1 translation table walk

On performing a translation table walk for the stage 1 translations, the descriptor addresses must be translated from IPA to PA, using a stage 2 translation. This means that a memory access made as part of a stage 1 translation table lookup might generate, on a stage 2 translation:

- A Translation fault, Access flag fault, or Permission fault.
- A synchronous external abort on the memory access.

If `SCR_EL3.EA` is set to 1, a synchronous external abort is taken to EL3. Otherwise, these faults are reported as stage 2 memory aborts. `ESR_EL2.ISS[7]` is set to 1, to indicate a stage 2 fault during a stage 1 translation table walk, and the part of the ISS field that might contain details of the instruction is invalid. For more information see *Use of the ESR_EL1, ESR_EL2, and ESR_EL3 on page D1-1801*.

Alternatively, a memory access made as part of a stage 1 translation table lookup might target an area of memory with the Device attribute assigned on the stage 2 translation of the address accessed. When the `HCR_EL2.PTW` bit is set to 1, such an access generates a stage 2 Permission fault.

———— Note ————

On most systems, such a mapping to Device memory on the stage 2 translation is likely to indicate a Guest OS error, where the stage 1 translation table is corrupted. Therefore, it is appropriate to trap this access to the hypervisor.

A TLB might hold entries that depend on the effect of `HCR_EL2.PTW`. Therefore, if `HCR_EL2.PTW` is changed without changing the current `VMID`, the TLBs must be invalidated before executing in Non-secure EL1 or Non-secure EL0 state. For more information see *Changing HCR_EL2.PTW on page D4-2132*.

A cache maintenance instruction executed at Non-secure EL1 can cause a stage 1 translation table walk that might generate a stage 2 Permission fault, as described in this section. This is an exception to the general rule that a cache maintenance instruction cannot generate a Permission fault. If the Point of Coherency is before any level of cache, it is IMPLEMENTATION DEFINED whether a cache maintenance by `VA` instruction can generate a Permission fault in this way.

If the Point of Unification is before any level of data cache, it is IMPLEMENTATION DEFINED whether a data or unified cache clean by `VA` to the Point of Unification instruction can generate a Permission fault in this way.

The level associated with MMU faults

For MMU faults, [Table D4-49](#) shows how the LL bits in the `ESR_ELx.STATUS` fields encode the lookup level associated with the fault.

Table D4-49 Use of LL bits to encode the lookup level at which the fault occurred

LL bits	Meaning
00	Level 0 of translation or translation table base register.
01	Level 1.
10	Level 2.
11	Level 3. When <code>xFSR.STATUS</code> indicates a Domain fault, this value is reserved.

The lookup level associated with a fault is:

- For a fault generated on a translation table walk, the lookup level of the walk being performed.
- For a Translation fault, the lookup level of the translation table that gave the fault. If a fault occurs because a stage of address translation is disabled, or because the input address is outside the range specified by the appropriate base address register or registers, the fault is reported as a level 1 fault.
- For an Access flag fault, the lookup level of the translation table that gave the fault.

- For a Permission fault, including a Permission fault caused by hierarchical permissions, the lookup level of the final level of translation table accessed for the translation. That is, the lookup level of the translation table that returned a Block or Page descriptor.

Also see [Synchronous external aborts from address translation caching structures](#) on page D4-2111

D4.7.3 AArch64 state prioritization of synchronous aborts from a single stage of address translation

[Synchronous exception prioritization for exceptions taken to AArch64](#) on page D1-1827 describes the prioritization of exceptions taken to an Exception level that is using AArch64. This section gives additional information about the prioritization of MMU faults from VMSAv8-64 translation regimes.

———— Note —————

The priority numbering in this list only shows the relative priorities of aborts from a single stage of address translation in a VMSAv8-64 translation regime. This numbering has no global significance and, for example, does not correlate with the equivalent AArch32 list in [AArch32 state prioritization of synchronous aborts from a single stage of address translation](#) on page G4-4660.

For a single stage of translation in a VMSAv8-64 translation regime, the following numbered list shows the priority of the possible memory management faults on a memory access. In this list:

- For memory accesses that undergo two stages of translation, the *italic entries show where the faults from the stage 2 translation can occur*. A stage 2 fault within a stage 1 translation table walk follows the same prioritization of faults:
- For synchronous external aborts from translation table walks see also [Synchronous external aborts from address translation caching structures](#) on page D4-2111.

The priority order, from highest priority to lowest priority, is:

1. Alignment fault not caused by memory type. This is possible for a stage 1 translation only.
2. Translation fault due to the input address being out of the address range to be translated or requiring a [TTBR_ELx](#) that is disabled. This includes [VTCR_EL2.SL0](#) being inconsistent with [VTCR_EL2.T0SZ](#) or programmed to a reserved value.
3. Address size fault on a [TTBR_ELx](#) caused by either:
 - The check on [TCR_EL1.IPS](#), [TCR_EL2.PS](#), [TCR_EL3.PS](#), or [VTCR_EL2.PS](#).
 - The [PA](#) being out of the range implemented.
4. *Second stage abort on a level 0 lookup of a stage 1 table walk. When stage 2 address translation is enabled this includes an Address size fault caused by the [PA](#) being out of the range implemented. This is second stage abort during a first stage translation table walk.*
5. Synchronous parity or ECC error on a level 0 lookup of a translation table walk.
6. Synchronous external abort on a level 0 lookup level of a translation table walk.
7. Translation fault on a level 0 translation table entry.
8. Address Size fault a level 0 lookup translation table entry caused by either:
 - The check on [TCR_EL1.IPS](#), [TCR_EL2.PS](#), [TCR_EL3.PS](#), or [VTCR_EL2.PS](#).
 - The output address being out of the range implemented.
9. *Second stage abort on a level 1 lookup of a stage 1 table walk. When stage 2 address translation is enabled this includes an Address size fault caused by the [PA](#) being out of the range implemented. This is second stage abort during a first stage translation table walk.*
10. Synchronous parity or ECC error on a level 1 lookup of a translation table walk.
11. Synchronous external abort on a level 1 lookup level of a translation table walk.

12. Translation fault on a level 1 translation table entry.
13. Address size fault on a level 1 lookup translation table entry caused by either:
 - The check on [TCR_EL1.IPS](#), [TCR_EL2.PS](#), [TCR_EL3.PS](#), or [VTCR_EL2.PS](#).
 - The output address being out of the range implemented.
14. *Second stage abort on a level 2 lookup of a stage 1 table walk. When stage 2 address translation is enabled this includes an Address size fault caused by the PA being out of the range implemented. This is second stage abort during a first stage translation table walk.*
15. Synchronous parity or ECC error on a level 2 lookup of a translation table walk.
16. Synchronous external abort on a level 2 lookup level of a translation table walk.
17. Translation fault on a level 2 translation table entry.
18. Address size fault on a level 2 lookup translation table entry caused by either:
 - The check on [TCR_EL1.IPS](#), [TCR_EL2.PS](#), [TCR_EL3.PS](#), or [VTCR_EL2.PS](#).
 - The output address being out of the range implemented.
19. *Second stage abort on a level 3 lookup of a stage 1 table walk. When stage 2 address translation is enabled this includes an Address size fault caused by the PA being out of the range implemented. This is second stage abort during a first stage translation table walk.*
20. Synchronous parity or ECC error on a level 3 lookup of a translation table walk.
21. Synchronous external abort on a level 3 lookup level of a translation table walk.
22. Translation fault on a level 3 translation table entry.
23. Address size fault on a level 3 lookup translation table entry caused by either:
 - The check on [TCR_EL1.IPS](#), [TCR_EL2.PS](#), [TCR_EL3.PS](#), or [VTCR_EL2.PS](#).
 - The output address being out of the range implemented.
24. Access Flag fault.
25. Alignment fault caused by the memory type.
26. Permission fault.
27. *A fault from the stage 2 translation of the memory access. When stage 2 address translation is enabled this includes an Address size fault caused by the PA being out of the range implemented.*
28. Synchronous parity or ECC error on the memory access.
29. Synchronous External Abort on the memory access.

———— **Note** —————

- The prioritization of TLB Conflict aborts is IMPLEMENTATION DEFINED, as the exact cause of these aborts depends on the form of TLBs implemented. However, the TLB conflict abort must have higher priority than any abort that depends on a value held in the TLB.
- The prioritization of IMPLEMENTATION DEFINED MMU faults for a Load-Exclusive or Store-Exclusive to an unsupported memory type is IMPLEMENTATION DEFINED.

Synchronous external aborts from address translation caching structures

A caching structure used for caching translation table walks might support:

- An arbitrary number of levels of translation table lookup.
- One or more stages of translation, that might not correspond to the stages of an address translation lookup.

This might mean that, on a synchronous external aborts arising from the caching structure, including parity or ECC errors, the PE cannot precisely determine one or both of the translation stage and level of lookup at which the error occurred. In this case:

- If the PE cannot determine precisely the translation stage at which the error occurred, it is reported and prioritized as a stage 1 error.
- If the PE cannot determine precisely the lookup level at which the error occurred, the level is reported and prioritized as either:
 - The lowest-numbered level that could have given rise to the error.
 - Level 0 if it the PE cannot determine any information about the level.

D4.7.4 Pseudocode description of the MMU faults

The following functions generate fault records that describe MMU faults:

- [AArch64.AccessFlagFault\(\)](#).
- [AArch64.AddressSizeFault\(\)](#).
- [AArch64.PermissionFault\(\)](#).
- [AArch64.TranslationFault\(\)](#).

[Abort exceptions on page D3-2002](#) describes how fault records are used.

D4.8 Translation Lookaside Buffers (TLBs)

Translation Lookaside Buffers (TLBs) reduce the average cost of a memory access by caching the results of translation table walks. TLBs behave as caches of the translation table information, and the VMSA provides TLB maintenance instructions for the management of TLB contents.

———— **Note** ————

The ARM architecture permits TLBs to hold any translation table entry that does not directly cause a Translation fault, an Address size fault, or an Access flag fault.

The following sections describe the architectural requirements for Translation Lookaside Buffers (TLBs) and their maintenance:

- [Use of ASIDs and VMIDs to reduce TLB maintenance requirements.](#)
- [About ARMv8 Translation Lookaside Buffers \(TLBs\) on page D4-2115.](#)
- [TLB maintenance requirements and the TLB maintenance instructions on page D4-2119.](#)

In these descriptions, TLB entries for a translation regime for a particular Exception level are *out of context* when executing at a higher Exception level.

D4.8.1 Use of ASIDs and VMIDs to reduce TLB maintenance requirements

To reduce the need for TLB maintenance on context switches, the lookups from some translation regimes can be associated with an ASID, or with an ASID and a VMID, as follows:

ASID For stage 1 translations that support two VA ranges the VMSA can distinguish between *Global pages* and *Process-specific pages*. The *Address Space Identifier (ASID)* identifies pages associated with a specific process and provides a mechanism for changing process-specific tables without having to maintain the TLB structures.

For these stage 1 translations, each of `TTBR0_ELx` and `TTBR1_ELx` has a valid ASID field, and `TCR_ELx.A1` determines which of these holds the current ASID.

———— **Note** ————

The selected ASID applies regardless of which set of translation tables are used. For example, when the value of `TCR_ELx.A1` is 0, any translation table lookup using this stage of translation is associated with the ASID from `TTBR0_ELx.ASID`, regardless of whether the translation lookup uses `TTBR0_ELx` or `TTBR1_ELx`.

See also [ASID size on page D4-2114](#) and [Global and process-specific translation table entries on page D4-2116](#).

For a symmetric multiprocessor cluster where a single operating system is running on the set of processing elements, the ARM architecture requires all ASID values to be assigned uniquely within any single Inner Shareable domain. In other words, each ASID value must have the same meaning to all processing elements in the system.

VMID For the Non-secure EL1&0 translation regime, the *virtual machine identifier (VMID)* identifies the current virtual machine, with its own independent [ASID](#) space. The TLB entries include this VMID information, meaning TLBs do not require explicit invalidation when changing from one virtual machine to another if the virtual machines have different VMIDs.

`VTTBR_EL2.VMID` holds the current VMID.

Common not private translations

In an implementation that includes ARMv8.2-TTCNP, multiple PEs in the same Inner Shareable domain can use the same translation table entries for a given stage of translation in a particular translation regime. This sharing is enabled by the TTBR_ELx.CnP field for the stage of address translation.

When the value of a TTBR_ELx.CnP field is 1, translation table entries pointed to by that TTBR_ELx are shared with all other PEs in the Inner Shareable domain for which the following conditions are met:

- The corresponding TTBR_ELx.CnP field has the value 1.
- That TTBR_ELx relates to the same translation regime.

———— Note —————

- For TTBR0_EL1 the current Security state determines whether the register relates to the Secure EL1&0 translation regime, or to the Non-secure EL1&0 translation regime.
- For TTBR0_EL2 the value of HCR_EL2.E2H determines whether the register relates to the EL2 translation regime, or to the EL2&0 translation regime.

- If an ASID applies to the stage of translation corresponding to that TTBR_ELx then the current ASID value must be the same for all of the PEs that are sharing entries.
- If a VMID applies to the stage of translation corresponding to that TTBR_ELx then the current VMID value must be the same for all of the PEs that are sharing entries.

Where a TLB combines information from stage 1 and stage 2 translation table entries into a single entry, this entry can be shared between different PEs only if the value of the TTBR_ELx.CnP bit is 1 for both stage 1 and stage 2 of the translation table walk.

The TTBR_ELx.CnP bit can be cached in a TLB.

For a given TTBR_ELx, if the value of TTBR_ELx.CnP is 1 on multiple PEs in the same Inner Shareable domain, and those PEs meet the other conditions for sharing translation table entries as defined in this section, but those TTBR_ELxs do not point to the same translation table entries, then the system is misconfigured, and performing an address translation using that TTBR_ELx:

- Might generate multiple hits in the TLB, and as a result generate an exception that is reported using the TLB conflict fault code, see *TLB conflict aborts* on page D4-2118.
- Otherwise, has a **CONSTRAINED UNPREDICTABLE** result, as described in *CONSTRAINED UNPREDICTABLE behaviors due to caching of control or data values* on page K1-6120.

ASID size

In VMSAv8-64, the **ASID** size is an IMPLEMENTATION DEFINED choice of 8 bits or 16 bits, and **ID_AA64MMFR0_EL1.ASIDBits** identifies the supported size.

When an implementation supports a 16-bit **ASID**, **TCR_ELx.AS** selects whether the top 8 bits of the **ASID** are used.

When the value of **TCR_ELx.AS** is 0, **ASID[15:8]**:

- Are ignored by hardware for every purpose other than direct reads of **TTBR0_ELx.ASID** and **TTBR1_ELx.ASID**.
- Are treated as if they are all zeros when used for allocating and matching entries in the TLB.

———— Note —————

VMSAv8-32 uses an 8-bit **ASID**. For backwards compatibility, when executing using translations controlled from an Exception level that is using AArch32, the **ASID** size remains at 8 bits. If the implementation supports 16-bit **ASIDs**, the 8-bit **ASID** used is zero-extended to 16 bits.

VMID size

From ARMv8.1, the **VMID** size is an IMPLEMENTATION DEFINED choice of 8 bits or 16 bits, and **ID_AA64MMFR1_EL1.VMIDBits** identifies the supported size.

When **ARMv8.1-VMID16** is implemented, **VTTBR_EL2[63:48]** contains the 16-bit **VMID**.

When an implementation supports a 16-bit **VMID**, **VTCR_EL2.VS** selects whether the top 8 bits of the **VMID** are used.

When the value of **VTCR_EL2.VS** is 0, **VMID[63:56]**:

- Are ignored by hardware for every purpose other than reads of **ID_AA64MMFR1_EL1**.
- Are treated as if they are all zeros when used for allocating and matching entries in the TLB.

ARMv8.1-VMID16 is only supported when EL2 is using AArch64.

D4.8.2 About ARMv8 Translation Lookaside Buffers (TLBs)

Translation Lookaside Buffers (TLBs) are an implementation technique that caches translations or translation table entries. TLBs avoid the requirement for every memory access to perform a translation table walk in memory. The ARM architecture does not specify the exact form of the TLB structures for any design. In a similar way to the requirements for caches, the architecture only defines certain principles for TLBs:

- The architecture has a concept of an entry locked down in the TLB. The method by which lockdown is achieved is IMPLEMENTATION DEFINED, and an implementation might not support lockdown.
- The architecture does not guarantee that an unlocked TLB entry remains in the TLB.
- The architecture guarantees that a locked TLB entry remains in the TLB. However, a locked TLB entry might be updated by subsequent updates to the translation tables. Therefore, when a change is made to the translation tables, the architecture does not guarantee that a locked TLB entry remains incoherent with an entry in the translation table.
- The architecture guarantees that a translation table entry that generates a Translation fault, an Address size fault, or an Access flag fault is not held in the TLB. However a translation table entry that generates a Permission fault might be held in the TLB.
- When address translation is enabled, any translation table entry that does not generate a Translation fault, an Address size fault, or an Access flag fault and is not from a translation regime for an Exception level that is lower than the current Exception level can be allocated to a TLB at any time. The only translation table entries guaranteed not to be held in a TLB are those that generate a Translation fault, an Address size fault, or an Access flag fault.

———— **Note** —————

A TLB can hold a translation table entry that does not itself generate a Translation fault but that points to a subsequent table in the translation table walk. This is referred to as *intermediate caching* of TLB entries.

- Software can rely on the fact that between disabling and re-enabling a stage of address translation, entries in the TLB relating to that stage of translation have not have been corrupted to give incorrect translations.

The following sections give more information about TLB implementation:

- [Global and process-specific translation table entries on page D4-2116.](#)
- [TLB matching on page D4-2116.](#)
- [TLB behavior at reset on page D4-2117.](#)
- [TLB lockdown on page D4-2117.](#)
- [TLB conflict aborts on page D4-2118.](#)

See also [TLB maintenance requirements and the TLB maintenance instructions on page D4-2119.](#)

Global and process-specific translation table entries

In a VMSA implementation, system software can divide the virtual memory map used by a stage of translation that supports two VA ranges into global and non-global regions, indicated by the nG bit in the translation table descriptors:

- nG == 0** The translation is global, meaning the region is available for all processes.
- nG == 1** The translation is non-global, or process-specific, meaning it relates to the current [ASID](#), as defined by:
- [TTBR0_ELx.ASID](#), if the value of [TCR_ELx.A1](#) is 0.
 - [TTBR1_ELx.ASID](#), if the value of [TCR_ELx.A1](#) is 1.

As indicated by the nG field definitions, each non-global region has an associated [ASID](#). These identifiers mean different translation table mappings can co-exist in a caching structure such as a TLB. This means that software can create a new mapping of a non-global memory region without removing previous mappings.

Note

- The selected [ASID](#) applies to the translation of any address for which the value of the nG bit is 1, regardless of whether the address is translated based on [TTBR0_ELx](#) or on [TTBR1_ELx](#).
- In an implementation that does not include [ARMv8.1-VHE](#), the only stage of translation that supports two VA ranges is stage 1 of the EL1&0 translation regime. In an implementation that includes [ARMv8.1-VHE](#) stage 1 of the EL2&0 translation regime also supports two VA ranges.

[ASIDs](#) are supported only by stage 1 translations that support two VA ranges. Stage 2 translations, and stage 1 translations that support only a single VA range do not support [ASIDs](#), and all descriptors in these regimes are treated as global.

In a translation regime that supports global and non-global translations, translation table entries from lookup levels other than the final level of lookup are treated as being non-global, regardless of the value of the nG bit.

When a PE is using the VMSAv8-64 translation table format, and is in Secure state, a translation must be treated as non-global, regardless of the value of the nG bit, if NSTable is set to 1 at any level of the translation table walk.

For more information, see [Control of Secure or Non-secure memory access on page D4-2070](#).

TLB matching

A TLB is a hardware caching structure for translation table information. Like other hardware caching structures, it is mostly invisible to software. However, there are some situations where it can become visible. These are associated with coherency problems caused by an update to the translation table that has not been reflected in the TLB. Use of the TLB maintenance instructions described in [TLB maintenance requirements and the TLB maintenance instructions on page D4-2119](#) can prevent any TLB incoherency becoming a problem.

A particular case where the presence of the TLB can become visible is if the translation table entries that are in use under a particular [ASID](#) and [VMID](#) are changed without suitable invalidation of the TLB. This can occur only if the architecturally-required break-before-make sequence described in [Using break-before-make when updating translation table entries on page D4-2120](#) is not used. If the break-before make sequence is not used, the TLB can hold two mappings for the same address, and this:

- Might generate an exception that is reported using the TLB conflict fault code, see [TLB conflict aborts on page D4-2118](#).
- Might lead to [CONSTRAINED UNPREDICTABLE](#) behavior. In this case, behavior will be consistent with one of the mappings held in the TLB, or with some amalgamation of the values held in the TLB, but cannot give access to regions of memory with permissions or attributes that could not be assigned by valid translation table entries in the translation regime being used for the access. For more information, see [CONSTRAINED UNPREDICTABLE behaviors due to caching of control or data values on page K1-6120](#).

TLB behavior at reset

The ARM architecture does not require a reset to invalidate the TLBs. The architecture recognizes that an implementation might require caches, including TLBs, to maintain their contents over a system reset. Possible reasons for doing so include power management and debug requirements.

Therefore, for ARMv8:

- All TLBs reset to an IMPLEMENTATION DEFINED state that might be UNKNOWN.
- All TLBs are disabled from reset. All stages of address translation are disabled from reset, and the contents of the TLBs have no effect on address translation. For more information, see [Controlling address translation stages on page D4-2012](#).
- An implementation can require the use of a specific TLB invalidation routine, to invalidate the TLB arrays before they are enabled after a reset. The exact form of this routine is IMPLEMENTATION DEFINED, but if an invalidation routine is required it must be documented clearly as part of the documentation of the device.
ARM recommends that if an invalidation routine is required for this purpose, the routine is based on the TLB maintenance instructions described in [TLB maintenance instructions on page D4-2121](#).

Similar rules apply to cache behavior, see [Behavior of caches at reset on page D3-1980](#).

TLB lockdown

The ARM architecture recognizes that any TLB lockdown scheme is heavily dependent on the microarchitecture, making it inappropriate to define a common mechanism across all implementations. This means that:

- VMSAv8-64 does not require TLB lockdown support.
- If TLB lockdown support is implemented, the lockdown mechanism is IMPLEMENTATION DEFINED. However, key properties of the interaction of lockdown with the architecture must be documented as part of the implementation documentation.

This means that a region of the system instruction encoding space is reserved for IMPLEMENTATION DEFINED functions, see [Reserved encodings for IMPLEMENTATION DEFINED registers on page C5-334](#). An implementation might use some of these encodings to implement TLB lockdown functions. These functions might include:

- Unlock all locked TLB entries.
- Preload into a specific level of TLB. This is beyond the scope of the PLI and PLD hint instructions.

In an implementation that includes EL2, exceptions generated as a result of TLB lockdown when executing in Non-secure EL1 or Non-secure EL0 state can be routed to either:

- Non-secure EL1, as a Data Abort exception.
- Non-secure EL2, as a Hyp Trap exception.

For more information, see [Traps to EL2 of Non-secure EL0 and EL1 accesses to lockdown, DMA, and TCM operations on page D1-1857](#).

TLB conflict aborts

If an address matches multiple entries in the TLB, it is IMPLEMENTATION DEFINED whether a TLB conflict abort is generated.

———— **Note** —————

An address can hit multiple entries in the TLB if the TLB has been invalidated inappropriately, for example if TLB invalidation required by the architecture has not been performed.

An implementation can generate TLB conflict aborts on either or both instruction fetches and data accesses. A TLB conflict abort:

- On an instruction fetch is reported as an Instruction Abort, see [ISS encoding for an exception from an Instruction Abort on page D7-2275](#).
- On a data access is reported as a Data Abort, see [ISS encoding for an exception from a Data Abort on page D7-2277](#).

ARMv8 defines the Fault status encoding of 0b110000 for TLB conflict aborts. On a TLB conflict abort, the returned syndrome includes the address that generated the fault. That is, it includes the address that was being looked up in the TLB.

It is IMPLEMENTATION DEFINED whether a TLB conflict abort is a stage 1 abort or a stage 2 abort.

———— **Note** —————

A stage 2 abort cannot be generated if stage 2 of the Non-secure EL1&0 translation regime is disabled.

The priority of the TLB conflict abort is IMPLEMENTATION DEFINED, because it depends on the form of a TLB that can generate the abort. However, the TLB conflict abort must have higher priority than any abort that depends on a value held in the TLB.

If an address matches multiple entries in the TLB and no TLB conflict abort is generated, the resulting behavior is CONSTRAINED UNPREDICTABLE, see [CONSTRAINED UNPREDICTABLE behaviors due to caching of control or data values on page K1-6120](#). The CONSTRAINED UNPREDICTABLE behavior must not permit access to regions of memory with permissions or attributes that mean they cannot be accessed in the current Security state at the current Exception level.

D4.9 TLB maintenance requirements and the TLB maintenance instructions

Translation Lookaside Buffers (TLBs) are an implementation mechanism that caches translations or translation table entries. The ARM architecture does not specify the form of any TLB structures, but defines the mechanisms by which TLBs can be maintained. The following sections describe the VMSA TLB maintenance instructions:

- [General TLB maintenance requirements](#).
- [TLB maintenance instructions on page D4-2121](#).

See also:

- [Maintenance requirements on changing System register values on page D4-2132](#).
- [Atomicity of register changes on changing virtual machine on page D4-2020](#).

D4.9.1 General TLB maintenance requirements

TLB maintenance instructions provide a mechanism for invalidating entries from TLB caching structures to ensure that changes to the translation tables are reflected correctly in those TLB caching structures.

The architecture permits the caching of any translation table entry that has been returned from memory without a fault, provided that the entry does not, itself, cause a Translation fault, an Address size fault, or an Access Flag fault. This means that the entries that can be cached include:

- Entries in translation tables that point to subsequent tables to be used in that stage of translation.
- Stage 2 translation table entries used as part of a stage 1 translation table walk
- Stage 2 translation table entries used to translate the output address of the stage 1 translation.

Such entries might be held in intermediate TLB caching structures that are used during a translation table walk and that are distinct from the data caches in that they are not required to be invalidated as the result of writes of the data. The architecture makes no restriction of the form of these intermediate TLB caching structures.

The architecture does not intend to restrict the form of TLB caching structures used for holding translation table entries, and in particular for a translation regime that involves two stages of translation, it is recognized that such caching structures might contain:

- Entries containing information from stage 1 translation table entries, at any level of the translation table walk.
- Entries containing information from stage 2 translation table entries, at any level of the translation table walk.
- Entries that combine information from stage 1 and stage 2 translation table entries, at any level of the translation table walk.

———— **Note** —————

For the purpose of TLB maintenance, the term *TLB entry* denotes any structure, including temporary working registers in translation table walk hardware, that holds a translation table entry.

Where a TLB maintenance instruction is:

- Required to apply to stage 1 entries, then it must apply to any cached entries in caching structures that include any stage 1 information that are used to translate the address being invalidated.

———— **Note** —————

- Where stage 1 information has been cached in multiple TLB entries, as could occur from splintering a page when caching in the TLB, then the invalidation must apply to each cached entry containing stage 1 information from the page that is used to translate the address being invalidated, regardless of whether or not that cached entry would be used to translate the address being invalidated.
- As stated in [Global and process-specific translation table entries on page D4-2116](#), translation table entries from levels of translation other than the final level are treated as being non-global. ARM expects that, in at least some implementations, cached copies of levels of the translation table walk other than the last level are tagged with their **ASID**, regardless of whether the final level is global. This means that TLB invalidations that involve the **ASID** require the **ASID** to match such entries to perform the required invalidation.

- Required to apply to stage 2 entries only, then:
 - It is not required to apply to caching structures that combine stage 1 and stage 2 translation table entries.
 - It must apply to caching structures that contain information only from stage 2 translation table entries.
- Required to apply to both stage 1 and stage 2 entries, then it must apply to any entry in the caching structures that includes information from either a stage 1 translation table entry or a stage 2 translation table entry, including any entry that combines information from both stage 1 and stage 2 translation table entries.

Whenever translation tables entries associated with a particular **VMID** or **ASID** are changed, the corresponding entries must be invalidated from the TLB to ensure that these changes are visible to subsequent execution, including speculative execution, that uses the changed translation table entries.

Some System register field descriptions state that the effect of the field is permitted to be cached in a TLB. This means that all TLB entries that might be affected by a change of the field must be invalidated whenever that field is changed, to ensure that the effect of the change of that control field is visible to subsequent execution, including speculative execution, that uses that control field. This invalidation is required in addition to, and after, the normal synchronization of the System registers described in [Synchronization requirements for AArch64 System registers on page D7-2191](#), and applies to any stage of address translation that is implemented for the translation regime, and **VMID** and **ASID** as appropriate, that is affected by that control field. A control field that is permitted to be cached in a TLB requires this maintenance even when all stages of address translation are disabled.

In addition to any TLB maintenance requirement, when changing the cacheability attributes of an area of memory, software must ensure that any cached copies of affected locations are removed from the caches. For more information see [Cache maintenance requirement created by changing translation table attributes on page D4-2135](#).

Because a TLB never holds any translation table entry that generates a Translation fault, an Address size fault, or an Access Flag fault, a change from a translation table entry that causes a Translation, Address size, or Access flag fault to one that does not fault, does not require any TLB invalidation.

Special considerations apply to translation table updates that change the memory type, cacheability, or output address of an entry, see [Using break-before-make when updating translation table entries](#).

Using break-before-make when updating translation table entries

To avoid possibly creating multiple TLB entries for the same address, and to avoid the effects of TLB caching possibly breaking coherency, ordering guarantees or uniprocessor semantics, or possibly failing to clear the Exclusives monitors, the architecture requires the use of a break-before-make sequence when changing translation table entries whenever multiple threads of execution can use the same translation tables and the change to the translation table entries involves any of:

- A change of the memory type.
- A change of the cacheability attributes.
- A change of the output address (OA), if the OA of at least one of the old translation table entry and the new translation table entry is writable, including if the DBM bit is set and hardware updates to the dirty bits are enabled.
- A change to the size of block used by the translation system. This applies both:
 - When changing from a smaller size to a larger size, for example by replacing a table mapping with a block mapping in a stage 2 translation table.
 - When changing from a larger size to a smaller size, for example by replacing a block mapping with a table mapping in a stage 2 translation table.
- Creating a global entry when there might be non-global entries in a TLB that overlap with that global entry.

A break-before-make sequence on changing from an old translation table entry to a new translation table entry requires the following steps:

1. Replace the old translation table entry with an invalid entry, and execute a DSB instruction.
2. Invalidate the translation table entry with a broadcast TLB invalidation instruction, and execute a DSB instruction to ensure the completion of that invalidation.
3. Write the new translation table entry, and execute a DSB instruction to ensure that the new entry is visible.

This sequence ensures that at no time are both the old and new entries simultaneously visible to different threads of execution, and therefore the problems described at the start of this subsection cannot arise.

In ARMv8.1, with the introduction of hardware updates to the translation table entries, the effects of not following the break-before-make rules are extended.

If the break-before-make rules are not followed for changing the translation table entries, the ARMv8.1 architecture permits that the following failures associated with the hardware updates of the translation table entries could occur:

- The Access flag is not set on such a translation table entry despite the fact that the memory location associated with that entry was accessed.
- The AP[2] or S2AP[1] bit is modified by the hardware on such a translation table entry despite the fact that the memory location associated with that entry was not written to.
- The AP[2] or S2AP[1] bit is not modified by the hardware on such a translation table entry despite the fact that the memory location associated with that entry was written to.
- The ordering required between hardware updates to such a translation table entry and stores appearing later in program order is not followed.

D4.9.2 TLB maintenance instructions

The architecture defines TLB maintenance instructions, that provide the following:

- Invalidate all entries in the TLB.
- Invalidate a single TLB entry by [ASID](#) for a non-global entry.
- Invalidate all TLB entries that match a specified [ASID](#).
- Invalidate all TLB entries that match a specified [VA](#), regardless of the [ASID](#).

Each instruction can be specified as applying only to the PE that executes the instruction, or as applying to all PEs in the same Inner Shareable shareability domain as the PE that executes the instruction.

The following subsections describe these instructions:

- [TLB maintenance instruction syntax on page D4-2122.](#)
- [Operation of the TLB maintenance instructions on page D4-2123.](#)
- [Scope of the A64 TLB maintenance instructions on page D4-2124.](#)
- [Invalidation of TLB entries from stage 2 translations on page D4-2128.](#)
- [Broadcast TLB maintenance between AArch32 and AArch64 on page D4-2128.](#)
- [Broadcast TLB maintenance with different translation granule sizes on page D4-2130.](#)
- [Ordering and completion of TLB maintenance instructions on page D4-2130.](#)
- [TLB maintenance in the event of TLB conflict on page D4-2131.](#)
- [The interaction of TLB lockdown with TLB maintenance instructions on page D4-2131.](#)

[TLB maintenance instructions on page C5-320](#) describes the encoding of the TLB maintenance instructions.

TLB maintenance instruction syntax

The A64 syntax for TLB maintenance instructions is:

```
TLBI <operation>{, <Xt>}
```

Where:

<operation> Is one of ALLE1, ALLE2, ALLE3, ALLE1IS, ALLE2IS, ALLE3IS, VMALLE1, VMALLE1IS, VMALLS12E1, VMALLS12E1IS, ASIDE1, ASIDE1IS, VA{L}E1, VA{L}E2, VA{L}E3, VA{L}E1IS, VA{L}E2IS, VA{L}E3IS, VAA{L}E1, VAA{L}E1IS, IPAS2{L}E1, or IPAS2{L}E1IS.

<operation> has a structure of <type><level>{IS} where:

<type> Is one of:

- ALL All translations used at <level>. For the scope of ALL instructions see [ALL on page D4-2124](#). The ALL instructions are valid for all values of <level>.
- VMALL All stage 1 translations used at <level> with the current VMID, if appropriate. For the scope of the VMALL instructions see [VMALL on page D4-2125](#). The VMALL instructions are valid only when level == E1.
- VMALLS12 All stage 1 and stage 2 translations used at EL1 with the current VMID, if appropriate. For the scope of the VMALLS12 instructions see [VMALLS12 on page D4-2125](#). The VMALLS12 instructions are valid only when level == E1.
- ASID All translations used at EL1 with the supplied ASID. For the scope of the ASID instructions see [ASID on page D4-2125](#). The ASID instructions are valid only when level == E1.
- VA{L} Translations used at <level> for the specified address and, if appropriate, the specified ASID. For the scope of the VA instructions see [VA on page D4-2126](#). For the scope of the VAL instructions see [VAL on page D4-2126](#). The VA{L} instructions are valid for all values of <level>.
- VAA{L} Translations used at <level> for the specified address, for all ASID values, if appropriate. For the scope of the VAA instructions see [VAA on page D4-2126](#). For the scope of the VAAL instructions see [VAAL on page D4-2126](#). The VAA{L} instructions are valid only when level == E1.
- IPAS2{L} Translations used at <level> for the specified IPA that are held in stage 2 only caching structures. For the scope of the IPAS2 instructions see [IPAS2 on page D4-2127](#). For the scope of the IPAS2L instructions see [IPAS2L on page D4-2127](#). The IPAS2{L} instructions are valid only when level == E1.

In the VA{L}, VAA{L}, and IPAS2{L} types:

- L An optional parameter that indicates that the invalidation only applies to caching of entries returned from the final lookup level of the translation table walk.

<level> Defines the Exception level of the translation regime that the invalidation applies to. Is one of:

- E1 EL1.
- E2 EL2.
- E3 EL3.

An instruction that applies to the translation regime of an Exception level higher than the Exception level at which the instruction is executed is UNDEFINED.

TLBI ALLE1{IS}, TLBI IPAS2{L}E1{IS} and TLBI VMALLS12E1{IS} are UNDEFINED at EL1.

———— **Note** —————

All TLB maintenance instructions are UNDEFINED at EL0.

IS When present, it indicates that the function applies to all TLBs in the Inner Shareable shareability domain.

<Xt> Passes one or both of an address and an **ASID** as an argument, where required. <Xt> is required for the TLB ASID, TLB VA{L}, TLB VAA{L}, and TLB IPAS2{L} instructions.

If EL2 is not implemented, the TLBI VA{L}E2, TLBI VA{L}E2IS, TLBI ALLE2, and TLBI ALLE2IS instructions are UNDEFINED.

VMSAv8-64 TLB maintenance instructions that take a register argument that holds a **VA**, an **ASID**, or both, use the following register argument format:

Bits[63:48] **ASID**. These bits are RES0 if the instruction does not require an **ASID** argument.

Bits[47:44] RES0.

Bits[43:0] **VA**[55:12]. For an instruction that requires a **VA** argument, the treatment of the low-order bits of this field depends on the translation granule size, as follows:

4KB granule size All bits are valid and used for the invalidation.

16KB granule size Bits[1:0] RES0 and ignored when the instruction is executed, because **VA**[13:12] have no effect on the operation of the instruction.

64KB granule size Bits[3:0] are RES0 and ignored when the instruction is executed, because **VA**[15:12] have no effect on the operation of the instruction.

These bits are RES0 if the instruction does not require a **VA** argument.

For TLB maintenance instructions that take an address argument, hardware interprets **VA**[63:56] as each having the same value as **VA**[55].

If a TLB maintenance instruction targets a translation regime that is using AArch32, meaning the **VA** is only 32-bit, then software must treat **VA**[55:32] as RES0, and these bits are ignored when the instruction is executed.

If the implementation supports 16 bits of **ASID** then the upper 8 bits of the **ASID** are RES0 when the context being invalidated only uses 8 bits.

VMSAv8-64 TLB maintenance instructions that take a register argument that holds an **IPA**, use the following register argument format:

Bits[63:36] RES0.

Bits[35:0] **IPA**[47:12]. For an instruction that requires a **VA** argument, the treatment of the low-order bits of this field depends on the translation granule size, as follows:

4KB granule size All bits are valid and used for the invalidation.

16KB granule size Bits[1:0] RES0 and ignored when the instruction is executed, because **IPA**[13:12] have no effect on the operation of the instruction.

64KB granule size Bits[3:0] are RES0 and ignored when the instruction is executed, because **IPA**[15:12] have no effect on the operation of the instruction.

Operation of the TLB maintenance instructions

Any TLB maintenance instruction can affect any TLB entries that are not locked down.

The TLB maintenance instructions specify the Exception level of the translation regime to which they apply.

———— **Note** —————

Because there is no guarantee that an unlocked TLB entry remains in the cache, architecturally it is not possible to tell whether a TLB maintenance instruction has affected any TLB entries that were not specified by the instruction.

If a TLB maintenance instruction specifies a VA, and a data or instruction access to that VA would generate an MMU abort, the TLB maintenance instruction does not generate an abort. VAs for which a TLB maintenance instruction does not generate an abort include VAs that are not in the range of VAs that can be translated.

When EL3 is implemented:

- The TLB maintenance instructions that apply to the EL1&0 translation regime take account of the current Security state, as part of the address translation required for the TLB operation.
- SCR_EL3.NS modifies the effect of the TLB maintenance instructions as follows:
 - For instructions that apply to the EL1&0 translation regime, the SCR_EL3.NS bit identifies whether the maintenance instructions apply to the Secure or Non-secure EL1&0 translation regime.

———— **Note** —————

If EL3 is not implemented, then there is only a single EL1&0 translation regime.

- For instructions that apply to the EL2 translation regime, or to the EL2&0 translation regime, the SCR_EL3.NS bit must be 1 or the instruction is UNDEFINED.
- For instructions that apply to the EL3 translation regime, the SCR_EL3.NS bit has no effect.

———— **Note** —————

- An address-based TLB maintenance instruction that applies to the Inner Shareable domain does so regardless of the Shareability attributes of the address supplied as an argument to the instruction.
- Previous versions of the ARM architecture included TLB maintenance instructions that operated only on instruction TLBs, or only on data TLBs. From the introduction of ARMv7, ARM deprecated any use of these instructions. In ARMv8:
 - AArch64 state does not include any of these instructions.
 - AArch32 state includes some of these instructions, but ARM deprecates their use.

The ARM architecture does not dictate the form in which the TLB stores translation table entries. However, when a TLB maintenance instruction is executed, the minimum size of the table entry that is invalidated from the TLB must be at least the size that appears in the translation table entry.

———— **Note** —————

The Contiguous bit does not affect the minimum size of entry that must be invalidated from the TLB

Scope of the A64 TLB maintenance instructions

The TLB invalidation instruction <type> affects the different possible cached entries in the TLB as follows:

ALL The invalidation applies to all cached copies of the stage 1 and stage 2 translation table entries from any level of the translation table walk required to translate any address at the specified Exception level, that would be used with the state specified by SCR_EL3.NS.

For entries from the Non-secure EL1&0 translation regime, ALL applies to entries with any VMID.

For entries from a translation regime for which an ASID is valid, the invalidation applies to:

- All entries above the final level of lookup.
- All entries at the final level of lookup.

———— **Note** —————

This means the invalidation applies to both:

- Global entries.
- Non-global entries with any ASID.

- VMALL** The invalidation applies to all cached copies of the stage 1 translation table entries, from any level of the translation table walk required to translate any address at the specified Exception level, that would be used with all of:
- The Security state specified by [SCR_EL3.NS](#).
 - For the Non-secure EL1&0 translation regime, the current [VMID](#).
- For entries from a translation regime for which an [ASID](#) is valid that meet the other specified conditions, the invalidation applies to:
- All entries above the final level of lookup.
 - All entries at the final level of lookup.
- **Note** —————
- This means the invalidation applies to both:
- Global entries.
 - Non-global entries with any [ASID](#).
- VMALL is valid for:
- EL1.
 - EL2, when [HCR_EL2](#).{E2H, TGE} is {1, 1}.
- VMALLS12** The invalidation applies to all cached copies of the stage 1 and stage 2 translation table entries from any level of the translation table walk required to translate any address at the specified Exception level, that would be used with all of:
- The Security state specified by [SCR_EL3.NS](#).
 - For the Non-secure EL1&0 translation regime, the current [VMID](#).
- For entries from a translation regime for which an [ASID](#) is valid that meet the other specified conditions, the invalidation applies to:
- All entries above the final level of lookup.
 - All entries at the final level of lookup.
- **Note** —————
- This means the invalidation applies to both:
- Global entries.
 - Non-global entries with any [ASID](#).
- VMALLS12 is valid for:
- EL1.
 - EL2, when [HCR_EL2](#).{E2H, TGE} is {1, 1}.
- If EL2 is not implemented, or if the TLBI VMALLS12 instruction is executed when the value of [SCR_EL3.NS](#) is 0, the instruction is not UNDEFINED but it has the same effect as TLBI VMALL. This is because there are no stage 2 translations to invalidate.
- ASID** The invalidation applies to all cached copies of the stage 1 translation table entries from any level of the translation table walk required to translate any address at the specified Exception level, that would be used with all of:
- The Security state specified by [SCR_EL3.NS](#).
 - For the Non-secure EL1&0 translation regime, the current [VMID](#).
- For entries from a translation regime for which an [ASID](#) is valid that meet the other specified conditions, the invalidation applies only if either:
- The entry is from a level of lookup above the final level and matches the specified [ASID](#).
 - The entry is a non-global entry from the final level of lookup and matches the specified [ASID](#).
- ASID is valid for:
- EL1.
 - EL2, when [HCR_EL2](#).{E2H, TGE} is {1, 1}.

VA	<p>The invalidation applies to all cached copies of the stage 1 translation table entries from any level of the translation table walk required to translate the address specified in the invalidation instruction at the specified Exception level that would be used with all of:</p> <ul style="list-style-type: none">• The Security state specified by SCR_EL3.NS.• For the Non-secure EL1&0 translation regime, the current VMID. <p>For entries from a translation regime for which an ASID is valid that meet the other specified conditions, the invalidation applies only if one of the following applies:</p> <ul style="list-style-type: none">• The entry is from a level of lookup above the final level and matches the specified ASID.• The entry is a global entry from the final level of lookup.• The entry is a non-global entry from the final level of lookup that matches the specified ASID.
VAL	<p>The invalidation applies to all cached copies of the stage 1 translation table entry from the final level of the translation table walk required to translate the address specified in the invalidation instruction at the specified Exception level, that would be used with all of:</p> <ul style="list-style-type: none">• The Security state specified by SCR_EL3.NS.• For the Non-secure EL1&0 translation regime, the current VMID. <p>For entries from a translation regime for which an ASID is valid that meet the other specified conditions, the invalidation applies only if either:</p> <ul style="list-style-type: none">• The entry is a global entry from the final level of lookup.• The entry is a non-global entry from the final level of lookup that matches the specified ASID.
VAA	<p>The invalidation applies to all cached copies of the stage 1 translation table entries from any level of the translation table walk required to translate the address specified in the invalidation instruction at the specified Exception level that would be used with all of:</p> <ul style="list-style-type: none">• The Security state specified by SCR_EL3.NS.• For the Non-secure EL1&0 translation regime, the current VMID. <p>For entries from a translation regime for which an ASID is valid that meet the other specified conditions, the invalidation applies to all of:</p> <ul style="list-style-type: none">• All entries above the final level of lookup.• All entries at the final level of lookup. <p style="text-align: center;">———— Note —————</p> <p>This means the invalidation applies to both:</p> <ul style="list-style-type: none">— Global entries.— Non-global entries with any ASID. <hr/>
VAA	<p>The invalidation applies to all cached copies of the stage 1 translation table entry from the final level of the translation table walk required to translate the address specified in the invalidation instruction at the specified Exception level that would be used with all of:</p> <ul style="list-style-type: none">• The Security state specified by SCR_EL3.NS.• For the Non-secure EL1&0 translation regime, the current VMID. <p>For entries from a translation regime for which an ASID is valid that meet the other specified conditions, the invalidation applies to all entries at the final level of lookup.</p> <p style="text-align: center;">———— Note —————</p> <p>This means the invalidation applies to both:</p> <ul style="list-style-type: none">• Global entries.• Non-global entries with any ASID. <hr/>

- IPAS2 The invalidation applies to all cached copies of the stage 2 translation table entries from any level of the translation table walk required to translate the specified **IPA**, that both:
- Are held in TLB caching structures holding stage 2 only entries.
 - Would be used with the current **VMID**.
- It is not required that this instruction invalidates TLB caching structures holding entries that combine stage 1 and stage 2 of the translation.
- The only translation regime to which this instruction can apply is the Non-secure EL1&0 translation regime.
- When executed with the **SCR_EL3.NS**=0, or in an implementation that does not implement EL2, this instruction is a NOP.
- For more information about the architectural requirements for the IPAS2 instruction see [Invalidation of TLB entries from stage 2 translations on page D4-2128](#).
- IPAS2L The invalidation applies to cached copies of the stage 2 translation table entry from the final level of the stage 2 translation table walk required to translate the specified **IPA**, that both:
- Are held in TLB caching structures holding stage 2 only entries.
 - Would be used with the current **VMID**.
- It is not required that this instruction invalidates TLB caching structures holding entries that combine stage 1 and stage 2 of the translation.
- The only translation regime to which this instruction can apply is the Non-secure EL1&0 translation regime.
- When executed with the **SCR_EL3.NS**=0, or in an implementation that does not implement EL2, this instruction is a NOP.
- For more information about the architectural requirements for the IPAS2L instruction see [Invalidation of TLB entries from stage 2 translations on page D4-2128](#).

The entries that the invalidations apply to are not affected by the state of any other control bits involved in the translation process. Therefore, the following is a non-exhaustive list of control bits that do not affect how a TLB maintenance instruction updates the TLB entries:

In AArch64 state

SCTLR_EL1.M, **SCTLR_EL2.M**, **SCTLR_EL3**.{M, RW}, **HCR_EL2**.{VM, RW},
TCR_EL1.{TG1, EPD1, T1SZ, TG0, EPD0, T0SZ, AS, A1}, **TCR_EL2**.{TG0, T0SZ},
TCR_EL3.{TG0, T0SZ}, **VTCR_EL2**.{SL0, T0SZ}, **TTBR0_EL1.ASID**, **TTBR1_EL1.ASID**.

In AArch32 state

SCTLR.M, **HCR.VM**, **TTBCR**.{EAE, PD1, PD0, N, EPD1, T1SZ, EPD0, T0SZ, A1},
HTCR.T0SZ, **VTCR**.{SL0, T0SZ}, **TTBR0.ASID**, **TTBR1.ASID**, **CONTEXTIDR.ASID**.

———— Note —————

- ARM expects most TLB maintenance performed by an operating system to occur to the last level entries of the stage 1 translation table walks, and the purpose of the address-based TLB invalidation instructions where the invalidation need only apply to caching of entries returned from the last level of translation table walk of stage 1 translation is to avoid unnecessary loss of the intermediate caching of the translation table entries. Similarly, for stage 2 translations ARM expects that most TLB maintenance performed by a hypervisor for a given Guest operation system will affect only the last level entries of the stage 2 translations. Therefore, similar capability is provided for instructions that invalidate single stage 2 entries.
- The architecture permits the invalidation of entries in TLB caching structures at any time, so for each of these instructions the definition is in terms of the minimum set of entries that must be invalidated from TLB caching structures, and an implementation might choose to invalidate more entries. In general, for best performance, ARM recommends not invalidating entries that are not required to be invalidated.

- Dependencies on the **VMID** for the Non-secure EL1&0 translation regime apply even when **HCR_EL2.VM** is set to 0. Because the architecture does not require the **VTTBR_EL2.VMID** field to be reset in hardware, the reset routine of each active PE must initialize **VTTBR_EL2.VMID[7:0]** to a common value such as 0, even if stage 2 translation is not in use.

Invalidation of TLB entries from stage 2 translations

The architectural requirements of the IPAS2 instruction are that:

1. The following code is sufficient to invalidate all cached copies of the stage 2 translation of the **IPA** held in Xt for the current **VMID**, with the corresponding requirement for the broadcast versions of the instructions:

```
TLBI IPAS2E1, Xt
DSB
TLBI VMALLE1
```

2. The following code is sufficient to invalidate all cached copies of the stage 2 translations of the **IPA** held in Xt used to translate the **VA** (and the specified **ASID** when executing **TLBI VAE1**) held in Xt2, with the corresponding requirement for the broadcast versions of the instructions:

```
TLBI IPAS2E1, Xt
DSB
TLBI VAE1, Xt2 ; or TLBI VAAE1, Xt2
```

3. The following code is sufficient to invalidate all cached copies of the stage 2 translations of the **IPA** held in Xt used to translate the **IPA** produced by the last level of stage 1 translation table lookup for the **VA** (and **ASID** when executing **TLBI VALE1**) held in Xt2, with the corresponding requirement for the broadcast versions of the instructions:

```
TLBI IPAS2E1, Xt
DSB
TLBI VALE1, Xt2 ; or TLBI VAALE1, Xt2
```

Note

Depending on the invalidation required, software must use the entire sequence 1, 2, or 3, even when Non-secure EL1&0 stage 1 translation is disabled.

Equivalent architectural requirements apply to the IPAS2L instruction, except that the only TLB entries that must be invalidated by an IPAS2L instruction are those that come from the final level of the translation table lookup.

Broadcast TLB maintenance between AArch32 and AArch64

In most cases, a TLB maintenance instruction affecting the Inner Shareable shareability domain executed by a PE in an Exception level that is using AArch64 also affects any other PE in the same Inner Shareable domain that is executing at the same Exception level and is using AArch32, provided that the address, qualify the scope of the **ASID** and **VMID** matching requirements of the original instruction are met, as specified in *Scope of the A64 TLB maintenance instructions on page D4-2124*.

Note

The requirement to match means that the invalidation only occurs on the PE that is using AArch32 if, for the PE that executed the TLB maintenance instruction at an Exception level that is using AArch64, both of the following apply:

- If **VA** matching is required, the **VA** is 0x0000FFFFFFFF or lower in the memory map.
- If **ASID** matching is required and the PE is using a 16-bit **ASID**, then the top 8 bits of the **ASID** are zero.

Except for the cases identified here, a TLB maintenance instructions affecting the Inner Shareable shareability domain executed by a PE in an Exception level that is using AArch32 also affects any other PE in the same Inner Shareable domain that is executing at the same Exception level and is using AArch64, provided that the address, ASID, and VMID matching requirements of the original instruction are met, as specified in *Scope of the A64 TLB maintenance instructions* on page D4-2124. In addition, for the instruction executed in AArch32 state:

- For a TLBIMVAAIS, TLBIMVAALIS, TLBIMVAHIS, TLBIMVAIS, TLBIMVALHIS, or TLBIMVALIS instruction, the VA supplied as an argument is zero-extended.
- For a TLBIIPAS2IS or TLBIIPAS2LIS instruction, the IPA supplied as an argument is zero-extended.
- For a TLBIASIDIS, TLBIMVAIS, or TLBIMVALIS instruction, the ASID supplied as an argument is zero-extended if the PE executing in AArch64 state is using a 16-bit ASID.

The VA from the instruction executed in AArch32 state is zero-extended, and the ASID is zero-extended if the PE executing in AArch64 state is using a 16-bit ASID.

The exceptions to these general rules are as follows:

1. An ARMv7 PE in the same Inner Shareable domain is treated in the same way as an ARMv8 PE for which EL3 is using AArch32, except that if an ARMv8 PE issues a broadcast instruction that is not defined in ARMv7, then that instruction is not required to have an effect on the TLBs of the ARMv7 PE. The instructions that do not exist in ARMv7 include the following TLB maintenance instructions that ARMv8 adds to the T32 and A32 instruction sets:
 - The following instructions that operate on TLB entries for the final level of translation table walk for stage 1 translations:
TLBIMVALIS, TLBIMVAALIS, TLBIMVALHIS, TLBIMVAL, TLBIMVAAL, and TLBIMVALH.
 - The following instructions that operate by IPA on TLB entries for stage 2 translations:
TLBIIPAS2IS, TLBIIPAS2LIS, TLBIIPAS2, and TLBIIPAS2L.
2. The number of Exception levels in Secure state depends on whether EL3 is using AArch32 or EL3 is using AArch64. This means that, within the Inner Shareable domain, there might be PEs with different numbers of Exception levels in Secure state. Therefore, the following exceptions are made to the general rules:
 - If a PE with EL3 using AArch32 issues a broadcast AArch32 TLB maintenance instruction affecting Secure entries, and the Inner Shareable domain also contains PEs with EL3 using AArch64, then the architecture does not require that the broadcast AArch32 TLB maintenance instruction has any effect on either:
 - The EL3 translation regime of the PEs with EL3 using AArch64.
 - The Secure EL1&0 translation regime of the PEs with EL3 using AArch64, regardless of whether the Secure EL1&0 translation regime is using AArch64 or AArch32.
 - If a PE with EL3 using AArch64 issues a broadcast AArch64 TLB maintenance instruction affecting EL3 entries, and the Inner Shareable domain also contains PEs with EL3 using AArch32, then the architecture does not require that the broadcast AArch64 TLB maintenance instruction has any effect on the EL3 translation regime of the PEs with EL3 using AArch32.
 - If a PE with EL3 using AArch64 issues a broadcast AArch64 TLB maintenance instruction affecting Secure EL1 entries, and the Inner Shareable domain also contains PEs with EL3 using AArch32 then the architecture does not require that the broadcast AArch64 TLB maintenance instruction has any effect on the EL3 translation regime of the PEs with EL3 using AArch32.

———— **Note** —————

While the exceptions to the general rule mean the architecture does not require the specified TLB invalidations, the architecture also does not require that entries in the TLB remain in the TLB at any time, and so it is permissible that such broadcast instructions affect these translation regimes.

Broadcast TLB maintenance with different translation granule sizes

In the following cases, a broadcast TLB maintenance instruction is not required to perform any invalidation on the recipient PE:

- The TLB maintenance instruction specifying a **VA** and affecting the EL2 translation regime, the EL2&0 translation regime, or the EL3 translation regime is broadcast from a PE using one translation granule size for that translation regime to a PE using a different translation granule size for that same translation regime
- The TLB maintenance instruction specifying a **VA** and affecting the EL1&0 translation regime is broadcast from a PE using one stage 1 translation granule size for that translation regime for a particular **ASID** (if applicable), **VMID** (if applicable), and Security state, to a PE where EL1 for the same **ASID** (if applicable), **VMID** (if applicable), and Security state, is using a different stage 1 translation granule size.
- The TLB maintenance instruction specifying a **VA** and affecting the Non-secure EL1&0 translation regime is broadcast from a PE using one stage 2 translation granule size for a particular **ASID** (if applicable) and **VMID**, to a PE where EL1 for the same **ASID** (if applicable) and **VMID** is using a different stage 2 translation granule size.
- The TLB maintenance instruction specifying an **IPA** and affecting the Non-secure EL1&0 translation regime is broadcast from a PE using one stage 2 translation granule size for a particular **VMID** to a PE where EL1 for the same **VMID** is using a different stage 2 translation granule size.

Ordering and completion of TLB maintenance instructions

For AArch64 execution, a TLB maintenance instruction can be executed in any order relative to:

- Any load or store instruction, unless a DSB is executed between the load or store and the TLB maintenance instruction.

———— **Note** —————

In the ARM architecture, a translation table walk is considered to be a separate observer, and a store to the translation tables can be observed by that separate observer at any time after the instruction has been executed, but is only guaranteed to be observable after the execution of a DSB instruction by the PE that executed the store to the translation tables.

- Another TLB maintenance instruction, unless a DSB is executed between the instructions.
- A data or instruction cache maintenance instruction, unless a DSB is executed between the instructions.

For AArch64 execution, the completion rules are:

- A TLB invalidate instruction is complete when all memory accesses using the TLB entries that have been invalidated have been observed by all observers, to the extent that those accesses must be observed. The shareability and cacheability of the accessed memory locations determine the extent to which the accesses must be observed.

———— **Note** —————

For TLB maintenance instructions that affect other PEs, the memory accesses from those PEs that used the TLB entries that have been invalidated are included in the set of memory accesses that must have been observed when the TLB maintenance instruction is complete.

After the TLB invalidate instruction is complete, no new memory accesses using the invalidated TLB entries will be observed by those observers.

———— **Note** —————

This requirement does not mean that speculative memory accesses cannot be performed using those entries if it is impossible to tell that those memory accesses have been observed by the observers.

- A TLB maintenance instruction can complete at any time after it is issued, but is only guaranteed to be complete after the execution of DSB by the PE that executed the TLB maintenance instruction.
- The effects of a completed TLB maintenance instruction are only guaranteed to be visible on the PE that executed the instruction after the execution of a *Context synchronization event* by the PE that executed the TLB maintenance instruction.

In all cases in this section where a DMB or DSB is referred to, it refers to a DMB or DSB whose required access type is both loads and stores. A DSB NSH is sufficient to ensure completion of TLB maintenance instructions that apply to a single PE. A DSB ISH is sufficient to ensure completion of TLB maintenance instructions that apply to PEs in the same Inner Shareable domain.

TLB maintenance in the event of TLB conflict

In the event that multiple entries in the TLB are being used to translate a given address (which implies that an attempt to access the given address might give rise to a TLB Conflict abort), it is IMPLEMENTATION DEFINED as to the form of TLB maintenance operation that the software must perform in order to be guaranteed that all TLB entries associated with the given address and translation regime have been invalidated. In all cases, an ALL or VMALL form of TLB maintenance operation that targets the given translation regime is guaranteed to remove all entries within that regime, even if there are multiple, conflicting TLB entries for any given address within that regime.

The interaction of TLB lockdown with TLB maintenance instructions

The precise interaction of TLB lockdown with the TLB maintenance instructions is IMPLEMENTATION DEFINED. However, the architecturally-defined TLB maintenance instructions must comply with these rules:

- The effect on a locked TLB entry of a TLB invalidate all operation that would invalidate that entry if the entry was not locked must be one of the following, and it is IMPLEMENTATION DEFINED which behavior applies:
 - The operation has no effect on entries that are locked down.
 - The operation generates an IMPLEMENTATION DEFINED Data Abort exception if an entry is locked down, or might be locked down.
Any such exceptions taken from Non-secure EL1 can be trapped to EL2, see *Traps to EL2 of Non-secure EL0 and EL1 accesses to lockdown, DMA, and TCM operations on page D1-1857*.

———— **Note** —————

These options permit a usage model for TLB invalidate routines, where the routine invalidates a large range of addresses, without considering whether any entries are locked in the TLB.

- The effect on a locked TLB entry of a TLB invalidate by VA or invalidate by ASID match operation that would invalidate that entry if the entry was not locked must be one of the following, and it is IMPLEMENTATION DEFINED which behavior applies:
 - The locked entry is invalidated in the TLB.
 - The operation has no effect on any locked entry in the TLB. In the case of an invalidate single entry by VA, this means the PE treats the operation as a NOP.
 - The operation generates an IMPLEMENTATION DEFINED Data Abort exception if it operates on an entry that is locked down, or might be locked down.

The exception syndrome definitions include a fault code for cache and TLB lockdown faults, see *ESR_EL1, Exception Syndrome Register (EL1) on page D7-2249*.

———— **Note** —————

Any implementation that uses an abort mechanism for entries that can be locked down but are not actually locked down must:

- Document the IMPLEMENTATION DEFINED instruction sequences that perform the required operations on entries that are not locked down.
- Implement one of the other specified alternatives for the locked entries.

ARM recommends that, when possible, such IMPLEMENTATION DEFINED instruction sequences use the architecturally-defined operations. This minimizes the number of customized operations required.

In addition, an implementation that uses an abort mechanism for handling the effect of TLB maintenance instructions on entries that can be locked down but are not actually locked down must provide an IMPLEMENTATION DEFINED mechanism that ensures that no TLB entries are locked.

Similar rules apply to cache lockdown, see [The interaction of cache lockdown with cache maintenance instructions on page D3-1995](#).

The architecture does not guarantee that any unlocked entry in the TLB remains in the TLB. This means that, as a side-effect of any TLB maintenance instruction, any unlocked entry in the TLB might be invalidated.

D4.9.3 Maintenance requirements on changing System register values

The TLB contents can be influenced by control bits in a number of System registers. This means the TLB must be invalidated after any changes to these bits, unless the changes are accompanied by a change to the [VMID](#) or [ASID](#) that defines the context to which the bits apply. The general form of the required invalidation sequence is as follows:

```
; Change control bits in System registers
ISB          ; Synchronize changes to the control bits
; Perform TLB invalidation of all entries that might be affected by the changed control bits
```

The System register changes that maintenance requirement applies to are:

- Any change to the [MAIR_EL1](#), [MAIR_EL2](#), or [MAIR_EL3](#) registers.
- Any change to the [AMAIR_EL1](#), [AMAIR_EL2](#), or [AMAIR_EL3](#) registers.
- Any change to [SCTLR_EL1.EE](#), [SCTLR_EL2.EE](#), or [SCTLR_EL3.EE](#).
- Any change to [SCTLR_EL1.WXN](#), [SCTLR_EL2.WXN](#), or [SCTLR_EL3.WXN](#).
- Any change to any of the [SCR_EL3](#).{RW, SIF} bits.
- Any change to any of the [HCR_EL2](#).{RW, DC, PTW, VM} bits. See also [Changing HCR_EL2.PTW](#).
- Any changes to the registers that control address translation:
 - Any change to any of the [TCR_EL1](#), [TCR_EL2](#), [TCR_EL3](#), or [VTCR_EL2](#) registers.
 - Any change to the [TTBR0_EL1](#), [TTBR1_EL1](#), [TTBR1_EL2](#), [TTBR0_EL2](#), [TTBR0_EL3](#), or [VTTBR_EL2](#) registers.

Changing HCR_EL2.PTW

When the value of the Protected table walk bit, [HCR_EL2.PTW](#), is 1, a stage 1 translation table access in the Non-secure EL1&0 translation regime, to an address that is mapped to any type of Device memory by its stage 2 translation, generates a stage 2 Permission fault. A TLB associated with a particular [VMID](#) might hold entries that depend on the effect of [HCR_EL2.PTW](#). Therefore, if the value of [HCR_EL2.PTW](#) is changed without a change to the [VMID](#) value, all TLB entries associated with the current [VMID](#) must be invalidated before executing software at Non-secure EL1 or EL0. If this is not done, behavior is CONstrained UNPREDICTABLE, see [CONstrained UNPREDICTABLE behaviors due to caching of control or data values on page K1-6120](#).

D4.10 Caches in a VMSAv8-64 implementation

The ARM architecture describes the required behavior of an implementation of the architecture. As far as possible it does not restrict the implemented microarchitecture, or the implementation techniques that might achieve the required behavior.

In particular, maintaining this level of abstraction is difficult when describing the relationship between memory address translation and caches, especially regarding the indexing and tagging policy of caches. This section:

- Summarizes the architectural requirements for the interaction between caches and address translation.
- Gives some information about the likely implementation impact of the required behavior.

The following sections give this information:

- [Data and unified caches](#).
- [Instruction caches](#).

In addition, [Cache maintenance requirement created by changing translation table attributes on page D4-2135](#) describes the cache maintenance required after updating the translation tables to change the attributes of an area of memory.

For more information about cache maintenance see [A64 Cache maintenance instructions on page D3-1985](#), that describes the cache maintenance instructions in the A64 instruction set.

D4.10.1 Data and unified caches

For data and unified caches, the use of address translation is entirely transparent to any data access other than as described in [Mismatched memory attributes on page B2-118](#).

This means that the behavior of accesses from the same observer to different VAs, that are translated to the same PA with the same memory attributes, is fully coherent. This means these accesses behave as follows, regardless of which VA is accessed:

- Two writes to the same PA occur in program order.
- A read of a PA returns the value of the last successful write to that PA.
- A write to a PA that occurs, in program order, after a read of that PA, has no effect on the value returned by that read.

The memory system behaves in this way without any requirement to use barrier or cache maintenance instructions.

In addition, if cache maintenance is performed on a memory location, the effect of that cache maintenance is visible to all aliases of that physical memory location.

These properties are consistent with implementing all caches that can handle data accesses as *Physically-indexed, physically-tagged* (PIPT) caches.

D4.10.2 Instruction caches

In the ARM architecture, an instruction cache is a cache that is accessed only as a result of an instruction fetch. Therefore, an instruction cache is never written to by any load or store instruction executed by the PE.

The ARM architecture permits different behaviors for instruction caches. These are identified by descriptions of the associated expected implementation. The following subsections describe the behavior associated with these cache types, including any occasions where explicit cache maintenance is required to make the use of address translation transparent to the instruction cache:

- [PIPT \(Physically-indexed, physically-tagged\) instruction caches on page D4-2134](#).
- [VPIPT \(VMID-aware PIPT\) instruction caches on page D4-2134](#).
- [VIPT \(Virtually-indexed, physically-tagged\) instruction caches on page D4-2134](#).
- [The IVIPT Extension on page D4-2135](#).

The `CTR_EL0.L1Ip` field identifies the form of the instruction caches.

Note

For software to be portable between implementations that might use any of PIPT instruction caches, VPIPT instruction caches, or VIPT instruction caches, software must invalidate the instruction cache whenever any condition occurs that would require instruction cache maintenance for at least one of the instruction cache types.

PIPT (*Physically-indexed, physically-tagged*) instruction caches

For a PIPT instruction cache:

- The use of memory address translation is entirely transparent to all instruction fetches other than as described in *Mismatched memory attributes* on page B2-118.
- If cache maintenance is performed on a memory location, the effect of that cache maintenance is visible to all aliases of that physical memory location.

An implementation that provides PIPT instruction caches implements the IVIPT Extension, see *The IVIPT Extension* on page D4-2135.

VPIPT (*VMID-aware PIPT*) instruction caches

An implementation that includes ARMv8.2-VPIPT can implement VPIPT instruction caches.

For a VPIPT instruction cache:

- Instruction fetches from Non-secure EL1 and Non-secure EL0 are only permitted to hit in the cache if the instruction fetch is made using the VMID that was used when the entry in the instruction cache was fetched.
- An instruction cache maintenance instruction executed at Non-secure EL0 or at Non-secure EL1 is required to have an effect on entries in the instruction cache only if those entries were fetched using the VMID that is current when the cache maintenance instruction is executed.

All other requirements for the use of cache maintenance instructions are the same as for *PIPT (Physically-indexed, physically-tagged) instruction caches*.

An implementation that provides VPIPT instruction caches implements the IVIPT Extension, see *The IVIPT Extension* on page D4-2135.

VIPT (*Virtually-indexed, physically-tagged*) instruction caches

For a VIPT instruction cache:

- The use of memory address translation is transparent to all instruction fetches other than for the effect of memory address translation on instruction cache invalidate by address operations or as described in *Mismatched memory attributes* on page B2-118.

Note

Cache invalidation is the only cache maintenance that can be performed on an instruction cache.

- If instruction cache invalidation by address is performed on a memory location, the effect of that invalidation is visible only to the VA supplied with the operation. The effect of the invalidation might not be visible to any other aliases of that physical memory location.

The only architecturally-guaranteed way to invalidate all aliases of a PA from a VIPT instruction cache is to invalidate the entire instruction cache.

An implementation that provides VIPT instruction caches implements the IVIPT Extension, see *The IVIPT Extension* on page D4-2135.

The IVIPT Extension

In ARMv8, any permitted instruction cache implementation can be described as implementing the *IVIPT Extension* to the ARM architecture.

The formal definition of the ARM IVIPT Extension is that it reduces the instruction cache maintenance requirement to the following condition:

- Instruction cache maintenance is required only after writing new data to a [PA](#) that holds an instruction.

Note

Previous versions of the ARM architecture have permitted an instruction cache option that does not implement the ARM IVIPT Extension.

D4.10.3 Cache maintenance requirement created by changing translation table attributes

Any change to the translation tables to change the attributes of an area of memory can require maintenance of the translation tables, as described in [General TLB maintenance requirements on page D4-2119](#). If the change affects the cacheability attributes of the area of memory, including any change between Write-Through and Write-Back attributes, software must ensure that any cached copies of affected locations are removed from the caches, typically by cleaning and invalidating the locations from the levels of cache that might hold copies of the locations affected by the attribute change. Any of the following changes to the inner cacheability or outer cacheability attribute creates this maintenance requirement:

- Write-Back to Write-Through
- Write-Back to Non-cacheable
- Write-Through to Non-cacheable
- Write-Through to Write-Back.

The cache clean and invalidate avoids any possible coherency errors caused by mismatched memory attributes.

Similarly, to avoid possible coherency errors caused by mismatched memory attributes, the following sequence must be followed when changing the shareability attributes of a cacheable memory location:

1. Make the memory location Non-cacheable, Outer Shareable.
2. Clean and invalidate the location from them cache.
3. Change the shareability attributes to the required new values.

Chapter D5

The Performance Monitors Extension

This chapter describes the ARMv8 implementation of the ARM Performance Monitors, that are an optional non-invasive debug component. It describes version 3 of the *Performance Monitor Unit* (PMU) architecture, PMUv3. It contains the following sections:

- *About the Performance Monitors* on page D5-2138.
- *Accuracy of the Performance Monitors* on page D5-2140.
- *Behavior on overflow* on page D5-2142.
- *Attributability* on page D5-2144.
- *Effect of EL3 and EL2* on page D5-2145.
- *Event filtering* on page D5-2147
- *Performance Monitors and Debug state* on page D5-2149.
- *Counter enables* on page D5-2150.
- *Counter access* on page D5-2151.
- *Events, event numbers, and mnemonics* on page D5-2152.
- *Performance Monitors Extension registers* on page D5-2176.

Note

[Table K11-1 on page K11-6282](#) disambiguates the general register references used in this chapter.

D5.1 About the Performance Monitors

In ARMv8-A, the Performance Monitors Extension is an OPTIONAL feature of an implementation, but ARM strongly recommends that ARMv8-A implementations include version 3 of the Performance Monitors Extension, PMUv3.

———— **Note** —————

No previous versions of the Performance Monitors Extension can be implemented in ARMv8.

The basic form of the Performance Monitors is:

- A 64-bit cycle counter, see *Time as measured by the Performance Monitors cycle counter* on page D5-2139.
- A number of 32-bit event counters. The event counted by each counter is programmable. ARMv8 provides space for up to 31 counters. The actual number of counters is IMPLEMENTATION DEFINED, and the specification includes an identification mechanism.

———— **Note** —————

ARM recommends that at least two counters are implemented, and that hypervisors provide at least this many counters to guest operating systems.

- When EL2 is implemented, the required controls to partition the implemented counters into the following sets:
 - A set which is available for use by the guest operating system.
 - A set which is available for use by the hypervisor.
- Controls for:
 - Enabling and resetting counters.
 - Flagging overflows.
 - Enabling interrupts on overflow.

Monitoring software can enable the cycle counter independently of the event counters.

The PMU architecture uses event numbers to identify an event. It:

- Defines event numbers for common events, for use across many architectures and microarchitectures.

———— **Note** —————

Implementations that include PMUv3 must, as a minimum requirement, implement a subset of the common events. See *Common event numbers* on page D5-2156.

- Reserves a large event number space for IMPLEMENTATION DEFINED events.

The full set of events for an implementation is IMPLEMENTATION DEFINED. ARM recommends that implementations include all of the events that are appropriate to the architecture profile and microarchitecture of the implementation.

When an implementation includes the Performance Monitors Extension, ARMv8 defines the following possible interfaces to the Performance Monitors Extension registers:

- A System register interface. This interface is mandatory.

———— **Note** —————

In AArch32 state, the interface is in the (coproc==0b1111) encoding space.

- An external debug interface which optionally supports memory-mapped accesses. Implementation of this interface is OPTIONAL. See *Chapter 12 Recommended External Interface to the Performance Monitors*.

An operating system can use the System registers to access the counters.

Also, if required, the operating system can enable application software to access the counters. This enables an application to monitor its own performance with fine-grain control without requiring operating system support. For example, an application might implement per-function performance monitoring.

To enable interaction with external monitoring, an implementation might consider additional enhancements, such as providing:

- A set of events, from which a selection can be exported onto a bus for use as external events.
- The ability to count external events. This enhancement requires the implementation to include a set of external event input signals.

The Performance Monitors Extension is common to AArch64 operation and AArch32 operation. This means the ARMv8 architecture defines both AArch64 and AArch32 System registers to access the Performance Monitors. For example, the Performance Monitors Cycle Count Register is accessible as:

- When executing in AArch64 state, [PMCCNTR_EL0](#), see [PMCCNTR_EL0, Performance Monitors Cycle Count Register on page D7-2633](#).
- When executing in AArch32 state, [PMCCNTR](#), see [PMCCNTR, Performance Monitors Cycle Count Register on page G6-5335](#).

D5.1.1 Time as measured by the Performance Monitors cycle counter

The Performance Monitors cycle counter, accessed through [PMCCNTR_EL0](#) or [PMCCNTR](#), increments from the hardware processor clock, not PE clock cycles.

The relationship between the count recorded by the Performance Monitors cycle counter and the passage of real time is IMPLEMENTATION DEFINED.

———— Note —————

- This means that, in an implementation where PEs are multithreaded, the counter continues to increment across all PEs, rather than only counting cycles for which the current PE is active.
- Although the architecture requires that direct reads of [PMCCNTR_EL0](#) or [PMCCNTR](#) occur in program order, there is no requirement that the count increments between two such reads. Even when the counter is incrementing on every clock cycle, software might need check that the difference between two reads of the counter is nonzero.

The architecture requires that an indirect write to the [PMCCNTR_EL0](#) or [PMCCNTR](#) is observable to direct reads of the register in finite time. The counter increments from the hardware processor clock are indirect writes to these registers.

D5.1.2 Interaction with trace

It is IMPLEMENTATION DEFINED whether the implementation exports counter events to a Trace macrocell, or other external monitoring agent, to provide triggering information. The form of any exporting is also IMPLEMENTATION DEFINED. If implemented, this exporting might be enabled as part of the performance monitoring control functionality.

ARM recommends system designers include a mechanism for importing a set of external events to be counted, but such a feature is IMPLEMENTATION DEFINED. When implemented, this feature enables the Trace macrocell to pass in events to be counted.

D5.1.3 Interaction with power saving operations

All counters are subject to any changes in clock frequency, including clock stopping caused by the WFI and WFE instructions.

D5.2 Accuracy of the Performance Monitors

The Performance Monitors:

- Are a non-invasive debug component. See *Non-invasive behavior*.
- Must provide broadly accurate and statistically useful count information.

However, the Performance Monitors allow for:

- A reasonable degree of inaccuracy in the counts to keep the implementation and validation cost low. See *A reasonable degree of inaccuracy on page D5-2141*.
- IMPLEMENTATION DEFINED controls, such as those in ACTLR registers, to put the PE in an operating state that might do one or both of the following:
 - Change the level of non-invasiveness of the Performance Monitors so that enabling an event counter can impact the performance or behavior of the PE.
 - Allow inaccurate counts. This includes, but is not limited to, cycle counts.

D5.2.1 Non-invasive behavior

The Performance Monitors are a non-invasive debug feature. A non-invasive debug feature permits the observation of data and program flow. Performance Monitors, PC Sample-based Profiling and Trace are non-invasive debug features.

Non-invasive debug components do not guarantee that they do not make any changes to the behavior or performance of the processor. Any changes that do occur must not be severe however, as this will reduce the usefulness of event counters for performance measurement and profiling. This does not include any change to program behavior that results from the same program being instrumented to use the Performance Monitors, or from some other performance monitoring process being run concurrently with the process being profiled in a multitasking operating system. As such, a reasonable variation in performance is permissible.

———— **Note** —————

Power consumption is one measure of performance. Therefore, a reasonable variation in power consumption is permissible.

ARM does not define a *reasonable variation in performance*, but recommends that such a variation is kept within 5% of normal operating performance, when averaged across a suite of code that is representative of the application workload.

———— **Note** —————

For profiles other than A-profile, there is the potential for stronger requirements. Ultimately, performance requirements are determined by end-users, and not set by the architecture.

For some common architectural events, this requirement to be non-invasive can conflict with the requirement to present an accurate value of the count under normal operating conditions. Should an implementation require more performance-invasive techniques to accurately count an event, there are the following options:

- If the event is optional, define an alternative IMPLEMENTATION DEFINED event that accurately counts the event and document the impact on performance of enabling the event.
- Provide an IMPLEMENTATION DEFINED control that disables accurate counting of the event to restore broadly accurate performance, and document the impact on performance of accurate counting.

D5.2.2 A reasonable degree of inaccuracy

The Performance Monitors provide broadly accurate and statistically useful count information. To keep the implementation and validation cost low, a reasonable degree of inaccuracy in the counts is acceptable. ARM does not define a *reasonable degree of inaccuracy* but recommends the following guidelines:

- Under normal operating conditions, the counters must present an accurate value of the count.
- In exceptional circumstances, such as a change in Security state or other boundary condition, it is acceptable for the count to be inaccurate.
- Under very unusual, non-repeating pathological cases, the counts can be inaccurate. These cases are likely to occur as a result of asynchronous exceptions, such as interrupts, where the chance of a systematic error in the count is very unlikely.

———— **Note** ————

An implementation must not introduce inaccuracies that can be triggered systematically by the execution of normal pieces of software. For example, it is not reasonable for the count of branch behavior to be inaccurate when caused by a systematic error generated by the loop structure producing a dropping in branch count.

However, dropping a single branch count as the result of a rare interaction with an interrupt is acceptable.

The permitted inaccuracy limits the possible uses of the Performance Monitors. In particular, the architecture does not define the point in a pipeline where the event counter is incremented, relative to the point where a read of the event counters is made. This means that pipelining effects can cause some imprecision.

A change of Security state can also affect the accuracy of the Performance Monitors, see [Interaction with EL3 on page D5-2145](#).

In addition to this, entry to and exit from Debug state can disturb the normal running of the PE, causing further inaccuracy in the Performance Monitors. Disabling the counters while in Debug state limits the extent of this inaccuracy. An implementation can employ methods to limit this inaccuracy, for example by promptly disabling the counters during the Debug state entry sequence.

An implementation must document any particular scenarios where significant inaccuracies are expected.

D5.3 Behavior on overflow

All events are counted in 32-bit wrapping counters, that overflow when they wrap. The cycle counter, [PMCCNTR](#), is a 64-bit wrapping counter, that is configured by [PMCR.LC](#) to either:

- Signal an overflow when bit [PMCCNTR\[63\]](#) overflows.
- Signal an overflow when bit [PMCCNTR\[31\]](#) overflows into bit [PMCCNTR\[32\]](#).

On a Performance Monitors counter overflow:

- An overflow status bit is set to 1. See [PMOVSCLR](#).
- An interrupt request is generated if the PE is configured to generate counter overflow interrupts. For more information, see [Generating overflow interrupt requests](#).
- The counter continues counting events.

D5.3.1 Generating overflow interrupt requests

Software can program the Performance Monitors so that an overflow interrupt request is generated when a counter overflows. See [PMINTENSET](#) and [PMINTENCLR](#).

———— **Note** ————

- The mechanism by which an interrupt request from the Performance Monitors generates an FIQ or IRQ exception is IMPLEMENTATION DEFINED.
- ARM recommends that the overflow interrupt requests:
 - Translate into a **PMUIRQ** signal, so that they are observable to external devices.
 - Connect to inputs on an IMPLEMENTATION DEFINED generic interrupt controller as a *Private Peripheral Interrupt* (PPI) for the originating processor. See the *ARM Generic Interrupt Controller Architecture Specification* for information about PPIs.
 - Connect to a *Cross Trigger Interface* (CTI), see [Chapter H5 The Embedded Cross-Trigger Interface](#).
- ARM strongly discourages implementations from connecting overflow interrupt requests from multiple PEs to the same *System Peripheral Interrupt* (SPI) identifier.
- From GICv3, the *ARM® Generic Interrupt Controller Architecture Specification* recommends that the *Private Peripheral Interrupt* (PPI) with ID 23 is used for overflow interrupt requests.

Counter overflow when counting one or more events generates an unsigned carry out. Software can write to the counters to control the frequency at which interrupt requests occur. For counters other than the cycle counter, the counter is always a 32-bit unsigned wrapping value. For example, software might set a counter to `0xFFFF0000`, to generate another counter overflow after 65 536 increments, and reset it to this value every time an overflow interrupt occurs.

———— **Note** ————

If an event can occur multiple times in a single clock cycle, then counter overflow can occur without the counter registering a value of zero.

The overflow interrupt request is a level-sensitive request. The PE signals a request for:

- Any given PMNx counter, when the value of [PMOVSSET\[x\]](#) is 1, the value of [PMINTENSET\[x\]](#) is 1, and one of the following is true:
 - EL2 is not implemented and the value of [PMCR.E](#) is 1.
 - EL2 is implemented, x is less than the value of [HDCR.HPMN](#), and the value of [PMCR.E](#) is 1.
 - EL2 is implemented, x is greater than or equal to the value of [HDCR.HPMN](#), and the value of [HDCR.HPME](#) is 1.
- The cycle counter, when the values of [PMOVSSET\[31\]](#), [PMINTENSET\[31\]](#), and [PMCR.E](#) are all 1.

The overflow interrupt request is active in both Secure and Non-secure states. In particular, if EL3 and EL2 are both implemented, overflow events from PMNx where *x* is greater than or equal to the value of [HDCR.HPMN](#) can be signaled from all modes and states but only if the value of [HDCR.HPME](#) is 1.

The interrupt handler for the counter overflow request must cancel the interrupt request, by writing to [PMOVSCLR\[x\]](#) to clear the overflow bit to 0.

Pseudocode description of overflow interrupt requests

See [Chapter J1 ARMv8 Pseudocode](#) for a pseudocode description of overflow interrupt requests. The [AArch64.CheckForPMUOverflow\(\)](#) and [AArch32.CheckForPMUOverflow\(\)](#) pseudocode functions signal PMU overflow interrupt requests to an interrupt controller and PMU overflow trigger events to the cross-trigger interface.

D5.4 Attributability

An event caused by the PE counting the event is Attributable. If an agent other than the PE that is counting the events causes an event, these events are Unattributable.

An event is defined as being either Attributable or Unattributable. If the event is Attributable, it is further defined whether it is Attributable to:

- The current Security state of the PE.
- The current Exception level of the PE.
- When the PE is in Debug state, operations issued to the PE by the debugger through the external debug interface.

In a multithreaded implementation, an event might be Attributable either to the current Exception level alone, or to both the Exception level and the Security state of another PE with the same values for affinity level 1 and higher.

———— **Note** ————

An implementation is described as multithreaded when the lowest level of affinity consists of logical PEs that are implemented using a multithreading type approach. In this section, when referring to a multithreaded implementation, *thread* is used to mean processing elements with different affinity level 0 values and the same values for affinity level 1 and higher.

An event can be defined as the combination of multiple subevents, which can be either Attributable or Unattributable.

All architecturally defined events are Attributable, unless otherwise stated.

Unattributable events might be counted when Attributable events are not counted. See:

- [Interaction with EL3 on page D5-2145](#).
- [Event filtering on page D5-2147](#).
- [Performance Monitors and Debug state on page D5-2149](#).

These sections are summarized by [Table D5-1](#) for events Attributable to the processor, and Unattributable events.

Table D5-1 Counting events

Counter and PMU enabled	State	Allowed or prohibited	Filtered	Event type		
				If Attributable to:	Then	Else
Yes	Non-debug	Allowed	Not filtered	X	Count	Count
			Filtered	Current Exception level	Do not count	IMPLEMENTATION DEFINED
	Prohibited	X	Current Security state	Do not count	IMPLEMENTATION DEFINED	
	Debug	X	X	Debugger operations or raw cycles	Do not count	IMPLEMENTATION DEFINED
No	X	X	X	X	Do not count	Do not count

D5.5 Effect of EL3 and EL2

This section describes the effects of implementing EL3 and EL2 on the Performance Monitors. It contains the following subsections:

- [Interaction with EL3](#).
- [Interaction with EL2 on page D5-2146](#).

D5.5.1 Interaction with EL3

While counting events is never prohibited in Non-secure state, there are some restrictions on counting events in Secure state. From reset, counting events Attributable to Secure state is prohibited in Secure state. When executing in AArch32 state, software can set [SDCR.SPME](#) to 1 to permit event counting in Secure state. In AArch64 state, software can set [MDCR_EL3.SPME](#) to 1 to permit event counting in Secure state.

———— **Note** —————

This enables a Secure Monitor to permit profiling within Secure state without having to configure an IMPLEMENTATION DEFINED debug authentication interface.

The system can use the external authentication interface to override SPME.

If EL3 is not implemented, the behavior is as if the value of [SDCR.SPME](#) or [MDCR_EL3.SPME](#) is 1, as appropriate.

Counting Attributable events in Secure state is prohibited unless any one of the following is true:

- EL3 is not implemented.
- EL3 is implemented, is using AArch64, and the value of [MDCR_EL3.SPME](#) is 1.
- EL3 is implemented, is using AArch32, and the value of [SDCR.SPME](#) is 1.
- EL3 is implemented, EL3 or EL1 is using AArch32, executing at EL0, and the value of [SDER32_EL3.SUNIDEN](#) is 1.
- In ARMv8.0 and ARMv8.1 implementations, EL3 is implemented, and counting is permitted by an IMPLEMENTATION DEFINED authentication interface, `ExternalSecureNoninvasiveDebugEnabled() == TRUE`.

———— **Note** —————

Software can read the Authentication Status register, [DBGAUTHSTATUS](#), to determine the state of an IMPLEMENTATION DEFINED authentication interface.

Software executing at EL3 can trap attempts by lower Exception levels to access the PMU. This means that the Secure monitor can identify any software which is using the PMU and switch contexts, if required.

The cycle counter, [PMCCNTR](#), counts even when event counting is prohibited, unless [PMCR.DP](#) is set to 1 or the PE is in Debug state.

The Performance Monitors registers are always accessible regardless of the values of the authentication signals and the [SDER.SUNIDEN](#) bit. Authentication controls whether the counters count events, it does not control access to the Performance Monitors registers.

For each Unattributable event, it is IMPLEMENTATION DEFINED whether it is counted when counting Attributable events is prohibited.

———— **Note** —————

- Additional controls in [PMCR](#), [HDCR](#), [PMCNTENSET](#), and [PMCNTENCLR](#) can also disable the event counters and the cycle counter.
- Controls in [PMEVTYPER<n>](#) and [PMCCFILTR](#) can also disable counting based on Exception level and Security state.

See [AArch64.CountEvents\(\)](#) and [AArch32.CountEvents\(\)](#) in [Chapter J1 ARMv8 Pseudocode](#) for more information. The [CountEvents\(\)](#) functions return TRUE if PMNx counts events or the cycle counter counts cycles at the current Exception level and state. However, these functions do not completely describe the behavior for Unattributable events.

In AArch32 state, the Performance Monitors registers are Common registers, see [Classification of System registers on page G4-4692](#).

The Performance Monitors are intended to be broadly accurate and statistically useful, see [Accuracy of the Performance Monitors on page D5-2140](#). Some inaccuracy is permitted at the point of changing Security state, however. To avoid the leaking of information from the Secure state, the permitted inaccuracy is that transactions that are not prohibited can be uncounted. Where possible, prohibited transactions must not be counted, but if they are counted, then that counting must not degrade security.

Multithreaded implementations

If an implementation is multithreaded and the value of [PMEVTYPER<n>.MT == 1](#), then the PE does not count an event that is Attributable to Secure state on another thread if counting events Attributable to Secure state is prohibited in Secure state on the PE that is counting the events.

Example D5-1 The effect of having [PMEVTYPER<n>.MT == 1](#)

If the value of [MDCR_EL3.SPME](#) is 0 on one thread, then it does not count events Attributable to Secure state on another thread, even if one or both of the following applies:

- This thread is in Non-secure state.
- [MDCR_EL3.SPME == 1](#) on the other thread.

Otherwise:

- When the current configuration prohibits counting of events Attributable to Secure state in Secure state, it is IMPLEMENTATION DEFINED whether:
 - Counting events Attributable to Secure state on this PE in Non-secure state is permitted.
 - Counting Unattributable events related to other secure operations in the system is permitted.
- Otherwise, counting events in Non-secure state is permitted.

D5.5.2 Interaction with EL2

In an implementation that includes EL2, Non-secure software executing at EL2 can:

- Trap any attempt by the Guest OS to access the PMU. This means the hypervisor can identify which Guest OSs are using the PMU and intelligently employ switching of the PMU state.
- Trap accesses to the [PMCR](#), so that it can fully virtualize the PMU identity registers, [PMCR.IMP](#) and [PMCR.IDCODE](#).
- Reserve the highest-numbered counters for its own use by overriding the value of [PMCR.N](#) seen by the Guest OS. The PE does not permit a Guest OS to access the reserved counters.

[HDCR](#) controls Performance Monitors virtualization.

- [Counter enables on page D5-2150](#).
- [Counter access on page D5-2151](#).

D5.6 Event filtering

The PMU can filter events by various combinations of Exception level and Security state. This gives software the flexibility to count events across multiple processes.

D5.6.1 Filtering by Exception level and PE state

In AArch64 state:

- For each event counter `PMEVTYPER<n>_EL0` specifies the Exception levels in which the counter counts events Attributable to Exception levels.
- `PMCCFILTR_EL0` specifies the Exception levels in which the cycle counter counts.

In an implementation that supports multithreading:

- When the value of `PMEVTYPER<n>_EL0.MT` is 1, if an event is Attributable to another thread, then the specified filtering applies to the current Exception level and PE state of the thread to which the event is attributable, regardless of the Exception level and state of the counting thread.
- When the value of `PMEVTYPER<n>_EL0.MT` is 0, the event only counts events that are attributable to the counting thread, and the filtering applies to the Exception level and PE state of the counting state, see [Example D5-2](#).

Example D5-2 Example of the effect of the `PMEVTYPER<n>_EL0.MT` control

If the value of `PMEVTYPER<n>_EL0.U` is 0 on the current thread, then it does not count events Attributable to EL0 on the other thread, even if this thread is not executing at EL0.

Otherwise, for each Unattributable event, it is IMPLEMENTATION DEFINED whether the filtering applies.

In AArch32 state, the filtering controls are provided by the `PMEVTYPER<n>` and `PMCCFILTR` registers.

For more information, see the individual register descriptions.

Reserved combinations of the filtering controls

The filtering controls are provided by the {P, U, NSK, NSU, NSH, M} fields of the controlling register, `PMEVTYPER<n>_EL0`, `PMCCFILTR_EL0`, `PMEVTYPER<n>`, or `PMCCFILTR`.

Some combinations of these fields select filtering options that do not represent a meaningful use case, and therefore these cases are reserved. [Table D5-2](#) shows these reserved filtering encodings.

Table D5-2 Reserved filter encodings

P	U	NSK	NSU	NSH	M	Exception level and state the filter applies to
0	1	1	1	x	x	Secure EL1 and Non-secure EL0 ^a
1	0	0	0	Not 0b00		EL0 and at least one of EL2 and EL3
1	0	0	1	Not 0b00		Secure EL0 and at least one of EL2 and EL3
1	0	1	1	x	x	Non-secure EL1 and Secure EL0 ^a
1	1	0	0	0	0	None
1	1	0	1	Not 0b00		Non-secure EL0 and at least one of EL2 and EL3

a. Software must not program the counter to count at EL0 in one state and at EL1 in the other state.

The reserved filtering encodings shown in [Table D5-2 on page D5-2147](#) are not UNPREDICTABLE and are not CONSTRAINED UNPREDICTABLE. Implementations must implement the filtering controls as described in the appropriate register descriptions.

D5.6.2 Accuracy of event filtering

The PMU architecture does not require event filtering to be accurate.

For most events, it is acceptable that, during a transition between states, events generated by instructions executed in one state are counted in the other state. The following sections describe the cases where event counts must not be counted in the wrong state:

- [Exception-related events](#).
- [Software increment events](#).

Exception-related events

The PMU must filter events related to exceptions and exception handling according to the Exception level in which the event occurred. These events are:

- [EXC_TAKEN on page D5-2159](#), Exception taken.
- [EXC_RETURN on page D5-2160](#), Instruction architecturally executed, Condition code check pass, exception return.
- [CID_WRITE_RETIRED on page D5-2160](#), Instruction architecturally executed, Condition code check pass, write to `CONTEXTIDR`.
- [TTBR_WRITE_RETIRED on page D5-2162](#), Instruction architecturally executed, Condition code check pass, write to translation table base.

The PMU must not count an exception after it has been taken because this could systematically report a result of zero exceptions at EL0. Similarly, it is not acceptable for the PMU to count exception returns or writes to `CONTEXTIDR` after the return from the exception.

Software increment events

The PMU must filter software increment events according to the Exception level in which the software increment occurred. Software increment counting must also be precise, meaning the PMU must count every architecturally executed software increment event, and must not count any speculatively executed software increment.

Software increment events must also be counted without the need for explicit synchronization. For example, two software increments executed without an intervening [Context synchronization event](#) must increment the event counter twice.

For more information, see [SW_INCR on page D5-2159](#), Instruction architecturally executed, Condition code check pass, software increment.

Pseudocode description of event filtering

See `AArch64.CountEvents()` and `AArch32.CountEvents()` in [Chapter J1 ARMv8 Pseudocode](#) for a pseudocode description of event filtering. However, this function does not completely describe the behavior for Unattributable events.

D5.7 Performance Monitors and Debug state

Events that count cycles are not counted in Debug state.

Events Attributable to the operations issued by the debugger through the external debug interface are not counted in Debug state.

In an implementation that supports multithreading, when the value of `PMEVTYPER<n>_EL0.MT` is 1, if an event is Attributable to an operation issued by the debugger through the external debug interface to another thread that is in Debug state, then the event is not counted, and it is IMPLEMENTATION DEFINED whether the event is counted when the counting thread is in Debug state.

For each Unattributable event, it is IMPLEMENTATION DEFINED whether it is counted when the counting PE is in Debug state. If the event might be counted, then the rules in [Filtering by Exception level and PE state on page D5-2147](#) apply for the current Security state in Debug state.

D5.8 Counter enables

Table D5-3 shows an implementation that does not include EL2, and where the `PMCR.E` bit is a global counter enable bit, and `PMCNTENSET` provides an enable bit for each counter.

Table D5-3 Event counter enables when an implementation does not include EL2

<code>PMCR.E</code>	<code>PMCNTENSET[x] == 0</code>	<code>PMCNTENSET[x] == 1</code>
0	PMNx disabled	PMNx disabled
1	PMNx disabled	PMNx enabled

If the implementation includes EL2, then in addition to the `PMCR.E` and `PMCNTENSET` enable bits:

- `HDCR.HPME` overrides the value of `PMCR.E` for counters configured for access in Hyp mode.
- `HDCR.HPMN` specifies the number of performance counters that the Guest OS can access. The minimum permitted value of `HDCR.HPMN` is 1, meaning there must be at least one counter that the Guest OS can access.

Table D5-4 shows the combined effect of all the counter enable controls.

Table D5-4 Event counter enables when an implementation includes EL2

<code>HDCR.HPME</code>	<code>PMCR.E</code>	<code>PMCNTENSET[x] == 0</code>	<code>PMCNTENSET[x] == 1</code>	
			<code>x < HDCR.HPMN</code>	<code>x ≥ HDCR.HPMN</code>
0	0	PMNx disabled	PMNx disabled	PMNx disabled
0	1	PMNx disabled	PMNx enabled	PMNx disabled
1	0	PMNx disabled	PMNx disabled	PMNx enabled
1	1	PMNx disabled	PMNx enabled	PMNx enabled

———— **Note** ————

The effect of `HDCR.{HPME, HPMN}` on the counter enables applies in both Security states. However, in Secure state the value returned for `PMCR.N` is not affected by `HDCR.HPMN`.

EL2 does not affect the enabling of `PMCCNTR`. Table D5-5 shows the `PMCCNTR` enables, for all implementations.

Table D5-5 Cycle counter enables

<code>PMCR.E</code>	<code>PMCNTENSET[31] == 0</code>	<code>PMCNTENSET[31] == 1</code>
0	<code>PMCCNTR</code> disabled	<code>PMCCNTR</code> disabled
1	<code>PMCCNTR</code> disabled	<code>PMCCNTR</code> enabled

D5.9 Counter access

All implemented counters are accessible in EL3, Secure EL1 and EL2. If EL2 is implemented the hypervisor uses [HDCR.HPMN](#) to reserve an event counter, with the effect that software cannot access that counter and its associated state from Non-secure EL1 or from Non-secure EL0.

———— **Note** —————

This section describes a counter as being accessible from a particular Exception level and state. However, access to the registers is subject to the access permissions described in [Access permissions on page D5-2176](#). In particular, accesses from EL0 might be UNDEFINED and accesses might be trapped to EL1 or EL2.

D5.9.1 PMNx event counters

For an implementation that includes EL2 and EL3, [Table D5-6](#) shows how the values of the [HDCR.HPMN](#) field control the behavior of accesses to the PMNx event counter registers.

Table D5-6 Result of PMNx event counter accesses

Condition	Secure state			Non-secure state		
	EL3	EL1	EL0	EL2	EL1	EL0
$x < \text{HDCR.HPMN}$	Succeeds	Succeeds	Succeeds	Succeeds	Succeeds	Succeeds
$x \geq \text{HDCR.HPMN}$	Succeeds	Succeeds	Succeeds	Succeeds	No access	No access

Where [Table D5-6](#) shows no access:

- If [PMSELR.SEL](#) is x then:
 - A direct read of [PMXEVTYPER](#) or [PMXEVCNTR](#) is CONSTRAINED UNPREDICTABLE.
 - A direct write to [PMXEVTYPER](#) or [PMXEVCNTR](#) is CONSTRAINED UNPREDICTABLE.
- A direct read of [PMEVTYPER<n>](#) or [PMEVCNTR<n>](#) is CONSTRAINED UNPREDICTABLE.
- A direct write of [PMEVTYPER<n>](#) or [PMEVCNTR<n>](#) is CONSTRAINED UNPREDICTABLE.
- For direct reads and direct writes, [PMOVSCLR\[x\]](#), [PMOVSSSET\[x\]](#), [PMCNTENSET\[x\]](#), [PMCNTENCLR\[x\]](#), [PMINTENSET\[x\]](#), and [PMINTENCLR\[x\]](#) are RAZ/WI.
- Direct writes to [PMSWINC\[x\]](#) are ignored.
- A direct write of 1 to [PMCR.P](#) does not reset PMNx.

For more information on the CONSTRAINED UNPREDICTABLE behavior of the Performance Monitor Extension, see:

- For AArch32, [The Performance Monitors Extension on page K1-6103](#).
- For AArch64, [The Performance Monitors Extension on page K1-6121](#).

———— **Note** —————

In Secure state, and in the Non-secure EL2 mode, the value of [HDCR.HPMN](#) does not affect the value returned for [PMCR.N](#).

D5.9.2 Cycle counter

The PMU does not provide any control that a hypervisor can use to reserve the cycle counter for its own use. The only control over the cycle counter is an access permission control for EL0. See [Access permissions on page D5-2176](#).

D5.10 Events, event numbers, and mnemonics

The following sections describe the events that can be counted and their associated event numbers, and the mnemonics for the events:

- [Definitions](#).
- [The event number space on page D5-2156](#).
- [Common event numbers on page D5-2156](#).
- [Common architectural event numbers on page D5-2159](#).
- [Common microarchitectural event numbers on page D5-2163](#).
- [Meaningful ratios between common microarchitectural events on page D5-2174](#).
- [Required events on page D5-2174](#).
- [IMPLEMENTATION DEFINED event numbers on page D5-2175](#).

D5.10.1 Definitions

The following subsections give more information about terms used in the event definitions:

- [Definition of terms](#).
- [Levels of caches and TLBs on page D5-2155](#).
- [Shared caches and buses on page D5-2155](#).

Definition of terms

Speculatively executed

Many events relate to speculatively executed operations. Here, speculatively executed means the PE did some work associated with one or more instructions but the instructions were not necessarily architecturally executed.

An instruction might create one or more *microarchitectural operations* (μ -ops) at any point in the execution pipeline. For the purpose of event counting, the μ -ops are counted. The definition of a μ -op is implementation specific. An architecture instruction might create more than one μ -op for each instruction. μ -ops might also be removed or merged in the execution stream, so an architecture instruction might create no μ -ops for an instruction. Any arbitrary translation of instructions to an equivalent sequence of μ -ops is permitted.

This means there is no architecturally guaranteed relationship between a speculatively executed μ -op and an architecturally executed instruction. The results of such an operation can also be discarded, if it transpires that the operation was not required, such as a mispredicted branch. Therefore, ARMv8-A defines these events as *operation speculatively executed*, where appropriate.

———— Note —————

The definition of *speculatively executed* does not mean only those operations that are executed speculatively and later abandoned, for example due to a branch misprediction or fault. That is, speculatively executed operations must count operations on both false and correct execution paths.

The counting of operations can indicate the workload on the PE. However, there is no requirement for operations to represent similar amounts of work, and direct comparisons between different microarchitectures are not meaningful.

For example, an implementation might split an A32 or T32 LDM instruction of six registers into six μ -ops, one for each load, and a seventh address-generation operation to determine the base address or writeback address. Also, for doubleword alignment, the six load μ -ops might combine into four operations, that is, a word load, two doubleword loads, and a second word load. This single instruction can then be counted as five, or possibly six, events:

- Four (Operation speculatively executed - Load) events.
- One (Operation speculatively executed - Integer data processing) event.
- One (Operation speculatively executed - Software change of the PC) event if the PC was one of the six registers in the LDM instruction.

Different groups of events can have different IMPLEMENTATION DEFINED definitions of speculatively executed. Such groups share a common base type, which the event name denotes. Each of the events in the previous example is of the base type, operation speculatively executed.

For groups of events with a common base type, speculatively executed operations are all counted on the same basis, which normally means at the same point in the pipeline. It is possible to compare the counts and make meaningful observations about the program being profiled.

Within these groups, events are commonly defined with reference to a particular architecture instruction or group of instructions. In the case of speculatively executed operations this means operations with semantics that map to that type of instruction.

Instruction memory access

A PE acquires instructions for execution through instruction fetches. Instruction fetches might be due to:

- Fetching instructions that are architecturally executed.
- The result of the execution of an instruction preload instruction, PLI.
- Speculation that a particular instruction might be executed in the future.

The relationship between the fetch of an individual instruction and an instruction memory access is IMPLEMENTATION DEFINED. For example, an implementation might fetch many instructions including a non-integer number of instructions in a single instruction memory access.

Memory-read operations

A PE accesses memory through memory-read and memory-write operations. A memory-read operation might be due to:

- The result of an architecturally executed memory-reading instructions.
- The result of a speculatively executed memory-reading instructions.
- A translation table walk.

For levels of cache hierarchy beyond the Level 1 caches, memory-read operations also include accesses made as part of a refill of another cache closer to the PE. Such refills might be due to:

- Memory-read operations or memory-write operations that miss in the cache
- The execution of a data preload instruction.
- The execution of an instruction preload instruction on a unified cache.
- The execution of a cache maintenance instruction.

———— **Note** —————

A preload instruction or cache maintenance instruction is not, in itself, an access to that cache. However, it might generate cache refills which are then treated as memory-read operations beyond that cache.

- Speculation that a future instruction might access the memory location.

This list is not exhaustive.

The relationship between memory-read instructions and memory-read operations is IMPLEMENTATION DEFINED. For example, for some implementations an LDP instruction that reads two 64-bit registers might generate one memory-read operation if the address is quadword-aligned, but for other addresses it generates two or more memory-read operations.

Memory-write operations

Memory-write operations might be due to:

- The result of an architecturally executed memory-writing instructions.
- The result of a speculatively executed memory-writing instructions.

———— **Note** —————

Speculatively executed memory-writing instructions that do not become architecturally executed must not alter the architecturally defined view of memory. They can, however, generate a memory-write operation that is later undone in some implementation specific way.

For levels of cache hierarchy beyond the Level 1 caches, memory-write operations also include accesses made as part of a write-back from another cache closer to the PE. Such write-backs might be due to:

- Evicting a dirty line from the cache, to allocate a cache line for a cache refill, see memory-read operations.
- The execution of a cache maintenance instruction.

———— **Note** —————

A cache maintenance instruction is not in itself an access to that cache. However, it might generate write-backs which are then treated as memory-write operations beyond that cache.

- The result of a coherency request from another PE.

This list is not exhaustive.

The relationship between memory-writing instructions and memory-write operations is IMPLEMENTATION DEFINED. For example, for some implementations an STP instruction that writes two 64-bit registers might generate one memory-write operation if the address is quadword-aligned, but for other addresses it generates two or more memory-write operations. In some implementations, the result of two STR instructions that write to adjacent memory might be merged into a single memory-write operation.

———— **Note** —————

The data written back from a cache that is shared with other PEs might not be data that was written by the PE that performs the operation that leads to the write-back. Nevertheless, the event is counted as a write-back event for that PE.

Instruction architecturally executed

Instruction architecturally executed is a class of event that counts for each instruction of the specified type. Architecturally executed means that the program flow is such that the counted instruction would be executed in a *Simple sequential execution* of the program. Therefore an instruction that has been executed and retired is defined to be *architecturally executed*. When a PE can perform speculative execution, an instruction is not architecturally executed if the PE discards the results of the speculative execution.

If an instruction that would be executed in a *Simple sequential execution* of the program generates a synchronous exception, it is IMPLEMENTATION DEFINED whether the instruction is counted.

Each architecturally executed instruction is counted once, even if the implementation splits the instruction into multiple operations. Instructions that have no visible effect on the architectural state of the PE are architecturally executed if they form part of the architecturally executed program flow. The point where such instructions are retired is IMPLEMENTATION DEFINED.

Examples of instructions that have no visible effect are:

- A NOP.
- A conditional instruction that fails its Condition code check.
- A Compare and Branch on Zero, CBZ, instruction that does not branch.
- A Compare and Branch on Nonzero, CBNZ, instruction that does not branch.

The point at which an event causes an event counter to be updated is not defined.

Unless otherwise stated, all instructions of the specified type are counted even if they have no visible effect on the architectural state of the PE. This includes a conditional instruction that fails its Condition code check.

For events that count only the execution of instructions that update context state, such as writes to the `CONTEXTIDR`, if such an instruction is executed twice without an intervening *Context synchronization event*, it is CONSTRAINED UNPREDICTABLE whether the first instruction is counted.

Instruction architecturally executed, Condition code check pass

Instruction architecturally executed, Condition code check pass is a class of events that explicitly do not occur for:

- A conditional instruction that fails its Condition code check.
- A Compare and Branch on Zero, CBZ, instruction that does not branch.
- A Compare and Branch on Nonzero, CBNZ, instruction that does not branch.
- A Test and Branch on Zero, TBZ, instruction that does not branch.
- A Test and Branch on Nonzero, TBNZ, instruction that does not branch.
- A Store-Exclusive instruction that does not write to memory.

Otherwise, the definition of architecturally executed is the same as for *Instruction architecturally executed*.

Levels of caches and TLBs

The mapping of different levels of cache or TLB to the PMU events is determined by the implementation. Although the `CLIDR_EL1`, or the AArch32 `CLIDR`, defines the implemented levels of cache, the architecture does provide any way of determining implemented levels of TLB. Also, many implementations include structures that provide some caching at a higher level than the level 1 caches or TLBs. Typically, these structures, that might be called Level 0 caches, or mini caches, or microcaches, are invisible to software. The implementation-specific nature of cache and TLB implementations mean that, in general, PMU event counts cannot be used reliably to make direct comparisons between different implementations.

Shared caches and buses

There is no architectural concept of a *shared* component. However, when a cache, a bus, or any other system component that might generate countable events is implemented, and:

- The extent of the first-order effects due to an event from that component are only applicable to a single PE, then the event is not shared.
- Otherwise, the event is shared.

Second-order effects are not considered when determining if an event is shared.

Example D5-3 First and second order effects of a cache miss in a multiple-PE implementation

In an implementation that consists of two PEs, each with its own L1 cache, a cache miss by one of the PEs is a first-order effect of an access to its cache. Any snoop that is performed on the L1 cache of the other PE in the implementation as a result of that cache miss is a second order effect.

————— **Note** —————

Shared events are inherently linked to microarchitectures and so the implementer must make an informed decision about how such events are implemented.

D5.10.2 The event number space

In ARMv8.0, the event number space is 12 bits. ARMv8.1 extends the event number space to 16 bits, and is allocated as follows:

0x0000-0x003F and 0x4000-0x403F

Common architectural and microarchitectural events, discoverable using PMCEID<n>_EL0.

ARM defines these event numbers. Supported events in this range can be discovered using:

- The PMCEID0_EL0 and PMCEID1_EL0 registers in AArch64 state.
- The PMCEID0 and PMCEID1 registers in AArch32 state.

For more information see:

- [Common event numbers](#).
- [Common architectural event numbers on page D5-2159](#).
- [Common microarchitectural event numbers on page D5-2163](#).

0x0040-0x00BF and 0x4040-0x40BF

ARM recommended common architectural and microarchitectural events.

These events are IMPLEMENTATION DEFINED. For more information see:

- [IMPLEMENTATION DEFINED event numbers on page D5-2175](#).
- [Appendix K3 Recommendations for Performance Monitors Event Numbers for IMPLEMENTATION DEFINED Events](#).

0x8000-0x80BF and 0xC000-0xC0BF

Reserved.

All other values

IMPLEMENTATION DEFINED events.

For more information see [IMPLEMENTATION DEFINED event numbers on page D5-2175](#).

To address this extended number space, the PMEVTYPER<n>_EL0.evtCount is extended to 16 bits.

D5.10.3 Common event numbers

The event numbers of the common events are reserved for the specified events. Each of these event numbers must either:

- Be used for its assigned event.
- Not be used.

However, see [Required events on page D5-2174](#).

When an implementation supports monitoring of an event that is assigned a common event number, ARM strongly recommends that it uses that number for the event. However, software might encounter implementations where an event assigned a number in this range is monitored using an event number from the IMPLEMENTATION DEFINED range.

———— Note —————

ARM might define other common event numbers. This is one reason why software must not assume that an event with an assigned common event number is never monitored using an event number from the IMPLEMENTATION DEFINED range.

Table D5-7 lists the PMU architectural and microarchitectural event numbers in event number order. The entries in the *Event mnemonic* column link to the event description in *Common architectural event numbers on page D5-2159* or *Common microarchitectural event numbers on page D5-2163*.

Table D5-7 PMU event numbers

Event number	Event type	Event mnemonic	Description
0x0000	Architectural	SW_INCR	Instruction architecturally executed, Condition code check pass, software increment
0x0001	Microarchitectural	L1I_CACHE_REFILL ^a	Attributable Level 1 instruction cache refill
0x0002	Microarchitectural	L1I_TLB_REFILL ^a	Attributable Level 1 instruction TLB refill
0x0003	Microarchitectural	L1D_CACHE_REFILL ^a	Attributable Level 1 data cache refill
0x0004	Microarchitectural	L1D_CACHE	Attributable Level 1 data cache access
0x0005	Microarchitectural	L1D_TLB_REFILL ^a	Attributable Level 1 data TLB refill
0x0006	Architectural	LD_RETIRED	Instruction architecturally executed, Condition code check pass, load
0x0007	Architectural	ST_RETIRED	Instruction architecturally executed, Condition code check pass, store
0x0008	Architectural	INST_RETIRED	Instruction architecturally executed
0x0009	Architectural	EXC_TAKEN	Exception taken
0x000A	Architectural	EXC_RETURN	Instruction architecturally executed, Condition code check pass, exception return
0x000B	Architectural	CID_WRITE_RETIRED	Instruction architecturally executed, Condition code check pass, write to CONTEXTIDR
0x000C	Architectural	PC_WRITE_RETIRED	Instruction architecturally executed, Condition code check pass, software change of the PC
0x000D	Architectural	BR_IMMED_RETIRED	Instruction architecturally executed, immediate branch
0x000E	Architectural	BR_RETURN_RETIRED	Instruction architecturally executed, Condition code check pass, procedure return
0x000F	Architectural	UNALIGNED_LDST_RETIRED	Instruction architecturally executed, Condition code check pass, unaligned load or store
0x0010	Microarchitectural	BR_MIS_PRED	Mispredicted or not predicted branch speculatively executed
0x0011	Microarchitectural	CPU_CYCLES	Cycle
0x0012	Microarchitectural	BR_PRED	Predictable branch speculatively executed
0x0013	Microarchitectural	MEM_ACCESS	Data memory access
0x0014	Microarchitectural	L1I_CACHE	Attributable Level 1 instruction cache access
0x0015	Microarchitectural	L1D_CACHE_WB	Attributable Level 1 data cache write-back
0x0016	Microarchitectural	L2D_CACHE	Attributable Level 2 data cache access
0x0017	Microarchitectural	L2D_CACHE_REFILL ^a	Attributable Level 2 data cache refill

Table D5-7 PMU event numbers (continued)

Event number	Event type	Event mnemonic	Description
0x0018	Microarchitectural	L2D_CACHE_WB	Attributable Level 2 data cache write-back
0x0019	Microarchitectural	BUS_ACCESS	Bus access
0x001A	Microarchitectural	MEMORY_ERROR	Local memory error
0x001B	Microarchitectural	INST_SPEC	Operation speculatively executed
0x001C	Architectural	TTBR_WRITE_RETIRED	Instruction architecturally executed, Condition code check pass, write to TTBR
0x001D	Microarchitectural	BUS_CYCLES	Bus cycle
0x001E	Architectural	CHAIN	For odd-numbered counters, increments the count by one for each overflow of the preceding even-numbered counter. For even-numbered counters, there is no increment.
0x001F	Microarchitectural	L1D_CACHE_ALLOCATE	Attributable Level 1 data cache allocation without refill
0x0020	Microarchitectural	L2D_CACHE_ALLOCATE	Attributable Level 2 data cache allocation without refill
0x0021	Architectural	BR_RETIRED	Instruction architecturally executed, branch
0x0022	Microarchitectural	BR_MIS_PRED_RETIRED	Instruction architecturally executed, mispredicted branch
0x0023	Microarchitectural	STALL_FRONTEND	No operation issued due to the frontend
0x0024	Microarchitectural	STALL_BACKEND	No operation issued due to backend
0x0025	Microarchitectural	L1D_TLB	Attributable Level 1 data or unified TLB access
0x0026	Microarchitectural	L1I_TLB	Attributable Level 1 instruction TLB access
0x0027	Microarchitectural	L2I_CACHE	Attributable Level 2 instruction cache access
0x0028	Microarchitectural	L2I_CACHE_REFILL ^a	Attributable Level 2 instruction cache refill
0x0029	Microarchitectural	L3D_CACHE_ALLOCATE	Attributable Level 3 data or unified cache allocation without refill
0x002A	Microarchitectural	L3D_CACHE_REFILL ^a	Attributable Level 3 data or unified cache refill
0x002B	Microarchitectural	L3D_CACHE	Attributable Level 3 data or unified cache access
0x002C	Microarchitectural	L3D_CACHE_WB	Attributable Level 3 data or unified cache write-back
0x002D	Microarchitectural	L2D_TLB_REFILL ^a	Attributable Level 2 data or unified TLB refill
0x002E	Microarchitectural	L2I_TLB_REFILL ^a	Attributable Level 2 instruction TLB refill
0x002F	Microarchitectural	L2D_TLB	Attributable Level 2 data or unified TLB access
0x0030	Microarchitectural	L2I_TLB	Attributable Level 2 instruction TLB access

a. For more information, see [Meaningful ratios between common microarchitectural events on page D5-2174](#).

The `PMCEID0_EL0` and `PMCEID1_EL0` registers identify the events that an implementation supports.

Future revisions of this manual, or of the architecture, might define additional common event numbers. Events that do not require additional features in the PMU can be implemented retrospectively, meaning such events can be supported as part of a PMUv3 implementation.

Note

This means that an ARMv7 PMUv2 implementation can include support for any of the event numbers defined in [Table D5-7 on page D5-2157](#).

D5.10.4 Common architectural event numbers

This section describes the defined common architectural event numbers.

For the common features, normally the counters must increment only once for each event. The event descriptions include any exceptions to this rule.

In these definitions, the term *architecturally executed* means that the instruction flow is such that the counted instruction would have been executed in a *Simple sequential execution* model.

The common architectural event numbers are:

0x0000, SW_INCR, Instruction architecturally executed, Condition code check pass, software increment

The counter increments on writes to the [PMSWINC](#) register.

If the PE performs two architecturally executed writes to the [PMSWINC](#) register without an intervening *Context synchronization event*, then the counter is incremented twice.

If [PMEVTYPER<n>_EL0.evtCount](#) is set to 0x000, then in AArch64 state, counts MSR writes to [PMSWINC_EL0](#) with bit [n] set to 1.

If the value of [PMEVTYPER<n>_EL0.MT](#) is 1 then, in a multithreaded implementation, this counts writes by all PEs that have the same affinity at level 1 and above.

0x0006, LD_RETIRED, Instruction architecturally executed, Condition code check pass, load

The counter increments for every executed memory-reading instruction.

Note

This event 0x006 does not count the return status value of a Store-Exclusive instruction.

Whether the preload instructions PRFM, PLD, PLDW, PLI, count as memory-reading instructions is IMPLEMENTATION DEFINED. ARM recommends that if the instruction is not implemented as a NOP then it is counted as a memory-reading instruction.

0x0007, ST_RETIRED, Instruction architecturally executed, Condition code check pass, store

The counter increments for every executed memory-writing instruction.

DC ZVA is counted as a store.

The counter does not increment for a Store-Exclusive instruction that fails.

0x0008, INST_RETIRED, Instruction architecturally executed

The counter increments for every architecturally executed instruction.

0x0009, EXC_TAKEN, Exception taken

The counter increments for each exception taken. See [Exception-related events on page D5-2148](#).

Note

The counter counts the PE exceptions described in:

- For exceptions taken to an Exception level using AArch64, [Exception entry on page D1-1799](#).
 - For exceptions taken to an Exception level using AArch32, [AArch32 state exception descriptions on page G1-4376](#).
-

0x000A, EXC_RETURN, Instruction architecturally executed, Condition code check pass, exception return

The counter increments for each executed exception return instruction. See also [Exception-related events on page D5-2148](#). The following sections define the counted instructions:

- For an exception return from an Exception level using AArch64, [Exception return on page D1-1815](#).
- For an exception return from an Exception level using AArch32, [Exception return instructions on page G1-4360](#).

0x000B, CID_WRITE_RETIRED, Instruction architecturally executed, Condition code check pass, write to CONTEXTIDR

The counter increments for every write to `CONTEXTIDR`. See [Exception-related events on page D5-2148](#).

If the PE performs two architecturally-executed writes to `CONTEXTIDR` without an intervening [Context synchronization event](#), it is CONSTRAINED UNPREDICTABLE whether the first write is counted.

When ARMv8.1-VHE is implemented, the counter is:

- Incremented as a result of the retirement of an instruction accessing the named register `CONTEXTIDR_EL1`, even when executing at EL2.
- Not incremented as a result of the retirement of an instruction accessing the named `CONTEXTIDR_EL12`.

———— **Note** —————

The event is defined by the name used to access the register. The counter does not count writes to the named register `CONTEXTIDR_EL2`.

0x000C, PC_WRITE_RETIRED, Instruction architecturally executed, Condition code check pass, software change of the PC

The counter increments for every software change of the PC. This includes all:

- Branch instructions.
- Memory-reading instructions that explicitly write to the PC.
- Data-processing instructions that explicitly write to the PC.
- Exception return instructions, ERET and RET.

It is IMPLEMENTATION DEFINED whether the counter increments for any or all of:

- BRK and BKPT instructions.
- An exception generated because an instruction is UNDEFINED.
- The exception-generating instructions, SVC, HVC, and SMC.

It is IMPLEMENTATION DEFINED whether an ISB is counted as a software change of the PC.

The counter does not increment for exceptions other than those explicitly identified in these lists.

———— **Note** —————

Conditional branches are only counted if the branch is taken.

0x000D, BR_IMMED_RETIRED, Instruction architecturally executed, immediate branch

The counter counts all immediate branch instructions that are architecturally executed.

In AArch32 state, the counter increments each time the PE executes one of the following instructions:

- B{<c>} <label>.
- BL{<c>} <label>.
- BLX{<c>} <label>.
- CBZ <Rn>, <label>.
- CBNZ <label>.

In AArch64 state, the counter increments each time the PE executes an immediate branch instructions:

- B <label>.
- B.cond <label>.
- BL <label>.
- CBZ <Rn>, <label>.
- CBNZ <Rn>, <label>.
- TBZ <Rn>, <label>.
- TBNZ <Rn>, <label>.

———— **Note** ————

Conditional branches are always counted, regardless of whether the branch is taken.

If an ISB is counted as a software change of the PC instruction, then it is IMPLEMENTATION DEFINED whether an ISB is counted as an immediate branch instruction.

0x000E, BR_RETURN_RETIRED, Instruction architecturally executed, Condition code check pass, procedure return

In AArch32 state, the counter counts the following procedure return instructions:

- BX R14.
- MOV PC, LR.
- POP {..., PC}.
- LDR PC, [SP], #offset.

———— **Note** ————

The counter counts only the listed instructions as procedure returns. For example, it does not count the following as procedure return instructions:

- BX R0, because Rm != R14.
- MOV PC, R0, because Rm != R14.
- LDM SP, {..., PC}, because writeback is not specified.
- LDR PC, [SP, #offset], because this specifies the wrong addressing mode.

In AArch64 state, the counter counts all architecturally executed RET instructions.

0x000F, UNALIGNED_LDST_RETIRED, Instruction architecturally executed, Condition code check pass, unaligned load or store

The counter counts each memory-reading instruction or memory-writing instruction access that would generate an Alignment fault when Alignment fault checking is enabled.

This event does not count accesses that would generate an SP alignment fault exception if the applicable stack pointer alignment check is enabled, unless that access would also generate an Alignment fault Data Abort exception if Alignment fault checking is enabled.

It is IMPLEMENTATION DEFINED whether this event counts accesses that generate an exception, including accesses that do generate Alignment fault Data Abort exceptions.

See *SP alignment checking on page D1-1793* for more information.

See [Unaligned data access](#) on page E2-2777 for more information.

0x001C, TTBR_WRITE_RETIRED, Instruction architecturally executed, Condition code check pass, write to TTBR

The counter counts writes to [TTBR0_EL1](#) and [TTBR1_EL1](#) in AArch64 state and [TTBR0](#) and [TTBR1](#) in AArch32 state. When EL3 is implemented and using AArch32, this includes counting writes to both banked copies of [TTBR0](#) and [TTBR1](#). See [Exception-related events](#) on page D5-2148.

If the PE executes two writes to the same [TTBR](#), without an intervening [Context synchronization event](#), it is CONSTRAINED UNPREDICTABLE whether the first write to the [TTBR](#), is counted.

If EL3 is implemented and using AArch64, the counter does not count writes to [TTBR0_EL3](#).

If EL2 is implemented and using AArch64, the counter does not count writes to [TTBR0_EL2](#) and to [VTBR_EL2](#).

If EL2 is implemented and using AArch32, the counter does not count writes to [HTTBR](#) and to [VTBR](#).

When ARMv8.1-VHE is implemented, the counter is:

- Incremented as a result of the retirement of an instruction accessing the named registers [TTBR0_EL1](#) and [TTBR1_EL1](#).
- Not incremented as a result of the retirement of an instruction accessing the named registers [TTBR0_EL12](#) and [TTBR1_EL12](#).

0x001E, CHAIN

For an odd-numbered counter, increments when an overflow occurs on the preceding even-numbered counter on the same PE. Even-numbered counters never increment as a result of this event. This means the CHAIN event links the odd-numbered counter with the preceding even-numbered counter to provide a 64-bit counter.

Note

- The CHAIN event means a system can provide N 32-bit counters, $N/2$ 64-bit counters, or a mixture of 32-bit counters and 64-bit counters.
- The CHAIN event only counts overflows from the preceding even-numbered counter on the same PE. This means it is unaffected by the value of [PMEVTYPEPER<n>_EL0.MT](#).

There is no atomic access to a pair of counters, so if software reads a counter-pair that is enabled, it must use a high-low-high read sequence, or employ reasonable heuristics, to avoid tearing. Similarly, if using CHAIN events, when disabling the counters software must take care that the result is not torn by the low counter overflowing at the same time as the counters are disabled [Example D5-4](#) shows suitable sequences for disabling and enabling CHAIN counters.

Example D5-4 Usage examples for 64-bit counters

An example high-low-high read sequence for a 64-bit counter is:

```
MRS W2,PMEVCNTR1_EL0    ;; read high counter, must be odd-numbered
retry:
  ISB                    ;; force ordering
  MRS W0,PMEVCNTR0_EL0  ;; read low counter
                        ;; must return the previous counter to PMEVCNTR1_EL0
  ISB                    ;; force ordering
  MRS W1,PMEVCNTR1_EL0  ;; read high counter
  CMP W1,W2
  BNE retry              ;; if the high counter has changed, then retry
```

When disabling a pair of counters that are paired by a CHAIN event, software must:

1. Disable the low counter, by setting [PMCNTENCLR_EL0\[n\]](#) to 1.
Typically, software uses a read-modify-write sequence to update [PMCNTENCLR_EL0](#).
2. Execute an ISB instruction, or perform another [Context synchronization event](#).

3. Disable the high counter, by setting `PMCNTENCLR_EL0[n+1]` to 1, or setting `PMCR_EL0.E` to 0.

When enabling a pair of counters that are paired by a CHAIN event, software must:

1. Enable the high counter, by setting `PMCNTENCLR_EL0[n+1]` to 0 and, if necessary, setting `PMCR_EL0.E` to 1.
2. Execute an ISB instruction, or perform another *Context synchronization event*.
3. Enable the low counter by setting `PMCNTENCLR_EL0[n]` to 0.

When using 64-bit counters, the architecture does not define the latency between the first counter overflowing and the second counter incrementing the CHAIN event. There is no requirement for updates to occur synchronously, but software reading or enabling the counter pair using a *low-ISB-high* sequence, as shown in [Example D5-4 on page D5-2162](#), must not observe the low counter incrementing and overflowing for the event and the high counter not incrementing for the resulting CHAIN event. This means that the ISB executed after reading the low counter must ensure the completion of the update of the high counter by the CHAIN event.

———— **Note** ————

The way the CHAIN event operates means that, to filter the Exception levels and Security states in which the event is counted, software must:

- Program `PMEVTYPER<n>_EL0` to count the event in the required conditions.
- Program `PMEVTYPER<n+1>_EL0` to count the CHAIN event in all Exception levels and states.

0x0021, BR_RETIRED, Instruction architecturally executed, branch.

The counter counts all branches on the architecturally executed path that would incur cost if mispredicted.

- Counts all branch instructions, memory-reading and data-processing instructions that explicitly write to the PC, at retirement.
- Counts both taken and not-taken branches.
- It is IMPLEMENTATION DEFINED whether this includes each of:
 - Unconditional direct branch instructions.
 - Exception-generating instructions.
 - Exception return instructions.
 - Context synchronization instructions.

D5.10.5 Common microarchitectural event numbers

This section describes the defined common microarchitectural event numbers.

The common microarchitectural events are features that are likely to be implemented across a wide range of implementations. Unlike the common architectural events, there can be some IMPLEMENTATION DEFINED variation between definitions on different implementations.

Unless otherwise stated, the common microarchitectural features relate only to events resulting from the operation of the PE counting the events. Events resulting from the operation of other PEs that might share a resource must not be counted. Where a resource can be subject to events that do not result from the operation of any of the PEs that share it, ARM recommends that the resource implements its own event counters. An example of a resource that might require its own event counters is a shared Level 2 cache that is subject to accesses from a system coherency port on that cache.

The event definitions relating to Level 2 caches generally assume the Level 2 cache is shared. The event definitions relating to Level 1 caches generally assume the Level 1 cache is not shared.

The common microarchitectural event numbers are:

0x0001, L1I_CACHE_REFILL, Attributable Level 1 instruction cache refill

The counter counts Attributable instruction memory accesses that cause a refill of at least the Level 1 instruction or unified cache. This includes each instruction memory access that causes a refill from outside the cache. It excludes accesses that do not cause a new cache refill but are satisfied from refilling data of a previous miss.

A refill includes any access that causes data to be fetched from outside the cache, even if the data is ultimately not allocated into the cache. For example, data might be fetched into a buffer but then discarded, rather than being allocated into a cache. These buffers are treated as part of the cache.

The counter does not count cache maintenance instructions.

See also:

- [Attributability on page D5-2144.](#)
- [Meaningful ratios between common microarchitectural events on page D5-2174.](#)

0x0002, L1I_TLB_REFILL, Attributable Level 1 instruction TLB refill

The counter counts Attributable instruction memory accesses that cause a TLB refill of at least the Level 1 instruction TLB. This includes each instruction memory access that causes an access to a level of memory system due to a translation table walk or an access to another level of TLB caching. It is IMPLEMENTATION DEFINED whether the count increments when:

- A refill results in a Translation fault.
- A refill is not allocated in the TLB.

The counter does not count:

- A TLB miss that does not cause a refill but does generate a translation table walk.
- TLB maintenance instructions.

See also:

- [Attributability on page D5-2144.](#)
- [Meaningful ratios between common microarchitectural events on page D5-2174.](#)

0x0003, L1D_CACHE_REFILL, Attributable Level 1 data cache refill

The counter counts each Attributable memory-read operation or Attributable memory-write operation that causes a refill of at least the Level 1 data or unified cache from outside the Level 1 cache. Each access to a cache line that causes a new linefill is counted, including those from instructions that generate multiple accesses, such as load or store multiples, and PUSH and POP instructions. In particular, the counter counts accesses to the Level 1 cache that cause a refill that is satisfied by another Level 1 data or unified cache, or a Level 2 cache, or memory.

A refill includes any access that causes data to be fetched from outside the cache, even if the data is ultimately not allocated into the cache. For example, data might be fetched into a buffer but then discarded, rather than being allocated into a cache. These buffers are treated as part of the cache.

The counter does not count:

- Accesses that do not cause a new Level 1 cache refill but are satisfied from refilling data of a previous miss.
- Accesses to a cache line that generate a memory access but not a new linefill, such as write-through writes that hit in the cache.
- Cache maintenance instructions.
- A write that writes an entire line to the cache and does not fetch any data from outside the Level 1 cache, for example:
 - A write of a full cache line from a coalescing buffer.
 - A DC ZVA operation.
- A write that misses in the cache, and writes through the cache without allocating a line.

See also:

- [Attributability on page D5-2144.](#)

- [Meaningful ratios between common microarchitectural events on page D5-2174.](#)

0x0004, L1D_CACHE, Attributable Level 1 data cache access

The counter counts each Attributable memory-read operation or Attributable memory-write operation that causes a cache access to at least the Level 1 data or unified cache. Each access to a cache line is counted including the multiple accesses of instructions, such as LDM or STM. Each access to other Level 1 data or unified memory structures, for example refill buffers, write buffers, and write-back buffers, is also counted.

The counter does not count cache maintenance instructions.

See also [Attributability on page D5-2144.](#)

0x0005, L1D_TLB_REFILL, Attributable Level 1 data TLB refill

The counter counts each Attributable memory-read operation or Attributable memory-write operation that causes a TLB refill of at least the Level 1 data or unified TLB. It counts each read or write that causes a refill, in the form of a translation table walk or an access to another level of TLB caching. It is IMPLEMENTATION DEFINED whether the count increments when:

- A refill results in a Translation fault.
- A refill is not allocated in the TLB.

The counter does not count:

- A TLB miss that does not cause a refill but does generate a translation table walk.
- TLB maintenance instructions.

See also:

- [Attributability on page D5-2144.](#)
- [Meaningful ratios between common microarchitectural events on page D5-2174.](#)

0x0010, BR_MIS_PRED, Mispredicted or not predicted branch speculatively executed

The counter counts each correction to the predicted program flow that occurs because of a misprediction from, or no prediction from, the branch prediction resources and that relates to instructions that the branch prediction resources are capable of predicting.

If no program-flow prediction resources are implemented, ARM recommends that the counter counts all branches that are not taken.

0x0011, CPU_CYCLES, Cycle

The counter increments on every cycle.

All counters are subject to changes in clock frequency, including when a WFI or WFE instruction stops the clock. This means that it is CONSTRAINED UNPREDICTABLE whether or not CPU_CYCLES continues to increment when the clocks are stopped by WFI and WFE instructions.

———— **Note** —————

Unlike [PMCCNTR](#), this count is not affected by [PMCR.DP](#), [PMCR.D](#), or [PMCR.C](#):

- The counter is not incremented in prohibited regions, so is not affected by [PMCR.DP](#).
- The counter increments on every cycle, regardless of the setting of [PMCR.D](#).
- The counter is reset when event counters are reset by [PMCR.P](#), never by [PMCR.C](#).

In a multithreaded implementation, CPU_CYCLES counts each cycle for the processor for which this PE thread was active and could issue an instruction. For more information, see [Cycle event counting on multithreaded implementations on page D5-2173.](#)

0x0012, BR_PRED, Predictable branch speculatively executed

The counter counts every branch or other change in the program flow that the branch prediction resources are capable of predicting.

If all branches are subject to prediction, for example a BTB or BTAC, then all branches are predictable branches.

If branches are decoded before the predictor, so that the branch prediction logic dynamically predicts only some branches, for example conditional and indirect branches, then it is IMPLEMENTATION DEFINED whether other branches are counted as predictable branches. ARM recommends that all branches are counted.

An implementation might include other structures that predict branches, such as a loop buffer that predicts short backwards direct branches as taken. Each execution of such a branch is a predictable branch. Terminating the loop might generate a misprediction event that is counted by [BR_MIS_PRED](#).

If no program-flow prediction resources are implemented, this event is optional, but ARM recommends that BR_PRED counts all branches.

0x0013, MEM_ACCESS, Data memory access

The counter counts memory-read or memory-write operations that the PE made. The counter increments whether the access results in an access to a Level 1 data or unified cache, a Level 2 data or unified cache, or neither of these.

The counter does not increment as a result of:

- Instruction memory accesses, see [Definition of terms on page D5-2152](#).
- Translation table walks.
- Cache maintenance instructions.
- Write-back from any cache.
- Refilling of any cache.

0x0014, L1I_CACHE, Attributable Level 1 instruction cache access

The counter counts Attributable instruction memory accesses that access at least the Level 1 instruction or unified cache. Each access to other Level 1 instruction memory structures, such as refill buffers, is also counted.

See also [Attributability on page D5-2144](#).

0x0015, L1D_CACHE_WB, Attributable Level 1 data cache write-back

The counter counts every write-back of data from the Level 1 data or unified cache. The counter counts each write-back that causes data to be written from the Level 1 cache to outside of the Level 1 cache. For example, the counter counts the following cases:

- A write-back that causes data to be written to a Level 2 cache or memory.
- A write-back of a recently fetched cache line that has not been allocated to the Level 1 cache.
- Transfer of data from the Level 1 cache to outside of this cache made as a result of a coherency request. The conditions determining which of these are counted for transfers to other Level 1 caches within the same multiprocessor cluster are IMPLEMENTATION DEFINED.

Each write-back is counted once, even if multiple accesses are required to complete the write-back.

Whether write-backs made as a result of cache maintenance instructions is IMPLEMENTATION DEFINED.

The counter does not count:

- The invalidation of a cache line without any write-back to a Level 2 cache or memory.
- Writes from the PE that write through the Level 1 cache to outside of the Level 1 cache.

An Unattributable write-back event occurs when a requestor outside the PE makes a coherency request that results in write-back. If the cache is shared, then an Unattributable write-back event is not counted. If the cache is not shared, then the event is counted. See [Attributability on page D5-2144](#).

It is IMPLEMENTATION DEFINED whether a write of a whole cache line that is not the result of the eviction of a line from the cache, is counted. For example, this applies when the PE determines streaming writes to memory and does not allocate lines to the cache, or by a DC ZVA operation.

See also [Attributability on page D5-2144](#).

0x0016, L2D_CACHE, Attributable Level 2 data cache access

The counter counts Attributable memory-read or Attributable memory-write operations, that the PE made, that access at least the Level 2 data or unified cache. Each access to a cache line is counted including refills of and write-backs from the Level 1 data, instruction, or unified caches. Each access to other Level 2 data or unified memory structures, such as refill buffers, write buffers, and write-back buffers, is also counted.

The counter does not count:

- Operations made by other PEs that share this cache.
- Cache maintenance instructions.

See also [Attributability](#) on page D5-2144.

0x0017, L2D_CACHE_REFILL, Attributable Level 2 data cache refill

The counter counts Attributable memory-read or Attributable memory-write operations, that the PE made, that access at least the Level 2 data or unified cache and cause a refill of a Level 1 data, instruction, or unified cache or of the Level 2 data or unified cache. Each read from or write to the cache that causes a refill from outside the Level 1 and Level 2 caches is counted.

A refill includes any access that causes data to be fetched from outside the cache, even if the data is ultimately not allocated into the cache. For example, data might be fetched into a buffer but then discarded, rather than being allocated into a cache. These buffers are treated as part of the cache.

For example, the counter counts:

- Accesses to the Level 2 cache that cause a refill that is satisfied by another Level 2 cache, a Level 3 cache, or memory.
- Refills of and write-backs from any Level 1 data, instruction or unified cache that cause a refill from outside the Level 1 and Level 2 caches.
- Accesses to the Level 2 cache that cause a refill of a Level 1 cache from outside of the Level 1 and Level 2 caches, even if there is no refill of the Level 2 cache.

The counter does not count, as events on this PE:

- Accesses that do not cause a new cache refill but are satisfied from refilling data of a previous miss.
- Accesses to the Level 2 cache that generate a memory access but not a new linefill, such as write-through writes that hit in the Level 2 cache.
- Accesses to the Level 2 cache that are part of a Level 1 cache refill or write-back that hit in the Level 2 cache so do not cause a refill from outside of the Level 1 and Level 2 caches.
- Operations made by other PEs that share this cache.
- Cache maintenance instructions.
- A write that writes an entire line to the cache and does not fetch any data from outside the Level 1 and Level 2 caches, for example:
 - A write-back from a Level 1 cache to a Level 2 cache.
 - A write from a coalescing buffer of a full cache line.
 - A DC ZVA operation.
- A write that misses in the cache, and writes through the cache without allocating a line.

See also:

- [Attributability](#) on page D5-2144.
- [Meaningful ratios between common microarchitectural events](#) on page D5-2174.

0x0018, L2D_CACHE_WB, Attributable Level 2 data cache write-back

The counter counts every write-back of data from the Level 2 data or unified cache that occurs as a result of an operation by this PE. It counts each write-back that causes data to be written from the Level 2 cache to outside the Level 1 and Level 2 caches. For example, the counter counts:

- A write-back that causes data to be written to a Level 3 cache or memory.
- A write-back of a recently fetched cache line that has not been allocated to the Level 2 cache.

Each write-back is counted once, even if it requires multiple accesses to complete the write-back.

It is IMPLEMENTATION DEFINED whether the counter counts:

- A transfer of data from the Level 2 cache to outside the Level 1 and Level 2 cache made as a result of a coherency request.
- Write-backs made as a result of Cache maintenance instructions.

The counter does not count:

- The invalidation of a cache line without any write-back to a Level 3 cache or memory.
- Writes from the PE or Level 1 data or unified cache that write through the Level 2 cache to outside the Level 1 and Level 2 caches.
- Transfers of data from the Level 2 cache to a Level 1 cache, to satisfy a Level 1 cache refill.

An Unattributable write-back event occurs when a requestor outside the PE makes a coherency request that results in write-back. If the cache is shared, then an Unattributable write-back event is not counted. If the cache is not shared, then the event is counted.

It is IMPLEMENTATION DEFINED whether a write of a whole cache line that is not the result of the eviction of a line from the cache, is counted. For example, this applies when the PE determines streaming writes to memory and does not allocate lines to the cache, or by a DC ZVA operation.

See also [Attributability on page D5-2144](#).

0x0019, **BUS_ACCESS, Attributable Bus access**

The counter counts memory-read or memory-write operations that access outside of the boundary of the PE and its closely-coupled caches. Where this boundary lies with respect to any implemented caches is IMPLEMENTATION DEFINED.

The definition of a bus access is IMPLEMENTATION DEFINED but physically is a single beat rather than a burst. That is, for each bus cycle for which the bus is active.

Bus accesses include refills of and write-backs from data, instruction, and unified caches. Whether bus accesses include operations that do use the bus but not explicitly transfer data is IMPLEMENTATION DEFINED.

An Unattributable bus access occurs when a requestor outside the PE makes a request that results in a bus access, for example, a coherency request. If the bus is shared, then an Unattributable bus access is not counted. If the bus is not shared, then the event is counted.

If the bus is shared, then only Attributable bus accesses are counted. If the bus is not shared, then all bus accesses are counted.

Where an implementation has multiple buses at this boundary, this event counts the sum of accesses across all buses.

If a bus supports multiple accesses per cycle, for example through multiple channels, the counter increments once for each channel that is active on a cycle, and so it might increment by more than one in any given cycle.

The maximum increment in any given cycle is IMPLEMENTATION DEFINED.

See also:

- [Attributability on page D5-2144](#).
- [Meaningful ratios between common microarchitectural events on page D5-2174](#).

0x001A, **MEMORY_ERROR, Local memory error**

The counter counts every occurrence of a memory error signaled by a memory closely coupled to this PE. The definition of local memories is IMPLEMENTATION DEFINED but includes caches, tightly-coupled memories, and TLB arrays.

Memory error refers to a physical error detected by the hardware, such as a parity or ECC error. It includes errors that are correctable and those that are not. It does not include errors as defined in the architecture, such as MMU faults.

0x001B, INST_SPEC, Operation speculatively executed

The counter counts instructions that are speculatively executed by the PE. This includes instructions that are subsequently not architecturally executed. As a result, this event counts a larger number of instructions than the number of instructions architecturally executed. The definition of speculatively executed is IMPLEMENTATION DEFINED.

0x001D, BUS_CYCLES, Bus cycle

The counter increments on every cycle of the interface at the boundary of the PE and its closely-coupled caches. Where this boundary lies with respect to any implemented caches is IMPLEMENTATION DEFINED.

———— **Note** —————

If the implementation clocks the external memory interface at the same rate as the processor hardware, the counter counts every cycle.

See also [Meaningful ratios between common microarchitectural events on page D5-2174](#).

0x001F, L1D_CACHE_ALLOCATE, Attributable Level 1 data cache allocation without refill

The counter increments on every Attributable write that writes an entire line into the Level 1 cache without fetching from outside the Level 1 cache, for example:

- A write from a coalescing buffer of a full cache line.
- A DC ZVA operation.

See also [Attributability on page D5-2144](#).

0x0020, L2D_CACHE_ALLOCATE, Attributable Level 2 data cache allocation without refill

The counter increments on every Attributable write that writes an entire line into the Level 2 cache without fetching from outside the Level 1 or Level 2 caches, for example:

- A write-back from a Level 1 to Level 2 cache.
- A write from a coalescing buffer of a full cache line.
- A DC ZVA operation.

See also [Attributability on page D5-2144](#).

0x0022, BR_MIS_PRED_RETIRED, Instruction architecturally executed, mispredicted branch

The counter counts all instructions counted by BR_RETIRED that were not correctly predicted. If no program-flow prediction resources are implemented, this event counts all retired not-taken branches.

0x0023, STALL_FRONTEND, No operation issued due to the frontend

The counter counts every cycle counted by the CPU_CYCLES event on which no operation was issued because there are no operations available to issue for this PE from the frontend.

The division between frontend and backend is IMPLEMENTATION DEFINED. Frontend and backend events must count at the same point in the pipeline.

———— **Note** —————

- For a simplified pipeline model of Fetch → Decode → Issue → Execute → Retire, ARM recommends that the events are counted when instructions are dispatched from Decode to Issue.
- On a given cycle, both events might be counted if the backend is unable to accept any operations and there are no operations available to issue from the frontend.

For more information, see [Cycle event counting on multithreaded implementations on page D5-2173](#).

0x0024, STALL_BACKEND, No operation issued due to the backend

The counter counts every cycle counted by the [CPU_CYCLES](#) event on which no operation was issued because either:

- The backend is unable to accept any of the operations available for issue for this PE.
- The backend is unable to accept any operations.

For example, the back end might be unable to accept operations because of a resource conflict or non-availability.

The division between frontend and backend is IMPLEMENTATION DEFINED. Frontend and backend events must count at the same point in the pipeline. See [STALL_FRONTEND](#) for more information.

For more information, see [Cycle event counting on multithreaded implementations on page D5-2173](#).

0x0025, L1D_TLB, Attributable Level 1 data or unified TLB access

The counter counts each Attributable memory-read operation or Attributable memory-write operation that causes a TLB access to at least the Level 1 data or unified TLB. Each access to a TLB record is counted including the multiple accesses of instructions, such as LDM or STM.

The counter does not count TLB maintenance instructions.

See also [Attributability on page D5-2144](#).

0x0026, L1I_TLB, Attributable Level 1 instruction TLB access

The counter counts each Attributable instruction memory access that causes a TLB access to at least the Level 1 instruction or unified TLB.

The counter does not count TLB maintenance instructions.

See also [Attributability on page D5-2144](#).

0x0027, L2I_CACHE, Attributable Level 2 instruction cache access

The counter counts Attributable instruction memory accesses that access at least the Level 2 instruction or unified cache. Each Attributable access to other Level 2 instruction memory structures, such as refill buffers, is also counted.

See also [Attributability on page D5-2144](#).

0x0028, L2I_CACHE_REFILL, Attributable Level 2 instruction cache refill

The counter counts Attributable instruction memory accesses that cause a refill of at least the Level 2 instruction or unified cache. This includes each Attributable memory access that causes a refill from outside the cache. It excludes accesses that do not cause a new cache refill but are satisfied from refilling data of a previous miss.

A refill includes any Attributable access that causes data to be fetched from outside the cache, even if the data is ultimately not allocated into the cache. For example, data might be fetched into a buffer but then discarded, rather than being allocated into a cache. These buffers are treated as part of the cache.

The counter does not count cache maintenance instructions.

See also:

- [Attributability on page D5-2144](#).
- [Meaningful ratios between common microarchitectural events on page D5-2174](#).

0x0029, L3D_CACHE_ALLOCATE, Attributable Level 3 data cache allocation without refill

The counter increments on every Attributable write that writes an entire line into the Level 3 cache without fetching from outside the Level 1, Level 2, or Level 3 cache, for example:

- A write-back from a Level 2 to Level 3 cache.
- A write from a coalescing buffer of a full cache line.
- A DC ZVA operation.

See also [Attributability on page D5-2144](#).

0x002A, L3D_CACHE_REFILL, Attributable Level 3 data cache refill

The counter counts each Attributable memory-read operation or Attributable memory-write operation that the PE makes that accesses at least the Level 3 data or unified cache and causes a refill of a Level 1 or Level 2 instruction, data, or unified cache or of the Level 3 data or unified cache. Each read from or write to the cache that causes a refill from outside the Level 1, Level 2, and Level 3 caches is counted.

A refill includes any access that causes data to be fetched from outside the cache, even if the data is ultimately not allocated into the cache. For example, data might be fetched into a buffer but then discarded, rather than being allocated into a cache. These buffers are treated as part of the cache.

The counter does not count as events on this PE:

- Accesses that do not cause a new cache refill but are satisfied from refilling data of a previous miss.
- Accesses to the Level 3 cache that generate a memory access but not a new linefill, such as write-through writes that hit in the Level 3 cache.
- Accesses to the Level 3 cache that are part of a Level 1 or Level 2 cache refill or write-back that hit in the Level 3 cache so do not cause a refill from outside of the Level 1, Level 2, and Level 3 caches.
- Operations made by other PEs that share this cache.
- Cache maintenance instructions.
- A write that writes an entire line to the cache and does not fetch any data from outside the Level 1, Level 2, and Level 3 cache, for example:
 - A write-back from a Level 2 to Level 3 cache.
 - A write of a full cache line from a coalescing buffer.
 - A DC ZVA operation.
- A write that misses in the cache, and writes through the cache without allocating a line.

See also:

- [Attributability on page D5-2144](#).
- [Meaningful ratios between common microarchitectural events on page D5-2174](#).

0x002B, L3D_CACHE, Attributable Level 3 data cache access

The counter counts Attributable memory-read or Attributable memory-write operations, that the PE made, that access at least the Level 3 data or unified cache. Each access to a cache line is counted including refills of and write-backs from the Level 1 or Level 2 data, instruction, or unified caches. Each access to other Level 3 data or unified memory structures, such as refill buffers, write buffers, and write-back buffers, is also counted.

The counter does not count:

- Operations made by other PEs that share the Level 3 data or unified cache.
- Cache maintenance instructions.

See also [Attributability on page D5-2144](#).

0x002C, L3D_CACHE_WB, Attributable Level 3 data cache write-back

The counter counts every write-back of data from the Level 3 data or unified cache that occurs as a result of an operation by this PE. It counts each write-back that causes data to be written from the Level 3 cache to outside of the Level 1, Level 2, and Level 3 caches. For example, the counter counts the following cases:

- A write-back that causes data to be written to a Level 4 cache, or to memory.
- A write-back of a recently fetched cache line that has not been allocated to the Level 3 cache.

Each write-back is counted once, even if multiple accesses are required to complete the write-back.

It is IMPLEMENTATION DEFINED whether the counter counts:

- A transfer of data from the Level 3 cache to outside the Level 1, Level 2, and Level 3 caches made as a result of a coherency request.

- A write-back made as a result of a Cache maintenance instruction.

The counter does not count:

- The invalidation of a cache line without any write-back to a Level 4 cache or memory.
- Writes from the PE, Level 1, or Level 2 data or unified cache, that write through the Level 3 cache to outside of the Level 3 cache.
- Transfers of data from the Level 3 cache to a Level 1 or Level 2 cache, to satisfy a Level 1 or Level 2 cache refill.

An Unattributable write-back event occurs when a requestor outside the PE makes a coherency request that results in write-back. If the cache is shared, then Unattributable write-back events are not counted. If the cache is not shared, then Unattributable write-back events are counted.

It is IMPLEMENTATION DEFINED whether a write of a whole cache line that is not the result of the eviction of a line from the cache, is counted. For example, this applies when the PE determines streaming writes to memory and does not allocate lines to the cache, or by a DC ZVA operation.

See also [Attributability on page D5-2144](#).

0x002D, L2D_TLB_REFILL, Attributable Level 2 data TLB refill

The counter counts each Attributable memory-read operation or Attributable memory-write operation that causes a TLB refill of at least the Level 2 data or unified TLB. It counts each Attributable read or Attributable write that causes a refill, in the form of a translation table walk or an access to another level of TLB caching. It is IMPLEMENTATION DEFINED whether the count increments when:

- A refill results in a Translation fault.
- A refill is not allocated in the TLB.

The counter does not count:

- A TLB miss that does not cause a refill but does generate a translation table walk.
- TLB maintenance instructions.

See also:

- [Attributability on page D5-2144](#).
- [Meaningful ratios between common microarchitectural events on page D5-2174](#).

0x002E, L2I_TLB_REFILL, Attributable Level 2 instruction TLB refill

The counter counts Attributable instruction memory accesses that cause a TLB refill of at least the Level 2 instruction TLB. This includes each Attributable instruction memory access that causes an access to a level of memory system due to a translation table walk or an access to another level of TLB caching. It is IMPLEMENTATION DEFINED whether the count increments when:

- A refill results in a Translation fault.
- A refill is not allocated in the TLB.

The counter does not count:

- A TLB miss that does not cause a refill but does generate a translation table walk.
- TLB maintenance instructions.

See also:

- [Attributability on page D5-2144](#).
- [Meaningful ratios between common microarchitectural events on page D5-2174](#).

0x002F, L2D_TLB, Attributable Level 2 data or unified TLB access

The counter counts each Attributable memory read operation or Attributable memory write operation that causes a TLB access to at least the Level 2 data or unified TLB. Each access to a TLB record is counted, including the multiple accesses of instructions such as LDM or STM.

The counter does not count TLB maintenance instructions.

See also [Attributability on page D5-2144](#).

0x0030, L2I_TLB, Attributable Level 2 instruction TLB access

The counter counts each Attributable memory read operation or Attributable memory write operation that causes a TLB access to at least the Level 2 instruction or unified TLB.

The counter does not count TLB maintenance instructions.

See also [Attributability](#) on page D5-2144.

D5.10.6 Cycle event counting on multithreaded implementations

For most events, the event is only counted when it is attributable to the counting PE or thread, see [Attributability](#) on page D5-2144.

Multithreaded implementations can have various forms, some examples of these are:

- *Simultaneous Multithreading* (SMT), where every PE thread is active on every cycle.
- *Fine-grained Multithreading* (FGMT), also known as a Barrel processor, where one PE thread is active on each cycle, and this changes regularly.
- *Switch on Event Multithreading* (SoEMT), also known as *Coarse-grained Multithreading* (CGMT), where high latency events cause the processor to switch the active PE thread.

In the above examples, active means that the PE might execute the instructions. A PE can be active but not executing instructions when no instruction is available or because of limited execution resources.

When the `PMEVTYPER<n>_EL0.MT` bit is set to 0, the `CPU_CYCLES` event only counts cycles on which the thread was active. For the example multithreaded implementations, this means that:

- For an SMT implementation, the `CPU_CYCLES` event counts every cycle.
- For a particular FGMT implementation, that alternates between two threads on each cycle, the `CPU_CYCLES` event counts every other cycle.
- For a particular SoEMT implementation, that is waiting for a long latency operation, the `CPU_CYCLES` event does not count cycles, as the PE thread is not active.

If the `PMEVTYPER<n>_EL0.MT` bit is set to 1, the processor counts each cycle, and can only count a maximum of one cycle each cycle.

In addition, the `STALL_FRONTEND` and `STALL_BACKEND` events only count cycles that are counted by the `CPU_CYCLES` event, and so have the same limitation. For example, in an SMT implementation, if a PE thread cannot issue an instruction because of contention with other PE threads, these are counted as `STALL_BACKEND` cycles.

If the `PMEVTYPER<n>_EL0.MT` bit is set to 1, the PE only counts cycles on which no operation is issued from any thread.

———— **Note** —————

The `PMCCNTR` register counts every processor cycle.

—————

D5.10.7 Meaningful ratios between common microarchitectural events

The architecture highlights some meaningful ratios that can be derived from the common microarchitectural events. Table D5-8 lists the highlighted ratios.

Table D5-8 REFILL events and associated access events

Numerator	Denominator	Ratio
0x0001 L1I_CACHE_REFILL	0x0014 L1I_CACHE	Attributable Level 1 instruction cache refill rate
0x0002 L1I_TLB_REFILL	0x0026 L1I_TLB	Attributable Level 1 instruction TLB refill rate
0x0003 L1D_CACHE_REFILL	0x0004 L1D_CACHE	Attributable Level 1 data or unified cache refill rate
0x0005 L1D_TLB_REFILL	0x0025 L1D_TLB	Attributable Level 1 data or unified TLB refill rate
0x0017 L2D_CACHE_REFILL	0x0016 L2D_CACHE	Attributable Level 2 data or unified cache refill rate
0x0028 L2I_CACHE_REFILL	0x0027 L2I_CACHE	Attributable Level 2 instruction cache refill rate
0x002A L3D_CACHE_REFILL	0x002B L3D_CACHE	Attributable Level 3 data or unified cache refill rate
0x002D L2D_TLB_REFILL	0x002F L2D_TLB	Attributable Level 2 data or unified TLB refill rate
0x002E L2I_TLB_REFILL	0x0030 L2I_TLB	Attributable Level 2 instruction TLB refill rate
0x0019 BUS_ACCESS	0x001D BUS_CYCLES	Attributable Bus accesses per cycle

D5.10.8 Required events

PMUv3 requires that an implementation includes the following common events:

- 0x0000, [SW_INCR](#), Instruction architecturally executed, Condition code check pass, software increment.
- 0x0003, [L1D_CACHE_REFILL](#), Attributable Level 1 data cache refill.

———— **Note** —————

Event 0x0003 is only required if the implementation includes a Level 1 data or unified cache.

- 0x0004, [L1D_CACHE](#), Attributable Level 1 data cache access.

———— **Note** —————

Event 0x0004 is only required if the implementation includes a Level 1 data or unified cache.

- 0x0010, [BR_MIS_PRED](#), Mispredicted or not predicted branch speculatively executed.

———— **Note** —————

Event 0x0010 is only required if the implementation includes program-flow prediction. However, ARM recommends that the event is implemented as described in [Common microarchitectural event numbers on page D5-2163](#).

- 0x0011, [CPU_CYCLES](#), Cycle.
- 0x0012, [BR_PRED](#), Predictable branch speculatively executed.

———— **Note** —————

Event 0x0012 is only required if the implementation includes program-flow prediction. However, ARM recommends that the event is implemented as described in [Common microarchitectural event numbers on page D5-2163](#).

- At least one of:
 - 0x0008, [INST_RETIRED](#), Instruction architecturally executed.
 - 0x001B, [INST_SPEC](#), Operation speculatively executed.

———— **Note** —————

ARM strongly recommends that event 0x008 is implemented.

- When [ARMv8.1-PMU](#) is implemented:
 - 0x0023, [STALL_FRONTEND](#), No operation issued due to the frontend.
 - 0x0024, [STALL_BACKEND](#), No operation issued due to the backend.

D5.10.9 IMPLEMENTATION DEFINED event numbers

For IMPLEMENTATION DEFINED event numbers, each counter is defined, independently, to either:

- Increment only once for each event.
- Count the duration for which an event occurs.

ARM recommends that implementers establish a standardized numbering scheme for their IMPLEMENTATION DEFINED events, with common definitions, and common count numbers, applied to all of their implementations. In general, the recommended approach is for standardization across implementations with common features. However, ARM recognizes that attempting to standardize the encoding of microarchitectural features across too wide a range of implementations is not productive.

ARM strongly recommends that at least the following classes of event are identified in the IMPLEMENTATION DEFINED events:

- Cumulative duration of stalls resulting from the holes in the instruction availability, separating out counts for key buffering points that might exist.
- Cumulative duration of data-dependent stalls, separating out counts for key dependency classes that might exist.
- Cumulative duration of stalls due to unavailability of execution resources, including, for example, write buffers, separating out counts for key resources that might exist.
- Missed superscalar issue opportunities, if relevant, separating out counts for key classes of issue that might exist.
- Miss rates for different levels of caches and TLBs.
- Any external events passed to the PE through an IMPLEMENTATION DEFINED mechanism.
- Cumulative duration of a [PSTATE](#). {A, I, F} interrupt mask set to 1.
- Cumulative occupancy for resource queues, such as data access queues, and entry/exit counts, so that average latencies can be determined, separating out counts for key resources that might exist. An implementation might also provide registers in the IMPLEMENTATION DEFINED space to further extend such counts, for example by specifying a minimum latency for an event to be counted.
- Any other microarchitectural features that the implementer considers are valuable to count.

The IMPLEMENTATION DEFINED event numbers are 0x040 to 0x3FF. [Appendix K3 Recommendations for Performance Monitors Event Numbers for IMPLEMENTATION DEFINED Events](#) lists the ARM recommended standardized numbering scheme for these events.

D5.11 Performance Monitors Extension registers

The following section describes the Performance Monitors Extension registers.

The following subsections give general information about the Performance Monitors Extension registers, that apply for both Execution states:

- [Relationship between AArch32 and AArch64 Performance Monitors registers.](#)
- [Access permissions.](#)

[Performance Monitors Extension registers, functional group on page G4-4738](#) summarizes the Performance Monitors Extension registers in AArch32 state.

[Instructions for accessing non-debug System registers on page C5-323](#) summarizes the Performance Monitors Extension registers in AArch64 state.

D5.11.1 Relationship between AArch32 and AArch64 Performance Monitors registers

[Table K11-2 on page K11-6284](#) lists the Performance Monitors register names for AArch32 and AArch64 states.

D5.11.2 Access permissions

Each Exception level is able to control Performance Monitors System register accesses at lower Exception levels. The access control flow is:

1. At EL0:
 - Writes to [PMUSERENR](#) are UNDEFINED.
 - Reads and writes of [PMINTENSET](#) and [PMINTENCLR](#) are UNDEFINED.
 - If [PMUSERENR.EN](#) == 0:
 - If [PMUSERENR.SW](#) == 0 then writes to [PMSWINC](#) are trapped to EL1.
 - If [PMUSERENR.CR](#) == 0 then reads of [PMCCNTR](#) are trapped to EL1.
 - If [PMUSERENR.ER](#) == 0 then reads of [PMEVCNTR<n>](#) and [PMXVCNTR](#), and reads and writes of [PMSELR](#), are trapped to EL1.
 - Otherwise, for all other Performance Monitors registers, other than reads of [PMUSERENR](#), reads and writes are trapped to EL1.

———— **Note** —————

If [HCR.TGE](#)==1, then all exceptions that would be taken to EL1 are instead taken to EL2.

2. Otherwise, at EL1 and EL0 in Non-secure state, if EL2 is implemented:
 - If [HDCR.TPMCR](#) == 1 then accesses to [PMCR](#) are trapped to EL2.
 - If [HDCR.TPM](#) == 1 then accesses to all Performance Monitors registers, including [PMCR](#), are trapped to EL2.
3. Otherwise, at EL2, EL1 and EL0, if EL3 is implemented and using AArch64, and if [MDCR_EL3.TPM](#) == 1 then accesses to all Performance Monitors registers are trapped to EL3.

———— **Note** —————

These traps are not possible if EL3 is using AArch32.

4. Otherwise, the access is permitted.

———— **Note** —————

These traps and enables only apply to System register accesses using System register access instructions. For accesses through the optional memory-mapped or external debug interfaces, see [Access permissions for external views of the Performance Monitors on page I2-5739](#).

For details of the headings used in Table D5-9, see *Configurable instruction enables and disables, and trap controls* on page D1-1842. In addition, the following terms are used:

Instruction This shows the access instruction, read (MRS), write (MSR), or both (-). In AArch32 state, the equivalent instructions are MRC and MCR.

Default access

If the *Default access* is - then the access is trapped from EL0 to EL1 unless the **PMUSERENR enables** are set to 1.

Resultant access permission

This indicates the resulting access permission provided the enables at EL0 are enabled and the traps to EL2 or EL3 are disabled.

Table D5-9 shows the access permissions for System register accesses to the Performance Monitors registers.

Table D5-9 Access permissions for the Performance Monitors System registers

Register	Instruction	At EL0:		Traps from below to:		Resultant access permission
		Default access	PMUSERENR enables	EL2	EL3 ^a	
PMCR	-	-	EN	TPMCR or TPM	TPM	RW
PMCNTENSET	-	-	EN	TPM	TPM	RW
PMCNTENCLR	-	-	EN	TPM	TPM	RW
PMOVSCLR	-	-	EN	TPM	TPM	RW
PMSWINC	-	-	EN or SW	TPM	TPM	WO
PMSELR	-	-	EN or ER	TPM	TPM	RW
PMCEID0	-	-	EN	TPM	TPM	RO
PMCEID1	-	-	EN	TPM	TPM	RO
PMCCNTR	Read	-	EN or CR	TPM	TPM	RW
	Write	-	EN			
PMXEVTYPER	-	-	EN	TPM	TPM	RW
PMXEVCNTR	Read	-	EN or ER	TPM	TPM	RW
	Write	-	EN			
PMUSERENR	Read	RO	-	TPM	TPM	RW
	Write	UND	-			
PMINTENSET	-	UND	-	TPM	TPM	RW
PMINTENCLR	-	UND	-	TPM	TPM	RW
PMOVSSSET	-	-	EN	TPM	TPM	RW

Table D5-9 Access permissions for the Performance Monitors System registers (continued)

Register	Instruction	At EL0:		Traps from below to:		Resultant access permission
		Default access	PMUSERENR enables	EL2	EL3 ^a	
PMEVCNTR<n>	Read	-	EN or ER	TPM	TPM	RW
	Write	-	EN			
PMEVTYPER<n>	-	-	EN	TPM	TPM	RW
PMCCFILTR	-	-	EN	TPM	TPM	RW

a. Only if EL3 is using AArch64.

Chapter D6

The Generic Timer in AArch64 state

This chapter describes the implementation of the ARM Generic Timer. It includes an overview of the AArch64 System register interface to an ARM Generic Timer.

It contains the following sections:

- [About the Generic Timer on page D6-2180.](#)
- [The AArch64 view of the Generic Timer on page D6-2184.](#)

[Chapter G5 The Generic Timer in AArch32 state](#) describes the AArch32 view of the Generic Timer, and [Chapter I1 System Level Implementation of the Generic Timer](#) describes the system level implementation of the Generic Timer.

D6.1 About the Generic Timer

Figure D6-1 shows an example system-on-chip that uses the Generic Timer as a system timer. In this figure:

- This manual defines the architecture of the individual PEs in the multiprocessor blocks.
- The *ARM Generic Interrupt Controller Architecture Specification* defines a possible architecture for the interrupt controllers.
- Generic Timer functionality is distributed across multiple components.

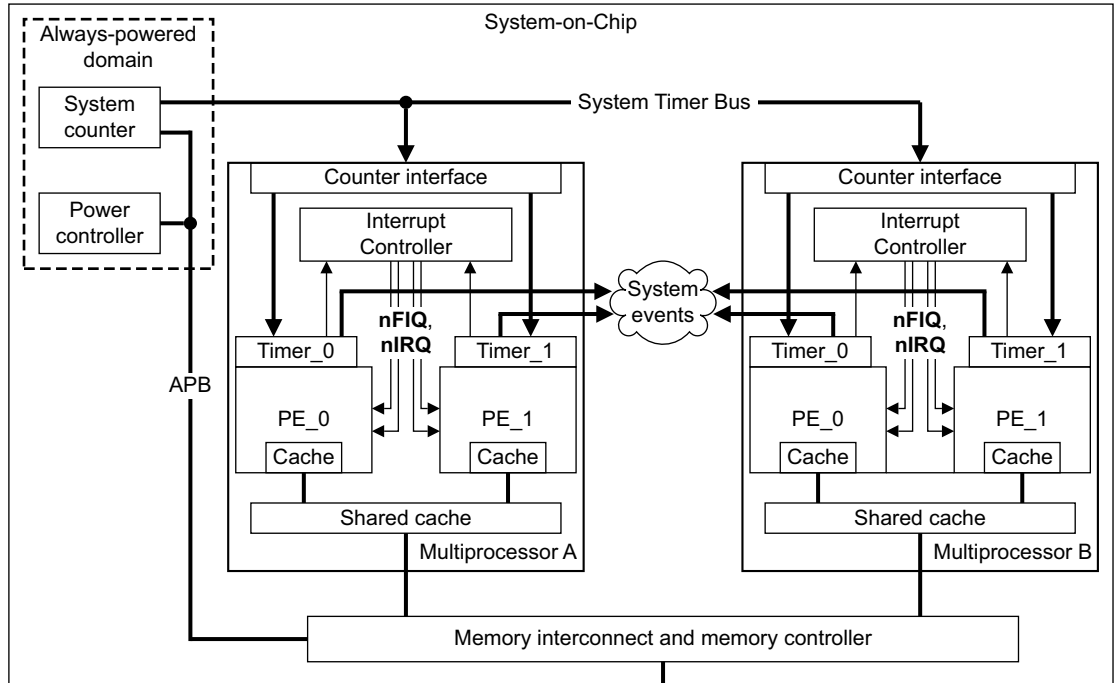

Figure D6-1 Generic Timer example

The Generic Timer:

- Provides a system counter, that measures the passing of time in real-time.

———— **Note** ————

The Generic Timer can also provide other components at a system level, but Figure D6-1 does not show any such components.

- Supports *virtual counters* that measure the passing of virtual-time. That is, a virtual counter can measure the passing of time on a particular virtual machine.
- Timers, that can trigger events after a period of time has passed. The timers:
 - Can be used as count-up or as count-down timers.
 - Can operate in real-time or in virtual-time.

This chapter describes an instance of the Generic Timer component that Figure D6-1 shows as Timer_0 or Timer_1 within the Multiprocessor A or Multiprocessor B block. This component can be accessed from AArch64 state or AArch32 state, and this chapter describes access from AArch64 state. Chapter G5 *The Generic Timer in AArch32 state* describes access to this component from AArch32 state.

A Generic Timer implementation must also include a memory-mapped system component. This component:

- Must provide the System counter shown in Figure D6-1
- Optionally, can provide timer components for use at a system level.

Chapter I1 *System Level Implementation of the Generic Timer* describes this memory-mapped component.

D6.1.1 The full set of Generic Timer components

Within a system that might include multiple PEs, a full set of Generic Timer components is as follows:

The system counter

This provides a uniform view of system time, see [The system counter on page D6-2182](#). Because this must be implemented at the system level, it is accessed through [The system level memory-mapped implementation of the Generic Timer](#). However, during initialization, a status register in each implemented timer in the system must be programmed with the frequency of the system counter, so that software can read this frequency.

PE implementations of the Generic Timer

Each PE implementation of the Generic Timer provides the following components:

- A physical counter, that gives access to the count value of the system counter.
- A virtual counter, that gives access to virtual time. In AArch64 state, the `CNTVOFF_EL2` register defines the offset between physical time, as defined by the value of the system counter, and virtual time.
- A number of timers. In an implementation where all Exception levels are implemented and can use AArch64 state, the timers that are accessible from AArch64 state are:
 - An EL1 physical timer.
 - An EL2 physical timer.
 - An EL3 physical timer.
 - A virtual timer.

[The AArch64 view of the Generic Timer on page D6-2184](#) describes these components.

The system level memory-mapped implementation of the Generic Timer

The memory-mapped registers that control the components of the system level implementation of the Generic Timer are grouped into *frames*. The Generic Timer architecture defines the offset of each register within its frame, but the base address of each frame is IMPLEMENTATION DEFINED, and defined by the system.

Each system level component has one or two register frames. The possible system level components are:

The memory-mapped counter module, required

This module controls the system counter. It has two frames:

- A control frame, `CNTControlBase`.
- A status frame, `CNTReadBase`.

The memory-mapped timer control module, required

The system level implementation of the Generic Timer can provide up to eight timers, and the memory-mapped timer control module identifies:

- Which timers are implemented.
- The features of each implemented timer.

This module has a single frame, `CNTCTLBase`.

Memory-mapped timers, optional

An implemented memory-mapped timer:

- Must provide a privileged view of the timer, in the `CNTBase N` frame.
- Optionally, provides an unprivileged view of the timer in the `CNTELOBase N` frame.

N is the timer number, and the corresponding frame number, in the range 0-7.

[Chapter 11 System Level Implementation of the Generic Timer](#) describes these components.

D6.1.2 The system counter

The Generic Timer provides a system counter with the following specification:

Width	At least 56 bits wide. The value returned by any 64-bit read of the counter is zero-extended to 64 bits.
Frequency	Increments at a fixed frequency, typically in the range 1-50MHz. Can support one or more alternative operating modes in which it increments by larger amounts at a lower frequency, typically for power-saving.
Roll-over	Roll-over time of not less than 40 years.
Accuracy	ARM does not specify a required accuracy, but recommends that the counter does not gain or lose more than ten seconds in a 24-hour period. Use of lower-frequency modes must not affect the implemented accuracy.
Start-up	Starts operating from zero.

The system counter, once configured and running, must provide a uniform view of system time. More precisely, it must be impossible for the following sequence of events to show system time going backwards:

1. Device A reads the time from the system counter.
2. Device A communicates with another agent in the system, Device B.
3. After recognizing the communication from Device A, Device B reads the time from the system counter.

The system counter must be implemented in an always-on power domain.

To support lower-power operating modes, the counter can increment by larger amounts at a lower frequency. For example, a 10MHz system counter might either increment:

- By 1 at 10MHz.
- By 500 at 20kHz, when the system lowers the clock frequency, to reduce power consumption.

In this case, the counter must support transitions between high-frequency, high-precision operation, and lower-frequency, lower-precision operation, without any impact on the required accuracy of the counter.

The `CNTFRQ_ELO` register is intended to hold a copy of the current clock frequency to allow fast reference to this frequency by software running on the PE. For more information, see [Initializing and reading the system counter frequency](#).

The mechanism by which the count from the system counter is distributed to system components is IMPLEMENTATION DEFINED, but each PE with a System register interface to the system counter must have a counter input that can capture each increment of the counter.

———— Note —————

So that the system counter can be clocked independently from the PE hardware, the count value might be distributed using a Gray code sequence. [Gray-count scheme for timer distribution scheme on page I1-5736](#) gives more information about this possibility.

Initializing and reading the system counter frequency

The `CNTFRQ_ELO` register must be programmed to the clock frequency of the system counter. Typically, this is done only during the system boot process, by using the System register interface to write the system counter frequency to the `CNTFRQ_ELO` register. Only software executing at the highest implemented Exception level can write to `CNTFRQ_ELO`.

———— Note —————

The `CNTFRQ_ELO` register is UNKNOWN at reset, and therefore the counter frequency must be set as part of the system boot process.

Software can read the `CNTFRQ_ELO` register, to determine the current system counter frequency, in the following states:

- EL2.

- Secure and Non-secure EL1.
- When [CNTKCTL_EL1.EL0PCTEN](#) is set to 1, Secure and Non-secure EL0.

Memory-mapped controls of the system counter

Some system counter controls are accessible only through the memory-mapped interface to the system counter. These controls are:

- Enabling and disabling the counter.
- Setting the counter value.
- Changing the operating mode, to change the update frequency and increment value.
- Enabling Halt-on-debug, that a debugger can then use to suspend counting.

For descriptions of these controls, see [Chapter 11 System Level Implementation of the Generic Timer](#).

D6.2 The AArch64 view of the Generic Timer

The following sections describe the components and features of a PE implementation of the Generic Timer, as seen from AArch64 state:

- [The physical counter](#).
- [The virtual counter](#) on page D6-2185.
- [Event streams](#) on page D6-2186.
- [Timers](#) on page D6-2187.

D6.2.1 The physical counter

The PE includes a physical counter that contains the count value of the system counter. The `CNTPCT_EL0` register holds the current physical counter value.

Accessing the physical counter

Software with sufficient privilege can read `CNTPCT_EL0` using a 64-bit System register read.

`CNTPCT_EL0`:

- Is always accessible from EL3, Non-secure EL2 and Secure EL1 states.
- Is accessible from Non-secure EL1 only when `CNTHCTL_EL2.EL1PCTEN` is set to 1. When the value of `CNTHCTL_EL2.EL1PCTEN` is 0, any attempt to access `CNTPCT_EL0` from Non-secure EL1 is trapped to EL2.
- Is accessible from Secure EL0 state when the value of `CNTKCTL_EL1.EL0PCTEN` is 1. When the value of `CNTKCTL_EL1.EL0PCTEN` is 0, any attempt to access `CNTPCT_EL0` is UNDEFINED.
- Is accessible from Non-secure EL0 when the value of `CNTHCTL_EL2.EL1PCTEN` is 1 and the value of `CNTKCTL_EL1.EL0PCTEN` is 1. Otherwise:
 - When the value of `CNTKCTL_EL1.EL0PCTEN` is 0, any attempt to access `CNTPCT_EL0` from Non-secure EL0 generates an UNDEFINED exception.
 - When the value of `CNTKCTL_EL1.EL0PCTEN` is 1 and the value of `CNTHCTL_EL2.EL1PCTEN` is 0, any attempt to access `CNTPCT_EL0` from Non-secure EL0 is trapped to EL2.

Reads of `CNTPCT_EL0` can occur speculatively and out of order relative to other instructions executed on the same PE.

For example, if a read from memory is used to obtain a signal from another agent that indicates that `CNTPCT_EL0` must be read, an ISB is used to ensure that the read of `CNTPCT_EL0` occurs after the signal has been read from memory, as shown in the following code sequence:

```
loop                ; polling for some communication to indicate a requirement to read the timer
  LDR R1, [R2]
  CMP R1, #1
  BNE loop
  ISB                ; without this, the CNTPCT could be read before the memory location in [R2]
                    ; has had the value 1 written to it
  MRS R1, CNTPCT
```

D6.2.2 The virtual counter

An implementation of the Generic Timer always includes a virtual counter, that indicates virtual time.

The virtual counter contains the value of the physical counter minus a 64-bit virtual offset. When executing at Non-secure EL1 or EL0, the virtual offset value relates to the current virtual machine.

The `CNTVOFF_EL2` register contains the virtual offset. `CNTVOFF_EL2` is only accessible from EL2 and EL3.

For more information, see *Status of the CNTVOFF register*.

The `CNTVCT_EL0` register holds the current virtual counter value.

Accessing the virtual counter

Software with sufficient privilege can read `CNTVCT_EL0` using a 64-bit System register read.

`CNTVCT_EL0` is always accessible from Secure EL3, from Secure EL1 when EL3 is using AArch64, and from Non-secure EL1 and EL2.

In addition, when `CNTKCTL_EL1.EL0VCTEN` is set to 1, `CNTVCT_EL0` is accessible from EL0.

When `CNTKCTL_EL1.EL0VCTEN` is set to 0, any attempt to access `CNTVCT_EL0` from EL0 is UNDEFINED.

Reads of `CNTVCT_EL0` can occur speculatively and out of order relative to other instructions executed on the same PE.

For example, if a read from memory is used to obtain a signal from another agent that indicates that `CNTVCT_EL0` must be read, an ISB is used to ensure that the read of `CNTVCT_EL0` occurs after the signal has been read from memory, as shown in the following code sequence:

```

loop                ; polling for some communication to indicate a requirement to read the timer
    LDR R1, [R2]
    CMP R1, #1
    BNE loop
    ISB              ; without this, the CNTVCT could be read before the memory location in [R2]
                    ; has had the value 1 written to it
    MRS R1, CNTVCT

```

Status of the CNTVOFF register

All implementations of the Generic Timer include the virtual counter. Therefore, conceptually, all implementations include the `CNTVOFF_EL2` register that defines the *virtual offset* between the physical count and the virtual count. `CNTVOFF_EL2` is only accessible at EL2 or above. If EL2 is not implemented, the virtual counter uses a fixed virtual offset of zero.

D6.2.3 Event streams

An implementation that includes the Generic Timer can use the system counter to generate one or more *event streams*, to generate periodic wake-up events as part of the mechanism described in [Wait for Event mechanism and Send event](#) on page D1-1879.

———— **Note** —————

An event stream might be used:

- To impose a time-out on a Wait For Event polling loop.
- To safeguard against any programming error that means an expected event is not generated.

An event stream is configured by:

- Selecting which bit, from the bottom 16 bits of a counter, triggers the event. This determines the frequency of the events in the stream.
- Selecting whether the event is generated on each 0 to 1 transition, or each 1 to 0 transition, of the selected counter bit.

The [CNTKCTL_EL1](#).{EVNTEN, EVNTPDIR, EVNTPDI} fields define an event stream that is generated from the virtual counter.

In all implementations, the [CNTHCTL_EL2](#).{EVNTEN, EVNTPDIR, EVNTPDI} fields define an event stream that is generated from the physical counter.

The operation of an event stream is as follows:

- The pseudocode variables PreviousCNTVCT and PreviousCNTPCT are initialized as:

```
// Variables used for generation of the timer event stream.  
bits(64) PreviousCNTVCT = bits(64) UNKNOWN;  
bits(64) PreviousCNTPCT = bits(64) UNKNOWN;
```
- The pseudocode functions TestEventCNTV() and TestEventCNTP() are called on each cycle of the PE clock.
- The TestEventCNTx() pseudocode template defines the functions TestEventCNTV() and TestEventCNTP():

```
// TestEventCNTx()  
// =====  
  
// Template for the TestEventCNTV() and TestEventCNTP() functions  
// Describes operation when all Exception Levels are using AArch64:  
// CNTxCT_EL0 is CNTVCT_EL0 or CNTPCT_EL0 64-bit count value  
// CNTx_CTL_EL0 is CNTV_CTL_EL0 or CNTP_CTL_EL0 Control register  
// PreviousCNTxCT_EL0 is PreviousCNTVCT_EL0 or PreviousCNTPCT_EL0
```

```
TestEventCNTx()  
  if CNTx_CTL_EL0.EVNTEN == '1' then  
    n = UInt(CNTx_CTL_EL0.EVNTPDI);  
    SampleBit = CNTxCT_EL0<n>;  
    PreviousBit = PreviousCNTxCT_EL0<n>;  
  
    if CNTx_CTL_EL0.EVNTPDIR == '0' then  
      if PreviousBit == '0' && SampleBit == '1' then EventRegisterSet();  
    else  
      if PreviousBit == '1' && SampleBit == '0' then EventRegisterSet();  
  
    PreviousCNTxCT_EL0 = CNTxCT_EL0;  
  
  return;
```

D6.2.4 Timers

In an implementation of the Generic Timer that includes EL3, if EL3 can use AArch64, the following timers are implemented:

- An EL1 physical timer, that:
 - In Secure state, can be accessed from EL1.
 - In Non-secure state, can be accessed from EL1 unless those accesses are trapped to EL2.
When this timer can be accessed from EL1, an EL1 control determines whether it can be accessed from EL0.
- A Non-secure EL2 physical timer.
- A Secure EL3 physical timer. An EL3 control determines whether this register is accessible from Secure EL1.
- A virtual timer.

The output of each implemented timer:

- Provides an output signal to the system.
- If the PE interfaces to a *Generic Interrupt Controller* (GIC), signals a *Private Peripheral Interrupt* (PPI) to that GIC. In a multiprocessor implementation, each PE must use the same interrupt number for each timer.

Each timer:

- Is based around a 64-bit CompareValue that provides a 64-bit unsigned upcounter.
- Provides an alternative view of the CompareValue, called the TimerValue, that appears to operate as a 32-bit downcounter.
- Has, in addition, a 32-bit Control register.

Table D6-1 Timer registers summary for the Generic Timer

Timer ^a register	EL1 physical timer	EL2 physical timer	EL3 physical timer	EL1 virtual timer	EL2 virtual timer
CV	CNTP_CVAL_EL0	CNTHP_CVAL_EL2	CNTPS_CVAL_EL1	CNTV_CVAL_EL0	CNTHV_CVAL_EL2 ^b
TV	CNTP_TVAL_EL0	CNTHP_TVAL_EL2	CNTPS_TVAL_EL1	CNTV_TVAL_EL0	CNTHV_TVAL_EL2 ^b
Control	CNTP_CTL_EL0	CNTHP_CTL_EL2	CNTPS_CTL_EL1	CNTV_CTL_EL0	CNTHV_CTL_EL2 ^b

a. In this column, CV indicates the ControlValue register, and TV indicates the TimerValue register.

b. Only when both the implementation includes [ARMv8.1-VHE](#) and the value of [HCR_EL2.E2H](#) is 1.

The following sections describe:

- [Operation of the CompareValue views of the timers](#)
- [Operation of the TimerValue views of the timers on page D6-2188.](#)

Operation of the CompareValue views of the timers

The CompareValue view of a timer operates as a 64-bit upcounter. The timer condition is met when the appropriate counter reaches the value programmed into its CompareValue register. When the timer condition is met, an interrupt is generated if the interrupt is not masked in the corresponding timer control register, [CNTP_CTL_EL0](#), [CNTHP_CTL_EL2](#), [CNTPS_CTL_EL1](#), or [CNTV_CTL_EL0](#). For [CNTP_CTL_EL0](#), the asserted interrupt is the same as the interrupt asserted by the Non-secure instance of the AArch32 register [CNTP_CTL](#).

The operation of this view of a timer is:

$$\text{TimerConditionMet} = (((\text{Counter}[63:0] - \text{Offset}[63:0])[63:0] - \text{CompareValue}[63:0]) \geq 0)$$

Where:

TimerConditionMet Is TRUE if the timer condition for this counter is met, and FALSE otherwise.

Counter	The physical counter value, that can be read from the CNTPCT_EL0 register.
<hr/> Note <hr/>	
	The virtual counter value, that can be read from the CNTVCT_EL0 register, is the value: (Counter - Offset)
Offset	For a physical timer it is zero, and for the virtual timer it is the virtual offset, held in the CNTVOFF_EL2 register.
CompareValue	The value of the appropriate CompareValue register, CNTP_CVAL_EL0 , CNTHP_CVAL_EL2 , CNTPS_CVAL_EL1 , or CNTV_CVAL_EL0 .

In this view of a timer, Counter, Offset, and CompareValue are all 64-bit unsigned values.

Note

This means that a timer with a CompareValue of, or close to, `0xFFFF_FFFF_FFFF_FFFF` might never meet its timer condition. However, there is no practical requirement to use values close to the counter wrap value.

Operation of the TimerValue views of the timers

The TimerValue view of a timer appears to operate as a signed 32-bit downcounter. A TimerValue register is programmed with a count value. This value decrements on each increment of the appropriate counter, and the timer condition is met when the value reaches zero. When the timer condition is met, an interrupt is generated if the interrupt is not masked in the corresponding timer control register, [CNTP_CTL_EL0](#), [CNTHP_CTL_EL2](#), [CNTPS_CTL_EL1](#), or [CNTV_CTL_EL0](#).

This view of a timer depends on the following behavior of accesses to TimerValue registers:

Reads $\text{TimerValue} = (\text{CompareValue} - (\text{Counter} - \text{Offset})) [31:0]$
Writes $\text{CompareValue} = ((\text{Counter} - \text{Offset}) [63:0] + \text{SignExtend}(\text{TimerValue})) [63:0]$

Where the arguments other than TimerValue have the definitions used in *Operation of the CompareValue views of the timers on page D6-2187*, and in addition:

TimerValue The value of a TimerValue register, [CNTP_TVAL_EL0](#), [CNTHP_TVAL_EL2](#), [CNTPS_TVAL_EL1](#), or [CNTV_TVAL_EL0](#).

In this view of a timer, values are signed in standard two's complement form.

A read of a TimerValue register after the timer condition has been met indicates the time since the timer condition was met.

Note

- *Operation of the CompareValue views of the timers on page D6-2187* gives a strict definition of `TimerConditionMet`. However, provided that the TimerValue is not expected to wrap as a 32-bit signed value when decremented from `0x80000000`, the TimerValue view can be used as giving an effect equivalent to:
 $\text{TimerConditionMet} = (\text{TimerValue} \leq 0)$
 - Programming TimerValue to a negative number with magnitude greater than $(\text{Counter} - \text{Offset})$ can lead to an arithmetic overflow that causes the CompareValue to be an extremely large positive value. This potentially delays meeting the timer condition for an extremely long period of time.
-

Chapter D7

AArch64 System Register Descriptions

This chapter defines the AArch64 System registers. It contains the following sections:

- *About the AArch64 System registers* on page D7-2190.
- *General system control registers* on page D7-2198.
- *Debug registers* on page D7-2554.
- *Performance Monitors registers* on page D7-2629.
- *Generic Timer registers* on page D7-2672.

D7.1 About the AArch64 System registers

The following sections describe common features of the AArch64 registers:

- [General information about the AArch64 System registers.](#)
- [Fixed values in the System register descriptions.](#)
- [General behavior of accesses to the AArch64 System registers.](#)
- [Principles of the ID scheme for fields in ID registers on page D7-2195.](#)

D7.1.1 General information about the AArch64 System registers

The structure of the System register descriptions has changed from that used in *ARM® Architecture Reference Manual, ARMv8, for ARMv8-A architecture profile*, Issue A.j and earlier:

- Information about the accessibility of the register from different Exception levels is given in the Accessibility section, that is the last but one section of a register description.
- Information about the traps and enables that apply to the register is given in the Traps and Enables section, that is the last section of a register description.

The information in these sections can depend on:

- The mnemonic that is used to access the register.
- The value of one or more of the controls {E2H, TGE, NS}.

These controls are:

- [HCR_EL2](#). {E2H, TGE} fields.
- [SCR_EL3](#). NS field.

————— **Note** —————

- These changes mean that the register descriptions can address:
 - Cases where a single register is accessible using more than one mnemonic, in different contexts, and that the accessibility can depend on the mnemonic that is used and the context in which it is used.
 - Cases where a single mnemonic can address different registers, depending on the context, and that the accessibility can also depend on the context.

These changes are needed to describe System register behaviors associated with the Virtualization Host Extension described in [Virtualization Host Extensions on page D4-2098](#). However, they also improve the representation of many ARMv8.0 register descriptions.

- This change to the structure of System register descriptions does not apply to the description of memory-mapped registers such as those described in [Chapter H9 External Debug Register Descriptions](#).

D7.1.2 Fixed values in the System register descriptions

See [Fixed values in AArch64 instruction and System register descriptions on page C2-151](#). This section defines how the glossary terms [RAZ](#), [RES0](#), [RAO](#), and [RES1](#) can be represented in the System register descriptions.

System register width

The register descriptions in this chapter describe each register as either a *32-bit register* or a *64-bit register*. For registers described as 32-bit registers, the upper bits, bits[63:32], are RES0.

D7.1.3 General behavior of accesses to the AArch64 System registers

The following subsections give general information about the behavior of accesses to the System registers:

- [Reset behavior of AArch64 System registers on page D7-2191.](#)
- [Synchronization requirements for AArch64 System registers on page D7-2191.](#)

Reset behavior of AArch64 System registers

Reset values apply only to RW registers and fields, however:

- Some RO registers or fields, including feature ID registers and some status registers or register fields, always return a known value.
- Some RW and RO registers or register fields return status information about the PE. Unless the register description indicates that the value is UNKNOWN on reset, a read of the register immediately after a reset returns valid information.
- Some RW and RO registers and fields are aliases of other registers or fields. In these cases, the reset behavior of the aliased register or field determines the value returned by a read of the register immediately after a reset.
- WO registers that only have an effect on writes do not have meaningful reset values. However, an access to a WO register might affect underlying state, and that state might have a defined reset value.
- IMPLEMENTATION DEFINED registers have IMPLEMENTATION DEFINED reset behavior.

After a reset, only a limited subset of the PE state is guaranteed to be set to defined values. Also, for debug and trace System registers, reset requirements must take account of different levels of reset. For more information about the reset behavior of System registers when the PE resets into an Exception level that is using AArch64, see:

- [PE state on reset to AArch64 state on page D1-1796](#).
- The appropriate Trace architecture specification, for the Trace System registers.

For a PE reset into an Exception level that is using AArch64, the architecture defines which AArch64 System registers have a defined reset value, and when that defined reset value applies. The register descriptions include this information, and [PE state on reset to AArch64 state on page D1-1796](#) summarizes these architectural requirements. Otherwise, RW registers that have a meaningful reset value reset to an architecturally UNKNOWN value.

———— Note —————

When the PE resets into an Exception level that is using AArch32, no PE state that relates to execution in AArch64 state is accessible until another reset causes the Execution state to change to AArch64. Therefore, on a reset into AArch32 state, PE state that relates only to execution in AArch64 state cannot have a meaningful reset value.

Pseudocode description of resetting System registers

The `AArch64.ResetSystemRegisters()` pseudocode function resets all System registers, and register fields, that have defined reset values, as described in this section and [PE state on reset to AArch64 state on page D1-1796](#).

———— Note —————

For debug and trace System registers, this function resets registers as defined for the appropriate level of reset.

Synchronization requirements for AArch64 System registers

Reads of the System registers can occur out of order with respect to earlier instructions executed on the same PE, provided that both:

- Any data dependencies between the instructions, including read-after-read dependencies, are respected.
- The reads to the register do not occur earlier than the most recent [Context synchronization event](#) to its architectural position in the instruction stream.

———— Note —————

In particular, the values read from System registers that hold self-incrementing counts, such as the performance counters or the Generic Timer counter or timers, could be accessed from any time after the previous [Context synchronization event](#). For example, where a memory access is used to communicate a read of such counters, an ISB

must be inserted between the read of the memory location that is known to have returned its data, either as a result of a condition on that data or of the write being completed, and the read of the Generic Timer counter, if it is necessary that the Generic Timer counter returns a count value after the memory communication.

Direct writes using the instructions in [Table C5-6 on page C5-324](#) require synchronization before software can rely on the effects of changes to the System registers to affect instructions appearing in program order after the direct write to the System register. Direct writes to these registers are not allowed to affect any instructions appearing in program order before the direct write. The only exceptions are:

- All direct writes to the same register, that use the same encoding for that register, are guaranteed to occur in program order relative to each other
- All direct writes to a register occur in program order with respect to all direct reads to the same register using the same encoding.
- Any System register access that an ARM *Architecture Specification* or equivalent specification defines as not requiring synchronization.

Explicit synchronization occurs as a result of a *Context synchronization event*, which is one of the following events:

- Execution of an ISB instruction.
- Exception entry.
- Exception return.
- Execution of a DCPS instruction in Debug state.
- Execution of a DRPS instruction in Debug state.
- Exit from Debug state.

Note

The ISB and exception entry events are applicable both in Debug state and in Non-debug state.

Conceptually, explicit synchronization occurs as the first step of each of these events, so that if the event uses state that has previously been changed but was not synchronized by the time of the event, the event is guaranteed to use the state as if it had been synchronized.

Note

This explicit synchronization applies as the first step of the execution of the events, and does not apply to any effect of System registers that apply to the fetch and decode of the instructions that cause these events, such as breakpoints or changes to the translation table.

In addition, any system instructions that cause a write to a System register must be synchronized before the result is guaranteed to be visible to subsequent direct reads of that System register.

Direct reads to any one of the following registers, using the same encoding, occur in program order relative to each other:

- [ISR_EL1](#).
- The Generic Timer registers, that is, [CNTPCT_EL0](#) and [CNTVCT_EL0](#), and the Counter registers [CNTP_TVAL_EL0](#), [CNTV_TVAL_EL0](#), [CNTHP_TVAL_EL2](#), and [CNTPS_TVAL_EL1](#).
- [DBGCLAIMCLR_EL1](#).
- The PMU Counters, that is, [PMCCNTR_EL0](#), [PMEVCNTR<n>_EL0](#), [PMXVCNTR_EL0](#), [PMOVSLR_EL0](#), and [PMOVSSSET_EL0](#).
- The Debug Communications Channel registers, that is, [DBGDTRRX_EL0](#), [DBGDTR_EL0](#), and [MDCCSR_EL0](#).

All other direct reads of System registers can occur in any order if synchronization has not been performed.

Table D7-1 describes the synchronization requirements between two successive read or write accesses to the same register, where the ordering of the read or write accesses is:

1. Program order, in the event that both the reads or writes are caused by an instruction executed on this PE, other than one caused by a memory access by this PE.
2. The order of arrival of asynchronous reads and writes at the PE relative to the execution of instructions that cause reads or writes.
3. The order of arrival of asynchronous reads and writes at the PE relative to each other.

Table D7-1 Synchronization requirements

First read-write	Second read-write	Synchronization requirement
Direct read	Direct read	None
	Direct write	None
	Indirect read	None
	Indirect write	None, see <i>Notes</i>
Direct write	Direct read	None
	Direct write	None
	Indirect read	Required
	Indirect write	None, see <i>Notes</i>
Indirect read	Direct read	None
	Direct write	None
	Indirect read	None
	Indirect write	None
Indirect write	Direct read	Required, see <i>Notes</i>
	Direct write	None, see <i>Notes</i>
	Indirect read	Required, see <i>Notes</i>
	Indirect write	None, see <i>Notes</i>

Notes

The terms Direct read, Direct write, Indirect read, and Indirect write, as used in Table D7-1, are defined as follows:

Direct read Where software uses a System register access instruction to read the register, see both:

- [Instructions for accessing non-debug System registers on page C5-323.](#)
- [Instructions for accessing debug System registers on page C5-322.](#)

Where a direct read of a register has a side-effect that changes the contents of a register, the effect of a direct read on that register is defined to be an indirect write. In this case, the indirect write is only guaranteed to have occurred, and be visible to subsequent direct or indirect reads or writes, if synchronization is performed after the direct read.

Direct write Where software uses a System register access instruction to write to the register, see both:

- [Instructions for accessing non-debug System registers on page C5-323.](#)
- [Instructions for accessing debug System registers on page C5-322.](#)

Where a direct write to a register has an effect on the register that means that the value in the register is not always the last value that is written (as is the case with set and clear registers), the effect of a direct write on that register is defined to be an indirect write. In this case, the indirect write is only guaranteed to be visible to subsequent direct or indirect reads or writes if synchronization is performed after the direct write and before the subsequent direct or indirect reads or writes.

Indirect read Where an instruction uses a System register to establish operating conditions for the instruction, for example, the `TTBR_ELx` address or whether memory accesses are forced to be Non-cacheable. This includes situations where the contents of one System register selects what value is read or written using a different register. Indirect reads also include reads of the System register by external agents such as debuggers. Where an indirect read of a register has a side-effect that changes the contents of that register, that is defined to be an indirect write.

Indirect write Where a System register is written as the consequence of some other instruction, exception, operation, or by the asynchronous operation of an external agent, including the passage of time as seen in counters, timers, or performance counters, the assertion of interrupts, or writes from an external debugger.

———— **Note** —————

Since an exception is context synchronizing, registers such as the Exception Syndrome registers that are indirectly written as part of exception entry do not require additional synchronization.

Where a direct read or write to a register is followed by an indirect write caused by an external agent, autonomous asynchronous event, or as a result of memory mapped write, synchronization is required to guarantee the order of those two accesses.

Where an indirect write caused by a direct write is followed by an indirect write caused by an external agent, autonomous asynchronous event, or as a result of memory mapped write, synchronization is required to guarantee the order of those two indirect accesses.

Where a direct read to one register causes a bit or field in a different register (or the same register using a different encoding) to be updated, the change to the different register (or same register using a different encoding) is defined to be an indirect write. In this case, the indirect write is only guaranteed to be visible to subsequent direct or indirect reads or writes if synchronization is performed after the direct read and before the subsequent direct or indirect reads or writes.

Where a direct write to one register causes a bit or field in a different register (or the same register using a different encoding) to be updated as a side-effect of that direct write (as opposed to simply being a direct write to the different encoding), the change to the different register (or same register using a different encoding) is defined to be an indirect write. In this case, the indirect write is only guaranteed to be visible to subsequent direct or indirect reads or writes if synchronization is performed after the direct write and before the subsequent direct or indirect reads or writes.

Where indirect writes are caused by the actions of external agents such as debuggers, or by memory-mapped reads or writes by the PE, then an indirect write by that agent and mechanism to a register, followed by an indirect read by that agent and mechanism to the same register using the same address, does not require synchronization.

Indirect writes caused by external agents, autonomous asynchronous events, or as a result of memory-mapped writes, to the registers shown in [Table D7-2 on page D7-2195](#), are required to be observable to:

- Direct reads in finite time without explicit synchronization.

- Subsequent indirect reads without explicit synchronization.

Table D7-2 Registers with a guarantee of observability, VMSAv8-64

Registers	Notes
ISR_EL1	Interrupt Status Register
DBGCLAIMCLR_EL1, DBGCLAIMSET_EL1	Debug CLAIM registers
CNTPCT_EL0, CNTVCT_EL0, CNTP_TVAL_EL0, CNTV_TVAL_EL0, CNTHP_TVAL_EL2, CNTPS_TVAL_EL1	Generic Timer registers
PMCCNTR_EL0, PMEVCNTR<n>_EL0, PMXEVCNTR_EL0, PMOVSCLR_EL0, PMOVSSET_EL0	PMU Counters
DBGDTRTX_EL0, DBGDTRRX_EL0, DBGDTR_EL0, and the DCC flags in MDCCSR_EL0 and EDSCR	Debug Communication Channel registers
EDSCR.PipeAdv	External Debug Status and Control Register PipeAdv field

In addition to the requirements shown in [Table D7-2](#):

- Indirect writes to the following registers as a result of memory-mapped writes, including accesses by external agents, are required to be observable to the indirect read made in determining the response to a subsequent memory-mapped access without explicit synchronization:
 - [OSLAR_EL1](#). [OSLAR_EL1](#) is indirectly read to determine whether the subsequent access is permitted.
 - [EDLAR](#), if implemented. [EDLAR](#) is indirectly read to determine whether a subsequent write or side-effect of an access is ignored.

———— **Note** —————

This requirement is stricter than the general requirement for the observability of indirect writes.

- When the PE is in Debug state, there are synchronization requirements for the Debug Communication Channel and Instruction Transfer registers. See [DCC and ITR access in Debug state on page H4-5513](#).

———— **Note** —————

- The provision of explicit synchronization requirements to System registers is provided to allow the direct access to these registers to be implemented in a small number of cycles, and that updates to multiple registers can be performed quickly with the synchronization penalty being paid only when the updates have occurred.
- Since toolkits might use registers such as the thread-local storage registers within compiled code, it is recommended that access to these registers is implemented to take a small number of cycles.
- While no synchronization is required between a direct write and a direct read, or between a direct read and an indirect write, this does not imply that a direct read causes synchronization of a previous direct write. That is, the sequence direct write → direct read → indirect read, with no intervening context synchronization, does not guarantee that the indirect read observes the result of the direct write.

D7.1.4 Principles of the ID scheme for fields in ID registers

The ARM architecture specifies a number of *ID registers* that are characterized as comprising a set of 4-bit *ID fields*. Each ID field identifies the presence, and possibly the level of support for, a particular feature in an implementation of the architecture. These fields follow an architectural model that aids their use by software and provides future compatibility. This section describes that model. [ID registers to which this scheme applies on page D7-2197](#) identifies the set of ID registers.

Note

These fields are distinct from register fields that enumerate the number of resources, such as the number of breakpoints, watchpoints, or performance monitors, or the amount of memory.

To provide forward compatibility, software can rely on the features of these fields that are described in this section.

The ID fields, which are either signed or unsigned, use increasing numerical values to indicate increases in functionality. Therefore, if a value of 0x1 indicates the presence of some instructions, then the value 0x2 will indicate the presence of those instructions plus some additional instructions or functionality. This means software can be written in the form:

```
if (value >= number) { // do something that relies on the value of the feature}
```

For ID fields where the value 0x0 defines that a feature is not present, the field holds an unsigned value. This covers the vast majority of such fields.

In a few cases, the architecture has been changed to permit implementations to exclude a feature that has previously been required and for which no ID field has been defined. In these cases, a new ID field is defined and:

- The field holds a signed value.
- The field value 0xF indicates that the feature is not implemented.
- The field value 0x0 indicates that the feature is implemented.
- Software that depends on the feature can use the test:

```
if value >= 0 {  
    // Software features that depend on the presence of the hardware feature  
}
```

In some cases, it has been decided retrospectively that the increase in functionality between two consecutive numerical values is too great, and it is desirable to permit an intermediate degree of functionality, and the means to discover this. This is done by the introduction of a *fractional* field that both:

- Is referred to in the definition of the original field.
- Applies only when the original field is at the lower value of the step.

In principle, a fractional field can be used for two different fractional steps, with different meanings associated with each of these steps. For this reason, a fractional field must be interpreted in the context of the field to which it relates and the value of that field. [Example D7-1](#) shows the use of such a field.

Example D7-1 Example of the use of a fractional field

For a field describing some class of functionality:

- The value 0x1 was defined as indicating that item A is present.
- The value 0x2 was defined as indicating that items B and C are present, in addition to item A.

Subsequently, it might be necessary to introduce a second ID field to indicate that A and B only are present. This new field is a fractional field, and might be defined as having the value 0x1 when A and B only are present. This fractional field is valid only when the original ID field has the value 0x1.

This approach means that:

- Software that depends on the test if (value >= 0x2) can rely on features A, B, and C being present,
- Software that depends on the test if (value >= 0x1) can rely on feature A being present.
- If new software needs to check only that features A and B are present, then it can test:

```
if (value >= 0x2 || (value == 0x1 && fractional_value >= 0x1)) {  
    // Software features that depend on A and B only  
}
```

A fractional field uses the same approach of increasing numerical values indicating increasing functionality, and the fractional approach can also be applied recursively to fractional fields.

Unused ID fields, and fractional fields that are not applicable, are RES0 to allow their future use when features, or fractional implementation options, are added.

ID registers to which this scheme applies

This scheme applies to the following registers:

AArch64 System registers

- The AArch64 views of the AArch32 feature ID registers given by:
 - The AArch32 Auxiliary Feature register [ID_AFR0_EL1](#).
 - The AArch32 Processor Feature registers [ID_PFR0_EL1](#) and [ID_PFR1_EL1](#).
 - The AArch32 Debug Feature register [ID_DFR0_EL1](#).
 - The AArch32 Memory Model Feature registers [ID_MMFR0_EL1](#), [ID_MMFR1_EL1](#), [ID_MMFR2_EL1](#), [ID_MMFR3_EL1](#), and [ID_MMFR4_EL1](#).
 - The AArch32 Instruction Set Attribute registers [ID_ISAR0_EL1](#), [ID_ISAR1_EL1](#), [ID_ISAR2_EL1](#), [ID_ISAR3_EL1](#), [ID_ISAR4_EL1](#), and [ID_ISAR5_EL1](#).
 - The AArch32 Media and VFP Feature registers [MVFR0_EL1](#), [MVFR1_EL1](#), and [MVFR2_EL1](#).
- The AArch64 Auxiliary Feature registers [ID_AA64AFR0_EL1](#) and [ID_AA64AFR1_EL1](#).
- The AArch64 Processor Feature registers [ID_AA64PFR0_EL1](#) and [ID_AA64PFR1_EL1](#).
- The AArch64 Debug Feature registers [ID_AA64DFR0_EL1](#) and [ID_AA64DFR1_EL1](#).
- The AArch64 Memory Model Feature registers [ID_AA64MMFR0_EL1](#), [ID_AA64MMFR1_EL1](#), and [ID_AA64MMFR2_EL1](#).
- The AArch64 Instruction Set Attribute registers [ID_AA64ISAR0_EL1](#) and [ID_AA64ISAR1_EL1](#).

AArch32 System registers

- The AArch32 Auxiliary Feature register [ID_AFR0](#).
- The AArch32 Processor Feature registers [ID_PFR0](#) and [ID_PFR1](#).
- The AArch32 Debug Feature register [ID_DFR0](#).
- The AArch32 Memory Model Feature registers [ID_MMFR0](#), [ID_MMFR1](#), [ID_MMFR2](#), [ID_MMFR3](#), and [ID_MMFR4](#).
- The AArch32 Instruction Set Attribute registers [ID_ISAR0](#), [ID_ISAR1](#), [ID_ISAR2](#), [ID_ISAR3](#), [ID_ISAR4](#), and [ID_ISAR5](#).
- The AArch32 Media and VFP Feature registers [MVFR0](#), [MVFR1](#), and [MVFR2](#).

Memory-mapped registers

- The External Debug Processor Feature register [EDPFR](#).
- The External Debug Feature register [EDDFR](#).

D7.2 General system control registers

This section lists the System registers in AArch64 that are not part of one of the other listed groups.

D7.2.1 ACTLR_EL1, Auxiliary Control Register (EL1)

The ACTLR_EL1 characteristics are:

Purpose

Provides IMPLEMENTATION DEFINED configuration and control options for execution at EL1 and EL0.

Note

ARM recommends the contents of this register have no effect on the PE when [HCR_EL2](#).{E2H, TGE} is {1, 1}, and instead the configuration and control fields are provided by the [ACTLR_EL2](#) register. This avoids the need for software to manage the contents of these register when switching between a Guest OS and a Host OS.

Configurations

AArch64 System register ACTLR_EL1[31:0] is architecturally mapped to AArch32 System register [ACTLR](#).

AArch64 System register ACTLR_EL1[63:32] is architecturally mapped to AArch32 System register [ACTLR2](#).

RW fields in this register reset to architecturally UNKNOWN values.

Attributes

ACTLR_EL1 is a 64-bit register.

Field descriptions

The ACTLR_EL1 bit assignments are:

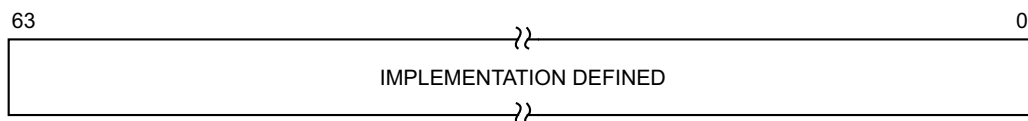

IMPLEMENTATION DEFINED, bits [63:0]

IMPLEMENTATION DEFINED.

Accessing the ACTLR_EL1

This register can be read using MRS with the following syntax:

MRS <Xt>, <systemreg>

This register can be written using MSR (register) with the following syntax:

MSR <systemreg>, <Xt>

This syntax is encoded with the following settings in the instruction encoding:

<systemreg>	op0	op1	CRn	CRm	op2
ACTLR_EL1	11	000	0001	0000	001

Accessibility

The register is accessible in software as follows:

Control			Accessibility			
E2H	TGE	NS	EL0	EL1	EL2	EL3
x	x	0	-	RW	n/a	RW
0	0	1	-	RW	RW	RW
0	1	1	-	n/a	RW	RW
1	0	1	-	RW	RW	RW
1	1	1	-	n/a	RW	RW

Traps and Enables

For a description of the prioritization of any generated exceptions, see [Synchronous exception prioritization for exceptions taken to AArch64 on page D1-1827](#). Subject to the prioritization rules:

- When EL2 is implemented and is using AArch64 and (SCR_EL3.NS == 1) && (HCR_EL2.E2H == 0):
 - If HCR_EL2.TACR==1, Non-secure accesses to this register from EL1 are trapped to EL2.
- When EL2 is implemented and is using AArch64 and (SCR_EL3.NS == 1) && (HCR_EL2.E2H == 1) && (HCR_EL2.TGE == 0):
 - If HCR_EL2.TACR==1, Non-secure accesses to this register from EL1 are trapped to EL2.

D7.2.2 ACTLR_EL2, Auxiliary Control Register (EL2)

The ACTLR_EL2 characteristics are:

Purpose

Provides IMPLEMENTATION DEFINED configuration and control options for EL2.

Note

ARM recommends the contents of this register are updated to apply to EL0 when [HCR_EL2](#).{E2H, TGE} is {1, 1}, gaining configuration and control fields from the [ACTLR_EL1](#). This avoids the need for software to manage the contents of these register when switching between a Guest OS and a Host OS.

Configurations

AArch64 System register ACTLR_EL2[31:0] is architecturally mapped to AArch32 System register [HACTLR](#).

AArch64 System register ACTLR_EL2[63:32] is architecturally mapped to AArch32 System register [HACTLR2](#).

If EL2 is not implemented, this register is RES0 from EL3.

RW fields in this register reset to architecturally UNKNOWN values.

Attributes

ACTLR_EL2 is a 64-bit register.

Field descriptions

The ACTLR_EL2 bit assignments are:

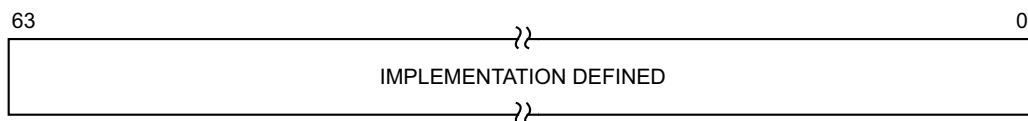

IMPLEMENTATION DEFINED, bits [63:0]

IMPLEMENTATION DEFINED.

Accessing the ACTLR_EL2

This register can be read using MRS with the following syntax:

```
MRS <Xt>, <systemreg>
```

This register can be written using MSR (register) with the following syntax:

```
MSR <systemreg>, <Xt>
```

This syntax is encoded with the following settings in the instruction encoding:

<systemreg>	op0	op1	CRn	CRm	op2
ACTLR_EL2	11	100	0001	0000	001

Accessibility

The register is accessible in software as follows:

Control			Accessibility			
E2H	TGE	NS	EL0	EL1	EL2	EL3
x	x	0	-	-	n/a	RW
0	0	1	-	-	RW	RW
0	1	1	-	n/a	RW	RW
1	0	1	-	-	RW	RW
1	1	1	-	n/a	RW	RW

D7.2.3 ACTLR_EL3, Auxiliary Control Register (EL3)

The ACTLR_EL3 characteristics are:

Purpose

Provides IMPLEMENTATION DEFINED configuration and control options for EL3.

Configurations

RW fields in this register reset to architecturally UNKNOWN values.

Attributes

ACTLR_EL3 is a 64-bit register.

Field descriptions

The ACTLR_EL3 bit assignments are:

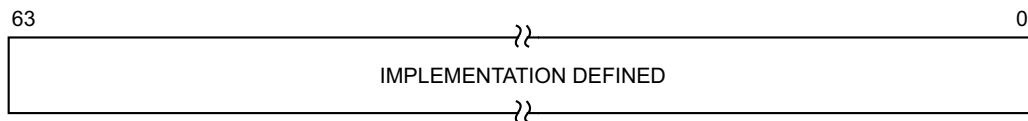

IMPLEMENTATION DEFINED, bits [63:0]

IMPLEMENTATION DEFINED.

Accessing the ACTLR_EL3

This register can be read using MRS with the following syntax:

MRS <Xt>, <systemreg>

This register can be written using MSR (register) with the following syntax:

MSR <systemreg>, <Xt>

This syntax is encoded with the following settings in the instruction encoding:

<systemreg>	op0	op1	CRn	CRm	op2
ACTLR_EL3	11	110	0001	0000	001

Accessibility

The register is accessible in software as follows:

Control			Accessibility			
E2H	TGE	NS	EL0	EL1	EL2	EL3
x	x	0	-	-	n/a	RW
x	0	1	-	-	-	RW
x	1	1	-	n/a	-	RW

D7.2.4 AFSR0_EL1, Auxiliary Fault Status Register 0 (EL1)

The AFSR0_EL1 characteristics are:

Purpose

Provides additional IMPLEMENTATION DEFINED fault status information for exceptions taken to EL1.

Configurations

AArch64 System register AFSR0_EL1 is architecturally mapped to AArch32 System register [ADFSR](#).

RW fields in this register reset to architecturally UNKNOWN values.

Attributes

AFSR0_EL1 is a 32-bit register.

Field descriptions

The AFSR0_EL1 bit assignments are:



IMPLEMENTATION DEFINED, bits [31:0]

IMPLEMENTATION DEFINED.

Accessing the AFSR0_EL1

This register can be read using MRS with the following syntax:

MRS <Xt>, <systemreg>

This register can be written using MSR (register) with the following syntax:

MSR <systemreg>, <Xt>

This syntax is encoded with the following settings in the instruction encoding:

<systemreg>	op0	op1	CRn	CRm	op2
AFSR0_EL1	11	000	0101	0001	000
AFSR0_EL12	11	101	0101	0001	000

Accessibility

The register is accessible in software as follows:

<systemreg>	Control			Accessibility			
	E2H	TGE	NS	EL0	EL1	EL2	EL3
AFSR0_EL1	x	x	0	-	RW	n/a	RW
AFSR0_EL1	0	0	1	-	RW	RW	RW
AFSR0_EL1	0	1	1	-	n/a	RW	RW
AFSR0_EL1	1	0	1	-	RW	AFSR0_EL2	RW
AFSR0_EL1	1	1	1	-	n/a	AFSR0_EL2	RW
AFSR0_EL12	x	x	0	-	-	n/a	-
AFSR0_EL12	0	0	1	-	-	-	-
AFSR0_EL12	0	1	1	-	n/a	-	-
AFSR0_EL12	1	0	1	-	-	RW	RW
AFSR0_EL12	1	1	1	-	n/a	RW	RW

This table applies to all instructions that can access this register.

When [HCR_EL2.E2H](#) is 1, without explicit synchronization, access from EL3 using the mnemonic [AFSR0_EL1](#) or [AFSR0_EL12](#) are not guaranteed to be ordered with respect to accesses using the other mnemonic.

Traps and Enables

For a description of the prioritization of any generated exceptions, see [Synchronous exception prioritization for exceptions taken to AArch64 on page D1-1827](#). Subject to the prioritization rules:

- When EL2 is implemented and is using AArch64 and $(SCR_EL3.NS == 1) \ \&\& \ (HCR_EL2.E2H == 0)$:
 - If [HCR_EL2.TRVM](#)==1, Non-secure read accesses to this register from EL1 are trapped to EL2.
 - If [HCR_EL2.TVM](#)==1, Non-secure write accesses to this register from EL1 are trapped to EL2.
- When EL2 is implemented and is using AArch64 and $(SCR_EL3.NS == 1) \ \&\& \ (HCR_EL2.E2H == 1) \ \&\& \ (HCR_EL2.TGE == 0)$:
 - If [HCR_EL2.TRVM](#)==1, Non-secure read accesses to this register from EL1 are trapped to EL2.
 - If [HCR_EL2.TVM](#)==1, Non-secure write accesses to this register from EL1 are trapped to EL2.

D7.2.5 AFSR0_EL2, Auxiliary Fault Status Register 0 (EL2)

The AFSR0_EL2 characteristics are:

Purpose

Provides additional IMPLEMENTATION DEFINED fault status information for exceptions taken to EL2.

Configurations

AArch64 System register AFSR0_EL2 is architecturally mapped to AArch32 System register [HADFSR](#).

If EL2 is not implemented, this register is RES0 from EL3.

RW fields in this register reset to architecturally UNKNOWN values.

Attributes

AFSR0_EL2 is a 32-bit register.

Field descriptions

The AFSR0_EL2 bit assignments are:



IMPLEMENTATION DEFINED, bits [31:0]

IMPLEMENTATION DEFINED.

Accessing the AFSR0_EL2

This register can be read using MRS with the following syntax:

MRS <Xt>, <systemreg>

This register can be written using MSR (register) with the following syntax:

MSR <systemreg>, <Xt>

This syntax is encoded with the following settings in the instruction encoding:

<systemreg>	op0	op1	CRn	CRm	op2
AFSR0_EL2	11	100	0101	0001	000
AFSR0_EL1	11	000	0101	0001	000

Accessibility

The register is accessible in software as follows:

<systemreg>	Control			Accessibility			
	E2H	TGE	NS	EL0	EL1	EL2	EL3
AFSR0_EL2	x	x	0	-	-	n/a	RW
AFSR0_EL2	0	0	1	-	-	RW	RW
AFSR0_EL2	0	1	1	-	n/a	RW	RW
AFSR0_EL2	1	0	1	-	-	RW	RW
AFSR0_EL2	1	1	1	-	n/a	RW	RW
AFSR0_EL1	x	x	0	-	AFSR0_EL1	n/a	AFSR0_EL1
AFSR0_EL1	0	0	1	-	AFSR0_EL1	AFSR0_EL1	AFSR0_EL1
AFSR0_EL1	0	1	1	-	n/a	AFSR0_EL1	AFSR0_EL1
AFSR0_EL1	1	0	1	-	AFSR0_EL1	RW	AFSR0_EL1
AFSR0_EL1	1	1	1	-	n/a	RW	AFSR0_EL1

This table applies to all instructions that can access this register.

When [HCR_EL2.E2H](#) is 1, without explicit synchronization, access from EL2 using the mnemonic [AFSR0_EL2](#) or [AFSR0_EL1](#) are not guaranteed to be ordered with respect to accesses using the other mnemonic.

D7.2.6 AFSR0_EL3, Auxiliary Fault Status Register 0 (EL3)

The AFSR0_EL3 characteristics are:

Purpose

Provides additional IMPLEMENTATION DEFINED fault status information for exceptions taken to EL3.

Configurations

RW fields in this register reset to architecturally UNKNOWN values.

Attributes

AFSR0_EL3 is a 32-bit register.

Field descriptions

The AFSR0_EL3 bit assignments are:



IMPLEMENTATION DEFINED, bits [31:0]

IMPLEMENTATION DEFINED.

Accessing the AFSR0_EL3

This register can be read using MRS with the following syntax:

MRS <Xt>, <systemreg>

This register can be written using MSR (register) with the following syntax:

MSR <systemreg>, <Xt>

This syntax is encoded with the following settings in the instruction encoding:

<systemreg>	op0	op1	CRn	CRm	op2
AFSR0_EL3	11	110	0101	0001	000

Accessibility

The register is accessible in software as follows:

Control			Accessibility			
E2H	TGE	NS	EL0	EL1	EL2	EL3
x	x	0	-	-	n/a	RW
x	0	1	-	-	-	RW
x	1	1	-	n/a	-	RW

D7.2.7 AFSR1_EL1, Auxiliary Fault Status Register 1 (EL1)

The AFSR1_EL1 characteristics are:

Purpose

Provides additional IMPLEMENTATION DEFINED fault status information for exceptions taken to EL1.

Configurations

AArch64 System register AFSR1_EL1 is architecturally mapped to AArch32 System register [AIFSR](#).

RW fields in this register reset to architecturally UNKNOWN values.

Attributes

AFSR1_EL1 is a 32-bit register.

Field descriptions

The AFSR1_EL1 bit assignments are:



IMPLEMENTATION DEFINED, bits [31:0]

IMPLEMENTATION DEFINED.

Accessing the AFSR1_EL1

This register can be read using MRS with the following syntax:

MRS <Xt>, <systemreg>

This register can be written using MSR (register) with the following syntax:

MSR <systemreg>, <Xt>

This syntax is encoded with the following settings in the instruction encoding:

<systemreg>	op0	op1	CRn	CRm	op2
AFSR1_EL1	11	000	0101	0001	001
AFSR1_EL12	11	101	0101	0001	001

Accessibility

The register is accessible in software as follows:

<systemreg>	Control			Accessibility			
	E2H	TGE	NS	EL0	EL1	EL2	EL3
AFSR1_EL1	x	x	0	-	RW	n/a	RW
AFSR1_EL1	0	0	1	-	RW	RW	RW
AFSR1_EL1	0	1	1	-	n/a	RW	RW
AFSR1_EL1	1	0	1	-	RW	AFSR1_EL2	RW
AFSR1_EL1	1	1	1	-	n/a	AFSR1_EL2	RW
AFSR1_EL12	x	x	0	-	-	n/a	-
AFSR1_EL12	0	0	1	-	-	-	-
AFSR1_EL12	0	1	1	-	n/a	-	-
AFSR1_EL12	1	0	1	-	-	RW	RW
AFSR1_EL12	1	1	1	-	n/a	RW	RW

This table applies to all instructions that can access this register.

When [HCR_EL2.E2H](#) is 1, without explicit synchronization, access from EL3 using the mnemonic [AFSR1_EL1](#) or [AFSR1_EL12](#) are not guaranteed to be ordered with respect to accesses using the other mnemonic.

Traps and Enables

For a description of the prioritization of any generated exceptions, see [Synchronous exception prioritization for exceptions taken to AArch64 on page D1-1827](#). Subject to the prioritization rules:

- When EL2 is implemented and is using AArch64 and $(SCR_EL3.NS == 1) \ \&\& \ (HCR_EL2.E2H == 0)$:
 - If [HCR_EL2.TRVM](#)==1, Non-secure read accesses to this register from EL1 are trapped to EL2.
 - If [HCR_EL2.TVM](#)==1, Non-secure write accesses to this register from EL1 are trapped to EL2.
- When EL2 is implemented and is using AArch64 and $(SCR_EL3.NS == 1) \ \&\& \ (HCR_EL2.E2H == 1) \ \&\& \ (HCR_EL2.TGE == 0)$:
 - If [HCR_EL2.TRVM](#)==1, Non-secure read accesses to this register from EL1 are trapped to EL2.
 - If [HCR_EL2.TVM](#)==1, Non-secure write accesses to this register from EL1 are trapped to EL2.

D7.2.8 AFSR1_EL2, Auxiliary Fault Status Register 1 (EL2)

The AFSR1_EL2 characteristics are:

Purpose

Provides additional IMPLEMENTATION DEFINED fault status information for exceptions taken to EL2.

Configurations

AArch64 System register AFSR1_EL2 is architecturally mapped to AArch32 System register [HAIFSR](#).

If EL2 is not implemented, this register is RES0 from EL3.

RW fields in this register reset to architecturally UNKNOWN values.

Attributes

AFSR1_EL2 is a 32-bit register.

Field descriptions

The AFSR1_EL2 bit assignments are:



IMPLEMENTATION DEFINED, bits [31:0]

IMPLEMENTATION DEFINED.

Accessing the AFSR1_EL2

This register can be read using MRS with the following syntax:

MRS <Xt>, <systemreg>

This register can be written using MSR (register) with the following syntax:

MSR <systemreg>, <Xt>

This syntax is encoded with the following settings in the instruction encoding:

<systemreg>	op0	op1	CRn	CRm	op2
AFSR1_EL2	11	100	0101	0001	001
AFSR1_EL1	11	000	0101	0001	001

Accessibility

The register is accessible in software as follows:

<systemreg>	Control			Accessibility			
	E2H	TGE	NS	EL0	EL1	EL2	EL3
AFSR1_EL2	x	x	0	-	-	n/a	RW
AFSR1_EL2	0	0	1	-	-	RW	RW
AFSR1_EL2	0	1	1	-	n/a	RW	RW
AFSR1_EL2	1	0	1	-	-	RW	RW
AFSR1_EL2	1	1	1	-	n/a	RW	RW
AFSR1_EL1	x	x	0	-	AFSR1_EL1	n/a	AFSR1_EL1
AFSR1_EL1	0	0	1	-	AFSR1_EL1	AFSR1_EL1	AFSR1_EL1
AFSR1_EL1	0	1	1	-	n/a	AFSR1_EL1	AFSR1_EL1
AFSR1_EL1	1	0	1	-	AFSR1_EL1	RW	AFSR1_EL1
AFSR1_EL1	1	1	1	-	n/a	RW	AFSR1_EL1

This table applies to all instructions that can access this register.

When [HCR_EL2.E2H](#) is 1, without explicit synchronization, access from EL2 using the mnemonic [AFSR1_EL2](#) or [AFSR1_EL1](#) are not guaranteed to be ordered with respect to accesses using the other mnemonic.

D7.2.9 AFSR1_EL3, Auxiliary Fault Status Register 1 (EL3)

The AFSR1_EL3 characteristics are:

Purpose

Provides additional IMPLEMENTATION DEFINED fault status information for exceptions taken to EL3.

Configurations

RW fields in this register reset to architecturally UNKNOWN values.

Attributes

AFSR1_EL3 is a 32-bit register.

Field descriptions

The AFSR1_EL3 bit assignments are:



IMPLEMENTATION DEFINED, bits [31:0]

IMPLEMENTATION DEFINED.

Accessing the AFSR1_EL3

This register can be read using MRS with the following syntax:

MRS <Xt>, <systemreg>

This register can be written using MSR (register) with the following syntax:

MSR <systemreg>, <Xt>

This syntax is encoded with the following settings in the instruction encoding:

<systemreg>	op0	op1	CRn	CRm	op2
AFSR1_EL3	11	110	0101	0001	001

Accessibility

The register is accessible in software as follows:

Control			Accessibility			
E2H	TGE	NS	EL0	EL1	EL2	EL3
x	x	0	-	-	n/a	RW
x	0	1	-	-	-	RW
x	1	1	-	n/a	-	RW

D7.2.10 AIDR_EL1, Auxiliary ID Register

The AIDR_EL1 characteristics are:

Purpose

Provides IMPLEMENTATION DEFINED identification information.

The value of this register must be interpreted in conjunction with the value of [MIDR_EL1](#).

Configurations

AArch64 System register AIDR_EL1 is architecturally mapped to AArch32 System register [AIDR](#).

Attributes

AIDR_EL1 is a 32-bit register.

Field descriptions

The AIDR_EL1 bit assignments are:



IMPLEMENTATION DEFINED, bits [31:0]

IMPLEMENTATION DEFINED.

Accessing the AIDR_EL1

This register can be read using MRS with the following syntax:

MRS <Xt>, <systemreg>

This syntax is encoded with the following settings in the instruction encoding:

<systemreg>	op0	op1	CRn	CRm	op2
AIDR_EL1	11	001	0000	0000	111

Accessibility

The register is accessible in software as follows:

Control			Accessibility			
E2H	TGE	NS	EL0	EL1	EL2	EL3
x	x	0	-	RO	n/a	RO
x	0	1	-	RO	RO	RO
x	1	1	-	n/a	RO	RO

Traps and Enables

For a description of the prioritization of any generated exceptions, see [Synchronous exception prioritization for exceptions taken to AArch64 on page D1-1827](#). Subject to the prioritization rules:

- When EL2 is implemented and is using AArch64 and (SCR_EL3.NS == 1) && (HCR_EL2.E2H == 0):
 - If [HCR_EL2.TID1](#)==1, Non-secure read accesses to this register from EL1 are trapped to EL2.
- When EL2 is implemented and is using AArch64 and (SCR_EL3.NS == 1) && (HCR_EL2.E2H == 1) && (HCR_EL2.TGE == 0):
 - If [HCR_EL2.TID1](#)==1, Non-secure read accesses to this register from EL1 are trapped to EL2.

D7.2.11 AMAIR_EL1, Auxiliary Memory Attribute Indirection Register (EL1)

The AMAIR_EL1 characteristics are:

Purpose

Provides IMPLEMENTATION DEFINED memory attributes for the memory regions specified by MAIR_EL1.

Configurations

AArch64 System register AMAIR_EL1[31:0] is architecturally mapped to AArch32 System register AMAIRO.

AArch64 System register AMAIR_EL1[63:32] is architecturally mapped to AArch32 System register AMAIR1.

RW fields in this register reset to architecturally UNKNOWN values.

Attributes

AMAIR_EL1 is a 64-bit register.

Field descriptions

The AMAIR_EL1 bit assignments are:

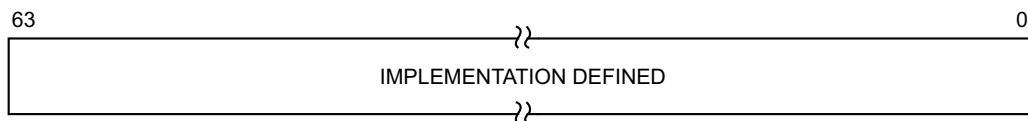

AMAIR_EL1 is permitted to be cached in a TLB.

IMPLEMENTATION DEFINED, bits [63:0]

IMPLEMENTATION DEFINED.

Accessing the AMAIR_EL1

This register can be read using MRS with the following syntax:

MRS <Xt>, <systemreg>

This register can be written using MSR (register) with the following syntax:

MSR <systemreg>, <Xt>

This syntax is encoded with the following settings in the instruction encoding:

<systemreg>	op0	op1	CRn	CRm	op2
AMAIR_EL1	11	000	1010	0011	000
AMAIR_EL12	11	101	1010	0011	000

Accessibility

The register is accessible in software as follows:

<systemreg>	Control			Accessibility			
	E2H	TGE	NS	EL0	EL1	EL2	EL3
AMAIR_EL1	x	x	0	-	RW	n/a	RW
AMAIR_EL1	0	0	1	-	RW	RW	RW
AMAIR_EL1	0	1	1	-	n/a	RW	RW
AMAIR_EL1	1	0	1	-	RW	AMAIR_EL2	RW
AMAIR_EL1	1	1	1	-	n/a	AMAIR_EL2	RW
AMAIR_EL12	x	x	0	-	-	n/a	-
AMAIR_EL12	0	0	1	-	-	-	-
AMAIR_EL12	0	1	1	-	n/a	-	-
AMAIR_EL12	1	0	1	-	-	RW	RW
AMAIR_EL12	1	1	1	-	n/a	RW	RW

This table applies to all instructions that can access this register.

When [HCR_EL2.E2H](#) is 1, without explicit synchronization, access from EL3 using the mnemonic [AMAIR_EL1](#) or [AMAIR_EL12](#) are not guaranteed to be ordered with respect to accesses using the other mnemonic.

Traps and Enables

For a description of the prioritization of any generated exceptions, see [Synchronous exception prioritization for exceptions taken to AArch64 on page D1-1827](#). Subject to the prioritization rules:

- When EL2 is implemented and is using AArch64 and $(SCR_EL3.NS == 1) \&\& (HCR_EL2.E2H == 0)$:
 - If [HCR_EL2.TRVM](#)==1, Non-secure read accesses to this register from EL1 are trapped to EL2.
 - If [HCR_EL2.TVM](#)==1, Non-secure write accesses to this register from EL1 are trapped to EL2.
- When EL2 is implemented and is using AArch64 and $(SCR_EL3.NS == 1) \&\& (HCR_EL2.E2H == 1) \&\& (HCR_EL2.TGE == 0)$:
 - If [HCR_EL2.TRVM](#)==1, Non-secure read accesses to this register from EL1 are trapped to EL2.
 - If [HCR_EL2.TVM](#)==1, Non-secure write accesses to this register from EL1 are trapped to EL2.

D7.2.12 AMAIR_EL2, Auxiliary Memory Attribute Indirection Register (EL2)

The AMAIR_EL2 characteristics are:

Purpose

Provides IMPLEMENTATION DEFINED memory attributes for the memory regions specified by [MAIR_EL2](#).

Configurations

AArch64 System register AMAIR_EL2[31:0] is architecturally mapped to AArch32 System register [HAMAIR0](#).

AArch64 System register AMAIR_EL2[63:32] is architecturally mapped to AArch32 System register [HAMAIR1](#).

If EL2 is not implemented, this register is RES0 from EL3.

RW fields in this register reset to architecturally UNKNOWN values.

Attributes

AMAIR_EL2 is a 64-bit register.

Field descriptions

The AMAIR_EL2 bit assignments are:



AMAIR_EL2 is permitted to be cached in a TLB.

IMPLEMENTATION DEFINED, bits [63:0]

IMPLEMENTATION DEFINED.

Accessing the AMAIR_EL2

This register can be read using MRS with the following syntax:

MRS <Xt>, <systemreg>

This register can be written using MSR (register) with the following syntax:

MSR <systemreg>, <Xt>

This syntax is encoded with the following settings in the instruction encoding:

<systemreg>	op0	op1	CRn	CRm	op2
AMAIR_EL2	11	100	1010	0011	000
AMAIR_EL1	11	000	1010	0011	000

Accessibility

The register is accessible in software as follows:

<systemreg>	Control			Accessibility			
	E2H	TGE	NS	EL0	EL1	EL2	EL3
AMAIR_EL2	x	x	0	-	-	n/a	RW
AMAIR_EL2	0	0	1	-	-	RW	RW
AMAIR_EL2	0	1	1	-	n/a	RW	RW
AMAIR_EL2	1	0	1	-	-	RW	RW
AMAIR_EL2	1	1	1	-	n/a	RW	RW
AMAIR_EL1	x	x	0	-	AMAIR_EL1	n/a	AMAIR_EL1
AMAIR_EL1	0	0	1	-	AMAIR_EL1	AMAIR_EL1	AMAIR_EL1
AMAIR_EL1	0	1	1	-	n/a	AMAIR_EL1	AMAIR_EL1
AMAIR_EL1	1	0	1	-	AMAIR_EL1	RW	AMAIR_EL1
AMAIR_EL1	1	1	1	-	n/a	RW	AMAIR_EL1

This table applies to all instructions that can access this register.

When [HCR_EL2.E2H](#) is 1, without explicit synchronization, access from EL2 using the mnemonic [AMAIR_EL2](#) or [AMAIR_EL1](#) are not guaranteed to be ordered with respect to accesses using the other mnemonic.

D7.2.13 AMAIR_EL3, Auxiliary Memory Attribute Indirection Register (EL3)

The AMAIR_EL3 characteristics are:

Purpose

Provides IMPLEMENTATION DEFINED memory attributes for the memory regions specified by MAIR_EL3.

Configurations

RW fields in this register reset to architecturally UNKNOWN values.

Attributes

AMAIR_EL3 is a 64-bit register.

Field descriptions

The AMAIR_EL3 bit assignments are:

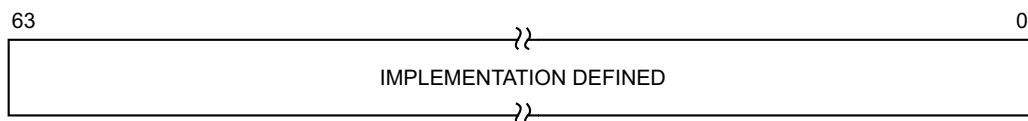

AMAIR_EL3 is permitted to be cached in a TLB.

IMPLEMENTATION DEFINED, bits [63:0]

IMPLEMENTATION DEFINED.

Accessing the AMAIR_EL3

This register can be read using MRS with the following syntax:

MRS <Xt>, <systemreg>

This register can be written using MSR (register) with the following syntax:

MSR <systemreg>, <Xt>

This syntax is encoded with the following settings in the instruction encoding:

<systemreg>	op0	op1	CRn	CRm	op2
AMAIR_EL3	11	110	1010	0011	000

Accessibility

The register is accessible in software as follows:

Control			Accessibility			
E2H	TGE	NS	EL0	EL1	EL2	EL3
x	x	0	-	-	n/a	RW
x	0	1	-	-	-	RW
x	1	1	-	n/a	-	RW

D7.2.14 CCSIDR_EL1, Current Cache Size ID Register

The CCSIDR_EL1 characteristics are:

Purpose

Provides information about the architecture of the currently selected cache.

Configurations

AArch64 System register CCSIDR_EL1 is architecturally mapped to AArch32 System register [CCSIDR](#).

The implementation includes one CCSIDR_EL1 for each cache that it can access. [CSSELR_EL1](#) selects which Cache Size ID Register is accessible.

Attributes

CCSIDR_EL1 is a 32-bit register.

Field descriptions

The CCSIDR_EL1 bit assignments are:

31	28 27	13 12	3 2 0
UNKNOWN	NumSets	Associativity	LineSize

UNKNOWN, bits [31:28]

Reserved, UNKNOWN.

NumSets, bits [27:13]

(Number of sets in cache) - 1, therefore a value of 0 indicates 1 set in the cache. The number of sets does not have to be a power of 2.

Associativity, bits [12:3]

(Associativity of cache) - 1, therefore a value of 0 indicates an associativity of 1. The associativity does not have to be a power of 2.

LineSize, bits [2:0]

($\log_2(\text{Number of bytes in cache line}) - 4$). For example:

For a line length of 16 bytes: $\log_2(16) = 4$, LineSize entry = 0. This is the minimum line length.

For a line length of 32 bytes: $\log_2(32) = 5$, LineSize entry = 1.

————— Note —————

The parameters NumSets, Associativity, and LineSize in these registers define the architecturally visible parameters that are required for the cache maintenance by Set/Way instructions. They are not guaranteed to represent the actual microarchitectural features of a design. You cannot make any inference about the actual sizes of caches based on these parameters.

Accessing the CCSIDR_EL1

This register can be read using MRS with the following syntax:

MRS <Xt>, <systemreg>

This syntax is encoded with the following settings in the instruction encoding:

<systemreg>	op0	op1	CRn	CRm	op2
CCSIDR_EL1	11	001	0000	0000	000

Accessibility

The register is accessible in software as follows:

Control			Accessibility			
E2H	TGE	NS	EL0	EL1	EL2	EL3
x	x	0	-	RO	n/a	RO
x	0	1	-	RO	RO	RO
x	1	1	-	n/a	RO	RO

If [CSSELR_EL1](#).Level is programmed to a cache level that is not implemented, then on a read of the [CCSIDR_EL1](#) the behavior is CONSTRAINED UNPREDICTABLE, and can be one of the following:

- The [CCSIDR_EL1](#) read is treated as NOP.
- The [CCSIDR_EL1](#) read is UNDEFINED.
- The [CCSIDR_EL1](#) read returns an UNKNOWN value.

Traps and Enables

For a description of the prioritization of any generated exceptions, see [Synchronous exception prioritization for exceptions taken to AArch64 on page D1-1827](#). Subject to the prioritization rules:

- When EL2 is implemented and is using AArch64 and ([SCR_EL3](#).NS == 1) && ([HCR_EL2](#).E2H == 0):
 - If [HCR_EL2](#).TID2==1, Non-secure read accesses to this register from EL1 are trapped to EL2.
- When EL2 is implemented and is using AArch64 and ([SCR_EL3](#).NS == 1) && ([HCR_EL2](#).E2H == 1) && ([HCR_EL2](#).TGE == 0):
 - If [HCR_EL2](#).TID2==1, Non-secure read accesses to this register from EL1 are trapped to EL2.

D7.2.15 CLIDR_EL1, Cache Level ID Register

The CLIDR_EL1 characteristics are:

Purpose

Identifies the type of cache, or caches, that are implemented at each level and can be managed using the architected cache maintenance instructions that operate by set/way, up to a maximum of seven levels. Also identifies the Level of Coherence (LoC) and Level of Unification (LoU) for the cache hierarchy.

Configurations

AArch64 System register CLIDR_EL1 is architecturally mapped to AArch32 System register [CLIDR](#).

Attributes

CLIDR_EL1 is a 64-bit register.

Field descriptions

The CLIDR_EL1 bit assignments are:

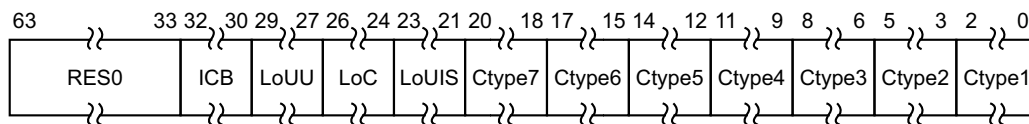

Bits [63:33]

Reserved, RES0.

ICB, bits [32:30]

Inner cache boundary. This field indicates the boundary for caching Inner Cacheable memory regions.

The possible values are:

000	Not disclosed by this mechanism.
001	L1 cache is the highest Inner Cacheable level.
010	L2 cache is the highest Inner Cacheable level.
011	L3 cache is the highest Inner Cacheable level.
100	L4 cache is the highest Inner Cacheable level.
101	L5 cache is the highest Inner Cacheable level.
110	L6 cache is the highest Inner Cacheable level.
111	L7 cache is the highest Inner Cacheable level.

LoUU, bits [29:27]

Level of Unification Uniprocessor for the cache hierarchy.

LoC, bits [26:24]

Level of Coherence for the cache hierarchy.

LoUIS, bits [23:21]

Level of Unification Inner Shareable for the cache hierarchy.

Ctype<n>, bits [3(n-1)+2:3(n-1)], for n = 1 to 7

Cache Type fields. Indicate the type of cache that is implemented and can be managed using the architected cache maintenance instructions that operate by set/way at each level, from Level 1 up to a maximum of seven levels of cache hierarchy. Possible values of each field are:

- 000 No cache.
- 001 Instruction cache only.
- 010 Data cache only.
- 011 Separate instruction and data caches.
- 100 Unified cache.

All other values are reserved.

If software reads the Cache Type fields from Ctype1 upwards, once it has seen a value of 000, no caches that can be managed using the architected cache maintenance instructions that operate by set/way exist at further-out levels of the hierarchy. So, for example, if Ctype3 is the first Cache Type field with a value of 000, the values of Ctype4 to Ctype7 must be ignored.

Accessing the CLIDR_EL1

This register can be read using MRS with the following syntax:

MRS <Xt>, <systemreg>

This syntax is encoded with the following settings in the instruction encoding:

<systemreg>	op0	op1	CRn	CRm	op2
CLIDR_EL1	11	001	0000	0000	001

Accessibility

The register is accessible in software as follows:

Control			Accessibility			
E2H	TGE	NS	EL0	EL1	EL2	EL3
x	x	0	-	RO	n/a	RO
x	0	1	-	RO	RO	RO
x	1	1	-	n/a	RO	RO

Traps and Enables

For a description of the prioritization of any generated exceptions, see *Synchronous exception prioritization for exceptions taken to AArch64* on page D1-1827. Subject to the prioritization rules:

- When EL2 is implemented and is using AArch64 and (SCR_EL3.NS == 1) && (HCR_EL2.E2H == 0):
 - If HCR_EL2.TID2==1, Non-secure read accesses to this register from EL1 are trapped to EL2.
- When EL2 is implemented and is using AArch64 and (SCR_EL3.NS == 1) && (HCR_EL2.E2H == 1) && (HCR_EL2.TGE == 0):
 - If HCR_EL2.TID2==1, Non-secure read accesses to this register from EL1 are trapped to EL2.

D7.2.16 CONTEXTIDR_EL1, Context ID Register (EL1)

The CONTEXTIDR_EL1 characteristics are:

Purpose

Identifies the current Process Identifier.

The value of the whole of this register is called the Context ID and is used by:

- The debug logic, for Linked and Unlinked Context ID matching.
- The trace logic, to identify the current process.

The significance of this register is for debug and trace use only.

This register is used:

- In ARMv8.0.
- When [ARMv8.1-VHE](#) is implemented and [HCR_EL2.E2H](#) is 0.

———— Note ————

When [ARMv8.1-VHE](#) is implemented and [HCR_EL2.E2H](#) is set to 1, [CONTEXTIDR_EL2](#) is used.

Configurations

AArch64 System register CONTEXTIDR_EL1 is architecturally mapped to AArch32 System register [CONTEXTIDR](#).

RW fields in this register reset to architecturally UNKNOWN values.

Attributes

CONTEXTIDR_EL1 is a 32-bit register.

Field descriptions

The CONTEXTIDR_EL1 bit assignments are:

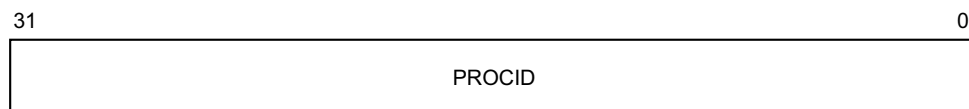

PROCID, bits [31:0]

Process Identifier. This field must be programmed with a unique value that identifies the current process.

———— Note ————

In AArch32 state, when [TTBCR.EAE](#) is set to 0, [CONTEXTIDR.ASID](#) holds the ASID.

In AArch64 state, CONTEXTIDR_EL1 is independent of the ASID, and for the EL1&0 translation regime either [TTBR0_EL1](#) or [TTBR1_EL1](#) holds the ASID.

Accessing the CONTEXTIDR_EL1

This register can be read using MRS with the following syntax:

```
MRS <Xt>, <systemreg>
```

This register can be written using MSR (register) with the following syntax:

```
MSR <systemreg>, <Xt>
```

This syntax is encoded with the following settings in the instruction encoding:

<systemreg>	op0	op1	CRn	CRm	op2
CONTEXTIDR_EL1	11	000	1101	0000	001
CONTEXTIDR_EL12	11	101	1101	0000	001

Accessibility

The register is accessible in software as follows:

<systemreg>	Control			Accessibility			
	E2H	TGE	NS	EL0	EL1	EL2	EL3
CONTEXTIDR_EL1	x	x	0	-	RW	n/a	RW
CONTEXTIDR_EL1	0	0	1	-	RW	RW	RW
CONTEXTIDR_EL1	0	1	1	-	n/a	RW	RW
CONTEXTIDR_EL1	1	0	1	-	RW	CONTEXTIDR_EL2	RW
CONTEXTIDR_EL1	1	1	1	-	n/a	CONTEXTIDR_EL2	RW
CONTEXTIDR_EL12	x	x	0	-	-	n/a	-
CONTEXTIDR_EL12	0	0	1	-	-	-	-
CONTEXTIDR_EL12	0	1	1	-	n/a	-	-
CONTEXTIDR_EL12	1	0	1	-	-	RW	RW
CONTEXTIDR_EL12	1	1	1	-	n/a	RW	RW

This table applies to all instructions that can access this register.

When [HCR_EL2.E2H](#) is 1, without explicit synchronization, access from EL3 using the mnemonic [CONTEXTIDR_EL1](#) or [CONTEXTIDR_EL12](#) are not guaranteed to be ordered with respect to accesses using the other mnemonic.

Traps and Enables

For a description of the prioritization of any generated exceptions, see [Synchronous exception prioritization for exceptions taken to AArch64 on page D1-1827](#). Subject to the prioritization rules:

- When EL2 is implemented and is using AArch64 and $(\text{SCR_EL3.NS} == 1) \ \&\& \ (\text{HCR_EL2.E2H} == 0)$:
 - If [HCR_EL2.TRVM](#)==1, Non-secure read accesses to this register from EL1 are trapped to EL2.
 - If [HCR_EL2.TVM](#)==1, Non-secure write accesses to this register from EL1 are trapped to EL2.
- When EL2 is implemented and is using AArch64 and $(\text{SCR_EL3.NS} == 1) \ \&\& \ (\text{HCR_EL2.E2H} == 1) \ \&\& \ (\text{HCR_EL2.TGE} == 0)$:
 - If [HCR_EL2.TRVM](#)==1, Non-secure read accesses to this register from EL1 are trapped to EL2.
 - If [HCR_EL2.TVM](#)==1, Non-secure write accesses to this register from EL1 are trapped to EL2.

D7.2.17 CONTEXTIDR_EL2, Context ID Register (EL2)

The CONTEXTIDR_EL2 characteristics are:

Purpose

When [ARMv8.1-VHE](#) is implemented and [HCR_EL2.E2H](#) is set to 1, identifies the current Process Identifier.

The value of the whole of this register is called the Context ID and is used by:

- The debug logic, for Linked and Unlinked Context ID matching.
- The trace logic, to identify the current process.

The significance of this register is for debug and trace use only.

Note

In ARMv8.0, or when [ARMv8.1-VHE](#) is implemented and [HCR_EL2.E2H](#) is 0, [CONTEXTIDR_EL1](#) is used.

Configurations

If EL2 is not implemented, this register is RES0 from EL3.

RW fields in this register reset to architecturally UNKNOWN values.

This register is introduced in ARMv8.1.

Attributes

CONTEXTIDR_EL2 is a 32-bit register.

Field descriptions

The CONTEXTIDR_EL2 bit assignments are:

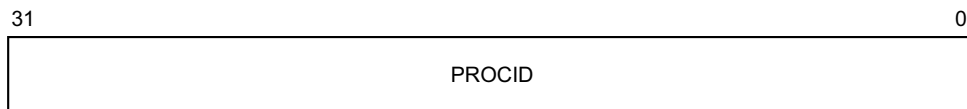

PROCID, bits [31:0]

Process Identifier. This field must be programmed with a unique value that identifies the current process.

Note

In AArch32 state, when [TTBCR.EAE](#) is set to 0, [CONTEXTIDR.ASID](#) holds the ASID.

In AArch64 state, [CONTEXTIDR_EL2](#) is independent of the ASID, and for the EL2&0 translation regime either [TTBR0_EL2](#) or [TTBR1_EL2](#) holds the ASID.

Accessing the CONTEXTIDR_EL2

This register can be read using MRS with the following syntax:

```
MRS <Xt>, <systemreg>
```

This register can be written using MSR (register) with the following syntax:

```
MSR <systemreg>, <Xt>
```

This syntax is encoded with the following settings in the instruction encoding:

<systemreg>	op0	op1	CRn	CRm	op2
CONTEXTIDR_EL2	11	100	1101	0000	001
CONTEXTIDR_EL1	11	000	1101	0000	001

Accessibility

The register is accessible in software as follows:

<systemreg>	Control			Accessibility			
	E2H	TGE	NS	EL0	EL1	EL2	EL3
CONTEXTIDR_EL2	x	x	0	-	-	n/a	RW
CONTEXTIDR_EL2	0	0	1	-	-	RW	RW
CONTEXTIDR_EL2	0	1	1	-	n/a	RW	RW
CONTEXTIDR_EL2	1	0	1	-	-	RW	RW
CONTEXTIDR_EL2	1	1	1	-	n/a	RW	RW
CONTEXTIDR_EL1	x	x	0	-	CONTEXTIDR_EL1	n/a	CONTEXTIDR_EL1
CONTEXTIDR_EL1	0	0	1	-	CONTEXTIDR_EL1	CONTEXTIDR_EL1	CONTEXTIDR_EL1
CONTEXTIDR_EL1	0	1	1	-	n/a	CONTEXTIDR_EL1	CONTEXTIDR_EL1
CONTEXTIDR_EL1	1	0	1	-	CONTEXTIDR_EL1	RW	CONTEXTIDR_EL1
CONTEXTIDR_EL1	1	1	1	-	n/a	RW	CONTEXTIDR_EL1

This table applies to all instructions that can access this register.

When [HCR_EL2.E2H](#) is 1, without explicit synchronization, access from EL2 using the mnemonic `CONTEXTIDR_EL2` or `CONTEXTIDR_EL1` are not guaranteed to be ordered with respect to accesses using the other mnemonic.

D7.2.18 CPACR_EL1, Architectural Feature Access Control Register

The CPACR_EL1 characteristics are:

Purpose

Controls access to trace, SVE, Advanced SIMD and floating-point functionality.

Configurations

AArch64 System register CPACR_EL1 is architecturally mapped to AArch32 System register [CPACR](#).

When [HCR_EL2](#).{E2H, TGE} == {1, 1}, the fields in this register have no effect on execution at EL0 and EL1. In this case, the controls provided by [CPTR_EL2](#) are used.

RW fields in this register reset to architecturally UNKNOWN values.

Attributes

CPACR_EL1 is a 32-bit register.

Field descriptions

The CPACR_EL1 bit assignments are:

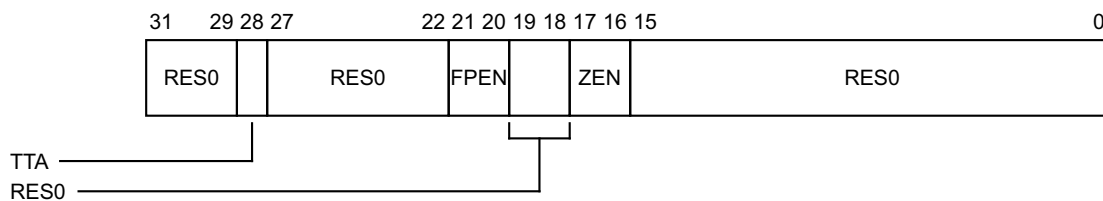

Bits [31:29]

Reserved, RES0.

TTA, bit [28]

Traps EL0 and EL1 System register accesses to all implemented trace registers to EL1, or to EL2 when [SCR_EL3](#).NS is 1 and [HCR_EL2](#).TGE is 1, from both Execution states.

0 This control does not cause any instructions to be trapped.

1 This control causes EL0 and EL1 System register accesses to all implemented trace registers to be trapped.

Note

- The ETMv4 architecture does not permit EL0 to access the trace registers. If the ARMv8-A architecture is implemented with an ETMv4 implementation, EL0 accesses to the trace registers are UNDEFINED, and any resulting exception is higher priority than an exception that would be generated because the value of [CPACR_EL1](#).TTA is 1.
- The ARMv8-A architecture does not provide traps on trace register accesses through the optional memory-mapped interface.

System register accesses to the trace registers can have side-effects. When a System register access is trapped, any side-effects that are normally associated with the access do not occur before the exception is taken.

If System register access to the trace functionality is not implemented, this bit is RES0.

Bits [27:22]

Reserved, RES0.

FPEN, bits [21:20]

Traps EL0 and EL1 accesses to the SVE, Advanced SIMD, and floating-point registers to EL1, or to EL2 when `SCR_EL3.NS` is 1 and `HCR_EL2.TGE` is 1, from both Execution states, unless SVE is implemented and they are trapped by `CPACR_EL1.ZEN`.

- | | |
|----|--|
| 00 | This control causes any instructions at EL0 or EL1 that use the registers associated with SVE, Advanced SIMD and floating-point execution to be trapped. |
| 01 | This control causes any instructions at EL0 that use the registers associated with SVE, Advanced SIMD and floating-point execution to be trapped, but does not cause any instruction in EL1 to be trapped. |
| 10 | This control causes any instructions at EL0 or EL1 that use the registers associated with SVE, Advanced SIMD and floating-point execution to be trapped. |
| 11 | This control does not cause any instructions to be trapped. |

Writes to `MVFR0`, `MVFR1` and `MVFR2` from EL1 or higher are CONstrained UNPREDICTABLE and whether these accesses can be trapped by this control depends on implemented CONstrained UNPREDICTABLE behavior.

Note

- Attempts to write to the FPSID count as use of the registers for accesses from EL1 or higher.
- Accesses from EL0 to `FPSID`, `MVFR0`, `MVFR1`, `MVFR2`, and `FPEXC` are UNDEFINED, and any resulting exception is higher priority than an exception that would be generated because the value of `CPACR_EL1.FPEN` is not 11.

Bits [19:18]

Reserved, RES0.

ZEN, bits [17:16]

In ARMv8.2

Traps SVE instructions and instructions that access SVE System registers at EL0 and EL1 to EL1, or to EL2 when `SCR_EL3.NS` and `HCR_EL2.TGE` are both 1. Defined values are:

- | | |
|----|--|
| 00 | This control causes these instructions executed at EL0 or EL1 to be trapped. |
| 01 | This control causes these instructions executed at EL0 to be trapped, but does not cause any instruction in EL1 to be trapped. |
| 10 | This control causes these instructions executed at EL0 or EL1 to be trapped. |
| 11 | This control does not cause any instruction to be trapped. |

If SVE is not implemented, this field is RES0.

In ARMv8.1 and ARMv8.0.

Reserved, RES0.

Bits [15:0]

Reserved, RES0.

Accessing the CPACR_EL1

This register can be read using MRS with the following syntax:

```
MRS <Xt>, <systemreg>
```

This register can be written using MSR (register) with the following syntax:

```
MSR <systemreg>, <Xt>
```

This syntax is encoded with the following settings in the instruction encoding:

<systemreg>	op0	op1	CRn	CRm	op2
CPACR_EL1	11	000	0001	0000	010
CPACR_EL12	11	101	0001	0000	010

Accessibility

The register is accessible in software as follows:

<systemreg>	Control			Accessibility			
	E2H	TGE	NS	EL0	EL1	EL2	EL3
CPACR_EL1	x	x	0	-	RW	n/a	RW
CPACR_EL1	0	0	1	-	RW	RW	RW
CPACR_EL1	0	1	1	-	n/a	RW	RW
CPACR_EL1	1	0	1	-	RW	CPTR_EL2	RW
CPACR_EL1	1	1	1	-	n/a	CPTR_EL2	RW
CPACR_EL12	x	x	0	-	-	n/a	-
CPACR_EL12	0	0	1	-	-	-	-
CPACR_EL12	0	1	1	-	n/a	-	-
CPACR_EL12	1	0	1	-	-	RW	RW
CPACR_EL12	1	1	1	-	n/a	RW	RW

This table applies to all instructions that can access this register.

When [HCR_EL2.E2H](#) is 1, without explicit synchronization, access from EL3 using the mnemonic CPACR_EL1 or CPACR_EL12 are not guaranteed to be ordered with respect to accesses using the other mnemonic.

Traps and Enables

For a description of the prioritization of any generated exceptions, see [Synchronous exception prioritization for exceptions taken to AArch64 on page D1-1827](#). Subject to the prioritization rules:

- When EL2 is implemented and is using AArch64 and (SCR_EL3.NS == 1) && (HCR_EL2.E2H == 0):
 - If [CPTR_EL2.TCPAC](#)==1, Non-secure accesses to this register from EL1 are trapped to EL2.
- When EL2 is implemented and is using AArch64 and (SCR_EL3.NS == 1) && (HCR_EL2.E2H == 1) && (HCR_EL2.TGE == 0):
 - If [CPTR_EL2.TCPAC](#)==1, Non-secure accesses to this register from EL1 are trapped to EL2.
- When EL3 is implemented and is using AArch64:
 - If [CPTR_EL3.TCPAC](#)==1, accesses to this register from EL1 and EL2 are trapped to EL3.

D7.2.19 CPTR_EL2, Architectural Feature Trap Register (EL2)

The CPTR_EL2 characteristics are:

Purpose

Controls:

- Trapping to EL2 of access to [CPACR](#), [CPACR_EL1](#), trace functionality, and to SVE, Advanced SIMD and floating-point functionality.
- EL2 access to trace functionality, and to SVE, Advanced SIMD and floating-point functionality.

Configurations

AArch64 System register CPTR_EL2 is architecturally mapped to AArch32 System register [HCPTR](#).

If EL2 is not implemented, this register is RES0 from EL3.

RW fields in this register reset to architecturally UNKNOWN values.

Attributes

CPTR_EL2 is a 32-bit register.

Field descriptions

The CPTR_EL2 bit assignments are:

When HCR_EL2.E2H == 0:

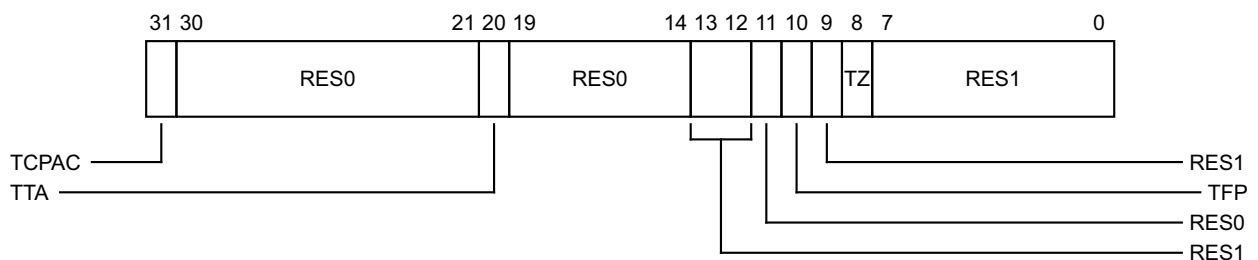

This format applies in all ARMv8.0 implementations.

TCPAC, bit [31]

Traps Non-secure EL1 accesses to [CPACR_EL1](#) or [CPACR](#) to EL2, from both Execution states.

0 This control does not cause any instructions to be trapped.

1 Non-secure EL1 accesses to [CPACR_EL1](#) and [CPACR](#) are trapped to EL2.

Note

[CPACR_EL1](#) and [CPACR](#) are not accessible at EL0.

Bits [30:21]

Reserved, RES0.

TTA, bit [20]

Traps Non-secure System register accesses to all implemented trace registers to EL2, from both Execution states.

0 This control does not cause any instructions to be trapped.

- 1 Any attempt at EL2, or Non-secure EL0 or EL1, to execute a System register access to an implemented trace register is trapped to EL2, unless it is trapped by [CPACR.NSTRCDIS](#) or [CPACR_EL1.TTA](#).

Note

- The ETMv4 architecture does not permit EL0 to access the trace registers. If the ARMv8-A architecture is implemented with an ETMv4 implementation, EL0 accesses to the trace registers are UNDEFINED, and any resulting exception is higher priority than an exception that would be generated because the value of [CPTR_EL2.TTA](#) is 1.
- EL2 does not provide traps on trace register accesses through the optional memory-mapped interface.

System register accesses to the trace registers can have side-effects. When a System register access is trapped, any side-effects that are normally associated with the access do not occur before the exception is taken.

If System register access to the trace functionality is not supported, this bit is RES0.

Bits [19:14]

Reserved, RES0.

Bits [13:12]

Reserved, RES1.

Bit [11]

Reserved, RES0.

TFP, bit [10]

Traps Non-secure accesses to SVE, Advanced SIMD and floating-point functionality to EL2, from both Execution states.

- 0 This control does not cause any instructions to be trapped.
- 1 Any attempt at EL2, or Non-secure EL0 or EL1, to execute an instruction that uses the registers associated with SVE, Advanced SIMD and floating-point execution is trapped to EL2, unless it is trapped by [CPACR.cp10](#), [CPACR_EL1.FPEN](#), and if SVE is implemented, [CPACR_EL1.ZEN](#), or [CPTR_EL2.TZ](#).

Bit [9]

Reserved, RES1.

TZ, bit [8]

In ARMv8.2

Present only if [SVE](#) is implemented.

Traps Non-secure execution at EL2, EL1, or EL0 of SVE instructions and instructions that access SVE System registers to EL2. Defined values are:

- 0 This control does not cause any instruction to be trapped.
- 1 This control causes these instructions to be trapped, unless [HCR_EL2.TGE](#) is 0 and they are trapped by [CPACR_EL1](#).

If [SVE](#) is not implemented, this field is RES1.

In ARMv8.1 and ARMv8.0.

Reserved, RES1.

Bits [7:0]

Reserved, RES1.

When HCR_EL2.E2H == 1:

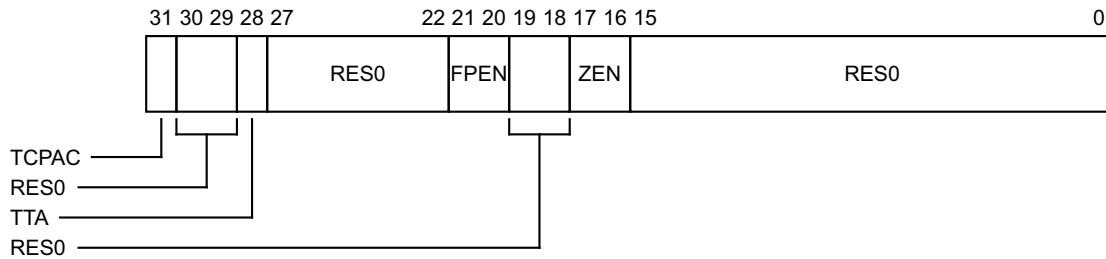

TCPAC, bit [31]

When HCR_EL2.TGE is 0, traps Non-secure EL1 accesses to CPACR_EL1 and CPACR to EL2, from both Execution states.

- 0 This control does not cause any instructions to be trapped.
- 1 Non-secure EL1 accesses to CPACR_EL1 and CPACR are trapped to EL2.

When HCR_EL2.TGE is 1, this control does not cause any instructions to be trapped.

———— **Note** ————

CPACR_EL1 and CPACR are not accessible at EL0.

Bits [30:29]

Reserved, RES0.

TTA, bit [28]

Traps Non-secure System register accesses to all implemented trace registers to EL2, from both Execution states.

- 0 This control does not cause any instructions to be trapped.
- 1 Any attempt at EL2, or Non-secure EL0 or EL1, to execute a System register access to an implemented trace register is trapped to EL2, unless HCR_EL2.TGE is 0 and it is trapped by CPACR.NSTRCDIS or CPACR_EL1.TTA.
When HCR_EL2.TGE is 1, any attempt at EL2, or Non-secure EL0, to execute a System register access to an implemented trace register is trapped to EL2.

———— **Note** ————

- The ETMv4 architecture does not permit EL0 to access the trace registers. If the ARMv8-A architecture is implemented with an ETMv4 implementation, EL0 accesses to the trace registers are UNDEFINED, and any resulting exception is higher priority than an exception that would be generated because the value of CPTR_EL2.TTA is 1.
- EL2 does not provide traps on trace register accesses through the optional memory-mapped interface.

System register accesses to the trace registers can have side-effects. When a System register access is trapped, any side-effects that are normally associated with the access do not occur before the exception is taken.

If System register access to the trace functionality is not supported, this bit is RES0.

Bits [27:22]

Reserved, RES0.

FPEN, bits [21:20]

Traps EL2, Non-secure EL0 and, when [HCR_EL2.TGE](#) is 0, Non-secure EL1 accesses to the SVE, Advanced SIMD and floating-point registers to EL2, from both Execution states.

- 00 This control causes any instructions at Non-secure EL0, EL1, or EL2 that use the registers associated with SVE, Advanced SIMD and floating-point execution to be trapped, unless [HCR_EL2.TGE](#) is 0 and they are trapped by [CPACR.cp10](#), [CPACR_EL1.FPEN](#), [CPACR_EL1.ZEN](#), or [CPTR_EL2.ZEN](#).
- 01 When [HCR_EL2.TGE](#) is 0, this control does not cause any instructions to be trapped. When [HCR_EL2.TGE](#) is 1, this control causes instructions at Non-secure EL0 that use the registers associated with SVE, Advanced SIMD and floating-point execution to be trapped, unless they are trapped by [CPTR_EL2.ZEN](#).
- 10 This control causes any instructions at Non-secure EL0, EL1, or EL2 that use the registers associated with SVE, Advanced SIMD and floating-point execution to be trapped, unless [HCR_EL2.TGE](#) is 0 and they are trapped by [CPACR.cp10](#), [CPACR_EL1.FPEN](#), [CPACR_EL1.ZEN](#), or [CPTR_EL2.ZEN](#).
- 11 This control does not cause any instructions to be trapped.

Writes to [MVFR0](#), [MVFR1](#), and [MVFR2](#) from EL1 or higher are CONstrained UNPREDICTABLE and whether these accesses can be trapped by this control depends on implemented CONstrained UNPREDICTABLE behavior.

———— **Note** —————

- Attempts to write to the FPSID count as use of the registers for accesses from EL1 or higher.
- Accesses from EL0 to [FPSID](#), [MVFR0](#), [MVFR1](#), [MVFR2](#), and [FPEXC](#) are UNDEFINED, and any resulting exception is higher priority than an exception that would be generated because the value of [CPTR_EL2.FPEN](#) is not 11.

Bits [19:18]

Reserved, RES0.

ZEN, bits [17:16]

In ARMv8.2

Present only if [SVE](#) is implemented.

Traps Non-secure execution at EL2, EL1, and EL0 of SVE instructions or instructions that access SVE System registers to EL2.

Defined values are:

- 00 This control causes Non-secure execution at EL2, EL1, and EL0 of these instructions to be trapped, unless [HCR_EL2.TGE](#) is 0 and they are trapped by [CPACR_EL1](#).
- 01 When [HCR_EL2.TGE](#) is 0, this control does not cause any instruction to be trapped. When [HCR_EL2.TGE](#) is 1, this control causes these instructions executed at Non-secure EL0 to be trapped, but does not cause any instruction at EL2 to be trapped.
- 10 This control causes Non-secure execution at EL2, EL1, and EL0 of these instructions to be trapped, unless [HCR_EL2.TGE](#) is 0 and they are trapped by [CPACR_EL1](#).
- 11 This control does not cause any instruction to be trapped.

If [SVE](#) is not implemented, this field is RES0.

In ARMv8.1.

Reserved, RES0.

Bits [15:0]

Reserved, RES0.

Accessing the CPTR_EL2

This register can be read using MRS with the following syntax:

MRS <Xt>, <systemreg>

This register can be written using MSR (register) with the following syntax:

MSR <systemreg>, <Xt>

This syntax is encoded with the following settings in the instruction encoding:

<systemreg>	op0	op1	CRn	CRm	op2
CPTR_EL2	11	100	0001	0001	010
CPACR_EL1	11	000	0001	0000	010

Accessibility

The register is accessible in software as follows:

<systemreg>	Control			Accessibility			
	E2H	TGE	NS	EL0	EL1	EL2	EL3
CPTR_EL2	x	x	0	-	-	n/a	RW
CPTR_EL2	0	0	1	-	-	RW	RW
CPTR_EL2	0	1	1	-	n/a	RW	RW
CPTR_EL2	1	0	1	-	-	RW	RW
CPTR_EL2	1	1	1	-	n/a	RW	RW
CPACR_EL1	x	x	0	-	CPACR_EL1	n/a	CPACR_EL1
CPACR_EL1	0	0	1	-	CPACR_EL1	CPACR_EL1	CPACR_EL1
CPACR_EL1	0	1	1	-	n/a	CPACR_EL1	CPACR_EL1
CPACR_EL1	1	0	1	-	CPACR_EL1	RW	CPACR_EL1
CPACR_EL1	1	1	1	-	n/a	RW	CPACR_EL1

This table applies to all instructions that can access this register.

Traps and Enables

For a description of the prioritization of any generated exceptions, see [Synchronous exception prioritization for exceptions taken to AArch64 on page D1-1827](#). Subject to the prioritization rules:

- When EL3 is implemented and is using AArch64:
 - If [CPTR_EL3.TCPAC](#)==1, accesses to this register from EL2 are trapped to EL3.

D7.2.20 CPTR_EL3, Architectural Feature Trap Register (EL3)

The CPTR_EL3 characteristics are:

Purpose

Controls trapping to EL3 of access to [CPACR_EL1](#), [CPTR_EL2](#), trace functionality and registers associated with SVE, Advanced SIMD and floating-point execution. Also controls EL3 access to trace functionality and registers associated with SVE, Advanced SIMD and floating-point execution.

Configurations

RW fields in this register reset to architecturally UNKNOWN values.

Attributes

CPTR_EL3 is a 32-bit register.

Field descriptions

The CPTR_EL3 bit assignments are:

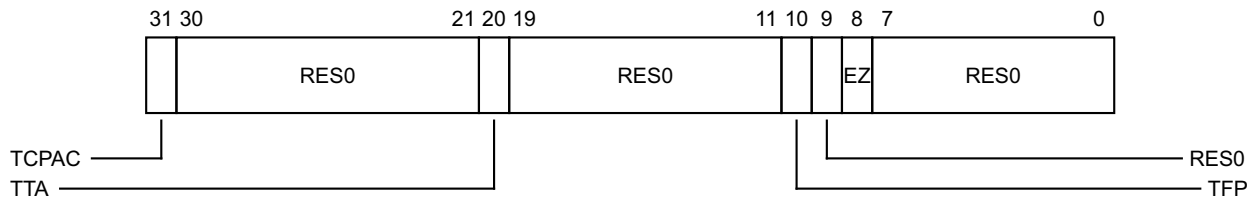

TCPAC, bit [31]

Traps all of the following to EL3, from both Security states and both Execution states.

- EL2 accesses to the [CPTR_EL2](#) or [HCPTR](#).
- EL2 and EL1 accesses to the [CPACR_EL1](#) or [CPACR](#).

When CPTR_EL3.TCPAC is:

- 0 This control does not cause any instructions to be trapped.
- 1 EL2 accesses to the [CPTR_EL2](#) or [HCPTR](#), and EL2 and EL1 accesses to the [CPACR_EL1](#) or [CPACR](#), are trapped to EL3, unless they are trapped by [CPTR_EL2.TCPAC](#).

Bits [30:21]

Reserved, RES0.

TTA, bit [20]

Traps System register accesses to the trace registers, from all Exception levels, both Security states, and both Execution states, to EL3.

- 0 This control does not cause any instructions to be trapped.
- 1 Any System register access to the trace registers is trapped to EL3, subject to the exception prioritization rules, unless it is trapped by [CPACR.NSTRCDIS](#), [CPACR_EL1.TTA](#) or [CPTR_EL2.TTA](#).

If System register access to trace functionality is not supported, this bit is RES0.

Bits [19:11]

Reserved, RES0.

TFP, bit [10]

Traps all accesses to SVE, Advanced SIMD and floating-point functionality, from all Exception levels, both Security states, and both Execution states, to EL3.

- 0 This control does not cause any instructions to be trapped.
- 1 Any attempt at any Exception level to execute an instruction that uses the registers associated with SVE, Advanced SIMD and floating-point is trapped to EL3, subject to the exception prioritization rules, unless it is trapped by CPACR.cp10, CPACR_EL1.FPEN, CPTR_EL2.TFP, and if SVE is implemented, CPACR_EL1.ZEN, CPTR_EL2.FPEN, CPTR_EL2.ZEN, or CPTR_EL2.TZ.

Bit [9]

Reserved, RES0.

EZ, bit [8]

In ARMv8.2

Present only if SVE is implemented.

Traps all accesses to SVE functionality and registers from all Exception levels, and both Security states, to EL3. Defined values are:

- 0 This control causes these instructions executed at any Exception level to be trapped, unless they are trapped by CPTR_EL2 or CPACR_EL1.
- 1 This control does not cause any instruction to be trapped.

If SVE is not implemented, this field is RES0.

In ARMv8.1 and ARMv8.0.

Reserved, RES0.

Bits [7:0]

Reserved, RES0.

Accessing the CPTR_EL3

This register can be read using MRS with the following syntax:

MRS <Xt>, <systemreg>

This register can be written using MSR (register) with the following syntax:

MSR <systemreg>, <Xt>

This syntax is encoded with the following settings in the instruction encoding:

<systemreg>	op0	op1	CRn	CRm	op2
CPTR_EL3	11	110	0001	0001	010

Accessibility

The register is accessible in software as follows:

Control			Accessibility			
E2H	TGE	NS	EL0	EL1	EL2	EL3
x	x	0	-	-	n/a	RW
x	0	1	-	-	-	RW
x	1	1	-	n/a	-	RW

D7.2.21 CSSELR_EL1, Cache Size Selection Register

The CSSELR_EL1 characteristics are:

Purpose

Selects the current Cache Size ID Register, [CCSIDR_EL1](#), by specifying the required cache level and the cache type (either instruction or data cache).

Configurations

AArch64 System register CSSELR_EL1 is architecturally mapped to AArch32 System register [CSSELR](#).

RW fields in this register reset to architecturally UNKNOWN values.

Attributes

CSSELR_EL1 is a 32-bit register.

Field descriptions

The CSSELR_EL1 bit assignments are:

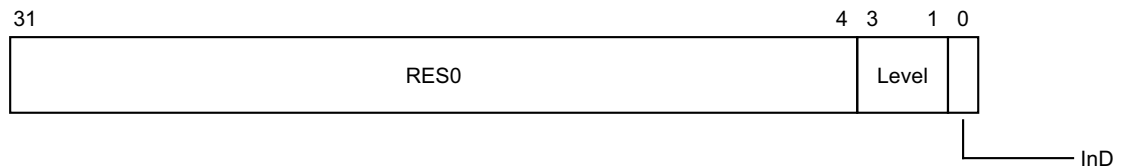

Bits [31:4]

Reserved, RES0.

Level, bits [3:1]

Cache level of required cache. Permitted values are:

000	Level 1 cache
001	Level 2 cache
010	Level 3 cache
011	Level 4 cache
100	Level 5 cache
101	Level 6 cache
110	Level 7 cache

All other values are reserved.

If CSSELR_EL1.Level is programmed to a cache level that is not implemented, then the value for this field on a read of CSSELR is UNKNOWN.

InD, bit [0]

Instruction not Data bit. Permitted values are:

0	Data or unified cache.
1	Instruction cache.

If CSSELR_EL1.Level is programmed to a cache level that is not implemented, then the value for this field on a read of CSSELR is UNKNOWN.

Accessing the CSSELR_EL1

This register can be read using MRS with the following syntax:

MRS <Xt>, <systemreg>

This syntax is encoded with the following settings in the instruction encoding:

<systemreg>	op0	op1	CRn	CRm	op2
CSSELR_EL1	11	010	0000	0000	000

Accessibility

The register is accessible in software as follows:

Control			Accessibility			
E2H	TGE	NS	EL0	EL1	EL2	EL3
x	x	0	-	RW	n/a	RW
x	0	1	-	RW	RW	RW
x	1	1	-	n/a	RW	RW

Traps and Enables

For a description of the prioritization of any generated exceptions, see [Synchronous exception prioritization for exceptions taken to AArch64 on page D1-1827](#). Subject to the prioritization rules:

- When EL2 is implemented and is using AArch64 and (SCR_EL3.NS == 1) && (HCR_EL2.E2H == 0):
 - If HCR_EL2.TID2==1, Non-secure accesses to this register from EL1 are trapped to EL2.
- When EL2 is implemented and is using AArch64 and (SCR_EL3.NS == 1) && (HCR_EL2.E2H == 1) && (HCR_EL2.TGE == 0):
 - If HCR_EL2.TID2==1, Non-secure accesses to this register from EL1 are trapped to EL2.

D7.2.22 CTR_EL0, Cache Type Register

The CTR_EL0 characteristics are:

Purpose

Provides information about the architecture of the caches.

Configurations

AArch64 System register CTR_EL0 is architecturally mapped to AArch32 System register [CTR](#).

Attributes

CTR_EL0 is a 32-bit register.

Field descriptions

The CTR_EL0 bit assignments are:

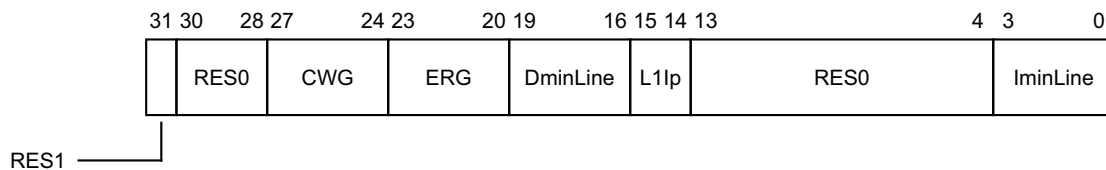

Bit [31]

Reserved, RES1.

Bits [30:28]

Reserved, RES0.

CWG, bits [27:24]

Cache writeback granule. \log_2 of the number of words of the maximum size of memory that can be overwritten as a result of the eviction of a cache entry that has had a memory location in it modified.

A value of `0b0000` indicates that this register does not provide Cache writeback granule information and either:

- The architectural maximum of 512 words (2KB) must be assumed.
- The Cache writeback granule can be determined from maximum cache line size encoded in the Cache Size ID Registers.

Values greater than `0b1001` are reserved.

ARM recommends that an implementation that does not support cache write-back implements this field as `0b0001`. This applies, for example, to an implementation that supports only write-through caches.

ERG, bits [23:20]

Exclusives reservation granule. \log_2 of the number of words of the maximum size of the reservation granule that has been implemented for the Load-Exclusive and Store-Exclusive instructions.

A value of `0b0000` indicates that this register does not provide Exclusives reservation granule information and the architectural maximum of 512 words (2KB) must be assumed.

Values greater than `0b1001` are reserved.

DminLine, bits [19:16]

\log_2 of the number of words in the smallest cache line of all the data caches and unified caches that are controlled by the PE.

L1Ip, bits [15:14]

Level 1 instruction cache policy. Indicates the indexing and tagging policy for the L1 instruction cache. Possible values of this field are:

00	VMID aware Physical Index, Physical tag (VPIPT)
01	ASID-tagged Virtual Index, Virtual Tag (AIVIVT)
10	Virtual Index, Physical Tag (VIPT)
11	Physical Index, Physical Tag (PIPT)

The value 0b01 is reserved in ARMv8.

Bits [13:4]

Reserved, RES0.

IminLine, bits [3:0]

Log₂ of the number of words in the smallest cache line of all the instruction caches that are controlled by the PE.

Accessing the CTR_EL0

This register can be read using MRS with the following syntax:

MRS <Xt>, <systemreg>

This syntax is encoded with the following settings in the instruction encoding:

<systemreg>	op0	op1	CRn	CRm	op2
CTR_EL0	11	011	0000	0000	001

Accessibility

The register is accessible in software as follows:

Control			Accessibility			
E2H	TGE	NS	EL0	EL1	EL2	EL3
x	x	0	RO	RO	n/a	RO
x	0	1	RO	RO	RO	RO
x	1	1	RO	n/a	RO	RO

Traps and Enables

For a description of the prioritization of any generated exceptions, see [Synchronous exception prioritization for exceptions taken to AArch64 on page D1-1827](#). Subject to the prioritization rules:

- In both security states, and not dependent on other bits:
 - If [SCTLR_EL1.UCT](#)==0, read accesses to this register from EL0 are trapped to EL1.
- When EL2 is implemented and is using AArch64 and ([SCR_EL3.NS](#) == 1) && ([HCR_EL2.E2H](#) == 0):
 - If [HCR_EL2.TID2](#)==1, Non-secure read accesses to this register from EL0 and EL1 are trapped to EL2.

- When EL2 is implemented and is using AArch64 and (SCR_EL3.NS == 1) && (HCR_EL2.E2H == 1) && (HCR_EL2.TGE == 0):
 - If [HCR_EL2.TID2](#)==1, Non-secure read accesses to this register from EL0 and EL1 are trapped to EL2.

D7.2.23 DACR32_EL2, Domain Access Control Register

The DACR32_EL2 characteristics are:

Purpose

Allows access to the AArch32 [DACR](#) register from AArch64 state only. Its value has no effect on execution in AArch64 state.

Configurations

AArch64 System register DACR32_EL2 is architecturally mapped to AArch32 System register [DACR](#).

If EL1 does not support AArch32, this register is UNDEFINED.

If EL2 is not implemented but EL3 is implemented, and EL1 is capable of using AArch32, then this register is not RES0.

RW fields in this register reset to architecturally UNKNOWN values.

Attributes

DACR32_EL2 is a 32-bit register.

Field descriptions

The DACR32_EL2 bit assignments are:

31	30	29	28	27	26	25	24	23	22	21	20	19	18	17	16	15	14	13	12	11	10	9	8	7	6	5	4	3	2	1	0
D15	D14	D13	D12	D11	D10	D9	D8	D7	D6	D5	D4	D3	D2	D1	D0																

D<n>, bits [2n+1:2n], for n = 0 to 15

Domain n access permission, where n = 0 to 15. Permitted values are:

- 00 No access. Any access to the domain generates a Domain fault.
 - 01 Client. Accesses are checked against the permission bits in the translation tables.
 - 11 Manager. Accesses are not checked against the permission bits in the translation tables.
- The value 10 is reserved.

Accessing the DACR32_EL2

This register can be read using MRS with the following syntax:

```
MRS <Xt>, <systemreg>
```

This register can be written using MSR (register) with the following syntax:

```
MSR <systemreg>, <Xt>
```

This syntax is encoded with the following settings in the instruction encoding:

<systemreg>	op0	op1	CRn	CRm	op2
DACR32_EL2	11	100	0011	0000	000

Accessibility

The register is accessible in software as follows:

Control			Accessibility			
E2H	TGE	NS	EL0	EL1	EL2	EL3
x	x	0	-	-	n/a	RW
x	0	1	-	-	RW	RW
x	1	1	-	n/a	RW	RW

D7.2.24 DCZID_EL0, Data Cache Zero ID register

The DCZID_EL0 characteristics are:

Purpose

Indicates the block size that is written with byte values of 0 by the [DC ZVA](#) (Data Cache Zero by Address) system instruction.

Configurations

There are no configuration notes.

Attributes

DCZID_EL0 is a 32-bit register.

Field descriptions

The DCZID_EL0 bit assignments are:

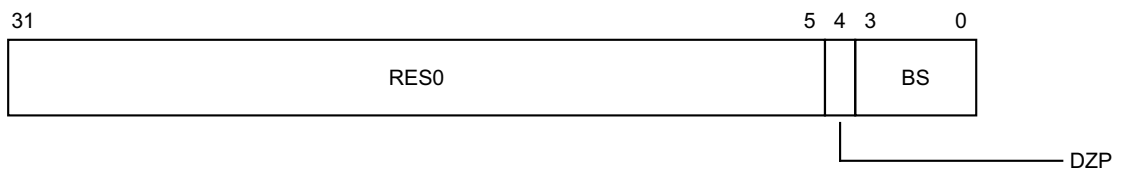

Bits [31:5]

Reserved, RES0.

DZP, bit [4]

Data Zero prohibited. Permitted values are:

- 0 [DC ZVA](#) instruction is permitted.
- 1 [DC ZVA](#) instruction is prohibited.

The value read from this field is governed by the access state and the values of the [HCR_EL2.TDZ](#) and [SCTLR_EL1.DZE](#) bits.

BS, bits [3:0]

\log_2 of the block size in words. The maximum size supported is 2KB (value == 9).

Accessing the DCZID_EL0

This register can be read using MRS with the following syntax:

MRS <Xt>, <systemreg>

This syntax is encoded with the following settings in the instruction encoding:

<systemreg>	op0	op1	CRn	CRm	op2
DCZID_EL0	11	011	0000	0000	111

Accessibility

The register is accessible in software as follows:

Control			Accessibility			
E2H	TGE	NS	EL0	EL1	EL2	EL3
x	x	0	RO	RO	n/a	RO
x	0	1	RO	RO	RO	RO
x	1	1	RO	n/a	RO	RO

D7.2.25 ESR_EL1, Exception Syndrome Register (EL1)

The ESR_EL1 characteristics are:

Purpose

Holds syndrome information for an exception taken to EL1.

Configurations

AArch64 System register ESR_EL1 is architecturally mapped to AArch32 System register [DFSR](#).
RW fields in this register reset to architecturally UNKNOWN values.

Attributes

ESR_EL1 is a 32-bit register.

Field descriptions

See [ESR_ELx](#).

Accessing the ESR_EL1

This register can be read using MRS with the following syntax:

MRS <Xt>, <systemreg>

This register can be written using MSR (register) with the following syntax:

MSR <systemreg>, <Xt>

This syntax is encoded with the following settings in the instruction encoding:

<systemreg>	op0	op1	CRn	CRm	op2
ESR_EL1	11	000	0101	0010	000
ESR_EL12	11	101	0101	0010	000

Accessibility

The register is accessible in software as follows:

<systemreg>	Control			Accessibility			
	E2H	TGE	NS	EL0	EL1	EL2	EL3
ESR_EL1	x	x	0	-	RW	n/a	RW
ESR_EL1	0	0	1	-	RW	RW	RW
ESR_EL1	0	1	1	-	n/a	RW	RW
ESR_EL1	1	0	1	-	RW	ESR_EL2	RW
ESR_EL1	1	1	1	-	n/a	ESR_EL2	RW
ESR_EL12	x	x	0	-	-	n/a	-
ESR_EL12	0	0	1	-	-	-	-

<systemreg>	Control			Accessibility			
	E2H	TGE	NS	EL0	EL1	EL2	EL3
ESR_EL12	0	1	1	-	n/a	-	-
ESR_EL12	1	0	1	-	-	RW	RW
ESR_EL12	1	1	1	-	n/a	RW	RW

This table applies to all instructions that can access this register.

When `HCR_EL2.E2H` is 1, without explicit synchronization, access from EL3 using the mnemonic `ESR_EL1` or `ESR_EL12` are not guaranteed to be ordered with respect to accesses using the other mnemonic.

Traps and Enables

For a description of the prioritization of any generated exceptions, see [Synchronous exception prioritization for exceptions taken to AArch64 on page D1-1827](#). Subject to the prioritization rules:

- When EL2 is implemented and is using AArch64 and `(SCR_EL3.NS == 1) && (HCR_EL2.E2H == 0)`:
 - If `HCR_EL2.TRVM==1`, Non-secure read accesses to this register from EL1 are trapped to EL2.
 - If `HCR_EL2.TVM==1`, Non-secure write accesses to this register from EL1 are trapped to EL2.
- When EL2 is implemented and is using AArch64 and `(SCR_EL3.NS == 1) && (HCR_EL2.E2H == 1) && (HCR_EL2.TGE == 0)`:
 - If `HCR_EL2.TRVM==1`, Non-secure read accesses to this register from EL1 are trapped to EL2.
 - If `HCR_EL2.TVM==1`, Non-secure write accesses to this register from EL1 are trapped to EL2.

D7.2.26 ESR_EL2, Exception Syndrome Register (EL2)

The ESR_EL2 characteristics are:

Purpose

Holds syndrome information for an exception taken to EL2.

Configurations

AArch64 System register ESR_EL2 is architecturally mapped to AArch32 System register [HSR](#).

If EL2 is not implemented, this register is RES0 from EL3.

RW fields in this register reset to architecturally UNKNOWN values.

Attributes

ESR_EL2 is a 32-bit register.

Field descriptions

See [ESR_ELx](#).

Accessing the ESR_EL2

This register can be read using MRS with the following syntax:

```
MRS <Xt>, <systemreg>
```

This register can be written using MSR (register) with the following syntax:

```
MSR <systemreg>, <Xt>
```

This syntax is encoded with the following settings in the instruction encoding:

<systemreg>	op0	op1	CRn	CRm	op2
ESR_EL2	11	100	0101	0010	000
ESR_EL1	11	000	0101	0010	000

Accessibility

The register is accessible in software as follows:

<systemreg>	Control			Accessibility			
	E2H	TGE	NS	EL0	EL1	EL2	EL3
ESR_EL2	x	x	0	-	-	n/a	RW
ESR_EL2	0	0	1	-	-	RW	RW
ESR_EL2	0	1	1	-	n/a	RW	RW
ESR_EL2	1	0	1	-	-	RW	RW
ESR_EL2	1	1	1	-	n/a	RW	RW
ESR_EL1	x	x	0	-	ESR_EL1	n/a	ESR_EL1
ESR_EL1	0	0	1	-	ESR_EL1	ESR_EL1	ESR_EL1

<systemreg>	Control			Accessibility			
	E2H	TGE	NS	EL0	EL1	EL2	EL3
ESR_EL1	0	1	1	-	n/a	ESR_EL1	ESR_EL1
ESR_EL1	1	0	1	-	ESR_EL1	RW	ESR_EL1
ESR_EL1	1	1	1	-	n/a	RW	ESR_EL1

This table applies to all instructions that can access this register.

When [HCR_EL2.E2H](#) is 1, without explicit synchronization, access from EL2 using the mnemonic ESR_EL2 or ESR_EL1 are not guaranteed to be ordered with respect to accesses using the other mnemonic.

D7.2.27 ESR_EL3, Exception Syndrome Register (EL3)

The ESR_EL3 characteristics are:

Purpose

Holds syndrome information for an exception taken to EL3.

Configurations

RW fields in this register reset to architecturally UNKNOWN values.

Attributes

ESR_EL3 is a 32-bit register.

Field descriptions

See [ESR_ELx](#).

Accessing the ESR_EL3

This register can be read using MRS with the following syntax:

MRS <Xt>, <systemreg>

This register can be written using MSR (register) with the following syntax:

MSR <systemreg>, <Xt>

This syntax is encoded with the following settings in the instruction encoding:

<systemreg>	op0	op1	CRn	CRm	op2
ESR_EL3	11	110	0101	0010	000

Accessibility

The register is accessible in software as follows:

Control			Accessibility			
E2H	TGE	NS	EL0	EL1	EL2	EL3
x	x	0	-	-	n/a	RW
0	0	1	-	-	-	RW
0	1	1	-	n/a	-	RW
1	0	1	-	-	-	RW
1	1	1	-	n/a	-	RW

D7.2.28 ESR_ELx, Exception Syndrome Register (ELx)

This page describes [ESR_EL1](#), [ESR_EL2](#), and [ESR_EL3](#).

The ESR_ELx characteristics are:

Purpose

Holds syndrome information for an exception taken to ELx.

Configurations

If EL2 is not implemented, [ESR_EL2](#) is RES0 from EL3.

Attributes

The ESR_ELx registers are 32-bit registers.

Field descriptions

The ESR_ELx bit assignments are:

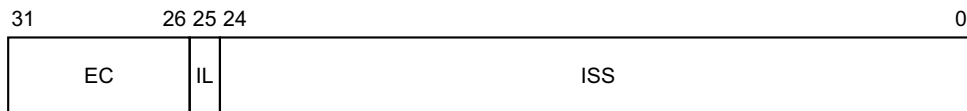

ESR_ELx is made UNKNOWN as a result of an exception return from ELx.

When an UNPREDICTABLE instruction is treated as UNDEFINED, and the exception is taken to ELx, the value of ESR_ELx is UNKNOWN. The value written to ESR_ELx must be consistent with a value that could be created as a result of an exception from the same Exception level that generated the exception as a result of a situation that is not UNPREDICTABLE at that Exception level, in order to avoid the possibility of a privilege violation.

EC, bits [31:26]

Exception Class. Indicates the reason for the exception that this register holds information about.

For each EC value, the table references a subsection that gives information about:

- The cause of the exception, for example the configuration required to enable the trap.
- The encoding of the associated ISS.

Possible values of the EC field are:

EC == 000000

Unknown reason.

This value is valid for all described registers.

See [ISS encoding for exceptions with an unknown reason](#).

EC == 000001

Trapped WFI or WFE instruction execution.

Conditional WFE and WFI instructions that fail their condition code check do not cause an exception.

This value is valid for all described registers.

See [ISS encoding for an exception from a WFI or WFE instruction](#).

EC == 000011

Trapped MCR or MRC access with (coproc==1111) that is not reported using EC 0b000000.

This value is valid for all described registers.

See [ISS encoding for an exception from an MCR or MRC access](#).

EC == 000100

Trapped MCRR or MRRC access with (coproc==1111) that is not reported using EC 0b000000.

This value is valid for all described registers.

See [ISS encoding for an exception from an MCRR or MRRC access](#).

EC == 000101

Trapped MCR or MRC access with (coproc==1110).

This value is valid for all described registers.

See [ISS encoding for an exception from an MCR or MRC access](#).

EC == 000110

Trapped LDC or STC access.

The only architected uses of these instructions are:

- An STC to write data to memory from [DBGDTRRXint](#).
- An LDC to read data from memory to [DBGDTRXint](#).

This value is valid for all described registers.

See [ISS encoding for an exception from an LDC or STC instruction](#).

EC == 000111

Access to SVE, Advanced SIMD, or floating-point functionality trapped by [CPACR_EL1.FPEN](#), [CPTR_EL2.FPEN](#), [CPTR_EL2.TFP](#), or [CPTR_EL3.TFP](#) control. Excludes exceptions resulting from [CPACR_EL1](#) when the value of [HCR_EL2.TGE](#) is 1, or because SVE or Advanced SIMD and floating-point are not implemented. These are reported with EC value 0b000000 as described in [The EC used to report an exception routed to EL2 because HCR_EL2.TGE is 1 on page D1-1813](#).

This value is valid for all described registers.

See [ISS encoding for an exception from an access to an Advanced SIMD or floating-point register, resulting from CPACR_EL1.FPEN or CPTR_ELx.TFP](#).

EC == 001000

Trapped VMRS access, from ID group trap, that is not reported using EC 0b000111.

This value is valid for [ESR_EL2](#).

See [ISS encoding for an exception from an MCR or MRC access](#).

EC == 001100

Trapped MRRC access with (coproc==1110).

This value is valid for all described registers.

See [ISS encoding for an exception from an MCRR or MRRC access](#).

EC == 001110

Illegal Execution state.

This value is valid for all described registers.

See [ISS encoding for an exception from an Illegal Execution state, or a PC or SP alignment fault](#).

EC == 010001

SVC instruction execution in AArch32 state.

This is reported in [ESR_EL2](#) only when the exception is generated because the value of [HCR_EL2.TGE](#) is 1.

This value is valid for [ESR_EL1](#) and [ESR_EL2](#).

See [ISS encoding for an exception from HVC or SVC instruction execution](#).

EC == 010010

HVC instruction execution in AArch32 state, when HVC is not disabled.

This value is valid for [ESR_EL2](#).

See [ISS encoding for an exception from HVC or SVC instruction execution](#).

EC == 010011

SMC instruction execution in AArch32 state, when SMC is not disabled.
This is reported in ESR_EL2 only when the exception is generated because the value of [HCR_EL2.TSC](#) is 1.
This value is valid for [ESR_EL2](#) and [ESR_EL3](#).
See [ISS encoding for an exception from SMC instruction execution in AArch32 state](#).

EC == 010101

SVC instruction execution in AArch64 state.
This value is valid for all described registers.
See [ISS encoding for an exception from HVC or SVC instruction execution](#).

EC == 010110

HVC instruction execution in AArch64 state, when HVC is not disabled.
This value is valid for [ESR_EL2](#) and [ESR_EL3](#).
See [ISS encoding for an exception from HVC or SVC instruction execution](#).

EC == 010111

SMC instruction execution in AArch64 state, when SMC is not disabled.
This is reported in ESR_EL2 only when the exception is generated because the value of [HCR_EL2.TSC](#) is 1.
This value is valid for [ESR_EL2](#) and [ESR_EL3](#).
See [ISS encoding for an exception from SMC instruction execution in AArch64 state](#).

EC == 011000

Trapped MSR, MRS or System instruction execution in AArch64 state, that is not reported using EC [0b000000](#), [0b000001](#) or [0b000111](#).
This include all instructions that cause exceptions that are part of the encoding space defined in [System instruction class encoding overview on page C5-313](#), except for those exceptions reported using EC values [0b000000](#), [0b000001](#), or [0b000111](#).
This value is valid for all described registers.
See [ISS encoding for an exception from MSR, MRS, or System instruction execution in AArch64 state](#).

EC == 011001

Access to SVE functionality as a result of [CPACR_EL1.ZEN](#), [CPTR_EL2.ZEN](#), [CPTR_EL2.TZ](#), or [CPTR_EL3.EZ](#), except those reported using EC value [0b000000](#).
This EC is defined only if SVE is implemented.
This value is valid for all described registers.
See [ISS encoding for an exception from an access to SVE functionality, resulting from CPACR_EL1.ZEN, CPTR_EL2.ZEN, CPTR_EL2.TZ, or CPTR_EL3.EZ..](#)

EC == 011111

IMPLEMENTATION DEFINED exception to EL3.
This value is valid for [ESR_EL3](#).
See [ISS encoding for a IMPLEMENTATION DEFINED exception to EL3](#).

EC == 100000

Instruction Abort from a lower Exception level.
Used for MMU faults generated by instruction accesses and Synchronous external aborts, including synchronous parity or ECC errors. Not used for debug related exceptions.
This value is valid for all described registers.
See [ISS encoding for an exception from an Instruction Abort](#).

EC == 100001

Instruction Abort taken without a change in Exception level.

Used for MMU faults generated by instruction accesses and Synchronous external aborts, including synchronous parity or ECC errors. Not used for debug related exceptions.

This value is valid for all described registers.

See [ISS encoding for an exception from an Instruction Abort](#).

EC == 100010

PC alignment fault exception.

This value is valid for all described registers.

See [ISS encoding for an exception from an Illegal Execution state, or a PC or SP alignment fault](#).

EC == 100100

Data Abort from a lower Exception level.

Used for MMU faults generated by data accesses, alignment faults other than those caused by the Stack Pointer misalignment, and Synchronous external aborts, including synchronous parity or ECC errors. Not used for debug related exceptions.

This value is valid for all described registers.

See [ISS encoding for an exception from a Data Abort](#).

EC == 100101

Data Abort taken without a change in Exception level.

Used for MMU faults generated by data accesses, alignment faults other than those caused by the Stack Pointer misalignment, and Synchronous external aborts, including synchronous parity or ECC errors. Not used for debug related exceptions.

This value is valid for all described registers.

See [ISS encoding for an exception from a Data Abort](#).

EC == 100110

SP alignment fault exception.

This value is valid for all described registers.

See [ISS encoding for an exception from an Illegal Execution state, or a PC or SP alignment fault](#).

EC == 101000

Trapped floating-point exception taken from AArch32 state.

Whether this Exception class is supported is IMPLEMENTATION DEFINED.

This value is valid for [ESR_EL1](#) and [ESR_EL2](#).

See [ISS encoding for an exception from a trapped floating-point exception](#).

EC == 101100

Trapped floating-point exception taken from AArch64 state.

Whether this Exception class is supported is IMPLEMENTATION DEFINED.

This value is valid for all described registers.

See [ISS encoding for an exception from a trapped floating-point exception](#).

EC == 101111

SError interrupt.

This value is valid for all described registers.

See [ISS encoding for an SError interrupt](#).

EC == 110000

Breakpoint exception from a lower Exception level.

This value is valid for [ESR_EL1](#) and [ESR_EL2](#).

See [ISS encoding for an exception from a Breakpoint or Vector Catch debug exception](#).

EC == 110001

Breakpoint exception taken without a change in Exception level.

This value is valid for [ESR_EL1](#) and [ESR_EL2](#).

See [ISS encoding for an exception from a Breakpoint or Vector Catch debug exception](#).

EC == 110010

Software Step exception from a lower Exception level.

This value is valid for [ESR_EL1](#) and [ESR_EL2](#).

See [ISS encoding for an exception from a Software Step exception](#).

EC == 110011

Software Step exception taken without a change in Exception level.

This value is valid for [ESR_EL1](#) and [ESR_EL2](#).

See [ISS encoding for an exception from a Software Step exception](#).

EC == 110100

Watchpoint exception from a lower Exception level.

This value is valid for [ESR_EL1](#) and [ESR_EL2](#).

See [ISS encoding for an exception from a Watchpoint exception](#).

EC == 110101

Watchpoint exception taken without a change in Exception level.

This value is valid for [ESR_EL1](#) and [ESR_EL2](#).

See [ISS encoding for an exception from a Watchpoint exception](#).

EC == 111000

BKPT instruction execution in AArch32 state.

This value is valid for [ESR_EL1](#) and [ESR_EL2](#).

See [ISS encoding for an exception from execution of a Breakpoint instruction](#).

EC == 111010

Vector Catch exception from AArch32 state.

The only case where a Vector Catch exception is taken to an Exception level that is using AArch64 is when the exception is routed to EL2 and EL2 is using AArch64.

This value is valid for [ESR_EL2](#).

See [ISS encoding for an exception from a Breakpoint or Vector Catch debug exception](#).

EC == 111100

BRK instruction execution in AArch64 state.

This is reported in [ESR_EL3](#) only if a BRK instruction is executed at EL3.

This value is valid for all described registers.

See [ISS encoding for an exception from execution of a Breakpoint instruction](#).

All other EC values are reserved by ARM, and:

- Unused values in the range `0b000000 - 0b101100` (`0x00 - 0x2C`) are reserved for future use for synchronous exceptions.
- Unused values in the range `0b101101 - 0b111111` (`0x2D - 0x3F`) are reserved for future use, and might be used for synchronous or asynchronous exceptions.

The effect of programming this field to a reserved value is that behavior is **CONSTRAINED UNPREDICTABLE**, as described in [Reserved values in System and memory-mapped registers and translation table entries](#) on page K1-6117.

IL, bit [25]

Instruction Length for synchronous exceptions. Possible values of this bit are:

- | | |
|---|--|
| 0 | 16-bit instruction trapped. |
| 1 | 32-bit instruction trapped. This value is also used when the exception is one of the following: <ul style="list-style-type: none">• An SError interrupt.• An Instruction Abort exception.• A PC alignment fault exception. |

- An SP alignment fault exception.
- A Data Abort exception for which the value of the ISV bit is 0.
- An Illegal Execution state exception.
- Any debug exception except for Breakpoint instruction exceptions. For Breakpoint instruction exceptions, this bit has its standard meaning:

0	16-bit T32 BKPT instruction.
1	32-bit A32 BKPT instruction or A64 BRK instruction.
- An exception reported using EC value 0b000000.

ISS, bits [24:0]

Instruction Specific Syndrome. Architecturally, this field can be defined independently for each defined Exception class. However, in practice, some ISS encodings are used for more than one Exception class.

Typically, an ISS encoding has a number of subfields. When an ISS subfield holds a register number, the value returned in that field is the AArch64 view of the register number. For an exception taken from AArch32 state, [Mapping of the general-purpose registers between the Execution states on page D1-1888](#) defines this view of the specified AArch32 register. If the AArch32 register descriptor is 0b1111, then:

- If the instruction that generated the exception was not UNPREDICTABLE, the field takes the value 0b11111.
- If the instruction that generated the exception was UNPREDICTABLE, the field takes an UNKNOWN value that must be either:
 - The AArch64 view of the register number of a register that might have been used at the Exception level from which the exception was taken.
 - The value 0b11111.

When the EC field is 0b000000, indicating an exception with an unknown reason, the ISS field is not valid, RES0.

The following subsections describe each ISS format.

ISS encoding for exceptions with an unknown reason

This encoding is used by:

- Unknown reason.

The ISS encoding for these exceptions is:

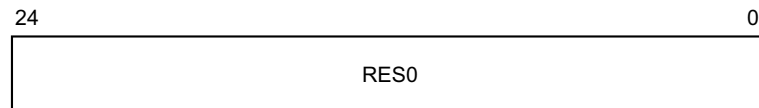

Bits [24:0]

Reserved, RES0.

This EC code is used for all exceptions that are not covered by any other EC value. This includes exceptions that are generated in the following situations:

- The attempted execution of an instruction bit pattern that has no allocated instruction at the current Exception level and Security state, including:
 - A read access using a System register pattern that is not allocated for reads at the current Exception level and Security state.
 - A write access using a System register pattern that is not allocated for writes at the current Exception level and Security state.

- Instruction encodings for instructions not implemented in the implementation.
- In Debug state, the attempted execution of an instruction bit pattern that is unallocated in Debug state.
- In Non-debug state, the attempted execution of an instruction bit pattern that is unallocated in Non-debug state.
- In AArch32 state, attempted execution of a short vector floating-point instruction.
- In an implementation that does not include Advanced SIMD and floating-point functionality, an attempted access to Advanced SIMD or floating-point functionality under conditions where that access would be permitted if that functionality was present. This includes the attempted execution of an Advanced SIMD or floating-point instruction, and attempted accesses to Advanced SIMD and floating-point System registers.
- An exception generated because of the value of one of the `SCTLR_EL1`.{ITD, SED, CP15BEN} control bits.
- Attempted execution of:
 - An HVC instruction when disabled by `HCR_EL2.HCD` or `SCR_EL3.HCE`.
 - An SMC instruction when disabled by `SCR_EL3.SMD`.
 - An HLT instruction when disabled by `EDSCR.HDE`.
- Attempted execution of an MSR or MRS instruction to access `SP_EL0` when the value of `SPSel.SP` is 0.
- Attempted execution, in Debug state, of:
 - A DCPS1 instruction in Non-secure state from EL0 when the value of `HCR_EL2.TGE` is 1.
 - A DCPS2 instruction from EL1 or EL0 when the value of `SCR_EL3.NS` is 0, or when EL2 is not implemented.
 - A DCPS3 instruction when the value of `EDSCR.SDD` is 1, or when EL3 is not implemented.
- When EL3 is using AArch64, attempted execution from Secure EL1 of an SRS instruction using `R13_mon`. See [Traps to EL3 of Secure monitor functionality from Secure EL1 using AArch32 on page D1-1870](#).
- In Debug state when the value of `EDSCR.SDD` is 1, the attempted execution at EL2, EL1, or EL0 of an instruction that is configured to trap to EL3.
- In AArch32 state, the attempted execution of an MRS (Banked register) or an MSR (Banked register) instruction to `SPSR_mon`, `SP_mon`, or `LR_mon`.
- An exception that is taken to EL2 because the value of `HCR_EL2.TGE` is 1 that, if the value of `HCR_EL2.TGE` was 0 would have been reported with an `ESR_ELx.EC` value of `0b000111`.
- In an implementation that does not include SVE, execution of an SVE instruction or an instruction which accesses the `ID_AA64ZFR0_EL1`, `ZCR_EL1`, `ZCR_EL2`, and `ZCR_EL3` registers.

ISS encoding for an exception from a WFI or WFE instruction

This encoding is used by:

- Trapped WFI or WFE instruction execution.
Conditional WFE and WFI instructions that fail their condition code check do not cause an exception.

The ISS encoding for these exceptions is:

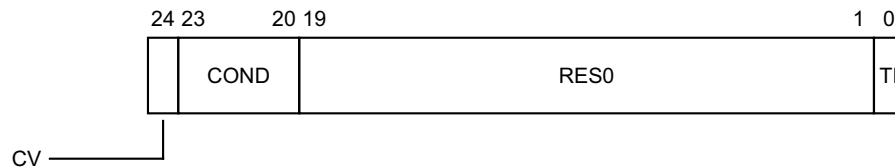

CV, bit [24]

Condition code valid. Possible values of this bit are:

- 0 The COND field is not valid.
- 1 The COND field is valid.

For exceptions taken from AArch64, CV is set to 1.

For exceptions taken from AArch32:

- When an A32 instruction is trapped, CV is set to 1.
- When a T32 instruction is trapped, it is IMPLEMENTATION DEFINED whether CV is set to 1 or set to 0. See the description of the COND field for more information.

COND, bits [23:20]

The condition code for the trapped instruction. This field is valid only for exceptions taken from AArch32, and only when the value of CV is 1.

For exceptions taken from AArch64, this field is set to 0b1110.

For exceptions taken from AArch32:

- When an A32 instruction is trapped, CV is set to 1 and:
 - If the instruction is conditional, COND is set to the condition code field value from the instruction.
 - If the instruction is unconditional, COND is set to 0b1110.
- A conditional A32 instruction that is known to pass its condition code check can be presented either:
 - With COND set to 0b1110, the value for unconditional.
 - With the COND value held in the instruction.
- When a T32 instruction is trapped, it is IMPLEMENTATION DEFINED whether:
 - CV is set to 0 and COND is set to an UNKNOWN value. Software must examine the SPSR.IT field to determine the condition, if any, of the T32 instruction.
 - CV is set to 1 and COND is set to the condition code for the condition that applied to the instruction.
- For an implementation that, for both A32 and T32 instructions, takes an exception on a trapped conditional instruction only if the instruction passes its condition code check, these definitions mean that when CV is set to 1 it is IMPLEMENTATION DEFINED whether the COND field is set to 0b1110, or to the value of any condition that applied to the instruction.

Bits [19:1]

Reserved, RES0.

TI, bit [0]

Trapped instruction. Possible values of this bit are:

- 0 WFI trapped.
- 1 WFE trapped.

The following sections describe configuration settings for generating this exception:

- [Traps to EL1 of EL0 execution of WFE and WFI instructions on page D1-1845.](#)

- [Traps to EL2 of Non-secure EL0 and EL1 execution of WFE and WFI instructions on page D1-1861.](#)
- [Traps to EL3 of EL2, EL1, and EL0 execution of WFE and WFI instructions on page D1-1871.](#)

ISS encoding for an exception from an MCR or MRC access

This encoding is used by:

- Trapped MCR or MRC access with (coproc==1111) that is not reported using EC 0b000000.
- Trapped MCR or MRC access with (coproc==1110).
- Trapped VMRS access, from ID group trap, that is not reported using EC 0b000111.

The ISS encoding for these exceptions is:

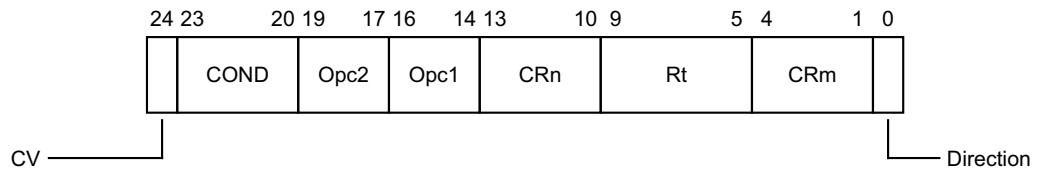

CV, bit [24]

Condition code valid. Possible values of this bit are:

- 0 The COND field is not valid.
- 1 The COND field is valid.

For exceptions taken from AArch64, CV is set to 1.

For exceptions taken from AArch32:

- When an A32 instruction is trapped, CV is set to 1.
- When a T32 instruction is trapped, it is IMPLEMENTATION DEFINED whether CV is set to 1 or set to 0. See the description of the COND field for more information.

COND, bits [23:20]

The condition code for the trapped instruction. This field is valid only for exceptions taken from AArch32, and only when the value of CV is 1.

For exceptions taken from AArch64, this field is set to 0b1110.

For exceptions taken from AArch32:

- When an A32 instruction is trapped, CV is set to 1 and:
 - If the instruction is conditional, COND is set to the condition code field value from the instruction.
 - If the instruction is unconditional, COND is set to 0b1110.
- A conditional A32 instruction that is known to pass its condition code check can be presented either:
 - With COND set to 0b1110, the value for unconditional.
 - With the COND value held in the instruction.
- When a T32 instruction is trapped, it is IMPLEMENTATION DEFINED whether:
 - CV is set to 0 and COND is set to an UNKNOWN value. Software must examine the SPSR.IT field to determine the condition, if any, of the T32 instruction.
 - CV is set to 1 and COND is set to the condition code for the condition that applied to the instruction.

- For an implementation that, for both A32 and T32 instructions, takes an exception on a trapped conditional instruction only if the instruction passes its condition code check, these definitions mean that when CV is set to 1 it is IMPLEMENTATION DEFINED whether the COND field is set to 0b1110, or to the value of any condition that applied to the instruction.

Opc2, bits [19:17]

The Opc2 value from the issued instruction.

For a trapped VMRS access, holds the value 0b000.

Opc1, bits [16:14]

The Opc1 value from the issued instruction.

For a trapped VMRS access, holds the value 0b111.

CRn, bits [13:10]

The CRn value from the issued instruction.

For a trapped VMRS access, holds the reg field from the VMRS instruction encoding.

Rt, bits [9:5]

The Rt value from the issued instruction, the general-purpose register used for the transfer. The reported value gives the AArch64 view of the register. See [Mapping of the general-purpose registers between the Execution states on page D1-1888](#).

CRm, bits [4:1]

The CRm value from the issued instruction.

For a trapped VMRS access, holds the value 0b0000.

Direction, bit [0]

Indicates the direction of the trapped instruction. The possible values of this bit are:

- 0 Write to System register space. MCR instruction.
- 1 Read from System register space. MRC or VMRS instruction.

The following sections describe configuration settings for generating exceptions that are reported using EC value 0b000011:

- [Traps to EL1 of EL0 accesses to the Generic Timer registers on page D1-1849.](#)
- [Traps to EL1 of EL0 accesses to Performance Monitors registers on page D1-1850.](#)
- [Traps to EL2 of Non-secure EL1 accesses to virtual memory control registers on page D1-1853.](#)
- [Traps to EL2 of Non-secure EL1 execution of TLB maintenance instructions on page D1-1854.](#)
- [Traps to EL2 of Non-secure EL0 and EL1 execution of cache maintenance instructions on page D1-1855.](#)
- [Traps to EL2 of Non-secure EL1 accesses to the Auxiliary Control Register on page D1-1856.](#)
- [Traps to EL2 of Non-secure EL0 and EL1 accesses to lockdown, DMA, and TCM operations on page D1-1857.](#)
- [Traps to EL2 of Non-secure EL0 and EL1 accesses to the ID registers on page D1-1858.](#)
- [Trapping to EL2 of Non-secure EL1 accesses to the CPACR_EL1 or CPACR on page D1-1862.](#)
- [General trapping to EL2 of Non-secure EL0 and EL1 accesses to System registers, from AArch32 state only on page D1-1864.](#)
- [Traps to EL2 of Non-secure EL0 and EL1 accesses to the Generic Timer registers on page D1-1867.](#)
- [Traps to EL2 of Non-secure EL0 and EL1 accesses to Performance Monitors registers on page D1-1868.](#)
- [Traps to EL3 of Secure monitor functionality from Secure EL1 using AArch32 on page D1-1870.](#)

- [Trapping to EL3 of EL2 accesses to the CPTR_EL2 or HCPTR, and EL2 and EL1 accesses to the CPACR_EL1 or CPACR on page D1-1873.](#)
- [Traps to EL3 of EL2, EL1, and EL0 accesses to Performance Monitors registers on page D1-1877.](#)

The following sections describe configuration settings for generating exceptions that are reported using EC value 0b000101:

- [Traps to EL1 of EL0 and EL1 System register accesses to the trace registers on page D1-1847.](#)
- [Traps to EL1 of EL0 accesses to the Debug Communications Channel \(DCC\) registers on page D1-1848.](#)
- [Traps to EL2 of Non-secure EL0 and EL1 accesses to the ID registers on page D1-1858, for trapped accesses to the JIDR.](#)
- [Traps to EL2 of Non-secure System register accesses to the trace registers on page D1-1863.](#)
- [Trapping System register accesses to Debug ROM registers to EL2 on page D1-1865.](#)
- [Trapping System register accesses to powerdown debug registers to EL2 on page D1-1866.](#)
- [Trapping general System register accesses to debug registers to EL2 on page D1-1866.](#)
- [Traps to EL3 of all System register accesses to the trace registers on page D1-1874.](#)
- [Trapping System register accesses to powerdown debug registers to EL3 on page D1-1875.](#)
- [Trapping general System register accesses to debug registers to EL3 on page D1-1876.](#)

[Traps to EL2 of Non-secure EL0 and EL1 accesses to the ID registers on page D1-1858](#) describes configuration settings for generating exceptions that are reported using EC value 0b001000.

ISS encoding for an exception from an MCRR or MRRC access

This encoding is used by:

- Trapped MCRR or MRRC access with (coproc==1111) that is not reported using EC 0b000000.
- Trapped MRRC access with (coproc==1110).

The ISS encoding for these exceptions is:

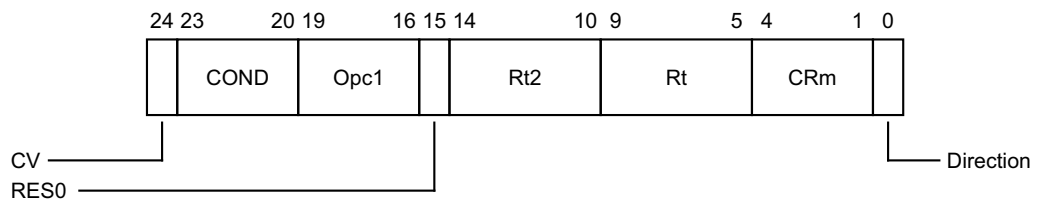

CV, bit [24]

Condition code valid. Possible values of this bit are:

- 0 The COND field is not valid.
- 1 The COND field is valid.

For exceptions taken from AArch64, CV is set to 1.

For exceptions taken from AArch32:

- When an A32 instruction is trapped, CV is set to 1.
- When a T32 instruction is trapped, it is IMPLEMENTATION DEFINED whether CV is set to 1 or set to 0. See the description of the COND field for more information.

COND, bits [23:20]

The condition code for the trapped instruction. This field is valid only for exceptions taken from AArch32, and only when the value of CV is 1.

For exceptions taken from AArch64, this field is set to 0b1110.

For exceptions taken from AArch32:

- When an A32 instruction is trapped, CV is set to 1 and:
 - If the instruction is conditional, COND is set to the condition code field value from the instruction.
 - If the instruction is unconditional, COND is set to 0b1110.
- A conditional A32 instruction that is known to pass its condition code check can be presented either:
 - With COND set to 0b1110, the value for unconditional.
 - With the COND value held in the instruction.
- When a T32 instruction is trapped, it is IMPLEMENTATION DEFINED whether:
 - CV is set to 0 and COND is set to an UNKNOWN value. Software must examine the SPSR.IT field to determine the condition, if any, of the T32 instruction.
 - CV is set to 1 and COND is set to the condition code for the condition that applied to the instruction.
- For an implementation that, for both A32 and T32 instructions, takes an exception on a trapped conditional instruction only if the instruction passes its condition code check, these definitions mean that when CV is set to 1 it is IMPLEMENTATION DEFINED whether the COND field is set to 0b1110, or to the value of any condition that applied to the instruction.

Opc1, bits [19:16]

The Opc1 value from the issued instruction.

Bit [15]

Reserved, RES0.

Rt2, bits [14:10]

The Rt2 value from the issued instruction, the second general-purpose register used for the transfer. The reported value gives the AArch64 view of the register. See *Mapping of the general-purpose registers between the Execution states* on page D1-1888.

Rt, bits [9:5]

The Rt value from the issued instruction, the first general-purpose register used for the transfer. The reported value gives the AArch64 view of the register. See *Mapping of the general-purpose registers between the Execution states* on page D1-1888.

CRm, bits [4:1]

The CRm value from the issued instruction.

Direction, bit [0]

Indicates the direction of the trapped instruction. The possible values of this bit are:

- | | |
|---|--|
| 0 | Write to System register space. MCRR instruction. |
| 1 | Read from System register space. MRRC instruction. |

The following sections describe configuration settings for generating exceptions that are reported using EC value 0b000100:

- [Traps to EL1 of EL0 accesses to the Generic Timer registers](#) on page D1-1849.
- [Traps to EL1 of EL0 accesses to Performance Monitors registers](#) on page D1-1850.
- [Traps to EL2 of Non-secure EL1 accesses to virtual memory control registers](#) on page D1-1853.

- [General trapping to EL2 of Non-secure EL0 and EL1 accesses to System registers, from AArch32 state only on page D1-1864.](#)
- [Traps to EL2 of Non-secure EL0 and EL1 accesses to the Generic Timer registers on page D1-1867.](#)
- [Traps to EL2 of Non-secure EL0 and EL1 accesses to Performance Monitors registers on page D1-1868.](#)
- [Traps to EL3 of EL2, EL1, and EL0 accesses to Performance Monitors registers on page D1-1877.](#)

The following sections describe configuration settings for generating exceptions that are reported using EC value 0b001100:

- [Traps to EL1 of EL0 and EL1 System register accesses to the trace registers on page D1-1847.](#)
- [Traps to EL1 of EL0 accesses to the Debug Communications Channel \(DCC\) registers on page D1-1848.](#)
- [Traps to EL2 of Non-secure System register accesses to the trace registers on page D1-1863.](#)
- [Trapping System register accesses to Debug ROM registers to EL2 on page D1-1865.](#)
- [Traps to EL3 of all System register accesses to the trace registers on page D1-1874.](#)
- [Trapping System register accesses to powerdown debug registers to EL2 on page D1-1866.](#)

ISS encoding for an exception from an LDC or STC instruction

This encoding is used by:

- Trapped LDC or STC access.
The only architected uses of these instructions are:
 - An STC to write data to memory from [DBGDTRRXint](#).
 - An LDC to read data from memory to [DBGDTRTXint](#).

The ISS encoding for these exceptions is:

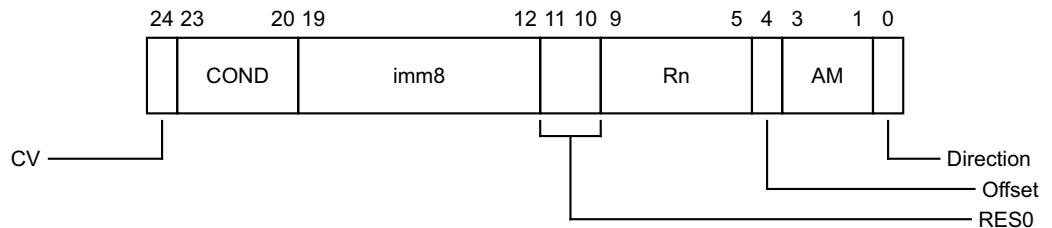

CV, bit [24]

Condition code valid. Possible values of this bit are:

- 0 The COND field is not valid.
- 1 The COND field is valid.

For exceptions taken from AArch64, CV is set to 1.

For exceptions taken from AArch32:

- When an A32 instruction is trapped, CV is set to 1.
- When a T32 instruction is trapped, it is IMPLEMENTATION DEFINED whether CV is set to 1 or set to 0. See the description of the COND field for more information.

COND, bits [23:20]

The condition code for the trapped instruction. This field is valid only for exceptions taken from AArch32, and only when the value of CV is 1.

For exceptions taken from AArch64, this field is set to 0b1110.

For exceptions taken from AArch32:

- When an A32 instruction is trapped, CV is set to 1 and:
 - If the instruction is conditional, COND is set to the condition code field value from the instruction.
 - If the instruction is unconditional, COND is set to 0b1110.
- A conditional A32 instruction that is known to pass its condition code check can be presented either:
 - With COND set to 0b1110, the value for unconditional.
 - With the COND value held in the instruction.
- When a T32 instruction is trapped, it is IMPLEMENTATION DEFINED whether:
 - CV is set to 0 and COND is set to an UNKNOWN value. Software must examine the SPSR.IT field to determine the condition, if any, of the T32 instruction.
 - CV is set to 1 and COND is set to the condition code for the condition that applied to the instruction.
- For an implementation that, for both A32 and T32 instructions, takes an exception on a trapped conditional instruction only if the instruction passes its condition code check, these definitions mean that when CV is set to 1 it is IMPLEMENTATION DEFINED whether the COND field is set to 0b1110, or to the value of any condition that applied to the instruction.

imm8, bits [19:12]

The immediate value from the issued instruction.

Bits [11:10]

Reserved, RES0.

Rn, bits [9:5]

The Rn value from the issued instruction, the general-purpose register used for the transfer. The reported value gives the AArch64 view of the register. See [Mapping of the general-purpose registers between the Execution states on page D1-1888](#).

This field is valid only when AM[2] is 0, indicating an immediate form of the LDC or STC instruction. When AM[2] is 1, indicating a literal form of the LDC or STC instruction, this field is UNKNOWN.

Offset, bit [4]

Indicates whether the offset is added or subtracted:

- | | |
|---|------------------|
| 0 | Subtract offset. |
| 1 | Add offset. |

This bit corresponds to the U bit in the instruction encoding.

AM, bits [3:1]

Addressing mode. The permitted values of this field are:

- | | |
|-----|---|
| 000 | Immediate unindexed. |
| 001 | Immediate post-indexed. |
| 010 | Immediate offset. |
| 011 | Immediate pre-indexed. |
| 100 | Literal unindexed.
LDC instruction in A32 instruction set only.
For a trapped STC instruction or a trapped T32 LDC instruction this encoding is reserved. |
| 110 | Literal offset.
LDC instruction only. |

For a trapped STC instruction, this encoding is reserved.

The values 0b101 and 0b111 are reserved. The effect of programming this field to a reserved value is that behavior is CONstrained UNPREDICTABLE, as described in *Reserved values in System and memory-mapped registers and translation table entries* on page K1-6133.

Bit [2] in this subfield indicates the instruction form, immediate or literal.

Bits [1:0] in this subfield correspond to the bits {P, W} in the instruction encoding.

Direction, bit [0]

Indicates the direction of the trapped instruction. The possible values of this bit are:

- 0 Write to memory. STC instruction.
- 1 Read from memory. LDC instruction.

The following sections describe the configuration settings for the traps that are reported using EC value 0b000110:

- *Traps to EL1 of EL0 accesses to the Debug Communications Channel (DCC) registers* on page D1-1848.
- *Trapping general System register accesses to debug registers to EL2* on page D1-1866.
- *Trapping general System register accesses to debug registers to EL3* on page D1-1876.

ISS encoding for an exception from an access to an Advanced SIMD or floating-point register, resulting from CPACR_EL1.FPEN or CPTR_ELx.TFP

This encoding is used by:

- Access to SVE, Advanced SIMD, or floating-point functionality trapped by CPACR_EL1.FPEN, CPTR_EL2.FPEN, CPTR_EL2.TFP, or CPTR_EL3.TFP control.
Excludes exceptions resulting from CPACR_EL1 when the value of HCR_EL2.TGE is 1, or because SVE or Advanced SIMD and floating-point are not implemented. These are reported with EC value 0b000000 as described in *The EC used to report an exception routed to EL2 because HCR_EL2.TGE is 1* on page D1-1813.

The ISS encoding for these exceptions is:

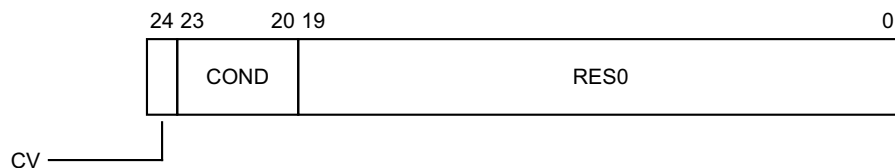

The accesses covered by this trap include:

- Execution of SVE or Advanced SIMD and floating-point instructions.
- Accesses to the Advanced SIMD and floating-point System registers.

For an implementation that does not include SVE, floating-point or Advanced SIMD, the exception is reported using the EC value 0b000000.

CV, bit [24]

Condition code valid. Possible values of this bit are:

- 0 The COND field is not valid.
- 1 The COND field is valid.

For exceptions taken from AArch64, CV is set to 1.

For exceptions taken from AArch32:

- When an A32 instruction is trapped, CV is set to 1.

- When a T32 instruction is trapped, it is IMPLEMENTATION DEFINED whether CV is set to 1 or set to 0. See the description of the COND field for more information.

COND, bits [23:20]

The condition code for the trapped instruction. This field is valid only for exceptions taken from AArch32, and only when the value of CV is 1.

For exceptions taken from AArch64, this field is set to 0b1110.

For exceptions taken from AArch32:

- When an A32 instruction is trapped, CV is set to 1 and:
 - If the instruction is conditional, COND is set to the condition code field value from the instruction.
 - If the instruction is unconditional, COND is set to 0b1110.
- A conditional A32 instruction that is known to pass its condition code check can be presented either:
 - With COND set to 0b1110, the value for unconditional.
 - With the COND value held in the instruction.
- When a T32 instruction is trapped, it is IMPLEMENTATION DEFINED whether:
 - CV is set to 0 and COND is set to an UNKNOWN value. Software must examine the SPSR.IT field to determine the condition, if any, of the T32 instruction.
 - CV is set to 1 and COND is set to the condition code for the condition that applied to the instruction.
- For an implementation that, for both A32 and T32 instructions, takes an exception on a trapped conditional instruction only if the instruction passes its condition code check, these definitions mean that when CV is set to 1 it is IMPLEMENTATION DEFINED whether the COND field is set to 0b1110, or to the value of any condition that applied to the instruction.

Bits [19:0]

Reserved, RES0.

The following sections describe the configuration settings for the traps that are reported using EC value 0b000111:

- [Traps to EL1 of EL0 and EL1 accesses to SIMD and floating-point functionality on page D1-1848.](#)
- [General trapping to EL2 of Non-secure accesses to the SIMD and floating-point registers on page D1-1863.](#)
- [Traps to EL3 of all System register accesses to the trace registers on page D1-1874.](#)

ISS encoding for an exception from an access to SVE functionality, resulting from CPACR_EL1.ZEN, CPTR_EL2.ZEN, CPTR_EL2.TZ, or CPTR_EL3.EZ.

This encoding is used by:

- Access to SVE functionality as a result of CPACR_EL1.ZEN, CPTR_EL2.ZEN, CPTR_EL2.TZ, or CPTR_EL3.EZ, except those reported using EC value 0b000000.

This EC is defined only if SVE is implemented.

The ISS encoding for these exceptions is:

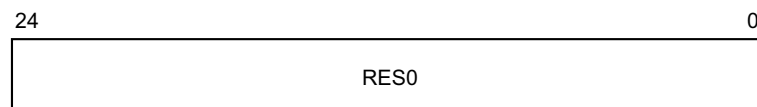

Bits [24:0]

Reserved, RES0.

The accesses covered by this trap include:

- Execution of SVE instructions.
- Accesses to the SVE system registers.

When an implementation does not include SVE, the exception is reported using the EC value 0b000000.

ISS encoding for an exception from an Illegal Execution state, or a PC or SP alignment fault

This encoding is used by:

- Illegal Execution state.
- PC alignment fault exception.
- SP alignment fault exception.

The ISS encoding for these exceptions is:

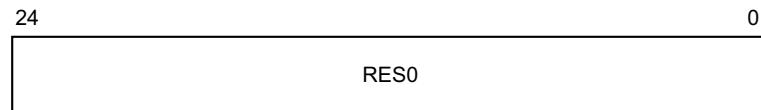

Bits [24:0]

Reserved, RES0.

There are no configuration settings for generating Illegal Execution state exceptions and PC alignment fault exceptions. [SP alignment checking on page D1-1793](#) describes the configuration settings for generating SP alignment fault exceptions.

ISS encoding for an exception from HVC or SVC instruction execution

This encoding is used by:

- SVC instruction execution in AArch32 state.
This is reported in ESR_EL2 only when the exception is generated because the value of [HCR_EL2.TGE](#) is 1.
- HVC instruction execution in AArch32 state, when HVC is not disabled.
- SVC instruction execution in AArch64 state.
- HVC instruction execution in AArch64 state, when HVC is not disabled.

The ISS encoding for these exceptions is:

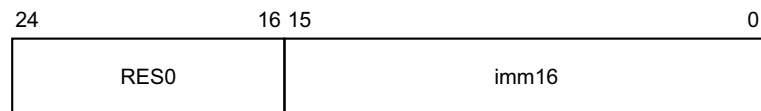

Bits [24:16]

Reserved, RES0.

imm16, bits [15:0]

The value of the immediate field from the HVC or SVC instruction.

For an HVC instruction, and for an A64 SVC instruction, this is the value of the imm16 field of the issued instruction.

For an A32 or T32 SVC instruction:

- If the instruction is unconditional, then:
 - For the T32 instruction, this field is zero-extended from the imm8 field of the instruction.
 - For the A32 instruction, this field is the bottom 16 bits of the imm24 field of the instruction.
- If the instruction is conditional, this field is UNKNOWN.

In AArch32 state, the HVC instruction is unconditional, and a conditional SVC instruction generates an exception only if it passes its condition code check. Therefore, the syndrome information for these exceptions does not require conditionality information.

For T32 and A32 instructions, see [SVC](#), and [HVC](#).

For A64 instructions, see [SVC](#) and [HVC](#).

ISS encoding for an exception from SMC instruction execution in AArch32 state

This encoding is used by:

- SMC instruction execution in AArch32 state, when SMC is not disabled.
This is reported in ESR_EL2 only when the exception is generated because the value of [HCR_EL2.TSC](#) is 1.

The ISS encoding for these exceptions is:

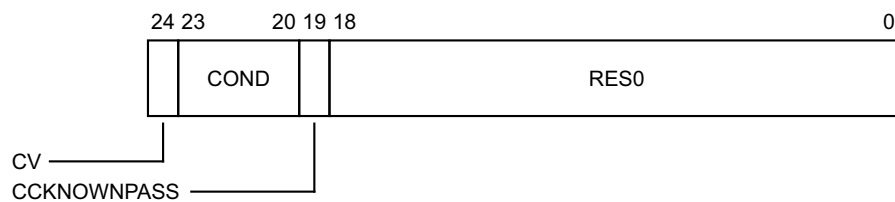

For an SMC instruction that completes normally and generates an exception that is taken to EL3, the ISS encoding is RES0.

For an SMC instruction that is trapped to EL2 from Non-secure EL1 because [HCR_EL2.TSC](#) is 1, the ISS encoding is as shown in the diagram.

CV, bit [24]

Condition code valid. Possible values of this bit are:

- 0 The COND field is not valid.
- 1 The COND field is valid.

For exceptions taken from AArch64, CV is set to 1.

For exceptions taken from AArch32:

- When an A32 instruction is trapped, CV is set to 1.
- When a T32 instruction is trapped, it is IMPLEMENTATION DEFINED whether CV is set to 1 or set to 0. See the description of the COND field for more information.

This field is only valid if CCKNOWNPASS is 1, otherwise it is RES0.

COND, bits [23:20]

The condition code for the trapped instruction. This field is valid only for exceptions taken from AArch32, and only when the value of CV is 1.

For exceptions taken from AArch64, this field is set to 0b1110.

For exceptions taken from AArch32:

- When an A32 instruction is trapped, CV is set to 1 and:
 - If the instruction is conditional, COND is set to the condition code field value from the instruction.
 - If the instruction is unconditional, COND is set to 0b1110.
- A conditional A32 instruction that is known to pass its condition code check can be presented either:
 - With COND set to 0b1110, the value for unconditional.
 - With the COND value held in the instruction.
- When a T32 instruction is trapped, it is IMPLEMENTATION DEFINED whether:
 - CV is set to 0 and COND is set to an UNKNOWN value. Software must examine the SPSR.IT field to determine the condition, if any, of the T32 instruction.
 - CV is set to 1 and COND is set to the condition code for the condition that applied to the instruction.
- For an implementation that, for both A32 and T32 instructions, takes an exception on a trapped conditional instruction only if the instruction passes its condition code check, these definitions mean that when CV is set to 1 it is IMPLEMENTATION DEFINED whether the COND field is set to 0b1110, or to the value of any condition that applied to the instruction.

This field is only valid if CCKNOWNPASS is 1, otherwise it is RES0.

CCKNOWNPASS, bit [19]

Indicates whether the instruction might have failed its condition code check.

- | | |
|---|--|
| 0 | The instruction was unconditional, or was conditional and passed its condition code check. |
| 1 | The instruction was conditional, and might have failed its condition code check. |

———— **Note** ————

In an implementation in which an SMC instruction that fails its code check is not trapped, this field can always return the value 0.

Bits [18:0]

Reserved, RES0.

[Traps to EL2 of Non-secure EL1 execution of SMC instructions on page D1-1858](#) describes the configuration settings for trapping SMC instructions from Non-secure EL1 modes, and [System calls on page D1-1878](#) describes the case where these exceptions are trapped to EL3.

ISS encoding for an exception from SMC instruction execution in AArch64 state

This encoding is used by:

- SMC instruction execution in AArch64 state, when SMC is not disabled.
This is reported in ESR_EL2 only when the exception is generated because the value of [HCR_EL2.TSC](#) is 1.

The ISS encoding for these exceptions is:

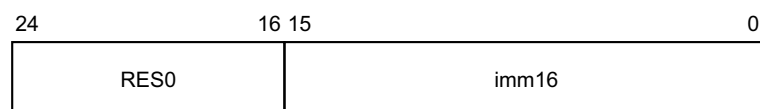

Bits [24:16]

Reserved, RES0.

imm16, bits [15:0]

The value of the immediate field from the issued SMC instruction.

The value of ISS[24:0] described here is used both:

- When an SMC instruction is trapped from Non-secure EL1 modes.
- When an SMC instruction is not trapped, so completes normally and generates an exception that is taken to EL3.

[Traps to EL2 of Non-secure EL1 execution of SMC instructions on page D1-1858](#) describes the configuration settings for trapping SMC instructions from Non-secure EL1 modes, and [System calls on page D1-1878](#) describes the case where these exceptions are trapped to EL3.

ISS encoding for an exception from MSR, MRS, or System instruction execution in AArch64 state

This encoding is used by:

- Trapped MSR, MRS or System instruction execution in AArch64 state, that is not reported using EC values 0b000000, 0b000001 or 0b000111.
This include all instructions that cause exceptions that are part of the encoding space defined in [System instruction class encoding overview on page C5-313](#), except for those exceptions reported using EC values 0b000000, 0b000001, or 0b000111.

The ISS encoding for these exceptions is:

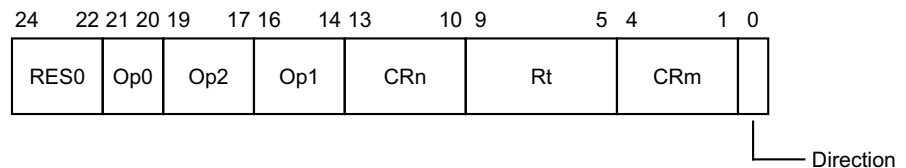

Bits [24:22]

Reserved, RES0.

Op0, bits [21:20]

The Op0 value from the issued instruction.

Op2, bits [19:17]

The Op2 value from the issued instruction.

Op1, bits [16:14]

The Op1 value from the issued instruction.

CRn, bits [13:10]

The CRn value from the issued instruction.

Rt, bits [9:5]

The Rt value from the issued instruction, the general-purpose register used for the transfer.

CRm, bits [4:1]

The CRm value from the issued instruction.

Direction, bit [0]

Indicates the direction of the trapped instruction. The possible values of this bit are:

- 0 Write access, including MSR instructions.
- 1 Read access, including MRS instructions.

For exceptions caused by System instructions, see *System* on page C4-215 for the encoding values returned by an instruction.

The following sections describe configuration settings for generating the exception that is reported using EC value 0b011000:

- In *EL1 configurable controls* on page D1-1843.
 - *Traps to EL1 of EL0 execution of cache maintenance instructions* on page D1-1844.
 - *Traps to EL1 of EL0 accesses to the CTR_EL0* on page D1-1845.
 - *Traps to EL1 of EL0 execution of DC ZVA instructions* on page D1-1846.
 - *Traps to EL1 of EL0 accesses to the PSTATE.{D, A, I, F} interrupt masks* on page D1-1846.
 - *Traps to EL1 of EL0 and EL1 System register accesses to the trace registers* on page D1-1847.
 - *Traps to EL1 of EL0 accesses to the Debug Communications Channel (DCC) registers* on page D1-1848.
 - *Traps to EL1 of EL0 accesses to the Generic Timer registers* on page D1-1849.
 - *Traps to EL1 of EL0 accesses to Performance Monitors registers* on page D1-1850.
- In *EL2 configurable controls* on page D1-1851.
 - *Traps to EL2 of Non-secure EL1 accesses to virtual memory control registers* on page D1-1853.
 - *Traps to EL2 of Non-secure EL0 and EL1 execution of DC ZVA instructions* on page D1-1854.
 - *Traps to EL2 of Non-secure EL1 execution of TLB maintenance instructions* on page D1-1854.
 - *Traps to EL2 of Non-secure EL0 and EL1 execution of cache maintenance instructions* on page D1-1855.
 - *Traps to EL2 of Non-secure EL1 accesses to the Auxiliary Control Register* on page D1-1856.
 - *Traps to EL2 of Non-secure EL0 and EL1 accesses to lockdown, DMA, and TCM operations* on page D1-1857.
 - *Traps to EL2 of Non-secure EL0 and EL1 accesses to the ID registers* on page D1-1858.
 - *Trapping to EL2 of Non-secure EL1 accesses to the CPACR_EL1 or CPACR* on page D1-1862.
 - *Traps to EL2 of Non-secure System register accesses to the trace registers* on page D1-1863.
 - *Trapping System register accesses to Debug ROM registers to EL2* on page D1-1865.
 - *Trapping System register accesses to powerdown debug registers to EL2* on page D1-1866.
 - *Traps to EL2 of Non-secure EL0 and EL1 accesses to the Generic Timer registers* on page D1-1867.
 - *Trapping general System register accesses to debug registers to EL2* on page D1-1866.
 - *Traps to EL2 of Non-secure EL0 and EL1 accesses to Performance Monitors registers* on page D1-1868.
- In *EL3 configurable controls* on page D1-1869.
 - *Traps to EL3 of Secure EL1 accesses to the Counter-timer Physical Secure timer registers* on page D1-1872.
 - *Trapping to EL3 of EL2 accesses to the CPTR_EL2 or HCPTR, and EL2 and EL1 accesses to the CPACR_EL1 or CPACR* on page D1-1873.
 - *Traps to EL3 of all System register accesses to the trace registers* on page D1-1874.
 - *Trapping System register accesses to powerdown debug registers to EL3* on page D1-1875.
 - *Trapping general System register accesses to debug registers to EL3* on page D1-1876.
 - *Traps to EL3 of EL2, EL1, and EL0 accesses to Performance Monitors registers* on page D1-1877.

ISS encoding for a IMPLEMENTATION DEFINED exception to EL3

This encoding is used by:

- IMPLEMENTATION DEFINED exception to EL3.

The ISS encoding for these exceptions is:



IMPLEMENTATION DEFINED, bits [24:0]

IMPLEMENTATION DEFINED.

ISS encoding for an exception from an Instruction Abort

This encoding is used by:

- Instruction Abort from a lower Exception level.
Used for MMU faults generated by instruction accesses and Synchronous external aborts, including synchronous parity or ECC errors. Not used for debug related exceptions.
- Instruction Abort taken without a change in Exception level.
Used for MMU faults generated by instruction accesses and Synchronous external aborts, including synchronous parity or ECC errors. Not used for debug related exceptions.

The ISS encoding for these exceptions is:

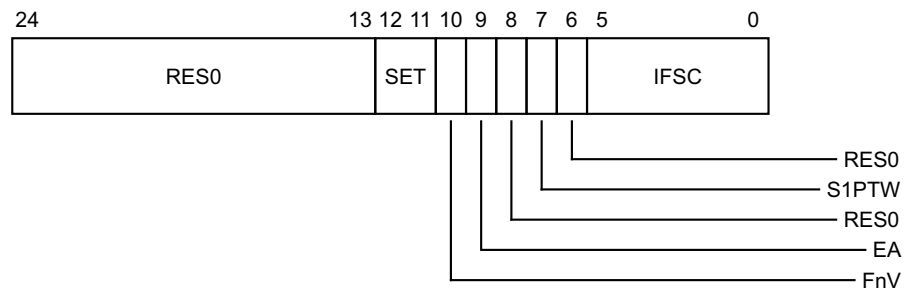

Bits [24:13]

Reserved, RES0.

SET, bits [12:11]

Synchronous Error Type. When the RAS Extension is implemented and IFSC is 010000, describes the state of the PE after taking the Instruction Abort exception. The possible values of this field are:

- 00 Recoverable error (UER).
- 01 Restartable error (UEO).
- 10 Uncontainable error (UC).
- 11 Corrected error (CE).

Note

Software can use this information to determine what recovery might be possible. Taking a synchronous External Abort exception might result in an unrecoverable PE state.

This field is RES0 if either:

- The RAS Extension is not implemented.
- The value returned in the IFSC field is not 010000.

FnV, bit [10]

FAR not Valid, for a Synchronous external abort other than a Synchronous external abort on a translation table walk.

- 0 FAR is valid.
- 1 FAR is not valid, and holds an UNKNOWN value.

This field is only valid if the IFSC code is 010000. It is RES0 for all other aborts.

EA, bit [9]

External abort type. This bit can provide an IMPLEMENTATION DEFINED classification of External aborts.

For any abort other than an External abort this bit returns a value of 0.

Bit [8]

Reserved, RES0.

S1PTW, bit [7]

For a stage 2 fault, indicates whether the fault was a stage 2 fault on an access made for a stage 1 translation table walk:

- 0 Fault not on a stage 2 translation for a stage 1 translation table walk.
- 1 Fault on the stage 2 translation of an access for a stage 1 translation table walk.

For any abort other than a stage 2 fault this bit is RES0.

Bit [6]

Reserved, RES0.

IFSC, bits [5:0]

Instruction Fault Status Code. Possible values of this field are:

- 000000 Address size fault, level 0 of translation or translation table base register
- 000001 Address size fault, level 1
- 000010 Address size fault, level 2
- 000011 Address size fault, level 3
- 000100 Translation fault, level 0
- 000101 Translation fault, level 1
- 000110 Translation fault, level 2
- 000111 Translation fault, level 3
- 001001 Access flag fault, level 1
- 001010 Access flag fault, level 2
- 001011 Access flag fault, level 3
- 001101 Permission fault, level 1
- 001110 Permission fault, level 2
- 001111 Permission fault, level 3
- 010000 Synchronous external abort, not on translation table walk
- 011000 Synchronous parity or ECC error on memory access, not on translation table walk
- 010100 Synchronous external abort, on translation table walk, level 0
- 010101 Synchronous external abort, on translation table walk, level 1
- 010110 Synchronous external abort, on translation table walk, level 2
- 010111 Synchronous external abort, on translation table walk, level 3
- 011100 Synchronous parity or ECC error on memory access on translation table walk, level 0

- 011101 Synchronous parity or ECC error on memory access on translation table walk, level 1
- 011110 Synchronous parity or ECC error on memory access on translation table walk, level 2
- 011111 Synchronous parity or ECC error on memory access on translation table walk, level 3
- 110000 TLB conflict abort

All other values are reserved.

When the RAS Extension is implemented, 011000, 011100, 011101, 011110, and 011111 are reserved.

For more information about the lookup level associated with a fault, see [The level associated with MMU faults on page D4-2109](#).

————— Note —————

Because Access flag faults and Permission faults can only result from a Block or Page translation table descriptor, they cannot occur at level 0.

ISS encoding for an exception from a Data Abort

This encoding is used by:

- Data Abort from a lower Exception level.
Used for MMU faults generated by data accesses, alignment faults other than those caused by the Stack Pointer misalignment, and Synchronous external aborts, including synchronous parity or ECC errors. Not used for debug related exceptions.
- Data Abort taken without a change in Exception level.
Used for MMU faults generated by data accesses, alignment faults other than those caused by the Stack Pointer misalignment, and Synchronous external aborts, including synchronous parity or ECC errors. Not used for debug related exceptions.

The ISS encoding for these exceptions is:

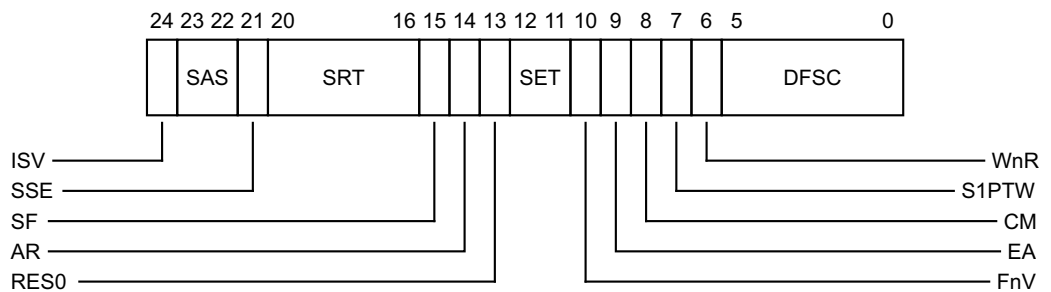

ISV, bit [24]

Instruction syndrome valid. Indicates whether the syndrome information in ISS[23:14] is valid.

- 0 No valid instruction syndrome. ISS[23:14] are RES0.
- 1 ISS[23:14] hold a valid instruction syndrome.

This bit is 0 for all faults reported in ESR_EL2 except the following stage 2 aborts:

- AArch64 loads and stores of a single general-purpose register (including the register specified with 0b11111), including those with Acquire/Release semantics, but excluding Load Exclusive or Store Exclusive and excluding those with writeback.
- AArch32 instructions where the instruction:
 - Is an LDR, LDA, LDRT, LDRSH, LDRSHT, LDRH, LDAH, LDRHT, LDRSB, LDRSBT, LDRB, LDAB, LDRBT, STR, STL, STRT, STRH, STLH, STRHT, STRB, STLB, or STRBT instruction.
 - Is not performing register writeback.

— Is not using R15 as a source or destination register.

For these cases, ISV is UNKNOWN if the exception was generated in Debug state in memory access mode, and otherwise indicates whether ISS[23:14] hold a valid syndrome.

ISV is 0 for all faults reported in ESR_EL1 or ESR_EL3.

When the RAS Extension is implemented, ISV is 0 for any Synchronous external abort.

For ISS reporting, a stage 2 abort on a stage 1 translation table walk does not return a valid instruction syndrome, and therefore ISV is 0 for these aborts.

When the RAS Extension is not implemented, the value of ISV on a Synchronous external abort on a stage 2 translation table walk is IMPLEMENTATION DEFINED.

SAS, bits [23:22]

Syndrome Access Size. When ISV is 1, indicates the size of the access attempted by the faulting operation.

00	Byte
01	Halfword
10	Word
11	Doubleword

This field is UNKNOWN when the value of ISV is UNKNOWN.

This field is RES0 when the value of ISV is 0.

SSE, bit [21]

Syndrome Sign Extend. When ISV is 1, for a byte, halfword, or word load operation, indicates whether the data item must be sign extended. For these cases, the possible values of this bit are:

0	Sign-extension not required.
1	Data item must be sign-extended.

For all other operations this bit is 0.

This field is UNKNOWN when the value of ISV is UNKNOWN.

This field is RES0 when the value of ISV is 0.

SRT, bits [20:16]

Syndrome Register transfer. When ISV is 1, the register number of the Rt operand of the faulting instruction. If the exception was taken from an Exception level that is using AArch32 then this is the AArch64 view of the register. See [Mapping of the general-purpose registers between the Execution states on page D1-1888](#).

This field is UNKNOWN when the value of ISV is UNKNOWN.

This field is RES0 when the value of ISV is 0.

SF, bit [15]

Width of the register accessed by the instruction is Sixty-Four. When ISV is 1, the possible values of this bit are:

0	Instruction loads/stores a 32-bit wide register.
1	Instruction loads/stores a 64-bit wide register.

————— Note —————

This field specifies the register width identified by the instruction, not the Execution state.

This field is UNKNOWN when the value of ISV is UNKNOWN.

This field is RES0 when the value of ISV is 0.

AR, bit [14]

Acquire/Release. When ISV is 1, the possible values of this bit are:

- 0 Instruction did not have acquire/release semantics.
- 1 Instruction did have acquire/release semantics.

This field is UNKNOWN when the value of ISV is UNKNOWN.

This field is RES0 when the value of ISV is 0.

Bit [13]

Reserved, RES0.

SET, bits [12:11]

Synchronous Error Type. When the RAS Extension is implemented and DFSC is 010000, describes the state of the PE after taking the Data Abort exception. The possible values of this field are:

- 00 Recoverable error (UER).
- 01 Restartable error (UEO).
- 10 Uncontainable error (UC).
- 11 Corrected error (CE).

———— Note ————

Software can use this information to determine what recovery might be possible. Taking a synchronous External Abort exception might result in an unrecoverable PE state.

This field is RES0 if either:

- The RAS Extension is not implemented.
- The value returned in the DFSC field is not 010000.

FnV, bit [10]

FAR not Valid, for a Synchronous external abort other than a Synchronous external abort on a translation table walk.

- 0 FAR is valid.
- 1 FAR is not valid, and holds an UNKNOWN value.

This field is valid only if the DFSC code is 010000. It is RES0 for all other aborts.

EA, bit [9]

External abort type. This bit can provide an IMPLEMENTATION DEFINED classification of External aborts.

For any abort other than an External abort this bit returns a value of 0.

CM, bit [8]

Cache maintenance. Indicates whether the Data Abort came from a cache maintenance or address translation instruction:

- 0 The Data Abort was not generated by the execution of one of the system instructions identified in the description of value 1.
- 1 The Data Abort was generated by either the execution of a cache maintenance instruction or by a synchronous fault on the execution of an address translation instruction. The DC ZVA instruction is not classified as a cache maintenance instruction, and therefore its execution cannot cause this field to be set to 1.

SIPTW, bit [7]

For a stage 2 fault, indicates whether the fault was a stage 2 fault on an access made for a stage 1 translation table walk:

- 0 Fault not on a stage 2 translation for a stage 1 translation table walk.

1 Fault on the stage 2 translation of an access for a stage 1 translation table walk.
For any abort other than a stage 2 fault this bit is RES0.

WnR, bit [6]

Write not Read. Indicates whether a synchronous abort was caused by an instruction writing to a memory location, or by an instruction reading from a memory location. The possible values of this bit are:

0 Abort caused by an instruction reading from a memory location.

1 Abort caused by an instruction writing to a memory location.

For faults on cache maintenance and address translation instructions, this bit always returns a value of 1.

For faults from an atomic instruction that both reads and writes from a memory location, this bit is set to 0 if a read of the address specified by the instruction would have generated the fault is being reported, otherwise it is set to 1. The architecture permits, but does not require, a relaxation of this requirement such that for all stage 2 aborts on stage 1 translation table walks for atomic instructions, the WnR bit is always 0.

This field is UNKNOWN for:

- An external abort.
- A fault reported using the DFSC value of 0b110101 that indicates the lack of support for atomic instructions by the memory type.

DFSC, bits [5:0]

Data Fault Status Code. Possible values of this field are:

000000	Address size fault, level 0 of translation or translation table base register
000001	Address size fault, level 1
000010	Address size fault, level 2
000011	Address size fault, level 3
000100	Translation fault, level 0
000101	Translation fault, level 1
000110	Translation fault, level 2
000111	Translation fault, level 3
001001	Access flag fault, level 1
001010	Access flag fault, level 2
001011	Access flag fault, level 3
001101	Permission fault, level 1
001110	Permission fault, level 2
001111	Permission fault, level 3
010000	Synchronous external abort, not on translation table walk
011000	Synchronous parity or ECC error on memory access, not on translation table walk
010100	Synchronous external abort, on translation table walk, level 0
010101	Synchronous external abort, on translation table walk, level 1
010110	Synchronous external abort, on translation table walk, level 2
010111	Synchronous external abort, on translation table walk, level 3
011100	Synchronous parity or ECC error on memory access on translation table walk, level 0
011101	Synchronous parity or ECC error on memory access on translation table walk, level 1
011110	Synchronous parity or ECC error on memory access on translation table walk, level 2
011111	Synchronous parity or ECC error on memory access on translation table walk, level 3

100001	Alignment fault
110000	TLB conflict abort
110001	Unsupported atomic hardware update fault, if the implementation includes ARMv8.1-TTHM . Otherwise reserved.
110100	IMPLEMENTATION DEFINED fault (Lockdown)
110101	IMPLEMENTATION DEFINED fault (Unsupported Exclusive or Atomic access)
111101	Section Domain Fault, used only for faults reported in the PAR_EL1
111110	Page Domain Fault, used only for faults reported in the PAR_EL1

All other values are reserved.

When the RAS Extension is implemented, 011000, 011100, 011101, 011110, and 011111 are reserved.

For more information about the lookup level associated with a fault, see [The level associated with MMU faults on page D4-2109](#).

———— **Note** ————

Because Access flag faults and Permission faults can only result from a Block or Page translation table descriptor, they cannot occur at level 0.

ISS encoding for an exception from a trapped floating-point exception

This encoding is used by:

- Trapped floating-point exception taken from AArch32 state.
Whether this Exception class is supported is IMPLEMENTATION DEFINED.
- Trapped floating-point exception taken from AArch64 state.
Whether this Exception class is supported is IMPLEMENTATION DEFINED.

The ISS encoding for these exceptions is:

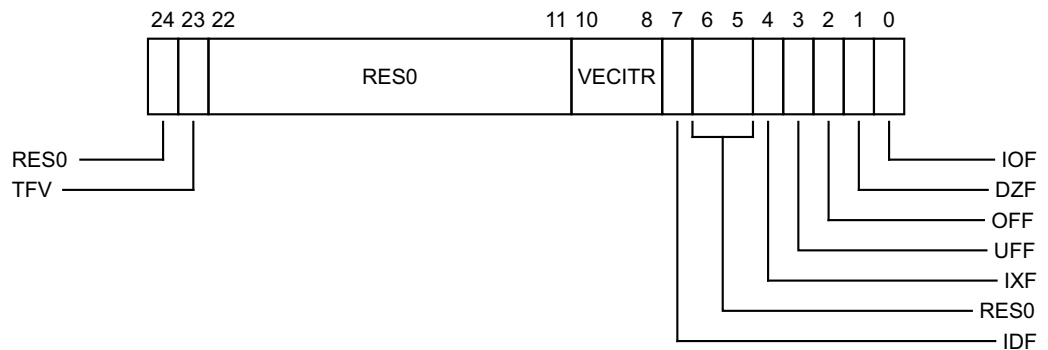

Bit [24]

Reserved, RES0.

TFV, bit [23]

Trapped Fault Valid bit. Indicates whether the IDF, IXF, UFF, OFF, DZF, and IOF bits hold valid information about trapped floating-point exceptions. The possible values of this bit are:

- 0 The IDF, IXF, UFF, OFF, DZF, and IOF bits do not hold valid information about trapped floating-point exceptions and are UNKNOWN.

- 1 One or more floating-point exceptions occurred during an operation performed while executing the reported instruction. The IDF, IXF, UFF, OFF, DZF, and IOF bits indicate trapped floating-point exceptions that occurred. For more information see [Floating-point exceptions and exception traps on page D1-1831](#).

It is IMPLEMENTATION DEFINED whether this field is set to 0 on an exception generated by a trapped floating point exception from a vector instruction.

———— **Note** ————

This is not a requirement. Implementations can set this field to 1 on a trapped floating-point exception from a vector instruction and return valid information in the {IDF, IXF, UFF, OFF, DZF, IOF} fields.

Bits [22:11]

Reserved, RES0.

VECITR, bits [10:8]

For a trapped floating-point exception from an instruction executed in AArch32 state this field is RES1.

For a trapped floating-point exception from an instruction executed in AArch64 state this field is UNKNOWN.

IDF, bit [7]

Input Denormal floating-point exception trapped bit. If the TFV field is 0, this bit is UNKNOWN. Otherwise, the possible values of this bit are:

- 0 Input denormal floating-point exception has not occurred.
1 Input denormal floating-point exception occurred during execution of the reported instruction.

Bits [6:5]

Reserved, RES0.

IXF, bit [4]

Inexact floating-point exception trapped bit. If the TFV field is 0, this bit is UNKNOWN. Otherwise, the possible values of this bit are:

- 0 Inexact floating-point exception has not occurred.
1 Inexact floating-point exception occurred during execution of the reported instruction.

UFF, bit [3]

Underflow floating-point exception trapped bit. If the TFV field is 0, this bit is UNKNOWN. Otherwise, the possible values of this bit are:

- 0 Underflow floating-point exception has not occurred.
1 Underflow floating-point exception occurred during execution of the reported instruction.

OFF, bit [2]

Overflow floating-point exception trapped bit. If the TFV field is 0, this bit is UNKNOWN. Otherwise, the possible values of this bit are:

- 0 Overflow floating-point exception has not occurred.
1 Overflow floating-point exception occurred during execution of the reported instruction.

DZF, bit [1]

Divide by Zero floating-point exception trapped bit. If the TFV field is 0, this bit is UNKNOWN. Otherwise, the possible values of this bit are:

- 0 Divide by Zero floating-point exception has not occurred.
- 1 Divide by Zero floating-point exception occurred during execution of the reported instruction.

IOF, bit [0]

Invalid Operation floating-point exception trapped bit. If the TFV field is 0, this bit is UNKNOWN. Otherwise, the possible values of this bit are:

- 0 Invalid Operation floating-point exception has not occurred.
- 1 Invalid Operation floating-point exception occurred during execution of the reported instruction.

In an implementation that supports the trapping of floating-point exceptions:

- From an Exception level using AArch64, the **FPCR**.{IDE, IXE, UFE, OFE, DZE, IOE} bits enable each of the floating-point exception traps.
- From an Exception level using AArch32, the **FPSCR**.{IDE, IXE, UFE, OFE, DZE, IOE} bits enable each of the floating-point exception traps.

ISS encoding for an SError interrupt

This encoding is used by:

- SError interrupt.

The ISS encoding for these exceptions is:

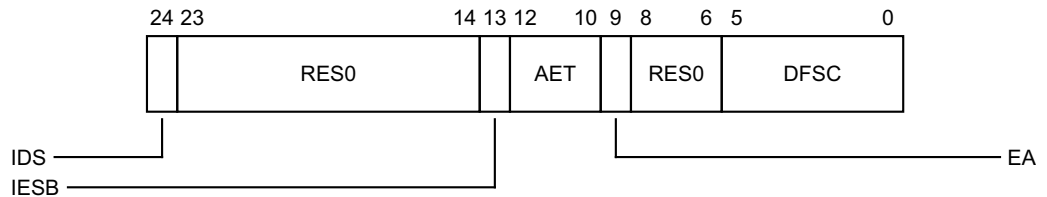

IDS, bit [24]

IMPLEMENTATION DEFINED syndrome. Possible values of this bit are:

- 0 Bits[23:0] of the ISS field are defined in this description.

———— **Note** ————

If the RAS Extension is not implemented, this means that bits[23:0] of the ISS field are RES0.

- 1 Bits[23:0] of the ISS field holds IMPLEMENTATION DEFINED syndrome information that can be used to provide additional information about the SError interrupt.

———— **Note** ————

This field was previously called ISV.

Bits [23:14]

Reserved, RES0.

IESB, bit [13]

Implicit Error Synchronization Barrier.

This field is part of the RAS Extension in an ARMv8.2 implementation.

The possible values of this field are:

- | | |
|---|--|
| 0 | The SError interrupt was either not synchronized by the implicit ErrorSynchronizationBarrier() or not taken immediately. |
| 1 | The SError interrupt was synchronized by the implicit ErrorSynchronizationBarrier() and taken immediately. |

This field is RES0 if either:

- The implementation is an ARMv8.0 or ARMv8.1 implementation.
- The value returned in the DFSC field is not 010001.

———— **Note** —————

ARMv8.2 requires the implementation of the RAS Extension.

AET, bits [12:10]

Asynchronous Error Type.

When the RAS Extension is implemented and DFSC is 010001, describes the state of the PE after taking the SError interrupt exception. The possible values of this field are:

- | | |
|-----|----------------------------|
| 000 | Uncontainable error (UC). |
| 001 | Unrecoverable error (UEU). |
| 010 | Restartable error (UEO). |
| 011 | Recoverable error (UER). |
| 110 | Corrected error (CE). |

All other values are reserved.

If multiple errors are taken as a single SError interrupt exception, the overall state of the PE is reported. For example, if both a Recoverable and Unrecoverable error occurred, the state is Unrecoverable.

———— **Note** —————

Software can use this information to determine what recovery might be possible. The recovery software must also examine any implemented fault records to determine the location and extent of the error.

This field is RES0 if either:

- The RAS Extension is not implemented.
- The value returned in the DFSC field is not 010001.

———— **Note** —————

ARMv8.2 requires the implementation of the RAS Extension.

EA, bit [9]

External abort type. When the RAS Extension is implemented, this bit can provide an IMPLEMENTATION DEFINED classification of External aborts.

For any abort other than an External abort this bit returns a value of 0.

This field is RES0 if either:

- The RAS Extension is not implemented.
- The value returned in the DFSC field is not 010001.

———— **Note** ————

ARMv8.2 requires the implementation of the RAS Extension.

Bits [8:6]

Reserved, RES0.

DFSC, bits [5:0]

Data Fault Status Code. When the RAS Extension is implemented, possible values of this field are:

000000 Uncategorized.

010001 Asynchronous SError interrupt.

All other values are reserved.

If the RAS Extension is not implemented, this field is RES0.

———— **Note** ————

ARMv8.2 requires the implementation of the RAS Extension.

ISS encoding for an exception from a Breakpoint or Vector Catch debug exception

This encoding is used by:

- Breakpoint exception from a lower Exception level.
- Breakpoint exception taken without a change in Exception level.
- Vector Catch exception from AArch32 state.

The only case where a Vector Catch exception is taken to an Exception level that is using AArch64 is when the exception is routed to EL2 and EL2 is using AArch64.

The ISS encoding for these exceptions is:

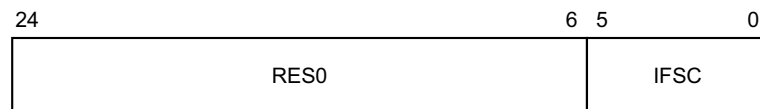

Bits [24:6]

Reserved, RES0.

IFSC, bits [5:0]

Instruction Fault Status Code. This field is set to 0b100010, to indicate a Debug exception.

For more information about generating these exceptions:

- For exceptions from AArch64, see [Breakpoint exceptions on page D2-1921](#).
- For exceptions from AArch32, see [Breakpoint exceptions on page G2-4470](#) and [Vector Catch exceptions on page G2-4510](#).

ISS encoding for an exception from a Software Step exception

This encoding is used by:

- Software Step exception from a lower Exception level.
- Software Step exception taken without a change in Exception level.

The ISS encoding for these exceptions is:

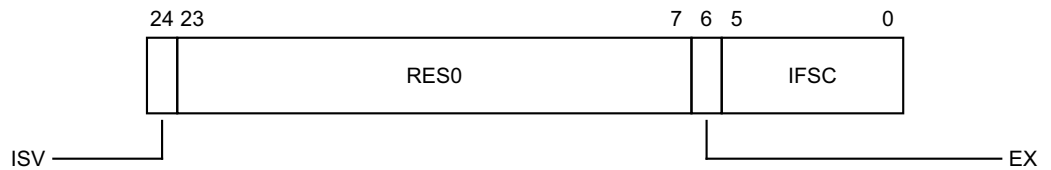

ISV, bit [24]

Instruction syndrome valid. Indicates whether the EX bit, ISS[6], is valid, as follows:

- 0 EX bit is RES0.
- 1 EX bit is valid.

See the EX bit description for more information.

Bits [23:7]

Reserved, RES0.

EX, bit [6]

Exclusive operation. If the ISV bit is set to 1, this bit indicates whether a Load-Exclusive instruction was stepped.

- 0 An instruction other than a Load-Exclusive instruction was stepped.
- 1 A Load-Exclusive instruction was stepped.

If the ISV bit is set to 0, this bit is RES0, indicating no syndrome data is available.

IFSC, bits [5:0]

Instruction Fault Status Code. This field is set to 0b100010, to indicate a Debug exception.

For more information about generating these exceptions, see [Software Step exceptions on page D2-1956](#).

ISS encoding for an exception from a Watchpoint exception

This encoding is used by:

- Watchpoint exception from a lower Exception level.
- Watchpoint exception taken without a change in Exception level.

The ISS encoding for these exceptions is:

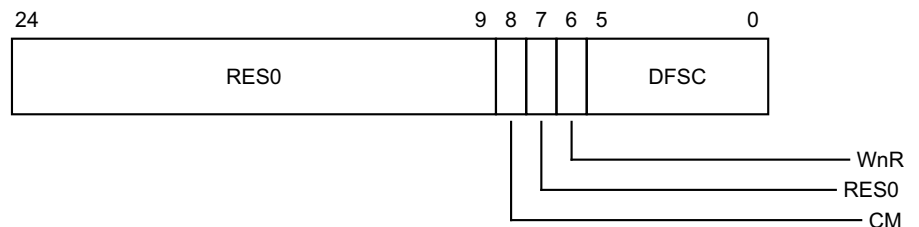

Bits [24:9]

Reserved, RES0.

CM, bit [8]

Cache maintenance. Indicates whether the Data Abort came from a cache maintenance or address translation instruction:

- 0 The Data Abort was not generated by the execution of one of the system instructions identified in the description of value 1.

- 1 The Data Abort was generated by either the execution of a cache maintenance instruction or by a synchronous fault on the execution of an address translation instruction. The **DC ZVA** instruction is not classified as a cache maintenance instruction, and therefore its execution cannot cause this field to be set to 1.

Bit [7]

Reserved, RES0.

WnR, bit [6]

Write not Read. Indicates whether the abort was caused by an instruction writing to a memory location, or by an instruction reading from a memory location. The possible values of this bit are:

- 0 Abort caused by an instruction reading from a memory location.
- 1 Abort caused by an instruction writing to a memory location.

For faults on cache maintenance and address translation instructions, this bit always returns a value of 1.

For faults from an atomic instruction, this field is set to 0 if a read of the location would have generated a fault, otherwise it is set to 1.

DFSC, bits [5:0]

Data Fault Status Code. This field is set to `0b100010`, to indicate a Debug exception.

For more information about generating these exceptions, see [Watchpoint exceptions on page D2-1940](#).

ISS encoding for an exception from execution of a Breakpoint instruction

This encoding is used by:

- BKPT instruction execution in AArch32 state.
- BRK instruction execution in AArch64 state.

This is reported in `ESR_EL3` only if a BRK instruction is executed at EL3.

The ISS encoding for these exceptions is:

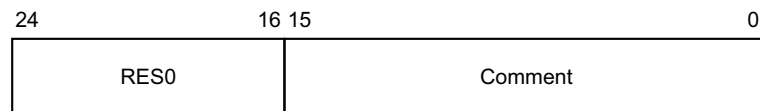

Bits [24:16]

Reserved, RES0.

Comment, bits [15:0]

Set to the instruction comment field value, zero extended as necessary. For the AArch32 BKPT instructions, the comment field is described as the immediate field.

For more information about generating these exceptions, see [Breakpoint Instruction exceptions on page D2-1919](#).

D7.2.29 FAR_EL1, Fault Address Register (EL1)

The FAR_EL1 characteristics are:

Purpose

Holds the faulting Virtual Address for all synchronous Instruction or Data Abort, PC alignment fault and Watchpoint exceptions that are taken to EL1.

Configurations

AArch64 System register FAR_EL1[31:0] is architecturally mapped to AArch32 System register [DFAR](#) (NS).

AArch64 System register FAR_EL1[63:32] is architecturally mapped to AArch32 System register [IFAR](#) (NS).

RW fields in this register reset to architecturally UNKNOWN values.

Attributes

FAR_EL1 is a 64-bit register.

Field descriptions

The FAR_EL1 bit assignments are:

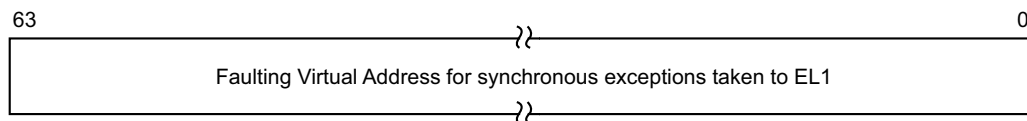

Bits [63:0]

Faulting Virtual Address for synchronous exceptions taken to EL1. Exceptions that set the FAR_EL1 are Instruction Aborts (EC 0x20 or 0x21), Data Aborts (EC 0x24 or 0x25), PC alignment faults (EC 0x22), and Watchpoints (EC 0x34 or 0x35). [ESR_EL1.EC](#) holds the EC value for the exception.

For a synchronous external abort, if the VA that generated the abort was from an address range for which $\text{TCR_ELx.TBI}\{<0|1>\} = 1$ for the translation regime in use when the abort was generated, then the top eight bits of FAR_EL1 are UNKNOWN.

For a synchronous external abort other than a synchronous external abort on a translation table walk, this field is valid only if [ESR_EL1.FnV](#) is 0, and the FAR_EL1 is UNKNOWN if [ESR_EL1.FnV](#) is 1.

For all other exceptions taken to EL1, the FAR_EL1 is UNKNOWN.

If a memory fault that sets FAR_EL1 is generated from a data cache maintenance or DC ZVA instruction, this field holds the address specified in the register argument of the instruction.

If the exception that updates FAR_EL1 is taken from an Exception level that is using AArch32, the top 32 bits are all zero, unless the faulting address is generated by a load or store instruction that sequentially increments from address 0xFFFFFFFF. This is an UNPREDICTABLE condition, and in this case the upper 32-bits are set to 0x00000001.

For a Data Abort or Watchpoint exception, if address tagging is enabled for the address accessed by the data access that caused the exception, then this field includes the tag. For more information about address tagging, see [Address tagging in AArch64 state on page D4-2006](#).

Note

The address held in this field is an address accessed by the instruction fetch or data access that caused the exception that gave rise to the instruction or data abort. It is the lower address that gave rise to the fault. Where different faults from different addresses arise from the same instruction, such as for an instruction that loads or stores a mis-aligned address that crosses a page boundary, the architecture does not prioritize between those different faults.

FAR_EL1 is made UNKNOWN on an exception return from EL1.

Accessing the FAR_EL1

This register can be read using MRS with the following syntax:

MRS <Xt>, <systemreg>

This register can be written using MSR (register) with the following syntax:

MSR <systemreg>, <Xt>

This syntax is encoded with the following settings in the instruction encoding:

<systemreg>	op0	op1	CRn	CRm	op2
FAR_EL1	11	000	0110	0000	000
FAR_EL12	11	101	0110	0000	000

Accessibility

The register is accessible in software as follows:

<systemreg>	Control			Accessibility			
	E2H	TGE	NS	EL0	EL1	EL2	EL3
FAR_EL1	x	x	0	-	RW	n/a	RW
FAR_EL1	0	0	1	-	RW	RW	RW
FAR_EL1	0	1	1	-	n/a	RW	RW
FAR_EL1	1	0	1	-	RW	FAR_EL2	RW
FAR_EL1	1	1	1	-	n/a	FAR_EL2	RW
FAR_EL12	x	x	0	-	-	n/a	-
FAR_EL12	0	0	1	-	-	-	-
FAR_EL12	0	1	1	-	n/a	-	-
FAR_EL12	1	0	1	-	-	RW	RW
FAR_EL12	1	1	1	-	n/a	RW	RW

This table applies to all instructions that can access this register.

When [HCR_EL2.E2H](#) is 1, without explicit synchronization, access from EL3 using the mnemonic FAR_EL1 or FAR_EL12 are not guaranteed to be ordered with respect to accesses using the other mnemonic.

Traps and Enables

For a description of the prioritization of any generated exceptions, see [Synchronous exception prioritization for exceptions taken to AArch64 on page D1-1827](#). Subject to the prioritization rules:

- When EL2 is implemented and is using AArch64 and (SCR_EL3.NS == 1) && (HCR_EL2.E2H == 0):
 - If [HCR_EL2.TRVM](#)==1, Non-secure read accesses to this register from EL1 are trapped to EL2.
 - If [HCR_EL2.TVM](#)==1, Non-secure write accesses to this register from EL1 are trapped to EL2.

- When EL2 is implemented and is using AArch64 and (SCR_EL3.NS == 1) && (HCR_EL2.E2H == 1) && (HCR_EL2.TGE == 0):
 - If HCR_EL2.TRVM==1, Non-secure read accesses to this register from EL1 are trapped to EL2.
 - If HCR_EL2.TVM==1, Non-secure write accesses to this register from EL1 are trapped to EL2.

D7.2.30 FAR_EL2, Fault Address Register (EL2)

The FAR_EL2 characteristics are:

Purpose

Holds the faulting Virtual Address for all synchronous Instruction or Data Abort, PC alignment fault and Watchpoint exceptions that are taken to EL2.

Configurations

AArch64 System register FAR_EL2[31:0] is architecturally mapped to AArch32 System register [HDFAR](#).

AArch64 System register FAR_EL2[63:32] is architecturally mapped to AArch32 System register [HIFAR](#).

AArch64 System register FAR_EL2[31:0] is architecturally mapped to AArch32 System register [DFAR](#) (S) when EL2 is implemented.

AArch64 System register FAR_EL2[63:32] is architecturally mapped to AArch32 System register [IFAR](#) (S) when EL2 is implemented.

If EL2 is not implemented, this register is RES0 from EL3.

RW fields in this register reset to architecturally UNKNOWN values.

Attributes

FAR_EL2 is a 64-bit register.

Field descriptions

The FAR_EL2 bit assignments are:

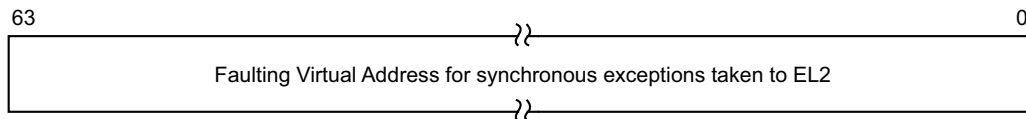

Bits [63:0]

Faulting Virtual Address for synchronous exceptions taken to EL2. Exceptions that set the FAR_EL2 are Instruction Aborts (EC 0x20 or 0x21), Data Aborts (EC 0x24 or 0x25), PC alignment faults (EC 0x22), and Watchpoints (EC 0x34 or 0x35). [ESR_EL2](#).EC holds the EC value for the exception.

For a synchronous external abort, if the VA that generated the abort was from an address range for which $\text{TCR_ELx.TBI}\{\langle 0 \rangle 1\} = 1$ for the translation regime in use when the abort was generated, then the top eight bits of FAR_EL2 are UNKNOWN.

For a synchronous external abort other than a synchronous external abort on a translation table walk, this field is valid only if [ESR_EL2](#).FnV is 0, and the FAR_EL2 is UNKNOWN if [ESR_EL2](#).FnV is 1.

For all other exceptions taken to EL2, the FAR_EL2 is UNKNOWN.

If a memory fault that sets FAR_EL2 is generated from a data cache maintenance or DC ZVA instruction, this field holds the address specified in the register argument of the instruction.

If the exception that updates FAR_EL2 is taken from an Exception level that is using AArch32, the top 32-bits are all zero, unless the faulting address is generated by a load or store instruction that sequentially increments from address 0xFFFFFFFF. This is an UNPREDICTABLE condition, and in this case the upper 32-bits are set to 0x00000001.

For a Data Abort or Watchpoint exception, if address tagging is enabled for the address accessed by the data access that caused the exception, then this field includes the tag. For more information about address tagging, see [Address tagging in AArch64 state on page D4-2006](#).

Note

The address held in this field is an address accessed by the instruction fetch or data access that caused the exception that gave rise to the instruction or data abort. It is the lower address that gave rise to the fault. Where different faults from different addresses arise from the same instruction, such as for an instruction that loads or stores a mis-aligned address that crosses a page boundary, the architecture does not prioritize between those different faults.

FAR_EL2 is made UNKNOWN on an exception return from EL2.

Accessing the FAR_EL2

This register can be read using MRS with the following syntax:

MRS <Xt>, <systemreg>

This register can be written using MSR (register) with the following syntax:

MSR <systemreg>, <Xt>

This syntax is encoded with the following settings in the instruction encoding:

<systemreg>	op0	op1	CRn	CRm	op2
FAR_EL2	11	100	0110	0000	000
FAR_EL1	11	000	0110	0000	000

Accessibility

The register is accessible in software as follows:

<systemreg>	Control			Accessibility			
	E2H	TGE	NS	EL0	EL1	EL2	EL3
FAR_EL2	x	x	0	-	-	n/a	RW
FAR_EL2	0	0	1	-	-	RW	RW
FAR_EL2	0	1	1	-	n/a	RW	RW
FAR_EL2	1	0	1	-	-	RW	RW
FAR_EL2	1	1	1	-	n/a	RW	RW
FAR_EL1	x	x	0	-	FAR_EL1	n/a	FAR_EL1
FAR_EL1	0	0	1	-	FAR_EL1	FAR_EL1	FAR_EL1
FAR_EL1	0	1	1	-	n/a	FAR_EL1	FAR_EL1
FAR_EL1	1	0	1	-	FAR_EL1	RW	FAR_EL1
FAR_EL1	1	1	1	-	n/a	RW	FAR_EL1

This table applies to all instructions that can access this register.

When [HCR_EL2.E2H](#) is 1, without explicit synchronization, access from EL2 using the mnemonic FAR_EL2 or FAR_EL1 are not guaranteed to be ordered with respect to accesses using the other mnemonic.

D7.2.31 FAR_EL3, Fault Address Register (EL3)

The FAR_EL3 characteristics are:

Purpose

Holds the faulting Virtual Address for all synchronous Instruction or Data Abort and PC alignment fault exceptions that are taken to EL3.

Configurations

RW fields in this register reset to architecturally UNKNOWN values.

Attributes

FAR_EL3 is a 64-bit register.

Field descriptions

The FAR_EL3 bit assignments are:

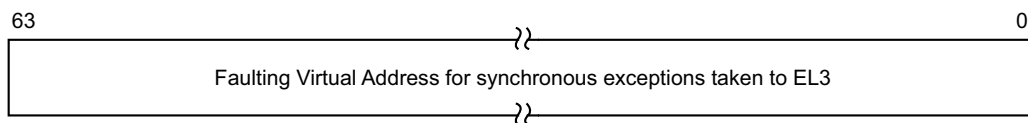

Bits [63:0]

Faulting Virtual Address for synchronous exceptions taken to EL3. Exceptions that set the FAR_EL3 are Instruction Aborts (EC 0x20 or 0x21), Data Aborts (EC 0x24 or 0x25), and PC alignment faults (EC 0x22). [ESR_EL3.EC](#) holds the EC value for the exception.

For a synchronous external abort, if the VA that generated the abort was from an address range for which [TCR_ELx.TBI](#){<0|1>} = 1 for the translation regime in use when the abort was generated, then the top eight bits of FAR_EL3 are UNKNOWN.

For a synchronous external abort other than a synchronous external abort on a translation table walk, this field is valid only if [ESR_EL3.FnV](#) is 0, and the FAR_EL3 is UNKNOWN if [ESR_EL3.FnV](#) is 1.

For all other exceptions taken to EL3, the FAR_EL3 is UNKNOWN.

If a memory fault that sets FAR_EL3 is generated from a data cache maintenance or DC ZVA instruction, this field holds the address specified in the register argument of the instruction.

If the exception that updates FAR_EL3 is taken from an EL using AArch32, the top 32-bits are all zero, unless the faulting address is generated by a load or store instruction that sequentially increments from address 0xffffffff. This is an UNPREDICTABLE condition, and in this case the upper 32-bits are set to 0x00000001.

For a Data Abort or Watchpoint exception, if address tagging is enabled for the address accessed by the data access that caused the exception, then this field includes the tag. For more information about address tagging, see [Address tagging in AArch64 state on page D4-2006](#).

———— Note —————

The address held in this register is an address accessed by the instruction fetch or data access that caused the exception that actually gave rise to the instruction or data abort. It is the lowest address that gave rise to the fault. Where different faults from different addresses arise from the same instruction, such as for an instruction that loads or stores a mis-aligned address that crosses a page boundary, the architecture does not prioritize between those different faults.

FAR_EL3 is made UNKNOWN on an exception return from EL3.

Accessing the FAR_EL3

This register can be read using MRS with the following syntax:

MRS <Xt>, <systemreg>

This register can be written using MSR (register) with the following syntax:

MSR <systemreg>, <Xt>

This syntax is encoded with the following settings in the instruction encoding:

<systemreg>	op0	op1	CRn	CRm	op2
FAR_EL3	11	110	0110	0000	000

Accessibility

The register is accessible in software as follows:

Control			Accessibility			
E2H	TGE	NS	EL0	EL1	EL2	EL3
x	x	0	-	-	n/a	RW
0	0	1	-	-	-	RW
0	1	1	-	n/a	-	RW
1	0	1	-	-	-	RW
1	1	1	-	n/a	-	RW

D7.2.32 FPEXC32_EL2, Floating-Point Exception Control register

The FPEXC32_EL2 characteristics are:

Purpose

Allows access to the AArch32 register [FPEXC](#) from AArch64 state only. Its value has no effect on execution in AArch64 state.

Configurations

AArch64 System register FPEXC32_EL2 is architecturally mapped to AArch32 System register [FPEXC](#).

If EL1 cannot use AArch32, this register is UNDEFINED.

If EL2 is not implemented but EL3 is implemented, and EL1 is capable of using AArch32, then this register is not RES0.

RW fields in this register reset to architecturally UNKNOWN values.

Attributes

FPEXC32_EL2 is a 32-bit register.

Field descriptions

The FPEXC32_EL2 bit assignments are:

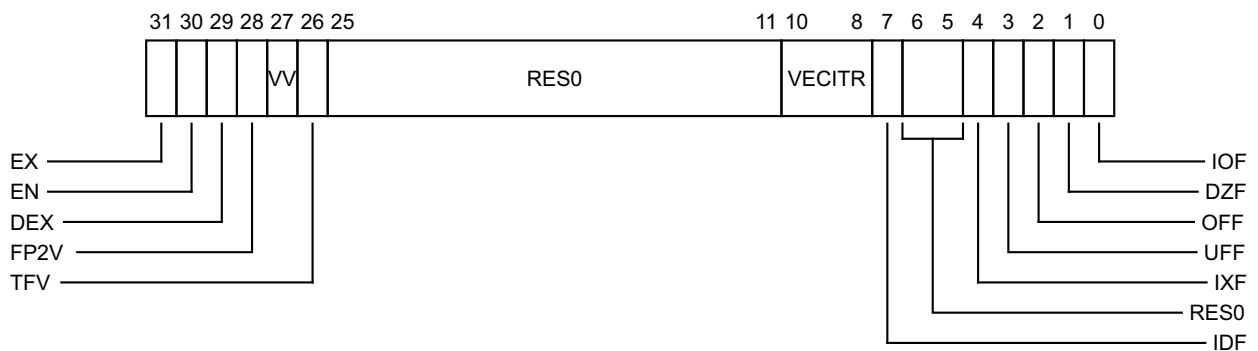

EX, bit [31]

Exception bit. In ARMv8, this bit is RAZ/WI.

EN, bit [30]

Enables access to the Advanced SIMD and floating-point functionality from all Exception levels, except that setting this field to 0 does not disable the following:

- VMSR accesses to the [FPEXC](#) or [FPSID](#).
 - VMRS accesses from the [FPEXC](#), [FPSID](#), [MVFR0](#), [MVFR1](#), or [MVFR2](#).
- 0 Accesses to the [FPSCR](#), and any of the SIMD and floating-point registers Q0-Q15, including their views as D0-D31 registers or S0-S31 registers, are UNDEFINED at all Exception levels.
- 1 This control permits access to the Advanced SIMD and floating-point functionality at all Exception levels.

Execution of floating-point and Advanced SIMD instructions in AArch32 state can be disabled or trapped by the following controls:

- [CPACR](#).cp10, or, if executing at EL0, [CPACR_EL1](#).FPEN.
- FPEXC.EN.

- If executing in Non-secure state:
 - `HCPTR.TCP10`, or if EL2 is using AArch64, `CPTR_EL2.TFP`.
 - `NSACR.cp10`, or if EL3 is using AArch64, `CPTR_EL3.TFP`.
- For Advanced SIMD instructions only:
 - `CPACR.ASEDIS`.
 - If executing in Non-secure state, `HCPTR.TASE` and `NSACR.NSTRCDIS`.

See the descriptions of the controls for more information.

———— **Note** —————

When executing at EL0 using AArch32:

- If EL1 is using AArch64 then behavior is as if the value of `FPEXC.EN` is 1.
- In Non-secure state, if EL2 is using AArch64 and the value of `HCR_EL2.{RW, TGE}` is {1, 1} then behavior is as if the value of `FPEXC.EN` is 1.
- In Non-secure state, if EL2 is using AArch64 and the value of `HCR_EL2.{RW, TGE}` is {0, 1} then it is IMPLEMENTATION DEFINED whether the behavior is:
 - As if the value of `FPEXC.EN` is 1.
 - Determined by the value of `FPEXC32_EL2.EN`, as described in this field description. ARM deprecates using the value of `FPEXC32_EL2.EN` to determine behavior.

DEX, bit [29]

Defined synchronous exception on floating-point execution.

This field identifies whether a synchronous exception generated by the attempted execution of an instruction was generated by an unallocated encoding. The instruction must be in the encoding space that is identified by the pseudocode function `ExecutingCP10or11Instr()` returning `TRUE`. This field also indicates whether the `FPEXC32_EL2.TFV` field is valid.

The meaning of this bit is:

- | | |
|---|---|
| 0 | The exception was generated by the attempted execution of an unallocated instruction in the encoding space that is identified by the pseudocode function <code>ExecutingCP10or11Instr()</code> . If <code>FPEXC32_EL2.TFV</code> is <code>RW</code> then it is invalid and <code>UNKNOWN</code> . If <code>FPEXC32_EL2.{IDF, IXF, UFF, OFF, DZF, IOF}</code> are <code>RW</code> then they are invalid and <code>UNKNOWN</code> . |
| 1 | The exception was generated during the execution of an unallocated encoding. <code>FPEXC32_EL2.TFV</code> is valid and indicates the cause of the exception. |

On an exception that sets this bit to 1 the exception-handling routine must clear this bit to 0.

On an implementation that both does not support trapping of floating-point exceptions and implements the AArch32 `FPSCR`. {Stride, Len} fields as `RAZ`, this bit is `RES0`.

FP2V, bit [28]

`FPINST2` instruction valid bit. In ARMv8, this bit is `RES0`.

VV, bit [27]

`VECITR` valid bit. In ARMv8, this bit is `RES0`.

TFV, bit [26]

Trapped Fault Valid bit. Valid only when the value of FPEXC.DEX is 1. When valid, it indicates the cause of the exception and therefore whether the FPEXC.{IDF, IXF, UFF, OFF, DZF, IOF} bits are valid.

- 0 The exception was caused by the execution of a floating-point VABS, VADD, VDIV, VFMA, VFMS, VFNMA, VFNMS, VMLA, VMLS, VMOV, VMUL, VNEG, VNMLA, VNMLS, VNMUL, VSQRT, or VSUB instruction when one or both of [FPSCR](#).{Stride, Len} was nonzero. If the FPEXC.{IDF, IXF, UFF, OFF, DZF, IOF} bits are RW then they are invalid and UNKNOWN.
- 1 FPEXC.{IDF, IXF, UFF, OFF, DZF, IOF} indicate the presence of trapped floating-point exceptions that had occurred at the time of the exception. Bits are set for all trapped exceptions that had occurred at the time of the exception.

This bit returns a status value and ignores writes.

When the value of FPEXC.DEX is 0 and this bit is RW, this bit is invalid and UNKNOWN.

On an implementation that does not support the trapping of floating-point exceptions this bit is RAZ/WI.

On an implementation that supports the trapping of floating-point exceptions and implements [FPSCR](#).{Stride, Len} as RAZ, this bit is RAO/WI.

Bits [25:11]

Reserved, RES0.

VECITR, bits [10:8]

Vector iteration count. In ARMv8, this field is RES1.

IDF, bit [7]

Input Denormal trapped exception bit. Valid only when the value of FPEXC.TFV is 1. When valid, it indicates whether an Input Denormal exception occurred while [FPSCR](#).IDE was 1:

- 0 Input denormal exception has not occurred.
- 1 Input denormal exception has occurred.

Input Denormal exceptions can occur only when [FPSCR](#).FZ is 1.

This bit must be cleared to 0 by the exception-handling routine.

When the value of FPEXC.TFV is 0 and this bit is RW, this bit is invalid and UNKNOWN.

On an implementation that does not support the trapping of floating-point exceptions this bit is RAZ/WI.

Bits [6:5]

Reserved, RES0.

IXF, bit [4]

Inexact trapped exception bit. Valid only when the value of FPEXC.TFV is 1. When valid, it indicates whether an Inexact exception occurred while [FPSCR](#).IXE was 1:

- 0 Inexact exception has not occurred.
- 1 Inexact exception has occurred.

This bit must be cleared to 0 by the exception-handling routine.

When the value of FPEXC.TFV is 0 and this bit is RW, this bit is invalid and UNKNOWN.

On an implementation that does not support the trapping of floating-point exceptions this bit is RAZ/WI.

UFF, bit [3]

Underflow trapped exception bit. Valid only when the value of FPEXC.TFV is 1. When valid, it indicates whether an Underflow exception occurred while FPSCR.UFE was 1:

- 0 Underflow exception has not occurred.
- 1 Underflow exception has occurred.

Underflow trapped exceptions can occur only when FPSCR.FZ is 0.

This bit must be cleared to 0 by the exception-handling routine.

When the value of FPEXC.TFV is 0 and this bit is RW, this bit is invalid and UNKNOWN.

On an implementation that does not support the trapping of floating-point exceptions this bit is RAZ/WI.

OFF, bit [2]

Overflow trapped exception bit. Valid only when the value of FPEXC.TFV is 1. When valid, it indicates whether an Overflow exception occurred while FPSCR.OFE was 1:

- 0 Overflow exception has not occurred.
- 1 Overflow exception has occurred.

This bit must be cleared to 0 by the exception-handling routine.

When the value of FPEXC.TFV is 0 and this bit is RW, this bit is invalid and UNKNOWN.

On an implementation that does not support the trapping of floating-point exceptions this bit is RAZ/WI.

DZF, bit [1]

Divide by Zero trapped exception bit. Valid only when the value of FPEXC.TFV is 1. When valid, it indicates whether a Divide by Zero exception occurred while FPSCR.DZE was 1:

- 0 Divide by Zero exception has not occurred.
- 1 Divide by Zero exception has occurred.

This bit must be cleared to 0 by the exception-handling routine.

When the value of FPEXC.TFV is 0 and this bit is RW, this bit is invalid and UNKNOWN.

On an implementation that does not support the trapping of floating-point exceptions this bit is RAZ/WI.

IOF, bit [0]

Invalid Operation trapped exception bit. Valid only when the value of FPEXC.TFV is 1. When valid, it indicates whether an Invalid Operation exception occurred while FPSCR.IOE was 1:

- 0 Invalid Operation exception has not occurred.
- 1 Invalid Operation exception has occurred.

This bit must be cleared to 0 by the exception-handling routine.

When the value of FPEXC.TFV is 0 and this bit is RW, this bit is invalid and UNKNOWN.

On an implementation that does not support the trapping of floating-point exceptions this bit is RAZ/WI.

Accessing the FPEXC32_EL2

This register can be read using MRS with the following syntax:

```
MRS <Xt>, <systemreg>
```

This register can be written using MSR (register) with the following syntax:

```
MSR <systemreg>, <Xt>
```

This syntax is encoded with the following settings in the instruction encoding:

<systemreg>	op0	op1	CRn	CRm	op2
FPEXC32_EL2	11	100	0101	0011	000

Accessibility

The register is accessible in software as follows:

Control			Accessibility			
E2H	TGE	NS	EL0	EL1	EL2	EL3
x	x	0	-	-	n/a	RW
x	0	1	-	-	RW	RW
x	1	1	-	n/a	RW	RW

Traps and Enables

For a description of the prioritization of any generated exceptions, see [Synchronous exception prioritization for exceptions taken to AArch64 on page D1-1827](#). Subject to the prioritization rules:

- When EL2 is implemented and is using AArch64 and (SCR_EL3.NS == 1) && (HCR_EL2.E2H == 0):
 - If CPTR_EL2.TFP==1, Non-secure accesses to this register from EL2 are trapped to EL2.
- When EL2 is implemented and is using AArch64 and (SCR_EL3.NS == 1) && (HCR_EL2.E2H == 1) && (HCR_EL2.TGE == 0):
 - If CPTR_EL2.FPEN==00, Non-secure accesses to this register from EL2 are trapped to EL2.
 - If CPTR_EL2.FPEN==10, Non-secure accesses to this register from EL2 are trapped to EL2.
- When EL2 is implemented and is using AArch64 and (SCR_EL3.NS == 1) && (HCR_EL2.E2H == 1) && (HCR_EL2.TGE == 1):
 - If CPTR_EL2.FPEN==00, Non-secure accesses to this register from EL2 are trapped to EL2.
 - If CPTR_EL2.FPEN==10, Non-secure accesses to this register from EL2 are trapped to EL2.
- When EL3 is implemented and is using AArch64:
 - If CPTR_EL3.TFP==1, accesses to this register from EL2 and EL3 are trapped to EL3.

D7.2.33 HACR_EL2, Hypervisor Auxiliary Control Register

The HACR_EL2 characteristics are:

Purpose

Controls trapping to EL2 of IMPLEMENTATION DEFINED aspects of Non-secure EL1 or EL0 operation.

———— Note —————

ARM recommends the values in this register do not cause unnecessary traps to EL2 when [HCR_EL2](#).{E2H, TGE} == {1, 1}.

Configurations

AArch64 System register HACR_EL2 is architecturally mapped to AArch32 System register [HACR](#).

If EL2 is not implemented, this register is RES0 from EL3.

RW fields in this register reset to architecturally UNKNOWN values.

Attributes

HACR_EL2 is a 32-bit register.

Field descriptions

The HACR_EL2 bit assignments are:



IMPLEMENTATION DEFINED, bits [31:0]

IMPLEMENTATION DEFINED.

Accessing the HACR_EL2

This register can be read using MRS with the following syntax:

MRS <Xt>, <systemreg>

This register can be written using MSR (register) with the following syntax:

MSR <systemreg>, <Xt>

This syntax is encoded with the following settings in the instruction encoding:

<systemreg>	op0	op1	CRn	CRm	op2
HACR_EL2	11	100	0001	0001	111

Accessibility

The register is accessible in software as follows:

Control			Accessibility			
E2H	TGE	NS	EL0	EL1	EL2	EL3
x	x	0	-	-	n/a	RW
0	0	1	-	-	RW	RW
0	1	1	-	n/a	RW	RW
1	0	1	-	-	RW	RW
1	1	1	-	n/a	RW	RW

D7.2.34 HCR_EL2, Hypervisor Configuration Register

The HCR_EL2 characteristics are:

Purpose

Provides configuration controls for virtualization, including defining whether various Non-secure operations are trapped to EL2.

Configurations

AArch64 System register HCR_EL2[31:0] is architecturally mapped to AArch32 System register [HCR](#).

AArch64 System register HCR_EL2[63:32] is architecturally mapped to AArch32 System register [HCR2](#).

If EL2 is not implemented, this register is RES0 from EL3.

RW fields in this register reset to architecturally UNKNOWN values.

Attributes

HCR_EL2 is a 64-bit register.

Field descriptions

The HCR_EL2 bit assignments are:

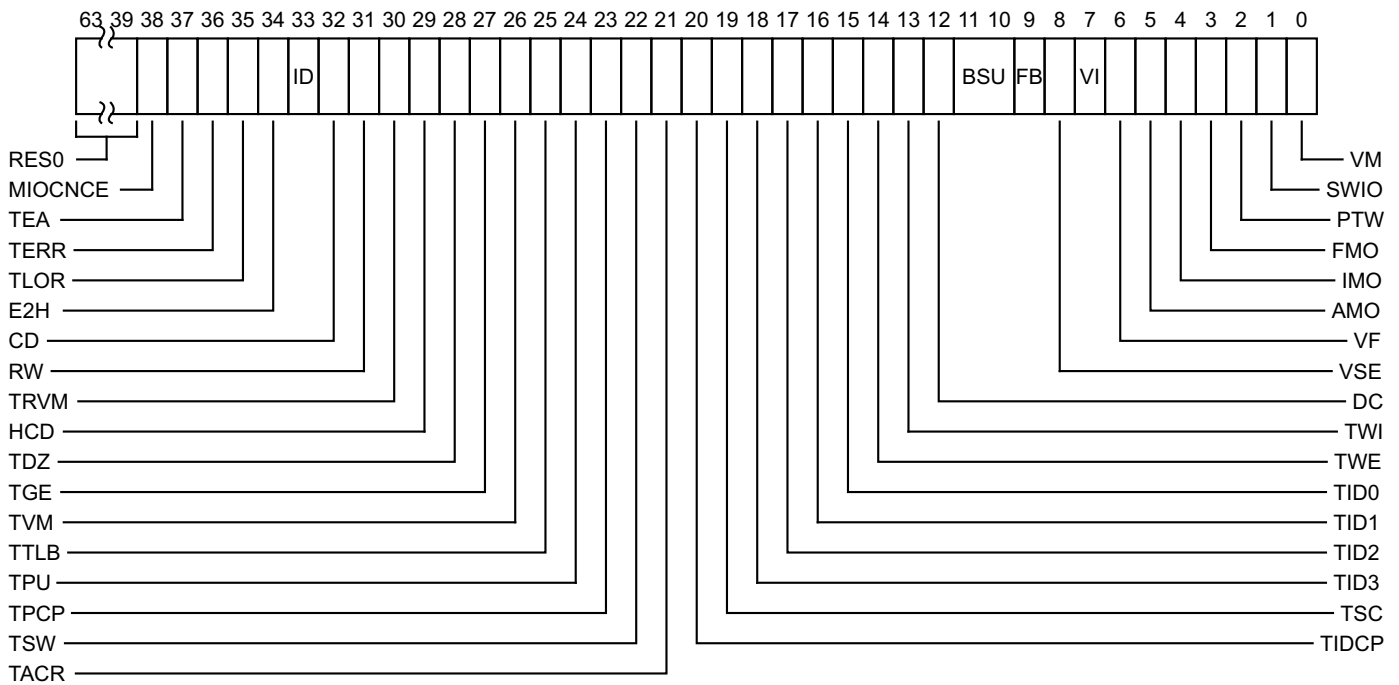

Bits [63:39]

Reserved, RES0.

MIOCNCNCE, bit [38]

Mismatched Inner/Outer Cacheable Non-Coherency Enable, for the Non-secure EL1&0 translation regime.

- 0 For the Non-secure EL1&0 translation regime, for permitted accesses to a memory location that use a common definition of the Shareability and Cacheability of the location, there must be no loss of coherency if the Inner Cacheability attribute for those accesses differs from the Outer Cacheability attribute.
- 1 For the Non-secure EL1&0 translation regime, for permitted accesses to a memory location that use a common definition of the Shareability and Cacheability of the location, there might be a loss of coherency if the Inner Cacheability attribute for those accesses differs from the Outer Cacheability attribute.

For more information see *Mismatched memory attributes* on page B2-118.

This field can be implemented as RAZ/WI.

In an implementation that includes EL3, when the value of `SCR_EL3.NS` is 0 the PE behaves as if this field is 0 for all purposes other than a direct read or write access of `HCR_EL2`.

When *ARMv8.1-VHE* is implemented, and the value of `HCR_EL2.{E2H, TGE}` is {1, 1}, the PE ignores the value of this field for all purposes other than a direct read of this field.

TEA, bit [37]

Route synchronous External Abort exceptions to EL2. If the RAS Extension is implemented, the possible values of this bit are:

- 0 Do not route synchronous External Abort exceptions from Non-secure EL0 and EL1 to EL2.
- 1 Route synchronous External Abort exceptions from Non-secure EL0 and EL1 to EL2, if not routed to EL3.

This bit resets to zero on a Warm reset into AArch32 state.

When the RAS Extension is not implemented, this field is RES0.

TERR, bit [36]

Trap Error record accesses. If the RAS Extension is implemented, the possible values of this bit are:

- 0 Do not trap accesses to error record registers from Non-secure EL1 to EL2.
- 1 Accesses to the ER* registers from Non-secure EL1 generate a Trap exception to EL2.

This bit resets to zero on a Warm reset into AArch32 state.

When the RAS Extension is not implemented, this field is RES0.

TLOR, bit [35]

In ARMv8.2 and ARMv8.1

Trap LOR registers. Traps accesses to the `LORSA_EL1`, `LOREA_EL1`, `LORN_EL1`, `LORC_EL1`, and `LORID_EL1` registers from Non-secure EL1 to EL2.

- 0 This control does not cause any instructions to be trapped.
- 1 Non-secure EL1 accesses to the LOR registers are trapped to EL2.

When `HCR_EL2.TGE` is 1, the PE ignores the value of this field for all purposes other than a direct read of this field.

In ARMv8.0.

Reserved, RES0.

E2H, bit [34]

In ARMv8.2 and ARMv8.1

EL2 Host. Enables a configuration where a Host Operating System is running in EL2, and the Host Operating System's applications are running in EL0.

- 0 EL2 is running a hypervisor.

1 EL2 is running a Host Operating System.

For information on the behavior of this bit see [Behavior of HCR_EL2.E2H on page D4-2098](#).

This bit is permitted to be cached in a TLB.

In an implementation that includes EL3, when the value of [SCR_EL3.NS](#) is 0 the PE behaves as if this field is 0 for all purposes other than a direct read or write access of [HCR_EL2](#).

In ARMv8.0.

Reserved, RES0.

ID, bit [33]

Stage 2 Instruction access cacheability disable. For the Non-secure EL1&0 translation regime, when [HCR_EL2.VM](#)==1, this control forces all stage 2 translations for instruction accesses to Normal memory to be Non-cacheable.

0 This control has no effect on stage 2 of the Non-secure EL1&0 translation regime.

1 For the Non-secure EL1&0 translation regime, forces all stage 2 translations for instruction accesses to Normal memory to be Non-cacheable.

In an implementation that includes EL3, when the value of [SCR_EL3.NS](#) is 0 the PE behaves as if this field is 0 for all purposes other than a direct read or write access of [HCR_EL2](#).

This bit has no effect on the EL2, EL2&0, or EL3 translation regimes.

When [ARMv8.1-VHE](#) is implemented, and the value of [HCR_EL2](#).{E2H, TGE} is {1, 1}, the PE ignores the value of this field for all purposes other than a direct read of this field.

CD, bit [32]

Stage 2 Data access cacheability disable. For the Non-secure EL1&0 translation regime, when [HCR_EL2.VM](#)==1, this control forces all stage 2 translations for data accesses and translation table walks to Normal memory to be Non-cacheable.

0 This control has no effect on stage 2 of the Non-secure EL1&0 translation regime for data accesses and translation table walks.

1 For the Non-secure EL1&0 translation regime, forces all stage 2 translations for data accesses and translation table walks to Normal memory to be Non-cacheable.

In an implementation that includes EL3, when the value of [SCR_EL3.NS](#) is 0 the PE behaves as if this field is 0 for all purposes other than a direct read or write access of [HCR_EL2](#).

This bit has no effect on the EL2, EL2&0, or EL3 translation regimes.

When [ARMv8.1-VHE](#) is implemented, and the value of [HCR_EL2](#).{E2H, TGE} is {1, 1}, the PE ignores the value of this field for all purposes other than a direct read of this field.

RW, bit [31]

Execution state control for lower Exception levels:

0 Lower levels are all AArch32.

1 The Execution state for EL1 is AArch64. The Execution state for EL0 is determined by the current value of [PSTATE.nRW](#) when executing at EL0.

If all lower Exception levels cannot use AArch32 then this bit is RAO/WI.

In an implementation that includes EL3, when [SCR_EL3.NS](#)==0, the PE behaves as if this bit has the same value as the [SCR_EL3.RW](#) bit for all purposes other than a direct read or write access of [HCR_EL2](#).

The RW bit is permitted to be cached in a TLB.

When [ARMv8.1-VHE](#) is implemented, and the value of [HCR_EL2](#).{E2H, TGE} is {1, 1}, this field behaves as 1 for all purposes other than a direct read of the value of this bit.

TRVM, bit [30]

Trap Reads of Virtual Memory controls. Traps Non-secure EL1 reads of the virtual memory control registers to EL2, from both Execution states. The registers for which read accesses are trapped are as follows:

Non-secure EL1 using AArch64: [SCTLR_EL1](#), [TTBR0_EL1](#), [TTBR1_EL1](#), [TCR_EL1](#), [ESR_EL1](#), [FAR_EL1](#), [AFSR0_EL1](#), [AFSR1_EL1](#), [MAIR_EL1](#), [AMAIR_EL1](#), [CONTEXTIDR_EL1](#).

Non-secure EL1 using AArch32: [SCTLR](#), [TTBR0](#), [TTBR1](#), [TTBCR](#), [TTBCR2](#), [DACR](#), [DFSR](#), [IFSR](#), [DFAR](#), [IFAR](#), [ADFSR](#), [AIFSR](#), [PRRR](#), [NMRR](#), [MAIR0](#), [MAIR1](#), [AMAIR0](#), [AMAIR1](#), [CONTEXTIDR](#).

- | | |
|---|---|
| 0 | This control does not cause any instructions to be trapped. |
| 1 | Non-secure EL1 read accesses to the specified Virtual Memory controls are trapped to EL2. |

In an implementation that includes EL3, when the value of [SCR_EL3.NS](#) is 0 the PE behaves as if this field is 0 for all purposes other than a direct read or write access of [HCR_EL2](#).

When [HCR_EL2.TGE](#) is 1, the PE ignores the value of this field for all purposes other than a direct read of this field.

HCD, bit [29]

HVC instruction disable. Disables Non-secure state execution of HVC instructions, from both Execution states.

- | | |
|---|---|
| 0 | HVC instruction execution is enabled at EL2 and Non-secure EL1. |
| 1 | HVC instructions are UNDEFINED at EL2 and Non-secure EL1. Any resulting exception is taken to the Exception level at which the HVC instruction is executed. |

———— **Note** —————

HVC instructions are always UNDEFINED at EL0.

This bit is only implemented if EL3 is not implemented. Otherwise, it is RES0.

When [HCR_EL2.TGE](#) is 1, the PE ignores the value of this field for all purposes other than a direct read of this field.

TDZ, bit [28]

Trap [DC ZVA](#) instructions. Traps Non-secure EL0 and EL1 execution of [DC ZVA](#) instructions to EL2, from AArch64 state only.

- | | |
|---|---|
| 0 | This control does not cause any instructions to be trapped. |
| 1 | In AArch64 state, any attempt to execute a DC ZVA instruction at Non-secure EL1, or at Non-secure EL0 when the instruction is not UNDEFINED at EL0, is trapped to EL2. Reading the DCZID_EL0 returns a value that indicates that DC ZVA instructions are not supported. |

In an implementation that includes EL3, when the value of [SCR_EL3.NS](#) is 0 the PE behaves as if this field is 0 for all purposes other than a direct read or write access of [HCR_EL2](#).

When [ARMv8.1-VHE](#) is implemented, and the value of [HCR_EL2.{E2H, TGE}](#) is {1, 1}, this field behaves as 0 for all purposes other than a direct read of the value of this bit.

TGE, bit [27]

Trap General Exceptions, from Non-secure EL0.

- | | |
|---|---|
| 0 | This control has no effect on execution at EL0. |
| 1 | When the value of SCR_EL3.NS is 0, this control has no effect on execution at EL0. When the value of SCR_EL3.NS is 1, in all cases: <ul style="list-style-type: none"> • All exceptions that would be routed to EL1 are routed to EL2. |

- The `SCTLR_EL1.M` field, or the `SCTLR.M` field if EL1 is using AArch32, is treated as being 0 for all purposes other than returning the result of a direct read of `SCTLR_EL1` or `SCTLR`.
- All virtual interrupts are disabled.
- Any IMPLEMENTATION DEFINED mechanisms for signaling virtual interrupts are disabled.
- An exception return to EL1 is treated as an illegal exception return.

When the value of `SCR_EL3.NS` is 1 and the value of `HCR_EL2.E2H` is 0, additionally:

- The `HCR_EL2.{FMO, IMO, AMO}` fields are treated as being 1 for all purposes other than a direct read or write access of `HCR_EL2`.
- The `MDCR_EL2.{TDRA, TDOSA, TDA, TDE}` fields are treated as being 1 for all purposes other than returning the result of a direct read of `MDCR_EL2`.

For information on the behavior of this bit when `E2H` is 1, see *Behavior of HCR_EL2.E2H* on page D4-2098.

`HCR_EL2.TGE` must not be cached in a TLB.

In an implementation that includes EL3, when the value of `SCR_EL3.NS` is 0 the PE behaves as if this field is 0 for all purposes other than a direct read or write access of `HCR_EL2`.

TVMM, bit [26]

Trap Virtual Memory controls. Traps Non-secure EL1 writes to the virtual memory control registers to EL2, from both Execution states. The registers for which write accesses are trapped are as follows:

Non-secure EL1 using AArch64: `SCTLR_EL1`, `TTBR0_EL1`, `TTBR1_EL1`, `TCR_EL1`, `ESR_EL1`, `FAR_EL1`, `AFSR0_EL1`, `AFSR1_EL1`, `MAIR_EL1`, `AMAIR_EL1`, `CONTEXTIDR_EL1`.

Non-secure EL1 using AArch32: `SCTLR`, `TTBR0`, `TTBR1`, `TTBCR`, `TTBCR2`, `DACR`, `DFSR`, `IFSR`, `DFAR`, `IFAR`, `ADFSR`, `AIFSR`, `PRRR`, `NMRR`, `MAIR0`, `MAIR1`, `AMAIR0`, `AMAIR1`, `CONTEXTIDR`.

0 This control does not cause any instructions to be trapped.

1 Non-secure EL1 write accesses to the specified EL1 virtual memory control registers are trapped to EL2.

In an implementation that includes EL3, when the value of `SCR_EL3.NS` is 0 the PE behaves as if this field is 0 for all purposes other than a direct read or write access of `HCR_EL2`.

When `HCR_EL2.TGE` is 1, the PE ignores the value of this field for all purposes other than a direct read of this field.

TTLB, bit [25]

Trap TLB maintenance instructions. Traps Non-secure EL1 execution of TLB maintenance instructions to EL2, from both Execution states. This applies to the following instructions:

Non-secure EL1 using AArch64: `TLBI VMALLE1IS`, `TLBI VAE1IS`, `TLBI ASIDE1IS`, `TLBI VAAE1IS`, `TLBI VALE1IS`, `TLBI VAALE1IS`, `TLBI VMALLE1`, `TLBI VAE1`, `TLBI ASIDE1`, `TLBI VAAE1`, `TLBI VALE1`, `TLBI VAALE1`.

Non-secure EL1 using AArch32: `TLBIALLIS`, `TLBIMVAIS`, `TLBIASIDIS`, `TLBIMVAAIS`, `TLBIMVALIS`, `TLBIMVAALIS`, `ITLBIALL`, `ITLBIMVA`, `ITLBIASID`, `DTLBIALL`, `DTLBIMVA`, `DTLBIASID`, `TLBIALL`, `TLBIMVA`, `TLBIASID`, `TLBIMVAA`, `TLBIMVAL`, `TLBIMVAAL`.

0 This control does not cause any instructions to be trapped.

1 Non-secure EL1 execution of the specified TLB maintenance instructions are trapped to EL2.

In an implementation that includes EL3, when the value of `SCR_EL3.NS` is 0 the PE behaves as if this field is 0 for all purposes other than a direct read or write access of `HCR_EL2`.

When `HCR_EL2.TGE` is 1, the PE ignores the value of this field for all purposes other than a direct read of this field.

TPU, bit [24]

Trap cache maintenance instructions that operate to the Point of Unification. Traps execution of those cache maintenance instructions at Non-secure EL1 or EL0 using AArch64, and at Non-secure EL1 using AArch32, to EL2. This applies to the following instructions:

Non-secure EL0 using AArch64: [IC IVAU](#), [DC CVAU](#). However, if the value of [SCTLR_EL1.UCI](#) is 0 these instructions are UNDEFINED at EL0 and any resulting exception is higher priority than this trap to EL2.

Non-secure EL1 using AArch64: [IC IVAU](#), [IC IALLU](#), [IC IALLUIS](#), [DC CVAU](#).

Non-secure EL1 using AArch32: [ICIMVAU](#), [ICIALLU](#), [ICIALLUIS](#), [DCCMVAU](#).

———— Note ————

An exception generated because an instruction is UNDEFINED at EL0 is higher priority than this trap to EL2. In addition:

- [IC IALLUIS](#) and [IC IALLU](#) are always UNDEFINED at EL0 using AArch64.
- [ICIMVAU](#), [ICIALLU](#), [ICIALLUIS](#), and [DCCMVAU](#) are always UNDEFINED at EL0 using AArch32.

0 This control does not cause any instructions to be trapped.

1 Non-secure execution of the specified instructions is trapped to EL2.

In an implementation that includes EL3, when the value of [SCR_EL3.NS](#) is 0 the PE behaves as if this field is 0 for all purposes other than a direct read or write access of [HCR_EL2](#).

When [ARMv8.1-VHE](#) is implemented, and the value of [HCR_EL2](#).{E2H, TGE} is {1, 1}, this field behaves as 0 for all purposes other than a direct read of the value of this bit.

TPCP, bit [23]

In ARMv8.2

Trap data or unified cache maintenance instructions that operate to the Point of Coherency or Persistence. Traps execution of those cache maintenance instructions at Non-secure EL1 or EL0 using AArch64, and at Non-secure EL1 using AArch32, to EL2. This applies to the following instructions:

Non-secure EL0 using AArch64: [DC CIVAC](#), [DC CVAC](#), [DC CVAP](#). However, if the value of [SCTLR_EL1.UCI](#) is 0 these instructions are UNDEFINED at EL0 and any resulting exception is higher priority than this trap to EL2.

Non-secure EL1 using AArch64: [DC IVAC](#), [DC CIVAC](#), [DC CVAC](#), [DC CVAP](#).

Non-secure EL1 using AArch32: [DCIMVAC](#), [DCCIMVAC](#), [DCCMVAC](#).

———— Note ————

An exception generated because an instruction is UNDEFINED at EL0 is higher priority than this trap to EL2. In addition:

- [DC IVAC](#) is always UNDEFINED at EL0 using AArch64.
- [DCIMVAC](#), [DCCIMVAC](#), and [DCCMVAC](#) are always UNDEFINED at EL0 using AArch32.

0 This control does not cause any instructions to be trapped.

1 Non-secure execution of the specified instructions is trapped to EL2.

In an implementation that includes EL3, when the value of [SCR_EL3.NS](#) is 0 the PE behaves as if this field is 0 for all purposes other than a direct read or write access of [HCR_EL2](#).

If [HCR_EL2](#).{E2H, TGE} is set to {1, 1}, this field behaves as 0 for all purposes other than a direct read of the value of this bit.

———— **Note** —————

In previous versions of the architecture this bit was named TPC. From ARMv8.2 this bit is named TPCP.

In ARMv8.1 and ARMv8.0.

Trap data or unified cache maintenance instructions that operate to the Point of Coherency. Traps execution of those cache maintenance instructions at Non-secure EL1 or EL0 using AArch64, and at Non-secure EL1 using AArch32, to EL2. This applies to the following instructions:

Non-secure EL0 using AArch64: [DC CIVAC](#), [DC CVAC](#). However, if the value of [SCTLR_EL1.UCI](#) is 0 these instructions are UNDEFINED at EL0 and any resulting exception is higher priority than this trap to EL2.

Non-secure EL1 using AArch64: [DC IVAC](#), [DC CIVAC](#), [DC CVAC](#).

Non-secure EL1 using AArch32: [DCIMVAC](#), [DCCIMVAC](#), [DCCMVAC](#).

———— **Note** —————

An exception generated because an instruction is UNDEFINED at EL0 is higher priority than this trap to EL2. In addition:

- [DC IVAC](#) is always UNDEFINED at EL0 using AArch64.
- [DCIMVAC](#), [DCCIMVAC](#), and [DCCMVAC](#) are always UNDEFINED at EL0 using AArch32.

0 This control does not cause any instructions to be trapped.

1 Non-secure execution of the specified instructions is trapped to EL2.

In an implementation that includes EL3, when the value of [SCR_EL3.NS](#) is 0 the PE behaves as if this field is 0 for all purposes other than a direct read or write access of [HCR_EL2](#).

When [ARMv8.1-VHE](#) is implemented, and the value of [HCR_EL2.{E2H, TGE}](#) is {1, 1}, this field behaves as 0 for all purposes other than a direct read of the value of this bit.

TSW, bit [22]

Trap data or unified cache maintenance instructions that operate by Set/Way. Traps execution of those cache maintenance instructions at Non-secure EL1 using AArch64, and at Non-secure EL1 using AArch32, to EL2. This applies to the following instructions:

Non-secure EL1 using AArch64: [DC ISW](#), [DC CSW](#), [DC CISW](#).

Non-secure EL1 using AArch32: [DCISW](#), [DCCSW](#), [DCCISW](#).

———— **Note** —————

An exception generated because an instruction is UNDEFINED at EL0 is higher priority than this trap to EL2, and these instructions are always UNDEFINED at EL0.

0 This control does not cause any instructions to be trapped.

1 Non-secure execution of the specified instructions is trapped to EL2.

In an implementation that includes EL3, when the value of [SCR_EL3.NS](#) is 0 the PE behaves as if this field is 0 for all purposes other than a direct read or write access of [HCR_EL2](#).

When [HCR_EL2.TGE](#) is 1, the PE ignores the value of this field for all purposes other than a direct read of this field.

TACR, bit [21]

Trap Auxiliary Control Registers. Traps Non-secure EL1 accesses to the Auxiliary Control Registers to EL2, from both Execution states. This applies to the following register accesses:

- Non-secure EL1 using AArch64: [ACTLR_EL1](#).
- Non-secure EL1 using AArch32: [ACTLR](#) and, if implemented, [ACTLR2](#).

0 This control does not cause any instructions to be trapped.

1 Non-secure EL1 accesses to the specified registers are trapped to EL2.

In an implementation that includes EL3, when the value of `SCR_EL3.NS` is 0 the PE behaves as if this field is 0 for all purposes other than a direct read or write access of `HCR_EL2`.

When `HCR_EL2.TGE` is 1, the PE ignores the value of this field for all purposes other than a direct read of this field.

TIDCP, bit [20]

Trap IMPLEMENTATION DEFINED functionality. Traps Non-secure EL1 accesses to the encodings reserved for IMPLEMENTATION DEFINED functionality to EL2. This applies to the following register accesses:

AArch64: The following reserved encoding spaces:

- IMPLEMENTATION DEFINED system instructions, which are accessed using `SYS` and `SYSL`, with `CRn` == {11, 15}.
- IMPLEMENTATION DEFINED System registers, which are accessed using `MRS` and `MSR` with the `S3_<op1>_<Cn>_<Cm>_<op2>` register name.

AArch32: MCR and MRC instructions accessing the following encodings:

- All coproc==p15, CRn==c9, opc1 == {0-7}, CRm == {c0-c2, c5-c8}, opc2 == {0-7}.
- All coproc==p15, CRn==c10, opc1 == {0-7}, CRm == {c0, c1, c4, c8}, opc2 == {0-7}.
- All coproc==p15, CRn==c11, opc1=={0-7}, CRm == {c0-c8, c15}, opc2 == {0-7}.

When the value of `HCR_EL2.TIDCP` is 1, it is IMPLEMENTATION DEFINED whether any of this functionality accessed from Non-secure EL0 is trapped to EL2. If it is not, then it is UNDEFINED, and any attempt to access it from Non-secure EL0 generates an exception that is taken to EL1.

0 This control does not cause any instructions to be trapped.

1 Non-secure EL1 accesses to or execution of the specified encodings reserved for IMPLEMENTATION DEFINED functionality are trapped to EL2.

In an implementation that includes EL3, when the value of `SCR_EL3.NS` is 0 the PE behaves as if this field is 0 for all purposes other than a direct read or write access of `HCR_EL2`.

TSC, bit [19]

Trap SMC instructions. Traps Non-secure EL1 execution of SMC instructions to EL2, from both Execution states.

0 This control does not cause any instructions to be trapped.

1 Any attempt to execute an SMC instruction at Non-secure EL1 using AArch64 or Non-secure EL1 using AArch32 is trapped to EL2, regardless of the value of `SCR_EL3.SMD`.

In AArch32 state, the ARMv8-A architecture permits, but does not require, this trap to apply to conditional SMC instructions that fail their condition code check, in the same way as with traps on other conditional instructions.

If EL3 is not implemented, this bit is RES0.

In an implementation that includes EL3, when the value of `SCR_EL3.NS` is 0 the PE behaves as if this field is 0 for all purposes other than a direct read or write access of `HCR_EL2`.

When `HCR_EL2.TGE` is 1, the PE ignores the value of this field for all purposes other than a direct read of this field.

TID3, bit [18]

Trap ID group 3. Traps Non-secure EL1 reads of the following registers to EL2:

AArch64: `ID_PFR0_EL1`, `ID_PFR1_EL1`, `ID_DFR0_EL1`, `ID_AFR0_EL1`, `ID_MMFR0_EL1`, `ID_MMFR1_EL1`, `ID_MMFR2_EL1`, `ID_MMFR3_EL1`, `ID_ISAR0_EL1`, `ID_ISAR1_EL1`, `ID_ISAR2_EL1`, `ID_ISAR3_EL1`, `ID_ISAR4_EL1`, `ID_ISAR5_EL1`, `MVFR0_EL1`, `MVFR1_EL1`, `MVFR2_EL1`, `ID_AA64PFR0_EL1`, `ID_AA64PFR1_EL1`, `ID_AA64DFR0_EL1`, `ID_AA64DFR1_EL1`, `ID_AA64ISAR0_EL1`, `ID_AA64ISAR1_EL1`, `ID_AA64MMFR0_EL1`, `ID_AA64MMFR1_EL1`, `ID_AA64MMFR2_EL1`, `ID_AA64AFR0_EL1`, `ID_AA64AFR1_EL1`,

ID_AA64ZFR0_EL1 (where SVE is implemented), and ID_MMFR4_EL1, except that if ID_MMFR4_EL1 is implemented as RAZ/WI then it is IMPLEMENTATION DEFINED whether accesses to ID_MMFR4_EL1 are trapped.

It is IMPLEMENTATION DEFINED whether this field traps MRS accesses to encodings in the following range that are not already mentioned in this field description:

- Op0 == 3, op1 == 0, CRn == c0, CRm == {c2-c7}, op2 == {0-7}.

AArch32: ID_PFR0, ID_PFR1, ID_DFR0, ID_AFR0, ID_MMFR0, ID_MMFR1, ID_MMFR2, ID_MMFR3, ID_ISAR0, ID_ISAR1, ID_ISAR2, ID_ISAR3, ID_ISAR4, ID_ISAR5, MVFR0, MVFR1, MVFR2, and ID_MMFR4, except that if ID_MMFR4 is implemented as RAZ/WI then it is IMPLEMENTATION DEFINED whether accesses to ID_MMFR4 are trapped.

MRC access to any of the following encodings are also trapped:

- coproc==p15, opc1 == 0, CRn == c0, CRm == {c3-c7}, opc2 == {0,1}.
- coproc==p15, opc1 == 0, CRn == c0, CRm == c3, opc2 == 2.
- coproc==p15, opc1 == 0, CRn == c0, CRm == c5, opc2 == {4,5}.

It is IMPLEMENTATION DEFINED whether this bit traps MRC accesses to the following encodings:

- coproc==p15, opc1 == 0, CRn == c0, CRm == c2, opc2 == 7.
- coproc==p15, opc1 == 0, CRn == c0, CRm == c3, opc2 == {3-7}.
- coproc==p15, opc1 == 0, CRn == c0, CRm == {c4, c6, c7}, opc2 == {2-7}.
- coproc==p15, opc1 == 0, CRn == c0, CRm == c5, opc2 == {2, 3, 6, 7}.

0 This control does not cause any instructions to be trapped.

1 The specified Non-secure EL1 read accesses to ID group 3 registers are trapped to EL2.

In an implementation that includes EL3, when the value of SCR_EL3.NS is 0 the PE behaves as if this field is 0 for all purposes other than a direct read or write access of HCR_EL2.

When HCR_EL2.TGE is 1, the PE ignores the value of this field for all purposes other than a direct read of this field.

TID2, bit [17]

Trap ID group 2. Traps the following register accesses to EL2:

AArch64:

- Non-secure EL1 reads of CTR_EL0, CCSIDR_EL1, CLIDR_EL1, and CSSELR_EL1.
- Non-secure EL0 reads of CTR_EL0, except that if the value of SCTLRL_EL1.UCT is 0 then EL0 reads of CTR_EL0 are UNDEFINED and any resulting exception takes precedence over this trap.
- Non-secure EL1 writes to CSSELR_EL1.

AArch32:

- Non-secure EL1 reads of the CTR, CCSIDR, CLIDR, and CSSELR.
- Non-secure EL1 writes to the CSSELR.

0 This control does not cause any instructions to be trapped.

1 The specified Non-secure EL1 and EL0 accesses to ID group 2 registers are trapped to EL2.

In an implementation that includes EL3, when the value of SCR_EL3.NS is 0 the PE behaves as if this field is 0 for all purposes other than a direct read or write access of HCR_EL2.

When ARMv8.1-VHE is implemented, and the value of HCR_EL2.{E2H, TGE} is {1, 1}, this field behaves as 0 for all purposes other than a direct read of the value of this bit.

TID1, bit [16]

Trap ID group 1. Traps Non-secure EL1 reads of the following registers are trapped to EL2:

AArch64: REVIDR_EL1, AIDR_EL1.

AArch32: [TCMTR](#), [TLBTR](#), [REVIDR](#), [AIDR](#).

0 This control does not cause any instructions to be trapped.

1 The specified Non-secure EL1 read accesses to ID group 1 registers are trapped to EL2.

In an implementation that includes EL3, when the value of [SCR_EL3.NS](#) is 0 the PE behaves as if this field is 0 for all purposes other than a direct read or write access of [HCR_EL2](#).

When [HCR_EL2.TGE](#) is 1, the PE ignores the value of this field for all purposes other than a direct read of this field.

TID0, bit [15]

Trap ID group 0. Traps the following register accesses to EL2:

AArch64: None.

AArch32:

- Non-secure EL1 reads of the [JIDR](#).
- If the [JIDR](#) is RAZ from Non-secure EL0, Non-secure EL0 of the [JIDR](#).
- Non-secure EL1 reads of the [FPSID](#).

Note

- It is IMPLEMENTATION DEFINED whether the [JIDR](#) is RAZ or UNDEFINED at EL0. If it is UNDEFINED at EL0 then any resulting exception takes precedence over this trap.
- The [FPSID](#) is not accessible at EL0 using AArch32.
- Writes to the [FPSID](#) are ignored, and not trapped by this control.

0 This control does not cause any instructions to be trapped.

1 The specified Non-secure EL1 read accesses to ID group 0 registers are trapped to EL2.

In an implementation that includes EL3, when the value of [SCR_EL3.NS](#) is 0 the PE behaves as if this field is 0 for all purposes other than a direct read or write access of [HCR_EL2](#).

In an AArch64-only implementation, this bit is RES0.

When [ARMv8.1-VHE](#) is implemented, and the value of [HCR_EL2](#).{E2H, TGE} is {1, 1}, this field behaves as 0 for all purposes other than a direct read of the value of this bit.

TWE, bit [14]

Traps Non-secure EL0 and EL1 execution of WFE instructions to EL2, from both Execution states.

0 This control does not cause any instructions to be trapped.

1 Any attempt to execute a WFE instruction at Non-secure EL0 or EL1 is trapped to EL2, if the instruction would otherwise have caused the PE to enter a low-power state and it is not trapped by [SCTLR.nTWE](#) or [SCTLR_EL1.nTWE](#).

In AArch32 state, the attempted execution of a conditional WFE instruction is only trapped if the instruction passes its condition code check.

In an implementation that includes EL3, when the value of [SCR_EL3.NS](#) is 0 the PE behaves as if this field is 0 for all purposes other than a direct read or write access of [HCR_EL2](#).

Note

Since a WFE can complete at any time, even without a Wakeup event, the traps on WFE are not guaranteed to be taken, even if the WFE is executed when there is no Wakeup event. The only guarantee is that if the instruction does not complete in finite time in the absence of a Wakeup event, the trap will be taken.

When [ARMv8.1-VHE](#) is implemented, and the value of [HCR_EL2](#).{E2H, TGE} is {1, 1}, this field behaves as 0 for all purposes other than a direct read of the value of this bit.

TWI, bit [13]

Traps Non-secure EL0 and EL1 execution of WFI instructions to EL2, from both Execution states.

- | | |
|---|---|
| 0 | This control does not cause any instructions to be trapped. |
| 1 | Any attempt to execute a WFI instruction at Non-secure EL0 or EL1 is trapped to EL2, if the instruction would otherwise have caused the PE to enter a low-power state and it is not trapped by <code>SCTLR.nTWI</code> or <code>SCTLR_EL1.nTWI</code> . |

In AArch32 state, the attempted execution of a conditional WFI instruction is only trapped if the instruction passes its condition code check.

In an implementation that includes EL3, when the value of `SCR_EL3.NS` is 0 the PE behaves as if this field is 0 for all purposes other than a direct read or write access of `HCR_EL2`.

Note

Since a WFI can complete at any time, even without a Wakeup event, the traps on WFI are not guaranteed to be taken, even if the WFI is executed when there is no Wakeup event. The only guarantee is that if the instruction does not complete in finite time in the absence of a Wakeup event, the trap will be taken.

When `ARMv8.1-VHE` is implemented, and the value of `HCR_EL2`.{E2H, TGE} is {1, 1}, this field behaves as 0 for all purposes other than a direct read of the value of this bit.

DC, bit [12]

This field is permitted to be cached in a TLB.

In an implementation that includes EL3, when the value of `SCR_EL3.NS` is 0 the PE behaves as if this field is 0 for all purposes other than a direct read or write access of `HCR_EL2`.

When `ARMv8.1-VHE` is implemented, and the value of `HCR_EL2`.{E2H, TGE} is {1, 1}, this field behaves as 0 for all purposes other than a direct read of the value of this field.

BSU, bits [11:10]

Barrier Shareability upgrade. This field determines the minimum shareability domain that is applied to any barrier instruction executed from Non-secure EL1 or Non-secure EL0:

- | | |
|----|-----------------|
| 00 | No effect |
| 01 | Inner Shareable |
| 10 | Outer Shareable |
| 11 | Full system |

This value is combined with the specified level of the barrier held in its instruction, using the same principles as combining the shareability attributes from two stages of address translation.

In an implementation that includes EL3, when the value of `SCR_EL3.NS` is 0 the PE behaves as if this field is 0 for all purposes other than a direct read or write access of `HCR_EL2`.

When `ARMv8.1-VHE` is implemented, and the value of `HCR_EL2`.{E2H, TGE} is {1, 1}, this field behaves as `0b00` for all purposes other than a direct read of the value of this bit.

FB, bit [9]

Force broadcast. Causes the following instructions to be broadcast within the Inner Shareable domain when executed from Non-secure EL1:

AArch32: `BPIALL`, `TLBIALL`, `TLBIMVA`, `TLBIASID`, `DTLBIALL`, `DTLBIMVA`, `DTLBIASID`, `ITLBIALL`, `ITLBIMVA`, `ITLBIASID`, `TLBIMVAA`, `ICIALLU`, `TLBIMVAL`, `TLBIMVAAL`.

AArch64: `TLBI VMALLE1`, `TLBI VAE1`, `TLBI ASIDE1`, `TLBI VAAE1`, `TLBI VALE1`, `TLBI VAALE1`, `IC IALLU`.

- | | |
|---|---|
| 0 | This field has no effect on the operation of the specified instructions. |
| 1 | When one of the specified instruction is executed at Non-secure EL1, the instruction is broadcast within the Inner Shareable shareability domain. |

In an implementation that includes EL3, when the value of [SCR_EL3.NS](#) is 0 the PE behaves as if this field is 0 for all purposes other than a direct read or write access of [HCR_EL2](#).

When [HCR_EL2.TGE](#) is 1, the PE ignores the value of this field for all purposes other than a direct read of this field.

VSE, bit [8]

Virtual SError interrupt.

0 This mechanism is not making a virtual SError interrupt pending.

1 A virtual SError interrupt is pending because of this mechanism.

The virtual SError interrupt is only enabled when the value of [HCR_EL2](#).{TGE, AMO} is {0, 1}.

In an implementation that includes EL3, when the value of [SCR_EL3.NS](#) is 0 the PE behaves as if this field is 0 for all purposes other than a direct read or write access of [HCR_EL2](#).

VI, bit [7]

Virtual IRQ Interrupt.

0 This mechanism is not making a virtual IRQ pending.

1 A virtual IRQ is pending because of this mechanism.

The virtual IRQ is enabled only when the value of [HCR_EL2](#).{TGE, IMO} is {0, 1}.

In an implementation that includes EL3, when the value of [SCR_EL3.NS](#) is 0 the PE behaves as if this field is 0 for all purposes other than a direct read or write access of [HCR_EL2](#).

VF, bit [6]

Virtual FIQ Interrupt.

0 This mechanism is not making a virtual FIQ pending.

1 A virtual FIQ is pending because of this mechanism.

The virtual FIQ is enabled only when the value of [HCR_EL2](#).{TGE, FMO} is {0, 1}.

In an implementation that includes EL3, when the value of [SCR_EL3.NS](#) is 0 the PE behaves as if this field is 0 for all purposes other than a direct read or write access of [HCR_EL2](#).

AMO, bit [5]

Physical SError Interrupt routing.

0 When executing at Non-secure Exception levels below EL2, physical SError Interrupts are not taken to EL2.

When the value of [HCR_EL2.TGE](#) is 0, if the PE is executing at EL2 using AArch64, physical SError Interrupts are not taken unless they are routed to EL3 by the [SCR_EL3.EA](#) bit.

Virtual SError interrupts are disabled.

1 When executing at any Exception level in Non-secure state:

- Physical SError interrupts are taken to EL2 unless they are routed to EL3.
- If [HCR_EL2.TGE](#)==0 then Virtual SError interrupts are enabled in the Non-secure state.

If the value of [HCR_EL2.TGE](#) is 1:

- Regardless of the value of the AMO bit, when executing in Non-secure state, physical Asynchronous External Aborts and SError Interrupts target EL2 unless they are routed to EL3.
- When [ARMv8.1-VHE](#) is not implemented, or if [HCR_EL2.E2H](#) is 0, this field behaves as 1 for all purposes other than a direct read of the value of this bit.
- When [ARMv8.1-VHE](#) is implemented and [HCR_EL2.E2H](#) is 1, this field behaves as 0 for all purposes other than a direct read of the value of this bit.

For more information, see [Asynchronous exception routing on page D1-1834](#).

In an implementation that includes EL3, when the value of `SCR_EL3.NS` is 0 the PE behaves as if this field is 0 for all purposes other than a direct read or write access of `HCR_EL2`.

IMO, bit [4]

Physical IRQ Routing.

- 0 When executing at Non-secure Exception levels below EL2, physical IRQ interrupts are not taken to EL2.
When the value of `HCR_EL2.TGE` is 0, if the PE is executing at EL2 using AArch64, physical IRQ interrupts are not taken unless they are routed to EL3 by the `SCR_EL3.IRQ` bit.
Virtual IRQ interrupts are disabled.
- 1 When executing at any Exception level in Non-secure state:
- Physical IRQ interrupts are taken to EL2 unless they are routed to EL3.
 - If `HCR_EL2.TGE`==0 then Virtual IRQ interrupts are enabled in Non-secure state.

If the value of `HCR_EL2.TGE` is 1:

- Regardless of the value of the IMO bit, when executing in Non-secure state, physical IRQ Interrupts target EL2 unless they are routed to EL3.
- When `ARMv8.1-VHE` is not implemented, or if `HCR_EL2.E2H` is 0, this field behaves as 1 for all purposes other than a direct read of the value of this bit.
- When `ARMv8.1-VHE` is implemented and `HCR_EL2.E2H` is 1, this field behaves as 0 for all purposes other than a direct read of the value of this bit.

For more information, see *Asynchronous exception routing* on page D1-1834.

In an implementation that includes EL3, when the value of `SCR_EL3.NS` is 0 the PE behaves as if this field is 0 for all purposes other than a direct read or write access of `HCR_EL2`.

FMO, bit [3]

Physical FIQ Routing.

- 0 When executing at Non-secure Exception levels below EL2, physical FIQ interrupts are not taken to EL2.
When the value of `HCR_EL2.TGE` is 0, if the PE is executing at EL2 using AArch64, physical FIQ interrupts are not taken unless they are routed to EL3 by the `SCR_EL3.FIQ` bit.
Virtual FIQ interrupts are disabled.
- 1 When executing at any Exception level in Non-secure state:
- Physical FIQ interrupts are taken to EL2 unless they are routed to EL3.
 - If `HCR_EL2.TGE`==0 then Virtual FIQ interrupts are enabled in Non-secure state.

If the value of `HCR_EL2.TGE` is 1:

- Regardless of the value of the FMO bit, when executing in Non-secure state, physical FIQ Interrupts target EL2 unless they are routed to EL3.
- When `ARMv8.1-VHE` is not implemented, or if `HCR_EL2.E2H` is 0, this field behaves as 1 for all purposes other than a direct read of the value of this bit.
- When `ARMv8.1-VHE` is implemented and `HCR_EL2.E2H` is 1, this field behaves as 0 for all purposes other than a direct read of the value of this bit.

For more information, see *Asynchronous exception routing* on page D1-1834.

In an implementation that includes EL3, when the value of `SCR_EL3.NS` is 0 the PE behaves as if this field is 0 for all purposes other than a direct read or write access of `HCR_EL2`.

PTW, bit [2]

Protected Table Walk. In the Non-secure EL1&0 translation regime, a translation table access made as part of a stage 1 translation table walk is subject to a stage 2 translation. The combining of the memory type attributes from the two stages of translation means the access might be made to a type of Device memory. If this occurs then the value of this bit determines the behavior:

- 0 The translation table walk occurs as if it is to Normal Non-cacheable memory. This means it can be made speculatively.
- 1 The memory access generates a stage 2 Permission fault.

This field is permitted to be cached in a TLB.

In an implementation that includes EL3, when the value of `SCR_EL3.NS` is 0 the PE behaves as if this field is 0 for all purposes other than a direct read or write access of `HCR_EL2`.

When `HCR_EL2.TGE` is 1, the PE ignores the value of this field for all purposes other than a direct read of this field.

SWIO, bit [1]

Set/Way Invalidation Override. Causes Non-secure EL1 execution of the data cache invalidate by set/way instructions to perform a data cache clean and invalidate by set/way:

- 0 This control has no effect on the operation of data cache invalidate by set/way instructions.
- 1 Data cache invalidate by set/way instructions perform a data cache clean and invalidate by set/way.

When the value of this bit is 1:

AArch32: `DCISW` performs the same invalidation as a `DCCISW` instruction.

AArch64: `DC ISW` performs the same invalidation as a `DC CISW` instruction.

This bit can be implemented as RES1.

In an implementation that includes EL3, when the value of `SCR_EL3.NS` is 0 the PE behaves as if this field is 0 for all purposes other than a direct read or write access of `HCR_EL2`.

When `HCR_EL2.TGE` is 1, the PE ignores the value of this field for all purposes other than a direct read of this field.

VM, bit [0]

Virtualization enable. Enables stage 2 address translation for the Non-secure EL1&0 translation regime. Possible values of this bit are:

- 0 Non-secure EL1&0 stage 2 address translation disabled.
- 1 Non-secure EL1&0 stage 2 address translation enabled.

When the value of this bit is 1, data cache invalidate instructions executed at Non-secure EL1 perform a data cache clean and invalidate. For the invalidate by set/way instruction this behavior applies regardless of the value of the `HCR_EL2.SWIO` bit.

This bit is permitted to be cached in a TLB.

In an implementation that includes EL3, when the value of `SCR_EL3.NS` is 0 the PE behaves as if this field is 0 for all purposes other than a direct read or write access of `HCR_EL2`.

When `ARMv8.1-VHE` is implemented, and the value of `HCR_EL2.{E2H, TGE}` is {1, 1}, this field behaves as 0 for all purposes other than a direct read of the value of this bit.

Accessing the HCR_EL2

This register can be read using MRS with the following syntax:

```
MRS <Xt>, <systemreg>
```

This register can be written using MSR (register) with the following syntax:

```
MSR <systemreg>, <Xt>
```

This syntax is encoded with the following settings in the instruction encoding:

<systemreg>	op0	op1	CRn	CRm	op2
HCR_EL2	11	100	0001	0001	000

Accessibility

The register is accessible in software as follows:

Control			Accessibility			
E2H	TGE	NS	EL0	EL1	EL2	EL3
x	x	0	-	-	n/a	RW
0	0	1	-	-	RW	RW
0	1	1	-	n/a	RW	RW
1	0	1	-	-	RW	RW
1	1	1	-	n/a	RW	RW

D7.2.35 HPFAR_EL2, Hypervisor IPA Fault Address Register

The HPFAR_EL2 characteristics are:

Purpose

Holds the faulting IPA for some aborts on a stage 2 translation taken to EL2.

Configurations

AArch64 System register HPFAR_EL2[31:0] is architecturally mapped to AArch32 System register [HPFAR](#).

If EL2 is not implemented, this register is RES0 from EL3.

RW fields in this register reset to architecturally UNKNOWN values.

Attributes

HPFAR_EL2 is a 64-bit register.

Field descriptions

The HPFAR_EL2 bit assignments are:

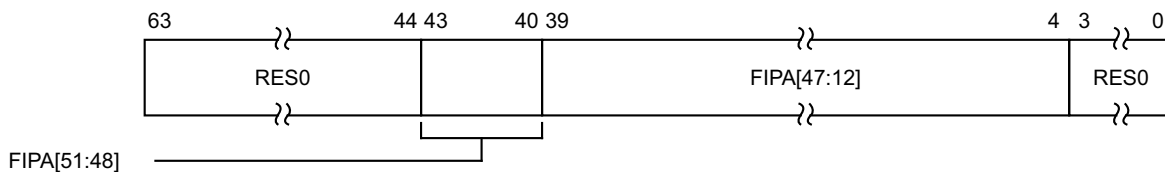

Execution at EL1 or EL0 makes HPFAR_EL2 become UNKNOWN.

Bits [63:44]

Reserved, RES0.

FIPA[51:48], bits [43:40]

In ARMv8.2

Extension to FIPA[47:12]. See FIPA[47:12] for more details.

In ARMv8.1 and ARMv8.0.

Reserved, RES0.

FIPA[47:12], bits [39:4]

Bits [47:12] of the faulting intermediate physical address. When [ARMv8.2-LPA](#) is implemented, and 52-bit addresses and a 64KB translation granule are in use, FIPA[51:48] form the upper part of the address value. Otherwise, for implementations with fewer than 52 physical address bits, FIPA[51:48] are RES0.

The HPFAR_EL2 is written for:

- Translation or Access faults in the second stage of translation.
- An abort in the second stage of translation performed during the translation table walk of a first stage translation, caused by a Translation fault, an Access flag fault, or a Permission fault.
- A stage 2 Address size fault.

Note

The address held in this register is an address accessed by the instruction fetch or data access that caused the exception that gave rise to the instruction or data abort. It is the lowest address that gave rise to the fault. Where different faults from different addresses arise from the same instruction, such as for an instruction that loads or stores a mis-aligned address that crosses a page boundary, the architecture does not prioritize between those different faults.

For all other exceptions taken to EL2, this register is UNKNOWN.

In an implementation or a translation granule that does not support [ARMv8.2-LPA](#), the upper bits of this field are RES0.

Bits [3:0]

Reserved, RES0.

Accessing the HPFAR_EL2

This register can be read using MRS with the following syntax:

MRS <Xt>, <systemreg>

This register can be written using MSR (register) with the following syntax:

MSR <systemreg>, <Xt>

This syntax is encoded with the following settings in the instruction encoding:

<systemreg>	op0	op1	CRn	CRm	op2
HPFAR_EL2	11	100	0110	0000	100

Accessibility

The register is accessible in software as follows:

Control			Accessibility			
E2H	TGE	NS	EL0	EL1	EL2	EL3
x	x	0	-	-	n/a	RW
x	0	1	-	-	RW	RW
x	1	1	-	n/a	RW	RW

D7.2.36 HSTR_EL2, Hypervisor System Trap Register

The HSTR_EL2 characteristics are:

Purpose

Controls trapping to Hyp mode of Non-secure accesses, at EL1 or lower in AArch32, to the System register in the coproc == 1111 encoding space, by the CRn value used to access the register using MCR or MRC instruction. When the register is accessible using an MCRR or MRRC instruction, this is the CRm value used to access the register.

Configurations

AArch64 System register HSTR_EL2 is architecturally mapped to AArch32 System register [HSTR](#).

If EL2 is not implemented, this register is RES0 from EL3.

If no Exception level can use AArch32, then this register is RES0

RW fields in this register reset to architecturally UNKNOWN values.

Attributes

HSTR_EL2 is a 32-bit register.

Field descriptions

The HSTR_EL2 bit assignments are:

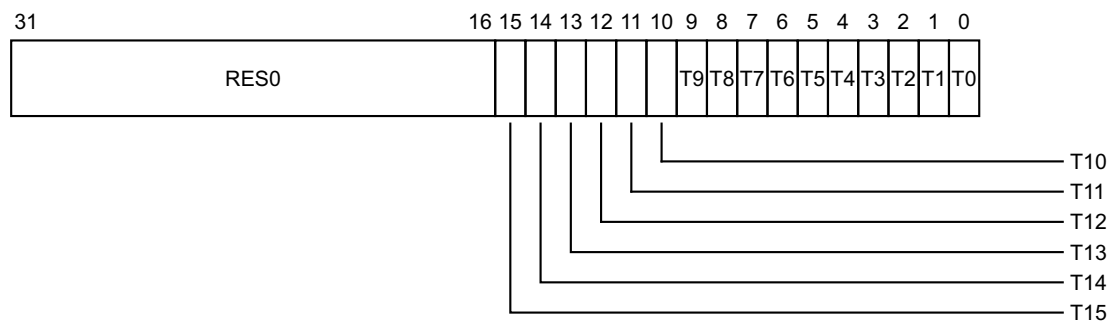

Bits [31:16]

Reserved, RES0.

T<n>, bit [n], for n = 0 to 15

Fields T14 and T4 are RES0.

The remaining fields control whether Non-secure EL0 and EL1 accesses, using MCR, MRC, MCRR, and MRRC instructions, to the System registers in the coproc == 1111 encoding space are trapped to Hyp mode:

- 0 This control has no effect on Non-secure EL0 or EL1 accesses to System registers.
- 1 Any Non-secure EL1 MCR, MRC access with coproc == 1111 and CRn == <n> is trapped to Hyp mode if the access is not UNDEFINED when the value of this field is 0.
Any Non-secure EL1 MCRR, MRRC access with coproc == 1111 and CRm == <n> is trapped to Hyp mode if the access is not UNDEFINED when the value of this field is 0.

For example, when HSTR_EL2.T7 is 1:

- Any 32-bit access from a Non-secure EL1 mode, using an MCR or MRC instruction with coproc set to 1111 and <CRn> set to c7, and that is not UNDEFINED when HSTR_EL2.T7 is 0, is trapped to Hyp mode.

- Any 64-bit access from a Non-secure EL1 mode, using an MCRR or MRRC instruction with coproc set to 1111 and <CRm> set to c7, and that is not UNDEFINED when HSTR_EL2.T7 is 0, is trapped to Hyp mode.

When [ARMv8.1-VHE](#) is implemented, and the value of [HCR_EL2](#).{E2H, TGE} is {1, 1}, this field behaves as 0 for all purposes other than a direct read of the value of this bit.

Accessing the HSTR_EL2

This register can be read using MRS with the following syntax:

MRS <Xt>, <systemreg>

This register can be written using MSR (register) with the following syntax:

MSR <systemreg>, <Xt>

This syntax is encoded with the following settings in the instruction encoding:

<systemreg>	op0	op1	CRn	CRm	op2
HSTR_EL2	11	100	0001	0001	011

Accessibility

The register is accessible in software as follows:

Control			Accessibility			
E2H	TGE	NS	EL0	EL1	EL2	EL3
x	x	0	-	-	n/a	RW
0	0	1	-	-	RW	RW
0	1	1	-	n/a	RW	RW
1	0	1	-	-	RW	RW
1	1	1	-	n/a	RW	RW

D7.2.37 ID_AA64AFR0_EL1, AArch64 Auxiliary Feature Register 0

The ID_AA64AFR0_EL1 characteristics are:

Purpose

Provides information about the IMPLEMENTATION DEFINED features of the PE in AArch64 state.

For general information about the interpretation of the ID registers see [Principles of the ID scheme for fields in ID registers on page D7-2195](#).

Configurations

There are no configuration notes.

Attributes

ID_AA64AFR0_EL1 is a 64-bit register.

Field descriptions

The ID_AA64AFR0_EL1 bit assignments are:

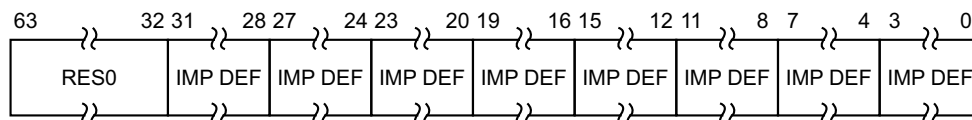

Bits [63:32]

Reserved, RES0.

IMPLEMENTATION DEFINED, bits [31:28]

IMPLEMENTATION DEFINED.

IMPLEMENTATION DEFINED, bits [27:24]

IMPLEMENTATION DEFINED.

IMPLEMENTATION DEFINED, bits [23:20]

IMPLEMENTATION DEFINED.

IMPLEMENTATION DEFINED, bits [19:16]

IMPLEMENTATION DEFINED.

IMPLEMENTATION DEFINED, bits [15:12]

IMPLEMENTATION DEFINED.

IMPLEMENTATION DEFINED, bits [11:8]

IMPLEMENTATION DEFINED.

IMPLEMENTATION DEFINED, bits [7:4]

IMPLEMENTATION DEFINED.

IMPLEMENTATION DEFINED, bits [3:0]

IMPLEMENTATION DEFINED.

Accessing the ID_AA64AFR0_EL1

This register can be read using MRS with the following syntax:

MRS <Xt>, <systemreg>

This syntax is encoded with the following settings in the instruction encoding:

<systemreg>	op0	op1	CRn	CRm	op2
ID_AA64AFR0_EL1	11	000	0000	0101	100

Accessibility

The register is accessible in software as follows:

Control			Accessibility			
E2H	TGE	NS	EL0	EL1	EL2	EL3
x	x	0	-	RO	n/a	RO
x	0	1	-	RO	RO	RO
x	1	1	-	n/a	RO	RO

Traps and Enables

For a description of the prioritization of any generated exceptions, see [Synchronous exception prioritization for exceptions taken to AArch64 on page D1-1827](#). Subject to the prioritization rules:

- When EL2 is implemented and is using AArch64 and (SCR_EL3.NS == 1) && (HCR_EL2.E2H == 0):
 - If [HCR_EL2.TID3](#)==1, Non-secure read accesses to this register from EL1 are trapped to EL2.
- When EL2 is implemented and is using AArch64 and (SCR_EL3.NS == 1) && (HCR_EL2.E2H == 1) && (HCR_EL2.TGE == 0):
 - If [HCR_EL2.TID3](#)==1, Non-secure read accesses to this register from EL1 are trapped to EL2.

D7.2.38 ID_AA64AFR1_EL1, AArch64 Auxiliary Feature Register 1

The ID_AA64AFR1_EL1 characteristics are:

Purpose

Reserved for future expansion of information about the IMPLEMENTATION DEFINED features of the PE in AArch64 state.

For general information about the interpretation of the ID registers see [Principles of the ID scheme for fields in ID registers on page D7-2195](#).

Configurations

There are no configuration notes.

Attributes

ID_AA64AFR1_EL1 is a 64-bit register.

Field descriptions

The ID_AA64AFR1_EL1 bit assignments are:

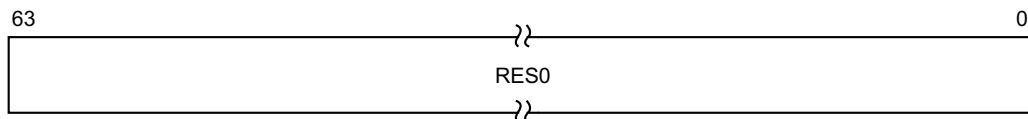

Bits [63:0]

Reserved, RES0.

Accessing the ID_AA64AFR1_EL1

This register can be read using MRS with the following syntax:

MRS <Xt>, <systemreg>

This syntax is encoded with the following settings in the instruction encoding:

<systemreg>	op0	op1	CRn	CRm	op2
ID_AA64AFR1_EL1	11	000	0000	0101	101

Accessibility

The register is accessible in software as follows:

Control			Accessibility			
E2H	TGE	NS	EL0	EL1	EL2	EL3
x	x	0	-	RO	n/a	RO
x	0	1	-	RO	RO	RO
x	1	1	-	n/a	RO	RO

Traps and Enables

For a description of the prioritization of any generated exceptions, see *Synchronous exception prioritization for exceptions taken to AArch64* on page D1-1827. Subject to the prioritization rules:

- When EL2 is implemented and is using AArch64 and $(SCR_EL3.NS == 1) \ \&\& \ (HCR_EL2.E2H == 0)$:
 - If $HCR_EL2.TID3 == 1$, Non-secure read accesses to this register from EL1 are trapped to EL2.
- When EL2 is implemented and is using AArch64 and $(SCR_EL3.NS == 1) \ \&\& \ (HCR_EL2.E2H == 1) \ \&\& \ (HCR_EL2.TGE == 0)$:
 - If $HCR_EL2.TID3 == 1$, Non-secure read accesses to this register from EL1 are trapped to EL2.

D7.2.39 ID_AA64DFR0_EL1, AArch64 Debug Feature Register 0

The ID_AA64DFR0_EL1 characteristics are:

Purpose

Provides top level information about the debug system in AArch64 state.

For general information about the interpretation of the ID registers see [Principles of the ID scheme for fields in ID registers](#) on page D7-2195.

Configurations

The external register [EDDFR](#) gives information from this register.

Attributes

ID_AA64DFR0_EL1 is a 64-bit register.

Field descriptions

The ID_AA64DFR0_EL1 bit assignments are:

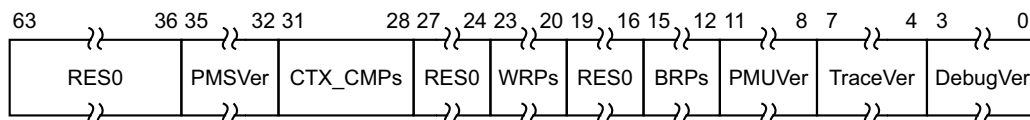

Bits [63:36]

Reserved, RES0.

PMSVer, bits [35:32]

In ARMv8.2

Statistical Profiling Extension version. When the Statistical Profiling Extension is implemented, the defined values of this field are:

0000 No Statistical Profiling extension.

0001 Version 1 of the Statistical Profiling extension present.

All other values are reserved.

When the Statistical Profiling Extension is not implemented this field is reserved, RES0.

In ARMv8.1 and ARMv8.0.

Reserved, RES0.

CTX_CMPs, bits [31:28]

Number of breakpoints that are context-aware, minus 1. These are the highest numbered breakpoints.

Bits [27:24]

Reserved, RES0.

WRPs, bits [23:20]

Number of watchpoints, minus 1. The value of 0b0000 is reserved.

Bits [19:16]

Reserved, RES0.

BRPs, bits [15:12]

Number of breakpoints, minus 1. The value of 0b0000 is reserved.

PMUVer, bits [11:8]

Performance Monitors Extension version. Indicates whether System register interface to Performance Monitors extension is implemented. Defined values are:

- 0000 Performance Monitors Extension System registers not implemented.
- 0001 Performance Monitors Extension System registers implemented, PMUv3.
- 0100 Performance Monitors Extension System registers implemented, PMUv3, with a 16-bit evtCount field, and if EL2 is implemented, the addition of the MDCR_EL2.HPMD bit.
- 1111 IMPLEMENTATION DEFINED form of performance monitors supported, PMUv3 not supported.

All other values are reserved.

In ARMv8.0 the permitted values are 0b0000, 0b0001 and 0b1111.

From ARMv8.1 the permitted values are 0b0000, 0b0100 and 0b1111.

TraceVer, bits [7:4]

Trace support. Indicates whether System register interface to a trace macrocell is implemented. Defined values are:

- 0000 Trace macrocell System registers not implemented.
- 0001 Trace macrocell System registers implemented.

All other values are reserved.

A value of 0b0000 only indicates that no System register interface to a trace macrocell is implemented. A trace macrocell might nevertheless be implemented without a System register interface.

DebugVer, bits [3:0]

Debug architecture version. Indicates presence of ARMv8 debug architecture.

- 0110 ARMv8 debug architecture.
- 0111 ARMv8 debug architecture with Virtualization Host Extensions.
- 1000 ARMv8.2 debug architecture

All other values are reserved.

In an ARMv8.0 implementation, the only permitted value is 0b0110.

In an ARMv8.1 implementation that includes ARMv8.1-VHE, the only permitted value is 0b0111.

In an ARMv8.1 implementation that does not include ARMv8.1-VHE, the permitted values are 0b0110 and 0b0111.

In an ARMv8.2 implementation, the only permitted value is 0b1000.

Accessing the ID_AA64DFR0_EL1

This register can be read using MRS with the following syntax:

MRS <Xt>, <systemreg>

This syntax is encoded with the following settings in the instruction encoding:

<systemreg>	op0	op1	CRn	CRm	op2
ID_AA64DFR0_EL1	11	000	0000	0101	000

Accessibility

The register is accessible in software as follows:

Control			Accessibility			
E2H	TGE	NS	EL0	EL1	EL2	EL3
x	x	0	-	RO	n/a	RO
x	0	1	-	RO	RO	RO
x	1	1	-	n/a	RO	RO

Traps and Enables

For a description of the prioritization of any generated exceptions, see [Synchronous exception prioritization for exceptions taken to AArch64 on page D1-1827](#). Subject to the prioritization rules:

- When EL2 is implemented and is using AArch64 and (SCR_EL3.NS == 1) && (HCR_EL2.E2H == 0):
 - If HCR_EL2.TID3==1, Non-secure read accesses to this register from EL1 are trapped to EL2.
- When EL2 is implemented and is using AArch64 and (SCR_EL3.NS == 1) && (HCR_EL2.E2H == 1) && (HCR_EL2.TGE == 0):
 - If HCR_EL2.TID3==1, Non-secure read accesses to this register from EL1 are trapped to EL2.

D7.2.40 ID_AA64DFR1_EL1, AArch64 Debug Feature Register 1

The ID_AA64DFR1_EL1 characteristics are:

Purpose

Reserved for future expansion of top level information about the debug system in AArch64 state.

For general information about the interpretation of the ID registers see [Principles of the ID scheme for fields in ID registers on page D7-2195](#).

Configurations

There are no configuration notes.

Attributes

ID_AA64DFR1_EL1 is a 64-bit register.

Field descriptions

The ID_AA64DFR1_EL1 bit assignments are:

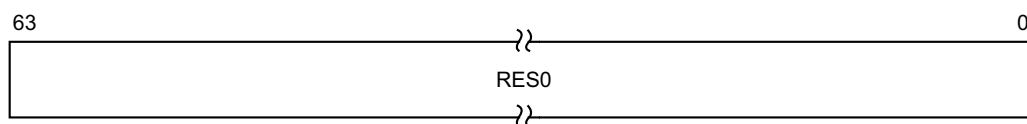

Bits [63:0]

Reserved, RES0.

Accessing the ID_AA64DFR1_EL1

This register can be read using MRS with the following syntax:

MRS <Xt>, <systemreg>

This syntax is encoded with the following settings in the instruction encoding:

<systemreg>	op0	op1	CRn	CRm	op2
ID_AA64DFR1_EL1	11	000	0000	0101	001

Accessibility

The register is accessible in software as follows:

Control			Accessibility			
E2H	TGE	NS	EL0	EL1	EL2	EL3
x	x	0	-	RO	n/a	RO
x	0	1	-	RO	RO	RO
x	1	1	-	n/a	RO	RO

Traps and Enables

For a description of the prioritization of any generated exceptions, see *Synchronous exception prioritization for exceptions taken to AArch64* on page D1-1827. Subject to the prioritization rules:

- When EL2 is implemented and is using AArch64 and (SCR_EL3.NS == 1) && (HCR_EL2.E2H == 0):
 - If HCR_EL2.TID3==1, Non-secure read accesses to this register from EL1 are trapped to EL2.
- When EL2 is implemented and is using AArch64 and (SCR_EL3.NS == 1) && (HCR_EL2.E2H == 1) && (HCR_EL2.TGE == 0):
 - If HCR_EL2.TID3==1, Non-secure read accesses to this register from EL1 are trapped to EL2.

D7.2.41 ID_AA64ISAR0_EL1, AArch64 Instruction Set Attribute Register 0

The ID_AA64ISAR0_EL1 characteristics are:

Purpose

Provides information about the instructions implemented in AArch64 state.

For general information about the interpretation of the ID registers see [Principles of the ID scheme for fields in ID registers on page D7-2195](#).

Configurations

There are no configuration notes.

Attributes

ID_AA64ISAR0_EL1 is a 64-bit register.

Field descriptions

The ID_AA64ISAR0_EL1 bit assignments are:

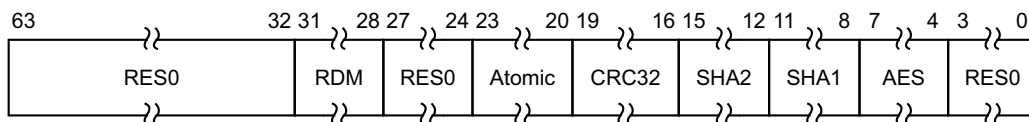

Bits [63:32]

Reserved, RES0.

RDM, bits [31:28]

In ARMv8.2 and ARMv8.1

SQRDMLAH and SQRDMLSH instructions implemented in AArch64 state. Defined values are:

0000 No SQRDMLAH and SQRDMLSH instructions implemented.

0001 SQRDMLAH and SQRDMLSH instructions implemented.

All other values are reserved.

In ARMv8.0 the only permitted value is 0000.

From ARMv8.1 the only permitted value is 0001. This feature is identified by the name [ARMv8.1-SIMD](#).

In ARMv8.0.

Reserved, RES0.

Bits [27:24]

Reserved, RES0.

Atomic, bits [23:20]

In ARMv8.2 and ARMv8.1

Atomic instructions implemented in AArch64 state. Defined values are:

0000 No Atomic instructions implemented.

0010 LDADD, LDCLR, LDEOR, LDSET, LDSMAX, LDSMIN, LDUMAX, LDUMIN, CAS, CASP, and SWP instructions implemented.

All other values are reserved.

In ARMv8.0 the only permitted value is 0000.

From ARMv8.1 the only permitted value is 0010. This feature is identified by the name [ARMv8.1-Atomics](#).

In ARMv8.0.

Reserved, RES0.

CRC32, bits [19:16]

CRC32 instructions implemented in AArch64 state. Defined values are:

0000 No CRC32 instructions implemented.

0001 CRC32B, CRC32H, CRC32W, CRC32X, CRC32CB, CRC32CH, CRC32CW, and CRC32CX instructions implemented.

All other values are reserved.

In ARMv8.0 the permitted values are 0000 and 0001.

From ARMv8.1 the only permitted value is 0001.

SHA2, bits [15:12]

SHA2 instructions implemented in AArch64 state. Defined values are:

0000 No SHA2 instructions implemented.

0001 SHA256H, SHA256H2, SHA256SU0, and SHA256SU1 instructions implemented.

All other values are reserved.

SHA1, bits [11:8]

SHA1 instructions implemented in AArch64 state. Defined values are:

0000 No SHA1 instructions implemented.

0001 SHA1C, SHA1P, SHA1M, SHA1H, SHA1SU0, and SHA1SU1 instructions implemented.

All other values are reserved.

AES, bits [7:4]

AES instructions implemented in AArch64 state. Defined values are:

0000 No AES instructions implemented.

0001 AESE, AESD, AESMC, and AESIMC instructions implemented.

0010 As for 0001, plus PMULL/PMULL2 instructions operating on 64-bit data quantities.

All other values are reserved.

Bits [3:0]

Reserved, RES0.

Accessing the ID_AA64ISAR0_EL1

This register can be read using MRS with the following syntax:

MRS <Xt>, <systemreg>

This syntax is encoded with the following settings in the instruction encoding:

<systemreg>	op0	op1	CRn	CRm	op2
ID_AA64ISAR0_EL1	11	000	0000	0110	000

Accessibility

The register is accessible in software as follows:

Control			Accessibility			
E2H	TGE	NS	EL0	EL1	EL2	EL3
x	x	0	-	RO	n/a	RO
x	0	1	-	RO	RO	RO
x	1	1	-	n/a	RO	RO

Traps and Enables

For a description of the prioritization of any generated exceptions, see [Synchronous exception prioritization for exceptions taken to AArch64 on page D1-1827](#). Subject to the prioritization rules:

- When EL2 is implemented and is using AArch64 and (SCR_EL3.NS == 1) && (HCR_EL2.E2H == 0):
 - If HCR_EL2.TID3==1, Non-secure read accesses to this register from EL1 are trapped to EL2.
- When EL2 is implemented and is using AArch64 and (SCR_EL3.NS == 1) && (HCR_EL2.E2H == 1) && (HCR_EL2.TGE == 0):
 - If HCR_EL2.TID3==1, Non-secure read accesses to this register from EL1 are trapped to EL2.

D7.2.42 ID_AA64ISAR1_EL1, AArch64 Instruction Set Attribute Register 1

The ID_AA64ISAR1_EL1 characteristics are:

Purpose

Reserved for future expansion of the information about the instructions implemented in AArch64 state.

For general information about the interpretation of the ID registers see [Principles of the ID scheme for fields in ID registers on page D7-2195](#).

Configurations

There are no configuration notes.

Attributes

ID_AA64ISAR1_EL1 is a 64-bit register.

Field descriptions

The ID_AA64ISAR1_EL1 bit assignments are:

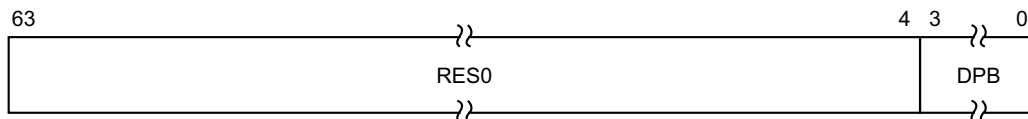

Bits [63:4]

Reserved, RES0.

DPB, bits [3:0]

In ARMv8.2

Indicates support for the [DC CVAP](#) instruction in AArch64 state. Defined values are:

0000 [DC CVAP](#) not supported.

0001 [DC CVAP](#) supported.

All other values are reserved.

In ARMv8.0 and ARMv8.1 the only permitted value is 0000.

From ARMv8.2 the only permitted value is 0001. This feature is identified by the name [ARMv8.2-DCPoP](#).

In ARMv8.1 and ARMv8.0.

Reserved, RES0.

Accessing the ID_AA64ISAR1_EL1

This register can be read using MRS with the following syntax:

MRS <Xt>, <systemreg>

This syntax is encoded with the following settings in the instruction encoding:

<systemreg>	op0	op1	CRn	CRm	op2
ID_AA64ISAR1_EL1	11	000	0000	0110	001

Accessibility

The register is accessible in software as follows:

Control			Accessibility			
E2H	TGE	NS	EL0	EL1	EL2	EL3
x	x	0	-	RO	n/a	RO
x	0	1	-	RO	RO	RO
x	1	1	-	n/a	RO	RO

Traps and Enables

For a description of the prioritization of any generated exceptions, see [Synchronous exception prioritization for exceptions taken to AArch64 on page D1-1827](#). Subject to the prioritization rules:

- When EL2 is implemented and is using AArch64 and (SCR_EL3.NS == 1) && (HCR_EL2.E2H == 0):
 - If [HCR_EL2.TID3](#)==1, Non-secure read accesses to this register from EL1 are trapped to EL2.
- When EL2 is implemented and is using AArch64 and (SCR_EL3.NS == 1) && (HCR_EL2.E2H == 1) && (HCR_EL2.TGE == 0):
 - If [HCR_EL2.TID3](#)==1, Non-secure read accesses to this register from EL1 are trapped to EL2.

D7.2.43 ID_AA64MMFR0_EL1, AArch64 Memory Model Feature Register 0

The ID_AA64MMFR0_EL1 characteristics are:

Purpose

Provides information about the implemented memory model and memory management support in AArch64 state.

For general information about the interpretation of the ID registers see [Principles of the ID scheme for fields in ID registers](#) on page D7-2195.

Configurations

There are no configuration notes.

Attributes

ID_AA64MMFR0_EL1 is a 64-bit register.

Field descriptions

The ID_AA64MMFR0_EL1 bit assignments are:

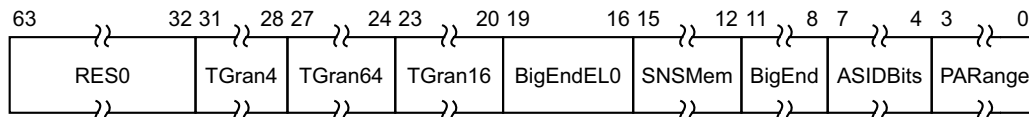

Bits [63:32]

Reserved, RES0.

TGran4, bits [31:28]

Support for 4KB memory translation granule size. Defined values are:

0000 4KB granule supported.

1111 4KB granule not supported.

All other values are reserved.

TGran64, bits [27:24]

Support for 64KB memory translation granule size. Defined values are:

0000 64KB granule supported.

1111 64KB granule not supported.

All other values are reserved.

TGran16, bits [23:20]

Support for 16KB memory translation granule size. Defined values are:

0000 16KB granule not supported.

0001 16KB granule supported.

All other values are reserved.

BigEndEL0, bits [19:16]

Mixed-endian support at EL0 only. Defined values are:

0000 No mixed-endian support at EL0. The `SCTLR_EL1.E0E` bit has a fixed value.

0001 Mixed-endian support at EL0. The `SCTLR_EL1.E0E` bit can be configured.

All other values are reserved.

This field is invalid and is RES0 if the BigEnd field, bits [11:8], is not 0000.

SNSMem, bits [15:12]

Secure versus Non-secure Memory distinction. Defined values are:

- 0000 Does not support a distinction between Secure and Non-secure Memory.
- 0001 Does support a distinction between Secure and Non-secure Memory.

All other values are reserved.

BigEnd, bits [11:8]

Mixed-endian configuration support. Defined values are:

- 0000 No mixed-endian support. The [SCTLR_ELx.EE](#) bits have a fixed value. See the BigEndEL0 field, bits[19:16], for whether EL0 supports mixed-endian.
- 0001 Mixed-endian support. The [SCTLR_ELx.EE](#) and [SCTLR_EL1.E0E](#) bits can be configured.

All other values are reserved.

ASIDBits, bits [7:4]

Number of ASID bits. Defined values are:

- 0000 8 bits.
- 0010 16 bits.

All other values are reserved.

PARange, bits [3:0]

Physical Address range supported. Defined values are:

- 0000 32 bits, 4GB.
- 0001 36 bits, 64GB.
- 0010 40 bits, 1TB.
- 0011 42 bits, 4TB.
- 0100 44 bits, 16TB.
- 0101 48 bits, 256TB.
- 0110 52 bits, 4PB.

All other values are reserved.

In all ARMv8 implementations, the values 0000, 0001, 0010, 0011, 0100 and 0101 are permitted.

From ARMv8.1, the value 0110 is permitted and indicates that [ARMv8.2-LPA](#) is implemented.

Accessing the ID_AA64MMFR0_EL1

This register can be read using MRS with the following syntax:

MRS <Xt>, <systemreg>

This syntax is encoded with the following settings in the instruction encoding:

<systemreg>	op0	op1	CRn	CRm	op2
ID_AA64MMFR0_EL1	11	000	0000	0111	000

Accessibility

The register is accessible in software as follows:

Control			Accessibility			
E2H	TGE	NS	EL0	EL1	EL2	EL3
x	x	0	-	RO	n/a	RO
x	0	1	-	RO	RO	RO
x	1	1	-	n/a	RO	RO

Traps and Enables

For a description of the prioritization of any generated exceptions, see [Synchronous exception prioritization for exceptions taken to AArch64 on page D1-1827](#). Subject to the prioritization rules:

- When EL2 is implemented and is using AArch64 and (SCR_EL3.NS == 1) && (HCR_EL2.E2H == 0):
 - If HCR_EL2.TID3==1, Non-secure read accesses to this register from EL1 are trapped to EL2.
- When EL2 is implemented and is using AArch64 and (SCR_EL3.NS == 1) && (HCR_EL2.E2H == 1) && (HCR_EL2.TGE == 0):
 - If HCR_EL2.TID3==1, Non-secure read accesses to this register from EL1 are trapped to EL2.

D7.2.44 ID_AA64MMFR1_EL1, AArch64 Memory Model Feature Register 1

The ID_AA64MMFR1_EL1 characteristics are:

Purpose

Provides information about the implemented memory model and memory management support in AArch64 state.

For general information about the interpretation of the ID registers see [Principles of the ID scheme for fields in ID registers on page D7-2195](#).

Configurations

There are no configuration notes.

Attributes

ID_AA64MMFR1_EL1 is a 64-bit register.

Field descriptions

The ID_AA64MMFR1_EL1 bit assignments are:

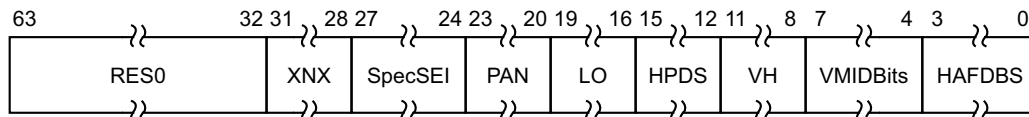

Bits [63:32]

Reserved, RES0.

XNX, bits [31:28]

In ARMv8.2

Indicates support for Execute Never control distinction at stage 2 bit. Defined values are:

- 0000 Distinction between EL0 and EL1 execute permission at stage 2 not supported.
- 0001 Distinction between EL0 and EL1 execute permission at stage 2 supported.

All other values are reserved.

In ARMv8.0 and ARMv8.1, the only permitted value is 0000.

From ARMv8.2, the only permitted value is 0001. This feature is identified by the name [ARMv8.2-TTS2UXN](#).

In ARMv8.1 and ARMv8.0.

Reserved, RES0.

SpecSEI, bits [27:24]

Describes whether the PE can generate SError interrupt exceptions from speculative reads of memory, including speculative instruction fetches. The defined values of this field are:

- 0000 The PE never generates an SError interrupt due to an external abort on a speculative read.

- 0001 The PE might generate an SError interrupt due to an external abort on a speculative read.

All other values are reserved.

When the RAS Extension is not implemented, this field is RAZ.

PAN, bits [23:20]

In ARMv8.2 and ARMv8.1

Privileged Access Never. Indicates support for the PAN bit in PSTATE, [SPSR_EL1](#), [SPSR_EL2](#), [SPSR_EL3](#), and [DPSR_EL0](#). Defined values are:

- 0000 PAN not supported.
- 0001 PAN supported.
- 0010 PAN supported and AT S1E1RP and AT S1E1WP instructions supported.

All other values are reserved.

In ARMv8.0 the only permitted value is 0000.

In ARMv8.1 the only permitted value is 0001. This feature is identified by the name [ARMv8.1-PAN](#).

From ARMv8.2, the only permitted value is 0010. This feature is identified by the name [ARMv8.2-ATS1E1](#).

In ARMv8.0.

Reserved, RES0.

LO, bits [19:16]

In ARMv8.2 and ARMv8.1

LORegions. Indicates support for LORegions. Defined values are:

- 0000 LORegions not supported.
- 0001 LORegions supported.

All other values are reserved.

In ARMv8.0 the only permitted value is 0000.

From ARMv8.1, the only permitted value is 0001. This feature is identified by the name [ARMv8.1-LOR](#).

In ARMv8.0.

Reserved, RES0.

HPDS, bits [15:12]

In ARMv8.2 and ARMv8.1

Hierarchical permission disables bits in translation tables. Defined values are:

- 0000 Disabling of hierarchical controls not supported.
- 0001 Disabling of hierarchical controls supported using [TCR_EL1.HPD0](#), [TCR_EL1.HPD1](#), [TCR_EL2.HPD](#), and [TCR_EL3.HPD](#) bits.
- 0010 Disabling of hierarchical controls supported using the [TCR_EL1.HPD0](#), [TCR_EL1.HPD1](#), [TCR_EL2.HPD](#), and [TCR_EL3.HPD](#) bits, and hardware allocation of bits[62:59] of the last level page table descriptor for IMPLEMENTATION DEFINED use.

All other values are reserved.

In ARMv8.0 the only permitted value is 0000.

In ARMv8.1 the only permitted value is 0001. This feature is identified by the name [ARMv8.1-HPD](#).

From ARMv8.2, the permitted values are 0001 and 0010. This feature is identified by the name [ARMv8.2-TTPBHA](#).

In ARMv8.0.

Reserved, RES0.

VH, bits [11:8]

In ARMv8.2 and ARMv8.1

Virtualization Host Extensions. Defined values are:

- 0000 Virtualization Host Extensions not supported.
- 0001 Virtualization Host Extensions supported.

All other values are reserved.

In ARMv8.0 the only permitted value is 0000.

From ARMv8.1, the only permitted value is 0001. This feature is identified by the name [ARMv8.1-VHE](#).

In ARMv8.0.

Reserved, RES0.

VMIDBits, bits [7:4]

In ARMv8.2 and ARMv8.1

Number of VMID bits. Defined values are:

0000 8 bits

0010 16 bits

All other values are reserved.

In ARMv8.0 the only permitted value is 0000.

From ARMv8.1, the permitted values are 0000 and 0010.

In ARMv8.0.

Reserved, RES0.

HAFDBS, bits [3:0]

In ARMv8.2 and ARMv8.1

Hardware updates to Access flag and Dirty state in translation tables. Defined values are:

0000 No hardware update of the Access flag and dirty state is supported in hardware.

0001 Hardware update of the Access flag is supported in hardware.

0010 Hardware update of both the Access flag and dirty state is supported in hardware.

All other values are reserved.

In ARMv8.0.

Reserved, RES0.

Accessing the ID_AA64MMFR1_EL1

This register can be read using MRS with the following syntax:

MRS <Xt>, <systemreg>

This syntax is encoded with the following settings in the instruction encoding:

<systemreg>	op0	op1	CRn	CRm	op2
ID_AA64MMFR1_EL1	11	000	0000	0111	001

Accessibility

The register is accessible in software as follows:

Control			Accessibility			
E2H	TGE	NS	EL0	EL1	EL2	EL3
x	x	0	-	RO	n/a	RO
x	0	1	-	RO	RO	RO
x	1	1	-	n/a	RO	RO

Traps and Enables

For a description of the prioritization of any generated exceptions, see [Synchronous exception prioritization for exceptions taken to AArch64 on page D1-1827](#). Subject to the prioritization rules:

- When EL2 is implemented and is using AArch64 and (SCR_EL3.NS == 1) && (HCR_EL2.E2H == 0):
 - If [HCR_EL2.TID3==1](#), Non-secure read accesses to this register from EL1 are trapped to EL2.
- When EL2 is implemented and is using AArch64 and (SCR_EL3.NS == 1) && (HCR_EL2.E2H == 1) && (HCR_EL2.TGE == 0):
 - If [HCR_EL2.TID3==1](#), Non-secure read accesses to this register from EL1 are trapped to EL2.

D7.2.45 ID_AA64MMFR2_EL1, AArch64 Memory Model Feature Register 2

The ID_AA64MMFR2_EL1 characteristics are:

Purpose

Provides information about the implemented memory model and memory management support in AArch64 state.

For general information about the interpretation of the ID registers see [Principles of the ID scheme for fields in ID registers](#) on page D7-2195.

Configurations

This register is introduced in ARMv8.2.

Attributes

ID_AA64MMFR2_EL1 is a 64-bit register.

Field descriptions

The ID_AA64MMFR2_EL1 bit assignments are:

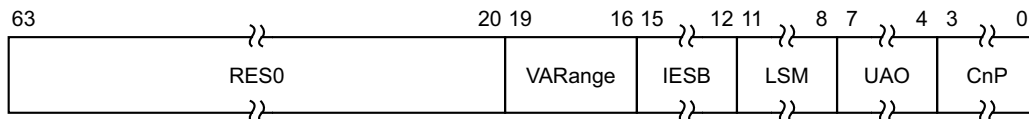

Bits [63:20]

Reserved, RES0.

VARange, bits [19:16]

Indicates support for a larger virtual address. Defined values are:

0000 48 bits of VA for each translation table page register are supported.

0001 52 bits of VA for each translation table page register are supported.

All other values are reserved.

From ARMv8.2, the permitted values are 0000 and 0001. This feature is identified by the name [ARMv8.2-LVA](#).

IESB, bits [15:12]

Indicates whether the implicit Error Synchronization Barrier operations are implemented. Defined values are:

0000 [SCTLR_ELx.IESB](#) implicit ErrorSynchronizationBarrier control not implemented.

0001 [SCTLR_ELx.IESB](#) implicit ErrorSynchronizationBarrier control implemented.

All other values are reserved.

LSM, bits [11:8]

Indicates support for LSMAOE and nTLSMD bits in [SCTLR_EL1](#) and [SCTLR_EL2](#). Defined values are:

0000 LSMAOE and nTLSMD bits not supported.

0001 LSMAOE and nTLSMD bits supported.

All other values are reserved.

From ARMv8.2, the permitted values are 0000 and 0001. This feature is identified by the name [ARMv8.2-LSMAOC](#).

UAO, bits [7:4]

User Access Override. Defined values are:

0000 UAO not supported.

0001 UAO supported.

All other values are reserved.

From ARMv8.2, the only permitted value is 0001. This feature is identified by the name [ARMv8.2-UAO](#).

CnP, bits [3:0]

Common not Private translations. Defined values are:

0000 Common not Private translations not supported.

0001 Common not Private translations supported.

All other values are reserved.

From ARMv8.2, the only permitted value is 0001. This feature is identified by the name [ARMv8.2-TTCNP](#).

Accessing the ID_AA64MMFR2_EL1

This register can be read using MRS with the following syntax:

MRS <Xt>, <systemreg>

This syntax is encoded with the following settings in the instruction encoding:

<systemreg>	op0	op1	CRn	CRm	op2
ID_AA64MMFR2_EL1	11	000	0000	0111	010

Accessibility

The register is accessible in software as follows:

Control			Accessibility			
E2H	TGE	NS	EL0	EL1	EL2	EL3
x	x	0	-	RO	n/a	RO
x	0	1	-	RO	RO	RO
x	1	1	-	n/a	RO	RO

Traps and Enables

For a description of the prioritization of any generated exceptions, see [Synchronous exception prioritization for exceptions taken to AArch64](#) on page D1-1827. Subject to the prioritization rules:

- When EL2 is implemented and is using AArch64 and (SCR_EL3.NS == 1) && (HCR_EL2.E2H == 0):
 - If HCR_EL2.TID3==1, Non-secure read accesses to this register from EL1 are trapped to EL2.
- When EL2 is implemented and is using AArch64 and (SCR_EL3.NS == 1) && (HCR_EL2.E2H == 1) && (HCR_EL2.TGE == 0):
 - If HCR_EL2.TID3==1, Non-secure read accesses to this register from EL1 are trapped to EL2.

D7.2.46 ID_AA64PFR0_EL1, AArch64 Processor Feature Register 0

The ID_AA64PFR0_EL1 characteristics are:

Purpose

Provides additional information about implemented PE features in AArch64 state.

For general information about the interpretation of the ID registers see [Principles of the ID scheme for fields in ID registers on page D7-2195](#).

Configurations

The external register [EDPFR](#) gives information from this register.

Attributes

ID_AA64PFR0_EL1 is a 64-bit register.

Field descriptions

The ID_AA64PFR0_EL1 bit assignments are:

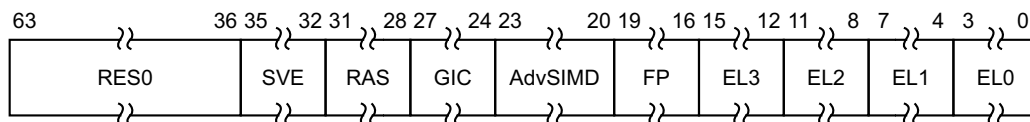

Bits [63:36]

Reserved, RES0.

SVE, bits [35:32]

In ARMv8.2

Scalable Vector Extension. Defined values are:

0000 SVE is not implemented.

0001 SVE is implemented.

All other values are reserved.

In ARMv8.1 and ARMv8.0.

Reserved, RES0.

RAS, bits [31:28]

RAS Extension version. The defined values of this field are:

0000 No RAS Extension.

0001 Version 1 of the RAS Extension present.

All other values are reserved.

GIC, bits [27:24]

System register GIC interface support. Defined values are:

0000 No System register interface to the GIC is supported.

0001 System register interface to versions 3.0 and 4.0 of the GIC CPU interface is supported.

All other values are reserved.

AdvSIMD, bits [23:20]

Advanced SIMD. Defined values are:

- 0000 Advanced SIMD is implemented, including support for the following SIMD and SIMD operations:
- Integer byte, halfword, word and doubleword element operations.
 - Single-precision and double-precision floating-point arithmetic.
 - Conversions between single-precision and half-precision data types, and double-precision and half-precision data types.
- 0001 As for 0000, and also includes support for half-precision floating-point arithmetic.
- 1111 Advanced SIMD is not implemented.

All other values are reserved.

This field must have the same value as the FP field.

The permitted values are:

- 0000 in an implementation with Advanced SIMD support, that does not include the [ARMv8.2-FP16](#) extension.
- 0001 in an implementation with Advanced SIMD support, that includes the [ARMv8.2-FP16](#) extension.
- 1111 in an implementation without Advanced SIMD support.

FP, bits [19:16]

Floating-point. Defined values are:

- 0000 Floating-point is implemented, and includes support for:
- Single-precision and double-precision floating-point types.
 - Conversions between single-precision and half-precision data types, and double-precision and half-precision data types.
- 0001 As for 0000, and also includes support for half-precision floating-point arithmetic.
- 1111 Floating-point is not implemented.

All other values are reserved.

This field must have the same value as the AdvSIMD field.

The permitted values are:

- 0000 in an implementation with floating-point support, that does not include the [ARMv8.2-FP16](#) extension.
- 0001 in an implementation with floating-point support, that includes the [ARMv8.2-FP16](#) extension.
- 1111 in an implementation without floating-point support.

EL3, bits [15:12]

EL3 Exception level handling. Defined values are:

- 0000 EL3 is not implemented.
- 0001 EL3 can be executed in AArch64 state only.
- 0010 EL3 can be executed in either AArch64 or AArch32 state.

All other values are reserved.

EL2, bits [11:8]

EL2 Exception level handling. Defined values are:

- 0000 EL2 is not implemented.
- 0001 EL2 can be executed in AArch64 state only.
- 0010 EL2 can be executed in either AArch64 or AArch32 state.

All other values are reserved.

EL1, bits [7:4]

EL1 Exception level handling. Defined values are:

0001 EL1 can be executed in AArch64 state only.

0010 EL1 can be executed in either AArch64 or AArch32 state.

All other values are reserved.

EL0, bits [3:0]

EL0 Exception level handling. Defined values are:

0001 EL0 can be executed in AArch64 state only.

0010 EL0 can be executed in either AArch64 or AArch32 state.

All other values are reserved.

Accessing the ID_AA64PFR0_EL1

This register can be read using MRS with the following syntax:

MRS <Xt>, <systemreg>

This syntax is encoded with the following settings in the instruction encoding:

<systemreg>	op0	op1	CRn	CRm	op2
ID_AA64PFR0_EL1	11	000	0000	0100	000

Accessibility

The register is accessible in software as follows:

Control			Accessibility			
E2H	TGE	NS	EL0	EL1	EL2	EL3
x	x	0	-	RO	n/a	RO
x	0	1	-	RO	RO	RO
x	1	1	-	n/a	RO	RO

Traps and Enables

For a description of the prioritization of any generated exceptions, see [Synchronous exception prioritization for exceptions taken to AArch64 on page D1-1827](#). Subject to the prioritization rules:

- When EL2 is implemented and is using AArch64 and (SCR_EL3.NS == 1) && (HCR_EL2.E2H == 0):
 - If HCR_EL2.TID3==1, Non-secure read accesses to this register from EL1 are trapped to EL2.
- When EL2 is implemented and is using AArch64 and (SCR_EL3.NS == 1) && (HCR_EL2.E2H == 1) && (HCR_EL2.TGE == 0):
 - If HCR_EL2.TID3==1, Non-secure read accesses to this register from EL1 are trapped to EL2.

D7.2.47 ID_AA64PFR1_EL1, AArch64 Processor Feature Register 1

The ID_AA64PFR1_EL1 characteristics are:

Purpose

Reserved for future expansion of information about implemented PE features in AArch64 state.
For general information about the interpretation of the ID registers see [Principles of the ID scheme for fields in ID registers on page D7-2195](#).

Configurations

There are no configuration notes.

Attributes

ID_AA64PFR1_EL1 is a 64-bit register.

Field descriptions

The ID_AA64PFR1_EL1 bit assignments are:

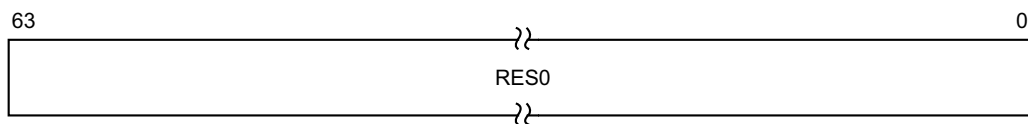

Bits [63:0]

Reserved, RES0.

Accessing the ID_AA64PFR1_EL1

This register can be read using MRS with the following syntax:

MRS <Xt>, <systemreg>

This syntax is encoded with the following settings in the instruction encoding:

<systemreg>	op0	op1	CRn	CRm	op2
ID_AA64PFR1_EL1	11	000	0000	0100	001

Accessibility

The register is accessible in software as follows:

Control			Accessibility			
E2H	TGE	NS	EL0	EL1	EL2	EL3
x	x	0	-	RO	n/a	RO
x	0	1	-	RO	RO	RO
x	1	1	-	n/a	RO	RO

Traps and Enables

For a description of the prioritization of any generated exceptions, see *Synchronous exception prioritization for exceptions taken to AArch64* on page D1-1827. Subject to the prioritization rules:

- When EL2 is implemented and is using AArch64 and $(SCR_EL3.NS == 1) \ \&\& \ (HCR_EL2.E2H == 0)$:
 - If $HCR_EL2.TID3 == 1$, Non-secure read accesses to this register from EL1 are trapped to EL2.
- When EL2 is implemented and is using AArch64 and $(SCR_EL3.NS == 1) \ \&\& \ (HCR_EL2.E2H == 1) \ \&\& \ (HCR_EL2.TGE == 0)$:
 - If $HCR_EL2.TID3 == 1$, Non-secure read accesses to this register from EL1 are trapped to EL2.

D7.2.48 ID_AFR0_EL1, AArch32 Auxiliary Feature Register 0

The ID_AFR0_EL1 characteristics are:

Purpose

Provides information about the IMPLEMENTATION DEFINED features of the PE in AArch32 state.

Must be interpreted with the Main ID Register, [MIDR_EL1](#).

For general information about the interpretation of the ID registers see [Principles of the ID scheme for fields in ID registers on page D7-2195](#).

Configurations

AArch64 System register ID_AFR0_EL1 is architecturally mapped to AArch32 System register [ID_AFR0](#).

In an implementation that supports only AArch64 state, this register is UNKNOWN.

Attributes

ID_AFR0_EL1 is a 32-bit register.

Field descriptions

The ID_AFR0_EL1 bit assignments are:

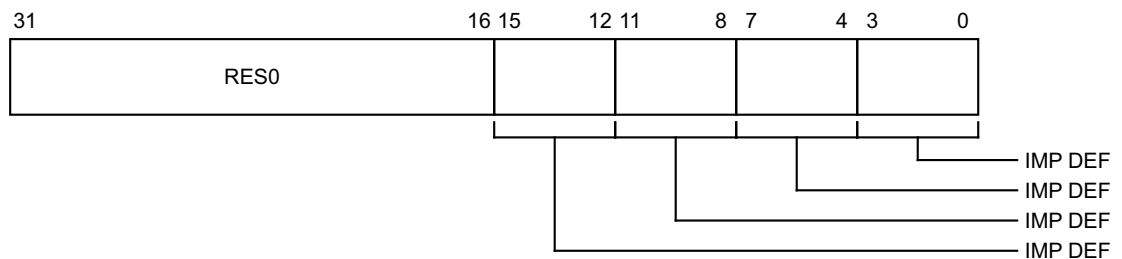

Bits [31:16]

Reserved, RES0.

IMPLEMENTATION DEFINED, bits [15:12]

IMPLEMENTATION DEFINED.

IMPLEMENTATION DEFINED, bits [11:8]

IMPLEMENTATION DEFINED.

IMPLEMENTATION DEFINED, bits [7:4]

IMPLEMENTATION DEFINED.

IMPLEMENTATION DEFINED, bits [3:0]

IMPLEMENTATION DEFINED.

Accessing the ID_AFR0_EL1

This register can be read using MRS with the following syntax:

MRS <Xt>, <systemreg>

This syntax is encoded with the following settings in the instruction encoding:

<systemreg>	op0	op1	CRn	CRm	op2
ID_AFR0_EL1	11	000	0000	0001	011

Accessibility

The register is accessible in software as follows:

Control			Accessibility			
E2H	TGE	NS	EL0	EL1	EL2	EL3
x	x	0	-	RO	n/a	RO
x	0	1	-	RO	RO	RO
x	1	1	-	n/a	RO	RO

Traps and Enables

For a description of the prioritization of any generated exceptions, see [Synchronous exception prioritization for exceptions taken to AArch64 on page D1-1827](#). Subject to the prioritization rules:

- When EL2 is implemented and is using AArch64 and (SCR_EL3.NS == 1) && (HCR_EL2.E2H == 0):
 - If HCR_EL2.TID3==1, Non-secure read accesses to this register from EL1 are trapped to EL2.
- When EL2 is implemented and is using AArch64 and (SCR_EL3.NS == 1) && (HCR_EL2.E2H == 1) && (HCR_EL2.TGE == 0):
 - If HCR_EL2.TID3==1, Non-secure read accesses to this register from EL1 are trapped to EL2.

D7.2.49 ID_DFR0_EL1, AArch32 Debug Feature Register 0

The ID_DFR0_EL1 characteristics are:

Purpose

Provides top level information about the debug system in AArch32 state.

Must be interpreted with the Main ID Register, [MIDR_EL1](#).

For general information about the interpretation of the ID registers see [Principles of the ID scheme for fields in ID registers on page D7-2195](#).

Configurations

AArch64 System register ID_DFR0_EL1 is architecturally mapped to AArch32 System register [ID_DFR0](#).

In an implementation that supports only AArch64 state, this register is UNKNOWN.

Attributes

ID_DFR0_EL1 is a 32-bit register.

Field descriptions

The ID_DFR0_EL1 bit assignments are:

31	28 27	24 23	20 19	16 15	12 11	8 7	4 3	0
RES0	PerfMon	MProfDbg	MMapTrc	CopTrc	MMapDbg	CopSDBG	CopDbg	

Bits [31:28]

Reserved, RES0.

PerfMon, bits [27:24]

Performance Monitors. Support for System registers-based ARM Performance Monitors Extension, using registers in the coproc == 1111 encoding space, for A and R profile processors. Defined values are:

0000	Performance Monitors Extension System registers not implemented.
0001	Support for Performance Monitors Extension version 1 (PMUv1) System registers.
0010	Support for Performance Monitors Extension version 2 (PMUv2) System registers.
0011	Support for Performance Monitors Extension version 3 (PMUv3) System registers.
0100	Support for Performance Monitors Extension version 3 (PMUv3) System registers, with a 16-bit evtCount field.
1111	IMPLEMENTATION DEFINED form of Performance Monitors System registers supported. PMUv3 not supported.

All other values are reserved.

In ARMv8.0 the permitted values are 0000, 0011, and 1111.

From ARMv8.1 the permitted values are 0000, 0100, and 1111.

In ARMv7, the value 0000 can mean that PMUv1 is implemented. PMUv1 is not permitted in an ARMv8 implementation.

MProfDbg, bits [23:20]

M Profile Debug. Support for memory-mapped debug model for M profile processors. Defined values are:

0000	Not supported.
------	----------------

0001 Support for M profile Debug architecture, with memory-mapped access.
All other values are reserved.
In ARMv8-A the only permitted value is 0000.

MMapTrc, bits [19:16]

Memory Mapped Trace. Support for memory-mapped trace model. Defined values are:
0000 Not supported.
0001 Support for ARM trace architecture, with memory-mapped access.
All other values are reserved.
In ARMv8-A the permitted values are 0000 and 0001.
In the Trace registers, the ETMIDR gives more information about the implementation.

CopTrc, bits [15:12]

Support for System registers-based trace model, using registers in the coproc == 1110 encoding space. Defined values are:
0000 Not supported.
0001 Support for ARM trace architecture, with System registers access.
All other values are reserved.
In ARMv8-A the permitted values are 0000 and 0001.
In the Trace registers, the ETMIDR gives more information about the implementation.

MMapDbg, bits [11:8]

Memory Mapped Debug. Support for v7 memory-mapped debug model, for A and R profile processors.
In ARMv8-A this field is RES0.
The optional memory map defined by ARMv8 is not compatible with ARMv7.

CopSDBG, bits [7:4]

Support for a System registers-based Secure debug model, using registers in the coproc = 1110 encoding space, for an A profile processor that includes EL3.
If EL3 is not implemented and the implemented Security state is Non-Secure state, this field is RES0.
Otherwise, this field reads the same as bits [3:0].

CopDbg, bits [3:0]

Support for System registers-based debug model, using registers in the coproc == 1110 encoding space, for A and R profile processors. Defined values are:
0000 Not supported.
0010 Support for ARMv6, v6 Debug architecture, with System registers access.
0011 Support for ARMv6, v6.1 Debug architecture, with System registers access.
0100 Support for ARMv7, v7 Debug architecture, with System registers access.
0101 Support for ARMv7, v7.1 Debug architecture, with System registers access.
0110 Support for ARMv8 debug architecture, with System registers access.
0111 Support for ARMv8 debug architecture, with System registers access, and Virtualization Host extensions.
1000 Support for ARMv8.2 debug architecture.
All other values are reserved.
In an ARMv8.0 implementation, the only permitted value is 0b0110.
In an ARMv8.1 implementation that does not include ARMv8.1-VHE, the permitted values are 0b0110 and 0b0111.

In an ARMv8.1 implementation that includes ARMv8.1-VHE, the only permitted value is 0b0111.

In an ARMv8.2 implementation, the only permitted value is 0b1000.

Accessing the ID_DFR0_EL1

This register can be read using MRS with the following syntax:

MRS <Xt>, <systemreg>

This syntax is encoded with the following settings in the instruction encoding:

<systemreg>	op0	op1	CRn	CRm	op2
ID_DFR0_EL1	11	000	0000	0001	010

Accessibility

The register is accessible in software as follows:

Control			Accessibility			
E2H	TGE	NS	EL0	EL1	EL2	EL3
x	x	0	-	RO	n/a	RO
x	0	1	-	RO	RO	RO
x	1	1	-	n/a	RO	RO

Traps and Enables

For a description of the prioritization of any generated exceptions, see [Synchronous exception prioritization for exceptions taken to AArch64 on page D1-1827](#). Subject to the prioritization rules:

- When EL2 is implemented and is using AArch64 and (SCR_EL3.NS == 1) && (HCR_EL2.E2H == 0):
 - If HCR_EL2.TID3==1, Non-secure read accesses to this register from EL1 are trapped to EL2.
- When EL2 is implemented and is using AArch64 and (SCR_EL3.NS == 1) && (HCR_EL2.E2H == 1) && (HCR_EL2.TGE == 0):
 - If HCR_EL2.TID3==1, Non-secure read accesses to this register from EL1 are trapped to EL2.

D7.2.50 ID_ISAR0_EL1, AArch32 Instruction Set Attribute Register 0

The ID_ISAR0_EL1 characteristics are:

Purpose

Provides information about the instruction sets implemented by the PE in AArch32 state.

Must be interpreted with ID_ISAR1_EL1, ID_ISAR2_EL1, ID_ISAR3_EL1, ID_ISAR4_EL1, and ID_ISAR5_EL1.

For general information about the interpretation of the ID registers see *Principles of the ID scheme for fields in ID registers* on page D7-2195.

Configurations

AArch64 System register ID_ISAR0_EL1 is architecturally mapped to AArch32 System register ID_ISAR0.

In an implementation that supports only AArch64 state, this register is UNKNOWN.

Attributes

ID_ISAR0_EL1 is a 32-bit register.

Field descriptions

The ID_ISAR0_EL1 bit assignments are:

31	28 27	24 23	20 19	16 15	12 11	8 7	4 3	0
RES0	Divide	Debug	Coprocc	CmpBranch	BitField	BitCount	Swap	

Bits [31:28]

Reserved, RES0.

Divide, bits [27:24]

Indicates the implemented Divide instructions. Defined values are:

0000 None implemented.

0001 Adds SDIV and UDIV in the T32 instruction set.

0010 As for 0001, and adds SDIV and UDIV in the A32 instruction set.

All other values are reserved.

In ARMv8-A the only permitted value is 0010.

Debug, bits [23:20]

Indicates the implemented Debug instructions. Defined values are:

0000 None implemented.

0001 Adds BKPT.

All other values are reserved.

In ARMv8-A the only permitted value is 0001.

Coprocc, bits [19:16]

Indicates the implemented System register access instructions. Defined values are:

0000 None implemented, except for instructions separately attributed by the architecture to provide access to AArch32 System registers and System instructions.

0001 Adds generic CDP, LDC, MCR, MRC, and STC.

0010 As for 0001, and adds generic CDP2, LDC2, MCR2, MRC2, and STC2.

0011 As for 0010, and adds generic MCRR and MRRC.
 0100 As for 0011, and adds generic MCRR2 and MRRC2.
 All other values are reserved.
 In ARMv8-A the only permitted value is 0000.

CmpBranch, bits [15:12]

Indicates the implemented combined Compare and Branch instructions in the T32 instruction set. Defined values are:
 0000 None implemented.
 0001 Adds CBNZ and CBZ.
 All other values are reserved.
 In ARMv8-A the only permitted value is 0001.

BitField, bits [11:8]

Indicates the implemented BitField instructions. Defined values are:
 0000 None implemented.
 0001 Adds BFC, BFI, SBFX, and UBFX.
 All other values are reserved.
 In ARMv8-A the only permitted value is 0001.

BitCount, bits [7:4]

Indicates the implemented Bit Counting instructions. Defined values are:
 0000 None implemented.
 0001 Adds CLZ.
 All other values are reserved.
 In ARMv8-A the only permitted value is 0001.

Swap, bits [3:0]

Indicates the implemented Swap instructions in the A32 instruction set. Defined values are:
 0000 None implemented.
 0001 Adds SWP and SWPB.
 All other values are reserved.
 In ARMv8-A the only permitted value is 0000.

Accessing the ID_ISAR0_EL1

This register can be read using MRS with the following syntax:

MRS <Xt>, <systemreg>

This syntax is encoded with the following settings in the instruction encoding:

<systemreg>	op0	op1	CRn	CRm	op2
ID_ISAR0_EL1	11	000	0000	0010	000

Accessibility

The register is accessible in software as follows:

Control			Accessibility			
E2H	TGE	NS	EL0	EL1	EL2	EL3
x	x	0	-	RO	n/a	RO
x	0	1	-	RO	RO	RO
x	1	1	-	n/a	RO	RO

Traps and Enables

For a description of the prioritization of any generated exceptions, see [Synchronous exception prioritization for exceptions taken to AArch64 on page D1-1827](#). Subject to the prioritization rules:

- When EL2 is implemented and is using AArch64 and (SCR_EL3.NS == 1) && (HCR_EL2.E2H == 0):
 - If HCR_EL2.TID3==1, Non-secure read accesses to this register from EL1 are trapped to EL2.
- When EL2 is implemented and is using AArch64 and (SCR_EL3.NS == 1) && (HCR_EL2.E2H == 1) && (HCR_EL2.TGE == 0):
 - If HCR_EL2.TID3==1, Non-secure read accesses to this register from EL1 are trapped to EL2.

D7.2.51 ID_ISAR1_EL1, AArch32 Instruction Set Attribute Register 1

The ID_ISAR1_EL1 characteristics are:

Purpose

Provides information about the instruction sets implemented by the PE in AArch32 state.

Must be interpreted with ID_ISAR0_EL1, ID_ISAR2_EL1, ID_ISAR3_EL1, ID_ISAR4_EL1, and ID_ISAR5_EL1.

For general information about the interpretation of the ID registers see *Principles of the ID scheme for fields in ID registers* on page D7-2195.

Configurations

AArch64 System register ID_ISAR1_EL1 is architecturally mapped to AArch32 System register ID_ISAR1.

In an implementation that supports only AArch64 state, this register is UNKNOWN.

Attributes

ID_ISAR1_EL1 is a 32-bit register.

Field descriptions

The ID_ISAR1_EL1 bit assignments are:

31	28 27	24 23	20 19	16 15	12 11	8 7	4 3	0
Jazelle	Interwork	Immediate	IfThen	Extend	Except_AR	Except	Endian	

Jazelle, bits [31:28]

Indicates the implemented Jazelle extension instructions. Defined values are:

0000 No support for Jazelle.

0001 Adds the BXJ instruction, and the J bit in the PSR. This setting might indicate a trivial implementation of the Jazelle extension.

All other values are reserved.

In ARMv8-A the only permitted value is 0001.

Interwork, bits [27:24]

Indicates the implemented Interworking instructions. Defined values are:

0000 None implemented.

0001 Adds the BX instruction, and the T bit in the PSR.

0010 As for 0001, and adds the BLX instruction. PC loads have BX-like behavior.

0011 As for 0010, and guarantees that data-processing instructions in the A32 instruction set with the PC as the destination and the S bit clear have BX-like behavior.

All other values are reserved.

In ARMv8-A the only permitted value is 0011.

Immediate, bits [23:20]

Indicates the implemented data-processing instructions with long immediates. Defined values are:

0000 None implemented.

0001 Adds:

- The MOVT instruction.

- The MOV instruction encodings with zero-extended 16-bit immediates.
- The T32 ADD and SUB instruction encodings with zero-extended 12-bit immediates, and the other ADD, ADR, and SUB encodings cross-referenced by the pseudocode for those encodings.

All other values are reserved.

In ARMv8-A the only permitted value is 0001.

IfThen, bits [19:16]

Indicates the implemented If-Then instructions in the T32 instruction set. Defined values are:

0000 None implemented.

0001 Adds the IT instructions, and the IT bits in the PSRs.

All other values are reserved.

In ARMv8-A the only permitted value is 0001.

Extend, bits [15:12]

Indicates the implemented Extend instructions. Defined values are:

0000 No scalar sign-extend or zero-extend instructions are implemented, where scalar instructions means non-Advanced SIMD instructions.

0001 Adds the SXTB, SXTB, UXTB, and UXTH instructions.

0010 As for 0001, and adds the SXTB16, SXTAB, SXTAB16, SXTAH, UXTB16, UXTAB, UXTAB16, and UXTAH instructions.

All other values are reserved.

In ARMv8-A the only permitted value is 0010.

Except_AR, bits [11:8]

Indicates the implemented A and R profile exception-handling instructions. Defined values are:

0000 None implemented.

0001 Adds the SRS and RFE instructions, and the A and R profile forms of the CPS instruction.

All other values are reserved.

In ARMv8-A the only permitted value is 0001.

Except, bits [7:4]

Indicates the implemented exception-handling instructions in the ARM instruction set. Defined values are:

0000 Not implemented. This indicates that the User bank and Exception return forms of the LDM and STM instructions are not implemented.

0001 Adds the LDM (exception return), LDM (user registers), and STM (user registers) instruction versions.

All other values are reserved.

In ARMv8-A the only permitted value is 0001.

Endian, bits [3:0]

Indicates the implemented Endian instructions. Defined values are:

0000 None implemented.

0001 Adds the SETEND instruction, and the E bit in the PSRs.

All other values are reserved.

In ARMv8-A the permitted values are 0000 and 0001.

Accessing the ID_ISAR1_EL1

This register can be read using MRS with the following syntax:

MRS <Xt>, <systemreg>

This syntax is encoded with the following settings in the instruction encoding:

<systemreg>	op0	op1	CRn	CRm	op2
ID_ISAR1_EL1	11	000	0000	0010	001

Accessibility

The register is accessible in software as follows:

Control			Accessibility			
E2H	TGE	NS	EL0	EL1	EL2	EL3
x	x	0	-	RO	n/a	RO
x	0	1	-	RO	RO	RO
x	1	1	-	n/a	RO	RO

Traps and Enables

For a description of the prioritization of any generated exceptions, see [Synchronous exception prioritization for exceptions taken to AArch64 on page D1-1827](#). Subject to the prioritization rules:

- When EL2 is implemented and is using AArch64 and (SCR_EL3.NS == 1) && (HCR_EL2.E2H == 0):
 - If HCR_EL2.TID3==1, Non-secure read accesses to this register from EL1 are trapped to EL2.
- When EL2 is implemented and is using AArch64 and (SCR_EL3.NS == 1) && (HCR_EL2.E2H == 1) && (HCR_EL2.TGE == 0):
 - If HCR_EL2.TID3==1, Non-secure read accesses to this register from EL1 are trapped to EL2.

D7.2.52 ID_ISAR2_EL1, AArch32 Instruction Set Attribute Register 2

The ID_ISAR2_EL1 characteristics are:

Purpose

Provides information about the instruction sets implemented by the PE in AArch32 state.

Must be interpreted with ID_ISAR0_EL1, ID_ISAR1_EL1, ID_ISAR3_EL1, ID_ISAR4_EL1, and ID_ISAR5_EL1.

For general information about the interpretation of the ID registers see *Principles of the ID scheme for fields in ID registers* on page D7-2195.

Configurations

AArch64 System register ID_ISAR2_EL1 is architecturally mapped to AArch32 System register ID_ISAR2.

In an implementation that supports only AArch64 state, this register is UNKNOWN.

Attributes

ID_ISAR2_EL1 is a 32-bit register.

Field descriptions

The ID_ISAR2_EL1 bit assignments are:

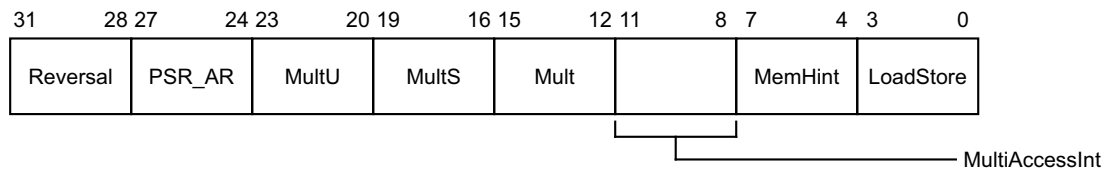

Reversal, bits [31:28]

Indicates the implemented Reversal instructions. Defined values are:

- 0000 None implemented.
- 0001 Adds the REV, REV16, and REVSH instructions.
- 0010 As for 0001, and adds the RBIT instruction.

All other values are reserved.

In ARMv8-A the only permitted value is 0010.

PSR_AR, bits [27:24]

Indicates the implemented A and R profile instructions to manipulate the PSR. Defined values are:

- 0000 None implemented.
- 0001 Adds the MRS and MSR instructions, and the exception return forms of data-processing instructions.

All other values are reserved.

In ARMv8-A the only permitted value is 0001.

The exception return forms of the data-processing instructions are:

- In the A32 instruction set, data-processing instructions with the PC as the destination and the S bit set. These instructions might be affected by the WithShifts attribute.
- In the T32 instruction set, the SUBS PC,LR,#N instruction.

MultU, bits [23:20]

Indicates the implemented advanced unsigned Multiply instructions. Defined values are:

- 0000 None implemented.
- 0001 Adds the UMULL and UMLAL instructions.
- 0010 As for 0001, and adds the UMAAL instruction.

All other values are reserved.

In ARMv8-A the only permitted value is 0010.

MultS, bits [19:16]

Indicates the implemented advanced signed Multiply instructions. Defined values are:

- 0000 None implemented.
- 0001 Adds the SMULL and SMLAL instructions.
- 0010 As for 0001, and adds the SMLABB, SMLABT, SMLALBB, SMLALBT, SMLALTB, SMLALTT, SMLATB, SMLATT, SMLAWB, SMLAWT, SMULBB, SMULBT, SMULTB, SMULTT, SMULWB, and SMULWT instructions. Also adds the Q bit in the PSRs.
- 0011 As for 0010, and adds the SMLAD, SMLADX, SMLALD, SMLALDX, SMLSD, SMLSDX, SMLSLD, SMLSLDX, SMMLA, SMMLAR, SMMLS, SMMLSR, SMMUL, SMMULR, SMUAD, SMUADX, SMUSD, and SMUSDX instructions.

All other values are reserved.

In ARMv8-A the only permitted value is 0011.

Mult, bits [15:12]

Indicates the implemented additional Multiply instructions. Defined values are:

- 0000 No additional instructions implemented. This means only MUL is implemented.
- 0001 Adds the MLA instruction.
- 0010 As for 0001, and adds the MLS instruction.

All other values are reserved.

In ARMv8-A the only permitted value is 0010.

MultiAccessInt, bits [11:8]

Indicates the support for interruptible multi-access instructions. Defined values are:

- 0000 No support. This means the LDM and STM instructions are not interruptible.
- 0001 LDM and STM instructions are restartable.
- 0010 LDM and STM instructions are continuable.

All other values are reserved.

In ARMv8-A the only permitted value is 0000.

MemHint, bits [7:4]

Indicates the implemented Memory Hint instructions. Defined values are:

- 0000 None implemented.
- 0001 Adds the PLD instruction.
- 0010 Adds the PLD instruction. (0001 and 0010 have identical effects.)
- 0011 As for 0001 (or 0010), and adds the PLI instruction.
- 0100 As for 0011, and adds the PLDW instruction.

All other values are reserved.

In ARMv8-A the only permitted value is 0100.

LoadStore, bits [3:0]

Indicates the implemented additional load/store instructions. Defined values are:

- 0000 No additional load/store instructions implemented.
- 0001 Adds the LDRD and STRD instructions.
- 0010 As for 0001, and adds the Load Acquire (LDAB, LDAH, LDA, LDAEXB, LDAEXH, LDAEX, LDAEXD) and Store Release (STLB, STLH, STL, STLEXB, STLEXH, STLEX, STLEXD) instructions.

All other values are reserved.

In ARMv8-A the only permitted value is 0010.

Accessing the ID_ISAR2_EL1

This register can be read using MRS with the following syntax:

MRS <Xt>, <systemreg>

This syntax is encoded with the following settings in the instruction encoding:

<systemreg>	op0	op1	CRn	CRm	op2
ID_ISAR2_EL1	11	000	0000	0010	010

Accessibility

The register is accessible in software as follows:

Control			Accessibility			
E2H	TGE	NS	EL0	EL1	EL2	EL3
x	x	0	-	RO	n/a	RO
x	0	1	-	RO	RO	RO
x	1	1	-	n/a	RO	RO

Traps and Enables

For a description of the prioritization of any generated exceptions, see [Synchronous exception prioritization for exceptions taken to AArch64 on page D1-1827](#). Subject to the prioritization rules:

- When EL2 is implemented and is using AArch64 and (SCR_EL3.NS == 1) && (HCR_EL2.E2H == 0):
 - If HCR_EL2.TID3==1, Non-secure read accesses to this register from EL1 are trapped to EL2.
- When EL2 is implemented and is using AArch64 and (SCR_EL3.NS == 1) && (HCR_EL2.E2H == 1) && (HCR_EL2.TGE == 0):
 - If HCR_EL2.TID3==1, Non-secure read accesses to this register from EL1 are trapped to EL2.

D7.2.53 ID_ISAR3_EL1, AArch32 Instruction Set Attribute Register 3

The ID_ISAR3_EL1 characteristics are:

Purpose

Provides information about the instruction sets implemented by the PE in AArch32 state.

Must be interpreted with ID_ISAR0_EL1, ID_ISAR1_EL1, ID_ISAR2_EL1, ID_ISAR4_EL1, and ID_ISAR5_EL1.

For general information about the interpretation of the ID registers see *Principles of the ID scheme for fields in ID registers* on page D7-2195.

Configurations

AArch64 System register ID_ISAR3_EL1 is architecturally mapped to AArch32 System register ID_ISAR3.

In an implementation that supports only AArch64 state, this register is UNKNOWN.

Attributes

ID_ISAR3_EL1 is a 32-bit register.

Field descriptions

The ID_ISAR3_EL1 bit assignments are:

31	28 27	24 23	20 19	16 15	12 11	8 7	4 3	0
T32EE	TrueNOP	T32Copy	TabBranch	SynchPrim	SVC	SIMD	Saturate	

T32EE, bits [31:28]

Indicates the implemented T32EE instructions. Defined values are:

0000 None implemented.

0001 Adds the ENTERX and LEAVEX instructions, and modifies the load behavior to include null checking.

All other values are reserved.

In ARMv8-A the only permitted value is 0000.

TrueNOP, bits [27:24]

Indicates the implemented true NOP instructions. Defined values are:

0000 None implemented. This means there are no NOP instructions that do not have any register dependencies.

0001 Adds true NOP instructions in both the T32 and A32 instruction sets. This also permits additional NOP-compatible hints.

All other values are reserved.

In ARMv8-A the only permitted value is 0001.

T32Copy, bits [23:20]

Indicates the support for T32 non flag-setting MOV instructions. Defined values are:

0000 Not supported. This means that in the T32 instruction set, encoding T1 of the MOV (register) instruction does not support a copy from a low register to a low register.

0001 Adds support for T32 instruction set encoding T1 of the MOV (register) instruction, copying from a low register to a low register.

All other values are reserved.

In ARMv8-A the only permitted value is 0001.

TabBranch, bits [19:16]

Indicates the implemented Table Branch instructions in the T32 instruction set. Defined values are:

- 0000 None implemented.
- 0001 Adds the TBB and TBH instructions.

All other values are reserved.

In ARMv8-A the only permitted value is 0001.

SynchPrim, bits [15:12]

Used in conjunction with ID_ISAR4.SynchPrim_frac to indicate the implemented Synchronization Primitive instructions. Defined values are:

- 0000 If SynchPrim_frac == 0000, no Synchronization Primitives implemented.
- 0001 If SynchPrim_frac == 0000, adds the LDREX and STREX instructions.
If SynchPrim_frac == 0011, also adds the CLREX, LDREXB, STREXB, and STREXH instructions.
- 0010 If SynchPrim_frac == 0000, as for [0001, 0011] and also adds the LDREXD and STREXD instructions.

All other combinations of SynchPrim and SynchPrim_frac are reserved.

In ARMv8-A the only permitted value is 0010.

SVC, bits [11:8]

Indicates the implemented SVC instructions. Defined values are:

- 0000 Not implemented.
- 0001 Adds the SVC instruction.

All other values are reserved.

In ARMv8-A the only permitted value is 0001.

SIMD, bits [7:4]

Indicates the implemented SIMD instructions. Defined values are:

- 0000 None implemented.
- 0001 Adds the SSAT and USAT instructions, and the Q bit in the PSRs.
- 0011 As for 0001, and adds the PKHBT, PKHTB, QADD16, QADD8, QASX, QSUB16, QSUB8, QSAX, SADD16, SADD8, SASX, SEL, SHADD16, SHADD8, SHASX, SHSUB16, SHSUB8, SHSAX, SSAT16, SSUB16, SSUB8, SSAX, SXTAB16, SXTB16, UADD16, UADD8, UASX, UHADD16, UHADD8, UHASX, UHSUB16, UHSUB8, UHSAX, UQADD16, UQADD8, UQASX, UQSUB16, UQSUB8, UQSAX, USAD8, USADA8, USAT16, USUB16, USUB8, USAX, UXTAB16, and UXTB16 instructions. Also adds support for the GE[3:0] bits in the PSRs.

All other values are reserved.

In ARMv8-A the only permitted value is 0011.

The SIMD field relates only to implemented instructions that perform SIMD operations on the general-purpose registers. In an implementation that supports floating-point and Advanced SIMD instructions, [MVFR0](#), [MVFR1](#), and [MVFR2](#) give information about the implemented Advanced SIMD instructions.

Saturate, bits [3:0]

Indicates the implemented Saturate instructions. Defined values are:

- 0000 None implemented. This means no non-Advanced SIMD saturate instructions are implemented.
- 0001 Adds the QADD, QDADD, QDSUB, and QSUB instructions, and the Q bit in the PSRs.

All other values are reserved.

In ARMv8-A the only permitted value is 0001.

Accessing the ID_ISAR3_EL1

This register can be read using MRS with the following syntax:

MRS <Xt>, <systemreg>

This syntax is encoded with the following settings in the instruction encoding:

<systemreg>	op0	op1	CRn	CRm	op2
ID_ISAR3_EL1	11	000	0000	0010	011

Accessibility

The register is accessible in software as follows:

Control			Accessibility			
E2H	TGE	NS	EL0	EL1	EL2	EL3
x	x	0	-	RO	n/a	RO
x	0	1	-	RO	RO	RO
x	1	1	-	n/a	RO	RO

Traps and Enables

For a description of the prioritization of any generated exceptions, see [Synchronous exception prioritization for exceptions taken to AArch64 on page D1-1827](#). Subject to the prioritization rules:

- When EL2 is implemented and is using AArch64 and (SCR_EL3.NS == 1) && (HCR_EL2.E2H == 0):
 - If HCR_EL2.TID3==1, Non-secure read accesses to this register from EL1 are trapped to EL2.
- When EL2 is implemented and is using AArch64 and (SCR_EL3.NS == 1) && (HCR_EL2.E2H == 1) && (HCR_EL2.TGE == 0):
 - If HCR_EL2.TID3==1, Non-secure read accesses to this register from EL1 are trapped to EL2.

D7.2.54 ID_ISAR4_EL1, AArch32 Instruction Set Attribute Register 4

The ID_ISAR4_EL1 characteristics are:

Purpose

Provides information about the instruction sets implemented by the PE in AArch32 state.

Must be interpreted with ID_ISAR0_EL1, ID_ISAR1_EL1, ID_ISAR2_EL1, ID_ISAR3_EL1, and ID_ISAR5_EL1.

For general information about the interpretation of the ID registers see *Principles of the ID scheme for fields in ID registers* on page D7-2195.

Configurations

AArch64 System register ID_ISAR4_EL1 is architecturally mapped to AArch32 System register ID_ISAR4.

In an implementation that supports only AArch64 state, this register is UNKNOWN.

Attributes

ID_ISAR4_EL1 is a 32-bit register.

Field descriptions

The ID_ISAR4_EL1 bit assignments are:

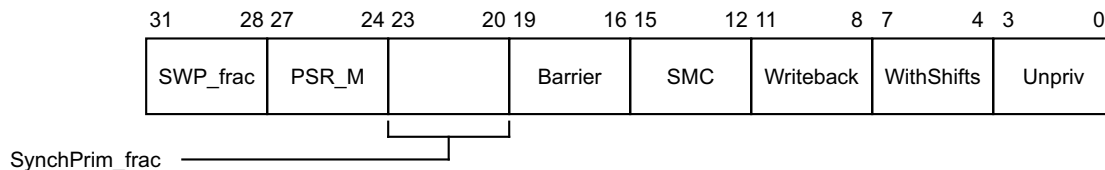

SWP_frac, bits [31:28]

Indicates support for the memory system locking the bus for SWP or SWPB instructions. Defined values are:

0000 SWP or SWPB instructions not implemented.

0001 SWP or SWPB implemented but only in a uniprocessor context. SWP and SWPB do not guarantee whether memory accesses from other masters can come between the load memory access and the store memory access of the SWP or SWPB.

All other values are reserved. This field is valid only if the ID_ISAR0.Swap_insts field is 0000.

In ARMv8-A the only permitted value is 0000.

PSR_M, bits [27:24]

Indicates the implemented M profile instructions to modify the PSRs. Defined values are:

0000 None implemented.

0001 Adds the M profile forms of the CPS, MRS, and MSR instructions.

All other values are reserved.

In ARMv8-A the only permitted value is 0000.

SynchPrim_frac, bits [23:20]

Used in conjunction with ID_ISAR3.SynchPrim to indicate the implemented Synchronization Primitive instructions. Possible values are:

- 0000 If SynchPrim == 0000, no Synchronization Primitives implemented. If SynchPrim == 0001, adds the LDREX and STREX instructions. If SynchPrim == 0010, also adds the CLREX, LDREXB, LDREXH, STREXB, STREXH, LDREXD, and STREXD instructions.
- 0011 If SynchPrim == 0001, adds the LDREX, STREX, CLREX, LDREXB, LDREXH, STREXB, and STREXH instructions.

All other combinations of SynchPrim and SynchPrim_frac are reserved.

In ARMv8-A the only permitted value is 0000.

Barrier, bits [19:16]

Indicates the implemented Barrier instructions in the A32 and T32 instruction sets. Defined values are:

- 0000 None implemented. Barrier operations are provided only as System instructions in the (coproc==1111) encoding space.
- 0001 Adds the DMB, DSB, and ISB barrier instructions.

All other values are reserved.

In ARMv8-A the only permitted value is 0001.

SMC, bits [15:12]

Indicates the implemented SMC instructions. Defined values are:

- 0000 None implemented.
- 0001 Adds the SMC instruction.

All other values are reserved.

In ARMv8-A the permitted values are 0001 and 0000.

If EL1 cannot use AArch32 then this field has the value 0000.

Writeback, bits [11:8]

Indicates the support for Writeback addressing modes. Defined values are:

- 0000 Basic support. Only the LDM, STM, PUSH, POP, SRS, and RFE instructions support writeback addressing modes. These instructions support all of their writeback addressing modes.
- 0001 Adds support for all of the writeback addressing modes.

All other values are reserved.

In ARMv8-A the only permitted value is 0001.

WithShifts, bits [7:4]

Indicates the support for instructions with shifts. Defined values are:

- 0000 Nonzero shifts supported only in MOV and shift instructions.
- 0001 Adds support for shifts of loads and stores over the range LSL 0-3.
- 0011 As for 0001, and adds support for other constant shift options, both on load/store and other instructions.
- 0100 As for 0011, and adds support for register-controlled shift options.

All other values are reserved.

In ARMv8-A the only permitted value is 0100.

Unpriv, bits [3:0]

Indicates the implemented unprivileged instructions. Defined values are:

0000 None implemented. No T variant instructions are implemented.

0001 Adds the LDRBT, LDRT, STRBT, and STRT instructions.

0010 As for 0001, and adds the LDRHT, LDRSBT, LDRSHT, and STRHT instructions.

All other values are reserved.

In ARMv8-A the only permitted value is 0010.

Accessing the ID_ISAR4_EL1

This register can be read using MRS with the following syntax:

MRS <Xt>, <systemreg>

This syntax is encoded with the following settings in the instruction encoding:

<systemreg>	op0	op1	CRn	CRm	op2
ID_ISAR4_EL1	11	000	0000	0010	100

Accessibility

The register is accessible in software as follows:

Control			Accessibility			
E2H	TGE	NS	EL0	EL1	EL2	EL3
x	x	0	-	RO	n/a	RO
x	0	1	-	RO	RO	RO
x	1	1	-	n/a	RO	RO

Traps and Enables

For a description of the prioritization of any generated exceptions, see [Synchronous exception prioritization for exceptions taken to AArch64 on page D1-1827](#). Subject to the prioritization rules:

- When EL2 is implemented and is using AArch64 and (SCR_EL3.NS == 1) && (HCR_EL2.E2H == 0):
 - If HCR_EL2.TID3==1, Non-secure read accesses to this register from EL1 are trapped to EL2.
- When EL2 is implemented and is using AArch64 and (SCR_EL3.NS == 1) && (HCR_EL2.E2H == 1) && (HCR_EL2.TGE == 0):
 - If HCR_EL2.TID3==1, Non-secure read accesses to this register from EL1 are trapped to EL2.

D7.2.55 ID_ISAR5_EL1, AArch32 Instruction Set Attribute Register 5

The ID_ISAR5_EL1 characteristics are:

Purpose

Provides information about the instruction sets implemented by the PE in AArch32 state.

Must be interpreted with [ID_ISAR0_EL1](#), [ID_ISAR1_EL1](#), [ID_ISAR2_EL1](#), [ID_ISAR3_EL1](#), and [ID_ISAR4_EL1](#).

For general information about the interpretation of the ID registers see [Principles of the ID scheme for fields in ID registers on page D7-2195](#).

Configurations

AArch64 System register ID_ISAR5_EL1 is architecturally mapped to AArch32 System register [ID_ISAR5](#).

In an implementation that supports only AArch64 state, this register is UNKNOWN.

Attributes

ID_ISAR5_EL1 is a 32-bit register.

Field descriptions

The ID_ISAR5_EL1 bit assignments are:

31	28 27	24 23	20 19	16 15	12 11	8 7	4 3	0
RES0	RDM	RES0	CRC32	SHA2	SHA1	AES	SEVL	

Bits [31:28]

Reserved, RES0.

RDM, bits [27:24]

In ARMv8.2 and ARMv8.1

Indicates whether the VQRDMLAH and VQRDMLSH instructions are implemented in AArch32 state. Defined values are:

0000 No VQRDMLAH and VQRDMLSH instructions implemented.

0001 VQRDMLAH and VQRDMLSH instructions implemented.

All other values are reserved.

In ARMv8.0 the only permitted value is 0000.

From ARMv8.1 the only permitted value is 0001. This feature is identified by the name [ARMv8.1-SIMD](#).

In ARMv8.0.

Reserved, RES0.

Bits [23:20]

Reserved, RES0.

CRC32, bits [19:16]

Indicates whether the CRC32 instructions are implemented in AArch32 state.

0000 No CRC32 instructions implemented.

0001 CRC32B, CRC32H, CRC32W, CRC32CB, CRC32CH, and CRC32CW instructions implemented.

All other values are reserved.

In ARMv8.0 the permitted values are 0000 and 0001.

From ARMv8.1 the only permitted value is 0001.

SHA2, bits [15:12]

Indicates whether the SHA2 instructions are implemented in AArch32 state.

0000 No SHA2 instructions implemented.

0001 SHA256H, SHA256H2, SHA256SU0, and SHA256SU1 implemented.

All other values are reserved.

In ARMv8-A the permitted values are 0000 and 0001.

SHA1, bits [11:8]

Indicates whether the SHA1 instructions are implemented in AArch32 state.

0000 No SHA1 instructions implemented.

0001 SHA1C, SHA1P, SHA1M, SHA1H, SHA1SU0, and SHA1SU1 implemented.

All other values are reserved.

In ARMv8-A the permitted values are 0000 and 0001.

AES, bits [7:4]

Indicates whether the AES instructions are implemented in AArch32 state.

0000 No AES instructions implemented.

0001 AESE, AESD, AESMC, and AESIMC implemented.

0010 As for 0001, plus PMULL/PMULL2 instructions operating on 64-bit data quantities.

All other values are reserved.

In ARMv8-A the permitted values are 0000 and 0010.

SEVL, bits [3:0]

Indicates whether the SEVL instruction is implemented in AArch32 state.

0000 SEVL is implemented as a NOP.

0001 SEVL is implemented as Send Event Local.

All other values are reserved.

In ARMv8-A the only permitted value is 0001.

Accessing the ID_ISAR5_EL1

This register can be read using MRS with the following syntax:

MRS <Xt>, <systemreg>

This syntax is encoded with the following settings in the instruction encoding:

<systemreg>	op0	op1	CRn	CRm	op2
ID_ISAR5_EL1	11	000	0000	0010	101

Accessibility

The register is accessible in software as follows:

Control			Accessibility			
E2H	TGE	NS	EL0	EL1	EL2	EL3
x	x	0	-	RO	n/a	RO
x	0	1	-	RO	RO	RO
x	1	1	-	n/a	RO	RO

Traps and Enables

For a description of the prioritization of any generated exceptions, see [Synchronous exception prioritization for exceptions taken to AArch64 on page D1-1827](#). Subject to the prioritization rules:

- When EL2 is implemented and is using AArch64 and (SCR_EL3.NS == 1) && (HCR_EL2.E2H == 0):
 - If HCR_EL2.TID3==1, Non-secure read accesses to this register from EL1 are trapped to EL2.
- When EL2 is implemented and is using AArch64 and (SCR_EL3.NS == 1) && (HCR_EL2.E2H == 1) && (HCR_EL2.TGE == 0):
 - If HCR_EL2.TID3==1, Non-secure read accesses to this register from EL1 are trapped to EL2.

D7.2.56 ID_MMFR0_EL1, AArch32 Memory Model Feature Register 0

The ID_MMFR0_EL1 characteristics are:

Purpose

Provides information about the implemented memory model and memory management support in AArch32 state.

Must be interpreted with [ID_MMFR1_EL1](#), [ID_MMFR2_EL1](#), [ID_MMFR3_EL1](#), and [ID_MMFR4_EL1](#).

For general information about the interpretation of the ID registers see *Principles of the ID scheme for fields in ID registers* on page D7-2195.

Configurations

AArch64 System register ID_MMFR0_EL1 is architecturally mapped to AArch32 System register [ID_MMFR0](#).

In an implementation that supports only AArch64 state, this register is UNKNOWN.

Attributes

ID_MMFR0_EL1 is a 32-bit register.

Field descriptions

The ID_MMFR0_EL1 bit assignments are:

31	28 27	24 23	20 19	16 15	12 11	8 7	4 3	0
InnerShr	FCSE	AuxReg	TCM	ShareLvl	OuterShr	PMSA	VMSA	

InnerShr, bits [31:28]

Innermost Shareability. Indicates the innermost shareability domain implemented. Defined values are:

- 0000 Implemented as Non-cacheable.
- 0001 Implemented with hardware coherency support.
- 1111 Shareability ignored.

All other values are reserved.

In ARMv8 the permitted values are 0000, 0001, and 1111.

This field is valid only if the implementation supports two levels of shareability, as indicated by ID_MMFR0_EL1.ShareLvl having the value 0001.

When ID_MMFR0_EL1.ShareLvl is zero, this field is UNK.

FCSE, bits [27:24]

Indicates whether the implementation includes the FCSE. Defined values are:

- 0000 Not supported.
- 0001 Support for FCSE.

All other values are reserved.

In ARMv8 the only permitted value is 0000.

AuxReg, bits [23:20]

Auxiliary Registers. Indicates support for Auxiliary registers. Defined values are:

- 0000 None supported.
- 0001 Support for Auxiliary Control Register only.

0010 Support for Auxiliary Fault Status Registers ([AIFSR](#) and [ADFSR](#)) and Auxiliary Control Register.

All other values are reserved.

In ARMv8 the only permitted value is 0010.

———— **Note** ————

Accesses to unimplemented Auxiliary registers are UNDEFINED.

TCM, bits [19:16]

Indicates support for TCMs and associated DMAs. Defined values are:

0000 Not supported.

0001 Support is IMPLEMENTATION DEFINED. ARMv7 requires this setting.

0010 Support for TCM only, ARMv6 implementation.

0011 Support for TCM and DMA, ARMv6 implementation.

All other values are reserved.

In ARMv8-A the only permitted value is 0000.

ShareLvl, bits [15:12]

Shareability Levels. Indicates the number of shareability levels implemented. Defined values are:

0000 One level of shareability implemented.

0001 Two levels of shareability implemented.

All other values are reserved.

In ARMv8 the only permitted value is 0001.

OuterShr, bits [11:8]

Outermost Shareability. Indicates the outermost shareability domain implemented. Defined values are:

0000 Implemented as Non-cacheable.

0001 Implemented with hardware coherency support.

1111 Shareability ignored.

All other values are reserved.

In ARMv8 the permitted values are 0000, 0001, and 1111.

PMSA, bits [7:4]

Indicates support for a PMSA. Defined values are:

0000 Not supported.

0001 Support for IMPLEMENTATION DEFINED PMSA.

0010 Support for PMSAv6, with a Cache Type Register implemented.

0011 Support for PMSAv7, with support for memory subsections. ARMv7-R profile.

All other values are reserved.

In ARMv8-A the only permitted value is 0000.

VMSA, bits [3:0]

Indicates support for a VMSA. Defined values are:

0000 Not supported.

0001 Support for IMPLEMENTATION DEFINED VMSA.

0010 Support for VMSAv6, with Cache and TLB Type Registers implemented.

- 0011 Support for VMSAv7, with support for remapping and the Access flag. ARMv7-A profile.
 - 0100 As for 0011, and adds support for the PXN bit in the Short-descriptor translation table format descriptors.
 - 0101 As for 0100, and adds support for the Long-descriptor translation table format.
- All other values are reserved.
- In ARMv8-A the only permitted value is 0101.

Accessing the ID_MMFR0_EL1

This register can be read using MRS with the following syntax:

MRS <Xt>, <systemreg>

This syntax is encoded with the following settings in the instruction encoding:

<systemreg>	op0	op1	CRn	CRm	op2
ID_MMFR0_EL1	11	000	0000	0001	100

Accessibility

The register is accessible in software as follows:

Control			Accessibility			
E2H	TGE	NS	EL0	EL1	EL2	EL3
x	x	0	-	RO	n/a	RO
x	0	1	-	RO	RO	RO
x	1	1	-	n/a	RO	RO

Traps and Enables

For a description of the prioritization of any generated exceptions, see [Synchronous exception prioritization for exceptions taken to AArch64 on page D1-1827](#). Subject to the prioritization rules:

- When EL2 is implemented and is using AArch64 and (SCR_EL3.NS == 1) && (HCR_EL2.E2H == 0):
 - If HCR_EL2.TID3==1, Non-secure read accesses to this register from EL1 are trapped to EL2.
- When EL2 is implemented and is using AArch64 and (SCR_EL3.NS == 1) && (HCR_EL2.E2H == 1) && (HCR_EL2.TGE == 0):
 - If HCR_EL2.TID3==1, Non-secure read accesses to this register from EL1 are trapped to EL2.

D7.2.57 ID_MMFR1_EL1, AArch32 Memory Model Feature Register 1

The ID_MMFR1_EL1 characteristics are:

Purpose

Provides information about the implemented memory model and memory management support in AArch32 state.

Must be interpreted with [ID_MMFR0_EL1](#), [ID_MMFR2_EL1](#), [ID_MMFR3_EL1](#), and [ID_MMFR4_EL1](#).

For general information about the interpretation of the ID registers see *Principles of the ID scheme for fields in ID registers* on page D7-2195.

Configurations

AArch64 System register ID_MMFR1_EL1 is architecturally mapped to AArch32 System register [ID_MMFR1](#).

In an implementation that supports only AArch64 state, this register is UNKNOWN.

Attributes

ID_MMFR1_EL1 is a 32-bit register.

Field descriptions

The ID_MMFR1_EL1 bit assignments are:

31	28 27	24 23	20 19	16 15	12 11	8 7	4 3	0
BPred	L1TstCln	L1Uni	L1Hvd	L1UniSW	L1HvdSW	L1UniVA	L1HvdVA	

BPred, bits [31:28]

Branch Predictor. Indicates branch predictor management requirements. Defined values are:

0000 No branch predictor, or no MMU present. Implies a fixed MPU configuration.

0001 Branch predictor requires flushing on:

- Enabling or disabling a stage of address translation.
- Writing new data to instruction locations.
- Writing new mappings to the translation tables.
- Changes to the [TTBR0](#), [TTBR1](#), or [TTBCR](#) registers.
- Changes to the ContextID or ASID, or to the FCSE ProcessID if this is supported.

0010 Branch predictor requires flushing on:

- Enabling or disabling a stage of address translation.
- Writing new data to instruction locations.
- Writing new mappings to the translation tables.
- Any change to the [TTBR0](#), [TTBR1](#), or [TTBCR](#) registers without a change to the corresponding ContextID or ASID, or FCSE ProcessID if this is supported.

0011 Branch predictor requires flushing only on writing new data to instruction locations.

0100 For execution correctness, branch predictor requires no flushing at any time.

All other values are reserved.

In ARMv8-A the permitted values are 0010, 0011, or 0100. For values other than 0000 and 0100 the ARM Architecture Reference Manual, or the product documentation, might give more information about the required maintenance.

L1TstCln, bits [27:24]

Level 1 cache Test and Clean. Indicates the supported Level 1 data cache test and clean operations, for Harvard or unified cache implementations. Defined values are:

- 0000 None supported.
- 0001 Supported Level 1 data cache test and clean operations are:
 - Test and clean data cache.
- 0010 As for 0001, and adds:
 - Test, clean, and invalidate data cache.

All other values are reserved.

In ARMv8-A the only permitted value is 0000.

L1Uni, bits [23:20]

Level 1 Unified cache. Indicates the supported entire Level 1 cache maintenance operations for a unified cache implementation. Defined values are:

- 0000 None supported.
- 0001 Supported entire Level 1 cache operations are:
 - Invalidate cache, including branch predictor if appropriate.
 - Invalidate branch predictor, if appropriate.
- 0010 As for 0001, and adds:
 - Clean cache, using a recursive model that uses the cache dirty status bit.
 - Clean and invalidate cache, using a recursive model that uses the cache dirty status bit.

All other values are reserved.

In ARMv8-A the only permitted value is 0000.

L1Hvd, bits [19:16]

Level 1 Harvard cache. Indicates the supported entire Level 1 cache maintenance operations for a Harvard cache implementation. Defined values are:

- 0000 None supported.
- 0001 Supported entire Level 1 cache operations are:
 - Invalidate instruction cache, including branch predictor if appropriate.
 - Invalidate branch predictor, if appropriate.
- 0010 As for 0001, and adds:
 - Invalidate data cache.
 - Invalidate data cache and instruction cache, including branch predictor if appropriate.
- 0011 As for 0010, and adds:
 - Clean data cache, using a recursive model that uses the cache dirty status bit.
 - Clean and invalidate data cache, using a recursive model that uses the cache dirty status bit.

All other values are reserved.

In ARMv8-A the only permitted value is 0000.

L1UniSW, bits [15:12]

Level 1 Unified cache by Set/Way. Indicates the supported Level 1 cache line maintenance operations by set/way, for a unified cache implementation. Defined values are:

- 0000 None supported.

0001 Supported Level 1 unified cache line maintenance operations by set/way are:

- Clean cache line by set/way.

0010 As for 0001, and adds:

- Clean and invalidate cache line by set/way.

0011 As for 0010, and adds:

- Invalidate cache line by set/way.

All other values are reserved.

In ARMv8-A the only permitted value is 0000.

L1HvdSW, bits [11:8]

Level 1 Harvard cache by Set/Way. Indicates the supported Level 1 cache line maintenance operations by set/way, for a Harvard cache implementation. Defined values are:

0000 None supported.

0001 Supported Level 1 Harvard cache line maintenance operations by set/way are:

- Clean data cache line by set/way.
- Clean and invalidate data cache line by set/way.

0010 As for 0001, and adds:

- Invalidate data cache line by set/way.

0011 As for 0010, and adds:

- Invalidate instruction cache line by set/way.

All other values are reserved.

In ARMv8-A the only permitted value is 0000.

L1UniVA, bits [7:4]

Level 1 Unified cache by Virtual Address. Indicates the supported Level 1 cache line maintenance operations by VA, for a unified cache implementation. Defined values are:

0000 None supported.

0001 Supported Level 1 unified cache line maintenance operations by VA are:

- Clean cache line by VA.
- Invalidate cache line by VA.
- Clean and invalidate cache line by VA.

0010 As for 0001, and adds:

- Invalidate branch predictor by VA, if branch predictor is implemented.

All other values are reserved.

In ARMv8-A the only permitted value is 0000.

L1HvdVA, bits [3:0]

Level 1 Harvard cache by Virtual Address. Indicates the supported Level 1 cache line maintenance operations by VA, for a Harvard cache implementation. Defined values are:

0000 None supported.

0001 Supported Level 1 Harvard cache line maintenance operations by VA are:

- Clean data cache line by VA.
- Invalidate data cache line by VA.
- Clean and invalidate data cache line by VA.
- Clean instruction cache line by VA.

0010 As for 0001, and adds:

- Invalidate branch predictor by VA, if branch predictor is implemented.

All other values are reserved.
In ARMv8-A the only permitted value is 0000.

Accessing the ID_MMFR1_EL1

This register can be read using MRS with the following syntax:

MRS <Xt>, <systemreg>

This syntax is encoded with the following settings in the instruction encoding:

<systemreg>	op0	op1	CRn	CRm	op2
ID_MMFR1_EL1	11	000	0000	0001	101

Accessibility

The register is accessible in software as follows:

Control			Accessibility			
E2H	TGE	NS	EL0	EL1	EL2	EL3
x	x	0	-	RO	n/a	RO
x	0	1	-	RO	RO	RO
x	1	1	-	n/a	RO	RO

Traps and Enables

For a description of the prioritization of any generated exceptions, see [Synchronous exception prioritization for exceptions taken to AArch64 on page D1-1827](#). Subject to the prioritization rules:

- When EL2 is implemented and is using AArch64 and (SCR_EL3.NS == 1) && (HCR_EL2.E2H == 0):
 - If HCR_EL2.TID3==1, Non-secure read accesses to this register from EL1 are trapped to EL2.
- When EL2 is implemented and is using AArch64 and (SCR_EL3.NS == 1) && (HCR_EL2.E2H == 1) && (HCR_EL2.TGE == 0):
 - If HCR_EL2.TID3==1, Non-secure read accesses to this register from EL1 are trapped to EL2.

D7.2.58 ID_MMFR2_EL1, AArch32 Memory Model Feature Register 2

The ID_MMFR2_EL1 characteristics are:

Purpose

Provides information about the implemented memory model and memory management support in AArch32 state.

Must be interpreted with [ID_MMFR0_EL1](#), [ID_MMFR1_EL1](#), [ID_MMFR3_EL1](#), and [ID_MMFR4_EL1](#).

For general information about the interpretation of the ID registers see *Principles of the ID scheme for fields in ID registers* on page D7-2195.

Configurations

AArch64 System register ID_MMFR2_EL1 is architecturally mapped to AArch32 System register [ID_MMFR2](#).

In an implementation that supports only AArch64 state, this register is UNKNOWN.

Attributes

ID_MMFR2_EL1 is a 32-bit register.

Field descriptions

The ID_MMFR2_EL1 bit assignments are:

31	28 27	24 23	20 19	16 15	12 11	8 7	4 3	0
HWAccFlg	WFIStall	MemBarr	UniTLB	HvdTLB	L1HvdRng	L1HvdBG	L1HvdFG	

HWAccFlg, bits [31:28]

Hardware Access Flag. In earlier versions of the ARM Architecture, this field indicates support for a Hardware Access flag, as part of the VMSAv7 implementation. Defined values are:

0000 Not supported.

0001 Support for VMSAv7 Access flag, updated in hardware.

All other values are reserved.

In ARMv8 the only permitted value is 0000.

WFIStall, bits [27:24]

Wait For Interrupt Stall. Indicates the support for Wait For Interrupt (WFI) stalling. Defined values are:

0000 Not supported.

0001 Support for WFI stalling.

All other values are reserved.

In ARMv8 the permitted values are 0000 and 0001.

MemBarr, bits [23:20]

Memory Barrier. Indicates the supported memory barrier System instructions in the (coproc==1111) encoding space:

0000 None supported.

0001 Supported memory barrier System instructions are:

- Data Synchronization Barrier (DSB).

- 0010 As for 0001, and adds:
- Instruction Synchronization Barrier (ISB).
 - Data Memory Barrier (DMB).

All other values are reserved.

In ARMv8 the only permitted value is 0010.

ARM deprecates the use of these operations. ID_ISAR4.Barrier_insts indicates the level of support for the preferred barrier instructions.

UniTLB, bits [19:16]

Unified TLB. Indicates the supported TLB maintenance operations, for a unified TLB implementation. Defined values are:

- 0000 Not supported.
- 0001 Supported unified TLB maintenance operations are:
- Invalidate all entries in the TLB.
 - Invalidate TLB entry by VA.
- 0010 As for 0001, and adds:
- Invalidate TLB entries by ASID match.
- 0011 As for 0010, and adds:
- Invalidate instruction TLB and data TLB entries by VA All ASID. This is a shared unified TLB operation.
- 0100 As for 0011, and adds:
- Invalidate Hyp mode unified TLB entry by VA.
 - Invalidate entire Non-secure PL1&0 unified TLB.
 - Invalidate entire Hyp mode unified TLB.
- 0101 As for 0100, and adds the following operations: [TLBIMVALIS](#), [TLBIMVAALIS](#), [TLBIMVALHIS](#), [TLBIMVAL](#), [TLBIMVAAL](#), [TLBIMVALH](#).
- 0110 As for 0101, and adds the following operations: [TLBIIPAS2IS](#), [TLBIIPAS2LIS](#), [TLBIIPAS2](#), [TLBIIPAS2L](#).

All other values are reserved.

In ARMv8-A the only permitted value is 0110.

HvdTLB, bits [15:12]

If the Unified TLB field (UniTLB, bits [19:16]) is not 0000, then the meaning of this field is IMPLEMENTATION DEFINED. ARM deprecates the use of this field by software.

L1HvdRng, bits [11:8]

Level 1 Harvard cache Range. Indicates the supported Level 1 cache maintenance range operations, for a Harvard cache implementation. Defined values are:

- 0000 Not supported.
- 0001 Supported Level 1 Harvard cache maintenance range operations are:
- Invalidate data cache range by VA.
 - Invalidate instruction cache range by VA.
 - Clean data cache range by VA.
 - Clean and invalidate data cache range by VA.

All other values are reserved.

In ARMv8 the only permitted value is 0000.

L1HvdBG, bits [7:4]

Level 1 Harvard cache Background fetch. Indicates the supported Level 1 cache background fetch operations, for a Harvard cache implementation. When supported, background fetch operations are non-blocking operations. Defined values are:

0000 Not supported.

0001 Supported Level 1 Harvard cache background fetch operations are:

- Fetch instruction cache range by VA.
- Fetch data cache range by VA.

All other values are reserved.

In ARMv8 the only permitted value is 0000.

L1HvdFG, bits [3:0]

Level 1 Harvard cache Foreground fetch. Indicates the supported Level 1 cache foreground fetch operations, for a Harvard cache implementation. When supported, foreground fetch operations are blocking operations. Defined values are:

0000 Not supported.

0001 Supported Level 1 Harvard cache foreground fetch operations are:

- Fetch instruction cache range by VA.
- Fetch data cache range by VA.

All other values are reserved.

In ARMv8 the only permitted value is 0000.

Accessing the ID_MMFR2_EL1

This register can be read using MRS with the following syntax:

MRS <Xt>, <systemreg>

This syntax is encoded with the following settings in the instruction encoding:

<systemreg>	op0	op1	CRn	CRm	op2
ID_MMFR2_EL1	11	000	0000	0001	110

Accessibility

The register is accessible in software as follows:

Control			Accessibility			
E2H	TGE	NS	EL0	EL1	EL2	EL3
x	x	0	-	RO	n/a	RO
x	0	1	-	RO	RO	RO
x	1	1	-	n/a	RO	RO

Traps and Enables

For a description of the prioritization of any generated exceptions, see *Synchronous exception prioritization for exceptions taken to AArch64* on page D1-1827. Subject to the prioritization rules:

- When EL2 is implemented and is using AArch64 and $(SCR_EL3.NS == 1) \ \&\& \ (HCR_EL2.E2H == 0)$:
 - If $HCR_EL2.TID3 == 1$, Non-secure read accesses to this register from EL1 are trapped to EL2.
- When EL2 is implemented and is using AArch64 and $(SCR_EL3.NS == 1) \ \&\& \ (HCR_EL2.E2H == 1) \ \&\& \ (HCR_EL2.TGE == 0)$:
 - If $HCR_EL2.TID3 == 1$, Non-secure read accesses to this register from EL1 are trapped to EL2.

D7.2.59 ID_MMFR3_EL1, AArch32 Memory Model Feature Register 3

The ID_MMFR3_EL1 characteristics are:

Purpose

Provides information about the implemented memory model and memory management support in AArch32 state.

Must be interpreted with ID_MMFR0_EL1, ID_MMFR1_EL1, ID_MMFR2_EL1, and ID_MMFR4_EL1.

For general information about the interpretation of the ID registers see *Principles of the ID scheme for fields in ID registers* on page D7-2195.

Configurations

AArch64 System register ID_MMFR3_EL1 is architecturally mapped to AArch32 System register ID_MMFR3.

In an implementation that supports only AArch64 state, this register is UNKNOWN.

Attributes

ID_MMFR3_EL1 is a 32-bit register.

Field descriptions

The ID_MMFR3_EL1 bit assignments are:

31	28 27	24 23	20 19	16 15	12 11	8 7	4 3	0
Supersec	CMemSz	CohWalk	PAN	MaintBcst	BPMaint	CMaintSW	CMaintVA	

Supersec, bits [31:28]

Supersections. On a VMSA implementation, indicates whether Supersections are supported. Defined values are:

0000 Supersections supported.

1111 Supersections not supported.

All other values are reserved.

In ARMv8-A the permitted values are 0000 and 1111.

CMemSz, bits [27:24]

Cached Memory Size. Indicates the physical memory size supported by the caches. Defined values are:

0000 4GB, corresponding to a 32-bit physical address range.

0001 64GB, corresponding to a 36-bit physical address range.

0010 1TB or more, corresponding to a 40-bit or larger physical address range.

All other values are reserved.

In ARMv8-A the permitted values are 0000, 0001, and 0010.

CohWalk, bits [23:20]

Coherent Walk. Indicates whether Translation table updates require a clean to the point of unification. Defined values are:

0000 Updates to the translation tables require a clean to the point of unification to ensure visibility by subsequent translation table walks.

0001 Updates to the translation tables do not require a clean to the point of unification to ensure visibility by subsequent translation table walks.

All other values are reserved.

In ARMv8-A the only permitted value is 0001.

PAN, bits [19:16]

In ARMv8.2 and ARMv8.1

Privileged Access Never. Indicates support for the PAN bit in [CPSR](#), [SPSR](#), and [DSPSR](#) in AArch32. Defined values are:

0000 PAN not supported.

0001 PAN supported.

0010 PAN supported and [ATS1CPRP](#) and [ATS1CPWP](#) instructions supported.

All other values are reserved.

In ARMv8.0 the only permitted value is 0000.

In ARMv8.1 the only permitted value is 0001. This feature is identified by the name [ARMv8.1-PAN](#).

From ARMv8.2, the only permitted value is 0010. This feature is identified by the name [ARMv8.2-ATS1E1](#).

In ARMv8.0.

Reserved, RES0.

MaintBcst, bits [15:12]

Maintenance Broadcast. Indicates whether Cache, TLB, and branch predictor operations are broadcast. Defined values are:

0000 Cache, TLB, and branch predictor operations only affect local structures.

0001 Cache and branch predictor operations affect structures according to shareability and defined behavior of instructions. TLB operations only affect local structures.

0010 Cache, TLB, and branch predictor operations affect structures according to shareability and defined behavior of instructions.

All other values are reserved.

In ARMv8-A the only permitted value is 0010.

BPMaint, bits [11:8]

Branch Predictor Maintenance. Indicates the supported branch predictor maintenance operations in an implementation with hierarchical cache maintenance operations. Defined values are:

0000 None supported.

0001 Supported branch predictor maintenance operations are:

- Invalidate all branch predictors.

0010 As for 0001, and adds:

- Invalidate branch predictors by VA.

All other values are reserved.

In ARMv8-A the only permitted value is 0010.

CMaintSW, bits [7:4]

Cache Maintenance by Set/Way. Indicates the supported cache maintenance operations by set/way, in an implementation with hierarchical caches. Defined values are:

0000 None supported.

0001 Supported hierarchical cache maintenance instructions by set/way are:

- Invalidate data cache by set/way.
- Clean data cache by set/way.

- Clean and invalidate data cache by set/way.

All other values are reserved.

In ARMv8-A the only permitted value is 0001.

In a unified cache implementation, the data cache maintenance operations apply to the unified caches.

CMaintVA, bits [3:0]

Cache Maintenance by Virtual Address. Indicates the supported cache maintenance operations by VA, in an implementation with hierarchical caches. Defined values are:

0000 None supported.

0001 Supported hierarchical cache maintenance operations by VA are:

- Invalidate data cache by VA.
- Clean data cache by VA.
- Clean and invalidate data cache by VA.
- Invalidate instruction cache by VA.
- Invalidate all instruction cache entries.

All other values are reserved.

In ARMv8-A the only permitted value is 0001.

In a unified cache implementation, data cache maintenance operations apply to the unified caches, and the instruction cache maintenance instructions are not implemented.

Accessing the ID_MMFR3_EL1

This register can be read using MRS with the following syntax:

MRS <Xt>, <systemreg>

This syntax is encoded with the following settings in the instruction encoding:

<systemreg>	op0	op1	CRn	CRm	op2
ID_MMFR3_EL1	11	000	0000	0001	111

Accessibility

The register is accessible in software as follows:

Control			Accessibility			
E2H	TGE	NS	EL0	EL1	EL2	EL3
x	x	0	-	RO	n/a	RO
x	0	1	-	RO	RO	RO
x	1	1	-	n/a	RO	RO

Traps and Enables

For a description of the prioritization of any generated exceptions, see *Synchronous exception prioritization for exceptions taken to AArch64* on page D1-1827. Subject to the prioritization rules:

- When EL2 is implemented and is using AArch64 and $(SCR_EL3.NS == 1) \ \&\& \ (HCR_EL2.E2H == 0)$:
 - If $HCR_EL2.TID3 == 1$, Non-secure read accesses to this register from EL1 are trapped to EL2.
- When EL2 is implemented and is using AArch64 and $(SCR_EL3.NS == 1) \ \&\& \ (HCR_EL2.E2H == 1) \ \&\& \ (HCR_EL2.TGE == 0)$:
 - If $HCR_EL2.TID3 == 1$, Non-secure read accesses to this register from EL1 are trapped to EL2.

D7.2.60 ID_MMFR4_EL1, AArch32 Memory Model Feature Register 4

The ID_MMFR4_EL1 characteristics are:

Purpose

Provides information about the implemented memory model and memory management support in AArch32 state.

Must be interpreted with [ID_MMFR0_EL1](#), [ID_MMFR1_EL1](#), [ID_MMFR2_EL1](#), and [ID_MMFR3_EL1](#).

For general information about the interpretation of the ID registers see *Principles of the ID scheme for fields in ID registers* on page D7-2195.

Configurations

AArch64 System register ID_MMFR4_EL1 is architecturally mapped to AArch32 System register [ID_MMFR4](#).

In an implementation that supports only AArch64 state, this register is UNKNOWN.

Attributes

ID_MMFR4_EL1 is a 32-bit register.

Field descriptions

The ID_MMFR4_EL1 bit assignments are:

31	24 23	20 19	16 15	12 11	8 7	4 3	0
RAZ	LSM	HPDS	CnP	XNX	AC2	SpecSEI	

Bits [31:24]

Reserved, RAZ.

LSM, bits [23:20]

In ARMv8.2

Indicates support for LSMAOE and nTLSMD bits in [HSCTLR](#) and [SCTLR](#). Defined values are:

0000 LSMAOE and nTLSMD bits not supported.

0001 LSMAOE and nTLSMD bits supported.

All other values are reserved.

In ARMv8.0 and ARMv8.1 the only permitted value is 0000.

From ARMv8.2, the permitted values are 0000 and 0001. This feature is identified by the name [ARMv8.2-LSMAOC](#).

In ARMv8.1 and ARMv8.0.

Reserved, RAZ.

HPDS, bits [19:16]

In ARMv8.2

Hierarchical permission disables bits in translation tables. Defined values are:

0000 Disabling of hierarchical controls not supported.

0001 Supports disabling of hierarchical controls using the TTBCR2.HPD0, TTBCR2.HPD1, and [HTCR](#).HPD bits.

0010 Supports disabling of hierarchical controls using the TTBCR2.HPD0, TTBCR2.HPD1, and HTCR.HPD bits, and hardware allocation of bits[62:59] of the last level page table descriptor for IMPLEMENTATION DEFINED use.

All other values are reserved.

In ARMv8.0 and ARMv8.1 the only permitted value is 0000.

From ARMv8.2, the permitted values are 0000, 0001 and 0010. This feature is identified by the name [ARMv8.2-AA32HPD](#).

———— **Note** ————

The encoding 0000 implies that the encoding for TTBCR2 is unallocated.

In ARMv8.1 and ARMv8.0.

Reserved, RAZ.

CnP, bits [15:12]

In ARMv8.2

Common not Private translations. Defined values are:

0000 Common not Private translations not supported.

0001 Common not Private translations supported.

All other values are reserved.

In ARMv8.0 and ARMv8.1 the only permitted value is 0000.

From ARMv8.2, the only permitted value is 0001. This feature is identified by the name [ARMv8.2-TTCNP](#).

In ARMv8.1 and ARMv8.0.

Reserved, RAZ.

XNX, bits [11:8]

In ARMv8.2

Support for execute never control distinction at stage 2 bit. Defined values are:

0000 Distinction between EL0 and EL1 execute permission at stage 2 not supported.

0001 Distinction between EL0 and EL1 execute permission at stage 2 supported.

All other values are reserved.

In ARMv8.0 and ARMv8.1 the only permitted value is 0000.

From ARMv8.2, the only permitted value is 0001. This feature is identified by the name [ARMv8.2-TTS2UXN](#).

In ARMv8.1 and ARMv8.0.

Reserved, RAZ.

AC2, bits [7:4]

Indicates the extension of the ACTLR and HACTLR registers using ACTLR2 and HACTLR2. Defined values are:

0000 [ACTLR2](#) and [HACTLR2](#) are not implemented.

0001 [ACTLR2](#) and [HACTLR2](#) are implemented.

All other values are reserved.

In ARMv8.0 and ARMv8.1 the permitted values are 0000 and 0001.

From ARMv8.2, the only permitted value is 0001.

SpecSEI, bits [3:0]

Describes whether the PE can generate SError interrupt exceptions from speculative reads of memory, including speculative instruction fetches. The defined values of this field are:

- 0000 The PE never generates an SError interrupt due to an external abort on a speculative read.
 - 0001 The PE might generate an SError interrupt due to an external abort on a speculative read.
- All other values are reserved.

When the RAS Extension is not implemented, this field is RAZ.

Accessing the ID_MMFR4_EL1

This register can be read using MRS with the following syntax:

MRS <Xt>, <systemreg>

This syntax is encoded with the following settings in the instruction encoding:

<systemreg>	op0	op1	CRn	CRm	op2
ID_MMFR4_EL1	11	000	0000	0010	110

Accessibility

The register is accessible in software as follows:

Control			Accessibility			
E2H	TGE	NS	EL0	EL1	EL2	EL3
x	x	0	-	RO	n/a	RO
x	0	1	-	RO	RO	RO
x	1	1	-	n/a	RO	RO

Traps and Enables

For a description of the prioritization of any generated exceptions, see [Synchronous exception prioritization for exceptions taken to AArch64 on page D1-1827](#). Subject to the prioritization rules:

If HCR_EL2.TID3==1, then:

- If the register is not RAZ/WI then Non-secure EL1 read accesses to this register are trapped to EL2.
- Otherwise, it is IMPLEMENTATION DEFINED whether Non-secure EL1 read accesses to this register are trapped to EL2.

D7.2.61 ID_PFR0_EL1, AArch32 Processor Feature Register 0

The ID_PFR0_EL1 characteristics are:

Purpose

Gives top-level information about the instruction sets supported by the PE in AArch32 state.

Must be interpreted with ID_PFR1_EL1.

For general information about the interpretation of the ID registers see *Principles of the ID scheme for fields in ID registers* on page D7-2195.

Configurations

AArch64 System register ID_PFR0_EL1 is architecturally mapped to AArch32 System register ID_PFR0.

In an implementation that supports only AArch64 state, this register is UNKNOWN.

Attributes

ID_PFR0_EL1 is a 32-bit register.

Field descriptions

The ID_PFR0_EL1 bit assignments are:

31	28 27	16 15	12 11	8 7	4 3	0
RAS	RES0	State3	State2	State1	State0	

RAS, bits [31:28]

RAS Extension version. The defined values of this field are:

0000 No RAS Extension.

0001 Version 1 of the RAS Extension present.

All other values are reserved.

Bits [27:16]

Reserved, RES0.

State3, bits [15:12]

T32EE instruction set support. Defined values are:

0000 Not implemented.

0001 T32EE instruction set implemented.

All other values are reserved.

In ARMv8-A the only permitted value is 0000.

State2, bits [11:8]

Jazelle extension support. Defined values are:

0000 Not implemented.

0001 Jazelle extension implemented, without clearing of JOSCR.CV on exception entry.

0010 Jazelle extension implemented, with clearing of JOSCR.CV on exception entry.

All other values are reserved.

In ARMv8-A the only permitted value is 0001.

State1, bits [7:4]

T32 instruction set support. Defined values are:

- 0000 T32 instruction set not implemented.
- 0001 T32 encodings before the introduction of Thumb-2 technology implemented:
 - All instructions are 16-bit.
 - A BL or BLX is a pair of 16-bit instructions.
 - 32-bit instructions other than BL and BLX cannot be encoded.
- 0011 T32 encodings after the introduction of Thumb-2 technology implemented, for all 16-bit and 32-bit T32 basic instructions.

All other values are reserved.

In ARMv8-A the only permitted value is 0011.

State0, bits [3:0]

A32 instruction set support. Defined values are:

- 0000 A32 instruction set not implemented.
- 0001 A32 instruction set implemented.

All other values are reserved.

In ARMv8-A the only permitted value is 0001.

Accessing the ID_PFR0_EL1

This register can be read using MRS with the following syntax:

MRS <Xt>, <systemreg>

This syntax is encoded with the following settings in the instruction encoding:

<systemreg>	op0	op1	CRn	CRm	op2
ID_PFR0_EL1	11	000	0000	0001	000

Accessibility

The register is accessible in software as follows:

Control			Accessibility			
E2H	TGE	NS	EL0	EL1	EL2	EL3
x	x	0	-	RO	n/a	RO
x	0	1	-	RO	RO	RO
x	1	1	-	n/a	RO	RO

Traps and Enables

For a description of the prioritization of any generated exceptions, see [Synchronous exception prioritization for exceptions taken to AArch64 on page D1-1827](#). Subject to the prioritization rules:

- When EL2 is implemented and is using AArch64 and (SCR_EL3.NS == 1) && (HCR_EL2.E2H == 0):
 - If HCR_EL2.TID3==1, Non-secure read accesses to this register from EL1 are trapped to EL2.

- When EL2 is implemented and is using AArch64 and (SCR_EL3.NS == 1) && (HCR_EL2.E2H == 1) && (HCR_EL2.TGE == 0):
 - If [HCR_EL2.TID3](#)==1, Non-secure read accesses to this register from EL1 are trapped to EL2.

D7.2.62 ID_PFR1_EL1, AArch32 Processor Feature Register 1

The ID_PFR1_EL1 characteristics are:

Purpose

Gives information about the AArch32 programmers' model.

Must be interpreted with ID_PFR0_EL1.

For general information about the interpretation of the ID registers see *Principles of the ID scheme for fields in ID registers* on page D7-2195.

Configurations

AArch64 System register ID_PFR1_EL1 is architecturally mapped to AArch32 System register ID_PFR1.

In an implementation that supports only AArch64 state, this register is UNKNOWN.

Attributes

ID_PFR1_EL1 is a 32-bit register.

Field descriptions

The ID_PFR1_EL1 bit assignments are:

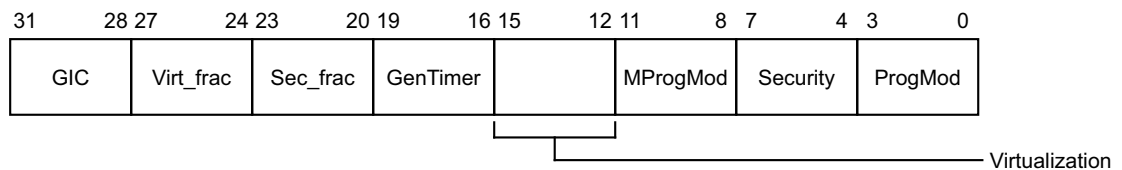

GIC, bits [31:28]

System register GIC CPU interface. Defined values are:

- 0000 No System register interface to the GIC CPU interface is supported.
 - 0001 System register interface to versions 3.0 and 4.0 of the GIC CPU interface is supported.
- All other values are reserved.

Virt_frac, bits [27:24]

Virtualization fractional field. When the Virtualization field is 0000, determines the support for features from the ARMv7 Virtualization Extensions. Defined values are:

- 0000 No features from the ARMv7 Virtualization Extensions are implemented.
- 0001 The following features of the ARMv7 Virtualization Extensions are implemented:
 - The SCR.SIF bit, if EL3 is implemented.
 - The modifications to the SCR.AW and SCR.FW bits described in the Virtualization Extensions, if EL3 is implemented.
 - The MSR (Banked register) and MRS (Banked register) instructions.
 - The ERET instruction.

All other values are reserved.

In ARMv8-A the permitted values are:

- 0000 when EL2 is implemented.
- 0001 when EL2 is not implemented.

This field is only valid when the value of ID_PFR1_EL1.Virtualization is 0, otherwise it holds the value 0000.

Note

The ID_ISAR registers do not identify whether the instructions added by the ARMv7 Virtualization Extensions are implemented.

Sec_frac, bits [23:20]

Security fractional field. When the Security field is 0000, determines the support for features from the ARMv7 Security Extensions. Defined values are:

- 0000 No features from the ARMv7 Security Extensions are implemented.
- 0001 The following features from the ARMv7 Security Extensions are implemented:
 - The VBAR register.
 - The TTBCR.PD0 and TTBCR.PD1 bits.
- 0010 As for 0001, plus the ability to access Secure or Non-secure physical memory is supported.

All other values are reserved.

In ARMv8-A the permitted values are:

- 0000 when EL3 is implemented.
- 0001 or 0010 when EL3 is not implemented.

This field is only valid when the value of ID_PFR1_EL1.Security is 0, otherwise it holds the value 0000.

GenTimer, bits [19:16]

Generic Timer support. Defined values are:

- 0000 Not implemented.
- 0001 Generic Timer implemented.

All other values are reserved.

In ARMv8-A the only permitted value is 0001.

Virtualization, bits [15:12]

Virtualization support. Defined values are:

- 0000 EL2, Hyp mode, and the HVC instruction not implemented.
- 0001 EL2, Hyp mode, the HVC instruction, and all the features described by Virt_frac == 0001 implemented.

All other values are reserved.

In ARMv8-A the permitted values are:

- 0000 when EL2 is not implemented.
- 0001 when EL2 is implemented.

In an implementation that includes EL2, if EL2 cannot use AArch32 but EL1 can use AArch32 then this field has the value 0001.

If EL1 cannot use AArch32 then this field has the value 0000.

Note

The ID_ISARs do not identify whether the HVC instruction is implemented.

MProgMod, bits [11:8]

M profile programmers' model support. Defined values are:

- 0000 Not supported.
- 0010 Support for two-stack programmers' model.

All other values are reserved.

In ARMv8-A the only permitted value is 0000.

Security, bits [7:4]

Security support. Defined values are:

- 0000 EL3, Monitor mode, and the SMC instruction not implemented.
- 0001 EL3, Monitor mode, the SMC instruction, and all the features described by Sec_frac == 0001 implemented.
- 0010 As for 0001, and adds the ability to set the NSACR.RFR bit. Not permitted in ARMv8 as the NSACR.RFR bit is RES0.

All other values are reserved.

In ARMv8-A the permitted values are:

- 0000 when EL3 is not implemented.
- 0001 when EL3 is implemented.

In an implementation that includes EL3, if EL3 cannot use AArch32 but EL1 can use AArch32 then this field has the value 0001.

If EL1 cannot use AArch32 then this field has the value 0000.

ProgMod, bits [3:0]

Support for the standard programmers' model for ARMv4 and later. Model must support User, FIQ, IRQ, Supervisor, Abort, Undefined, and System modes. Defined values are:

- 0000 Not supported.
- 0001 Supported.

All other values are reserved.

In ARMv8-A the permitted values are 0001 and 0000.

If EL1 cannot use AArch32 then this field has the value 0000.

Accessing the ID_PFR1_EL1

This register can be read using MRS with the following syntax:

MRS <Xt>, <systemreg>

This syntax is encoded with the following settings in the instruction encoding:

<systemreg>	op0	op1	CRn	CRm	op2
ID_PFR1_EL1	11	000	0000	0001	001

Accessibility

The register is accessible in software as follows:

Control			Accessibility			
E2H	TGE	NS	EL0	EL1	EL2	EL3
x	x	0	-	RO	n/a	RO
x	0	1	-	RO	RO	RO
x	1	1	-	n/a	RO	RO

Traps and Enables

For a description of the prioritization of any generated exceptions, see *Synchronous exception prioritization for exceptions taken to AArch64* on page D1-1827. Subject to the prioritization rules:

- When EL2 is implemented and is using AArch64 and (SCR_EL3.NS == 1) && (HCR_EL2.E2H == 0):
 - If HCR_EL2.TID3==1, Non-secure read accesses to this register from EL1 are trapped to EL2.
- When EL2 is implemented and is using AArch64 and (SCR_EL3.NS == 1) && (HCR_EL2.E2H == 1) && (HCR_EL2.TGE == 0):
 - If HCR_EL2.TID3==1, Non-secure read accesses to this register from EL1 are trapped to EL2.

D7.2.63 IFSR32_EL2, Instruction Fault Status Register (EL2)

The IFSR32_EL2 characteristics are:

Purpose

Allows access to the AArch32 [IFSR](#) register from AArch64 state only. Its value has no effect on execution in AArch64 state.

Configurations

AArch64 System register IFSR32_EL2 is architecturally mapped to AArch32 System register [IFSR](#).

If EL1 is AArch64 only, this register is UNDEFINED.

If EL2 is not implemented but EL3 is implemented, and EL1 is capable of using AArch32, then this register is not RES0.

RW fields in this register reset to architecturally UNKNOWN values.

Attributes

IFSR32_EL2 is a 32-bit register.

Field descriptions

The IFSR32_EL2 bit assignments are:

When *TTBCR.EAE*==0:

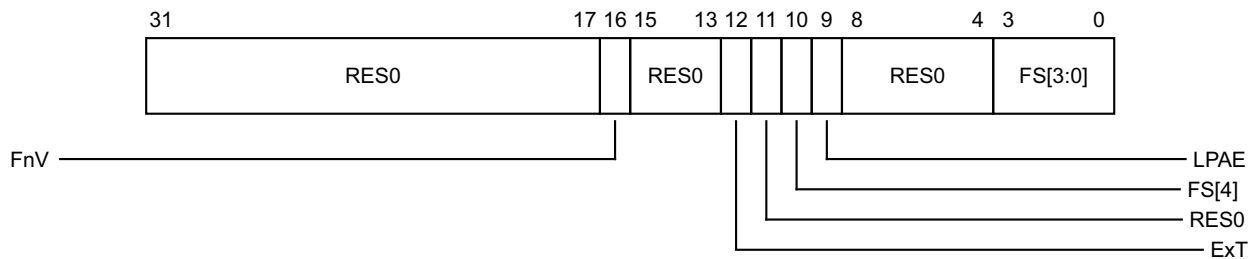

Bits [31:17]

Reserved, RES0.

FnV, bit [16]

FAR not Valid, for a Synchronous external abort other than a Synchronous external abort on a translation table walk.

0 [IFAR](#) is valid.

1 [IFAR](#) is not valid, and holds an UNKNOWN value.

This field is only valid for a Synchronous external abort other than a Synchronous external abort on a translation table walk. It is RES0 for all other Prefetch Abort exceptions.

Bits [15:13]

Reserved, RES0.

ExT, bit [12]

External abort type. This bit can be used to provide an IMPLEMENTATION DEFINED classification of external aborts.

In an implementation that does not provide any classification of external aborts, this bit is RES0.

For aborts other than external aborts this bit always returns 0.

Bit [11]

Reserved, RES0.

FS[4], bit [10]

See FS[3:0], bits [3:0] for description of the FS field.

LPAAE, bit [9]

On taking a Data Abort exception, this bit is set as follows:

- 0 Using the Short-descriptor translation table formats.
- 1 Using the Long-descriptor translation table formats.

Hardware does not interpret this bit to determine the behavior of the memory system, and therefore software can set this bit to 0 or 1 without affecting operation.

Bits [8:4]

Reserved, RES0.

FS[3:0], bits [3:0]

Fault status bits. Interpreted with bit [10]. Possible values of FS[4:0] are:

- 00001 PC alignment fault
- 00010 Debug exception
- 00011 Access flag fault, level 1
- 00101 Translation fault, level 1
- 00110 Access flag fault, level 2
- 00111 Translation fault, level 2
- 01000 Synchronous external abort, not on translation table walk
- 01001 Domain fault, level 1
- 01011 Domain fault, level 2
- 01100 Synchronous external abort, on translation table walk, level 1
- 01101 Permission fault, level 1
- 01110 Synchronous external abort, on translation table walk, level 2
- 01111 Permission fault, level 2
- 10000 TLB conflict abort
- 10100 IMPLEMENTATION DEFINED fault (Lockdown fault)
- 11001 Synchronous parity or ECC error on memory access, not on translation table walk
- 11100 Synchronous parity or ECC error on translation table walk, level 1
- 11110 Synchronous parity or ECC error on translation table walk, level 2

All other values are reserved.

When the RAS Extension is implemented, 11001, 11100, and 11110 are reserved.

When TTBCR.EAE==1:

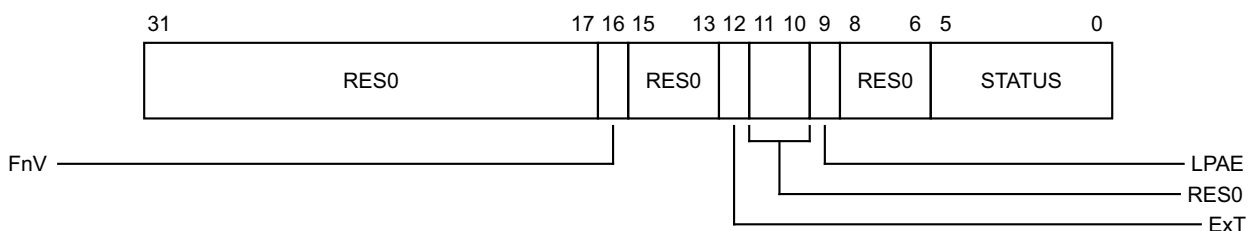

Bits [31:17]

Reserved, RES0.

FnV, bit [16]

FAR not Valid, for a Synchronous external abort other than a Synchronous external abort on a translation table walk.

0 **IFAR** is valid.

1 **IFAR** is not valid, and holds an UNKNOWN value.

This field is only valid for a Synchronous external abort other than a Synchronous external abort on a translation table walk. It is RES0 for all other Prefetch Abort exceptions.

Bits [15:13]

Reserved, RES0.

ExT, bit [12]

External abort type. This bit can be used to provide an IMPLEMENTATION DEFINED classification of external aborts.

In an implementation that does not provide any classification of external aborts, this bit is RES0.

For aborts other than external aborts this bit always returns 0.

Bits [11:10]

Reserved, RES0.

LPAE, bit [9]

On taking a Data Abort exception, this bit is set as follows:

0 Using the Short-descriptor translation table formats.

1 Using the Long-descriptor translation table formats.

Hardware does not interpret this bit to determine the behavior of the memory system, and therefore software can set this bit to 0 or 1 without affecting operation.

Bits [8:6]

Reserved, RES0.

STATUS, bits [5:0]

Fault status bits. All encodings not shown below are reserved:

000000	Address size fault in TTBR0 or TTBR1
000001	Address size fault, level 1
000010	Address size fault, level 2
000011	Address size fault, level 3
000101	Translation fault, level 1
000110	Translation fault, level 2
000111	Translation fault, level 3
001001	Access flag fault, level 1
001010	Access flag fault, level 2
001011	Access flag fault, level 3
001101	Permission fault, level 1
001110	Permission fault, level 2
001111	Permission fault, level 3
010000	Synchronous external abort, not on translation table walk
010101	Synchronous external abort, on translation table walk, level 1

010110	Synchronous external abort, on translation table walk, level 2
010111	Synchronous external abort, on translation table walk, level 3
011000	Synchronous parity or ECC error on memory access, not on translation table walk
011101	Synchronous parity or ECC error on memory access on translation table walk, level 1
011110	Synchronous parity or ECC error on memory access on translation table walk, level 2
011111	Synchronous parity or ECC error on memory access on translation table walk, level 3
100001	PC alignment fault
100010	Debug exception
110000	TLB conflict abort

All other values are reserved.

The lookup level associated with a fault is:

When the RAS Extension is implemented, 011000, 011101, 011110, and 011111 are reserved.

- For a fault generated on a translation table walk, the lookup level of the walk being performed.
- For a Translation fault, the lookup level of the translation table that gave the fault. If a fault occurs because a stage of address translation is disabled, or because the input address is outside the range specified by the appropriate base address register or registers, the fault is reported as a fault at level 1.
- For an Access flag fault, the lookup level of the translation table that gave the fault.
- For a Permission fault, including a Permission fault caused by hierarchical permissions, the lookup level of the final level of translation table accessed for the translation. That is, the lookup level of the translation table that returned a Block or Page descriptor.

Accessing the IFSR32_EL2

This register can be read using MRS with the following syntax:

MRS <Xt>, <systemreg>

This register can be written using MSR (register) with the following syntax:

MSR <systemreg>, <Xt>

This syntax is encoded with the following settings in the instruction encoding:

<systemreg>	op0	op1	CRn	CRm	op2
IFSR32_EL2	11	100	0101	0000	001

Accessibility

The register is accessible in software as follows:

Control			Accessibility			
E2H	TGE	NS	EL0	EL1	EL2	EL3
x	x	0	-	-	n/a	RW
x	0	1	-	-	RW	RW
x	1	1	-	n/a	RW	RW

D7.2.64 ISR_EL1, Interrupt Status Register

The ISR_EL1 characteristics are:

Purpose

Shows whether any IRQ, FIQ, or SError interrupt is pending. In an implementation that includes EL2, when the register is accessed from Non-secure EL1, a pending interrupt or external abort might be physical or virtual, and the architecture does not provide any mechanism that software executing at Non-secure EL1 can use to determine whether a pending interrupt or external abort is physical or virtual. For all other accesses, any indicated interrupt or external abort must be physical.

Configurations

AArch64 System register ISR_EL1 is architecturally mapped to AArch32 System register [ISR](#).

Attributes

ISR_EL1 is a 32-bit register.

Field descriptions

The ISR_EL1 bit assignments are:

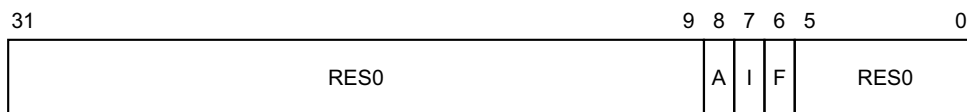

Bits [31:9]

Reserved, RES0.

A, bit [8]

SError interrupt pending bit:

0 No pending SError.

1 An SError interrupt is pending.

I, bit [7]

IRQ pending bit. Indicates whether an IRQ interrupt is pending:

0 No pending IRQ.

1 An IRQ interrupt is pending.

F, bit [6]

FIQ pending bit. Indicates whether an FIQ interrupt is pending.

0 No pending FIQ.

1 An FIQ interrupt is pending.

Bits [5:0]

Reserved, RES0.

Accessing the ISR_EL1

This register can be read using MRS with the following syntax:

```
MRS <Xt>, <systemreg>
```

This syntax is encoded with the following settings in the instruction encoding:

<systemreg>	op0	op1	CRn	CRm	op2
ISR_EL1	11	000	1100	0001	000

Accessibility

The register is accessible in software as follows:

Control			Accessibility			
E2H	TGE	NS	EL0	EL1	EL2	EL3
x	x	0	-	RO	n/a	RO
x	0	1	-	RO	RO	RO
x	1	1	-	n/a	RO	RO

D7.2.65 LORC_EL1, LORegion Control (EL1)

The LORC_EL1 characteristics are:

Purpose

Enables and disables LORegions, and selects the current LORegion descriptor.

Configurations

If no LORegion descriptors are supported by the PE, then this register is RES0.

RW fields in this register reset to architecturally UNKNOWN values.

This register is introduced in ARMv8.1.

Attributes

LORC_EL1 is a 64-bit register.

Field descriptions

The LORC_EL1 bit assignments are:

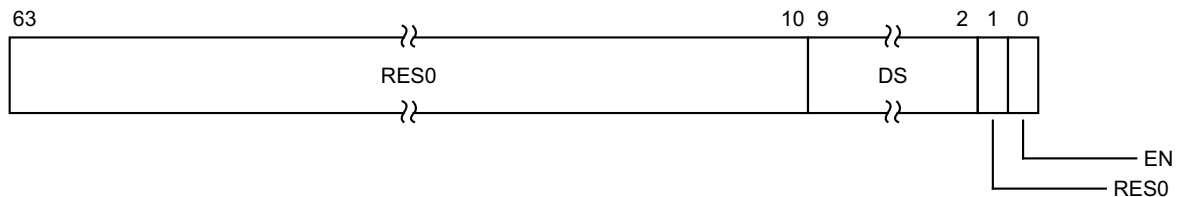

Bits [63:10]

Reserved, RES0.

DS, bits [9:2]

Descriptor Select. Selects the current LORegion descriptor accessed by [LORSA_EL1](#), [LOREA_EL1](#), and [LORN_EL1](#).

The number of LORegion descriptors in IMPLEMENTATION DEFINED. The maximum number of LORegion descriptors supported is 256. If the number is less than 256, then bits[63:M+2] are RES0, where M is $\text{Log}_2(\text{Number of LORegion descriptors supported by the implementation})$.

If this field points to an LORegion descriptor that is not supported by an implementation, then the registers [LORN_EL1](#), [LOREA_EL1](#), and [LORSA_EL1](#) are RES0.

Bit [1]

Reserved, RES0.

EN, bit [0]

Enable. Indicates whether LORegions are enabled:

0 Disabled. Memory accesses do not match any LORegions.

1 Enabled. Memory accesses may match a LORegion.

This bit is permitted to be cached in a TLB.

Accessing the LORC_EL1

This register can be read using MRS with the following syntax:

```
MRS <Xt>, <systemreg>
```

This register can be written using MSR (register) with the following syntax:

MSR <systemreg>, <Xt>

This syntax is encoded with the following settings in the instruction encoding:

<systemreg>	op0	op1	CRn	CRm	op2
LORC_EL1	11	000	1010	0100	011

Accessibility

The register is accessible in software as follows:

Control			Accessibility			
E2H	TGE	NS	EL0	EL1	EL2	EL3
x	x	0	-	-	n/a	-
x	0	1	-	RW	RW	RW
x	1	1	-	n/a	RW	RW

Traps and Enables

For a description of the prioritization of any generated exceptions, see [Synchronous exception prioritization for exceptions taken to AArch64 on page D1-1827](#). Subject to the prioritization rules:

- When EL2 is implemented and is using AArch64 and (SCR_EL3.NS == 1) && (HCR_EL2.E2H == 0):
 - If HCR_EL2.TLOR==1, Non-secure accesses to this register from EL1 are trapped to EL2.
- When EL2 is implemented and is using AArch64 and (SCR_EL3.NS == 1) && (HCR_EL2.E2H == 1) && (HCR_EL2.TGE == 0):
 - If HCR_EL2.TLOR==1, Non-secure accesses to this register from EL1 are trapped to EL2.
- When EL3 is implemented and is using AArch64 and SCR_EL3.NS == 1:
 - If SCR_EL3.TLOR==1, Non-secure accesses to this register from EL1 and EL2 are trapped to EL3.

D7.2.66 LOREA_EL1, LORegion End Address (EL1)

The LOREA_EL1 characteristics are:

Purpose

Holds the physical address of the end of the LORegion described in the current LORegion descriptor selected by [LORC_EL1.DS](#).

Configurations

This register is RES0 if any of the following apply:

- No LORegion descriptors are supported by the PE.
- [LORC_EL1.DS](#) points to a LORegion that is not supported by the PE.

RW fields in this register reset to architecturally UNKNOWN values.

This register is introduced in ARMv8.1.

Attributes

LOREA_EL1 is a 64-bit register.

Field descriptions

The LOREA_EL1 bit assignments are:

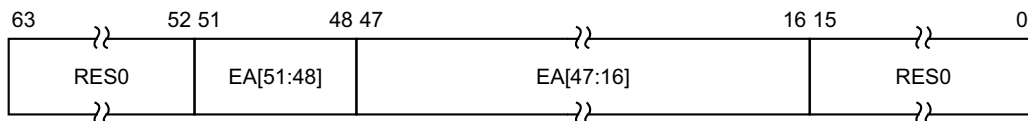

Any of the fields in this register are permitted to be cached in a TLB.

Bits [63:52]

Reserved, RES0.

EA[51:48], bits [51:48]

In ARMv8.2

Extension to EA[47:16]. See EA[47:16] for more details.

In ARMv8.1.

Reserved, RES0.

EA[47:16], bits [47:16]

Bits [47:16] of the end physical address of an LORegion described in the current LORegion descriptor selected by [LORC_EL1.DS](#). Bits[15:0] of this address are defined to be 0xFFFF.

When [ARMv8.2-LPA](#) is implemented, and 52-bit addresses and a 64KB translation granule are in use, EA[51:48] form the upper part of the address value. Otherwise, for implementations with fewer than 52 physical address bits, EA[51:48] are RES0.

Bits [15:0]

Reserved, RES0.

Accessing the LOREA_EL1

This register can be read using MRS with the following syntax:

```
MRS <Xt>, <systemreg>
```

This register can be written using MSR (register) with the following syntax:

MSR <systemreg>, <Xt>

This syntax is encoded with the following settings in the instruction encoding:

<systemreg>	op0	op1	CRn	CRm	op2
LOREA_EL1	11	000	1010	0100	001

Accessibility

The register is accessible in software as follows:

Control			Accessibility			
E2H	TGE	NS	EL0	EL1	EL2	EL3
x	x	0	-	-	n/a	-
x	0	1	-	RW	RW	RW
x	1	1	-	n/a	RW	RW

Traps and Enables

For a description of the prioritization of any generated exceptions, see [Synchronous exception prioritization for exceptions taken to AArch64 on page D1-1827](#). Subject to the prioritization rules:

- When EL2 is implemented and is using AArch64 and (SCR_EL3.NS == 1) && (HCR_EL2.E2H == 0):
 - If HCR_EL2.TLOR==1, Non-secure accesses to this register from EL1 are trapped to EL2.
- When EL2 is implemented and is using AArch64 and (SCR_EL3.NS == 1) && (HCR_EL2.E2H == 1) && (HCR_EL2.TGE == 0):
 - If HCR_EL2.TLOR==1, Non-secure accesses to this register from EL1 are trapped to EL2.
- When EL3 is implemented and is using AArch64 and SCR_EL3.NS == 1:
 - If SCR_EL3.TLOR==1, Non-secure accesses to this register from EL1 and EL2 are trapped to EL3.

D7.2.67 LORID_EL1, LORegionID (EL1)

The LORID_EL1 characteristics are:

Purpose

Indicates the number of LORegions and LORegion descriptors supported by the PE.

Configurations

If no LORegion descriptors are implemented, then the registers [LORC_EL1](#), [LORN_EL1](#), [LOREA_EL1](#), and [LORSA_EL1](#) are RES0.

RW fields in this register reset to architecturally UNKNOWN values.

This register is introduced in ARMv8.1.

Attributes

LORID_EL1 is a 64-bit register.

Field descriptions

The LORID_EL1 bit assignments are:

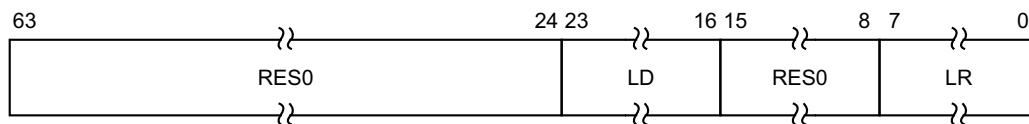

Bits [63:24]

Reserved, RES0.

LD, bits [23:16]

Number of LORegion descriptors supported by the PE. This is an 8-bit binary number.

Bits [15:8]

Reserved, RES0.

LR, bits [7:0]

Number of LORegions supported by the PE. This is an 8-bit binary number.

———— Note ————

If LORID_EL1 indicates that no LORegions are implemented, then LoadLOAcquire and StoreLORelease will behave as LoadAcquire and StoreRelease.

Accessing the LORID_EL1

This register can be read using MRS with the following syntax:

MRS <Xt>, <systemreg>

This syntax is encoded with the following settings in the instruction encoding:

<systemreg>	op0	op1	CRn	CRm	op2
LORID_EL1	11	000	1010	0100	111

Accessibility

The register is accessible in software as follows:

Control			Accessibility			
E2H	TGE	NS	EL0	EL1	EL2	EL3
x	x	0	-	RO	n/a	RO
x	0	1	-	RO	RO	RO
x	1	1	-	n/a	RO	RO

Traps and Enables

For a description of the prioritization of any generated exceptions, see [Synchronous exception prioritization for exceptions taken to AArch64 on page D1-1827](#). Subject to the prioritization rules:

- When EL2 is implemented and is using AArch64 and (SCR_EL3.NS == 1) && (HCR_EL2.E2H == 0):
 - If [HCR_EL2.TLOR](#)==1, Non-secure accesses to this register from EL1 are trapped to EL2.
- When EL2 is implemented and is using AArch64 and (SCR_EL3.NS == 1) && (HCR_EL2.E2H == 1) && (HCR_EL2.TGE == 0):
 - If [HCR_EL2.TLOR](#)==1, Non-secure accesses to this register from EL1 are trapped to EL2.
- When EL3 is implemented and is using AArch64:
 - If [SCR_EL3.TLOR](#)==1, accesses to this register from EL1 and EL2 are trapped to EL3.

D7.2.68 LORN_EL1, LORegion Number (EL1)

The LORN_EL1 characteristics are:

Purpose

Holds the number of the LORegion described in the current LORegion descriptor selected by [LORC_EL1.DS](#).

Configurations

This register is RES0 if any of the following apply:

- No LORegion descriptors are supported by the PE.
- [LORC_EL1.DS](#) points to a LORegion that is not supported by the PE.

RW fields in this register reset to architecturally UNKNOWN values.

This register is introduced in ARMv8.1.

Attributes

LORN_EL1 is a 64-bit register.

Field descriptions

The LORN_EL1 bit assignments are:

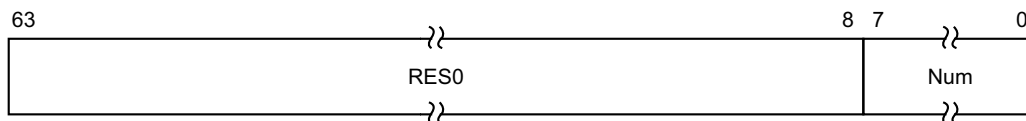

Any of the fields in this register are permitted to be cached in a TLB.

Bits [63:8]

Reserved, RES0.

Num, bits [7:0]

Number of the LORegion described in the current LORegion descriptor selected by [LORC_EL1.DS](#).

The maximum number of LORegions supported by the PE is 256. If the maximum number is less than 256, then bits[8:N] are RES0, where N is (Log₂(Number of LORegions supported by the PE)).

If this field points to a LORegion that is not supported by the PE, then the current LORegion descriptor does not match any LORegion.

Accessing the LORN_EL1

This register can be read using MRS with the following syntax:

```
MRS <Xt>, <systemreg>
```

This register can be written using MSR (register) with the following syntax:

```
MSR <systemreg>, <Xt>
```

This syntax is encoded with the following settings in the instruction encoding:

<systemreg>	op0	op1	CRn	CRm	op2
LORN_EL1	11	000	1010	0100	010

Accessibility

The register is accessible in software as follows:

Control			Accessibility			
E2H	TGE	NS	EL0	EL1	EL2	EL3
x	x	0	-	-	n/a	-
x	0	1	-	RW	RW	RW
x	1	1	-	n/a	RW	RW

Traps and Enables

For a description of the prioritization of any generated exceptions, see [Synchronous exception prioritization for exceptions taken to AArch64 on page D1-1827](#). Subject to the prioritization rules:

- When EL2 is implemented and is using AArch64 and (SCR_EL3.NS == 1) && (HCR_EL2.E2H == 0):
 - If HCR_EL2.TLOR==1, Non-secure accesses to this register from EL1 are trapped to EL2.
- When EL2 is implemented and is using AArch64 and (SCR_EL3.NS == 1) && (HCR_EL2.E2H == 1) && (HCR_EL2.TGE == 0):
 - If HCR_EL2.TLOR==1, Non-secure accesses to this register from EL1 are trapped to EL2.
- When EL3 is implemented and is using AArch64 and SCR_EL3.NS == 1:
 - If SCR_EL3.TLOR==1, Non-secure accesses to this register from EL1 and EL2 are trapped to EL3.

D7.2.69 LORSA_EL1, LORegion Start Address (EL1)

The LORSA_EL1 characteristics are:

Purpose

Indicates whether the current LORegion descriptor selected by `LORC_EL1.DS` is enabled, and holds the physical address of the start of the LORegion.

Configurations

This register is RES0 if any of the following apply:

- No LORegion descriptors are supported by the PE.
- `LORC_EL1.DS` points to a LORegion that is not supported by the PE.

RW fields in this register reset to architecturally UNKNOWN values.

This register is introduced in ARMv8.1.

Attributes

LORSA_EL1 is a 64-bit register.

Field descriptions

The LORSA_EL1 bit assignments are:

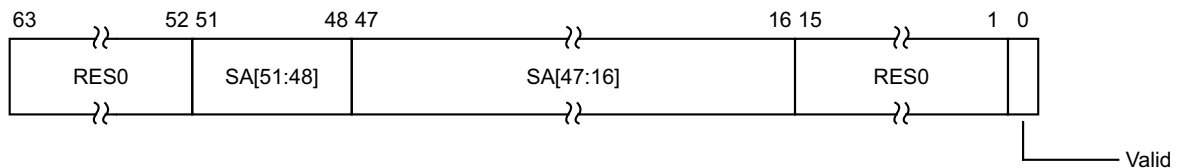

Any of the fields in this register are permitted to be cached in a TLB.

Bits [63:52]

Reserved, RES0.

SA[51:48], bits [51:48]

In ARMv8.2

Extension to SA[47:16]. See SA[47:16] for more details.

In ARMv8.1.

Reserved, RES0.

SA[47:16], bits [47:16]

Bits [47:16] of the start physical address of the LORegion described in the current LORegion descriptor selected by `LORC_EL1.DS`. Bits[15:0] of this address are defined to be `0x0000`.

When `ARMv8.2-LPA` is implemented, and 52-bit addresses and a 64KB translation granule are in use, SA[51:48] form the upper part of the address value. Otherwise, for implementations with fewer than 52 physical address bits, SA[51:48] are RES0.

Bits [15:1]

Reserved, RES0.

Valid, bit [0]

Indicates whether the current LORegion Descriptor is enabled.

0	Disabled
1	Enabled

Accessing the LORSA_EL1

This register can be read using MRS with the following syntax:

MRS <Xt>, <systemreg>

This register can be written using MSR (register) with the following syntax:

MSR <systemreg>, <Xt>

This syntax is encoded with the following settings in the instruction encoding:

<systemreg>	op0	op1	CRn	CRm	op2
LORSA_EL1	11	000	1010	0100	000

Accessibility

The register is accessible in software as follows:

Control			Accessibility			
E2H	TGE	NS	EL0	EL1	EL2	EL3
x	x	0	-	-	n/a	-
x	0	1	-	RW	RW	RW
x	1	1	-	n/a	RW	RW

Traps and Enables

For a description of the prioritization of any generated exceptions, see [Synchronous exception prioritization for exceptions taken to AArch64 on page D1-1827](#). Subject to the prioritization rules:

- When EL2 is implemented and is using AArch64 and (SCR_EL3.NS == 1) && (HCR_EL2.E2H == 0):
 - If HCR_EL2.TLOR==1, Non-secure accesses to this register from EL1 are trapped to EL2.
- When EL2 is implemented and is using AArch64 and (SCR_EL3.NS == 1) && (HCR_EL2.E2H == 1) && (HCR_EL2.TGE == 0):
 - If HCR_EL2.TLOR==1, Non-secure accesses to this register from EL1 are trapped to EL2.
- When EL3 is implemented and is using AArch64 and SCR_EL3.NS == 1:
 - If SCR_EL3.TLOR==1, Non-secure accesses to this register from EL1 and EL2 are trapped to EL3.

D7.2.70 MAIR_EL1, Memory Attribute Indirection Register (EL1)

The MAIR_EL1 characteristics are:

Purpose

Provides the memory attribute encodings corresponding to the possible AttrIdx values in a Long-descriptor format translation table entry for stage 1 translations at EL1.

Configurations

AArch64 System register MAIR_EL1[31:0] is architecturally mapped to AArch32 System register [PRRR](#) when TTBCR.EAE==0.

AArch64 System register MAIR_EL1[31:0] is architecturally mapped to AArch32 System register [MAIRO](#) when TTBCR.EAE==1.

AArch64 System register MAIR_EL1[63:32] is architecturally mapped to AArch32 System register [NMRR](#) when TTBCR.EAE==0.

AArch64 System register MAIR_EL1[63:32] is architecturally mapped to AArch32 System register [MAIR1](#) when TTBCR.EAE==1.

RW fields in this register reset to architecturally UNKNOWN values.

Attributes

MAIR_EL1 is a 64-bit register.

Field descriptions

The MAIR_EL1 bit assignments are:

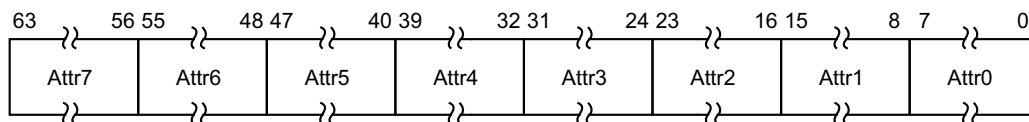

MAIR_EL1 is permitted to be cached in a TLB.

Attr<n>, bits [8n+7:8n], for n = 0 to 7

The memory attribute encoding for an AttrIdx[2:0] entry in a Long descriptor format translation table entry, where AttrIdx[2:0] gives the value of <n> in Attr<n>.

Bits [7:4] are encoded as follows:

Attr<n>[7:4]	Meaning
0000	Device memory. See encoding of Attr<n>[3:0] for the type of Device memory.
00RW, RW not 00	Normal memory, Outer Write-Through Transient
0100	Normal memory, Outer Non-cacheable
01RW, RW not 00	Normal memory, Outer Write-Back Transient
10RW	Normal memory, Outer Write-Through Non-transient
11RW	Normal memory, Outer Write-Back Non-transient

R = Outer Read-Allocate policy, W = Outer Write-Allocate policy.

The meaning of bits [3:0] depends on the value of bits [7:4]:

Attr<n>[3:0]	Meaning when Attr<n>[7:4] is 0000	Meaning when Attr<n>[7:4] is not 0000
0000	Device-nGnRnE memory	UNPREDICTABLE
00RW, RW not 00	UNPREDICTABLE	Normal memory, Inner Write-Through Transient
0100	Device-nGnRE memory	Normal memory, Inner Non-cacheable
01RW, RW not 00	UNPREDICTABLE	Normal memory, Inner Write-Back Transient
1000	Device-nGRE memory	Normal memory, Inner Write-Through Non-transient (RW=00)
10RW, RW not 00	UNPREDICTABLE	Normal memory, Inner Write-Through Non-transient
1100	Device-GRE memory	Normal memory, Inner Write-Back Non-transient (RW=00)
11RW, RW not 00	UNPREDICTABLE	Normal memory, Inner Write-Back Non-transient

R = Inner Read-Allocate policy, W = Inner Write-Allocate policy.

The R and W bits in some Attr<n> fields have the following meanings:

R or W	Meaning
0	No Allocate
1	Allocate

Accessing the MAIR_EL1

This register can be read using MRS with the following syntax:

MRS <Xt>, <systemreg>

This register can be written using MSR (register) with the following syntax:

MSR <systemreg>, <Xt>

This syntax is encoded with the following settings in the instruction encoding:

<systemreg>	op0	op1	CRn	CRm	op2
MAIR_EL1	11	000	1010	0010	000
MAIR_EL12	11	101	1010	0010	000

Accessibility

The register is accessible in software as follows:

<systemreg>	Control			Accessibility			
	E2H	TGE	NS	EL0	EL1	EL2	EL3
MAIR_EL1	x	x	0	-	RW	n/a	RW
MAIR_EL1	0	0	1	-	RW	RW	RW
MAIR_EL1	0	1	1	-	n/a	RW	RW

<systemreg>	Control			Accessibility			
	E2H	TGE	NS	EL0	EL1	EL2	EL3
MAIR_EL1	1	0	1	-	RW	MAIR_EL2	RW
MAIR_EL1	1	1	1	-	n/a	MAIR_EL2	RW
MAIR_EL12	x	x	0	-	-	n/a	-
MAIR_EL12	0	0	1	-	-	-	-
MAIR_EL12	0	1	1	-	n/a	-	-
MAIR_EL12	1	0	1	-	-	RW	RW
MAIR_EL12	1	1	1	-	n/a	RW	RW

This table applies to all instructions that can access this register.

When [HCR_EL2.E2H](#) is 1, without explicit synchronization, access from EL3 using the mnemonic MAIR_EL1 or MAIR_EL12 are not guaranteed to be ordered with respect to accesses using the other mnemonic.

Traps and Enables

For a description of the prioritization of any generated exceptions, see [Synchronous exception prioritization for exceptions taken to AArch64 on page D1-1827](#). Subject to the prioritization rules:

- When EL2 is implemented and is using AArch64 and (SCR_EL3.NS == 1) && (HCR_EL2.E2H == 0):
 - If [HCR_EL2.TRVM](#)==1, Non-secure read accesses to this register from EL1 are trapped to EL2.
 - If [HCR_EL2.TVM](#)==1, Non-secure write accesses to this register from EL1 are trapped to EL2.
- When EL2 is implemented and is using AArch64 and (SCR_EL3.NS == 1) && (HCR_EL2.E2H == 1) && (HCR_EL2.TGE == 0):
 - If [HCR_EL2.TRVM](#)==1, Non-secure read accesses to this register from EL1 are trapped to EL2.
 - If [HCR_EL2.TVM](#)==1, Non-secure write accesses to this register from EL1 are trapped to EL2.

D7.2.71 MAIR_EL2, Memory Attribute Indirection Register (EL2)

The MAIR_EL2 characteristics are:

Purpose

Provides the memory attribute encodings corresponding to the possible AttrIdx values in a Long-descriptor format translation table entry for stage 1 translations at EL2.

Configurations

AArch64 System register MAIR_EL2[31:0] is architecturally mapped to AArch32 System register [HMAIR0](#).

AArch64 System register MAIR_EL2[63:32] is architecturally mapped to AArch32 System register [HMAIR1](#).

If EL2 is not implemented, this register is RES0 from EL3.

RW fields in this register reset to architecturally UNKNOWN values.

Attributes

MAIR_EL2 is a 64-bit register.

Field descriptions

The MAIR_EL2 bit assignments are:

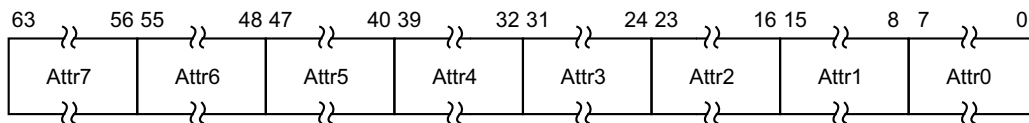

MAIR_EL2 is permitted to be cached in a TLB.

Attr<n>, bits [8n+7:8n], for n = 0 to 7

The memory attribute encoding for an AttrIdx[2:0] entry in a Long descriptor format translation table entry, where AttrIdx[2:0] gives the value of <n> in Attr<n>.

Bits [7:4] are encoded as follows:

Attr<n>[7:4]	Meaning
0000	Device memory. See encoding of Attr<n>[3:0] for the type of Device memory.
00RW, RW not 00	Normal memory, Outer Write-Through Transient
0100	Normal memory, Outer Non-cacheable
01RW, RW not 00	Normal memory, Outer Write-Back Transient
10RW	Normal memory, Outer Write-Through Non-transient
11RW	Normal memory, Outer Write-Back Non-transient

R = Outer Read-Allocate policy, W = Outer Write-Allocate policy.

The meaning of bits [3:0] depends on the value of bits [7:4]:

Attr<n>[3:0]	Meaning when Attr<n>[7:4] is 0000	Meaning when Attr<n>[7:4] is not 0000
0000	Device-nGnRnE memory	UNPREDICTABLE
00RW, RW not 00	UNPREDICTABLE	Normal memory, Inner Write-Through Transient
0100	Device-nGnRE memory	Normal memory, Inner Non-cacheable
01RW, RW not 00	UNPREDICTABLE	Normal memory, Inner Write-Back Transient
1000	Device-nGRE memory	Normal memory, Inner Write-Through Non-transient (RW=00)
10RW, RW not 00	UNPREDICTABLE	Normal memory, Inner Write-Through Non-transient
1100	Device-GRE memory	Normal memory, Inner Write-Back Non-transient (RW=00)
11RW, RW not 00	UNPREDICTABLE	Normal memory, Inner Write-Back Non-transient

R = Inner Read-Allocate policy, W = Inner Write-Allocate policy.

The R and W bits in some Attr<n> fields have the following meanings:

R or W	Meaning
0	No Allocate
1	Allocate

Accessing the MAIR_EL2

This register can be read using MRS with the following syntax:

MRS <Xt>, <systemreg>

This register can be written using MSR (register) with the following syntax:

MSR <systemreg>, <Xt>

This syntax is encoded with the following settings in the instruction encoding:

<systemreg>	op0	op1	CRn	CRm	op2
MAIR_EL2	11	100	1010	0010	000
MAIR_EL1	11	000	1010	0010	000

Accessibility

The register is accessible in software as follows:

<systemreg>	Control			Accessibility			
	E2H	TGE	NS	EL0	EL1	EL2	EL3
MAIR_EL2	x	x	0	-	-	n/a	RW
MAIR_EL2	0	0	1	-	-	RW	RW
MAIR_EL2	0	1	1	-	n/a	RW	RW

<systemreg>	Control			Accessibility			
	E2H	TGE	NS	EL0	EL1	EL2	EL3
MAIR_EL2	1	0	1	-	-	RW	RW
MAIR_EL2	1	1	1	-	n/a	RW	RW
MAIR_EL1	x	x	0	-	MAIR_EL1	n/a	MAIR_EL1
MAIR_EL1	0	0	1	-	MAIR_EL1	MAIR_EL1	MAIR_EL1
MAIR_EL1	0	1	1	-	n/a	MAIR_EL1	MAIR_EL1
MAIR_EL1	1	0	1	-	MAIR_EL1	RW	MAIR_EL1
MAIR_EL1	1	1	1	-	n/a	RW	MAIR_EL1

This table applies to all instructions that can access this register.

When [HCR_EL2.E2H](#) is 1, without explicit synchronization, access from EL2 using the mnemonic MAIR_EL2 or MAIR_EL1 are not guaranteed to be ordered with respect to accesses using the other mnemonic.

D7.2.72 MAIR_EL3, Memory Attribute Indirection Register (EL3)

The MAIR_EL3 characteristics are:

Purpose

Provides the memory attribute encodings corresponding to the possible AttrIdx values in a Long-descriptor format translation table entry for stage 1 translations at EL3.

Configurations

RW fields in this register reset to architecturally UNKNOWN values.

Attributes

MAIR_EL3 is a 64-bit register.

Field descriptions

The MAIR_EL3 bit assignments are:

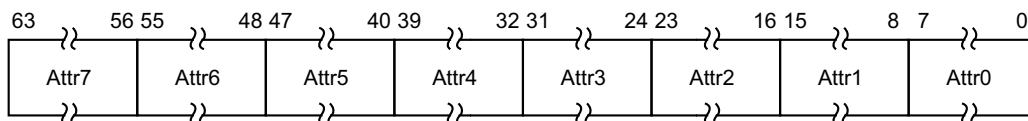

MAIR_EL3 is permitted to be cached in a TLB.

Attr<n>, bits [8n+7:8n], for n = 0 to 7

The memory attribute encoding for an AttrIdx[2:0] entry in a Long descriptor format translation table entry, where AttrIdx[2:0] gives the value of <n> in Attr<n>.

Bits [7:4] are encoded as follows:

Attr<n>[7:4]	Meaning
0000	Device memory. See encoding of Attr<n>[3:0] for the type of Device memory.
00RW, RW not 00	Normal memory, Outer Write-Through Transient
0100	Normal memory, Outer Non-cacheable
01RW, RW not 00	Normal memory, Outer Write-Back Transient
10RW	Normal memory, Outer Write-Through Non-transient
11RW	Normal memory, Outer Write-Back Non-transient

R = Outer Read-Allocate policy, W = Outer Write-Allocate policy.

The meaning of bits [3:0] depends on the value of bits [7:4]:

Attr<n>[3:0]	Meaning when Attr<n>[7:4] is 0000	Meaning when Attr<n>[7:4] is not 0000
0000	Device-nGnRnE memory	UNPREDICTABLE
00RW, RW not 00	UNPREDICTABLE	Normal memory, Inner Write-Through Transient
0100	Device-nGnRE memory	Normal memory, Inner Non-cacheable
01RW, RW not 00	UNPREDICTABLE	Normal memory, Inner Write-Back Transient
1000	Device-nGRE memory	Normal memory, Inner Write-Through Non-transient (RW=00)

Attr<n>[3:0]	Meaning when Attr<n>[7:4] is 0000	Meaning when Attr<n>[7:4] is not 0000
10RW, RW not 00	UNPREDICTABLE	Normal memory, Inner Write-Through Non-transient
1100	Device-GRE memory	Normal memory, Inner Write-Back Non-transient (RW=00)
11RW, RW not 00	UNPREDICTABLE	Normal memory, Inner Write-Back Non-transient

R = Inner Read-Allocate policy, W = Inner Write-Allocate policy.

The R and W bits in some Attr<n> fields have the following meanings:

R or W	Meaning
0	No Allocate
1	Allocate

Accessing the MAIR_EL3

This register can be read using MRS with the following syntax:

MRS <Xt>, <systemreg>

This register can be written using MSR (register) with the following syntax:

MSR <systemreg>, <Xt>

This syntax is encoded with the following settings in the instruction encoding:

<systemreg>	op0	op1	CRn	CRm	op2
MAIR_EL3	11	110	1010	0010	000

Accessibility

The register is accessible in software as follows:

Control			Accessibility			
E2H	TGE	NS	EL0	EL1	EL2	EL3
x	x	0	-	-	n/a	RW
x	0	1	-	-	-	RW
x	1	1	-	n/a	-	RW

D7.2.73 MIDR_EL1, Main ID Register

The MIDR_EL1 characteristics are:

Purpose

Provides identification information for the PE, including an implementer code for the device and a device ID number.

Configurations

AArch64 System register MIDR_EL1 is architecturally mapped to AArch32 System register [MIDR](#).

AArch64 System register MIDR_EL1 is architecturally mapped to External register [MIDR_EL1](#).

Attributes

MIDR_EL1 is a 32-bit register.

Field descriptions

The MIDR_EL1 bit assignments are:

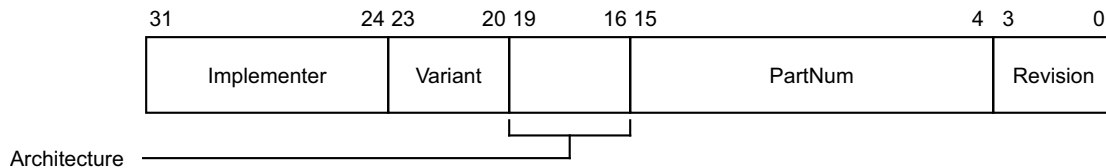

Implementer, bits [31:24]

The Implementer code. This field must hold an implementer code that has been assigned by ARM. Assigned codes include the following:

Hex representation	ASCII representation	Implementer
0x41	A	ARM Limited
0x42	B	Broadcom Corporation
0x43	C	Cavium Inc.
0x44	D	Digital Equipment Corporation
0x49	I	Infineon Technologies AG
0x4D	M	Motorola or Freescale Semiconductor Inc.
0x4E	N	NVIDIA Corporation
0x50	P	Applied Micro Circuits Corporation
0x51	Q	Qualcomm Inc.
0x56	V	Marvell International Ltd.
0x69	i	Intel Corporation

ARM can assign codes that are not published in this manual. All values not assigned by ARM are reserved and must not be used.

Variant, bits [23:20]

An IMPLEMENTATION DEFINED variant number. Typically, this field is used to distinguish between different product variants, or major revisions of a product.

Architecture, bits [19:16]

The permitted values of this field are:

- 0001 ARMv4
- 0010 ARMv4T
- 0011 ARMv5 (obsolete)
- 0100 ARMv5T
- 0101 ARMv5TE
- 0110 ARMv5TEJ
- 0111 ARMv6
- 1111 Architectural features are individually identified in the ID_* registers, see *Identification registers, functional group on page G4-4727*.

All other values are reserved.

PartNum, bits [15:4]

An IMPLEMENTATION DEFINED primary part number for the device.

On processors implemented by ARM, if the top four bits of the primary part number are 0x0 or 0x7, the variant and architecture are encoded differently.

Revision, bits [3:0]

An IMPLEMENTATION DEFINED revision number for the device.

Accessing the MIDR_EL1

This register can be read using MRS with the following syntax:

MRS <Xt>, <systemreg>

This syntax is encoded with the following settings in the instruction encoding:

<systemreg>	op0	op1	CRn	CRm	op2
MIDR_EL1	11	000	0000	0000	000

Accessibility

The register is accessible in software as follows:

Control			Accessibility			
E2H	TGE	NS	EL0	EL1	EL2	EL3
x	x	0	-	RO	n/a	RO
x	0	1	-	RO	RO	RO
x	1	1	-	n/a	RO	RO

D7.2.74 MPIDR_EL1, Multiprocessor Affinity Register

The MPIDR_EL1 characteristics are:

Purpose

In a multiprocessor system, provides an additional PE identification mechanism for scheduling purposes.

Configurations

AArch64 System register MPIDR_EL1 is architecturally mapped to AArch32 System register [MPIDR](#).

The assigned value of the [MPIDR](#). {Aff2, Aff1, Aff0} or MPIDR_EL1. {Aff3, Aff2, Aff1, Aff0} set of fields of each PE must be unique within the system as a whole.

In a uniprocessor system ARM recommends that each Aff<n> field of this register returns a value of 0.

Attributes

MPIDR_EL1 is a 64-bit register.

Field descriptions

The MPIDR_EL1 bit assignments are:

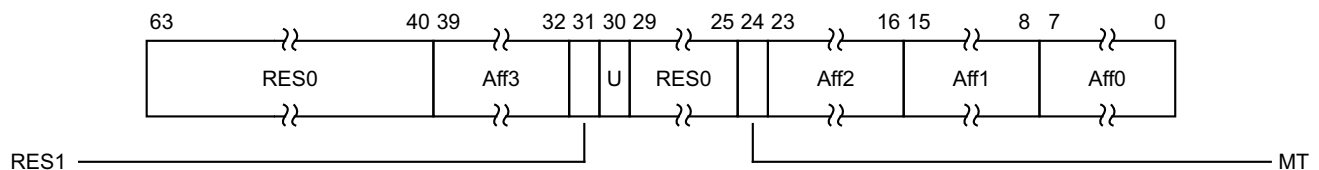

Bits [63:40]

Reserved, RES0.

Aff3, bits [39:32]

Affinity level 3. Highest level affinity field.

Bit [31]

Reserved, RES1.

U, bit [30]

Indicates a Uniprocessor system, as distinct from PE 0 in a multiprocessor system. The possible values of this bit are:

- 0 Processor is part of a multiprocessor system.
- 1 Processor is part of a uniprocessor system.

Bits [29:25]

Reserved, RES0.

MT, bit [24]

Indicates whether the lowest level of affinity consists of logical PEs that are implemented using a multithreading type approach. The possible values of this bit are:

- 0 Performance of PEs at the lowest affinity level is largely independent.
- 1 Performance of PEs at the lowest affinity level is very interdependent.

Aff2, bits [23:16]

Affinity level 2. Second highest level affinity field.

Aff1, bits [15:8]

Affinity level 1. Third highest level affinity field.

Aff0, bits [7:0]

Affinity level 0. Lowest level affinity field.

Accessing the MPIDR_EL1

This register can be read using MRS with the following syntax:

MRS <Xt>, <systemreg>

This syntax is encoded with the following settings in the instruction encoding:

<systemreg>	op0	op1	CRn	CRm	op2
MPIDR_EL1	11	000	0000	0000	101

Accessibility

The register is accessible in software as follows:

Control			Accessibility			
E2H	TGE	NS	EL0	EL1	EL2	EL3
x	x	0	-	RO	n/a	RO
x	0	1	-	RO	RO	RO
x	1	1	-	n/a	RO	RO

D7.2.75 MVFR0_EL1, AArch32 Media and VFP Feature Register 0

The MVFR0_EL1 characteristics are:

Purpose

Describes the features provided by the AArch32 Advanced SIMD and Floating-point implementation.

Must be interpreted with [MVFR1_EL1](#) and [MVFR2_EL1](#).

For general information about the interpretation of the ID registers see [Principles of the ID scheme for fields in ID registers on page D7-2195](#).

Configurations

AArch64 System register MVFR0_EL1 is architecturally mapped to AArch32 System register [MVFR0](#).

In an implementation where at least one Exception level supports execution in AArch32 state, but there is no support for Advanced SIMD and floating-point operation, this register is RAZ.

In an AArch64-only implementation, this register is UNKNOWN.

Attributes

MVFR0_EL1 is a 32-bit register.

Field descriptions

The MVFR0_EL1 bit assignments are:

31	28 27	24 23	20 19	16 15	12 11	8 7	4 3	0
FPRound	FPShVec	FPSqrt	FPDivide	FPTrap	FPDP	FPSP	SIMDReg	

FPRound, bits [31:28]

Floating-Point Rounding modes. Indicates whether the floating-point implementation provides support for rounding modes. Defined values are:

0000 Not implemented, or only Round to Nearest mode supported, except that Round towards Zero mode is supported for VCVT instructions that always use that rounding mode regardless of the [FPSCR](#) setting.

0001 All rounding modes supported.

All other values are reserved.

In ARMv8-A the permitted values are 0000 and 0001.

FPShVec, bits [27:24]

Short Vectors. Indicates whether the floating-point implementation provides support for the use of short vectors. Defined values are:

0000 Short vectors not supported.

0001 Short vector operation supported.

All other values are reserved.

In ARMv8-A the only permitted value is 0000.

FPSqrt, bits [23:20]

Square Root. Indicates whether the floating-point implementation provides support for the ARMv6 VFP square root operations. Defined values are:

0000 Not supported in hardware.

0001 Supported.

All other values are reserved.

In ARMv8-A the permitted values are 0000 and 0001.

The VSQRT.F32 instruction also requires the single-precision floating-point attribute, bits [7:4], and the VSQRT.F64 instruction also requires the double-precision floating-point attribute, bits [11:8].

FPDivide, bits [19:16]

Indicates whether the floating-point implementation provides support for VFP divide operations. Defined values are:

0000 Not supported in hardware.

0001 Supported.

All other values are reserved.

In ARMv8-A the permitted values are 0000 and 0001.

The VDIV.F32 instruction also requires the single-precision floating-point attribute, bits [7:4], and the VDIV.F64 instruction also requires the double-precision floating-point attribute, bits [11:8].

FPTrap, bits [15:12]

Floating Point Exception Trapping. Indicates whether the floating-point implementation provides support for exception trapping. Defined values are:

0000 Not supported.

0001 Supported.

All other values are reserved.

A value of 0001 indicates that, when the corresponding trap is enabled, a floating-point exception generates an exception.

FPDP, bits [11:8]

Double Precision. Indicates whether the floating-point implementation provides support for double-precision operations. Defined values are:

0000 Not supported in hardware.

0001 Supported, VFPv2.

0010 Supported, VFPv3, VFPv4, or ARMv8. VFPv3 and ARMv8 add an instruction to load a double-precision floating-point constant, and conversions between double-precision and fixed-point values.

All other values are reserved.

In ARMv8-A the permitted values are 0000 and 0010.

A value of 0b0001 or 0b0010 indicates support for all VFP double-precision instructions in the supported version of VFP, except that, in addition to this field being nonzero:

- VSQRT.F64 is only available if the Square root field is 0001.
- VDIV.F64 is only available if the Divide field is 0001.
- Conversion between double-precision and single-precision is only available if the single-precision field is nonzero.

FPSP, bits [7:4]

Single Precision. Indicates whether the floating-point implementation provides support for single-precision operations. Defined values are:

0000 Not supported in hardware.

0001 Supported, VFPv2.

0010 Supported, VFPv3 or VFPv4. VFPv3 adds an instruction to load a single-precision floating-point constant, and conversions between single-precision and fixed-point values.

All other values are reserved.

In ARMv8-A the permitted values are 0000 and 0010.

A value of 0b0001 or 0b0010 indicates support for all VFP single-precision instructions in the supported version of VFP, except that, in addition to this field being nonzero:

- VSQRT.F32 is only available if the Square root field is 0001.
- VDIV.F32 is only available if the Divide field is 0001.
- Conversion between double-precision and single-precision is only available if the double-precision field is nonzero.

SIMDReg, bits [3:0]

Advanced SIMD registers. Indicates whether the Advanced SIMD and floating-point implementation provides support for the Advanced SIMD and floating-point register bank. Defined values are:

- 0000 The implementation has no Advanced SIMD and floating-point support.
- 0001 The implementation includes floating-point support with 16 x 64-bit registers.
- 0010 The implementation includes Advanced SIMD and floating-point support with 32 x 64-bit registers.

All other values are reserved.

In ARMv8-A the permitted values are 0000 and 0010.

Accessing the MVFR0_EL1

This register can be read using MRS with the following syntax:

MRS <Xt>, <systemreg>

This syntax is encoded with the following settings in the instruction encoding:

<systemreg>	op0	op1	CRn	CRm	op2
MVFR0_EL1	11	000	0000	0011	000

Accessibility

The register is accessible in software as follows:

Control			Accessibility			
E2H	TGE	NS	EL0	EL1	EL2	EL3
x	x	0	-	RO	n/a	RO
x	0	1	-	RO	RO	RO
x	1	1	-	n/a	RO	RO

Traps and Enables

For a description of the prioritization of any generated exceptions, see *Synchronous exception prioritization for exceptions taken to AArch64* on page D1-1827. Subject to the prioritization rules:

- When EL2 is implemented and is using AArch64 and $(SCR_EL3.NS == 1) \ \&\& \ (HCR_EL2.E2H == 0)$:
 - If $HCR_EL2.TID3 == 1$, Non-secure read accesses to this register from EL1 are trapped to EL2.
- When EL2 is implemented and is using AArch64 and $(SCR_EL3.NS == 1) \ \&\& \ (HCR_EL2.E2H == 1) \ \&\& \ (HCR_EL2.TGE == 0)$:
 - If $HCR_EL2.TID3 == 1$, Non-secure read accesses to this register from EL1 are trapped to EL2.

D7.2.76 MVFR1_EL1, AArch32 Media and VFP Feature Register 1

The MVFR1_EL1 characteristics are:

Purpose

Describes the features provided by the AArch32 Advanced SIMD and Floating-point implementation.

Must be interpreted with [MVFR0_EL1](#) and [MVFR2_EL1](#).

For general information about the interpretation of the ID registers see *Principles of the ID scheme for fields in ID registers* on page D7-2195.

Configurations

AArch64 System register MVFR1_EL1 is architecturally mapped to AArch32 System register [MVFR1](#).

In an implementation where at least one Exception level supports execution in AArch32 state, but there is no support for Advanced SIMD and floating-point operation, this register is RAZ.

In an AArch64-only implementation, this register is UNKNOWN.

Attributes

MVFR1_EL1 is a 32-bit register.

Field descriptions

The MVFR1_EL1 bit assignments are:

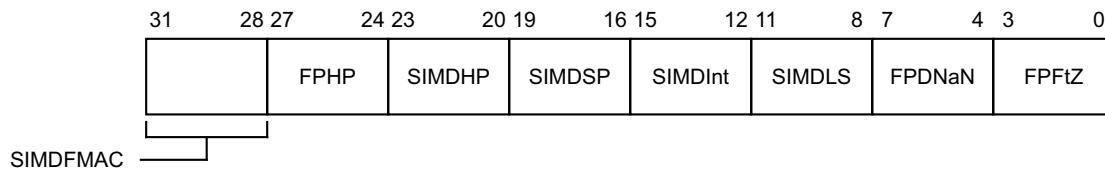

SIMDFMAC, bits [31:28]

Advanced SIMD Fused Multiply-Accumulate. Indicates whether the Advanced SIMD implementation provides fused multiply accumulate instructions. Defined values are:

0000 Not implemented.

0001 Implemented.

All other values are reserved.

In ARMv8-A the permitted values are 0000 and 0001.

The Advanced SIMD and floating-point implementations must provide the same level of support for these instructions.

FPHP, bits [27:24]

Floating Point Half Precision. Indicates the level of half-precision floating-point support. Defined values are:

0000 Not supported.

0001 Floating-point half-precision conversion instructions are supported for conversion between single-precision and half-precision.

0010 Floating-point half-precision conversion instructions are supported for conversion between single-precision and half-precision and between double-precision and half-precision.

0011 As for 0010, and also includes support for half-precision floating-point arithmetic.

All other values are reserved.

The permitted values are:

- 0000 in an implementation without floating-point support.
- 0010 in an implementation with floating-point support, that does not include the [ARMv8.2-FP16](#) extension.
- 0011 in an implementation with floating-point support, that includes the [ARMv8.2-FP16](#) extension.

SIMDHP, bits [23:20]

Advanced SIMD Half Precision. Indicates the level of half-precision floating-point support.

Defined values are:

- | | |
|------|---|
| 0000 | Not supported. |
| 0001 | SIMD half-precision conversion instructions are supported for conversion between single-precision and half-precision. |
| 0010 | As for 0010, and also includes support for half-precision floating-point arithmetic. |

All other values are reserved.

The permitted values are:

- 0000 in an implementation without SIMD floating-point support.
- 0001 in an implementation with SIMD floating-point support, that does not include the [ARMv8.2-FP16](#) extension.
- 0010 in an implementation with SIMD floating-point support, that includes the [ARMv8.2-FP16](#) extension.

SIMDSP, bits [19:16]

Advanced SIMD Single Precision. Indicates whether the Advanced SIMD and floating-point implementation provides single-precision floating-point instructions. Defined values are:

- | | |
|------|---|
| 0000 | Not implemented. |
| 0001 | Implemented. This value is permitted only if the SIMDInt field is 0001. |

All other values are reserved.

In ARMv8-A the permitted values are 0000 and 0001.

SIMDInt, bits [15:12]

Advanced SIMD Integer. Indicates whether the Advanced SIMD and floating-point implementation provides integer instructions. Defined values are:

- | | |
|------|------------------|
| 0000 | Not implemented. |
| 0001 | Implemented. |

All other values are reserved.

In ARMv8-A the permitted values are 0000 and 0001.

SIMDLS, bits [11:8]

Advanced SIMD Load/Store. Indicates whether the Advanced SIMD and floating-point implementation provides load/store instructions. Defined values are:

- | | |
|------|------------------|
| 0000 | Not implemented. |
| 0001 | Implemented. |

All other values are reserved.

In ARMv8-A the permitted values are 0000 and 0001.

FPDNaN, bits [7:4]

Default NaN mode. Indicates whether the floating-point implementation provides support only for the Default NaN mode. Defined values are:

0000 Not implemented, or hardware supports only the Default NaN mode.

0001 Hardware supports propagation of NaN values.

All other values are reserved.

In ARMv8-A the permitted values are 0000 and 0001.

FPFtZ, bits [3:0]

Flush to Zero mode. Indicates whether the floating-point implementation provides support only for the Flush-to-Zero mode of operation. Defined values are:

0000 Not implemented, or hardware supports only the Flush-to-Zero mode of operation.

0001 Hardware supports full denormalized number arithmetic.

All other values are reserved.

In ARMv8-A the permitted values are 0000 and 0001.

Accessing the MVFR1_EL1

This register can be read using MRS with the following syntax:

MRS <Xt>, <systemreg>

This syntax is encoded with the following settings in the instruction encoding:

<systemreg>	op0	op1	CRn	CRm	op2
MVFR1_EL1	11	000	0000	0011	001

Accessibility

The register is accessible in software as follows:

Control			Accessibility			
E2H	TGE	NS	EL0	EL1	EL2	EL3
x	x	0	-	RO	n/a	RO
x	0	1	-	RO	RO	RO
x	1	1	-	n/a	RO	RO

Traps and Enables

For a description of the prioritization of any generated exceptions, see [Synchronous exception prioritization for exceptions taken to AArch64 on page D1-1827](#). Subject to the prioritization rules:

- When EL2 is implemented and is using AArch64 and (SCR_EL3.NS == 1) && (HCR_EL2.E2H == 0):
 - If HCR_EL2.TID3==1, Non-secure read accesses to this register from EL1 are trapped to EL2.
- When EL2 is implemented and is using AArch64 and (SCR_EL3.NS == 1) && (HCR_EL2.E2H == 1) && (HCR_EL2.TGE == 0):
 - If HCR_EL2.TID3==1, Non-secure read accesses to this register from EL1 are trapped to EL2.

D7.2.77 MVFR2_EL1, AArch32 Media and VFP Feature Register 2

The MVFR2_EL1 characteristics are:

Purpose

Describes the features provided by the AArch32 Advanced SIMD and Floating-point implementation.

Must be interpreted with [MVFR0_EL1](#) and [MVFR1_EL1](#).

For general information about the interpretation of the ID registers see [Principles of the ID scheme for fields in ID registers on page D7-2195](#).

Configurations

AArch64 System register MVFR2_EL1 is architecturally mapped to AArch32 System register [MVFR2](#).

In an implementation where at least one Exception level supports execution in AArch32 state, but there is no support for Advanced SIMD and floating-point operation, this register is RAZ.

In an AArch64-only implementation, this register is UNKNOWN.

Attributes

MVFR2_EL1 is a 32-bit register.

Field descriptions

The MVFR2_EL1 bit assignments are:

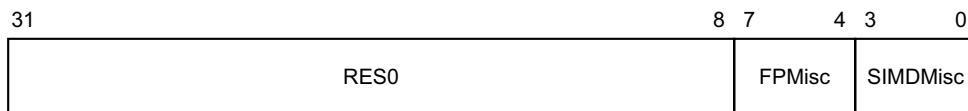

Bits [31:8]

Reserved, RES0.

FPMisc, bits [7:4]

Indicates whether the floating-point implementation provides support for miscellaneous VFP features.

0000 Not implemented, or no support for miscellaneous features.

0001 Support for Floating-point selection.

0010 As 0001, and Floating-point Conversion to Integer with Directed Rounding modes.

0011 As 0010, and Floating-point Round to Integer Floating-point.

0100 As 0011, and Floating-point MaxNum and MinNum.

All other values are reserved.

In ARMv8-A the permitted values are 0000 and 0100.

SIMDMisc, bits [3:0]

Indicates whether the Advanced SIMD implementation provides support for miscellaneous Advanced SIMD features.

0000 Not implemented, or no support for miscellaneous features.

0001 Floating-point Conversion to Integer with Directed Rounding modes.

0010 As 0001, and Floating-point Round to Integer Floating-point.

0011 As 0010, and Floating-point MaxNum and MinNum.

All other values are reserved.

In ARMv8-A the permitted values are 0000 and 0011.

Accessing the MVFR2_EL1

This register can be read using MRS with the following syntax:

MRS <Xt>, <systemreg>

This syntax is encoded with the following settings in the instruction encoding:

<systemreg>	op0	op1	CRn	CRm	op2
MVFR2_EL1	11	000	0000	0011	010

Accessibility

The register is accessible in software as follows:

Control			Accessibility			
E2H	TGE	NS	EL0	EL1	EL2	EL3
x	x	0	-	RO	n/a	RO
x	0	1	-	RO	RO	RO
x	1	1	-	n/a	RO	RO

Traps and Enables

For a description of the prioritization of any generated exceptions, see [Synchronous exception prioritization for exceptions taken to AArch64 on page D1-1827](#). Subject to the prioritization rules:

- When EL2 is implemented and is using AArch64 and (SCR_EL3.NS == 1) && (HCR_EL2.E2H == 0):
 - If HCR_EL2.TID3==1, Non-secure read accesses to this register from EL1 are trapped to EL2.
- When EL2 is implemented and is using AArch64 and (SCR_EL3.NS == 1) && (HCR_EL2.E2H == 1) && (HCR_EL2.TGE == 0):
 - If HCR_EL2.TID3==1, Non-secure read accesses to this register from EL1 are trapped to EL2.

D7.2.78 PAR_EL1, Physical Address Register

The PAR_EL1 characteristics are:

Purpose

Returns the output address (OA) from an address translation instruction that executed successfully, or fault information if the instruction did not execute successfully.

Configurations

AArch64 System register PAR_EL1 is architecturally mapped to AArch32 System register [PAR](#).
RW fields in this register reset to architecturally UNKNOWN values.

Attributes

PAR_EL1 is a 64-bit register.

Field descriptions

The PAR_EL1 bit assignments are:

For all register layouts:

F, bit [0]

Indicates whether the instruction performed a successful address translation.

- 0 Address translation completed successfully.
- 1 Address translation aborted.

When PAR_EL1.F==0:

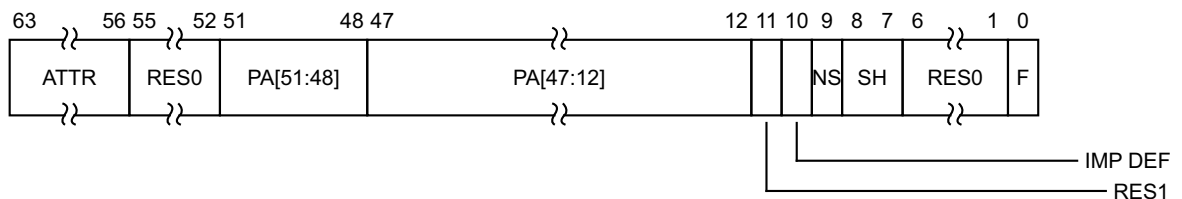

This section describes the register value returned by the successful execution of an Address translation instruction. Software might subsequently write a different value to the register, and that write does not affect the operation of the PE.

On a successful conversion, the PAR_EL1 can return a value that indicates the resulting attributes, rather than the values that appear in the translation table descriptors. More precisely:

- The ATTR and SH fields are permitted to report the resulting attributes, as determined by any permitted implementation choices and any applicable configuration bits, instead of reporting the values that appear in the translation table descriptors.
- See the NS bit description for constraints on the value it returns.

ATTR, bits [63:56]

Memory attributes for the returned output address. This field uses the same encoding as the Attr<n> fields in [MAIR_EL1](#), [MAIR_EL2](#), and [MAIR_EL3](#).

The value returned in this field can be the resulting attribute, as determined by any permitted implementation choices and any applicable configuration bits, instead of the value that appears in the translation table descriptor.

Bits [55:52]

Reserved, RES0.

PA[51:48], bits [51:48]

In ARMv8.2

Extension to PA[47:12]. See PA[47:12] for more details.

In ARMv8.1 and ARMv8.0.

Reserved, RES0.

PA[47:12], bits [47:12]

Output address. The output address (OA) corresponding to the supplied input address. This field returns address bits[47:12].

When [ARMv8.2-LPA](#) is implemented, and 52-bit addresses and a 64KB translation granule are in use, PA[51:48] form the upper part of the address value. Otherwise, for implementations with fewer than 52 physical address bits, the upper bits of this field, corresponding to address bits that are not implemented, are RES0.

Bit [11]

Reserved, RES1.

IMP DEF, bit [10]

IMPLEMENTATION DEFINED.

NS, bit [9]

Non-secure. The NS attribute for a translation table entry from a Secure translation regime.

For a result from a Secure translation regime, this bit reflects the Security state of the physical address space of the translation. This means it reflects the effect of the NSTable bits of earlier levels of the translation table walk if those NSTable bits have an effect on the translation.

For a result from a Non-secure translation regime, this bit is UNKNOWN.

SH, bits [8:7]

Shareability attribute, for the returned output address. Permitted values are:

00 Non-shareable.

10 Outer Shareable.

11 Inner Shareable.

The value 01 is reserved.

———— **Note** —————

This field returns the value 10 for:

- Any type of Device memory.
- Normal memory with both Inner Non-cacheable and Outer Non-cacheable attributes.

—————

The value returned in this field can be the resulting attribute, as determined by any permitted implementation choices and any applicable configuration bits, instead of the value that appears in the translation table descriptor.

Bits [6:1]

Reserved, RES0.

F, bit [0]

Indicates whether the instruction performed a successful address translation.

0 Address translation completed successfully.

When `PAR_EL1.F==1`:

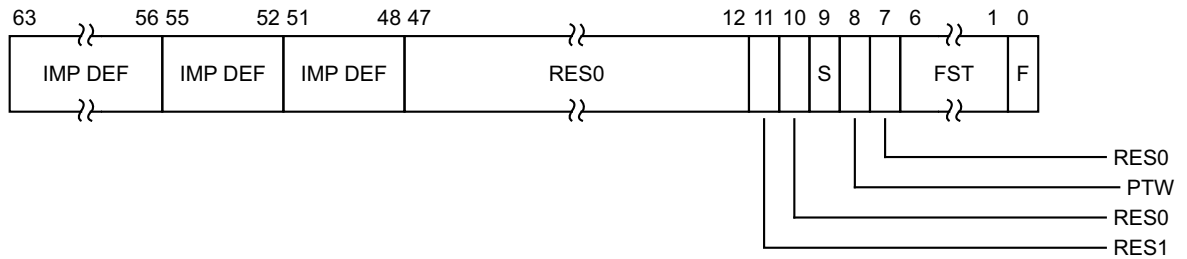

This section describes the register value returned by a fault on the execution of an Address translation instruction. Software might subsequently write a different value to the register, and that write does not affect the operation of the PE.

IMP DEF, bits [63:56]

IMPLEMENTATION DEFINED.

IMP DEF, bits [55:52]

IMPLEMENTATION DEFINED.

IMP DEF, bits [51:48]

IMPLEMENTATION DEFINED.

Bits [47:12]

Reserved, RES0.

Bit [11]

Reserved, RES1.

Bit [10]

Reserved, RES0.

S, bit [9]

Indicates the translation stage at which the translation aborted:

- 0 Translation aborted because of a fault in the stage 1 translation.
- 1 Translation aborted because of a fault in the stage 2 translation.

PTW, bit [8]

If this bit is set to 1, it indicates the translation aborted because of a stage 2 fault during a stage 1 translation table walk.

Bit [7]

Reserved, RES0.

FST, bits [6:1]

Fault status code, as shown in the Data Abort ESR encoding.

F, bit [0]

Indicates whether the instruction performed a successful address translation.

- 1 Address translation aborted.

Accessing the `PAR_EL1`

This register can be read using MRS with the following syntax:

MRS <Xt>, <systemreg>

This register can be written using MSR (register) with the following syntax:

MSR <systemreg>, <Xt>

This syntax is encoded with the following settings in the instruction encoding:

<systemreg>	op0	op1	CRn	CRm	op2
PAR_EL1	11	000	0111	0100	000

Accessibility

The register is accessible in software as follows:

Control			Accessibility			
E2H	TGE	NS	EL0	EL1	EL2	EL3
x	x	0	-	RW	n/a	RW
x	0	1	-	RW	RW	RW
x	1	1	-	n/a	RW	RW

D7.2.79 REVIDR_EL1, Revision ID Register

The REVIDR_EL1 characteristics are:

Purpose

Provides implementation-specific minor revision information.

Configurations

AArch64 System register REVIDR_EL1 is architecturally mapped to AArch32 System register [REVIDR](#).

If REVIDR_EL1 has the same value as [MIDR_EL1](#), then its contents have no significance.

Attributes

REVIDR_EL1 is a 32-bit register.

Field descriptions

The REVIDR_EL1 bit assignments are:



IMPLEMENTATION DEFINED, bits [31:0]

IMPLEMENTATION DEFINED.

Accessing the REVIDR_EL1

This register can be read using MRS with the following syntax:

MRS <Xt>, <systemreg>

This syntax is encoded with the following settings in the instruction encoding:

<systemreg>	op0	op1	CRn	CRm	op2
REVIDR_EL1	11	000	0000	0000	110

Accessibility

The register is accessible in software as follows:

Control			Accessibility			
E2H	TGE	NS	EL0	EL1	EL2	EL3
x	x	0	-	RO	n/a	RO
x	0	1	-	RO	RO	RO
x	1	1	-	n/a	RO	RO

Traps and Enables

For a description of the prioritization of any generated exceptions, see [Synchronous exception prioritization for exceptions taken to AArch64 on page D1-1827](#). Subject to the prioritization rules:

- When EL2 is implemented and is using AArch64 and $(SCR_EL3.NS == 1) \ \&\& \ (HCR_EL2.E2H == 0)$:
 - If $HCR_EL2.TID1 == 1$, Non-secure read accesses to this register from EL1 are trapped to EL2.
- When EL2 is implemented and is using AArch64 and $(SCR_EL3.NS == 1) \ \&\& \ (HCR_EL2.E2H == 1) \ \&\& \ (HCR_EL2.TGE == 0)$:
 - If $HCR_EL2.TID1 == 1$, Non-secure read accesses to this register from EL1 are trapped to EL2.

D7.2.80 RMR_EL1, Reset Management Register (EL1)

The RMR_EL1 characteristics are:

Purpose

If EL1 is the highest implemented Exception level and this register is implemented:

- A write to the register at EL1 can request a Warm reset.
- If EL1 can use AArch32 and AArch64, this register specifies the Execution state that the PE boots into on a Warm reset.

Configurations

AArch64 System register RMR_EL1 is architecturally mapped to AArch32 System register RMR when EL1 is highest implemented Exception level.

Only implemented if EL1 is the highest implemented Exception level. In this case:

- If EL1 can use AArch32 and AArch64 then this register must be implemented.
- If EL1 cannot use AArch32 then it is IMPLEMENTATION DEFINED whether the register is implemented.

See the field descriptions for the reset values. These apply whenever the register is implemented.

Attributes

RMR_EL1 is a 32-bit register.

Field descriptions

The RMR_EL1 bit assignments are:

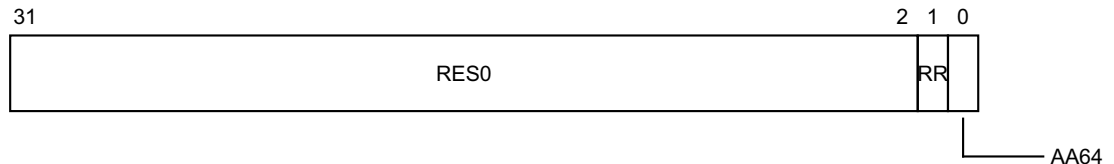

Bits [31:2]

Reserved, RES0.

RR, bit [1]

Reset Request. Setting this bit to 1 requests a Warm reset.

This field resets to 0 on a Warm or Cold reset.

AA64, bit [0]

When EL1 can use AArch32, determines which Execution state the PE boots into after a Warm reset:

- 0 AArch32.
- 1 AArch64.

On coming out of the Warm reset, execution starts at the IMPLEMENTATION DEFINED reset vector address of the specified Execution state.

If EL1 cannot use AArch32 this bit is RAO/WI.

When implemented as a RW field, this field resets to 1 on a Cold reset.

Accessing the RMR_EL1

This register can be read using MRS with the following syntax:

MRS <Xt>, <systemreg>

This register can be written using MSR (register) with the following syntax:

MSR <systemreg>, <Xt>

This syntax is encoded with the following settings in the instruction encoding:

<systemreg>	op0	op1	CRn	CRm	op2
RMR_EL1	11	000	1100	0000	010

Accessibility

The register is accessible in software as follows:

Configuration	Control			Accessibility			
	E2H	TGE	NS	EL0	EL1	EL2	EL3
EL1 is the highest implemented Exception level.	x	x	x	-	RW	n/a	n/a

When RMR_EL1 is not implemented, the encoding for this register is UNDEFINED.

D7.2.81 RMR_EL2, Reset Management Register (EL2)

The RMR_EL2 characteristics are:

Purpose

If EL2 is the highest implemented Exception level and this register is implemented:

- A write to the register at EL2 can request a Warm reset.
- If EL2 can use AArch32 and AArch64, this register specifies the Execution state that the PE boots into on a Warm reset.

Configurations

AArch64 System register RMR_EL2 is architecturally mapped to AArch32 System register [HRMR](#).

Only implemented if EL2 is the highest implemented Exception level. In this case:

- If EL2 can use AArch32 and AArch64 then this register must be implemented.
- If EL2 cannot use AArch32 then it is IMPLEMENTATION DEFINED whether the register is implemented.

See the field descriptions for the reset values. These apply whenever the register is implemented.

Attributes

RMR_EL2 is a 32-bit register.

Field descriptions

The RMR_EL2 bit assignments are:

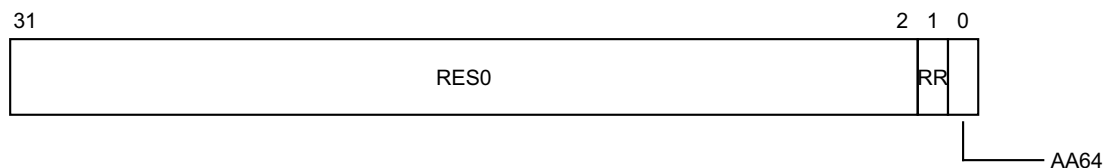

Bits [31:2]

Reserved, RES0.

RR, bit [1]

Reset Request. Setting this bit to 1 requests a Warm reset.

This field resets to 0 on a Warm or Cold reset.

AA64, bit [0]

When EL2 can use AArch32, determines which Execution state the PE boots into after a Warm reset:

- 0 AArch32.
- 1 AArch64.

On coming out of the Warm reset, execution starts at the IMPLEMENTATION DEFINED reset vector address of the specified Execution state.

If EL2 cannot use AArch32 this bit is RAO/WI.

When implemented as a RW field, this field resets to 1 on a Cold reset.

Accessing the RMR_EL2

This register can be read using MRS with the following syntax:

MRS <Xt>, <systemreg>

This register can be written using MSR (register) with the following syntax:

MSR <systemreg>, <Xt>

This syntax is encoded with the following settings in the instruction encoding:

<systemreg>	op0	op1	CRn	CRm	op2
RMR_EL2	11	100	1100	0000	010

Accessibility

The register is accessible in software as follows:

Configuration	Control			Accessibility			
	E2H	TGE	NS	EL0	EL1	EL2	EL3
EL2 is the highest implemented Exception level.	x	0	1	-	-	RW	n/a
EL2 is the highest implemented Exception level.	x	1	1	-	n/a	RW	n/a

When RMR_EL2 is not implemented, the encoding for this register is UNDEFINED.

D7.2.82 RMR_EL3, Reset Management Register (EL3)

The RMR_EL3 characteristics are:

Purpose

If EL3 is implemented and this register is implemented:

- A write to the register at EL3 can request a Warm reset.
- If EL3 can use AArch32 and AArch64, this register specifies the Execution state that the PE boots into on a Warm reset.

Configurations

AArch64 System register RMR_EL3 is architecturally mapped to AArch32 System register RMR when EL3 is implemented.

When EL3 is implemented:

- If EL3 can use AArch32 and AArch64 then this register must be implemented.
- If EL3 cannot use AArch32 then it is IMPLEMENTATION DEFINED whether the register is implemented.

See the field descriptions for the reset values. These apply whenever the register is implemented.

Attributes

RMR_EL3 is a 32-bit register.

Field descriptions

The RMR_EL3 bit assignments are:

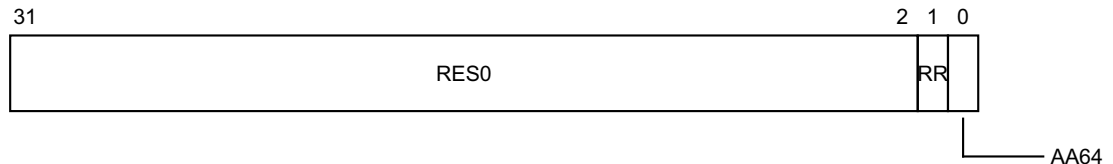

Bits [31:2]

Reserved, RES0.

RR, bit [1]

Reset Request. Setting this bit to 1 requests a Warm reset.

This field resets to 0 on a Warm or Cold reset.

AA64, bit [0]

When EL3 can use AArch32, determines which Execution state the PE boots into after a Warm reset:

- 0 AArch32.
- 1 AArch64.

On coming out of the Warm reset, execution starts at the IMPLEMENTATION DEFINED reset vector address of the specified Execution state.

If EL3 cannot use AArch32 this bit is RAO/WI.

When implemented as a RW field, this field resets to 1 on a Cold reset.

Accessing the RMR_EL3

This register can be read using MRS with the following syntax:

MRS <Xt>, <systemreg>

This register can be written using MSR (register) with the following syntax:

MSR <systemreg>, <Xt>

This syntax is encoded with the following settings in the instruction encoding:

<systemreg>	op0	op1	CRn	CRm	op2
RMR_EL3	11	110	1100	0000	010

Accessibility

The register is accessible in software as follows:

Configuration	Control			Accessibility			
	E2H	TGE	NS	EL0	EL1	EL2	EL3
EL3 is the highest implemented Exception level.	x	x	0	-	-	n/a	RW
EL3 is the highest implemented Exception level.	x	0	1	-	-	-	RW
EL3 is the highest implemented Exception level.	x	1	1	-	n/a	-	RW

When RMR_EL3 is not implemented, the encoding for this register is UNDEFINED.

D7.2.83 RVBAR_EL1, Reset Vector Base Address Register (if EL2 and EL3 not implemented)

The RVBAR_EL1 characteristics are:

Purpose

If EL1 is the highest Exception level implemented, contains the IMPLEMENTATION DEFINED address that execution starts from after reset when executing in AArch64 state.

Configurations

Only implemented if the highest Exception level implemented is EL1.

Attributes

RVBAR_EL1 is a 64-bit register.

Field descriptions

The RVBAR_EL1 bit assignments are:



Bits [63:0]

Reset Address. The IMPLEMENTATION DEFINED address that execution starts from after reset when executing in 64-bit state. Bits[1:0] of this register are 00, as this address must be aligned, and the address must be within the physical address size supported by the PE.

Accessing the RVBAR_EL1

This register can be read using MRS with the following syntax:

MRS <Xt>, <systemreg>

This syntax is encoded with the following settings in the instruction encoding:

<systemreg>	op0	op1	CRn	CRm	op2
RVBAR_EL1	11	000	1100	0000	001

Accessibility

The register is accessible in software as follows:

Configuration	Control			Accessibility			
	E2H	TGE	NS	EL0	EL1	EL2	EL3
EL1 is the highest implemented Exception level.	x	x	x	-	RO	n/a	n/a

When EL1 is not the highest implemented Exception level, the encoding for this register is UNDEFINED.

D7.2.84 RVBAR_EL2, Reset Vector Base Address Register (if EL3 not implemented)

The RVBAR_EL2 characteristics are:

Purpose

If EL2 is the highest Exception level implemented, contains the IMPLEMENTATION DEFINED address that execution starts from after reset when executing in AArch64 state.

Configurations

Only implemented if the highest Exception level implemented is EL2.

Attributes

RVBAR_EL2 is a 64-bit register.

Field descriptions

The RVBAR_EL2 bit assignments are:

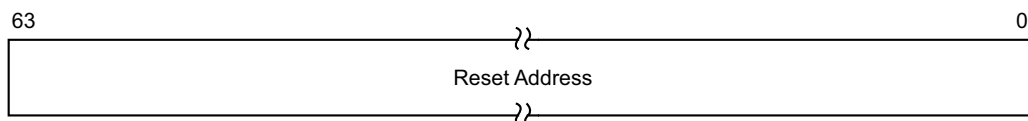

Bits [63:0]

Reset Address. The IMPLEMENTATION DEFINED address that execution starts from after reset when executing in 64-bit state. Bits[1:0] of this register are 00, as this address must be aligned, and the address must be within the physical address size supported by the PE.

Accessing the RVBAR_EL2

This register can be read using MRS with the following syntax:

MRS <Xt>, <systemreg>

This syntax is encoded with the following settings in the instruction encoding:

<systemreg>	op0	op1	CRn	CRm	op2
RVBAR_EL2	11	100	1100	0000	001

Accessibility

The register is accessible in software as follows:

Configuration	Control			Accessibility			
	E2H	TGE	NS	EL0	EL1	EL2	EL3
EL2 is the highest implemented Exception level.	x	0	1	-	-	RO	n/a
EL2 is the highest implemented Exception level.	x	1	1	-	n/a	RO	n/a

When EL2 is not the highest implemented Exception level, the encoding for this register is UNDEFINED.

D7.2.85 RVBAR_EL3, Reset Vector Base Address Register (if EL3 implemented)

The RVBAR_EL3 characteristics are:

Purpose

If EL3 is the highest Exception level implemented, contains the IMPLEMENTATION DEFINED address that execution starts from after reset when executing in AArch64 state.

Configurations

Only implemented if the highest Exception level implemented is EL3.

Attributes

RVBAR_EL3 is a 64-bit register.

Field descriptions

The RVBAR_EL3 bit assignments are:

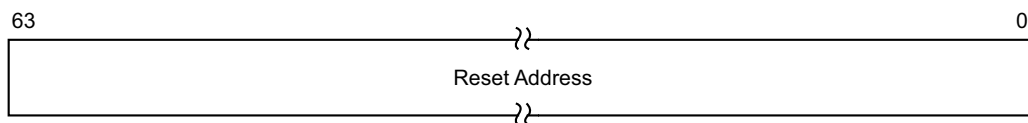

Bits [63:0]

Reset Address. The IMPLEMENTATION DEFINED address that execution starts from after reset when executing in 64-bit state. Bits[1:0] of this register are 00, as this address must be aligned, and the address must be within the physical address size supported by the PE.

Accessing the RVBAR_EL3

This register can be read using MRS with the following syntax:

MRS <Xt>, <systemreg>

This syntax is encoded with the following settings in the instruction encoding:

<systemreg>	op0	op1	CRn	CRm	op2
RVBAR_EL3	11	110	1100	0000	001

Accessibility

The register is accessible in software as follows:

Configuration	Control			Accessibility			
	E2H	TGE	NS	EL0	EL1	EL2	EL3
EL3 is the highest implemented Exception level.	x	x	0	-	-	n/a	RO
EL3 is the highest implemented Exception level.	x	0	1	-	-	-	RO
EL3 is the highest implemented Exception level.	x	1	1	-	n/a	-	RO

When EL3 is not the highest implemented Exception level, the encoding for this register is UNDEFINED.

D7.2.86 S3_<op1>_<Cn>_<Cm>_<op2>, IMPLEMENTATION DEFINED registers

The S3_<op1>_<Cn>_<Cm>_<op2> characteristics are:

Purpose

This area of the instruction set space is reserved for IMPLEMENTATION DEFINED registers.

Configurations

There are no configuration notes.

Attributes

S3_<op1>_<Cn>_<Cm>_<op2> is a 64-bit register.

Field descriptions

The S3_<op1>_<Cn>_<Cm>_<op2> bit assignments are:

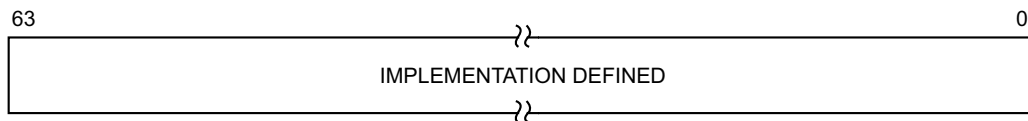

IMPLEMENTATION DEFINED, bits [63:0]

IMPLEMENTATION DEFINED.

Accessing the S3_<op1>_<Cn>_<Cm>_<op2>

This register can be read using MRS with the following syntax:

MRS <Xt>, <systemreg>

This register can be written using MSR (register) with the following syntax:

MSR <systemreg>, <Xt>

This syntax is encoded with the following settings in the instruction encoding:

<systemreg>	op0	op1	CRn	CRm	op2
S3_<op1>_C<Cn>_C<Cm>_<op2>	11	op1<2:0>	Cn<3:0>	Cm<3:0>	op2<2:0>

- <op1> is in the range 0 - 7.
- <CRn> can take the values: 11, 15.
- <CRm> is in the range 0 - 15.
- <op2> is in the range 0 - 7.

The value of <Cn> must be either 11 or 15. Other values may refer to architecturally-defined registers.

Accessibility

The accessibility of registers with these encodings is IMPLEMENTATION DEFINED.

Traps and Enables

For a description of the prioritization of any generated exceptions, see *Synchronous exception prioritization for exceptions taken to AArch64* on page D1-1827. Subject to the prioritization rules:

- When EL2 is implemented and is using AArch64 and (SCR_EL3.NS == 1) && (HCR_EL2.E2H == 0):
 - If HCR_EL2.TIDCP==1, Non-secure accesses to this register from EL1 are trapped to EL2.
- When EL2 is implemented and is using AArch64 and (SCR_EL3.NS == 1) && (HCR_EL2.E2H == 1) && (HCR_EL2.TGE == 0):
 - If HCR_EL2.TIDCP==1, Non-secure accesses to this register from EL1 are trapped to EL2.

D7.2.87 SCR_EL3, Secure Configuration Register

The SCR_EL3 characteristics are:

Purpose

Defines the configuration of the current Security state. It specifies:

- The Security state of EL0 and EL1, either Secure or Non-secure.
- The Execution state at lower Exception levels.
- Whether IRQ, FIQ, and External Abort interrupts are taken to EL3.

Configurations

AArch64 System register SCR_EL3 can be mapped to AArch32 System register SCR, but this is not architecturally mandated.

RW fields in this register reset to architecturally UNKNOWN values.

Attributes

SCR_EL3 is a 32-bit register.

Field descriptions

The SCR_EL3 bit assignments are:

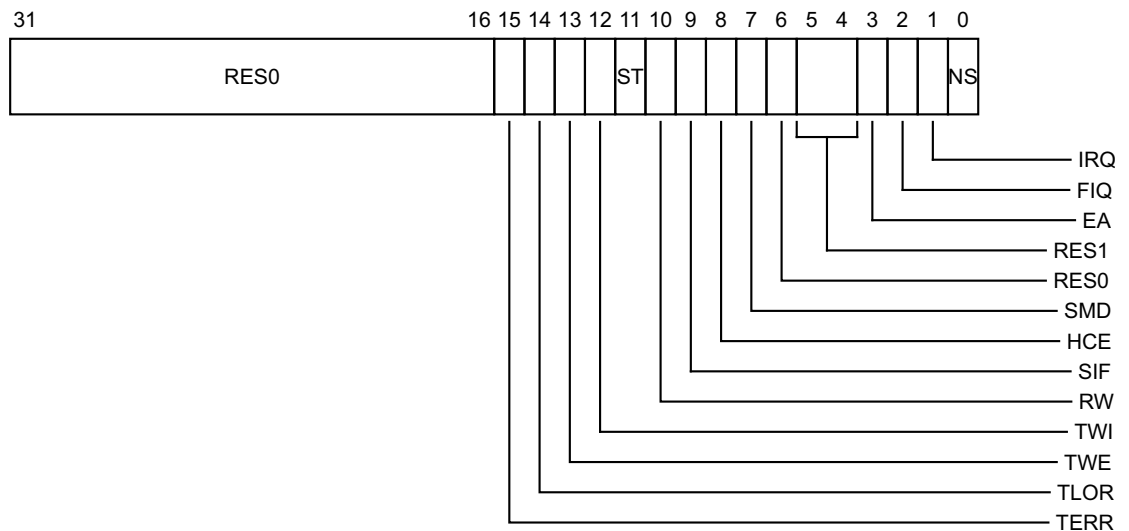

Bits [31:16]

Reserved, RES0.

TERR, bit [15]

Trap Error record accesses. If the RAS Extension is implemented, the possible values of this bit are:

- 0 Do not trap accesses to record registers from EL1 and EL2 to EL3.
- 1 Accesses to the ER* registers from EL1 and EL2 generate a Trap exception to EL3.

This bit resets to 0 on Warm reset.

When the RAS Extension is not implemented, this field is RES0.

TLOR, bit [14]

In ARMv8.2 and ARMv8.1

Trap LOR registers. Traps accesses to the `LORSA_EL1`, `LOREA_EL1`, `LORN_EL1`, `LORC_EL1`, and `LORID_EL1` registers from EL1 and EL2 to EL3, unless the access has been trapped to EL2.

- 0 This control does not cause any instructions to be trapped.
- 1 EL1 and EL2 accesses to the LOR registers that are not UNDEFINED are trapped to EL3, unless it is trapped `HCR_EL2.TLOR`.

When `HCR_EL2.TGE` is 1, the PE ignores the value of this field for all purposes other than a direct read of this field.

In ARMv8.0.

Reserved, RES0.

TWE, bit [13]

Traps EL2, EL1, and EL0 execution of WFE instructions to EL3, from both Security states and both Execution states.

- 0 This control does not cause any instructions to be trapped.
- 1 Any attempt to execute a WFE instruction at any Exception level lower than EL3 is trapped to EL3, if the instruction would otherwise have caused the PE to enter a low-power state and it is not trapped by `SCTLR.nTWE`, `HCR.TWE`, `SCTLR_EL1.nTWE`, `SCTLR_EL2.nTWE`, or `HCR_EL2.TWE`.

In AArch32 state, the attempted execution of a conditional WFE instruction is only trapped if the instruction passes its condition code check.

———— **Note** —————

Since a WFE or WFI can complete at any time, even without a Wakeup event, the traps on WFE of WFI are not guaranteed to be taken, even if the WFE or WFI is executed when there is no Wakeup event. The only guarantee is that if the instruction does not complete in finite time in the absence of a Wakeup event, the trap will be taken.

TWI, bit [12]

Traps EL2, EL1, and EL0 execution of WFI instructions to EL3, from both Security states and both Execution states.

- 0 This control does not cause any instructions to be trapped.
- 1 Any attempt to execute a WFI instruction at any Exception level lower than EL3 is trapped to EL3, if the instruction would otherwise have caused the PE to enter a low-power state and it is not trapped by `SCTLR.nTWI`, `HCR.TWI`, `SCTLR_EL1.nTWI`, `SCTLR_EL2.nTWI`, or `HCR_EL2.TWI`.

In AArch32 state, the attempted execution of a conditional WFI instruction is only trapped if the instruction passes its condition code check.

———— **Note** —————

Since a WFE or WFI can complete at any time, even without a Wakeup event, the traps on WFE of WFI are not guaranteed to be taken, even if the WFE or WFI is executed when there is no Wakeup event. The only guarantee is that if the instruction does not complete in finite time in the absence of a Wakeup event, the trap will be taken.

ST, bit [11]

Traps Secure EL1 accesses to the Counter-timer Physical Secure timer registers to EL3, from AArch64 state only.

- 0 Secure EL1 using AArch64 accesses to the `CNTPS_TVAL_EL1`, `CNTPS_CTL_EL1`, and `CNTPS_CVAL_EL1` are trapped to EL3.
- 1 This control does not cause any instructions to be trapped.

RW, bit [10]

Execution state control for lower Exception levels.

0 Lower levels are all AArch32.

1 The next lower level is AArch64.

If EL2 is present:

- EL2 is AArch64.
- EL2 controls EL1 and EL0 behaviors.

If EL2 is not present:

- EL1 is AArch64.
- EL0 is determined by the Execution state described in the current process state when executing at EL0.

If all lower Exception levels cannot use AArch32 then this bit is RAO/WI.

This bit is permitted to be cached in a TLB.

SIF, bit [9]

Secure instruction fetch. When the PE is in Secure state, this bit disables instruction fetch from Non-secure memory. The possible values for this bit are:

0 Secure state instruction fetches from Non-secure memory are permitted.

1 Secure state instruction fetches from Non-secure memory are not permitted.

This bit is permitted to be cached in a TLB.

HCE, bit [8]

Hypervisor Call instruction enable. Enables HVC instructions at EL3, EL2, and Non-secure EL1, in both Execution states.

0 HVC instructions are UNDEFINED at EL3, EL2, and Non-secure EL1, and any resulting exception is taken from the current Exception level to the current Exception level.

1 HVC instructions are enabled at EL1 and above.

———— **Note** ————

HVC instructions are always UNDEFINED at EL0.

If EL2 is not implemented, this bit is RES0.

SMD, bit [7]

Secure Monitor Call disable. Disables SMC instructions at EL1 and above, from both Security states and both Execution states.

0 SMC instructions are enabled at EL1 and above.

1 SMC instructions are UNDEFINED at EL1 and above.

———— **Note** ————

SMC instructions are always UNDEFINED at EL0.

Bit [6]

Reserved, RES0.

Bits [5:4]

Reserved, RES1.

EA, bit [3]

External Abort and SError Interrupt Routing.

- 0 When executing at Exception levels below EL3, External Aborts and SError Interrupts are not taken to EL3.
In addition, when executing at EL3:
- SError Interrupts are not taken.
 - External Aborts are taken to EL3.
- 1 When executing at any Exception level, External Aborts and SError Interrupts are taken to EL3.

For more information, see [Asynchronous exception routing on page D1-1834](#).

FIQ, bit [2]

Physical FIQ Routing.

- 0 When executing at Exception levels below EL3, physical FIQ interrupts are not taken to EL3.
When executing at EL3, physical FIQ interrupts are not taken.
- 1 When executing at any Exception level, physical FIQ interrupts are taken to EL3.

For more information, see [Asynchronous exception routing on page D1-1834](#).

IRQ, bit [1]

Physical IRQ Routing.

- 0 When executing at Exception levels below EL3, physical IRQ interrupts are not taken to EL3.
When executing at EL3, physical IRQ interrupts are not taken.
- 1 When executing at any Exception level, physical IRQ interrupts are taken to EL3.

For more information, see [Asynchronous exception routing on page D1-1834](#).

NS, bit [0]

Non-secure bit.

- 0 Indicates that EL0 and EL1 are in Secure state, and so memory accesses from those Exception levels can access Secure memory.
When executing at EL3:
- The [AT S1E2R](#), [AT S1E2W](#), [TLBI VAE2](#), [TLBI VALE2](#), [TLBI VAE2IS](#), [TLBI VALE2IS](#), [TLBI ALLE2](#), and [TLBI ALLE2IS](#) System instructions are UNDEFINED.
 - Each [AT S1E**](#) System instruction executes as the corresponding [AT S1E**](#) instruction. For example, [AT S1E0R](#) executes as [AT S1E0R](#).
 - Each of the [TLBI IPAS2E1](#), [TLBI IPAS2E1IS](#), [TLBI IPAS2LE1](#), and [TLBI IPAS2LE1IS](#) System instructions executes as a NOP.
 - A [TLBI VMALLS12E1](#) System instruction executes as [TLBI VMALLE1](#), and a [TLBI VMALLS12E1IS](#) System instruction executes as [TLBI VMALLE1IS](#).
- 1 Indicates that EL0 and EL1 are in Non-secure state, and so memory accesses from those Exception levels cannot access Secure memory.

————— Note —————

EL2 is not supported in the Secure state. When `SCR_EL3.NS==0`, it is not possible to enter EL2, and the EL2 state has no effect on execution. See [Virtualization on page D1-1782](#).

Accessing the SCR_EL3

This register can be read using MRS with the following syntax:

MRS <Xt>, <systemreg>

This register can be written using MSR (register) with the following syntax:

MSR <systemreg>, <Xt>

This syntax is encoded with the following settings in the instruction encoding:

<systemreg>	op0	op1	CRn	CRm	op2
SCR_EL3	11	110	0001	0001	000

Accessibility

The register is accessible in software as follows:

Control			Accessibility			
E2H	TGE	NS	EL0	EL1	EL2	EL3
x	x	0	-	-	n/a	RW
0	0	1	-	-	-	RW
0	1	1	-	n/a	-	RW
1	0	1	-	-	-	RW
1	1	1	-	n/a	-	RW

D7.2.88 SCTLR_EL1, System Control Register (EL1)

The SCTLR_EL1 characteristics are:

Purpose

Provides top level control of the system, including its memory system, at EL1 and EL0.

Configurations

AArch64 System register SCTLR_EL1 is architecturally mapped to AArch32 System register [SCTLR](#).

Some or all RW fields of this register have defined reset values. These apply only if the PE resets into EL1 using AArch64. Otherwise, RW fields in this register reset to architecturally UNKNOWN values.

Attributes

SCTLR_EL1 is a 32-bit register.

Field descriptions

The SCTLR_EL1 bit assignments are:

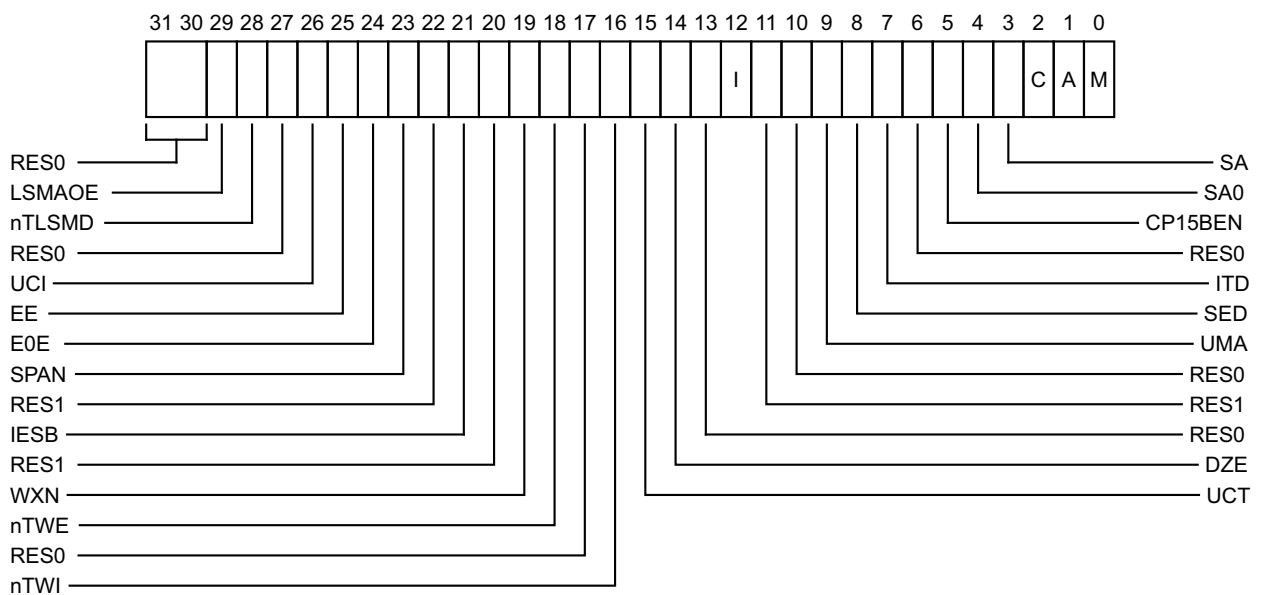

Bits [31:30]

Reserved, RES0.

LSMAOE, bit [29]

In ARMv8.2

Load Multiple and Store Multiple Atomicity and Ordering Enable. When the OPTIONAL feature [ARMv8.2-LSMAOC](#) is implemented, defined values are:

- 0 For all memory accesses at EL0, A32 and T32 Load Multiple and Store Multiple can have an interrupt taken during the sequence memory accesses, and the memory accesses are not required to be ordered.
- 1 The ordering and interrupt behavior of A32 and T32 Load Multiple and Store Multiple at EL0 is as defined for ARMv8.0.

This bit is permitted to be cached in a TLB.

If this bit is not implemented, it is RES1.

When [ARMv8.1-VHE](#) is implemented, and the value of [HCR_EL2](#).{E2H, TGE} is {1,1}, this bit has no effect on execution at EL0.

In ARMv8.1 and ARMv8.0.

Reserved, RES1.

nTLSMD, bit [28]

In ARMv8.2

No Trap Load Multiple and Store Multiple to Device-nGRE/Device-nGnRE/Device-nGnRnE memory. When the OPTIONAL feature [ARMv8.2-LSMAOC](#) is implemented, defined values are:

- 0 All memory accesses by A32 and T32 Load Multiple and Store Multiple at EL0 that are marked at stage 1 as Device-nGRE/Device-nGnRE/Device-nGnRnE memory are trapped and generate a stage 1 Alignment fault.
- 1 All memory accesses by A32 and T32 Load Multiple and Store Multiple at EL0 that are marked at stage 1 as Device-nGRE/Device-nGnRE/Device-nGnRnE memory are not trapped.

This bit is permitted to be cached in a TLB.

If this bit is not implemented, it is RES1.

When [ARMv8.1-VHE](#) is implemented, and the value of [HCR_EL2](#).{E2H, TGE} is {1,1}, this bit has no effect on execution at EL0.

In ARMv8.1 and ARMv8.0.

Reserved, RES1.

Bit [27]

Reserved, RES0.

UCI, bit [26]

Traps EL0 execution of cache maintenance instructions to EL1, from AArch64 state only.

- 0 Any attempt to execute a [DC CVAU](#), [DC CIVAC](#), [DC CVAC](#), [DC CVAP](#), or [IC IVAU](#) instruction at EL0 using AArch64 is trapped to EL1.
- 1 This control does not cause any instructions to be trapped.

When [ARMv8.1-VHE](#) is implemented, and the value of [HCR_EL2](#).{E2H, TGE} is {1, 1}, this bit has no effect on execution at EL0.

This field resets to a value that is architecturally UNKNOWN.

EE, bit [25]

Endianness of data accesses at EL1, and stage 1 translation table walks in the EL1&0 translation regime.

The possible values of this bit are:

- 0 Explicit data accesses at EL1, and stage 1 translation table walks in the EL1&0 translation regime are little-endian.
- 1 Explicit data accesses at EL1, and stage 1 translation table walks in the EL1&0 translation regime are big-endian.

If an implementation does not provide Big-endian support at Exception Levels higher than EL0, this bit is RES0.

If an implementation does not provide Little-endian support at Exception Levels higher than EL0, this bit is RES1.

The EE bit is permitted to be cached in a TLB.

When [ARMv8.1-VHE](#) is implemented, and the value of [HCR_EL2](#).{E2H, TGE} is {1, 1}, this bit has no effect on the PE.

When this register has an architecturally-defined reset value, if this field is implemented as an RW field, it resets to an IMPLEMENTATION DEFINED value.

E0E, bit [24]

Endianness of data accesses at EL0.

The possible values of this bit are:

- 0 Explicit data accesses at EL0 are little-endian.
- 1 Explicit data accesses at EL0 are big-endian.

If an implementation only supports Little-endian accesses at EL0 then this bit is RES0. This option is not permitted when SCTLR_EL1.EE is RES1.

If an implementation only supports Big-endian accesses at EL0 then this bit is RES1. This option is not permitted when SCTLR_EL1.EE is RES0.

This bit has no effect on the endianness of LDTR, LDTRH, LDTRSH, LDTRSW, STTR, and STTRH instructions executed at EL1.

When [ARMv8.1-VHE](#) is implemented, and the value of [HCR_EL2](#).{E2H, TGE} is {1, 1}, this bit has no effect on execution at EL0.

If this field is implemented as an RW field, it resets to a value that is architecturally UNKNOWN.

SPAN, bit [23]

In ARMv8.2 and ARMv8.1

Set Privileged Access Never, on taking an exception to EL1.

- 0 PSTATE.PAN is set to 1 on taking an exception to EL1.
- 1 The value of PSTATE.PAN is left unchanged on taking an exception to EL1.

When [ARMv8.1-VHE](#) is implemented, and the value of [HCR_EL2](#).{E2H, TGE} is {1, 1}, this bit has no effect on execution at EL0.

This field resets to a value that is architecturally UNKNOWN.

In ARMv8.0.

Reserved, RES1.

Bit [22]

Reserved, RES1.

IESB, bit [21]

In ARMv8.2

Implicit Error Synchronization Barrier enable. Permitted values are:

- 0 Disabled.
- 1 An implicit `ErrorSynchronizationBarrier()` call is added:
 - After each exception taken to EL1.
 - Before the operational pseudocode of each ERET instruction executed at EL1.

When the PE is in Debug state, the effect of this field is CONstrained UNPREDICTABLE, and regardless of the value of the field its effective value might be 0 or 1. If the effective value of the field is 1, then an implicit `ErrorSynchronizationBarrier()` is added after each DCPSx instruction and before each DRPS instruction, in addition to the other cases where it is added.

This field is part of the required ARMv8.2 implementation of the RAS Extension. See [The Reliability, Availability, and Serviceability \(RAS\) Extension on page A1-63](#).

This field resets to a value that is architecturally UNKNOWN.

In ARMv8.1 and ARMv8.0.

Reserved, RES0.

Bit [20]

Reserved, RES1.

WXN, bit [19]

Write permission implies XN (Execute-never). For the EL1&0 translation regime, this bit can force all memory regions that are writable to be treated as XN. The possible values of this bit are:

- 0 This control has no effect on memory access permissions.
- 1 Any region that is writable in the EL1&0 translation regime is forced to XN for accesses from software executing at EL1 or EL0.

The WXN bit is permitted to be cached in a TLB.

When [ARMv8.1-VHE](#) is implemented, and the value of [HCR_EL2](#).{E2H, TGE} is {1, 1}, this bit has no effect on the PE.

This field resets to a value that is architecturally UNKNOWN.

nTWE, bit [18]

Traps EL0 execution of WFE instructions to EL1, from both Execution states.

- 0 Any attempt to execute a WFE instruction at EL0 is trapped to EL1, if the instruction would otherwise have caused the PE to enter a low-power state.
- 1 This control does not cause any instructions to be trapped.

In AArch32 state, the attempted execution of a conditional WFE instruction is only trapped if the instruction passes its condition code check.

———— Note ————

Since a WFE or WFI can complete at any time, even without a Wakeup event, the traps on WFE of WFI are not guaranteed to be taken, even if the WFE or WFI is executed when there is no Wakeup event. The only guarantee is that if the instruction does not complete in finite time in the absence of a Wakeup event, the trap will be taken.

When [ARMv8.1-VHE](#) is implemented, and the value of [HCR_EL2](#).{E2H, TGE} is {1, 1}, this bit has no effect on execution at EL0.

This field resets to a value that is architecturally UNKNOWN.

Bit [17]

Reserved, RES0.

nTWI, bit [16]

Traps EL0 execution of WFI instructions to EL1, from both Execution states.

- 0 Any attempt to execute a WFI instruction at EL0 is trapped EL1, if the instruction would otherwise have caused the PE to enter a low-power state.
- 1 This control does not cause any instructions to be trapped.

In AArch32 state, the attempted execution of a conditional WFI instruction is only trapped if the instruction passes its condition code check.

———— Note ————

Since a WFE or WFI can complete at any time, even without a Wakeup event, the traps on WFE of WFI are not guaranteed to be taken, even if the WFE or WFI is executed when there is no Wakeup event. The only guarantee is that if the instruction does not complete in finite time in the absence of a Wakeup event, the trap will be taken.

When [ARMv8.1-VHE](#) is implemented, and the value of [HCR_EL2](#).{E2H, TGE} is {1, 1}, this bit has no effect on execution at EL0.

This field resets to a value that is architecturally UNKNOWN.

UCT, bit [15]

Traps EL0 accesses to the [CTR_EL0](#) to EL1, from AArch64 state only.

0 Accesses to the [CTR_EL0](#) from EL0 using AArch64 are trapped to EL1.

1 This control does not cause any instructions to be trapped.

When [ARMv8.1-VHE](#) is implemented, and the value of [HCR_EL2](#).{E2H, TGE} is {1, 1}, this bit has no effect on execution at EL0.

This field resets to a value that is architecturally UNKNOWN.

DZE, bit [14]

Traps EL0 execution of [DC ZVA](#) instructions to EL1, from AArch64 state only.

0 Any attempt to execute a [DC ZVA](#) instruction at EL0 using AArch64 is trapped to EL1. Reading [DCZID_EL0](#).DZP from EL0 returns 1, indicating that [DC ZVA](#) instructions are not supported.

1 This control does not cause any instructions to be trapped.

When [ARMv8.1-VHE](#) is implemented, and the value of [HCR_EL2](#).{E2H, TGE} is {1, 1}, this bit has no effect on execution at EL0.

This field resets to a value that is architecturally UNKNOWN.

Bit [13]

Reserved, RES0.

I, bit [12]

Instruction access Cacheability control, for accesses at EL0 and EL1:

0 All instruction access to Normal memory from EL0 and EL1 are Non-cacheable for all levels of instruction and unified cache.

If the value of [SCTLR_EL1](#).M is 0, instruction accesses from stage 1 of the EL1&0 translation regime are to Normal, Outer Shareable, Inner Non-cacheable, Outer Non-cacheable memory.

1 This control has no effect on the Cacheability of instruction access to Normal memory from EL0 and EL1.

If the value of [SCTLR_EL1](#).M is 0, instruction accesses from stage 1 of the EL1&0 translation regime are to Normal, Outer Shareable, Inner Write-Through, Outer Write-Through memory.

When the value of the [HCR_EL2](#).DC bit is 1, then instruction access to Normal memory from EL0 and EL1 are Cacheable regardless of the value of the [SCTLR_EL1](#).I bit.

When [ARMv8.1-VHE](#) is implemented, and the value of [HCR_EL2](#).{E2H, TGE} is {1, 1}, this bit has no effect on the PE.

When this register has an architecturally-defined reset value, this field resets to 0.

Bit [11]

Reserved, RES1.

Bit [10]

Reserved, RES0.

UMA, bit [9]

User Mask Access. Traps EL0 execution of MSR and MRS instructions that access the PSTATE. {D, A, I, F} masks to EL1, from AArch64 state only.

0 Any attempt at EL0 using AArch64 to execute an MRS, MSR(register), or MSR(immediate) instruction that accesses the [DAIF](#) is trapped to EL1.

1 This control does not cause any instructions to be trapped.

When [ARMv8.1-VHE](#) is implemented, and the value of `HCR_EL2.{E2H, TGE}` is {1, 1}, this bit has no effect on execution at EL0.

This field resets to a value that is architecturally UNKNOWN.

SED, bit [8]

SETEND instruction disable. Disables SETEND instructions at EL0 using AArch32.

- 0 SETEND instruction execution is enabled at EL0 using AArch32.
- 1 SETEND instructions are UNDEFINED at EL0 using AArch32.

If the implementation does not support mixed-endian operation at any Exception level, this bit is RES1.

If EL0 cannot use AArch32, this bit is RES1.

When [ARMv8.1-VHE](#) is implemented, and the value of `HCR_EL2.{E2H, TGE}` is {1, 1}, this bit has no effect on execution at EL0.

If this field is implemented as an RW field, it resets to a value that is architecturally UNKNOWN.

ITD, bit [7]

IT Disable. Disables some uses of IT instructions at EL0 using AArch32.

- 0 All IT instruction functionality is enabled at EL0 using AArch32.
- 1 Any attempt at EL0 using AArch32 to execute any of the following is UNDEFINED:
 - All encodings of the IT instruction with `hw1[3:0] != 1000`.
 - All encodings of the subsequent instruction with the following values for `hw1`:
 - 11xxxxxxxxxxxxx
All 32-bit instructions, and the 16-bit instructions B, UDF, SVC, LDM, and STM.
 - 1011xxxxxxxxxxxx
All instructions in [Miscellaneous 16-bit instructions on page F3-2883](#).
 - 10100xxxxxxxxxxxx
ADD Rd, PC, #imm
 - 01001xxxxxxxxxxxx
LDR Rd, [PC, #imm]
 - 0100x1xxx1111xxx
ADD Rdn, PC; CMP Rn, PC; MOV Rd, PC; BX PC; BLX PC.
 - 010001xx1xxxx111
ADD PC, Rm; CMP PC, Rm; MOV PC, Rm. This pattern also covers UNPREDICTABLE cases with BLX Rn.

These instructions are always UNDEFINED, regardless of whether they would pass or fail the condition code check that applies to them as a result of being in an IT block.

It is IMPLEMENTATION DEFINED whether the IT instruction is treated as:

- A 16-bit instruction, that can only be followed by another 16-bit instruction.
- The first half of a 32-bit instruction.

This means that, for the situations that are UNDEFINED, either the second 16-bit instruction or the 32-bit instruction is UNDEFINED.

An implementation might vary dynamically as to whether IT is treated as a 16-bit instruction or the first half of a 32-bit instruction.

If an instruction in an active IT block that would be disabled by this field sets this field to 1 then behavior is CONSTRAINED UNPREDICTABLE. For more information see [Changes to an ITD control by an instruction in an IT block on page E1-2738](#)

If EL0 cannot use AArch32, this bit is RES1.

ITD is optional, but if it is implemented in the [SCTLR](#) then it must also be implemented in the [SCTLR_EL1](#). If it is not implemented then this bit is RAZ/WI.

When [ARMv8.1-VHE](#) is implemented, and the value of [HCR_EL2](#).{E2H, TGE} is {1, 1}, this bit has no effect on execution at EL0.

If this field is implemented as an RW field, it resets to a value that is architecturally UNKNOWN.

Bit [6]

Reserved, RES0.

CP15BEN, bit [5]

System instruction memory barrier enable. Enables accesses to the DMB, DSB, and ISB System instructions in the (coproc==1111) encoding space from EL0:

- | | |
|---|--|
| 0 | EL0 using AArch32: EL0 execution of the CP15DMB , CP15DSB , and CP15ISB instructions is UNDEFINED. |
| 1 | EL0 using AArch32: EL0 execution of the CP15DMB , CP15DSB , and CP15ISB instructions is enabled. |

If EL0 cannot use AArch32, this bit is RES0.

CP15BEN is optional, but if it is implemented in the [SCTLR](#) then it must also be implemented in the [SCTLR_EL1](#). If it is not implemented then this bit is RAO/WI.

When [ARMv8.1-VHE](#) is implemented, and the value of [HCR_EL2](#).{E2H, TGE} is {1, 1}, this bit has no effect on execution at EL0.

If this field is implemented as an RW field, it resets to a value that is architecturally UNKNOWN.

SA0, bit [4]

SP Alignment check enable for EL0. When set to 1, if a load or store instruction executed at EL0 uses the SP as the base address and the SP is not aligned to a 16-byte boundary, then a SP alignment fault exception is generated. For more information, see [SP alignment checking on page D1-1793](#).

When [ARMv8.1-VHE](#) is implemented, and the value of [HCR_EL2](#).{E2H, TGE} is {1, 1}, this bit has no effect on execution at EL0.

This field resets to a value that is architecturally UNKNOWN.

SA, bit [3]

SP Alignment check enable. When set to 1, if a load or store instruction executed at EL1 uses the SP as the base address and the SP is not aligned to a 16-byte boundary, then a SP alignment fault exception is generated. For more information, see [SP alignment checking on page D1-1793](#).

When [ARMv8.1-VHE](#) is implemented, and the value of [HCR_EL2](#).{E2H, TGE} is {1, 1}, this bit has no effect on the PE.

This field resets to a value that is architecturally UNKNOWN.

C, bit [2]

Cacheability control, for data accesses.

- | | |
|---|---|
| 0 | All data access to Normal memory from EL0 and EL1, and all Normal memory accesses to the EL1&0 stage 1 translation tables, are Non-cacheable for all levels of data and unified cache. |
| 1 | This control has no effect on the Cacheability of: <ul style="list-style-type: none">• Data access to Normal memory from EL0 and EL1.• Normal memory accesses to the EL1&0 stage 1 translation tables. |

When the value of the [HCR_EL2](#).DC bit is 1, the PE ignores SCLTR.C. This means that Non-secure EL0 and Non-secure EL1 data accesses to Normal memory are Cacheable.

When [ARMv8.1-VHE](#) is implemented, and the value of [HCR_EL2](#).{E2H, TGE} is {1, 1}, this bit has no effect on the PE.

When this register has an architecturally-defined reset value, this field resets to 0.

A, bit [1]

Alignment check enable. This is the enable bit for Alignment fault checking at EL1 and EL0:

- 0 Alignment fault checking disabled when executing at EL1 or EL0.
Instructions that load or store one or more registers, other than load/store exclusive and load-acquire/store-release, do not check that the address being accessed is aligned to the size of the data element(s) being accessed.
- 1 Alignment fault checking enabled when executing at EL1 or EL0.
All instructions that load or store one or more registers have an alignment check that the address being accessed is aligned to the size of the data element(s) being accessed. If this check fails it causes an Alignment fault, which is taken as a Data Abort exception.

Load/store exclusive and load-acquire/store-release instructions have an alignment check regardless of the value of the A bit.

When [ARMv8.1-VHE](#) is implemented, and the value of [HCR_EL2](#).{E2H, TGE} is {1, 1}, this bit has no effect on execution at EL0.

This field resets to a value that is architecturally UNKNOWN.

M, bit [0]

MMU enable for EL1 and EL0 stage 1 address translation. Possible values of this bit are:

- 0 EL1 and EL0 stage 1 address translation disabled.
See the [SCTLR_EL1.I](#) field for the behavior of instruction accesses to Normal memory.
- 1 EL1 and EL0 stage 1 address translation enabled.

If the value of [HCR_EL2](#).{DC, TGE} is not {0, 0} then in Non-secure state the PE behaves as if the value of the [SCTLR_EL1.M](#) field is 0 for all purposes other than returning the value of a direct read of the field.

When [ARMv8.1-VHE](#) is implemented, and the value of [HCR_EL2](#).{E2H, TGE} is {1, 1}, this bit has no effect on the PE.

When this register has an architecturally-defined reset value, this field resets to 0.

Accessing the SCTLR_EL1

This register can be read using MRS with the following syntax:

```
MRS <Xt>, <systemreg>
```

This register can be written using MSR (register) with the following syntax:

```
MSR <systemreg>, <Xt>
```

This syntax is encoded with the following settings in the instruction encoding:

<systemreg>	op0	op1	CRn	CRm	op2
SCTLR_EL1	11	000	0001	0000	000
SCTLR_EL12	11	101	0001	0000	000

Accessibility

The register is accessible in software as follows:

<systemreg>	Control			Accessibility			
	E2H	TGE	NS	EL0	EL1	EL2	EL3
SCTLR_EL1	x	x	0	-	RW	n/a	RW
SCTLR_EL1	0	0	1	-	RW	RW	RW
SCTLR_EL1	0	1	1	-	n/a	RW	RW
SCTLR_EL1	1	0	1	-	RW	SCTLR_EL2	RW
SCTLR_EL1	1	1	1	-	n/a	SCTLR_EL2	RW
SCTLR_EL12	x	x	0	-	-	n/a	-
SCTLR_EL12	0	0	1	-	-	-	-
SCTLR_EL12	0	1	1	-	n/a	-	-
SCTLR_EL12	1	0	1	-	-	RW	RW
SCTLR_EL12	1	1	1	-	n/a	RW	RW

This table applies to all instructions that can access this register.

When [HCR_EL2.E2H](#) is 1, without explicit synchronization, access from EL3 using the mnemonic [SCTLR_EL1](#) or [SCTLR_EL12](#) are not guaranteed to be ordered with respect to accesses using the other mnemonic.

Traps and Enables

For a description of the prioritization of any generated exceptions, see [Synchronous exception prioritization for exceptions taken to AArch64 on page D1-1827](#). Subject to the prioritization rules:

- When EL2 is implemented and is using AArch64 and $(SCR_EL3.NS == 1) \&\& (HCR_EL2.E2H == 0)$:
 - If [HCR_EL2.TRVM](#)==1, Non-secure read accesses to this register from EL1 are trapped to EL2.
 - If [HCR_EL2.TVM](#)==1, Non-secure write accesses to this register from EL1 are trapped to EL2.
- When EL2 is implemented and is using AArch64 and $(SCR_EL3.NS == 1) \&\& (HCR_EL2.E2H == 1) \&\& (HCR_EL2.TGE == 0)$:
 - If [HCR_EL2.TRVM](#)==1, Non-secure read accesses to this register from EL1 are trapped to EL2.
 - If [HCR_EL2.TVM](#)==1, Non-secure write accesses to this register from EL1 are trapped to EL2.

D7.2.89 SCTLR_EL2, System Control Register (EL2)

The SCTLR_EL2 characteristics are:

Purpose

Provides top level control of the system, including its memory system, at EL2.

When [ARMv8.1-VHE](#) is implemented, and the value of [HCR_EL2.{E2H, TGE}](#) is {1, 1}, these controls apply also to execution at Non-secure EL0.

Configurations

AArch64 System register SCTLR_EL2 is architecturally mapped to AArch32 System register [HSCTLR](#).

If EL2 is not implemented, this register is RES0 from EL3.

Some or all RW fields of this register have defined reset values. These apply only if the PE resets into EL2 using AArch64. Otherwise, RW fields in this register reset to architecturally UNKNOWN values.

Attributes

SCTLR_EL2 is a 32-bit register.

Field descriptions

The SCTLR_EL2 bit assignments are:

When [HCR_EL2.{E2H, TGE}](#) != {1, 1}:

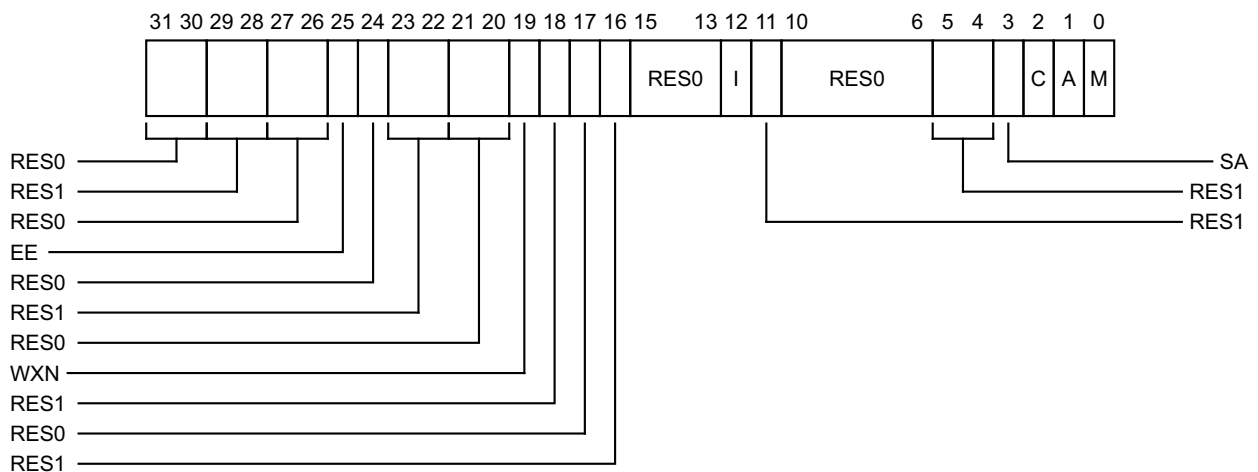

This format applies in all ARMv8.0 implementations, and from ARMv8.1 in Secure state.

Bits [31:30]

Reserved, RES0.

Bits [29:28]

Reserved, RES1.

Bits [27:26]

Reserved, RES0.

EE, bit [25]

Endianness of data accesses at EL2, stage 1 translation table walks in the EL2 or EL2&0 translation regime, and stage 2 translation table walks in the EL1&0 translation regime.

The possible values of this bit are:

- 0 Explicit data accesses at EL2, stage 1 translation table walks in the EL2 or EL2&0 translation regime, and stage 2 translation table walks in the EL1&0 translation regime are little-endian.
- 1 Explicit data accesses at EL2, stage 1 translation table walks in the EL2 or EL2&0 translation regime, and stage 2 translation table walks in the EL1&0 translation regime are big-endian.

If an implementation does not provide Big-endian support at Exception Levels higher than EL0, this bit is RES0.

If an implementation does not provide Little-endian support at Exception Levels higher than EL0, this bit is RES1.

The EE bit is permitted to be cached in a TLB.

When this register has an architecturally-defined reset value, if this field is implemented as an RW field, it resets to an IMPLEMENTATION DEFINED value.

Bit [24]

Reserved, RES0.

Bits [23:22]

Reserved, RES1.

Bits [21:20]

Reserved, RES0.

WXN, bit [19]

Write permission implies XN (Execute-never). For the EL2 or EL2&0 translation regime, this bit can force all memory regions that are writable to be treated as XN. The possible values of this bit are:

- 0 This control has no effect on memory access permissions.
- 1 Any region that is writable in the EL2 or EL2&0 translation regime is forced to XN for accesses from software executing at EL2.

The WXN bit is permitted to be cached in a TLB.

This field resets to a value that is architecturally UNKNOWN.

Bit [18]

Reserved, RES1.

Bit [17]

Reserved, RES0.

Bit [16]

Reserved, RES1.

Bits [15:13]

Reserved, RES0.

I, bit [12]

Instruction access Cacheability control, for accesses at EL2:

- 0 All instruction access to Normal memory from EL2 are Non-cacheable for all levels of instruction and unified cache.

If the value of SCTLR_EL2.M is 0, instruction accesses from stage 1 of the EL2 or EL2&0 translation regime are to Normal, Outer Shareable, Inner Non-cacheable, Outer Non-cacheable memory.

1 This control has no effect on the Cacheability of instruction access to Normal memory from EL2.

If the value of SCTLR_EL2.M is 0, instruction accesses from stage 1 of the EL2 or EL2&0 translation regime are to Normal, Outer Shareable, Inner Write-Through, Outer Write-Through memory.

This bit has no effect on the EL1&0 or EL3 translation regimes.

When this register has an architecturally-defined reset value, this field resets to 0.

Bit [11]

Reserved, RES1.

Bits [10:6]

Reserved, RES0.

Bits [5:4]

Reserved, RES1.

SA, bit [3]

SP Alignment check enable. When set to 1, if a load or store instruction executed at EL2 uses the SP as the base address and the SP is not aligned to a 16-byte boundary, then a SP alignment fault exception is generated. For more information, see [SP alignment checking on page D1-1793](#).

This field resets to a value that is architecturally UNKNOWN.

C, bit [2]

Cacheability control, for data accesses.

0 All data access to Normal memory from EL2, and all Normal memory accesses to the EL2 translation tables, are Non-cacheable for all levels of data and unified cache.

1 This control has no effect on the Cacheability of:

- Data access to Normal memory from EL2.
- Normal memory accesses to the EL2 translation tables.

This bit has no effect on the EL1&0 or EL3 translation regimes.

When this register has an architecturally-defined reset value, this field resets to 0.

A, bit [1]

Alignment check enable. This is the enable bit for Alignment fault checking at EL2:

0 Alignment fault checking disabled when executing at EL2.

Instructions that load or store one or more registers, other than load/store exclusive and load-acquire/store-release, do not check that the address being accessed is aligned to the size of the data element(s) being accessed.

1 Alignment fault checking enabled when executing at EL2.

All instructions that load or store one or more registers have an alignment check that the address being accessed is aligned to the size of the data element(s) being accessed. If this check fails it causes an Alignment fault, which is taken as a Data Abort exception.

Load/store exclusive and load-acquire/store-release instructions have an alignment check regardless of the value of the A bit.

This field resets to a value that is architecturally UNKNOWN.

M, bit [0]

MMU enable for EL2 stage 1 address translation. Possible values of this bit are:

0 EL2 stage 1 address translation disabled.

See the SCTLR_EL2.I field for the behavior of instruction accesses to Normal memory.

1 EL2 stage 1 address translation enabled.

When this register has an architecturally-defined reset value, this field resets to 0.

When $HCR_EL2.\{E2H, TGE\} == \{1, 1\}$:

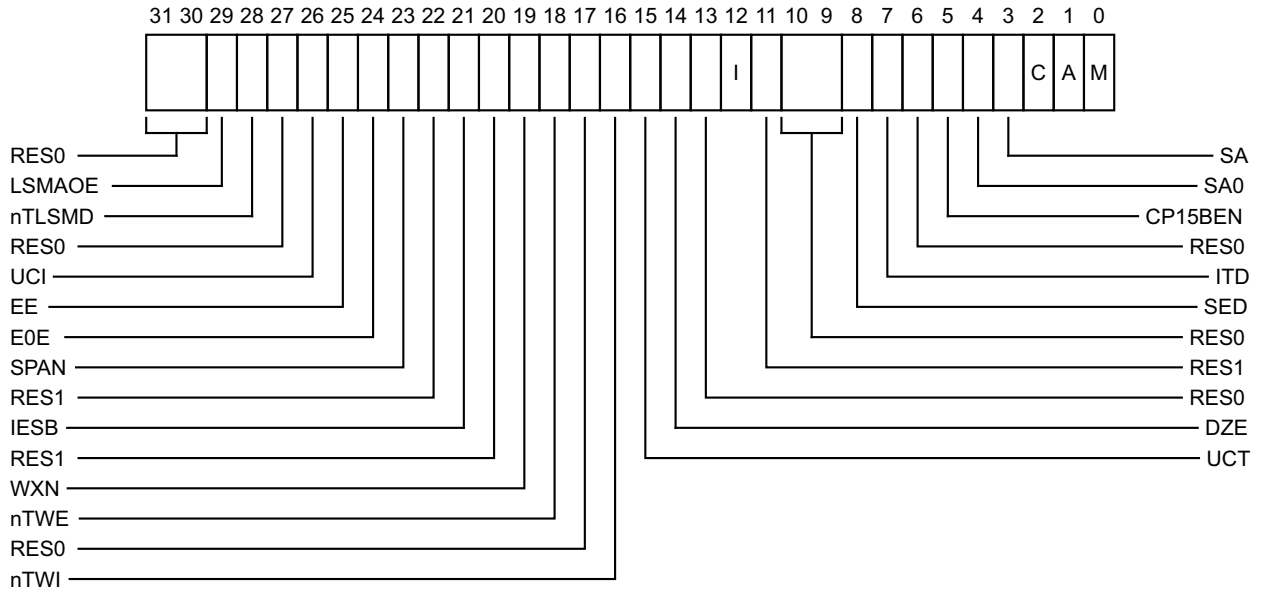

This format applies only from ARMv8.1 and only in Non-secure state when $HCR_EL2.\{E2H, TGE\} == \{1, 1\}$.

Bits [31:30]

Reserved, RES0.

LSMAOE, bit [29]

In ARMv8.2

Load Multiple and Store Multiple Atomicity and Ordering Enable. When the OPTIONAL feature [ARMv8.2-LSMAOC](#) is implemented, defined values are:

- 0 For all memory accesses at EL0, A32 and T32 Load Multiple and Store Multiple can have an interrupt taken during the sequence memory accesses, and the memory accesses are not required to be ordered.
- 1 The ordering and interrupt behavior of A32 and T32 Load Multiple and Store Multiple at EL0 is as defined for ARMv8.0.

This bit is permitted to be cached in a TLB.

If this bit is not implemented, it is RES1.

In ARMv8.1.

Reserved, RES1.

nTLSMD, bit [28]

In ARMv8.2

No Trap Load Multiple and Store Multiple to Device-nGRE/Device-nGnRE/Device-nGnRnE memory. When the OPTIONAL feature [ARMv8.2-LSMAOC](#) is implemented, defined values are:

- 0 All memory accesses by A32 and T32 Load Multiple and Store Multiple at EL0 that are marked at stage 1 as Device-nGRE/Device-nGnRE/Device-nGnRnE memory are trapped and generate a stage 1 Alignment fault.

- 1 All memory accesses by A32 and T32 Load Multiple and Store Multiple at EL0 that are marked at stage 1 as Device-nGRE/Device-nGnRE/Device-nGnRnE memory are not trapped.

This bit is permitted to be cached in a TLB.

If this bit is not implemented, it is RES1.

In ARMv8.1.

Reserved, RES1.

Bit [27]

Reserved, RES0.

UCI, bit [26]

Traps EL0 execution of cache maintenance instructions to EL2, from AArch64 state only.

- 0 Any attempt to execute a [DC CVAU](#), [DC CIVAC](#), [DC CVAC](#), or [IC IVAU](#) instruction at EL0 using AArch64 is trapped to EL2.

- 1 This control does not cause any instructions to be trapped.

This field resets to a value that is architecturally UNKNOWN.

EE, bit [25]

Endianness of data accesses at EL2, stage 1 translation table walks in the EL2 or EL2&0 translation regime, and stage 2 translation table walks in the EL2&0 translation regime.

The possible values of this bit are:

- 0 Explicit data accesses at EL2, stage 1 translation table walks in the EL2 or EL2&0 translation regime, and stage 2 translation table walks in the EL2&0 translation regime are little-endian.

- 1 Explicit data accesses at EL2, stage 1 translation table walks in the EL2 or EL2&0 translation regime, and stage 2 translation table walks in the EL2&0 translation regime are big-endian.

If an implementation does not provide Big-endian support at Exception Levels higher than EL0, this bit is RES0.

If an implementation does not provide Little-endian support at Exception Levels higher than EL0, this bit is RES1.

The EE bit is permitted to be cached in a TLB.

When this register has an architecturally-defined reset value, if this field is implemented as an RW field, it resets to an IMPLEMENTATION DEFINED value.

E0E, bit [24]

Endianness of data accesses at EL0.

The possible values of this bit are:

- 0 Explicit data accesses at EL0 are little-endian.

- 1 Explicit data accesses at EL0 are big-endian.

If an implementation only supports Little-endian accesses at EL0 then this bit is RES0. This option is not permitted when SCTLR_EL1.EE is RES1.

If an implementation only supports Big-endian accesses at EL0 then this bit is RES1. This option is not permitted when SCTLR_EL1.EE is RES0.

This bit has no effect on the endianness of LDTR, LDTRH, LDTRSH, LDTRSW, STTR, and STTRH instructions executed at EL1.

If this field is implemented as an RW field, it resets to a value that is architecturally UNKNOWN.

SPAN, bit [23]

Set Privileged Access Never, on taking an exception to EL2.

0 PSTATE.PAN is set to 1 on taking an exception to EL2.

1 The value of PSTATE.PAN is left unchanged on taking an exception to EL2.

This field resets to a value that is architecturally UNKNOWN.

Bit [22]

Reserved, RES1.

IESB, bit [21]

In ARMv8.2

Implicit Error Synchronization Barrier enable. Permitted values are:

0 Disabled.

1 An implicit ErrorSynchronizationBarrier() call is added:

- After each exception taken to EL2.
- Before the operational pseudocode of each ERET instruction executed at EL2.

When the PE is in Debug state, the effect of this field is CONSTRAINED UNPREDICTABLE, and regardless of the value of the field its effective value might be 0 or 1. If the effective value of the field is 1, then an implicit ErrorSynchronizationBarrier() is added after each DCPSx instruction and before each DRPS instruction, in addition to the other cases where it is added.

This field is part of the required ARMv8.2 implementation of the RAS Extension. See [The Reliability, Availability, and Serviceability \(RAS\) Extension on page A1-63](#).

In ARMv8.1.

Reserved, RES0.

Bit [20]

Reserved, RES1.

WXN, bit [19]

Write permission implies XN (Execute-never). For the EL2 or EL2&0 translation regime, this bit can force all memory regions that are writable to be treated as XN. The possible values of this bit are:

0 This control has no effect on memory access permissions.

1 Any region that is writable in the EL2 or EL2&0 translation regime is forced to XN for accesses from software executing at EL2.

The WXN bit is permitted to be cached in a TLB.

This field resets to a value that is architecturally UNKNOWN.

nTWE, bit [18]

Traps EL0 execution of WFE instructions to EL2, from both Execution states.

0 Any attempt to execute a WFE instruction at EL0 is trapped to EL2, if the instruction would otherwise have caused the PE to enter a low-power state.

1 This control does not cause any instructions to be trapped.

In AArch32 state, the attempted execution of a conditional WFE instruction is only trapped if the instruction passes its condition code check.

Note

Since a WFE or WFI can complete at any time, even without a Wakeup event, the traps on WFE or WFI are not guaranteed to be taken, even if the WFE or WFI is executed when there is no Wakeup event. The only guarantee is that if the instruction does not complete in finite time in the absence of a Wakeup event, the trap will be taken.

This field resets to a value that is architecturally UNKNOWN.

Bit [17]

Reserved, RES0.

nTWI, bit [16]

Traps EL0 execution of WFI instructions to EL2, from both Execution states.

- 0 Any attempt to execute a WFI instruction at EL0 is trapped EL2, if the instruction would otherwise have caused the PE to enter a low-power state.
- 1 This control does not cause any instructions to be trapped.

In AArch32 state, the attempted execution of a conditional WFI instruction is only trapped if the instruction passes its condition code check.

———— **Note** —————

Since a WFE or WFI can complete at any time, even without a Wakeup event, the traps on WFE or WFI are not guaranteed to be taken, even if the WFE or WFI is executed when there is no Wakeup event. The only guarantee is that if the instruction does not complete in finite time in the absence of a Wakeup event, the trap will be taken.

This field resets to a value that is architecturally UNKNOWN.

UCT, bit [15]

Traps EL0 accesses to the [CTR_EL0](#) to EL2, from AArch64 state only.

- 0 Accesses to the [CTR_EL0](#) from EL0 using AArch64 are trapped to EL2.
- 1 This control does not cause any instructions to be trapped.

This field resets to a value that is architecturally UNKNOWN.

DZE, bit [14]

Traps EL0 execution of [DC ZVA](#) instructions to EL2, from AArch64 state only.

- 0 Any attempt to execute a [DC ZVA](#) instruction at EL0 using AArch64 is trapped to EL2. Reading [DCZID_EL0.DZP](#) from EL0 returns 1, indicating that [DC ZVA](#) instructions are not supported.
- 1 This control does not cause any instructions to be trapped.

This field resets to a value that is architecturally UNKNOWN.

Bit [13]

Reserved, RES0.

I, bit [12]

Instruction access Cacheability control, for accesses at EL2 and EL0:

- 0 All instruction access to Normal memory from EL2 and EL0 are Non-cacheable for all levels of instruction and unified cache.
If the value of [SCTLR_EL2.M](#) is 0, instruction accesses from stage 1 of the EL2&0 translation regime are to Normal, Outer Shareable, Inner Non-cacheable, Outer Non-cacheable memory.
- 1 This control has no effect on the Cacheability of instruction access to Normal memory from EL2 and EL0.
If the value of [SCTLR_EL2.M](#) is 0, instruction accesses from stage 1 of the EL2&0 translation regime are to Normal, Outer Shareable, Inner Write-Through, Outer Write-Through memory.

This bit has no effect on the EL3 translation regimes.

When this register has an architecturally-defined reset value, this field resets to 0.

Bit [11]

Reserved, RES1.

Bits [10:9]

Reserved, RES0.

SED, bit [8]

SETEND instruction disable. Disables SETEND instructions at EL0 using AArch32.

0 SETEND instruction execution is enabled at EL0 using AArch32.

1 SETEND instructions are UNDEFINED at EL0 using AArch32.

If the implementation does not support mixed-endian operation at any Exception level, this bit is RES1.

If EL0 cannot use AArch32, this bit is RES1.

If this field is implemented as an RW field, it resets to a value that is architecturally UNKNOWN.

ITD, bit [7]

IT Disable. Disables some uses of IT instructions at EL0 using AArch32.

0 All IT instruction functionality is enabled at EL0 using AArch32.

1 Any attempt at EL0 using AArch32 to execute any of the following is UNDEFINED:

- All encodings of the IT instruction with $hw1[3:0] \neq 1000$.
- All encodings of the subsequent instruction with the following values for $hw1$:

11xxxxxxxxxxxx

All 32-bit instructions, and the 16-bit instructions B, UDF, SVC, LDM, and STM.

1011xxxxxxxxxxxx

All instructions in *Miscellaneous 16-bit instructions* on page F3-2883.

10100xxxxxxxxxxx

ADD Rd, PC, #imm

01001xxxxxxxxxxx

LDR Rd, [PC, #imm]

0100x1xxx1111xxx

ADD Rdn, PC; CMP Rn, PC; MOV Rd, PC; BX PC; BLX PC.

010001xx1xxxx111

ADD PC, Rm; CMP PC, Rm; MOV PC, Rm. This pattern also covers UNPREDICTABLE cases with BLX Rn.

These instructions are always UNDEFINED, regardless of whether they would pass or fail the condition code check that applies to them as a result of being in an IT block.

It is IMPLEMENTATION DEFINED whether the IT instruction is treated as:

- A 16-bit instruction, that can only be followed by another 16-bit instruction.
- The first half of a 32-bit instruction.

This means that, for the situations that are UNDEFINED, either the second 16-bit instruction or the 32-bit instruction is UNDEFINED.

An implementation might vary dynamically as to whether IT is treated as a 16-bit instruction or the first half of a 32-bit instruction.

If an instruction in an active IT block that would be disabled by this field sets this field to 1 then behavior is CONSTRAINED UNPREDICTABLE. For more information see [Changes to an ITD control by an instruction in an IT block on page E1-2738](#)

If EL0 cannot use AArch32, this bit is RES1.

ITD is optional, but if it is implemented in the [SCTLR](#) then it must also be implemented in the [SCTLR_EL1](#). If it is not implemented then this bit is RAZ/WI.

If this field is implemented as an RW field, it resets to a value that is architecturally UNKNOWN.

Bit [6]

Reserved, RES0.

CP15BEN, bit [5]

System instruction memory barrier enable. Enables accesses to the DMB, DSB, and ISB System instructions in the (coproc==1111) encoding space from EL0:

- | | |
|---|--|
| 0 | EL0 using AArch32: EL0 execution of the CP15DMB , CP15DSB , and CP15ISB instructions is UNDEFINED. |
| 1 | EL0 using AArch32: EL0 execution of the CP15DMB , CP15DSB , and CP15ISB instructions is enabled. |

If EL0 cannot use AArch32, this bit is RES0.

CP15BEN is optional, but if it is implemented in the [SCTLR](#) then it must also be implemented in the [SCTLR_EL1](#). If it is not implemented then this bit is RAO/WI.

If this field is implemented as an RW field, it resets to a value that is architecturally UNKNOWN.

SA0, bit [4]

SP Alignment check enable for EL0. When set to 1, if a load or store instruction executed at EL0 uses the SP as the base address and the SP is not aligned to a 16-byte boundary, then a SP alignment fault exception is generated. For more information, see [SP alignment checking on page D1-1793](#).

This field resets to a value that is architecturally UNKNOWN.

SA, bit [3]

SP Alignment check enable. When set to 1, if a load or store instruction executed at EL2 uses the SP as the base address and the SP is not aligned to a 16-byte boundary, then a SP alignment fault exception is generated. For more information, see [SP alignment checking on page D1-1793](#).

This field resets to a value that is architecturally UNKNOWN.

C, bit [2]

Cacheability control, for data accesses.

- | | |
|---|---|
| 0 | All data access to Normal memory from EL2 and EL0, and all Normal memory accesses to the EL2&0 translation tables, are Non-cacheable for all levels of data and unified cache. |
| 1 | This control has no effect on the Cacheability of: <ul style="list-style-type: none">• Data access to Normal memory from EL2 and EL0.• Normal memory accesses to the EL2&0 translation tables. |

This bit has no effect on the EL3 translation regimes.

When this register has an architecturally-defined reset value, this field resets to 0.

A, bit [1]

Alignment check enable. This is the enable bit for Alignment fault checking at EL2 and EL0:

- | | |
|---|---|
| 0 | Alignment fault checking disabled when executing at EL2 and EL0. Instructions that load or store one or more registers, other than load/store exclusive and load-acquire/store-release, do not check that the address being accessed is aligned to the size of the data element(s) being accessed. |
| 1 | Alignment fault checking enabled when executing at EL2 and EL0. All instructions that load or store one or more registers have an alignment check that the address being accessed is aligned to the size of the data element(s) being accessed. If this check fails it causes an Alignment fault, which is taken as a Data Abort exception. |

Load/store exclusive and load-acquire/store-release instructions have an alignment check regardless of the value of the A bit.

This field resets to a value that is architecturally UNKNOWN.

M, bit [0]

MMU enable for EL2&0 stage 1 address translation. Possible values of this bit are:

- 0 EL2&0 stage 1 address translation disabled.
See the SCTLR_EL2.I field for the behavior of instruction accesses to Normal memory.
- 1 EL2&1 stage 1 address translation enabled.

When this register has an architecturally-defined reset value, this field resets to 0.

Accessing the SCTLR_EL2

This register can be read using MRS with the following syntax:

MRS <Xt>, <systemreg>

This register can be written using MSR (register) with the following syntax:

MSR <systemreg>, <Xt>

This syntax is encoded with the following settings in the instruction encoding:

<systemreg>	op0	op1	CRn	CRm	op2
SCTLR_EL2	11	100	0001	0000	000
SCTLR_EL1	11	000	0001	0000	000

Accessibility

The register is accessible in software as follows:

<systemreg>	Control			Accessibility			
	E2H	TGE	NS	EL0	EL1	EL2	EL3
SCTLR_EL2	x	x	0	-	-	n/a	RW
SCTLR_EL2	0	0	1	-	-	RW	RW
SCTLR_EL2	0	1	1	-	n/a	RW	RW
SCTLR_EL2	1	0	1	-	-	RW	RW
SCTLR_EL2	1	1	1	-	n/a	RW	RW
SCTLR_EL1	x	x	0	-	SCTLR_EL1	n/a	SCTLR_EL1
SCTLR_EL1	0	0	1	-	SCTLR_EL1	SCTLR_EL1	SCTLR_EL1
SCTLR_EL1	0	1	1	-	n/a	SCTLR_EL1	SCTLR_EL1
SCTLR_EL1	1	0	1	-	SCTLR_EL1	RW	SCTLR_EL1
SCTLR_EL1	1	1	1	-	n/a	RW	SCTLR_EL1

This table applies to all instructions that can access this register.

When [HCR_EL2.E2H](#) is 1, without explicit synchronization, access from EL2 using the mnemonic `SCTLR_EL2` or `SCTLR_EL1` are not guaranteed to be ordered with respect to accesses using the other mnemonic.

D7.2.90 SCTLR_EL3, System Control Register (EL3)

The SCTLR_EL3 characteristics are:

Purpose

Provides top level control of the system, including its memory system, at EL3.

Configurations

Some or all RW fields of this register have defined reset values. These apply only if the PE resets into EL3 using AArch64. Otherwise, RW fields in this register reset to architecturally UNKNOWN values.

Attributes

SCTLR_EL3 is a 32-bit register.

Field descriptions

The SCTLR_EL3 bit assignments are:

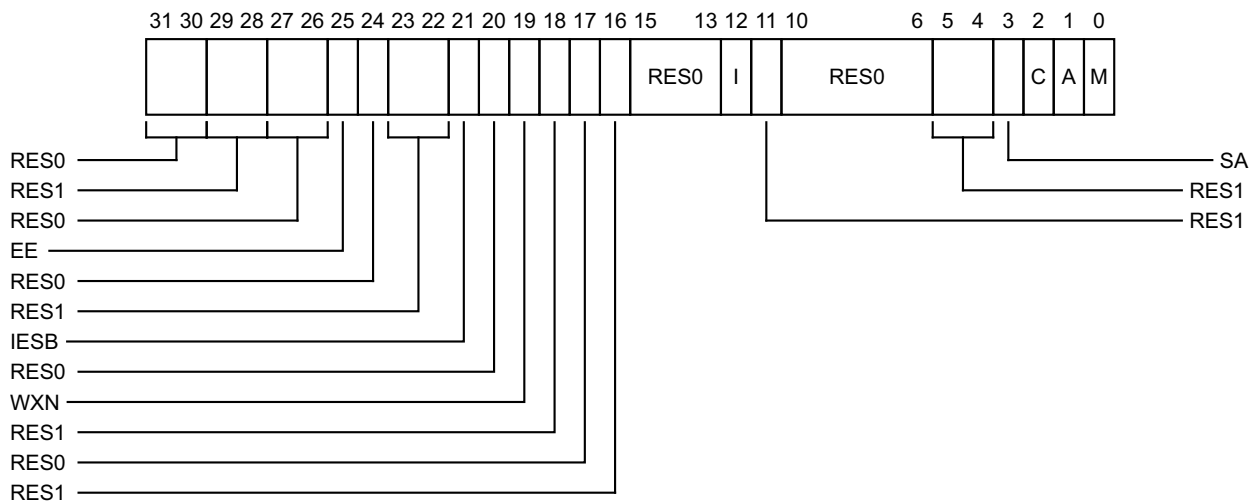

Bits [31:30]

Reserved, RES0.

Bits [29:28]

Reserved, RES1.

Bits [27:26]

Reserved, RES0.

EE, bit [25]

Endianness of data accesses at EL3, and stage 1 translation table walks in the EL3 translation regime.

The possible values of this bit are:

- 0 Explicit data accesses at EL3, and stage 1 translation table walks in the EL3 translation regime are little-endian.
- 1 Explicit data accesses at EL3, and stage 1 translation table walks in the EL3 translation regime are big-endian.

If an implementation does not provide Big-endian support at Exception Levels higher than EL0, this bit is RES0.

If an implementation does not provide Little-endian support at Exception Levels higher than EL0, this bit is RES1.

The EE bit is permitted to be cached in a TLB.

When this register has an architecturally-defined reset value, if this field is implemented as an RW field, it resets to an IMPLEMENTATION DEFINED value.

Bit [24]

Reserved, RES0.

Bits [23:22]

Reserved, RES1.

IESB, bit [21]

In ARMv8.2

Implicit Error Synchronization Barrier enable. Permitted values are:

0 Disabled.

1 An implicit ErrorSynchronizationBarrier() call is added:

- After each exception taken to EL3.
- Before the operational pseudocode of each ERET instruction executed at EL3.

When the PE is in Debug state, the effect of this field is CONSTRAINED UNPREDICTABLE, and regardless of the value of the field its effective value might be 0 or 1. If the effective value of the field is 1, then an implicit ErrorSynchronizationBarrier() is added after each DCPSx instruction and before each DRPS instruction, in addition to the other cases where it is added.

This field is part of the required ARMv8.2 implementation of the RAS Extension. See [The Reliability, Availability, and Serviceability \(RAS\) Extension on page A1-63](#).

In ARMv8.1 and ARMv8.0.

Reserved, RES0.

Bit [20]

Reserved, RES0.

WXN, bit [19]

Write permission implies XN (Execute-never). For the EL3 translation regime, this bit can force all memory regions that are writable to be treated as XN. The possible values of this bit are:

0 This control has no effect on memory access permissions.

1 Any region that is writable in the EL3 translation regime is forced to XN for accesses from software executing at EL3.

The WXN bit is permitted to be cached in a TLB.

This field resets to a value that is architecturally UNKNOWN.

Bit [18]

Reserved, RES1.

Bit [17]

Reserved, RES0.

Bit [16]

Reserved, RES1.

Bits [15:13]

Reserved, RES0.

I, bit [12]

Instruction access Cacheability control, for accesses at EL3:

0 All instruction access to Normal memory from EL3 are Non-cacheable for all levels of instruction and unified cache.

If the value of SCTLR_EL3.M is 0, instruction accesses from stage 1 of the EL3 translation regime are to Normal, Outer Shareable, Inner Non-cacheable, Outer Non-cacheable memory.

1 This control has no effect on the Cacheability of instruction access to Normal memory from EL3.

If the value of SCTLR_EL3.M is 0, instruction accesses from stage 1 of the EL3 translation regime are to Normal, Outer Shareable, Inner Write-Through, Outer Write-Through memory.

This bit has no effect on the EL1&0, EL2, or EL2&0 translation regimes.

When this register has an architecturally-defined reset value, this field resets to 0.

Bit [11]

Reserved, RES1.

Bits [10:6]

Reserved, RES0.

Bits [5:4]

Reserved, RES1.

SA, bit [3]

SP Alignment check enable. When set to 1, if a load or store instruction executed at EL3 uses the SP as the base address and the SP is not aligned to a 16-byte boundary, then a SP alignment fault exception is generated. For more information, see [SP alignment checking on page D1-1793](#).

This field resets to a value that is architecturally UNKNOWN.

C, bit [2]

Cacheability control, for data accesses.

0 All data access to Normal memory from EL3, and all Normal memory accesses to the EL3 translation tables, are Non-cacheable for all levels of data and unified cache.

1 This control has no effect on the Cacheability of:

- Data access to Normal memory from EL3.
- Normal memory accesses to the EL3 translation tables.

This bit has no effect on the EL1&0, EL2, or EL2&0 translation regimes.

When this register has an architecturally-defined reset value, this field resets to 0.

A, bit [1]

Alignment check enable. This is the enable bit for Alignment fault checking at EL3:

0 Alignment fault checking disabled when executing at EL3.

Instructions that load or store one or more registers, other than load/store exclusive and load-acquire/store-release, do not check that the address being accessed is aligned to the size of the data element(s) being accessed.

1 Alignment fault checking enabled when executing at EL3.

All instructions that load or store one or more registers have an alignment check that the address being accessed is aligned to the size of the data element(s) being accessed. If this check fails it causes an Alignment fault, which is taken as a Data Abort exception.

Load/store exclusive and load-acquire/store-release instructions have an alignment check regardless of the value of the A bit.

This field resets to a value that is architecturally UNKNOWN.

M, bit [0]

MMU enable for EL3 stage 1 address translation. Possible values of this bit are:

- 0 EL3 stage 1 address translation disabled.
See the SCTLR_EL3.I field for the behavior of instruction accesses to Normal memory.
- 1 EL3 stage 1 address translation enabled.

When this register has an architecturally-defined reset value, this field resets to 0.

Accessing the SCTLR_EL3

This register can be read using MRS with the following syntax:

MRS <Xt>, <systemreg>

This register can be written using MSR (register) with the following syntax:

MSR <systemreg>, <Xt>

This syntax is encoded with the following settings in the instruction encoding:

<systemreg>	op0	op1	CRn	CRm	op2
SCTLR_EL3	11	110	0001	0000	000

Accessibility

The register is accessible in software as follows:

Control			Accessibility			
E2H	TGE	NS	EL0	EL1	EL2	EL3
x	x	0	-	-	n/a	RW
x	0	1	-	-	-	RW
x	1	1	-	n/a	-	RW

D7.2.91 TCR_EL1, Translation Control Register (EL1)

The TCR_EL1 characteristics are:

Purpose

The control register for stage 1 of the EL1&0 translation regime.

Configurations

AArch64 System register TCR_EL1[31:0] is architecturally mapped to AArch32 System register [TTBCR](#).

AArch64 System register TCR_EL1[63:32] is architecturally mapped to AArch32 System register [TTBCR2](#).

RW fields in this register reset to architecturally UNKNOWN values.

Attributes

TCR_EL1 is a 64-bit register.

Field descriptions

The TCR_EL1 bit assignments are:

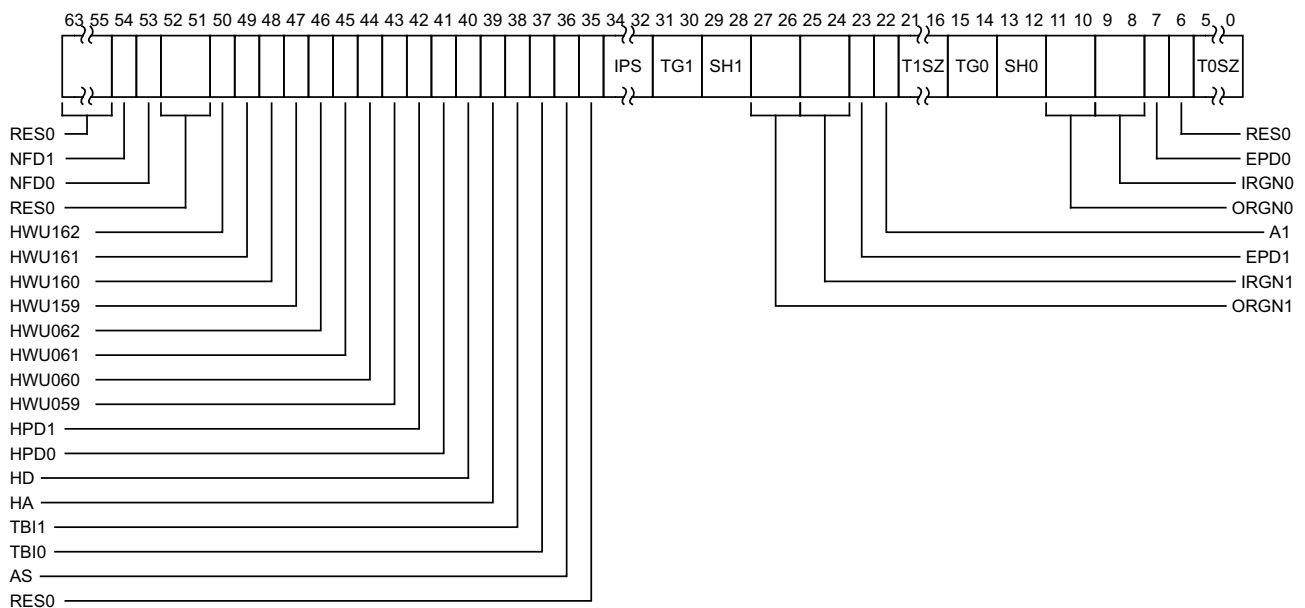

Any of the bits in TCR_EL1 are permitted to be cached in a TLB.

Bits [63:55]

Reserved, RES0.

NFD1, bit [54]

In ARMv8.2

Present only if [SVE](#) is implemented.

Non-fault translation table walk disable for translations using [TTBR1_EL1](#).

This bit controls whether to perform a translation table walk in response to an SVE non-fault access for an address that is translated using [TTBR1_EL1](#). The affected access types are:

- All accesses due to an SVE non-fault contiguous load instruction.
- Only the speculative accesses due to an SVE first-fault gather load. Speculative accesses due to an SVE first-fault contiguous load are not affected.
- Accesses due to prefetch instructions might be affected, but the effect is not architecturally visible.

See [The Scalable Vector Extension \(SVE\) on page A1-66](#) for more information.

Defined values are:

- | | |
|---|---|
| 0 | Perform translation table walks using TTBR1_EL1 . |
| 1 | A TLB miss on an address that is translated using TTBR1_EL1 due to an SVE non-fault access generates a Translation fault. No translation table walk is performed. |

If [SVE](#) is not implemented, this field is RES0.

In ARMv8.1 and ARMv8.0.

Reserved, RES0.

NFD0, bit [53]

In ARMv8.2

Present only if [SVE](#) is implemented.

Non-fault translation table walk disable for translations using [TTBR0_EL1](#).

This bit controls whether to perform a translation table walk in response to an SVE non-fault access for an address that is translated using [TTBR0_EL1](#). The affected access types are:

- All accesses due to an SVE non-fault contiguous load instruction.
- Only the speculative accesses due to an SVE first-fault gather load. Speculative accesses due to an SVE first-fault contiguous load are not affected.
- Accesses due to prefetch instructions might be affected, but the effect is not architecturally visible.

See [The Scalable Vector Extension \(SVE\) on page A1-66](#) for more information.

Defined values are:

- | | |
|---|---|
| 0 | Perform translation table walks using TTBR0_EL1 . |
| 1 | A TLB miss on an address that is translated using TTBR0_EL1 due to an SVE non-fault access generates a Translation fault. No translation table walk is performed. |

If [SVE](#) is not implemented, this field is RES0.

In ARMv8.1 and ARMv8.0.

Reserved, RES0.

Bits [52:51]

Reserved, RES0.

HWU162, bit [50]

In ARMv8.2

Hardware Use. Indicates IMPLEMENTATION DEFINED hardware use of bit[62] of the stage 1 translation table block or level 3 entry for pages pointed to by [TTBR1_EL1](#) if the TCR_EL1.HPD1 value is 1.

Defined values are:

- | | |
|---|---|
| 0 | The stage 1 translation table entry block or level 3 bit cannot be interpreted by hardware for an IMPLEMENTATION DEFINED purpose. |
| 1 | The stage 1 translation table entry block or level 3 bit can be interpreted by hardware for an IMPLEMENTATION DEFINED purpose if the TCR_EL1.HPD1 value is 1. |

This bit is RES0 if [ARMv8.2-TTPBHA](#) is not implemented.

In ARMv8.1 and ARMv8.0.

Reserved, RES0.

HWU161, bit [49]

In ARMv8.2

Hardware Use. Indicates IMPLEMENTATION DEFINED hardware use of bit[61] of the stage 1 translation table block or level 3 entry for pages pointed to by [TTBR1_EL1](#) if the TCR_EL1.HPD1 value is 1.

Defined values are:

- 0 The stage 1 translation table entry block or level 3 bit cannot be interpreted by hardware for an IMPLEMENTATION DEFINED purpose.
- 1 The stage 1 translation table entry block or level 3 bit can be interpreted by hardware for an IMPLEMENTATION DEFINED purpose if the TCR_EL1.HPD1 value is 1.

This bit is RES0 if [ARMv8.2-TTPBHA](#) is not implemented.

In ARMv8.1 and ARMv8.0.

Reserved, RES0.

HWU160, bit [48]

In ARMv8.2

Hardware Use. Indicates IMPLEMENTATION DEFINED hardware use of bit[60] of the stage 1 translation table block or level 3 entry for pages pointed to by [TTBR1_EL1](#) if the TCR_EL1.HPD1 value is 1.

Defined values are:

- 0 The stage 1 translation table entry block or level 3 bit cannot be interpreted by hardware for an IMPLEMENTATION DEFINED purpose.
- 1 The stage 1 translation table entry block or level 3 bit can be interpreted by hardware for an IMPLEMENTATION DEFINED purpose if the TCR_EL1.HPD1 value is 1.

This bit is RES0 if [ARMv8.2-TTPBHA](#) is not implemented.

In ARMv8.1 and ARMv8.0.

Reserved, RES0.

HWU159, bit [47]

In ARMv8.2

Hardware Use. Indicates IMPLEMENTATION DEFINED hardware use of bit[59] of the stage 1 translation table block or level 3 entry for pages pointed to by [TTBR1_EL1](#) if the TCR_EL1.HPD1 value is 1.

Defined values are:

- 0 The stage 1 translation table entry block or level 3 bit cannot be interpreted by hardware for an IMPLEMENTATION DEFINED purpose.
- 1 The stage 1 translation table entry block or level 3 bit can be interpreted by hardware for an IMPLEMENTATION DEFINED purpose if the TCR_EL1.HPD1 value is 1.

This bit is RES0 if [ARMv8.2-TTPBHA](#) is not implemented.

In ARMv8.1 and ARMv8.0.

Reserved, RES0.

HWU062, bit [46]

In ARMv8.2

Hardware Use. Indicates IMPLEMENTATION DEFINED hardware use of bit[62] of the stage 1 translation table block or level 3 entry for pages pointed to by [TTBR0_EL1](#) if the TCR_EL1.HPD0 value is 1.

Defined values are:

- 0 The stage 1 translation table entry block or level 3 bit cannot be interpreted by hardware for an IMPLEMENTATION DEFINED purpose.
- 1 The stage 1 translation table entry block or level 3 bit can be interpreted by hardware for an IMPLEMENTATION DEFINED purpose if the TCR_EL1.HPD0 value is 1.

This bit is RES0 if [ARMv8.2-TTPBHA](#) is not implemented.

In ARMv8.1 and ARMv8.0.

Reserved, RES0.

HWU061, bit [45]

In ARMv8.2

Hardware Use. Indicates IMPLEMENTATION DEFINED hardware use of bit[61] of the stage 1 translation table block or level 3 entry for pages pointed to by [TTBR0_EL1](#) if the TCR_EL1.HPD0 value is 1.

Defined values are:

- 0 The stage 1 translation table entry block or level 3 bit cannot be interpreted by hardware for an IMPLEMENTATION DEFINED purpose.
- 1 The stage 1 translation table entry block or level 3 bit can be interpreted by hardware for an IMPLEMENTATION DEFINED purpose if the TCR_EL1.HPD0 value is 1.

This bit is RES0 if [ARMv8.2-TTPBHA](#) is not implemented.

In ARMv8.1 and ARMv8.0.

Reserved, RES0.

HWU060, bit [44]

In ARMv8.2

Hardware Use. Indicates IMPLEMENTATION DEFINED hardware use of bit[60] of the stage 1 translation table block or level 3 entry for pages pointed to by [TTBR0_EL1](#) if the TCR_EL1.HPD0 value is 1.

Defined values are:

- 0 The stage 1 translation table entry block or level 3 bit cannot be interpreted by hardware for an IMPLEMENTATION DEFINED purpose.
- 1 The stage 1 translation table entry block or level 3 bit can be interpreted by hardware for an IMPLEMENTATION DEFINED purpose if the TCR_EL1.HPD0 value is 1.

This bit is RES0 if [ARMv8.2-TTPBHA](#) is not implemented.

In ARMv8.1 and ARMv8.0.

Reserved, RES0.

HWU059, bit [43]

In ARMv8.2

Hardware Use. Indicates IMPLEMENTATION DEFINED hardware use of bit[59] of the stage 1 translation table block or level 3 entry for pages pointed to by [TTBR0_EL1](#) if the TCR_EL1.HPD0 value is 1.

Defined values are:

- 0 The stage 1 translation table entry block or level 3 bit cannot be interpreted by hardware for an IMPLEMENTATION DEFINED purpose.
- 1 The stage 1 translation table entry block or level 3 bit can be interpreted by hardware for an IMPLEMENTATION DEFINED purpose if the TCR_EL1.HPD0 value is 1.

This bit is RES0 if [ARMv8.2-TTPBHA](#) is not implemented.

In ARMv8.1 and ARMv8.0.

Reserved, RES0.

HPD1, bit [42]

In ARMv8.2 and ARMv8.1

Hierarchical Permission Disables. This affects the hierarchical control bits, APTable, PXNTable, and UXNTable, except NSTable, in the translation tables pointed to by [TTBR1_EL1](#).

Defined values are:

0 Hierarchical permissions are enabled.

1 Hierarchical permissions are disabled.

When disabled, the permissions are treated as if the bits are zero.

This bit is RES0 if [ARMv8.1-HPD](#) is not implemented.

In ARMv8.0.

Reserved, RES0.

HPD0, bit [41]

In ARMv8.2 and ARMv8.1

Hierarchical Permission Disables. This affects the hierarchical control bits, APTable, PXNTable, and UXNTable, except NSTable, in the translation tables pointed to by [TTBR0_EL1](#).

Defined values are:

0 Hierarchical permissions are enabled.

1 Hierarchical permissions are disabled.

When disabled, the permissions are treated as if the bits are zero.

This bit is RES0 if [ARMv8.1-HPD](#) is not implemented.

In ARMv8.0.

Reserved, RES0.

HD, bit [40]

In ARMv8.2 and ARMv8.1

Hardware management of dirty state in stage 1 translations from EL0 and EL1.

Defined values are:

0 Stage 1 hardware management of dirty state disabled.

1 Stage 1 hardware management of dirty state enabled, only if the HA bit is also set to 1.

This bit is RES0 if [ARMv8.1-TTHM](#) is not implemented.

In ARMv8.0.

Reserved, RES0.

HA, bit [39]

In ARMv8.2 and ARMv8.1

Hardware Access flag update in stage 1 translations from EL0 and EL1.

Defined values are:

0 Stage 1 Access flag update disabled.

1 Stage 1 Access flag update enabled.

This bit is RES0 if [ARMv8.1-TTHM](#) is not implemented.

In ARMv8.0.

Reserved, RES0.

TBI1, bit [38]

Top Byte ignored - indicates whether the top byte of an address is used for address match for the [TTBR1_EL1](#) region, or ignored and used for tagged addresses. Defined values are:

- 0 Top Byte used in the address calculation.
- 1 Top Byte ignored in the address calculation.

This affects addresses generated in EL0 and EL1 using AArch64 where the address would be translated by tables pointed to by [TTBR1_EL1](#). It has an effect whether the EL1&0 translation regime is enabled or not.

Additionally, this affects changes to the program counter, when TBI1 is 1 and bit [55] of the target address is 1, caused by:

- A branch or procedure return within EL0 or EL1.
- An exception taken to EL1.
- An exception return to EL0 or EL1.

In these cases bits [63:56] of the address are also set to 1 before it is stored in the PC.

TBI0, bit [37]

Top Byte ignored - indicates whether the top byte of an address is used for address match for the [TTBR0_EL1](#) region, or ignored and used for tagged addresses. Defined values are:

- 0 Top Byte used in the address calculation.
- 1 Top Byte ignored in the address calculation.

This affects addresses generated in EL0 and EL1 using AArch64 where the address would be translated by tables pointed to by [TTBR0_EL1](#). It has an effect whether the EL1&0 translation regime is enabled or not.

Additionally, this affects changes to the program counter, when TBI0 is 1 and bit [55] of the target address is 0, caused by:

- A branch or procedure return within EL0 or EL1.
- An exception taken to EL1.
- An exception return to EL0 or EL1.

In these cases bits [63:56] of the address are also set to 0 before it is stored in the PC.

AS, bit [36]

ASID Size. Defined values are:

- 0 8 bit - the upper 8 bits of [TTBR0_EL1](#) and [TTBR1_EL1](#) are ignored by hardware for every purpose except reading back the register, and are treated as if they are all zeros for when used for allocation and matching entries in the TLB.
- 1 16 bit - the upper 16 bits of [TTBR0_EL1](#) and [TTBR1_EL1](#) are used for allocation and matching in the TLB.

If the implementation has only 8 bits of ASID, this field is RES0.

Bit [35]

Reserved, RES0.

IPS, bits [34:32]

Intermediate Physical Address Size.

- 000 32 bits, 4GB.
- 001 36 bits, 64GB.
- 010 40 bits, 1TB.
- 011 42 bits, 4TB.
- 100 44 bits, 16TB.
- 101 48 bits, 256TB.

110 52 bits, 4PB

Other values are reserved.

The reserved values behave in the same way as the 101 encoding, but software must not rely on this property as the behavior of the reserved values might change in a future revision of the architecture.

The value 110 is permitted only if [ARMv8.2-LPA](#) is implemented and the granule size is 64KB.

In an implementation that supports 52-bit PAs, if the value of this field is not 110, then bits[51:48] of every translation table base addresses for the stage of translation controlled by TCR_EL1 are 0000.

TG1, bits [31:30]

Granule size for the [TTBR1_EL1](#).

01 16KB

10 4KB

11 64KB

Other values are reserved.

If the value is programmed to either a reserved value, or a size that has not been implemented, then the hardware will treat the field as if it has been programmed to an IMPLEMENTATION DEFINED choice of the sizes that has been implemented for all purposes other than the value read back from this register.

It is IMPLEMENTATION DEFINED whether the value read back is the value programmed or the value that corresponds to the size chosen.

SH1, bits [29:28]

Shareability attribute for memory associated with translation table walks using [TTBR1_EL1](#).

Defined values are:

00 Non-shareable

10 Outer Shareable

11 Inner Shareable

Other values are reserved. The effect of programming this field to a Reserved value is that behavior is CONSTRAINED UNPREDICTABLE, as described in [Reserved values in System and memory-mapped registers and translation table entries](#) on page K1-6133.

ORGN1, bits [27:26]

Outer cacheability attribute for memory associated with translation table walks using [TTBR1_EL1](#).

00 Normal memory, Outer Non-cacheable

01 Normal memory, Outer Write-Back Read-Allocate Write-Allocate Cacheable

10 Normal memory, Outer Write-Through Read-Allocate No Write-Allocate Cacheable

11 Normal memory, Outer Write-Back Read-Allocate No Write-Allocate Cacheable

IRGN1, bits [25:24]

Inner cacheability attribute for memory associated with translation table walks using [TTBR1_EL1](#).

00 Normal memory, Inner Non-cacheable

01 Normal memory, Inner Write-Back Read-Allocate Write-Allocate Cacheable

10 Normal memory, Inner Write-Through Read-Allocate No Write-Allocate Cacheable

11 Normal memory, Inner Write-Back Read-Allocate No Write-Allocate Cacheable

EPD1, bit [23]

Translation table walk disable for translations using [TTBR1_EL1](#). This bit controls whether a translation table walk is performed on a TLB miss, for an address that is translated using [TTBR1_EL1](#). The encoding of this bit is:

0 Perform translation table walks using [TTBR1_EL1](#).

- 1 A TLB miss on an address that is translated using [TTBR1_EL1](#) generates a Translation fault. No translation table walk is performed.

A1, bit [22]

Selects whether [TTBR0_EL1](#) or [TTBR1_EL1](#) defines the ASID. The encoding of this bit is:

- 0 [TTBR0_EL1](#).ASID defines the ASID.
1 [TTBR1_EL1](#).ASID defines the ASID.

T1SZ, bits [21:16]

The size offset of the memory region addressed by [TTBR1_EL1](#). The region size is $2^{(64-T1SZ)}$ bytes. The maximum and minimum possible values for T1SZ depend on the level of translation table and the memory translation granule size, as described in the AArch64 Virtual Memory System Architecture chapter.

TG0, bits [15:14]

Granule size for the [TTBR0_EL1](#).

- 00 4KB
01 64KB
10 16KB

Other values are reserved.

If the value is programmed to either a reserved value, or a size that has not been implemented, then the hardware will treat the field as if it has been programmed to an IMPLEMENTATION DEFINED choice of the sizes that has been implemented for all purposes other than the value read back from this register.

It is IMPLEMENTATION DEFINED whether the value read back is the value programmed or the value that corresponds to the size chosen.

SH0, bits [13:12]

Shareability attribute for memory associated with translation table walks using [TTBR0_EL1](#).

- 00 Non-shareable
10 Outer Shareable
11 Inner Shareable

Other values are reserved. The effect of programming this field to a Reserved value is that behavior is CONSTRAINED UNPREDICTABLE, as described in *Reserved values in System and memory-mapped registers and translation table entries* on page K1-6133.

ORGN0, bits [11:10]

Outer cacheability attribute for memory associated with translation table walks using [TTBR0_EL1](#).

- 00 Normal memory, Outer Non-cacheable
01 Normal memory, Outer Write-Back Read-Allocate Write-Allocate Cacheable
10 Normal memory, Outer Write-Through Read-Allocate No Write-Allocate Cacheable
11 Normal memory, Outer Write-Back Read-Allocate No Write-Allocate Cacheable

IRGN0, bits [9:8]

Inner cacheability attribute for memory associated with translation table walks using [TTBR0_EL1](#).

- 00 Normal memory, Inner Non-cacheable
01 Normal memory, Inner Write-Back Read-Allocate Write-Allocate Cacheable
10 Normal memory, Inner Write-Through Read-Allocate No Write-Allocate Cacheable
11 Normal memory, Inner Write-Back Read-Allocate No Write-Allocate Cacheable

EPD0, bit [7]

Translation table walk disable for translations using [TTBR0_EL1](#). This bit controls whether a translation table walk is performed on a TLB miss, for an address that is translated using [TTBR0_EL1](#). The encoding of this bit is:

- 0 Perform translation table walks using [TTBR0_EL1](#).
- 1 A TLB miss on an address that is translated using [TTBR0_EL1](#) generates a Translation fault. No translation table walk is performed.

Bit [6]

Reserved, RES0.

T0SZ, bits [5:0]

The size offset of the memory region addressed by [TTBR0_EL1](#). The region size is $2^{(64-T0SZ)}$ bytes. The maximum and minimum possible values for T0SZ depend on the level of translation table and the memory translation granule size, as described in the AArch64 Virtual Memory System Architecture chapter.

Accessing the TCR_EL1

This register can be read using MRS with the following syntax:

MRS <Xt>, <systemreg>

This register can be written using MSR (register) with the following syntax:

MSR <systemreg>, <Xt>

This syntax is encoded with the following settings in the instruction encoding:

<systemreg>	op0	op1	CRn	CRm	op2
TCR_EL1	11	000	0010	0000	010
TCR_EL12	11	101	0010	0000	010

Accessibility

The register is accessible in software as follows:

<systemreg>	Control			Accessibility			
	E2H	TGE	NS	EL0	EL1	EL2	EL3
TCR_EL1	x	x	0	-	RW	n/a	RW
TCR_EL1	0	0	1	-	RW	RW	RW
TCR_EL1	0	1	1	-	n/a	RW	RW
TCR_EL1	1	0	1	-	RW	TCR_EL2	RW
TCR_EL1	1	1	1	-	n/a	TCR_EL2	RW
TCR_EL12	x	x	0	-	-	n/a	-
TCR_EL12	0	0	1	-	-	-	-

<systemreg>	Control			Accessibility			
	E2H	TGE	NS	EL0	EL1	EL2	EL3
TCR_EL12	0	1	1	-	n/a	-	-
TCR_EL12	1	0	1	-	-	RW	RW
TCR_EL12	1	1	1	-	n/a	RW	RW

This table applies to all instructions that can access this register.

When `HCR_EL2.E2H` is 1, without explicit synchronization, access from EL3 using the mnemonic `TCR_EL1` or `TCR_EL12` are not guaranteed to be ordered with respect to accesses using the other mnemonic.

Traps and Enables

For a description of the prioritization of any generated exceptions, see *Synchronous exception prioritization for exceptions taken to AArch64* on page D1-1827. Subject to the prioritization rules:

- When EL2 is implemented and is using AArch64 and `(SCR_EL3.NS == 1) && (HCR_EL2.E2H == 0)`:
 - If `HCR_EL2.TRVM==1`, Non-secure read accesses to this register from EL1 are trapped to EL2.
 - If `HCR_EL2.TVM==1`, Non-secure write accesses to this register from EL1 are trapped to EL2.
- When EL2 is implemented and is using AArch64 and `(SCR_EL3.NS == 1) && (HCR_EL2.E2H == 1) && (HCR_EL2.TGE == 0)`:
 - If `HCR_EL2.TRVM==1`, Non-secure read accesses to this register from EL1 are trapped to EL2.
 - If `HCR_EL2.TVM==1`, Non-secure write accesses to this register from EL1 are trapped to EL2.

D7.2.92 TCR_EL2, Translation Control Register (EL2)

The TCR_EL2 characteristics are:

Purpose

The control register for stage 1 of the EL2, or EL2&0, translation regime:

- When the Effective value of `HCR_EL2.E2H` is 0, this register controls stage 1 of the EL2 translation regime, that supports a single VA range, translated using `TTBR0_EL2`.
- When the value of `HCR_EL2.E2H` is 1, this register controls stage 1 of the EL2&0 translation regime, that supports both:
 - A lower VA range, translated using `TTBR0_EL2`.
 - A higher VA range, translated using `TTBR1_EL2`.

Configurations

AArch64 System register TCR_EL2 is architecturally mapped to AArch32 System register `HTCR`.

If EL2 is not implemented, this register is RES0 from EL3.

RW fields in this register reset to architecturally UNKNOWN values.

Attributes

TCR_EL2 is a 64-bit register.

Field descriptions

The TCR_EL2 bit assignments are:

When `HCR_EL2.E2H==0`:

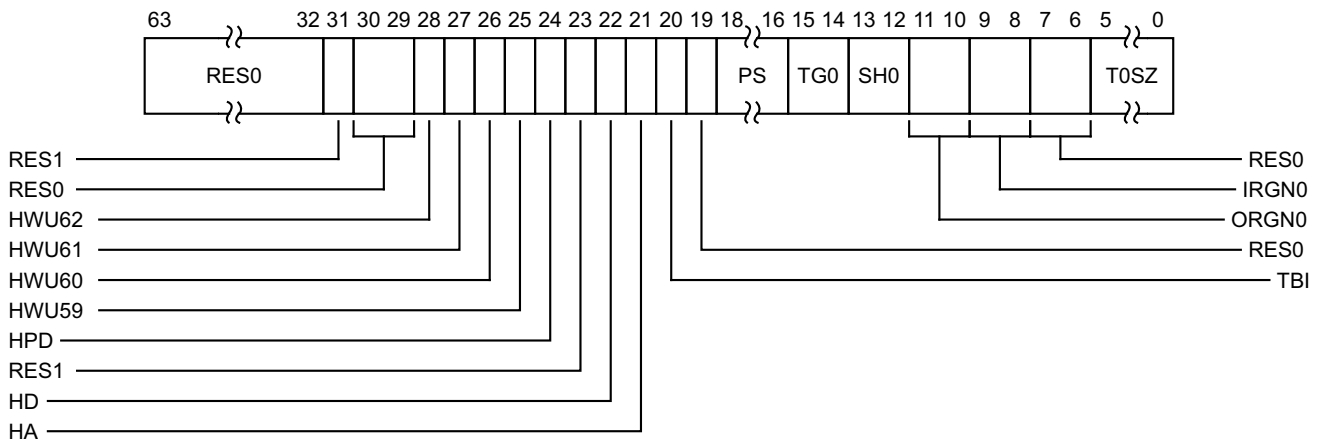

This format applies in Secure state, and in all ARMv8.0 implementations.

Any of the bits in TCR_EL2 are permitted to be cached in a TLB.

Bits [63:32]

Reserved, RES0.

Bit [31]

Reserved, RES1.

Bits [30:29]

Reserved, RES0.

HWU62, bit [28]

In ARMv8.2

Hardware Use. Indicates IMPLEMENTATION DEFINED hardware use of bit[62] of the stage 1 translation table block or level 3 entry if the TCR_EL2.HPD value is 1.

Defined values are:

- 0 The stage 1 translation table entry block or level 3 bit cannot be interpreted by hardware for an IMPLEMENTATION DEFINED purpose.
- 1 The stage 1 translation table entry block or level 3 bit can be interpreted by hardware for an IMPLEMENTATION DEFINED purpose if the TCR_EL2.HPD value is 1.

This bit is RES0 if [ARMv8.2-TTPBHA](#) is not implemented.

In ARMv8.1 and ARMv8.0.

Reserved, RES0.

HWU61, bit [27]

In ARMv8.2

Hardware Use. Indicates IMPLEMENTATION DEFINED hardware use of bit[61] of the stage 1 translation table block or level 3 entry if the TCR_EL2.HPD value is 1.

Defined values are:

- 0 The stage 1 translation table entry block or level 3 bit cannot be interpreted by hardware for an IMPLEMENTATION DEFINED purpose.
- 1 The stage 1 translation table entry block or level 3 bit can be interpreted by hardware for an IMPLEMENTATION DEFINED purpose if the TCR_EL2.HPD value is 1.

This bit is RES0 if [ARMv8.2-TTPBHA](#) is not implemented.

In ARMv8.1 and ARMv8.0.

Reserved, RES0.

HWU60, bit [26]

In ARMv8.2

Hardware Use. Indicates IMPLEMENTATION DEFINED hardware use of bit[60] of the stage 1 translation table block or level 3 entry if the TCR_EL2.HPD value is 1.

Defined values are:

- 0 The stage 1 translation table entry block or level 3 bit cannot be interpreted by hardware for an IMPLEMENTATION DEFINED purpose.
- 1 The stage 1 translation table entry block or level 3 bit can be interpreted by hardware for an IMPLEMENTATION DEFINED purpose if the TCR_EL2.HPD bit value is 1.

This bit is RES0 if [ARMv8.2-TTPBHA](#) is not implemented.

In ARMv8.1 and ARMv8.0.

Reserved, RES0.

HWU59, bit [25]

In ARMv8.2

Hardware Use. Indicates IMPLEMENTATION DEFINED hardware use of bit[59] of the stage 1 translation table block or level 3 entry if the TCR_EL2.HPD value is 1.

Defined values are:

- 0 The stage 1 translation table entry block or level 3 bit cannot be interpreted by hardware for an IMPLEMENTATION DEFINED purpose.
- 1 The stage 1 translation table entry block or level 3 bit can be interpreted by hardware for an IMPLEMENTATION DEFINED purpose if the TCR_EL2.HPD bit value is 1.

This bit is RES0 if [ARMv8.2-TTPBHA](#) is not implemented.

In ARMv8.1 and ARMv8.0.

Reserved, RES0.

HPD, bit [24]

In ARMv8.2 and ARMv8.1

Hierarchical Permission Disables. This affects the hierarchical control bits, APTable, PXNTable, and UXNTable, except NSTable, in the translation tables pointed to by [TTBR0_EL2](#).

Defined values are:

- | | |
|---|--|
| 0 | Hierarchical permissions are enabled. |
| 1 | Hierarchical permissions are disabled. |

Note

In this case bit[61] (APTable[0]) and bit[59] (PXNTable) of the next level descriptor attributes are required to be ignored by the PE, and are no longer reserved, allowing them to be used by software.

When disabled, the permissions are treated as if the bits are zero.

This bit is RES0 if [ARMv8.1-HPD](#) is not implemented.

In ARMv8.0.

Reserved, RES0.

Bit [23]

Reserved, RES1.

HD, bit [22]

In ARMv8.2 and ARMv8.1

Hardware management of dirty state in stage 1 translations from EL2.

Defined values are:

- | | |
|---|--|
| 0 | Stage 1 hardware management of dirty state disabled. |
| 1 | Stage 1 hardware management of dirty state enabled, only if the HA bit is also set to 1. |

This bit is RES0 if [ARMv8.1-TTHM](#) is not implemented.

In ARMv8.0.

Reserved, RES0.

HA, bit [21]

In ARMv8.2 and ARMv8.1

Hardware Access flag update in stage 1 translations from EL2.

Defined values are:

- | | |
|---|--------------------------------------|
| 0 | Stage 1 Access flag update disabled. |
| 1 | Stage 1 Access flag update enabled. |

This bit is RES0 if [ARMv8.1-TTHM](#) is not implemented.

In ARMv8.0.

Reserved, RES0.

TBI, bit [20]

Additionally, this affects changes to the program counter, when TBI is 1, caused by:

- A branch or procedure return within EL2.
- An exception taken to EL2.
- An exception return to EL2.

In these cases bits [63:56] of the address are set to 0 before it is stored in the PC.

This affects addresses generated in EL2 using AArch64 where the address would be translated by tables pointed to by [TTBR0_EL2](#). It has an effect whether the EL2, or EL2&0, translation regime is enabled or not.

Bit [19]

Reserved, RES0.

PS, bits [18:16]

Physical Address Size.

000	32 bits, 4GB.
001	36 bits, 64GB.
010	40 bits, 1TB.
011	42 bits, 4TB.
100	44 bits, 16TB.
101	48 bits, 256TB.
110	52 bits, 4PB

Other values are reserved.

The reserved values behave in the same way as the 101 encoding, but software must not rely on this property as the behavior of the reserved values might change in a future revision of the architecture.

The value 110 is permitted only if [ARMv8.2-LPA](#) is implemented and the granule size is 64KB.

In an implementation that supports 52-bit PAs, if the value of this field is not 110, then bits[51:48] of every translation table base address for the stage of translation controlled by [TCR_EL2](#) are 0000.

TG0, bits [15:14]

Granule size for the [TTBR0_EL2](#).

00	4KB
01	64KB
10	16KB

Other values are reserved.

If the value is programmed to either a reserved value, or a size that has not been implemented, then the hardware will treat the field as if it has been programmed to an IMPLEMENTATION DEFINED choice of the sizes that has been implemented for all purposes other than the value read back from this register.

It is IMPLEMENTATION DEFINED whether the value read back is the value programmed or the value that corresponds to the size chosen.

SH0, bits [13:12]

Shareability attribute for memory associated with translation table walks using [TTBR0_EL2](#).

00	Non-shareable
10	Outer Shareable
11	Inner Shareable

Other values are reserved. The effect of programming this field to a Reserved value is that behavior is CONstrained UNPREDICTABLE, as described in [Reserved values in System and memory-mapped registers and translation table entries](#) on page K1-6133.

ORGN0, bits [11:10]

Outer cacheability attribute for memory associated with translation table walks using [TTBR0_EL2](#).

00	Normal memory, Outer Non-cacheable
01	Normal memory, Outer Write-Back Read-Allocate Write-Allocate Cacheable

- 10 Normal memory, Outer Write-Through Read-Allocate No Write-Allocate Cacheable
- 11 Normal memory, Outer Write-Back Read-Allocate No Write-Allocate Cacheable

IRGN0, bits [9:8]

Inner cacheability attribute for memory associated with translation table walks using [TTBR0_EL2](#).

- 00 Normal memory, Inner Non-cacheable
- 01 Normal memory, Inner Write-Back Read-Allocate Write-Allocate Cacheable
- 10 Normal memory, Inner Write-Through Read-Allocate No Write-Allocate Cacheable
- 11 Normal memory, Inner Write-Back Read-Allocate No Write-Allocate Cacheable

Bits [7:6]

Reserved, RES0.

T0SZ, bits [5:0]

The size offset of the memory region addressed by [TTBR0_EL2](#). The region size is $2^{(64-T0SZ)}$ bytes.

The maximum and minimum possible values for T0SZ depend on the level of translation table and the memory translation granule size, as described in the AArch64 Virtual Memory System Architecture chapter.

When HCR_EL2.E2H==1:

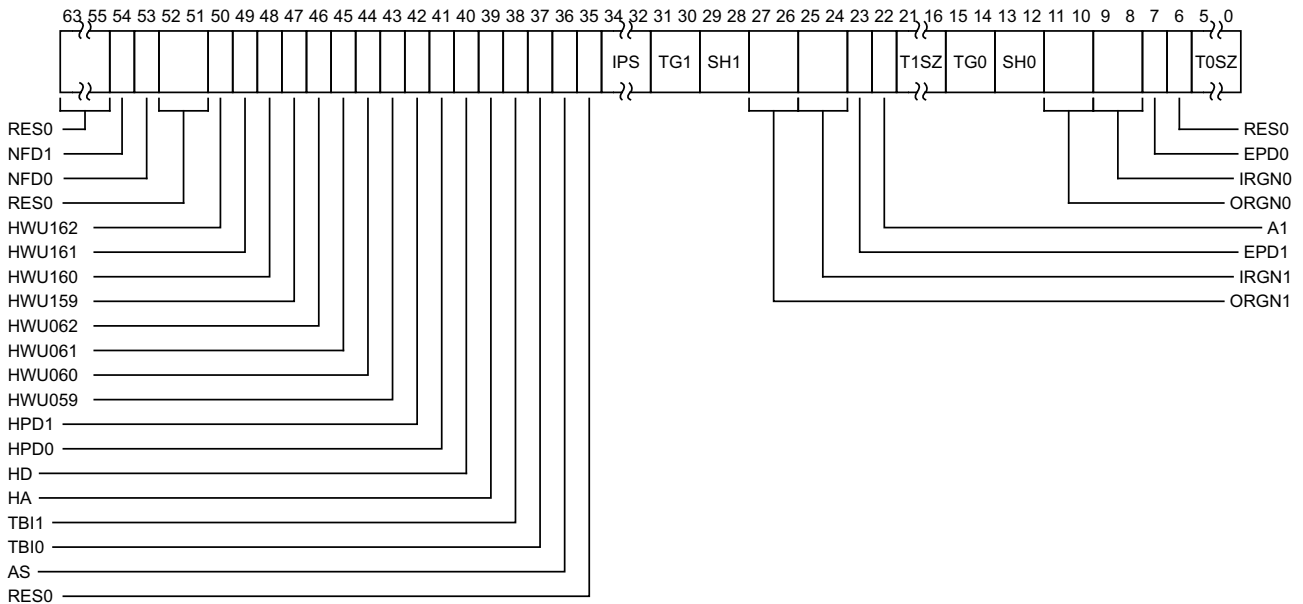

This view of the register is only valid from ARMv8.1, in Non-secure state, when HCR_EL2.E2H is 1.

Any of the bits in TCR_EL2 are permitted to be cached in a TLB.

Bits [63:55]

Reserved, RES0.

NFD1, bit [54]

In ARMv8.2

Present only if SVE is implemented.

Non-fault translation table walk disable for translations using [TTBR1_EL2](#).

This bit controls whether to perform a translation table walk in response to an SVE non-fault access for an address that is translated using TTBR1_EL2. The affected access types are:

- All accesses due to an SVE non-fault contiguous load instruction.
- Only the speculative accesses due to an SVE first-fault gather load. Speculative accesses due to an SVE first-fault contiguous load are not affected.
- Accesses due to prefetch instructions might be affected, but the effect is not architecturally visible.

See *The Scalable Vector Extension (SVE)* on page A1-66 for more information.

Defined values are:

- 0 Perform translation table walks using TTBR1_EL2.
- 1 A TLB miss on an address that is translated using TTBR1_EL2 due to an SVE non-fault access generates a Translation fault. No translation table walk is performed.

If SVE is not implemented, this bit is RES0.

In ARMv8.1.

Reserved, RES0.

NFD0, bit [53]

In ARMv8.2

Present only if SVE is implemented.

Non-fault translation table walk disable for translations using TTBR0_EL2.

This bit controls whether to perform a translation table walk in response to an SVE non-fault access for an address that is translated using TTBR0_EL2. The affected access types are:

- All accesses due to an SVE non-fault contiguous load instruction.
- Only the speculative accesses due to an SVE first-fault gather load. Speculative accesses due to an SVE first-fault contiguous load are not affected.
- Accesses due to prefetch instructions might be affected, but the effect is not architecturally visible.

See *The Scalable Vector Extension (SVE)* on page A1-66 for more information.

Defined values are:

- 0 Perform translation table walks using TTBR0_EL2.
- 1 A TLB miss on an address that is translated using TTBR0_EL2 due to an SVE non-fault access generates a Translation fault. No translation table walk is performed.

If SVE is not implemented, this bit is RES0.

In ARMv8.1.

Reserved, RES0.

Bits [52:51]

Reserved, RES0.

HWU162, bit [50]

In ARMv8.2

Hardware Use. Indicates IMPLEMENTATION DEFINED hardware use of bit[62] of the stage 1 translation table block or level 3 entry for pages pointed to by TTBR1_EL2 if the TCR_EL2.HPD1 value is 1.

Defined values are:

- 0 The stage 1 translation table entry block or level 3 bit cannot be interpreted by hardware for an IMPLEMENTATION DEFINED purpose.
- 1 The stage 1 translation table entry block or level 3 bit can be interpreted by hardware for an IMPLEMENTATION DEFINED purpose if the TCR_EL2.HPD1 value is 1.

This bit is RES0 if [ARMv8.2-TTPBHA](#) is not implemented.

In ARMv8.1.

Reserved, RES0.

HWU161, bit [49]

In ARMv8.2

Hardware Use. Indicates IMPLEMENTATION DEFINED hardware use of bit[61] of the stage 1 translation table block or level 3 entry for pages pointed to by [TTBR1_EL2](#) if the TCR_EL2.HPD1 value is 1.

Defined values are:

- 0 The stage 1 translation table entry block or level 3 bit cannot be interpreted by hardware for an IMPLEMENTATION DEFINED purpose.
- 1 The stage 1 translation table entry block or level 3 bit can be interpreted by hardware for an IMPLEMENTATION DEFINED purpose if the TCR_EL2.HPD1 value is 1.

This bit is RES0 if [ARMv8.2-TTPBHA](#) is not implemented.

In ARMv8.1.

Reserved, RES0.

HWU160, bit [48]

In ARMv8.2

Hardware Use. Indicates IMPLEMENTATION DEFINED hardware use of bit[60] of the stage 1 translation table block or level 3 entry for pages pointed to by [TTBR1_EL2](#) if the TCR_EL2.HPD1 value is 1.

Defined values are:

- 0 The stage 1 translation table entry block or level 3 bit cannot be interpreted by hardware for an IMPLEMENTATION DEFINED purpose.
- 1 The stage 1 translation table entry block or level 3 bit can be interpreted by hardware for an IMPLEMENTATION DEFINED purpose if the TCR_EL2.HPD1 value is 1.

This bit is RES0 if [ARMv8.2-TTPBHA](#) is not implemented.

In ARMv8.1.

Reserved, RES0.

HWU159, bit [47]

In ARMv8.2

Hardware Use. Indicates IMPLEMENTATION DEFINED hardware use of bit[59] of the stage 1 translation table block or level 3 entry for pages pointed to by [TTBR1_EL2](#) if the TCR_EL2.HPD1 value is 1.

Defined values are:

- 0 The stage 1 translation table entry block or level 3 bit cannot be interpreted by hardware for an IMPLEMENTATION DEFINED purpose.
- 1 The stage 1 translation table entry block or level 3 bit can be interpreted by hardware for an IMPLEMENTATION DEFINED purpose if the TCR_EL2.HPD1 value is 1.

This bit is RES0 if [ARMv8.2-TTPBHA](#) is not implemented.

In ARMv8.1.

Reserved, RES0.

HWU062, bit [46]

In ARMv8.2

Hardware Use. Indicates IMPLEMENTATION DEFINED hardware use of bit[62] of the stage 1 translation table block or level 3 entry for pages pointed to by [TTBR0_EL2](#) if the TCR_EL2.HPD0 value is 1.

Defined values are:

- 0 The stage 1 translation table entry block or level 3 bit cannot be interpreted by hardware for an IMPLEMENTATION DEFINED purpose.
- 1 The stage 1 translation table entry block or level 3 bit can be interpreted by hardware for an IMPLEMENTATION DEFINED purpose if the TCR_EL2.HPD0 value is 1.

This bit is RES0 if [ARMv8.2-TTPBHA](#) is not implemented.

In ARMv8.1.

Reserved, RES0.

HWU061, bit [45]

In ARMv8.2

Hardware Use. Indicates IMPLEMENTATION DEFINED hardware use of bit[61] of the stage 1 translation table block or level 3 entry for pages pointed to by [TTBR0_EL2](#) if the TCR_EL2.HPD0 value is 1.

Defined values are:

- 0 The stage 1 translation table entry block or level 3 bit cannot be interpreted by hardware for an IMPLEMENTATION DEFINED purpose.
- 1 The stage 1 translation table entry block or level 3 bit can be interpreted by hardware for an IMPLEMENTATION DEFINED purpose if the TCR_EL2.HPD0 value is 1.

This bit is RES0 if [ARMv8.2-TTPBHA](#) is not implemented.

In ARMv8.1.

Reserved, RES0.

HWU060, bit [44]

In ARMv8.2

Hardware Use. Indicates IMPLEMENTATION DEFINED hardware use of bit[60] of the stage 1 translation table block or level 3 entry for pages pointed to by [TTBR0_EL2](#) if the TCR_EL2.HPD0 value is 1.

Defined values are:

- 0 The stage 1 translation table entry block or level 3 bit cannot be interpreted by hardware for an IMPLEMENTATION DEFINED purpose.
- 1 The stage 1 translation table entry block or level 3 bit can be interpreted by hardware for an IMPLEMENTATION DEFINED purpose if the TCR_EL2.HPD0 value is 1.

This bit is RES0 if [ARMv8.2-TTPBHA](#) is not implemented.

In ARMv8.1.

Reserved, RES0.

HWU059, bit [43]

In ARMv8.2

Hardware Use. Indicates IMPLEMENTATION DEFINED hardware use of bit[59] of the stage 1 translation table block or level 3 entry for pages pointed to by [TTBR0_EL2](#) if the TCR_EL2.HPD0 value is 1.

Defined values are:

- 0 The stage 1 translation table entry block or level 3 bit cannot be interpreted by hardware for an IMPLEMENTATION DEFINED purpose.
- 1 The stage 1 translation table entry block or level 3 bit can be interpreted by hardware for an IMPLEMENTATION DEFINED purpose if the TCR_EL2.HPD0 value is 1.

This bit is RES0 if [ARMv8.2-TTPBHA](#) is not implemented.

In ARMv8.1.

Reserved, RES0.

HPD1, bit [42]

Hierarchical Permission Disables. This affects the hierarchical control bits, APTable, PXNTable, and UXNTable, except NSTable, in the translation tables pointed to by [TTBR1_EL2](#).

Defined values are:

- 0 Hierarchical permissions are enabled.
- 1 Hierarchical permissions are disabled.

When disabled, the permissions are treated as if the bits are zero.

This bit is RES0 if [ARMv8.1-HPD](#) is not implemented.

HPD0, bit [41]

Hierarchical Permission Disables. This affects the hierarchical control bits, APTable, PXNTable, and UXNTable, except NSTable, in the translation tables pointed to by [TTBR0_EL2](#).

Defined values are:

- 0 Hierarchical permissions are enabled.
- 1 Hierarchical permissions are disabled.

When disabled, the permissions are treated as if the bits are zero.

This bit is RES0 if [ARMv8.1-HPD](#) is not implemented.

HD, bit [40]

Hardware management of dirty state in stage 1 translations from EL2.

Defined values are:

- 0 Stage 1 hardware management of dirty state disabled.
- 1 Stage 1 hardware management of dirty state enabled, only if the HA bit is also set to 1.

This bit is RES0 if [ARMv8.1-TTHM](#) is not implemented.

HA, bit [39]

Hardware Access flag update in stage 1 translations from EL2.

Defined values are:

- 0 Stage 1 Access flag update disabled.
- 1 Stage 1 Access flag update enabled.

This bit is RES0 if [ARMv8.1-TTHM](#) is not implemented.

TBI1, bit [38]

Additionally, this affects changes to the program counter, when TBI1 is 1 and bit [55] of the target address is 1, caused by:

- A branch or procedure return within EL0 or EL1.
- An exception taken to EL1.
- An exception return to EL0 or EL1.

In these cases bits [63:56] of the address are also set to 1 before it is stored in the PC.

This affects addresses generated in EL0 and EL2 using AArch64 where the address would be translated by tables pointed to by [TTBR1_EL2](#). It has an effect whether the EL2, or EL2&0, translation regime is enabled or not.

TBI0, bit [37]

Additionally, this affects changes to the program counter, when TBI0 is 1 and bit [55] of the target address is 0, caused by:

- A branch or procedure return within EL0 or EL1.
- An exception taken to EL1.
- An exception return to EL0 or EL1.

In these cases bits [63:56] of the address are also set to 0 before it is stored in the PC.

This affects addresses generated in EL0 and EL2 using AArch64 where the address would be translated by tables pointed to by [TTBR0_EL2](#). It has an effect whether the EL2, or EL2&0, translation regime is enabled or not.

AS, bit [36]

ASID Size. Defined values are:

- | | |
|---|--|
| 0 | 8 bit - the upper 8 bits of TTBR0_EL2 and TTBR1_EL2 are ignored by hardware for every purpose except reading back the register, and are treated as if they are all zeros for when used for allocation and matching entries in the TLB. |
| 1 | 16 bit - the upper 16 bits of TTBR0_EL2 and TTBR1_EL2 are used for allocation and matching in the TLB. |

If the implementation has only 8 bits of ASID, this field is RES0.

Bit [35]

Reserved, RES0.

IPS, bits [34:32]

Intermediate Physical Address Size.

- | | |
|-----|-----------------|
| 000 | 32 bits, 4GB. |
| 001 | 36 bits, 64GB. |
| 010 | 40 bits, 1TB. |
| 011 | 42 bits, 4TB. |
| 100 | 44 bits, 16TB. |
| 101 | 48 bits, 256TB. |
| 110 | 52 bits, 4PB |

Other values are reserved.

The reserved values behave in the same way as the 101 encoding, but software must not rely on this property as the behavior of the reserved values might change in a future revision of the architecture.

The value 110 is permitted only if [ARMv8.2-LPA](#) is implemented and the granule size is 64KB.

In an implementation that supports 52-bit PAs, if the value of this field is not 110, then bits[51:48] of every translation table base address for the stage of translation controlled by [TCR_EL2](#) are 0000.

TG1, bits [31:30]

Granule size for the [TTBR1_EL2](#).

- | | |
|----|------|
| 01 | 16KB |
| 10 | 4KB |
| 11 | 64KB |

Other values are reserved.

If the value is programmed to either a reserved value, or a size that has not been implemented, then the hardware will treat the field as if it has been programmed to an IMPLEMENTATION DEFINED choice of the sizes that has been implemented for all purposes other than the value read back from this register.

It is IMPLEMENTATION DEFINED whether the value read back is the value programmed or the value that corresponds to the size chosen.

SH1, bits [29:28]

Shareability attribute for memory associated with translation table walks using [TTBR1_EL2](#).
Defined values are:

00	Non-shareable
10	Outer Shareable
11	Inner Shareable

Other values are reserved. The effect of programming this field to a Reserved value is that behavior is CONSTRAINED UNPREDICTABLE, as described in *Reserved values in System and memory-mapped registers and translation table entries* on page K1-6133.

ORGN1, bits [27:26]

Outer cacheability attribute for memory associated with translation table walks using [TTBR1_EL2](#).

00	Normal memory, Outer Non-cacheable
01	Normal memory, Outer Write-Back Read-Allocate Write-Allocate Cacheable
10	Normal memory, Outer Write-Through Read-Allocate No Write-Allocate Cacheable
11	Normal memory, Outer Write-Back Read-Allocate No Write-Allocate Cacheable

IRGN1, bits [25:24]

Inner cacheability attribute for memory associated with translation table walks using [TTBR1_EL2](#).

00	Normal memory, Inner Non-cacheable
01	Normal memory, Inner Write-Back Read-Allocate Write-Allocate Cacheable
10	Normal memory, Inner Write-Through Read-Allocate No Write-Allocate Cacheable
11	Normal memory, Inner Write-Back Read-Allocate No Write-Allocate Cacheable

EPD1, bit [23]

Translation table walk disable for translations using [TTBR1_EL2](#). This bit controls whether a translation table walk is performed on a TLB miss, for an address that is translated using [TTBR1_EL2](#). The encoding of this bit is:

0	Perform translation table walks using TTBR1_EL2 .
1	A TLB miss on an address that is translated using TTBR1_EL2 generates a Translation fault. No translation table walk is performed.

A1, bit [22]

Selects whether [TTBR0_EL2](#) or [TTBR1_EL2](#) defines the ASID. The encoding of this bit is:

0	TTBR0_EL2 .ASID defines the ASID.
1	TTBR1_EL2 .ASID defines the ASID.

T1SZ, bits [21:16]

The size offset of the memory region addressed by [TTBR1_EL2](#). The region size is $2^{(64-T1SZ)}$ bytes.

The maximum and minimum possible values for T1SZ depend on the level of translation table and the memory translation granule size, as described in the AArch64 Virtual Memory System Architecture chapter.

TG0, bits [15:14]

Granule size for the [TTBR0_EL2](#).

00	4KB
01	64KB
10	16KB

Other values are reserved.

If the value is programmed to either a reserved value, or a size that has not been implemented, then the hardware will treat the field as if it has been programmed to an IMPLEMENTATION DEFINED choice of the sizes that has been implemented for all purposes other than the value read back from this register.

It is IMPLEMENTATION DEFINED whether the value read back is the value programmed or the value that corresponds to the size chosen.

SH0, bits [13:12]

Shareability attribute for memory associated with translation table walks using [TTBR0_EL2](#).

00	Non-shareable
10	Outer Shareable
11	Inner Shareable

Other values are reserved. The effect of programming this field to a Reserved value is that behavior is CONSTRAINED UNPREDICTABLE, as described in *Reserved values in System and memory-mapped registers and translation table entries* on page K1-6133.

ORGN0, bits [11:10]

Outer cacheability attribute for memory associated with translation table walks using [TTBR0_EL2](#).

00	Normal memory, Outer Non-cacheable
01	Normal memory, Outer Write-Back Read-Allocate Write-Allocate Cacheable
10	Normal memory, Outer Write-Through Read-Allocate No Write-Allocate Cacheable
11	Normal memory, Outer Write-Back Read-Allocate No Write-Allocate Cacheable

IRGN0, bits [9:8]

Inner cacheability attribute for memory associated with translation table walks using [TTBR0_EL2](#).

00	Normal memory, Inner Non-cacheable
01	Normal memory, Inner Write-Back Read-Allocate Write-Allocate Cacheable
10	Normal memory, Inner Write-Through Read-Allocate No Write-Allocate Cacheable
11	Normal memory, Inner Write-Back Read-Allocate No Write-Allocate Cacheable

EPD0, bit [7]

Translation table walk disable for translations using [TTBR0_EL2](#). This bit controls whether a translation table walk is performed on a TLB miss, for an address that is translated using [TTBR0_EL2](#). The encoding of this bit is:

0	Perform translation table walks using TTBR0_EL2 .
1	A TLB miss on an address that is translated using TTBR0_EL2 generates a Translation fault. No translation table walk is performed.

Bit [6]

Reserved, RES0.

T0SZ, bits [5:0]

The size offset of the memory region addressed by [TTBR0_EL2](#). The region size is $2^{(64-T0SZ)}$ bytes.

The maximum and minimum possible values for T0SZ depend on the level of translation table and the memory translation granule size, as described in the AArch64 Virtual Memory System Architecture chapter.

Accessing the TCR_EL2

This register can be read using MRS with the following syntax:

```
MRS <Xt>, <systemreg>
```

This register can be written using MSR (register) with the following syntax:

MSR <systemreg>, <Xt>

This syntax is encoded with the following settings in the instruction encoding:

<systemreg>	op0	op1	CRn	CRm	op2
TCR_EL2	11	100	0010	0000	010
TCR_EL1	11	000	0010	0000	010

Accessibility

The register is accessible in software as follows:

<systemreg>	Control			Accessibility			
	E2H	TGE	NS	EL0	EL1	EL2	EL3
TCR_EL2	x	x	0	-	-	n/a	RW
TCR_EL2	0	0	1	-	-	RW	RW
TCR_EL2	0	1	1	-	n/a	RW	RW
TCR_EL2	1	0	1	-	-	RW	RW
TCR_EL2	1	1	1	-	n/a	RW	RW
TCR_EL1	x	x	0	-	TCR_EL1	n/a	TCR_EL1
TCR_EL1	0	0	1	-	TCR_EL1	TCR_EL1	TCR_EL1
TCR_EL1	0	1	1	-	n/a	TCR_EL1	TCR_EL1
TCR_EL1	1	0	1	-	TCR_EL1	RW	TCR_EL1
TCR_EL1	1	1	1	-	n/a	RW	TCR_EL1

This table applies to all instructions that can access this register.

When [HCR_EL2.E2H](#) is 1, without explicit synchronization, access from EL2 using the mnemonic TCR_EL2 or TCR_EL1 are not guaranteed to be ordered with respect to accesses using the other mnemonic.

D7.2.93 TCR_EL3, Translation Control Register (EL3)

The TCR_EL3 characteristics are:

Purpose

The control register for stage 1 of the EL3 translation regime.

Configurations

RW fields in this register reset to architecturally UNKNOWN values.

Attributes

TCR_EL3 is a 32-bit register.

Field descriptions

The TCR_EL3 bit assignments are:

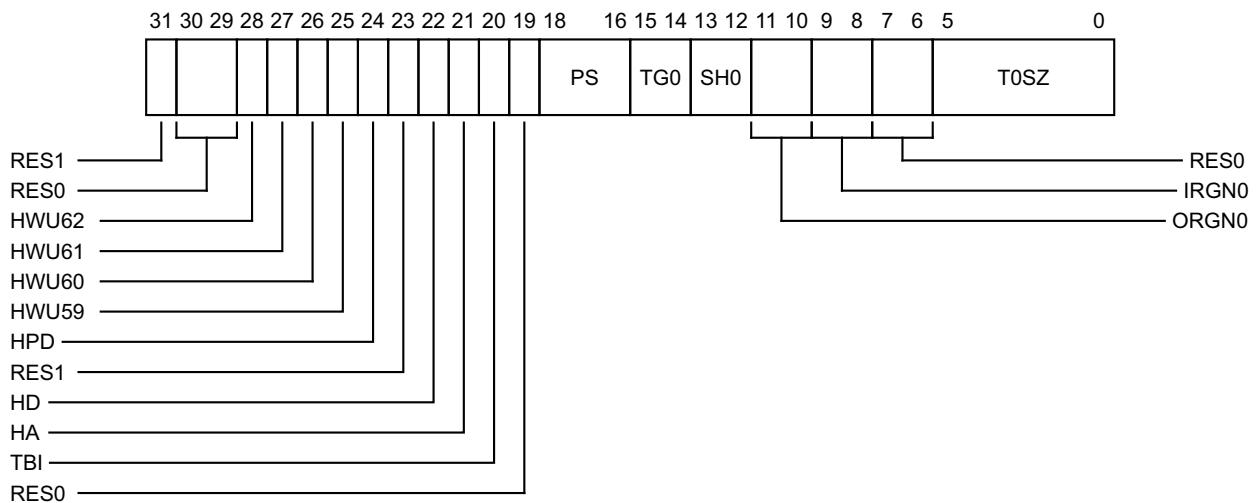

Any of the bits in TCR_EL3 are permitted to be cached in a TLB.

Bit [31]

Reserved, RES1.

Bits [30:29]

Reserved, RES0.

HWU62, bit [28]

In ARMv8.2

Hardware Use. Indicates IMPLEMENTATION DEFINED hardware use of bit[62] of the stage 1 translation table block or level 3 entry if the TCR_EL3.HPD value is 1.

Defined values are:

- 0 The stage 1 translation table entry block or level 3 bit cannot be interpreted by hardware for an IMPLEMENTATION DEFINED purpose.
- 1 The stage 1 translation table entry block or level 3 bit can be interpreted by hardware for an IMPLEMENTATION DEFINED purpose if the TCR_EL3.HPD value is 1.

This bit is RES0 if [ARMv8.2-TTPBHA](#) is not implemented.

In ARMv8.1 and ARMv8.0.

Reserved, RES0.

HWU61, bit [27]

In ARMv8.2

Hardware Use. Indicates IMPLEMENTATION DEFINED hardware use of bit[61] of the stage 1 translation table block or level 3 entry if the TCR_EL3.HPD value is 1.

Defined values are:

- 0 The stage 1 translation table entry block or level 3 bit cannot be interpreted by hardware for an IMPLEMENTATION DEFINED purpose.
- 1 The stage 1 translation table entry block or level 3 bit can be interpreted by hardware for an IMPLEMENTATION DEFINED purpose if the TCR_EL3.HPD bit value is 1.

This bit is RES0 if [ARMv8.2-TTPBHA](#) is not implemented.

In ARMv8.1 and ARMv8.0.

Reserved, RES0.

HWU60, bit [26]

In ARMv8.2

Hardware Use. Indicates IMPLEMENTATION DEFINED hardware use of bit[60] of the stage 1 translation table block or level 3 entry if the TCR_EL3.HPD value is 1.

Defined values are:

- 0 The stage 1 translation table entry block or level 3 bit cannot be interpreted by hardware for an IMPLEMENTATION DEFINED purpose.
- 1 The stage 1 translation table entry block or level 3 bit can be interpreted by hardware for an IMPLEMENTATION DEFINED purpose if the TCR_EL3.HPD bit value is 1.

This bit is RES0 if [ARMv8.2-TTPBHA](#) is not implemented.

In ARMv8.1 and ARMv8.0.

Reserved, RES0.

HWU59, bit [25]

In ARMv8.2

Hardware Use. Indicates IMPLEMENTATION DEFINED hardware use of bit[59] of the stage 1 translation table block or level 3 entry if the TCR_EL3.HPD value is 1.

Defined values are:

- 0 The stage 1 translation table entry block or level 3 bit cannot be interpreted by hardware for an IMPLEMENTATION DEFINED purpose.
- 1 The stage 1 translation table entry block or level 3 bit can be interpreted by hardware for an IMPLEMENTATION DEFINED purpose if the TCR_EL3.HPD bit value is 1.

This bit is RES0 if [ARMv8.2-TTPBHA](#) is not implemented.

In ARMv8.1 and ARMv8.0.

Reserved, RES0.

HPD, bit [24]

In ARMv8.2 and ARMv8.1

Hierarchical Permission Disables. This affects the hierarchical control bits, APTTable, PXNTable, and UXNTable, except NSTable, in the translation tables pointed to by [TTBR0_EL3](#).

Defined values are:

- 0 Hierarchical permissions are enabled.
- 1 Hierarchical permissions are disabled.

———— **Note** ————

In this case bit[61] (APTable[0]) and bit[59] (PXNTable) of the next level descriptor attributes are required to be ignored by the PE, and are no longer reserved, allowing them to be used by software.

When disabled, the permissions are treated as if the bits are zero.

This bit is RES0 if [ARMv8.1-HPD](#) is not implemented.

In ARMv8.0.

Reserved, RES0.

Bit [23]

Reserved, RES1.

HD, bit [22]

In ARMv8.2 and ARMv8.1

Hardware management of dirty state in stage 1 translations from EL3.

Defined values are:

0 Stage 1 hardware management of dirty state disabled.

1 Stage 1 hardware management of dirty state enabled, only if the HA bit is also set to 1.

This bit is RES0 if [ARMv8.1-TTHM](#) is not implemented.

In ARMv8.0.

Reserved, RES0.

HA, bit [21]

In ARMv8.2 and ARMv8.1

Hardware Access flag update in stage 1 translations from EL3.

Defined values are:

0 Stage 1 Access flag update disabled.

1 Stage 1 Access flag update enabled.

This bit is RES0 if [ARMv8.1-TTHM](#) is not implemented.

In ARMv8.0.

Reserved, RES0.

TBI, bit [20]

Top Byte ignored - indicates whether the top byte of an address is used for address match for the [TTBR0_EL3](#) region, or ignored and used for tagged addresses.

0 Top Byte used in the address calculation.

1 Top Byte ignored in the address calculation.

This affects addresses generated in EL3 using AArch64 where the address would be translated by tables pointed to by [TTBR0_EL3](#). It has an effect whether the EL3 translation regime is enabled or not.

Additionally, this affects changes to the program counter, when TBI is 1, caused by:

- A branch or procedure return within EL3.
- A exception taken to EL3.
- An exception return to EL3.

In these cases bits [63:56] of the address are set to 0 before it is stored in the PC.

Bit [19]

Reserved, RES0.

PS, bits [18:16]

Physical Address Size.

000	32 bits, 4GB.
001	36 bits, 64GB.
010	40 bits, 1TB.
011	42 bits, 4TB.
100	44 bits, 16TB.
101	48 bits, 256TB.
110	52 bits, 4PB

Other values are reserved.

The reserved values behave in the same way as the 101 encoding, but software must not rely on this property as the behavior of the reserved values might change in a future revision of the architecture.

The value 110 is permitted only if [ARMv8.2-LPA](#) is implemented and the granule size is 64KB.

In an implementation that supports 52-bit PAs, if the value of this field is not 110, then bits[51:48] of every translation table base address for the stage of translation controlled by TCR_EL3 are 0000.

TG0, bits [15:14]

Granule size for the [TTBR0_EL3](#).

00	4KB
01	64KB
10	16KB

Other values are reserved.

If the value is programmed to either a reserved value, or a size that has not been implemented, then the hardware will treat the field as if it has been programmed to an IMPLEMENTATION DEFINED choice of the sizes that has been implemented for all purposes other than the value read back from this register.

It is IMPLEMENTATION DEFINED whether the value read back is the value programmed or the value that corresponds to the size chosen.

SH0, bits [13:12]

Shareability attribute for memory associated with translation table walks using [TTBR0_EL3](#).

00	Non-shareable
10	Outer Shareable
11	Inner Shareable

Other values are reserved. The effect of programming this field to a Reserved value is that behavior is CONSTRAINED UNPREDICTABLE, as described in *Reserved values in System and memory-mapped registers and translation table entries* on page K1-6133.

ORGN0, bits [11:10]

Outer cacheability attribute for memory associated with translation table walks using [TTBR0_EL3](#).

00	Normal memory, Outer Non-cacheable
01	Normal memory, Outer Write-Back Read-Allocate Write-Allocate Cacheable
10	Normal memory, Outer Write-Through Read-Allocate No Write-Allocate Cacheable
11	Normal memory, Outer Write-Back Read-Allocate No Write-Allocate Cacheable

IRGN0, bits [9:8]

Inner cacheability attribute for memory associated with translation table walks using [TTBR0_EL3](#).

00	Normal memory, Inner Non-cacheable
01	Normal memory, Inner Write-Back Read-Allocate Write-Allocate Cacheable

- 10 Normal memory, Inner Write-Through Read-Allocate No Write-Allocate Cacheable
- 11 Normal memory, Inner Write-Back Read-Allocate No Write-Allocate Cacheable

Bits [7:6]

Reserved, RES0.

T0SZ, bits [5:0]

The size offset of the memory region addressed by [TTBR0_EL3](#). The region size is $2^{(64-T0SZ)}$ bytes. The maximum and minimum possible values for T0SZ depend on the level of translation table and the memory translation granule size, as described in the AArch64 Virtual Memory System Architecture chapter.

Accessing the TCR_EL3

This register can be read using MRS with the following syntax:

MRS <Xt>, <systemreg>

This register can be written using MSR (register) with the following syntax:

MSR <systemreg>, <Xt>

This syntax is encoded with the following settings in the instruction encoding:

<systemreg>	op0	op1	CRn	CRm	op2
TCR_EL3	11	110	0010	0000	010

Accessibility

The register is accessible in software as follows:

Control			Accessibility			
E2H	TGE	NS	EL0	EL1	EL2	EL3
x	x	0	-	-	n/a	RW
0	0	1	-	-	-	RW
0	1	1	-	n/a	-	RW
1	0	1	-	-	-	RW
1	1	1	-	n/a	-	RW

D7.2.94 TPIDR_EL0, EL0 Read/Write Software Thread ID Register

The TPIDR_EL0 characteristics are:

Purpose

Provides a location where software executing at EL0 can store thread identifying information, for OS management purposes.

The PE makes no use of this register.

Configurations

AArch64 System register TPIDR_EL0[31:0] is architecturally mapped to AArch32 System register [TPIDRURW](#).

RW fields in this register reset to architecturally UNKNOWN values.

Attributes

TPIDR_EL0 is a 64-bit register.

Field descriptions

The TPIDR_EL0 bit assignments are:

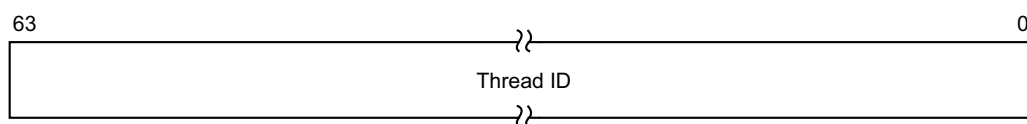

Bits [63:0]

Thread ID. Thread identifying information stored by software running at this Exception level.

Accessing the TPIDR_EL0

This register can be read using MRS with the following syntax:

MRS <Xt>, <systemreg>

This register can be written using MSR (register) with the following syntax:

MSR <systemreg>, <Xt>

This syntax is encoded with the following settings in the instruction encoding:

<systemreg>	op0	op1	CRn	CRm	op2
TPIDR_EL0	11	011	1101	0000	010

Accessibility

The register is accessible in software as follows:

Control			Accessibility			
E2H	TGE	NS	EL0	EL1	EL2	EL3
x	x	0	RW	RW	n/a	RW
x	0	1	RW	RW	RW	RW
x	1	1	RW	n/a	RW	RW

D7.2.95 TPIDR_EL1, EL1 Software Thread ID Register

The TPIDR_EL1 characteristics are:

Purpose

Provides a location where software executing at EL1 can store thread identifying information, for OS management purposes.

The PE makes no use of this register.

Configurations

AArch64 System register TPIDR_EL1[31:0] is architecturally mapped to AArch32 System register [TPIDRPRW](#).

RW fields in this register reset to architecturally UNKNOWN values.

Attributes

TPIDR_EL1 is a 64-bit register.

Field descriptions

The TPIDR_EL1 bit assignments are:

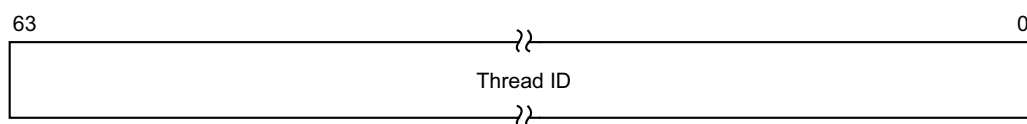

Bits [63:0]

Thread ID. Thread identifying information stored by software running at this Exception level.

Accessing the TPIDR_EL1

This register can be read using MRS with the following syntax:

MRS <Xt>, <systemreg>

This register can be written using MSR (register) with the following syntax:

MSR <systemreg>, <Xt>

This syntax is encoded with the following settings in the instruction encoding:

<systemreg>	op0	op1	CRn	CRm	op2
TPIDR_EL1	11	000	1101	0000	100

Accessibility

The register is accessible in software as follows:

Control			Accessibility			
E2H	TGE	NS	EL0	EL1	EL2	EL3
x	x	0	-	RW	n/a	RW
x	0	1	-	RW	RW	RW
x	1	1	-	n/a	RW	RW

D7.2.96 TPIDR_EL2, EL2 Software Thread ID Register

The TPIDR_EL2 characteristics are:

Purpose

Provides a location where software executing at EL2 can store thread identifying information, for OS management purposes.

The PE makes no use of this register.

Configurations

AArch64 System register TPIDR_EL2[31:0] is architecturally mapped to AArch32 System register [HTPIDR](#).

If EL2 is not implemented, this register is RES0 from EL3.

RW fields in this register reset to architecturally UNKNOWN values.

Attributes

TPIDR_EL2 is a 64-bit register.

Field descriptions

The TPIDR_EL2 bit assignments are:

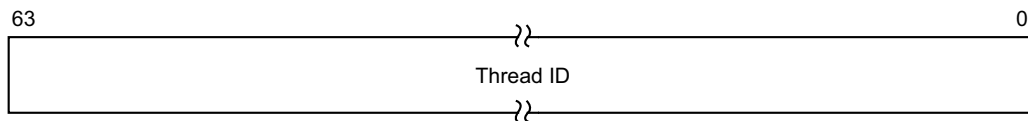

Bits [63:0]

Thread ID. Thread identifying information stored by software running at this Exception level.

Accessing the TPIDR_EL2

This register can be read using MRS with the following syntax:

MRS <Xt>, <systemreg>

This register can be written using MSR (register) with the following syntax:

MSR <systemreg>, <Xt>

This syntax is encoded with the following settings in the instruction encoding:

<systemreg>	op0	op1	CRn	CRm	op2
TPIDR_EL2	11	100	1101	0000	010

Accessibility

The register is accessible in software as follows:

Control			Accessibility			
E2H	TGE	NS	EL0	EL1	EL2	EL3
x	x	0	-	-	n/a	RW
x	0	1	-	-	RW	RW
x	1	1	-	n/a	RW	RW

D7.2.97 TPIDR_EL3, EL3 Software Thread ID Register

The TPIDR_EL3 characteristics are:

Purpose

Provides a location where software executing at EL3 can store thread identifying information, for OS management purposes.

The PE makes no use of this register.

Configurations

RW fields in this register reset to architecturally UNKNOWN values.

Attributes

TPIDR_EL3 is a 64-bit register.

Field descriptions

The TPIDR_EL3 bit assignments are:

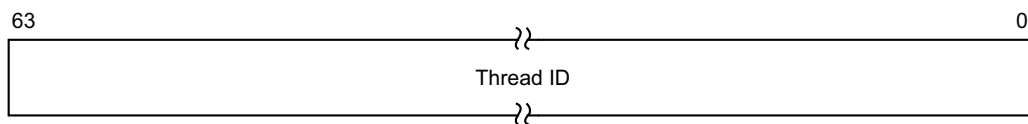

Bits [63:0]

Thread ID. Thread identifying information stored by software running at this Exception level.

Accessing the TPIDR_EL3

This register can be read using MRS with the following syntax:

MRS <Xt>, <systemreg>

This register can be written using MSR (register) with the following syntax:

MSR <systemreg>, <Xt>

This syntax is encoded with the following settings in the instruction encoding:

<systemreg>	op0	op1	CRn	CRm	op2
TPIDR_EL3	11	110	1101	0000	010

Accessibility

The register is accessible in software as follows:

Control			Accessibility			
E2H	TGE	NS	EL0	EL1	EL2	EL3
x	x	0	-	-	n/a	RW
x	0	1	-	-	-	RW
x	1	1	-	n/a	-	RW

D7.2.98 TPIDRRO_EL0, EL0 Read-Only Software Thread ID Register

The TPIDRRO_EL0 characteristics are:

Purpose

Provides a location where software executing at EL1 or higher can store thread identifying information that is visible to software executing at EL0, for OS management purposes.

The PE makes no use of this register.

Configurations

AArch64 System register TPIDRRO_EL0[31:0] is architecturally mapped to AArch32 System register [TPIDRURO](#).

RW fields in this register reset to architecturally UNKNOWN values.

Attributes

TPIDRRO_EL0 is a 64-bit register.

Field descriptions

The TPIDRRO_EL0 bit assignments are:

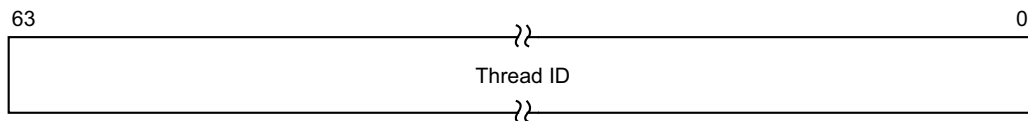

Bits [63:0]

Thread ID. Thread identifying information stored by software running at this Exception level.

Accessing the TPIDRRO_EL0

This register can be read using MRS with the following syntax:

MRS <Xt>, <systemreg>

This register can be written using MSR (register) with the following syntax:

MSR <systemreg>, <Xt>

This syntax is encoded with the following settings in the instruction encoding:

<systemreg>	op0	op1	CRn	CRm	op2
TPIDRRO_EL0	11	011	1101	0000	011

Accessibility

The register is accessible in software as follows:

Control			Accessibility			
E2H	TGE	NS	EL0	EL1	EL2	EL3
x	x	0	RO	RW	n/a	RW
x	0	1	RO	RW	RW	RW
x	1	1	RO	n/a	RW	RW

D7.2.99 TTBR0_EL1, Translation Table Base Register 0 (EL1)

The TTBR0_EL1 characteristics are:

Purpose

Holds the base address of the translation table for the initial lookup for stage 1 of the translation of an address from the lower VA range in the EL1&0 translation regime, and other information for this translation regime.

Configurations

AArch64 System register TTBR0_EL1 is architecturally mapped to AArch32 System register [TTBR0](#).

RW fields in this register reset to architecturally UNKNOWN values.

Attributes

TTBR0_EL1 is a 64-bit register.

Field descriptions

The TTBR0_EL1 bit assignments are:

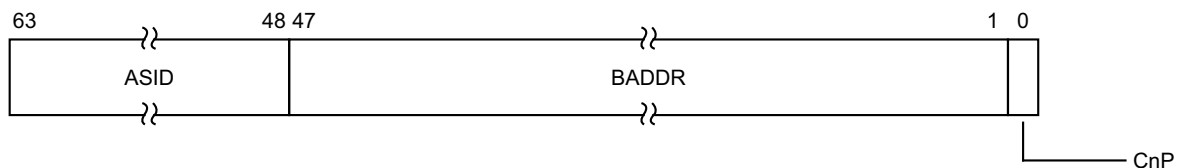

Any of the fields in this register are permitted to be cached in a TLB.

ASID, bits [63:48]

An ASID for the translation table base address. The [TCR_EL1.A1](#) field selects either TTBR0_EL1.ASID or [TTBR1_EL1.ASID](#).

If the implementation has only 8 bits of ASID, then the upper 8 bits of this field are RES0.

BADDR, bits [47:1]

Translation table base address, $A[47:x]$ or $A[51:x]$, bits[47:1].

Note

- Translation table base addresses of 52 bits, $A[51:x]$, are supported only in an implementation that includes [ARMv8.2-LPA](#) and is using the 64KB translation granule.
- A translation table must be aligned to the size of the table, except that when using a translation table base address larger than 48 bits the minimum alignment of a table containing fewer than eight entries is 64 bytes.

In an implementation that includes [ARMv8.2-LPA](#), if the value of [TCR_EL1.IPS](#) is 110, then:

- Register bits[47:z] hold bits[47:z] of the stage 1 translation table base address, where z is determined as follows:
 - If $x \geq 6$ then $z=x$.
 - Otherwise, $z=6$.
- Register bits[5:2] hold bits[51:48] of the stage 1 translation table base address.
- When $z > x$ register bits[(z-1):x] are RES0, and bits[(z-1):x] of the translation table base address are zero.
- When $x > 6$ register bits[(x-1):6] are RES0.

- Register bit[1] is RES0.
- Bits[5:2] of the stage 1 translation table base address are zero.
- In an implementation that includes [ARMv8.2-TTCNP](#) bit[0] of the stage 1 translation table base address is zero.

———— **Note** ————

In an implementation that includes [ARMv8.2-LPA](#) a [TCR_EL1](#).IPS value of 110, that selects an IPA size of 52 bits, is permitted only when using the 64KB translation granule.

When the value of [ID_AA64MMFR0_EL1](#).PARange indicates that the implementation does not support a 52-bit IPA size, if a translation table lookup uses this register with the 64KB translation granule when the value of [TCR_EL1](#).IPS is 110 and the value of register bits[5:2] is nonzero then it is IMPLEMENTATION DEFINED whether an Address size fault is generated, but ARM deprecates not generating an Address size fault.

If the *Effective value* of [TCR_EL1](#).IPS is not 110 then:

- Register bits[47:x] hold bits[47:x] of the stage 1 translation table base address.
- Register bits[(x-1):1] are RES0.
- If the implementation supports 52-bit PAs and IPAs then bits[51:49] of the translation table base addresses used in this stage of translation are 0b0000.

———— **Note** ————

This definition applies:

- To an implementation that includes [ARMv8.2-LPA](#) and is using a translation granule smaller than 64KB.
- To any implementation that does not include [ARMv8.2-LPA](#).

If any [TTBR0_EL1](#)[47:0] bit that is defined as RES0 has the value 1 when a translation table walk is performed using [TTBR0_EL1](#), then the translation table base address might be misaligned, with effects that are CONSTRAINED UNPREDICTABLE, and must be one of the following:

- Bits[x-1:0] of the translation table base address are treated as if all the bits are zero. The value read back from the corresponding register bits is either the value written to the register or zero.
- The result of the calculation of an address for a translation table walk using this register can be corrupted in those bits that are nonzero.

The AArch64 Virtual Memory System Architecture chapter describes how x is calculated based on the value of [TCR_EL1](#).TOSZ, the stage of translation, and the translation granule size.

CnP, bit [0]

In ARMv8.2

Common not Private. In an implementation that includes [ARMv8.2-TTCNP](#), indicates whether each entry that is pointed to by [TTBR0_EL1](#) is a member of a common set that can be used by every PE in the Inner Shareable domain for which the value of [TTBR0_EL1](#).CnP is 1.

- 0 The translation table entries pointed to by [TTBR0_EL1](#), for the current translation regime and ASID, are permitted to differ from corresponding entries for [TTBR0_EL1](#) for other PEs in the Inner Shareable domain. This is not affected by:
- The value of [TTBR0_EL1](#).CnP on those other PEs.
 - The value of the current ASID or, in Non-secure state, the value of the current VMID.

- 1 The translation table entries pointed to by TTBR0_EL1 are the same as the translation table entries for every other PE in the Inner Shareable domain for which the value of TTBR0_EL1.CnP is 1 and all of the following apply:
- The translation table entries are pointed to by TTBR0_EL1.
 - The translation tables relate to the same translation regime.
 - The ASID is the same as the current ASID.
 - In Non-secure state, the VMID is the same as the current VMID.

When a TLB combines entries from stage 1 translation and stage 2 translation into a single entry, that entry can only be shared between different PEs if the value of the CnP bit is 1 for both stage 1 and stage 2.

———— **Note** ————

If the value of the TTBR0_EL1.CnP bit is 1 on multiple PEs in the same Inner Shareable domain and those TTBR0_EL1s do not point to the same translation table entries when the other conditions specified for the case when the value of CnP is 1 apply, then the results of translations are CONstrained UNpredictable, see [CONstrained UNpredictable behaviors due to caching of control or data values on page K1-6120](#).

In an implementation that does not include [ARMv8.2-TTCNP](#) this field is RES0.

In ARMv8.1 and ARMv8.0.

Reserved, RES0.

Accessing the TTBR0_EL1

This register can be read using MRS with the following syntax:

MRS <Xt>, <systemreg>

This register can be written using MSR (register) with the following syntax:

MSR <systemreg>, <Xt>

This syntax is encoded with the following settings in the instruction encoding:

<systemreg>	op0	op1	CRn	CRm	op2
TTBR0_EL1	11	000	0010	0000	000
TTBR0_EL12	11	101	0010	0000	000

Accessibility

The register is accessible in software as follows:

<systemreg>	Control			Accessibility			
	E2H	TGE	NS	EL0	EL1	EL2	EL3
TTBR0_EL1	x	x	0	-	RW	n/a	RW
TTBR0_EL1	0	0	1	-	RW	RW	RW
TTBR0_EL1	0	1	1	-	n/a	RW	RW
TTBR0_EL1	1	0	1	-	RW	TTBR0_EL2	RW
TTBR0_EL1	1	1	1	-	n/a	TTBR0_EL2	RW

<systemreg>	Control			Accessibility			
	E2H	TGE	NS	EL0	EL1	EL2	EL3
TTBR0_EL12	x	x	0	-	-	n/a	-
TTBR0_EL12	0	0	1	-	-	-	-
TTBR0_EL12	0	1	1	-	n/a	-	-
TTBR0_EL12	1	0	1	-	-	RW	RW
TTBR0_EL12	1	1	1	-	n/a	RW	RW

This table applies to all instructions that can access this register.

When `HCR_EL2.E2H` is 1, without explicit synchronization, access from EL3 using the mnemonic `TTBR0_EL1` or `TTBR0_EL12` are not guaranteed to be ordered with respect to accesses using the other mnemonic.

Traps and Enables

For a description of the prioritization of any generated exceptions, see *Synchronous exception prioritization for exceptions taken to AArch64* on page D1-1827. Subject to the prioritization rules:

- When EL2 is implemented and is using AArch64 and $(SCR_EL3.NS == 1) \&\& (HCR_EL2.E2H == 0)$:
 - If `HCR_EL2.TRVM==1`, Non-secure read accesses to this register from EL1 are trapped to EL2.
 - If `HCR_EL2.TVM==1`, Non-secure write accesses to this register from EL1 are trapped to EL2.
- When EL2 is implemented and is using AArch64 and $(SCR_EL3.NS == 1) \&\& (HCR_EL2.E2H == 1) \&\& (HCR_EL2.TGE == 0)$:
 - If `HCR_EL2.TRVM==1`, Non-secure read accesses to this register from EL1 are trapped to EL2.
 - If `HCR_EL2.TVM==1`, Non-secure write accesses to this register from EL1 are trapped to EL2.

D7.2.100 TTBR0_EL2, Translation Table Base Register 0 (EL2)

The TTBR0_EL2 characteristics are:

Purpose

When [HCR_EL2.E2H](#) is 0, holds the base address of the translation table for the initial lookup for stage 1 of an address translation in the EL2 translation regime, and other information for this translation regime.

When [HCR_EL2.E2H](#) is 1, holds the base address of translation for the initial lookup for stage 1 of the translation of an address from the lower VA range in the EL2&0 translation regime, and other information for this translation regime.

Configurations

AArch64 System register TTBR0_EL2 is architecturally mapped to AArch32 System register [HTTBR](#).

If EL2 is not implemented, this register is RES0 from EL3.

RW fields in this register reset to architecturally UNKNOWN values.

Attributes

TTBR0_EL2 is a 64-bit register.

Field descriptions

The TTBR0_EL2 bit assignments are:

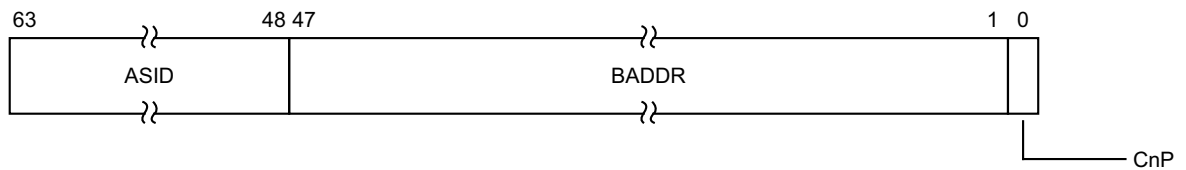

Any of the fields in this register are permitted to be cached in a TLB.

ASID, bits [63:48]

In ARMv8.2 and ARMv8.1

When [HCR_EL2.E2H](#) is 0, this field is RES0.

When [HCR_EL2.E2H](#) is 1, it holds an ASID for the translation table base address. The [TCR_EL2.A1](#) field selects either TTBR0_EL2.ASID or TTBR1_EL2.ASID.

If the implementation has only 8 bits of ASID, then the upper 8 bits of this field are RES0.

In ARMv8.0.

Reserved, RES0.

BADDR, bits [47:1]

Translation table base address, A[47:x] or A[51:x], bits[47:1].

Note

- Translation table base addresses of 52 bits, A[51:x], are supported only in an implementation that includes [ARMv8.2-LPA](#) and is using the 64KB translation granule.
- A translation table must be aligned to the size of the table, except that when using a translation table base address larger than 48 bits the minimum alignment of a table containing fewer than eight entries is 64 bytes.

In an implementation that includes [ARMv8.2-LPA](#), if the value of `TCR_EL2.{I}PS` is 110, then:

- Register bits[47:z] hold bits[47:z] of the stage 1 translation table base address, where z is determined as follows:
 - If $x \geq 6$ then $z=x$.
 - Otherwise, $z=6$.
- Register bits[5:2] hold bits[51:48] of the stage 1 translation table base address.
- When $z > x$ register bits[(z-1):x] are RES0, and bits[(z-1):x] of the translation table base address are zero.
- When $x > 6$ register bits[(x-1):6] are RES0.
- Register bit[1] is RES0.
- Bits[5:2] of the stage 1 translation table base address are zero.
- In an implementation that includes [ARMv8.2-TTCNP](#) bit[0] of the stage 1 translation table base address is zero.

Note

In an implementation that includes [ARMv8.2-LPA](#):

- A `TCR_EL2.{I}PS` value of 110, that selects an OA size of 52 bits, is permitted only when using the 64KB translation granule.
- The OA size is specified by:
 - The value of `TCR_EL2.PS` when the value of `HCR_EL2.E2H` is 0.
 - The value of `TCR_EL2.IPS` when the value of `HCR_EL2.E2H` is 1.

When the value of `ID_AA64MMFR0_EL1.PARange` indicates that the implementation does not support a 52-bit IPA size, if a translation table lookup uses this register with the 64KB translation granule when the value of `TCR_EL2.{I}PS` is 110 and the value of register bits[5:2] is nonzero then it is IMPLEMENTATION DEFINED whether an Address size fault is generated, but ARM deprecates not generating an Address size fault.

If the *Effective value* of `TCR_EL2.{I}PS` is not 110 then:

- Register bits[47:x] hold bits[47:x] of the stage 1 translation table base address.
- Register bits[(x-1):1] are RES0.
- If the implementation supports 52-bit PAs and IPAs then bits[51:49] of the translation table base addresses used in this stage of translation are 0b0000.

Note

This definition applies:

- To an implementation that includes [ARMv8.2-LPA](#) and is using a translation granule smaller than 64KB.
- To any implementation that does not include [ARMv8.2-LPA](#).

If any `TTBR0_EL2[47:0]` bit that is defined as RES0 has the value 1 when a translation table walk is performed using `TTBR0_EL2`, then the translation table base address might be misaligned, with effects that are CONSTRAINED UNPREDICTABLE, and must be one of the following:

- Bits[x-1:0] of the translation table base address are treated as if all the bits are zero. The value read back from the corresponding register bits is either the value written to the register or zero.
- The result of the calculation of an address for a translation table walk using this register can be corrupted in those bits that are nonzero.

The AArch64 Virtual Memory System Architecture chapter describes how x is calculated based on the value of `TCR_EL2.T0SZ`, the stage of translation, and the translation granule size.

CnP, bit [0]

In ARMv8.2

Common not Private. In an implementation that includes [ARMv8.2-TTCNP](#), indicates whether each entry that is pointed to by TTBR0_EL2 is a member of a common set that can be used by every PE in the Inner Shareable domain for which the value of TTBR0_EL2.CnP is 1.

- 0 The translation table entries pointed to by TTBR0_EL2 for the current translation regime, and ASID if applicable, are permitted to differ from corresponding entries for TTBR0_EL2 for other PEs in the Inner Shareable domain. This is not affected by:
- The value of TTBR0_EL2.CnP on those other PEs.
 - When the current translation regime is the EL2&0 regime, the value of the current ASID.
- 1 The translation table entries pointed to by TTBR0_EL2 are the same as the translation table entries for every other PE in the Inner Shareable domain for which the value of TTBR0_EL2.CnP is 1 and all of the following apply:
- The translation table entries are pointed to by TTBR0_EL2.
 - The translation tables relate to the same translation regime.
 - If that translation regime is the EL2&0 regime, the ASID is the same as the current ASID.

Note

If the value of the TTBR0_EL2.CnP bit is 1 on multiple PEs in the same Inner Shareable domain and those TTBR0_EL2s do not point to the same translation table entries when the other conditions specified for the case when the value of CnP is 1 apply, then the results of translations are **CONSTRAINED UNPREDICTABLE**, see [CONSTRAINED UNPREDICTABLE behaviors due to caching of control or data values](#) on page K1-6120.

In an implementation that does not include [ARMv8.2-TTCNP](#) this field is RES0.

In ARMv8.1 and ARMv8.0.

Reserved, RES0.

Accessing the TTBR0_EL2

This register can be read using MRS with the following syntax:

```
MRS <Xt>, <systemreg>
```

This register can be written using MSR (register) with the following syntax:

```
MSR <systemreg>, <Xt>
```

This syntax is encoded with the following settings in the instruction encoding:

<systemreg>	op0	op1	CRn	CRm	op2
TTBR0_EL2	11	100	0010	0000	000
TTBR0_EL1	11	000	0010	0000	000

Accessibility

The register is accessible in software as follows:

<systemreg>	Control			Accessibility			
	E2H	TGE	NS	EL0	EL1	EL2	EL3
TTBR0_EL2	x	x	0	-	-	n/a	RW
TTBR0_EL2	0	0	1	-	-	RW	RW
TTBR0_EL2	0	1	1	-	n/a	RW	RW
TTBR0_EL2	1	0	1	-	-	RW	RW
TTBR0_EL2	1	1	1	-	n/a	RW	RW
TTBR0_EL1	x	x	0	-	TTBR0_EL1	n/a	TTBR0_EL1
TTBR0_EL1	0	0	1	-	TTBR0_EL1	TTBR0_EL1	TTBR0_EL1
TTBR0_EL1	0	1	1	-	n/a	TTBR0_EL1	TTBR0_EL1
TTBR0_EL1	1	0	1	-	TTBR0_EL1	RW	TTBR0_EL1
TTBR0_EL1	1	1	1	-	n/a	RW	TTBR0_EL1

This table applies to all instructions that can access this register.

When [HCR_EL2.E2H](#) is 1, without explicit synchronization, access from EL2 using the mnemonic [TTBR0_EL2](#) or [TTBR0_EL1](#) are not guaranteed to be ordered with respect to accesses using the other mnemonic.

D7.2.101 TTBR0_EL3, Translation Table Base Register 0 (EL3)

The TTBR0_EL3 characteristics are:

Purpose

Holds the base address of the translation table for the initial lookup for stage 1 of an address translation in the EL3 translation regime, and other information for this translation regime.

Configurations

RW fields in this register reset to architecturally UNKNOWN values.

Attributes

TTBR0_EL3 is a 64-bit register.

Field descriptions

The TTBR0_EL3 bit assignments are:

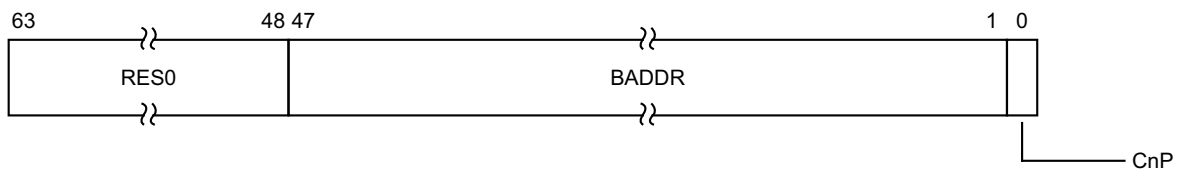

Any of the fields in this register are permitted to be cached in a TLB.

Bits [63:48]

Reserved, RES0.

BADDR, bits [47:1]

Translation table base address, A[47:x] or A[51:x].

Note

- Translation table base addresses of 52 bits, A[51:x], are supported only in an implementation that includes [ARMv8.2-LPA](#) and is using the 64KB translation granule.
- A translation table must be aligned to the size of the table, except that when using a translation table base address larger than 48 bits the minimum alignment of a table containing fewer than eight entries is 64 bytes.

In an implementation that includes [ARMv8.2-LPA](#), if the value of [TCR_EL3.PS](#) is 110, then:

- Register bits[47:z] hold bits[47:z] of the stage 1 translation table base address, where z is determined as follows:
 - If $x \geq 6$ then $z=x$.
 - Otherwise, $z=6$.
- Register bits[5:2] hold bits[51:48] of the stage 1 translation table base address.
- When $z > x$ register bits[(z-1):x] are RES0, and bits[(z-1):x] of the translation table base address are zero.
- When $x > 6$ register bits[(x-1):6] are RES0.
- Register bit[1] is RES0.
- Bits[5:2] of the stage 1 translation table base address are zero.
- In an implementation that includes [ARMv8.2-TTCNP](#) bit[0] of the stage 1 translation table base address is zero.

———— **Note** ————

In an implementation that includes [ARMv8.2-LPA](#) a [TCR_EL3.PS](#) value of 110, that selects a PA size of 52 bits, is permitted only when using the 64KB translation granule.

When the value of [ID_AA64MMFR0_EL1.PARange](#) indicates that the implementation does not support a 52-bit PA size, if a translation table lookup uses this register with the 64KB translation granule when the value of [TCR_EL3.PS](#) is 110 and the value of register bits[5:2] is nonzero then it IS IMPLEMENTATION DEFINED whether an Address size fault is generated, but ARM deprecates not generating an Address size fault.

If the *Effective value* of [TCR_EL3.PS](#) is not 110 then:

- Register bits[47:x] hold bits[47:x] of the stage 1 translation table base address.
- Register bits[(x-1):1] are RES0.
- If the implementation supports 52-bit PAs and IPAs then bits[51:49] of the translation table base addresses used in this stage of translation are 0b0000.

———— **Note** ————

This definition applies:

- To an implementation that includes [ARMv8.2-LPA](#) and is using a translation granule smaller than 64KB.
- To any implementation that does not include [ARMv8.2-LPA](#).

If any [TTBR0_EL3\[47:0\]](#) bit that is defined as RES0 has the value 1 when a translation table walk is performed using [TTBR0_EL3](#), then the translation table base address might be misaligned, with effects that are CONstrained UNPREDICTABLE, and must be one of the following:

- Bits[x-1:0] of the translation table base address are treated as if all the bits are zero. The value read back from the corresponding register bits is either the value written to the register or zero.
- The result of the calculation of an address for a translation table walk using this register can be corrupted in those bits that are nonzero.

The AArch64 Virtual Memory System Architecture chapter describes how x is calculated based on the value of [TCR_EL3.T0SZ](#), the stage of translation, and the translation granule size.

CnP, bit [0]

In ARMv8.2

Common not Private. In an implementation that includes [ARMv8.2-TTCNP](#), indicates whether each entry that is pointed to by [TTBR0_EL3](#) is a member of a common set that can be used by every PE in the Inner Shareable domain for which the value of [TTBR0_EL3.CnP](#) is 1.

- 0 The translation table entries pointed to by [TTBR0_EL3](#), for the current translation regime, are permitted to differ from corresponding entries for [TTBR0_EL3](#) for other PEs in the Inner Shareable domain. This is not affected by the value of [TTBR0_EL3.CnP](#) on those other PEs.
- 1 The translation table entries pointed to by [TTBR0_EL3](#) are the same as the translation table entries for every other PE in the Inner Shareable domain for which the value of [TTBR0_EL3.CnP](#) is 1 and the translation table entries are pointed to by [TTBR0_EL3](#).

———— **Note** ————

If the value of the [TTBR0_EL3.CnP](#) bit is 1 on multiple PEs in the same Inner Shareable domain and those [TTBR0_EL3s](#) do not point to the same translation table entries the results of translations using [TTBR0_EL3](#) are CONstrained UNPREDICTABLE, see [CONstrained UNPREDICTABLE behaviors due to caching of control or data values on page K1-6120](#).

In an implementation that does not include [ARMv8.2-TTCNP](#) this field is RES0.

In ARMv8.1 and ARMv8.0.

Reserved, RES0.

Accessing the TTBR0_EL3

This register can be read using MRS with the following syntax:

MRS <Xt>, <systemreg>

This register can be written using MSR (register) with the following syntax:

MSR <systemreg>, <Xt>

This syntax is encoded with the following settings in the instruction encoding:

<systemreg>	op0	op1	CRn	CRm	op2
TTBR0_EL3	11	110	0010	0000	000

Accessibility

The register is accessible in software as follows:

Control			Accessibility			
E2H	TGE	NS	EL0	EL1	EL2	EL3
x	x	0	-	-	n/a	RW
x	0	1	-	-	-	RW
x	1	1	-	n/a	-	RW

D7.2.102 TTBR1_EL1, Translation Table Base Register 1 (EL1)

The TTBR1_EL1 characteristics are:

Purpose

Holds the base address of the translation table for the initial lookup for stage 1 of the translation of an address from the higher VA range in the EL1&0 translation regime, and other information for this translation regime.

Configurations

AArch64 System register TTBR1_EL1 is architecturally mapped to AArch32 System register [TTBR1](#).

RW fields in this register reset to architecturally UNKNOWN values.

Attributes

TTBR1_EL1 is a 64-bit register.

Field descriptions

The TTBR1_EL1 bit assignments are:

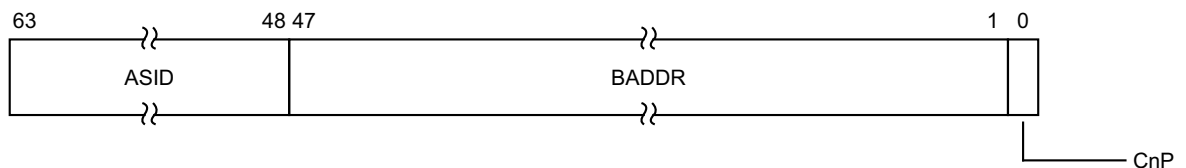

Any of the fields in this register are permitted to be cached in a TLB.

ASID, bits [63:48]

An ASID for the translation table base address. The [TCR_EL1.A1](#) field selects either [TTBR0_EL1.ASID](#) or [TTBR1_EL1.ASID](#).

If the implementation has only 8 bits of ASID, then the upper 8 bits of this field are RES0.

BADDR, bits [47:1]

Translation table base address, $A[47:x]$ or $A[51:x]$, bits[47:1].

Note

- Translation table base addresses of 52 bits, $A[51:x]$, are supported only in an implementation that includes [ARMv8.2-LPA](#) and is using the 64KB translation granule.
- A translation table must be aligned to the size of the table, except that when using a translation table base address larger than 48 bits the minimum alignment of a table containing fewer than eight entries is 64 bytes.

In an implementation that includes [ARMv8.2-LPA](#), if the value of [TCR_EL1.IPS](#) is 110, then:

- Register bits[47:z] hold bits[47:z] of the stage 1 translation table base address, where z is determined as follows:
 - If $x \geq 6$ then $z=x$.
 - Otherwise, $z=6$.
- Register bits[5:2] hold bits[51:48] of the stage 1 translation table base address.
- When $z > x$ register bits[(z-1):x] are RES0, and bits[(z-1):x] of the translation table base address are zero.
- When $x > 6$ register bits[(x-1):6] are RES0.

- Register bit[1] is RES0.
- Bits[5:2] of the stage 1 translation table base address are zero.
- In an implementation that includes [ARMv8.2-TTCNP](#) bit[0] of the stage 1 translation table base address is zero.

———— **Note** ————

In an implementation that includes [ARMv8.2-LPA](#) a [TCR_EL1](#).IPS value of 110, that selects an IPA size of 52 bits, is permitted only when using the 64KB translation granule.

When the value of [ID_AA64MMFR0_EL1](#).PARange indicates that the implementation does not support a 52-bit IPA size, if a translation table lookup uses this register with the 64KB translation granule when the value of [TCR_EL1](#).IPS is 110 and the value of register bits[5:2] is nonzero then it is IMPLEMENTATION DEFINED whether an Address size fault is generated, but ARM deprecates not generating an Address size fault.

If the *Effective value* of [TCR_EL1](#).IPS is not 110 then:

- Register bits[47:x] hold bits[47:x] of the stage 1 translation table base address.
- Register bits[(x-1):1] are RES0.
- If the implementation supports 52-bit PAs and IPAs then bits[51:49] of the translation table base addresses used in this stage of translation are 0b0000.

———— **Note** ————

This definition applies:

- To an implementation that includes [ARMv8.2-LPA](#) and is using a translation granule smaller than 64KB.
- To any implementation that does not include [ARMv8.2-LPA](#).

If any [TTBR1_EL1](#)[47:0] bit that is defined as RES0 has the value 1 when a translation table walk is performed using [TTBR1_EL1](#), then the translation table base address might be misaligned, with effects that are CONSTRAINED UNPREDICTABLE, and must be one of the following:

- Bits[x-1:0] of the translation table base address are treated as if all the bits are zero. The value read back from the corresponding register bits is either the value written to the register or zero.
- The result of the calculation of an address for a translation table walk using this register can be corrupted in those bits that are nonzero.

The AArch64 Virtual Memory System Architecture chapter describes how x is calculated based on the value of [TCR_EL1](#).T1SZ, the stage of translation, and the translation granule size.

CnP, bit [0]

In ARMv8.2

Common not Private. In an implementation that includes [ARMv8.2-TTCNP](#), indicates whether each entry that is pointed to by [TBR1_EL1](#) is a member of a common set that can be used by every PE in the Inner Shareable domain for which the value of [TTBR1_EL1](#).CnP is 1.

- 0 The translation table entries pointed to by [TTBR1_EL1](#), for the current translation regime and ASID, are permitted to differ from corresponding entries for [TTBR1_EL1](#) for other PEs in the Inner Shareable domain. This is not affected by:
- The value of [TTBR1_EL1](#).CnP on those other PEs.
 - The value of the current ASID or, in Non-secure state, the value of the current VMID.

- 1 The translation table entries pointed to by TTBR1_EL1 are the same as the translation table entries for every other PE in the Inner Shareable domain for which the value of TTBR1_EL1.CnP is 1 and all of the following apply:
- The translation table entries are pointed to by TTBR1_EL1.
 - The translation tables relate to the same translation regime.
 - The ASID is the same as the current ASID.
 - In Non-secure state, the VMID is the same as the current VMID.

When a TLB combines entries from stage 1 translation and stage 2 translation into a single entry, that entry can only be shared between different PEs if the value of the CnP bit is 1 for both stage 1 and stage 2.

———— **Note** ————

If the value of the TTBR1_EL1.CnP bit is 1 on multiple PEs in the same Inner Shareable domain and those TTBR1_EL1s do not point to the same translation table entries when the other conditions specified for the case when the value of CnP is 1 apply, then the results of translations are CONstrained UNPREDICTABLE, see [CONstrained UNPREDICTABLE behaviors due to caching of control or data values on page K1-6120](#).

In an implementation that does not include [ARMv8.2-TTCNP](#) this field is RES0.

In ARMv8.1 and ARMv8.0.

Reserved, RES0.

Accessing the TTBR1_EL1

This register can be read using MRS with the following syntax:

MRS <Xt>, <systemreg>

This register can be written using MSR (register) with the following syntax:

MSR <systemreg>, <Xt>

This syntax is encoded with the following settings in the instruction encoding:

<systemreg>	op0	op1	CRn	CRm	op2
TTBR1_EL1	11	000	0010	0000	001
TTBR1_EL12	11	101	0010	0000	001

Accessibility

The register is accessible in software as follows:

<systemreg>	Control			Accessibility			
	E2H	TGE	NS	EL0	EL1	EL2	EL3
TTBR1_EL1	x	x	0	-	RW	n/a	RW
TTBR1_EL1	0	0	1	-	RW	RW	RW
TTBR1_EL1	0	1	1	-	n/a	RW	RW
TTBR1_EL1	1	0	1	-	RW	TTBR1_EL2	RW
TTBR1_EL1	1	1	1	-	n/a	TTBR1_EL2	RW

<systemreg>	Control			Accessibility			
	E2H	TGE	NS	EL0	EL1	EL2	EL3
TTBR1_EL12	x	x	0	-	-	n/a	-
TTBR1_EL12	0	0	1	-	-	-	-
TTBR1_EL12	0	1	1	-	n/a	-	-
TTBR1_EL12	1	0	1	-	-	RW	RW
TTBR1_EL12	1	1	1	-	n/a	RW	RW

This table applies to all instructions that can access this register.

When `HCR_EL2.E2H` is 1, without explicit synchronization, access from EL3 using the mnemonic `TTBR1_EL1` or `TTBR1_EL12` are not guaranteed to be ordered with respect to accesses using the other mnemonic.

Traps and Enables

For a description of the prioritization of any generated exceptions, see *Synchronous exception prioritization for exceptions taken to AArch64* on page D1-1827. Subject to the prioritization rules:

- When EL2 is implemented and is using AArch64 and $(SCR_EL3.NS == 1) \ \&\& \ (HCR_EL2.E2H == 0)$:
 - If `HCR_EL2.TRVM==1`, Non-secure read accesses to this register from EL1 are trapped to EL2.
 - If `HCR_EL2.TVM==1`, Non-secure write accesses to this register from EL1 are trapped to EL2.
- When EL2 is implemented and is using AArch64 and $(SCR_EL3.NS == 1) \ \&\& \ (HCR_EL2.E2H == 1) \ \&\& \ (HCR_EL2.TGE == 0)$:
 - If `HCR_EL2.TRVM==1`, Non-secure read accesses to this register from EL1 are trapped to EL2.
 - If `HCR_EL2.TVM==1`, Non-secure write accesses to this register from EL1 are trapped to EL2.

D7.2.103 TTBR1_EL2, Translation Table Base Register 1 (EL2)

The TTBR1_EL2 characteristics are:

Purpose

When [HCR_EL2.E2H](#) is 1, holds the base address of the translation table for the initial lookup for stage 1 of the translation of an address from the higher VA range in the EL2&0 translation regime, and other information for this translation regime.

Note

When [HCR_EL2.E2H](#) is 0, the contents of this register are ignored by the PE, except for a direct read or write of the register.

Configurations

If EL2 is not implemented, this register is RES0 from EL3.

RW fields in this register reset to architecturally UNKNOWN values.

This register is introduced in ARMv8.1.

Attributes

TTBR1_EL2 is a 64-bit register.

Field descriptions

The TTBR1_EL2 bit assignments are:

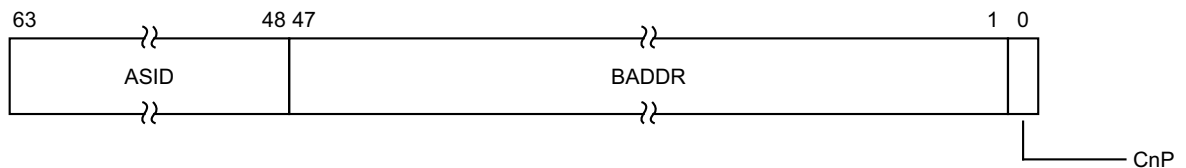

Any of the fields in this register are permitted to be cached in a TLB.

ASID, bits [63:48]

An ASID for the translation table base address. The [TCR_EL2.A1](#) field selects either [TTBR0_EL2.ASID](#) or [TTBR1_EL2.ASID](#).

If the implementation has only 8 bits of ASID, then the upper 8 bits of this field are RES0.

BADDR, bits [47:1]

Translation table base address, $A[47:x]$ or $A[51:x]$, bits[47:1].

Note

- Translation table base addresses of 52 bits, $A[51:x]$, are supported only in an implementation that includes [ARMv8.2-LPA](#) and is using the 64KB translation granule.
- A translation table must be aligned to the size of the table, except that when using a translation table base address larger than 48 bits the minimum alignment of a table containing fewer than eight entries is 64 bytes.

In an implementation that includes [ARMv8.2-LPA](#), if the value of [TCR_EL2.{I}PS](#) is 110, then:

- Register bits[47:z] hold bits[47:z] of the stage 1 translation table base address, where z is determined as follows:
 - If $x \geq 6$ then $z=x$.
 - Otherwise, $z=6$.

- Register bits[5:2] hold bits[51:48] of the stage 1 translation table base address.
- When $z > x$ register bits[(z-1):x] are RES0, and bits[(z-1):x] of the translation table base address are zero.
- When $x > 6$ register bits[(x-1):6] are RES0.
- Register bit[1] is RES0.
- Bits[5:2] of the stage 1 translation table base address are zero.
- In an implementation that includes [ARMv8.2-TTCNP](#) bit[0] of the stage 1 translation table base address is zero.

———— **Note** ————

In an implementation that includes [ARMv8.2-LPA](#) a [TCR_EL2](#).IPS value of 110, that selects an OA size of 52 bits, is permitted only when using the 64KB translation granule.

When the value of [ID_AA64MMFR0_EL1](#).PARange indicates that the implementation does not support a 52-bit PA size, if a translation table lookup uses this register with the 64KB translation granule when the value of [TCR_EL2](#).IPS is 110 and the value of register bits[5:2] is nonzero then it is IMPLEMENTATION DEFINED whether an Address size fault is generated, but ARM deprecates not generating an Address size fault.

If the *Effective value* of [TCR_EL2](#).IPS is not 110 then:

- Register bits[47:x] hold bits[47:x] of the stage 1 translation table base address.
- Register bits[(x-1):1] are RES0.
- If the implementation supports 52-bit PAs and IPAs then bits[51:49] of the translation table base addresses used in this stage of translation are 0b0000.

———— **Note** ————

This definition applies:

- To an implementation that includes [ARMv8.2-LPA](#) and is using a translation granule smaller than 64KB.
- To any implementation that does not include [ARMv8.2-LPA](#).

If any [TTBR1_EL2](#)[47:0] bit that is defined as RES0 has the value 1 when a translation table walk is performed using [TTBR1_EL2](#), then the translation table base address might be misaligned, with effects that are CONSTRAINED UNPREDICTABLE, and must be one of the following:

- Bits[x-1:0] of the translation table base address are treated as if all the bits are zero. The value read back from the corresponding register bits is either the value written to the register or zero.
- The result of the calculation of an address for a translation table walk using this register can be corrupted in those bits that are nonzero.

The AArch64 Virtual Memory System Architecture chapter describes how x is calculated based on the value of [TCR_EL2](#).T1SZ, the stage of translation, and the translation granule size.

CnP, bit [0]

In ARMv8.2

Common not Private. In an implementation that includes [ARMv8.2-TTCNP](#), indicates whether each entry that is pointed to by [TBR1_EL2](#) is a member of a common set that can be used by every PE in the Inner Shareable domain for which the value of [TTBR1_EL2](#).CnP is 1.

0 The translation table entries pointed to by [TTBR1_EL2](#) for the current ASID are permitted to differ from corresponding entries for [TTBR1_EL2](#) for other PEs in the Inner Shareable domain. This is not affected by:

- The value of [TTBR1_EL2](#).CnP on those other PEs.
- The value of the current ASID.

- 1 The translation table entries pointed to by TTBR1_EL2 are the same as the translation table entries for every other PE in the Inner Shareable domain for which the value of TTBR1_EL2.CnP is 1 and all of the following apply:
- The translation table entries are pointed to by TTBR1_EL2.
 - The ASID is the same as the current ASID.

———— **Note** —————

TTBR1_EL2 is accessible only when the value of HCR_EL2.E2H is 1, meaning the current translation regime is the EL2&0 regime.

If the value of the TTBR1_EL2.CnP bit is 1 on multiple PEs in the same Inner Shareable domain and those TTBR1_EL2s do not point to the same translation table entries when the other conditions specified for the case when the value of CnP is 1 apply, then the results of translations are CONstrained UNPREDICTABLE, see *CONstrained UNPREDICTABLE behaviors due to caching of control or data values on page K1-6120*.

In an implementation that does not include ARMv8.2-TTCNP this field is RES0.

In ARMv8.1.

Reserved, RES0.

Accessing the TTBR1_EL2

This register can be read using MRS with the following syntax:

MRS <Xt>, <systemreg>

This register can be written using MSR (register) with the following syntax:

MSR <systemreg>, <Xt>

This syntax is encoded with the following settings in the instruction encoding:

<systemreg>	op0	op1	CRn	CRm	op2
TTBR1_EL2	11	100	0010	0000	001
TTBR1_EL1	11	000	0010	0000	001

Accessibility

The register is accessible in software as follows:

<systemreg>	Control			Accessibility			
	E2H	TGE	NS	EL0	EL1	EL2	EL3
TTBR1_EL2	x	x	0	-	-	n/a	RW
TTBR1_EL2	0	0	1	-	-	RW	RW
TTBR1_EL2	0	1	1	-	n/a	RW	RW
TTBR1_EL2	1	0	1	-	-	RW	RW
TTBR1_EL2	1	1	1	-	n/a	RW	RW
TTBR1_EL1	x	x	0	-	TTBR1_EL1	n/a	TTBR1_EL1
TTBR1_EL1	0	0	1	-	TTBR1_EL1	TTBR1_EL1	TTBR1_EL1

<systemreg>	Control			Accessibility			
	E2H	TGE	NS	EL0	EL1	EL2	EL3
TTBR1_EL1	0	1	1	-	n/a	TTBR1_EL1	TTBR1_EL1
TTBR1_EL1	1	0	1	-	TTBR1_EL1	RW	TTBR1_EL1
TTBR1_EL1	1	1	1	-	n/a	RW	TTBR1_EL1

This table applies to all instructions that can access this register.

When [HCR_EL2.E2H](#) is 1, without explicit synchronization, access from EL2 using the mnemonic TTBR1_EL2 or TTBR1_EL1 are not guaranteed to be ordered with respect to accesses using the other mnemonic.

D7.2.104 VBAR_EL1, Vector Base Address Register (EL1)

The VBAR_EL1 characteristics are:

Purpose

Holds the vector base address for any exception that is taken to EL1.

Configurations

AArch64 System register VBAR_EL1[31:0] is architecturally mapped to AArch32 System register [VBAR](#).

RW fields in this register reset to architecturally UNKNOWN values.

Attributes

VBAR_EL1 is a 64-bit register.

Field descriptions

The VBAR_EL1 bit assignments are:

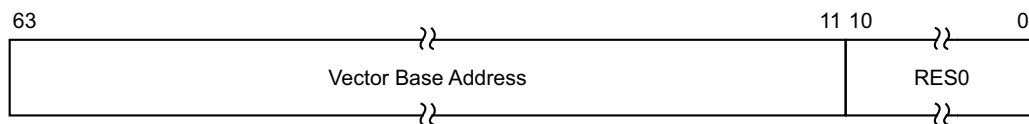

Bits [63:11]

Vector Base Address. Base address of the exception vectors for exceptions taken to EL1.

If the implementation does not support [ARMv8.2-LVA](#), then:

- If tagged addresses are being used, bits [55:48] of VBAR_EL1 must be the same or else the use of the vector address will result in a recursive exception.
- If tagged addresses are not being used, bits [63:48] of VBAR_EL1 must be the same or else the use of the vector address will result in a recursive exception.

If the implementation supports [ARMv8.2-LVA](#), then:

- If tagged addresses are being used, bits [55:52] of VBAR_EL1 must be the same or else the use of the vector address will result in a recursive exception.
- If tagged addresses are not being used, bits [63:52] of VBAR_EL1 must be the same or else the use of the vector address will result in a recursive exception.

Bits [10:0]

Reserved, RES0.

Accessing the VBAR_EL1

This register can be read using MRS with the following syntax:

```
MRS <Xt>, <systemreg>
```

This register can be written using MSR (register) with the following syntax:

```
MSR <systemreg>, <Xt>
```

This syntax is encoded with the following settings in the instruction encoding:

<systemreg>	op0	op1	CRn	CRm	op2
VBAR_EL1	11	000	1100	0000	000
VBAR_EL12	11	101	1100	0000	000

Accessibility

The register is accessible in software as follows:

<systemreg>	Control			Accessibility			
	E2H	TGE	NS	EL0	EL1	EL2	EL3
VBAR_EL1	x	x	0	-	RW	n/a	RW
VBAR_EL1	0	0	1	-	RW	RW	RW
VBAR_EL1	0	1	1	-	n/a	RW	RW
VBAR_EL1	1	0	1	-	RW	VBAR_EL2	RW
VBAR_EL1	1	1	1	-	n/a	VBAR_EL2	RW
VBAR_EL12	x	x	0	-	-	n/a	-
VBAR_EL12	0	0	1	-	-	-	-
VBAR_EL12	0	1	1	-	n/a	-	-
VBAR_EL12	1	0	1	-	-	RW	RW
VBAR_EL12	1	1	1	-	n/a	RW	RW

This table applies to all instructions that can access this register.

When [HCR_EL2.E2H](#) is 1, without explicit synchronization, access from EL3 using the mnemonic VBAR_EL1 or VBAR_EL12 are not guaranteed to be ordered with respect to accesses using the other mnemonic.

D7.2.105 VBAR_EL2, Vector Base Address Register (EL2)

The VBAR_EL2 characteristics are:

Purpose

Holds the vector base address for any exception that is taken to EL2.

Configurations

AArch64 System register VBAR_EL2[31:0] is architecturally mapped to AArch32 System register [HVBAR](#).

If EL2 is not implemented, this register is RES0 from EL3.

RW fields in this register reset to architecturally UNKNOWN values.

Attributes

VBAR_EL2 is a 64-bit register.

Field descriptions

The VBAR_EL2 bit assignments are:

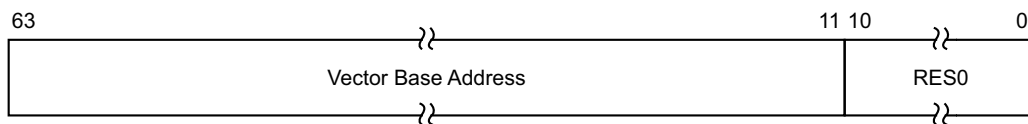

Bits [63:11]

Vector Base Address. Base address of the exception vectors for exceptions taken to EL2.

If the implementation does not support [ARMv8.2-LVA](#), then:

- If tagged addresses are being used, bits [55:48] of VBAR_EL2 must be 0 or else the use of the vector address will result in a recursive exception.
- If tagged addresses are not being used, bits [63:48] of VBAR_EL2 must be 0 or else the use of the vector address will result in a recursive exception.

If the implementation supports [ARMv8.2-LVA](#), then:

- If tagged addresses are being used, bits [55:52] of VBAR_EL2 must be the same or else the use of the vector address will result in a recursive exception.
- If tagged addresses are not being used, bits [63:52] of VBAR_EL2 must be the same or else the use of the vector address will result in a recursive exception.

Bits [10:0]

Reserved, RES0.

Accessing the VBAR_EL2

This register can be read using MRS with the following syntax:

```
MRS <Xt>, <systemreg>
```

This register can be written using MSR (register) with the following syntax:

```
MSR <systemreg>, <Xt>
```

This syntax is encoded with the following settings in the instruction encoding:

<systemreg>	op0	op1	CRn	CRm	op2
VBAR_EL2	11	100	1100	0000	000
VBAR_EL1	11	000	1100	0000	000

Accessibility

The register is accessible in software as follows:

<systemreg>	Control			Accessibility			
	E2H	TGE	NS	EL0	EL1	EL2	EL3
VBAR_EL2	x	x	0	-	-	n/a	RW
VBAR_EL2	0	0	1	-	-	RW	RW
VBAR_EL2	0	1	1	-	n/a	RW	RW
VBAR_EL2	1	0	1	-	-	RW	RW
VBAR_EL2	1	1	1	-	n/a	RW	RW
VBAR_EL1	x	x	0	-	VBAR_EL1	n/a	VBAR_EL1
VBAR_EL1	0	0	1	-	VBAR_EL1	VBAR_EL1	VBAR_EL1
VBAR_EL1	0	1	1	-	n/a	VBAR_EL1	VBAR_EL1
VBAR_EL1	1	0	1	-	VBAR_EL1	RW	VBAR_EL1
VBAR_EL1	1	1	1	-	n/a	RW	VBAR_EL1

This table applies to all instructions that can access this register.

When [HCR_EL2.E2H](#) is 1, without explicit synchronization, access from EL2 using the mnemonic VBAR_EL2 or VBAR_EL1 are not guaranteed to be ordered with respect to accesses using the other mnemonic.

D7.2.106 VBAR_EL3, Vector Base Address Register (EL3)

The VBAR_EL3 characteristics are:

Purpose

Holds the vector base address for any exception that is taken to EL3.

Configurations

RW fields in this register reset to architecturally UNKNOWN values.

Attributes

VBAR_EL3 is a 64-bit register.

Field descriptions

The VBAR_EL3 bit assignments are:

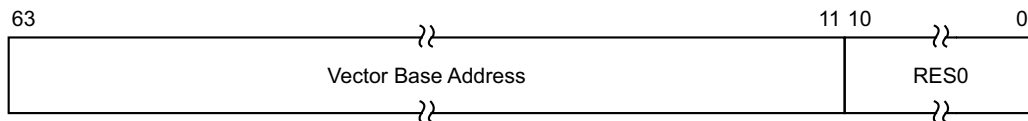

Bits [63:11]

Vector Base Address. Base address of the exception vectors for exceptions taken to EL3.

If the implementation does not support [ARMv8.2-LVA](#), then:

- If tagged addresses are being used, bits [55:48] of VBAR_EL3 must be 0 or else the use of the vector address will result in a recursive exception.
- If tagged addresses are not being used, bits [63:48] of VBAR_EL3 must be 0 or else the use of the vector address will result in a recursive exception.

If the implementation supports [ARMv8.2-LVA](#), then:

- If tagged addresses are being used, bits [55:52] of VBAR_EL3 must be the same or else the use of the vector address will result in a recursive exception.
- If tagged addresses are not being used, bits [63:52] of VBAR_EL3 must be the same or else the use of the vector address will result in a recursive exception.

Bits [10:0]

Reserved, RES0.

Accessing the VBAR_EL3

This register can be read using MRS with the following syntax:

```
MRS <Xt>, <systemreg>
```

This register can be written using MSR (register) with the following syntax:

```
MSR <systemreg>, <Xt>
```

This syntax is encoded with the following settings in the instruction encoding:

<systemreg>	op0	op1	CRn	CRm	op2
VBAR_EL3	11	110	1100	0000	000

Accessibility

The register is accessible in software as follows:

Control			Accessibility			
E2H	TGE	NS	EL0	EL1	EL2	EL3
x	x	0	-	-	n/a	RW
0	0	1	-	-	-	RW
0	1	1	-	n/a	-	RW
1	0	1	-	-	-	RW
1	1	1	-	n/a	-	RW

D7.2.107 VMPIDR_EL2, Virtualization Multiprocessor ID Register

The VMPIDR_EL2 characteristics are:

Purpose

Holds the value of the Virtualization Multiprocessor ID. This is the value returned by Non-secure EL1 reads of [VMPIDR_EL1](#).

Configurations

AArch64 System register VMPIDR_EL2[31:0] is architecturally mapped to AArch32 System register [VMPIDR](#).

If EL2 is not implemented, reads of this register return the value of the [VMPIDR_EL1](#), and writes to the register are ignored.

RW fields in this register reset to architecturally UNKNOWN values.

Attributes

VMPIDR_EL2 is a 64-bit register.

Field descriptions

The VMPIDR_EL2 bit assignments are:

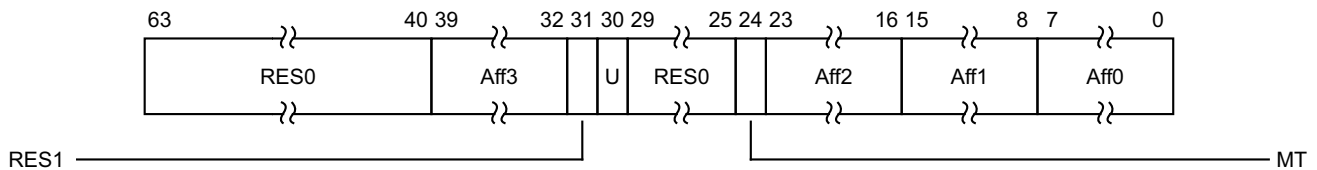

Bits [63:40]

Reserved, RES0.

Aff3, bits [39:32]

Affinity level 3. Highest level affinity field.

Bit [31]

Reserved, RES1.

U, bit [30]

Indicates a Uniprocessor system, as distinct from PE 0 in a multiprocessor system. The possible values of this bit are:

- 0 Processor is part of a multiprocessor system.
- 1 Processor is part of a uniprocessor system.

Bits [29:25]

Reserved, RES0.

MT, bit [24]

Indicates whether the lowest level of affinity consists of logical PEs that are implemented using a multithreading type approach. The possible values of this bit are:

- 0 Performance of PEs at the lowest affinity level is largely independent.
- 1 Performance of PEs at the lowest affinity level is very interdependent.

Aff2, bits [23:16]

Affinity level 2. Second highest level affinity field.

Aff1, bits [15:8]

Affinity level 1. Third highest level affinity field.

Aff0, bits [7:0]

Affinity level 0. Lowest level affinity field.

Accessing the VMPIDR_EL2

This register can be read using MRS with the following syntax:

MRS <Xt>, <systemreg>

This register can be written using MSR (register) with the following syntax:

MSR <systemreg>, <Xt>

This syntax is encoded with the following settings in the instruction encoding:

<systemreg>	op0	op1	CRn	CRm	op2
VMPIDR_EL2	11	100	0000	0000	101

Accessibility

The register is accessible in software as follows:

Control			Accessibility			
E2H	TGE	NS	EL0	EL1	EL2	EL3
x	x	0	-	-	n/a	RW
x	0	1	-	-	RW	RW
x	1	1	-	n/a	RW	RW

D7.2.108 VPIDR_EL2, Virtualization Processor ID Register

The VPIDR_EL2 characteristics are:

Purpose

Holds the value of the Virtualization Processor ID. This is the value returned by Non-secure EL1 reads of [MIDR_EL1](#).

Configurations

AArch64 System register VPIDR_EL2 is architecturally mapped to AArch32 System register [VPIDR](#).

If EL2 is not implemented, reads of this register return the value of the [MIDR_EL1](#), and writes to the register are ignored.

RW fields in this register reset to architecturally UNKNOWN values.

Attributes

VPIDR_EL2 is a 32-bit register.

Field descriptions

The VPIDR_EL2 bit assignments are:

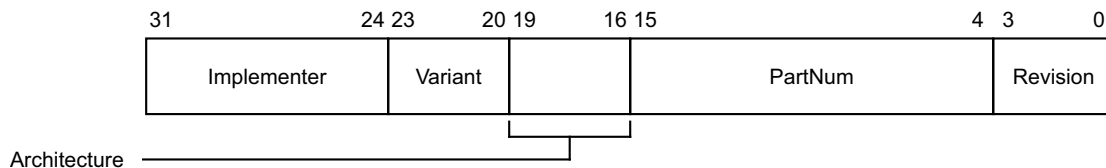

Implementer, bits [31:24]

The Implementer code. This field must hold an implementer code that has been assigned by ARM. Assigned codes include the following:

Hex representation	ASCII representation	Implementer
0x41	A	ARM Limited
0x42	B	Broadcom Corporation
0x43	C	Cavium Inc.
0x44	D	Digital Equipment Corporation
0x49	I	Infineon Technologies AG
0x4D	M	Motorola or Freescale Semiconductor Inc.
0x4E	N	NVIDIA Corporation
0x50	P	Applied Micro Circuits Corporation
0x51	Q	Qualcomm Inc.
0x56	V	Marvell International Ltd.
0x69	i	Intel Corporation

ARM can assign codes that are not published in this manual. All values not assigned by ARM are reserved and must not be used.

Variant, bits [23:20]

An IMPLEMENTATION DEFINED variant number. Typically, this field is used to distinguish between different product variants, or major revisions of a product.

Architecture, bits [19:16]

The permitted values of this field are:

0001	ARMv4
0010	ARMv4T
0011	ARMv5 (obsolete)
0100	ARMv5T
0101	ARMv5TE
0110	ARMv5TEJ
0111	ARMv6
1111	Architectural features are individually identified in the ID_* registers, see Identification registers, functional group on page G4-4727 .

All other values are reserved.

PartNum, bits [15:4]

An IMPLEMENTATION DEFINED primary part number for the device.

On processors implemented by ARM, if the top four bits of the primary part number are 0x0 or 0x7, the variant and architecture are encoded differently.

Revision, bits [3:0]

An IMPLEMENTATION DEFINED revision number for the device.

Accessing the VPIDR_EL2

This register can be read using MRS with the following syntax:

MRS <Xt>, <systemreg>

This register can be written using MSR (register) with the following syntax:

MSR <systemreg>, <Xt>

This syntax is encoded with the following settings in the instruction encoding:

<systemreg>	op0	op1	CRn	CRm	op2
VPIDR_EL2	11	100	0000	0000	000

Accessibility

The register is accessible in software as follows:

Control			Accessibility			
E2H	TGE	NS	EL0	EL1	EL2	EL3
x	x	0	-	-	n/a	RW
x	0	1	-	-	RW	RW
x	1	1	-	n/a	RW	RW

D7.2.109 VTCR_EL2, Virtualization Translation Control Register

The VTCR_EL2 characteristics are:

Purpose

The control register for stage 2 of the EL1&0 translation regime.

Configurations

AArch64 System register VTCR_EL2 is architecturally mapped to AArch32 System register [VTCR](#).

If EL2 is not implemented, this register is RES0 from EL3.

RW fields in this register reset to architecturally UNKNOWN values.

Attributes

VTCR_EL2 is a 32-bit register.

Field descriptions

The VTCR_EL2 bit assignments are:

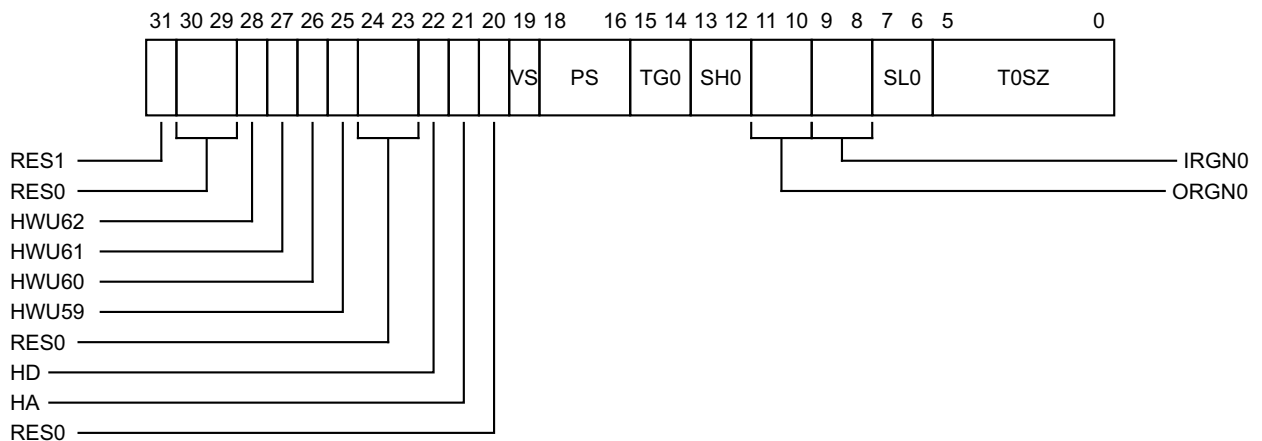

Any of the bits in VTCR_EL2 are permitted to be cached in a TLB.

Bit [31]

Reserved, RES1.

Bits [30:29]

Reserved, RES0.

HWU62, bit [28]

In ARMv8.2

Hardware Use. Indicates IMPLEMENTATION DEFINED hardware use of bit[62] of the stage 2 translation table block or level 3 entry.

Defined values are:

- 0 The stage 2 translation table entry block or level 3 bit cannot be interpreted by hardware for an IMPLEMENTATION DEFINED purpose.
- 1 The stage 2 translation table entry block or level 3 bit can be interpreted by hardware for an IMPLEMENTATION DEFINED purpose.

This bit is RES0, if [ARMv8.2-TTPBHA](#) is not implemented.

In ARMv8.1 and ARMv8.0.

Reserved, RES0.

HWU61, bit [27]

In ARMv8.2

Hardware Use. Indicates IMPLEMENTATION DEFINED hardware use of bit[61] of the stage 2 translation table block or level 3 entry.

Defined values are:

- 0 The stage 2 translation table entry block or level 3 bit cannot be interpreted by hardware for an IMPLEMENTATION DEFINED purpose.
- 1 The stage 2 translation table entry block or level 3 bit can be interpreted by hardware for an IMPLEMENTATION DEFINED purpose.

This bit is RES0, if [ARMv8.2-TTPBHA](#) is not implemented.

In ARMv8.1 and ARMv8.0.

Reserved, RES0.

HWU60, bit [26]

In ARMv8.2

Hardware Use. Indicates IMPLEMENTATION DEFINED hardware use of bit[60] of the stage 2 translation table block or level 3 entry.

Defined values are:

- 0 The stage 2 translation table entry block or level 3 bit cannot be interpreted by hardware for an IMPLEMENTATION DEFINED purpose.
- 1 The stage 2 translation table entry block or level 3 bit can be interpreted by hardware for an IMPLEMENTATION DEFINED purpose.

This bit is RES0 if [ARMv8.2-TTPBHA](#) is not implemented.

In ARMv8.1 and ARMv8.0.

Reserved, RES0.

HWU59, bit [25]

In ARMv8.2

Hardware Use. Indicates IMPLEMENTATION DEFINED hardware use of bit[59] of the stage 2 translation table block or level 3 entry.

Defined values are:

- 0 The stage 2 translation table entry block or level 3 bit cannot be interpreted by hardware for an IMPLEMENTATION DEFINED purpose.
- 1 The stage 2 translation table entry block or level 3 bit can be interpreted by hardware for an IMPLEMENTATION DEFINED purpose.

This bit is RES0 if [ARMv8.2-TTPBHA](#) is not implemented.

In ARMv8.1 and ARMv8.0.

Reserved, RES0.

Bits [24:23]

Reserved, RES0.

HD, bit [22]

In ARMv8.2 and ARMv8.1

Hardware management of dirty state in stage 2 translations from Non-secure EL0 and EL1.

Defined values are:

- 0 Stage 2 hardware management of dirty state disabled.
- 1 Stage 2 hardware management of dirty state enabled, only if the HA bit is also set to 1.

This bit is RES0 if [ARMv8.1-TTHM](#) is not implemented.

In ARMv8.0.

Reserved, RES0.

HA, bit [21]

In ARMv8.2 and ARMv8.1

Hardware Access flag update in stage 2 translations from Non-secure EL0 and EL1.

Defined values are:

- 0 Stage 2 Access flag update disabled.
- 1 Stage 2 Access flag update enabled.

This bit is RES0 if [ARMv8.1-TTHM](#) is not implemented.

In ARMv8.0.

Reserved, RES0.

Bit [20]

Reserved, RES0.

VS, bit [19]

In ARMv8.2 and ARMv8.1

VMID Size.

Defined values are:

- 0 8 bit - the upper 8 bits of [VTTBR_EL2](#) are ignored by the hardware, and treated as if they are all zeros, for every purpose except when reading back the register.
- 1 16 bit - the upper 8 bits of [VTTBR_EL2](#) are used for allocation and matching in the TLB.

If the implementation only supports an 8-bit VMID, this field is RES0.

This bit is RES0 if [ARMv8.1-VMID16](#) is not implemented.

In ARMv8.0.

Reserved, RES0.

PS, bits [18:16]

Physical Address Size.

- 000 32 bits, 4GB.
- 001 36 bits, 64GB.
- 010 40 bits, 1TB.
- 011 42 bits, 4TB.
- 100 44 bits, 16TB.
- 101 48 bits, 256TB.
- 110 52 bits, 4PB

Other values are reserved.

The reserved values behave in the same way as the 101 encoding, but software must not rely on this property as the behavior of the reserved values might change in a future revision of the architecture.

The value 110 is permitted only if [ARMv8.2-LPA](#) is implemented and the granule size is 64KB.

In an implementation that supports 52-bit PAs, if the value of this field is not 110, then bits[51:48] of every translation table base address for the stage of translation controlled by VTCR_EL2 are 0000.

TG0, bits [15:14]

Granule size for the [VTTBR_EL2](#).

00	4KB
01	64KB
10	16KB

Other values are reserved.

If the value is programmed to either a reserved value, or a size that has not been implemented, then the hardware will treat the field as if it has been programmed to an IMPLEMENTATION DEFINED choice of the sizes that has been implemented for all purposes other than the value read back from this register.

It is IMPLEMENTATION DEFINED whether the value read back is the value programmed or the value that corresponds to the size chosen.

SH0, bits [13:12]

Shareability attribute for memory associated with translation table walks using [VTTBR_EL2](#).

00	Non-shareable
10	Outer Shareable
11	Inner Shareable

Other values are reserved. The effect of programming this field to a Reserved value is that behavior is CONSTRAINED UNPREDICTABLE, as described in *Reserved values in System and memory-mapped registers and translation table entries* on page K1-6133.

ORGN0, bits [11:10]

Outer cacheability attribute for memory associated with translation table walks using [VTTBR_EL2](#).

00	Normal memory, Outer Non-cacheable
01	Normal memory, Outer Write-Back Read-Allocate Write-Allocate Cacheable
10	Normal memory, Outer Write-Through Read-Allocate No Write-Allocate Cacheable
11	Normal memory, Outer Write-Back Read-Allocate No Write-Allocate Cacheable

IRGN0, bits [9:8]

Inner cacheability attribute for memory associated with translation table walks using [VTTBR_EL2](#).

00	Normal memory, Inner Non-cacheable
01	Normal memory, Inner Write-Back Read-Allocate Write-Allocate Cacheable
10	Normal memory, Inner Write-Through Read-Allocate No Write-Allocate Cacheable
11	Normal memory, Inner Write-Back Read-Allocate No Write-Allocate Cacheable

SL0, bits [7:6]

Starting level of the [VTCR_EL2](#) addressed region. The meaning of this field depends on the value of VTCR_EL2.TG0 (the granule size).

00	If TG0 is 00 (4KB granule), start at level 2. If TG0 is 10 (16KB granule) or 01 (64KB granule), start at level 3.
01	If TG0 is 00 (4KB granule), start at level 1. If TG0 is 10 (16KB granule) or 01 (64KB granule), start at level 2.
10	If TG0 is 00 (4KB granule), start at level 0. If TG0 is 10 (16KB granule) or 01 (64KB granule), start at level 1.

All other values are reserved. If this field is programmed to a reserved value, or to a value that is not consistent with the programming of TOSZ, then a stage 2 level 0 Translation fault is generated.

T0SZ, bits [5:0]

The size offset of the memory region addressed by [VTTBR_EL2](#). The region size is $2^{(64-T0SZ)}$ bytes.

The maximum and minimum possible values for T0SZ depend on the level of translation table and the memory translation granule size, as described in the AArch64 Virtual Memory System Architecture chapter.

If this field is programmed to a value that is not consistent with the programming of SL0 then a stage 2 level 0 Translation fault is generated.

Accessing the VTCR_EL2

This register can be read using MRS with the following syntax:

MRS <Xt>, <systemreg>

This register can be written using MSR (register) with the following syntax:

MSR <systemreg>, <Xt>

This syntax is encoded with the following settings in the instruction encoding:

<systemreg>	op0	op1	CRn	CRm	op2
VTCR_EL2	11	100	0010	0001	010

Accessibility

The register is accessible in software as follows:

Control			Accessibility			
E2H	TGE	NS	EL0	EL1	EL2	EL3
x	x	0	-	-	n/a	RW
x	0	1	-	-	RW	RW
x	1	1	-	n/a	RW	RW

D7.2.110 VTTBR_EL2, Virtualization Translation Table Base Register

The VTTBR_EL2 characteristics are:

Purpose

Holds the base address of the translation table for the initial lookup for stage 2 of an address translation in the Non-secure EL1&0 translation regime, and other information for this translation regime.

Configurations

AArch64 System register VTTBR_EL2 is architecturally mapped to AArch32 System register [VTTBR](#).

If EL2 is not implemented, this register is RES0 from EL3.

RW fields in this register reset to architecturally UNKNOWN values.

Attributes

VTTBR_EL2 is a 64-bit register.

Field descriptions

The VTTBR_EL2 bit assignments are:

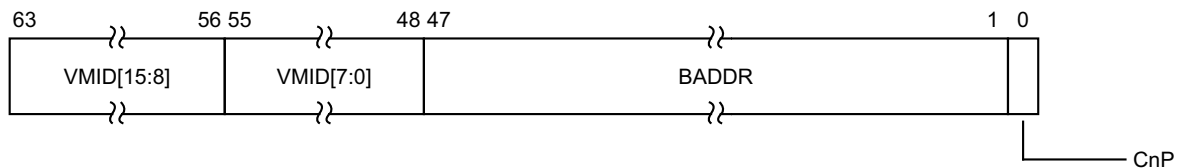

Any of the fields in this register are permitted to be cached in a TLB.

VMID[15:8], bits [63:56]

In ARMv8.2 and ARMv8.1

Extension to VMID[7:0]. See VMID[7:0] for more details.

In ARMv8.0.

Reserved, RES0.

VMID[7:0], bits [55:48]

The VMID for the translation table.

It is IMPLEMENTATION DEFINED whether the VMID is 8 bits or 16 bits.

If the implementation has an 8-bit VMID, then VMID[15:8] are RES0.

If the implementation has a 16-bit VMID, then:

- The [VTCR_EL2.VS](#) bit selects whether VMID[15:8] are ignored by the hardware for every purpose except reading back the register, or whether these bits are used for allocation and matching in the TLB.
- The 16-bit VMID is only supported when EL2 is using AArch64. This means the hardware must ignore VMID[15:8] when EL2 is using AArch32.

BADDR, bits [47:1]

Translation table base address, A[47:x] or A[51:x], bits[47:1].

Note

- Translation table base addresses of 52 bits, A[51:x], are supported only in an implementation that includes [ARMv8.2-LPA](#) and is using the 64KB translation granule.
- A translation table must be aligned to the size of the table, except that when using a translation table base address larger than 48 bits the minimum alignment of a table containing fewer than eight entries is 64 bytes.

In an implementation that includes [ARMv8.2-LPA](#), if the value of [VTCCR_EL2.IPS](#) is 110, then:

- Register bits[47:z] hold bits[47:z] of the stage 1 translation table base address, where z is determined as follows:
 - If $x \geq 6$ then $z=x$.
 - Otherwise, $z=6$.
- Register bits[5:2] hold bits[51:48] of the stage 1 translation table base address.
- When $z > x$ register bits[(z-1):x] are RES0, and bits[(z-1):x] of the translation table base address are zero.
- When $x > 6$ register bits[(x-1):6] are RES0.
- Register bit[1] is RES0.
- Bits[5:2] of the stage 1 translation table base address are zero.
- In an implementation that includes [ARMv8.2-TTCNP](#) bit[0] of the stage 1 translation table base address is zero.

Note

In an implementation that includes [ARMv8.2-LPA](#) a [VTCCR_EL2.PS](#) value of 110, that selects a PA size of 52 bits, is permitted only when using the 64KB translation granule.

When the value of [ID_AA64MMFR0_EL1.PARange](#) indicates that the implementation does not support a 52-bit PA size, if a translation table lookup uses this register with the 64KB translation granule when the value of [VTCCR_EL2.PS](#) is 110 and the value of register bits[5:2] is nonzero then it is IMPLEMENTATION DEFINED whether an Address size fault is generated, but ARM deprecates not generating an Address size fault.

If the *Effective value* of [VTCCR_EL2.PS](#) is not 110 then:

- Register bits[47:x] hold bits[47:x] of the stage 1 translation table base address.
- Register bits[(x-1):1] are RES0.
- If the implementation supports 52-bit PAs and IPAs then bits[51:49] of the translation table base addresses used in this stage of translation are 0b0000.

Note

This definition applies:

- To an implementation that includes [ARMv8.2-LPA](#) and is using a translation granule smaller than 64KB.
- To any implementation that does not include [ARMv8.2-LPA](#).

If any [VTTBR_EL2\[47:0\]](#) bit that is defined as RES0 has the value 1 when a translation table walk is performed using [VTTBR_EL2](#), then the translation table base address might be misaligned, with effects that are CONstrained UNPREDICTABLE, and must be one of the following:

- Bits[x-1:0] of the translation table base address are treated as if all the bits are zero. The value read back from the corresponding register bits is either the value written to the register or zero.

- The result of the calculation of an address for a translation table walk using this register can be corrupted in those bits that are nonzero.

The AArch64 Virtual Memory System Architecture chapter describes how x is calculated based on the value of `VTCR_EL2.T0SZ`, the stage of translation, and the translation granule size.

CnP, bit [0]

In ARMv8.2

Common not Private. In an implementation that includes [ARMv8.2-TTCNP](#), indicates whether each entry that is pointed to by `VTTBR_EL2` is a member of a common set that can be used by every PE in the Inner Shareable domain for which the value of `VTTBR_EL2.CnP` is 1.

- 0 The translation table entries pointed to by `VTTBR_EL2` are permitted to differ from the entries for `VTTBR_EL2` for other PEs in the Inner Shareable domain. This is not affected by the value of the current VMID.
- 1 The translation table entries pointed to by `VTTBR_EL2` are the same as the translation table entries for every other PE in the Inner Shareable domain for which the value of `VTTBR_EL2.CnP` is 1 and the VMID is the same as the current VMID.

———— Note ————

If the value of `VTTBR_EL2.CnP` bit is 1 on multiple PEs in the same Inner Shareable domain and those `VTTBR_EL2`s do not point to the same translation table entries when using the current VMID then the results of translations using `VTTBR_EL2` are *CONSTRAINED UNPREDICTABLE*, see [CONSTRAINED UNPREDICTABLE behaviors due to caching of control or data values on page K1-6120](#).

In an implementation that does not include [ARMv8.2-TTCNP](#) this field is RES0.

In ARMv8.1 and ARMv8.0.

Reserved, RES0.

Accessing the VTTBR_EL2

This register can be read using MRS with the following syntax:

MRS <Xt>, <systemreg>

This register can be written using MSR (register) with the following syntax:

MSR <systemreg>, <Xt>

This syntax is encoded with the following settings in the instruction encoding:

<systemreg>	op0	op1	CRn	CRm	op2
VTTBR_EL2	11	100	0010	0001	000

Accessibility

The register is accessible in software as follows:

Control			Accessibility			
E2H	TGE	NS	EL0	EL1	EL2	EL3
x	x	0	-	-	n/a	RW
x	0	1	-	-	RW	RW
x	1	1	-	n/a	RW	RW

D7.3 Debug registers

This section lists the Debug System registers in AArch64 state, in alphabetic order:

- The principal encoding space for debug registers is $0p0==0b10$, $0p1==\{0, 3, 4\}$. [Instructions for accessing debug System registers on page C5-322](#) summarizes the registers in this encoding space and lists them in order of their encodings.
- In addition, the following registers in the $0p0==0b11$ encoding space are classified as Debug registers:
 - [DLR_EL0](#).
 - [DSPSR_EL0](#).
 - [MDCR_EL2](#).
 - [MDCR_EL3](#).
 - [SDER32_EL3](#).

D7.3.1 DBGAUTHSTATUS_EL1, Debug Authentication Status register

The DBGAUTHSTATUS_EL1 characteristics are:

Purpose

Provides information about the state of the IMPLEMENTATION DEFINED authentication interface for debug.

Configurations

AArch64 System register DBGAUTHSTATUS_EL1 is architecturally mapped to AArch32 System register [DBGAUTHSTATUS](#).

AArch64 System register DBGAUTHSTATUS_EL1 is architecturally mapped to External register [DBGAUTHSTATUS_EL1](#).

Attributes

DBGAUTHSTATUS_EL1 is a 32-bit register.

Field descriptions

The DBGAUTHSTATUS_EL1 bit assignments are:

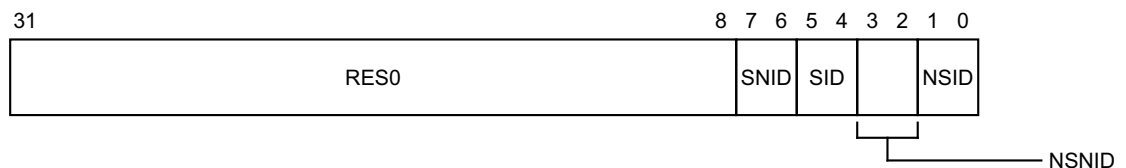

Bits [31:8]

Reserved, RES0.

SNID, bits [7:6]

Secure non-invasive debug. Possible values of this field are:

- 00 Not implemented. EL3 is not implemented and the implemented Security state is Non-secure state.
- 10 Implemented and disabled. `ExternalSecureNoninvasiveDebugEnabled() == FALSE`.
- 11 Implemented and enabled. `ExternalSecureNoninvasiveDebugEnabled() == TRUE`.

Other values are reserved.

SID, bits [5:4]

Secure invasive debug. Possible values of this field are:

- 00 Not implemented. EL3 is not implemented and the implemented Security state is Non-secure state.
- 10 Implemented and disabled. `ExternalSecureInvasiveDebugEnabled() == FALSE`.
- 11 Implemented and enabled. `ExternalSecureInvasiveDebugEnabled() == TRUE`.

Other values are reserved.

NSNID, bits [3:2]

Non-secure non-invasive debug. Possible values of this field are:

- 00 Not implemented. EL3 is not implemented and the implemented Security state is Secure state.
- 10 Implemented and disabled. `ExternalNoninvasiveDebugEnabled() == FALSE`.
- 11 Implemented and enabled. `ExternalNoninvasiveDebugEnabled() == TRUE`.

Other values are reserved.

NSID, bits [1:0]

Non-secure invasive debug. Possible values of this field are:

- 00 Not implemented. EL3 is not implemented and the implemented Security state is Secure state.
 - 10 Implemented and disabled. ExternalInvasiveDebugEnabled() == FALSE.
 - 11 Implemented and enabled. ExternalInvasiveDebugEnabled() == TRUE.
- Other values are reserved.

Accessing the DBGAUTHSTATUS_EL1

This register can be read using MRS with the following syntax:

MRS <Xt>, <systemreg>

This syntax is encoded with the following settings in the instruction encoding:

<systemreg>	op0	op1	CRn	CRm	op2
DBGAUTHSTATUS_EL1	10	000	0111	1110	110

Accessibility

The register is accessible in software as follows:

Control			Accessibility			
E2H	TGE	NS	EL0	EL1	EL2	EL3
x	x	0	-	RO	n/a	RO
x	0	1	-	RO	RO	RO
x	1	1	-	n/a	RO	RO

Traps and Enables

For a description of the prioritization of any generated exceptions, see [Synchronous exception prioritization for exceptions taken to AArch64 on page D1-1827](#). Subject to the prioritization rules:

- When EL2 is implemented and is using AArch64 and SCR_EL3.NS == 1:
 - If MDCR_EL2.TDA==1, Non-secure read accesses to this register from EL1 are trapped to EL2.
- When EL3 is implemented and is using AArch64:
 - If MDCR_EL3.TDA==1, read accesses to this register from EL1 and EL2 are trapped to EL3.

D7.3.2 DBGBCR<n>_EL1, Debug Breakpoint Control Registers, n = 0 - 15

The DBGBCR<n>_EL1 characteristics are:

Purpose

Holds control information for a breakpoint. Forms breakpoint n together with value register [DBGBVR<n>_EL1](#).

Configurations

AArch64 System register DBGBCR<n>_EL1 is architecturally mapped to AArch32 System register [DBGBCR<n>](#).

AArch64 System register DBGBCR<n>_EL1 is architecturally mapped to External register [DBGBCR<n>_EL1](#).

If breakpoint n is not implemented then this register is unallocated.

This register is in the Cold reset domain. On a Cold reset RW fields in this register reset to architecturally UNKNOWN values. The register is not affected by a Warm reset.

Attributes

DBGBCR<n>_EL1 is a 32-bit register.

Field descriptions

The DBGBCR<n>_EL1 bit assignments are:

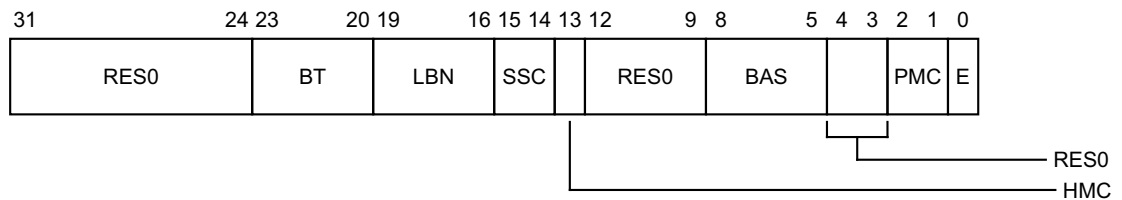

Bits [31:24]

Reserved, RES0.

BT, bits [23:20]

Breakpoint Type. Possible values are:

0000	Unlinked instruction address match.
0001	Linked instruction address match.
0010	Unlinked Context ID match.
0011	Linked Context ID match.
0110	Unlinked CONTEXTIDR_EL1 match (introduced in ARMv8.1).
0111	Linked CONTEXTIDR_EL1 match (introduced in ARMv8.1).
1000	Unlinked VMID match.
1001	Linked VMID match.
1010	Unlinked VMID and Context ID match.
1011	Linked VMID and Context ID match.
1100	Unlinked CONTEXTIDR_EL2 match (introduced in ARMv8.1).
1101	Linked CONTEXTIDR_EL2 match (introduced in ARMv8.1).
1110	Unlinked Full Context ID match (introduced in ARMv8.1).
1111	Linked Full Context ID match (introduced in ARMv8.1).

The field breaks down as follows:

- BT[3:1]: Base type.
 - 000 Match address. [DBGVCR<n>_EL1](#) is the address of an instruction.
 - 001 Match Context ID. [DBGVCR<n>_EL1.ContextID](#) is a Context ID compared against [CONTEXTIDR_EL1](#) when [ARMv8.1-VHE](#) is not implemented, or not in a Host OS or a Host Application. When [ARMv8.1-VHE](#) is implemented, and in a Host OS or Host Application, the Context ID is compared against [CONTEXTIDR_EL2](#).
 - 011 Match [CONTEXTIDR_EL1](#). [DBGVCR<n>_EL1.ContextID](#) is a Context ID compared against [CONTEXTIDR_EL1](#).
 - 100 Match VMID. [DBGVCR<n>_EL1.VMID](#) is a VMID compared against [VTTBR_EL2.VMID](#).
 - 101 Match VMID and Context ID. [DBGVCR<n>_EL1.ContextID](#) is a Context ID compared against [CONTEXTIDR_EL1](#), and [DBGVCR<n>_EL1.VMID](#) is a VMID compared against [VTTBR_EL2.VMID](#).
 - 110 Match [CONTEXTIDR_EL2](#). [DBGVCR<n>_EL1.ContextID2](#) is a Context ID compared against [CONTEXTIDR_EL2](#).
 - 111 Match Full Context ID. [DBGVCR<n>_EL1.ContextID](#) is compared against [CONTEXTIDR_EL1](#), and [DBGVCR<n>_EL1.ContextID2](#) is compared against [CONTEXTIDR_EL2](#).
- BT[0]: Enable linking.

All other values are reserved. Constraints on breakpoint programming mean other values are reserved under some conditions. For more information, including the effect of programming this field to a reserved value, see [Reserved DBGVCR<n>_EL1.BT values on page D2-1935](#).

This field resets to a value that is architecturally UNKNOWN.

LBN, bits [19:16]

Linked breakpoint number. For Linked address matching breakpoints, this specifies the index of the Context-matching breakpoint linked to.

For all other breakpoint types this field is ignored and reads of the register return an UNKNOWN value.

This field is ignored when the value of [DBGVCR<n>_EL1.E](#) is 0.

This field resets to a value that is architecturally UNKNOWN.

SSC, bits [15:14]

Security state control. Determines the Security states under which a Breakpoint debug event for breakpoint n is generated. This field must be interpreted along with the HMC and PMC fields, and there are constraints on the permitted values of the {HMC, SSC, PMC} fields. For more information, including the effect of programming the fields to a reserved set of values, see [Reserved DBGVCR<n>_EL1.{SSC, HMC, PMC} values on page D2-1936](#).

For more information on the operation of the SSC, HMC, and PMC fields, see [Execution conditions for which a breakpoint generates Breakpoint exceptions on page D2-1931](#).

This field resets to a value that is architecturally UNKNOWN.

HMC, bit [13]

Higher mode control. Determines the debug perspective for deciding when a Breakpoint debug event for breakpoint n is generated. This field must be interpreted along with the SSC and PMC fields, and there are constraints on the permitted values of the {HMC, SSC, PMC} fields. For more information see the SSC, bits [15:14] description.

For more information on the operation of the SSC, HMC, and PMC fields, see [Execution conditions for which a breakpoint generates Breakpoint exceptions on page D2-1931](#).

This field resets to a value that is architecturally UNKNOWN.

Bits [12:9]

Reserved, RES0.

BAS, bits [8:5]

Byte address select. Defines which half-words an address-matching breakpoint matches, regardless of the instruction set and Execution state. In an AArch64-only implementation, this field is reserved, RES1.

The permitted values depend on the breakpoint type.

For Address match breakpoints, the permitted values are:

BAS	Match instruction at	Constraint for debuggers
0011	DBGVVR<n>_EL1	Use for T32 instructions.
1100	DBGVVR<n>_EL1+2	Use for T32 instructions.
1111	DBGVVR<n>_EL1	Use for A64 and A32 instructions.

All other values are reserved. For more information, see [Reserved DBGBCR<n>_EL1.BAS values on page D2-1937](#).

For more information on using the BAS field in address match breakpoints, see [Using the BAS field in Address Match breakpoints on page G2-4483](#).

For Context matching breakpoints, this field is RES1 and ignored.

If this field is implemented as an RW field, it resets to a value that is architecturally UNKNOWN.

Bits [4:3]

Reserved, RES0.

PMC, bits [2:1]

Privilege mode control. Determines the Exception level or levels at which a Breakpoint debug event for breakpoint n is generated. This field must be interpreted along with the SSC and HMC fields, and there are constraints on the permitted values of the {HMC, SSC, PMC} fields. For more information see the DBGBCR<n>_EL1.SSC description.

For more information on the operation of the SSC, HMC, and PMC fields, see [Execution conditions for which a breakpoint generates Breakpoint exceptions on page D2-1931](#).

This field resets to a value that is architecturally UNKNOWN.

E, bit [0]

Enable breakpoint DBGVVR<n>_EL1. Possible values are:

- 0 Breakpoint disabled.
- 1 Breakpoint enabled.

This field resets to a value that is architecturally UNKNOWN.

Accessing the DBGBCR<n>_EL1

This register can be read using MRS with the following syntax:

```
MRS <Xt>, <systemreg>
```

This register can be written using MSR (register) with the following syntax:

```
MSR <systemreg>, <Xt>
```

This syntax is encoded with the following settings in the instruction encoding:

<systemreg>	op0	op1	CRn	CRm	op2
DBGBCR<n>_EL1	10	000	0000	n<3:0>	101

- <CRm> is in the range 0 - 15.

Accessibility

The register is accessible in software as follows:

Control			Accessibility			
E2H	TGE	NS	EL0	EL1	EL2	EL3
x	x	0	-	RW	n/a	RW
x	0	1	-	RW	RW	RW
x	1	1	-	n/a	RW	RW

Traps and Enables

For a description of the prioritization of any generated exceptions, see [Synchronous exception prioritization for exceptions taken to AArch64 on page D1-1827](#) and [Software Access debug event on page H3-5493](#). Subject to the prioritization rules:

- In both security states, and not dependent on other bits:
 - If `EDSCR.TDA==1`, `OSLSR_EL1.OSLK==0`, and halting is allowed, EL1, EL2, and EL3 accesses to this register generate a Software Access debug event.
- When EL2 is implemented and is using AArch64 and `SCR_EL3.NS == 1`:
 - If `MDCR_EL2.TDA==1`, Non-secure accesses to this register from EL1 are trapped to EL2.
- When EL3 is implemented and is using AArch64:
 - If `MDCR_EL3.TDA==1`, accesses to this register from EL1 and EL2 are trapped to EL3.

D7.3.3 DBGBVR<n>_EL1, Debug Breakpoint Value Registers, n = 0 - 15

The DBGBVR<n>_EL1 characteristics are:

Purpose

Holds a virtual address, or a VMID and/or a context ID, for use in breakpoint matching. Forms breakpoint n together with control register [DBGBCR<n>_EL1](#).

Configurations

AArch64 System register DBGBVR<n>_EL1[31:0] is architecturally mapped to AArch32 System register [DBGBVR<n>](#).

If the breakpoint is context-aware and EL2 is implemented then AArch64 System register DBGBVR<n>_EL1[63:32] is architecturally mapped to AArch32 System register [DBG BXVR<n>](#). Otherwise there is no System register access to DBGBVR<n>_EL1[63:32] from AArch32 state.

AArch64 System register DBGBVR<n>_EL1 is architecturally mapped to External register [DBGBVR<n>_EL1](#).

If breakpoint n is not implemented then this register is unallocated.

This register is in the Cold reset domain. On a Cold reset RW fields in this register reset to architecturally UNKNOWN values. The register is not affected by a Warm reset.

Attributes

How this register is interpreted depends on the value of [DBGBCR<n>_EL1.BT](#).

- When [DBGBCR<n>_EL1.BT](#) is 0b000x, this register holds a virtual address.
- When [DBGBCR<n>_EL1.BT](#) is 0b001x, 0b011x, or 0b110x, this register holds a Context ID.
- When [DBGBCR<n>_EL1.BT](#) is 0b100x, this register holds a VMID.
- When [DBGBCR<n>_EL1.BT](#) is 0b101x, this register holds a VMID and a Context ID.
- When [DBGBCR<n>_EL1.BT](#) is 0b111x, this register holds two Context ID values.

For other values of [DBGBCR<n>_EL1.BT](#), this register is RES0.

Field descriptions

The DBGBVR<n>_EL1 bit assignments are:

When [DBGBCR<n>_EL1.BT](#)==0b000x:

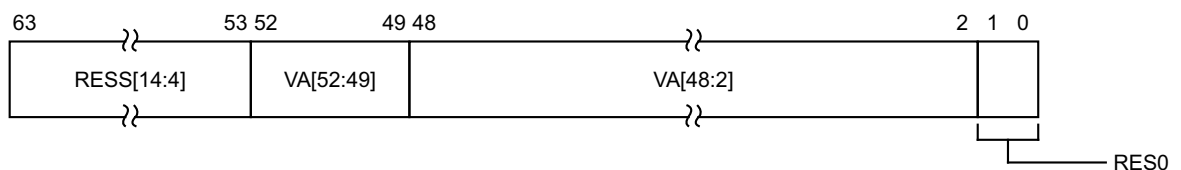

RESS[14:4], bits [63:53]

Reserved, Sign extended. Software must treat this field as RES0 if the most significant bit of VA is 0 or RES0, and as RES1 if the most significant bit of VA is 1.

Hardware always ignores the value of these bits and it is IMPLEMENTATION DEFINED whether:

- The bits are hardwired to a copy of the most significant bit of VA, meaning writes to these bits are ignored, and reads to the bits always return the hardwired value.
- The value in those bits can be written, and reads will return the last value written. The value held in those bits is ignored by hardware.

VA[52:49], bits [52:49]

In ARMv8.2

Extension to VA[48:2]. See VA[48:2] for more details.

This field resets to a value that is architecturally UNKNOWN.

In ARMv8.1 and ARMv8.0.

Extension to RESS[14:4]. See RESS[14:4] for more details.

VA[48:2], bits [48:2]

Bits[48:2] of the address value for comparison.

When [ARMv8.2-LVA](#) is implemented, and 52-bit addresses and a 64KB translation granule are in use, VA[52:49] form the upper part of the address value. Otherwise, VA[52:49] are RESS.

This field resets to a value that is architecturally UNKNOWN.

Bits [1:0]

Reserved, RES0.

When $DBGBCR<n>_{EL1.BT}==0b001x$:

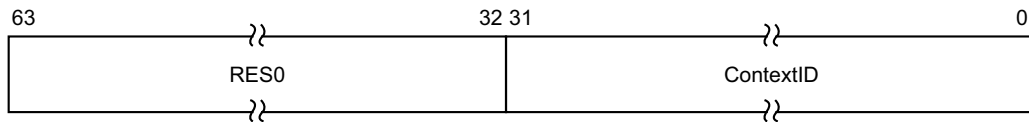

Bits [63:32]

Reserved, RES0.

ContextID, bits [31:0]

Context ID value for comparison.

The value is compared against [CONTEXTIDR_EL1](#) in the following cases:

- The PE is in Secure state.
- When [ARMv8.1-VHE](#) is not implemented.
- When [ARMv8.1-VHE](#) is implemented, [HCR_EL2.E2H](#) is 0 and the PE is in Non-secure EL0, EL1 or EL2.
- When [ARMv8.1-VHE](#) is implemented, [HCR_EL2](#).{E2H, TGE} is {1, 0} and the PE is in Non-secure EL0 or EL1.

When [ARMv8.1-VHE](#) is implemented, [HCR_EL2.E2H](#) is 1, the value is compared against [CONTEXTIDR_EL2](#) in the following cases:

- The PE is executing at EL2.
- [HCR_EL2.TGE](#) is 1 and the PE is in Non-secure EL0.

This field resets to a value that is architecturally UNKNOWN.

When $DBGBCR<n>_{EL1.BT}==0b011x$:

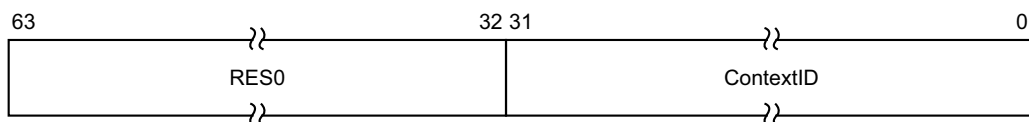

Bits [63:32]

Reserved, RES0.

ContextID, bits [31:0]

Context ID value for comparison against [CONTEXTIDR_EL1](#).

This field resets to a value that is architecturally UNKNOWN.

When $DBGBCR<n>_{EL1}.BT==0b100x$ and EL2 implemented:

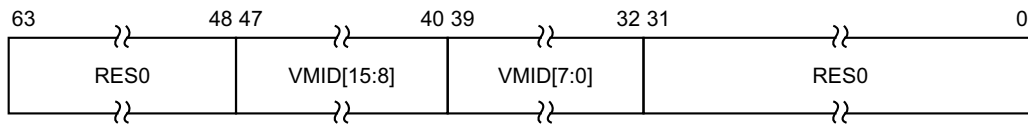

Bits [63:48]

Reserved, RES0.

VMID[15:8], bits [47:40]

In ARMv8.2 and ARMv8.1

Extension to VMID[7:0]. See VMID[7:0] for more details.

This field resets to a value that is architecturally UNKNOWN.

In ARMv8.0.

Reserved, RES0.

VMID[7:0], bits [39:32]

VMID value for comparison.

The VMID is 8 bits in the following cases.

- EL2 is using AArch32.
- [ARMv8.1-VMID16](#) is not implemented.

When [ARMv8.1-VMID16](#) is implemented and EL2 is using AArch64, it is IMPLEMENTATION DEFINED whether the VMID is 8 bits or 16 bits.

VMID[15:8] is RES0 if any of the following applies:

- The implementation has an 8-bit VMID.
- [VTCR_EL2.VS](#) has a value of 0.
- EL2 is using AArch32.

This field resets to a value that is architecturally UNKNOWN.

Bits [31:0]

Reserved, RES0.

When $DBGBCR<n>_{EL1}.BT==0b101x$ and EL2 implemented:

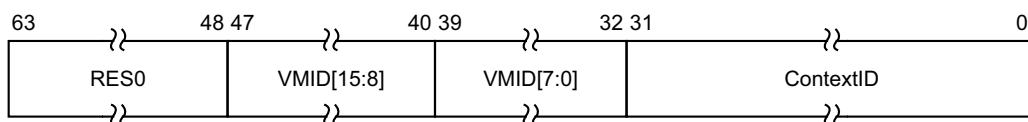

Bits [63:48]

Reserved, RES0.

VMID[15:8], bits [47:40]

In ARMv8.2 and ARMv8.1

Extension to VMID[7:0]. See VMID[7:0] for more details.

This field resets to a value that is architecturally UNKNOWN.

In ARMv8.0.

Reserved, RES0.

VMID[7:0], bits [39:32]

VMID value for comparison.

The VMID is 8 bits in the following cases.

- EL2 is using AArch32.
- [ARMv8.1-VMID16](#) is not implemented.

When [ARMv8.1-VMID16](#) is implemented and EL2 is using AArch64, it is IMPLEMENTATION DEFINED whether the VMID is 8 bits or 16 bits.

VMID[15:8] is RES0 if any of the following applies:

- The implementation has an 8-bit VMID.
- [VTCCR_EL2.VS](#) has a value of 0.
- EL2 is using AArch32.

This field resets to a value that is architecturally UNKNOWN.

ContextID, bits [31:0]

Context ID value for comparison against [CONTEXTIDR_EL1](#).

This field resets to a value that is architecturally UNKNOWN.

When $DBGBCR<n>_{EL1.BT}==0b110x$ and EL2 implemented:

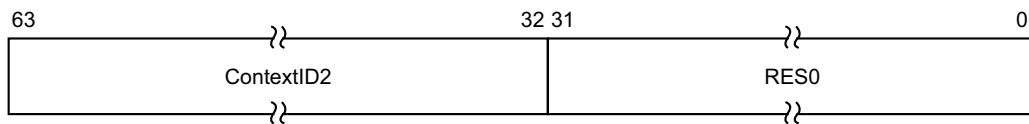

ContextID2, bits [63:32]

Context ID value for comparison against [CONTEXTIDR_EL2](#).

This field resets to a value that is architecturally UNKNOWN.

Bits [31:0]

Reserved, RES0.

When $DBGBCR<n>_{EL1.BT}==0b111x$ and EL2 implemented:

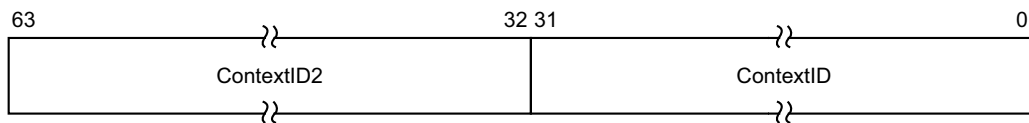

ContextID2, bits [63:32]

Context ID value for comparison against [CONTEXTIDR_EL2](#).

This field resets to a value that is architecturally UNKNOWN.

ContextID, bits [31:0]

Context ID value for comparison against [CONTEXTIDR_EL1](#).

This field resets to a value that is architecturally UNKNOWN.

Accessing the DBGBVR<n>_EL1

This register can be read using MRS with the following syntax:

MRS <Xt>, <systemreg>

This register can be written using MSR (register) with the following syntax:

MSR <systemreg>, <Xt>

This syntax is encoded with the following settings in the instruction encoding:

<systemreg>	op0	op1	CRn	CRm	op2
DBGBVR<n>_EL1	10	000	0000	n<3:0>	100

- <CRm> is in the range 0 - 15.

Accessibility

The register is accessible in software as follows:

Control			Accessibility			
E2H	TGE	NS	EL0	EL1	EL2	EL3
x	x	0	-	RW	n/a	RW
x	0	1	-	RW	RW	RW
x	1	1	-	n/a	RW	RW

Traps and Enables

For a description of the prioritization of any generated exceptions, see [Synchronous exception prioritization for exceptions taken to AArch64 on page D1-1827](#) and [Software Access debug event on page H3-5493](#). Subject to the prioritization rules:

- In both security states, and not dependent on other bits:
 - If `EDSCR.TDA==1`, `OSLSR_EL1.OSLK==0`, and halting is allowed, EL1, EL2, and EL3 accesses to this register generate a Software Access debug event.
- When EL2 is implemented and is using AArch64 and `SCR_EL3.NS == 1`:
 - If `MDCR_EL2.TDA==1`, Non-secure accesses to this register from EL1 are trapped to EL2.
- When EL3 is implemented and is using AArch64:
 - If `MDCR_EL3.TDA==1`, accesses to this register from EL1 and EL2 are trapped to EL3.

D7.3.4 DBGCLAIMCLR_EL1, Debug Claim Tag Clear register

The DBGCLAIMCLR_EL1 characteristics are:

Purpose

Used by software to read the values of the CLAIM tag bits, and to clear these bits to 0.
The architecture does not define any functionality for the CLAIM tag bits.

Note

CLAIM tags are typically used for communication between the debugger and target software.

Used in conjunction with the [DBGCLAIMSET_EL1](#) register.

Configurations

AArch64 System register DBGCLAIMCLR_EL1 is architecturally mapped to AArch32 System register [DBGCLAIMCLR](#).

AArch64 System register DBGCLAIMCLR_EL1 is architecturally mapped to External register [DBGCLAIMCLR_EL1](#).

An implementation must include 8 CLAIM tag bits.

This register is in the Cold reset domain. See the CLAIM field description for the effect of a Cold reset on the value returned by this register. This register is not affected by a Warm reset.

Attributes

DBGCLAIMCLR_EL1 is a 32-bit register.

Field descriptions

The DBGCLAIMCLR_EL1 bit assignments are:

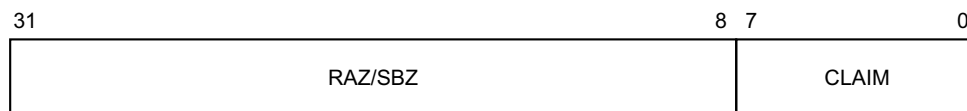

Bits [31:8]

Reserved, RAZ/SBZ. Software can rely on these bits reading as zero, and must use a should-be-zero policy on writes. Implementations must ignore writes.

CLAIM, bits [7:0]

Read or clear CLAIM tag bits. Reading this field returns the current value of the CLAIM tag bits.

Writing a 1 to one of these bits clears the corresponding CLAIM tag bit to 0. This is an indirect write to the CLAIM tag bits. A single write operation can clear multiple CLAIM tag bits to 0.

Writing 0 to one of these bits has no effect.

A cold reset clears the CLAIM tag bits to 0.

Accessing the DBGCLAIMCLR_EL1

This register can be read using MRS with the following syntax:

```
MRS <Xt>, <systemreg>
```

This register can be written using MSR (register) with the following syntax:

```
MSR <systemreg>, <Xt>
```

This syntax is encoded with the following settings in the instruction encoding:

<systemreg>	op0	op1	CRn	CRm	op2
DBGCLAIMCLR_EL1	10	000	0111	1001	110

Accessibility

The register is accessible in software as follows:

Control			Accessibility			
E2H	TGE	NS	EL0	EL1	EL2	EL3
x	x	0	-	RW	n/a	RW
x	0	1	-	RW	RW	RW
x	1	1	-	n/a	RW	RW

Traps and Enables

For a description of the prioritization of any generated exceptions, see [Synchronous exception prioritization for exceptions taken to AArch64 on page D1-1827](#). Subject to the prioritization rules:

- When EL2 is implemented and is using AArch64 and SCR_EL3.NS == 1:
 - If MDCR_EL2.TDA==1, Non-secure accesses to this register from EL1 are trapped to EL2.
- When EL3 is implemented and is using AArch64:
 - If MDCR_EL3.TDA==1, accesses to this register from EL1 and EL2 are trapped to EL3.

D7.3.5 DBGCLAIMSET_EL1, Debug Claim Tag Set register

The DBGCLAIMSET_EL1 characteristics are:

Purpose

Used by software to set the CLAIM tag bits to 1.

The architecture does not define any functionality for the CLAIM tag bits.

———— Note —————

CLAIM tags are typically used for communication between the debugger and target software.

Used in conjunction with the [DBGCLAIMCLR_EL1](#) register.

Configurations

AArch64 System register DBGCLAIMSET_EL1 is architecturally mapped to AArch32 System register [DBGCLAIMSET](#).

AArch64 System register DBGCLAIMSET_EL1 is architecturally mapped to External register [DBGCLAIMSET_EL1](#).

An implementation must include 8 CLAIM tag bits.

Attributes

DBGCLAIMSET_EL1 is a 32-bit register.

Field descriptions

The DBGCLAIMSET_EL1 bit assignments are:

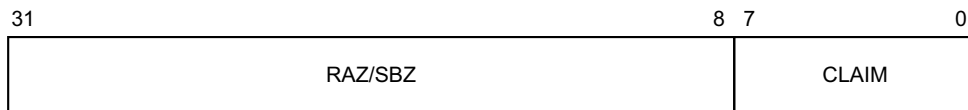

Bits [31:8]

Reserved, RAZ/SBZ. Software can rely on these bits reading as zero, and must use a should-be-zero policy on writes. Implementations must ignore writes.

CLAIM, bits [7:0]

Set CLAIM tag bits. RAO.

Writing a 1 to one of these bits sets the corresponding CLAIM tag bit to 1. This is an indirect write to the CLAIM tag bits. A single write operation can set multiple CLAIM tag bits to 1.

Writing 0 to one of these bits has no effect.

A cold reset clears the CLAIM tag bits to 0.

Accessing the DBGCLAIMSET_EL1

This register can be read using MRS with the following syntax:

```
MRS <Xt>, <systemreg>
```

This register can be written using MSR (register) with the following syntax:

```
MSR <systemreg>, <Xt>
```

This syntax is encoded with the following settings in the instruction encoding:

<systemreg>	op0	op1	CRn	CRm	op2
DBGCLAIMSET_EL1	10	000	0111	1000	110

Accessibility

The register is accessible in software as follows:

Control			Accessibility			
E2H	TGE	NS	EL0	EL1	EL2	EL3
x	x	0	-	RW	n/a	RW
x	0	1	-	RW	RW	RW
x	1	1	-	n/a	RW	RW

Traps and Enables

For a description of the prioritization of any generated exceptions, see [Synchronous exception prioritization for exceptions taken to AArch64 on page D1-1827](#). Subject to the prioritization rules:

- When EL2 is implemented and is using AArch64 and SCR_EL3.NS == 1:
 - If MDCR_EL2.TDA==1, Non-secure accesses to this register from EL1 are trapped to EL2.
- When EL3 is implemented and is using AArch64:
 - If MDCR_EL3.TDA==1, accesses to this register from EL1 and EL2 are trapped to EL3.

D7.3.6 DBGDTR_EL0, Debug Data Transfer Register, half-duplex

The DBGDTR_EL0 characteristics are:

Purpose

Transfers 64 bits of data between the PE and an external debugger. Can transfer both ways using only a single register.

Configurations

There are no configuration notes.

Attributes

DBGDTR_EL0 is a 64-bit register.

Field descriptions

The DBGDTR_EL0 bit assignments are:

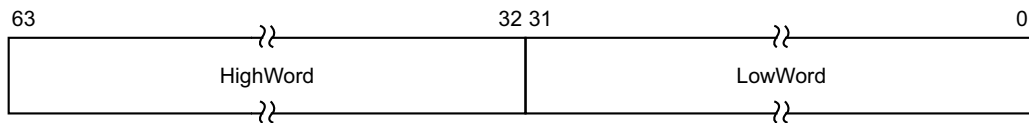

HighWord, bits [63:32]

Writes to this register set DTRRX to the value in this field and do not change RXfull.
Reads from this register return the value of DTRTX and do not change TXfull.

LowWord, bits [31:0]

Writes to this register set DTRTX to the value in this field and set TXfull to 1.
Reads from this register return the value of DTRRX and clear RXfull to 0.

Accessing the DBGDTR_EL0

This register can be read using MRS with the following syntax:

MRS <Xt>, <systemreg>

This register can be written using MSR (register) with the following syntax:

MSR <systemreg>, <Xt>

This syntax is encoded with the following settings in the instruction encoding:

<systemreg>	op0	op1	CRn	CRm	op2
DBGDTR_EL0	10	011	0000	0100	000

Accessibility

The register is accessible in software as follows:

Control			Accessibility			
E2H	TGE	NS	EL0	EL1	EL2	EL3
x	x	0	RW	RW	n/a	RW
x	0	1	RW	RW	RW	RW
x	1	1	RW	n/a	RW	RW

Traps and Enables

For a description of the prioritization of any generated exceptions, see [Synchronous exception prioritization for exceptions taken to AArch64 on page D1-1827](#). Subject to the prioritization rules, in Non-debug state:

- In both security states, and not dependent on other bits:
 - If `MDCR_EL1.TDCC==1`, accesses to this register from EL0 are trapped to EL1.
- When EL2 is implemented and is using AArch64 and `SCR_EL3.NS == 1`:
 - If `MDCR_EL2.TDA==1`, Non-secure accesses to this register from EL0 and EL1 are trapped to EL2.
- When EL3 is implemented and is using AArch64:
 - If `MDCR_EL3.TDA==1`, accesses to this register from EL0, EL1, and EL2 are trapped to EL3.

———— Note —————

Read and write accesses to this register are not trapped in Debug state.

D7.3.7 DBGDTRRX_EL0, Debug Data Transfer Register, Receive

The DBGDTRRX_EL0 characteristics are:

Purpose

Transfers data from an external debugger to the PE. For example, it is used by a debugger transferring commands and data to a debug target. It is a component of the Debug Communications Channel.

Configurations

AArch64 System register DBGDTRRX_EL0 is architecturally mapped to AArch32 System register [DBGDTRRXint](#).

AArch64 System register DBGDTRRX_EL0 is architecturally mapped to External register [DBGDTRRX_EL0](#).

This register is in the Cold reset domain. On a Cold reset RW fields in this register reset to architecturally UNKNOWN values. The register is not affected by a Warm reset.

Attributes

DBGDTRRX_EL0 is a 32-bit register.

Field descriptions

The DBGDTRRX_EL0 bit assignments are:



Bits [31:0]

Update DTRRX.

If RXfull is set to 1, then reads of this register return the last value written to DTRRX and clear RXfull to 0.

For the full behavior of the Debug Communications Channel, see [Chapter H4 The Debug Communication Channel and Instruction Transfer Register](#).

This field resets to a value that is architecturally UNKNOWN.

Accessing the DBGDTRRX_EL0

This register can be read using MRS with the following syntax:

MRS <Xt>, <systemreg>

This syntax is encoded with the following settings in the instruction encoding:

<systemreg>	op0	op1	CRn	CRm	op2
DBGDTRRX_EL0	10	011	0000	0101	000

Accessibility

The register is accessible in software as follows:

Control			Accessibility			
E2H	TGE	NS	EL0	EL1	EL2	EL3
x	x	0	RO	RO	n/a	RO
x	0	1	RO	RO	RO	RO
x	1	1	RO	n/a	RO	RO

Traps and Enables

For a description of the prioritization of any generated exceptions, see *Synchronous exception prioritization for exceptions taken to AArch64* on page D1-1827. Subject to the prioritization rules, in Non-debug state:

- In both security states, and not dependent on other bits:
 - If `MDCR_EL1.TDCC==1`, read accesses to this register from EL0 are trapped to EL1.
- When EL2 is implemented and is using AArch64 and `SCR_EL3.NS == 1`:
 - If `MDCR_EL2.TDA==1`, Non-secure read accesses to this register from EL0 and EL1 are trapped to EL2.
- When EL3 is implemented and is using AArch64:
 - If `MDCR_EL3.TDA==1`, read accesses to this register from EL0, EL1, and EL2 are trapped to EL3.

———— **Note** —————

Read accesses to this register are not trapped in Debug state.

D7.3.8 DBGDTRTX_EL0, Debug Data Transfer Register, Transmit

The DBGDTRTX_EL0 characteristics are:

Purpose

Transfers data from the PE to an external debugger. For example, it is used by a debug target to transfer data to the debugger. It is a component of the Debug Communication Channel.

Configurations

AArch64 System register DBGDTRTX_EL0 is architecturally mapped to AArch32 System register [DBGDTRTXint](#).

AArch64 System register DBGDTRTX_EL0 is architecturally mapped to External register [DBGDTRTX_EL0](#).

This register is in the Cold reset domain. On a Cold reset RW fields in this register reset to architecturally UNKNOWN values. The register is not affected by a Warm reset.

Attributes

DBGDTRTX_EL0 is a 32-bit register.

Field descriptions

The DBGDTRTX_EL0 bit assignments are:

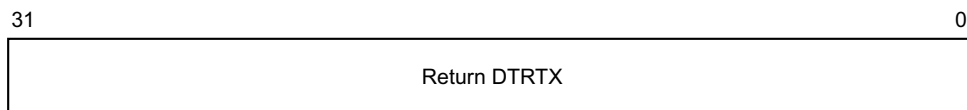

Bits [31:0]

Return DTRTX.

If TXfull is set to 0, then writes of this register update the value in DTRTX and set TXfull to 1.

For the full behavior of the Debug Communications Channel, see [Chapter H4 The Debug Communication Channel and Instruction Transfer Register](#).

This field resets to a value that is architecturally UNKNOWN.

Accessing the DBGDTRTX_EL0

This register can be written using MSR (register) with the following syntax:

MSR <systemreg>, <Xt>

This syntax is encoded with the following settings in the instruction encoding:

<systemreg>	op0	op1	CRn	CRm	op2
DBGDTRTX_EL0	10	011	0000	0101	000

Accessibility

The register is accessible in software as follows:

Control			Accessibility			
E2H	TGE	NS	EL0	EL1	EL2	EL3
x	x	0	WO	WO	n/a	WO
x	0	1	WO	WO	WO	WO
x	1	1	WO	n/a	WO	WO

Traps and Enables

For a description of the prioritization of any generated exceptions, see *Synchronous exception prioritization for exceptions taken to AArch64* on page D1-1827. Subject to the prioritization rules, in Non-debug state:

- In both security states, and not dependent on other bits:
 - If `MDCR_EL1.TDCC==1`, write accesses to this register from EL0 are trapped to EL1.
- When EL2 is implemented and is using AArch64 and `SCR_EL3.NS == 1`:
 - If `MDCR_EL2.TDA==1`, Non-secure write accesses to this register from EL0 and EL1 are trapped to EL2.
- When EL3 is implemented and is using AArch64:
 - If `MDCR_EL3.TDA==1`, write accesses to this register from EL0, EL1, and EL2 are trapped to EL3.

———— **Note** —————

Write accesses to this register are not trapped in Debug state.

D7.3.9 DBGPRCR_EL1, Debug Power Control Register

The DBGPRCR_EL1 characteristics are:

Purpose

Controls behavior of the PE on powerdown request.

Configurations

AArch64 System register DBGPRCR_EL1 is architecturally mapped to AArch32 System register [DBGPRCR](#).

Bit [0] of this register is mapped to [EDPRCR](#).CORENPDRQ, bit [0] of the external view of this register.

The other bits in these registers are not mapped to each other.

This register is in the Cold reset domain. On a Cold reset RW fields in this register reset to architecturally UNKNOWN values. The register is not affected by a Warm reset.

Attributes

DBGPRCR_EL1 is a 32-bit register.

Field descriptions

The DBGPRCR_EL1 bit assignments are:

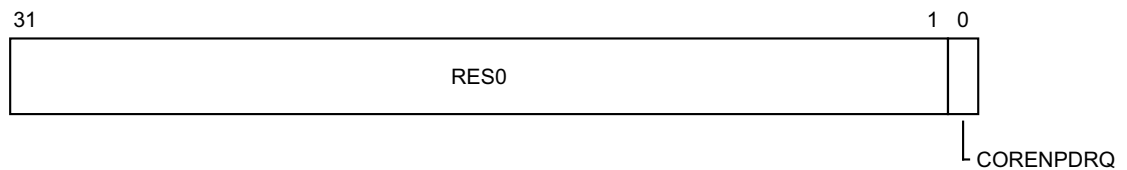

Bits [31:1]

Reserved, RES0.

CORENPDRQ, bit [0]

Core no powerdown request. Requests emulation of powerdown. Possible values of this bit are:

- 0 If the system responds to a powerdown request, it powers down Core power domain.
- 1 If the system responds to a powerdown request, it does not powerdown the Core power domain, but instead emulates a powerdown of that domain.

Writes to this bit are permitted regardless of the state of the IMPLEMENTATION DEFINED authentication interface. This means that a debugger can request Core no powerdown regardless of whether invasive debug is permitted.

It is IMPLEMENTATION DEFINED whether this bit is reset to the value of [EDPRCR](#).COREPURQ on exit from an IMPLEMENTATION DEFINED software-visible retention state.

Accessing the DBGPRCR_EL1

This register can be read using MRS with the following syntax:

```
MRS <Xt>, <systemreg>
```

This register can be written using MSR (register) with the following syntax:

```
MSR <systemreg>, <Xt>
```

This syntax is encoded with the following settings in the instruction encoding:

<systemreg>	op0	op1	CRn	CRm	op2
DBGPRCR_EL1	10	000	0001	0100	100

Accessibility

The register is accessible in software as follows:

Control			Accessibility			
E2H	TGE	NS	EL0	EL1	EL2	EL3
x	x	0	-	RW	n/a	RW
x	0	1	-	RW	RW	RW
x	1	1	-	n/a	RW	RW

Traps and Enables

For a description of the prioritization of any generated exceptions, see [Synchronous exception prioritization for exceptions taken to AArch64 on page D1-1827](#). Subject to the prioritization rules:

- When EL2 is implemented and is using AArch64 and SCR_EL3.NS == 1:
 - If MDCR_EL2.TDOSA==1, Non-secure accesses to this register from EL1 are trapped to EL2.
- When EL3 is implemented and is using AArch64:
 - If MDCR_EL3.TDOSA==1, accesses to this register from EL1 and EL2 are trapped to EL3.

D7.3.10 DBGVCR32_EL2, Debug Vector Catch Register

The DBGVCR32_EL2 characteristics are:

Purpose

Allows access to the AArch32 register [DBGVCR](#) from AArch64 state only. Its value has no effect on execution in AArch64 state.

Configurations

AArch64 System register DBGVCR32_EL2 is architecturally mapped to AArch32 System register [DBGVCR](#).

If EL1 does not support AArch32, this register is UNDEFINED.

If EL2 is not implemented but EL3 is implemented, and EL1 is capable of using AArch32, then this register is not RES0.

This register is in the Warm reset domain. On a Warm or Cold reset RW fields in this register reset to architecturally UNKNOWN values.

Attributes

DBGVCR32_EL2 is a 32-bit register.

Field descriptions

The DBGVCR32_EL2 bit assignments are:

When EL3 implemented and using AArch64:

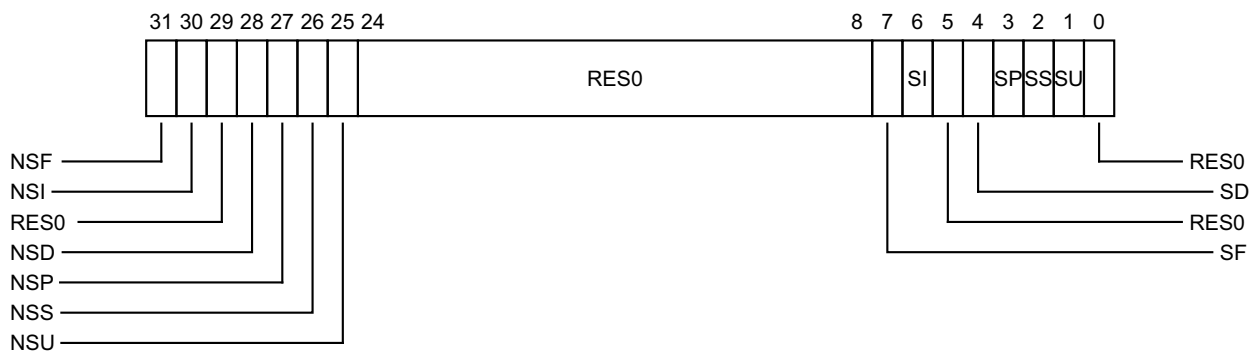

NSF, bit [31]

FIQ vector catch enable in Non-secure state.

The exception vector offset is 0x1C.

This field resets to a value that is architecturally UNKNOWN.

NSI, bit [30]

IRQ vector catch enable in Non-secure state.

The exception vector offset is 0x18.

This field resets to a value that is architecturally UNKNOWN.

Bit [29]

Reserved, RES0.

NSD, bit [28]

Data Abort vector catch enable in Non-secure state.

The exception vector offset is $0x10$.
This field resets to a value that is architecturally UNKNOWN.

NSP, bit [27]

Prefetch Abort vector catch enable in Non-secure state.
The exception vector offset is $0x0C$.
This field resets to a value that is architecturally UNKNOWN.

NSS, bit [26]

Supervisor Call (SVC) vector catch enable in Non-secure state.
The exception vector offset is $0x08$.
This field resets to a value that is architecturally UNKNOWN.

NSU, bit [25]

Undefined Instruction vector catch enable in Non-secure state.
The exception vector offset is $0x04$.
This field resets to a value that is architecturally UNKNOWN.

Bits [24:8]

Reserved, RES0.

SF, bit [7]

FIQ vector catch enable in Secure state.
The exception vector offset is $0x1C$.
This field resets to a value that is architecturally UNKNOWN.

SI, bit [6]

IRQ vector catch enable in Secure state.
The exception vector offset is $0x18$.
This field resets to a value that is architecturally UNKNOWN.

Bit [5]

Reserved, RES0.

SD, bit [4]

Data Abort vector catch enable in Secure state.
The exception vector offset is $0x10$.
This field resets to a value that is architecturally UNKNOWN.

SP, bit [3]

Prefetch Abort vector catch enable in Secure state.
The exception vector offset is $0x0C$.
This field resets to a value that is architecturally UNKNOWN.

SS, bit [2]

Supervisor Call (SVC) vector catch enable in Secure state.
The exception vector offset is $0x08$.
This field resets to a value that is architecturally UNKNOWN.

SU, bit [1]

Undefined Instruction vector catch enable in Secure state.
The exception vector offset is $0x04$.

This field resets to a value that is architecturally UNKNOWN.

Bit [0]

Reserved, RES0.

When EL3 not implemented:

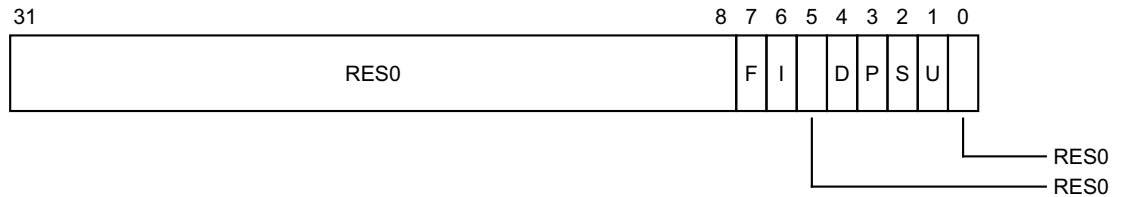

Bits [31:8]

Reserved, RES0.

F, bit [7]

FIQ vector catch enable.
The exception vector offset is 0x1C.
This field resets to a value that is architecturally UNKNOWN.

I, bit [6]

IRQ vector catch enable.
The exception vector offset is 0x18.
This field resets to a value that is architecturally UNKNOWN.

Bit [5]

Reserved, RES0.

D, bit [4]

Data Abort vector catch enable.
The exception vector offset is 0x10.
This field resets to a value that is architecturally UNKNOWN.

P, bit [3]

Prefetch Abort vector catch enable.
The exception vector offset 0x0C.
This field resets to a value that is architecturally UNKNOWN.

S, bit [2]

Supervisor Call (SVC) vector catch enable.
The exception vector offset is 0x08.
This field resets to a value that is architecturally UNKNOWN.

U, bit [1]

Undefined Instruction vector catch enable.
The exception vector offset is 0x04.
This field resets to a value that is architecturally UNKNOWN.

Bit [0]

Reserved, RES0.

Accessing the DBGVCR32_EL2

This register can be read using MRS with the following syntax:

MRS <Xt>, <systemreg>

This register can be written using MSR (register) with the following syntax:

MSR <systemreg>, <Xt>

This syntax is encoded with the following settings in the instruction encoding:

<systemreg>	op0	op1	CRn	CRm	op2
DBGVCR32_EL2	10	100	0000	0111	000

Accessibility

The register is accessible in software as follows:

Control			Accessibility			
E2H	TGE	NS	EL0	EL1	EL2	EL3
x	x	0	-	-	n/a	RW
x	0	1	-	-	RW	RW
x	1	1	-	n/a	RW	RW

Traps and Enables

For a description of the prioritization of any generated exceptions, see [Synchronous exception prioritization for exceptions taken to AArch64 on page D1-1827](#). Subject to the prioritization rules:

- When EL3 is implemented and is using AArch64:
 - If `MDCR_EL3.TDA==1`, accesses to this register from EL2 are trapped to EL3.

D7.3.11 DBGWCR<n>_EL1, Debug Watchpoint Control Registers, n = 0 - 15

The DBGWCR<n>_EL1 characteristics are:

Purpose

Holds control information for a watchpoint. Forms watchpoint n together with value register [DBGWVR<n>_EL1](#).

Configurations

AArch64 System register DBGWCR<n>_EL1 is architecturally mapped to AArch32 System register [DBGWCR<n>](#).

AArch64 System register DBGWCR<n>_EL1 is architecturally mapped to External register [DBGWCR<n>_EL1](#).

If breakpoint n is not implemented then this register is unallocated.

This register is in the Cold reset domain. On a Cold reset RW fields in this register reset to architecturally UNKNOWN values. The register is not affected by a Warm reset.

Attributes

DBGWCR<n>_EL1 is a 32-bit register.

Field descriptions

The DBGWCR<n>_EL1 bit assignments are:

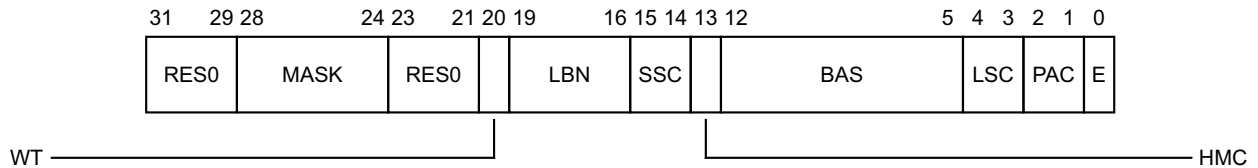

Bits [31:29]

Reserved, RES0.

MASK, bits [28:24]

Address mask. Only objects up to 2GB can be watched using a single mask.

- 00000 No mask.
- 00001 Reserved.
- 00010 Reserved.

If programmed with a reserved value, a watchpoint must behave as if either:

- MASK has been programmed with a defined value, which might be 0 (no mask), other than for a direct read of DBGWCRn_EL1.
- The watchpoint is disabled.

Software must not rely on this property because the behavior of reserved values might change in a future revision of the architecture.

Other values mask the corresponding number of address bits, from 0b00011 masking 3 address bits (0x00000007 mask for address) to 0b11111 masking 31 address bits (0xFFFFFFFF mask for address).

This field resets to a value that is architecturally UNKNOWN.

Bits [23:21]

Reserved, RES0.

WT, bit [20]

Watchpoint type. Possible values are:

- 0 Unlinked data address match.
- 1 Linked data address match.

This field resets to a value that is architecturally UNKNOWN.

LBN, bits [19:16]

Linked breakpoint number. For Linked data address watchpoints, this specifies the index of the Context-matching breakpoint linked to.

This field resets to a value that is architecturally UNKNOWN.

SSC, bits [15:14]

Security state control. Determines the Security states under which a Watchpoint debug event for watchpoint *n* is generated. This field must be interpreted along with the HMC and PAC fields.

For more information on the operation of the SSC, HMC, and PAC fields, see [Execution conditions for which a watchpoint generates Watchpoint exceptions](#) on page D2-1943.

This field resets to a value that is architecturally UNKNOWN.

HMC, bit [13]

Higher mode control. Determines the debug perspective for deciding when a Watchpoint debug event for watchpoint *n* is generated. This field must be interpreted along with the SSC and PAC fields.

For more information on the operation of the SSC, HMC, and PAC fields, see [Execution conditions for which a watchpoint generates Watchpoint exceptions](#) on page D2-1943.

This field resets to a value that is architecturally UNKNOWN.

BAS, bits [12:5]

Byte address select. Each bit of this field selects whether a byte from within the word or double-word addressed by `DBGWVR<n>_EL1` is being watched.

BAS	Description
xxxxxxx1	Match byte at <code>DBGWVR<n>_EL1</code>
xxxxxxx1x	Match byte at <code>DBGWVR<n>_EL1+1</code>
xxxxx1xx	Match byte at <code>DBGWVR<n>_EL1+2</code>
xxxx1xxx	Match byte at <code>DBGWVR<n>_EL1+3</code>

In cases where `DBGWVR<n>_EL1` addresses a double-word:

BAS	Description, if <code>DBGWVR<n>_EL1[2] == 0</code>
xxx1xxxx	Match byte at <code>DBGWVR<n>_EL1+4</code>
xx1xxxxx	Match byte at <code>DBGWVR<n>_EL1+5</code>
x1xxxxxx	Match byte at <code>DBGWVR<n>_EL1+6</code>
1xxxxxxx	Match byte at <code>DBGWVR<n>_EL1+7</code>

If `DBGWVR<n>_EL1[2] == 1`, only `BAS[3:0]` are used and `BAS[7:4]` are ignored. ARM deprecates setting `DBGWVR<n>_EL1[2] == 1`.

The valid values for BAS are nonzero binary numbers all of whose set bits are contiguous. All other values are reserved and must not be used by software. See [Reserved DBGWCR<n>_EL1.BAS values on page D2-1951](#).

This field resets to a value that is architecturally UNKNOWN.

LSC, bits [4:3]

Load/store control. This field enables watchpoint matching on the type of access being made. Possible values of this field are:

- 01 Match instructions that load from a watchpointed address.
- 10 Match instructions that store to a watchpointed address.
- 11 Match instructions that load from or store to a watchpointed address.

All other values are reserved, but must behave as if the watchpoint is disabled. Software must not rely on this property as the behavior of reserved values might change in a future revision of the architecture.

This field resets to a value that is architecturally UNKNOWN.

PAC, bits [2:1]

Privilege of access control. Determines the Exception level or levels at which a Watchpoint debug event for watchpoint n is generated. This field must be interpreted along with the SSC and HMC fields.

For more information on the operation of the SSC, HMC, and PAC fields, see [Execution conditions for which a watchpoint generates Watchpoint exceptions on page D2-1943](#).

This field resets to a value that is architecturally UNKNOWN.

E, bit [0]

Enable watchpoint n. Possible values are:

- 0 Watchpoint disabled.
- 1 Watchpoint enabled.

This field resets to a value that is architecturally UNKNOWN.

Accessing the DBGWCR<n>_EL1

This register can be read using MRS with the following syntax:

```
MRS <Xt>, <systemreg>
```

This register can be written using MSR (register) with the following syntax:

```
MSR <systemreg>, <Xt>
```

This syntax is encoded with the following settings in the instruction encoding:

<systemreg>	op0	op1	CRn	CRm	op2
DBGWCR<n>_EL1	10	000	0000	n<3:0>	111

- <CRm> is in the range 0 - 15.

Accessibility

The register is accessible in software as follows:

Control			Accessibility			
E2H	TGE	NS	EL0	EL1	EL2	EL3
x	x	0	-	RW	n/a	RW
x	0	1	-	RW	RW	RW
x	1	1	-	n/a	RW	RW

Traps and Enables

For a description of the prioritization of any generated exceptions, see *Synchronous exception prioritization for exceptions taken to AArch64* on page D1-1827 and *Software Access debug event* on page H3-5493. Subject to the prioritization rules:

- In both security states, and not dependent on other bits:
 - If `EDSCR.TDA==1`, `OSLSR_EL1.OSLK==0`, and halting is allowed, EL1, EL2, and EL3 accesses to this register generate a Software Access debug event.
- When EL2 is implemented and is using AArch64 and `SCR_EL3.NS == 1`:
 - If `MDCR_EL2.TDA==1`, Non-secure accesses to this register from EL1 are trapped to EL2.
- When EL3 is implemented and is using AArch64:
 - If `MDCR_EL3.TDA==1`, accesses to this register from EL1 and EL2 are trapped to EL3.

D7.3.12 DBGWVR<n>_EL1, Debug Watchpoint Value Registers, n = 0 - 15

The DBGWVR<n>_EL1 characteristics are:

Purpose

Holds a data address value for use in watchpoint matching. Forms watchpoint n together with control register [DBGWCR<n>_EL1](#).

Configurations

AArch64 System register DBGWVR<n>_EL1[31:0] is architecturally mapped to AArch32 System register [DBGWVR<n>](#).

AArch64 System register DBGWVR<n>_EL1 is architecturally mapped to External register [DBGWVR<n>_EL1](#).

If breakpoint n is not implemented then this register is unallocated.

This register is in the Cold reset domain. On a Cold reset RW fields in this register reset to architecturally UNKNOWN values. The register is not affected by a Warm reset.

Attributes

DBGWVR<n>_EL1 is a 64-bit register.

Field descriptions

The DBGWVR<n>_EL1 bit assignments are:

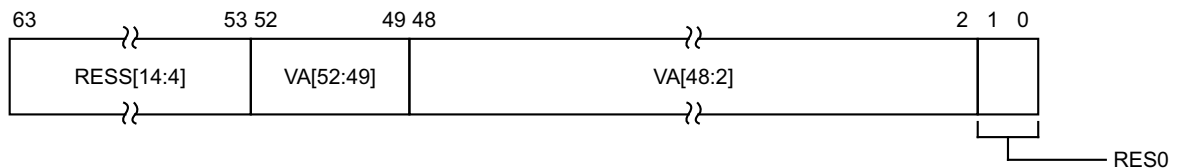

RESS[14:4], bits [63:53]

Reserved, Sign extended. Hardware and software must treat this field as RES0 if the most significant bit of VA is 0 or RES0, and as RES1 if the most significant bit of VA is 1.

Hardware always ignores the value of these bits and it is IMPLEMENTATION DEFINED whether:

- The bits are hardwired to a copy of the most significant bit of VA, meaning writes to these bits are ignored, and reads to the bits always return the hardwired value.
- The value in those bits can be written, and reads will return the last value written. The value held in those bits is ignored by hardware.

VA[52:49], bits [52:49]

In ARMv8.2

Extension to VA[48:2]. See VA[48:2] for more details.

This field resets to a value that is architecturally UNKNOWN.

In ARMv8.1 and ARMv8.0.

Extension to RESS[14:4]. See RESS[14:4] for more details.

VA[48:2], bits [48:2]

Bits[48:2] of the address value for comparison.

When [ARMv8.2-LVA](#) is implemented, and 52-bit addresses and a 64KB translation granule are in use, VA[52:49] forms the upper part of the address value. Otherwise, VA[52:49] are RESS.

ARM deprecates setting [DBGWVR<n>_EL1\[2\] == 1](#).

This field resets to a value that is architecturally UNKNOWN.

Bits [1:0]

Reserved, RES0.

Accessing the DBGWVR<n>_EL1

This register can be read using MRS with the following syntax:

MRS <Xt>, <systemreg>

This register can be written using MSR (register) with the following syntax:

MSR <systemreg>, <Xt>

This syntax is encoded with the following settings in the instruction encoding:

<systemreg>	op0	op1	CRn	CRm	op2
DBGWVR<n>_EL1	10	000	0000	n<3:0>	110

- <CRm> is in the range 0 - 15.

Accessibility

The register is accessible in software as follows:

Control			Accessibility			
E2H	TGE	NS	EL0	EL1	EL2	EL3
x	x	0	-	RW	n/a	RW
x	0	1	-	RW	RW	RW
x	1	1	-	n/a	RW	RW

Traps and Enables

For a description of the prioritization of any generated exceptions, see [Synchronous exception prioritization for exceptions taken to AArch64 on page D1-1827](#) and [Software Access debug event on page H3-5493](#). Subject to the prioritization rules:

- In both security states, and not dependent on other bits:
 - If `EDSCR.TDA==1`, `OSLSR_EL1.OSLK==0`, and halting is allowed, EL1, EL2, and EL3 accesses to this register generate a Software Access debug event.
- When EL2 is implemented and is using AArch64 and `SCR_EL3.NS == 1`:
 - If `MDCR_EL2.TDA==1`, Non-secure accesses to this register from EL1 are trapped to EL2.
- When EL3 is implemented and is using AArch64:
 - If `MDCR_EL3.TDA==1`, accesses to this register from EL1 and EL2 are trapped to EL3.

D7.3.13 DLR_EL0, Debug Link Register

The DLR_EL0 characteristics are:

Purpose

In Debug state, holds the address to restart from.

Configurations

AArch64 System register DLR_EL0[31:0] is architecturally mapped to AArch32 System register [DLR](#).

Attributes

DLR_EL0 is a 64-bit register.

Field descriptions

The DLR_EL0 bit assignments are:

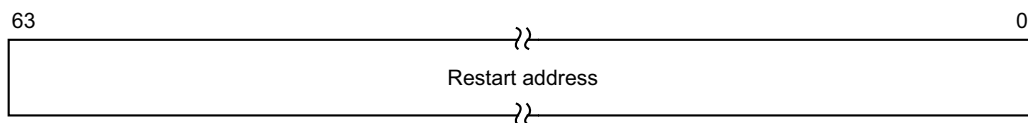

Bits [63:0]

Restart address.

Accessing the DLR_EL0

This register can be read using MRS with the following syntax:

MRS <Xt>, <systemreg>

This register can be written using MSR (register) with the following syntax:

MSR <systemreg>, <Xt>

This syntax is encoded with the following settings in the instruction encoding:

<systemreg>	op0	op1	CRn	CRm	op2
DLR_EL0	11	011	0100	0101	001

Accessibility

The register is accessible in software as follows:

Control			Accessibility			
E2H	TGE	NS	EL0	EL1	EL2	EL3
x	x	0	RW	RW	n/a	RW
x	0	1	RW	RW	RW	RW
x	1	1	RW	n/a	RW	RW

Access to this register is from Debug state only. During normal execution this register is unallocated.

D7.3.14 DSPSR_EL0, Debug Saved Program Status Register

The DSPSR_EL0 characteristics are:

Purpose

Holds the saved process state on entry to Debug state.

Configurations

AArch64 System register DSPSR_EL0 is architecturally mapped to AArch32 System register [DSPSR](#).

Attributes

DSPSR_EL0 is a 32-bit register.

Field descriptions

The DSPSR_EL0 bit assignments are:

When exiting Debug state to AArch32:

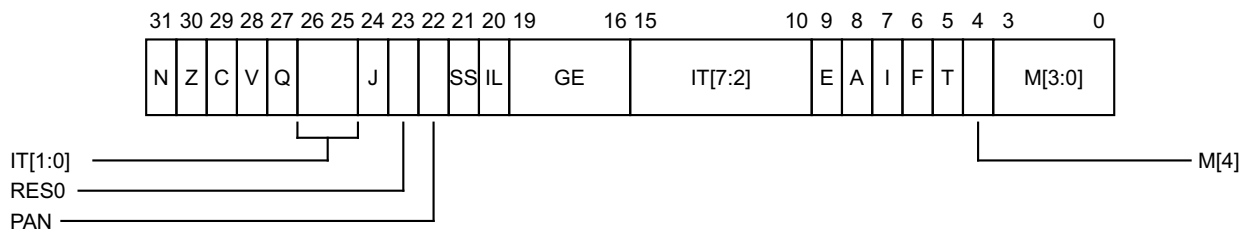

N, bit [31]

Copied to [CPSR.N](#) on exiting Debug state.

Z, bit [30]

Copied to [CPSR.Z](#) on exiting Debug state.

C, bit [29]

Copied to [CPSR.C](#) on exiting Debug state.

V, bit [28]

Copied to [CPSR.V](#) on exiting Debug state.

Q, bit [27]

Cumulative saturation bit. Set to 1 to indicate that overflow or saturation occurred in some instructions.

IT[1:0], bits [26:25]

IT block state bits for the T32 IT (If-Then) instruction. See IT[7:2] for explanation of this field.

J, bit [24]

RES0.

In previous versions of the architecture, the {J, T} bits determined the AArch32 Instruction set state. ARMv8 does not support either Jazelle state or T32EE state, and the T bit determines the Instruction set state.

Bit [23]

Reserved, RES0.

PAN, bit [22]

In ARMv8.2 and ARMv8.1

When [ARMv8.1-PAN](#) is implemented, set to the value of [CPSR.PAN](#) on entering Debug state, and copied to [CPSR.PAN](#) on exiting Debug state.

When [ARMv8.1-PAN](#) is not implemented, this bit is RES0.

In ARMv8.0.

Reserved, RES0.

SS, bit [21]

Software step. Shows the value of [PSTATE.SS](#) immediately before Debug state was entered.

IL, bit [20]

Illegal Execution state bit. Shows the value of [PSTATE.IL](#) immediately before Debug state was entered.

GE, bits [19:16]

Greater than or Equal flags, for parallel addition and subtraction.

IT[7:2], bits [15:10]

IT block state bits for the T32 IT (If-Then) instruction. This field must be interpreted in two parts.

- IT[7:5] holds the base condition for the IT block. The base condition is the top 3 bits of the condition code specified by the first condition field of the IT instruction.
- IT[4:0] encodes the size of the IT block, which is the number of instructions that are to be conditionally executed, by the position of the least significant 1 in this field. It also encodes the value of the least significant bit of the condition code for each instruction in the block.

The IT field is 0b00000000 when no IT block is active.

E, bit [9]

Endianness state bit. Controls the load and store endianness for data accesses:

- | | |
|---|-------------------------|
| 0 | Little-endian operation |
| 1 | Big-endian operation. |

Instruction fetches ignore this bit.

When the reset value of the [SCTLR.EE](#) bit is defined by a configuration input signal, that value also applies to the [CPSR.E](#) bit on reset, and therefore applies to software execution from reset.

If an implementation does not provide Big-endian support, this bit is RES0. If it does not provide Little-endian support, this bit is RES1.

If an implementation provides Big-endian support but only at EL0, this bit is RES0 for an exception return to any Exception level other than EL0.

Likewise, if it provides Little-endian support only at EL0, this bit is RES1 for an exception return to any Exception level other than EL0.

A, bit [8]

SError interrupt mask bit. The possible values of this bit are:

- | | |
|---|-----------------------|
| 0 | Exception not masked. |
| 1 | Exception masked. |

I, bit [7]

IRQ mask bit. The possible values of this bit are:

- | | |
|---|-----------------------|
| 0 | Exception not masked. |
| 1 | Exception masked. |

F, bit [6]

FIQ mask bit. The possible values of this bit are:

- 0 Exception not masked.
- 1 Exception masked.

T, bit [5]

T32 Instruction set state bit. Determines the AArch32 instruction set state that the Debug state entry was taken from. Possible values of this bit are:

- 0 Taken from A32 state.
- 1 Taken from T32 state.

M[4], bit [4]

Execution state that Debug state was entered from. Possible values of this bit are:

- 1 Exception taken from AArch32.

M[3:0], bits [3:0]

AArch32 mode that Debug state was entered from. The possible values are:

M[3:0]	Mode
0b0000	User
0b0001	FIQ
0b0010	IRQ
0b0011	Supervisor
0b0110	Monitor
0b0111	Abort
0b1010	Hyp
0b1011	Undefined
0b1111	System

Other values are reserved. The effect of programming this field to a Reserved value is that behavior is CONstrained UNPREDICTABLE, as described in [Reserved values in System and memory-mapped registers and translation table entries](#) on page K1-6133.

When entering Debug state from AArch64 and exiting Debug state to AArch64:

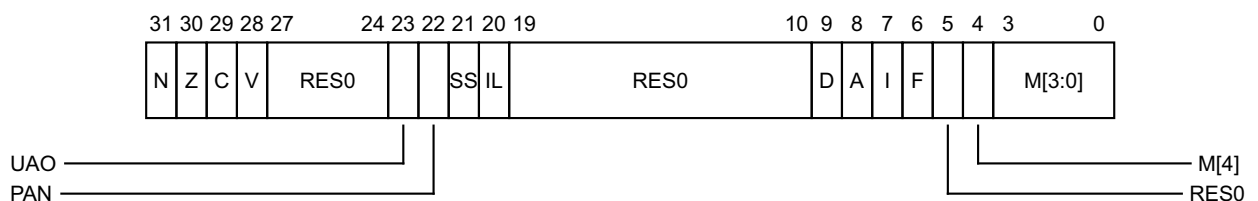

N, bit [31]

Set to the value of the N condition flag on entering Debug state, and copied to the N condition flag on exiting Debug state.

Z, bit [30]

Set to the value of the Z condition flag on entering Debug state, and copied to the Z condition flag on exiting Debug state.

C, bit [29]

Set to the value of the C condition flag on entering Debug state, and copied to the C condition flag on exiting Debug state.

V, bit [28]

Set to the value of the V condition flag on entering Debug state, and copied to the V condition flag on exiting Debug state.

Bits [27:24]

Reserved, RES0.

UAO, bit [23]

In ARMv8.2

When [ARMv8.2-UAO](#) is implemented, set to the value of PSTATE.UAO on entering Debug state, and copied to PSTATE.UAO on exiting Debug state.

When [ARMv8.2-UAO](#) is not implemented, this bit is RES0.

In ARMv8.1 and ARMv8.0.

Reserved, RES0.

PAN, bit [22]

In ARMv8.2 and ARMv8.1

When [ARMv8.1-PAN](#) is implemented, set to the value of PSTATE.PAN on entering Debug state, and copied to PSTATE.PAN on exiting Debug state.

When [ARMv8.1-PAN](#) is not implemented, this bit is RES0.

In ARMv8.0.

Reserved, RES0.

SS, bit [21]

Software step. Shows the value of PSTATE.SS immediately before Debug state was entered.

IL, bit [20]

Illegal Execution state bit. Shows the value of PSTATE.IL immediately before Debug state was entered.

Bits [19:10]

Reserved, RES0.

D, bit [9]

Process state D mask. The possible values of this bit are:

0 Watchpoint, Breakpoint, and Software Step exceptions targeted at the current Exception level are not masked.

1 Watchpoint, Breakpoint, and Software Step exceptions targeted at the current Exception level are masked.

When the target Exception level of the debug exception is higher than the current Exception level, the exception is not masked by this bit.

A, bit [8]

SError interrupt mask bit. The possible values of this bit are:

0 Exception not masked.

1 Exception masked.

I, bit [7]

IRQ mask bit. The possible values of this bit are:

0 Exception not masked.
1 Exception masked.

F, bit [6]

FIQ mask bit. The possible values of this bit are:

0 Exception not masked.
1 Exception masked.

Bit [5]

Reserved, RES0.

M[4], bit [4]

Execution state that Debug state was entered from. Possible values of this bit are:

0 Exception taken from AArch64.

M[3:0], bits [3:0]

AArch64 state (Exception level and selected SP) that Debug state was entered from. The possible values are:

M[3:0]	State
0b0000	EL0t
0b0100	EL1t
0b0101	EL1h
0b1000	EL2t
0b1001	EL2h
0b1100	EL3t
0b1101	EL3h

Other values are reserved, and returning to an Exception level that is using AArch64 with a reserved value in this field is treated as an illegal exception return.

The bits in this field are interpreted as follows:

- M[3:2] holds the Exception Level.
- M[1] is unused and is RES0 for all non-reserved values.
- M[0] is used to select the SP:
 - 0 means the SP is always SP0.
 - 1 means the exception SP is determined by the EL.

Accessing the DSPSR_EL0

This register can be read using MRS with the following syntax:

MRS <Xt>, <systemreg>

This register can be written using MSR (register) with the following syntax:

MSR <systemreg>, <Xt>

This syntax is encoded with the following settings in the instruction encoding:

<systemreg>	op0	op1	CRn	CRm	op2
DSPSR_EL0	11	011	0100	0101	000

Accessibility

The register is accessible in software as follows:

Control			Accessibility			
E2H	TGE	NS	EL0	EL1	EL2	EL3
x	x	0	RW	RW	n/a	RW
x	0	1	RW	RW	RW	RW
x	1	1	RW	n/a	RW	RW

Access to this register is from Debug state only. During normal execution this register is unallocated.

D7.3.15 MDCCINT_EL1, Monitor DCC Interrupt Enable Register

The MDCCINT_EL1 characteristics are:

Purpose

Enables interrupt requests to be signaled based on the DCC status flags.

Configurations

AArch64 System register MDCCINT_EL1 is architecturally mapped to AArch32 System register [DBGDCCINT](#).

This register is in the Warm reset domain. Some or all RW fields of this register have defined reset values. On a Warm or Cold reset these apply only if the PE resets into an Exception level that is using AArch64. Otherwise, on a Warm or Cold reset RW fields in this register reset to architecturally UNKNOWN values.

Attributes

MDCCINT_EL1 is a 32-bit register.

Field descriptions

The MDCCINT_EL1 bit assignments are:

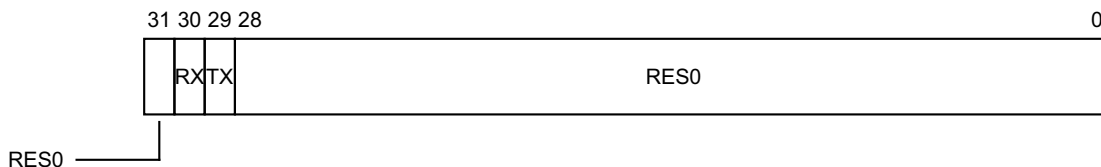

Bit [31]

Reserved, RES0.

RX, bit [30]

DCC interrupt request enable control for DTRRX. Enables a common COMMIRQ interrupt request to be signaled based on the DCC status flags.

0 No interrupt request generated by DTRRX.

1 Interrupt request will be generated on RXfull == 1.

If legacy COMMRX and COMMTX signals are implemented, then these are not affected by the value of this bit.

When this register has an architecturally-defined reset value, this field resets to 0.

TX, bit [29]

DCC interrupt request enable control for DTRTX. Enables a common COMMIRQ interrupt request to be signaled based on the DCC status flags.

0 No interrupt request generated by DTRTX.

1 Interrupt request will be generated on TXfull == 0.

If legacy COMMRX and COMMTX signals are implemented, then these are not affected by the value of this bit.

When this register has an architecturally-defined reset value, this field resets to 0.

Bits [28:0]

Reserved, RES0.

Accessing the MDCCINT_EL1

This register can be read using MRS with the following syntax:

MRS <Xt>, <systemreg>

This register can be written using MSR (register) with the following syntax:

MSR <systemreg>, <Xt>

This syntax is encoded with the following settings in the instruction encoding:

<systemreg>	op0	op1	CRn	CRm	op2
MDCCINT_EL1	10	000	0000	0010	000

Accessibility

The register is accessible in software as follows:

Control			Accessibility			
E2H	TGE	NS	EL0	EL1	EL2	EL3
x	x	0	-	RW	n/a	RW
x	0	1	-	RW	RW	RW
x	1	1	-	n/a	RW	RW

Traps and Enables

For a description of the prioritization of any generated exceptions, see [Synchronous exception prioritization for exceptions taken to AArch64 on page D1-1827](#). Subject to the prioritization rules:

- When EL2 is implemented and is using AArch64 and SCR_EL3.NS == 1:
 - If MDCR_EL2.TDA==1, Non-secure accesses to this register from EL1 are trapped to EL2.
- When EL3 is implemented and is using AArch64:
 - If MDCR_EL3.TDA==1, accesses to this register from EL1 and EL2 are trapped to EL3.

D7.3.16 MDCCSR_EL0, Monitor DCC Status Register

The MDCCSR_EL0 characteristics are:

Purpose

Main control register for the debug implementation, containing flow-control flags for the DCC. This is an internal, read-only view.

Configurations

There are no configuration notes.

Attributes

MDCCSR_EL0 is a 32-bit register.

Field descriptions

The MDCCSR_EL0 bit assignments are:

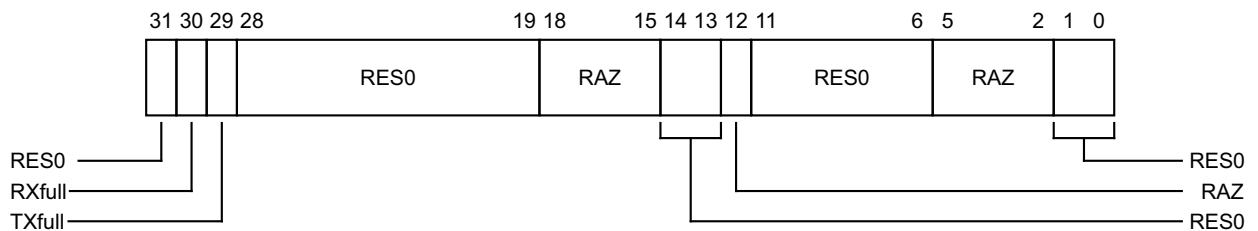

Bit [31]

Reserved, RES0.

RXfull, bit [30]

DTRRX full. Read-only view of the equivalent bit in the [EDSCR](#).

TXfull, bit [29]

DTRTX full. Read-only view of the equivalent bit in the [EDSCR](#).

Bits [28:19]

Reserved, RES0.

Bits [18:15]

Reserved. Hardware must implement this field as RAZ. Software must not rely on the register reading as zero.

Bits [14:13]

Reserved, RES0.

Bit [12]

Reserved. Hardware must implement this field as RAZ. Software must not rely on the register reading as zero.

Bits [11:6]

Reserved, RES0.

Bits [5:2]

Reserved. Hardware must implement this field as RAZ. Software must not rely on the register reading as zero.

Bits [1:0]

Reserved, RES0.

Accessing the MDCCSR_ELO

This register can be read using MRS with the following syntax:

MRS <Xt>, <systemreg>

This syntax is encoded with the following settings in the instruction encoding:

<systemreg>	op0	op1	CRn	CRm	op2
MDCCSR_ELO	10	011	0000	0001	000

Accessibility

The register is accessible in software as follows:

Control			Accessibility			
E2H	TGE	NS	EL0	EL1	EL2	EL3
x	x	0	RO	RO	n/a	RO
x	0	1	RO	RO	RO	RO
x	1	1	RO	n/a	RO	RO

Traps and Enables

For a description of the prioritization of any generated exceptions, see [Synchronous exception prioritization for exceptions taken to AArch64 on page D1-1827](#). Subject to the prioritization rules:

- In both security states, and not dependent on other bits:
 - If `MDSCR_EL1.TDCC==1`, read accesses to this register from EL0 are trapped to EL1.
- When EL2 is implemented and is using AArch64 and `SCR_EL3.NS == 1`:
 - If `MDCR_EL2.TDA==1`, Non-secure read accesses to this register from EL0 and EL1 are trapped to EL2.
- When EL3 is implemented and is using AArch64:
 - If `MDCR_EL3.TDA==1`, read accesses to this register from EL0, EL1, and EL2 are trapped to EL3.

D7.3.17 MDCR_EL2, Monitor Debug Configuration Register (EL2)

The MDCR_EL2 characteristics are:

Purpose

Provides EL2 configuration options for self-hosted debug and the Performance Monitors Extension.

Configurations

AArch64 System register MDCR_EL2 is architecturally mapped to AArch32 System register [HDCR](#).

If EL2 is not implemented, this register is RES0 from EL3.

This register is in the Warm reset domain. Some or all RW fields of this register have defined reset values. On a Warm or Cold reset these apply only if the PE resets into an Exception level that is using AArch64. Otherwise, on a Warm or Cold reset RW fields in this register reset to architecturally UNKNOWN values.

Attributes

MDCR_EL2 is a 32-bit register.

Field descriptions

The MDCR_EL2 bit assignments are:

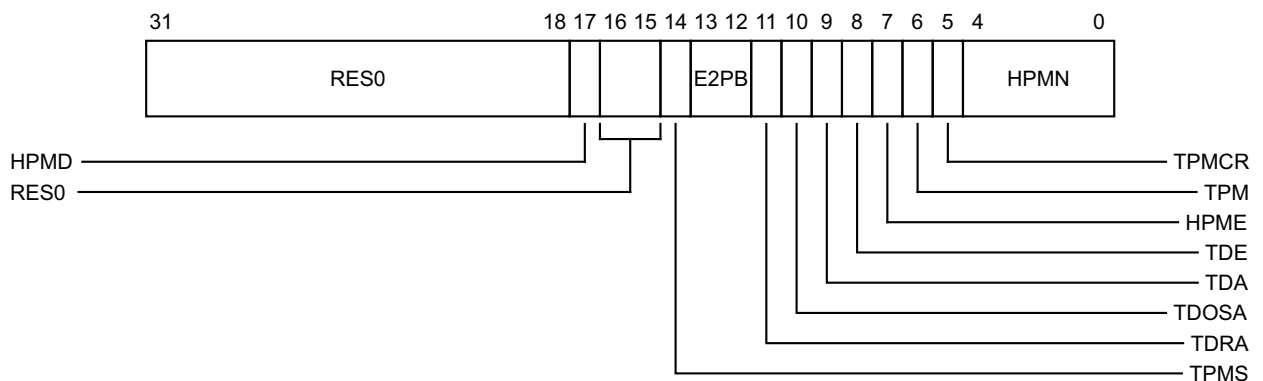

Bits [31:18]

Reserved, RES0.

HPMD, bit [17]

In ARMv8.2 and ARMv8.1

Guest Performance Monitors Disable. This control prohibits event counting at EL2. Permitted values are:

- 0 Event counting allowed at EL2.
- 1 Event counting prohibited at EL2.

In an ARMv8.1 implementation, event counting is prohibited unless enabled by the IMPLEMENTATION DEFINED authentication interface `ExternalSecureNoninvasiveDebugEnabled()`.

This control applies only to:

- The event counters in the range `[0..(HPMN-1)]`.
- If `PMCR_EL0.DP` is set to 1, `PMCCNTR_EL0`.

The other event counters are unaffected, and when `PMCR_EL0.DP` is set to 0, `PMCCNTR_EL0` is unaffected.

When this register has an architecturally-defined reset value, this field resets to 0.

In ARMv8.0.

Reserved, RES0.

Bits [16:15]

Reserved, RES0.

TPMS, bit [14]

In ARMv8.2

Trap Performance Monitor Sampling. When the Statistical Profiling Extension is implemented this field controls access to Statistical Profiling control registers from Non-secure EL1 and EL0. The possible values of this bit are:

- 0 Do not trap Statistical Profiling controls to EL2.
- 1 Accesses to Statistical Profiling controls at Non-secure EL1 generate a Trap exception to EL2.

If EL2 is not implemented, the PE behaves as if TPMS == 0, other than for a direct read of the register.

When the Statistical Profiling Extension is not implemented this field is reserved, RES0.

In ARMv8.1 and ARMv8.0.

Reserved, RES0.

E2PB, bits [13:12]

In ARMv8.2

EL2 Profiling Buffer. When the Statistical Profiling Extension is implemented this field controls the owning translation regime and access to Profiling Buffer control registers from Non-secure EL1. The possible values of this field are:

- 00 Profiling Buffer uses the EL2 stage 1 translation regime. Accesses to Profiling Buffer controls at Non-secure EL1 generate a Trap exception to EL2.
- 10 Profiling Buffer uses the EL1&0 stage 1 translation regime. Accesses to Profiling Buffer controls at Non-secure EL1 generate a Trap exception to EL2.
- 11 Profiling Buffer uses the EL1&0 stage 1 translation regime. Accesses to Profiling Buffer controls at Non-secure EL1 are not trapped to EL2.

All other values are reserved. If this field is programmed with a reserved value, the PE behaves as if this field has a defined value, other than for a direct read of the register. Software must not rely on the behavior of reserved values, as they might change in a future version of the architecture.

If EL2 is not implemented, the PE behaves as if E2PB == 0b11, other than for a direct read of the register.

When the Statistical Profiling Extension is not implemented this field is reserved, RES0.

In ARMv8.1 and ARMv8.0.

Reserved, RES0.

TDRA, bit [11]

Trap Debug ROM Address register access. Traps Non-secure System register accesses to the Debug ROM registers to EL2. This trap is from:

- Non-secure EL0 using AArch32.
- Non-secure EL1, regardless of which Execution state it is using.

0 This control does not cause any instructions to be trapped.

1 Non-secure EL0 and EL1 System register accesses to the Debug ROM registers are trapped to EL2, unless it is trapped by [DBGDSCRExt](#).UDCCdis or [MDSR_EL1](#).TDCC.

The registers for which accesses are trapped are as follows:

AArch64: [MDRAR_EL1](#).

AArch32: [DBGDRAR](#), [DBGDSAR](#).

If [MDCR_EL2.TDE](#) == 1 or [HCR_EL2.TGE](#) == 1, behavior is as if this bit is 1 other than for the purpose of a direct read.

This field resets to a value that is architecturally UNKNOWN.

TDOSA, bit [10]

Trap debug OS-related register access. Traps Non-secure EL1 System register accesses to the powerdown debug registers to EL2, from both Execution states:

- | | |
|---|--|
| 0 | This control does not cause any instructions to be trapped. |
| 1 | Non-secure EL1 System register accesses to the powerdown debug registers are trapped to EL2. |

The registers for which accesses are trapped are as follows:

AArch64: [OSLAR_EL1](#), [OSLSR_EL1](#), [OSDLR_EL1](#), and the [DBGPRCR_EL1](#).

AArch32: [DBGOSLSR](#), [DBGOSLAR](#), [DBGOSDLR](#), and the [DBGPRCR](#).

AArch64 and AArch32: Any IMPLEMENTATION DEFINED register with similar functionality that the implementation specifies as trapped by this bit.

———— Note —————

These registers are not accessible at EL0.

If [MDCR_EL2.TDE](#) == 1 or [HCR_EL2.TGE](#) == 1, behavior is as if this bit is 1 other than for the purpose of a direct read.

This field resets to a value that is architecturally UNKNOWN.

TDA, bit [9]

Trap Debug Access. Traps Non-secure EL0 and EL1 System register accesses to those debug System registers that are not trapped by either of the following:

- [MDCR_EL2.TDRA](#).
- [MDCR_EL2.TDOSA](#).

- | | |
|---|---|
| 0 | This control does not cause any instructions to be trapped. |
| 1 | Non-secure EL0 or EL1 System register accesses to the debug registers, other than the registers trapped by MDCR_EL2.TDRA and MDCR_EL2.TDOSA , are trapped to EL2, from both Execution states, unless it is trapped by DBGDSCRExt.UDCCdis or MDSR_EL1.TDCC . |

Traps of AArch32 accesses to [DBGDTRRXint](#) and [DBGDTRTXint](#) are ignored in Debug state.

Traps of AArch64 accesses to [DBGDTR_EL0](#), [DBGDTRRX_EL0](#), and [DBGDTRTX_EL0](#) are ignored in Debug state.

If [MDCR_EL2.TDE](#) == 1 or [HCR_EL2.TGE](#) == 1, behavior is as if this bit is 1 other than for the purpose of a direct read.

This field resets to a value that is architecturally UNKNOWN.

TDE, bit [8]

Trap Debug exceptions. The possible values of this field are:

- | | |
|---|---|
| 0 | This control has no effect on the routing of debug exceptions, and has no effect on Non-secure accesses to debug registers. |
| 1 | In Non-secure state: <ul style="list-style-type: none"> • Debug exceptions generated at EL1 or EL0 are routed to EL2. • The MDCR_EL2. {TDRA, TDOSA, TDA} fields are treated as being 1 for all purposes other than returning the result of a direct read of the register. |

When `HCR_EL2.TGE == 1`, the PE behaves as if the value of this field is 1 for all purposes other than returning the value of a direct read of the register.

This field resets to a value that is architecturally UNKNOWN.

HPME, bit [7]

Hypervisor Performance Monitors Counters Enable. The possible values of this bit are:

- 0 EL2 Performance Monitors counters disabled.
- 1 EL2 Performance Monitors counters enabled.

When the value of this bit is 1, the Performance Monitors counters that are reserved for use from EL2 or Secure state are enabled. For more information see the description of the HPMN field.

If the Performance Monitors Extension is not implemented, this field is RES0.

If this field is implemented as an RW field, it resets to a value that is architecturally UNKNOWN.

TPM, bit [6]

Trap Performance Monitors accesses. Traps Non-secure EL0 and EL1 accesses to all Performance Monitors registers to EL2, from both Execution states:

- 0 This control does not cause any instructions to be trapped.
- 1 Non-secure EL0 and EL1 accesses to all Performance Monitors registers are trapped to EL2.

———— Note ————

EL2 does not provide traps on Performance Monitor register accesses through the optional memory-mapped external debug interface.

If the Performance Monitors Extension is not implemented, this field is RES0.

If this field is implemented as an RW field, it resets to a value that is architecturally UNKNOWN.

TPMCR, bit [5]

Trap `PMCR_EL0` or `PMCR` accesses. Traps Non-secure EL0 and EL1 accesses to the `PMCR_EL0` or `PMCR` to EL2.

- 0 This control does not cause any instructions to be trapped.
- 1 Non-secure EL0 and EL1 accesses to the `PMCR_EL0` or `PMCR` are trapped to EL2, unless it is trapped by `PMUSERENR.EN` or `PMUSERENR_EL0.EN`.

———— Note ————

EL2 does not provide traps on Performance Monitor register accesses through the optional memory-mapped external debug interface.

If the Performance Monitors Extension is not implemented, this field is RES0.

If this field is implemented as an RW field, it resets to a value that is architecturally UNKNOWN.

HPMN, bits [4:0]

Defines the number of Performance Monitors counters that are accessible from Non-secure EL0 and EL1 modes.

If the Performance Monitors Extension is not implemented, this field is RES0.

In Non-secure state, HPMN divides the Performance Monitors counters as follows. For counter *n* in Non-secure state:

- If *n* is in the range $0 \leq n < \text{HPMN}$, the counter is accessible from EL1 and EL2, and from EL0 if permitted by `PMUSERENR_EL0.PMCR_EL0.E` enables the operation of counters in this range.
- If *n* is in the range $\text{HPMN} \leq n < \text{PMCR_EL0.N}$, the counter is accessible only from EL2 and from Secure state. `MDCR_EL2.HPME` enables the operation of counters in this range.

If this field is set to 0, or to a value larger than `PMCR_EL0.N`, then the following CONSTRAINED UNPREDICTABLE behavior applies:

- The value returned by a direct read of `MDCR_EL2.HPMN` is UNKNOWN.
- Either:
 - An UNKNOWN number of counters are reserved for EL2 use. That is, the PE behaves as if `MDCR_EL2.HPMN` is set to an UNKNOWN nonzero value less than `PMCR_EL0.N`.
 - All counters are reserved for EL2 use, meaning no counters are accessible from Non-secure EL1 and Non-secure EL0.

When this register has an architecturally-defined reset value, if this field is implemented as an RW field, it resets to the value of `PMCR_EL0.N`.

Accessing the MDCR_EL2

This register can be read using MRS with the following syntax:

MRS <Xt>, <systemreg>

This register can be written using MSR (register) with the following syntax:

MSR <systemreg>, <Xt>

This syntax is encoded with the following settings in the instruction encoding:

<systemreg>	op0	op1	CRn	CRm	op2
MDCR_EL2	11	100	0001	0001	001

Accessibility

The register is accessible in software as follows:

Control			Accessibility			
E2H	TGE	NS	EL0	EL1	EL2	EL3
x	x	0	-	-	n/a	RW
x	0	1	-	-	RW	RW
x	1	1	-	n/a	RW	RW

Traps and Enables

For a description of the prioritization of any generated exceptions, see [Synchronous exception prioritization for exceptions taken to AArch64 on page D1-1827](#). Subject to the prioritization rules:

- When EL3 is implemented and is using AArch64:
 - If `MDCR_EL3.TDA==1`, accesses to this register from EL2 are trapped to EL3.

D7.3.18 MDCR_EL3, Monitor Debug Configuration Register (EL3)

The MDCR_EL3 characteristics are:

Purpose

Provides EL3 configuration options for self-hosted debug and the Performance Monitors Extension.

Configurations

AArch64 System register MDCR_EL3 can be mapped to AArch32 System register [SDCR](#), but this is not architecturally mandated.

This register is in the Warm reset domain. Some or all RW fields of this register have defined reset values. On a Warm or Cold reset these apply only if the PE resets into an Exception level that is using AArch64. Otherwise, on a Warm or Cold reset RW fields in this register reset to architecturally UNKNOWN values.

Attributes

MDCR_EL3 is a 32-bit register.

Field descriptions

The MDCR_EL3 bit assignments are:

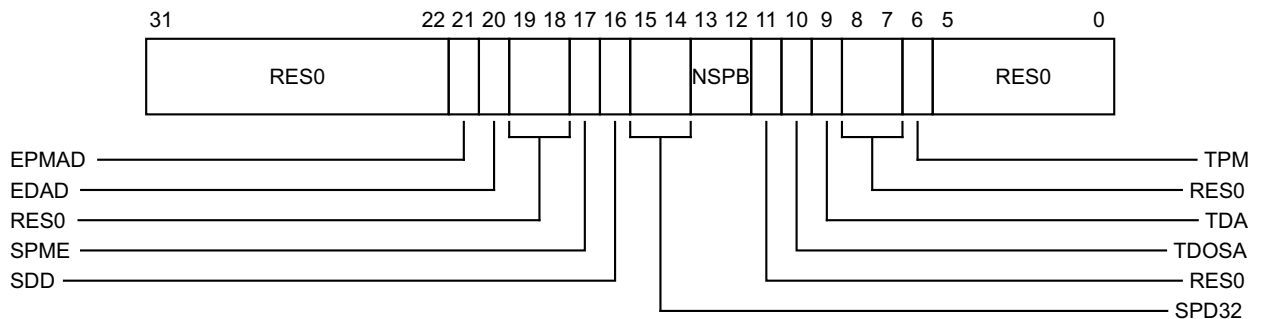

Bits [31:22]

Reserved, RES0.

EPMAD, bit [21]

External debug interface Performance Monitors registers disable. This disables access to these registers by an external debugger:

- 0 Access to Performance Monitors registers from external debugger is permitted.
- 1 Access to Performance Monitors registers from external debugger is disabled, unless overridden by the IMPLEMENTATION DEFINED authentication interface.

If the Performance Monitors Extension is not implemented or does not support external debug interface accesses this bit is RES0.

When this register has an architecturally-defined reset value, if this field is implemented as an RW field, it resets to 0.

EDAD, bit [20]

External debug interface breakpoint and watchpoint register access disable. This disables access to these registers by an external debugger:

- 0 Access to breakpoint and watchpoint registers from external debugger is permitted.
- 1 Access to breakpoint and watchpoint registers from external debugger is disabled, unless overridden by the IMPLEMENTATION DEFINED authentication interface.

When this register has an architecturally-defined reset value, this field resets to 0.

Bits [19:18]

Reserved, RES0.

SPME, bit [17]

Secure Performance Monitors enable. This allows event counting in Secure state:

- | | |
|---|---|
| 0 | Event counting prohibited in Secure state.
In an ARMv8.0 or ARMv8.1 implementation, event counting is prohibited unless <code>ExternalSecureNoninvasiveDebugEnabled()</code> is TRUE, meaning this control is overridden by the IMPLEMENTATION DEFINED authentication interface. |
| 1 | Event counting allowed in Secure state. |

If the Performance Monitors Extension is not implemented, this field is RES0.

When this register has an architecturally-defined reset value, this field resets to 0.

SDD, bit [16]

AArch64 Secure self-hosted invasive debug disable. Disables Software debug exceptions in Secure state, other than Breakpoint Instruction exceptions.

- | | |
|---|---|
| 0 | Debug exceptions from Secure EL0 are enabled, and debug exceptions from Secure EL1 are enabled if the value of <code>MDSCR_EL1.KDE</code> is 1 and the value of <code>PSTATE.D</code> is 0. |
| 1 | Debug exceptions, other than Breakpoint Instruction exceptions, are disabled from all Exception levels in Secure state. |

The SDD bit is ignored unless both of the following are true:

- The PE is in Secure state.
- Secure EL1 is using AArch64.

This field resets to a value that is architecturally UNKNOWN.

SPD32, bits [15:14]

AArch32 Secure self-hosted privileged invasive debug control. Enables or disables debug exceptions from Secure EL1 using AArch32, other than Breakpoint Instruction exceptions. Valid values for this field are:

- | | |
|----|---|
| 00 | Legacy mode. Debug exceptions from Secure EL1 are enabled by the IMPLEMENTATION DEFINED authentication interface. |
| 10 | Secure privileged debug disabled. Debug exceptions from Secure EL1 are disabled. |
| 11 | Secure privileged debug enabled. Debug exceptions from Secure EL1 are enabled. |

Other values are reserved, and have the CONstrained UNPREDICTABLE behavior that they must have the same behavior as 0b00. Software must not rely on this property as the behavior of reserved values might change in a future revision of the architecture.

This field has no effect on Breakpoint Instruction exceptions. These are always enabled.

This field is:

- Ignored if either the PE is in Non-secure state or Secure EL1 is using AArch64.
- RES0 if the implementation does not support EL1 using AArch32.

If Secure EL1 is using AArch32 then:

- If debug exceptions from Secure EL1 are enabled, then debug exceptions from Secure EL0 are also enabled.
- Otherwise, debug exceptions from Secure EL0 are enabled only if the value of `SDER32_EL3.SUIDEN` is 1.

If this field is implemented as an RW field, it resets to a value that is architecturally UNKNOWN.

NSPB, bits [13:12]

In ARMv8.2

Non-secure Profiling Buffer. When the Statistical Profiling Extension is implemented this field controls the owning translation regime and accesses to Statistical Profiling and Profiling Buffer control registers. The possible values of this field are:

- 00 Profiling Buffer uses Secure Virtual Addresses. Statistical Profiling enabled in Secure state and disabled in Non-secure state. Accesses to Statistical Profiling and Profiling Buffer controls at EL2 and EL1 in both security states generate Trap exceptions to EL3.
- 01 Profiling Buffer uses Secure Virtual Addresses. Statistical Profiling enabled in Secure state and disabled in Non-secure state. Accesses to Statistical Profiling and Profiling Buffer controls in Non-secure state generate Trap exceptions to EL3.
- 10 Profiling Buffer uses Non-secure Virtual Addresses. Statistical Profiling enabled in Non-secure state and disabled in Secure state. Accesses to Statistical Profiling and Profiling Buffer controls at EL2 and EL1 in both security states generate Trap exceptions to EL3.
- 11 Profiling Buffer uses Non-secure Virtual Addresses. Statistical Profiling enabled in Non-secure state and disabled in Secure state. Accesses to Statistical Profiling and Profiling Buffer controls at Secure EL1 generate Trap exceptions to EL3.

If EL3 is not implemented and the PE executes in Non-secure state, the PE behaves as if NSPB == 0b11.

If EL3 is not implemented and the PE executes in Secure state, the PE behaves as if NSPB == 0b01.

When the Statistical Profiling Extension is not implemented this field is reserved, RES0.

In ARMv8.1 and ARMv8.0.

Reserved, RES0.

Bit [11]

Reserved, RES0.

TDOSA, bit [10]

Trap debug OS-related register access. Traps EL2 and EL1 System register accesses to the powerdown debug registers to EL3:

- 0 This control does not cause any instructions to be trapped.
- 1 EL2 and EL1 System register accesses to the powerdown debug registers are trapped to EL3, unless it is trapped by [HDCR.TDOSA](#) or [MDCR_EL2.TDOSA](#).

The registers for which accesses are trapped are as follows:

AArch64: [OSLAR_EL1](#), [OSLSR_EL1](#), [OSDLR_EL1](#), [DBGPRCR_EL1](#).

AArch32: [DBGOSLAR](#), [DBGOSLSR](#), [DBGOSDLR](#), [DBGPRCR](#).

AArch64 and AArch32: Any IMPLEMENTATION DEFINED register with similar functionality that the implementation specifies as trapped by this bit.

This field resets to a value that is architecturally UNKNOWN.

TDA, bit [9]

Trap Debug Access. Traps EL2, EL1, and EL0 System register accesses to those debug System registers that cannot be trapped using the [MDCR_EL3.TDOSA](#) field. When [MDCR_EL3.TDA](#) is:

- 0 This control does not cause any instructions to be trapped.
- 1 EL0, EL1, and EL2 accesses to the debug registers, other than the registers that can be trapped by [MDCR_EL3.TDOSA](#), are trapped to EL3, from both Security states and both Execution states, unless it is trapped by [DBGDSCRExt.UDCCdis](#), [MDCR_EL1.TDCC](#), [HDCR.TDA](#) or [MDCR_EL2.TDA](#).

Traps of AArch32 accesses to [DBGDTRRXint](#) and [DBGDTRTXint](#) are ignored in Debug state.

Traps of AArch64 accesses to [DBGDTR_EL0](#), [DBGDTRRX_EL0](#), and [DBGDTRTX_EL0](#) are ignored in Debug state.

This field resets to a value that is architecturally UNKNOWN.

Bits [8:7]

Reserved, RES0.

TPM, bit [6]

Trap Performance Monitors accesses. Traps EL2, EL1, and EL0 accesses to all Performance Monitors registers to EL3, from both Security states and both Execution states.

0 This control does not cause any instructions to be trapped.

1 EL2, EL1, and EL0 System register accesses to all Performance Monitors registers are trapped to EL3, unless it is trapped by [HDCR.TPM](#) or [MDCR_EL2.TPM](#).

If the Performance Monitors Extension is not implemented, this field is RES0.

If this field is implemented as an RW field, it resets to a value that is architecturally UNKNOWN.

Bits [5:0]

Reserved, RES0.

Accessing the MDCR_EL3

This register can be read using MRS with the following syntax:

MRS <Xt>, <systemreg>

This register can be written using MSR (register) with the following syntax:

MSR <systemreg>, <Xt>

This syntax is encoded with the following settings in the instruction encoding:

<systemreg>	op0	op1	CRn	CRm	op2
MDCR_EL3	11	110	0001	0011	001

Accessibility

The register is accessible in software as follows:

Control			Accessibility			
E2H	TGE	NS	EL0	EL1	EL2	EL3
x	x	0	-	-	n/a	RW
x	0	1	-	-	-	RW
x	1	1	-	n/a	-	RW

D7.3.19 MDRAR_EL1, Monitor Debug ROM Address Register

The MDRAR_EL1 characteristics are:

Purpose

Defines the base physical address of a 4KB-aligned memory-mapped debug component, usually a ROM table that locates and describes the memory-mapped debug components in the system. ARMv8 deprecates any use of this register.

Configurations

AArch64 System register MDRAR_EL1 is architecturally mapped to AArch32 System register [DBGDRAR](#).

Attributes

MDRAR_EL1 is a 64-bit register.

Field descriptions

The MDRAR_EL1 bit assignments are:

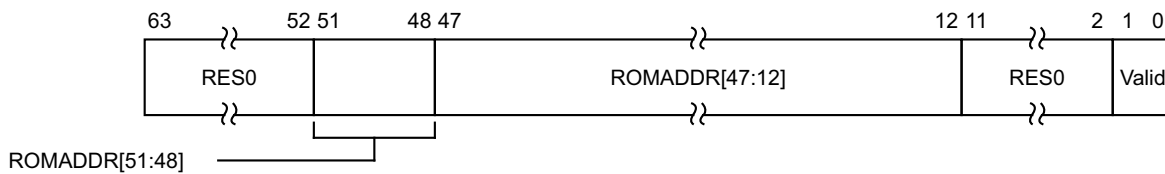

Bits [63:52]

Reserved, RES0.

ROMADDR[51:48], bits [51:48]

In ARMv8.2

Extension to ROMADDR[47:12]. See ROMADDR[47:12] for more details.

In ARMv8.1 and ARMv8.0.

Reserved, RES0.

ROMADDR[47:12], bits [47:12]

Bits[47:12] of the ROM table physical address.

When [ARMv8.2-LPA](#) is implemented, and 52-bit addresses and a 64KB translation granule are in use, ROMADDR[52:49] forms the upper part of the address value. Otherwise, ROMADDR[52:49] is RES0.

If the physical address size in bits (PAsize) is less than 52 then the register bits corresponding to ROMADDR [51:PAsize] are RES0.

Bits [11:0] of the ROM table physical address are zero.

ARM strongly recommends that bits ROMADDR[(PAsize-1):32] are zero in any system that supports AArch32 at the highest implemented Exception level.

In an implementation that includes EL3, ROMADDR is an address in Non-secure memory. It is IMPLEMENTATION DEFINED whether the ROM table is also accessible in Secure memory.

Bits [11:2]

Reserved, RES0.

Valid, bits [1:0]

This field indicates whether the ROM Table address is valid. The permitted values of this field are:

00 ROM Table address is not valid. Software must ignore ROMADDR.

11 ROM Table address is valid.

Other values are reserved.

Accessing the MDRAR_EL1

This register can be read using MRS with the following syntax:

MRS <Xt>, <systemreg>

This syntax is encoded with the following settings in the instruction encoding:

<systemreg>	op0	op1	CRn	CRm	op2
MDRAR_EL1	10	000	0001	0000	000

Accessibility

The register is accessible in software as follows:

Control			Accessibility			
E2H	TGE	NS	EL0	EL1	EL2	EL3
x	x	0	-	RO	n/a	RO
x	0	1	-	RO	RO	RO
x	1	1	-	n/a	RO	RO

Traps and Enables

For a description of the prioritization of any generated exceptions, see [Synchronous exception prioritization for exceptions taken to AArch64 on page D1-1827](#). Subject to the prioritization rules:

- When EL2 is implemented and is using AArch64 and SCR_EL3.NS == 1:
 - If MDCR_EL2.TDRA==1, Non-secure read accesses to this register from EL1 are trapped to EL2.
- When EL3 is implemented and is using AArch64:
 - If MDCR_EL3.TDA==1, read accesses to this register from EL1 and EL2 are trapped to EL3.

D7.3.20 MDSCR_EL1, Monitor Debug System Control Register

The MDSCR_EL1 characteristics are:

Purpose

Main control register for the debug implementation.

Configurations

AArch64 System register MDSCR_EL1 is architecturally mapped to AArch32 System register [DBGDSCRExt](#).

This register is in the Warm reset domain. Some or all RW fields of this register have defined reset values. On a Warm or Cold reset these apply only if the PE resets into an Exception level that is using AArch64. Otherwise, on a Warm or Cold reset RW fields in this register reset to architecturally UNKNOWN values.

Attributes

MDSCR_EL1 is a 32-bit register.

Field descriptions

The MDSCR_EL1 bit assignments are:

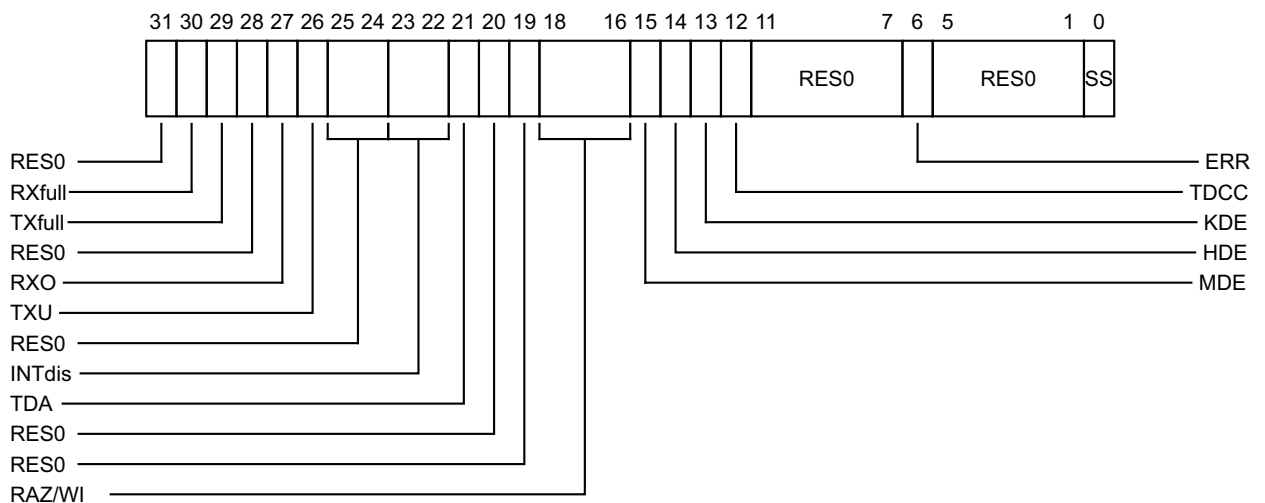

Bit [31]

Reserved, RES0.

RXfull, bit [30]

Used for save/restore of [EDSCR.RXfull](#).

When [OSLSR_EL1.OSLK](#) == 0 (the OS lock is unlocked), this bit is RO, and software must treat it as UNK/SBZP.

When [OSLSR_EL1.OSLK](#) == 1 (the OS lock is locked), this bit is RW and holds the value of [EDSCR.RXfull](#).

Reads and writes of this bit are indirect accesses to [EDSCR.RXfull](#).

The architected behavior of this field determines the value it returns after a reset.

TXfull, bit [29]

Used for save/restore of [EDSCR.TXfull](#).

When `OSLSR_EL1.OSLK == 0` (the OS lock is unlocked), this bit is RO, and software must treat it as UNK/SBZP.

When `OSLSR_EL1.OSLK == 1` (the OS lock is locked), this bit is RW and holds the value of `EDSCR.TXfull`.

Reads and writes of this bit are indirect accesses to `EDSCR.TXfull`.

The architected behavior of this field determines the value it returns after a reset.

Bit [28]

Reserved, RES0.

RXO, bit [27]

Used for save/restore of `EDSCR.RXO`.

When `OSLSR_EL1.OSLK == 0` (the OS lock is unlocked), this bit is RO, and software must treat it as UNK/SBZP.

When `OSLSR_EL1.OSLK == 1` (the OS lock is locked), this bit is RW and holds the value of `EDSCR.RXO`.

Reads and writes of this bit are indirect accesses to `EDSCR.RXO`.

The architected behavior of this field determines the value it returns after a reset.

TXU, bit [26]

Used for save/restore of `EDSCR.TXU`.

When `OSLSR_EL1.OSLK == 0` (the OS lock is unlocked), this bit is RO, and software must treat it as UNK/SBZP.

When `OSLSR_EL1.OSLK == 1` (the OS lock is locked), this bit is RW and holds the value of `EDSCR.TXU`.

Reads and writes of this bit are indirect accesses to `EDSCR.TXU`.

The architected behavior of this field determines the value it returns after a reset.

Bits [25:24]

Reserved, RES0.

INTdis, bits [23:22]

Used for save/restore of `EDSCR.INTdis`.

When `OSLSR_EL1.OSLK == 0` (the OS lock is unlocked), this field is RO, and software must treat it as UNK/SBZP.

When `OSLSR_EL1.OSLK == 1` (the OS lock is locked), this field is RW and holds the value of `EDSCR.INTdis`.

Reads and writes of this field are indirect accesses to `EDSCR.INTdis`.

The architected behavior of this field determines the value it returns after a reset.

TDA, bit [21]

Used for save/restore of `EDSCR.TDA`.

When `OSLSR_EL1.OSLK == 0` (the OS lock is unlocked), this bit is RO, and software must treat it as UNK/SBZP.

When `OSLSR_EL1.OSLK == 1` (the OS lock is locked), this bit is RW and holds the value of `EDSCR.TDA`.

Reads and writes of this bit are indirect accesses to `EDSCR.TDA`.

The architected behavior of this field determines the value it returns after a reset.

Bit [20]

Reserved, RES0.

SC2, bit [19]

In ARMv8.1

Used for save/restore of [EDSCR.SC2](#).

When [OSLSR_EL1.OSLK](#) == 0 (the OS lock is unlocked), this bit is RO, and software must treat it as UNK/SBZP.

When [OSLSR_EL1.OSLK](#) == 1 (the OS lock is locked), this bit is RW and holds the value of [EDSCR.SC2](#).

Reads and writes of this bit are indirect accesses to [EDSCR.SC2](#).

If the PC Sample-based Profiling Extension is not implemented, then this field is RES0.

In ARMv8.2 and ARMv8.0.

Reserved, RES0.

Bits [18:16]

Reserved. Hardware must implement this field as RAZ/WI. Software must not rely on the register reading as zero, and must use a read-modify-write sequence to write to the register.

MDE, bit [15]

Monitor debug events. Enable Breakpoint, Watchpoint, and Vector Catch exceptions.

0 Breakpoint, Watchpoint, and Vector Catch exceptions disabled.

1 Breakpoint, Watchpoint, and Vector Catch exceptions enabled.

This field resets to a value that is architecturally UNKNOWN.

HDE, bit [14]

Used for save/restore of [EDSCR.HDE](#).

When [OSLSR_EL1.OSLK](#) == 0 (the OS lock is unlocked), this bit is RO, and software must treat it as UNK/SBZP.

When [OSLSR_EL1.OSLK](#) == 1 (the OS lock is locked), this bit is RW and holds the value of [EDSCR.HDE](#).

Reads and writes of this bit are indirect accesses to [EDSCR.HDE](#).

The architected behavior of this field determines the value it returns after a reset.

KDE, bit [13]

Local (kernel) debug enable. If EL_D is using AArch64, enable debug exceptions within EL_D . Permitted values are:

0 Debug exceptions, other than Breakpoint Instruction exceptions, disabled within EL_D .

1 All debug exceptions enabled within EL_D .

RES0 if EL_D is using AArch32.

This field resets to a value that is architecturally UNKNOWN.

TDCC, bit [12]

Traps EL0 accesses to the DCC registers to EL1, from both Execution states:

0 This control does not cause any instructions to be trapped.

1 EL0 using AArch64: EL0 accesses to the [MDCCSR_EL0](#), [DBGDTR_EL0](#), [DBGDTRTX_EL0](#), and [DBGDTRRX_EL0](#) registers are trapped to EL1.

EL0 using AArch32: EL0 accesses to the [DBGDSCRint](#), [DBGDTRRXint](#), [DBGDTRTXint](#), [DBGDIDR](#), [DBGDSAR](#), and [DBGDRAR](#) registers are trapped to EL1.

Note

All accesses to these AArch32 registers are trapped, including LDC and STC accesses to [DBGDTRTXint](#) and [DBGDTRRXint](#), and MRRC accesses to [DBGDSAR](#) and [DBGDRAR](#).

Traps of AArch32 accesses to the [DBGDTRRXint](#) and [DBGDTRTXint](#) are ignored in Debug state.

Traps of AArch64 accesses to [DBGDTR_EL0](#), [DBGDTRRX_EL0](#), and [DBGDTRTX_EL0](#) are ignored in Debug state.

This field resets to a value that is architecturally UNKNOWN.

Bits [11:7]

Reserved, RES0.

ERR, bit [6]

Used for save/restore of [EDSCR.ERR](#).

When [OSLSR_EL1.OSLK](#) == 0 (the OS lock is unlocked), this bit is RO, and software must treat it as UNK/SBZP.

When [OSLSR_EL1.OSLK](#) == 1 (the OS lock is locked), this bit is RW and holds the value of [EDSCR.ERR](#).

Reads and writes of this bit are indirect accesses to [EDSCR.ERR](#).

The architected behavior of this field determines the value it returns after a reset.

Bits [5:1]

Reserved, RES0.

SS, bit [0]

Software step control bit. If EL_D is using AArch64, enable Software step. Permitted values are:

- 0 Software step disabled
- 1 Software step enabled.

RES0 if EL_D is using AArch32.

This field resets to a value that is architecturally UNKNOWN.

Accessing the MDSCR_EL1

This register can be read using MRS with the following syntax:

MRS <Xt>, <systemreg>

This register can be written using MSR (register) with the following syntax:

MSR <systemreg>, <Xt>

This syntax is encoded with the following settings in the instruction encoding:

<systemreg>	op0	op1	CRn	CRm	op2
MDSCR_EL1	10	000	0000	0010	010

Accessibility

The register is accessible in software as follows:

Control			Accessibility			
E2H	TGE	NS	EL0	EL1	EL2	EL3
x	x	0	-	RW	n/a	RW
x	0	1	-	RW	RW	RW
x	1	1	-	n/a	RW	RW

Individual fields within this register might have restricted accessibility when `OSLSR_EL1.OSLK == 0` (the OS lock is unlocked.) See the field descriptions for more detail.

Traps and Enables

For a description of the prioritization of any generated exceptions, see [Synchronous exception prioritization for exceptions taken to AArch64 on page D1-1827](#). Subject to the prioritization rules:

- When EL2 is implemented and is using AArch64 and `SCR_EL3.NS == 1`:
 - If `MDCR_EL2.TDA==1`, Non-secure accesses to this register from EL1 are trapped to EL2.
- When EL3 is implemented and is using AArch64:
 - If `MDCR_EL3.TDA==1`, accesses to this register from EL1 and EL2 are trapped to EL3.

D7.3.21 OSDLR_EL1, OS Double Lock Register

The OSDLR_EL1 characteristics are:

Purpose

Used to control the OS Double Lock.

Configurations

AArch64 System register OSDLR_EL1 is architecturally mapped to AArch32 System register [DBGOSDLR](#).

This register is in the Warm reset domain. Some or all RW fields of this register have defined reset values. On a Warm or Cold reset these apply only if the PE resets into an Exception level that is using AArch64. Otherwise, on a Warm or Cold reset RW fields in this register reset to architecturally UNKNOWN values.

Attributes

OSDLR_EL1 is a 32-bit register.

Field descriptions

The OSDLR_EL1 bit assignments are:

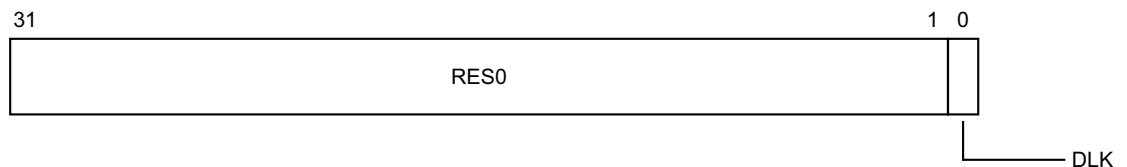

Bits [31:1]

Reserved, RES0.

DLK, bit [0]

OS Double Lock control bit. Possible values are:

- 0 OS Double Lock unlocked.
- 1 OS Double Lock locked, if [DBGPRCR_EL1](#).CORENPDRQ (Core no powerdown request) bit is set to 0 and the PE is in Non-debug state.

When this register has an architecturally-defined reset value, this field resets to 0.

Accessing the OSDLR_EL1

This register can be read using MRS with the following syntax:

MRS <Xt>, <systemreg>

This register can be written using MSR (register) with the following syntax:

MSR <systemreg>, <Xt>

This syntax is encoded with the following settings in the instruction encoding:

<systemreg>	op0	op1	CRn	CRm	op2
OSDLR_EL1	10	000	0001	0011	100

Accessibility

The register is accessible in software as follows:

Control			Accessibility			
E2H	TGE	NS	EL0	EL1	EL2	EL3
x	x	0	-	RW	n/a	RW
x	0	1	-	RW	RW	RW
x	1	1	-	n/a	RW	RW

Traps and Enables

For a description of the prioritization of any generated exceptions, see [Synchronous exception prioritization for exceptions taken to AArch64 on page D1-1827](#). Subject to the prioritization rules:

- When EL2 is implemented and is using AArch64 and SCR_EL3.NS == 1:
 - If MDCR_EL2.TDOSA==1, Non-secure accesses to this register from EL1 are trapped to EL2.
- When EL3 is implemented and is using AArch64:
 - If MDCR_EL3.TDOSA==1, accesses to this register from EL1 and EL2 are trapped to EL3.

D7.3.22 OSDTRRX_EL1, OS Lock Data Transfer Register, Receive

The OSDTRRX_EL1 characteristics are:

Purpose

Used for save/restore of [DBGDTRRX_EL0](#). It is a component of the Debug Communications Channel.

Configurations

AArch64 System register OSDTRRX_EL1 is architecturally mapped to AArch32 System register [DBGDTRRXext](#).

Attributes

OSDTRRX_EL1 is a 32-bit register.

Field descriptions

The OSDTRRX_EL1 bit assignments are:

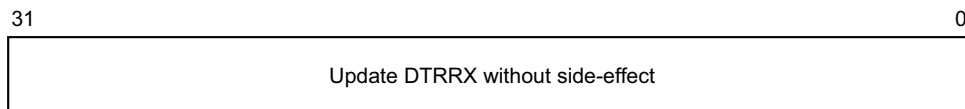

Bits [31:0]

Update DTRRX without side-effect.

Writes to this register update the value in DTRRX and do not change RXfull.

Reads of this register return the last value written to DTRRX and do not change RXfull.

For the full behavior of the Debug Communications Channel, see [Chapter H4 The Debug Communication Channel and Instruction Transfer Register](#).

Accessing the OSDTRRX_EL1

This register can be read using MRS with the following syntax:

MRS <Xt>, <systemreg>

This register can be written using MSR (register) with the following syntax:

MSR <systemreg>, <Xt>

This syntax is encoded with the following settings in the instruction encoding:

<systemreg>	op0	op1	CRn	CRm	op2
OSDTRRX_EL1	10	000	0000	0000	010

Accessibility

The register is accessible in software as follows:

Control			Accessibility			
E2H	TGE	NS	EL0	EL1	EL2	EL3
x	x	0	-	RW	n/a	RW
x	0	1	-	RW	RW	RW
x	1	1	-	n/a	RW	RW

ARM deprecates reads and writes of OSDTRRX_EL1 when the OS lock is unlocked.

Traps and Enables

For a description of the prioritization of any generated exceptions, see [Synchronous exception prioritization for exceptions taken to AArch64 on page D1-1827](#). Subject to the prioritization rules:

- When EL2 is implemented and is using AArch64 and SCR_EL3.NS == 1:
 - If MDCR_EL2.TDA==1, Non-secure accesses to this register from EL1 are trapped to EL2.
- When EL3 is implemented and is using AArch64:
 - If MDCR_EL3.TDA==1, accesses to this register from EL1 and EL2 are trapped to EL3.

D7.3.23 OSDTRTX_EL1, OS Lock Data Transfer Register, Transmit

The OSDTRTX_EL1 characteristics are:

Purpose

Used for save/restore of [DBGDTRTX_EL0](#). It is a component of the Debug Communications Channel.

Configurations

AArch64 System register OSDTRTX_EL1 is architecturally mapped to AArch32 System register [DBGDTRTXext](#).

Attributes

OSDTRTX_EL1 is a 32-bit register.

Field descriptions

The OSDTRTX_EL1 bit assignments are:

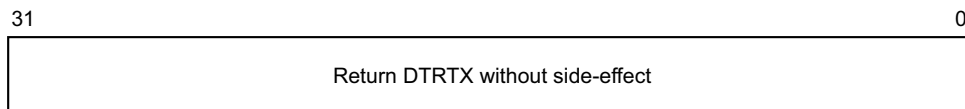

Bits [31:0]

Return DTRTX without side-effect.

Reads of this register return the value in DTRTX and do not change TXfull.

Writes of this register update the value in DTRTX and do not change TXfull.

For the full behavior of the Debug Communications Channel, see [Chapter H4 The Debug Communication Channel and Instruction Transfer Register](#).

Accessing the OSDTRTX_EL1

This register can be read using MRS with the following syntax:

MRS <Xt>, <systemreg>

This register can be written using MSR (register) with the following syntax:

MSR <systemreg>, <Xt>

This syntax is encoded with the following settings in the instruction encoding:

<systemreg>	op0	op1	CRn	CRm	op2
OSDTRTX_EL1	10	000	0000	0011	010

Accessibility

The register is accessible in software as follows:

Control			Accessibility			
E2H	TGE	NS	EL0	EL1	EL2	EL3
x	x	0	-	RW	n/a	RW
x	0	1	-	RW	RW	RW
x	1	1	-	n/a	RW	RW

ARM deprecates reads and writes of OSDTRTX_EL1 when the OS lock is unlocked.

Traps and Enables

For a description of the prioritization of any generated exceptions, see [Synchronous exception prioritization for exceptions taken to AArch64 on page D1-1827](#). Subject to the prioritization rules:

- When EL2 is implemented and is using AArch64 and SCR_EL3.NS == 1:
 - If MDCR_EL2.TDA==1, Non-secure accesses to this register from EL1 are trapped to EL2.
- When EL3 is implemented and is using AArch64:
 - If MDCR_EL3.TDA==1, accesses to this register from EL1 and EL2 are trapped to EL3.

D7.3.24 OSECCR_EL1, OS Lock Exception Catch Control Register

The OSECCR_EL1 characteristics are:

Purpose

Provides a mechanism for an operating system to access the contents of [EDECCR](#) that are otherwise invisible to software, so it can save/restore the contents of [EDECCR](#) over powerdown on behalf of the external debugger.

Configurations

AArch64 System register OSECCR_EL1 is architecturally mapped to AArch32 System register [DBGOSECCR](#).

AArch64 System register OSECCR_EL1 is architecturally mapped to External register [EDECCR](#). If [OSLSR_EL1.OSLK](#) == 0 then OSECCR_EL1 returns an UNKNOWN value on reads and ignores writes.

Attributes

OSECCR_EL1 is a 32-bit register.

Field descriptions

The OSECCR_EL1 bit assignments are:

When [OSLSR.OSLK](#)==1:



EDECCR, bits [31:0]

Used for save/restore to [EDECCR](#) over powerdown.

Reads or writes to this field are indirect accesses to [EDECCR](#).

Accessing the OSECCR_EL1

This register can be read using MRS with the following syntax:

MRS <Xt>, <systemreg>

This register can be written using MSR (register) with the following syntax:

MSR <systemreg>, <Xt>

This syntax is encoded with the following settings in the instruction encoding:

<systemreg>	op0	op1	CRn	CRm	op2
OSECCR_EL1	10	000	0000	0110	010

Accessibility

The register is accessible in software as follows:

Control			Accessibility			
E2H	TGE	NS	EL0	EL1	EL2	EL3
x	x	0	-	RW	n/a	RW
x	0	1	-	RW	RW	RW
x	1	1	-	n/a	RW	RW

Traps and Enables

For a description of the prioritization of any generated exceptions, see [Synchronous exception prioritization for exceptions taken to AArch64 on page D1-1827](#). Subject to the prioritization rules:

- When EL2 is implemented and is using AArch64 and SCR_EL3.NS == 1:
 - If MDCR_EL2.TDA==1, Non-secure accesses to this register from EL1 are trapped to EL2.
- When EL3 is implemented and is using AArch64:
 - If MDCR_EL3.TDA==1, accesses to this register from EL1 and EL2 are trapped to EL3.

D7.3.25 OSLAR_EL1, OS Lock Access Register

The OSLAR_EL1 characteristics are:

Purpose

Used to lock or unlock the OS lock.

Configurations

AArch64 System register OSLAR_EL1 is architecturally mapped to AArch32 System register [DBGOSLAR](#).

AArch64 System register OSLAR_EL1 is architecturally mapped to External register [OSLAR_EL1](#).

Attributes

OSLAR_EL1 is a 32-bit register.

Field descriptions

The OSLAR_EL1 bit assignments are:

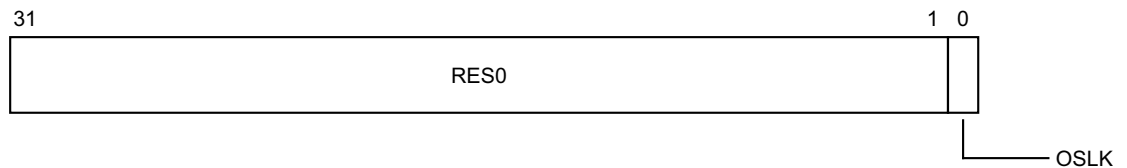

Bits [31:1]

Reserved, RES0.

OSLK, bit [0]

On writes to OSLAR_EL1, bit[0] is copied to the OS lock.

Use [OSLSR_EL1](#).OSLK to check the current status of the lock.

Accessing the OSLAR_EL1

This register can be written using MSR (register) with the following syntax:

MSR <systemreg>, <Xt>

This syntax is encoded with the following settings in the instruction encoding:

<systemreg>	op0	op1	CRn	CRm	op2
OSLAR_EL1	10	000	0001	0000	100

Accessibility

The register is accessible in software as follows:

Control			Accessibility			
E2H	TGE	NS	EL0	EL1	EL2	EL3
x	x	0	-	WO	n/a	WO
x	0	1	-	WO	WO	WO
x	1	1	-	n/a	WO	WO

Traps and Enables

For a description of the prioritization of any generated exceptions, see [Synchronous exception prioritization for exceptions taken to AArch64 on page D1-1827](#). Subject to the prioritization rules:

- When EL2 is implemented and is using AArch64 and SCR_EL3.NS == 1:
 - If MDCR_EL2.TDOSA==1, Non-secure write accesses to this register from EL1 are trapped to EL2.
- When EL3 is implemented and is using AArch64:
 - If MDCR_EL3.TDOSA==1, write accesses to this register from EL1 and EL2 are trapped to EL3.

D7.3.26 OSLSR_EL1, OS Lock Status Register

The OSLSR_EL1 characteristics are:

Purpose

Provides the status of the OS lock.

Configurations

AArch64 System register OSLSR_EL1 is architecturally mapped to AArch32 System register [DBGOSLSR](#).

This register is in the Cold reset domain. Some or all RW fields of this register have defined reset values. On a Cold reset these apply only if the PE resets into an Exception level that is using AArch64. Otherwise, on a Cold reset RW fields in this register reset to architecturally UNKNOWN values. The register is not affected by a Warm reset.

Attributes

OSLSR_EL1 is a 32-bit register.

Field descriptions

The OSLSR_EL1 bit assignments are:

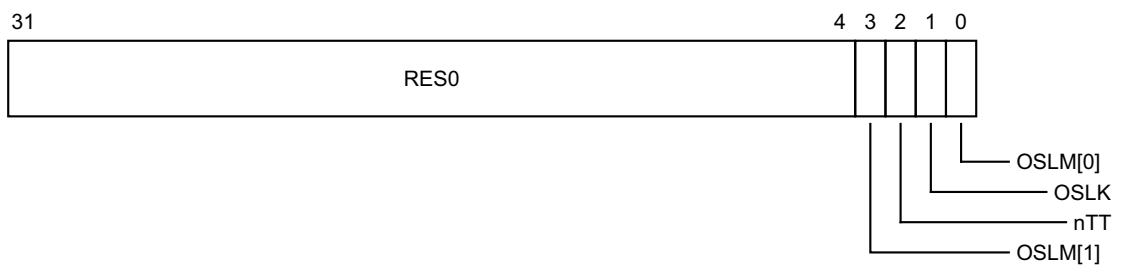

Bits [31:4]

Reserved, RES0.

OSLM[1], bit [3]

See below for description of the OSLM field.

nTT, bit [2]

Not 32-bit access. This bit is always RAZ. It indicates that a 32-bit access is needed to write the key to the OS Lock Access Register.

OSLK, bit [1]

OS Lock Status. The possible values are:

- 0 OS lock unlocked.
- 1 OS lock locked.

The OS lock is locked and unlocked by writing to the OS Lock Access Register.

When this register has an architecturally-defined reset value, this field resets to 1.

OSLM[0], bit [0]

OS lock model implemented. Identifies the form of OS save and restore mechanism implemented. In ARMv8 these bits are as follows:

- 10 OS lock implemented. DBGOSRR not implemented.

All other values are reserved.

Accessing the OLSR_EL1

This register can be read using MRS with the following syntax:

MRS <Xt>, <systemreg>

This syntax is encoded with the following settings in the instruction encoding:

<systemreg>	op0	op1	CRn	CRm	op2
OLSR_EL1	10	000	0001	0001	100

Accessibility

The register is accessible in software as follows:

Control			Accessibility			
E2H	TGE	NS	EL0	EL1	EL2	EL3
x	x	0	-	RO	n/a	RO
x	0	1	-	RO	RO	RO
x	1	1	-	n/a	RO	RO

Traps and Enables

For a description of the prioritization of any generated exceptions, see [Synchronous exception prioritization for exceptions taken to AArch64 on page D1-1827](#). Subject to the prioritization rules:

- When EL2 is implemented and is using AArch64 and SCR_EL3.NS == 1:
 - If MDCR_EL2.TDOSA==1, Non-secure read accesses to this register from EL1 are trapped to EL2.
- When EL3 is implemented and is using AArch64:
 - If MDCR_EL3.TDOSA==1, read accesses to this register from EL1 and EL2 are trapped to EL3.

D7.3.27 SDER32_EL3, AArch32 Secure Debug Enable Register

The SDER32_EL3 characteristics are:

Purpose

Allows access to the AArch32 register [SDER](#) from AArch64 state only. Its value has no effect on execution in AArch64 state.

Configurations

AArch64 System register SDER32_EL3 is architecturally mapped to AArch32 System register [SDER](#).

If EL1 is AArch64 only, this register is UNDEFINED.

This register is in the Warm reset domain. On a Warm or Cold reset RW fields in this register reset to architecturally UNKNOWN values.

Attributes

SDER32_EL3 is a 32-bit register.

Field descriptions

The SDER32_EL3 bit assignments are:

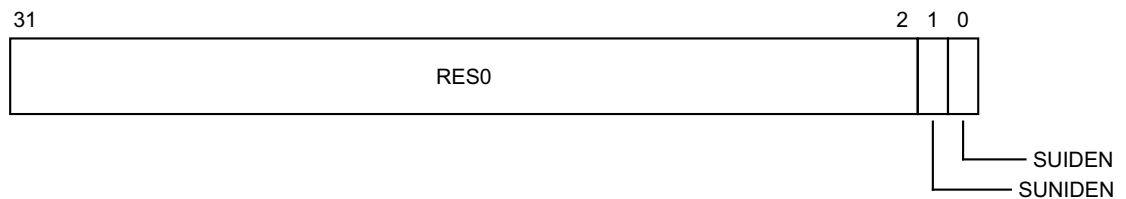

Bits [31:2]

Reserved, RES0.

SUNIDEN, bit [1]

Secure User Non-Invasive Debug Enable:

0 Performance Monitors event counting prohibited in Secure EL0 unless allowed by [MDCR_EL3.SPME](#) or the IMPLEMENTATION DEFINED authentication interface `ExternalSecureNoninvasiveDebugEnabled()`.

1 Performance Monitors event counting allowed in Secure EL0.

This field resets to a value that is architecturally UNKNOWN.

SUIDEN, bit [0]

Secure User Invasive Debug Enable:

0 Debug exceptions other than Breakpoint Instruction exceptions from Secure EL0 are disabled, unless enabled by [MDCR_EL3.SPD32](#).

1 Debug exceptions from Secure EL0 are enabled.

This field resets to a value that is architecturally UNKNOWN.

Accessing the SDER32_EL3

This register can be read using MRS with the following syntax:

```
MRS <Xt>, <systemreg>
```

This register can be written using MSR (register) with the following syntax:

MSR <systemreg>, <Xt>

This syntax is encoded with the following settings in the instruction encoding:

<systemreg>	op0	op1	CRn	CRm	op2
SDER_EL3	11	110	0001	0001	001

Accessibility

The register is accessible in software as follows:

Control			Accessibility			
E2H	TGE	NS	EL0	EL1	EL2	EL3
x	x	0	-	-	n/a	RW
x	0	1	-	-	-	RW
x	1	1	-	n/a	-	RW

D7.4 Performance Monitors registers

This section lists the Performance Monitoring registers in AArch64.

D7.4.1 PMCCFILTR_EL0, Performance Monitors Cycle Count Filter Register

The PMCCFILTR_EL0 characteristics are:

Purpose

Determines the modes in which the Cycle Counter, [PMCCNTR_EL0](#), increments.

Configurations

AArch64 System register PMCCFILTR_EL0 is architecturally mapped to AArch32 System register [PMCCFILTR](#).

AArch64 System register PMCCFILTR_EL0 is architecturally mapped to External register [PMCCFILTR_EL0](#).

This register is in the Warm reset domain. On a Warm or Cold reset RW fields in this register reset to architecturally UNKNOWN values.

Attributes

PMCCFILTR_EL0 is a 32-bit register.

Field descriptions

The PMCCFILTR_EL0 bit assignments are:

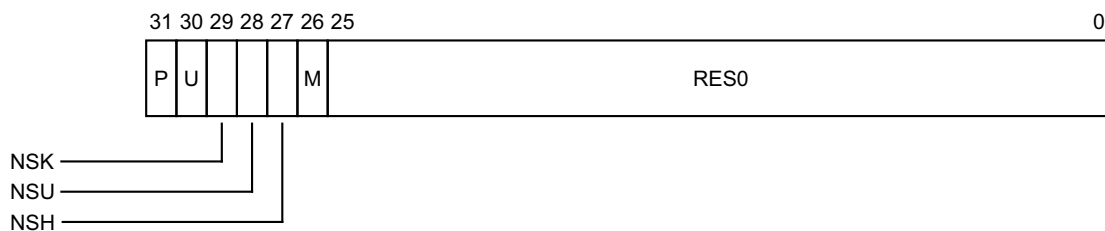

P, bit [31]

Privileged filtering bit. Controls counting in EL1. If EL3 is implemented, then counting in Non-secure EL1 is further controlled by the NSK bit. The possible values of this bit are:

- 0 Count cycles in EL1.
- 1 Do not count cycles in EL1.

U, bit [30]

User filtering bit. Controls counting in EL0. If EL3 is implemented, then counting in Non-secure EL0 is further controlled by the NSU bit. The possible values of this bit are:

- 0 Count cycles in EL0.
- 1 Do not count cycles in EL0.

NSK, bit [29]

Non-secure EL1 (kernel) modes filtering bit. Controls counting in Non-secure EL1. If EL3 is not implemented, this bit is RES0.

If the value of this bit is equal to the value of P, cycles in Non-secure EL1 are counted.

Otherwise, cycles in Non-secure EL1 are not counted.

NSU, bit [28]

Non-secure EL0 (Unprivileged) filtering. Controls counting in Non-secure EL0. If EL3 is not implemented, this bit is RES0.

If the value of this bit is equal to the value of U, cycles in Non-secure EL0 are counted.

Otherwise, cycles in Non-secure EL0 are not counted.

NSH, bit [27]

Non-secure EL2 (Hypervisor) filtering bit. Controls counting in Non-secure EL2. If EL2 is not implemented, this bit is RES0.

- 0 Do not count cycles in EL2.
- 1 Count cycles in EL2.

M, bit [26]

Secure EL3 filtering bit. If EL3 is not implemented, this bit is RES0.

If the value of this bit is equal to the value of P, cycles in Secure EL3 are counted.

Otherwise, cycles in Secure EL3 are not counted.

Most applications can ignore this field and set its value to 0.

———— **Note** —————

This field is not visible in the AArch32 PMCCFILTR System register.

Bits [25:0]

Reserved, RES0.

Accessing the PMCCFILTR_EL0

This register can be read using MRS with the following syntax:

MRS <Xt>, <systemreg>

This register can be written using MSR (register) with the following syntax:

MSR <systemreg>, <Xt>

This syntax is encoded with the following settings in the instruction encoding:

<systemreg>	op0	op1	CRn	CRm	op2
PMCCFILTR_EL0	11	011	1110	1111	111

PMCCFILTR_EL0 can also be accessed by using [PMXEVTYPYPER_EL0](#) with [PMSELR_EL0](#).SEL set to 0b11111.

Accessibility

The register is accessible in software as follows:

Control			Accessibility			
E2H	TGE	NS	EL0	EL1	EL2	EL3
x	x	0	RW	RW	n/a	RW
x	0	1	RW	RW	RW	RW
x	1	1	RW	n/a	RW	RW

Traps and Enables

For a description of the prioritization of any generated exceptions, see [Synchronous exception prioritization for exceptions taken to AArch64 on page D1-1827](#). Subject to the prioritization rules:

- In both security states, and not dependent on other bits:
 - If [PMUSERENR_EL0.EN](#)==0, accesses to this register from EL0 are trapped to EL1.
- When EL2 is implemented and is using AArch64 and [SCR_EL3.NS](#) == 1:
 - If [MDCR_EL2.TPM](#)==1, Non-secure accesses to this register from EL0 and EL1 are trapped to EL2.
- When EL3 is implemented and is using AArch64:
 - If [MDCR_EL3.TPM](#)==1, accesses to this register from EL0, EL1, and EL2 are trapped to EL3.

D7.4.2 PMCCNTR_EL0, Performance Monitors Cycle Count Register

The PMCCNTR_EL0 characteristics are:

Purpose

Holds the value of the processor Cycle Counter, CCNT, that counts processor clock cycles. See [Time as measured by the Performance Monitors cycle counter on page D5-2139](#) for more information.

[PMCCFILTR_EL0](#) determines the modes and states in which the PMCCNTR_EL0 can increment.

Configurations

AArch64 System register PMCCNTR_EL0 is architecturally mapped to AArch32 System register [PMCCNTR](#).

AArch64 System register PMCCNTR_EL0 is architecturally mapped to External register [PMCCNTR_EL0](#).

All counters are subject to any changes in clock frequency, including clock stopping caused by the WFI and WFE instructions. This means that it is CONSTRAINED UNPREDICTABLE whether or not PMCCNTR_EL0 continues to increment when clocks are stopped by WFI and WFE instructions.

This register is in the Warm reset domain. On a Warm or Cold reset RW fields in this register reset to architecturally UNKNOWN values.

Attributes

PMCCNTR_EL0 is a 64-bit register.

Field descriptions

The PMCCNTR_EL0 bit assignments are:

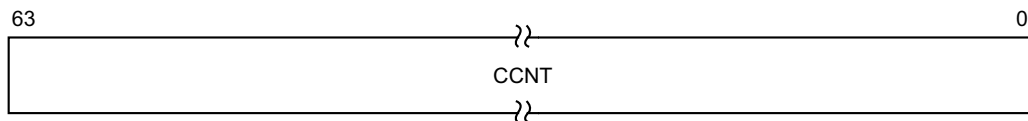

CCNT, bits [63:0]

Cycle count. Depending on the values of [PMCR_EL0](#).{LC,D}, this field increments in one of the following ways:

- Every processor clock cycle.
- Every 64th processor clock cycle.

Writing 1 to [PMCR_EL0](#).C sets this field to 0.

Accessing the PMCCNTR_EL0

This register can be read using MRS with the following syntax:

```
MRS <Xt>, <systemreg>
```

This register can be written using MSR (register) with the following syntax:

```
MSR <systemreg>, <Xt>
```

This syntax is encoded with the following settings in the instruction encoding:

<systemreg>	op0	op1	CRn	CRm	op2
PMCCNTR_EL0	11	011	1001	1101	000

Accessibility

The register is accessible in software as follows:

Control			Accessibility			
E2H	TGE	NS	EL0	EL1	EL2	EL3
x	x	0	RW	RW	n/a	RW
x	0	1	RW	RW	RW	RW
x	1	1	RW	n/a	RW	RW

Traps and Enables

For a description of the prioritization of any generated exceptions, see *Synchronous exception prioritization for exceptions taken to AArch64* on page D1-1827. Subject to the prioritization rules:

- In both security states, and not dependent on other bits:
 - If `PMUSERENR_EL0.CR==0`, and `PMUSERENR_EL0.EN==0`, read accesses to this register from EL0 are trapped to EL1.
 - If `PMUSERENR_EL0.EN==0`, write accesses to this register from EL0 are trapped to EL1.
- When EL2 is implemented and is using AArch64 and `SCR_EL3.NS == 1`:
 - If `MDCR_EL2.TPM==1`, Non-secure accesses to this register from EL0 and EL1 are trapped to EL2.
- When EL3 is implemented and is using AArch64:
 - If `MDCR_EL3.TPM==1`, accesses to this register from EL0, EL1, and EL2 are trapped to EL3.

D7.4.3 PMCEID0_EL0, Performance Monitors Common Event Identification register 0

The PMCEID0_EL0 characteristics are:

Purpose

Defines which common architectural and common microarchitectural feature events in the ranges 0x0000 to 0x001F and 0x4000 to 0x401F are implemented. If a particular bit is set to 1, then the event for that bit is implemented.

Configurations

AArch64 System register PMCEID0_EL0[31:0] is architecturally mapped to AArch32 System register [PMCEID0](#).

AArch64 System register PMCEID0_EL0[63:32] is architecturally mapped to AArch32 System register PMCEID2.

AArch64 System register PMCEID0_EL0[31:0] is architecturally mapped to External register [PMCEID0](#).

AArch64 System register PMCEID0_EL0[63:32] is architecturally mapped to External register PMCEID2.

Attributes

PMCEID0_EL0 is a 64-bit register.

Field descriptions

The PMCEID0_EL0 bit assignments are:

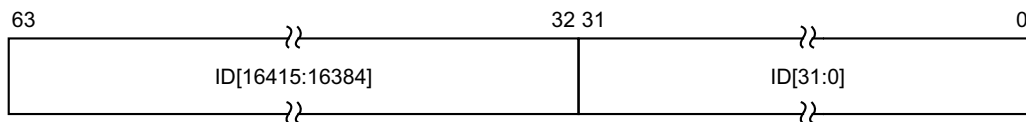

ID[16415:16384], bits [63:32]

In ARMv8.2 and ARMv8.1

PMCEID0_EL0[63:32] maps to common events 0x4000 to 0x401F. For a list of event numbers and descriptions, see [Events, event numbers, and mnemonics on page D5-2152](#).

For each bit:

- 0 The common event is not implemented.
- 1 The common event is implemented.

Bits that map to reserved event numbers are reserved to identify events that might be defined in future revisions to the architecture.

Events that do not require additional features in the PMU can be defined retrospectively, meaning that they can be implemented as part of a PMUv3 implementation.

In ARMv8.0.

Reserved, RES0.

ID[31:0], bits [31:0]

PMCEID0_EL0[31:0] maps to common events 0x0000 to 0x001F. For a list of event numbers and descriptions, see [Events, event numbers, and mnemonics on page D5-2152](#).

For each bit:

- 0 The common event is not implemented.
- 1 The common event is implemented.

Bits that map to reserved event numbers are reserved to identify events that might be defined in future revisions to the architecture.

Events that do not require additional features in the PMU can be defined retrospectively, meaning that they can be implemented as part of a PMUv3 implementation.

Accessing the PMCEID0_ELO

This register can be read using MRS with the following syntax:

MRS <Xt>, <systemreg>

This syntax is encoded with the following settings in the instruction encoding:

<systemreg>	op0	op1	CRn	CRm	op2
PMCEID0_ELO	11	011	1001	1100	110

Accessibility

The register is accessible in software as follows:

Control			Accessibility			
E2H	TGE	NS	EL0	EL1	EL2	EL3
x	x	0	RO	RO	n/a	RO
x	0	1	RO	RO	RO	RO
x	1	1	RO	n/a	RO	RO

Traps and Enables

For a description of the prioritization of any generated exceptions, see [Synchronous exception prioritization for exceptions taken to AArch64 on page D1-1827](#). Subject to the prioritization rules:

- In both security states, and not dependent on other bits:
 - If `PMUSERENR_EL0.EN==0`, read accesses to this register from EL0 are trapped to EL1.
- When EL2 is implemented and is using AArch64 and `SCR_EL3.NS == 1`:
 - If `MDCR_EL2.TPM==1`, Non-secure read accesses to this register from EL0 and EL1 are trapped to EL2.
- When EL3 is implemented and is using AArch64:
 - If `MDCR_EL3.TPM==1`, read accesses to this register from EL0, EL1, and EL2 are trapped to EL3.

D7.4.4 PMCEID1_EL0, Performance Monitors Common Event Identification register 1

The PMCEID1_EL0 characteristics are:

Purpose

Defines which common architectural and common microarchitectural feature events in the ranges 0x0020 to 0x003F and 0x4020 to 0x403F are implemented. If a particular bit is set to 1, then the event for that bit is implemented.

Configurations

AArch64 System register PMCEID1_EL0[31:0] is architecturally mapped to AArch32 System register [PMCEID1](#).

AArch64 System register PMCEID1_EL0[63:32] is architecturally mapped to AArch32 System register PMCEID3.

AArch64 System register PMCEID1_EL0[31:0] is architecturally mapped to External register [PMCEID1](#).

AArch64 System register PMCEID1_EL0[63:32] is architecturally mapped to External register PMCEID3.

Attributes

PMCEID1_EL0 is a 64-bit register.

Field descriptions

The PMCEID1_EL0 bit assignments are:

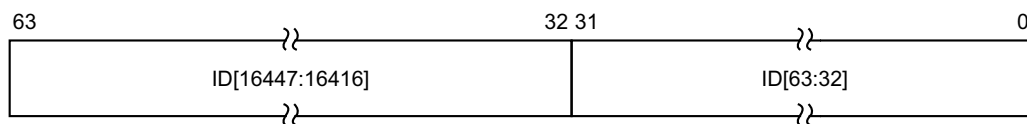

ID[16447:16416], bits [63:32]

In ARMv8.2 and ARMv8.1

PMCEID1_EL0[63:32] maps to common events 0x4020 to 0x403F. For a list of event numbers and descriptions, see [Events, event numbers, and mnemonics on page D5-2152](#).

For each bit:

- 0 The common event is not implemented.
- 1 The common event is implemented.

Bits that map to reserved event numbers are reserved to identify events that might be defined in future revisions to the architecture.

Events that do not require additional features in the PMU can be defined retrospectively, meaning that they can be implemented as part of a PMUv3 implementation.

In ARMv8.0.

Reserved, RES0.

ID[63:32], bits [31:0]

PMCEID1_EL0[31:0] maps to common events 0x0020 to 0x003F. For a list of event numbers and descriptions, see [Events, event numbers, and mnemonics on page D5-2152](#).

For each bit:

- 0 The common event is not implemented.
- 1 The common event is implemented.

Bits that map to reserved event numbers are reserved to identify events that might be defined in future revisions to the architecture.

Events that do not require additional features in the PMU can be defined retrospectively, meaning that they can be implemented as part of a PMUv3 implementation.

Accessing the PMCEID1_ELO

This register can be read using MRS with the following syntax:

MRS <Xt>, <systemreg>

This syntax is encoded with the following settings in the instruction encoding:

<systemreg>	op0	op1	CRn	CRm	op2
PMCEID1_ELO	11	011	1001	1100	111

Accessibility

The register is accessible in software as follows:

Control			Accessibility			
E2H	TGE	NS	EL0	EL1	EL2	EL3
x	x	0	RO	RO	n/a	RO
x	0	1	RO	RO	RO	RO
x	1	1	RO	n/a	RO	RO

Traps and Enables

For a description of the prioritization of any generated exceptions, see [Synchronous exception prioritization for exceptions taken to AArch64 on page D1-1827](#). Subject to the prioritization rules:

- In both security states, and not dependent on other bits:
 - If `PMUSERENR_EL0.EN==0`, read accesses to this register from EL0 are trapped to EL1.
- When EL2 is implemented and is using AArch64 and `SCR_EL3.NS == 1`:
 - If `MDCR_EL2.TPM==1`, Non-secure read accesses to this register from EL0 and EL1 are trapped to EL2.
- When EL3 is implemented and is using AArch64:
 - If `MDCR_EL3.TPM==1`, read accesses to this register from EL0, EL1, and EL2 are trapped to EL3.

D7.4.5 PMCNTENCLR_EL0, Performance Monitors Count Enable Clear register

The PMCNTENCLR_EL0 characteristics are:

Purpose

Disables the Cycle Count Register, [PMCCNTR_EL0](#), and any implemented event counters [PMEVCNTR<n>](#). Reading this register shows which counters are enabled.

Configurations

AArch64 System register PMCNTENCLR_EL0 is architecturally mapped to AArch32 System register [PMCNTENCLR](#).

AArch64 System register PMCNTENCLR_EL0 is architecturally mapped to External register [PMCNTENCLR_EL0](#).

This register is in the Warm reset domain. On a Warm or Cold reset RW fields in this register reset to architecturally UNKNOWN values.

Attributes

PMCNTENCLR_EL0 is a 32-bit register.

Field descriptions

The PMCNTENCLR_EL0 bit assignments are:

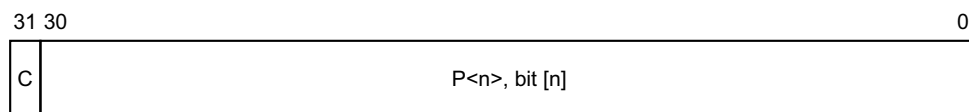

C, bit [31]

[PMCCNTR_EL0](#) disable bit. Disables the cycle counter register. Possible values are:

- | | |
|---|--|
| 0 | When read, means the cycle counter is disabled. When written, has no effect. |
| 1 | When read, means the cycle counter is enabled. When written, disables the cycle counter. |

P<n>, bit [n], for n = 0 to 30

Event counter disable bit for [PMEVCNTR<n>_EL0](#).

Bits [30:N] are RAZ/WI. When EL2 is implemented, in Non-secure EL1 and EL0, N is the value in [MDCR_EL2.HPMN](#). Otherwise, N is the value in [PMCR_EL0.N](#).

Possible values of each bit are:

- | | |
|---|--|
| 0 | When read, means that PMEVCNTR<n>_EL0 is disabled. When written, has no effect. |
| 1 | When read, means that PMEVCNTR<n>_EL0 is enabled. When written, disables PMEVCNTR<n>_EL0 . |

Accessing the PMCNTENCLR_EL0

This register can be read using MRS with the following syntax:

```
MRS <Xt>, <systemreg>
```

This register can be written using MSR (register) with the following syntax:

```
MSR <systemreg>, <Xt>
```

This syntax is encoded with the following settings in the instruction encoding:

<systemreg>	op0	op1	CRn	CRm	op2
PMCNTENCLR_EL0	11	011	1001	1100	010

Accessibility

The register is accessible in software as follows:

Control			Accessibility			
E2H	TGE	NS	EL0	EL1	EL2	EL3
x	x	0	RW	RW	n/a	RW
x	0	1	RW	RW	RW	RW
x	1	1	RW	n/a	RW	RW

Traps and Enables

For a description of the prioritization of any generated exceptions, see [Synchronous exception prioritization for exceptions taken to AArch64 on page D1-1827](#). Subject to the prioritization rules:

- In both security states, and not dependent on other bits:
 - If `PMUSERENR_EL0.EN==0`, accesses to this register from EL0 are trapped to EL1.
- When EL2 is implemented and is using AArch64 and `SCR_EL3.NS == 1`:
 - If `MDCR_EL2.TPM==1`, Non-secure accesses to this register from EL0 and EL1 are trapped to EL2.
- When EL3 is implemented and is using AArch64:
 - If `MDCR_EL3.TPM==1`, accesses to this register from EL0, EL1, and EL2 are trapped to EL3.

D7.4.6 PMCNTENSET_EL0, Performance Monitors Count Enable Set register

The PMCNTENSET_EL0 characteristics are:

Purpose

Enables the Cycle Count Register, [PMCCNTR_EL0](#), and any implemented event counters [PMEVCNTR<n>](#). Reading this register shows which counters are enabled.

Configurations

AArch64 System register PMCNTENSET_EL0 is architecturally mapped to AArch32 System register [PMCNTENSET](#).

AArch64 System register PMCNTENSET_EL0 is architecturally mapped to External register [PMCNTENSET_EL0](#).

This register is in the Warm reset domain. On a Warm or Cold reset RW fields in this register reset to architecturally UNKNOWN values.

Attributes

PMCNTENSET_EL0 is a 32-bit register.

Field descriptions

The PMCNTENSET_EL0 bit assignments are:

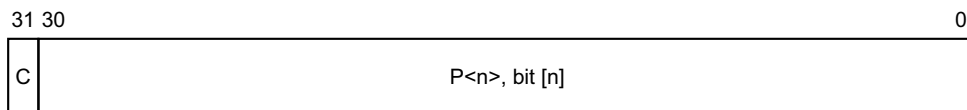

C, bit [31]

[PMCCNTR_EL0](#) enable bit. Enables the cycle counter register. Possible values are:

- 0 When read, means the cycle counter is disabled. When written, has no effect.
- 1 When read, means the cycle counter is enabled. When written, enables the cycle counter.

P<n>, bit [n], for n = 0 to 30

Event counter enable bit for [PMEVCNTR<n>_EL0](#).

Bits [30:N] are RAZ/WI. When EL2 is implemented, in Non-secure EL1 and EL0, N is the value in [MDCR_EL2.HPMN](#). Otherwise, N is the value in [PMCR_EL0.N](#).

Possible values of each bit are:

- 0 When read, means that [PMEVCNTR<n>_EL0](#) is disabled. When written, has no effect.
- 1 When read, means that [PMEVCNTR<n>_EL0](#) event counter is enabled. When written, enables [PMEVCNTR<n>_EL0](#).

Accessing the PMCNTENSET_EL0

This register can be read using MRS with the following syntax:

```
MRS <Xt>, <systemreg>
```

This register can be written using MSR (register) with the following syntax:

```
MSR <systemreg>, <Xt>
```

This syntax is encoded with the following settings in the instruction encoding:

<systemreg>	op0	op1	CRn	CRm	op2
PMCNTENSET_ELO	11	011	1001	1100	001

Accessibility

The register is accessible in software as follows:

Control			Accessibility			
E2H	TGE	NS	EL0	EL1	EL2	EL3
x	x	0	RW	RW	n/a	RW
x	0	1	RW	RW	RW	RW
x	1	1	RW	n/a	RW	RW

Traps and Enables

For a description of the prioritization of any generated exceptions, see [Synchronous exception prioritization for exceptions taken to AArch64 on page D1-1827](#). Subject to the prioritization rules:

- In both security states, and not dependent on other bits:
 - If `PMUSERENR_ELO.EN==0`, accesses to this register from EL0 are trapped to EL1.
- When EL2 is implemented and is using AArch64 and `SCR_EL3.NS == 1`:
 - If `MDCR_EL2.TPM==1`, Non-secure accesses to this register from EL0 and EL1 are trapped to EL2.
- When EL3 is implemented and is using AArch64:
 - If `MDCR_EL3.TPM==1`, accesses to this register from EL0, EL1, and EL2 are trapped to EL3.

D7.4.7 PMCR_EL0, Performance Monitors Control Register

The PMCR_EL0 characteristics are:

Purpose

Provides details of the Performance Monitors implementation, including the number of counters implemented, and configures and controls the counters.

Configurations

AArch64 System register PMCR_EL0 is architecturally mapped to AArch32 System register [PMCR](#).

AArch64 System register PMCR_EL0[6:0] is architecturally mapped to External register [PMCR_EL0](#)[6:0].

This register is in the Warm reset domain. Some or all RW fields of this register have defined reset values. On a Warm or Cold reset these apply only if the PE resets into an Exception level that is using AArch64. Otherwise, on a Warm or Cold reset RW fields in this register reset to architecturally UNKNOWN values.

Attributes

PMCR_EL0 is a 32-bit register.

Field descriptions

The PMCR_EL0 bit assignments are:

31	24 23	16 15	11 10	7 6 5 4 3 2 1 0
IMP	IDCODE	N	RES0	LCDP X D C P E

IMP, bits [31:24]

Implementer code. This field is RO with an IMPLEMENTATION DEFINED value.

The implementer codes are allocated by ARM. Values have the same interpretation as bits [31:24] of the [MIDR](#).

IDCODE, bits [23:16]

Identification code. This field is RO with an IMPLEMENTATION DEFINED value.

Each implementer must maintain a list of identification codes that is specific to the implementer. A specific implementation is identified by the combination of the implementer code and the identification code.

N, bits [15:11]

Number of event counters. A RO field that indicates the number counters implemented. A value of 0b00000 in this field indicates that only the Cycle Count Register [PMCCNTR_EL0](#) is implemented.

The value of this field is the number of event counters implemented. This value is in the range of 0b00000, in which case only the [PMCCNTR_EL0](#) is implemented, to 0b11111, which indicates that the [PMCCNTR_EL0](#) and 31 event counters are implemented.

In an implementation that includes EL2, reads of this field from Non-secure EL1 and Non-secure EL0 return the value of [MDCR_EL2](#).HPMN.

Bits [10:7]

Reserved, RES0.

LC, bit [6]

Long cycle counter enable. Determines which [PMCCNTR_ELO](#) bit generates an overflow recorded by [PMOVSr](#)[31].

- 0 Cycle counter overflow on increment that changes [PMCCNTR_ELO](#)[31] from 1 to 0.
- 1 Cycle counter overflow on increment that changes [PMCCNTR_ELO](#)[63] from 1 to 0.

ARM deprecates use of `PMCR_EL0.LC = 0`.

In an AArch64-only implementation, this field is RES1.

If this field is implemented as an RW field, it resets to a value that is architecturally UNKNOWN.

DP, bit [5]

Disable cycle counter when event counting is prohibited. The possible values of this bit are:

- 0 [PMCCNTR_ELO](#), if enabled, counts when event counting is prohibited.
- 1 [PMCCNTR_ELO](#) does not count when event counting is prohibited.

Counting events is never prohibited in Non-secure state. However, there are some restrictions on counting events in Secure state. For more information about the interaction between the Performance Monitors and EL3, see [Interaction with EL3 on page D5-2145](#).

When EL3 is not implemented, this field is RES0:

- When [ARMv8.1-PMU](#) is not implemented.
- When [ARMv8.1-PMU](#) is implemented, only if EL2 is not implemented.

Otherwise this field is RW.

If this field is implemented as an RW field, it resets to a value that is architecturally UNKNOWN.

X, bit [4]

Enable export of events in an IMPLEMENTATION DEFINED event stream. The possible values of this bit are:

- 0 Do not export events.
- 1 Export events where not prohibited.

This field enables the exporting of events over an event bus to another device, for example to an OPTIONAL trace macrocell. If the implementation does not include such an event bus then this field is RAZ/WI, otherwise it is an RW field.

In an implementation that includes an event bus, no events are exported when counting is prohibited.

This field does not affect the generation of Performance Monitors overflow interrupt requests or signaling to a cross-trigger interface (CTI) that can be implemented as signals exported from the PE.

If this field is implemented as an RW field, it resets to a value that is architecturally UNKNOWN.

D, bit [3]

Clock divider. The possible values of this bit are:

- 0 When enabled, [PMCCNTR_ELO](#) counts every clock cycle.
- 1 When enabled, [PMCCNTR_ELO](#) counts once every 64 clock cycles.

In an AArch64-only implementation this field is RES0, otherwise it is an RW field. If `PMCR_EL0.LC == 1`, this bit is ignored and the cycle counter counts every clock cycle.

ARM deprecates use of `PMCR_EL0.D = 1`.

If this field is implemented as an RW field, it resets to a value that is architecturally UNKNOWN.

C, bit [2]

Cycle counter reset. This bit is WO. The effects of writing to this bit are:

- 0 No action.
- 1 Reset [PMCCNTR_ELO](#) to zero.

This bit is always RAZ.

Resetting `PMCCNTR_EL0` does not clear the `PMCCNTR_EL0` overflow bit to 0.

P, bit [1]

Event counter reset. This bit is WO. The effects of writing to this bit are:

- 0 No action.
- 1 Reset all event counters accessible in the current EL, not including `PMCCNTR_EL0`, to zero.

This bit is always RAZ.

In Non-secure EL0 and EL1, if EL2 is implemented, a write of 1 to this bit does not reset event counters that `MDCR_EL2`.HPMN reserves for EL2 use.

In EL2 and EL3, a write of 1 to this bit resets all the event counters.

Resetting the event counters does not clear any overflow bits to 0.

E, bit [0]

Enable. The possible values of this bit are:

- 0 All counters that are accessible at Non-secure EL1, including `PMCCNTR_EL0`, are disabled.
- 1 All counters that are accessible at Non-secure EL1 are enabled by `PMCNTENSET_EL0`.

This bit is RW.

If EL2 is implemented, this bit does not affect the operation of event counters that `MDCR_EL2`.HPMN reserves for EL2 use.

When this register has an architecturally-defined reset value, this field resets to 0.

Accessing the PMCR_EL0

This register can be read using MRS with the following syntax:

MRS <Xt>, <systemreg>

This register can be written using MSR (register) with the following syntax:

MSR <systemreg>, <Xt>

This syntax is encoded with the following settings in the instruction encoding:

<systemreg>	op0	op1	CRn	CRm	op2
PMCR_EL0	11	011	1001	1100	000

Accessibility

The register is accessible in software as follows:

Control			Accessibility			
E2H	TGE	NS	EL0	EL1	EL2	EL3
x	x	0	RW	RW	n/a	RW
x	0	1	RW	RW	RW	RW
x	1	1	RW	n/a	RW	RW

Traps and Enables

For a description of the prioritization of any generated exceptions, see [Synchronous exception prioritization for exceptions taken to AArch64 on page D1-1827](#). Subject to the prioritization rules:

- In both security states, and not dependent on other bits:
 - If [PMUSERENR_EL0.EN](#)==0, accesses to this register from EL0 are trapped to EL1.
- When EL2 is implemented and is using AArch64 and [SCR_EL3.NS](#) == 1:
 - If [MDCR_EL2.TPM](#)==1, Non-secure accesses to this register from EL0 and EL1 are trapped to EL2.
 - If [MDCR_EL2.TPMCR](#)==1, Non-secure accesses to this register from EL0 and EL1 are trapped to EL2.
- When EL3 is implemented and is using AArch64:
 - If [MDCR_EL3.TPM](#)==1, accesses to this register from EL0, EL1, and EL2 are trapped to EL3.

D7.4.8 PMEVCNTR<n>_EL0, Performance Monitors Event Count Registers, n = 0 - 30

The PMEVCNTR<n>_EL0 characteristics are:

Purpose

Holds event counter n, which counts events, where n is 0 to 30.

Configurations

AArch64 System register PMEVCNTR<n>_EL0 is architecturally mapped to AArch32 System register [PMEVCNTR<n>](#).

AArch64 System register PMEVCNTR<n>_EL0 is architecturally mapped to External register [PMEVCNTR<n>_EL0](#).

This register is in the Warm reset domain. On a Warm or Cold reset RW fields in this register reset to architecturally UNKNOWN values.

Attributes

PMEVCNTR<n>_EL0 is a 32-bit register.

Field descriptions

The PMEVCNTR<n>_EL0 bit assignments are:

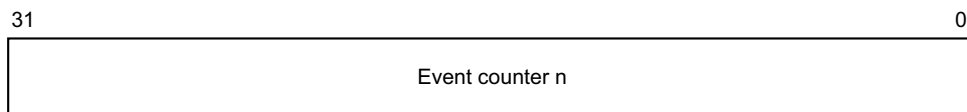

Bits [31:0]

Event counter n. Value of event counter n, where n is the number of this register and is a number from 0 to 30.

Accessing the PMEVCNTR<n>_EL0

This register can be read using MRS with the following syntax:

MRS <Xt>, <systemreg>

This register can be written using MSR (register) with the following syntax:

MSR <systemreg>, <Xt>

This syntax is encoded with the following settings in the instruction encoding:

<systemreg>	op0	op1	CRn	CRm	op2
PMEVCNTR<n>_EL0	11	011	1110	10:n<4:3>	n<2:0>

- <CRm> is in the range 8 - 11.
- <op2> is in the range 0 - 7.

PMEVCNTR<n>_EL0 can also be accessed by using [PMXEVCNTR_EL0](#) with [PMSELR_EL0.SEL](#) set to the value of <n>.

Accessibility

The register is accessible in software as follows:

Control			Accessibility			
E2H	TGE	NS	EL0	EL1	EL2	EL3
x	x	0	RW	RW	n/a	RW
x	0	1	RW	RW	RW	RW
x	1	1	RW	n/a	RW	RW

If $\langle n \rangle$ is greater than or equal to the number of accessible counters, reads and writes of `PMEVCNTR<n>_EL0` are CONstrained UNPREDICTABLE, and the following behaviors are permitted:

- Accesses to the register are UNDEFINED.
- Accesses to the register behave as RAZ/WI.
- Accesses to the register execute as a NOP.
- For an access from Non-secure EL1, or an access from Non-secure EL0 when the value of `PMUSERENR_EL0.EN` is 1, if `PMSELR_EL0.SEL` is greater than or equal to the number of accessible counters but is less than the number of implemented counters, the register access is trapped to EL2.

———— Note ————

In an implementation that includes EL2, in Non-secure state at EL0 and EL1, `MDCR_EL2.HPMN` identifies the number of accessible counters. Otherwise, the number of accessible counters is the number of implemented counters.

Traps and Enables

For a description of the prioritization of any generated exceptions, see [Synchronous exception prioritization for exceptions taken to AArch64 on page D1-1827](#). Subject to the prioritization rules:

- In both security states, and not dependent on other bits:
 - If `PMUSERENR_EL0.EN`==0, and `PMUSERENR_EL0.ER`==0, read accesses to this register from EL0 are trapped to EL1.
 - If `PMUSERENR_EL0.EN`==0, write accesses to this register from EL0 are trapped to EL1.
- When EL2 is implemented and is using AArch64 and `SCR_EL3.NS` == 1:
 - If `MDCR_EL2.TPM`==1, Non-secure accesses to this register from EL0 and EL1 are trapped to EL2.
- When EL3 is implemented and is using AArch64:
 - If `MDCR_EL3.TPM`==1, accesses to this register from EL0, EL1, and EL2 are trapped to EL3.

D7.4.9 PMEVTYPER<n>_EL0, Performance Monitors Event Type Registers, n = 0 - 30

The PMEVTYPER<n>_EL0 characteristics are:

Purpose

Configures event counter n, where n is 0 to 30.

Configurations

AArch64 System register PMEVTYPER<n>_EL0 is architecturally mapped to AArch32 System register [PMEVTYPER<n>](#).

AArch64 System register PMEVTYPER<n>_EL0 is architecturally mapped to External register [PMEVTYPER<n>_EL0](#).

This register is in the Warm reset domain. On a Warm or Cold reset RW fields in this register reset to architecturally UNKNOWN values.

Attributes

PMEVTYPER<n>_EL0 is a 32-bit register.

Field descriptions

The PMEVTYPER<n>_EL0 bit assignments are:

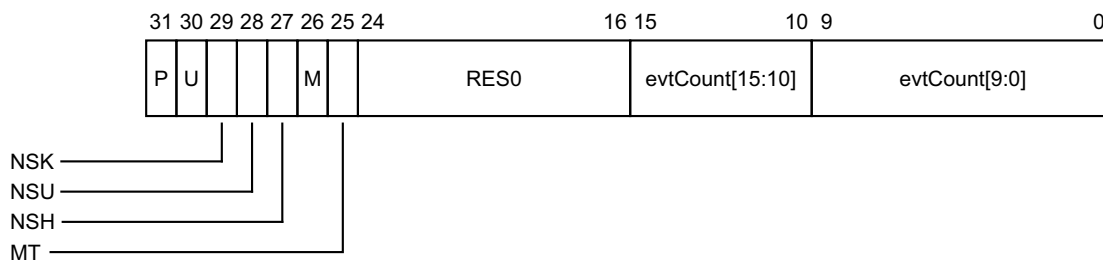

P, bit [31]

Privileged filtering bit. Controls counting in EL1. If EL3 is implemented, then counting in Non-secure EL1 is further controlled by the NSK bit. The possible values of this bit are:

- 0 Count events in EL1.
- 1 Do not count events in EL1.

U, bit [30]

User filtering bit. Controls counting in EL0. If EL3 is implemented, then counting in Non-secure EL0 is further controlled by the NSU bit. The possible values of this bit are:

- 0 Count events in EL0.
- 1 Do not count events in EL0.

NSK, bit [29]

Non-secure EL1 (kernel) modes filtering bit. Controls counting in Non-secure EL1. If EL3 is not implemented, this bit is RES0.

If the value of this bit is equal to the value of P, events in Non-secure EL1 are counted.

Otherwise, events in Non-secure EL1 are not counted.

NSU, bit [28]

Non-secure EL0 (Unprivileged) filtering. Controls counting in Non-secure EL0. If EL3 is not implemented, this bit is RES0.

If the value of this bit is equal to the value of U, events in Non-secure EL0 are counted.

Otherwise, events in Non-secure EL0 are not counted.

NSH, bit [27]

Non-secure EL2 (Hypervisor) filtering. Controls counting in Non-secure EL2. If EL2 is not implemented, this bit is RES0.

- | | |
|---|-----------------------------|
| 0 | Do not count events in EL2. |
| 1 | Count events in EL2. |

M, bit [26]

Secure EL3 filtering bit. If EL3 is not implemented, this bit is RES0.

If the value of this bit is equal to the value of P, cycles in Secure EL3 are counted.

Otherwise, cycles in Secure EL3 are not counted.

Most applications can ignore this field and set its value to 0.

———— **Note** —————

This field is not visible in the AArch32 PMEVTYPER System register.

MT, bit [25]

Multithreading. When the implementation is multi-threaded, the valid values for this bit are:

- | | |
|---|--|
| 0 | Count events only on controlling PE. |
| 1 | Count events from any PE with the same affinity at level 1 and above as this PE. |

When the implementation is not multi-threaded, this bit is RES0.

———— **Note** —————

- An implementation is described as multi-threaded when the lowest level of affinity consists of logical PEs that are implemented using a multi-threading type approach. That is, the performance of PEs at the lowest affinity level is highly interdependent. On such an implementation, the value of MPIDR_EL1.MT, when read at the highest implemented Exception level, is 1.
- Events from a different thread of a multithreaded implementation are not Attributable to the thread counting the event.

Bits [24:16]

Reserved, RES0.

evtCount[15:10], bits [15:10]

In ARMv8.2 and ARMv8.1

Extension to evtCount[9:0]. See evtCount[9:0] for more details.

In ARMv8.0.

Reserved, RES0.

evtCount[9:0], bits [9:0]

Event to count. The event number of the event that is counted by event counter **PMEVCNTR<n>_EL0**.

Software must program this field with an event that is supported by the PE being programmed.

There are three ranges of event numbers:

- Event numbers in the range 0x000 to 0x03F are common architectural and microarchitectural events.
- Event numbers in the range 0x040 to 0x0BF are ARM recommended common architectural and microarchitectural events.
- Event numbers in the range 0x0C0 to 0x3FF are IMPLEMENTATION DEFINED events.

If evtCount is programmed to an event that is reserved or not supported by the PE, the behavior depends on the event type:

- For the range 0x000 to 0x03F, no events are counted, and the value returned by a direct or external read of the evtCount field is the value written to the field.
- For IMPLEMENTATION DEFINED events, it is UNPREDICTABLE what event, if any, is counted, and the value returned by a direct or external read of the evtCount field is UNKNOWN.

———— **Note** —————

UNPREDICTABLE means the event must not expose privileged information.

ARM recommends that the behavior across a family of implementations is defined such that if a given implementation does not include an event from a set of common IMPLEMENTATION DEFINED events, then no event is counted and the value read back on evtCount is the value written.

Accessing the PMEVTYPER<n>_EL0

This register can be read using MRS with the following syntax:

MRS <Xt>, <systemreg>

This register can be written using MSR (register) with the following syntax:

MSR <systemreg>, <Xt>

This syntax is encoded with the following settings in the instruction encoding:

<systemreg>	op0	op1	CRn	CRm	op2
PMEVTYPER<n>_EL0	11	011	1110	11:n<4:3>	n<2:0>

- <CRm> is in the range 12 - 15.
- <op2> is in the range 0 - 7.

Accessibility

The register is accessible in software as follows:

Control			Accessibility			
E2H	TGE	NS	EL0	EL1	EL2	EL3
x	x	0	RW	RW	n/a	RW
x	0	1	RW	RW	RW	RW
x	1	1	RW	n/a	RW	RW

PMEVTYPER<n>_EL0 can also be accessed by using PMXEVTYPER_EL0 with PMSELR_EL0.SEL set to n.

If <n> is greater than or equal to the number of accessible counters, reads and writes of PMEVTYPER<n>_EL0 are CONSTRAINED UNPREDICTABLE, and the following behaviors are permitted:

- Accesses to the register are UNDEFINED.
- Accesses to the register behave as RAZ/WI.
- Accesses to the register execute as a NOP.

- For an access from Non-secure EL1, or an access from Non-secure EL0 when the value of [PMUSERENR_EL0.EN](#) is 1, if [PMSELR_EL0.SEL](#) is greater than or equal to the number of accessible counters but is less than the number of implemented counters, the register access is trapped to EL2.

———— **Note** —————

In an implementation that includes EL2, in Non-secure state at EL0 and EL1, [MDCR_EL2.HPMN](#) identifies the number of accessible counters. Otherwise, the number of accessible counters is the number of implemented counters.

Traps and Enables

For a description of the prioritization of any generated exceptions, see [Synchronous exception prioritization for exceptions taken to AArch64 on page D1-1827](#). Subject to the prioritization rules:

- In both security states, and not dependent on other bits:
 - If [PMUSERENR_EL0.EN](#)==0, accesses to this register from EL0 are trapped to EL1.
- When EL2 is implemented and is using AArch64 and [SCR_EL3.NS](#) == 1:
 - If [MDCR_EL2.TPM](#)==1, Non-secure accesses to this register from EL0 and EL1 are trapped to EL2.
- When EL3 is implemented and is using AArch64:
 - If [MDCR_EL3.TPM](#)==1, accesses to this register from EL0, EL1, and EL2 are trapped to EL3.

D7.4.10 PMINTENCLR_EL1, Performance Monitors Interrupt Enable Clear register

The PMINTENCLR_EL1 characteristics are:

Purpose

Disables the generation of interrupt requests on overflows from the Cycle Count Register, [PMCCNTR_ELO](#), and the event counters [PMEVCNTR<n>_ELO](#). Reading the register shows which overflow interrupt requests are enabled.

Configurations

AArch64 System register PMINTENCLR_EL1 is architecturally mapped to AArch32 System register [PMINTENCLR](#).

AArch64 System register PMINTENCLR_EL1 is architecturally mapped to External register [PMINTENCLR_EL1](#).

This register is in the Warm reset domain. On a Warm or Cold reset RW fields in this register reset to architecturally UNKNOWN values.

Attributes

PMINTENCLR_EL1 is a 32-bit register.

Field descriptions

The PMINTENCLR_EL1 bit assignments are:

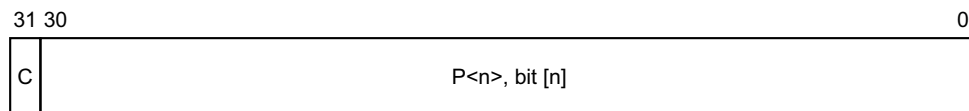

C, bit [31]

[PMCCNTR_ELO](#) overflow interrupt request disable bit. Possible values are:

- 0 When read, means the cycle counter overflow interrupt request is disabled. When written, has no effect.
- 1 When read, means the cycle counter overflow interrupt request is enabled. When written, disables the cycle count overflow interrupt request.

P<n>, bit [n], for n = 0 to 30

Event counter overflow interrupt request disable bit for [PMEVCNTR<n>_ELO](#).

When EL2 is implemented, in Non-secure EL1 and EL0, N is the value in [MDCR_EL2.HPMN](#). Otherwise, N is the value in [PMCR_ELO.N](#).

Bits [30:N] are RAZ/WI.

Possible values are:

- 0 When read, means that the [PMEVCNTR<n>_ELO](#) event counter interrupt request is disabled. When written, has no effect.
- 1 When read, means that the [PMEVCNTR<n>_ELO](#) event counter interrupt request is enabled. When written, disables the [PMEVCNTR<n>_ELO](#) interrupt request.

Accessing the PMINTENCLR_EL1

This register can be read using MRS with the following syntax:

```
MRS <Xt>, <systemreg>
```

This register can be written using MSR (register) with the following syntax:

MSR <systemreg>, <Xt>

This syntax is encoded with the following settings in the instruction encoding:

<systemreg>	op0	op1	CRn	CRm	op2
PMINTENCLR_EL1	11	000	1001	1110	010

Accessibility

The register is accessible in software as follows:

Control			Accessibility			
E2H	TGE	NS	EL0	EL1	EL2	EL3
x	x	0	RW	RW	n/a	RW
x	0	1	RW	RW	RW	RW
x	1	1	RW	n/a	RW	RW

Traps and Enables

For a description of the prioritization of any generated exceptions, see [Synchronous exception prioritization for exceptions taken to AArch64 on page D1-1827](#). Subject to the prioritization rules:

- When EL2 is implemented and is using AArch64 and SCR_EL3.NS == 1:
 - If MDCR_EL2.TPM==1, Non-secure accesses to this register from EL1 are trapped to EL2.
- When EL3 is implemented and is using AArch64:
 - If MDCR_EL3.TPM==1, accesses to this register from EL1 and EL2 are trapped to EL3.

D7.4.11 PMINTENSET_EL1, Performance Monitors Interrupt Enable Set register

The PMINTENSET_EL1 characteristics are:

Purpose

Enables the generation of interrupt requests on overflows from the Cycle Count Register, [PMCCNTR_ELO](#), and the event counters [PMEVCNTR<n>_ELO](#). Reading the register shows which overflow interrupt requests are enabled.

Configurations

AArch64 System register PMINTENSET_EL1 is architecturally mapped to AArch32 System register [PMINTENSET](#).

AArch64 System register PMINTENSET_EL1 is architecturally mapped to External register [PMINTENSET_EL1](#).

This register is in the Warm reset domain. On a Warm or Cold reset RW fields in this register reset to architecturally UNKNOWN values.

Attributes

PMINTENSET_EL1 is a 32-bit register.

Field descriptions

The PMINTENSET_EL1 bit assignments are:

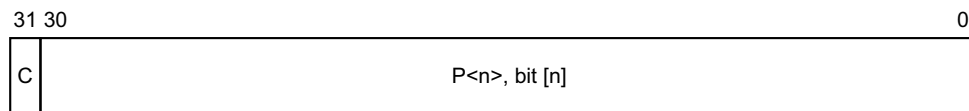

C, bit [31]

[PMCCNTR_ELO](#) overflow interrupt request enable bit. Possible values are:

- 0 When read, means the cycle counter overflow interrupt request is disabled. When written, has no effect.
- 1 When read, means the cycle counter overflow interrupt request is enabled. When written, enables the cycle count overflow interrupt request.

P<n>, bit [n], for n = 0 to 30

Event counter overflow interrupt request enable bit for [PMEVCNTR<n>_ELO](#).

When EL2 is implemented, in Non-secure EL1 and EL0, N is the value in [MDCR_EL2.HPMN](#). Otherwise, N is the value in [PMCR_ELO.N](#).

Bits [30:N] are RAZ/WI.

Possible values are:

- 0 When read, means that the [PMEVCNTR<n>_ELO](#) event counter interrupt request is disabled. When written, has no effect.
- 1 When read, means that the [PMEVCNTR<n>_ELO](#) event counter interrupt request is enabled. When written, enables the [PMEVCNTR<n>_ELO](#) interrupt request.

Accessing the PMINTENSET_EL1

This register can be read using MRS with the following syntax:

```
MRS <Xt>, <systemreg>
```

This register can be written using MSR (register) with the following syntax:

MSR <systemreg>, <Xt>

This syntax is encoded with the following settings in the instruction encoding:

<systemreg>	op0	op1	CRn	CRm	op2
PMINTENSET_EL1	11	000	1001	1110	001

Accessibility

The register is accessible in software as follows:

Control			Accessibility			
E2H	TGE	NS	EL0	EL1	EL2	EL3
x	x	0	RW	RW	n/a	RW
x	0	1	RW	RW	RW	RW
x	1	1	RW	n/a	RW	RW

Traps and Enables

For a description of the prioritization of any generated exceptions, see [Synchronous exception prioritization for exceptions taken to AArch64 on page D1-1827](#). Subject to the prioritization rules:

- When EL2 is implemented and is using AArch64 and SCR_EL3.NS == 1:
 - If MDCR_EL2.TPM==1, Non-secure accesses to this register from EL1 are trapped to EL2.
- When EL3 is implemented and is using AArch64:
 - If MDCR_EL3.TPM==1, accesses to this register from EL1 and EL2 are trapped to EL3.

D7.4.12 PMOVSCLR_EL0, Performance Monitors Overflow Flag Status Clear Register

The PMOVSCLR_EL0 characteristics are:

Purpose

Contains the state of the overflow bit for the Cycle Count Register, [PMCCNTR_EL0](#), and each of the implemented event counters [PMEVCNTR<n>](#). Writing to this register clears these bits.

Configurations

AArch64 System register PMOVSCLR_EL0 is architecturally mapped to AArch32 System register [PMOVSRR](#).

AArch64 System register PMOVSCLR_EL0 is architecturally mapped to External register [PMOVSCLR_EL0](#).

This register is in the Warm reset domain. On a Warm or Cold reset RW fields in this register reset to architecturally UNKNOWN values.

Attributes

PMOVSCLR_EL0 is a 32-bit register.

Field descriptions

The PMOVSCLR_EL0 bit assignments are:

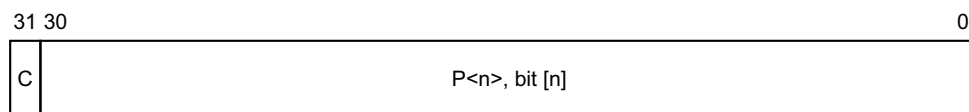

C, bit [31]

[PMCCNTR_EL0](#) overflow bit. Possible values are:

- 0 When read, means the cycle counter has not overflowed. When written, has no effect.
- 1 When read, means the cycle counter has overflowed. When written, clears the overflow bit to 0.

[PMCR_EL0](#).LC controls whether an overflow is detected from [PMCCNTR_EL0](#)[31] or from [PMCCNTR_EL0](#).

P<n>, bit [n], for n = 0 to 30

Event counter overflow clear bit for [PMEVCNTR<n>_EL0](#).

Bits [30:N] are RAZ/WI.

When EL2 is implemented, in Non-secure EL1 and EL0, N is the value in [MDCR_EL2](#).HPMN. Otherwise, N is the value in [PMCR_EL0](#).N.

Possible values of each bit are:

- 0 When read, means that [PMEVCNTR<n>_EL0](#) has not overflowed. When written, has no effect.
- 1 When read, means that [PMEVCNTR<n>_EL0](#) has overflowed. When written, clears the [PMEVCNTR<n>_EL0](#) overflow bit to 0.

Accessing the PMOVSCLR_EL0

This register can be read using MRS with the following syntax:

```
MRS <Xt>, <systemreg>
```

This register can be written using MSR (register) with the following syntax:

MSR <systemreg>, <Xt>

This syntax is encoded with the following settings in the instruction encoding:

<systemreg>	op0	op1	CRn	CRm	op2
PMOVSLR_EL0	11	011	1001	1100	011

Accessibility

The register is accessible in software as follows:

Control			Accessibility			
E2H	TGE	NS	EL0	EL1	EL2	EL3
x	x	0	RW	RW	n/a	RW
x	0	1	RW	RW	RW	RW
x	1	1	RW	n/a	RW	RW

Traps and Enables

For a description of the prioritization of any generated exceptions, see [Synchronous exception prioritization for exceptions taken to AArch64 on page D1-1827](#). Subject to the prioritization rules:

- In both security states, and not dependent on other bits:
 - If [PMUSERENR_EL0.EN](#)==0, accesses to this register from EL0 are trapped to EL1.
- When EL2 is implemented and is using AArch64 and [SCR_EL3.NS](#) == 1:
 - If [MDCR_EL2.TPM](#)==1, Non-secure accesses to this register from EL0 and EL1 are trapped to EL2.
- When EL3 is implemented and is using AArch64:
 - If [MDCR_EL3.TPM](#)==1, accesses to this register from EL0, EL1, and EL2 are trapped to EL3.

D7.4.13 PMOVSSET_EL0, Performance Monitors Overflow Flag Status Set register

The PMOVSSET_EL0 characteristics are:

Purpose

Sets the state of the overflow bit for the Cycle Count Register, [PMCCNTR_EL0](#), and each of the implemented event counters [PMEVCNTR<n>](#).

Configurations

AArch64 System register PMOVSSET_EL0 is architecturally mapped to AArch32 System register [PMOVSSET](#).

AArch64 System register PMOVSSET_EL0 is architecturally mapped to External register [PMOVSSET_EL0](#).

This register is in the Warm reset domain. On a Warm or Cold reset RW fields in this register reset to architecturally UNKNOWN values.

Attributes

PMOVSSET_EL0 is a 32-bit register.

Field descriptions

The PMOVSSET_EL0 bit assignments are:

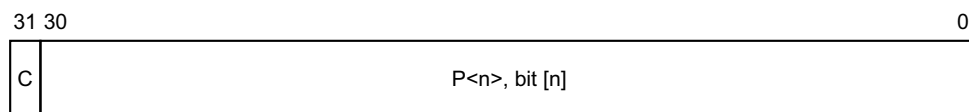

C, bit [31]

[PMCCNTR_EL0](#) overflow bit. Possible values are:

- 0 When read, means the cycle counter has not overflowed. When written, has no effect.
- 1 When read, means the cycle counter has overflowed. When written, sets the overflow bit to 1.

P<n>, bit [n], for n = 0 to 30

Event counter overflow set bit for [PMEVCNTR<n>_EL0](#).

Bits [30:N] are RAZ/WI.

When EL2 is implemented, in Non-secure EL1 and EL0, N is the value in [MDCR_EL2.HPMN](#). Otherwise, N is the value in [PMCR_EL0.N](#).

Possible values are:

- 0 When read, means that [PMEVCNTR<n>_EL0](#) has not overflowed. When written, has no effect.
- 1 When read, means that [PMEVCNTR<n>_EL0](#) has overflowed. When written, sets the [PMEVCNTR<n>_EL0](#) overflow bit to 1.

Accessing the PMOVSSET_EL0

This register can be read using MRS with the following syntax:

```
MRS <Xt>, <systemreg>
```

This register can be written using MSR (register) with the following syntax:

```
MSR <systemreg>, <Xt>
```

This syntax is encoded with the following settings in the instruction encoding:

<systemreg>	op0	op1	CRn	CRm	op2
PMOVSSET_ELO	11	011	1001	1110	011

Accessibility

The register is accessible in software as follows:

Control			Accessibility			
E2H	TGE	NS	EL0	EL1	EL2	EL3
x	x	0	RW	RW	n/a	RW
x	0	1	RW	RW	RW	RW
x	1	1	RW	n/a	RW	RW

Traps and Enables

For a description of the prioritization of any generated exceptions, see [Synchronous exception prioritization for exceptions taken to AArch64 on page D1-1827](#). Subject to the prioritization rules:

- In both security states, and not dependent on other bits:
 - If `PMUSERENR_ELO.EN==0`, accesses to this register from EL0 are trapped to EL1.
- When EL2 is implemented and is using AArch64 and `SCR_EL3.NS == 1`:
 - If `MDCR_EL2.TPM==1`, Non-secure accesses to this register from EL0 and EL1 are trapped to EL2.
- When EL3 is implemented and is using AArch64:
 - If `MDCR_EL3.TPM==1`, accesses to this register from EL0, EL1, and EL2 are trapped to EL3.

D7.4.14 PMSELR_EL0, Performance Monitors Event Counter Selection Register

The PMSELR_EL0 characteristics are:

Purpose

Selects the current event counter [PMEVCNTR<n>](#) or the cycle counter, CCNT.

PMSELR_EL0 is used in conjunction with [PMXEVTYPYPER_EL0](#) to determine the event that increments a selected event counter, and the modes and states in which the selected counter increments.

It is also used in conjunction with [PMXEVCNTR_EL0](#), to determine the value of a selected event counter.

Configurations

AArch64 System register PMSELR_EL0 is architecturally mapped to AArch32 System register [PMSELR](#).

This register is in the Warm reset domain. On a Warm or Cold reset RW fields in this register reset to architecturally UNKNOWN values.

Attributes

PMSELR_EL0 is a 32-bit register.

Field descriptions

The PMSELR_EL0 bit assignments are:

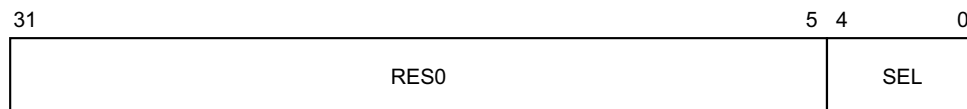

Bits [31:5]

Reserved, RES0.

SEL, bits [4:0]

Selects event counter, [PMEVCNTR<n>](#), where n is the value held in this field. This value identifies which event counter is accessed when a subsequent access to [PMXEVTYPYPER_EL0](#) or [PMXEVCNTR_EL0](#) occurs.

This field can take any value from 0 (0b00000) to (PMCR.N)-1, or 31 (0b11111).

When PMSELR_EL0.SEL is 0b11111 it selects the cycle counter and:

- A read of the [PMXEVTYPYPER_EL0](#) returns the value of [PMCCFILTR_EL0](#).
- A write of the [PMXEVTYPYPER_EL0](#) writes to [PMCCFILTR_EL0](#).
- A read or write of [PMXEVCNTR_EL0](#) has CONSTRAINED UNPREDICTABLE effects, that can be one of the following:
 - Access to [PMXEVCNTR_EL0](#) is UNDEFINED.
 - Access to [PMXEVCNTR_EL0](#) behaves as a NOP.
 - Access to [PMXEVCNTR_EL0](#) behaves as if the register is RAZ/WI.
 - Access to [PMXEVCNTR_EL0](#) behaves as if the PMSELR_EL0.SEL field contains an UNKNOWN value.

If this field is set to a value greater than or equal to the number of implemented counters, but not equal to 31, the results of access to [PMXEVTYPYPER_EL0](#) or [PMXEVCNTR_EL0](#) are CONSTRAINED UNPREDICTABLE, and can be one of the following:

- Access to [PMXEVTYPYPER_EL0](#) or [PMXEVCNTR_EL0](#) is UNDEFINED.

- Access to [PMXEVTYPYPER_EL0](#) or [PMXEVCNTR_EL0](#) behaves as a NOP.
- Access to [PMXEVTYPYPER_EL0](#) or [PMXEVCNTR_EL0](#) behaves as if the register is RAZ/WI.
- Access to [PMXEVTYPYPER_EL0](#) or [PMXEVCNTR_EL0](#) behaves as if the [PMSELR_EL0.SEL](#) field contains an UNKNOWN value.
- Access to [PMXEVTYPYPER_EL0](#) or [PMXEVCNTR_EL0](#) behaves as if the [PMSELR_EL0.SEL](#) field contains 0b11111.

Direct reads of this field return an UNKNOWN value.

Accessing the PMSELR_EL0

This register can be read using MRS with the following syntax:

MRS <Xt>, <systemreg>

This register can be written using MSR (register) with the following syntax:

MSR <systemreg>, <Xt>

This syntax is encoded with the following settings in the instruction encoding:

<systemreg>	op0	op1	CRn	CRm	op2
PMSELR_EL0	11	011	1001	1100	101

Accessibility

The register is accessible in software as follows:

Control			Accessibility			
E2H	TGE	NS	EL0	EL1	EL2	EL3
x	x	0	RW	RW	n/a	RW
x	0	1	RW	RW	RW	RW
x	1	1	RW	n/a	RW	RW

Traps and Enables

For a description of the prioritization of any generated exceptions, see [Synchronous exception prioritization for exceptions taken to AArch64 on page D1-1827](#). Subject to the prioritization rules:

- In both security states, and not dependent on other bits:
 - If [PMUSERENR_EL0.EN](#)==0, and [PMUSERENR_EL0.ER](#)==0, accesses to this register from EL0 are trapped to EL1.
- When EL2 is implemented and is using AArch64 and [SCR_EL3.NS](#) == 1:
 - If [MDCR_EL2.TPM](#)==1, Non-secure accesses to this register from EL0 and EL1 are trapped to EL2.
- When EL3 is implemented and is using AArch64:
 - If [MDCR_EL3.TPM](#)==1, accesses to this register from EL0, EL1, and EL2 are trapped to EL3.

D7.4.15 PMSWINC_EL0, Performance Monitors Software Increment register

The PMSWINC_EL0 characteristics are:

Purpose

Increments a counter that is configured to count the Software increment event, event 0x00. For more information, see [SW_INCR](#).

Configurations

AArch64 System register PMSWINC_EL0 is architecturally mapped to AArch32 System register [PMSWINC](#).

AArch64 System register PMSWINC_EL0 is architecturally mapped to External register [PMSWINC_EL0](#).

Attributes

PMSWINC_EL0 is a 32-bit register.

Field descriptions

The PMSWINC_EL0 bit assignments are:

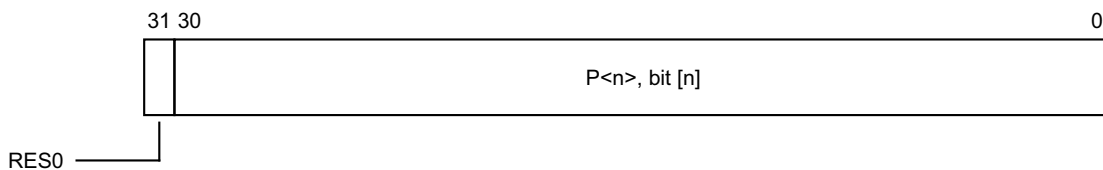

Bit [31]

Reserved, RES0.

P<n>, bit [n], for n = 0 to 30

Event counter software increment bit for [PMEVCNTR<n>_EL0](#).

Bits [30:N] are WI.

When EL2 is implemented, in Non-secure EL1 and EL0, N is the value in [MDCR_EL2.HPMN](#). Otherwise, N is the value in [PMCR.N](#).

The effects of writing to this bit are:

- 0 No action. The write to this bit is ignored.
- 1 If [PMEVCNTR<n>_EL0](#) is enabled and configured to count the software increment event, increments [PMEVCNTR<n>_EL0](#) by 1. If [PMEVCNTR<n>_EL0](#) is disabled, or not configured to count the software increment event, the write to this bit is ignored.

Accessing the PMSWINC_EL0

This register can be read using MRS with the following syntax:

```
MRS <Xt>, <systemreg>
```

This register can be written using MSR (register) with the following syntax:

```
MSR <systemreg>, <Xt>
```

This syntax is encoded with the following settings in the instruction encoding:

<systemreg>	op0	op1	CRn	CRm	op2
PMSWINC_ELO	11	011	1001	1100	100

Accessibility

The register is accessible in software as follows:

Control			Accessibility			
E2H	TGE	NS	EL0	EL1	EL2	EL3
x	x	0	RW	RW	n/a	RW
x	0	1	RW	RW	RW	RW
x	1	1	RW	n/a	RW	RW

Traps and Enables

For a description of the prioritization of any generated exceptions, see [Synchronous exception prioritization for exceptions taken to AArch64 on page D1-1827](#). Subject to the prioritization rules:

- In both security states, and not dependent on other bits:
 - If `PMUSERENR_ELO.EN==0`, and `PMUSERENR_ELO.SW==0`, write accesses to this register from EL0 are trapped to EL1.
- When EL2 is implemented and is using AArch64 and `SCR_EL3.NS == 1`:
 - If `MDCR_EL2.TPM==1`, Non-secure write accesses to this register from EL0 and EL1 are trapped to EL2.
- When EL3 is implemented and is using AArch64:
 - If `MDCR_EL3.TPM==1`, write accesses to this register from EL0, EL1, and EL2 are trapped to EL3.

D7.4.16 PMUSERENR_EL0, Performance Monitors User Enable Register

The PMUSERENR_EL0 characteristics are:

Purpose

Enables or disables EL0 access to the Performance Monitors.

Configurations

AArch64 System register PMUSERENR_EL0 is architecturally mapped to AArch32 System register [PMUSERENR](#).

This register is in the Warm reset domain. On a Warm or Cold reset RW fields in this register reset to architecturally UNKNOWN values.

Attributes

PMUSERENR_EL0 is a 32-bit register.

Field descriptions

The PMUSERENR_EL0 bit assignments are:

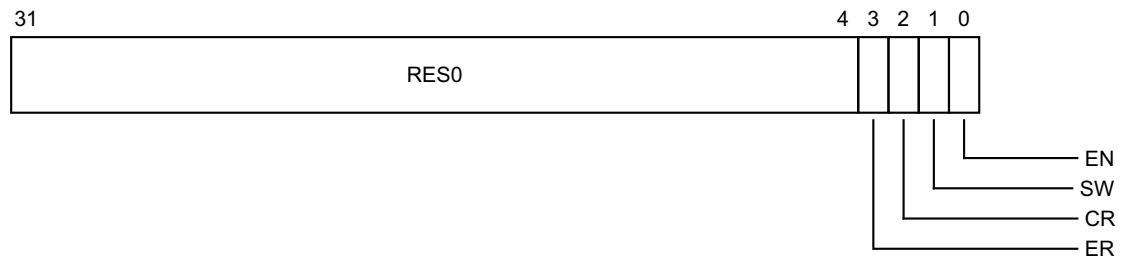

Bits [31:4]

Reserved, RES0.

ER, bit [3]

Event counter read trap control:

0 EL0 using AArch64: EL0 reads of the [PMXVCNTR_EL0](#) and [PMEVCNTR<n>_EL0](#), and EL0 read/write accesses to the [PMSELR_EL0](#), are trapped to EL1 if PMUSERENR_EL0.EN is also 0.

EL0 using AArch32: EL0 reads of the [PMXVCNTR](#) and [PMEVCNTR<n>](#), and EL0 read/write accesses to the [PMSELR](#), are trapped to EL1 if PMUSERENR_EL0.EN is also 0.

1 This control does not cause any instructions to be trapped.

CR, bit [2]

Cycle counter read trap control:

0 EL0 using AArch64: EL0 read accesses to the [PMCCNTR_EL0](#) are trapped to EL1 if PMUSERENR_EL0.EN is also 0.

EL0 using AArch32: EL0 read accesses to the [PMCCNTR](#) are trapped to EL1 if PMUSERENR_EL0.EN is also 0.

1 This control does not cause any instructions to be trapped.

SW, bit [1]

Software Increment write trap control:

0 EL0 using AArch64: EL0 writes to the [PMSWINC_EL0](#) are trapped to EL1 if PMUSERENR_EL0.EN is also 0.

EL0 using AArch32: EL0 writes to the [PMSWINC](#) are trapped to EL1 if [PMUSERENR_EL0.EN](#) is also 0.

- 1 This control does not cause any instructions to be trapped.

EN, bit [0]

Traps EL0 accesses to the Performance Monitors registers to EL1, from both Execution states:

- 0 EL0 accesses to the Performance Monitors registers are trapped to EL1, unless enabled by one of [PMUSERENR_EL0](#).{ER, CR, SW}.
- 1 This control does not cause any instructions to be trapped. Software can access all PMU registers at EL0.

———— **Note** —————

- The [PMUSERENR_EL0](#) and [PMUSERENR](#) registers are always RO at EL0 and not trapped by this bit.
- EL0 cannot read or write [PMINTENSET_EL1](#) and [PMINTENCLR_EL1](#), or [PMINTENSET](#) and [PMINTENCLR](#).

Accessing the PMUSERENR_EL0

This register can be read using MRS with the following syntax:

MRS <Xt>, <systemreg>

This register can be written using MSR (register) with the following syntax:

MSR <systemreg>, <Xt>

This syntax is encoded with the following settings in the instruction encoding:

<systemreg>	op0	op1	CRn	CRm	op2
PMUSERENR_EL0	11	011	1001	1110	000

Accessibility

The register is accessible in software as follows:

Control			Accessibility			
E2H	TGE	NS	EL0	EL1	EL2	EL3
x	x	0	RO	RW	n/a	RW
x	0	1	RO	RW	RW	RW
x	1	1	RO	n/a	RW	RW

Traps and Enables

For a description of the prioritization of any generated exceptions, see [Synchronous exception prioritization for exceptions taken to AArch64 on page D1-1827](#). Subject to the prioritization rules:

- When EL2 is implemented and is using AArch64 and [SCR_EL3.NS](#) == 1:
 - If [MDCR_EL2.TPM](#)==1, Non-secure accesses to this register from EL0 and EL1 are trapped to EL2.

- When EL3 is implemented and is using AArch64:
 - If [MDCR_EL3.TPM](#)=1, accesses to this register from EL0, EL1, and EL2 are trapped to EL3.

D7.4.17 PMXEVNTR_EL0, Performance Monitors Selected Event Count Register

The PMXEVNTR_EL0 characteristics are:

Purpose

Reads or writes the value of the selected event counter, [PMXEVNTR<n>_EL0](#). [PMSELR_EL0](#).SEL determines which event counter is selected.

Configurations

AArch64 System register PMXEVNTR_EL0 is architecturally mapped to AArch32 System register [PMXEVNTR](#).

This register is in the Warm reset domain. On a Warm or Cold reset RW fields in this register reset to architecturally UNKNOWN values.

Attributes

PMXEVNTR_EL0 is a 32-bit register.

Field descriptions

The PMXEVNTR_EL0 bit assignments are:

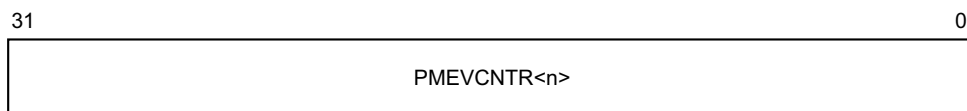

PMXEVNTR<n>, bits [31:0]

Value of the selected event counter, [PMXEVNTR<n>_EL0](#), where n is the value stored in [PMSELR_EL0](#).SEL.

Accessing the PMXEVNTR_EL0

This register can be read using MRS with the following syntax:

MRS <Xt>, <systemreg>

This register can be written using MSR (register) with the following syntax:

MSR <systemreg>, <Xt>

This syntax is encoded with the following settings in the instruction encoding:

<systemreg>	op0	op1	CRn	CRm	op2
PMXEVNTR_EL0	11	011	1001	1101	010

Accessibility

The register is accessible in software as follows:

Control			Accessibility			
E2H	TGE	NS	EL0	EL1	EL2	EL3
x	x	0	RW	RW	n/a	RW
x	0	1	RW	RW	RW	RW
x	1	1	RW	n/a	RW	RW

If `PMSELR_EL0.SEL` is greater than or equal to the number of accessible counters then reads and writes of `PMXVCNTR_EL0` are CONstrained UNPREDICTABLE, and the following behaviors are permitted:

- Accesses to the register are UNDEFINED.
- Accesses to the register behave as RAZ/WI.
- Accesses to the register execute as a NOP.
- Accesses to the register behave as if `PMSELR_EL0.SEL` has an UNKNOWN value less than the number of counters accessible at the current Exception level and Security state.
- Accesses to the register behave as if `PMSELR_EL0.SEL` is 31.
- For an access from Non-secure EL1, or an access from Non-secure EL0 when the value of `PMUSERENR_EL0.EN` is 1, if `PMSELR_EL0.SEL` is greater than or equal to the number of accessible counters but is less than the number of implemented counters, the register access is trapped to EL2.

———— Note ————

In an implementation that includes EL2, in Non-secure state at EL0 and EL1, `MDCR_EL2.HPMN` identifies the number of accessible counters. Otherwise, the number of accessible counters is the number of implemented counters.

Traps and Enables

For a description of the prioritization of any generated exceptions, see [Synchronous exception prioritization for exceptions taken to AArch64 on page D1-1827](#). Subject to the prioritization rules:

- In both security states, and not dependent on other bits:
 - If `PMUSERENR_EL0.EN`==0, and `PMUSERENR_EL0.ER`==0, read accesses to this register from EL0 are trapped to EL1.
 - If `PMUSERENR_EL0.EN`==0, write accesses to this register from EL0 are trapped to EL1.
- When EL2 is implemented and is using AArch64 and `SCR_EL3.NS` == 1:
 - If `MDCR_EL2.TPM`==1, Non-secure accesses to this register from EL0 and EL1 are trapped to EL2.
- When EL3 is implemented and is using AArch64:
 - If `MDCR_EL3.TPM`==1, accesses to this register from EL0, EL1, and EL2 are trapped to EL3.

D7.4.18 PMXEVTYPER_ELO, Performance Monitors Selected Event Type Register

The PMXEVTYPER_ELO characteristics are:

Purpose

When [PMSELR_ELO.SEL](#) selects an event counter, this accesses a [PMEVTYPER<n>_ELO](#) register. When [PMSELR_ELO.SEL](#) selects the cycle counter, this accesses [PMCCFILTR_ELO](#).

Configurations

AArch64 System register PMXEVTYPER_ELO is architecturally mapped to AArch32 System register [PMXEVTYPER](#).

This register is in the Warm reset domain. On a Warm or Cold reset RW fields in this register reset to architecturally UNKNOWN values.

Attributes

PMXEVTYPER_ELO is a 32-bit register.

Field descriptions

The PMXEVTYPER_ELO bit assignments are:

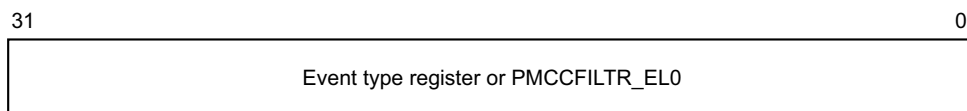

Bits [31:0]

Event type register or [PMCCFILTR_ELO](#).

When [PMSELR_ELO.SEL](#) == 31, this register accesses [PMCCFILTR_ELO](#).

Otherwise, this register accesses [PMEVTYPER<n>_ELO](#) where n is the value in [PMSELR_ELO.SEL](#).

Accessing the PMXEVTYPER_ELO

This register can be read using MRS with the following syntax:

MRS <Xt>, <systemreg>

This register can be written using MSR (register) with the following syntax:

MSR <systemreg>, <Xt>

This syntax is encoded with the following settings in the instruction encoding:

<systemreg>	op0	op1	CRn	CRm	op2
PMXEVTYPER_ELO	11	011	1001	1101	001

Accessibility

The register is accessible in software as follows:

Control			Accessibility			
E2H	TGE	NS	EL0	EL1	EL2	EL3
x	x	0	RW	RW	n/a	RW
x	0	1	RW	RW	RW	RW
x	1	1	RW	n/a	RW	RW

If `PMSELR_EL0.SEL` is greater than or equal to the number of accessible counters then reads and writes of `PMXEVTYPER_EL0` are CONstrained UNPREDICTABLE, and the following behaviors are permitted:

- Accesses to the register are UNDEFINED.
- Accesses to the register behave as RAZ/WI.
- Accesses to the register execute as a NOP.
- Accesses to the register behave as if `PMSELR_EL0.SEL` has an UNKNOWN value less than the number of counters accessible at the current Exception level and Security state.
- Accesses to the register behave as if `PMSELR_EL0.SEL` is 31.
- For an access from Non-secure EL1, or an access from Non-secure EL0 when the value of `PMUSERENR_EL0.EN` is 1, if `PMSELR_EL0.SEL` is greater than or equal to the number of accessible counters but is less than the number of implemented counters, the register access is trapped to EL2.

———— Note ————

In an implementation that includes EL2, in Non-secure state at EL0 and EL1, `MDCR_EL2.HPMN` identifies the number of accessible counters. Otherwise, the number of accessible counters is the number of implemented counters.

Traps and Enables

For a description of the prioritization of any generated exceptions, see *Synchronous exception prioritization for exceptions taken to AArch64* on page D1-1827. Subject to the prioritization rules:

- In both security states, and not dependent on other bits:
 - If `PMUSERENR_EL0.EN`==0, accesses to this register from EL0 are trapped to EL1.
- When EL2 is implemented and is using AArch64 and `SCR_EL3.NS` == 1:
 - If `MDCR_EL2.TPM`==1, Non-secure accesses to this register from EL0 and EL1 are trapped to EL2.
- When EL3 is implemented and is using AArch64:
 - If `MDCR_EL3.TPM`==1, accesses to this register from EL0, EL1, and EL2 are trapped to EL3.

D7.5 Generic Timer registers

This section lists the Generic Timer registers in AArch64.

D7.5.1 CNTFRQ_EL0, Counter-timer Frequency register

The CNTFRQ_EL0 characteristics are:

Purpose

This register is provided so that software can discover the frequency of the system counter. It must be programmed with this value as part of system initialization. The value of the register is not interpreted by hardware.

Configurations

AArch64 System register CNTFRQ_EL0 is architecturally mapped to AArch32 System register [CNTFRQ](#).

RW fields in this register reset to architecturally UNKNOWN values.

Attributes

CNTFRQ_EL0 is a 32-bit register.

Field descriptions

The CNTFRQ_EL0 bit assignments are:

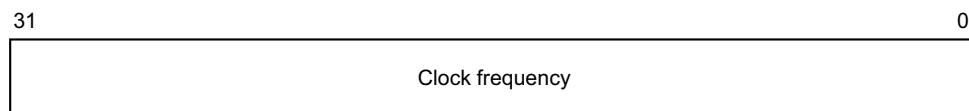

Bits [31:0]

Clock frequency. Indicates the system counter clock frequency, in Hz.

Accessing the CNTFRQ_EL0

This register can be read using MRS with the following syntax:

MRS <Xt>, <systemreg>

This register can be written using MSR (register) with the following syntax:

MSR <systemreg>, <Xt>

This syntax is encoded with the following settings in the instruction encoding:

<systemreg>	op0	op1	CRn	CRm	op2
CNTFRQ_EL0	11	011	1110	0000	000

Accessibility

The register is accessible in software as follows:

Configuration	Control			Accessibility			
	E2H	TGE	NS	EL0	EL1	EL2	EL3
EL1 is the highest implemented Exception level.	x	x	x	RO	RW	n/a	n/a
EL2 is the highest implemented Exception level.	x	0	1	RO	RO	RW	n/a
EL2 is the highest implemented Exception level.	x	1	1	RO	n/a	RW	n/a
EL3 is the highest implemented Exception level.	x	x	0	RO	RO	RO	RW
EL3 is the highest implemented Exception level.	x	0	1	RO	RO	RO	RW
EL3 is the highest implemented Exception level.	x	1	1	RO	n/a	RO	RW

Traps and Enables

For a description of the prioritization of any generated exceptions, see [Synchronous exception prioritization for exceptions taken to AArch64 on page D1-1827](#). Subject to the prioritization rules:

- When $\text{HCR_EL2.E2H} == 0$:
 - If $\text{CNTKCTL_EL1.EL0PCTEN} == 0$, and $\text{CNTKCTL_EL1.EL0VCTEN} == 0$, read accesses to this register from EL0 are trapped to EL1.
- When EL2 is implemented and is using AArch64 and $(\text{SCR_EL3.NS} == 1) \ \&\& \ (\text{HCR_EL2.E2H} == 1) \ \&\& \ (\text{HCR_EL2.TGE} == 0)$:
 - If $\text{CNTKCTL_EL1.EL0PCTEN} == 0$, and $\text{CNTKCTL_EL1.EL0VCTEN} == 0$, Non-secure read accesses to this register from EL0 are trapped to EL1.
- When EL2 is implemented and is using AArch64 and $(\text{SCR_EL3.NS} == 1) \ \&\& \ (\text{HCR_EL2.E2H} == 1) \ \&\& \ (\text{HCR_EL2.TGE} == 1)$:
 - If $\text{CNTHCTL_EL2.EL0PCTEN} == 0$, and $\text{CNTHCTL_EL2.EL0VCTEN} == 0$, Non-secure read accesses to this register from EL0 are trapped to EL2.

D7.5.2 CNTHCTL_EL2, Counter-timer Hypervisor Control register

The CNTHCTL_EL2 characteristics are:

Purpose

Controls the generation of an event stream from the physical counter, and access from Non-secure EL1 to the physical counter and the Non-secure EL1 physical timer.

Configurations

AArch64 System register CNTHCTL_EL2 is architecturally mapped to AArch32 System register [CNTHCTL](#).

If EL2 is not implemented, this register is RES0 from EL3.

RW fields in this register reset to architecturally UNKNOWN values.

Attributes

CNTHCTL_EL2 is a 32-bit register.

Field descriptions

The CNTHCTL_EL2 bit assignments are:

When HCR_EL2.E2H == 0:

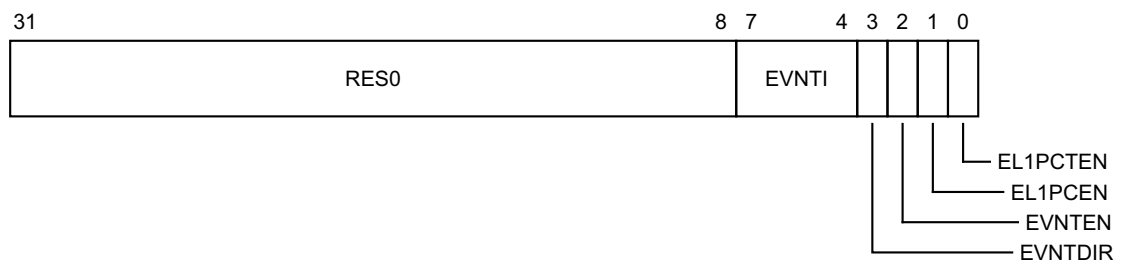

This format applies in all ARMv8.0 implementations, and it also contains a description of the behavior when EL3 is implemented and EL2 is not implemented.

Bits [31:8]

Reserved, RES0.

EVNTI, bits [7:4]

Selects which bit (0 to 15) of the counter register [CNTPCT_EL0](#) is the trigger for the event stream generated from that counter, when that stream is enabled.

EVNTDIR, bit [3]

Controls which transition of the counter register [CNTPCT_EL0](#) trigger bit, defined by EVNTI, generates an event when the event stream is enabled:

- 0 A 0 to 1 transition of the trigger bit triggers an event.
- 1 A 1 to 0 transition of the trigger bit triggers an event.

EVNTEN, bit [2]

Enables the generation of an event stream from the counter register [CNTPCT_EL0](#):

- 0 Disables the event stream.
- 1 Enables the event stream.

EL1PCEN, bit [1]

Traps Non-secure EL0 and EL1 accesses to the physical timer registers to EL2.

0 From AArch64 state: Non-secure EL0 and EL1 accesses to the [CNTP_CTL_EL0](#), [CNTP_CVAL_EL0](#), and [CNTP_TVAL_EL0](#) are trapped to EL2, unless it is trapped by [CNTKCTL_EL1.EL0PTEN](#).

From AArch32 state: Non-secure EL0 and EL1 accesses to the [CNTP_CTL](#), [CNTP_CVAL](#), and [CNTP_TVAL](#) are trapped to EL2, unless it is trapped by [CNTKCTL_EL1.EL0PTEN](#) or [CNTKCTL.PL0PTEN](#).

1 This control does not cause any instructions to be trapped.

If EL3 is implemented and EL2 is not implemented, behavior is as if this bit is 1 other than for the purpose of a direct read.

EL1PCTEN, bit [0]

Traps Non-secure EL0 and EL1 accesses to the physical counter register to EL2.

0 From AArch64 state: Non-secure EL0 and EL1 accesses to the [CNTPCT_EL0](#) are trapped to EL2, unless it is trapped by [CNTKCTL_EL1.EL0PCTEN](#).

From AArch32 state: Non-secure EL0 and EL1 accesses to the [CNTPCT](#) are trapped to EL2, unless it is trapped by [CNTKCTL_EL1.EL0PCTEN](#) or [CNTKCTL.PL0PCTEN](#).

1 This control does not cause any instructions to be trapped.

If EL3 is implemented and EL2 is not implemented, behavior is as if this bit is 1 other than for the purpose of a direct read.

When HCR_EL2.E2H == 1:

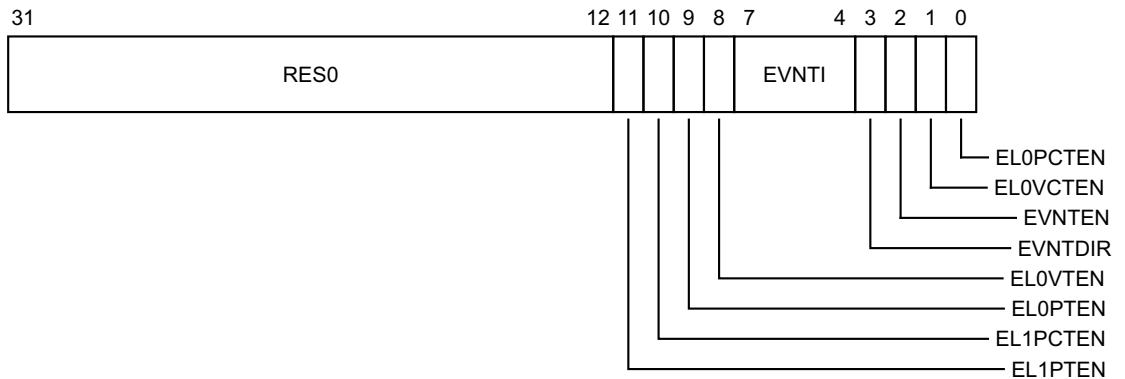

Bits [31:12]

Reserved, RES0.

EL1PTEN, bit [11]

When [HCR_EL2.TGE](#) is 0, traps Non-secure EL0 and EL1 accesses to the physical timer registers to EL2.

0 From AArch64 state: Non-secure EL0 and EL1 accesses to the [CNTP_CTL_EL0](#), [CNTP_CVAL_EL0](#), and [CNTP_TVAL_EL0](#) are trapped to EL2, unless it is trapped by [CNTKCTL_EL1.EL0PTEN](#).

From AArch32 state: Non-secure EL0 and EL1 accesses to the [CNTP_CTL](#), [CNTP_CVAL](#), and [CNTP_TVAL](#) are trapped to EL2, unless it is trapped by [CNTKCTL_EL1.EL0PTEN](#) or [CNTKCTL.PL0PTEN](#).

1 This control does not cause any instructions to be trapped.

When [HCR_EL2.TGE](#) is 1, this control does not cause any instructions to be trapped.

EL1PCTEN, bit [10]

When `HCR_EL2.TGE` is 0, traps Non-secure EL0 and EL1 accesses to the physical counter register to EL2.

- 0 From AArch64 state: Non-secure EL0 and EL1 accesses to the `CNTPCT_EL0` are trapped to EL2, unless it is trapped by `CNTKCTL_EL1.EL0PCTEN`.
From AArch32 state: Non-secure EL0 and EL1 accesses to the `CNTPCT` are trapped to EL2, unless it is trapped by `CNTKCTL_EL1.EL0PCTEN` or `CNTKCTL.PL0PCTEN`.
- 1 This control does not cause any instructions to be trapped.

When `HCR_EL2.TGE` is 1, this control does not cause any instructions to be trapped.

EL0PTEN, bit [9]

When `HCR_EL2.TGE` is 0, this control does not cause any instructions to be trapped.

When `HCR_EL2.TGE` is 1, traps EL0 accesses to the physical timer registers to EL2.

- 0 EL0 using AArch64: EL0 accesses to the `CNTP_CTL_EL0`, `CNTP_CVAL_EL0`, and `CNTP_TVAL_EL0` registers are trapped to EL2.
EL0 using AArch32: EL0 accesses to the `CNTP_CTL`, `CNTP_CVAL`, and `CNTP_TVAL` registers are trapped to EL2.
- 1 This control does not cause any instructions to be trapped.

EL0VTEN, bit [8]

When `HCR_EL2.TGE` is 0, this control does not cause any instructions to be trapped.

When `HCR_EL2.TGE` is 1, traps EL0 accesses to the virtual timer registers to EL2.

- 0 EL0 using AArch64: EL0 accesses to the `CNTV_CTL_EL0`, `CNTV_CVAL_EL0`, and `CNTV_TVAL_EL0` registers are trapped to EL2.
EL0 using AArch32: EL0 accesses to the `CNTV_CTL`, `CNTV_CVAL`, and `CNTV_TVAL` registers are trapped to EL2.
- 1 This control does not cause any instructions to be trapped.

EVNTI, bits [7:4]

Selects which bit (0 to 15) of the counter register `CNTPCT_EL0` is the trigger for the event stream generated from that counter, when that stream is enabled.

EVNTDIR, bit [3]

Controls which transition of the counter register `CNTPCT_EL0` trigger bit, defined by `EVNTI`, generates an event when the event stream is enabled:

- 0 A 0 to 1 transition of the trigger bit triggers an event.
- 1 A 1 to 0 transition of the trigger bit triggers an event.

EVNTEN, bit [2]

Enables the generation of an event stream from the counter register `CNTPCT_EL0`:

- 0 Disables the event stream.
- 1 Enables the event stream.

EL0VCTEN, bit [1]

When `HCR_EL2.TGE` is 0, this control does not cause any instructions to be trapped.

When `HCR_EL2.TGE` is 1, traps EL0 accesses to the frequency register and virtual counter register to EL2.

- 0 EL0 using AArch64: EL0 accesses to the `CNTVCT_EL0` are trapped to EL2.
EL0 using AArch64: EL0 accesses to the `CNTFRQ_EL0` register are trapped to EL2, if `CNTHCTL_EL2.EL0PCTEN` is also 0.
EL0 using AArch32: EL0 accesses to the `CNTVCT` are trapped to EL2.

EL0 using AArch32: EL0 accesses to the [CNTFRQ](#) register are trapped to EL2, if [CNTHCTL_EL2.EL0PCTEN](#) is also 0.

1 This control does not cause any instructions to be trapped.

EL0PCTEN, bit [0]

When [HCR_EL2.TGE](#) is 0, this control does not cause any instructions to be trapped.

When [HCR_EL2.TGE](#) is 1, traps EL0 accesses to the frequency register and physical counter register to EL2.

0 EL0 using AArch64: EL0 accesses to the [CNTPCT_EL0](#) are trapped to EL2.

EL0 using AArch64: EL0 accesses to the [CNTFRQ_EL0](#) register are trapped to EL2, if [CNTHCTL_EL2.EL0VCTEN](#) is also 0.

EL0 using AArch32: EL0 accesses to the [CNTPCT](#) are trapped to EL2.

EL0 using AArch32: EL0 accesses to the [CNTFRQ](#) and register are trapped to EL2, if [CNTHCTL_EL2.EL0VCTEN](#) is also 0.

1 This control does not cause any instructions to be trapped.

Accessing the CNTHCTL_EL2

This register can be read using MRS with the following syntax:

MRS <Xt>, <systemreg>

This register can be written using MSR (register) with the following syntax:

MSR <systemreg>, <Xt>

This syntax is encoded with the following settings in the instruction encoding:

<systemreg>	op0	op1	CRn	CRm	op2
CNTHCTL_EL2	11	100	1110	0001	000
CNTKCTL_EL1	11	000	1110	0001	000

Accessibility

The register is accessible in software as follows:

<systemreg>	Control			Accessibility			
	E2H	TGE	NS	EL0	EL1	EL2	EL3
CNTHCTL_EL2	x	x	0	-	-	n/a	RW
CNTHCTL_EL2	0	0	1	-	-	RW	RW
CNTHCTL_EL2	0	1	1	-	n/a	RW	RW
CNTHCTL_EL2	1	0	1	-	-	RW	RW
CNTHCTL_EL2	1	1	1	-	n/a	RW	RW
CNTKCTL_EL1	x	x	0	-	CNTKCTL_EL1	n/a	CNTKCTL_EL1
CNTKCTL_EL1	0	0	1	-	CNTKCTL_EL1	CNTKCTL_EL1	CNTKCTL_EL1

<systemreg>	Control			Accessibility			
	E2H	TGE	NS	EL0	EL1	EL2	EL3
CNTKCTL_EL1	0	1	1	-	n/a	CNTKCTL_EL1	CNTKCTL_EL1
CNTKCTL_EL1	1	0	1	-	CNTKCTL_EL1	RW	CNTKCTL_EL1
CNTKCTL_EL1	1	1	1	-	n/a	RW	CNTKCTL_EL1

This table applies to all instructions that can access this register.

When [HCR_EL2.E2H](#) is 1, without explicit synchronization, access from EL2 using the mnemonic [CNTCTL_EL2](#) or [CNTKCTL_EL1](#) are not guaranteed to be ordered with respect to accesses using the other mnemonic.

D7.5.3 CNTHP_CTL_EL2, Counter-timer Hypervisor Physical Timer Control register

The CNTHP_CTL_EL2 characteristics are:

Purpose

Control register for the EL2 physical timer.

Configurations

AArch64 System register CNTHP_CTL_EL2 is architecturally mapped to AArch32 System register [CNTHP_CTL](#).

If EL2 is not implemented, this register is RES0 from EL3.

RW fields in this register reset to architecturally UNKNOWN values.

Attributes

CNTHP_CTL_EL2 is a 32-bit register.

Field descriptions

The CNTHP_CTL_EL2 bit assignments are:

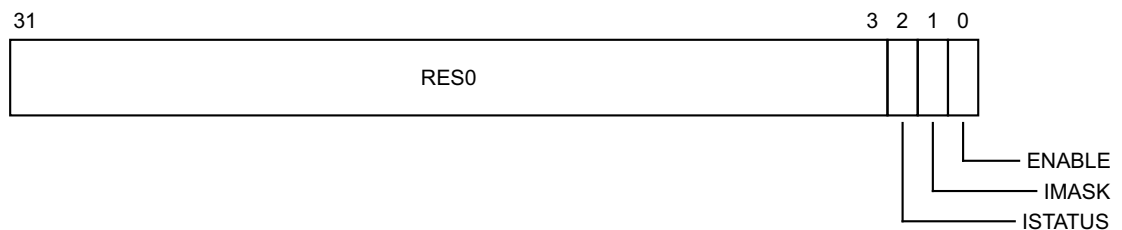

Bits [31:3]

Reserved, RES0.

ISTATUS, bit [2]

The status of the timer. This bit indicates whether the timer condition is met:

- 0 Timer condition is not met.
- 1 Timer condition is met.

When the value of the ENABLE bit is 1, ISTATUS indicates whether the timer condition is met. ISTATUS takes no account of the value of the IMASK bit. If the value of ISTATUS is 1 and the value of IMASK is 0 then the timer interrupt is asserted.

When the value of the ENABLE bit is 0, the ISTATUS field is UNKNOWN.

For more information see [Operation of the CompareValue views of the timers on page D6-2187](#) and [Operation of the TimerValue views of the timers on page D6-2188](#).

This bit is read-only.

IMASK, bit [1]

Timer interrupt mask bit. Permitted values are:

- 0 Timer interrupt is not masked by the IMASK bit.
- 1 Timer interrupt is masked by the IMASK bit.

For more information, see the description of the ISTATUS bit.

ENABLE, bit [0]

Enables the timer. Permitted values are:

- 0 Timer disabled.

1 Timer enabled.

Setting this bit to 0 disables the timer output signal, but the timer value accessible from [CNTHP_TVAL_EL2](#) continues to count down.

———— **Note** —————

Disabling the output signal might be a power-saving option.

Accessing the CNTHP_CTL_EL2

This register can be read using MRS with the following syntax:

MRS <Xt>, <systemreg>

This register can be written using MSR (register) with the following syntax:

MSR <systemreg>, <Xt>

This syntax is encoded with the following settings in the instruction encoding:

<systemreg>	op0	op1	CRn	CRm	op2
CNTHP_CTL_EL2	11	100	1110	0010	001
CNTP_CTL_EL0	11	011	1110	0010	001

Accessibility

The register is accessible in software as follows:

<systemreg>	Control			Accessibility			
	E2H	TGE	NS	EL0	EL1	EL2	EL3
CNTHP_CTL_EL2	x	x	0	-	-	n/a	RW
CNTHP_CTL_EL2	0	0	1	-	-	RW	RW
CNTHP_CTL_EL2	0	1	1	-	n/a	RW	RW
CNTHP_CTL_EL2	1	0	1	-	-	RW	RW
CNTHP_CTL_EL2	1	1	1	-	n/a	RW	RW
CNTP_CTL_EL0	x	x	0	CNTP_CTL_EL0	CNTP_CTL_EL0	n/a	CNTP_CTL_EL0
CNTP_CTL_EL0	0	0	1	CNTP_CTL_EL0	CNTP_CTL_EL0	CNTP_CTL_EL0	CNTP_CTL_EL0
CNTP_CTL_EL0	0	1	1	CNTP_CTL_EL0	n/a	CNTP_CTL_EL0	CNTP_CTL_EL0
CNTP_CTL_EL0	1	0	1	CNTP_CTL_EL0	CNTP_CTL_EL0	RW	RW
CNTP_CTL_EL0	1	1	1	RW	n/a	RW	RW

This table applies to all instructions that can access this register.

When [HCR_EL2.E2H](#) is 1, without explicit synchronization, access from EL2 using the mnemonic CNTHP_CTL_EL2 or CNTP_CTL_EL0 are not guaranteed to be ordered with respect to accesses using the other mnemonic.

Traps and Enables

For a description of the prioritization of any generated exceptions, see *Synchronous exception prioritization for exceptions taken to AArch64* on page D1-1827. Subject to the prioritization rules:

- When EL2 is implemented and is using AArch64 and (SCR_EL3.NS == 1) && (HCR_EL2.E2H == 1) && (HCR_EL2.TGE == 1):
 - If CNTHCTL_EL2.EL0PTEN==0, Non-secure accesses to this register from EL0 are trapped to EL2.

D7.5.4 CNTHP_CVAL_EL2, Counter-timer Hypervisor Physical Timer CompareValue register

The CNTHP_CVAL_EL2 characteristics are:

Purpose

Holds the compare value for the EL2 physical timer.

Configurations

AArch64 System register CNTHP_CVAL_EL2 is architecturally mapped to AArch32 System register [CNTHP_CVAL](#).

If EL2 is not implemented, this register is RES0 from EL3.

RW fields in this register reset to architecturally UNKNOWN values.

Attributes

CNTHP_CVAL_EL2 is a 64-bit register.

Field descriptions

The CNTHP_CVAL_EL2 bit assignments are:

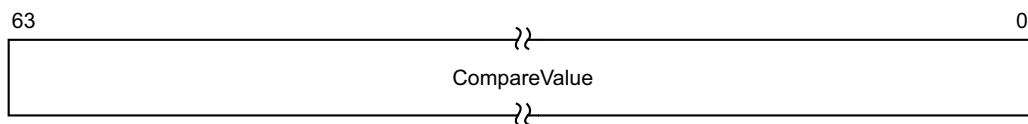

CompareValue, bits [63:0]

Holds the EL2 physical timer CompareValue.

When [CNTHP_CTL_EL2.ENABLE](#) is 1, the timer condition is met when ([CNTPCT_EL0](#) - CompareValue) is greater than zero. This means that CompareValue acts like a 64-bit upcounter timer. When the timer condition is met:

- [CNTHP_CTL_EL2.ISTATUS](#) is set to 1.
- If [CNTHP_CTL_EL2.IMASK](#) is 0, an interrupt is generated.

When [CNTHP_CTL_EL2.ENABLE](#) is 0, the timer condition is not met, but [CNTPCT_EL0](#) continues to count.

Accessing the CNTHP_CVAL_EL2

This register can be read using MRS with the following syntax:

MRS <Xt>, <systemreg>

This register can be written using MSR (register) with the following syntax:

MSR <systemreg>, <Xt>

This syntax is encoded with the following settings in the instruction encoding:

<systemreg>	op0	op1	CRn	CRm	op2
CNTHP_CVAL_EL2	11	100	1110	0010	010
CNTP_CVAL_EL0	11	011	1110	0010	010

Accessibility

The register is accessible in software as follows:

<systemreg>	Control			Accessibility			
	E2H	TGE	NS	EL0	EL1	EL2	EL3
CNTHP_CVAL_EL2	x	x	0	-	-	n/a	RW
CNTHP_CVAL_EL2	0	0	1	-	-	RW	RW
CNTHP_CVAL_EL2	0	1	1	-	n/a	RW	RW
CNTHP_CVAL_EL2	1	0	1	-	-	RW	RW
CNTHP_CVAL_EL2	1	1	1	-	n/a	RW	RW
CNTP_CVAL_EL0	x	x	0	CNTP_CVAL_EL0	CNTP_CVAL_EL0	n/a	CNTP_CVAL_EL0
CNTP_CVAL_EL0	0	0	1	CNTP_CVAL_EL0	CNTP_CVAL_EL0	CNTP_CVAL_EL0	CNTP_CVAL_EL0
CNTP_CVAL_EL0	0	1	1	CNTP_CVAL_EL0	n/a	CNTP_CVAL_EL0	CNTP_CVAL_EL0
CNTP_CVAL_EL0	1	0	1	CNTP_CVAL_EL0	CNTP_CVAL_EL0	RW	RW
CNTP_CVAL_EL0	1	1	1	RW	n/a	RW	RW

This table applies to all instructions that can access this register.

When `HCR_EL2.E2H` is 1, without explicit synchronization, access from EL2 using the mnemonic `CNTHP_CVAL_EL2` or `CNTP_CVAL_EL0` are not guaranteed to be ordered with respect to accesses using the other mnemonic.

Traps and Enables

For a description of the prioritization of any generated exceptions, see *Synchronous exception prioritization for exceptions taken to AArch64* on page D1-1827. Subject to the prioritization rules:

- When EL2 is implemented and is using AArch64 and `(SCR_EL3.NS == 1) && (HCR_EL2.E2H == 1) && (HCR_EL2.TGE == 1)`:
 - If `CNTHCTL_EL2.EL0PTEN==0`, Non-secure accesses to this register from EL0 are trapped to EL2.

D7.5.5 CNTHP_TVAL_EL2, Counter-timer Hypervisor Physical Timer TimerValue register

The CNTHP_TVAL_EL2 characteristics are:

Purpose

Holds the timer value for the EL2 physical timer.

Configurations

AArch64 System register CNTHP_TVAL_EL2 is architecturally mapped to AArch32 System register [CNTHP_TVAL](#).

If EL2 is not implemented, this register is RES0 from EL3.

RW fields in this register reset to architecturally UNKNOWN values.

Attributes

CNTHP_TVAL_EL2 is a 32-bit register.

Field descriptions

The CNTHP_TVAL_EL2 bit assignments are:

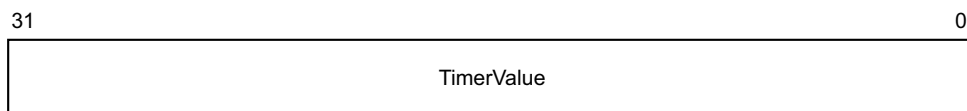

TimerValue, bits [31:0]

The TimerValue view of the EL2 physical timer.

On a read of this register:

- If [CNTHP_CTL_EL2.ENABLE](#) is 0, the value returned is UNKNOWN.
- If [CNTHP_CTL_EL2.ENABLE](#) is 1, the value returned is ([CNTHP_CVAL_EL2](#) - [CNTPCT_EL0](#)).

On a write of this register, [CNTHP_CVAL_EL2](#) is set to ([CNTPCT_EL0](#) + TimerValue), where TimerValue is treated as a signed 32-bit integer.

When [CNTHP_CTL_EL2.ENABLE](#) is 1, the timer condition is met when ([CNTPCT_EL0](#) - [CNTHP_CVAL_EL2](#)) is greater than zero. This means that TimerValue acts like a 32-bit downcounter timer. When the timer condition is met:

- [CNTHP_CTL_EL2.ISTATUS](#) is set to 1.
- If [CNTHP_CTL_EL2.IMASK](#) is 0, an interrupt is generated.

When [CNTHP_CTL_EL2.ENABLE](#) is 0, the timer condition is not met, but [CNTPCT_EL0](#) continues to count, so the TimerValue view appears to continue to count down.

Accessing the CNTHP_TVAL_EL2

This register can be read using MRS with the following syntax:

```
MRS <Xt>, <systemreg>
```

This register can be written using MSR (register) with the following syntax:

```
MSR <systemreg>, <Xt>
```

This syntax is encoded with the following settings in the instruction encoding:

<systemreg>	op0	op1	CRn	CRm	op2
CNTHP_TVAL_EL2	11	100	1110	0010	000
CNTP_TVAL_EL0	11	011	1110	0010	000

Accessibility

The register is accessible in software as follows:

<systemreg>	Control			Accessibility			
	E2H	TGE	NS	EL0	EL1	EL2	EL3
CNTHP_TVAL_EL2	x	x	0	-	-	n/a	RW
CNTHP_TVAL_EL2	0	0	1	-	-	RW	RW
CNTHP_TVAL_EL2	0	1	1	-	n/a	RW	RW
CNTHP_TVAL_EL2	1	0	1	-	-	RW	RW
CNTHP_TVAL_EL2	1	1	1	-	n/a	RW	RW
CNTP_TVAL_EL0	x	x	0	CNTP_TVAL_EL0	CNTP_TVAL_EL0	n/a	CNTP_TVAL_EL0
CNTP_TVAL_EL0	0	0	1	CNTP_TVAL_EL0	CNTP_TVAL_EL0	CNTP_TVAL_EL0	CNTP_TVAL_EL0
CNTP_TVAL_EL0	0	1	1	CNTP_TVAL_EL0	n/a	CNTP_TVAL_EL0	CNTP_TVAL_EL0
CNTP_TVAL_EL0	1	0	1	CNTP_TVAL_EL0	CNTP_TVAL_EL0	RW	RW
CNTP_TVAL_EL0	1	1	1	RW	n/a	RW	RW

This table applies to all instructions that can access this register.

When [HCR_EL2.E2H](#) is 1, without explicit synchronization, access from EL2 using the mnemonic [CNTHP_TVAL_EL2](#) or [CNTP_TVAL_EL0](#) are not guaranteed to be ordered with respect to accesses using the other mnemonic.

Traps and Enables

For a description of the prioritization of any generated exceptions, see [Synchronous exception prioritization for exceptions taken to AArch64 on page D1-1827](#). Subject to the prioritization rules:

- When EL2 is implemented and is using AArch64 and $(SCR_EL3.NS == 1) \&\& (HCR_EL2.E2H == 1) \&\& (HCR_EL2.TGE == 1)$:
 - If [CNTHCTL_EL2.EL0PTEN](#)==0, Non-secure accesses to this register from EL0 are trapped to EL2.

D7.5.6 CNTHV_CTL_EL2, Counter-timer Virtual Timer Control register (EL2)

The CNTHV_CTL_EL2 characteristics are:

Purpose

Control register for the EL2 virtual timer.

Configurations

AArch64 System register CNTHV_CTL_EL2 is architecturally mapped to AArch32 System register CNTHV_CTL.

If EL2 is not implemented, this register is RES0 from EL3.

RW fields in this register reset to architecturally UNKNOWN values.

This register is introduced in ARMv8.1.

Attributes

CNTHV_CTL_EL2 is a 32-bit register.

Field descriptions

The CNTHV_CTL_EL2 bit assignments are:

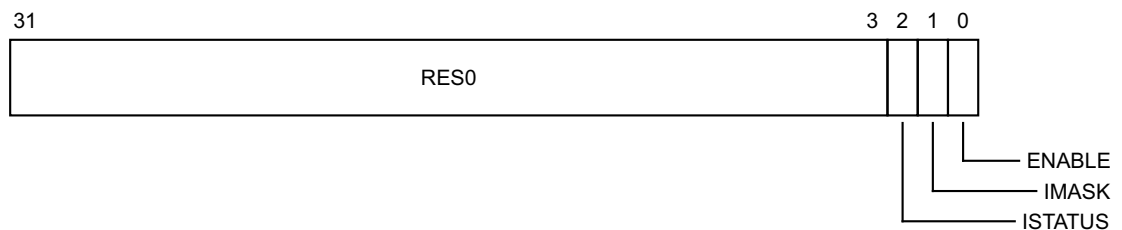

Bits [31:3]

Reserved, RES0.

ISTATUS, bit [2]

The status of the timer. This bit indicates whether the timer condition is met:

0 Timer condition is not met.

1 Timer condition is met.

When the value of the ENABLE bit is 1, ISTATUS indicates whether the timer condition is met. ISTATUS takes no account of the value of the IMASK bit. If the value of ISTATUS is 1 and the value of IMASK is 0 then the timer interrupt is asserted.

When the value of the ENABLE bit is 0, the ISTATUS field is UNKNOWN.

For more information see [Operation of the CompareValue views of the timers on page D6-2187](#) and [Operation of the TimerValue views of the timers on page D6-2188](#).

This bit is read-only.

IMASK, bit [1]

Timer interrupt mask bit. Permitted values are:

0 Timer interrupt is not masked by the IMASK bit.

1 Timer interrupt is masked by the IMASK bit.

For more information, see the description of the ISTATUS bit.

ENABLE, bit [0]

Enables the timer. Permitted values are:

- 0 Timer disabled.
- 1 Timer enabled.

Setting this bit to 0 disables the timer output signal, but the timer value accessible from [CNTHV_TVAL_EL2](#) continues to count down.

————— Note —————

Disabling the output signal might be a power-saving option.

Accessing the CNTHV_CTL_EL2

This register can be read using MRS with the following syntax:

MRS <Xt>, <systemreg>

This register can be written using MSR (register) with the following syntax:

MSR <systemreg>, <Xt>

This syntax is encoded with the following settings in the instruction encoding:

<systemreg>	op0	op1	CRn	CRm	op2
CNTHV_CTL_EL2	11	100	1110	0011	001
CNTV_CTL_EL0	11	011	1110	0011	001

Accessibility

The register is accessible in software as follows:

<systemreg>	Control			Accessibility			
	E2H	TGE	NS	EL0	EL1	EL2	EL3
CNTHV_CTL_EL2	x	x	0	-	-	n/a	RW
CNTHV_CTL_EL2	0	0	1	-	-	RW	RW
CNTHV_CTL_EL2	0	1	1	-	n/a	RW	RW
CNTHV_CTL_EL2	1	0	1	-	-	RW	RW
CNTHV_CTL_EL2	1	1	1	-	n/a	RW	RW
CNTV_CTL_EL0	x	x	0	CNTV_CTL_EL0	CNTV_CTL_EL0	n/a	CNTV_CTL_EL0
CNTV_CTL_EL0	0	0	1	CNTV_CTL_EL0	CNTV_CTL_EL0	CNTV_CTL_EL0	CNTV_CTL_EL0
CNTV_CTL_EL0	0	1	1	CNTV_CTL_EL0	n/a	CNTV_CTL_EL0	CNTV_CTL_EL0
CNTV_CTL_EL0	1	0	1	CNTV_CTL_EL0	CNTV_CTL_EL0	RW	CNTV_CTL_EL0
CNTV_CTL_EL0	1	1	1	RW	n/a	RW	CNTV_CTL_EL0

This table applies to all instructions that can access this register.

When `HCR_EL2.E2H` is 1, without explicit synchronization, access from EL2 using the mnemonic `CNTHV_CTL_EL2` or `CNTV_CTL_EL0` are not guaranteed to be ordered with respect to accesses using the other mnemonic.

Traps and Enables

For a description of the prioritization of any generated exceptions, see *Synchronous exception prioritization for exceptions taken to AArch64* on page D1-1827. Subject to the prioritization rules:

- When EL2 is implemented and is using AArch64 and `(SCR_EL3.NS == 1) && (HCR_EL2.E2H == 1) && (HCR_EL2.TGE == 1)`:
 - If `CNTHCTL_EL2.EL0VTEN==0`, Non-secure accesses to this register from EL0 are trapped to EL2.

D7.5.7 CNTHV_CVAL_EL2, Counter-timer Virtual Timer CompareValue register (EL2)

The CNTHV_CVAL_EL2 characteristics are:

Purpose

Holds the compare value for the EL2 virtual timer.

Configurations

AArch64 System register CNTHV_CVAL_EL2 is architecturally mapped to AArch32 System register CNTHV_CVAL.

If EL2 is not implemented, this register is RES0 from EL3.

RW fields in this register reset to architecturally UNKNOWN values.

This register is introduced in ARMv8.1.

Attributes

CNTHV_CVAL_EL2 is a 64-bit register.

Field descriptions

The CNTHV_CVAL_EL2 bit assignments are:

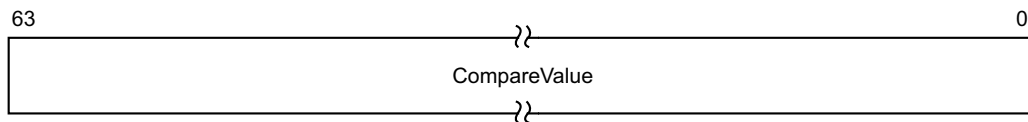

CompareValue, bits [63:0]

Holds the EL2 virtual timer CompareValue.

When [CNTHV_CTL_EL2.ENABLE](#) is 1, the timer condition is met when ([CNTVCT_EL0](#) - CompareValue) is greater than zero. This means that CompareValue acts like a 64-bit upcounter timer. When the timer condition is met:

- [CNTHV_CTL_EL2.ISTATUS](#) is set to 1.
- If [CNTHV_CTL_EL2.IMASK](#) is 0, an interrupt is generated.

When [CNTHV_CTL_EL2.ENABLE](#) is 0, the timer condition is not met, but [CNTVCT_EL0](#) continues to count.

Accessing the CNTHV_CVAL_EL2

This register can be read using MRS with the following syntax:

MRS <Xt>, <systemreg>

This register can be written using MSR (register) with the following syntax:

MSR <systemreg>, <Xt>

This syntax is encoded with the following settings in the instruction encoding:

<systemreg>	op0	op1	CRn	CRm	op2
CNTHV_CVAL_EL2	11	100	1110	0011	010
CNTV_CVAL_EL0	11	011	1110	0011	010

Accessibility

The register is accessible in software as follows:

<systemreg>	Control			Accessibility			
	E2H	TGE	NS	EL0	EL1	EL2	EL3
CNTHV_CVAL_EL2	x	x	0	-	-	n/a	RW
CNTHV_CVAL_EL2	0	0	1	-	-	RW	RW
CNTHV_CVAL_EL2	0	1	1	-	n/a	RW	RW
CNTHV_CVAL_EL2	1	0	1	-	-	RW	RW
CNTHV_CVAL_EL2	1	1	1	-	n/a	RW	RW
CNTV_CVAL_EL0	x	x	0	CNTV_CVAL_EL0	CNTV_CVAL_EL0	n/a	CNTV_CVAL_EL0
CNTV_CVAL_EL0	0	0	1	CNTV_CVAL_EL0	CNTV_CVAL_EL0	CNTV_CVAL_EL0	CNTV_CVAL_EL0
CNTV_CVAL_EL0	0	1	1	CNTV_CVAL_EL0	n/a	CNTV_CVAL_EL0	CNTV_CVAL_EL0
CNTV_CVAL_EL0	1	0	1	CNTV_CVAL_EL0	CNTV_CVAL_EL0	RW	CNTV_CVAL_EL0
CNTV_CVAL_EL0	1	1	1	RW	n/a	RW	CNTV_CVAL_EL0

This table applies to all instructions that can access this register.

When [HCR_EL2.E2H](#) is 1, without explicit synchronization, access from EL2 using the mnemonic [CNTHV_CVAL_EL2](#) or [CNTV_CVAL_EL0](#) are not guaranteed to be ordered with respect to accesses using the other mnemonic.

Traps and Enables

For a description of the prioritization of any generated exceptions, see [Synchronous exception prioritization for exceptions taken to AArch64 on page D1-1827](#). Subject to the prioritization rules:

- When EL2 is implemented and is using AArch64 and $(SCR_EL3.NS == 1) \ \&\& \ (HCR_EL2.E2H == 1) \ \&\& \ (HCR_EL2.TGE == 1)$:
 - If [CNTHCTL_EL2.EL0VTEN](#)==0, Non-secure accesses to this register from EL0 are trapped to EL2.

D7.5.8 CNTHV_TVAL_EL2, Counter-timer Virtual Timer TimerValue register (EL2)

The CNTHV_TVAL_EL2 characteristics are:

Purpose

Holds the timer value for the EL2 virtual timer.

Configurations

AArch64 System register CNTHV_TVAL_EL2 is architecturally mapped to AArch32 System register CNTHV_TVAL.

If EL2 is not implemented, this register is RES0 from EL3.

RW fields in this register reset to architecturally UNKNOWN values.

This register is introduced in ARMv8.1.

Attributes

CNTHV_TVAL_EL2 is a 32-bit register.

Field descriptions

The CNTHV_TVAL_EL2 bit assignments are:

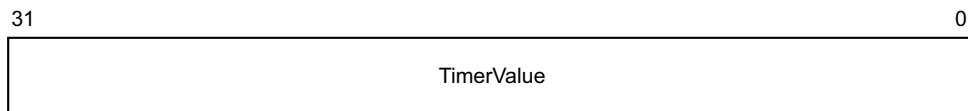

TimerValue, bits [31:0]

The TimerValue view of the EL2 virtual timer.

On a read of this register:

- If CNTHV_CTL_EL2.ENABLE is 0, the value returned is UNKNOWN.
- If CNTHV_CTL_EL2.ENABLE is 1, the value returned is (CNTHV_CVAL_EL2 - CNTVCT_EL0).

On a write of this register, CNTHV_CVAL_EL2 is set to (CNTVCT_EL0 + TimerValue), where TimerValue is treated as a signed 32-bit integer.

When CNTHV_CTL_EL2.ENABLE is 1, the timer condition is met when ((CNTVCT_EL0 - CNTHV_CVAL_EL2) is greater than zero. This means that TimerValue acts like a 32-bit downcounter timer. When the timer condition is met:

- CNTHV_CTL_EL2.ISTATUS is set to 1.
- If CNTHV_CTL_EL2.IMASK is 0, an interrupt is generated.

When CNTHV_CTL_EL2.ENABLE is 0, the timer condition is not met, but CNTVCT_EL0 continues to count, so the TimerValue view appears to continue to count down.

Accessing the CNTHV_TVAL_EL2

This register can be read using MRS with the following syntax:

```
MRS <Xt>, <systemreg>
```

This register can be written using MSR (register) with the following syntax:

```
MSR <systemreg>, <Xt>
```

This syntax is encoded with the following settings in the instruction encoding:

<systemreg>	op0	op1	CRn	CRm	op2
CNTHV_TVAL_EL2	11	100	1110	0011	000
CNTV_TVAL_EL0	11	011	1110	0011	000

Accessibility

The register is accessible in software as follows:

<systemreg>	Control			Accessibility			
	E2H	TGE	NS	EL0	EL1	EL2	EL3
CNTHV_TVAL_EL2	x	x	0	-	-	n/a	RW
CNTHV_TVAL_EL2	0	0	1	-	-	RW	RW
CNTHV_TVAL_EL2	0	1	1	-	n/a	RW	RW
CNTHV_TVAL_EL2	1	0	1	-	-	RW	RW
CNTHV_TVAL_EL2	1	1	1	-	n/a	RW	RW
CNTV_TVAL_EL0	x	x	0	CNTV_TVAL_EL0	CNTV_TVAL_EL0	n/a	CNTV_TVAL_EL0
CNTV_TVAL_EL0	0	0	1	CNTV_TVAL_EL0	CNTV_TVAL_EL0	CNTV_TVAL_EL0	CNTV_TVAL_EL0
CNTV_TVAL_EL0	0	1	1	CNTV_TVAL_EL0	n/a	CNTV_TVAL_EL0	CNTV_TVAL_EL0
CNTV_TVAL_EL0	1	0	1	CNTV_TVAL_EL0	CNTV_TVAL_EL0	RW	CNTV_TVAL_EL0
CNTV_TVAL_EL0	1	1	1	RW	n/a	RW	CNTV_TVAL_EL0

This table applies to all instructions that can access this register.

When [HCR_EL2.E2H](#) is 1, without explicit synchronization, access from EL2 using the mnemonic [CNTHV_TVAL_EL2](#) or [CNTV_TVAL_EL0](#) are not guaranteed to be ordered with respect to accesses using the other mnemonic.

Traps and Enables

For a description of the prioritization of any generated exceptions, see [Synchronous exception prioritization for exceptions taken to AArch64 on page D1-1827](#). Subject to the prioritization rules:

- When EL2 is implemented and is using AArch64 and $(SCR_EL3.NS == 1) \ \&\& \ (HCR_EL2.E2H == 1) \ \&\& \ (HCR_EL2.TGE == 1)$:
 - If [CNTHCTL_EL2.EL0VTEN](#)==0, Non-secure accesses to this register from EL0 are trapped to EL2.

D7.5.9 CNTKCTL_EL1, Counter-timer Kernel Control register

The CNTKCTL_EL1 characteristics are:

Purpose

When [ARMv8.1-VHE](#) is not implemented, or when [HCR_EL2](#).{E2H, TGE} is not {1, 1}, this register controls the generation of an event stream from the virtual counter, and access from EL0 to the physical counter, virtual counter, EL1 physical timers, and the virtual timer.

When [ARMv8.1-VHE](#) is implemented and [HCR_EL2](#).{E2H, TGE} is {1, 1}, this register does not cause any event stream from the virtual counter to be generated, and does not control access to the counters and timers. The access to counters and timers at EL0 is controlled by [CNTHTCTL_EL2](#).

Configurations

AArch64 System register CNTKCTL_EL1 is architecturally mapped to AArch32 System register [CNTKCTL](#).

RW fields in this register reset to architecturally UNKNOWN values.

Attributes

CNTKCTL_EL1 is a 32-bit register.

Field descriptions

The CNTKCTL_EL1 bit assignments are:

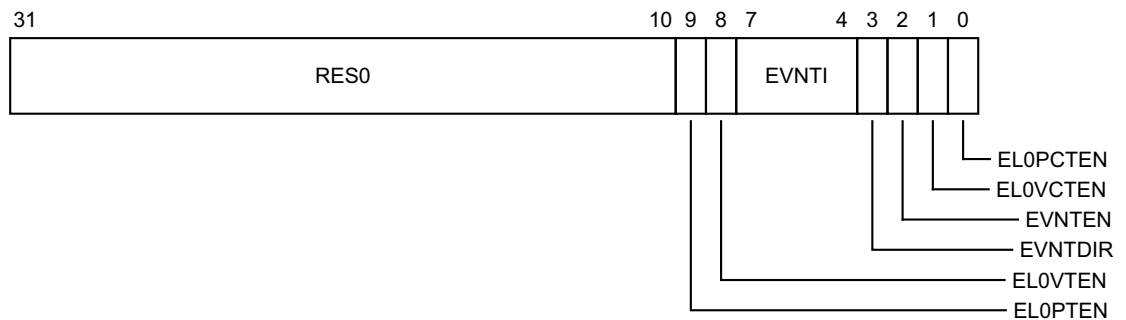

Bits [31:10]

Reserved, RES0.

EL0PTEN, bit [9]

When [ARMv8.1-VHE](#) is not implemented, or when [HCR_EL2](#).{E2H, TGE} is not {1, 1}, traps EL0 accesses to the physical timer registers to EL1.

0 EL0 using AArch64: EL0 accesses to the [CNTP_CTL_EL0](#), [CNTP_CVAL_EL0](#), and [CNTP_TVAL_EL0](#) registers are trapped to EL1.

EL0 using AArch32: EL0 accesses to the [CNTP_CTL](#), [CNTP_CVAL](#), and [CNTP_TVAL](#) registers are trapped to EL1.

When [HCR_EL2](#).TGE is 1, this trap is routed to EL2.

1 This control does not cause any instructions to be trapped.

When [ARMv8.1-VHE](#) is implemented and [HCR_EL2](#).{E2H, TGE} is {1, 1}, this control does not cause any instructions to be trapped.

EL0VTEN, bit [8]

When [ARMv8.1-VHE](#) is not implemented, or when [HCR_EL2](#).{E2H, TGE} is not {1, 1}, traps EL0 accesses to the virtual timer registers to EL1.

- 0 EL0 using AArch64: EL0 accesses to the [CNTV_CTL_EL0](#), [CNTV_CVAL_EL0](#), and [CNTV_TVAL_EL0](#) registers are trapped to EL1.
EL0 using AArch32: EL0 accesses to the [CNTV_CTL](#), [CNTV_CVAL](#), and [CNTV_TVAL](#) registers are trapped to EL1.
When [HCR_EL2](#).TGE is 1, this trap is routed to EL2.

- 1 This control does not cause any instructions to be trapped.

When [ARMv8.1-VHE](#) is implemented and [HCR_EL2](#).{E2H, TGE} is {1, 1}, this control does not cause any instructions to be trapped.

EVNTI, bits [7:4]

Selects which bit (0 to 15) of the counter register [CNTVCT_EL0](#) is the trigger for the event stream generated from that counter, when that stream is enabled.

EVNTDIR, bit [3]

Controls which transition of the counter register [CNTVCT_EL0](#) trigger bit, defined by EVNTI, generates an event when the event stream is enabled:

- 0 A 0 to 1 transition of the trigger bit triggers an event.
- 1 A 1 to 0 transition of the trigger bit triggers an event.

EVNTEN, bit [2]

When [ARMv8.1-VHE](#) is not implemented, or when [HCR_EL2](#).{E2H, TGE} is not {1, 1}, enables the generation of an event stream from the counter register [CNTVCT_EL0](#):

- 0 Disables the event stream.
- 1 Enables the event stream.

When [ARMv8.1-VHE](#) is implemented and [HCR_EL2](#).{E2H, TGE} is {1, 1}, this control does not enable the event stream.

EL0VCTEN, bit [1]

When [ARMv8.1-VHE](#) is not implemented, or when [HCR_EL2](#).{E2H, TGE} is not {1, 1}, traps EL0 accesses to the frequency register and virtual counter register to EL1.

- 0 EL0 using AArch64: EL0 accesses to the [CNTVCT_EL0](#) are trapped to EL1.
EL0 using AArch64: EL0 accesses to the [CNTFRQ_EL0](#) register are trapped to EL1, if [CNTKCTL_EL1](#).EL0PCTEN is also 0.
EL0 using AArch32: EL0 accesses to the [CNTVCT](#) are trapped to EL1.
EL0 using AArch32: EL0 accesses to the [CNTFRQ](#) register are trapped to EL1, if [CNTKCTL_EL1](#).EL0PCTEN is also 0.
When [HCR_EL2](#).TGE is 1, this trap is routed to EL2.

- 1 This control does not cause any instructions to be trapped.

When [ARMv8.1-VHE](#) is implemented and [HCR_EL2](#).{E2H, TGE} is {1, 1}, this control does not cause any instructions to be trapped.

EL0PCTEN, bit [0]

When [ARMv8.1-VHE](#) is not implemented, or when [HCR_EL2](#).{E2H, TGE} is not {1, 1}, traps EL0 accesses to the frequency register and physical counter register to EL1.

- 0 EL0 using AArch64: EL0 accesses to the [CNTPCT_EL0](#) are trapped to EL1.
EL0 using AArch64: EL0 accesses to the [CNTFRQ_EL0](#) register are trapped to EL1, if [CNTKCTL_EL1](#).EL0VCTEN is also 0.
EL0 using AArch32: EL0 accesses to the [CNTPCT](#) are trapped to EL1.
EL0 using AArch32: EL0 accesses to the [CNTFRQ](#) and register are trapped to EL1, if [CNTKCTL_EL1](#).EL0VCTEN is also 0.

When [HCR_EL2.TGE](#) is 1, this trap is routed to EL2.

1 This control does not cause any instructions to be trapped.

When [ARMv8.1-VHE](#) is implemented and [HCR_EL2.{E2H, TGE}](#) is {1, 1}, this control does not cause any instructions to be trapped.

Accessing the CNTKCTL_EL1

This register can be read using MRS with the following syntax:

MRS <Xt>, <systemreg>

This register can be written using MSR (register) with the following syntax:

MSR <systemreg>, <Xt>

This syntax is encoded with the following settings in the instruction encoding:

<systemreg>	op0	op1	CRn	CRm	op2
CNTKCTL_EL1	11	000	1110	0001	000
CNTKCTL_EL12	11	101	1110	0001	000

Accessibility

The register is accessible in software as follows:

<systemreg>	Control			Accessibility			
	E2H	TGE	NS	EL0	EL1	EL2	EL3
CNTKCTL_EL1	x	x	0	-	RW	n/a	RW
CNTKCTL_EL1	0	0	1	-	RW	RW	RW
CNTKCTL_EL1	0	1	1	-	n/a	RW	RW
CNTKCTL_EL1	1	0	1	-	RW	CNTHCTL_EL2	RW
CNTKCTL_EL1	1	1	1	-	n/a	CNTHCTL_EL2	RW
CNTKCTL_EL12	x	x	0	-	-	n/a	-
CNTKCTL_EL12	0	0	1	-	-	-	-
CNTKCTL_EL12	0	1	1	-	n/a	-	-
CNTKCTL_EL12	1	0	1	-	-	RW	RW
CNTKCTL_EL12	1	1	1	-	n/a	RW	RW

This table applies to all instructions that can access this register.

When [HCR_EL2.E2H](#) is 1, without explicit synchronization, access from EL3 using the mnemonic CNTKCTL_EL1 or CNTKCTL_EL12 are not guaranteed to be ordered with respect to accesses using the other mnemonic.

D7.5.10 CNTP_CTL_EL0, Counter-timer Physical Timer Control register

The CNTP_CTL_EL0 characteristics are:

Purpose

Control register for the EL1 physical timer.

Configurations

AArch64 System register CNTP_CTL_EL0 is architecturally mapped to AArch32 System register [CNTP_CTL](#).

RW fields in this register reset to architecturally UNKNOWN values.

Attributes

CNTP_CTL_EL0 is a 32-bit register.

Field descriptions

The CNTP_CTL_EL0 bit assignments are:

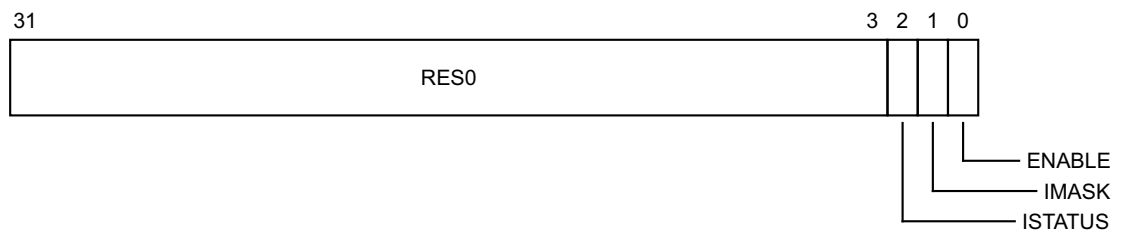

Bits [31:3]

Reserved, RES0.

ISTATUS, bit [2]

The status of the timer. This bit indicates whether the timer condition is met:

- 0 Timer condition is not met.
- 1 Timer condition is met.

When the value of the ENABLE bit is 1, ISTATUS indicates whether the timer condition is met. ISTATUS takes no account of the value of the IMASK bit. If the value of ISTATUS is 1 and the value of IMASK is 0 then the timer interrupt is asserted.

When the value of the ENABLE bit is 0, the ISTATUS field is UNKNOWN.

For more information see [Operation of the CompareValue views of the timers](#) on page D6-2187 and [Operation of the TimerValue views of the timers](#) on page D6-2188.

This bit is read-only.

IMASK, bit [1]

Timer interrupt mask bit. Permitted values are:

- 0 Timer interrupt is not masked by the IMASK bit.
- 1 Timer interrupt is masked by the IMASK bit.

For more information, see the description of the ISTATUS bit.

ENABLE, bit [0]

Enables the timer. Permitted values are:

- 0 Timer disabled.
- 1 Timer enabled.

Setting this bit to 0 disables the timer output signal, but the timer value accessible from [CNTP_TVAL_ELO](#) continues to count down.

Note

Disabling the output signal might be a power-saving option.

Accessing the CNTP_CTL_ELO

This register can be read using MRS with the following syntax:

MRS <Xt>, <systemreg>

This register can be written using MSR (register) with the following syntax:

MSR <systemreg>, <Xt>

This syntax is encoded with the following settings in the instruction encoding:

<systemreg>	op0	op1	CRn	CRm	op2
CNTP_CTL_ELO	11	011	1110	0010	001
CNTP_CTL_ELO2	11	101	1110	0010	001

Accessibility

The register is accessible in software as follows:

<systemreg>	Control			Accessibility			
	E2H	TGE	NS	EL0	EL1	EL2	EL3
CNTP_CTL_ELO	x	x	0	RW	RW	n/a	RW
CNTP_CTL_ELO	0	0	1	RW	RW	RW	RW
CNTP_CTL_ELO	0	1	1	RW	n/a	RW	RW
CNTP_CTL_ELO	1	0	1	RW	RW	CNTHP_CTL_EL2	RW
CNTP_CTL_ELO	1	1	1	CNTHP_CTL_EL2	n/a	CNTHP_CTL_EL2	RW
CNTP_CTL_ELO2	x	x	0	-	-	n/a	-
CNTP_CTL_ELO2	0	0	1	-	-	-	-
CNTP_CTL_ELO2	0	1	1	-	n/a	-	-
CNTP_CTL_ELO2	1	0	1	-	-	RW	RW
CNTP_CTL_ELO2	1	1	1	-	n/a	RW	RW

This table applies to all instructions that can access this register.

When [HCR_EL2.E2H](#) is 1, without explicit synchronization, access from EL3 using the mnemonic [CNTP_CTL_ELO](#) or [CNTP_CTL_ELO2](#) are not guaranteed to be ordered with respect to accesses using the other mnemonic.

Traps and Enables

For a description of the prioritization of any generated exceptions, see *Synchronous exception prioritization for exceptions taken to AArch64* on page D1-1827. Subject to the prioritization rules:

- When $\text{HCR_EL2.E2H} == 0$:
 - If $\text{CNTKCTL_EL1.EL0PTEN} == 0$, accesses to this register from EL0 are trapped to EL1.
- When EL2 is implemented and is using AArch64 and $(\text{SCR_EL3.NS} == 1) \ \&\& \ (\text{HCR_EL2.E2H} == 0)$:
 - If $\text{CNTHCTL_EL2.EL1PCEN} == 0$, Non-secure accesses to this register from EL1 are trapped to EL2.
 - If $\text{CNTHCTL_EL2.EL1PCEN} == 0$, and $\text{CNTKCTL_EL1.EL0PTEN} == 1$, Non-secure accesses to this register from EL0 are trapped to EL2.
- When EL2 is implemented and is using AArch64 and $(\text{SCR_EL3.NS} == 1) \ \&\& \ (\text{HCR_EL2.E2H} == 1) \ \&\& \ (\text{HCR_EL2.TGE} == 0)$:
 - If $\text{CNTHCTL_EL2.EL1PTEN} == 0$, Non-secure accesses to this register from EL1 are trapped to EL2.
 - If $\text{CNTHCTL_EL2.EL1PTEN} == 0$, and $\text{CNTKCTL_EL1.EL0PTEN} == 1$, Non-secure accesses to this register from EL0 are trapped to EL2.
 - If $\text{CNTKCTL_EL1.EL0PTEN} == 0$, Non-secure accesses to this register from EL0 are trapped to EL1.
- When EL2 is implemented and is using AArch64 and $(\text{SCR_EL3.NS} == 1) \ \&\& \ (\text{HCR_EL2.E2H} == 1) \ \&\& \ (\text{HCR_EL2.TGE} == 1)$:
 - If $\text{CNTHCTL_EL2.EL0PTEN} == 0$, Non-secure accesses to this register from EL0 are trapped to EL2.

D7.5.11 CNTP_CVAL_EL0, Counter-timer Physical Timer CompareValue register

The CNTP_CVAL_EL0 characteristics are:

Purpose

Holds the compare value for the EL1 physical timer.

Configurations

AArch64 System register CNTP_CVAL_EL0 is architecturally mapped to AArch32 System register [CNTP_CVAL](#).

RW fields in this register reset to architecturally UNKNOWN values.

Attributes

CNTP_CVAL_EL0 is a 64-bit register.

Field descriptions

The CNTP_CVAL_EL0 bit assignments are:

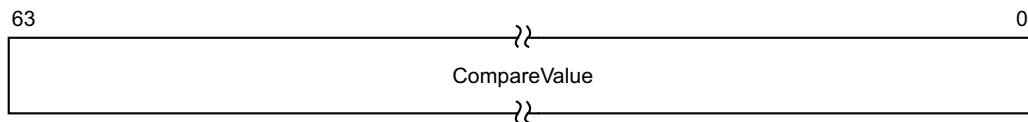

CompareValue, bits [63:0]

Holds the EL1 physical timer CompareValue.

When [CNTP_CTL_EL0.ENABLE](#) is 1, the timer condition is met when ([CNTPCT_EL0 - CompareValue](#)) is greater than zero. This means that CompareValue acts like a 64-bit upcounter timer. When the timer condition is met:

- [CNTP_CTL_EL0.ISTATUS](#) is set to 1.
- If [CNTP_CTL_EL0.IMASK](#) is 0, an interrupt is generated.

When [CNTP_CTL_EL0.ENABLE](#) is 0, the timer condition is not met, but [CNTPCT_EL0](#) continues to count.

Accessing the CNTP_CVAL_EL0

This register can be read using MRS with the following syntax:

MRS <Xt>, <systemreg>

This register can be written using MSR (register) with the following syntax:

MSR <systemreg>, <Xt>

This syntax is encoded with the following settings in the instruction encoding:

<systemreg>	op0	op1	CRn	CRm	op2
CNTP_CVAL_EL0	11	011	1110	0010	010
CNTP_CVAL_EL02	11	101	1110	0010	010

Accessibility

The register is accessible in software as follows:

<systemreg>	Control			Accessibility			
	E2H	TGE	NS	EL0	EL1	EL2	EL3
CNTP_CVAL_EL0	x	x	0	RW	RW	n/a	RW
CNTP_CVAL_EL0	0	0	1	RW	RW	RW	RW
CNTP_CVAL_EL0	0	1	1	RW	n/a	RW	RW
CNTP_CVAL_EL0	1	0	1	RW	RW	CNTHP_CVAL_EL2	RW
CNTP_CVAL_EL0	1	1	1	CNTHP_CVAL_EL2	n/a	CNTHP_CVAL_EL2	RW
CNTP_CVAL_EL02	x	x	0	-	-	n/a	-
CNTP_CVAL_EL02	0	0	1	-	-	-	-
CNTP_CVAL_EL02	0	1	1	-	n/a	-	-
CNTP_CVAL_EL02	1	0	1	-	-	RW	RW
CNTP_CVAL_EL02	1	1	1	-	n/a	RW	RW

This table applies to all instructions that can access this register.

When [HCR_EL2.E2H](#) is 1, without explicit synchronization, access from EL3 using the mnemonic [CNTP_CVAL_EL0](#) or [CNTP_CVAL_EL02](#) are not guaranteed to be ordered with respect to accesses using the other mnemonic.

Traps and Enables

For a description of the prioritization of any generated exceptions, see [Synchronous exception prioritization for exceptions taken to AArch64 on page D1-1827](#). Subject to the prioritization rules:

- When [HCR_EL2.E2H](#) == 0:
 - If [CNTKCTL_EL1.EL0PTEN](#)==0, accesses to this register from EL0 are trapped to EL1.
- When EL2 is implemented and is using AArch64 and ([SCR_EL3.NS](#) == 1) && ([HCR_EL2.E2H](#) == 0):
 - If [CNTHCTL_EL2.EL1PCEN](#)==0, Non-secure accesses to this register from EL1 are trapped to EL2.
 - If [CNTHCTL_EL2.EL1PCEN](#)==0, and [CNTKCTL_EL1.EL0PTEN](#)==1, Non-secure accesses to this register from EL0 are trapped to EL2.
- When EL2 is implemented and is using AArch64 and ([SCR_EL3.NS](#) == 1) && ([HCR_EL2.E2H](#) == 1) && ([HCR_EL2.TGE](#) == 0):
 - If [CNTHCTL_EL2.EL1PTEN](#)==0, Non-secure accesses to this register from EL1 are trapped to EL2.
 - If [CNTHCTL_EL2.EL1PTEN](#)==0, and [CNTKCTL_EL1.EL0PTEN](#)==1, Non-secure accesses to this register from EL0 are trapped to EL2.
 - If [CNTKCTL_EL1.EL0PTEN](#)==0, Non-secure accesses to this register from EL0 are trapped to EL1.
- When EL2 is implemented and is using AArch64 and ([SCR_EL3.NS](#) == 1) && ([HCR_EL2.E2H](#) == 1) && ([HCR_EL2.TGE](#) == 1):
 - If [CNTHCTL_EL2.EL0PTEN](#)==0, Non-secure accesses to this register from EL0 are trapped to EL2.

D7.5.12 CNTP_TVAL_EL0, Counter-timer Physical Timer TimerValue register

The CNTP_TVAL_EL0 characteristics are:

Purpose

Holds the timer value for the EL1 physical timer.

Configurations

AArch64 System register CNTP_TVAL_EL0 is architecturally mapped to AArch32 System register [CNTP_TVAL](#).

RW fields in this register reset to architecturally UNKNOWN values.

Attributes

CNTP_TVAL_EL0 is a 32-bit register.

Field descriptions

The CNTP_TVAL_EL0 bit assignments are:

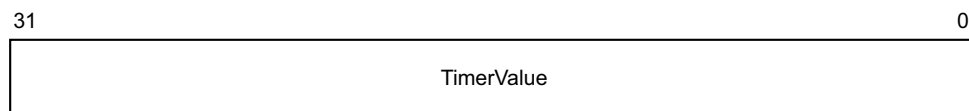

TimerValue, bits [31:0]

The TimerValue view of the EL1 physical timer.

On a read of this register:

- If [CNTP_CTL_EL0.ENABLE](#) is 0, the value returned is UNKNOWN.
- If [CNTP_CTL_EL0.ENABLE](#) is 1, the value returned is ([CNTP_CVAL_EL0](#) - [CNTPCT_EL0](#)).

On a write of this register, [CNTP_CVAL_EL0](#) is set to ([CNTPCT_EL0](#) + TimerValue), where TimerValue is treated as a signed 32-bit integer.

When [CNTP_CTL_EL0.ENABLE](#) is 1, the timer condition is met when ([CNTPCT_EL0](#) - [CNTP_CVAL_EL0](#)) is greater than zero. This means that TimerValue acts like a 32-bit downcounter timer. When the timer condition is met:

- [CNTP_CTL_EL0.ISTATUS](#) is set to 1.
- If [CNTP_CTL_EL0.IMASK](#) is 0, an interrupt is generated.

When [CNTP_CTL_EL0.ENABLE](#) is 0, the timer condition is not met, but [CNTPCT_EL0](#) continues to count, so the TimerValue view appears to continue to count down.

Accessing the CNTP_TVAL_EL0

This register can be read using MRS with the following syntax:

```
MRS <Xt>, <systemreg>
```

This register can be written using MSR (register) with the following syntax:

```
MSR <systemreg>, <Xt>
```

This syntax is encoded with the following settings in the instruction encoding:

<systemreg>	op0	op1	CRn	CRm	op2
CNTP_TVAL_EL0	11	011	1110	0010	000
CNTP_TVAL_EL02	11	101	1110	0010	000

Accessibility

The register is accessible in software as follows:

<systemreg>	Control			Accessibility			
	E2H	TGE	NS	EL0	EL1	EL2	EL3
CNTP_TVAL_EL0	x	x	0	RW	RW	n/a	RW
CNTP_TVAL_EL0	0	0	1	RW	RW	RW	RW
CNTP_TVAL_EL0	0	1	1	RW	n/a	RW	RW
CNTP_TVAL_EL0	1	0	1	RW	RW	CNTHP_TVAL_EL2	RW
CNTP_TVAL_EL0	1	1	1	CNTHP_TVAL_EL2	n/a	CNTHP_TVAL_EL2	RW
CNTP_TVAL_EL02	x	x	0	-	-	n/a	-
CNTP_TVAL_EL02	0	0	1	-	-	-	-
CNTP_TVAL_EL02	0	1	1	-	n/a	-	-
CNTP_TVAL_EL02	1	0	1	-	-	RW	RW
CNTP_TVAL_EL02	1	1	1	-	n/a	RW	RW

This table applies to all instructions that can access this register.

When [HCR_EL2.E2H](#) is 1, without explicit synchronization, access from EL3 using the mnemonic [CNTP_TVAL_EL0](#) or [CNTP_TVAL_EL02](#) are not guaranteed to be ordered with respect to accesses using the other mnemonic.

Traps and Enables

For a description of the prioritization of any generated exceptions, see [Synchronous exception prioritization for exceptions taken to AArch64 on page D1-1827](#). Subject to the prioritization rules:

- When [HCR_EL2.E2H](#) == 0:
 - If [CNTKCTL_EL1.EL0PTEN](#)==0, accesses to this register from EL0 are trapped to EL1.
- When EL2 is implemented and is using AArch64 and ([SCR_EL3.NS](#) == 1) && ([HCR_EL2.E2H](#) == 0):
 - If [CNTHCTL_EL2.EL1PCEN](#)==0, Non-secure accesses to this register from EL1 are trapped to EL2.
 - If [CNTHCTL_EL2.EL1PCEN](#)==0, and [CNTKCTL_EL1.EL0PTEN](#)==1, Non-secure accesses to this register from EL0 are trapped to EL2.
- When EL2 is implemented and is using AArch64 and ([SCR_EL3.NS](#) == 1) && ([HCR_EL2.E2H](#) == 1) && ([HCR_EL2.TGE](#) == 0):
 - If [CNTHCTL_EL2.EL1PTEN](#)==0, Non-secure accesses to this register from EL1 are trapped to EL2.

- If `CNTHCTL_EL2.EL1PTEN==0`, and `CNTKCTL_EL1.EL0PTEN==1`, Non-secure accesses to this register from EL0 are trapped to EL2.
- If `CNTKCTL_EL1.EL0PTEN==0`, Non-secure accesses to this register from EL0 are trapped to EL1.
- When EL2 is implemented and is using AArch64 and `(SCR_EL3.NS == 1) && (HCR_EL2.E2H == 1) && (HCR_EL2.TGE == 1)`:
 - If `CNTHCTL_EL2.EL0PTEN==0`, Non-secure accesses to this register from EL0 are trapped to EL2.

D7.5.13 CNTPCT_EL0, Counter-timer Physical Count register

The CNTPCT_EL0 characteristics are:

Purpose

Holds the 64-bit physical count value.

Configurations

AArch64 System register CNTPCT_EL0 is architecturally mapped to AArch32 System register [CNTPCT](#).

Attributes

CNPCT_EL0 is a 64-bit register.

Field descriptions

The CNTPCT_EL0 bit assignments are:

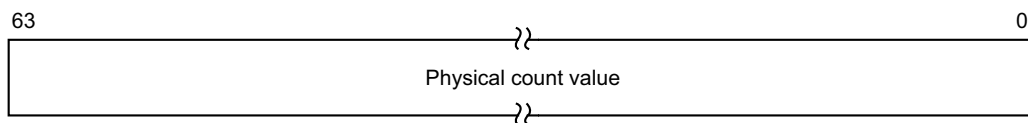

Bits [63:0]

Physical count value.

Accessing the CNTPCT_EL0

This register can be read using MRS with the following syntax:

MRS <Xt>, <systemreg>

This syntax is encoded with the following settings in the instruction encoding:

<systemreg>	op0	op1	CRn	CRm	op2
CNPCT_EL0	11	011	1110	0000	001

Accessibility

The register is accessible in software as follows:

Control			Accessibility			
E2H	TGE	NS	EL0	EL1	EL2	EL3
x	x	0	RO	RO	n/a	RO
x	0	1	RO	RO	RO	RO
x	1	1	RO	n/a	RO	RO

Traps and Enables

For a description of the prioritization of any generated exceptions, see *Synchronous exception prioritization for exceptions taken to AArch64* on page D1-1827. Subject to the prioritization rules:

- When $\text{HCR_EL2.E2H} == 0$:
 - If $\text{CNTKCTL_EL1.EL0PCTEN} == 0$, read accesses to this register from EL0 are trapped to EL1.
- When EL2 is implemented and is using AArch64 and $(\text{SCR_EL3.NS} == 1) \ \&\& \ (\text{HCR_EL2.E2H} == 0)$:
 - If $\text{CNTHCTL_EL2.EL1PCTEN} == 0$, Non-secure read accesses to this register from EL1 are trapped to EL2.
 - If $\text{CNTHCTL_EL2.EL1PCTEN} == 0$, and $\text{CNTKCTL_EL1.EL0PCTEN} == 1$, Non-secure read accesses to this register from EL0 are trapped to EL2.
- When EL2 is implemented and is using AArch64 and $(\text{SCR_EL3.NS} == 1) \ \&\& \ (\text{HCR_EL2.E2H} == 1) \ \&\& \ (\text{HCR_EL2.TGE} == 0)$:
 - If $\text{CNTHCTL_EL2.EL1PCTEN} == 0$, Non-secure read accesses to this register from EL1 are trapped to EL2.
 - If $\text{CNTHCTL_EL2.EL1PCTEN} == 0$, and $\text{CNTKCTL_EL1.EL0PCTEN} == 1$, Non-secure read accesses to this register from EL0 are trapped to EL2.
 - If $\text{CNTKCTL_EL1.EL0PCTEN} == 0$, Non-secure read accesses to this register from EL0 are trapped to EL1.
- When EL2 is implemented and is using AArch64 and $(\text{SCR_EL3.NS} == 1) \ \&\& \ (\text{HCR_EL2.E2H} == 1) \ \&\& \ (\text{HCR_EL2.TGE} == 1)$:
 - If $\text{CNTHCTL_EL2.EL0PCTEN} == 0$, Non-secure read accesses to this register from EL0 are trapped to EL2.

D7.5.14 CNTPS_CTL_EL1, Counter-timer Physical Secure Timer Control register

The CNTPS_CTL_EL1 characteristics are:

Purpose

Control register for the secure physical timer, usually accessible at EL3 but configurably accessible at EL1 in Secure state.

Configurations

RW fields in this register reset to architecturally UNKNOWN values.

Attributes

CNTPS_CTL_EL1 is a 32-bit register.

Field descriptions

The CNTPS_CTL_EL1 bit assignments are:

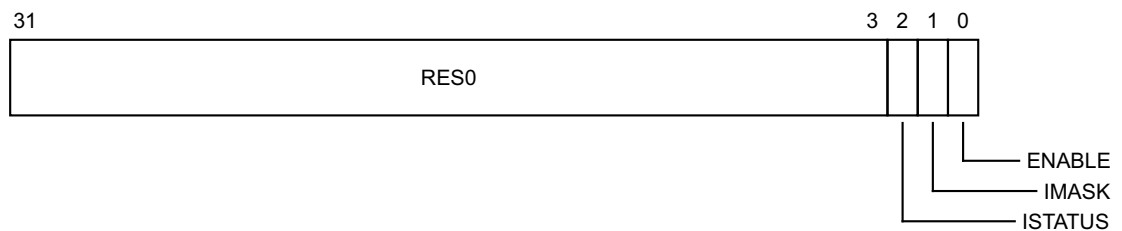

Bits [31:3]

Reserved, RES0.

ISTATUS, bit [2]

The status of the timer. This bit indicates whether the timer condition is met:

- 0 Timer condition is not met.
- 1 Timer condition is met.

When the value of the ENABLE bit is 1, ISTATUS indicates whether the timer condition is met. ISTATUS takes no account of the value of the IMASK bit. If the value of ISTATUS is 1 and the value of IMASK is 0 then the timer interrupt is asserted.

When the value of the ENABLE bit is 0, the ISTATUS field is UNKNOWN.

For more information see [Operation of the CompareValue views of the timers on page D6-2187](#) and [Operation of the TimerValue views of the timers on page D6-2188](#).

This bit is read-only.

IMASK, bit [1]

Timer interrupt mask bit. Permitted values are:

- 0 Timer interrupt is not masked by the IMASK bit.
- 1 Timer interrupt is masked by the IMASK bit.

For more information, see the description of the ISTATUS bit.

ENABLE, bit [0]

Enables the timer. Permitted values are:

- 0 Timer disabled.
- 1 Timer enabled.

Setting this bit to 0 disables the timer output signal, but the timer value accessible from [CNTPS_TVAL_EL1](#) continues to count down.

Note

Disabling the output signal might be a power-saving option.

Accessing the CNTPS_CTL_EL1

This register can be read using MRS with the following syntax:

MRS <Xt>, <systemreg>

This register can be written using MSR (register) with the following syntax:

MSR <systemreg>, <Xt>

This syntax is encoded with the following settings in the instruction encoding:

<systemreg>	op0	op1	CRn	CRm	op2
CNTPS_CTL_EL1	11	111	1110	0010	001

Accessibility

The register is accessible in software as follows:

Control			Accessibility			
E2H	TGE	NS	EL0	EL1	EL2	EL3
x	x	0	-	RW	n/a	RW
0	0	1	-	-	-	RW
0	1	1	-	n/a	-	RW
1	0	1	-	-	-	RW
1	1	1	-	n/a	-	RW

Traps and Enables

For a description of the prioritization of any generated exceptions, see [Synchronous exception prioritization for exceptions taken to AArch64 on page D1-1827](#). Subject to the prioritization rules:

- When EL3 is implemented and is using AArch64 and SCR_EL3.NS == 0:
 - If SCR_EL3.ST==0, Secure accesses to this register from EL1 are trapped to EL3.

D7.5.15 CNTPS_CVAL_EL1, Counter-timer Physical Secure Timer CompareValue register

The CNTPS_CVAL_EL1 characteristics are:

Purpose

Holds the compare value for the secure physical timer, usually accessible at EL3 but configurably accessible at EL1 in Secure state.

Configurations

RW fields in this register reset to architecturally UNKNOWN values.

Attributes

CNTPS_CVAL_EL1 is a 64-bit register.

Field descriptions

The CNTPS_CVAL_EL1 bit assignments are:

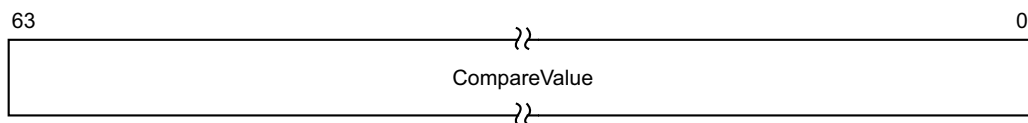

CompareValue, bits [63:0]

Holds the secure physical timer CompareValue.

When [CNTPS_CTL_EL1.ENABLE](#) is 1, the timer condition is met when ([CNTPCT_EL0](#) - CompareValue) is greater than zero. This means that CompareValue acts like a 64-bit upcounter timer. When the timer condition is met:

- [CNTPS_CTL_EL1.ISTATUS](#) is set to 1.
- If [CNTPS_CTL_EL1.IMASK](#) is 0, an interrupt is generated.

When [CNTPS_CTL_EL1.ENABLE](#) is 0, the timer condition is not met, but [CNTPCT_EL0](#) continues to count.

Accessing the CNTPS_CVAL_EL1

This register can be read using MRS with the following syntax:

```
MRS <Xt>, <systemreg>
```

This register can be written using MSR (register) with the following syntax:

```
MSR <systemreg>, <Xt>
```

This syntax is encoded with the following settings in the instruction encoding:

<systemreg>	op0	op1	CRn	CRm	op2
CNTPS_CVAL_EL1	11	111	1110	0010	010

Accessibility

The register is accessible in software as follows:

Control			Accessibility			
E2H	TGE	NS	EL0	EL1	EL2	EL3
x	x	0	-	RW	n/a	RW
0	0	1	-	-	-	RW
0	1	1	-	n/a	-	RW
1	0	1	-	-	-	RW
1	1	1	-	n/a	-	RW

Traps and Enables

For a description of the prioritization of any generated exceptions, see [Synchronous exception prioritization for exceptions taken to AArch64 on page D1-1827](#). Subject to the prioritization rules:

- When EL3 is implemented and is using AArch64 and `SCR_EL3.NS == 0`:
 - If `SCR_EL3.ST == 0`, Secure accesses to this register from EL1 are trapped to EL3.

D7.5.16 CNTPS_TVAL_EL1, Counter-timer Physical Secure Timer TimerValue register

The CNTPS_TVAL_EL1 characteristics are:

Purpose

Holds the timer value for the secure physical timer, usually accessible at EL3 but configurably accessible at EL1 in Secure state.

Configurations

RW fields in this register reset to architecturally UNKNOWN values.

Attributes

CNTPS_TVAL_EL1 is a 32-bit register.

Field descriptions

The CNTPS_TVAL_EL1 bit assignments are:

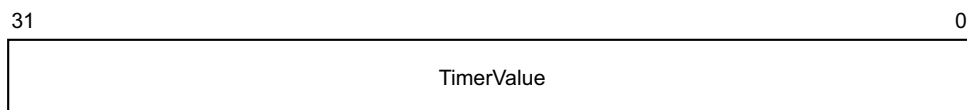

TimerValue, bits [31:0]

The TimerValue view of the secure physical timer.

On a read of this register:

- If CNTPS_CTL_EL1.ENABLE is 0, the value returned is UNKNOWN.
- If CNTPS_CTL_EL1.ENABLE is 1, the value returned is (CNTPS_CVAL_EL1 - CNTPCT_EL0).

On a write of this register, CNTPS_CVAL_EL1 is set to (CNTPCT_EL0 + TimerValue), where TimerValue is treated as a signed 32-bit integer.

When CNTPS_CTL_EL1.ENABLE is 1, the timer condition is met when (CNTPCT_EL0 - CNTPS_CVAL_EL1) is greater than zero. This means that TimerValue acts like a 32-bit downcounter timer. When the timer condition is met:

- CNTPS_CTL_EL1.ISTATUS is set to 1.
- If CNTPS_CTL_EL1.IMASK is 0, an interrupt is generated.

When CNTPS_CTL_EL1.ENABLE is 0, the timer condition is not met, but CNTPCT_EL0 continues to count, so the TimerValue view appears to continue to count down.

Accessing the CNTPS_TVAL_EL1

This register can be read using MRS with the following syntax:

MRS <Xt>, <systemreg>

This register can be written using MSR (register) with the following syntax:

MSR <systemreg>, <Xt>

This syntax is encoded with the following settings in the instruction encoding:

<systemreg>	op0	op1	CRn	CRm	op2
CNTPS_TVAL_EL1	11	111	1110	0010	000

Accessibility

The register is accessible in software as follows:

Control			Accessibility			
E2H	TGE	NS	EL0	EL1	EL2	EL3
x	x	0	-	RW	n/a	RW
0	0	1	-	-	-	RW
0	1	1	-	n/a	-	RW
1	0	1	-	-	-	RW
1	1	1	-	n/a	-	RW

Traps and Enables

For a description of the prioritization of any generated exceptions, see [Synchronous exception prioritization for exceptions taken to AArch64 on page D1-1827](#). Subject to the prioritization rules:

- When EL3 is implemented and is using AArch64 and `SCR_EL3.NS == 0`:
 - If `SCR_EL3.ST == 0`, Secure accesses to this register from EL1 are trapped to EL3.

D7.5.17 CNTV_CTL_EL0, Counter-timer Virtual Timer Control register

The CNTV_CTL_EL0 characteristics are:

Purpose

Control register for the virtual timer.

Configurations

AArch64 System register CNTV_CTL_EL0 is architecturally mapped to AArch32 System register [CNTV_CTL](#).

RW fields in this register reset to architecturally UNKNOWN values.

Attributes

CNTV_CTL_EL0 is a 32-bit register.

Field descriptions

The CNTV_CTL_EL0 bit assignments are:

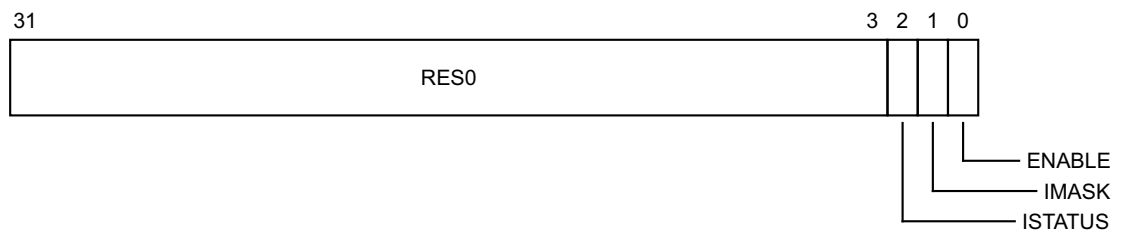

Bits [31:3]

Reserved, RES0.

ISTATUS, bit [2]

The status of the timer. This bit indicates whether the timer condition is met:

- 0 Timer condition is not met.
- 1 Timer condition is met.

When the value of the ENABLE bit is 1, ISTATUS indicates whether the timer condition is met. ISTATUS takes no account of the value of the IMASK bit. If the value of ISTATUS is 1 and the value of IMASK is 0 then the timer interrupt is asserted.

When the value of the ENABLE bit is 0, the ISTATUS field is UNKNOWN.

For more information see [Operation of the CompareValue views of the timers](#) on page D6-2187 and [Operation of the TimerValue views of the timers](#) on page D6-2188.

This bit is read-only.

IMASK, bit [1]

Timer interrupt mask bit. Permitted values are:

- 0 Timer interrupt is not masked by the IMASK bit.
- 1 Timer interrupt is masked by the IMASK bit.

For more information, see the description of the ISTATUS bit.

ENABLE, bit [0]

Enables the timer. Permitted values are:

- 0 Timer disabled.
- 1 Timer enabled.

Setting this bit to 0 disables the timer output signal, but the timer value accessible from [CNTV_TVAL_EL0](#) continues to count down.

Note

Disabling the output signal might be a power-saving option.

Accessing the CNTV_CTL_EL0

This register can be read using MRS with the following syntax:

MRS <Xt>, <systemreg>

This register can be written using MSR (register) with the following syntax:

MSR <systemreg>, <Xt>

This syntax is encoded with the following settings in the instruction encoding:

<systemreg>	op0	op1	CRn	CRm	op2
CNTV_CTL_EL0	11	011	1110	0011	001
CNTV_CTL_EL02	11	101	1110	0011	001

Accessibility

The register is accessible in software as follows:

<systemreg>	Control			Accessibility			
	E2H	TGE	NS	EL0	EL1	EL2	EL3
CNTV_CTL_EL0	x	x	0	RW	RW	n/a	RW
CNTV_CTL_EL0	0	0	1	RW	RW	RW	RW
CNTV_CTL_EL0	0	1	1	RW	n/a	RW	RW
CNTV_CTL_EL0	1	0	1	RW	RW	CNTHV_CTL_EL2	RW
CNTV_CTL_EL0	1	1	1	CNTHV_CTL_EL2	n/a	CNTHV_CTL_EL2	RW
CNTV_CTL_EL02	x	x	0	-	-	n/a	-
CNTV_CTL_EL02	0	0	1	-	-	-	-
CNTV_CTL_EL02	0	1	1	-	n/a	-	-
CNTV_CTL_EL02	1	0	1	-	-	RW	RW
CNTV_CTL_EL02	1	1	1	-	n/a	RW	RW

This table applies to all instructions that can access this register.

When [HCR_EL2.E2H](#) is 1, without explicit synchronization, access from EL3 using the mnemonic [CNTV_CTL_EL0](#) or [CNTV_CTL_EL02](#) are not guaranteed to be ordered with respect to accesses using the other mnemonic.

Traps and Enables

For a description of the prioritization of any generated exceptions, see [Synchronous exception prioritization for exceptions taken to AArch64 on page D1-1827](#). Subject to the prioritization rules:

- When $\text{HCR_EL2.E2H} == 0$:
 - If $\text{CNTKCTL_EL1.EL0VTEN} == 0$, accesses to this register from EL0 are trapped to EL1.
- When EL2 is implemented and is using AArch64 and $(\text{SCR_EL3.NS} == 1) \ \&\& \ (\text{HCR_EL2.E2H} == 1) \ \&\& \ (\text{HCR_EL2.TGE} == 0)$:
 - If $\text{CNTKCTL_EL1.EL0VTEN} == 0$, Non-secure accesses to this register from EL0 are trapped to EL1.
- When EL2 is implemented and is using AArch64 and $(\text{SCR_EL3.NS} == 1) \ \&\& \ (\text{HCR_EL2.E2H} == 1) \ \&\& \ (\text{HCR_EL2.TGE} == 1)$:
 - If $\text{CNTHCTL_EL2.EL0VTEN} == 0$, Non-secure accesses to this register from EL0 are trapped to EL2.

D7.5.18 CNTV_CVAL_EL0, Counter-timer Virtual Timer CompareValue register

The CNTV_CVAL_EL0 characteristics are:

Purpose

Holds the compare value for the virtual timer.

Configurations

AArch64 System register CNTV_CVAL_EL0 is architecturally mapped to AArch32 System register [CNTV_CVAL](#).

RW fields in this register reset to architecturally UNKNOWN values.

Attributes

CNTV_CVAL_EL0 is a 64-bit register.

Field descriptions

The CNTV_CVAL_EL0 bit assignments are:

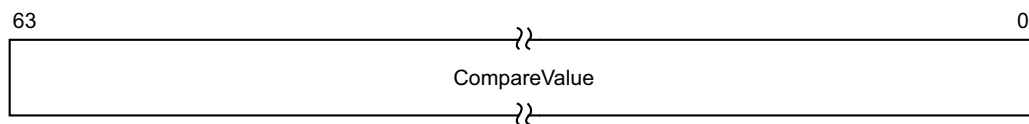

CompareValue, bits [63:0]

Holds the EL1 virtual timer CompareValue.

When [CNTV_CTL_EL0.ENABLE](#) is 1, the timer condition is met when ([CNTVCT_EL0](#) - CompareValue) is greater than zero. This means that CompareValue acts like a 64-bit upcounter timer. When the timer condition is met:

- [CNTV_CTL_EL0.ISTATUS](#) is set to 1.
- If [CNTV_CTL_EL0.IMASK](#) is 0, an interrupt is generated.

When [CNTV_CTL_EL0.ENABLE](#) is 0, the timer condition is not met, but [CNTVCT_EL0](#) continues to count.

Accessing the CNTV_CVAL_EL0

This register can be read using MRS with the following syntax:

```
MRS <Xt>, <systemreg>
```

This register can be written using MSR (register) with the following syntax:

```
MSR <systemreg>, <Xt>
```

This syntax is encoded with the following settings in the instruction encoding:

<systemreg>	op0	op1	CRn	CRm	op2
CNTV_CVAL_EL0	11	011	1110	0011	010
CNTV_CVAL_EL02	11	101	1110	0011	010

Accessibility

The register is accessible in software as follows:

<systemreg>	Control			Accessibility			
	E2H	TGE	NS	EL0	EL1	EL2	EL3
CNTV_CVAL_EL0	x	x	0	RW	RW	n/a	RW
CNTV_CVAL_EL0	0	0	1	RW	RW	RW	RW
CNTV_CVAL_EL0	0	1	1	RW	n/a	RW	RW
CNTV_CVAL_EL0	1	0	1	RW	RW	CNTHV_CVAL_EL2	RW
CNTV_CVAL_EL0	1	1	1	CNTHV_CVAL_EL2	n/a	CNTHV_CVAL_EL2	RW
CNTV_CVAL_EL02	x	x	0	-	-	n/a	-
CNTV_CVAL_EL02	0	0	1	-	-	-	-
CNTV_CVAL_EL02	0	1	1	-	n/a	-	-
CNTV_CVAL_EL02	1	0	1	-	-	RW	RW
CNTV_CVAL_EL02	1	1	1	-	n/a	RW	RW

This table applies to all instructions that can access this register.

When [HCR_EL2.E2H](#) is 1, without explicit synchronization, access from EL3 using the mnemonic [CNTV_CVAL_EL0](#) or [CNTV_CVAL_EL02](#) are not guaranteed to be ordered with respect to accesses using the other mnemonic.

Traps and Enables

For a description of the prioritization of any generated exceptions, see [Synchronous exception prioritization for exceptions taken to AArch64 on page D1-1827](#). Subject to the prioritization rules:

- When [HCR_EL2.E2H](#) == 0:
 - If [CNTKCTL_EL1.EL0VTEN](#)==0, accesses to this register from EL0 are trapped to EL1.
- When EL2 is implemented and is using AArch64 and ([SCR_EL3.NS](#) == 1) && ([HCR_EL2.E2H](#) == 1) && ([HCR_EL2.TGE](#) == 0):
 - If [CNTKCTL_EL1.EL0VTEN](#)==0, Non-secure accesses to this register from EL0 are trapped to EL1.
- When EL2 is implemented and is using AArch64 and ([SCR_EL3.NS](#) == 1) && ([HCR_EL2.E2H](#) == 1) && ([HCR_EL2.TGE](#) == 1):
 - If [CNTHCTL_EL2.EL0VTEN](#)==0, Non-secure accesses to this register from EL0 are trapped to EL2.

D7.5.19 CNTV_TVAL_EL0, Counter-timer Virtual Timer TimerValue register

The CNTV_TVAL_EL0 characteristics are:

Purpose

Holds the timer value for the EL1 virtual timer.

Configurations

AArch64 System register CNTV_TVAL_EL0 is architecturally mapped to AArch32 System register [CNTV_TVAL](#).

RW fields in this register reset to architecturally UNKNOWN values.

Attributes

CNTV_TVAL_EL0 is a 32-bit register.

Field descriptions

The CNTV_TVAL_EL0 bit assignments are:

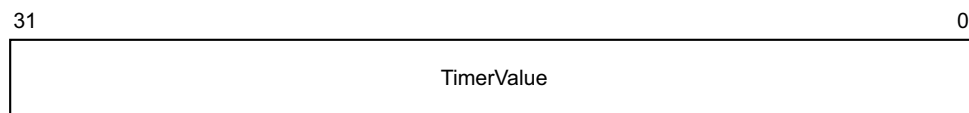

TimerValue, bits [31:0]

The TimerValue view of the EL1 virtual timer.

On a read of this register:

- If [CNTV_CTL_EL0.ENABLE](#) is 0, the value returned is UNKNOWN.
- If [CNTV_CTL_EL0.ENABLE](#) is 1, the value returned is $(\text{CNTV_CVAL_EL0} - (\text{CNTPCT_EL0} - \text{CNTVOFF_EL2}))$.

On a write of this register, [CNTV_CVAL_EL0](#) is set to $(\text{CNTPCT_EL0} + \text{TimerValue})$, where TimerValue is treated as a signed 32-bit integer.

When [CNTV_CTL_EL0.ENABLE](#) is 1, the timer condition is met when $(\text{CNTPCT_EL0} - \text{CNTV_CVAL_EL0})$ is greater than zero. This means that TimerValue acts like a 32-bit downcounter timer. When the timer condition is met:

- [CNTV_CTL_EL0.ISTATUS](#) is set to 1.
- If [CNTV_CTL_EL0.IMASK](#) is 0, an interrupt is generated.

When [CNTV_CTL_EL0.ENABLE](#) is 0, the timer condition is not met, but [CNTVCT_EL0](#) continues to count, so the TimerValue view appears to continue to count down.

Accessing the CNTV_TVAL_EL0

This register can be read using MRS with the following syntax:

```
MRS <Xt>, <systemreg>
```

This register can be written using MSR (register) with the following syntax:

```
MSR <systemreg>, <Xt>
```

This syntax is encoded with the following settings in the instruction encoding:

<systemreg>	op0	op1	CRn	CRm	op2
CNTV_TVAL_EL0	11	011	1110	0011	000
CNTV_TVAL_EL02	11	101	1110	0011	000

Accessibility

The register is accessible in software as follows:

<systemreg>	Control			Accessibility			
	E2H	TGE	NS	EL0	EL1	EL2	EL3
CNTV_TVAL_EL0	x	x	0	RW	RW	n/a	RW
CNTV_TVAL_EL0	0	0	1	RW	RW	RW	RW
CNTV_TVAL_EL0	0	1	1	RW	n/a	RW	RW
CNTV_TVAL_EL0	1	0	1	RW	RW	CNTHV_TVAL_EL2	RW
CNTV_TVAL_EL0	1	1	1	CNTHV_TVAL_EL2	n/a	CNTHV_TVAL_EL2	RW
CNTV_TVAL_EL02	x	x	0	-	-	n/a	-
CNTV_TVAL_EL02	0	0	1	-	-	-	-
CNTV_TVAL_EL02	0	1	1	-	n/a	-	-
CNTV_TVAL_EL02	1	0	1	-	-	RW	RW
CNTV_TVAL_EL02	1	1	1	-	n/a	RW	RW

This table applies to all instructions that can access this register.

When [HCR_EL2.E2H](#) is 1, without explicit synchronization, access from EL3 using the mnemonic [CNTV_TVAL_EL0](#) or [CNTV_TVAL_EL02](#) are not guaranteed to be ordered with respect to accesses using the other mnemonic.

Traps and Enables

For a description of the prioritization of any generated exceptions, see [Synchronous exception prioritization for exceptions taken to AArch64 on page D1-1827](#). Subject to the prioritization rules:

- When [HCR_EL2.E2H](#) == 0:
 - If [CNTKCTL_EL1.EL0VTEN](#)==0, accesses to this register from EL0 are trapped to EL1.
- When EL2 is implemented and is using AArch64 and ([SCR_EL3.NS](#) == 1) && ([HCR_EL2.E2H](#) == 1) && ([HCR_EL2.TGE](#) == 0):
 - If [CNTKCTL_EL1.EL0VTEN](#)==0, Non-secure accesses to this register from EL0 are trapped to EL1.
- When EL2 is implemented and is using AArch64 and ([SCR_EL3.NS](#) == 1) && ([HCR_EL2.E2H](#) == 1) && ([HCR_EL2.TGE](#) == 1):
 - If [CNTHCTL_EL2.EL0VTEN](#)==0, Non-secure accesses to this register from EL0 are trapped to EL2.

D7.5.20 CNTVCT_EL0, Counter-timer Virtual Count register

The CNTVCT_EL0 characteristics are:

Purpose

Holds the 64-bit virtual count value. The virtual count value is equal to the physical count value visible in [CNTPCT_EL0](#) minus the virtual offset visible in [CNTVOFF_EL2](#).

Configurations

AArch64 System register CNTVCT_EL0 is architecturally mapped to AArch32 System register [CNTVCT](#).

The value of this register is the same as the value of [CNTPCT_EL0](#) in the following conditions:

- When EL2 is not implemented.
- When EL2 is implemented, [HCR_EL2.E2H](#) is 1, and this register is read from EL2.
- When EL2 is implemented, [HCR_EL2.{E2H, TGE}](#) is {1, 1}, and this register is read from Non-secure EL0 or EL2.

Attributes

CNTVCT_EL0 is a 64-bit register.

Field descriptions

The CNTVCT_EL0 bit assignments are:

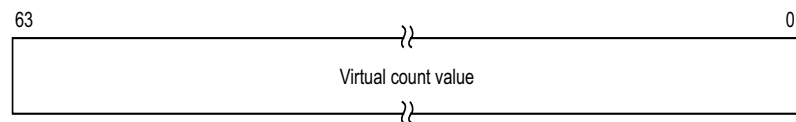

Bits [63:0]

Virtual count value.

Accessing the CNTVCT_EL0

This register can be read using MRS with the following syntax:

MRS <Xt>, <systemreg>

This syntax is encoded with the following settings in the instruction encoding:

<systemreg>	op0	op1	CRn	CRm	op2
CNTVCT_EL0	11	011	1110	0000	010

Accessibility

The register is accessible in software as follows:

Control			Accessibility			
E2H	TGE	NS	EL0	EL1	EL2	EL3
x	x	0	RO	RO	n/a	RO
x	0	1	RO	RO	RO	RO
x	1	1	RO	n/a	RO	RO

Traps and Enables

For a description of the prioritization of any generated exceptions, see [Synchronous exception prioritization for exceptions taken to AArch64 on page D1-1827](#). Subject to the prioritization rules:

- When $\text{HCR_EL2.E2H} == 0$:
 - If $\text{CNTKCTL_EL1.EL0VCTEN} == 0$, read accesses to this register from EL0 are trapped to EL1.
- When EL2 is implemented and is using AArch64 and $(\text{SCR_EL3.NS} == 1) \ \&\& \ (\text{HCR_EL2.E2H} == 1) \ \&\& \ (\text{HCR_EL2.TGE} == 0)$:
 - If $\text{CNTKCTL_EL1.EL0VCTEN} == 0$, Non-secure read accesses to this register from EL0 are trapped to EL1.
- When EL2 is implemented and is using AArch64 and $(\text{SCR_EL3.NS} == 1) \ \&\& \ (\text{HCR_EL2.E2H} == 1) \ \&\& \ (\text{HCR_EL2.TGE} == 1)$:
 - If $\text{CNTHCTL_EL2.EL0PCTEN} == 0$, Non-secure read accesses to this register from EL0 are trapped to EL2.

D7.5.21 CNTVOFF_EL2, Counter-timer Virtual Offset register

The CNTVOFF_EL2 characteristics are:

Purpose

Holds the 64-bit virtual offset. This is the offset between the physical count value visible in [CNTPCT_EL0](#) and the virtual count value visible in [CNTVCT_EL0](#).

Configurations

AArch64 System register CNTVOFF_EL2 is architecturally mapped to AArch32 System register [CNTVOFF](#).

If EL2 is not implemented, this register is RES0 from EL3 and the virtual counter uses a fixed virtual offset of zero.

Note

When EL2 is implemented and is using AArch64, the virtual counter uses a fixed virtual offset of zero in the following situations:

- [HCR_EL2.E2H](#) is 1, and [CNTVCT_EL0](#) is read from EL2.
- [HCR_EL2.{E2H, TGE}](#) is {1, 1}, and either:
 - [CNTVCT_EL0](#) is read from Non-secure EL0 or EL2.
 - [CNTVCT](#) is read from Non-secure EL0.

RW fields in this register reset to architecturally UNKNOWN values.

Attributes

CNTVOFF_EL2 is a 64-bit register.

Field descriptions

The CNTVOFF_EL2 bit assignments are:

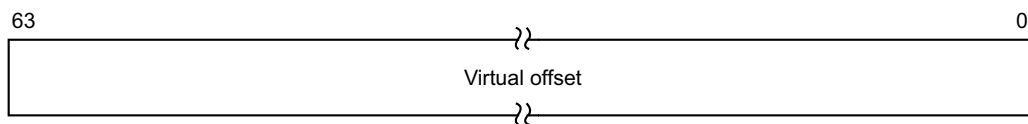

Bits [63:0]

Virtual offset.

Accessing the CNTVOFF_EL2

This register can be read using MRS with the following syntax:

MRS <Xt>, <systemreg>

This register can be written using MSR (register) with the following syntax:

MSR <systemreg>, <Xt>

This syntax is encoded with the following settings in the instruction encoding:

<systemreg>	op0	op1	CRn	CRm	op2
CNTVOFF_EL2	11	100	1110	0000	011

Accessibility

The register is accessible in software as follows:

Control			Accessibility			
E2H	TGE	NS	EL0	EL1	EL2	EL3
x	x	0	-	-	n/a	RW
x	0	1	-	-	RW	RW
x	1	1	-	n/a	RW	RW

Part E

The AArch32 Application Level Architecture

Chapter E1

The AArch32 Application Level Programmers' Model

This chapter gives an Application level description of the programmers' model for software executing in AArch32 state. This means it describes execution in EL0 when EL0 is using AArch32. It contains the following sections:

- *About the Application level programmers' model on page E1-2728.*
- *The Application level programmers' model in AArch32 state on page E1-2729.*
- *Advanced SIMD and floating-point instructions on page E1-2740.*
- *About the AArch32 System register interface on page E1-2752.*
- *Exceptions on page E1-2753.*

E1.1 About the Application level programmers' model

This chapter contains the programmers' model information required for the development of applications that will execute in AArch32 state.

The information in this chapter is distinct from the system information required to service and support application execution under an operating system, or higher level of system software. However, some knowledge of that system information is needed to put the Application level programmers' model into context.

Depending on the implementation, the architecture supports multiple levels of execution privilege. These privilege levels are indicated by different *Exception levels* that number upwards from EL0, where EL0 corresponds to the lowest privilege level and is often described as *unprivileged*. The Application level programmers' model is the programmers' model for software executing at EL0. For more information see [ARMv8 architectural concepts on page A1-34](#).

System software determines the Exception level, and therefore the level of privilege, at which application software runs. When an operating system supports execution at both EL1 and EL0, an application usually runs unprivileged. This has the following effects:

- It means that the operating system can allocate system resources to an application in a unique or shared manner.
- It provides a degree of protection from other processes, and so helps protect the operating system from malfunctioning software.

This chapter indicates where some System level understanding is helpful, and if appropriate it gives a reference to the System level description.

When included in an implementation:

- EL3 provides two Security states, Secure and Non-secure. Secure state provides additional hardware features that support the development of secure applications.
- EL2 provides virtualization of operation in Non-secure state.

However, application level software is generally unaware of its Security state, and of any virtualization. For more information, see [The ARMv8-A security model on page G1-4315](#) and [The effect of implementing EL2 on the Exception model on page G1-4320](#).

Note

- When an implementation includes EL3, application and operating system software normally executes in Non-secure state.
 - EL2, that provides the virtualization features, is implemented only in Non-secure state.
 - Older documentation, describing implementations or architecture versions that support only two privilege levels, often refers to execution at EL1 as *privileged* execution.
 - In this manual, the terms *CONSTRAINED UNPREDICTABLE, IMPLEMENTATION DEFINED, OPTIONAL, RES0, RES1, UNDEFINED, UNKNOWN, and UNPREDICTABLE* have ARM-specific meanings, as defined in the [Glossary](#). In body text, these terms are shown in SMALL CAPS, for example IMPLEMENTATION DEFINED.
-

E1.2 The Application level programmers' model in AArch32 state

The following sections give more information about the Application level programmers' model in AArch32 state:

- [Instruction sets, arithmetic operations, and register files.](#)
- [Core data types and arithmetic in AArch32 state.](#)
- [The general-purpose registers, and the PC, in AArch32 state on page E1-2731.](#)
- [Process state, PSTATE on page E1-2734.](#)
- [Jazelle support on page E1-2739.](#)

E1.2.1 Instruction sets, arithmetic operations, and register files

The A32 and T32 instruction sets both provide a wide range of integer arithmetic and logical operations, that operate on a register file of sixteen 32-bit registers, that are comprised of the AArch32 general-purpose registers and the PC. As described in [The general-purpose registers, and the PC, in AArch32 state on page E1-2731](#), these registers include the registers SP (R13) and LR (R14), which have specialized uses. [Core data types and arithmetic in AArch32 state](#) gives more information about these operations.

In addition, an implementation that implements the T32 and A32 instruction sets includes both:

- Scalar floating-point instructions.
- The Advanced SIMD vector instructions.

Floating-point and vector instructions operate on a separate common register file, described in [The SIMD and floating-point register file on page E1-2740](#). [Advanced SIMD and floating-point instructions on page E1-2740](#) gives more information about these instructions.

E1.2.2 Core data types and arithmetic in AArch32 state

When executing in AArch32 state, a PE supports the following data types in memory:

Byte	8 bits.
Halfword	16 bits.
Word	32 bits.
Doubleword	64 bits.

PE registers are 32 bits in size. The instruction sets provide instructions that use the following data types for data held in registers:

- 32-bit pointers.
- Unsigned or signed 32-bit integers.
- Unsigned 16-bit or 8-bit integers, held in zero-extended form.
- Signed 16-bit or 8-bit integers, held in sign-extended form.
- Two 16-bit integers packed into a register.
- Four 8-bit integers packed into a register.
- Unsigned or signed 64-bit integers held in two registers.

Load and store operations can transfer bytes, halfwords, or words to and from memory. Loads of bytes or halfwords zero-extend or sign-extend the data as it is loaded, as specified in the appropriate load instruction.

The instruction sets include load and store operations that transfer two or more words to and from memory. Software can load and store doublewords using these instructions.

———— **Note** ————

For information about the atomicity of memory accesses see [Atomicity in the ARM architecture on page E2-2758](#).

When any of the data types is described as *unsigned*, the N-bit data value represents a non-negative integer in the range 0 to 2^N-1 , using normal binary format.

When any of these types is described as *signed*, the N-bit data value represents an integer in the range $-2^{(N-1)}$ to $+2^{(N-1)}-1$, using two's complement format.

The instructions that operate on packed halfwords or bytes include some multiply instructions that use only one of two halfwords, and SIMD instructions that perform parallel addition or subtraction on all of the halfwords or bytes.

———— **Note** ————

These SIMD instructions operate on values held in the general-purpose registers, and must not be confused with the Advanced SIMD instructions that operate on a separate register file that provides registers of up to 128 bits.

Direct instruction support for 64-bit integers is limited, and most 64-bit operations require sequences of two or more instructions to synthesize them.

Integer arithmetic

The instruction set provides a wide range of operations on the values in registers, including bitwise logical operations, shifts, additions, subtractions, multiplications, and divisions. The pseudocode described in [Appendix K10 ARM Pseudocode Definition](#) defines these operations, usually in one of three ways:

- By direct use of the pseudocode operators and built-in functions defined in [Operators on page K10-6262](#).
- By use of pseudocode helper functions defined in the main text. See [Appendix K12 Pseudocode Index](#).
- By a sequence of the form:
 1. Use of the `SInt()`, `UInt()`, and `Int()` built-in functions defined in [Converting bitstrings to integers on page K10-6274](#) to convert the bitstring contents of the instruction operands to the unbounded integers that they represent as two's complement or unsigned integers.
 2. Use of mathematical operators, built-in functions and helper functions on those unbounded integers to calculate other such integers.
 3. Use of either the bitstring extraction operator defined in [Bitstring concatenation and slicing on page K10-6263](#) or of the saturation helper functions described in [Pseudocode description of saturation on page E1-2731](#) to convert an unbounded integer result into a bitstring result that can be written to a register.

Shift and rotate operations

The following types of shift and rotate operations are used in instructions:

Logical Shift Left

The `LSL()` pseudocode function moves each bit of a bitstring left by a specified number of bits. Zeros are shifted in at the right end of the bitstring. Bits that are shifted off the left end of the bitstring are discarded, except that the last such bit can be produced as a carry output.

Logical Shift Right

The `LSR()` pseudocode function moves each bit of a bitstring right by a specified number of bits. Zeros are shifted in at the left end of the bitstring. Bits that are shifted off the right end of the bitstring are discarded, except that the last such bit can be produced as a carry output.

Arithmetic Shift Right

The `ASR()` pseudocode function moves each bit of a bitstring right by a specified number of bits. Copies of the leftmost bit are shifted in at the left end of the bitstring. Bits that are shifted off the right end of the bitstring are discarded, except that the last such bit can be produced as a carry output.

Rotate Right The `ROR()` pseudocode function moves each bit of a bitstring right by a specified number of bits. Each bit that is shifted off the right end of the bitstring is re-introduced at the left end. The last bit shifted off the right end of the bitstring can be produced as a carry output.

Rotate Right with Extend

The `RRX()` pseudocode function moves each bit of a bitstring right by one bit. A carry input is shifted in at the left end of the bitstring. The bit shifted off the right end of the bitstring can be produced as a carry output.

Pseudocode description of addition and subtraction

In pseudocode, addition and subtraction can be performed on any combination of unbounded integers and bitstrings, provided that if they are performed on two bitstrings, the bitstrings must be identical in length. The result is another unbounded integer if both operands are unbounded integers, and a bitstring of the same length as the bitstring operand or operands otherwise. For the definition of these operations, see [Addition and subtraction on page K10-6264](#).

The main addition and subtraction instructions can produce status information about both unsigned carry and signed overflow conditions. When necessary, multi-word additions and subtractions can be synthesized from this status information. In pseudocode the `AddWithCarry()` function provides an addition with a carry input and a set of output Condition flags including carry output and overflow:

An important property of the `AddWithCarry()` function is that if:

```
(result, nzcvc) = AddWithCarry(x, NOT(y), carry_in)
```

Then:

- If `carry_in == '1'`, then `result == x-y` with:
 - `nzcvc<0> == '1'` if signed overflow occurred during the subtraction.
 - `nzcvc<1> == '1'` if unsigned borrow did not occur during the subtraction, that is, if $x \geq y$.
- If `carry_in == '0'`, then `result == x-y-1` with:
 - `nzcvc<0> == '1'` if signed overflow occurred during the subtraction.
 - `nzcvc<1> == '1'` if unsigned borrow did not occur during the subtraction, that is, if $x \geq y$.

Taken together, this means that the `carry_in` and `nzcvc<1>` output in `AddWithCarry()` calls can act as NOT borrow flags for subtractions as well as carry flags for additions.

Pseudocode description of saturation

Some instructions perform *saturating arithmetic*, that is, if the result of the arithmetic overflows the destination signed or unsigned N-bit integer range, the result produced is the largest or smallest value in that range, rather than wrapping around modulo 2^N . This is supported in pseudocode by:

- The `SignedSatQ()` and `UnsignedSatQ()` functions when an operation requires, in addition to the saturated result, a Boolean argument that indicates whether saturation occurred.
- The `SignedSat()` and `UnsignedSat()` functions when only the saturated result is required.

`SatQ(i, N, unsigned)` returns either `UnsignedSatQ(i, N)` or `SignedSatQ(i, N)` depending on the value of its third argument, and `Sat(i, N, unsigned)` returns either `UnsignedSat(i, N)` or `SignedSat(i, N)` depending on the value of its third argument.

E1.2.3 The general-purpose registers, and the PC, in AArch32 state

In the AArch32 Application level view, a PE has:

- Fifteen general-purpose 32-bit registers, R0 to R14, of which R13 and R14 have alternative names reflecting how they are, or can be, used:
 - R13 is usually identified as SP.
 - R14 is usually identified as LR.
- The PC (*program counter*), that can be described as R15.

The specialized uses of the SP (R13), LR (R14), and PC (R15) are:

SP, the stack pointer

The PE uses SP as a pointer to the active stack.

In the T32 instruction set, some instructions cannot access SP. Instructions that can access SP can use SP as a general-purpose register.

The A32 instruction set provides more general access to SP, and it can be used as a general-purpose register.

———— Note —————

Using SP for any purpose other than as a stack pointer might break the requirements of operating systems, debuggers, and other software systems, causing them to malfunction.

Software can refer to SP as R13.

LR, the link register

The link register can be used to hold return link information, and some cases described in this manual require this use of the LR. When software does not require the LR for linking, it can use it for other purposes. Software can refer to LR as R14.

PC, the program counter

- When executing an A32 instruction, PC reads as the address of the current instruction plus 8.
- When executing a T32 instruction, PC reads as the address of the current instruction plus 4.
- Writing an address to PC causes a branch to that address.

Most T32 instructions cannot access PC.

The A32 instruction set provides more general access to the PC, and many A32 instructions can use the PC as a general-purpose register. However, ARM deprecates the use of PC for any purpose other than as the program counter. See [Writing to the PC](#) for more information.

Software can refer to PC as R15.

See [AArch32 general-purpose registers, the PC, and the Special-purpose registers on page G1-4327](#) for the system level view of these registers.

———— Note —————

In general, ARM strongly recommends using the names SP, LR and PC instead of R13, R14 and R15. However, sometimes it is simpler to use the R13-R15 names when referring to a group of registers. For example, it is simpler to refer to *registers R8 to R15*, rather than to *registers R8 to R12, the SP, LR and PC*. These two descriptions of the group of registers have exactly the same meaning.

Writing to the PC

In the A32 and T32 instruction sets, many data-processing instructions can write to the PC. Writes to the PC are handled as follows:

- In T32 state, the following 16-bit T32 instruction encodings branch to the value written to the PC:
 - Encoding T2 of *ADD, ADDS (register)* on page F5-3017.
 - Encoding T1 of *MOV, MOVs (register)* on page F5-3260.

The value written to the PC is forced to be halfword-aligned by ignoring its least significant bit, treating that bit as being 0.

- The B, BL, CBNZ, CBZ, CHKA, HB, HBL, HBLP, HBP, TBB, and TBH instructions remain in the same instruction set state and branch to the value written to the PC.

The definition of each of these instructions ensures that the value written to the PC is correctly aligned for the current instruction set state.

- The BLX (immediate) instruction switches between A32 and T32 states and branches to the value written to the PC. Its definition ensures that the value written to the PC is correctly aligned for the new instruction set state.
- The following instructions write a value to the PC, treating that value as an interworking address to branch to, with low-order bits that determine the new instruction set state:
 - BLX (register), BX, and BXJ.
 - LDR instructions with <Rt> equal to the PC.
 - POP and all forms of LDM except LDM (exception return), when the register list includes the PC.
 - In A32 state only, ADC, ADD, ADR, AND, ASR (immediate), BIC, EOR, LSL (immediate), LSR (immediate), MOV, MVN, ORR, ROR (immediate), RRX, RSB, RSC, SBC, and SUB instructions with <Rd> equal to the PC and without flag-setting specified.

For details of how an interworking address specifies the new instruction set state and instruction address, see [Pseudocode description of operations on the AArch32 general-purpose registers and the PC](#).

———— **Note** —————

The register-shifted register instructions, that are available only in the A32 instruction set and are summarized in [Data-processing register \(register shift\) on page F4-2955](#), are CONSTRAINED UNPREDICTABLE if they attempt to write to the PC, see [Using R15 on page K1-6097](#).

- Some instructions are treated as exception return instructions, and write both the PC and the CPSR. For more information, including which instructions are exception return instructions, see [Exception return to an Exception level using AArch32 on page G1-4360](#).
- Some instructions cause an exception, and the exception handler address is written to the PC as part of the exception entry.

Pseudocode description of operations on the AArch32 general-purpose registers and the PC

In pseudocode, the uses of the `R[]` function, with an index parameter `n`, are:

- Reading or writing R0-R12, SP, and LR, using `n = 0-12, 13, and 14` respectively.
- Reading the PC, using `n = 15`.

[Pseudocode description of general-purpose register and PC operations on page G1-4329](#) describes accesses to these registers.

Descriptions of A32 store instructions that store the PC value use the `PCStoreValue()` pseudocode function to specify the PC value stored by the instruction.

Writing an address to the PC causes either a simple branch to that address or an *interworking* branch that also selects the instruction set to execute after the branch. A simple branch is performed by the `BranchWritePC()` function.

An interworking branch is performed by the `BXWritePC()` function.

The `LoadWritePC()` and `ALUWritePC()` functions are used for two cases where the behavior was systematically modified between architecture versions.

E1.2.4 Process state, PSTATE

Process state or **PSTATE** is an abstraction of process state information. All of the instruction sets provide instructions that operate on elements of PSTATE.

———— Note ————

In this chapter, references to **PSTATE** link to the more appropriate of:

- The Application-level view of **PSTATE** given in this section.
- The System-level description in *Process state, PSTATE* on page G1-4332.

The following **PSTATE** information is accessible at EL0:

The Condition flags

Flag-setting instructions set these. They are:

- N** Negative Condition flag. If the result of the instruction is regarded as a two's complement signed integer, the PE sets this to:
- 1 if the result is negative.
 - 0 if the result is positive or zero.
- Z** Zero Condition flag. Set to:
- 1 if the result of the instruction is zero.
 - 0 otherwise.
- A result of zero often indicates an equal result from a comparison.
- C** Carry Condition flag. Set to:
- 1 if the instruction results in a carry condition, for example an unsigned overflow that is the result of an addition.
 - 0 otherwise.
- V** Overflow Condition flag. Set to:
- 1 if the instruction results in an overflow condition, for example a signed overflow that is the result of an addition.
 - 0 otherwise.

Conditional instructions test the N, Z, C, and V Condition flags, combining them with the *Condition code* for the instruction, to determine whether the instruction must be executed. In this way, execution of the instruction is conditional on the result of a previous operation. For more information about conditional execution, see *Conditional execution* on page F2-2849.

The overflow or saturation flag

- Q** Some instructions can set this. For those instructions that can, the PE:
- Sets it to 1 if the instruction indicates overflow or saturation.
 - Leaves it unchanged otherwise.

For more information, see *Pseudocode description of saturation* on page E1-2731.

The greater than or equal flags

- GE[3:0]** The instructions described in *Parallel addition and subtraction instructions* on page F1-2818 update these to indicate the results from individual bytes or halfwords of the operation. These flags can control a later SEL instruction. For more information, see *SEL* on page F5-3409.

PSTATE also contains *PE state controls*. There is no direct access to these from application level instructions, but they can be changed by side-effects of application level instructions. They are:

Instruction set state

J, T The current instruction set state, as shown in [Table E1-1](#). In ARMv8, the J bit is RES0, see the Note in this section.

Table E1-1 PSTATE.{J, T} encoding

J	T	Instruction set state
0	0	A32
0	1	T32

A32 The PE is executing the A32 instruction set, summarized in [Chapter F4 A32 Instruction Set Encoding](#).

T32 The PE is executing the T32 instruction set, summarized in [Chapter F3 T32 Instruction Set Encoding](#).

Note

Encoding with J==1 before ARMv8, Jazelle and T32EE states

In previous versions of the ARM architecture, the encoding {1, 0} selected Jazelle state, and encoding {1, 1} selected T32EE state. ARMv8 does not support either of these states, and these are encodings for unimplemented instruction set states, see [Unimplemented instruction sets on page G1-4338](#). ARMv8 AArch32 state requires a Trivial Jazelle implementation, see [Trivial implementation of the Jazelle extension on page G1-4338](#).

The IT block state

IT[7:0] The If-Then controls for the T32 IT instruction, that applies to the *IT block* of instructions that immediately follow the IT instruction. See [IT on page F5-3126](#) for a description of the IT instruction and its associated IT block.
For more information about the use of **PSTATE.IT** see [Use of PSTATE.IT on page E1-2737](#).

Endianness mapping

E For data accesses, controls the endianness:
0 Little-endian.
1 Big-endian.
If an implementation does not provide:

- Big-endian support for data accesses, this bit is RES0.
- Little-endian support for data accesses, this bit is RES1.

Instruction fetches are always little-endian, and ignore **PSTATE.E**.

Accessing PSTATE fields at EL0

The following sections describe which **PSTATE** fields can be directly accessed at EL0, and how they can be accessed:

- [The Application Program Status Register, APSR.](#)
- [The SETEND instruction.](#)

The Application Program Status Register, APSR

At EL0, some **PSTATE** fields can be accessed using the Special-purpose *Application Program Status Register* (APSR). The APSR can be directly read using the **MRS** instruction, and directly written using the **MSR (register)** and **MSR (immediate)** instructions.

The APSR bit assignments are:

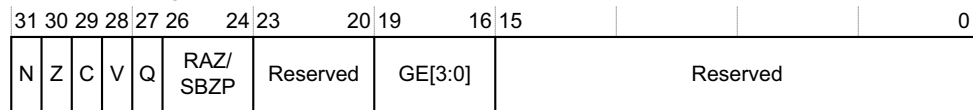

Condition flags

N, Z, C, V, bits [31:28]

The **PSTATE** Condition flags.

Q, bit [27] The **PSTATE** overflow or saturation flag.

Bits[26:24] Reserved, RAZ/SBZP. Software can use MSR instructions that write the top byte of the APSR without using a read-modify-write sequence. If it does this, it must write zeros to bits[26:24].

Bits[23:20, 15:0]

Reserved bits that are allocated to system features, or are available for future expansion. Unprivileged execution ignores writes to fields that are accessible only at EL1 or higher. However, application level software that writes to the APSR must treat reserved bits as *Do-Not-Modify* (DNM) bits. For more information about the reserved bits, see [The Current Program Status Register, CPSR on page G1-4334](#).

GE[3:0], bits [19:16]

The **PSTATE** greater than or equal flags.

The other **PSTATE** fields cannot be accessed by using the APSR.

The system level alias for the APSR is the **CPSR**. The **CPSR** is a superset of the APSR. See [The Current Program Status Register, CPSR on page G1-4334](#).

Writes to the **PSTATE** fields have side-effects on various aspects of PE operation. All of these side-effects, except side-effects on memory accesses associated with fetching instructions, are synchronous to the APSR write. This means they are guaranteed:

- Not to be visible to earlier instructions in the execution stream.
- To be visible to later instructions in the execution stream.

The SETEND instruction

The A32 and T32 instruction sets both include an instruction to manipulate **PSTATE.E**:

SETEND BE Sets **PSTATE.E** to 1, for big-endian operation.
 SETEND LE Sets **PSTATE.E** to 0, for little-endian operation.

The SETEND instruction is unconditional. For more information, see [SETEND on page F5-3411](#). ARM deprecates use of the SETEND instruction.

Use of PSTATE.IT

PSTATE.IT provides the If-Then controls for the T32 IT instruction, that applies to the *IT block* of instructions that immediately follow the IT instruction.

PSTATE.IT divides into two subfields:

IT[7:5] Holds the *base condition* for the current IT block. The base condition is the top three bits of the Condition code specified by the <firstcond> field of the IT instruction.

IT[4:0] Encodes:

- Implicitly, the size of the IT block. This is the number of instructions that are to be conditionally executed. The size of the block is indicated by the position of the least significant 1 in this field, as shown in [Table E1-2](#).
- For each instruction in the IT block, the least significant bit of the Condition code. This is encoded in the IT block entries that [Table E1-2](#) shows as Nx.

———— **Note** —————

Changing the least significant bit of a Condition code from 0 to 1 has the effect of inverting the Condition code.

Both subfields are all zeros when no IT block is active.

When an IT instruction is executed, PSTATE.IT is set according to the <firstcond> field of the instruction and the *Then* and *Else* (T and E) parameters in the instruction, see [IT on page F5-3126](#). This means that, on executing an IT instruction, the initial state of PSTATE.IT depends on the number of instructions in the IT block, as [Table E1-2](#) shows:

Table E1-2 Initial state of PSTATE.IT on executing an IT instruction

Number of instructions in IT block	PSTATE.IT bits ^a						Notes
	[7:5]	[4]	[3]	[2]	[1]	[0]	
4	cond_base	N1	N2	N3	N4	1	-
3	cond_base	N1	N2	N3	1	0	-
2	cond_base	N1	N2	1	0	0	-
1	cond_base	N1	1	0	0	0	-
Not executing an IT instruction	000	0	0	0	0	0	No IT block is active

a. Combinations of the IT bits not shown in this table are reserved.

In [Table E1-2](#), N1 refers to the first instruction in the IT block, and N2, N3, and N4 refer to the second, third, and fourth instructions in the IT block if they are present,

When permitted, an instruction in an IT block is conditional, see [Conditional instructions on page F1-2809](#) and [Conditional execution on page F2-2849](#). The Condition code used is the current value of IT[7:4]. When an instruction in an IT block completes its execution normally, PSTATE.IT[4:0] is left-shifted by one bit, so that PSTATE[4] always relates to the next instruction to be executed. [Table E1-3 on page E1-2738](#) shows how PSTATE.IT during the execution of an IT instruction with four instructions in the IT block.

Table E1-3 Updates to `PSTATE.IT` when executing an IT instruction with a four-instruction IT block

IT block instruction being executed	<code>PSTATE.IT</code> bits						Notes
	[7:5]	[4]	[3]	[2]	[1]	[0]	
First	cond_base	N1	N2	N3	N4	1	-
Second	cond_base	N2	N3	N4	1	0	-
Third	cond_base	N3	N4	1	0	0	-
Fourth	cond_base	N4	1	0	0	0	-
Not executing an IT instruction	000	0	0	0	0	0	No IT block is active

A few instructions, for example BKPT, cannot be conditional and therefore are always executed ignoring the current value of `PSTATE.IT`.

For details of what happens if an instruction in an IT block takes an exception, see [Overview of exception entry on page G1-4347](#).

An instruction that might complete its normal execution by branching is only permitted in an IT block as the last instruction in the block. This means that normal execution of the instruction always results in `PSTATE.IT` advancing to execution where no IT block is active.

For performance reasons, ARMv8 deprecates the use of IT other than with a single 16-bit T32 instruction from a specified subset of the 16-bit T32 instructions, see [Partial deprecation of IT on page F1-2826](#). In addition, implementations can provide a set of ITD control fields, `SCTLR.ITD`, `SCTLR_EL1.ITD`, and `HSCTLR.ITD`, to disable these deprecated uses, making them UNDEFINED. When an implementation includes ITD control fields, [Changes to an ITD control by an instruction in an IT block](#) describes the permitted CONSTRAINED UNPREDICTABLE behaviors if an instruction in an IT block changes the value of an ITD control to disable the use of the IT instruction.

On a branch or an exception return, if `PSTATE.IT` is set to a value that is not consistent with the instruction stream being branched to or returned to, then instruction execution is CONSTRAINED UNPREDICTABLE.

`PSTATE.IT` affects instruction execution only in T32 state. In A32 state, `PSTATE.IT` must be `0b00000000`, otherwise the behavior is CONSTRAINED UNPREDICTABLE.

For more information see [CONSTRAINED UNPREDICTABLE behavior associated with IT instructions and PSTATE.IT on page K1-6098](#).

Changes to an ITD control by an instruction in an IT block

In an implementation that includes `SCTLR.ITD`, `SCTLR_EL1.ITD`, and `HSCTLR.ITD` controls, if an instruction in an IT block changes an ITD control so that the IT instruction using the IT block would be disabled, then one of the following behaviors applies:

- The change to the ITD field, once synchronized, has no effect on the execution of instructions in the current IT block, but applies only to any subsequent execution of an IT instruction to which the control applies.
- Synchronizing the change to the ITD field guarantees that all bits of `PSTATE.IT` are cleared to 0.

In addition, after the change to the ITD field has been synchronized, any remaining instructions in the IT block that would be made UNDEFINED by the new value of ITD are either:

- Executed normally.
- Treated as UNDEFINED.

The choice between the options described in this section is determined by the implementation, and any choice can vary between different changes to an ITD control by an instruction in an IT block.

Pseudocode description of PSTATE PE state fields

The pseudocode function [CurrentInstrSet\(\)](#) returns the current instruction set. The pseudocode function [SelectInstrSet\(\)](#) selects a new instruction set.

[PSTATE.IT](#) advances after normal execution of an IT block instruction. This is described by the [AArch32.ITAdvance\(\)](#) pseudocode function.

The pseudocode function [InITBlock\(\)](#) tests whether the current instruction is in an IT block. The pseudocode function [LastInITBlock\(\)](#) tests whether the current instruction is the last instruction in an IT block.

The [BigEndian\(\)](#) pseudocode function tests whether big-endian data memory accesses are currently selected.

E1.2.5 Jazelle support

ARMv8 requires AArch32 state to include a trivial implementation of the Jazelle extension, as described in [Trivial implementation of the Jazelle extension on page G1-4338](#).

E1.3 Advanced SIMD and floating-point instructions

In general, ARMv8 requires implementation of Advanced SIMD and floating-point instructions in the T32 and A32 instruction sets, but see [Implications of not including Advanced SIMD and floating-point support on page E1-2747](#).

The Advanced SIMD instructions perform packed *Single Instruction Multiple Data* (SIMD) operations, either integer or single-precision floating-point. The floating-point instructions perform single-precision or double-precision scalar floating-point operations. **When ARMv8.2-FP16 is implemented, half-precision floating-point can also be used for data processing.**

These instructions permit *floating-point exceptions*, such as Overflow or Divide by Zero, to be handled without trapping. When handled in this way, a floating-point exception causes a cumulative status register bit to be set to 1 and a default result to be produced by the operation. ARMv8 also optionally supports the trapping of floating-point exceptions, see [Trapping of floating-point exceptions on page E1-2742](#). For more information about floating-point exceptions see [Floating-point exceptions and exception traps on page E1-2743](#).

The floating-point and Advanced SIMD instructions also provide conversion functions in both directions between half-precision floating-point and single-precision floating-point.

Some Advanced SIMD instructions support polynomial arithmetic over $\{0, 1\}$, as described in [Polynomial arithmetic over \$\{0, 1\}\$ on page A1-47](#).

For system level information about the Advanced SIMD and Floating-point implementation see [Advanced SIMD and floating-point support on page G1-4412](#).

The following sections give more information about the Advanced SIMD and floating-point instructions:

- [Floating-point standards, and terminology on page A1-49](#).
- [The SIMD and floating-point register file](#).
- [Data types supported by the Advanced SIMD implementation on page E1-2742](#).
- [Advanced SIMD and floating-point System registers on page E1-2742](#).
- [Trapping of floating-point exceptions on page E1-2742](#).
- [Floating-point data types and arithmetic on page E1-2743](#).
- [Floating-point exceptions and exception traps on page E1-2743](#).
- [Controls of Advanced SIMD operation that do not apply to floating-point operation on page E1-2746](#).
- [Implications of not including Advanced SIMD and floating-point support on page E1-2747](#).
- [Pseudocode description of floating-point operations on page E1-2747](#).

E1.3.1 The SIMD and floating-point register file

The Advanced SIMD and floating-point instructions use the same register file, that comprises 32 registers. This is distinct from the register file that holds the general-purpose registers and the PC.

The Advanced SIMD and floating-point views of the register file are different. The following sections describe these different views. [Figure E1-1 on page E1-2741](#) shows the views of the register file, and the way the word, doubleword, and quadword registers overlap.

Advanced SIMD views of the register file

Advanced SIMD can view this register file as:

- Sixteen 128-bit quadword registers, Q0-Q15.
- Thirty-two 64-bit doubleword registers, D0-D31.

These views can be used simultaneously. For example, a program might hold 64-bit vectors in D0 and D1 and a 128-bit vector in Q1.

Floating-point views of the register file

The Advanced SIMD and floating-point register file consists of thirty-two doubleword registers, that can be viewed as:

- Thirty-two 64-bit doubleword registers, D0–D31. This view is also available to Advanced SIMD instructions.
- Thirty-two 32-bit single word registers, S0–S31. Only half of the set is accessible in this view.

The two views can be used simultaneously.

SIMD and Floating-point register file mapping onto registers

Figure E1-1 shows the different views of the SIMD and floating-point register file, and the relationship between them.

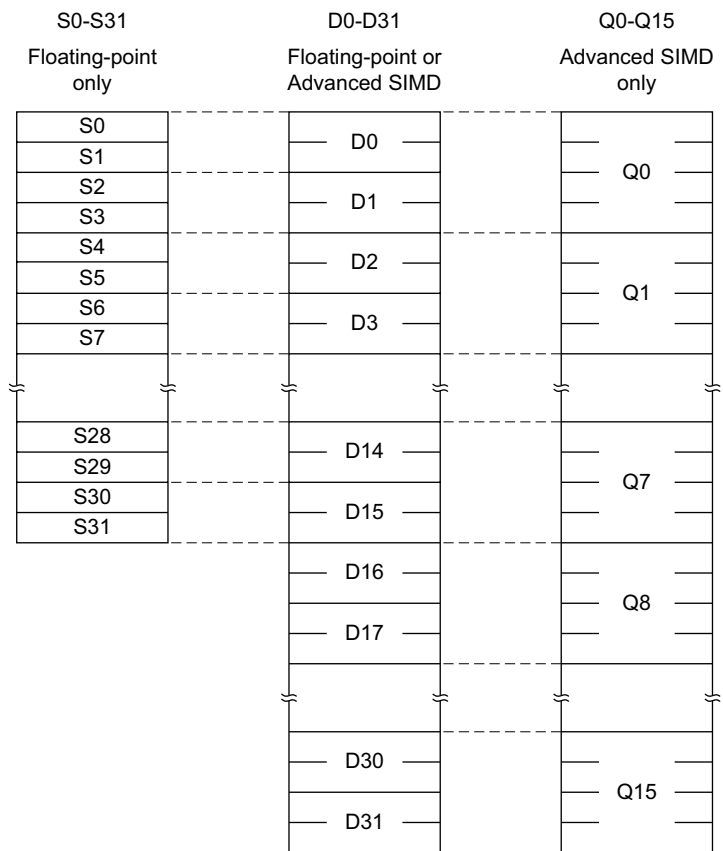

Figure E1-1 SIMD and floating-point register file, AArch32 operation

The mapping between the registers is as follows:

- S<2n> maps to the least significant half of D<n>.
- S<2n+1> maps to the most significant half of D<n>.
- D<2n> maps to the least significant half of Q<n>.
- D<2n+1> maps to the most significant half of Q<n>.

For example, software can access the least significant half of the elements of a vector in Q6 by referring to D12, and the most significant half of the elements by referring to D13.

Pseudocode description of the SIMD and Floating-point register file

The functions `_Dc1one`, `S[]`, and `D[]` provide the S0-S31, D0-D31, and Q0-Q15 views of the Advanced SIMD and floating-point registers:

The `Din[]` function returns a Doubleword register from the `_Dc1one[]` copy of the SIMD and Floating-point register file, and the `Qin[]` function returns a Quadword register from that register file.

———— Note —————

The `CheckAdvSIMDEnabled()` function copies the `D[]` register file to `_Dc1one[]`, see [Pseudocode description of enabling SIMD and floating-point functionality on page G1-4451](#).

E1.3.2 Data types supported by the Advanced SIMD implementation

Advanced SIMD instructions can operate on integer and floating-point data, and the implementation defines a set of data types that support the required data formats. [Vector formats in AArch32 state on page A1-40](#) describes these formats.

Advanced SIMD vectors

In an implementation that includes support for Advanced SIMD operation, a register can hold one or more packed elements, all of the same size and type. The combination of a register and a data type describes a vector of elements. The vector is considered to be an array of elements of the data type specified in the instruction. The number of elements in the vector is implied by the size of the data elements and the size of the register.

Vector indices are in the range 0 to (number of elements – 1). An index of 0 refers to the least significant end of the vector. In [Vector formats in AArch32 state on page A1-40](#), [Figure A1-3 on page A1-42](#) shows the Advanced SIMD vector formats.

Pseudocode description of Advanced SIMD vectors

The pseudocode function `E1em[]` accesses the element of a specified index and size in a vector.

E1.3.3 Advanced SIMD and floating-point System registers

The Advanced SIMD and floating-point instructions have a shared register space for System registers. Only one register in this space is accessible at the Application level, see [FPSCR, Floating-Point Status and Control Register on page G6-4885](#).

Writes to the `FPSCR` can have side-effects on various aspects of PE operation. All of these side-effects are synchronous to the `FPSCR` write. This means they are guaranteed not to be visible to earlier instructions in the execution stream, and they are guaranteed to be visible to later instructions in the execution stream.

See [Advanced SIMD and floating-point System registers on page G1-4415](#) for the system level view of the registers.

These registers can be described as the *SIMD and floating-point System registers*.

E1.3.4 Trapping of floating-point exceptions

It is IMPLEMENTATION DEFINED whether the floating-point implementation supports the trapping of floating-point exceptions:

- If it does, the `FPSCR`.{IDE, IXE, UFE, OFE, DZE, IOE} bits enable the exception traps.
- Otherwise, the `FPSCR` trap bits are RES0.

Trapped exception handling never causes the corresponding cumulative exception bit of the `FPSCR` to be set to 1. If this behavior is desired, the trap handler routine must use a read, modify, write sequence on the `FPSCR` to set the cumulative exception bit.

E1.3.5 Floating-point data types and arithmetic

The T32 and A32 floating-point instructions support single-precision (32-bit) and double-precision (64-bit) data types and arithmetic as defined by the IEEE 754 floating-point standard. They also support the half-precision (16-bit) floating-point data type for data storage, by supporting conversions between single-precision and half-precision data types. **When ARMv8.2-FP16 is implemented, it also supports the half-precision floating-point data type for data processing operations.**

ARM standard floating-point arithmetic means IEEE 754 floating-point arithmetic with the restrictions described in *Floating-point and Advanced SIMD support* on page A1-48, including supporting only the input and output values described in *ARM standard floating-point input and output values* on page A1-50.

The AArch32 Advanced SIMD instructions support only single-precision **and, when ARMv8.2-FP16 is implemented, half-precision** ARM standard floating-point arithmetic.

The following sections describe the Advanced SIMD and floating-point formats:

- *Half-precision floating-point formats* on page A1-42.
- *Single-precision floating-point format* on page A1-44.
- *Double-precision floating-point format* on page A1-45.

The following sections describe features of Advanced SIMD and floating-point processing:

- *Flush-to-zero* on page A1-51.
- *NaN handling and the Default NaN* on page A1-52.

E1.3.6 Floating-point exceptions and exception traps

ARM Advanced SIMD and floating-point instructions record the following floating-point exceptions in the **FPSCR** cumulative bits, unless the floating-point exception is trapped and generates an exception:

FPSCR.IOC Invalid Operation. The bit is set to 1 if the result of an operation has no mathematical value or cannot be represented. Cases include, for example:

- $(\text{infinity}) \times 0$.
- $(+\text{infinity}) + (-\text{infinity})$.

These tests are made after flush-to-zero processing. For example, if flush-to-zero mode is selected, multiplying a denormalized number and an infinity is treated as $(0 \times \text{infinity})$, and causes an Invalid Operation floating-point exception.

IOC is also set on any floating-point operation with one or more signaling NaNs as operands, except for negation and absolute value, as described in *Floating-point negation and absolute value* on page E1-2747.

FPSCR.DZC Divide by Zero. The bit is set to 1 if a divide operation has a zero divisor and a dividend that is not zero, an infinity or a NaN. These tests are made after flush-to-zero processing, so if flush-to-zero processing is selected, a denormalized dividend is treated as zero and prevents Divide by Zero from occurring, and a denormalized divisor is treated as zero and causes Divide by Zero to occur if the dividend is a normalized number.

For the reciprocal and reciprocal square root estimate functions the dividend is assumed to be +1.0. This means that a zero or denormalized operand to these functions sets the DZC bit.

FPSCR.OFC Overflow. The bit is set to 1 if the absolute value of the result of an operation, produced after rounding, is greater than the maximum positive normalized number for the destination precision.

FPSCR.UFC Underflow. The bit is set to 1 if the absolute value of the result of an operation, produced before rounding, is less than the minimum positive normalized number for the destination precision, and the rounded result is inexact.

The criteria for the Underflow floating-point exception to occur are different in Flush-to-zero mode. For details, see *Flush-to-zero* on page A1-51.

FPSCR.IXC Inexact. The bit is set to 1 if the result of an operation is not equivalent to the value that would be produced if the operation were performed with unbounded precision and exponent range.

The criteria for the Inexact floating-point exception to occur are different in Flush-to-zero mode. For details, see [Flush-to-zero](#) on page A1-51.

FPSCR.IDC Input Denormal. The bit is set to 1 if a denormalized input operand is replaced in the computation by a zero, as described in [Flush-to-zero](#) on page A1-51.

For Advanced SIMD instructions, and for floating-point instructions when floating-point exception trapping is not supported, these are non-trapping exceptions and the data-processing instructions do not generate any trapped exceptions.

For floating-point instructions when floating-point exception trapping is supported:

- The floating-point exceptions can be trapped, by setting trap enable bits in the **FPSCR**, see [Trapping of floating-point exceptions](#) on page E1-2742 and [Floating-point exception traps](#) on page G1-4416, and:
 - When a trap is not enabled the corresponding floating-point exception updates the corresponding **FPSCR** cumulative bit does not generate an exception.
 - When a trap is enabled the corresponding floating-point exception does not update the **FPSCR**, but generates an exception. In this case, bits in the **FPEXC** indicate which floating-point exceptions have occurred.
- The definition of the Underflow floating-point exception is different in the trapped and cumulative exception cases. In the trapped case the definition is:
 - The trapped Underflow floating-point exception occurs if the absolute value of the result of an operation, produced before rounding, is less than the minimum positive normalized number for the destination precision, regardless of whether the rounded result is inexact.
- As with cumulative exceptions, higher priority trapped exceptions can prevent lower priority exceptions from occurring, as described in [Combinations of floating-point exceptions](#) on page E1-2745.
- For Invalid Operation floating-point exceptions, for details of which quiet NaN is produced as the default result see [NaN handling and the Default NaN](#) on page A1-52.
- For Overflow floating-point exceptions, the sign bit of the default result is determined normally for the overflowing operation.
- For Divide by Zero floating-point exceptions, the sign bit of the default result is determined normally for a division. This means it is the exclusive OR of the sign bits of the two operands.

Table E1-4 shows the results of untrapped floating-point exceptions. That table uses the following abbreviations:

MaxNorm	The maximum normalized number of the destination precision.
RM	Round towards Minus Infinity mode, as defined in the IEEE 754 standard.
RN	Round to Nearest mode, as defined in the IEEE 754 standard.
RP	Round towards Plus Infinity mode, as defined in the IEEE 754 standard.
RZ	Round towards Zero mode, as defined in the IEEE 754 standard.

For more information about the IEEE 754 descriptions of the rounding modes see [Floating-point standards, and terminology](#) on page A1-49.

Table E1-4 Results of untrapped floating-point exceptions

Exception type	Default result for positive sign	Default result for negative sign
IOC, Invalid Operation	Quiet NaN	Quiet NaN
DZC, Divide by Zero	+infinity	-infinity
OFC, Overflow	RN, RP: +infinity RM, RZ: +MaxNorm	RN, RM: -infinity RP, RZ: -MaxNorm

Table E1-4 Results of untrapped floating-point exceptions (continued)

Exception type	Default result for positive sign	Default result for negative sign
UFC, Underflow	Normal rounded result	Normal rounded result
IXC, Inexact	Normal rounded result	Normal rounded result
IDC, Input Denormal	Normal rounded result	Normal rounded result

Combinations of floating-point exceptions

Many pseudocode functions perform *floating-point operations*, including `FixedToFP()`, `FAdd()`, `FCompare()`, `FCompareEQ()`, `FCompareGE()`, `FCompareGT()`, `FDiv()`, `FMax()`, `FMin()`, `FMul()`, `FMulAdd()`, `FRecipEstimate()`, `FRecipStep()`, `FPRsqrtEstimate()`, `FPRsqrtStep()`, `FPSqrt()`, `FSub()`, and `FPToFixed()`. All of these operations can generate floating-point exceptions.

———— **Note** —————

`FPAbs()` and `FPNeg()` are not classified as *floating-point operations* because:

- They cannot generate floating-point exceptions.
- The floating-point operation behavior described in the following sections does not apply to them:
 - [Flush-to-zero on page A1-51](#).
 - [NaN handling and the Default NaN on page A1-52](#).

More than one exception can occur on the same operation. The only combinations of floating-point exceptions that can occur are:

- Overflow with Inexact.
- Underflow with Inexact.
- Input Denormal with other floating-point exceptions.

The priority order of these floating-point exceptions is that the Inexact exception is treated as lowest priority, and the Input Denormal exception is treated as highest priority.

When none of the floating-point exceptions caused by an operation is trapped, any floating-point exception that occurs causes the associated cumulative bit in the `FPSCR` to be set.

When one or more floating-point exceptions caused by an operation is trapped, the behavior of the instruction depends on the priority of the exceptions:

- If the higher priority floating-point exception is trapped, its trap handler is called. It is IMPLEMENTATION DEFINED whether any information about the lower priority floating-point exception is provided.

———— **Note** —————

Information about the lower priority floating-point exception might be provided in:

- The `FPEXC`, if the exception generated by the trap is taken to an Exception level that is using AArch32.
- The `ESR_ELx.ISS` field, if the exception generated by the trap is taken to an Exception level that is using AArch64.

However, information might be provided in another IMPLEMENTATION DEFINED way, for example using an IMPLEMENTATION DEFINED register.

Apart from this, the lower priority floating-point exception is ignored in this case.

- If the higher priority floating-point exception is untrapped, its cumulative bit is set to 1 and its default result is evaluated. Then the lower priority floating-point exception is handled normally, using this default result.

Some floating-point instructions specify more than one floating-point operation, as indicated by the pseudocode descriptions of the instruction. In such cases, a floating-point exception on one operation is treated as higher priority than a floating-point exception on another operation if the occurrence of the second floating-point exception depends on the result of the first operation. Otherwise, it is **CONSTRAINED UNPREDICTABLE** which floating-point exception is treated as higher priority.

For example, a `VMLA.F32` instruction specifies a floating-point multiplication followed by a floating-point addition. The addition can generate Overflow, Underflow and Inexact floating-point exceptions, all of which depend on both operands to the addition and so are treated as lower priority than any floating-point exception on the multiplication. The same applies to Invalid Operation floating-point exceptions on the addition caused by adding opposite-signed infinities. The addition can also generate an Input Denormal floating-point exception, caused by the addend being a denormalized number while in Flush-to-zero mode. It is **CONSTRAINED UNPREDICTABLE** which of an Input Denormal floating-point exception on the addition and a floating-point exception on the multiplication is treated as higher priority, because the occurrence of the Input Denormal floating-point exception does not depend on the result of the multiplication. The same applies to an Invalid Operation floating-point exception on the addition caused by the addend being a signaling NaN.

———— **Note** —————

The `VFMA` instruction performs a vector addition and a vector multiplication as a single operation. The `VFMS` instruction performs a vector subtraction and a vector multiplication as a single operation.

E1.3.7 Controls of Advanced SIMD operation that do not apply to floating-point operation

ARMv7 permitted implementation of either, both, or neither of the Advanced SIMD and floating-point additions to the base instruction set, and provided some controls that applied to the Advanced SIMD functionality but not to the floating-point functionality. In ARMv8, Advanced SIMD functionality cannot be separated from floating-point functionality, but in AArch32 state these controls function as they did in ARMv7. This means they apply only to the following instructions and instruction encodings:

- All instructions with encodings defined in:
 - [Advanced SIMD data-processing on page F3-2904](#), for the T32 instruction set.
 - [Advanced SIMD data-processing on page F4-2985](#), for the A32 instruction set.
- All instructions with encodings defined in:
 - [Advanced SIMD element or structure load/store on page F3-2922](#), for the T32 instruction set.
 - [Advanced SIMD element or structure load/store on page F4-2997](#), for the A32 instruction set.
- The form of the `VDUP` instruction described in [VDUP \(general-purpose register\) on page F6-3851](#).
- The byte and halfword forms of the `VMOV` instructions described in each of:
 - [VMOV \(general-purpose register to scalar\) on page F6-4002](#).
 - [VMOV \(scalar to general-purpose register\) on page F6-4006](#).

The controls of this functionality are:

- The `CPACR.ASEDIS` field.
- The `HCPTR.TASE` field.

In an implementation that supports Advanced SIMD functionality, support for each of these controls is optional:

- If the `CPACR.ASEDIS` control is not supported then the `CPACR.ASEDIS` field is RAZ/WI. This is equivalent to the control permitting the execution of Advanced SIMD instructions at EL1 and EL0.
- If the `HCPTR.TASE` control is not supported then the `HCPTR.TASE` field is RAZ/WI. This means the `HCPTR` does not provide a control that can trap Non-secure execution of Advanced SIMD instructions to Hyp mode.

E1.3.8 Implications of not including Advanced SIMD and floating-point support

In general, ARMv8 requires the inclusion of the Advanced SIMD and floating-point instructions in all instruction sets. Exceptionally, for implementation targeting specialized markets, ARM might produce or license an ARMv8-A implementation that does not provide any support for Advanced SIMD and floating-point instructions. In such an implementation, in AArch32 state:

- Each of the [CPACR](#).{cp10, cp11} fields is RES0.
- The [CPACR](#).ASEDIS bit is RES0.
- Each of the [HCPTR](#).{TASE, TCP10, TCP11} fields is RES1.
- Each of the [NSACR](#).{NSASEDIS, cp10, cp11} fields is RES0.
- The [FPEXC](#) register is UNDEFINED.

E1.3.9 Pseudocode description of floating-point operations

The following subsections contain pseudocode definitions of the floating-point functionality supported by the ARMv8 architecture:

- [Generation of specific floating-point values](#).
- [Floating-point negation and absolute value](#).
- [Floating-point value unpacking](#).
- [Floating-point exception and NaN handling on page E1-2748](#).
- [Floating-point rounding on page E1-2748](#).
- [Selection of ARM standard floating-point arithmetic on page E1-2748](#).
- [Floating-point comparisons on page E1-2748](#).
- [Floating-point maximum and minimum on page E1-2748](#).
- [Floating-point addition and subtraction on page E1-2748](#).
- [Floating-point multiplication and division on page E1-2749](#).
- [Floating-point fused multiply-add on page E1-2749](#).
- [Floating-point reciprocal estimate and step on page E1-2749](#).
- [Floating-point square root on page E1-2750](#).
- [Floating-point reciprocal square root estimate and step on page E1-2750](#).
- [Floating-point conversions on page E1-2751](#).

Generation of specific floating-point values

The following pseudocode functions generate specific floating-point values. The `sign` argument is '0' for the positive version and '1' for the negative version:

- [FPInfinity\(\)](#).
- [FPMaxNormal\(\)](#).
- [FPZero\(\)](#).
- [FPTwo\(\)](#).
- [FPThree\(\)](#).
- [FPDefaultNaN\(\)](#).

Floating-point negation and absolute value

The floating-point negation and absolute value operations only affect the sign bit. They do not treat NaN operands specially, nor denormalized number operands when flush-to-zero is selected.

The floating-point negation operation is described by the pseudocode function [FPNeg\(\)](#). The floating-point absolute value operation is described by the pseudocode function [FPAbs\(\)](#).

Floating-point value unpacking

The [FPUnpack\(\)](#) function determines the type of a floating-point number, defined by [FPType{}](#), and its numerical value. It also does flush-to-zero processing on input operands.

Floating-point exception and NaN handling

The `FPProcessException()` procedure checks whether a floating-point exception is trapped, and handles it accordingly. The floating-point exception types are defined by `FPExc{}`.

The `FPProcessNaN()` function processes a NaN operand, producing the correct result value and generating an Invalid Operation floating-point exception if necessary. The `FPProcessNaNs()` function performs the standard NaN processing for a two-operand operation. The `FPProcessNaNs3()` function performs the standard NaN processing for a three-operand operation.

Floating-point rounding

The `FPRound()` function rounds and encodes a floating-point result to a specified destination format. This includes processing Overflow, Underflow and Inexact floating-point exceptions and performing flush-to-zero processing on result values.

Selection of ARM standard floating-point arithmetic

The `StandardFPSCRValue()` function returns the `FPSCR` value that selects ARM standard floating-point arithmetic. Most of the arithmetic functions have a Boolean `fpscr_controlled` argument that is `TRUE` for Floating-point operations and `FALSE` for Advanced SIMD operations, and that selects between using the real `FPSCR` value and this value.

Floating-point comparisons

The `FPCompare()` function compares two floating-point numbers, producing a {N, Z, C, V} Condition flags result as shown in [Table E1-5](#):

Table E1-5 Effect of a Floating-point comparison on the Condition flags

Comparison result	N	Z	C	V
Equal	0	1	1	0
Less than	1	0	0	0
Greater than	0	0	1	0
Unordered	0	0	1	1

This result defines the operation of the `VCMP` floating-point instruction. The `VCMP` instruction writes these flag values in the `FPSCR`. After using a `VMRS` instruction to transfer them to the `APSR`, they can control conditional execution as shown in [Table F2-1 on page F2-2849](#).

The `FPCompareEQ()`, `FPCompareGE()`, and `FPCompareGT()` functions describe the operation of Advanced SIMD instructions that perform floating-point comparisons.

Floating-point maximum and minimum

The `FPMax()` function returns the maximum of two floating-point numbers. The `FPMin()` function returns the minimum of two floating-point numbers.

Floating-point addition and subtraction

The `FPAdd()` function adds two floating-point numbers. The `FPSub()` function subtracts one floating-point number from another floating-point number.

Floating-point multiplication and division

The `FPMu1()` function multiplies two floating-point numbers. The `FPDiv()` function divides one floating-point number by another floating-point number.

Floating-point fused multiply-add

The `FPMu1Add()` function performs a floating-point fused multiply-add.

Floating-point reciprocal estimate and step

The Advanced SIMD implementation includes instructions that support Newton-Raphson calculation of the reciprocal of a number.

The `VRECPE` instruction produces the initial estimate of the reciprocal. It uses the pseudocode functions:

- `FPrecipEstimate()`.
- `UnsignedRecipEstimate()`. This pseudocode function calls the C function `recip_estimate()`:

```
double recip_estimate(double a)
{
    int q, s;
    double r;
    q = (int)(a * 512.0);          /* a in units of 1/512 rounded down */
    r = 1.0 / (((double)q + 0.5) / 512.0); /* reciprocal r */
    s = (int)(256.0 * r + 0.5);   /* r in units of 1/256 rounded to nearest */
    return (double)s / 256.0;
}
```

Table E1-6 shows the results where input values are out of range.

Table E1-6 VRECPE results for out of range inputs

Number type	Input Vm[i]	Result Vd[i]
Integer	$\leq 0x7FFFFFFF$	$0xFFFFFFFF$
Floating-point	NaN	Default NaN
Floating-point	± 0 or denormalized number	$\pm\text{infinity}^a$
Floating-point	$\pm\text{infinity}$	± 0
Floating-point	Absolute value $\geq 2^{126}$	± 0

a. `FPSCR.DZC` is set to 1

The Newton-Raphson iteration:

$$x_{n+1} = x_n(2 - dx_n)$$

converges to $(1/d)$ if x_0 is the result of `VRECPE` applied to d .

The `VRECPS` instruction performs a $(2 - op1 \times op2)$ calculation and can be used with a multiplication to perform a step of this iteration. The functionality of this instruction is defined by the `FPrecipStep()` pseudocode function.

Table E1-7 shows the results where input values are out of range.

Table E1-7 VRECPS results for out of range inputs

Input Vn[i]	Input Vm[i]	Result Vd[i]
Any NaN	-	Default NaN
-	Any NaN	Default NaN
±0.0 or denormalized number	±infinity	2.0
±infinity	±0.0 or denormalized number	2.0

Floating-point square root

The `FPSqrt()` function returns the square root of a floating-point number.

Floating-point reciprocal square root estimate and step

The Advanced SIMD implementation includes instructions that support Newton-Raphson calculation of the reciprocal of the square root of a number.

The `VRSQRTE` instruction produces the initial estimate of the reciprocal of the square root. It uses the pseudocode functions:

- `FPRSqrtEstimate()`.
- `UnsignedRSqrtEstimate()`. This pseudocode function calls the C function `recip_sqrt_estimate()`.

```
double recip_sqrt_estimate(double a)
{
    int q0, q1, s;
    double r;
    if (a < 0.5) /* range 0.25 <= a < 0.5 */
    {
        q0 = (int)(a * 512.0); /* a in units of 1/512 rounded down */
        r = 1.0 / sqrt(((double)q0 + 0.5) / 512.0); /* reciprocal root r */
    }
    else /* range 0.5 <= a < 1.0 */
    {
        q1 = (int)(a * 256.0); /* a in units of 1/256 rounded down */
        r = 1.0 / sqrt(((double)q1 + 0.5) / 256.0); /* reciprocal root r */
    }
    s = (int)(256.0 * r + 0.5); /* r in units of 1/256 rounded to nearest */
    return (double)s / 256.0;
}
```

Table E1-8 shows the results where input values are out of range.

Table E1-8 VRSQRTE results for out of range inputs

Number type	Input Vm[i]	Result Vd[i]
Integer	≤ 0x3FFFFFFF	0xFFFFFFFF
Floating-point	NaN, -(normalized number), -infinity	Default NaN
Floating-point	-0 or -(denormalized number)	-infinity ^a
Floating-point	+0 or +(denormalized number)	+infinity ^a
Floating-point	+infinity	+0

a. `FPSCR.DZC` is set to 1.

The Newton-Raphson iteration:

$$x_{n+1} = x_n(3 - dx_n^2)/2$$

converges to $(1/\sqrt{d})$ if x_0 is the result of VRSQRTE applied to d .

The VRSQRTS instruction performs a $(3 - op1 \times op2)/2$ calculation and can be used with two multiplications to perform a step of this iteration. The functionality of this instruction is defined by the [FPRSqrtStep\(\)](#) pseudocode function.

[Table E1-9](#) shows the results where input values are out of range.

Table E1-9 VRSQRTS results for out of range inputs

Input Vn[i]	Input Vm[i]	Result Vd[i]
Any NaN	-	Default NaN
-	Any NaN	Default NaN
± 0.0 or denormalized number	\pm infinity	1.5
\pm infinity	± 0.0 or denormalized number	1.5

[FPRSqrtStep\(\)](#) calls the [FPHalvedSub\(\)](#) pseudocode function.

Floating-point conversions

The [FPConvert\(\)](#) pseudocode function performs conversions between half-precision, single-precision, and double-precision floating-point numbers.

The [FPToFixed\(\)](#) and [FixedToFP\(\)](#) functions perform conversions between floating-point numbers and integers or fixed-point numbers.

E1.4 About the AArch32 System register interface

AArch32 state provides a System register encoding space, that is indexed by the parameter set {coproc, opc1, CRn, CRm, opc2}, and a set of System register access instructions. This encoding space is used for:

- System registers.
- System instructions, for:
 - Cache and branch predictor maintenance.
 - Address translation.
 - TLB maintenance.

In ARMv8, this encoding space uses only the coproc values 0b111x.

Note

The encoding space with coproc values 0b101x is redefined to provide Advanced SIMD and floating-point functionality.

In ARMv8:

- The (coproc==0b1111) encodings provide system control functionality, by providing access to System registers and System instructions. This includes architecture and feature identification, as well as control, status information and configuration support.

The following sections give a general description of these encodings:

- [About the System registers for VMSAv8-32 on page G4-4689.](#)
- [VMSAv8-32 organization of registers in the \(coproc == 0b1111\) encoding space on page G4-4707.](#)
- [Functional grouping of VMSAv8-32 System registers on page G4-4726.](#)

These encodings also provide the Performance monitor registers, see [Chapter D5 The Performance Monitors Extension](#).

- The (coproc==0b1110) encodings provide access to additional registers, that support:
 - Debug, see [Chapter G2 AArch32 Self-hosted Debug](#).
 - The Jazelle identification registers, see [Jazelle support on page E1-2739](#).

[UNPREDICTABLE, CONSTRAINED UNPREDICTABLE, and UNDEFINED behavior for AArch32 System register accesses on page G6-4764](#) gives information more information about permitted accesses to the System registers in AArch32 state.

Most functionality in the (coproc==0b111x) encoding space cannot be accessed by software executing at EL0. This manual clearly identifies those functions that can be accessed at EL0.

For more information:

- About this encoding space, including the naming of the parameters that index the space, see [The AArch32 System register interface on page G1-4408](#).
- About the System interface access instructions, see [System register access instructions on page F1-2828](#).

E1.5 Exceptions

The ARM architecture uses the following terms to describe various types of exceptional condition:

Exceptions In the ARM architecture, an *exception* causes entry to EL1, EL2, or EL3. If the Exception level that is entered is using AArch32, it also causes entry to the PE mode in which the exception must be taken. A software handler for the exception is then executed.

———— **Note** —————

The term *floating-point exception* does not use this meaning of *exception*. This term is described later in this list.

Exceptions include:

- Reset.
- Interrupts.
- Memory system aborts.
- Undefined instructions.
- Supervisor calls (SVCs), Secure Monitor calls (SMCs), and hypervisor calls (HVCs).
- Debug exceptions.

Most details of exception handling are not visible to application level software, and are described in [Handling exceptions that are taken to an Exception level using AArch32 on page G1-4340](#). In an ARMv8 implementation that includes all the Exception levels, aspects that are visible to application level software are:

- The SVC instruction causes a Supervisor Call exception. This provides a mechanism for unprivileged software to make a call to the operating system, or other system component that is accessible only at EL1.
- The SMC instruction causes a Secure Monitor Call exception, but only if software execution is at EL1 or higher. Unprivileged software can only cause a Secure Monitor Call exception by methods defined by the operating system, or by another component of the software system that executes at EL1 or higher.
- The HVC instruction causes a Hypervisor Call exception, but only if software execution is at EL1 or higher. Unprivileged software can only cause a Hypervisor Call exception by methods defined by the hypervisor, or by another component of the software system that executes at EL1 or higher.
- The BKPT instruction causes a Breakpoint Instruction exception, that is taken as a Prefetch Abort exception. This provides a mechanism for a debugger to insert breakpoints into unprivileged software, or for unprivileged software to make a call into a debugger that is accessible at EL1.
- The WFI (Wait for Interrupt) instruction provides a hint that nothing needs to be done until an interrupt or another WFI wake-up event occurs, see [Wait For Interrupt on page G1-4406](#). This means the hardware might enter a low-power state until the wake-up event occurs.
- The WFE (Wait for Event) instruction provides a hint that nothing needs to be done until either an SEV instruction generates an event, or another WFE wake-up event occurs, see [Wait For Event and Send Event on page G1-4403](#). This means the hardware might enter a low-power state until the wake-up event occurs.

Floating-point exceptions

These relate to exceptional conditions encountered during floating-point arithmetic, such as Divide by Zero or Overflow. For more information see:

- [Floating-point exceptions and exception traps on page E1-2743](#).
- [FPExc, Floating-Point Exception Control register on page G6-4880](#).
- [FPSCR, Floating-Point Status and Control Register on page G6-4885](#).
- ANSI/IEEE Std. 754, *IEEE Standard for Binary Floating-Point Arithmetic*.

Chapter E2

The AArch32 Application Level Memory Model

This chapter gives an application level description of the memory model for software executing in AArch32 state. This means it describes the memory model for execution in EL0 when EL0 is using AArch32 in the following sections:

- *About the ARM memory model* on page E2-2756.
- *Atomicity in the ARM architecture* on page E2-2758.
- *Definition of the ARMv8 memory model* on page E2-2762.
- *Caches and memory hierarchy* on page E2-2772.
- *Alignment support* on page E2-2777.
- *Endian support* on page E2-2779.
- *Memory types and attributes* on page E2-2782.
- *Mismatched memory attributes* on page E2-2792.
- *Synchronization and semaphores* on page E2-2795

Note

In this chapter, System register names usually link to the description of the register in [Chapter G6 AArch32 System Register Descriptions](#), for example [SCTLR](#).

E2.1 About the ARM memory model

The ARM architecture is a weakly ordered memory architecture that permits the observation and completion of memory accesses in a different order from the program order. The following sections of this chapter provide the complete definition of the ARMv8 memory model, this introduction is not intended to contradict the definition found in those sections. In general, the basic principles of the ARMv8 memory model are:

- To provide a memory model that has similar weaknesses to those found in the memory models used by high-level programming languages such as C or Java. For example, by permitting independent memory accesses to be re-ordered as seen by other observers.
- To avoid the requirement for multi-copy atomicity in the majority of memory types.
- The provision of instructions and memory barriers to compensate for the lack of multi-copy atomicity in the cases where it would be needed.
- The use of address, data, and control dependencies in the creation of order so as to avoid having excessive numbers of barriers or other explicit instructions in common situations where some order is required by the programmer or the compiler.

This section contains:

- [Address space](#).
- [Memory type overview](#).

E2.1.1 Address space

Address calculations are performed using 32-bit registers. Supervisory software determines the valid address range. Attempting to access an address that is not valid generates an MMU fault.

Address calculations are performed modulo 2^{32} .

The result of an address calculation is UNKNOWN if it overflows or underflows the 32-bit address range A[31:0].

Memory accesses use the `MemA[]`, `MemO[]`, `MemU[]`, and `MemU_unpriv[]` pseudocode functions:

- The `MemA[]` function makes an aligned access of the required type.
- The `MemO[]` function makes an ordered access of the required type.
- The `MemU[]` function makes an unaligned access of the required type
- The `MemU_unpriv[]` function makes an unaligned, unprivileged access of the required type.

Each of these functions calls `Mem_with_type[]` function, that specifies the required access. This calls `AArch32.MemSingle[]`, which performs an atomic, little-endian read of size bytes.

The `AccType` enumeration defines the different access types.

———— Note ————

- [Chapter G3 The AArch32 System Level Memory Model](#) and [Chapter G4 The AArch32 Virtual Memory System Architecture](#) include descriptions of memory system features that are transparent to the application, including memory access, address translation, memory maintenance instructions, and alignment checking and the associated fault handling. These chapters also reference pseudocode descriptions of these operations.
- For references to the pseudocode that relates to memory accesses, see [Basic memory access on page G3-4553](#), [Unaligned memory access on page G3-4554](#), and [Aligned memory access on page G3-4554](#).

E2.1.2 Memory type overview

ARMv8 provides the following mutually-exclusive memory types:

Normal This is generally used for bulk memory operations, both read-write and read-only operations.

Device The ARM architecture forbids speculative reads of any type of Device memory. This means Device memory types are suitable attributes for read-sensitive locations.

Locations of the memory map that are assigned to peripherals are usually assigned the Device memory attribute.

Device memory has additional attributes that have the following effects:

- They prevent aggregation of reads and writes, maintaining the number and size of the specified memory accesses. See [Gathering on page E2-2788](#).
- They preserve the access order and synchronization requirements, both for accesses to a single peripheral and where there is a synchronization requirement on the observability of one or more memory write and read accesses. See [Reordering on page E2-2789](#)
- They indicate whether a write can be acknowledged other than at the end point. See [Early Write Acknowledgement on page E2-2790](#).

For more information on Normal memory and Device memory, see [Memory types and attributes on page E2-2782](#).

Note

Earlier versions of the ARM architecture defined a single Device memory type and a Strongly-Ordered memory type. A Note in [Device memory on page E2-2786](#) describes how these memory types map onto the ARMv8 memory types.

E2.2 Atomicity in the ARM architecture

Atomicity is a feature of memory accesses, described as *atomic* accesses. The ARM architecture description refers to two types of atomicity, *single-copy atomicity* and *multi-copy atomicity*. In the ARMv8 architecture, the atomicity requirements for memory accesses depend on the memory type, and whether the access is explicit or implicit. For more information see:

- [Requirements for single-copy atomicity.](#)
- [Properties of single-copy atomic accesses on page E2-2759.](#)
- [Multi-copy atomicity on page E2-2759.](#)
- [Requirements for multi-copy atomicity on page E2-2760.](#)
- [Concurrent modification and execution of instructions on page E2-2760.](#)

For more information about the memory types, see [Memory type overview on page E2-2756.](#)

E2.2.1 Requirements for single-copy atomicity

In AArch32 state, the single-copy atomic PE accesses are:

- All byte accesses.
- All halfword accesses to halfword-aligned locations.
- All word accesses to word-aligned locations.
- Memory accesses caused by LDREXD and STREXD instructions to doubleword-aligned locations.

LDM, LDC, LDRD, STM, STC, STRD, PUSH, POP, RFE, SRS, VLDM, VLDR, VSTM, and VSTR instructions are executed as a sequence of word-aligned word accesses. Each 32-bit word access is guaranteed to be single-copy atomic. The architecture does not require subsequences of two or more word accesses from the sequence to be single-copy atomic.

LDRD and STRD accesses to 64-bit aligned locations are 64-bit single-copy atomic as seen by translation table walks and accesses to translation tables.

————— **Note** —————

This requirement has been added to avoid the need for complex measures to avoid atomicity issues when changing translation table entries, without creating a requirement that all locations in the memory system are 64-bit single-copy atomic. This addition means:

- The system designer must ensure that all writable memory locations that might be used to hold translations, such as bulk SDRAM, can be accessed with 64-bit single-copy atomicity.
- Software must ensure that translation tables are not held in memory locations that cannot meet this atomicity requirement, such as peripherals that are typically accessed using a narrow bus.

This requirement places no burden on read-only memory locations for which reads have no side effects, since it is impossible to detect the size of memory accesses to such locations.

Advanced SIMD element and structure loads and stores are executed as a sequence of accesses of the element or structure size. The architecture requires the element accesses to be single-copy atomic if and only if both:

- The element size is 32 bits, or smaller.
- The elements are naturally aligned.

Accesses to 64-bit elements or structures that are 32-bit aligned are executed as a sequence of 32-bit accesses, each of which is single-copy atomic. The architecture does not require subsequences of two or more 32-bit accesses from the sequence to be single-copy atomic.

When an access is not single-copy atomic by the rules described in this section, it is executed as a sequence of one or more accesses that aggregate to the size of the original access. Each of the accesses in this sequence is single-copy atomic, at least at the byte level.

———— **Note** —————

In this section, the terms *before the write operation* and *after the write operation* mean before or after the write operation has had its effect on the coherence order of the bytes of the memory location accessed by the write operation.

If, according to these rules, an instruction is executed as a sequence of accesses, a synchronous Data Abort exception or Debug state entry can be taken during that sequence. This causes execution of the instruction to be abandoned. See [Data Abort exception on page G1-4387](#) and, when ARMv8.2-LSMAOC is implemented, [Taking an interrupt or other exception during a multiple-register load or store on page G1-4374](#).

If the synchronous Data Abort exception is returned from using the preferred return address, the instruction that generated the sequence of accesses is re-executed and so any access that was performed before the exception was taken is repeated. This also applies to an exit from Debug state.

———— **Note** —————

The exception behavior for these multiple access instructions means they are not suitable for use for writes to memory for the purpose of software synchronization.

For implicit accesses:

- Cache linefills and evictions have no effect on the single-copy atomicity of explicit transactions or instruction fetches.
- Instruction fetches are single-copy atomic:
 - At 32-bit granularity in A32 state.
 - At 16-bit granularity in T32 state.
- [Concurrent modification and execution of instructions on page E2-2760](#) describes additional constraints on the behavior of instruction fetches.
- Translation table walks are performed using accesses that are single-copy atomic:
 - At 32-bit granularity when using Short-descriptor format translation tables.
 - At 64-bit granularity when using Long-descriptor format translation tables.

E2.2.2 Properties of single-copy atomic accesses

A memory access instruction that is single-copy atomic has the following properties:

1. For a pair of overlapping single-copy atomic store instructions, all of the overlapping writes generated by one of the stores are [Coherence-after](#) the corresponding overlapping writes generated by the other store.
2. For a single-copy atomic load instruction L_1 that overlaps a single-copy atomic store instruction S_2 , if one of the overlapping reads generated by L_1 [Reads-from](#) one of the overlapping writes generated by S_2 , then none of the overlapping writes generated by S_2 are [Coherence-after](#) the corresponding overlapping reads generated by L_1 .

For more information, see [Definition of the ARMv8 memory model on page E2-2762](#).

E2.2.3 Multi-copy atomicity

In a multiprocessing system, writes to a memory location are *multi-copy atomic* if the following conditions are both true:

- All writes to the same location are *serialized*, meaning they are observed in the same order by all observers, although some observers might not observe all of the writes.
- A read of a location does not return the value of a write until all observers observe that write.

———— **Note** —————

Writes that are not coherent are not multi-copy atomic.

E2.2.4 Requirements for multi-copy atomicity

For Normal memory, writes are not required to be multi-copy atomic.

For Device memory, writes are not required to be multi-copy atomic.

The ARMv8 memory model is [Other-multi-copy atomic](#). For more information, see [Ordering constraints on page E2-2766](#).

E2.2.5 Concurrent modification and execution of instructions

The ARMv8 architecture limits the set of instructions that can be executed by one thread of execution as they are being modified by another thread of execution without requiring explicit synchronization.

Concurrent modification and execution of instructions can lead to the resulting instruction performing any behavior that can be achieved by executing any sequence of instructions that can be executed from the same Exception level, except where the instruction before modification and the instruction after modification is a:

- B, BL, NOP, BKPT, SVC, HVC, or SMC A32 instruction
- B, BX, BLX, NOP, BKPT, or SVC 16-bit T32 instruction.

In addition, for the T32 instructions, for which [Instruction encodings on page F2-2844](#) describes the meaning of {hw1, hw2}:

- hw1 of a 32-bit BL (immediate) instruction can be concurrently modified to hw1 of another BL (immediate) instruction:
 - This means that some of the most significant bits of the immediate value can be modified.
- hw1 of a 32-bit BLX (immediate) instruction can be concurrently modified to hw1 of another BLX immediate instruction:
 - This means that some of the most significant bits of the immediate value can be modified.
- hw1 of a 32-bit BL (immediate) or BLX (immediate) instruction can be concurrently modified to a T32 16-bit B, BX, BLX, BKPT, or SVC instruction. This modification also works in reverse.
- hw2 of a 32-bit BL (immediate) instruction can be concurrently modified to hw2 of another BL (immediate) instruction with a different immediate:
 - This means that some bits of the immediate value, including the least significant bits, can be modified.
- hw2 of a 32-bit BLX (immediate) instruction can be concurrently modified to hw2 of another BLX (immediate) instruction with a different immediate:
 - This means that some bits of the immediate value, including the least significant bits, can be modified.
- hw2 of a 32-bit B (immediate) instruction with a condition field can be concurrently modified to hw2 of another 32-bit B (immediate) instruction with a condition field with a different immediate:
 - This means that some bits of the immediate value, including the least significant bits, can be modified.
- hw2 of a 32-bit B (immediate) instruction without a condition field can be concurrently modified to hw2 of another 32-bit B (immediate) instruction without a condition field:
 - This means that some bits of the immediate value, including the least significant bits, can be modified.

———— **Note** —————

In the T32 instruction set:

- The only encodings of BKPT and SVC are 16-bit.
 - The only encoding of BL is 32-bit.
-

For the instructions explicitly identified in this section, the architecture guarantees that, after modification of the instruction, behavior is consistent with execution of either:

- The instruction originally fetched.
- A fetch of the modified instruction.

The instructions to which this applies are the B, BL, NOP, BKPT, SVC, HVC, and SMC instructions.

For both instruction sets, if one thread of execution changes a conditional branch instruction to another conditional branch instruction, and the change affects both the condition field and the branch target, execution of the changed instruction by another thread of execution before the change is synchronized can lead to either:

- The old condition being associated with the new target address.
- The new condition being associated with the old target address.

These possibilities apply regardless of whether the condition, either before or after the change to the branch instruction, is the *always* condition.

For all other instructions, to avoid UNPREDICTABLE or CONSTRAINED UNPREDICTABLE behavior, instruction modifications must be explicitly synchronized before they are executed. The required synchronization is as follows:

1. No PE must be executing an instruction when another PE is modifying that instruction.
2. To ensure that the modified instructions are observable, the PE that modified the instructions must issue the following sequence of instructions and operations:

```

; Coherency example for self-modifying code
; Enter this code with <Rt> containing a new 32-bit instruction,
; to be held in Cacheable space at a location pointed to by Rn. Use STRH in the first
; line instead of STR for a 16-bit instruction.
STR <Rt>, [Rn]
DCCMVAU Rn          ; Clean data cache by MVA to point of unification (PoU)
DSB                 ; Ensure visibility of the data stored
ICIMVAU Rn          ; Invalidate instruction cache by VA to PoU
BPIMVA Rn           ; Invalidate branch predictor by MVA to PoU
DSB                 ; Ensure completion of the invalidations

```

———— **Note** —————

The DCCMVAU operation is not required if the area of memory is either Non-cacheable or Write-through Cacheable.

3. In a multiprocessor system, the ICIMVAU and BPIMVA are broadcast to all PEs within the Inner Shareable domain of the PE running this sequence. However, once the modified instructions are observable, each PE that is executing the modified instructions must issue the following instruction to ensure execution of the modified instructions:

```
ISB                 ; Synchronize fetched instruction stream
```

For more information about the required synchronization operation, see [Synchronization and coherency issues between data and instruction accesses](#) on page E2-2774.

———— **Note** —————

For information about memory accesses caused by instruction fetches, see [Ordering constraints](#) on page E2-2766.

E2.3 Definition of the ARMv8 memory model

This section describes observation and ordering in the ARMv8 memory model. It contains the following subsections:

- [Locations](#).
- [Ordering and observability](#) on page E2-2763.
- [Ordering constraints](#) on page E2-2766.
- [Completion and endpoint ordering](#) on page E2-2767.
- [Memory barriers](#) on page E2-2768.

For more information on endpoint ordering of memory accesses, see [Reordering](#) on page E2-2789.

In the ARMv8 memory model, the Shareability memory attribute indicates the degree to which hardware must ensure memory coherency between a set of observers, see [Memory types and attributes](#) on page E2-2782.

The ARMv8 memory system architecture defines additional memory attributes and associated behaviors, which are defined in the system level section of this manual. See:

- [Chapter G3 The AArch32 System Level Memory Model](#).
- [Chapter G4 The AArch32 Virtual Memory System Architecture](#).

See also [Mismatched memory attributes](#) on page E2-2792.

E2.3.1 Locations

The ARMv8 memory model provides a set of definitions that are used to construct conditions on the permitted sequences of accesses to memory. The ARMv8 memory model defines:

- The ordering of observation of memory accesses between different observers.
- The ordering of arrival of memory accesses arriving at an endpoint.
- The mechanisms to control the ordering of observation of memory accesses and the arrival of memory accesses at an endpoint.

Locations, Memory effects, and Observers

The ARMv8 memory model provides the following definition of a *Location* in memory:

Location

A *Location* refers to a single byte in memory.

As part of its execution an instruction might generate a [Memory effect](#). [Observers](#) in the system might observe the [Memory effects](#) of that instruction on a [Location](#). The ARMv8 memory model provides the following definitions of a [Memory effect](#) and an [Observer](#):

Memory effect

The *Memory effects* of an instruction are the read, write, or barrier effects of that instruction. For an instruction that accesses memory:

- A read effect is generated for each [Location](#) that is read by the instruction.
- A write effect is generated for each [Location](#) that is written by the instruction.

An instruction can generate both read and write effects.

The memory effects of an instruction I_1 are said to appear in program order before the Memory effects of instruction I_2 if and only if I_1 occurs before I_2 in program order.

For the purposes of describing the ARMv8 memory model, all read and write effects access only Normal memory locations in a [Common Shareability Domain](#). Where this section refers to a read, write, or memory barrier without any qualification, then it is referring to the corresponding Memory effect.

Observer

An *Observer* refers to either a processing element, or some other memory accessing agent that can generate reads from or writes to memory.

Common Shareability Domain

A *Common Shareability Domain* for a program is the smallest Shareability domain that contains all of the active [Observers](#) of the [Memory effects](#) generated by a program.

E2.3.2 Ordering and observability

The ARMv8 memory model permits reordering of memory accesses. This section defines the permitted reordering of memory accesses using the following:

- Register value dependencies to establish order between instructions on a PE.
- Ordering constraints to establish order between accesses to a [Location](#).

Register value dependencies

The ARMv8 memory model defines the following dependencies between instructions:

Register dependency

A *Register dependency* from a first data value V_1 to a second data value V_2 exists within a PE if and only if either:

- The register, excluding the AArch64 zero register (XZR or WZR), that is used to hold V_1 is used in the calculation of V_2 .
- There is a Register dependency from V_1 to a third data value V_3 and there is a register dependency from V_3 to V_2 .

Register data dependency

A *Register data dependency* from a first data value V_1 to a second data value V_2 exists within a PE if and only if either:

- The register, excluding the AArch64 zero register (XZR or WZX) and the AArch32 PC, that is used to hold V_1 and is used in the calculation of V_2 , and the calculation between V_1 and the V_2 does not consist of either:
 - A conditional branch whose condition is determined by V_1 .
 - A conditional selection, move, or computation whose condition is determined by V_1 , where the input data values for the selection, move, or computation do not have a data dependency on V_1 .
- There is a Register data dependency from V_1 to a third data value V_3 , and there is a Register data dependency from V_3 to V_2 .

Address dependency

An *Address dependency* from a read R_1 to a subsequent read R_2 exists if and only if there is a [Register data dependency](#) from the data value that is returned by R_1 to the address used by R_2 .

An *Address dependency* from a read R_1 to a subsequent read W_2 exists if and only if there is a [Register data dependency](#) from the data value that is returned by R_1 to the address used by W_2 .

Data dependency

A *Data dependency* from a read R_1 to a subsequent write W_2 exists if and only if there is a [Register dependency](#) from the data value returned by R_1 to the data value written by W_2 .

Control dependency

A *Control dependency* from a read R_1 to a subsequent instruction I_2 exists if and only if there is a [Register dependency](#) from the data value returned by R_1 to the data value used in the evaluation of a conditional branch or the determination of a synchronous exception on an instruction and I_2 is only executed as a result of one of the possible outcomes of that conditional branch or synchronous exception.

Ordering and observability at a Location

[Memory effects](#) on a [Location](#) are related by the following relations:

Reads-from

A *Reads-from* relation that couples reads and writes to the same [Location](#) such that each read is paired with a single write in the program. If a read R_2 of a [Location](#) Reads-from a write W_1 to the same [Location](#) if and only if R_2 takes its data from W_1 .

———— **Note** —————

The Reads-from relation represents a read being satisfied by a write and then returning the written data.

Coherence order

A *Coherence order* relation for each [Location](#) in the program that provides a total order on all writes from all coherent [Observers](#) to that [Location](#), starting with a notional write of the initial value.

———— **Note** —————

The Coherence order of a [Location](#) represents the order in which writes to the [Location](#) arrive at memory.

Coherence-after

A write W_2 to a [Location](#) is *Coherence-after* another write W_1 to the same [Location](#) if and only if W_2 is sequenced after W_1 in the [Coherence order](#) of the [Location](#).

A write W_2 to a [Location](#) is Coherence-after a read R_1 of the same location if and only if R_1 [Reads-from](#) a write W_3 to the same [Location](#) and W_2 is Coherence-after W_3 .

Overlapping accesses

Two [Memory effect](#) overlap if and only if they access the same [Location](#). Two instructions overlap if and only if one or more of their generated [Memory effects](#) overlap.

Observed-by

A read or a write RW_1 from an [Observer](#) is *Observed-by* a write W_2 from a different [Observer](#) if and only if W_2 is coherence-after RW_1 .

A write W_1 from an [Observer](#) is Observed-by a read R_2 from a different [Observer](#) if and only if R_2 [Reads-from](#) W_1 .

———— **Note** —————

The Observed-by relation only relates accesses generated by different [Observers](#).

DMB FULL

A DMB FULL is a DMB with neither the LD or the ST qualifier.

Where this section refers to DMB without any qualification, then it is referring to all types of DMB. Unless a specific shareability domain is defined, a DMB applies to the [Common Shareability Domain](#).

All properties that apply to DMB also apply to the corresponding DSB.

Ordering relations

In addition to the ordering relations that describe order at a location, the ARMv8 memory model also provides ordering relations to describe the ordering of instructions. These are as follows:

Dependency-ordered-before

A dependency creates externally-visible order between a read and another [Memory effect](#) generated by the same [Observer](#). A read R_1 is *Dependency-ordered-before* a read or write RW_2 from the same [Observer](#) if and only if R_1 appears in program order before RW_2 and any of the following cases apply:

- There is an [Address dependency](#) or a [Data dependency](#) from R_1 to RW_2 .
- RW_2 is a write W_2 and there is a [Control dependency](#) from R_1 to W_2 .
- RW_2 is a read R_2 generated by an instruction appearing in program order after an instruction I_3 that generates a [Context synchronization event](#), and there is a [Control dependency](#) from R_1 to I_3 .
- RW_2 is a write W_2 appearing in program order after a read or a write RW_3 and there is an [Address dependency](#) from R_1 to RW_3 .
- RW_2 is a write W_2 that is [Coherence-after](#) a write W_3 and there is a [Control dependency](#) or a [Data dependency](#) from R_1 to W_3 .
- RW_2 is a read R_2 that [Reads-from](#) a write W_3 and there is an [Address dependency](#) or a [Data dependency](#) from R_1 to W_3 .

Atomic-ordered-before

Load-Exclusive and Store-Exclusive instructions provide some ordering guarantees, even in the absence of dependencies. A read R_1 is *Atomic-ordered-before* a read or a write RW_2 from the same [Observer](#) if and only if R_1 appears in program order before RW_2 and either of the following cases apply:

- RW_2 is a write W_2 such that R_1 and W_2 are generated by an atomic instruction or a successful Load-Exclusive/Store-Exclusive instruction pair to the same [Location](#).
- RW_2 is a read R_2 such that R_1 is Atomic-ordered-before a write W_3 and R_2 [Reads-from](#) W_3 .

For more information, see [Synchronization and semaphores on page E2-2795](#).

Barrier-ordered-before

Barrier instructions order prior [Memory effects](#) before subsequent [Memory effects](#) generated by the same [Observer](#). A read or a write RW_1 is *Barrier-ordered-before* a read or a write RW_2 from the same [Observer](#) if and only if RW_1 appears in program order before RW_2 and any of the following cases apply:

- RW_1 appears in program order before a DMB FULL that appears in program order before RW_2 .
- RW_1 is a write W_1 generated by a Store-Release instruction and RW_2 is a read R_2 generated by a Load-Acquire instruction.
- RW_1 is a read R_1 and either:
 - R_1 appears in program order before a DMB LD that appears in program order before RW_2 .
 - R_1 is generated by a Load-Acquire instruction.
- RW_2 is a write W_2 and either:
 - RW_1 is a write W_1 appearing in program order before a DMB ST that appears in program order before W_2 .
 - W_2 is generated by a Store-Release instruction.
 - RW_1 appears in program order before a write W_3 generated by a Store-Release instruction and W_2 is [Coherence-after](#) W_3 .

Ordered-before

An arbitrary pair of **Memory effects** is ordered if it can be linked by a chain of ordered accesses consistent with external observation. A read or a write RW_1 is *Ordered-before* a read or a write RW_2 if and only if any of the following cases apply:

- RW_1 is **Observed-by** RW_2 .
- RW_1 is **Dependency-ordered-before** RW_2 .
- RW_1 is **Atomic-ordered-before** RW_2 .
- RW_1 is **Barrier-ordered-before** RW_2 .
- RW_1 is **Ordered-before** a read or a write that is **Ordered-before** RW_2 .

E2.3.3 Ordering constraints

The ARMv8 memory model is described as being **Other-multi-copy atomic**. The definition of Other-multi-copy atomic is as follows:

Other-multi-copy atomic

In an *Other-multi-copy atomic* system, it is required that a write from an **Observer**, if observed by a different **Observer**, is then observed by all other **Observers** that access the **Location** coherently. It is, however, permitted for an **Observer** to observe its own writes prior to making them visible to other observers in the system.

The **Other-multi-copy atomic** property of the ARMv8 memory model is enforced by placing constraints on the possible executions of a program. Those executions that meet the constraints given by the ordering model are said to be *architecturally well-formed*. An implementation that is executing a program is only permitted to exhibit behavior consistent with an architecturally well-formed execution.

An architecturally well-formed execution must satisfy both of the following requirements:

Internal visibility requirement

For a read or a write RW_1 that appears in program order before a read or a write RW_2 to the same **Location**, the internal visibility requirement requires that exactly one of the following statements is true:

- RW_2 is a write W_2 that is **Coherence-after** RW_1 .
- RW_1 is a write W_1 and RW_2 is a read R_2 such that either:
 - R_2 **Reads-from** W_1 .
 - R_2 **Reads-from** another write that is **Coherence-after** W_1 .
- RW_1 and RW_2 are both reads R_1 and R_2 such that R_1 **Reads-from** a write W_3 and either:
 - R_2 **Reads-from** W_3 .
 - R_2 **Reads-from** another write that is **Coherence-after** W_3 .

Note

Informally, if a **Memory effect** M_1 from an **Observer** appears in program order before a **Memory effect** M_2 from the same **Observer**, then M_1 will be seen to occur before M_2 by that **Observer**.

External visibility requirement

For a read or a write RW_1 that is **Ordered-before** a read or a write RW_2 , to the same **Location** and from a different **Observer**, the external visibility requirement requires that exactly one of the following statements is true:

- RW_2 is a write W_2 and RW_1 is **Observed-by** W_2 .
- RW_1 is a write W_1 and RW_2 is a read R_2 such that either:
 - W_1 is **Observed-by** R_2 .

- There is a write W_3 such that W_3 is **Observed-by** R_2 and W_1 is **Observed-by** W_3 .
- RW_1 and RW_2 are both reads R_1 and R_2 and there is a write W_3 such that either:
 - W_3 is **Observed-by** both R_1 and R_2 .
 - R_1 is **Observed-by** W_3 and W_3 is **Observed-by** R_2 .

———— **Note** —————

If a **Memory effect** M_1 is **Ordered-before** another **Memory effect** M_2 , to the same **Location** and from a different **Observer**, then M_1 will be seen to occur before M_2 by all **Observers** in the system.

E2.3.4 Completion and endpoint ordering

Interaction between **Observers** in a system is not restricted to communication via shared variables in coherent memory. For example, an **Observer** could configure an interrupt controller to raise an interrupt on another **Observer** as a form of message passing. These interactions typically involve an additional agent, which defines the instruction sequence that is required to establish communication links between different **Observers**. When these forms of interaction are used in conjunction with shared variables, a DSB instruction can be used to enforce ordering between them.

Peripherals

This section defines a **Memory-mapped peripheral** and the total order of reads and write to a peripheral which is defined as the **Peripheral coherence order**:

Memory-mapped peripheral

A *Memory-mapped peripheral* occupies a memory region of IMPLEMENTATION DEFINED size and can be accessed using load and store instructions. **Memory effects** to a Memory-mapped peripheral can have side-effects, such as causing the peripheral to perform an action. Values that are read from addresses within a Memory-mapped peripheral might not correspond to the last data value written to those addresses. As such, **Memory effects** to a Memory-mapped peripheral might not appear in the **Reads-from** or **Coherence order** relations.

Peripheral coherence order

The *Peripheral coherence order* of a **Memory-mapped peripheral** is a total order on all reads and writes to that peripheral.

———— **Note** —————

The Peripheral coherence order for a **Memory-mapped peripheral** signifies the order in which accesses arrive at the endpoint.

For a read or a write RW_1 and a read or a write RW_2 to the same peripheral, then RW_1 will appear in the Peripheral coherence order for the peripheral before RW_2 if either of the following cases apply:

- RW_1 and RW_2 are accesses using Non-cacheable or Device attributes and RW_1 is **Ordered-before** RW_2 .
- RW_1 and RW_2 are accesses using Device-nGnRE or Device-nGnRnE attributes and RW_1 appears in program order before RW_2 .

Out-of-band-ordered-before

A read or a write RW_1 is *Out-of-band-ordered-before* a read or a write RW_2 if and only if either of the following cases apply:

- RW_1 appears in program order before a DSB instruction that begins an IMPLEMENTATION DEFINED instruction sequence indirectly leading to the generation of RW_2 .
- RW_1 is **Ordered-before** a read or a write RW_3 and RW_3 is **Out-of-band-ordered-before** RW_2 .

If a **Memory effect** M_1 is Out-of-band-ordered-before a read or a write M_2 , then M_1 is seen to occur before M_2 by all **Observers**.

E2.3.5 Memory barriers

The ARM architecture is a weakly ordered memory architecture that supports out of order completion. *Memory barrier* is the general term applied to an instruction, or sequence of instructions, that forces synchronization events by a PE with respect to retiring Load/Store instructions. The memory barriers defined by the ARMv8 architecture provide a range of functionality, including:

- Ordering of Load/Store instructions.
- Completion of Load/Store instructions.
- Context synchronization.

The following subsections describe the ARMv8 memory barrier instructions:

- [Instruction Synchronization Barrier \(ISB\)](#).
- [Data Memory Barrier \(DMB\)](#) on page E2-2769.
- [Data Synchronization Barrier \(DSB\)](#) on page E2-2769.
- [Shareability and access limitations on the data barrier operations](#) on page E2-2769.
- [Load-Acquire, Store-Release](#) on page E2-2770.

Note

Depending on the required synchronization, a program might use memory barriers on their own, or it might use them in conjunction with cache maintenance and memory management instructions that in general are only available when software execution is at EL1 or higher.

The DMB and DSB memory barriers affect reads and writes to the memory system generated by Load/Store instructions and data or unified cache maintenance instructions being executed by the PE. Instruction fetches or accesses caused by a hardware translation table access are not explicit accesses.

AArch32 state also supports the legacy barrier instructions [CP15DMB](#), [CP15DSB](#), and [CP15ISB](#). These instructions are executed as MCRs using the appropriate encoding, and are accessible from EL0. However, for performance reasons ARM deprecates any use of these operations, and strongly recommends that software uses the DMB, DSB, and ISB instructions described in this section instead. Optionally, an implementation can support a CP15BEN control that supervisory software can use to disable use of these instructions, meaning the corresponding MCR encodings are UNDEFINED. When the CP15BEN control is supported, setting one of the following CP15BEN fields to 0 makes execution of [CP15DMB](#), [CP15DSB](#), and [CP15ISB](#) UNDEFINED:

- [SCTLR_EL1](#).CP15BEN, for execution of these instructions at EL0 using AArch32 when EL1 is using AArch64.
- [SCTLR](#).CP15BEN, for execution of these instructions at EL0 or EL1 when EL1 is using AArch32.
- [HSCTLR](#).CP15BEN, for execution of these instructions at EL2 when EL2 is using AArch32.

Instruction Synchronization Barrier (ISB)

An ISB instruction flushes the pipeline in the PE, so that all instructions that come after the ISB instruction in program order are fetched from the cache or memory after the ISB instruction has completed. Using an ISB ensures that the effects of context-changing operations executed before the ISB are visible to the instructions fetched after the ISB instruction. Examples of context-changing operations that require the insertion of an ISB instruction to ensure the effects of the operation are visible to instructions fetched after the ISB instruction are:

- Completed cache and TLB maintenance instructions.
- Changes to System registers.

Any context-changing operations appearing in program order after the ISB instruction only take effect after the ISB has been executed.

The pseudocode function for the operation of an ISB is [InstructionSynchronizationBarrier\(\)](#).

See also [Memory barriers on page G3-4555](#).

Data Memory Barrier (DMB)

The DMB instruction is a memory barrier instruction that ensures the relative order of memory accesses before the barrier with memory accesses after the barrier. The DMB instruction does not ensure the completion of any of the memory accesses for which it ensures relative order.

The full definition of the DMB is covered formally in the [Definition of the ARMv8 memory model on page E2-2762](#) and this introduction to the DMB instruction is not intended to contradict that section.

The basic principle of a DMB instruction is to introduce order between memory accesses that are specified to be affected by the DMB options supplied as arguments to the DMB instruction. The DMB instruction ensures that all affected memory accesses by the PE executing the DMB that appear in program order before the DMB and those which originate from a different PE, to the extent required by the DMB options, which have been **Observed-by** the PE before the DMB is executed, are **Observed-by** each PE, to the extent required by the DMB options, before any affected memory accesses that appear in program order after the DMB are **Observed-by** that PE.

The use of a DMB creates order between the [Memory effects](#) of instructions as described in the definition of [Barrier-ordered-before](#).

The pseudocode function for the operation of a DMB is `DataMemoryBarrier()`.

Data Synchronization Barrier (DSB)

A DSB is a memory barrier that ensures that memory accesses that occur before the DSB have completed before the completion of the DSB instruction. In doing this, it acts as a stronger barrier than a DMB and all ordering that is created by a DMB with specific options is also generated by a DSB with the same options.

Execution of a DSB at EL2 ensures that any memory accesses caused by speculative translation table walks from the Non-secure PL1&0 translation regime have been observed.

For more information, see [Use of out-of-context translation regimes on page G4-4564](#).

A DSB completes when all of the following apply:

- All explicit memory accesses that are observed by PE_e before the DSB is executed and are of the required access types, and are from observers in the same required shareability domain as PE_e, are complete for the set of observers in the required shareability domain.
- If the required access types of the DSB is reads and writes, then all cache and branch predictor maintenance instructions and all TLB maintenance instructions issued by PE_e before the DSB are complete for the required shareability domain.

In addition, no instruction that appears in program order after the DSB instruction can alter any state of the system or perform any part of its functionality other than:

- Being fetched from memory and decoded.
- Reading the general-purpose, SIMD and floating-point, Special-purpose, or System registers that are directly or indirectly read without causing side-effects until the DSB completes.

The pseudocode function for the operation of a DSB is `DataSynchronizationBarrier()`.

See also [Memory barrier instructions on page G3-4552](#) and [Memory barriers on page G3-4555](#).

Shareability and access limitations on the data barrier operations

The DMB and DSB instructions can each take an optional limitation argument that specifies:

- The shareability domain over which the instruction must operate. This is one of:
 - Full system.
 - Outer Shareable.
 - Inner Shareable.

- Non-shareable.
- The accesses for which the instruction operates. This is one of:
 - Read and write accesses, both before and after the barrier instruction.
 - Write accesses only, before and after the barrier instruction.
 - Read accesses before the barrier instruction, and read and write accesses after the barrier instruction.

Note

This form of a DMB or DSB instruction can be described as a Load-Load/Store barrier.

For more information on whether an access is before or after a barrier instruction, see [Data Memory Barrier \(DMB\) on page E2-2769](#) or [Data Synchronization Barrier \(DSB\) on page E2-2769](#).

Table E2-1 shows how these options are encoded in the <option> field of the instruction.

Table E2-1 Encoding of the DMB and DSB <option> parameter

Accesses		Shareability domain			
		Full system	Outer Shareable	Inner Shareable	Non-shareable
Before the barrier	After the barrier				
Reads and writes	Reads and writes	SY	OSH	ISH	NSH
Writes	Writes	ST	OSHST	ISHST	NSHST
Reads	Reads and writes	LD	OSHL	ISHL	NSHL

If no <option> is specified then the instruction operates for read and write accesses, over the full system, meaning the operation is the same as for the SY option. See the instruction descriptions for more information:

- [DMB on page F5-3103](#).
- [DSB on page F5-3106](#).

Note

ISB also supports an optional limitation argument that can only contain one value that corresponds to full system operation, see [ISB on page F5-3125](#).

Load-Acquire, Store-Release

ARMv8 provides a set of instructions with Acquire semantics for loads, and Release semantics for stores.

The full definition of the Load-Acquire instruction is covered formally in the [Definition of the ARMv8 memory model on page E2-2762](#) and this introduction to the Load-Acquire instruction is not intended to contradict that section.

The basic principle of a Load-Acquire instruction is to introduce order between the memory access generated by the Load-Acquire instruction and the memory accesses appearing in program order after the Load-Acquire instruction, such that the memory access generated by the Load-Acquire instruction is **Observed-by** each PE, to the extent that that PE is required to observe the access coherently, before any of the memory accesses appearing in program order after the Load-Acquire instruction are **Observed-by** that PE, to the extent that the PE is required to observe the accesses coherently.

The use of a Load-Acquire instruction creates order between the **Memory effects** of instructions as described in the definition of [Barrier-ordered-before](#).

The full definition of the Store-Release instruction is covered formally in the [Definition of the ARMv8 memory model on page E2-2762](#) and this introduction to the Store-Release instruction is not intended to contradict that section.

The basic principle of a Store-Release instruction is to introduce order between the memory accesses generated by the PEE executing the Store-Release instruction, together with those which originate from a different PE, to the extent that the PEE is required to observe them coherently, **Observed-by** the PEE before executing the Store-release.

The use of a Store-Release instruction creates order between the **Memory effects** of instructions as described in the definition of **Barrier-ordered-before**.

In addition, the use of a Load-Acquire or a Store-Release instruction on accesses to a **Memory-mapped peripheral** introduces order between the **Memory effects** of the instructions that access that peripheral, as described in the definition of **Peripheral coherence order**.

Load-Acquire and Store-Release, other than LDAEXD and STLEXD, access only a single data element. This access is single-copy atomic. The address of the data object must be aligned to the size of the data element being accessed, otherwise the access generates an Alignment fault.

LDAEXD and STLEXD access two data elements. The address supplied to the instructions must be doubleword aligned, otherwise the access generates an Alignment fault.

A Store-Release Exclusive instruction only has the release semantics if the store is successful.

———— **Note** ————

- Each Load-Acquire Exclusive and Store-Release Exclusive instruction is essentially a variant of the equivalent Load-Exclusive or Store-Exclusive instruction. All usage restrictions and single-copy atomicity properties:
 - That apply to the Load-Exclusive instructions also apply to the Load-Acquire Exclusive instructions.
 - That apply to the Store-Exclusive instructions also apply to the Store-Release Exclusive instructions.
- The Load-Acquire/Store-Release instructions can remove the requirement to use the explicit DMB memory barrier instruction.

[Table E2-2](#) summarizes the Load-Acquire/Store-release instructions.

Table E2-2 Load-Acquire/Store-Release instructions

Data type	Load-Acquire	Store-Release	Load-Acquire Exclusive	Store-Release Exclusive
32-bit word	LDA	STL	LDAEX	STLEX
16-bit halfword	LDAH	STLH	LDAEXH	STLEXH
8-bit byte	LDAB	STLB	LDAEXB	STLEXB
64-bit doubleword	-	-	LDAEXD	STLEXD

E2.4 Caches and memory hierarchy

The implementation of a memory system depends heavily on the microarchitecture and therefore many details of the memory system are IMPLEMENTATION DEFINED. ARMv8 defines the application level interface to the memory system, including a hierarchical memory system with multiple levels of cache. This section describes an application level view of this system. It contains the subsections:

- [Introduction to caches.](#)
- [Memory hierarchy.](#)
- [Implication of caches for the application programmer on page E2-2774.](#)
- [Preloading caches on page E2-2775.](#)

E2.4.1 Introduction to caches

A cache is a block of high-speed memory that contains a number of entries, each consisting of:

- Main memory address information, commonly known as a *tag*.
- The associated data.

Caches increase the average speed of a memory access and take account of two principles of locality:

Spatial locality

An access to one location is likely to be followed by accesses to adjacent locations. Examples of this principle are:

- Sequential instruction execution.
- Accessing a data structure.

Temporal locality

An access to an area of memory is likely to be repeated in a short time period. An example of this principle is the execution of a software loop.

To minimize the quantity of control information stored, the spatial locality property groups several locations together under the same tag. This logical block is commonly known as a *cache line*. When data is loaded into a cache, access times for subsequent loads and stores are reduced, resulting in overall performance benefits. An access to information already in a cache is known as a *cache hit*, and other accesses are called *cache misses*.

Normally, caches are self-managing, with the updates occurring automatically. Whenever the PE accesses a cacheable memory location, the cache is checked. If the access is a cache hit, the access occurs in the cache. Otherwise, the access is made to memory. Typically, when making this access, a cache location is allocated and the cache line loaded from memory. ARMv8 permits different cache topologies and access policies, provided they comply with the memory coherency model described in this manual.

Caches introduce a number of potential problems, mainly because:

- Memory accesses can occur at times other than when the programmer would expect them.
- A data item can be held in multiple physical locations.

E2.4.2 Memory hierarchy

Typically memory close to a PE has very low latency, but is limited in size and expensive to implement. Further from the PE it is common to implement larger blocks of memory but these have increased latency. To optimize overall performance, an ARMv8 memory system can include multiple levels of cache in a hierarchical memory system that exploits this trade-off between size and latency. [Figure E2-1 on page E2-2773](#) shows an example of such a system in an ARMv8-A system that supports virtual addressing.

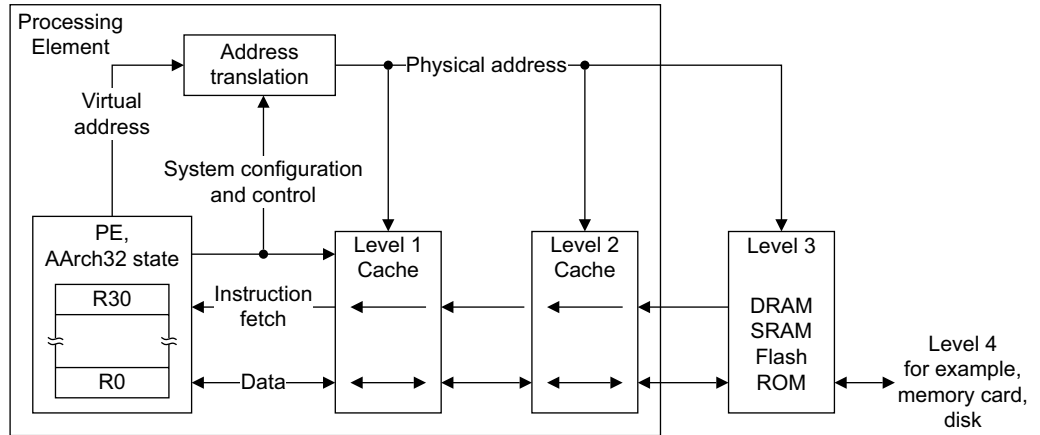

Figure E2-1 Multiple levels of cache in a memory hierarchy

Note

In this manual, in a hierarchical memory system, Level 1 refers to the level closest to the PE, as shown in [Figure E2-1](#).

Instructions and data can be held in separate caches or in a unified cache. A cache hierarchy can have one or more levels of separate instruction and data caches, with one or more unified caches located at the levels closest to the main memory. Memory coherency for cache topologies can be defined by two conceptual points:

Point of Unification (PoU)

The point at which the instruction cache, data cache, and translation table walks of a particular PE are guaranteed to see the same copy of a memory location. In many cases, the point of unification is the point in a uniprocessor memory system by which the instruction and data caches and the translation table walks have merged. The point of unification might coincide with the point of coherency.

Point of Coherency (PoC)

The point at which all agents that can access memory are guaranteed to see the same copy of a memory location for accesses of any memory type or cacheability attribute. In many cases this is effectively the main system memory, although the architecture does not prohibit the implementation of caches beyond the PoC that have no effect on the coherency between memory system agents.

Note

The presence of system caches can affect the determination of the point of coherency as described in [System level caches](#) on page D3-1996.

See also [About cache maintenance in AArch32 state](#) on page G3-4531.

The Cacheability and Shareability memory attributes

Cacheability and Shareability are two attributes that describe the memory hierarchy in a multiprocessing system:

Cacheability This term defines whether memory locations are allowed to be allocated into a cache or not. Cacheability is defined independently for Inner and Outer Cacheability locations.

Shareability This term defines whether memory locations are shareable between different agents in a system. Marking a memory location as shareable for a particular domain requires hardware to ensure that the location is coherent for all agents in that domain. Shareability is defined independently for Inner and Outer Shareability domains.

For more information about the Cacheability and Shareability attributes see [Memory types and attributes on page E2-2782](#).

E2.4.3 Implication of caches for the application programmer

In normal operation, the caches are largely invisible to the application programmer. However they can become visible when there is a breakdown in the coherency of the caches. Such a breakdown can occur:

- When memory locations are updated by other agents in the system that do not use hardware management of coherency.
- When memory updates made from the application software must be made visible to other agents in the system, without the use of hardware management of coherency.

For example:

- In the absence of hardware management of coherency of DMA accesses, in a system with a DMA controller that reads memory locations that are held in the data cache of a PE, a breakdown of coherency occurs when the PE has written new data in the data cache, but the DMA controller reads the old data held in memory.
- In a Harvard cache implementation, where there are separate instruction and data caches, a breakdown of coherency occurs when new instruction data has been written into the data cache, but the instruction cache still contains the old instruction data.

Data coherency issues

Software can ensure the data coherency of caches in the following ways:

- By not using the caches in situations where coherency issues can arise. This can be achieved by:
 - Using Non-cacheable or, in some cases, Write-Through Cacheable memory.
 - Not enabling caches in the system.
- By using system calls to functions using cache maintenance instructions that execute at a higher Exception level.
- By using hardware coherency mechanisms to ensure the coherency of data accesses to memory for cacheable locations by observers within the different shareability domains, see [Non-shareable Normal memory on page E2-2784](#) and [Shareable, Inner Shareable, and Outer Shareable Normal memory on page E2-2783](#).

———— **Note** —————

The performance of these hardware coherency mechanisms is highly implementation-specific. In some implementations the mechanism suppresses the ability to cache shareable locations. In other implementations, cache coherency hardware can hold data in caches while managing coherency between observers within the shareability domains.

Synchronization and coherency issues between data and instruction accesses

How far ahead of the current point of execution instructions are fetched from is IMPLEMENTATION DEFINED. Such prefetching can be either a fixed or a dynamically varying number of instructions, and can follow any or all possible future execution paths. For all types of memory:

- The PE might have fetched the instructions from memory at any time since the last [Context synchronization event](#) on that PE.
- Any instructions fetched in this way might be executed multiple times, if this is required by the execution of the program, without being re-fetched from memory.

The ARM architecture does not require the hardware to ensure coherency between instruction caches and memory, even for locations of shared memory.

If software requires coherency between instruction execution and memory, it must manage this coherency using [Context synchronization events](#) and cache maintenance instructions. These can only be accessed from an Exception level that is higher than EL0, and therefore require a system call, see [Exception-generating and exception-handling instructions on page F1-2827](#). The following code sequence can be used for this purpose:

```
; Coherency example for data and instruction accesses within the same Inner Shareable domain.
; Enter this code with <Rt> containing a new 32-bit instruction,
; to be held in Cacheable space at a location pointed to by Rn. Use STRH in the first line
; instead of STR for a 16-bit instruction.
STR Rt, [Rn]
DCCMVAU Rn      ; Clean data cache by MVA to point of unification (PoU)
DSB             ; Ensure visibility of the data cleaned from cache
ICIMVAU Rn     ; Invalidate instruction cache by MVA to PoU
BPIMVA Rn      ; Invalidate branch predictor by MVA to PoU
DSB             ; Ensure completion of the invalidations
ISB            ; Synchronize the fetched instruction stream
```

Note

- For accesses that are Non-cacheable or Write-Through, the clean data cache instruction is not required. For accesses that are Non-cacheable, the invalidate instruction cache is not required, because in AArch32 state these accesses are not permitted to be held in an instruction cache.
 - This code can be used when the thread of execution modifying the code is the same thread of execution that is executing the code. The ARMv8 architecture limits the set of instructions that can be executed by one thread of execution as they are being modified by another thread of execution without requiring explicit synchronization. See [Concurrent modification and execution of instructions on page E2-2760](#).
-

E2.4.4 Preloading caches

The ARM architecture provides the memory system hints PLD (Preload Data), PLDW (Preload Data With Intent To Write) and PLI (Preload Instruction) that software can use to communicate the expected use of memory locations to the hardware. The memory system can respond by taking actions that are expected to speed up the memory accesses if they occur. The effect of these memory system hints is IMPLEMENTATION DEFINED. Typically, implementations use this information to bring data or instruction locations into caches.

The Preload instructions are hints, and so implementations can treat them as NOPs without affecting the functional behavior of the device. The instructions cannot generate synchronous Data Abort exceptions, but the resulting memory system operations might, under exceptional circumstances, generate an asynchronous external abort, which is reported using an SError interrupt and taken using an asynchronous Data Abort exception. For more information, see [Data Abort exception on page G1-4387](#).

A PLD, PLDW, or PLI instruction can only cause allocation to software-visible caching structures such caches or TLBs for memory locations that can be accessed, according to the permissions defined by the current translation regime or a translation regime for a higher Exception level in the current Security state, by any of:

- Reads.
- Writes.
- Instruction fetches.

A PLD, PLDW, or PLI instruction can access any memory location in Normal memory that can be accessed, according to the permissions defined by the current translation regime or a translation regime for a higher Exception level in the current Security state, by any of:

- Reads.
- Writes.
- Instruction fetches.

Note

In each case, the entire list applies to each of PLD, PLDW, and PLI.

A PLD, PLDW, or PLI instruction is guaranteed not to access any type of Device memory.

A PLI instruction must not perform any access that cannot be performed by a speculative instruction fetch by the processor. Therefore in a VMSA implementation, if all associated MMUs are disabled, a PLI instruction cannot access any memory location that cannot be accessed by instruction fetches.

The pseudocode enumeration [PrefetchHint](#) defines the prefetch hint types.

The [Hint_Prefetch\(\)](#) pseudocode function signals to the memory system that memory accesses of the type hint to or from the specified address are likely to occur in the near future. The memory system might take some action to speed up the memory accesses when they do occur, such as preloading the specified address into one or more caches as indicated by the innermost cache level target and non-temporal hint stream.

For more information on PLD, PLI, and PLDW, see:

- [PLD, PLDW \(immediate\)](#) on page F5-3314.
- [PLD \(literal\)](#) on page F5-3316.
- [PLD, PLDW \(register\)](#) on page F5-3318.
- [PLI \(immediate, literal\)](#) on page F5-3320.
- [PLI \(register\)](#) on page F5-3323.

E2.5 Alignment support

This section describes alignment support. It contains the following subsections:

- [Instruction alignment](#).
- [Unaligned data access](#).
- [Cases where unaligned accesses are CONstrained UNpredictable](#) on page E2-2778.
- [Unaligned data access restrictions](#) on page E2-2778.

E2.5.1 Instruction alignment

A32 instructions are word-aligned.

T32 instructions are halfword-aligned.

E2.5.2 Unaligned data access

An ARMv8 implementation must support unaligned data accesses to Normal memory by some load and store instructions. As [Table E2-3](#) shows, software can control whether a misaligned access to Normal memory by one of these instructions causes an Alignment fault Data Abort exception:

- By setting [SCTLR.A](#), for unaligned accesses from any mode other than Hyp mode.
- By setting [HSCTLR.A](#), for unaligned accesses from Hyp mode.

Table E2-3 Alignment requirements of load/store instructions

Instructions	Alignment check	Result if check fails when:	
		SCTLR.A or HSCTLR.A is 0	SCTLR.A or HSCTLR.A is 1
LDRB, LDREXB, LDRBT, LDRSB, LDRSBT, STRB, STREXB, STRBT, TBB	None	-	-
LDRH, LDRHT, LDRSH, LDRSHT, STRH, STRHT, TBH	Halfword	Unaligned access	Alignment fault
LDREXH, STREXH, LDAH, STLH, LDAEXH, STLEXH	Halfword	Alignment fault	Alignment fault
LDR, LDRT, STR, STRT PUSH, encodings T3 and A2 only POP, encodings T3 and A2 only	Word	Unaligned access	Alignment fault
LDREX, STREX, LDA, STL, LDAEX, STLEX	Word	Alignment fault	Alignment fault
LDREXD, STREXD, LDAEXD, STLEXD	Doubleword	Alignment fault	Alignment fault
All forms of LDM and STM, LDRD, RFE, SRS, STRD	Word	Alignment fault	Alignment fault
LDC, STC	Word	Alignment fault	Alignment fault
VLDM, VLDR, VPOP, VPUSH, VSTM, VSTR	Word	Alignment fault	Alignment fault
VLD1, VLD2, VLD3, VLD4, VST1, VST2, VST3, VST4, all with standard alignment	Element size	Unaligned access	Alignment fault
VLD1, VLD2, VLD3, VLD4, VST1, VST2, VST3, VST4, all with :<align> specified ^a	As specified by :<align>	Alignment fault	Alignment fault

a. Previous versions of this manual used @<align> to specify alignment. Both forms are supported, see [Chapter F6 T32 and A32 Advanced SIMD and floating-point Instruction Descriptions](#) for more information.

Note

Any unaligned access to any type of Device memory generates an Alignment fault, see [Alignment faults on page G4-4656](#).

E2.5.3 Cases where unaligned accesses are CONSTRAINED UNPREDICTABLE

Any load instruction that is not faulted by the alignment restrictions shown in [Table E2-3 on page E2-2777](#) and that loads the PC has CONSTRAINED UNPREDICTABLE behavior if the address it loads from is not word-aligned, see [Loads and Stores to unaligned locations on page K1-6098](#). This overrides any permitted Load/Store behavior shown in [Table E2-3 on page E2-2777](#).

E2.5.4 Unaligned data access restrictions

The following points apply to unaligned data accesses in ARMv8:

- Accesses are not guaranteed to be single-copy atomic except at the byte access level, see [Atomicity in the ARM architecture on page E2-2758](#).
- Unaligned accesses typically take a number of additional cycles to complete compared to a naturally-aligned access.
- An operation that performs an unaligned access can abort on any memory access that it makes, and can abort on more than one access. This means that an unaligned access that occurs across a page boundary can generate an abort on either side of the boundary.

E2.6 Endian support

General description of endianness in the ARM architecture describes the relationship between endianness and memory addressing in the ARM architecture.

The following subsections then describe the endianness schemes supported by the architecture:

- *Instruction endianness.*
- *Data endianness on page E2-2780.*
- *Endianness of memory-mapped peripherals on page E2-2781.*

E2.6.1 General description of endianness in the ARM architecture

This section only describes memory addressing and the effects of endianness for data elements up to doubleword of 64 bits. However, this description can be extended to apply to larger data elements.

For an address A, [Figure E2-2](#) shows, for big-endian and little-endian memory systems, the relationship between:

- The doubleword at address A.
- The words at addresses A and A+4.
- The halfwords at addresses A, A+2, A+4, and A+6.
- The bytes at addresses A, A+1, A+2, A+3, A+4, A+5, A+6, and A+7.

The terms in [Figure E2-2](#) have the following definitions:

MSByte Most-significant byte.

LSByte Least-significant byte.

Big-endian memory system

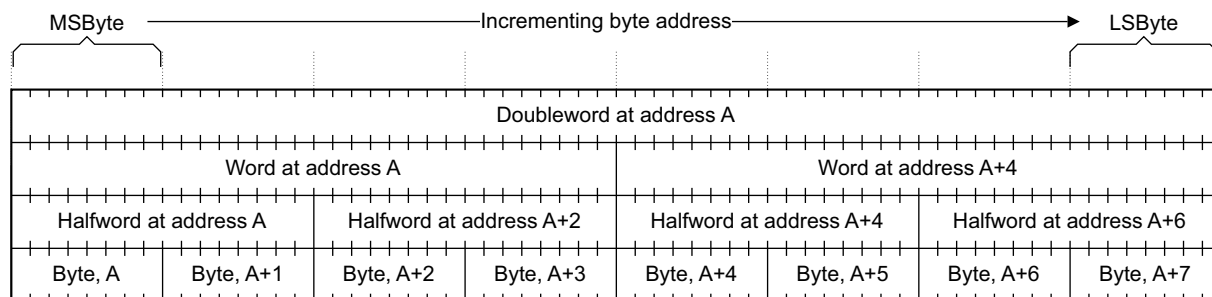

Little-endian memory system

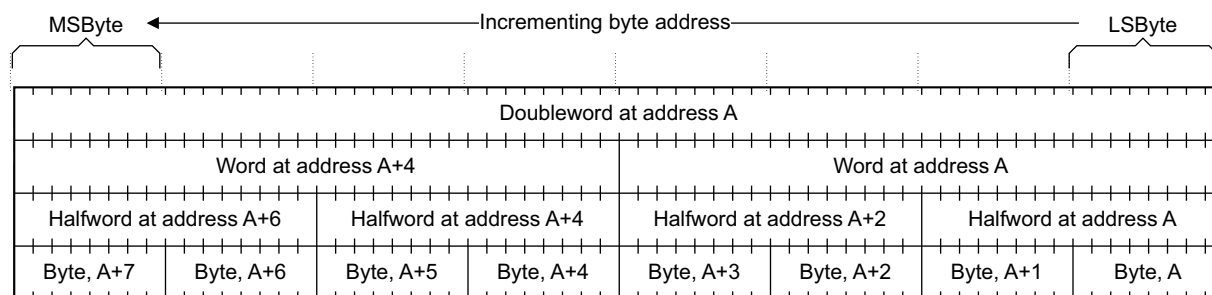

In this figure, *Byte, A+1* is an abbreviation for *Byte at address A+1*

Figure E2-2 Endianness relationships in AArch32 state

E2.6.2 Instruction endianness

In ARMv8-A, the mapping of instruction memory is always little-endian.

E2.6.3 Data endianness

The size of the data value that is loaded or stored is the size that is used for the purpose of endian conversion for floating-point, Advanced SIMD, and general-purpose register loads and stores.

Table E2-4 shows the element sizes of all the load/store instructions, for all instruction sets.

Table E2-4 Element size of load/store instructions

Instructions	Element size
LDRB, LDREXB, LDRBT, LDRSB, LDRSBT, STRB, STREXB, STRBT, TBB	Byte
LDRH, LDREXH, LDRHT, LDRSH, LDRSHT, STRH, STREXH, STRHT, TBH	Halfword
LDR, LDRT, LDREX, STR, STRT, STREX	Word
LDRD, LDREXD, STRD, STREXD	Word
All forms of LDM, PUSH, POP, RFE, SRS, all forms of STM,	Word
LDC, STC	Word
Forms of VLDM, VLDR, VPOP, VPUSH, VSTM, VSTR that transfer 32-bit Si registers	Word
Forms of VLDM, VLDR, VPOP, VPUSH, VSTM, VSTR that transfer 64-bit Di registers	Doubleword
VLD1, VLD2, VLD3, VLD4, VST1, VST2, VST3, VST4	Element size of the Advanced SIMD access

CPSR.E determines the data endianness.

The data size used for endianness conversions:

- Is the size of the data value that is loaded or stored for Advanced SIMD and floating-point register and general-purpose register loads and stores.
- Is the size of the data element that is loaded or stored for Advanced SIMD element and data structure loads and stores. For more information see *Endianness in Advanced SIMD* on page E2-2781.

Instructions to reverse bytes in registers

An application or device driver might have to interface to memory-mapped peripheral registers or shared memory structures that are not the same endianness as the internal data structures. Similarly, the endianness of the operating system might not match that of the peripheral registers or shared memory. In these cases, the PE requires an efficient method to transform explicitly the endianness of the data.

Table E2-5 shows the instructions that provide this functionality in the A32 and T32 instruction sets.

Table E2-5 Byte reversal instructions

Function	T32 / A32 Instruction	Notes
Reverse bytes in whole register	REV	For use with general purpose registers.
Reverse bytes in 16-bit halfwords	REV16	For use with general purpose registers.
Reverse bytes in halfword and sign-extend	REVSH	For use with general purpose registers.
Reverse elements in doublewords, vector	VREV64	For use with registers in the SIMD and floating-point register file
Reverse elements in words, vector	VREV32	For use with registers in the SIMD and floating-point register file
Reverse elements in halfwords, vector	VREV16	For use with registers in the SIMD and floating-point register file

Endianness in Advanced SIMD

Advanced SIMD element Load/Store instructions transfer vectors of elements between memory and the SIMD and floating-point register file. An instruction specifies both the length of the transfer and the size of the data elements being transferred. This information is used by the PE to load and store data correctly in both big-endian and little-endian systems.

Consider, for example, the A32 or T32 instruction:

```
VLD1.16 {D0}, [R1]
```

This loads a 64-bit register with four 16-bit values. The four elements appear in the register in array order, with the lowest indexed element fetched from the lowest address. The order of bytes in the elements depends on the endianness configuration, as shown in Figure E2-3. Therefore, the order of the elements in the registers is the same regardless of the endianness configuration.

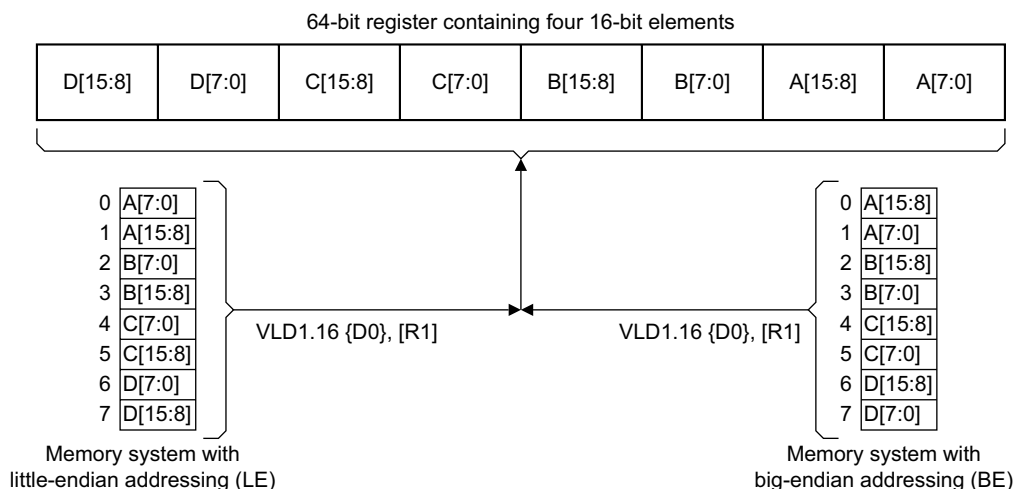

Figure E2-3 Advanced SIMD byte order example for AArch32 state

For information about the alignment of Advanced SIMD instructions see [Alignment support on page E2-2777](#).

The `BigEndian()` pseudocode function determines the current endianness of the data.

The `BigEndianReverse()` pseudocode function reverses the endianness of a bitstring.

The `BigEndian()` and `BigEndianReverse()` functions are defined in [Chapter J1 ARMv8 Pseudocode](#).

E2.6.4 Endianness of memory-mapped peripherals

All memory-mapped peripherals defined in the ARM architecture must be little-endian.

Peripherals to which this requirement applies include:

- Memory-mapped register interfaces to a debugger, or to a cross-trigger interface, see [Chapter H8 About the External Debug Registers](#).
- The memory-mapped register interface to the system level implementation of the Generic Timer, see [Chapter I1 System Level Implementation of the Generic Timer](#).
- A memory-mapped register interface to the Performance Monitors, see [Chapter I2 Recommended External Interface to the Performance Monitors](#).
- Memory-mapped register interfaces to an ARM Generic Interface Controller, see the *ARM® Generic Interrupt Controller Architecture Specification, GIC architecture version 3.0 and version 4.0*.
- The memory-mapped register interface to an ARM trace component. See, for example, the *ARM® Embedded Trace Macrocell Architecture Specification, ETMv4*.

E2.7 Memory types and attributes

In ARMv8 the ordering of accesses for addresses in memory, referred to as the memory order model, is defined by the memory attributes. The following sections describe this model:

- [Normal memory](#).
- [Device memory on page E2-2786](#).
- [Memory access restrictions on page E2-2791](#).

E2.7.1 Normal memory

The Normal memory type attribute applies to most memory in a system. It indicates that the hardware is permitted by the architecture to perform speculative data read accesses to these locations, regardless of the access permissions for these locations.

The Normal memory type has the following properties:

- A write to a memory location with the Normal attribute completes in finite time. This means that it is globally observed for the shareability domain of the memory location in finite time. For a Non-cacheable location, the location is observed by all observers in finite time.
- A completed write to a memory location with the Normal attribute is globally observed for the shareability domain of the memory location in finite time without the need for explicit cache maintenance instructions or barriers. For a Non-cacheable location, the completed write is globally observed for all observers in finite time without the need for explicit cache maintenance instructions or barriers.
- Writes to a memory location with the Normal memory attribute that is Non-cacheable must reach the endpoint for that location in the memory system in finite time.
- Unaligned memory accesses can access Normal memory if the system is configured to generate such accesses.
- There is no requirement for the memory system beyond the PE to be able to identify the elements accessed by multi-register Load/Store instructions. See [Multi-register loads and stores that access Normal memory on page E2-2786](#).

Note

- The Normal memory attribute is appropriate for locations of memory that are idempotent, meaning that they exhibit all of the following properties:
 - Read accesses can be repeated with no side-effects.
 - Repeated read accesses return the last value written to the resource being read.
 - Read accesses can fetch additional memory locations with no side-effects.
 - Write accesses can be repeated with no side-effects if the contents of the location accessed are unchanged between the repeated writes or as the result of an exception, as described in this section.
 - Unaligned accesses can be supported.
 - Accesses can be merged before accessing the target memory system.
- An instruction that generates a sequence of accesses as described in [Atomicity in the ARM architecture on page E2-2758](#) might be abandoned as a result of an exception being taken during the sequence of accesses. On return from the exception the instruction is restarted, and therefore one or more of the memory locations might be accessed multiple times. This can result in repeated write accesses to a location that has been changed between the write accesses.

The following sections describe the other attributes for Normal memory:

- [Shareable Normal memory on page E2-2783](#).
- [Non-shareable Normal memory on page E2-2784](#).
- [Cacheability attributes for Normal memory on page E2-2784](#).

See also:

- [Multi-register loads and stores that access Normal memory on page E2-2786.](#)
- [Atomicity in the ARM architecture on page E2-2758.](#)
- [Memory barriers on page E2-2768.](#) For accesses to Normal memory, a DMB instruction is required to ensure the required ordering.
- [Concurrent modification and execution of instructions on page E2-2760.](#)

Shareable Normal memory

A Normal memory location has a Shareability attribute that is defined as one of:

- Inner Shareable.
- Outer Shareable.
- Non-shareable.

The shareability attributes define the data coherency requirements of the location, that hardware must enforce. They do not affect the coherency requirements of instruction fetches, see [Synchronization and coherency issues between data and instruction accesses on page E2-2774.](#)

———— Note ————

- System designers can use the Shareability attribute to specify the locations in Normal memory for which coherency must be maintained. However, software developers must not assume that specifying a memory location as Non-shareable permits software to make assumptions about the incoherency of the location between different PEs in a shared memory system. Such assumptions are not portable between different multiprocessing implementations that might use the Shareability attribute. Any multiprocessing implementation might implement caches that are shared, inherently, between different PEs.
- This architecture assumes that all PEs that use the same operating system or hypervisor are in the same Inner Shareable shareability domain.

Shareable, Inner Shareable, and Outer Shareable Normal memory

The ARM architecture abstracts the system as a series of Inner and Outer Shareability domains.

Each Inner Shareability domain contains a set of observers that are data coherent for each member of that set for data accesses with the Inner Shareable attribute made by any member of that set.

Each Outer Shareability domain contains a set of observers that are data coherent for each member of that set for data accesses with the Outer Shareable attribute made by any member of that set.

The following properties also hold:

- Each observer is only a member of a single Inner Shareability domain.
- Each observer is only a member of a single Outer Shareability domain.
- All observers in an Inner Shareability domain are always members of the same Outer Shareability domain. This means that an Inner Shareability domain is a subset of an Outer Shareability domain, although it is not required to be a proper subset.

———— Note ————

- Because all data accesses to Non-cacheable locations are data coherent to all observers, Non-cacheable locations are always treated as Outer Shareable.
- The Inner Shareable domain is expected to be the set of PEs controlled by a single hypervisor or operating system.

The details of the use of the Shareability attributes are system-specific. [Example E2-1](#) shows how they might be used.

Example E2-1 Use of shareability attributes

In an implementation, a particular subsystem with two clusters of PEs has the requirement that:

- In each cluster, the data caches or unified caches of the PEs in the cluster are transparent for all data accesses to memory locations with the Inner Shareable attribute.
- However, between the two clusters, the caches:
 - Are not required to be coherent for data accesses that have only the Inner Shareable attribute.
 - Are coherent for data accesses that have the Outer Shareable attribute.

In this system, each cluster is in a different Shareability domain for the Inner Shareable attribute, but all components of the subsystem are in the same Shareability domain for the Outer Shareable attribute.

A system might implement two such subsystems. If the data caches or unified caches of one subsystem are not transparent to the accesses from the other subsystem, this system has two Outer Shareable Shareability domains.

Having two levels of shareability means system designers can reduce the performance and power overhead for shared memory locations that do not need to be part of the Outer Shareable Shareability domain.

For Shareable Normal memory, the Load-Exclusive and Store-Exclusive synchronization primitives take account of the possibility of accesses by more than one observer in the same Shareability domain.

Non-shareable Normal memory

For Normal memory locations, the Non-shareable attribute identifies Normal memory that is likely to be accessed only by a single PE.

A location in Normal memory with the Non-shareable attribute does not require the hardware to make data accesses by different observers coherent, unless the memory is Non-cacheable. For a Non-shareable location, if other observers share the memory system, software must use cache maintenance instructions, if the presence of caches might lead to coherency issues when communicating between the observers. This cache maintenance requirement is in addition to the barrier operations that are required to ensure memory ordering.

For Non-shareable Normal memory, it is IMPLEMENTATION DEFINED whether the Load-Exclusive and Store-Exclusive synchronization primitives take account of the possibility of accesses by more than one observer.

Cacheability attributes for Normal memory

In addition to being Outer Shareable, Inner Shareable or Non-shareable, each region of Normal memory is assigned a Cacheability attribute that is one of:

- Write-Through Cacheable.
- Write-Back Cacheable.
- Non-cacheable.

Also, for Write-Through Cacheable and Write-Back Cacheable Normal memory regions:

- A region might be assigned cache allocation hints for read and write accesses.
- It is IMPLEMENTATION DEFINED whether the cache allocation hints can have an additional attribute of Transient or Non-transient.

For more information see [Cacheability, cache allocation hints, and cache transient hints on page G3-4528](#).

A memory location can be marked as having different cacheability attributes, for example when using aliases in a virtual to physical address mapping:

- If the attributes differ only in the cache allocation hint this does not affect the behavior of accesses to that location.
- For other cases see [Mismatched memory attributes on page E2-2792](#).

The cacheability attributes provide a mechanism of coherency control with observers that lie outside the Shareability domain of a region of memory. In some cases, the use of Write-Through Cacheable or Non-cacheable regions of memory might provide a better mechanism for controlling coherency than the use of hardware coherency mechanisms or the use of cache maintenance routines. To this end, the architecture requires the following properties for Non-cacheable or Write-Through Cacheable memory:

- A completed write to a memory location that is Non-cacheable or Write-Through Cacheable for a level of cache made by an observer accessing the memory system inside the level of cache is visible to all observers accessing the memory system outside the level of cache without the need of explicit cache maintenance.
- A completed write to a memory location that is Non-cacheable for a level of cache made by an observer accessing the memory system outside the level of cache is visible to all observers accessing the memory system inside the level of cache without the need of explicit cache maintenance.

Note

Implementations can use the cache allocation hints to indicate a probable performance benefit of caching. For example, a programmer might know that a piece of memory is not going to be accessed again and would be better treated as Non-cacheable. The distinction between memory regions with attributes that differ only in the cache allocation hints exists only as a hint for performance.

For Normal memory, the ARM architecture provides cacheability attributes that are defined independently for each of two conceptual levels of cache, the *inner* and the *outer* cache. The relationship between these conceptual levels of cache and the implemented physical levels of cache is IMPLEMENTATION DEFINED, and can differ from the boundaries between the Inner and Outer Shareability domains. However:

- Inner refers to the innermost caches, meaning the caches that are closest to the PE, and always includes the lowest level of cache.
- No cache that is controlled by the Inner cacheability attributes can lie outside a cache that is controlled by the Outer cacheability attributes.
- An implementation might not have any outer cache.

[Example E2-2](#), [Example E2-3 on page E2-2786](#), and [Example E2-4 on page E2-2786](#) describe the possible ways of implementing a system with three levels of cache, *level 1* (L1) to *level 3* (L3).

Note

- L1 cache is the level closest to the PE, see [Memory hierarchy on page E2-2772](#).
- When managing coherency, system designs must consider both the inner and outer cacheability attributes, as well as the Shareability attributes. This is because hardware might have to manage the coherency of caches at one conceptual level, even when another conceptual level has the Non-cacheable attribute.

Example E2-2 Implementation with two inner and one outer cache levels

Implement the three levels of cache in the system, L1 to L3, with:

- The Inner cacheability attribute applied to L1 and L2 cache.
 - The Outer cacheability attribute applied to L3 cache.
-

Example E2-3 Implementation with three inner and no outer cache levels

Implement the three levels of cache in the system, L1 to L3, with the Inner cacheability attribute applied to L1, L2, and L3 cache. Do not use the Outer cacheability attribute.

Example E2-4 Implementation with one inner and two outer cache levels

Implement the three levels of cache in the system, L1 to L3, with:

- The Inner cacheability attribute applied to L1 cache.
 - The Outer cacheability attribute applied to L2 and L3 cache.
-

Multi-register loads and stores that access Normal memory

For all instructions that load or store more than one general-purpose register from an Exception level there is no requirement for the memory system beyond the PE to be able to identify the size of the elements accessed by these load or store instructions.

For all instructions that load or store more than one general-purpose register from an Exception level the order in which the registers are accessed is not defined by the architecture.

For all instructions that load or store one or more registers from the SIMD and floating-point register file from an Exception level there is no requirement for the memory system beyond the PE to be able to identify the size of the element accessed by these load or store instructions.

E2.7.2 Device memory

The Device memory type attributes define memory locations where an access to the location can cause side-effects, or where the value returned for a load can vary depending on the number of loads performed. Typically, the Device memory attributes are used for memory-mapped peripherals and similar locations.

The attributes for ARMv8 Device memory are:

Gathering Identified as G or nG, see [Gathering on page E2-2788](#).

Reordering Identified as R or nR, see [Reordering on page E2-2789](#).

Early Write Acknowledgement hint

Identified as E or nE, see [Early Write Acknowledgement on page E2-2790](#).

The ARMv8 Device memory types are:

Device-nGnRnE Device non-Gathering, non-Reordering, No Early write acknowledgement.
Equivalent to the Strongly-ordered memory type in earlier versions of the architecture.

Device-nGnRE Device non-Gathering, non-Reordering, Early Write Acknowledgement.
Equivalent to the Device memory type in earlier versions of the architecture.

Device-nGRE Device non-Gathering, Reordering, Early Write Acknowledgement.
ARMv8 adds this memory type to the translation table formats found in earlier versions of the architecture. The use of barriers is required to order accesses to Device-nGRE memory. The Device-nGRE memory type is introduced into the AArch32 translation table formats when the PE is using the Long Descriptor Translation Table format.

Device-GRE Device Gathering, Reordering, Early Write Acknowledgement.

ARMv8 adds this memory type to the translation table formats found in earlier versions of the architecture. Device-GRE memory has the fewest constraints. It behaves similar to Normal memory, with the restriction that speculative accesses to Device-GRE memory is forbidden.

The Device-GRE memory type is introduced into the AArch32 translation table formats when the PE is using the Long Descriptor Translation Table format.

Collectively these are referred to as *any Device memory type*. Going down the list, the memory types are described as getting *weaker*; conversely the going up the list the memory types are described as getting *stronger*.

Note

- As the list of types shows, these additional attributes are hierarchical. For example, a memory location that permits Gathering must also permit Reordering and Early Write Acknowledgement.
- The architecture does not require an implementation to distinguish between each of these memory types and ARM recognizes that not all implementations will do so. The subsection that describes each of the attributes, describes the implementation rules for the attribute.
- Earlier versions of the ARM architecture defined the following memory types:
 - Strongly-ordered memory. This is the equivalent of the Device-nGnRnE memory type.
 - Device memory. This is the equivalent of the Device-nGnRE memory type.

All of these memory types have the following properties:

- Speculative data accesses are not permitted to any memory location with any Device memory attribute. This means that each memory access to any Device memory type must be one that would be generated by a simple sequential execution of the program.

An exception to this applies:

- Reads generated by the Advanced SIMD and floating-point instructions can access bytes that are not explicitly accessed by the instruction if the bytes accessed are in a 16-byte window, aligned to 16-bytes, that contains at least one byte that is explicitly accessed by the instruction.

Note

- An instruction that generates a sequence of accesses as described in [Atomicity in the ARM architecture on page E2-2758](#) might be abandoned as a result of an exception being taken during the sequence of accesses. On return from the exception the instruction is restarted, and therefore one or more of the memory locations might be accessed multiple times. This can result in repeated accesses to a location where the program only defines a single access. For this reason, ARM strongly recommends that no accesses to Device memory are performed from a single instruction that spans the boundary of a translation granule or which in some other way could lead to some of the accesses being aborted.
 - Write speculation that is visible to other observers is prohibited for all memory types.

-
- A write to a memory location with any Device memory attribute completes in finite time. This means that it is globally observed for all observers in the system in finite time.
 - If a location with any Device memory attribute changes without an explicit write by an observer, this change must also be globally observed for all observers in the system in finite time. Such a change might occur in a peripheral location that holds status information.
 - A completed write to a memory location with any Device memory attribute is globally observed for all observers in finite time without the need for explicit maintenance.
 - Data accesses to memory locations are coherent for all observers in the system, and correspondingly are treated as being Outer Shareable.
 - A memory location with any Device memory attribute cannot be allocated into a cache.
 - Writes to a memory location with any Device memory attribute must reach the endpoint for that address in the memory system in finite time. Typically, the endpoint is a peripheral or some physical memory.

- All accesses to memory with any Device memory attribute must be aligned. Any unaligned access generates an Alignment fault at the first stage of translation that defined the location as being Device.

———— **Note** —————

In the Non-secure PL1&0 translation regime in systems where `HCR.TGE==1` and `HCR.DC==0`, any Alignment fault that results from the fact that all locations are treated as Device is a fault at the first stage of translation. This causes the value of `HSR.ISS.[24]` to be 0.

- Hardware does not prevent speculative instruction fetches from a memory location with any of the Device memory attributes unless the memory location is also marked as Execute-never for all Exception levels.

———— **Note** —————

This means that to prevent speculative instruction fetches from memory locations with Device memory attributes, any location that is assigned any Device memory type must also be marked as Execute-never for all Exception levels. Failure to mark a memory location with any Device memory attribute as Execute-never for all Exception levels is a programming error.

See also [Memory access restrictions on page E2-2791](#).

The memory types for Translation table walks cannot be defined as any Device memory type within the TCR. For the Non-secure EL1&0 translation regime, the memory accesses made during a stage 1 translation table walk are subject to a stage 2 translation, and as a result of this second stage of translation, the accesses from the first stage translation table walk might be made to memory locations with any Device memory type. These accesses might be made speculatively. When the value of the `HCR.PTW` bit is 1, a stage 2 permission fault is generated if a first stage translation table walk is made to any Device memory type.

For instruction fetches, if branches cause the program counter to point to an area of memory with the Device attribute which is not marked as Execute-never for the current Exception level, an implementation can either:

- Treat the instruction fetch as if it were to a memory location with the Normal Non-cacheable attribute.
- Take a Permission fault.

Gathering

In the Device memory attribute:

- G** Indicates that the location has the Gathering attribute.
- nG** Indicates that the location does not have the Gathering attribute, meaning it is non-Gathering.

The Gathering attribute determines whether it is permissible for either:

- Multiple memory accesses of the same type, read or write, to the same memory location to be merged into a single transaction.
- Multiple memory accesses of the same type, read or write, to different memory locations to be merged into a single memory transaction on an interconnect.

For memory types with the Gathering attribute, either of these behaviors is permitted, provided that the ordering and coherency rules of the memory location are followed.

For memory types with the non-Gathering attribute, neither of these behaviors is permitted. As a result:

- The number of memory accesses that are made corresponds to the number that would be generated by a simple sequential execution of the program.
- All access occur at their programmed size, except that there is no requirement for the memory system beyond the PE to be able to identify the elements accessed by multi-register Load/Store instructions. See [Multi-register loads and stores that access Device memory on page E2-2790](#).

Gathering between memory accesses separated by a memory barrier that affects those memory accesses is not permitted. This applies if one memory access is in Group A and one memory access is in Group B. That is, gathering is not permitted between a memory access in Group A and a memory access in Group B if the two accesses are separated by a barrier that affects at least one of the accesses.

Gathering between two memory accesses generated by a Load-Acquire/Store-Release is not permitted.

A read from a memory location with the non-Gathering attribute cannot come from a cache or a buffer, but must come from the endpoint for that address in the memory system. Typically this is a peripheral or physical memory.

Note

- A read from a memory location with the Gathering attribute can come from intermediate buffering of a previous write, provided that:
 - The accesses are not separated by a DMB or DSB barrier that affects both of the accesses, for example if one access is in Group A and the other is in Group B.
 - The accesses are not separated by other ordering constructions that require that the accesses are in order. Such a construction might be a combination of Load-Acquire and Store-Release.
 - The accesses are not generated by a Store-Release instruction.
- The ARM architecture only defines programmer visible behavior. Therefore, gathering can be performed if a programmer cannot tell whether gathering has occurred.

An implementation is permitted to perform an access with the Gathering attribute in a manner consistent with the requirements specified by the Non-gathering attribute.

An implementation is not permitted to perform an access with the Non-gathering attribute in a manner consistent with the relaxations allowed by the Gathering attribute.

Reordering

In the Device memory attribute:

- R** Indicates that the location has the Reordering attribute.
- nR** Indicates that the location does not have the Reordering attribute, meaning it is non-Reordering.

For all memory types with the non-Reordering attribute, the order of memory accesses arriving at a single peripheral of IMPLEMENTATION DEFINED size, as defined by the peripheral, must be the same order that occurs in a simple sequential execution of the program. That is, the accesses appear in program order. This ordering applies to all accesses using any of the memory types with the non-Reordering attribute. As a result, if there is a mixture of Device-nGnRE and Device-nGnRnE accesses to the same peripheral, these occur in program order. If the memory accesses are not to a peripheral, then this attribute imposes no restrictions.

Note

- The IMPLEMENTATION DEFINED size of the single peripheral is the same as applies for the ordering guarantee provided by the DMB instruction.
- The ARM architecture only defines programmer visible behavior. Therefore, reordering can be performed if a programmer cannot tell whether reordering has occurred.

An implementation is permitted to perform an access with the Reordering attribute in a manner consistent with the requirements specified by the non-Reordering attribute.

An additional relaxation is that an implementation is not permitted to perform an access with the non-Reordering attribute in a manner consistent with the relaxations allowed by the Reordering attribute.

The non-Reordering attribute does not require any additional ordering, other than that which applies to Normal memory, between:

- Accesses with the non-Reordering attribute and accesses with the Reordering attribute.

- Accesses with the non-Reordering attribute and accesses to Normal memory.
- Accesses with the non-Reordering attribute and accesses to different peripherals of IMPLEMENTATION DEFINED size.

Early Write Acknowledgement

In the Device memory attribute:

- E** Indicates that the location has the Early Write Acknowledgement attribute.
nE Indicates that the location has the No Early Write Acknowledgement attribute.

Early Write Acknowledgement is a hint to the platform memory system. Assigning the No Early Write Acknowledgement attribute to a Device memory location recommends that only the endpoint of the write access returns a write acknowledgement of the access, and that no earlier point in the memory system returns a write acknowledge. This means that a DSB barrier, executed by the PE that performed the write to the No Early Write Acknowledgement location, completes only after the write has reached its endpoint in the memory system. Typically, this endpoint is a peripheral or physical memory.

When the Early Write Acknowledgement attribute is assigned to a Device memory location, there is no such recommendation for the handling of accesses to that location.

Note

- The Early Write Acknowledgement hint has no effect on the ordering rules. The purpose of signaling no Early Write Acknowledgement is to signal to the interconnect that the peripheral requires the ability to signal the acknowledgement. The No Write Acknowledgement signal also provides an additional semantic that can be interpreted by the driver that is accessing the peripheral.
- This attribute is treated as a hint, as the exact nature of the interconnects attached to a PE is outside the scope of the ARM architecture definition, and not all interconnects provide a mechanism to ensure that a write has reached the physical endpoint of the memory system.
- ARM recommends that writes with the No Early Write Acknowledgement hint are used for PCIe configuration writes. However, the mechanisms by which PCIe configuration writes are identified are IMPLEMENTATION DEFINED.
- ARM strongly recommends that the Early Write Acknowledgement hint is not ignored by a PE, but is made available for use by the system.

Because the No Early Write Acknowledgement attribute is a hint:

- An implementation is permitted to perform an access with the Early Write Acknowledgement attribute in a manner consistent with the requirements specified by the No Early Write Acknowledgement attribute.
- An implementation is permitted to perform an access with the No Early Write Acknowledgement attribute in a manner consistent with the relaxations allowed by the Early Write Acknowledgement attribute.

Multi-register loads and stores that access Device memory

For all instructions that load or store more than one general-purpose register there is no requirement for the memory system beyond the PE to be able to identify the size of the elements accessed by these load and store instructions.

For all instructions that load or store one or more registers from the SIMD and floating-point register file there is no requirement for the memory system beyond the PE to be able to identify the size of the element accessed by these load and store instructions.

For an LDRD, STRD, or LDM instruction with a register list that includes the PC, or an STM instruction with a register list that includes the PC, the order in which the registers are accessed is not defined by the architecture.

For a load or store of an Advanced SIMD element or structure, the order in which the registers are accessed is not defined by the architecture.

In ARMv8.0 only, for a VLDM, VSTM, LDM and STM instruction with a register list that does not include the PC, all registers are accessed in ascending address order for Device accesses with the non-Reordering attribute.

For a VLDM and VSTM instruction with a register list that does not include the PC, all registers are accessed in ascending address order for Device accesses with the non-Reordering attribute.

For a LDM and STM instruction with a register list that does not include the PC:

- When ARMv8.2-LSMAOC is not implemented, all registers are accessed in ascending address order for Device accesses with the non-Reordering attribute.
- When ARMv8.2-LSMAOC is implemented, and when SCTL.RLSMAOE is 1, then behavior at that Exception level is as if ARMv8.2-LSMAOC is not implemented.
- When ARMv8.2-LSMAOC is implemented, and when SCTL.RLSMAOE is 0, then memory accesses are not required to be ordered at that Exception level.

E2.7.3 Memory access restrictions

The following restrictions apply to memory accesses:

- For accesses to any two bytes, p and q , that are generated by the same instruction:
 - The bytes p and q must have the same memory type and Shareability attributes. otherwise the results are CONSTRAINED UNPREDICTABLE. For example, an LDC, LDM, LDRD STC, STM or STRD instruction, or an unaligned load or store that spans the boundary between Normal memory and Device memory is CONSTRAINED UNPREDICTABLE.
 - Except for possible differences in the cache allocation hints, ARM deprecates having different cacheability attributes for bytes p and q .

For the permitted CONSTRAINED UNPREDICTABLE behavior, see [Crossing a page boundary with different memory types or Shareability attributes on page K1-6105](#).

- If the accesses of an instruction that causes multiple accesses to any type of Device memory cross a 4KB address boundary then behavior is CONSTRAINED UNPREDICTABLE and [Crossing a 4KB boundary with a Device access on page K1-6106](#) describes the permitted behaviors.

———— **Note** —————

- The boundary referred to is between two Device memory regions that are both of 4KB and aligned to 4KB.
- This restriction means it is important that an access to a volatile memory device is not made using a single instruction that crosses a 4KB address boundary.
- ARM expects this restriction to constrain the placing of volatile memory devices in the system memory map, rather than expecting a compiler to be aware of the alignment of memory accesses.

E2.8 Mismatched memory attributes

In the ARMv8 architecture mismatched memory attributes are controlled by privileged software. For more information, see [Chapter G4 The AArch32 Virtual Memory System Architecture](#).

Physical memory locations are accessed with *mismatched attributes* if all accesses to the location do not use a common definition of all of the following attributes of that location:

- Memory type, Device or Normal.
- Shareability.
- Cacheability, for the same level of the inner or outer cache, but excluding any cache allocation hints.

Collectively these are referred to as memory attributes.

———— **Note** —————

The terms *location* and *memory location* refer to any byte within the current coherency granule and are used interchangeably.

When a memory location is accessed with mismatched attributes the only software visible effects are one or more of the following:

- Uniprocessor semantics for reads and writes to that memory location might be lost. This means:
 - A read of the memory location by one agent might not return the value most recently written to that memory location by the same agent.
 - Multiple writes to the memory location by one agent with different memory attributes might not be ordered in program order.
- There might be a loss of coherency when multiple agents attempt to access a memory location.
- There might be a loss of properties derived from the memory type, as described in later bullets in this section.
- If all Load-Exclusive/Store-Exclusive instructions executed across all threads to access a given memory location do not use consistent memory attributes, the Exclusives monitor state becomes UNKNOWN.
- Bytes written without the Write-Back cacheable attribute within the same Write-Back granule as bytes written with the Write-Back cacheable attribute might have their values reverted to the old values as a result of cache Write-Back.

The loss of properties associated with mismatched memory type attributes refers only to the following properties of Device memory that are additional to the properties of Normal memory:

- Prohibition of speculative read accesses.
- Prohibition on Gathering.
- Prohibition on Re-ordering.

For the following situations, when a physical memory location is accessed with mismatched attributes, a more restrictive set of behaviors applies. The description of each situation also describes the behaviors that apply:

1. If the only memory type mismatch associated with a memory location across all users of the memory location is between different types of Device memory, then all accesses might take the properties of the weakest Device memory type.
2. Any agent that reads that memory location using the same common definition of the Shareability and Cacheability attributes is guaranteed to access it coherently, to the extent required by that common definition of the memory attributes, only if all the following conditions are met:
 - All writes are performed to an alias of the memory location that uses the same definition of the Shareability and Cacheability attributes.
 - Either:
 - In the Non-secure PL1&0 translation regime, [HCR2.MIOCNC](#) has a value of 0.
 - All aliases with write permission have the Inner Cacheability attribute the same as the Outer Cacheability attribute.

- Either:
 - All writes are performed to an alias of the memory location that has Inner Cacheability and Outer Cacheability attributes both as Non-cacheable.
 - All aliases to a memory location use a definition of the Shareability attributes that encompasses all the agents with permission to access the location.
- 3. The possible software-visible effects caused by mismatched attributes for a memory location are defined more precisely if all of the mismatched attributes define the memory location as one of:
 - Any Device memory type.
 - Normal Inner Non-cacheable, Outer Non-cacheable memory.

In these cases, the only permitted software-visible effects of the mismatched attributes are one or more of the following:

- Possible loss of properties derived from the memory type when multiple agents attempt to access the memory location.
- Possible reordering of memory transactions to the same memory location with different memory attributes, potentially leading to a loss of coherency or uniprocessor semantics. Any possible loss of coherency or uniprocessor semantics can be avoided by inserting DMB barrier instructions between accesses to the same memory location that might use different attributes.

Where there is a loss of the uniprocessor semantics, ordering, or coherency, the following approaches can be used:

1. If the mismatched attributes for a memory location all assign the same Shareability attribute to the location, any loss of uniprocessor semantics, ordering, or coherency within a Shareability domain can be avoided by use of software cache management. To do so, software must use the techniques that are required for the software management of the ordering or coherency of cacheable locations between agents in different shareability domains. This means:
 - Before writing to a location not using the Write-Back attribute, software must invalidate, or clean, a location from the caches if any agent might have written to the location with the Write-Back attribute. This avoids the possibility of overwriting the location with stale data.
 - After writing to a location with the Write-Back attribute, software must clean the location from the caches, to make the write visible to external memory.
 - Before reading the location with a cacheable attribute, software must invalidate, or clean and invalidate, the location from the caches, to ensure that any value held in the caches reflects the last value made visible in external memory.
 - Executing a DMB barrier instruction, with scope that applies to the common Shareability of the accesses, between any accesses to the same memory location that use different attributes.

———— **Note** —————

In AArch32 state, cache maintenance instructions can only be accessed from an Exception level that is higher than EL0, and therefore require a system call. For information on system calls, see [Exception-generating and exception-handling instructions on page F1-2827](#). For information about the AArch32 cache maintenance instructions, see [AArch32 cache and branch predictor support on page G3-4525](#).

In all cases:

- Location refers to any byte within the current coherency granule.
- A clean and invalidate instruction can be used instead of a clean instruction, or instead of an invalidate instruction.
- In the sequences outlined in this section, all cache maintenance instructions and memory transactions must be completed, or ordered by the use of barrier operations, if they are not naturally ordered by the use of a common address, see [Ordering of cache and branch predictor maintenance instructions on page G3-4543](#).

———— **Note** —————

With software management of coherency, race conditions can cause loss of data. A race condition occurs when different agents write simultaneously to bytes that are in the same location, and the invalidate, write, clean sequence of one agent overlaps with the equivalent sequence of another agent. A race condition also occurs if the first operation of either sequence is a clean, rather than an invalidate.

-
2. If the mismatched attributes for a location mean that multiple cacheable accesses to the location might be made with different Shareability attributes, then ordering and coherency are guaranteed only if:
- Each PE that accesses the location with a cacheable attribute performs a clean and invalidate of the location before and after accessing that location.
 - A DMB barrier with scope that covers the full Shareability of the accesses is placed between any accesses to the same memory location that use different attributes.

———— **Note** —————

The Note in rule 1 of this list, about possible race conditions, also applies to this rule.

In addition, if multiple agents attempt to use Load-Exclusive or Store-Exclusive instructions to access a location, and the accesses from the different agents have different memory attributes associated with the location, the Exclusives monitor state becomes UNKNOWN.

ARM strongly recommends that software does not use mismatched attributes for aliases of the same location. An implementation might not optimize the performance of a system that uses mismatched aliases.

E2.9 Synchronization and semaphores

ARMv8 provides non-blocking synchronization of shared memory, using *synchronization primitives*. The information in this section about memory accesses by synchronization primitives applies to accesses to both Normal and Device memory.

———— **Note** —————

Use of the ARMv8 synchronization primitives scales for multiprocessing system designs.

Table E2-6 shows the synchronization primitives and the associated CLREX instruction.

Table E2-6 Synchronization primitives and associated instruction, T32 and A32 instruction sets

Transaction size	Additional semantics	Load-Exclusive ^a	Store-Exclusive ^a	Other ^a
Byte	-	LDREXB	STREXB	-
	Load-Acquire/Store-Release	LDAEXB	STLEXB	-
Halfword	-	LDREXH	STREXH	-
	Load-Acquire/Store-Release	LDAEXH	STLEXH	-
Word	-	LDREX	STREX	-
	Load-Acquire/Store-Release	LDAEX	STLEX	-
Doubleword	-	LDREXD	STREXD	-
	Load-Acquire/Store-Release	LDAEXD	STLEXD	-
None	Clear-Exclusive	-	-	CLREX

a. Instruction in the T32 and A32 instruction sets.

Except for the row showing the CLREX instruction, the two instructions in a single row are a Load-Exclusive/Store-Exclusive instruction pair. The model for the use of a Load-Exclusive/Store-Exclusive instruction pair accessing a non-aborting memory address *x* is:

- The Load-Exclusive instruction reads a value from memory address *x*.
- The corresponding Store-Exclusive instruction succeeds in writing back to memory address *x* only if no other observer, process, or thread has performed a more recent store to address *x*. The Store-Exclusive instruction returns a status bit that indicates whether the memory write succeeded.

A Load-Exclusive instruction marks a small block of memory for exclusive access. The size of the marked block is IMPLEMENTATION DEFINED, see [Marking and the size of the marked memory block on page E2-2801](#). A Store-Exclusive instruction to any address in the marked block clears the marking.

———— **Note** —————

In this section, the term PE includes any observer that can generate a Load-Exclusive or a Store-Exclusive instruction.

The following sections give more information:

- [Exclusive access instructions and Non-shareable memory locations on page E2-2796](#).
- [Exclusive access instructions and shareable memory locations on page E2-2798](#).
- [Marking and the size of the marked memory block on page E2-2801](#).
- [Context switch support on page E2-2802](#).
- [Load-Exclusive and Store-Exclusive instruction usage restrictions on page E2-2802](#).
- [Use of WFE and SEV instructions by spin-locks on page E2-2804](#).

E2.9.1 Exclusive access instructions and Non-shareable memory locations

For memory locations for which the Shareability attribute is Non-shareable, the exclusive access instructions rely on a *local Exclusives monitor*, or *local monitor*, that marks any address from which the PE executes a Load-Exclusive instruction. Any non-aborted attempt by the same PE to use a Store-Exclusive instruction to modify any address is guaranteed to clear the marking.

A Load-Exclusive instruction performs a load from memory, and:

- The executing PE marks the physical memory address for exclusive access.
- The local monitor of the executing PE transitions to the Exclusive Access state.

A Store-Exclusive instruction performs a conditional store to memory that depends on the state of the local monitor:

If the local monitor is in the Exclusive Access state

- If the address of the Store-Exclusive instruction is the same as the address that has been marked in the monitor by an earlier Load-Exclusive instruction, then the store occurs. Otherwise, it is IMPLEMENTATION DEFINED whether the store occurs.
- A status value is returned to a register:
 - If the store took place the status value is 0.
 - Otherwise, the status value is 1.
- The local monitor of the executing PE transitions to the Open Access state.

When an Exclusives monitor is in the Exclusive Access state the monitor is *set*.

If the local monitor is in the Open Access state

- No store takes place.
- A status value of 1 is returned to a register.
- The local monitor remains in the Open Access state.

When an Exclusives monitor is in the Exclusive Access state the monitor is *clear*.

The Store-Exclusive instruction defines the register to which the status value is returned.

When a PE writes using any instruction other than a Store-Exclusive instruction:

- If the write is to a physical address that is not marked as Exclusive Access by its local monitor and that local monitor is in the Exclusive Access state it is IMPLEMENTATION DEFINED whether the write affects the state of the local monitor.
- If the write is to a physical address that is marked as Exclusive Access by its local monitor it is IMPLEMENTATION DEFINED whether the write affects the state of the local monitor.

It is IMPLEMENTATION DEFINED whether a store to a marked physical address causes a mark in the local monitor to be cleared if that store is by an observer other than the one that caused the physical address to be marked.

[Figure E2-4 on page E2-2797](#) shows the state machine for the local monitor and the effect of each of the operations shown in the figure.

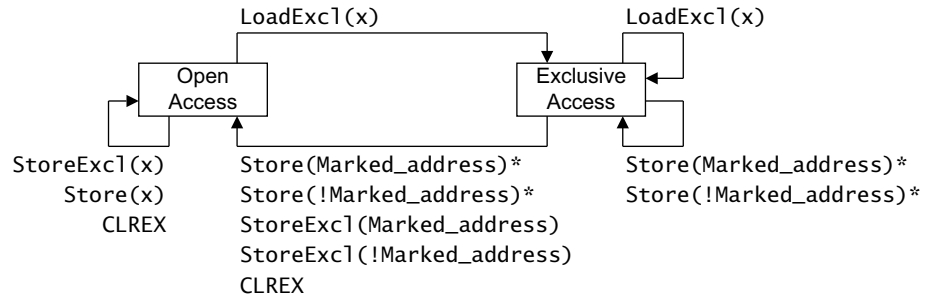

Operations marked * are possible alternative IMPLEMENTATION DEFINED options.

In the diagram: `LoadExc1` represents any Load-Exclusive instruction
`StoreExc1` represents any Store-Exclusive instruction
`Store` represents any other store instruction.

Any `LoadExc1` operation updates the marked address to the most significant bits of the address `x` used for the operation.

Figure E2-4 Local monitor state machine diagram

For more information about marking see [Marking and the size of the marked memory block](#) on page E2-2801.

———— **Note** ————

For the local monitor state machine, as shown in [Figure E2-4](#):

- The IMPLEMENTATION DEFINED options for the local monitor are consistent with the local monitor being constructed so that it does not hold any physical address, but instead treats any access as matching the address of the previous Load-Exclusive instruction.
- A local monitor implementation can be unaware of Load-Exclusive and Store-Exclusive instructions from other PEs.
- The architecture does not require a load instruction, by another PE, that is not a Load-Exclusive instruction, to have any effect on the local monitor.
- It is IMPLEMENTATION DEFINED whether the transition from Exclusive Access to Open Access state occurs when the `Store` or `StoreExc1` is from another observer.

Changes to the local monitor state resulting from speculative execution

The architecture permits a local monitor to transition to the Open Access state as a result of speculation, or from some other cause. This is in addition to the transitions to Open Access state caused by the architectural execution of an operation shown in [Figure E2-4](#).

An implementation must ensure that:

- The local monitor cannot be seen to transition to the Exclusive Access state except as a result of the architectural execution of one of the operations shown in [Figure E2-4](#).
- Any transition of the local monitor to the Open Access state not caused by the architectural execution of an operation shown in [Figure E2-4](#) must not indefinitely delay forward progress of execution.

E2.9.2 Exclusive access instructions and shareable memory locations

In the context of this section, a shareable memory location is a memory location that has, or is treated as if it has, a Shareability attribute of Inner Shareable or Outer Shareable.

For shareable memory locations, exclusive access instructions rely on:

- A *local monitor* for each PE in the system, that marks any address from which the PE executes a Load-Exclusive. The local monitor operates as described in *Exclusive access instructions and Non-shareable memory locations on page E2-2796*, except that for shareable memory any Store-Exclusive is then subject to checking by the global monitor if it is described in that section as doing at least one of the following:
 - Updating memory.
 - Returning a status value of 0.

The local monitor can ignore accesses from other PEs in the system.

- A *global monitor* that marks a physical address as exclusive access for a particular PE. This marking is used later to determine whether a Store-Exclusive to that address that has not been failed by the local monitor can occur. Any successful write to the marked block by any other observer in the Shareability domain of the memory location is guaranteed to clear the marking. For each PE in the system, the global monitor:
 - Can hold at least one marked block.
 - Maintains a state machine for each marked block it can hold.

———— **Note** —————

For each PE, the architecture only requires global monitor support for a single marked address. Any situation that might benefit from the use of multiple marked addresses on a single PE is CONstrained UNPREDICTABLE, see *Load-Exclusive and Store-Exclusive instruction usage restrictions on page E2-2802*.

———— **Note** —————

The global monitor can either reside in a block that is part of the hardware on which the PE executes or exist as a secondary monitor at the memory interfaces. The IMPLEMENTATION DEFINED aspects of the monitors mean that the global monitor and local monitor can be combined into a single unit, provided that the unit performs the global monitor and local monitor functions defined in this manual.

For shareable memory locations, in some implementations and for some memory types, the properties of the global monitor require functionality outside the PE. Some system implementations might not implement this functionality for all locations of memory. In particular, this can apply to:

- Any type of memory in the system implementation that does not support hardware cache coherency.
- Non-cacheable memory, or memory treated as Non-cacheable, in an implementation that does support hardware cache coherency.

In such a system, it is defined by the system:

- Whether the global monitor is implemented.
- If the global monitor is implemented, which address ranges or memory types it monitors.

———— **Note** —————

To support the use of the Load-Exclusive/Store-Exclusive mechanism when address translation is disabled, a system might define at least one location of memory, of at least the size of the translation granule, in the system memory map to support the global monitor for all PEs within a common Inner Shareable domain. However, this is not an architectural requirement. Therefore, architecturally-compliant software that requires mutual exclusion must not rely on using the Load-Exclusive/Store-Exclusive mechanism, and must instead use a software algorithm such as Lamport's Bakery algorithm to achieve mutual exclusion.

Because implementations can choose which memory types are treated as Non-cacheable, the only memory types for which it is architecturally guaranteed that a global Exclusives monitor is implemented are:

- Inner Shareable, Inner Write-Back, Outer Write-Back Normal memory with Read allocation hint and Write allocation hint and not transient.
- Outer Shareable, Inner Write-Back, Outer Write-Back Normal memory with Read allocation hint and Write allocation hints and not transient.

The set of memory types that support atomic instructions must include all of the memory types for which a global monitor is implemented.

If the global monitor is not implemented for an address range or memory type, then performing a Load-Exclusive/Store-Exclusive instruction to such a location has one or more of the following effects:

- The instruction generates an external abort.
- The instruction generates an IMPLEMENTATION DEFINED MMU fault. This is reported using the Fault status code of:
 - `DFSR.STATUS = 0b110101` when using the Long-descriptor translation table format. The fault can also be reported in the `HSR.ISS[5:0]` field for exceptions to Hyp mode.
 - `DFSR.FS = 0b10101` when using the Short-descriptor translation table format.

If the IMPLEMENTATION DEFINED MMU fault is generated for the Non-secure PL1&0 translation regime then:

- If the fault is generated because of the memory type defined in the first stage of translation, or if the second stage of translation is disabled, then this is a first stage fault and the exception is taken to EL1.
- Otherwise, the fault is a second stage fault and the exception is taken to EL2.

The priority of this fault is IMPLEMENTATION DEFINED.

- The instruction is treated as a NOP.
- The Load-Exclusive instruction is treated as if it were accessing a Non-shareable location, but the state of the local monitor becomes UNKNOWN.
- The Store-Exclusive instruction is treated as if it were accessing a Non-shareable location, but the state of the local monitor becomes UNKNOWN.
- The value held in the result register of the Store-Exclusive instruction becomes UNKNOWN.

In addition, for write transactions generated by non-PE observers that do not implement exclusive accesses or other atomic access mechanisms, the effect that writes have on the global and local monitors used by an ARM PE is IMPLEMENTATION DEFINED. The writes might not clear the global monitors of other PEs for:

- Some address ranges.
- Some memory types.

Operation of the global Exclusives monitor

A Load-Exclusive instruction from shareable memory performs a load from memory, and causes the physical address of the access to be marked as exclusive access for the requesting PE. This access can also cause the exclusive access mark to be removed from any other physical address that has been marked by the requesting PE.

———— Note —————

The global monitor only supports a single outstanding exclusive access to shareable memory for each PE.

A Load-Exclusive instruction by one PE has no effect on the global monitor state for any other PE.

A Store-Exclusive instruction performs a conditional store to memory:

- The store is guaranteed to succeed only if the physical address accessed is marked as exclusive access for the requesting PE and both the local monitor and the global monitor state machines for the requesting PE are in the Exclusive Access state. In this case:
 - A status value of 0 is returned to a register to acknowledge the successful store.
 - The final state of the global monitor state machine for the requesting PE is IMPLEMENTATION DEFINED.
 - If the address accessed is marked for exclusive access in the global monitor state machine for any other PE then that state machine transitions to Open Access state.
- If no address is marked as exclusive access for the requesting PE, the store does not succeed:
 - A status value of 1 is returned to a register to indicate that the store failed.
 - The global monitor is not affected and remains in Open Access state for the requesting PE.
- If a different physical address is marked as exclusive access for the requesting PE, it is IMPLEMENTATION DEFINED whether the store succeeds or not:
 - If the store succeeds a status value of 0 is returned to a register, otherwise a value of 1 is returned.
 - If the global monitor state machine for the PE was in the Exclusive Access state before the Store-Exclusive instruction it is IMPLEMENTATION DEFINED whether that state machine transitions to the Open Access state.

The Store-Exclusive instruction defines the register to which the status value is returned.

In a shared memory system, the global monitor implements a separate state machine for each PE in the system. The state machine for accesses to shareable memory by PE(n) can respond to all the shareable memory accesses visible to it. This means it responds to:

- Accesses generated by PE(n).
- Accesses generated by the other observers in the Shareability domain of the memory location. These accesses are identified as (!n).

In a shared memory system, the global monitor implements a separate state machine for each observer that can generate a Load-Exclusive or a Store-Exclusive instruction in the system.

A global monitor:

- In the Exclusive Access state is *set*.
- In the Open Access state is *clear*.

Clear global monitor event

Whenever the global monitor state for a PE changes from Exclusive access to Open access, an event is generated and held in the Event register for that PE. This register is used by the Wait for Event mechanism, see [Wait For Event and Send Event on page G1-4403](#).

[Figure E2-5 on page E2-2801](#) shows the state machine for PE(n) in a global monitor.

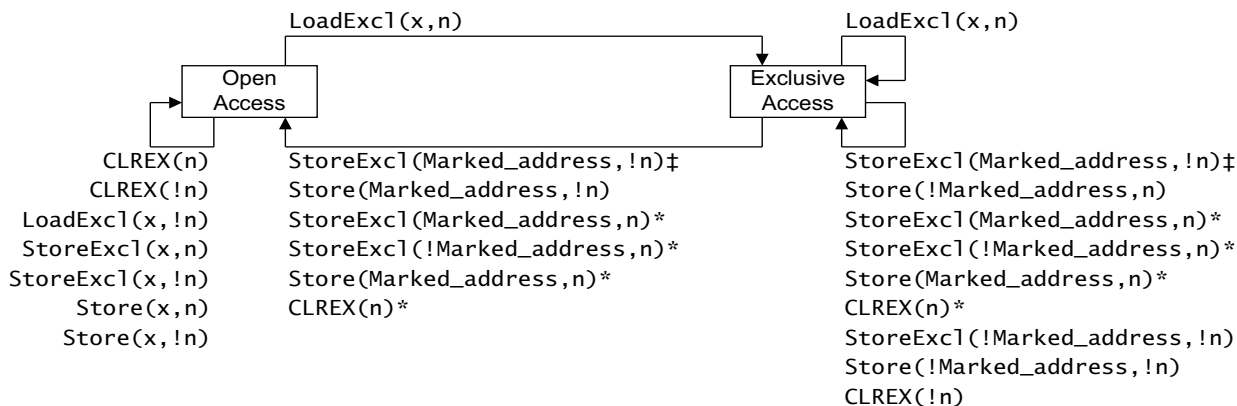

‡StoreExc1(Marked_address,!n) clears the monitor only if the StoreExc1 updates memory

Operations marked * are possible alternative IMPLEMENTATION DEFINED options.

In the diagram: LoadExc1 represents any Load-Exclusive instruction

StoreExc1 represents any Store-Exclusive instruction

Store represents any other store instruction.

Any LoadExc1 operation updates the marked address to the most significant bits of the address x used for the operation.

Figure E2-5 Global monitor state machine diagram for PE(n) in a multiprocessor system

For more information about marking see [Marking and the size of the marked memory block](#).

Note

For the global monitor state machine, as shown in [Figure E2-5](#):

- The architecture does not require a load instruction by another PE, that is not a Load-Exclusive instruction, to have any effect on the global monitor.
- Whether a Store-Exclusive instruction successfully updates memory or not depends on whether the address accessed matches the marked shareable memory address for the PE issuing the Store-Exclusive instruction, and whether the local and global monitors are in the exclusive state. For this reason, [Figure E2-5](#) only shows how the operations by (!n) cause state transitions of the state machine for PE(n).
- A Load-Exclusive instruction can only update the marked shareable memory address for the PE issuing the Load-Exclusive instruction.
- When the global monitor is in the Exclusive Access state, it is IMPLEMENTATION DEFINED whether a CLREX instruction causes the global monitor to transition from Exclusive Access to Open Access state.
- It is IMPLEMENTATION DEFINED:
 - Whether a modification to a Non-shareable memory location can cause a global monitor to transition from Exclusive Access to Open Access state.
 - Whether a Load-Exclusive instruction to a Non-shareable memory location can cause a global monitor to transition from Open Access to Exclusive Access state.

E2.9.3 Marking and the size of the marked memory block

When a Load-Exclusive instruction is executed, the resulting marked block ignores the least significant bits of the 64-bit memory address.

When a Load-Exclusive instruction is executed, a marked block of size 2^a bytes is created by ignoring the least significant bits of the memory address. A marked address is any address within this marked block. The size of the marked memory block is called the *Exclusives reservation granule*. The Exclusives reservation granule is IMPLEMENTATION DEFINED in the range 4 - 512 words.

———— **Note** —————

This definition means that the Exclusives reservation granule is:

- 4 words in an implementation where a is 4.
- 512 words in an implementation where a is 11.

For example, in an implementation where a is 4, a successful LDREXB of address 0x341B4 defines a marked block using bits[47:4] of the address. This means that the four words of memory from 0x341B0 to 0x341BF are marked for exclusive access.

In some implementations the CTR identifies the Exclusives reservation granule, see [CTR](#). Otherwise, software must assume that the maximum Exclusives reservation granule, 512 words, is implemented.

E2.9.4 Context switch support

An exception return clears the local monitor. As a result, performing a CLREX instruction as part of a context switch is not required in most situations.

———— **Note** —————

Context switching is not an application level operation. However, this information is included here to complete the description of the exclusive operations.

E2.9.5 Load-Exclusive and Store-Exclusive instruction usage restrictions

The Load-Exclusive and Store-Exclusive instructions are intended to work together as a pair, for example a LDREX/STREX pair or a LDREXB/STREXB pair. To support different implementations of these functions, software must follow the notes and restrictions given in this subsection.

The following notes describe use of a Load-Exclusive/ Store-Exclusive instruction pair, LoadExc1/StoreExc1, to indicate the use of any of the Load-Exclusive/Store-Exclusive instruction pairs shown in [Table E2-6 on page E2-2795](#). In this context, a LoadExc1/StoreExc1 pair comprises two instructions in the same thread of execution:

- The exclusives support a single outstanding exclusive access for each PE thread that is executed. The architecture makes use of this by not requiring an address or size check as part of the `IsExclusiveLocal()` function. If the target virtual address of a StoreExc1 is different from the virtual address of the preceding LoadExc1 instruction in the same thread of execution, behavior can be CONSTRAINED UNPREDICTABLE with the following behavior:
 - The StoreExc1 either passes or fails, and the status value returned by the StoreExc1 is UNKNOWN.

———— **Note** —————

This means the StoreExc1 might pass for some instances of a LoadExc1/StoreExc1 pair with mismatched addresses, and fail for other instances of a LoadExc1/StoreExc1 pair with mismatched addresses.

- The data at the address accessed by the LoadExc1, and at the address accessed by the StoreExc1, is UNKNOWN.

This means software can rely on a LoadExc1/StoreExc1 pair to eventually succeed only if the LoadExc1 and the StoreExc1 are executed with the same virtual address.

- If two StoreExc1 instructions are executed without an intervening LoadExc1 instruction the second StoreExc1 instruction returns a status value of 1. This means that:
 - ARM recommends that, in a given thread of execution, every StoreExc1 instruction has a preceding LoadExc1 instruction associated with it.

It is not necessary for every LoadExc1 instruction to have a subsequent StoreExc1 instruction.

- An implementation of the Load-Exclusive and Store-Exclusive instructions can require that, in any thread of execution, the transaction size of a StoreExc1 instruction is the same as the transaction size of the preceding LoadExc1 instruction executed in that thread. If the transaction size of a StoreExc1 instruction is different from the preceding LoadExc1 instruction in the same thread of execution, behavior can be **CONSTRAINED UNPREDICTABLE** with the following behavior:

- The StoreExc1 either passes or fails, and the status value returned by the StoreExc1 is **UNKNOWN**.

———— **Note** —————

This means the StoreExc1 might pass for some instances of a LoadExc1/StoreExc1 pair with mismatched transaction sizes, and fail for other instances of a LoadExc1/StoreExc1 pair with mismatched transaction sizes.

- The block of data of the size of the larger of the transaction sizes used by the LoadExc1/StoreExc1 pair at the address accessed by the LoadExc1/StoreExc1 pair, is **UNKNOWN**.

This means software can rely on a LoadExc1/StoreExc1 pair to eventually succeed only if the LoadExc1 and the StoreExc1 have the same transaction size.

- LoadExc1/StoreExc1 loops are guaranteed to make forward progress only if, for any LoadExc1/StoreExc1 loop within a single thread of execution, the software meets all of the following conditions:

- 1 Between the Load-Exclusive and the Store-Exclusive, there are no explicit memory accesses, preloads, direct or indirect System register writes, address translation instructions, cache or TLB maintenance instructions, exception generating instructions, exception returns, or indirect branches.
- 2 Between the Store-Exclusive returning a failing result and the retry of the corresponding Load-Exclusive:
 - There are no stores or PLDW instructions to any address within the Exclusives reservation granule accessed by the Store-Exclusive.
 - There are no loads or preloads to any address within the Exclusives reservation granule accessed by the Store-Exclusive that use a different VA alias to that address.
 - There are no direct or indirect System register writes, other than changes to the flag fields in the **CPSR** or **FPSCR**, caused by data processing or comparison instructions.
 - There are no direct or indirect address translation instructions, cache or TLB maintenance instructions, exception generating instructions, exception returns, or indirect branches.
 - All loads and stores are to a block of contiguous virtual memory of not more than 512 bytes in size.

The Exclusives monitor can be cleared at any time without an application-related cause, provided that such clearing is not systematically repeated so as to prevent the forward progress in finite time of at least one of the threads that is accessing the Exclusives monitor.

- Implementations can benefit from keeping the LoadExc1 and StoreExc1 operations close together in a single thread of execution. This minimizes the likelihood of the Exclusives monitor state being cleared between the LoadExc1 instruction and the StoreExc1 instruction. Therefore, for best performance, ARM strongly recommends a limit of 128 bytes between LoadExc1 and StoreExc1 instructions in a single thread of execution.
- The architecture sets an upper limit of 2048 bytes on the Exclusives reservation granule that can be marked as exclusive. For performance reasons, ARM recommends that objects that are accessed by exclusive accesses are separated by the size of the Exclusives reservation granule. This is a performance guideline rather than a functional requirement.
- After taking a Data Abort exception, the state of the Exclusives monitors is **UNKNOWN**.
- For the memory location accessed by a LoadExc1/StoreExc1 pair, if the memory attributes for a StoreExc1 instruction are different from the memory attributes for the preceding LoadExc1 instruction in the same thread of execution, behavior is **CONSTRAINED UNPREDICTABLE**. Where this occurs because the translation of the accessed address changes between the LoadExc1 instruction and the StoreExc1 instruction, the **CONSTRAINED UNPREDICTABLE** behavior is as follows:
 - The StoreExc1 either passes or fails, and the status value returned by the StoreExc1 is **UNKNOWN**.

———— **Note** —————

This means the StoreExc1 might pass for some instances of a LoadExc1/StoreExc1 pair with changed memory attributes, and fail for other instances of a LoadExc1/StoreExc1 pair with changed memory attributes.

-
- The data at the address accessed by the StoreExc1 is UNKNOWN.

———— **Note** —————

Another bullet point in this list covers the case where the memory attributes of a LoadExc1/StoreExc1 pair differ as a result of using different virtual addresses with different attributes that point to the same physical address.

-
- The effect of a data or unified cache invalidate, clean, or clean and invalidate instruction on a local or global Exclusives monitor that is in the Exclusive Access state is CONSTRAINED UNPREDICTABLE, and the instruction might clear the monitor, or it might leave it in the Exclusive Access state. For address-based maintenance instructions, this also applies to the monitors of other PEs in the same Shareability domain as the PE executing the cache maintenance instruction, as determined by the Shareability domain of the address being maintained.

———— **Note** —————

ARM strongly recommends that implementations ensure that the use of such maintenance instructions by a PE in the Non-secure state cannot cause a denial of service on a PE in the Secure state.

-
- If the mapping of the virtual to physical address is changed between the LoadExc1 instruction and the StoreExc1 instruction, and the change is performed using a break-before-make sequence as described in [Using break-before-make when updating translation table entries on page G4-4633](#), if the StoreExc1 is performed after another write to the same physical address as the StoreExc1, and that other write was performed after the old translation was properly invalidated and that invalidation was properly synchronized, then the StoreExc1 will not pass its monitor check.

———— **Note** —————

ARM expects that, in many implementations, either:

- The TLB invalidation will clear either the local or global monitor.
- The physical address will be checked between the LoadExc1 and StoreExc1.

———— **Note** —————

In the event of repeatedly-contending LoadExc1/StoreExc1 instruction sequences from multiple PEs, an implementation must ensure that forward progress is made by at least one PE.

E2.9.6 Use of WFE and SEV instructions by spin-locks

ARMv8 provides Wait For Event, Send Event, and Send Event Local instructions, WFE, SEV, SEVL, that can assist with reducing power consumption and bus contention caused by PEs repeatedly attempting to obtain a spin-lock. These instructions can be used at the application level, but a complete understanding of what they do depends on a system level understanding of exceptions. They are described in [Wait For Event and Send Event on page G1-4403](#). However, in ARMv8, when the global monitor for a PE changes from Exclusive Access state to Open Access state, an event is generated.

———— **Note** —————

This is equivalent to issuing an SEVL instruction on the PE for which the monitor state has changed. It removes the need for spinlock code to include an SEV instruction after clearing a spinlock.

Part F

The AArch32 Instruction Sets

Chapter F1

The AArch32 Instruction Sets Overview

This chapter describes the T32 and A32 instruction sets. It contains the following sections:

- *Support for instructions in different versions of the ARM architecture* on page F1-2808.
- *Unified Assembler Language* on page F1-2809.
- *Branch instructions* on page F1-2811.
- *Data-processing instructions* on page F1-2812.
- *PSTATE and banked register access instructions* on page F1-2820.
- *Load/store instructions* on page F1-2821.
- *Load/store multiple instructions* on page F1-2824.
- *Miscellaneous instructions* on page F1-2825.
- *Exception-generating and exception-handling instructions* on page F1-2827.
- *System register access instructions* on page F1-2828.
- *Advanced SIMD and floating-point load/store instructions* on page F1-2829.
- *Advanced SIMD and floating-point register transfer instructions* on page F1-2831.
- *Advanced SIMD data-processing instructions* on page F1-2832.
- *Floating-point data-processing instructions* on page F1-2840.

F1.1 Support for instructions in different versions of the ARM architecture

This manual describes the ARM AArch32 instruction sets, T32 and A32, for the ARMv8 architecture. Therefore, it indicates how any options or extensions in the ARMv8 architecture affect the available instructions.

This manual does not provide any information about which T32 and A32 instructions were supported in specific earlier versions of the architecture. For this information, see the *ARM® Architecture Reference Manual, ARMv7-A and ARMv7-R edition*.

F1.2 Unified Assembler Language

This manual uses the ARM *Unified Assembler Language* (UAL). This assembly language syntax provides a canonical form for all T32 and A32 instructions.

UAL describes the syntax for the mnemonic and the operands of each instruction. In addition, it assumes that instructions and data items can be given labels. It does not specify the syntax to be used for labels, nor what assembler directives and options are available. See your assembler documentation for these details.

Most earlier ARM assembly language mnemonics are still supported as synonyms, as described in the instruction details.

———— **Note** —————

Most earlier T32 assembly language mnemonics are *not* supported.

UAL includes *instruction selection* rules that specify which instruction encoding is selected when more than one can provide the required functionality. For example, both 16-bit and 32-bit encodings exist for an ADD R0, R1, R2 instruction. The most common instruction selection rule is that when both a 16-bit encoding and a 32-bit encoding are available, the 16-bit encoding is selected, to optimize code density.

Syntax options exist to override the normal instruction selection rules and ensure that a particular encoding is selected. These are useful when disassembling code, to ensure that subsequent assembly produces the original code, and in some other situations.

F1.2.1 Conditional instructions

For maximum portability of UAL assembly language between the T32 and A32 instruction sets, ARM recommends that:

- IT instructions are written before conditional instructions in the correct way for the T32 instruction set.
- When assembling to the A32 instruction set, assemblers check that any IT instructions are correct, but do not generate any code for them.

Although other T32 instructions are unconditional, all instructions that are made conditional by an IT instruction must be written with a condition. These conditions must match the conditions imposed by the IT instruction. For example, an IT EE EQ instruction imposes the EQ condition on the first two following instructions, and the NE condition on the next two. Those four instructions must be written with EQ, EQ, NE and NE conditions respectively.

Some instructions cannot be made conditional by an IT instruction. Some instructions can be conditional if they are the last instruction in the IT block, but not otherwise.

The branch instruction encodings that include a Condition code field cannot be made conditional by an IT instruction. If the assembler syntax indicates a conditional branch that correctly matches a preceding IT instruction, it is assembled using a branch instruction encoding that does not include a Condition code field.

———— **Note** —————

For performance reasons ARMv8 deprecates many uses of IT, see [Partial deprecation of IT on page F1-2826](#). As described in that section, an implementation can include ITD controls that disable those uses of IT, making them UNDEFINED.

F1.2.2 Use of labels in UAL instruction syntax

The UAL syntax for some instructions includes the label of an instruction or a literal data item that is at a fixed offset from the instruction being specified. The assembler must:

1. Calculate the PC or $\text{Align}(\text{PC}, 4)$ value of the instruction. The PC value of an instruction is its address plus 4 for a T32 instruction, or plus 8 for an A32 instruction. The $\text{Align}(\text{PC}, 4)$ value of an instruction is its PC value ANDed with 0xFFFFFFFC to force it to be word-aligned. There is no difference between the PC and $\text{Align}(\text{PC}, 4)$ values for an A32 instruction, but there can be for a T32 instruction.

2. Calculate the offset from the PC or `Align(PC, 4)` value of the instruction to the address of the labeled instruction or literal data item.
3. Assemble a *PC-relative* encoding of the instruction, that is, one that reads its PC or `Align(PC, 4)` value and adds the calculated offset to form the required address.

———— **Note** ————

For instructions that can encode a subtraction operation, if the instruction cannot encode the calculated offset but can encode minus the calculated offset, the instruction encoding specifies a subtraction of minus the calculated offset.

The syntax of the following instructions includes a label:

- B, BL, and BLX (immediate). The assembler syntax for these instructions always specifies the label of the instruction that they branch to. Their encodings specify a sign-extended immediate offset that is added to the PC value of the instruction to form the target address of the branch.
- CBNZ and CBZ. The assembler syntax for these instructions always specifies the label of the instruction that they branch to. Their encodings specify a zero-extended immediate offset that is added to the PC value of the instruction to form the target address of the branch. They do not support backward branches.
- LDR, LDRB, LDRD, LDRH, LDRSB, LDRSH, PLD, PLDW, PLI, and VLDR. The normal assembler syntax of these load instructions can specify the label of a literal data item that is to be loaded. The encodings of these instructions specify a zero-extended immediate offset that is either added to or subtracted from the `Align(PC, 4)` value of the instruction to form the address of the data item. A few such encodings perform a fixed addition or a fixed subtraction and must only be used when that operation is required, but most contain a bit that specifies whether the offset is to be added or subtracted.

When the assembler calculates an offset of 0 for the normal syntax of these instructions, it must assemble an encoding that adds 0 to the `Align(PC, 4)` value of the instruction. Encodings that subtract 0 from the `Align(PC, 4)` value cannot be specified by the normal syntax.

There is an alternative syntax for these instructions that specifies the addition or subtraction and the immediate offset explicitly. In this syntax, the label is replaced by `[PC, #+/-<imm>]`, where:

+/- Is + or omitted to specify that the immediate offset is to be added to the `Align(PC, 4)` value, or - if it is to be subtracted.

<imm> Is the immediate offset.

This alternative syntax makes it possible to assemble the encodings that subtract 0 from the `Align(PC, 4)` value, and to disassemble them to a syntax that can be re-assembled correctly.

- ADR. The normal assembler syntax for this instruction can specify the label of an instruction or literal data item whose address is to be calculated. Its encoding specifies a zero-extended immediate offset that is either added to or subtracted from the `Align(PC, 4)` value of the instruction to form the address of the data item, and some opcode bits that determine whether it is an addition or subtraction.

When the assembler calculates an offset of 0 for the normal syntax of this instruction, it must assemble the encoding that adds 0 to the `Align(PC, 4)` value of the instruction. The encoding that subtracts 0 from the `Align(PC, 4)` value cannot be specified by the normal syntax.

There is an alternative syntax for this instruction that specifies the addition or subtraction and the immediate value explicitly, by writing them as additions `ADD <Rd>, PC, #<imm>` or subtractions `SUB <Rd>, PC, #<imm>`. This alternative syntax makes it possible to assemble the encoding that subtracts 0 from the `Align(PC, 4)` value, and to disassemble it to a syntax that can be re-assembled correctly.

———— **Note** ————

ARM recommends that where possible, software avoids using:

- The alternative syntax for the ADR, LDC, LDR, LDRB, LDRD, LDRH, LDRSB, LDRSH, PLD, PLI, PLDW, and VLDR instructions.
- The encodings of these instructions that subtract 0 from the `Align(PC, 4)` value.

F1.3 Branch instructions

Table F1-1 summarizes the branch instructions in the T32 and A32 instruction sets. In addition to providing for changes in the flow of execution, some branch instructions can change instruction set.

Table F1-1 Branch instructions

Instruction	See	Range, T32	Range, A32
Branch to target address	B on page F5-3051	±16MB	±32MB
Compare and Branch on Nonzero, Compare and Branch on Zero	CBNZ, CBZ on page F5-3074	0-126 bytes	a
Call a subroutine	BL, BLX (immediate) on page F5-3067	±16MB	±32MB
Call a subroutine, change instruction set ^b	BL, BLX (immediate) on page F5-3067	±16MB	±32MB
Call a subroutine, optionally change instruction set	BLX (register) on page F5-3069	Any	Any
Branch to target address, change instruction set	BX on page F5-3071	Any	Any
Change to Jazelle state	BXJ on page F5-3073	-	-
Table Branch (byte offsets)	TBB, TBH on page F5-3589	0-510 bytes	a
Table Branch (halfword offsets)		0-131070 bytes	

- a. These instructions do not exist in the A32 instruction set.
b. The range is determined by the instruction set of the BLX instruction, not of the instruction it branches to.

Branches to loaded and calculated addresses can be performed by LDR, LDM and data-processing instructions. For details see [Load/store instructions on page F1-2821](#), [Load/store multiple instructions on page F1-2824](#), [Standard data-processing instructions on page F1-2812](#), and [Shift instructions on page F1-2814](#).

In addition to the branch instructions shown in Table F1-1:

- In the A32 instruction set, a data-processing instruction that targets the PC behaves as a branch instruction. For more information, see [Data-processing instructions on page F1-2812](#).
- In the T32 and A32 instruction sets, a load instruction that targets the PC behaves as a branch instruction. For more information, see [Load/store instructions on page F1-2821](#).

F1.4 Data-processing instructions

Core data-processing instructions belong to one of the following groups:

- [Standard data-processing instructions](#).
These instructions perform basic data-processing operations, and share a common format with some variations.
- [Shift instructions on page F1-2814](#).
- [Multiply instructions on page F1-2814](#).
- [Saturating instructions on page F1-2816](#).
- [Saturating addition and subtraction instructions on page F1-2816](#).
- [Packing and unpacking instructions on page F1-2817](#).
- [Parallel addition and subtraction instructions on page F1-2818](#).
- [Divide instructions on page F1-2819](#).
- [Miscellaneous data-processing instructions on page F1-2819](#).

For related Advanced SIMD and floating-point instructions see [Advanced SIMD data-processing instructions on page F1-2832](#) and [Floating-point data-processing instructions on page F1-2840](#).

F1.4.1 Standard data-processing instructions

These instructions generally have a destination register Rd, a first operand register Rn, and a second operand. The second operand can be another register Rm, or an immediate constant.

If the second operand is an immediate constant, it can be:

- Encoded directly in the instruction.
- A *modified immediate constant* that uses 12 bits of the instruction to encode a range of constants. T32 and A32 instructions have slightly different ranges of modified immediate constants. For more information, see [Modified immediate constants in T32 instructions on page F2-2863](#) and [Modified immediate constants in A32 instructions on page F2-2864](#).

If the second operand is another register, it can optionally be shifted in any of the following ways:

LSL	Logical Shift Left by 1-31 bits.
LSR	Logical Shift Right by 1-32 bits.
ASR	Arithmetic Shift Right by 1-32 bits.
ROR	Rotate Right by 1-31 bits.
RRX	Rotate Right with Extend. For details see Shift and rotate operations on page E1-2730 .

In T32 code, the amount to shift by is always a constant encoded in the instruction. In A32 code, the amount to shift by is either a constant encoded in the instruction, or the value of a register, Rs.

For instructions other than CMN, CMP, TEQ, and TST, the result of the data-processing operation is placed in the destination register. In the A32 instruction set, the destination register can be the PC, causing the result to be treated as a branch address. In the T32 instruction set, this is only permitted for some 16-bit forms of the ADD and MOV instructions.

These instructions can optionally set the Condition flags, according to the result of the operation. If they do not set the flags, existing flag settings from a previous instruction are preserved.

[Table F1-2 on page F1-2813](#) summarizes the main data-processing instructions in the T32 and A32 instruction sets. Generally, each of these instructions is described in three sections in [Chapter F2 About the T32 and A32 Instruction Descriptions](#), one section for each of the following:

- INSTRUCTION (immediate) where the second operand is a modified immediate constant.
- INSTRUCTION (register) where the second operand is a register, or a register shifted by a constant.
- INSTRUCTION (register-shifted register) where the second operand is a register shifted by a value obtained from another register. These are only available in the A32 instruction set.

Table F1-2 Standard data-processing instructions

Instruction	Mnemonic	Notes
Add with Carry	ADC	-
Add	ADD	T32 instruction set permits use of a modified immediate constant or a zero-extended 12-bit immediate constant.
Form PC-relative Address	ADR	First operand is the PC. Second operand is an immediate constant. T32 instruction set uses a zero-extended 12-bit immediate constant. Operation is an addition or a subtraction.
Bitwise AND	AND	-
Bitwise Bit Clear	BIC	-
Compare Negative	CMN	Sets flags. Like ADD but with no destination register.
Compare	CMP	Sets flags. Like SUB but with no destination register.
Bitwise Exclusive OR	EOR	-
Copy operand to destination	MOV	Has only one operand, with the same options as the second operand in most of these instructions. If the operand is a shifted register, the instruction is an LSL, LSR, ASR, or ROR instruction instead. For details see Shift instructions on page F1-2814 . The T32 and A32 instruction sets permit use of a modified immediate constant or a zero-extended 16-bit immediate constant.
Bitwise NOT	MVN	Has only one operand, with the same options as the second operand in most of these instructions.
Bitwise OR NOT	ORN	Not available in the A32 instruction set.
Bitwise OR	ORR	-
Reverse Subtract	RSB	Subtracts first operand from second operand. This permits subtraction from constants and shifted registers.
Reverse Subtract with Carry	RSC	Not available in the T32 instruction set.
Subtract with Carry	SBC	-
Subtract	SUB	T32 instruction set permits use of a modified immediate constant or a zero-extended 12-bit immediate constant.
Test Equivalence	TEQ	Sets flags. Like EOR but with no destination register.
Test	TST	Sets flags. Like AND but with no destination register.

F1.4.2 Shift instructions

Table F1-3 lists the shift instructions in the T32 and A32 instruction sets.

Table F1-3 Shift instructions

Instruction	See
Arithmetic Shift Right	<i>ASR (immediate)</i> on page F5-3043 <i>ASR (register)</i> on page F5-3045 <i>ASRS (immediate)</i> on page F5-3047 <i>ASRS (register)</i> on page F5-3049
Logical Shift Left	<i>LSL (immediate)</i> on page F5-3233 <i>LSL (register)</i> on page F5-3235 <i>LSLs (immediate)</i> on page F5-3237 <i>LSLs (register)</i> on page F5-3239
Logical Shift Right	<i>LSR (immediate)</i> on page F5-3241 <i>LSR (register)</i> on page F5-3243 <i>LSRS (immediate)</i> on page F5-3245 <i>LSRS (register)</i> on page F5-3247
Rotate Right	<i>ROR (immediate)</i> on page F5-3366 <i>ROR (register)</i> on page F5-3368 <i>RORS (immediate)</i> on page F5-3370 <i>RORS (register)</i> on page F5-3372
Rotate Right with Extend	<i>RRX</i> on page F5-3374 <i>RRXS</i> on page F5-3376

In the A32 instruction set only, the destination register of these instructions can be the PC, causing the result to be treated as an address to branch to.

F1.4.3 Multiply instructions

These instructions can operate on signed or unsigned quantities. In some types of operation, the results are the same whether the operands are signed or unsigned.

- [Table F1-4](#) summarizes the multiply instructions where there is no distinction between signed and unsigned quantities.
 The least significant 32 bits of the result are used. More significant bits are discarded.
- [Table F1-5 on page F1-2815](#) summarizes the signed multiply instructions.
- [Table F1-6 on page F1-2815](#) summarizes the unsigned multiply instructions.

Table F1-4 General multiply instructions

Instruction	See	Operation (number of bits)
Multiply Accumulate	<i>MLA, MLAS</i> on page F5-3253	$32 = 32 + 32 \times 32$
Multiply and Subtract	<i>MLS</i> on page F5-3255	$32 = 32 - 32 \times 32$
Multiply	<i>MUL, MULS</i> on page F5-3290	$32 = 32 \times 32$

Table F1-5 Signed multiply instructions

Instruction	See	Operation (number of bits)
Signed Multiply Accumulate (halfwords)	<i>SMLABB, SMLABT, SMLATB, SMLATT</i> on page F5-3431	$32 = 32 + 16 \times 16$
Signed Multiply Accumulate Dual	<i>SMLAD, SMLADX</i> on page F5-3433	$32 = 32 + 16 \times 16 + 16 \times 16$
Signed Multiply Accumulate Long	<i>SMLAL, SMLALS</i> on page F5-3435	$64 = 64 + 32 \times 32$
Signed Multiply Accumulate Long (halfwords)	<i>SMLALBB, SMLALBT, SMLALTB, SMLALTT</i> on page F5-3437	$64 = 64 + 16 \times 16$
Signed Multiply Accumulate Long Dual	<i>SMLALD, SMLALDX</i> on page F5-3440	$64 = 64 + 16 \times 16 + 16 \times 16$
Signed Multiply Accumulate (word by halfword)	<i>SMLAWB, SMLAWT</i> on page F5-3442	$32 = 32 + 32 \times 16^a$
Signed Multiply Subtract Dual	<i>SMLSDD, SMLSDDX</i> on page F5-3444	$32 = 32 + 16 \times 16 - 16 \times 16$
Signed Multiply Subtract Long Dual	<i>SMLSDD, SMLSDDX</i> on page F5-3446	$64 = 64 + 16 \times 16 - 16 \times 16$
Signed Most Significant Word Multiply Accumulate	<i>SMMLA, SMMLAR</i> on page F5-3448	$32 = 32 + 32 \times 32^b$
Signed Most Significant Word Multiply Subtract	<i>SMMLS, SMMLSR</i> on page F5-3450	$32 = 32 - 32 \times 32^b$
Signed Most Significant Word Multiply	<i>SMMUL, SMMULR</i> on page F5-3452	$32 = 32 \times 32^b$
Signed Dual Multiply Add	<i>SMUAD, SMUADX</i> on page F5-3454	$32 = 16 \times 16 + 16 \times 16$
Signed Multiply (halfwords)	<i>SMULBB, SMULBT, SMULTB, SMULTT</i> on page F5-3456	$32 = 16 \times 16$
Signed Multiply Long	<i>SMULL, SMULLS</i> on page F5-3458	$64 = 32 \times 32$
Signed Multiply (word by halfword)	<i>SMULWB, SMULWT</i> on page F5-3460	$32 = 32 \times 16^a$
Signed Dual Multiply Subtract	<i>SMUSD, SMUSDX</i> on page F5-3462	$32 = 16 \times 16 - 16 \times 16$

a. The most significant 32 bits of the 48-bit product are used. Less significant bits are discarded.

b. The most significant 32 bits of the 64-bit product are used. Less significant bits are discarded.

Table F1-6 Unsigned multiply instructions

Instruction	See	Operation (number of bits)
Unsigned Multiply Accumulate Accumulate Long	<i>UMAAL</i> on page F5-3624	$64 = 32 + 32 + 32 \times 32$
Unsigned Multiply Accumulate Long	<i>UMLAL, UMLALS</i> on page F5-3626	$64 = 64 + 32 \times 32$
Unsigned Multiply Long	<i>UMULL, UMULLS</i> on page F5-3628	$64 = 32 \times 32$

F1.4.4 Saturating instructions

Table F1-7 lists the saturating instructions in the T32 and A32 instruction sets. For more information, see [Pseudocode description of saturation on page E1-2731](#).

Table F1-7 Saturating instructions

Instruction	See	Operation
Signed Saturate	SSAT on page F5-3468	Saturates optionally shifted 32-bit value to selected range
Signed Saturate 16	SSAT16 on page F5-3470	Saturates two 16-bit values to selected range
Unsigned Saturate	USAT on page F5-3646	Saturates optionally shifted 32-bit value to selected range
Unsigned Saturate 16	USAT16 on page F5-3648	Saturates two 16-bit values to selected range

F1.4.5 Saturating addition and subtraction instructions

Table F1-8 lists the saturating addition and subtraction instructions in the T32 and A32 instruction sets. For more information, see [Pseudocode description of saturation on page E1-2731](#).

Table F1-8 Saturating addition and subtraction instructions

Instruction	See	Operation
Saturating Add	QADD on page F5-3336	Add, saturating result to the 32-bit signed integer range
Saturating Subtract	QSUB on page F5-3349	Subtract, saturating result to the 32-bit signed integer range
Saturating Double and Add	QADD on page F5-3336	Doubles one value and adds a second value, saturating the doubling and the addition to the 32-bit signed integer range
Saturating Double and Subtract	QDSUB on page F5-3345	Doubles one value and subtracts the result from a second value, saturating the doubling and the subtraction to the 32-bit signed integer range

F1.4.6 Packing and unpacking instructions

Table F1-9 lists the packing and unpacking instructions in the T32 and A32 instruction sets.

Table F1-9 Packing and unpacking instructions

Instruction	See	Operation
Pack Halfword	PKHBT, PKHTB on page F5-3312	Combine halfwords
Signed Extend and Add Byte	SXTAB on page F5-3577	Extend 8 bits to 32 and add
Signed Extend and Add Byte 16	SXTAB16 on page F5-3579	Dual extend 8 bits to 16 and add
Signed Extend and Add Halfword	SXTAH on page F5-3581	Extend 16 bits to 32 and add
Signed Extend Byte	SXTB on page F5-3583	Extend 8 bits to 32
Signed Extend Byte 16	SXTB16 on page F5-3585	Dual extend 8 bits to 16
Signed Extend Halfword	SXTH on page F5-3587	Extend 16 bits to 32
Unsigned Extend and Add Byte	UXTAB on page F5-3656	Extend 8 bits to 32 and add
Unsigned Extend and Add Byte 16	UXTAB16 on page F5-3658	Dual extend 8 bits to 16 and add
Unsigned Extend and Add Halfword	UXTAH on page F5-3660	Extend 16 bits to 32 and add
Unsigned Extend Byte	UXTB on page F5-3662	Extend 8 bits to 32
Unsigned Extend Byte 16	UXTB16 on page F5-3664	Dual extend 8 bits to 16
Unsigned Extend Halfword	UXTH on page F5-3666	Extend 16 bits to 32

F1.4.7 Parallel addition and subtraction instructions

These instructions perform additions and subtractions on the values of two registers and write the result to a destination register, treating the register values as sets of two halfwords or four bytes. That is, they perform SIMD additions or subtractions on the general-purpose registers.

These instructions consist of a prefix followed by a main instruction mnemonic. The prefixes are as follows:

S	Signed arithmetic modulo 2^8 or 2^{16} .
Q	Signed saturating arithmetic.
SH	Signed arithmetic, halving the results.
U	Unsigned arithmetic modulo 2^8 or 2^{16} .
UQ	Unsigned saturating arithmetic.
UH	Unsigned arithmetic, halving the results.

The main instruction mnemonics are as follows:

ADD16	Adds the top halfwords of two operands to form the top halfword of the result, and the bottom halfwords of the same two operands to form the bottom halfword of the result.
ASX	Exchanges halfwords of the second operand, and then adds top halfwords and subtracts bottom halfwords.
SAX	Exchanges halfwords of the second operand, and then subtracts top halfwords and adds bottom halfwords.
SUB16	Subtracts each halfword of the second operand from the corresponding halfword of the first operand to form the corresponding halfword of the result.
ADD8	Adds each byte of the second operand to the corresponding byte of the first operand to form the corresponding byte of the result.
SUB8	Subtracts each byte of the second operand from the corresponding byte of the first operand to form the corresponding byte of the result.

The instruction set permits all 36 combinations of prefix and main instruction operand, as [Table F1-10](#) shows.

See also [Advanced SIMD parallel addition and subtraction on page F1-2833](#).

Table F1-10 Parallel addition and subtraction instructions

Main instruction	Signed	Saturating	Signed halving	Unsigned	Unsigned saturating	Unsigned halving
ADD16, add, two halfwords	SADD16	QADD16	SHADD16	UADD16	UQADD16	UHADD16
ASX, add and subtract with exchange	SASX	QASX	SHASX	UASX	UQASX	UHASX
SAX, subtract and add with exchange	SSAX	QSAX	SHSAX	USAX	UQSAX	UHSAX
SUB16, subtract, two halfwords	SSUB16	QSUB16	SHSUB16	USUB16	UQSUB16	UHSUB16
ADD8, add, four bytes	SADD8	QADD8	SHADD8	UADD8	UQADD8	UHADD8
SUB8, subtract, four bytes	SSUB8	QSUB8	SHSUB8	USUB8	UQSUB8	UHSUB8

F1.4.8 Divide instructions

In ARMv8, signed and unsigned integer divide instructions are included in both the T32 instruction set and the A32 instruction set. For more information about their implementation in previous versions of the ARM architecture see the *ARM® Architecture Reference Manual, ARMv7-A and ARMv7-R edition*.

For descriptions of the instructions see:

- [SDIV on page F5-3407](#).
- [UDIV on page F5-3610](#).

For the SDIV and UDIV instructions, division by zero always returns a zero result.

The `ID_ISAR0.Divide_instrs` field indicates the level of support for these instructions. The field value of `0b0010` indicates they are implemented in both the T32 and A32 instruction sets.

F1.4.9 Miscellaneous data-processing instructions

[Table F1-11](#) lists the miscellaneous data-processing instructions in the T32 and A32 instruction sets. Immediate values in these instructions are simple binary numbers.

Table F1-11 Miscellaneous data-processing instructions

Instruction	See	Notes
BitField Clear	BFC on page F5-3054	-
BitField Insert	BFI on page F5-3056	-
Count Leading Zeros	CLZ on page F5-3076	-
Move Top	MOVT on page F5-3269	Moves 16-bit immediate value to top halfword. Bottom halfword unchanged.
Reverse Bits	RBIT on page F5-3355	-
Byte-Reverse Word	REV on page F5-3357	-
Byte-Reverse Packed Halfword	REV16 on page F5-3359	-
Byte-Reverse Signed Halfword	REVSH on page F5-3361	-
Signed BitField Extract	SBFX on page F5-3405	-
Select Bytes using GE flags	SEL on page F5-3409	-
Unsigned BitField Extract	UBFX on page F5-3606	-
Unsigned Sum of Absolute Differences	USAD8 on page F5-3642	-
Unsigned Sum of Absolute Differences and Accumulate	USADA8 on page F5-3644	-

F1.5 PSTATE and banked register access instructions

These instructions transfer PE state information to or from a general-purpose register.

F1.5.1 PSTATE access instructions

PSTATE holds process state information, see *Process state, PSTATE* on page E1-2734. In AArch32 state:

- At EL1 or higher, PSTATE is accessible using the *Current Program Status Register (CPSR)*.
- At EL0, a subset of the CPSR is accessible as the *Application Program Status Register (APSR)*.
- On taking an exception, the contents of the CPSR are copied to the *Saved Program Status Register (SPSR)* of the mode from which the exception is taken.

The MRS and MSR instructions move the contents of the CPSR, APSR, or the SPSR of the current mode to or from a general-purpose register, see:

- *MRS* on page F5-3275.
- *MSR (immediate)* on page F5-3285.
- *MSR (register)* on page F5-3287.

When executed at EL0, MRS and MSR instructions can only access the APSR.

The PSTATE Condition flags, PSTATE.{N, Z, C, V} are set by the execution of data-processing instructions, and can control the execution of conditional instructions. However, software can set the Condition flags explicitly using the MSR instruction, and can read the current state of the Condition flags explicitly using the MRS instruction.

In addition, at EL1 or higher, software can use the CPS instruction to change the PSTATE.M field and the PSTATE.{A, I, F} interrupt mask bits, see *CPS, CPSID, CPSIE* on page F5-3089.

F1.5.2 Banked register access instructions

At EL1 or higher, the MRS (Banked register) and MSR (Banked register) instructions move the contents of a Banked general-purpose register, the SPSR, or the ELR_hyp, to or from a general-purpose register. See:

- *MRS (Banked register)* on page F5-3277.
- *MSR (Banked register)* on page F5-3281.

F1.6 Load/store instructions

Table F1-12 summarizes the general-purpose register load/store instructions in the T32 and A32 instruction sets. Some of these instructions can also operate on the PC. See also:

- [Load/store multiple instructions on page F1-2824](#).
- [Synchronization and semaphores on page E2-2795](#), for more information about the Load-Exclusive and Store-Exclusive instructions.
- [Load-Acquire, Store-Release on page E2-2770](#), for more information about the Load-Acquire/Store-Release and Load-Acquire Exclusive/Store-Release Exclusive instructions.
- [Advanced SIMD and floating-point load/store instructions on page F1-2829](#).

Load/store instructions have several options for addressing memory. For more information, see [Addressing modes on page F1-2822](#).

Table F1-12 Load/store instructions

Data type	Load	Store	Unprivileged		Exclusive		Load-Acquire	Store-Release	Exclusive	
			Load	Store	Load	Store			Load-Acquire	Store-Release
32-bit word	LDR	STR	LDRT	STRT	LDREX	STREX	LDA	STL	LDAEX	STLEX
16-bit halfword	-	STRH	-	STRHT	-	STREXH	LDAH	STLH	LDAEXH	STLEXH
16-bit unsigned halfword	LDRH	-	LDRHT	-	LDREXH	-	-	-	-	-
16-bit signed halfword	LDRSH	-	LDRSHT	-	-	-	-	-	-	-
8-bit byte	-	STRB	-	STRBT	-	STREXB	LDAB	STLB	LDAEXB	STLEXB
8-bit unsigned byte	LDRB	-	LDRBT	-	LDREXB	-	-	-	-	-
8-bit signed byte	LDRSB	-	LDRSBT	-	-	-	-	-	-	-
Two 32-bit words	LDRD	STRD	-	-	-	-	-	-	-	-
64-bit doubleword	-	-	-	-	LDREXD	STREXD	-	-	LDAEXD	STLEXD

F1.6.1 Loads to the PC

The LDR instruction can load a value into the PC. The value loaded is treated as an interworking address, as described by the `LoadWritePC()` pseudocode function in [Pseudocode description of operations on the AArch32 general-purpose registers and the PC on page E1-2733](#).

F1.6.2 Halfword and byte loads and stores

Halfword and byte stores store the least significant halfword or byte from the register, to 16 or 8 bits of memory respectively. There is no distinction between signed and unsigned stores.

Halfword and byte loads load 16 or 8 bits from memory into the least significant halfword or byte of a register. Unsigned loads zero-extend the loaded value to 32 bits, and signed loads sign-extend the value to 32 bits.

F1.6.3 Load unprivileged and Store unprivileged

When executing at EL0, a Load unprivileged or Store unprivileged instruction operates in exactly the same way as the corresponding ordinary load or store instruction. For example, an LDRT instruction executes in exactly the same way as the equivalent LDR instruction. When executed at PL1, Load unprivileged and Store unprivileged instructions behave as they would if they were executed at EL0. For example, an LDRT instruction executes in exactly the way that the equivalent LDR instruction would execute at EL0. In particular, the instructions make unprivileged memory accesses.

———— **Note** —————

As described in [Security state, Exception levels, and AArch32 execution privilege on page G1-4318](#), execution at PL1 describes all of the following:

- Execution at Non-secure EL1 using AArch32.
- Execution at Secure EL1 using AArch32 when EL3 is not implemented.
- Execution at Secure EL1 using AArch32 when EL3 is implemented and is using AArch64.
- Execution at Secure EL3 when EL3 is implemented and is using AArch32.

The Load unprivileged and Store unprivileged instructions are CONstrained UNPREDICTABLE if executed at EL2, see [Execution of Load/Store unprivileged instructions in Hyp mode on page K1-6115](#).

For more information about execution privilege, see [About access permissions on page G4-4605](#).

F1.6.4 Load-Exclusive and Store-Exclusive

Load-Exclusive and Store-Exclusive instructions provide shared memory synchronization. For more information, see [Synchronization and semaphores on page E2-2795](#).

F1.6.5 Load-Acquire and Store-Release

Load-Acquire and Store-Release instructions provide memory barriers. Load-Acquire Exclusive and Store-Release Exclusive instructions provide memory barriers with shared memory synchronization. For more information, see [Load-Acquire, Store-Release on page E2-2770](#).

F1.6.6 Addressing modes

The address for a load or store is formed from two parts: a value from a base register, and an offset.

The base register can be any one of the general-purpose registers R0-R12, SP, or LR.

For loads, the base register can be the PC. This provides PC-relative addressing for position-independent code. Instructions marked (literal) in their title in [Chapter F2 About the T32 and A32 Instruction Descriptions](#) are PC-relative loads.

The offset takes one of three formats:

Immediate	The offset is an unsigned number that can be added to or subtracted from the base register value. Immediate offset addressing is useful for accessing data elements that are a fixed distance from the start of the data object, such as structure fields, stack offsets and input/output registers.
Register	The offset is a value from a general-purpose register. The value can be added to, or subtracted from, the base register value. Register offsets are useful for accessing arrays or blocks of data.
Scaled register	The offset is a general-purpose register, shifted by an immediate value, then added to or subtracted from the base register. This means an array index can be scaled by the size of each array element.

The offset and base register can be used in three different ways to form the memory address. The addressing modes are described as follows:

- Offset** The offset is added to or subtracted from the base register to form the memory address.
- Pre-indexed** The offset is added to or subtracted from the base register to form the memory address. The base register is then updated with this new address, to permit automatic indexing through an array or memory block.
- Post-indexed** The value of the base register alone is used as the memory address. The offset is then added to or subtracted from the base register. The result is stored back in the base register, to permit automatic indexing through an array or memory block.

———— **Note** —————

Not every variant is available for every instruction, and the range of permitted immediate values and the options for scaled registers vary from instruction to instruction. See [Chapter F2 About the T32 and A32 Instruction Descriptions](#) for full details for each instruction.

F1.7 Load/store multiple instructions

Load Multiple instructions load from memory a subset, or possibly all, of the general-purpose registers and the PC.

Store Multiple instructions store to memory a subset, or possibly all, of the general-purpose registers.

The memory locations are consecutive word-aligned words. The addresses used are obtained from a base register, and can be either above or below the value in the base register. The base register can optionally be updated by the total size of the data transferred.

Table F1-13 summarizes the load/store multiple instructions in the T32 and A32 instruction sets.

Table F1-13 Load/store multiple instructions

Instruction	See
Load Multiple, Increment After or Full Descending	LDM, LDMIA, LDMFD on page F5-3144
Load Multiple, Decrement After or Full Ascending ^a	LDMDA, LDMFA on page F5-3152
Load Multiple, Decrement Before or Empty Ascending	LDMDB, LDMEA on page F5-3154
Load Multiple, Increment Before or Empty Descending ^a	LDMIB, LDMED on page F5-3157
Pop multiple registers off the stack ^b	POP on page F5-3325
Push multiple registers onto the stack ^c	PUSH on page F5-3331
Store Multiple, Increment After or Empty Ascending	STM, STMIA, STMEA on page F5-3495
Store Multiple, Decrement After or Empty Descending ^a	STMDA, STMED on page F5-3501
Store Multiple, Decrement Before or Full Descending	STMDB, STMFD on page F5-3503
Store Multiple, Increment Before or Full Ascending ^a	STMIB, STMFA on page F5-3506

a. Not available in the T32 instruction set.

b. This instruction is equivalent to an LDM instruction with the SP as base register, and base register updating.

c. This instruction is equivalent to an STMDB instruction with the SP as base register, and base register updating.

When executing at EL1, variants of the LDM and STM instructions load and store User mode registers. Another system level variant of the LDM instruction performs an exception return.

F1.7.1 Loads to the PC

The LDM, LDMDA, LDMDB, LDMIB, and POP instructions can load a value into the PC. The value loaded is treated as an interworking address, as described by the [LoadWritePC\(\)](#) pseudocode function in [Pseudocode description of operations on the AArch32 general-purpose registers and the PC on page E1-2733](#).

F1.8 Miscellaneous instructions

Table F1-14 summarizes the miscellaneous instructions in the T32 and A32 instruction sets.

Table F1-14 Miscellaneous instructions

Instruction	See
Clear-Exclusive	CLREX on page F5-3075
Data Memory Barrier	DMB on page F5-3103
Data Synchronization Barrier	DSB on page F5-3106
Instruction Synchronization Barrier	ISB on page F5-3125
If-Then	IT on page F5-3126 ^a
No Operation	NOP on page F5-3299
Preload Data	PLD , PLDW (immediate) on page F5-3314 PLD (literal) on page F5-3316 PLD , PLDW (register) on page F5-3318
Preload Instruction	PLI (immediate, literal) on page F5-3320 PLI (register) on page F5-3323
Set Endianness	SETEND on page F5-3411 ^b
Set Privileged Access Never	SETPAN on page F5-3412
Send Event	SEV on page F5-3413
Send Event Local	SEVL on page F5-3415
Wait For Event	WFE on page F5-3668
Wait For Interrupt	WFI on page F5-3670
Yield	YIELD on page F5-3672 ^c

- a. For performance reasons, ARM deprecates many uses of the IT instruction, see [Partial deprecation of IT](#) on page F1-2826.
- b. ARM deprecates any use of the SETEND instruction.
- c. See also [The Yield instruction](#).

Note

Previous versions of the architecture defined the DBG instruction, that could provide a hint to the debug system, in this group. In ARMv8, this instruction executes as a NOP. ARM deprecates any use of the DBG instruction.

F1.8.1 The Yield instruction

In a *Symmetric Multithreading* (SMT) design, a thread can use the YIELD instruction to give a hint to the PE that it is running on. The YIELD hint indicates that whatever the thread is currently doing is of low importance, and so could yield. For example, the thread might be sitting in a spin-lock. A similar use might be in modifying the arbitration priority of the snoop bus in a multiprocessor (MP) system. Defining such an instruction permits binary compatibility between SMT and SMP systems.

AArch32 state defines a YIELD instruction as a specific NOP (No Operation) hint instruction.

The YIELD instruction has no effect in a single-threaded system, but developers of such systems can use the instruction to flag its intended use on migration to a multiprocessor or multithreading system. Operating systems can use YIELD in places where a yield hint is wanted, knowing that it will be treated as a NOP if there is no implementation benefit.

F1.8.2 Partial deprecation of IT

ARMv8-A deprecates some uses of the T32 IT instruction, for performance reasons. All uses of IT that apply to instructions other than a single subsequent 16-bit instruction from a restricted set are deprecated, as are explicit references to the PC within that single 16-bit instruction. This permits the non-deprecated forms of IT and subsequent instructions to be treated as a single 32-bit conditional instruction. Table F1-15 shows the restricted set of 16-bit instructions that are not deprecated when used in conjunction with IT.

Table F1-15 Non-deprecated IT 16-bit conditional instructions

Non-deprecated 16-bit instructions	Class	Notes
MOV, MVN	Move	Deprecated when Rm or Rd is the PC.
LDR, LDRB, LDRH, LDRSB, LDRSH	Load	Deprecated for PC-relative load literal forms
STR, STRB, STRH	Store	-
ADD, ADC, RSB, SBC, SUB	Add/Subtract	Deprecated for ADD SP, SP, #imm, SUB SP, SP, #imm, and when Rm, Rdn, or Rdm is the PC
CMP, CMN	Compare	Deprecated when Rm or Rn is the PC
MUL	Multiply	-
ASR, LSL, LSR, ROR	Shift	-
AND, BIC, EOR, ORR, TST	Logical	-
BX, BLX	Branch to register	Deprecated when Rm is the PC

The full ARMv7 IT instruction functionality remains available in order to execute legacy T32 code. It is IMPLEMENTATION DEFINED whether an ARMv8 implementation provides an ITD control, that software can use to disable the deprecated uses of the IT instruction. In an implementation that included the ITD control, setting an ITD field to 1 disables the deprecated uses of the IT instruction, making those uses of the IT instruction UNDEFINED. The ITD control fields are:

HSCTLR.ITD When EL2 is using AArch32, makes execution of the deprecated uses of the IT UNDEFINED at EL2.

SCTLR.ITD When EL1 is using AArch32, makes execution of the deprecated uses of the IT UNDEFINED at EL0 and EL1.

SCTLR_EL1.ITD

When EL1 is using AArch64, makes execution of the deprecated uses of the IT UNDEFINED at EL0 when EL0 is using AArch32.

F1.9 Exception-generating and exception-handling instructions

The following instructions are intended specifically to cause a synchronous exception to occur:

- The SVC instruction generates a Supervisor Call exception. For more information, see [Supervisor Call \(SVC\) exception on page G1-4380](#).
- The Breakpoint instruction BKPT provides software breakpoints. For more information, see [Breakpoint Instruction exceptions on page G2-4467](#).
- In an implementation that includes EL3, when executing at EL1 or higher, the SMC instruction generates a Secure Monitor Call exception. For more information, see [Secure Monitor Call \(SMC\) exception on page G1-4382](#).
- In an implementation that includes EL2, in software executing in a Non-secure EL1 mode, the HVC instruction generates a Hypervisor Call exception. For more information, see [Hypervisor Call \(HVC\) exception on page G1-4383](#).

For an exception taken to an EL1 mode:

- The system level variants of the SUBS and LDM instructions can perform a return from an exception.

———— **Note** —————

The variants of SUBS include MOV_S. See the references to [Subtract \(exception return\)](#), [Move \(exception return\)](#), and [Load Multiple \(exception return\)](#) in [Table F1-16](#) for more information.

- The SRS instruction can be used near the start of the handler, to store return information. The RFE instruction can then perform a return from the exception using the stored return information.

In an implementation that includes EL2, the ERET instruction performs a return from an exception taken to Hyp mode.

For more information, see [Exception return to an Exception level using AArch32 on page G1-4360](#).

[Table F1-16](#) summarizes the instructions, in the T32 and A32 instruction sets, for generating or handling an exception. Except for BKPT and SVC, these are system level instructions.

Table F1-16 Exception-generating and exception-handling instructions

Instruction	See
Supervisor Call	SVC on page F5-3575
Breakpoint	BKPT on page F5-3065
Secure Monitor Call	SMC on page F5-3429
Return From Exception	RFE, RFEDA, RFEDB, RFEIA, RFEIB on page F5-3363
Subtract (exception return) ^a	SUB, SUBS (immediate) on page F5-3560^a
Move (exception return) ^a	MOV, MOV_S (register) on page F5-3260^a
Hypervisor Call	HVC on page F5-3123
Exception Return	ERET on page F5-3117
Load Multiple (exception return)	LDM (exception return) on page F5-3148
Store Return State	SRS, SRSDA, SRSDB, SRSIA, SRSIB on page F5-3464

a. The A32 instruction set includes other instruction forms that can be used for an exception return, that have previously been described as variants of SUBS PC, LR. ARM deprecates any use of these instruction forms.

F1.10 System register access instructions

The System register encoding space is indexed using the parameters {coproc, opc1, CRn, CRm, opc2}, see [The AArch32 System register interface on page G1-4408](#). This encoding space provides System registers and System instructions. In ARMv8, the only permitted values of coproc are 0b1110 and 0b1111, and the following instructions give access to this encoding space:

- Instructions that transfer data between general-purpose registers and System registers. See:
 - [MCR on page F5-3249](#).
 - [MCRR on page F5-3251](#).
 - [MRC on page F5-3271](#).
 - [MRRC on page F5-3273](#).
- Instructions that load or store from memory to a System register. See:
 - [LDC \(immediate\) on page F5-3140](#).
 - [LDC \(literal\) on page F5-3142](#).
 - [STC on page F5-3478](#).

Note

The System register encoding space with coproc==0b101x is redefined to provide some of the Advanced SIMD and floating-point functionality. That is, to:

- Initiate a floating-point data-processing operation, see [Floating-point data-processing instructions on page F1-2840](#).
- Transfer data between general-purpose registers and the Advanced SIMD and floating-point registers, see [Advanced SIMD and floating-point register transfer instructions on page F1-2831](#).
- Load or store data to the Advanced SIMD and floating-point registers, see [Advanced SIMD and floating-point load/store instructions on page F1-2829](#).

System register access instructions are part of the instruction stream executed by the PE, and therefore any System register access instruction that cannot be executed by the implementation causes an Undefined Instruction exception. In ARMv8-A and ARMv8-R, the instruction encodings in the System register access instruction encoding space are unallocated, and generate Undefined Instruction exceptions, except for:

- The instructions summarized in this section that access the coproc==0b111x encoding space.
- The instructions in the coproc==0b101x encoding space that are redefined to provide Advanced SIMD and floating-point functionality, as summarized in the Note in this section.

F1.11 Advanced SIMD and floating-point load/store instructions

Table F1-17 summarizes the SIMD and floating-point register file load/store instructions in the Advanced SIMD and floating-point instruction sets.

Advanced SIMD also provides instructions for loading and storing multiple elements, or structures of elements, see *Element and structure load/store instructions*.

Table F1-17 SIMD and floating-point register file load/store instructions

Instruction	See	Operation
Vector Load Multiple	<i>VLDM, VLDMDB, VLDMIA</i> on page F6-3935	Load 1-16 consecutive 64-bit registers, Advanced SIMD and floating-point. Load 1-16 consecutive 32-bit registers, floating-point only.
Vector Load Register	<i>VLDR (immediate)</i> on page F6-3940 <i>VLDR (literal)</i> on page F6-3943	Load one 64-bit register, Advanced SIMD and floating-point. Load one 32-bit register, floating-point only.
Vector Store Multiple	<i>VSTM, VSTMDB, VSTMIA</i> on page F6-4268	Store 1-16 consecutive 64-bit registers, Advanced SIMD and floating-point. Store 1-16 consecutive 32-bit registers, floating-point only.
Vector Store Register	<i>VSTR</i> on page F6-4273	Store one 64-bit register, Advanced SIMD and floating-point. Store one 32-bit register, floating-point only.

F1.11.1 Element and structure load/store instructions

Table F1-18 shows the element and structure load/store instructions available in the Advanced SIMD instruction set. Loading and storing structures of more than one element automatically de-interleaves or interleaves the elements, see [Figure F1-1 on page F1-2830](#) for an example of de-interleaving. Interleaving is the inverse process.

Table F1-18 Element and structure load/store instructions

Instruction	See
Load single element	
Multiple elements	<i>VLD1 (multiple single elements)</i> on page F6-3889
To one lane	<i>VLD1 (single element to one lane)</i> on page F6-3881
To all lanes	<i>VLD1 (single element to all lanes)</i> on page F6-3886
Load 2-element structure	
Multiple structures	<i>VLD2 (multiple 2-element structures)</i> on page F6-3906
To one lane	<i>VLD2 (single 2-element structure to one lane)</i> on page F6-3897
To all lanes	<i>VLD2 (single 2-element structure to all lanes)</i> on page F6-3903
Load 3-element structure	
Multiple structures	<i>VLD3 (multiple 3-element structures)</i> on page F6-3920
To one lane	<i>VLD3 (single 3-element structure to one lane)</i> on page F6-3911
To all lanes	<i>VLD3 (single 3-element structure to all lanes)</i> on page F6-3917

Table F1-18 Element and structure load/store instructions (continued)

Instruction	See
Load 4-element structure	
Multiple structures	<i>VLD4 (multiple 4-element structures)</i> on page F6-3932
To one lane	<i>VLD4 (single 4-element structure to one lane)</i> on page F6-3923
To all lanes	<i>VLD4 (single 4-element structure to all lanes)</i> on page F6-3929
Store single element	
Multiple elements	<i>VST1 (multiple single elements)</i> on page F6-4231
From one lane	<i>VST1 (single element from one lane)</i> on page F6-4226
Store 2-element structure	
Multiple structures	<i>VST2 (multiple 2-element structures)</i> on page F6-4245
From one lane	<i>VST2 (single 2-element structure from one lane)</i> on page F6-4239
Store 3-element structure	
Multiple structures	<i>VST3 (multiple 3-element structures)</i> on page F6-4256
From one lane	<i>VST3 (single 3-element structure from one lane)</i> on page F6-4250
Store 4-element structure	
Multiple structures	<i>VST4 (multiple 4-element structures)</i> on page F6-4265
From one lane	<i>VST4 (single 4-element structure from one lane)</i> on page F6-4259

Figure F1-1 shows the de-interleaving of a VLD3.16 (multiple 3-element structures) instruction:

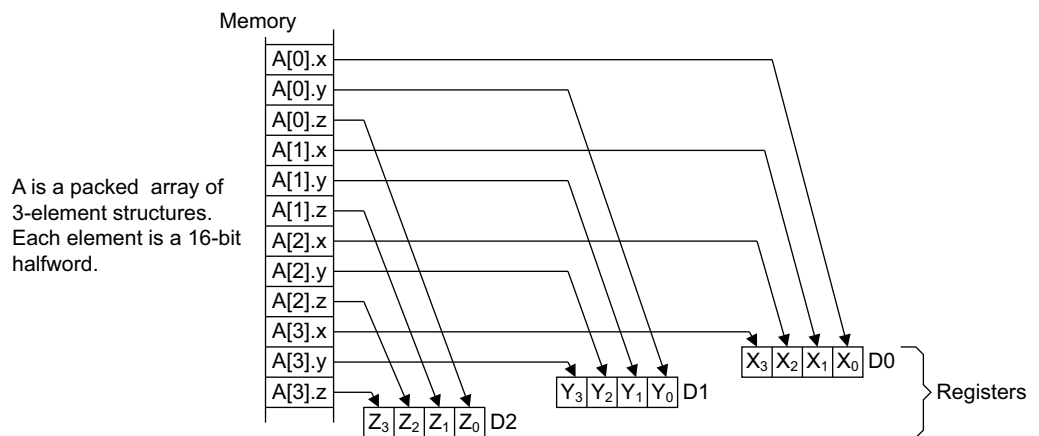

Figure F1-1 De-interleaving an array of 3-element structures

Figure F1-1 shows the VLD3.16 instruction operating to three 64-bit registers that comprise four 16-bit elements:

- Different instructions in this group would produce similar figures, but operate on different numbers of registers. For example, VLD4 and VST4 instructions operate on four registers.
- Different element sizes would produce similar figures but with 8-bit or 32-bit elements.
- These instructions operate only on doubleword (64-bit) registers.

F1.12 Advanced SIMD and floating-point register transfer instructions

Table F1-19 summarizes the SIMD and floating-point register file transfer instructions in the Advanced SIMD and floating-point instruction sets. These instructions transfer data between the general-purpose registers and the registers in the SIMD and floating-point register file.

Advanced SIMD vectors, and single-precision and double-precision floating-point registers, are all views of the same register file. For details see *The SIMD and floating-point register file* on page E1-2740.

Table F1-19 SIMD and floating-point register file transfer instructions

Instruction	See
Copy element from general-purpose register to every element of an Advanced SIMD vector	<i>VDUP (general-purpose register)</i> on page F6-3851
Copy byte, halfword, or word from general-purpose register to a register in the SIMD and floating-point register file	<i>VMOV (general-purpose register to scalar)</i> on page F6-4002
Copy byte, halfword, or word from a register in the SIMD and floating-point register file to a general-purpose register	<i>VMOV (scalar to general-purpose register)</i> on page F6-4006
Copy from half-precision floating-point register to general-purpose register, or from general-purpose register to half-precision floating-point register Only supported if ARMv8.2-FP16 is implemented	<i>VMOV (between general-purpose register and half-precision)</i> on page F6-3990
Copy from single-precision floating-point register to general-purpose register, or from general-purpose register to single-precision floating-point register	<i>VMOV (between general-purpose register and single-precision)</i> on page F6-4004
Copy two words from general-purpose registers to consecutive single-precision floating-point registers, or from consecutive single-precision floating-point registers to general-purpose registers	<i>VMOV (between two general-purpose registers and two single-precision registers)</i> on page F6-4008
Copy two words from general-purpose registers to a doubleword register in the SIMD and floating-point register file, or from a doubleword register in the SIMD and floating-point register file to general-purpose registers	<i>VMOV (between two general-purpose registers and a doubleword floating-point register)</i> on page F6-3988
Copy from an Advanced SIMD and floating-point System Register to a general-purpose register	<i>VMRS</i> on page F6-4017
Copy from a general-purpose register to an Advanced SIMD and floating-point System Register	<i>VMSR</i> on page F6-4020

F1.13 Advanced SIMD data-processing instructions

Advanced SIMD data-processing instructions process registers containing vectors of elements of the same type packed together, enabling the same operation to be performed on multiple items in parallel.

Instructions operate on vectors held in 64-bit or 128-bit registers. [Figure F1-2](#) shows an operation on two 64-bit operand vectors, generating a 64-bit vector result.

———— **Note** —————

[Figure F1-2](#) and other similar figures show 64-bit vectors that consist of four 16-bit elements, and 128-bit vectors that consist of four 32-bit elements. Other element sizes produce similar figures, but with one, two, eight, or sixteen operations performed in parallel instead of four.

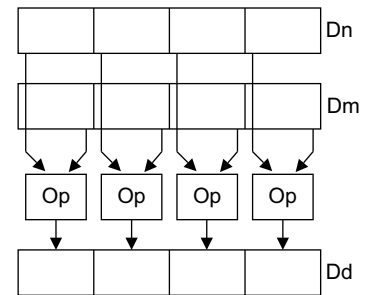

Figure F1-2 Advanced SIMD instruction operating on 64-bit registers

Many Advanced SIMD instructions have variants that produce vectors of elements double the size of the inputs. In this case, the number of elements in the result vector is the same as the number of elements in the operand vectors, but each element, and the whole vector, is double the size.

[Figure F1-3](#) shows an example of an Advanced SIMD instruction operating on 64-bit registers, and generating a 128-bit result.

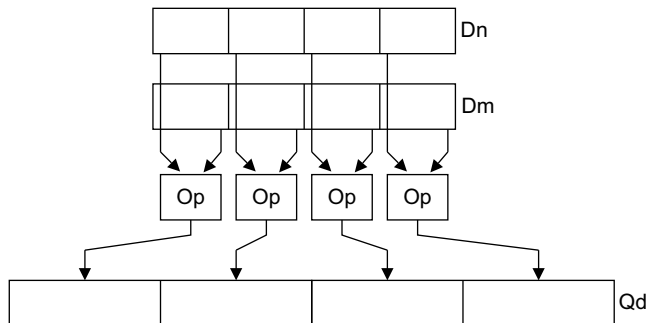

Figure F1-3 Advanced SIMD instruction producing wider result

There are also Advanced SIMD instructions that have variants that produce vectors containing elements half the size of the inputs. [Figure F1-4 on page F1-2833](#) shows an example of an Advanced SIMD instruction operating on one 128-bit register, and generating a 64-bit result.

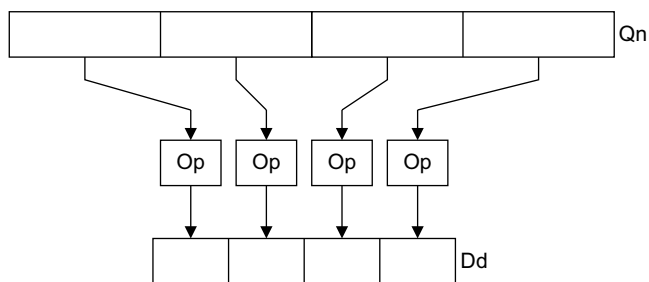

Figure F1-4 Advanced SIMD instruction producing narrower result

Some Advanced SIMD instructions do not conform to these standard patterns. Their operation patterns are described in the individual instruction descriptions.

Advanced SIMD instructions that perform floating-point arithmetic use the ARM standard floating-point arithmetic defined in *Floating-point and Advanced SIMD support* on page A1-48.

F1.13.1 Advanced SIMD parallel addition and subtraction

Table F1-20 shows the Advanced SIMD parallel add and subtract instructions.

Table F1-20 Advanced SIMD parallel add and subtract instructions

Instruction	See
Vector Add	<i>VADD (integer)</i> on page F6-3737 <i>VADD (floating-point)</i> on page F6-3733
Vector Add and Narrow, returning High Half	<i>VADDHN</i> on page F6-3739
Vector Add Long	<i>VADDL</i> on page F6-3741
Vector Add Wide	<i>VADDW</i> on page F6-3743
Vector Halving Add	<i>VHADD</i> on page F6-3875
Vector Halving Subtract	<i>VHSUB</i> on page F6-3877
Vector Pairwise Add and Accumulate Long	<i>VPADAL</i> on page F6-4064
Vector Pairwise Add	<i>VPADD (integer)</i> on page F6-4068 <i>VPADD (floating-point)</i> on page F6-4066
Vector Pairwise Add Long	<i>VPADDL</i> on page F6-4070
Vector Rounding Add and Narrow, returning High Half	<i>VRADDHN</i> on page F6-4138
Vector Rounding Halving Add	<i>VRHADD</i> on page F6-4153
Vector Rounding Subtract and Narrow, returning High Half	<i>VRSUBHN</i> on page F6-4197
Vector Saturating Add	<i>VQADD</i> on page F6-4086
Vector Saturating Subtract	<i>VQSUB</i> on page F6-4136
Vector Subtract	<i>VSUB (integer)</i> on page F6-4280 <i>VSUB (floating-point)</i> on page F6-4276

Table F1-20 Advanced SIMD parallel add and subtract instructions (continued)

Instruction	See
Vector Subtract and Narrow, returning High Half	<i>VSUBHN</i> on page F6-4282
Vector Subtract Long	<i>VSUBL</i> on page F6-4284
Vector Subtract Wide	<i>VSUBW</i> on page F6-4286

F1.13.2 Bitwise Advanced SIMD data-processing instructions

Table F1-21 shows bitwise Advanced SIMD data-processing instructions. These operate on the doubleword (64-bit) or quadword (128-bit) registers in the SIMD and floating-point register file, and there is no division into vector elements.

Table F1-21 Bitwise Advanced SIMD data-processing instructions

Instruction	See
Vector Bitwise AND	<i>VAND (register)</i> on page F6-3748
Vector Bitwise Bit Clear (AND complement)	<i>VBIC (immediate)</i> on page F6-3750 <i>VBIC (register)</i> on page F6-3753
Vector Bitwise Exclusive OR	<i>VEOR</i> on page F6-3855
Vector Bitwise Insert if False	<i>VBIF</i> on page F6-3755
Vector Bitwise Insert if True	<i>VBIT</i> on page F6-3757
Vector Bitwise Move	<i>VMOV (immediate)</i> on page F6-3992 <i>VMOV (register)</i> on page F6-3998
Vector Bitwise NOT	<i>VMVN (immediate)</i> on page F6-4035 <i>VMVN (register)</i> on page F6-4039
Vector Bitwise OR	<i>VORR (immediate)</i> on page F6-4059 <i>VORR (register)</i> on page F6-4062
Vector Bitwise OR NOT	<i>VORN (register)</i> on page F6-4057
Vector Bitwise Select	<i>VBSL</i> on page F6-3759

F1.13.3 Advanced SIMD comparison instructions

Table F1-22 shows Advanced SIMD comparison instructions.

Table F1-22 Advanced SIMD comparison instructions

Instruction	See
Vector Absolute Compare Greater Than or Equal	<i>VACGE</i> on page F6-3725
Vector Absolute Compare Greater Than	<i>VACGT</i> on page F6-3729
Vector Compare Equal	<i>VCEQ (register)</i> on page F6-3763
Vector Compare Equal to Zero	<i>VCEQ (immediate #0)</i> on page F6-3761

Table F1-22 Advanced SIMD comparison instructions (continued)

Instruction	See
Vector Compare Greater Than or Equal	VCGE (register) on page F6-3768
Vector Compare Greater Than or Equal to Zero	VCGE (immediate #0) on page F6-3766
Vector Compare Greater Than	VCGT (register) on page F6-3774
Vector Compare Greater Than Zero	VCGT (immediate #0) on page F6-3772
Vector Compare Less Than or Equal to Zero	VCLE (immediate #0) on page F6-3778
Vector Compare Less Than Zero	VCLT (immediate #0) on page F6-3785
Vector Test Bits	VTST on page F6-4295

F1.13.4 Advanced SIMD shift instructions

Table F1-23 lists the shift instructions in the Advanced SIMD instruction set.

Table F1-23 Advanced SIMD shift instructions

Instruction	See
Vector Saturating Rounding Shift Left	<i>VQRSHL</i> on page F6-4115
Vector Saturating Rounding Shift Right and Narrow	<i>VQRSHRN</i> , <i>VQRSHRUN</i> on page F6-4119
Vector Saturating Shift Left	<i>VQSHL (register)</i> on page F6-4127 <i>VQSHL</i> , <i>VQSHLU (immediate)</i> on page F6-4124
Vector Saturating Shift Right and Narrow	<i>VQSHRN</i> , <i>VQSHRUN</i> on page F6-4131
Vector Rounding Shift Left	<i>VRSHL</i> on page F6-4181
Vector Rounding Shift Right	<i>VRSHR</i> on page F6-4183
Vector Rounding Shift Right and Accumulate	<i>VRSRA</i> on page F6-4195
Vector Rounding Shift Right and Narrow	<i>VRSHRN</i> on page F6-4187
Vector Shift Left	<i>VSHL (immediate)</i> on page F6-4203 <i>VSHL (register)</i> on page F6-4205
Vector Shift Left Long	<i>VSHLL</i> on page F6-4207
Vector Shift Right	<i>VSHR</i> on page F6-4210
Vector Shift Right and Narrow	<i>VSHRN</i> on page F6-4214
Vector Shift Left and Insert	<i>VSLI</i> on page F6-4218
Vector Shift Right and Accumulate	<i>VSRA</i> on page F6-4222
Vector Shift Right and Insert	<i>VSRI</i> on page F6-4224

F1.13.5 Advanced SIMD multiply instructions

Table F1-24 summarizes the Advanced SIMD multiply instructions.

Table F1-24 Advanced SIMD multiply instructions

Instruction	See
Vector Multiply Accumulate	<i>VMLA (integer)</i> on page F6-3966 <i>VMLA (floating-point)</i> on page F6-3962 <i>VMLA (by scalar)</i> on page F6-3968
Vector Multiply Accumulate Long	<i>VMLAL (integer)</i> on page F6-3971 <i>VMLAL (by scalar)</i> on page F6-3973
Vector Multiply Subtract	<i>VMLS (integer)</i> on page F6-3979 <i>VMLS (floating-point)</i> on page F6-3975 <i>VMLS (by scalar)</i> on page F6-3981
Vector Multiply Subtract Long	<i>VMLS (integer)</i> on page F6-3984 <i>VMLS (by scalar)</i> on page F6-3986
Vector Multiply	<i>VMUL (integer and polynomial)</i> on page F6-4026 <i>VMUL (floating-point)</i> on page F6-4022 <i>VMUL (by scalar)</i> on page F6-4028
Vector Multiply Long	<i>VMULL (integer and polynomial)</i> on page F6-4031 <i>VMULL (by scalar)</i> on page F6-4033
Vector Fused Multiply Accumulate	<i>VFMA</i> on page F6-3861
Vector Fused Multiply Subtract	<i>VFMS</i> on page F6-3865
Vector Saturating Doubling Multiply Accumulate Long	<i>VQDMLAL</i> on page F6-4088
Vector Saturating Doubling Multiply Subtract Long	<i>VQDMLSL</i> on page F6-4091
Vector Saturating Doubling Multiply Returning High Half	<i>VQDMULH</i> on page F6-4094
Vector Saturating Doubling Multiply Long	<i>VQDMULL</i> on page F6-4097
Vector Saturating Rounding Doubling Multiply Accumulate Returning High Half	<i>VQRDMLAH</i> on page F6-4104
Vector Saturating Rounding Doubling Multiply Subtract Returning High Half	<i>VQRDMLSH</i> on page F6-4108
Vector Saturating Rounding Doubling Multiply Returning High Half	<i>VQRDMULH</i> on page F6-4112

Advanced SIMD multiply instructions can operate on vectors of:

- 8-bit, 16-bit, or 32-bit unsigned integers.
- 8-bit, 16-bit, or 32-bit signed integers.
- 8-bit polynomials over {0, 1}. *VMUL* and *VMULL* are the only instructions that operate on polynomials. *VMULL* produces a 16-bit polynomial over {0, 1}.
- Single-precision (32-bit) or half-precision (16-bit) floating-point numbers.

They can also act on one vector and one scalar.

Long instructions have doubleword (64-bit) operands, and produce quadword (128-bit) results. Other Advanced SIMD multiply instructions can have either doubleword or quadword operands, and produce results of the same size.

Floating-point multiply instructions can operate on:

- **Half-precision (16-bit) floating-point numbers.**
- Single-precision (32-bit) floating-point numbers.
- Double-precision (64-bit) floating-point numbers.

F1.13.6 Miscellaneous Advanced SIMD data-processing instructions

Table F1-25 shows miscellaneous Advanced SIMD data-processing instructions.

Table F1-25 Miscellaneous Advanced SIMD data-processing instructions

Instruction	See
Vector Absolute Difference and Accumulate	<i>VABA</i> on page F6-3711
Vector Absolute Difference and Accumulate Long	<i>VABAL</i> on page F6-3713
Vector Absolute Difference	<i>VABD</i> (<i>integer</i>) on page F6-3717 <i>VABD</i> (<i>floating-point</i>) on page F6-3715
Vector Absolute Difference Long	<i>VABDL</i> (<i>integer</i>) on page F6-3719
Vector Absolute	<i>VABS</i> on page F6-3721
Vector Convert between floating-point and fixed point	<i>VCVT</i> (<i>between floating-point and fixed-point, Advanced SIMD</i>) on page F6-3816
Vector Convert between floating-point and integer	<i>VCVT</i> (<i>between floating-point and integer, Advanced SIMD</i>) on page F6-3806
Vector Convert between half-precision and single-precision	<i>VCVT</i> (<i>between half-precision and single-precision, Advanced SIMD</i>) on page F6-3804
Vector Count Leading Sign Bits	<i>VCLS</i> on page F6-3783
Vector Count Leading Zeros	<i>VCLZ</i> on page F6-3790
Vector Count Set Bits	<i>VCNT</i> on page F6-3800
Vector Duplicate scalar	<i>VDUP</i> (<i>scalar</i>) on page F6-3853
Vector Extract	<i>VEXT</i> (<i>byte elements</i>) on page F6-3857
Vector move Insertion	<i>VINS</i> on page F6-3879
Vector Move and Narrow	<i>VMOVN</i> on page F6-4013
Vector Move Long	<i>VMOVL</i> on page F6-4011
Vector Move extraction	<i>VMOVX</i> on page F6-4015
Vector Maximum	<i>VMAX</i> (<i>integer</i>) on page F6-3948 <i>VMAX</i> (<i>floating-point</i>) on page F6-3946
Vector Minimum	<i>VMIN</i> (<i>integer</i>) on page F6-3956 <i>VMIN</i> (<i>floating-point</i>) on page F6-3954
Vector Negate	<i>VNEG</i> on page F6-4041
Vector Pairwise Maximum	<i>VPMAX</i> (<i>integer</i>) on page F6-4074 <i>VPMAX</i> (<i>floating-point</i>) on page F6-4072

Table F1-25 Miscellaneous Advanced SIMD data-processing instructions (continued)

Instruction	See
Vector Pairwise Minimum	<i>VPMIN (integer)</i> on page F6-4078 <i>VPMIN (floating-point)</i> on page F6-4076
Vector Reciprocal Estimate	<i>VRECPE</i> on page F6-4140
Vector Reciprocal Step	<i>VRECPS</i> on page F6-4142
Vector Reciprocal Square Root Estimate	<i>VRSQRTE</i> on page F6-4191
Vector Reciprocal Square Root Step	<i>VRSQRTS</i> on page F6-4193
Vector Reverse in halfwords	<i>VREV16</i> on page F6-4144
Vector Reverse in words	<i>VREV32</i> on page F6-4147
Vector Reverse in doublewords	<i>VREV64</i> on page F6-4150
Vector Saturating Absolute	<i>VQABS</i> on page F6-4084
Vector Saturating Move and Narrow	<i>VQMOVN</i> , <i>VQMOVUN</i> on page F6-4100
Vector Saturating Negate	<i>VQNEG</i> on page F6-4102
Vector Swap	<i>VSWP</i> on page F6-4288
Vector Table Lookup	<i>VTBL</i> , <i>VTBX</i> on page F6-4290
Vector Transpose	<i>VTRN</i> on page F6-4293
Vector Unzip	<i>VUZP</i> on page F6-4297
Vector Zip	<i>VZIP</i> on page F6-4300

F1.14 Floating-point data-processing instructions

Table F1-26 summarizes the data-processing instructions in the floating-point instruction set. In this table, *floating-point register* means a register in the SIMD and floating-point register file.

For details of the floating-point arithmetic used by floating-point instructions, see *Floating-point and Advanced SIMD support* on page A1-48.

Table F1-26 Floating-point data-processing instructions

Instruction	See
Convert between double-precision and single-precision	<i>VCVT (between double-precision and single-precision)</i> on page F6-3802
Convert between floating-point and fixed-point	<i>VCVT (between floating-point and fixed-point, floating-point)</i> on page F6-3819
Convert between half-precision and single-precision, writing to bottom half of single-precision register	<i>VCVTB</i> on page F6-3827
Convert between half-precision and single-precision, writing to top half of single-precision register	<i>VCVTT</i> on page F6-3846
Convert from floating-point to integer	<i>VCVT (floating-point to integer, floating-point)</i> on page F6-3809
Convert from floating-point to integer using FPSCR rounding mode	<i>VCVTR</i> on page F6-3842
Convert from integer to floating-point	<i>VCVT (integer to floating-point, floating-point)</i> on page F6-3813
Copy from one floating-point register to another	<i>VMOV (register)</i> on page F6-3998
Divide	<i>VDIV</i> on page F6-3849
Move immediate value to a floating-point register	<i>VMOV (immediate)</i> on page F6-3992
Square Root	<i>VSQRT</i> on page F6-4220
Vector Absolute value	<i>VABS</i> on page F6-3721
Vector Add	<i>VADD (floating-point)</i> on page F6-3733
Vector Compare with exceptions disabled	<i>VCMP</i> on page F6-3796
Vector Compare with exceptions enabled	<i>VCMP</i> on page F6-3792
Vector Fused Multiply Accumulate	<i>VFMA</i> on page F6-3861
Vector Fused Multiply Subtract	<i>VFMS</i> on page F6-3865
Vector Fused Negate Multiply Accumulate	<i>VFNMA</i> on page F6-3869
Vector Fused Negate Multiply Subtract	<i>VFNMS</i> on page F6-3872
Vector Multiply	<i>VMUL (floating-point)</i> on page F6-4022
Vector Multiply Accumulate	<i>VMLA (floating-point)</i> on page F6-3962
Vector Multiply Subtract	<i>VMLS (floating-point)</i> on page F6-3975
Vector Negate Multiply	<i>VNMUL</i> on page F6-4051
Vector Negate Multiply Accumulate	<i>VNMLA</i> on page F6-4045

Table F1-26 Floating-point data-processing instructions (continued)

Instruction	See
Vector Negate Multiply Subtract	VNMLS on page F6-4048
Vector Negate, by inverting the sign bit	VNEG on page F6-4041
Vector Subtract	VSUB (floating-point) on page F6-4276

Chapter F2

About the T32 and A32 Instruction Descriptions

This chapter describes each instruction. It contains the following sections:

- *Format of instruction descriptions* on page F2-2844.
- *Standard assembler syntax fields* on page F2-2848.
- *Conditional execution* on page F2-2849.
- *Shifts applied to a register* on page F2-2852.
- *Memory accesses* on page F2-2854.
- *Encoding of lists of general-purpose registers and the PC* on page F2-2855.
- *General information about the T32 and A32 instruction descriptions* on page F2-2856.
- *Additional pseudocode support for instruction descriptions* on page F2-2868.
- *Additional information about Advanced SIMD and floating-point instructions* on page F2-2869.

F2.1 Format of instruction descriptions

The instruction descriptions in [Chapter F5 T32 and A32 Base Instruction Set Instruction Descriptions](#) and [Chapter F6 T32 and A32 Advanced SIMD and floating-point Instruction Descriptions](#) normally use the following format:

- Instruction section title.
- Introduction to the instruction.
- A description of each encoding of the instruction.
- Assembler syntax.
- Pseudocode describing how the instruction operates.
- Notes, if applicable.

Each of these items is described in more detail in the following subsections.

F2.1.1 Instruction section title

The instruction section title gives the base mnemonic for the instruction or instructions described in the section. When one mnemonic has multiple forms described in separate instruction sections, this is followed by a short description of the form in parentheses. The most common use of this is to distinguish between forms of an instruction in which one of the operands is an immediate value and forms in which it is a register.

F2.1.2 Introduction to the instruction

The introduction to the instruction briefly describes the main features of the instruction. This description is not necessarily complete and is not definitive. If there is any conflict between it and the more detailed information that follows, the latter takes priority.

F2.1.3 Instruction encodings

This is a list of one or more instruction encodings. Each instruction encoding is labelled as:

- A1, A2, A3 ... for the first, second, third and any additional A32 encodings.
- T1, T2, T3 ... for the first, second, third and any additional T32 encodings.

Each instruction encoding description consists of:

- An assembly syntax that ensures that the assembler selects the encoding in preference to any other encoding. In some cases, multiple syntax variants are given. These are written in a typewriter font using the conventions described in [Assembler syntax prototype line conventions on page F2-2846](#). The correct one to use can be indicated by:
 - A subheading that identifies the encodings that correspond to the syntax. See, for example, the subheading *Flag setting, rotate right with extend variant* in the description of the A1 encoding of the ADC, ADCS (register) instructions in [A1 on page F5-3007](#).
 - An annotation to the syntax, such as *Inside IT block* or *Outside IT block*. See, for example, the syntax descriptions of the T1 encoding of the ADC, ADCS (register) instructions in [T1 on page F5-3008](#).

In other cases, the correct one to use can be determined by looking at the assembler syntax description and using it to determine which syntax corresponds to the instruction being disassembled.

There is usually more than one syntax variant that ensures re-assembly to any particular encoding, and the exact set of syntaxes that do so usually depends on the register numbers, immediate constants and other operands to the instruction. For example, when assembling to the T32 instruction set, the syntax `AND R0, R0, R8` ensures selection of a 32-bit encoding but `AND R0, R0, R1` selects a 16-bit encoding.

For each instruction encoding belonging to a target instruction set, an assembler can use this information to determine whether it can use that encoding to encode the instruction requested by the UAL source. If multiple encodings can encode the instruction then:

- If both a 16-bit encoding and a 32-bit encoding can encode the instruction, the architecture *prefers* the 16-bit encoding. This means the assembler must use the 16-bit encoding rather than the 32-bit encoding.
 Software can use the `.W` and `.N` qualifiers to specify the required encoding width, see [Standard assembler syntax fields on page F2-2848](#).
- If multiple encodings of the same length can encode the instruction, the *Assembler syntax* subsection says which encoding is preferred, and how software can, instead, select the other encodings.
 Each encoding also documents UAL syntax that selects it in preference to any other encoding.

If no encodings of the target instruction set can encode the instruction requested by the UAL source, normally the assembler generates an error saying that the instruction is not available in that instruction set.

———— **Note** —————

In some cases, an instruction is available in one instruction set but not in another. The *Assembler syntax* subsection identifies many of these cases. For example, the A32 instructions with bits<31:28> == 0b1111 described in [Branch, branch with link, and block data transfer on page F4-2970](#), [System register access, Advanced SIMD, floating-point, and Supervisor call on page F4-2972](#), and [Unconditional instructions on page F4-2983](#) cannot have a Condition code, but the equivalent T32 instructions often can, and this usually appears in the *Assembler syntax* subsection as a statement that the A32 instruction cannot be conditional.

However, some such cases are too complex to describe in the available space, so the definitive test of whether an instruction is available in a given instruction set is whether there is an available encoding for it in that instruction set.

The assembly syntax given for an encoding is therefore a suitable one for a disassembler to disassemble that encoding to. However, disassemblers might wish to use simpler syntaxes when they are suitable for the operand combination, in order to produce more readable disassembled code.

- An encoding diagram, where:
 - For a 32-bit A32 encoding diagram, the bits are numbered from 31 to 0.
 - For a 16-bit T32 encoding diagram, the bits are numbered from 15 to 0.
 This halfword can be described as `hw1` of the instruction.
 - For a 32-bit T32 encoding diagram, the bits are numbered from 15 to 0 for each halfword, as a reminder that a 32-bit T32 instruction consists of two consecutive halfwords rather than a word.
 In this case, the left-hand halfword in the diagram is identified as `hw1`, and the right-hand halfword is identified as `hw2`.

Where instructions are stored using the standard little-endian instruction endianness:

- The encoding diagram for an A32 instruction at address `A` shows, from left to right, the bytes at addresses `A+3`, `A+2`, `A+1`, `A`.
- The encoding diagram for a 32-bit T32 instruction shows bytes in the order `A+1`, `A` for `hw1`, followed by bytes `A+3`, `A+2` for `hw2`.
- Encoding-specific pseudocode. This is pseudocode that translates the encoding-specific instruction fields into inputs to the encoding-independent pseudocode in the *Operation* subsection, and that picks out any special cases in the encoding. For a detailed description of the pseudocode used and of the relationship between the encoding diagram, the encoding-specific pseudocode and the encoding-independent pseudocode, see [Appendix K10 ARM Pseudocode Definition](#).

F2.1.4 Assembler symbols

The *Assembly symbols* describes the standard UAL syntax for the instruction.

Each syntax description consists of the following elements:

- Descriptions of all of the variable or optional fields of the syntax.
Some syntax fields are standardized across all or most instructions. [Standard assembler syntax fields on page F2-2848](#) describes these fields.
By default, syntax fields that specify registers, such as <Rd>, <Rn>, or <Rt>, can be any of R0-R12 or LR in T32 instructions, and any of R0-R12, SP or LR in A32 instructions. These require that the encoding-specific pseudocode set the corresponding integer variable (such as d, n, or t) to the corresponding register number, using 0-12 for R0-R12, 13 for SP, or 14 for LR:
 - Normally, software can do this by setting the corresponding field in the instruction, typically named Rd, Rn, Rt, to the binary encoding of that number.
 - In the case of 16-bit T32 encodings, the field is normally of length 3, and so the encoding is only available when the assembler syntax specifies one of R0-R7. Such encodings often use a register field name like Rdn. This indicates that the encoding is only available if <Rd> and <Rn> specify the same register, and that the register number of that register is encoded in the field if they do.The description of a syntax field that specifies a register sometimes extends or restricts the permitted range of registers or documents other differences from the default rules for such fields. Examples of extensions are permitting the use of the SP in a T32 instruction, or permitting the use of the PC, identified using register number 15.
- Where appropriate, text that briefly describes changes from the pre-UAL assembler syntax. Where present, this usually consists of an alternative pre-UAL form of the assembler mnemonic. The pre-UAL assembler syntax does not conflict with UAL. ARM recommends that it is supported, as an optional extension to UAL, so that pre-UAL assembler source files can be assembled.

Assembler syntax prototype line conventions

The following conventions are used in assembler syntax prototype lines and their subfields:

- < > Any item bracketed by < and > is a short description of a type of value to be supplied by the user in that position. A longer description of the item is normally supplied by subsequent text. Such items often correspond to a similarly named field in an encoding diagram for an instruction. When the correspondence only requires the binary encoding of an integer value or register number to be substituted into the instruction encoding, it is not described explicitly. For example, if the assembler syntax for an instruction contains an item <Rn> and the instruction encoding diagram contains a 4-bit field named Rn, the number of the register specified in the assembler syntax is encoded in binary in the instruction field.
If the correspondence between the assembler syntax item and the instruction encoding is more complex than simple binary encoding of an integer or register number, the item description indicates how it is encoded. This is often done by specifying a required output from the encoding-specific pseudocode, such as add = TRUE. The assembler must only use encodings that produce that output.
- { } Any item bracketed by { and } is optional. A description of the item and of how its presence or absence is encoded in the instruction is normally supplied by subsequent text.
Many instructions have an optional destination register. Unless otherwise stated, if such a destination register is omitted, it is the same as the immediately following source register in the instruction syntax.
- # In the assembler syntax, numeric constants are normally preceded by a #. Some UAL instruction syntax descriptions explicitly show this # as optional. Any UAL assembler:
 - Must treat the # as optional where an instruction syntax description shows it as optional.
 - Can treat the # either as mandatory or as optional where an instruction syntax description does not show it as optional.

Note

ARM recommends that UAL assemblers treat all uses of # shown in this manual as optional.

spaces Single spaces are used for clarity, to separate items. When a space is obligatory in the assembler syntax, two or more consecutive spaces are used.

+/- This indicates an optional + or - sign. If neither is coded, + is assumed.

All other characters must be encoded precisely as they appear in the assembler syntax. Apart from { and }, the special characters described above do not appear in the basic forms of assembler instructions documented in this manual. In a few places, the { and } characters must be encoded as part of a variable item. When this happens, the long description of the variable item indicates how they must be used.

F2.1.5 Pseudocode describing how the instruction operates

The *Operation for all classes* subsection contains encoding-independent pseudocode that describes the main operation of the instruction. For a detailed description of the pseudocode used and of the relationship between the encoding diagram, the encoding-specific pseudocode and the encoding-independent pseudocode, see [Appendix K10 ARM Pseudocode Definition](#).

F2.2 Standard assembler syntax fields

The following assembler syntax fields are standard across all or most instructions:

<c> Is an optional field. It specifies the condition under which the instruction is executed. See [Conditional execution on page F2-2849](#) for the range of available conditions and their encoding. If <c> is omitted, it defaults to *always* (AL).

<q> Specifies optional assembler qualifiers on the instruction. The following qualifiers are defined:

.N Meaning narrow, specifies that the assembler must select a 16-bit encoding for the instruction. If this is not possible, an assembler error is produced.

.W Meaning wide, specifies that the assembler must select a 32-bit encoding for the instruction. If this is not possible, an assembler error is produced.

If neither .W nor .N is specified, the assembler can select either 16-bit or 32-bit encodings. If both are available, it must select a 16-bit encoding. In a few cases, more than one encoding of the same length can be available for an instruction. The rules for selecting between such encodings are instruction-specific and are part of the instruction description. The assembler syntax includes a mandatory .W qualifier, along with a note describing the cases in which it applies, where this qualifier is required to select a particular encoding for an instruction. Additional assembler syntax will describe the syntax when the conditions are not met.

———— **Note** —————

When assembling to the A32 instruction set, the .N qualifier produces an assembler error and the .W qualifier has no effect.

F2.3 Conditional execution

Most T32 and A32 instructions can be executed conditionally, based on the values of the APSR Condition flags. [Table F2-1](#) lists the available conditions.

Table F2-1 Condition codes

cond	Mnemonic extension	Meaning (integer)	Meaning (floating-point) ^a	Condition flags
0000	EQ	Equal	Equal	Z == 1
0001	NE	Not equal	Not equal, or unordered	Z == 0
0010	CS ^b	Carry set	Greater than, equal, or unordered	C == 1
0011	CC ^c	Carry clear	Less than	C == 0
0100	MI	Minus, negative	Less than	N == 1
0101	PL	Plus, positive or zero	Greater than, equal, or unordered	N == 0
0110	VS	Overflow	Unordered	V == 1
0111	VC	No overflow	Not unordered	V == 0
1000	HI	Unsigned higher	Greater than, or unordered	C == 1 and Z == 0
1001	LS	Unsigned lower or same	Less than or equal	C == 0 or Z == 1
1010	GE	Signed greater than or equal	Greater than or equal	N == V
1011	LT	Signed less than	Less than, or unordered	N != V
1100	GT	Signed greater than	Greater than	Z == 0 and N == V
1101	LE	Signed less than or equal	Less than, equal, or unordered	Z == 1 or N != V
1110	None (AL) ^d	Always (unconditional)	Always (unconditional)	Any

- a. Unordered means at least one NaN operand.
- b. HS (unsigned higher or same) is a synonym for CS.
- c. L0 (unsigned lower) is a synonym for CC.
- d. AL is an optional mnemonic extension for always, except in IT instructions. For details see [IT on page F5-3126](#).

In T32 instructions, the condition, if it is not AL, is normally encoded in a preceding IT instruction. For more information see [Conditional instructions on page F1-2809](#) and [IT on page F5-3126](#). Some conditional branch instructions do not require a preceding IT instruction, because they include a Condition code in their encoding.

For performance reasons, ARMv8 deprecates the use of IT other than with a single 16-bit T32 instruction from a specified subset of the 16-bit T32 instructions, see [Partial deprecation of IT on page F1-2826](#). In addition, implementations can provide a set of ITD control fields, `SCTLR.ITD`, `SCTLR_EL1.ITD`, and `HSCTLR.ITD`, to disable these deprecated uses, making them UNDEFINED. For more information see:

- [Disabling or enabling PL0 and PL1 use of AArch32 deprecated functionality on page G1-4421](#).
- [Disabling or enabling EL2 use of AArch32 deprecated functionality on page G1-4430](#).

In A32 instructions, bits[31:28] of the instruction contain either:

- The Condition code, see [The Condition code field in A32 instruction encodings on page F2-2850](#).
- `0b1111` for some A32 instructions that can only be executed unconditionally.

ARM deprecates the conditional execution of any instruction encoding provided by Advanced SIMD that is not also provided by floating-point, and strongly recommends that:

- For A32 instructions, any such Advanced SIMD instruction that can be conditionally executed is executed with the <c> field omitted or set to AL.

———— **Note** ————

This applies only to VDUP, see *VDUP (general-purpose register)* on page F6-3851. The other A32 instructions do not permit conditional execution.

- For T32 instructions, such Advanced SIMD instructions are never included in an IT block. This means they must be specified with the <c> field omitted or set to AL.

This deprecation does not apply to Advanced SIMD instruction encodings that are also available as floating-point instruction encodings. That is, it does not apply to the Advanced SIMD encodings of the instructions described in the following sections:

- *VLDM, VLDMDB, VLDMIA* on page F6-3935.
- *VLDR (immediate)* on page F6-3940 and *VLDR (literal)* on page F6-3943.
- *VMOV (general-purpose register to scalar)* on page F6-4002.
- *VMOV (between two general-purpose registers and a doubleword floating-point register)* on page F6-3988.
- *VMSR* on page F6-4017.
- *VMSR* on page F6-4020.
- *VPOP* on page F6-4080.
- *VPUSH* on page F6-4082.
- *VSTM, VSTMDB, VSTMIA* on page F6-4268.
- *VSTR* on page F6-4273.

See also *Conditional execution of undefined instructions* on page G1-4378.

F2.3.1 The Condition code field in A32 instruction encodings

Every conditional A32 instruction contains a 4-bit Condition code field, the cond field, in bits 31 to 28:

31	30	29	28	27	26	25	24	23	22	21	20	19	18	17	16	15	14	13	12	11	10	9	8	7	6	5	4	3	2	1	0
cond																															

This field contains one of the values 0b0000-0b1110, as shown in Table F2-1 on page F2-2849. Most instruction mnemonics can be extended with the letters defined in the *Mnemonic extension* on page F2-2849 column of that table.

If the *always* (AL) condition is specified, the instruction is executed irrespective of the value of the Condition flags. The absence of a Condition code on an instruction mnemonic implies the AL Condition code.

F2.3.2 Pseudocode description of conditional execution

The `AArch32.CurrentCond()` function returns a 4-bit condition specifier as follows:

- For A32 instructions, it returns bits[31:28] of the instruction.
- For the T1 and T3 encodings of the Branch instruction (see *B* on page F5-3051), it returns the 4-bit cond field of the encoding.
- For all other T32 instructions:
 - If `PSTATE.IT<3:0> != '0000'` it returns `PSTATE.IT<7:4>`.
 - If `PSTATE.IT<7:0> == '00000000'` it returns `'1110'`.
 - Otherwise, execution of the instruction is CONstrained UNpredictable.

For more information, see *Process state, PSTATE* on page E1-2734.

The `ConditionPassed()` function uses this condition specifier and the Condition flags to determine whether the instruction must be executed, by calling the `ConditionHolds()` function.

Chapter J1 *ARMv8 Pseudocode* includes the definitions of these functions.

Undefined Instruction exception on page G1-4376 describes the handling of conditional instructions that are UNDEFINED, UNPREDICTABLE, or CONSTRAINED UNPREDICTABLE. The pseudocode in the manual, as a sequential description of the instructions, has limitations in this respect. For more information, see *Limitations of the instruction pseudocode* on page K10-6256.

F2.4 Shifts applied to a register

A32 register offset load/store word and unsigned byte instructions can apply a wide range of different constant shifts to the offset register. Both T32 and A32 data-processing instructions can apply the same range of different constant shifts to the second operand register. For details see *Constant shifts*.

A32 data-processing instructions can apply a register-controlled shift to the second operand register.

F2.4.1 Constant shifts

These are the same in T32 and A32 instructions, except that the input bits come from different positions.

<shift> is an optional shift to be applied to <Rm>. It can be any one of:

(omitted)	No shift.
LSL #<n>	Logical shift left <n> bits. $1 \leq \langle n \rangle \leq 31$.
LSR #<n>	Logical shift right <n> bits. $1 \leq \langle n \rangle \leq 32$.
ASR #<n>	Arithmetic shift right <n> bits. $1 \leq \langle n \rangle \leq 32$.
ROR #<n>	Rotate right <n> bits. $1 \leq \langle n \rangle \leq 31$.
RRX	Rotate right one bit, with extend. Bit[0] is written to shifter_carry_out, bits[31:1] are shifted right one bit, and the Carry flag is shifted into bit[31].

————— Note —————

Assemblers can permit the use of some or all of ASR #0, LSL #0, LSR #0, and ROR #0 to specify that no shift is to be performed. This is not standard UAL, and the encoding selected for T32 instructions might vary between UAL assemblers if it is used. To ensure disassembled code assembles to the original instructions, disassemblers must omit the shift specifier when the instruction specifies no shift.

Similarly, assemblers can permit the use of #0 in the immediate forms of ASR, LSL, LSR, and ROR instructions to specify that no shift is to be performed, that is, that a MOV (register) instruction is wanted. Again, this is not standard UAL, and the encoding selected for T32 instructions might vary between UAL assemblers if it is used. To ensure disassembled code assembles to the original instructions, disassemblers must use the MOV (register) syntax when the instruction specifies no shift.

Encoding

The assembler encodes <shift> into two type bits and five immediate bits, as follows:

(omitted)	type = 0b00, immediate = 0.
LSL #<n>	type = 0b00, immediate = <n>.
LSR #<n>	type = 0b01. If <n> < 32, immediate = <n>. If <n> == 32, immediate = 0.
ASR #<n>	type = 0b10. If <n> < 32, immediate = <n>. If <n> == 32, immediate = 0.
ROR #<n>	type = 0b11, immediate = <n>.
RRX	type = 0b11, immediate = 0.

F2.4.2 Register controlled shifts

These are only available in A32 instructions.

<type> is the type of shift to apply to the value read from <Rm>. It must be one of:

ASR	Arithmetic shift right, encoded as type = 0b10.
LSL	Logical shift left, encoded as type = 0b00.
LSR	Logical shift right, encoded as type = 0b01.
ROR	Rotate right, encoded as type = 0b11.

The bottom byte of <Rs> contains the shift amount.

F2.4.3 Pseudocode description of instruction-specified shifts and rotates

The pseudocode enumeration [SRTType](#){`}` defines the shift types. Shift and rotate instruction decode is described by the pseudocode function:

- [DecodeImmShift](#)() for a constant shift.
- [DecodeRegShift](#)() for a register controlled shift.

Shift and rotate operations are made by the pseudocode function [Shift](#)().

F2.5 Memory accesses

Commonly, the following addressing modes are permitted for memory access instructions:

Offset addressing

The offset value is applied to an address obtained from the base register. The result is used as the address for the memory access. The value of the base register is unchanged.

The assembly language syntax for this mode is:

[<Rn>, <offset>]

Pre-indexed addressing

The offset value is applied to an address obtained from the base register. The result is used as the address for the memory access, and written back into the base register.

The assembly language syntax for this mode is:

[<Rn>, <offset>]!

Post-indexed addressing

The address obtained from the base register is used, unchanged, as the address for the memory access. The offset value is applied to the address, and written back into the base register.

The assembly language syntax for this mode is:

[<Rn>], <offset>

In each case, <Rn> is the base register. <offset> can be:

- An immediate constant, such as <imm8> or <imm12>.
- An index register, <Rm>.
- A shifted index register, such as <Rm>, LSL #<shift>.

For information about unaligned access, endianness, and exclusive access, see:

- [Alignment support on page E2-2777](#).
- [Endian support on page E2-2779](#).
- [Synchronization and semaphores on page E2-2795](#).

F2.6 Encoding of lists of general-purpose registers and the PC

A number of instructions operate on lists of general-purpose registers. For some load instructions, the list of registers to be loaded can include the PC. For these instructions, the assembler syntax includes a <registers> field, that provides a list of the registers to be operated on, with list entries separated by commas.

The registers list is encoded in the instruction encoding. Most often, this is done using an 8-bit, 13-bit, or 16-bit register_list field. This section gives more information about these and other possible register list encodings.

In a register_list field, each bit corresponds to a single register, and if the <registers> field of the assembler instruction includes Rt then register_list<t> is set to 1, otherwise it is set to 0.

The full rules for the encoding of lists of general-purpose registers, and possibly the PC, are:

- Except for the cases listed here, 16-bit T32 encodings use an 8-bit register list, and can access only registers R0-R7.

The exceptions to this rule are:

- The T1 encoding of POP uses an 8-bit register list, and an additional bit, P, that corresponds to the PC. This means it can access any of R0-R7 and the PC.
- The T1 encoding of PUSH uses an 8-bit register list, and an additional bit, M, that corresponds to the LR. This means it can access any of R0-R7 and the LR.
- 32-bit T32 encodings of load operations use a 13-bit register list, and two additional bits, M, corresponding to the LR, and P, corresponding to the PC. This means these instructions can access any of R0-R12 and the LR and PC.
- 32-bit T32 encodings of store operations use a 13-bit register list, and one additional bit, M, corresponding to the LR. This means these instructions can access any of R0-R12 and the LR.
- Except for the case listed here, A32 encodings use a 16-bit register list. This means these instructions can access any of R0-R12 and the SP, LR, and PC.
The exception to this rule is:
 - The system instructions LDM (exception return) and LDM (User registers) use a 15-bit register list. This means these instructions can access any of R0-R12 and the SP and LR.
- The T3 and A2 encodings of POP, and the T3 and A2 encodings of PUSH, access a single register from the set of registers {R0-R12, LR, PC} and encode the register number in the Rt field.

———— **Note** —————

POP is a load operation, and PUSH is a store operation.

In every case, the encoding-specific pseudocode converts the register list into a 32-bit variable, registers, with a bit corresponding to each of the registers R0-R12, SP, LR, and PC.

———— **Note** —————

Some floating-point and Advanced SIMD instructions operate on lists of SIMD and floating-point registers. The assembler syntax of these instructions includes a <list> field that specifies the registers to be operated on, and the description of the instruction in [Alphabetical list of T32 and A32 base instruction set instructions on page F5-3004](#) defines the use and encoding of this field.

F2.7 General information about the T32 and A32 instruction descriptions

Chapter F3 *T32 Instruction Set Encoding* describes the T32 instruction encodings, and Chapter F4 *A32 Instruction Set Encoding* describes the A32 instruction encodings. The following subsections give more information about the descriptions of these instructions and their encodings:

- *UNDEFINED, UNPREDICTABLE, and CONSTRAINED UNPREDICTABLE instruction set space.*
- *T32 and A32 Advanced SIMD and floating-point instruction encodings on page F2-2857.*
- *The PC and the use of 0b1111 as a register specifier in T32 and A32 instructions on page F2-2861.*
- *The SP and the use of 0b1101 as a register specifier in T32 and A32 instructions on page F2-2862.*
- *Modified immediate constants in T32 and A32 instructions on page F2-2862.*

F2.7.1 UNDEFINED, UNPREDICTABLE, and CONSTRAINED UNPREDICTABLE instruction set space

An attempt to execute an unallocated instruction results in either:

- Unpredictable behavior. The instruction is described as UNPREDICTABLE or CONSTRAINED UNPREDICTABLE. ARMv8-A greatly reduces the architecturally UNPREDICTABLE behavior in AArch32 state. Most cases that earlier versions of the architecture describe as UNPREDICTABLE become either:
 - CONSTRAINED UNPREDICTABLE, meaning the architecture defines a limited range of permitted behaviors.
 - Fully predictable.For more information see [Appendix K1 Architectural Constraints on UNPREDICTABLE behaviors](#).
- An Undefined Instruction exception. The instruction is described as UNDEFINED.

An instruction is UNDEFINED if it is declared as UNDEFINED in an instruction description, or in [Chapter F3 T32 Instruction Set Encoding](#) or [Chapter F4 A32 Instruction Set Encoding](#).

An instruction is UNPREDICTABLE only if:

- It is declared as UNPREDICTABLE in an instruction description or in [Chapter F3](#) or [Chapter F4](#), and [Appendix K1](#) does not redefine the behavior as CONSTRAINED UNPREDICTABLE.
- The pseudocode for that encoding does not indicate that a different special case applies, and a bit marked (0) or (1) in the encoding diagram of an instruction is not 0 or 1 respectively. In most cases, ARMv8 makes these cases CONSTRAINED UNPREDICTABLE, as described in [SBZ or SBO fields T32 and A32 in instructions on page K1-6100](#).

Unless otherwise specified, T32 and A32 instructions provided as part of an architectural extension, or by an optional feature of the architecture, are UNDEFINED in an implementation that does not include that extension or feature.

———— **Note** —————

Examples of where this rule applies are:

- The instructions provided by the Cryptographic Extension.
- The system instructions that provide access to the System registers of the OPTIONAL Performance Monitors Extension.
- The Advanced SIMD and floating-point instructions.

For more information about UNDEFINED, UNPREDICTABLE, and CONSTRAINED UNPREDICTABLE instruction behavior, see [Undefined Instruction exception on page G1-4376](#).

For more information about the behavior of T32 and A32 instructions in earlier versions of the architecture see the *ARM® Architecture Reference Manual, ARMv7-A and ARMv7-R edition*.

F2.7.2 T32 and A32 Advanced SIMD and floating-point instruction encodings

The T32 and A32 encodings of Advanced SIMD and floating-point instructions that are described in [Chapter F3 T32 Instruction Set Encoding](#) and in [Chapter F4 A32 Instruction Set Encoding](#) are common to the T32 and A32 instruction sets. This means:

- The instruction groups, and the set of instructions in each group, are identical for T32 and A32.
- For each instruction:
 - Each T32 encoding is exactly equivalent to an A32 encoding.
 - There is no T32 encoding without an equivalent A32 encoding, and no A32 encoding without an equivalent T32 encoding.

———— **Note** —————

- In the T32 instruction sets, the Advanced SIMD and floating-point instructions have 32-bit encodings.
- In the base instruction sets, some instructions are common to the T32 and A32 instruction sets, whereas other instructions have equivalent but not identical functionality in the two instruction sets.

32-bit T32 encodings are described as two contiguous halfwords, {hw1:hw2}, as described in [Instruction encodings on page F2-2844](#). In general:

- hw1 of a T32 encoding maps onto bits[31:16] of an equivalent A32 encoding.
- hw2 of a T32 encoding maps onto bits[15:0] of an equivalent A32 encoding.

However, the different structures of the T32 instruction encoding space and the A32 instruction encoding space mean that:

- For a given Advanced SIMD and floating-point instruction group:
 - The positions of the fields that identify the instruction, or instruction encoding, within the instruction group might differ between the T32 encodings and the A32 encodings.
 - However, the field values that identify the instruction of instruction encoding are identical for the T32 encoding and the A32 encoding.

The remainder of this section describes the equivalence of the T32 and A32 encodings for each of the Advanced SIMD and floating-point instruction groups.

Advanced SIMD data-processing

The T32 encoding of the Advanced SIMD data-processing group is:



The A32 encoding of the Advanced SIMD data-processing group is:

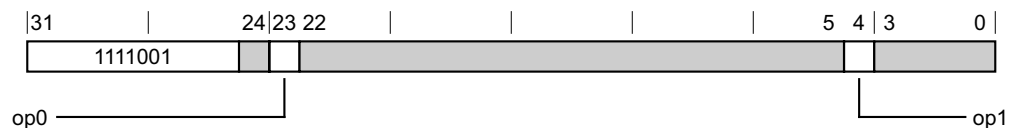

The encodings in this group are identified by:

- $hw1[15:13]$ of the T32 encoding is equivalent to bits[27:25] of the A32 encoding, and:
 - Has the value `0b111` in the T32 encoding.
 - Has the value `0b001` in the A32 encoding.
- $hw1[11:8]$ of the T32 encoding is equivalent to bits[31:28] of the A32 encoding, and has the value `0b111`.

This table shows the equivalence of the fields that identify the instructions, or instruction encodings, within this group:

T32 encoding	A32 encoding	Field size
op0:op1	op0	2 bits
op2	op1	15 bits
op3	op2	1 bit
op4	op3	1 bit

Advanced SIMD element or structure load/store

The T32 encoding of the Advanced SIMD element or structure load/store group is:

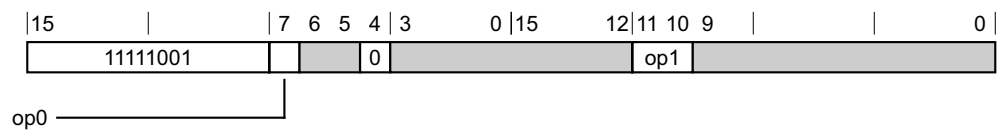

The A32 encoding of the Advanced SIMD element or structure load/store group is:

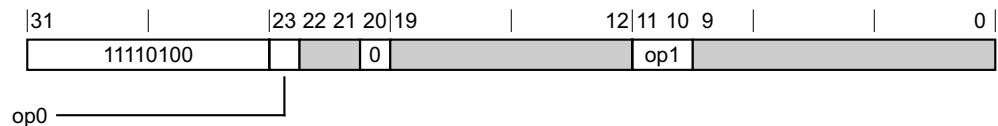

The encodings in this group are identified by:

- $hw1[15:12]$ of the T32 encoding is equivalent to bits[31:28] of the A32 encoding, and has the value `0b1111`.
- $hw1[11:8]$ of the T32 encoding is equivalent to bits[27:24] of the A32 encoding, and:
 - Has the value `0b1001` in the T32 encoding.
 - Has the value `0b0100` in the A32 encoding.
- $hw1[4]$ of the T32 encoding is equivalent to bit[20] of the A32 encoding, and has the value `0b0`.

op0, op1, and op2 are the fields that identify the instructions, or instruction encodings, within this group, and they are in equivalent positions in the T32 and A32 encodings.

Floating-point and Advanced SIMD load/store and 64-bit register moves

The T32 encoding of the Floating-point and Advanced SIMD load/store and 64-bit register moves group is:

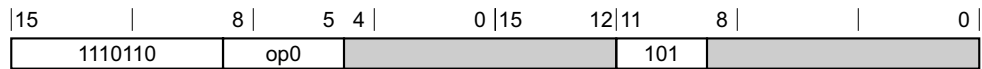

The A32 encoding of the Floating-point and Advanced SIMD load/store and 64-bit register moves group is:



The encodings in the group are identified by:

- hw1[15:12] of the T32 encoding is equivalent to bits[31:28] of the A32 encoding, and:
 - Has the value 0b1110 in the T32 encoding.
 - Can have any value other than 0b1111 in the A32 encoding.
This range of values is required because A32 instructions in this group can be executed conditionally, see [Conditional execution on page F2-2849](#).
- hw1[11:9] of the T32 encoding is equivalent to bits[27:25] of the A32 encoding, and has the value 0b110.
- hw2[11:9] of the T32 encoding is equivalent to bits[11:9] of the A32 encoding, and has the value 0b101.

op0 is the field that identifies the instructions, or instruction encodings, within this group, and is in equivalent positions in the T32 and A32 encodings.

Floating-point and Advanced SIMD 32-bit register moves

The T32 encoding of the Floating-point and Advanced SIMD 32-bit register moves group is:

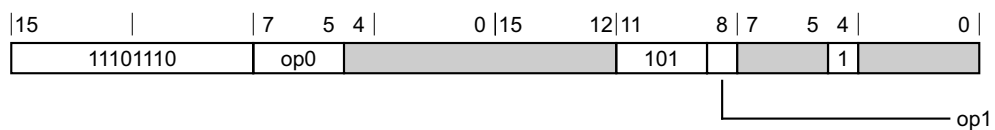

The A32 encoding of the Advanced SIMD 32-bit register moves group is:

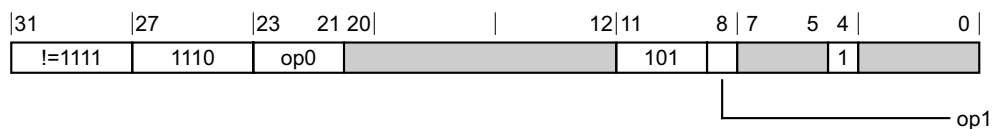

The encodings in this group are identified by:

- hw1[15:12] of the T32 encoding is equivalent to bits[31:28] of the A32 encoding, and:
 - Has the value 0b1110 in the T32 encoding.
 - Can have any value other than 0b1111 in the A32 encoding.
This range of values is required because A32 instructions in this group can be executed conditionally, see [Conditional execution on page F2-2849](#).
- hw1[11:8] of the T32 encoding is equivalent to bits[27:24] of the A32 encoding, and has the value 0b1110.

- $hw2[11:9]$ of the T32 encoding is equivalent to bits[11:9] of the A32 encoding, and has the value $0b101$.
 - $hw2[4:0]$ of the T32 encoding is equivalent to bits[4:0] of the A32 encoding, and has the value $0b11111$.
- $op0$ is the field that identifies the instructions, or instruction encodings, within this group, and is in equivalent positions in the T32 and A32 encodings.

Floating-point data-processing

The T32 encoding of the Floating-point data-processing group is:

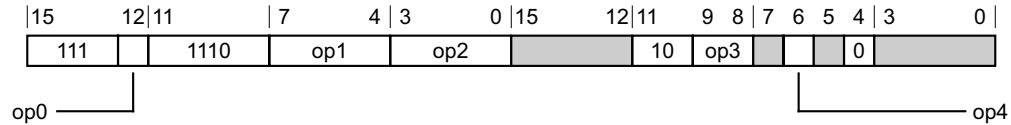

The A32 encoding of the Floating-point data-processing group is:



The encodings in this group are identified by:

- $hw1[15:12]$ of the T32 encoding is equivalent to bits[31:28] of the A32 encoding, and:
 - In the T32 encoding, $hw1[15:13]$ has the value $0b111$, and $hw1[12]$ is the $op0$ parameter used in identifying instruction encodings within this group.
 - In the A32 encoding, is the $cond$ field and also implies the value of bit[28] of some A32 instruction encodings within this group, as the following table shows:

cond	Significance of bit[28] in A32 encodings
$\neq 0b1111$	Part of the $cond$ field.
$0b1111$	Has fixed value of 1.

The range of $cond$ values other than $0b1111$ is required because A32 instructions in this group can be executed conditionally, see [Conditional execution on page F2-2849](#).

- $hw1[11:8]$ of the T32 encoding is equivalent to bits[27:24] of the A32 encoding, and has the value $0b1110$.
- $hw2[11:9]$ of the T32 encoding is equivalent to bits[11:9] of the A32 encoding, and has the value $0b101$.
- $hw2[4]$ of the T32 encoding is equivalent to bit[4] of the A32 encoding, and has the value $0b0$.

This table shows the equivalence of the fields that identify the instructions, or instruction encodings, within this group:

T32 encoding	A32 encoding
op0	Bit[28] of the instruction encoding is 1 when cond is 0b1111.
op1	op0
op2	op1
op3	op2

F2.7.3 The PC and the use of 0b1111 as a register specifier in T32 and A32 instructions

Restrictions on the use of PC or 0b1111 as a register specifier differ between the T32 and the A32 instruction sets, as described in:

- [T32 restrictions on the use of the PC, and use of 0b1111 as a register specifier.](#)
- [A32 restrictions on the use of PC or 0b1111 as a register specifier on page F2-2862.](#)

T32 restrictions on the use of the PC, and use of 0b1111 as a register specifier

The use of 0b1111 as a register specifier is not normally permitted in T32 instructions. When a value of 0b1111 is permitted, a variety of meanings is possible. For register reads, these meanings include:

- Read the PC value, that is, the address of the current instruction + 4. The base register of the table branch instructions TBB and TBH can be the PC. This means branch tables can be placed in memory immediately after the instruction.

———— **Note** —————

ARM deprecates use of the PC as the base register in the STC instruction.

- Read the word-aligned PC value, that is, the address of the current instruction + 4, with bits[1:0] forced to zero. The base register of LDC, LDR, LDRB, LDRD (pre-indexed, no writeback), LDRH, LDRSB, and LDRSH instructions can be the word-aligned PC. This provides PC-relative data addressing. In addition, some encodings of the ADD and SUB instructions permit their source registers to be 0b1111 for the same purpose.
- Read zero. This is done in some cases when one instruction is a special case of another, more general instruction, but with one operand zero. In these cases, the instructions are listed on separate pages, with a special case in the pseudocode for the more general instruction cross-referencing the other page.

For register writes, these meanings include:

- The PC can be specified as the destination register of an LDR instruction. This is done by encoding Rt as 0b1111. The loaded value is treated as an address, and the effect of execution is a branch to that address. Bit[0] of the loaded value selects whether to execute A32 or T32 instructions after the branch.
- Some other instructions write the PC in similar ways. An instruction can specify that the PC is written:
 - Implicitly, for example, branch instructions.
 - Explicitly by a register specifier of 0b1111, for example 16-bit MOV (register) instructions.
 - Explicitly by using a register mask, for example LDM instructions.

The address to branch to can be:

- A loaded value, for example, RFE.
- A register value, for example, BX.
- The result of a calculation, for example, TBB or TBH.

The method of choosing the instruction set used after the branch can be:

- Similar to the LDR case, for example, LDM or BX.
 - A fixed instruction set other than the one currently being used, for example, the immediate form of BLX.
 - Unchanged, for example, branch instructions or 16-bit MOV (register) instructions.
 - Set from the **SPSR.T** bit, for RFE and SUBS PC, LR, #imm8.
- Discard the result of a calculation. This is done in some cases when one instruction is a special case of another, more general instruction, but with the result discarded. In these cases, the instructions are listed on separate pages, with a special case in the pseudocode for the more general instruction cross-referencing the other page.
 - If the destination register specifier of an LDRB, LDRH, LDRSB, or LDRSH instruction is 0b1111, the instruction is a memory hint instead of a load operation.
 - If the destination register specifier of an MRC instruction is 0b1111, bits[31:28] of the value transferred from the System register are written to the N, Z, C, and V Condition flags in the APSR, and bits[27:0] are discarded.

A32 restrictions on the use of PC or 0b1111 as a register specifier

In A32 instructions, the use of 0b1111 as a register specifier specifies the PC.

Many instructions are **CONSTRAINED UNPREDICTABLE** if they use 0b1111 as a register specifier. This is specified by pseudocode in the instruction description. ARMv8-A constrains the resulting **CONSTRAINED UNPREDICTABLE** behavior, see [Using R15 on page K1-6097](#).

———— Note —————

ARM deprecates use of the PC as the base register in any store instruction.

F2.7.4 The SP and the use of 0b1101 as a register specifier in T32 and A32 instructions

In the T32 and A32 instruction sets, ARM recommends that the use of 0b1101 as a register specifier specifies the SP.

———— Note —————

- The recommendation that the register specifier 0b1101 is only used to specify the SP applies to both the T32 and the A32 instruction sets.
 - Despite this recommendation, T32 instructions that can access R13, or the SP, behave predictably in ARMv8. This differs from ARMv7, where many uses of R13 are defined as **UNPREDICTABLE**. For more information about these cases see the *ARM® Architecture Reference Manual, ARMv7-A and ARMv7-R edition*.
-

F2.7.5 Modified immediate constants in T32 and A32 instructions

The following sections describe the encoding of modified immediate constants:

- [Modified immediate constants in T32 instructions on page F2-2863](#).
- [Modified immediate constants in A32 instructions on page F2-2864](#).
- [Modified immediate constants in T32 and A32 Advanced SIMD instructions on page F2-2865](#).
- [Modified immediate constants in T32 and A32 floating-point instructions on page F2-2866](#).

Modified immediate constants in T32 instructions

The encoding of a modified immediate constant in a 32-bit T32 instruction is:

15	14	13	12	11	10	9	8	7	6	5	4	3	2	1	0	15	14	13	12	11	10	9	8	7	6	5	4	3	2	1	0
															imm3			a b c d e f g h													

Table F2-2 shows the range of modified immediate constants available in T32 data-processing instructions, and their encoding in the a, b, c, d, e, f, g, h, and i bits, and the imm3 field, in the instruction.

Table F2-2 Encoding of modified immediates in T32 data-processing instructions

i:imm3:a	<const> ^a
0000x	00000000 00000000 00000000 abcdefgh
0001x	00000000 abcdefgh 00000000 abcdefgh ^b
0010x	abcdefgh 00000000 abcdefgh 00000000 ^b
0011x	abcdefgh abcdefgh abcdefgh abcdefgh ^b
01000	1bcdefgh 00000000 00000000 00000000
01001	01bcdefg h0000000 00000000 00000000 ^c
01010	001bcdef gh000000 00000000 00000000
01011	0001bcde fgh00000 00000000 00000000 ^c
.	.
.	8-bit values shifted to other positions
.	.
11101	00000000 00000000 000001bc defgh000 ^c
11110	00000000 00000000 0000001b cdefgh00
11111	00000000 00000000 00000001 bcdefgh0 ^c

- a. This table shows the immediate constant value in binary form, to relate abcdefgh to the encoding diagram. In assembly syntax, the immediate value is specified in the usual way (a decimal number by default).
- b. ARM deprecates using a modified immediate with abcdefgh == 00000000, and these cases are CONSTRAINED UNPREDICTABLE, see [UNPREDICTABLE cases in immediate constants in T32 data-processing instructions](#) on page K1-6100.
- c. Not available in A32 instructions if h == 1.

Note

As the footnotes to Table F2-2 show, the range of values available in T32 modified immediate constants is slightly different from the range of values available in A32 instructions. See [Modified immediate constants in A32 instructions](#) on page F2-2864 for the A32 values.

Carry out

A logical instruction with i:imm3:a == '00xxx' does not affect the Carry flag. Otherwise, a logical flag-setting instruction sets the Carry flag to the value of bit[31] of the modified immediate constant.

Operation of modified immediate constants, T32 instructions

For a T32 data-processing instruction, the `T32ExpandImm()` pseudocode function returns the value of the 32-bit immediate constant, calling `T32ExpandImm_C()` to evaluate the constant.

Modified immediate constants in A32 instructions

The encoding of a modified immediate constant in an A32 instruction is:

31	30	29	28	27	26	25	24	23	22	21	20	19	18	17	16	15	14	13	12	11	10	9	8	7	6	5	4	3	2	1	0
																rotation		a	b	c	d	e	f	g	h						

Table F2-3 shows the range of modified immediate constants available in A32 data-processing instructions, and their encoding in the a, b, c, d, e, f, g, and h bits and the rotation field in the instruction.

Table F2-3 Encoding of modified immediates in A32 processing instructions

rotation	<const> ^a
0000	00000000 00000000 00000000 abcdefgh
0001	gh000000 00000000 00000000 00abcdef
0010	efgh0000 00000000 00000000 0000abcd
0011	cdefgh00 00000000 00000000 000000ab
0100	abcdefgh 00000000 00000000 00000000
.	.
.	8-bit values shifted to other even-numbered positions
.	.
1001	00000000 00abcdef gh000000 00000000
.	.
.	8-bit values shifted to other even-numbered positions
.	.
1110	00000000 00000000 0000abcd efgh0000
1111	00000000 00000000 000000ab cdefgh00

a. This table shows the immediate constant value in binary form, to relate abcdefgh to the encoding diagram. In assembly syntax, the immediate value is specified in the usual way (a decimal number by default).

Note

The range of values available in A32 modified immediate constants is slightly different from the range of values available in 32-bit T32 instructions. See *Modified immediate constants in T32 instructions* on page F2-2863.

Carry out

A logical instruction with the rotation field set to 0b0000 does not affect APSR.C. Otherwise, a logical flag-setting instruction sets APSR.C to the value of bit[31] of the modified immediate constant.

Constants with multiple encodings

Some constant values have multiple possible encodings. In this case, a UAL assembler must select the encoding with the lowest unsigned value of the rotation field. This is the encoding that appears first in Table F2-3. For example, the constant #3 must be encoded with (rotation, abcdefgh) == (0b0000, 0b00000011), not (0b0001, 0b00001100), (0b0010, 0b00110000), or (0b0011, 0b11000000).

In particular, this means that all constants in the range 0-255 are encoded with rotation == 0b0000, and permitted constants outside that range are encoded with rotation != 0b0000. A flag-setting logical instruction with a modified immediate constant therefore leaves APSR.C unchanged if the constant is in the range 0-255 and sets it to the most significant bit of the constant otherwise. This matches the behavior of T32 modified immediate constants for all constants that are permitted in both the A32 and T32 instruction sets.

An alternative syntax is available for a modified immediate constant that permits the programmer to specify the encoding directly. In this syntax, #<const> is instead written as #<byte>, #<rot>, where:

- <byte> Is the numeric value of abcdefgh, in the range 0-255.
- <rot> Is twice the numeric value of rotation, an even number in the range 0-30.

This syntax permits all A32 data-processing instructions with modified immediate constants to be disassembled to assembler syntax that assembles to the original instruction.

This syntax also makes it possible to write variants of some flag-setting logical instructions that have different effects on APSR.C to those obtained with the normal #<const> syntax. For example, ANDS R1, R2, #12, #2 has the same behavior as ANDS R1, R2, #3 except that it sets APSR.C to 0 instead of leaving it unchanged. Such variants of flag-setting logical instructions do not have equivalents in the T32 instruction set, and ARM deprecates their use.

Operation of modified immediate constants, A32 instructions

For an A32 data-processing instruction, the `A32ExpandImm()` pseudocode function returns the value of the 32-bit immediate constant, calling `A32ExpandImm_C()` to evaluate the constant.

Modified immediate constants in T32 and A32 Advanced SIMD instructions

Table F2-4 shows the modified immediate constants available with Advanced SIMD instructions, and how they are encoded.

Table F2-4 Modified immediate values for Advanced SIMD instructions

op	cmode	Constant ^a	<dt> ^b	Notes
-	000x	00000000 00000000 00000000 abcdefgh 00000000 00000000 00000000 abcdefgh	I32	c
	001x	00000000 00000000 abcdefgh 00000000 00000000 00000000 abcdefgh 00000000	I32	c, d
	010x	00000000 abcdefgh 00000000 00000000 00000000 abcdefgh 00000000 00000000	I32	c, d
	011x	abcdefgh 00000000 00000000 00000000 abcdefgh 00000000 00000000 00000000	I32	c, d
	100x	00000000 abcdefgh 00000000 abcdefgh 00000000 abcdefgh 00000000 abcdefgh	I16	c
	101x	abcdefgh 00000000 abcdefgh 00000000 abcdefgh 00000000 abcdefgh 00000000	I16	c, d
	1100	00000000 00000000 abcdefgh 11111111 00000000 00000000 abcdefgh 11111111	I32	d, e
	1101	00000000 abcdefgh 11111111 11111111 00000000 abcdefgh 11111111 11111111	I32	d, e
0	1110	abcdefgh abcdefgh abcdefgh abcdefgh abcdefgh abcdefgh abcdefgh abcdefgh	I8	f
	1111	aBbbbbc defgh000 00000000 00000000 aBbbbbc defgh000 00000000 00000000	F32	f, g
1	1110	aaaaaaaa bbbbbbbb cccccccc dddddddd eeeeeeee ffffffff gggggggg hhhhhhhh	I64	f
	1111	UNDEFINED	-	-

- a. In this table, the immediate value is shown in binary form, to relate abcdefgh to the encoding diagram. In assembler syntax, the constant is specified by a data type and a value of that type. That value is specified in the normal way (a decimal number by default) and is replicated enough times to fill the 64-bit immediate. For example, a data type of I32 and a value of 10 specify the 64-bit constant `0x0000000A0000000A`.
- b. This specifies the data type used when the instruction is disassembled. On assembly, the data type must be matched in the table if possible. Other data types are permitted as pseudo-instructions when a program is assembled, provided the 64-bit constant specified by the data type and value is available for the instruction. If a constant is available in more than one way, the first entry in this table that can produce it is used. For example, `VMOV.I64 D0, #0x8000000080000000` does not specify a 64-bit constant that is available from the I64 line of the table, but does specify one that is available from the fourth I32 line or the F32 line. It is assembled to the first of these, and therefore is disassembled as `VMOV.I32 D0, #0x80000000`.
- c. This constant is available for the VBIC, VMOV, VMVN, and VORR instructions.

- d. CONSTRAINED UNPREDICTABLE if abcdefgh == 0b00000000, see *UNPREDICTABLE cases in immediate constants in Advanced SIMD instructions* on page K1-6101. The required behavior is that these encodings produce an immediate constant of zero.
- e. This constant is available for the VMOV and VMVN instructions only.
- f. This constant is available for the VMOV instruction only.
- g. In this entry, B = NOT(b). The bit pattern represents the floating-point number $(-1)^S \times 2^{\text{exp}} \times \text{mantissa}$, where $S = \text{UInt}(a)$, $\text{exp} = \text{UInt}(\text{NOT}(b):c:d)-3$ and $\text{mantissa} = (16+\text{UInt}(e:f:g:h))/16$.

Operation of modified immediate constants, Advanced SIMD instructions

For a T32 or A32 Advanced SIMD instruction that uses a modified immediate constant, the operation described by the AdvSIMDExpandImm() pseudocode function returns the value of the 64-bit immediate constant.

Modified immediate constants in T32 and A32 floating-point instructions

Table F2-5 shows the immediate constants available in the VMOV (immediate) floating-point instruction, and Table F2-6 shows the resulting floating-point values.

Table F2-5 Floating-point modified immediate constants

Data type	imm4H	imm4L	Constant ^a
F16	abcd	efgh	aBbbcd ef gh000000
F32	abcd	efgh	aBbbbbb c defgh000 00000000 00000000
F64	abcd	efgh	aBbbbbbb b cdefgh 00000000 00000000 00000000 00000000 00000000 00000000

a. In this column, B = NOT(b). The bit pattern represents the floating-point number $(-1)^S \times 2^{\text{exp}} \times \text{mantissa}$, where $S = \text{UInt}(a)$, $\text{exp} = \text{UInt}(\text{NOT}(b):c:d)-3$ and $\text{mantissa} = (16+\text{UInt}(e:f:g:h))/16$.

Table F2-6 Floating-point constant values

efgh	bcd							
	000	001	010	011	100	101	110	111
0000	2.0	4.0	8.0	16.0	0.125	0.25	0.5	1.0
0001	2.125	4.25	8.5	17.0	0.1328125	0.265625	0.53125	1.0625
0010	2.25	4.5	9.0	18.0	0.140625	0.28125	0.5625	1.125
0011	2.375	4.75	9.5	19.0	0.1484375	0.296875	0.59375	1.1875
0100	2.5	5.0	10.0	20.0	0.15625	0.3125	0.625	1.25
0101	2.625	5.25	10.5	21.0	0.1640625	0.328125	0.65625	1.3125
0110	2.75	5.5	11.0	22.0	0.171875	0.34375	0.6875	1.375
0111	2.875	5.75	11.5	23.0	0.1796875	0.359375	0.71875	1.4375
1000	3.0	6.0	12.0	24.0	0.1875	0.375	0.75	1.5
1001	3.125	6.25	12.5	25.0	0.1953125	0.390625	0.78125	1.5625
1010	3.25	6.5	13.0	26.0	0.203125	0.40625	0.8125	1.625
1011	3.375	6.75	13.5	27.0	0.2109375	0.421875	0.84375	1.6875
1100	3.5	7.0	14.0	28.0	0.21875	0.4375	0.875	1.75

Table F2-6 Floating-point constant values (continued)

efgh	bcd							
	000	001	010	011	100	101	110	111
1101	3.625	7.25	14.5	29.0	0.2265625	0.453125	0.90625	1.8125
1110	3.75	7.5	15.0	30.0	0.234375	0.46875	0.9375	1.875
1111	3.875	7.75	15.5	31.0	0.2421875	0.484375	0.96875	1.9375

Operation of modified immediate constants, floating-point instructions

For a T32 or A32 floating-point instruction that uses a modified immediate constant, the operation described by the [VFPEExpandImm\(\)](#) pseudocode function returns the value of the immediate constant.

F2.8 Additional pseudocode support for instruction descriptions

Earlier sections of this chapter include pseudocode that describes features of the execution of A32 and T32 instructions, see:

- [Pseudocode description of conditional execution on page F2-2850.](#)
- [Pseudocode description of instruction-specified shifts and rotates on page F2-2853](#)

The following subsection gives additional pseudocode support functions for some of the instructions described in [Alphabetical list of T32 and A32 base instruction set instructions on page F5-3004](#). See also [Pseudocode support for the Banked register transfer instructions on page F5-3677](#).

F2.8.1 Pseudocode description of operations for System register access instructions

The `AArch32.CheckSystemAccess()` pseudocode function determines whether a System register access instruction is accepted for execution.

The `AArch32.SysRegRead()` function obtains the word for an MRC instruction from the System register.

The `AArch32.SysRegRead64()` function obtains the two words for an MRRC instruction from the System register.

———— **Note** —————

The relative significance of the two words returned is IMPLEMENTATION DEFINED, but all uses within this manual present the two words in the order (most significant, least significant).

The `AArch32.SysRegWrite()` procedure sends the word for an MCR instruction to the System register.

The `AArch32.SysRegWrite64()` procedure sends the two words for an MCRR instruction to the System register.

———— **Note** —————

The relative significance of word2 and word1 is IMPLEMENTATION DEFINED, but all uses within this manual treat word2 as more significant than word1.

The `CP14DebugInstrDecode()` pseudocode function decodes an accepted access to a debug System register in the (coproc==0b1110) encoding space.

The `CP14JazelleInstrDecode()` pseudocode function decodes an accepted access to a Jazelle System register. These registers are in the (coproc==0b1110) encoding space.

The `CP14TraceInstrDecode()` pseudocode function decodes an accepted access to a Trace System register. These registers are in the (coproc==0b1110) encoding space.

The `CP15InstrDecode()` pseudocode function decodes an accepted access to a System register in the (coproc==0b1111) encoding space.

F2.8.2 Pseudocode details of system calls

The `AArch32.CallSupervisor()` pseudocode function generates a Supervisor Call exception. Valid execution of the SVC instruction calls this function.

The `AArch32.CallHypervisor()` pseudocode function generates an HVC exception. Valid execution of the HVC instruction calls this function.

F2.9 Additional information about Advanced SIMD and floating-point instructions

The following subsections give additional information about the Advanced SIMD and floating-point instructions:

- [Advanced SIMD and floating-point instruction syntax](#).
- [The Advanced SIMD addressing mode](#).
- [Advanced SIMD instruction modifiers](#) on page F2-2870.
- [Advanced SIMD operand shapes](#) on page F2-2870.
- [Data type specifiers](#) on page F2-2871.
- [Register specifiers](#) on page F2-2872.
- [Register lists](#) on page F2-2873.
- [Register encoding](#) on page F2-2873.
- [Advanced SIMD scalars](#) on page F2-2874.

Note

The Advanced SIMD architecture, its associated implementations, and supporting software, are commonly referred to as NEON™ technology.

F2.9.1 Advanced SIMD and floating-point instruction syntax

Advanced SIMD and floating-point instructions use the general conventions of the T32 and A32 instruction sets.

Advanced SIMD and floating-point data-processing instructions use the following general format:

$V\{\langle\text{modifier}\rangle\}\langle\text{operation}\rangle\{\langle\text{shape}\rangle\}\{\langle\text{c}\rangle\}\{\langle\text{q}\rangle\}\{.\langle\text{dt}\rangle\} \{\langle\text{dest}\rangle,\} \langle\text{src1}\rangle, \langle\text{src2}\rangle$

All Advanced SIMD and floating-point instructions begin with a *v*. This distinguishes Advanced SIMD vector and floating-point instructions from scalar instructions.

The main operation is specified in the $\langle\text{operation}\rangle$ field. It is usually a three letter mnemonic the same as or similar to the corresponding scalar integer instruction.

The $\langle\text{c}\rangle$ and $\langle\text{q}\rangle$ fields are standard assembler syntax fields. For details see [Standard assembler syntax fields](#) on page F2-2848.

F2.9.2 The Advanced SIMD addressing mode

All the element and structure load/store instructions use this addressing mode. There is a choice of three formats:

$[\langle\text{Rn}\rangle\{:\langle\text{align}\rangle\}]$ The address is contained in general-purpose register *Rn*.

Rn is not updated by this instruction.

Encoded as $Rm = 0b1111$.

If *Rn* is encoded as $0b1111$, the instruction is CONstrained UNpredictable.

$[\langle\text{Rn}\rangle\{:\langle\text{align}\rangle\}]!$ The address is contained in general-purpose register *Rn*.

Rn is updated by this instruction: $Rn = Rn + \text{transfer_size}$

Encoded as $Rm = 0b1101$.

transfer_size is the number of bytes transferred by the instruction. This means that, after the instruction is executed, *Rn* points to the address in memory immediately following the last address loaded from or stored to.

If *Rn* is encoded as $0b1111$, the instruction is CONstrained UNpredictable.

This addressing mode can also be written as:

$[\langle\text{Rn}\rangle\{:\langle\text{align}\rangle\}], \#\langle\text{transfer_size}\rangle$

However, disassembly produces the $[\langle\text{Rn}\rangle\{:\langle\text{align}\rangle\}]!$ form.

[<Rn>{:<align>}], <Rm>

The address is contained in general-purpose register <Rn>.

Rn is updated by this instruction: $Rn = Rn + Rm$

Encoded as $Rm = Rm$. Rm must not be encoded as 0b1111 or 0b1101, the PC or the SP.

If Rn is encoded as 0b1111, the instruction is CONSTRAINED UNPREDICTABLE.

The CONSTRAINED UNPREDICTABLE behavior of encodings where Rn is 0b1111 is that the instruction is either UNDEFINED or executes as a NOP, see *CONSTRAINED UNPREDICTABLE behavior for A32 and T32 instruction encodings* on page K1-6107.

In all cases, <align> specifies an alignment, as specified by the individual instruction descriptions.

Previous versions of the manual used the @ character for alignment. So, for example, the first format in this section was shown as [<Rn>{@<align>}]. Both @ and : are supported. However, to ensure portability of code to assemblers that treat @ as a comment character, : is preferred.

F2.9.3 Advanced SIMD instruction modifiers

The <modifier> field provides additional variants of some instructions. Table F2-7 provides definitions of the modifiers. Modifiers are not available for every instruction.

Table F2-7 Advanced SIMD instruction modifiers

<modifier>	Meaning
Q	The operation uses saturating arithmetic.
R	The operation performs rounding.
D	The operation doubles the result (before accumulation, if any).
H	The operation halves the result.

F2.9.4 Advanced SIMD operand shapes

The <shape> field provides additional variants of some instructions. Table F2-8 provides definitions of the shapes. Operand shapes are not available for every instruction.

Table F2-8 Advanced SIMD operand shapes

<shape>	Meaning	Typical register shape
(none)	The operands and result are all the same width.	Dd, Dn, Dm Qd, Qn, Qm
L	Long operation - result is twice the width of both operands	Qd, Dn, Dm
N	Narrow operation - result is half the width of both operands	Dd, Qn, Qm
W	Wide operation - result and first operand are twice the width of the second operand	Qd, Qn, Dm

Note

- Some assemblers support a Q shape specifier, that requires all operands to be Q registers. An example of using this specifier is `VADDQ.S32 q0, q1, q2`. This is not standard UAL, and ARM recommends that programmers do not use a Q shape specifier.
- A disassembler must not generate any shape specifier not shown in Table F2-8.

F2.9.5 Data type specifiers

The <dt> field normally contains one data type specifier. Unless the assembler syntax description for the instruction indicates otherwise, this indicates the data type contained in:

- The second operand, if any.
- The operand, if there is no second operand.
- The result, if there are no operand registers.

The data types of the other operand and result are implied by the <dt> field combined with the instruction shape. For information about data type formats see [Data types supported by the Advanced SIMD implementation on page E1-2742](#).

In the instruction syntax descriptions in [Chapter F2 About the T32 and A32 Instruction Descriptions](#), the <dt> field is usually specified as a single field. However, where more convenient, it is sometimes specified as a concatenation of two fields, <type><size>.

Syntax flexibility

There is some flexibility in the data type specifier syntax:

- Software can specify three data types, specifying the result and both operand data types. For example:
 VSUBW.I16.I16.S8 Q3, Q5, D0 instead of VSUBW.S8 Q3, Q5, D0
- Software can specify two data types, specifying the data types of the two operands. The data type of the result is implied by the instruction shape. For example:
 VSUBW.I16.S8 Q3, Q5, D0 instead of VSUBW.S8 Q3, Q5, D0
- Software can specify two data types, specifying the data types of the single operand and the result. For example:
 VMOVN.I16.I32 D0, Q1 instead of VMOVN.I32 D0, Q1
- Where an instruction requires a less specific data type, software can instead specify a more specific type, as shown in [Table F2-9](#).
- Where an instruction does not require a data type, software can provide one.
- The F32 data type can be abbreviated to F.
- The F64 data type can be abbreviated to D.

In all cases, if software provides additional information, the additional information must match the instruction shape. Disassembly does not regenerate this additional information.

Table F2-9 Data type specification flexibility

Specified data type	Permitted more specific data types				
None	Any				
.I<size>	-	.S<size>	.U<size>	-	-
.8	.I8	.S8	.U8	.P8	-
.16	.I16	.S16	.U16	.P16	.F16
.32	.I32	.S32	.U32	-	.F32 or .F
.64	.I64	.S64	.U64	-	.F64 or .D

F2.9.6 Register specifiers

The <dest>, <src1>, and <src2> fields contain register specifiers, or in some cases scalar specifiers or register lists. Table F2-10 shows the register and scalar specifier formats that appear in the instruction descriptions.

If <dest> is omitted, it is the same as <src1>.

Table F2-10 Advanced SIMD and floating-point register specifier formats

<specifier>	Usual meaning ^a	Used in
<Qd>	A quadword destination register for the result vector.	Advanced SIMD
<Qn>	A quadword source register for the first operand vector.	Advanced SIMD
<Qm>	A quadword source register for the second operand vector.	Advanced SIMD
<Dd>	A doubleword destination register for the result vector.	Both
<Dn>	A doubleword source register for the first operand vector.	Both
<Dm>	A doubleword source register for the second operand vector.	Both
<Sd>	A singleword destination register for the result vector.	Floating-point
<Sn>	A singleword source register for the first operand vector.	Floating-point
<Sm>	A singleword source register for the second operand vector.	Floating-point
<Dd[x]>	A destination scalar for the result. Element x of vector <Dd>.	Advanced SIMD
<Dn[x]>	A source scalar for the first operand. Element x of vector <Dn>.	Both ^b
<Dm[x]>	A source scalar for the second operand. Element x of vector <Dm>.	Advanced SIMD
<Rt>	A general-purpose register, used for a source or destination address.	Both
<Rt2>	A general-purpose register, used for a source or destination address.	Both
<Rn>	A general-purpose register, used as a load or store base address.	Both
<Rm>	A general-purpose register, used as a post-indexed address source.	Both

- a. In some instructions the roles of registers are different.
- b. In the floating-point instructions, <Dn[x]> is used only in *VMOV* (scalar to general-purpose register), see *VMOV (scalar to general-purpose register)* on page F6-4006.

F2.9.7 Register lists

A register list is a list of register specifiers separated by commas and enclosed in brackets { and }. There are restrictions on what registers can appear in a register list. These restrictions are described in the individual instruction descriptions. Table F2-11 shows some register list formats, with examples of actual register lists corresponding to those formats.

———— **Note** —————

Register lists must not wrap around the end of the register bank.

Syntax flexibility

There is some flexibility in the register list syntax:

- Where a register list contains consecutive registers, they can be specified as a range, instead of listing every register, for example {D0-D3} instead of {D0, D1, D2, D3}.
- Where a register list contains an even number of consecutive doubleword registers starting with an even numbered register, it can be written as a list of quadword registers instead, for example {Q1, Q2} instead of {D2-D5}.
- Where a register list contains only one register, the enclosing braces can be omitted, for example VLD1.8 D0, [R0] instead of VLD1.8 {D0}, [R0].

Table F2-11 Example register lists

Format	Example	Alternative
{<Dd>}	{D3}	D3
{<Dd>, <Dd+1>, <Dd+2>}	{D3, D4, D5}	{D3-D5}
{<Dd[x]>, <Dd+2[x]>}	{D0[3], D2[3]}	-
{<Dd[]>}	{D7[]}	D7[]

F2.9.8 Register encoding

An Advanced SIMD register is either:

- *Quadword*, meaning it is 128 bits wide.
- *Doubleword*, meaning it is 64 bits wide.

Some instructions have options for either doubleword or quadword registers. This is normally encoded in Q, bit[6], as Q = 0 for doubleword operations, or Q = 1 for quadword operations.

A floating-point register is either:

- *Double-precision*, meaning it is 64 bits wide.
- *Single-precision*, meaning it is 32 bits wide.

This is encoded in the sz field, bit[8], as sz = 1 for double-precision operations, or sz = 0 for single-precision operations.

The T32 instruction encoding of Advanced SIMD or floating-point registers is:

15	14	13	12	11	10	9	8	7	6	5	4	3	2	1	0	15	14	13	12	11	10	9	8	7	6	5	4	3	2	1	0
								D	Vn				Vd				sz	N	Q	M	Vm										

The A32 instruction encoding of Advanced SIMD or floating-point registers is:

31	30	29	28	27	26	25	24	23	22	21	20	19	18	17	16	15	14	13	12	11	10	9	8	7	6	5	4	3	2	1	0
								D	Vn				Vd				sz	N	Q	M	Vm										

Some instructions use only one or two registers, and use the unused register fields as additional opcode bits.

Table F2-12 shows the encodings for the registers.

Table F2-12 Encoding of register numbers

Register mnemonic	Usual usage	Register number encoded in ^a	Notes ^a	Used in
<Qd>	Destination (quadword)	D, Vd (bits[22, 15:13])	bit[12] == 0 ^b	Advanced SIMD
<Qn>	First operand (quadword)	N, Vn (bits[7, 19:17])	bit[16] == 0 ^b	Advanced SIMD
<Qm>	Second operand (quadword)	M, Vm (bits[5, 3:1])	bit[0] == 0 ^b	Advanced SIMD
<Dd>	Destination (doubleword)	D, Vd (bits[22, 15:12])	-	Both
<Dn>	First operand (doubleword)	N, Vn (bits[7, 19:16])	-	Both
<Dm>	Second operand (doubleword)	M, Vm (bits[5, 3:0])	-	Both
<Sd>	Destination (single-precision)	Vd, D (bits[15:12, 22])	-	Floating-point
<Sn>	First operand (single-precision)	Vn, N (bits[19:16, 7])	-	Floating-point
<Sm>	Second operand (single-precision)	Vm, M (bits[3:0, 5])	-	Floating-point

- a. Bit numbers given for the A32 instruction encoding. See the figures in this section for the equivalent bits in the T32 encoding.
 b. If this bit is 1, the instruction is UNDEFINED.

F2.9.9 Advanced SIMD scalars

Advanced SIMD scalars can be 8-bit, 16-bit, 32-bit, or 64-bit. Instructions other than multiply instructions can access any element in the register set. The instruction syntax refers to the scalars using an index into a doubleword vector. The descriptions of the individual instructions contain details of the encodings.

Table F2-13 shows the form of encoding for scalars used in multiply instructions. These instructions cannot access scalars in some registers. The descriptions of the individual instructions contain cross references to this section where appropriate.

32-bit Advanced SIMD scalars, when used as single-precision floating-point numbers, are equivalent to Floating-point single-precision registers. That is, $D_m[x]$ in a 32-bit context ($0 \leq m \leq 15$, $0 \leq x \leq 1$) is equivalent to $S[2m + x]$.

Table F2-13 Encoding of scalars in multiply instructions

Scalar mnemonic	Usual usage	Scalar size	Register specifier	Index specifier	Accessible registers
<D _m [x]>	Second operand	16-bit	Vm[2:0]	M, Vm[3]	D0-D7
		32-bit	Vm[3:0]	M	D0-D15

Chapter F3

T32 Instruction Set Encoding

This chapter describes the encoding of the T32 instruction set. It contains the following sections:

- [T32 instruction set encoding on page F3-2876.](#)
- [About the T32 Advanced SIMD and floating-point instructions and their encoding on page F3-2941.](#)

In this chapter:

- In the decode tables, an entry of - for a field value means the value of the field does not affect the decoding.
- In the decode diagrams, a shaded field indicates that the bits in that field are not used in that level of decode.

F3.1 T32 instruction set encoding

The T32 instruction stream is a sequence of halfword-aligned halfwords. Each T32 instruction is either a single 16-bit halfword in that stream, or a 32-bit instruction consisting of two consecutive halfwords in that stream.

If the value of bits[15:11] of the halfword being decoded is one of the following, the halfword is the first halfword of a 32-bit instruction:

- 0b11101.
- 0b11110.
- 0b11111.

Otherwise, the halfword is a 16-bit instruction.

The T32 instruction encoding is:

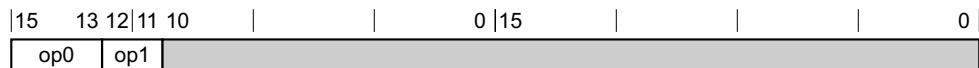

Table F3-1 Main encoding table for the T32 instruction set

Decode fields		Decode group or instruction page
op0	op1	
!= 111	-	16-bit
111	00	B - T2 variant
111	!= 00	32-bit on page F3-2887

F3.1.1 16-bit

This section describes the encoding of the 16-bit group. This section is decoded from *T32 instruction set encoding*.



This decode also imposes the constraint:

- op0<5:3> != 111.

Table F3-2 Encoding table for the 16-bit group

Decode fields	Decode group or instruction page
op0	
00xxxx	<i>Shift (immediate), add, subtract, move, and compare on page F3-2880</i>
010000	<i>Data-processing (two low registers) on page F3-2877</i>
010001	<i>Special data instructions and branch and exchange on page F3-2882</i>
01001x	<i>LDR (literal) - T1 variant on page F5-3163</i>

Table F3-2 Encoding table for the 16-bit group (continued)

Decode fields	Decode group or instruction page
op0	
0101xx	<i>Load/store (register offset) on page F3-2878</i>
011xxx	<i>Load/store word/byte (immediate offset) on page F3-2878</i>
1000xx	<i>Load/store halfword (immediate offset) on page F3-2879</i>
1001xx	<i>Load/store (SP-relative) on page F3-2879</i>
1010xx	<i>Add PC/SP (immediate) on page F3-2879</i>
1011xx	<i>Miscellaneous 16-bit instructions on page F3-2883</i>
1100xx	<i>Load/store multiple on page F3-2880</i>
1101xx	<i>Conditional branch, and Supervisor Call on page F3-2886</i>

Data-processing (two low registers)

This section describes the encoding of the Data-processing (two low registers) instruction class. This section is decoded from *16-bit on page F3-2876*.

15 14 13 12 11 10 9	6 5	3 2	0
0 1 0 0 0 0	op	Rs	Rd

Decode fields	Instruction page
op	
0000	AND, ANDS (register)
0001	EOR, EORS (register)
0010	MOV, MOVS (register-shifted register) - <i>Logical shift left variant on page F5-3265</i>
0011	MOV, MOVS (register-shifted register) - <i>Logical shift right variant on page F5-3265</i>
0100	MOV, MOVS (register-shifted register) - <i>Arithmetic shift right variant on page F5-3265</i>
0101	ADC, ADCS (register)
0110	SBC, SBS (register)
0111	MOV, MOVS (register-shifted register) - <i>Rotate right variant on page F5-3266</i>
1000	TST (register)
1001	RSB, RSBS (immediate)
1010	CMP (register)
1011	CMN (register)
1100	ORR, ORRS (register)

Decode fields	Instruction page
op	
1101	MUL, MULS
1110	BIC, BICS (register)
1111	MVN, MVNS (register)

Load/store (register offset)

This section describes the encoding of the Load/store (register offset) instruction class. This section is decoded from *16-bit* on page F3-2876.

15	14	13	12	11	10	9	8	6	5	3	2	0
0	1	0	1	L	B	H	Rm	Rn	Rt			

Decode fields			Instruction page
L	B	H	
0	0	0	STR (register)
0	0	1	STRH (register)
0	1	0	STRB (register)
0	1	1	LDRSB (register)
1	0	0	LDR (register)
1	0	1	LDRH (register)
1	1	0	LDRB (register)
1	1	1	LDRSH (register)

Load/store word/byte (immediate offset)

This section describes the encoding of the Load/store word/byte (immediate offset) instruction class. This section is decoded from *16-bit* on page F3-2876.

15	14	13	12	11	10	6	5	3	2	0
0	1	1	B	L	imm5	Rn	Rt			

Decode fields		Instruction page
B	L	
0	0	STR (immediate)

Decode fields		Instruction page
B	L	
0	1	LDR (immediate)
1	0	STRB (immediate)
1	1	LDRB (immediate)

Load/store halfword (immediate offset)

This section describes the encoding of the Load/store halfword (immediate offset) instruction class. This section is decoded from *16-bit on page F3-2876*.

15	14	13	12	11	10		6	5	3	2	0
1	0	0	0	L	imm5		Rn		Rt		

Decode fields		Instruction page
L		
0		STRH (immediate)
1		LDRH (immediate)

Load/store (SP-relative)

This section describes the encoding of the Load/store (SP-relative) instruction class. This section is decoded from *16-bit on page F3-2876*.

15	14	13	12	11	10	8	7		0
1	0	0	1	L	Rt	imm8			

Decode fields		Instruction page
L		
0		STR (immediate)
1		LDR (immediate)

Add PC/SP (immediate)

This section describes the encoding of the Add PC/SP (immediate) instruction class. This section is decoded from *16-bit on page F3-2876*.

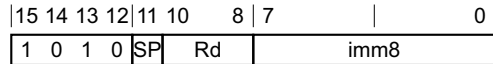

Decode fields	Instruction page
SP	
0	ADR
1	ADD, ADDS (SP plus immediate)

Load/store multiple

This section describes the encoding of the Load/store multiple instruction class. This section is decoded from *16-bit* on page F3-2876.

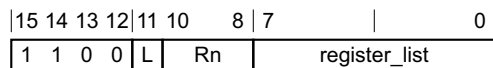

Decode fields	Instruction page
L	
0	STM, STMIA, STMEA
1	LDM, LDMIA, LDMFD

F3.1.2 Shift (immediate), add, subtract, move, and compare

This section describes the encoding of the Shift (immediate), add, subtract, move, and compare group. This section is decoded from *16-bit* on page F3-2876.

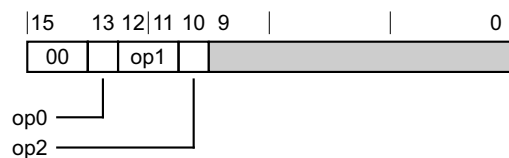

Table F3-3 Encoding table for the Shift (immediate), add, subtract, move, and compare group

Decode fields			Decode group or instruction page
op0	op1	op2	
0	11	0	Add, subtract (three low registers) on page F3-2881
0	11	1	Add, subtract (two low registers and immediate) on page F3-2881
0	!= 11	-	MOV, MOVS (register) - T2 variant on page F5-3261
1	-	-	Add, subtract, compare, move (one low register and immediate) on page F3-2881

Add, subtract (three low registers)

This section describes the encoding of the Add, subtract (three low registers) instruction class. This section is decoded from *Shift (immediate), add, subtract, move, and compare* on page F3-2880.

15	14	13	12	11	10	9	8	6	5	3	2	0
0	0	0	1	1	0	S	Rm	Rn	Rd			

Decode fields	Instruction page
S	
0	ADD, ADDS (register)
1	SUB, SUBS (register)

Add, subtract (two low registers and immediate)

This section describes the encoding of the Add, subtract (two low registers and immediate) instruction class. This section is decoded from *Shift (immediate), add, subtract, move, and compare* on page F3-2880.

15	14	13	12	11	10	9	8	6	5	3	2	0
0	0	0	1	1	1	S	imm3	Rn	Rd			

Decode fields	Instruction page
S	
0	ADD, ADDS (immediate)
1	SUB, SUBS (immediate)

Add, subtract, compare, move (one low register and immediate)

This section describes the encoding of the Add, subtract, compare, move (one low register and immediate) instruction class. This section is decoded from *Shift (immediate), add, subtract, move, and compare* on page F3-2880.

15	14	13	12	11	10	8	7	0
0	0	1	op	Rd	imm8			

Decode fields	Instruction page
op	
00	MOV, MOVS (immediate)

Decode fields	Instruction page
op	
01	CMP (immediate)
10	ADD, ADDS (immediate)
11	SUB, SUBS (immediate)

F3.1.3 Special data instructions and branch and exchange

This section describes the encoding of the Special data instructions and branch and exchange group. This section is decoded from *16-bit* on page F3-2876.

15		9 8 7		0
010001	op0			

Table F3-4 Encoding table for the Special data instructions and branch and exchange group

Decode fields	Decode group or instruction page
op0	
11	<i>Branch and exchange</i>
!= 11	<i>Add, subtract, compare, move (two high registers)</i>

Branch and exchange

This section describes the encoding of the Branch and exchange instruction class. This section is decoded from *Special data instructions and branch and exchange*.

15 14 13 12 11 10 9 8 7 6		3 2 1 0
0 1 0 0 0 1 1 1	L	Rm (0)(0)(0)

Decode fields	Instruction page
L	
0	BX
1	BLX (register)

Add, subtract, compare, move (two high registers)

This section describes the encoding of the Add, subtract, compare, move (two high registers) instruction class. This section is decoded from *Special data instructions and branch and exchange*.

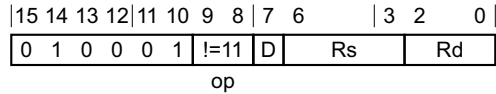

Decode fields			Instruction page
op	D:Rd	Rs	
00	!= 1101	!= 1101	ADD, ADDS (register)
00	-	1101	ADD, ADDS (SP plus register) - <i>T1</i> on page F5-3027
00	1101	!= 1101	ADD, ADDS (SP plus register) - <i>T2</i> on page F5-3027
01	-	-	CMP (register)
10	-	-	MOV, MOVS (register)

F3.1.4 Miscellaneous 16-bit instructions

This section describes the encoding of the Miscellaneous 16-bit instructions group. This section is decoded from *16-bit* on page F3-2876.

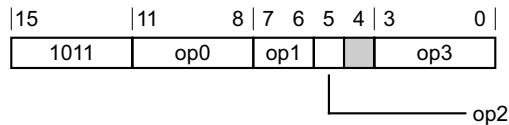

Table F3-5 Encoding table for the Miscellaneous 16-bit instructions group

Decode fields				Decode group or instruction page	Architecture version
op0	op1	op2	op3		
0000	-	-	-	<i>Adjust SP (immediate)</i> on page F3-2884	-
0010	-	-	-	<i>Extend</i> on page F3-2884	-
0110	00	0	-	SETPAN	ARMv8.1
0110	00	1	-	Unallocated.	-
0110	01	-	-	<i>Change Processor State</i> on page F3-2884	-
0110	1x	-	-	Unallocated.	-
0111	-	-	-	Unallocated.	-
1000	-	-	-	Unallocated.	-
1010	10	-	-	HLT	-
1010	!= 10	-	-	<i>Reverse bytes</i> on page F3-2885	-
1110	-	-	-	BKPT	-
1111	-	-	0000	<i>Hints</i> on page F3-2885	-

Table F3-5 Encoding table for the Miscellaneous 16-bit instructions group (continued)

Decode fields				Decode group or instruction page	Architecture version
op0	op1	op2	op3		
1111	-	-	!= 0000	IT	-
x0x1	-	-	-	CBNZ, CBZ	-
x10x	-	-	-	Push and Pop on page F3-2886	-

Adjust SP (immediate)

This section describes the encoding of the Adjust SP (immediate) instruction class. This section is decoded from *Miscellaneous 16-bit instructions* on page F3-2883.

15	14	13	12	11	10	9	8	7	6		0
1	0	1	1	0	0	0	0	S	imm7		

Decode fields		Instruction page
S		
0		ADD, ADDS (SP plus immediate)
1		SUB, SUBS (SP minus immediate)

Extend

This section describes the encoding of the Extend instruction class. This section is decoded from *Miscellaneous 16-bit instructions* on page F3-2883.

15	14	13	12	11	10	9	8	7	6	5	3	2	0
1	0	1	1	0	0	1	0	U	B	Rm	Rd		

Decode fields			Instruction page
U	B		
0	0		SXTH
0	1		SXTB
1	0		UXTH
1	1		UXTB

Change Processor State

This section describes the encoding of the Change Processor State instruction class. This section is decoded from *Miscellaneous 16-bit instructions* on page F3-2883.

15	14	13	12	11	10	9	8	7	6	5	4	0
1	0	1	1	0	1	1	0	0	1	op	flags	

Decode fields		Instruction page
op	flags	
0	-	SETEND
1	-	CPS, CPSID, CPSIE

Reverse bytes

This section describes the encoding of the Reverse bytes instruction class. This section is decoded from [Miscellaneous 16-bit instructions on page F3-2883](#).

15	14	13	12	11	10	9	8	7	6	5	3	2	0
1	0	1	1	1	0	1	0	!=10	Rm	Rd			

op

Decode fields		Instruction page
op		
00		REV
01		REV16
11		REVSH

Hints

This section describes the encoding of the Hints instruction class. This section is decoded from [Miscellaneous 16-bit instructions on page F3-2883](#).

15	14	13	12	11	10	9	8	7	4	3	2	1	0
1	0	1	1	1	1	1	1	hint	0	0	0	0	

Decode fields		Instruction page
hint		
0000		NOP
0001		YIELD
0010		WFE
0011		WFI
0100		SEV

Decode fields	Instruction page
hint	
0101	SEVL
011x	Reserved hint, behaves as NOP .
1xxx	Reserved hint, behaves as NOP .

Push and Pop

This section describes the encoding of the Push and Pop instruction class. This section is decoded from [Miscellaneous 16-bit instructions on page F3-2883](#).

15	14	13	12	11	10	9	8	7							0
1	0	1	1	L	1	0	P		register_list						

Decode fields	Instruction page
L	
0	PUSH
1	POP

F3.1.5 Conditional branch, and Supervisor Call

This section describes the encoding of the Conditional branch, and Supervisor Call group. This section is decoded from [16-bit on page F3-2876](#).

15		11		8	7										0
1101		op0													

Table F3-6 Encoding table for the Conditional branch, and Supervisor Call group

Decode fields	Decode group or instruction page
op0	
111x	Exception generation
!= 111x	B - TI variant on page F5-3051

Exception generation

This section describes the encoding of the Exception generation instruction class. This section is decoded from [Conditional branch, and Supervisor Call](#).

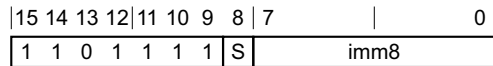

Decode fields	Instruction page
S	
0	UDF
1	SVC

F3.1.6 32-bit

This section describes the encoding of the 32-bit group. This section is decoded from *T32 instruction set encoding* on page F3-2876.

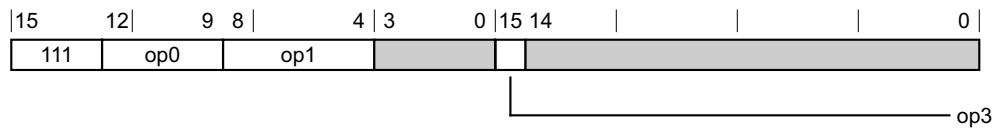

This decode also imposes the constraint:

- $op0<3:2> \neq 00$.

Table F3-7 Encoding table for the 32-bit group

Decode fields			Decode group or instruction page
op0	op1	op3	
x11x	-	-	<i>System register access, Advanced SIMD, and floating-point</i> on page F3-2893
0100	xx0xx	-	<i>Load/store multiple</i> on page F3-2888
0100	xx1xx	-	<i>Load/store dual, load/store exclusive, load-acquire/store-release, and table branch</i> on page F3-2913
0101	-	-	<i>Data-processing (shifted register)</i> on page F3-2888
10xx	-	1	<i>Branches and miscellaneous control</i> on page F3-2916
10x0	-	0	<i>Data-processing (modified immediate)</i> on page F3-2890
10x1	-	0	<i>Data-processing (plain binary immediate)</i> on page F3-2920
1100	1xxx0	-	<i>Advanced SIMD element or structure load/store</i> on page F3-2922
1100	$\neq 1xxx0$	-	<i>Load/store single</i> on page F3-2926
1101	0xxxx	-	<i>Data-processing (register)</i> on page F3-2934
1101	10xxx	-	<i>Multiply, multiply accumulate, and absolute difference</i> on page F3-2938
1101	11xxx	-	<i>Long multiply and divide</i> on page F3-2891

Load/store multiple

This section describes the encoding of the Load/store multiple instruction class. This section is decoded from *32-bit* on page F3-2887.

15	14	13	12	11	10	9	8	7	6	5	4	3	0	15	14	13	12					0
1	1	1	0	1	0	0	opc	0	W	L		Rn	P	M	(0)	register_list						

Decode fields		Instruction page
opc	L	
00	0	SRS, SRSDA, SRSDDB, SRSIA, SRSIB - <i>T1</i> on page F5-3464
00	1	RFE, RFEDA, RFEDB, RFEIA, RFEIB - <i>T1</i> on page F5-3363
01	0	STM, STMIA, STMEA
01	1	LDM, LDMIA, LDMFD
10	0	STMDB, STMFD
10	1	LDMDB, LDMEA
11	0	SRS, SRSDA, SRSDDB, SRSIA, SRSIB - <i>T2</i> on page F5-3465
11	1	RFE, RFEDA, RFEDB, RFEIA, RFEIB - <i>T2</i> on page F5-3364

Data-processing (shifted register)

This section describes the encoding of the Data-processing (shifted register) instruction class. This section is decoded from *32-bit* on page F3-2887.

15	14	13	12	11	10	9	8		5	4	3	0	15	14	12	11		8	7	6	5	4	3	0
1	1	1	0	1	0	1	op1	S		Rn	(0)	imm3	Rd	imm2	type		Rm							

Decode fields					Instruction page
op1	S	Rn	imm3:imm2: type	Rd	
0000	0	-	-	-	AND, ANDS (register) - <i>AND, rotate right with extend variant</i> on page F5-3038
0000	1	-	!= 0000011	!= 1111	AND, ANDS (register) - <i>ANDS, shift or rotate by value variant</i> on page F5-3038
0000	1	-	!= 0000011	1111	TST (register) - <i>Shift or rotate by value variant</i> on page F5-3597
0000	1	-	0000011	!= 1111	AND, ANDS (register) - <i>ANDS, rotate right with extend variant</i> on page F5-3038
0000	1	-	0000011	1111	TST (register) - <i>Rotate right with extend variant</i> on page F5-3597
0001	-	-	-	-	BIC, BICS (register)

Decode fields					Instruction page
op1	S	Rn	imm3:imm2: type	Rd	
0010	0	!= 1111	-	-	ORR, ORRS (register) - <i>ORR, rotate right with extend variant on page F5-3307</i>
0010	0	1111	-	-	MOV, MOVS (register) - <i>MOV, rotate right with extend variant on page F5-3261</i>
0010	1	!= 1111	-	-	ORR, ORRS (register) - <i>ORRS, rotate right with extend variant on page F5-3307</i>
0010	1	1111	-	-	MOV, MOVS (register) - <i>MOVS, rotate right with extend variant on page F5-3262</i>
0011	0	!= 1111	-	-	ORN, ORNS (register) - <i>ORN, rotate right with extend variant on page F5-3302</i>
0011	0	1111	-	-	MVN, MVNS (register) - <i>MVN, rotate right with extend variant on page F5-3295</i>
0011	1	!= 1111	-	-	ORN, ORNS (register) - <i>ORNS, rotate right with extend variant on page F5-3302</i>
0011	1	1111	-	-	MVN, MVNS (register) - <i>MVNS, rotate right with extend variant on page F5-3295</i>
0100	0	-	-	-	EOR, EORS (register) - <i>EOR, rotate right with extend variant on page F5-3112</i>
0100	1	-	!= 000011	!= 1111	EOR, EORS (register) - <i>EORS, shift or rotate by value variant on page F5-3112</i>
0100	1	-	!= 000011	1111	TEQ (register) - <i>Shift or rotate by value variant on page F5-3592</i>
0100	1	-	000011	!= 1111	EOR, EORS (register) - <i>EORS, rotate right with extend variant on page F5-3112</i>
0100	1	-	000011	1111	TEQ (register) - <i>Rotate right with extend variant on page F5-3592</i>
0101	-	-	-	-	Unallocated.
0110	0	-	xxxx00	-	PKHBT, PKHTB - <i>PKHBT variant on page F5-3312</i>
0110	0	-	xxxx01	-	Unallocated.
0110	0	-	xxxx10	-	PKHBT, PKHTB - <i>PKHTB variant on page F5-3312</i>
0110	0	-	xxxx11	-	Unallocated.
0111	-	-	-	-	Unallocated.
1000	0	!= 1101	-	-	ADD, ADDS (register) - <i>ADD, rotate right with extend variant on page F5-3018</i>
1000	0	1101	-	-	ADD, ADDS (SP plus register) - <i>ADD, rotate right with extend variant on page F5-3027</i>
1000	1	!= 1101	-	!= 1111	ADD, ADDS (register) - <i>ADDS, rotate right with extend variant on page F5-3019</i>

Decode fields					Instruction page
op1	S	Rn	imm3:imm2: type	Rd	
1000	1	1101	-	!= 1111	ADD, ADDS (SP plus register) - <i>ADDS, rotate right with extend variant on page F5-3027</i>
1000	1	-	-	1111	CMN (register)
1001	-	-	-	-	Unallocated.
1010	-	-	-	-	ADC, ADCS (register)
1011	-	-	-	-	SBC, SBS (register)
1100	-	-	-	-	Unallocated.
1101	0	!= 1101	-	-	SUB, SUBS (register) - <i>SUB, rotate right with extend variant on page F5-3565</i>
1101	0	1101	-	-	SUB, SUBS (SP minus register) - <i>SUB, rotate right with extend variant on page F5-3573</i>
1101	1	!= 1101	-	!= 1111	SUB, SUBS (register) - <i>SUBS, rotate right with extend variant on page F5-3565</i>
1101	1	1101	-	!= 1111	SUB, SUBS (SP minus register) - <i>SUBS, rotate right with extend variant on page F5-3573</i>
1101	1	-	-	1111	CMP (register)
1110	-	-	-	-	RSB, RSBS (register)
1111	-	-	-	-	Unallocated.

Data-processing (modified immediate)

This section describes the encoding of the Data-processing (modified immediate) instruction class. This section is decoded from *32-bit on page F3-2887*.

15	14	13	12	11	10	9	8	5	4	3	0	15	14	12	11	8	7	0
1	1	1	1	0	i	0	op1	S	Rn	0	imm3	Rd	imm8					

Decode fields					Instruction page
op1	S	Rn	Rd		
0000	0	-	-		AND, ANDS (immediate) - <i>AND variant on page F5-3035</i>
0000	1	-	!= 1111		AND, ANDS (immediate) - <i>ANDS variant on page F5-3035</i>
0000	1	-	1111		TST (immediate)
0001	-	-	-		BIC, BICS (immediate)
0010	0	!= 1111	-		ORR, ORRS (immediate) - <i>ORR variant on page F5-3304</i>
0010	0	1111	-		MOV, MOVS (immediate) - <i>MOV variant on page F5-3258</i>

Decode fields				Instruction page
op1	S	Rn	Rd	
0010	1	!= 1111	-	ORR, ORRS (immediate) - <i>ORRS variant</i> on page F5-3304
0010	1	1111	-	MOV, MOVS (immediate) - <i>MOVS variant</i> on page F5-3258
0011	0	!= 1111	-	ORN, ORNS (immediate) - <i>Not flag setting variant</i> on page F5-3301
0011	0	1111	-	MVN, MVNS (immediate) - <i>MVN variant</i> on page F5-3292
0011	1	!= 1111	-	ORN, ORNS (immediate) - <i>Flag setting variant</i> on page F5-3301
0011	1	1111	-	MVN, MVNS (immediate) - <i>MVNS variant</i> on page F5-3292
0100	0	-	-	EOR, EORS (immediate) - <i>EOR variant</i> on page F5-3109
0100	1	-	!= 1111	EOR, EORS (immediate) - <i>EORS variant</i> on page F5-3109
0100	1	-	1111	TEQ (immediate)
0101	-	-	-	Unallocated.
011x	-	-	-	Unallocated.
1000	0	!= 1101	-	ADD, ADDS (immediate) - <i>ADD variant</i> on page F5-3014
1000	0	1101	-	ADD, ADDS (SP plus immediate) - <i>ADD variant</i> on page F5-3024
1000	1	!= 1101	!= 1111	ADD, ADDS (immediate) - <i>ADDS variant</i> on page F5-3014
1000	1	1101	!= 1111	ADD, ADDS (SP plus immediate) - <i>ADDS variant</i> on page F5-3024
1000	1	-	1111	CMN (immediate)
1001	-	-	-	Unallocated.
1010	-	-	-	ADC, ADCS (immediate)
1011	-	-	-	SBC, SBCS (immediate)
1100	-	-	-	Unallocated.
1101	0	!= 1101	-	SUB, SUBS (immediate) - <i>SUB variant</i> on page F5-3561
1101	0	1101	-	SUB, SUBS (SP minus immediate) - <i>SUB variant</i> on page F5-3570
1101	1	!= 1101	!= 1111	SUB, SUBS (immediate) - <i>SUBS variant</i> on page F5-3561
1101	1	1101	!= 1111	SUB, SUBS (SP minus immediate) - <i>SUBS variant</i> on page F5-3570
1101	1	-	1111	CMP (immediate)
1110	-	-	-	RSB, RSBS (immediate)
1111	-	-	-	Unallocated.

Long multiply and divide

This section describes the encoding of the Long multiply and divide instruction class. This section is decoded from [32-bit on page F3-2887](#).

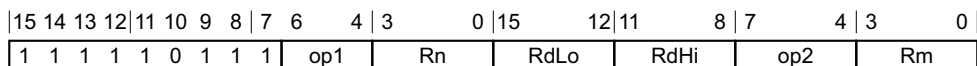

Decode fields

Instruction page

op1 op2

000	!= 0000	Unallocated.
000	0000	SMULL, SMULLS
001	!= 1111	Unallocated.
001	1111	SDIV
010	!= 0000	Unallocated.
010	0000	UMULL, UMULLS
011	!= 1111	Unallocated.
011	1111	UDIV
100	0000	SMLAL, SMLALS
100	0001	Unallocated.
100	001x	Unallocated.
100	01xx	Unallocated.
100	1000	SMLALBB, SMLALBT, SMLALTB, SMLALTT - <i>SMLALBB variant on page F5-3438</i>
100	1001	SMLALBB, SMLALBT, SMLALTB, SMLALTT - <i>SMLALBT variant on page F5-3438</i>
100	1010	SMLALBB, SMLALBT, SMLALTB, SMLALTT - <i>SMLALTB variant on page F5-3438</i>
100	1011	SMLALBB, SMLALBT, SMLALTB, SMLALTT - <i>SMLALTT variant on page F5-3438</i>
100	1100	SMLALD, SMLALDX - <i>SMLALD variant on page F5-3440</i>
100	1101	SMLALD, SMLALDX - <i>SMLALDX variant on page F5-3440</i>
100	111x	Unallocated.
101	0xxx	Unallocated.
101	10xx	Unallocated.
101	1100	SMLS LD, SMLS LD X - <i>SMLS LD variant on page F5-3446</i>
101	1101	SMLS LD, SMLS LD X - <i>SMLS LD X variant on page F5-3446</i>
101	111x	Unallocated.
110	0000	UMLAL, UMLALS
110	0001	Unallocated.
110	001x	Unallocated.
110	010x	Unallocated.

Decode fields		
op1	op2	Instruction page
110	0110	UMAAL
110	0111	Unallocated.
110	1xxx	Unallocated.
111	-	Unallocated.

F3.1.7 System register access, Advanced SIMD, and floating-point

This section describes the encoding of the System register access, Advanced SIMD, and floating-point group. This section is decoded from *32-bit on page F3-2887*.

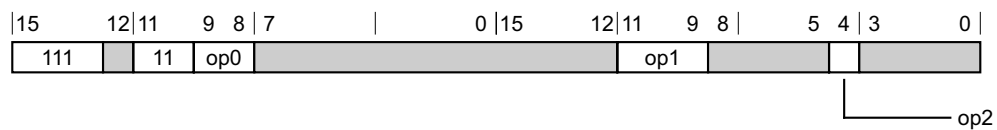

Table F3-8 Encoding table for the System register access, Advanced SIMD, and floating-point group

Decode fields			
op0	op1	op2	Decode group or instruction page
0x	10x	-	<i>Advanced SIMD load/store and 64-bit move on page F3-2894</i>
0x	111	-	<i>System register load/store and 64-bit move on page F3-2896</i>
10	10x	0	<i>Floating-point data-processing on page F3-2898</i>
10	10x	1	<i>Advanced SIMD and floating-point 32-bit move on page F3-2902</i>
10	111	1	<i>System register 32-bit move</i>
11	-	-	<i>Advanced SIMD data-processing on page F3-2904</i>

System register 32-bit move

This section describes the encoding of the System register 32-bit move instruction class. This section is decoded from *System register access, Advanced SIMD, and floating-point*.



Decode fields		Instruction page
o0	L	
0	0	MCR
0	1	MRC
1	-	Unallocated.

F3.1.8 Advanced SIMD load/store and 64-bit move

This section describes the encoding of the Advanced SIMD load/store and 64-bit move group. This section is decoded from *System register access, Advanced SIMD, and floating-point* on page F3-2893.

This group has encodings in both the T32 and A32 instruction sets. For information about mappings between the encodings of this group, see *About the T32 Advanced SIMD and floating-point instructions and their encoding* on page F3-2941

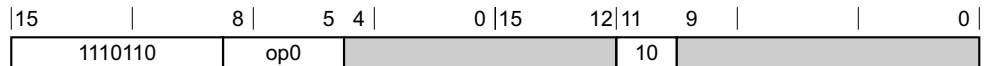

Table F3-9 Encoding table for the Advanced SIMD load/store and 64-bit move group

Decode fields		Decode group or instruction page
op0		
00x0		<i>Advanced SIMD and floating-point 64-bit move</i>
!= 00x0		<i>Advanced SIMD and floating-point load/store on page F3-2895</i>

Advanced SIMD and floating-point 64-bit move

This section describes the encoding of the Advanced SIMD and floating-point 64-bit move instruction class. This section is decoded from *Advanced SIMD load/store and 64-bit move*.

15	14	13	12	11	10	9	8	7	6	5	4	3	0	15	12	11	10	9	8	7	6	5	4	3	0
1	1	1	0	1	1	0	0	0	D	0	op	Rt2	Rt	1	0	size	opc2	M	o3	Vm					

Decode fields

Decode fields					Instruction page
D	op	size	opc2	o3	
0	-	-	-	-	Unallocated.
1	-	-	-	0	Unallocated.
1	-	0x	00	1	Unallocated.
1	-	-	01	-	Unallocated.
1	0	10	00	1	VMOV (between two general-purpose registers and two single-precision registers) - From general-purpose registers variant on page F6-4009
1	0	11	00	1	VMOV (between two general-purpose registers and a doubleword floating-point register) - From general-purpose registers variant on page F6-3988
1	-	-	1x	-	Unallocated.
1	1	10	00	1	VMOV (between two general-purpose registers and two single-precision registers) - To general-purpose registers variant on page F6-4009
1	1	11	00	1	VMOV (between two general-purpose registers and a doubleword floating-point register) - To general-purpose registers variant on page F6-3988

Advanced SIMD and floating-point load/store

This section describes the encoding of the Advanced SIMD and floating-point load/store instruction class. This section is decoded from [Advanced SIMD load/store and 64-bit move on page F3-2894](#).

15	14	13	12	11	10	9	8	7	6	5	4	3	0	15	12	11	10	9	8	7				0
1	1	1	0	1	1	0	P	U	D	W	L	Rn	Vd	1	0	size	imm8							

Decode fields

Decode fields								Instruction page
P	U	W	L	Rn	size	imm8		
0	0	1	-	-	-	-	Unallocated.	
0	1	-	-	-	0x	-	Unallocated.	
0	1	-	0	-	10	-	VSTM, VSTMDB, VSTMIA - Increment After variant on page F6-4270	
0	1	-	0	-	11	xxxxxxx0	VSTM, VSTMDB, VSTMIA - Increment After variant on page F6-4270	
0	1	-	0	-	11	xxxxxxx1	FSTMDBX, FSTMIAX - Increment After variant on page F6-3692	
0	1	-	1	-	10	-	VLDM, VLDMDB, VLDMIA - Increment After variant on page F6-3937	
0	1	-	1	-	11	xxxxxxx0	VLDM, VLDMDB, VLDMIA - Increment After variant on page F6-3937	
0	1	-	1	-	11	xxxxxxx1	FLDM*X (FLDMDBX, FLDMIAX) - Increment After variant on page F6-3689	

Decode fields							Instruction page
P	U	W	L	Rn	size	imm8	
1	-	0	0	-	-	-	VSTR
1	-	0	-	-	00	-	Unallocated.
1	-	0	1	!= 1111	-	-	VLDR (immediate)
1	0	1	-	-	0x	-	Unallocated.
1	0	1	0	-	10	-	VSTM, VSTMDB, VSTMIA - <i>Decrement Before variant on page F6-4270</i>
1	0	1	0	-	11	xxxxxxx0	VSTM, VSTMDB, VSTMIA - <i>Decrement Before variant on page F6-4269</i>
1	0	1	0	-	11	xxxxxxx1	FSTMDBX, FSTMIA - <i>Decrement Before variant on page F6-3692</i>
1	0	1	1	-	10	-	VLDM, VLDMDB, VLDMIA - <i>Decrement Before variant on page F6-3937</i>
1	0	1	1	-	11	xxxxxxx0	VLDM, VLDMDB, VLDMIA - <i>Decrement Before variant on page F6-3936</i>
1	0	1	1	-	11	xxxxxxx1	FLDM*X (FLDMDBX, FLDMIA) - <i>Decrement Before variant on page F6-3689</i>
1	-	0	1	1111	-	-	VLDR (literal)
1	1	1	-	-	-	-	Unallocated.

F3.1.9 System register load/store and 64-bit move

This section describes the encoding of the System register load/store and 64-bit move group. This section is decoded from *System register access, Advanced SIMD, and floating-point* on page F3-2893.

This group has encodings in both the T32 and A32 instruction sets. For information about mappings between the encodings of this group, see *About the T32 Advanced SIMD and floating-point instructions and their encoding* on page F3-2941

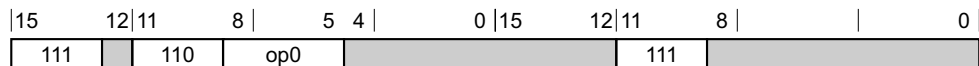
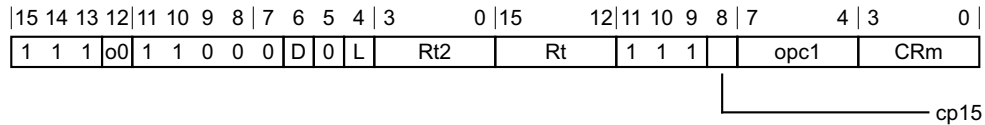

Table F3-10 Encoding table for the System register load/store and 64-bit move group

Decode fields	Decode group or instruction page
op0	
00x0	<i>System register 64-bit move</i>
!= 00x0	<i>System register Load/Store on page F3-2897</i>

System register 64-bit move

This section describes the encoding of the System register 64-bit move instruction class. This section is decoded from *System register load/store and 64-bit move*.



Decode fields			Instruction page
o0	D	L	
0	0	-	Unallocated.
0	1	0	MCRR
0	1	1	MRRC
1	0	-	Unallocated.
1	1	-	Unallocated.

System register Load/Store

This section describes the encoding of the System register Load/Store instruction class. This section is decoded from [System register load/store and 64-bit move on page F3-2896](#).

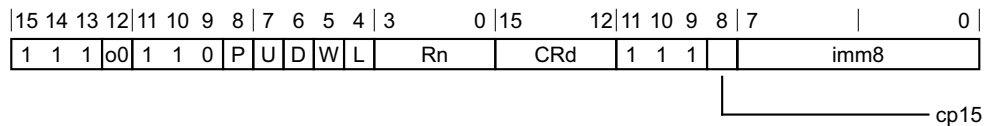

Decode fields							Instruction page
o0	P:U:W	D	L	Rn	CRd	cp15	
-	!= 000	-	-	-	!= 0101	0	Unallocated.
-	!= 000	-	-	-	-	1	Unallocated.
-	!= 000	1	-	-	0101	0	Unallocated.
0	!= 000	0	1	1111	0101	0	LDC (literal)
0	0x1	0	0	-	0101	0	STC - Post-indexed variant on page F5-3479
0	0x1	0	1	!= 1111	0101	0	LDC (immediate) - Post-indexed variant on page F5-3141
0	010	0	0	-	0101	0	STC - Unindexed variant on page F5-3479
0	010	0	1	!= 1111	0101	0	LDC (immediate) - Unindexed variant on page F5-3141
0	1x0	0	0	-	0101	0	STC - Offset variant on page F5-3479
0	1x0	0	1	!= 1111	0101	0	LDC (immediate) - Offset variant on page F5-3140
0	1x1	0	0	-	0101	0	STC - Pre-indexed variant on page F5-3479
0	1x1	0	1	!= 1111	0101	0	LDC (immediate) - Pre-indexed variant on page F5-3141
1	!= 000	0	-	-	0101	0	Unallocated.

F3.1.10 Floating-point data-processing

This section describes the encoding of the Floating-point data-processing group. This section is decoded from *System register access, Advanced SIMD, and floating-point* on page F3-2893.

This group has encodings in both the T32 and A32 instruction sets. For information about mappings between the encodings of this group, see *About the T32 Advanced SIMD and floating-point instructions and their encoding* on page F3-2941

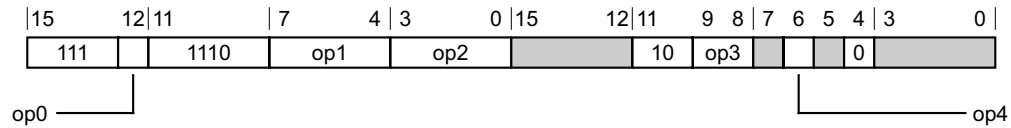
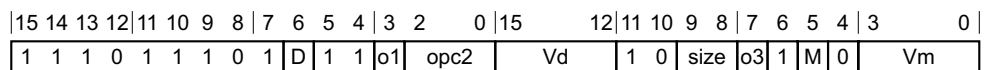

Table F3-11 Encoding table for the Floating-point data-processing group

Decode fields					Decode group or instruction page
op0	op1	op2	op3	op4	
0	1x11	-	-	1	<i>Floating-point data-processing (two registers)</i>
0	1x11	-	-	0	<i>Floating-point move immediate</i> on page F3-2899
0	!= 1x11	-	-	-	<i>Floating-point data-processing (three registers)</i> on page F3-2900
1	0xxx	-	!= 00	0	<i>Floating-point conditional select</i> on page F3-2901
1	1x00	-	!= 00	-	<i>Floating-point minNum/maxNum</i> on page F3-2901
1	1x11	0000	!= 00	1	<i>Floating-point extraction and insertion</i> on page F3-2901
1	1x11	1xxx	!= 00	1	<i>Floating-point directed convert to integer</i> on page F3-2902

Floating-point data-processing (two registers)

This section describes the encoding of the Floating-point data-processing (two registers) instruction class. This section is decoded from *Floating-point data-processing*.



Decode fields				Instruction page
o1	opc2	size	o3	
-	-	00	-	Unallocated.
0	000	01	0	Unallocated.
0	000	-	1	VABS
0	000	10	0	VMOV (register) - <i>Single-precision scalar variant</i> on page F6-3998
0	000	11	0	VMOV (register) - <i>Double-precision scalar variant</i> on page F6-3998
0	001	-	0	VNEG

Decode fields				Instruction page
o1	opc2	size	o3	
0	001	-	1	VSQRT
0	01x	01	-	Unallocated.
0	010	-	0	VCVTB - <i>Half-precision to double-precision variant</i> on page F6-3828
0	010	-	1	VCVTT - <i>Half-precision to double-precision variant</i> on page F6-3847
0	011	-	0	VCVTB - <i>Double-precision to half-precision variant</i> on page F6-3828
0	011	-	1	VCVTT - <i>Double-precision to half-precision variant</i> on page F6-3847
0	100	-	0	VCMP - <i>T1</i> on page F6-3793
0	100	-	1	VCMPE - <i>T1</i> on page F6-3797
0	101	-	0	VCMP - <i>T2</i> on page F6-3794
0	101	-	1	VCMPE - <i>T2</i> on page F6-3798
0	110	-	0	VRINTR
0	110	-	1	VRINTZ (floating-point)
0	111	-	0	VRINTX (floating-point)
0	111	01	1	Unallocated.
0	111	10	1	VCVT (between double-precision and single-precision) - <i>Single-precision to double-precision variant</i> on page F6-3802
0	111	11	1	VCVT (between double-precision and single-precision) - <i>Double-precision to single-precision variant</i> on page F6-3802
1	000	-	-	VCVT (integer to floating-point, floating-point)
1	001	01	-	Unallocated.
1	001	10	-	Unallocated.
1	001	11	0	Unallocated.
1	01x	-	-	VCVT (between floating-point and fixed-point, floating-point)
1	100	-	0	VCVTR
1	100	-	1	VCVT (floating-point to integer, floating-point)
1	101	-	0	VCVTR
1	101	-	1	VCVT (floating-point to integer, floating-point)
1	11x	-	-	VCVT (between floating-point and fixed-point, floating-point)

Floating-point move immediate

This section describes the encoding of the Floating-point move immediate instruction class. This section is decoded from *Floating-point data-processing* on page F3-2898.

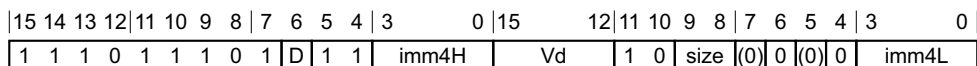

Decode fields	Instruction page	Architecture version
size		
00	Unallocated.	-
01	VMOV (immediate) - Half-precision scalar variant on page F6-3995	ARMv8.2
10	VMOV (immediate) - Single-precision scalar variant on page F6-3995	-
11	VMOV (immediate) - Double-precision scalar variant on page F6-3995	-

Floating-point data-processing (three registers)

This section describes the encoding of the Floating-point data-processing (three registers) instruction class. This section is decoded from [Floating-point data-processing on page F3-2898](#).

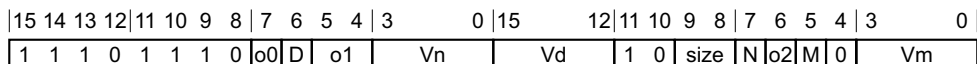

Decode fields	Instruction page		
o0:o1	size	o2	
!= 111	00	-	Unallocated.
000	-	0	VMLA (floating-point)
000	-	1	VMLS (floating-point)
001	-	0	VNMLS
001	-	1	VNMLA
010	-	0	VMUL (floating-point)
010	-	1	VNML
011	-	0	VADD (floating-point)
011	-	1	VSUB (floating-point)
100	-	0	VDIV
101	-	0	VFNMS
101	-	1	VFNMA
110	-	0	VFMA
110	-	1	VFMS

Floating-point conditional select

This section describes the encoding of the Floating-point conditional select instruction class. This section is decoded from *Floating-point data-processing* on page F3-2898.

15	14	13	12	11	10	9	8	7	6	5	4	3	0	15	12	11	10	9	8	7	6	5	4	3	0
1	1	1	1	1	1	1	0	0	D	cc		Vn		Vd	1	0	!=00	N	0	M	0		Vm		

size

Decode fields		Instruction page
cc	size	
00	-	VSELEQ, VSELGE, VSELGT, VSELVS - <i>VSELEQ</i>,doubleprec variant on page F6-4200
01	-	VSELEQ, VSELGE, VSELGT, VSELVS - <i>VSELVS</i>,doubleprec variant on page F6-4201
-	01	Unallocated.
10	-	VSELEQ, VSELGE, VSELGT, VSELVS - <i>VSELGE</i>,doubleprec variant on page F6-4200
11	-	VSELEQ, VSELGE, VSELGT, VSELVS - <i>VSELGT</i>,doubleprec variant on page F6-4201

Floating-point minNum/maxNum

This section describes the encoding of the Floating-point minNum/maxNum instruction class. This section is decoded from *Floating-point data-processing* on page F3-2898.

15	14	13	12	11	10	9	8	7	6	5	4	3	0	15	12	11	10	9	8	7	6	5	4	3	0
1	1	1	1	1	1	1	0	1	D	0	0	Vn		Vd	1	0	!=00	N	op	M	0		Vm		

size

Decode fields		Instruction page
size	op	
-	0	VMAXNM
01	-	Unallocated.
-	1	VMINNM

Floating-point extraction and insertion

This section describes the encoding of the Floating-point extraction and insertion instruction class. This section is decoded from *Floating-point data-processing* on page F3-2898.

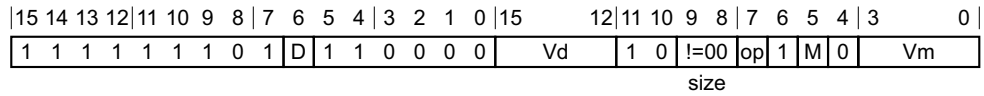

Decode fields		Instruction page	Architecture version
size	op		
01	-	Unallocated.	-
10	0	VMOVX	ARMv8.2
10	1	VINS	ARMv8.2
11	-	Unallocated.	-

Floating-point directed convert to integer

This section describes the encoding of the Floating-point directed convert to integer instruction class. This section is decoded from [Floating-point data-processing on page F3-2898](#).

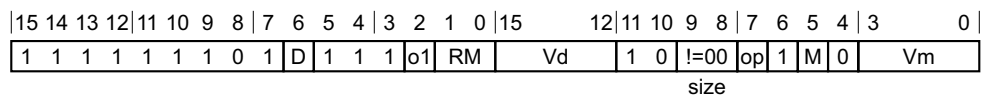

Decode fields			Instruction page
o1	RM	size	
0	00	-	VRINTA (floating-point)
0	01	-	VRINTN (floating-point)
-	-	01	Unallocated.
0	10	-	VRINTP (floating-point)
0	11	-	VRINTM (floating-point)
1	00	-	VCVTA (floating-point)
1	01	-	VCVTN (floating-point)
1	10	-	VCVTP (floating-point)
1	11	-	VCVTM (floating-point)

F3.1.11 Advanced SIMD and floating-point 32-bit move

This section describes the encoding of the Advanced SIMD and floating-point 32-bit move group. This section is decoded from [System register access, Advanced SIMD, and floating-point on page F3-2893](#).

This group has encodings in both the T32 and A32 instruction sets. For information about mappings between the encodings of this group, see [About the T32 Advanced SIMD and floating-point instructions and their encoding on page F3-2941](#)

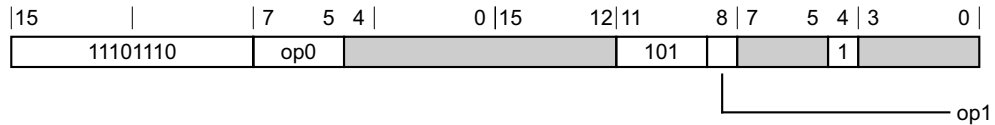
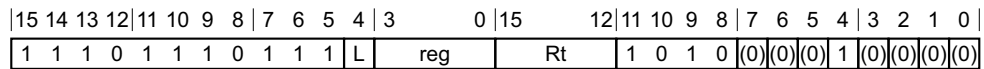

Table F3-12 Encoding table for the Advanced SIMD and floating-point 32-bit move group

Decode fields		Decode group or instruction page
op0	op1	
000	0	VMOV (between general-purpose register and single-precision)
111	0	Floating-point move special register
-	1	Advanced SIMD 8/16/32-bit element move/duplicate

Floating-point move special register

This section describes the encoding of the Floating-point move special register instruction class. This section is decoded from *Advanced SIMD and floating-point 32-bit move* on page F3-2902.



Decode fields		Instruction page
L		
0		VMSR
1		VMRS

Advanced SIMD 8/16/32-bit element move/duplicate

This section describes the encoding of the Advanced SIMD 8/16/32-bit element move/duplicate instruction class. This section is decoded from *Advanced SIMD and floating-point 32-bit move* on page F3-2902.

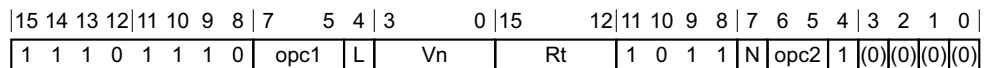

Decode fields			Instruction page
opc1	L	opc2	
0xx	0	-	VMOV (general-purpose register to scalar)
-	1	-	VMOV (scalar to general-purpose register)
1xx	0	0x	VDUP (general-purpose register)
1xx	0	1x	Unallocated.

F3.1.12 Advanced SIMD data-processing

This section describes the encoding of the Advanced SIMD data-processing group. This section is decoded from *System register access, Advanced SIMD, and floating-point* on page F3-2893.

This group has encodings in both the T32 and A32 instruction sets. For information about mappings between the encodings of this group, see *About the T32 Advanced SIMD and floating-point instructions and their encoding* on page F3-2941

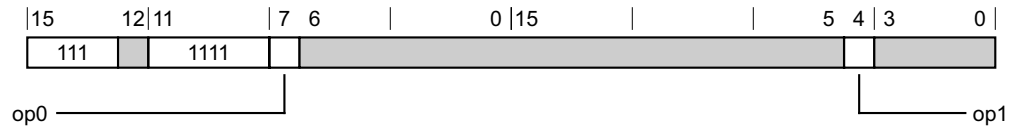
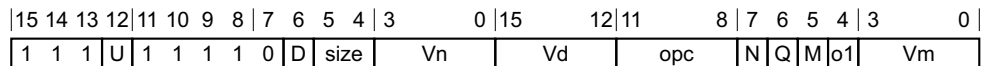

Table F3-13 Encoding table for the Advanced SIMD data-processing group

Decode fields		Decode group or instruction page
op0	op1	
0	-	<i>Advanced SIMD three registers of the same length</i>
1	0	<i>Advanced SIMD two registers, or three registers of different lengths on page F3-2907</i>
1	1	<i>Advanced SIMD shifts and immediate generation on page F3-2911</i>

Advanced SIMD three registers of the same length

This section describes the encoding of the Advanced SIMD three registers of the same length instruction class. This section is decoded from *Advanced SIMD data-processing*.



Decode fields					Instruction page	Architecture version
U	size	opc	Q	o1		
0	0x	1100	-	1	VFMA	-
0	0x	1101	-	0	VADD (floating-point)	-
0	0x	1101	-	1	VMLA (floating-point)	-
0	0x	1110	-	0	VCEQ (register) - T2 on page F6-3764	-
0	0x	1111	-	0	VMAX (floating-point)	-
0	0x	1111	-	1	VRECPS	-
-	-	0000	-	0	VHADD	-
0	00	0001	-	1	VAND (register)	-
-	-	0000	-	1	VQADD	-

Decode fields					Instruction page	Architecture version
U	size	opc	Q	o1		
-	-	0001	-	0	VRHADD	-
0	00	1100	-	0	SHA1C	-
-	-	0010	-	0	VHSUB	-
0	01	0001	-	1	VBIC (register)	-
-	-	0010	-	1	VQSUB	-
-	-	0011	-	0	VCGT (register) - <i>T1</i> on page F6-3775	-
-	-	0011	-	1	VCGE (register) - <i>T1</i> on page F6-3769	-
0	01	1100	-	0	SHA1P	-
0	1x	1100	-	1	VFMS	-
0	1x	1101	-	0	VSUB (floating-point)	-
0	1x	1101	-	1	VMLS (floating-point)	-
0	1x	1110	-	0	Unallocated.	-
0	1x	1111	-	0	VMIN (floating-point)	-
0	1x	1111	-	1	VRSQRTS	-
-	-	0100	-	0	VSHL (register)	-
0	-	1000	-	0	VADD (integer)	-
0	10	0001	-	1	VORR (register)	-
0	-	1000	-	1	VTST	-
-	-	0100	-	1	VQSHL (register)	-
0	-	1001	-	0	VMLA (integer)	-
-	-	0101	-	0	VRSHL	-
-	-	0101	-	1	VQRSHL	-
0	-	1011	-	0	VQDMULH	-
0	10	1100	-	0	SHA1M	-
0	-	1011	-	1	VPADD (integer)	-
-	-	0110	-	0	VMAX (integer)	-
0	11	0001	-	1	VORN (register)	-
-	-	0110	-	1	VMIN (integer)	-
-	-	0111	-	0	VABD (integer)	-
-	-	0111	-	1	VABA	-
0	11	1100	-	0	SHA1SU0	-

Decode fields					Instruction page	Architecture version
U	size	opc	Q	o1		
1	0x	1101	-	0	VPADD (floating-point)	-
1	0x	1101	-	1	VMUL (floating-point)	-
1	0x	1110	-	0	VCGE (register) - T2 on page F6-3769	-
1	0x	1110	-	1	VACGE	-
1	0x	1111	0	0	VPMAX (floating-point)	-
1	0x	1111	-	1	VMAXNM	-
1	00	0001	-	1	VEOR	-
-	-	1001	-	1	VMUL (integer and polynomial)	-
1	00	1100	-	0	SHA256H	-
-	-	1010	0	0	VPMAX (integer)	-
1	01	0001	-	1	VBSL	-
-	-	1010	0	1	VPMIN (integer)	-
-	-	1010	1	-	Unallocated.	-
1	01	1100	-	0	SHA256H2	-
1	1x	1101	-	0	VABD (floating-point)	-
1	1x	1110	-	0	VCGT (register) - T2 on page F6-3775	-
1	1x	1110	-	1	VACGT	-
1	1x	1111	0	0	VPMIN (floating-point)	-
1	1x	1111	-	1	VMINNM	-
1	-	1000	-	0	VSUB (integer)	-
1	10	0001	-	1	VBIT	-
1	-	1000	-	1	VCEQ (register) - T1 on page F6-3764	-
1	-	1001	-	0	VMLS (integer)	-
1	-	1011	-	0	VQRDMULH	-
1	10	1100	-	0	SHA256SU1	-
1	-	1011	-	1	VQRDMLAH	ARMv8.1
1	11	0001	-	1	VBIF	-
1	-	1100	-	1	VQRDMLSH	ARMv8.1
1	-	1111	1	0	Unallocated.	-

F3.1.13 Advanced SIMD two registers, or three registers of different lengths

This section describes the encoding of the Advanced SIMD two registers, or three registers of different lengths group. This section is decoded from *Advanced SIMD data-processing* on page F3-2904.

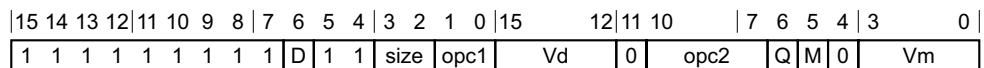

Table F3-14 Encoding table for the Advanced SIMD two registers, or three registers of different lengths group

Decode fields				Decode group or instruction page
op0	op1	op2	op3	
0	11	-	-	VEXT (byte elements)
1	11	0x	-	<i>Advanced SIMD two registers misc</i>
1	11	10	-	VTBL, VTBX
1	11	11	-	<i>Advanced SIMD duplicate (scalar) on page F3-2909</i>
-	!= 11	-	0	<i>Advanced SIMD three registers of different lengths on page F3-2909</i>
-	!= 11	-	1	<i>Advanced SIMD two registers and a scalar on page F3-2910</i>

Advanced SIMD two registers misc

This section describes the encoding of the Advanced SIMD two registers misc instruction class. This section is decoded from *Advanced SIMD two registers, or three registers of different lengths*.



Decode fields				Instruction page
size	opc1	opc2	Q	
-	00	0000	-	VREV64
-	00	0001	-	VREV32
-	00	0010	-	VREV16
-	00	0011	-	Unallocated.
-	00	010x	-	VPADDL
-	00	0110	0	AESE
-	00	0110	1	AESD
-	00	0111	0	AESMC

Decode fields				Instruction page
size	opc1	opc2	Q	
-	00	0111	1	AESIMC
-	00	1000	-	VCLS
00	10	0000	-	VSWP
-	00	1001	-	VCLZ
-	00	1010	-	VCNT
-	00	1011	-	VMVN (register)
-	00	110x	-	VPADAL
-	00	1110	-	VQABS
-	00	1111	-	VQNEG
-	01	x000	-	VCGT (immediate #0)
-	01	x001	-	VCGE (immediate #0)
-	01	x010	-	VCEQ (immediate #0)
-	01	x011	-	VCLE (immediate #0)
-	01	x100	-	VCLT (immediate #0)
-	01	x110	-	VABS
-	01	x111	-	VNEG
-	01	0101	1	SHA1H
-	10	0001	-	VTRN
-	10	0010	-	VUZP
-	10	0011	-	VZIP
-	10	0100	0	VMOVN
-	10	0100	1	VQMOVN, VQMOVUN - <i>Unsigned result variant on page F6-4101</i>
-	10	0101	-	VQMOVN, VQMOVUN - <i>Signed result variant on page F6-4100</i>
-	10	0110	0	VSHLL
-	10	0111	0	SHA1SU1
-	10	0111	1	SHA256SU0
-	10	1000	-	VRINTN (Advanced SIMD)
-	10	1001	-	VRINTX (Advanced SIMD)
-	10	1010	-	VRINTA (Advanced SIMD)
-	10	1011	-	VRINTZ (Advanced SIMD)
-	10	1100	0	VCVT (between half-precision and single-precision, Advanced SIMD) - <i>Single-precision to half-precision variant on page F6-3804</i>

Decode fields				Instruction page
size	opc1	opc2	Q	
-	10	1100	1	Unallocated.
-	10	1101	-	VRINTM (Advanced SIMD)
-	10	1110	0	VCVT (between half-precision and single-precision, Advanced SIMD) - Half-precision to single-precision variant on page F6-3804
-	10	1110	1	Unallocated.
-	10	1111	-	VRINTP (Advanced SIMD)
-	11	000x	-	VCVTA (Advanced SIMD)
-	11	001x	-	VCVTN (Advanced SIMD)
-	11	010x	-	VCVTP (Advanced SIMD)
-	11	011x	-	VCVTM (Advanced SIMD)
-	11	10x0	-	VRECPE
-	11	10x1	-	VRSQRTE
-	11	11xx	-	VCVT (between floating-point and integer, Advanced SIMD)

Advanced SIMD duplicate (scalar)

This section describes the encoding of the Advanced SIMD duplicate (scalar) instruction class. This section is decoded from *Advanced SIMD two registers, or three registers of different lengths* on page F3-2907.

15	14	13	12	11	10	9	8	7	6	5	4	3	0	15	12	11	10	9	7	6	5	4	3	0
1	1	1	1	1	1	1	1	1	D	1	1	imm4	Vd	1	1	opc	Q	M	0	Vm				

Decode fields		Instruction page
opc		
000		VDUP (scalar)
001		Unallocated.
01x		Unallocated.
1xx		Unallocated.

Advanced SIMD three registers of different lengths

This section describes the encoding of the Advanced SIMD three registers of different lengths instruction class. This section is decoded from *Advanced SIMD two registers, or three registers of different lengths* on page F3-2907.

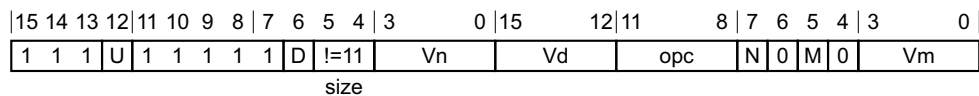

Decode fields		Instruction page
U	opc	
-	0000	VADDL
-	0001	VADDW
-	0010	VSUBL
0	0100	VADDHN
-	0011	VSUBW
0	0110	VSUBHN
0	1001	VQDMLAL
-	0101	VABAL
0	1011	VQDMLSL
0	1101	VQDMULL
-	0111	VABDL (integer)
-	1000	VMLAL (integer)
-	1010	VMLSL (integer)
1	0100	VRADDHN
1	0110	VRSUBHN
-	11x0	VMULL (integer and polynomial)
1	1001	Unallocated.
1	1011	Unallocated.
1	1101	Unallocated.
-	1111	Unallocated.

Advanced SIMD two registers and a scalar

This section describes the encoding of the Advanced SIMD two registers and a scalar instruction class. This section is decoded from *Advanced SIMD two registers, or three registers of different lengths* on page F3-2907.

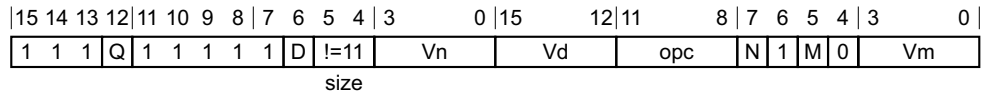

Decode fields		Instruction page	Architecture version
Q	opc		
-	000x	VMLA (by scalar)	-
0	0011	VQDMLAL	-
-	0010	VMLAL (by scalar)	-
0	0111	VQDMLSL	-
-	010x	VMLS (by scalar)	-
0	1011	VQDMULL	-
-	0110	VMLSL (by scalar)	-
-	100x	VMUL (by scalar)	-
1	0011	Unallocated.	-
-	1010	VMULL (by scalar)	-
1	0111	Unallocated.	-
-	1100	VQDMULH	-
-	1101	VQRDMULH	-
1	1011	Unallocated.	-
-	1110	VQRDMLAH	ARMv8.1
-	1111	VQRDMLSH	ARMv8.1

F3.1.14 Advanced SIMD shifts and immediate generation

This section describes the encoding of the Advanced SIMD shifts and immediate generation group. This section is decoded from *Advanced SIMD data-processing* on page F3-2904.

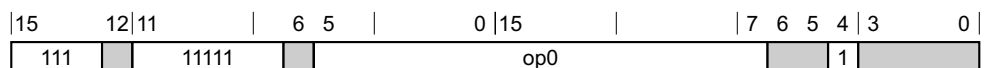
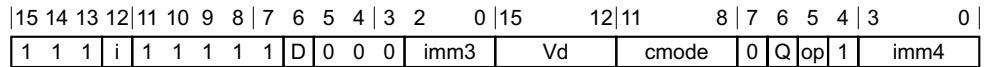

Table F3-15 Encoding table for the Advanced SIMD shifts and immediate generation group

Decode fields	Decode group or instruction page
op0	
000xxxxxxxxxxx0	<i>Advanced SIMD one register and modified immediate</i> on page F3-2912
!= 000xxxxxxxxxxx0	<i>Advanced SIMD two registers and shift amount</i> on page F3-2912

Advanced SIMD one register and modified immediate

This section describes the encoding of the Advanced SIMD one register and modified immediate instruction class. This section is decoded from *Advanced SIMD shifts and immediate generation* on page F3-2911.



Decode fields		Instruction page
cmode	op	
0xx0	0	VMOV (immediate) - T1 on page F6-3994
0xx0	1	VMVN (immediate) - T1 on page F6-4036
0xx1	0	VORR (immediate) - T1 on page F6-4060
0xx1	1	VBIC (immediate) - T1 on page F6-3751
10x0	0	VMOV (immediate) - T3 on page F6-3995
10x0	1	VMVN (immediate) - T2 on page F6-4036
10x1	0	VORR (immediate) - T2 on page F6-4060
10x1	1	VBIC (immediate) - T2 on page F6-3751
11xx	0	VMOV (immediate) - T4 on page F6-3996
110x	1	VMVN (immediate) - T3 on page F6-4037
1110	1	VMOV (immediate) - T5 on page F6-3996
1111	1	Unallocated.

Advanced SIMD two registers and shift amount

This section describes the encoding of the Advanced SIMD two registers and shift amount instruction class. This section is decoded from *Advanced SIMD shifts and immediate generation* on page F3-2911.

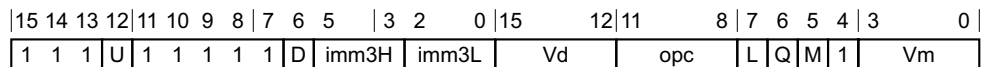

Decode fields				Instruction page
U	imm3L	opc	L Q	
-	-	0000	- -	VSHR
-	-	0001	- -	VSRA
-	-	0010	- -	VRSRHR
-	-	0011	- -	VRSRA
1	-	0100	- -	VSRI

Decode fields					Instruction page
U	imm3L	opc	L	Q	
0	-	0101	-	-	VSHL (immediate)
1	-	0101	-	-	VSLI
1	-	0110	-	-	VQSHL, VQSHLU (immediate)
-	-	0111	-	-	
0	-	1000	0	0	VSHRN
1	-	1000	0	0	VQSHRN, VQSHRUN - <i>Unsigned result variant on page F6-4132</i>
0	-	1000	0	1	VRSHRN
1	-	1000	0	1	VQRSHRN, VQRSHRUN - <i>Unsigned result variant on page F6-4120</i>
-	-	1001	0	0	VQSHRN, VQSHRUN - <i>Signed result variant on page F6-4131</i>
-	-	1001	0	1	VQRSHRN, VQRSHRUN - <i>Signed result variant on page F6-4119</i>
-	!= 000	1010	0	0	VSHLL
-	000	1010	0	0	VMOVL
-	-	111x	0	-	VCVT (between floating-point and fixed-point, Advanced SIMD)

F3.1.15 Load/store dual, load/store exclusive, load-acquire/store-release, and table branch

This section describes the encoding of the Load/store dual, load/store exclusive, load-acquire/store-release, and table branch group. This section is decoded from *32-bit on page F3-2887*.

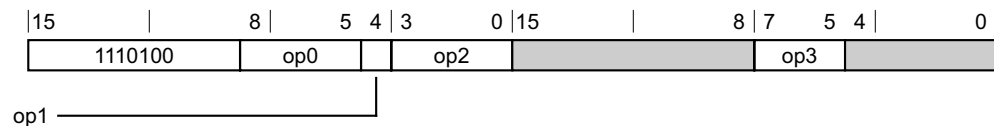

This decode also imposes the constraint:

- $op0 < 1 \Rightarrow 1$.

Table F3-16 Encoding table for the Load/store dual, load/store exclusive, load-acquire/store-release, and table branch group

Decode fields				Decode group or instruction page
op0	op1	op2	op3	
0010	-	-	-	<i>Load/store exclusive on page F3-2914</i>
0110	0	-	000	Unallocated.
0110	1	-	000	TBB, TBH
0110	-	-	01x	<i>Load/store exclusive byte/half/dual on page F3-2914</i>
0110	-	-	1xx	<i>Load-acquire / Store-release on page F3-2915</i>
0x11	-	!= 1111	-	<i>Load/store dual (immediate, post-indexed) on page F3-2915</i>

Table F3-16 Encoding table for the Load/store dual, load/store exclusive, load-acquire/store-release, and table branch group (continued)

Decode fields				Decode group or instruction page
op0	op1	op2	op3	
1x10	-	!= 1111	-	Load/store dual (immediate) on page F3-2916
1x11	-	!= 1111	-	Load/store dual (immediate, pre-indexed) on page F3-2916
!= 0xx0	-	1111	-	LDRD (literal)

Load/store exclusive

This section describes the encoding of the Load/store exclusive instruction class. This section is decoded from [Load/store dual, load/store exclusive, load-acquire/store-release, and table branch](#) on page F3-2913.

15	14	13	12	11	10	9	8	7	6	5	4	3	0	15	12	11	8	7	0
1	1	1	0	1	0	0	0	0	1	0	L	Rn	Rt	Rd	imm8				

Decode fields		Instruction page
L		
0		STREX
1		LDREX

Load/store exclusive byte/half/dual

This section describes the encoding of the Load/store exclusive byte/half/dual instruction class. This section is decoded from [Load/store dual, load/store exclusive, load-acquire/store-release, and table branch](#) on page F3-2913.

15	14	13	12	11	10	9	8	7	6	5	4	3	0	15	12	11	8	7	6	5	4	3	0
1	1	1	0	1	0	0	0	1	1	0	L	Rn	Rt	Rt2	0	1	sz	Rd					

Decode fields			Instruction page
L	sz		
0	00		STREXB
0	01		STREXH
0	10		Unallocated.
0	11		STREXD
1	00		LDREXB

Decode fields		Instruction page
L	sz	
1	01	LDREXH
1	10	Unallocated.
1	11	LDREXD

Load-acquire / Store-release

This section describes the encoding of the Load-acquire / Store-release instruction class. This section is decoded from *Load/store dual, load/store exclusive, load-acquire/store-release, and table branch* on page F3-2913.

15	14	13	12	11	10	9	8	7	6	5	4	3	0	15	12	11	8	7	6	5	4	3	0	
1	1	1	0	1	0	0	0	1	1	0	L	Rn	Rt	Rt2	1	op	sz	Rd						

Decode fields			Instruction page
L	op	sz	
0	0	00	STLB
0	0	01	STLH
0	0	10	STL
0	0	11	Unallocated.
0	1	00	STLEXB
0	1	01	STLEXH
0	1	10	STLEX
0	1	11	STLEXD
1	0	00	LDAB
1	0	01	LDAH
1	0	10	LDA
1	0	11	Unallocated.
1	1	00	LDAEXB
1	1	01	LDAEXH
1	1	10	LDAEX
1	1	11	LDAEXD

Load/store dual (immediate, post-indexed)

This section describes the encoding of the Load/store dual (immediate, post-indexed) instruction class. This section is decoded from *Load/store dual, load/store exclusive, load-acquire/store-release, and table branch* on page F3-2913.

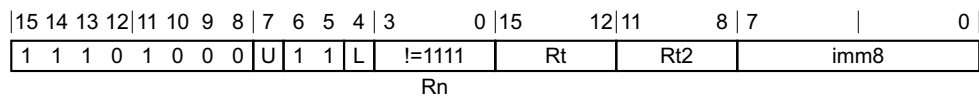

Decode fields	Instruction page
L	
0	STRD (immediate)
1	LDRD (immediate)

Load/store dual (immediate)

This section describes the encoding of the Load/store dual (immediate) instruction class. This section is decoded from [Load/store dual, load/store exclusive, load-acquire/store-release, and table branch on page F3-2913](#).

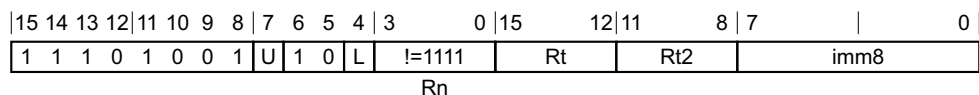

Decode fields	Instruction page
L	
0	STRD (immediate)
1	LDRD (immediate)

Load/store dual (immediate, pre-indexed)

This section describes the encoding of the Load/store dual (immediate, pre-indexed) instruction class. This section is decoded from [Load/store dual, load/store exclusive, load-acquire/store-release, and table branch on page F3-2913](#).

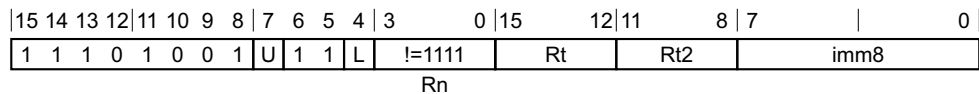

Decode fields	Instruction page
L	
0	STRD (immediate)
1	LDRD (immediate)

F3.1.16 Branches and miscellaneous control

This section describes the encoding of the Branches and miscellaneous control group. This section is decoded from [32-bit on page F3-2887](#).

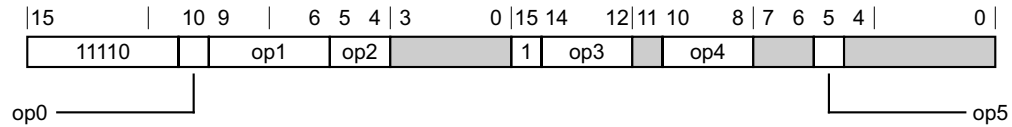

Table F3-17 Encoding table for the Branches and miscellaneous control group

Decode fields						Decode group or instruction page
op0	op1	op2	op3	op4	op5	
0	1110	0x	0x0	-	0	MSR (register)
0	1110	0x	0x0	-	1	MSR (Banked register)
0	1110	10	0x0	000	-	Hints
0	1110	10	0x0	!= 000	-	Change processor state on page F3-2918
0	1110	11	0x0	-	-	Miscellaneous system on page F3-2919
0	1111	00	0x0	-	-	BXJ
0	1111	01	0x0	-	-	Exception return on page F3-2919
0	1111	1x	0x0	-	0	MRS
0	1111	1x	0x0	-	1	MRS (Banked register)
1	1110	00	000	-	-	DCPS on page F3-2920
1	1110	00	010	-	-	Unallocated.
1	1110	01	0x0	-	-	Unallocated.
1	1110	1x	0x0	-	-	Unallocated.
1	1111	0x	0x0	-	-	Unallocated.
1	1111	1x	0x0	-	-	Exception generation on page F3-2920
-	!= 111x	-	0x0	-	-	B - T3 variant on page F5-3052
-	-	-	0x1	-	-	B - T4 variant on page F5-3052
-	-	-	1x0	-	-	BL, BLX (immediate) - T2 variant on page F5-3068
-	-	-	1x1	-	-	BL, BLX (immediate) - T1 variant on page F5-3067

Hints

This section describes the encoding of the Hints instruction class. This section is decoded from [Branches and miscellaneous control on page F3-2916](#).

15	14	13	12	11	10	9	8	7	6	5	4	3	2	1	0	15	14	13	12	11	10	9	8	7	6	5	4	3	2	1	0
1	1	1	1	0	0	1	1	1	0	1	0	(1)	(1)	(1)	(1)	1	0	(0)	0	(0)	0	0	0	0	0	0	0	0	0	hint	option

Decode fields		Instruction page	Architecture version
hint	option		
0000	0000	NOP	-
0000	0001	YIELD	-
0000	0010	WFE	-
0000	0011	WFI	-
0000	0100	SEV	-
0000	0101	SEVL	-
0000	011x	Reserved hint, behaves as NOP .	-
0000	1xxx	Reserved hint, behaves as NOP .	-
0001	!= 0000	Reserved hint, behaves as NOP .	-
0001	0000	ESB	ARMv8.2
001x	-	Reserved hint, behaves as NOP .	-
01xx	-	Reserved hint, behaves as NOP .	-
10xx	-	Reserved hint, behaves as NOP .	-
110x	-	Reserved hint, behaves as NOP .	-
1110	-	Reserved hint, behaves as NOP .	-
1111	-	DBG	-

Change processor state

This section describes the encoding of the Change processor state instruction class. This section is decoded from [Branches and miscellaneous control on page F3-2916](#).

15	14	13	12	11	10	9	8	7	6	5	4	3	2	1	0	15	14	13	12	11	10	9	8	7	6	5	4	3	2	1	0
1	1	1	1	0	0	1	1	1	0	1	0	(1)	(1)	(1)	(1)	1	0	(0)	0	(0)	imod	M	A	I	F	mode					

Decode fields		Instruction page
imod	M	
00	1	CPS, CPSID, CPSIE - CPS variant on page F5-3091

Decode fields		Instruction page
imod	M	
01	-	Unallocated.
10	-	CPS, CPSID, CPSIE - CPSIE variant on page F5-3091
11	-	CPS, CPSID, CPSIE - CPSID variant on page F5-3091

Miscellaneous system

This section describes the encoding of the Miscellaneous system instruction class. This section is decoded from [Branches and miscellaneous control on page F3-2916](#).

15	14	13	12	11	10	9	8	7	6	5	4	3	2	1	0	15	14	13	12	11	10	9	8	7	4	3	0
1	1	1	1	0	0	1	1	1	0	1	1	(1)	(1)	(1)	(1)	1	0	(0)	0	(1)	(1)	(1)	(1)	opc	option		

Decode fields		Instruction page
opc		
000x		Unallocated.
0010		CLREX
0011		Unallocated.
0100		DSB
0101		DMB
0110		ISB
0111		Unallocated.
1xxx		Unallocated.

Exception return

This section describes the encoding of the Exception return instruction class. This section is decoded from [Branches and miscellaneous control on page F3-2916](#).

15	14	13	12	11	10	9	8	7	6	5	4	3	0	15	14	13	12	11	10	9	8	7	0
1	1	1	1	0	0	1	1	1	0	1	Rn	1	0	(0)	0	(1)	(1)	(1)	(1)	imm8			

Decode fields		Instruction page
Rn	imm8	
-	!= 00000000	SUB, SUBS (immediate)
1110	00000000	ERET

DCPS

This section describes the encoding of the DCPS instruction class. This section is decoded from *Branches and miscellaneous control* on page F3-2916.

15	14	13	12	11	10	9	8	7	6	5	4	3	0	15	14	13	12	11				2	1	0
1	1	1	1	0	1	1	1	1	0	0	0	0	imm4	1	0	0	0				imm10			opt

Decode fields

Decode fields			Instruction page
imm4	imm10	opt	
!= 1111	-	-	Unallocated.
1111	!= 0000000000	-	Unallocated.
1111	0000000000	00	Unallocated.
1111	0000000000	01	DCPS1, DCPS2, DCPS3 - DCPS1 variant on page F5-3102
1111	0000000000	10	DCPS1, DCPS2, DCPS3 - DCPS2 variant on page F5-3102
1111	0000000000	11	DCPS1, DCPS2, DCPS3 - DCPS3 variant on page F5-3102

Exception generation

This section describes the encoding of the Exception generation instruction class. This section is decoded from *Branches and miscellaneous control* on page F3-2916.

15	14	13	12	11	10	9	8	7	6	5	4	3	0	15	14	13	12	11					0	
1	1	1	1	0	1	1	1	1	1	1	1	o1	imm4	1	0	o2	0				imm12			

Decode fields

Decode fields		Instruction page
o1	o2	
0	0	HVC
0	1	Unallocated.
1	0	SMC
1	1	UDF

F3.1.17 Data-processing (plain binary immediate)

This section describes the encoding of the Data-processing (plain binary immediate) group. This section is decoded from *32-bit* on page F3-2887.

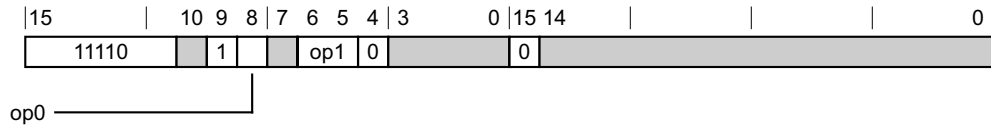
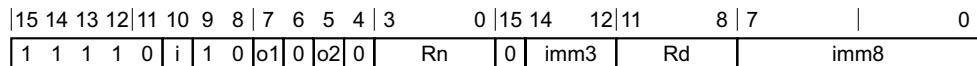

Table F3-18 Encoding table for the Data-processing (plain binary immediate) group

Decode fields		Decode group or instruction page
op0	op1	
0	0x	<i>Data-processing (simple immediate)</i>
0	10	<i>Move Wide (16-bit immediate)</i>
0	11	Unallocated.
1	-	<i>Saturate, Bitfield on page F3-2922</i>

Data-processing (simple immediate)

This section describes the encoding of the Data-processing (simple immediate) instruction class. This section is decoded from *Data-processing (plain binary immediate)* on page F3-2920.



Decode fields			Instruction page
o1	o2	Rn	
0	0	!= 11x1	<i>ADD, ADDS (immediate)</i>
0	0	1101	<i>ADD, ADDS (SP plus immediate)</i>
0	0	1111	<i>ADR - T3 on page F5-3033</i>
0	1	-	Unallocated.
1	0	-	Unallocated.
1	1	!= 11x1	<i>SUB, SUBS (immediate)</i>
1	1	1101	<i>SUB, SUBS (SP minus immediate)</i>
1	1	1111	<i>ADR - T2 on page F5-3032</i>

Move Wide (16-bit immediate)

This section describes the encoding of the Move Wide (16-bit immediate) instruction class. This section is decoded from *Data-processing (plain binary immediate)* on page F3-2920.

15	14	13	12	11	10	9	8	7	6	5	4	3	0	15	14	12	11	8	7	0
1	1	1	1	0	i	1	0	o1	1	0	0	imm4	0	imm3	Rd	imm8				

Decode fields		Instruction page
o1		
0		MOV, MOVS (immediate)
1		MOVT

Saturate, Bitfield

This section describes the encoding of the Saturate, Bitfield instruction class. This section is decoded from [Data-processing \(plain binary immediate\)](#) on page F3-2920.

15	14	13	12	11	10	9	8	7	5	4	3	0	15	14	12	11	8	7	6	5	4	0
1	1	1	1	0	(0)	1	1	op1	0	Rn	0	imm3	Rd	imm2	(0)	widthm1						

Decode fields			Instruction page
op1	Rn	imm3:imm2	
000	-	-	SSAT - Logical shift left variant on page F5-3468
001	-	!= 00000	SSAT - Arithmetic shift right variant on page F5-3468
001	-	00000	SSAT16
010	-	-	SBFX
011	!= 1111	-	BFI
011	1111	-	BFC
100	-	-	USAT - Logical shift left variant on page F5-3646
101	-	!= 00000	USAT - Arithmetic shift right variant on page F5-3646
101	-	00000	USAT16
110	-	-	UBFX
111	-	-	Unallocated.

F3.1.18 Advanced SIMD element or structure load/store

This section describes the encoding of the Advanced SIMD element or structure load/store group. This section is decoded from [32-bit](#) on page F3-2887.

This group has encodings in both the T32 and A32 instruction sets. For information about mappings between the encodings of this group, see [About the T32 Advanced SIMD and floating-point instructions and their encoding on page F3-2941](#)

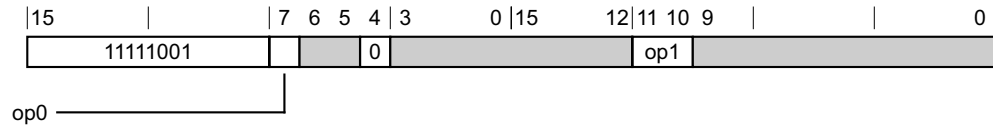
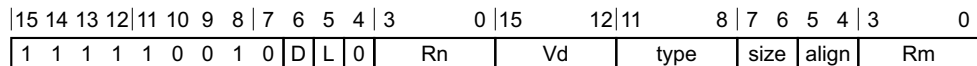

Table F3-19 Encoding table for the Advanced SIMD element or structure load/store group

Decode fields		Decode group or instruction page
op0	op1	
0	-	<i>Advanced SIMD load/store multiple structures</i>
1	11	<i>Advanced SIMD load single structure to all lanes on page F3-2924</i>
1	!= 11	<i>Advanced SIMD load/store single structure to one lane on page F3-2924</i>

Advanced SIMD load/store multiple structures

This section describes the encoding of the Advanced SIMD load/store multiple structures instruction class. This section is decoded from *Advanced SIMD element or structure load/store* on page F3-2922.



Decode fields		Instruction page
L	type	
0	000x	<i>VST4 (multiple 4-element structures)</i>
0	0010	<i>VST1 (multiple single elements) - T4 on page F6-4236</i>
0	0011	<i>VST2 (multiple 2-element structures) - T2 on page F6-4247</i>
0	010x	<i>VST3 (multiple 3-element structures)</i>
0	0110	<i>VST1 (multiple single elements) - T3 on page F6-4235</i>
0	0111	<i>VST1 (multiple single elements) - T1 on page F6-4234</i>
0	100x	<i>VST2 (multiple 2-element structures) - T1 on page F6-4246</i>
0	1010	<i>VST1 (multiple single elements) - T2 on page F6-4234</i>
1	000x	<i>VLD4 (multiple 4-element structures)</i>
1	0010	<i>VLD1 (multiple single elements) - T4 on page F6-3894</i>
1	0011	<i>VLD2 (multiple 2-element structures) - T2 on page F6-3908</i>
1	010x	<i>VLD3 (multiple 3-element structures)</i>
-	1011	Unallocated.

Decode fields		Instruction page
L	type	
1	0110	VLD1 (multiple single elements) - T3 on page F6-3893
1	0111	VLD1 (multiple single elements) - T1 on page F6-3892
-	11xx	Unallocated.
1	100x	VLD2 (multiple 2-element structures) - T1 on page F6-3907
1	1010	VLD1 (multiple single elements) - T2 on page F6-3892

Advanced SIMD load single structure to all lanes

This section describes the encoding of the Advanced SIMD load single structure to all lanes instruction class. This section is decoded from *Advanced SIMD element or structure load/store* on page F3-2922.

15	14	13	12	11	10	9	8	7	6	5	4	3	0	15	12	11	10	9	8	7	6	5	4	3	0
1	1	1	1	1	0	0	1	1	D	L	0	Rn	Vd	1	1	N	size	T	a	Rm					

Decode fields			Instruction page
L	N	a	
0	-	-	Unallocated.
1	00	-	VLD1 (single element to all lanes)
1	01	-	VLD2 (single 2-element structure to all lanes)
1	10	0	VLD3 (single 3-element structure to all lanes)
1	10	1	Unallocated.
1	11	-	VLD4 (single 4-element structure to all lanes)

Advanced SIMD load/store single structure to one lane

This section describes the encoding of the Advanced SIMD load/store single structure to one lane instruction class. This section is decoded from *Advanced SIMD element or structure load/store* on page F3-2922.

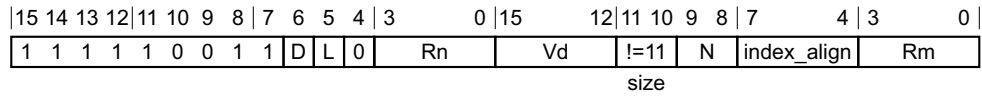

Decode fields			Instruction page
L	size	N	
0	00	00	VST1 (single element from one lane) - <i>T1</i> on page F6-4227
0	00	01	VST2 (single 2-element structure from one lane) - <i>T1</i> on page F6-4241
0	00	10	VST3 (single 3-element structure from one lane) - <i>T1</i> on page F6-4252
0	00	11	VST4 (single 4-element structure from one lane) - <i>T1</i> on page F6-4261
0	01	00	VST1 (single element from one lane) - <i>T2</i> on page F6-4228
0	01	01	VST2 (single 2-element structure from one lane) - <i>T2</i> on page F6-4242
0	01	10	VST3 (single 3-element structure from one lane) - <i>T2</i> on page F6-4253
0	01	11	VST4 (single 4-element structure from one lane) - <i>T2</i> on page F6-4262
0	10	00	VST1 (single element from one lane) - <i>T3</i> on page F6-4228
0	10	01	VST2 (single 2-element structure from one lane) - <i>T3</i> on page F6-4242
0	10	10	VST3 (single 3-element structure from one lane) - <i>T3</i> on page F6-4253
0	10	11	VST4 (single 4-element structure from one lane) - <i>T3</i> on page F6-4262
1	00	00	VLD1 (single element to one lane) - <i>T1</i> on page F6-3882
1	00	01	VLD2 (single 2-element structure to one lane) - <i>T1</i> on page F6-3899
1	00	10	VLD3 (single 3-element structure to one lane) - <i>T1</i> on page F6-3913
1	00	11	VLD4 (single 4-element structure to one lane) - <i>T1</i> on page F6-3925
1	01	00	VLD1 (single element to one lane) - <i>T2</i> on page F6-3883
1	01	01	VLD2 (single 2-element structure to one lane) - <i>T2</i> on page F6-3900
1	01	10	VLD3 (single 3-element structure to one lane) - <i>T2</i> on page F6-3914
1	01	11	VLD4 (single 4-element structure to one lane) - <i>T2</i> on page F6-3926
1	10	00	VLD1 (single element to one lane) - <i>T3</i> on page F6-3883

Decode fields			Instruction page
L	size	N	
1	10	01	VLD2 (single 2-element structure to one lane) - T3 on page F6-3900
1	10	10	VLD3 (single 3-element structure to one lane) - T3 on page F6-3914
1	10	11	VLD4 (single 4-element structure to one lane) - T3 on page F6-3926

F3.1.19 Load/store single

This section describes the encoding of the Load/store single group. This section is decoded from *32-bit* on page F3-2887.

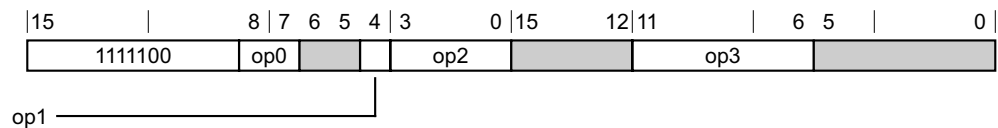

This decode also imposes the constraint:

- $op0 < 1 > : op1 \neq 10$.

Table F3-20 Encoding table for the Load/store single group

Decode fields				Decode group or instruction page
op0	op1	op2	op3	
00	-	!= 1111	000000	Load/store, unsigned (register offset) on page F3-2927
00	-	!= 1111	000001	Unallocated.
00	-	!= 1111	00001x	Unallocated.
00	-	!= 1111	0001xx	Unallocated.
00	-	!= 1111	001xxx	Unallocated.
00	-	!= 1111	01xxxx	Unallocated.
00	-	!= 1111	10x0xx	Unallocated.
00	-	!= 1111	10x1xx	Load/store, unsigned (immediate, post-indexed) on page F3-2928
00	-	!= 1111	1100xx	Load/store, unsigned (negative immediate) on page F3-2928
00	-	!= 1111	1110xx	Load/store, unsigned (unprivileged) on page F3-2929
00	-	!= 1111	11x1xx	Load/store, unsigned (immediate, pre-indexed) on page F3-2929
01	-	!= 1111	-	Load/store, unsigned (positive immediate) on page F3-2929
0x	-	1111	-	Load, unsigned (literal) on page F3-2930
10	1	!= 1111	000000	Load/store, signed (register offset) on page F3-2930
10	1	!= 1111	000001	Unallocated.

Table F3-20 Encoding table for the Load/store single group (continued)

Decode fields				Decode group or instruction page
op0	op1	op2	op3	
10	1	!= 1111	00001x	Unallocated.
10	1	!= 1111	0001xx	Unallocated.
10	1	!= 1111	001xxx	Unallocated.
10	1	!= 1111	01xxxx	Unallocated.
10	1	!= 1111	10x0xx	Unallocated.
10	1	!= 1111	10x1xx	<i>Load/store, signed (immediate, post-indexed) on page F3-2931</i>
10	1	!= 1111	1100xx	<i>Load/store, signed (negative immediate) on page F3-2931</i>
10	1	!= 1111	1110xx	<i>Load/store, signed (unprivileged) on page F3-2932</i>
10	1	!= 1111	11x1xx	<i>Load/store, signed (immediate, pre-indexed) on page F3-2932</i>
11	1	!= 1111	-	<i>Load/store, signed (positive immediate) on page F3-2933</i>
1x	1	1111	-	<i>Load, signed (literal) on page F3-2933</i>

Load/store, unsigned (register offset)

This section describes the encoding of the Load/store, unsigned (register offset) instruction class. This section is decoded from *Load/store single on page F3-2926*.

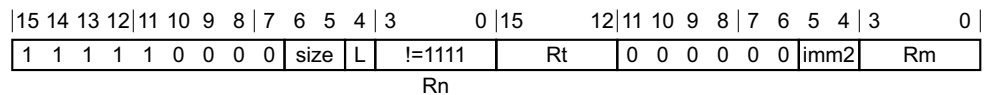

Decode fields			Instruction page
size	L	Rt	
00	0	-	<i>STRB (register)</i>
00	1	!= 1111	<i>LDRB (register)</i>
00	1	1111	<i>PLD, PLDW (register) - Preload read variant on page F5-3318</i>
01	0	-	<i>STRH (register)</i>
01	1	!= 1111	<i>LDRH (register)</i>
01	1	1111	<i>PLD, PLDW (register) - Preload write variant on page F5-3318</i>
10	0	-	<i>STR (register)</i>
10	1	-	<i>LDR (register)</i>
11	-	-	Unallocated.

Load/store, unsigned (immediate, post-indexed)

This section describes the encoding of the Load/store, unsigned (immediate, post-indexed) instruction class. This section is decoded from *Load/store single* on page F3-2926.

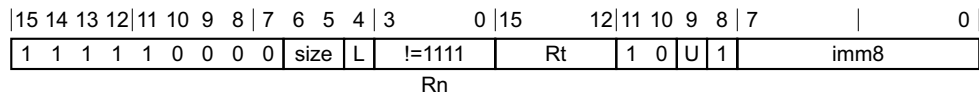

Decode fields		Instruction page
size	L	
00	0	STRB (immediate)
00	1	LDRB (immediate)
01	0	STRH (immediate)
01	1	LDRH (immediate)
10	0	STR (immediate)
10	1	LDR (immediate)
11	-	Unallocated.

Load/store, unsigned (negative immediate)

This section describes the encoding of the Load/store, unsigned (negative immediate) instruction class. This section is decoded from *Load/store single* on page F3-2926.

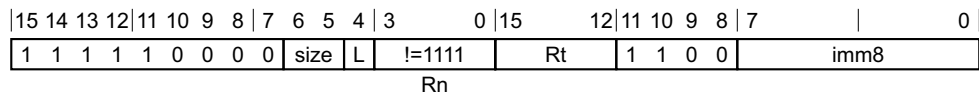

Decode fields			Instruction page
size	L	Rt	
00	0	-	STRB (immediate)
00	1	!= 1111	LDRB (immediate)
00	1	1111	PLD, PLDW (immediate) - <i>Preload read variant</i> on page F5-3315
01	0	-	STRH (immediate)
01	1	!= 1111	LDRH (immediate)
01	1	1111	PLD, PLDW (immediate) - <i>Preload write variant</i> on page F5-3315
10	0	-	STR (immediate)
10	1	-	LDR (immediate)
11	-	-	Unallocated.

Load/store, unsigned (unprivileged)

This section describes the encoding of the Load/store, unsigned (unprivileged) instruction class. This section is decoded from *Load/store single* on page F3-2926.

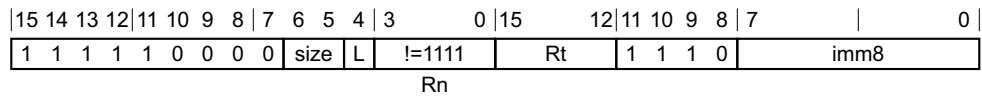

Decode fields		Instruction page
size	L	
00	0	STRBT
00	1	LDRBT
01	0	STRHT
01	1	LDRHT
10	0	STRT
10	1	LDRT
11	-	Unallocated.

Load/store, unsigned (immediate, pre-indexed)

This section describes the encoding of the Load/store, unsigned (immediate, pre-indexed) instruction class. This section is decoded from *Load/store single* on page F3-2926.

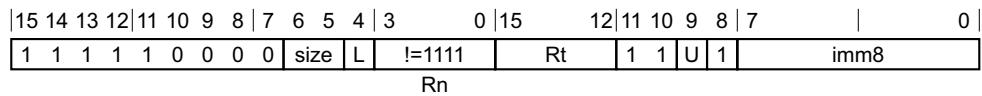

Decode fields		Instruction page
size	L	
00	0	STRB (immediate)
00	1	LDRB (immediate)
01	0	STRH (immediate)
01	1	LDRH (immediate)
10	0	STR (immediate)
10	1	LDR (immediate)
11	-	Unallocated.

Load/store, unsigned (positive immediate)

This section describes the encoding of the Load/store, unsigned (positive immediate) instruction class. This section is decoded from *Load/store single* on page F3-2926.

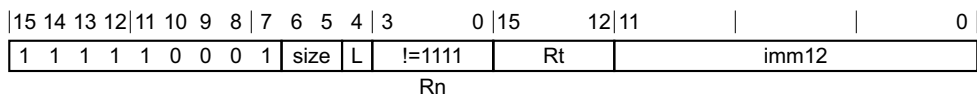

Decode fields			Instruction page
size	L	Rt	
00	0	-	STRB (immediate)
00	1	!= 1111	LDRB (immediate)
00	1	1111	PLD, PLDW (immediate) - <i>Preload read variant on page F5-3314</i>
01	0	-	STRH (immediate)
01	1	!= 1111	LDRH (immediate)
01	1	1111	PLD, PLDW (immediate) - <i>Preload write variant on page F5-3314</i>
10	0	-	STR (immediate)
10	1	-	LDR (immediate)

Load, unsigned (literal)

This section describes the encoding of the Load, unsigned (literal) instruction class. This section is decoded from [Load/store single on page F3-2926](#).

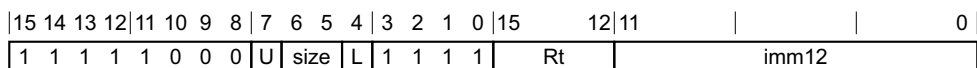

Decode fields			Instruction page
size	L	Rt	
0x	1	1111	PLD (literal)
00	1	!= 1111	LDRB (literal)
01	1	!= 1111	LDRH (literal)
10	1	-	LDR (literal)
11	-	-	Unallocated.

Load/store, signed (register offset)

This section describes the encoding of the Load/store, signed (register offset) instruction class. This section is decoded from [Load/store single on page F3-2926](#).

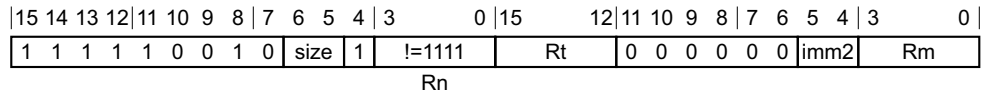

Decode fields		Instruction page
size	Rt	
00	!= 1111	LDRSB (register)
00	1111	PLI (register)
01	!= 1111	LDRSH (register)
01	1111	Reserved hint, behaves as NOP .
1x	-	Unallocated.

Load/store, signed (immediate, post-indexed)

This section describes the encoding of the Load/store, signed (immediate, post-indexed) instruction class. This section is decoded from [Load/store single](#) on page F3-2926.

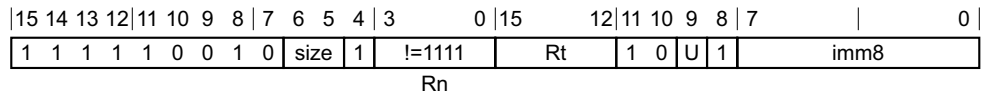

Decode fields		Instruction page
size		
00		LDRSB (immediate)
01		LDRSH (immediate)
1x		Unallocated.

Load/store, signed (negative immediate)

This section describes the encoding of the Load/store, signed (negative immediate) instruction class. This section is decoded from [Load/store single](#) on page F3-2926.

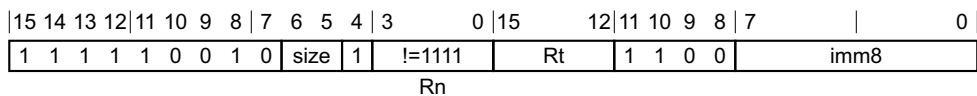

Decode fields		Instruction page
size	Rt	
00	!= 1111	LDRSB (immediate)
00	1111	PLI (immediate, literal)
01	!= 1111	LDRSH (immediate)
01	1111	Reserved hint, behaves as <i>NOP</i> .
1x	-	Unallocated.

Load/store, signed (unprivileged)

This section describes the encoding of the Load/store, signed (unprivileged) instruction class. This section is decoded from *Load/store single* on page F3-2926.

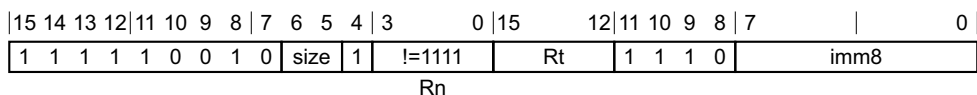

Decode fields		Instruction page
size		
00		LDRSBT
01		LDRSHT
1x		Unallocated.

Load/store, signed (immediate, pre-indexed)

This section describes the encoding of the Load/store, signed (immediate, pre-indexed) instruction class. This section is decoded from *Load/store single* on page F3-2926.

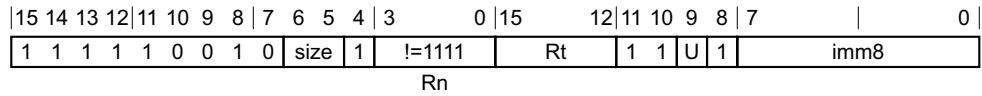

Decode fields		Instruction page
size		
00		LDRSB (immediate)
01		LDRSH (immediate)
1x		Unallocated.

Load/store, signed (positive immediate)

This section describes the encoding of the Load/store, signed (positive immediate) instruction class. This section is decoded from [Load/store single](#) on page F3-2926.

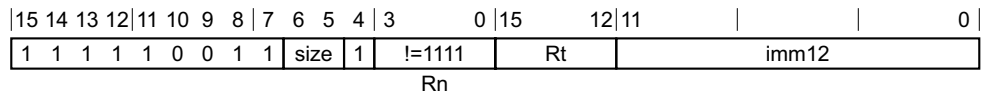

Decode fields		Instruction page
size	Rt	
00	!= 1111	LDRSB (immediate)
00	1111	PLI (immediate, literal)
01	!= 1111	LDRSH (immediate)
01	1111	Reserved hint, behaves as NOP.

Load, signed (literal)

This section describes the encoding of the Load, signed (literal) instruction class. This section is decoded from [Load/store single](#) on page F3-2926.

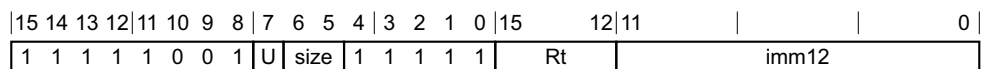

Decode fields		Instruction page
size	Rt	
00	!= 1111	LDRSB (literal)
00	1111	PLI (immediate, literal)

Decode fields		Instruction page
size	Rt	
01	!= 1111	LDRSH (literal)
01	1111	Reserved hint, behaves as NOP.
1x	-	Unallocated.

F3.1.20 Data-processing (register)

This section describes the encoding of the Data-processing (register) group. This section is decoded from *32-bit* on page F3-2887.

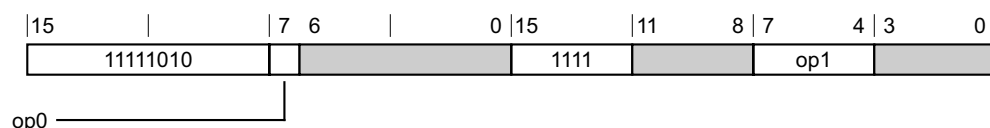

Table F3-21 Encoding table for the Data-processing (register) group

Decode fields		Decode group or instruction page
op0	op1	
0	0000	MOV, MOVS (register-shifted register) - <i>Flag setting variant</i> on page F5-3266
0	0001	Unallocated.
0	001x	Unallocated.
0	01xx	Unallocated.
0	1xxx	<i>Register extends</i>
1	0xxx	<i>Parallel add-subtract</i> on page F3-2935
1	10xx	<i>Data-processing (two source registers)</i> on page F3-2937
1	11xx	Unallocated.

Register extends

This section describes the encoding of the Register extends instruction class. This section is decoded from *Data-processing (register)*.

15	14	13	12	11	10	9	8	7	6	5	4	3	0	15	14	13	12	11	8	7	6	5	4	3	0
1	1	1	1	1	0	1	0	0	op1	U	Rn	1	1	1	1	Rd	1	(0)	rotate	Rm					

Decode fields				Instruction page
op1	U	Rn		
00	0	!= 1111	SXTAH	SXTAH
00	0	1111	SXTH	SXTH
00	1	!= 1111	UXTAH	UXTAH
00	1	1111	UXTH	UXTH
01	0	!= 1111	SXTAB16	SXTAB16
01	0	1111	SXTB16	SXTB16
01	1	!= 1111	UXTAB16	UXTAB16
01	1	1111	UXTB16	UXTB16
10	0	!= 1111	SXTAB	SXTAB
10	0	1111	SXTB	SXTB
10	1	!= 1111	UXTAB	UXTAB
10	1	1111	UXTB	UXTB
11	-	-		Unallocated.

Parallel add-subtract

This section describes the encoding of the Parallel add-subtract instruction class. This section is decoded from [Data-processing \(register\)](#) on page F3-2934.

15	14	13	12	11	10	9	8	7	6	4	3	0	15	14	13	12	11	8	7	6	5	4	3	0
1	1	1	1	1	0	1	0	1	op1	Rn	1	1	1	1	Rd	0	U	H	S	Rm				

Decode fields				Instruction page
op1	U	H	S	
000	0	0	0	SADD8
000	0	0	1	QADD8
000	0	1	0	SHADD8
000	0	1	1	Unallocated.
000	1	0	0	UADD8
000	1	0	1	UQADD8

Decode fields				Instruction page
op1	U	H	S	
000	1	1	0	UHADD8
000	1	1	1	Unallocated.
001	0	0	0	SADD16
001	0	0	1	QADD16
001	0	1	0	SHADD16
001	0	1	1	Unallocated.
001	1	0	0	UADD16
001	1	0	1	UQADD16
001	1	1	0	UHADD16
001	1	1	1	Unallocated.
010	0	0	0	SASX
010	0	0	1	QASX
010	0	1	0	SHASX
010	0	1	1	Unallocated.
010	1	0	0	UASX
010	1	0	1	UQASX
010	1	1	0	UHASX
010	1	1	1	Unallocated.
100	0	0	0	SSUB8
100	0	0	1	QSUB8
100	0	1	0	SHSUB8
100	0	1	1	Unallocated.
100	1	0	0	USUB8
100	1	0	1	UQSUB8
100	1	1	0	UHSUB8
100	1	1	1	Unallocated.
101	0	0	0	SSUB16
101	0	0	1	QSUB16
101	0	1	0	SHSUB16
101	0	1	1	Unallocated.
101	1	0	0	USUB16
101	1	0	1	UQSUB16

Decode fields				Instruction page
op1	U	H	S	
101	1	1	0	UHSUB16
101	1	1	1	Unallocated.
110	0	0	0	SSAX
110	0	0	1	QSAX
110	0	1	0	SHSAX
110	0	1	1	Unallocated.
110	1	0	0	USAX
110	1	0	1	UQSAX
110	1	1	0	UHSAX
110	1	1	1	Unallocated.
111	-	-	-	Unallocated.

Data-processing (two source registers)

This section describes the encoding of the Data-processing (two source registers) instruction class. This section is decoded from *Data-processing (register)* on page F3-2934.

15	14	13	12	11	10	9	8	7	6	4	3	0	15	14	13	12	11	8	7	6	5	4	3	0
1	1	1	1	1	0	1	0	1	op1			Rn	1	1	1	1	Rd	1	0	op2		Rm		

Decode fields		Instruction page
op1	op2	
000	00	QADD
000	01	QDADD
000	10	QSUB
000	11	QDSUB
001	00	REV
001	01	REV16
001	10	RBIT
001	11	REVSH
010	00	SEL
010	01	Unallocated.
010	1x	Unallocated.
011	00	CLZ

Decode fields		Instruction page
op1	op2	
011	01	Unallocated.
011	1x	Unallocated.
100	00	CRC32 - CRC32B variant on page F5-3095
100	01	CRC32 - CRC32H variant on page F5-3095
100	10	CRC32 - CRC32W variant on page F5-3095
100	11	CONSTRAINED UNPREDICTABLE
101	00	CRC32C - CRC32CB variant on page F5-3098
101	01	CRC32C - CRC32CH variant on page F5-3098
101	10	CRC32C - CRC32CW variant on page F5-3098
101	11	CONSTRAINED UNPREDICTABLE
11x	-	Unallocated.

The behavior of the CONSTRAINED UNPREDICTABLE encodings in this table is described in [CONSTRAINED UNPREDICTABLE behavior for A32 and T32 instruction encodings on page K1-6107](#).

F3.1.21 Multiply, multiply accumulate, and absolute difference

This section describes the encoding of the Multiply, multiply accumulate, and absolute difference group. This section is decoded from [32-bit on page F3-2887](#).

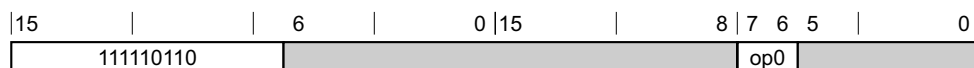

Table F3-22 Encoding table for the Multiply, multiply accumulate, and absolute difference group

Decode fields	
op0	Decode group or instruction page
00	Multiply and absolute difference
01	Unallocated.
1x	Unallocated.

Multiply and absolute difference

This section describes the encoding of the Multiply and absolute difference instruction class. This section is decoded from [Multiply, multiply accumulate, and absolute difference](#).

15	14	13	12	11	10	9	8	7	6	4	3	0	15	12	11	8	7	6	5	4	3	0				
1	1	1	1	1	0	1	1	0	op1			Rn			Ra			Rd			0 0		op2		Rm	

Decode fields

			Instruction page
op1	Ra	op2	
000	!= 1111	00	MLA, MLAS
000	-	01	MLS
000	-	1x	Unallocated.
000	1111	00	MUL, MULS
001	!= 1111	00	SMLABB, SMLABT, SMLATB, SMLATT - SMLABB variant on page F5-3431
001	!= 1111	01	SMLABB, SMLABT, SMLATB, SMLATT - SMLABT variant on page F5-3431
001	!= 1111	10	SMLABB, SMLABT, SMLATB, SMLATT - SMLATB variant on page F5-3432
001	!= 1111	11	SMLABB, SMLABT, SMLATB, SMLATT - SMLATT variant on page F5-3432
001	1111	00	SMULBB, SMULBT, SMULTB, SMULTT - SMULBB variant on page F5-3456
001	1111	01	SMULBB, SMULBT, SMULTB, SMULTT - SMULBT variant on page F5-3456
001	1111	10	SMULBB, SMULBT, SMULTB, SMULTT - SMULTB variant on page F5-3457
001	1111	11	SMULBB, SMULBT, SMULTB, SMULTT - SMULTT variant on page F5-3457
010	!= 1111	00	SMLAD, SMLADX - SMLAD variant on page F5-3433
010	!= 1111	01	SMLAD, SMLADX - SMLADX variant on page F5-3433
010	-	1x	Unallocated.
010	1111	00	SMUAD, SMUADX - SMUAD variant on page F5-3454
010	1111	01	SMUAD, SMUADX - SMUADX variant on page F5-3454
011	!= 1111	00	SMLAWB, SMLAWT - SMLAWB variant on page F5-3442
011	!= 1111	01	SMLAWB, SMLAWT - SMLAWT variant on page F5-3442
011	-	1x	Unallocated.
011	1111	00	SMULWB, SMULWT - SMULWB variant on page F5-3460
011	1111	01	SMULWB, SMULWT - SMULWT variant on page F5-3460
100	!= 1111	00	SMLSXD, SMLSXD - SMLSXD variant on page F5-3444
100	!= 1111	01	SMLSXD, SMLSXD - SMLSXD variant on page F5-3444
100	-	1x	Unallocated.
100	1111	00	SMUSD, SMUSD - SMUSD variant on page F5-3462
100	1111	01	SMUSD, SMUSD - SMUSD variant on page F5-3462
101	!= 1111	00	SMMLA, SMMLAR - SMMLA variant on page F5-3448

Decode fields			Instruction page
op1	Ra	op2	
101	!= 1111	01	SMMLA, SMMLAR - SMMLAR variant on page F5-3448
101	-	1x	Unallocated.
101	1111	00	SMMUL, SMMULR - SMMUL variant on page F5-3452
101	1111	01	SMMUL, SMMULR - SMMULR variant on page F5-3452
110	-	00	SMMLS, SMMLSR - SMMLS variant on page F5-3450
110	-	01	SMMLS, SMMLSR - SMMLSR variant on page F5-3450
110	-	1x	Unallocated.
111	!= 1111	00	USADA8
111	-	01	Unallocated.
111	-	1x	Unallocated.
111	1111	00	USAD8

F3.2 About the T32 Advanced SIMD and floating-point instructions and their encoding

The Advanced SIMD and floating-point instructions are common to the T32 and A32 instruction sets. These instructions perform Advanced SIMD and floating-point operations on a common register file, the SIMD&FP register file. This means:

- In general, the instructions that load or store registers in this file, or move data between general-purpose registers and this register file, are common to the Advanced SIMD and floating-point instructions.
- There are distinct Advanced SIMD data-processing instructions and floating-point data-processing instructions.

All T32 Advanced SIMD and floating-point instructions have 32-bit encodings. Different groups of these instructions are decoded from different points in the 32-bit T32 instruction decode structure. [Table F3-23](#) shows these instruction groups, and where each group is decoded from the overall T32 decode structure:

Table F3-23 Advanced SIMD and floating-point instructions in the T32 decode structure

Advanced SIMD and floating-point instruction group	T32 decode is from
<i>Advanced SIMD load/store and 64-bit move on page F3-2894</i>	<i>System register access, Advanced SIMD, and floating-point on page F3-2893</i>
<i>Floating-point data-processing on page F3-2898</i>	<i>System register access, Advanced SIMD, and floating-point on page F3-2893</i>
<i>Advanced SIMD and floating-point 32-bit move on page F3-2902</i>	<i>System register access, Advanced SIMD, and floating-point on page F3-2893</i>
<i>Advanced SIMD data-processing on page F3-2904</i>	<i>System register access, Advanced SIMD, and floating-point on page F3-2893</i>
<i>Advanced SIMD element or structure load/store on page F3-2922</i>	<i>32-bit on page F3-2887</i>

Chapter F4

A32 Instruction Set Encoding

This chapter describes the encoding of the A32 instruction set. It contains the following sections:

- [A32 instruction set encoding on page F4-2944.](#)
- [About the A32 Advanced SIMD and floating-point instructions and their encoding on page F4-3001.](#)

In this chapter:

- In the decode tables, an entry of - for a field value means the value of the field does not affect the decoding.
- In the decode diagrams, a shaded field indicates that the bits in that field are not used in that level of decode.

F4.1 A32 instruction set encoding

The A32 instruction stream is a sequence of word-aligned words. Each A32 instruction is either a single 32-bit word in that stream.

Most A32 instructions can be conditional, with a condition determined by bits[31:28] of the instruction, the cond field. For more information see *The Condition code field in A32 instruction encodings* on page F2-2850. This applies to all instructions except those with the cond field equal to 0b111.

The behavior of an attempt to execute an unallocated instruction is described in *UNDEFINED, UNPREDICTABLE, and CONSTRAINED UNPREDICTABLE instruction set space* on page F2-2856.

For more information on A32 instruction encodings see *Chapter F2 About the T32 and A32 Instruction Descriptions*.

The A32 instruction encoding is:

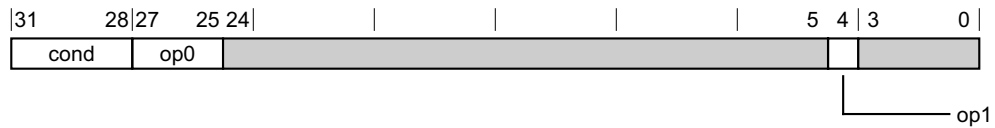

Table F4-1 Main encoding table for the A32 instruction set

Decode fields			Decode group or instruction page
cond	op0	op1	
!= 1111	00x	-	<i>Data-processing and miscellaneous instructions</i>
!= 1111	010	-	<i>Load/Store Word, Unsigned Byte (immediate, literal)</i> on page F4-2960
!= 1111	011	0	<i>Load/Store Word, Unsigned Byte (register)</i> on page F4-2961
!= 1111	011	1	<i>Media instructions</i> on page F4-2962
-	10x	-	<i>Branch, branch with link, and block data transfer</i> on page F4-2970
-	11x	-	<i>System register access, Advanced SIMD, floating-point, and Supervisor call</i> on page F4-2972
1111	0xx	-	<i>Unconditional instructions</i> on page F4-2983

F4.1.1 Data-processing and miscellaneous instructions

This section describes the encoding of the Data-processing and miscellaneous instructions group. This section is decoded from *A32 instruction set encoding*.

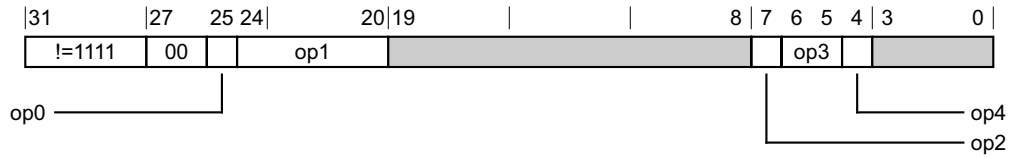
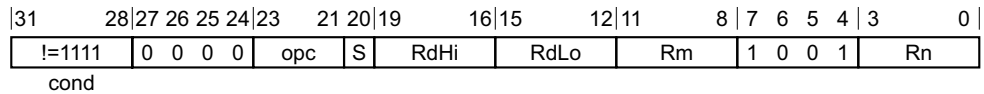

Table F4-2 Encoding table for the Data-processing and miscellaneous instructions group

Decode fields					Decode group or instruction page
op0	op1	op2	op3	op4	
0	-	1	!= 00	1	Extra load/store on page F4-2946
0	0xxxx	1	00	1	Multiply and Accumulate
0	1xxxx	1	00	1	Synchronization primitives and Load-Acquire/Store-Release on page F4-2949
0	10xx0	0	-	-	Miscellaneous on page F4-2950
0	10xx0	1	-	0	Halfword Multiply and Accumulate on page F4-2946
0	!= 10xx0	-	-	0	Data-processing register (immediate shift) on page F4-2953
0	!= 10xx0	0	-	1	Data-processing register (register shift) on page F4-2955
1	-	-	-	-	Data-processing immediate on page F4-2957

Multiply and Accumulate

This section describes the encoding of the Multiply and Accumulate instruction class. This section is decoded from [Data-processing and miscellaneous instructions on page F4-2944](#).



Decode fields		Instruction page
opc	S	
000	-	MUL, MULS
001	-	MLA, MLAS
010	0	UMAAL
010	1	Unallocated.
011	0	MLS
011	1	Unallocated.
100	-	UMULL, UMULLS

Decode fields		Instruction page
opc	S	
101	-	UMLAL, UMLALS
110	-	SMULL, SMULLS
111	-	SMLAL, SMLALS

Halfword Multiply and Accumulate

This section describes the encoding of the Halfword Multiply and Accumulate instruction class. This section is decoded from *Data-processing and miscellaneous instructions* on page F4-2944.

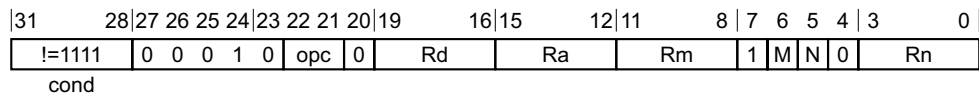

Decode fields			Instruction page
opc	M	N	
00	-	-	SMLABB, SMLABT, SMLATB, SMLATT
01	0	0	SMLAWB, SMLAWT - <i>SMLAWB variant</i> on page F5-3442
01	0	1	SMULWB, SMULWT - <i>SMULWB variant</i> on page F5-3460
01	1	0	SMLAWB, SMLAWT - <i>SMLAWT variant</i> on page F5-3442
01	1	1	SMULWB, SMULWT - <i>SMULWT variant</i> on page F5-3460
10	-	-	SMLALBB, SMLALBT, SMLALTB, SMLALTT
11	-	-	SMULBB, SMULBT, SMULTB, SMULTT

F4.1.2 Extra load/store

This section describes the encoding of the Extra load/store group. This section is decoded from *Data-processing and miscellaneous instructions* on page F4-2944.

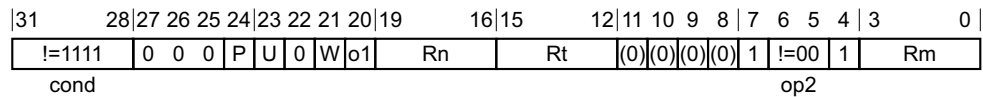

Table F4-3 Encoding table for the Extra load/store group

Decode fields		Decode group or instruction page
op0		
0		<i>Load/Store Dual, Half, Signed Byte (register)</i> on page F4-2947
1		<i>Load/Store Dual, Half, Signed Byte (immediate, literal)</i> on page F4-2947

Load/Store Dual, Half, Signed Byte (register)

This section describes the encoding of the Load/Store Dual, Half, Signed Byte (register) instruction class. This section is decoded from *Extra load/store* on page F4-2946.



Decode fields				Instruction page
P	W	o1	op2	
0	0	0	01	STRH (register) - Post-indexed variant on page F5-3548
0	0	0	10	LDRD (register) - Post-indexed variant on page F5-3186
0	0	0	11	STRD (register) - Post-indexed variant on page F5-3530
0	0	1	01	LDRH (register) - Post-indexed variant on page F5-3202
0	0	1	10	LDRSB (register) - Post-indexed variant on page F5-3213
0	0	1	11	LDRSH (register) - Post-indexed variant on page F5-3224
0	1	0	01	STRHT
0	1	0	10	Unallocated.
0	1	0	11	Unallocated.
0	1	1	01	LDRHT
0	1	1	10	LDRSBT
0	1	1	11	LDRSHT
1	-	0	01	STRH (register) - Pre-indexed variant on page F5-3548
1	-	0	10	LDRD (register) - Pre-indexed variant on page F5-3186
1	-	0	11	STRD (register) - Pre-indexed variant on page F5-3530
1	-	1	01	LDRH (register) - Pre-indexed variant on page F5-3202
1	-	1	10	LDRSB (register) - Pre-indexed variant on page F5-3213
1	-	1	11	LDRSH (register) - Pre-indexed variant on page F5-3224

Load/Store Dual, Half, Signed Byte (immediate, literal)

This section describes the encoding of the Load/Store Dual, Half, Signed Byte (immediate, literal) instruction class. This section is decoded from *Extra load/store* on page F4-2946.

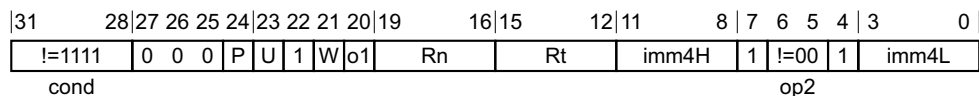

Decode fields

Instruction page

P:W	o1	Rn	op2	Instruction page
-	0	1111	10	LDRD (literal)
!= 01	1	1111	01	LDRH (literal)
!= 01	1	1111	10	LDRSB (literal)
!= 01	1	1111	11	LDRSH (literal)
00	0	!= 1111	10	LDRD (immediate) - Post-indexed variant on page F5-3180
00	0	-	01	STRH (immediate) - Post-indexed variant on page F5-3544
00	0	-	11	STRD (immediate) - Post-indexed variant on page F5-3526
00	1	!= 1111	01	LDRH (immediate) - Post-indexed variant on page F5-3196
00	1	!= 1111	10	LDRSB (immediate) - Post-indexed variant on page F5-3208
00	1	!= 1111	11	LDRSH (immediate) - Post-indexed variant on page F5-3219
01	0	!= 1111	10	Unallocated.
01	0	-	01	STRHT
01	0	-	11	Unallocated.
01	1	-	01	LDRHT
01	1	-	10	LDRSBT
01	1	-	11	LDRSHT
10	0	!= 1111	10	LDRD (immediate) - Offset variant on page F5-3180
10	0	-	01	STRH (immediate) - Offset variant on page F5-3544
10	0	-	11	STRD (immediate) - Offset variant on page F5-3526
10	1	!= 1111	01	LDRH (immediate) - Offset variant on page F5-3196
10	1	!= 1111	10	LDRSB (immediate) - Offset variant on page F5-3208
10	1	!= 1111	11	LDRSH (immediate) - Offset variant on page F5-3219
11	0	!= 1111	10	LDRD (immediate) - Pre-indexed variant on page F5-3180
11	0	-	01	STRH (immediate) - Pre-indexed variant on page F5-3544
11	0	-	11	STRD (immediate) - Pre-indexed variant on page F5-3526
11	1	!= 1111	01	LDRH (immediate) - Pre-indexed variant on page F5-3196
11	1	!= 1111	10	LDRSB (immediate) - Pre-indexed variant on page F5-3208
11	1	!= 1111	11	LDRSH (immediate) - Pre-indexed variant on page F5-3219

F4.1.3 Synchronization primitives and Load-Acquire/Store-Release

This section describes the encoding of the Synchronization primitives and Load-Acquire/Store-Release group. This section is decoded from *Data-processing and miscellaneous instructions* on page F4-2944.

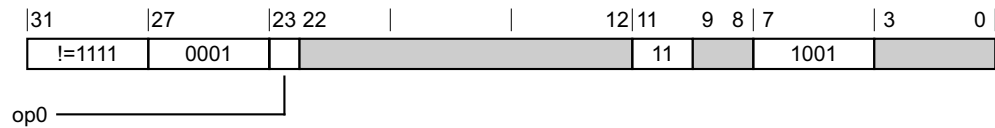
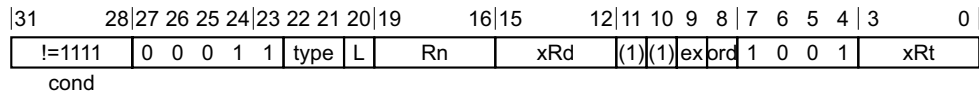

Table F4-4 Encoding table for the Synchronization primitives and Load-Acquire/Store-Release group

Decode fields	
op0	Decode group or instruction page
0	Unallocated.
1	<i>Load/Store Exclusive and Load-Acquire/Store-Release</i>

Load/Store Exclusive and Load-Acquire/Store-Release

This section describes the encoding of the Load/Store Exclusive and Load-Acquire/Store-Release instruction class. This section is decoded from *Synchronization primitives and Load-Acquire/Store-Release*.



Decode fields				Instruction page
type	L	ex	ord	
00	0	0	0	STL
00	0	0	1	Unallocated.
00	0	1	0	STLEX
00	0	1	1	STREX
00	1	0	0	LDA
00	1	0	1	Unallocated.
00	1	1	0	LDAEX
00	1	1	1	LDREX
01	0	0	-	Unallocated.
01	0	1	0	STLEXD
01	0	1	1	STREXD
01	1	0	-	Unallocated.
01	1	1	0	LDAEXD

Decode fields				Instruction page
type	L	ex	ord	
01	1	1	1	LDREXD
10	0	0	0	STLB
10	0	0	1	Unallocated.
10	0	1	0	STLEXB
10	0	1	1	STREXB
10	1	0	0	LDAB
10	1	0	1	Unallocated.
10	1	1	0	LDAEXB
10	1	1	1	LDREXB
11	0	0	0	STLH
11	0	0	1	Unallocated.
11	0	1	0	STLEXH
11	0	1	1	STREXH
11	1	0	0	LDAH
11	1	0	1	Unallocated.
11	1	1	0	LDAEXH
11	1	1	1	LDREXH

F4.1.4 Miscellaneous

This section describes the encoding of the Miscellaneous group. This section is decoded from *Data-processing and miscellaneous instructions* on page F4-2944.

31	27	22 21 20 19		8 7 6 4 3	0
!=1111	00010	op0 0		0 op1	

Table F4-5 Encoding table for the Miscellaneous group

Decode fields		Decode group or instruction page
op0	op1	
00	001	Unallocated.
00	010	Unallocated.
00	011	Unallocated.
00	110	Unallocated.
01	001	BX

Table F4-5 Encoding table for the Miscellaneous group (continued)

Decode fields		Decode group or instruction page
op0	op1	
01	010	BXJ
01	011	BLX (register)
01	110	Unallocated.
10	001	Unallocated.
10	010	Unallocated.
10	011	Unallocated.
10	110	Unallocated.
11	001	CLZ
11	010	Unallocated.
11	011	Unallocated.
11	110	ERET
-	111	Exception Generation
-	000	Move special register (register)
-	100	Cyclic Redundancy Check on page F4-2952
-	101	Integer Saturating Arithmetic on page F4-2952

Exception Generation

This section describes the encoding of the Exception Generation instruction class. This section is decoded from [Miscellaneous on page F4-2950](#).

31	28	27	26	25	24	23	22	21	20	19			8	7	6	5	4	3	0						
=1111										0	0	0	1	0	opc	0	imm12				0	1	1	1	imm4
cond																									

Decode fields		Instruction page
opc		
00		HLT
01		BKPT
10		HVC
11		SMC

Move special register (register)

This section describes the encoding of the Move special register (register) instruction class. This section is decoded from [Miscellaneous on page F4-2950](#).

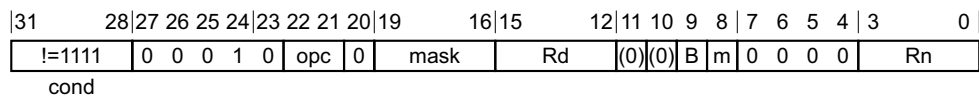

Decode fields		Instruction page
opc	B	
x0	0	MRS
x0	1	MRS (Banked register)
x1	0	MSR (register)
x1	1	MSR (Banked register)

Cyclic Redundancy Check

This section describes the encoding of the Cyclic Redundancy Check instruction class. This section is decoded from [Miscellaneous on page F4-2950](#).

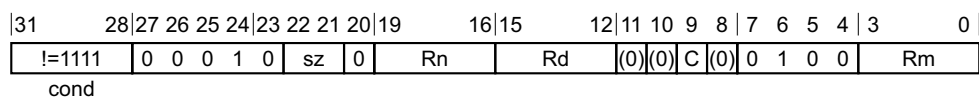

Decode fields		Instruction page
sz	C	
00	0	CRC32 - CRC32B variant on page F5-3094
00	1	CRC32C - CRC32CB variant on page F5-3097
01	0	CRC32 - CRC32H variant on page F5-3094
01	1	CRC32C - CRC32CH variant on page F5-3097
10	0	CRC32 - CRC32W variant on page F5-3094
10	1	CRC32C - CRC32CW variant on page F5-3097
11	-	CONSTRAINED UNPREDICTABLE

The behavior of the CONSTRAINED UNPREDICTABLE encodings in this table is described in [CONSTRAINED UNPREDICTABLE behavior for A32 and T32 instruction encodings on page K1-6107](#).

Integer Saturating Arithmetic

This section describes the encoding of the Integer Saturating Arithmetic instruction class. This section is decoded from [Miscellaneous on page F4-2950](#).

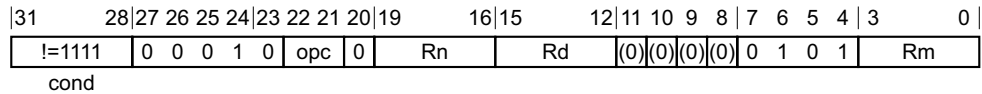

Decode fields		Instruction page
opc		
00		QADD
01		QSUB
10		QDADD
11		QDSUB

F4.1.5 Data-processing register (immediate shift)

This section describes the encoding of the Data-processing register (immediate shift) group. This section is decoded from *Data-processing and miscellaneous instructions* on page F4-2944.

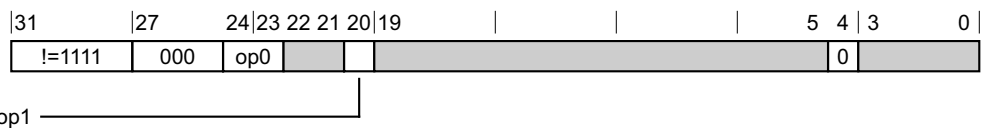

This decode also imposes the constraint:

- op0:op1 != 100.

Table F4-6 Encoding table for the Data-processing register (immediate shift) group

Decode fields		Decode group or instruction page
op0	op1	
0x	-	<i>Integer Data Processing (three register, immediate shift)</i>
10	1	<i>Integer Test and Compare (two register, immediate shift) on page F4-2954</i>
11	-	<i>Logical Arithmetic (three register, immediate shift) on page F4-2955</i>

Integer Data Processing (three register, immediate shift)

This section describes the encoding of the Integer Data Processing (three register, immediate shift) instruction class. This section is decoded from *Data-processing register (immediate shift)*.

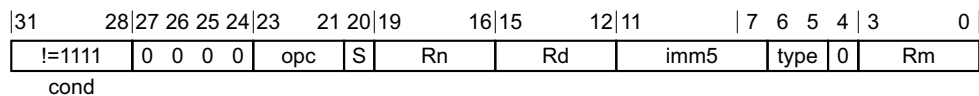

Decode fields			Instruction page
opc	S	Rn	
000	-	-	AND, ANDS (register)
001	-	-	EOR, EORS (register)
010	0	!= 1101	SUB, SUBS (register) - SUB, rotate right with extend variant on page F5-3564
010	0	1101	SUB, SUBS (SP minus register) - SUB, rotate right with extend variant on page F5-3572
010	1	!= 1101	SUB, SUBS (register) - SUBS, rotate right with extend variant on page F5-3564
010	1	1101	SUB, SUBS (SP minus register) - SUBS, rotate right with extend variant on page F5-3572
011	-	-	RSB, RSBS (register)
100	0	!= 1101	ADD, ADDS (register) - ADD, rotate right with extend variant on page F5-3017
100	0	1101	ADD, ADDS (SP plus register) - ADD, rotate right with extend variant on page F5-3026
100	1	!= 1101	ADD, ADDS (register) - ADDS, rotate right with extend variant on page F5-3017
100	1	1101	ADD, ADDS (SP plus register) - ADDS, rotate right with extend variant on page F5-3026
101	-	-	ADC, ADCS (register)
110	-	-	SBC, SBCS (register)
111	-	-	RSC, RSCS (register)

Integer Test and Compare (two register, immediate shift)

This section describes the encoding of the Integer Test and Compare (two register, immediate shift) instruction class. This section is decoded from *Data-processing register (immediate shift)* on page F4-2953.

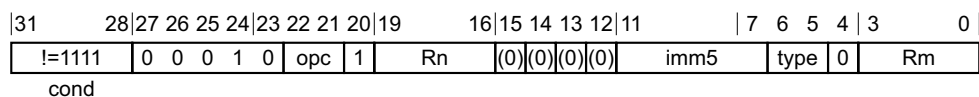

Decode fields		Instruction page
opc		
00		TST (register)
01		TEQ (register)
10		CMP (register)
11		CMN (register)

Logical Arithmetic (three register, immediate shift)

This section describes the encoding of the Logical Arithmetic (three register, immediate shift) instruction class. This section is decoded from *Data-processing register (immediate shift)* on page F4-2953.

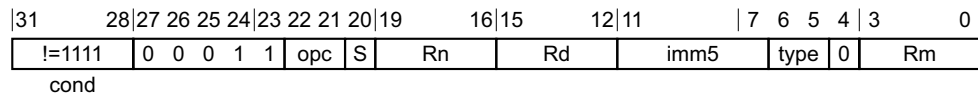

Decode fields		Instruction page
opc		
00	ORR, ORRS (register)	
01	MOV, MOVS (register)	
10	BIC, BICS (register)	
11	MVN, MVNS (register)	

F4.1.6 Data-processing register (register shift)

This section describes the encoding of the Data-processing register (register shift) group. This section is decoded from *Data-processing and miscellaneous instructions* on page F4-2944.

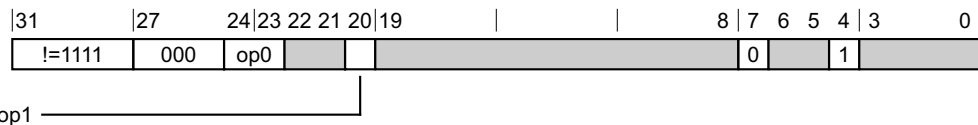

This decode also imposes the constraint:

- op0:op1 != 100.

Table F4-7 Encoding table for the Data-processing register (register shift) group

Decode fields		Decode group or instruction page
op0	op1	
0x	-	<i>Integer Data Processing (three register, register shift)</i>
10	1	<i>Integer Test and Compare (two register, register shift)</i> on page F4-2956
11	-	<i>Logical Arithmetic (three register, register shift)</i> on page F4-2956

Integer Data Processing (three register, register shift)

This section describes the encoding of the Integer Data Processing (three register, register shift) instruction class. This section is decoded from *Data-processing register (register shift)*.

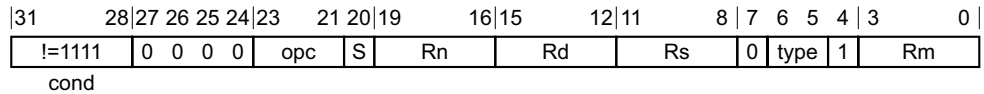

Decode fields	
Instruction page	
opc	
000	AND, ANDS (register-shifted register)
001	EOR, EORS (register-shifted register)
010	SUB, SUBS (register-shifted register)
011	RSB, RSBS (register-shifted register)
100	ADD, ADDS (register-shifted register)
101	ADC, ADCS (register-shifted register)
110	SBC, SBCS (register-shifted register)
111	RSC, RSCS (register-shifted register)

Integer Test and Compare (two register, register shift)

This section describes the encoding of the Integer Test and Compare (two register, register shift) instruction class. This section is decoded from *Data-processing register (register shift)* on page F4-2955.

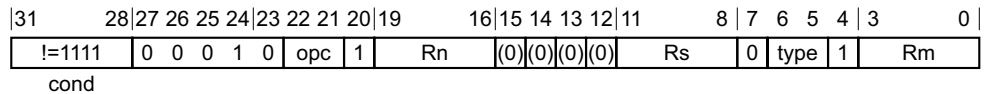

Decode fields	
Instruction page	
opc	
00	TST (register-shifted register)
01	TEQ (register-shifted register)
10	CMP (register-shifted register)
11	CMN (register-shifted register)

Logical Arithmetic (three register, register shift)

This section describes the encoding of the Logical Arithmetic (three register, register shift) instruction class. This section is decoded from *Data-processing register (register shift)* on page F4-2955.

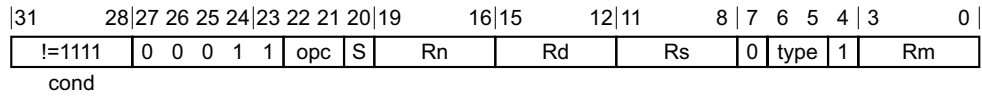

Decode fields	
Instruction page	
opc	
00	ORR, ORRS (register-shifted register)
01	MOV, MOVS (register-shifted register)
10	BIC, BICS (register-shifted register)
11	MVN, MVNS (register-shifted register)

F4.1.7 Data-processing immediate

This section describes the encoding of the Data-processing immediate group. This section is decoded from *Data-processing and miscellaneous instructions* on page F4-2944.

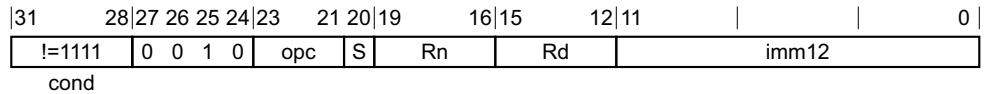

Table F4-8 Encoding table for the Data-processing immediate group

Decode fields		Decode group or instruction page
op0	op1	
0x	-	<i>Integer Data Processing (two register and immediate)</i>
10	00	<i>Move Halfword (immediate) on page F4-2958</i>
10	10	<i>Move Special Register and Hints (immediate) on page F4-2959</i>
10	x1	<i>Integer Test and Compare (one register and immediate) on page F4-2959</i>
11	-	<i>Logical Arithmetic (two register and immediate) on page F4-2960</i>

Integer Data Processing (two register and immediate)

This section describes the encoding of the Integer Data Processing (two register and immediate) instruction class. This section is decoded from *Data-processing immediate*.



Decode fields

			Instruction page
opc	S	Rn	
000	-	-	AND, ANDS (immediate)
001	-	-	EOR, EORS (immediate)
010	0	!= 11x1	SUB, SUBS (immediate) - SUB variant on page F5-3560
010	0	1101	SUB, SUBS (SP minus immediate) - SUB variant on page F5-3569
010	0	1111	ADR - A2 on page F5-3032
010	1	!= 1101	SUB, SUBS (immediate) - SUBS variant on page F5-3560
010	1	1101	SUB, SUBS (SP minus immediate) - SUBS variant on page F5-3569
011	-	-	RSB, RSBS (immediate)
100	0	!= 11x1	ADD, ADDS (immediate) - ADD variant on page F5-3013
100	0	1101	ADD, ADDS (SP plus immediate) - ADD variant on page F5-3023
100	0	1111	ADR - A1 on page F5-3032
100	1	!= 1101	ADD, ADDS (immediate) - ADDS variant on page F5-3013
100	1	1101	ADD, ADDS (SP plus immediate) - ADDS variant on page F5-3023
101	-	-	ADC, ADCS (immediate)
110	-	-	SBC, SBCS (immediate)
111	-	-	RSC, RSCS (immediate)

Move Halfword (immediate)

This section describes the encoding of the Move Halfword (immediate) instruction class. This section is decoded from [Data-processing immediate on page F4-2957](#).

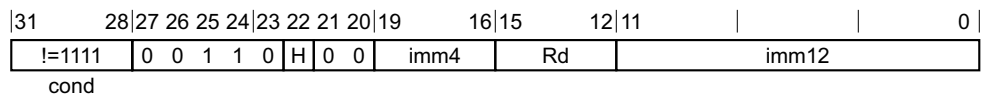

Decode fields

		Instruction page
H		
0		MOV, MOVS (immediate)
1		MOVT

Move Special Register and Hints (immediate)

This section describes the encoding of the Move Special Register and Hints (immediate) instruction class. This section is decoded from *Data-processing immediate* on page F4-2957.

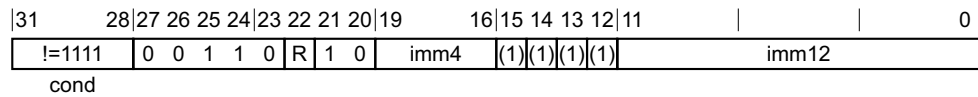

Decode fields		Instruction page	Architecture version
R:imm4	imm12		
!= 00000	-	MSR (immediate)	-
00000	xxxx00000000	NOP	-
00000	xxxx00000001	YIELD	-
00000	xxxx00000010	WFE	-
00000	xxxx00000011	WFI	-
00000	xxxx00000100	SEV	-
00000	xxxx00000101	SEVL	-
00000	xxxx0000011x	Reserved hint, behaves as NOP .	-
00000	xxxx00001xxx	Reserved hint, behaves as NOP .	-
00000	xxxx00010000	ESB	ARMv8.2
00000	xxxx00010001	Reserved hint, behaves as NOP .	-
00000	xxxx0001001x	Reserved hint, behaves as NOP .	-
00000	xxxx000101xx	Reserved hint, behaves as NOP .	-
00000	xxxx00011xxx	Reserved hint, behaves as NOP .	-
00000	xxxx001xxxxx	Reserved hint, behaves as NOP .	-
00000	xxxx01xxxxxx	Reserved hint, behaves as NOP .	-
00000	xxxx10xxxxxx	Reserved hint, behaves as NOP .	-
00000	xxxx110xxxxx	Reserved hint, behaves as NOP .	-
00000	xxxx1110xxxx	Reserved hint, behaves as NOP .	-
00000	xxxx1111xxxx	DBG	-

Integer Test and Compare (one register and immediate)

This section describes the encoding of the Integer Test and Compare (one register and immediate) instruction class. This section is decoded from *Data-processing immediate* on page F4-2957.

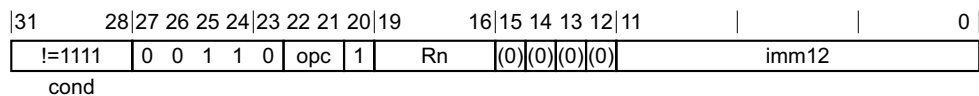

Decode fields	Instruction page
opc	
00	TST (immediate)
01	TEQ (immediate)
10	CMP (immediate)
11	CMN (immediate)

Logical Arithmetic (two register and immediate)

This section describes the encoding of the Logical Arithmetic (two register and immediate) instruction class. This section is decoded from [Data-processing immediate on page F4-2957](#).

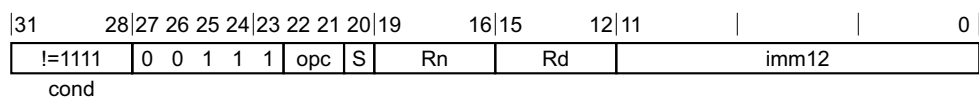

Decode fields	Instruction page
opc	
00	ORR, ORRS (immediate)
01	MOV, MOVS (immediate)
10	BIC, BICS (immediate)
11	MVN, MVNS (immediate)

F4.1.8 Load/Store Word, Unsigned Byte (immediate, literal)

This section describes the encoding of the Load/Store Word, Unsigned Byte (immediate, literal) instruction class. This section is decoded from [A32 instruction set encoding on page F4-2944](#).

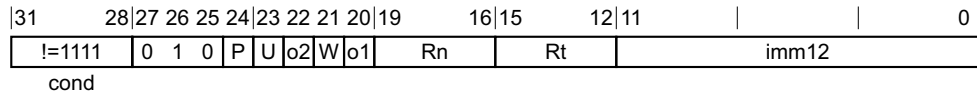

Decode fields				Instruction page
P:W	o2	o1	Rn	
!= 01	0	1	1111	LDR (literal)
!= 01	1	1	1111	LDRB (literal)
00	0	0	-	STR (immediate) - <i>Post-indexed variant</i> on page F5-3508
00	0	1	!= 1111	LDR (immediate) - <i>Post-indexed variant</i> on page F5-3159
00	1	0	-	STRB (immediate) - <i>Post-indexed variant</i> on page F5-3515
00	1	1	!= 1111	LDRB (immediate) - <i>Post-indexed variant</i> on page F5-3169
01	0	0	-	STRT
01	0	1	-	LDRT
01	1	0	-	STRBT
01	1	1	-	LDRBT
10	0	0	-	STR (immediate) - <i>Offset variant</i> on page F5-3508
10	0	1	!= 1111	LDR (immediate) - <i>Offset variant</i> on page F5-3159
10	1	0	-	STRB (immediate) - <i>Offset variant</i> on page F5-3515
10	1	1	!= 1111	LDRB (immediate) - <i>Offset variant</i> on page F5-3169
11	0	0	-	STR (immediate) - <i>Pre-indexed variant</i> on page F5-3508
11	0	1	!= 1111	LDR (immediate) - <i>Pre-indexed variant</i> on page F5-3159
11	1	0	-	STRB (immediate) - <i>Pre-indexed variant</i> on page F5-3515
11	1	1	!= 1111	LDRB (immediate) - <i>Pre-indexed variant</i> on page F5-3169

F4.1.9 Load/Store Word, Unsigned Byte (register)

This section describes the encoding of the Load/Store Word, Unsigned Byte (register) instruction class. This section is decoded from [A32 instruction set encoding](#) on page F4-2944.

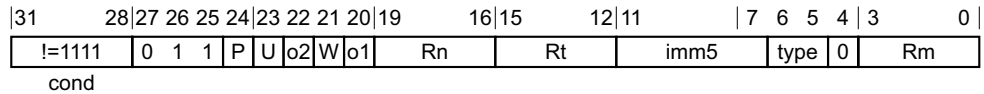

Decode fields				Instruction page
P	o2	W	o1	
0	0	0	0	STR (register) - Post-indexed variant on page F5-3512
0	0	0	1	LDR (register) - Post-indexed variant on page F5-3166
0	0	1	0	STRT
0	0	1	1	LDRT
0	1	0	0	STRB (register) - Post-indexed variant on page F5-3519
0	1	0	1	LDRB (register) - Post-indexed variant on page F5-3174
0	1	1	0	STRBT
0	1	1	1	LDRBT
1	0	-	0	STR (register) - Pre-indexed variant on page F5-3512
1	0	-	1	LDR (register) - Pre-indexed variant on page F5-3166
1	1	-	0	STRB (register) - Pre-indexed variant on page F5-3519
1	1	-	1	LDRB (register) - Pre-indexed variant on page F5-3174

F4.1.10 Media instructions

This section describes the encoding of the Media instructions group. This section is decoded from [A32 instruction set encoding on page F4-2944](#).



Table F4-9 Encoding table for the Media instructions group

Decode fields		Decode group or instruction page
op0	op1	
00xxx	-	Parallel Arithmetic on page F4-2963
01000	101	SEL
01000	001	Unallocated.
01000	xx0	PKHBT, PKHTB
01001	x01	Unallocated.
01001	xx0	Unallocated.
0110x	x01	Unallocated.

Table F4-9 Encoding table for the Media instructions group (continued)

Decode fields		Decode group or instruction page
op0	op1	
0110x	xx0	Unallocated.
01x10	001	<i>Saturate 16-bit</i> on page F4-2965
01x10	101	Unallocated.
01x11	x01	<i>Reverse Bit/Byte</i> on page F4-2966
01x1x	xx0	<i>Saturate 32-bit</i> on page F4-2966
01xxx	111	Unallocated.
01xxx	011	<i>Extend and Add</i> on page F4-2967
10xxx	-	<i>Signed multiply, Divide</i> on page F4-2967
11000	000	<i>Unsigned Sum of Absolute Differences</i> on page F4-2968
11000	100	Unallocated.
11001	x00	Unallocated.
1101x	x00	Unallocated.
110xx	111	Unallocated.
1110x	111	Unallocated.
1110x	x00	<i>Bitfield Insert</i> on page F4-2969
11110	111	Unallocated.
11111	111	<i>Permanently UNDEFINED</i> on page F4-2969
1111x	x00	Unallocated.
11x0x	x10	Unallocated.
11x1x	x10	<i>Bitfield Extract</i> on page F4-2970
11xxx	011	Unallocated.
11xxx	x01	Unallocated.

Parallel Arithmetic

This section describes the encoding of the Parallel Arithmetic instruction class. This section is decoded from *Media instructions* on page F4-2962.

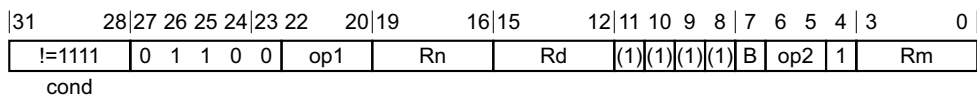

Decode fields			Instruction page
op1	B	op2	
000	-	-	Unallocated.
001	0	00	SADD16
001	0	01	SASX
001	0	10	SSAX
001	0	11	SSUB16
001	1	00	SADD8
001	1	01	Unallocated.
001	1	10	Unallocated.
001	1	11	SSUB8
010	0	00	QADD16
010	0	01	QASX
010	0	10	QSAX
010	0	11	QSUB16
010	1	00	QADD8
010	1	01	Unallocated.
010	1	10	Unallocated.
010	1	11	QSUB8
011	0	00	SHADD16
011	0	01	SHASX
011	0	10	SHSAX
011	0	11	SHSUB16
011	1	00	SHADD8
011	1	01	Unallocated.
011	1	10	Unallocated.
011	1	11	SHSUB8
100	-	-	Unallocated.
101	0	00	UADD16
101	0	01	UASX

Decode fields			Instruction page
op1	B	op2	
101	0	10	USAX
101	0	11	USUB16
101	1	00	UADD8
101	1	01	Unallocated.
101	1	10	Unallocated.
101	1	11	USUB8
110	0	00	UQADD16
110	0	01	UQASX
110	0	10	UQSAX
110	0	11	UQSUB16
110	1	00	UQADD8
110	1	01	Unallocated.
110	1	10	Unallocated.
110	1	11	UQSUB8
111	0	00	UHADD16
111	0	01	UHASX
111	0	10	UHSAX
111	0	11	UHSUB16
111	1	00	UHADD8
111	1	01	Unallocated.
111	1	10	Unallocated.
111	1	11	UHSUB8

Saturate 16-bit

This section describes the encoding of the Saturate 16-bit instruction class. This section is decoded from *Media instructions* on page F4-2962.

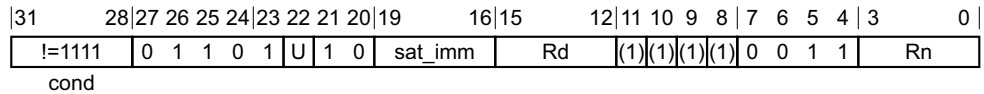

Decode fields		Instruction page
U		
0		SSAT16
1		USAT16

Reverse Bit/Byte

This section describes the encoding of the Reverse Bit/Byte instruction class. This section is decoded from *Media instructions* on page F4-2962.

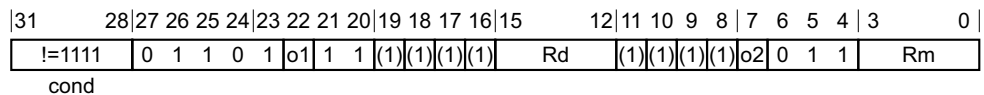

Decode fields			Instruction page
o1	o2		
0	0		REV
0	1		REV16
1	0		RBIT
1	1		REVSH

Saturate 32-bit

This section describes the encoding of the Saturate 32-bit instruction class. This section is decoded from *Media instructions* on page F4-2962.

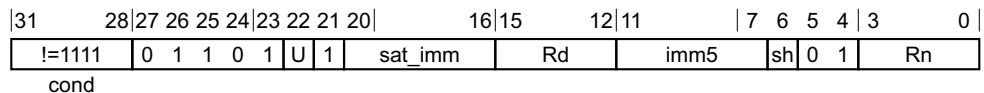

Decode fields		Instruction page
U		
0		SSAT
1		USAT

Extend and Add

This section describes the encoding of the Extend and Add instruction class. This section is decoded from *Media instructions* on page F4-2962.

31	28	27	26	25	24	23	22	21	20	19	16	15	12	11	10	9	8	7	6	5	4	3	0
!=1111	0	1	1	0	1	U	op	Rn	Rd	rotate(0)	(0)	0	1	1	1	Rm							
cond																							

Decode fields			Instruction page
U	op	Rn	
0	00	!= 1111	SXTAB16
0	00	1111	SXTB16
0	10	!= 1111	SXTAB
0	10	1111	SXTB
0	11	!= 1111	SXTAH
0	11	1111	SXTH
1	00	!= 1111	UXTAB16
1	00	1111	UXTB16
1	10	!= 1111	UXTAB
1	10	1111	UXTB
1	11	!= 1111	UXTAH
1	11	1111	UXTH

Signed multiply, Divide

This section describes the encoding of the Signed multiply, Divide instruction class. This section is decoded from *Media instructions* on page F4-2962.

31	28	27	26	25	24	23	22	20	19	16	15	12	11	8	7	5	4	3	0
!=1111	0	1	1	1	0	op1	Rd	Ra	Rm	op2	1	Rn							
cond																			

Decode fields			Instruction page
op1	Ra	op2	
000	!= 1111	000	SMLAD, SMLADX - <i>SMLAD variant</i> on page F5-3433
000	!= 1111	001	SMLAD, SMLADX - <i>SMLADX variant</i> on page F5-3433
000	!= 1111	010	SMLSd, SMLSdX - <i>SMLSd variant</i> on page F5-3444
000	!= 1111	011	SMLSd, SMLSdX - <i>SMLSdX variant</i> on page F5-3444
000	-	1xx	Unallocated.

Decode fields			Instruction page
op1	Ra	op2	
000	1111	000	SMUAD, SMUADX - SMUAD variant on page F5-3454
000	1111	001	SMUAD, SMUADX - SMUADX variant on page F5-3454
000	1111	010	SMUSD, SMUSDX - SMUSD variant on page F5-3462
000	1111	011	SMUSD, SMUSDX - SMUSDX variant on page F5-3462
001	-	000	SDIV
001	-	!= 000	Unallocated.
010	-	-	Unallocated.
011	-	000	UDIV
011	-	!= 000	Unallocated.
100	-	000	SMLALD, SMLALDX - SMLALD variant on page F5-3440
100	-	001	SMLALD, SMLALDX - SMLALDX variant on page F5-3440
100	-	010	SMLS LD, SMLS LDX - SMLS LD variant on page F5-3446
100	-	011	SMLS LD, SMLS LDX - SMLS LDX variant on page F5-3446
100	-	1xx	Unallocated.
101	!= 1111	000	SMMLA, SMMLAR - SMMLA variant on page F5-3448
101	!= 1111	001	SMMLA, SMMLAR - SMMLAR variant on page F5-3448
101	-	01x	Unallocated.
101	-	10x	Unallocated.
101	-	110	SMMLS, SMMLSR - SMMLS variant on page F5-3450
101	-	111	SMMLS, SMMLSR - SMMLSR variant on page F5-3450
101	1111	000	SMMUL, SMMULR - SMMUL variant on page F5-3452
101	1111	001	SMMUL, SMMULR - SMMULR variant on page F5-3452
11x	-	-	Unallocated.

Unsigned Sum of Absolute Differences

This section describes the encoding of the Unsigned Sum of Absolute Differences instruction class. This section is decoded from [Media instructions on page F4-2962](#).

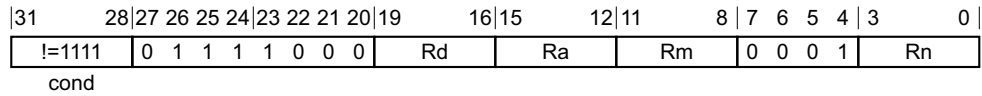

Decode fields	Instruction page
Ra	
!= 1111	USADA8
1111	USAD8

Bitfield Insert

This section describes the encoding of the Bitfield Insert instruction class. This section is decoded from *Media instructions* on page F4-2962.

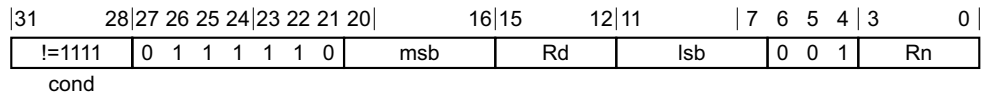

Decode fields	Instruction page
Rn	
!= 1111	BFI
1111	BFC

Permanently UNDEFINED

This section describes the encoding of the Permanently UNDEFINED instruction class. This section is decoded from *Media instructions* on page F4-2962.

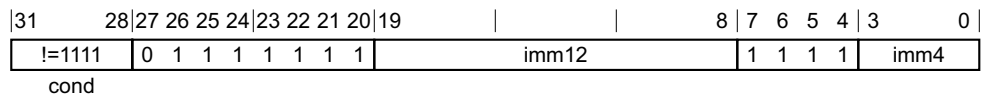

Decode fields	Instruction page
cond	
0xxx	Unallocated.
10xx	Unallocated.
110x	Unallocated.
1110	UDF

Bitfield Extract

This section describes the encoding of the Bitfield Extract instruction class. This section is decoded from *Media instructions* on page F4-2962.

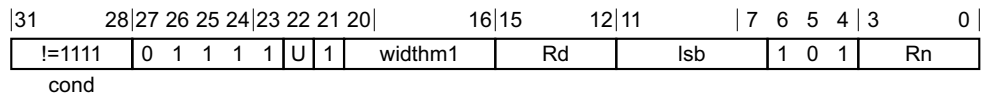

Decode fields		Instruction page
U		
0		SBFX
1		UBFX

F4.1.11 Branch, branch with link, and block data transfer

This section describes the encoding of the Branch, branch with link, and block data transfer group. This section is decoded from *A32 instruction set encoding* on page F4-2944.

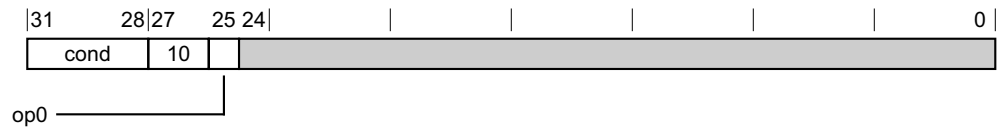
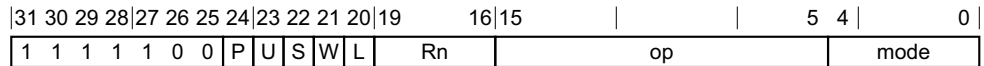

Table F4-10 Encoding table for the Branch, branch with link, and block data transfer group

Decode fields		Decode group or instruction page
cond	op0	
1111	0	Exception Save/Restore
!= 1111	0	Load/Store Multiple on page F4-2971
-	1	Branch (immediate) on page F4-2972

Exception Save/Restore

This section describes the encoding of the Exception Save/Restore instruction class. This section is decoded from *Branch, branch with link, and block data transfer*.



Decode fields

Instruction page

P U S L

-	-	0	0	Unallocated.
0	0	0	1	RFE, RFEDA, RFEDB, RFEIA, RFEIB - Decrement After variant on page F5-3363
0	0	1	0	SRS, SRSDA, SRSDB, SRSIA, SRSIB - Decrement After variant on page F5-3464
0	1	0	1	RFE, RFEDA, RFEDB, RFEIA, RFEIB - Increment After variant on page F5-3363
0	1	1	0	SRS, SRSDA, SRSDB, SRSIA, SRSIB - Increment After variant on page F5-3464
1	0	0	1	RFE, RFEDA, RFEDB, RFEIA, RFEIB - Decrement Before variant on page F5-3363
1	0	1	0	SRS, SRSDA, SRSDB, SRSIA, SRSIB - Decrement Before variant on page F5-3464
-	-	1	1	Unallocated.
1	1	0	1	RFE, RFEDA, RFEDB, RFEIA, RFEIB - Increment Before variant on page F5-3363
1	1	1	0	SRS, SRSDA, SRSDB, SRSIA, SRSIB - Increment Before variant on page F5-3464

Load/Store Multiple

This section describes the encoding of the Load/Store Multiple instruction class. This section is decoded from [Branch, branch with link, and block data transfer on page F4-2970](#).

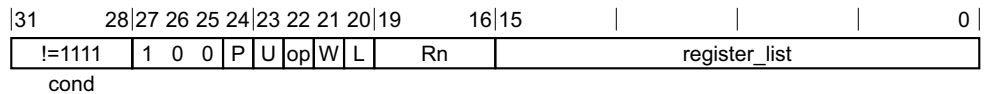

Decode fields

Instruction page

P U op L register_list

0	0	0	0	-	STMDA, STMED
0	0	0	1	-	LDMDA, LDMFA
0	1	0	0	-	STM, STMIA, STMEA
0	1	0	1	-	LDM, LDMIA, LDMFD
-	-	1	0	-	STM (User registers)
1	0	0	0	-	STMDB, STMFD
1	0	0	1	-	LDMDB, LDMEA
-	-	1	1	0xxxxxxxxxxxxxx	LDM (User registers)

Decode fields					Instruction page
P	U	op	L	register_list	
1	1	0	0	-	STMIB, STMFA
1	1	0	1	-	LDMIB, LDMED
-	-	1	1	1xxxxxxxxxxxxxxx	LDM (exception return)

Branch (immediate)

This section describes the encoding of the Branch (immediate) instruction class. This section is decoded from *Branch, branch with link, and block data transfer* on page F4-2970.

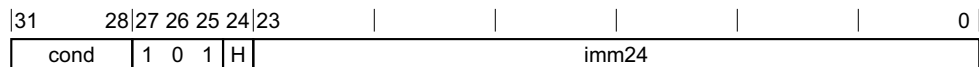

Decode fields		Instruction page
cond	H	
!= 1111	0	B
!= 1111	1	BL, BLX (immediate) - <i>A1</i> on page F5-3067
1111	-	BL, BLX (immediate) - <i>A2</i> on page F5-3067

F4.1.12 System register access, Advanced SIMD, floating-point, and Supervisor call

This section describes the encoding of the System register access, Advanced SIMD, floating-point, and Supervisor call group. This section is decoded from *A32 instruction set encoding* on page F4-2944.

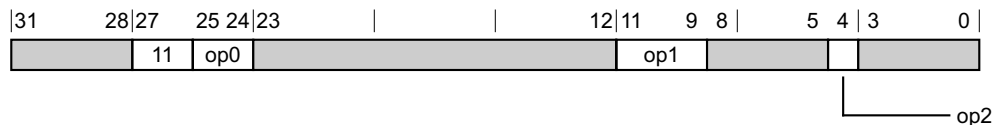
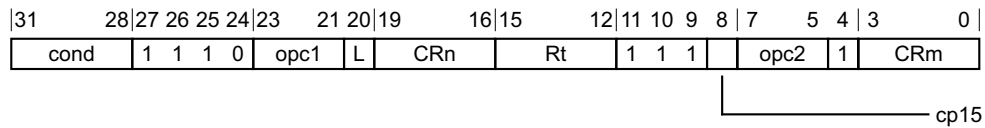

Table F4-11 Encoding table for the System register access, Advanced SIMD, floating-point, and Supervisor call group

Decode fields			Decode group or instruction page
op0	op1	op2	
0x	10x	-	<i>Advanced SIMD load/store and 64-bit move</i> on page F4-2973
0x	111	-	<i>System register load/store and 64-bit move</i> on page F4-2975
10	10x	0	<i>Floating-point data-processing</i> on page F4-2977
10	10x	1	<i>Advanced SIMD and floating-point 32-bit move</i> on page F4-2982
10	111	1	<i>System register 32-bit move</i> on page F4-2973
11	-	-	SVC

System register 32-bit move

This section describes the encoding of the System register 32-bit move instruction class. This section is decoded from *System register access, Advanced SIMD, floating-point, and Supervisor call* on page F4-2972.



Decode fields		Instruction page
cond	L	
!= 1111	0	MCR
!= 1111	1	MRC
1111	-	Unallocated.

F4.1.13 Advanced SIMD load/store and 64-bit move

This section describes the encoding of the Advanced SIMD load/store and 64-bit move group. This section is decoded from *System register access, Advanced SIMD, floating-point, and Supervisor call* on page F4-2972.

This group has encodings in both the T32 and A32 instruction sets. For information about mappings between the encodings of this group, see *About the A32 Advanced SIMD and floating-point instructions and their encoding* on page F4-3001

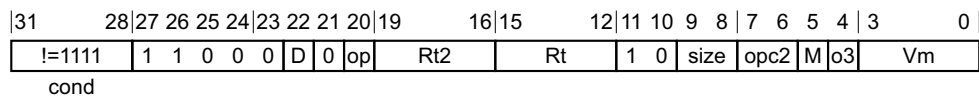

Table F4-12 Encoding table for the Advanced SIMD load/store and 64-bit move group

Decode fields	Decode group or instruction page
op0	
00x0	<i>Advanced SIMD and floating-point 64-bit move</i>
!= 00x0	<i>Advanced SIMD and floating-point load/store on page F4-2974</i>

Advanced SIMD and floating-point 64-bit move

This section describes the encoding of the Advanced SIMD and floating-point 64-bit move instruction class. This section is decoded from *Advanced SIMD load/store and 64-bit move*.



Decode fields

					Instruction page
D	op	size	opc2	o3	
0	-	-	-	-	Unallocated.
1	-	-	-	0	Unallocated.
1	-	0x	00	1	Unallocated.
1	-	-	01	-	Unallocated.
1	0	10	00	1	VMOV (between two general-purpose registers and two single-precision registers) - <i>From general-purpose registers variant on page F6-4008</i>
1	0	11	00	1	VMOV (between two general-purpose registers and a doubleword floating-point register) - <i>From general-purpose registers variant on page F6-3988</i>
1	-	-	1x	-	Unallocated.
1	1	10	00	1	VMOV (between two general-purpose registers and two single-precision registers) - <i>To general-purpose registers variant on page F6-4008</i>
1	1	11	00	1	VMOV (between two general-purpose registers and a doubleword floating-point register) - <i>To general-purpose registers variant on page F6-3988</i>

Advanced SIMD and floating-point load/store

This section describes the encoding of the Advanced SIMD and floating-point load/store instruction class. This section is decoded from *Advanced SIMD load/store and 64-bit move on page F4-2973*.

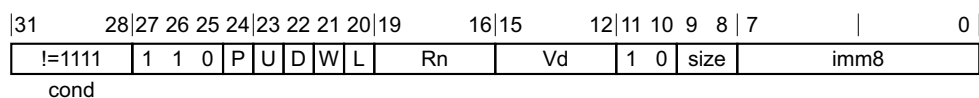

Decode fields

								Instruction page
P	U	W	L	Rn	size	imm8		
0	0	1	-	-	-	-	Unallocated.	
0	1	-	-	-	0x	-	Unallocated.	
0	1	-	0	-	10	-	VSTM, VSTMDB, VSTMIA - <i>Increment After variant on page F6-4269</i>	
0	1	-	0	-	11	xxxxxxx0	VSTM, VSTMDB, VSTMIA - <i>Increment After variant on page F6-4268</i>	
0	1	-	0	-	11	xxxxxxx1	FSTMDBX, FSTMIAX - <i>Increment After variant on page F6-3691</i>	
0	1	-	1	-	10	-	VLDM, VLDMDB, VLDMIA - <i>Increment After variant on page F6-3936</i>	
0	1	-	1	-	11	xxxxxxx0	VLDM, VLDMDB, VLDMIA - <i>Increment After variant on page F6-3935</i>	
0	1	-	1	-	11	xxxxxxx1	FLDM*X (FLDMDBX, FLDMIAX) - <i>Increment After variant on page F6-3688</i>	

Decode fields								Instruction page
P	U	W	L	Rn	size	imm8		
1	-	0	0	-	-	-	VSTR	
1	-	0	-	-	00	-	Unallocated.	
1	-	0	1	!= 1111	-	-	VLDR (immediate)	
1	0	1	-	-	0x	-	Unallocated.	
1	0	1	0	-	10	-	VSTM, VSTMDB, VSTMIA - <i>Decrement Before variant on page F6-4269</i>	
1	0	1	0	-	11	xxxxxxx0	VSTM, VSTMDB, VSTMIA - <i>Decrement Before variant on page F6-4268</i>	
1	0	1	0	-	11	xxxxxxx1	FSTMDBX, FSTMIAX - <i>Decrement Before variant on page F6-3691</i>	
1	0	1	1	-	10	-	VLDM, VLDMDB, VLDMIA - <i>Decrement Before variant on page F6-3936</i>	
1	0	1	1	-	11	xxxxxxx0	VLDM, VLDMDB, VLDMIA - <i>Decrement Before variant on page F6-3935</i>	
1	0	1	1	-	11	xxxxxxx1	FLDM*X (FLDMDBX, FLDMIA) - <i>Decrement Before variant on page F6-3688</i>	
1	-	0	1	1111	-	-	VLDR (literal)	
1	1	1	-	-	-	-	Unallocated.	

F4.1.14 System register load/store and 64-bit move

This section describes the encoding of the System register load/store and 64-bit move group. This section is decoded from *System register access, Advanced SIMD, floating-point, and Supervisor call* on page F4-2972.

This group has encodings in both the T32 and A32 instruction sets. For information about mappings between the encodings of this group, see *About the A32 Advanced SIMD and floating-point instructions and their encoding* on page F4-3001

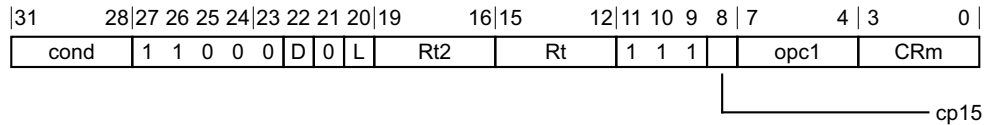

Table F4-13 Encoding table for the System register load/store and 64-bit move group

Decode fields	
op0	Decode group or instruction page
00x0	<i>System register 64-bit move</i>
!= 00x0	<i>System register load/store on page F4-2976</i>

System register 64-bit move

This section describes the encoding of the System register 64-bit move instruction class. This section is decoded from *System register load/store and 64-bit move*.



Decode fields			Instruction page
cond	D	L	
!= 1111	1	0	MCRR
!= 1111	1	1	MRRC
-	0	-	Unallocated.
1111	1	-	Unallocated.

System register load/store

This section describes the encoding of the System register load/store instruction class. This section is decoded from [System register load/store and 64-bit move on page F4-2975](#).

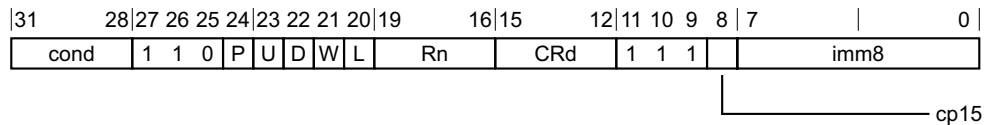

Decode fields							Instruction page
cond	P:U:W	D	L	Rn	CRd	cp15	
!= 1111	!= 000	0	-	-	!= 0101	0	Unallocated.
!= 1111	!= 000	0	1	1111	0101	0	LDC (literal)
!= 1111	!= 000	-	-	-	-	1	Unallocated.
!= 1111	!= 000	1	-	-	0101	0	Unallocated.
!= 1111	0x1	0	0	-	0101	0	STC - Post-indexed variant on page F5-3478
!= 1111	0x1	0	1	!= 1111	0101	0	LDC (immediate) - Post-indexed variant on page F5-3140
!= 1111	010	0	0	-	0101	0	STC - Unindexed variant on page F5-3478
!= 1111	010	0	1	!= 1111	0101	0	LDC (immediate) - Unindexed variant on page F5-3140
!= 1111	1x0	0	0	-	0101	0	STC - Offset variant on page F5-3478
!= 1111	1x0	0	1	!= 1111	0101	0	LDC (immediate) - Offset variant on page F5-3140
!= 1111	1x1	0	0	-	0101	0	STC - Pre-indexed variant on page F5-3478
!= 1111	1x1	0	1	!= 1111	0101	0	LDC (immediate) - Pre-indexed variant on page F5-3140
1111	!= 000	-	-	-	-	-	Unallocated.

F4.1.15 Floating-point data-processing

This section describes the encoding of the Floating-point data-processing group. This section is decoded from *System register access, Advanced SIMD, floating-point, and Supervisor call* on page F4-2972.

This group has encodings in both the T32 and A32 instruction sets. For information about mappings between the encodings of this group, see *About the A32 Advanced SIMD and floating-point instructions and their encoding* on page F4-3001

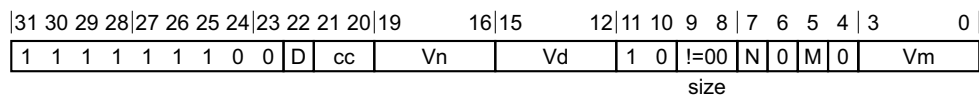

Table F4-14 Encoding table for the Floating-point data-processing group

Decode fields					Decode group or instruction page
cond	op0	op1	op2	op3	
1111	0xxx	-	!= 00	0	<i>Floating-point conditional select</i>
1111	1x00	-	!= 00	-	<i>Floating-point minNum/maxNum</i> on page F4-2978
1111	1x11	0000	!= 00	1	<i>Floating-point extraction and insertion</i> on page F4-2978
1111	1x11	1xxx	!= 00	1	<i>Floating-point directed convert to integer</i> on page F4-2978
!= 1111	1x11	-	-	1	<i>Floating-point data-processing (two registers)</i> on page F4-2979
!= 1111	1x11	-	-	0	<i>Floating-point move immediate</i> on page F4-2980
!= 1111	!= 1x11	-	-	-	<i>Floating-point data-processing (three registers)</i> on page F4-2981

Floating-point conditional select

This section describes the encoding of the Floating-point conditional select instruction class. This section is decoded from *Floating-point data-processing*.



Decode fields		Instruction page
cc	size	
00	-	<i>VSELEQ, VSELGE, VSELGT, VSELVS - VSELEQ, doubleprec variant</i> on page F6-4199
01	-	<i>VSELEQ, VSELGE, VSELGT, VSELVS - VSELVS, doubleprec variant</i> on page F6-4200
-	01	Unallocated.
10	-	<i>VSELEQ, VSELGE, VSELGT, VSELVS - VSELGE, doubleprec variant</i> on page F6-4199
11	-	<i>VSELEQ, VSELGE, VSELGT, VSELVS - VSELGT, doubleprec variant</i> on page F6-4199

Floating-point minNum/maxNum

This section describes the encoding of the Floating-point minNum/maxNum instruction class. This section is decoded from *Floating-point data-processing* on page F4-2977.

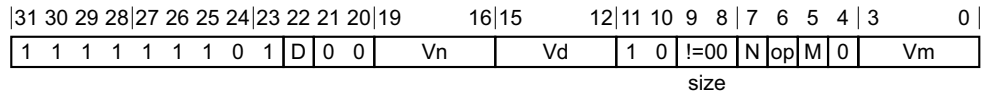

Decode fields		Instruction page
size	op	
-	0	VMAXNM
01	-	Unallocated.
-	1	VMINNM

Floating-point extraction and insertion

This section describes the encoding of the Floating-point extraction and insertion instruction class. This section is decoded from *Floating-point data-processing* on page F4-2977.

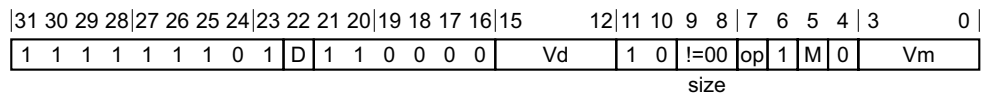

Decode fields		Instruction page	Architecture version
size	op		
01	-	Unallocated.	-
10	0	VMOVX	ARMv8.2
10	1	VINS	ARMv8.2
11	-	Unallocated.	-

Floating-point directed convert to integer

This section describes the encoding of the Floating-point directed convert to integer instruction class. This section is decoded from *Floating-point data-processing* on page F4-2977.

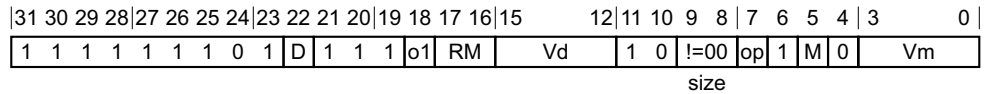

Decode fields			Instruction page
o1	RM	size	
0	00	-	VRINTA (floating-point)
0	01	-	VRINTN (floating-point)
-	-	01	Unallocated.
0	10	-	VRINTP (floating-point)
0	11	-	VRINTM (floating-point)
1	00	-	VCVTA (floating-point)
1	01	-	VCVTN (floating-point)
1	10	-	VCVTP (floating-point)
1	11	-	VCVTM (floating-point)

Floating-point data-processing (two registers)

This section describes the encoding of the Floating-point data-processing (two registers) instruction class. This section is decoded from [Floating-point data-processing on page F4-2977](#).

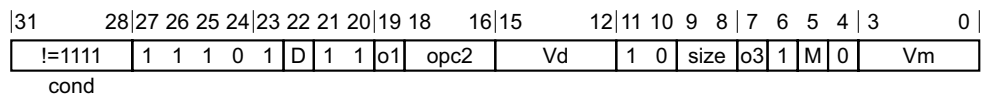

Decode fields				Instruction page
o1	opc2	size	o3	
-	-	00	-	Unallocated.
0	000	01	0	Unallocated.
0	000	-	1	VABS
0	000	10	0	VMOV (register) - Single-precision scalar variant on page F6-3998
0	000	11	0	VMOV (register) - Double-precision scalar variant on page F6-3998
0	001	-	0	VNEG
0	001	-	1	VSQRT
0	01x	01	-	Unallocated.
0	010	-	0	VCVTB - Half-precision to double-precision variant on page F6-3827
0	010	-	1	VCVTT - Half-precision to double-precision variant on page F6-3846

Decode fields				Instruction page
o1	opc2	size	o3	
0	011	-	0	VCVTB - Double-precision to half-precision variant on page F6-3827
0	011	-	1	VCVTT - Double-precision to half-precision variant on page F6-3846
0	100	-	0	VCMP - A1 on page F6-3792
0	100	-	1	VCMPE - A1 on page F6-3796
0	101	-	0	VCMP - A2 on page F6-3792
0	101	-	1	VCMPE - A2 on page F6-3796
0	110	-	0	VRINTR
0	110	-	1	VRINTZ (floating-point)
0	111	-	0	VRINTX (floating-point)
0	111	01	1	Unallocated.
0	111	10	1	VCVT (between double-precision and single-precision) - Single-precision to double-precision variant on page F6-3802
0	111	11	1	VCVT (between double-precision and single-precision) - Double-precision to single-precision variant on page F6-3802
1	000	-	-	VCVT (integer to floating-point, floating-point)
1	001	01	-	Unallocated.
1	001	10	-	Unallocated.
1	001	11	0	Unallocated.
1	01x	-	-	VCVT (between floating-point and fixed-point, floating-point)
1	100	-	0	VCVTR
1	100	-	1	VCVT (floating-point to integer, floating-point)
1	101	-	0	VCVTR
1	101	-	1	VCVT (floating-point to integer, floating-point)
1	11x	-	-	VCVT (between floating-point and fixed-point, floating-point)

Floating-point move immediate

This section describes the encoding of the Floating-point move immediate instruction class. This section is decoded from [Floating-point data-processing on page F4-2977](#).

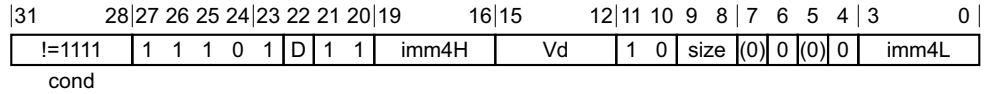

Decode fields	Instruction page	Architecture version
size		
00	Unallocated.	-
01	VMOV (immediate) - Half-precision scalar variant on page F6-3992	ARMv8.2
10	VMOV (immediate) - Single-precision scalar variant on page F6-3992	-
11	VMOV (immediate) - Double-precision scalar variant on page F6-3992	-

Floating-point data-processing (three registers)

This section describes the encoding of the Floating-point data-processing (three registers) instruction class. This section is decoded from [Floating-point data-processing on page F4-2977](#).

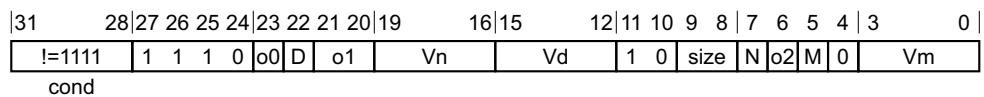

Decode fields			Instruction page
o0:o1	size	o2	
!= 111	00	-	Unallocated.
000	-	0	VMLA (floating-point)
000	-	1	VMLS (floating-point)
001	-	0	VNMLS
001	-	1	VNMLA
010	-	0	VMUL (floating-point)
010	-	1	VNMUL
011	-	0	VADD (floating-point)
011	-	1	VSUB (floating-point)
100	-	0	VDIV
101	-	0	VFNMS
101	-	1	VFNMA
110	-	0	VFMA
110	-	1	VFMS

F4.1.16 Advanced SIMD and floating-point 32-bit move

This section describes the encoding of the Advanced SIMD and floating-point 32-bit move group. This section is decoded from *System register access, Advanced SIMD, floating-point, and Supervisor call* on page F4-2972.

This group has encodings in both the T32 and A32 instruction sets. For information about mappings between the encodings of this group, see *About the A32 Advanced SIMD and floating-point instructions and their encoding* on page F4-3001

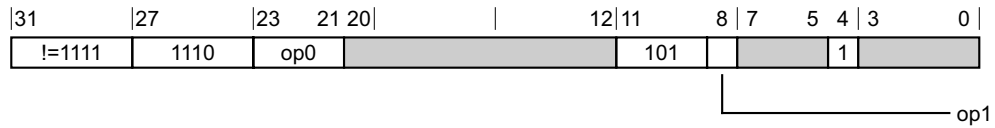
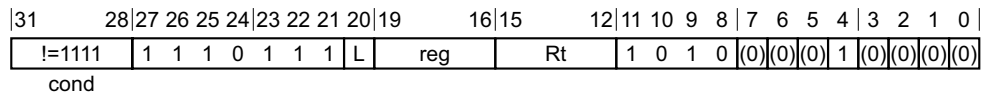

Table F4-15 Encoding table for the Advanced SIMD and floating-point 32-bit move group

Decode fields		Decode group or instruction page
op0	op1	
000	0	VMOV (between general-purpose register and single-precision)
111	0	Floating-point move special register
-	1	Advanced SIMD 8/16/32-bit element move/duplicate

Floating-point move special register

This section describes the encoding of the Floating-point move special register instruction class. This section is decoded from *Advanced SIMD and floating-point 32-bit move*.



Decode fields		Instruction page
L		
0		VMSR
1		VMRS

Advanced SIMD 8/16/32-bit element move/duplicate

This section describes the encoding of the Advanced SIMD 8/16/32-bit element move/duplicate instruction class. This section is decoded from *Advanced SIMD and floating-point 32-bit move*.

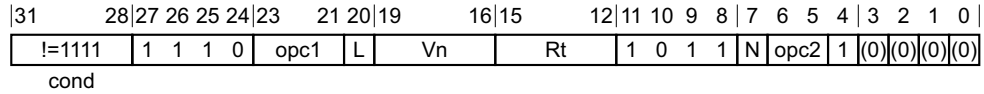

Decode fields			Instruction page
opc1	L	opc2	
0xx	0	-	VMOV (general-purpose register to scalar)
-	1	-	VMOV (scalar to general-purpose register)
1xx	0	0x	VDUP (general-purpose register)
1xx	0	1x	Unallocated.

F4.1.17 Supervisor call

This section describes the encoding of the Supervisor call group. This section is decoded from *System register access, Advanced SIMD, floating-point, and Supervisor call* on page F4-2972.



Table F4-16 Encoding table for the Supervisor call group

Decode fields		Decode group or instruction page
cond		
1111		Unallocated.
!= 1111		SVC

F4.1.18 Unconditional instructions

This section describes the encoding of the Unconditional instructions group. This section is decoded from *A32 instruction set encoding* on page F4-2944.

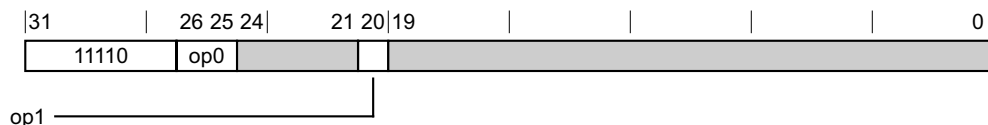

Table F4-17 Encoding table for the Unconditional instructions group

Decode fields		Decode group or instruction page
op0	op1	
00	-	<i>Miscellaneous</i>
01	-	<i>Advanced SIMD data-processing on page F4-2985</i>
1x	1	<i>Memory hints and barriers on page F4-2995</i>
10	0	<i>Advanced SIMD element or structure load/store on page F4-2997</i>
11	0	Unallocated.

F4.1.19 Miscellaneous

This section describes the encoding of the Miscellaneous group. This section is decoded from *Unconditional instructions* on page F4-2983.



Table F4-18 Encoding table for the Miscellaneous group

Decode fields		Decode group or instruction page	Architecture version
op0	op1		
0xxxx	-	Unallocated.	-
10000	xx0x	<i>Change Process State on page F4-2985</i>	-
10001	1000	Unallocated.	-
10001	x100	Unallocated.	-
10001	xx01	Unallocated.	-
10001	0000	SETPAN	ARMv8.1
1000x	0111	Unallocated.	-
10010	0111	CONSTRAINED UNPREDICTABLE	-
10011	0111	Unallocated.	-
1001x	xx0x	Unallocated.	-
100xx	0011	Unallocated.	-
100xx	0x10	Unallocated.	-

Table F4-18 Encoding table for the Miscellaneous group (continued)

Decode fields		Decode group or instruction page	Architecture version
op0	op1		
100xx	1x1x	Unallocated.	-
101xx	-	Unallocated.	-
11xxx	-	Unallocated.	-

The behavior of the **CONSTRAINED UNPREDICTABLE** encodings in this table is described in [CONSTRAINED UNPREDICTABLE behavior for A32 and T32 instruction encodings on page K1-6107](#).

Change Process State

This section describes the encoding of the Change Process State instruction class. This section is decoded from [Miscellaneous on page F4-2984](#).

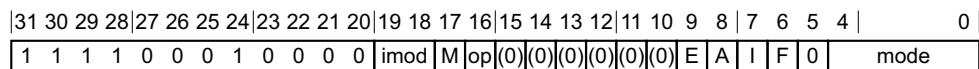

Decode fields				Instruction page
imod	M	op	mode	
-	-	1	0xxxx	SETEND
-	-	0	-	CPS, CPSID, CPSIE
-	-	1	1xxxx	Unallocated.

F4.1.20 Advanced SIMD data-processing

This section describes the encoding of the Advanced SIMD data-processing group. This section is decoded from [Unconditional instructions on page F4-2983](#).

This group has encodings in both the T32 and A32 instruction sets. For information about mappings between the encodings of this group, see [About the A32 Advanced SIMD and floating-point instructions and their encoding on page F4-3001](#)

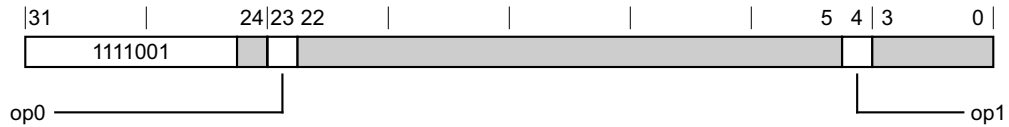
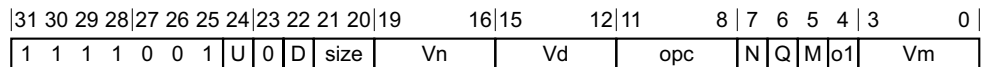

Table F4-19 Encoding table for the Advanced SIMD data-processing group

Decode fields		Decode group or instruction page
op0	op1	
0	-	<i>Advanced SIMD three registers of the same length</i>
1	0	<i>Advanced SIMD two registers, or three registers of different lengths on page F4-2988</i>
1	1	<i>Advanced SIMD shifts and immediate generation on page F4-2993</i>

Advanced SIMD three registers of the same length

This section describes the encoding of the Advanced SIMD three registers of the same length instruction class. This section is decoded from *Advanced SIMD data-processing on page F4-2985*.



Decode fields					Instruction page	Architecture version
U	size	opc	Q	o1		
0	0x	1100	-	1	VFMA	-
0	0x	1101	-	0	VADD (floating-point)	-
0	0x	1101	-	1	VMLA (floating-point)	-
0	0x	1110	-	0	VCEQ (register) - A2 on page F6-3763	-
0	0x	1111	-	0	VMAX (floating-point)	-
0	0x	1111	-	1	VRECPS	-
-	-	0000	-	0	VHADD	-
0	00	0001	-	1	VAND (register)	-
-	-	0000	-	1	VQADD	-
-	-	0001	-	0	VRHADD	-
0	00	1100	-	0	SHA1C	-
-	-	0010	-	0	VHSUB	-
0	01	0001	-	1	VBIC (register)	-
-	-	0010	-	1	VQSUB	-
-	-	0011	-	0	VCGT (register) - A1 on page F6-3774	-

Decode fields					Instruction page	Architecture version
U	size	opc	Q	o1		
-	-	0011	-	1	VCGE (register) - <i>A1</i> on page F6-3768	-
0	01	1100	-	0	SHA1P	-
0	1x	1100	-	1	VFMS	-
0	1x	1101	-	0	VSUB (floating-point)	-
0	1x	1101	-	1	VMLS (floating-point)	-
0	1x	1110	-	0	Unallocated.	-
0	1x	1111	-	0	VMIN (floating-point)	-
0	1x	1111	-	1	VRSQRTS	-
-	-	0100	-	0	VSHL (register)	-
0	-	1000	-	0	VADD (integer)	-
0	10	0001	-	1	VORR (register)	-
0	-	1000	-	1	VTST	-
-	-	0100	-	1	VQSHL (register)	-
0	-	1001	-	0	VMLA (integer)	-
-	-	0101	-	0	VRSHL	-
-	-	0101	-	1	VQRSHL	-
0	-	1011	-	0	VQDMULH	-
0	10	1100	-	0	SHA1M	-
0	-	1011	-	1	VPADD (integer)	-
-	-	0110	-	0	VMAX (integer)	-
0	11	0001	-	1	VORN (register)	-
-	-	0110	-	1	VMIN (integer)	-
-	-	0111	-	0	VABD (integer)	-
-	-	0111	-	1	VABA	-
0	11	1100	-	0	SHA1SU0	-
1	0x	1101	-	0	VPADD (floating-point)	-
1	0x	1101	-	1	VMUL (floating-point)	-
1	0x	1110	-	0	VCGE (register) - <i>A2</i> on page F6-3768	-
1	0x	1110	-	1	VACGE	-
1	0x	1111	0	0	VPMAX (floating-point)	-
1	0x	1111	-	1	VMAXNM	-
1	00	0001	-	1	VEOR	-

Decode fields					Instruction page	Architecture version
U	size	opc	Q	o1		
-	-	1001	-	1	VMUL (integer and polynomial)	-
1	00	1100	-	0	SHA256H	-
-	-	1010	0	0	VPMAX (integer)	-
1	01	0001	-	1	VBSL	-
-	-	1010	0	1	VPMIN (integer)	-
-	-	1010	1	-	Unallocated.	-
1	01	1100	-	0	SHA256H2	-
1	1x	1101	-	0	VABD (floating-point)	-
1	1x	1110	-	0	VCGT (register) - <i>A2</i> on page F6-3774	-
1	1x	1110	-	1	VACGT	-
1	1x	1111	0	0	VPMIN (floating-point)	-
1	1x	1111	-	1	VMINNM	-
1	-	1000	-	0	VSUB (integer)	-
1	10	0001	-	1	VBIT	-
1	-	1000	-	1	VCEQ (register) - <i>A1</i> on page F6-3763	-
1	-	1001	-	0	VMLS (integer)	-
1	-	1011	-	0	VQRDMULH	-
1	10	1100	-	0	SHA256SU1	-
1	-	1011	-	1	VQRDMLAH	ARMv8.1
1	11	0001	-	1	VBIF	-
1	-	1100	-	1	VQRDMLSH	ARMv8.1
1	-	1111	1	0	Unallocated.	-

F4.1.21 Advanced SIMD two registers, or three registers of different lengths

This section describes the encoding of the Advanced SIMD two registers, or three registers of different lengths group. This section is decoded from [Advanced SIMD data-processing on page F4-2985](#).

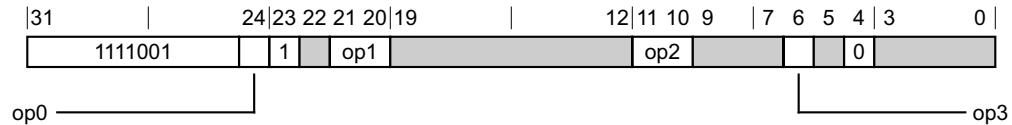
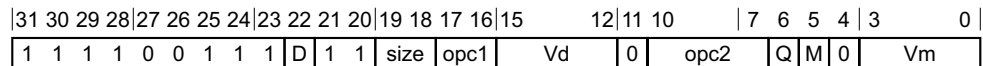

Table F4-20 Encoding table for the Advanced SIMD two registers, or three registers of different lengths group

Decode fields				Decode group or instruction page
op0	op1	op2	op3	
0	11	-	-	VEXT (byte elements)
1	11	0x	-	Advanced SIMD two registers misc
1	11	10	-	VTBL, VTBX
1	11	11	-	Advanced SIMD duplicate (scalar) on page F4-2991
-	!= 11	-	0	Advanced SIMD three registers of different lengths on page F4-2991
-	!= 11	-	1	Advanced SIMD two registers and a scalar on page F4-2992

Advanced SIMD two registers misc

This section describes the encoding of the Advanced SIMD two registers misc instruction class. This section is decoded from *Advanced SIMD two registers, or three registers of different lengths* on page F4-2988.



Decode fields				Instruction page
size	opc1	opc2	Q	
-	00	0000	-	VREV64
-	00	0001	-	VREV32
-	00	0010	-	VREV16
-	00	0011	-	Unallocated.
-	00	010x	-	VPADDL
-	00	0110	0	AESE
-	00	0110	1	AESD
-	00	0111	0	AESMC
-	00	0111	1	AESIMC
-	00	1000	-	VCLS
00	10	0000	-	VSWP

Decode fields				Instruction page
size	opc1	opc2	Q	
-	00	1001	-	VCLZ
-	00	1010	-	VCNT
-	00	1011	-	VMVN (register)
-	00	110x	-	VPADAL
-	00	1110	-	VQABS
-	00	1111	-	VQNEG
-	01	x000	-	VCGT (immediate #0)
-	01	x001	-	VCGE (immediate #0)
-	01	x010	-	VCEQ (immediate #0)
-	01	x011	-	VCLE (immediate #0)
-	01	x100	-	VCLT (immediate #0)
-	01	x110	-	VABS
-	01	x111	-	VNEG
-	01	0101	1	SHA1H
-	10	0001	-	VTRN
-	10	0010	-	VUZP
-	10	0011	-	VZIP
-	10	0100	0	VMOVN
-	10	0100	1	VQMOVN, VQMOVUN - <i>Unsigned result variant on page F6-4100</i>
-	10	0101	-	VQMOVN, VQMOVUN - <i>Signed result variant on page F6-4100</i>
-	10	0110	0	VSHLL
-	10	0111	0	SHA1SU1
-	10	0111	1	SHA256SU0
-	10	1000	-	VRINTN (Advanced SIMD)
-	10	1001	-	VRINTX (Advanced SIMD)
-	10	1010	-	VRINTA (Advanced SIMD)
-	10	1011	-	VRINTZ (Advanced SIMD)
-	10	1100	0	VCVT (between half-precision and single-precision, Advanced SIMD) - <i>Single-precision to half-precision variant on page F6-3804</i>
-	10	1100	1	Unallocated.
-	10	1101	-	VRINTM (Advanced SIMD)
-	10	1110	0	VCVT (between half-precision and single-precision, Advanced SIMD) - <i>Half-precision to single-precision variant on page F6-3804</i>

Decode fields				Instruction page
size	opc1	opc2	Q	
-	10	1110	1	Unallocated.
-	10	1111	-	VRINTP (Advanced SIMD)
-	11	000x	-	VCVTA (Advanced SIMD)
-	11	001x	-	VCVTN (Advanced SIMD)
-	11	010x	-	VCVTP (Advanced SIMD)
-	11	011x	-	VCVTM (Advanced SIMD)
-	11	10x0	-	VRECPE
-	11	10x1	-	VRSQRTE
-	11	11xx	-	VCVT (between floating-point and integer, Advanced SIMD)

Advanced SIMD duplicate (scalar)

This section describes the encoding of the Advanced SIMD duplicate (scalar) instruction class. This section is decoded from *Advanced SIMD two registers, or three registers of different lengths* on page F4-2988.

31	30	29	28	27	26	25	24	23	22	21	20	19	16	15	12	11	10	9	7	6	5	4	3	0
1	1	1	1	0	0	1	1	1	D	1	1	imm4	Vd	1	1	opc	Q	M	0	Vm				

Decode fields	
opc	Instruction page
000	VDUP (scalar)
001	Unallocated.
01x	Unallocated.
1xx	Unallocated.

Advanced SIMD three registers of different lengths

This section describes the encoding of the Advanced SIMD three registers of different lengths instruction class. This section is decoded from *Advanced SIMD two registers, or three registers of different lengths* on page F4-2988.

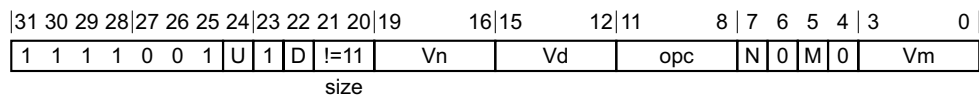

Decode fields		Instruction page
U	opc	
-	0000	VADDL
-	0001	VADDW
-	0010	VSUBL
0	0100	VADDHN
-	0011	VSUBW
0	0110	VSUBHN
0	1001	VQDMLAL
-	0101	VABAL
0	1011	VQDMLSL
0	1101	VQDMULL
-	0111	VABDL (integer)
-	1000	VMLAL (integer)
-	1010	VMLSL (integer)
1	0100	VRADDHN
1	0110	VRSUBHN
-	11x0	VMULL (integer and polynomial)
1	1001	Unallocated.
1	1011	Unallocated.
1	1101	Unallocated.
-	1111	Unallocated.

Advanced SIMD two registers and a scalar

This section describes the encoding of the Advanced SIMD two registers and a scalar instruction class. This section is decoded from *Advanced SIMD two registers, or three registers of different lengths* on page F4-2988.

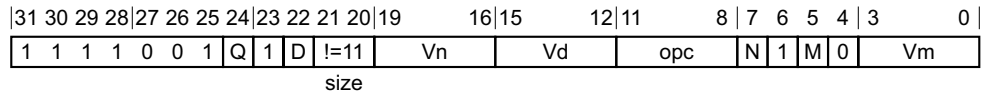

Decode fields		Instruction page	Architecture version
Q	opc		
-	000x	VMLA (by scalar)	-
0	0011	VQDMLAL	-
-	0010	VMLAL (by scalar)	-
0	0111	VQDMLSL	-
-	010x	VMLS (by scalar)	-
0	1011	VQDMULL	-
-	0110	VMLSL (by scalar)	-
-	100x	VMUL (by scalar)	-
1	0011	Unallocated.	-
-	1010	VMULL (by scalar)	-
1	0111	Unallocated.	-
-	1100	VQDMULH	-
-	1101	VQRDMULH	-
1	1011	Unallocated.	-
-	1110	VQRDMLAH	ARMv8.1
-	1111	VQRDMLSH	ARMv8.1

F4.1.22 Advanced SIMD shifts and immediate generation

This section describes the encoding of the Advanced SIMD shifts and immediate generation group. This section is decoded from *Advanced SIMD data-processing* on page F4-2985.

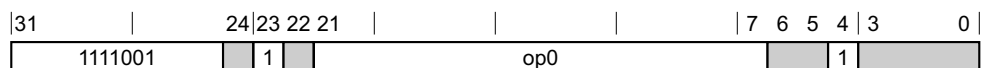

Table F4-21 Encoding table for the Advanced SIMD shifts and immediate generation group

Decode fields	Decode group or instruction page
op0	
000xxxxxxxxxxx0	<i>Advanced SIMD one register and modified immediate</i> on page F4-2994
!= 000xxxxxxxxxxx0	<i>Advanced SIMD two registers and shift amount</i> on page F4-2994

Advanced SIMD one register and modified immediate

This section describes the encoding of the Advanced SIMD one register and modified immediate instruction class. This section is decoded from *Advanced SIMD shifts and immediate generation* on page F4-2993.

31	30	29	28	27	26	25	24	23	22	21	20	19	18	16	15	12	11	8	7	6	5	4	3	0
1	1	1	1	0	0	1	i	1	D	0	0	0	imm3	Vd	cmode	0	Q	op	1	imm4				

Decode fields		Instruction page
cmode	op	
0xx0	0	VMOV (immediate) - <i>A1</i> on page F6-3992
0xx0	1	VMVN (immediate) - <i>A1</i> on page F6-4035
0xx1	0	VORR (immediate) - <i>A1</i> on page F6-4059
0xx1	1	VBIC (immediate) - <i>A1</i> on page F6-3750
10x0	0	VMOV (immediate) - <i>A3</i> on page F6-3993
10x0	1	VMVN (immediate) - <i>A2</i> on page F6-4035
10x1	0	VORR (immediate) - <i>A2</i> on page F6-4059
10x1	1	VBIC (immediate) - <i>A2</i> on page F6-3750
11xx	0	VMOV (immediate) - <i>A4</i> on page F6-3993
110x	1	VMVN (immediate) - <i>A3</i> on page F6-4036
1110	1	VMOV (immediate) - <i>A5</i> on page F6-3994
1111	1	Unallocated.

Advanced SIMD two registers and shift amount

This section describes the encoding of the Advanced SIMD two registers and shift amount instruction class. This section is decoded from *Advanced SIMD shifts and immediate generation* on page F4-2993.

31	30	29	28	27	26	25	24	23	22	21	19	18	16	15	12	11	8	7	6	5	4	3	0
1	1	1	1	0	0	1	U	1	D	imm3H	imm3L	Vd	opc	L	Q	M	1	Vm					

Decode fields					Instruction page
U	imm3L	opc	L	Q	
-	-	0000	-	-	VSHR
-	-	0001	-	-	VSRA
-	-	0010	-	-	VRSRHR
-	-	0011	-	-	VRSRA
1	-	0100	-	-	VSRI

Decode fields					Instruction page
U	imm3L	opc	L	Q	
0	-	0101	-	-	VSHL (immediate)
1	-	0101	-	-	VSLI
1	-	0110	-	-	VQSHL, VQSHLU (immediate)
-	-	0111	-	-	
0	-	1000	0	0	VSHRN
1	-	1000	0	0	VQSHRN, VQSHRUN - <i>Unsigned result variant on page F6-4131</i>
0	-	1000	0	1	VRSHRN
1	-	1000	0	1	VQRSHRN, VQRSHRUN - <i>Unsigned result variant on page F6-4119</i>
-	-	1001	0	0	VQSHRN, VQSHRUN - <i>Signed result variant on page F6-4131</i>
-	-	1001	0	1	VQRSHRN, VQRSHRUN - <i>Signed result variant on page F6-4119</i>
-	!= 000	1010	0	0	VSHLL
-	000	1010	0	0	VMOVL
-	-	111x	0	-	VCVT (between floating-point and fixed-point, Advanced SIMD)

F4.1.23 Memory hints and barriers

This section describes the encoding of the Memory hints and barriers group. This section is decoded from *Unconditional instructions on page F4-2983*.

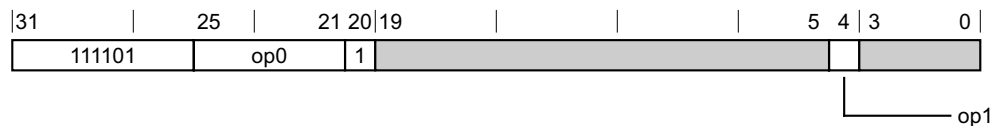

Table F4-22 Encoding table for the Memory hints and barriers group

Decode fields		Decode group or instruction page
op0	op1	
00xx1	-	CONSTRAINED UNPREDICTABLE
01001	-	CONSTRAINED UNPREDICTABLE
01011	-	<i>Barriers on page F4-2996</i>
011x1	-	CONSTRAINED UNPREDICTABLE
0xxx0	-	<i>Preload (immediate) on page F4-2996</i>
1xxx0	0	<i>Preload (register) on page F4-2997</i>
1xxx1	0	CONSTRAINED UNPREDICTABLE
1xxxx	1	Unallocated.

The behavior of the CONSTRAINED UNPREDICTABLE encodings in this table is described in *CONSTRAINED UNPREDICTABLE behavior for A32 and T32 instruction encodings* on page K1-6107.

Barriers

This section describes the encoding of the Barriers instruction class. This section is decoded from *Memory hints and barriers* on page F4-2995.

31	30	29	28	27	26	25	24	23	22	21	20	19	18	17	16	15	14	13	12	11	10	9	8	7	4	3	0
1	1	1	1	0	1	0	1	0	1	1	1	(1)	(1)	(1)	(1)	(1)	(1)	(1)	(1)	(0)	(0)	(0)	(0)	opcode		option	

Decode fields	
opcode	Instruction page
0000	CONSTRAINED UNPREDICTABLE
0001	CLREX
001x	CONSTRAINED UNPREDICTABLE
0100	DSB
0101	DMB
0110	ISB
0111	CONSTRAINED UNPREDICTABLE
1xxx	CONSTRAINED UNPREDICTABLE

The behavior of the CONSTRAINED UNPREDICTABLE encodings in this table is described in *CONSTRAINED UNPREDICTABLE behavior for A32 and T32 instruction encodings* on page K1-6107.

Preload (immediate)

This section describes the encoding of the Preload (immediate) instruction class. This section is decoded from *Memory hints and barriers* on page F4-2995.

31	30	29	28	27	26	25	24	23	22	21	20	19	16	15	14	13	12	11							0
1	1	1	1	0	1	0	D	U	R	0	1	Rn	(1)	(1)	(1)	(1)	imm12								

Decode fields			Instruction page
D	R	Rn	
0	0	-	Reserved hint, behaves as NOP .
0	1	-	PLI (immediate, literal)
1	-	1111	PLD (literal)
1	0	!= 1111	PLD, PLDW (immediate) - <i>Preload write variant</i> on page F5-3314
1	1	!= 1111	PLD, PLDW (immediate) - <i>Preload read variant</i> on page F5-3314

Preload (register)

This section describes the encoding of the Preload (register) instruction class. This section is decoded from *Memory hints and barriers* on page F4-2995.

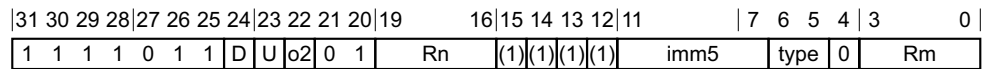

Decode fields		Instruction page
D	o2	
0	0	Reserved hint, behaves as NOP .
0	1	PLI (register)
1	0	PLD, PLDW (register) - Preload write, rotate right with extend variant on page F5-3318
1	1	PLD, PLDW (register) - Preload read, rotate right with extend variant on page F5-3318

F4.1.24 Advanced SIMD element or structure load/store

This section describes the encoding of the Advanced SIMD element or structure load/store group. This section is decoded from *Unconditional instructions* on page F4-2983.

This group has encodings in both the T32 and A32 instruction sets. For information about mappings between the encodings of this group, see *About the A32 Advanced SIMD and floating-point instructions and their encoding* on page F4-3001



Table F4-23 Encoding table for the Advanced SIMD element or structure load/store group

Decode fields		Decode group or instruction page
op0	op1	
0	-	Advanced SIMD load/store multiple structures
1	11	Advanced SIMD load single structure to all lanes on page F4-2998
1	!= 11	Advanced SIMD load/store single structure to one lane on page F4-2999

Advanced SIMD load/store multiple structures

This section describes the encoding of the Advanced SIMD load/store multiple structures instruction class. This section is decoded from *Advanced SIMD element or structure load/store*.

31	30	29	28	27	26	25	24	23	22	21	20	19	16	15	12	11	8	7	6	5	4	3	0
1	1	1	1	0	1	0	0	0	D	L	0	Rn	Vd	type	size	align	Rm						

Decode fields		Instruction page
L	type	
0	000x	VST4 (multiple 4-element structures)
0	0010	VST1 (multiple single elements) - A4 on page F6-4233
0	0011	VST2 (multiple 2-element structures) - A2 on page F6-4246
0	010x	VST3 (multiple 3-element structures)
0	0110	VST1 (multiple single elements) - A3 on page F6-4232
0	0111	VST1 (multiple single elements) - A1 on page F6-4231
0	100x	VST2 (multiple 2-element structures) - A1 on page F6-4245
0	1010	VST1 (multiple single elements) - A2 on page F6-4231
1	000x	VLD4 (multiple 4-element structures)
1	0010	VLD1 (multiple single elements) - A4 on page F6-3891
1	0011	VLD2 (multiple 2-element structures) - A2 on page F6-3907
1	010x	VLD3 (multiple 3-element structures)
-	1011	Unallocated.
1	0110	VLD1 (multiple single elements) - A3 on page F6-3890
1	0111	VLD1 (multiple single elements) - A1 on page F6-3889
-	11xx	Unallocated.
1	100x	VLD2 (multiple 2-element structures) - A1 on page F6-3906
1	1010	VLD1 (multiple single elements) - A2 on page F6-3889

Advanced SIMD load single structure to all lanes

This section describes the encoding of the Advanced SIMD load single structure to all lanes instruction class. This section is decoded from [Advanced SIMD element or structure load/store](#) on page F4-2997.

31	30	29	28	27	26	25	24	23	22	21	20	19	16	15	12	11	10	9	8	7	6	5	4	3	0
1	1	1	1	0	1	0	0	1	D	L	0	Rn	Vd	1	1	N	size	T	a	Rm					

Decode fields

Instruction page

L	N	a	
0	-	-	Unallocated.
1	00	-	VLD1 (single element to all lanes)
1	01	-	VLD2 (single 2-element structure to all lanes)
1	10	0	VLD3 (single 3-element structure to all lanes)
1	10	1	Unallocated.
1	11	-	VLD4 (single 4-element structure to all lanes)

Advanced SIMD load/store single structure to one lane

This section describes the encoding of the Advanced SIMD load/store single structure to one lane instruction class. This section is decoded from *Advanced SIMD element or structure load/store* on page F4-2997.

31	30	29	28	27	26	25	24	23	22	21	20	19	16	15	12	11	10	9	8	7	4	3	0
1	1	1	1	0	1	0	0	1	D	L	0	Rn	Vd	!=11	N	index_align	size	Rm					

Decode fields

Instruction page

L	size	N	
0	00	00	VST1 (single element from one lane) - <i>A1</i> on page F6-4226
0	00	01	VST2 (single 2-element structure from one lane) - <i>A1</i> on page F6-4239
0	00	10	VST3 (single 3-element structure from one lane) - <i>A1</i> on page F6-4250
0	00	11	VST4 (single 4-element structure from one lane) - <i>A1</i> on page F6-4259
0	01	00	VST1 (single element from one lane) - <i>A2</i> on page F6-4226
0	01	01	VST2 (single 2-element structure from one lane) - <i>A2</i> on page F6-4239
0	01	10	VST3 (single 3-element structure from one lane) - <i>A2</i> on page F6-4250
0	01	11	VST4 (single 4-element structure from one lane) - <i>A2</i> on page F6-4259
0	10	00	VST1 (single element from one lane) - <i>A3</i> on page F6-4227
0	10	01	VST2 (single 2-element structure from one lane) - <i>A3</i> on page F6-4240
0	10	10	VST3 (single 3-element structure from one lane) - <i>A3</i> on page F6-4251
0	10	11	VST4 (single 4-element structure from one lane) - <i>A3</i> on page F6-4260
1	00	00	VLD1 (single element to one lane) - <i>A1</i> on page F6-3881

Decode fields			Instruction page
L	size	N	
1	00	01	VLD2 (single 2-element structure to one lane) - <i>A1</i> on page F6-3897
1	00	10	VLD3 (single 3-element structure to one lane) - <i>A1</i> on page F6-3911
1	00	11	VLD4 (single 4-element structure to one lane) - <i>A1</i> on page F6-3923
1	01	00	VLD1 (single element to one lane) - <i>A2</i> on page F6-3881
1	01	01	VLD2 (single 2-element structure to one lane) - <i>A2</i> on page F6-3897
1	01	10	VLD3 (single 3-element structure to one lane) - <i>A2</i> on page F6-3911
1	01	11	VLD4 (single 4-element structure to one lane) - <i>A2</i> on page F6-3923
1	10	00	VLD1 (single element to one lane) - <i>A3</i> on page F6-3882
1	10	01	VLD2 (single 2-element structure to one lane) - <i>A3</i> on page F6-3898
1	10	10	VLD3 (single 3-element structure to one lane) - <i>A3</i> on page F6-3912
1	10	11	VLD4 (single 4-element structure to one lane) - <i>A3</i> on page F6-3924

F4.2 About the A32 Advanced SIMD and floating-point instructions and their encoding

The Advanced SIMD and floating-point instructions are common to the T32 and A32 instruction sets. These instructions perform Advanced SIMD and floating-point operations on a common register file, the SIMD&FP register file. This means:

- In general, the instructions that load or store registers in this file, or move data between general-purpose registers and this register file, are common to the Advanced SIMD and floating-point instructions.
- There are distinct Advanced SIMD data-processing instructions and floating-point data-processing instructions.

All A32 Advanced SIMD and floating-point instructions have 32-bit encodings. Different groups of these instructions are decoded from different points in the 32-bit A32 instruction decode structure. [Table F4-24](#) shows these instruction groups, and where each group is decoded from the overall A32 decode structure:

Table F4-24 Advanced SIMD and floating-point instructions in the A32 decode structure

Advanced SIMD and floating-point instruction group	A32 decode is from
<i>Advanced SIMD load/store and 64-bit move on page F4-2973</i>	<i>System register access, Advanced SIMD, floating-point, and Supervisor call on page F4-2972</i>
<i>Floating-point data-processing on page F4-2977</i>	<i>System register access, Advanced SIMD, floating-point, and Supervisor call on page F4-2972</i>
<i>Advanced SIMD and floating-point 32-bit move on page F4-2982</i>	<i>System register access, Advanced SIMD, floating-point, and Supervisor call on page F4-2972</i>
<i>Advanced SIMD data-processing on page F4-2985</i>	<i>Unconditional instructions on page F4-2983</i>
<i>Advanced SIMD element or structure load/store on page F4-2997</i>	<i>Unconditional instructions on page F4-2983</i>

Chapter F5

T32 and A32 Base Instruction Set Instruction Descriptions

This chapter describes each instruction. It contains the following sections:

- *Alphabetical list of T32 and A32 base instruction set instructions on page F5-3004.*
- *Encoding and use of Banked register transfer instructions on page F5-3674.*

F5.1 Alphabetical list of T32 and A32 base instruction set instructions

This section lists every instruction in the T32 and A32 base instruction sets. For details of the format used see [Format of instruction descriptions on page F2-2844](#).

This section is formatted so that each instruction description starts on a new page.

F5.1.1 ADC, ADCS (immediate)

Add with Carry (immediate) adds an immediate value and the Carry flag value to a register value, and writes the result to the destination register.

If the destination register is not the PC, the ADCS variant of the instruction updates the condition flags based on the result.

The field descriptions for <Rd> identify the encodings where the PC is permitted as the destination register. ARM deprecates any use of these encodings. However, when the destination register is the PC:

- The ADC variant of the instruction is an interworking branch, see *Pseudocode description of operations on the AArch32 general-purpose registers and the PC* on page E1-2733.
- The ADCS variant of the instruction performs an exception return without the use of the stack. In this case:
 - The PE branches to the address written to the PC, and restores `PSTATE` from `SPSR_<current_mode>`.
 - The PE checks `SPSR_<current_mode>` for an illegal return event. See *Illegal return events from AArch32 state* on page G1-4361.
 - The instruction is UNDEFINED in Hyp mode.
 - The instruction is CONSTRAINED UNPREDICTABLE in User mode and System mode.

A1

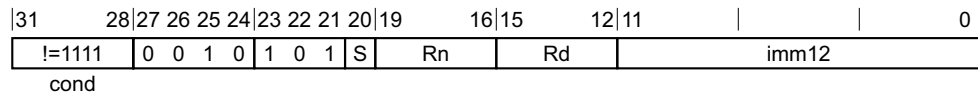

ADC variant

Applies when `S == 0`.

`ADC{<c>}{<q>} {<Rd>}, <Rn>, #<const>`

ADCS variant

Applies when `S == 1`.

`ADCS{<c>}{<q>} {<Rd>}, <Rn>, #<const>`

Decode for all variants of this encoding

`d = UInt(Rd); n = UInt(Rn); setflags = (S == '1'); imm32 = A32ExpandImm(imm12);`

T1

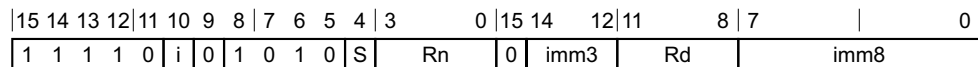

ADC variant

Applies when `S == 0`.

`ADC{<c>}{<q>} {<Rd>}, <Rn>, #<const>`

ADCS variant

Applies when `S == 1`.

ADCS{<c>}{<q>} {<Rd>}, <Rn>, #<const>

Decode for all variants of this encoding

```
d = UInt(Rd); n = UInt(Rn); setflags = (S == '1'); imm32 = T32ExpandImm(i:imm3:imm8);  
if d == 15 || n == 15 then UNPREDICTABLE; // ARMv8-A removes UNPREDICTABLE for R13
```

Notes for all encodings

For more information about the CONSTRAINED UNPREDICTABLE behavior, see [Appendix K1 Architectural Constraints on UNPREDICTABLE behaviors](#).

Assembler symbols

<c>	See Standard assembler syntax fields on page F2-2848 .
<q>	See Standard assembler syntax fields on page F2-2848 .
<Rd>	For encoding A1: is the general-purpose destination register, encoded in the "Rd" field. If omitted, this register is the same as <Rn>. ARM deprecates using the PC as the destination register, but if the PC is used: <ul style="list-style-type: none">For the ADC variant, the instruction is a branch to the address calculated by the operation. This is an interworking branch, see Pseudocode description of operations on the AArch32 general-purpose registers and the PC on page E1-2733.For the ADCS variant, the instruction performs an exception return, that restores PSTATE from SPSR_<current_mode>. For encoding T1: is the general-purpose destination register, encoded in the "Rd" field. If omitted, this register is the same as <Rn>.
<Rn>	For encoding A1: is the general-purpose source register, encoded in the "Rn" field. The PC can be used, but this is deprecated. For encoding T1: is the general-purpose source register, encoded in the "Rn" field.
<const>	For encoding A1: an immediate value. See Modified immediate constants in A32 instructions on page F2-2864 for the range of values. For encoding T1: an immediate value. See Modified immediate constants in T32 instructions on page F2-2863 for the range of values.

Operation for all encodings

```
if ConditionPassed() then  
  EncodingSpecificOperations();  
  (result, nzcV) = AddWithCarry(R[n], imm32, PSTATE.C);  
  if d == 15 then // Can only occur for A32 encoding  
    if setflags then  
      ALUExceptionReturn(result);  
    else  
      ALUWritePC(result);  
  else  
    R[d] = result;  
    if setflags then  
      PSTATE.<N,Z,C,V> = nzcV;
```

F5.1.2 ADC, ADCS (register)

Add with Carry (register) adds a register value, the Carry flag value, and an optionally-shifted register value, and writes the result to the destination register.

If the destination register is not the PC, the ADCS variant of the instruction updates the condition flags based on the result.

The field descriptions for <Rd> identify the encodings where the PC is permitted as the destination register. ARM deprecates any use of these encodings. However, when the destination register is the PC:

- The ADC variant of the instruction is an interworking branch, see *Pseudocode description of operations on the AArch32 general-purpose registers and the PC* on page E1-2733.
- The ADCS variant of the instruction performs an exception return without the use of the stack. In this case:
 - The PE branches to the address written to the PC, and restores `PSTATE` from `SPSR_<current_mode>`.
 - The PE checks `SPSR_<current_mode>` for an illegal return event. See *Illegal return events from AArch32 state* on page G1-4361.
 - The instruction is UNDEFINED in Hyp mode.
 - The instruction is CONSTRAINED UNPREDICTABLE in User mode and System mode.

A1

31	28 27 26 25 24 23 22 21 20 19	16 15	12 11	7 6 5 4 3	0
!=1111	0 0 0 0 1 0 1 S	Rn	Rd	imm5	type 0 Rm
cond					

ADC, rotate right with extend variant

Applies when `S == 0 && imm5 == 00000 && type == 11`.

`ADC{<c>}{<q>} {<Rd>}, <Rn>, <Rm>, RRX`

ADC, shift or rotate by value variant

Applies when `S == 0 && !(imm5 == 00000 && type == 11)`.

`ADC{<c>}{<q>} {<Rd>}, <Rn>, <Rm> {, <shift> #<amount>}`

ADCS, rotate right with extend variant

Applies when `S == 1 && imm5 == 00000 && type == 11`.

`ADCS{<c>}{<q>} {<Rd>}, <Rn>, <Rm>, RRX`

ADCS, shift or rotate by value variant

Applies when `S == 1 && !(imm5 == 00000 && type == 11)`.

`ADCS{<c>}{<q>} {<Rd>}, <Rn>, <Rm> {, <shift> #<amount>}`

Decode for all variants of this encoding

```
d = UInt(Rd); n = UInt(Rn); m = UInt(Rm); setflags = (S == '1');
(shift_t, shift_n) = DecodeImmShift(type, imm5);
```

T1

15	14	13	12	11	10	9	8	7	6	5	3	2	0
0	1	0	0	0	0	0	1	0	1	Rm	Rdn		

T1 variant

ADC<c>{<q>} {<Rdn>}, <Rdn>, <Rm> // Inside IT block
 ADCS{<q>} {<Rdn>}, <Rdn>, <Rm> // Outside IT block

Decode for this encoding

```
d = UInt(Rdn); n = UInt(Rdn); m = UInt(Rm); setFlags = !InITBlock();
(shift_t, shift_n) = (SRTYPE_LSL, 0);
```

T2

15	14	13	12	11	10	9	8	7	6	5	4	3	0	15	14	12	11	8	7	6	5	4	3	0
1	1	1	0	1	0	1	1	0	1	0	S	Rn	(0)	imm3	Rd	imm2	type	Rm						

ADC, rotate right with extend variant

Applies when S == 0 && imm3 == 000 && imm2 == 00 && type == 11.

ADC{<c>}{<q>} {<Rd>}, <Rn>, <Rm>, RRX

ADC, shift or rotate by value variant

Applies when S == 0 && !(imm3 == 000 && imm2 == 00 && type == 11).

ADC<c>.W {<Rd>}, <Rn>, <Rm> // Inside IT block, and <Rd>, <Rn>, <Rm> can be represented in T1
 ADC{<c>}{<q>} {<Rd>}, <Rn>, <Rm> {, <shift> #<amount>}

ADCS, rotate right with extend variant

Applies when S == 1 && imm3 == 000 && imm2 == 00 && type == 11.

ADCS{<c>}{<q>} {<Rd>}, <Rn>, <Rm>, RRX

ADCS, shift or rotate by value variant

Applies when S == 1 && !(imm3 == 000 && imm2 == 00 && type == 11).

ADCS.W {<Rd>}, <Rn>, <Rm> // Outside IT block, and <Rd>, <Rn>, <Rm> can be represented in T1
 ADCS{<c>}{<q>} {<Rd>}, <Rn>, <Rm> {, <shift> #<amount>}

Decode for all variants of this encoding

```
d = UInt(Rd); n = UInt(Rn); m = UInt(Rm); setFlags = (S == '1');
(shift_t, shift_n) = DecodeImmShift(type, imm3:imm2);
if d == 15 || n == 15 || m == 15 then UNPREDICTABLE; // ARMv8-A removes UNPREDICTABLE for R13
```

Notes for all encodings

For more information about the CONSTRAINED UNPREDICTABLE behavior, see [Appendix K1 Architectural Constraints on UNPREDICTABLE behaviors](#).

Assembler symbols

- <c> See [Standard assembler syntax fields on page F2-2848](#).
- <q> See [Standard assembler syntax fields on page F2-2848](#).
- <Rdn> Is the first general-purpose source register and the destination register, encoded in the "Rdn" field.
- <Rd> For encoding A1: is the general-purpose destination register, encoded in the "Rd" field. If omitted, this register is the same as <Rn>. ARM deprecates using the PC as the destination register, but if the PC is used:
- For the ADC variant, the instruction is a branch to the address calculated by the operation. This is an interworking branch, see [Pseudocode description of operations on the AArch32 general-purpose registers and the PC on page E1-2733](#).
 - For the ADCS variant, the instruction performs an exception return, that restores PSTATE from SPSR_<current_mode>.
- For encoding T2: is the general-purpose destination register, encoded in the "Rd" field. If omitted, this register is the same as <Rn>.
- <Rn> For encoding A1: is the first general-purpose source register, encoded in the "Rn" field. The PC can be used, but this is deprecated.
- For encoding T2: is the first general-purpose source register, encoded in the "Rn" field.
- <Rm> For encoding A1: is the second general-purpose source register, encoded in the "Rm" field. The PC can be used, but this is deprecated.
- For encoding T1 and T2: is the second general-purpose source register, encoded in the "Rm" field.
- <shift> Is the type of shift to be applied to the second source register, encoded in the "type" field. It can have the following values:
- | | |
|-----|----------------|
| LSL | when type = 00 |
| LSR | when type = 01 |
| ASR | when type = 10 |
| ROR | when type = 11 |
- <amount> For encoding A1: is the shift amount, in the range 1 to 31 (when <shift> = LSL or ROR) or 1 to 32 (when <shift> = LSR or ASR) encoded in the "imm5" field as <amount> modulo 32.
- For encoding T2: is the shift amount, in the range 1 to 31 (when <shift> = LSL or ROR) or 1 to 32 (when <shift> = LSR or ASR) encoded in the "imm3:imm2" field as <amount> modulo 32.

In T32 assembly:

- Outside an IT block, if ADCS <Rd>, <Rn>, <Rd> has <Rd> and <Rn> both in the range R0-R7, it is assembled using encoding T1 as though ADCS <Rd>, <Rn> had been written.
- Inside an IT block, if ADC<c> <Rd>, <Rn>, <Rd> has <Rd> and <Rn> both in the range R0-R7, it is assembled using encoding T1 as though ADC<c> <Rd>, <Rn> had been written.

To prevent either of these happening, use the .W qualifier.

Operation for all encodings

```
if ConditionPassed() then
    EncodingSpecificOperations();
    shifted = Shift(R[m], shift_t, shift_n, PSTATE.C);
    (result, nzc) = AddWithCarry(R[n], shifted, PSTATE.C);
    if d == 15 then // Can only occur for A32 encoding
        if setflags then
            ALUExceptionReturn(result);
        else
            ALUWritePC(result);
```

```
else  
  R[d] = result;  
  if setflags then  
    PSTATE.<N,Z,C,V> = nzcv;
```

F5.1.3 ADC, ADCS (register-shifted register)

Add with Carry (register-shifted register) adds a register value, the Carry flag value, and a register-shifted register value. It writes the result to the destination register, and can optionally update the condition flags based on the result.

A1

31	28	27	26	25	24	23	22	21	20	19	16	15	12	11	8	7	6	5	4	3	0	
!=1111				0	0	0	0	1	0	1	S	Rn	Rd	Rs	0	type	1	Rm				
cond																						

Flag setting variant

Applies when S == 1.

ADCS{<c>}{<q>} {<Rd>,<Rn>,<Rm>,<type> <Rs>

Not flag setting variant

Applies when S == 0.

ADC{<c>}{<q>} {<Rd>,<Rn>,<Rm>,<type> <Rs>

Decode for all variants of this encoding

```
d = UInt(Rd); n = UInt(Rn); m = UInt(Rm); s = UInt(Rs);
setflags = (S == '1'); shift_t = DecodeRegShift(type);
if d == 15 || n == 15 || m == 15 || s == 15 then UNPREDICTABLE;
```

Notes for all encodings

For more information about the CONSTRAINED UNPREDICTABLE behavior, see [Appendix K1 Architectural Constraints on UNPREDICTABLE behaviors](#).

Assembler symbols

<c>	See Standard assembler syntax fields on page F2-2848 .
<q>	See Standard assembler syntax fields on page F2-2848 .
<Rd>	Is the general-purpose destination register, encoded in the "Rd" field.
<Rn>	Is the first general-purpose source register, encoded in the "Rn" field.
<Rm>	Is the second general-purpose source register, encoded in the "Rm" field.
<type>	Is the type of shift to be applied to the second source register, encoded in the "type" field. It can have the following values: LSL when type = 00 LSR when type = 01 ASR when type = 10 ROR when type = 11
<Rs>	Is the third general-purpose source register holding a shift amount in its bottom 8 bits, encoded in the "Rs" field.

Operation

```
if ConditionPassed() then
    EncodingSpecificOperations();
    shift_n = UInt(R[s]<7:0>);
    shifted = Shift(R[m], shift_t, shift_n, PSTATE.C);
    (result, nzc) = AddWithCarry(R[n], shifted, PSTATE.C);
    R[d] = result;
    if setflags then
        PSTATE.<N,Z,C,V> = nzc;
```

F5.1.4 ADD, ADDS (immediate)

Add (immediate) adds an immediate value to a register value, and writes the result to the destination register.

If the destination register is not the PC, the ADDS variant of the instruction updates the condition flags based on the result.

The field descriptions for <Rd> identify the encodings where the PC is permitted as the destination register. If the destination register is the PC:

- The ADD variant of the instruction is an interworking branch, see *Pseudocode description of operations on the AArch32 general-purpose registers and the PC* on page E1-2733.
- The ADDS variant of the instruction performs an exception return without the use of the stack. ARM deprecates use of this instruction. However, in this case:
 - The PE branches to the address written to the PC, and restores `PSTATE` from `SPSR_<current_mode>`.
 - The PE checks `SPSR_<current_mode>` for an illegal return event. See *Illegal return events from AArch32 state* on page G1-4361.
 - The instruction is UNDEFINED in Hyp mode.
 - The instruction is CONSTRAINED UNPREDICTABLE in User mode and System mode.

A1

31	28 27 26 25 24 23 22 21 20 19	16 15	12 11			0
!=1111	0 0 1 0 1 0 0 S	Rn	Rd	imm12		
cond						

ADD variant

Applies when `S == 0` && `Rn != 11x1`.

ADD{<c>}{<q>} {<Rd>}, {<Rn>, #<const>

ADDS variant

Applies when `S == 1` && `Rn != 1101`.

ADDS{<c>}{<q>} {<Rd>}, {<Rn>, #<const>

Decode for all variants of this encoding

```
if Rn == '1111' && S == '0' then SEE ADR;
if Rn == '1101' then SEE ADD (SP plus immediate);
d = UInt(Rd); n = UInt(Rn); setflags = (S == '1'); imm32 = A32ExpandImm(imm12);
```

T1

15 14 13 12 11 10 9 8	6 5	3 2	0
0 0 0 1 1 1 0	imm3	Rn	Rd

T1 variant

ADD<c>{<q>} <Rd>, <Rn>, #<imm3> // Inside IT block
 ADDS{<q>} <Rd>, <Rn>, #<imm3> // Outside IT block

Decode for this encoding

```
d = UInt(Rd); n = UInt(Rn); setflags = !InITBlock(); imm32 = ZeroExtend(imm3, 32);
```

T2

15	14	13	12	11	10	8	7								0
0	0	1	1	0		Rdn		imm8							

T2 variant

ADD<c>{<q>} <Rdn>, #<imm8> // Inside IT block, and <Rdn>, <imm8> can be represented in T1
 ADD<c>{<q>} {<Rdn>}, <Rdn>, #<imm8> // Inside IT block, and <Rdn>, <imm8> cannot be represented in T1
 ADDS{<q>} <Rdn>, #<imm8> // Outside IT block, and <Rdn>, <imm8> can be represented in T1
 ADDS{<q>} {<Rdn>}, <Rdn>, #<imm8> // Outside IT block, and <Rdn>, <imm8> cannot be represented in T1

Decode for this encoding

d = UInt(Rdn); n = UInt(Rdn); setflags = !InITBlock(); imm32 = ZeroExtend(imm8, 32);

T3

15	14	13	12	11	10	9	8	7	6	5	4	3		0	15	14	12	11	8	7						0
1	1	1	1	0	i	0	1	0	0	0	S	!=1101		0	imm3		Rd		imm8							

Rn

ADD variant

Applies when S == 0.

ADD<c>.W {<Rd>}, <Rn>, #<const> // Inside IT block, and <Rd>, <Rn>, <const> can be represented in T1 or T2
 ADD{<c>}{<q>} {<Rd>}, <Rn>, #<const>

ADDS variant

Applies when S == 1 && Rd != 1111.

ADDS.W {<Rd>}, <Rn>, #<const> // Outside IT block, and <Rd>, <Rn>, <const> can be represented in T1 or T2
 ADDS{<c>}{<q>} {<Rd>}, <Rn>, #<const>

Decode for all variants of this encoding

if Rd == '1111' && S == '1' then SEE CMN (immediate);
 if Rn == '1101' then SEE ADD (SP plus immediate);
 d = UInt(Rd); n = UInt(Rn); setflags = (S == '1'); imm32 = T32ExpandImm(i:imm3:imm8);
 if (d == 15 && !setflags) || n == 15 then UNPREDICTABLE; // ARMv8-A removes UNPREDICTABLE for R13

T4

15	14	13	12	11	10	9	8	7	6	5	4	3		0	15	14	12	11	8	7						0
1	1	1	1	0	i	1	0	0	0	0	0	0	!=11x1		0	imm3		Rd		imm8						

Rn

T4 variant

ADD{<c>}{<q>} {<Rd>}, <Rn>, #<imm12> // <imm12> cannot be represented in T1, T2, or T3
 ADDW{<c>}{<q>} {<Rd>}, <Rn>, #<imm12> // <imm12> can be represented in T1, T2, or T3

Decode for this encoding

```

if Rn == '1111' then SEE ADR;
if Rn == '1101' then SEE ADD (SP plus immediate);
d = UInt(Rd); n = UInt(Rn); setflags = FALSE; imm32 = ZeroExtend(i:imm3:imm8, 32);
if d == 15 then UNPREDICTABLE; // ARMv8-A removes UNPREDICTABLE for R13
  
```

Notes for all encodings

For more information about the CONSTRAINED UNPREDICTABLE behavior, see [Appendix K1 Architectural Constraints on UNPREDICTABLE behaviors](#).

Assembler symbols

<c>	See Standard assembler syntax fields on page F2-2848 .
<q>	See Standard assembler syntax fields on page F2-2848 .
<Rdn>	Is the general-purpose source and destination register, encoded in the "Rdn" field.
<imm8>	Is a 8-bit unsigned immediate, in the range 0 to 255, encoded in the "imm8" field.
<Rd>	For encoding A1: is the general-purpose destination register, encoded in the "Rd" field. If omitted, this register is the same as <Rn>. If the PC is used: <ul style="list-style-type: none"> For the ADD variant, the instruction is a branch to the address calculated by the operation. This is an interworking branch, see Pseudocode description of operations on the AArch32 general-purpose registers and the PC on page E1-2733. For the ADDS variant, the instruction performs an exception return, that restores PSTATE from SPSR_<current_mode>. ARM deprecates use of this instruction. For encoding T1, T3 and T4: is the general-purpose destination register, encoded in the "Rd" field. If omitted, this register is the same as <Rn>.
<Rn>	For encoding A1 and T4: is the general-purpose source register, encoded in the "Rn" field. If the SP is used, see ADD, ADDS (SP plus immediate) . If the PC is used, see ADR . For encoding T1: is the general-purpose source register, encoded in the "Rn" field. For encoding T3: is the general-purpose source register, encoded in the "Rn" field. If the SP is used, see ADD, ADDS (SP plus immediate) .
<imm3>	Is a 3-bit unsigned immediate, in the range 0 to 7, encoded in the "imm3" field.
<imm12>	Is a 12-bit unsigned immediate, in the range 0 to 4095, encoded in the "i:imm3:imm8" field.
<const>	For encoding A1: an immediate value. See Modified immediate constants in A32 instructions on page F2-2864 for the range of values. For encoding T3: an immediate value. See Modified immediate constants in T32 instructions on page F2-2863 for the range of values.

When multiple encodings of the same length are available for an instruction, encoding T3 is preferred to encoding T4 (if encoding T4 is required, use the ADDW syntax). Encoding T1 is preferred to encoding T2 if <Rd> is specified and encoding T2 is preferred to encoding T1 if <Rd> is omitted.

Operation for all encodings

```

if CurrentInstrSet() == InstrSet_A32 then
  if ConditionPassed() then
    EncodingSpecificOperations();
    (result, nzcvc) = AddWithCarry(R[n], imm32, '0');
    if d == 15 then // Can only occur for A32 encoding
      if setflags then
        ALUExceptionReturn(result);
      else
  
```

```
        ALUWritePC(result);
    else
        R[d] = result;
        if setflags then
            PSTATE.<N,Z,C,V> = nzcvc;
    else
        if ConditionPassed() then
            EncodingSpecificOperations();
            (result, nzcvc) = AddWithCarry(R[n], imm32, '0');
            R[d] = result;
            if setflags then
                PSTATE.<N,Z,C,V> = nzcvc;
```

F5.1.5 ADD, ADDS (register)

Add (register) adds a register value and an optionally-shifted register value, and writes the result to the destination register.

If the destination register is not the PC, the ADDS variant of the instruction updates the condition flags based on the result.

The field descriptions for <Rd> identify the encodings where the PC is permitted as the destination register. If the destination register is the PC:

- The ADD variant of the instruction is an interworking branch, see *Pseudocode description of operations on the AArch32 general-purpose registers and the PC on page E1-2733*.
- The ADDS variant of the instruction performs an exception return without the use of the stack. ARM deprecates use of this instruction. However, in this case:
 - The PE branches to the address written to the PC, and restores `PSTATE` from `SPSR_<current_mode>`.
 - The PE checks `SPSR_<current_mode>` for an illegal return event. See *Illegal return events from AArch32 state on page G1-4361*.
 - The instruction is UNDEFINED in Hyp mode.
 - The instruction is CONSTRAINED UNPREDICTABLE in User mode and System mode.

A1

31	28	27	26	25	24	23	22	21	20	19	16	15	12	11	7	6	5	4	3	0	
!=1111				0 0 0 0				1 0 0 S				!=1101		Rd		imm5		type		0	Rm
cond								Rn													

ADD, rotate right with extend variant

Applies when $S == 0$ && $imm5 == 00000$ && $type == 11$.

ADD{<c>}{<q>} {<Rd>}, <Rn>, <Rm>, RRX

ADD, shift or rotate by value variant

Applies when $S == 0$ && $!(imm5 == 00000 \ \&\& \ type == 11)$.

ADD{<c>}{<q>} {<Rd>}, <Rn>, <Rm> {, <shift> #<amount>}

ADDS, rotate right with extend variant

Applies when $S == 1$ && $imm5 == 00000$ && $type == 11$.

ADDS{<c>}{<q>} {<Rd>}, <Rn>, <Rm>, RRX

ADDS, shift or rotate by value variant

Applies when $S == 1$ && $!(imm5 == 00000 \ \&\& \ type == 11)$.

ADDS{<c>}{<q>} {<Rd>}, <Rn>, <Rm> {, <shift> #<amount>}

Decode for all variants of this encoding

```
if Rn == '1101' then SEE ADD (SP plus register);
d = UInt(Rd); n = UInt(Rn); m = UInt(Rm); setflags = (S == '1');
(shift_t, shift_n) = DecodeImmShift(type, imm5);
```

T1

15	14	13	12	11	10	9	8	6	5	3	2	0
0	0	0	1	1	0	0	Rm	Rn	Rd			

T1 variant

ADD<c>{<q>} <Rd>, <Rn>, <Rm> // Inside IT block
 ADDS{<q>} {<Rd>}, <Rn>, <Rm> // Outside IT block

Decode for this encoding

d = UInt(Rd); n = UInt(Rn); m = UInt(Rm); setflags = !InITBlock();
 (shift_t, shift_n) = (SRType_LSL, 0);

T2

15	14	13	12	11	10	9	8	7	6	3	2	0
0	1	0	0	0	1	0	0	!=1101	Rdn			

Rm
DN

T2 variant

Applies when !(DN == 1 && Rdn == 101).

ADD<c>{<q>} <Rdn>, <Rm> // Preferred syntax, Inside IT block
 ADD{<c>}{<q>} {<Rdn>}, <Rdn>, <Rm>

Decode for this encoding

if (DN:Rdn == '1101' || Rm == '1101') then SEE ADD (SP plus register);
 d = UInt(DN:Rdn); n = d; m = UInt(Rm); setflags = FALSE; (shift_t, shift_n) = (SRType_LSL, 0);
 if n == 15 && m == 15 then UNPREDICTABLE;
 if d == 15 && InITBlock() && !LastInITBlock() then UNPREDICTABLE;

T3

15	14	13	12	11	10	9	8	7	6	5	4	3	0	15	14	12	11	8	7	6	5	4	3	0
1	1	1	0	1	0	1	1	0	0	0	S	!=1101	(0)	imm3	Rd	imm2	type	Rm						

Rn

ADD, rotate right with extend variant

Applies when S == 0 && imm3 == 000 && imm2 == 00 && type == 11.

ADD{<c>}{<q>} {<Rd>}, <Rn>, <Rm>, RRX

ADD, shift or rotate by value variant

Applies when S == 0 && !(imm3 == 000 && imm2 == 00 && type == 11).

ADD<c>.W {<Rd>}, <Rn>, <Rm> // Inside IT block, and <Rd>, <Rn>, <Rm> can be represented in T1
 ADD{<c>}.W {<Rd>}, <Rn>, <Rm> // <Rd> == <Rn>, and <Rd>, <Rn>, <Rm> can be represented in T2
 ADD{<c>}{<q>} {<Rd>}, <Rn>, <Rm> {, <shift> #<amount>}

ADDS, rotate right with extend variant

Applies when $S == 1 \ \&\& \ imm3 == 000 \ \&\& \ Rd \neq 1111 \ \&\& \ imm2 == 00 \ \&\& \ type == 11$.

ADDS{<c>}{<q>} {<Rd>}, <Rn>, <Rm>, RRX

ADDS, shift or rotate by value variant

Applies when $S == 1 \ \&\& \ !(imm3 == 000 \ \&\& \ imm2 == 00 \ \&\& \ type == 11) \ \&\& \ Rd \neq 1111$.

ADDS.W {<Rd>}, <Rn>, <Rm> // Outside IT block, and <Rd>, <Rn>, <Rm> can be represented in T1 or T2
ADDS{<c>}{<q>} {<Rd>}, <Rn>, <Rm> {, <shift> #<amount>}

Decode for all variants of this encoding

```
if Rd == '1111' && S == '1' then SEE CMN (register);
if Rn == '1101' then SEE ADD (SP plus register);
d = UInt(Rd); n = UInt(Rn); m = UInt(Rm); setflags = (S == '1');
(shift_t, shift_n) = DecodeImmShift(type, imm3:imm2);
if (d == 15 && !setflags) || n == 15 || m == 15 then UNPREDICTABLE;
// ARMv8-A removes UNPREDICTABLE for R13
```

Notes for all encodings

For more information about the CONSTRAINED UNPREDICTABLE behavior, see [Appendix K1 Architectural Constraints on UNPREDICTABLE behaviors](#).

Assembler symbols

<c> See [Standard assembler syntax fields on page F2-2848](#).

<q> See [Standard assembler syntax fields on page F2-2848](#).

<Rdn> Is the general-purpose source and destination register, encoded in the "DN:Rdn" field. If the PC is used, the instruction is a branch to the address calculated by the operation. This is a simple branch, see [Pseudocode description of operations on the AArch32 general-purpose registers and the PC on page E1-2733](#).

The assembler language allows <Rdn> to be specified once or twice in the assembler syntax. When used inside an IT block, and <Rdn> and <Rm> are in the range R0 to R7, <Rdn> must be specified once so that encoding T2 is preferred to encoding T1. In all other cases there is no difference in behavior when <Rdn> is specified once or twice.

<Rd> For encoding A1: is the general-purpose destination register, encoded in the "Rd" field. If omitted, this register is the same as <Rn>. If the PC is used:

- For the ADD variant, the instruction is a branch to the address calculated by the operation. This is an interworking branch, see [Pseudocode description of operations on the AArch32 general-purpose registers and the PC on page E1-2733](#).
- For the ADDS variant, the instruction performs an exception return, that restores PSTATE from SPSR_<current_mode>. ARM deprecates use of this instruction.

For encoding T1: is the general-purpose destination register, encoded in the "Rd" field.

When used inside an IT block, <Rd> must be specified. When used outside an IT block, <Rd> is optional, and:

- If omitted, this register is the same as <Rn>.
- If present, encoding T1 is preferred to encoding T2.

For encoding T3: is the general-purpose destination register, encoded in the "Rd" field. If omitted, this register is the same as <Rn>.

<Rn> For encoding A1: is the first general-purpose source register, encoded in the "Rn" field. The PC can be used. If the SP is used, see [ADD, ADDS \(SP plus register\)](#).

For encoding T1: is the first general-purpose source register, encoded in the "Rn" field.

For encoding T3: is the first general-purpose source register, encoded in the "Rn" field. If the SP is used, see [ADD, ADDS \(SP plus register\)](#).

<Rm> For encoding A1: is the second general-purpose source register, encoded in the "Rm" field. The PC can be used, but this is deprecated.

For encoding T1 and T3: is the second general-purpose source register, encoded in the "Rm" field.

For encoding T2: is the second general-purpose source register, encoded in the "Rm" field. The PC can be used.

<shift> Is the type of shift to be applied to the second source register, encoded in the "type" field. It can have the following values:

LSL when type = 00

LSR when type = 01

ASR when type = 10

ROR when type = 11

<amount> For encoding A1: is the shift amount, in the range 1 to 31 (when <shift> = LSL or ROR) or 1 to 32 (when <shift> = LSR or ASR) encoded in the "imm5" field as <amount> modulo 32.

For encoding T3: is the shift amount, in the range 1 to 31 (when <shift> = LSL or ROR) or 1 to 32 (when <shift> = LSR or ASR) encoded in the "imm3:imm2" field as <amount> modulo 32.

Inside an IT block, if `ADD<c> <Rd>, <Rn>, <Rd>` cannot be assembled using encoding T1, it is assembled using encoding T2 as though `ADD<c> <Rd>, <Rn>` had been written. To prevent this happening, use the `.w` qualifier.

Operation for all encodings

```
if ConditionPassed() then
    EncodingSpecificOperations();
    shifted = Shift(R[m], shift_t, shift_n, PSTATE.C);
    (result, nzc) = AddWithCarry(R[n], shifted, '0');
    if d == 15 then
        if setflags then
            ALUExceptionReturn(result);
        else
            ALUWritePC(result);
    else
        R[d] = result;
        if setflags then
            PSTATE.<N,Z,C,V> = nzc;
```

F5.1.6 ADD, ADDS (register-shifted register)

Add (register-shifted register) adds a register value and a register-shifted register value. It writes the result to the destination register, and can optionally update the condition flags based on the result.

A1

31	28	27	26	25	24	23	22	21	20	19	16	15	12	11	8	7	6	5	4	3	0		
!=1111				0 0 0 0				1 0 0 S				Rn		Rd		Rs		0 type		1 Rm			
cond																							

Flag setting variant

Applies when S == 1.

ADDS{<c>}{<q>} {<Rd>}, {<Rn>, <Rm>, <type> <Rs>

Not flag setting variant

Applies when S == 0.

ADD{<c>}{<q>} {<Rd>}, {<Rn>, <Rm>, <type> <Rs>

Decode for all variants of this encoding

```
d = UInt(Rd); n = UInt(Rn); m = UInt(Rm); s = UInt(Rs);
setflags = (S == '1'); shift_t = DecodeRegShift(type);
if d == 15 || n == 15 || m == 15 || s == 15 then UNPREDICTABLE;
```

Notes for all encodings

For more information about the CONSTRAINED UNPREDICTABLE behavior, see [Appendix K1 Architectural Constraints on UNPREDICTABLE behaviors](#).

Assembler symbols

<c>	See Standard assembler syntax fields on page F2-2848 .								
<q>	See Standard assembler syntax fields on page F2-2848 .								
<Rd>	Is the general-purpose destination register, encoded in the "Rd" field.								
<Rn>	Is the first general-purpose source register, encoded in the "Rn" field.								
<Rm>	Is the second general-purpose source register, encoded in the "Rm" field.								
<type>	Is the type of shift to be applied to the second source register, encoded in the "type" field. It can have the following values: <table style="margin-left: 20px;"> <tr> <td>LSL</td> <td>when type = 00</td> </tr> <tr> <td>LSR</td> <td>when type = 01</td> </tr> <tr> <td>ASR</td> <td>when type = 10</td> </tr> <tr> <td>ROR</td> <td>when type = 11</td> </tr> </table>	LSL	when type = 00	LSR	when type = 01	ASR	when type = 10	ROR	when type = 11
LSL	when type = 00								
LSR	when type = 01								
ASR	when type = 10								
ROR	when type = 11								
<Rs>	Is the third general-purpose source register holding a shift amount in its bottom 8 bits, encoded in the "Rs" field.								

Operation

```
if ConditionPassed() then
    EncodingSpecificOperations();
    shift_n = UInt(R[s]<7:0>);
    shifted = Shift(R[m], shift_t, shift_n, PSTATE.C);
    (result, nzc) = AddWithCarry(R[n], shifted, '0');
    R[d] = result;
    if setflags then
        PSTATE.<N,Z,C,V> = nzc;
```

F5.1.7 ADD, ADDS (SP plus immediate)

Add to SP (immediate) adds an immediate value to the SP value, and writes the result to the destination register.

If the destination register is not the PC, the ADDS variant of the instruction updates the condition flags based on the result.

The field descriptions for <Rd> identify the encodings where the PC is permitted as the destination register. However, when the destination register is the PC:

- The ADD variant of the instruction is an interworking branch, see [Pseudocode description of operations on the AArch32 general-purpose registers and the PC on page E1-2733](#).
- The ADDS variant of the instruction performs an exception return without the use of the stack. ARM deprecates use of this instruction. However, in this case:
 - The PE branches to the address written to the PC, and restores `PSTATE` from `SPSR_<current_mode>`.
 - The PE checks `SPSR_<current_mode>` for an illegal return event. See [Illegal return events from AArch32 state on page G1-4361](#).
 - The instruction is UNDEFINED in Hyp mode.
 - The instruction is CONSTRAINED UNPREDICTABLE in User mode and System mode.

A1

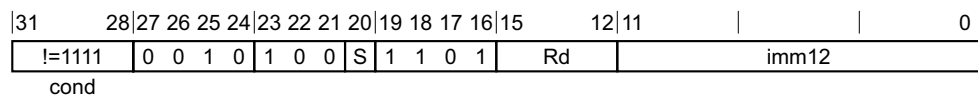

ADD variant

Applies when $S == 0$.

ADD{<c>}{<q>} {<Rd>}, SP, #<const>

ADDS variant

Applies when $S == 1$.

ADDS{<c>}{<q>} {<Rd>}, SP, #<const>

Decode for all variants of this encoding

$d = \text{UInt}(\text{Rd}); \text{setflags} = (S == '1');$ $\text{imm32} = \text{A32ExpandImm}(\text{imm12});$

T1

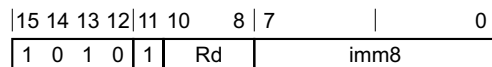

T1 variant

ADD{<c>}{<q>} <Rd>, SP, #<imm8>

Decode for this encoding

$d = \text{UInt}(\text{Rd}); \text{setflags} = \text{FALSE}; \text{imm32} = \text{ZeroExtend}(\text{imm8}: '00', 32);$

T2

15	14	13	12	11	10	9	8	7	6									0
1	0	1	1	0	0	0	0	0		imm7								

T2 variant

ADD{<c>}{<q>} {SP,} SP, #<imm7>

Decode for this encoding

d = 13; setflags = FALSE; imm32 = ZeroExtend(imm7:'00', 32);

T3

15	14	13	12	11	10	9	8	7	6	5	4	3	2	1	0	15	14	12	11	8	7									0
1	1	1	1	0	i	0	1	0	0	0	S	1	1	0	1	0	imm3		Rd			imm8								

ADD variant

Applies when S == 0.

ADD{<c>}.W {<Rd>}, SP, #<const> // <Rd>, <const> can be represented in T1 or T2
 ADD{<c>}{<q>} {<Rd>}, SP, #<const>

ADDS variant

Applies when S == 1 && Rd != 1111.

ADDS{<c>}{<q>} {<Rd>}, SP, #<const>

Decode for all variants of this encoding

if Rd == '1111' && S == '1' then SEE CMN (immediate);
 d = UInt(Rd); setflags = (S == '1'); imm32 = T32ExpandImm(i:imm3:imm8);
 if d == 15 && !setflags then UNPREDICTABLE;

T4

15	14	13	12	11	10	9	8	7	6	5	4	3	2	1	0	15	14	12	11	8	7									0
1	1	1	1	0	i	1	0	0	0	0	0	0	1	1	0	1	0	imm3		Rd			imm8							

T4 variant

ADD{<c>}{<q>} {<Rd>}, SP, #<imm12> // <imm12> cannot be represented in T1, T2, or T3
 ADDW{<c>}{<q>} {<Rd>}, SP, #<imm12> // <imm12> can be represented in T1, T2, or T3

Decode for this encoding

d = UInt(Rd); setflags = FALSE; imm32 = ZeroExtend(i:imm3:imm8, 32);
 if d == 15 then UNPREDICTABLE;

Notes for all encodings

For more information about the CONSTRAINED UNPREDICTABLE behavior, see [Appendix K1 Architectural Constraints on UNPREDICTABLE behaviors](#).

Assembler symbols

<c>	See Standard assembler syntax fields on page F2-2848 .
<q>	See Standard assembler syntax fields on page F2-2848 .
<imm7>	Is the unsigned immediate, a multiple of 4, in the range 0 to 508, encoded in the "imm7" field as <imm7>/4.
<Rd>	For encoding A1: is the general-purpose destination register, encoded in the "Rd" field. If omitted, this register is the SP. ARM deprecates using the PC as the destination register, but if the PC is used: <ul style="list-style-type: none">For the ADD variant, the instruction is a branch to the address calculated by the operation. This is an interworking branch, see Pseudocode description of operations on the AArch32 general-purpose registers and the PC on page E1-2733.For the ADDS variant, the instruction performs an exception return, that restores PSTATE from SPSR_<current_mode>. For encoding T1: is the general-purpose destination register, encoded in the "Rd" field. For encoding T3 and T4: is the general-purpose destination register, encoded in the "Rd" field. If omitted, this register is the SP.
<imm8>	Is an unsigned immediate, a multiple of 4, in the range 0 to 1020, encoded in the "imm8" field as <imm8>/4.
<imm12>	Is a 12-bit unsigned immediate, in the range 0 to 4095, encoded in the "i:imm3:imm8" field.
<const>	For encoding A1: an immediate value. See Modified immediate constants in A32 instructions on page F2-2864 for the range of values. For encoding T3: an immediate value. See Modified immediate constants in T32 instructions on page F2-2863 for the range of values.

Operation for all encodings

```
if ConditionPassed() then
    EncodingSpecificOperations();
    (result, nzcvc) = AddWithCarry(SP, imm32, '0');
    if d == 15 then // Can only occur for A32 encoding
        if setflags then
            ALUExceptionReturn(result);
        else
            ALUWritePC(result);
    else
        R[d] = result;
        if setflags then
            PSTATE.<N,Z,C,V> = nzcvc;
```

F5.1.8 ADD, ADDS (SP plus register)

Add to SP (register) adds an optionally-shifted register value to the SP value, and writes the result to the destination register.

If the destination register is not the PC, the ADDS variant of the instruction updates the condition flags based on the result.

The field descriptions for <Rd> identify the encodings where the PC is permitted as the destination register. ARM deprecates any use of these encodings. However, when the destination register is the PC:

- The ADD variant of the instruction is an interworking branch, see *Pseudocode description of operations on the AArch32 general-purpose registers and the PC* on page E1-2733.
- The ADDS variant of the instruction performs an exception return without the use of the stack. In this case:
 - The PE branches to the address written to the PC, and restores PSTATE from SPSR_<current_mode>.
 - The PE checks SPSR_<current_mode> for an illegal return event. See *Illegal return events from AArch32 state* on page G1-4361.
 - The instruction is UNDEFINED in Hyp mode.
 - The instruction is CONSTRAINED UNPREDICTABLE in User mode and System mode.

A1

31	28	27	26	25	24	23	22	21	20	19	18	17	16	15	12	11	7	6	5	4	3	0	
!=1111				0	0	0	0	1	0	0	S	1	1	0	1	Rd	imm5				type	0	Rm
cond																							

ADD, rotate right with extend variant

Applies when S == 0 && imm5 == 00000 && type == 11.

ADD{<c>}{<q>} {<Rd>}, SP, <Rm> , RRX

ADD, shift or rotate by value variant

Applies when S == 0 && !(imm5 == 00000 && type == 11).

ADD{<c>}{<q>} {<Rd>}, SP, <Rm> {, <shift> #<amount>}

ADDS, rotate right with extend variant

Applies when S == 1 && imm5 == 00000 && type == 11.

ADDS{<c>}{<q>} {<Rd>}, SP, <Rm> , RRX

ADDS, shift or rotate by value variant

Applies when S == 1 && !(imm5 == 00000 && type == 11).

ADDS{<c>}{<q>} {<Rd>}, SP, <Rm> {, <shift> #<amount>}

Decode for all variants of this encoding

```
d = UInt(Rd); m = UInt(Rm); setflags = (S == '1');
(shift_t, shift_n) = DecodeImmShift(type, imm5);
```

T1

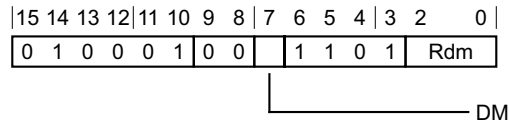

T1 variant

ADD{<c>}{<q>} {<Rdm>}, SP, <Rdm>

Decode for this encoding

```
d = UInt(DM:Rdm); m = UInt(DM:Rdm); setflags = FALSE;
(shift_t, shift_n) = (SRTYPE_LSL, 0);
if d == 15 && InITBlock() && !LastInITBlock() then UNPREDICTABLE;
```

T2

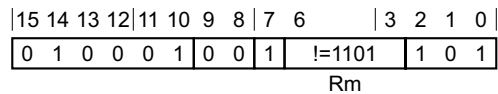

T2 variant

ADD{<c>}{<q>} {SP,} SP, <Rm>

Decode for this encoding

```
if Rm == '1101' then SEE encoding T1;
d = 13; m = UInt(Rm); setflags = FALSE;
(shift_t, shift_n) = (SRTYPE_LSL, 0);
```

T3

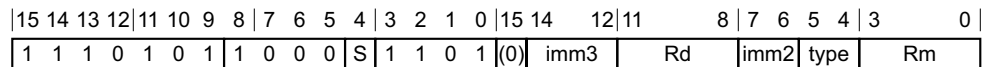

ADD, rotate right with extend variant

Applies when S == 0 && imm3 == 000 && imm2 == 00 && type == 11.

ADD{<c>}{<q>} {<Rd>}, SP, <Rm>, RRX

ADD, shift or rotate by value variant

Applies when S == 0 && !(imm3 == 000 && imm2 == 00 && type == 11).

ADD{<c>}.W {<Rd>}, SP, <Rm> // <Rd>, <Rm> can be represented in T1 or T2
 ADD{<c>}{<q>} {<Rd>}, SP, <Rm> {, <shift> #<amount>}

ADDS, rotate right with extend variant

Applies when S == 1 && imm3 == 000 && Rd != 1111 && imm2 == 00 && type == 11.

ADDS{<c>}{<q>} {<Rd>}, SP, <Rm>, RRX

ADDS, shift or rotate by value variant

Applies when $S == 1 \ \&\& \ !(imm3 == 000 \ \&\& \ imm2 == 00 \ \&\& \ type == 11) \ \&\& \ Rd \ != \ 1111$.

ADDS{<c>}{<q>} {<Rd>}, SP, <Rm> {, <shift> #<amount>}

Decode for all variants of this encoding

```
if Rd == '1111' && S == '1' then SEE CMN (register);
d = UInt(Rd); m = UInt(Rm); setflags = (S == '1');
(shift_t, shift_n) = DecodeImmShift(type, imm3:imm2);
if (d == 15 && !setflags) || m == 15 then UNPREDICTABLE; // ARMv8-A removes UNPREDICTABLE for R13
```

Notes for all encodings

For more information about the CONSTRAINED UNPREDICTABLE behavior, see [Appendix K1 Architectural Constraints on UNPREDICTABLE behaviors](#).

Assembler symbols

- <c> See [Standard assembler syntax fields on page F2-2848](#).
- <q> See [Standard assembler syntax fields on page F2-2848](#).
- <Rdm> Is the general-purpose destination and second source register, encoded in the "Rdm" field. If omitted, this register is the SP. ARM deprecates using the PC as the destination register, but if the PC is used, the instruction is a branch to the address calculated by the operation. This is a simple branch, see [Pseudocode description of operations on the AArch32 general-purpose registers and the PC on page E1-2733](#).
- <Rd> For encoding A1: is the general-purpose destination register, encoded in the "Rd" field. If omitted, this register is the SP. ARM deprecates using the PC as the destination register, but if the PC is used:
 - For the ADD variant, the instruction is a branch to the address calculated by the operation. This is an interworking branch, see [Pseudocode description of operations on the AArch32 general-purpose registers and the PC on page E1-2733](#).
 - For the ADDS variant, the instruction performs an exception return, that restores PSTATE from SPSR_<current_mode>.
 For encoding T3: is the general-purpose destination register, encoded in the "Rd" field. If omitted, this register is the SP.
- <Rm> For encoding A1 and T2: is the second general-purpose source register, encoded in the "Rm" field. The PC can be used, but this is deprecated.
 For encoding T3: is the second general-purpose source register, encoded in the "Rm" field.
- <shift> Is the type of shift to be applied to the second source register, encoded in the "type" field. It can have the following values:

LSL	when type = 00
LSR	when type = 01
ASR	when type = 10
ROR	when type = 11
- <amount> For encoding A1: is the shift amount, in the range 1 to 31 (when <shift> = LSL or ROR) or 1 to 32 (when <shift> = LSR or ASR) encoded in the "imm5" field as <amount> modulo 32.
 For encoding T3: is the shift amount, in the range 1 to 31 (when <shift> = LSL or ROR) or 1 to 32 (when <shift> = LSR or ASR) encoded in the "imm3:imm2" field as <amount> modulo 32.

Operation for all encodings

```
if ConditionPassed() then
    EncodingSpecificOperations();
    shifted = Shift(R[m], shift_t, shift_n, PSTATE.C);
    (result, nzcvc) = AddWithCarry(SP, shifted, '0');
    if d == 15 then
        if setflags then
            ALUExceptionReturn(result);
        else
            ALUWritePC(result);
    else
        R[d] = result;
        if setflags then
            PSTATE.<N,Z,C,V> = nzcvc;
```

F5.1.9 ADD (immediate, to PC)

ADD to PC adds an immediate value to the $\text{Align}(\text{PC}, 4)$ value to form a PC-relative address, and writes the result to the destination register. ARM recommends that, where possible, software avoids using this alias

This instruction is a pseudo-instruction of the [ADR](#) instruction. This means that:

- The encodings in this description are named to match the encodings of [ADR](#).
- The assembler syntax is used only for assembly, and is not used on disassembly.
- The description of [ADR](#) gives the operational pseudocode for this instruction.

A1

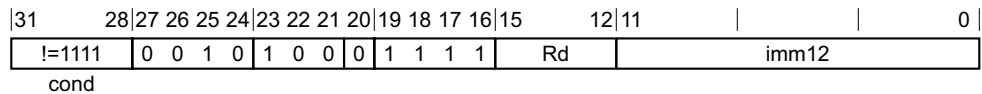

A1 variant

ADD{<c>}{<q>} <Rd>, PC, #<const>

is equivalent to

ADR{<c>}{<q>} <Rd>, <label>

and is never the preferred disassembly.

T1

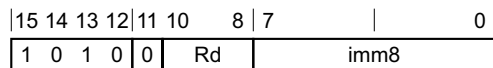

T1 variant

ADD{<c>}{<q>} <Rd>, PC, #<imm8>

is equivalent to

ADR{<c>}{<q>} <Rd>, <label>

and is never the preferred disassembly.

T3

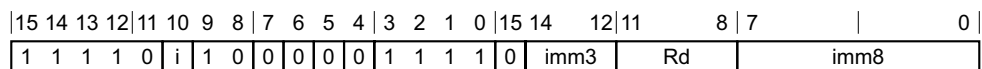

T3 variant

ADDW{<c>}{<q>} <Rd>, PC, #<imm12> // <Rd>, <imm12> can be represented in T1

is equivalent to

ADR{<c>}{<q>} <Rd>, <label>

and is never the preferred disassembly.

ADD{<c>}{<q>} <Rd>, PC, #<imm12>

is equivalent to

ADR{<c>}{<q>} <Rd>, <label>

and is never the preferred disassembly.

Assembler symbols

<c> See [Standard assembler syntax fields on page F2-2848](#).

<q> See [Standard assembler syntax fields on page F2-2848](#).

<Rd> For encoding A1: is the general-purpose destination register, encoded in the "Rd" field. If the PC is used, the instruction is a branch to the address calculated by the operation. This is an interworking branch, see [Pseudocode description of operations on the AArch32 general-purpose registers and the PC on page E1-2733](#).

For encoding T1 and T3: is the general-purpose destination register, encoded in the "Rd" field.

<label> For encoding A1 and A2: the label of an instruction or literal data item whose address is to be loaded into <Rd>. The assembler calculates the required value of the offset from the `Align(PC, 4)` value of the ADR instruction to this label.

If the offset is zero or positive, encoding A1 is used, with `imm32` equal to the offset.

If the offset is negative, encoding A2 is used, with `imm32` equal to the size of the offset. That is, the use of encoding A2 indicates that the required offset is minus the value of `imm32`.

Permitted values of the size of the offset are any of the constants described in [Modified immediate constants in A32 instructions on page F2-2864](#).

For encoding T1: the label of an instruction or literal data item whose address is to be loaded into <Rd>. The assembler calculates the required value of the offset from the `Align(PC, 4)` value of the ADR instruction to this label. Permitted values of the size of the offset are multiples of 4 in the range 0 to 1020.

For encoding T2 and T3: the label of an instruction or literal data item whose address is to be loaded into <Rd>. The assembler calculates the required value of the offset from the `Align(PC, 4)` value of the ADR instruction to this label.

If the offset is zero or positive, encoding T3 is used, with `imm32` equal to the offset.

If the offset is negative, encoding T2 is used, with `imm32` equal to the size of the offset. That is, the use of encoding T2 indicates that the required offset is minus the value of `imm32`.

Permitted values of the size of the offset are 0-4095.

<imm8> Is an unsigned immediate, a multiple of 4, in the range 0 to 1020, encoded in the "imm8" field as `<imm8>/4`.

<imm12> Is a 12-bit unsigned immediate, in the range 0 to 4095, encoded in the "i:imm3:imm8" field.

<const> An immediate value. See [Modified immediate constants in A32 instructions on page F2-2864](#) for the range of values.

Operation for all encodings

The description of [ADR](#) gives the operational pseudocode for this instruction.

F5.1.10 ADR

Form PC-relative address adds an immediate value to the PC value to form a PC-relative address, and writes the result to the destination register.

This instruction is used by the pseudo-instructions [ADD \(immediate, to PC\)](#) and [SUB \(immediate, from PC\)](#). The pseudo-instruction is never the preferred disassembly.

A1

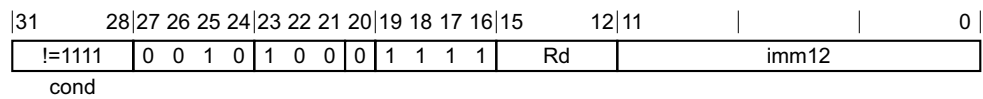

A1 variant

ADR{<c>}{<q>} <Rd>, <label>

Decode for this encoding

d = UInt(Rd); imm32 = A32ExpandImm(imm12); add = TRUE;

A2

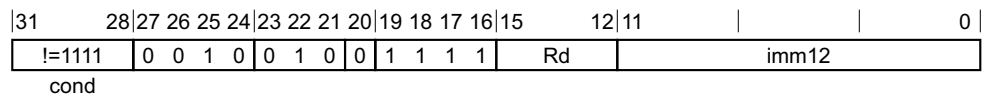

A2 variant

ADR{<c>}{<q>} <Rd>, <label>

Decode for this encoding

d = UInt(Rd); imm32 = A32ExpandImm(imm12); add = FALSE;

T1

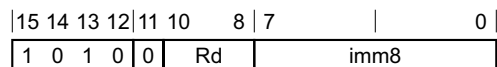

T1 variant

ADR{<c>}{<q>} <Rd>, <label>

Decode for this encoding

d = UInt(Rd); imm32 = ZeroExtend(imm8:'00', 32); add = TRUE;

T2

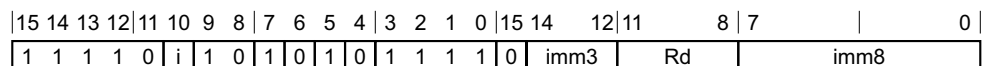

T2 variant

ADR{<c>}{<q>} <Rd>, <label>

Decode for this encoding

```
d = UInt(Rd); imm32 = ZeroExtend(i:imm3:imm8, 32); add = FALSE;
if d == 15 then UNPREDICTABLE; // ARMv8-A removes UNPREDICTABLE for R13
```

T3

15	14	13	12	11	10	9	8	7	6	5	4	3	2	1	0	15	14	12	11	8	7	0
1	1	1	1	0	i	1	0	0	0	0	0	1	1	1	1	0	imm3	Rd	imm8			

T3 variant

ADR{<c>}.W <Rd>, <label> // <Rd>, <label> can be presented in T1
 ADR{<c>}{<q>} <Rd>, <label>

Decode for this encoding

```
d = UInt(Rd); imm32 = ZeroExtend(i:imm3:imm8, 32); add = TRUE;
if d == 15 then UNPREDICTABLE; // ARMv8-A removes UNPREDICTABLE for R13
```

Notes for all encodings

For more information about the CONSTRAINED UNPREDICTABLE behavior, see [Appendix K1 Architectural Constraints on UNPREDICTABLE behaviors](#).

Alias conditions

Alias or pseudo-instruction	of variant	is preferred when
ADD (immediate, to PC)	-	Never
SUB (immediate, from PC)	T2	i:imm3:imm8 == '000000000000'
SUB (immediate, from PC)	A2	imm12 == '000000000000'

Assembler symbols

<c> See [Standard assembler syntax fields on page F2-2848](#).

<q> See [Standard assembler syntax fields on page F2-2848](#).

<Rd> For encoding A1 and A2: is the general-purpose destination register, encoded in the "Rd" field. If the PC is used, the instruction is a branch to the address calculated by the operation. This is an interworking branch, see [Pseudocode description of operations on the AArch32 general-purpose registers and the PC on page E1-2733](#).

For encoding T1, T2 and T3: is the general-purpose destination register, encoded in the "Rd" field.

<label> For encoding A1 and A2: the label of an instruction or literal data item whose address is to be loaded into <Rd>. The assembler calculates the required value of the offset from the A1ign(PC, 4) value of the ADR instruction to this label.

If the offset is zero or positive, encoding A1 is used, with imm32 equal to the offset.

If the offset is negative, encoding A2 is used, with imm32 equal to the size of the offset. That is, the use of encoding A2 indicates that the required offset is minus the value of imm32.

Permitted values of the size of the offset are any of the constants described in *Modified immediate constants in A32 instructions* on page F2-2864.

For encoding T1: the label of an instruction or literal data item whose address is to be loaded into <Rd>. The assembler calculates the required value of the offset from the `Align(PC, 4)` value of the ADR instruction to this label. Permitted values of the size of the offset are multiples of 4 in the range 0 to 1020.

For encoding T2 and T3: the label of an instruction or literal data item whose address is to be loaded into <Rd>. The assembler calculates the required value of the offset from the `Align(PC, 4)` value of the ADR instruction to this label.

If the offset is zero or positive, encoding T3 is used, with `imm32` equal to the offset.

If the offset is negative, encoding T2 is used, with `imm32` equal to the size of the offset. That is, the use of encoding T2 indicates that the required offset is minus the value of `imm32`.

Permitted values of the size of the offset are 0-4095.

The instruction aliases permit the addition or subtraction of the offset and the immediate offset to be specified separately, including permitting a subtraction of 0 that cannot be specified using the normal syntax. For more information, see *Use of labels in UAL instruction syntax* on page F1-2809.

Operation for all encodings

```
if ConditionPassed() then
    EncodingSpecificOperations();
    result = if add then (Align(PC,4) + imm32) else (Align(PC,4) - imm32);
    if d == 15 then // Can only occur for A32 encodings
        ALUWritePC(result);
    else
        R[d] = result;
```

F5.1.11 AND, ANDS (immediate)

Bitwise AND (immediate) performs a bitwise AND of a register value and an immediate value, and writes the result to the destination register.

If the destination register is not the PC, the ANDS variant of the instruction updates the condition flags based on the result.

The field descriptions for <Rd> identify the encodings where the PC is permitted as the destination register. ARM deprecates any use of these encodings. However, when the destination register is the PC:

- The AND variant of the instruction is an interworking branch, see *Pseudocode description of operations on the AArch32 general-purpose registers and the PC* on page E1-2733.
- The ANDS variant of the instruction performs an exception return without the use of the stack. In this case:
 - The PE branches to the address written to the PC, and restores `PSTATE` from `SPSR_<current_mode>`.
 - The PE checks `SPSR_<current_mode>` for an illegal return event. See *Illegal return events from AArch32 state* on page G1-4361.
 - The instruction is UNDEFINED in Hyp mode.
 - The instruction is CONSTRAINED UNPREDICTABLE in User mode and System mode.

A1

31	28 27 26 25 24 23 22 21 20 19	16 15	12 11			0
!=1111	0 0 1 0 0 0 0 S	Rn	Rd	imm12		
cond						

AND variant

Applies when `S == 0`.

AND{<c>}{<q>} {<Rd>}, <Rn>, #<const>

ANDS variant

Applies when `S == 1`.

ANDS{<c>}{<q>} {<Rd>}, <Rn>, #<const>

Decode for all variants of this encoding

```
d = UInt(Rd); n = UInt(Rn); setflags = (S == '1');
(imm32, carry) = A32ExpandImm_C(imm12, PSTATE.C);
```

T1

15 14 13 12 11 10 9 8 7 6 5 4 3	0 15 14	12 11	8 7			0
1 1 1 1 0 i 0 0 0 0 0 S	Rn	0	imm3	Rd	imm8	

AND variant

Applies when `S == 0`.

AND{<c>}{<q>} {<Rd>}, <Rn>, #<const>

ANDS variant

Applies when `S == 1 && Rd != 1111`.

ANDS{<c>}{<q>} {<Rd>}, <Rn>, #<const>

Decode for all variants of this encoding

```
if Rd == '1111' && S == '1' then SEE TST (immediate);
d = UInt(Rd); n = UInt(Rn); setflags = (S == '1');
(imm32, carry) = T32ExpandImm_C(i:imm3:imm8, PSTATE.C);
if (d == 15 && !setflags) || n == 15 then UNPREDICTABLE; // ARMv8-A removes UNPREDICTABLE for R13
```

Notes for all encodings

For more information about the CONSTRAINED UNPREDICTABLE behavior, see [Appendix K1 Architectural Constraints on UNPREDICTABLE behaviors](#).

Assembler symbols

<c> See [Standard assembler syntax fields on page F2-2848](#).

<q> See [Standard assembler syntax fields on page F2-2848](#).

<Rd> For encoding A1: is the general-purpose destination register, encoded in the "Rd" field. If omitted, this register is the same as <Rn>. ARM deprecates using the PC as the destination register, but if the PC is used:

- For the AND variant, the instruction is a branch to the address calculated by the operation. This is an interworking branch, see [Pseudocode description of operations on the AArch32 general-purpose registers and the PC on page E1-2733](#).
- For the ANDS variant, the instruction performs an exception return, that restores PSTATE from SPSR_<current_mode>.

For encoding T1: is the general-purpose destination register, encoded in the "Rd" field. If omitted, this register is the same as <Rn>.

<Rn> For encoding A1: is the general-purpose source register, encoded in the "Rn" field. The PC can be used, but this is deprecated.

For encoding T1: is the general-purpose source register, encoded in the "Rn" field.

<const> For encoding A1: an immediate value. See [Modified immediate constants in A32 instructions on page F2-2864](#) for the range of values.

For encoding T1: an immediate value. See [Modified immediate constants in T32 instructions on page F2-2863](#) for the range of values.

Operation for all encodings

```
if ConditionPassed() then
    EncodingSpecificOperations();
    result = R[n] AND imm32;
    if d == 15 then // Can only occur for A32 encoding
        if setflags then
            ALUExceptionReturn(result);
        else
            ALUWritePC(result);
    else
        R[d] = result;
        if setflags then
            PSTATE.N = result<31>;
            PSTATE.Z = IsZeroBit(result);
            PSTATE.C = carry;
            // PSTATE.V unchanged
```

F5.1.12 AND, ANDS (register)

Bitwise AND (register) performs a bitwise AND of a register value and an optionally-shifted register value, and writes the result to the destination register.

If the destination register is not the PC, the ANDS variant of the instruction updates the condition flags based on the result.

The field descriptions for <Rd> identify the encodings where the PC is permitted as the destination register. ARM deprecates any use of these encodings. However, when the destination register is the PC:

- The AND variant of the instruction is an interworking branch, see *Pseudocode description of operations on the AArch32 general-purpose registers and the PC* on page E1-2733.
- The ANDS variant of the instruction performs an exception return without the use of the stack. In this case:
 - The PE branches to the address written to the PC, and restores `PSTATE` from `SPSR_<current_mode>`.
 - The PE checks `SPSR_<current_mode>` for an illegal return event. See *Illegal return events from AArch32 state* on page G1-4361.
 - The instruction is UNDEFINED in Hyp mode.
 - The instruction is CONSTRAINED UNPREDICTABLE in User mode and System mode.

A1

31	28 27 26 25 24 23 22 21 20 19	16 15	12 11	7 6 5 4 3	0
!=1111	0 0 0 0 0 0 0 S	Rn	Rd	imm5	type 0 Rm
cond					

AND, rotate right with extend variant

Applies when `S == 0` && `imm5 == 00000` && `type == 11`.

AND{<c>}{<q>} {<Rd>}, <Rn>, <Rm>, RRX

AND, shift or rotate by value variant

Applies when `S == 0` && `!(imm5 == 00000 && type == 11)`.

AND{<c>}{<q>} {<Rd>}, <Rn>, <Rm> {, <shift> #<amount>}

ANDS, rotate right with extend variant

Applies when `S == 1` && `imm5 == 00000` && `type == 11`.

ANDS{<c>}{<q>} {<Rd>}, <Rn>, <Rm>, RRX

ANDS, shift or rotate by value variant

Applies when `S == 1` && `!(imm5 == 00000 && type == 11)`.

ANDS{<c>}{<q>} {<Rd>}, <Rn>, <Rm> {, <shift> #<amount>}

Decode for all variants of this encoding

```
d = UInt(Rd); n = UInt(Rn); m = UInt(Rm); setflags = (S == '1');
(shift_t, shift_n) = DecodeImmShift(type, imm5);
```

T1

15	14	13	12	11	10	9	8	7	6	5	3	2	0
0	1	0	0	0	0	0	0	0	0	Rm	Rdn		

T1 variant

AND<c>{<q>} {<Rdn>}, <Rdn>, <Rm> // Inside IT block
 ANDS{<q>} {<Rdn>}, <Rdn>, <Rm> // Outside IT block

Decode for this encoding

```
d = UInt(Rdn); n = UInt(Rdn); m = UInt(Rm); setflags = !InITBlock();
(shift_t, shift_n) = (SRTYPE_LSL, 0);
```

T2

15	14	13	12	11	10	9	8	7	6	5	4	3	0	15	14	12	11	8	7	6	5	4	3	0
1	1	1	0	1	0	1	0	0	0	0	S	Rn	(0)	imm3	Rd	imm2	type	Rm						

AND, rotate right with extend variant

Applies when S == 0 && imm3 == 000 && imm2 == 00 && type == 11.

AND{<c>}{<q>} {<Rd>}, <Rn>, <Rm>, RRX

AND, shift or rotate by value variant

Applies when S == 0 && !(imm3 == 000 && imm2 == 00 && type == 11).

AND<c>.W {<Rd>}, <Rn>, <Rm> // Inside IT block, and <Rd>, <Rn>, <Rm> can be represented in T1
 AND{<c>}{<q>} {<Rd>}, <Rn>, <Rm> {, <shift> #<amount>}

ANDS, rotate right with extend variant

Applies when S == 1 && imm3 == 000 && Rd != 1111 && imm2 == 00 && type == 11.

ANDS{<c>}{<q>} {<Rd>}, <Rn>, <Rm>, RRX

ANDS, shift or rotate by value variant

Applies when S == 1 && !(imm3 == 000 && imm2 == 00 && type == 11) && Rd != 1111.

ANDS.W {<Rd>}, <Rn>, <Rm> // Outside IT block, and <Rd>, <Rn>, <Rm> can be represented in T1
 ANDS{<c>}{<q>} {<Rd>}, <Rn>, <Rm> {, <shift> #<amount>}

Decode for all variants of this encoding

```
if Rd == '1111' && S == '1' then SEE TST (register);
d = UInt(Rd); n = UInt(Rn); m = UInt(Rm); setflags = (S == '1');
(shift_t, shift_n) = DecodeImmShift(type, imm3:imm2);
if (d == 15 && !setflags) || n == 15 || m == 15 then UNPREDICTABLE;
// ARMv8-A removes UNPREDICTABLE for R13
```

Notes for all encodings

For more information about the CONSTRAINED UNPREDICTABLE behavior, see [Appendix K1 Architectural Constraints on UNPREDICTABLE behaviors](#).

Assembler symbols

- <c> See [Standard assembler syntax fields on page F2-2848](#).
- <q> See [Standard assembler syntax fields on page F2-2848](#).
- <Rdn> Is the first general-purpose source register and the destination register, encoded in the "Rdn" field.
- <Rd> For encoding A1: is the general-purpose destination register, encoded in the "Rd" field. If omitted, this register is the same as <Rn>. ARM deprecates using the PC as the destination register, but if the PC is used:
- For the AND variant, the instruction is a branch to the address calculated by the operation. This is an interworking branch, see [Pseudocode description of operations on the AArch32 general-purpose registers and the PC on page E1-2733](#).
 - For the ANDS variant, the instruction performs an exception return, that restores PSTATE from SPSR_<current_mode>.
- For encoding T2: is the general-purpose destination register, encoded in the "Rd" field. If omitted, this register is the same as <Rn>.
- <Rn> For encoding A1: is the first general-purpose source register, encoded in the "Rn" field. The PC can be used, but this is deprecated.
- For encoding T2: is the first general-purpose source register, encoded in the "Rn" field.
- <Rm> For encoding A1: is the second general-purpose source register, encoded in the "Rm" field. The PC can be used, but this is deprecated.
- For encoding T1 and T2: is the second general-purpose source register, encoded in the "Rm" field.
- <shift> Is the type of shift to be applied to the second source register, encoded in the "type" field. It can have the following values:
- | | |
|-----|----------------|
| LSL | when type = 00 |
| LSR | when type = 01 |
| ASR | when type = 10 |
| ROR | when type = 11 |
- <amount> For encoding A1: is the shift amount, in the range 1 to 31 (when <shift> = LSL or ROR) or 1 to 32 (when <shift> = LSR or ASR) encoded in the "imm5" field as <amount> modulo 32.
- For encoding T2: is the shift amount, in the range 1 to 31 (when <shift> = LSL or ROR) or 1 to 32 (when <shift> = LSR or ASR) encoded in the "imm3:imm2" field as <amount> modulo 32.

In T32 assembly:

- Outside an IT block, if ANDS <Rd>, <Rn>, <Rd> has <Rd> and <Rn> both in the range R0-R7, it is assembled using encoding T1 as though ANDS <Rd>, <Rn> had been written.
- Inside an IT block, if AND<c> <Rd>, <Rn>, <Rd> has <Rd> and <Rn> both in the range R0-R7, it is assembled using encoding T1 as though AND<c> <Rd>, <Rn> had been written.

To prevent either of these happening, use the .W qualifier.

Operation for all encodings

```
if ConditionPassed() then
    EncodingSpecificOperations();
    (shifted, carry) = Shift_C(R[m], shift_t, shift_n, PSTATE.C);
    result = R[n] AND shifted;
    if d == 15 then // Can only occur for A32 encoding
        if setflags then
            ALUExceptionReturn(result);
        else
            ALUWritePC(result);
```

```
else
  R[d] = result;
  if setflags then
    PSTATE.N = result<31>;
    PSTATE.Z = IsZeroBit(result);
    PSTATE.C = carry;
    // PSTATE.V unchanged
```

F5.1.13 AND, ANDS (register-shifted register)

Bitwise AND (register-shifted register) performs a bitwise AND of a register value and a register-shifted register value. It writes the result to the destination register, and can optionally update the condition flags based on the result.

A1

31	28	27	26	25	24	23	22	21	20	19	16	15	12	11	8	7	6	5	4	3	0	
!=1111				0	0	0	0	0	0	0	S	Rn	Rd	Rs	0	type	1	Rm				
cond																						

Flag setting variant

Applies when S == 1.

ANDS{<c>}{<q>} {<Rd>}, {<Rn>, <Rm>, <type> <Rs>

Not flag setting variant

Applies when S == 0.

AND{<c>}{<q>} {<Rd>}, {<Rn>, <Rm>, <type> <Rs>

Decode for all variants of this encoding

```
d = UInt(Rd); n = UInt(Rn); m = UInt(Rm); s = UInt(Rs);
setflags = (S == '1'); shift_t = DecodeRegShift(type);
if d == 15 || n == 15 || m == 15 || s == 15 then UNPREDICTABLE;
```

Notes for all encodings

For more information about the CONSTRAINED UNPREDICTABLE behavior, see [Appendix K1 Architectural Constraints on UNPREDICTABLE behaviors](#).

Assembler symbols

<c>	See Standard assembler syntax fields on page F2-2848 .								
<q>	See Standard assembler syntax fields on page F2-2848 .								
<Rd>	Is the general-purpose destination register, encoded in the "Rd" field.								
<Rn>	Is the first general-purpose source register, encoded in the "Rn" field.								
<Rm>	Is the second general-purpose source register, encoded in the "Rm" field.								
<type>	Is the type of shift to be applied to the second source register, encoded in the "type" field. It can have the following values: <table style="margin-left: 20px;"> <tr> <td>LSL</td> <td>when type = 00</td> </tr> <tr> <td>LSR</td> <td>when type = 01</td> </tr> <tr> <td>ASR</td> <td>when type = 10</td> </tr> <tr> <td>ROR</td> <td>when type = 11</td> </tr> </table>	LSL	when type = 00	LSR	when type = 01	ASR	when type = 10	ROR	when type = 11
LSL	when type = 00								
LSR	when type = 01								
ASR	when type = 10								
ROR	when type = 11								
<Rs>	Is the third general-purpose source register holding a shift amount in its bottom 8 bits, encoded in the "Rs" field.								

Operation

```
if ConditionPassed() then
    EncodingSpecificOperations();
    shift_n = UInt(R[s]<7:0>);
    (shifted, carry) = Shift_C(R[m], shift_t, shift_n, PSTATE.C);
    result = R[n] AND shifted;
    R[d] = result;
    if setflags then
        PSTATE.N = result<31>;
        PSTATE.Z = IsZeroBit(result);
        PSTATE.C = carry;
        // PSTATE.V unchanged
```

F5.1.14 ASR (immediate)

Arithmetic Shift Right (immediate) shifts a register value right by an immediate number of bits, shifting in copies of its sign bit, and writes the result to the destination register.

This instruction is an alias of the [MOV, MOVS \(register\)](#) instruction. This means that:

- The encodings in this description are named to match the encodings of [MOV, MOVS \(register\)](#).
- The description of [MOV, MOVS \(register\)](#) gives the operational pseudocode for this instruction.

A1

31	28	27	26	25	24	23	22	21	20	19	18	17	16	15	12	11	7	6	5	4	3	0		
!=1111				0 0 0 1 1				0 1 0				(0)(0)(0)(0)				Rd		imm5			1 0 0		Rm	
cond								S											type					

MOV, shift or rotate by value variant

ASR{<c>}{<q>} {<Rd>}, <Rm>, #<imm>

is equivalent to

MOV{<c>}{<q>} <Rd>, <Rm>, ASR #<imm>

and is always the preferred disassembly.

T2

15	14	13	12	11	10	6	5	3	2	0
0 0 0			1 0			imm5		Rm		Rd
op										

T2 variant

ASR<c>{<q>} {<Rd>}, <Rm>, #<imm> // Inside IT block

is equivalent to

MOV<c>{<q>} <Rd>, <Rm>, ASR #<imm>

and is the preferred disassembly when InITBlock().

T3

15	14	13	12	11	10	9	8	7	6	5	4	3	2	1	0	15	14	12	11	8	7	6	5	4	3	0	
1 1 1 0				1 0 1				0 0 1 0				0 1 1 1 1				(0)		imm3		Rd		imm2		1 0		Rm	
S																						type					

MOV, shift or rotate by value variant

ASR<c>.W {<Rd>}, <Rm>, #<imm> // Inside IT block, and <Rd>, <Rm>, <imm> can be represented in T2

is equivalent to

MOV{<c>}{<q>} <Rd>, <Rm>, ASR #<imm>

and is always the preferred disassembly.

ASR{<c>}{<q>} {<Rd>}, <Rm>, #<imm>

is equivalent to

MOV{<c>}{<q>} <Rd>, <Rm>, ASR #<imm>

and is always the preferred disassembly.

Assembler symbols

<c>	See <i>Standard assembler syntax fields</i> on page F2-2848.
<q>	See <i>Standard assembler syntax fields</i> on page F2-2848.
<Rd>	For encoding A1: is the general-purpose destination register, encoded in the "Rd" field. ARM deprecates using the PC as the destination register, but if the PC is used, the instruction is a branch to the address calculated by the operation. This is an interworking branch, see <i>Pseudocode description of operations on the AArch32 general-purpose registers and the PC</i> on page E1-2733. For encoding T2 and T3: is the general-purpose destination register, encoded in the "Rd" field.
<Rm>	For encoding A1: is the general-purpose source register, encoded in the "Rm" field. The PC can be used, but this is deprecated. For encoding T2 and T3: is the general-purpose source register, encoded in the "Rm" field.
<imm>	For encoding A1 and T2: is the shift amount, in the range 1 to 32, encoded in the "imm5" field as <imm> modulo 32. For encoding T3: is the shift amount, in the range 1 to 32, encoded in the "imm3:imm2" field as <imm> modulo 32.

Operation for all encodings

The description of [MOV, MOVS \(register\)](#) gives the operational pseudocode for this instruction.

F5.1.15 ASR (register)

Arithmetic Shift Right (register) shifts a register value right by a variable number of bits, shifting in copies of its sign bit, and writes the result to the destination register. The variable number of bits is read from the bottom byte of a register

This instruction is an alias of the [MOV, MOVS \(register-shifted register\)](#) instruction. This means that:

- The encodings in this description are named to match the encodings of [MOV, MOVS \(register-shifted register\)](#).
- The description of [MOV, MOVS \(register-shifted register\)](#) gives the operational pseudocode for this instruction.

A1

31	28	27	26	25	24	23	22	21	20	19	18	17	16	15	12	11	8	7	6	5	4	3	0	
!=1111				0	0	0	1	1	0	1	0	(0)(0)(0)(0)	Rd	Rs	0	1	0	1	Rm					
cond				S								type												

Not flag setting variant

ASR{<c>}{<q>} {<Rd>}, <Rm>, <Rs>

is equivalent to

MOV{<c>}{<q>} <Rd>, <Rm>, ASR <Rs>

and is always the preferred disassembly.

T1

15	14	13	12	11	10	9	6	5	3	2	0
0	1	0	0	0	0	0	1	0	0	Rs	Rdm
op											

Arithmetic shift right variant

ASR<c>{<q>} {<Rdm>}, <Rdm>, <Rs> // Inside IT block

is equivalent to

MOV<c>{<q>} <Rdm>, <Rdm>, ASR <Rs>

and is the preferred disassembly when InITBlock().

T2

15	14	13	12	11	10	9	8	7	6	5	4	3	0	15	14	13	12	11	8	7	6	5	4	3	0
1	1	1	1	1	0	1	0	0	1	0	0	Rm	1	1	1	1	Rd	0	0	0	0	Rs			
type S																									

Not flag setting variant

ASR<c>.W {<Rd>}, <Rm>, <Rs> // Inside IT block, and <Rd>, <Rm>, <type>, <Rs> can be represented in T1

is equivalent to

MOV{<c>}{<q>} <Rd>, <Rm>, ASR <Rs>

and is always the preferred disassembly.

ASR{<C>}{<q>} {<Rd>}, <Rm>, <Rs>

is equivalent to

MOV{<C>}{<q>} <Rd>, <Rm>, ASR <Rs>

and is always the preferred disassembly.

Assembler symbols

- <C> See [Standard assembler syntax fields on page F2-2848](#).
- <q> See [Standard assembler syntax fields on page F2-2848](#).
- <Rdm> Is the first general-purpose source register and the destination register, encoded in the "Rdm" field.
- <Rd> Is the general-purpose destination register, encoded in the "Rd" field.
- <Rm> Is the first general-purpose source register, encoded in the "Rm" field.
- <Rs> Is the second general-purpose source register holding a shift amount in its bottom 8 bits, encoded in the "Rs" field.

Operation for all encodings

The description of [MOV, MOVS \(register-shifted register\)](#) gives the operational pseudocode for this instruction.

F5.1.16 ASRS (immediate)

Arithmetic Shift Right, setting flags (immediate) shifts a register value right by an immediate number of bits, shifting in copies of its sign bit, and writes the result to the destination register.

If the destination register is not the PC, this instruction updates the condition flags based on the result.

The field descriptions for <Rd> identify the encodings where the PC is permitted as the destination register. ARM deprecates any use of these encodings. However, when the destination register is the PC:

- The PE branches to the address written to the PC, and restores [PSTATE](#) from SPSR_<current_mode>.
- The PE checks SPSR_<current_mode> for an illegal return event. See [Illegal return events from AArch32 state on page G1-4361](#).
- The instruction is UNDEFINED in Hyp mode.
- The instruction is CONSTRAINED UNPREDICTABLE in User mode and System mode.

This instruction is an alias of the [MOV, MOVS \(register\)](#) instruction. This means that:

- The encodings in this description are named to match the encodings of [MOV, MOVS \(register\)](#).
- The description of [MOV, MOVS \(register\)](#) gives the operational pseudocode for this instruction.

A1

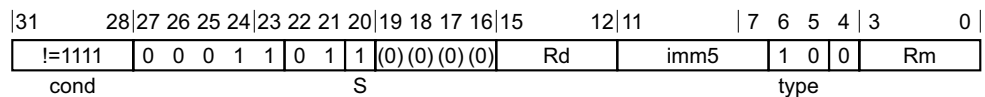

MOVS, shift or rotate by value variant

ASRS{<c>}{<q>} {<Rd>}, <Rm>, #<imm>

is equivalent to

MOVS{<c>}{<q>} <Rd>, <Rm>, ASR #<imm>

and is always the preferred disassembly.

T2

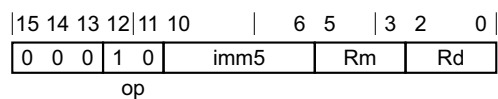

T2 variant

ASRS{<q>} {<Rd>}, <Rm>, #<imm> // Outside IT block

is equivalent to

MOVS{<q>} <Rd>, <Rm>, ASR #<imm>

and is the preferred disassembly when !InITBlock().

T3

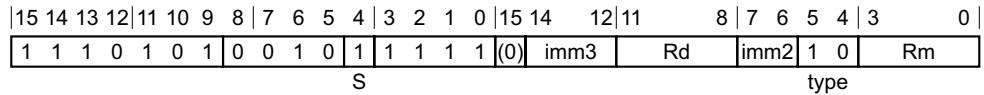

MOVS, shift or rotate by value variant

ASRS.W {<Rd>,} <Rm>, #<imm> // Outside IT block, and <Rd>, <Rm>, <imm> can be represented in T2 is equivalent to

MOVS{<c>}{<q>} <Rd>, <Rm>, ASR #<imm>

and is always the preferred disassembly.

ASRS{<c>}{<q>} {<Rd>,} <Rm>, #<imm>

is equivalent to

MOVS{<c>}{<q>} <Rd>, <Rm>, ASR #<imm>

and is always the preferred disassembly.

Assembler symbols

<c> See [Standard assembler syntax fields on page F2-2848](#).

<q> See [Standard assembler syntax fields on page F2-2848](#).

<Rd> For encoding A1: is the general-purpose destination register, encoded in the "Rd" field. ARM deprecates using the PC as the destination register, but if the PC is used, the instruction performs an exception return, that restores [PSTATE](#) from `SPSR_<current_mode>`.

For encoding T2 and T3: is the general-purpose destination register, encoded in the "Rd" field.

<Rm> For encoding A1: is the general-purpose source register, encoded in the "Rm" field. The PC can be used, but this is deprecated.

For encoding T2 and T3: is the general-purpose source register, encoded in the "Rm" field.

<imm> For encoding A1 and T2: is the shift amount, in the range 1 to 32, encoded in the "imm5" field as <imm> modulo 32.

For encoding T3: is the shift amount, in the range 1 to 32, encoded in the "imm3:imm2" field as <imm> modulo 32.

Operation for all encodings

The description of [MOV, MOVS \(register\)](#) gives the operational pseudocode for this instruction.

F5.1.17 ASRS (register)

Arithmetic Shift Right, setting flags (register) shifts a register value right by a variable number of bits, shifting in copies of its sign bit, writes the result to the destination register, and updates the condition flags based on the result. The variable number of bits is read from the bottom byte of a register

This instruction is an alias of the [MOV, MOVS \(register-shifted register\)](#) instruction. This means that:

- The encodings in this description are named to match the encodings of [MOV, MOVS \(register-shifted register\)](#).
- The description of [MOV, MOVS \(register-shifted register\)](#) gives the operational pseudocode for this instruction.

A1

31	28	27	26	25	24	23	22	21	20	19	18	17	16	15	12	11	8	7	6	5	4	3	0		
!=1111				0 0 0 1 1				0 1 1				(0)(0)(0)(0)				Rd		Rs		0 1 0 1				Rm	
cond				S												type									

Flag setting variant

ASRS{<c>}{<q>} {<Rd>}, <Rm>, <Rs>

is equivalent to

MOVS{<c>}{<q>} <Rd>, <Rm>, ASR <Rs>

and is always the preferred disassembly.

T1

15	14	13	12	11	10	9	6	5	3	2	0
0 1 0 0 0 0				0 1 0 0				Rs		Rdm	
op											

Arithmetic shift right variant

ASRS{<q>} {<Rdm>}, <Rdm>, <Rs> // Outside IT block

is equivalent to

MOVS{<q>} <Rdm>, <Rdm>, ASR <Rs>

and is the preferred disassembly when !InITBlock().

T2

15	14	13	12	11	10	9	8	7	6	5	4	3	0	15	14	13	12	11	8	7	6	5	4	3	0
1 1 1 1				1 0 1 0 0				1 0 1				Rm		1 1 1 1				Rd		0 0 0 0				Rs	
type S																									

Flag setting variant

ASRS.W {<Rd>}, <Rm>, <Rs> // Outside IT block, and <Rd>, <Rm>, <type>, <Rs> can be represented in T1

is equivalent to

MOVS{<c>}{<q>} <Rd>, <Rm>, ASR <Rs>

and is always the preferred disassembly.

ASRS{<c>}{<q>} {<Rd>, } <Rm>, <Rs>

is equivalent to

MOVS{<c>}{<q>} <Rd>, <Rm>, ASR <Rs>

and is always the preferred disassembly.

Assembler symbols

- <c> See [Standard assembler syntax fields on page F2-2848](#).
- <q> See [Standard assembler syntax fields on page F2-2848](#).
- <Rdm> Is the first general-purpose source register and the destination register, encoded in the "Rdm" field.
- <Rd> Is the general-purpose destination register, encoded in the "Rd" field.
- <Rm> Is the first general-purpose source register, encoded in the "Rm" field.
- <Rs> Is the second general-purpose source register holding a shift amount in its bottom 8 bits, encoded in the "Rs" field.

Operation for all encodings

The description of [MOV, MOVS \(register-shifted register\)](#) gives the operational pseudocode for this instruction.

T3 variant

B<c>.W <label> // Not permitted in IT block, and <label> can be represented in T1
 B<c>{<q>} <label> // Not permitted in IT block

Decode for this encoding

```
if cond<3:1> == '111' then SEE "Related encodings";
imm32 = SignExtend(S:J2:J1:imm6:imm11:'0', 32);
if InITBlock() then UNPREDICTABLE;
```

T4

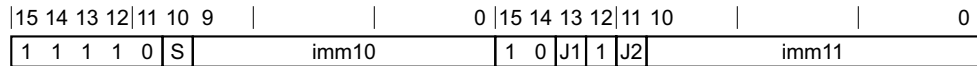

T4 variant

B{<c>}.W <label> // <label> can be represented in T2
 B{<c>}{<q>} <label>

Decode for this encoding

```
I1 = NOT(J1 EOR S); I2 = NOT(J2 EOR S); imm32 = SignExtend(S:I1:I2:imm10:imm11:'0', 32);
if InITBlock() && !LastInITBlock() then UNPREDICTABLE;
```

Notes for all encodings

For more information about the CONSTRAINED UNPREDICTABLE behavior, see [Appendix K1 Architectural Constraints on UNPREDICTABLE behaviors](#).

Related encodings: [Branches and miscellaneous control on page F3-2916](#).

Assembler symbols

- <c> For encoding A1, T2 and T4: see [Standard assembler syntax fields on page F2-2848](#).
 For encoding T1: see [Standard assembler syntax fields on page F2-2848](#). Must not be AL or omitted.
 For encoding T3: see [Standard assembler syntax fields on page F2-2848](#). <c> must not be AL or omitted.
- <q> See [Standard assembler syntax fields on page F2-2848](#).
- <label> For encoding A1: the label of the instruction that is to be branched to. The assembler calculates the required value of the offset from the PC value of the B instruction to this label, then selects an encoding that sets imm32 to that offset.
 Permitted offsets are multiples of 4 in the range –33554432 to 33554428.
 For encoding T1: the label of the instruction that is to be branched to. The assembler calculates the required value of the offset from the PC value of the B instruction to this label, then selects an encoding that sets imm32 to that offset. Permitted offsets are even numbers in the range –256 to 254.
 For encoding T2: the label of the instruction that is to be branched to. The assembler calculates the required value of the offset from the PC value of the B instruction to this label, then selects an encoding that sets imm32 to that offset. Permitted offsets are even numbers in the range –2048 to 2046.
 For encoding T3: the label of the instruction that is to be branched to. The assembler calculates the required value of the offset from the PC value of the B instruction to this label, then selects an encoding that sets imm32 to that offset.
 Permitted offsets are even numbers in the range –1048576 to 1048574.

For encoding T4: the label of the instruction that is to be branched to. The assembler calculates the required value of the offset from the PC value of the B instruction to this label, then selects an encoding that sets `imm32` to that offset.

Permitted offsets are even numbers in the range -16777216 to 16777214 .

Operation for all encodings

```
if ConditionPassed() then
    EncodingSpecificOperations();
    BranchWritePC(PC + imm32);
```

F5.1.19 BFC

Bit Field Clear clears any number of adjacent bits at any position in a register, without affecting the other bits in the register.

A1

31	28	27	26	25	24	23	22	21	20	16	15	12	11	7	6	5	4	3	2	1	0
!=1111				0	1	1	1	1	1	0	msb	Rd	lsb	0	0	1	1	1	1		
cond																					

A1 variant

BFC{<c>}{<q>} <Rd>, #<lsb>, #<width>

Decode for this encoding

d = UInt(Rd); msbit = UInt(msb); lsb = UInt(lsb);
 if d == 15 then UNPREDICTABLE;

T1

15	14	13	12	11	10	9	8	7	6	5	4	3	2	1	0	15	14	12	11	8	7	6	5	4	0
1	1	1	1	0	(0)	1	1	0	1	1	0	1	1	1	1	0	imm3	Rd	imm2	(0)	msb				

T1 variant

BFC{<c>}{<q>} <Rd>, #<lsb>, #<width>

Decode for this encoding

d = UInt(Rd); msbit = UInt(msb); lsb = UInt(imm3:imm2);
 if d == 15 then UNPREDICTABLE; // ARMv8-A removes UNPREDICTABLE for R13

Notes for all encodings

For more information about the CONSTRAINED UNPREDICTABLE behavior of this instruction, see [Appendix K1 Architectural Constraints on UNPREDICTABLE behaviors](#).

Assembler symbols

- <c> See [Standard assembler syntax fields on page F2-2848](#).
- <q> See [Standard assembler syntax fields on page F2-2848](#).
- <Rd> Is the general-purpose destination register, encoded in the "Rd" field.
- <lsb> For encoding A1: is the least significant bit to be cleared, in the range 0 to 31, encoded in the "lsb" field.
 For encoding T1: is the least significant bit that is to be cleared, in the range 0 to 31, encoded in the "imm3:imm2" field.
- <width> Is the number of bits to be cleared, in the range 1 to 32-<lsb>, encoded in the "msb" field as <lsb>+<width>-1.

Operation for all encodings

```
if ConditionPassed() then
    EncodingSpecificOperations();
    if msbit >= lsbit then
        R[d]<msbit:lsbit> = Replicate('0', msbit-lsbit+1);
        // Other bits of R[d] are unchanged
    else
        UNPREDICTABLE;
```

CONSTRAINED UNPREDICTABLE behavior

If $msbit < lsbit$, then one of the following behaviors must occur:

- The instruction is UNDEFINED.
- The instruction executes as NOP.
- The value in the destination register is UNKNOWN.

F5.1.20 BFI

Bit Field Insert copies any number of low order bits from a register into the same number of adjacent bits at any position in the destination register.

A1

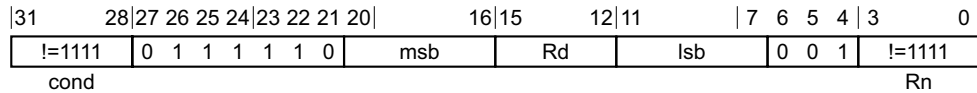

A1 variant

BFI{<c>}{<q>} <Rd>, <Rn>, #<lsb>, #<width>

Decode for this encoding

```
if Rn == '1111' then SEE BFC;
d = UInt(Rd); n = UInt(Rn); msbit = UInt(msb); lsb = UInt(lsb);
if d == 15 then UNPREDICTABLE;
```

T1

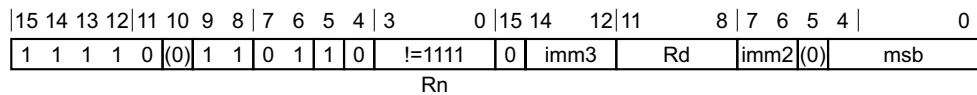

T1 variant

BFI{<c>}{<q>} <Rd>, <Rn>, #<lsb>, #<width>

Decode for this encoding

```
if Rn == '1111' then SEE BFC;
d = UInt(Rd); n = UInt(Rn); msbit = UInt(msb); lsb = UInt(imm3:imm2);
if d == 15 then UNPREDICTABLE; // ARMv8-A removes UNPREDICTABLE for R13
```

Notes for all encodings

For more information about the CONSTRAINED UNPREDICTABLE behavior of this instruction, see [Appendix K1 Architectural Constraints on UNPREDICTABLE behaviors](#).

Assembler symbols

- <c> See [Standard assembler syntax fields on page F2-2848](#).
- <q> See [Standard assembler syntax fields on page F2-2848](#).
- <Rd> Is the general-purpose destination register, encoded in the "Rd" field.
- <Rn> Is the general-purpose source register, encoded in the "Rn" field.
- <lsb> For encoding A1: is the least significant destination bit, in the range 0 to 31, encoded in the "lsb" field.
For encoding T1: is the least significant destination bit, in the range 0 to 31, encoded in the "imm3:imm2" field.
- <width> Is the number of bits to be copied, in the range 1 to 32-<lsb>, encoded in the "msb" field as <lsb>+<width>-1.

Operation for all encodings

```
if ConditionPassed() then
    EncodingSpecificOperations();
    if msbit >= lsbit then
        R[d]<msbit:lsbit> = R[n]<(msbit-lsbit):0>;
        // Other bits of R[d] are unchanged
    else
        UNPREDICTABLE;
```

CONSTRAINED UNPREDICTABLE behavior

If $msbit < lsbit$, then one of the following behaviors must occur:

- The instruction is UNDEFINED.
- The instruction executes as NOP.
- The value in the destination register is UNKNOWN.

F5.1.21 BIC, BICS (immediate)

Bitwise Bit Clear (immediate) performs a bitwise AND of a register value and the complement of an immediate value, and writes the result to the destination register.

If the destination register is not the PC, the BICS variant of the instruction updates the condition flags based on the result.

The field descriptions for <Rd> identify the encodings where the PC is permitted as the destination register. ARM deprecates any use of these encodings. However, when the destination register is the PC:

- The BIC variant of the instruction is an interworking branch, see [Pseudocode description of operations on the AArch32 general-purpose registers and the PC on page E1-2733](#).
- The BICS variant of the instruction performs an exception return without the use of the stack. In this case:
 - The PE branches to the address written to the PC, and restores `PSTATE` from `SPSR_<current_mode>`.
 - The PE checks `SPSR_<current_mode>` for an illegal return event. See [Illegal return events from AArch32 state on page G1-4361](#).
 - The instruction is UNDEFINED in Hyp mode.
 - The instruction is CONSTRAINED UNPREDICTABLE in User mode and System mode.

A1

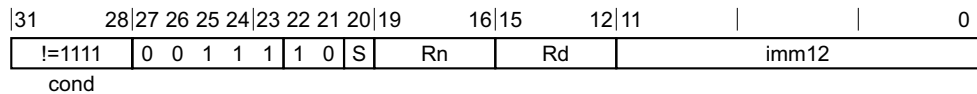

BIC variant

Applies when `S == 0`.

`BIC{<c>}{<q>} {<Rd>}, <Rn>, #<const>`

BICS variant

Applies when `S == 1`.

`BICS{<c>}{<q>} {<Rd>}, <Rn>, #<const>`

Decode for all variants of this encoding

```
d = UInt(Rd); n = UInt(Rn); setflags = (S == '1');
(imm32, carry) = A32ExpandImm_C(imm12, PSTATE.C);
```

T1

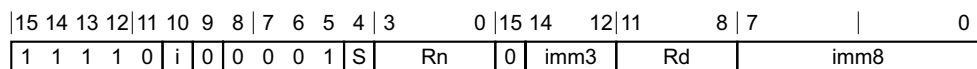

BIC variant

Applies when `S == 0`.

`BIC{<c>}{<q>} {<Rd>}, <Rn>, #<const>`

BICS variant

Applies when `S == 1`.

BICS{<c>}{<q>} {<Rd>}, <Rn>, #<const>

Decode for all variants of this encoding

```
d = UInt(Rd); n = UInt(Rn); setflags = (S == '1');
(imm32, carry) = T32ExpandImm_C(i:imm3:imm8, PSTATE.C);
if d == 15 || n == 15 then UNPREDICTABLE; // ARMv8-A removes UNPREDICTABLE for R13
```

Notes for all encodings

For more information about the CONSTRAINED UNPREDICTABLE behavior, see [Appendix K1 Architectural Constraints on UNPREDICTABLE behaviors](#).

Assembler symbols

<c> See [Standard assembler syntax fields on page F2-2848](#).

<q> See [Standard assembler syntax fields on page F2-2848](#).

<Rd> For encoding A1: is the general-purpose destination register, encoded in the "Rd" field. If omitted, this register is the same as <Rn>. ARM deprecates using the PC as the destination register, but if the PC is used:

- For the BIC variant, the instruction is a branch to the address calculated by the operation. This is an interworking branch, see [Pseudocode description of operations on the AArch32 general-purpose registers and the PC on page E1-2733](#).
- For the BICS variant, the instruction performs an exception return, that restores PSTATE from SPSR_<current_mode>.

For encoding T1: is the general-purpose destination register, encoded in the "Rd" field. If omitted, this register is the same as <Rn>.

<Rn> For encoding A1: is the general-purpose source register, encoded in the "Rn" field. The PC can be used, but this is deprecated.

For encoding T1: is the general-purpose source register, encoded in the "Rn" field.

<const> For encoding A1: an immediate value. See [Modified immediate constants in A32 instructions on page F2-2864](#) for the range of values.

For encoding T1: an immediate value. See [Modified immediate constants in T32 instructions on page F2-2863](#) for the range of values.

Operation for all encodings

```
if ConditionPassed() then
  EncodingSpecificOperations();
  result = R[n] AND NOT(imm32);
  if d == 15 then // Can only occur for A32 encoding
    if setflags then
      ALUExceptionReturn(result);
    else
      ALUWritePC(result);
  else
    R[d] = result;
    if setflags then
      PSTATE.N = result<31>;
      PSTATE.Z = IsZeroBit(result);
      PSTATE.C = carry;
      // PSTATE.V unchanged
```

F5.1.22 BIC, BICS (register)

Bitwise Bit Clear (register) performs a bitwise AND of a register value and the complement of an optionally-shifted register value, and writes the result to the destination register.

If the destination register is not the PC, the BICS variant of the instruction updates the condition flags based on the result.

The field descriptions for <Rd> identify the encodings where the PC is permitted as the destination register. ARM deprecates any use of these encodings. However, when the destination register is the PC:

- The BIC variant of the instruction is an interworking branch, see [Pseudocode description of operations on the AArch32 general-purpose registers and the PC on page E1-2733](#).
- The BICS variant of the instruction performs an exception return without the use of the stack. In this case:
 - The PE branches to the address written to the PC, and restores `PSTATE` from `SPSR_<current_mode>`.
 - The PE checks `SPSR_<current_mode>` for an illegal return event. See [Illegal return events from AArch32 state on page G1-4361](#).
 - The instruction is UNDEFINED in Hyp mode.
 - The instruction is CONSTRAINED UNPREDICTABLE in User mode and System mode.

A1

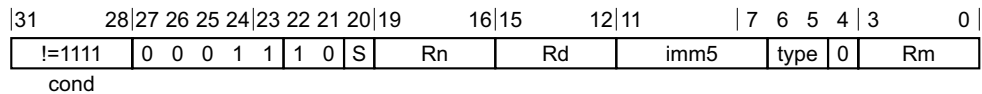

BIC, rotate right with extend variant

Applies when $S == 0$ && $imm5 == 00000$ && $type == 11$.

$BIC\{<c>\}\{<q>\} \{<Rd>, \} <Rn>, <Rm>, RRX$

BIC, shift or rotate by value variant

Applies when $S == 0$ && $!(imm5 == 00000 \ \&\& \ type == 11)$.

$BIC\{<c>\}\{<q>\} \{<Rd>, \} <Rn>, <Rm> \{, <shift> \#<amount>\}$

BICS, rotate right with extend variant

Applies when $S == 1$ && $imm5 == 00000$ && $type == 11$.

$BICS\{<c>\}\{<q>\} \{<Rd>, \} <Rn>, <Rm>, RRX$

BICS, shift or rotate by value variant

Applies when $S == 1$ && $!(imm5 == 00000 \ \&\& \ type == 11)$.

$BICS\{<c>\}\{<q>\} \{<Rd>, \} <Rn>, <Rm> \{, <shift> \#<amount>\}$

Decode for all variants of this encoding

```
d = UInt(Rd); n = UInt(Rn); m = UInt(Rm); setflags = (S == '1');
(shift_t, shift_n) = DecodeImmShift(type, imm5);
```

T1

15	14	13	12	11	10	9	8	7	6	5	3	2	0
0	1	0	0	0	0	1	1	1	0	Rm	Rdn		

T1 variant

BIC<c>{<q>} {<Rdn>}, <Rdn>, <Rm> // Inside IT block
 BICS{<q>} {<Rdn>}, <Rdn>, <Rm> // Outside IT block

Decode for this encoding

```
d = UInt(Rdn); n = UInt(Rdn); m = UInt(Rm); setFlags = !InITBlock();
(shift_t, shift_n) = (SRTYPE_LSL, 0);
```

T2

15	14	13	12	11	10	9	8	7	6	5	4	3	0	15	14	12	11	8	7	6	5	4	3	0
1	1	1	0	1	0	1	0	0	0	1	S	Rn	(0)	imm3	Rd	imm2	type	Rm						

BIC, rotate right with extend variant

Applies when S == 0 && imm3 == 000 && imm2 == 00 && type == 11.

BIC{<c>}{<q>} {<Rd>}, <Rn>, <Rm>, RRX

BIC, shift or rotate by value variant

Applies when S == 0 && !(imm3 == 000 && imm2 == 00 && type == 11).

BIC<c>.W {<Rd>}, <Rn>, <Rm> // Inside IT block, and <Rd>, <Rn>, <Rm> can be represented in T1
 BIC{<c>}{<q>} {<Rd>}, <Rn>, <Rm> {, <shift> #<amount>}

BICS, rotate right with extend variant

Applies when S == 1 && imm3 == 000 && imm2 == 00 && type == 11.

BICS{<c>}{<q>} {<Rd>}, <Rn>, <Rm>, RRX

BICS, shift or rotate by value variant

Applies when S == 1 && !(imm3 == 000 && imm2 == 00 && type == 11).

BICS.W {<Rd>}, <Rn>, <Rm> // Outside IT block, and <Rd>, <Rn>, <Rm> can be represented in T1
 BICS{<c>}{<q>} {<Rd>}, <Rn>, <Rm> {, <shift> #<amount>}

Decode for all variants of this encoding

```
d = UInt(Rd); n = UInt(Rn); m = UInt(Rm); setFlags = (S == '1');
(shift_t, shift_n) = DecodeImmShift(type, imm3:imm2);
if d == 15 || n == 15 || m == 15 then UNPREDICTABLE; // ARMv8-A removes UNPREDICTABLE for R13
```

Notes for all encodings

For more information about the CONSTRAINED UNPREDICTABLE behavior, see [Appendix K1 Architectural Constraints on UNPREDICTABLE behaviors](#).

Assembler symbols

<c>	See Standard assembler syntax fields on page F2-2848 .								
<q>	See Standard assembler syntax fields on page F2-2848 .								
<Rdn>	Is the first general-purpose source register and the destination register, encoded in the "Rdn" field.								
<Rd>	For encoding A1: is the general-purpose destination register, encoded in the "Rd" field. If omitted, this register is the same as <Rn>. ARM deprecates using the PC as the destination register, but if the PC is used: <ul style="list-style-type: none">For the BIC variant, the instruction is a branch to the address calculated by the operation. This is an interworking branch, see Pseudocode description of operations on the AArch32 general-purpose registers and the PC on page E1-2733.For the BICS variant, the instruction performs an exception return, that restores PSTATE from SPSR_<current_mode>. For encoding T2: is the general-purpose destination register, encoded in the "Rd" field. If omitted, this register is the same as <Rn>.								
<Rn>	For encoding A1: is the first general-purpose source register, encoded in the "Rn" field. The PC can be used, but this is deprecated. For encoding T2: is the first general-purpose source register, encoded in the "Rn" field.								
<Rm>	For encoding A1: is the second general-purpose source register, encoded in the "Rm" field. The PC can be used, but this is deprecated. For encoding T1 and T2: is the second general-purpose source register, encoded in the "Rm" field.								
<shift>	Is the type of shift to be applied to the second source register, encoded in the "type" field. It can have the following values: <table><tr><td>LSL</td><td>when type = 00</td></tr><tr><td>LSR</td><td>when type = 01</td></tr><tr><td>ASR</td><td>when type = 10</td></tr><tr><td>ROR</td><td>when type = 11</td></tr></table>	LSL	when type = 00	LSR	when type = 01	ASR	when type = 10	ROR	when type = 11
LSL	when type = 00								
LSR	when type = 01								
ASR	when type = 10								
ROR	when type = 11								
<amount>	For encoding A1: is the shift amount, in the range 1 to 31 (when <shift> = LSL or ROR) or 1 to 32 (when <shift> = LSR or ASR) encoded in the "imm5" field as <amount> modulo 32. For encoding T2: is the shift amount, in the range 1 to 31 (when <shift> = LSL or ROR) or 1 to 32 (when <shift> = LSR or ASR) encoded in the "imm3:imm2" field as <amount> modulo 32.								

Operation for all encodings

```
if ConditionPassed() then
    EncodingSpecificOperations();
    (shifted, carry) = Shift_C(R[m], shift_t, shift_n, PSTATE.C);
    result = R[n] AND NOT(shifted);
    if d == 15 then // Can only occur for A32 encoding
        if setflags then
            ALUExceptionReturn(result);
        else
            ALUWritePC(result);
    else
        R[d] = result;
        if setflags then
            PSTATE.N = result<31>;
            PSTATE.Z = IsZeroBit(result);
            PSTATE.C = carry;
            // PSTATE.V unchanged
```

F5.1.23 BIC, BICS (register-shifted register)

Bitwise Bit Clear (register-shifted register) performs a bitwise AND of a register value and the complement of a register-shifted register value. It writes the result to the destination register, and can optionally update the condition flags based on the result.

A1

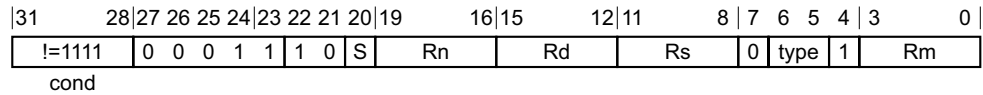

Flag setting variant

Applies when S == 1.

BICS{<c>}{<q>} {<Rd>}, <Rn>, <Rm>, <type> <Rs>

Not flag setting variant

Applies when S == 0.

BIC{<c>}{<q>} {<Rd>}, <Rn>, <Rm>, <type> <Rs>

Decode for all variants of this encoding

```
d = UInt(Rd); n = UInt(Rn); m = UInt(Rm); s = UInt(Rs);
setflags = (S == '1'); shift_t = DecodeRegShift(type);
if d == 15 || n == 15 || m == 15 || s == 15 then UNPREDICTABLE;
```

Notes for all encodings

For more information about the CONSTRAINED UNPREDICTABLE behavior, see [Appendix K1 Architectural Constraints on UNPREDICTABLE behaviors](#).

Assembler symbols

- <c> See [Standard assembler syntax fields on page F2-2848](#).
- <q> See [Standard assembler syntax fields on page F2-2848](#).
- <Rd> Is the general-purpose destination register, encoded in the "Rd" field.
- <Rn> Is the first general-purpose source register, encoded in the "Rn" field.
- <Rm> Is the second general-purpose source register, encoded in the "Rm" field.
- <type> Is the type of shift to be applied to the second source register, encoded in the "type" field. It can have the following values:
 - LSL when type = 00
 - LSR when type = 01
 - ASR when type = 10
 - ROR when type = 11
- <Rs> Is the general-purpose source register holding a shift amount in its bottom 8 bits, encoded in the "Rs" field.

Operation

```
if ConditionPassed() then
    EncodingSpecificOperations();
    shift_n = UInt(R[s]<7:0>);
    (shifted, carry) = Shift_C(R[m], shift_t, shift_n, PSTATE.C);
    result = R[n] AND NOT(shifted);
    R[d] = result;
    if setflags then
        PSTATE.N = result<31>;
        PSTATE.Z = IsZeroBit(result);
        PSTATE.C = carry;
        // PSTATE.V unchanged
```

F5.1.24 BKPT

Breakpoint causes a Breakpoint Instruction exception.

Breakpoint is always unconditional, even when inside an IT block.

A1

31	28	27	26	25	24	23	22	21	20	19				8	7	6	5	4	3	0
!=1111										imm12				0 1 1 1			imm4			
cond																				

A1 variant

BKPT{<q>} {#}<imm>

Decode for this encoding

```
imm16 = imm12:imm4;
if cond != '1110' then UNPREDICTABLE; // BKPT must be encoded with AL condition
```

CONSTRAINED UNPREDICTABLE behavior

If cond != '1110', then one of the following behaviors must occur:

- The instruction is UNDEFINED.
- The instruction executes as NOP.
- The instruction executes unconditionally.
- The instruction executes conditionally.

T1

15	14	13	12	11	10	9	8	7												0
1 0 1 1 1 1 1 0								imm8												

T1 variant

BKPT{<q>} {#}<imm>

Decode for this encoding

```
imm16 = ZeroExtend(imm8, 16);
```

Notes for all encodings

For more information about the CONSTRAINED UNPREDICTABLE behavior of this instruction, see [Appendix K1 Architectural Constraints on UNPREDICTABLE behaviors](#).

Assembler symbols

<q> See [Standard assembler syntax fields on page F2-2848](#). An BKPT instruction must be unconditional.

- <imm> For encoding A1: is a 16-bit unsigned immediate, in the range 0 to 65535, encoded in the "imm12:imm4" field. This value:
- Is recorded in the Comment field of [ESR_ELx](#).ISS if the Software Breakpoint Instruction exception is taken to an exception level that is using AArch64.
 - Is ignored otherwise.
- For encoding T1: is a 8-bit unsigned immediate, in the range 0 to 255, encoded in the "imm8" field. This value:
- Is recorded in the Comment field of [ESR_ELx](#).ISS if the Software Breakpoint Instruction exception is taken to an exception level that is using AArch64.
 - Is ignored otherwise.

Operation for all encodings

```
EncodingSpecificOperations();  
AArch32.SoftwareBreakpoint(imm16);
```

F5.1.25 BL, BLX (immediate)

Branch with Link calls a subroutine at a PC-relative address, and setting LR to the return address.

Branch with Link and Exchange Instruction Sets (immediate) calls a subroutine at a PC-relative address, setting LR to the return address, and changes the instruction set from A32 to T32, or from T32 to A32.

A1

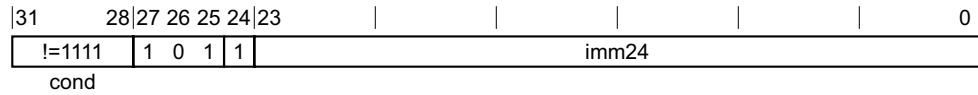

A1 variant

BL{<c>}{<q>} <label>

Decode for this encoding

imm32 = [SignExtend](#)(imm24:'00', 32); targetInstrSet = [InstrSet_A32](#);

A2

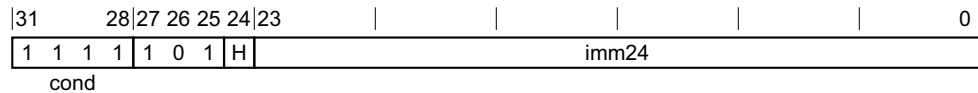

A2 variant

BLX{<c>}{<q>} <label>

Decode for this encoding

imm32 = [SignExtend](#)(imm24:H:'0', 32); targetInstrSet = [InstrSet_T32](#);

T1

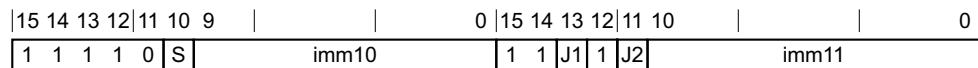

T1 variant

BL{<c>}{<q>} <label>

Decode for this encoding

I1 = NOT(J1 EOR S); I2 = NOT(J2 EOR S); imm32 = [SignExtend](#)(S:I1:I2:imm10:imm11:'0', 32);
 targetInstrSet = [InstrSet_T32](#);
 if [InITBlock](#)() && ![LastInITBlock](#)() then UNPREDICTABLE;

T2

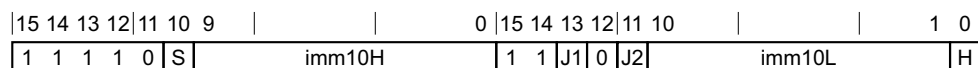

T2 variant

```
BLX{<c>}{<q>} <label>
```

Decode for this encoding

```
if H == '1' then UNDEFINED;  
I1 = NOT(J1 EOR S); I2 = NOT(J2 EOR S); imm32 = SignExtend(S:I1:I2:imm10H:imm10L:'00', 32);  
targetInstrSet = InstrSet_A32;  
if InITBlock() && !LastInITBlock() then UNPREDICTABLE;
```

Notes for all encodings

For more information about the CONSTRAINED UNPREDICTABLE behavior, see [Appendix K1 Architectural Constraints on UNPREDICTABLE behaviors](#).

Assembler symbols

<c> For encoding A1, T1 and T2: see [Standard assembler syntax fields on page F2-2848](#).
For encoding A2: see [Standard assembler syntax fields on page F2-2848](#). <c> must be AL or omitted.

<q> See [Standard assembler syntax fields on page F2-2848](#).

<label> For encoding A1: the label of the instruction that is to be branched to. The assembler calculates the required value of the offset from the PC value of the BL instruction to this label, then selects an encoding that sets imm32 to that offset.
Permitted offsets are multiples of 4 in the range –33554432 to 33554428.
For encoding A2: the label of the instruction that is to be branched to. The assembler calculates the required value of the offset from the PC value of the BLX instruction to this label, then selects an encoding with imm32 set to that offset.
Permitted offsets are even numbers in the range –33554432 to 33554430.
For encoding T1: the label of the instruction that is to be branched to.
The assembler calculates the required value of the offset from the PC value of the BL instruction to this label, then selects an encoding with imm32 set to that offset.
Permitted offsets are even numbers in the range –16777216 to 16777214.
For encoding T2: the label of the instruction that is to be branched to.
The assembler calculates the required value of the offset from the Align(PC, 4) value of the BLX instruction to this label, then selects an encoding with imm32 set to that offset.
Permitted offsets are multiples of 4 in the range –16777216 to 16777212.

Operation for all encodings

```
if ConditionPassed() then  
    EncodingSpecificOperations();  
    if CurrentInstrSet() == InstrSet_A32 then  
        LR = PC - 4;  
    else  
        LR = PC<31:1> : '1';  
    if targetInstrSet == InstrSet_A32 then  
        targetAddress = Align(PC,4) + imm32;  
    else  
        targetAddress = PC + imm32;  
    SelectInstrSet(targetInstrSet);  
    BranchWritePC(targetAddress);
```

F5.1.26 BLX (register)

Branch with Link and Exchange (register) calls a subroutine at an address specified in the register, and if necessary changes to the instruction set indicated by bit[0] of the register value. If the value in bit[0] is 0, the instruction set after the branch will be A32. If the value in bit[0] is 1, the instruction set after the branch will be T32.

A1

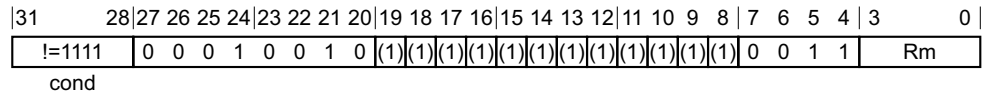

A1 variant

BLX{<c>}{<q>} <Rm>

Decode for this encoding

```
m = UInt(Rm);
if m == 15 then UNPREDICTABLE;
```

T1

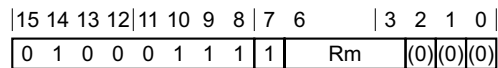

T1 variant

BLX{<c>}{<q>} <Rm>

Decode for this encoding

```
m = UInt(Rm);
if m == 15 then UNPREDICTABLE;
if InITBlock() && !LastInITBlock() then UNPREDICTABLE;
```

Notes for all encodings

For more information about the CONSTRAINED UNPREDICTABLE behavior, see [Appendix K1 Architectural Constraints on UNPREDICTABLE behaviors](#).

Assembler symbols

- <c> See [Standard assembler syntax fields on page F2-2848](#).
- <q> See [Standard assembler syntax fields on page F2-2848](#).
- <Rm> Is the general-purpose register holding the address to be branched to, encoded in the "Rm" field.

Operation for all encodings

```
if ConditionPassed() then
    EncodingSpecificOperations();
    target = R[m];
    if CurrentInstrSet() == InstrSet_A32 then
        next_instr_addr = PC - 4;
        LR = next_instr_addr;
    else
```

```
next_instr_addr = PC - 2;  
LR = next_instr_addr<31:1> : '1';  
BXWritePC(target);
```

F5.1.27 BX

Branch and Exchange causes a branch to an address and instruction set specified by a register.

A1

31	28	27	26	25	24	23	22	21	20	19	18	17	16	15	14	13	12	11	10	9	8	7	6	5	4	3	0	
!=1111				0	0	0	1	0	0	1	0	(1)	(1)	(1)	(1)	(1)	(1)	(1)	(1)	(1)	(1)	(1)	(1)	0	0	0	1	Rm
cond																												

A1 variant

BX{<c>}{<q>} <Rm>

Decode for this encoding

m = UInt(Rm);

T1

15	14	13	12	11	10	9	8	7	6	3	2	1	0
0	1	0	0	0	1	1	1	0	Rm	(0)	(0)	(0)	

T1 variant

BX{<c>}{<q>} <Rm>

Decode for this encoding

m = UInt(Rm);
 if InITBlock() && !LastInITBlock() then UNPREDICTABLE;

Notes for all encodings

For more information about the CONSTRAINED UNPREDICTABLE behavior, see [Appendix K1 Architectural Constraints on UNPREDICTABLE behaviors](#).

Assembler symbols

<c> See [Standard assembler syntax fields on page F2-2848](#).

<q> See [Standard assembler syntax fields on page F2-2848](#).

<Rm> For encoding A1: is the general-purpose register holding the address to be branched to, encoded in the "Rm" field. The PC can be used.

For encoding T1: is the general-purpose register holding the address to be branched to, encoded in the "Rm" field. The PC can be used.

————— Note —————

If <Rm> is the PC at a non word-aligned address, it results in UNPREDICTABLE behavior because the address passed to the BXwritePC() pseudocode function has bits<1:0> = '10'.

Operation for all encodings

```
if ConditionPassed() then  
    EncodingSpecificOperations();  
    BXWritePC(R[m]);
```

F5.1.28 BXJ

Branch and Exchange, previously Branch and Exchange Jazelle.

In ARMv8, BXJ behaves as a BX instruction, see [BX](#). This means it causes a branch to an address and instruction set specified by a register.

A1

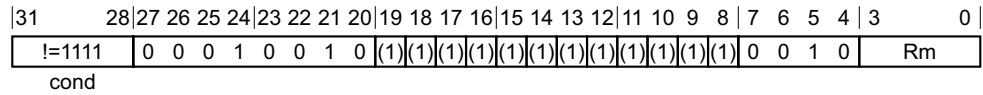

A1 variant

BXJ{<c>}{<q>} <Rm>

Decode for this encoding

```
m = UInt(Rm);
if m == 15 then UNPREDICTABLE;
```

T1

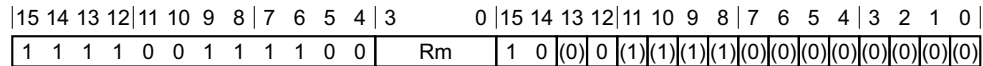

T1 variant

BXJ{<c>}{<q>} <Rm>

Decode for this encoding

```
m = UInt(Rm);
if m == 15 then UNPREDICTABLE; // ARMv8-A removes UNPREDICTABLE for R13
if InITBlock() && !LastInITBlock() then UNPREDICTABLE;
```

Notes for all encodings

For more information about the CONSTRAINED UNPREDICTABLE behavior, see [Appendix K1 Architectural Constraints on UNPREDICTABLE behaviors](#).

Assembler symbols

<c> See [Standard assembler syntax fields on page F2-2848](#).

<q> See [Standard assembler syntax fields on page F2-2848](#).

<Rm> Is the general-purpose register holding the address to be branched to, encoded in the "Rm" field.

Operation for all encodings

```
if ConditionPassed() then
    EncodingSpecificOperations();
    BXWritePC(R[m]);
```

F5.1.29 CBNZ, CBZ

Compare and Branch on Nonzero and Compare and Branch on Zero compare the value in a register with zero, and conditionally branch forward a constant value. They do not affect the condition flags.

T1

15	14	13	12	11	10	9	8	7				3	2	0
1	0	1	1	op	0	i	1	imm5				Rn		

CBNZ variant

Applies when `op == 1`.

CBNZ{<q>} <Rn>, <label>

CBZ variant

Applies when `op == 0`.

CBZ{<q>} <Rn>, <label>

Decode for all variants of this encoding

```
n = UInt(Rn); imm32 = ZeroExtend(i:imm5:'0', 32); nonzero = (op == '1');
if InITBlock() then UNPREDICTABLE;
```

Notes for all encodings

For more information about the CONSTRAINED UNPREDICTABLE behavior, see [Appendix K1 Architectural Constraints on UNPREDICTABLE behaviors](#).

Assembler symbols

<q> See [Standard assembler syntax fields on page F2-2848](#).

<Rn> Is the general-purpose register to be tested, encoded in the "Rn" field.

<label> Is the program label to be conditionally branched to. Its offset from the PC, a multiple of 2 and in the range 0 to 126, is encoded as "i:imm5" times 4.

Operation

```
EncodingSpecificOperations();
if nonzero != IsZero(R[n]) then
  BranchWritePC(PC + imm32);
```

F5.1.30 CLREX

Clear-Exclusive clears the local monitor of the executing PE.

A1

31	30	29	28	27	26	25	24	23	22	21	20	19	18	17	16	15	14	13	12	11	10	9	8	7	6	5	4	3	2	1	0
1	1	1	1	0	1	0	1	0	1	1	1	(1)	(1)	(1)	(1)	(1)	(1)	(1)	(1)	(0)	(0)	(0)	(0)	0	0	0	1	(1)	(1)	(1)	(1)

A1 variant

CLREX{<c>}{<q>}

Decode for this encoding

// No additional decoding required

T1

15	14	13	12	11	10	9	8	7	6	5	4	3	2	1	0	15	14	13	12	11	10	9	8	7	6	5	4	3	2	1	0
1	1	1	1	0	0	1	1	1	0	1	1	(1)	(1)	(1)	(1)	1	0	(0)	0	(1)	(1)	(1)	(1)	0	0	1	0	(1)	(1)	(1)	(1)

T1 variant

CLREX{<c>}{<q>}

Decode for this encoding

// No additional decoding required

Notes for all encodings

For more information about the CONSTRAINED UNPREDICTABLE behavior, see [Appendix K1 Architectural Constraints on UNPREDICTABLE behaviors](#).

Assembler symbols

- <c> For encoding A1: see [Standard assembler syntax fields on page F2-2848](#). Must be AL or omitted.
 For encoding T1: see [Standard assembler syntax fields on page F2-2848](#).
- <q> See [Standard assembler syntax fields on page F2-2848](#).

Operation for all encodings

```
if ConditionPassed() then
    EncodingSpecificOperations();
    ClearExclusiveLocal(ProcessorID());
```

F5.1.31 CLZ

Count Leading Zeros returns the number of binary zero bits before the first binary one bit in a value.

A1

31	28	27	26	25	24	23	22	21	20	19	18	17	16	15	12	11	10	9	8	7	6	5	4	3	0
!=1111				0	0	0	1	0	1	1	0	(1)	(1)	(1)	(1)	Rd	(1)	(1)	(1)	(1)	0	0	0	1	Rm
cond																									

A1 variant

CLZ{<c>}{<q>} <Rd>, <Rm>

Decode for this encoding

d = UInt(Rd); m = UInt(Rm);
 if d == 15 || m == 15 then UNPREDICTABLE;

T1

15	14	13	12	11	10	9	8	7	6	5	4	3	0	15	14	13	12	11	8	7	6	5	4	3	0
1	1	1	1	1	0	1	0	1	0	1	1		Rn	1	1	1	1		Rd	1	0	0	0		Rm

T1 variant

CLZ{<c>}{<q>} <Rd>, <Rm>

Decode for this encoding

d = UInt(Rd); m = UInt(Rm); n = UInt(Rn);
 if m != n || d == 15 || m == 15 then UNPREDICTABLE; // ARMv8-A removes UNPREDICTABLE for R13

CONSTRAINED UNPREDICTABLE behavior

If m != n, then one of the following behaviors must occur:

- The instruction is UNDEFINED.
- The instruction executes as NOP.
- The instruction executes as described, with no change to its behavior and no additional side effects.
- The instruction executes with the additional decode: m = UInt(Rn);.
- The value in the destination register is UNKNOWN.

Notes for all encodings

For more information about the CONSTRAINED UNPREDICTABLE behavior of this instruction, see [Appendix K1 Architectural Constraints on UNPREDICTABLE behaviors](#).

Assembler symbols

- <c> See [Standard assembler syntax fields on page F2-2848](#).
- <q> See [Standard assembler syntax fields on page F2-2848](#).
- <Rd> Is the general-purpose destination register, encoded in the "Rd" field.

<Rm> For encoding A1: is the general-purpose source register, encoded in the "Rm" field.
For encoding T1: is the general-purpose source register, encoded in the "Rm" field. It must be encoded with an identical value in the "Rn" field.

Operation for all encodings

```
if ConditionPassed() then
    EncodingSpecificOperations();
    result = CountLeadingZeroBits(R[m]);
    R[d] = result<31:0>;
```

F5.1.32 CMN (immediate)

Compare Negative (immediate) adds a register value and an immediate value. It updates the condition flags based on the result, and discards the result.

A1

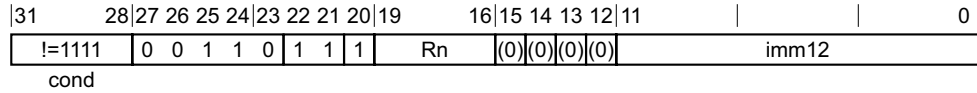

A1 variant

CMN{<c>}{<q>} <Rn>, #<const>

Decode for this encoding

n = UInt(Rn); imm32 = A32ExpandImm(imm12);

T1

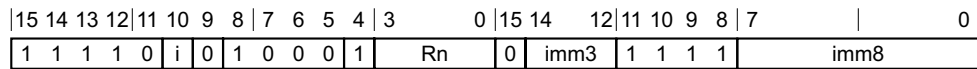

T1 variant

CMN{<c>}{<q>} <Rn>, #<const>

Decode for this encoding

n = UInt(Rn); imm32 = T32ExpandImm(i:imm3:imm8);
 if n == 15 then UNPREDICTABLE;

Notes for all encodings

For more information about the CONSTRAINED UNPREDICTABLE behavior, see [Appendix K1 Architectural Constraints on UNPREDICTABLE behaviors](#).

Assembler symbols

<c> See [Standard assembler syntax fields on page F2-2848](#).

<q> See [Standard assembler syntax fields on page F2-2848](#).

<Rn> For encoding A1: is the general-purpose source register, encoded in the "Rn" field. The PC can be used, but this is deprecated.

For encoding T1: is the general-purpose source register, encoded in the "Rn" field.

<const> For encoding A1: an immediate value. See [Modified immediate constants in A32 instructions on page F2-2864](#) for the range of values.

For encoding T1: an immediate value. See [Modified immediate constants in T32 instructions on page F2-2863](#) for the range of values.

Operation for all encodings

```
if ConditionPassed() then
    EncodingSpecificOperations();
    (result, nzcvc) = AddWithCarry(R[n], imm32, '0');
    PSTATE.<N,Z,C,V> = nzcvc;
```

F5.1.33 CMN (register)

Compare Negative (register) adds a register value and an optionally-shifted register value. It updates the condition flags based on the result, and discards the result.

A1

31	28	27	26	25	24	23	22	21	20	19	16	15	14	13	12	11	7	6	5	4	3	0	
!=1111				0	0	0	1	0	1	1	1	Rn	(0)	(0)	(0)	(0)	imm5	type	0	Rm			
cond																							

Rotate right with extend variant

Applies when imm5 == 00000 && type == 11.

CMN{<c>}{<q>} <Rn>, <Rm>, RRX

Shift or rotate by value variant

Applies when !(imm5 == 00000 && type == 11).

CMN{<c>}{<q>} <Rn>, <Rm> {, <shift> #<amount>}

Decode for all variants of this encoding

n = UInt(Rn); m = UInt(Rm);
 (shift_t, shift_n) = DecodeImmShift(type, imm5);

T1

15	14	13	12	11	10	9	8	7	6	5	3	2	0
0	1	0	0	0	0	1	0	1	1	Rm	Rn		

T1 variant

CMN{<c>}{<q>} <Rn>, <Rm>

Decode for this encoding

n = UInt(Rn); m = UInt(Rm);
 (shift_t, shift_n) = (SRTYPE_LSL, 0);

T2

15	14	13	12	11	10	9	8	7	6	5	4	3	0	15	14	12	11	10	9	8	7	6	5	4	3	0
1	1	1	0	1	0	1	1	0	0	0	1	Rn	(0)	imm3	1	1	1	1	imm2	type	Rm					

Rotate right with extend variant

Applies when imm3 == 000 && imm2 == 00 && type == 11.

CMN{<c>}{<q>} <Rn>, <Rm>, RRX

Shift or rotate by value variant

Applies when !(imm3 == 000 && imm2 == 00 && type == 11).

CMN{<c>}.W <Rn>, <Rm> // <Rn>, <Rm> can be represented in T1
CMN{<c>}{<q>} <Rn>, <Rm> {, <shift> #<amount>}

Decode for all variants of this encoding

```
n = UInt(Rn); m = UInt(Rm);  
(shift_t, shift_n) = DecodeImmShift(type, imm3:imm2);  
if n == 15 || m == 15 then UNPREDICTABLE; // ARMv8-A removes UNPREDICTABLE for R13
```

Notes for all encodings

For more information about the CONSTRAINED UNPREDICTABLE behavior, see [Appendix K1 Architectural Constraints on UNPREDICTABLE behaviors](#).

Assembler symbols

<c>	See Standard assembler syntax fields on page F2-2848 .
<q>	See Standard assembler syntax fields on page F2-2848 .
<Rn>	For encoding A1: is the first general-purpose source register, encoded in the "Rn" field. The PC can be used, but this is deprecated. For encoding T1 and T2: is the first general-purpose source register, encoded in the "Rn" field.
<Rm>	For encoding A1: is the second general-purpose source register, encoded in the "Rm" field. The PC can be used, but this is deprecated. For encoding T1 and T2: is the second general-purpose source register, encoded in the "Rm" field.
<shift>	Is the type of shift to be applied to the second source register, encoded in the "type" field. It can have the following values: LSL when type = 00 LSR when type = 01 ASR when type = 10 ROR when type = 11
<amount>	For encoding A1: is the shift amount, in the range 1 to 31 (when <shift> = LSL or ROR) or 1 to 32 (when <shift> = LSR or ASR) encoded in the "imm5" field as <amount> modulo 32. For encoding T2: is the shift amount, in the range 1 to 31 (when <shift> = LSL or ROR) or 1 to 32 (when <shift> = LSR or ASR) encoded in the "imm3:imm2" field as <amount> modulo 32.

Operation for all encodings

```
if ConditionPassed() then  
  EncodingSpecificOperations();  
  shifted = Shift(R[m], shift_t, shift_n, PSTATE.C);  
  (result, nzcV) = AddWithCarry(R[n], shifted, '0');  
  PSTATE.<N,Z,C,V> = nzcV;
```

F5.1.34 CMN (register-shifted register)

Compare Negative (register-shifted register) adds a register value and a register-shifted register value. It updates the condition flags based on the result, and discards the result.

A1

31	28	27	26	25	24	23	22	21	20	19	16	15	14	13	12	11	8	7	6	5	4	3	0
!=1111				0	0	0	1	0	1	1	1	Rn	(0)	(0)	(0)	(0)	Rs	0	type	1	Rm		
cond																							

A1 variant

CMN{<c>}{<q>} <Rn>, <Rm>, <type> <Rs>

Decode for this encoding

```
n = UInt(Rn); m = UInt(Rm); s = UInt(Rs);
shift_t = DecodeRegShift(type);
if n == 15 || m == 15 || s == 15 then UNPREDICTABLE;
```

Notes for all encodings

For more information about the CONSTRAINED UNPREDICTABLE behavior, see [Appendix K1 Architectural Constraints on UNPREDICTABLE behaviors](#).

Assembler symbols

- <c> See [Standard assembler syntax fields on page F2-2848](#).
- <q> See [Standard assembler syntax fields on page F2-2848](#).
- <Rn> Is the first general-purpose source register, encoded in the "Rn" field.
- <Rm> Is the second general-purpose source register, encoded in the "Rm" field.
- <type> Is the type of shift to be applied to the second source register, encoded in the "type" field. It can have the following values:
 - LSL when type = 00
 - LSR when type = 01
 - ASR when type = 10
 - ROR when type = 11
- <Rs> Is the third general-purpose source register holding a shift amount in its bottom 8 bits, encoded in the "Rs" field.

Operation

```
if ConditionPassed() then
  EncodingSpecificOperations();
  shift_n = UInt(R[s]<7:0>);
  shifted = Shift(R[m], shift_t, shift_n, PSTATE.C);
  (result, nzcvc) = AddWithCarry(R[n], shifted, '0');
  PSTATE.<N,Z,C,V> = nzcvc;
```

F5.1.35 CMP (immediate)

Compare (immediate) subtracts an immediate value from a register value. It updates the condition flags based on the result, and discards the result.

A1

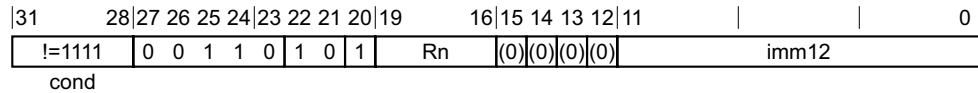

A1 variant

CMP{<c>}{<q>} <Rn>, #<const>

Decode for this encoding

n = UInt(Rn); imm32 = A32ExpandImm(imm12);

T1

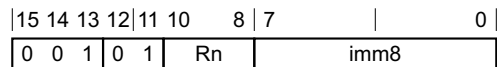

T1 variant

CMP{<c>}{<q>} <Rn>, #<imm8>

Decode for this encoding

n = UInt(Rn); imm32 = ZeroExtend(imm8, 32);

T2

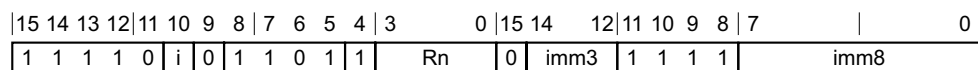

T2 variant

CMP{<c>}.W <Rn>, #<const> // <Rd>, <const> can be represented in T1

CMP{<c>}{<q>} <Rn>, #<const>

Decode for this encoding

n = UInt(Rn); imm32 = T32ExpandImm(i:imm3:imm8);
 if n == 15 then UNPREDICTABLE;

Notes for all encodings

For more information about the CONSTRAINED UNPREDICTABLE behavior, see [Appendix K1 Architectural Constraints on UNPREDICTABLE behaviors](#).

Assembler symbols

<c> See [Standard assembler syntax fields on page F2-2848](#).

- <q> See [Standard assembler syntax fields on page F2-2848](#).
- <Rn> For encoding A1: is the general-purpose source register, encoded in the "Rn" field. The PC can be used, but this is deprecated.
For encoding T1: is a general-purpose source register, encoded in the "Rn" field.
For encoding T2: is the general-purpose source register, encoded in the "Rn" field.
- <imm8> Is a 8-bit unsigned immediate, in the range 0 to 255, encoded in the "imm8" field.
- <const> For encoding A1: an immediate value. See [Modified immediate constants in A32 instructions on page F2-2864](#) for the range of values.
For encoding T2: an immediate value. See [Modified immediate constants in T32 instructions on page F2-2863](#) for the range of values.

Operation for all encodings

```
if ConditionPassed() then
    EncodingSpecificOperations();
(result, nzcV) = AddWithCarry(R[n], NOT(imm32), '1');
PSTATE.<N,Z,C,V> = nzcV;
```

F5.1.36 CMP (register)

Compare (register) subtracts an optionally-shifted register value from a register value. It updates the condition flags based on the result, and discards the result.

A1

31	28	27	26	25	24	23	22	21	20	19	16	15	14	13	12	11	7	6	5	4	3	0	
!=1111				0	0	0	1	0	1	0	1	Rn	(0)	(0)	(0)	(0)	imm5	type	0	Rm			
cond																							

Rotate right with extend variant

Applies when imm5 == 00000 && type == 11.

CMP{<c>}{<q>} <Rn>, <Rm>, RRX

Shift or rotate by value variant

Applies when !(imm5 == 00000 && type == 11).

CMP{<c>}{<q>} <Rn>, <Rm> {, <shift> #<amount>}

Decode for all variants of this encoding

```
n = UInt(Rn); m = UInt(Rm);
(shift_t, shift_n) = DecodeImmShift(type, imm5);
```

T1

15	14	13	12	11	10	9	8	7	6	5	3	2	0
0	1	0	0	0	0	1	0	1	0	Rm	Rn		

T1 variant

CMP{<c>}{<q>} <Rn>, <Rm> // <Rn> and <Rm> both from R0-R7

Decode for this encoding

```
n = UInt(Rn); m = UInt(Rm);
(shift_t, shift_n) = (SRTYPE_LSL, 0);
```

T2

15	14	13	12	11	10	9	8	7	6	3	2	0
0	1	0	0	0	1	0	1	N	Rm	Rn		

T2 variant

CMP{<c>}{<q>} <Rn>, <Rm> // <Rn> and <Rm> not both from R0-R7

Decode for this encoding

```
n = UInt(N:Rn); m = UInt(Rm);
(shift_t, shift_n) = (SRTYPE_LSL, 0);
if n < 8 && m < 8 then UNPREDICTABLE;
if n == 15 || m == 15 then UNPREDICTABLE;
```

CONSTRAINED UNPREDICTABLE behavior

If $n < 8$ && $m < 8$, then one of the following behaviors must occur:

- The instruction is UNDEFINED.
- The instruction executes as NOP.
- The instruction executes as described, with no change to its behavior and no additional side effects.
- The condition flags become UNKNOWN.

T3

15	14	13	12	11	10	9	8	7	6	5	4	3	0	15	14	12	11	10	9	8	7	6	5	4	3	0
1	1	1	0	1	0	1	1	1	0	1	1	Rn	(0)	imm3	1	1	1	1	imm2	type	Rm					

Rotate right with extend variant

Applies when $imm3 == 000$ && $imm2 == 00$ && $type == 11$.

CMP{<c>}{<q>} <Rn>, <Rm>, RRX

Shift or rotate by value variant

Applies when $!(imm3 == 000$ && $imm2 == 00$ && $type == 11)$.

CMP{<c>}.W <Rn>, <Rm> // <Rn>, <Rm> can be represented in T1 or T2

CMP{<c>}{<q>} <Rn>, <Rm>, <shift> #<amount>

Decode for all variants of this encoding

```
n = UInt(Rn); m = UInt(Rm);
(shift_t, shift_n) = DecodeImmShift(type, imm3:imm2);
if n == 15 || m == 15 then UNPREDICTABLE; // ARMv8-A removes UNPREDICTABLE for R13
```

Notes for all encodings

For more information about the CONSTRAINED UNPREDICTABLE behavior of this instruction, see [Appendix K1 Architectural Constraints on UNPREDICTABLE behaviors](#).

Assembler symbols

<c>	See Standard assembler syntax fields on page F2-2848 .
<q>	See Standard assembler syntax fields on page F2-2848 .
<Rn>	For encoding A1: is the first general-purpose source register, encoded in the "Rn" field. The PC can be used, but this is deprecated. For encoding T1 and T3: is the first general-purpose source register, encoded in the "Rn" field. For encoding T2: is the first general-purpose source register, encoded in the "N:Rn" field.
<Rm>	For encoding A1: is the second general-purpose source register, encoded in the "Rm" field. The PC can be used, but this is deprecated. For encoding T1, T2 and T3: is the second general-purpose source register, encoded in the "Rm" field.
<shift>	Is the type of shift to be applied to the second source register, encoded in the "type" field. It can have the following values: LSL when type = 00

LSR when type = 01
ASR when type = 10
ROR when type = 11

<amount> For encoding A1: is the shift amount, in the range 1 to 31 (when <shift> = LSL or ROR) or 1 to 32 (when <shift> = LSR or ASR) encoded in the "imm5" field as <amount> modulo 32.
For encoding T3: is the shift amount, in the range 1 to 31 (when <shift> = LSL or ROR) or 1 to 32 (when <shift> = LSR or ASR) encoded in the "imm3:imm2" field as <amount> modulo 32.

Operation for all encodings

```
if ConditionPassed() then
    EncodingSpecificOperations();
    shifted = Shift(R[m], shift_t, shift_n, PSTATE.C);
    (result, nzcV) = AddWithCarry(R[n], NOT(shifted), '1');
    PSTATE.<N,Z,C,V> = nzcV;
```

F5.1.37 CMP (register-shifted register)

Compare (register-shifted register) subtracts a register-shifted register value from a register value. It updates the condition flags based on the result, and discards the result.

A1

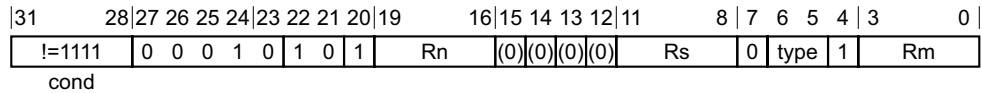

A1 variant

CMP{<c>}{<q>} <Rn>, <Rm>, <type> <Rs>

Decode for this encoding

```
n = UInt(Rn); m = UInt(Rm); s = UInt(Rs);
shift_t = DecodeRegShift(type);
if n == 15 || m == 15 || s == 15 then UNPREDICTABLE;
```

Notes for all encodings

For more information about the CONSTRAINED UNPREDICTABLE behavior, see [Appendix K1 Architectural Constraints on UNPREDICTABLE behaviors](#).

Assembler symbols

- <c> See [Standard assembler syntax fields on page F2-2848](#).
- <q> See [Standard assembler syntax fields on page F2-2848](#).
- <Rn> Is the first general-purpose source register, encoded in the "Rn" field.
- <Rm> Is the second general-purpose source register, encoded in the "Rm" field.
- <type> Is the type of shift to be applied to the second source register, encoded in the "type" field. It can have the following values:
 - LSL when type = 00
 - LSR when type = 01
 - ASR when type = 10
 - ROR when type = 11
- <Rs> Is the third general-purpose source register holding a shift amount in its bottom 8 bits, encoded in the "Rs" field.

Operation

```
if ConditionPassed() then
  EncodingSpecificOperations();
  shift_n = UInt(R[s]<7:0>);
  shifted = Shift(R[m], shift_t, shift_n, PSTATE.C);
  (result, nzc) = AddWithCarry(R[n], NOT(shifted), '1');
  PSTATE.<N,Z,C,V> = nzc;
```

F5.1.38 CPS, CPSID, CPSIE

Change PE State changes one or more of the `PSTATE.{A, I, F}` interrupt mask bits and, optionally, the `PSTATE.M` mode field, without changing any other `PSTATE` bits.

CPS is treated as NOP if executed in User mode unless it is defined as being `CONSTRAINED UNPREDICTABLE` elsewhere in this section.

The PE checks whether the value being written to `PSTATE.M` is legal. See *Illegal changes to PSTATE.M* on page G1-4336.

A1

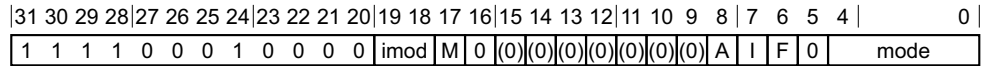

CPS variant

Applies when `imod == 00 && M == 1`.

`CPS{<q>} #<mode>` // Cannot be conditional

CPSID variant

Applies when `imod == 11 && M == 0`.

`CPSID{<q>} <iflags>` // Cannot be conditional

CPSID variant

Applies when `imod == 11 && M == 1`.

`CPSID{<q>} <iflags>` , #<mode> // Cannot be conditional

CPSIE variant

Applies when `imod == 10 && M == 0`.

`CPSIE{<q>} <iflags>` // Cannot be conditional

CPSIE variant

Applies when `imod == 10 && M == 1`.

`CPSIE{<q>} <iflags>` , #<mode> // Cannot be conditional

Decode for all variants of this encoding

```

if mode != '00000' && M == '0' then UNPREDICTABLE;
if (imod<1> == '1' && A:I:F == '000') || (imod<1> == '0' && A:I:F != '000') then UNPREDICTABLE;
enable = (imod == '10'); disable = (imod == '11'); changemode = (M == '1');
affectA = (A == '1'); affectI = (I == '1'); affectF = (F == '1');
if (imod == '00' && M == '0') || imod == '01' then UNPREDICTABLE;

```

CONSTRAINED UNPREDICTABLE behavior

If `imod == '01'`, then one of the following behaviors must occur:

- The instruction is UNDEFINED.
- The instruction executes as NOP.

If `imod == '00' && M == '0'`, then one of the following behaviors must occur:

- The instruction is UNDEFINED.
- The instruction executes as NOP.

If `mode != '00000' && M == '0'`, then one of the following behaviors must occur:

- The instruction is UNDEFINED.
- The instruction executes as NOP.
- The instruction executes with the additional decode: `changemode = TRUE`.
- The instruction executes as described, and the value specified by `mode` is ignored. There are no additional side-effects.

If `imod<1> == '1' && A:I:F == '000'`, then one of the following behaviors must occur:

- The instruction is UNDEFINED.
- The instruction executes as NOP.
- The instruction behaves as if `imod<1> == '0'`.
- The instruction behaves as if `A:I:F` has an UNKNOWN nonzero value.

If `imod<1> == '0' && A:I:F != '000'`, then one of the following behaviors must occur:

- The instruction is UNDEFINED.
- The instruction executes as NOP.
- The instruction behaves as if `imod<1> == '1'`.
- The instruction behaves as if `A:I:F == '000'`.

T1

15	14	13	12	11	10	9	8	7	6	5	4	3	2	1	0
1	0	1	1	0	1	1	0	0	1	1	im(0)	A	I	F	

CPSID variant

Applies when `im == 1`.

`CPSID{<q>} <iflags> // Not permitted in IT block`

CPSIE variant

Applies when `im == 0`.

`CPSIE{<q>} <iflags> // Not permitted in IT block`

Decode for all variants of this encoding

```

if A:I:F == '000' then UNPREDICTABLE;
enable = (im == '0'); disable = (im == '1'); changemode = FALSE;
affectA = (A == '1'); affectI = (I == '1'); affectF = (F == '1');
if InITBlock() then UNPREDICTABLE;
  
```

CONSTRAINED UNPREDICTABLE behavior

If A:I:F == '000', then one of the following behaviors must occur:

- The instruction is UNDEFINED.
- The instruction executes as NOP.

T2

15	14	13	12	11	10	9	8	7	6	5	4	3	2	1	0	15	14	13	12	11	10	9	8	7	6	5	4	0
1	1	1	1	0	0	1	1	1	0	1	0	(1)	(1)	(1)	(1)	1	0	(0)	0	(0)	imod	M	A	I	F	mode		

CPS variant

Applies when imod == 00 && M == 1.

CPS{<q>} #<mode> // Not permitted in IT block

CPSID variant

Applies when imod == 11 && M == 0.

CPSID.W <iflags> // Not permitted in IT block

CPSID variant

Applies when imod == 11 && M == 1.

CPSID{<q>} <iflags>, #<mode> // Not permitted in IT block

CPSIE variant

Applies when imod == 10 && M == 0.

CPSIE.W <iflags> // Not permitted in IT block

CPSIE variant

Applies when imod == 10 && M == 1.

CPSIE{<q>} <iflags>, #<mode> // Not permitted in IT block

Decode for all variants of this encoding

```

if imod == '00' && M == '0' then SEE "Hint instructions";
if mode != '00000' && M == '0' then UNPREDICTABLE;
if (imod<1> == '1' && A:I:F == '000') || (imod<1> == '0' && A:I:F != '000') then UNPREDICTABLE;
enable = (imod == '10'); disable = (imod == '11'); changemode = (M == '1');
affectA = (A == '1'); affectI = (I == '1'); affectF = (F == '1');
if imod == '01' || InITBlock() then UNPREDICTABLE;
    
```

CONSTRAINED UNPREDICTABLE behavior

If imod == '01', then one of the following behaviors must occur:

- The instruction is UNDEFINED.
- The instruction executes as NOP.

If mode != '00000' && M == '0', then one of the following behaviors must occur:

- The instruction is UNDEFINED.

- The instruction executes as NOP.
- The instruction executes with the additional decode: changemode = TRUE.
- The instruction executes as described, and the value specified by mode is ignored. There are no additional side-effects.

If `imod<1> == '1' && A:I:F == '000'`, then one of the following behaviors must occur:

- The instruction is UNDEFINED.
- The instruction executes as NOP.
- The instruction behaves as if `imod<1> == '0'`.
- The instruction behaves as if `A:I:F` has an UNKNOWN nonzero value.

If `imod<1> == '0' && A:I:F != '000'`, then one of the following behaviors must occur:

- The instruction is UNDEFINED.
- The instruction executes as NOP.
- The instruction behaves as if `imod<1> == '1'`.
- The instruction behaves as if `A:I:F == '000'`.

Notes for all encodings

Hint instructions: In encoding T2, if the `imod` field is `00` and the `M` bit is `0`, a hint instruction is encoded. To determine which hint instruction, see [Branches and miscellaneous control on page F3-2916](#).

For more information about the CONSTRAINED UNPREDICTABLE behavior of this instruction, see [Appendix K1 Architectural Constraints on UNPREDICTABLE behaviors](#).

Assembler symbols

<code><q></code>	See Standard assembler syntax fields on page F2-2848 .						
<code><iflags></code>	Is a sequence of one or more of the following, specifying which interrupt mask bits are affected: <table> <tr> <td><code>a</code></td> <td>Sets the A bit in the instruction, causing the specified effect on <code>PSTATE.A</code>, the SError interrupt mask bit.</td> </tr> <tr> <td><code>i</code></td> <td>Sets the I bit in the instruction, causing the specified effect on <code>PSTATE.I</code>, the IRQ interrupt mask bit.</td> </tr> <tr> <td><code>f</code></td> <td>Sets the F bit in the instruction, causing the specified effect on <code>PSTATE.F</code>, the FIQ interrupt mask bit.</td> </tr> </table>	<code>a</code>	Sets the A bit in the instruction, causing the specified effect on <code>PSTATE.A</code> , the SError interrupt mask bit.	<code>i</code>	Sets the I bit in the instruction, causing the specified effect on <code>PSTATE.I</code> , the IRQ interrupt mask bit.	<code>f</code>	Sets the F bit in the instruction, causing the specified effect on <code>PSTATE.F</code> , the FIQ interrupt mask bit.
<code>a</code>	Sets the A bit in the instruction, causing the specified effect on <code>PSTATE.A</code> , the SError interrupt mask bit.						
<code>i</code>	Sets the I bit in the instruction, causing the specified effect on <code>PSTATE.I</code> , the IRQ interrupt mask bit.						
<code>f</code>	Sets the F bit in the instruction, causing the specified effect on <code>PSTATE.F</code> , the FIQ interrupt mask bit.						
<code><mode></code>	Is the number of the mode to change to, in the range 0 to 31, encoded in the "mode" field.						

Operation for all encodings

```

if CurrentInstrSet() == InstrSet_A32 then
  EncodingSpecificOperations();
  if PSTATE.EL != EL0 then
    if enable then
      if affectA then PSTATE.A = '0';
      if affectI then PSTATE.I = '0';
      if affectF then PSTATE.F = '0';
    if disable then
      if affectA then PSTATE.A = '1';
      if affectI then PSTATE.I = '1';
      if affectF then PSTATE.F = '1';
    if changemode then
      // AArch32.WriteModeByInstr() sets PSTATE.IL to 1 if this is an illegal mode change.
  
```

```
        AArch32.WriteModeByInstr(mode);
else
    EncodingSpecificOperations();
    if PSTATE.EL != EL0 then
        if enable then
            if affectA then PSTATE.A = '0';
            if affectI then PSTATE.I = '0';
            if affectF then PSTATE.F = '0';
        if disable then
            if affectA then PSTATE.A = '1';
            if affectI then PSTATE.I = '1';
            if affectF then PSTATE.F = '1';
        if changemode then
            // AArch32.WriteModeByInstr() sets PSTATE.IL to 1 if this is an illegal mode change.
            AArch32.WriteModeByInstr(mode);
```

F5.1.39 CRC32

CRC32 performs a cyclic redundancy check (CRC) calculation on a value held in a general-purpose register. It takes an input CRC value in the first source operand, performs a CRC on the input value in the second source operand, and returns the output CRC value. The second source operand can be 8, 16, or 32 bits. To align with common usage, the bit order of the values is reversed as part of the operation, and the polynomial 0x04C11DB7 is used for the CRC calculation.

In ARMv8-A, this is an OPTIONAL instruction, and in ARMv8.1 it is mandatory for all implementations to implement it.

———— **Note** ————

[ID_ISAR5.CRC32](#) indicates whether this instruction is supported in the T32 and A32 instruction sets.

A1

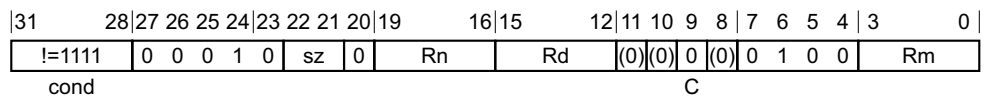

CRC32B variant

Applies when `sz == 00`.

CRC32B{<q>} <Rd>, <Rn>, <Rm>

CRC32H variant

Applies when `sz == 01`.

CRC32H{<q>} <Rd>, <Rn>, <Rm>

CRC32W variant

Applies when `sz == 10`.

CRC32W{<q>} <Rd>, <Rn>, <Rm>

Decode for all variants of this encoding

```

if ! HaveCRCExt() then UNDEFINED;
d = UInt(Rd); n = UInt(Rn); m = UInt(Rm);
size = 8 << UInt(sz);
crc32c = (C == '1');
if d == 15 || n == 15 || m == 15 then UNPREDICTABLE;
if size == 64 then UNPREDICTABLE;
if cond != '1110' then UNPREDICTABLE;
  
```

CONSTRAINED UNPREDICTABLE behavior

If `size == 64`, then one of the following behaviors must occur:

- The instruction is UNDEFINED.
- The instruction executes as NOP.
- The instruction executes with the additional decode: `size = 32`.

If `cond != '1110'`, then one of the following behaviors must occur:

- The instruction is UNDEFINED.
- The instruction executes as NOP.

- The instruction executes unconditionally.
- The instruction executes conditionally.

T1

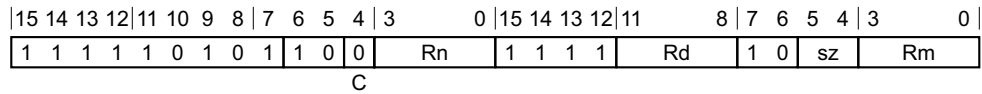

CRC32B variant

Applies when `sz == 00`.

CRC32B{<q>} <Rd>, <Rn>, <Rm>

CRC32H variant

Applies when `sz == 01`.

CRC32H{<q>} <Rd>, <Rn>, <Rm>

CRC32W variant

Applies when `sz == 10`.

CRC32W{<q>} <Rd>, <Rn>, <Rm>

Decode for all variants of this encoding

```

if ! HaveCRCExt() then UNDEFINED;
d = UInt(Rd); n = UInt(Rn); m = UInt(Rm);
size = 8 << UInt(sz);
crc32c = (C == '1');
if d == 15 || n == 15 || m == 15 then UNPREDICTABLE;
if size == 64 then UNPREDICTABLE;
if InITBlock() then UNPREDICTABLE;
    
```

CONSTRAINED UNPREDICTABLE behavior

If `size == 64`, then one of the following behaviors must occur:

- The instruction is UNDEFINED.
- The instruction executes as NOP.
- The instruction executes with the additional decode: `size = 32;`.

Notes for all encodings

For more information about the CONSTRAINED UNPREDICTABLE behavior, see [Appendix K1 Architectural Constraints on UNPREDICTABLE behaviors](#).

Assembler symbols

- <q> See [Standard assembler syntax fields on page F2-2848](#). An CRC32 instruction must be unconditional.
- <Rd> Is the general-purpose accumulator output register, encoded in the "Rd" field.
- <Rn> Is the general-purpose accumulator input register, encoded in the "Rn" field.
- <Rm> Is the general-purpose data source register, encoded in the "Rm" field.

Operation for all encodings

```
if ConditionPassed() then
    EncodingSpecificOperations();

    acc = R[n];           // accumulator
    val = R[m]<size-1:0>; // input value
    poly = (if crc32c then 0x1EDC6F41 else 0x04C11DB7)<31:0>;
    tempacc = BitReverse(acc):Zeros(size);
    tempval = BitReverse(val):Zeros(32);
    // Poly32Mod2 on a bitstring does a polynomial Modulus over {0,1} operation
    R[d] = BitReverse(Poly32Mod2(tempacc EOR tempval, poly));
```

F5.1.40 CRC32C

CRC32C performs a cyclic redundancy check (CRC) calculation on a value held in a general-purpose register. It takes an input CRC value in the first source operand, performs a CRC on the input value in the second source operand, and returns the output CRC value. The second source operand can be 8, 16, or 32 bits. To align with common usage, the bit order of the values is reversed as part of the operation, and the polynomial 0x1EDC6F41 is used for the CRC calculation.

In ARMv8-A, this is an OPTIONAL instruction, and in ARMv8.1 it is mandatory for all implementations to implement it.

———— **Note** ————

[ID_ISAR5.CRC32](#) indicates whether this instruction is supported in the T32 and A32 instruction sets.

A1

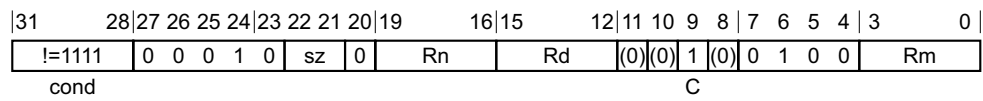

CRC32CB variant

Applies when `sz == 00`.

CRC32CB{<q>} <Rd>, <Rn>, <Rm>

CRC32CH variant

Applies when `sz == 01`.

CRC32CH{<q>} <Rd>, <Rn>, <Rm>

CRC32CW variant

Applies when `sz == 10`.

CRC32CW{<q>} <Rd>, <Rn>, <Rm>

Decode for all variants of this encoding

```

if ! HaveCRCExt() then UNDEFINED;
d = UInt(Rd); n = UInt(Rn); m = UInt(Rm);
size = 8 << UInt(sz);
crc32c = (C == '1');
if d == 15 || n == 15 || m == 15 then UNPREDICTABLE;
if size == 64 then UNPREDICTABLE;
if cond != '1110' then UNPREDICTABLE;
  
```

CONSTRAINED UNPREDICTABLE behavior

If `size == 64`, then one of the following behaviors must occur:

- The instruction is UNDEFINED.
- The instruction executes as NOP.
- The instruction executes with the additional decode: `size = 32`.

If `cond != '1110'`, then one of the following behaviors must occur:

- The instruction is UNDEFINED.
- The instruction executes as NOP.

- The instruction executes unconditionally.
- The instruction executes conditionally.

T1

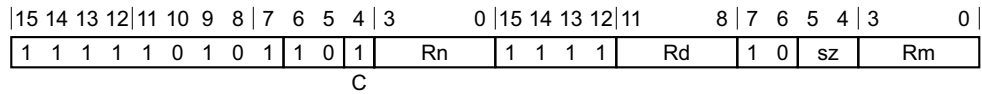

CRC32CB variant

Applies when `sz == 00`.

CRC32CB{<q>} <Rd>, <Rn>, <Rm>

CRC32CH variant

Applies when `sz == 01`.

CRC32CH{<q>} <Rd>, <Rn>, <Rm>

CRC32CW variant

Applies when `sz == 10`.

CRC32CW{<q>} <Rd>, <Rn>, <Rm>

Decode for all variants of this encoding

```

if ! HaveCRCExt() then UNDEFINED;
d = UInt(Rd); n = UInt(Rn); m = UInt(Rm);
size = 8 << UInt(sz);
crc32c = (C == '1');
if d == 15 || n == 15 || m == 15 then UNPREDICTABLE;
if size == 64 then UNPREDICTABLE;
if InITBlock() then UNPREDICTABLE;
  
```

CONSTRAINED UNPREDICTABLE behavior

If `size == 64`, then one of the following behaviors must occur:

- The instruction is UNDEFINED.
- The instruction executes as NOP.
- The instruction executes with the additional decode: `size = 32;`

Notes for all encodings

For more information about the CONSTRAINED UNPREDICTABLE behavior, see [Appendix K1 Architectural Constraints on UNPREDICTABLE behaviors](#).

Assembler symbols

- <q> See [Standard assembler syntax fields on page F2-2848](#). An CRC32C instruction must be unconditional.
- <Rd> Is the general-purpose accumulator output register, encoded in the "Rd" field.
- <Rn> Is the general-purpose accumulator input register, encoded in the "Rn" field.
- <Rm> Is the general-purpose data source register, encoded in the "Rm" field.

Operation for all encodings

```
if ConditionPassed() then
    EncodingSpecificOperations();

    acc = R[n];           // accumulator
    val = R[m]<size-1:0>; // input value
    poly = (if crc32c then 0x1EDC6F41 else 0x04C11DB7)<31:0>;
    tempacc = BitReverse(acc):Zeros(size);
    tempval = BitReverse(val):Zeros(32);
    // Poly32Mod2 on a bitstring does a polynomial Modulus over {0,1} operation
    R[d] = BitReverse(Poly32Mod2(tempacc EOR tempval, poly));
```

F5.1.41 DBG

In ARMv8, DBG executes as a NOP. ARM deprecates any use of the DBG instruction.

A1

31	28	27	26	25	24	23	22	21	20	19	18	17	16	15	14	13	12	11	10	9	8	7	6	5	4	3	0	
!=1111				0	0	1	1	0	0	1	0	0	0	0	0	(1)	(1)	(1)	(1)	(0)	(0)	(0)	(0)	1	1	1	1	option
cond																												

A1 variant

DBG{<c>}{<q>} #<option>

Decode for this encoding

// DBG executes as a NOP. The 'option' field is ignored

T1

15	14	13	12	11	10	9	8	7	6	5	4	3	2	1	0	15	14	13	12	11	10	9	8	7	6	5	4	3	0
1	1	1	1	0	0	1	1	1	0	1	0	(1)	(1)	(1)	(1)	1	0	(0)	0	(0)	0	0	0	1	1	1	1	option	

T1 variant

DBG{<c>}{<q>} #<option>

Decode for this encoding

// DBG executes as a NOP. The 'option' field is ignored

Notes for all encodings

For more information about the CONSTRAINED UNPREDICTABLE behavior, see [Appendix K1 Architectural Constraints on UNPREDICTABLE behaviors](#).

Assembler symbols

<c> See [Standard assembler syntax fields on page F2-2848](#).

<q> See [Standard assembler syntax fields on page F2-2848](#).

<option> Is a 4-bit unsigned immediate, in the range 0 to 15, encoded in the "option" field.

Operation for all encodings

```
if ConditionPassed() then
    EncodingSpecificOperations();
```

F5.1.42 DCPS1, DCPS2, DCPS3

DCPS_x, Debug Change PE State to EL_x, where x is 1, 2, or 3.

When executed in Debug state, the target Exception level of the instruction is:

- EL_x, if the instruction is executed at an Exception level lower than EL_x.
- Otherwise, the Exception level at which the instruction is executed.

On executing a DCPS_x instruction in Debug state when the instruction is not UNDEFINED:

- If the instruction is executed at an Exception level that is lower than the target Exception level the PE enters the target Exception level, EL_x, and:
 - If EL_x is using AArch64, the PE selects SP_EL_x.
 - If the target Exception level is EL1 using AArch32 the PE enters Supervisor mode.
 - If the instruction was executed in Non-secure state and the target Exception level is EL2 using AArch32 the PE enters Hyp mode.
 - If the target Exception level is EL3 using AArch32 the PE enters Supervisor mode and SCR.NS is set to 0.
- Otherwise, there is no change to the Exception level and:
 - If the instruction was executed at EL1 the PE enters Supervisor mode.
 - If the instruction was executed at EL2 the PE remains in Hyp mode.
 - If the instruction was a DCPS1 instruction executed at EL3 the PE enters Supervisor mode and SCR.NS is set to 0.
 - If the instruction was a DCPS3 instruction executed at EL3 the PE enters Monitor mode and SCR.NS is set to 0.

These instructions are always UNDEFINED in Non-debug state.

DCPS1 is UNDEFINED at EL0 in Non-secure state if either:

- EL2 is implemented and using AArch64 and HCR_EL2.TGE == 1.
- EL2 is implemented and using AArch32 and HCR.TGE == 1.

DCPS2 is UNDEFINED at all Exception levels if EL2 is not implemented.

DCPS2 is UNDEFINED in the following states if EL2 is implemented:

- At EL0 and EL1 in Secure state.
- At EL3 if EL3 is using AArch32.

DCPS3 is UNDEFINED at all Exception levels if either:

- EDSCR.SDD == 1.
- EL3 is not implemented.

On executing a DCPS_x instruction that is not UNDEFINED and targets EL_x:

- If EL_x is using AArch64:
 - ELR_EL_x, SPSR_EL_x, and ESR_EL_x become UNKNOWN.
 - DLR_EL0 and DSPSR_EL0 become UNKNOWN.
- If EL_x is using AArch32 DLR and DSPSR become UNKNOWN and:
 - If the target Exception level is EL1 or EL3, the LR and SPSR of the target PE mode become UNKNOWN.
 - If the target Exception level is EL2, then ELR_hyp, SPSR_hyp, and HSR become UNKNOWN.

For more information on the operation of these instructions, see [DCPS<n>](#) on page H2-5461.

T1

15	14	13	12	11	10	9	8	7	6	5	4	3	2	1	0	15	14	13	12	11	10	9	8	7	6	5	4	3	2	1	0
1	1	1	1	0	1	1	1	1	0	0	0	1	1	1	1	1	0	0	0	0	0	0	0	0	0	0	0	0	0	0	opt

DCPS1 variant

Applies when opt == 01.

DCPS1

DCPS2 variant

Applies when opt == 10.

DCPS2

DCPS3 variant

Applies when opt == 11.

DCPS3

Decode for all variants of this encoding

```
if !Halted() || opt == '00' then UNDEFINED;
```

Operation

```
DCPSInstruction(opt);
```

F5.1.43 DMB

Data Memory Barrier is a memory barrier that ensures the ordering of observations of memory accesses, see [Data Memory Barrier \(DMB\) on page E2-2769](#).

A1

31	30	29	28	27	26	25	24	23	22	21	20	19	18	17	16	15	14	13	12	11	10	9	8	7	6	5	4	3	0
1	1	1	1	0	1	0	1	0	1	1	1	(1)	(1)	(1)	(1)	(1)	(1)	(1)	(1)	(0)	(0)	(0)	(0)	0	1	0	1	option	

A1 variant

DMB{<c>}{<q>} {<option>}

Decode for this encoding

// No additional decoding required

T1

15	14	13	12	11	10	9	8	7	6	5	4	3	2	1	0	15	14	13	12	11	10	9	8	7	6	5	4	3	0
1	1	1	1	0	0	1	1	1	0	1	1	(1)	(1)	(1)	(1)	1	0	(0)	0	(1)	(1)	(1)	(1)	0	1	0	1	option	

T1 variant

DMB{<c>}{<q>} {<option>}

Decode for this encoding

// No additional decoding required

Notes for all encodings

For more information about the CONstrained UNpredictable behavior, see [Appendix K1 Architectural Constraints on UNpredictable behaviors](#).

Assembler symbols

<c>	For encoding A1: see Standard assembler syntax fields on page F2-2848 . Must be AL or omitted. For encoding T1: see Standard assembler syntax fields on page F2-2848 .						
<q>	See Standard assembler syntax fields on page F2-2848 .						
<option>	Specifies an optional limitation on the barrier operation. Values are: <table> <tr> <td>SY</td> <td>Full system is the required shareability domain, reads and writes are the required access types, both before and after the barrier instruction. Can be omitted. This option is referred to as the full system barrier. Encoded as option = 0b1111.</td> </tr> <tr> <td>ST</td> <td>Full system is the required shareability domain, writes are the required access type, both before and after the barrier instruction. SYST is a synonym for ST. Encoded as option = 0b1110.</td> </tr> <tr> <td>LD</td> <td>Full system is the required shareability domain, reads are the required access type before the barrier instruction, and reads and writes are the required access types after the barrier instruction. Encoded as option = 0b1101.</td> </tr> </table>	SY	Full system is the required shareability domain, reads and writes are the required access types, both before and after the barrier instruction. Can be omitted. This option is referred to as the full system barrier. Encoded as option = 0b1111.	ST	Full system is the required shareability domain, writes are the required access type, both before and after the barrier instruction. SYST is a synonym for ST. Encoded as option = 0b1110.	LD	Full system is the required shareability domain, reads are the required access type before the barrier instruction, and reads and writes are the required access types after the barrier instruction. Encoded as option = 0b1101.
SY	Full system is the required shareability domain, reads and writes are the required access types, both before and after the barrier instruction. Can be omitted. This option is referred to as the full system barrier. Encoded as option = 0b1111.						
ST	Full system is the required shareability domain, writes are the required access type, both before and after the barrier instruction. SYST is a synonym for ST. Encoded as option = 0b1110.						
LD	Full system is the required shareability domain, reads are the required access type before the barrier instruction, and reads and writes are the required access types after the barrier instruction. Encoded as option = 0b1101.						

ISH	Inner Shareable is the required shareability domain, reads and writes are the required access types, both before and after the barrier instruction. Encoded as option = 0b1011.
ISHST	Inner Shareable is the required shareability domain, writes are the required access type, both before and after the barrier instruction. Encoded as option = 0b1010.
ISHLD	Inner Shareable is the required shareability domain, reads are the required access type before the barrier instruction, and reads and writes are the required access types after the barrier instruction. Encoded as option = 0b1001.
NSH	Non-shareable is the required shareability domain, reads and writes are the required access, both before and after the barrier instruction. Encoded as option = 0b0111.
NSHST	Non-shareable is the required shareability domain, writes are the required access type before the barrier instruction, and reads and writes are the required type after the barrier instruction. Encoded as option = 0b0110.
NSHLD	Non-shareable is the required shareability domain, reads are the required access type before the barrier instruction, and reads and writes are the required access types after the barrier instruction. Encoded as option = 0b0101.
OSH	Outer Shareable is the required shareability domain, reads and writes are the required access types, both before and after the barrier instruction. Encoded as option = 0b0011.
OSHST	Outer Shareable is the required shareability domain, writes are the required access type, both before and after the barrier instruction. Encoded as option = 0b0010.
OSHLD	Outer Shareable is the required shareability domain, reads are the required access type before the barrier instruction, and reads and writes are the required access types after the barrier instruction. Encoded as option = 0b0001.

For more information on whether an access is before or after a barrier instruction, see [Data Memory Barrier \(DMB\) on page E2-2769](#). All other encodings of option are reserved. It is IMPLEMENTATION DEFINED whether options other than SY are implemented. All unsupported and reserved options must execute as a full system DMB operation, but software must not rely on this behavior.

Note

The instruction supports the following alternative <option> values, but ARM recommends that software does not use these alternative values:

- SH as an alias for ISH.
- SHST as an alias for ISHST.
- UN as an alias for NSH.
- UNST as an alias for NSHST.

Operation for all encodings

```

if ConditionPassed() then
    EncodingSpecificOperations();
    case option of
        when '0001' domain = MBRReqDomain_OuterShareable; types = MBRReqTypes_Reads;
        when '0010' domain = MBRReqDomain_OuterShareable; types = MBRReqTypes_Writes;
        when '0011' domain = MBRReqDomain_OuterShareable; types = MBRReqTypes_All;
        when '0101' domain = MBRReqDomain_Nonshareable; types = MBRReqTypes_Reads;
        when '0110' domain = MBRReqDomain_Nonshareable; types = MBRReqTypes_Writes;
        when '0111' domain = MBRReqDomain_Nonshareable; types = MBRReqTypes_All;
        when '1001' domain = MBRReqDomain_InnerShareable; types = MBRReqTypes_Reads;
        when '1010' domain = MBRReqDomain_InnerShareable; types = MBRReqTypes_Writes;
        when '1011' domain = MBRReqDomain_InnerShareable; types = MBRReqTypes_All;
        when '1101' domain = MBRReqDomain_FullSystem; types = MBRReqTypes_Reads;
        when '1110' domain = MBRReqDomain_FullSystem; types = MBRReqTypes_Writes;
        otherwise domain = MBRReqDomain_FullSystem; types = MBRReqTypes_All;

    if HaveEL(EL2) && !IsSecure() && PSTATE.EL IN {EL0,EL1} then
        if HCR.BSU == '11' then
            domain = MBRReqDomain_FullSystem;
  
```

```
if HCR.BSU == '10' && domain != MBReqDomain_FullSystem then
    domain = MBReqDomain_OuterShareable;
if HCR.BSU == '01' && domain == MBReqDomain_Nonshareable then
    domain = MBReqDomain_InnerShareable;
```

```
DataMemoryBarrier(domain, types);
```

F5.1.44 DSB

Data Synchronization Barrier is a memory barrier that ensures the completion of memory accesses, see [Data Synchronization Barrier \(DSB\) on page E2-2769](#).

A1

31	30	29	28	27	26	25	24	23	22	21	20	19	18	17	16	15	14	13	12	11	10	9	8	7	6	5	4	3	0
1	1	1	1	0	1	0	1	0	1	1	1	(1)	(1)	(1)	(1)	(1)	(1)	(1)	(1)	(0)	(0)	(0)	(0)	0	1	0	0	option	

A1 variant

DSB{<c>}{<q>} {<option>}

Decode for this encoding

// No additional decoding required

T1

15	14	13	12	11	10	9	8	7	6	5	4	3	2	1	0	15	14	13	12	11	10	9	8	7	6	5	4	3	0
1	1	1	1	0	0	1	1	1	0	1	1	(1)	(1)	(1)	(1)	1	0	(0)	0	(1)	(1)	(1)	(1)	0	1	0	0	option	

T1 variant

DSB{<c>}{<q>} {<option>}

Decode for this encoding

// No additional decoding required

Notes for all encodings

For more information about the CONstrained UNpredictable behavior, see [Appendix K1 Architectural Constraints on UNpredictable behaviors](#).

Assembler symbols

<c>	For encoding A1: see Standard assembler syntax fields on page F2-2848 . Must be AL or omitted. For encoding T1: see Standard assembler syntax fields on page F2-2848 .						
<q>	See Standard assembler syntax fields on page F2-2848 .						
<option>	Specifies an optional limitation on the barrier operation. Values are: <table> <tr> <td>SY</td> <td>Full system is the required shareability domain, reads and writes are the required access types, both before and after the barrier instruction. Can be omitted. This option is referred to as the full system barrier. Encoded as option = 0b1111.</td> </tr> <tr> <td>ST</td> <td>Full system is the required shareability domain, writes are the required access type, both before and after the barrier instruction. SYST is a synonym for ST. Encoded as option = 0b1110.</td> </tr> <tr> <td>LD</td> <td>Full system is the required shareability domain, reads are the required access type before the barrier instruction, and reads and writes are the required access types after the barrier instruction. Encoded as option = 0b1101.</td> </tr> </table>	SY	Full system is the required shareability domain, reads and writes are the required access types, both before and after the barrier instruction. Can be omitted. This option is referred to as the full system barrier. Encoded as option = 0b1111.	ST	Full system is the required shareability domain, writes are the required access type, both before and after the barrier instruction. SYST is a synonym for ST. Encoded as option = 0b1110.	LD	Full system is the required shareability domain, reads are the required access type before the barrier instruction, and reads and writes are the required access types after the barrier instruction. Encoded as option = 0b1101.
SY	Full system is the required shareability domain, reads and writes are the required access types, both before and after the barrier instruction. Can be omitted. This option is referred to as the full system barrier. Encoded as option = 0b1111.						
ST	Full system is the required shareability domain, writes are the required access type, both before and after the barrier instruction. SYST is a synonym for ST. Encoded as option = 0b1110.						
LD	Full system is the required shareability domain, reads are the required access type before the barrier instruction, and reads and writes are the required access types after the barrier instruction. Encoded as option = 0b1101.						

ISH	Inner Shareable is the required shareability domain, reads and writes are the required access types, both before and after the barrier instruction. Encoded as option = 0b1011.
ISHST	Inner Shareable is the required shareability domain, writes are the required access type, both before and after the barrier instruction. Encoded as option = 0b1010.
ISHLD	Inner Shareable is the required shareability domain, reads are the required access type before the barrier instruction, and reads and writes are the required access types after the barrier instruction. Encoded as option = 0b1001.
NSH	Non-shareable is the required shareability domain, reads and writes are the required access, both before and after the barrier instruction. Encoded as option = 0b0111.
NSHST	Non-shareable is the required shareability domain, writes are the required access type before the barrier instruction, and reads and writes are the required type after the barrier instruction. Encoded as option = 0b0110.
NSHLD	Non-shareable is the required shareability domain, reads are the required access type before the barrier instruction, and reads and writes are the required access types after the barrier instruction. Encoded as option = 0b0101.
OSH	Outer Shareable is the required shareability domain, reads and writes are the required access types, both before and after the barrier instruction. Encoded as option = 0b0011.
OSHST	Outer Shareable is the required shareability domain, writes are the required access type, both before and after the barrier instruction. Encoded as option = 0b0010.
OSHLD	Outer Shareable is the required shareability domain, reads are the required access type before the barrier instruction, and reads and writes are the required access types after the barrier instruction. Encoded as option = 0b0001.

For more information on whether an access is before or after a barrier instruction, see [Data Synchronization Barrier \(DSB\) on page E2-2769](#). All other encodings of option are reserved. It is IMPLEMENTATION DEFINED whether options other than SY are implemented. All unsupported and reserved options must execute as a full system DSB operation, but software must not rely on this behavior.

———— **Note** ————

The instruction supports the following alternative <option> values, but ARM recommends that software does not use these alternative values:

- SH as an alias for ISH.
- SHST as an alias for ISHST.
- UN as an alias for NSH.
- UNST as an alias for NSHST.

Operation for all encodings

```

if ConditionPassed() then
    EncodingSpecificOperations();
    case option of
        when '0001' domain = MBRReqDomain_OuterShareable; types = MBRReqTypes_Reads;
        when '0010' domain = MBRReqDomain_OuterShareable; types = MBRReqTypes_Writes;
        when '0011' domain = MBRReqDomain_OuterShareable; types = MBRReqTypes_All;
        when '0101' domain = MBRReqDomain_Nonshareable; types = MBRReqTypes_Reads;
        when '0110' domain = MBRReqDomain_Nonshareable; types = MBRReqTypes_Writes;
        when '0111' domain = MBRReqDomain_Nonshareable; types = MBRReqTypes_All;
        when '1001' domain = MBRReqDomain_InnerShareable; types = MBRReqTypes_Reads;
        when '1010' domain = MBRReqDomain_InnerShareable; types = MBRReqTypes_Writes;
        when '1011' domain = MBRReqDomain_InnerShareable; types = MBRReqTypes_All;
        when '1101' domain = MBRReqDomain_FullSystem; types = MBRReqTypes_Reads;
        when '1110' domain = MBRReqDomain_FullSystem; types = MBRReqTypes_Writes;
        otherwise domain = MBRReqDomain_FullSystem; types = MBRReqTypes_All;

    if HaveEL(EL2) && !IsSecure() && PSTATE.EL IN {EL0,EL1} then
        if HCR.BSU == '11' then
  
```

```
    domain = MReqDomain_FullSystem;
    if HCR.BSU == '10' && domain != MReqDomain_FullSystem then
        domain = MReqDomain_OuterShareable;
    if HCR.BSU == '01' && domain == MReqDomain_Nonshareable then
        domain = MReqDomain_InnerShareable;

DataSynchronizationBarrier(domain, types);
```

F5.1.45 EOR, EORS (immediate)

Bitwise Exclusive OR (immediate) performs a bitwise Exclusive OR of a register value and an immediate value, and writes the result to the destination register.

If the destination register is not the PC, the EORS variant of the instruction updates the condition flags based on the result.

The field descriptions for <Rd> identify the encodings where the PC is permitted as the destination register. ARM deprecates any use of these encodings. However, when the destination register is the PC:

- The EOR variant of the instruction is an interworking branch, see *Pseudocode description of operations on the AArch32 general-purpose registers and the PC* on page E1-2733.
- The EORS variant of the instruction performs an exception return without the use of the stack. In this case:
 - The PE branches to the address written to the PC, and restores `PSTATE` from `SPSR_<current_mode>`.
 - The PE checks `SPSR_<current_mode>` for an illegal return event. See *Illegal return events from AArch32 state* on page G1-4361.
 - The instruction is UNDEFINED in Hyp mode.
 - The instruction is CONSTRAINED UNPREDICTABLE in User mode and System mode.

A1

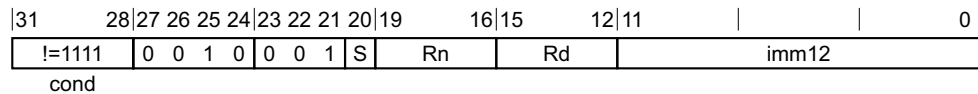

EOR variant

Applies when `S == 0`.

`EOR{<c>}{<q>} {<Rd>}, <Rn>, #<const>`

EORS variant

Applies when `S == 1`.

`EORS{<c>}{<q>} {<Rd>}, <Rn>, #<const>`

Decode for all variants of this encoding

```
d = UInt(Rd); n = UInt(Rn); setflags = (S == '1');
(imm32, carry) = A32ExpandImm_C(imm12, PSTATE.C);
```

T1

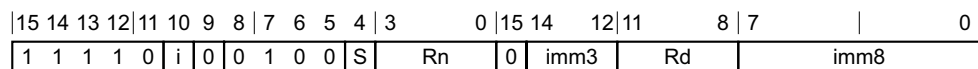

EOR variant

Applies when `S == 0`.

`EOR{<c>}{<q>} {<Rd>}, <Rn>, #<const>`

EORS variant

Applies when `S == 1 && Rd != 1111`.

EORS{<c>}{<q>} {<Rd>}, <Rn>, #<const>

Decode for all variants of this encoding

```
if Rd == '1111' && S == '1' then SEE TEQ (immediate);
d = UInt(Rd); n = UInt(Rn); setflags = (S == '1');
(imm32, carry) = T32ExpandImm_C(i:imm3:imm8, PSTATE.C);
if (d == 15 && !setflags) || n == 15 then UNPREDICTABLE;
// ARMv8-A removes UNPREDICTABLE for R13
```

Notes for all encodings

For more information about the CONSTRAINED UNPREDICTABLE behavior, see [Appendix K1 Architectural Constraints on UNPREDICTABLE behaviors](#).

Assembler symbols

<c>	See Standard assembler syntax fields on page F2-2848 .
<q>	See Standard assembler syntax fields on page F2-2848 .
<Rd>	For encoding A1: is the general-purpose destination register, encoded in the "Rd" field. If omitted, this register is the same as <Rn>. ARM deprecates using the PC as the destination register, but if the PC is used: <ul style="list-style-type: none"> For the EOR variant, the instruction is a branch to the address calculated by the operation. This is an interworking branch, see Pseudocode description of operations on the AArch32 general-purpose registers and the PC on page E1-2733. For the EORS variant, the instruction performs an exception return, that restores PSTATE from SPSR_<current_mode>. For encoding T1: is the general-purpose destination register, encoded in the "Rd" field. If omitted, this register is the same as <Rn>.
<Rn>	For encoding A1: is the general-purpose source register, encoded in the "Rn" field. The PC can be used, but this is deprecated. For encoding T1: is the general-purpose source register, encoded in the "Rn" field.
<const>	For encoding A1: an immediate value. See Modified immediate constants in A32 instructions on page F2-2864 for the range of values. For encoding T1: an immediate value. See Modified immediate constants in T32 instructions on page F2-2863 for the range of values.

Operation for all encodings

```
if ConditionPassed() then
  EncodingSpecificOperations();
  result = R[n] EOR imm32;
  if d == 15 then // Can only occur for A32 encoding
    if setflags then
      ALUExceptionReturn(result);
    else
      ALUWritePC(result);
  else
    R[d] = result;
    if setflags then
      PSTATE.N = result<31>;
      PSTATE.Z = IsZeroBit(result);
      PSTATE.C = carry;
      // PSTATE.V unchanged
```

F5.1.46 EOR, EORS (register)

Bitwise Exclusive OR (register) performs a bitwise Exclusive OR of a register value and an optionally-shifted register value, and writes the result to the destination register.

If the destination register is not the PC, the EORS variant of the instruction updates the condition flags based on the result.

The field descriptions for <Rd> identify the encodings where the PC is permitted as the destination register. ARM deprecates any use of these encodings. However, when the destination register is the PC:

- The EOR variant of the instruction is an interworking branch, see *Pseudocode description of operations on the AArch32 general-purpose registers and the PC* on page E1-2733.
- The EORS variant of the instruction performs an exception return without the use of the stack. In this case:
 - The PE branches to the address written to the PC, and restores `PSTATE` from `SPSR_<current_mode>`.
 - The PE checks `SPSR_<current_mode>` for an illegal return event. See *Illegal return events from AArch32 state* on page G1-4361.
 - The instruction is UNDEFINED in Hyp mode.
 - The instruction is CONSTRAINED UNPREDICTABLE in User mode and System mode.

A1

31	28 27 26 25 24 23 22 21 20 19	16 15	12 11	7 6 5 4 3	0
!=1111	0 0 0 0 0 0 1 S	Rn	Rd	imm5	type 0 Rm
cond					

EOR, rotate right with extend variant

Applies when `S == 0` && `imm5 == 00000` && `type == 11`.

`EOR{<c>}{<q>} {<Rd>}, <Rn>, <Rm>, RRX`

EOR, shift or rotate by value variant

Applies when `S == 0` && `!(imm5 == 00000 && type == 11)`.

`EOR{<c>}{<q>} {<Rd>}, <Rn>, <Rm> {, <shift> #<amount>}`

EORS, rotate right with extend variant

Applies when `S == 1` && `imm5 == 00000` && `type == 11`.

`EORS{<c>}{<q>} {<Rd>}, <Rn>, <Rm>, RRX`

EORS, shift or rotate by value variant

Applies when `S == 1` && `!(imm5 == 00000 && type == 11)`.

`EORS{<c>}{<q>} {<Rd>}, <Rn>, <Rm> {, <shift> #<amount>}`

Decode for all variants of this encoding

```
d = UInt(Rd); n = UInt(Rn); m = UInt(Rm); setflags = (S == '1');
(shift_t, shift_n) = DecodeImmShift(type, imm5);
```

T1

15	14	13	12	11	10	9	8	7	6	5	3	2	0
0	1	0	0	0	0	0	0	0	1	Rm	Rdn		

T1 variant

EOR<c>{<q>} {<Rdn>}, <Rdn>, <Rm> // Inside IT block
 EORS{<q>} {<Rdn>}, <Rdn>, <Rm> // Outside IT block

Decode for this encoding

```
d = UInt(Rdn); n = UInt(Rdn); m = UInt(Rm); setflags = !InITBlock();
(shift_t, shift_n) = (SRTYPE_LSL, 0);
```

T2

15	14	13	12	11	10	9	8	7	6	5	4	3	0	15	14	12	11	8	7	6	5	4	3	0
1	1	1	0	1	0	1	0	1	0	0	S	Rn	(0)	imm3	Rd	imm2	type	Rm						

EOR, rotate right with extend variant

Applies when S == 0 && imm3 == 000 && imm2 == 00 && type == 11.

EOR{<c>}{<q>} {<Rd>}, <Rn>, <Rm>, RRX

EOR, shift or rotate by value variant

Applies when S == 0 && !(imm3 == 000 && imm2 == 00 && type == 11).

EOR<c>.W {<Rd>}, <Rn>, <Rm> // Inside IT block, and <Rd>, <Rn>, <Rm> can be represented in T1
 EOR{<c>}{<q>} {<Rd>}, <Rn>, <Rm> {, <shift> #<amount>}

EORS, rotate right with extend variant

Applies when S == 1 && imm3 == 000 && Rd != 1111 && imm2 == 00 && type == 11.

EORS{<c>}{<q>} {<Rd>}, <Rn>, <Rm>, RRX

EORS, shift or rotate by value variant

Applies when S == 1 && !(imm3 == 000 && imm2 == 00 && type == 11) && Rd != 1111.

EORS.W {<Rd>}, <Rn>, <Rm> // Outside IT block, and <Rd>, <Rn>, <Rm> can be represented in T1
 EORS{<c>}{<q>} {<Rd>}, <Rn>, <Rm> {, <shift> #<amount>}

Decode for all variants of this encoding

```
if Rd == '1111' && S == '1' then SEE TEQ (register);
d = UInt(Rd); n = UInt(Rn); m = UInt(Rm); setflags = (S == '1');
(shift_t, shift_n) = DecodeImmShift(type, imm3:imm2);
if (d == 15 && !setflags) || n == 15 || m == 15 then UNPREDICTABLE;
// ARMv8-A removes UNPREDICTABLE for R13
```

Notes for all encodings

For more information about the CONSTRAINED UNPREDICTABLE behavior, see [Appendix K1 Architectural Constraints on UNPREDICTABLE behaviors](#).

Assembler symbols

- <c> See [Standard assembler syntax fields on page F2-2848](#).
- <q> See [Standard assembler syntax fields on page F2-2848](#).
- <Rdn> Is the first general-purpose source register and the destination register, encoded in the "Rdn" field.
- <Rd> For encoding A1: is the general-purpose destination register, encoded in the "Rd" field. If omitted, this register is the same as <Rn>. ARM deprecates using the PC as the destination register, but if the PC is used:
- For the EOR variant, the instruction is a branch to the address calculated by the operation. This is an interworking branch, see [Pseudocode description of operations on the AArch32 general-purpose registers and the PC on page E1-2733](#).
 - For the EORS variant, the instruction performs an exception return, that restores PSTATE from SPSR_<current_mode>.
- For encoding T2: is the general-purpose destination register, encoded in the "Rd" field. If omitted, this register is the same as <Rn>.
- <Rn> For encoding A1: is the first general-purpose source register, encoded in the "Rn" field. The PC can be used, but this is deprecated.
- For encoding T2: is the first general-purpose source register, encoded in the "Rn" field.
- <Rm> For encoding A1: is the second general-purpose source register, encoded in the "Rm" field. The PC can be used, but this is deprecated.
- For encoding T1 and T2: is the second general-purpose source register, encoded in the "Rm" field.
- <shift> Is the type of shift to be applied to the second source register, encoded in the "type" field. It can have the following values:
- | | |
|-----|----------------|
| LSL | when type = 00 |
| LSR | when type = 01 |
| ASR | when type = 10 |
| ROR | when type = 11 |
- <amount> For encoding A1: is the shift amount, in the range 1 to 31 (when <shift> = LSL or ROR) or 1 to 32 (when <shift> = LSR or ASR) encoded in the "imm5" field as <amount> modulo 32.
- For encoding T2: is the shift amount, in the range 1 to 31 (when <shift> = LSL or ROR) or 1 to 32 (when <shift> = LSR or ASR) encoded in the "imm3:imm2" field as <amount> modulo 32.

In T32 assembly:

- Outside an IT block, if EORS <Rd>, <Rn>, <Rd> has <Rd> and <Rn> both in the range R0-R7, it is assembled using encoding T1 as though EORS <Rd>, <Rn> had been written
- Inside an IT block, if EOR<c> <Rd>, <Rn>, <Rd> has <Rd> and <Rn> both in the range R0-R7, it is assembled using encoding T1 as though EOR<c> <Rd>, <Rn> had been written.

To prevent either of these happening, use the .W qualifier.

Operation for all encodings

```
if ConditionPassed() then
    EncodingSpecificOperations();
    (shifted, carry) = Shift_C(R[m], shift_t, shift_n, PSTATE.C);
    result = R[n] EOR shifted;
    if d == 15 then // Can only occur for A32 encoding
        if setflags then
            ALUExceptionReturn(result);
        else
            ALUWritePC(result);
```

```
else
  R[d] = result;
  if setflags then
    PSTATE.N = result<31>;
    PSTATE.Z = IsZeroBit(result);
    PSTATE.C = carry;
    // PSTATE.V unchanged
```

F5.1.47 EOR, EORS (register-shifted register)

Bitwise Exclusive OR (register-shifted register) performs a bitwise Exclusive OR of a register value and a register-shifted register value. It writes the result to the destination register, and can optionally update the condition flags based on the result.

A1

31	28	27	26	25	24	23	22	21	20	19	16	15	12	11	8	7	6	5	4	3	0	
!=1111				0 0 0 0				0 0 1		S	Rn			Rd		Rs		0	type	1	Rm	
cond																						

Flag setting variant

Applies when S == 1.

EORS{<c>}{<q>} {<Rd>}, <Rn>, <Rm>, <type> <Rs>

Not flag setting variant

Applies when S == 0.

EOR{<c>}{<q>} {<Rd>}, <Rn>, <Rm>, <type> <Rs>

Decode for all variants of this encoding

```
d = UInt(Rd); n = UInt(Rn); m = UInt(Rm); s = UInt(Rs);
setflags = (S == '1'); shift_t = DecodeRegShift(type);
if d == 15 || n == 15 || m == 15 || s == 15 then UNPREDICTABLE;
```

Notes for all encodings

For more information about the CONSTRAINED UNPREDICTABLE behavior, see [Appendix K1 Architectural Constraints on UNPREDICTABLE behaviors](#).

Assembler symbols

<c>	See Standard assembler syntax fields on page F2-2848 .								
<q>	See Standard assembler syntax fields on page F2-2848 .								
<Rd>	Is the general-purpose destination register, encoded in the "Rd" field.								
<Rn>	Is the first general-purpose source register, encoded in the "Rn" field.								
<Rm>	Is the second general-purpose source register, encoded in the "Rm" field.								
<type>	Is the type of shift to be applied to the second source register, encoded in the "type" field. It can have the following values: <table style="margin-left: 20px;"> <tr> <td>LSL</td> <td>when type = 00</td> </tr> <tr> <td>LSR</td> <td>when type = 01</td> </tr> <tr> <td>ASR</td> <td>when type = 10</td> </tr> <tr> <td>ROR</td> <td>when type = 11</td> </tr> </table>	LSL	when type = 00	LSR	when type = 01	ASR	when type = 10	ROR	when type = 11
LSL	when type = 00								
LSR	when type = 01								
ASR	when type = 10								
ROR	when type = 11								
<Rs>	Is the third general-purpose source register holding a shift amount in its bottom 8 bits, encoded in the "Rs" field.								

Operation

```
if ConditionPassed() then
    EncodingSpecificOperations();
    shift_n = UInt(R[s]<7:0>);
    (shifted, carry) = Shift_C(R[m], shift_t, shift_n, PSTATE.C);
    result = R[n] EOR shifted;
    R[d] = result;
    if setflags then
        PSTATE.N = result<31>;
        PSTATE.Z = IsZeroBit(result);
        PSTATE.C = carry;
        // PSTATE.V unchanged
```

F5.1.48 ERET

Exception Return.

The PE branches to the address held in the register holding the preferred return address, and restores [PSTATE](#) from `SPSR_<current_mode>`.

The register holding the preferred return address is:

- [ELR_hyp](#), when executing in Hyp mode.
- `LR`, when executing in a mode other than Hyp mode, User mode, or System mode.

The PE checks `SPSR_<current_mode>` for an illegal return event. See *Illegal return events from AArch32 state* on page G1-4361.

Exception Return is **CONSTRAINED UNPREDICTABLE** in User mode and System mode.

In Debug state, the T1 encoding of ERET executes the DRPS operation.

A1

31	28	27	26	25	24	23	22	21	20	19	18	17	16	15	14	13	12	11	10	9	8	7	6	5	4	3	2	1	0
!=1111	0	0	0	1	0	1	1	0	(0)	(0)	(0)	(0)	(0)	(0)	(0)	(0)	(0)	(0)	(0)	(0)	0	1	1	0	(1)	(1)	(1)	(0)	
cond																													

A1 variant

ERET{<c>}{<q>}

Decode for this encoding

// No additional decoding required

T1

15	14	13	12	11	10	9	8	7	6	5	4	3	2	1	0	15	14	13	12	11	10	9	8	7	6	5	4	3	2	1	0
1	1	1	1	0	0	1	1	1	1	0	1	1	1	0	1	0	(0)	0	(1)	(1)	(1)	(1)	0	0	0	0	0	0	0	0	

T1 variant

ERET{<c>}{<q>}

Decode for this encoding

if `InITBlock()` && `!LastInITBlock()` then UNPREDICTABLE;

Notes for all encodings

For more information about the **CONSTRAINED UNPREDICTABLE** behavior of this instruction, see [Appendix K1 Architectural Constraints on UNPREDICTABLE behaviors](#).

Assembler symbols

<c> See *Standard assembler syntax fields* on page F2-2848.

<q> See *Standard assembler syntax fields* on page F2-2848.

Operation for all encodings

```
if ConditionPassed() then
    EncodingSpecificOperations();
if PSTATE.M IN {M32_User, M32_System} then
    UNPREDICTABLE; // UNDEFINED or NOP
else
    new_pc_value = if PSTATE.EL == EL2 then ELR_hyp else R[14];
    AArch32.ExceptionReturn(new_pc_value, SPSR[]);
```

CONSTRAINED UNPREDICTABLE behavior

If PSTATE.M IN {M32_User, M32_System}, then one of the following behaviors must occur:

- The instruction is UNDEFINED.
- The instruction executes as NOP.

F5.1.49 ESB

Error Synchronization Barrier is a synchronization barrier instruction to barrier between errors. This instruction can be used at all Exception levels and in Debug state. This instruction might update DISR and VDISR.

In Debug state, this instruction behaves as if SError interrupts are masked at all Exception levels. See Error Synchronization Barrier in the *ARM® Reliability, Availability, and Serviceability (RAS) Specification, ARMv8, for ARMv8-A Architecture Profile*.

A1

ARMv8.2

31	28	27	26	25	24	23	22	21	20	19	18	17	16	15	14	13	12	11	10	9	8	7	6	5	4	3	2	1	0		
!	=	1	1	1	1	0	0	1	0	0	0	0	0	(1)	(1)	(1)	(1)	(0)	(0)	(0)	(0)	0	0	0	1	0	0	0	0		
cond																															

A1 variant

ESB{<c>}{<q>}

Decode for this encoding

if cond != '1110' then UNPREDICTABLE; // ESB must be encoded with AL condition

CONSTRAINED UNPREDICTABLE behavior

If cond != '1110', then one of the following behaviors must occur:

- The instruction is UNDEFINED.
- The instruction executes as NOP.
- The instruction executes unconditionally.
- The instruction executes conditionally.

T1

ARMv8.2

15	14	13	12	11	10	9	8	7	6	5	4	3	2	1	0	15	14	13	12	11	10	9	8	7	6	5	4	3	2	1	0
1	1	1	1	0	0	1	1	1	0	1	0	(1)	(1)	(1)	(1)	1	0	(0)	0	(0)	0	0	0	0	0	0	1	0	0	0	0

T1 variant

ESB{<c>}.W

Decode for this encoding

if InITBlock() then UNPREDICTABLE;

CONSTRAINED UNPREDICTABLE behavior

If InITBlock(), then one of the following behaviors must occur:

- The instruction is UNDEFINED.
- The instruction executes as NOP.

- The instruction executes unconditionally.
- The instruction executes conditionally.

Assembler symbols

<c> See *Standard assembler syntax fields* on page F2-2848.

<q> See *Standard assembler syntax fields* on page F2-2848.

Operation for all encodings

```
if ConditionPassed() then
    EncodingSpecificOperations();

    ErrorSynchronizationBarrier(MBReqDomain_FullSystem, MBReqTypes_All);
    AArch32.ESB0peration();
    if HaveEL(EL2) && !IsSecure() && PSTATE.EL IN {EL0,EL1} then AArch32.vESB0peration();
    TakeUnmaskedSErrorInterrupts();
```

F5.1.50 HLT

Halting breakpoint causes a software breakpoint to occur.

Halting breakpoint is always unconditional, even inside an IT block.

A1

31	28	27	26	25	24	23	22	21	20	19					8	7	6	5	4	3	0
!=1111										imm12						0 1 1 1				imm4	
cond																					

A1 variant

HLT{<q>} {#}<imm>

Decode for this encoding

```
if EDSCR.HDE == '0' || !HaltingAllowed() then UNDEFINED;
if cond != '1110' then UNPREDICTABLE; // HLT must be encoded with AL condition
```

CONSTRAINED UNPREDICTABLE behavior

If cond != '1110', then one of the following behaviors must occur:

- The instruction is UNDEFINED.
- The instruction executes as NOP.
- The instruction executes unconditionally.
- The instruction executes conditionally.

T1

15	14	13	12	11	10	9	8	7	6	5											0
1 0 1 1 1 0 1 0 1 0												imm6									

T1 variant

HLT{<q>} {#}<imm>

Decode for this encoding

```
if EDSCR.HDE == '0' || !HaltingAllowed() then UNDEFINED;
```

Notes for all encodings

For more information about the CONSTRAINED UNPREDICTABLE behavior of this instruction, see [Appendix K1 Architectural Constraints on UNPREDICTABLE behaviors](#).

Assembler symbols

<q> See [Standard assembler syntax fields on page F2-2848](#). An HLT instruction must be unconditional.

<imm> For encoding A1: is a 16-bit unsigned immediate, in the range 0 to 65535, encoded in the "imm12:imm4" field. This value is for assembly and disassembly only. It is ignored by the PE, but can be used by a debugger to store more information about the halting breakpoint.

For encoding T1: is a 6-bit unsigned immediate, in the range 0 to 63, encoded in the "imm6" field. This value is for assembly and disassembly only. It is ignored by the PE, but can be used by a debugger to store more information about the halting breakpoint.

Operation for all encodings

```
EncodingSpecificOperations();  
Halt(DebugHalt_HaltInstruction);
```

F5.1.51 HVC

Hypervisor Call causes a Hypervisor Call exception. For more information see [Hypervisor Call \(HVC\) exception on page G1-4383](#). Non-secure software executing at EL1 can use this instruction to call the hypervisor to request a service.

The HVC instruction is:

- UNDEFINED in Secure state, and in User mode in Non-secure state.
- When SCR.HCE is set to 0, UNDEFINED in Non-secure EL1 modes and CONSTRAINED UNPREDICTABLE in Hyp mode.

On executing an HVC instruction, the HSR reports the exception as a Hypervisor Call exception, using the EC value 0x12, and captures the value of the immediate argument, see [Use of the HSR on page G4-4677](#).

A1

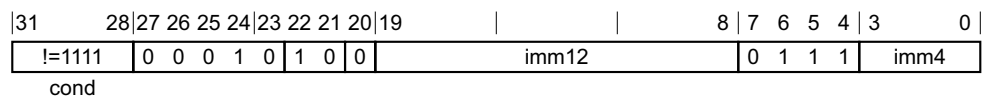

A1 variant

HVC{<q>} {#}<imm16>

Decode for this encoding

```
if cond != '1110' then UNPREDICTABLE;
imm16 = imm12:imm4;
```

CONSTRAINED UNPREDICTABLE behavior

If cond != '1110', then one of the following behaviors must occur:

- The instruction is UNDEFINED.
- The instruction executes as NOP.
- The instruction executes unconditionally.
- The instruction executes conditionally.

T1

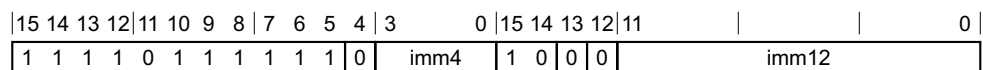

T1 variant

HVC{<q>} {#}<imm16>

Decode for this encoding

```
imm16 = imm4:imm12;
if InITBlock() then UNPREDICTABLE;
```

Notes for all encodings

For more information about the CONSTRAINED UNPREDICTABLE behavior of this instruction, see [Appendix K1 Architectural Constraints on UNPREDICTABLE behaviors](#).

Assembler symbols

- <q> See [Standard assembler syntax fields on page F2-2848](#). An HVC instruction must be unconditional.
- <imm16> For encoding A1: is a 16-bit unsigned immediate, in the range 0 to 65535, encoded in the "imm12:imm4" field. This value is for assembly and disassembly only. It is reported in the HSR but otherwise is ignored by hardware. An HVC handler might interpret imm16, for example to determine the required service.
- For encoding T1: is a 16-bit unsigned immediate, in the range 0 to 65535, encoded in the "imm4:imm12" field. This value is for assembly and disassembly only. It is reported in the HSR but otherwise is ignored by hardware. An HVC handler might interpret imm16, for example to determine the required service.

Operation for all encodings

```
EncodingSpecificOperations();
if !HaveEL(EL2) || PSTATE.EL == EL0 || IsSecure() then
    UNDEFINED;

if HaveEL(EL3) then
    if ELUsingAArch32(EL3) && SCR.HCE == '0' && PSTATE.EL == EL2 then
        UNPREDICTABLE;
    else
        hvc_enable = SCR_GEN[].HCE;
else
    hvc_enable = if ELUsingAArch32(EL2) then NOT(HCR.HCD) else NOT(HCR_EL2.HCD);

if hvc_enable == '0' then
    UNDEFINED;
else
    AArch32.CallHypervisor(imm16);
```

CONSTRAINED UNPREDICTABLE behavior

If ELUsingAArch32(EL3) && SCR.HCE == '0' && PSTATE.EL == EL2, then one of the following behaviors must occur:

- The instruction is UNDEFINED.
- The instruction executes as NOP.

F5.1.52 ISB

Instruction Synchronization Barrier flushes the pipeline in the PE and is a context synchronization event. For more information, see [Instruction Synchronization Barrier \(ISB\)](#) on page E2-2768.

A1

31	30	29	28	27	26	25	24	23	22	21	20	19	18	17	16	15	14	13	12	11	10	9	8	7	6	5	4	3	0
1	1	1	1	0	1	0	1	0	1	1	1	(1)	(1)	(1)	(1)	(1)	(1)	(1)	(1)	(0)	(0)	(0)	(0)	0	1	1	0	option	

A1 variant

ISB{<c>}{<q>} {<option>}

Decode for this encoding

// No additional decoding required

T1

15	14	13	12	11	10	9	8	7	6	5	4	3	2	1	0	15	14	13	12	11	10	9	8	7	6	5	4	3	0
1	1	1	1	0	0	1	1	1	0	1	1	(1)	(1)	(1)	(1)	1	0	(0)	0	(1)	(1)	(1)	(1)	0	1	1	0	option	

T1 variant

ISB{<c>}{<q>} {<option>}

Decode for this encoding

// No additional decoding required

Notes for all encodings

For more information about the CONSTRAINED UNPREDICTABLE behavior, see [Appendix K1 Architectural Constraints on UNPREDICTABLE behaviors](#).

Assembler symbols

- <c> For encoding A1: see [Standard assembler syntax fields](#) on page F2-2848. Must be AL or omitted.
 For encoding T1: see [Standard assembler syntax fields](#) on page F2-2848.
- <q> See [Standard assembler syntax fields](#) on page F2-2848.
- <option> Specifies an optional limitation on the barrier operation. Values are:
 - SY Full system barrier operation, encoded as option = 0b1111. Can be omitted.
 All other encodings of option are reserved. The corresponding instructions execute as full system barrier operations, but must not be relied upon by software.

Operation for all encodings

```
if ConditionPassed() then
    EncodingSpecificOperations();
    InstructionSynchronizationBarrier();
```

F5.1.53 IT

If-Then makes up to four following instructions (the IT block) conditional. The conditions for the instructions in the IT block are the same as, or the inverse of, the condition the IT instruction specifies for the first instruction in the block.

The IT instruction itself does not affect the condition flags, but the execution of the instructions in the IT block can change the condition flags.

16-bit instructions in the IT block, other than CMP, CMN and TST, do not set the condition flags. An IT instruction with the AL condition can change the behavior without conditional execution.

The architecture permits exception return to an instruction in the IT block only if the restoration of the CPSR restores ITSTATE to a state consistent with the conditions specified by the IT instruction. Any other exception return to an instruction in an IT block is UNPREDICTABLE. Any branch to a target instruction in an IT block is not permitted, and if such a branch is made it is UNPREDICTABLE what condition is used when executing that target instruction and any subsequent instruction in the IT block.

Many uses of the IT instruction are deprecated for performance reasons, and an implementation might include ITD controls that can disable those uses of IT, making them UNDEFINED.

For more information see [Conditional execution on page F2-2849](#) and [Conditional instructions on page F1-2809](#). The first of these sections includes more information about the ITD controls.

T1

15	14	13	12	11	10	9	8	7	4	3	0
1	0	1	1	1	1	1	1	firstcond	!=0000		
mask											

T1 variant

IT{<x>{<y>{<z>}}}{<q> <cond>

Decode for this encoding

```
if mask == '0000' then SEE "Related encodings";
if firstcond == '1111' || (firstcond == '1110' && BitCount(mask) != 1) then UNPREDICTABLE;
if InITBlock() then UNPREDICTABLE;
```

CONSTRAINED UNPREDICTABLE behavior

If firstcond == '1111', then one of the following behaviors must occur:

- The instruction is UNDEFINED.
- The instruction executes as NOP.
- The instruction executes with the additional decode: firstcond = '1110';

If firstcond == '1110' && BitCount(mask) != 1, then one of the following behaviors must occur:

- The instruction is UNDEFINED.
- The instruction executes as NOP.

Notes for all encodings

For more information about the CONSTRAINED UNPREDICTABLE behavior of this instruction, see [Appendix K1 Architectural Constraints on UNPREDICTABLE behaviors](#).

Related encodings: [Miscellaneous 16-bit instructions on page F3-2883](#).

Assembler symbols

- <x> The condition for the second instruction in the IT block. If omitted, the "mask" field is set to 0b1000. If present it is encoded in the "mask[3]" field:
- | | |
|---|------------------|
| T | firstcond[0] |
| E | NOT firstcond[0] |
- <y> The condition for the third instruction in the IT block. If omitted and <x> is present, the "mask[2:0]" field is set to 0b100. If <y> is present it is encoded in the "mask[2]" field:
- | | |
|---|------------------|
| T | firstcond[0] |
| E | NOT firstcond[0] |
- <z> The condition for the fourth instruction in the IT block. If omitted and <y> is present, the "mask[1:0]" field is set to 0b10. If <z> is present, the "mask[0]" field is set to 1, and it is encoded in the "mask[1]" field:
- | | |
|---|------------------|
| T | firstcond[0] |
| E | NOT firstcond[0] |
- <q> See [Standard assembler syntax fields on page F2-2848](#).
- <cond> The condition for the first instruction in the IT block, encoded in the "firstcond" field. See [Table F2-1 on page F2-2849](#) for the range of conditions available, and the encodings.

The conditions specified in an IT instruction must match those specified in the syntax of the instructions in its IT block. When assembling to A32 code, assemblers check IT instruction syntax for validity but do not generate assembled instructions for them. See [Conditional instructions on page F1-2809](#).

Operation

```
EncodingSpecificOperations();  
AArch32.CheckITEnabled(mask);  
PSTATE.IT<7:0> = firstcond:mask;
```

F5.1.54 LDA

Load-Acquire Word loads a word from memory and writes it to a register. The instruction also has memory ordering semantics as described in *Load-Acquire, Store-Release* on page E2-2770

For more information about support for shared memory see *Synchronization and semaphores* on page E2-2795. For information about memory accesses see *Memory accesses* on page F2-2854.

A1

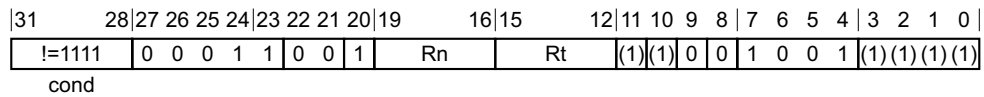

A1 variant

LDA{<c>}{<q>} <Rt>, [<Rn>]

Decode for this encoding

```
t = UInt(Rt); n = UInt(Rn);
if t == 15 || n == 15 then UNPREDICTABLE;
```

T1

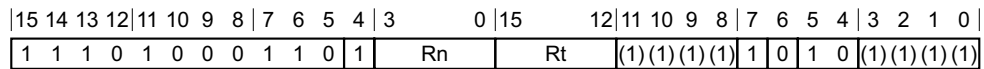

T1 variant

LDA{<c>}{<q>} <Rt>, [<Rn>]

Decode for this encoding

```
t = UInt(Rt); n = UInt(Rn);
if t == 15 || n == 15 then UNPREDICTABLE;
```

Notes for all encodings

For more information about the CONSTRAINED UNPREDICTABLE behavior, see [Appendix K1 Architectural Constraints on UNPREDICTABLE behaviors](#).

Assembler symbols

- <c> See [Standard assembler syntax fields](#) on page F2-2848.
- <q> See [Standard assembler syntax fields](#) on page F2-2848.
- <Rt> Is the general-purpose register to be transferred, encoded in the "Rt" field.
- <Rn> Is the general-purpose base register, encoded in the "Rn" field.

Operation for all encodings

```
if ConditionPassed() then
    EncodingSpecificOperations();
    address = R[n];
    R[t] = Mem0[address, 4];
```

F5.1.55 LDAB

Load-Acquire Byte loads a byte from memory, zero-extends it to form a 32-bit word and writes it to a register. The instruction also has memory ordering semantics as described in *Load-Acquire, Store-Release* on page E2-2770.

For more information about support for shared memory see *Synchronization and semaphores* on page E2-2795. For information about memory accesses see *Memory accesses* on page F2-2854.

A1

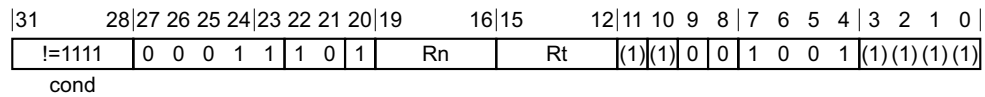

A1 variant

LDAB{<c>}{<q>} <Rt>, [<Rn>]

Decode for this encoding

```
t = UInt(Rt); n = UInt(Rn);
if t == 15 || n == 15 then UNPREDICTABLE;
```

T1

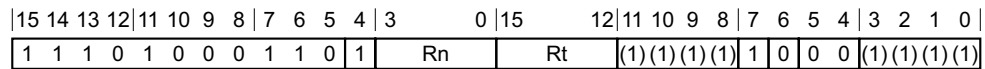

T1 variant

LDAB{<c>}{<q>} <Rt>, [<Rn>]

Decode for this encoding

```
t = UInt(Rt); n = UInt(Rn);
if t == 15 || n == 15 then UNPREDICTABLE;
```

Notes for all encodings

For more information about the CONSTRAINED UNPREDICTABLE behavior, see [Appendix K1 Architectural Constraints on UNPREDICTABLE behaviors](#).

Assembler symbols

- <c> See *Standard assembler syntax fields* on page F2-2848.
- <q> See *Standard assembler syntax fields* on page F2-2848.
- <Rt> Is the general-purpose register to be transferred, encoded in the "Rt" field.
- <Rn> Is the general-purpose base register, encoded in the "Rn" field.

Operation for all encodings

```
if ConditionPassed() then
    EncodingSpecificOperations();
    address = R[n];
    R[t] = ZeroExtend(Mem0[address, 1], 32);
```

F5.1.56 LDAEX

Load-Acquire Exclusive Word loads a word from memory, writes it to a register and:

- If the address has the Shared Memory attribute, marks the physical address as exclusive access for the executing PE in a global monitor.
- Causes the executing PE to indicate an active exclusive access in the local monitor.

The instruction also has memory ordering semantics as described in *Load-Acquire, Store-Release* on page E2-2770.

For more information about support for shared memory see *Synchronization and semaphores* on page E2-2795. For information about memory accesses see *Memory accesses* on page F2-2854.

A1

31	28	27	26	25	24	23	22	21	20	19	16	15	12	11	10	9	8	7	6	5	4	3	2	1	0
!=1111				0	0	0	1	1	0	0	1	Rn	Rt	(1)	(1)	1	0	1	0	0	1	(1)	(1)	(1)	(1)
cond																									

A1 variant

LDAEX{<c>}{<q>} <Rt>, [<Rn>]

Decode for this encoding

t = UInt(Rt); n = UInt(Rn);
 if t == 15 || n == 15 then UNPREDICTABLE;

T1

15	14	13	12	11	10	9	8	7	6	5	4	3	0	15	12	11	10	9	8	7	6	5	4	3	2	1	0
1	1	1	0	1	0	0	0	1	1	0	1	Rn	Rt	(1)	(1)	(1)	(1)	1	1	1	0	(1)	(1)	(1)	(1)		

T1 variant

LDAEX{<c>}{<q>} <Rt>, [<Rn>]

Decode for this encoding

t = UInt(Rt); n = UInt(Rn);
 if t == 15 || n == 15 then UNPREDICTABLE;

Notes for all encodings

For more information about the CONSTRAINED UNPREDICTABLE behavior of this instruction, see [Appendix K1 Architectural Constraints on UNPREDICTABLE behaviors](#).

Assembler symbols

- <c> See [Standard assembler syntax fields](#) on page F2-2848.
- <q> See [Standard assembler syntax fields](#) on page F2-2848.
- <Rt> Is the general-purpose register to be transferred, encoded in the "Rt" field.
- <Rn> Is the general-purpose base register, encoded in the "Rn" field.

Operation for all encodings

```
if ConditionPassed() then
    EncodingSpecificOperations();
    address = R[n];
    AArch32.SetExclusiveMonitors(address, 4);
    R[t] = Mem0[address, 4];
```

F5.1.57 LDAEXB

Load-Acquire Exclusive Byte loads a byte from memory, zero-extends it to form a 32-bit word, writes it to a register and:

- If the address has the Shared Memory attribute, marks the physical address as exclusive access for the executing PE in a global monitor.
- Causes the executing PE to indicate an active exclusive access in the local monitor.

The instruction also has memory ordering semantics as described in *Load-Acquire, Store-Release* on page E2-2770.

For more information about support for shared memory see *Synchronization and semaphores* on page E2-2795. For information about memory accesses see *Memory accesses* on page F2-2854.

A1

31	28	27	26	25	24	23	22	21	20	19	16	15	12	11	10	9	8	7	6	5	4	3	2	1	0		
!=1111				0	0	0	1	1	1	0	1	Rn	Rt	(1)	(1)	1	0	1	0	0	1	(1)	(1)	(1)	(1)		
cond																											

A1 variant

LDAEXB{<c>}{<q>} <Rt>, [<Rn>]

Decode for this encoding

t = UInt(Rt); n = UInt(Rn);
 if t == 15 || n == 15 then UNPREDICTABLE;

T1

15	14	13	12	11	10	9	8	7	6	5	4	3	0	15	12	11	10	9	8	7	6	5	4	3	2	1	0
1	1	1	0	1	0	0	0	1	1	0	1	Rn	Rt	(1)	(1)	(1)	(1)	1	1	0	0	(1)	(1)	(1)	(1)		

T1 variant

LDAEXB{<c>}{<q>} <Rt>, [<Rn>]

Decode for this encoding

t = UInt(Rt); n = UInt(Rn);
 if t == 15 || n == 15 then UNPREDICTABLE;

Notes for all encodings

For more information about the CONSTRAINED UNPREDICTABLE behavior of this instruction, see [Appendix K1 Architectural Constraints on UNPREDICTABLE behaviors](#).

Assembler symbols

- <c> See [Standard assembler syntax fields](#) on page F2-2848.
- <q> See [Standard assembler syntax fields](#) on page F2-2848.
- <Rt> Is the general-purpose register to be transferred, encoded in the "Rt" field.
- <Rn> Is the general-purpose base register, encoded in the "Rn" field.

Operation for all encodings

```
if ConditionPassed() then
    EncodingSpecificOperations();
    address = R[n];
    AArch32.SetExclusiveMonitors(address, 1);
    R[t] = ZeroExtend(Mem0[address, 1], 32);
```

F5.1.58 LDAEXD

Load-Acquire Exclusive Doubleword loads a doubleword from memory, writes it to two registers and:

- If the address has the Shared Memory attribute, marks the physical address as exclusive access for the executing PE in a global monitor
- Causes the executing PE to indicate an active exclusive access in the local monitor.

The instruction also acts as a barrier instruction with the ordering requirements described in [Load-Acquire, Store-Release on page E2-2770](#).

For more information about support for shared memory see [Synchronization and semaphores on page E2-2795](#). For information about memory accesses see [Memory accesses on page F2-2854](#).

A1

31	28	27	26	25	24	23	22	21	20	19	16	15	12	11	10	9	8	7	6	5	4	3	2	1	0		
!=1111				0	0	0	1	1	0	1	1	Rn	Rt	(1)	(1)	1	0	1	0	0	1	(1)	(1)	(1)	(1)		
cond																											

A1 variant

LDAEXD{<c>}{<q>} <Rt>, <Rt2>, [<Rn>]

Decode for this encoding

t = UInt(Rt); t2 = t + 1; n = UInt(Rn);
 if Rt<0> == '1' || t2 == 15 || n == 15 then UNPREDICTABLE;

CONSTRAINED UNPREDICTABLE behavior

If Rt<0> == '1', then one of the following behaviors must occur:

- The instruction is UNDEFINED.
- The instruction executes as NOP.
- The instruction executes with the additional decode: t<0> = '0'.
- The instruction executes with the additional decode: t2 = t.
- The instruction executes as described, with no change to its behavior and no additional side effects.

If Rt == '1110', then one of the following behaviors must occur:

- The instruction is UNDEFINED.
- The instruction executes as NOP.
- The instruction is handled as described in [Using R15 on page K1-6097](#).

T1

15	14	13	12	11	10	9	8	7	6	5	4	3	0	15	12	11	8	7	6	5	4	3	2	1	0
1	1	1	0	1	0	0	0	1	1	0	1	Rn	Rt	Rt2	1	1	1	1	(1)	(1)	(1)	(1)			

T1 variant

LDAEXD{<c>}{<q>} <Rt>, <Rt2>, [<Rn>]

Decode for this encoding

```
t = UInt(Rt); t2 = UInt(Rt2); n = UInt(Rn);  
if t == 15 || t2 == 15 || t == t2 || n == 15 then UNPREDICTABLE;
```

CONSTRAINED UNPREDICTABLE behavior

If $t == t2$, then one of the following behaviors must occur:

- The instruction is UNDEFINED.
- The instruction executes as NOP.
- The load instruction executes but the destination register takes an UNKNOWN value.

Notes for all encodings

For more information about the CONSTRAINED UNPREDICTABLE behavior of this instruction, see [Appendix K1 Architectural Constraints on UNPREDICTABLE behaviors](#).

Assembler symbols

<c>	See Standard assembler syntax fields on page F2-2848 .
<q>	See Standard assembler syntax fields on page F2-2848 .
<Rt>	For encoding A1: is the first general-purpose register to be transferred, encoded in the "Rt" field. <Rt> must be even-numbered and not R14. For encoding T1: is the first general-purpose register to be transferred, encoded in the "Rt" field.
<Rt2>	For encoding A1: is the second general-purpose register to be transferred. <Rt2> must be <R(t+1)>. For encoding T1: is the second general-purpose register to be transferred, encoded in the "Rt2" field.
<Rn>	Is the general-purpose base register, encoded in the "Rn" field.

Operation for all encodings

```
if ConditionPassed() then  
    EncodingSpecificOperations();  
    address = R[n];  
    AArch32.SetExclusiveMonitors(address, 8);  
    value = Mem0[address, 8];  
    // Extract words from 64-bit loaded value such that R[t] is  
    // loaded from address and R[t2] from address+4.  
    R[t] = if BigEndian() then value<63:32> else value<31:0>;  
    R[t2] = if BigEndian() then value<31:0> else value<63:32>;
```

F5.1.59 LDAEXH

Load-Acquire Exclusive Halfword loads a halfword from memory, zero-extends it to form a 32-bit word, writes it to a register and:

- If the address has the Shared Memory attribute, marks the physical address as exclusive access for the executing PE in a global monitor.
- Causes the executing PE to indicate an active exclusive access in the local monitor.

The instruction also has memory ordering semantics as described in *Load-Acquire, Store-Release* on page E2-2770.

For more information about support for shared memory see *Synchronization and semaphores* on page E2-2795. For information about memory accesses see *Memory accesses* on page F2-2854.

A1

31	28	27	26	25	24	23	22	21	20	19	16	15	12	11	10	9	8	7	6	5	4	3	2	1	0		
!=1111				0	0	0	1	1	1	1	Rn	Rt	(1)	(1)	1	0	1	0	0	1	(1)	(1)	(1)	(1)			
cond																											

A1 variant

LDAEXH{<c>}{<q>} <Rt>, [<Rn>]

Decode for this encoding

t = UInt(Rt); n = UInt(Rn);
 if t == 15 || n == 15 then UNPREDICTABLE;

T1

15	14	13	12	11	10	9	8	7	6	5	4	3	0	15	12	11	10	9	8	7	6	5	4	3	2	1	0
1	1	1	0	1	0	0	0	1	1	0	1	Rn	Rt	(1)	(1)	(1)	(1)	1	1	0	1	(1)	(1)	(1)	(1)		

T1 variant

LDAEXH{<c>}{<q>} <Rt>, [<Rn>]

Decode for this encoding

t = UInt(Rt); n = UInt(Rn);
 if t == 15 || n == 15 then UNPREDICTABLE;

Notes for all encodings

For more information about the CONSTRAINED UNPREDICTABLE behavior of this instruction, see [Appendix K1 Architectural Constraints on UNPREDICTABLE behaviors](#).

Assembler symbols

- <c> See [Standard assembler syntax fields](#) on page F2-2848.
- <q> See [Standard assembler syntax fields](#) on page F2-2848.
- <Rt> Is the general-purpose register to be transferred, encoded in the "Rt" field.
- <Rn> Is the general-purpose base register, encoded in the "Rn" field.

Operation for all encodings

```
if ConditionPassed() then
    EncodingSpecificOperations();
    address = R[n];
    AArch32.SetExclusiveMonitors(address, 2);
    R[t] = ZeroExtend(Mem0[address, 2], 32);
```

F5.1.60 LDAH

Load-Acquire Halfword loads a halfword from memory, zero-extends it to form a 32-bit word and writes it to a register. The instruction also has memory ordering semantics as described in [Load-Acquire, Store-Release on page E2-2770](#).

For more information about support for shared memory see [Synchronization and semaphores on page E2-2795](#). For information about memory accesses see [Memory accesses on page F2-2854](#).

A1

31	28	27	26	25	24	23	22	21	20	19	16	15	12	11	10	9	8	7	6	5	4	3	2	1	0		
!=1111				0	0	0	1	1	1	1	Rn	Rt	(1)	(1)	0	0	1	0	0	1	(1)	(1)	(1)	(1)			
cond																											

A1 variant

LDAH{<c>}{<q>} <Rt>, [<Rn>]

Decode for this encoding

t = UInt(Rt); n = UInt(Rn);
 if t == 15 || n == 15 then UNPREDICTABLE;

T1

15	14	13	12	11	10	9	8	7	6	5	4	3	0	15	12	11	10	9	8	7	6	5	4	3	2	1	0
1	1	1	0	1	0	0	0	1	1	0	1	Rn	Rt	(1)	(1)	(1)	(1)	1	0	0	1	(1)	(1)	(1)	(1)		

T1 variant

LDAH{<c>}{<q>} <Rt>, [<Rn>]

Decode for this encoding

t = UInt(Rt); n = UInt(Rn);
 if t == 15 || n == 15 then UNPREDICTABLE;

Notes for all encodings

For more information about the CONSTRAINED UNPREDICTABLE behavior, see [Appendix K1 Architectural Constraints on UNPREDICTABLE behaviors](#).

Assembler symbols

- <c> See [Standard assembler syntax fields on page F2-2848](#).
- <q> See [Standard assembler syntax fields on page F2-2848](#).
- <Rt> Is the general-purpose register to be transferred, encoded in the "Rt" field.
- <Rn> Is the general-purpose base register, encoded in the "Rn" field.

Operation for all encodings

```
if ConditionPassed() then
    EncodingSpecificOperations();
    address = R[n];
    R[t] = ZeroExtend(Mem0[address, 2], 32);
```

F5.1.61 LDC (immediate)

Load data to System register (immediate) calculates an address from a base register value and an immediate offset, loads a word from memory, and writes it to the **DBGDTRXint** System register. It can use offset, post-indexed, pre-indexed, or unindexed addressing. For information about memory accesses see [Memory accesses on page F2-2854](#).

In an implementation that includes EL2, the permitted LDC access to **DBGDTRXint** can be trapped to Hyp mode, meaning that an attempt to execute an LDC instruction in a Non-secure mode other than Hyp mode, that would be permitted in the absence of the Hyp trap controls, generates a Hyp Trap exception. For more information, see [Trapping general Non-secure System register accesses to debug registers on page G1-4443](#).

For simplicity, the LDC pseudocode does not show this possible trap to Hyp mode.

A1

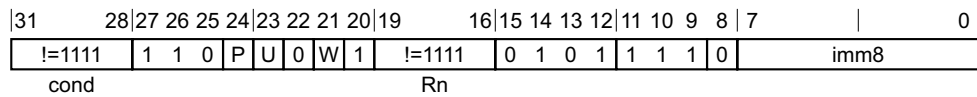

Offset variant

Applies when $P == 1 \ \&\& \ W == 0$.

LDC{<c>}{<q>} p14, c5, [<Rn>{, #<+/-><imm>}]

Post-indexed variant

Applies when $P == 0 \ \&\& \ W == 1$.

LDC{<c>}{<q>} p14, c5, [<Rn>], #<+/-><imm>

Pre-indexed variant

Applies when $P == 1 \ \&\& \ W == 1$.

LDC{<c>}{<q>} p14, c5, [<Rn>, #<+/-><imm>]!

Unindexed variant

Applies when $P == 0 \ \&\& \ U == 1 \ \&\& \ W == 0$.

LDC{<c>}{<q>} p14, c5, [<Rn>], <option>

Decode for all variants of this encoding

```

if Rn == '1111' then SEE LDC (literal);
if P == '0' && U == '0' && W == '0' then UNDEFINED;
n = UInt(Rn); cp = 14;
imm32 = ZeroExtend(imm8:'00', 32); index = (P == '1'); add = (U == '1'); wback = (W == '1');
```

T1

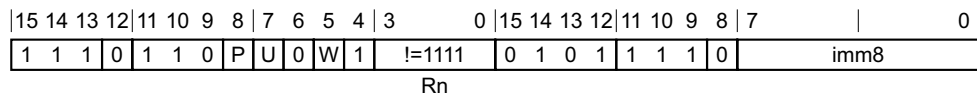

Offset variant

Applies when $P == 1 \ \&\& \ W == 0$.

LDC{<c>}{<q>} p14, c5, [<Rn>{, #<+/-><imm>}]

Post-indexed variant

Applies when P == 0 && W == 1.

LDC{<c>}{<q>} p14, c5, [<Rn>], #<+/-><imm>

Pre-indexed variant

Applies when P == 1 && W == 1.

LDC{<c>}{<q>} p14, c5, [<Rn>, #<+/-><imm>]!

Unindexed variant

Applies when P == 0 && U == 1 && W == 0.

LDC{<c>}{<q>} p14, c5, [<Rn>], <option>

Decode for all variants of this encoding

```
if Rn == '1111' then SEE LDC (literal);
if P == '0' && U == '0' && W == '0' then UNDEFINED;
n = UInt(Rn); cp = 14;
imm32 = ZeroExtend(imm8:'00', 32); index = (P == '1'); add = (U == '1'); wback = (W == '1');
```

Assembler symbols

- <c> See [Standard assembler syntax fields on page F2-2848](#).
- <q> See [Standard assembler syntax fields on page F2-2848](#).
- <Rn> Is the general-purpose base register, encoded in the "Rn" field. If the PC is used, see [LDC \(literal\)](#).
- <option> Is an 8-bit immediate, in the range 0 to 255 enclosed in { }, encoded in the "imm8" field. The value of this field is ignored when executing this instruction.
- +/- Specifies the offset is added to or subtracted from the base register, defaulting to + if omitted and encoded in the "U" field. It can have the following values:
 - when U = 0
 - + when U = 1
- <imm> Is the immediate offset used for forming the address, a multiple of 4 in the range 0-1020, defaulting to 0 and encoded in the "imm8" field, as <imm>/4.

Operation for all encodings

```
if ConditionPassed() then
  EncodingSpecificOperations();
  AArch32.CheckSystemAccess(cp, ThisInstr());
  offset_addr = if add then (R[n] + imm32) else (R[n] - imm32);
  address = if index then offset_addr else R[n];

  // System register write to DBGDTRXint.
  DBGDTR_EL0[] = MemA[address,4];

  if wback then R[n] = offset_addr;
```

F5.1.62 LDC (literal)

Load data to System register (literal) calculates an address from the PC value and an immediate offset, loads a word from memory, and writes it to the **DBGDTRXint** System register. For information about memory accesses see [Memory accesses on page F2-2854](#).

In an implementation that includes EL2, the permitted LDC access to **DBGDTRXint** can be trapped to Hyp mode, meaning that an attempt to execute an LDC instruction in a Non-secure mode other than Hyp mode, that would be permitted in the absence of the Hyp trap controls, generates a Hyp Trap exception. For more information, see [Trapping general Non-secure System register accesses to debug registers on page G1-4443](#).

For simplicity, the LDC pseudocode does not show this possible trap to Hyp mode.

A1

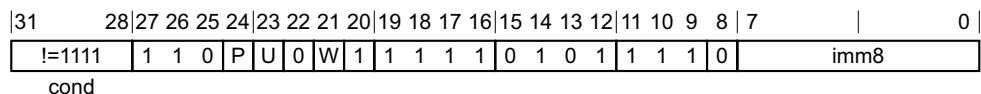

A1 variant

Applies when $!(P == 0 \ \&\& \ U == 0 \ \&\& \ W == 0)$.

```
LDC{<c>}{<q>} p14, c5, <label>
LDC{<c>}{<q>} p14, c5, [PC, #+/-<imm>]
LDC{<c>}{<q>} p14, c5, [PC], <option>
```

Decode for this encoding

```
if P == '0' && U == '0' && W == '0' then UNDEFINED;
index = (P == '1'); add = (U == '1'); cp = 14; imm32 = ZeroExtend(imm8:'00', 32);
if W == '1' || (P == '0' && CurrentInstrSet() != InstrSet_A32) then UNPREDICTABLE;
```

CONSTRAINED UNPREDICTABLE behavior

If $W == '1'$, then one of the following behaviors must occur:

- The instruction is UNDEFINED.
- The instruction executes as NOP.
- The instruction executes without writeback of the base address.
- The instruction uses the addressing mode described in the equivalent immediate offset instruction.

T1

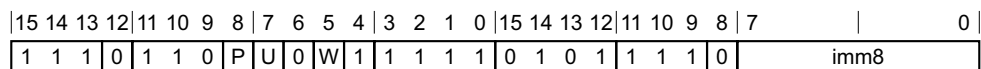

T1 variant

Applies when $!(P == 0 \ \&\& \ U == 0 \ \&\& \ W == 0)$.

```
LDC{<c>}{<q>} p14, c5, <label>
LDC{<c>}{<q>} p14, c5, [PC, #+/-<imm>]
```

Decode for this encoding

```
if P == '0' && U == '0' && W == '0' then UNDEFINED;
index = (P == '1'); add = (U == '1'); cp = 14; imm32 = ZeroExtend(imm8:'00', 32);
if W == '1' || (P == '0' && CurrentInstrSet() != InstrSet_A32) then UNPREDICTABLE;
```

CONSTRAINED UNPREDICTABLE behavior

If $W == '1' || P == '0'$, then one of the following behaviors must occur:

- The instruction is UNDEFINED.
- The instruction executes as NOP.
- The instruction executes without writeback of the base address.
- The instruction executes as LDC (immediate) with writeback to the PC. The instruction is handled as described in [Using R15 on page K1-6097](#).

Assembler symbols

<c>	See Standard assembler syntax fields on page F2-2848 .
<q>	See Standard assembler syntax fields on page F2-2848 .
<option>	Is an 8-bit immediate, in the range 0 to 255 enclosed in { }, encoded in the "imm8" field. The value of this field is ignored when executing this instruction.
<label>	The label of the literal data item that is to be loaded into <Rt>. The assembler calculates the required value of the offset from the <code>Align(PC, 4)</code> value of the instruction to this label. Permitted values of the offset are multiples of 4 in the range -1020 to 1020. If the offset is zero or positive, <code>imm32</code> is equal to the offset and <code>add == TRUE</code> (encoded as <code>U == 1</code>). If the offset is negative, <code>imm32</code> is equal to minus the offset and <code>add == FALSE</code> (encoded as <code>U == 0</code>).
+/-	Specifies the offset is added to or subtracted from the base register, defaulting to + if omitted and encoded in the "U" field. It can have the following values: - when <code>U = 0</code> + when <code>U = 1</code>
<imm>	Is the immediate offset used for forming the address, a multiple of 4 in the range 0-1020, defaulting to 0 and encoded in the "imm8" field, as <imm>/4.

The alternative syntax permits the addition or subtraction of the offset and the immediate offset to be specified separately, including permitting a subtraction of 0 that cannot be specified using the normal syntax. For more information, see [Use of labels in UAL instruction syntax on page F1-2809](#).

Operation for all encodings

```
if ConditionPassed() then
    EncodingSpecificOperations();
    AArch32.CheckSystemAccess(cp, ThisInstr());
    offset_addr = if add then (Align(PC,4) + imm32) else (Align(PC,4) - imm32);
    address = if index then offset_addr else Align(PC,4);

    // System register write to DBGDTRXint.
    DBGDTR_EL0[] = MemA[address,4];
```

F5.1.63 LDM, LDMIA, LDMFD

Load Multiple (Increment After, Full Descending) loads multiple registers from consecutive memory locations using an address from a base register. The consecutive memory locations start at this address, and the address just above the highest of those locations can optionally be written back to the base register.

The lowest-numbered register is loaded from the lowest memory address, through to the highest-numbered register from the highest memory address. See also [Encoding of lists of general-purpose registers and the PC on page F2-2855](#).

ARMv8.2 permits the deprecation of some Load Multiple ordering behaviors in AArch32 state, for more information see [ARMv8.2-LSMAOC](#). The registers loaded can include the PC, causing a branch to a loaded address. This is an interworking branch, see [Pseudocode description of operations on the AArch32 general-purpose registers and the PC on page E1-2733](#). Related system instructions are [LDM \(User registers\)](#) and [LDM \(exception return\)](#).

This instruction is used by the alias [POP \(multiple registers\)](#). See [Alias conditions on page F5-3146](#) for details of when each alias is preferred.

A1

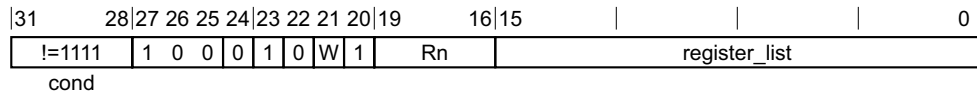

A1 variant

LDM{IA}{<c>}{<q>} <Rn>{!}, <registers> // Preferred syntax
 LDMFD{<c>}{<q>} <Rn>{!}, <registers> // Alternate syntax, Full Descending stack

Decode for this encoding

```
n = UInt(Rn); registers = register_list; wback = (W == '1');
if n == 15 || BitCount(registers) < 1 then UNPREDICTABLE;
if wback && registers<n> == '1' then UNPREDICTABLE;
```

CONSTRAINED UNPREDICTABLE behavior

If $\text{BitCount}(\text{registers}) < 1$, then one of the following behaviors must occur:

- The instruction is UNDEFINED.
- The instruction executes as NOP.
- The instruction executes as LDM with the same addressing mode but targeting an unspecified set of registers. These registers might include R15. If the instruction specifies writeback, the modification to the base address on writeback might differ from the number of registers loaded.

If $\text{wback} \ \&\& \ \text{registers}\langle n \rangle == '1'$, then one of the following behaviors must occur:

- The instruction is UNDEFINED.
- The instruction executes as NOP.
- The instruction performs all of the loads using the specified addressing mode and the content of the register that is written back is UNKNOWN. In addition, if an exception occurs during such an instruction, the base address might be corrupted so that the instruction cannot be repeated.

T1

15	14	13	12	11	10	8	7									0
1	1	0	0	1	Rn	register_list										

T1 variant

LDM{IA}{<c>}{<q>} <Rn>{!}, <registers> // Preferred syntax
 LDMFD{<c>}{<q>} <Rn>{!}, <registers> // Alternate syntax, Full Descending stack

Decode for this encoding

```
n = UInt(Rn); registers = '00000000':register_list; wback = (registers<n> == '0');
if BitCount(registers) < 1 then UNPREDICTABLE;
```

CONSTRAINED UNPREDICTABLE behavior

If BitCount(registers) < 1, then one of the following behaviors must occur:

- The instruction is UNDEFINED.
- The instruction executes as NOP.
- The instruction executes as LDM with the same addressing mode but targeting an unspecified set of registers. These registers might include R15. If the instruction specifies writeback, the modification to the base address on writeback might differ from the number of registers loaded.

T2

15	14	13	12	11	10	9	8	7	6	5	4	3	0	15	14	13	12													0
1	1	1	0	1	0	0	0	1	0	W	1	Rn	P	M	(0)	register_list														

register_list<13>

T2 variant

LDM{IA}{<c>}.W <Rn>{!}, <registers> // Preferred syntax, if <Rn>, '!' and <registers> can be represented in T1
 LDMFD{<c>}.W <Rn>{!}, <registers> // Alternate syntax, Full Descending stack, if <Rn>, '!' and <registers> can be represented in T1
 LDM{IA}{<c>}{<q>} <Rn>{!}, <registers> // Preferred syntax
 LDMFD{<c>}{<q>} <Rn>{!}, <registers> // Alternate syntax, Full Descending stack

Decode for this encoding

```
n = UInt(Rn); registers = P:M:register_list; wback = (W == '1');
if n == 15 || BitCount(registers) < 2 || (P == '1' && M == '1') then UNPREDICTABLE;
if wback && registers<n> == '1' then UNPREDICTABLE;
if registers<13> == '1' then UNPREDICTABLE;
if registers<15> == '1' && InITBlock() && !LastInITBlock() then UNPREDICTABLE;
```

CONSTRAINED UNPREDICTABLE behavior

If BitCount(registers) < 1, then one of the following behaviors must occur:

- The instruction is UNDEFINED.
- The instruction executes as NOP.
- The instruction executes as LDM with the same addressing mode but targeting an unspecified set of registers. These registers might include R15. If the instruction specifies writeback, the modification to the base address on writeback might differ from the number of registers loaded.

If `wback && registers<n> == '1'`, then one of the following behaviors must occur:

- The instruction is UNDEFINED.
- The instruction executes as NOP.
- The instruction performs all of the loads using the specified addressing mode and the content of the register that is written back is UNKNOWN. In addition, if an exception occurs during such an instruction, the base address might be corrupted so that the instruction cannot be repeated.

If `BitCount(registers) == 1`, then one of the following behaviors must occur:

- The instruction is UNDEFINED.
- The instruction executes as NOP.
- The instruction loads a single register using the specified addressing modes.
- The instruction executes as LDM with the same addressing mode but targeting an unspecified set of registers. These registers might include R15.

If `registers<13> == '1'`, then one of the following behaviors must occur:

- The instruction is UNDEFINED.
- The instruction executes as NOP.
- The instruction performs all of the loads using the specified addressing mode, but R13 is UNKNOWN.

If `P == '1' && M == '1'`, then one of the following behaviors must occur:

- The instruction is UNDEFINED.
- The instruction executes as NOP.
- The instruction loads the register list and either R14 or R15, both R14 and R15, or neither of these registers.

Notes for all encodings

For more information about the CONstrained UNpredictable behavior of this instruction, see [Appendix K1 Architectural Constraints on UNpredictable behaviors](#).

Alias conditions

Alias	of variant	is preferred when
POP (multiple registers)	T2	<code>W == '1' && Rn == '1101' && BitCount(P:M:register_list) > 1</code>
POP (multiple registers)	A1	<code>W == '1' && Rn == '1101' && BitCount(register_list) > 1</code>

Assembler symbols

IA	Is an optional suffix for the Increment After form.
<c>	See Standard assembler syntax fields on page F2-2848 .
<q>	See Standard assembler syntax fields on page F2-2848 .
<Rn>	Is the general-purpose base register, encoded in the "Rn" field.
!	For encoding A1 and T2: the address adjusted by the size of the data loaded is written back to the base register. If specified, it is encoded in the "W" field as 1, otherwise this field defaults to 0.

For encoding T1: the address adjusted by the size of the data loaded is written back to the base register. It is omitted if <Rn> is included in <registers>, otherwise it must be present.

<registers> For encoding A1: is a list of one or more registers to be loaded, separated by commas and surrounded by { and }.

The PC can be in the list.

ARM deprecates using these instructions with both the LR and the PC in the list.

For encoding T1: is a list of one or more registers to be loaded, separated by commas and surrounded by { and }. The registers in the list must be in the range R0-R7, encoded in the "register_list" field.

For encoding T2: is a list of one or more registers to be loaded, separated by commas and surrounded by { and }. The registers in the list must be in the range R0-R12, encoded in the "register_list" field, and can optionally contain one of the LR or the PC. If the LR is in the list, the "M" field is set to 1, otherwise it defaults to 0. If the PC is in the list, the "P" field is set to 1, otherwise it defaults to 0.

If the PC is in the list:

- The LR must not be in the list.
- The instruction must be either outside any IT block, or the last instruction in an IT block.

Operation for all encodings

```
if ConditionPassed() then
    EncodingSpecificOperations();
    address = R[n];
    for i = 0 to 14
        if registers<i> == '1' then
            R[i] = MemA[address,4]; address = address + 4;
    if registers<15> == '1' then
        LoadWritePC(MemA[address,4]);
    if wback && registers<n> == '0' then R[n] = R[n] + 4*BitCount(registers);
    if wback && registers<n> == '1' then R[n] = bits(32) UNKNOWN;
```

F5.1.64 LDM (exception return)

Load Multiple (exception return) loads multiple registers from consecutive memory locations using an address from a base register. The **SPSR** of the current mode is copied to the **CPSR**. An address adjusted by the size of the data loaded can optionally be written back to the base register.

The registers loaded include the PC. The word loaded for the PC is treated as an address and a branch occurs to that address.

Load Multiple (exception return) is:

- UNDEFINED in Hyp mode.
- UNPREDICTABLE in debug state, and in User mode and System mode.

A1

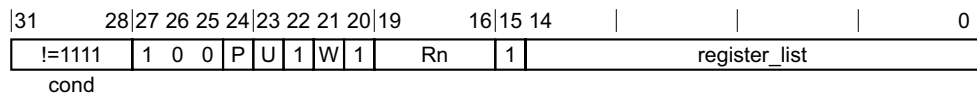

A1 variant

LDM{<amode>}{<c>}{<q>} <Rn>{!}, <registers_with_pc>^

Decode for this encoding

```
n = UInt(Rn); registers = register_list;
wback = (W == '1'); increment = (U == '1'); wordhigher = (P == U);
if n == 15 then UNPREDICTABLE;
if wback && registers<n> == '1' then UNPREDICTABLE;
```

CONSTRAINED UNPREDICTABLE behavior

If wback && registers<n> == '1', then one of the following behaviors must occur:

- The instruction is UNDEFINED.
- The instruction executes as NOP.
- The instruction performs all the loads using the specified addressing mode and the content of the register being written back is UNKNOWN. In addition, if an exception occurs during the execution of this instruction, the base address might be corrupted so that the instruction cannot be repeated.

Notes for all encodings

For more information about the CONSTRAINED UNPREDICTABLE behavior of this instruction, see [Appendix K1 Architectural Constraints on UNPREDICTABLE behaviors](#).

Assembler symbols

<amode> is one of:

DA	Decrement After. The consecutive memory addresses end at the address in the base register. Encoded as P = 0, U = 0.
FA	Full Ascending. For this instruction, a synonym for DA.
DB	Decrement Before. The consecutive memory addresses end one word below the address in the base register. Encoded as P = 1, U = 0.
EA	Empty Ascending. For this instruction, a synonym for DB.

IA	Increment After. The consecutive memory addresses start at the address in the base register. This is the default. Encoded as P = 0, U = 1.
FD	Full Descending. For this instruction, a synonym for IA.
IB	Increment Before. The consecutive memory addresses start one word above the address in the base register. Encoded as P = 1, U = 1.
ED	Empty Descending. For this instruction, a synonym for IB.
<c>	See Standard assembler syntax fields on page F2-2848 .
<q>	See Standard assembler syntax fields on page F2-2848 .
<Rn>	Is the general-purpose base register, encoded in the "Rn" field.
!	The address adjusted by the size of the data loaded is written back to the base register. If specified, it is encoded in the "W" field as 1, otherwise this field defaults to 0.
<registers_with_pc>	Is a list of one or more registers, separated by commas and surrounded by { and }. It specifies the set of registers to be loaded. The registers are loaded with the lowest-numbered register from the lowest memory address, through to the highest-numbered register from the highest memory address. The PC must be specified in the register list, and the instruction causes a branch to the address (data) loaded into the PC. See also Encoding of lists of general-purpose registers and the PC on page F2-2855 .

Instructions with similar syntax but without the PC included in the registers list are described in [LDM \(User registers\)](#).

Operation

```

if ConditionPassed() then
    EncodingSpecificOperations();
    if PSTATE.EL == EL2 then
        UNDEFINED;
    elseif PSTATE.M IN {M32_User, M32_System} then
        UNPREDICTABLE; // UNDEFINED or NOP
    else
        length = 4 * BitCount(registers) + 4;
        address = if increment then R[n] else R[n]-length;
        if wordhigher then address = address+4;

        for i = 0 to 14
            if registers<i> == '1' then
                R[i] = MemA[address,4]; address = address + 4;
                new_pc_value = MemA[address,4];

        if wback && registers<n> == '0' then R[n] = if increment then R[n]+length else R[n]-length;
        if wback && registers<n> == '1' then R[n] = bits(32) UNKNOWN;

    AArch32.ExceptionReturn(new_pc_value, SPSR[]);
  
```

CONSTRAINED UNPREDICTABLE behavior

If PSTATE.M IN {M32_User, M32_System}, then one of the following behaviors must occur:

- The instruction is UNDEFINED.
- The instruction executes as NOP.

F5.1.65 LDM (User registers)

In an EL1 mode other than System mode, Load Multiple (User registers) loads multiple User mode registers from consecutive memory locations using an address from a base register. The registers loaded cannot include the PC. The PE reads the base register value normally, using the current mode to determine the correct Banked version of the register. This instruction cannot writeback to the base register.

Load Multiple (User registers) is UNDEFINED in Hyp mode, and UNPREDICTABLE in User and System modes.

ARMv8.2 permits the deprecation of some Load Multiple ordering behaviors in AArch32 state, for more information see [ARMv8.2-LSMAOC](#).

A1

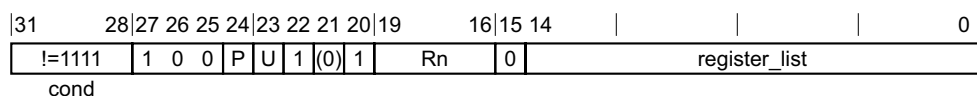

A1 variant

LDM{<amode>}{<c>}{<q>} <Rn>, <registers_without_pc>^

Decode for this encoding

```
n = UInt(Rn); registers = register_list; increment = (U == '1'); wordhigher = (P == U);
if n == 15 || BitCount(registers) < 1 then UNPREDICTABLE;
```

CONSTRAINED UNPREDICTABLE behavior

If BitCount(registers) < 1, then one of the following behaviors must occur:

- The instruction is UNDEFINED.
- The instruction executes as NOP.
- The instruction operates as an LDM with the same addressing mode but targeting an unspecified set of registers. These registers might include R15.

Notes for all encodings

For more information about the CONSTRAINED UNPREDICTABLE behavior of this instruction, see [Appendix K1 Architectural Constraints on UNPREDICTABLE behaviors](#).

Assembler symbols

<amode>	is one of:	
DA	Decrement After. The consecutive memory addresses end at the address in the base register. Encoded as P = 0, U = 0.	
FA	Full Ascending. For this instruction, a synonym for DA.	
DB	Decrement Before. The consecutive memory addresses end one word below the address in the base register. Encoded as P = 1, U = 0.	
EA	Empty Ascending. For this instruction, a synonym for DB.	
IA	Increment After. The consecutive memory addresses start at the address in the base register. This is the default. Encoded as P = 0, U = 1.	
FD	Full Descending. For this instruction, a synonym for IA.	
IB	Increment Before. The consecutive memory addresses start one word above the address in the base register. Encoded as P = 1, U = 1.	

- ED Empty Descending. For this instruction, a synonym for IB.
- <c> See [Standard assembler syntax fields on page F2-2848](#).
- <q> See [Standard assembler syntax fields on page F2-2848](#).
- <Rn> Is the general-purpose base register, encoded in the "Rn" field.
- <registers_without_pc>
Is a list of one or more registers, separated by commas and surrounded by { and }. It specifies the set of registers to be loaded by the LDM instruction. The registers are loaded with the lowest-numbered register from the lowest memory address, through to the highest-numbered register from the highest memory address. The PC must not be in the register list. See also [Encoding of lists of general-purpose registers and the PC on page F2-2855](#).

Instructions with similar syntax but with the PC included in <registers_without_pc> are described in [LDM \(exception return\)](#).

Operation

```
if ConditionPassed() then
    EncodingSpecificOperations();
    if PSTATE.EL == EL2 then UNDEFINED;
    elsif PSTATE.M IN {M32_User, M32_System} then UNPREDICTABLE;
    else
        length = 4*BitCount(registers);
        address = if increment then R[n] else R[n]-length;
        if wordhigher then address = address+4;
        for i = 0 to 14
            if registers<i> == '1' then // Load User mode register
                Rmode[i, M32_User] = MemA[address,4]; address = address + 4;
```

CONSTRAINED UNPREDICTABLE behavior

If PSTATE.M IN {M32_User, M32_System}, then one of the following behaviors must occur:

- The instruction is UNDEFINED.
- The instruction executes as NOP.
- The instruction operates as an LDM with the same addressing mode but targeting an unspecified set of registers. These registers might include R15.

F5.1.66 LDMDA, LDMFA

Load Multiple Decrement After (Full Ascending) loads multiple registers from consecutive memory locations using an address from a base register. The consecutive memory locations end at this address, and the address just below the lowest of those locations can optionally be written back to the base register.

The lowest-numbered register is loaded from the lowest memory address, through to the highest-numbered register from the highest memory address. See also [Encoding of lists of general-purpose registers and the PC on page F2-2855](#).

ARMv8.2 permits the deprecation of some Load Multiple ordering behaviors in AArch32 state, for more information see [ARMv8.2-LSMAOC](#). The registers loaded can include the PC, causing a branch to a loaded address. This is an interworking branch, see [Pseudocode description of operations on the AArch32 general-purpose registers and the PC on page E1-2733](#). Related system instructions are [LDM \(User registers\)](#) and [LDM \(exception return\)](#).

A1

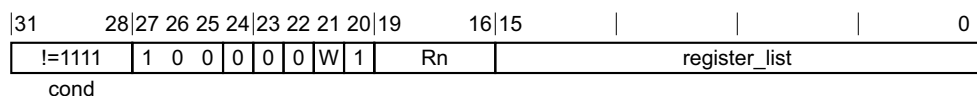

A1 variant

LDMDA{<c>}{<q>} <Rn>{!}, <registers> // Preferred syntax
 LDMFA{<c>}{<q>} <Rn>{!}, <registers> // Alternate syntax, Full Ascending stack

Decode for this encoding

```
n = UInt(Rn); registers = register_list; wback = (W == '1');
if n == 15 || BitCount(registers) < 1 then UNPREDICTABLE;
if wback && registers<n> == '1' then UNPREDICTABLE;
```

CONSTRAINED UNPREDICTABLE behavior

If BitCount(registers) < 1, then one of the following behaviors must occur:

- The instruction is UNDEFINED.
- The instruction executes as NOP.
- The instruction operates as an LDM with the same addressing mode but targeting an unspecified set of registers. These registers might include R15. If the instruction specifies writeback, the modification to the base address on writeback might differ from the number of registers loaded.

If wback && registers<n> == '1', then one of the following behaviors must occur:

- The instruction is UNDEFINED.
- The instruction executes as NOP.
- The instruction performs all of the loads using the specified addressing mode and the content of the register that is written back is UNKNOWN. In addition, if an exception occurs during such as instruction, the base address might be corrupted so that the instruction cannot be repeated.

Notes for all encodings

For more information about the CONSTRAINED UNPREDICTABLE behavior of this instruction, see [Appendix K1 Architectural Constraints on UNPREDICTABLE behaviors](#).

Assembler symbols

- <c> See [Standard assembler syntax fields on page F2-2848](#).
- <q> See [Standard assembler syntax fields on page F2-2848](#).
- <Rn> Is the general-purpose base register, encoded in the "Rn" field.
- ! The address adjusted by the size of the data loaded is written back to the base register. If specified, it is encoded in the "W" field as 1, otherwise this field defaults to 0.
- <registers> Is a list of one or more registers to be loaded, separated by commas and surrounded by { and }.
The PC can be in the list.
ARM deprecates using these instructions with both the LR and the PC in the list.

Operation

```
if ConditionPassed() then
    EncodingSpecificOperations();
    address = R[n] - 4*BitCount(registers) + 4;
    for i = 0 to 14
        if registers<i> == '1' then
            R[i] = MemA[address,4]; address = address + 4;
    if registers<15> == '1' then
        LoadWritePC(MemA[address,4]);
    if wback && registers<n> == '0' then R[n] = R[n] - 4*BitCount(registers);
    if wback && registers<n> == '1' then R[n] = bits(32) UNKNOWN;
```

F5.1.67 LDMDB, LDMEA

Load Multiple Decrement Before (Empty Ascending) loads multiple registers from consecutive memory locations using an address from a base register. The consecutive memory locations end just below this address, and the address of the lowest of those locations can optionally be written back to the base register.

The lowest-numbered register is loaded from the lowest memory address, through to the highest-numbered register from the highest memory address. See also [Encoding of lists of general-purpose registers and the PC on page F2-2855](#).

ARMv8.2 permits the deprecation of some Load Multiple ordering behaviors in AArch32 state, for more information see [ARMv8.2-LSMAOC](#). The registers loaded can include the PC, causing a branch to a loaded address. This is an interworking branch, see [Pseudocode description of operations on the AArch32 general-purpose registers and the PC on page E1-2733](#). Related system instructions are [LDM \(User registers\)](#) and [LDM \(exception return\)](#).

A1

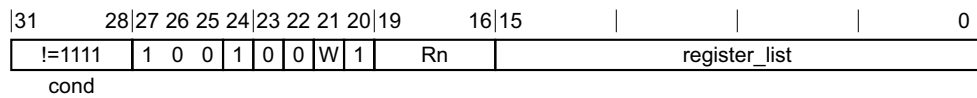

A1 variant

LDMDB{<c>}{<q>} <Rn>{!}, <registers> // Preferred syntax
 LDMEA{<c>}{<q>} <Rn>{!}, <registers> // Alternate syntax, Empty Ascending stack

Decode for this encoding

```
n = UInt(Rn); registers = register_list; wback = (W == '1');
if n == 15 || BitCount(registers) < 1 then UNPREDICTABLE;
if wback && registers<n> == '1' then UNPREDICTABLE;
```

CONSTRAINED UNPREDICTABLE behavior

If wback && registers<n> == '1', then one of the following behaviors must occur:

- The instruction is UNDEFINED.
- The instruction executes as NOP.
- The instruction performs all of the loads using the specified addressing mode and the content of the register that is written back is UNKNOWN. In addition, if an exception occurs during such an instruction, the base address might be corrupted so that the instruction cannot be repeated.

If BitCount(registers) < 1, then one of the following behaviors must occur:

- The instruction is UNDEFINED.
- The instruction executes as NOP.
- The instruction executes as LDM with the same addressing mode but targeting an unspecified set of registers. These registers might include R15. If the instruction specifies writeback, the modification to the base address on writeback might differ from the number of registers loaded.

T1

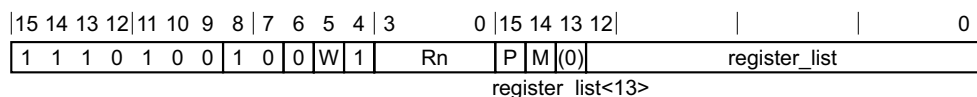

T1 variant

```
LDMDB{<c>}{<q>} <Rn>{!}, <registers> // Preferred syntax  
LDMEA{<c>}{<q>} <Rn>{!}, <registers> // Alternate syntax, Empty Ascending stack
```

Decode for this encoding

```
n = UInt(Rn); registers = P:M:register_list; wback = (W == '1');  
if n == 15 || BitCount(registers) < 2 || (P == '1' && M == '1') then UNPREDICTABLE;  
if wback && registers<n> == '1' then UNPREDICTABLE;  
if registers<13> == '1' then UNPREDICTABLE;  
if registers<15> == '1' && InITBlock() && !LastInITBlock() then UNPREDICTABLE;
```

CONSTRAINED UNPREDICTABLE behavior

If `wback && registers<n> == '1'`, then one of the following behaviors must occur:

- The instruction is UNDEFINED.
- The instruction executes as NOP.
- The instruction performs all of the loads using the specified addressing mode and the content of the register that is written back is UNKNOWN. In addition, if an exception occurs during such an instruction, the base address might be corrupted so that the instruction cannot be repeated.

If `BitCount(registers) < 1`, then one of the following behaviors must occur:

- The instruction is UNDEFINED.
- The instruction executes as NOP.
- The instruction executes as LDM with the same addressing mode but targeting an unspecified set of registers. These registers might include R15. If the instruction specifies writeback, the modification to the base address on writeback might differ from the number of registers loaded.

If `BitCount(registers) == 1`, then one of the following behaviors must occur:

- The instruction is UNDEFINED.
- The instruction executes as NOP.
- The instruction loads a single register using the specified addressing modes.
- The instruction executes as LDM with the same addressing mode but targeting an unspecified set of registers. These registers might include R15.

If `registers<13> == '1'`, then one of the following behaviors must occur:

- The instruction is UNDEFINED.
- The instruction executes as NOP.
- The instruction performs all of the loads using the specified addressing mode, but R13 is UNKNOWN.

If `P == '1' && M == '1'`, then one of the following behaviors must occur:

- The instruction is UNDEFINED.
- The instruction executes as NOP.
- The instruction loads the register list and either R14 or R15, both R14 and R15, or neither of these registers.

Notes for all encodings

For more information about the CONSTRAINED UNPREDICTABLE behavior of this instruction, see [Appendix K1 Architectural Constraints on UNPREDICTABLE behaviors](#).

Assembler symbols

- <c> See [Standard assembler syntax fields on page F2-2848](#).
- <q> See [Standard assembler syntax fields on page F2-2848](#).
- <Rn> Is the general-purpose base register, encoded in the "Rn" field.
- ! The address adjusted by the size of the data loaded is written back to the base register. If specified, it is encoded in the "W" field as 1, otherwise this field defaults to 0.
- <registers> For encoding A1: is a list of one or more registers to be loaded, separated by commas and surrounded by { and }.
- The PC can be in the list.
- ARM deprecates using these instructions with both the LR and the PC in the list.
- For encoding T1: is a list of one or more registers to be loaded, separated by commas and surrounded by { and }. The registers in the list must be in the range R0-R12, encoded in the "register_list" field, and can optionally contain one of the LR or the PC. If the LR is in the list, the "M" field is set to 1, otherwise it defaults to 0. If the PC is in the list, the "P" field is set to 1, otherwise it defaults to 0.
- If the PC is in the list:
- The LR must not be in the list.
 - The instruction must be either outside any IT block, or the last instruction in an IT block.

Operation for all encodings

```
if ConditionPassed() then
    EncodingSpecificOperations();
    address = R[n] - 4*BitCount(registers);
    for i = 0 to 14
        if registers<i> == '1' then
            R[i] = MemA[address,4]; address = address + 4;
    if registers<15> == '1' then
        LoadWritePC(MemA[address,4]);
    if wback && registers<n> == '0' then R[n] = R[n] - 4*BitCount(registers);
    if wback && registers<n> == '1' then R[n] = bits(32) UNKNOWN;
```

F5.1.68 LDMIB, LDMED

Load Multiple Increment Before (Empty Descending) loads multiple registers from consecutive memory locations using an address from a base register. The consecutive memory locations start just above this address, and the address of the last of those locations can optionally be written back to the base register.

The lowest-numbered register is loaded from the lowest memory address, through to the highest-numbered register from the highest memory address. See also [Encoding of lists of general-purpose registers and the PC on page F2-2855](#).

ARMv8.2 permits the deprecation of some Load Multiple ordering behaviors in AArch32 state, for more information see [ARMv8.2-LSMAOC](#). The registers loaded can include the PC, causing a branch to a loaded address. This is an interworking branch, see [Pseudocode description of operations on the AArch32 general-purpose registers and the PC on page E1-2733](#). Related system instructions are [LDM \(User registers\)](#) and [LDM \(exception return\)](#).

A1

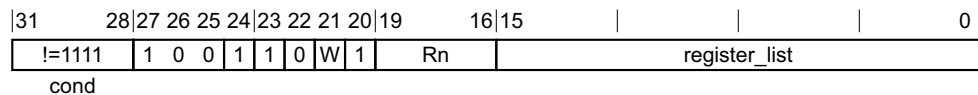

A1 variant

LDMIB{<c>}{<q>} <Rn>{!}, <registers> // Preferred syntax
 LDMED{<c>}{<q>} <Rn>{!}, <registers> // Alternate syntax, Empty Descending stack

Decode for this encoding

```
n = UInt(Rn); registers = register_list; wback = (W == '1');
if n == 15 || BitCount(registers) < 1 then UNPREDICTABLE;
if wback && registers<n> == '1' then UNPREDICTABLE;
```

CONSTRAINED UNPREDICTABLE behavior

If `BitCount(registers) < 1`, then one of the following behaviors must occur:

- The instruction is UNDEFINED.
- The instruction executes as NOP.
- The instruction operates as an LDM with the same addressing mode but targeting an unspecified set of registers. These registers might include R15. If the instruction specifies writeback, the modification to the base address on writeback might differ from the number of registers loaded.

If `wback && registers<n> == '1'`, then one of the following behaviors must occur:

- The instruction is UNDEFINED.
- The instruction executes as NOP.
- The instruction performs all of the loads using the specified addressing mode and the content of the register that is written back is UNKNOWN. In addition, if an exception occurs during such as instruction, the base address might be corrupted so that the instruction cannot be repeated.

Notes for all encodings

For more information about the CONSTRAINED UNPREDICTABLE behavior of this instruction, see [Appendix K1 Architectural Constraints on UNPREDICTABLE behaviors](#).

Assembler symbols

- <c> See [Standard assembler syntax fields on page F2-2848](#).
- <q> See [Standard assembler syntax fields on page F2-2848](#).
- <Rn> Is the general-purpose base register, encoded in the "Rn" field.
- ! The address adjusted by the size of the data loaded is written back to the base register. If specified, it is encoded in the "W" field as 1, otherwise this field defaults to 0.
- <registers> Is a list of one or more registers to be loaded, separated by commas and surrounded by { and }.
The PC can be in the list.
ARM deprecates using these instructions with both the LR and the PC in the list.

Operation

```
if ConditionPassed() then
    EncodingSpecificOperations();
    address = R[n] + 4;
    for i = 0 to 14
        if registers<i> == '1' then
            R[i] = MemA[address,4]; address = address + 4;
    if registers<15> == '1' then
        LoadWritePC(MemA[address,4]);
    if wback && registers<n> == '0' then R[n] = R[n] + 4*BitCount(registers);
    if wback && registers<n> == '1' then R[n] = bits(32) UNKNOWN;
```

F5.1.69 LDR (immediate)

Load Register (immediate) calculates an address from a base register value and an immediate offset, loads a word from memory, and writes it to a register. It can use offset, post-indexed, or pre-indexed addressing. For information about memory accesses see [Memory accesses](#) on page F2-2854.

This instruction is used by the alias [POP \(single register\)](#). See [Alias conditions](#) on page F5-3161 for details of when each alias is preferred.

A1

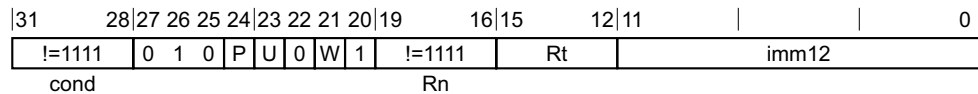

Offset variant

Applies when P == 1 && W == 0.

LDR{<c>}{<q>} <Rt>, [<Rn> {, #<+/-><imm>}]

Post-indexed variant

Applies when P == 0 && W == 0.

LDR{<c>}{<q>} <Rt>, [<Rn>], #<+/-><imm>

Pre-indexed variant

Applies when P == 1 && W == 1.

LDR{<c>}{<q>} <Rt>, [<Rn>, #<+/-><imm>]!

Decode for all variants of this encoding

```

if Rn == '1111' then SEE LDR (literal);
if P == '0' && W == '1' then SEE LDRT;
t = UInt(Rt); n = UInt(Rn); imm32 = ZeroExtend(imm12, 32);
index = (P == '1'); add = (U == '1'); wback = (P == '0') || (W == '1');
if wback && n == t then UNPREDICTABLE;
```

CONSTRAINED UNPREDICTABLE behavior

If wback && n == t, then one of the following behaviors must occur:

- The instruction is UNDEFINED.
- The instruction executes as NOP.
- The instruction performs all of the loads using the specified addressing mode and the content of the register that is written back is UNKNOWN. In addition, if an exception occurs during such an instruction, the base address might be corrupted so that the instruction cannot be repeated.

T1

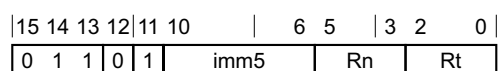

T1 variant

LDR{<c>}{<q>} <Rt>, [<Rn> {, #+<imm>}]

Decode for this encoding

t = UInt(Rt); n = UInt(Rn); imm32 = ZeroExtend(imm5:'00', 32);
 index = TRUE; add = TRUE; wback = FALSE;

T2

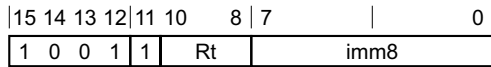

T2 variant

LDR{<c>}{<q>} <Rt>, [SP{, #+<imm>}]

Decode for this encoding

t = UInt(Rt); n = 13; imm32 = ZeroExtend(imm8:'00', 32);
 index = TRUE; add = TRUE; wback = FALSE;

T3

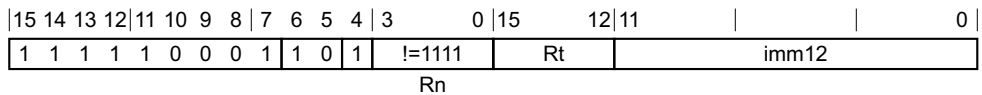

T3 variant

LDR{<c>}.W <Rt>, [<Rn> {, #+<imm>}] // <Rt>, <Rn>, <imm> can be represented in T1 or T2
 LDR{<c>}{<q>} <Rt>, [<Rn> {, #+<imm>}]

Decode for this encoding

if Rn == '1111' then SEE LDR (literal);
 t = UInt(Rt); n = UInt(Rn); imm32 = ZeroExtend(imm12, 32); index = TRUE; add = TRUE;
 wback = FALSE; if t == 15 && InITBlock() && !LastInITBlock() then UNPREDICTABLE;

T4

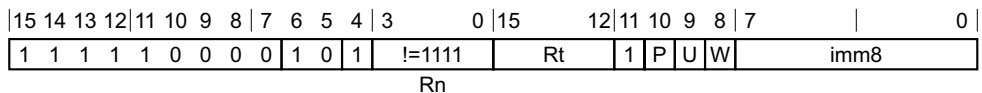

Offset variant

Applies when P == 1 && U == 0 && W == 0.

LDR{<c>}{<q>} <Rt>, [<Rn> {, #-<imm>}]

Post-indexed variant

Applies when P == 0 && W == 1.

LDR{<c>}{<q>} <Rt>, [<Rn>], #+/-<imm>

Pre-indexed variant

Applies when P == 1 && W == 1.

LDR{<c>}{<q>} <Rt>, [<Rn>, #<+/-><imm>]!

Decode for all variants of this encoding

```
if Rn == '1111' then SEE LDR (literal);
if P == '1' && U == '1' && W == '0' then SEE LDRT;
if P == '0' && W == '0' then UNDEFINED;
t = UInt(Rt); n = UInt(Rn);
imm32 = ZeroExtend(imm8, 32); index = (P == '1'); add = (U == '1'); wback = (W == '1');
if (wback && n == t) || (t == 15 && InITBlock() && !LastInITBlock()) then UNPREDICTABLE;
```

CONSTRAINED UNPREDICTABLE behavior

If wback && n == t, then one of the following behaviors must occur:

- The instruction is UNDEFINED.
- The instruction executes as NOP.
- The instruction performs all of the loads using the specified addressing mode and the content of the register that is written back is UNKNOWN. In addition, if an exception occurs during such an instruction, the base address might be corrupted so that the instruction cannot be repeated.

Notes for all encodings

For more information about the CONSTRAINED UNPREDICTABLE behavior of this instruction, see [Appendix K1 Architectural Constraints on UNPREDICTABLE behaviors](#).

Alias conditions

Alias	of variant	is preferred when
POP (single register)	A1 (post-indexed)	P == '0' && U == '1' && W == '0' && Rn == '1101' && imm12 == '00000000100'
POP (single register)	T4 (post-indexed)	Rn == '1101' && U == '1' && imm8 == '00000100'

Assembler symbols

<c>	See Standard assembler syntax fields on page F2-2848 .
<q>	See Standard assembler syntax fields on page F2-2848 .
<Rt>	For encoding A1: is the general-purpose register to be transferred, encoded in the "Rt" field. The PC can be used. If the PC is used, the instruction branches to the address (data) loaded to the PC. This is an interworking branch, see Pseudocode description of operations on the AArch32 general-purpose registers and the PC on page E1-2733 . For encoding T1 and T2: is the general-purpose register to be transferred, encoded in the "Rt" field. For encoding T3 and T4: is the general-purpose register to be transferred, encoded in the "Rt" field. The PC can be used, provided the instruction is either outside an IT block or the last instruction of an IT block. If the PC is used, the instruction branches to the address (data) loaded to the PC. This is an interworking branch, see Pseudocode description of operations on the AArch32 general-purpose registers and the PC on page E1-2733 .
<Rn>	For encoding A1, T3 and T4: is the general-purpose base register, encoded in the "Rn" field. For PC use see LDR (literal) . For encoding T1: is the general-purpose base register, encoded in the "Rn" field.

- +/- Specifies the offset is added to or subtracted from the base register, defaulting to + if omitted and encoded in the "U" field. It can have the following values:
 - when U = 0
 - + when U = 1
- + Specifies the offset is added to the base register.
- <imm> For encoding A1: is the 12-bit unsigned immediate byte offset, in the range 0 to 4095, defaulting to 0 if omitted, and encoded in the "imm12" field.
 For encoding T1: is the optional positive unsigned immediate byte offset, a multiple of 4, in the range 0 to 124, defaulting to 0 and encoded in the "imm5" field as <imm>/4.
 For encoding T2: is the optional positive unsigned immediate byte offset, a multiple of 4, in the range 0 to 1020, defaulting to 0 and encoded in the "imm8" field as <imm>/4.
 For encoding T3: is an optional 12-bit unsigned immediate byte offset, in the range 0 to 4095, defaulting to 0 and encoded in the "imm12" field.
 For encoding T4: is an 8-bit unsigned immediate byte offset, in the range 0 to 255, defaulting to 0 if omitted, and encoded in the "imm8" field.

Operation for all encodings

```

if CurrentInstrSet() == InstrSet_A32 then
  if ConditionPassed() then
    EncodingSpecificOperations();
    offset_addr = if add then (R[n] + imm32) else (R[n] - imm32);
    address = if index then offset_addr else R[n];
    data = MemU[address,4];
    if wback then R[n] = offset_addr;
    if t == 15 then
      if address<1:0> == '00' then
        LoadWritePC(data);
      else
        UNPREDICTABLE;
    else
      R[t] = data;
else
  if ConditionPassed() then
    EncodingSpecificOperations();
    offset_addr = if add then (R[n] + imm32) else (R[n] - imm32);
    address = if index then offset_addr else R[n];
    data = MemU[address,4];
    if wback then R[n] = offset_addr;
    if t == 15 then
      if address<1:0> == '00' then
        LoadWritePC(data);
      else
        UNPREDICTABLE;
    else
      R[t] = data;
  
```

F5.1.70 LDR (literal)

Load Register (literal) calculates an address from the PC value and an immediate offset, loads a word from memory, and writes it to a register. For information about memory accesses see [Memory accesses](#) on page F2-2854.

A1

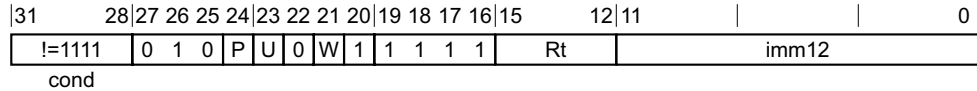

A1 variant

Applies when !(P == 0 && W == 1).

LDR{<c>}{<q>} <Rt>, <label> // Normal form
 LDR{<c>}{<q>} <Rt>, [PC, #<+/-><imm>] // Alternative form

Decode for this encoding

```
if P == '0' && W == '1' then SEE LDRT;
t = UInt(Rt); imm32 = ZeroExtend(imm12, 32);
add = (U == '1'); wback = (P == '0') || (W == '1');
if wback then UNPREDICTABLE;
```

CONSTRAINED UNPREDICTABLE behavior

If wback, then one of the following behaviors must occur:

- The instruction is UNDEFINED.
- The instruction executes as NOP.
- The instruction executes with the additional decode: wback = FALSE;.
- The instruction treats bit[24] as the P bit, and bit[21] as the writeback (W) bit, and uses the same addressing mode as described in [LDR \(immediate\)](#). The instruction uses post-indexed addressing when P == '0' and uses pre-indexed addressing otherwise. The instruction is handled as described in [Using R15](#) on page K1-6097.

T1

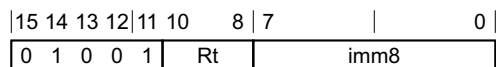

T1 variant

LDR{<c>}{<q>} <Rt>, <label> // Normal form

Decode for this encoding

```
t = UInt(Rt); imm32 = ZeroExtend(imm8:'00', 32); add = TRUE;
```

T2

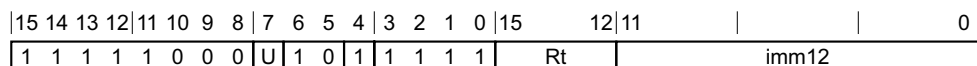

T2 variant

```
LDR{<c>}.W <Rt>, <label> // Preferred syntax, and <Rt>, <label> can be represented in T1  
LDR{<c>}{<q>} <Rt>, <label> // Preferred syntax  
LDR{<c>}{<q>} <Rt>, [PC, #<+/-><imm>] // Alternative syntax
```

Decode for this encoding

```
t = UInt(Rt); imm32 = ZeroExtend(imm12, 32); add = (U == '1');  
if t == 15 && InITBlock() && !LastInITBlock() then UNPREDICTABLE;
```

Notes for all encodings

For more information about the CONSTRAINED UNPREDICTABLE behavior of this instruction, see [Appendix K1 Architectural Constraints on UNPREDICTABLE behaviors](#).

Assembler symbols

- <c> See [Standard assembler syntax fields on page F2-2848](#).
- <q> See [Standard assembler syntax fields on page F2-2848](#).
- <Rt> For encoding A1: is the general-purpose register to be transferred, encoded in the "Rt" field. The PC can be used. If the PC is used, the instruction branches to the address (data) loaded to the PC. This is an interworking branch, see [Pseudocode description of operations on the AArch32 general-purpose registers and the PC on page E1-2733](#).
For encoding T1: is the general-purpose register to be transferred, encoded in the "Rt" field.
For encoding T2: is the general-purpose register to be transferred, encoded in the "Rt" field. The SP can be used. The PC can be used, provided the instruction is either outside an IT block or the last instruction of an IT block. If the PC is used, the instruction branches to the address (data) loaded to the PC. This is an interworking branch, see [Pseudocode description of operations on the AArch32 general-purpose registers and the PC on page E1-2733](#).
- <label> For encoding A1 and T2: the label of the literal data item that is to be loaded into <Rt>. The assembler calculates the required value of the offset from the `Align(PC, 4)` value of the instruction to this label. Permitted values of the offset are -4095 to 4095.
If the offset is zero or positive, `imm32` is equal to the offset and `add == TRUE`, encoded as `U == 1`.
If the offset is negative, `imm32` is equal to minus the offset and `add == FALSE`, encoded as `U == 0`.
For encoding T1: the label of the literal data item that is to be loaded into <Rt>. The assembler calculates the required value of the offset from the `Align(PC, 4)` value of the instruction to this label. Permitted values of the offset are Multiples of four in the range 0 to 1020.
- +/- Specifies the offset is added to or subtracted from the base register, defaulting to + if omitted and encoded in the "U" field. It can have the following values:
- when `U = 0`
+ when `U = 1`
- <imm> For encoding A1: is the 12-bit unsigned immediate byte offset, in the range 0 to 4095, defaulting to 0 if omitted, and encoded in the "imm12" field.
For encoding T2: is a 12-bit unsigned immediate byte offset, in the range 0 to 4095, encoded in the "imm12" field.

The alternative syntax permits the addition or subtraction of the offset and the immediate offset to be specified separately, including permitting a subtraction of 0 that cannot be specified using the normal syntax. For more information, see [Use of labels in UAL instruction syntax on page F1-2809](#).

Operation for all encodings

```
if ConditionPassed() then
    EncodingSpecificOperations();
    base = Align(PC,4);
    address = if add then (base + imm32) else (base - imm32);
    data = MemU[address,4];
    if t == 15 then
        if address<1:0> == '00' then
            LoadWritePC(data);
        else
            UNPREDICTABLE;
    else
        R[t] = data;
```

F5.1.71 LDR (register)

Load Register (register) calculates an address from a base register value and an offset register value, loads a word from memory, and writes it to a register. The offset register value can optionally be shifted. For information about memory accesses, see [Memory accesses](#) on page F2-2854.

The T32 form of LDR (register) does not support register writeback.

A1

31	28	27	26	25	24	23	22	21	20	19	16	15	12	11	7	6	5	4	3	0
!=1111				0	1	1	P	U	0	W	1	Rn	Rt	imm5	type	0	Rm			
cond																				

Offset variant

Applies when $P == 1$ && $W == 0$.

LDR{<c>}{<q>} <Rt>, [<Rn>, {+/-}<Rm>{, <shift>}]

Post-indexed variant

Applies when $P == 0$ && $W == 0$.

LDR{<c>}{<q>} <Rt>, [<Rn>], {+/-}<Rm>{, <shift>}]

Pre-indexed variant

Applies when $P == 1$ && $W == 1$.

LDR{<c>}{<q>} <Rt>, [<Rn>, {+/-}<Rm>{, <shift>}]!

Decode for all variants of this encoding

```

if P == '0' && W == '1' then SEE LDRT;
t = UInt(Rt); n = UInt(Rn); m = UInt(Rm);
index = (P == '1'); add = (U == '1'); wback = (P == '0') || (W == '1');
(shift_t, shift_n) = DecodeImmShift(type, imm5);
if m == 15 then UNPREDICTABLE;
if wback && (n == 15 || n == t) then UNPREDICTABLE;
    
```

CONSTRAINED UNPREDICTABLE behavior

If $wback$ && $n == t$, then one of the following behaviors must occur:

- The instruction is UNDEFINED.
- The instruction executes as NOP.
- The instruction performs all of the loads using the specified addressing mode and the content of the register that is written back is UNKNOWN. In addition, if an exception occurs during such as instruction, the base address might be corrupted so that the instruction cannot be repeated.

T1

15	14	13	12	11	10	9	8	6	5	3	2	0
0	1	0	1	1	0	0	Rm	Rn	Rt			

T1 variant

LDR{<c>}{<q>} <Rt>, [<Rn>, {+}<Rm>]

Decode for this encoding

```
t = UInt(Rt); n = UInt(Rn); m = UInt(Rm);
(shift_t, shift_n) = (SRTYPE_LSL, 0);
```

T2

15	14	13	12	11	10	9	8	7	6	5	4	3	0	15	12	11	10	9	8	7	6	5	4	3	0
1	1	1	1	1	0	0	0	0	1	0	1	!	1111	Rt	0	0	0	0	0	0	0	imm2	Rm		

Rn

T2 variant

LDR{<c>}.W <Rt>, [<Rn>, {+}<Rm>] // <Rt>, <Rn>, <Rm> can be represented in T1
LDR{<c>}{<q>} <Rt>, [<Rn>, {+}<Rm>{, LSL #<imm>}]

Decode for this encoding

```
if Rn == '1111' then SEE LDR (literal);
t = UInt(Rt); n = UInt(Rn); m = UInt(Rm);
(shift_t, shift_n) = (SRTYPE_LSL, UInt(imm2));
if m == 15 then UNPREDICTABLE; // ARMv8-A removes UNPREDICTABLE for R13
if t == 15 && InITBlock() && !LastInITBlock() then UNPREDICTABLE;
```

Notes for all encodings

For more information about the CONSTRAINED UNPREDICTABLE behavior of this instruction, see [Appendix K1 Architectural Constraints on UNPREDICTABLE behaviors](#).

Assembler symbols

- <c> See [Standard assembler syntax fields on page F2-2848](#).
- <q> See [Standard assembler syntax fields on page F2-2848](#).
- <Rt> For encoding A1: is the general-purpose register to be transferred, encoded in the "Rt" field. The PC can be used. If the PC is used, the instruction branches to the address (data) loaded to the PC. This branch is an interworking branch, see [Pseudocode description of operations on the AArch32 general-purpose registers and the PC on page E1-2733](#).
For encoding T1: is the general-purpose register to be transferred, encoded in the "Rt" field.
For encoding T2: is the general-purpose register to be transferred, encoded in the "Rt" field. The PC can be used, provided the instruction is either outside an IT block or the last instruction of an IT block. If the PC is used, the instruction branches to the address (data) loaded to the PC. This is an interworking branch, see [Pseudocode description of operations on the AArch32 general-purpose registers and the PC on page E1-2733](#).
- <Rn> For encoding A1: is the general-purpose base register, encoded in the "Rn" field. The PC can be used in the offset variant.
For encoding T1 and T2: is the general-purpose base register, encoded in the "Rn" field.
- +/- Specifies the index register is added to or subtracted from the base register, defaulting to + if omitted and encoded in the "U" field. It can have the following values:
 - when U = 0
 - + when U = 1

- + Specifies the index register is added to the base register.
- <Rm> Is the general-purpose index register, encoded in the "Rm" field.
- <shift> The shift to apply to the value read from <Rm>. If absent, no shift is applied. Otherwise, see [Shifts applied to a register on page F2-2852](#).
- <imm> If present, the size of the left shift to apply to the value from <Rm>, in the range 1-3. <imm> is encoded in imm2. If absent, no shift is specified and imm2 is encoded as 0b00.

Operation for all encodings

```
if CurrentInstrSet() == InstrSet_A32 then
  if ConditionPassed() then
    EncodingSpecificOperations();
    offset = Shift(R[m], shift_t, shift_n, PSTATE.C);
    offset_addr = if add then (R[n] + offset) else (R[n] - offset);
    address = if index then offset_addr else R[n];
    data = MemU[address,4];
    if wback then R[n] = offset_addr;
    if t == 15 then
      if address<1:0> == '00' then
        LoadWritePC(data);
      else
        UNPREDICTABLE;
    else
      R[t] = data;
else
  if ConditionPassed() then
    EncodingSpecificOperations();
    offset = Shift(R[m], shift_t, shift_n, PSTATE.C);
    offset_addr = (R[n] + offset);
    address = offset_addr;
    data = MemU[address,4];
    if t == 15 then
      if address<1:0> == '00' then
        LoadWritePC(data);
      else
        UNPREDICTABLE;
    else
      R[t] = data;
```

F5.1.72 LDRB (immediate)

Load Register Byte (immediate) calculates an address from a base register value and an immediate offset, loads a byte from memory, zero-extends it to form a 32-bit word, and writes it to a register. It can use offset, post-indexed, or pre-indexed addressing. For information about memory accesses see [Memory accesses on page F2-2854](#).

A1

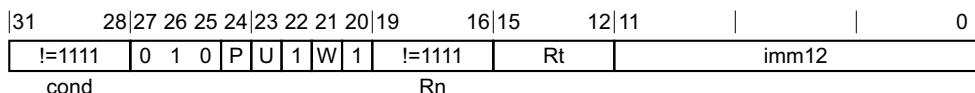

Offset variant

Applies when $P == 1 \ \&\& \ W == 0$.

LDRB{<c>}{<q>} <Rt>, [<Rn> {, #<+/-><imm>}]

Post-indexed variant

Applies when $P == 0 \ \&\& \ W == 0$.

LDRB{<c>}{<q>} <Rt>, [<Rn>], #<+/-><imm>

Pre-indexed variant

Applies when $P == 1 \ \&\& \ W == 1$.

LDRB{<c>}{<q>} <Rt>, [<Rn>, #<+/-><imm>]!

Decode for all variants of this encoding

```

if Rn == '1111' then SEE LDRB (literal);
if P == '0' && W == '1' then SEE LDRBT;
t = UInt(Rt); n = UInt(Rn); imm32 = ZeroExtend(imm12, 32);
index = (P == '1'); add = (U == '1'); wback = (P == '0') || (W == '1');
if t == 15 || (wback && n == t) then UNPREDICTABLE;
  
```

CONSTRAINED UNPREDICTABLE behavior

If $wback \ \&\& \ n == t$, then one of the following behaviors must occur:

- The instruction is UNDEFINED.
- The instruction executes as NOP.
- The instruction performs all of the loads using the specified addressing mode and the content of the register that is written back is UNKNOWN. In addition, if an exception occurs during such an instruction, the base address might be corrupted so that the instruction cannot be repeated.

T1

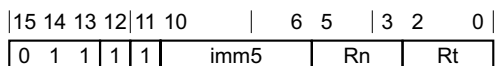

T1 variant

LDRB{<c>}{<q>} <Rt>, [<Rn> {, #<+><imm>}]

Decode for this encoding

```
t = UInt(Rt); n = UInt(Rn); imm32 = ZeroExtend(imm5, 32);
index = TRUE; add = TRUE; wback = FALSE;
```

T2

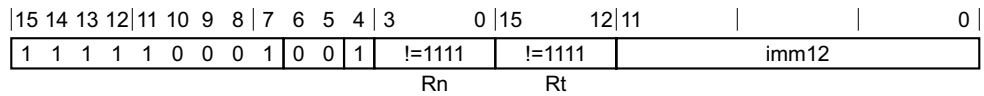

T2 variant

```
LDRB{<c>}.W <Rt>, [<Rn> {, #<+><imm>}] // <Rt>, <Rn>, <imm> can be represented in T1
LDRB{<c>}{<q>} <Rt>, [<Rn> {, #<+><imm>}]
```

Decode for this encoding

```
if Rt == '1111' then SEE PLD;
if Rn == '1111' then SEE LDRB (literal);
t = UInt(Rt); n = UInt(Rn); imm32 = ZeroExtend(imm12, 32);
index = TRUE; add = TRUE; wback = FALSE;
// ARMv8-A removes UNPREDICTABLE for R13
```

T3

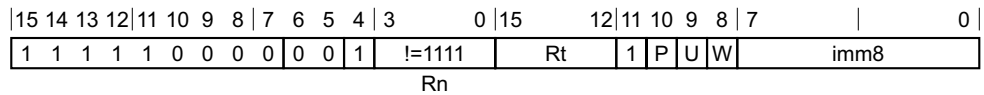

Offset variant

Applies when Rt != 1111 && P == 1 && U == 0 && W == 0.

```
LDRB{<c>}{<q>} <Rt>, [<Rn> {, #-<imm>}]
```

Post-indexed variant

Applies when P == 0 && W == 1.

```
LDRB{<c>}{<q>} <Rt>, [<Rn>], #<+/-><imm>
```

Pre-indexed variant

Applies when P == 1 && W == 1.

```
LDRB{<c>}{<q>} <Rt>, [<Rn>, #<+/-><imm>!]
```

Decode for all variants of this encoding

```
if Rt == '1111' && P == '1' && U == '0' && W == '0' then SEE PLD, PLDW (immediate);
if Rn == '1111' then SEE LDRB (literal);
if P == '1' && U == '1' && W == '0' then SEE LDRBT;
if P == '0' && W == '0' then UNDEFINED;
t = UInt(Rt); n = UInt(Rn); imm32 = ZeroExtend(imm8, 32);
index = (P == '1'); add = (U == '1'); wback = (W == '1');
if (t == 15 && W == '1') || (wback && n == t) then UNPREDICTABLE;
// ARMv8-A removes UNPREDICTABLE for R13
```

CONSTRAINED UNPREDICTABLE behavior

If `wback && n == t`, then one of the following behaviors must occur:

- The instruction is UNDEFINED.
- The instruction executes as NOP.
- The instruction performs all of the loads using the specified addressing mode and the content of the register that is written back is UNKNOWN. In addition, if an exception occurs during such an instruction, the base address might be corrupted so that the instruction cannot be repeated.

Notes for all encodings

For more information about the CONSTRAINED UNPREDICTABLE behavior of this instruction, see [Appendix K1 Architectural Constraints on UNPREDICTABLE behaviors](#).

Assembler symbols

<c>	See Standard assembler syntax fields on page F2-2848 .
<q>	See Standard assembler syntax fields on page F2-2848 .
<Rt>	Is the general-purpose register to be transferred, encoded in the "Rt" field.
<Rn>	For encoding A1, T2 and T3: is the general-purpose base register, encoded in the "Rn" field. For PC use see LDRB (literal) . For encoding T1: is the general-purpose base register, encoded in the "Rn" field.
+/-	Specifies the offset is added to or subtracted from the base register, defaulting to + if omitted and encoded in the "U" field. It can have the following values: - when U = 0 + when U = 1
+	Specifies the offset is added to the base register.
<imm>	For encoding A1: is the 12-bit unsigned immediate byte offset, in the range 0 to 4095, defaulting to 0 if omitted, and encoded in the "imm12" field. For encoding T1: is an optional 5-bit unsigned immediate byte offset, in the range 0 to 31, defaulting to 0 and encoded in the "imm5" field. For encoding T2: is an optional 12-bit unsigned immediate byte offset, in the range 0 to 4095, defaulting to 0 and encoded in the "imm12" field. For encoding T3: is an 8-bit unsigned immediate byte offset, in the range 0 to 255, defaulting to 0 if omitted, and encoded in the "imm8" field.

Operation for all encodings

```

if CurrentInstrSet() == InstrSet_A32 then
  if ConditionPassed() then
    EncodingSpecificOperations();
    offset_addr = if add then (R[n] + imm32) else (R[n] - imm32);
    address = if index then offset_addr else R[n];
    R[t] = ZeroExtend(MemU[address,1], 32);
    if wback then R[n] = offset_addr;
else
  if ConditionPassed() then
    EncodingSpecificOperations();
    offset_addr = if add then (R[n] + imm32) else (R[n] - imm32);
    address = if index then offset_addr else R[n];
    R[t] = ZeroExtend(MemU[address,1], 32);
    if wback then R[n] = offset_addr;
  
```

F5.1.73 LDRB (literal)

Load Register Byte (literal) calculates an address from the PC value and an immediate offset, loads a byte from memory, zero-extends it to form a 32-bit word, and writes it to a register. For information about memory accesses see [Memory accesses on page F2-2854](#).

A1

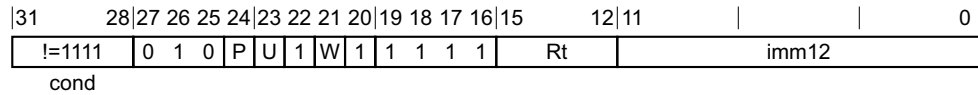

A1 variant

Applies when $!(P == 0 \ \&\& \ W == 1)$.

LDRB{<c>}{<q>} <Rt>, <label> // Normal form
 LDRB{<c>}{<q>} <Rt>, [PC, #<+/-><imm>] // Alternative form

Decode for this encoding

```
if P == '0' && W == '1' then SEE LDRBT;
t = UInt(Rt); imm32 = ZeroExtend(imm12, 32);
add = (U == '1'); wback = (P == '0') || (W == '1');
if t == 15 || wback then UNPREDICTABLE;
```

CONSTRAINED UNPREDICTABLE behavior

If wback, then one of the following behaviors must occur:

- The instruction is UNDEFINED.
- The instruction executes as NOP.
- The instruction executes with the additional decode: wback = FALSE;.
- The instruction treats bit[24] as the P bit, and bit[21] as the writeback (W) bit, and uses the same addressing mode as described in [LDRB \(immediate\)](#). The instruction uses post-indexed addressing when P == '0' and uses pre-indexed addressing otherwise. The instruction is handled as described in [Using R15 on page K1-6097](#).

T1

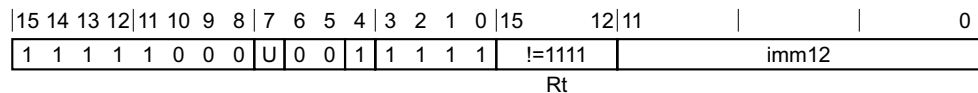

T1 variant

LDRB{<c>}{<q>} <Rt>, <label> // Preferred syntax
 LDRB{<c>}{<q>} <Rt>, [PC, #<+/-><imm>] // Alternative syntax

Decode for this encoding

```
if Rt == '1111' then SEE PLD;
t = UInt(Rt); imm32 = ZeroExtend(imm12, 32); add = (U == '1');
// ARMv8-A removes UNPREDICTABLE for R13
```

Notes for all encodings

For more information about the CONSTRAINED UNPREDICTABLE behavior of this instruction, see [Appendix K1 Architectural Constraints on UNPREDICTABLE behaviors](#).

Assembler symbols

- <c> See [Standard assembler syntax fields on page F2-2848](#).
- <q> See [Standard assembler syntax fields on page F2-2848](#).
- <Rt> Is the general-purpose register to be transferred, encoded in the "Rt" field.
- <label> The label of the literal data item that is to be loaded into <Rt>. The assembler calculates the required value of the offset from the `Align(PC, 4)` value of the instruction to this label. Permitted values of the offset are -4095 to 4095.
- If the offset is zero or positive, `imm32` is equal to the offset and `add == TRUE`, encoded as `U == 1`.
- If the offset is negative, `imm32` is equal to minus the offset and `add == FALSE`, encoded as `U == 0`.
- +/- Specifies the offset is added to or subtracted from the base register, defaulting to + if omitted and encoded in the "U" field. It can have the following values:
- when `U = 0`
 - + when `U = 1`
- <imm> For encoding A1: is the 12-bit unsigned immediate byte offset, in the range 0 to 4095, defaulting to 0 if omitted, and encoded in the "imm12" field.
- For encoding T1: is a 12-bit unsigned immediate byte offset, in the range 0 to 4095, encoded in the "imm12" field.

The alternative syntax permits the addition or subtraction of the offset and the immediate offset to be specified separately, including permitting a subtraction of 0 that cannot be specified using the normal syntax. For more information, see [Use of labels in UAL instruction syntax on page F1-2809](#).

Operation for all encodings

```
if ConditionPassed() then
    EncodingSpecificOperations();
    base = Align(PC,4);
    address = if add then (base + imm32) else (base - imm32);
    R[t] = ZeroExtend(MemU[address,1], 32);
```

F5.1.74 LDRB (register)

Load Register Byte (register) calculates an address from a base register value and an offset register value, loads a byte from memory, zero-extends it to form a 32-bit word, and writes it to a register. The offset register value can optionally be shifted. For information about memory accesses see [Memory accesses on page F2-2854](#).

A1

31	28	27	26	25	24	23	22	21	20	19	16	15	12	11	7	6	5	4	3	0
!=1111				0	1	1	P	U	1	W	1	Rn	Rt	imm5	type	0	Rm			
cond																				

Offset variant

Applies when $P == 1$ && $W == 0$.

LDRB{<c>}{<q>} <Rt>, [<Rn>, {+/-}<Rm>{, <shift>}]

Post-indexed variant

Applies when $P == 0$ && $W == 0$.

LDRB{<c>}{<q>} <Rt>, [<Rn>], {+/-}<Rm>{, <shift>}]

Pre-indexed variant

Applies when $P == 1$ && $W == 1$.

LDRB{<c>}{<q>} <Rt>, [<Rn>, {+/-}<Rm>{, <shift>}]!

Decode for all variants of this encoding

```

if P == '0' && W == '1' then SEE LDRBT;
t = UInt(Rt); n = UInt(Rn); m = UInt(Rm);
index = (P == '1'); add = (U == '1'); wback = (P == '0') || (W == '1');
(shift_t, shift_n) = DecodeImmShift(type, imm5);
if t == 15 || m == 15 then UNPREDICTABLE;
if wback && (n == 15 || n == t) then UNPREDICTABLE;
    
```

CONSTRAINED UNPREDICTABLE behavior

If $wback$ && $n == t$, then one of the following behaviors must occur:

- The instruction is UNDEFINED.
- The instruction executes as NOP.
- The instruction performs all of the loads using the specified addressing mode and the content of the register that is written back is UNKNOWN. In addition, if an exception occurs during such as instruction, the base address might be corrupted so that the instruction cannot be repeated.

T1

15	14	13	12	11	10	9	8	6	5	3	2	0
0	1	0	1	1	1	0	Rm	Rn	Rt			

T1 variant

LDRB{<c>}{<q>} <Rt>, [<Rn>, {+}<Rm>]

Decode for this encoding

```
t = UInt(Rt); n = UInt(Rn); m = UInt(Rm);
index = TRUE; add = TRUE; wback = FALSE;
(shift_t, shift_n) = (SRTYPE_LSL, 0);
```

T2

15	14	13	12	11	10	9	8	7	6	5	4	3	0	15	12	11	10	9	8	7	6	5	4	3	0	
1	1	1	1	1	0	0	0	0	0	0	1	!	=1111	!	=1111	0	0	0	0	0	0	0	imm2	Rm		
													Rn												Rt	

T2 variant

```
LDRB{<c>}.W <Rt>, [<Rn>, {+}<Rm>] // <Rt>, <Rn>, <Rm> can be represented in T1
LDRB{<c>}{<q>} <Rt>, [<Rn>, {+}<Rm>{, LSL #<imm>}]
```

Decode for this encoding

```
if Rt == '1111' then SEE PLD;
if Rn == '1111' then SEE LDRB (literal);
t = UInt(Rt); n = UInt(Rn); m = UInt(Rm);
index = TRUE; add = TRUE; wback = FALSE;
(shift_t, shift_n) = (SRTYPE_LSL, UInt(imm2));
if m == 15 then UNPREDICTABLE; // ARMv8-A removes UNPREDICTABLE for R13
```

Notes for all encodings

For more information about the CONSTRAINED UNPREDICTABLE behavior of this instruction, see [Appendix K1 Architectural Constraints on UNPREDICTABLE behaviors](#).

Assembler symbols

- <c> See [Standard assembler syntax fields on page F2-2848](#).
- <q> See [Standard assembler syntax fields on page F2-2848](#).
- <Rt> Is the general-purpose register to be transferred, encoded in the "Rt" field.
- <Rn> For encoding A1: is the general-purpose base register, encoded in the "Rn" field. The PC can be used in the offset variant.
For encoding T1 and T2: is the general-purpose base register, encoded in the "Rn" field.
- +/- Specifies the index register is added to or subtracted from the base register, defaulting to + if omitted and encoded in the "U" field. It can have the following values:
 - when U = 0
 - + when U = 1
- + Specifies the index register is added to the base register.
- <Rm> Is the general-purpose index register, encoded in the "Rm" field.
- <shift> The shift to apply to the value read from <Rm>. If absent, no shift is applied. Otherwise, see [Shifts applied to a register on page F2-2852](#).
- <imm> If present, the size of the left shift to apply to the value from <Rm>, in the range 1-3. <imm> is encoded in imm2. If absent, no shift is specified and imm2 is encoded as 0b00.

Operation for all encodings

```
if ConditionPassed() then
    EncodingSpecificOperations();
    offset = Shift(R[m], shift_t, shift_n, PSTATE.C);
    offset_addr = if add then (R[n] + offset) else (R[n] - offset);
    address = if index then offset_addr else R[n];
    R[t] = ZeroExtend(MemU[address,1],32);
    if wback then R[n] = offset_addr;
```

F5.1.75 LDRBT

Load Register Byte Unprivileged loads a byte from memory, zero-extends it to form a 32-bit word, and writes it to a register. For information about memory accesses see [Memory accesses on page F2-2854](#).

The memory access is restricted as if the PE were running in User mode. This makes no difference if the PE is actually running in User mode.

LDRBT is UNPREDICTABLE in Hyp mode.

The T32 instruction uses an offset addressing mode, that calculates the address used for the memory access from a base register value and an immediate offset, and leaves the base register unchanged.

The A32 instruction uses a post-indexed addressing mode, that uses a base register value as the address for the memory access, and calculates a new address from a base register value and an offset and writes it back to the base register. The offset can be an immediate value or an optionally-shifted register value.

A1

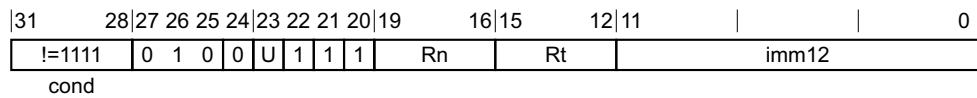

A1 variant

LDRBT{<c>}{<q>} <Rt>, [<Rn>] {, #{+/-}<imm>}

Decode for this encoding

```
t = UInt(Rt); n = UInt(Rn); postindex = TRUE; add = (U == '1');
register_form = FALSE; imm32 = ZeroExtend(imm12, 32);
if t == 15 || n == 15 || n == t then UNPREDICTABLE;
```

CONSTRAINED UNPREDICTABLE behavior

If $n == 15$, then one of the following behaviors must occur:

- The instruction is UNDEFINED.
- The instruction executes as NOP.
- The instruction uses post-indexed addressing with the base register as PC. This is handled as described in [Using R15 on page K1-6097](#).
- The instruction uses immediate offset addressing with the base register as PC, without writeback.

If $n == t$ && $n != 15$, then one of the following behaviors must occur:

- The instruction is UNDEFINED.
- The instruction executes as NOP.
- The instruction performs all of the loads using the specified addressing mode and the content of the register that is written back is UNKNOWN. In addition, if an exception occurs during such as instruction, the base address might be corrupted so that the instruction cannot be repeated.

A2

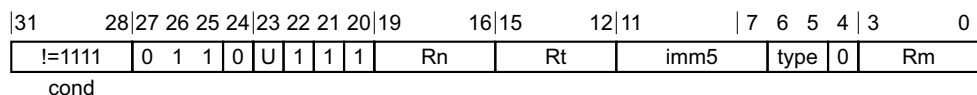

A2 variant

LDRBT{<c>}{<q>} <Rt>, [<Rn>], {+/-}<Rm>{, <shift>}

Decode for this encoding

```
t = UInt(Rt); n = UInt(Rn); m = UInt(Rm); postindex = TRUE; add = (U == '1');
register_form = TRUE; (shift_t, shift_n) = DecodeImmShift(type, imm5);
if t == 15 || n == 15 || n == t || m == 15 then UNPREDICTABLE;
```

CONSTRAINED UNPREDICTABLE behavior

If $n == t$ && $n != 15$, then one of the following behaviors must occur:

- The instruction is UNDEFINED.
- The instruction executes as NOP.
- The instruction performs all of the loads using the specified addressing mode and the content of the register that is written back is UNKNOWN. In addition, if an exception occurs during such as instruction, the base address might be corrupted so that the instruction cannot be repeated.

T1

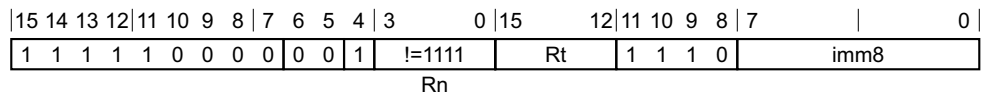

T1 variant

LDRBT{<c>}{<q>} <Rt>, [<Rn> {, #<+><imm>}]

Decode for this encoding

```
if Rn == '1111' then SEE LDRB (literal);
t = UInt(Rt); n = UInt(Rn); postindex = FALSE; add = TRUE;
register_form = FALSE; imm32 = ZeroExtend(imm8, 32);
if t == 15 then UNPREDICTABLE; // ARMv8-A removes UNPREDICTABLE for R13
```

Notes for all encodings

For more information about the CONSTRAINED UNPREDICTABLE behavior of this instruction, see [Appendix K1 Architectural Constraints on UNPREDICTABLE behaviors](#).

Assembler symbols

- <c> See [Standard assembler syntax fields on page F2-2848](#).
- <q> See [Standard assembler syntax fields on page F2-2848](#).
- <Rt> For encoding A1: is the general-purpose register to be transferred, encoded in the "Rt" field. The PC can be used, but this is deprecated.
 For encoding A2 and T1: is the general-purpose register to be transferred, encoded in the "Rt" field.
- <Rn> Is the general-purpose base register, encoded in the "Rn" field.
- +/- For encoding A1: specifies the offset is added to or subtracted from the base register, defaulting to + if omitted and encoded in the "U" field. It can have the following values:
- when U = 0
 - + when U = 1

For encoding A2: specifies the index register is added to or subtracted from the base register, defaulting to + if omitted and encoded in the "U" field. It can have the following values:

- when U = 0
- + when U = 1

- <Rm> Is the general-purpose index register, encoded in the "Rm" field.
- <shift> The shift to apply to the value read from <Rm>. If absent, no shift is applied. Otherwise, see [Shifts applied to a register on page F2-2852](#).
- + Specifies the offset is added to the base register.
- <imm> For encoding A1: is the 12-bit unsigned immediate byte offset, in the range 0 to 4095, defaulting to 0 if omitted, and encoded in the "imm12" field.
For encoding T1: is an optional 8-bit unsigned immediate byte offset, in the range 0 to 255, defaulting to 0 and encoded in the "imm8" field.

Operation for all encodings

```
if ConditionPassed() then
    if PSTATE.EL == EL2 then UNPREDICTABLE;           // Hyp mode
    EncodingSpecificOperations();
    offset = if register_form then Shift(R[m], shift_t, shift_n, PSTATE.C) else imm32;
    offset_addr = if add then (R[n] + offset) else (R[n] - offset);
    address = if postindex then R[n] else offset_addr;
    R[t] = ZeroExtend(MemU_unpriv[address,1],32);
    if postindex then R[n] = offset_addr;
```

CONSTRAINED UNPREDICTABLE behavior

If PSTATE.EL == EL2, then one of the following behaviors must occur:

- The instruction is UNDEFINED.
- The instruction executes as NOP.
- The instruction executes as LDRB (immediate).

F5.1.76 LDRD (immediate)

Load Register Dual (immediate) calculates an address from a base register value and an immediate offset, loads two words from memory, and writes them to two registers. It can use offset, post-indexed, or pre-indexed addressing. For information about memory accesses see [Memory accesses](#) on page F2-2854.

A1

31	28	27	26	25	24	23	22	21	20	19	16	15	12	11	8	7	6	5	4	3	0				
!=1111				0 0 0			P	U	1	W	0	!=1111			Rt		imm4H			1	1	0	1	imm4L	
cond											Rn														

Offset variant

Applies when $P == 1 \ \&\& \ W == 0$.

LDRD{<c>}{<q>} <Rt>, <Rt2>, [<Rn> {, #<+/-><imm>}]

Post-indexed variant

Applies when $P == 0 \ \&\& \ W == 0$.

LDRD{<c>}{<q>} <Rt>, <Rt2>, [<Rn>], #<+/-><imm>

Pre-indexed variant

Applies when $P == 1 \ \&\& \ W == 1$.

LDRD{<c>}{<q>} <Rt>, <Rt2>, [<Rn>, #<+/-><imm>]!

Decode for all variants of this encoding

```

if Rn == '1111' then SEE LDRD (literal);
if Rt<0> == '1' then UNPREDICTABLE;
t = UInt(Rt); t2 = t+1; n = UInt(Rn); imm32 = ZeroExtend(imm4H:imm4L, 32);
index = (P == '1'); add = (U == '1'); wback = (P == '0') || (W == '1');
if P == '0' && W == '1' then UNPREDICTABLE;
if wback && (n == t || n == t2) then UNPREDICTABLE;
if t2 == 15 then UNPREDICTABLE;
    
```

CONSTRAINED UNPREDICTABLE behavior

If $wback \ \&\& \ (n == t \ || \ n == t2)$, then one of the following behaviors must occur:

- The instruction is UNDEFINED.
- The instruction executes as NOP.
- The instruction performs all of the loads using the specified addressing mode and the content of the register that is written back is UNKNOWN. In addition, if an exception occurs during such an instruction, the base address might be corrupted so that the instruction cannot be repeated.

If $P == '0' \ \&\& \ W == '1'$, then one of the following behaviors must occur:

- The instruction is UNDEFINED.
- The instruction executes as NOP.
- The instruction executes as an LDRD using one of offset, post-indexed, or pre-indexed addressing.

If $Rt<0> == '1'$, then one of the following behaviors must occur:

- The instruction is UNDEFINED.
- The instruction executes as NOP.

- The instruction executes with the additional decode: $t<0> = '0'$.
- The instruction executes with the additional decode: $t2 = t$.
- The instruction executes as described, with no change to its behavior and no additional side-effects. This does not apply when $Rt == '1111'$.

T1

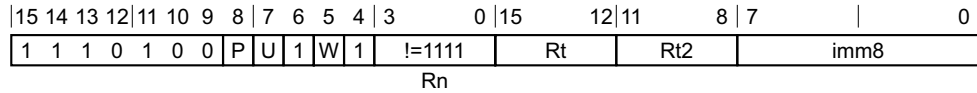

Offset variant

Applies when $P == 1$ && $W == 0$.

LDRD{<c>}{<q>} <Rt>, <Rt2>, [<Rn> {, #<+/-><imm>}]

Post-indexed variant

Applies when $P == 0$ && $W == 1$.

LDRD{<c>}{<q>} <Rt>, <Rt2>, [<Rn>], #<+/-><imm>

Pre-indexed variant

Applies when $P == 1$ && $W == 1$.

LDRD{<c>}{<q>} <Rt>, <Rt2>, [<Rn>, #<+/-><imm>]!

Decode for all variants of this encoding

```

if P == '0' && W == '0' then SEE "Related encodings";
if Rn == '1111' then SEE LDRD (literal);
t = UInt(Rt); t2 = UInt(Rt2); n = UInt(Rn); imm32 = ZeroExtend(imm8:'00', 32);
index = (P == '1'); add = (U == '1'); wback = (W == '1');
if wback && (n == t || n == t2) then UNPREDICTABLE;
if t == 15 || t2 == 15 || t == t2 then UNPREDICTABLE; // ARMv8-A removes UNPREDICTABLE for R13
  
```

CONSTRAINED UNPREDICTABLE behavior

If $wback$ && $(n == t || n == t2)$, then one of the following behaviors must occur:

- The instruction is UNDEFINED.
- The instruction executes as NOP.
- The instruction performs all of the loads using the specified addressing mode and the content of the register that is written back is UNKNOWN. In addition, if an exception occurs during such an instruction, the base address might be corrupted so that the instruction cannot be repeated.

If $t == t2$, then one of the following behaviors must occur:

- The instruction is UNDEFINED.
- The instruction executes as NOP.
- The load instruction executes but the destination register takes an UNKNOWN value.

Notes for all encodings

For more information about the CONSTRAINED UNPREDICTABLE behavior of this instruction, see [Appendix K1 Architectural Constraints on UNPREDICTABLE behaviors](#).

Related encodings: [Load/store dual, load/store exclusive, load-acquire/store-release, and table branch](#) on page F3-2913.

Assembler symbols

- <c> See [Standard assembler syntax fields](#) on page F2-2848.
- <q> See [Standard assembler syntax fields](#) on page F2-2848.
- <Rt> For encoding A1: is the first general-purpose register to be transferred, encoded in the "Rt" field. This register must be even-numbered and not R14.
For encoding T1: is the first general-purpose register to be transferred, encoded in the "Rt" field.
- <Rt2> For encoding A1: is the second general-purpose register to be transferred. This register must be <R(t+1)>.
For encoding T1: is the second general-purpose register to be transferred, encoded in the "Rt2" field.
- <Rn> Is the general-purpose base register, encoded in the "Rn" field. For PC use see [LDRD \(literal\)](#).
- +/- Specifies the offset is added to or subtracted from the base register, defaulting to + if omitted and encoded in the "U" field. It can have the following values:
- when U = 0
+ when U = 1
- <imm> For encoding A1: is the 8-bit unsigned immediate byte offset, in the range 0 to 255, defaulting to 0 if omitted, and encoded in the "imm4H:imm4L" field.
For encoding T1: is the unsigned immediate byte offset, a multiple of 4, in the range 0 to 1020, defaulting to 0 if omitted, and encoded in the "imm8" field as <imm>/4.

Operation for all encodings

```
if ConditionPassed() then
    EncodingSpecificOperations();
    offset_addr = if add then (R[n] + imm32) else (R[n] - imm32);
    address = if index then offset_addr else R[n];
    if address == Align(address, 8) then
        data = MemA[address,8];
        if BigEndian() then
            R[t] = data<63:32>;
            R[t2] = data<31:0>;
        else
            R[t] = data<31:0>;
            R[t2] = data<63:32>;
    else
        R[t] = MemA[address,4];
        R[t2] = MemA[address+4,4];
    if wback then R[n] = offset_addr;
```

F5.1.77 LDRD (literal)

Load Register Dual (literal) calculates an address from the PC value and an immediate offset, loads two words from memory, and writes them to two registers. For information about memory accesses see [Memory accesses on page F2-2854](#).

A1

31	28	27	26	25	24	23	22	21	20	19	18	17	16	15	12	11	8	7	6	5	4	3	0
!=1111				0	0	0	(1)	U	1	(0)	0	1	1	1	1	Rt	imm4H	1	1	0	1	imm4L	
cond																							

A1 variant

LDRD{<c>}{<q>} <Rt>, <Rt2>, <label> // Normal form
 LDRD{<c>}{<q>} <Rt>, <Rt2>, [PC, #<+/-><imm>] // Alternative form

Decode for this encoding

```
if Rt<0> == '1' then UNPREDICTABLE;
t = UInt(Rt); t2 = t+1; imm32 = ZeroExtend(imm4H:imm4L, 32); add = (U == '1');
if t2 == 15 then UNPREDICTABLE;
```

CONSTRAINED UNPREDICTABLE behavior

If Rt<0> == '1', then one of the following behaviors must occur:

- The instruction is UNDEFINED.
- The instruction executes as NOP.
- The instruction executes with the additional decode: t<0> = '0';.
- The instruction executes with the additional decode: t2 = t;.
- The instruction executes as described, with no change to its behavior and no additional side-effects. This does not apply when Rt == '1111'.

If P == '0' || W == '1', then one of the following behaviors must occur:

- The instruction is UNDEFINED.
- The instruction executes as NOP.
- The instruction executes as if P == 1 and W == 0.'

T1

15	14	13	12	11	10	9	8	7	6	5	4	3	2	1	0	15	12	11	8	7		0
1	1	1	0	1	0	0	P	U	1	W	1	1	1	1	1	Rt	Rt2				imm8	

T1 variant

Applies when !(P == 0 && W == 0).

LDRD{<c>}{<q>} <Rt>, <Rt2>, <label> // Normal form
 LDRD{<c>}{<q>} <Rt>, <Rt2>, [PC, #<+/-><imm>] // Alternative form

Decode for this encoding

```
if P == '0' && W == '0' then SEE "Related encodings";  
t = UInt(Rt); t2 = UInt(Rt2);  
imm32 = ZeroExtend(imm8:'00', 32); add = (U == '1');  
if t == 15 || t2 == 15 || t == t2 then UNPREDICTABLE; // ARMv8-A removes UNPREDICTABLE for R13  
if W == '1' then UNPREDICTABLE;
```

CONSTRAINED UNPREDICTABLE behavior

If $t == t2$, then one of the following behaviors must occur:

- The instruction is UNDEFINED.
- The instruction executes as NOP.
- The load instruction executes but the destination register takes an UNKNOWN value.

If $W == '1'$, then one of the following behaviors must occur:

- The instruction is UNDEFINED.
- The instruction executes as NOP.
- The instruction executes without writeback of the base address.
- The instruction uses post-indexed addressing when $P == '0'$ and uses pre-indexed addressing otherwise. The instruction is handled as described in *Using R15* on page K1-6097.

Notes for all encodings

For more information about the CONSTRAINED UNPREDICTABLE behavior of this instruction, see [Appendix K1 Architectural Constraints on UNPREDICTABLE behaviors](#).

Related encodings: [Load/store dual](#), [load/store exclusive](#), [load-acquire/store-release](#), and [table branch](#) on page F3-2913.

Assembler symbols

<c> See [Standard assembler syntax fields](#) on page F2-2848.

<q> See [Standard assembler syntax fields](#) on page F2-2848.

<Rt> For encoding A1: is the first general-purpose register to be transferred, encoded in the "Rt" field. This register must be even-numbered and not R14.

For encoding T1: is the first general-purpose register to be transferred, encoded in the "Rt" field.

<Rt2> For encoding A1: is the second general-purpose register to be transferred. This register must be <R(t+1)>.

For encoding T1: is the second general-purpose register to be transferred, encoded in the "Rt2" field.

<label> For encoding A1: the label of the literal data item that is to be loaded into <Rt>. The assembler calculates the required value of the offset from the $A1 \text{ign}(PC, 4)$ value of the instruction to this label. Any value in the range -255 to 255 is permitted.

If the offset is zero or positive, imm32 is equal to the offset and $\text{add} == \text{TRUE}$, encoded as $U == 1$. If the offset is negative, imm32 is equal to minus the offset and $\text{add} == \text{FALSE}$, encoded as $U == 0$.

For encoding T1: the label of the literal data item that is to be loaded into <Rt>. The assembler calculates the required value of the offset from the $A1 \text{ign}(PC, 4)$ value of the instruction to this label. Permitted values of the offset are multiples of 4 in the range -1020 to 1020.

If the offset is zero or positive, imm32 is equal to the offset and $\text{add} == \text{TRUE}$, encoded as $U == 1$.

If the offset is negative, imm32 is equal to minus the offset and $\text{add} == \text{FALSE}$, encoded as $U == 0$.

- +/- Specifies the offset is added to or subtracted from the base register, defaulting to + if omitted and encoded in the "U" field. It can have the following values:
- when U = 0
 - + when U = 1
- <imm> For encoding A1: is the 8-bit unsigned immediate byte offset, in the range 0 to 255, defaulting to 0 if omitted, and encoded in the "imm4H:imm4L" field.
- For encoding T1: is the optional 8-bit unsigned immediate byte offset, in the range 0 to 255, defaulting to 0 and encoded in the "imm8" field.

The alternative syntax permits the addition or subtraction of the offset and the immediate offset to be specified separately, including permitting a subtraction of 0 that cannot be specified using the normal syntax. For more information, see [Use of labels in UAL instruction syntax on page F1-2809](#).

Operation for all encodings

```
if ConditionPassed() then
    EncodingSpecificOperations();
    address = if add then (Align(PC,4) + imm32) else (Align(PC,4) - imm32);
    if address == Align(address, 8) then
        data = MemA[address,8];
        if BigEndian() then
            R[t] = data<63:32>;
            R[t2] = data<31:0>;
        else
            R[t] = data<31:0>;
            R[t2] = data<63:32>;
    else
        R[t] = MemA[address,4];
        R[t2] = MemA[address+4,4];
```

F5.1.78 LDRD (register)

Load Register Dual (register) calculates an address from a base register value and a register offset, loads two words from memory, and writes them to two registers. It can use offset, post-indexed, or pre-indexed addressing. For information about memory accesses see *Memory accesses* on page F2-2854.

A1

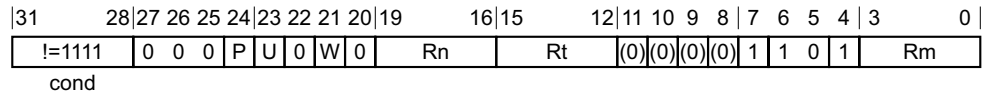

Offset variant

Applies when $P == 1 \ \&\& \ W == 0$.

LDRD{<c>}{<q>} <Rt>, <Rt2>, [<Rn>, {+/-}<Rm>]

Post-indexed variant

Applies when $P == 0 \ \&\& \ W == 0$.

LDRD{<c>}{<q>} <Rt>, <Rt2>, [<Rn>], {+/-}<Rm>

Pre-indexed variant

Applies when $P == 1 \ \&\& \ W == 1$.

LDRD{<c>}{<q>} <Rt>, <Rt2>, [<Rn>, {+/-}<Rm>]!

Decode for all variants of this encoding

```

if Rt<0> == '1' then UNPREDICTABLE;
t = UInt(Rt); t2 = t+1; n = UInt(Rn); m = UInt(Rm);
index = (P == '1'); add = (U == '1'); wback = (P == '0') || (W == '1');
if P == '0' && W == '1' then UNPREDICTABLE;
if t2 == 15 || m == 15 || m == t || m == t2 then UNPREDICTABLE;
if wback && (n == 15 || n == t || n == t2) then UNPREDICTABLE;
    
```

CONSTRAINED UNPREDICTABLE behavior

If $wback \ \&\& \ (n == t \ || \ n == t2)$, then one of the following behaviors must occur:

- The instruction is UNDEFINED.
- The instruction executes as NOP.
- The instruction performs all of the loads using the specified addressing mode and the content of the register that is written back is UNKNOWN. In addition, if an exception occurs during such as instruction, the base address might be corrupted so that the instruction cannot be repeated.

If $P == '0' \ \&\& \ W == '1'$, then one of the following behaviors must occur:

- The instruction is UNDEFINED.
- The instruction executes as NOP.
- The instruction executes as an LDRD using one of offset, post-indexed, or pre-indexed addressing.

If $m == t \ || \ m == t2$, then one of the following behaviors must occur:

- The instruction is UNDEFINED.
- The instruction executes as NOP.

- The instruction loads register Rm with an UNKNOWN value.

If Rt<0> == '1', then one of the following behaviors must occur:

- The instruction is UNDEFINED.
- The instruction executes as NOP.
- The instruction executes with the additional decode: t<0> = '0'.
- The instruction executes with the additional decode: t2 = t.
- The instruction executes as described, with no change to its behavior and no additional side-effects. This does not apply when Rt == '1111'.

Notes for all encodings

For more information about the CONSTRAINED UNPREDICTABLE behavior of this instruction, see [Appendix K1 Architectural Constraints on UNPREDICTABLE behaviors](#).

Assembler symbols

<c>	See Standard assembler syntax fields on page F2-2848 .
<q>	See Standard assembler syntax fields on page F2-2848 .
<Rt>	Is the first general-purpose register to be transferred, encoded in the "Rt" field. This register must be even-numbered and not R14.
<Rt2>	Is the second general-purpose register to be transferred. This register must be <R(t+1)>.
<Rn>	Is the general-purpose base register, encoded in the "Rn" field. The PC can be used in the offset variant.
+/-	Specifies the index register is added to or subtracted from the base register, defaulting to + if omitted and encoded in the "U" field. It can have the following values: <ul style="list-style-type: none">- when U = 0+ when U = 1
<Rm>	Is the general-purpose index register, encoded in the "Rm" field.

Operation

```
if ConditionPassed() then
    EncodingSpecificOperations();
    offset_addr = if add then (R[n] + R[m]) else (R[n] - R[m]);
    address = if index then offset_addr else R[n];
    if address == Align(address, 8) then
        data = MemA[address,8];
        if BigEndian() then
            R[t] = data<63:32>;
            R[t2] = data<31:0>;
        else
            R[t] = data<31:0>;
            R[t2] = data<63:32>;
    else
        R[t] = MemA[address,4];
        R[t2] = MemA[address+4,4];

    if wback then R[n] = offset_addr;
```

F5.1.79 LDREX

Load Register Exclusive calculates an address from a base register value and an immediate offset, loads a word from memory, writes it to a register and:

- If the address has the Shared Memory attribute, marks the physical address as exclusive access for the executing PE in a global monitor.
- Causes the executing PE to indicate an active exclusive access in the local monitor.

For more information about support for shared memory see [Synchronization and semaphores on page E2-2795](#). For information about memory accesses see [Memory accesses on page F2-2854](#).

A1

31	28	27	26	25	24	23	22	21	20	19	16	15	12	11	10	9	8	7	6	5	4	3	2	1	0		
!=1111				0	0	0	1	1	0	0	1	Rn	Rt	(1)	(1)	1	1	1	0	0	1	(1)	(1)	(1)	(1)		
cond																											

A1 variant

LDREX{<c>}{<q>} <Rt>, [<Rn> {, {#}<imm>}]

Decode for this encoding

```
t = UInt(Rt); n = UInt(Rn); imm32 = Zeros(32); // Zero offset
if t == 15 || n == 15 then UNPREDICTABLE;
```

T1

15	14	13	12	11	10	9	8	7	6	5	4	3	0	15	12	11	10	9	8	7						0
1	1	1	0	1	0	0	0	0	1	0	1	Rn	Rt	(1)	(1)	(1)	(1)	imm8								

T1 variant

LDREX{<c>}{<q>} <Rt>, [<Rn> {, #<imm>}]

Decode for this encoding

```
t = UInt(Rt); n = UInt(Rn); imm32 = ZeroExtend(imm8:'00', 32);
if t == 15 || n == 15 then UNPREDICTABLE; // ARMv8-A removes UNPREDICTABLE for R13
```

Notes for all encodings

For more information about the CONSTRAINED UNPREDICTABLE behavior of this instruction, see [Appendix K1 Architectural Constraints on UNPREDICTABLE behaviors](#).

Assembler symbols

- <c> See [Standard assembler syntax fields on page F2-2848](#).
- <q> See [Standard assembler syntax fields on page F2-2848](#).
- <Rt> Is the general-purpose register to be transferred, encoded in the "Rt" field.
- <Rn> Is the general-purpose base register, encoded in the "Rn" field.
- <imm> For encoding A1: the immediate offset added to the value of <Rn> to calculate the address. <imm> can only be 0 or omitted.

For encoding T1: the immediate offset added to the value of <Rn> to calculate the address. <imm> can be omitted, meaning an offset of 0. Values are multiples of 4 in the range 0-1020.

Operation for all encodings

```
if ConditionPassed() then
    EncodingSpecificOperations();
    address = R[n] + imm32;
    AArch32.SetExclusiveMonitors(address,4);
    R[t] = MemA[address,4];
```

F5.1.80 LDREXB

Load Register Exclusive Byte derives an address from a base register value, loads a byte from memory, zero-extends it to form a 32-bit word, writes it to a register and:

- If the address has the Shared Memory attribute, marks the physical address as exclusive access for the executing PE in a global monitor.
- Causes the executing PE to indicate an active exclusive access in the local monitor.

For more information about support for shared memory see [Synchronization and semaphores on page E2-2795](#). For information about memory accesses see [Memory accesses on page F2-2854](#).

A1

31	28	27	26	25	24	23	22	21	20	19	16	15	12	11	10	9	8	7	6	5	4	3	2	1	0		
!=1111				0	0	0	1	1	1	0	1	Rn	Rt	(1)	(1)	1	1	1	0	0	1	(1)	(1)	(1)	(1)		
cond																											

A1 variant

LDREXB{<c>}{<q>} <Rt>, [<Rn>]

Decode for this encoding

t = UInt(Rt); n = UInt(Rn);
 if t == 15 || n == 15 then UNPREDICTABLE;

T1

15	14	13	12	11	10	9	8	7	6	5	4	3	0	15	12	11	10	9	8	7	6	5	4	3	2	1	0
1	1	1	0	1	0	0	0	1	1	0	1	Rn	Rt	(1)	(1)	(1)	(1)	0	1	0	0	(1)	(1)	(1)	(1)		

T1 variant

LDREXB{<c>}{<q>} <Rt>, [<Rn>]

Decode for this encoding

t = UInt(Rt); n = UInt(Rn);
 if t == 15 || n == 15 then UNPREDICTABLE; // ARMv8-A removes UNPREDICTABLE for R13

Notes for all encodings

For more information about the CONSTRAINED UNPREDICTABLE behavior of this instruction, see [Appendix K1 Architectural Constraints on UNPREDICTABLE behaviors](#).

Assembler symbols

- <c> See [Standard assembler syntax fields on page F2-2848](#).
- <q> See [Standard assembler syntax fields on page F2-2848](#).
- <Rt> Is the general-purpose register to be transferred, encoded in the "Rt" field.
- <Rn> Is the general-purpose base register, encoded in the "Rn" field.

Operation for all encodings

```
if ConditionPassed() then
    EncodingSpecificOperations();
    address = R[n];
    AArch32.SetExclusiveMonitors(address,1);
    R[t] = ZeroExtend(MemA[address,1], 32);
```

F5.1.81 LDREXD

Load Register Exclusive Doubleword derives an address from a base register value, loads a 64-bit doubleword from memory, writes it to two registers and:

- If the address has the Shared Memory attribute, marks the physical address as exclusive access for the executing PE in a global monitor.
- Causes the executing PE to indicate an active exclusive access in the local monitor.

For more information about support for shared memory see [Synchronization and semaphores on page E2-2795](#). For information about memory accesses see [Memory accesses on page F2-2854](#).

A1

31	28	27	26	25	24	23	22	21	20	19	16	15	12	11	10	9	8	7	6	5	4	3	2	1	0		
!=1111				0	0	0	1	1	0	1	1	Rn	Rt	(1)	(1)	1	1	1	0	0	1	(1)	(1)	(1)	(1)		
cond																											

A1 variant

LDREXD{<c>}{<q>} <Rt>, <Rt2>, [<Rn>]

Decode for this encoding

```
t = UInt(Rt); t2 = t + 1; n = UInt(Rn);
if Rt<0> == '1' || t2 == 15 || n == 15 then UNPREDICTABLE;
```

CONSTRAINED UNPREDICTABLE behavior

If Rt<0> == '1', then one of the following behaviors must occur:

- The instruction is UNDEFINED.
- The instruction executes as NOP.
- The instruction executes with the additional decode: t<0> = '0'.
- The instruction executes with the additional decode: t2 = t.
- The instruction executes as described, with no change to its behavior and no additional side effects.

If Rt == '1110', then one of the following behaviors must occur:

- The instruction is UNDEFINED.
- The instruction executes as NOP.
- The instruction is handled as described in [Using R15 on page K1-6097](#).

T1

15	14	13	12	11	10	9	8	7	6	5	4	3	0	15	12	11	8	7	6	5	4	3	2	1	0
1	1	1	0	1	0	0	0	1	1	0	1	Rn	Rt	Rt2	0	1	1	1	(1)	(1)	(1)	(1)			

T1 variant

LDREXD{<c>}{<q>} <Rt>, <Rt2>, [<Rn>]

Decode for this encoding

```
t = UInt(Rt); t2 = UInt(Rt2); n = UInt(Rn);  
if t == 15 || t2 == 15 || t == t2 || n == 15 then UNPREDICTABLE;  
// ARMv8-A removes UNPREDICTABLE for R13
```

CONSTRAINED UNPREDICTABLE behavior

If $t == t2$, then one of the following behaviors must occur:

- The instruction is UNDEFINED.
- The instruction executes as NOP.
- The load instruction executes but the destination register takes an UNKNOWN value.

Notes for all encodings

For more information about the CONSTRAINED UNPREDICTABLE behavior of this instruction, see [Appendix K1 Architectural Constraints on UNPREDICTABLE behaviors](#).

Assembler symbols

<c>	See Standard assembler syntax fields on page F2-2848 .
<q>	See Standard assembler syntax fields on page F2-2848 .
<Rt>	For encoding A1: is the first general-purpose register to be transferred, encoded in the "Rt" field. <Rt> must be even-numbered and not R14. For encoding T1: is the first general-purpose register to be transferred, encoded in the "Rt" field.
<Rt2>	For encoding A1: is the second general-purpose register to be transferred. <Rt2> must be <R(t+1)>. For encoding T1: is the second general-purpose register to be transferred, encoded in the "Rt2" field.
<Rn>	Is the general-purpose base register, encoded in the "Rn" field.

Operation for all encodings

```
if ConditionPassed() then  
  EncodingSpecificOperations();  
  address = R[n];  
  AArch32.SetExclusiveMonitors(address,8);  
  value = MemA[address,8];  
  // Extract words from 64-bit loaded value such that R[t] is  
  // loaded from address and R[t2] from address+4.  
  R[t] = if BigEndian() then value<63:32> else value<31:0>;  
  R[t2] = if BigEndian() then value<31:0> else value<63:32>;
```

F5.1.82 LDREXH

Load Register Exclusive Halfword derives an address from a base register value, loads a halfword from memory, zero-extends it to form a 32-bit word, writes it to a register and:

- If the address has the Shared Memory attribute, marks the physical address as exclusive access for the executing PE in a global monitor.
- Causes the executing PE to indicate an active exclusive access in the local monitor.

For more information about support for shared memory see [Synchronization and semaphores on page E2-2795](#). For information about memory accesses see [Memory accesses on page F2-2854](#).

A1

31	28	27	26	25	24	23	22	21	20	19	16	15	12	11	10	9	8	7	6	5	4	3	2	1	0		
!=1111				0	0	0	1	1	1	1	Rn	Rt	(1)	(1)	1	1	1	0	0	1	(1)	(1)	(1)	(1)			
cond																											

A1 variant

LDREXH{<c>}{<q>} <Rt>, [<Rn>]

Decode for this encoding

t = UInt(Rt); n = UInt(Rn);
 if t == 15 || n == 15 then UNPREDICTABLE;

T1

15	14	13	12	11	10	9	8	7	6	5	4	3	0	15	12	11	10	9	8	7	6	5	4	3	2	1	0
1	1	1	0	1	0	0	0	1	1	0	1	Rn	Rt	(1)	(1)	(1)	(1)	0	1	0	1	(1)	(1)	(1)	(1)		

T1 variant

LDREXH{<c>}{<q>} <Rt>, [<Rn>]

Decode for this encoding

t = UInt(Rt); n = UInt(Rn);
 if t == 15 || n == 15 then UNPREDICTABLE; // ARMv8-A removes UNPREDICTABLE for R13

Notes for all encodings

For more information about the CONSTRAINED UNPREDICTABLE behavior of this instruction, see [Appendix K1 Architectural Constraints on UNPREDICTABLE behaviors](#).

Assembler symbols

- <c> See [Standard assembler syntax fields on page F2-2848](#).
- <q> See [Standard assembler syntax fields on page F2-2848](#).
- <Rt> Is the general-purpose register to be transferred, encoded in the "Rt" field.
- <Rn> Is the general-purpose base register, encoded in the "Rn" field.

Operation for all encodings

```
if ConditionPassed() then
    EncodingSpecificOperations();
    address = R[n];
    AArch32.SetExclusiveMonitors(address,2);
    R[t] = ZeroExtend(MemA[address,2], 32);
```

F5.1.83 LDRH (immediate)

Load Register Halfword (immediate) calculates an address from a base register value and an immediate offset, loads a halfword from memory, zero-extends it to form a 32-bit word, and writes it to a register. It can use offset, post-indexed, or pre-indexed addressing. For information about memory accesses see [Memory accesses on page F2-2854](#).

A1

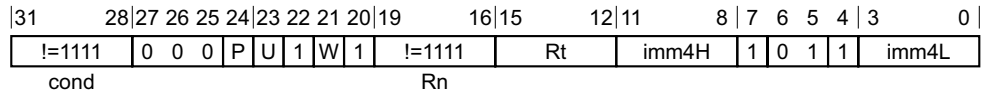

Offset variant

Applies when P == 1 && W == 0.

LDRH{<c>}{<q>} <Rt>, [<Rn> {, #+/-}<imm>}]

Post-indexed variant

Applies when P == 0 && W == 0.

LDRH{<c>}{<q>} <Rt>, [<Rn>], #+/-<imm>

Pre-indexed variant

Applies when P == 1 && W == 1.

LDRH{<c>}{<q>} <Rt>, [<Rn>, #+/-<imm>!]

Decode for all variants of this encoding

```

if Rn == '1111' then SEE LDRH (literal);
if P == '0' && W == '1' then SEE LDRHT;
t = UInt(Rt); n = UInt(Rn); imm32 = ZeroExtend(imm4H:imm4L, 32);
index = (P == '1'); add = (U == '1'); wback = (P == '0') || (W == '1');
if t == 15 || (wback && n == t) then UNPREDICTABLE;
    
```

CONSTRAINED UNPREDICTABLE behavior

If wback && n == t, then one of the following behaviors must occur:

- The instruction is UNDEFINED.
- The instruction executes as NOP.
- The instruction performs all of the loads using the specified addressing mode and the content of the register that is written back is UNKNOWN. In addition, if an exception occurs during such an instruction, the base address might be corrupted so that the instruction cannot be repeated.

T1

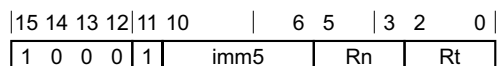

T1 variant

LDRH{<c>}{<q>} <Rt>, [<Rn> {, #+}<imm>}]

Decode for this encoding

```
t = UInt(Rt); n = UInt(Rn); imm32 = ZeroExtend(imm5:'0', 32);
index = TRUE; add = TRUE; wback = FALSE;
```

T2

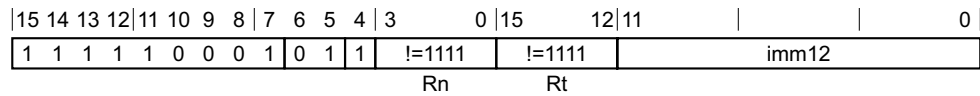

T2 variant

LDRH{<c>}.W <Rt>, [<Rn> {, #<+><imm>}] // <Rt>, <Rn>, <imm> can be represented in T1
 LDRH{<c>}{<q>} <Rt>, [<Rn> {, #<+><imm>}]

Decode for this encoding

```
if Rt == '1111' then SEE PLD (immediate);
if Rn == '1111' then SEE LDRH (literal);
t = UInt(Rt); n = UInt(Rn); imm32 = ZeroExtend(imm12, 32);
index = TRUE; add = TRUE; wback = FALSE;
// ARMv8-A removes UNPREDICTABLE for R13
```

T3

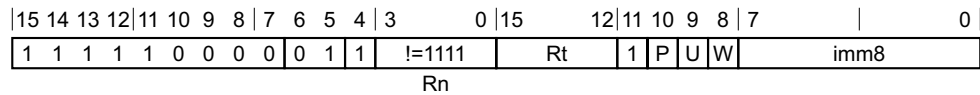

Offset variant

Applies when Rt != 1111 && P == 1 && U == 0 && W == 0.

LDRH{<c>}{<q>} <Rt>, [<Rn> {, #-<imm>}]

Post-indexed variant

Applies when P == 0 && W == 1.

LDRH{<c>}{<q>} <Rt>, [<Rn>], #<+/-><imm>

Pre-indexed variant

Applies when P == 1 && W == 1.

LDRH{<c>}{<q>} <Rt>, [<Rn>, #<+/-><imm>!]

Decode for all variants of this encoding

```
if Rn == '1111' then SEE LDRH (literal);
if Rt == '1111' && P == '1' && U == '0' && W == '0' then SEE PLDW (immediate);
if P == '1' && U == '1' && W == '0' then SEE LDRHT;
if P == '0' && W == '0' then UNDEFINED;
t = UInt(Rt); n = UInt(Rn); imm32 = ZeroExtend(imm8, 32);
index = (P == '1'); add = (U == '1'); wback = (W == '1');
if (t == 15 && W == '1') || (wback && n == t) then UNPREDICTABLE;
// ARMv8-A removes UNPREDICTABLE for R13
```

CONSTRAINED UNPREDICTABLE behavior

If `wback && n == t`, then one of the following behaviors must occur:

- The instruction is UNDEFINED.
- The instruction executes as NOP.
- The instruction performs all of the loads using the specified addressing mode and the content of the register that is written back is UNKNOWN. In addition, if an exception occurs during such an instruction, the base address might be corrupted so that the instruction cannot be repeated.

Notes for all encodings

For more information about the CONSTRAINED UNPREDICTABLE behavior of this instruction, see [Appendix K1 Architectural Constraints on UNPREDICTABLE behaviors](#).

Assembler symbols

<c>	See Standard assembler syntax fields on page F2-2848 .
<q>	See Standard assembler syntax fields on page F2-2848 .
<Rt>	Is the general-purpose register to be transferred, encoded in the "Rt" field.
<Rn>	For encoding A1, T2 and T3: is the general-purpose base register, encoded in the "Rn" field. For PC use see LDRH (literal) . For encoding T1: is the general-purpose base register, encoded in the "Rn" field.
+/-	Specifies the offset is added to or subtracted from the base register, defaulting to + if omitted and encoded in the "U" field. It can have the following values: - when U = 0 + when U = 1
+	Specifies the offset is added to the base register.
<imm>	For encoding A1: is the 8-bit unsigned immediate byte offset, in the range 0 to 255, defaulting to 0 if omitted, and encoded in the "imm4H:imm4L" field. For encoding T1: is the optional positive unsigned immediate byte offset, a multiple of 2, in the range 0 to 62, defaulting to 0 and encoded in the "imm5" field as <imm>/2. For encoding T2: is an optional 12-bit unsigned immediate byte offset, in the range 0 to 4095, defaulting to 0 and encoded in the "imm12" field. For encoding T3: is an 8-bit unsigned immediate byte offset, in the range 0 to 255, defaulting to 0 if omitted, and encoded in the "imm8" field.

Operation for all encodings

```
if CurrentInstrSet() == InstrSet_A32 then
  if ConditionPassed() then
    EncodingSpecificOperations();
    offset_addr = if add then (R[n] + imm32) else (R[n] - imm32);
    address = if index then offset_addr else R[n];
    data = MemU[address,2];
    if wback then R[n] = offset_addr;
    R[t] = ZeroExtend(data, 32);
else
  if ConditionPassed() then
    EncodingSpecificOperations();
    offset_addr = if add then (R[n] + imm32) else (R[n] - imm32);
    address = if index then offset_addr else R[n];
```

```
data = MemU[address,2];  
if wback then R[n] = offset_addr;  
R[t] = ZeroExtend(data, 32);
```

F5.1.84 LDRH (literal)

Load Register Halfword (literal) calculates an address from the PC value and an immediate offset, loads a halfword from memory, zero-extends it to form a 32-bit word, and writes it to a register. For information about memory accesses see [Memory accesses](#) on page F2-2854.

A1

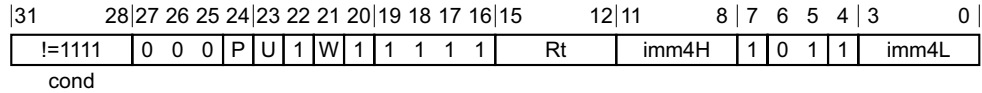

A1 variant

Applies when $!(P == 0 \ \&\& \ W == 1)$.

LDRH{<c>}{<q>} <Rt>, <label> // Normal form
 LDRH{<c>}{<q>} <Rt>, [PC, #{+/-}<imm>] // Alternative form

Decode for this encoding

```
if P == '0' && W == '1' then SEE LDRHT;
t = UInt(Rt); imm32 = ZeroExtend(imm4H:imm4L, 32);
add = (U == '1'); wback = (P == '0') || (W == '1');
if t == 15 || wback then UNPREDICTABLE;
```

CONSTRAINED UNPREDICTABLE behavior

If wback, then one of the following behaviors must occur:

- The instruction is UNDEFINED.
- The instruction executes as NOP.
- The instruction executes with the additional decode: wback = FALSE;.
- The instruction treats bit[24] as the P bit, and bit[21] as the writeback (W) bit, and uses the same addressing mode as described in [LDRH \(immediate\)](#). The instruction uses post-indexed addressing when P == '0' and uses pre-indexed addressing otherwise. The instruction is handled as described in [Using R15](#) on page K1-6097.

T1

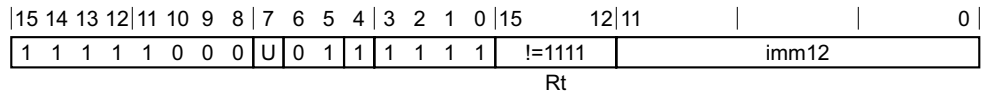

T1 variant

LDRH{<c>}{<q>} <Rt>, <label> // Preferred syntax
 LDRH{<c>}{<q>} <Rt>, [PC, #{+/-}<imm>] // Alternative syntax

Decode for this encoding

```
if Rt == '1111' then SEE PLD (literal);
t = UInt(Rt); imm32 = ZeroExtend(imm12, 32); add = (U == '1');
// ARMv8-A removes UNPREDICTABLE for R13
```

Notes for all encodings

For more information about the CONSTRAINED UNPREDICTABLE behavior of this instruction, see [Appendix K1 Architectural Constraints on UNPREDICTABLE behaviors](#).

Assembler symbols

- <c> See [Standard assembler syntax fields on page F2-2848](#).
- <q> See [Standard assembler syntax fields on page F2-2848](#).
- <Rt> Is the general-purpose register to be transferred, encoded in the "Rt" field.
- <label> For encoding A1: the label of the literal data item that is to be loaded into <Rt>. The assembler calculates the required value of the offset from the `Align(PC, 4)` value of the instruction to this label. Any value in the range -255 to 255 is permitted.
- If the offset is zero or positive, `imm32` is equal to the offset and `add == TRUE`, encoded as `U == 1`. If the offset is negative, `imm32` is equal to minus the offset and `add == FALSE`, encoded as `U == 0`.
- For encoding T1: the label of the literal data item that is to be loaded into <Rt>. The assembler calculates the required value of the offset from the `Align(PC, 4)` value of the instruction to this label. Permitted values of the offset are -4095 to 4095.
- If the offset is zero or positive, `imm32` is equal to the offset and `add == TRUE`, encoded as `U == 1`.
- If the offset is negative, `imm32` is equal to minus the offset and `add == FALSE`, encoded as `U == 0`.
- +/- Specifies the offset is added to or subtracted from the base register, defaulting to + if omitted and encoded in the "U" field. It can have the following values:
- when `U = 0`
 - + when `U = 1`
- <imm> For encoding A1: is the 8-bit unsigned immediate byte offset, in the range 0 to 255, defaulting to 0 if omitted, and encoded in the "imm4H:imm4L" field.
- For encoding T1: is a 12-bit unsigned immediate byte offset, in the range 0 to 4095, encoded in the "imm12" field.

The alternative syntax permits the addition or subtraction of the offset and the immediate offset to be specified separately, including permitting a subtraction of 0 that cannot be specified using the normal syntax. For more information, see [Use of labels in UAL instruction syntax on page F1-2809](#).

Operation for all encodings

```
if ConditionPassed() then
    EncodingSpecificOperations();
    base = Align(PC,4);
    address = if add then (base + imm32) else (base - imm32);
    data = MemU[address,2];
    R[t] = ZeroExtend(data, 32);
```

F5.1.85 LDRH (register)

Load Register Halfword (register) calculates an address from a base register value and an offset register value, loads a halfword from memory, zero-extends it to form a 32-bit word, and writes it to a register. The offset register value can be shifted left by 0, 1, 2, or 3 bits. For information about memory accesses see [Memory accesses on page F2-2854](#).

A1

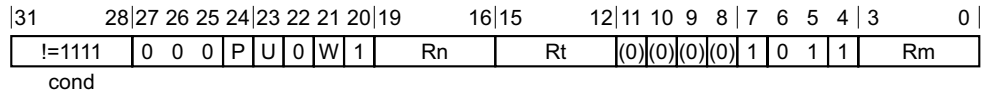

Offset variant

Applies when P == 1 && W == 0.

LDRH{<c>}{<q>} <Rt>, [<Rn>, {+/-}<Rm>]

Post-indexed variant

Applies when P == 0 && W == 0.

LDRH{<c>}{<q>} <Rt>, [<Rn>], {+/-}<Rm>

Pre-indexed variant

Applies when P == 1 && W == 1.

LDRH{<c>}{<q>} <Rt>, [<Rn>, {+/-}<Rm>]!

Decode for all variants of this encoding

```

if P == '0' && W == '1' then SEE LDRHT;
t = UInt(Rt); n = UInt(Rn); m = UInt(Rm);
index = (P == '1'); add = (U == '1'); wback = (P == '0') || (W == '1');
(shift_t, shift_n) = (SRTYPE_LSL, 0);
if t == 15 || m == 15 then UNPREDICTABLE;
if wback && (n == 15 || n == t) then UNPREDICTABLE;
    
```

CONSTRAINED UNPREDICTABLE behavior

If wback && n == t, then one of the following behaviors must occur:

- The instruction is UNDEFINED.
- The instruction executes as NOP.
- The instruction performs all of the loads using the specified addressing mode and the content of the register that is written back is UNKNOWN. In addition, if an exception occurs during such as instruction, the base address might be corrupted so that the instruction cannot be repeated.

T1

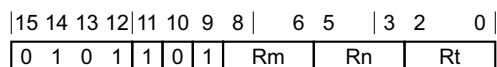

T1 variant

LDRH{<c>}{<q>} <Rt>, [<Rn>, {+}<Rm>]

Decode for this encoding

```
t = UInt(Rt); n = UInt(Rn); m = UInt(Rm);
index = TRUE; add = TRUE; wback = FALSE;
(shift_t, shift_n) = (SRTYPE_LSL, 0);
```

T2

15	14	13	12	11	10	9	8	7	6	5	4	3	0	15	12	11	10	9	8	7	6	5	4	3	0		
1	1	1	1	1	0	0	0	0	0	1	1	!	1111	!	1111	0	0	0	0	0	0	0	imm2	Rm			
												Rn		Rt													

T2 variant

LDRH{<c>}.W <Rt>, [<Rn>, {+}<Rm>] // <Rt>, <Rn>, <Rm> can be represented in T1
 LDRH{<c>}{<q>} <Rt>, [<Rn>, {+}<Rm>{, LSL #<imm>}]

Decode for this encoding

```
if Rn == '1111' then SEE LDRH (literal);
if Rt == '1111' then SEE PLDW (register);
t = UInt(Rt); n = UInt(Rn); m = UInt(Rm);
index = TRUE; add = TRUE; wback = FALSE;
(shift_t, shift_n) = (SRTYPE_LSL, UInt(imm2));
if m == 15 then UNPREDICTABLE; // ARMv8-A removes UNPREDICTABLE for R13
```

Notes for all encodings

For more information about the CONSTRAINED UNPREDICTABLE behavior of this instruction, see [Appendix K1 Architectural Constraints on UNPREDICTABLE behaviors](#).

Assembler symbols

- <c> See [Standard assembler syntax fields on page F2-2848](#).
- <q> See [Standard assembler syntax fields on page F2-2848](#).
- <Rt> Is the general-purpose register to be transferred, encoded in the "Rt" field.
- <Rn> For encoding A1: is the general-purpose base register, encoded in the "Rn" field. The PC can be used in the offset variant.
 For encoding T1 and T2: is the general-purpose base register, encoded in the "Rn" field.
- +/- Specifies the index register is added to or subtracted from the base register, defaulting to + if omitted and encoded in the "U" field. It can have the following values:
 - when U = 0
 - + when U = 1
- + Specifies the index register is added to the base register.
- <Rm> Is the general-purpose index register, encoded in the "Rm" field.
- <imm> If present, the size of the left shift to apply to the value from <Rm>, in the range 1-3. <imm> is encoded in imm2. If absent, no shift is specified and imm2 is encoded as 0b00.

Operation for all encodings

```
if ConditionPassed() then
  EncodingSpecificOperations();
  offset = Shift(R[m], shift_t, shift_n, PSTATE.C);
```

```
offset_addr = if add then (R[n] + offset) else (R[n] - offset);  
address = if index then offset_addr else R[n];  
data = MemU[address,2];  
if wback then R[n] = offset_addr;  
R[t] = ZeroExtend(data, 32);
```

F5.1.86 LDRHT

Load Register Halfword Unprivileged loads a halfword from memory, zero-extends it to form a 32-bit word, and writes it to a register. For information about memory accesses see [Memory accesses on page F2-2854](#).

The memory access is restricted as if the PE were running in User mode. This makes no difference if the PE is actually running in User mode.

LDRHT is UNPREDICTABLE in Hyp mode.

The T32 instruction uses an offset addressing mode, that calculates the address used for the memory access from a base register value and an immediate offset, and leaves the base register unchanged.

The A32 instruction uses a post-indexed addressing mode, that uses a base register value as the address for the memory access, and calculates a new address from a base register value and an offset and writes it back to the base register. The offset can be an immediate value or a register value.

A1

31	28	27	26	25	24	23	22	21	20	19	16	15	12	11	8	7	6	5	4	3	0	
!=1111				0	0	0	0	U	1	1	1	Rn	Rt	imm4H		1	0	1	1	imm4L		
cond																						

A1 variant

LDRHT{<c>}{<q>} <Rt>, [<Rn>] {, #<+/->{<imm>}}

Decode for this encoding

```
t = UInt(Rt); n = UInt(Rn); postindex = TRUE; add = (U == '1');
register_form = FALSE; imm32 = ZeroExtend(imm4H:imm4L, 32);
if t == 15 || n == 15 || n == t then UNPREDICTABLE;
```

CONSTRAINED UNPREDICTABLE behavior

If $n == 15$, then one of the following behaviors must occur:

- The instruction is UNDEFINED.
- The instruction executes as NOP.
- The instruction uses post-indexed addressing with the base register as PC. This is handled as described in [Using R15 on page K1-6097](#).
- The instruction is treated as if bit[24] == '1' and bit[21] == '0'. The instruction uses immediate offset addressing with the base register as PC, without writeback.

If $n == t$ && $n != 15$, then one of the following behaviors must occur:

- The instruction is UNDEFINED.
- The instruction executes as NOP.
- The instruction performs all of the loads using the specified addressing mode and the content of the register that is written back is UNKNOWN. In addition, if an exception occurs during such as instruction, the base address might be corrupted so that the instruction cannot be repeated.

A2

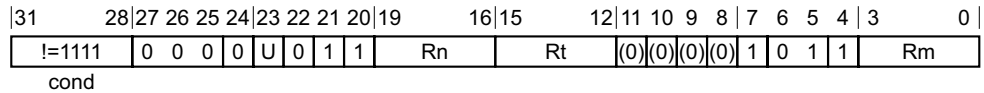

A2 variant

LDRHT{<c>}{<q>} <Rt>, [<Rn>], {+/-}<Rm>

Decode for this encoding

```
t = UInt(Rt); n = UInt(Rn); m = UInt(Rm); postindex = TRUE; add = (U == '1');
register_form = TRUE;
if t == 15 || n == 15 || n == t || m == 15 then UNPREDICTABLE;
```

CONSTRAINED UNPREDICTABLE behavior

If $n == t$ && $n != 15$, then one of the following behaviors must occur:

- The instruction is UNDEFINED.
- The instruction executes as NOP.
- The instruction performs all of the loads using the specified addressing mode and the content of the register that is written back is UNKNOWN. In addition, if an exception occurs during such as instruction, the base address might be corrupted so that the instruction cannot be repeated.

T1

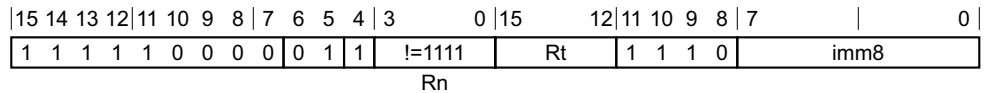

T1 variant

LDRHT{<c>}{<q>} <Rt>, [<Rn> {, #+}<imm>]

Decode for this encoding

```
if Rn == '1111' then SEE LDRH (literal);
t = UInt(Rt); n = UInt(Rn); postindex = FALSE; add = TRUE;
register_form = FALSE; imm32 = ZeroExtend(imm8, 32);
if t == 15 then UNPREDICTABLE; // ARMv8-A removes UNPREDICTABLE for R13
```

Notes for all encodings

For more information about the CONSTRAINED UNPREDICTABLE behavior of this instruction, see [Appendix K1 Architectural Constraints on UNPREDICTABLE behaviors](#).

Assembler symbols

- <c> See [Standard assembler syntax fields on page F2-2848](#).
- <q> See [Standard assembler syntax fields on page F2-2848](#).
- <Rt> Is the general-purpose register to be transferred, encoded in the "Rt" field.
- <Rn> Is the general-purpose base register, encoded in the "Rn" field.

- +/- For encoding A1: specifies the offset is added to or subtracted from the base register, defaulting to + if omitted and encoded in the "U" field. It can have the following values:
- when U = 0
 - + when U = 1
- For encoding A2: specifies the index register is added to or subtracted from the base register, defaulting to + if omitted and encoded in the "U" field. It can have the following values:
- when U = 0
 - + when U = 1
- <Rm> Is the general-purpose index register, encoded in the "Rm" field.
- + Specifies the offset is added to the base register.
- <imm> For encoding A1: is the 8-bit unsigned immediate byte offset, in the range 0 to 255, defaulting to 0 if omitted, and encoded in the "imm4H:imm4L" field.
- For encoding T1: is an optional 8-bit unsigned immediate byte offset, in the range 0 to 255, defaulting to 0 and encoded in the "imm8" field.

Operation for all encodings

```
if ConditionPassed() then
    if PSTATE.EL == EL2 then UNPREDICTABLE;           // Hyp mode
    EncodingSpecificOperations();
    offset = if register_form then R[m] else imm32;
    offset_addr = if add then (R[n] + offset) else (R[n] - offset);
    address = if postindex then R[n] else offset_addr;
    data = MemU_unpriv[address,2];
    if postindex then R[n] = offset_addr;
    R[t] = ZeroExtend(data, 32);
```

CONSTRAINED UNPREDICTABLE behavior

If PSTATE.EL == EL2, then one of the following behaviors must occur:

- The instruction is UNDEFINED.
- The instruction executes as NOP.
- The instruction executes as LDRH (immediate).

F5.1.87 LDRSB (immediate)

Load Register Signed Byte (immediate) calculates an address from a base register value and an immediate offset, loads a byte from memory, sign-extends it to form a 32-bit word, and writes it to a register. It can use offset, post-indexed, or pre-indexed addressing. For information about memory accesses see [Memory accesses on page F2-2854](#).

A1

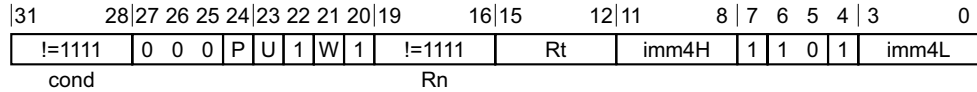

Offset variant

Applies when P == 1 && W == 0.

LDRSB{<c>}{<q>} <Rt>, [<Rn> {, #<+/-><imm>}]

Post-indexed variant

Applies when P == 0 && W == 0.

LDRSB{<c>}{<q>} <Rt>, [<Rn>], #<+/-><imm>

Pre-indexed variant

Applies when P == 1 && W == 1.

LDRSB{<c>}{<q>} <Rt>, [<Rn>, #<+/-><imm>]!

Decode for all variants of this encoding

```

if Rn == '1111' then SEE LDRSB (literal);
if P == '0' && W == '1' then SEE LDRSBT;
t = UInt(Rt); n = UInt(Rn); imm32 = ZeroExtend(imm4H:imm4L, 32);
index = (P == '1'); add = (U == '1'); wback = (P == '0') || (W == '1');
if t == 15 || (wback && n == t) then UNPREDICTABLE;
    
```

CONSTRAINED UNPREDICTABLE behavior

If wback && n == t, then one of the following behaviors must occur:

- The instruction is UNDEFINED.
- The instruction executes as NOP.
- The instruction performs all of the loads using the specified addressing mode and the content of the register that is written back is UNKNOWN. In addition, if an exception occurs during such an instruction, the base address might be corrupted so that the instruction cannot be repeated.

T1

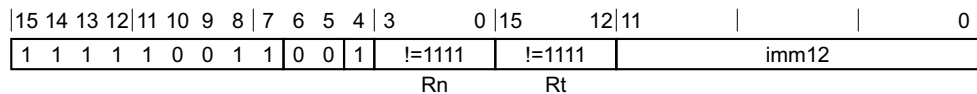

T1 variant

LDRSB{<c>}{<q>} <Rt>, [<Rn> {, #<+><imm>}]

Decode for this encoding

```

if Rt == '1111' then SEE PLI;
if Rn == '1111' then SEE LDRSB (literal);
t = UInt(Rt); n = UInt(Rn); imm32 = ZeroExtend(imm12, 32);
index = TRUE; add = TRUE; wback = FALSE;
// ARMv8-A removes UNPREDICTABLE for R13
    
```

T2

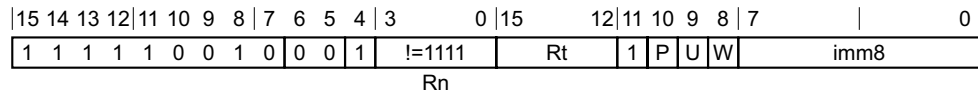

Offset variant

Applies when Rt != 1111 && P == 1 && U == 0 && W == 0.

LDRSB{<c>}{<q>} <Rt>, [<Rn> {, #-<imm>}]

Post-indexed variant

Applies when P == 0 && W == 1.

LDRSB{<c>}{<q>} <Rt>, [<Rn>], #{+/-}<imm>

Pre-indexed variant

Applies when P == 1 && W == 1.

LDRSB{<c>}{<q>} <Rt>, [<Rn>, #{+/-}<imm>]!

Decode for all variants of this encoding

```

if Rt == '1111' && P == '1' && U == '0' && W == '0' then SEE PLI;
if Rn == '1111' then SEE LDRSB (literal);
if P == '1' && U == '1' && W == '0' then SEE LDRSBT;
if P == '0' && W == '0' then UNDEFINED;
t = UInt(Rt); n = UInt(Rn); imm32 = ZeroExtend(imm8, 32);
index = (P == '1'); add = (U == '1'); wback = (W == '1');
if (t == 15 && W == '1') || (wback && n == t) then UNPREDICTABLE;
// ARMv8-A removes UNPREDICTABLE for R13
    
```

CONSTRAINED UNPREDICTABLE behavior

If wback && n == t, then one of the following behaviors must occur:

- The instruction is UNDEFINED.
- The instruction executes as NOP.
- The instruction performs all of the loads using the specified addressing mode and the content of the register that is written back is UNKNOWN. In addition, if an exception occurs during such an instruction, the base address might be corrupted so that the instruction cannot be repeated.

Notes for all encodings

For more information about the CONSTRAINED UNPREDICTABLE behavior of this instruction, see [Appendix K1 Architectural Constraints on UNPREDICTABLE behaviors](#).

Assembler symbols

<c> See [Standard assembler syntax fields on page F2-2848](#).

<q>	See Standard assembler syntax fields on page F2-2848 .
<Rt>	Is the general-purpose register to be transferred, encoded in the "Rt" field.
<Rn>	Is the general-purpose base register, encoded in the "Rn" field. For PC use see LDRSB (literal) .
+/-	Specifies the offset is added to or subtracted from the base register, defaulting to + if omitted and encoded in the "U" field. It can have the following values: - when U = 0 + when U = 1
+	Specifies the offset is added to the base register.
<imm>	For encoding A1: is the 8-bit unsigned immediate byte offset, in the range 0 to 255, defaulting to 0 if omitted, and encoded in the "imm4H:imm4L" field. For encoding T1: is an optional 12-bit unsigned immediate byte offset, in the range 0 to 4095, defaulting to 0 and encoded in the "imm12" field. For encoding T2: is an 8-bit unsigned immediate byte offset, in the range 0 to 255, defaulting to 0 if omitted, and encoded in the "imm8" field.

Operation for all encodings

```
if ConditionPassed() then
    EncodingSpecificOperations();
    offset_addr = if add then (R[n] + imm32) else (R[n] - imm32);
    address = if index then offset_addr else R[n];
    R[t] = SignExtend(MemU[address,1], 32);
    if wback then R[n] = offset_addr;
```

F5.1.88 LDRSB (literal)

Load Register Signed Byte (literal) calculates an address from the PC value and an immediate offset, loads a byte from memory, sign-extends it to form a 32-bit word, and writes it to a register. For information about memory accesses see [Memory accesses](#) on page F2-2854.

A1

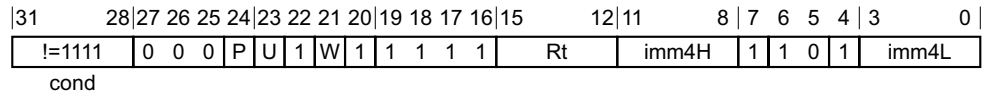

A1 variant

Applies when $!(P == 0 \ \&\& \ W == 1)$.

LDRSB{<c>}{<q>} <Rt>, <label> // Normal form
 LDRSB{<c>}{<q>} <Rt>, [PC, #+/-<imm>] // Alternative form

Decode for this encoding

```
if P == '0' && W == '1' then SEE LDRSBT;
t = UInt(Rt); imm32 = ZeroExtend(imm4H:imm4L, 32);
add = (U == '1'); wback = (P == '0') || (W == '1');
if t == 15 || wback then UNPREDICTABLE;
```

CONSTRAINED UNPREDICTABLE behavior

If wback, then one of the following behaviors must occur:

- The instruction is UNDEFINED.
- The instruction executes as NOP.
- The instruction executes with the additional decode: wback = FALSE;.
- The instruction treats bit[24] as the P bit, and bit[21] as the writeback (W) bit, and uses the same addressing mode as described in [LDRSB \(immediate\)](#). The instruction uses post-indexed addressing when P == '0' and uses pre-indexed addressing otherwise. The instruction is handled as described in [Using R15](#) on page K1-6097.

T1

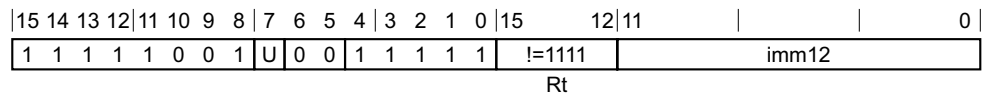

T1 variant

LDRSB{<c>}{<q>} <Rt>, <label> // Preferred syntax
 LDRSB{<c>}{<q>} <Rt>, [PC, #+/-<imm>] // Alternative syntax

Decode for this encoding

```
if Rt == '1111' then SEE PLI;
t = UInt(Rt); imm32 = ZeroExtend(imm12, 32); add = (U == '1');
// ARMv8-A removes UNPREDICTABLE for R13
```

Notes for all encodings

For more information about the CONSTRAINED UNPREDICTABLE behavior of this instruction, see [Appendix K1 Architectural Constraints on UNPREDICTABLE behaviors](#).

Assembler symbols

- <c> See [Standard assembler syntax fields on page F2-2848](#).
- <q> See [Standard assembler syntax fields on page F2-2848](#).
- <Rt> Is the general-purpose register to be transferred, encoded in the "Rt" field.
- <label> For encoding A1: the label of the literal data item that is to be loaded into <Rt>. The assembler calculates the required value of the offset from the `Align(PC, 4)` value of the instruction to this label. Any value in the range -255 to 255 is permitted.
- If the offset is zero or positive, `imm32` is equal to the offset and `add == TRUE`, encoded as `U == 1`. If the offset is negative, `imm32` is equal to minus the offset and `add == FALSE`, encoded as `U == 0`.
- For encoding T1: the label of the literal data item that is to be loaded into <Rt>. The assembler calculates the required value of the offset from the `Align(PC, 4)` value of the instruction to this label. Permitted values of the offset are -4095 to 4095.
- If the offset is zero or positive, `imm32` is equal to the offset and `add == TRUE`, encoded as `U == 1`. If the offset is negative, `imm32` is equal to minus the offset and `add == FALSE`, encoded as `U == 0`.
- +/- Specifies the offset is added to or subtracted from the base register, defaulting to + if omitted and encoded in the "U" field. It can have the following values:
- when `U = 0`
 - + when `U = 1`
- <imm> For encoding A1: is the 8-bit unsigned immediate byte offset, in the range 0 to 255, defaulting to 0 if omitted, and encoded in the "imm4H:imm4L" field.
- For encoding T1: is a 12-bit unsigned immediate byte offset, in the range 0 to 4095, encoded in the "imm12" field.

The alternative syntax permits the addition or subtraction of the offset and the immediate offset to be specified separately, including permitting a subtraction of 0 that cannot be specified using the normal syntax. For more information, see [Use of labels in UAL instruction syntax on page F1-2809](#).

Operation for all encodings

```
if ConditionPassed() then
    EncodingSpecificOperations();
    base = Align(PC,4);
    address = if add then (base + imm32) else (base - imm32);
    R[t] = SignExtend(MemU[address,1], 32);
```

F5.1.89 LDRSB (register)

Load Register Signed Byte (register) calculates an address from a base register value and an offset register value, loads a byte from memory, sign-extends it to form a 32-bit word, and writes it to a register. The offset register value can be shifted left by 0, 1, 2, or 3 bits. For information about memory accesses see [Memory accesses on page F2-2854](#).

A1

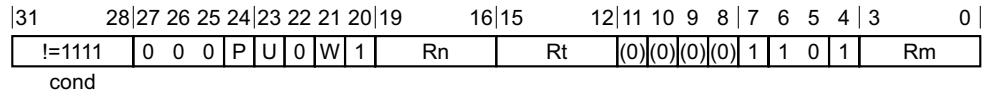

Offset variant

Applies when P == 1 && W == 0.

LDRSB{<c>}{<q>} <Rt>, [<Rn>, {+/-}<Rm>]

Post-indexed variant

Applies when P == 0 && W == 0.

LDRSB{<c>}{<q>} <Rt>, [<Rn>], {+/-}<Rm>

Pre-indexed variant

Applies when P == 1 && W == 1.

LDRSB{<c>}{<q>} <Rt>, [<Rn>, {+/-}<Rm>]!

Decode for all variants of this encoding

```

if P == '0' && W == '1' then SEE LDRSBT;
t = UInt(Rt); n = UInt(Rn); m = UInt(Rm);
index = (P == '1'); add = (U == '1'); wback = (P == '0') || (W == '1');
(shift_t, shift_n) = (SRTYPE_LSL, 0);
if t == 15 || m == 15 then UNPREDICTABLE;
if wback && (n == 15 || n == t) then UNPREDICTABLE;
    
```

CONSTRAINED UNPREDICTABLE behavior

If wback && n == t, then one of the following behaviors must occur:

- The instruction is UNDEFINED.
- The instruction executes as NOP.
- The instruction performs all of the loads using the specified addressing mode and the content of the register that is written back is UNKNOWN. In addition, if an exception occurs during such as instruction, the base address might be corrupted so that the instruction cannot be repeated.

T1

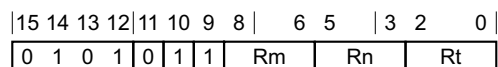

T1 variant

LDRSB{<c>}{<q>} <Rt>, [<Rn>, {+}<Rm>]

Decode for this encoding

```
t = UInt(Rt); n = UInt(Rn); m = UInt(Rm);
index = TRUE; add = TRUE; wback = FALSE;
(shift_t, shift_n) = (SRTYPE_LSL, 0);
```

T2

15	14	13	12	11	10	9	8	7	6	5	4	3	0	15	12	11	10	9	8	7	6	5	4	3	0
1	1	1	1	1	0	0	1	0	0	0	1	!	1111	!	1111	0	0	0	0	0	0	0	imm2	Rm	
												Rn		Rt											

T2 variant

LDRSB{<c>}.W <Rt>, [<Rn>, {+}<Rm>] // <Rt>, <Rn>, <Rm> can be represented in T1
 LDRSB{<c>}{<q>} <Rt>, [<Rn>, {+}<Rm>{, LSL #<imm>}]

Decode for this encoding

```
if Rt == '1111' then SEE PLI;
if Rn == '1111' then SEE LDRSB (literal);
t = UInt(Rt); n = UInt(Rn); m = UInt(Rm);
index = TRUE; add = TRUE; wback = FALSE;
(shift_t, shift_n) = (SRTYPE_LSL, UInt(imm2));
if m == 15 then UNPREDICTABLE; // ARMv8-A removes UNPREDICTABLE for R13
```

Notes for all encodings

For more information about the CONSTRAINED UNPREDICTABLE behavior of this instruction, see [Appendix K1 Architectural Constraints on UNPREDICTABLE behaviors](#).

Assembler symbols

- <c> See [Standard assembler syntax fields on page F2-2848](#).
- <q> See [Standard assembler syntax fields on page F2-2848](#).
- <Rt> Is the general-purpose register to be transferred, encoded in the "Rt" field.
- <Rn> For encoding A1: is the general-purpose base register, encoded in the "Rn" field. The PC can be used in the offset variant.
 For encoding T1 and T2: is the general-purpose base register, encoded in the "Rn" field.
- +/- Specifies the index register is added to or subtracted from the base register, defaulting to + if omitted and encoded in the "U" field. It can have the following values:
 - when U = 0
 - + when U = 1
- + Specifies the index register is added to the base register.
- <Rm> Is the general-purpose index register, encoded in the "Rm" field.
- <imm> If present, the size of the left shift to apply to the value from <Rm>, in the range 1-3. <imm> is encoded in imm2. If absent, no shift is specified and imm2 is encoded as 0b00.

Operation for all encodings

```
if ConditionPassed() then
  EncodingSpecificOperations();
offset = Shift(R[m], shift_t, shift_n, PSTATE.C);
```

```
offset_addr = if add then (R[n] + offset) else (R[n] - offset);  
address = if index then offset_addr else R[n];  
R[t] = SignExtend(MemU[address,1], 32);  
if wback then R[n] = offset_addr;
```

F5.1.90 LDRSBT

Load Register Signed Byte Unprivileged loads a byte from memory, sign-extends it to form a 32-bit word, and writes it to a register. For information about memory accesses see [Memory accesses on page F2-2854](#).

The memory access is restricted as if the PE were running in User mode. This makes no difference if the PE is actually running in User mode.

LDRSBT is UNPREDICTABLE in Hyp mode.

The T32 instruction uses an offset addressing mode, that calculates the address used for the memory access from a base register value and an immediate offset, and leaves the base register unchanged.

The A32 instruction uses a post-indexed addressing mode, that uses a base register value as the address for the memory access, and calculates a new address from a base register value and an offset and writes it back to the base register. The offset can be an immediate value or a register value.

A1

31	28	27	26	25	24	23	22	21	20	19	16	15	12	11	8	7	6	5	4	3	0	
!1111				0	0	0	0	U	1	1	1	Rn	Rt	imm4H		1	1	0	1	imm4L		
cond																						

A1 variant

LDRSBT{<C>}{<q>} <Rt>, [<Rn>] {, #<+/-><imm>}

Decode for this encoding

```
t = UInt(Rt); n = UInt(Rn); postindex = TRUE; add = (U == '1');
register_form = FALSE; imm32 = ZeroExtend(imm4H:imm4L, 32);
if t == 15 || n == 15 || n == t then UNPREDICTABLE;
```

CONSTRAINED UNPREDICTABLE behavior

If $n == 15$, then one of the following behaviors must occur:

- The instruction is UNDEFINED.
- The instruction executes as NOP.
- The instruction uses post-indexed addressing with the base register as PC. This is handled as described in [Using R15 on page K1-6097](#).
- The instruction is treated as if $\text{bit}[24] == '1'$ and $\text{bit}[21] == '0'$. The instruction uses immediate offset addressing with the base register as PC, without writeback.

If $n == t \ \&\& \ n \neq 15$, then one of the following behaviors must occur:

- The instruction is UNDEFINED.
- The instruction executes as NOP.
- The instruction performs all of the loads using the specified addressing mode and the content of the register that is written back is UNKNOWN. In addition, if an exception occurs during such as instruction, the base address might be corrupted so that the instruction cannot be repeated.

A2

31	28	27	26	25	24	23	22	21	20	19	16	15	12	11	10	9	8	7	6	5	4	3	0
!=1111				0	0	0	0	U	0	1	1	Rn	Rt	(0)	(0)	(0)	(0)	1	1	0	1	Rm	
cond																							

A2 variant

LDRSBT{<c>}{<q>} <Rt>, [<Rn>], {+/-}<Rm>

Decode for this encoding

```
t = UInt(Rt); n = UInt(Rn); m = UInt(Rm); postindex = TRUE; add = (U == '1');
register_form = TRUE;
if t == 15 || n == 15 || n == t || m == 15 then UNPREDICTABLE;
```

CONSTRAINED UNPREDICTABLE behavior

If $n == t$ && $n != 15$, then one of the following behaviors must occur:

- The instruction is UNDEFINED.
- The instruction executes as NOP.
- The instruction performs all of the loads using the specified addressing mode and the content of the register that is written back is UNKNOWN. In addition, if an exception occurs during such as instruction, the base address might be corrupted so that the instruction cannot be repeated.

T1

15	14	13	12	11	10	9	8	7	6	5	4	3	0	15	12	11	10	9	8	7	0
1	1	1	1	1	0	0	1	0	0	0	1	!=1111	Rt	1	1	1	0	imm8			
Rn																					

T1 variant

LDRSBT{<c>}{<q>} <Rt>, [<Rn> {, #+}<imm>}]

Decode for this encoding

```
if Rn == '1111' then SEE LDRSB (literal);
t = UInt(Rt); n = UInt(Rn); postindex = FALSE; add = TRUE;
register_form = FALSE; imm32 = ZeroExtend(imm8, 32);
if t == 15 then UNPREDICTABLE; // ARMv8-A removes UNPREDICTABLE for R13
```

Notes for all encodings

For more information about the CONSTRAINED UNPREDICTABLE behavior of this instruction, see [Appendix K1 Architectural Constraints on UNPREDICTABLE behaviors](#).

Assembler symbols

- <c> See [Standard assembler syntax fields on page F2-2848](#).
- <q> See [Standard assembler syntax fields on page F2-2848](#).
- <Rt> Is the general-purpose register to be transferred, encoded in the "Rt" field.
- <Rn> Is the general-purpose base register, encoded in the "Rn" field.

+/-	For encoding A1: specifies the offset is added to or subtracted from the base register, defaulting to + if omitted and encoded in the "U" field. It can have the following values: - when U = 0 + when U = 1 For encoding A2: specifies the index register is added to or subtracted from the base register, defaulting to + if omitted and encoded in the "U" field. It can have the following values: - when U = 0 + when U = 1
<Rm>	Is the general-purpose index register, encoded in the "Rm" field.
+	Specifies the offset is added to the base register.
<imm>	For encoding A1: is the 8-bit unsigned immediate byte offset, in the range 0 to 255, defaulting to 0 if omitted, and encoded in the "imm4H:imm4L" field. For encoding T1: is an optional 8-bit unsigned immediate byte offset, in the range 0 to 255, defaulting to 0 and encoded in the "imm8" field.

Operation for all encodings

```
if ConditionPassed() then
    if PSTATE.EL == EL2 then UNPREDICTABLE;           // Hyp mode
    EncodingSpecificOperations();
    offset = if register_form then R[m] else imm32;
    offset_addr = if add then (R[n] + offset) else (R[n] - offset);
    address = if postindex then R[n] else offset_addr;
    R[t] = SignExtend(MemU_unpriv[address,1], 32);
    if postindex then R[n] = offset_addr;
```

CONSTRAINED UNPREDICTABLE behavior

If PSTATE.EL == EL2, then one of the following behaviors must occur:

- The instruction is UNDEFINED.
- The instruction executes as NOP.
- The instruction executes as LDRSB (immediate).

F5.1.91 LDRSH (immediate)

Load Register Signed Halfword (immediate) calculates an address from a base register value and an immediate offset, loads a halfword from memory, sign-extends it to form a 32-bit word, and writes it to a register. It can use offset, post-indexed, or pre-indexed addressing. For information about memory accesses see [Memory accesses on page F2-2854](#).

A1

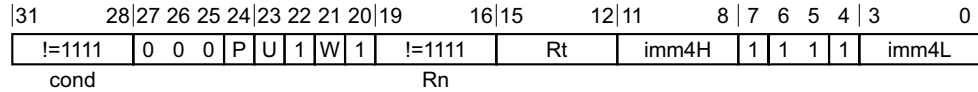

Offset variant

Applies when $P == 1$ && $W == 0$.

LDRSH{<c>}{<q>} <Rt>, [<Rn> {, #<+/-><imm>}]

Post-indexed variant

Applies when $P == 0$ && $W == 0$.

LDRSH{<c>}{<q>} <Rt>, [<Rn>], #<+/-><imm>

Pre-indexed variant

Applies when $P == 1$ && $W == 1$.

LDRSH{<c>}{<q>} <Rt>, [<Rn>, #<+/-><imm>]!

Decode for all variants of this encoding

```

if Rn == '1111' then SEE LDRSH (literal);
if P == '0' && W == '1' then SEE LDRSHT;
t = UInt(Rt); n = UInt(Rn); imm32 = ZeroExtend(imm4H:imm4L, 32);
index = (P == '1'); add = (U == '1'); wback = (P == '0') || (W == '1');
if t == 15 || (wback && n == t) then UNPREDICTABLE;
    
```

CONSTRAINED UNPREDICTABLE behavior

If $wback$ && $n == t$, then one of the following behaviors must occur:

- The instruction is UNDEFINED.
- The instruction executes as NOP.
- The instruction performs all of the loads using the specified addressing mode and the content of the register that is written back is UNKNOWN. In addition, if an exception occurs during such an instruction, the base address might be corrupted so that the instruction cannot be repeated.

T1

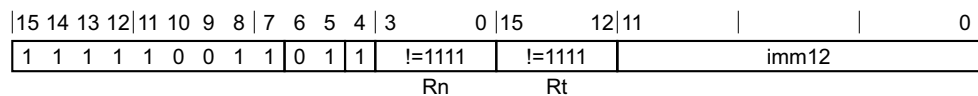

T1 variant

LDRSH{<c>}{<q>} <Rt>, [<Rn> {, #<+><imm>}]

Decode for this encoding

```
if Rn == '1111' then SEE LDRSH (literal);
if Rt == '1111' then SEE "Related instructions";
t = UInt(Rt); n = UInt(Rn); imm32 = ZeroExtend(imm12, 32);
index = TRUE; add = TRUE; wback = FALSE;
// ARMv8-A removes UNPREDICTABLE for R13
```

T2

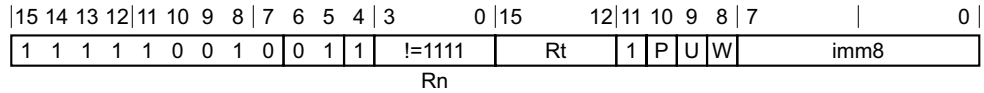

Offset variant

Applies when Rt != 1111 && P == 1 && U == 0 && W == 0.

```
LDRSH{<c>}{<q>} <Rt>, [<Rn> {, #-<imm>}]
```

Post-indexed variant

Applies when P == 0 && W == 1.

```
LDRSH{<c>}{<q>} <Rt>, [<Rn>], #{+/-}<imm>
```

Pre-indexed variant

Applies when P == 1 && W == 1.

```
LDRSH{<c>}{<q>} <Rt>, [<Rn>, #{+/-}<imm>]!
```

Decode for all variants of this encoding

```
if Rn == '1111' then SEE LDRSH (literal);
if Rt == '1111' && P == '1' && U == '0' && W == '0' then SEE "Related instructions";
if P == '1' && U == '1' && W == '0' then SEE LDRSHT;
if P == '0' && W == '0' then UNDEFINED;
t = UInt(Rt); n = UInt(Rn); imm32 = ZeroExtend(imm8, 32);
index = (P == '1'); add = (U == '1'); wback = (W == '1');
if (t == 15 && W == '1') || (wback && n == t) then UNPREDICTABLE;
// ARMv8-A removes UNPREDICTABLE for R13
```

CONSTRAINED UNPREDICTABLE behavior

If wback && n == t, then one of the following behaviors must occur:

- The instruction is UNDEFINED.
- The instruction executes as NOP.
- The instruction performs all of the loads using the specified addressing mode and the content of the register that is written back is UNKNOWN. In addition, if an exception occurs during such an instruction, the base address might be corrupted so that the instruction cannot be repeated.

Notes for all encodings

For more information about the CONSTRAINED UNPREDICTABLE behavior of this instruction, see [Appendix K1 Architectural Constraints on UNPREDICTABLE behaviors](#).

Related instructions: [Load/store single on page F3-2926](#).

Assembler symbols

<c>	See Standard assembler syntax fields on page F2-2848 .
<q>	See Standard assembler syntax fields on page F2-2848 .
<Rt>	Is the general-purpose register to be transferred, encoded in the "Rt" field.
<Rn>	Is the general-purpose base register, encoded in the "Rn" field. For PC use see LDRSH (literal) .
+/-	Specifies the offset is added to or subtracted from the base register, defaulting to + if omitted and encoded in the "U" field. It can have the following values: - when U = 0 + when U = 1
+	Specifies the offset is added to the base register.
<imm>	For encoding A1: is the 8-bit unsigned immediate byte offset, in the range 0 to 255, defaulting to 0 if omitted, and encoded in the "imm4H:imm4L" field. For encoding T1: is an optional 12-bit unsigned immediate byte offset, in the range 0 to 4095, defaulting to 0 and encoded in the "imm12" field. For encoding T2: is an 8-bit unsigned immediate byte offset, in the range 0 to 255, defaulting to 0 if omitted, and encoded in the "imm8" field.

Operation for all encodings

```
if ConditionPassed() then
    EncodingSpecificOperations();
    offset_addr = if add then (R[n] + imm32) else (R[n] - imm32);
    address = if index then offset_addr else R[n];
    data = MemU(address,2);
    if wback then R[n] = offset_addr;
    R[t] = SignExtend(data, 32);
```

F5.1.92 LDRSH (literal)

Load Register Signed Halfword (literal) calculates an address from the PC value and an immediate offset, loads a halfword from memory, sign-extends it to form a 32-bit word, and writes it to a register. For information about memory accesses see [Memory accesses on page F2-2854](#).

A1

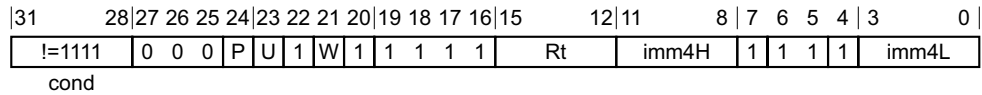

A1 variant

Applies when $!(P == 0 \ \&\& \ W == 1)$.

LDRSH{<c>}{<q>} <Rt>, <label> // Normal form
 LDRSH{<c>}{<q>} <Rt>, [PC, #+/-<imm>] // Alternative form

Decode for this encoding

```
if P == '0' && W == '1' then SEE LDRSHT;
t = UInt(Rt); imm32 = ZeroExtend(imm4H:imm4L, 32);
add = (U == '1'); wback = (P == '0') || (W == '1');
if t == 15 || wback then UNPREDICTABLE;
```

CONSTRAINED UNPREDICTABLE behavior

If wback, then one of the following behaviors must occur:

- The instruction is UNDEFINED.
- The instruction executes as NOP.
- The instruction executes with the additional decode: wback = FALSE;.
- The instruction treats bit[24] as the P bit, and bit[21] as the writeback (W) bit, and uses the same addressing mode as described in [LDRSH \(immediate\)](#). The instruction uses post-indexed addressing when P == '0' and uses pre-indexed addressing otherwise. The instruction is handled as described in [Using R15 on page K1-6097](#).

T1

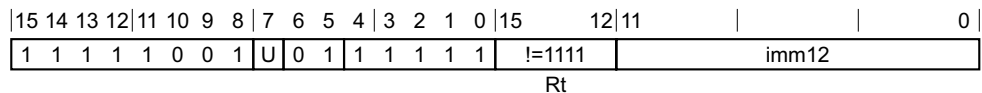

T1 variant

LDRSH{<c>}{<q>} <Rt>, <label> // Preferred syntax
 LDRSH{<c>}{<q>} <Rt>, [PC, #+/-<imm>] // Alternative syntax

Decode for this encoding

```
if Rt == '1111' then SEE "Related instructions";
t = UInt(Rt); imm32 = ZeroExtend(imm12, 32); add = (U == '1');
// ARMv8-A removes UNPREDICTABLE for R13
```

Notes for all encodings

For more information about the CONSTRAINED UNPREDICTABLE behavior of this instruction, see [Appendix K1 Architectural Constraints on UNPREDICTABLE behaviors](#).

Related instructions: [Load, signed \(literal\)](#) on page F3-2933.

Assembler symbols

<c>	See Standard assembler syntax fields on page F2-2848.				
<q>	See Standard assembler syntax fields on page F2-2848.				
<Rt>	Is the general-purpose register to be transferred, encoded in the "Rt" field.				
<label>	<p>For encoding A1: the label of the literal data item that is to be loaded into <Rt>. The assembler calculates the required value of the offset from the <code>Align(PC, 4)</code> value of the instruction to this label. Any value in the range -255 to 255 is permitted.</p> <p>If the offset is zero or positive, <code>imm32</code> is equal to the offset and <code>add == TRUE</code>, encoded as <code>U == 1</code>. If the offset is negative, <code>imm32</code> is equal to minus the offset and <code>add == FALSE</code>, encoded as <code>U == 0</code>.</p> <p>For encoding T1: the label of the literal data item that is to be loaded into <Rt>. The assembler calculates the required value of the offset from the <code>Align(PC, 4)</code> value of the instruction to this label. Permitted values of the offset are -4095 to 4095.</p> <p>If the offset is zero or positive, <code>imm32</code> is equal to the offset and <code>add == TRUE</code>, encoded as <code>U == 1</code>.</p> <p>If the offset is negative, <code>imm32</code> is equal to minus the offset and <code>add == FALSE</code>, encoded as <code>U == 0</code>.</p>				
+/-	<p>Specifies the offset is added to or subtracted from the base register, defaulting to + if omitted and encoded in the "U" field. It can have the following values:</p> <table><tr><td>-</td><td>when <code>U = 0</code></td></tr><tr><td>+</td><td>when <code>U = 1</code></td></tr></table>	-	when <code>U = 0</code>	+	when <code>U = 1</code>
-	when <code>U = 0</code>				
+	when <code>U = 1</code>				
<imm>	<p>For encoding A1: is the 8-bit unsigned immediate byte offset, in the range 0 to 255, defaulting to 0 if omitted, and encoded in the "imm4H:imm4L" field.</p> <p>For encoding T1: is a 12-bit unsigned immediate byte offset, in the range 0 to 4095, encoded in the "imm12" field.</p>				

The alternative syntax permits the addition or subtraction of the offset and the immediate offset to be specified separately, including permitting a subtraction of 0 that cannot be specified using the normal syntax. For more information, see [Use of labels in UAL instruction syntax](#) on page F1-2809.

Operation for all encodings

```
if ConditionPassed() then
    EncodingSpecificOperations();
    base = Align(PC,4);
    address = if add then (base + imm32) else (base - imm32);
    data = MemU[address,2];
    R[t] = SignExtend(data, 32);
```

F5.1.93 LDRSH (register)

Load Register Signed Halfword (register) calculates an address from a base register value and an offset register value, loads a halfword from memory, sign-extends it to form a 32-bit word, and writes it to a register. The offset register value can be shifted left by 0, 1, 2, or 3 bits. For information about memory accesses see [Memory accesses on page F2-2854](#).

A1

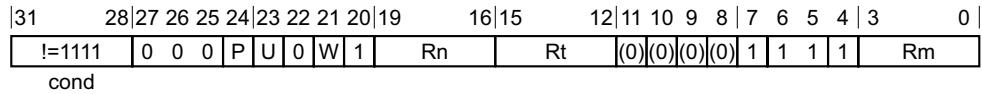

Offset variant

Applies when $P == 1 \ \&\& \ W == 0$.

LDRSH{<c>}{<q>} <Rt>, [<Rn>, {+/-}<Rm>]

Post-indexed variant

Applies when $P == 0 \ \&\& \ W == 0$.

LDRSH{<c>}{<q>} <Rt>, [<Rn>], {+/-}<Rm>

Pre-indexed variant

Applies when $P == 1 \ \&\& \ W == 1$.

LDRSH{<c>}{<q>} <Rt>, [<Rn>, {+/-}<Rm>]!

Decode for all variants of this encoding

```

if P == '0' && W == '1' then SEE LDRSHT;
t = UInt(Rt); n = UInt(Rn); m = UInt(Rm);
index = (P == '1'); add = (U == '1'); wback = (P == '0') || (W == '1');
(shift_t, shift_n) = (SRTYPE_LSL, 0);
if t == 15 || m == 15 then UNPREDICTABLE;
if wback && (n == 15 || n == t) then UNPREDICTABLE;
    
```

CONSTRAINED UNPREDICTABLE behavior

If $wback \ \&\& \ n == t$, then one of the following behaviors must occur:

- The instruction is UNDEFINED.
- The instruction executes as NOP.
- The instruction performs all of the loads using the specified addressing mode and the content of the register that is written back is <arm-defined-word>unknown</arm-defined-word>. In addition, if an exception occurs during such as instruction, the base address might be corrupted so that the instruction cannot be repeated.

T1

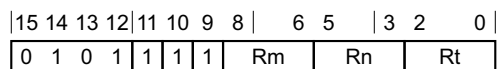

T1 variant

LDRSH{<c>}{<q>} <Rt>, [<Rn>, {+}<Rm>]

Decode for this encoding

```
t = UInt(Rt); n = UInt(Rn); m = UInt(Rm);
index = TRUE; add = TRUE; wback = FALSE;
(shift_t, shift_n) = (SRTYPE_LSL, 0);
```

T2

15	14	13	12	11	10	9	8	7	6	5	4	3	0	15	12	11	10	9	8	7	6	5	4	3	0
1	1	1	1	1	0	0	1	0	0	1	1	!	1111	!	1111	0	0	0	0	0	0	imm2			Rm
Rn													Rt												

T2 variant

LDRSH{<c>}.W <Rt>, [<Rn>, {+}<Rm>] // <Rt>, <Rn>, <Rm> can be represented in T1
 LDRSH{<c>}{<q>} <Rt>, [<Rn>, {+}<Rm>{, LSL #<imm>}]

Decode for this encoding

```
if Rn == '1111' then SEE LDRSH (literal);
if Rt == '1111' then SEE "Related instructions";
t = UInt(Rt); n = UInt(Rn); m = UInt(Rm);
index = TRUE; add = TRUE; wback = FALSE;
(shift_t, shift_n) = (SRTYPE_LSL, UInt(imm2));
if m == 15 then UNPREDICTABLE; // ARMv8-A removes UNPREDICTABLE for R13
```

Notes for all encodings

For more information about the CONSTRAINED UNPREDICTABLE behavior of this instruction, see [Appendix K1 Architectural Constraints on UNPREDICTABLE behaviors](#).

Related instructions: [Load/store, signed \(register offset\)](#) on page F3-2930.

Assembler symbols

- <c> See [Standard assembler syntax fields](#) on page F2-2848.
- <q> See [Standard assembler syntax fields](#) on page F2-2848.
- <Rt> Is the general-purpose register to be transferred, encoded in the "Rt" field.
- <Rn> For encoding A1: is the general-purpose base register, encoded in the "Rn" field. The PC can be used in the offset variant.
 For encoding T1 and T2: is the general-purpose base register, encoded in the "Rn" field.
- +/- Specifies the index register is added to or subtracted from the base register, defaulting to + if omitted and encoded in the "U" field. It can have the following values:
 - when U = 0
 - + when U = 1
- + Specifies the index register is added to the base register.
- <Rm> Is the general-purpose index register, encoded in the "Rm" field.
- <imm> If present, the size of the left shift to apply to the value from <Rm>, in the range 1-3. <imm> is encoded in imm2. If absent, no shift is specified and imm2 is encoded as 0b00.

Operation for all encodings

```
if ConditionPassed() then
    EncodingSpecificOperations();
    offset = Shift(R[m], shift_t, shift_n, PSTATE.C);
    offset_addr = if add then (R[n] + offset) else (R[n] - offset);
    address = if index then offset_addr else R[n];
    data = MemU[address,2];
    if wback then R[n] = offset_addr;
    R[t] = SignExtend(data, 32);
```

F5.1.94 LDRSHT

Load Register Signed Halfword Unprivileged loads a halfword from memory, sign-extends it to form a 32-bit word, and writes it to a register. For information about memory accesses see [Memory accesses on page F2-2854](#).

The memory access is restricted as if the PE were running in User mode. This makes no difference if the PE is actually running in User mode.

LDRSHT is UNPREDICTABLE in Hyp mode.

The T32 instruction uses an offset addressing mode, that calculates the address used for the memory access from a base register value and an immediate offset, and leaves the base register unchanged.

The A32 instruction uses a post-indexed addressing mode, that uses a base register value as the address for the memory access, and calculates a new address from a base register value and an offset and writes it back to the base register. The offset can be an immediate value or a register value.

A1

31	28	27	26	25	24	23	22	21	20	19	16	15	12	11	8	7	6	5	4	3	0	
!=1111				0	0	0	0	U	1	1	1	Rn	Rt	imm4H	1	1	1	1	imm4L			
cond																						

A1 variant

LDRSHT{<C>}{<q>} <Rt>, [<Rn>] {, #<+/-><imm>}

Decode for this encoding

```
t = UInt(Rt); n = UInt(Rn); postindex = TRUE; add = (U == '1');
register_form = FALSE; imm32 = ZeroExtend(imm4H:imm4L, 32);
if t == 15 || n == 15 || n == t then UNPREDICTABLE;
```

CONSTRAINED UNPREDICTABLE behavior

If $n == 15$, then one of the following behaviors must occur:

- The instruction is UNDEFINED.
- The instruction executes as NOP.
- The instruction uses post-indexed addressing with the base register as PC. This is handled as described in [Using R15 on page K1-6097](#).
- The instruction is treated as if $\text{bit}[24] == '1'$ and $\text{bit}[21] == '0'$. The instruction uses immediate offset addressing with the base register as PC, without writeback.

If $n == t$ && $n != 15$, then one of the following behaviors must occur:

- The instruction is UNDEFINED.
- The instruction executes as NOP.
- The instruction performs all of the loads using the specified addressing mode and the content of the register that is written back is UNKNOWN. In addition, if an exception occurs during such as instruction, the base address might be corrupted so that the instruction cannot be repeated.

A2

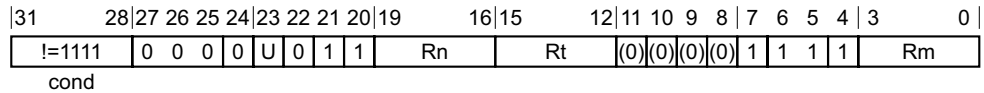

A2 variant

LDRSHT{<c>}{<q>} <Rt>, [<Rn>], {+/-}<Rm>

Decode for this encoding

```
t = UInt(Rt); n = UInt(Rn); m = UInt(Rm); postindex = TRUE; add = (U == '1');
register_form = TRUE;
if t == 15 || n == 15 || n == t || m == 15 then UNPREDICTABLE;
```

CONSTRAINED UNPREDICTABLE behavior

If $n == t$ && $n != 15$, then one of the following behaviors must occur:

- The instruction is UNDEFINED.
- The instruction executes as NOP.
- The instruction performs all of the loads using the specified addressing mode and the content of the register that is written back is UNKNOWN. In addition, if an exception occurs during such as instruction, the base address might be corrupted so that the instruction cannot be repeated.

T1

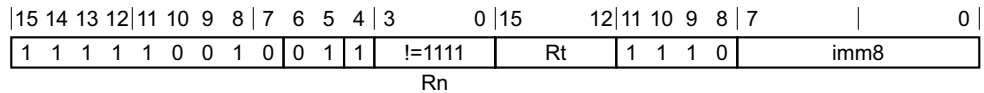

T1 variant

LDRSHT{<c>}{<q>} <Rt>, [<Rn> {, #+}<imm>}]

Decode for this encoding

```
if Rn == '1111' then SEE LDRSH (literal);
t = UInt(Rt); n = UInt(Rn); postindex = FALSE; add = TRUE;
register_form = FALSE; imm32 = ZeroExtend(imm8, 32);
if t == 15 then UNPREDICTABLE; // ARMv8-A removes UNPREDICTABLE for R13
```

Notes for all encodings

For more information about the CONSTRAINED UNPREDICTABLE behavior of this instruction, see [Appendix K1 Architectural Constraints on UNPREDICTABLE behaviors](#).

Assembler symbols

- <c> See [Standard assembler syntax fields on page F2-2848](#).
- <q> See [Standard assembler syntax fields on page F2-2848](#).
- <Rt> Is the general-purpose register to be transferred, encoded in the "Rt" field.
- <Rn> Is the general-purpose base register, encoded in the "Rn" field.

- +/- For encoding A1: specifies the offset is added to or subtracted from the base register, defaulting to + if omitted and encoded in the "U" field. It can have the following values:
- when U = 0
 - + when U = 1
- For encoding A2: specifies the index register is added to or subtracted from the base register, defaulting to + if omitted and encoded in the "U" field. It can have the following values:
- when U = 0
 - + when U = 1
- <Rm> Is the general-purpose index register, encoded in the "Rm" field.
- + Specifies the offset is added to the base register.
- <imm> For encoding A1: is the 8-bit unsigned immediate byte offset, in the range 0 to 255, defaulting to 0 if omitted, and encoded in the "imm4H:imm4L" field.
- For encoding T1: is an optional 8-bit unsigned immediate byte offset, in the range 0 to 255, defaulting to 0 and encoded in the "imm8" field.

Operation for all encodings

```
if ConditionPassed() then
    if PSTATE.EL == EL2 then UNPREDICTABLE;           // Hyp mode
    EncodingSpecificOperations();
    offset = if register_form then R[m] else imm32;
    offset_addr = if add then (R[n] + offset) else (R[n] - offset);
    address = if postindex then R[n] else offset_addr;
    data = MemU_unpriv[address,2];
    if postindex then R[n] = offset_addr;
    R[t] = SignExtend(data, 32);
```

CONSTRAINED UNPREDICTABLE behavior

If PSTATE.EL == EL2, then one of the following behaviors must occur:

- The instruction is UNDEFINED.
- The instruction executes as NOP.
- The instruction executes as LDRSH (immediate).

F5.1.95 LDRT

Load Register Unprivileged loads a word from memory, and writes it to a register. For information about memory accesses see [Memory accesses](#) on page F2-2854.

The memory access is restricted as if the PE were running in User mode. This makes no difference if the PE is actually running in User mode.

LDRT is UNPREDICTABLE in Hyp mode.

The T32 instruction uses an offset addressing mode, that calculates the address used for the memory access from a base register value and an immediate offset, and leaves the base register unchanged.

The A32 instruction uses a post-indexed addressing mode, that uses a base register value as the address for the memory access, and calculates a new address from a base register value and an offset and writes it back to the base register. The offset can be an immediate value or an optionally-shifted register value.

A1

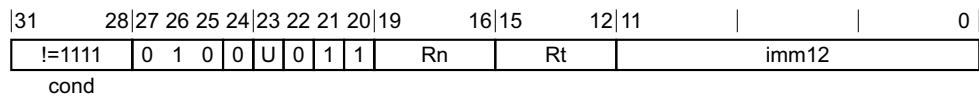

A1 variant

LDRT{<c>}{<q>} <Rt>, [<Rn>] {, #{+/-}<imm>}

Decode for this encoding

```
t = UInt(Rt); n = UInt(Rn); postindex = TRUE; add = (U == '1');
register_form = FALSE; imm32 = ZeroExtend(imm12, 32);
if t == 15 || n == 15 || n == t then UNPREDICTABLE;
```

CONSTRAINED UNPREDICTABLE behavior

If $n == 15$, then one of the following behaviors must occur:

- The instruction is UNDEFINED.
- The instruction executes as NOP.
- The instruction uses post-indexed addressing with the base register as PC. This is handled as described in [Using R15](#) on page K1-6097.
- The instruction is treated as if bit[24] == '1' and bit[21] == '0'. The instruction uses immediate offset addressing with the base register as PC, without writeback.

If $n == t$ && $n != 15$, then one of the following behaviors must occur:

- The instruction is UNDEFINED.
- The instruction executes as NOP.
- The instruction performs all of the loads using the specified addressing mode and the content of the register that is written back is UNKNOWN. In addition, if an exception occurs during such as instruction, the base address might be corrupted so that the instruction cannot be repeated.

A2

31	28	27	26	25	24	23	22	21	20	19	16	15	12	11	7	6	5	4	3	0	
!=1111				0	1	1	0	U	0	1	1	Rn	Rt	imm5	type	0	Rm				
cond																					

A2 variant

LDRT{<c>}{<q>} <Rt>, [<Rn>], {+/-}<Rm>{, <shift>}

Decode for this encoding

```
t = UInt(Rt); n = UInt(Rn); m = UInt(Rm); postindex = TRUE; add = (U == '1');
register_form = TRUE; (shift_t, shift_n) = DecodeImmShift(type, imm5);
if t == 15 || n == 15 || n == t || m == 15 then UNPREDICTABLE;
```

CONSTRAINED UNPREDICTABLE behavior

If $n == t$ && $n != 15$, then one of the following behaviors must occur:

- The instruction is UNDEFINED.
- The instruction executes as NOP.
- The instruction performs all of the loads using the specified addressing mode and the content of the register that is written back is UNKNOWN. In addition, if an exception occurs during such as instruction, the base address might be corrupted so that the instruction cannot be repeated.

T1

15	14	13	12	11	10	9	8	7	6	5	4	3	0	15	12	11	10	9	8	7	0
1	1	1	1	1	0	0	0	0	1	0	1	!=1111	Rt	1	1	1	0	imm8			
Rn																					

T1 variant

LDRT{<c>}{<q>} <Rt>, [<Rn> {, #<+><imm>}]

Decode for this encoding

```
if Rn == '1111' then SEE LDR (literal);
t = UInt(Rt); n = UInt(Rn); postindex = FALSE; add = TRUE;
register_form = FALSE; imm32 = ZeroExtend(imm8, 32);
if t == 15 then UNPREDICTABLE; // ARMv8-A removes UNPREDICTABLE for R13
```

Notes for all encodings

For more information about the CONSTRAINED UNPREDICTABLE behavior of this instruction, see [Appendix K1 Architectural Constraints on UNPREDICTABLE behaviors](#).

Assembler symbols

- <c> See [Standard assembler syntax fields on page F2-2848](#).
- <q> See [Standard assembler syntax fields on page F2-2848](#).
- <Rt> For encoding A1: is the general-purpose register to be transferred, encoded in the "Rt" field. The PC can be used, but this is deprecated.
 For encoding A2 and T1: is the general-purpose register to be transferred, encoded in the "Rt" field.

<Rn>	Is the general-purpose base register, encoded in the "Rn" field.
+/-	For encoding A1: specifies the offset is added to or subtracted from the base register, defaulting to + if omitted and encoded in the "U" field. It can have the following values: - when U = 0 + when U = 1 For encoding A2: specifies the index register is added to or subtracted from the base register, defaulting to + if omitted and encoded in the "U" field. It can have the following values: - when U = 0 + when U = 1
<Rm>	Is the general-purpose index register, encoded in the "Rm" field.
<shift>	The shift to apply to the value read from <Rm>. If absent, no shift is applied. Otherwise, see Shifts applied to a register on page F2-2852 .
+	Specifies the offset is added to the base register.
<imm>	For encoding A1: is the 12-bit unsigned immediate byte offset, in the range 0 to 4095, defaulting to 0 if omitted, and encoded in the "imm12" field. For encoding T1: is an optional 8-bit unsigned immediate byte offset, in the range 0 to 255, defaulting to 0 and encoded in the "imm8" field.

Operation for all encodings

```
if ConditionPassed() then
    if PSTATE.EL == EL2 then UNPREDICTABLE;           // Hyp mode
    EncodingSpecificOperations();
    offset = if register_form then Shift(R[m], shift_t, shift_n, PSTATE.C) else imm32;
    offset_addr = if add then (R[n] + offset) else (R[n] - offset);
    address = if postindex then R[n] else offset_addr;
    data = MemU_unpriv[address,4];
    if postindex then R[n] = offset_addr;
    R[t] = data;
```

CONSTRAINED UNPREDICTABLE behavior

If PSTATE.EL == EL2, then one of the following behaviors must occur:

- The instruction is UNDEFINED.
- The instruction executes as NOP.
- The instruction executes as LDR (immediate).

F5.1.96 LSL (immediate)

Logical Shift Left (immediate) shifts a register value left by an immediate number of bits, shifting in zeros, and writes the result to the destination register.

This instruction is an alias of the [MOV, MOVS \(register\)](#) instruction. This means that:

- The encodings in this description are named to match the encodings of [MOV, MOVS \(register\)](#).
- The description of [MOV, MOVS \(register\)](#) gives the operational pseudocode for this instruction.

A1

31	28	27	26	25	24	23	22	21	20	19	18	17	16	15	12	11	7	6	5	4	3	0	
!=1111				0 0 0 1 1				0 1 0				(0)(0)(0)(0)				Rd		!=00000		0 0 0		Rm	
cond								S										imm5		type			

MOV, shift or rotate by value variant

LSL{<c>}{<q>} {<Rd>}, <Rm>, #<imm>

is equivalent to

MOV{<c>}{<q>} <Rd>, <Rm>, LSL #<imm>

and is always the preferred disassembly.

T2

15	14	13	12	11	10	6	5	3	2	0
0 0 0				0 0		!=00000		Rm		Rd
op				imm5						

T2 variant

LSL<c>{<q>} {<Rd>}, <Rm>, #<imm> // Inside IT block

is equivalent to

MOV<c>{<q>} <Rd>, <Rm>, LSL #<imm>

and is the preferred disassembly when InITBlock().

T3

15	14	13	12	11	10	9	8	7	6	5	4	3	2	1	0	15	14	12	11	8	7	6	5	4	3	0
1 1 1				0 1 0 1				0 0 1 0				0 1 1 1 1				(0) imm3		Rd		imm2		0 0		Rm		
								S														type				

MOV, shift or rotate by value variant

LSL<c>.<w> {<Rd>}, <Rm>, #<imm> // Inside IT block, and <Rd>, <Rm>, <imm> can be represented in T2

is equivalent to

MOV{<c>}{<q>} <Rd>, <Rm>, LSL #<imm>

and is always the preferred disassembly.

LSL{<c>}{<q>} {<Rd>}, <Rm>, #<imm>

is equivalent to

MOV{<c>}{<q>} <Rd>, <Rm>, LSL #<imm>

and is always the preferred disassembly.

Assembler symbols

- <c> See [Standard assembler syntax fields on page F2-2848](#).
- <q> See [Standard assembler syntax fields on page F2-2848](#).
- <Rd> For encoding A1: is the general-purpose destination register, encoded in the "Rd" field. ARM deprecates using the PC as the destination register, but if the PC is used, the instruction is a branch to the address calculated by the operation. This is an interworking branch, see [Pseudocode description of operations on the AArch32 general-purpose registers and the PC on page E1-2733](#).
For encoding T2 and T3: is the general-purpose destination register, encoded in the "Rd" field.
- <Rm> For encoding A1: is the general-purpose source register, encoded in the "Rm" field. The PC can be used, but this is deprecated.
For encoding T2 and T3: is the general-purpose source register, encoded in the "Rm" field.
- <imm> For encoding A1 and T2: is the shift amount, in the range 1 to 31, encoded in the "imm5" field.
For encoding T3: is the shift amount, in the range 1 to 31, encoded in the "imm3:imm2" field.

Operation for all encodings

The description of [MOV, MOVS \(register\)](#) gives the operational pseudocode for this instruction.

F5.1.97 LSL (register)

Logical Shift Left (register) shifts a register value left by a variable number of bits, shifting in zeros, and writes the result to the destination register. The variable number of bits is read from the bottom byte of a register

This instruction is an alias of the [MOV, MOVS \(register-shifted register\)](#) instruction. This means that:

- The encodings in this description are named to match the encodings of [MOV, MOVS \(register-shifted register\)](#).
- The description of [MOV, MOVS \(register-shifted register\)](#) gives the operational pseudocode for this instruction.

A1

31	28	27	26	25	24	23	22	21	20	19	18	17	16	15	12	11	8	7	6	5	4	3	0
!=1111				0	0	0	1	1	0	1	0	(0)	(0)	(0)	(0)	Rd	Rs	0	0	0	1	Rm	
cond				S												type							

Not flag setting variant

LSL<<c>>{<q>} {<Rd>}, <Rm>, <Rs>

is equivalent to

MOV<<c>>{<q>} <Rd>, <Rm>, LSL <Rs>

and is always the preferred disassembly.

T1

15	14	13	12	11	10	9	6	5	3	2	0	
0	1	0	0	0	0	0	0	0	1	0	Rs	Rdm
op												

Logical shift left variant

LSL<<c>>{<q>} {<Rdm>}, <Rdm>, <Rs> // Inside IT block

is equivalent to

MOV<<c>>{<q>} <Rdm>, <Rdm>, LSL <Rs>

and is the preferred disassembly when InITBlock().

T2

15	14	13	12	11	10	9	8	7	6	5	4	3	0	15	14	13	12	11	8	7	6	5	4	3	0
1	1	1	1	1	0	1	0	0	0	0	0	Rm	1	1	1	1	Rd	0	0	0	0	Rs			
type												S													

Not flag setting variant

LSL<<c>>.W {<Rd>}, <Rm>, <Rs> // Inside IT block, and <Rd>, <Rm>, <type>, <Rs> can be represented in T1

is equivalent to

MOV<<c>>{<q>} <Rd>, <Rm>, LSL <Rs>

and is always the preferred disassembly.

LSL{<c>}{<q>} {<Rd>}, <Rm>, <Rs>

is equivalent to

MOV{<c>}{<q>} <Rd>, <Rm>, LSL <Rs>

and is always the preferred disassembly.

Assembler symbols

<c> See [Standard assembler syntax fields on page F2-2848](#).

<q> See [Standard assembler syntax fields on page F2-2848](#).

<Rdm> Is the first general-purpose source register and the destination register, encoded in the "Rdm" field.

<Rd> Is the general-purpose destination register, encoded in the "Rd" field.

<Rm> Is the first general-purpose source register, encoded in the "Rm" field.

<Rs> Is the second general-purpose source register holding a shift amount in its bottom 8 bits, encoded in the "Rs" field.

Operation for all encodings

The description of [MOV, MOVS \(register-shifted register\)](#) gives the operational pseudocode for this instruction.

F5.1.98 LSLS (immediate)

Logical Shift Left, setting flags (immediate) shifts a register value left by an immediate number of bits, shifting in zeros, and writes the result to the destination register.

If the destination register is not the PC, this instruction updates the condition flags based on the result.

The field descriptions for <Rd> identify the encodings where the PC is permitted as the destination register. ARM deprecates any use of these encodings. However, when the destination register is the PC:

- The PE branches to the address written to the PC, and restores **PSTATE** from SPSR_<current_mode>.
- The PE checks SPSR_<current_mode> for an illegal return event. See *Illegal return events from AArch32 state* on page G1-4361.
- The instruction is UNDEFINED in Hyp mode.
- The instruction is CONSTRAINED UNPREDICTABLE in User mode and System mode.

This instruction is an alias of the **MOV, MOVS (register)** instruction. This means that:

- The encodings in this description are named to match the encodings of **MOV, MOVS (register)**.
- The description of **MOV, MOVS (register)** gives the operational pseudocode for this instruction.

A1

31	28	27	26	25	24	23	22	21	20	19	18	17	16	15	12	11	7	6	5	4	3	0		
!=1111				0 0 0 1 1				0 1 1				(0)(0)(0)(0)				Rd		!=00000			0 0 0		Rm	
cond								S										imm5			type			

MOVS, shift or rotate by value variant

LSLS{<c>}{<q>} {<Rd>}, <Rm>, #<imm>

is equivalent to

MOVS{<c>}{<q>} <Rd>, <Rm>, LSL #<imm>

and is always the preferred disassembly.

T2

15	14	13	12	11	10	6	5	3	2	0
0 0 0		0 0		!=00000			Rm		Rd	
op		imm5								

T2 variant

LSLS{<q>} {<Rd>}, <Rm>, #<imm> // Outside IT block

is equivalent to

MOVS{<q>} <Rd>, <Rm>, LSL #<imm>

and is the preferred disassembly when !InITBlock().

T3

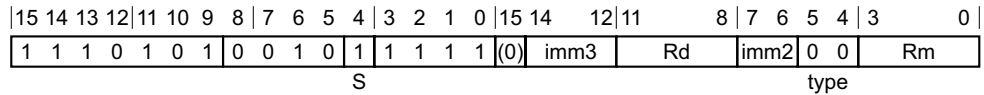

MOVS, shift or rotate by value variant

LSLS.W {<Rd>}, {<Rm>}, #<imm> // Outside IT block, and <Rd>, <Rm>, <imm> can be represented in T2 is equivalent to

MOVS{<c>}{<q>} <Rd>, <Rm>, LSL #<imm>

and is always the preferred disassembly.

LSLS{<c>}{<q>} {<Rd>}, {<Rm>}, #<imm>

is equivalent to

MOVS{<c>}{<q>} <Rd>, <Rm>, LSL #<imm>

and is always the preferred disassembly.

Assembler symbols

<c> See [Standard assembler syntax fields on page F2-2848](#).

<q> See [Standard assembler syntax fields on page F2-2848](#).

<Rd> For encoding A1: is the general-purpose destination register, encoded in the "Rd" field. ARM deprecates using the PC as the destination register, but if the PC is used, the instruction performs an exception return, that restores [PSTATE](#) from `SPSR_<current_mode>`.

For encoding T2 and T3: is the general-purpose destination register, encoded in the "Rd" field.

<Rm> For encoding A1: is the general-purpose source register, encoded in the "Rm" field. The PC can be used, but this is deprecated.

For encoding T2 and T3: is the general-purpose source register, encoded in the "Rm" field.

<imm> For encoding A1 and T2: is the shift amount, in the range 1 to 31, encoded in the "imm5" field.

For encoding T3: is the shift amount, in the range 1 to 31, encoded in the "imm3:imm2" field.

Operation for all encodings

The description of [MOV, MOVS \(register\)](#) gives the operational pseudocode for this instruction.

F5.1.99 LSLS (register)

Logical Shift Left, setting flags (register) shifts a register value left by a variable number of bits, shifting in zeros, writes the result to the destination register, and updates the condition flags based on the result. The variable number of bits is read from the bottom byte of a register

This instruction is an alias of the [MOV, MOVS \(register-shifted register\)](#) instruction. This means that:

- The encodings in this description are named to match the encodings of [MOV, MOVS \(register-shifted register\)](#).
- The description of [MOV, MOVS \(register-shifted register\)](#) gives the operational pseudocode for this instruction.

A1

31	28	27	26	25	24	23	22	21	20	19	18	17	16	15	12	11	8	7	6	5	4	3	0	
!=1111				0	0	0	1	1	0	1	1	(0)	(0)	(0)	(0)	Rd	Rs	0	0	0	1	Rm		
cond				S												type								

Flag setting variant

LSLS{<c>}{<q>} {<Rd>}, <Rm>, <Rs>

is equivalent to

MOVS{<c>}{<q>} <Rd>, <Rm>, LSL <Rs>

and is always the preferred disassembly.

T1

15	14	13	12	11	10	9	6	5	3	2	0	
0	1	0	0	0	0	0	0	0	1	0	Rs	Rdm
op												

Logical shift left variant

LSLS{<q>} {<Rdm>}, <Rdm>, <Rs> // Outside IT block

is equivalent to

MOVS{<q>} <Rdm>, <Rdm>, LSL <Rs>

and is the preferred disassembly when !InITBlock().

T2

15	14	13	12	11	10	9	8	7	6	5	4	3	0	15	14	13	12	11	8	7	6	5	4	3	0
1	1	1	1	1	0	1	0	0	0	0	1	Rm	1	1	1	1	Rd	0	0	0	0	Rs			
type S																									

Flag setting variant

LSLS.W {<Rd>}, <Rm>, <Rs> // Outside IT block, and <Rd>, <Rm>, <type>, <Rs> can be represented in T1

is equivalent to

MOVS{<c>}{<q>} <Rd>, <Rm>, LSL <Rs>

and is always the preferred disassembly.

LSLS{<c>}{<q>} {<Rd>, } <Rm>, <Rs>

is equivalent to

MOVS{<c>}{<q>} <Rd>, <Rm>, LSL <Rs>

and is always the preferred disassembly.

Assembler symbols

<c>	See Standard assembler syntax fields on page F2-2848 .
<q>	See Standard assembler syntax fields on page F2-2848 .
<Rdm>	Is the first general-purpose source register and the destination register, encoded in the "Rdm" field.
<Rd>	Is the general-purpose destination register, encoded in the "Rd" field.
<Rm>	Is the first general-purpose source register, encoded in the "Rm" field.
<Rs>	Is the second general-purpose source register holding a shift amount in its bottom 8 bits, encoded in the "Rs" field.

Operation for all encodings

The description of [MOV, MOVS \(register-shifted register\)](#) gives the operational pseudocode for this instruction.

F5.1.100 LSR (immediate)

Logical Shift Right (immediate) shifts a register value right by an immediate number of bits, shifting in zeros, and writes the result to the destination register.

This instruction is an alias of the [MOV, MOVS \(register\)](#) instruction. This means that:

- The encodings in this description are named to match the encodings of [MOV, MOVS \(register\)](#).
- The description of [MOV, MOVS \(register\)](#) gives the operational pseudocode for this instruction.

A1

31	28	27	26	25	24	23	22	21	20	19	18	17	16	15	12	11	7	6	5	4	3	0
!=1111				0	0	0	1	1	0	1	0	(0)	(0)	(0)	(0)	Rd	imm5	0	1	0	Rm	
cond				S										type								

MOV, shift or rotate by value variant

LSR{<c>}{<q>} {<Rd>}, <Rm>, #<imm>

is equivalent to

MOV{<c>}{<q>} <Rd>, <Rm>, LSR #<imm>

and is always the preferred disassembly.

T2

15	14	13	12	11	10	6	5	3	2	0
0	0	0	0	1	imm5	Rm	Rd			
op										

T2 variant

LSR<c>{<q>} {<Rd>}, <Rm>, #<imm> // Inside IT block

is equivalent to

MOV<c>{<q>} <Rd>, <Rm>, LSR #<imm>

and is the preferred disassembly when InITBlock().

T3

15	14	13	12	11	10	9	8	7	6	5	4	3	2	1	0	15	14	12	11	8	7	6	5	4	3	0
1	1	1	0	1	0	1	0	0	0	1	0	0	1	1	1	1	(0)	imm3	Rd	imm2	0	1	Rm			
S																type										

MOV, shift or rotate by value variant

LSR<c>.W {<Rd>}, <Rm>, #<imm> // Inside IT block, and <Rd>, <Rm>, <imm> can be represented in T2

is equivalent to

MOV{<c>}{<q>} <Rd>, <Rm>, LSR #<imm>

and is always the preferred disassembly.

LSR{<c>}{<q>} {<Rd>}, <Rm>, #<imm>

is equivalent to

MOV{<c>}{<q>} <Rd>, <Rm>, LSR #<imm>

and is always the preferred disassembly.

Assembler symbols

- <c> See [Standard assembler syntax fields on page F2-2848](#).
- <q> See [Standard assembler syntax fields on page F2-2848](#).
- <Rd> For encoding A1: is the general-purpose destination register, encoded in the "Rd" field. ARM deprecates using the PC as the destination register, but if the PC is used, the instruction is a branch to the address calculated by the operation. This is an interworking branch, see [Pseudocode description of operations on the AArch32 general-purpose registers and the PC on page E1-2733](#).
For encoding T2 and T3: is the general-purpose destination register, encoded in the "Rd" field.
- <Rm> For encoding A1: is the general-purpose source register, encoded in the "Rm" field. The PC can be used, but this is deprecated.
For encoding T2 and T3: is the general-purpose source register, encoded in the "Rm" field.
- <imm> For encoding A1 and T2: is the shift amount, in the range 1 to 32, encoded in the "imm5" field as <imm> modulo 32.
For encoding T3: is the shift amount, in the range 1 to 32, encoded in the "imm3:imm2" field as <imm> modulo 32.

Operation for all encodings

The description of [MOV, MOVS \(register\)](#) gives the operational pseudocode for this instruction.

F5.1.101 LSR (register)

Logical Shift Right (register) shifts a register value right by a variable number of bits, shifting in zeros, and writes the result to the destination register. The variable number of bits is read from the bottom byte of a register

This instruction is an alias of the [MOV, MOVS \(register-shifted register\)](#) instruction. This means that:

- The encodings in this description are named to match the encodings of [MOV, MOVS \(register-shifted register\)](#).
- The description of [MOV, MOVS \(register-shifted register\)](#) gives the operational pseudocode for this instruction.

A1

31	28	27	26	25	24	23	22	21	20	19	18	17	16	15	12	11	8	7	6	5	4	3	0
!=1111				0	0	0	1	1	0	1	0	(0)	(0)	(0)	(0)	Rd	Rs	0	0	1	1	Rm	
cond				S												type							

Not flag setting variant

LSR{<c>}{<q>} {<Rd>}, <Rm>, <Rs>

is equivalent to

MOV{<c>}{<q>} <Rd>, <Rm>, LSR <Rs>

and is always the preferred disassembly.

T1

15	14	13	12	11	10	9	6	5	3	2	0	
0	1	0	0	0	0	0	0	0	1	1	Rs	Rdm
op												

Logical shift right variant

LSR<c>{<q>} {<Rdm>}, <Rdm>, <Rs> // Inside IT block

is equivalent to

MOV<c>{<q>} <Rdm>, <Rdm>, LSR <Rs>

and is the preferred disassembly when InITBlock().

T2

15	14	13	12	11	10	9	8	7	6	5	4	3	0	15	14	13	12	11	8	7	6	5	4	3	0
1	1	1	1	1	0	1	0	0	0	1	0	Rm	1	1	1	1	Rd	0	0	0	0	Rs			
type												S													

Not flag setting variant

LSR<c>.W {<Rd>}, <Rm>, <Rs> // Inside IT block, and <Rd>, <Rm>, <type>, <Rs> can be represented in T1

is equivalent to

MOV{<c>}{<q>} <Rd>, <Rm>, LSR <Rs>

and is always the preferred disassembly.

LSR{<c>}{<q>} {<Rd>}, <Rm>, <Rs>

is equivalent to

MOV{<c>}{<q>} <Rd>, <Rm>, LSR <Rs>

and is always the preferred disassembly.

Assembler symbols

<c> See [Standard assembler syntax fields on page F2-2848](#).

<q> See [Standard assembler syntax fields on page F2-2848](#).

<Rdm> Is the first general-purpose source register and the destination register, encoded in the "Rdm" field.

<Rd> Is the general-purpose destination register, encoded in the "Rd" field.

<Rm> Is the first general-purpose source register, encoded in the "Rm" field.

<Rs> Is the second general-purpose source register holding a shift amount in its bottom 8 bits, encoded in the "Rs" field.

Operation for all encodings

The description of [MOV, MOVS \(register-shifted register\)](#) gives the operational pseudocode for this instruction.

F5.1.102 LSRS (immediate)

Logical Shift Right, setting flags (immediate) shifts a register value right by an immediate number of bits, shifting in zeros, and writes the result to the destination register.

If the destination register is not the PC, this instruction updates the condition flags based on the result.

The field descriptions for <Rd> identify the encodings where the PC is permitted as the destination register. ARM deprecates any use of these encodings. However, when the destination register is the PC:

- The PE branches to the address written to the PC, and restores [PSTATE](#) from `SPSR_<current_mode>`.
- The PE checks `SPSR_<current_mode>` for an illegal return event. See [Illegal return events from AArch32 state on page G1-4361](#).
- The instruction is UNDEFINED in Hyp mode.
- The instruction is CONSTRAINED UNPREDICTABLE in User mode and System mode.

This instruction is an alias of the [MOV, MOVS \(register\)](#) instruction. This means that:

- The encodings in this description are named to match the encodings of [MOV, MOVS \(register\)](#).
- The description of [MOV, MOVS \(register\)](#) gives the operational pseudocode for this instruction.

A1

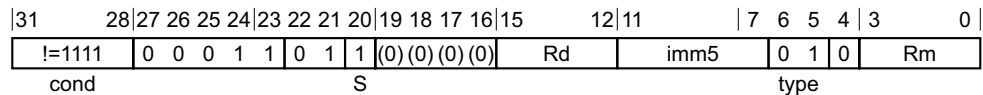

MOVS, shift or rotate by value variant

LSRS{<c>}{<q>} {<Rd>}, <Rm>, #<imm>

is equivalent to

MOVS{<c>}{<q>} <Rd>, <Rm>, LSR #<imm>

and is always the preferred disassembly.

T2

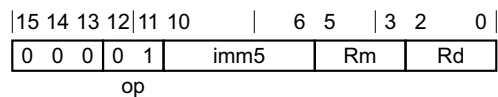

T2 variant

LSRS{<q>} {<Rd>}, <Rm>, #<imm> // Outside IT block

is equivalent to

MOVS{<q>} <Rd>, <Rm>, LSR #<imm>

and is the preferred disassembly when !InITBlock().

T3

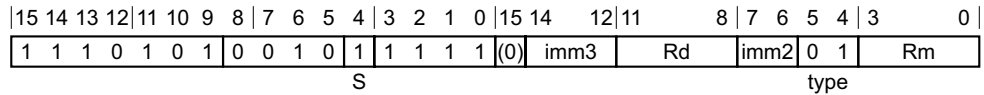

MOVS, shift or rotate by value variant

LSRS.W {<Rd>,} <Rm>, #<imm> // Outside IT block, and <Rd>, <Rm>, <imm> can be represented in T2 is equivalent to

MOVS{<c>}{<q>} <Rd>, <Rm>, LSR #<imm>

and is always the preferred disassembly.

LSRS{<c>}{<q>} {<Rd>,} <Rm>, #<imm>

is equivalent to

MOVS{<c>}{<q>} <Rd>, <Rm>, LSR #<imm>

and is always the preferred disassembly.

Assembler symbols

<c> See [Standard assembler syntax fields on page F2-2848](#).

<q> See [Standard assembler syntax fields on page F2-2848](#).

<Rd> For encoding A1: is the general-purpose destination register, encoded in the "Rd" field. ARM deprecates using the PC as the destination register, but if the PC is used, the instruction performs an exception return, that restores [PSTATE](#) from `SPSR_<current_mode>`.

For encoding T2 and T3: is the general-purpose destination register, encoded in the "Rd" field.

<Rm> For encoding A1: is the general-purpose source register, encoded in the "Rm" field. The PC can be used, but this is deprecated.

For encoding T2 and T3: is the general-purpose source register, encoded in the "Rm" field.

<imm> For encoding A1 and T2: is the shift amount, in the range 1 to 32, encoded in the "imm5" field as <imm> modulo 32.

For encoding T3: is the shift amount, in the range 1 to 32, encoded in the "imm3:imm2" field as <imm> modulo 32.

Operation for all encodings

The description of [MOV, MOVS \(register\)](#) gives the operational pseudocode for this instruction.

F5.1.103 LSRS (register)

Logical Shift Right, setting flags (register) shifts a register value right by an immediate number of bits, shifting in zeros, writes the result to the destination register, and updates the condition flags based on the result. The variable number of bits is read from the bottom byte of a register

This instruction is an alias of the [MOV, MOVS \(register-shifted register\)](#) instruction. This means that:

- The encodings in this description are named to match the encodings of [MOV, MOVS \(register-shifted register\)](#).
- The description of [MOV, MOVS \(register-shifted register\)](#) gives the operational pseudocode for this instruction.

A1

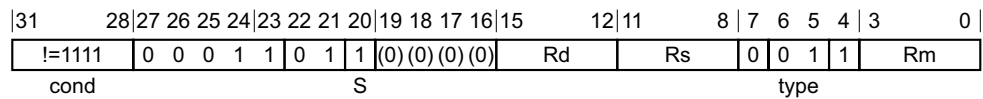

Flag setting variant

LSRS{<c>}{<q>} {<Rd>}, <Rm>, <Rs>

is equivalent to

MOVS{<c>}{<q>} <Rd>, <Rm>, LSR <Rs>

and is always the preferred disassembly.

T1

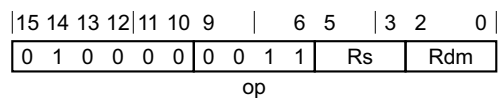

Logical shift right variant

LSRS{<q>} {<Rdm>}, <Rdm>, <Rs> // Outside IT block

is equivalent to

MOVS{<q>} <Rdm>, <Rdm>, LSR <Rs>

and is the preferred disassembly when !InITBlock().

T2

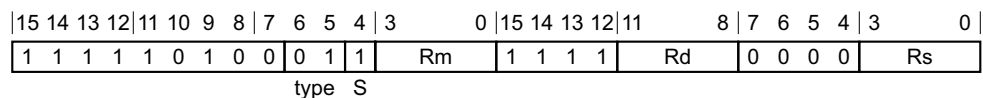

Flag setting variant

LSRS.W {<Rd>}, <Rm>, <Rs> // Outside IT block, and <Rd>, <Rm>, <type>, <Rs> can be represented in T1

is equivalent to

MOVS{<c>}{<q>} <Rd>, <Rm>, LSR <Rs>

and is always the preferred disassembly.

LSRS{<c>}{<q>} {<Rd>, } <Rm>, <Rs>

is equivalent to

MOVS{<c>}{<q>} <Rd>, <Rm>, LSR <Rs>

and is always the preferred disassembly.

Assembler symbols

- <c> See [Standard assembler syntax fields on page F2-2848](#).
- <q> See [Standard assembler syntax fields on page F2-2848](#).
- <Rdm> Is the first general-purpose source register and the destination register, encoded in the "Rdm" field.
- <Rd> Is the general-purpose destination register, encoded in the "Rd" field.
- <Rm> Is the first general-purpose source register, encoded in the "Rm" field.
- <Rs> Is the second general-purpose source register holding a shift amount in its bottom 8 bits, encoded in the "Rs" field.

Operation for all encodings

The description of [MOV, MOVS \(register-shifted register\)](#) gives the operational pseudocode for this instruction.

F5.1.104 MCR

Move to System register from general-purpose register or execute a System instruction. This instruction copies the value of a general-purpose register to a System register, or executes a System instruction.

The System register and System instruction descriptions identify valid encodings for this instruction. Other encodings are UNDEFINED. For more information see [About the AArch32 System register interface on page E1-2752](#) and [General behavior of System registers on page G6-4764](#).

In an implementation that includes EL2, MCR accesses to System registers can be trapped to Hyp mode, meaning that an attempt to execute an MCR instruction in a Non-secure mode other than Hyp mode, that would be permitted in the absence of the Hyp trap controls, generates a Hyp Trap exception. For more information, see [EL2 configurable controls on page G1-4427](#).

Because of the range of possible traps to Hyp mode, the MCR pseudocode does not show these possible traps.

A1

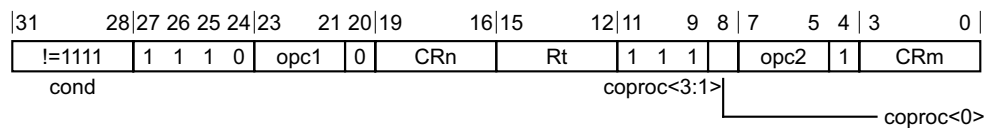

A1 variant

MCR{<c>}{<q>} <coproc>, {#}<opc1>, <Rt>, <CRn>, <CRm>{, {#}<opc2>}

Decode for this encoding

```
t = UInt(Rt); cp = if coproc<0> == '0' then 14 else 15;
if t == 15 then UNPREDICTABLE; // ARMv8-A removes UNPREDICTABLE for R13
```

T1

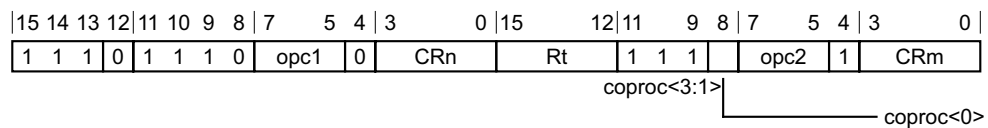

T1 variant

MCR{<c>}{<q>} <coproc>, {#}<opc1>, <Rt>, <CRn>, <CRm>{, {#}<opc2>}

Decode for this encoding

```
t = UInt(Rt); cp = if coproc<0> == '0' then 14 else 15;
if t == 15 then UNPREDICTABLE; // ARMv8-A removes UNPREDICTABLE for R13
```

Notes for all encodings

For more information about the CONSTRAINED UNPREDICTABLE behavior of this instruction, see [Appendix K1 Architectural Constraints on UNPREDICTABLE behaviors](#).

Assembler symbols

<c> See [Standard assembler syntax fields on page F2-2848](#).

<q> See [Standard assembler syntax fields on page F2-2848](#).

- <coproc> Is the System register encoding space, encoded in the "coproc<0>" field. It can have the following values:
- p14 when coproc<0> = 0
 - p15 when coproc<0> = 1
- <opc1> Is the opc1 parameter within the System register encoding space, in the range 0 to 7, encoded in the "opc1" field.
- <Rt> Is the general-purpose register to be transferred, encoded in the "Rt" field.
- <CRn> Is the CRn parameter within the System register encoding space, in the range c0 to c15, encoded in the "CRn" field.
- <CRm> Is the CRm parameter within the System register encoding space, in the range c0 to c15, encoded in the "CRm" field.
- <opc2> Is the opc2 parameter within the System register encoding space, in the range 0 to 7, encoded in the "opc2" field.

The possible values of { <coproc>, <opc1>, <CRn>, <CRm>, <opc2> } encode the entire System register and System instruction encoding space. Not all of this space is allocated, and the System register and System instruction descriptions identify the allocated encodings.

Operation for all encodings

```
if ConditionPassed() then
    EncodingSpecificOperations();
    AArch32.CheckSystemAccess(cp, ThisInstr());
    AArch32.SysRegWrite(cp, ThisInstr(), R[t]);
```

F5.1.105 MCRR

Move to System register from two general-purpose registers. This instruction copies the values of two general-purpose registers to a System register.

The System register descriptions identify valid encodings for this instruction. Other encodings are UNDEFINED. For more information see [About the AArch32 System register interface on page E1-2752](#) and [General behavior of System registers on page G6-4764](#).

In an implementation that includes EL2, MCRR accesses to System registers can be trapped to Hyp mode, meaning that an attempt to execute an MCRR instruction in a Non-secure mode other than Hyp mode, that would be permitted in the absence of the Hyp trap controls, generates a Hyp Trap exception. For more information, see [EL2 configurable controls on page G1-4427](#).

Because of the range of possible traps to Hyp mode, the MCRR pseudocode does not show these possible traps.

A1

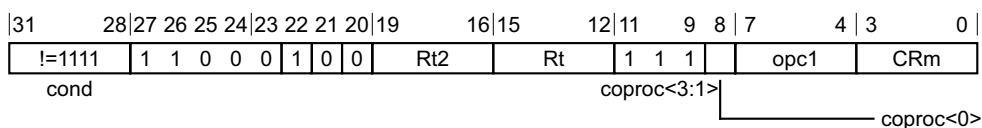

A1 variant

MCRR{<c>}{<q>} <coproc>, {#}<opc1>, <Rt>, <Rt2>, <CRm>

Decode for this encoding

```
t = UInt(Rt); t2 = UInt(Rt2); cp = if coproc<0> == '0' then 14 else 15;
if t == 15 || t2 == 15 then UNPREDICTABLE;
// ARMv8-A removes UNPREDICTABLE for R13
```

T1

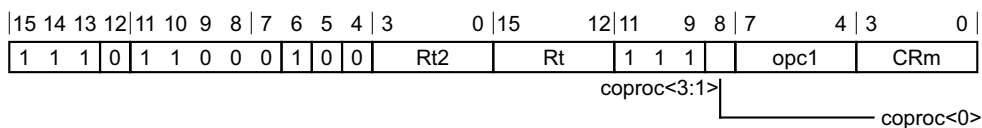

T1 variant

MCRR{<c>}{<q>} <coproc>, {#}<opc1>, <Rt>, <Rt2>, <CRm>

Decode for this encoding

```
t = UInt(Rt); t2 = UInt(Rt2); cp = if coproc<0> == '0' then 14 else 15;
if t == 15 || t2 == 15 then UNPREDICTABLE;
// ARMv8-A removes UNPREDICTABLE for R13
```

Notes for all encodings

For more information about the CONSTRAINED UNPREDICTABLE behavior of this instruction, see [Appendix K1 Architectural Constraints on UNPREDICTABLE behaviors](#).

Assembler symbols

<c> See [Standard assembler syntax fields on page F2-2848](#).

- <q> See *Standard assembler syntax fields* on page F2-2848.
- <coproc> Is the System register encoding space, encoded in the "coproc<0>" field. It can have the following values:
p14 when coproc<0> = 0
p15 when coproc<0> = 1
- <opc1> Is the opc1 parameter within the System register encoding space, in the range 0 to 15, encoded in the "opc1" field.
- <Rt> Is the first general-purpose register that is transferred into, encoded in the "Rt" field.
- <Rt2> Is the second general-purpose register that is transferred into, encoded in the "Rt2" field.
- <CRm> Is the CRm parameter within the System register encoding space, in the range c0 to c15, encoded in the "CRm" field.

The possible values of { <coproc>, <opc1>, <CRm> } encode the entire System register encoding space. Not all of this space is allocated, and the System register descriptions identify the allocated encodings.

For the permitted uses of these instructions, as described in this manual, <Rt2> transfers bits[63:32] of the selected System register, while <Rt> transfers bits[31:0].

Operation for all encodings

```
if ConditionPassed() then
    EncodingSpecificOperations();
    AArch32.CheckSystemAccess(cp, ThisInstr());
    value = R[t2]:R[t];
    AArch32.SysRegWrite64(cp, ThisInstr(), value);
```

F5.1.106 MLA, MLAS

Multiply Accumulate multiplies two register values, and adds a third register value. The least significant 32 bits of the result are written to the destination register. These 32 bits do not depend on whether the source register values are considered to be signed values or unsigned values.

In an A32 instruction, the condition flags can optionally be updated based on the result. Use of this option adversely affects performance on many implementations.

A1

31	28 27	26	25	24 23	22	21	20 19	16 15	12 11	8	7	6	5	4	3	0
!=1111	0	0	0	0	0	0	1	S	Rd	Ra	Rm	1	0	0	1	Rn
cond																

Flag setting variant

Applies when S == 1.

MLAS{<c>}{<q>} <Rd>, <Rn>, <Rm>, <Ra>

Not flag setting variant

Applies when S == 0.

MLA{<c>}{<q>} <Rd>, <Rn>, <Rm>, <Ra>

Decode for all variants of this encoding

```
d = UInt(Rd); n = UInt(Rn); m = UInt(Rm); a = UInt(Ra); setflags = (S == '1');
if d == 15 || n == 15 || m == 15 || a == 15 then UNPREDICTABLE;
```

T1

15	14	13	12 11	10	9	8	7	6	5	4	3	0	15	12 11	8	7	6	5	4	3	0
1	1	1	1	1	0	1	1	0	0	0	0	Rn	!=1111	Rd	0	0	0	0	Rm		
Ra																					

T1 variant

MLA{<c>}{<q>} <Rd>, <Rn>, <Rm>, <Ra>

Decode for this encoding

```
if Ra == '1111' then SEE MUL;
d = UInt(Rd); n = UInt(Rn); m = UInt(Rm); a = UInt(Ra); setflags = FALSE;
if d == 15 || n == 15 || m == 15 then UNPREDICTABLE; // ARMv8-A removes UNPREDICTABLE for R13
```

Notes for all encodings

For more information about the CONSTRAINED UNPREDICTABLE behavior of this instruction, see [Appendix K1 Architectural Constraints on UNPREDICTABLE behaviors](#).

Assembler symbols

<c> See [Standard assembler syntax fields on page F2-2848](#).

<q> See [Standard assembler syntax fields on page F2-2848](#).

<Rd> Is the general-purpose destination register, encoded in the "Rd" field.

- <Rn> Is the first general-purpose source register holding the multiplicand, encoded in the "Rn" field.
- <Rm> Is the second general-purpose source register holding the multiplier, encoded in the "Rm" field.
- <Ra> Is the third general-purpose source register holding the addend, encoded in the "Ra" field.

Operation for all encodings

```
if ConditionPassed() then
    EncodingSpecificOperations();
operand1 = SInt(R[n]); // operand1 = UInt(R[n]) produces the same final results
operand2 = SInt(R[m]); // operand2 = UInt(R[m]) produces the same final results
addend = SInt(R[a]); // addend = UInt(R[a]) produces the same final results
result = operand1 * operand2 + addend;
R[d] = result<31:0>;
if setflags then
    PSTATE.N = result<31>;
    PSTATE.Z = IsZeroBit(result<31:0>);
    // PSTATE.C, PSTATE.V unchanged
```

F5.1.107 MLS

Multiply and Subtract multiplies two register values, and subtracts the product from a third register value. The least significant 32 bits of the result are written to the destination register. These 32 bits do not depend on whether the source register values are considered to be signed values or unsigned values.

A1

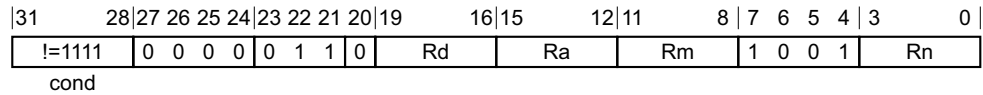

A1 variant

MLS{<c>}{<q>} <Rd>, <Rn>, <Rm>, <Ra>

Decode for this encoding

```
d = UInt(Rd); n = UInt(Rn); m = UInt(Rm); a = UInt(Ra);
if d == 15 || n == 15 || m == 15 || a == 15 then UNPREDICTABLE;
```

T1

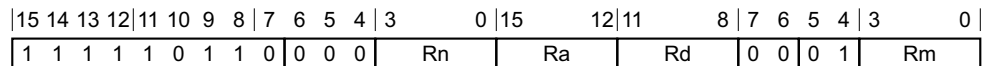

T1 variant

MLS{<c>}{<q>} <Rd>, <Rn>, <Rm>, <Ra>

Decode for this encoding

```
d = UInt(Rd); n = UInt(Rn); m = UInt(Rm); a = UInt(Ra);
if d == 15 || n == 15 || m == 15 || a == 15 then UNPREDICTABLE;
// ARMv8-A removes UNPREDICTABLE for R13
```

Notes for all encodings

For more information about the CONSTRAINED UNPREDICTABLE behavior of this instruction, see [Appendix K1 Architectural Constraints on UNPREDICTABLE behaviors](#).

Assembler symbols

- <c> See *Standard assembler syntax fields* on page F2-2848.
- <q> See *Standard assembler syntax fields* on page F2-2848.
- <Rd> Is the general-purpose destination register, encoded in the "Rd" field.
- <Rn> Is the first general-purpose source register holding the multiplicand, encoded in the "Rn" field.
- <Rm> Is the second general-purpose source register holding the multiplier, encoded in the "Rm" field.
- <Ra> Is the third general-purpose source register holding the minuend, encoded in the "Ra" field.

Operation for all encodings

```
if ConditionPassed() then
    EncodingSpecificOperations();
operand1 = SInt(R[n]); // operand1 = UInt(R[n]) produces the same final results
operand2 = SInt(R[m]); // operand2 = UInt(R[m]) produces the same final results
addend = SInt(R[a]); // addend = UInt(R[a]) produces the same final results
result = addend - operand1 * operand2;
R[d] = result<31:0>;
```

F5.1.108 MOV, MOVS (immediate)

Move (immediate) writes an immediate value to the destination register.

If the destination register is not the PC, the MOVS variant of the instruction updates the condition flags based on the result.

The field descriptions for <Rd> identify the encodings where the PC is permitted as the destination register. ARM deprecates any use of these encodings. However, when the destination register is the PC:

- The MOV variant of the instruction is an interworking branch, see [Pseudocode description of operations on the AArch32 general-purpose registers and the PC on page E1-2733](#).
- The MOVS variant of the instruction performs an exception return without the use of the stack. In this case:
 - The PE branches to the address written to the PC, and restores PSTATE from SPSR_<current_mode>.
 - The PE checks SPSR_<current_mode> for an illegal return event. See [Illegal return events from AArch32 state on page G1-4361](#).
 - The instruction is UNDEFINED in Hyp mode.
 - The instruction is CONSTRAINED UNPREDICTABLE in User mode and System mode.

A1

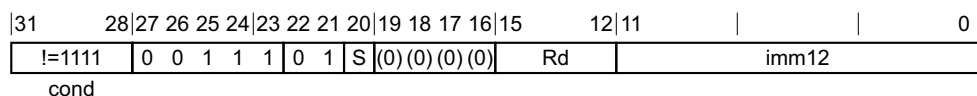

MOV variant

Applies when S == 0.

MOV{<c>}{<q>} <Rd>, #<const>

MOVS variant

Applies when S == 1.

MOVS{<c>}{<q>} <Rd>, #<const>

Decode for all variants of this encoding

d = UInt(Rd); setflags = (S == '1'); (imm32, carry) = A32ExpandImm_C(imm12, PSTATE.C);

A2

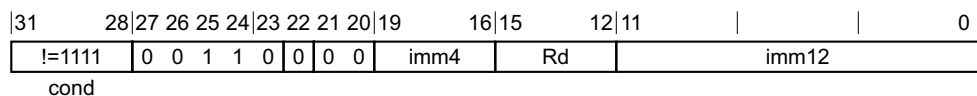

A2 variant

MOV{<c>}{<q>} <Rd>, #<imm16> // <imm16> can not be represented in A1

MOVW{<c>}{<q>} <Rd>, #<imm16> // <imm16> can be represented in A1

Decode for this encoding

d = UInt(Rd); setflags = FALSE; imm32 = ZeroExtend(imm4:imm12, 32);
 if d == 15 then UNPREDICTABLE;

T1

15	14	13	12	11	10	8	7			0
0	0	1	0	0	Rd	imm8				

T1 variant

MOV<c>{<q>} <Rd>, #<imm8> // Inside IT block
 MOVS{<q>} <Rd>, #<imm8> // Outside IT block

Decode for this encoding

d = UInt(Rd); setflags = !InITBlock(); imm32 = ZeroExtend(imm8, 32); carry = PSTATE.C;

T2

15	14	13	12	11	10	9	8	7	6	5	4	3	2	1	0	15	14	12	11	8	7			0
1	1	1	1	0	i	0	0	0	1	0	S	1	1	1	1	0	imm3	Rd	imm8					

MOV variant

Applies when S == 0.

MOV<c>.W <Rd>, #<const> // Inside IT block, and <Rd>, <const> can be represented in T1
 MOV{<c>}{<q>} <Rd>, #<const>

MOVS variant

Applies when S == 1.

MOVS.W <Rd>, #<const> // Outside IT block, and <Rd>, <const> can be represented in T1
 MOVS{<c>}{<q>} <Rd>, #<const>

Decode for all variants of this encoding

d = UInt(Rd); setflags = (S == '1'); (imm32, carry) = T32ExpandImm_C(i:imm3:imm8, PSTATE.C);
 if d == 15 then UNPREDICTABLE; // ARMv8-A removes UNPREDICTABLE for R13

T3

15	14	13	12	11	10	9	8	7	6	5	4	3		0	15	14	12	11	8	7			0
1	1	1	1	0	i	1	0	0	1	0	0	imm4	0	imm3	Rd	imm8							

T3 variant

MOV{<c>}{<q>} <Rd>, #<imm16> // <imm16> cannot be represented in T1 or T2
 MOVW{<c>}{<q>} <Rd>, #<imm16> // <imm16> can be represented in T1 or T2

Decode for this encoding

d = UInt(Rd); setflags = FALSE; imm32 = ZeroExtend(imm4:i:imm3:imm8, 32);
 if d == 15 then UNPREDICTABLE; // ARMv8-A removes UNPREDICTABLE for R13

Notes for all encodings

For more information about the CONSTRAINED UNPREDICTABLE behavior of this instruction, see [Appendix K1 Architectural Constraints on UNPREDICTABLE behaviors](#).

Assembler symbols

- <c> See [Standard assembler syntax fields on page F2-2848](#).
- <q> See [Standard assembler syntax fields on page F2-2848](#).
- <Rd> For encoding A1: is the general-purpose destination register, encoded in the "Rd" field. ARM deprecates using the PC as the destination register, but if the PC is used:
- For the MOV variant, the instruction is a branch to the address calculated by the operation. This is an interworking branch, see [Pseudocode description of operations on the AArch32 general-purpose registers and the PC on page E1-2733](#).
 - For the MOVS variant, the instruction performs an exception return, that restores PSTATE from SPSR_<current_mode>.
- For encoding A2, T1, T2 and T3: is the general-purpose destination register, encoded in the "Rd" field.
- <imm8> Is a 8-bit unsigned immediate, in the range 0 to 255, encoded in the "imm8" field.
- <imm16> For encoding A2: is a 16-bit unsigned immediate, in the range 0 to 65535, encoded in the "imm4:imm12" field.
- For encoding T3: is a 16-bit unsigned immediate, in the range 0 to 65535, encoded in the "imm4:i:imm3:imm8" field.
- <const> For encoding A1: an immediate value. See [Modified immediate constants in A32 instructions on page F2-2864](#) for the range of values.
- For encoding T2: an immediate value. See [Modified immediate constants in T32 instructions on page F2-2863](#) for the range of values.

Operation for all encodings

```
if ConditionPassed() then
    EncodingSpecificOperations();
    result = imm32;
    if d == 15 then          // Can only occur for encoding A1
        if setflags then
            ALUExceptionReturn(result);
        else
            ALUWritePC(result);
    else
        R[d] = result;
        if setflags then
            PSTATE.N = result<31>;
            PSTATE.Z = IsZeroBit(result);
            PSTATE.C = carry;
            // PSTATE.V unchanged
```

F5.1.109 MOV, MOVS (register)

Move (register) copies a value from a register to the destination register.

If the destination register is not the PC, the MOVS variant of the instruction updates the condition flags based on the result.

The field descriptions for <Rd> identify the encodings where the PC is permitted as the destination register. If the destination register is the PC:

- The MOV variant of the instruction is a branch. In the T32 instruction set (encoding T1) this is a simple branch, and in the A32 instruction set it is an interworking branch, see [Pseudocode description of operations on the AArch32 general-purpose registers and the PC on page E1-2733](#).
- The MOVS variant of the instruction performs an exception return without the use of the stack. In this case:
 - The PE branches to the address written to the PC, and restores `PSTATE` from `SPSR_<current_mode>`.
 - The PE checks `SPSR_<current_mode>` for an illegal return event. See [Illegal return events from AArch32 state on page G1-4361](#).
 - The instruction is UNDEFINED in Hyp mode.
 - The instruction is CONSTRAINED UNPREDICTABLE in User mode and System mode.

This instruction is used by the aliases [ASRS \(immediate\)](#), [ASR \(immediate\)](#), [LSLS \(immediate\)](#), [LSL \(immediate\)](#), [LSRS \(immediate\)](#), [LSR \(immediate\)](#), [RORS \(immediate\)](#), [ROR \(immediate\)](#), [RRXS](#), and [RRX](#). See [Alias conditions on page F5-3262](#) for details of when each alias is preferred.

A1

31	28	27	26	25	24	23	22	21	20	19	18	17	16	15	12	11	7	6	5	4	3	0
I=1111				0	0	0	1	1	0	1	S	(0)(0)(0)(0)	Rd	imm5	type	0	Rm					
cond																						

MOV, rotate right with extend variant

Applies when `S == 0` && `imm5 == 00000` && `type == 11`.

MOV{<c>}{<q>} <Rd>, <Rm>, RRX

MOV, shift or rotate by value variant

Applies when `S == 0` && `!(imm5 == 00000 && type == 11)`.

MOV{<c>}{<q>} <Rd>, <Rm> {, <shift> #<amount>}

MOVS, rotate right with extend variant

Applies when `S == 1` && `imm5 == 00000` && `type == 11`.

MOVS{<c>}{<q>} <Rd>, <Rm>, RRX

MOVS, shift or rotate by value variant

Applies when `S == 1` && `!(imm5 == 00000 && type == 11)`.

MOVS{<c>}{<q>} <Rd>, <Rm> {, <shift> #<amount>}

Decode for all variants of this encoding

```
d = UInt(Rd); m = UInt(Rm); setflags = (S == '1');
(shift_t, shift_n) = DecodeImmShift(type, imm5);
```

T1

15	14	13	12	11	10	9	8	7	6	3	2	0
0	1	0	0	0	1	1	0	D	Rm	Rd		

T1 variant

MOV{<c>}{<q>} <Rd>, <Rm>

Decode for this encoding

```
d = UInt(D:Rd); m = UInt(Rm); setflags = FALSE;
(shift_t, shift_n) = (SRTYPE_LSL, 0);
if d == 15 && InITBlock() && !LastInITBlock() then UNPREDICTABLE;
```

T2

15	14	13	12	11	10	6	5	3	2	0	
0	0	0	!=11	imm5			Rm	Rd			

op

T2 variant

MOV<c>{<q>} <Rd>, <Rm> {, <shift> #<amount>} // Inside IT block
 MOV{<q>} <Rd>, <Rm> {, <shift> #<amount>} // Outside IT block

Decode for this encoding

```
d = UInt(Rd); m = UInt(Rm); setflags = !InITBlock();
(shift_t, shift_n) = DecodeImmShift(op, imm5);
if op == '00' && imm5 == '00000' && InITBlock() then UNPREDICTABLE;
```

CONSTRAINED UNPREDICTABLE behavior

If op == '00' && imm5 == '00000' && InITBlock(), then one of the following behaviors must occur:

- The instruction is UNDEFINED.
- The instruction executes as if it passed its condition code check.
- The instruction executes as NOP, as if it failed its condition code check.
- The instruction executes as MOV Rd, Rm.

T3

15	14	13	12	11	10	9	8	7	6	5	4	3	2	1	0	15	14	12	11	8	7	6	5	4	3	0
1	1	1	0	1	0	1	0	0	0	1	0	S	1	1	1	1	(0)	imm3	Rd	imm2	type	Rm				

MOV, rotate right with extend variant

Applies when S == 0 && imm3 == 000 && imm2 == 00 && type == 11.

MOV{<c>}{<q>} <Rd>, <Rm>, RRX

MOV, shift or rotate by value variant

Applies when S == 0 && !(imm3 == 000 && imm2 == 00 && type == 11).

MOV{<c>}.W <Rd>, <Rm> {, LSL #0} // <Rd>, <Rm> can be represented in T1
 MOV<c>.W <Rd>, <Rm> {, <shift> #<amount>} // Inside IT block, and <Rd>, <Rm>, <shift>, <amount> can be represented in T2
 MOV{<c>}{<q>} <Rd>, <Rm> {, <shift> #<amount>}

MOVS, rotate right with extend variant

Applies when S == 1 && imm3 == 000 && imm2 == 00 && type == 11.

MOVS{<c>}{<q>} <Rd>, <Rm>, RRX

MOVS, shift or rotate by value variant

Applies when S == 1 && !(imm3 == 000 && imm2 == 00 && type == 11).

MOVS.W <Rd>, <Rm> {, <shift> #<amount>} // Outside IT block, and <Rd>, <Rm>, <shift>, <amount> can be represented in T1 or T2
 MOVS{<c>}{<q>} <Rd>, <Rm> {, <shift> #<amount>}

Decode for all variants of this encoding

```
d = UInt(Rd); m = UInt(Rm); setflags = (S == '1');
(shift_t, shift_n) = DecodeImmShift(type, imm3:imm2);
if d == 15 || m == 15 then UNPREDICTABLE; // ARMv8-A removes UNPREDICTABLE for R13
```

Notes for all encodings

For more information about the CONSTRAINED UNPREDICTABLE behavior of this instruction, see [Appendix K1 Architectural Constraints on UNPREDICTABLE behaviors](#).

Alias conditions

Alias	of variant	is preferred when
ASRS (immediate)	T3 (MOVS, shift or rotate by value), A1 (MOVS, shift or rotate by value)	S == '1' && type == '10'
ASRS (immediate)	T2	op == '10' && !InITBlock()
ASR (immediate)	T3 (MOV, shift or rotate by value), A1 (MOV, shift or rotate by value)	S == '0' && type == '10'
ASR (immediate)	T2	op == '10' && InITBlock()
LSLS (immediate)	T3 (MOVS, shift or rotate by value)	S == '1' && imm3:Rd:imm2 != '000xxxx00' && type == '00'
LSLS (immediate)	A1 (MOVS, shift or rotate by value)	S == '1' && imm5 != '00000' && type == '00'
LSLS (immediate)	T2	op == '00' && imm5 != '00000' && !InITBlock()
LSL (immediate)	T3 (MOV, shift or rotate by value)	S == '0' && imm3:Rd:imm2 != '000xxxx00' && type == '00'
LSL (immediate)	A1 (MOV, shift or rotate by value)	S == '0' && imm5 != '00000' && type == '00'
LSL (immediate)	T2	op == '00' && imm5 != '00000' && InITBlock()
LSRS (immediate)	T3 (MOVS, shift or rotate by value), A1 (MOVS, shift or rotate by value)	S == '1' && type == '01'
LSRS (immediate)	T2	op == '01' && !InITBlock()

Alias	of variant	is preferred when
LSR (immediate)	T3 (MOV, shift or rotate by value), A1 (MOV, shift or rotate by value)	S == '0' && type == '01'
LSR (immediate)	T2	op == '01' && InITBlock()
RORS (immediate)	T3 (MOVS, shift or rotate by value)	S == '1' && imm3:Rd:imm2 != '000xxxx00' && type == '11'
RORS (immediate)	A1 (MOVS, shift or rotate by value)	S == '1' && imm5 != '00000' && type == '11'
ROR (immediate)	T3 (MOV, shift or rotate by value)	S == '0' && imm3:Rd:imm2 != '000xxxx00' && type == '11'
ROR (immediate)	A1 (MOV, shift or rotate by value)	S == '0' && imm5 != '00000' && type == '11'
RRXS	T3 (MOVS, rotate right with extend)	S == '1' && imm3 == '000' && imm2 == '00' && type == '11'
RRXS	A1 (MOVS, rotate right with extend)	S == '1' && imm5 == '00000' && type == '11'
RRX	T3 (MOV, rotate right with extend)	S == '0' && imm3 == '000' && imm2 == '00' && type == '11'
RRX	A1 (MOV, rotate right with extend)	S == '0' && imm5 == '00000' && type == '11'

Assembler symbols

<c> See [Standard assembler syntax fields on page F2-2848](#).

<q> See [Standard assembler syntax fields on page F2-2848](#).

<Rd> For encoding A1: is the general-purpose destination register, encoded in the "Rd" field. If the PC is used:

- For the MOV variant, the instruction is a branch to the address calculated by the operation. This is an interworking branch, see [Pseudocode description of operations on the AArch32 general-purpose registers and the PC on page E1-2733](#). ARM deprecates use of the instruction if <Rn> is the PC.
- For the MOVS variant, the instruction performs an exception return, that restores PSTATE from SPSR_<current_mode>. ARM deprecates use of the instruction if <Rn> is not the LR, or if the optional shift or RRX argument is specified.

For encoding T1: is the general-purpose destination register, encoded in the "D:Rd" field. If the PC is used:

- The instruction causes a branch to the address moved to the PC. This is a simple branch, see [Pseudocode description of operations on the AArch32 general-purpose registers and the PC on page E1-2733](#).
- The instruction must either be outside an IT block or the last instruction of an IT block.

For encoding T2 and T3: is the general-purpose destination register, encoded in the "Rd" field.

<Rm> For encoding A1 and T1: is the general-purpose source register, encoded in the "Rm" field. The PC can be used. ARM deprecates use of the instruction if <Rd> is the PC.

For encoding T2 and T3: is the general-purpose source register, encoded in the "Rm" field.

<shift> For encoding A1 and T3: is the type of shift to be applied to the source register, encoded in the "type" field. It can have the following values:

LSL	when type = 00
LSR	when type = 01
ASR	when type = 10
ROR	when type = 11

For encoding T2: is the type of shift to be applied to the source register, encoded in the "op" field. It can have the following values:

LSL when op = 00
LSR when op = 01
ASR when op = 10

<amount> For encoding A1 and T2: is the shift amount, in the range 1 to 31 (when <shift> = LSL or ROR) or 1 to 32 (when <shift> = LSR or ASR) encoded in the "imm5" field as <amount> modulo 32.

For encoding T3: is the shift amount, in the range 1 to 31 (when <shift> = LSL or ROR) or 1 to 32 (when <shift> = LSR or ASR) encoded in the "imm3:imm2" field as <amount> modulo 32.

Operation for all encodings

```
if ConditionPassed() then
    EncodingSpecificOperations();
    (shifted, carry) = Shift_C(R[m], shift_t, shift_n, PSTATE.C);
    result = shifted;
    if d == 15 then
        if setflags then
            ALUExceptionReturn(result);
        else
            ALUWritePC(result);
    else
        R[d] = result;
        if setflags then
            PSTATE.N = result<31>;
            PSTATE.Z = IsZeroBit(result);
            PSTATE.C = carry;
            // PSTATE.V unchanged
```

F5.1.110 MOV, MOVS (register-shifted register)

Move (register-shifted register) copies a register-shifted register value to the destination register. It can optionally update the condition flags based on the value.

This instruction is used by the aliases [ASRS \(register\)](#), [ASR \(register\)](#), [LSLS \(register\)](#), [LSL \(register\)](#), [LSRS \(register\)](#), [LSR \(register\)](#), [RORS \(register\)](#), and [ROR \(register\)](#). See *Alias conditions* on page F5-3267 for details of when each alias is preferred.

A1

31	28	27	26	25	24	23	22	21	20	19	18	17	16	15	12	11	8	7	6	5	4	3	0
!=1111				0	0	0	1	1	0	1	S	(0)	(0)	(0)	(0)	Rd	Rs	0	type	1	Rm		
cond																							

Flag setting variant

Applies when S == 1.

MOV{<c>}{<q>} <Rd>, <Rm>, <type> <Rs>

Not flag setting variant

Applies when S == 0.

MOV{<c>}{<q>} <Rd>, <Rm>, <type> <Rs>

Decode for all variants of this encoding

```
d = UInt(Rd); m = UInt(Rm); s = UInt(Rs);
setflags = (S == '1'); shift_t = DecodeRegShift(type);
if d == 15 || m == 15 || s == 15 then UNPREDICTABLE;
```

T1

15	14	13	12	11	10	9	6	5	3	2	0
0	1	0	0	0	0	0	0	x	x	x	Rdm
op											

Arithmetic shift right variant

Applies when op == 0100.

MOV<c>{<q>} <Rdm>, <Rdm>, ASR <Rs> // Inside IT block
 MOV{<q>} <Rdm>, <Rdm>, ASR <Rs> // Outside IT block

Logical shift left variant

Applies when op == 0010.

MOV<c>{<q>} <Rdm>, <Rdm>, LSL <Rs> // Inside IT block
 MOV{<q>} <Rdm>, <Rdm>, LSL <Rs> // Outside IT block

Logical shift right variant

Applies when op == 0011.

MOV<c>{<q>} <Rdm>, <Rdm>, LSR <Rs> // Inside IT block
 MOV{<q>} <Rdm>, <Rdm>, LSR <Rs> // Outside IT block

Rotate right variant

Applies when op == 0111.

```
MOV<c>{<q>} <Rdm>, <Rdm>, ROR <Rs> // Inside IT block
MOVS{<q>} <Rdm>, <Rdm>, ROR <Rs> // Outside IT block
```

Decode for all variants of this encoding

```
if !(op IN {'0010', '0011', '0100', '0111'}) then SEE "Related encodings";
d = UInt(Rdm); m = UInt(Rdm); s = UInt(Rs);
setflags = !InITBlock(); shift_t = DecodeRegShift(op<2>:op<0>);
```

T2

15	14	13	12	11	10	9	8	7	6	5	4	3	0	15	14	13	12	11	8	7	6	5	4	3	0
1	1	1	1	1	0	1	0	0	type	S		Rm		1	1	1	1		Rd		0	0	0	0	Rs

Flag setting variant

Applies when S == 1.

```
MOVS.W <Rd>, <Rm>, <type> <Rs> // Outside IT block, and <Rd>, <Rm>, <type>, <Rs> can be represented in T1
MOVS{<c>}{<q>} <Rd>, <Rm>, <type> <Rs>
```

Not flag setting variant

Applies when S == 0.

```
MOV<c>.W <Rd>, <Rm>, <type> <Rs> // Inside IT block, and <Rd>, <Rm>, <type>, <Rs> can be represented in T1
MOV{<c>}{<q>} <Rd>, <Rm>, <type> <Rs>
```

Decode for all variants of this encoding

```
d = UInt(Rd); m = UInt(Rm); s = UInt(Rs);
setflags = (S == '1'); shift_t = DecodeRegShift(type);
if d == 15 || m == 15 || s == 15 then UNPREDICTABLE; // ARMv8-A removes UNPREDICTABLE for R13
```

Notes for all encodings

Related encodings: In encoding T1, for an op field value that is not described above, see [Data-processing \(two low registers\) on page F3-2877](#).

For more information about the CONSTRAINED UNPREDICTABLE behavior of this instruction, see [Appendix K1 Architectural Constraints on UNPREDICTABLE behaviors](#).

Alias conditions

Alias	of variant	is preferred when
ASRS (register)	A1 (flag setting)	S == '1' && type == '10'
ASRS (register)	T1 (arithmetic shift right)	op == '0100' && !InITBlock()
ASRS (register)	T2 (flag setting)	type == '10' && S == '1'
ASR (register)	A1 (not flag setting)	S == '0' && type == '10'
ASR (register)	T1 (arithmetic shift right)	op == '0100' && InITBlock()
ASR (register)	T2 (not flag setting)	type == '10' && S == '0'
LSLS (register)	A1 (flag setting)	S == '1' && type == '00'
LSLS (register)	T1 (logical shift left)	op == '0010' && !InITBlock()
LSLS (register)	T2 (flag setting)	type == '00' && S == '1'
LSL (register)	A1 (not flag setting)	S == '0' && type == '00'
LSL (register)	T1 (logical shift left)	op == '0010' && InITBlock()
LSL (register)	T2 (not flag setting)	type == '00' && S == '0'
LSRS (register)	A1 (flag setting)	S == '1' && type == '01'
LSRS (register)	T1 (logical shift right)	op == '0011' && !InITBlock()
LSRS (register)	T2 (flag setting)	type == '01' && S == '1'
LSR (register)	A1 (not flag setting)	S == '0' && type == '01'
LSR (register)	T1 (logical shift right)	op == '0011' && InITBlock()
LSR (register)	T2 (not flag setting)	type == '01' && S == '0'
RORS (register)	A1 (flag setting)	S == '1' && type == '11'
RORS (register)	T1 (rotate right)	op == '0111' && !InITBlock()
RORS (register)	T2 (flag setting)	type == '11' && S == '1'
ROR (register)	A1 (not flag setting)	S == '0' && type == '11'
ROR (register)	T1 (rotate right)	op == '0111' && InITBlock()
ROR (register)	T2 (not flag setting)	type == '11' && S == '0'

Assembler symbols

<c>	See <i>Standard assembler syntax fields</i> on page F2-2848.
<q>	See <i>Standard assembler syntax fields</i> on page F2-2848.
<Rdm>	Is the general-purpose source register and the destination register, encoded in the "Rdm" field.
<Rd>	Is the general-purpose destination register, encoded in the "Rd" field.
<Rm>	Is the general-purpose source register, encoded in the "Rm" field.

<type> Is the type of shift to be applied to the second source register, encoded in the "type" field. It can have the following values:

LSL	when type = 00
LSR	when type = 01
ASR	when type = 10
ROR	when type = 11

<Rs> Is the general-purpose source register holding a shift amount in its bottom 8 bits, encoded in the "Rs" field.

Operation for all encodings

```
if ConditionPassed() then
    EncodingSpecificOperations();
    shift_n = UInt(R[s]<7:0>);
    (result, carry) = Shift_C(R[m], shift_t, shift_n, PSTATE.C);
    R[d] = result;
    if setflags then
        PSTATE.N = result<31>;
        PSTATE.Z = IsZeroBit(result);
        PSTATE.C = carry;
        // PSTATE.V unchanged
```

F5.1.111 MOV_T

Move Top writes an immediate value to the top halfword of the destination register. It does not affect the contents of the bottom halfword.

A1

31	28	27	26	25	24	23	22	21	20	19	16	15	12	11					0
!=1111				0	0	1	1	0	1	0	0	imm4	Rd	imm12					
cond																			

A1 variant

MOV_T{<c>}{<q>} <Rd>, #<imm16>

Decode for this encoding

d = UInt(Rd); imm16 = imm4:imm12;
 if d == 15 then UNPREDICTABLE;

T1

15	14	13	12	11	10	9	8	7	6	5	4	3	0	15	14	12	11	8	7					0
1	1	1	1	0	i	1	0	1	1	0	0	imm4	0	imm3	Rd	imm8								

T1 variant

MOV_T{<c>}{<q>} <Rd>, #<imm16>

Decode for this encoding

d = UInt(Rd); imm16 = imm4:i:imm3:imm8;
 if d == 15 then UNPREDICTABLE; // ARMv8-A removes UNPREDICTABLE for R13

Notes for all encodings

For more information about the CONSTRAINED UNPREDICTABLE behavior of this instruction, see [Appendix K1 Architectural Constraints on UNPREDICTABLE behaviors](#).

Assembler symbols

- <c> See [Standard assembler syntax fields on page F2-2848](#).
- <q> See [Standard assembler syntax fields on page F2-2848](#).
- <Rd> Is the general-purpose destination register, encoded in the "Rd" field.
- <imm16> For encoding A1: is a 16-bit unsigned immediate, in the range 0 to 65535, encoded in the "imm4:imm12" field.
 For encoding T1: is a 16-bit unsigned immediate, in the range 0 to 65535, encoded in the "imm4:i:imm3:imm8" field.

Operation for all encodings

```
if ConditionPassed() then
    EncodingSpecificOperations();
    R[d]<31:16> = imm16;
    // R[d]<15:0> unchanged
```

F5.1.112 MRC

Move to general-purpose register from System register. This instruction copies the value of a System register to a general-purpose register.

The System register descriptions identify valid encodings for this instruction. Other encodings are UNDEFINED. For more information see [About the AArch32 System register interface on page E1-2752](#) and [General behavior of System registers on page G6-4764](#).

In an implementation that includes EL2, MRC accesses to system control registers can be trapped to Hyp mode, meaning that an attempt to execute an MRC instruction in a Non-secure mode other than Hyp mode, that would be permitted in the absence of the Hyp trap controls, generates a Hyp Trap exception. For more information, see [EL2 configurable controls on page G1-4427](#).

Because of the range of possible traps to Hyp mode, the MRC pseudocode does not show these possible traps.

A1

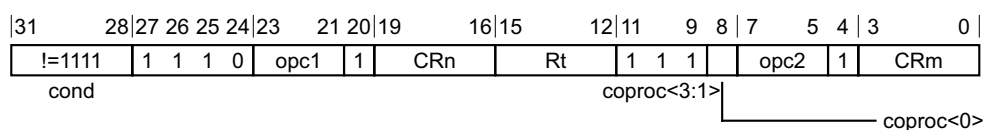

A1 variant

MRC{<c>}{<q>} <coproc>, {#}<opc1>, <Rt>, <CRn>, <CRm>{, {#}<opc2>}

Decode for this encoding

```
t = UInt(Rt); cp = if coproc<0> == '0' then 14 else 15;
// ARMv8-A removes UNPREDICTABLE for R13
```

T1

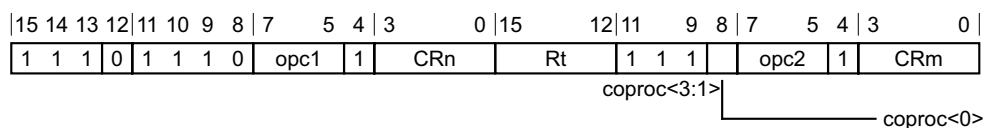

T1 variant

MRC{<c>}{<q>} <coproc>, {#}<opc1>, <Rt>, <CRn>, <CRm>{, {#}<opc2>}

Decode for this encoding

```
t = UInt(Rt); cp = if coproc<0> == '0' then 14 else 15;
// ARMv8-A removes UNPREDICTABLE for R13
```

Assembler symbols

<c> See [Standard assembler syntax fields on page F2-2848](#).

<q> See [Standard assembler syntax fields on page F2-2848](#).

<coproc> Is the System register encoding space, encoded in the "coproc<0>" field. It can have the following values:

- p14 when coproc<0> = 0
- p15 when coproc<0> = 1

<opc1>	Is the opc1 parameter within the System register encoding space, in the range 0 to 7, encoded in the "opc1" field.
<Rt>	Is the general-purpose register to be transferred or APSR_nzcv (encoded as 0b1111), encoded in the "Rt" field. If APSR_nzcv is used, bits [31:28] of the transferred value are written to the PSTATE condition flags.
<CRn>	Is the CRn parameter within the System register encoding space, in the range c0 to c15, encoded in the "CRn" field.
<CRm>	Is the CRm parameter within the System register encoding space, in the range c0 to c15, encoded in the "CRm" field.
<opc2>	Is the opc2 parameter within the System register encoding space, in the range 0 to 7, encoded in the "opc2" field.

The possible values of { <coproc>, <opc1>, <CRn>, <CRm>, <opc2> } encode the entire System register and System instruction encoding space. Not all of this space is allocated, and the System register and System instruction descriptions identify the allocated encodings.

Operation for all encodings

```

if ConditionPassed() then
    EncodingSpecificOperations();
    AArch32.CheckSystemAccess(cp, ThisInstr());
    bits(32) value = AArch32.SysRegRead(cp, ThisInstr());
    if t != 15 then
        R[t] = value;
    elseif AArch32.SysRegReadCanWriteAPSR(cp, ThisInstr()) then
        PSTATE.<N,Z,C,V> = value<31:28>;
        // value<27:0> are not used.
    else
        PSTATE.<N,Z,C,V> = bits(4) UNKNOWN;

```

F5.1.113 MRRC

Move to two general-purpose registers from System register. This instruction copies the value of a System register to two general-purpose registers.

The System register descriptions identify valid encodings for this instruction. Other encodings are UNDEFINED. For more information see [About the AArch32 System register interface on page E1-2752](#) and [General behavior of System registers on page G6-4764](#).

In an implementation that includes EL2, MRRC accesses to System registers can be trapped to Hyp mode, meaning that an attempt to execute an MRRC instruction in a Non-secure mode other than Hyp mode, that would be permitted in the absence of the Hyp trap controls, generates a Hyp Trap exception. For more information, see [EL2 configurable controls on page G1-4427](#).

Because of the range of possible traps to Hyp mode, the MRRC pseudocode does not show these possible traps.

A1

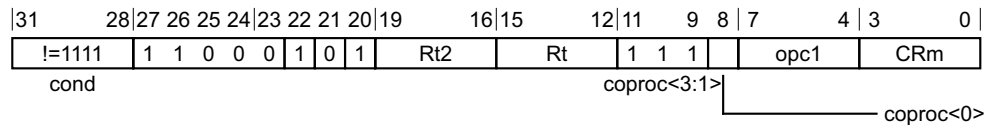

A1 variant

MRRC{<c>}{<q>} <coproc>, {#}<opc1>, <Rt>, <Rt2>, <CRm>

Decode for this encoding

```
t = UInt(Rt); t2 = UInt(Rt2); cp = if coproc<0> == '0' then 14 else 15;
if t == 15 || t2 == 15 || t == t2 then UNPREDICTABLE; // ARMv8-A removes UNPREDICTABLE for R13
```

CONSTRAINED UNPREDICTABLE behavior

If t == t2, then one of the following behaviors must occur:

- The instruction is UNDEFINED.
- The instruction executes as NOP.
- The value in the destination register is UNKNOWN.

T1

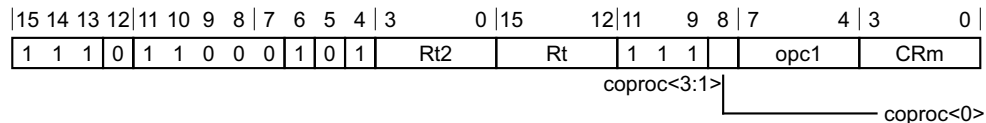

T1 variant

MRRC{<c>}{<q>} <coproc>, {#}<opc1>, <Rt>, <Rt2>, <CRm>

Decode for this encoding

```
t = UInt(Rt); t2 = UInt(Rt2); cp = if coproc<0> == '0' then 14 else 15;
if t == 15 || t2 == 15 || t == t2 then UNPREDICTABLE; // ARMv8-A removes UNPREDICTABLE for R13
```

CONSTRAINED UNPREDICTABLE behavior

If $t == t2$, then one of the following behaviors must occur:

- The instruction is UNDEFINED.
- The instruction executes as NOP.
- The value in the destination register is UNKNOWN.

Notes for all encodings

For more information about the CONSTRAINED UNPREDICTABLE behavior of this instruction, see [Appendix K1 Architectural Constraints on UNPREDICTABLE behaviors](#).

Assembler symbols

<c>	See Standard assembler syntax fields on page F2-2848 .
<q>	See Standard assembler syntax fields on page F2-2848 .
<coproc>	Is the System register encoding space, encoded in the "coproc<0>" field. It can have the following values: p14 when coproc<0> = 0 p15 when coproc<0> = 1
<opc1>	Is the opc1 parameter within the System register encoding space, in the range 0 to 15, encoded in the "opc1" field.
<Rt>	Is the first general-purpose register that is transferred into, encoded in the "Rt" field.
<Rt2>	Is the second general-purpose register that is transferred into, encoded in the "Rt2" field.
<CRm>	Is the CRm parameter within the System register encoding space, in the range c0 to c15, encoded in the "CRm" field.

The possible values of { <coproc>, <opc1>, <CRm> } encode the entire System register encoding space. Not all of this space is allocated, and the System register descriptions identify the allocated encodings.

For the permitted uses of these instructions, as described in this manual, <Rt2> transfers bits[63:32] of the selected System register, while <Rt> transfers bits[31:0].

Operation for all encodings

```
if ConditionPassed() then
    EncodingSpecificOperations();
    AArch32.CheckSystemAccess(cp, ThisInstr());
    value = AArch32.SysRegRead64(cp, ThisInstr());
    R[t] = value<31:0>;
    R[t2] = value<63:32>;
```

F5.1.114 MRS

Move Special register to general-purpose register moves the value of the [APSR](#), [CPSR](#), or [SPSR_<current_mode>](#) into a general-purpose register.

ARM recommends the APSR form when only the N, Z, C, V, Q, and GE[3:0] bits are being written. For more information, see [The Application Program Status Register, APSR](#) on page E1-2736.

An MRS that accesses the [SPSR](#) is UNPREDICTABLE if executed in User mode or System mode.

An MRS that is executed in User mode and accesses the [CPSR](#) returns an UNKNOWN value for the [CPSR](#). {E, A, I, F, M} fields.

A1

31	28	27	26	25	24	23	22	21	20	19	18	17	16	15	12	11	10	9	8	7	6	5	4	3	2	1	0
!=1111	0	0	0	1	0	R	0	0	(1)	(1)	(1)	(1)	Rd	(0)	(0)	0	(0)	0	0	0	0	0	(0)	(0)	(0)	(0)	
cond																											

A1 variant

MRS{<c>}{<q>} <Rd>, <spec_reg>

Decode for this encoding

```
d = UInt(Rd); read_spsr = (R == '1');
if d == 15 then UNPREDICTABLE;
```

T1

15	14	13	12	11	10	9	8	7	6	5	4	3	2	1	0	15	14	13	12	11	8	7	6	5	4	3	2	1	0
1	1	1	1	0	0	1	1	1	1	1	R	(1)	(1)	(1)	(1)	1	0	(0)	0	Rd	(0)	(0)	0	(0)	(0)	(0)	(0)	(0)	

T1 variant

MRS{<c>}{<q>} <Rd>, <spec_reg>

Decode for this encoding

```
d = UInt(Rd); read_spsr = (R == '1');
if d == 15 then UNPREDICTABLE; // ARMv8-A removes UNPREDICTABLE for R13
```

Notes for all encodings

For more information about the CONSTRAINED UNPREDICTABLE behavior of this instruction, see [Appendix K1 Architectural Constraints on UNPREDICTABLE behaviors](#).

Assembler symbols

<c> See [Standard assembler syntax fields](#) on page F2-2848.

<q> See [Standard assembler syntax fields](#) on page F2-2848.

<Rd> Is the general-purpose destination register, encoded in the "Rd" field.

<spec_reg> Is the special register to be accessed, encoded in the "R" field. It can have the following values:

CPSR|APSR when R = 0

SPSR when R = 1

Operation for all encodings

```
if ConditionPassed() then
    EncodingSpecificOperations();
if read_spsr then
    if PSTATE.M IN {M32_User, M32_System} then
        UNPREDICTABLE;
    else
        R[d] = SPSR[];
else
    // CPSR has same bit assignments as SPSR, but with the IT, J, SS, IL, and T bits masked out.
    bits(32) mask = '11111000 00001111 00000011 11011111';
    if HavePANExt() then
        mask<22> = '1';
    psr_val = GetPSRFromPSTATE() AND mask;
    if PSTATE.EL == EL0 then
        // If accessed from User mode return UNKNOWN values for E, A, I, F bits, bits<9:6>,
        // and for the M field, bits<4:0>
        psr_val<22> = bits(1) UNKNOWN;
        psr_val<9:6> = bits(4) UNKNOWN;
        psr_val<4:0> = bits(5) UNKNOWN;
    R[d] = psr_val;
```

CONSTRAINED UNPREDICTABLE behavior

If PSTATE.M IN {M32_User, M32_System} && read_spsr, then one of the following behaviors must occur:

- The instruction is UNDEFINED.
- The instruction executes as NOP.

F5.1.115 MRS (Banked register)

Move to Register from Banked or Special register moves the value from the Banked general-purpose register or SPSR of the specified mode, or the value of *ELR_hyp* on page G1-4331, to a general-purpose register.

MRS (Banked register) is UNPREDICTABLE if executed in User mode.

When EL3 is using AArch64, if an MRS (Banked register) instruction that is executed in a Secure EL1 mode would access SPSR_mon, SP_mon, or LR_mon, it is trapped to EL3.

The effect of using an MRS (Banked register) instruction with a register argument that is not valid for the current mode is UNPREDICTABLE. For more information see *Usage restrictions on the Banked register transfer instructions* on page F5-3675.

A1

31	28	27	26	25	24	23	22	21	20	19	16	15	12	11	10	9	8	7	6	5	4	3	2	1	0		
!=1111				0	0	0	1	0	R	0	0	M1	Rd	(0)	(0)	1	M	0	0	0	0	(0)	(0)	(0)	(0)		
cond																											

A1 variant

MRS{<c>}{<q>} <Rd>, <banked_reg>

Decode for this encoding

```
d = UInt(Rd); read_spsr = (R == '1');
if d == 15 then UNPREDICTABLE;
SYSm = M:M1;
```

T1

15	14	13	12	11	10	9	8	7	6	5	4	3	0	15	14	13	12	11	8	7	6	5	4	3	2	1	0
1	1	1	1	0	0	1	1	1	1	1	R	M1	1	0	(0)	0	Rd	(0)	(0)	1	M	(0)	(0)	(0)	(0)		

T1 variant

MRS{<c>}{<q>} <Rd>, <banked_reg>

Decode for this encoding

```
d = UInt(Rd); read_spsr = (R == '1');
if d == 15 then UNPREDICTABLE; // ARMv8-A removes UNPREDICTABLE for R13
SYSm = M:M1;
```

Notes for all encodings

For more information about the CONSTRAINED UNPREDICTABLE behavior of this instruction, see [Appendix K1 Architectural Constraints on UNPREDICTABLE behaviors](#).

Assembler symbols

- <c> See *Standard assembler syntax fields* on page F2-2848.
- <q> See *Standard assembler syntax fields* on page F2-2848.
- <Rd> Is the general-purpose destination register, encoded in the "Rd" field.

<banked_reg> Is the name of the banked register to be transferred to or from, encoded in the "R:M:M1" field. It can have the following values:

R8_usr	when R = 0, M = 0, M1 = 0000
R9_usr	when R = 0, M = 0, M1 = 0001
R10_usr	when R = 0, M = 0, M1 = 0010
R11_usr	when R = 0, M = 0, M1 = 0011
R12_usr	when R = 0, M = 0, M1 = 0100
SP_usr	when R = 0, M = 0, M1 = 0101
LR_usr	when R = 0, M = 0, M1 = 0110
R8_fiq	when R = 0, M = 0, M1 = 1000
R9_fiq	when R = 0, M = 0, M1 = 1001
R10_fiq	when R = 0, M = 0, M1 = 1010
R11_fiq	when R = 0, M = 0, M1 = 1011
R12_fiq	when R = 0, M = 0, M1 = 1100
SP_fiq	when R = 0, M = 0, M1 = 1101
LR_fiq	when R = 0, M = 0, M1 = 1110
LR_irq	when R = 0, M = 1, M1 = 0000
SP_irq	when R = 0, M = 1, M1 = 0001
LR_svc	when R = 0, M = 1, M1 = 0010
SP_svc	when R = 0, M = 1, M1 = 0011
LR_abt	when R = 0, M = 1, M1 = 0100
SP_abt	when R = 0, M = 1, M1 = 0101
LR_und	when R = 0, M = 1, M1 = 0110
SP_und	when R = 0, M = 1, M1 = 0111
LR_mon	when R = 0, M = 1, M1 = 1100
SP_mon	when R = 0, M = 1, M1 = 1101
ELR_hyp	when R = 0, M = 1, M1 = 1110
SP_hyp	when R = 0, M = 1, M1 = 1111
SPSR_fiq	when R = 1, M = 0, M1 = 1110
SPSR_irq	when R = 1, M = 1, M1 = 0000
SPSR_svc	when R = 1, M = 1, M1 = 0010
SPSR_abt	when R = 1, M = 1, M1 = 0100
SPSR_und	when R = 1, M = 1, M1 = 0110
SPSR_mon	when R = 1, M = 1, M1 = 1100
SPSR_hyp	when R = 1, M = 1, M1 = 1110

The following encodings are UNPREDICTABLE:

- R = 0, M = 0, M1 = 0111.
- R = 0, M = 0, M1 = 1111.
- R = 0, M = 1, M1 = 10xx.
- R = 1, M = 0, M1 = 0xxx.
- R = 1, M = 0, M1 = 10xx.
- R = 1, M = 0, M1 = 110x.
- R = 1, M = 0, M1 = 1111.
- R = 1, M = 1, M1 = 0001.

- R = 1, M = 1, M1 = 0011.
- R = 1, M = 1, M1 = 0101.
- R = 1, M = 1, M1 = 0111.
- R = 1, M = 1, M1 = 10xx.
- R = 1, M = 1, M1 = 1101.
- R = 1, M = 1, M1 = 1111.

Operation for all encodings

```

if ConditionPassed() then
  EncodingSpecificOperations();
if PSTATE.EL == EL0 then
  UNPREDICTABLE;
else
  mode = PSTATE.M;
  if read_spsr then
    SPSRAccessValid(SYSm, mode); // Check for UNPREDICTABLE cases
    case SYSm of
      when '01110' R[d] = SPSR_fiq;
      when '10000' R[d] = SPSR_irq;
      when '10010' R[d] = SPSR_svc;
      when '10100' R[d] = SPSR_abt;
      when '10110' R[d] = SPSR_und;
      when '11100'
        if !ELUsingAArch32(EL3) then AArch64.MonitorModeTrap();
        R[d] = SPSR_mon;
      when '11110' R[d] = SPSR_hyp;
    else
      BankedRegisterAccessValid(SYSm, mode); // Check for UNPREDICTABLE cases
      case SYSm of
        when '00xxx' // Access the User mode registers
          m = UInt(SYSm<2:0>) + 8;
          R[d] = Rmode[m, M32_User];
        when '01xxx' // Access the FIQ mode registers
          m = UInt(SYSm<2:0>) + 8;
          R[d] = Rmode[m, M32_FIQ];
        when '1000x' // Access the IRQ mode registers
          // LR when SYSm<0> == 0, otherwise SP
          m = 14 - UInt(SYSm<0>);
          R[d] = Rmode[m, M32_IRQ];
        when '1001x' // Access the Supervisor mode registers
          // LR when SYSm<0> == 0, otherwise SP
          m = 14 - UInt(SYSm<0>);
          R[d] = Rmode[m, M32_Svc];
        when '1010x' // Access the Abort mode registers
          // LR when SYSm<0> == 0, otherwise SP
          m = 14 - UInt(SYSm<0>);
          R[d] = Rmode[m, M32_Abort];
        when '1011x' // Access the Undefined mode registers
          // LR when SYSm<0> == 0, otherwise SP
          m = 14 - UInt(SYSm<0>);
          R[d] = Rmode[m, M32_Undef];
        when '1110x' // Access Monitor registers
          if !ELUsingAArch32(EL3) then AArch64.MonitorModeTrap();
          m = 14 - UInt(SYSm<0>); // LR when SYSm<0> == 0, otherwise SP
          R[d] = Rmode[m, M32_Monitor];
        when '11110' // Access ELR_hyp register
          R[d] = ELR_hyp;
        when '11111' // Access SP_hyp register
          R[d] = Rmode[13, M32_Hyp];
      end case
    end case
  end if
end if

```

CONSTRAINED UNPREDICTABLE behavior

If PSTATE.EL == EL0, then one of the following behaviors must occur:

- The instruction is UNDEFINED.

- The instruction executes as NOP.

F5.1.116 MSR (Banked register)

Move to Banked or Special register from general-purpose register moves the value of a general-purpose register to the Banked general-purpose register or *SPSR* of the specified mode, or to *ELR_hyp* on page G1-4331.

MSR (Banked register) is UNPREDICTABLE if executed in User mode.

When EL3 is using AArch64, if an MSR (Banked register) instruction that is executed in a Secure EL1 mode would access *SPSR_mon*, *SP_mon*, or *LR_mon*, it is trapped to EL3.

The effect of using an MSR (Banked register) instruction with a register argument that is not valid for the current mode is UNPREDICTABLE. For more information see *Usage restrictions on the Banked register transfer instructions* on page F5-3675.

A1

31	28	27	26	25	24	23	22	21	20	19	16	15	14	13	12	11	10	9	8	7	6	5	4	3	0		
!=1111				0	0	0	1	0	R	1	0	M1	(1)	(1)	(1)	(1)	(0)	(0)	1	M	0	0	0	0	Rn		
cond																											

A1 variant

MSR{<c>}{<q>} <banked_reg>, <Rn>

Decode for this encoding

```
n = UInt(Rn); write_spsr = (R == '1');
if n == 15 then UNPREDICTABLE;
SYSm = M:M1;
```

T1

15	14	13	12	11	10	9	8	7	6	5	4	3	0	15	14	13	12	11	8	7	6	5	4	3	2	1	0
1	1	1	1	0	0	1	1	1	0	0	R	Rn	1	0	(0)	0	M1	(0)	(0)	1	M	(0)	(0)	(0)	(0)		

T1 variant

MSR{<c>}{<q>} <banked_reg>, <Rn>

Decode for this encoding

```
n = UInt(Rn); write_spsr = (R == '1');
if n == 15 then UNPREDICTABLE; // ARMv8-A removes UNPREDICTABLE for R13
SYSm = M:M1;
```

Notes for all encodings

For more information about the CONSTRAINED UNPREDICTABLE behavior of this instruction, see [Appendix K1 Architectural Constraints on UNPREDICTABLE behaviors](#).

Assembler symbols

<c> See [Standard assembler syntax fields](#) on page F2-2848.

<q> See [Standard assembler syntax fields](#) on page F2-2848.

<banked_reg> Is the name of the banked register to be transferred to or from, encoded in the "R:M:M1" field. It can have the following values:

R8_usr	when R = 0, M = 0, M1 = 0000
R9_usr	when R = 0, M = 0, M1 = 0001
R10_usr	when R = 0, M = 0, M1 = 0010
R11_usr	when R = 0, M = 0, M1 = 0011
R12_usr	when R = 0, M = 0, M1 = 0100
SP_usr	when R = 0, M = 0, M1 = 0101
LR_usr	when R = 0, M = 0, M1 = 0110
R8_fiq	when R = 0, M = 0, M1 = 1000
R9_fiq	when R = 0, M = 0, M1 = 1001
R10_fiq	when R = 0, M = 0, M1 = 1010
R11_fiq	when R = 0, M = 0, M1 = 1011
R12_fiq	when R = 0, M = 0, M1 = 1100
SP_fiq	when R = 0, M = 0, M1 = 1101
LR_fiq	when R = 0, M = 0, M1 = 1110
LR_irq	when R = 0, M = 1, M1 = 0000
SP_irq	when R = 0, M = 1, M1 = 0001
LR_svc	when R = 0, M = 1, M1 = 0010
SP_svc	when R = 0, M = 1, M1 = 0011
LR_abt	when R = 0, M = 1, M1 = 0100
SP_abt	when R = 0, M = 1, M1 = 0101
LR_und	when R = 0, M = 1, M1 = 0110
SP_und	when R = 0, M = 1, M1 = 0111
LR_mon	when R = 0, M = 1, M1 = 1100
SP_mon	when R = 0, M = 1, M1 = 1101
ELR_hyp	when R = 0, M = 1, M1 = 1110
SP_hyp	when R = 0, M = 1, M1 = 1111
SPSR_fiq	when R = 1, M = 0, M1 = 1110
SPSR_irq	when R = 1, M = 1, M1 = 0000
SPSR_svc	when R = 1, M = 1, M1 = 0010
SPSR_abt	when R = 1, M = 1, M1 = 0100
SPSR_und	when R = 1, M = 1, M1 = 0110
SPSR_mon	when R = 1, M = 1, M1 = 1100
SPSR_hyp	when R = 1, M = 1, M1 = 1110

The following encodings are UNPREDICTABLE:

- R = 0, M = 0, M1 = 0111.
- R = 0, M = 0, M1 = 1111.
- R = 0, M = 1, M1 = 10xx.
- R = 1, M = 0, M1 = 0xxx.
- R = 1, M = 0, M1 = 10xx.
- R = 1, M = 0, M1 = 110x.
- R = 1, M = 0, M1 = 1111.
- R = 1, M = 1, M1 = 0001.

- R = 1, M = 1, M1 = 0011.
- R = 1, M = 1, M1 = 0101.
- R = 1, M = 1, M1 = 0111.
- R = 1, M = 1, M1 = 10xx.
- R = 1, M = 1, M1 = 1101.
- R = 1, M = 1, M1 = 1111.

<Rn> Is the general-purpose source register, encoded in the "Rn" field.

Operation for all encodings

```

if ConditionPassed() then
    EncodingSpecificOperations();
if PSTATE.EL == EL0 then
    UNPREDICTABLE;
else
    mode = PSTATE.M;
    if write_spsr then
        SPSRaccessValid(SYSm, mode);           // Check for UNPREDICTABLE cases
        case SYSm of
            when '01110' SPSR_fiq = R[n];
            when '10000' SPSR_irq = R[n];
            when '10010' SPSR_svc = R[n];
            when '10100' SPSR_abt = R[n];
            when '10110' SPSR_und = R[n];
            when '11100'
                if !ELUsingAArch32(EL3) then AArch64.MonitorModeTrap();
                SPSR_mon = R[n];
            when '11110' SPSR_hyp = R[n];
        else
            BankedRegisterAccessValid(SYSm, mode); // Check for UNPREDICTABLE cases
            case SYSm of
                when '00xxx' // Access the User mode registers
                    m = UInt(SYSm<2:0>) + 8;
                    Rmode[m,M32_User] = R[n];
                when '01xxx' // Access the FIQ mode registers
                    m = UInt(SYSm<2:0>) + 8;
                    Rmode[m,M32_FIQ] = R[n];
                when '1000x' // Access the IRQ mode registers
                    m = 14 - UInt(SYSm<0>); // LR when SYSm<0> == 0, otherwise SP
                    Rmode[m,M32_IRQ] = R[n];
                when '1001x' // Access the Supervisor mode registers
                    m = 14 - UInt(SYSm<0>); // LR when SYSm<0> == 0, otherwise SP
                    Rmode[m,M32_Svc] = R[n];
                when '1010x' // Access the Abort mode registers
                    m = 14 - UInt(SYSm<0>); // LR when SYSm<0> == 0, otherwise SP
                    Rmode[m,M32_Abort] = R[n];
                when '1011x' // Access the Undefined mode registers
                    m = 14 - UInt(SYSm<0>); // LR when SYSm<0> == 0, otherwise SP
                    Rmode[m,M32_Undef] = R[n];
                when '1110x' // Access Monitor registers
                    if !ELUsingAArch32(EL3) then AArch64.MonitorModeTrap();
                    m = 14 - UInt(SYSm<0>); // LR when SYSm<0> == 0, otherwise SP
                    Rmode[m,M32_Monitor] = R[n];
                when '11110' // Access ELR_hyp register
                    ELR_hyp = R[n];
                when '11111' // Access SP_hyp register
                    Rmode[13,M32_Hyp] = R[n];
            end
        end
    end

```

CONSTRAINED UNPREDICTABLE behavior

If `PSTATE.EL == EL0`, then one of the following behaviors must occur:

- The instruction is UNDEFINED.
- The instruction executes as NOP.

F5.1.117 MSR (immediate)

Move immediate value to Special register moves selected bits of an immediate value to the corresponding bits in the [APSR](#), [CPSR](#), or [SPSR](#) <current_mode>.

Because of the Do-Not-Modify nature of its reserved bits, the immediate form of MSR is normally only useful at the Application level for writing to [APSR_nzcvq](#) ([CPSR_f](#)).

If an MSR (immediate) moves selected bits of an immediate value to the [CPSR](#), the PE checks whether the value being written to [PSTATE.M](#) is legal. See *Illegal changes to PSTATE.M* on page G1-4336.

An MSR (immediate) executed in User mode:

- Is **CONSTRAINED UNPREDICTABLE** if it attempts to update the [SPSR](#).
- Otherwise, does not update any [CPSR](#) field that is accessible only at EL1 or higher,

An MSR (immediate) executed in System mode is **CONSTRAINED UNPREDICTABLE** if it attempts to update the [SPSR](#).

The [CPSR.E](#) bit is writable from any mode using an MSR instruction. ARM deprecates using this to change its value.

A1

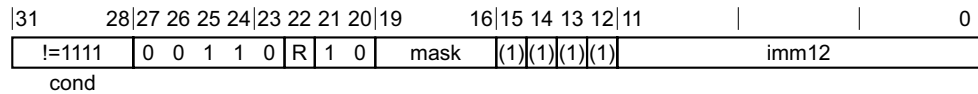

A1 variant

Applies when !(R == 0 && mask == 0000).

MSR{<c>}{<q>} <spec_reg>, #<imm>

Decode for this encoding

```
if mask == '0000' && R == '0' then SEE "Related encodings";
imm32 = A32ExpandImm(imm12); write_spsr = (R == '1');
if mask == '0000' then UNPREDICTABLE;
```

CONSTRAINED UNPREDICTABLE behavior

If mask == '0000' && R == '1', then one of the following behaviors must occur:

- The instruction is **UNDEFINED**.
- The instruction executes as **NOP**.

Notes for all encodings

For more information about the **CONSTRAINED UNPREDICTABLE** behavior of this instruction, see [Appendix K1 Architectural Constraints on UNPREDICTABLE behaviors](#).

Related encodings: *Move Special Register and Hints (immediate)* on page F4-2959.

Assembler symbols

<c> See *Standard assembler syntax fields* on page F2-2848.

<q> See *Standard assembler syntax fields* on page F2-2848.

<spec_reg> Is one of:

- [APSR_<bits>](#).

- CPSR_<fields>.
- SPSR_<fields>.

For CPSR and SPSR, <fields> is a sequence of one or more of the following:

- c mask<0> = '1' to enable writing of bits<7:0> of the destination PSR.
- x mask<1> = '1' to enable writing of bits<15:8> of the destination PSR.
- s mask<2> = '1' to enable writing of bits<23:16> of the destination PSR.
- f mask<3> = '1' to enable writing of bits<31:24> of the destination PSR.

For APSR, <bits> is one of nzcvcq, g, or nzcvcqg. These map to the following CPSR_<fields> values:

- APSR_nzcvcq is the same as CPSR_f (mask == '1000').
- APSR_g is the same as CPSR_s (mask == '0100').
- APSR_nzcvcqg is the same as CPSR_fs (mask == '1100').

ARM recommends the APSR_<bits> forms when only the N, Z, C, V, Q, and GE[3:0] bits are being written. For more information, see [The Application Program Status Register, APSR](#) on page E1-2736.

<imm> Is an immediate value. See [Modified immediate constants in A32 instructions](#) on page F2-2864 for the range of values.

Operation

```
if ConditionPassed() then
    EncodingSpecificOperations();
    if write_spsr then
        if PSTATE.M IN {M32_User,M32_System} then
            UNPREDICTABLE;
        else
            SPSRWriteByInstr(imm32, mask);
    else
        // Attempts to change to an illegal mode will invoke the Illegal Execution state mechanism
        CPSRWriteByInstr(imm32, mask);
```

CONSTRAINED UNPREDICTABLE behavior

If PSTATE.M IN {M32_User,M32_System} && write_spsr, then one of the following behaviors must occur:

- The instruction is UNDEFINED.
- The instruction executes as NOP.

F5.1.118 MSR (register)

Move general-purpose register to Special register moves selected bits of a general-purpose register to the [APSR](#), [CPSR](#) or [SPSR](#) <current_mode>.

Because of the Do-Not-Modify nature of its reserved bits, a read-modify-write sequence is normally required when the MSR instruction is being used at Application level and its destination is not [APSR_nzcvq](#) ([CPSR_f](#)).

If an MSR (register) moves selected bits of an immediate value to the [CPSR](#), the PE checks whether the value being written to [PSTATE.M](#) is legal. See *Illegal changes to PSTATE.M* on page G1-4336.

An MSR (register) executed in User mode:

- Is UNPREDICTABLE if it attempts to update the [SPSR](#).
- Otherwise, does not update any [CPSR](#) field that is accessible only at EL1 or higher.

An MSR (register) executed in System mode is UNPREDICTABLE if it attempts to update the [SPSR](#).

The [CPSR.E](#) bit is writable from any mode using an MSR instruction. ARM deprecates using this to change its value.

A1

31	28	27	26	25	24	23	22	21	20	19	16	15	14	13	12	11	10	9	8	7	6	5	4	3	0		
!=1111				0	0	0	1	0	R	1	0	mask	(1)	(1)	(1)	(1)	(0)	(0)	0	(0)	0	0	0	0	Rn		
cond																											

A1 variant

MSR{<c>}{<q>} <spec_reg>, <Rn>

Decode for this encoding

```
n = UInt(Rn); write_spsr = (R == '1');
if mask == '0000' then UNPREDICTABLE;
if n == 15 then UNPREDICTABLE;
```

CONSTRAINED UNPREDICTABLE behavior

If mask == '0000', then one of the following behaviors must occur:

- The instruction is UNDEFINED.
- The instruction executes as NOP.

T1

15	14	13	12	11	10	9	8	7	6	5	4	3	0	15	14	13	12	11	8	7	6	5	4	3	2	1	0
1	1	1	1	0	0	1	1	1	0	0	R	Rn	1	0	(0)	0	mask	(0)	(0)	0	(0)	(0)	(0)	(0)	(0)	(0)	

T1 variant

MSR{<c>}{<q>} <spec_reg>, <Rn>

Decode for this encoding

```
n = UInt(Rn); write_spsr = (R == '1');
if mask == '0000' then UNPREDICTABLE;
if n == 15 then UNPREDICTABLE; // ARMv8-A removes UNPREDICTABLE for R13
```

CONSTRAINED UNPREDICTABLE behavior

If mask == '0000', then one of the following behaviors must occur:

- The instruction is UNDEFINED.
- The instruction executes as NOP.

Notes for all encodings

For more information about the CONSTRAINED UNPREDICTABLE behavior of this instruction, see [Appendix K1 Architectural Constraints on UNPREDICTABLE behaviors](#).

Assembler symbols

<c> See [Standard assembler syntax fields on page F2-2848](#).

<q> See [Standard assembler syntax fields on page F2-2848](#).

<spec_reg> Is one of:

- APSR_<bits>.
- CPSR_<fields>.
- SPSR_<fields>.

For CPSR and SPSR, <fields> is a sequence of one or more of the following:

- c mask<0> = '1' to enable writing of bits<7:0> of the destination PSR.
- x mask<1> = '1' to enable writing of bits<15:8> of the destination PSR.
- s mask<2> = '1' to enable writing of bits<23:16> of the destination PSR.
- f mask<3> = '1' to enable writing of bits<31:24> of the destination PSR.

For APSR, <bits> is one of nzcvcq, g, or nzcvcqg. These map to the following CPSR_<fields> values:

- APSR_nzcvcq is the same as CPSR_f (mask == '1000').
- APSR_g is the same as CPSR_s (mask == '0100').
- APSR_nzcvcqg is the same as CPSR_fs (mask == '1100').

ARM recommends the APSR_<bits> forms when only the N, Z, C, V, Q, and GE[3:0] bits are being written. For more information, see [The Application Program Status Register, APSR on page E1-2736](#).

<Rn> Is the general-purpose source register, encoded in the "Rn" field.

Operation for all encodings

```
if ConditionPassed() then
    EncodingSpecificOperations();
    if write_spsr then
        if PSTATE.M IN {M32_User,M32_System} then
            UNPREDICTABLE;
        else
            SPSRWriteByInstr(R[n], mask);
    else
        // Attempts to change to an illegal mode will invoke the Illegal Execution state mechanism
        CPSRWriteByInstr(R[n], mask);
```

CONSTRAINED UNPREDICTABLE behavior

If write_spsr && PSTATE.M IN {M32_User,M32_System}, then one of the following behaviors must occur:

- The instruction is UNDEFINED.

- The instruction executes as NOP.

F5.1.119 MUL, MULS

Multiply multiplies two register values. The least significant 32 bits of the result are written to the destination register. These 32 bits do not depend on whether the source register values are considered to be signed values or unsigned values.

Optionally, it can update the condition flags based on the result. In the T32 instruction set, this option is limited to only a few forms of the instruction. Use of this option adversely affects performance on many implementations.

A1

31	28 27 26 25 24 23 22 21 20 19	16 15 14 13 12 11	8 7 6 5 4 3	0			
!=1111	0 0 0 0	0 0 0 S	Rd	(0)(0)(0)(0)	Rm	1 0 0 1	Rn
cond							

Flag setting variant

Applies when S == 1.

MULS{<c>}{<q>} <Rd>, <Rn>{, <Rm>}

Not flag setting variant

Applies when S == 0.

MUL{<c>}{<q>} <Rd>, <Rn>{, <Rm>}

Decode for all variants of this encoding

```
d = UInt(Rd); n = UInt(Rn); m = UInt(Rm); setflags = (S == '1');
if d == 15 || n == 15 || m == 15 then UNPREDICTABLE;
```

T1

15 14 13 12 11 10 9 8 7 6 5	3 2	0
0 1 0 0 0 0	1 1 0 1	Rn Rdm

T1 variant

MUL<c>{<q>} <Rdm>, <Rn>{, <Rdm>} // Inside IT block
 MULS{<q>} <Rdm>, <Rn>{, <Rdm>} // Outside IT block

Decode for this encoding

```
d = UInt(Rdm); n = UInt(Rn); m = UInt(Rdm); setflags = !InITBlock();
```

T2

15 14 13 12 11 10 9 8 7 6 5 4 3	0 15 14 13 12 11	8 7 6 5 4 3	0			
1 1 1 1 1 0 1 1 0	0 0 0	Rn	1 1 1 1	Rd	0 0 0 0	Rm

T2 variant

MUL<c>.W <Rd>, <Rn>{, <Rm>} // Inside IT block, and <Rd>, <Rn>, <Rm> can be represented in T1
 MUL{<c>}{<q>} <Rd>, <Rn>{, <Rm>}

Decode for this encoding

```
d = UInt(Rd); n = UInt(Rn); m = UInt(Rm); setFlags = FALSE;
if d == 15 || n == 15 || m == 15 then UNPREDICTABLE; // ARMv8-A removes UNPREDICTABLE for R13
```

Notes for all encodings

For more information about the CONSTRAINED UNPREDICTABLE behavior of this instruction, see [Appendix K1 Architectural Constraints on UNPREDICTABLE behaviors](#).

Assembler symbols

- <c> See [Standard assembler syntax fields on page F2-2848](#).
- <q> See [Standard assembler syntax fields on page F2-2848](#).
- <Rdm> Is the second general-purpose source register holding the multiplier and the destination register, encoded in the "Rdm" field.
- <Rd> Is the general-purpose destination register, encoded in the "Rd" field.
- <Rn> Is the first general-purpose source register holding the multiplicand, encoded in the "Rn" field.
- <Rm> Is the second general-purpose source register holding the multiplier, encoded in the "Rm" field. If omitted, <Rd> is used.

Operation for all encodings

```
if ConditionPassed() then
  EncodingSpecificOperations();
operand1 = SInt(R[n]); // operand1 = UInt(R[n]) produces the same final results
operand2 = SInt(R[m]); // operand2 = UInt(R[m]) produces the same final results
result = operand1 * operand2;
R[d] = result<31:0>;
if setFlags then
  PSTATE.N = result<31>;
  PSTATE.Z = IsZeroBit(result<31:0>);
  // PSTATE.C, PSTATE.V unchanged
```

F5.1.120 MVN, MVNS (immediate)

Bitwise NOT (immediate) writes the bitwise inverse of an immediate value to the destination register.

If the destination register is not the PC, the MVNS variant of the instruction updates the condition flags based on the result.

The field descriptions for <Rd> identify the encodings where the PC is permitted as the destination register. ARM deprecates any use of these encodings. However, when the destination register is the PC:

- The MVN variant of the instruction is an interworking branch, see *Pseudocode description of operations on the AArch32 general-purpose registers and the PC* on page E1-2733.
- The MVNS variant of the instruction performs an exception return without the use of the stack. In this case:
 - The PE branches to the address written to the PC, and restores PSTATE from SPSR_<current_mode>.
 - The PE checks SPSR_<current_mode> for an illegal return event. See *Illegal return events from AArch32 state* on page G1-4361.
 - The instruction is UNDEFINED in Hyp mode.
 - The instruction is CONSTRAINED UNPREDICTABLE in User mode and System mode.

A1

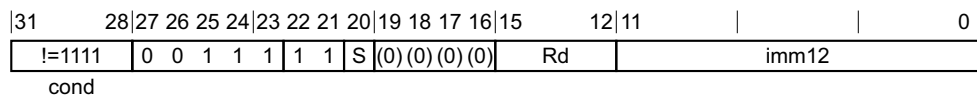

MVN variant

Applies when S == 0.

MVN{<c>}{<q>} <Rd>, #<const>

MVNS variant

Applies when S == 1.

MVNS{<c>}{<q>} <Rd>, #<const>

Decode for all variants of this encoding

```
d = UInt(Rd); setFlags = (S == '1');
(imm32, carry) = A32ExpandImm_C(imm12, PSTATE.C);
```

T1

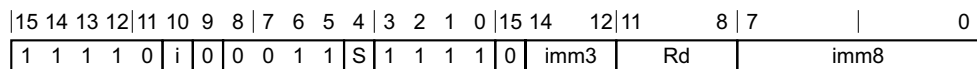

MVN variant

Applies when S == 0.

MVN{<c>}{<q>} <Rd>, #<const>

MVNS variant

Applies when S == 1.

MVNS{<c>}{<q>} <Rd>, #<const>

Decode for all variants of this encoding

```
d = UInt(Rd); setFlags = (S == '1');  
(imm32, carry) = T32ExpandImm_C(i:imm3:imm8, PSTATE.C);  
if d == 15 then UNPREDICTABLE; // ARMv8-A removes UNPREDICTABLE for R13
```

Notes for all encodings

For more information about the CONSTRAINED UNPREDICTABLE behavior of this instruction, see [Appendix K1 Architectural Constraints on UNPREDICTABLE behaviors](#).

Assembler symbols

- <c> See [Standard assembler syntax fields on page F2-2848](#).
- <q> See [Standard assembler syntax fields on page F2-2848](#).
- <Rd> For encoding A1: is the general-purpose destination register, encoded in the "Rd" field. ARM deprecates using the PC as the destination register, but if the PC is used:
- For the MVN variant, the instruction is a branch to the address calculated by the operation. This is an interworking branch, see [Pseudocode description of operations on the AArch32 general-purpose registers and the PC on page E1-2733](#).
 - For the MVNS variant, the instruction performs an exception return, that restores PSTATE from SPSR_<current_mode>.
- For encoding T1: is the general-purpose destination register, encoded in the "Rd" field.
- <const> For encoding A1: an immediate value. See [Modified immediate constants in A32 instructions on page F2-2864](#) for the range of values.
- For encoding T1: an immediate value. See [Modified immediate constants in T32 instructions on page F2-2863](#) for the range of values.

Operation for all encodings

```
if ConditionPassed() then  
  EncodingSpecificOperations();  
  result = NOT(imm32);  
  if d == 15 then // Can only occur for A32 encoding  
    if setFlags then  
      ALUExceptionReturn(result);  
    else  
      ALUWritePC(result);  
  else  
    R[d] = result;  
    if setFlags then  
      PSTATE.N = result<31>;  
      PSTATE.Z = IsZeroBit(result);  
      PSTATE.C = carry;  
      // PSTATE.V unchanged
```

F5.1.121 MVN, MVNS (register)

Bitwise NOT (register) writes the bitwise inverse of a register value to the destination register.

If the destination register is not the PC, the MVNS variant of the instruction updates the condition flags based on the result.

The field descriptions for <Rd> identify the encodings where the PC is permitted as the destination register. ARM deprecates any use of these encodings. However, when the destination register is the PC:

- The MVN variant of the instruction is an interworking branch, see *Pseudocode description of operations on the AArch32 general-purpose registers and the PC* on page E1-2733.
- The MVNS variant of the instruction performs an exception return without the use of the stack. In this case:
 - The PE branches to the address written to the PC, and restores `PSTATE` from `SPSR_<current_mode>`.
 - The PE checks `SPSR_<current_mode>` for an illegal return event. See *Illegal return events from AArch32 state* on page G1-4361.
 - The instruction is UNDEFINED in Hyp mode.
 - The instruction is CONSTRAINED UNPREDICTABLE in User mode and System mode.

A1

31	28	27	26	25	24	23	22	21	20	19	18	17	16	15	12	11	7	6	5	4	3	0
!=1111				0 0 0 1 1		1 1		S	(0)	(0)	(0)	(0)	Rd	imm5	type	0	Rm					
cond																						

MVN, rotate right with extend variant

Applies when `S == 0` && `imm5 == 00000` && `type == 11`.

`MVN{<c>}{<q>} <Rd>, <Rm>, RRX`

MVN, shift or rotate by value variant

Applies when `S == 0` && `!(imm5 == 00000 && type == 11)`.

`MVN{<c>}{<q>} <Rd>, <Rm> {, <shift> #<amount>}`

MVNS, rotate right with extend variant

Applies when `S == 1` && `imm5 == 00000` && `type == 11`.

`MVNS{<c>}{<q>} <Rd>, <Rm>, RRX`

MVNS, shift or rotate by value variant

Applies when `S == 1` && `!(imm5 == 00000 && type == 11)`.

`MVNS{<c>}{<q>} <Rd>, <Rm> {, <shift> #<amount>}`

Decode for all variants of this encoding

```
d = UInt(Rd); m = UInt(Rm); setflags = (S == '1');
(shift_t, shift_n) = DecodeImmShift(type, imm5);
```

T1

15	14	13	12	11	10	9	8	7	6	5	3	2	0
0 1 0 0 0 0				1 1 1 1				Rm	Rd				

T1 variant

MVN<c>{<q>} <Rd>, <Rm> // Inside IT block
 MVNS{<q>} <Rd>, <Rm> // Outside IT block

Decode for this encoding

```
d = UInt(Rd); m = UInt(Rm); setflags = !InITBlock();
(shift_t, shift_n) = (SRTYPE_LSL, 0);
```

T2

15	14	13	12	11	10	9	8	7	6	5	4	3	2	1	0	15	14	12	11	8	7	6	5	4	3	0
1	1	1	0	1	0	1	0	0	1	1	S	1	1	1	1	(0)	imm3		Rd	imm2	type		Rm			

MVN, rotate right with extend variant

Applies when S == 0 && imm3 == 000 && imm2 == 00 && type == 11.

MVN{<c>}{<q>} <Rd>, <Rm>, RRX

MVN, shift or rotate by value variant

Applies when S == 0 && !(imm3 == 000 && imm2 == 00 && type == 11).

MVN<c>.W <Rd>, <Rm> // Inside IT block, and <Rd>, <Rm> can be represented in T1
 MVN{<c>}{<q>} <Rd>, <Rm> {, <shift> #<amount>}

MVNS, rotate right with extend variant

Applies when S == 1 && imm3 == 000 && imm2 == 00 && type == 11.

MVNS{<c>}{<q>} <Rd>, <Rm>, RRX

MVNS, shift or rotate by value variant

Applies when S == 1 && !(imm3 == 000 && imm2 == 00 && type == 11).

MVNS.W <Rd>, <Rm> // Outside IT block, and <Rd>, <Rm> can be represented in T1
 MVNS{<c>}{<q>} <Rd>, <Rm> {, <shift> #<amount>}

Decode for all variants of this encoding

```
d = UInt(Rd); m = UInt(Rm); setflags = (S == '1');
(shift_t, shift_n) = DecodeImmShift(type, imm3:imm2);
if d == 15 || m == 15 then UNPREDICTABLE; // ARMv8-A removes UNPREDICTABLE for R13
```

Notes for all encodings

For more information about the CONSTRAINED UNPREDICTABLE behavior of this instruction, see [Appendix K1 Architectural Constraints on UNPREDICTABLE behaviors](#).

Assembler symbols

<c> See [Standard assembler syntax fields on page F2-2848](#).

<q> See [Standard assembler syntax fields on page F2-2848](#).

<Rd>	<p>For encoding A1: is the general-purpose destination register, encoded in the "Rd" field. ARM deprecates using the PC as the destination register, but if the PC is used:</p> <ul style="list-style-type: none">• For the MVN variant, the instruction is a branch to the address calculated by the operation. This is an interworking branch, see Pseudocode description of operations on the AArch32 general-purpose registers and the PC on page E1-2733.• For the MVNS variant, the instruction performs an exception return, that restores PSTATE from SPSR_<current_mode>. <p>For encoding T1 and T2: is the general-purpose destination register, encoded in the "Rd" field.</p>								
<Rm>	<p>For encoding A1: is the general-purpose source register, encoded in the "Rm" field. The PC can be used, but this is deprecated.</p> <p>For encoding T1 and T2: is the general-purpose source register, encoded in the "Rm" field.</p>								
<shift>	<p>Is the type of shift to be applied to the source register, encoded in the "type" field. It can have the following values:</p> <table><tr><td>LSL</td><td>when type = 00</td></tr><tr><td>LSR</td><td>when type = 01</td></tr><tr><td>ASR</td><td>when type = 10</td></tr><tr><td>ROR</td><td>when type = 11</td></tr></table>	LSL	when type = 00	LSR	when type = 01	ASR	when type = 10	ROR	when type = 11
LSL	when type = 00								
LSR	when type = 01								
ASR	when type = 10								
ROR	when type = 11								
<amount>	<p>For encoding A1: is the shift amount, in the range 1 to 31 (when <shift> = LSL or ROR) or 1 to 32 (when <shift> = LSR or ASR) encoded in the "imm5" field as <amount> modulo 32.</p> <p>For encoding T2: is the shift amount, in the range 1 to 31 (when <shift> = LSL or ROR) or 1 to 32 (when <shift> = LSR or ASR) encoded in the "imm3:imm2" field as <amount> modulo 32.</p>								

Operation for all encodings

```
if ConditionPassed() then
    EncodingSpecificOperations();
    (shifted, carry) = Shift_C(R[m], shift_t, shift_n, PSTATE.C);
    result = NOT(shifted);
    if d == 15 then // Can only occur for A32 encoding
        if setflags then
            ALUExceptionReturn(result);
        else
            ALUWritePC(result);
    else
        R[d] = result;
        if setflags then
            PSTATE.N = result<31>;
            PSTATE.Z = IsZeroBit(result);
            PSTATE.C = carry;
            // PSTATE.V unchanged
```

F5.1.122 MVN, MVNS (register-shifted register)

Bitwise NOT (register-shifted register) writes the bitwise inverse of a register-shifted register value to the destination register. It can optionally update the condition flags based on the result.

A1

31	28	27	26	25	24	23	22	21	20	19	18	17	16	15	12	11	8	7	6	5	4	3	0
!=1111				0	0	0	1	1	1	1	S	(0)	(0)	(0)	(0)	Rd	Rs	0	type	1	Rm		
cond																							

Flag setting variant

Applies when S == 1.

MVNS{<c>}{<q>} <Rd>, <Rm>, <type> <Rs>

Not flag setting variant

Applies when S == 0.

MVN{<c>}{<q>} <Rd>, <Rm>, <type> <Rs>

Decode for all variants of this encoding

```
d = UInt(Rd); m = UInt(Rm); s = UInt(Rs);
setflags = (S == '1'); shift_t = DecodeRegShift(type);
if d == 15 || m == 15 || s == 15 then UNPREDICTABLE;
```

Notes for all encodings

For more information about the CONSTRAINED UNPREDICTABLE behavior of this instruction, see [Appendix K1 Architectural Constraints on UNPREDICTABLE behaviors](#).

Assembler symbols

<c> See [Standard assembler syntax fields on page F2-2848](#).

<q> See [Standard assembler syntax fields on page F2-2848](#).

<Rd> Is the general-purpose destination register, encoded in the "Rd" field.

<Rm> Is the general-purpose source register, encoded in the "Rm" field.

<type> Is the type of shift to be applied to the second source register, encoded in the "type" field. It can have the following values:

LSL	when type = 00
LSR	when type = 01
ASR	when type = 10
ROR	when type = 11

<Rs> Is the general-purpose source register holding a shift amount in its bottom 8 bits, encoded in the "Rs" field.

Operation

```
if ConditionPassed() then
  EncodingSpecificOperations();
  shift_n = UInt(R[s]<7:0>);
  (shifted, carry) = Shift_C(R[m], shift_t, shift_n, PSTATE.C);
```

```
result = NOT(shifted);  
R[d] = result;  
if setflags then  
    PSTATE.N = result<31>;  
    PSTATE.Z = IsZeroBit(result);  
    PSTATE.C = carry;  
    // PSTATE.V unchanged
```

F5.1.123 NOP

No Operation does nothing. This instruction can be used for instruction alignment purposes.

———— **Note** —————

The timing effects of including a NOP instruction in a program are not guaranteed. It can increase execution time, leave it unchanged, or even reduce it. Therefore, NOP instructions are not suitable for timing loops.

A1

31	28	27	26	25	24	23	22	21	20	19	18	17	16	15	14	13	12	11	10	9	8	7	6	5	4	3	2	1	0
!	1	1	1	1	0	0	1	0	0	0	0	0	0	(1)	(1)	(1)	(1)	(0)	(0)	(0)	(0)	0	0	0	0	0	0	0	0
cond																													

A1 variant

NOP{<c>}{<q>}

Decode for this encoding

// No additional decoding required

T1

15	14	13	12	11	10	9	8	7	6	5	4	3	2	1	0
1	0	1	1	1	1	1	1	0	0	0	0	0	0	0	0

T1 variant

NOP{<c>}{<q>}

Decode for this encoding

// No additional decoding required

T2

15	14	13	12	11	10	9	8	7	6	5	4	3	2	1	0	15	14	13	12	11	10	9	8	7	6	5	4	3	2	1	0
1	1	1	1	0	0	1	1	1	0	1	0	(1)	(1)	(1)	(1)	1	0	(0)	0	(0)	0	0	0	0	0	0	0	0	0	0	0

T2 variant

NOP{<c>}.W

Decode for this encoding

// No additional decoding required

Notes for all encodings

For more information about the CONSTRAINED UNPREDICTABLE behavior of this instruction, see [Appendix K1 Architectural Constraints on UNPREDICTABLE behaviors](#).

Assembler symbols

<c> See [Standard assembler syntax fields on page F2-2848](#).

<q> See [Standard assembler syntax fields on page F2-2848](#).

Operation for all encodings

```
if ConditionPassed() then
    EncodingSpecificOperations();
// Do nothing
```

F5.1.124 ORN, ORNS (immediate)

Bitwise OR NOT (immediate) performs a bitwise (inclusive) OR of a register value and the complement of an immediate value, and writes the result to the destination register. It can optionally update the condition flags based on the result.

T1

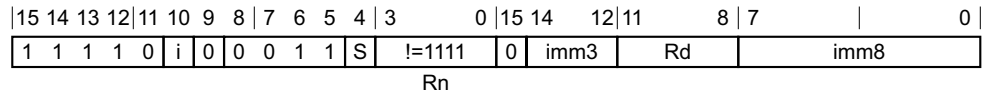

Flag setting variant

Applies when S == 1.

ORNS{<c>}{<q>} {<Rd>}, <Rn>, #<const>

Not flag setting variant

Applies when S == 0.

ORN{<c>}{<q>} {<Rd>}, <Rn>, #<const>

Decode for all variants of this encoding

```
if Rn == '1111' then SEE MVN (immediate);
d = UInt(Rd); n = UInt(Rn); setflags = (S == '1');
(imm32, carry) = T32ExpandImm_C(i:imm3:imm8, PSTATE.C);
if d == 15 then UNPREDICTABLE; // ARMv8-A removes UNPREDICTABLE for R13
```

Notes for all encodings

For more information about the CONSTRAINED UNPREDICTABLE behavior of this instruction, see [Appendix K1 Architectural Constraints on UNPREDICTABLE behaviors](#).

Assembler symbols

- <c> See [Standard assembler syntax fields on page F2-2848](#).
- <q> See [Standard assembler syntax fields on page F2-2848](#).
- <Rd> Is the general-purpose destination register, encoded in the "Rd" field. If omitted, this register is the same as <Rn>.
- <Rn> Is the general-purpose source register, encoded in the "Rn" field.
- <const> An immediate value. See [Modified immediate constants in T32 instructions on page F2-2863](#) for the range of values.

Operation

```
if ConditionPassed() then
    EncodingSpecificOperations();
    result = R[n] OR NOT(imm32);
    R[d] = result;
    if setflags then
        PSTATE.N = result<31>;
        PSTATE.Z = IsZeroBit(result);
        PSTATE.C = carry;
        // PSTATE.V unchanged
```

F5.1.125 ORN, ORNS (register)

Bitwise OR NOT (register) performs a bitwise (inclusive) OR of a register value and the complement of an optionally-shifted register value, and writes the result to the destination register. It can optionally update the condition flags based on the result.

T1

15	14	13	12	11	10	9	8	7	6	5	4	3	0	15	14	12	11	8	7	6	5	4	3	0
1	1	1	0	1	0	1	0	0	1	1	S	!=1111	(0)	imm3	Rd	imm2	type	Rm						

Rn

ORN, rotate right with extend variant

Applies when $S == 0$ && $imm3 == 000$ && $imm2 == 00$ && $type == 11$.

ORN{<c>}{<q>} {<Rd>}, <Rn>, <Rm>, RRX

ORN, shift or rotate by value variant

Applies when $S == 0$ && $!(imm3 == 000 \&\& imm2 == 00 \&\& type == 11)$.

ORN{<c>}{<q>} {<Rd>}, <Rn>, <Rm> {, <shift> #<amount>}

ORNS, rotate right with extend variant

Applies when $S == 1$ && $imm3 == 000$ && $imm2 == 00$ && $type == 11$.

ORNS{<c>}{<q>} {<Rd>}, <Rn>, <Rm>, RRX

ORNS, shift or rotate by value variant

Applies when $S == 1$ && $!(imm3 == 000 \&\& imm2 == 00 \&\& type == 11)$.

ORNS{<c>}{<q>} {<Rd>}, <Rn>, <Rm> {, <shift> #<amount>}

Decode for all variants of this encoding

```
if Rn == '1111' then SEE MVN (register);
d = UInt(Rd); n = UInt(Rn); m = UInt(Rm); setflags = (S == '1');
(shift_t, shift_n) = DecodeImmShift(type, imm3:imm2);
if d == 15 || m == 15 then UNPREDICTABLE; // ARMv8-A removes UNPREDICTABLE for R13
```

Notes for all encodings

For more information about the CONSTRAINED UNPREDICTABLE behavior of this instruction, see [Appendix K1 Architectural Constraints on UNPREDICTABLE behaviors](#).

Assembler symbols

- <c> See [Standard assembler syntax fields on page F2-2848](#).
- <q> See [Standard assembler syntax fields on page F2-2848](#).
- <Rd> Is the general-purpose destination register, encoded in the "Rd" field.
- <Rn> Is the first general-purpose source register, encoded in the "Rn" field.
- <Rm> Is the second general-purpose source register, encoded in the "Rm" field.

- <shift> Is the type of shift to be applied to the second source register, encoded in the "type" field. It can have the following values:
- LSL when type = 00
 - LSR when type = 01
 - ASR when type = 10
 - ROR when type = 11
- <amount> Is the shift amount, in the range 1 to 31 (when <shift> = LSL or ROR) or 1 to 32 (when <shift> = LSR or ASR) encoded in the "imm3:imm2" field as <amount> modulo 32.

Operation

```
if ConditionPassed() then
    EncodingSpecificOperations();
    (shifted, carry) = Shift_C(R[m], shift_t, shift_n, PSTATE.C);
    result = R[n] OR NOT(shifted);
    R[d] = result;
    if setflags then
        PSTATE.N = result<31>;
        PSTATE.Z = IsZeroBit(result);
        PSTATE.C = carry;
        // PSTATE.V unchanged
```

F5.1.126 ORR, ORRS (immediate)

Bitwise OR (immediate) performs a bitwise (inclusive) OR of a register value and an immediate value, and writes the result to the destination register.

If the destination register is not the PC, the ORRS variant of the instruction updates the condition flags based on the result.

The field descriptions for <Rd> identify the encodings where the PC is permitted as the destination register. ARM deprecates any use of these encodings. However, when the destination register is the PC:

- The ORR variant of the instruction is an interworking branch, see *Pseudocode description of operations on the AArch32 general-purpose registers and the PC* on page E1-2733.
- The ORRS variant of the instruction performs an exception return without the use of the stack. In this case:
 - The PE branches to the address written to the PC, and restores `PSTATE` from `SPSR_<current_mode>`.
 - The PE checks `SPSR_<current_mode>` for an illegal return event. See *Illegal return events from AArch32 state* on page G1-4361.
 - The instruction is UNDEFINED in Hyp mode.
 - The instruction is CONSTRAINED UNPREDICTABLE in User mode and System mode.

A1

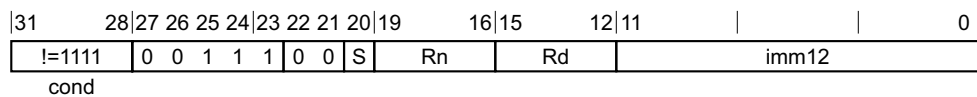

ORR variant

Applies when `S == 0`.

ORR{<c>}{<q>} {<Rd>}, <Rn>, #<const>

ORRS variant

Applies when `S == 1`.

ORRS{<c>}{<q>} {<Rd>}, <Rn>, #<const>

Decode for all variants of this encoding

```
d = UInt(Rd); n = UInt(Rn); setflags = (S == '1');
(imm32, carry) = A32ExpandImm_C(imm12, PSTATE.C);
```

T1

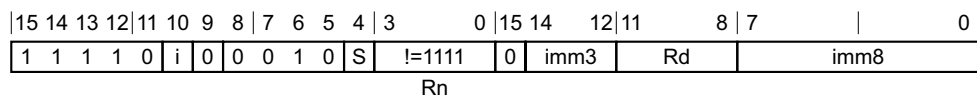

ORR variant

Applies when `S == 0`.

ORR{<c>}{<q>} {<Rd>}, <Rn>, #<const>

ORRS variant

Applies when `S == 1`.

ORRS{<c>}{<q>} {<Rd>}, <Rn>, #<const>

Decode for all variants of this encoding

```
if Rn == '1111' then SEE MOV (immediate);
d = UInt(Rd); n = UInt(Rn); setflags = (S == '1');
(imm32, carry) = T32ExpandImm_C(i:imm3:imm8, PSTATE.C);
if d == 15 then UNPREDICTABLE; // ARMv8-A removes UNPREDICTABLE for R13
```

Notes for all encodings

For more information about the CONSTRAINED UNPREDICTABLE behavior of this instruction, see [Appendix K1 Architectural Constraints on UNPREDICTABLE behaviors](#).

Assembler symbols

<c> See [Standard assembler syntax fields on page F2-2848](#).

<q> See [Standard assembler syntax fields on page F2-2848](#).

<Rd> For encoding A1: is the general-purpose destination register, encoded in the "Rd" field. If omitted, this register is the same as <Rn>. ARM deprecates using the PC as the destination register, but if the PC is used:

- For the ORR variant, the instruction is a branch to the address calculated by the operation. This is an interworking branch, see [Pseudocode description of operations on the AArch32 general-purpose registers and the PC on page E1-2733](#).
- For the ORRS variant, the instruction performs an exception return, that restores PSTATE from SPSR_<current_mode>.

For encoding T1: is the general-purpose destination register, encoded in the "Rd" field. If omitted, this register is the same as <Rn>.

<Rn> For encoding A1: is the general-purpose source register, encoded in the "Rn" field. The PC can be used, but this is deprecated.

For encoding T1: is the general-purpose source register, encoded in the "Rn" field.

<const> For encoding A1: an immediate value. See [Modified immediate constants in A32 instructions on page F2-2864](#) for the range of values.

For encoding T1: an immediate value. See [Modified immediate constants in T32 instructions on page F2-2863](#) for the range of values.

Operation for all encodings

```
if ConditionPassed() then
  EncodingSpecificOperations();
  result = R[n] OR imm32;
  if d == 15 then // Can only occur for A32 encoding
    if setflags then
      ALUExceptionReturn(result);
    else
      ALUWritePC(result);
  else
    R[d] = result;
    if setflags then
      PSTATE.N = result<31>;
      PSTATE.Z = IsZeroBit(result);
      PSTATE.C = carry;
      // PSTATE.V unchanged
```

F5.1.127 ORR, ORRS (register)

Bitwise OR (register) performs a bitwise (inclusive) OR of a register value and an optionally-shifted register value, and writes the result to the destination register.

If the destination register is not the PC, the ORRS variant of the instruction updates the condition flags based on the result.

The field descriptions for <Rd> identify the encodings where the PC is permitted as the destination register. ARM deprecates any use of these encodings. However, when the destination register is the PC:

- The ORR variant of the instruction is an interworking branch, see *Pseudocode description of operations on the AArch32 general-purpose registers and the PC* on page E1-2733.
- The ORRS variant of the instruction performs an exception return without the use of the stack. In this case:
 - The PE branches to the address written to the PC, and restores `PSTATE` from `SPSR_<current_mode>`.
 - The PE checks `SPSR_<current_mode>` for an illegal return event. See *Illegal return events from AArch32 state* on page G1-4361.
 - The instruction is UNDEFINED in Hyp mode.
 - The instruction is CONSTRAINED UNPREDICTABLE in User mode and System mode.

A1

31	28	27	26	25	24	23	22	21	20	19	16	15	12	11	7	6	5	4	3	0
!=1111		0	0	0	1	1	0	0	S	Rn	Rd	imm5	type	0	Rm					
cond																				

ORR, rotate right with extend variant

Applies when `S == 0` && `imm5 == 00000` && `type == 11`.

`ORR{<c>}{<q>} {<Rd>}, <Rn>, <Rm>, RRX`

ORR, shift or rotate by value variant

Applies when `S == 0` && `!(imm5 == 00000 && type == 11)`.

`ORR{<c>}{<q>} {<Rd>}, <Rn>, <Rm> {, <shift> #<amount>}`

ORRS, rotate right with extend variant

Applies when `S == 1` && `imm5 == 00000` && `type == 11`.

`ORRS{<c>}{<q>} {<Rd>}, <Rn>, <Rm>, RRX`

ORRS, shift or rotate by value variant

Applies when `S == 1` && `!(imm5 == 00000 && type == 11)`.

`ORRS{<c>}{<q>} {<Rd>}, <Rn>, <Rm> {, <shift> #<amount>}`

Decode for all variants of this encoding

```
d = UInt(Rd); n = UInt(Rn); m = UInt(Rm); setflags = (S == '1');
(shift_t, shift_n) = DecodeImmShift(type, imm5);
```

T1

15	14	13	12	11	10	9	8	7	6	5	3	2	0
0	1	0	0	0	0	1	1	0	0	Rm	Rdn		

T1 variant

ORR<c>{<q>} {<Rdn>}, <Rdn>, <Rm> // Inside IT block
 ORRS{<q>} {<Rdn>}, <Rdn>, <Rm> // Outside IT block

Decode for this encoding

```
d = UInt(Rdn); n = UInt(Rdn); m = UInt(Rm); setflags = !InITBlock();
(shift_t, shift_n) = (SRTYPE_LSL, 0);
```

T2

15	14	13	12	11	10	9	8	7	6	5	4	3	0	15	14	12	11	8	7	6	5	4	3	0
1	1	1	0	1	0	1	0	0	0	1	0	S	!=1111	(0)	imm3	Rd	imm2	type	Rm					

Rn

ORR, rotate right with extend variant

Applies when S == 0 && imm3 == 000 && imm2 == 00 && type == 11.

ORR{<c>}{<q>} {<Rd>}, <Rn>, <Rm>, RRX

ORR, shift or rotate by value variant

Applies when S == 0 && !(imm3 == 000 && imm2 == 00 && type == 11).

ORR<c>.W {<Rd>}, <Rn>, <Rm> // Inside IT block, and <Rd>, <Rn>, <Rm> can be represented in T1
 ORR{<c>}{<q>} {<Rd>}, <Rn>, <Rm> {, <shift> #<amount>}

ORRS, rotate right with extend variant

Applies when S == 1 && imm3 == 000 && imm2 == 00 && type == 11.

ORRS{<c>}{<q>} {<Rd>}, <Rn>, <Rm>, RRX

ORRS, shift or rotate by value variant

Applies when S == 1 && !(imm3 == 000 && imm2 == 00 && type == 11).

ORRS.W {<Rd>}, <Rn>, <Rm> // Outside IT block, and <Rd>, <Rn>, <Rm> can be represented in T1
 ORRS{<c>}{<q>} {<Rd>}, <Rn>, <Rm> {, <shift> #<amount>}

Decode for all variants of this encoding

```
if Rn == '1111' then SEE "Related encodings";
d = UInt(Rd); n = UInt(Rn); m = UInt(Rm); setflags = (S == '1');
(shift_t, shift_n) = DecodeImmShift(type, imm3:imm2);
if d == 15 || m == 15 then UNPREDICTABLE; // ARMv8-A removes UNPREDICTABLE for R13
```

Notes for all encodings

For more information about the CONSTRAINED UNPREDICTABLE behavior of this instruction, see [Appendix K1 Architectural Constraints on UNPREDICTABLE behaviors](#).

Related encodings: [Data-processing \(shifted register\)](#) on page F3-2888

Assembler symbols

<c>	See Standard assembler syntax fields on page F2-2848 .								
<q>	See Standard assembler syntax fields on page F2-2848 .								
<Rdn>	Is the first general-purpose source register and the destination register, encoded in the "Rdn" field.								
<Rd>	For encoding A1: is the general-purpose destination register, encoded in the "Rd" field. If omitted, this register is the same as <Rn>. ARM deprecates using the PC as the destination register, but if the PC is used: <ul style="list-style-type: none">For the ORR variant, the instruction is a branch to the address calculated by the operation. This is an interworking branch, see Pseudocode description of operations on the AArch32 general-purpose registers and the PC on page E1-2733.For the ORRS variant, the instruction performs an exception return, that restores <code>PSTATE</code> from <code>SPSR_<current_mode></code>. For encoding T2: is the general-purpose destination register, encoded in the "Rd" field. If omitted, this register is the same as <Rn>.								
<Rn>	For encoding A1: is the first general-purpose source register, encoded in the "Rn" field. The PC can be used, but this is deprecated. For encoding T2: is the first general-purpose source register, encoded in the "Rn" field.								
<Rm>	For encoding A1: is the second general-purpose source register, encoded in the "Rm" field. The PC can be used, but this is deprecated. For encoding T1 and T2: is the second general-purpose source register, encoded in the "Rm" field.								
<shift>	Is the type of shift to be applied to the second source register, encoded in the "type" field. It can have the following values: <table><tr><td>LSL</td><td>when type = 00</td></tr><tr><td>LSR</td><td>when type = 01</td></tr><tr><td>ASR</td><td>when type = 10</td></tr><tr><td>ROR</td><td>when type = 11</td></tr></table>	LSL	when type = 00	LSR	when type = 01	ASR	when type = 10	ROR	when type = 11
LSL	when type = 00								
LSR	when type = 01								
ASR	when type = 10								
ROR	when type = 11								
<amount>	For encoding A1: is the shift amount, in the range 1 to 31 (when <shift> = LSL or ROR) or 1 to 32 (when <shift> = LSR or ASR) encoded in the "imm5" field as <amount> modulo 32. For encoding T2: is the shift amount, in the range 1 to 31 (when <shift> = LSL or ROR) or 1 to 32 (when <shift> = LSR or ASR) encoded in the "imm3:imm2" field as <amount> modulo 32.								

In T32 assembly:

- Outside an IT block, if `ORRS <Rd>, <Rn>, <Rd>` is written with <Rd> and <Rn> both in the range R0-R7, it is assembled using encoding T1 as though `ORRS <Rd>, <Rn>` had been written.
- Inside an IT block, if `ORR<c> <Rd>, <Rn>, <Rd>` is written with <Rd> and <Rn> both in the range R0-R7, it is assembled using encoding T1 as though `ORR<c> <Rd>, <Rn>` had been written.

To prevent either of these happening, use the `.W` qualifier.

Operation for all encodings

```
if ConditionPassed() then
    EncodingSpecificOperations();
    (shifted, carry) = Shift_C(R[m], shift_t, shift_n, PSTATE.C);
    result = R[n] OR shifted;
    if d == 15 then // Can only occur for A32 encoding
        if setflags then
            ALUExceptionReturn(result);
        else
            ALUWritePC(result);
```

```
else
  R[d] = result;
  if setflags then
    PSTATE.N = result<31>;
    PSTATE.Z = IsZeroBit(result);
    PSTATE.C = carry;
    // PSTATE.V unchanged
```

F5.1.128 ORR, ORRS (register-shifted register)

Bitwise OR (register-shifted register) performs a bitwise (inclusive) OR of a register value and a register-shifted register value, and writes the result to the destination register. It can optionally update the condition flags based on the result.

A1

31	28	27	26	25	24	23	22	21	20	19	16	15	12	11	8	7	6	5	4	3	0
!=1111				0	0	0	1	1	0	0	S	Rn	Rd	Rs	0	type	1	Rm			
cond																					

Flag setting variant

Applies when S == 1.

ORRS{<c>}{<q>} {<Rd>}, <Rn>, <Rm>, <type> <Rs>

Not flag setting variant

Applies when S == 0.

ORR{<c>}{<q>} {<Rd>}, <Rn>, <Rm>, <type> <Rs>

Decode for all variants of this encoding

```
d = UInt(Rd); n = UInt(Rn); m = UInt(Rm); s = UInt(Rs);
setflags = (S == '1'); shift_t = DecodeRegShift(type);
if d == 15 || n == 15 || m == 15 || s == 15 then UNPREDICTABLE;
```

Notes for all encodings

For more information about the CONSTRAINED UNPREDICTABLE behavior of this instruction, see [Appendix K1 Architectural Constraints on UNPREDICTABLE behaviors](#).

Assembler symbols

<c>	See Standard assembler syntax fields on page F2-2848 .								
<q>	See Standard assembler syntax fields on page F2-2848 .								
<Rd>	Is the general-purpose destination register, encoded in the "Rd" field.								
<Rn>	Is the first general-purpose source register, encoded in the "Rn" field.								
<Rm>	Is the second general-purpose source register, encoded in the "Rm" field.								
<type>	Is the type of shift to be applied to the second source register, encoded in the "type" field. It can have the following values: <table style="margin-left: 20px;"> <tr> <td>LSL</td> <td>when type = 00</td> </tr> <tr> <td>LSR</td> <td>when type = 01</td> </tr> <tr> <td>ASR</td> <td>when type = 10</td> </tr> <tr> <td>ROR</td> <td>when type = 11</td> </tr> </table>	LSL	when type = 00	LSR	when type = 01	ASR	when type = 10	ROR	when type = 11
LSL	when type = 00								
LSR	when type = 01								
ASR	when type = 10								
ROR	when type = 11								
<Rs>	Is the general-purpose source register holding a shift amount in its bottom 8 bits, encoded in the "Rs" field.								

Operation

```
if ConditionPassed() then
    EncodingSpecificOperations();
    shift_n = UInt(R[s]<7:0>);
    (shifted, carry) = Shift_C(R[m], shift_t, shift_n, PSTATE.C);
    result = R[n] OR shifted;
    R[d] = result;
    if setflags then
        PSTATE.N = result<31>;
        PSTATE.Z = IsZeroBit(result);
        PSTATE.C = carry;
        // PSTATE.V unchanged
```

F5.1.129 PKHBT, PKHTB

Pack Halfword combines one halfword of its first operand with the other halfword of its shifted second operand.

A1

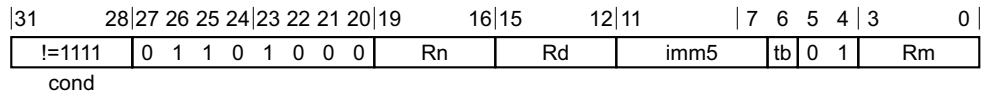

PKHBT variant

Applies when `tb == 0`.

PKHBT{<c>}{<q>} {<Rd>}, <Rn>, <Rm> {, LSL #<imm>}

PKHTB variant

Applies when `tb == 1`.

PKHTB{<c>}{<q>} {<Rd>}, <Rn>, <Rm> {, ASR #<imm>}

Decode for all variants of this encoding

```
d = UInt(Rd); n = UInt(Rn); m = UInt(Rm); tbform = (tb == '1');
(shift_t, shift_n) = DecodeImmShift(tb:'0', imm5);
if d == 15 || n == 15 || m == 15 then UNPREDICTABLE;
```

T1

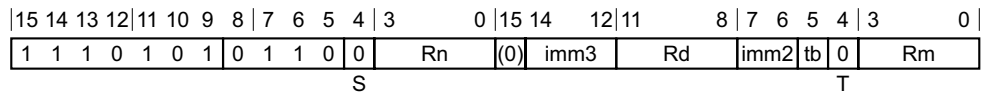

PKHBT variant

Applies when `tb == 0`.

PKHBT{<c>}{<q>} {<Rd>}, <Rn>, <Rm> {, LSL #<imm>} // `tbform == FALSE`

PKHTB variant

Applies when `tb == 1`.

PKHTB{<c>}{<q>} {<Rd>}, <Rn>, <Rm> {, ASR #<imm>} // `tbform == TRUE`

Decode for all variants of this encoding

```
if S == '1' || T == '1' then UNDEFINED;
d = UInt(Rd); n = UInt(Rn); m = UInt(Rm); tbform = (tb == '1');
(shift_t, shift_n) = DecodeImmShift(tb:'0', imm3:imm2);
if d == 15 || n == 15 || m == 15 then UNPREDICTABLE; // ARMv8-A removes UNPREDICTABLE for R13
```

Notes for all encodings

For more information about the CONSTRAINED UNPREDICTABLE behavior of this instruction, see [Appendix K1 Architectural Constraints on UNPREDICTABLE behaviors](#).

Assembler symbols

<c>	See Standard assembler syntax fields on page F2-2848 .
<q>	See Standard assembler syntax fields on page F2-2848 .
<Rd>	Is the general-purpose destination register, encoded in the "Rd" field.
<Rn>	Is the first general-purpose source register, encoded in the "Rn" field.
<Rm>	Is the second general-purpose source register, encoded in the "Rm" field.
<imm>	For encoding A1: the shift to apply to the value read from <Rm>, encoded in imm5. Is one of: omitted No shift, encoded as 0b00000. 1-31 Left shift by specified number of bits, encoded as a binary number. For encoding A1: the shift to apply to the value read from <Rm>, encoded in imm5. Is one of: omitted Instruction is a pseudo-instruction and is assembled as though PKHBT{<c>}{<q>} <Rd>, <Rm>, <Rn> had been written. 1-32 Arithmetic right shift by specified number of bits. A shift by 32 bits is encoded as 0b00000. Other shift amounts are encoded as binary numbers.

Note

An assembler can permit <imm> = 0 to mean the same thing as omitting the shift, but this is not standard UAL and must not be used for disassembly.

For encoding T1: the shift to apply to the value read from <Rm>, encoded in imm3:imm2.

For PKHBT, it is one of:

omitted No shift, encoded as 0b00000.

1-31 Left shift by specified number of bits, encoded as a binary number.

For PKHTB, it is one of:

omitted Instruction is a pseudo-instruction and is assembled as though PKHBT{<c>}{<q>} <Rd>, <Rm>, <Rn> had been written.

1-32 Arithmetic right shift by specified number of bits. A shift by 32 bits is encoded as 0b00000. Other shift amounts are encoded as binary numbers.

Note

An assembler can permit <imm> = 0 to mean the same thing as omitting the shift, but this is not standard UAL and must not be used for disassembly.

Operation for all encodings

```
if ConditionPassed() then
    EncodingSpecificOperations();
operand2 = Shift(R[m], shift_t, shift_n, PSTATE.C); // PSTATE.C ignored
R[d]<15:0> = if tbform then operand2<15:0> else R[n]<15:0>;
R[d]<31:16> = if tbform then R[n]<31:16> else operand2<31:16>;
```

F5.1.130 PLD, PLDW (immediate)

Preload Data (immediate) signals the memory system that data memory accesses from a specified address are likely in the near future. The memory system can respond by taking actions that are expected to speed up the memory accesses when they do occur, such as preloading the cache line containing the specified address into the data cache.

The PLD instruction signals that the likely memory access is a read, and the PLDW instruction signals that it is a write.

The effect of a PLD or PLDW instruction is IMPLEMENTATION DEFINED. For more information, see [Preloading caches on page E2-2775](#).

A1

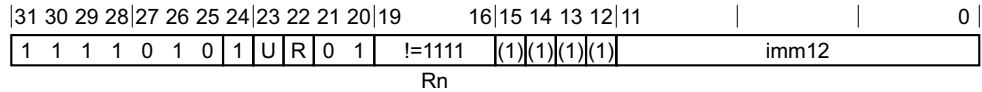

Preload read variant

Applies when R == 1.

PLD{<c>}{<q>} [<Rn> {, #<+/-><imm>}]

Preload write variant

Applies when R == 0.

PLDW{<c>}{<q>} [<Rn> {, #<+/-><imm>}]

Decode for all variants of this encoding

```
if Rn == '1111' then SEE PLD (literal);
n = UInt(Rn); imm32 = ZeroExtend(imm12, 32); add = (U == '1'); is_pldw = (R == '0');
```

T1

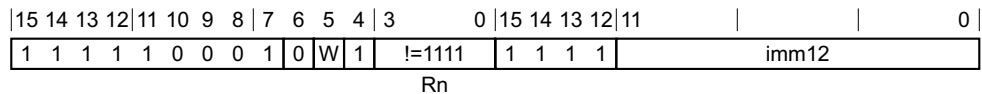

Preload read variant

Applies when W == 0.

PLD{<c>}{<q>} [<Rn> {, #<+><imm>}]

Preload write variant

Applies when W == 1.

PLDW{<c>}{<q>} [<Rn> {, #<+><imm>}]

Decode for all variants of this encoding

```
if Rn == '1111' then SEE PLD (literal);
n = UInt(Rn); imm32 = ZeroExtend(imm12, 32); add = TRUE; is_pldw = (W == '1');
```

T2

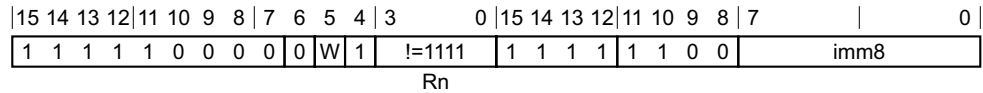

Preload read variant

Applies when W == 0.

PLD{<c>}{<q>} [<Rn> {, #-<imm>}]

Preload write variant

Applies when W == 1.

PLDW{<c>}{<q>} [<Rn> {, #-<imm>}]

Decode for all variants of this encoding

```
if Rn == '1111' then SEE PLD (literal);
n = UInt(Rn); imm32 = ZeroExtend(imm8, 32); add = FALSE; is_pldw = (W == '1');
```

Notes for all encodings

For more information about the CONSTRAINED UNPREDICTABLE behavior of this instruction, see [Appendix K1 Architectural Constraints on UNPREDICTABLE behaviors](#).

Assembler symbols

- <c> For encoding A1: see [Standard assembler syntax fields on page F2-2848](#). Must be AL or omitted.
For encoding T1 and T2: see [Standard assembler syntax fields on page F2-2848](#).
- <q> See [Standard assembler syntax fields on page F2-2848](#).
- <Rn> Is the general-purpose base register, encoded in the "Rn" field. If the PC is used, see [PLD \(literal\)](#).
- +/- Specifies the offset is added to or subtracted from the base register, defaulting to + if omitted and encoded in the "U" field. It can have the following values:
 - when U = 0
 - + when U = 1
- + Specifies the offset is added to the base register.
- <imm> For encoding A1: is the optional 12-bit unsigned immediate byte offset, in the range 0 to 4095, defaulting to 0 and encoded in the "imm12" field.
For encoding T1: is an optional 12-bit unsigned immediate byte offset, in the range 0 to 4095, defaulting to 0 and encoded in the "imm12" field.
For encoding T2: is an 8-bit unsigned immediate byte offset, in the range 0 to 255, defaulting to 0 if omitted, and encoded in the "imm8" field.

Operation for all encodings

```
if ConditionPassed() then
  EncodingSpecificOperations();
  address = if add then (R[n] + imm32) else (R[n] - imm32);
  if is_pldw then
    Hint_PreloadDataForWrite(address);
  else
    Hint_PreloadData(address);
```

F5.1.131 PLD (literal)

Preload Data (literal) signals the memory system that data memory accesses from a specified address are likely in the near future. The memory system can respond by taking actions that are expected to speed up the memory accesses when they do occur, such as preloading the cache line containing the specified address into the data cache.

The effect of a PLD instruction is IMPLEMENTATION DEFINED. For more information, see [Preloading caches on page E2-2775](#).

A1

31	30	29	28	27	26	25	24	23	22	21	20	19	18	17	16	15	14	13	12	11					0
1	1	1	1	0	1	0	1	U	(1)	0	1	1	1	1	1	(1)	(1)	(1)	(1)	imm12					

A1 variant

PLD{<c>}{<q>} <label> // Normal form
 PLD{<c>}{<q>} [PC, #{+/-}<imm>] // Alternative form

Decode for this encoding

imm32 = ZeroExtend(imm12, 32); add = (U == '1');

T1

15	14	13	12	11	10	9	8	7	6	5	4	3	2	1	0	15	14	13	12	11					0
1	1	1	1	1	0	0	0	U	0	(0)	1	1	1	1	1	1	1	1	1	imm12					

T1 variant

PLD{<c>}{<q>} <label> // Preferred syntax
 PLD{<c>}{<q>} [PC, #{+/-}<imm>] // Alternative syntax

Decode for this encoding

imm32 = ZeroExtend(imm12, 32); add = (U == '1');

Notes for all encodings

For more information about the CONSTRAINED UNPREDICTABLE behavior of this instruction, see [Appendix K1 Architectural Constraints on UNPREDICTABLE behaviors](#).

Assembler symbols

- <c> For encoding A1: see [Standard assembler syntax fields on page F2-2848](#). Must be AL or omitted.
 For encoding T1: see [Standard assembler syntax fields on page F2-2848](#).
- <q> See [Standard assembler syntax fields on page F2-2848](#).
- <label> The label of the literal data item that is likely to be accessed in the near future. The assembler calculates the required value of the offset from the Align(PC, 4) value of the instruction to this label. The offset must be in the range -4095 to 4095.
 If the offset is zero or positive, imm32 is equal to the offset and add == TRUE.
 If the offset is negative, imm32 is equal to minus the offset and add == FALSE.

- +/- Specifies the offset is added to or subtracted from the base register, defaulting to + if omitted and encoded in the "U" field. It can have the following values:
- when U = 0
 - + when U = 1
- <imm> For encoding A1: is the 12-bit unsigned immediate byte offset, in the range 0 to 4095, encoded in the "imm12" field.
- For encoding T1: is a 12-bit unsigned immediate byte offset, in the range 0 to 4095, encoded in the "imm12" field.

The alternative syntax permits the addition or subtraction of the offset and the immediate offset to be specified separately, including permitting a subtraction of 0 that cannot be specified using the normal syntax. For more information, see [Use of labels in UAL instruction syntax on page F1-2809](#).

Operation for all encodings

```
if ConditionPassed() then
    EncodingSpecificOperations();
address = if add then (Align(PC,4) + imm32) else (Align(PC,4) - imm32);
Hint_PreloadData(address);
```

F5.1.132 PLD, PLDW (register)

Preload Data (register) signals the memory system that data memory accesses from a specified address are likely in the near future. The memory system can respond by taking actions that are expected to speed up the memory accesses when they do occur, such as preloading the cache line containing the specified address into the data cache.

The PLD instruction signals that the likely memory access is a read, and the PLDW instruction signals that it is a write.

The effect of a PLD or PLDW instruction is IMPLEMENTATION DEFINED. For more information, see [Preloading caches on page E2-2775](#).

A1

31	30	29	28	27	26	25	24	23	22	21	20	19	16	15	14	13	12	11	7	6	5	4	3	0
1	1	1	1	0	1	1	1	U	R	0	1	Rn	(1)	(1)	(1)	(1)	imm5	type	0	Rm				

Preload read, optional shift or rotate variant

Applies when $R == 1 \ \&\& \ !(\text{imm5} == 00000 \ \&\& \ \text{type} == 11)$.

PLD{<c>}{<q>} [<Rn>, {+/-}<Rm> {, <shift> #<amount>}]

Preload read, rotate right with extend variant

Applies when $R == 1 \ \&\& \ \text{imm5} == 00000 \ \&\& \ \text{type} == 11$.

PLD{<c>}{<q>} [<Rn>, {+/-}<Rm> , RRX]

Preload write, optional shift or rotate variant

Applies when $R == 0 \ \&\& \ !(\text{imm5} == 00000 \ \&\& \ \text{type} == 11)$.

PLDW{<c>}{<q>} [<Rn>, {+/-}<Rm> {, <shift> #<amount>}]

Preload write, rotate right with extend variant

Applies when $R == 0 \ \&\& \ \text{imm5} == 00000 \ \&\& \ \text{type} == 11$.

PLDW{<c>}{<q>} [<Rn>, {+/-}<Rm> , RRX]

Decode for all variants of this encoding

```
n = UInt(Rn); m = UInt(Rm); add = (U == '1'); is_pldw = (R == '0');
(shift_t, shift_n) = DecodeImmShift(type, imm5);
if m == 15 || (n == 15 && is_pldw) then UNPREDICTABLE;
```

T1

15	14	13	12	11	10	9	8	7	6	5	4	3	0	15	14	13	12	11	10	9	8	7	6	5	4	3	0
1	1	1	1	1	0	0	0	0	0	W	1	!=1111		1	1	1	1	0	0	0	0	0	0	imm2	Rm		

Rn

Preload read variant

Applies when $W == 0$.

PLD{<c>}{<q>} [<Rn>, {+}<Rm> {, LSL #<amount>}]

Preload write variant

Applies when $W == 1$.

PLDW{<c>}{<q>} [<Rn>, {+}<Rm> {, LSL #<amount>}]

Decode for all variants of this encoding

```
if Rn == '1111' then SEE PLD (literal);
n = UInt(Rn); m = UInt(Rm); add = TRUE; is_pldw = (W == '1');
(shift_t, shift_n) = (SRTYPE_LSL, UInt(imm2));
if m == 15 then UNPREDICTABLE; // ARMv8-A removes UNPREDICTABLE for R13
```

Notes for all encodings

For more information about the CONSTRAINED UNPREDICTABLE behavior of this instruction, see [Appendix K1 Architectural Constraints on UNPREDICTABLE behaviors](#).

Assembler symbols

- <c> For encoding A1: see [Standard assembler syntax fields on page F2-2848](#). <c> must be AL or omitted.
For encoding T1: see [Standard assembler syntax fields on page F2-2848](#).
- <q> See [Standard assembler syntax fields on page F2-2848](#).
- <Rn> For encoding A1: is the general-purpose base register, encoded in the "Rn" field. The PC can be used.
For encoding T1: is the general-purpose base register, encoded in the "Rn" field.
- +/- Specifies the index register is added to or subtracted from the base register, defaulting to + if omitted and encoded in the "U" field. It can have the following values:
 - when U = 0
 - + when U = 1
- + Specifies the index register is added to the base register.
- <Rm> Is the general-purpose index register, encoded in the "Rm" field.
- <shift> Is the type of shift to be applied to the index register, encoded in the "type" field. It can have the following values:
 - LSL when type = 00
 - LSR when type = 01
 - ASR when type = 10
 - ROR when type = 11
- <amount> For encoding A1: is the shift amount, in the range 1 to 31 (when <shift> = LSL or ROR) or 1 to 32 (when <shift> = LSR or ASR) encoded in the "imm5" field as <amount> modulo 32.
For encoding T1: is the shift amount, in the range 0 to 3, defaulting to 0 and encoded in the "imm2" field.

Operation for all encodings

```
if ConditionPassed() then
  EncodingSpecificOperations();
offset = Shift(R[m], shift_t, shift_n, PSTATE.C);
address = if add then (R[n] + offset) else (R[n] - offset);
if is_pldw then
  Hint_PreloadDataForWrite(address);
else
  Hint_PreloadData(address);
```

F5.1.133 PLI (immediate, literal)

Preload Instruction signals the memory system that instruction memory accesses from a specified address are likely in the near future. The memory system can respond by taking actions that are expected to speed up the memory accesses when they do occur, such as pre-loading the cache line containing the specified address into the instruction cache.

The effect of a PLI instruction is IMPLEMENTATION DEFINED. For more information, see [Preloading caches on page E2-2775](#).

A1

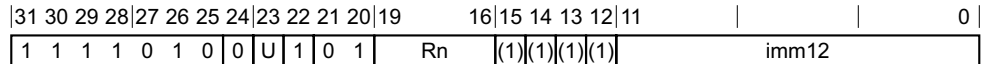

A1 variant

PLI{<c>}{<q>} [<Rn> {, #<+/-><imm>}]
 PLI{<c>}{<q>} <label> // Normal form
 PLI{<c>}{<q>} [PC, #<+/-><imm>] // Alternative form

Decode for this encoding

n = UInt(Rn); imm32 = ZeroExtend(imm12, 32); add = (U == '1');

T1

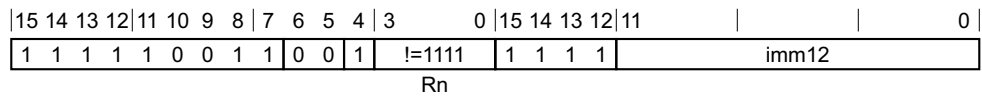

T1 variant

PLI{<c>}{<q>} [<Rn> {, #<+><imm>}]

Decode for this encoding

if Rn == '1111' then SEE encoding T3;
 n = UInt(Rn); imm32 = ZeroExtend(imm12, 32); add = TRUE;

T2

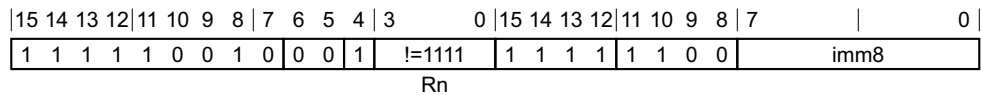

T2 variant

PLI{<c>}{<q>} [<Rn> {, #<-><imm>}]

Decode for this encoding

if Rn == '1111' then SEE encoding T3;
 n = UInt(Rn); imm32 = ZeroExtend(imm8, 32); add = FALSE;

T3

15	14	13	12	11	10	9	8	7	6	5	4	3	2	1	0	15	14	13	12	11						0
1	1	1	1	1	0	0	1	U	0	0	1	1	1	1	1	1	1	1	1	imm12						

T3 variant

PLI{<c>}{<q>} <label> // Preferred syntax
 PLI{<c>}{<q>} [PC, #{+/-}<imm>] // Alternative syntax

Decode for this encoding

n = 15; imm32 = ZeroExtend(imm12, 32); add = (U == '1');

Notes for all encodings

For more information about the CONSTRAINED UNPREDICTABLE behavior of this instruction, see [Appendix K1 Architectural Constraints on UNPREDICTABLE behaviors](#).

Assembler symbols

- <c> For encoding A1: see [Standard assembler syntax fields on page F2-2848](#). Must be AL or omitted.
 For encoding T1, T2 and T3: see [Standard assembler syntax fields on page F2-2848](#).
- <q> See [Standard assembler syntax fields on page F2-2848](#).
- <label> The label of the instruction that is likely to be accessed in the near future. The assembler calculates the required value of the offset from the `Align(PC, 4)` value of the instruction to this label. The offset must be in the range -4095 to 4095 .
 If the offset is zero or positive, `imm32` is equal to the offset and `add == TRUE`.
 If the offset is negative, `imm32` is equal to minus the offset and `add == FALSE`.
- <Rn> Is the general-purpose base register, encoded in the "Rn" field.
- +/- Specifies the offset is added to or subtracted from the base register, defaulting to + if omitted and encoded in the "U" field. It can have the following values:
 - when U = 0
 - + when U = 1
- + Specifies the offset is added to the base register.
- <imm> For encoding A1: is the optional 12-bit unsigned immediate byte offset, in the range 0 to 4095, defaulting to 0 and encoded in the "imm12" field.
 For encoding T1: is an optional 12-bit unsigned immediate byte offset, in the range 0 to 4095, defaulting to 0 and encoded in the "imm12" field.
 For encoding T2: is an 8-bit unsigned immediate byte offset, in the range 0 to 255, defaulting to 0 if omitted, and encoded in the "imm8" field.
 For encoding T3: is a 12-bit unsigned immediate byte offset, in the range 0 to 4095, encoded in the "imm12" field.

For the literal forms of the instruction, encoding T3 is used, or Rn is encoded as `0b1111` in encoding A1, to indicate that the PC is the base register.

The alternative literal syntax permits the addition or subtraction of the offset and the immediate offset to be specified separately, including permitting a subtraction of 0 that cannot be specified using the normal syntax. For more information, see [Use of labels in UAL instruction syntax on page F1-2809](#).

Operation for all encodings

```
if ConditionPassed() then
    EncodingSpecificOperations();
base = if n == 15 then Align(PC,4) else R[n];
address = if add then (base + imm32) else (base - imm32);
Hint_PreloadInstr(address);
```

F5.1.134 PLI (register)

Preload Instruction signals the memory system that instruction memory accesses from a specified address are likely in the near future. The memory system can respond by taking actions that are expected to speed up the memory accesses when they do occur, such as pre-loading the cache line containing the specified address into the instruction cache.

The effect of a PLI instruction is IMPLEMENTATION DEFINED. For more information, see [Preloading caches on page E2-2775](#).

A1

31	30	29	28	27	26	25	24	23	22	21	20	19	16	15	14	13	12	11	7	6	5	4	3	0
1	1	1	1	0	1	1	0	U	1	0	1	Rn	(1)	(1)	(1)	(1)	imm5	type	0	Rm				

Rotate right with extend variant

Applies when imm5 == 00000 && type == 11.

PLI{<c>}{<q>} [<Rn>, {+/-}<Rm> , RRX]

Shift or rotate by value variant

Applies when !(imm5 == 00000 && type == 11).

PLI{<c>}{<q>} [<Rn>, {+/-}<Rm> {, <shift> #<amount>}]

Decode for all variants of this encoding

```
n = UInt(Rn); m = UInt(Rm); add = (U == '1');
(shift_t, shift_n) = DecodeImmShift(type, imm5);
if m == 15 then UNPREDICTABLE;
```

T1

15	14	13	12	11	10	9	8	7	6	5	4	3	0	15	14	13	12	11	10	9	8	7	6	5	4	3	0
1	1	1	1	1	0	0	1	0	0	0	1	!=1111		1	1	1	1	0	0	0	0	0	0	imm2	Rm		

Rn

T1 variant

PLI{<c>}{<q>} [<Rn>, {+}<Rm> {, LSL #<amount>}]

Decode for this encoding

```
if Rn == '1111' then SEE PLI (immediate, literal);
n = UInt(Rn); m = UInt(Rm); add = TRUE;
(shift_t, shift_n) = (SRTType_LSL, UInt(imm2));
if m == 15 then UNPREDICTABLE; // ARMv8-A removes UNPREDICTABLE for R13
```

Notes for all encodings

For more information about the CONSTRAINED UNPREDICTABLE behavior of this instruction, see [Appendix K1 Architectural Constraints on UNPREDICTABLE behaviors](#).

Assembler symbols

<c> For encoding A1: see [Standard assembler syntax fields on page F2-2848](#). <c> must be AL or omitted.

	For encoding T1: see <i>Standard assembler syntax fields</i> on page F2-2848.
<q>	See <i>Standard assembler syntax fields</i> on page F2-2848.
<Rn>	Is the general-purpose base register, encoded in the "Rn" field.
+/-	Specifies the index register is added to or subtracted from the base register, defaulting to + if omitted and encoded in the "U" field. It can have the following values: - when U = 0 + when U = 1
+	Specifies the index register is added to the base register.
<Rm>	Is the general-purpose index register, encoded in the "Rm" field.
<shift>	Is the type of shift to be applied to the index register, encoded in the "type" field. It can have the following values: LSL when type = 00 LSR when type = 01 ASR when type = 10 ROR when type = 11
<amount>	For encoding A1: is the shift amount, in the range 1 to 31 (when <shift> = LSL or ROR) or 1 to 32 (when <shift> = LSR or ASR) encoded in the "imm5" field as <amount> modulo 32. For encoding T1: is the shift amount, in the range 0 to 3, defaulting to 0 and encoded in the "imm2" field.

Operation for all encodings

```
if ConditionPassed() then
    EncodingSpecificOperations();
offset = Shift(R[m], shift_t, shift_n, PSTATE.C);
address = if add then (R[n] + offset) else (R[n] - offset);
Hint_PreloadInstr(address);
```

F5.1.135 POP

Pop Multiple Registers from Stack loads multiple general-purpose registers from the stack, loading from consecutive memory locations starting at the address in SP, and updates SP to point just above the loaded data.

The lowest-numbered register is loaded from the lowest memory address, through to the highest-numbered register from the highest memory address. See also [Encoding of lists of general-purpose registers and the PC on page F2-2855](#).

The registers loaded can include the PC, causing a branch to a loaded address. This is an interworking branch, see [Pseudocode description of operations on the AArch32 general-purpose registers and the PC on page E1-2733](#).

T1

15	14	13	12	11	10	9	8	7											0
1	0	1	1	1	1	0	P	register_list											

T1 variant

```
POP{<c>}{<q>} <registers> // Preferred syntax
LDM{<c>}{<q>} SP!, <registers> // Alternate syntax
```

Decode for this encoding

```
registers = P:'0000000':register_list; UnalignedAllowed = FALSE;
if BitCount(registers) < 1 then UNPREDICTABLE;
if registers<15> == '1' && InITBlock() && !LastInITBlock() then UNPREDICTABLE;
```

CONSTRAINED UNPREDICTABLE behavior

If $\text{BitCount}(\text{registers}) < 1$, then one of the following behaviors must occur:

- The instruction is UNDEFINED.
- The instruction executes as NOP.
- The instruction targets an unspecified set of registers. These registers might include R15. If the instruction specifies writeback, the modification to the base address on writeback might differ from the number of registers loaded.

Notes for all encodings

For more information about the CONSTRAINED UNPREDICTABLE behavior of this instruction, see [Appendix K1 Architectural Constraints on UNPREDICTABLE behaviors](#).

Assembler symbols

- <c> See [Standard assembler syntax fields on page F2-2848](#).
- <q> See [Standard assembler syntax fields on page F2-2848](#).
- <registers> Is a list of one or more registers to be loaded, separated by commas and surrounded by { and }.
- The registers in the list must be in the range R0-R7, encoded in the "register_list" field, and can optionally include the PC. If the PC is in the list, the "P" field is set to 1, otherwise this field defaults to 0.
- If the PC is in the list, the instruction must be either outside any IT block, or the last instruction in an IT block.

Operation

```
if ConditionPassed() then
    EncodingSpecificOperations();
    address = SP;
    for i = 0 to 14
        if registers<i> == '1' then
            R[i] = if UnalignedAllowed then MemU[address,4] else MemA[address,4];
            address = address + 4;
    if registers<15> == '1' then
        if UnalignedAllowed then
            if address<1:0> == '00' then
                LoadWritePC(MemU[address,4]);
            else
                UNPREDICTABLE;
        else
            LoadWritePC(MemA[address,4]);
    if registers<13> == '0' then SP = SP + 4*BitCount(registers);
    if registers<13> == '1' then SP = bits(32) UNKNOWN;
```

F5.1.136 POP (multiple registers)

Pop Multiple Registers from Stack loads multiple general-purpose registers from the stack, loading from consecutive memory locations starting at the address in SP, and updates SP to point just above the loaded data.

This instruction is an alias of the [LDM](#), [LDMIA](#), [LDMFD](#) instruction. This means that:

- The encodings in this description are named to match the encodings of [LDM](#), [LDMIA](#), [LDMFD](#).
- The description of [LDM](#), [LDMIA](#), [LDMFD](#) gives the operational pseudocode for this instruction.

A1

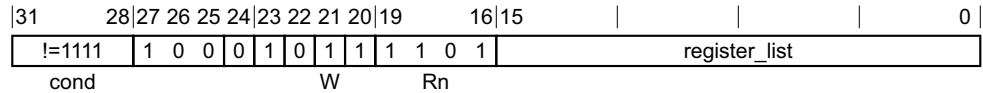

A1 variant

POP{<c>}{<q>} <registers>

is equivalent to

LDM{<c>}{<q>} SP!, <registers>

and is the preferred disassembly when `BitCount(register_list) > 1`.

T2

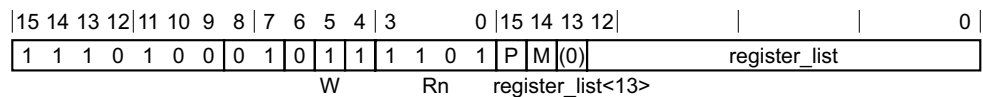

T2 variant

POP{<c>}.W <registers> // All registers in R0-R7, PC

is equivalent to

LDM{<c>}{<q>} SP!, <registers>

and is the preferred disassembly when `BitCount(P:M:register_list) > 1`.

POP{<c>}{<q>} <registers>

is equivalent to

LDM{<c>}{<q>} SP!, <registers>

and is the preferred disassembly when `BitCount(P:M:register_list) > 1`.

Assembler symbols

<c> See [Standard assembler syntax fields on page F2-2848](#).

<q> See [Standard assembler syntax fields on page F2-2848](#).

<registers> For encoding A1: is a list of two or more registers to be loaded, separated by commas and surrounded by { and }. The lowest-numbered register is loaded from the lowest memory address, through to the highest-numbered register from the highest memory address. See also [Encoding of lists of general-purpose registers and the PC on page F2-2855](#).

If the SP is in the list, the value of the SP after such an instruction is UNKNOWN.

The PC can be in the list. If it is, the instruction branches to the address loaded to the PC. This is an interworking branch, see [Pseudocode description of operations on the AArch32 general-purpose registers and the PC on page E1-2733](#).

ARM deprecates the use of this instruction with both the LR and the PC in the list.

For encoding T2: is a list of two or more registers to be loaded, separated by commas and surrounded by { and }. The lowest-numbered register is loaded from the lowest memory address, through to the highest-numbered register from the highest memory address. See also [Encoding of lists of general-purpose registers and the PC on page F2-2855](#).

The registers in the list must be in the range R0-R12, encoded in the "register_list" field, and can optionally contain one of the LR or the PC. If the LR is in the list, the "M" field is set to 1, otherwise it defaults to 0. If the PC is in the list, the "P" field is set to 1, otherwise it defaults to 0.

The PC can be in the list. If it is, the instruction branches to the address loaded to the PC. This is an interworking branch, see [Pseudocode description of operations on the AArch32 general-purpose registers and the PC on page E1-2733](#). If the PC is in the list:

- The LR must not be in the list.
- The instruction must be either outside any IT block, or the last instruction in an IT block.

Operation for all encodings

The description of [LDM](#), [LDMIA](#), [LDMFD](#) gives the operational pseudocode for this instruction.

F5.1.137 POP (single register)

Pop Single Register from Stack loads a single general-purpose register from the stack, loading from the address in SP, and updates SP to point just above the loaded data.

This instruction is an alias of the [LDR \(immediate\)](#) instruction. This means that:

- The encodings in this description are named to match the encodings of [LDR \(immediate\)](#).
- The description of [LDR \(immediate\)](#) gives the operational pseudocode for this instruction.

A1

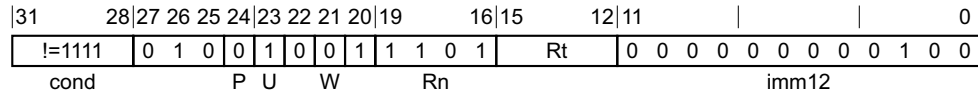

Post-indexed variant

POP{<c>}{<q>} <single_register_list>

is equivalent to

LDR{<c>}{<q>} <Rt>, [SP], #4

and is always the preferred disassembly.

T4

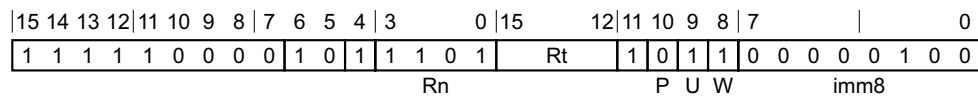

Post-indexed variant

POP{<c>}{<q>} <single_register_list>

is equivalent to

LDR{<c>}{<q>} <Rt>, [SP], #4

and is always the preferred disassembly.

Assembler symbols

<c> See [Standard assembler syntax fields on page F2-2848](#).

<q> See [Standard assembler syntax fields on page F2-2848](#).

<single_register_list>

Is the general-purpose register <Rt> to be loaded surrounded by { and }.

<Rt> For encoding A1: is the general-purpose register to be transferred, encoded in the "Rt" field. The PC can be used. If the PC is used, the instruction branches to the address (data) loaded to the PC. This is an interworking branch, see [Pseudocode description of operations on the AArch32 general-purpose registers and the PC on page E1-2733](#).

For encoding T4: is the general-purpose register to be transferred, encoded in the "Rt" field. The PC can be used, provided the instruction is either outside an IT block or the last instruction of an IT block. If the PC is used, the instruction branches to the address (data) loaded to the PC. This is an interworking branch, see [Pseudocode description of operations on the AArch32 general-purpose registers and the PC](#) on page E1-2733.

Operation for all encodings

The description of [LDR \(immediate\)](#) gives the operational pseudocode for this instruction.

F5.1.138 PUSH

Push Multiple Registers to Stack stores multiple general-purpose registers to the stack, storing to consecutive memory locations ending just below the address in SP, and updates SP to point to the start of the stored data.

The lowest-numbered register is stored to the lowest memory address, through to the highest-numbered register to the highest memory address. See also [Encoding of lists of general-purpose registers and the PC on page F2-2855](#).

T1

15	14	13	12	11	10	9	8	7											0
1	0	1	1	0	1	0	M	register_list											

T1 variant

```
PUSH{<c>}{<q>} <registers> // Preferred syntax
STMDB{<c>}{<q>} SP!, <registers> // Alternate syntax
```

Decode for this encoding

```
registers = '0':M:'000000':register_list; UnalignedAllowed = FALSE;
if BitCount(registers) < 1 then UNPREDICTABLE;
```

CONSTRAINED UNPREDICTABLE behavior

If `BitCount(registers) < 1`, then one of the following behaviors must occur:

- The instruction is UNDEFINED.
- The instruction executes as NOP.
- The instruction targets an unspecified set of registers. These registers might include R15. If the instruction specifies writeback, the modification to the base address on writeback might differ from the number of registers loaded.

Notes for all encodings

For more information about the CONSTRAINED UNPREDICTABLE behavior of this instruction, see [Appendix K1 Architectural Constraints on UNPREDICTABLE behaviors](#).

Assembler symbols

- <c> See [Standard assembler syntax fields on page F2-2848](#).
- <q> See [Standard assembler syntax fields on page F2-2848](#).
- <registers> Is a list of one or more registers to be stored, separated by commas and surrounded by { and }.
 The registers in the list must be in the range R0-R7, encoded in the "register_list" field, and can optionally include the LR. If the LR is in the list, the "M" field is set to 1, otherwise this field defaults to 0.

Operation

```
if ConditionPassed() then
  EncodingSpecificOperations();
  address = SP - 4*BitCount(registers);
  for i = 0 to 14
    if registers<i> == '1' then
      if i == 13 && i != LowestSetBit(registers) then // Only possible for encoding A1
        MemA[address,4] = bits(32) UNKNOWN;
```

```
    else
        if UnalignedAllowed then
            MemU[address,4] = R[i];
        else
            MemA[address,4] = R[i];
        address = address + 4;
if registers<15> == '1' then // Only possible for encoding A1 or A2
    if UnalignedAllowed then
        MemU[address,4] = PCStoreValue();
    else
        MemA[address,4] = PCStoreValue();
SP = SP - 4*BitCount(registers);
```

F5.1.139 PUSH (multiple registers)

Push multiple registers to Stack stores multiple general-purpose registers to the stack, storing to consecutive memory locations ending just below the address in SP, and updates SP to point to the start of the stored data.

This instruction is an alias of the [STMDB](#), [STMFD](#) instruction. This means that:

- The encodings in this description are named to match the encodings of [STMDB](#), [STMFD](#).
- The description of [STMDB](#), [STMFD](#) gives the operational pseudocode for this instruction.

A1

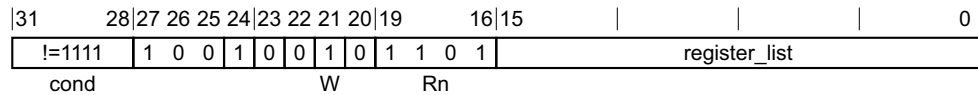

A1 variant

PUSH{<c>}{<q>} <registers>

is equivalent to

STMDB{<c>}{<q>} SP!, <registers>

and is the preferred disassembly when BitCount(register_list) > 1.

T1

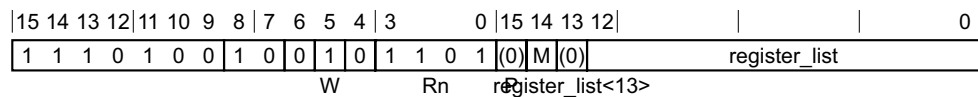

T1 variant

PUSH{<c>}.W <registers> // All registers in R0-R7, LR

is equivalent to

STMDB{<c>}{<q>} SP!, <registers>

and is the preferred disassembly when BitCount(M:register_list) > 1.

PUSH{<c>}{<q>} <registers>

is equivalent to

STMDB{<c>}{<q>} SP!, <registers>

and is the preferred disassembly when BitCount(M:register_list) > 1.

Assembler symbols

<c> See [Standard assembler syntax fields on page F2-2848](#).

<q> See [Standard assembler syntax fields on page F2-2848](#).

<registers> For encoding A1: is a list of two or more registers to be stored, separated by commas and surrounded by { and }. The lowest-numbered register is stored to the lowest memory address, through to the highest-numbered register to the highest memory address. See also [Encoding of lists of general-purpose registers and the PC on page F2-2855](#).

The SP and PC can be in the list. However:

- ARM deprecates the use of instructions that include the PC in the list.
- If the SP is in the list, and it is not the lowest-numbered register in the list, the instruction stores an UNKNOWN value for the SP.

For encoding T1: is a list of one or more registers to be stored, separated by commas and surrounded by { and }. The lowest-numbered register is stored to the lowest memory address, through to the highest-numbered register to the highest memory address. See also [Encoding of lists of general-purpose registers and the PC](#) on page F2-2855.

The registers in the list must be in the range R0-R12, encoded in the "register_list" field, and can optionally contain the LR. If the LR is in the list, the "M" field is set to 1, otherwise it defaults to 0.

Operation for all encodings

The description of [STMDB](#), [STMTD](#) gives the operational pseudocode for this instruction.

F5.1.140 PUSH (single register)

Push Single Register to Stack stores a single general-purpose register to the stack, storing to the 32-bit word below the address in SP, and updates SP to point to the start of the stored data.

This instruction is an alias of the [STR \(immediate\)](#) instruction. This means that:

- The encodings in this description are named to match the encodings of [STR \(immediate\)](#).
- The description of [STR \(immediate\)](#) gives the operational pseudocode for this instruction.

A1

31	28	27	26	25	24	23	22	21	20	19	16	15	12	11										0				
1	1	1	1	0	1	0	0	1	0	1	1	0	1		Rt	0	0	0	0	0	0	0	0	0	0	1	0	0
cond				P			U		W		Rn			imm12														

Pre-indexed variant

PUSH{<c>}{<q>} <single_register_list>

is equivalent to

STR{<c>}{<q>} <Rt>, [SP, #-4]!

and is always the preferred disassembly.

T4

15	14	13	12	11	10	9	8	7	6	5	4	3	0	15	12	11	10	9	8	7							0		
1	1	1	1	1	0	0	0	0	1	0	0	1	1	0	1		Rt	1	1	0	1	0	0	0	0	0	1	0	0
													Rn			P			U		W		imm8						

Pre-indexed variant

PUSH{<c>}{<q>} <single_register_list> // Standard syntax

is equivalent to

STR{<c>}{<q>} <Rt>, [SP, #-4]!

and is always the preferred disassembly.

Assembler symbols

<c> See [Standard assembler syntax fields on page F2-2848](#).

<q> See [Standard assembler syntax fields on page F2-2848](#).

<single_register_list>

Is the general-purpose register <Rt> to be stored surrounded by { and }.

<Rt> For encoding A1: is the general-purpose register to be transferred, encoded in the "Rt" field. The PC can be used, but this is deprecated.

For encoding T4: is the general-purpose register to be transferred, encoded in the "Rt" field.

Operation for all encodings

The description of [STR \(immediate\)](#) gives the operational pseudocode for this instruction.

F5.1.141 QADD

Saturating Add adds two register values, saturates the result to the 32-bit signed integer range -2^{31} to $(2^{31} - 1)$, and writes the result to the destination register. If saturation occurs, it sets `PSTATE.Q` to 1.

A1

31	28	27	26	25	24	23	22	21	20	19	16	15	12	11	10	9	8	7	6	5	4	3	0			
!=1111				0	0	0	1	0	0	0	Rn	Rd	(0)	(0)	(0)	(0)	0	1	0	1	Rm					
cond																										

A1 variant

QADD{<c>}{<q>} {<Rd>}, <Rm>, <Rn>

Decode for this encoding

```
d = UInt(Rd); n = UInt(Rn); m = UInt(Rm);
if d == 15 || n == 15 || m == 15 then UNPREDICTABLE;
```

T1

15	14	13	12	11	10	9	8	7	6	5	4	3	0	15	14	13	12	11	8	7	6	5	4	3	0
1	1	1	1	1	0	1	0	1	0	0	0	Rn	1	1	1	1	Rd	1	0	0	0	Rm			

T1 variant

QADD{<c>}{<q>} {<Rd>}, <Rm>, <Rn>

Decode for this encoding

```
d = UInt(Rd); n = UInt(Rn); m = UInt(Rm);
if d == 15 || n == 15 || m == 15 then UNPREDICTABLE; // ARMv8-A removes UNPREDICTABLE for R13
```

Notes for all encodings

For more information about the CONSTRAINED UNPREDICTABLE behavior of this instruction, see [Appendix K1 Architectural Constraints on UNPREDICTABLE behaviors](#).

Assembler symbols

- <c> See [Standard assembler syntax fields on page F2-2848](#).
- <q> See [Standard assembler syntax fields on page F2-2848](#).
- <Rd> Is the general-purpose destination register, encoded in the "Rd" field.
- <Rm> Is the first general-purpose source register, encoded in the "Rm" field.
- <Rn> Is the second general-purpose source register, encoded in the "Rn" field.

Operation for all encodings

```
if ConditionPassed() then
  EncodingSpecificOperations();
  (R[d], sat) = SignedSatQ(SInt(R[m]) + SInt(R[n]), 32);
  if sat then
    PSTATE.Q = '1';
```

F5.1.142 QADD16

Saturating Add 16 performs two 16-bit integer additions, saturates the results to the 16-bit signed integer range $-2^{15} \leq x \leq 2^{15} - 1$, and writes the results to the destination register.

A1

31	28	27	26	25	24	23	22	21	20	19	16	15	12	11	10	9	8	7	6	5	4	3	0			
!=1111				0	1	1	0	0	0	1	0	Rn	Rd	(1)	(1)	(1)	(1)	0	0	0	1	Rm				
cond																										

A1 variant

QADD16{<C>}{<q>} {<Rd>}, <Rn>, <Rm>

Decode for this encoding

```
d = UInt(Rd); n = UInt(Rn); m = UInt(Rm);
if d == 15 || n == 15 || m == 15 then UNPREDICTABLE;
```

T1

15	14	13	12	11	10	9	8	7	6	5	4	3	0	15	14	13	12	11	8	7	6	5	4	3	0
1	1	1	1	1	0	1	0	1	0	0	1	Rn	1	1	1	1	Rd	0	0	0	1	Rm			

T1 variant

QADD16{<C>}{<q>} {<Rd>}, <Rn>, <Rm>

Decode for this encoding

```
d = UInt(Rd); n = UInt(Rn); m = UInt(Rm);
if d == 15 || n == 15 || m == 15 then UNPREDICTABLE; // ARMv8-A removes UNPREDICTABLE for R13
```

Notes for all encodings

For more information about the CONSTRAINED UNPREDICTABLE behavior of this instruction, see [Appendix K1 Architectural Constraints on UNPREDICTABLE behaviors](#).

Assembler symbols

- <c> See [Standard assembler syntax fields on page F2-2848](#).
- <q> See [Standard assembler syntax fields on page F2-2848](#).
- <Rd> Is the general-purpose destination register, encoded in the "Rd" field.
- <Rn> Is the first general-purpose source register, encoded in the "Rn" field.
- <Rm> Is the second general-purpose source register, encoded in the "Rm" field.

Operation for all encodings

```
if ConditionPassed() then
    EncodingSpecificOperations();
    sum1 = SInt(R[n]<15:0>) + SInt(R[m]<15:0>);
```

```
sum2 = SInt(R[n]<31:16>) + SInt(R[m]<31:16>);  
R[d]<15:0> = SignedSat(sum1, 16);  
R[d]<31:16> = SignedSat(sum2, 16);
```

F5.1.143 QADD8

Saturating Add 8 performs four 8-bit integer additions, saturates the results to the 8-bit signed integer range $-2^7 \leq x \leq 2^7 - 1$, and writes the results to the destination register.

A1

31	28	27	26	25	24	23	22	21	20	19	16	15	12	11	10	9	8	7	6	5	4	3	0			
!=1111				0	1	1	0	0	0	1	0	Rn	Rd	(1)	(1)	(1)	(1)	1	0	0	1	Rm				
cond																										

A1 variant

QADD8{<c>}{<q>} {<Rd>}, {<Rn>}, <Rm>

Decode for this encoding

d = UInt(Rd); n = UInt(Rn); m = UInt(Rm);
 if d == 15 || n == 15 || m == 15 then UNPREDICTABLE;

T1

15	14	13	12	11	10	9	8	7	6	5	4	3	0	15	14	13	12	11	8	7	6	5	4	3	0
1	1	1	1	1	0	1	0	1	0	0	0	Rn	1	1	1	1	Rd	0	0	0	1	Rm			

T1 variant

QADD8{<c>}{<q>} {<Rd>}, {<Rn>}, <Rm>

Decode for this encoding

d = UInt(Rd); n = UInt(Rn); m = UInt(Rm);
 if d == 15 || n == 15 || m == 15 then UNPREDICTABLE; // ARMv8-A removes UNPREDICTABLE for R13

Notes for all encodings

For more information about the CONSTRAINED UNPREDICTABLE behavior of this instruction, see [Appendix K1 Architectural Constraints on UNPREDICTABLE behaviors](#).

Assembler symbols

- <c> See [Standard assembler syntax fields on page F2-2848](#).
- <q> See [Standard assembler syntax fields on page F2-2848](#).
- <Rd> Is the general-purpose destination register, encoded in the "Rd" field.
- <Rn> Is the first general-purpose source register, encoded in the "Rn" field.
- <Rm> Is the second general-purpose source register, encoded in the "Rm" field.

Operation for all encodings

```
if ConditionPassed() then
  EncodingSpecificOperations();
  sum1 = SInt(R[n]<7:0>) + SInt(R[m]<7:0>);
  sum2 = SInt(R[n]<15:8>) + SInt(R[m]<15:8>);
  sum3 = SInt(R[n]<23:16>) + SInt(R[m]<23:16>);
```

```
sum4 = SInt(R[n]<31:24>) + SInt(R[m]<31:24>);  
R[d]<7:0> = SignedSat(sum1, 8);  
R[d]<15:8> = SignedSat(sum2, 8);  
R[d]<23:16> = SignedSat(sum3, 8);  
R[d]<31:24> = SignedSat(sum4, 8);
```

F5.1.144 QASX

Saturating Add and Subtract with Exchange exchanges the two halfwords of the second operand, performs one 16-bit integer addition and one 16-bit subtraction, saturates the results to the 16-bit signed integer range $-2^{15} \leq x \leq 2^{15} - 1$, and writes the results to the destination register.

A1

31	28	27	26	25	24	23	22	21	20	19	16	15	12	11	10	9	8	7	6	5	4	3	0
!=1111				0	1	1	0	0	0	1	0	Rn	Rd	(1)	(1)	(1)	(1)	0	0	1	1	Rm	
cond																							

A1 variant

QASX{<c>}{<q>} {<Rd>}, <Rn>, <Rm>

Decode for this encoding

```
d = UInt(Rd); n = UInt(Rn); m = UInt(Rm);
if d == 15 || n == 15 || m == 15 then UNPREDICTABLE;
```

T1

15	14	13	12	11	10	9	8	7	6	5	4	3	0	15	14	13	12	11	8	7	6	5	4	3	0
1	1	1	1	1	0	1	0	1	0	1	0	Rn	1	1	1	1	Rd	0	0	0	1	Rm			

T1 variant

QASX{<c>}{<q>} {<Rd>}, <Rn>, <Rm>

Decode for this encoding

```
d = UInt(Rd); n = UInt(Rn); m = UInt(Rm);
if d == 15 || n == 15 || m == 15 then UNPREDICTABLE; // ARMv8-A removes UNPREDICTABLE for R13
```

Notes for all encodings

For more information about the CONSTRAINED UNPREDICTABLE behavior of this instruction, see [Appendix K1 Architectural Constraints on UNPREDICTABLE behaviors](#).

Assembler symbols

- <c> See [Standard assembler syntax fields on page F2-2848](#).
- <q> See [Standard assembler syntax fields on page F2-2848](#).
- <Rd> Is the general-purpose destination register, encoded in the "Rd" field.
- <Rn> Is the first general-purpose source register, encoded in the "Rn" field.
- <Rm> Is the second general-purpose source register, encoded in the "Rm" field.

Operation for all encodings

```
if ConditionPassed() then
    EncodingSpecificOperations();
diff = SInt(R[n]<15:0>) - SInt(R[m]<31:16>);
```

```
sum = SInt(R[n]<31:16>) + SInt(R[m]<15:0>);  
R[d]<15:0> = SignedSat(diff, 16);  
R[d]<31:16> = SignedSat(sum, 16);
```

F5.1.145 QDADD

Saturating Double and Add adds a doubled register value to another register value, and writes the result to the destination register. Both the doubling and the addition have their results saturated to the 32-bit signed integer range $-2^{31} \leq x \leq 2^{31} - 1$. If saturation occurs in either operation, it sets `PSTATE.Q` to 1.

A1

31	28	27	26	25	24	23	22	21	20	19	16	15	12	11	10	9	8	7	6	5	4	3	0
!=1111				0	0	0	1	0	1	0	0	Rn	Rd	(0)	(0)	(0)	(0)	0	1	0	1	Rm	
cond																							

A1 variant

QDADD{<c>}{<q>} {<Rd>}, {<Rm>}, <Rn>

Decode for this encoding

```
d = UInt(Rd); n = UInt(Rn); m = UInt(Rm);
if d == 15 || n == 15 || m == 15 then UNPREDICTABLE;
```

T1

15	14	13	12	11	10	9	8	7	6	5	4	3	0	15	14	13	12	11	8	7	6	5	4	3	0
1	1	1	1	1	0	1	0	1	0	0	0	Rn	1	1	1	1	Rd	1	0	0	1	Rm			

T1 variant

QDADD{<c>}{<q>} {<Rd>}, {<Rm>}, <Rn>

Decode for this encoding

```
d = UInt(Rd); n = UInt(Rn); m = UInt(Rm);
if d == 15 || n == 15 || m == 15 then UNPREDICTABLE; // ARMv8-A removes UNPREDICTABLE for R13
```

Notes for all encodings

For more information about the CONSTRAINED UNPREDICTABLE behavior of this instruction, see [Appendix K1 Architectural Constraints on UNPREDICTABLE behaviors](#).

Assembler symbols

- <c> See [Standard assembler syntax fields on page F2-2848](#).
- <q> See [Standard assembler syntax fields on page F2-2848](#).
- <Rd> Is the general-purpose destination register, encoded in the "Rd" field.
- <Rm> Is the first general-purpose source register, encoded in the "Rm" field.
- <Rn> Is the second general-purpose source register, encoded in the "Rn" field.

Operation for all encodings

```
if ConditionPassed() then
    EncodingSpecificOperations();
    (doubled, sat1) = SignedSatQ(2 * SInt(R[n]), 32);
```

```
(R[d], sat2) = SignedSatQ(SInt(R[m]) + SInt(doubled), 32);  
if sat1 || sat2 then  
    PSTATE.Q = '1';
```

F5.1.146 QDSUB

Saturating Double and Subtract subtracts a doubled register value from another register value, and writes the result to the destination register. Both the doubling and the subtraction have their results saturated to the 32-bit signed integer range $-2^{31} \leq x \leq 2^{31} - 1$. If saturation occurs in either operation, it sets `PSTATE.Q` to 1.

A1

31	28	27	26	25	24	23	22	21	20	19	16	15	12	11	10	9	8	7	6	5	4	3	0
!=1111				0	0	0	1	0	1	1	0	Rn	Rd	(0)	(0)	(0)	(0)	0	1	0	1	Rm	
cond																							

A1 variant

QDSUB{<c>}{<q>} {<Rd>}, {<Rm>}, <Rn>

Decode for this encoding

```
d = UInt(Rd); n = UInt(Rn); m = UInt(Rm);
if d == 15 || n == 15 || m == 15 then UNPREDICTABLE;
```

T1

15	14	13	12	11	10	9	8	7	6	5	4	3	0	15	14	13	12	11	8	7	6	5	4	3	0
1	1	1	1	1	0	1	0	1	0	0	0	Rn	1	1	1	1	Rd	1	0	1	1	Rm			

T1 variant

QDSUB{<c>}{<q>} {<Rd>}, {<Rm>}, <Rn>

Decode for this encoding

```
d = UInt(Rd); n = UInt(Rn); m = UInt(Rm);
if d == 15 || n == 15 || m == 15 then UNPREDICTABLE; // ARMv8-A removes UNPREDICTABLE for R13
```

Notes for all encodings

For more information about the CONSTRAINED UNPREDICTABLE behavior of this instruction, see [Appendix K1 Architectural Constraints on UNPREDICTABLE behaviors](#).

Assembler symbols

- <c> See [Standard assembler syntax fields on page F2-2848](#).
- <q> See [Standard assembler syntax fields on page F2-2848](#).
- <Rd> Is the general-purpose destination register, encoded in the "Rd" field.
- <Rm> Is the first general-purpose source register, encoded in the "Rm" field.
- <Rn> Is the second general-purpose source register, encoded in the "Rn" field.

Operation for all encodings

```
if ConditionPassed() then
    EncodingSpecificOperations();
    (doubled, sat1) = SignedSatQ(2 * SInt(R[n]), 32);
```

```
(R[d], sat2) = SignedSatQ(SInt(R[m]) - SInt(doubled), 32);  
if sat1 || sat2 then  
    PSTATE.Q = '1';
```

F5.1.147 QSAX

Saturating Subtract and Add with Exchange exchanges the two halfwords of the second operand, performs one 16-bit integer subtraction and one 16-bit addition, saturates the results to the 16-bit signed integer range $-2^{15} \leq x \leq 2^{15} - 1$, and writes the results to the destination register.

A1

31	28	27	26	25	24	23	22	21	20	19	16	15	12	11	10	9	8	7	6	5	4	3	0
!=1111				0	1	1	0	0	0	1	0	Rn	Rd	(1)	(1)	(1)	(1)	0	1	0	1	Rm	
cond																							

A1 variant

QSAX{<c>}{<q>} {<Rd>}, <Rn>, <Rm>

Decode for this encoding

```
d = UInt(Rd); n = UInt(Rn); m = UInt(Rm);
if d == 15 || n == 15 || m == 15 then UNPREDICTABLE;
```

T1

15	14	13	12	11	10	9	8	7	6	5	4	3	0	15	14	13	12	11	8	7	6	5	4	3	0
1	1	1	1	1	0	1	0	1	1	1	0	Rn	1	1	1	1	Rd	0	0	0	1	Rm			

T1 variant

QSAX{<c>}{<q>} {<Rd>}, <Rn>, <Rm>

Decode for this encoding

```
d = UInt(Rd); n = UInt(Rn); m = UInt(Rm);
if d == 15 || n == 15 || m == 15 then UNPREDICTABLE; // ARMv8-A removes UNPREDICTABLE for R13
```

Notes for all encodings

For more information about the CONSTRAINED UNPREDICTABLE behavior of this instruction, see [Appendix K1 Architectural Constraints on UNPREDICTABLE behaviors](#).

Assembler symbols

- <c> See [Standard assembler syntax fields on page F2-2848](#).
- <q> See [Standard assembler syntax fields on page F2-2848](#).
- <Rd> Is the general-purpose destination register, encoded in the "Rd" field.
- <Rn> Is the first general-purpose source register, encoded in the "Rn" field.
- <Rm> Is the second general-purpose source register, encoded in the "Rm" field.

Operation for all encodings

```
if ConditionPassed() then
    EncodingSpecificOperations();
    sum = SInt(R[n]<15:0>) + SInt(R[m]<31:16>);
```

```
diff = SInt(R[n]<31:16>) - SInt(R[m]<15:0>);  
R[d]<15:0> = SignedSat(sum, 16);  
R[d]<31:16> = SignedSat(diff, 16);
```

F5.1.148 QSUB

Saturating Subtract subtracts one register value from another register value, saturates the result to the 32-bit signed integer range $-2^{31} \leq x \leq 2^{31} - 1$, and writes the result to the destination register. If saturation occurs, it sets [PSTATE.Q](#) to 1.

A1

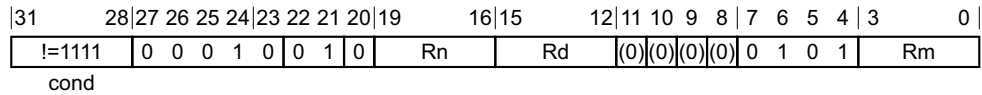

A1 variant

QSUB{<c>}{<q>} {<Rd>}, <Rm>, <Rn>

Decode for this encoding

d = UInt(Rd); n = UInt(Rn); m = UInt(Rm);
 if d == 15 || n == 15 || m == 15 then UNPREDICTABLE;

T1

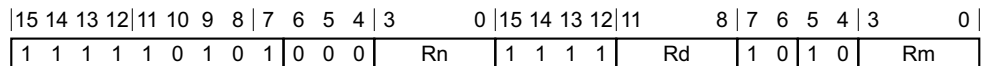

T1 variant

QSUB{<c>}{<q>} {<Rd>}, <Rm>, <Rn>

Decode for this encoding

d = UInt(Rd); n = UInt(Rn); m = UInt(Rm);
 if d == 15 || n == 15 || m == 15 then UNPREDICTABLE; // ARMv8-A removes UNPREDICTABLE for R13

Notes for all encodings

For more information about the CONSTRAINED UNPREDICTABLE behavior of this instruction, see [Appendix K1 Architectural Constraints on UNPREDICTABLE behaviors](#).

Assembler symbols

- <c> See [Standard assembler syntax fields on page F2-2848](#).
- <q> See [Standard assembler syntax fields on page F2-2848](#).
- <Rd> Is the general-purpose destination register, encoded in the "Rd" field.
- <Rm> Is the first general-purpose source register, encoded in the "Rm" field.
- <Rn> Is the second general-purpose source register, encoded in the "Rn" field.

Operation for all encodings

```
if ConditionPassed() then
    EncodingSpecificOperations();
(R[d], sat) = SignedSatQ(SInt(R[m]) - SInt(R[n]), 32);
if sat then
    PSTATE.Q = '1';
```

F5.1.149 QSUB16

Saturating Subtract 16 performs two 16-bit integer subtractions, saturates the results to the 16-bit signed integer range $-2^{15} \leq x \leq 2^{15} - 1$, and writes the results to the destination register.

A1

31	28	27	26	25	24	23	22	21	20	19	16	15	12	11	10	9	8	7	6	5	4	3	0
!=1111				0	1	1	0	0	0	1	0	Rn	Rd	(1)	(1)	(1)	(1)	0	1	1	1	Rm	
cond																							

A1 variant

QSUB16{<c>}{<q>} {<Rd>}, <Rn>, <Rm>

Decode for this encoding

d = UInt(Rd); n = UInt(Rn); m = UInt(Rm);
 if d == 15 || n == 15 || m == 15 then UNPREDICTABLE;

T1

15	14	13	12	11	10	9	8	7	6	5	4	3	0	15	14	13	12	11	8	7	6	5	4	3	0
1	1	1	1	1	0	1	0	1	1	0	1	Rn	1	1	1	1	Rd	0	0	0	1	Rm			

T1 variant

QSUB16{<c>}{<q>} {<Rd>}, <Rn>, <Rm>

Decode for this encoding

d = UInt(Rd); n = UInt(Rn); m = UInt(Rm);
 if d == 15 || n == 15 || m == 15 then UNPREDICTABLE; // ARMv8-A removes UNPREDICTABLE for R13

Notes for all encodings

For more information about the CONSTRAINED UNPREDICTABLE behavior of this instruction, see [Appendix K1 Architectural Constraints on UNPREDICTABLE behaviors](#).

Assembler symbols

- <c> See [Standard assembler syntax fields on page F2-2848](#).
- <q> See [Standard assembler syntax fields on page F2-2848](#).
- <Rd> Is the general-purpose destination register, encoded in the "Rd" field.
- <Rn> Is the first general-purpose source register, encoded in the "Rn" field.
- <Rm> Is the second general-purpose source register, encoded in the "Rm" field.

Operation for all encodings

```
if ConditionPassed() then
    EncodingSpecificOperations();
    diff1 = SInt(R[n]<15:0>) - SInt(R[m]<15:0>);
```

```
diff2 = SInt(R[n]<31:16>) - SInt(R[m]<31:16>);  
R[d]<15:0> = SignedSat(diff1, 16);  
R[d]<31:16> = SignedSat(diff2, 16);
```

F5.1.150 QSUB8

Saturating Subtract 8 performs four 8-bit integer subtractions, saturates the results to the 8-bit signed integer range $-2^7 \leq x \leq 2^7 - 1$, and writes the results to the destination register.

A1

31	28	27	26	25	24	23	22	21	20	19	16	15	12	11	10	9	8	7	6	5	4	3	0			
!=1111				0	1	1	0	0	0	1	0	Rn	Rd	(1)	(1)	(1)	(1)	1	1	1	1	Rm				
cond																										

A1 variant

QSUB8{<c>}{<q>} {<Rd>}, {<Rn>}, <Rm>

Decode for this encoding

```
d = UInt(Rd); n = UInt(Rn); m = UInt(Rm);
if d == 15 || n == 15 || m == 15 then UNPREDICTABLE;
```

T1

15	14	13	12	11	10	9	8	7	6	5	4	3	0	15	14	13	12	11	8	7	6	5	4	3	0
1	1	1	1	1	0	1	0	1	1	0	0	Rn	1	1	1	1	Rd	0	0	0	1	Rm			

T1 variant

QSUB8{<c>}{<q>} {<Rd>}, {<Rn>}, <Rm>

Decode for this encoding

```
d = UInt(Rd); n = UInt(Rn); m = UInt(Rm);
if d == 15 || n == 15 || m == 15 then UNPREDICTABLE; // ARMv8-A removes UNPREDICTABLE for R13
```

Notes for all encodings

For more information about the CONSTRAINED UNPREDICTABLE behavior of this instruction, see [Appendix K1 Architectural Constraints on UNPREDICTABLE behaviors](#).

Assembler symbols

- <c> See [Standard assembler syntax fields on page F2-2848](#).
- <q> See [Standard assembler syntax fields on page F2-2848](#).
- <Rd> Is the general-purpose destination register, encoded in the "Rd" field.
- <Rn> Is the first general-purpose source register, encoded in the "Rn" field.
- <Rm> Is the second general-purpose source register, encoded in the "Rm" field.

Operation for all encodings

```
if ConditionPassed() then
  EncodingSpecificOperations();
  diff1 = SInt(R[n]<7:0>) - SInt(R[m]<7:0>);
  diff2 = SInt(R[n]<15:8>) - SInt(R[m]<15:8>);
  diff3 = SInt(R[n]<23:16>) - SInt(R[m]<23:16>);
```

```
diff4 = SInt(R[n]<31:24>) - SInt(R[m]<31:24>);  
R[d]<7:0> = SignedSat(diff1, 8);  
R[d]<15:8> = SignedSat(diff2, 8);  
R[d]<23:16> = SignedSat(diff3, 8);  
R[d]<31:24> = SignedSat(diff4, 8);
```

F5.1.151 RBIT

Reverse Bits reverses the bit order in a 32-bit register.

A1

31	28	27	26	25	24	23	22	21	20	19	18	17	16	15	12	11	10	9	8	7	6	5	4	3	0						
!=1111				0	1	1	0	1	1	1	1	(1)	(1)	(1)	(1)	Rd	(1)	(1)	(1)	(1)	0	0	1	1	Rm						
cond																															

A1 variant

RBIT{<c>}{<q>} <Rd>, <Rm>

Decode for this encoding

d = UInt(Rd); m = UInt(Rm);
 if d == 15 || m == 15 then UNPREDICTABLE;

T1

15	14	13	12	11	10	9	8	7	6	5	4	3	0	15	14	13	12	11	8	7	6	5	4	3	0
1	1	1	1	1	0	1	0	1	0	0	1	Rn	1	1	1	1	Rd	1	0	1	0	Rm			

T1 variant

RBIT{<c>}{<q>} <Rd>, <Rm>

Decode for this encoding

d = UInt(Rd); m = UInt(Rm); n = UInt(Rn);
 if m != n || d == 15 || m == 15 then UNPREDICTABLE; // ARMv8-A removes UNPREDICTABLE for R13

CONSTRAINED UNPREDICTABLE behavior

If m != n, then one of the following behaviors must occur:

- The instruction is UNDEFINED.
- The instruction executes as NOP.
- The instruction executes with the additional decode: m = UInt(Rn);.
- The instruction executes with the additional decode: m = UInt(Rm);.
- The value in the destination register is UNKNOWN.

Notes for all encodings

For more information about the CONSTRAINED UNPREDICTABLE behavior of this instruction, see [Appendix K1 Architectural Constraints on UNPREDICTABLE behaviors](#).

Assembler symbols

- <c> See [Standard assembler syntax fields on page F2-2848](#).
- <q> See [Standard assembler syntax fields on page F2-2848](#).
- <Rd> Is the general-purpose destination register, encoded in the "Rd" field.

<Rm> For encoding A1: is the general-purpose source register, encoded in the "Rm" field.
For encoding T1: is the general-purpose source register, encoded in the "Rm" field. It must be encoded with an identical value in the "Rn" field.

Operation for all encodings

```
if ConditionPassed() then
    EncodingSpecificOperations();
    bits(32) result;
    for i = 0 to 31
        result<31-i> = R[m]<i>;
    R[d] = result;
```

F5.1.152 REV

Byte-Reverse Word reverses the byte order in a 32-bit register.

A1

31	28	27	26	25	24	23	22	21	20	19	18	17	16	15	12	11	10	9	8	7	6	5	4	3	0
!=1111				0	1	1	0	1	0	1	1	(1)	(1)	(1)	(1)	Rd	(1)	(1)	(1)	(1)	0	0	1	1	Rm
cond																									

A1 variant

REV{<c>}{<q>} <Rd>, <Rm>

Decode for this encoding

d = UInt(Rd); m = UInt(Rm);
 if d == 15 || m == 15 then UNPREDICTABLE;

T1

15	14	13	12	11	10	9	8	7	6	5	3	2	0
1	0	1	1	1	0	1	0	0	0	Rm	Rd		

T1 variant

REV{<c>}{<q>} <Rd>, <Rm>

Decode for this encoding

d = UInt(Rd); m = UInt(Rm);

T2

15	14	13	12	11	10	9	8	7	6	5	4	3	0	15	14	13	12	11	8	7	6	5	4	3	0
1	1	1	1	1	0	1	0	1	0	0	1	Rn	1	1	1	1	Rd	1	0	0	0	Rm			

T2 variant

REV{<c>}.W <Rd>, <Rm> // <Rd>, <Rm> can be represented in T1
 REV{<c>}{<q>} <Rd>, <Rm>

Decode for this encoding

d = UInt(Rd); m = UInt(Rm); n = UInt(Rn);
 if m != n || d == 15 || m == 15 then UNPREDICTABLE; // ARMv8-A removes UNPREDICTABLE for R13

CONSTRAINED UNPREDICTABLE behavior

If m != n, then one of the following behaviors must occur:

- The instruction is UNDEFINED.
- The instruction executes as NOP.
- The instruction executes with the additional decode: m = UInt(Rn);.

- The instruction executes with the additional decode: $m = \text{UInt}(Rm)$;
- The value in the destination register is UNKNOWN.

Notes for all encodings

For more information about the CONSTRAINED UNPREDICTABLE behavior of this instruction, see [Appendix K1 Architectural Constraints on UNPREDICTABLE behaviors](#).

Assembler symbols

- <c> See [Standard assembler syntax fields on page F2-2848](#).
- <q> See [Standard assembler syntax fields on page F2-2848](#).
- <Rd> Is the general-purpose destination register, encoded in the "Rd" field.
- <Rm> For encoding A1 and T1: is the general-purpose source register, encoded in the "Rm" field.
For encoding T2: is the general-purpose source register, encoded in the "Rm" field. It must be encoded with an identical value in the "Rn" field.

Operation for all encodings

```
if ConditionPassed() then
    EncodingSpecificOperations();
bits(32) result;
result<31:24> = R[m]<7:0>;
result<23:16> = R[m]<15:8>;
result<15:8> = R[m]<23:16>;
result<7:0> = R[m]<31:24>;
R[d] = result;
```

F5.1.153 REV16

Byte-Reverse Packed Halfword reverses the byte order in each 16-bit halfword of a 32-bit register.

A1

31	28	27	26	25	24	23	22	21	20	19	18	17	16	15	12	11	10	9	8	7	6	5	4	3	0
!=1111				0	1	1	0	1	0	1	1	(1)	(1)	(1)	(1)	Rd	(1)	(1)	(1)	(1)	1	0	1	1	Rm
cond																									

A1 variant

REV16{<c>}{<q>} <Rd>, <Rm>

Decode for this encoding

d = UInt(Rd); m = UInt(Rm);
 if d == 15 || m == 15 then UNPREDICTABLE;

T1

15	14	13	12	11	10	9	8	7	6	5	3	2	0
1	0	1	1	1	0	1	0	0	1	Rm	Rd		

T1 variant

REV16{<c>}{<q>} <Rd>, <Rm>

Decode for this encoding

d = UInt(Rd); m = UInt(Rm);

T2

15	14	13	12	11	10	9	8	7	6	5	4	3	0	15	14	13	12	11	8	7	6	5	4	3	0
1	1	1	1	1	0	1	0	1	0	0	1	Rn	1	1	1	1	Rd	1	0	0	1	Rm			

T2 variant

REV16{<c>}.W <Rd>, <Rm> // <Rd>, <Rm> can be represented in T1
 REV16{<c>}{<q>} <Rd>, <Rm>

Decode for this encoding

d = UInt(Rd); m = UInt(Rm); n = UInt(Rn);
 if m != n || d == 15 || m == 15 then UNPREDICTABLE; // ARMv8-A removes UNPREDICTABLE for R13

CONSTRAINED UNPREDICTABLE behavior

If m != n, then one of the following behaviors must occur:

- The instruction is UNDEFINED.
- The instruction executes as NOP.
- The instruction executes with the additional decode: m = UInt(Rn);

- The instruction executes with the additional decode: $m = \text{UInt}(Rm)$;
- The value in the destination register is UNKNOWN.

Notes for all encodings

For more information about the CONSTRAINED UNPREDICTABLE behavior of this instruction, see [Appendix K1 Architectural Constraints on UNPREDICTABLE behaviors](#).

Assembler symbols

- <c> See [Standard assembler syntax fields on page F2-2848](#).
- <q> See [Standard assembler syntax fields on page F2-2848](#).
- <Rd> Is the general-purpose destination register, encoded in the "Rd" field.
- <Rm> For encoding A1 and T1: is the general-purpose source register, encoded in the "Rm" field.
For encoding T2: is the general-purpose source register, encoded in the "Rm" field. It must be encoded with an identical value in the "Rn" field.

Operation for all encodings

```
if ConditionPassed() then
    EncodingSpecificOperations();
bits(32) result;
result<31:24> = R[m]<23:16>;
result<23:16> = R[m]<31:24>;
result<15:8> = R[m]<7:0>;
result<7:0> = R[m]<15:8>;
R[d] = result;
```

F5.1.154 REVSH

Byte-Reverse Signed Halfword reverses the byte order in the lower 16-bit halfword of a 32-bit register, and sign-extends the result to 32 bits.

A1

31	28	27	26	25	24	23	22	21	20	19	18	17	16	15	12	11	10	9	8	7	6	5	4	3	0
!=1111				0	1	1	0	1	1	1	1	(1)	(1)	(1)	(1)	Rd	(1)	(1)	(1)	(1)	1	0	1	1	Rm
cond																									

A1 variant

REVSH{<c>}{<q>} <Rd>, <Rm>

Decode for this encoding

d = UInt(Rd); m = UInt(Rm);
 if d == 15 || m == 15 then UNPREDICTABLE;

T1

15	14	13	12	11	10	9	8	7	6	5	3	2	0
1	0	1	1	1	0	1	0	1	1	Rm	Rd		

T1 variant

REVSH{<c>}{<q>} <Rd>, <Rm>

Decode for this encoding

d = UInt(Rd); m = UInt(Rm);

T2

15	14	13	12	11	10	9	8	7	6	5	4	3	0	15	14	13	12	11	8	7	6	5	4	3	0
1	1	1	1	1	0	1	0	1	0	0	1	Rn	1	1	1	1	Rd	1	0	1	1	Rm			

T2 variant

REVSH{<c>}.W <Rd>, <Rm> // <Rd>, <Rm> can be represented in T1
 REVSH{<c>}{<q>} <Rd>, <Rm>

Decode for this encoding

d = UInt(Rd); m = UInt(Rm); n = UInt(Rn);
 if m != n || d == 15 || m == 15 then UNPREDICTABLE; // ARMv8-A removes UNPREDICTABLE for R13

CONSTRAINED UNPREDICTABLE behavior

If m != n, then one of the following behaviors must occur:

- The instruction is UNDEFINED.
- The instruction executes as NOP.

- The instruction executes with the additional decode: $m = \text{UInt}(\text{Rn})$;
- The instruction executes with the additional decode: $m = \text{UInt}(\text{Rm})$;
- The value in the destination register is UNKNOWN.

Notes for all encodings

For more information about the CONSTRAINED UNPREDICTABLE behavior of this instruction, see [Appendix K1 Architectural Constraints on UNPREDICTABLE behaviors](#).

Assembler symbols

- <c> See [Standard assembler syntax fields on page F2-2848](#).
- <q> See [Standard assembler syntax fields on page F2-2848](#).
- <Rd> Is the general-purpose destination register, encoded in the "Rd" field.
- <Rm> For encoding A1 and T1: is the general-purpose source register, encoded in the "Rm" field.
For encoding T2: is the general-purpose source register, encoded in the "Rm" field. It must be encoded with an identical value in the "Rn" field.

Operation for all encodings

```
if ConditionPassed() then
    EncodingSpecificOperations();
    bits(32) result;
    result<31:8> = SignExtend(R[m]<7:0>, 24);
    result<7:0> = R[m]<15:8>;
    R[d] = result;
```

F5.1.155 RFE, RFEDA, RFEDB, RFEIA, RFEIB

Return From Exception loads two consecutive memory locations using an address in a base register:

- The word loaded from the lower address is treated as an instruction address. The PE branches to it.
- The word loaded from the higher address is used to restore [PSTATE](#). This word must be in the format of an SPSR.

An address adjusted by the size of the data loaded can optionally be written back to the base register.

The PE checks the value of the word loaded from the higher address for an illegal return event. See [Illegal return events from AArch32 state on page G1-4361](#).

RFE is UNDEFINED in Hyp mode and CONSTRAINED UNPREDICTABLE in User mode.

A1

31	30	29	28	27	26	25	24	23	22	21	20	19	16	15	14	13	12	11	10	9	8	7	6	5	4	3	2	1	0
1	1	1	1	1	0	0	P	U	0	W	1	Rn	(0)	(0)	(0)	(0)	(1)	(0)	(1)	(0)	(0)	(0)	(0)	(0)	(0)	(0)	(0)	(0)	(0)

Decrement After variant

Applies when $P == 0$ && $U == 0$.

$RFEDA\{<c>\}\{<q>\} <Rn>\{!\}$

Decrement Before variant

Applies when $P == 1$ && $U == 0$.

$RFEDB\{<c>\}\{<q>\} <Rn>\{!\}$

Increment After variant

Applies when $P == 0$ && $U == 1$.

$RFE\{IA\}\{<c>\}\{<q>\} <Rn>\{!\}$

Increment Before variant

Applies when $P == 1$ && $U == 1$.

$RFEIB\{<c>\}\{<q>\} <Rn>\{!\}$

Decode for all variants of this encoding

```
n = UInt(Rn);
wback = (W == '1'); increment = (U == '1'); wordhigher = (P == U);
if n == 15 then UNPREDICTABLE;
```

T1

15	14	13	12	11	10	9	8	7	6	5	4	3	0	15	14	13	12	11	10	9	8	7	6	5	4	3	2	1	0
1	1	1	0	1	0	0	0	0	0	W	1	Rn	(1)	(1)	(0)	(0)	(0)	(0)	(0)	(0)	(0)	(0)	(0)	(0)	(0)	(0)	(0)	(0)	(0)

T1 variant

$RFEDB\{<c>\}\{<q>\} <Rn>\{!\}$ // Outside or last in IT block

Decode for this encoding

```
n = UInt(Rn); wback = (W == '1'); increment = FALSE; wordhigher = FALSE;
if n == 15 then UNPREDICTABLE;
if InITBlock() && !LastInITBlock() then UNPREDICTABLE;
```

T2

15	14	13	12	11	10	9	8	7	6	5	4	3	0	15	14	13	12	11	10	9	8	7	6	5	4	3	2	1	0
1	1	1	0	1	0	0	1	1	0	W	1	Rn	(1)	(1)	(0)	(0)	(0)	(0)	(0)	(0)	(0)	(0)	(0)	(0)	(0)	(0)	(0)	(0)	(0)

T2 variant

RFE{IA}{<c>}{<q>} <Rn>{!} // Outside or last in IT block

Decode for this encoding

```
n = UInt(Rn); wback = (W == '1'); increment = TRUE; wordhigher = FALSE;
if n == 15 then UNPREDICTABLE;
if InITBlock() && !LastInITBlock() then UNPREDICTABLE;
```

Notes for all encodings

For more information about the CONSTRAINED UNPREDICTABLE behavior of this instruction, see [Appendix K1 Architectural Constraints on UNPREDICTABLE behaviors](#).

Assembler symbols

- IA For encoding A1: is an optional suffix to indicate the Increment After variant.
For encoding T2: is an optional suffix for the Increment After form.
- <c> For encoding A1: see [Standard assembler syntax fields on page F2-2848](#). <c> must be AL or omitted.
For encoding T1 and T2: see [Standard assembler syntax fields on page F2-2848](#).
- <q> See [Standard assembler syntax fields on page F2-2848](#).
- <Rn> Is the general-purpose base register, encoded in the "Rn" field.
- ! The address adjusted by the size of the data loaded is written back to the base register. If specified, it is encoded in the "W" field as 1, otherwise this field defaults to 0.

RFEFA, RFEFA, RFEFD, and RFEED are pseudo-instructions for RFEDA, RFEDB, RFEIA, and RFEIB respectively, referring to their use for popping data from Full Ascending, Empty Ascending, Full Descending, and Empty Descending stacks.

Operation for all encodings

```
if ConditionPassed() then
  EncodingSpecificOperations();
  if PSTATE.EL == EL2 then
    UNDEFINED;
  elseif PSTATE.EL == EL0 then
    UNPREDICTABLE; // UNDEFINED or NOP
  else
    address = if increment then R[n] else R[n]-8;
    if wordhigher then address = address+4;
    new_pc_value = MemA[address,4];
    spsr = MemA[address+4,4];
    if wback then R[n] = if increment then R[n]+8 else R[n]-8;
    AArch32.ExceptionReturn(new_pc_value, spsr);
```

CONSTRAINED UNPREDICTABLE behavior

If `PSTATE.EL == EL0`, then one of the following behaviors must occur:

- The instruction is UNDEFINED.
- The instruction executes as NOP.

F5.1.156 ROR (immediate)

Rotate Right (immediate) provides the value of the contents of a register rotated by a constant value. The bits that are rotated off the right end are inserted into the vacated bit positions on the left.

This instruction is an alias of the [MOV, MOVS \(register\)](#) instruction. This means that:

- The encodings in this description are named to match the encodings of [MOV, MOVS \(register\)](#).
- The description of [MOV, MOVS \(register\)](#) gives the operational pseudocode for this instruction.

A1

31	28	27	26	25	24	23	22	21	20	19	18	17	16	15	12	11	7	6	5	4	3	0	
!=1111				0 0 0 1 1				0 1 0				(0)(0)(0)(0)				Rd		!=00000			1 1 0		Rm
cond								S						imm5			type						

MOV, shift or rotate by value variant

ROR{<c>}{<q>} {<Rd>}, <Rm>, #<imm>

is equivalent to

MOV{<c>}{<q>} <Rd>, <Rm>, ROR #<imm>

and is always the preferred disassembly.

T3

15	14	13	12	11	10	9	8	7	6	5	4	3	2	1	0	15	14	12	11	8	7	6	5	4	3	0
1 1 1 0				1 0 1				0 0 1 0				0 1 1 1 1				(0) imm3		Rd		imm2			1 1		Rm	
								S											type							

MOV, shift or rotate by value variant

Applies when !(imm3 == 000 && imm2 == 00).

ROR{<c>}{<q>} {<Rd>}, <Rm>, #<imm>

is equivalent to

MOV{<c>}{<q>} <Rd>, <Rm>, ROR #<imm>

and is always the preferred disassembly.

Assembler symbols

<c> See [Standard assembler syntax fields on page F2-2848](#).

<q> See [Standard assembler syntax fields on page F2-2848](#).

<Rd> For encoding A1: is the general-purpose destination register, encoded in the "Rd" field. ARM deprecates using the PC as the destination register, but if the PC is used, the instruction is a branch to the address calculated by the operation. This is an interworking branch, see [Pseudocode description of operations on the AArch32 general-purpose registers and the PC on page E1-2733](#).

For encoding T3: is the general-purpose destination register, encoded in the "Rd" field.

<Rm> For encoding A1: is the general-purpose source register, encoded in the "Rm" field. The PC can be used, but this is deprecated.

For encoding T3: is the general-purpose source register, encoded in the "Rm" field.

<imm> For encoding A1: is the shift amount, in the range 1 to 31, encoded in the "imm5" field.
For encoding T3: is the shift amount, in the range 1 to 31, encoded in the "imm3:imm2" field.

Operation for all encodings

The description of [MOV, MOVS \(register\)](#) gives the operational pseudocode for this instruction.

F5.1.157 ROR (register)

Rotate Right (register) provides the value of the contents of a register rotated by a variable number of bits. The bits that are rotated off the right end are inserted into the vacated bit positions on the left. The variable number of bits is read from the bottom byte of a register.

This instruction is an alias of the [MOV, MOVS \(register-shifted register\)](#) instruction. This means that:

- The encodings in this description are named to match the encodings of [MOV, MOVS \(register-shifted register\)](#).
- The description of [MOV, MOVS \(register-shifted register\)](#) gives the operational pseudocode for this instruction.

A1

31	28	27	26	25	24	23	22	21	20	19	18	17	16	15	12	11	8	7	6	5	4	3	0	
!=1111				0	0	0	1	1	0	1	0	(0)(0)(0)(0)	Rd	Rs	0	1	1	1	Rm					
cond				S								type												

Not flag setting variant

ROR{<c>}{<q>} {<Rd>}, <Rm>, <Rs>

is equivalent to

MOV{<c>}{<q>} <Rd>, <Rm>, ROR <Rs>

and is always the preferred disassembly.

T1

15	14	13	12	11	10	9	6	5	3	2	0	
0	1	0	0	0	0	0	0	1	1	1	Rs	Rdm
op												

Rotate right variant

ROR<c>{<q>} {<Rdm>}, <Rdm>, <Rs> // Inside IT block

is equivalent to

MOV<c>{<q>} <Rdm>, <Rdm>, ROR <Rs>

and is the preferred disassembly when InITBlock().

T2

15	14	13	12	11	10	9	8	7	6	5	4	3	0	15	14	13	12	11	8	7	6	5	4	3	0
1	1	1	1	1	0	1	0	0	1	1	0	Rm	1	1	1	1	Rd	0	0	0	0	Rs			
type												S													

Not flag setting variant

ROR<c> .W {<Rd>}, <Rm>, <Rs> // Inside IT block, and <Rd>, <Rm>, <type>, <Rs> can be represented in T1

is equivalent to

MOV{<c>}{<q>} <Rd>, <Rm>, ROR <Rs>

and is always the preferred disassembly.

ROR{<C>}{<Q>} {<Rd>}, <Rm>, <Rs>

is equivalent to

MOV{<C>}{<Q>} <Rd>, <Rm>, ROR <Rs>

and is always the preferred disassembly.

Assembler symbols

- <C> See [Standard assembler syntax fields on page F2-2848](#).
- <Q> See [Standard assembler syntax fields on page F2-2848](#).
- <Rdm> Is the first general-purpose source register and the destination register, encoded in the "Rdm" field.
- <Rd> Is the general-purpose destination register, encoded in the "Rd" field.
- <Rm> Is the first general-purpose source register, encoded in the "Rm" field.
- <Rs> Is the second general-purpose source register holding a rotate amount in its bottom 8 bits, encoded in the "Rs" field.

Operation for all encodings

The description of [MOV, MOVS \(register-shifted register\)](#) gives the operational pseudocode for this instruction.

F5.1.158 RORS (immediate)

Rotate Right, setting flags (immediate) provides the value of the contents of a register rotated by a constant value. The bits that are rotated off the right end are inserted into the vacated bit positions on the left.

If the destination register is not the PC, this instruction updates the condition flags based on the result.

The field descriptions for <Rd> identify the encodings where the PC is permitted as the destination register. ARM deprecates any use of these encodings. However, when the destination register is the PC:

- The PE branches to the address written to the PC, and restores [PSTATE](#) from SPSR_<current_mode>.
- The PE checks SPSR_<current_mode> for an illegal return event. See [Illegal return events from AArch32 state on page G1-4361](#).
- The instruction is UNDEFINED in Hyp mode.
- The instruction is CONSTRAINED UNPREDICTABLE in User mode and System mode.

This instruction is an alias of the [MOV, MOVS \(register\)](#) instruction. This means that:

- The encodings in this description are named to match the encodings of [MOV, MOVS \(register\)](#).
- The description of [MOV, MOVS \(register\)](#) gives the operational pseudocode for this instruction.

A1

31	28	27	26	25	24	23	22	21	20	19	18	17	16	15	12	11	7	6	5	4	3	0	
!=1111				0	0	0	1	1	0	1	1	(0)	(0)	(0)	(0)	Rd	!=00000	1	1	0	Rm		
cond				S											imm5			type					

MOVS, shift or rotate by value variant

RORS{<c>}{<q>} {<Rd>}, <Rm>, #<imm>

is equivalent to

MOVS{<c>}{<q>} <Rd>, <Rm>, ROR #<imm>

and is always the preferred disassembly.

T3

15	14	13	12	11	10	9	8	7	6	5	4	3	2	1	0	15	14	12	11	8	7	6	5	4	3	0
1	1	1	0	1	0	1	0	0	1	0	1	1	1	1	1	(0)	imm3	Rd	imm2	1	1	Rm				
S																type										

MOVS, shift or rotate by value variant

Applies when !(imm3 == 000 && imm2 == 00).

RORS{<c>}{<q>} {<Rd>}, <Rm>, #<imm>

is equivalent to

MOVS{<c>}{<q>} <Rd>, <Rm>, ROR #<imm>

and is always the preferred disassembly.

Assembler symbols

<c> See [Standard assembler syntax fields on page F2-2848](#).

- <q> See *Standard assembler syntax fields* on page F2-2848.
- <Rd> For encoding A1: is the general-purpose destination register, encoded in the "Rd" field. ARM deprecates using the PC as the destination register, but if the PC is used, the instruction performs an exception return, that restores [PSTATE](#) from `SPSR_<current_mode>`.
For encoding T3: is the general-purpose destination register, encoded in the "Rd" field.
- <Rm> For encoding A1: is the general-purpose source register, encoded in the "Rm" field. The PC can be used, but this is deprecated.
For encoding T3: is the general-purpose source register, encoded in the "Rm" field.
- <imm> For encoding A1: is the shift amount, in the range 1 to 31, encoded in the "imm5" field.
For encoding T3: is the shift amount, in the range 1 to 31, encoded in the "imm3:imm2" field.

Operation for all encodings

The description of [MOV, MOVS \(register\)](#) gives the operational pseudocode for this instruction.

F5.1.159 RORS (register)

Rotate Right, setting flags (register) provides the value of the contents of a register rotated by a variable number of bits, and updates the condition flags based on the result. The bits that are rotated off the right end are inserted into the vacated bit positions on the left. The variable number of bits is read from the bottom byte of a register.

This instruction is an alias of the [MOV, MOVS \(register-shifted register\)](#) instruction. This means that:

- The encodings in this description are named to match the encodings of [MOV, MOVS \(register-shifted register\)](#).
- The description of [MOV, MOVS \(register-shifted register\)](#) gives the operational pseudocode for this instruction.

A1

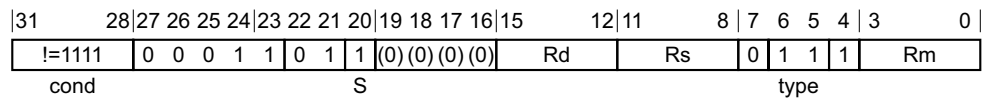

Flag setting variant

RORS{<c>}{<q>} {<Rd>}, <Rm>, <Rs>

is equivalent to

MOVS{<c>}{<q>} <Rd>, <Rm>, ROR <Rs>

and is always the preferred disassembly.

T1

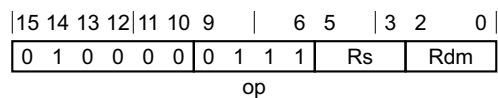

Rotate right variant

RORS{<q>} {<Rdm>}, <Rdm>, <Rs> // Outside IT block

is equivalent to

MOVS{<q>} <Rdm>, <Rdm>, ROR <Rs>

and is the preferred disassembly when !InITBlock().

T2

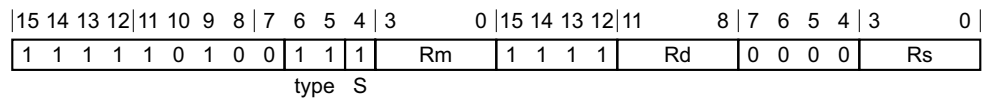

Flag setting variant

RORS.W {<Rd>}, <Rm>, <Rs> // Outside IT block, and <Rd>, <Rm>, <type>, <Rs> can be represented in T1

is equivalent to

MOVS{<c>}{<q>} <Rd>, <Rm>, ROR <Rs>

and is always the preferred disassembly.

RORS{<c>}{<q>} {<Rd>, } <Rm>, <Rs>

is equivalent to

MOVS{<c>}{<q>} <Rd>, <Rm>, ROR <Rs>

and is always the preferred disassembly.

Assembler symbols

- <c> See [Standard assembler syntax fields on page F2-2848](#).
- <q> See [Standard assembler syntax fields on page F2-2848](#).
- <Rdm> Is the first general-purpose source register and the destination register, encoded in the "Rdm" field.
- <Rd> Is the general-purpose destination register, encoded in the "Rd" field.
- <Rm> Is the first general-purpose source register, encoded in the "Rm" field.
- <Rs> Is the second general-purpose source register holding a rotate amount in its bottom 8 bits, encoded in the "Rs" field.

Operation for all encodings

The description of [MOV, MOVS \(register-shifted register\)](#) gives the operational pseudocode for this instruction.

F5.1.160 RRX

Rotate Right with Extend provides the value of the contents of a register shifted right by one place, with the Carry flag shifted into bit[31].

This instruction is an alias of the [MOV, MOVS \(register\)](#) instruction. This means that:

- The encodings in this description are named to match the encodings of [MOV, MOVS \(register\)](#).
- The description of [MOV, MOVS \(register\)](#) gives the operational pseudocode for this instruction.

A1

31	28	27	26	25	24	23	22	21	20	19	18	17	16	15	12	11	7	6	5	4	3	0									
!=1111				0 0 0 1 1				0 1 0				(0)(0)(0)(0)				Rd				0 0 0 0 0				1 1 0				Rm			
cond								S												imm5				type							

MOV, rotate right with extend variant

RRX{<c>}{<q>} {<Rd>}, <Rm>

is equivalent to

MOV{<c>}{<q>} <Rd>, <Rm>, RRX

and is always the preferred disassembly.

T3

15	14	13	12	11	10	9	8	7	6	5	4	3	2	1	0	15	14	12	11	8	7	6	5	4	3	0					
1 1 1 0				1 0 1 0				0 1 1 1 1				(0)				0 0 0				Rd				0 0 1 1				Rm			
								S								imm3								imm2				type			

MOV, rotate right with extend variant

RRX{<c>}{<q>} {<Rd>}, <Rm>

is equivalent to

MOV{<c>}{<q>} <Rd>, <Rm>, RRX

and is always the preferred disassembly.

Assembler symbols

<c> See [Standard assembler syntax fields on page F2-2848](#).

<q> See [Standard assembler syntax fields on page F2-2848](#).

<Rd> For encoding A1: is the general-purpose destination register, encoded in the "Rd" field. ARM deprecates using the PC as the destination register, but if the PC is used, the instruction is a branch to the address calculated by the operation. This is an interworking branch, see [Pseudocode description of operations on the AArch32 general-purpose registers and the PC on page E1-2733](#).

For encoding T3: is the general-purpose destination register, encoded in the "Rd" field.

<Rm> For encoding A1: is the general-purpose source register, encoded in the "Rm" field. The PC can be used, but this is deprecated.

For encoding T3: is the general-purpose source register, encoded in the "Rm" field.

Operation for all encodings

The description of [MOV, MOVS \(register\)](#) gives the operational pseudocode for this instruction.

F5.1.161 RRXS

Rotate Right with Extend, setting flags provides the value of the contents of a register shifted right by one place, with the Carry flag shifted into bit[31].

If the destination register is not the PC, this instruction updates the condition flags based on the result, and bit[0] is shifted into the Carry flag.

The field descriptions for <Rd> identify the encodings where the PC is permitted as the destination register. ARM deprecates any use of these encodings. However, when the destination register is the PC:

- The PE branches to the address written to the PC, and restores [PSTATE](#) from SPSR_<current_mode>.
- The PE checks SPSR_<current_mode> for an illegal return event. See [Illegal return events from AArch32 state on page G1-4361](#).
- The instruction is UNDEFINED in Hyp mode.
- The instruction is CONSTRAINED UNPREDICTABLE in User mode and System mode.

This instruction is an alias of the [MOV, MOVS \(register\)](#) instruction. This means that:

- The encodings in this description are named to match the encodings of [MOV, MOVS \(register\)](#).
- The description of [MOV, MOVS \(register\)](#) gives the operational pseudocode for this instruction.

A1

31	28	27	26	25	24	23	22	21	20	19	18	17	16	15	12	11	7	6	5	4	3	0			
!=1111				0	0	0	1	1	0	1	1	(0)	(0)	(0)	(0)	Rd	0	0	0	0	0	1	1	0	Rm
cond				S								imm5					type								

MOVS, rotate right with extend variant

RRXS{<c>}{<q>} {<Rd>}, <Rm>

is equivalent to

MOVS{<c>}{<q>} <Rd>, <Rm>, RRX

and is always the preferred disassembly.

T3

15	14	13	12	11	10	9	8	7	6	5	4	3	2	1	0	15	14	12	11	8	7	6	5	4	3	0
1	1	1	0	1	0	1	0	0	1	0	1	1	1	1	1	(0)	0	0	0	Rd	0	0	1	1	Rm	
S																imm3			imm2 type							

MOVS, rotate right with extend variant

RRXS{<c>}{<q>} {<Rd>}, <Rm>

is equivalent to

MOVS{<c>}{<q>} <Rd>, <Rm>, RRX

and is always the preferred disassembly.

Assembler symbols

<c> See [Standard assembler syntax fields on page F2-2848](#).

- <q> See *Standard assembler syntax fields* on page F2-2848.
- <Rd> For encoding A1: is the general-purpose destination register, encoded in the "Rd" field. ARM deprecates using the PC as the destination register, but if the PC is used, the instruction performs an exception return, that restores [PSTATE](#) from SPSR_<current_mode>.
For encoding T3: is the general-purpose destination register, encoded in the "Rd" field.
- <Rm> For encoding A1: is the general-purpose source register, encoded in the "Rm" field. The PC can be used, but this is deprecated.
For encoding T3: is the general-purpose source register, encoded in the "Rm" field.

Operation for all encodings

The description of [MOV, MOVS \(register\)](#) gives the operational pseudocode for this instruction.

F5.1.162 RSB, RSBS (immediate)

Reverse Subtract (immediate) subtracts a register value from an immediate value, and writes the result to the destination register.

If the destination register is not the PC, the RSBS variant of the instruction updates the condition flags based on the result.

The field descriptions for <Rd> identify the encodings where the PC is permitted as the destination register. ARM deprecates any use of these encodings. However, when the destination register is the PC:

- The RSB variant of the instruction is an interworking branch, see *Pseudocode description of operations on the AArch32 general-purpose registers and the PC* on page E1-2733.
- The RSBS variant of the instruction performs an exception return without the use of the stack. In this case:
 - The PE branches to the address written to the PC, and restores `PSTATE` from `SPSR_<current_mode>`.
 - The PE checks `SPSR_<current_mode>` for an illegal return event. See *Illegal return events from AArch32 state* on page G1-4361.
 - The instruction is UNDEFINED in Hyp mode.
 - The instruction is CONSTRAINED UNPREDICTABLE in User mode and System mode.

A1

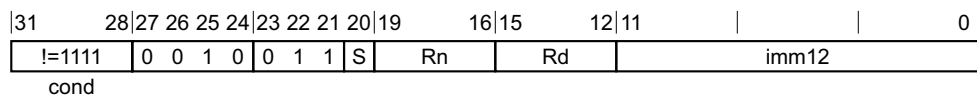

RSB variant

Applies when `S == 0`.

`RSB{<c>}{<q>} {<Rd>}, <Rn>, #<const>`

RSBS variant

Applies when `S == 1`.

`RSBS{<c>}{<q>} {<Rd>}, <Rn>, #<const>`

Decode for all variants of this encoding

`d = UInt(Rd); n = UInt(Rn); setflags = (S == '1'); imm32 = A32ExpandImm(imm12);`

T1

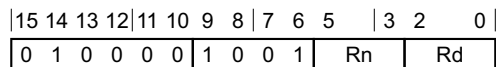

T1 variant

`RSB<c>{<q>} {<Rd>}, <Rn>, #0 // Inside IT block`

`RSBS{<q>} {<Rd>}, <Rn>, #0 // Outside IT block`

Decode for this encoding

`d = UInt(Rd); n = UInt(Rn); setflags = !InITBlock(); imm32 = Zeros(32); // immediate = #0`

T2

15	14	13	12	11	10	9	8	7	6	5	4	3	0	15	14	12	11	8	7					0
1	1	1	1	0	i	0	1	1	1	0	S	Rn	0	imm3	Rd									imm8

RSB variant

Applies when S == 0.

RSB<c>.W {<Rd>}, <Rn>, #0 // Inside IT block
 RSB{<c>}{<q>} {<Rd>}, <Rn>, #<const>

RSBS variant

Applies when S == 1.

RSBS.W {<Rd>}, <Rn>, #0 // Outside IT block
 RSBS{<c>}{<q>} {<Rd>}, <Rn>, #<const>

Decode for all variants of this encoding

```
d = UInt(Rd); n = UInt(Rn); setflags = (S == '1'); imm32 = T32ExpandImm(i:imm3:imm8);
if d == 15 || n == 15 then UNPREDICTABLE; // ARMv8-A removes UNPREDICTABLE for R13
```

Notes for all encodings

For more information about the CONSTRAINED UNPREDICTABLE behavior of this instruction, see [Appendix K1 Architectural Constraints on UNPREDICTABLE behaviors](#).

Assembler symbols

<c> See [Standard assembler syntax fields on page F2-2848](#).

<q> See [Standard assembler syntax fields on page F2-2848](#).

<Rd> For encoding A1: is the general-purpose destination register, encoded in the "Rd" field. If omitted, this register is the same as <Rn>. ARM deprecates using the PC as the destination register, but if the PC is used:

- For the RSB variant, the instruction is a branch to the address calculated by the operation. This is an interworking branch, see [Pseudocode description of operations on the AArch32 general-purpose registers and the PC on page E1-2733](#).
- For the RSBS variant, the instruction performs an exception return, that restores PSTATE from SPSR_<current_mode>.

For encoding T1 and T2: is the general-purpose destination register, encoded in the "Rd" field. If omitted, this register is the same as <Rn>.

<Rn> For encoding A1: is the general-purpose source register, encoded in the "Rn" field. The PC can be used, but this is deprecated.

For encoding T1 and T2: is the general-purpose source register, encoded in the "Rn" field.

<const> For encoding A1: an immediate value. See [Modified immediate constants in A32 instructions on page F2-2864](#) for the range of values.

For encoding T2: an immediate value. See [Modified immediate constants in T32 instructions on page F2-2863](#) for the range of values.

Operation for all encodings

```
if ConditionPassed() then
    EncodingSpecificOperations();
    (result, nzcvc) = AddWithCarry(NOT(R[n]), imm32, '1');
    if d == 15 then // Can only occur for A32 encoding
        if setflags then
            ALUExceptionReturn(result);
        else
            ALUWritePC(result);
    else
        R[d] = result;
        if setflags then
            PSTATE.<N,Z,C,V> = nzcvc;
```

F5.1.163 RSB, RSBS (register)

Reverse Subtract (register) subtracts a register value from an optionally-shifted register value, and writes the result to the destination register.

If the destination register is not the PC, the RSBS variant of the instruction updates the condition flags based on the result.

The field descriptions for <Rd> identify the encodings where the PC is permitted as the destination register. ARM deprecates any use of these encodings. However, when the destination register is the PC:

- The RSB variant of the instruction is an interworking branch, see *Pseudocode description of operations on the AArch32 general-purpose registers and the PC* on page E1-2733.
- The RSBS variant of the instruction performs an exception return without the use of the stack. In this case:
 - The PE branches to the address written to the PC, and restores `PSTATE` from `SPSR_<current_mode>`.
 - The PE checks `SPSR_<current_mode>` for an illegal return event. See *Illegal return events from AArch32 state* on page G1-4361.
 - The instruction is UNDEFINED in Hyp mode.
 - The instruction is CONSTRAINED UNPREDICTABLE in User mode and System mode.

A1

31	28 27 26 25 24 23 22 21 20 19	16 15	12 11	7 6 5 4 3	0
!=1111	0 0 0 0 0 1 1 S	Rn	Rd	imm5	type 0 Rm
cond					

RSB, rotate right with extend variant

Applies when `S == 0` && `imm5 == 00000` && `type == 11`.

`RSB{<c>}{<q>} {<Rd>}, <Rn>, <Rm>, RRX`

RSB, shift or rotate by value variant

Applies when `S == 0` && `!(imm5 == 00000 && type == 11)`.

`RSB{<c>}{<q>} {<Rd>}, <Rn>, <Rm> {, <shift> #<amount>}`

RSBS, rotate right with extend variant

Applies when `S == 1` && `imm5 == 00000` && `type == 11`.

`RSBS{<c>}{<q>} {<Rd>}, <Rn>, <Rm>, RRX`

RSBS, shift or rotate by value variant

Applies when `S == 1` && `!(imm5 == 00000 && type == 11)`.

`RSBS{<c>}{<q>} {<Rd>}, <Rn>, <Rm> {, <shift> #<amount>}`

Decode for all variants of this encoding

```
d = UInt(Rd); n = UInt(Rn); m = UInt(Rm); setflags = (S == '1');
(shift_t, shift_n) = DecodeImmShift(type, imm5);
```

T1

15	14	13	12	11	10	9	8	7	6	5	4	3	0	15	14	12	11	8	7	6	5	4	3	0
1	1	1	0	1	0	1	1	1	1	0	S	Rn	(0)	imm3	Rd	imm2	type	Rm						

RSB, rotate right with extend variant

Applies when $S == 0$ && $imm3 == 000$ && $imm2 == 00$ && $type == 11$.

RSB{<c>}{<q>} {<Rd>}, <Rn>, <Rm>, RRX

RSB, shift or rotate by value variant

Applies when $S == 0$ && $!(imm3 == 000$ && $imm2 == 00$ && $type == 11)$.

RSB{<c>}{<q>} {<Rd>}, <Rn>, <Rm> {, <shift> #<amount>}

RSBS, rotate right with extend variant

Applies when $S == 1$ && $imm3 == 000$ && $imm2 == 00$ && $type == 11$.

RSBS{<c>}{<q>} {<Rd>}, <Rn>, <Rm>, RRX

RSBS, shift or rotate by value variant

Applies when $S == 1$ && $!(imm3 == 000$ && $imm2 == 00$ && $type == 11)$.

RSBS{<c>}{<q>} {<Rd>}, <Rn>, <Rm> {, <shift> #<amount>}

Decode for all variants of this encoding

```
d = UInt(Rd); n = UInt(Rn); m = UInt(Rm); setFlags = (S == '1');
(shift_t, shift_n) = DecodeImmShift(type, imm3:imm2);
if d == 15 || n == 15 || m == 15 then UNPREDICTABLE; // ARMv8-A removes UNPREDICTABLE for R13
```

Notes for all encodings

For more information about the CONSTRAINED UNPREDICTABLE behavior of this instruction, see [Appendix K1 Architectural Constraints on UNPREDICTABLE behaviors](#).

Assembler symbols

<c> See [Standard assembler syntax fields on page F2-2848](#).

<q> See [Standard assembler syntax fields on page F2-2848](#).

<Rd> For encoding A1: is the general-purpose destination register, encoded in the "Rd" field. If omitted, this register is the same as <Rn>. ARM deprecates using the PC as the destination register, but if the PC is used:

- For the RSB variant, the instruction is a branch to the address calculated by the operation. This is an interworking branch, see [Pseudocode description of operations on the AArch32 general-purpose registers and the PC on page E1-2733](#).
- For the RSBS variant, the instruction performs an exception return, that restores PSTATE from SPSR_<current_mode>.

For encoding T1: is the general-purpose destination register, encoded in the "Rd" field. If omitted, this register is the same as <Rn>.

<Rn> For encoding A1: is the first general-purpose source register, encoded in the "Rn" field. The PC can be used, but this is deprecated.

For encoding T1: is the first general-purpose source register, encoded in the "Rn" field.

- <Rm> For encoding A1: is the second general-purpose source register, encoded in the "Rm" field. The PC can be used, but this is deprecated.
For encoding T1: is the second general-purpose source register, encoded in the "Rm" field.
- <shift> Is the type of shift to be applied to the second source register, encoded in the "type" field. It can have the following values:
- | | |
|-----|----------------|
| LSL | when type = 00 |
| LSR | when type = 01 |
| ASR | when type = 10 |
| ROR | when type = 11 |
- <amount> For encoding A1: is the shift amount, in the range 1 to 31 (when <shift> = LSL or ROR) or 1 to 32 (when <shift> = LSR or ASR) encoded in the "imm5" field as <amount> modulo 32.
For encoding T1: is the shift amount, in the range 1 to 31 (when <shift> = LSL or ROR) or 1 to 32 (when <shift> = LSR or ASR) encoded in the "imm3:imm2" field as <amount> modulo 32.

Operation for all encodings

```
if ConditionPassed() then
    EncodingSpecificOperations();
    shifted = Shift(R[m], shift_t, shift_n, PSTATE.C);
    (result, nzcV) = AddWithCarry(NOT(R[n]), shifted, '1');
    if d == 15 then // Can only occur for A32 encoding
        if setflags then
            ALUExceptionReturn(result);
        else
            ALUWritePC(result);
    else
        R[d] = result;
        if setflags then
            PSTATE.<N,Z,C,V> = nzcV;
```

F5.1.164 RSB, RSBS (register-shifted register)

Reverse Subtract (register-shifted register) subtracts a register value from a register-shifted register value, and writes the result to the destination register. It can optionally update the condition flags based on the result.

A1

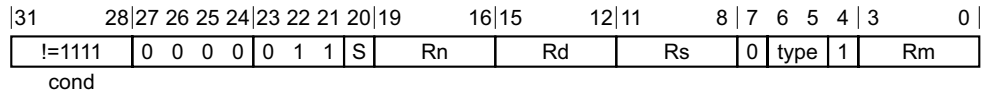

Flag setting variant

Applies when S == 1.

RSBS{<c>}{<q>} {<Rd>}, <Rn>, <Rm>, <type> <Rs>

Not flag setting variant

Applies when S == 0.

RSB{<c>}{<q>} {<Rd>}, <Rn>, <Rm>, <type> <Rs>

Decode for all variants of this encoding

```
d = UInt(Rd); n = UInt(Rn); m = UInt(Rm); s = UInt(Rs);
setflags = (S == '1'); shift_t = DecodeRegShift(type);
if d == 15 || n == 15 || m == 15 || s == 15 then UNPREDICTABLE;
```

Notes for all encodings

For more information about the CONSTRAINED UNPREDICTABLE behavior of this instruction, see [Appendix K1 Architectural Constraints on UNPREDICTABLE behaviors](#).

Assembler symbols

- <c> See [Standard assembler syntax fields on page F2-2848](#).
- <q> See [Standard assembler syntax fields on page F2-2848](#).
- <Rd> Is the general-purpose destination register, encoded in the "Rd" field.
- <Rn> Is the first general-purpose source register, encoded in the "Rn" field.
- <Rm> Is the second general-purpose source register, encoded in the "Rm" field.
- <type> Is the type of shift to be applied to the second source register, encoded in the "type" field. It can have the following values:
 - LSL when type = 00
 - LSR when type = 01
 - ASR when type = 10
 - ROR when type = 11
- <Rs> Is the third general-purpose source register holding a shift amount in its bottom 8 bits, encoded in the "Rs" field.

Operation

```
if ConditionPassed() then
    EncodingSpecificOperations();
    shift_n = UInt(R[s]<7:0>);
    shifted = Shift(R[m], shift_t, shift_n, PSTATE.C);
    (result, nzcvc) = AddWithCarry(NOT(R[n]), shifted, '1');
    R[d] = result;
    if setflags then
        PSTATE.<N,Z,C,V> = nzcvc;
```

F5.1.165 RSC, RSCS (immediate)

Reverse Subtract with Carry (immediate) subtracts a register value and the value of NOT (Carry flag) from an immediate value, and writes the result to the destination register.

If the destination register is not the PC, the RSCS variant of the instruction updates the condition flags based on the result.

The field descriptions for <Rd> identify the encodings where the PC is permitted as the destination register. ARM deprecates any use of these encodings. However, when the destination register is the PC:

- The RSC variant of the instruction is an interworking branch, see *Pseudocode description of operations on the AArch32 general-purpose registers and the PC* on page E1-2733.
- The RSCS variant of the instruction performs an exception return without the use of the stack. In this case:
 - The PE branches to the address written to the PC, and restores `PSTATE` from `SPSR_<current_mode>`.
 - The PE checks `SPSR_<current_mode>` for an illegal return event. See *Illegal return events from AArch32 state* on page G1-4361.
 - The instruction is UNDEFINED in Hyp mode.
 - The instruction is CONSTRAINED UNPREDICTABLE in User mode and System mode.

A1

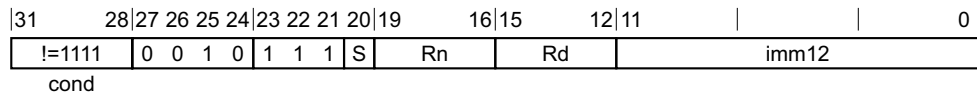

RSC variant

Applies when `S == 0`.

RSC{<c>}{<q>} {<Rd>}, <Rn>, #<const>

RSCS variant

Applies when `S == 1`.

RSCS{<c>}{<q>} {<Rd>}, <Rn>, #<const>

Decode for all variants of this encoding

`d = UInt(Rd); n = UInt(Rn); setflags = (S == '1');` `imm32 = A32ExpandImm(imm12);`

Assembler symbols

- <c> See *Standard assembler syntax fields* on page F2-2848.
- <q> See *Standard assembler syntax fields* on page F2-2848.
- <Rd> Is the general-purpose destination register, encoded in the "Rd" field. If omitted, this register is the same as <Rn>. ARM deprecates using the PC as the destination register, but if the PC is used:
 - For the RSC variant, the instruction is a branch to the address calculated by the operation. This is an interworking branch, see *Pseudocode description of operations on the AArch32 general-purpose registers and the PC* on page E1-2733.
 - For the RSCS variant, the instruction performs an exception return, that restores `PSTATE` from `SPSR_<current_mode>`.
- <Rn> Is the general-purpose source register, encoded in the "Rn" field. The PC can be used, but this is deprecated.

<const> An immediate value. See *Modified immediate constants in A32 instructions* on page F2-2864 for the range of values.

Operation

```
if ConditionPassed() then
    EncodingSpecificOperations();
    (result, nzcvc) = AddWithCarry(NOT(R[n]), imm32, PSTATE.C);
    if d == 15 then
        if setflags then
            ALUExceptionReturn(result);
        else
            ALUWritePC(result);
    else
        R[d] = result;
        if setflags then
            PSTATE.<N,Z,C,V> = nzcvc;
```

F5.1.166 RSC, RSCS (register)

Reverse Subtract with Carry (register) subtracts a register value and the value of NOT (Carry flag) from an optionally-shifted register value, and writes the result to the destination register.

If the destination register is not the PC, the RSCS variant of the instruction updates the condition flags based on the result.

The field descriptions for <Rd> identify the encodings where the PC is permitted as the destination register. ARM deprecates any use of these encodings. However, when the destination register is the PC:

- The RSC variant of the instruction is an interworking branch, see *Pseudocode description of operations on the AArch32 general-purpose registers and the PC* on page E1-2733.
- The RSCS variant of the instruction performs an exception return without the use of the stack. In this case:
 - The PE branches to the address written to the PC, and restores `PSTATE` from `SPSR_<current_mode>`.
 - The PE checks `SPSR_<current_mode>` for an illegal return event. See *Illegal return events from AArch32 state* on page G1-4361.
 - The instruction is UNDEFINED in Hyp mode.
 - The instruction is CONSTRAINED UNPREDICTABLE in User mode and System mode.

A1

31	28	27	26	25	24	23	22	21	20	19	16	15	12	11	7	6	5	4	3	0
!=1111				0	0	0	0	1	1	1	S	Rn	Rd	imm5	type	0	Rm			
cond																				

RSC, rotate right with extend variant

Applies when `S == 0` && `imm5 == 00000` && `type == 11`.

`RSC{<c>}{<q>} {<Rd>}, <Rn>, <Rm>, RRX`

RSC, shift or rotate by value variant

Applies when `S == 0` && `!(imm5 == 00000 && type == 11)`.

`RSC{<c>}{<q>} {<Rd>}, <Rn>, <Rm> {, <shift> #<amount>}`

RSCS, rotate right with extend variant

Applies when `S == 1` && `imm5 == 00000` && `type == 11`.

`RSCS{<c>}{<q>} {<Rd>}, <Rn>, <Rm>, RRX`

RSCS, shift or rotate by value variant

Applies when `S == 1` && `!(imm5 == 00000 && type == 11)`.

`RSCS{<c>}{<q>} {<Rd>}, <Rn>, <Rm> {, <shift> #<amount>}`

Decode for all variants of this encoding

```
d = UInt(Rd); n = UInt(Rn); m = UInt(Rm); setFlags = (S == '1');
(shift_t, shift_n) = DecodeImmShift(type, imm5);
```

Assembler symbols

<c> See *Standard assembler syntax fields* on page F2-2848.

<q> See *Standard assembler syntax fields* on page F2-2848.

<Rd>	Is the general-purpose destination register, encoded in the "Rd" field. If omitted, this register is the same as <Rn>. ARM deprecates using the PC as the destination register, but if the PC is used: <ul style="list-style-type: none">For the RSC variant, the instruction is a branch to the address calculated by the operation. This is an interworking branch, see Pseudocode description of operations on the AArch32 general-purpose registers and the PC on page E1-2733.For the RSCS variant, the instruction performs an exception return, that restores PSTATE from <code>SPSR_<current_mode></code>.								
<Rn>	Is the first general-purpose source register, encoded in the "Rn" field. The PC can be used, but this is deprecated.								
<Rm>	Is the second general-purpose source register, encoded in the "Rm" field. The PC can be used, but this is deprecated.								
<shift>	Is the type of shift to be applied to the second source register, encoded in the "type" field. It can have the following values: <table><tr><td>LSL</td><td>when type = 00</td></tr><tr><td>LSR</td><td>when type = 01</td></tr><tr><td>ASR</td><td>when type = 10</td></tr><tr><td>ROR</td><td>when type = 11</td></tr></table>	LSL	when type = 00	LSR	when type = 01	ASR	when type = 10	ROR	when type = 11
LSL	when type = 00								
LSR	when type = 01								
ASR	when type = 10								
ROR	when type = 11								
<amount>	Is the shift amount, in the range 1 to 31 (when <shift> = LSL or ROR) or 1 to 32 (when <shift> = LSR or ASR) encoded in the "imm5" field as <amount> modulo 32.								

Operation

```
if ConditionPassed() then
    EncodingSpecificOperations();
    shifted = Shift(R[m], shift_t, shift_n, PSTATE.C);
    (result, nzcV) = AddWithCarry(NOT(R[n]), shifted, PSTATE.C);
    if d == 15 then
        if setflags then
            ALUExceptionReturn(result);
        else
            ALUWritePC(result);
    else
        R[d] = result;
        if setflags then
            PSTATE.<N,Z,C,V> = nzcV;
```

F5.1.167 RSC, RSCS (register-shifted register)

Reverse Subtract (register-shifted register) subtracts a register value and the value of NOT (Carry flag) from a register-shifted register value, and writes the result to the destination register. It can optionally update the condition flags based on the result.

A1

31	28	27	26	25	24	23	22	21	20	19	16	15	12	11	8	7	6	5	4	3	0			
!=1111				0 0 0 0				1 1 1		S	Rn			Rd			Rs			0	type	1	Rm	
cond																								

Flag setting variant

Applies when S == 1.

RSCS{<c>}{<q>} {<Rd>}, <Rn>, <Rm>, <type> <Rs>

Not flag setting variant

Applies when S == 0.

RSC{<c>}{<q>} {<Rd>}, <Rn>, <Rm>, <type> <Rs>

Decode for all variants of this encoding

```
d = UInt(Rd); n = UInt(Rn); m = UInt(Rm); s = UInt(Rs);
setflags = (S == '1'); shift_t = DecodeRegShift(type);
if d == 15 || n == 15 || m == 15 || s == 15 then UNPREDICTABLE;
```

Notes for all encodings

For more information about the CONSTRAINED UNPREDICTABLE behavior of this instruction, see [Appendix K1 Architectural Constraints on UNPREDICTABLE behaviors](#).

Assembler symbols

<c>	See Standard assembler syntax fields on page F2-2848 .								
<q>	See Standard assembler syntax fields on page F2-2848 .								
<Rd>	Is the general-purpose destination register, encoded in the "Rd" field.								
<Rn>	Is the first general-purpose source register, encoded in the "Rn" field.								
<Rm>	Is the second general-purpose source register, encoded in the "Rm" field.								
<type>	Is the type of shift to be applied to the second source register, encoded in the "type" field. It can have the following values: <table style="margin-left: 20px;"> <tr> <td>LSL</td> <td>when type = 00</td> </tr> <tr> <td>LSR</td> <td>when type = 01</td> </tr> <tr> <td>ASR</td> <td>when type = 10</td> </tr> <tr> <td>ROR</td> <td>when type = 11</td> </tr> </table>	LSL	when type = 00	LSR	when type = 01	ASR	when type = 10	ROR	when type = 11
LSL	when type = 00								
LSR	when type = 01								
ASR	when type = 10								
ROR	when type = 11								
<Rs>	Is the third general-purpose source register holding a shift amount in its bottom 8 bits, encoded in the "Rs" field.								

Operation

```
if ConditionPassed() then
    EncodingSpecificOperations();
    shift_n = UInt(R[s]<7:0>);
    shifted = Shift(R[m], shift_t, shift_n, PSTATE.C);
    (result, nzcvc) = AddWithCarry(NOT(R[n]), shifted, PSTATE.C);
    R[d] = result;
    if setflags then
        PSTATE.<N,Z,C,V> = nzcvc;
```

F5.1.168 SADD16

Signed Add 16 performs two 16-bit signed integer additions, and writes the results to the destination register. It sets [PSTATE.GE](#) according to the results of the additions.

A1

31	28	27	26	25	24	23	22	21	20	19	16	15	12	11	10	9	8	7	6	5	4	3	0
!=1111				0	1	1	0	0	0	0	1	Rn	Rd	(1)	(1)	(1)	(1)	0	0	0	1	Rm	
cond																							

A1 variant

SADD16{<c>}{<q>} {<Rd>}, <Rn>, <Rm>

Decode for this encoding

```
d = UInt(Rd); n = UInt(Rn); m = UInt(Rm);
if d == 15 || n == 15 || m == 15 then UNPREDICTABLE;
```

T1

15	14	13	12	11	10	9	8	7	6	5	4	3	0	15	14	13	12	11	8	7	6	5	4	3	0
1	1	1	1	1	0	1	0	1	0	0	1	Rn	1	1	1	1	Rd	0	0	0	0	Rm			

T1 variant

SADD16{<c>}{<q>} {<Rd>}, <Rn>, <Rm>

Decode for this encoding

```
d = UInt(Rd); n = UInt(Rn); m = UInt(Rm);
if d == 15 || n == 15 || m == 15 then UNPREDICTABLE; // ARMv8-A removes UNPREDICTABLE for R13
```

Notes for all encodings

For more information about the [CONSTRAINED UNPREDICTABLE](#) behavior of this instruction, see [Appendix K1 Architectural Constraints on UNPREDICTABLE behaviors](#).

Assembler symbols

- <c> See [Standard assembler syntax fields on page F2-2848](#).
- <q> See [Standard assembler syntax fields on page F2-2848](#).
- <Rd> Is the general-purpose destination register, encoded in the "Rd" field.
- <Rn> Is the first general-purpose source register, encoded in the "Rn" field.
- <Rm> Is the second general-purpose source register, encoded in the "Rm" field.

Operation for all encodings

```
if ConditionPassed() then
  EncodingSpecificOperations();
  sum1 = SInt(R[n]<15:0>) + SInt(R[m]<15:0>);
  sum2 = SInt(R[n]<31:16>) + SInt(R[m]<31:16>);
  R[d]<15:0> = sum1<15:0>;
```

```
R[d]<31:16> = sum2<15:0>;  
PSTATE.GE<1:0> = if sum1 >= 0 then '11' else '00';  
PSTATE.GE<3:2> = if sum2 >= 0 then '11' else '00';
```

F5.1.169 SADD8

Signed Add 8 performs four 8-bit signed integer additions, and writes the results to the destination register. It sets [PSTATE.GE](#) according to the results of the additions.

A1

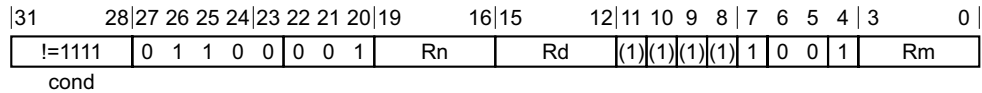

A1 variant

SADD8{<c>}{<q>} {<Rd>}, {<Rn>}, <Rm>

Decode for this encoding

```
d = UInt(Rd); n = UInt(Rn); m = UInt(Rm);
if d == 15 || n == 15 || m == 15 then UNPREDICTABLE;
```

T1

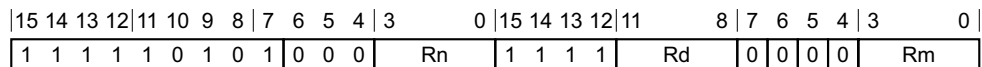

T1 variant

SADD8{<c>}{<q>} {<Rd>}, {<Rn>}, <Rm>

Decode for this encoding

```
d = UInt(Rd); n = UInt(Rn); m = UInt(Rm);
if d == 15 || n == 15 || m == 15 then UNPREDICTABLE; // ARMv8-A removes UNPREDICTABLE for R13
```

Notes for all encodings

For more information about the [CONSTRAINED UNPREDICTABLE](#) behavior of this instruction, see [Appendix K1 Architectural Constraints on UNPREDICTABLE behaviors](#).

Assembler symbols

- <c> See [Standard assembler syntax fields on page F2-2848](#).
- <q> See [Standard assembler syntax fields on page F2-2848](#).
- <Rd> Is the general-purpose destination register, encoded in the "Rd" field.
- <Rn> Is the first general-purpose source register, encoded in the "Rn" field.
- <Rm> Is the second general-purpose source register, encoded in the "Rm" field.

Operation for all encodings

```
if ConditionPassed() then
    EncodingSpecificOperations();
    sum1 = SInt(R[n]<7:0>) + SInt(R[m]<7:0>);
    sum2 = SInt(R[n]<15:8>) + SInt(R[m]<15:8>);
    sum3 = SInt(R[n]<23:16>) + SInt(R[m]<23:16>);
```



```
sum4 = SInt(R[n]<31:24>) + SInt(R[m]<31:24>);  
R[d]<7:0> = sum1<7:0>;  
R[d]<15:8> = sum2<7:0>;  
R[d]<23:16> = sum3<7:0>;  
R[d]<31:24> = sum4<7:0>;  
PSTATE.GE<0> = if sum1 >= 0 then '1' else '0';  
PSTATE.GE<1> = if sum2 >= 0 then '1' else '0';  
PSTATE.GE<2> = if sum3 >= 0 then '1' else '0';  
PSTATE.GE<3> = if sum4 >= 0 then '1' else '0';
```

F5.1.170 SASX

Signed Add and Subtract with Exchange exchanges the two halfwords of the second operand, performs one 16-bit integer addition and one 16-bit subtraction, and writes the results to the destination register. It sets `PSTATE.GE` according to the results.

A1

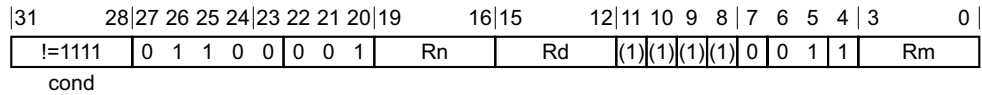

A1 variant

SASX{<c>}{<q>} {<Rd>}, <Rn>, <Rm>

Decode for this encoding

```
d = UInt(Rd); n = UInt(Rn); m = UInt(Rm);
if d == 15 || n == 15 || m == 15 then UNPREDICTABLE;
```

T1

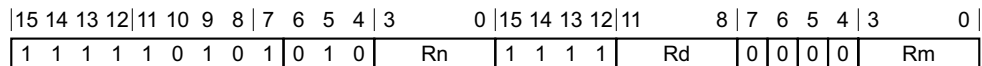

T1 variant

SASX{<c>}{<q>} {<Rd>}, <Rn>, <Rm>

Decode for this encoding

```
d = UInt(Rd); n = UInt(Rn); m = UInt(Rm);
if d == 15 || n == 15 || m == 15 then UNPREDICTABLE; // ARMv8-A removes UNPREDICTABLE for R13
```

Notes for all encodings

For more information about the `CONSTRAINED UNPREDICTABLE` behavior of this instruction, see [Appendix K1 Architectural Constraints on UNPREDICTABLE behaviors](#).

Assembler symbols

- <c> See [Standard assembler syntax fields on page F2-2848](#).
- <q> See [Standard assembler syntax fields on page F2-2848](#).
- <Rd> Is the general-purpose destination register, encoded in the "Rd" field.
- <Rn> Is the first general-purpose source register, encoded in the "Rn" field.
- <Rm> Is the second general-purpose source register, encoded in the "Rm" field.

Operation for all encodings

```
if ConditionPassed() then
    EncodingSpecificOperations();
diff = SInt(R[n]<15:0>) - SInt(R[m]<31:16>);
sum = SInt(R[n]<31:16>) + SInt(R[m]<15:0>);
```

```
R[d]<15:0> = diff<15:0>;  
R[d]<31:16> = sum<15:0>;  
PSTATE.GE<1:0> = if diff >= 0 then '11' else '00';  
PSTATE.GE<3:2> = if sum >= 0 then '11' else '00';
```

F5.1.171 SBC, SBCS (immediate)

Subtract with Carry (immediate) subtracts an immediate value and the value of NOT (Carry flag) from a register value, and writes the result to the destination register.

If the destination register is not the PC, the SBCS variant of the instruction updates the condition flags based on the result.

The field descriptions for <Rd> identify the encodings where the PC is permitted as the destination register. ARM deprecates any use of these encodings. However, when the destination register is the PC:

- The SBC variant of the instruction is an interworking branch, see [Pseudocode description of operations on the AArch32 general-purpose registers and the PC on page E1-2733](#).
- The SBCS variant of the instruction performs an exception return without the use of the stack. In this case:
 - The PE branches to the address written to the PC, and restores `PSTATE` from `SPSR_<current_mode>`.
 - The PE checks `SPSR_<current_mode>` for an illegal return event. See [Illegal return events from AArch32 state on page G1-4361](#).
 - The instruction is UNDEFINED in Hyp mode.
 - The instruction is CONSTRAINED UNPREDICTABLE in User mode and System mode.

A1

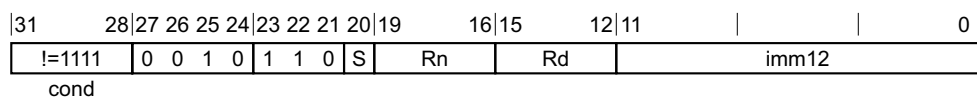

SBC variant

Applies when `S == 0`.

`SBC{<c>}{<q>} {<Rd>}, <Rn>, #<const>`

SBCS variant

Applies when `S == 1`.

`SBCS{<c>}{<q>} {<Rd>}, <Rn>, #<const>`

Decode for all variants of this encoding

`d = UInt(Rd); n = UInt(Rn); setflags = (S == '1');` `imm32 = A32ExpandImm(imm12);`

T1

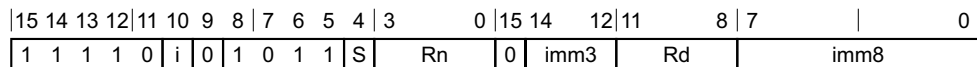

SBC variant

Applies when `S == 0`.

`SBC{<c>}{<q>} {<Rd>}, <Rn>, #<const>`

SBCS variant

Applies when `S == 1`.

SBCS{<c>}{<q>} {<Rd>}, <Rn>, #<const>

Decode for all variants of this encoding

```
d = UInt(Rd); n = UInt(Rn); setflags = (S == '1'); imm32 = T32ExpandImm(i:imm3:imm8);  
if d == 15 || n == 15 then UNPREDICTABLE; // ARMv8-A removes UNPREDICTABLE for R13
```

Notes for all encodings

For more information about the CONSTRAINED UNPREDICTABLE behavior of this instruction, see [Appendix K1 Architectural Constraints on UNPREDICTABLE behaviors](#).

Assembler symbols

<c>	See Standard assembler syntax fields on page F2-2848 .
<q>	See Standard assembler syntax fields on page F2-2848 .
<Rd>	For encoding A1: is the general-purpose destination register, encoded in the "Rd" field. If omitted, this register is the same as <Rn>. ARM deprecates using the PC as the destination register, but if the PC is used: <ul style="list-style-type: none">For the SBC variant, the instruction is a branch to the address calculated by the operation. This is an interworking branch, see Pseudocode description of operations on the AArch32 general-purpose registers and the PC on page E1-2733.For the SBCS variant, the instruction performs an exception return, that restores PSTATE from SPSR_<current_mode>. For encoding T1: is the general-purpose destination register, encoded in the "Rd" field. If omitted, this register is the same as <Rn>.
<Rn>	For encoding A1: is the general-purpose source register, encoded in the "Rn" field. The PC can be used, but this is deprecated. For encoding T1: is the general-purpose source register, encoded in the "Rn" field.
<const>	For encoding A1: an immediate value. See Modified immediate constants in A32 instructions on page F2-2864 for the range of values. For encoding T1: an immediate value. See Modified immediate constants in T32 instructions on page F2-2863 for the range of values.

Operation for all encodings

```
if ConditionPassed() then  
  EncodingSpecificOperations();  
  (result, nzcV) = AddWithCarry(R[n], NOT(imm32), PSTATE.C);  
  if d == 15 then // Can only occur for A32 encoding  
    if setflags then  
      ALUExceptionReturn(result);  
    else  
      ALUWritePC(result);  
  else  
    R[d] = result;  
    if setflags then  
      PSTATE.<N,Z,C,V> = nzcV;
```

F5.1.172 SBC, SBCS (register)

Subtract with Carry (register) subtracts an optionally-shifted register value and the value of NOT (Carry flag) from a register value, and writes the result to the destination register.

If the destination register is not the PC, the SBCS variant of the instruction updates the condition flags based on the result.

The field descriptions for <Rd> identify the encodings where the PC is permitted as the destination register. ARM deprecates any use of these encodings. However, when the destination register is the PC:

- The SBC variant of the instruction is an interworking branch, see *Pseudocode description of operations on the AArch32 general-purpose registers and the PC* on page E1-2733.
- The SBCS variant of the instruction performs an exception return without the use of the stack. In this case:
 - The PE branches to the address written to the PC, and restores `PSTATE` from `SPSR_<current_mode>`.
 - The PE checks `SPSR_<current_mode>` for an illegal return event. See *Illegal return events from AArch32 state* on page G1-4361.
 - The instruction is UNDEFINED in Hyp mode.
 - The instruction is CONSTRAINED UNPREDICTABLE in User mode and System mode.

A1

31	28	27	26	25	24	23	22	21	20	19	16	15	12	11	7	6	5	4	3	0
!=1111				0	0	0	0	1	1	0	S	Rn	Rd	imm5	type	0	Rm			
cond																				

SBC, rotate right with extend variant

Applies when `S == 0` && `imm5 == 00000` && `type == 11`.

`SBC{<c>}{<q>} {<Rd>}, <Rn>, <Rm>, RRX`

SBC, shift or rotate by value variant

Applies when `S == 0` && `!(imm5 == 00000 && type == 11)`.

`SBC{<c>}{<q>} {<Rd>}, <Rn>, <Rm> {, <shift> #<amount>}`

SBCS, rotate right with extend variant

Applies when `S == 1` && `imm5 == 00000` && `type == 11`.

`SBCS{<c>}{<q>} {<Rd>}, <Rn>, <Rm>, RRX`

SBCS, shift or rotate by value variant

Applies when `S == 1` && `!(imm5 == 00000 && type == 11)`.

`SBCS{<c>}{<q>} {<Rd>}, <Rn>, <Rm> {, <shift> #<amount>}`

Decode for all variants of this encoding

```
d = UInt(Rd); n = UInt(Rn); m = UInt(Rm); setflags = (S == '1');
(shift_t, shift_n) = DecodeImmShift(type, imm5);
```

T1

15	14	13	12	11	10	9	8	7	6	5	3	2	0
0	1	0	0	0	0	0	1	1	0	Rm	Rdn		

T1 variant

SBC<c>{<q>} {<Rdn>}, <Rdn>, <Rm> // Inside IT block
 SBCS{<q>} {<Rdn>}, <Rdn>, <Rm> // Outside IT block

Decode for this encoding

```
d = UInt(Rdn); n = UInt(Rdn); m = UInt(Rm); setFlags = !InITBlock();
(shift_t, shift_n) = (SRTYPE_LSL, 0);
```

T2

15	14	13	12	11	10	9	8	7	6	5	4	3	0	15	14	12	11	8	7	6	5	4	3	0
1	1	1	0	1	0	1	1	0	1	1	S	Rn	(0)	imm3	Rd	imm2	type	Rm						

SBC, rotate right with extend variant

Applies when S == 0 && imm3 == 000 && imm2 == 00 && type == 11.

SBC{<c>}{<q>} {<Rd>}, <Rn>, <Rm>, RRX

SBC, shift or rotate by value variant

Applies when S == 0 && !(imm3 == 000 && imm2 == 00 && type == 11).

SBC<c>.W {<Rd>}, <Rn>, <Rm> // Inside IT block, and <Rd>, <Rn>, <Rm> can be represented in T1
 SBC{<c>}{<q>} {<Rd>}, <Rn>, <Rm> {, <shift> #<amount>}

SBCS, rotate right with extend variant

Applies when S == 1 && imm3 == 000 && imm2 == 00 && type == 11.

SBCS{<c>}{<q>} {<Rd>}, <Rn>, <Rm>, RRX

SBCS, shift or rotate by value variant

Applies when S == 1 && !(imm3 == 000 && imm2 == 00 && type == 11).

SBCS.W {<Rd>}, <Rn>, <Rm> // Outside IT block, and <Rd>, <Rn>, <Rm> can be represented in T1
 SBCS{<c>}{<q>} {<Rd>}, <Rn>, <Rm> {, <shift> #<amount>}

Decode for all variants of this encoding

```
d = UInt(Rd); n = UInt(Rn); m = UInt(Rm); setFlags = (S == '1');
(shift_t, shift_n) = DecodeImmShift(type, imm3:imm2);
if d == 15 || n == 15 || m == 15 then UNPREDICTABLE; // ARMv8-A removes UNPREDICTABLE for R13
```

Notes for all encodings

For more information about the CONSTRAINED UNPREDICTABLE behavior of this instruction, see [Appendix K1 Architectural Constraints on UNPREDICTABLE behaviors](#).

Assembler symbols

<c>	See Standard assembler syntax fields on page F2-2848 .								
<q>	See Standard assembler syntax fields on page F2-2848 .								
<Rdn>	Is the first general-purpose source register and the destination register, encoded in the "Rdn" field.								
<Rd>	For encoding A1: is the general-purpose destination register, encoded in the "Rd" field. If omitted, this register is the same as <Rn>. ARM deprecates using the PC as the destination register, but if the PC is used: <ul style="list-style-type: none">For the SBC variant, the instruction is a branch to the address calculated by the operation. This is an interworking branch, see Pseudocode description of operations on the AArch32 general-purpose registers and the PC on page E1-2733.For the SBCS variant, the instruction performs an exception return, that restores PSTATE from SPSR_<current_mode>. For encoding T2: is the general-purpose destination register, encoded in the "Rd" field. If omitted, this register is the same as <Rn>.								
<Rn>	For encoding A1: is the first general-purpose source register, encoded in the "Rn" field. The PC can be used, but this is deprecated. For encoding T2: is the first general-purpose source register, encoded in the "Rn" field.								
<Rm>	For encoding A1: is the second general-purpose source register, encoded in the "Rm" field. The PC can be used, but this is deprecated. For encoding T1 and T2: is the second general-purpose source register, encoded in the "Rm" field.								
<shift>	Is the type of shift to be applied to the second source register, encoded in the "type" field. It can have the following values: <table><tr><td>LSL</td><td>when type = 00</td></tr><tr><td>LSR</td><td>when type = 01</td></tr><tr><td>ASR</td><td>when type = 10</td></tr><tr><td>ROR</td><td>when type = 11</td></tr></table>	LSL	when type = 00	LSR	when type = 01	ASR	when type = 10	ROR	when type = 11
LSL	when type = 00								
LSR	when type = 01								
ASR	when type = 10								
ROR	when type = 11								
<amount>	For encoding A1: is the shift amount, in the range 1 to 31 (when <shift> = LSL or ROR) or 1 to 32 (when <shift> = LSR or ASR) encoded in the "imm5" field as <amount> modulo 32. For encoding T2: is the shift amount, in the range 1 to 31 (when <shift> = LSL or ROR) or 1 to 32 (when <shift> = LSR or ASR) encoded in the "imm3:imm2" field as <amount> modulo 32.								

Operation for all encodings

```
if ConditionPassed() then
    EncodingSpecificOperations();
    shifted = Shift(R[m], shift_t, shift_n, PSTATE.C);
    (result, nzc) = AddWithCarry(R[n], NOT(shifted), PSTATE.C);
    if d == 15 then // Can only occur for A32 encoding
        if setflags then
            ALUExceptionReturn(result);
        else
            ALUWritePC(result);
    else
        R[d] = result;
        if setflags then
            PSTATE.<N,Z,C,V> = nzc;
```

F5.1.173 SBC, SBCS (register-shifted register)

Subtract with Carry (register-shifted register) subtracts a register-shifted register value and the value of NOT (Carry flag) from a register value, and writes the result to the destination register. It can optionally update the condition flags based on the result.

A1

31	28	27	26	25	24	23	22	21	20	19	16	15	12	11	8	7	6	5	4	3	0						
!=1111				0 0 0 0				1 1 0 S				Rn				Rd				Rs				0 type 1 Rm			
cond																											

Flag setting variant

Applies when S == 1.

SBCS{<c>}{<q>} {<Rd>}, <Rn>, <Rm>, <type> <Rs>

Not flag setting variant

Applies when S == 0.

SBC{<c>}{<q>} {<Rd>}, <Rn>, <Rm>, <type> <Rs>

Decode for all variants of this encoding

```
d = UInt(Rd); n = UInt(Rn); m = UInt(Rm); s = UInt(Rs);
setflags = (S == '1'); shift_t = DecodeRegShift(type);
if d == 15 || n == 15 || m == 15 || s == 15 then UNPREDICTABLE;
```

Notes for all encodings

For more information about the CONSTRAINED UNPREDICTABLE behavior of this instruction, see [Appendix K1 Architectural Constraints on UNPREDICTABLE behaviors](#).

Assembler symbols

<c>	See Standard assembler syntax fields on page F2-2848 .								
<q>	See Standard assembler syntax fields on page F2-2848 .								
<Rd>	Is the general-purpose destination register, encoded in the "Rd" field.								
<Rn>	Is the first general-purpose source register, encoded in the "Rn" field.								
<Rm>	Is the second general-purpose source register, encoded in the "Rm" field.								
<type>	Is the type of shift to be applied to the second source register, encoded in the "type" field. It can have the following values: <table style="margin-left: 20px;"> <tr> <td>LSL</td> <td>when type = 00</td> </tr> <tr> <td>LSR</td> <td>when type = 01</td> </tr> <tr> <td>ASR</td> <td>when type = 10</td> </tr> <tr> <td>ROR</td> <td>when type = 11</td> </tr> </table>	LSL	when type = 00	LSR	when type = 01	ASR	when type = 10	ROR	when type = 11
LSL	when type = 00								
LSR	when type = 01								
ASR	when type = 10								
ROR	when type = 11								
<Rs>	Is the third general-purpose source register holding a shift amount in its bottom 8 bits, encoded in the "Rs" field.								

Operation

```
if ConditionPassed() then
    EncodingSpecificOperations();
    shift_n = UInt(R[s]<7:0>);
    shifted = Shift(R[m], shift_t, shift_n, PSTATE.C);
    (result, nzc) = AddWithCarry(R[n], NOT(shifted), PSTATE.C);
    R[d] = result;
    if setflags then
        PSTATE.<N,Z,C,V> = nzc;
```

F5.1.174 SBFX

Signed Bit Field Extract extracts any number of adjacent bits at any position from a register, sign-extends them to 32 bits, and writes the result to the destination register.

A1

31	28	27	26	25	24	23	22	21	20	16	15	12	11	7	6	5	4	3	0	
!=1111				0	1	1	1	1	0	1	widthm1	Rd	lsb	1	0	1	Rn			
cond																				

A1 variant

SBFX{<c>}{<q>} <Rd>, <Rn>, #<lsb>, #<width>

Decode for this encoding

```
d = UInt(Rd); n = UInt(Rn);
lsbit = UInt(lsb); widthminus1 = UInt(widthm1);
if d == 15 || n == 15 then UNPREDICTABLE;
```

T1

15	14	13	12	11	10	9	8	7	6	5	4	3	0	15	14	12	11	8	7	6	5	4	0
1	1	1	1	0	(0)	1	1	0	1	0	0	Rn	0	imm3	Rd	imm2	(0)	widthm1					

T1 variant

SBFX{<c>}{<q>} <Rd>, <Rn>, #<lsb>, #<width>

Decode for this encoding

```
d = UInt(Rd); n = UInt(Rn);
lsbit = UInt(imm3:imm2); widthminus1 = UInt(widthm1);
if d == 15 || n == 15 then UNPREDICTABLE; // ARMv8-A removes UNPREDICTABLE for R13
```

Notes for all encodings

For more information about the CONSTRAINED UNPREDICTABLE behavior of this instruction, see [Appendix K1 Architectural Constraints on UNPREDICTABLE behaviors](#).

Assembler symbols

<c>	See Standard assembler syntax fields on page F2-2848 .
<q>	See Standard assembler syntax fields on page F2-2848 .
<Rd>	Is the general-purpose destination register, encoded in the "Rd" field.
<Rn>	Is the general-purpose source register, encoded in the "Rn" field.
<lsb>	For encoding A1: is the bit number of the least significant bit in the field, in the range 0 to 31, encoded in the "lsb" field. For encoding T1: is the bit number of the least significant bit in the field, in the range 0 to 31, encoded in the "imm3:imm2" field.
<width>	Is the width of the field, in the range 1 to 32-<lsb>, encoded in the "widthm1" field as <width>-1.

Operation for all encodings

```
if ConditionPassed() then
    EncodingSpecificOperations();
    msbit = lsb + widthminus1;
    if msbit <= 31 then
        R[d] = SignExtend(R[n]<msbit:lsb>, 32);
    else
        UNPREDICTABLE;
```

CONSTRAINED UNPREDICTABLE behavior

If $msbit > 31$, then one of the following behaviors must occur:

- The instruction is UNDEFINED.
- The instruction executes as NOP.
- The value in the destination register is UNKNOWN.

F5.1.175 SDIV

Signed Divide divides a 32-bit signed integer register value by a 32-bit signed integer register value, and writes the result to the destination register. The condition flags are not affected.

A1

31	28	27	26	25	24	23	22	21	20	19	16	15	12	11	8	7	6	5	4	3	0	
!=1111				0	1	1	1	0	0	0	1	Rd	(1)	(1)	(1)	(1)	Rm	0	0	0	1	Rn
cond											Ra											

A1 variant

SDIV{<c>}{<q>} {<Rd>}, {<Rn>, <Rm>

Decode for this encoding

d = UInt(Rd); n = UInt(Rn); m = UInt(Rm); a = UInt(Ra);
 if d == 15 || n == 15 || m == 15 || a != 15 then UNPREDICTABLE;

CONSTRAINED UNPREDICTABLE behavior

If Ra != '1111', then one of the following behaviors must occur:

- The instruction is UNDEFINED.
- The instruction executes as NOP.
- The instruction executes as described, with no change to its behavior and no additional side effects.
- The instruction executes as described, and the register specified by Ra becomes UNKNOWN.

T1

15	14	13	12	11	10	9	8	7	6	5	4	3	0	15	12	11	8	7	6	5	4	3	0
1	1	1	1	1	0	1	1	1	0	0	1	Rn	(1)	(1)	(1)	(1)	Rd	1	1	1	1	Rm	
													Ra										

T1 variant

SDIV{<c>}{<q>} {<Rd>}, {<Rn>, <Rm>

Decode for this encoding

d = UInt(Rd); n = UInt(Rn); m = UInt(Rm); a = UInt(Ra);
 if d == 15 || n == 15 || m == 15 || a != 15 then UNPREDICTABLE; // ARMv8-A removes UNPREDICTABLE for R13

CONSTRAINED UNPREDICTABLE behavior

If Ra != '1111', then one of the following behaviors must occur:

- The instruction is UNDEFINED.
- The instruction executes as NOP.
- The instruction executes as described, with no change to its behavior and no additional side effects.
- The instruction executes as described, and the register specified by Ra becomes UNKNOWN.

Notes for all encodings

For more information about the CONSTRAINED UNPREDICTABLE behavior of this instruction, see [Appendix K1 Architectural Constraints on UNPREDICTABLE behaviors](#).

Assembler symbols

- <c> See [Standard assembler syntax fields on page F2-2848](#).
- <q> See [Standard assembler syntax fields on page F2-2848](#).
- <Rd> Is the general-purpose destination register, encoded in the "Rd" field.
- <Rn> Is the first general-purpose source register holding the dividend, encoded in the "Rn" field.
- <Rm> Is the second general-purpose source register holding the divisor, encoded in the "Rm" field.

Overflow

If the signed integer division $0x80000000 / 0xFFFFFFFF$ is performed, the pseudocode produces the intermediate integer result $+2^{31}$, that overflows the 32-bit signed integer range. No indication of this overflow case is produced, and the 32-bit result written to <Rd> must be the bottom 32 bits of the binary representation of $+2^{31}$. So the result of the division is $0x80000000$.

Operation for all encodings

```
if ConditionPassed() then
    EncodingSpecificOperations();
    if SInt(R[m]) == 0 then
        result = 0;
    else
        result = RoundTowardsZero(Real(SInt(R[n])) / Real(SInt(R[m]]));
    R[d] = result<31:0>;
```

F5.1.176 SEL

Select Bytes selects each byte of its result from either its first operand or its second operand, according to the values of the `PSTATE.GE` flags.

A1

31	28	27	26	25	24	23	22	21	20	19	16	15	12	11	10	9	8	7	6	5	4	3	0
!=1111				0	1	1	0	1	0	0	0	Rn	Rd	(1)	(1)	(1)	(1)	1	0	1	1	Rm	
cond																							

A1 variant

SEL{<c>}{<q>} {<Rd>}, <Rn>, <Rm>

Decode for this encoding

```
d = UInt(Rd); n = UInt(Rn); m = UInt(Rm);
if d == 15 || n == 15 || m == 15 then UNPREDICTABLE;
```

T1

15	14	13	12	11	10	9	8	7	6	5	4	3	0	15	14	13	12	11	8	7	6	5	4	3	0
1	1	1	1	1	0	1	0	1	0	1	0	1	0	Rn	1	1	1	1	Rd	1	0	0	0	Rm	

T1 variant

SEL{<c>}{<q>} {<Rd>}, <Rn>, <Rm>

Decode for this encoding

```
d = UInt(Rd); n = UInt(Rn); m = UInt(Rm);
if d == 15 || n == 15 || m == 15 then UNPREDICTABLE; // ARMv8-A removes UNPREDICTABLE for R13
```

Notes for all encodings

For more information about the CONSTRAINED UNPREDICTABLE behavior of this instruction, see [Appendix K1 Architectural Constraints on UNPREDICTABLE behaviors](#).

Assembler symbols

- <c> See [Standard assembler syntax fields on page F2-2848](#).
- <q> See [Standard assembler syntax fields on page F2-2848](#).
- <Rd> Is the general-purpose destination register, encoded in the "Rd" field.
- <Rn> Is the first general-purpose source register, encoded in the "Rn" field.
- <Rm> Is the second general-purpose source register, encoded in the "Rm" field.

Operation for all encodings

```
if ConditionPassed() then
  EncodingSpecificOperations();
  R[d]<7:0> = if PSTATE.GE<0> == '1' then R[n]<7:0> else R[m]<7:0>;
```

```
R[d]<15:8> = if PSTATE.GE<1> == '1' then R[n]<15:8> else R[m]<15:8>;  
R[d]<23:16> = if PSTATE.GE<2> == '1' then R[n]<23:16> else R[m]<23:16>;  
R[d]<31:24> = if PSTATE.GE<3> == '1' then R[n]<31:24> else R[m]<31:24>;
```

F5.1.177 SETEND

Set Endianness writes a new value to `PSTATE.E`.

A1

31	30	29	28	27	26	25	24	23	22	21	20	19	18	17	16	15	14	13	12	11	10	9	8	7	6	5	4	3	2	1	0	
1	1	1	1	0	0	0	1	0	0	0	0	(0)	(0)	(0)	1	(0)	(0)	(0)	(0)	(0)	(0)	(0)	E	(0)	0	0	0	0	(0)	(0)	(0)	(0)

A1 variant

`SETEND{<q>} <endian_specifier>` // Cannot be conditional

Decode for this encoding

```
set_bigend = (E == '1');
```

T1

15	14	13	12	11	10	9	8	7	6	5	4	3	2	1	0
1	0	1	1	0	1	1	0	0	1	0	(1)	E	(0)	(0)	(0)

T1 variant

`SETEND{<q>} <endian_specifier>` // Not permitted in IT block

Decode for this encoding

```
set_bigend = (E == '1');
if InITBlock() then UNPREDICTABLE;
```

Notes for all encodings

For more information about the CONSTRAINED UNPREDICTABLE behavior of this instruction, see [Appendix K1 Architectural Constraints on UNPREDICTABLE behaviors](#).

Assembler symbols

<q> See [Standard assembler syntax fields on page F2-2848](#).

<endian_specifier> Is the endianness to be selected, and the value to be set in `PSTATE.E`, encoded in the "E" field.

It can have the following values:

LE when E = 0

BE when E = 1

Operation for all encodings

```
EncodingSpecificOperations();
AArch32.CheckSETENabled();
PSTATE.E = if set_bigend then '1' else '0';
```

F5.1.178 SETPAN

Set Privileged Access Never writes a new value to `PSTATE.PAN`.

This instruction is available only in privileged mode and it is a NOP when executed in User mode.

A1

ARMv8.1

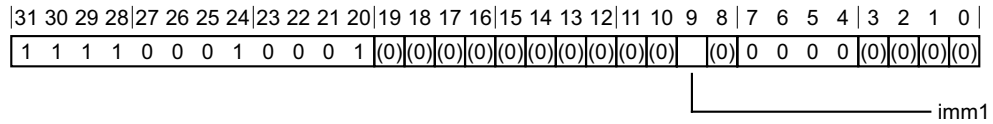

A1 variant

SETPAN{<q>} #<imm> // Cannot be conditional

Decode for this encoding

```
if !HavePANExt() then UNDEFINED;
value = imm1;
```

T1

ARMv8.1

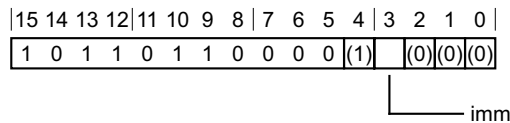

T1 variant

SETPAN{<q>} #<imm> // Not permitted in IT block

Decode for this encoding

```
if !HavePANExt() then UNDEFINED;
if InITBlock() then UNPREDICTABLE;
value = imm1;
```

Assembler symbols

<q> See [Standard assembler syntax fields on page F2-2848](#).

<imm> Is the unsigned immediate 0 or 1, encoded in the "imm1" field.

Operation for all encodings

```
EncodingSpecificOperations();
if PSTATE.EL != EL0 then
    PSTATE.PAN = value;
```

F5.1.179 SEV

Send Event is a hint instruction. It causes an event to be signaled to all PEs in the multiprocessor system. For more information, see [Wait For Event and Send Event](#) on page G1-4403.

A1

31	28	27	26	25	24	23	22	21	20	19	18	17	16	15	14	13	12	11	10	9	8	7	6	5	4	3	2	1	0
!=1111	0	0	1	1	0	0	1	0	0	0	0	0	(1)	(1)	(1)	(1)	(0)	(0)	(0)	(0)	0	0	0	0	0	0	1	0	0
cond																													

A1 variant

SEV{<c>}{<q>}

Decode for this encoding

// No additional decoding required

T1

15	14	13	12	11	10	9	8	7	6	5	4	3	2	1	0
1	0	1	1	1	1	1	1	0	1	0	0	0	0	0	0

T1 variant

SEV{<c>}{<q>}

Decode for this encoding

// No additional decoding required

T2

15	14	13	12	11	10	9	8	7	6	5	4	3	2	1	0	15	14	13	12	11	10	9	8	7	6	5	4	3	2	1	0
1	1	1	1	0	0	1	1	1	0	1	0	(1)	(1)	(1)	(1)	1	0	(0)	0	(0)	0	0	0	0	0	0	0	0	1	0	0

T2 variant

SEV{<c>}.W

Decode for this encoding

// No additional decoding required

Notes for all encodings

For more information about the CONSTRAINED UNPREDICTABLE behavior of this instruction, see [Appendix K1 Architectural Constraints on UNPREDICTABLE behaviors](#).

Assembler symbols

<c> See [Standard assembler syntax fields](#) on page F2-2848.

<q> See [Standard assembler syntax fields](#) on page F2-2848.

Operation for all encodings

```
if ConditionPassed() then  
    EncodingSpecificOperations();  
    SendEvent();
```

F5.1.180 SEVL

Send Event Local is a hint instruction that causes an event to be signaled locally without requiring the event to be signaled to other PEs in the multiprocessor system. It can prime a wait-loop which starts with a WFE instruction.

A1

31	28	27	26	25	24	23	22	21	20	19	18	17	16	15	14	13	12	11	10	9	8	7	6	5	4	3	2	1	0
!	1	1	1	1	0	0	1	0	0	0	0	0	(1)	(1)	(1)	(1)	(0)	(0)	(0)	(0)	0	0	0	0	0	1	0	1	
cond																													

A1 variant

SEVL{<c>}{<q>}

Decode for this encoding

// No additional decoding required

T1

15	14	13	12	11	10	9	8	7	6	5	4	3	2	1	0
1	0	1	1	1	1	1	1	0	1	0	1	0	0	0	0

T1 variant

SEVL{<c>}{<q>}

Decode for this encoding

// No additional decoding required

T2

15	14	13	12	11	10	9	8	7	6	5	4	3	2	1	0	15	14	13	12	11	10	9	8	7	6	5	4	3	2	1	0
1	1	1	1	0	0	1	1	1	0	1	0	(1)	(1)	(1)	(1)	1	0	(0)	0	(0)	0	0	0	0	0	0	0	0	1	0	1

T2 variant

SEVL{<c>}.W

Decode for this encoding

// No additional decoding required

Notes for all encodings

For more information about the CONSTRAINED UNPREDICTABLE behavior of this instruction, see [Appendix K1 Architectural Constraints on UNPREDICTABLE behaviors](#).

Assembler symbols

<c> See [Standard assembler syntax fields on page F2-2848](#).

<q> See [Standard assembler syntax fields on page F2-2848](#).

Operation for all encodings

```
if ConditionPassed() then  
    EncodingSpecificOperations();  
    SendEventLocal();
```

F5.1.181 SHADD16

Signed Halving Add 16 performs two signed 16-bit integer additions, halves the results, and writes the results to the destination register.

A1

31	28	27	26	25	24	23	22	21	20	19	16	15	12	11	10	9	8	7	6	5	4	3	0
!=1111				0	1	1	0	0	0	1	1	Rn	Rd	(1)	(1)	(1)	(1)	0	0	0	1	Rm	
cond																							

A1 variant

SHADD16{<c>}{<q>} {<Rd>}, <Rn>, <Rm>

Decode for this encoding

d = UInt(Rd); n = UInt(Rn); m = UInt(Rm);
 if d == 15 || n == 15 || m == 15 then UNPREDICTABLE;

T1

15	14	13	12	11	10	9	8	7	6	5	4	3	0	15	14	13	12	11	8	7	6	5	4	3	0
1	1	1	1	1	0	1	0	1	0	0	1	Rn	1	1	1	1	Rd	0	0	1	0	Rm			

T1 variant

SHADD16{<c>}{<q>} {<Rd>}, <Rn>, <Rm>

Decode for this encoding

d = UInt(Rd); n = UInt(Rn); m = UInt(Rm);
 if d == 15 || n == 15 || m == 15 then UNPREDICTABLE; // ARMv8-A removes UNPREDICTABLE for R13

Notes for all encodings

For more information about the CONSTRAINED UNPREDICTABLE behavior of this instruction, see [Appendix K1 Architectural Constraints on UNPREDICTABLE behaviors](#).

Assembler symbols

- <c> See [Standard assembler syntax fields on page F2-2848](#).
- <q> See [Standard assembler syntax fields on page F2-2848](#).
- <Rd> Is the general-purpose destination register, encoded in the "Rd" field.
- <Rn> Is the first general-purpose source register, encoded in the "Rn" field.
- <Rm> Is the second general-purpose source register, encoded in the "Rm" field.

Operation for all encodings

```
if ConditionPassed() then
    EncodingSpecificOperations();
    sum1 = SInt(R[n]<15:0>) + SInt(R[m]<15:0>);
```

```
sum2 = SInt(R[n]<31:16>) + SInt(R[m]<31:16>);  
R[d]<15:0> = sum1<16:1>;  
R[d]<31:16> = sum2<16:1>;
```

F5.1.182 SHADD8

Signed Halving Add 8 performs four signed 8-bit integer additions, halves the results, and writes the results to the destination register.

A1

31	28	27	26	25	24	23	22	21	20	19	16	15	12	11	10	9	8	7	6	5	4	3	0
!=1111				0	1	1	0	0	0	1	1	Rn	Rd	(1)	(1)	(1)	(1)	1	0	0	1	Rm	
cond																							

A1 variant

SHADD8{<c>}{<q>} {<Rd>}, <Rn>, <Rm>

Decode for this encoding

d = UInt(Rd); n = UInt(Rn); m = UInt(Rm);
 if d == 15 || n == 15 || m == 15 then UNPREDICTABLE;

T1

15	14	13	12	11	10	9	8	7	6	5	4	3	0	15	14	13	12	11	8	7	6	5	4	3	0
1	1	1	1	1	0	1	0	1	0	0	0	Rn	1	1	1	1	Rd	0	0	1	0	Rm			

T1 variant

SHADD8{<c>}{<q>} {<Rd>}, <Rn>, <Rm>

Decode for this encoding

d = UInt(Rd); n = UInt(Rn); m = UInt(Rm);
 if d == 15 || n == 15 || m == 15 then UNPREDICTABLE; // ARMv8-A removes UNPREDICTABLE for R13

Notes for all encodings

For more information about the CONSTRAINED UNPREDICTABLE behavior of this instruction, see [Appendix K1 Architectural Constraints on UNPREDICTABLE behaviors](#).

Assembler symbols

- <c> See [Standard assembler syntax fields on page F2-2848](#).
- <q> See [Standard assembler syntax fields on page F2-2848](#).
- <Rd> Is the general-purpose destination register, encoded in the "Rd" field.
- <Rn> Is the first general-purpose source register, encoded in the "Rn" field.
- <Rm> Is the second general-purpose source register, encoded in the "Rm" field.

Operation for all encodings

```
if ConditionPassed() then
    EncodingSpecificOperations();
    sum1 = SInt(R[n]<7:0>) + SInt(R[m]<7:0>);
    sum2 = SInt(R[n]<15:8>) + SInt(R[m]<15:8>);
    sum3 = SInt(R[n]<23:16>) + SInt(R[m]<23:16>);
```

```
sum4 = SInt(R[n]<31:24>) + SInt(R[m]<31:24>);  
R[d]<7:0> = sum1<8:1>;  
R[d]<15:8> = sum2<8:1>;  
R[d]<23:16> = sum3<8:1>;  
R[d]<31:24> = sum4<8:1>;
```

F5.1.183 SHASX

Signed Halving Add and Subtract with Exchange exchanges the two halfwords of the second operand, performs one signed 16-bit integer addition and one signed 16-bit subtraction, halves the results, and writes the results to the destination register.

A1

31	28	27	26	25	24	23	22	21	20	19	16	15	12	11	10	9	8	7	6	5	4	3	0
!=1111				0	1	1	0	0	0	1	1	Rn	Rd	(1)	(1)	(1)	(1)	0	0	1	1	Rm	
cond																							

A1 variant

SHASX{<c>}{<q>} {<Rd>}, <Rn>, <Rm>

Decode for this encoding

```
d = UInt(Rd); n = UInt(Rn); m = UInt(Rm);
if d == 15 || n == 15 || m == 15 then UNPREDICTABLE;
```

T1

15	14	13	12	11	10	9	8	7	6	5	4	3	0	15	14	13	12	11	8	7	6	5	4	3	0
1	1	1	1	1	0	1	0	1	0	1	0	Rn	1	1	1	1	Rd	0	0	1	0	Rm			

T1 variant

SHASX{<c>}{<q>} {<Rd>}, <Rn>, <Rm>

Decode for this encoding

```
d = UInt(Rd); n = UInt(Rn); m = UInt(Rm);
if d == 15 || n == 15 || m == 15 then UNPREDICTABLE; // ARMv8-A removes UNPREDICTABLE for R13
```

Notes for all encodings

For more information about the CONSTRAINED UNPREDICTABLE behavior of this instruction, see [Appendix K1 Architectural Constraints on UNPREDICTABLE behaviors](#).

Assembler symbols

- <c> See [Standard assembler syntax fields on page F2-2848](#).
- <q> See [Standard assembler syntax fields on page F2-2848](#).
- <Rd> Is the general-purpose destination register, encoded in the "Rd" field.
- <Rn> Is the first general-purpose source register, encoded in the "Rn" field.
- <Rm> Is the second general-purpose source register, encoded in the "Rm" field.

Operation for all encodings

```
if ConditionPassed() then
    EncodingSpecificOperations();
diff = SInt(R[n]<15:0>) - SInt(R[m]<31:16>);
```

```
sum = SInt(R[n]<31:16>) + SInt(R[m]<15:0>);  
R[d]<15:0> = diff<16:1>;  
R[d]<31:16> = sum<16:1>;
```

F5.1.184 SHSAX

Signed Halving Subtract and Add with Exchange exchanges the two halfwords of the second operand, performs one signed 16-bit integer subtraction and one signed 16-bit addition, halves the results, and writes the results to the destination register.

A1

31	28	27	26	25	24	23	22	21	20	19	16	15	12	11	10	9	8	7	6	5	4	3	0		
!=1111				0	1	1	0	0	0	1	1	Rn	Rd	(1)	(1)	(1)	(1)	0	1	0	1	Rm			
cond																									

A1 variant

SHSAX{<c>}{<q>} {<Rd>}, <Rn>, <Rm>

Decode for this encoding

```
d = UInt(Rd); n = UInt(Rn); m = UInt(Rm);
if d == 15 || n == 15 || m == 15 then UNPREDICTABLE;
```

T1

15	14	13	12	11	10	9	8	7	6	5	4	3	0	15	14	13	12	11	8	7	6	5	4	3	0
1	1	1	1	1	0	1	0	1	1	1	0	Rn	1	1	1	1	Rd	0	0	1	0	Rm			

T1 variant

SHSAX{<c>}{<q>} {<Rd>}, <Rn>, <Rm>

Decode for this encoding

```
d = UInt(Rd); n = UInt(Rn); m = UInt(Rm);
if d == 15 || n == 15 || m == 15 then UNPREDICTABLE; // ARMv8-A removes UNPREDICTABLE for R13
```

Notes for all encodings

For more information about the CONSTRAINED UNPREDICTABLE behavior of this instruction, see [Appendix K1 Architectural Constraints on UNPREDICTABLE behaviors](#).

Assembler symbols

- <c> See [Standard assembler syntax fields on page F2-2848](#).
- <q> See [Standard assembler syntax fields on page F2-2848](#).
- <Rd> Is the general-purpose destination register, encoded in the "Rd" field.
- <Rn> Is the first general-purpose source register, encoded in the "Rn" field.
- <Rm> Is the second general-purpose source register, encoded in the "Rm" field.

Operation for all encodings

```
if ConditionPassed() then
    EncodingSpecificOperations();
    sum = SInt(R[n]<15:0>) + SInt(R[m]<31:16>);
```

```
diff = SInt(R[n]<31:16>) - SInt(R[m]<15:0>);  
R[d]<15:0> = sum<16:1>;  
R[d]<31:16> = diff<16:1>;
```

F5.1.185 SHSUB16

Signed Halving Subtract 16 performs two signed 16-bit integer subtractions, halves the results, and writes the results to the destination register.

A1

31	28	27	26	25	24	23	22	21	20	19	16	15	12	11	10	9	8	7	6	5	4	3	0
!=1111				0	1	1	0	0	0	1	1	Rn	Rd	(1)	(1)	(1)	(1)	0	1	1	1	Rm	
cond																							

A1 variant

SHSUB16{<c>}{<q>} {<Rd>}, <Rn>, <Rm>

Decode for this encoding

d = UInt(Rd); n = UInt(Rn); m = UInt(Rm);
 if d == 15 || n == 15 || m == 15 then UNPREDICTABLE;

T1

15	14	13	12	11	10	9	8	7	6	5	4	3	0	15	14	13	12	11	8	7	6	5	4	3	0
1	1	1	1	1	0	1	0	1	1	0	1	Rn	1	1	1	1	Rd	0	0	1	0	Rm			

T1 variant

SHSUB16{<c>}{<q>} {<Rd>}, <Rn>, <Rm>

Decode for this encoding

d = UInt(Rd); n = UInt(Rn); m = UInt(Rm);
 if d == 15 || n == 15 || m == 15 then UNPREDICTABLE; // ARMv8-A removes UNPREDICTABLE for R13

Notes for all encodings

For more information about the CONSTRAINED UNPREDICTABLE behavior of this instruction, see [Appendix K1 Architectural Constraints on UNPREDICTABLE behaviors](#).

Assembler symbols

- <c> See [Standard assembler syntax fields on page F2-2848](#).
- <q> See [Standard assembler syntax fields on page F2-2848](#).
- <Rd> Is the general-purpose destination register, encoded in the "Rd" field.
- <Rn> Is the first general-purpose source register, encoded in the "Rn" field.
- <Rm> Is the second general-purpose source register, encoded in the "Rm" field.

Operation for all encodings

```
if ConditionPassed() then
    EncodingSpecificOperations();
    diff1 = SInt(R[n]<15:0>) - SInt(R[m]<15:0>);
```

```
diff2 = SInt(R[n]<31:16>) - SInt(R[m]<31:16>);  
R[d]<15:0> = diff1<16:1>;  
R[d]<31:16> = diff2<16:1>;
```

F5.1.186 SHSUB8

Signed Halving Subtract 8 performs four signed 8-bit integer subtractions, halves the results, and writes the results to the destination register.

A1

31	28	27	26	25	24	23	22	21	20	19	16	15	12	11	10	9	8	7	6	5	4	3	0
!=1111				0	1	1	0	0	0	1	1	Rn	Rd	(1)	(1)	(1)	(1)	1	1	1	1	Rm	
cond																							

A1 variant

SHSUB8{<c>}{<q>} {<Rd>}, <Rn>, <Rm>

Decode for this encoding

d = UInt(Rd); n = UInt(Rn); m = UInt(Rm);
 if d == 15 || n == 15 || m == 15 then UNPREDICTABLE;

T1

15	14	13	12	11	10	9	8	7	6	5	4	3	0	15	14	13	12	11	8	7	6	5	4	3	0
1	1	1	1	1	0	1	0	1	1	0	0	Rn	1	1	1	1	Rd	0	0	1	0	Rm			

T1 variant

SHSUB8{<c>}{<q>} {<Rd>}, <Rn>, <Rm>

Decode for this encoding

d = UInt(Rd); n = UInt(Rn); m = UInt(Rm);
 if d == 15 || n == 15 || m == 15 then UNPREDICTABLE; // ARMv8-A removes UNPREDICTABLE for R13

Notes for all encodings

For more information about the CONSTRAINED UNPREDICTABLE behavior of this instruction, see [Appendix K1 Architectural Constraints on UNPREDICTABLE behaviors](#).

Assembler symbols

- <c> See [Standard assembler syntax fields on page F2-2848](#).
- <q> See [Standard assembler syntax fields on page F2-2848](#).
- <Rd> Is the general-purpose destination register, encoded in the "Rd" field.
- <Rn> Is the first general-purpose source register, encoded in the "Rn" field.
- <Rm> Is the second general-purpose source register, encoded in the "Rm" field.

Operation for all encodings

```
if ConditionPassed() then
    EncodingSpecificOperations();
    diff1 = SInt(R[n]<7:0>) - SInt(R[m]<7:0>);
    diff2 = SInt(R[n]<15:8>) - SInt(R[m]<15:8>);
    diff3 = SInt(R[n]<23:16>) - SInt(R[m]<23:16>);
```

```
diff4 = SInt(R[n]<31:24>) - SInt(R[m]<31:24>);  
R[d]<7:0> = diff1<8:1>;  
R[d]<15:8> = diff2<8:1>;  
R[d]<23:16> = diff3<8:1>;  
R[d]<31:24> = diff4<8:1>;
```

F5.1.187 SMC

Secure Monitor Call causes a Secure Monitor Call exception. For more information see [Secure Monitor Call \(SMC\) exception on page G1-4382](#).

SMC is available only for software executing at EL1 or higher. It is UNDEFINED in User mode.

If the values of `HCR.TSC` and `SCR.SCD` are both 0, execution of an SMC instruction at EL1 or higher generates a Secure Monitor Call exception that is taken to EL3. When EL3 is using AArch32 this exception is taken to Monitor mode. When EL3 is using AArch64, it is the `SCR_EL3.SMD` bit, rather than the `SCR.SCD` bit, that can change the effect of executing an SMC instruction.

If the value of `HCR.TSC` is 1, execution of an SMC instruction in a Non-secure EL1 mode generates an exception that is taken to EL2, regardless of the value of `SCR.SCD`. When EL2 is using AArch32, this is a Hyp Trap exception that is taken to Hyp mode. For more information see [Traps to Hyp mode of Non-secure EL1 execution of SMC instructions on page G1-4434](#).

If the value of `HCR.TSC` is 0 and the value of `SCR.SCD` is 1, the SMC instruction is:

- UNDEFINED in Non-secure state.
- CONSTRAINED UNPREDICTABLE if executed in Secure state at EL1 or higher.

A1

31	28	27	26	25	24	23	22	21	20	19	18	17	16	15	14	13	12	11	10	9	8	7	6	5	4	3	0
!=1111	0	0	0	1	0	1	1	0	(0)	(0)	(0)	(0)	(0)	(0)	(0)	(0)	(0)	(0)	(0)	(0)	0	1	1	1	imm4		
cond																											

A1 variant

SMC{<c>}{<q>} {#}<imm4>

Decode for this encoding

// imm4 is for assembly/disassembly only and is ignored by hardware

T1

15	14	13	12	11	10	9	8	7	6	5	4	3	0	15	14	13	12	11	10	9	8	7	6	5	4	3	2	1	0
1	1	1	1	0	1	1	1	1	1	1	1	imm4	1	0	0	0	(0)	(0)	(0)	(0)	(0)	(0)	(0)	(0)	(0)	(0)	(0)	(0)	(0)

T1 variant

SMC{<c>}{<q>} {#}<imm4>

Decode for this encoding

// imm4 is for assembly/disassembly only and is ignored by hardware
 if `InITBlock()` && `!LastInITBlock()` then UNPREDICTABLE;

Notes for all encodings

For more information about the CONSTRAINED UNPREDICTABLE behavior of this instruction, see [Appendix K1 Architectural Constraints on UNPREDICTABLE behaviors](#).

Assembler symbols

- <c> See [Standard assembler syntax fields on page F2-2848](#).
- <q> See [Standard assembler syntax fields on page F2-2848](#).
- <imm4> Is a 4-bit unsigned immediate value, in the range 0 to 15, encoded in the "imm4" field. This is ignored by the PE. The Secure Monitor Call exception handler (Secure Monitor code) can use this value to determine what service is being requested, but ARM does not recommend this.

Operation for all encodings

```
if ConditionPassed() then
    EncodingSpecificOperations();

    if !HaveEL(EL3) || PSTATE.EL == EL0 then
        UNDEFINED;

    AArch32.CheckForSMCTrap();

    if !ELUsingAArch32(EL3) then
        if SCR_EL3.SMD == '1' then
            // SMC disabled.
            UNDEFINED;
        else
            if SCR.SCD == '1' then
                // SMC disabled
                if IsSecure() then
                    // Executes either as a NOP or UNALLOCATED.
                    c = ConstrainUnpredictable(Unpredictable_SMD);
                    assert c IN {Constraint_NOP, Constraint_UNDEF};
                    if c == Constraint_NOP then EndOfInstruction();
                    UNDEFINED;

            if !ELUsingAArch32(EL3) then
                AArch64.CallSecureMonitor(Zeros(16));
            else
                AArch32.TakeSMCException();
```

CONSTRAINED UNPREDICTABLE behavior

If SCR.SCD == '1' && IsSecure(), then one of the following behaviors must occur:

- The instruction is UNDEFINED.
- The instruction executes as NOP.

F5.1.188 SMLABB, SMLABT, SMLATB, SMLATT

Signed Multiply Accumulate (halfwords) performs a signed multiply accumulate operation. The multiply acts on two signed 16-bit quantities, taken from either the bottom or the top half of their respective source registers. The other halves of these source registers are ignored. The 32-bit product is added to a 32-bit accumulate value and the result is written to the destination register.

If overflow occurs during the addition of the accumulate value, the instruction sets `PSTATE.Q` to 1. It is not possible for overflow to occur during the multiplication.

A1

31				28 27 26 25 24 23 22 21 20 19				16 15		12 11		8 7 6 5 4 3				0			
!=1111				0 0 0 1 0 0 0 0				Rd		Ra		Rm		1	M	N	0	Rn	
cond																			

SMLABB variant

Applies when `M == 0 && N == 0`.

SMLABB{<c>}{<q>} <Rd>, <Rn>, <Rm>, <Ra>

SMLABT variant

Applies when `M == 1 && N == 0`.

SMLABT{<c>}{<q>} <Rd>, <Rn>, <Rm>, <Ra>

SMLATB variant

Applies when `M == 0 && N == 1`.

SMLATB{<c>}{<q>} <Rd>, <Rn>, <Rm>, <Ra>

SMLATT variant

Applies when `M == 1 && N == 1`.

SMLATT{<c>}{<q>} <Rd>, <Rn>, <Rm>, <Ra>

Decode for all variants of this encoding

```
d = UInt(Rd); n = UInt(Rn); m = UInt(Rm); a = UInt(Ra);
n_high = (N == '1'); m_high = (M == '1');
if d == 15 || n == 15 || m == 15 || a == 15 then UNPREDICTABLE;
```

T1

15 14 13 12 11 10 9 8 7 6 5 4 3				0 15		12 11		8 7 6 5 4 3				0					
1 1 1 1 1 0 1 1 0				0 0 1		Rn		!=1111		Rd		0	0	N	M	Rm	
Ra																	

SMLABB variant

Applies when `N == 0 && M == 0`.

SMLABB{<c>}{<q>} <Rd>, <Rn>, <Rm>, <Ra>

SMLABT variant

Applies when `N == 0 && M == 1`.

SMLABT{<c>}{<q>} <Rd>, <Rn>, <Rm>, <Ra>

SMLATB variant

Applies when N == 1 && M == 0.

SMLATB{<c>}{<q>} <Rd>, <Rn>, <Rm>, <Ra>

SMLATT variant

Applies when N == 1 && M == 1.

SMLATT{<c>}{<q>} <Rd>, <Rn>, <Rm>, <Ra>

Decode for all variants of this encoding

```
if Ra == '1111' then SEE SMULBB, SMULBT, SMULTB, SMULTT;  
d = UInt(Rd); n = UInt(Rn); m = UInt(Rm); a = UInt(Ra);  
n_high = (N == '1'); m_high = (M == '1');  
if d == 15 || n == 15 || m == 15 then UNPREDICTABLE; // ARMv8-A removes UNPREDICTABLE for R13
```

Notes for all encodings

For more information about the CONSTRAINED UNPREDICTABLE behavior of this instruction, see [Appendix K1 Architectural Constraints on UNPREDICTABLE behaviors](#).

Assembler symbols

- <c> See [Standard assembler syntax fields on page F2-2848](#).
- <q> See [Standard assembler syntax fields on page F2-2848](#).
- <Rd> Is the general-purpose destination register, encoded in the "Rd" field.
- <Rn> Is the first general-purpose source register holding the multiplicand in the bottom or top half (selected by <x>), encoded in the "Rn" field.
- <Rm> Is the second general-purpose source register holding the multiplier in the bottom or top half (selected by <y>), encoded in the "Rm" field.
- <Ra> Is the third general-purpose source register holding the addend, encoded in the "Ra" field.

Operation for all encodings

```
if ConditionPassed() then  
  EncodingSpecificOperations();  
  operand1 = if n_high then R[n]<31:16> else R[n]<15:0>;  
  operand2 = if m_high then R[m]<31:16> else R[m]<15:0>;  
  result = SInt(operand1) * SInt(operand2) + SInt(R[a]);  
  R[d] = result<31:0>;  
  if result != SInt(result<31:0>) then // Signed overflow  
    PSTATE.Q = '1';
```

F5.1.189 SMLAD, SMLADX

Signed Multiply Accumulate Dual performs two signed 16 x 16-bit multiplications. It adds the products to a 32-bit accumulate operand.

Optionally, the instruction can exchange the halfwords of the second operand before performing the arithmetic. This produces top x bottom and bottom x top multiplication.

This instruction sets `PSTATE.Q` to 1 if the accumulate operation overflows. Overflow cannot occur during the multiplications.

A1

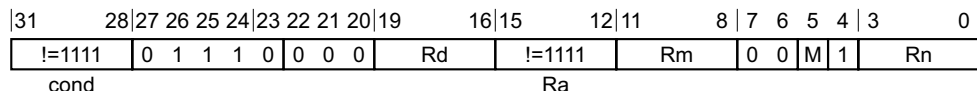

SMLAD variant

Applies when `M == 0`.

`SMLAD{<c>}{<q>} <Rd>, <Rn>, <Rm>, <Ra>`

SMLADX variant

Applies when `M == 1`.

`SMLADX{<c>}{<q>} <Rd>, <Rn>, <Rm>, <Ra>`

Decode for all variants of this encoding

```
if Ra == '1111' then SEE SMUAD;
d = UInt(Rd); n = UInt(Rn); m = UInt(Rm); a = UInt(Ra);
m_swap = (M == '1');
if d == 15 || n == 15 || m == 15 then UNPREDICTABLE;
```

T1

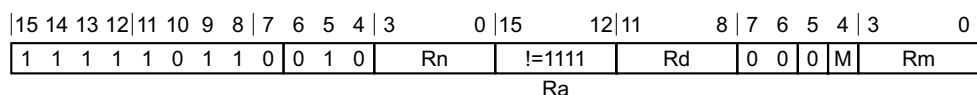

SMLAD variant

Applies when `M == 0`.

`SMLAD{<c>}{<q>} <Rd>, <Rn>, <Rm>, <Ra>`

SMLADX variant

Applies when `M == 1`.

`SMLADX{<c>}{<q>} <Rd>, <Rn>, <Rm>, <Ra>`

Decode for all variants of this encoding

```
if Ra == '1111' then SEE SMUAD;
d = UInt(Rd); n = UInt(Rn); m = UInt(Rm); a = UInt(Ra);
m_swap = (M == '1');
if d == 15 || n == 15 || m == 15 then UNPREDICTABLE; // ARMv8-A removes UNPREDICTABLE for R13
```

Notes for all encodings

For more information about the CONSTRAINED UNPREDICTABLE behavior of this instruction, see [Appendix K1 Architectural Constraints on UNPREDICTABLE behaviors](#).

Assembler symbols

- <c> See *Standard assembler syntax fields* on page F2-2848.
- <q> See *Standard assembler syntax fields* on page F2-2848.
- <Rd> Is the general-purpose destination register, encoded in the "Rd" field.
- <Rn> Is the first general-purpose source register, encoded in the "Rn" field.
- <Rm> Is the second general-purpose source register, encoded in the "Rm" field.
- <Ra> Is the third general-purpose source register holding the addend, encoded in the "Ra" field.

Operation for all encodings

```
if ConditionPassed() then
    EncodingSpecificOperations();
    operand2 = if m_swap then ROR(R[m],16) else R[m];
    product1 = SInt(R[n]<15:0>) * SInt(operand2<15:0>);
    product2 = SInt(R[n]<31:16>) * SInt(operand2<31:16>);
    result = product1 + product2 + SInt(R[a]);
    R[d] = result<31:0>;
    if result != SInt(result<31:0>) then // Signed overflow
        PSTATE.Q = '1';
```

F5.1.190 SMLAL, SMLALS

Signed Multiply Accumulate Long multiplies two signed 32-bit values to produce a 64-bit value, and accumulates this with a 64-bit value.

In A32 instructions, the condition flags can optionally be updated based on the result. Use of this option adversely affects performance on many implementations.

A1

31	28 27	26	25	24 23	22	21	20 19	16 15	12 11	8	7	6	5	4	3	0	
!=1111		0	0	0	0	1	1	1	S	RdHi	RdLo	Rm	1	0	0	1	Rn
cond																	

Flag setting variant

Applies when S == 1.

SMLALS{<c>}{<q>} <RdLo>, <RdHi>, <Rn>, <Rm>

Not flag setting variant

Applies when S == 0.

SMLAL{<c>}{<q>} <RdLo>, <RdHi>, <Rn>, <Rm>

Decode for all variants of this encoding

```
dLo = UInt(RdLo); dHi = UInt(RdHi); n = UInt(Rn); m = UInt(Rm); setflags = (S == '1');
if dLo == 15 || dHi == 15 || n == 15 || m == 15 then UNPREDICTABLE;
if dHi == dLo then UNPREDICTABLE;
```

CONSTRAINED UNPREDICTABLE behavior

If dHi == dLo, then one of the following behaviors must occur:

- The instruction is UNDEFINED.
- The instruction executes as NOP.
- The value in the destination register is UNKNOWN.

T1

15	14	13	12 11	10	9	8	7	6	5	4	3	0	15	12 11	8	7	6	5	4	3	0
1	1	1	1	1	0	1	1	1	1	0	0	Rn	RdLo	RdHi	0	0	0	0	Rm		

T1 variant

SMLAL{<c>}{<q>} <RdLo>, <RdHi>, <Rn>, <Rm>

Decode for this encoding

```
dLo = UInt(RdLo); dHi = UInt(RdHi); n = UInt(Rn); m = UInt(Rm); setflags = FALSE;
if dLo == 15 || dHi == 15 || n == 15 || m == 15 then UNPREDICTABLE;
// ARMv8-A removes UNPREDICTABLE for R13
if dHi == dLo then UNPREDICTABLE;
```

CONSTRAINED UNPREDICTABLE behavior

If $dHi == dLo$, then one of the following behaviors must occur:

- The instruction is UNDEFINED.
- The instruction executes as NOP.
- The value in the destination register is UNKNOWN.

Notes for all encodings

For more information about the CONSTRAINED UNPREDICTABLE behavior of this instruction, see [Appendix K1 Architectural Constraints on UNPREDICTABLE behaviors](#).

Assembler symbols

<c>	See Standard assembler syntax fields on page F2-2848 .
<q>	See Standard assembler syntax fields on page F2-2848 .
<RdLo>	Is the general-purpose source register holding the lower 32 bits of the addend, and the destination register for the lower 32 bits of the result, encoded in the "RdLo" field.
<RdHi>	Is the general-purpose source register holding the upper 32 bits of the addend, and the destination register for the upper 32 bits of the result, encoded in the "RdHi" field.
<Rn>	Is the first general-purpose source register holding the multiplicand, encoded in the "Rn" field.
<Rm>	Is the second general-purpose source register holding the multiplier, encoded in the "Rm" field.

Operation for all encodings

```
if ConditionPassed() then
    EncodingSpecificOperations();
    result = SInt(R[n]) * SInt(R[m]) + SInt(R[dHi]:R[dLo]);
    R[dHi] = result<63:32>;
    R[dLo] = result<31:0>;
    if setflags then
        PSTATE.N = result<63>;
        PSTATE.Z = IsZeroBit(result<63:0>);
        // PSTATE.C, PSTATE.V unchanged
```

F5.1.191 SMLALBB, SMLALBT, SMLALTB, SMLALTT

Signed Multiply Accumulate Long (halfwords) multiplies two signed 16-bit values to produce a 32-bit value, and accumulates this with a 64-bit value. The multiply acts on two signed 16-bit quantities, taken from either the bottom or the top half of their respective source registers. The other halves of these source registers are ignored. The 32-bit product is sign-extended and accumulated with a 64-bit accumulate value.

Overflow is possible during this instruction, but only as a result of the 64-bit addition. This overflow is not detected if it occurs. Instead, the result wraps around modulo 2^{64} .

A1

31	28 27 26 25 24 23 22 21 20 19	16 15	12 11	8 7 6 5 4 3	0
!=1111	0 0 0 1 0 1 0 0	RdHi	RdLo	Rm	1 M N 0 Rn
cond					

SMLALBB variant

Applies when $M == 0 \ \&\& \ N == 0$.

SMLALBB{<c>}{<q>} <RdLo>, <RdHi>, <Rn>, <Rm>

SMLALBT variant

Applies when $M == 1 \ \&\& \ N == 0$.

SMLALBT{<c>}{<q>} <RdLo>, <RdHi>, <Rn>, <Rm>

SMLALTB variant

Applies when $M == 0 \ \&\& \ N == 1$.

SMLALTB{<c>}{<q>} <RdLo>, <RdHi>, <Rn>, <Rm>

SMLALTT variant

Applies when $M == 1 \ \&\& \ N == 1$.

SMLALTT{<c>}{<q>} <RdLo>, <RdHi>, <Rn>, <Rm>

Decode for all variants of this encoding

```
dLo = UInt(RdLo); dHi = UInt(RdHi); n = UInt(Rn); m = UInt(Rm);
n_high = (N == '1'); m_high = (M == '1');
if dLo == 15 || dHi == 15 || n == 15 || m == 15 then UNPREDICTABLE;
if dHi == dLo then UNPREDICTABLE;
```

CONSTRAINED UNPREDICTABLE behavior

If $dHi == dLo$, then one of the following behaviors must occur:

- The instruction is UNDEFINED.
- The instruction executes as NOP.
- The value in the destination register is UNKNOWN.

T1

15	14	13	12	11	10	9	8	7	6	5	4	3	0	15	12	11	8	7	6	5	4	3	0	
1	1	1	1	1	0	1	1	1	1	0	0	Rn	RdLo	RdHi	1	0	N	M	Rm					

SMLALBB variant

Applies when N == 0 && M == 0.

SMLALBB{<c>}{<q>} <RdLo>, <RdHi>, <Rn>, <Rm>

SMLALBT variant

Applies when N == 0 && M == 1.

SMLALBT{<c>}{<q>} <RdLo>, <RdHi>, <Rn>, <Rm>

SMLALTB variant

Applies when N == 1 && M == 0.

SMLALTB{<c>}{<q>} <RdLo>, <RdHi>, <Rn>, <Rm>

SMLALTT variant

Applies when N == 1 && M == 1.

SMLALTT{<c>}{<q>} <RdLo>, <RdHi>, <Rn>, <Rm>

Decode for all variants of this encoding

```
dLo = UInt(RdLo); dHi = UInt(RdHi); n = UInt(Rn); m = UInt(Rm);
n_high = (N == '1'); m_high = (M == '1');
if dLo == 15 || dHi == 15 || n == 15 || m == 15 then UNPREDICTABLE;
// ARMv8-A removes UNPREDICTABLE for R13
if dHi == dLo then UNPREDICTABLE;
```

CONSTRAINED UNPREDICTABLE behavior

If dHi == dLo, then one of the following behaviors must occur:

- The instruction is UNDEFINED.
- The instruction executes as NOP.
- The value in the destination register is UNKNOWN.

Notes for all encodings

For more information about the CONSTRAINED UNPREDICTABLE behavior of this instruction, see [Appendix K1 Architectural Constraints on UNPREDICTABLE behaviors](#).

Assembler symbols

<c> See [Standard assembler syntax fields on page F2-2848](#).

<q> See [Standard assembler syntax fields on page F2-2848](#).

<RdLo> Is the general-purpose source register holding the lower 32 bits of the addend, and the destination register for the lower 32 bits of the result, encoded in the "RdLo" field.

<RdHi> Is the general-purpose source register holding the upper 32 bits of the addend, and the destination register for the upper 32 bits of the result, encoded in the "RdHi" field.

- <Rn> For encoding A1: is the first general-purpose source register holding the multiplicand in the bottom or top half (selected by <x>), encoded in the "Rn" field.
For encoding T1: is the first general-purpose source register holding the multiplicand in the bottom or top half (selected by <x>), encoded in the "Rn" field.
- <Rm> For encoding A1: is the second general-purpose source register holding the multiplier in the bottom or top half (selected by <y>), encoded in the "Rm" field.
For encoding T1: is the second general-purpose source register holding the multiplier in the bottom or top half (selected by <x>), encoded in the "Rm" field.

Operation for all encodings

```
if ConditionPassed() then
    EncodingSpecificOperations();
    operand1 = if n_high then R[n]<31:16> else R[n]<15:0>;
    operand2 = if m_high then R[m]<31:16> else R[m]<15:0>;
    result = SInt(operand1) * SInt(operand2) + SInt(R[dHi]:R[dLo]);
    R[dHi] = result<63:32>;
    R[dLo] = result<31:0>;
```

F5.1.192 SMLALD, SMLALDX

Signed Multiply Accumulate Long Dual performs two signed 16 x 16-bit multiplications. It adds the products to a 64-bit accumulate operand.

Optionally, the instruction can exchange the halfwords of the second operand before performing the arithmetic. This produces top x bottom and bottom x top multiplication.

Overflow is possible during this instruction, but only as a result of the 64-bit addition. This overflow is not detected if it occurs. Instead, the result wraps around modulo 2^{64} .

A1

31	28	27	26	25	24	23	22	21	20	19	16	15	12	11	8	7	6	5	4	3	0	
!=1111				0	1	1	1	0	1	0	0	RdHi	RdLo	Rm	0	0	M	1	Rn			
cond																						

SMLALD variant

Applies when M == 0.

SMLALD{<c>}{<q>} <RdLo>, <RdHi>, <Rn>, <Rm>

SMLALDX variant

Applies when M == 1.

SMLALDX{<c>}{<q>} <RdLo>, <RdHi>, <Rn>, <Rm>

Decode for all variants of this encoding

```
dLo = UInt(RdLo); dHi = UInt(RdHi); n = UInt(Rn); m = UInt(Rm); m_swap = (M == '1');
if dLo == 15 || dHi == 15 || n == 15 || m == 15 then UNPREDICTABLE;
if dHi == dLo then UNPREDICTABLE;
```

CONSTRAINED UNPREDICTABLE behavior

If dHi == dLo, then one of the following behaviors must occur:

- The instruction is UNDEFINED.
- The instruction executes as NOP.
- The value in the destination register is UNKNOWN.

T1

15	14	13	12	11	10	9	8	7	6	5	4	3	0	15	12	11	8	7	6	5	4	3	0
1	1	1	1	1	0	1	1	1	1	0	0	Rn	RdLo	RdHi	1	1	0	M	Rm				

SMLALD variant

Applies when M == 0.

SMLALD{<c>}{<q>} <RdLo>, <RdHi>, <Rn>, <Rm>

SMLALDX variant

Applies when M == 1.

SMLALDX{<c>}{<q>} <RdLo>, <RdHi>, <Rn>, <Rm>

Decode for all variants of this encoding

```
dLo = UInt(RdLo); dHi = UInt(RdHi); n = UInt(Rn); m = UInt(Rm); m_swap = (M == '1');  
if dLo == 15 || dHi == 15 || n == 15 || m == 15 then UNPREDICTABLE;  
// ARMv8-A removes UNPREDICTABLE for R13  
if dHi == dLo then UNPREDICTABLE;
```

CONSTRAINED UNPREDICTABLE behavior

If $dHi == dLo$, then one of the following behaviors must occur:

- The instruction is UNDEFINED.
- The instruction executes as NOP.
- The value in the destination register is UNKNOWN.

Notes for all encodings

For more information about the CONSTRAINED UNPREDICTABLE behavior of this instruction, see [Appendix K1 Architectural Constraints on UNPREDICTABLE behaviors](#).

Assembler symbols

<c>	See Standard assembler syntax fields on page F2-2848 .
<q>	See Standard assembler syntax fields on page F2-2848 .
<RdLo>	Is the general-purpose source register holding the lower 32 bits of the addend, and the destination register for the lower 32 bits of the result, encoded in the "RdLo" field.
<RdHi>	Is the general-purpose source register holding the upper 32 bits of the addend, and the destination register for the upper 32 bits of the result, encoded in the "RdHi" field.
<Rn>	Is the first general-purpose source register, encoded in the "Rn" field.
<Rm>	Is the second general-purpose source register, encoded in the "Rm" field.

Operation for all encodings

```
if ConditionPassed() then  
  EncodingSpecificOperations();  
  operand2 = if m_swap then ROR(R[m],16) else R[m];  
  product1 = SInt(R[n]<15:0>) * SInt(operand2<15:0>);  
  product2 = SInt(R[n]<31:16>) * SInt(operand2<31:16>);  
  result = product1 + product2 + SInt(R[dHi]:R[dLo]);  
  R[dHi] = result<63:32>;  
  R[dLo] = result<31:0>;
```

F5.1.193 SMLAWB, SMLAWT

Signed Multiply Accumulate (word by halfword) performs a signed multiply accumulate operation. The multiply acts on a signed 32-bit quantity and a signed 16-bit quantity. The signed 16-bit quantity is taken from either the bottom or the top half of its source register. The other half of the second source register is ignored. The top 32 bits of the 48-bit product are added to a 32-bit accumulate value and the result is written to the destination register. The bottom 16 bits of the 48-bit product are ignored.

If overflow occurs during the addition of the accumulate value, the instruction sets `PSTATE.Q` to 1. No overflow can occur during the multiplication.

A1

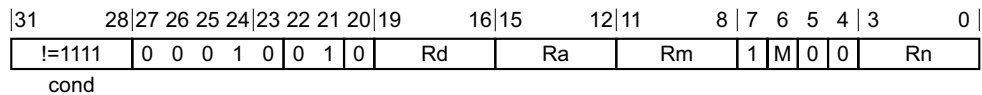

SMLAWB variant

Applies when `M == 0`.

`SMLAWB{<c>}{<q>} <Rd>, <Rn>, <Rm>, <Ra>`

SMLAWT variant

Applies when `M == 1`.

`SMLAWT{<c>}{<q>} <Rd>, <Rn>, <Rm>, <Ra>`

Decode for all variants of this encoding

```
d = UInt(Rd); n = UInt(Rn); m = UInt(Rm); a = UInt(Ra); m_high = (M == '1');
if d == 15 || n == 15 || m == 15 || a == 15 then UNPREDICTABLE;
```

T1

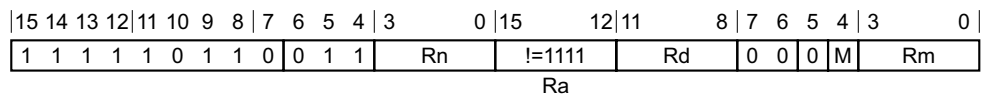

SMLAWB variant

Applies when `M == 0`.

`SMLAWB{<c>}{<q>} <Rd>, <Rn>, <Rm>, <Ra>`

SMLAWT variant

Applies when `M == 1`.

`SMLAWT{<c>}{<q>} <Rd>, <Rn>, <Rm>, <Ra>`

Decode for all variants of this encoding

```
if Ra == '1111' then SEE SMULWB, SMULWT;
d = UInt(Rd); n = UInt(Rn); m = UInt(Rm); a = UInt(Ra); m_high = (M == '1');
if d == 15 || n == 15 || m == 15 then UNPREDICTABLE; // ARMv8-A removes UNPREDICTABLE for R13
```

Notes for all encodings

For more information about the CONSTRAINED UNPREDICTABLE behavior of this instruction, see [Appendix K1 Architectural Constraints on UNPREDICTABLE behaviors](#).

Assembler symbols

- <c> See *Standard assembler syntax fields* on page F2-2848.
- <q> See *Standard assembler syntax fields* on page F2-2848.
- <Rd> Is the general-purpose destination register, encoded in the "Rd" field.
- <Rn> Is the first general-purpose source register holding the multiplicand, encoded in the "Rn" field.
- <Rm> Is the second general-purpose source register holding the multiplier in the bottom or top half (selected by <y>), encoded in the "Rm" field.
- <Ra> Is the third general-purpose source register holding the addend, encoded in the "Ra" field.

Operation for all encodings

```
if ConditionPassed() then
    EncodingSpecificOperations();
operand2 = if m_high then R[m]<31:16> else R[m]<15:0>;
result = SInt(R[n]) * SInt(operand2) + (SInt(R[a]) << 16);
R[d] = result<47:16>;
if (result >> 16) != SInt(R[d]) then // Signed overflow
    PSTATE.Q = '1';
```

F5.1.194 SMLSD, SMLSDX

Signed Multiply Subtract Dual performs two signed 16 x 16-bit multiplications. It adds the difference of the products to a 32-bit accumulate operand.

Optionally, the instruction can exchange the halfwords of the second operand before performing the arithmetic. This produces top x bottom and bottom x top multiplication.

This instruction sets `PSTATE.Q` to 1 if the accumulate operation overflows. Overflow cannot occur during the multiplications or subtraction.

A1

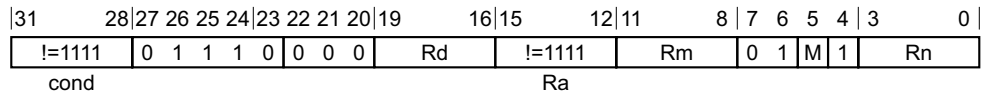

SMLSD variant

Applies when `M == 0`.

`SMLSD{<c>}{<q>} <Rd>, <Rn>, <Rm>, <Ra>`

SMLSDX variant

Applies when `M == 1`.

`SMLSDX{<c>}{<q>} <Rd>, <Rn>, <Rm>, <Ra>`

Decode for all variants of this encoding

```
if Ra == '1111' then SEE SMUSD;
d = UInt(Rd); n = UInt(Rn); m = UInt(Rm); a = UInt(Ra); m_swap = (M == '1');
if d == 15 || n == 15 || m == 15 then UNPREDICTABLE;
```

T1

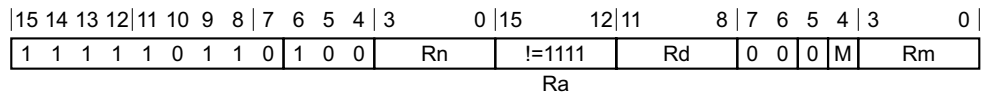

SMLSD variant

Applies when `M == 0`.

`SMLSD{<c>}{<q>} <Rd>, <Rn>, <Rm>, <Ra>`

SMLSDX variant

Applies when `M == 1`.

`SMLSDX{<c>}{<q>} <Rd>, <Rn>, <Rm>, <Ra>`

Decode for all variants of this encoding

```
if Ra == '1111' then SEE SMUSD;
d = UInt(Rd); n = UInt(Rn); m = UInt(Rm); a = UInt(Ra); m_swap = (M == '1');
if d == 15 || n == 15 || m == 15 then UNPREDICTABLE; // ARMv8-A removes UNPREDICTABLE for R13
```

Notes for all encodings

For more information about the CONSTRAINED UNPREDICTABLE behavior of this instruction, see [Appendix K1 Architectural Constraints on UNPREDICTABLE behaviors](#).

Assembler symbols

- <c> See *Standard assembler syntax fields* on page F2-2848.
- <q> See *Standard assembler syntax fields* on page F2-2848.
- <Rd> Is the general-purpose destination register, encoded in the "Rd" field.
- <Rn> Is the first general-purpose source register, encoded in the "Rn" field.
- <Rm> Is the second general-purpose source register, encoded in the "Rm" field.
- <Ra> Is the third general-purpose source register holding the addend, encoded in the "Ra" field.

Operation for all encodings

```
if ConditionPassed() then
    EncodingSpecificOperations();
    operand2 = if m_swap then ROR(R[m],16) else R[m];
    product1 = SInt(R[n]<15:0>) * SInt(operand2<15:0>);
    product2 = SInt(R[n]<31:16>) * SInt(operand2<31:16>);
    result = product1 - product2 + SInt(R[a]);
    R[d] = result<31:0>;
    if result != SInt(result<31:0>) then // Signed overflow
        PSTATE.Q = '1';
```

F5.1.195 SMLS LD, SMLS LD X

Signed Multiply Subtract Long Dual performs two signed 16 x 16-bit multiplications. It adds the difference of the products to a 64-bit accumulate operand.

Optionally, the instruction can exchange the halfwords of the second operand before performing the arithmetic. This produces top x bottom and bottom x top multiplication.

Overflow is possible during this instruction, but only as a result of the 64-bit addition. This overflow is not detected if it occurs. Instead, the result wraps around modulo 2^{64} .

A1

31	28	27	26	25	24	23	22	21	20	19	16	15	12	11	8	7	6	5	4	3	0	
!=1111				0	1	1	1	0	1	0	0	RdHi	RdLo	Rm	0	1	M	1	Rn			
cond																						

SMLS LD variant

Applies when M == 0.

SMLS LD{<c>}{<q>} <RdLo>, <RdHi>, <Rn>, <Rm>

SMLS LD X variant

Applies when M == 1.

SMLS LD X{<c>}{<q>} <RdLo>, <RdHi>, <Rn>, <Rm>

Decode for all variants of this encoding

```
dLo = UInt(RdLo); dHi = UInt(RdHi); n = UInt(Rn); m = UInt(Rm); m_swap = (M == '1');
if dLo == 15 || dHi == 15 || n == 15 || m == 15 then UNPREDICTABLE;
if dHi == dLo then UNPREDICTABLE;
```

CONSTRAINED UNPREDICTABLE behavior

If dHi == dLo, then one of the following behaviors must occur:

- The instruction is UNDEFINED.
- The instruction executes as NOP.
- The value in the destination register is UNKNOWN.

T1

15	14	13	12	11	10	9	8	7	6	5	4	3	0	15	12	11	8	7	6	5	4	3	0
1	1	1	1	1	0	1	1	1	1	0	1	Rn	RdLo	RdHi	1	1	0	M	Rm				

SMLS LD variant

Applies when M == 0.

SMLS LD{<c>}{<q>} <RdLo>, <RdHi>, <Rn>, <Rm>

SMLS LD X variant

Applies when M == 1.

SMLS LD X{<c>}{<q>} <RdLo>, <RdHi>, <Rn>, <Rm>

Decode for all variants of this encoding

```
dLo = UInt(RdLo); dHi = UInt(RdHi); n = UInt(Rn); m = UInt(Rm); m_swap = (M == '1');  
if dLo == 15 || dHi == 15 || n == 15 || m == 15 then UNPREDICTABLE;  
// ARMv8-A removes UNPREDICTABLE for R13  
if dHi == dLo then UNPREDICTABLE;
```

CONSTRAINED UNPREDICTABLE behavior

If $dHi == dLo$, then one of the following behaviors must occur:

- The instruction is UNDEFINED.
- The instruction executes as NOP.
- The value in the destination register is UNKNOWN.

Notes for all encodings

For more information about the CONSTRAINED UNPREDICTABLE behavior of this instruction, see [Appendix K1 Architectural Constraints on UNPREDICTABLE behaviors](#).

Assembler symbols

<c>	See Standard assembler syntax fields on page F2-2848 .
<q>	See Standard assembler syntax fields on page F2-2848 .
<RdLo>	Is the general-purpose source register holding the lower 32 bits of the addend, and the destination register for the lower 32 bits of the result, encoded in the "RdLo" field.
<RdHi>	Is the general-purpose source register holding the upper 32 bits of the addend, and the destination register for the upper 32 bits of the result, encoded in the "RdHi" field.
<Rn>	Is the first general-purpose source register, encoded in the "Rn" field.
<Rm>	Is the second general-purpose source register, encoded in the "Rm" field.

Operation for all encodings

```
if ConditionPassed() then  
  EncodingSpecificOperations();  
  operand2 = if m_swap then ROR(R[m],16) else R[m];  
  product1 = SInt(R[n]<15:0>) * SInt(operand2<15:0>);  
  product2 = SInt(R[n]<31:16>) * SInt(operand2<31:16>);  
  result = product1 - product2 + SInt(R[dHi]:R[dLo]);  
  R[dHi] = result<63:32>;  
  R[dLo] = result<31:0>;
```

F5.1.196 SMMLA, SMMLAR

Signed Most Significant Word Multiply Accumulate multiplies two signed 32-bit values, extracts the most significant 32 bits of the result, and adds an accumulate value.

Optionally, the instruction can specify that the result is rounded instead of being truncated. In this case, the constant $0x80000000$ is added to the product before the high word is extracted.

A1

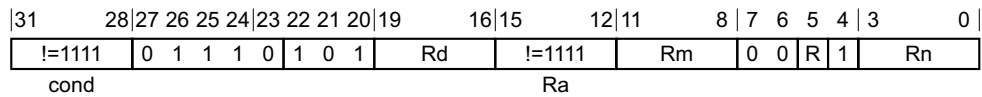

SMMLA variant

Applies when R == 0.

SMMLA{<c>}{<q>} <Rd>, <Rn>, <Rm>, <Ra>

SMMLAR variant

Applies when R == 1.

SMMLAR{<c>}{<q>} <Rd>, <Rn>, <Rm>, <Ra>

Decode for all variants of this encoding

```
if Ra == '1111' then SEE SMMUL;
d = UInt(Rd); n = UInt(Rn); m = UInt(Rm); a = UInt(Ra); round = (R == '1');
if d == 15 || n == 15 || m == 15 then UNPREDICTABLE;
```

T1

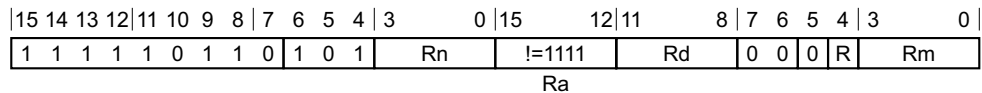

SMMLA variant

Applies when R == 0.

SMMLA{<c>}{<q>} <Rd>, <Rn>, <Rm>, <Ra>

SMMLAR variant

Applies when R == 1.

SMMLAR{<c>}{<q>} <Rd>, <Rn>, <Rm>, <Ra>

Decode for all variants of this encoding

```
if Ra == '1111' then SEE SMMUL;
d = UInt(Rd); n = UInt(Rn); m = UInt(Rm); a = UInt(Ra); round = (R == '1');
if d == 15 || n == 15 || m == 15 then UNPREDICTABLE; // ARMv8-A removes UNPREDICTABLE for R13
```

Notes for all encodings

For more information about the CONSTRAINED UNPREDICTABLE behavior of this instruction, see [Appendix K1 Architectural Constraints on UNPREDICTABLE behaviors](#).

Assembler symbols

- <c> See [Standard assembler syntax fields on page F2-2848](#).
- <q> See [Standard assembler syntax fields on page F2-2848](#).
- <Rd> Is the general-purpose destination register, encoded in the "Rd" field.
- <Rn> Is the first general-purpose source register holding the multiplicand, encoded in the "Rn" field.
- <Rm> Is the second general-purpose source register holding the multiplier, encoded in the "Rm" field.
- <Ra> Is the third general-purpose source register holding the addend, encoded in the "Ra" field.

Operation for all encodings

```
if ConditionPassed() then
    EncodingSpecificOperations();
    result = (SInt(R[a]) << 32) + SInt(R[n]) * SInt(R[m]);
    if round then result = result + 0x80000000;
    R[d] = result<63:32>;
```

F5.1.197 SMMLS, SMMLSR

Signed Most Significant Word Multiply Subtract multiplies two signed 32-bit values, subtracts the result from a 32-bit accumulate value that is shifted left by 32 bits, and extracts the most significant 32 bits of the result of that subtraction.

Optionally, the instruction can specify that the result of the instruction is rounded instead of being truncated. In this case, the constant $0x80000000$ is added to the result of the subtraction before the high word is extracted.

A1

31	28 27 26 25 24 23 22 21 20 19	16 15	12 11	8 7 6 5 4 3	0
!=1111	0 1 1 1 0 1 0 1	Rd	Ra	Rm	1 1 R 1 Rn
cond					

SMMLS variant

Applies when R == 0.

SMMLS{<c>}{<q>} <Rd>, <Rn>, <Rm>, <Ra>

SMMLSR variant

Applies when R == 1.

SMMLSR{<c>}{<q>} <Rd>, <Rn>, <Rm>, <Ra>

Decode for all variants of this encoding

```
d = UInt(Rd); n = UInt(Rn); m = UInt(Rm); a = UInt(Ra); round = (R == '1');
if d == 15 || n == 15 || m == 15 || a == 15 then UNPREDICTABLE;
```

T1

15 14 13 12 11 10 9 8 7 6 5 4 3	0 15	12 11	8 7 6 5 4 3	0
1 1 1 1 1 0 1 1 0 1 1 0	Rn	Ra	Rd	0 0 0 R Rm

SMMLS variant

Applies when R == 0.

SMMLS{<c>}{<q>} <Rd>, <Rn>, <Rm>, <Ra>

SMMLSR variant

Applies when R == 1.

SMMLSR{<c>}{<q>} <Rd>, <Rn>, <Rm>, <Ra>

Decode for all variants of this encoding

```
d = UInt(Rd); n = UInt(Rn); m = UInt(Rm); a = UInt(Ra); round = (R == '1');
if d == 15 || n == 15 || m == 15 || a == 15 then UNPREDICTABLE;
// ARMv8-A removes UNPREDICTABLE for R13
```

Notes for all encodings

For more information about the CONSTRAINED UNPREDICTABLE behavior of this instruction, see [Appendix K1 Architectural Constraints on UNPREDICTABLE behaviors](#).

Assembler symbols

- <c> See [Standard assembler syntax fields on page F2-2848](#).
- <q> See [Standard assembler syntax fields on page F2-2848](#).
- <Rd> Is the general-purpose destination register, encoded in the "Rd" field.
- <Rn> Is the first general-purpose source register holding the multiplicand, encoded in the "Rn" field.
- <Rm> Is the second general-purpose source register holding the multiplier, encoded in the "Rm" field.
- <Ra> Is the third general-purpose source register holding the addend, encoded in the "Ra" field.

Operation for all encodings

```
if ConditionPassed() then
    EncodingSpecificOperations();
    result = (SInt(R[a]) << 32) - SInt(R[n]) * SInt(R[m]);
    if round then result = result + 0x80000000;
    R[d] = result<63:32>;
```

F5.1.198 SMMUL, SMMULR

Signed Most Significant Word Multiply multiplies two signed 32-bit values, extracts the most significant 32 bits of the result, and writes those bits to the destination register.

Optionally, the instruction can specify that the result is rounded instead of being truncated. In this case, the constant $0x80000000$ is added to the product before the high word is extracted.

A1

31	28	27	26	25	24	23	22	21	20	19	16	15	14	13	12	11	8	7	6	5	4	3	0	
!=1111				0	1	1	1	0	1	0	1	Rd	1	1	1	1	Rm	0	0	R	1	Rn		
cond																								

SMMUL variant

Applies when R == 0.

SMMUL{<c>}{<q>} {<Rd>}, <Rn>, <Rm>

SMMULR variant

Applies when R == 1.

SMMULR{<c>}{<q>} {<Rd>}, <Rn>, <Rm>

Decode for all variants of this encoding

```
d = UInt(Rd); n = UInt(Rn); m = UInt(Rm); round = (R == '1');
if d == 15 || n == 15 || m == 15 then UNPREDICTABLE;
```

T1

15	14	13	12	11	10	9	8	7	6	5	4	3	0	15	14	13	12	11	8	7	6	5	4	3	0
1	1	1	1	1	0	1	1	0	1	0	1	Rn	1	1	1	1	Rd	0	0	0	R	Rm			

SMMUL variant

Applies when R == 0.

SMMUL{<c>}{<q>} {<Rd>}, <Rn>, <Rm>

SMMULR variant

Applies when R == 1.

SMMULR{<c>}{<q>} {<Rd>}, <Rn>, <Rm>

Decode for all variants of this encoding

```
d = UInt(Rd); n = UInt(Rn); m = UInt(Rm); round = (R == '1');
if d == 15 || n == 15 || m == 15 then UNPREDICTABLE; // ARMv8-A removes UNPREDICTABLE for R13
```

Notes for all encodings

For more information about the CONSTRAINED UNPREDICTABLE behavior of this instruction, see [Appendix K1 Architectural Constraints on UNPREDICTABLE behaviors](#).

Assembler symbols

- <c> See [Standard assembler syntax fields on page F2-2848](#).
- <q> See [Standard assembler syntax fields on page F2-2848](#).
- <Rd> Is the general-purpose destination register, encoded in the "Rd" field.
- <Rn> Is the first general-purpose source register, encoded in the "Rn" field.
- <Rm> Is the second general-purpose source register, encoded in the "Rm" field.

Operation for all encodings

```
if ConditionPassed() then
    EncodingSpecificOperations();
    result = SInt(R[n]) * SInt(R[m]);
    if round then result = result + 0x80000000;
    R[d] = result<63:32>;
```

F5.1.199 SMUAD, SMUADX

Signed Dual Multiply Add performs two signed 16 x 16-bit multiplications. It adds the products together, and writes the result to the destination register.

Optionally, the instruction can exchange the halfwords of the second operand before performing the arithmetic. This produces top x bottom and bottom x top multiplication.

This instruction sets `PSTATE.Q` to 1 if the addition overflows. The multiplications cannot overflow.

A1

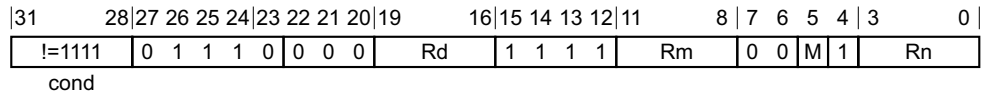

SMUAD variant

Applies when `M == 0`.

SMUAD{<c>}{<q>} {<Rd>}, <Rn>, <Rm>

SMUADX variant

Applies when `M == 1`.

SMUADX{<c>}{<q>} {<Rd>}, <Rn>, <Rm>

Decode for all variants of this encoding

```
d = UInt(Rd); n = UInt(Rn); m = UInt(Rm); m_swap = (M == '1');
if d == 15 || n == 15 || m == 15 then UNPREDICTABLE;
```

T1

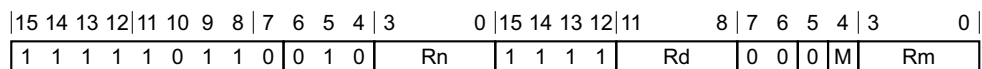

SMUAD variant

Applies when `M == 0`.

SMUAD{<c>}{<q>} {<Rd>}, <Rn>, <Rm>

SMUADX variant

Applies when `M == 1`.

SMUADX{<c>}{<q>} {<Rd>}, <Rn>, <Rm>

Decode for all variants of this encoding

```
d = UInt(Rd); n = UInt(Rn); m = UInt(Rm); m_swap = (M == '1');
if d == 15 || n == 15 || m == 15 then UNPREDICTABLE; // ARMv8-A removes UNPREDICTABLE for R13
```

Notes for all encodings

For more information about the `CONSTRAINED UNPREDICTABLE` behavior of this instruction, see [Appendix K1 Architectural Constraints on UNPREDICTABLE behaviors](#).

Assembler symbols

- <c> See [Standard assembler syntax fields on page F2-2848](#).
- <q> See [Standard assembler syntax fields on page F2-2848](#).
- <Rd> Is the general-purpose destination register, encoded in the "Rd" field.
- <Rn> Is the first general-purpose source register, encoded in the "Rn" field.
- <Rm> Is the second general-purpose source register, encoded in the "Rm" field.

Operation for all encodings

```
if ConditionPassed() then
    EncodingSpecificOperations();
operand2 = if m_swap then ROR(R[m],16) else R[m];
product1 = SInt(R[n]<15:0>) * SInt(operand2<15:0>);
product2 = SInt(R[n]<31:16>) * SInt(operand2<31:16>);
result = product1 + product2;
R[d] = result<31:0>;
if result != SInt(result<31:0>) then // Signed overflow
    PSTATE.Q = '1';
```

F5.1.200 SMULBB, SMULBT, SMULTB, SMULTT

Signed Multiply (halfwords) multiplies two signed 16-bit quantities, taken from either the bottom or the top half of their respective source registers. The other halves of these source registers are ignored. The 32-bit product is written to the destination register. No overflow is possible during this instruction.

A1

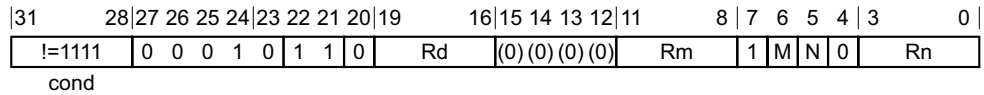

SMULBB variant

Applies when M == 0 && N == 0.

SMULBB{<C>}{<q>} {<Rd>}, <Rn>, <Rm>

SMULBT variant

Applies when M == 1 && N == 0.

SMULBT{<C>}{<q>} {<Rd>}, <Rn>, <Rm>

SMULTB variant

Applies when M == 0 && N == 1.

SMULTB{<C>}{<q>} {<Rd>}, <Rn>, <Rm>

SMULTT variant

Applies when M == 1 && N == 1.

SMULTT{<C>}{<q>} {<Rd>}, <Rn>, <Rm>

Decode for all variants of this encoding

```
d = UInt(Rd); n = UInt(Rn); m = UInt(Rm);
n_high = (N == '1'); m_high = (M == '1');
if d == 15 || n == 15 || m == 15 then UNPREDICTABLE;
```

T1

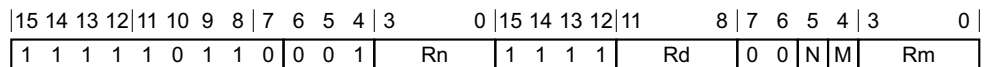

SMULBB variant

Applies when N == 0 && M == 0.

SMULBB{<C>}{<q>} {<Rd>}, <Rn>, <Rm>

SMULBT variant

Applies when N == 0 && M == 1.

SMULBT{<C>}{<q>} {<Rd>}, <Rn>, <Rm>

SMULTB variant

Applies when N == 1 && M == 0.

```
SMULTB{<c>}{<q>} {<Rd>}, <Rn>, <Rm>
```

SMULTT variant

Applies when N == 1 && M == 1.

```
SMULTT{<c>}{<q>} {<Rd>}, <Rn>, <Rm>
```

Decode for all variants of this encoding

```
d = UInt(Rd); n = UInt(Rn); m = UInt(Rm);  
n_high = (N == '1'); m_high = (M == '1');  
if d == 15 || n == 15 || m == 15 then UNPREDICTABLE; // ARMv8-A removes UNPREDICTABLE for R13
```

Notes for all encodings

For more information about the CONSTRAINED UNPREDICTABLE behavior of this instruction, see [Appendix K1 Architectural Constraints on UNPREDICTABLE behaviors](#).

Assembler symbols

- <c> See [Standard assembler syntax fields on page F2-2848](#).
- <q> See [Standard assembler syntax fields on page F2-2848](#).
- <Rd> Is the general-purpose destination register, encoded in the "Rd" field.
- <Rn> Is the first general-purpose source register holding the multiplicand in the bottom or top half (selected by <x>), encoded in the "Rn" field.
- <Rm> Is the second general-purpose source register holding the multiplier in the bottom or top half (selected by <y>), encoded in the "Rm" field.

Operation for all encodings

```
if ConditionPassed() then  
  EncodingSpecificOperations();  
  operand1 = if n_high then R[n]<31:16> else R[n]<15:0>;  
  operand2 = if m_high then R[m]<31:16> else R[m]<15:0>;  
  result = SInt(operand1) * SInt(operand2);  
  R[d] = result<31:0>;  
  // Signed overflow cannot occur
```

F5.1.201 SMULL, SMULLS

Signed Multiply Long multiplies two 32-bit signed values to produce a 64-bit result.

In A32 instructions, the condition flags can optionally be updated based on the result. Use of this option adversely affects performance on many implementations.

A1

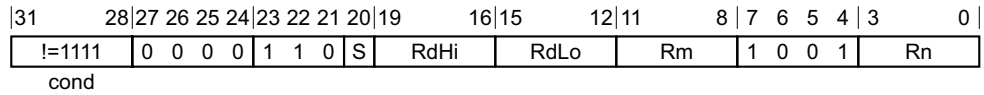

Flag setting variant

Applies when S == 1.

SMULLS{<c>}{<q>} <RdLo>, <RdHi>, <Rn>, <Rm>

Not flag setting variant

Applies when S == 0.

SMULL{<c>}{<q>} <RdLo>, <RdHi>, <Rn>, <Rm>

Decode for all variants of this encoding

```
dLo = UInt(RdLo); dHi = UInt(RdHi); n = UInt(Rn); m = UInt(Rm); setflags = (S == '1');
if dLo == 15 || dHi == 15 || n == 15 || m == 15 then UNPREDICTABLE;
if dHi == dLo then UNPREDICTABLE;
```

CONSTRAINED UNPREDICTABLE behavior

If dHi == dLo, then one of the following behaviors must occur:

- The instruction is UNDEFINED.
- The instruction executes as NOP.
- The value in the destination register is UNKNOWN.

T1

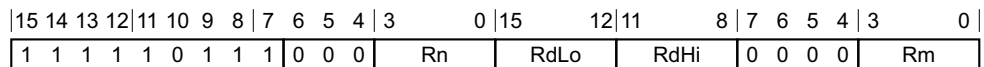

T1 variant

SMULL{<c>}{<q>} <RdLo>, <RdHi>, <Rn>, <Rm>

Decode for this encoding

```
dLo = UInt(RdLo); dHi = UInt(RdHi); n = UInt(Rn); m = UInt(Rm); setflags = FALSE;
if dLo == 15 || dHi == 15 || n == 15 || m == 15 then UNPREDICTABLE;
// ARMv8-A removes UNPREDICTABLE for R13
if dHi == dLo then UNPREDICTABLE;
```

CONSTRAINED UNPREDICTABLE behavior

If $dHi == dLo$, then one of the following behaviors must occur:

- The instruction is UNDEFINED.
- The instruction executes as NOP.
- The value in the destination register is UNKNOWN.

Notes for all encodings

For more information about the CONSTRAINED UNPREDICTABLE behavior of this instruction, see [Appendix K1 Architectural Constraints on UNPREDICTABLE behaviors](#).

Assembler symbols

<c>	See Standard assembler syntax fields on page F2-2848 .
<q>	See Standard assembler syntax fields on page F2-2848 .
<RdLo>	Is the general-purpose destination register for the lower 32 bits of the result, encoded in the "RdLo" field.
<RdHi>	Is the general-purpose destination register for the upper 32 bits of the result, encoded in the "RdHi" field.
<Rn>	Is the first general-purpose source register holding the multiplicand, encoded in the "Rn" field.
<Rm>	Is the second general-purpose source register holding the multiplier, encoded in the "Rm" field.

Operation for all encodings

```
if ConditionPassed() then
    EncodingSpecificOperations();
    result = SInt(R[n]) * SInt(R[m]);
    R[dHi] = result<63:32>;
    R[dLo] = result<31:0>;
    if setflags then
        PSTATE.N = result<63>;
        PSTATE.Z = IsZeroBit(result<63:0>);
        // PSTATE.C, PSTATE.V unchanged
```

F5.1.202 SMULWB, SMULWT

Signed Multiply (word by halfword) multiplies a signed 32-bit quantity and a signed 16-bit quantity. The signed 16-bit quantity is taken from either the bottom or the top half of its source register. The other half of the second source register is ignored. The top 32 bits of the 48-bit product are written to the destination register. The bottom 16 bits of the 48-bit product are ignored. No overflow is possible during this instruction.

A1

31	28	27	26	25	24	23	22	21	20	19	16	15	14	13	12	11	8	7	6	5	4	3	0	
!=1111				0	0	0	1	0	0	1	0	Rd	(0)	(0)	(0)	(0)	Rm	1	M	1	0	Rn		
cond																								

SMULWB variant

Applies when M == 0.

SMULWB{<C>}{<q>} {<Rd>}, <Rn>, <Rm>

SMULWT variant

Applies when M == 1.

SMULWT{<C>}{<q>} {<Rd>}, <Rn>, <Rm>

Decode for all variants of this encoding

```
d = UInt(Rd); n = UInt(Rn); m = UInt(Rm); m_high = (M == '1');
if d == 15 || n == 15 || m == 15 then UNPREDICTABLE;
```

T1

15	14	13	12	11	10	9	8	7	6	5	4	3	0	15	14	13	12	11	8	7	6	5	4	3	0
1	1	1	1	1	0	1	1	0	0	1	1	Rn	1	1	1	1	Rd	0	0	0	M	Rm			

SMULWB variant

Applies when M == 0.

SMULWB{<C>}{<q>} {<Rd>}, <Rn>, <Rm>

SMULWT variant

Applies when M == 1.

SMULWT{<C>}{<q>} {<Rd>}, <Rn>, <Rm>

Decode for all variants of this encoding

```
d = UInt(Rd); n = UInt(Rn); m = UInt(Rm); m_high = (M == '1');
if d == 15 || n == 15 || m == 15 then UNPREDICTABLE; // ARMv8-A removes UNPREDICTABLE for R13
```

Notes for all encodings

For more information about the CONSTRAINED UNPREDICTABLE behavior of this instruction, see [Appendix K1 Architectural Constraints on UNPREDICTABLE behaviors](#).

Assembler symbols

- <c> See [Standard assembler syntax fields on page F2-2848](#).
- <q> See [Standard assembler syntax fields on page F2-2848](#).
- <Rd> Is the general-purpose destination register, encoded in the "Rd" field.
- <Rn> Is the first general-purpose source register holding the multiplicand, encoded in the "Rn" field.
- <Rm> Is the second general-purpose source register holding the multiplier in the bottom or top half (selected by <y>), encoded in the "Rm" field.

Operation for all encodings

```
if ConditionPassed() then
    EncodingSpecificOperations();
operand2 = if m_high then R[m]<31:16> else R[m]<15:0>;
product = SInt(R[n]) * SInt(operand2);
R[d] = product<47:16>;
// Signed overflow cannot occur
```

F5.1.203 SMUSD, SMUSDX

Signed Multiply Subtract Dual performs two signed 16 x 16-bit multiplications. It subtracts one of the products from the other, and writes the result to the destination register.

Optionally, the instruction can exchange the halfwords of the second operand before performing the arithmetic. This produces top x bottom and bottom x top multiplication.

Overflow cannot occur.

A1

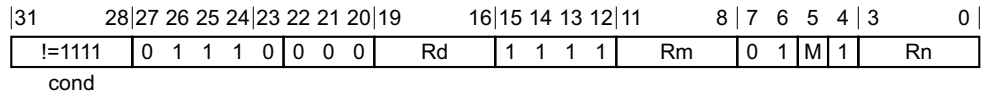

SMUSD variant

Applies when M == 0.

SMUSD{<c>}{<q>} {<Rd>}, <Rn>, <Rm>

SMUSDX variant

Applies when M == 1.

SMUSDX{<c>}{<q>} {<Rd>}, <Rn>, <Rm>

Decode for all variants of this encoding

```
d = UInt(Rd); n = UInt(Rn); m = UInt(Rm); m_swap = (M == '1');
if d == 15 || n == 15 || m == 15 then UNPREDICTABLE;
```

T1

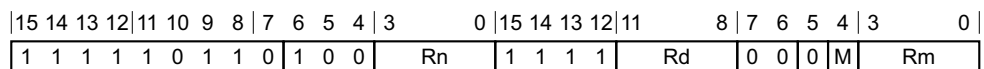

SMUSD variant

Applies when M == 0.

SMUSD{<c>}{<q>} {<Rd>}, <Rn>, <Rm>

SMUSDX variant

Applies when M == 1.

SMUSDX{<c>}{<q>} {<Rd>}, <Rn>, <Rm>

Decode for all variants of this encoding

```
d = UInt(Rd); n = UInt(Rn); m = UInt(Rm); m_swap = (M == '1');
if d == 15 || n == 15 || m == 15 then UNPREDICTABLE; // ARMv8-A removes UNPREDICTABLE for R13
```

Notes for all encodings

For more information about the CONSTRAINED UNPREDICTABLE behavior of this instruction, see [Appendix K1 Architectural Constraints on UNPREDICTABLE behaviors](#).

Assembler symbols

- <c> See [Standard assembler syntax fields on page F2-2848](#).
- <q> See [Standard assembler syntax fields on page F2-2848](#).
- <Rd> Is the general-purpose destination register, encoded in the "Rd" field.
- <Rn> Is the first general-purpose source register, encoded in the "Rn" field.
- <Rm> Is the second general-purpose source register, encoded in the "Rm" field.

Operation for all encodings

```
if ConditionPassed() then
    EncodingSpecificOperations();
operand2 = if m_swap then ROR(R[m],16) else R[m];
product1 = SInt(R[n]<15:0>) * SInt(operand2<15:0>);
product2 = SInt(R[n]<31:16>) * SInt(operand2<31:16>);
result = product1 - product2;
R[d] = result<31:0>;
// Signed overflow cannot occur
```

F5.1.204 SRS, SRSDA, SRSDB, SRSIA, SRSIB

Store Return State stores the LR_<current_mode> and SPSR_<current_mode> to the stack of a specified mode. For information about memory accesses see [Memory accesses on page F2-2854](#).

SRS is UNDEFINED in Hyp mode.

SRS is CONSTRAINED UNPREDICTABLE if it is executed in User or System mode, or if the specified mode is any of the following:

- Not implemented.
- A mode that [Table G1-5 on page G1-4322](#) does not show.
- Hyp mode.
- Monitor mode, if the SRS instruction is executed in Non-secure state.

If EL3 is using AArch64 and an SRS instruction that is executed in a Secure EL1 mode specifies Monitor mode, it is trapped to EL3.

See [Traps to EL3 of Secure monitor functionality from Secure EL1 using AArch32 on page D1-1870](#).

A1

31	30	29	28	27	26	25	24	23	22	21	20	19	18	17	16	15	14	13	12	11	10	9	8	7	6	5	4	0
1	1	1	1	1	0	0	P	U	1	W	0	(1)	(1)	(0)	(1)	(0)	(0)	(0)	(0)	(0)	(1)	(0)	(1)	(0)	(0)	(0)		mode

Decrement After variant

Applies when P == 0 && U == 0.

SRSDA{<c>}{<q>} SP{!}, #<mode>

Decrement Before variant

Applies when P == 1 && U == 0.

SRSDB{<c>}{<q>} SP{!}, #<mode>

Increment After variant

Applies when P == 0 && U == 1.

SRS{IA}{<c>}{<q>} SP{!}, #<mode>

Increment Before variant

Applies when P == 1 && U == 1.

SRSIB{<c>}{<q>} SP{!}, #<mode>

Decode for all variants of this encoding

wback = (W == '1'); increment = (U == '1'); wordhigher = (P == U);

T1

15	14	13	12	11	10	9	8	7	6	5	4	3	2	1	0	15	14	13	12	11	10	9	8	7	6	5	4	0
1	1	1	0	1	0	0	0	0	W	0	(1)	(1)	(0)	(1)	(1)	(1)	(0)	(0)	(0)	(0)	(0)	(0)	(0)	(0)	(0)	(0)		mode

T1 variant

SRSDB{<c>}{<q>} SP{!}, #<mode>

Decode for this encoding

wback = (W == '1'); increment = FALSE; wordhigher = FALSE;

T2

15	14	13	12	11	10	9	8	7	6	5	4	3	2	1	0	15	14	13	12	11	10	9	8	7	6	5	4	0
1	1	1	0	1	0	0	1	1	0	W	0	(1)	(1)	(0)	(1)	(1)	(1)	(0)	(0)	(0)	(0)	(0)	(0)	(0)	(0)	(0)	mode	

T2 variant

SRS{IA}{<c>}{<q>} SP{!}, #<mode>

Decode for this encoding

wback = (W == '1'); increment = TRUE; wordhigher = FALSE;

Notes for all encodings

For more information about the CONSTRAINED UNPREDICTABLE behavior of this instruction, see [Appendix K1 Architectural Constraints on UNPREDICTABLE behaviors](#), and particularly *SRS (T32)* on page K1-6108 and *SRS (A32)* on page K1-6108.

Assembler symbols

- IA For encoding A1: is an optional suffix to indicate the Increment After variant.
 For encoding T2: is an optional suffix for the Increment After form.
- <c> For encoding A1: see [Standard assembler syntax fields on page F2-2848](#). <c> must be AL or omitted.
 For encoding T1 and T2: see [Standard assembler syntax fields on page F2-2848](#).
- <q> See [Standard assembler syntax fields on page F2-2848](#).
- ! The address adjusted by the size of the data loaded is written back to the base register. If specified, it is encoded in the "W" field as 1, otherwise this field defaults to 0.
- <mode> Is the number of the mode whose Banked SP is used as the base register, encoded in the "mode" field. For details of PE modes and their numbers see [AArch32 PE mode descriptions on page G1-4322](#).

SRSFA, SRSEA, SRSFD, and SRSED are pseudo-instructions for SRSIB, SRSIA, SRSDb, and SRSDA respectively, referring to their use for pushing data onto Full Ascending, Empty Ascending, Full Descending, and Empty Descending stacks.

Operation for all encodings

```

if CurrentInstrSet() == InstrSet_A32 then
  if ConditionPassed() then
    EncodingSpecificOperations();
    if PSTATE.EL == EL2 then // UNDEFINED at EL2
      UNDEFINED;

    // Check for UNPREDICTABLE cases. The definition of UNPREDICTABLE does not permit these
    // to be security holes
    if PSTATE.M IN {M32_User, M32_System} then
      UNPREDICTABLE;
    elsif mode == M32_Hyp then // Check for attempt to access Hyp mode SP

```

```

    UNPREDICTABLE;
  elseif mode == M32_Monitor then // Check for attempt to access Monitor mode SP
    if !HaveEL(EL3) || !IsSecure() then
      UNPREDICTABLE;
    elseif !ELUsingAArch32(EL3) then
      AArch64.MonitorModeTrap();
  elseif BadMode(mode) then
    UNPREDICTABLE;

  base = Rmode[13,mode];
  address = if increment then base else base-8;
  if wordhigher then address = address+4;
  MemA[address,4] = LR;
  MemA[address+4,4] = SPSR[];
  if wback then Rmode[13,mode] = if increment then base+8 else base-8;
else
  if ConditionPassed() then
    EncodingSpecificOperations();
    if PSTATE.EL == EL2 then // UNDEFINED at EL2
      UNDEFINED;

    // Check for UNPREDICTABLE cases. The definition of UNPREDICTABLE does not permit these
    // to be security holes
    if PSTATE.M IN {M32_User,M32_System} then
      UNPREDICTABLE;
    elseif mode == M32_Hyp then // Check for attempt to access Hyp mode SP
      UNPREDICTABLE;
    elseif mode == M32_Monitor then // Check for attempt to access Monitor mode SP
      if !HaveEL(EL3) || !IsSecure() then
        UNPREDICTABLE;
      elseif !ELUsingAArch32(EL3) then
        AArch64.MonitorModeTrap();
    elseif BadMode(mode) then
      UNPREDICTABLE;

    base = Rmode[13,mode];
    address = if increment then base else base-8;
    if wordhigher then address = address+4;
    MemA[address,4] = LR;
    MemA[address+4,4] = SPSR[];
    if wback then Rmode[13,mode] = if increment then base+8 else base-8;

```

CONSTRAINED UNPREDICTABLE behavior

If PSTATE.M IN {M32_User,M32_System}, then one of the following behaviors must occur:

- The instruction is UNDEFINED.
- The instruction executes as NOP.

If mode == M32_Hyp, then one of the following behaviors must occur:

- The instruction is UNDEFINED.
- The instruction executes as NOP.

If mode == M32_Monitor && (!HaveEL(EL3) || !IsSecure()), then one of the following behaviors must occur:

- The instruction is UNDEFINED.
- The instruction executes as NOP.

If BadMode(mode), then one of the following behaviors must occur:

- The instruction is UNDEFINED.
- The instruction executes as NOP.

- The instruction stores to the stack of the mode in which it is executed.
- The instruction stores to an UNKNOWN address, and if the instruction specifies writeback then any general-purpose register that can be accessed from the current Exception level without a privilege violation becomes UNKNOWN.

F5.1.205 SSAT

Signed Saturate saturates an optionally-shifted signed value to a selectable signed range.

This instruction sets `PSTATE.Q` to 1 if the operation saturates.

A1

31	28	27	26	25	24	23	22	21	20	16	15	12	11	7	6	5	4	3	0	
!=1111				0	1	1	0	1	0	1	sat_imm	Rd	imm5	sh	0	1	Rn			
cond																				

Arithmetic shift right variant

Applies when `sh == 1`.

SSAT{<c>}{<q>} <Rd>, #<imm>, <Rn>, ASR #<amount>

Logical shift left variant

Applies when `sh == 0`.

SSAT{<c>}{<q>} <Rd>, #<imm>, <Rn> {, LSL #<amount>}

Decode for all variants of this encoding

```
d = UInt(Rd); n = UInt(Rn); saturate_to = UInt(sat_imm)+1;
(shift_t, shift_n) = DecodeImmShift(sh:'0', imm5);
if d == 15 || n == 15 then UNPREDICTABLE;
```

T1

15	14	13	12	11	10	9	8	7	6	5	4	3	0	15	14	12	11	8	7	6	5	4	0
1	1	1	1	0	(0)	1	1	0	0	sh	0	Rn	0	imm3	Rd	imm2	(0)	sat_imm					

Arithmetic shift right variant

Applies when `sh == 1 && !(imm3 == 000 && imm2 == 00)`.

SSAT{<c>}{<q>} <Rd>, #<imm>, <Rn>, ASR #<amount>

Logical shift left variant

Applies when `sh == 0`.

SSAT{<c>}{<q>} <Rd>, #<imm>, <Rn> {, LSL #<amount>}

Decode for all variants of this encoding

```
if sh == '1' && (imm3:imm2) == '0000' then SEE SSAT16;
d = UInt(Rd); n = UInt(Rn); saturate_to = UInt(sat_imm)+1;
(shift_t, shift_n) = DecodeImmShift(sh:'0', imm3:imm2);
if d == 15 || n == 15 then UNPREDICTABLE; // ARMv8-A removes UNPREDICTABLE for R13
```

Notes for all encodings

For more information about the CONSTRAINED UNPREDICTABLE behavior of this instruction, see [Appendix K1 Architectural Constraints on UNPREDICTABLE behaviors](#).

Assembler symbols

<c>	See <i>Standard assembler syntax fields</i> on page F2-2848.
<q>	See <i>Standard assembler syntax fields</i> on page F2-2848.
<Rd>	Is the general-purpose destination register, encoded in the "Rd" field.
<imm>	Is the bit position for saturation, in the range 1 to 32, encoded in the "sat_imm" field as <imm>-1.
<Rn>	Is the general-purpose source register, encoded in the "Rn" field.
<amount>	For encoding A1: is the optional shift amount, in the range 0 to 31, defaulting to 0 and encoded in the "imm5" field. For encoding A1: is the shift amount, in the range 1 to 32 encoded in the "imm5" field as <amount> modulo 32. For encoding T1: is the optional shift amount, in the range 0 to 31, defaulting to 0 and encoded in the "imm3:imm2" field. For encoding T1: is the shift amount, in the range 1 to 31 encoded in the "imm3:imm2" field as <amount>.

Operation for all encodings

```
if ConditionPassed() then
    EncodingSpecificOperations();
    operand = Shift(R[n], shift_t, shift_n, PSTATE.C); // PSTATE.C ignored
    (result, sat) = SignedSatQ(SInt(operand), saturate_to);
    R[d] = SignExtend(result, 32);
    if sat then
        PSTATE.Q = '1';
```

F5.1.206 SSAT16

Signed Saturate 16 saturates two signed 16-bit values to a selected signed range.

This instruction sets `PSTATE.Q` to 1 if the operation saturates.

A1

31	28	27	26	25	24	23	22	21	20	19	16	15	12	11	10	9	8	7	6	5	4	3	0
!=1111				0	1	1	0	1	0	1	0	sat_imm	Rd	(1)	(1)	(1)	(1)	0	0	1	1	Rn	
cond																							

A1 variant

SSAT16{<c>}{<q>} <Rd>, #<imm>, <Rn>

Decode for this encoding

```
d = UInt(Rd); n = UInt(Rn); saturate_to = UInt(sat_imm)+1;
if d == 15 || n == 15 then UNPREDICTABLE;
```

T1

15	14	13	12	11	10	9	8	7	6	5	4	3	0	15	14	13	12	11	8	7	6	5	4	3	0
1	1	1	1	0	(0)	1	1	0	0	1	0	Rn	0	0	0	0	Rd	0	0	(0)	(0)	sat_imm			

T1 variant

SSAT16{<c>}{<q>} <Rd>, #<imm>, <Rn>

Decode for this encoding

```
d = UInt(Rd); n = UInt(Rn); saturate_to = UInt(sat_imm)+1;
if d == 15 || n == 15 then UNPREDICTABLE; // ARMv8-A removes UNPREDICTABLE for R13
```

Notes for all encodings

For more information about the CONSTRAINED UNPREDICTABLE behavior of this instruction, see [Appendix K1 Architectural Constraints on UNPREDICTABLE behaviors](#).

Assembler symbols

- <c> See [Standard assembler syntax fields on page F2-2848](#).
- <q> See [Standard assembler syntax fields on page F2-2848](#).
- <Rd> Is the general-purpose destination register, encoded in the "Rd" field.
- <imm> Is the bit position for saturation, in the range 1 to 16, encoded in the "sat_imm" field as <imm>-1.
- <Rn> Is the general-purpose source register, encoded in the "Rn" field.

Operation for all encodings

```
if ConditionPassed() then
    EncodingSpecificOperations();
    (result1, sat1) = SignedSatQ(SInt(R[n]<15:0>), saturate_to);
    (result2, sat2) = SignedSatQ(SInt(R[n]<31:16>), saturate_to);
```

```
R[d]<15:0> = SignExtend(result1, 16);  
R[d]<31:16> = SignExtend(result2, 16);  
if sat1 || sat2 then  
    PSTATE.Q = '1';
```

F5.1.207 SSAX

Signed Subtract and Add with Exchange exchanges the two halfwords of the second operand, performs one 16-bit integer subtraction and one 16-bit addition, and writes the results to the destination register. It sets `PSTATE.GE` according to the results.

A1

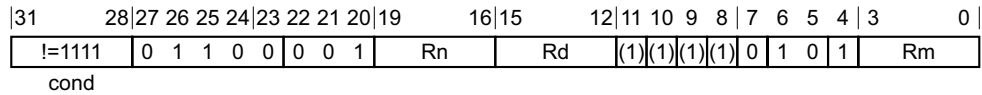

A1 variant

SSAX{<c>}{<q>} {<Rd>}, <Rn>, <Rm>

Decode for this encoding

```
d = UInt(Rd); n = UInt(Rn); m = UInt(Rm);
if d == 15 || n == 15 || m == 15 then UNPREDICTABLE;
```

T1

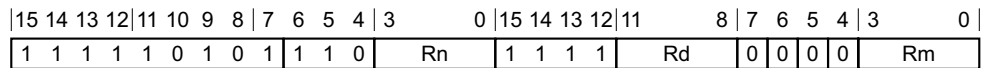

T1 variant

SSAX{<c>}{<q>} {<Rd>}, <Rn>, <Rm>

Decode for this encoding

```
d = UInt(Rd); n = UInt(Rn); m = UInt(Rm);
if d == 15 || n == 15 || m == 15 then UNPREDICTABLE; // ARMv8-A removes UNPREDICTABLE for R13
```

Notes for all encodings

For more information about the `CONSTRAINED UNPREDICTABLE` behavior of this instruction, see [Appendix K1 Architectural Constraints on UNPREDICTABLE behaviors](#).

Assembler symbols

- <c> See [Standard assembler syntax fields on page F2-2848](#).
- <q> See [Standard assembler syntax fields on page F2-2848](#).
- <Rd> Is the general-purpose destination register, encoded in the "Rd" field.
- <Rn> Is the first general-purpose source register, encoded in the "Rn" field.
- <Rm> Is the second general-purpose source register, encoded in the "Rm" field.

Operation for all encodings

```
if ConditionPassed() then
    EncodingSpecificOperations();
    sum = SInt(R[n]<15:0>) + SInt(R[m]<31:16>);
    diff = SInt(R[n]<31:16>) - SInt(R[m]<15:0>);
```

```
R[d]<15:0> = sum<15:0>;  
R[d]<31:16> = diff<15:0>;  
PSTATE.GE<1:0> = if sum >= 0 then '11' else '00';  
PSTATE.GE<3:2> = if diff >= 0 then '11' else '00';
```

F5.1.208 SSUB16

Signed Subtract 16 performs two 16-bit signed integer subtractions, and writes the results to the destination register. It sets `PSTATE.GE` according to the results of the subtractions.

A1

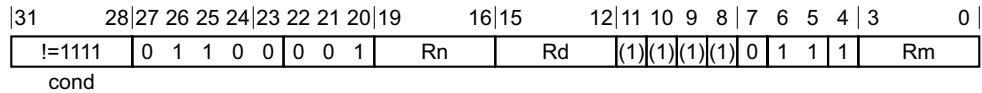

A1 variant

SSUB16{<c>}{<q>} {<Rd>}, <Rn>, <Rm>

Decode for this encoding

d = UInt(Rd); n = UInt(Rn); m = UInt(Rm);
 if d == 15 || n == 15 || m == 15 then UNPREDICTABLE;

T1

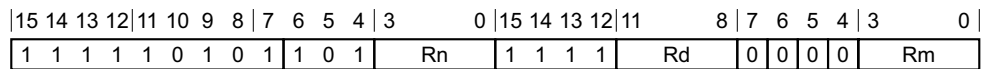

T1 variant

SSUB16{<c>}{<q>} {<Rd>}, <Rn>, <Rm>

Decode for this encoding

d = UInt(Rd); n = UInt(Rn); m = UInt(Rm);
 if d == 15 || n == 15 || m == 15 then UNPREDICTABLE; // ARMv8-A removes UNPREDICTABLE for R13

Notes for all encodings

For more information about the CONSTRAINED UNPREDICTABLE behavior of this instruction, see [Appendix K1 Architectural Constraints on UNPREDICTABLE behaviors](#).

Assembler symbols

- <c> See [Standard assembler syntax fields on page F2-2848](#).
- <q> See [Standard assembler syntax fields on page F2-2848](#).
- <Rd> Is the general-purpose destination register, encoded in the "Rd" field.
- <Rn> Is the first general-purpose source register, encoded in the "Rn" field.
- <Rm> Is the second general-purpose source register, encoded in the "Rm" field.

Operation for all encodings

```
if ConditionPassed() then
    EncodingSpecificOperations();
    diff1 = SInt(R[n]<15:0>) - SInt(R[m]<15:0>);
    diff2 = SInt(R[n]<31:16>) - SInt(R[m]<31:16>);
    R[d]<15:0> = diff1<15:0>;
```



```
R[d]<31:16> = diff2<15:0>;  
PSTATE.GE<1:0> = if diff1 >= 0 then '11' else '00';  
PSTATE.GE<3:2> = if diff2 >= 0 then '11' else '00';
```

F5.1.209 SSUB8

Signed Subtract 8 performs four 8-bit signed integer subtractions, and writes the results to the destination register. It sets `PSTATE.GE` according to the results of the subtractions.

A1

31	28	27	26	25	24	23	22	21	20	19	16	15	12	11	10	9	8	7	6	5	4	3	0
!=1111				0	1	1	0	0	0	0	1	Rn	Rd	(1)	(1)	(1)	(1)	1	1	1	1	Rm	
cond																							

A1 variant

SSUB8{<c>}{<q>} {<Rd>}, <Rn>, <Rm>

Decode for this encoding

d = UInt(Rd); n = UInt(Rn); m = UInt(Rm);
 if d == 15 || n == 15 || m == 15 then UNPREDICTABLE;

T1

15	14	13	12	11	10	9	8	7	6	5	4	3	0	15	14	13	12	11	8	7	6	5	4	3	0
1	1	1	1	1	0	1	0	1	1	0	0	Rn	1	1	1	1	Rd	0	0	0	0	Rm			

T1 variant

SSUB8{<c>}{<q>} {<Rd>}, <Rn>, <Rm>

Decode for this encoding

d = UInt(Rd); n = UInt(Rn); m = UInt(Rm);
 if d == 15 || n == 15 || m == 15 then UNPREDICTABLE; // ARMv8-A removes UNPREDICTABLE for R13

Notes for all encodings

For more information about the CONSTRAINED UNPREDICTABLE behavior of this instruction, see [Appendix K1 Architectural Constraints on UNPREDICTABLE behaviors](#).

Assembler symbols

- <c> See [Standard assembler syntax fields on page F2-2848](#).
- <q> See [Standard assembler syntax fields on page F2-2848](#).
- <Rd> Is the general-purpose destination register, encoded in the "Rd" field.
- <Rn> Is the first general-purpose source register, encoded in the "Rn" field.
- <Rm> Is the second general-purpose source register, encoded in the "Rm" field.

Operation for all encodings

```
if ConditionPassed() then
    EncodingSpecificOperations();
    diff1 = SInt(R[n]<7:0>) - SInt(R[m]<7:0>);
    diff2 = SInt(R[n]<15:8>) - SInt(R[m]<15:8>);
    diff3 = SInt(R[n]<23:16>) - SInt(R[m]<23:16>);
```

```
diff4 = SInt(R[n]<31:24>) - SInt(R[m]<31:24>);  
R[d]<7:0> = diff1<7:0>;  
R[d]<15:8> = diff2<7:0>;  
R[d]<23:16> = diff3<7:0>;  
R[d]<31:24> = diff4<7:0>;  
PSTATE.GE<0> = if diff1 >= 0 then '1' else '0';  
PSTATE.GE<1> = if diff2 >= 0 then '1' else '0';  
PSTATE.GE<2> = if diff3 >= 0 then '1' else '0';  
PSTATE.GE<3> = if diff4 >= 0 then '1' else '0';
```

F5.1.210 STC

Store data to System register calculates an address from a base register value and an immediate offset, and stores a word from the **DBGDTRRXint** System register to memory. It can use offset, post-indexed, pre-indexed, or unindexed addressing. For information about memory accesses see [Memory accesses on page F2-2854](#).

In an implementation that includes EL2, the permitted STC access to **DBGDTRRXint** can be trapped to Hyp mode, meaning that an attempt to execute an STC instruction in a Non-secure mode other than Hyp mode, that would be permitted in the absence of the Hyp trap controls, generates a Hyp Trap exception. For more information, see [Trapping general Non-secure System register accesses to debug registers on page G1-4443](#).

For simplicity, the STC pseudocode does not show this possible trap to Hyp mode.

A1

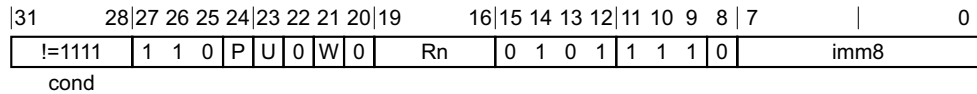

Offset variant

Applies when $P == 1 \ \&\& \ W == 0$.

STC{<c>}{<q>} p14, c5, [<Rn>{, #<+/-><imm>}]

Post-indexed variant

Applies when $P == 0 \ \&\& \ W == 1$.

STC{<c>}{<q>} p14, c5, [<Rn>], #<+/-><imm>

Pre-indexed variant

Applies when $P == 1 \ \&\& \ W == 1$.

STC{<c>}{<q>} p14, c5, [<Rn>, #<+/-><imm>]!

Unindexed variant

Applies when $P == 0 \ \&\& \ U == 1 \ \&\& \ W == 0$.

STC{<c>}{<q>} p14, c5, [<Rn>], <option>

Decode for all variants of this encoding

```
if P == '0' && U == '0' && W == '0' then UNDEFINED;
n = UInt(Rn); cp = 14;
imm32 = ZeroExtend(imm8:'00', 32); index = (P == '1'); add = (U == '1'); wback = (W == '1');
if n == 15 && (wback || CurrentInstrSet() != InstrSet_A32) then UNPREDICTABLE;
```

CONSTRAINED UNPREDICTABLE behavior

If $n == 15 \ \&\& \ wback$, then one of the following behaviors must occur:

- The instruction is UNDEFINED.
- The instruction executes as NOP.
- The instruction executes without writeback of the base address.
- The instruction executes with writeback to the PC. The instruction is handled as described in [Using R15 on page K1-6097](#).

T1

15	14	13	12	11	10	9	8	7	6	5	4	3	0	15	14	13	12	11	10	9	8	7	0
1	1	1	0	1	1	0	P	U	0	W	0	Rn	0	1	0	1	1	1	1	0	imm8		

Offset variant

Applies when P == 1 && W == 0.

STC{<c>}{<q>} p14, c5, [<Rn>{, #<+/-><imm>}]

Post-indexed variant

Applies when P == 0 && W == 1.

STC{<c>}{<q>} p14, c5, [<Rn>], #<+/-><imm>

Pre-indexed variant

Applies when P == 1 && W == 1.

STC{<c>}{<q>} p14, c5, [<Rn>, #<+/-><imm>]!

Unindexed variant

Applies when P == 0 && U == 1 && W == 0.

STC{<c>}{<q>} p14, c5, [<Rn>], <option>

Decode for all variants of this encoding

```
if P == '0' && U == '0' && W == '0' then UNDEFINED;
n = UInt(Rn); cp = 14;
imm32 = ZeroExtend(imm8:'00', 32); index = (P == '1'); add = (U == '1'); wback = (W == '1');
if n == 15 && (wback || CurrentInstrSet() != InstrSet_A32) then UNPREDICTABLE;
```

CONSTRAINED UNPREDICTABLE behavior

If n == 15, then one of the following behaviors must occur:

- The instruction is UNDEFINED.
- The instruction executes as NOP.
- The instruction executes without writeback of the base address.
- The instruction executes with writeback to the PC. The instruction is handled as described in [Using R15 on page K1-6097](#).

Assembler symbols

<c> See [Standard assembler syntax fields on page F2-2848](#).

<q> See [Standard assembler syntax fields on page F2-2848](#).

<Rn> For the offset or unindexed variant: is the general-purpose base register, encoded in the "Rn" field. The PC can be used, but this is deprecated.

For the offset, post-indexed or pre-indexed variant: is the general-purpose base register, encoded in the "Rn" field.

<option> Is an 8-bit immediate, in the range 0 to 255 enclosed in { }, encoded in the "imm8" field. The value of this field is ignored when executing this instruction.

- +/- Specifies the offset is added to or subtracted from the base register, defaulting to + if omitted and encoded in the "U" field. It can have the following values:
- when U = 0
 - + when U = 1
- <imm> Is the immediate offset used for forming the address, a multiple of 4 in the range 0-1020, defaulting to 0 and encoded in the "imm8" field, as <imm>/4.

Operation for all encodings

```
if ConditionPassed() then
    EncodingSpecificOperations();
    AArch32.CheckSystemAccess(cp, ThisInstr());
    offset_addr = if add then (R[n] + imm32) else (R[n] - imm32);
    address = if index then offset_addr else R[n];

    // System register read from DBGDTRRXint.
    MemA[address,4] = DBGDTR_EL0[];

    if wback then R[n] = offset_addr;
```

F5.1.211 STL

Store-Release Word stores a word from a register to memory. The instruction also has memory ordering semantics as described in [Load-Acquire, Store-Release](#) on page E2-2770.

For more information about support for shared memory see [Synchronization and semaphores](#) on page E2-2795. For information about memory accesses see [Memory accesses](#) on page F2-2854.

A1

31	28	27	26	25	24	23	22	21	20	19	16	15	14	13	12	11	10	9	8	7	6	5	4	3	0		
!=1111				0	0	0	1	1	0	0	0	Rn	(1)	(1)	(1)	(1)	(1)	(1)	0	0	1	0	0	1	Rt		
cond																											

A1 variant

STL{<c>}{<q>} <Rt>, [<Rn>]

Decode for this encoding

```
t = UInt(Rt); n = UInt(Rn);
if t == 15 || n == 15 then UNPREDICTABLE;
```

T1

15	14	13	12	11	10	9	8	7	6	5	4	3	0	15	12	11	10	9	8	7	6	5	4	3	2	1	0
1	1	1	0	1	0	0	0	1	1	0	0	Rn	Rt	(1)	(1)	(1)	(1)	1	0	1	0	(1)	(1)	(1)	(1)		

T1 variant

STL{<c>}{<q>} <Rt>, [<Rn>]

Decode for this encoding

```
t = UInt(Rt); n = UInt(Rn);
if t == 15 || n == 15 then UNPREDICTABLE;
```

Notes for all encodings

For more information about the CONSTRAINED UNPREDICTABLE behavior of this instruction, see [Appendix K1 Architectural Constraints on UNPREDICTABLE behaviors](#).

Assembler symbols

- <c> See [Standard assembler syntax fields](#) on page F2-2848.
- <q> See [Standard assembler syntax fields](#) on page F2-2848.
- <Rt> Is the general-purpose register to be transferred, encoded in the "Rt" field.
- <Rn> Is the general-purpose base register, encoded in the "Rn" field.

Operation for all encodings

```
if ConditionPassed() then
    EncodingSpecificOperations();
    address = R[n];
    MemO[address, 4] = R[t];
```

F5.1.212 STLB

Store-Release Byte stores a byte from a register to memory. The instruction also has memory ordering semantics as described in *Load-Acquire, Store-Release* on page E2-2770.

For more information about support for shared memory see *Synchronization and semaphores* on page E2-2795. For information about memory accesses see *Memory accesses* on page F2-2854.

A1

31	28	27	26	25	24	23	22	21	20	19	16	15	14	13	12	11	10	9	8	7	6	5	4	3	0		
!=1111				0	0	0	1	1	1	0	0	Rn	(1)	(1)	(1)	(1)	(1)	(1)	0	0	1	0	0	1	Rt		
cond																											

A1 variant

STLB{<c>}{<q>} <Rt>, [<Rn>]

Decode for this encoding

```
t = UInt(Rt); n = UInt(Rn);
if t == 15 || n == 15 then UNPREDICTABLE;
```

T1

15	14	13	12	11	10	9	8	7	6	5	4	3	0	15	12	11	10	9	8	7	6	5	4	3	2	1	0
1	1	1	0	1	0	0	0	1	1	0	0	Rn	Rt	(1)	(1)	(1)	(1)	(1)	1	0	0	0	(1)	(1)	(1)	(1)	

T1 variant

STLB{<c>}{<q>} <Rt>, [<Rn>]

Decode for this encoding

```
t = UInt(Rt); n = UInt(Rn);
if t == 15 || n == 15 then UNPREDICTABLE;
```

Notes for all encodings

For more information about the CONSTRAINED UNPREDICTABLE behavior of this instruction, see [Appendix K1 Architectural Constraints on UNPREDICTABLE behaviors](#).

Assembler symbols

- <c> See *Standard assembler syntax fields* on page F2-2848.
- <q> See *Standard assembler syntax fields* on page F2-2848.
- <Rt> Is the general-purpose register to be transferred, encoded in the "Rt" field.
- <Rn> Is the general-purpose base register, encoded in the "Rn" field.

Operation for all encodings

```
if ConditionPassed() then
    EncodingSpecificOperations();
    address = R[n];
    MemO[address, 1] = R[t]<7:0>;
```

F5.1.213 STLEX

Store-Release Exclusive Word stores a word from a register to memory if the executing PE has exclusive access to the memory at that address, and returns a status value of 0 if the store was successful, or of 1 if no store was performed.

The instruction also has memory ordering semantics as described in *Load-Acquire, Store-Release* on page E2-2770.

For more information about support for shared memory see *Synchronization and semaphores* on page E2-2795. For information about memory accesses see *Memory accesses* on page F2-2854.

A1

31	28	27	26	25	24	23	22	21	20	19	16	15	12	11	10	9	8	7	6	5	4	3	0
!=1111				0	0	0	1	1	0	0	0	Rn	Rd	(1)	(1)	1	0	1	0	0	1	Rt	
cond																							

A1 variant

STLEX{<c>}{<q>} <Rd>, <Rt>, [<Rn>]

Decode for this encoding

```
d = UInt(Rd); t = UInt(Rt); n = UInt(Rn);
if d == 15 || t == 15 || n == 15 then UNPREDICTABLE;
if d == n || d == t then UNPREDICTABLE;
```

CONSTRAINED UNPREDICTABLE behavior

If $d == t$, then one of the following behaviors must occur:

- The instruction is UNDEFINED.
- The instruction executes as NOP.
- The store instruction executes but the value stored is UNKNOWN.

If $d == n$, then one of the following behaviors must occur:

- The instruction is UNDEFINED.
- The instruction executes as NOP.
- The instruction performs the store to an UNKNOWN address.

T1

15	14	13	12	11	10	9	8	7	6	5	4	3	0	15	12	11	10	9	8	7	6	5	4	3	0
1	1	1	0	1	0	0	0	1	1	0	0	Rn	Rt	(1)	(1)	(1)	(1)	1	1	1	0	Rd			

T1 variant

STLEX{<c>}{<q>} <Rd>, <Rt>, [<Rn>]

Decode for this encoding

```
d = UInt(Rd); t = UInt(Rt); n = UInt(Rn);
if d == 15 || t == 15 || n == 15 then UNPREDICTABLE;
if d == n || d == t then UNPREDICTABLE;
```

CONSTRAINED UNPREDICTABLE behavior

If $d == t$, then one of the following behaviors must occur:

- The instruction is UNDEFINED.
- The instruction executes as NOP.
- The store instruction executes but the value stored is UNKNOWN.

If $d == n$, then one of the following behaviors must occur:

- The instruction is UNDEFINED.
- The instruction executes as NOP.
- The instruction performs the store to an UNKNOWN address.

Notes for all encodings

For more information about the CONSTRAINED UNPREDICTABLE behavior of this instruction, see [Appendix K1 Architectural Constraints on UNPREDICTABLE behaviors](#).

Assembler symbols

<c>	See Standard assembler syntax fields on page F2-2848 .				
<q>	See Standard assembler syntax fields on page F2-2848 .				
<Rd>	Is the destination general-purpose register into which the status result of the store exclusive is written, encoded in the "Rd" field. The value returned is: <table><tr><td>0</td><td>If the operation updates memory.</td></tr><tr><td>1</td><td>If the operation fails to update memory.</td></tr></table>	0	If the operation updates memory.	1	If the operation fails to update memory.
0	If the operation updates memory.				
1	If the operation fails to update memory.				
<Rt>	Is the general-purpose register to be transferred, encoded in the "Rt" field.				
<Rn>	Is the general-purpose base register, encoded in the "Rn" field.				

Aborts and alignment

If a synchronous Data Abort exception is generated by the execution of this instruction:

- Memory is not updated.
- <Rd> is not updated.

A non word-aligned memory address causes an Alignment fault Data Abort exception to be generated, subject to the following rules:

- If `AArch32.ExclusiveMonitorsPass()` returns TRUE, the exception is generated.
- Otherwise, it is IMPLEMENTATION DEFINED whether the exception is generated.

If `AArch32.ExclusiveMonitorsPass()` returns FALSE and the memory address, if accessed, would generate a synchronous Data Abort exception, it is IMPLEMENTATION DEFINED whether the exception is generated.

Operation for all encodings

```
if ConditionPassed() then
    EncodingSpecificOperations();
    address = R[n];
    if AArch32.ExclusiveMonitorsPass(address,4) then
        Mem0[address, 4] = R[t];
```

```
R[d] = ZeroExtend('0');  
else  
R[d] = ZeroExtend('1');
```

F5.1.214 STLEXB

Store-Release Exclusive Byte stores a byte from a register to memory if the executing PE has exclusive access to the memory at that address, and returns a status value of 0 if the store was successful, or of 1 if no store was performed.

The instruction also has memory ordering semantics as described in *Load-Acquire, Store-Release* on page E2-2770.

For more information about support for shared memory see *Synchronization and semaphores* on page E2-2795. For information about memory accesses see *Memory accesses* on page F2-2854.

A1

31	28	27	26	25	24	23	22	21	20	19	16	15	12	11	10	9	8	7	6	5	4	3	0
!=1111				0	0	0	1	1	1	0	0	Rn	Rd	(1)	(1)	1	0	1	0	0	1	Rt	
cond																							

A1 variant

STLEXB{<c>}{<q>} <Rd>, <Rt>, [<Rn>]

Decode for this encoding

```
d = UInt(Rd); t = UInt(Rt); n = UInt(Rn);
if d == 15 || t == 15 || n == 15 then UNPREDICTABLE;
if d == n || d == t then UNPREDICTABLE;
```

CONSTRAINED UNPREDICTABLE behavior

If $d == t$, then one of the following behaviors must occur:

- The instruction is UNDEFINED.
- The instruction executes as NOP.
- The store instruction executes but the value stored is UNKNOWN.

If $d == n$, then one of the following behaviors must occur:

- The instruction is UNDEFINED.
- The instruction executes as NOP.
- The instruction performs the store to an UNKNOWN address.

T1

15	14	13	12	11	10	9	8	7	6	5	4	3	0	15	12	11	10	9	8	7	6	5	4	3	0
1	1	1	0	1	0	0	0	1	1	0	0	Rn	Rt	(1)	(1)	(1)	(1)	1	1	0	0	Rd			

T1 variant

STLEXB{<c>}{<q>} <Rd>, <Rt>, [<Rn>]

Decode for this encoding

```
d = UInt(Rd); t = UInt(Rt); n = UInt(Rn);
if d == 15 || t == 15 || n == 15 then UNPREDICTABLE;
if d == n || d == t then UNPREDICTABLE;
```

CONSTRAINED UNPREDICTABLE behavior

If $d == t$, then one of the following behaviors must occur:

- The instruction is UNDEFINED.
- The instruction executes as NOP.
- The store instruction executes but the value stored is UNKNOWN.

If $d == n$, then one of the following behaviors must occur:

- The instruction is UNDEFINED.
- The instruction executes as NOP.
- The instruction performs the store to an UNKNOWN address.

Notes for all encodings

For more information about the CONSTRAINED UNPREDICTABLE behavior of this instruction, see [Appendix K1 Architectural Constraints on UNPREDICTABLE behaviors](#).

Assembler symbols

<c>	See Standard assembler syntax fields on page F2-2848 .				
<q>	See Standard assembler syntax fields on page F2-2848 .				
<Rd>	Is the destination general-purpose register into which the status result of the store exclusive is written, encoded in the "Rd" field. The value returned is: <table><tr><td>0</td><td>If the operation updates memory.</td></tr><tr><td>1</td><td>If the operation fails to update memory.</td></tr></table>	0	If the operation updates memory.	1	If the operation fails to update memory.
0	If the operation updates memory.				
1	If the operation fails to update memory.				
<Rt>	Is the general-purpose register to be transferred, encoded in the "Rt" field.				
<Rn>	Is the general-purpose base register, encoded in the "Rn" field.				

Aborts

If a synchronous Data Abort exception is generated by the execution of this instruction:

- Memory is not updated.
- <Rd> is not updated.

If `AArch32.ExclusiveMonitorsPass()` returns FALSE and the memory address, if accessed, would generate a synchronous Data Abort exception, it is IMPLEMENTATION DEFINED whether the exception is generated.

Operation for all encodings

```
if ConditionPassed() then
    EncodingSpecificOperations();
    address = R[n];
    if AArch32.ExclusiveMonitorsPass(address,1) then
        Mem0[address, 1] = R[t]<7:0>;
        R[d] = ZeroExtend('0');
    else
        R[d] = ZeroExtend('1');
```

F5.1.215 STLEXD

Store-Release Exclusive Doubleword stores a doubleword from two registers to memory if the executing PE has exclusive access to the memory at that address, and returns a status value of 0 if the store was successful, or of 1 if no store was performed.

The instruction also has memory ordering semantics as described in *Load-Acquire, Store-Release* on page E2-2770.

For more information about support for shared memory see *Synchronization and semaphores* on page E2-2795. For information about memory accesses see *Memory accesses* on page F2-2854.

A1

31	28	27	26	25	24	23	22	21	20	19	16	15	12	11	10	9	8	7	6	5	4	3	0
!=1111				0	0	0	1	1	0	1	0	Rn	Rd	(1)	(1)	1	0	1	0	0	1	Rt	
cond																							

A1 variant

STLEXD{<c>}{<q>} <Rd>, <Rt>, <Rt2>, [<Rn>]

Decode for this encoding

```
d = UInt(Rd); t = UInt(Rt); t2 = t+1; n = UInt(Rn);
if d == 15 || Rt<0> == '1' || t2 == 15 || n == 15 then UNPREDICTABLE;
if d == n || d == t || d == t2 then UNPREDICTABLE;
```

CONSTRAINED UNPREDICTABLE behavior

If $d == t$, then one of the following behaviors must occur:

- The instruction is UNDEFINED.
- The instruction executes as NOP.
- The store instruction executes but the value stored is UNKNOWN.

If $d == n$, then one of the following behaviors must occur:

- The instruction is UNDEFINED.
- The instruction executes as NOP.
- The instruction performs the store to an UNKNOWN address.

If $Rt<0> == '1'$, then one of the following behaviors must occur:

- The instruction is UNDEFINED.
- The instruction executes as NOP.
- The instruction executes with the additional decode: $Rt<0> = '0'$.
- The instruction executes with the additional decode: $t2 = t$.
- The instruction executes as described, with no change to its behavior and no additional side effects.

If $Rt == '1110'$, then one of the following behaviors must occur:

- The instruction is UNDEFINED.
- The instruction executes as NOP.
- The instruction is handled as described in *Using R15* on page K1-6097.

T1

15	14	13	12	11	10	9	8	7	6	5	4	3	0	15	12	11	8	7	6	5	4	3	0
1	1	1	0	1	0	0	0	1	1	0	0	Rn	Rt	Rt2	1	1	1	1	Rd				

T1 variant

STLEXD{<c>}{<q>} <Rd>, <Rt>, <Rt2>, [<Rn>]

Decode for this encoding

```
d = UInt(Rd); t = UInt(Rt); t2 = UInt(Rt2); n = UInt(Rn);
if d == 15 || t == 15 || t2 == 15 || n == 15 then UNPREDICTABLE;
if d == n || d == t || d == t2 then UNPREDICTABLE;
```

CONSTRAINED UNPREDICTABLE behavior

If $d == t$, then one of the following behaviors must occur:

- The instruction is UNDEFINED.
- The instruction executes as NOP.
- The store instruction executes but the value stored is UNKNOWN.

If $d == n$, then one of the following behaviors must occur:

- The instruction is UNDEFINED.
- The instruction executes as NOP.
- The instruction performs the store to an UNKNOWN address.

Notes for all encodings

For more information about the CONSTRAINED UNPREDICTABLE behavior of this instruction, see [Appendix K1 Architectural Constraints on UNPREDICTABLE behaviors](#).

Assembler symbols

<c>	See Standard assembler syntax fields on page F2-2848 .				
<q>	See Standard assembler syntax fields on page F2-2848 .				
<Rd>	Is the destination general-purpose register into which the status result of the store exclusive is written, encoded in the "Rd" field. The value returned is: <table> <tr> <td>0</td> <td>If the operation updates memory.</td> </tr> <tr> <td>1</td> <td>If the operation fails to update memory.</td> </tr> </table>	0	If the operation updates memory.	1	If the operation fails to update memory.
0	If the operation updates memory.				
1	If the operation fails to update memory.				
<Rt>	For encoding A1: is the first general-purpose register to be transferred, encoded in the "Rt" field. <Rt> must be even-numbered and not R14. For encoding T1: is the first general-purpose register to be transferred, encoded in the "Rt" field.				
<Rt2>	For encoding A1: is the second general-purpose register to be transferred. <Rt2> must be <R(t+1)>. For encoding T1: is the second general-purpose register to be transferred, encoded in the "Rt2" field.				
<Rn>	Is the general-purpose base register, encoded in the "Rn" field.				

Aborts and alignment

If a synchronous Data Abort exception is generated by the execution of this instruction:

- Memory is not updated.
- <Rd> is not updated.

A non word-aligned memory address causes an Alignment fault Data Abort exception to be generated, subject to the following rules:

- If `AArch32.ExclusiveMonitorsPass()` returns TRUE, the exception is generated.
- Otherwise, it is IMPLEMENTATION DEFINED whether the exception is generated.

If `AArch32.ExclusiveMonitorsPass()` returns FALSE and the memory address, if accessed, would generate a synchronous Data Abort exception, it is IMPLEMENTATION DEFINED whether the exception is generated.

Operation for all encodings

```
if ConditionPassed() then
    EncodingSpecificOperations();
    address = R[n];
    // Create doubleword to store such that R[t] will be stored at address and R[t2] at address+4.
    value = if BigEndian() then R[t]:R[t2] else R[t2]:R[t];
    if AArch32.ExclusiveMonitorsPass(address, 8) then
        Mem0[address, 8] = value;
        R[d] = ZeroExtend('0');
    else
        R[d] = ZeroExtend('1');
```

F5.1.216 STLEXH

Store-Release Exclusive Halfword stores a halfword from a register to memory if the executing PE has exclusive access to the memory at that address, and returns a status value of 0 if the store was successful, or of 1 if no store was performed.

The instruction also has memory ordering semantics as described in *Load-Acquire, Store-Release* on page E2-2770.

For more information about support for shared memory see *Synchronization and semaphores* on page E2-2795. For information about memory accesses see *Memory accesses* on page F2-2854.

A1

31	28	27	26	25	24	23	22	21	20	19	16	15	12	11	10	9	8	7	6	5	4	3	0
!=1111				0	0	0	1	1	1	1	0	Rn	Rd	(1)	(1)	1	0	1	0	0	1	Rt	
cond																							

A1 variant

STLEXH{<c>}{<q>} <Rd>, <Rt>, [<Rn>]

Decode for this encoding

```
d = UInt(Rd); t = UInt(Rt); n = UInt(Rn);
if d == 15 || t == 15 || n == 15 then UNPREDICTABLE;
if d == n || d == t then UNPREDICTABLE;
```

CONSTRAINED UNPREDICTABLE behavior

If $d == t$, then one of the following behaviors must occur:

- The instruction is UNDEFINED.
- The instruction executes as NOP.
- The store instruction executes but the value stored is UNKNOWN.

If $d == n$, then one of the following behaviors must occur:

- The instruction is UNDEFINED.
- The instruction executes as NOP.
- The instruction performs the store to an UNKNOWN address.

T1

15	14	13	12	11	10	9	8	7	6	5	4	3	0	15	12	11	10	9	8	7	6	5	4	3	0
1	1	1	0	1	0	0	0	1	1	0	0	Rn	Rt	(1)	(1)	(1)	(1)	1	1	0	1	Rd			

T1 variant

STLEXH{<c>}{<q>} <Rd>, <Rt>, [<Rn>]

Decode for this encoding

```
d = UInt(Rd); t = UInt(Rt); n = UInt(Rn);
if d == 15 || t == 15 || n == 15 then UNPREDICTABLE;
if d == n || d == t then UNPREDICTABLE;
```

CONSTRAINED UNPREDICTABLE behavior

If $d == t$, then one of the following behaviors must occur:

- The instruction is UNDEFINED.
- The instruction executes as NOP.
- The store instruction executes but the value stored is UNKNOWN.

If $d == n$, then one of the following behaviors must occur:

- The instruction is UNDEFINED.
- The instruction executes as NOP.
- The instruction performs the store to an UNKNOWN address.

Notes for all encodings

For more information about the CONSTRAINED UNPREDICTABLE behavior of this instruction, see [Appendix K1 Architectural Constraints on UNPREDICTABLE behaviors](#).

Assembler symbols

<c>	See Standard assembler syntax fields on page F2-2848 .
<q>	See Standard assembler syntax fields on page F2-2848 .
<Rd>	Is the destination general-purpose register into which the status result of the store exclusive is written, encoded in the "Rd" field. The value returned is: 0 If the operation updates memory. 1 If the operation fails to update memory.
<Rt>	Is the general-purpose register to be transferred, encoded in the "Rt" field.
<Rn>	Is the general-purpose base register, encoded in the "Rn" field.

Aborts and alignment

If a synchronous Data Abort exception is generated by the execution of this instruction:

- Memory is not updated
- <Rd> is not updated.

A non word-aligned memory address causes an Alignment fault Data Abort exception to be generated, subject to the following rules:

- If `AArch32.ExclusiveMonitorsPass()` returns TRUE, the exception is generated.
- Otherwise, it is IMPLEMENTATION DEFINED whether the exception is generated.

If `AArch32.ExclusiveMonitorsPass()` returns FALSE and the memory address, if accessed, would generate a synchronous Data Abort exception, it is IMPLEMENTATION DEFINED whether the exception is generated.

Operation for all encodings

```
if ConditionPassed() then
    EncodingSpecificOperations();
    address = R[n];
    if AArch32.ExclusiveMonitorsPass(address,2) then
        Mem0[address, 2] = R[t]<15:0>;
```

```
R[d] = ZeroExtend('0');  
else  
R[d] = ZeroExtend('1');
```

F5.1.217 STLH

Store-Release Halfword stores a halfword from a register to memory. The instruction also has memory ordering semantics as described in *Load-Acquire, Store-Release* on page E2-2770.

For more information about support for shared memory see *Synchronization and semaphores* on page E2-2795. For information about memory accesses see *Memory accesses* on page F2-2854.

A1

31	28	27	26	25	24	23	22	21	20	19	16	15	14	13	12	11	10	9	8	7	6	5	4	3	0		
!=1111				0	0	0	1	1	1	1	0	Rn	(1)	(1)	(1)	(1)	(1)	(1)	0	0	1	0	0	1	Rt		
cond																											

A1 variant

STLH{<c>}{<q>} <Rt>, [<Rn>]

Decode for this encoding

```
t = UInt(Rt); n = UInt(Rn);
if t == 15 || n == 15 then UNPREDICTABLE;
```

T1

15	14	13	12	11	10	9	8	7	6	5	4	3	0	15	12	11	10	9	8	7	6	5	4	3	2	1	0
1	1	1	0	1	0	0	0	1	1	0	0	Rn	Rt	(1)	(1)	(1)	(1)	(1)	1	0	0	1	(1)	(1)	(1)	(1)	

T1 variant

STLH{<c>}{<q>} <Rt>, [<Rn>]

Decode for this encoding

```
t = UInt(Rt); n = UInt(Rn);
if t == 15 || n == 15 then UNPREDICTABLE;
```

Notes for all encodings

For more information about the CONSTRAINED UNPREDICTABLE behavior of this instruction, see [Appendix K1 Architectural Constraints on UNPREDICTABLE behaviors](#).

Assembler symbols

- <c> See *Standard assembler syntax fields* on page F2-2848.
- <q> See *Standard assembler syntax fields* on page F2-2848.
- <Rt> Is the general-purpose register to be transferred, encoded in the "Rt" field.
- <Rn> Is the general-purpose base register, encoded in the "Rn" field.

Operation for all encodings

```
if ConditionPassed() then
    EncodingSpecificOperations();
    address = R[n];
    MemO[address, 2] = R[t]<15:0>;
```

F5.1.218 STM, STMIA, STMEA

Store Multiple (Increment After, Empty Ascending) stores multiple registers to consecutive memory locations using an address from a base register. The consecutive memory locations start at this address, and the address just above the last of those locations can optionally be written back to the base register.

The lowest-numbered register is loaded from the lowest memory address, through to the highest-numbered register from the highest memory address. See also [Encoding of lists of general-purpose registers and the PC on page F2-2855](#).

ARMv8.2 permits the deprecation of some Store Multiple ordering behaviors in AArch32 state, for more information see [ARMv8.2-LSMAOC](#). For details of related system instructions see [STM \(User registers\)](#).

A1

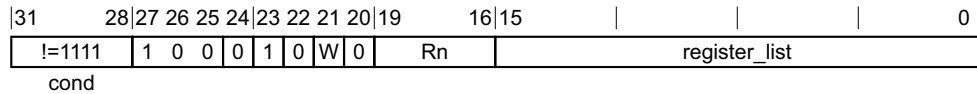

A1 variant

STM{IA}{<c>}{<q>} <Rn>{!}, <registers> // Preferred syntax
 STMEA{<c>}{<q>} <Rn>{!}, <registers> // Alternate syntax, Empty Ascending stack

Decode for this encoding

```
n = UInt(Rn); registers = register_list; wback = (W == '1');
if n == 15 || BitCount(registers) < 1 then UNPREDICTABLE;
```

CONSTRAINED UNPREDICTABLE behavior

If $\text{BitCount}(\text{registers}) < 1$, then one of the following behaviors must occur:

- The instruction is UNDEFINED.
- The instruction executes as NOP.
- The instruction operates as an STM with the same addressing mode but targeting an unspecified set of registers. These registers might include R15. If the instruction specifies writeback, the modification to the base address on writeback might differ from the number of registers stored.

If $n == 15 \ \&\& \ wback$, then one of the following behaviors must occur:

- The instruction is UNDEFINED.
- The instruction executes as NOP.
- The instruction executes without writeback of the base address.
- The instruction executes with writeback to the PC. The instruction is handled as described in [Using R15 on page K1-6097](#).

T1

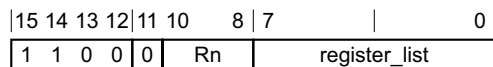

T1 variant

STM{IA}{<c>}{<q>} <Rn>!, <registers> // Preferred syntax

STMEA{<c>}{<q>} <Rn>!, <registers> // Alternate syntax, Empty Ascending stack

Decode for this encoding

```
n = UInt(Rn); registers = '00000000':register_list; wback = TRUE;
if BitCount(registers) < 1 then UNPREDICTABLE;
```

CONSTRAINED UNPREDICTABLE behavior

If BitCount(registers) < 1, then one of the following behaviors must occur:

- The instruction is UNDEFINED.
- The instruction executes as NOP.
- The instruction operates as an STM with the same addressing mode but targeting an unspecified set of registers. These registers might include R15. If the instruction specifies writeback, the modification to the base address on writeback might differ from the number of registers stored.

If n == 15 && wback, then one of the following behaviors must occur:

- The instruction is UNDEFINED.
- The instruction executes as NOP.
- The instruction executes without writeback of the base address.
- The instruction executes with writeback to the PC. The instruction is handled as described in [Using R15 on page K1-6097](#).

T2

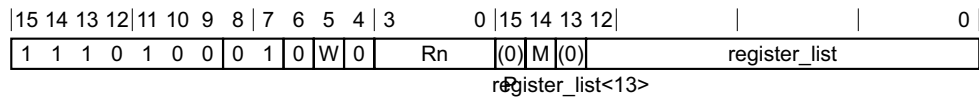

T2 variant

STM{IA}{<c>}.W <Rn>{!}, <registers> // Preferred syntax, if <Rn>, '!' and <registers> can be represented in T1
 STMEA{<c>}.W <Rn>{!}, <registers> // Alternate syntax, Empty Ascending stack, if <Rn>, '!' and <registers> can be represented in T1
 STM{IA}{<c>}{<q>} <Rn>{!}, <registers> // Preferred syntax
 STMEA{<c>}{<q>} <Rn>{!}, <registers> // Alternate syntax, Empty Ascending stack

Decode for this encoding

```
n = UInt(Rn); registers = P:M:register_list; wback = (W == '1');
if n == 15 || BitCount(registers) < 2 then UNPREDICTABLE;
if wback && registers<n> == '1' then UNPREDICTABLE;
if registers<13> == '1' then UNPREDICTABLE;
if registers<15> == '1' then UNPREDICTABLE;
```

CONSTRAINED UNPREDICTABLE behavior

If BitCount(registers) < 1, then one of the following behaviors must occur:

- The instruction is UNDEFINED.
- The instruction executes as NOP.
- The instruction operates as an STM with the same addressing mode but targeting an unspecified set of registers. These registers might include R15. If the instruction specifies writeback, the modification to the base address on writeback might differ from the number of registers stored.

If `BitCount(registers) == 1`, then one of the following behaviors must occur:

- The instruction is UNDEFINED.
- The instruction executes as NOP.
- The instruction executes as described, with no change to its behavior and no additional side effects.
- The instruction operates as an STM with the same addressing mode but targeting an unspecified set of registers. These registers might include R15.

If `wback && registers<n> == '1'`, then one of the following behaviors must occur:

- The instruction is UNDEFINED.
- The instruction executes as NOP.
- The store instruction executes but the value stored for the base register is UNKNOWN.

If `registers<13> == '1'`, then one of the following behaviors must occur:

- The instruction is UNDEFINED.
- The instruction executes as NOP.
- The store instruction performs all of the stores using the specified addressing mode but the value of R13 is UNKNOWN.

If `registers<15> == '1'`, then one of the following behaviors must occur:

- The instruction is UNDEFINED.
- The instruction executes as NOP.
- The store instruction performs all of the stores using the specified addressing mode but the value of R15 is UNKNOWN.

If `n == 15 && wback`, then one of the following behaviors must occur:

- The instruction is UNDEFINED.
- The instruction executes as NOP.
- The instruction executes without writeback of the base address.
- The instruction executes with writeback to the PC. The instruction is handled as described in [Using R15 on page K1-6097](#).

Notes for all encodings

For more information about the CONSTRAINED UNPREDICTABLE behavior of this instruction, see [Appendix K1 Architectural Constraints on UNPREDICTABLE behaviors](#).

Assembler symbols

IA	Is an optional suffix for the Increment After form.
<c>	See Standard assembler syntax fields on page F2-2848 .
<q>	See Standard assembler syntax fields on page F2-2848 .
<Rn>	Is the general-purpose base register, encoded in the "Rn" field.
!	The address adjusted by the size of the data loaded is written back to the base register. If specified, it is encoded in the "W" field as 1, otherwise this field defaults to 0.

<registers> For encoding A1: is a list of one or more registers to be stored, separated by commas and surrounded by { and }.

The PC can be in the list. However, ARM deprecates the use of instructions that include the PC in the list.

If base register writeback is specified, and the base register is not the lowest-numbered register in the list, such an instruction stores an UNKNOWN value for the base register.

For encoding T1: is a list of one or more registers to be stored, separated by commas and surrounded by { and }. The registers in the list must be in the range R0-R7, encoded in the "register_list" field. If the base register is not the lowest-numbered register in the list, such an instruction stores an UNKNOWN value for the base register.

For encoding T2: is a list of one or more registers to be stored, separated by commas and surrounded by { and }.

The registers in the list must be in the range R0-R12, encoded in the "register_list" field, and can optionally contain the LR. If the LR is in the list, the "M" field is set to 1, otherwise it defaults to 0.

Operation for all encodings

```
if ConditionPassed() then
    EncodingSpecificOperations();
    address = R[n];
    for i = 0 to 14
        if registers<i> == '1' then
            if i == n && wback && i != LowestSetBit(registers) then
                MemA[address,4] = bits(32) UNKNOWN; // Only possible for encodings T1 and A1
            else
                MemA[address,4] = R[i];
            address = address + 4;
    if registers<15> == '1' then // Only possible for encoding A1
        MemA[address,4] = PCStoreValue();
    if wback then R[n] = R[n] + 4*BitCount(registers);
```



F5.1.219 STM (User registers)

In an EL1 mode other than System mode, Store Multiple (User registers) stores multiple User mode registers to consecutive memory locations using an address from a base register. The PE reads the base register value normally, using the current mode to determine the correct Banked version of the register. This instruction cannot writeback to the base register.

Store Multiple (User registers) is UNDEFINED in Hyp mode, and CONSTRAINED UNPREDICTABLE in User or System modes.

ARMv8.2 permits the deprecation of some Store Multiple ordering behaviors in AArch32 state, for more information see [ARMv8.2-LSMAOC](#).

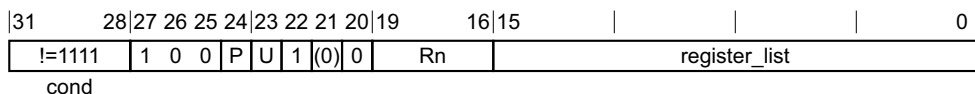
A1



A1 variant

STM{<amode>}{<c>}{<q>} <Rn>, <registers>^

Decode for this encoding

n = UInt(Rn); registers = register_list; increment = (U == '1'); wordhigher = (P == U);
 if n == 15 || BitCount(registers) < 1 then UNPREDICTABLE;

CONSTRAINED UNPREDICTABLE behavior

If BitCount(registers) < 1, then one of the following behaviors must occur:

- The instruction is UNDEFINED.
- The instruction executes as NOP.
- The instruction operates as an STM with the same addressing mode but targeting an unspecified set of registers. These registers might include R15.

Notes for all encodings

For more information about the CONSTRAINED UNPREDICTABLE behavior of this instruction, see [Appendix K1 Architectural Constraints on UNPREDICTABLE behaviors](#).

Assembler symbols

<amode> is one of:

- | | |
|----|--|
| DA | Decrement After. The consecutive memory addresses end at the address in the base register. Encoded as P = 0, U = 0. |
| ED | Empty Descending. For this instruction, a synonym for DA. |
| DB | Decrement Before. The consecutive memory addresses end one word below the address in the base register. Encoded as P = 1, U = 0. |
| FD | Full Descending. For this instruction, a synonym for DB. |
| IA | Increment After. The consecutive memory addresses start at the address in the base register. This is the default. Encoded as P = 0, U = 1. |
| EA | Empty Ascending. For this instruction, a synonym for IA. |
| IB | Increment Before. The consecutive memory addresses start one word above the address in the base register. Encoded as P = 1, U = 1. |

	FA	Full Ascending. For this instruction, a synonym for IB.
<c>		See Standard assembler syntax fields on page F2-2848 .
<q>		See Standard assembler syntax fields on page F2-2848 .
<Rn>		Is the general-purpose base register, encoded in the "Rn" field.
<registers>		Is a list of one or more registers, separated by commas and surrounded by { and }. It specifies the set of registers to be stored by the STM instruction. The registers are stored with the lowest-numbered register to the lowest memory address, through to the highest-numbered register to the highest memory address. See also Encoding of lists of general-purpose registers and the PC on page F2-2855 .

Operation

```
if ConditionPassed() then
    EncodingSpecificOperations();
    if PSTATE.EL == EL2 then
        UNDEFINED;
    elsif PSTATE.M IN {M32_User,M32_System} then
        UNPREDICTABLE;
    else
        length = 4*BitCount(registers);
        address = if increment then R[n] else R[n]-length;
        if wordhigher then address = address+4;
        for i = 0 to 14
            if registers<i> == '1' then // Store User mode register
                MemA[address,4] = Rmode[i, M32_User];
                address = address + 4;
            if registers<15> == '1' then
                MemA[address,4] = PCStoreValue();
```

CONSTRAINED UNPREDICTABLE behavior

If PSTATE.M IN {M32_User,M32_System}, then one of the following behaviors must occur:

- The instruction is UNDEFINED.
- The instruction executes as NOP.
- The instruction operates as an STM with the same addressing mode but targeting an unspecified set of registers. These registers might include R15.

F5.1.220 STMDA, STMED

Store Multiple Decrement After (Empty Descending) stores multiple registers to consecutive memory locations using an address from a base register. The consecutive memory locations end at this address, and the address just below the lowest of those locations can optionally be written back to the base register.

The lowest-numbered register is loaded from the lowest memory address, through to the highest-numbered register from the highest memory address. See also [Encoding of lists of general-purpose registers and the PC on page F2-2855](#).

ARMv8.2 permits the deprecation of some Store Multiple ordering behaviors in AArch32 state, for more information see [ARMv8.2-LSMAOC](#). For details of related system instructions see [STM \(User registers\)](#).

A1

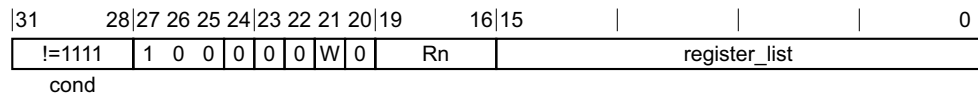

A1 variant

STMDA{<c>}{<q>} <Rn>{!}, <registers> // Preferred syntax
 STMED{<c>}{<q>} <Rn>{!}, <registers> // Alternate syntax, Empty Descending stack

Decode for this encoding

```
n = UInt(Rn); registers = register_list; wback = (W == '1');
if n == 15 || BitCount(registers) < 1 then UNPREDICTABLE;
```

CONSTRAINED UNPREDICTABLE behavior

If $\text{BitCount}(\text{registers}) < 1$, then one of the following behaviors must occur:

- The instruction is UNDEFINED.
- The instruction executes as NOP.
- The instruction targets an unspecified set of registers. These registers might include R15. If the instruction specifies writeback, the modification to the base address on writeback might differ from the number of registers stored.

If $n == 15$ && $wback$, then one of the following behaviors must occur:

- The instruction is UNDEFINED.
- The instruction executes as NOP.
- The instruction executes without writeback of the base address.
- The instruction uses the addressing mode described in the equivalent immediate offset instruction.

Notes for all encodings

For more information about the CONSTRAINED UNPREDICTABLE behavior of this instruction, see [Appendix K1 Architectural Constraints on UNPREDICTABLE behaviors](#).

Assembler symbols

- <c> See [Standard assembler syntax fields on page F2-2848](#).
 <q> See [Standard assembler syntax fields on page F2-2848](#).

- <Rn> Is the general-purpose base register, encoded in the "Rn" field.
- ! The address adjusted by the size of the data loaded is written back to the base register. If specified, it is encoded in the "W" field as 1, otherwise this field defaults to 0.
- <registers> Is a list of one or more registers to be stored, separated by commas and surrounded by { and }.
The PC can be in the list. However, ARM deprecates the use of instructions that include the PC in the list.
If base register writeback is specified, and the base register is not the lowest-numbered register in the list, such an instruction stores an UNKNOWN value for the base register.

Operation

```
if ConditionPassed() then
    EncodingSpecificOperations();
    address = R[n] - 4*BitCount(registers) + 4;
    for i = 0 to 14
        if registers<i> == '1' then
            if i == n && wback && i != LowestSetBit(registers) then
                MemA[address,4] = bits(32) UNKNOWN;
            else
                MemA[address,4] = R[i];
            address = address + 4;
    if registers<15> == '1' then
        MemA[address,4] = PCStoreValue();
    if wback then R[n] = R[n] - 4*BitCount(registers);
```

F5.1.221 STMDB, STMFD

Store Multiple Decrement Before (Full Descending) stores multiple registers to consecutive memory locations using an address from a base register. The consecutive memory locations end just below this address, and the address of the first of those locations can optionally be written back to the base register.

The lowest-numbered register is loaded from the lowest memory address, through to the highest-numbered register from the highest memory address. See also [Encoding of lists of general-purpose registers and the PC on page F2-2855](#).

ARMv8.2 permits the deprecation of some Store Multiple ordering behaviors in AArch32 state, for more information see [ARMv8.2-LSMAOC](#). For details of related system instructions see [STM \(User registers\)](#).

This instruction is used by the alias [PUSH \(multiple registers\)](#). See [Alias conditions on page F5-3505](#) for details of when each alias is preferred.

A1

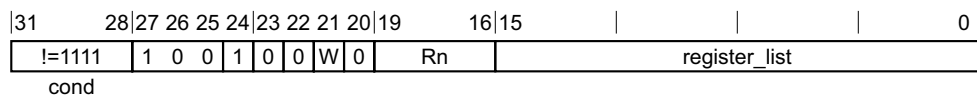

A1 variant

STMDB{<c>}{<q>} <Rn>{!}, <registers> // Preferred syntax
 STMFD{<c>}{<q>} <Rn>{!}, <registers> // Alternate syntax, Full Descending stack

Decode for this encoding

```
n = UInt(Rn); registers = register_list; wback = (W == '1');
if n == 15 || BitCount(registers) < 1 then UNPREDICTABLE;
```

CONSTRAINED UNPREDICTABLE behavior

If BitCount(registers) < 1, then one of the following behaviors must occur:

- The instruction is UNDEFINED.
- The instruction executes as NOP.
- The instruction operates as an STM with the same addressing mode but targeting an unspecified set of registers. These registers might include R15. If the instruction specifies writeback, the modification to the base address on writeback might differ from the number of registers stored.

T1

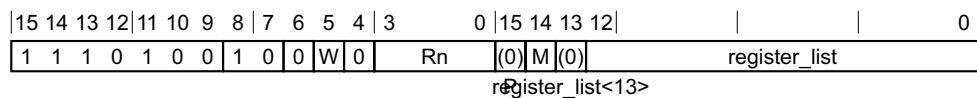

T1 variant

STMDB{<c>}{<q>} <Rn>{!}, <registers> // Preferred syntax
 STMFD{<c>}{<q>} <Rn>{!}, <registers> // Alternate syntax, Full Descending stack

Decode for this encoding

```
n = UInt(Rn); registers = P:M:register_list; wback = (W == '1');  
if n == 15 || BitCount(registers) < 2 then UNPREDICTABLE;  
if wback && registers<n> == '1' then UNPREDICTABLE;  
if registers<13> == '1' then UNPREDICTABLE;  
if registers<15> == '1' then UNPREDICTABLE;
```

CONSTRAINED UNPREDICTABLE behavior

If $\text{BitCount}(\text{registers}) < 1$, then one of the following behaviors must occur:

- The instruction is UNDEFINED.
- The instruction executes as NOP.
- The instruction operates as an STM with the same addressing mode but targeting an unspecified set of registers. These registers might include R15. If the instruction specifies writeback, the modification to the base address on writeback might differ from the number of registers stored.

If $\text{wback} \ \&\& \ \text{registers}\langle n \rangle == '1'$, then one of the following behaviors must occur:

- The instruction is UNDEFINED.
- The instruction executes as NOP.
- The store instruction executes but the value stored for the base register is UNKNOWN.

If $\text{BitCount}(\text{registers}) == 1$, then one of the following behaviors must occur:

- The instruction is UNDEFINED.
- The instruction executes as NOP.
- The instruction executes as described, with no change to its behavior and no additional side effects.
- The instruction operates as an STM with the same addressing mode but targeting an unspecified set of registers. These registers might include R15.

If $\text{registers}\langle 13 \rangle == '1'$, then one of the following behaviors must occur:

- The instruction is UNDEFINED.
- The instruction executes as NOP.
- The instruction executes as described, with no change to its behavior and no additional side effects.
- The store instruction performs all of the stores using the specified addressing mode but the value of R13 is UNKNOWN.

If $\text{registers}\langle 15 \rangle == '1'$, then one of the following behaviors must occur:

- The instruction is UNDEFINED.
- The instruction executes as NOP.
- The store instruction performs all of the stores using the specified addressing mode but the value of R15 is UNKNOWN.

Notes for all encodings

For more information about the CONSTRAINED UNPREDICTABLE behavior of this instruction, see [Appendix K1 Architectural Constraints on UNPREDICTABLE behaviors](#).

Alias conditions

Alias	of variant	is preferred when
PUSH (multiple registers)	T1	W == '1' && Rn == '1101' && BitCount(M:register_list) > 1
PUSH (multiple registers)	A1	W == '1' && Rn == '1101' && BitCount(register_list) > 1

Assembler symbols

- <c> See [Standard assembler syntax fields on page F2-2848](#).
- <q> See [Standard assembler syntax fields on page F2-2848](#).
- <Rn> Is the general-purpose base register, encoded in the "Rn" field.
- ! The address adjusted by the size of the data loaded is written back to the base register. If specified, it is encoded in the "W" field as 1, otherwise this field defaults to 0.
- <registers> For encoding A1: is a list of one or more registers to be stored, separated by commas and surrounded by { and }.
 The PC can be in the list. However, ARM deprecates the use of instructions that include the PC in the list.
 If base register writeback is specified, and the base register is not the lowest-numbered register in the list, such an instruction stores an UNKNOWN value for the base register.
 For encoding T1: is a list of one or more registers to be stored, separated by commas and surrounded by { and }.
 The registers in the list must be in the range R0-R12, encoded in the "register_list" field, and can optionally contain the LR. If the LR is in the list, the "M" field is set to 1, otherwise it defaults to 0.

Operation for all encodings

```

if ConditionPassed() then
  EncodingSpecificOperations();
  address = R[n] - 4*BitCount(registers);
  for i = 0 to 14
    if registers<i> == '1' then
      if i == n && wback && i != LowestSetBit(registers) then
        MemA[address,4] = bits(32) UNKNOWN; // Only possible for encoding A1
      else
        MemA[address,4] = R[i];
        address = address + 4;
  if registers<15> == '1' then // Only possible for encoding A1
    MemA[address,4] = PCStoreValue();
  if wback then R[n] = R[n] - 4*BitCount(registers);

```

F5.1.222 STMIB, STMFA

Store Multiple Increment Before (Full Ascending) stores multiple registers to consecutive memory locations using an address from a base register. The consecutive memory locations start just above this address, and the address of the last of those locations can optionally be written back to the base register.

The lowest-numbered register is loaded from the lowest memory address, through to the highest-numbered register from the highest memory address. See also [Encoding of lists of general-purpose registers and the PC on page F2-2855](#).

ARMv8.2 permits the deprecation of some Store Multiple ordering behaviors in AArch32 state, for more information see [ARMv8.2-LSMAOC](#). For details of related system instructions see [STM \(User registers\)](#).

A1

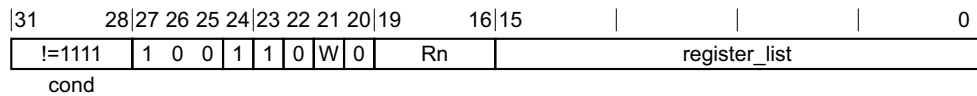

A1 variant

STMIB{<c>}{<q>} <Rn>{!}, <registers> // Preferred syntax
 STMFA{<c>}{<q>} <Rn>{!}, <registers> // Alternate syntax, Full Ascending stack

Decode for this encoding

```
n = UInt(Rn); registers = register_list; wback = (W == '1');
if n == 15 || BitCount(registers) < 1 then UNPREDICTABLE;
```

CONSTRAINED UNPREDICTABLE behavior

If $\text{BitCount}(\text{registers}) < 1$, then one of the following behaviors must occur:

- The instruction is UNDEFINED.
- The instruction executes as NOP.
- The instruction operates as an STM with the same addressing mode but targeting an unspecified set of registers. These registers might include R15.

If $n == 15$ && $wback$, then one of the following behaviors must occur:

- The instruction is UNDEFINED.
- The instruction executes as NOP.
- The instruction executes without writeback of the base address.
- The instruction uses the addressing mode described in the equivalent immediate offset instruction.

Notes for all encodings

For more information about the CONSTRAINED UNPREDICTABLE behavior of this instruction, see [Appendix K1 Architectural Constraints on UNPREDICTABLE behaviors](#).

Assembler symbols

- <c> See [Standard assembler syntax fields on page F2-2848](#).
- <q> See [Standard assembler syntax fields on page F2-2848](#).
- <Rn> Is the general-purpose base register, encoded in the "Rn" field.

- ! The address adjusted by the size of the data loaded is written back to the base register. If specified, it is encoded in the "W" field as 1, otherwise this field defaults to 0.
- <registers> Is a list of one or more registers to be stored, separated by commas and surrounded by { and }.
The PC can be in the list. However, ARM deprecates the use of instructions that include the PC in the list.
If base register writeback is specified, and the base register is not the lowest-numbered register in the list, such an instruction stores an UNKNOWN value for the base register.

Operation

```
if ConditionPassed() then
    EncodingSpecificOperations();
    address = R[n] + 4;
    for i = 0 to 14
        if registers<i> == '1' then
            if i == n && wback && i != LowestSetBit(registers) then
                MemA[address,4] = bits(32) UNKNOWN;
            else
                MemA[address,4] = R[i];
            address = address + 4;
    if registers<15> == '1' then
        MemA[address,4] = PCStoreValue();
    if wback then R[n] = R[n] + 4*BitCount(registers);
```

F5.1.223 STR (immediate)

Store Register (immediate) calculates an address from a base register value and an immediate offset, and stores a word from a register to memory. It can use offset, post-indexed, or pre-indexed addressing. For information about memory accesses see [Memory accesses on page F2-2854](#).

This instruction is used by the alias [PUSH \(single register\)](#). See [Alias conditions on page F5-3511](#) for details of when each alias is preferred.

A1

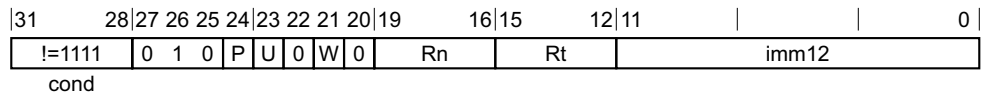

Offset variant

Applies when $P == 1 \ \&\& \ W == 0$.

STR{<c>}{<q>} <Rt>, [<Rn> {, #<+/-><imm>}]

Post-indexed variant

Applies when $P == 0 \ \&\& \ W == 0$.

STR{<c>}{<q>} <Rt>, [<Rn>], #<+/-><imm>

Pre-indexed variant

Applies when $P == 1 \ \&\& \ W == 1$.

STR{<c>}{<q>} <Rt>, [<Rn>, #<+/-><imm>]!

Decode for all variants of this encoding

```
if P == '0' && W == '1' then SEE STRT;
t = UInt(Rt); n = UInt(Rn); imm32 = ZeroExtend(imm12, 32);
index = (P == '1'); add = (U == '1'); wback = (P == '0') || (W == '1');
if wback && (n == 15 || n == t) then UNPREDICTABLE;
```

CONSTRAINED UNPREDICTABLE behavior

If $wback \ \&\& \ n == t$, then one of the following behaviors must occur:

- The instruction is UNDEFINED.
- The instruction executes as NOP.
- The store instruction executes but the value stored is UNKNOWN.

If $wback \ \&\& \ n == 15$, then one of the following behaviors must occur:

- The instruction is UNDEFINED.
- The instruction executes as NOP.
- The instruction executes without writeback of the base address.
- The instruction uses the addressing mode described in the equivalent immediate offset instruction.

T1

15	14	13	12	11	10		6	5	3	2	0
0	1	1	0	0	imm5			Rn	Rt		

T1 variant

STR{<c>}{<q>} <Rt>, [<Rn> {, #<+><imm>}]

Decode for this encoding

t = UInt(Rt); n = UInt(Rn); imm32 = ZeroExtend(imm5:'00', 32);
 index = TRUE; add = TRUE; wback = FALSE;

T2

15	14	13	12	11	10	8	7		0
1	0	0	1	0	Rt	imm8			

T2 variant

STR{<c>}{<q>} <Rt>, [SP{, #<+><imm>}]

Decode for this encoding

t = UInt(Rt); n = 13; imm32 = ZeroExtend(imm8:'00', 32);
 index = TRUE; add = TRUE; wback = FALSE;

T3

15	14	13	12	11	10	9	8	7	6	5	4	3	0	15	12	11		0
1	1	1	1	1	0	0	0	1	1	0	0	!=1111	Rt	imm12				

Rn

T3 variant

STR{<c>}.W <Rt>, [<Rn> {, #<+><imm>}] // <Rt>, <Rn>, <imm> can be represented in T1 or T2
 STR{<c>}{<q>} <Rt>, [<Rn> {, #<+><imm>}]

Decode for this encoding

if Rn == '1111' then UNDEFINED;
 t = UInt(Rt); n = UInt(Rn); imm32 = ZeroExtend(imm12, 32);
 index = TRUE; add = TRUE; wback = FALSE;
 if t == 15 then UNPREDICTABLE;

CONSTRAINED UNPREDICTABLE behavior

If t == 15, then one of the following behaviors must occur:

- The instruction is UNDEFINED.
- The instruction executes as NOP.
- The store instruction performs the store using the specified addressing mode but the value corresponding to R15 is UNKNOWN.

T4

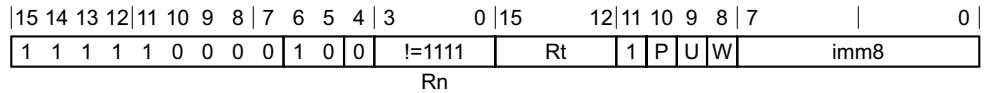

Offset variant

Applies when P == 1 && U == 0 && W == 0.

STR{<c>}{<q>} <Rt>, [<Rn> {, #-<imm>}]

Post-indexed variant

Applies when P == 0 && W == 1.

STR{<c>}{<q>} <Rt>, [<Rn>], #{+/-}<imm>

Pre-indexed variant

Applies when P == 1 && W == 1.

STR{<c>}{<q>} <Rt>, [<Rn>, #{+/-}<imm>]!

Decode for all variants of this encoding

```

if P == '1' && U == '1' && W == '0' then SEE STRT;
if Rn == '1111' || (P == '0' && W == '0') then UNDEFINED;
t = UInt(Rt); n = UInt(Rn); imm32 = ZeroExtend(imm8, 32);
index = (P == '1'); add = (U == '1'); wback = (W == '1');
if t == 15 || (wback && n == t) then UNPREDICTABLE;
    
```

CONSTRAINED UNPREDICTABLE behavior

If wback && n == t, then one of the following behaviors must occur:

- The instruction is UNDEFINED.
- The instruction executes as NOP.
- The store instruction executes but the value stored is UNKNOWN.

If wback && n == 15, then one of the following behaviors must occur:

- The instruction is UNDEFINED.
- The instruction executes as NOP.
- The instruction executes without writeback of the base address.
- The instruction uses the addressing mode described in the equivalent immediate offset instruction.

If t == 15, then one of the following behaviors must occur:

- The instruction is UNDEFINED.
- The instruction executes as NOP.
- The store instruction performs the store using the specified addressing mode but the value corresponding to R15 is UNKNOWN.

Notes for all encodings

For more information about the CONSTRAINED UNPREDICTABLE behavior of this instruction, see [Appendix K1 Architectural Constraints on UNPREDICTABLE behaviors](#).

Alias conditions

Alias	of variant	is preferred when
PUSH (single register)	A1 (pre-indexed)	$P == '1' \ \&\& \ U == '0' \ \&\& \ W == '1' \ \&\& \ Rn == '1101' \ \&\& \ imm12 == '00000000100'$
PUSH (single register)	T4 (pre-indexed)	$Rn == '1101' \ \&\& \ U == '0' \ \&\& \ imm8 == '0000100'$

Assembler symbols

<c>	See Standard assembler syntax fields on page F2-2848 .
<q>	See Standard assembler syntax fields on page F2-2848 .
<Rt>	For encoding A1: is the general-purpose register to be transferred, encoded in the "Rt" field. The PC can be used, but this is deprecated. For encoding T1, T2, T3 and T4: is the general-purpose register to be transferred, encoded in the "Rt" field.
<Rn>	For encoding A1: is the general-purpose base register, encoded in the "Rn" field. The PC can be used in the offset variant, but this is deprecated. For encoding T1, T3 and T4: is the general-purpose base register, encoded in the "Rn" field.
+/-	Specifies the offset is added to or subtracted from the base register, defaulting to + if omitted and encoded in the "U" field. It can have the following values: - when U = 0 + when U = 1
+	Specifies the offset is added to the base register.
<imm>	For encoding A1: is the 12-bit unsigned immediate byte offset, in the range 0 to 4095, defaulting to 0 if omitted, and encoded in the "imm12" field. For encoding T1: is the optional positive unsigned immediate byte offset, a multiple of 4, in the range 0 to 124, defaulting to 0 and encoded in the "imm5" field as <imm>/4. For encoding T2: is the optional positive unsigned immediate byte offset, a multiple of 4, in the range 0 to 1020, defaulting to 0 and encoded in the "imm8" field as <imm>/4. For encoding T3: is an optional 12-bit unsigned immediate byte offset, in the range 0 to 4095, defaulting to 0 and encoded in the "imm12" field. For encoding T4: is an 8-bit unsigned immediate byte offset, in the range 0 to 255, defaulting to 0 if omitted, and encoded in the "imm8" field.

Operation for all encodings

```

if CurrentInstrSet() == InstrSet_A32 then
  if ConditionPassed() then
    EncodingSpecificOperations();
    offset_addr = if add then (R[n] + imm32) else (R[n] - imm32);
    address = if index then offset_addr else R[n];
    MemU[address,4] = if t == 15 then PCStoreValue() else R[t];
    if wback then R[n] = offset_addr;
else
  if ConditionPassed() then
    EncodingSpecificOperations();
    offset_addr = if add then (R[n] + imm32) else (R[n] - imm32);
    address = if index then offset_addr else R[n];
    MemU[address,4] = R[t];
    if wback then R[n] = offset_addr;
  
```

F5.1.224 STR (register)

Store Register (register) calculates an address from a base register value and an offset register value, stores a word from a register to memory. The offset register value can optionally be shifted. For information about memory accesses see [Memory accesses](#) on page F2-2854.

A1

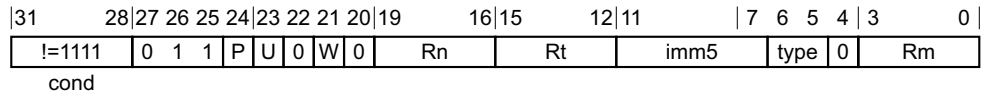

Offset variant

Applies when $P == 1$ && $W == 0$.

STR{<c>}{<q>} <Rt>, [<Rn>, {+/-}<Rm>{, <shift>}]

Post-indexed variant

Applies when $P == 0$ && $W == 0$.

STR{<c>}{<q>} <Rt>, [<Rn>], {+/-}<Rm>{, <shift>}]

Pre-indexed variant

Applies when $P == 1$ && $W == 1$.

STR{<c>}{<q>} <Rt>, [<Rn>, {+/-}<Rm>{, <shift>}]!

Decode for all variants of this encoding

```

if P == '0' && W == '1' then SEE STRT;
t = UInt(Rt); n = UInt(Rn); m = UInt(Rm);
index = (P == '1'); add = (U == '1'); wback = (P == '0') || (W == '1');
(shift_t, shift_n) = DecodeImmShift(type, imm5);
if m == 15 then UNPREDICTABLE;
if wback && (n == 15 || n == t) then UNPREDICTABLE;
    
```

CONSTRAINED UNPREDICTABLE behavior

If $wback$ && $n == t$, then one of the following behaviors must occur:

- The instruction is UNDEFINED.
- The instruction executes as NOP.
- The store instruction executes but the value stored is UNKNOWN.

If $wback$ && $n == 15$, then one of the following behaviors must occur:

- The instruction is UNDEFINED.
- The instruction executes as NOP.
- The instruction executes without writeback of the base address.
- The instruction uses the addressing mode described in the equivalent immediate offset instruction.

T1

15	14	13	12	11	10	9	8	6	5	3	2	0
0	1	0	1	0	0	0	Rm	Rn	Rt			

T1 variant

STR{<c>}{<q>} <Rt>, [<Rn>, {+}<Rm>]

Decode for this encoding

t = UInt(Rt); n = UInt(Rn); m = UInt(Rm);
 index = TRUE; add = TRUE; wback = FALSE;
 (shift_t, shift_n) = (SRTYPE_LSL, 0);

T2

15	14	13	12	11	10	9	8	7	6	5	4	3	0	15	12	11	10	9	8	7	6	5	4	3	0
1	1	1	1	1	0	0	0	0	1	0	0	!=1111	Rt	0	0	0	0	0	0	0	imm2	Rm			

Rn

T2 variant

STR{<c>}.W <Rt>, [<Rn>, {+}<Rm>] // <Rt>, <Rn>, <Rm> can be represented in T1
 STR{<c>}{<q>} <Rt>, [<Rn>, {+}<Rm>{, LSL #<imm>}]

Decode for this encoding

if Rn == '1111' then UNDEFINED;
 t = UInt(Rt); n = UInt(Rn); m = UInt(Rm);
 index = TRUE; add = TRUE; wback = FALSE;
 (shift_t, shift_n) = (SRTYPE_LSL, UInt(imm2));
 if t == 15 || m == 15 then UNPREDICTABLE; // ARMv8-A removes UNPREDICTABLE for R13

CONSTRAINED UNPREDICTABLE behavior

If t == 15, then one of the following behaviors must occur:

- The instruction is UNDEFINED.
- The instruction executes as NOP.
- The store instruction performs the store using the specified addressing mode but the value corresponding to R15 is UNKNOWN.

Notes for all encodings

For more information about the CONSTRAINED UNPREDICTABLE behavior of this instruction, see [Appendix K1 Architectural Constraints on UNPREDICTABLE behaviors](#).

Assembler symbols

<c> See [Standard assembler syntax fields on page F2-2848](#).

<q> See [Standard assembler syntax fields on page F2-2848](#).

<Rt> For encoding A1: is the general-purpose register to be transferred, encoded in the "Rt" field. The PC can be used, but this is deprecated.

For encoding T1 and T2: is the general-purpose register to be transferred, encoded in the "Rt" field.

<Rn>	For encoding A1: is the general-purpose base register, encoded in the "Rn" field. The PC can be used in the offset variant, but this is deprecated. For encoding T1 and T2: is the general-purpose base register, encoded in the "Rn" field.
+/-	Specifies the index register is added to or subtracted from the base register, defaulting to + if omitted and encoded in the "U" field. It can have the following values: - when U = 0 + when U = 1
+	Specifies the index register is added to the base register.
<Rm>	Is the general-purpose index register, encoded in the "Rm" field.
<shift>	The shift to apply to the value read from <Rm>. If absent, no shift is applied. Otherwise, see Shifts applied to a register on page F2-2852 .
<imm>	If present, the size of the left shift to apply to the value from <Rm>, in the range 1-3. <imm> is encoded in imm2. If absent, no shift is specified and imm2 is encoded as 0b00.

Operation for all encodings

```

if ConditionPassed() then
    EncodingSpecificOperations();
    offset = Shift(R[m], shift_t, shift_n, PSTATE.C);
    offset_addr = if add then (R[n] + offset) else (R[n] - offset);
    address = if index then offset_addr else R[n];
    if t == 15 then // Only possible for encoding A1
        data = PCStoreValue();
    else
        data = R[t];
    MemU[address,4] = data;
    if wback then R[n] = offset_addr;

```

F5.1.225 STRB (immediate)

Store Register Byte (immediate) calculates an address from a base register value and an immediate offset, and stores a byte from a register to memory. It can use offset, post-indexed, or pre-indexed addressing. For information about memory accesses see [Memory accesses on page F2-2854](#).

A1

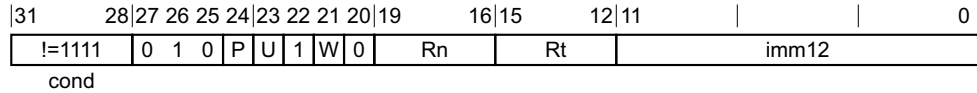

Offset variant

Applies when $P == 1$ && $W == 0$.

STRB{<c>}{<q>} <Rt>, [<Rn> {, #<+/-><imm>}]

Post-indexed variant

Applies when $P == 0$ && $W == 0$.

STRB{<c>}{<q>} <Rt>, [<Rn>], #<+/-><imm>

Pre-indexed variant

Applies when $P == 1$ && $W == 1$.

STRB{<c>}{<q>} <Rt>, [<Rn>, #<+/-><imm>]!

Decode for all variants of this encoding

```

if P == '0' && W == '1' then SEE STRBT;
t = UInt(Rt); n = UInt(Rn); imm32 = ZeroExtend(imm12, 32);
index = (P == '1'); add = (U == '1'); wback = (P == '0') || (W == '1');
if t == 15 then UNPREDICTABLE;
if wback && (n == 15 || n == t) then UNPREDICTABLE;
  
```

CONSTRAINED UNPREDICTABLE behavior

If $t == 15$, then one of the following behaviors must occur:

- The instruction is UNDEFINED.
- The instruction executes as NOP.
- The store instruction performs the store using the specified addressing mode but the value corresponding to R15 is UNKNOWN.

If $wback$ && $n == t$, then one of the following behaviors must occur:

- The instruction is UNDEFINED.
- The instruction executes as NOP.
- The store instruction executes but the value stored is UNKNOWN.

If $wback$ && $n == 15$, then one of the following behaviors must occur:

- The instruction is UNDEFINED.
- The instruction executes as NOP.
- The instruction executes without writeback of the base address.

- The instruction uses the addressing mode described in the equivalent immediate offset instruction.

T1

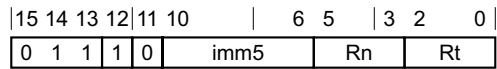

T1 variant

STRB{<c>}{<q>} <Rt>, [<Rn> {, #<+><imm>}]

Decode for this encoding

t = UInt(Rt); n = UInt(Rn); imm32 = ZeroExtend(imm5, 32);
 index = TRUE; add = TRUE; wback = FALSE;

T2

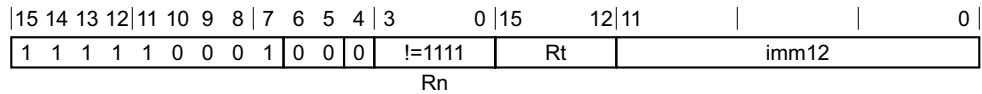

T2 variant

STRB{<c>}.W <Rt>, [<Rn> {, #<+><imm>}] // <Rt>, <Rn>, <imm> can be represented in T1
 STRB{<c>}{<q>} <Rt>, [<Rn> {, #<+><imm>}]

Decode for this encoding

if Rn == '1111' then UNDEFINED;
 t = UInt(Rt); n = UInt(Rn); imm32 = ZeroExtend(imm12, 32);
 index = TRUE; add = TRUE; wback = FALSE;
 if t == 15 then UNPREDICTABLE; // ARMv8-A removes UNPREDICTABLE for R13

CONSTRAINED UNPREDICTABLE behavior

If t == 15, then one of the following behaviors must occur:

- The instruction is UNDEFINED.
- The instruction executes as NOP.
- The store instruction performs the store using the specified addressing mode but the value corresponding to R15 is UNKNOWN.

T3

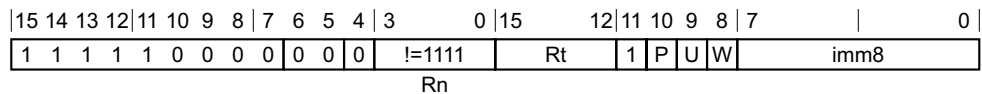

Offset variant

Applies when P == 1 && U == 0 && W == 0.

STRB{<c>}{<q>} <Rt>, [<Rn> {, #-<imm>}]

Post-indexed variant

Applies when $P == 0$ && $W == 1$.

STRB{<c>}{<q>} <Rt>, [<Rn>], #{+/-}<imm>

Pre-indexed variant

Applies when $P == 1$ && $W == 1$.

STRB{<c>}{<q>} <Rt>, [<Rn>, #{+/-}<imm>]!

Decode for all variants of this encoding

```
if P == '1' && U == '1' && W == '0' then SEE STRBT;
if Rn == '1111' || (P == '0' && W == '0') then UNDEFINED;
t = UInt(Rt); n = UInt(Rn); imm32 = ZeroExtend(imm8, 32);
index = (P == '1'); add = (U == '1'); wback = (W == '1');
if t == 15 || (wback && n == t) then UNPREDICTABLE; // ARMv8-A removes UNPREDICTABLE for R13
```

CONSTRAINED UNPREDICTABLE behavior

If $t == 15$, then one of the following behaviors must occur:

- The instruction is UNDEFINED.
- The instruction executes as NOP.
- The store instruction performs the store using the specified addressing mode but the value corresponding to R15 is UNKNOWN.

If $wback$ && $n == t$, then one of the following behaviors must occur:

- The instruction is UNDEFINED.
- The instruction executes as NOP.
- The store instruction executes but the value stored is UNKNOWN.

If $wback$ && $n == 15$, then one of the following behaviors must occur:

- The instruction is UNDEFINED.
- The instruction executes as NOP.
- The instruction executes without writeback of the base address.
- The instruction uses the addressing mode described in the equivalent immediate offset instruction.

Notes for all encodings

For more information about the CONSTRAINED UNPREDICTABLE behavior of this instruction, see [Appendix K1 Architectural Constraints on UNPREDICTABLE behaviors](#).

Assembler symbols

<c> See [Standard assembler syntax fields on page F2-2848](#).

<q> See [Standard assembler syntax fields on page F2-2848](#).

<Rt> Is the general-purpose register to be transferred, encoded in the "Rt" field.

<Rn> For encoding A1: is the general-purpose base register, encoded in the "Rn" field. The PC can be used in the offset variant, but this is deprecated.

For encoding T1, T2 and T3: is the general-purpose base register, encoded in the "Rn" field.

- +/- Specifies the offset is added to or subtracted from the base register, defaulting to + if omitted and encoded in the "U" field. It can have the following values:
- when U = 0
 - + when U = 1
- + Specifies the offset is added to the base register.
- <imm> For encoding A1: is the 12-bit unsigned immediate byte offset, in the range 0 to 4095, defaulting to 0 if omitted, and encoded in the "imm12" field.
- For encoding T1: is an optional 5-bit unsigned immediate byte offset, in the range 0 to 31, defaulting to 0 and encoded in the "imm5" field.
- For encoding T2: is an optional 12-bit unsigned immediate byte offset, in the range 0 to 4095, defaulting to 0 and encoded in the "imm12" field.
- For encoding T3: is an 8-bit unsigned immediate byte offset, in the range 0 to 255, defaulting to 0 if omitted, and encoded in the "imm8" field.

Operation for all encodings

```
if CurrentInstrSet() == InstrSet_A32 then
  if ConditionPassed() then
    EncodingSpecificOperations();
    offset_addr = if add then (R[n] + imm32) else (R[n] - imm32);
    address = if index then offset_addr else R[n];
    MemU[address,1] = R[t]<7:0>;
    if wback then R[n] = offset_addr;
else
  if ConditionPassed() then
    EncodingSpecificOperations();
    offset_addr = if add then (R[n] + imm32) else (R[n] - imm32);
    address = if index then offset_addr else R[n];
    MemU[address,1] = R[t]<7:0>;
    if wback then R[n] = offset_addr;
```

F5.1.226 STRB (register)

Store Register Byte (register) calculates an address from a base register value and an offset register value, and stores a byte from a register to memory. The offset register value can optionally be shifted. For information about memory accesses see [Memory accesses](#) on page F2-2854.

A1

31	28	27	26	25	24	23	22	21	20	19	16	15	12	11	7	6	5	4	3	0
!=1111				0	1	1	P	U	1	W	0	Rn	Rt	imm5	type	0	Rm			
cond																				

Offset variant

Applies when $P == 1$ && $W == 0$.

STRB{<c>}{<q>} <Rt>, [<Rn>, {+/-}<Rm>{, <shift>}]

Post-indexed variant

Applies when $P == 0$ && $W == 0$.

STRB{<c>}{<q>} <Rt>, [<Rn>], {+/-}<Rm>{, <shift>}]

Pre-indexed variant

Applies when $P == 1$ && $W == 1$.

STRB{<c>}{<q>} <Rt>, [<Rn>, {+/-}<Rm>{, <shift>}]!

Decode for all variants of this encoding

```
if P == '0' && W == '1' then SEE STRBT;
t = UInt(Rt); n = UInt(Rn); m = UInt(Rm);
index = (P == '1'); add = (U == '1'); wback = (P == '0') || (W == '1');
(shift_t, shift_n) = DecodeImmShift(type, imm5);
if t == 15 || m == 15 then UNPREDICTABLE;
if wback && (n == 15 || n == t) then UNPREDICTABLE;
```

CONSTRAINED UNPREDICTABLE behavior

If $t == 15$, then one of the following behaviors must occur:

- The instruction is UNDEFINED.
- The instruction executes as NOP.
- The store instruction performs the store using the specified addressing mode but the value corresponding to R15 is UNKNOWN.

If $wback$ && $n == t$, then one of the following behaviors must occur:

- The instruction is UNDEFINED.
- The instruction executes as NOP.
- The store instruction executes but the value stored is UNKNOWN.

If $wback$ && $n == 15$, then one of the following behaviors must occur:

- The instruction is UNDEFINED.
- The instruction executes as NOP.
- The instruction executes without writeback of the base address.

- The instruction uses the addressing mode described in the equivalent immediate offset instruction.

T1

15	14	13	12	11	10	9	8	6	5	3	2	0
0	1	0	1	0	1	0		Rm		Rn		Rt

T1 variant

STRB{<c>}{<q>} <Rt>, [<Rn>, {+}<Rm>]

Decode for this encoding

```
t = UInt(Rt); n = UInt(Rn); m = UInt(Rm);
index = TRUE; add = TRUE; wback = FALSE;
(shift_t, shift_n) = (SRTYPE_LSL, 0);
```

T2

15	14	13	12	11	10	9	8	7	6	5	4	3	0	15	12	11	10	9	8	7	6	5	4	3	0
1	1	1	1	1	0	0	0	0	0	0	0	0	!=1111		Rt		0	0	0	0	0	0	imm2		Rm

Rn

T2 variant

STRB{<c>}.W <Rt>, [<Rn>, {+}<Rm>] // <Rt>, <Rn>, <Rm> can be represented in T1
 STRB{<c>}{<q>} <Rt>, [<Rn>, {+}<Rm>{, LSL #<imm>}]

Decode for this encoding

```
if Rn == '1111' then UNDEFINED;
t = UInt(Rt); n = UInt(Rn); m = UInt(Rm);
index = TRUE; add = TRUE; wback = FALSE;
(shift_t, shift_n) = (SRTYPE_LSL, UInt(imm2));
if t == 15 || m == 15 then UNPREDICTABLE; // ARMv8-A removes UNPREDICTABLE for R13
```

CONSTRAINED UNPREDICTABLE behavior

If t == 15, then one of the following behaviors must occur:

- The instruction is UNDEFINED.
- The instruction executes as NOP.
- The store instruction performs the store using the specified addressing mode but the value corresponding to R15 is UNKNOWN.

Notes for all encodings

For more information about the CONSTRAINED UNPREDICTABLE behavior of this instruction, see [Appendix K1 Architectural Constraints on UNPREDICTABLE behaviors](#).

Assembler symbols

- <c> See [Standard assembler syntax fields on page F2-2848](#).
- <q> See [Standard assembler syntax fields on page F2-2848](#).
- <Rt> Is the general-purpose register to be transferred, encoded in the "Rt" field.

<Rn>	For encoding A1: is the general-purpose base register, encoded in the "Rn" field. The PC can be used in the offset variant, but this is deprecated. For encoding T1 and T2: is the general-purpose base register, encoded in the "Rn" field.
+/-	Specifies the index register is added to or subtracted from the base register, defaulting to + if omitted and encoded in the "U" field. It can have the following values: - when U = 0 + when U = 1
+	Specifies the index register is added to the base register.
<Rm>	Is the general-purpose index register, encoded in the "Rm" field.
<shift>	The shift to apply to the value read from <Rm>. If absent, no shift is applied. Otherwise, see Shifts applied to a register on page F2-2852 .
<imm>	If present, the size of the left shift to apply to the value from <Rm>, in the range 1-3. <imm> is encoded in imm2. If absent, no shift is specified and imm2 is encoded as 0b00.

Operation for all encodings

```
if ConditionPassed() then
    EncodingSpecificOperations();
    offset = Shift(R[m], shift_t, shift_n, PSTATE.C);
    offset_addr = if add then (R[n] + offset) else (R[n] - offset);
    address = if index then offset_addr else R[n];
    MemU[address,1] = R[t]<7:0>;
    if wback then R[n] = offset_addr;
```

F5.1.227 STRBT

Store Register Byte Unprivileged stores a byte from a register to memory. For information about memory accesses see [Memory accesses on page F2-2854](#).

The memory access is restricted as if the PE were running in User mode. This makes no difference if the PE is actually running in User mode.

STRBT is UNPREDICTABLE in Hyp mode.

The T32 instruction uses an offset addressing mode, that calculates the address used for the memory access from a base register value and an immediate offset, and leaves the base register unchanged.

The A32 instruction uses a post-indexed addressing mode, that uses a base register value as the address for the memory access, and calculates a new address from a base register value and an offset and writes it back to the base register. The offset can be an immediate value or an optionally-shifted register value.

A1

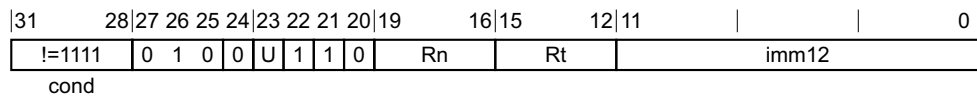

A1 variant

STRBT{<c>}{<q>} <Rt>, [<Rn>] {, #{+/-}<imm>}

Decode for this encoding

```
t = UInt(Rt); n = UInt(Rn); postindex = TRUE; add = (U == '1');
register_form = FALSE; imm32 = ZeroExtend(imm12, 32);
if t == 15 || n == 15 || n == t then UNPREDICTABLE;
```

CONSTRAINED UNPREDICTABLE behavior

If t == 15, then one of the following behaviors must occur:

- The instruction is UNDEFINED.
- The instruction executes as NOP.
- The store instruction performs the store using the specified addressing mode but the value corresponding to R15 is UNKNOWN.

If n == t, then one of the following behaviors must occur:

- The instruction is UNDEFINED.
- The instruction executes as NOP.
- The store instruction executes but the value stored is UNKNOWN.

If n == 15, then one of the following behaviors must occur:

- The instruction is UNDEFINED.
- The instruction executes as NOP.
- The instruction executes without writeback of the base address.
- The instruction uses the addressing mode described in the equivalent immediate offset instruction.

A2

31	28	27	26	25	24	23	22	21	20	19	16	15	12	11	7	6	5	4	3	0	
!=1111				0	1	1	0	U	1	1	0	Rn	Rt	imm5	type	0	Rm				
cond																					

A2 variant

STRBT{<c>}{<q>} <Rt>, [<Rn>], {+/-}<Rm>{, <shift>}

Decode for this encoding

```
t = UInt(Rt); n = UInt(Rn); m = UInt(Rm); postindex = TRUE; add = (U == '1');
register_form = TRUE; (shift_t, shift_n) = DecodeImmShift(type, imm5);
if t == 15 || n == 15 || n == t || m == 15 then UNPREDICTABLE;
```

CONSTRAINED UNPREDICTABLE behavior

If t == 15, then one of the following behaviors must occur:

- The instruction is UNDEFINED.
- The instruction executes as NOP.
- The store instruction performs the store using the specified addressing mode but the value corresponding to R15 is UNKNOWN.

If n == t, then one of the following behaviors must occur:

- The instruction is UNDEFINED.
- The instruction executes as NOP.
- The store instruction executes but the value stored is UNKNOWN.

If n == 15, then one of the following behaviors must occur:

- The instruction is UNDEFINED.
- The instruction executes as NOP.
- The instruction executes without writeback of the base address.
- The instruction uses the addressing mode described in the equivalent immediate offset instruction.

T1

15	14	13	12	11	10	9	8	7	6	5	4	3	0	15	12	11	10	9	8	7	0	
1	1	1	1	1	0	0	0	0	0	0	0	0	!=1111	Rt	1	1	1	0	imm8			
Rn																						

T1 variant

STRBT{<c>}{<q>} <Rt>, [<Rn> {, #+}<imm>]

Decode for this encoding

```
if Rn == '1111' then UNDEFINED;
t = UInt(Rt); n = UInt(Rn); postindex = FALSE; add = TRUE;
register_form = FALSE; imm32 = ZeroExtend(imm8, 32);
if t == 15 then UNPREDICTABLE; // ARMv8-A removes UNPREDICTABLE for R13
```

CONSTRAINED UNPREDICTABLE behavior

If $t == 15$, then one of the following behaviors must occur:

- The instruction is UNDEFINED.
- The instruction executes as NOP.
- The store instruction performs the store using the specified addressing mode but the value corresponding to R15 is UNKNOWN.

Notes for all encodings

For more information about the CONSTRAINED UNPREDICTABLE behavior of this instruction, see [Appendix K1 Architectural Constraints on UNPREDICTABLE behaviors](#).

Assembler symbols

<c>	See Standard assembler syntax fields on page F2-2848 .
<q>	See Standard assembler syntax fields on page F2-2848 .
<Rt>	For encoding A1: is the general-purpose register to be transferred, encoded in the "Rt" field. The PC can be used, but this is deprecated. For encoding A2 and T1: is the general-purpose register to be transferred, encoded in the "Rt" field.
<Rn>	Is the general-purpose base register, encoded in the "Rn" field.
+/-	For encoding A1: specifies the offset is added to or subtracted from the base register, defaulting to + if omitted and encoded in the "U" field. It can have the following values: - when U = 0 + when U = 1 For encoding A2: specifies the index register is added to or subtracted from the base register, defaulting to + if omitted and encoded in the "U" field. It can have the following values: - when U = 0 + when U = 1
<Rm>	Is the general-purpose index register, encoded in the "Rm" field.
<shift>	The shift to apply to the value read from <Rm>. If absent, no shift is applied. Otherwise, see Shifts applied to a register on page F2-2852 .
+	Specifies the offset is added to the base register.
<imm>	For encoding A1: is the 12-bit unsigned immediate byte offset, in the range 0 to 4095, defaulting to 0 if omitted, and encoded in the "imm12" field. For encoding T1: is an optional 8-bit unsigned immediate byte offset, in the range 0 to 255, defaulting to 0 and encoded in the "imm8" field.

Operation for all encodings

```
if ConditionPassed() then
    if PSTATE.EL == EL2 then UNPREDICTABLE;           // Hyp mode
    EncodingSpecificOperations();
    offset = if register_form then Shift(R[m], shift_t, shift_n, PSTATE.C) else imm32;
    offset_addr = if add then (R[n] + offset) else (R[n] - offset);
    address = if postindex then R[n] else offset_addr;
    MemU_unpriv[address,1] = R[t]<7:0>;
    if postindex then R[n] = offset_addr;
```

CONSTRAINED UNPREDICTABLE behavior

If `PSTATE.EL == EL2`, then one of the following behaviors must occur:

- The instruction is UNDEFINED.
- The instruction executes as NOP.
- The instruction executes as STRB (immediate).

F5.1.228 STRD (immediate)

Store Register Dual (immediate) calculates an address from a base register value and an immediate offset, and stores two words from two registers to memory. It can use offset, post-indexed, or pre-indexed addressing. For information about memory accesses see [Memory accesses](#) on page F2-2854.

A1

31	28	27	26	25	24	23	22	21	20	19	16	15	12	11	8	7	6	5	4	3	0		
!=1111				0 0 0			P	U	1	W	0	Rn		Rt		imm4H		1	1	1	1	imm4L	
cond																							

Offset variant

Applies when $P == 1 \ \&\& \ W == 0$.

STRD{<c>}{<q>} <Rt>, <Rt2>, [<Rn> {, #<+/-><imm>}]

Post-indexed variant

Applies when $P == 0 \ \&\& \ W == 0$.

STRD{<c>}{<q>} <Rt>, <Rt2>, [<Rn>], #<+/-><imm>

Pre-indexed variant

Applies when $P == 1 \ \&\& \ W == 1$.

STRD{<c>}{<q>} <Rt>, <Rt2>, [<Rn>, #<+/-><imm>]!

Decode for all variants of this encoding

```

if Rt<0> == '1' then UNPREDICTABLE;
t = UInt(Rt); t2 = t+1; n = UInt(Rn); imm32 = ZeroExtend(imm4H:imm4L, 32);
index = (P == '1'); add = (U == '1'); wback = (P == '0') || (W == '1');
if P == '0' && W == '1' then UNPREDICTABLE;
if wback && (n == 15 || n == t || n == t2) then UNPREDICTABLE;
if t2 == 15 then UNPREDICTABLE;
    
```

CONSTRAINED UNPREDICTABLE behavior

If $t == 15 \ || \ t2 == 15$, then one of the following behaviors must occur:

- The instruction is UNDEFINED.
- The instruction executes as NOP.
- The store instruction performs the store using the specified addressing mode but the value corresponding to R15 is UNKNOWN.

If $wback \ \&\& \ (n == t \ || \ n == t2)$, then one of the following behaviors must occur:

- The instruction is UNDEFINED.
- The instruction executes as NOP.
- The store instruction executes but the value stored is UNKNOWN.

If $wback \ \&\& \ n == 15$, then one of the following behaviors must occur:

- The instruction is UNDEFINED.
- The instruction executes as NOP.
- The instruction executes without writeback of the base address.

- The instruction uses the addressing mode described in the equivalent immediate offset instruction.

If $Rt <0> == '1'$, then one of the following behaviors must occur:

- The instruction is UNDEFINED.
- The instruction executes as NOP.
- The instruction executes with the additional decode: $t <0> = '0'$.
- The instruction executes with the additional decode: $t2 = t$.
- The instruction executes as described, with no change to its behavior and no additional side-effects. This does not apply when $Rt == '1111'$.

If $P == '0'$ && $W == '1'$, then one of the following behaviors must occur:

- The instruction is UNDEFINED.
- The instruction executes as NOP.
- The instruction executes as an LDRD using one of offset, post-indexed, or pre-indexed addressing.

T1

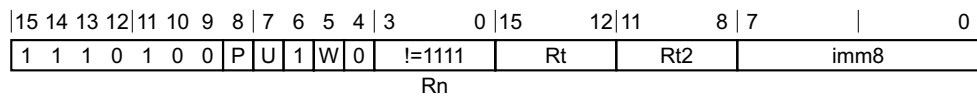

Offset variant

Applies when $P == 1$ && $W == 0$.

STRD{<c>}{<q>} <Rt>, <Rt2>, [<Rn> {, #<+/-><imm>}]

Post-indexed variant

Applies when $P == 0$ && $W == 1$.

STRD{<c>}{<q>} <Rt>, <Rt2>, [<Rn>], #<+/-><imm>

Pre-indexed variant

Applies when $P == 1$ && $W == 1$.

STRD{<c>}{<q>} <Rt>, <Rt2>, [<Rn>, #<+/-><imm>]!

Decode for all variants of this encoding

```

if P == '0' && W == '0' then SEE "Related encodings";
t = UInt(Rt); t2 = UInt(Rt2); n = UInt(Rn); imm32 = ZeroExtend(imm8:'00', 32);
index = (P == '1'); add = (U == '1'); wback = (W == '1');
if wback && (n == t || n == t2) then UNPREDICTABLE;
if n == 15 || t == 15 || t2 == 15 then UNPREDICTABLE; // ARMv8-A removes UNPREDICTABLE for R13
  
```

CONSTRAINED UNPREDICTABLE behavior

If $t == 15$ || $t2 == 15$, then one of the following behaviors must occur:

- The instruction is UNDEFINED.
- The instruction executes as NOP.
- The store instruction performs the store using the specified addressing mode but the value corresponding to R15 is UNKNOWN.

If `wback && (n == t || n == t2)`, then one of the following behaviors must occur:

- The instruction is UNDEFINED.
- The instruction executes as NOP.
- The store instruction executes but the value stored is UNKNOWN.

If `wback && n == 15`, then one of the following behaviors must occur:

- The instruction is UNDEFINED.
- The instruction executes as NOP.
- The instruction executes without writeback of the base address.
- The instruction uses the addressing mode described in the equivalent immediate offset instruction.

Notes for all encodings

For more information about the CONSTRAINED UNPREDICTABLE behavior of this instruction, see [Appendix K1 Architectural Constraints on UNPREDICTABLE behaviors](#).

Related encodings: *Load/store dual, load/store exclusive, load-acquire/store-release, and table branch* on page F3-2913.

Assembler symbols

<c>	See <i>Standard assembler syntax fields</i> on page F2-2848.
<q>	See <i>Standard assembler syntax fields</i> on page F2-2848.
<Rt>	For encoding A1: is the first general-purpose register to be transferred, encoded in the "Rt" field. This register must be even-numbered and not R14. For encoding T1: is the first general-purpose register to be transferred, encoded in the "Rt" field.
<Rt2>	For encoding A1: is the second general-purpose register to be transferred. This register must be <R(t+1)>. For encoding T1: is the second general-purpose register to be transferred, encoded in the "Rt2" field.
<Rn>	For encoding A1: is the general-purpose base register, encoded in the "Rn" field. The PC can be used in the offset variant, but this is deprecated. For encoding T1: is the general-purpose base register, encoded in the "Rn" field.
+/-	Specifies the offset is added to or subtracted from the base register, defaulting to + if omitted and encoded in the "U" field. It can have the following values: - when U = 0 + when U = 1
<imm>	For encoding A1: is the 8-bit unsigned immediate byte offset, in the range 0 to 255, defaulting to 0 if omitted, and encoded in the "imm4H:imm4L" field. For encoding T1: is the unsigned immediate byte offset, a multiple of 4, in the range 0 to 1020, defaulting to 0 if omitted, and encoded in the "imm8" field as <imm>/4.

Operation for all encodings

```
if ConditionPassed() then
    EncodingSpecificOperations();
offset_addr = if add then (R[n] + imm32) else (R[n] - imm32);
address = if index then offset_addr else R[n];
if address == Align(address, 8) then
    bits(64) data;
```

```
if BigEndian() then
    data<63:32> = R[t];
    data<31:0> = R[t2];
else
    data<31:0> = R[t];
    data<63:32> = R[t2];
MemA[address,8] = data;
else
    MemA[address,4] = R[t];
    MemA[address+4,4] = R[t2];
if wback then R[n] = offset_addr;
```

F5.1.229 STRD (register)

Store Register Dual (register) calculates an address from a base register value and a register offset, and stores two words from two registers to memory. It can use offset, post-indexed, or pre-indexed addressing. For information about memory accesses see [Memory accesses](#) on page F2-2854.

A1

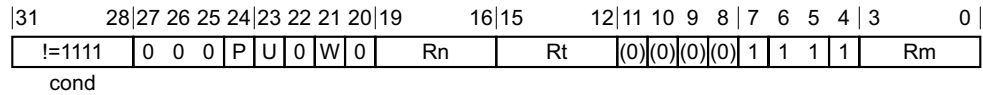

Offset variant

Applies when $P == 1$ && $W == 0$.

STRD{<c>}{<q>} <Rt>, <Rt2>, [<Rn>, {+/-}<Rm>]

Post-indexed variant

Applies when $P == 0$ && $W == 0$.

STRD{<c>}{<q>} <Rt>, <Rt2>, [<Rn>], {+/-}<Rm>

Pre-indexed variant

Applies when $P == 1$ && $W == 1$.

STRD{<c>}{<q>} <Rt>, <Rt2>, [<Rn>, {+/-}<Rm>]!

Decode for all variants of this encoding

```

if Rt<0> == '1' then UNPREDICTABLE;
t = UInt(Rt); t2 = t+1; n = UInt(Rn); m = UInt(Rm);
index = (P == '1'); add = (U == '1'); wback = (P == '0') || (W == '1');
if P == '0' && W == '1' then UNPREDICTABLE;
if t2 == 15 || m == 15 then UNPREDICTABLE;
if wback && (n == 15 || n == t || n == t2) then UNPREDICTABLE;
    
```

CONSTRAINED UNPREDICTABLE behavior

If $t == 15$ || $t2 == 15$, then one of the following behaviors must occur:

- The instruction is UNDEFINED.
- The instruction executes as NOP.
- The store instruction performs the store using the specified addressing mode but the value corresponding to R15 is UNKNOWN.

If $wback$ && ($n == t$ || $n == t2$), then one of the following behaviors must occur:

- The instruction is UNDEFINED.
- The instruction executes as NOP.
- The store instruction executes but the value stored is UNKNOWN.

If $wback$ && $n == 15$, then one of the following behaviors must occur:

- The instruction is UNDEFINED.
- The instruction executes as NOP.
- The instruction executes without writeback of the base address.

- The instruction uses the addressing mode described in the equivalent immediate offset instruction.

If $Rt<0> == '1'$, then one of the following behaviors must occur:

- The instruction is UNDEFINED.
- The instruction executes as NOP.
- The instruction executes with the additional decode: $t<0> = '0'$.
- The instruction executes with the additional decode: $t2 = t$.
- The instruction executes as described, with no change to its behavior and no additional side-effects. This does not apply when $Rt == '1111'$.

If $P == '0'$ && $W == '1'$, then one of the following behaviors must occur:

- The instruction is UNDEFINED.
- The instruction executes as NOP.
- The instruction executes with the additional decode: $P = '1'$; $W = '0'$.
- The instruction executes with the additional decode: $P = '1'$; $W = '1'$.
- The instruction executes with the additional decode: $P = '0'$; $W = '0'$.

Notes for all encodings

For more information about the CONSTRAINED UNPREDICTABLE behavior of this instruction, see [Appendix K1 Architectural Constraints on UNPREDICTABLE behaviors](#).

Assembler symbols

<c>	See <i>Standard assembler syntax fields</i> on page F2-2848.
<q>	See <i>Standard assembler syntax fields</i> on page F2-2848.
<Rt>	Is the first general-purpose register to be transferred, encoded in the "Rt" field. This register must be even-numbered and not R14.
<Rt2>	Is the second general-purpose register to be transferred. This register must be <R(t+1)>.
<Rn>	Is the general-purpose base register, encoded in the "Rn" field. The PC can be used in the offset variant, but this is deprecated.
+/-	Specifies the index register is added to or subtracted from the base register, defaulting to + if omitted and encoded in the "U" field. It can have the following values: <ul style="list-style-type: none"> - when $U = 0$ + when $U = 1$
<Rm>	Is the general-purpose index register, encoded in the "Rm" field.

Operation

```

if ConditionPassed() then
    EncodingSpecificOperations();
    offset_addr = if add then (R[n] + R[m]) else (R[n] - R[m]);
    address = if index then offset_addr else R[n];
    if address == Align(address, 8) then
        bits(64) data;
        if BigEndian() then
            data<63:32> = R[t];
            data<31:0> = R[t2];
  
```

```
else
    data<31:0> = R[t];
    data<63:32> = R[t2];
    MemA[address,8] = data;
else
    MemA[address,4] = R[t];
    MemA[address+4,4] = R[t2];
if wback then R[n] = offset_addr;
```

F5.1.230 STREX

Store Register Exclusive calculates an address from a base register value and an immediate offset, stores a word from a register to the calculated address if the PE has exclusive access to the memory at that address, and returns a status value of 0 if the store was successful, or of 1 if no store was performed.

For more information about support for shared memory see [Synchronization and semaphores on page E2-2795](#). For information about memory accesses see [Memory accesses on page F2-2854](#).

A1

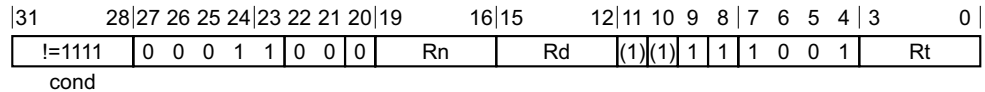

A1 variant

STREX{<c>}{<q>} <Rd>, <Rt>, [<Rn> {, {#}<imm>}]

Decode for this encoding

```
d = UInt(Rd); t = UInt(Rt); n = UInt(Rn); imm32 = Zeros(32); // Zero offset
if d == 15 || t == 15 || n == 15 then UNPREDICTABLE;
if d == n || d == t then UNPREDICTABLE;
```

CONSTRAINED UNPREDICTABLE behavior

If $d == t$, then one of the following behaviors must occur:

- The instruction is UNDEFINED.
- The instruction executes as NOP.
- The store instruction executes but the value stored is UNKNOWN.

If $d == n$, then one of the following behaviors must occur:

- The instruction is UNDEFINED.
- The instruction executes as NOP.
- The instruction performs the store to an UNKNOWN address.

T1

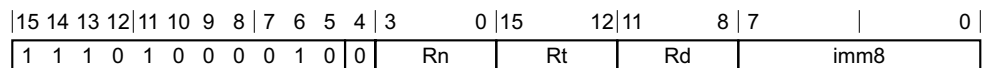

T1 variant

STREX{<c>}{<q>} <Rd>, <Rt>, [<Rn> {, #<imm>}]

Decode for this encoding

```
d = UInt(Rd); t = UInt(Rt); n = UInt(Rn); imm32 = ZeroExtend(imm8:'00', 32);
if d == 15 || t == 15 || n == 15 then UNPREDICTABLE; // ARMv8-A removes UNPREDICTABLE for R13
if d == n || d == t then UNPREDICTABLE;
```

CONSTRAINED UNPREDICTABLE behavior

If $d == t$, then one of the following behaviors must occur:

- The instruction is UNDEFINED.
- The instruction executes as NOP.
- The store instruction executes but the value stored is UNKNOWN.

If $d == n$, then one of the following behaviors must occur:

- The instruction is UNDEFINED.
- The instruction executes as NOP.
- The instruction performs the store to an UNKNOWN address.

Notes for all encodings

For more information about the CONSTRAINED UNPREDICTABLE behavior of this instruction, see [Appendix K1 Architectural Constraints on UNPREDICTABLE behaviors](#).

Assembler symbols

<c>	See Standard assembler syntax fields on page F2-2848 .				
<q>	See Standard assembler syntax fields on page F2-2848 .				
<Rd>	Is the destination general-purpose register into which the status result of the store exclusive is written, encoded in the "Rd" field. The value returned is: <table><tr><td>0</td><td>If the operation updates memory.</td></tr><tr><td>1</td><td>If the operation fails to update memory.</td></tr></table>	0	If the operation updates memory.	1	If the operation fails to update memory.
0	If the operation updates memory.				
1	If the operation fails to update memory.				
<Rt>	Is the general-purpose register to be transferred, encoded in the "Rt" field.				
<Rn>	Is the general-purpose base register, encoded in the "Rn" field.				
<imm>	For encoding A1: the immediate offset added to the value of <Rn> to calculate the address. <imm> can only be 0 or omitted. For encoding T1: the immediate offset added to the value of <Rn> to calculate the address. <imm> can be omitted, meaning an offset of 0. Values are multiples of 4 in the range 0-1020.				

Aborts and alignment

If a synchronous Data Abort exception is generated by the execution of this instruction:

- Memory is not updated.
- <Rd> is not updated.

A non word-aligned memory address causes an Alignment fault Data Abort exception to be generated, subject to the following rules:

- If `AArch32.ExclusiveMonitorsPass()` returns TRUE, the exception is generated.
- Otherwise, it is IMPLEMENTATION DEFINED whether the exception is generated.

If `AArch32.ExclusiveMonitorsPass()` returns FALSE and the memory address, if accessed, would generate a synchronous Data Abort exception, it is IMPLEMENTATION DEFINED whether the exception is generated.

Operation for all encodings

```
if ConditionPassed() then
    EncodingSpecificOperations();
    address = R[n] + imm32;
    if AArch32.ExclusiveMonitorsPass(address,4) then
        MemA[address,4] = R[t];
        R[d] = ZeroExtend('0');
    else
        R[d] = ZeroExtend('1');
```

F5.1.231 STREXB

Store Register Exclusive Byte derives an address from a base register value, stores a byte from a register to the derived address if the executing PE has exclusive access to the memory at that address, and returns a status value of 0 if the store was successful, or of 1 if no store was performed.

For more information about support for shared memory see [Synchronization and semaphores on page E2-2795](#). For information about memory accesses see [Memory accesses on page F2-2854](#).

A1

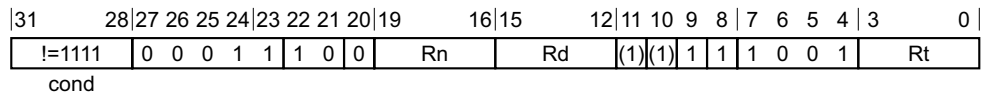

A1 variant

STREXB{<c>}{<q>} <Rd>, <Rt>, [<Rn>]

Decode for this encoding

```
d = UInt(Rd); t = UInt(Rt); n = UInt(Rn);
if d == 15 || t == 15 || n == 15 then UNPREDICTABLE;
if d == n || d == t then UNPREDICTABLE;
```

CONSTRAINED UNPREDICTABLE behavior

If $d == t$, then one of the following behaviors must occur:

- The instruction is UNDEFINED.
- The instruction executes as NOP.
- The store instruction executes but the value stored is UNKNOWN.

If $d == n$, then one of the following behaviors must occur:

- The instruction is UNDEFINED.
- The instruction executes as NOP.
- The instruction performs the store to an UNKNOWN address.

T1

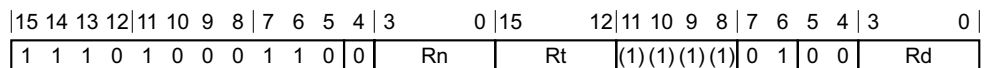

T1 variant

STREXB{<c>}{<q>} <Rd>, <Rt>, [<Rn>]

Decode for this encoding

```
d = UInt(Rd); t = UInt(Rt); n = UInt(Rn);
if d == 15 || t == 15 || n == 15 then UNPREDICTABLE; // ARMv8-A removes UNPREDICTABLE for R13
if d == n || d == t then UNPREDICTABLE;
```

CONSTRAINED UNPREDICTABLE behavior

If $d == t$, then one of the following behaviors must occur:

- The instruction is UNDEFINED.
- The instruction executes as NOP.
- The store instruction executes but the value stored is UNKNOWN.

If $d == n$, then one of the following behaviors must occur:

- The instruction is UNDEFINED.
- The instruction executes as NOP.
- The instruction performs the store to an UNKNOWN address.

Notes for all encodings

For more information about the CONSTRAINED UNPREDICTABLE behavior of this instruction, see [Appendix K1 Architectural Constraints on UNPREDICTABLE behaviors](#).

Assembler symbols

<c>	See Standard assembler syntax fields on page F2-2848 .				
<q>	See Standard assembler syntax fields on page F2-2848 .				
<Rd>	Is the destination general-purpose register into which the status result of the store exclusive is written, encoded in the "Rd" field. The value returned is: <table><tr><td>0</td><td>If the operation updates memory.</td></tr><tr><td>1</td><td>If the operation fails to update memory.</td></tr></table>	0	If the operation updates memory.	1	If the operation fails to update memory.
0	If the operation updates memory.				
1	If the operation fails to update memory.				
<Rt>	Is the general-purpose register to be transferred, encoded in the "Rt" field.				
<Rn>	Is the general-purpose base register, encoded in the "Rn" field.				

Aborts

If a synchronous Data Abort exception is generated by the execution of this instruction:

- Memory is not updated.
- <Rd> is not updated.

If `AArch32.ExclusiveMonitorsPass()` returns FALSE and the memory address, if accessed, would generate a synchronous Data Abort exception, it is IMPLEMENTATION DEFINED whether the exception is generated.

Operation for all encodings

```
if ConditionPassed() then
    EncodingSpecificOperations();
    address = R[n];
    if AArch32.ExclusiveMonitorsPass(address,1) then
        MemA[address,1] = R[t]<7:0>;
        R[d] = ZeroExtend('0');
    else
        R[d] = ZeroExtend('1');
```

F5.1.232 STREXD

Store Register Exclusive Doubleword derives an address from a base register value, stores a 64-bit doubleword from two registers to the derived address if the executing PE has exclusive access to the memory at that address, and returns a status value of 0 if the store was successful, or of 1 if no store was performed.

For more information about support for shared memory see [Synchronization and semaphores on page E2-2795](#). For information about memory accesses see [Memory accesses on page F2-2854](#).

A1

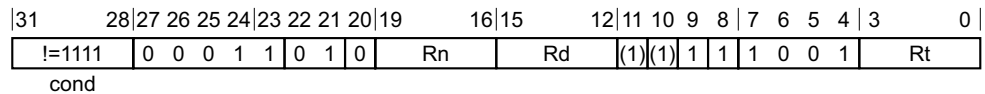

A1 variant

STREXD{<c>}{<q>} <Rd>, <Rt>, <Rt2>, [<Rn>]

Decode for this encoding

```
d = UInt(Rd); t = UInt(Rt); t2 = t+1; n = UInt(Rn);
if d == 15 || Rt<0> == '1' || t2 == 15 || n == 15 then UNPREDICTABLE;
if d == n || d == t || d == t2 then UNPREDICTABLE;
```

CONSTRAINED UNPREDICTABLE behavior

If $d == t$, then one of the following behaviors must occur:

- The instruction is UNDEFINED.
- The instruction executes as NOP.
- The store instruction executes but the value stored is UNKNOWN.

If $d == n$, then one of the following behaviors must occur:

- The instruction is UNDEFINED.
- The instruction executes as NOP.
- The instruction performs the store to an UNKNOWN address.

If $Rt<0> == '1'$, then one of the following behaviors must occur:

- The instruction is UNDEFINED.
- The instruction executes as NOP.
- The instruction executes with the additional decode: $Rt<0> = '0'$.
- The instruction executes with the additional decode: $t2 = t$.
- The instruction executes as described, with no change to its behavior and no additional side effects.

If $Rt == '1110'$, then one of the following behaviors must occur:

- The instruction is UNDEFINED.
- The instruction executes as NOP.
- The instruction is handled as described in [Using R15 on page K1-6097](#).

T1

15	14	13	12	11	10	9	8	7	6	5	4	3	0	15	12	11	8	7	6	5	4	3	0
1	1	1	0	1	0	0	0	1	1	0	0	Rn	Rt	Rt2	0	1	1	1	Rd				

T1 variant

STREXD{<c>}{<q>} <Rd>, <Rt>, <Rt2>, [<Rn>]

Decode for this encoding

```
d = UInt(Rd); t = UInt(Rt); t2 = UInt(Rt2); n = UInt(Rn);
if d == 15 || t == 15 || t2 == 15 || n == 15 then UNPREDICTABLE;
// ARMv8-A removes UNPREDICTABLE for R13
if d == n || d == t || d == t2 then UNPREDICTABLE;
```

CONSTRAINED UNPREDICTABLE behavior

If $d == t$, then one of the following behaviors must occur:

- The instruction is UNDEFINED.
- The instruction executes as NOP.
- The store instruction executes but the value stored is UNKNOWN.

If $d == n$, then one of the following behaviors must occur:

- The instruction is UNDEFINED.
- The instruction executes as NOP.
- The instruction performs the store to an UNKNOWN address.

Notes for all encodings

For more information about the CONSTRAINED UNPREDICTABLE behavior of this instruction, see [Appendix K1 Architectural Constraints on UNPREDICTABLE behaviors](#).

Assembler symbols

<c>	See Standard assembler syntax fields on page F2-2848 .
<q>	See Standard assembler syntax fields on page F2-2848 .
<Rd>	Is the destination general-purpose register into which the status result of the store exclusive is written, encoded in the "Rd" field. The value returned is: 0 If the operation updates memory. 1 If the operation fails to update memory. <Rd> must not be the same as <Rn>, <Rt>, or <Rt2>.
<Rt>	For encoding A1: is the first general-purpose register to be transferred, encoded in the "Rt" field. <Rt> must be even-numbered and not R14. For encoding T1: is the first general-purpose register to be transferred, encoded in the "Rt" field.
<Rt2>	For encoding A1: is the second general-purpose register to be transferred. <Rt2> must be <R(t+1)>. For encoding T1: is the second general-purpose register to be transferred, encoded in the "Rt2" field.
<Rn>	Is the general-purpose base register, encoded in the "Rn" field.

Aborts and alignment

If a synchronous Data Abort exception is generated by the execution of this instruction:

- Memory is not updated.
- <Rd> is not updated.

A non doubleword-aligned memory address causes an Alignment fault Data Abort exception to be generated, subject to the following rules:

- If `AArch32.ExclusiveMonitorsPass()` returns TRUE, the exception is generated.
- Otherwise, it is IMPLEMENTATION DEFINED whether the exception is generated.

If `AArch32.ExclusiveMonitorsPass()` returns FALSE and the memory address, if accessed, would generate a synchronous Data Abort exception, it is IMPLEMENTATION DEFINED whether the exception is generated.

Operation for all encodings

```
if ConditionPassed() then
    EncodingSpecificOperations();
    address = R[n];
    // Create doubleword to store such that R[t] will be stored at address and R[t2] at address+4.
    value = if BigEndian() then R[t]:R[t2] else R[t2]:R[t];
    if AArch32.ExclusiveMonitorsPass(address,8) then
        MemA[address,8] = value; R[d] = ZeroExtend('0');
    else
        R[d] = ZeroExtend('1');
```

F5.1.233 STREXH

Store Register Exclusive Halfword derives an address from a base register value, stores a halfword from a register to the derived address if the executing PE has exclusive access to the memory at that address, and returns a status value of 0 if the store was successful, or of 1 if no store was performed.

For more information about support for shared memory see [Synchronization and semaphores on page E2-2795](#). For information about memory accesses see [Memory accesses on page F2-2854](#).

A1

31	28	27	26	25	24	23	22	21	20	19	16	15	12	11	10	9	8	7	6	5	4	3	0	
!=1111				0	0	0	1	1	1	1	0	Rn	Rd	(1)	(1)	1	1	1	0	0	1	Rt		
cond																								

A1 variant

STREXH{<c>}{<q>} <Rd>, <Rt>, [<Rn>]

Decode for this encoding

```
d = UInt(Rd); t = UInt(Rt); n = UInt(Rn);
if d == 15 || t == 15 || n == 15 then UNPREDICTABLE;
if d == n || d == t then UNPREDICTABLE;
```

CONSTRAINED UNPREDICTABLE behavior

If $d == t$, then one of the following behaviors must occur:

- The instruction is UNDEFINED.
- The instruction executes as NOP.
- The store instruction executes but the value stored is UNKNOWN.

If $d == n$, then one of the following behaviors must occur:

- The instruction is UNDEFINED.
- The instruction executes as NOP.
- The instruction performs the store to an UNKNOWN address.

T1

15	14	13	12	11	10	9	8	7	6	5	4	3	0	15	12	11	10	9	8	7	6	5	4	3	0
1	1	1	0	1	0	0	0	1	1	0	0	Rn	Rt	(1)	(1)	(1)	(1)	0	1	0	1	Rd			

T1 variant

STREXH{<c>}{<q>} <Rd>, <Rt>, [<Rn>]

Decode for this encoding

```
d = UInt(Rd); t = UInt(Rt); n = UInt(Rn);
if d == 15 || t == 15 || n == 15 then UNPREDICTABLE; // ARMv8-A removes UNPREDICTABLE for R13
if d == n || d == t then UNPREDICTABLE;
```

CONSTRAINED UNPREDICTABLE behavior

If $d == t$, then one of the following behaviors must occur:

- The instruction is UNDEFINED.
- The instruction executes as NOP.
- The store instruction executes but the value stored is UNKNOWN.

If $d == n$, then one of the following behaviors must occur:

- The instruction is UNDEFINED.
- The instruction executes as NOP.
- The instruction performs the store to an UNKNOWN address.

Notes for all encodings

For more information about the CONSTRAINED UNPREDICTABLE behavior of this instruction, see [Appendix K1 Architectural Constraints on UNPREDICTABLE behaviors](#).

Assembler symbols

<c>	See Standard assembler syntax fields on page F2-2848 .				
<q>	See Standard assembler syntax fields on page F2-2848 .				
<Rd>	Is the destination general-purpose register into which the status result of the store exclusive is written, encoded in the "Rd" field. The value returned is: <table><tr><td>0</td><td>If the operation updates memory.</td></tr><tr><td>1</td><td>If the operation fails to update memory.</td></tr></table>	0	If the operation updates memory.	1	If the operation fails to update memory.
0	If the operation updates memory.				
1	If the operation fails to update memory.				
<Rt>	Is the general-purpose register to be transferred, encoded in the "Rt" field.				
<Rn>	Is the general-purpose base register, encoded in the "Rn" field.				

Aborts and alignment

If a synchronous Data Abort exception is generated by the execution of this instruction:

- Memory is not updated.
- <Rd> is not updated.

A non halfword-aligned memory address causes an Alignment fault Data Abort exception to be generated, subject to the following rules:

- If `AArch32.ExclusiveMonitorsPass()` returns TRUE, the exception is generated.
- Otherwise, it is IMPLEMENTATION DEFINED whether the exception is generated.

If `AArch32.ExclusiveMonitorsPass()` returns FALSE and the memory address, if accessed, would generate a synchronous Data Abort exception, it is IMPLEMENTATION DEFINED whether the exception is generated.

Operation for all encodings

```
if ConditionPassed() then
    EncodingSpecificOperations();
    address = R[n];
    if AArch32.ExclusiveMonitorsPass(address,2) then
        MemA[address,2] = R[t]<15:0>;
```

```
R[d] = ZeroExtend('0');  
else  
R[d] = ZeroExtend('1');
```

F5.1.234 STRH (immediate)

Store Register Halfword (immediate) calculates an address from a base register value and an immediate offset, and stores a halfword from a register to memory. It can use offset, post-indexed, or pre-indexed addressing. For information about memory accesses see [Memory accesses on page F2-2854](#).

A1

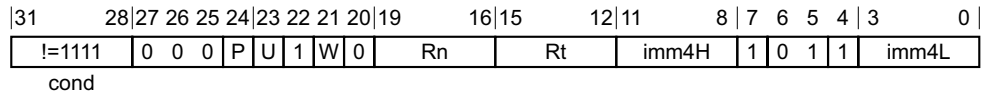

Offset variant

Applies when $P == 1 \ \&\& \ W == 0$.

STRH{<c>}{<q>} <Rt>, [<Rn> {, #<+/-><imm>}]

Post-indexed variant

Applies when $P == 0 \ \&\& \ W == 0$.

STRH{<c>}{<q>} <Rt>, [<Rn>], #<+/-><imm>

Pre-indexed variant

Applies when $P == 1 \ \&\& \ W == 1$.

STRH{<c>}{<q>} <Rt>, [<Rn>, #<+/-><imm>]!

Decode for all variants of this encoding

```

if P == '0' && W == '1' then SEE STRHT;
t = UInt(Rt); n = UInt(Rn); imm32 = ZeroExtend(imm4H:imm4L, 32);
index = (P == '1'); add = (U == '1'); wback = (P == '0') || (W == '1');
if t == 15 then UNPREDICTABLE;
if wback && (n == 15 || n == t) then UNPREDICTABLE;
    
```

CONSTRAINED UNPREDICTABLE behavior

If $t == 15$, then one of the following behaviors must occur:

- The instruction is UNDEFINED.
- The instruction executes as NOP.
- The store instruction performs the store using the specified addressing mode but the value corresponding to R15 is UNKNOWN.

If $wback \ \&\& \ n == t$, then one of the following behaviors must occur:

- The instruction is UNDEFINED.
- The instruction executes as NOP.
- The store instruction executes but the value stored is UNKNOWN.

If $wback \ \&\& \ n == 15$, then one of the following behaviors must occur:

- The instruction is UNDEFINED.
- The instruction executes as NOP.
- The instruction executes without writeback of the base address.

- The instruction uses the addressing mode described in the equivalent immediate offset instruction.

T1

15	14	13	12	11	10	6	5	3	2	0
1	0	0	0	0		imm5		Rn		Rt

T1 variant

STRH{<c>}{<q>} <Rt>, [<Rn> {, #<+><imm>}]

Decode for this encoding

t = UInt(Rt); n = UInt(Rn); imm32 = ZeroExtend(imm5:'0', 32);
 index = TRUE; add = TRUE; wback = FALSE;

T2

15	14	13	12	11	10	9	8	7	6	5	4	3	0	15	12	11			0
1	1	1	1	1	0	0	0	1	0	1	0	!=1111		Rt					imm12
Rn																			

T2 variant

STRH{<c>}.W <Rt>, [<Rn> {, #<+><imm>}] // <Rt>, <Rn>, <imm> can be represented in T1
 STRH{<c>}{<q>} <Rt>, [<Rn> {, #<+><imm>}]

Decode for this encoding

if Rn == '1111' then UNDEFINED;
 t = UInt(Rt); n = UInt(Rn); imm32 = ZeroExtend(imm12, 32);
 index = TRUE; add = TRUE; wback = FALSE;
 if t == 15 then UNPREDICTABLE; // ARMv8-A removes UNPREDICTABLE for R15

CONSTRAINED UNPREDICTABLE behavior

If t == 15, then one of the following behaviors must occur:

- The instruction is UNDEFINED.
- The instruction executes as NOP.
- The store instruction performs the store using the specified addressing mode but the value corresponding to R15 is UNKNOWN.

T3

15	14	13	12	11	10	9	8	7	6	5	4	3	0	15	12	11	10	9	8	7			0
1	1	1	1	1	0	0	0	0	0	1	0	!=1111		Rt	1	P	U	W				imm8	
Rn																							

Offset variant

Applies when P == 1 && U == 0 && W == 0.

STRH{<c>}{<q>} <Rt>, [<Rn> {, #-<imm>}]

Post-indexed variant

Applies when $P == 0$ && $W == 1$.

STRH{<c>}{<q>} <Rt>, [<Rn>], #{+/-}<imm>

Pre-indexed variant

Applies when $P == 1$ && $W == 1$.

STRH{<c>}{<q>} <Rt>, [<Rn>, #{+/-}<imm>]!

Decode for all variants of this encoding

```
if P == '1' && U == '1' && W == '0' then SEE STRHT;
if Rn == '1111' || (P == '0' && W == '0') then UNDEFINED;
t = UInt(Rt); n = UInt(Rn); imm32 = ZeroExtend(imm8, 32);
index = (P == '1'); add = (U == '1'); wback = (W == '1');
if t == 15 || (wback && n == t) then UNPREDICTABLE; // ARMv8-A removes UNPREDICTABLE for R13
```

CONSTRAINED UNPREDICTABLE behavior

If $t == 15$, then one of the following behaviors must occur:

- The instruction is UNDEFINED.
- The instruction executes as NOP.
- The store instruction performs the store using the specified addressing mode but the value corresponding to R15 is UNKNOWN.

If $wback$ && $n == t$, then one of the following behaviors must occur:

- The instruction is UNDEFINED.
- The instruction executes as NOP.
- The store instruction executes but the value stored is UNKNOWN.

Notes for all encodings

For more information about the CONSTRAINED UNPREDICTABLE behavior of this instruction, see [Appendix K1 Architectural Constraints on UNPREDICTABLE behaviors](#).

Assembler symbols

<c>	See Standard assembler syntax fields on page F2-2848 .
<q>	See Standard assembler syntax fields on page F2-2848 .
<Rt>	Is the general-purpose register to be transferred, encoded in the "Rt" field.
<Rn>	For encoding A1: is the general-purpose base register, encoded in the "Rn" field. The PC can be used in the offset variant, but this is deprecated. For encoding A1, T1, T2, T3: is the general-purpose base register, encoded in the "Rn" field.
+/-	Specifies the offset is added to or subtracted from the base register, defaulting to + if omitted and encoded in the "U" field. It can have the following values: - when $U = 0$ + when $U = 1$
+	Specifies the offset is added to the base register.

<imm> For encoding A1: is the 8-bit unsigned immediate byte offset, in the range 0 to 255, defaulting to 0 if omitted, and encoded in the "imm4H:imm4L" field.

For encoding T1: is the optional positive unsigned immediate byte offset, a multiple of 2, in the range 0 to 62, defaulting to 0 and encoded in the "imm5" field as <imm>/2.

For encoding T2: is an optional 12-bit unsigned immediate byte offset, in the range 0 to 4095, defaulting to 0 and encoded in the "imm12" field.

For encoding T3: is an 8-bit unsigned immediate byte offset, in the range 0 to 255, defaulting to 0 if omitted, and encoded in the "imm8" field.

Operation for all encodings

```
if CurrentInstrSet() == InstrSet_A32 then
  if ConditionPassed() then
    EncodingSpecificOperations();
    offset_addr = if add then (R[n] + imm32) else (R[n] - imm32);
    address = if index then offset_addr else R[n];
    MemU[address,2] = R[t]<15:0>;
    if wback then R[n] = offset_addr;
else
  if ConditionPassed() then
    EncodingSpecificOperations();
    offset_addr = if add then (R[n] + imm32) else (R[n] - imm32);
    address = if index then offset_addr else R[n];
    MemU[address,2] = R[t]<15:0>;
    if wback then R[n] = offset_addr;
```

F5.1.235 STRH (register)

Store Register Halfword (register) calculates an address from a base register value and an offset register value, and stores a halfword from a register to memory. The offset register value can be shifted left by 0, 1, 2, or 3 bits. For information about memory accesses see [Memory accesses on page F2-2854](#).

A1

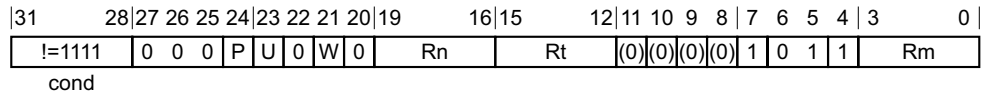

Offset variant

Applies when $P == 1 \ \&\& \ W == 0$.

STRH{<c>}{<q>} <Rt>, [<Rn>, {+/-}<Rm>]

Post-indexed variant

Applies when $P == 0 \ \&\& \ W == 0$.

STRH{<c>}{<q>} <Rt>, [<Rn>], {+/-}<Rm>

Pre-indexed variant

Applies when $P == 1 \ \&\& \ W == 1$.

STRH{<c>}{<q>} <Rt>, [<Rn>, {+/-}<Rm>]!

Decode for all variants of this encoding

```

if P == '0' && W == '1' then SEE STRHT;
t = UInt(Rt); n = UInt(Rn); m = UInt(Rm);
index = (P == '1'); add = (U == '1'); wback = (P == '0') || (W == '1');
(shift_t, shift_n) = (SRTYPE_LSL, 0);
if t == 15 || m == 15 then UNPREDICTABLE;
if wback && (n == 15 || n == t) then UNPREDICTABLE;
    
```

CONSTRAINED UNPREDICTABLE behavior

If $t == 15$, then one of the following behaviors must occur:

- The instruction is UNDEFINED.
- The instruction executes as NOP.
- The store instruction performs the store using the specified addressing mode but the value corresponding to R15 is UNKNOWN.

If $wback \ \&\& \ n == t$, then one of the following behaviors must occur:

- The instruction is UNDEFINED.
- The instruction executes as NOP.
- The store instruction executes but the value stored is UNKNOWN.

If $wback \ \&\& \ n == 15$, then one of the following behaviors must occur:

- The instruction is UNDEFINED.
- The instruction executes as NOP.
- The instruction executes without writeback of the base address.

- The instruction uses the addressing mode described in the equivalent immediate offset instruction.

T1

15	14	13	12	11	10	9	8	6	5	3	2	0
0	1	0	1	0	0	1	Rm	Rn	Rt			

T1 variant

STRH{<c>}{<q>} <Rt>, [<Rn>, {+}<Rm>]

Decode for this encoding

```
t = UInt(Rt); n = UInt(Rn); m = UInt(Rm);
index = TRUE; add = TRUE; wback = FALSE;
(shift_t, shift_n) = (SRTYPE_LSL, 0);
```

T2

15	14	13	12	11	10	9	8	7	6	5	4	3	0	15	12	11	10	9	8	7	6	5	4	3	0
1	1	1	1	1	0	0	0	0	0	1	0	!=1111	Rt		0	0	0	0	0	0	imm2			Rm	

Rn

T2 variant

STRH{<c>}.W <Rt>, [<Rn>, {+}<Rm>] // <Rt>, <Rn>, <Rm> can be represented in T1
 STRH{<c>}{<q>} <Rt>, [<Rn>, {+}<Rm>{, LSL #<imm>}]

Decode for this encoding

```
if Rn == '1111' then UNDEFINED;
t = UInt(Rt); n = UInt(Rn); m = UInt(Rm);
index = TRUE; add = TRUE; wback = FALSE;
(shift_t, shift_n) = (SRTYPE_LSL, UInt(imm2));
if t == 15 || m == 15 then UNPREDICTABLE; // ARMv8-A removes UNPREDICTABLE for R13
```

CONSTRAINED UNPREDICTABLE behavior

If t == 15, then one of the following behaviors must occur:

- The instruction is UNDEFINED.
- The instruction executes as NOP.
- The store instruction performs the store using the specified addressing mode but the value corresponding to R15 is UNKNOWN.

Notes for all encodings

For more information about the CONSTRAINED UNPREDICTABLE behavior of this instruction, see [Appendix K1 Architectural Constraints on UNPREDICTABLE behaviors](#).

Assembler symbols

- <c> See [Standard assembler syntax fields on page F2-2848](#).
- <q> See [Standard assembler syntax fields on page F2-2848](#).
- <Rt> Is the general-purpose register to be transferred, encoded in the "Rt" field.

- <Rn> For encoding A1: is the general-purpose base register, encoded in the "Rn" field. The PC can be used in the offset variant, but this is deprecated.
For encoding T1 and T2: is the general-purpose base register, encoded in the "Rn" field.
- +/- Specifies the index register is added to or subtracted from the base register, defaulting to + if omitted and encoded in the "U" field. It can have the following values:
- when U = 0
+ when U = 1
- + Specifies the index register is added to the base register.
- <Rm> Is the general-purpose index register, encoded in the "Rm" field.
- <imm> If present, the size of the left shift to apply to the value from <Rm>, in the range 1-3. <imm> is encoded in imm2. If absent, no shift is specified and imm2 is encoded as 0b00.

Operation for all encodings

```
if ConditionPassed() then
    EncodingSpecificOperations();
    offset = Shift(R[m], shift_t, shift_n, PSTATE.C);
    offset_addr = if add then (R[n] + offset) else (R[n] - offset);
    address = if index then offset_addr else R[n];
    MemU[address,2] = R[t]<15:0>;
    if wback then R[n] = offset_addr;
```

F5.1.236 STRHT

Store Register Halfword Unprivileged stores a halfword from a register to memory. For information about memory accesses see [Memory accesses](#) on page F2-2854.

The memory access is restricted as if the PE were running in User mode. This makes no difference if the PE is actually running in User mode.

STRHT is UNPREDICTABLE in Hyp mode.

The T32 instruction uses an offset addressing mode, that calculates the address used for the memory access from a base register value and an immediate offset, and leaves the base register unchanged.

The A32 instruction uses a post-indexed addressing mode, that uses a base register value as the address for the memory access, and calculates a new address from a base register value and an offset and writes it back to the base register. The offset can be an immediate value or a register value.

A1

31	28	27	26	25	24	23	22	21	20	19	16	15	12	11	8	7	6	5	4	3	0	
!1111				0	0	0	0	U	1	1	0	Rn	Rt	imm4H		1	0	1	1	imm4L		
cond																						

A1 variant

STRHT{<c>}{<q>} <Rt>, [<Rn>] {, #{+/-}<imm>}

Decode for this encoding

```
t = UInt(Rt); n = UInt(Rn); postindex = TRUE; add = (U == '1');
register_form = FALSE; imm32 = ZeroExtend(imm4H:imm4L, 32);
if t == 15 || n == 15 || n == t then UNPREDICTABLE;
```

CONSTRAINED UNPREDICTABLE behavior

If t == 15, then one of the following behaviors must occur:

- The instruction is UNDEFINED.
- The instruction executes as NOP.
- The store instruction performs the store using the specified addressing mode but the value corresponding to R15 is UNKNOWN.

If n == t, then one of the following behaviors must occur:

- The instruction is UNDEFINED.
- The instruction executes as NOP.
- The store instruction executes but the value stored is UNKNOWN.

If n == 15, then one of the following behaviors must occur:

- The instruction is UNDEFINED.
- The instruction executes as NOP.
- The instruction executes without writeback of the base address.
- The instruction uses the addressing mode described in the equivalent immediate offset instruction.

A2

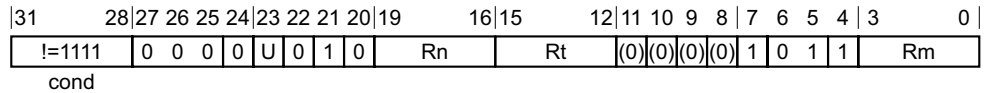

A2 variant

STRHT{<c>}{<q>} <Rt>, [<Rn>], {+/-}<Rm>

Decode for this encoding

```
t = UInt(Rt); n = UInt(Rn); m = UInt(Rm); postindex = TRUE; add = (U == '1');
register_form = TRUE;
if t == 15 || n == 15 || n == t || m == 15 then UNPREDICTABLE;
```

CONSTRAINED UNPREDICTABLE behavior

If t == 15, then one of the following behaviors must occur:

- The instruction is UNDEFINED.
- The instruction executes as NOP.
- The store instruction performs the store using the specified addressing mode but the value corresponding to R15 is UNKNOWN.

If n == t, then one of the following behaviors must occur:

- The instruction is UNDEFINED.
- The instruction executes as NOP.
- The store instruction executes but the value stored is UNKNOWN.

If n == 15, then one of the following behaviors must occur:

- The instruction is UNDEFINED.
- The instruction executes as NOP.
- The instruction executes without writeback of the base address.
- The instruction uses the addressing mode described in the equivalent immediate offset instruction.

T1

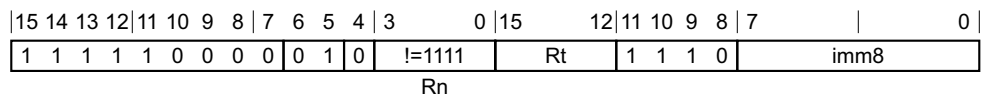

T1 variant

STRHT{<c>}{<q>} <Rt>, [<Rn> {, #+}<imm>]

Decode for this encoding

```
if Rn == '1111' then UNDEFINED;
t = UInt(Rt); n = UInt(Rn); postindex = FALSE; add = TRUE;
register_form = FALSE; imm32 = ZeroExtend(imm8, 32);
if t == 15 then UNPREDICTABLE; // ARMv8-A removes UNPREDICTABLE for R13
```

CONSTRAINED UNPREDICTABLE behavior

If $t == 15$, then one of the following behaviors must occur:

- The instruction is UNDEFINED.
- The instruction executes as NOP.
- The store instruction performs the store using the specified addressing mode but the value corresponding to R15 is UNKNOWN.

Notes for all encodings

For more information about the CONSTRAINED UNPREDICTABLE behavior of this instruction, see [Appendix K1 Architectural Constraints on UNPREDICTABLE behaviors](#).

Assembler symbols

<c>	See Standard assembler syntax fields on page F2-2848 .
<q>	See Standard assembler syntax fields on page F2-2848 .
<Rt>	Is the general-purpose register to be transferred, encoded in the "Rt" field.
<Rn>	Is the general-purpose base register, encoded in the "Rn" field.
+/-	For encoding A1: specifies the offset is added to or subtracted from the base register, defaulting to + if omitted and encoded in the "U" field. It can have the following values: - when U = 0 + when U = 1 For encoding A2: specifies the index register is added to or subtracted from the base register, defaulting to + if omitted and encoded in the "U" field. It can have the following values: - when U = 0 + when U = 1
<Rm>	Is the general-purpose index register, encoded in the "Rm" field.
+	Specifies the offset is added to the base register.
<imm>	For encoding A1: is the 8-bit unsigned immediate byte offset, in the range 0 to 255, defaulting to 0 if omitted, and encoded in the "imm4H:imm4L" field. For encoding T1: is an optional 8-bit unsigned immediate byte offset, in the range 0 to 255, defaulting to 0 and encoded in the "imm8" field.

Operation for all encodings

```
if ConditionPassed() then
    if PSTATE.EL == EL2 then UNPREDICTABLE;           // Hyp mode
    EncodingSpecificOperations();
    offset = if register_form then R[m] else imm32;
    offset_addr = if add then (R[n] + offset) else (R[n] - offset);
    address = if postindex then R[n] else offset_addr;
    MemU_unpriv[address,2] = R[t]<15:0>;
    if postindex then R[n] = offset_addr;
```

CONSTRAINED UNPREDICTABLE behavior

If PSTATE.EL == EL2, then one of the following behaviors must occur:

- The instruction is UNDEFINED.

- The instruction executes as NOP.
- The instruction executes as STRH (immediate).

F5.1.237 STRT

Store Register Unprivileged stores a word from a register to memory. For information about memory accesses see [Memory accesses on page F2-2854](#).

The memory access is restricted as if the PE were running in User mode. This makes no difference if the PE is actually running in User mode.

STRT is UNPREDICTABLE in Hyp mode.

The T32 instruction uses an offset addressing mode, that calculates the address used for the memory access from a base register value and an immediate offset, and leaves the base register unchanged.

The A32 instruction uses a post-indexed addressing mode, that uses a base register value as the address for the memory access, and calculates a new address from a base register value and an offset and writes it back to the base register. The offset can be an immediate value or an optionally-shifted register value.

A1

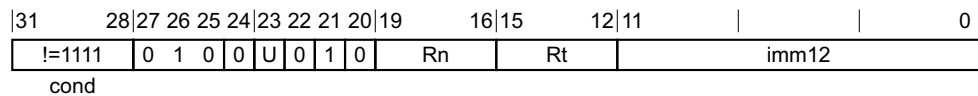

A1 variant

STRT{<c>}{<q>} <Rt>, [<Rn>] {, #{+/-}<imm>}

Decode for this encoding

```
t = UInt(Rt); n = UInt(Rn); postindex = TRUE; add = (U == '1');
register_form = FALSE; imm32 = ZeroExtend(imm12, 32);
if n == 15 || n == t then UNPREDICTABLE;
```

CONSTRAINED UNPREDICTABLE behavior

If $n == t$, then one of the following behaviors must occur:

- The instruction is UNDEFINED.
- The instruction executes as NOP.
- The store instruction executes but the value stored is UNKNOWN.

If $n == 15$, then one of the following behaviors must occur:

- The instruction is UNDEFINED.
- The instruction executes as NOP.
- The instruction executes without writeback of the base address.
- The instruction uses the addressing mode described in the equivalent immediate offset instruction.

A2

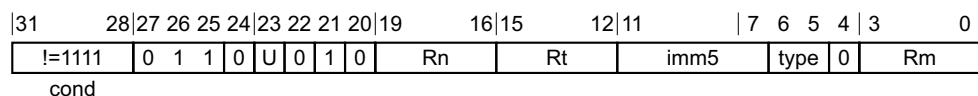

A2 variant

STRT{<c>}{<q>} <Rt>, [<Rn>], {+/-}<Rm>{, <shift>}

Decode for this encoding

```
t = UInt(Rt); n = UInt(Rn); m = UInt(Rm); postindex = TRUE; add = (U == '1');
register_form = TRUE; (shift_t, shift_n) = DecodeImmShift(type, imm5);
if n == 15 || n == t || m == 15 then UNPREDICTABLE;
```

CONSTRAINED UNPREDICTABLE behavior

If n == t, then one of the following behaviors must occur:

- The instruction is UNDEFINED.
- The instruction executes as NOP.
- The store instruction executes but the value stored is UNKNOWN.

If n == 15, then one of the following behaviors must occur:

- The instruction is UNDEFINED.
- The instruction executes as NOP.
- The instruction executes without writeback of the base address.
- The instruction uses the addressing mode described in the equivalent immediate offset instruction.

T1

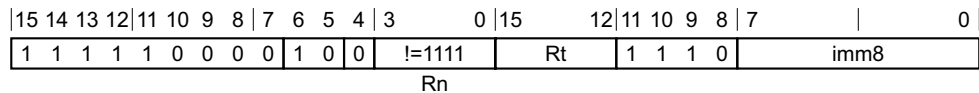

T1 variant

STRT{<c>}{<q>} <Rt>, [<Rn> {, #<+><imm>}]

Decode for this encoding

```
if Rn == '1111' then UNDEFINED;
t = UInt(Rt); n = UInt(Rn); postindex = FALSE; add = TRUE;
register_form = FALSE; imm32 = ZeroExtend(imm8, 32);
if t == 15 then UNPREDICTABLE; // ARMv8-A removes UNPREDICTABLE for R13
```

CONSTRAINED UNPREDICTABLE behavior

If t == 15, then one of the following behaviors must occur:

- The instruction is UNDEFINED.
- The instruction executes as NOP.
- The store instruction performs the store using the specified addressing mode but the value corresponding to R15 is UNKNOWN.

Notes for all encodings

For more information about the CONSTRAINED UNPREDICTABLE behavior of this instruction, see [Appendix K1 Architectural Constraints on UNPREDICTABLE behaviors](#).

Assembler symbols

<c> See [Standard assembler syntax fields on page F2-2848](#).

- <q> See [Standard assembler syntax fields on page F2-2848](#).
- <Rt> For encoding A1 and A2: is the general-purpose register to be transferred, encoded in the "Rt" field. The PC can be used, but this is deprecated.
For encoding T1: is the general-purpose register to be transferred, encoded in the "Rt" field.
- <Rn> Is the general-purpose base register, encoded in the "Rn" field.
- +/- For encoding A1: specifies the offset is added to or subtracted from the base register, defaulting to + if omitted and encoded in the "U" field. It can have the following values:
- when U = 0
+ when U = 1
For encoding A2: specifies the index register is added to or subtracted from the base register, defaulting to + if omitted and encoded in the "U" field. It can have the following values:
- when U = 0
+ when U = 1
- <Rm> Is the general-purpose index register, encoded in the "Rm" field.
- <shift> The shift to apply to the value read from <Rm>. If absent, no shift is applied. Otherwise, see [Shifts applied to a register on page F2-2852](#).
- + Specifies the offset is added to the base register.
- <imm> For encoding A1: is the 12-bit unsigned immediate byte offset, in the range 0 to 4095, defaulting to 0 if omitted, and encoded in the "imm12" field.
For encoding T1: is an optional 8-bit unsigned immediate byte offset, in the range 0 to 255, defaulting to 0 and encoded in the "imm8" field.

Operation for all encodings

```
if ConditionPassed() then
  if PSTATE.EL == EL2 then UNPREDICTABLE;           // Hyp mode
  EncodingSpecificOperations();
  offset = if register_form then Shift(R[m], shift_t, shift_n, PSTATE.C) else imm32;
  offset_addr = if add then (R[n] + offset) else (R[n] - offset);
  address = if postindex then R[n] else offset_addr;
  if t == 15 then // Only possible for encodings A1 and A2
    data = PCStoreValue();
  else
    data = R[t];
  MemU_unpriv[address,4] = data;
  if postindex then R[n] = offset_addr;
```

CONSTRAINED UNPREDICTABLE behavior

If PSTATE.EL == EL2, then one of the following behaviors must occur:

- The instruction is UNDEFINED.
- The instruction executes as NOP.
- The instruction executes as STR (immediate).

F5.1.238 SUB (immediate, from PC)

Subtract from PC subtracts an immediate value from the `Align(PC, 4)` value to form a PC-relative address, and writes the result to the destination register. ARM recommends that, where possible, software avoids using this alias.

This instruction is an alias of the [ADR](#) instruction. This means that:

- The encodings in this description are named to match the encodings of [ADR](#).
- The description of [ADR](#) gives the operational pseudocode for this instruction.

A2

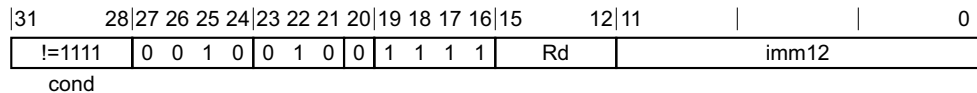

A2 variant

`SUB{<c>}{<q>} <Rd>, PC, #<const>`

is equivalent to

`ADR{<c>}{<q>} <Rd>, <label>`

and is the preferred disassembly when `imm12 == '000000000000'`.

T2

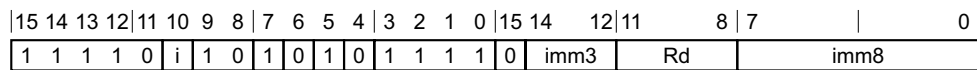

T2 variant

`SUB{<c>}{<q>} <Rd>, PC, #imm12`

is equivalent to

`ADR{<c>}{<q>} <Rd>, <label>`

and is the preferred disassembly when `i:imm3:imm8 == '000000000000'`.

Assembler symbols

<c> See [Standard assembler syntax fields on page F2-2848](#).

<q> See [Standard assembler syntax fields on page F2-2848](#).

<Rd> For encoding A2: is the general-purpose destination register, encoded in the "Rd" field. If the PC is used, the instruction is a branch to the address calculated by the operation. This is an interworking branch, see [Pseudocode description of operations on the AArch32 general-purpose registers and the PC on page E1-2733](#).

For encoding T2: is the general-purpose destination register, encoded in the "Rd" field.

<label> For encoding A1 and A2: the label of an instruction or literal data item whose address is to be loaded into <Rd>. The assembler calculates the required value of the offset from the `Align(PC, 4)` value of the ADR instruction to this label.

If the offset is zero or positive, encoding A1 is used, with `imm32` equal to the offset.

If the offset is negative, encoding A2 is used, with `imm32` equal to the size of the offset. That is, the use of encoding A2 indicates that the required offset is minus the value of `imm32`.

Permitted values of the size of the offset are any of the constants described in *Modified immediate constants in A32 instructions* on page F2-2864.

For encoding T1: the label of an instruction or literal data item whose address is to be loaded into `<Rd>`. The assembler calculates the required value of the offset from the `Align(PC, 4)` value of the ADR instruction to this label. Permitted values of the size of the offset are multiples of 4 in the range 0 to 1020.

For encoding T2 and T3: the label of an instruction or literal data item whose address is to be loaded into `<Rd>`. The assembler calculates the required value of the offset from the `Align(PC, 4)` value of the ADR instruction to this label.

If the offset is zero or positive, encoding T3 is used, with `imm32` equal to the offset.

If the offset is negative, encoding T2 is used, with `imm32` equal to the size of the offset. That is, the use of encoding T2 indicates that the required offset is minus the value of `imm32`.

Permitted values of the size of the offset are 0-4095.

- `<imm12>` Is a 12-bit unsigned immediate, in the range 0 to 4095, encoded in the "i:imm3:imm8" field.
- `<const>` An immediate value. See *Modified immediate constants in A32 instructions* on page F2-2864 for the range of values.

Operation for all encodings

The description of [ADR](#) gives the operational pseudocode for this instruction.

F5.1.239 SUB, SUBS (immediate)

Subtract (immediate) subtracts an immediate value from a register value, and writes the result to the destination register.

If the destination register is not the PC, the SUBS variant of the instruction updates the condition flags based on the result.

The field descriptions for <Rd> identify the encodings where the PC is permitted as the destination register. If the destination register is the PC:

- The SUB variant of the instruction is an interworking branch, see *Pseudocode description of operations on the AArch32 general-purpose registers and the PC* on page E1-2733.
- The SUBS variant of the instruction performs an exception return without the use of the stack. In this case:
 - The PE branches to the address written to the PC, and restores `PSTATE` from `SPSR_<current_mode>`.
 - The PE checks `SPSR_<current_mode>` for an illegal return event. See *Illegal return events from AArch32 state* on page G1-4361.
 - The instruction is UNDEFINED in Hyp mode, except for encoding T5 with <imm8> set to zero, which is the encoding for the ERET instruction, see ERET.
 - The instruction is CONSTRAINED UNPREDICTABLE in User mode and System mode.

A1

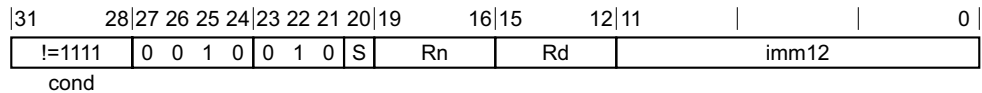

SUB variant

Applies when `S == 0` && `Rn != 11x1`.

SUB{<c>}{<q>} {<Rd>}, <Rn>, #<const>

SUBS variant

Applies when `S == 1` && `Rn != 1101`.

SUBS{<c>}{<q>} {<Rd>}, <Rn>, #<const>

Decode for all variants of this encoding

```
if Rn == '1111' && S == '0' then SEE ADR;
if Rn == '1101' then SEE SUB (SP minus immediate);
d = UInt(Rd); n = UInt(Rn); setflags = (S == '1'); imm32 = A32ExpandImm(imm12);
```

T1

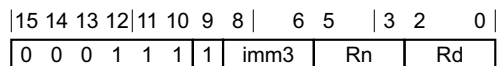

T1 variant

SUB<c>{<q>} <Rd>, <Rn>, #<imm3> // Inside IT block
 SUBS{<q>} <Rd>, <Rn>, #<imm3> // Outside IT block

Decode for this encoding

d = UInt(Rd); n = UInt(Rn); setflags = !InITBlock(); imm32 = ZeroExtend(imm3, 32);

T2

15	14	13	12	11	10	8	7								0
0	0	1	1	1		Rdn									imm8

T2 variant

SUB<c>{<q>} <Rdn>, #<imm8> // Inside IT block, and <Rdn>, <imm8> can be represented in T1
 SUB<c>{<q>} {<Rdn>}, <Rdn>, #<imm8> // Inside IT block, and <Rdn>, <imm8> cannot be represented in T1
 SUBS{<q>} <Rdn>, #<imm8> // Outside IT block, and <Rdn>, <imm8> can be represented in T1
 SUBS{<q>} {<Rdn>}, <Rdn>, #<imm8> // Outside IT block, and <Rdn>, <imm8> cannot be represented in T1

Decode for this encoding

d = UInt(Rdn); n = UInt(Rdn); setflags = !InITBlock(); imm32 = ZeroExtend(imm8, 32);

T3

15	14	13	12	11	10	9	8	7	6	5	4	3	0	15	14	12	11	8	7							0
1	1	1	1	0	i	0	1	1	0	1	S	!=1101	0	imm3		Rd										imm8

Rn

SUB variant

Applies when S == 0.

SUB<c>.W {<Rd>}, <Rn>, #<const> // Inside IT block, and <Rd>, <Rn>, <const> can be represented in T1 or T2
 SUB{<c>}{<q>} {<Rd>}, <Rn>, #<const>

SUBS variant

Applies when S == 1 && Rd != 1111.

SUBS.W {<Rd>}, <Rn>, #<const> // Outside IT block, and <Rd>, <Rn>, <const> can be represented in T1 or T2
 SUBS{<c>}{<q>} {<Rd>}, <Rn>, #<const>

Decode for all variants of this encoding

if Rd == '1111' && S == '1' then SEE CMP (immediate);
 if Rn == '1101' then SEE SUB (SP minus immediate);
 d = UInt(Rd); n = UInt(Rn); setflags = (S == '1'); imm32 = T32ExpandImm(i:imm3:imm8);
 if (d == 15 && !setflags) || n == 15 then UNPREDICTABLE; // ARMv8-A removes UNPREDICTABLE for R13

T4

15	14	13	12	11	10	9	8	7	6	5	4	3	0	15	14	12	11	8	7							0
1	1	1	1	0	i	1	0	1	0	1	0	!=11x1	0	imm3		Rd										imm8

Rn

T4 variant

SUB{<c>}{<q>} {<Rd>}, <Rn>, #<imm12> // <imm12> cannot be represented in T1, T2, or T3
 SUBW{<c>}{<q>} {<Rd>}, <Rn>, #<imm12> // <imm12> can be represented in T1, T2, or T3

Decode for this encoding

```
if Rn == '1111' then SEE ADR;
if Rn == '1101' then SEE SUB (SP minus immediate);
d = UInt(Rd); n = UInt(Rn); setflags = FALSE; imm32 = ZeroExtend(i:imm3:imm8, 32);
if d == 15 then UNPREDICTABLE; // ARMv8-A removes UNPREDICTABLE for R13
```

T5

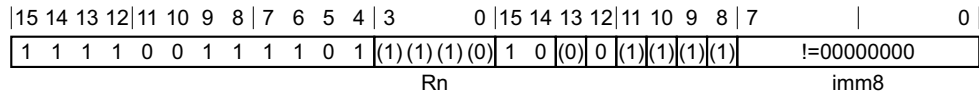

T5 variant

SUBS{<c>}{<q>} PC, LR, #<imm8>

Decode for this encoding

```
if Rn == '1110' && IsZero(imm8) then SEE ERET;
d = 15; n = UInt(Rn); setflags = TRUE; imm32 = ZeroExtend(imm8, 32);
if n != 14 then UNPREDICTABLE;
if InITBlock() && !LastInITBlock() then UNPREDICTABLE;
```

Notes for all encodings

For more information about the CONSTRAINED UNPREDICTABLE behavior of this instruction, see [Appendix K1 Architectural Constraints on UNPREDICTABLE behaviors](#), and particularly *SUBS PC, LR and related instructions (A32)* on page K1-6109 and *SUBS PC, LR and related instructions (T32)* on page K1-6109.

Assembler symbols

- <c> See [Standard assembler syntax fields on page F2-2848](#).
- <q> See [Standard assembler syntax fields on page F2-2848](#).
- <Rdn> Is the general-purpose source and destination register, encoded in the "Rdn" field.
- <imm8> For encoding T2: is a 8-bit unsigned immediate, in the range 0 to 255, encoded in the "imm8" field.
 For encoding T5: is a 8-bit unsigned immediate, in the range 0 to 255, encoded in the "imm8" field.
 If <Rn> is the LR, and zero is used, see [ERET](#).
- <Rd> For encoding A1: is the general-purpose destination register, encoded in the "Rd" field. If omitted, this register is the same as <Rn>. If the PC is used:
 - For the SUB variant, the instruction is a branch to the address calculated by the operation. This is an interworking branch, see [Pseudocode description of operations on the AArch32 general-purpose registers and the PC on page E1-2733](#).
 - For the SUBS variant, the instruction performs an exception return, that restores [PSTATE](#) from [SPSR_<current_mode>](#). ARM deprecates use of this instruction unless <Rn> is the LR.
 For encoding T1, T3 and T4: is the general-purpose destination register, encoded in the "Rd" field. If omitted, this register is the same as <Rn>.
- <Rn> For encoding A1 and T4: is the general-purpose source register, encoded in the "Rn" field. If the SP is used, see [SUB, SUBS \(SP minus immediate\)](#). If the PC is used, see [ADR](#).
 For encoding T1: is the general-purpose source register, encoded in the "Rn" field.
 For encoding T3: is the general-purpose source register, encoded in the "Rn" field. If the SP is used, see [SUB, SUBS \(SP minus immediate\)](#).
- <imm3> Is a 3-bit unsigned immediate, in the range 0 to 7, encoded in the "imm3" field.

- <imm12> Is a 12-bit unsigned immediate, in the range 0 to 4095, encoded in the "i:imm3:imm8" field.
- <const> For encoding A1: an immediate value. See [Modified immediate constants in A32 instructions on page F2-2864](#) for the range of values.
For encoding T3: an immediate value. See [Modified immediate constants in T32 instructions on page F2-2863](#) for the range of values.

In the T32 instruction set, MOVS{<c>}{<q>} PC, LR is a pseudo-instruction for SUBS{<c>}{<q>} PC, LR, #0.

Operation for all encodings

```
if ConditionPassed() then
    EncodingSpecificOperations();
    (result, nzcvc) = AddWithCarry(R[n], NOT(imm32), '1');
    if d == 15 then
        if setflags then
            ALUExceptionReturn(result);
        else
            ALUWritePC(result);
    else
        R[d] = result;
        if setflags then
            PSTATE.<N,Z,C,V> = nzcvc;
```

F5.1.240 SUB, SUBS (register)

Subtract (register) subtracts an optionally-shifted register value from a register value, and writes the result to the destination register.

If the destination register is not the PC, the SUBS variant of the instruction updates the condition flags based on the result.

The field descriptions for <Rd> identify the encodings where the PC is permitted as the destination register. However, when the destination register is the PC:

- The SUB variant of the instruction is an interworking branch, see *Pseudocode description of operations on the AArch32 general-purpose registers and the PC on page E1-2733*.
- The SUBS variant of the instruction performs an exception return without the use of the stack. ARM deprecates use of this instruction. However, in this case:
 - The PE branches to the address written to the PC, and restores `PSTATE` from `SPSR_<current_mode>`.
 - The PE checks `SPSR_<current_mode>` for an illegal return event. See *Illegal return events from AArch32 state on page G1-4361*.
 - The instruction is UNDEFINED in Hyp mode.
 - The instruction is CONSTRAINED UNPREDICTABLE in User mode and System mode.

A1

31	28	27	26	25	24	23	22	21	20	19	16	15	12	11	7	6	5	4	3	0		
!=1111				0 0 0 0				0 1 0 S				!=1101		Rd		imm5		type		0		Rm
cond										Rn												

SUB, rotate right with extend variant

Applies when `S == 0` && `imm5 == 00000` && `type == 11`.

`SUB{<c>}{<q>} {<Rd>}, <Rn>, <Rm>, RRX`

SUB, shift or rotate by value variant

Applies when `S == 0` && `!(imm5 == 00000 && type == 11)`.

`SUB{<c>}{<q>} {<Rd>}, <Rn>, <Rm> {, <shift> #<amount>}`

SUBS, rotate right with extend variant

Applies when `S == 1` && `imm5 == 00000` && `type == 11`.

`SUBS{<c>}{<q>} {<Rd>}, <Rn>, <Rm>, RRX`

SUBS, shift or rotate by value variant

Applies when `S == 1` && `!(imm5 == 00000 && type == 11)`.

`SUBS{<c>}{<q>} {<Rd>}, <Rn>, <Rm> {, <shift> #<amount>}`

Decode for all variants of this encoding

```
if Rn == '1101' then SEE SUB (SP minus register);
d = UInt(Rd); n = UInt(Rn); m = UInt(Rm); setflags = (S == '1');
(shift_t, shift_n) = DecodeImmShift(type, imm5);
```

T1

15	14	13	12	11	10	9	8	6	5	3	2	0
0	0	0	1	1	0	1	Rm	Rn	Rd			

T1 variant

SUB<c>{<q>} <Rd>, <Rn>, <Rm> // Inside IT block
 SUBS{<q>} {<Rd>,} <Rn>, <Rm> // Outside IT block

Decode for this encoding

```
d = UInt(Rd); n = UInt(Rn); m = UInt(Rm); setflags = !InITBlock();
(shift_t, shift_n) = (SRTYPE_LSL, 0);
```

T2

15	14	13	12	11	10	9	8	7	6	5	4	3	0	15	14	12	11	8	7	6	5	4	3	0	
1	1	1	0	1	0	1	1	1	0	1	S	!=1101	(0)	imm3	Rd	imm2	type	Rm							

Rn

SUB, rotate right with extend variant

Applies when S == 0 && imm3 == 000 && imm2 == 00 && type == 11.

SUB{<c>}{<q>} {<Rd>,} <Rn>, <Rm>, RRX

SUB, shift or rotate by value variant

Applies when S == 0 && !(imm3 == 000 && imm2 == 00 && type == 11).

SUB<c>.W {<Rd>,} <Rn>, <Rm> // Inside IT block, and <Rd>, <Rn>, <Rm> can be represented in T1
 SUB{<c>}{<q>} {<Rd>,} <Rn>, <Rm> {, <shift> #<amount>}

SUBS, rotate right with extend variant

Applies when S == 1 && imm3 == 000 && Rd != 1111 && imm2 == 00 && type == 11.

SUBS{<c>}{<q>} {<Rd>,} <Rn>, <Rm>, RRX

SUBS, shift or rotate by value variant

Applies when S == 1 && !(imm3 == 000 && imm2 == 00 && type == 11) && Rd != 1111.

SUBS.W {<Rd>,} <Rn>, <Rm> // Outside IT block, and <Rd>, <Rn>, <Rm> can be represented in T1
 SUBS{<c>}{<q>} {<Rd>,} <Rn>, <Rm> {, <shift> #<amount>}

Decode for all variants of this encoding

```
if Rd == '1111' && S == '1' then SEE CMP (register);
if Rn == '1101' then SEE SUB (SP minus register);
d = UInt(Rd); n = UInt(Rn); m = UInt(Rm); setflags = (S == '1');
(shift_t, shift_n) = DecodeImmShift(type, imm3:imm2);
if (d == 15 && !setflags) || n == 15 || m == 15 then UNPREDICTABLE;
// ARMv8-A removes UNPREDICTABLE for R13
```

Notes for all encodings

For more information about the CONSTRAINED UNPREDICTABLE behavior of this instruction, see [Appendix K1 Architectural Constraints on UNPREDICTABLE behaviors](#).

Assembler symbols

<c>	See Standard assembler syntax fields on page F2-2848 .								
<q>	See Standard assembler syntax fields on page F2-2848 .								
<Rd>	<p>For encoding A1: is the general-purpose destination register, encoded in the "Rd" field. If omitted, this register is the same as <Rn>. ARM deprecates using the PC as the destination register, but if the PC is used:</p> <ul style="list-style-type: none"> For the SUB variant, the instruction is a branch to the address calculated by the operation. This is an interworking branch, see Pseudocode description of operations on the AArch32 general-purpose registers and the PC on page E1-2733. For the SUBS variant, the instruction performs an exception return, that restores PSTATE from SPSR_<current_mode>. <p>For encoding T1 and T2: is the general-purpose destination register, encoded in the "Rd" field. If omitted, this register is the same as <Rn>.</p>								
<Rn>	<p>For encoding A1: is the first general-purpose source register, encoded in the "Rn" field. The PC can be used, but this is deprecated. If the SP is used, see SUB, SUBS (SP minus register).</p> <p>For encoding T1: is the first general-purpose source register, encoded in the "Rn" field.</p> <p>For encoding T2: is the first general-purpose source register, encoded in the "Rn" field. If the SP is used, see SUB, SUBS (SP minus register).</p>								
<Rm>	<p>For encoding A1: is the second general-purpose source register, encoded in the "Rm" field. The PC can be used, but this is deprecated.</p> <p>For encoding T1 and T2: is the second general-purpose source register, encoded in the "Rm" field.</p>								
<shift>	<p>Is the type of shift to be applied to the second source register, encoded in the "type" field. It can have the following values:</p> <table> <tr> <td>LSL</td> <td>when type = 00</td> </tr> <tr> <td>LSR</td> <td>when type = 01</td> </tr> <tr> <td>ASR</td> <td>when type = 10</td> </tr> <tr> <td>ROR</td> <td>when type = 11</td> </tr> </table>	LSL	when type = 00	LSR	when type = 01	ASR	when type = 10	ROR	when type = 11
LSL	when type = 00								
LSR	when type = 01								
ASR	when type = 10								
ROR	when type = 11								
<amount>	<p>For encoding A1: is the shift amount, in the range 1 to 31 (when <shift> = LSL or ROR) or 1 to 32 (when <shift> = LSR or ASR) encoded in the "imm5" field as <amount> modulo 32.</p> <p>For encoding T2: is the shift amount, in the range 1 to 31 (when <shift> = LSL or ROR) or 1 to 32 (when <shift> = LSR or ASR) encoded in the "imm3:imm2" field as <amount> modulo 32.</p>								

Operation for all encodings

```

if ConditionPassed() then
    EncodingSpecificOperations();
    shifted = Shift(R[m], shift_t, shift_n, PSTATE.C);
    (result, nzcvc) = AddWithCarry(R[n], NOT(shifted), '1');
    if d == 15 then // Can only occur for A32 encoding
        if setflags then
            ALUExceptionReturn(result);
        else
            ALUWritePC(result);
    else
        R[d] = result;
        if setflags then
            PSTATE.<N,Z,C,V> = nzcvc;
  
```

F5.1.241 SUB, SUBS (register-shifted register)

Subtract (register-shifted register) subtracts a register-shifted register value from a register value, and writes the result to the destination register. It can optionally update the condition flags based on the result.

A1

31	28	27	26	25	24	23	22	21	20	19	16	15	12	11	8	7	6	5	4	3	0	
!=1111				0	0	0	0	0	1	0	S	Rn	Rd	Rs	0	type	1	Rm				
cond																						

Flag setting variant

Applies when S == 1.

SUBS{<c>}{<q>} {<Rd>}, {<Rn>}, <Rm>, <type> <Rs>

Not flag setting variant

Applies when S == 0.

SUB{<c>}{<q>} {<Rd>}, {<Rn>}, <Rm>, <type> <Rs>

Decode for all variants of this encoding

```
d = UInt(Rd); n = UInt(Rn); m = UInt(Rm); s = UInt(Rs);
setflags = (S == '1'); shift_t = DecodeRegShift(type);
if d == 15 || n == 15 || m == 15 || s == 15 then UNPREDICTABLE;
```

Notes for all encodings

For more information about the CONSTRAINED UNPREDICTABLE behavior of this instruction, see [Appendix K1 Architectural Constraints on UNPREDICTABLE behaviors](#).

Assembler symbols

<c>	See Standard assembler syntax fields on page F2-2848 .								
<q>	See Standard assembler syntax fields on page F2-2848 .								
<Rd>	Is the general-purpose destination register, encoded in the "Rd" field.								
<Rn>	Is the first general-purpose source register, encoded in the "Rn" field.								
<Rm>	Is the second general-purpose source register, encoded in the "Rm" field.								
<type>	Is the type of shift to be applied to the second source register, encoded in the "type" field. It can have the following values: <table> <tr> <td>LSL</td> <td>when type = 00</td> </tr> <tr> <td>LSR</td> <td>when type = 01</td> </tr> <tr> <td>ASR</td> <td>when type = 10</td> </tr> <tr> <td>ROR</td> <td>when type = 11</td> </tr> </table>	LSL	when type = 00	LSR	when type = 01	ASR	when type = 10	ROR	when type = 11
LSL	when type = 00								
LSR	when type = 01								
ASR	when type = 10								
ROR	when type = 11								
<Rs>	Is the third general-purpose source register holding a shift amount in its bottom 8 bits, encoded in the "Rs" field.								

Operation

```
if ConditionPassed() then
    EncodingSpecificOperations();
    shift_n = UInt(R[s]<7:0>);
    shifted = Shift(R[m], shift_t, shift_n, PSTATE.C);
    (result, nzc) = AddWithCarry(R[n], NOT(shifted), '1');
    R[d] = result;
    if setflags then
        PSTATE.<N,Z,C,V> = nzc;
```

F5.1.242 SUB, SUBS (SP minus immediate)

Subtract from SP (immediate) subtracts an immediate value from the SP value, and writes the result to the destination register.

If the destination register is not the PC, the SUBS variant of the instruction updates the condition flags based on the result.

The field descriptions for <Rd> identify the encodings where the PC is permitted as the destination register. If the destination register is the PC:

- The SUB variant of the instruction is an interworking branch, see *Pseudocode description of operations on the AArch32 general-purpose registers and the PC on page E1-2733*.
- The SUBS variant of the instruction performs an exception return without the use of the stack. ARM deprecates use of this instruction. However, in this case:
 - The PE branches to the address written to the PC, and restores *PSTATE* from *SPSR_<current_mode>*.
 - The PE checks *SPSR_<current_mode>* for an illegal return event. See *Illegal return events from AArch32 state on page G1-4361*.
 - The instruction is UNDEFINED in Hyp mode.
 - The instruction is CONSTRAINED UNPREDICTABLE in User mode and System mode.

A1

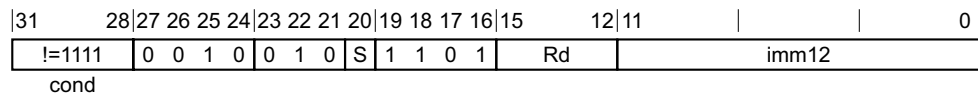

SUB variant

Applies when S == 0.

SUB{<c>}{<q>} {<Rd>}, SP, #<const>

SUBS variant

Applies when S == 1.

SUBS{<c>}{<q>} {<Rd>}, SP, #<const>

Decode for all variants of this encoding

d = UInt(Rd); setflags = (S == '1'); imm32 = A32ExpandImm(imm12);

T1

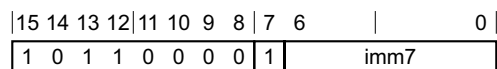

T1 variant

SUB{<c>}{<q>} {SP}, SP, #<imm7>

Decode for this encoding

d = 13; setflags = FALSE; imm32 = ZeroExtend(imm7:'00', 32);

T2

15	14	13	12	11	10	9	8	7	6	5	4	3	2	1	0	15	14	12	11	8	7	0
1	1	1	1	0	i	0	1	1	0	1	S	1	1	0	1	0	imm3	Rd	imm8			

SUB variant

Applies when S == 0.

SUB{<c>}.W {<Rd>}, SP, #<const> // <Rd>, <const> can be represented in T1
 SUB{<c>}{<q>} {<Rd>}, SP, #<const>

SUBS variant

Applies when S == 1 && Rd != 1111.

SUBS{<c>}{<q>} {<Rd>}, SP, #<const>

Decode for all variants of this encoding

```
if Rd == '1111' && S == '1' then SEE CMP (immediate);
d = UInt(Rd); setflags = (S == '1'); imm32 = T32ExpandImm(i:imm3:imm8);
if d == 15 && !setflags then UNPREDICTABLE;
```

T3

15	14	13	12	11	10	9	8	7	6	5	4	3	2	1	0	15	14	12	11	8	7	0
1	1	1	1	0	i	1	0	1	0	1	0	1	1	0	1	0	imm3	Rd	imm8			

T3 variant

SUB{<c>}{<q>} {<Rd>}, SP, #<imm12> // <imm12> cannot be represented in T1, T2, or T3
 SUBW{<c>}{<q>} {<Rd>}, SP, #<imm12> // <imm12> can be represented in T1, T2, or T3

Decode for this encoding

```
d = UInt(Rd); setflags = FALSE; imm32 = ZeroExtend(i:imm3:imm8, 32);
if d == 15 then UNPREDICTABLE;
```

Notes for all encodings

For more information about the CONSTRAINED UNPREDICTABLE behavior of this instruction, see [Appendix K1 Architectural Constraints on UNPREDICTABLE behaviors](#).

Assembler symbols

- <c> See [Standard assembler syntax fields on page F2-2848](#).
- <q> See [Standard assembler syntax fields on page F2-2848](#).
- <imm7> Is the unsigned immediate, a multiple of 4, in the range 0 to 508, encoded in the "imm7" field as <imm7>/4.
- <Rd> For encoding A1: is the general-purpose destination register, encoded in the "Rd" field. If omitted, this register is the SP. If the PC is used:
 - For the SUB variant, the instruction is a branch to the address calculated by the operation. This is an interworking branch, see [Pseudocode description of operations on the AArch32 general-purpose registers and the PC on page E1-2733](#).

- For the SUBS variant, the instruction performs an exception return, that restores [PSTATE](#) from `SPSR_<current_mode>`. ARM deprecates use of this instruction unless `<Rn>` is the LR.

For encoding T2 and T3: is the general-purpose destination register, encoded in the "Rd" field. If omitted, this register is the SP.

`<imm12>` Is a 12-bit unsigned immediate, in the range 0 to 4095, encoded in the "i:imm3:imm8" field.

`<const>` For encoding A1: an immediate value. See [Modified immediate constants in A32 instructions on page F2-2864](#) for the range of values.

For encoding T2: an immediate value. See [Modified immediate constants in T32 instructions on page F2-2863](#) for the range of values.

Operation for all encodings

```
if ConditionPassed() then
    EncodingSpecificOperations();
    (result, nzcvc) = AddWithCarry(SP, NOT(imm32), '1');
    if d == 15 then // Can only occur for A32 encoding
        if setflags then
            ALUExceptionReturn(result);
        else
            ALUWritePC(result);
    else
        R[d] = result;
        if setflags then
            PSTATE.<N,Z,C,V> = nzcvc;
```

F5.1.243 SUB, SUBS (SP minus register)

Subtract from SP (register) subtracts an optionally-shifted register value from the SP value, and writes the result to the destination register.

If the destination register is not the PC, the SUBS variant of the instruction updates the condition flags based on the result.

The field descriptions for <Rd> identify the encodings where the PC is permitted as the destination register. If the destination register is the PC:

- The SUB variant of the instruction is an interworking branch, see *Pseudocode description of operations on the AArch32 general-purpose registers and the PC on page E1-2733*.
- The SUBS variant of the instruction performs an exception return without the use of the stack. ARM deprecates use of this instruction. However, in this case:
 - The PE branches to the address written to the PC, and restores `PSTATE` from `SPSR_<current_mode>`.
 - The PE checks `SPSR_<current_mode>` for an illegal return event. See *Illegal return events from AArch32 state on page G1-4361*.
 - The instruction is UNDEFINED in Hyp mode.
 - The instruction is CONSTRAINED UNPREDICTABLE in User mode and System mode.

A1

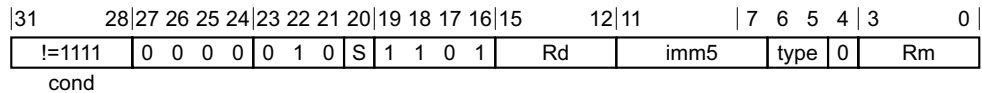

SUB, rotate right with extend variant

Applies when $S == 0$ && $imm5 == 00000$ && $type == 11$.

`SUB{<c>}{<q>} {<Rd>}, SP, <Rm> , RRX`

SUB, shift or rotate by value variant

Applies when $S == 0$ && $!(imm5 == 00000 \ \&\& \ type == 11)$.

`SUB{<c>}{<q>} {<Rd>}, SP, <Rm> {, <shift> #<amount>}`

SUBS, rotate right with extend variant

Applies when $S == 1$ && $imm5 == 00000$ && $type == 11$.

`SUBS{<c>}{<q>} {<Rd>}, SP, <Rm> , RRX`

SUBS, shift or rotate by value variant

Applies when $S == 1$ && $!(imm5 == 00000 \ \&\& \ type == 11)$.

`SUBS{<c>}{<q>} {<Rd>}, SP, <Rm> {, <shift> #<amount>}`

Decode for all variants of this encoding

```
d = UInt(Rd); m = UInt(Rm); setflags = (S == '1');
(shift_t, shift_n) = DecodeImmShift(type, imm5);
```

T1

15	14	13	12	11	10	9	8	7	6	5	4	3	2	1	0	15	14	12	11	8	7	6	5	4	3	0
1	1	1	0	1	0	1	1	1	0	1	S	1	1	0	1	(0)	imm3	Rd	imm2	type	Rm					

SUB, rotate right with extend variant

Applies when S == 0 && imm3 == 000 && imm2 == 00 && type == 11.

SUB{<c>}{<q>} {<Rd>}, SP, <Rm>, RRX

SUB, shift or rotate by value variant

Applies when S == 0 && !(imm3 == 000 && imm2 == 00 && type == 11).

SUB{<c>}.W {<Rd>}, SP, <Rm> // <Rd>, <Rm> can be represented in T1 or T2
 SUB{<c>}{<q>} {<Rd>}, SP, <Rm> {, <shift> #<amount>}

SUBS, rotate right with extend variant

Applies when S == 1 && imm3 == 000 && Rd != 1111 && imm2 == 00 && type == 11.

SUBS{<c>}{<q>} {<Rd>}, SP, <Rm>, RRX

SUBS, shift or rotate by value variant

Applies when S == 1 && !(imm3 == 000 && imm2 == 00 && type == 11) && Rd != 1111.

SUBS{<c>}{<q>} {<Rd>}, SP, <Rm> {, <shift> #<amount>}

Decode for all variants of this encoding

```
if Rd == '1111' && S == '1' then SEE CMP (register);
d = UInt(Rd); m = UInt(Rm); setflags = (S == '1');
(shift_t, shift_n) = DecodeImmShift(type, imm3:imm2);
if (d == 15 && !setflags) || m == 15 then UNPREDICTABLE; // ARMv8-A removes UNPREDICTABLE for R13
```

Notes for all encodings

For more information about the CONSTRAINED UNPREDICTABLE behavior of this instruction, see [Appendix K1 Architectural Constraints on UNPREDICTABLE behaviors](#).

Assembler symbols

<c> See [Standard assembler syntax fields on page F2-2848](#).

<q> See [Standard assembler syntax fields on page F2-2848](#).

<Rd> For encoding A1: is the general-purpose destination register, encoded in the "Rd" field. If omitted, this register is the SP. ARM deprecates using the PC as the destination register, but if the PC is used:

- For the SUB variant, the instruction is a branch to the address calculated by the operation. This is an interworking branch, see [Pseudocode description of operations on the AArch32 general-purpose registers and the PC on page E1-2733](#).
- For the SUBS variant, the instruction performs an exception return, that restores PSTATE from SPSR_<current_mode>.

For encoding T1: is the general-purpose destination register, encoded in the "Rd" field. If omitted, this register is the SP.

<Rm> For encoding A1: is the second general-purpose source register, encoded in the "Rm" field. The PC can be used, but this is deprecated.

For encoding T1: is the second general-purpose source register, encoded in the "Rm" field.

<shift> Is the type of shift to be applied to the second source register, encoded in the "type" field. It can have the following values:

LSL when type = 00
LSR when type = 01
ASR when type = 10
ROR when type = 11

<amount> For encoding A1: is the shift amount, in the range 1 to 31 (when <shift> = LSL or ROR) or 1 to 32 (when <shift> = LSR or ASR) encoded in the "imm5" field as <amount> modulo 32.

For encoding T1: is the shift amount, in the range 1 to 31 (when <shift> = LSL or ROR) or 1 to 32 (when <shift> = LSR or ASR) encoded in the "imm3:imm2" field as <amount> modulo 32.

Operation for all encodings

```
if ConditionPassed() then
    EncodingSpecificOperations();
    shifted = Shift(R[m], shift_t, shift_n, PSTATE.C);
    (result, nzc) = AddWithCarry(SP, NOT(shifted), '1');
    if d == 15 then // Can only occur for A32 encoding
        if setflags then
            ALUExceptionReturn(result);
        else
            ALUWritePC(result);
    else
        R[d] = result;
        if setflags then
            PSTATE.<N,Z,C,V> = nzc;
```

F5.1.244 SVC

Supervisor Call causes a Supervisor Call exception. For more information, see [Supervisor Call \(SVC\) exception on page G1-4380](#).

———— Note —————

SVC was previously called SWI, Software Interrupt, and this name is still found in some documentation.

Software can use this instruction as a call to an operating system to provide a service.

In the following cases, the Supervisor Call exception generated by the SVC instruction is taken to Hyp mode:

- If the SVC is executed in Hyp mode.
- If *HCR.TGE* is set to 1, and the SVC is executed in Non-secure User mode. For more information, see [Supervisor Call exception, when the value of HCR.TGE is 1 on page G1-4357](#)

In these cases, the *HSR* identifies that the exception entry was caused by a Supervisor Call exception, EC value 0x11, see [Use of the HSR on page G4-4677](#). The immediate field in the *HSR*:

- If the SVC is unconditional:
 - For the T32 instruction, is the zero-extended value of the *imm8* field.
 - For the A32 instruction, is the least-significant 16 bits the *imm24* field.
- If the SVC is conditional, is UNKNOWN.

A1

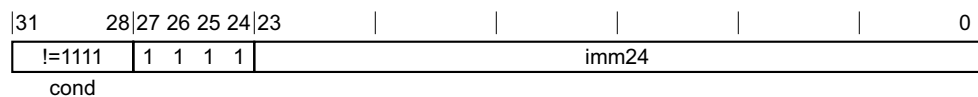

A1 variant

SVC{<c>}{<q>} {#}<imm>

Decode for this encoding

imm32 = ZeroExtend(*imm24*, 32);

T1

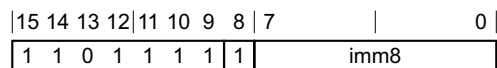

T1 variant

SVC{<c>}{<q>} {#}<imm>

Decode for this encoding

imm32 = ZeroExtend(*imm8*, 32);

Assembler symbols

<c> See [Standard assembler syntax fields on page F2-2848](#).

- <q> See [Standard assembler syntax fields on page F2-2848](#).
- <imm> For encoding A1: is a 24-bit unsigned immediate, in the range 0 to 16777215, encoded in the "imm24" field. This value is for assembly and disassembly only. SVC handlers in some systems interpret imm24 in software, for example to determine the required service.
- For encoding T1: is a 8-bit unsigned immediate, in the range 0 to 255, encoded in the "imm8" field. This value is for assembly and disassembly only. SVC handlers in some systems interpret imm8 in software, for example to determine the required service.

Operation for all encodings

```
if ConditionPassed() then
    EncodingSpecificOperations();
    AArch32.CallSupervisor(imm32<15:0>);
```

F5.1.245 SXTAB

Signed Extend and Add Byte extracts an 8-bit value from a register, sign-extends it to 32 bits, adds the result to the value in another register, and writes the final result to the destination register. The instruction can specify a rotation by 0, 8, 16, or 24 bits before extracting the 8-bit value.

A1

31	28	27	26	25	24	23	22	21	20	19	16	15	12	11	10	9	8	7	6	5	4	3	0	
!=1111				0	1	1	0	1	0	1	0	!=1111		Rd	rotate	(0)	(0)	0	1	1	1	Rm		
cond											Rn													

A1 variant

SXTAB{<c>}{<q>} {<Rd>}, <Rn>, <Rm> {, ROR #<amount>}

Decode for this encoding

```
if Rn == '1111' then SEE SXTB;
d = UInt(Rd); n = UInt(Rn); m = UInt(Rm); rotation = UInt(rotate:'000');
if d == 15 || m == 15 then UNPREDICTABLE;
```

T1

15	14	13	12	11	10	9	8	7	6	5	4	3	0	15	14	13	12	11	8	7	6	5	4	3	0
1	1	1	1	1	0	1	0	0	1	0	0	!=1111		1	1	1	1	Rd	1	(0)	rotate	Rm			
Rn																									

T1 variant

SXTAB{<c>}{<q>} {<Rd>}, <Rn>, <Rm> {, ROR #<amount>}

Decode for this encoding

```
if Rn == '1111' then SEE SXTB;
d = UInt(Rd); n = UInt(Rn); m = UInt(Rm); rotation = UInt(rotate:'000');
if d == 15 || m == 15 then UNPREDICTABLE; // ARMv8-A removes UNPREDICTABLE for R13
```

Notes for all encodings

For more information about the CONSTRAINED UNPREDICTABLE behavior of this instruction, see [Appendix K1 Architectural Constraints on UNPREDICTABLE behaviors](#).

Assembler symbols

<c>	See Standard assembler syntax fields on page F2-2848 .
<q>	See Standard assembler syntax fields on page F2-2848 .
<Rd>	Is the general-purpose destination register, encoded in the "Rd" field.
<Rn>	Is the first general-purpose source register, encoded in the "Rn" field.
<Rm>	Is the second general-purpose source register, encoded in the "Rm" field.
<amount>	Is the rotate amount, encoded in the "rotate" field. It can have the following values: (omitted) when rotate = 00 8 when rotate = 01

16 when rotate = 10
24 when rotate = 11

Operation for all encodings

```
if ConditionPassed() then
    EncodingSpecificOperations();
    rotated = ROR(R[m], rotation);
    R[d] = R[n] + SignExtend(rotated<7:0>, 32);
```

F5.1.246 SXTAB16

Signed Extend and Add Byte 16 extracts two 8-bit values from a register, sign-extends them to 16 bits each, adds the results to two 16-bit values from another register, and writes the final results to the destination register. The instruction can specify a rotation by 0, 8, 16, or 24 bits before extracting the 8-bit values.

A1

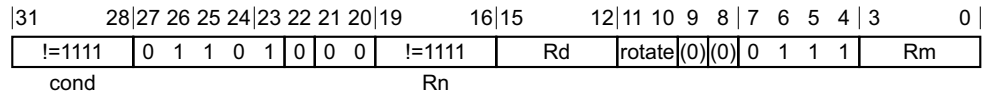

A1 variant

SXTAB16{<c>}{<q>} {<Rd>}, <Rn>, <Rm> {, ROR #<amount>}

Decode for this encoding

```
if Rn == '1111' then SEE SXTB16;
d = UInt(Rd); n = UInt(Rn); m = UInt(Rm); rotation = UInt(rotate:'000');
if d == 15 || m == 15 then UNPREDICTABLE;
```

T1

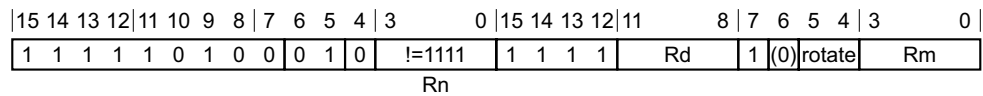

T1 variant

SXTAB16{<c>}{<q>} {<Rd>}, <Rn>, <Rm> {, ROR #<amount>}

Decode for this encoding

```
if Rn == '1111' then SEE SXTB16;
d = UInt(Rd); n = UInt(Rn); m = UInt(Rm); rotation = UInt(rotate:'000');
if d == 15 || m == 15 then UNPREDICTABLE; // ARMv8-A removes UNPREDICTABLE for R13
```

Notes for all encodings

For more information about the CONSTRAINED UNPREDICTABLE behavior of this instruction, see [Appendix K1 Architectural Constraints on UNPREDICTABLE behaviors](#).

Assembler symbols

- <c> See [Standard assembler syntax fields on page F2-2848](#).
- <q> See [Standard assembler syntax fields on page F2-2848](#).
- <Rd> Is the general-purpose destination register, encoded in the "Rd" field.
- <Rn> Is the first general-purpose source register, encoded in the "Rn" field.
- <Rm> Is the second general-purpose source register, encoded in the "Rm" field.
- <amount> Is the rotate amount, encoded in the "rotate" field. It can have the following values:
 - (omitted) when rotate = 00
 - 8 when rotate = 01

16 when rotate = 10
24 when rotate = 11

Operation for all encodings

```
if ConditionPassed() then
    EncodingSpecificOperations();
    rotated = ROR(R[m], rotation);
    R[d]<15:0> = R[n]<15:0> + SignExtend(rotated<7:0>, 16);
    R[d]<31:16> = R[n]<31:16> + SignExtend(rotated<23:16>, 16);
```

F5.1.247 SXTAH

Signed Extend and Add Halfword extracts a 16-bit value from a register, sign-extends it to 32 bits, adds the result to a value from another register, and writes the final result to the destination register. The instruction can specify a rotation by 0, 8, 16, or 24 bits before extracting the 16-bit value.

A1

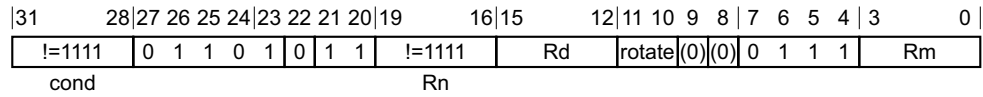

A1 variant

SXTAH{<c>}{<q>} {<Rd>}, <Rn>, <Rm> {, ROR #<amount>}

Decode for this encoding

```
if Rn == '1111' then SEE SXTAH;
d = UInt(Rd); n = UInt(Rn); m = UInt(Rm); rotation = UInt(rotate:'000');
if d == 15 || m == 15 then UNPREDICTABLE;
```

T1

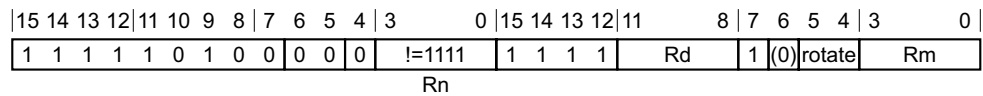

T1 variant

SXTAH{<c>}{<q>} {<Rd>}, <Rn>, <Rm> {, ROR #<amount>}

Decode for this encoding

```
if Rn == '1111' then SEE SXTAH;
d = UInt(Rd); n = UInt(Rn); m = UInt(Rm); rotation = UInt(rotate:'000');
if d == 15 || m == 15 then UNPREDICTABLE; // ARMv8-A removes UNPREDICTABLE for R13
```

Notes for all encodings

For more information about the CONSTRAINED UNPREDICTABLE behavior of this instruction, see [Appendix K1 Architectural Constraints on UNPREDICTABLE behaviors](#).

Assembler symbols

- <c> See [Standard assembler syntax fields on page F2-2848](#).
- <q> See [Standard assembler syntax fields on page F2-2848](#).
- <Rd> Is the general-purpose destination register, encoded in the "Rd" field.
- <Rn> Is the first general-purpose source register, encoded in the "Rn" field.
- <Rm> Is the second general-purpose source register, encoded in the "Rm" field.
- <amount> Is the rotate amount, encoded in the "rotate" field. It can have the following values:
 - (omitted) when rotate = 00
 - 8 when rotate = 01

16 when rotate = 10
24 when rotate = 11

Operation for all encodings

```
if ConditionPassed() then
    EncodingSpecificOperations();
    rotated = ROR(R[m], rotation);
    R[d] = R[n] + SignExtend(rotated<15:0>, 32);
```

F5.1.248 SXTB

Signed Extend Byte extracts an 8-bit value from a register, sign-extends it to 32 bits, and writes the result to the destination register. The instruction can specify a rotation by 0, 8, 16, or 24 bits before extracting the 8-bit value.

A1

31	28	27	26	25	24	23	22	21	20	19	18	17	16	15	12	11	10	9	8	7	6	5	4	3	0		
!=1111				0	1	1	0	1	0	1	0	1	1	1	1	Rd	rotate	(0)	(0)	0	1	1	1	Rm			
cond																											

A1 variant

SXTB{<c>}{<q>} {<Rd>,<Rm> {, ROR #<amount>}

Decode for this encoding

d = UInt(Rd); m = UInt(Rm); rotation = UInt(rotate:'000');
 if d == 15 || m == 15 then UNPREDICTABLE;

T1

15	14	13	12	11	10	9	8	7	6	5	3	2	0
1	0	1	1	0	0	1	0	0	1	Rm	Rd		

T1 variant

SXTB{<c>}{<q>} {<Rd>,<Rm>

Decode for this encoding

d = UInt(Rd); m = UInt(Rm); rotation = 0;

T2

15	14	13	12	11	10	9	8	7	6	5	4	3	2	1	0	15	14	13	12	11	8	7	6	5	4	3	0
1	1	1	1	1	0	1	0	0	1	0	0	1	1	1	1	1	1	1	1	Rd	1	(0)	rotate	Rm			

T2 variant

SXTB{<c>}.W {<Rd>,<Rm> // <Rd>,<Rm> can be represented in T1
 SXTB{<c>}{<q>} {<Rd>,<Rm> {, ROR #<amount>}

Decode for this encoding

d = UInt(Rd); m = UInt(Rm); rotation = UInt(rotate:'000');
 if d == 15 || m == 15 then UNPREDICTABLE; // ARMv8-A removes UNPREDICTABLE for R13

Notes for all encodings

For more information about the CONSTRAINED UNPREDICTABLE behavior of this instruction, see [Appendix K1 Architectural Constraints on UNPREDICTABLE behaviors](#).

Assembler symbols

<c>	See Standard assembler syntax fields on page F2-2848 .
<q>	See Standard assembler syntax fields on page F2-2848 .
<Rd>	Is the general-purpose destination register, encoded in the "Rd" field.
<Rm>	Is the general-purpose source register, encoded in the "Rm" field.
<amount>	Is the rotate amount, encoded in the "rotate" field. It can have the following values: (omitted) when rotate = 00 8 when rotate = 01 16 when rotate = 10 24 when rotate = 11

Operation for all encodings

```
if ConditionPassed() then
    EncodingSpecificOperations();
    rotated = ROR(R[m], rotation);
    R[d] = SignExtend(rotated<7:0>, 32);
```

F5.1.249 SXTB16

Signed Extend Byte 16 extracts two 8-bit values from a register, sign-extends them to 16 bits each, and writes the results to the destination register. The instruction can specify a rotation by 0, 8, 16, or 24 bits before extracting the 8-bit values.

A1

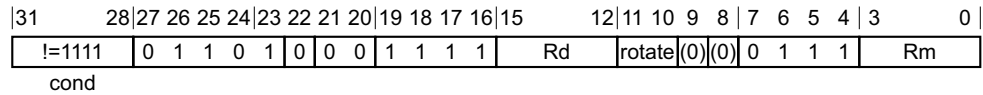

A1 variant

SXTB16{<c>}{<q>} {<Rd>}, {<Rm>} {, ROR #<amount>}

Decode for this encoding

d = UInt(Rd); m = UInt(Rm); rotation = UInt(rotate:'000');
 if d == 15 || m == 15 then UNPREDICTABLE;

T1

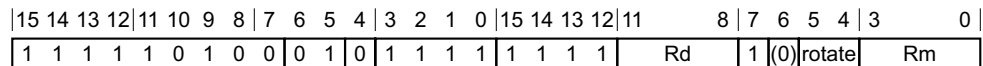

T1 variant

SXTB16{<c>}{<q>} {<Rd>}, {<Rm>} {, ROR #<amount>}

Decode for this encoding

d = UInt(Rd); m = UInt(Rm); rotation = UInt(rotate:'000');
 if d == 15 || m == 15 then UNPREDICTABLE; // ARMv8-A removes UNPREDICTABLE for R13

Notes for all encodings

For more information about the CONSTRAINED UNPREDICTABLE behavior of this instruction, see [Appendix K1 Architectural Constraints on UNPREDICTABLE behaviors](#).

Assembler symbols

- <c> See [Standard assembler syntax fields on page F2-2848](#).
- <q> See [Standard assembler syntax fields on page F2-2848](#).
- <Rd> Is the general-purpose destination register, encoded in the "Rd" field.
- <Rm> Is the general-purpose source register, encoded in the "Rm" field.
- <amount> Is the rotate amount, encoded in the "rotate" field. It can have the following values:
 - (omitted) when rotate = 00
 - 8 when rotate = 01
 - 16 when rotate = 10
 - 24 when rotate = 11

Operation for all encodings

```
if ConditionPassed() then
    EncodingSpecificOperations();
    rotated = ROR(R[m], rotation);
    R[d]<15:0> = SignExtend(rotated<7:0>, 16);
    R[d]<31:16> = SignExtend(rotated<23:16>, 16);
```

F5.1.250 SXTB

Signed Extend Halfword extracts a 16-bit value from a register, sign-extends it to 32 bits, and writes the result to the destination register. The instruction can specify a rotation by 0, 8, 16, or 24 bits before extracting the 16-bit value.

A1

31	28	27	26	25	24	23	22	21	20	19	18	17	16	15	12	11	10	9	8	7	6	5	4	3	0		
!=1111				0	1	1	0	1	0	1	1	1	1	1	Rd	rotate	(0)	(0)	0	1	1	1	Rm				
cond																											

A1 variant

SXTB{<c>}{<q>} {<Rd>}, <Rm> {, ROR #<amount>}

Decode for this encoding

d = UInt(Rd); m = UInt(Rm); rotation = UInt(rotate:'000');
 if d == 15 || m == 15 then UNPREDICTABLE;

T1

15	14	13	12	11	10	9	8	7	6	5	3	2	0
1	0	1	1	0	0	1	0	0	0	Rm	Rd		

T1 variant

SXTB{<c>}{<q>} {<Rd>}, <Rm>

Decode for this encoding

d = UInt(Rd); m = UInt(Rm); rotation = 0;

T2

15	14	13	12	11	10	9	8	7	6	5	4	3	2	1	0	15	14	13	12	11	8	7	6	5	4	3	0
1	1	1	1	1	0	1	0	0	0	0	0	1	1	1	1	1	1	1	1	1	Rd	1	(0)	rotate	Rm		

T2 variant

SXTB{<c>}.W {<Rd>}, <Rm> // <Rd>, <Rm> can be represented in T1
 SXTB{<c>}{<q>} {<Rd>}, <Rm> {, ROR #<amount>}

Decode for this encoding

d = UInt(Rd); m = UInt(Rm); rotation = UInt(rotate:'000');
 if d == 15 || m == 15 then UNPREDICTABLE; // ARMv8-A removes UNPREDICTABLE for R13

Notes for all encodings

For more information about the CONSTRAINED UNPREDICTABLE behavior of this instruction, see [Appendix K1 Architectural Constraints on UNPREDICTABLE behaviors](#).

Assembler symbols

<c>	See Standard assembler syntax fields on page F2-2848 .
<q>	See Standard assembler syntax fields on page F2-2848 .
<Rd>	Is the general-purpose destination register, encoded in the "Rd" field.
<Rm>	Is the general-purpose source register, encoded in the "Rm" field.
<amount>	Is the rotate amount, encoded in the "rotate" field. It can have the following values: (omitted) when rotate = 00 8 when rotate = 01 16 when rotate = 10 24 when rotate = 11

Operation for all encodings

```
if ConditionPassed() then
    EncodingSpecificOperations();
    rotated = ROR(R[m], rotation);
    R[d] = SignExtend(rotated<15:0>, 32);
```

F5.1.251 TBB, TBH

Table Branch Byte or Halfword causes a PC-relative forward branch using a table of single byte or halfword offsets. A base register provides a pointer to the table, and a second register supplies an index into the table. The branch length is twice the value returned from the table.

T1

15	14	13	12	11	10	9	8	7	6	5	4	3	0	15	14	13	12	11	10	9	8	7	6	5	4	3	0
1	1	1	0	1	0	0	0	1	1	0	1	Rn	(1)	(1)	(1)	(1)	(0)	(0)	(0)	(0)	0	0	0	H	Rm		

Byte variant

Applies when H == 0.

TBB{<c>}{<q>} [<Rn>, <Rm>] // Outside or last in IT block

Halfword variant

Applies when H == 1.

TBH{<c>}{<q>} [<Rn>, <Rm>, LSL #1] // Outside or last in IT block

Decode for all variants of this encoding

```
n = UInt(Rn); m = UInt(Rm); is_tbh = (H == '1');
if m == 15 then UNPREDICTABLE; // ARMv8-A removes UNPREDICTABLE for R13
if InITBlock() && !LastInITBlock() then UNPREDICTABLE;
```

Notes for all encodings

For more information about the CONSTRAINED UNPREDICTABLE behavior of this instruction, see [Appendix K1 Architectural Constraints on UNPREDICTABLE behaviors](#).

Assembler symbols

<c> See [Standard assembler syntax fields on page F2-2848](#).

<q> See [Standard assembler syntax fields on page F2-2848](#).

<Rn> Is the general-purpose base register holding the address of the table of branch lengths, encoded in the "Rn" field. The PC can be used. If it is, the table immediately follows this instruction.

<Rm> For the byte variant: is the general-purpose index register, encoded in the "Rm" field. This register contains an integer pointing to a single byte in the table. The offset in the table is the value of the index.

For the halfword variant: is the general-purpose index register, encoded in the "Rm" field. This register contains an integer pointing to a halfword in the table. The offset in the table is twice the value of the index.

Operation

```
if ConditionPassed() then
  EncodingSpecificOperations();
  if is_tbh then
    halfwords = UInt(MemU[R[n]+LSL(R[m],1), 2]);
  else
    halfwords = UInt(MemU[R[n]+R[m], 1]);
  BranchWritePC(PC + 2*halfwords);
```

F5.1.252 TEQ (immediate)

Test Equivalence (immediate) performs a bitwise exclusive OR operation on a register value and an immediate value. It updates the condition flags based on the result, and discards the result.

A1

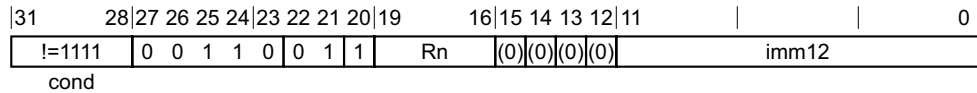

A1 variant

TEQ{<c>}{<q>} <Rn>, #<const>

Decode for this encoding

n = UInt(Rn);
 (imm32, carry) = A32ExpandImm_C(imm12, PSTATE.C);

T1

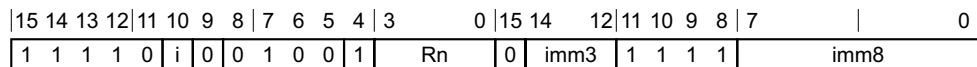

T1 variant

TEQ{<c>}{<q>} <Rn>, #<const>

Decode for this encoding

n = UInt(Rn);
 (imm32, carry) = T32ExpandImm_C(i:imm3:imm8, PSTATE.C);
 if n == 15 then UNPREDICTABLE; // ARMv8-A removes UNPREDICTABLE for R13

Notes for all encodings

For more information about the CONSTRAINED UNPREDICTABLE behavior of this instruction, see [Appendix K1 Architectural Constraints on UNPREDICTABLE behaviors](#).

Assembler symbols

- <c> See [Standard assembler syntax fields on page F2-2848](#).
- <q> See [Standard assembler syntax fields on page F2-2848](#).
- <Rn> For encoding A1: is the general-purpose source register, encoded in the "Rn" field. The PC can be used, but this is deprecated.
 For encoding T1: is the general-purpose source register, encoded in the "Rn" field.
- <const> For encoding A1: an immediate value. See [Modified immediate constants in A32 instructions on page F2-2864](#) for the range of values.
 For encoding T1: an immediate value. See [Modified immediate constants in T32 instructions on page F2-2863](#) for the range of values.

Operation for all encodings

```
if ConditionPassed() then
    EncodingSpecificOperations();
    result = R[n] EOR imm32;
    PSTATE.N = result<31>;
    PSTATE.Z = IsZeroBit(result);
    PSTATE.C = carry;
    // PSTATE.V unchanged
```

F5.1.253 TEQ (register)

Test Equivalence (register) performs a bitwise exclusive OR operation on a register value and an optionally-shifted register value. It updates the condition flags based on the result, and discards the result.

A1

31	28	27	26	25	24	23	22	21	20	19	16	15	14	13	12	11	7	6	5	4	3	0
!=1111				0	0	0	1	0	0	1	1	Rn	(0)	(0)	(0)	(0)	imm5	type	0	Rm		
cond																						

Rotate right with extend variant

Applies when imm5 == 00000 && type == 11.

TEQ{<c>}{<q>} <Rn>, <Rm>, RRX

Shift or rotate by value variant

Applies when !(imm5 == 00000 && type == 11).

TEQ{<c>}{<q>} <Rn>, <Rm> {, <shift> #<amount>}

Decode for all variants of this encoding

n = UInt(Rn); m = UInt(Rm);
 (shift_t, shift_n) = DecodeImmShift(type, imm5);

T1

15	14	13	12	11	10	9	8	7	6	5	4	3	0	15	14	12	11	10	9	8	7	6	5	4	3	0
1	1	1	0	1	0	1	0	1	0	0	1	Rn	(0)	imm3	1	1	1	1	imm2	type	Rm					

Rotate right with extend variant

Applies when imm3 == 000 && imm2 == 00 && type == 11.

TEQ{<c>}{<q>} <Rn>, <Rm>, RRX

Shift or rotate by value variant

Applies when !(imm3 == 000 && imm2 == 00 && type == 11).

TEQ{<c>}{<q>} <Rn>, <Rm> {, <shift> #<amount>}

Decode for all variants of this encoding

n = UInt(Rn); m = UInt(Rm);
 (shift_t, shift_n) = DecodeImmShift(type, imm3:imm2);
 if n == 15 || m == 15 then UNPREDICTABLE; // ARMv8-A removes UNPREDICTABLE for R13

Notes for all encodings

For more information about the CONSTRAINED UNPREDICTABLE behavior of this instruction, see [Appendix K1 Architectural Constraints on UNPREDICTABLE behaviors](#).

Assembler symbols

<c> See [Standard assembler syntax fields on page F2-2848](#).

- <q> See *Standard assembler syntax fields* on page F2-2848.
- <Rn> For encoding A1: is the first general-purpose source register, encoded in the "Rn" field. The PC can be used, but this is deprecated.
For encoding T1: is the first general-purpose source register, encoded in the "Rn" field.
- <Rm> For encoding A1: is the second general-purpose source register, encoded in the "Rm" field. The PC can be used, but this is deprecated.
For encoding T1: is the second general-purpose source register, encoded in the "Rm" field.
- <shift> Is the type of shift to be applied to the second source register, encoded in the "type" field. It can have the following values:
LSL when type = 00
LSR when type = 01
ASR when type = 10
ROR when type = 11
- <amount> For encoding A1: is the shift amount, in the range 1 to 31 (when <shift> = LSL or ROR) or 1 to 32 (when <shift> = LSR or ASR) encoded in the "imm5" field as <amount> modulo 32.
For encoding T1: is the shift amount, in the range 1 to 31 (when <shift> = LSL or ROR) or 1 to 32 (when <shift> = LSR or ASR) encoded in the "imm3:imm2" field as <amount> modulo 32.

Operation for all encodings

```
if ConditionPassed() then
    EncodingSpecificOperations();
    (shifted, carry) = Shift_C(R[m], shift_t, shift_n, PSTATE.C);
    result = R[n] EOR shifted;
    PSTATE.N = result<31>;
    PSTATE.Z = IsZeroBit(result);
    PSTATE.C = carry;
    // PSTATE.V unchanged
```

F5.1.254 TEQ (register-shifted register)

Test Equivalence (register-shifted register) performs a bitwise exclusive OR operation on a register value and a register-shifted register value. It updates the condition flags based on the result, and discards the result.

A1

31	28	27	26	25	24	23	22	21	20	19	16	15	14	13	12	11	8	7	6	5	4	3	0	
!=1111				0	0	0	1	0	0	1	1	Rn	(0)	(0)	(0)	(0)	Rs	0	type	1	Rm			
cond																								

A1 variant

TEQ{<c>}{<q>} <Rn>, <Rm>, <type> <Rs>

Decode for this encoding

```
n = UInt(Rn); m = UInt(Rm); s = UInt(Rs);
shift_t = DecodeRegShift(type);
if n == 15 || m == 15 || s == 15 then UNPREDICTABLE;
```

Notes for all encodings

For more information about the CONSTRAINED UNPREDICTABLE behavior of this instruction, see [Appendix K1 Architectural Constraints on UNPREDICTABLE behaviors](#).

Assembler symbols

- <c> See [Standard assembler syntax fields on page F2-2848](#).
- <q> See [Standard assembler syntax fields on page F2-2848](#).
- <Rn> Is the first general-purpose source register, encoded in the "Rn" field.
- <Rm> Is the second general-purpose source register, encoded in the "Rm" field.
- <type> Is the type of shift to be applied to the second source register, encoded in the "type" field. It can have the following values:
 - LSL when type = 00
 - LSR when type = 01
 - ASR when type = 10
 - ROR when type = 11
- <Rs> Is the third general-purpose source register holding a shift amount in its bottom 8 bits, encoded in the "Rs" field.

Operation

```
if ConditionPassed() then
    EncodingSpecificOperations();
    shift_n = UInt(R[s]<7:0>);
    (shifted, carry) = Shift_C(R[m], shift_t, shift_n, PSTATE.C);
    result = R[n] EOR shifted;
    PSTATE.N = result<31>;
    PSTATE.Z = IsZeroBit(result);
    PSTATE.C = carry;
    // PSTATE.V unchanged
```

F5.1.255 TST (immediate)

Test (immediate) performs a bitwise AND operation on a register value and an immediate value. It updates the condition flags based on the result, and discards the result.

A1

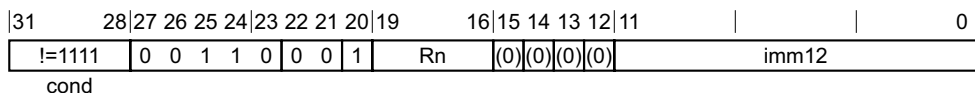

A1 variant

TST{<c>}{<q>} <Rn>, #<const>

Decode for this encoding

n = UInt(Rn);
 (imm32, carry) = A32ExpandImm_C(imm12, PSTATE.C);

T1

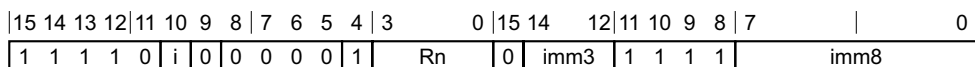

T1 variant

TST{<c>}{<q>} <Rn>, #<const>

Decode for this encoding

n = UInt(Rn);
 (imm32, carry) = T32ExpandImm_C(i:imm3:imm8, PSTATE.C);
 if n == 15 then UNPREDICTABLE; // ARMv8-A removes UNPREDICTABLE for R13

Notes for all encodings

For more information about the CONSTRAINED UNPREDICTABLE behavior of this instruction, see [Appendix K1 Architectural Constraints on UNPREDICTABLE behaviors](#).

Assembler symbols

- <c> See [Standard assembler syntax fields on page F2-2848](#).
- <q> See [Standard assembler syntax fields on page F2-2848](#).
- <Rn> For encoding A1: is the general-purpose source register, encoded in the "Rn" field. The PC can be used, but this is deprecated.
 For encoding T1: is the general-purpose source register, encoded in the "Rn" field.
- <const> For encoding A1: an immediate value. See [Modified immediate constants in A32 instructions on page F2-2864](#) for the range of values.
 For encoding T1: an immediate value. See [Modified immediate constants in T32 instructions on page F2-2863](#) for the range of values.

Operation for all encodings

```
if ConditionPassed() then
    EncodingSpecificOperations();
    result = R[n] AND imm32;
    PSTATE.N = result<31>;
    PSTATE.Z = IsZeroBit(result);
    PSTATE.C = carry;
    // PSTATE.V unchanged
```

F5.1.256 TST (register)

Test (register) performs a bitwise AND operation on a register value and an optionally-shifted register value. It updates the condition flags based on the result, and discards the result.

A1

31	28	27	26	25	24	23	22	21	20	19	16	15	14	13	12	11	7	6	5	4	3	0	
!=1111				0	0	0	1	0	0	0	1	Rn	(0)	(0)	(0)	(0)	imm5	type	0	Rm			
cond																							

Rotate right with extend variant

Applies when imm5 == 00000 && type == 11.

TST{<c>}{<q>} <Rn>, <Rm>, RRX

Shift or rotate by value variant

Applies when !(imm5 == 00000 && type == 11).

TST{<c>}{<q>} <Rn>, <Rm> {, <shift> #<amount>}

Decode for all variants of this encoding

n = UInt(Rn); m = UInt(Rm);
 (shift_t, shift_n) = DecodeImmShift(type, imm5);

T1

15	14	13	12	11	10	9	8	7	6	5	3	2	0
0	1	0	0	0	0	1	0	0	0	Rm	Rn		

T1 variant

TST{<c>}{<q>} <Rn>, <Rm>

Decode for this encoding

n = UInt(Rn); m = UInt(Rm);
 (shift_t, shift_n) = (SRTYPE_LSL, 0);

T2

15	14	13	12	11	10	9	8	7	6	5	4	3	0	15	14	12	11	10	9	8	7	6	5	4	3	0
1	1	1	0	1	0	1	0	0	0	0	1	Rn	(0)	imm3	1	1	1	1	imm2	type	Rm					

Rotate right with extend variant

Applies when imm3 == 000 && imm2 == 00 && type == 11.

TST{<c>}{<q>} <Rn>, <Rm>, RRX

Shift or rotate by value variant

Applies when !(imm3 == 000 && imm2 == 00 && type == 11).

```
TST{<c>}.W <Rn>, <Rm> // <Rn>, <Rm> can be represented in T1  
TST{<c>}{<q>} <Rn>, <Rm> {, <shift> #<amount>}
```

Decode for all variants of this encoding

```
n = UInt(Rn); m = UInt(Rm);  
(shift_t, shift_n) = DecodeImmShift(type, imm3:imm2);  
if n == 15 || m == 15 then UNPREDICTABLE; // ARMv8-A removes UNPREDICTABLE for R13
```

Notes for all encodings

For more information about the CONSTRAINED UNPREDICTABLE behavior of this instruction, see [Appendix K1 Architectural Constraints on UNPREDICTABLE behaviors](#).

Assembler symbols

<c>	See Standard assembler syntax fields on page F2-2848 .
<q>	See Standard assembler syntax fields on page F2-2848 .
<Rn>	For encoding A1: is the first general-purpose source register, encoded in the "Rn" field. The PC can be used, but this is deprecated. For encoding T1 and T2: is the first general-purpose source register, encoded in the "Rn" field.
<Rm>	For encoding A1: is the second general-purpose source register, encoded in the "Rm" field. The PC can be used, but this is deprecated. For encoding T1 and T2: is the second general-purpose source register, encoded in the "Rm" field.
<shift>	Is the type of shift to be applied to the second source register, encoded in the "type" field. It can have the following values: LSL when type = 00 LSR when type = 01 ASR when type = 10 ROR when type = 11
<amount>	For encoding A1: is the shift amount, in the range 1 to 31 (when <shift> = LSL or ROR) or 1 to 32 (when <shift> = LSR or ASR) encoded in the "imm5" field as <amount> modulo 32. For encoding T2: is the shift amount, in the range 1 to 31 (when <shift> = LSL or ROR) or 1 to 32 (when <shift> = LSR or ASR) encoded in the "imm3:imm2" field as <amount> modulo 32.

Operation for all encodings

```
if ConditionPassed() then  
  EncodingSpecificOperations();  
  (shifted, carry) = Shift_C(R[m], shift_t, shift_n, PSTATE.C);  
  result = R[n] AND shifted;  
  PSTATE.N = result<31>;  
  PSTATE.Z = IsZeroBit(result);  
  PSTATE.C = carry;  
  // PSTATE.V unchanged
```

F5.1.257 TST (register-shifted register)

Test (register-shifted register) performs a bitwise AND operation on a register value and a register-shifted register value. It updates the condition flags based on the result, and discards the result.

A1

31	28	27	26	25	24	23	22	21	20	19	16	15	14	13	12	11	8	7	6	5	4	3	0	
!=1111				0	0	0	1	0	0	0	1	Rn	(0)	(0)	(0)	(0)	Rs	0	type	1	Rm			
cond																								

A1 variant

TST{<c>}{<q>} <Rn>, <Rm>, <type> <Rs>

Decode for this encoding

```
n = UInt(Rn); m = UInt(Rm); s = UInt(Rs);
shift_t = DecodeRegShift(type);
if n == 15 || m == 15 || s == 15 then UNPREDICTABLE;
```

Notes for all encodings

For more information about the CONSTRAINED UNPREDICTABLE behavior of this instruction, see [Appendix K1 Architectural Constraints on UNPREDICTABLE behaviors](#).

Assembler symbols

<c>	See <i>Standard assembler syntax fields</i> on page F2-2848.								
<q>	See <i>Standard assembler syntax fields</i> on page F2-2848.								
<Rn>	Is the first general-purpose source register, encoded in the "Rn" field.								
<Rm>	Is the second general-purpose source register, encoded in the "Rm" field.								
<type>	Is the type of shift to be applied to the second source register, encoded in the "type" field. It can have the following values: <table style="margin-left: 20px;"> <tr> <td>LSL</td> <td>when type = 00</td> </tr> <tr> <td>LSR</td> <td>when type = 01</td> </tr> <tr> <td>ASR</td> <td>when type = 10</td> </tr> <tr> <td>ROR</td> <td>when type = 11</td> </tr> </table>	LSL	when type = 00	LSR	when type = 01	ASR	when type = 10	ROR	when type = 11
LSL	when type = 00								
LSR	when type = 01								
ASR	when type = 10								
ROR	when type = 11								
<Rs>	Is the third general-purpose source register holding a shift amount in its bottom 8 bits, encoded in the "Rs" field.								

Operation

```
if ConditionPassed() then
    EncodingSpecificOperations();
    shift_n = UInt(R[s]<7:0>);
    (shifted, carry) = Shift_C(R[m], shift_t, shift_n, PSTATE.C);
    result = R[n] AND shifted;
    PSTATE.N = result<31>;
    PSTATE.Z = IsZeroBit(result);
    PSTATE.C = carry;
    // PSTATE.V unchanged
```

F5.1.258 UADD16

Unsigned Add 16 performs two 16-bit unsigned integer additions, and writes the results to the destination register. It sets `PSTATE.GE` according to the results of the additions.

A1

31	28	27	26	25	24	23	22	21	20	19	16	15	12	11	10	9	8	7	6	5	4	3	0
!=1111				0	1	1	0	0	1	0	1	Rn	Rd	(1)	(1)	(1)	(1)	0	0	0	1	Rm	
cond																							

A1 variant

UADD16{<c>}{<q>} {<Rd>}, <Rn>, <Rm>

Decode for this encoding

```
d = UInt(Rd); n = UInt(Rn); m = UInt(Rm);
if d == 15 || n == 15 || m == 15 then UNPREDICTABLE;
```

T1

15	14	13	12	11	10	9	8	7	6	5	4	3	0	15	14	13	12	11	8	7	6	5	4	3	0
1	1	1	1	1	0	1	0	1	0	0	1	Rn	1	1	1	1	Rd	0	1	0	0	Rm			

T1 variant

UADD16{<c>}{<q>} {<Rd>}, <Rn>, <Rm>

Decode for this encoding

```
d = UInt(Rd); n = UInt(Rn); m = UInt(Rm);
if d == 15 || n == 15 || m == 15 then UNPREDICTABLE; // ARMv8-A removes UNPREDICTABLE for R13
```

Notes for all encodings

For more information about the CONSTRAINED UNPREDICTABLE behavior of this instruction, see [Appendix K1 Architectural Constraints on UNPREDICTABLE behaviors](#).

Assembler symbols

- <c> See [Standard assembler syntax fields on page F2-2848](#).
- <q> See [Standard assembler syntax fields on page F2-2848](#).
- <Rd> Is the general-purpose destination register, encoded in the "Rd" field.
- <Rn> Is the first general-purpose source register, encoded in the "Rn" field.
- <Rm> Is the second general-purpose source register, encoded in the "Rm" field.

Operation for all encodings

```
if ConditionPassed() then
    EncodingSpecificOperations();
    sum1 = UInt(R[n]<15:0>) + UInt(R[m]<15:0>);
    sum2 = UInt(R[n]<31:16>) + UInt(R[m]<31:16>);
    R[d]<15:0> = sum1<15:0>;
```

```
R[d]<31:16> = sum2<15:0>;  
PSTATE.GE<1:0> = if sum1 >= 0x10000 then '11' else '00';  
PSTATE.GE<3:2> = if sum2 >= 0x10000 then '11' else '00';
```

F5.1.259 UADD8

Unsigned Add 8 performs four unsigned 8-bit integer additions, and writes the results to the destination register. It sets `PSTATE.GE` according to the results of the additions.

A1

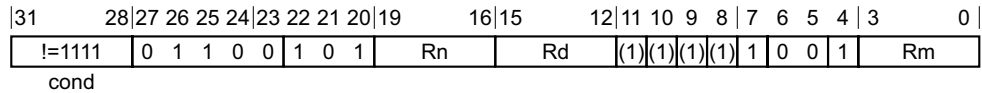

A1 variant

UADD8{<c>}{<q>} {<Rd>}, {<Rn>}, <Rm>

Decode for this encoding

```
d = UInt(Rd); n = UInt(Rn); m = UInt(Rm);
if d == 15 || n == 15 || m == 15 then UNPREDICTABLE;
```

T1

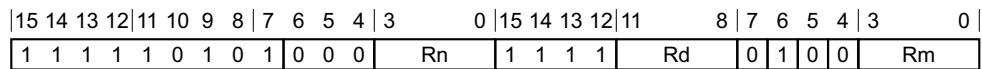

T1 variant

UADD8{<c>}{<q>} {<Rd>}, {<Rn>}, <Rm>

Decode for this encoding

```
d = UInt(Rd); n = UInt(Rn); m = UInt(Rm);
if d == 15 || n == 15 || m == 15 then UNPREDICTABLE; // ARMv8-A removes UNPREDICTABLE for R13
```

Notes for all encodings

For more information about the `CONSTRAINED UNPREDICTABLE` behavior of this instruction, see [Appendix K1 Architectural Constraints on UNPREDICTABLE behaviors](#).

Assembler symbols

- <c> See [Standard assembler syntax fields on page F2-2848](#).
- <q> See [Standard assembler syntax fields on page F2-2848](#).
- <Rd> Is the general-purpose destination register, encoded in the "Rd" field.
- <Rn> Is the first general-purpose source register, encoded in the "Rn" field.
- <Rm> Is the second general-purpose source register, encoded in the "Rm" field.

Operation for all encodings

```
if ConditionPassed() then
    EncodingSpecificOperations();
    sum1 = UInt(R[n]<7:0>) + UInt(R[m]<7:0>);
    sum2 = UInt(R[n]<15:8>) + UInt(R[m]<15:8>);
    sum3 = UInt(R[n]<23:16>) + UInt(R[m]<23:16>);
```



```
sum4 = UInt(R[n]<31:24>) + UInt(R[m]<31:24>);  
R[d]<7:0> = sum1<7:0>;  
R[d]<15:8> = sum2<7:0>;  
R[d]<23:16> = sum3<7:0>;  
R[d]<31:24> = sum4<7:0>;  
PSTATE.GE<0> = if sum1 >= 0x100 then '1' else '0';  
PSTATE.GE<1> = if sum2 >= 0x100 then '1' else '0';  
PSTATE.GE<2> = if sum3 >= 0x100 then '1' else '0';  
PSTATE.GE<3> = if sum4 >= 0x100 then '1' else '0';
```

F5.1.260 UASX

Unsigned Add and Subtract with Exchange exchanges the two halfwords of the second operand, performs one unsigned 16-bit integer addition and one unsigned 16-bit subtraction, and writes the results to the destination register. It sets `PSTATE.GE` according to the results.

A1

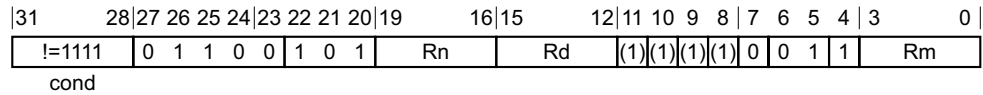

A1 variant

UASX{<c>}{<q>} {<Rd>}, <Rn>, <Rm>

Decode for this encoding

```
d = UInt(Rd); n = UInt(Rn); m = UInt(Rm);
if d == 15 || n == 15 || m == 15 then UNPREDICTABLE;
```

T1

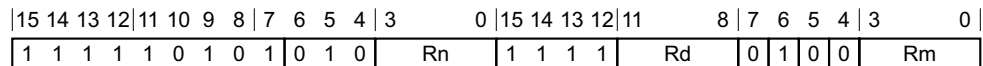

T1 variant

UASX{<c>}{<q>} {<Rd>}, <Rn>, <Rm>

Decode for this encoding

```
d = UInt(Rd); n = UInt(Rn); m = UInt(Rm);
if d == 15 || n == 15 || m == 15 then UNPREDICTABLE; // ARMv8-A removes UNPREDICTABLE for R13
```

Notes for all encodings

For more information about the `CONSTRAINED UNPREDICTABLE` behavior of this instruction, see [Appendix K1 Architectural Constraints on UNPREDICTABLE behaviors](#).

Assembler symbols

- <c> See [Standard assembler syntax fields on page F2-2848](#).
- <q> See [Standard assembler syntax fields on page F2-2848](#).
- <Rd> Is the general-purpose destination register, encoded in the "Rd" field.
- <Rn> Is the first general-purpose source register, encoded in the "Rn" field.
- <Rm> Is the second general-purpose source register, encoded in the "Rm" field.

Operation for all encodings

```
if ConditionPassed() then
    EncodingSpecificOperations();
diff = UInt(R[n]<15:0>) - UInt(R[m]<31:16>);
sum = UInt(R[n]<31:16>) + UInt(R[m]<15:0>);
```

```
R[d]<15:0> = diff<15:0>;  
R[d]<31:16> = sum<15:0>;  
PSTATE.GE<1:0> = if diff >= 0 then '11' else '00';  
PSTATE.GE<3:2> = if sum >= 0x10000 then '11' else '00';
```

F5.1.261 UBFX

Unsigned Bit Field Extract extracts any number of adjacent bits at any position from a register, zero-extends them to 32 bits, and writes the result to the destination register.

A1

31	28	27	26	25	24	23	22	21	20	16	15	12	11	7	6	5	4	3	0	
!=1111				0	1	1	1	1	1	widthm1		Rd	lsb		1	0	1	Rn		
cond																				

A1 variant

UBFX{<c>}{<q>} <Rd>, <Rn>, #<lsb>, #<width>

Decode for this encoding

```
d = UInt(Rd); n = UInt(Rn);
lsbit = UInt(lsb); widthminus1 = UInt(widthm1);
if d == 15 || n == 15 then UNPREDICTABLE;
```

T1

15	14	13	12	11	10	9	8	7	6	5	4	3	0	15	14	12	11	8	7	6	5	4	0
1	1	1	1	0	(0)	1	1	1	1	0	0	Rn	0	imm3	Rd	imm2	(0)	widthm1					

T1 variant

UBFX{<c>}{<q>} <Rd>, <Rn>, #<lsb>, #<width>

Decode for this encoding

```
d = UInt(Rd); n = UInt(Rn);
lsbit = UInt(imm3:imm2); widthminus1 = UInt(widthm1);
if d == 15 || n == 15 then UNPREDICTABLE; // ARMv8-A removes UNPREDICTABLE for R13
```

Notes for all encodings

For more information about the CONSTRAINED UNPREDICTABLE behavior of this instruction, see [Appendix K1 Architectural Constraints on UNPREDICTABLE behaviors](#).

Assembler symbols

<c>	See Standard assembler syntax fields on page F2-2848 .
<q>	See Standard assembler syntax fields on page F2-2848 .
<Rd>	Is the general-purpose destination register, encoded in the "Rd" field.
<Rn>	Is the general-purpose source register, encoded in the "Rn" field.
<lsb>	For encoding A1: is the bit number of the least significant bit in the field, in the range 0 to 31, encoded in the "lsb" field. For encoding T1: is the bit number of the least significant bit in the field, in the range 0 to 31, encoded in the "imm3:imm2" field.
<width>	Is the width of the field, in the range 1 to 32-<lsb>, encoded in the "widthm1" field as <width>-1.

Operation for all encodings

```
if ConditionPassed() then
    EncodingSpecificOperations();
    msbit = lsb + widthminus1;
    if msbit <= 31 then
        R[d] = ZeroExtend(R[n]<msbit:lsb>, 32);
    else
        UNPREDICTABLE;
```

CONSTRAINED UNPREDICTABLE behavior

If $msbit > 31$, then one of the following behaviors must occur:

- The instruction is UNDEFINED.
- The instruction executes as NOP.
- The value in the destination register is UNKNOWN.

F5.1.262 UDF

Permanently Undefined generates an Undefined Instruction exception.

The encodings for UDF used in this section are defined as permanently UNDEFINED in the ARMv8-A architecture. However:

- With the T32 instruction set, ARM deprecates using the UDF instruction in an IT block.
- In the A32 instruction set, UDF is not conditional.

A1

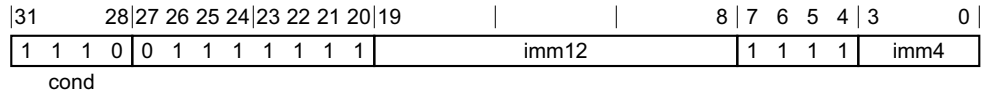

A1 variant

UDF{<c>}{<q>} {#}<imm>

Decode for this encoding

```
imm32 = ZeroExtend(imm12:imm4, 32);
// imm32 is for assembly and disassembly only, and is ignored by hardware.
```

T1

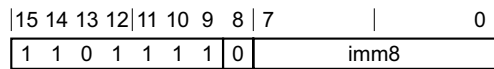

T1 variant

UDF{<c>}{<q>} {#}<imm>

Decode for this encoding

```
imm32 = ZeroExtend(imm8, 32);
// imm32 is for assembly and disassembly only, and is ignored by hardware.
```

T2

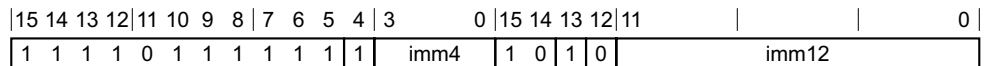

T2 variant

UDF{<c>}.W {#}<imm> // <imm> can be represented in T1
 UDF{<c>}{<q>} {#}<imm>

Decode for this encoding

```
imm32 = ZeroExtend(imm4:imm12, 32);
// imm32 is for assembly and disassembly only, and is ignored by hardware.
```

Assembler symbols

- <c> For encoding A1: see [Standard assembler syntax fields on page F2-2848](#). <c> must be AL or omitted.
For encoding T1 and T2: see [Standard assembler syntax fields on page F2-2848](#). ARM deprecates using any <c> value other than AL.
- <q> See [Standard assembler syntax fields on page F2-2848](#).
- <imm> For encoding A1: is a 16-bit unsigned immediate, in the range 0 to 65535, encoded in the "imm12:imm4" field. The PE ignores the value of this constant.
For encoding T1: is a 8-bit unsigned immediate, in the range 0 to 255, encoded in the "imm8" field. The PE ignores the value of this constant.
For encoding T2: is a 16-bit unsigned immediate, in the range 0 to 65535, encoded in the "imm4:imm12" field. The PE ignores the value of this constant.

Operation for all encodings

```
if ConditionPassed() then
    EncodingSpecificOperations();
    UNDEFINED;
```

F5.1.263 UDIV

Unsigned Divide divides a 32-bit unsigned integer register value by a 32-bit unsigned integer register value, and writes the result to the destination register. The condition flags are not affected.

See *Divide instructions* on page F1-2819 for more information about this instruction.

A1

31	28	27	26	25	24	23	22	21	20	19	16	15	12	11	8	7	6	5	4	3	0	
!=1111				0	1	1	1	0	0	1	1	Rd	(1)	(1)	(1)	(1)	Rm	0	0	0	1	Rn
cond											Ra											

A1 variant

UDIV{<c>}{<q>} {<Rd>}, {<Rn>}, {<Rm>}

Decode for this encoding

d = UInt(Rd); n = UInt(Rn); m = UInt(Rm); a = UInt(Ra);
 if d == 15 || n == 15 || m == 15 || a != 15 then UNPREDICTABLE;

CONSTRAINED UNPREDICTABLE behavior

If Ra != '1111', then one of the following behaviors must occur:

- The instruction is UNDEFINED.
- The instruction executes as NOP.
- The instruction executes as described, with no change to its behavior and no additional side effects.
- The instruction performs a divide and the register specified by Ra becomes UNKNOWN.

T1

15	14	13	12	11	10	9	8	7	6	5	4	3	0	15	12	11	8	7	6	5	4	3	0
1	1	1	1	1	0	1	1	1	0	1	1	Rn	(1)	(1)	(1)	(1)	Rd	1	1	1	1	Rm	
													Ra										

T1 variant

UDIV{<c>}{<q>} {<Rd>}, {<Rn>}, {<Rm>}

Decode for this encoding

d = UInt(Rd); n = UInt(Rn); m = UInt(Rm); a = UInt(Ra);
 if d == 15 || n == 15 || m == 15 || a != 15 then UNPREDICTABLE; // ARMv8-A removes UNPREDICTABLE for R13

CONSTRAINED UNPREDICTABLE behavior

If Ra != '1111', then one of the following behaviors must occur:

- The instruction is UNDEFINED.
- The instruction executes as NOP.
- The instruction executes as described, with no change to its behavior and no additional side effects.
- The instruction performs a divide and the register specified by Ra becomes UNKNOWN.

Notes for all encodings

For more information about the CONSTRAINED UNPREDICTABLE behavior of this instruction, see [Appendix K1 Architectural Constraints on UNPREDICTABLE behaviors](#).

Assembler symbols

- <c> See *Standard assembler syntax fields* on page F2-2848.
- <q> See *Standard assembler syntax fields* on page F2-2848.
- <Rd> Is the general-purpose destination register, encoded in the "Rd" field.
- <Rn> Is the first general-purpose source register holding the dividend, encoded in the "Rn" field.
- <Rm> Is the second general-purpose source register holding the divisor, encoded in the "Rm" field.

Operation for all encodings

```
if ConditionPassed() then
    EncodingSpecificOperations();
    if UInt(R[m]) == 0 then
        result = 0;
    else
        result = RoundTowardsZero(Real(UInt(R[n])) / Real(UInt(R[m])));
    R[d] = result<31:0>;
```

F5.1.264 UHADD16

Unsigned Halving Add 16 performs two unsigned 16-bit integer additions, halves the results, and writes the results to the destination register.

A1

31	28	27	26	25	24	23	22	21	20	19	16	15	12	11	10	9	8	7	6	5	4	3	0	
!=1111				0	1	1	0	0	1	1	1	Rn	Rd	(1)	(1)	(1)	(1)	0	0	0	1	Rm		
cond																								

A1 variant

UHADD16{<c>}{<q>} {<Rd>,<Rn>,<Rm>

Decode for this encoding

d = UInt(Rd); n = UInt(Rn); m = UInt(Rm);
 if d == 15 || n == 15 || m == 15 then UNPREDICTABLE;

T1

15	14	13	12	11	10	9	8	7	6	5	4	3	0	15	14	13	12	11	8	7	6	5	4	3	0
1	1	1	1	1	0	1	0	1	0	0	1	Rn	1	1	1	1	Rd	0	1	1	0	Rm			

T1 variant

UHADD16{<c>}{<q>} {<Rd>,<Rn>,<Rm>

Decode for this encoding

d = UInt(Rd); n = UInt(Rn); m = UInt(Rm);
 if d == 15 || n == 15 || m == 15 then UNPREDICTABLE; // ARMv8-A removes UNPREDICTABLE for R13

Notes for all encodings

For more information about the CONSTRAINED UNPREDICTABLE behavior of this instruction, see [Appendix K1 Architectural Constraints on UNPREDICTABLE behaviors](#).

Assembler symbols

- <c> See [Standard assembler syntax fields on page F2-2848](#).
- <q> See [Standard assembler syntax fields on page F2-2848](#).
- <Rd> Is the general-purpose destination register, encoded in the "Rd" field.
- <Rn> Is the first general-purpose source register, encoded in the "Rn" field.
- <Rm> Is the second general-purpose source register, encoded in the "Rm" field.

Operation for all encodings

```
if ConditionPassed() then
    EncodingSpecificOperations();
    sum1 = UInt(R[n]<15:0>) + UInt(R[m]<15:0>);
```

```
sum2 = UInt(R[n]<31:16>) + UInt(R[m]<31:16>);  
R[d]<15:0> = sum1<16:1>;  
R[d]<31:16> = sum2<16:1>;
```

F5.1.265 UHADD8

Unsigned Halving Add 8 performs four unsigned 8-bit integer additions, halves the results, and writes the results to the destination register.

A1

31	28	27	26	25	24	23	22	21	20	19	16	15	12	11	10	9	8	7	6	5	4	3	0
!=1111				0	1	1	0	0	1	1	1	Rn	Rd	(1)	(1)	(1)	(1)	1	0	0	1	Rm	
cond																							

A1 variant

UHADD8{<c>}{<q>} {<Rd>}, <Rn>, <Rm>

Decode for this encoding

d = UInt(Rd); n = UInt(Rn); m = UInt(Rm);
 if d == 15 || n == 15 || m == 15 then UNPREDICTABLE;

T1

15	14	13	12	11	10	9	8	7	6	5	4	3	0	15	14	13	12	11	8	7	6	5	4	3	0
1	1	1	1	1	0	1	0	1	0	0	0	Rn	1	1	1	1	Rd	0	1	1	0	Rm			

T1 variant

UHADD8{<c>}{<q>} {<Rd>}, <Rn>, <Rm>

Decode for this encoding

d = UInt(Rd); n = UInt(Rn); m = UInt(Rm);
 if d == 15 || n == 15 || m == 15 then UNPREDICTABLE; // ARMv8-A removes UNPREDICTABLE for R13

Notes for all encodings

For more information about the CONSTRAINED UNPREDICTABLE behavior of this instruction, see [Appendix K1 Architectural Constraints on UNPREDICTABLE behaviors](#).

Assembler symbols

- <c> See [Standard assembler syntax fields on page F2-2848](#).
- <q> See [Standard assembler syntax fields on page F2-2848](#).
- <Rd> Is the general-purpose destination register, encoded in the "Rd" field.
- <Rn> Is the first general-purpose source register, encoded in the "Rn" field.
- <Rm> Is the second general-purpose source register, encoded in the "Rm" field.

Operation for all encodings

```
if ConditionPassed() then
    EncodingSpecificOperations();
    sum1 = UInt(R[n]<7:0>) + UInt(R[m]<7:0>);
    sum2 = UInt(R[n]<15:8>) + UInt(R[m]<15:8>);
    sum3 = UInt(R[n]<23:16>) + UInt(R[m]<23:16>);
```

```
sum4 = UInt(R[n]<31:24>) + UInt(R[m]<31:24>);  
R[d]<7:0> = sum1<8:1>;  
R[d]<15:8> = sum2<8:1>;  
R[d]<23:16> = sum3<8:1>;  
R[d]<31:24> = sum4<8:1>;
```

F5.1.266 UHASX

Unsigned Halving Add and Subtract with Exchange exchanges the two halfwords of the second operand, performs one unsigned 16-bit integer addition and one unsigned 16-bit subtraction, halves the results, and writes the results to the destination register.

A1

31	28	27	26	25	24	23	22	21	20	19	16	15	12	11	10	9	8	7	6	5	4	3	0
!=1111				0	1	1	0	0	1	1	1	Rn	Rd	(1)	(1)	(1)	(1)	0	0	1	1	Rm	
cond																							

A1 variant

UHASX{<c>}{<q>} {<Rd>}, <Rn>, <Rm>

Decode for this encoding

```
d = UInt(Rd); n = UInt(Rn); m = UInt(Rm);
if d == 15 || n == 15 || m == 15 then UNPREDICTABLE;
```

T1

15	14	13	12	11	10	9	8	7	6	5	4	3	0	15	14	13	12	11	8	7	6	5	4	3	0
1	1	1	1	1	0	1	0	1	0	1	0	Rn	1	1	1	1	Rd	0	1	1	0	Rm			

T1 variant

UHASX{<c>}{<q>} {<Rd>}, <Rn>, <Rm>

Decode for this encoding

```
d = UInt(Rd); n = UInt(Rn); m = UInt(Rm);
if d == 15 || n == 15 || m == 15 then UNPREDICTABLE; // ARMv8-A removes UNPREDICTABLE for R13
```

Notes for all encodings

For more information about the CONSTRAINED UNPREDICTABLE behavior of this instruction, see [Appendix K1 Architectural Constraints on UNPREDICTABLE behaviors](#).

Assembler symbols

- <c> See [Standard assembler syntax fields on page F2-2848](#).
- <q> See [Standard assembler syntax fields on page F2-2848](#).
- <Rd> Is the general-purpose destination register, encoded in the "Rd" field.
- <Rn> Is the first general-purpose source register, encoded in the "Rn" field.
- <Rm> Is the second general-purpose source register, encoded in the "Rm" field.

Operation for all encodings

```
if ConditionPassed() then
  EncodingSpecificOperations();
diff = UInt(R[n]<15:0>) - UInt(R[m]<31:16>);
```

```
sum = UInt(R[n]<31:16>) + UInt(R[m]<15:0>);  
R[d]<15:0> = diff<16:1>;  
R[d]<31:16> = sum<16:1>;
```

F5.1.267 UHSAX

Unsigned Halving Subtract and Add with Exchange exchanges the two halfwords of the second operand, performs one unsigned 16-bit integer subtraction and one unsigned 16-bit addition, halves the results, and writes the results to the destination register.

A1

31	28	27	26	25	24	23	22	21	20	19	16	15	12	11	10	9	8	7	6	5	4	3	0
!=1111				0	1	1	0	0	1	1	1	Rn	Rd	(1)	(1)	(1)	(1)	0	1	0	1	Rm	
cond																							

A1 variant

UHSAX{<c>}{<q>} {<Rd>}, <Rn>, <Rm>

Decode for this encoding

```
d = UInt(Rd); n = UInt(Rn); m = UInt(Rm);
if d == 15 || n == 15 || m == 15 then UNPREDICTABLE;
```

T1

15	14	13	12	11	10	9	8	7	6	5	4	3	0	15	14	13	12	11	8	7	6	5	4	3	0
1	1	1	1	1	0	1	0	1	1	1	0	Rn	1	1	1	1	Rd	0	1	1	0	Rm			

T1 variant

UHSAX{<c>}{<q>} {<Rd>}, <Rn>, <Rm>

Decode for this encoding

```
d = UInt(Rd); n = UInt(Rn); m = UInt(Rm);
if d == 15 || n == 15 || m == 15 then UNPREDICTABLE; // ARMv8-A removes UNPREDICTABLE for R13
```

Notes for all encodings

For more information about the CONSTRAINED UNPREDICTABLE behavior of this instruction, see [Appendix K1 Architectural Constraints on UNPREDICTABLE behaviors](#).

Assembler symbols

- <c> See [Standard assembler syntax fields on page F2-2848](#).
- <q> See [Standard assembler syntax fields on page F2-2848](#).
- <Rd> Is the general-purpose destination register, encoded in the "Rd" field.
- <Rn> Is the first general-purpose source register, encoded in the "Rn" field.
- <Rm> Is the second general-purpose source register, encoded in the "Rm" field.

Operation for all encodings

```
if ConditionPassed() then
    EncodingSpecificOperations();
    sum = UInt(R[n]<15:0>) + UInt(R[m]<31:16>);
```



```
diff = UInt(R[n]<31:16>) - UInt(R[m]<15:0>);  
R[d]<15:0> = sum<16:1>;  
R[d]<31:16> = diff<16:1>;
```

F5.1.268 UHSUB16

Unsigned Halving Subtract 16 performs two unsigned 16-bit integer subtractions, halves the results, and writes the results to the destination register.

A1

31	28	27	26	25	24	23	22	21	20	19	16	15	12	11	10	9	8	7	6	5	4	3	0			
!=1111				0	1	1	0	0	1	1	1	Rn	Rd	(1)	(1)	(1)	(1)	0	1	1	1	Rm				
cond																										

A1 variant

UHSUB16{<c>}{<q>} {<Rd>}, <Rn>, <Rm>

Decode for this encoding

d = UInt(Rd); n = UInt(Rn); m = UInt(Rm);
 if d == 15 || n == 15 || m == 15 then UNPREDICTABLE;

T1

15	14	13	12	11	10	9	8	7	6	5	4	3	0	15	14	13	12	11	8	7	6	5	4	3	0
1	1	1	1	1	0	1	0	1	1	0	1	Rn	1	1	1	1	Rd	0	1	1	0	Rm			

T1 variant

UHSUB16{<c>}{<q>} {<Rd>}, <Rn>, <Rm>

Decode for this encoding

d = UInt(Rd); n = UInt(Rn); m = UInt(Rm);
 if d == 15 || n == 15 || m == 15 then UNPREDICTABLE; // ARMv8-A removes UNPREDICTABLE for R13

Notes for all encodings

For more information about the CONSTRAINED UNPREDICTABLE behavior of this instruction, see [Appendix K1 Architectural Constraints on UNPREDICTABLE behaviors](#).

Assembler symbols

- <c> See [Standard assembler syntax fields on page F2-2848](#).
- <q> See [Standard assembler syntax fields on page F2-2848](#).
- <Rd> Is the general-purpose destination register, encoded in the "Rd" field.
- <Rn> Is the first general-purpose source register, encoded in the "Rn" field.
- <Rm> Is the second general-purpose source register, encoded in the "Rm" field.

Operation for all encodings

```
if ConditionPassed() then
    EncodingSpecificOperations();
    diff1 = UInt(R[n]<15:0>) - UInt(R[m]<15:0>);
```

```
diff2 = UInt(R[n]<31:16>) - UInt(R[m]<31:16>);  
R[d]<15:0> = diff1<16:1>;  
R[d]<31:16> = diff2<16:1>;
```

F5.1.269 UHSUB8

Unsigned Halving Subtract 8 performs four unsigned 8-bit integer subtractions, halves the results, and writes the results to the destination register.

A1

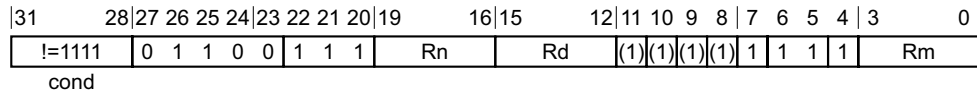

A1 variant

UHSUB8{<c>}{<q>} {<Rd>}, <Rn>, <Rm>

Decode for this encoding

```
d = UInt(Rd); n = UInt(Rn); m = UInt(Rm);
if d == 15 || n == 15 || m == 15 then UNPREDICTABLE;
```

T1

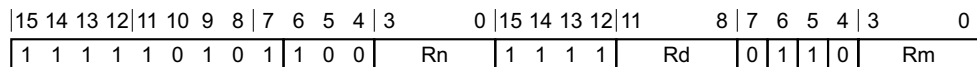

T1 variant

UHSUB8{<c>}{<q>} {<Rd>}, <Rn>, <Rm>

Decode for this encoding

```
d = UInt(Rd); n = UInt(Rn); m = UInt(Rm);
if d == 15 || n == 15 || m == 15 then UNPREDICTABLE; // ARMv8-A removes UNPREDICTABLE for R13
```

Notes for all encodings

For more information about the CONSTRAINED UNPREDICTABLE behavior of this instruction, see [Appendix K1 Architectural Constraints on UNPREDICTABLE behaviors](#).

Assembler symbols

- <c> See [Standard assembler syntax fields on page F2-2848](#).
- <q> See [Standard assembler syntax fields on page F2-2848](#).
- <Rd> Is the general-purpose destination register, encoded in the "Rd" field.
- <Rn> Is the first general-purpose source register, encoded in the "Rn" field.
- <Rm> Is the second general-purpose source register, encoded in the "Rm" field.

Operation for all encodings

```
if ConditionPassed() then
    EncodingSpecificOperations();
diff1 = UInt(R[n]<7:0>) - UInt(R[m]<7:0>);
diff2 = UInt(R[n]<15:8>) - UInt(R[m]<15:8>);
diff3 = UInt(R[n]<23:16>) - UInt(R[m]<23:16>);
```

```
diff4 = UInt(R[n]<31:24>) - UInt(R[m]<31:24>);  
R[d]<7:0> = diff1<8:1>;  
R[d]<15:8> = diff2<8:1>;  
R[d]<23:16> = diff3<8:1>;  
R[d]<31:24> = diff4<8:1>;
```

F5.1.270 UMAAL

Unsigned Multiply Accumulate Accumulate Long multiplies two unsigned 32-bit values to produce a 64-bit value, adds two unsigned 32-bit values, and writes the 64-bit result to two registers.

A1

31	28	27	26	25	24	23	22	21	20	19	16	15	12	11	8	7	6	5	4	3	0
!=1111				0 0 0 0				0 1 0 0				RdHi		RdLo		Rm		1 0 0 1		Rn	
cond																					

A1 variant

UMAAL{<c>}{<q>} <RdLo>, <RdHi>, <Rn>, <Rm>

Decode for this encoding

```
dLo = UInt(RdLo); dHi = UInt(RdHi); n = UInt(Rn); m = UInt(Rm);
if dLo == 15 || dHi == 15 || n == 15 || m == 15 then UNPREDICTABLE;
if dHi == dLo then UNPREDICTABLE;
```

CONSTRAINED UNPREDICTABLE behavior

If $dHi == dLo$, then one of the following behaviors must occur:

- The instruction is UNDEFINED.
- The instruction executes as NOP.
- The value in the destination register is UNKNOWN.

T1

15	14	13	12	11	10	9	8	7	6	5	4	3	0	15	12	11	8	7	6	5	4	3	0
1 1 1 1				1 0 1 1				1 1 0				Rn		RdLo		RdHi		0 1 1 0		Rm			

T1 variant

UMAAL{<c>}{<q>} <RdLo>, <RdHi>, <Rn>, <Rm>

Decode for this encoding

```
dLo = UInt(RdLo); dHi = UInt(RdHi); n = UInt(Rn); m = UInt(Rm);
if dLo == 15 || dHi == 15 || n == 15 || m == 15 then UNPREDICTABLE;
// ARMv8-A removes UNPREDICTABLE for R13
if dHi == dLo then UNPREDICTABLE;
```

CONSTRAINED UNPREDICTABLE behavior

If $dHi == dLo$, then one of the following behaviors must occur:

- The instruction is UNDEFINED.
- The instruction executes as NOP.
- The value in the destination register is UNKNOWN.

Notes for all encodings

For more information about the CONSTRAINED UNPREDICTABLE behavior of this instruction, see [Appendix K1 Architectural Constraints on UNPREDICTABLE behaviors](#).

Assembler symbols

- <c> See *Standard assembler syntax fields* on page F2-2848.
- <q> See *Standard assembler syntax fields* on page F2-2848.
- <RdLo> Is the general-purpose source register holding the first addend and the destination register for the lower 32 bits of the result, encoded in the "RdLo" field.
- <RdHi> Is the general-purpose source register holding the second addend and the destination register for the upper 32 bits of the result, encoded in the "RdHi" field.
- <Rn> Is the first general-purpose source register holding the multiplicand, encoded in the "Rn" field.
- <Rm> Is the second general-purpose source register holding the multiplier, encoded in the "Rm" field.

Operation for all encodings

```
if ConditionPassed() then
    EncodingSpecificOperations();
    result = UInt(R[n]) * UInt(R[m]) + UInt(R[dHi]) + UInt(R[dLo]);
    R[dHi] = result<63:32>;
    R[dLo] = result<31:0>;
```

F5.1.271 UMLAL, UMLALS

Unsigned Multiply Accumulate Long multiplies two unsigned 32-bit values to produce a 64-bit value, and accumulates this with a 64-bit value.

In A32 instructions, the condition flags can optionally be updated based on the result. Use of this option adversely affects performance on many implementations.

A1

31	28 27	26	25	24 23	22	21	20 19	16 15	12 11	8	7	6	5	4	3	0
!=1111	0	0	0	0	1	0	1	S	RdHi	RdLo	Rm	1	0	0	1	Rn
cond																

Flag setting variant

Applies when S == 1.

UMLALS{<c>}{<q>} <RdLo>, <RdHi>, <Rn>, <Rm>

Not flag setting variant

Applies when S == 0.

UMLAL{<c>}{<q>} <RdLo>, <RdHi>, <Rn>, <Rm>

Decode for all variants of this encoding

```
dLo = UInt(RdLo); dHi = UInt(RdHi); n = UInt(Rn); m = UInt(Rm); setflags = (S == '1');
if dLo == 15 || dHi == 15 || n == 15 || m == 15 then UNPREDICTABLE;
if dHi == dLo then UNPREDICTABLE;
```

CONSTRAINED UNPREDICTABLE behavior

If dHi == dLo, then one of the following behaviors must occur:

- The instruction is UNDEFINED.
- The instruction executes as NOP.
- The value in the destination register is UNKNOWN.

T1

15	14	13	12 11	10	9	8	7	6	5	4	3	0	15	12 11	8	7	6	5	4	3	0
1	1	1	1	1	0	1	1	1	1	0	Rn	RdLo	RdHi	0	0	0	0	Rm			

T1 variant

UMLAL{<c>}{<q>} <RdLo>, <RdHi>, <Rn>, <Rm>

Decode for this encoding

```
dLo = UInt(RdLo); dHi = UInt(RdHi); n = UInt(Rn); m = UInt(Rm); setflags = FALSE;
if dLo == 15 || dHi == 15 || n == 15 || m == 15 then UNPREDICTABLE;
// ARMv8-A removes UNPREDICTABLE for R13
if dHi == dLo then UNPREDICTABLE;
```

CONSTRAINED UNPREDICTABLE behavior

If $dHi == dLo$, then one of the following behaviors must occur:

- The instruction is UNDEFINED.
- The instruction executes as NOP.
- The value in the destination register is UNKNOWN.

Notes for all encodings

For more information about the CONSTRAINED UNPREDICTABLE behavior of this instruction, see [Appendix K1 Architectural Constraints on UNPREDICTABLE behaviors](#).

Assembler symbols

<c>	See Standard assembler syntax fields on page F2-2848 .
<q>	See Standard assembler syntax fields on page F2-2848 .
<RdLo>	Is the general-purpose source register holding the lower 32 bits of the addend, and the destination register for the lower 32 bits of the result, encoded in the "RdLo" field.
<RdHi>	Is the general-purpose source register holding the upper 32 bits of the addend, and the destination register for the upper 32 bits of the result, encoded in the "RdHi" field.
<Rn>	Is the first general-purpose source register holding the multiplicand, encoded in the "Rn" field.
<Rm>	Is the second general-purpose source register holding the multiplier, encoded in the "Rm" field.

Operation for all encodings

```
if ConditionPassed() then
    EncodingSpecificOperations();
    result = UInt(R[n]) * UInt(R[m]) + UInt(R[dHi]:R[dLo]);
    R[dHi] = result<63:32>;
    R[dLo] = result<31:0>;
    if setflags then
        PSTATE.N = result<63>;
        PSTATE.Z = IsZeroBit(result<63:0>);
        // PSTATE.C, PSTATE.V unchanged
```

F5.1.272 UMULL, UMULLS

Unsigned Multiply Long multiplies two 32-bit unsigned values to produce a 64-bit result.

In A32 instructions, the condition flags can optionally be updated based on the result. Use of this option adversely affects performance on many implementations.

A1

31	28	27	26	25	24	23	22	21	20	19	16	15	12	11	8	7	6	5	4	3	0	
!=1111				0	0	0	0	1	0	0	S	RdHi	RdLo	Rm	1	0	0	1	Rn			
cond																						

Flag setting variant

Applies when S == 1.

UMULLS{<c>}{<q>} <RdLo>, <RdHi>, <Rn>, <Rm>

Not flag setting variant

Applies when S == 0.

UMULL{<c>}{<q>} <RdLo>, <RdHi>, <Rn>, <Rm>

Decode for all variants of this encoding

```
dLo = UInt(RdLo); dHi = UInt(RdHi); n = UInt(Rn); m = UInt(Rm); setflags = (S == '1');
if dLo == 15 || dHi == 15 || n == 15 || m == 15 then UNPREDICTABLE;
if dHi == dLo then UNPREDICTABLE;
```

CONSTRAINED UNPREDICTABLE behavior

If dHi == dLo, then one of the following behaviors must occur:

- The instruction is UNDEFINED.
- The instruction executes as NOP.
- The value in the destination register is UNKNOWN.

T1

15	14	13	12	11	10	9	8	7	6	5	4	3	0	15	12	11	8	7	6	5	4	3	0
1	1	1	1	1	0	1	1	1	0	1	0	Rn	RdLo	RdHi	0	0	0	0	Rm				

T1 variant

UMULL{<c>}{<q>} <RdLo>, <RdHi>, <Rn>, <Rm>

Decode for this encoding

```
dLo = UInt(RdLo); dHi = UInt(RdHi); n = UInt(Rn); m = UInt(Rm); setflags = FALSE;
if dLo == 15 || dHi == 15 || n == 15 || m == 15 then UNPREDICTABLE;
// ARMv8-A removes UNPREDICTABLE for R13
if dHi == dLo then UNPREDICTABLE;
```

CONSTRAINED UNPREDICTABLE behavior

If $dHi == dLo$, then one of the following behaviors must occur:

- The instruction is UNDEFINED.
- The instruction executes as NOP.
- The value in the destination register is UNKNOWN.

Notes for all encodings

For more information about the CONSTRAINED UNPREDICTABLE behavior of this instruction, see [Appendix K1 Architectural Constraints on UNPREDICTABLE behaviors](#).

Assembler symbols

<c>	See Standard assembler syntax fields on page F2-2848 .
<q>	See Standard assembler syntax fields on page F2-2848 .
<RdLo>	Is the general-purpose destination register for the lower 32 bits of the result, encoded in the "RdLo" field.
<RdHi>	Is the general-purpose destination register for the upper 32 bits of the result, encoded in the "RdHi" field.
<Rn>	Is the first general-purpose source register holding the multiplicand, encoded in the "Rn" field.
<Rm>	Is the second general-purpose source register holding the multiplier, encoded in the "Rm" field.

Operation for all encodings

```
if ConditionPassed() then
    EncodingSpecificOperations();
    result = UInt(R[n]) * UInt(R[m]);
    R[dHi] = result<63:32>;
    R[dLo] = result<31:0>;
    if setflags then
        PSTATE.N = result<63>;
        PSTATE.Z = IsZeroBit(result<63:0>);
        // PSTATE.C, PSTATE.V unchanged
```

F5.1.273 UQADD16

Unsigned Saturating Add 16 performs two unsigned 16-bit integer additions, saturates the results to the 16-bit unsigned integer range $0 \leq x \leq 2^{16} - 1$, and writes the results to the destination register.

A1

31	28	27	26	25	24	23	22	21	20	19	16	15	12	11	10	9	8	7	6	5	4	3	0
!=1111				0	1	1	0	0	1	1	0	Rn	Rd	(1)	(1)	(1)	(1)	0	0	0	1	Rm	
cond																							

A1 variant

UQADD16{<c>}{<q>} {<Rd>}, <Rn>, <Rm>

Decode for this encoding

d = UInt(Rd); n = UInt(Rn); m = UInt(Rm);
 if d == 15 || n == 15 || m == 15 then UNPREDICTABLE;

T1

15	14	13	12	11	10	9	8	7	6	5	4	3	0	15	14	13	12	11	8	7	6	5	4	3	0
1	1	1	1	1	0	1	0	1	0	0	1	Rn	1	1	1	1	Rd	0	1	0	1	Rm			

T1 variant

UQADD16{<c>}{<q>} {<Rd>}, <Rn>, <Rm>

Decode for this encoding

d = UInt(Rd); n = UInt(Rn); m = UInt(Rm);
 if d == 15 || n == 15 || m == 15 then UNPREDICTABLE; // ARMv8-A removes UNPREDICTABLE for R13

Notes for all encodings

For more information about the CONSTRAINED UNPREDICTABLE behavior of this instruction, see [Appendix K1 Architectural Constraints on UNPREDICTABLE behaviors](#).

Assembler symbols

- <c> See [Standard assembler syntax fields on page F2-2848](#).
- <q> See [Standard assembler syntax fields on page F2-2848](#).
- <Rd> Is the general-purpose destination register, encoded in the "Rd" field.
- <Rn> Is the first general-purpose source register, encoded in the "Rn" field.
- <Rm> Is the second general-purpose source register, encoded in the "Rm" field.

Operation for all encodings

```
if ConditionPassed() then
    EncodingSpecificOperations();
    sum1 = UInt(R[n]<15:0>) + UInt(R[m]<15:0>);
```

```
sum2 = UInt(R[n]<31:16>) + UInt(R[m]<31:16>);  
R[d]<15:0> = UnsignedSat(sum1, 16);  
R[d]<31:16> = UnsignedSat(sum2, 16);
```

F5.1.274 UQADD8

Unsigned Saturating Add 8 performs four unsigned 8-bit integer additions, saturates the results to the 8-bit unsigned integer range $0 \leq x \leq 2^8 - 1$, and writes the results to the destination register.

A1

31	28	27	26	25	24	23	22	21	20	19	16	15	12	11	10	9	8	7	6	5	4	3	0
!=1111				0	1	1	0	0	1	1	0	Rn	Rd	(1)	(1)	(1)	(1)	1	0	0	1	Rm	
cond																							

A1 variant

UQADD8{<c>}{<q>} {<Rd>}, <Rn>, <Rm>

Decode for this encoding

```
d = UInt(Rd); n = UInt(Rn); m = UInt(Rm);
if d == 15 || n == 15 || m == 15 then UNPREDICTABLE;
```

T1

15	14	13	12	11	10	9	8	7	6	5	4	3	0	15	14	13	12	11	8	7	6	5	4	3	0
1	1	1	1	1	0	1	0	1	0	0	0	Rn	1	1	1	1	Rd	0	1	0	1	Rm			

T1 variant

UQADD8{<c>}{<q>} {<Rd>}, <Rn>, <Rm>

Decode for this encoding

```
d = UInt(Rd); n = UInt(Rn); m = UInt(Rm);
if d == 15 || n == 15 || m == 15 then UNPREDICTABLE; // ARMv8-A removes UNPREDICTABLE for R13
```

Notes for all encodings

For more information about the CONSTRAINED UNPREDICTABLE behavior of this instruction, see [Appendix K1 Architectural Constraints on UNPREDICTABLE behaviors](#).

Assembler symbols

- <c> See [Standard assembler syntax fields on page F2-2848](#).
- <q> See [Standard assembler syntax fields on page F2-2848](#).
- <Rd> Is the general-purpose destination register, encoded in the "Rd" field.
- <Rn> Is the first general-purpose source register, encoded in the "Rn" field.
- <Rm> Is the second general-purpose source register, encoded in the "Rm" field.

Operation for all encodings

```
if ConditionPassed() then
    EncodingSpecificOperations();
    sum1 = UInt(R[n]<7:0>) + UInt(R[m]<7:0>);
    sum2 = UInt(R[n]<15:8>) + UInt(R[m]<15:8>);
    sum3 = UInt(R[n]<23:16>) + UInt(R[m]<23:16>);
```

```
sum4 = UInt(R[n]<31:24>) + UInt(R[m]<31:24>);  
R[d]<7:0> = UnsignedSat(sum1, 8);  
R[d]<15:8> = UnsignedSat(sum2, 8);  
R[d]<23:16> = UnsignedSat(sum3, 8);  
R[d]<31:24> = UnsignedSat(sum4, 8);
```

F5.1.275 UQASX

Unsigned Saturating Add and Subtract with Exchange exchanges the two halfwords of the second operand, performs one unsigned 16-bit integer addition and one unsigned 16-bit subtraction, saturates the results to the 16-bit unsigned integer range $0 \leq x \leq 2^{16} - 1$, and writes the results to the destination register.

A1

31	28	27	26	25	24	23	22	21	20	19	16	15	12	11	10	9	8	7	6	5	4	3	0
!=1111				0	1	1	0	0	1	1	0	Rn	Rd	(1)	(1)	(1)	(1)	0	0	1	1	Rm	
cond																							

A1 variant

UQASX{<c>}{<q>} {<Rd>}, {<Rn>}, <Rm>

Decode for this encoding

```
d = UInt(Rd); n = UInt(Rn); m = UInt(Rm);
if d == 15 || n == 15 || m == 15 then UNPREDICTABLE;
```

T1

15	14	13	12	11	10	9	8	7	6	5	4	3	0	15	14	13	12	11	8	7	6	5	4	3	0
1	1	1	1	1	0	1	0	1	0	1	0	Rn	1	1	1	1	Rd	0	1	0	1	Rm			

T1 variant

UQASX{<c>}{<q>} {<Rd>}, {<Rn>}, <Rm>

Decode for this encoding

```
d = UInt(Rd); n = UInt(Rn); m = UInt(Rm);
if d == 15 || n == 15 || m == 15 then UNPREDICTABLE; // ARMv8-A removes UNPREDICTABLE for R13
```

Notes for all encodings

For more information about the CONSTRAINED UNPREDICTABLE behavior of this instruction, see [Appendix K1 Architectural Constraints on UNPREDICTABLE behaviors](#).

Assembler symbols

- <c> See [Standard assembler syntax fields on page F2-2848](#).
- <q> See [Standard assembler syntax fields on page F2-2848](#).
- <Rd> Is the general-purpose destination register, encoded in the "Rd" field.
- <Rn> Is the first general-purpose source register, encoded in the "Rn" field.
- <Rm> Is the second general-purpose source register, encoded in the "Rm" field.

Operation for all encodings

```
if ConditionPassed() then
  EncodingSpecificOperations();
diff = UInt(R[n]<15:0>) - UInt(R[m]<31:16>);
```



```
sum = UInt(R[n]<31:16>) + UInt(R[m]<15:0>);  
R[d]<15:0> = UnsignedSat(diff, 16);  
R[d]<31:16> = UnsignedSat(sum, 16);
```

F5.1.276 UQSAX

Unsigned Saturating Subtract and Add with Exchange exchanges the two halfwords of the second operand, performs one unsigned 16-bit integer subtraction and one unsigned 16-bit addition, saturates the results to the 16-bit unsigned integer range $0 \leq x \leq 2^{16} - 1$, and writes the results to the destination register.

A1

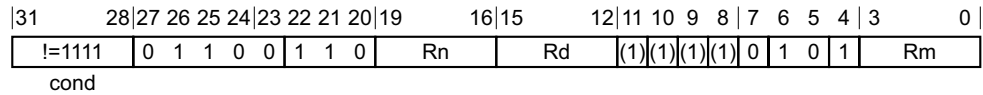

A1 variant

UQSAX{<c>}{<q>} {<Rd>}, <Rn>, <Rm>

Decode for this encoding

```
d = UInt(Rd); n = UInt(Rn); m = UInt(Rm);
if d == 15 || n == 15 || m == 15 then UNPREDICTABLE;
```

T1

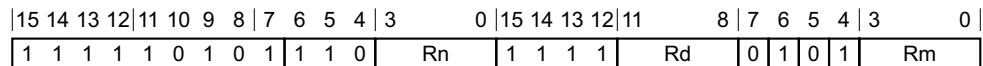

T1 variant

UQSAX{<c>}{<q>} {<Rd>}, <Rn>, <Rm>

Decode for this encoding

```
d = UInt(Rd); n = UInt(Rn); m = UInt(Rm);
if d == 15 || n == 15 || m == 15 then UNPREDICTABLE; // ARMv8-A removes UNPREDICTABLE for R13
```

Notes for all encodings

For more information about the CONSTRAINED UNPREDICTABLE behavior of this instruction, see [Appendix K1 Architectural Constraints on UNPREDICTABLE behaviors](#).

Assembler symbols

- <c> See [Standard assembler syntax fields on page F2-2848](#).
- <q> See [Standard assembler syntax fields on page F2-2848](#).
- <Rd> Is the general-purpose destination register, encoded in the "Rd" field.
- <Rn> Is the first general-purpose source register, encoded in the "Rn" field.
- <Rm> Is the second general-purpose source register, encoded in the "Rm" field.

Operation for all encodings

```
if ConditionPassed() then
    EncodingSpecificOperations();
    sum = UInt(R[n]<15:0>) + UInt(R[m]<31:16>);
```

```
diff = UInt(R[n]<31:16>) - UInt(R[m]<15:0>);  
R[d]<15:0> = UnsignedSat(sum, 16);  
R[d]<31:16> = UnsignedSat(diff, 16);
```

F5.1.277 UQSUB16

Unsigned Saturating Subtract 16 performs two unsigned 16-bit integer subtractions, saturates the results to the 16-bit unsigned integer range $0 \leq x \leq 2^{16} - 1$, and writes the results to the destination register.

A1

31	28	27	26	25	24	23	22	21	20	19	16	15	12	11	10	9	8	7	6	5	4	3	0
!=1111				0	1	1	0	0	1	1	0	Rn	Rd	(1)	(1)	(1)	(1)	0	1	1	1	Rm	
cond																							

A1 variant

UQSUB16{<c>}{<q>} {<Rd>}, <Rn>, <Rm>

Decode for this encoding

```
d = UInt(Rd); n = UInt(Rn); m = UInt(Rm);
if d == 15 || n == 15 || m == 15 then UNPREDICTABLE;
```

T1

15	14	13	12	11	10	9	8	7	6	5	4	3	0	15	14	13	12	11	8	7	6	5	4	3	0
1	1	1	1	1	0	1	0	1	1	0	1	Rn	1	1	1	1	Rd	0	1	0	1	Rm			

T1 variant

UQSUB16{<c>}{<q>} {<Rd>}, <Rn>, <Rm>

Decode for this encoding

```
d = UInt(Rd); n = UInt(Rn); m = UInt(Rm);
if d == 15 || n == 15 || m == 15 then UNPREDICTABLE; // ARMv8-A removes UNPREDICTABLE for R13
```

Notes for all encodings

For more information about the CONSTRAINED UNPREDICTABLE behavior of this instruction, see [Appendix K1 Architectural Constraints on UNPREDICTABLE behaviors](#).

Assembler symbols

- <c> See [Standard assembler syntax fields on page F2-2848](#).
- <q> See [Standard assembler syntax fields on page F2-2848](#).
- <Rd> Is the general-purpose destination register, encoded in the "Rd" field.
- <Rn> Is the first general-purpose source register, encoded in the "Rn" field.
- <Rm> Is the second general-purpose source register, encoded in the "Rm" field.

Operation for all encodings

```
if ConditionPassed() then
    EncodingSpecificOperations();
    diff1 = UInt(R[n]<15:0>) - UInt(R[m]<15:0>);
```

```
diff2 = UInt(R[n]<31:16>) - UInt(R[m]<31:16>);  
R[d]<15:0> = UnsignedSat(diff1, 16);  
R[d]<31:16> = UnsignedSat(diff2, 16);
```

F5.1.278 UQSUB8

Unsigned Saturating Subtract 8 performs four unsigned 8-bit integer subtractions, saturates the results to the 8-bit unsigned integer range $0 \leq x \leq 2^8 - 1$, and writes the results to the destination register.

A1

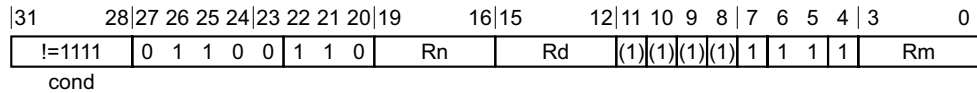

A1 variant

UQSUB8{<c>}{<q>} {<Rd>}, <Rn>, <Rm>

Decode for this encoding

```
d = UInt(Rd); n = UInt(Rn); m = UInt(Rm);
if d == 15 || n == 15 || m == 15 then UNPREDICTABLE;
```

T1

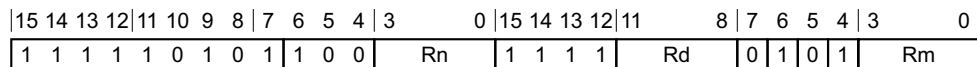

T1 variant

UQSUB8{<c>}{<q>} {<Rd>}, <Rn>, <Rm>

Decode for this encoding

```
d = UInt(Rd); n = UInt(Rn); m = UInt(Rm);
if d == 15 || n == 15 || m == 15 then UNPREDICTABLE; // ARMv8-A removes UNPREDICTABLE for R13
```

Notes for all encodings

For more information about the CONSTRAINED UNPREDICTABLE behavior of this instruction, see [Appendix K1 Architectural Constraints on UNPREDICTABLE behaviors](#).

Assembler symbols

- <c> See [Standard assembler syntax fields on page F2-2848](#).
- <q> See [Standard assembler syntax fields on page F2-2848](#).
- <Rd> Is the general-purpose destination register, encoded in the "Rd" field.
- <Rn> Is the first general-purpose source register, encoded in the "Rn" field.
- <Rm> Is the second general-purpose source register, encoded in the "Rm" field.

Operation for all encodings

```
if ConditionPassed() then
    EncodingSpecificOperations();
diff1 = UInt(R[n]<7:0>) - UInt(R[m]<7:0>);
diff2 = UInt(R[n]<15:8>) - UInt(R[m]<15:8>);
diff3 = UInt(R[n]<23:16>) - UInt(R[m]<23:16>);
```

```
diff4 = UInt(R[n]<31:24>) - UInt(R[m]<31:24>);  
R[d]<7:0> = UnsignedSat(diff1, 8);  
R[d]<15:8> = UnsignedSat(diff2, 8);  
R[d]<23:16> = UnsignedSat(diff3, 8);  
R[d]<31:24> = UnsignedSat(diff4, 8);
```

F5.1.279 USAD8

Unsigned Sum of Absolute Differences performs four unsigned 8-bit subtractions, and adds the absolute values of the differences together.

A1

31	28	27	26	25	24	23	22	21	20	19	16	15	14	13	12	11	8	7	6	5	4	3	0
!=1111				0	1	1	1	1	0	0	0	Rd	1	1	1	1	Rm	0	0	0	1	Rn	
cond																							

A1 variant

USAD8{<c>}{<q>} {<Rd>}, <Rn>, <Rm>

Decode for this encoding

```
d = UInt(Rd); n = UInt(Rn); m = UInt(Rm);
if d == 15 || n == 15 || m == 15 then UNPREDICTABLE;
```

T1

15	14	13	12	11	10	9	8	7	6	5	4	3	0	15	14	13	12	11	8	7	6	5	4	3	0
1	1	1	1	1	0	1	1	0	1	1	1	Rn	1	1	1	1	Rd	0	0	0	0	Rm			

T1 variant

USAD8{<c>}{<q>} {<Rd>}, <Rn>, <Rm>

Decode for this encoding

```
d = UInt(Rd); n = UInt(Rn); m = UInt(Rm);
if d == 15 || n == 15 || m == 15 then UNPREDICTABLE; // ARMv8-A removes UNPREDICTABLE for R13
```

Notes for all encodings

For more information about the CONSTRAINED UNPREDICTABLE behavior of this instruction, see [Appendix K1 Architectural Constraints on UNPREDICTABLE behaviors](#).

Assembler symbols

- <c> See [Standard assembler syntax fields on page F2-2848](#).
- <q> See [Standard assembler syntax fields on page F2-2848](#).
- <Rd> Is the general-purpose destination register, encoded in the "Rd" field.
- <Rn> Is the first general-purpose source register, encoded in the "Rn" field.
- <Rm> Is the second general-purpose source register, encoded in the "Rm" field.

Operation for all encodings

```
if ConditionPassed() then
    EncodingSpecificOperations();
    absdiff1 = Abs(UInt(R[n]<7:0>) - UInt(R[m]<7:0>));
    absdiff2 = Abs(UInt(R[n]<15:8>) - UInt(R[m]<15:8>));
    absdiff3 = Abs(UInt(R[n]<23:16>) - UInt(R[m]<23:16>));
```



```
absdiff4 = Abs(UInt(R[n]<31:24>) - UInt(R[m]<31:24>));  
result = absdiff1 + absdiff2 + absdiff3 + absdiff4;  
R[d] = result<31:0>;
```

F5.1.280 USADA8

Unsigned Sum of Absolute Differences and Accumulate performs four unsigned 8-bit subtractions, and adds the absolute values of the differences to a 32-bit accumulate operand.

A1

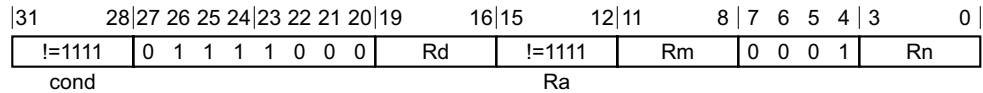

A1 variant

USADA8{<c>}{<q>} <Rd>, <Rn>, <Rm>, <Ra>

Decode for this encoding

```
if Ra == '1111' then SEE USAD8;
d = UInt(Rd); n = UInt(Rn); m = UInt(Rm); a = UInt(Ra);
if d == 15 || n == 15 || m == 15 then UNPREDICTABLE;
```

T1

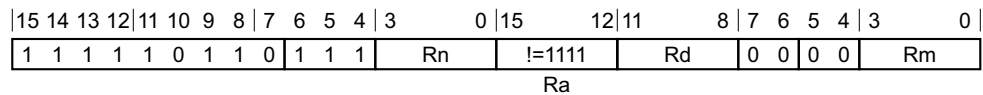

T1 variant

USADA8{<c>}{<q>} <Rd>, <Rn>, <Rm>, <Ra>

Decode for this encoding

```
if Ra == '1111' then SEE USAD8;
d = UInt(Rd); n = UInt(Rn); m = UInt(Rm); a = UInt(Ra);
if d == 15 || n == 15 || m == 15 then UNPREDICTABLE; // ARMv8-A removes UNPREDICTABLE for R13
```

Notes for all encodings

For more information about the CONSTRAINED UNPREDICTABLE behavior of this instruction, see [Appendix K1 Architectural Constraints on UNPREDICTABLE behaviors](#).

Assembler symbols

- <c> See [Standard assembler syntax fields on page F2-2848](#).
- <q> See [Standard assembler syntax fields on page F2-2848](#).
- <Rd> Is the general-purpose destination register, encoded in the "Rd" field.
- <Rn> Is the first general-purpose source register, encoded in the "Rn" field.
- <Rm> Is the second general-purpose source register, encoded in the "Rm" field.
- <Ra> Is the third general-purpose source register holding the addend, encoded in the "Ra" field.

Operation for all encodings

```
if ConditionPassed() then
    EncodingSpecificOperations();
    absdiff1 = Abs(UInt(R[n]<7:0>) - UInt(R[m]<7:0>));
    absdiff2 = Abs(UInt(R[n]<15:8>) - UInt(R[m]<15:8>));
    absdiff3 = Abs(UInt(R[n]<23:16>) - UInt(R[m]<23:16>));
    absdiff4 = Abs(UInt(R[n]<31:24>) - UInt(R[m]<31:24>));
    result = UInt(R[a]) + absdiff1 + absdiff2 + absdiff3 + absdiff4;
    R[d] = result<31:0>;
```

F5.1.281 USAT

Unsigned Saturate saturates an optionally-shifted signed value to a selected unsigned range.

This instruction sets `PSTATE.Q` to 1 if the operation saturates.

A1

31	28	27	26	25	24	23	22	21	20	16	15	12	11	7	6	5	4	3	0		
!=1111				0	1	1	0	1	1	1	sat_imm		Rd		imm5		sh	0	1	Rn	
cond																					

Arithmetic shift right variant

Applies when `sh == 1`.

USAT{<c>}{<q>} <Rd>, #<imm>, <Rn>, ASR #<amount>

Logical shift left variant

Applies when `sh == 0`.

USAT{<c>}{<q>} <Rd>, #<imm>, <Rn> {, LSL #<amount>}

Decode for all variants of this encoding

```
d = UInt(Rd); n = UInt(Rn); saturate_to = UInt(sat_imm);
(shift_t, shift_n) = DecodeImmShift(sh:'0', imm5);
if d == 15 || n == 15 then UNPREDICTABLE;
```

T1

15	14	13	12	11	10	9	8	7	6	5	4	3	0	15	14	12	11	8	7	6	5	4	0
1	1	1	1	0	(0)	1	1	1	0	sh	0	Rn		0	imm3		Rd		imm2		(0)	sat_imm	

Arithmetic shift right variant

Applies when `sh == 1 && !(imm3 == 000 && imm2 == 00)`.

USAT{<c>}{<q>} <Rd>, #<imm>, <Rn>, ASR #<amount>

Logical shift left variant

Applies when `sh == 0`.

USAT{<c>}{<q>} <Rd>, #<imm>, <Rn> {, LSL #<amount>}

Decode for all variants of this encoding

```
if sh == '1' && (imm3:imm2) == '0000' then SEE USAT16;
d = UInt(Rd); n = UInt(Rn); saturate_to = UInt(sat_imm);
(shift_t, shift_n) = DecodeImmShift(sh:'0', imm3:imm2);
if d == 15 || n == 15 then UNPREDICTABLE; // ARMv8-A removes UNPREDICTABLE for R13
```

Notes for all encodings

For more information about the CONSTRAINED UNPREDICTABLE behavior of this instruction, see [Appendix K1 Architectural Constraints on UNPREDICTABLE behaviors](#).

Assembler symbols

- <c> See *Standard assembler syntax fields* on page F2-2848.
- <q> See *Standard assembler syntax fields* on page F2-2848.
- <Rd> Is the general-purpose destination register, encoded in the "Rd" field.
- <imm> Is the bit position for saturation, in the range 0 to 31, encoded in the "sat_imm" field.
- <Rn> Is the general-purpose source register, encoded in the "Rn" field.
- <amount> For encoding A1: is the optional shift amount, in the range 0 to 31, defaulting to 0 and encoded in the "imm5" field.
For encoding A1: is the shift amount, in the range 1 to 32 encoded in the "imm5" field as <amount> modulo 32.
For encoding T1: is the optional shift amount, in the range 0 to 31, defaulting to 0 and encoded in the "imm3:imm2" field.
For encoding T1: is the shift amount, in the range 1 to 31 encoded in the "imm3:imm2" field as <amount>.

Operation for all encodings

```
if ConditionPassed() then
    EncodingSpecificOperations();
    operand = Shift(R[n], shift_t, shift_n, PSTATE.C); // PSTATE.C ignored
    (result, sat) = UnsignedSatQ(SInt(operand), saturate_to);
    R[d] = ZeroExtend(result, 32);
    if sat then
        PSTATE.Q = '1';
```

F5.1.282 USAT16

Unsigned Saturate 16 saturates two signed 16-bit values to a selected unsigned range.

This instruction sets `PSTATE.Q` to 1 if the operation saturates.

A1

31	28	27	26	25	24	23	22	21	20	19	16	15	12	11	10	9	8	7	6	5	4	3	0
!=1111				0	1	1	0	1	1	1	0	sat_imm	Rd	(1)	(1)	(1)	(1)	0	0	1	1	Rn	
cond																							

A1 variant

USAT16{<c>}{<q>} <Rd>, #<imm>, <Rn>

Decode for this encoding

```
d = UInt(Rd); n = UInt(Rn); saturate_to = UInt(sat_imm);
if d == 15 || n == 15 then UNPREDICTABLE;
```

T1

15	14	13	12	11	10	9	8	7	6	5	4	3	0	15	14	13	12	11	8	7	6	5	4	3	0
1	1	1	1	0	(0)	1	1	1	0	1	0	Rn	0	0	0	0	Rd	0	0	(0)	(0)	sat_imm			

T1 variant

USAT16{<c>}{<q>} <Rd>, #<imm>, <Rn>

Decode for this encoding

```
d = UInt(Rd); n = UInt(Rn); saturate_to = UInt(sat_imm);
if d == 15 || n == 15 then UNPREDICTABLE; // ARMv8-A removes UNPREDICTABLE for R13
```

Notes for all encodings

For more information about the CONSTRAINED UNPREDICTABLE behavior of this instruction, see [Appendix K1 Architectural Constraints on UNPREDICTABLE behaviors](#).

Assembler symbols

- <c> See [Standard assembler syntax fields on page F2-2848](#).
- <q> See [Standard assembler syntax fields on page F2-2848](#).
- <Rd> Is the general-purpose destination register, encoded in the "Rd" field.
- <imm> Is the bit position for saturation, in the range 0 to 15, encoded in the "sat_imm" field.
- <Rn> Is the general-purpose source register, encoded in the "Rn" field.

Operation for all encodings

```
if ConditionPassed() then
    EncodingSpecificOperations();
    (result1, sat1) = UnsignedSatQ(SInt(R[n]<15:0>), saturate_to);
    (result2, sat2) = UnsignedSatQ(SInt(R[n]<31:16>), saturate_to);
```

```
R[d]<15:0> = ZeroExtend(result1, 16);  
R[d]<31:16> = ZeroExtend(result2, 16);  
if sat1 || sat2 then  
    PSTATE.Q = '1';
```

F5.1.283 USAX

Unsigned Subtract and Add with Exchange exchanges the two halfwords of the second operand, performs one unsigned 16-bit integer subtraction and one unsigned 16-bit addition, and writes the results to the destination register. It sets `PSTATE.GE` according to the results.

A1

31	28	27	26	25	24	23	22	21	20	19	16	15	12	11	10	9	8	7	6	5	4	3	0
!=1111				0	1	1	0	0	1	0	1	Rn	Rd	(1)	(1)	(1)	(1)	0	1	0	1	Rm	
cond																							

A1 variant

USAX{<c>}{<q>} {<Rd>}, <Rn>, <Rm>

Decode for this encoding

```
d = UInt(Rd); n = UInt(Rn); m = UInt(Rm);
if d == 15 || n == 15 || m == 15 then UNPREDICTABLE;
```

T1

15	14	13	12	11	10	9	8	7	6	5	4	3	0	15	14	13	12	11	8	7	6	5	4	3	0
1	1	1	1	1	0	1	0	1	1	1	0	Rn	1	1	1	1	Rd	0	1	0	0	Rm			

T1 variant

USAX{<c>}{<q>} {<Rd>}, <Rn>, <Rm>

Decode for this encoding

```
d = UInt(Rd); n = UInt(Rn); m = UInt(Rm);
if d == 15 || n == 15 || m == 15 then UNPREDICTABLE; // ARMv8-A removes UNPREDICTABLE for R13
```

Notes for all encodings

For more information about the `CONSTRAINED UNPREDICTABLE` behavior of this instruction, see [Appendix K1 Architectural Constraints on UNPREDICTABLE behaviors](#).

Assembler symbols

- <c> See [Standard assembler syntax fields on page F2-2848](#).
- <q> See [Standard assembler syntax fields on page F2-2848](#).
- <Rd> Is the general-purpose destination register, encoded in the "Rd" field.
- <Rn> Is the first general-purpose source register, encoded in the "Rn" field.
- <Rm> Is the second general-purpose source register, encoded in the "Rm" field.

Operation for all encodings

```
if ConditionPassed() then
    EncodingSpecificOperations();
sum = UInt(R[n]<15:0>) + UInt(R[m]<31:16>);
diff = UInt(R[n]<31:16>) - UInt(R[m]<15:0>);
```



```
R[d]<15:0> = sum<15:0>;  
R[d]<31:16> = diff<15:0>;  
PSTATE.GE<1:0> = if sum >= 0x10000 then '11' else '00';  
PSTATE.GE<3:2> = if diff >= 0 then '11' else '00';
```

F5.1.284 USUB16

Unsigned Subtract 16 performs two 16-bit unsigned integer subtractions, and writes the results to the destination register. It sets `PSTATE.GE` according to the results of the subtractions.

A1

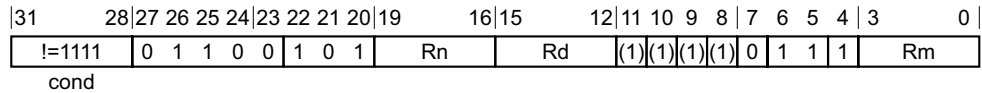

A1 variant

USUB16{<c>}{<q>} {<Rd>}, <Rn>, <Rm>

Decode for this encoding

```
d = UInt(Rd); n = UInt(Rn); m = UInt(Rm);
if d == 15 || n == 15 || m == 15 then UNPREDICTABLE;
```

T1

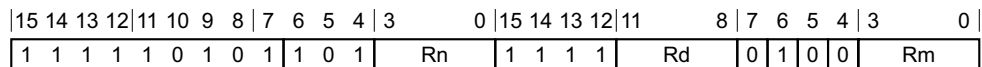

T1 variant

USUB16{<c>}{<q>} {<Rd>}, <Rn>, <Rm>

Decode for this encoding

```
d = UInt(Rd); n = UInt(Rn); m = UInt(Rm);
if d == 15 || n == 15 || m == 15 then UNPREDICTABLE; // ARMv8-A removes UNPREDICTABLE for R13
```

Notes for all encodings

For more information about the CONSTRAINED UNPREDICTABLE behavior of this instruction, see [Appendix K1 Architectural Constraints on UNPREDICTABLE behaviors](#).

Assembler symbols

- <c> See [Standard assembler syntax fields on page F2-2848](#).
- <q> See [Standard assembler syntax fields on page F2-2848](#).
- <Rd> Is the general-purpose destination register, encoded in the "Rd" field.
- <Rn> Is the first general-purpose source register, encoded in the "Rn" field.
- <Rm> Is the second general-purpose source register, encoded in the "Rm" field.

Operation for all encodings

```
if ConditionPassed() then
    EncodingSpecificOperations();
    diff1 = UInt(R[n]<15:0>) - UInt(R[m]<15:0>);
    diff2 = UInt(R[n]<31:16>) - UInt(R[m]<31:16>);
    R[d]<15:0> = diff1<15:0>;
```

```
R[d]<31:16> = diff2<15:0>;  
PSTATE.GE<1:0> = if diff1 >= 0 then '11' else '00';  
PSTATE.GE<3:2> = if diff2 >= 0 then '11' else '00';
```

F5.1.285 USUB8

Unsigned Subtract 8 performs four 8-bit unsigned integer subtractions, and writes the results to the destination register. It sets `PSTATE.GE` according to the results of the subtractions.

A1

31	28	27	26	25	24	23	22	21	20	19	16	15	12	11	10	9	8	7	6	5	4	3	0
!=1111				0	1	1	0	0	1	0	1	Rn	Rd	(1)	(1)	(1)	(1)	1	1	1	1	Rm	
cond																							

A1 variant

USUB8{<c>}{<q>} {<Rd>}, {<Rn>}, <Rm>

Decode for this encoding

```
d = UInt(Rd); n = UInt(Rn); m = UInt(Rm);
if d == 15 || n == 15 || m == 15 then UNPREDICTABLE;
```

T1

15	14	13	12	11	10	9	8	7	6	5	4	3	0	15	14	13	12	11	8	7	6	5	4	3	0
1	1	1	1	1	0	1	0	1	1	0	0	Rn	1	1	1	1	Rd	0	1	0	0	Rm			

T1 variant

USUB8{<c>}{<q>} {<Rd>}, {<Rn>}, <Rm>

Decode for this encoding

```
d = UInt(Rd); n = UInt(Rn); m = UInt(Rm);
if d == 15 || n == 15 || m == 15 then UNPREDICTABLE; // ARMv8-A removes UNPREDICTABLE for R13
```

Notes for all encodings

For more information about the CONSTRAINED UNPREDICTABLE behavior of this instruction, see [Appendix K1 Architectural Constraints on UNPREDICTABLE behaviors](#).

Assembler symbols

- <c> See [Standard assembler syntax fields on page F2-2848](#).
- <q> See [Standard assembler syntax fields on page F2-2848](#).
- <Rd> Is the general-purpose destination register, encoded in the "Rd" field.
- <Rn> Is the first general-purpose source register, encoded in the "Rn" field.
- <Rm> Is the second general-purpose source register, encoded in the "Rm" field.

Operation for all encodings

```
if ConditionPassed() then
    EncodingSpecificOperations();
diff1 = UInt(R[n]<7:0>) - UInt(R[m]<7:0>);
diff2 = UInt(R[n]<15:8>) - UInt(R[m]<15:8>);
diff3 = UInt(R[n]<23:16>) - UInt(R[m]<23:16>);
```

```
diff4 = UInt(R[n]<31:24>) - UInt(R[m]<31:24>);  
R[d]<7:0> = diff1<7:0>;  
R[d]<15:8> = diff2<7:0>;  
R[d]<23:16> = diff3<7:0>;  
R[d]<31:24> = diff4<7:0>;  
PSTATE.GE<0> = if diff1 >= 0 then '1' else '0';  
PSTATE.GE<1> = if diff2 >= 0 then '1' else '0';  
PSTATE.GE<2> = if diff3 >= 0 then '1' else '0';  
PSTATE.GE<3> = if diff4 >= 0 then '1' else '0';
```

F5.1.286 UXTAB

Unsigned Extend and Add Byte extracts an 8-bit value from a register, zero-extends it to 32 bits, adds the result to the value in another register, and writes the final result to the destination register. The instruction can specify a rotation by 0, 8, 16, or 24 bits before extracting the 8-bit value.

A1

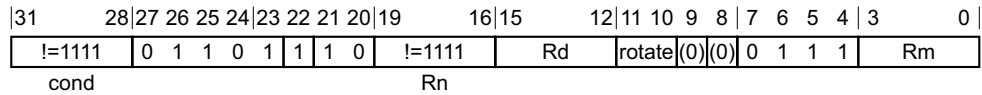

A1 variant

UXTAB{<c>}{<q>} {<Rd>}, <Rn>, <Rm> {, ROR #<amount>}

Decode for this encoding

```
if Rn == '1111' then SEE UXTB;
d = UInt(Rd); n = UInt(Rn); m = UInt(Rm); rotation = UInt(rotate:'000');
if d == 15 || m == 15 then UNPREDICTABLE;
```

T1

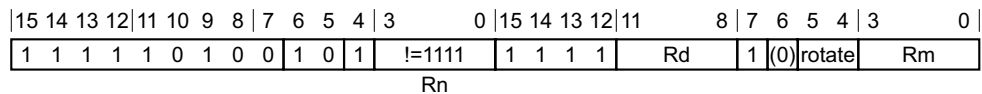

T1 variant

UXTAB{<c>}{<q>} {<Rd>}, <Rn>, <Rm> {, ROR #<amount>}

Decode for this encoding

```
if Rn == '1111' then SEE UXTB;
d = UInt(Rd); n = UInt(Rn); m = UInt(Rm); rotation = UInt(rotate:'000');
if d == 15 || m == 15 then UNPREDICTABLE; // ARMv8-A removes UNPREDICTABLE for R13
```

Notes for all encodings

For more information about the CONSTRAINED UNPREDICTABLE behavior of this instruction, see [Appendix K1 Architectural Constraints on UNPREDICTABLE behaviors](#).

Assembler symbols

- <c> See [Standard assembler syntax fields on page F2-2848](#).
- <q> See [Standard assembler syntax fields on page F2-2848](#).
- <Rd> Is the general-purpose destination register, encoded in the "Rd" field.
- <Rn> Is the first general-purpose source register, encoded in the "Rn" field.
- <Rm> Is the second general-purpose source register, encoded in the "Rm" field.
- <amount> Is the rotate amount, encoded in the "rotate" field. It can have the following values:
 - (omitted) when rotate = 00
 - 8 when rotate = 01

16 when rotate = 10
24 when rotate = 11

Operation for all encodings

```
if ConditionPassed() then
    EncodingSpecificOperations();
    rotated = ROR(R[m], rotation);
    R[d] = R[n] + ZeroExtend(rotated<7:0>, 32);
```

F5.1.287 UXTAB16

Unsigned Extend and Add Byte 16 extracts two 8-bit values from a register, zero-extends them to 16 bits each, adds the results to two 16-bit values from another register, and writes the final results to the destination register. The instruction can specify a rotation by 0, 8, 16, or 24 bits before extracting the 8-bit values.

A1

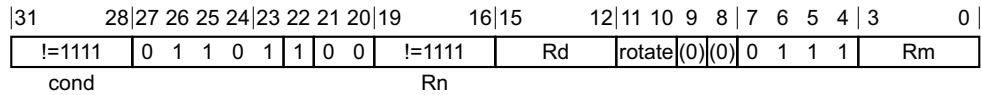

A1 variant

UXTAB16{<c>}{<q>} {<Rd>}, <Rn>, <Rm> {, ROR #<amount>}

Decode for this encoding

```
if Rn == '1111' then SEE UXTB16;
d = UInt(Rd); n = UInt(Rn); m = UInt(Rm); rotation = UInt(rotate:'000');
if d == 15 || m == 15 then UNPREDICTABLE;
```

T1

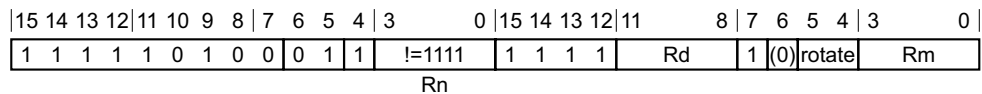

T1 variant

UXTAB16{<c>}{<q>} {<Rd>}, <Rn>, <Rm> {, ROR #<amount>}

Decode for this encoding

```
if Rn == '1111' then SEE UXTB16;
d = UInt(Rd); n = UInt(Rn); m = UInt(Rm); rotation = UInt(rotate:'000');
if d == 15 || m == 15 then UNPREDICTABLE; // ARMv8-A removes UNPREDICTABLE for R13
```

Notes for all encodings

For more information about the CONSTRAINED UNPREDICTABLE behavior of this instruction, see [Appendix K1 Architectural Constraints on UNPREDICTABLE behaviors](#).

Assembler symbols

- <c> See [Standard assembler syntax fields on page F2-2848](#).
- <q> See [Standard assembler syntax fields on page F2-2848](#).
- <Rd> Is the general-purpose destination register, encoded in the "Rd" field.
- <Rn> Is the first general-purpose source register, encoded in the "Rn" field.
- <Rm> Is the second general-purpose source register, encoded in the "Rm" field.
- <amount> Is the rotate amount, encoded in the "rotate" field. It can have the following values:
 - (omitted) when rotate = 00
 - 8 when rotate = 01

16 when rotate = 10
24 when rotate = 11

Operation for all encodings

```
if ConditionPassed() then
    EncodingSpecificOperations();
    rotated = ROR(R[m], rotation);
    R[d]<15:0> = R[n]<15:0> + ZeroExtend(rotated<7:0>, 16);
    R[d]<31:16> = R[n]<31:16> + ZeroExtend(rotated<23:16>, 16);
```

F5.1.288 UXTAH

Unsigned Extend and Add Halfword extracts a 16-bit value from a register, zero-extends it to 32 bits, adds the result to a value from another register, and writes the final result to the destination register. The instruction can specify a rotation by 0, 8, 16, or 24 bits before extracting the 16-bit value.

A1

31	28	27	26	25	24	23	22	21	20	19	16	15	12	11	10	9	8	7	6	5	4	3	0	
!=1111				0	1	1	0	1	1	1	1	!=1111		Rd		rotate(0)(0)		0	1	1	1	Rm		
cond											Rn													

A1 variant

UXTAH{<c>}{<q>} {<Rd>}, <Rn>, <Rm> {, ROR #<amount>}

Decode for this encoding

```
if Rn == '1111' then SEE UXTH;
d = UInt(Rd); n = UInt(Rn); m = UInt(Rm); rotation = UInt(rotate:'000');
if d == 15 || m == 15 then UNPREDICTABLE;
```

T1

15	14	13	12	11	10	9	8	7	6	5	4	3	0	15	14	13	12	11	8	7	6	5	4	3	0
1	1	1	1	1	0	1	0	0	0	0	1	!=1111		1 1 1 1		Rd		1 (0) rotate		Rm					
Rn																									

T1 variant

UXTAH{<c>}{<q>} {<Rd>}, <Rn>, <Rm> {, ROR #<amount>}

Decode for this encoding

```
if Rn == '1111' then SEE UXTH;
d = UInt(Rd); n = UInt(Rn); m = UInt(Rm); rotation = UInt(rotate:'000');
if d == 15 || m == 15 then UNPREDICTABLE; // ARMv8-A removes UNPREDICTABLE for R13
```

Notes for all encodings

For more information about the CONSTRAINED UNPREDICTABLE behavior of this instruction, see [Appendix K1 Architectural Constraints on UNPREDICTABLE behaviors](#).

Assembler symbols

<c>	See Standard assembler syntax fields on page F2-2848 .
<q>	See Standard assembler syntax fields on page F2-2848 .
<Rd>	Is the general-purpose destination register, encoded in the "Rd" field.
<Rn>	Is the first general-purpose source register, encoded in the "Rn" field.
<Rm>	Is the second general-purpose source register, encoded in the "Rm" field.
<amount>	Is the rotate amount, encoded in the "rotate" field. It can have the following values: (omitted) when rotate = 00 8 when rotate = 01

16 when rotate = 10
24 when rotate = 11

Operation for all encodings

```
if ConditionPassed() then
    EncodingSpecificOperations();
    rotated = ROR(R[m], rotation);
    R[d] = R[n] + ZeroExtend(rotated<15:0>, 32);
```

F5.1.289 UXTB

Unsigned Extend Byte extracts an 8-bit value from a register, zero-extends it to 32 bits, and writes the result to the destination register. The instruction can specify a rotation by 0, 8, 16, or 24 bits before extracting the 8-bit value.

A1

31	28	27	26	25	24	23	22	21	20	19	18	17	16	15	12	11	10	9	8	7	6	5	4	3	0
!=1111				0	1	1	0	1	1	1	0	1	1	1	1	Rd	rotate	(0)	(0)	0	1	1	1	Rm	
cond																									

A1 variant

UXTB{<c>}{<q>} {<Rd>,<Rm> {, ROR #<amount>}

Decode for this encoding

d = UInt(Rd); m = UInt(Rm); rotation = UInt(rotate:'000');
 if d == 15 || m == 15 then UNPREDICTABLE;

T1

15	14	13	12	11	10	9	8	7	6	5	3	2	0
1	0	1	1	0	0	1	0	1	1	Rm	Rd		

T1 variant

UXTB{<c>}{<q>} {<Rd>,<Rm>}

Decode for this encoding

d = UInt(Rd); m = UInt(Rm); rotation = 0;

T2

15	14	13	12	11	10	9	8	7	6	5	4	3	2	1	0	15	14	13	12	11	8	7	6	5	4	3	0
1	1	1	1	1	0	1	0	0	1	0	1	1	1	1	1	Rd	1	(0)	rotate	Rm							

T2 variant

UXTB{<c>}.W {<Rd>,<Rm> // <Rd>,<Rm> can be represented in T1
 UXTB{<c>}{<q>} {<Rd>,<Rm> {, ROR #<amount>}

Decode for this encoding

d = UInt(Rd); m = UInt(Rm); rotation = UInt(rotate:'000');
 if d == 15 || m == 15 then UNPREDICTABLE; // ARMv8-A removes UNPREDICTABLE for R13

Notes for all encodings

For more information about the CONSTRAINED UNPREDICTABLE behavior of this instruction, see [Appendix K1 Architectural Constraints on UNPREDICTABLE behaviors](#).

Assembler symbols

<c>	See Standard assembler syntax fields on page F2-2848 .
<q>	See Standard assembler syntax fields on page F2-2848 .
<Rd>	Is the general-purpose destination register, encoded in the "Rd" field.
<Rm>	Is the general-purpose source register, encoded in the "Rm" field.
<amount>	Is the rotate amount, encoded in the "rotate" field. It can have the following values: (omitted) when rotate = 00 8 when rotate = 01 16 when rotate = 10 24 when rotate = 11

Operation for all encodings

```
if ConditionPassed() then
    EncodingSpecificOperations();
    rotated = ROR(R[m], rotation);
    R[d] = ZeroExtend(rotated<7:0>, 32);
```

F5.1.290 UXTB16

Unsigned Extend Byte 16 extracts two 8-bit values from a register, zero-extends them to 16 bits each, and writes the results to the destination register. The instruction can specify a rotation by 0, 8, 16, or 24 bits before extracting the 8-bit values.

A1

31	28	27	26	25	24	23	22	21	20	19	18	17	16	15	12	11	10	9	8	7	6	5	4	3	0		
!=1111				0	1	1	0	1	1	0	0	1	1	1	1	Rd	rotate	(0)	(0)	0	1	1	1	Rm			
cond																											

A1 variant

UXTB16{<c>}{<q>} {<Rd>}, {<Rm>} {, ROR #<amount>}

Decode for this encoding

d = UInt(Rd); m = UInt(Rm); rotation = UInt(rotate:'000');
 if d == 15 || m == 15 then UNPREDICTABLE;

T1

15	14	13	12	11	10	9	8	7	6	5	4	3	2	1	0	15	14	13	12	11	8	7	6	5	4	3	0
1	1	1	1	1	0	1	0	0	0	1	1	1	1	1	1	Rd	1	(0)	rotate	Rm							

T1 variant

UXTB16{<c>}{<q>} {<Rd>}, {<Rm>} {, ROR #<amount>}

Decode for this encoding

d = UInt(Rd); m = UInt(Rm); rotation = UInt(rotate:'000');
 if d == 15 || m == 15 then UNPREDICTABLE; // ARMv8-A removes UNPREDICTABLE for R13

Notes for all encodings

For more information about the CONSTRAINED UNPREDICTABLE behavior of this instruction, see [Appendix K1 Architectural Constraints on UNPREDICTABLE behaviors](#).

Assembler symbols

- <c> See [Standard assembler syntax fields on page F2-2848](#).
- <q> See [Standard assembler syntax fields on page F2-2848](#).
- <Rd> Is the general-purpose destination register, encoded in the "Rd" field.
- <Rm> For encoding A1: is the general-purpose source register, encoded in the "Rm" field.
 For encoding T1: is the second general-purpose source register, encoded in the "Rm" field.
- <amount> Is the rotate amount, encoded in the "rotate" field. It can have the following values:
 - (omitted) when rotate = 00
 - 8 when rotate = 01
 - 16 when rotate = 10
 - 24 when rotate = 11

Operation for all encodings

```
if ConditionPassed() then
    EncodingSpecificOperations();
    rotated = ROR(R[m], rotation);
    R[d]<15:0> = ZeroExtend(rotated<7:0>, 16);
    R[d]<31:16> = ZeroExtend(rotated<23:16>, 16);
```

F5.1.291 UXTH

Unsigned Extend Halfword extracts a 16-bit value from a register, zero-extends it to 32 bits, and writes the result to the destination register. The instruction can specify a rotation by 0, 8, 16, or 24 bits before extracting the 16-bit value.

A1

31	28	27	26	25	24	23	22	21	20	19	18	17	16	15	12	11	10	9	8	7	6	5	4	3	0		
!=1111				0	1	1	0	1	1	1	1	1	1	1	Rd	rotate	(0)	(0)	0	1	1	1	Rm				
cond																											

A1 variant

UXTH{<c>}{<q>} {<Rd>}, <Rm> {, ROR #<amount>}

Decode for this encoding

d = UInt(Rd); m = UInt(Rm); rotation = UInt(rotate:'000');
 if d == 15 || m == 15 then UNPREDICTABLE;

T1

15	14	13	12	11	10	9	8	7	6	5	3	2	0
1	0	1	1	0	0	1	0	1	0	Rm	Rd		

T1 variant

UXTH{<c>}{<q>} {<Rd>}, <Rm>

Decode for this encoding

d = UInt(Rd); m = UInt(Rm); rotation = 0;

T2

15	14	13	12	11	10	9	8	7	6	5	4	3	2	1	0	15	14	13	12	11	8	7	6	5	4	3	0
1	1	1	1	1	0	1	0	0	0	0	1	1	1	1	1	1	1	1	1	Rd	1	(0)	rotate	Rm			

T2 variant

UXTH{<c>}.W {<Rd>}, <Rm> // <Rd>, <Rm> can be represented in T1
 UXTH{<c>}{<q>} {<Rd>}, <Rm> {, ROR #<amount>}

Decode for this encoding

d = UInt(Rd); m = UInt(Rm); rotation = UInt(rotate:'000');
 if d == 15 || m == 15 then UNPREDICTABLE; // ARMv8-A removes UNPREDICTABLE for R13

Notes for all encodings

For more information about the CONSTRAINED UNPREDICTABLE behavior of this instruction, see [Appendix K1 Architectural Constraints on UNPREDICTABLE behaviors](#).

Assembler symbols

<c>	See Standard assembler syntax fields on page F2-2848 .
<q>	See Standard assembler syntax fields on page F2-2848 .
<Rd>	Is the general-purpose destination register, encoded in the "Rd" field.
<Rm>	Is the general-purpose source register, encoded in the "Rm" field.
<amount>	Is the rotate amount, encoded in the "rotate" field. It can have the following values: (omitted) when rotate = 00 8 when rotate = 01 16 when rotate = 10 24 when rotate = 11

Operation for all encodings

```
if ConditionPassed() then
    EncodingSpecificOperations();
    rotated = ROR(R[m], rotation);
    R[d] = ZeroExtend(rotated<15:0>, 32);
```

F5.1.292 WFE

Wait For Event is a hint instruction that indicates that the PE can enter a low-power state and remain there until a wakeup event occurs. Wakeup events include the event signaled as a result of executing the SEV instruction on any PE in the multiprocessor system. For more information, see [Wait For Event and Send Event on page G1-4403](#).

As described in [Wait For Event and Send Event on page G1-4403](#), the execution of a WFE instruction that would otherwise cause entry to a low-power state can be trapped to a higher Exception level, see:

- [Traps to Undefined mode of EL0 execution of WFE and WFI instructions on page G1-4421](#).
- [Traps to Hyp mode of Non-secure EL0 and EL1 execution of WFE and WFI instructions on page G1-4437](#).
- [Traps to Monitor mode of the execution of WFE and WFI instructions in modes other than Monitor mode on page G1-4447](#).

A1

31	28	27	26	25	24	23	22	21	20	19	18	17	16	15	14	13	12	11	10	9	8	7	6	5	4	3	2	1	0		
!	=	1	1	1	1	0	0	1	0	0	0	0	0	(1)	(1)	(1)	(1)	(0)	(0)	(0)	(0)	0	0	0	0	0	0	1	0		
cond																															

A1 variant

WFE{<c>}{<q>}

Decode for this encoding

// No additional decoding required

T1

15	14	13	12	11	10	9	8	7	6	5	4	3	2	1	0
1	0	1	1	1	1	1	1	0	0	1	0	0	0	0	0

T1 variant

WFE{<c>}{<q>}

Decode for this encoding

// No additional decoding required

T2

15	14	13	12	11	10	9	8	7	6	5	4	3	2	1	0	15	14	13	12	11	10	9	8	7	6	5	4	3	2	1	0
1	1	1	1	0	0	1	1	1	0	1	0	(1)	(1)	(1)	(1)	1	0	(0)	0	(0)	0	0	0	0	0	0	0	0	0	1	0

T2 variant

WFE{<c>}.W

Decode for this encoding

// No additional decoding required

Notes for all encodings

For more information about the CONSTRAINED UNPREDICTABLE behavior of this instruction, see [Appendix K1 Architectural Constraints on UNPREDICTABLE behaviors](#).

Assembler symbols

<c> See [Standard assembler syntax fields](#) on page F2-2848.

<q> See [Standard assembler syntax fields](#) on page F2-2848.

Operation for all encodings

```
if ConditionPassed() then
    EncodingSpecificOperations();
    if IsEventRegisterSet() then
        ClearEventRegister();
    else
        if PSTATE.EL == EL0 then
            // Check for traps described by the OS which may be EL1 or EL2.
            AArch32.CheckForWfxTrap(EL1, TRUE);
        if HaveEL(EL2) && !IsSecure() && PSTATE.EL IN {EL0,EL1} && !IsInHost() then
            // Check for traps described by the Hypervisor.
            AArch32.CheckForWfxTrap(EL2, TRUE);
        if HaveEL(EL3) && PSTATE.M != M32_Monitor then
            // Check for traps described by the Secure Monitor.
            AArch32.CheckForWfxTrap(EL3, TRUE);
        WaitForEvent();
```

F5.1.293 WFI

Wait For Interrupt is a hint instruction that indicates that the PE can enter a low-power state and remain there until a wakeup event occurs. For more information, see *Wait For Interrupt* on page G1-4406.

As described in *Wait For Interrupt* on page G1-4406, the execution of a WFI instruction that would otherwise cause entry to a low-power state can be trapped to a higher Exception level, see:

- *Traps to Undefined mode of EL0 execution of WFE and WFI instructions* on page G1-4421.
- *Traps to Hyp mode of Non-secure EL0 and EL1 execution of WFE and WFI instructions* on page G1-4437.
- *Traps to Monitor mode of the execution of WFE and WFI instructions in modes other than Monitor mode* on page G1-4447.

A1

31	28	27	26	25	24	23	22	21	20	19	18	17	16	15	14	13	12	11	10	9	8	7	6	5	4	3	2	1	0		
!=1111				0	0	1	1	0	0	1	0	0	0	0	0	(1)	(1)	(1)	(1)	(0)	(0)	(0)	(0)	0	0	0	0	0	0	1	1
cond																															

A1 variant

WFI{<c>}{<q>}

Decode for this encoding

// No additional decoding required

T1

15	14	13	12	11	10	9	8	7	6	5	4	3	2	1	0
1	0	1	1	1	1	1	1	0	0	1	1	0	0	0	0

T1 variant

WFI{<c>}{<q>}

Decode for this encoding

// No additional decoding required

T2

15	14	13	12	11	10	9	8	7	6	5	4	3	2	1	0	15	14	13	12	11	10	9	8	7	6	5	4	3	2	1	0
1	1	1	1	0	0	1	1	1	0	1	0	(1)	(1)	(1)	(1)	1	0	(0)	0	(0)	0	0	0	0	0	0	0	0	0	1	1

T2 variant

WFI{<c>}.W

Decode for this encoding

// No additional decoding required

Notes for all encodings

For more information about the CONSTRAINED UNPREDICTABLE behavior of this instruction, see [Appendix K1 Architectural Constraints on UNPREDICTABLE behaviors](#).

Assembler symbols

<c> See [Standard assembler syntax fields on page F2-2848](#).

<q> See [Standard assembler syntax fields on page F2-2848](#).

Operation for all encodings

```
if ConditionPassed() then
    EncodingSpecificOperations();
if !InterruptPending() then
    if PSTATE.EL == EL0 then
        // Check for traps described by the OS which may be EL1 or EL2.
        AArch32.CheckForWfxTrap(EL1, FALSE);
    if HaveEL(EL2) && !IsSecure() && PSTATE.EL IN {EL0,EL1} && !IsInHost() then
        // Check for traps described by the Hypervisor.
        AArch32.CheckForWfxTrap(EL2, FALSE);
    if HaveEL(EL3) && PSTATE.M != M32_Monitor then
        // Check for traps described by the Secure Monitor.
        AArch32.CheckForWfxTrap(EL3, FALSE);
    WaitForInterrupt();
```

F5.1.294 YIELD

YIELD is a hint instruction. Software with a multithreading capability can use a YIELD instruction to indicate to the PE that it is performing a task, for example a spin-lock, that could be swapped out to improve overall system performance. The PE can use this hint to suspend and resume multiple software threads if it supports the capability.

For more information about the recommended use of this instruction see [The Yield instruction on page F1-2825](#).

A1

31	28	27	26	25	24	23	22	21	20	19	18	17	16	15	14	13	12	11	10	9	8	7	6	5	4	3	2	1	0		
!=1111	0	0	1	1	0	0	1	0	0	0	0	0	(1)	(1)	(1)	(1)	(0)	(0)	(0)	(0)	0	0	0	0	0	0	0	0	1		
cond																															

A1 variant

YIELD{<c>}{<q>}

Decode for this encoding

// No additional decoding required

T1

15	14	13	12	11	10	9	8	7	6	5	4	3	2	1	0
1	0	1	1	1	1	1	1	0	0	0	1	0	0	0	0

T1 variant

YIELD{<c>}{<q>}

Decode for this encoding

// No additional decoding required

T2

15	14	13	12	11	10	9	8	7	6	5	4	3	2	1	0	15	14	13	12	11	10	9	8	7	6	5	4	3	2	1	0
1	1	1	1	0	0	1	1	1	0	1	0	(1)	(1)	(1)	(1)	1	0	(0)	0	(0)	0	0	0	0	0	0	0	0	0	0	1

T2 variant

YIELD{<c>}.W

Decode for this encoding

// No additional decoding required

Notes for all encodings

For more information about the CONSTRAINED UNPREDICTABLE behavior of this instruction, see [Appendix K1 Architectural Constraints on UNPREDICTABLE behaviors](#).

Assembler symbols

- <c> See [Standard assembler syntax fields on page F2-2848](#).
- <q> See [Standard assembler syntax fields on page F2-2848](#).

Operation for all encodings

```
if ConditionPassed() then
    EncodingSpecificOperations();
    Hint_Yield();
```

F5.2 Encoding and use of Banked register transfer instructions

Software executing at EL1 or higher can use the MRS (Banked register) and MSR (Banked register) instructions to transfer values between the general-purpose registers and Special-purpose registers. One particular use of these instructions is for a hypervisor to save or restore the register values of a Guest OS. The following sections give more information about these instructions:

- [Register arguments in the Banked register transfer instructions.](#)
- [Usage restrictions on the Banked register transfer instructions on page F5-3675.](#)
- [Encoding the register argument in the Banked register transfer instructions on page F5-3676.](#)
- [Pseudocode support for the Banked register transfer instructions on page F5-3677.](#)

For descriptions of the instructions see [MRS \(Banked register\) on page F5-3277](#) and [MSR \(Banked register\) on page F5-3281](#).

F5.2.1 Register arguments in the Banked register transfer instructions

Figure F5-1 shows the Banked general-purpose registers and Special-purpose registers:

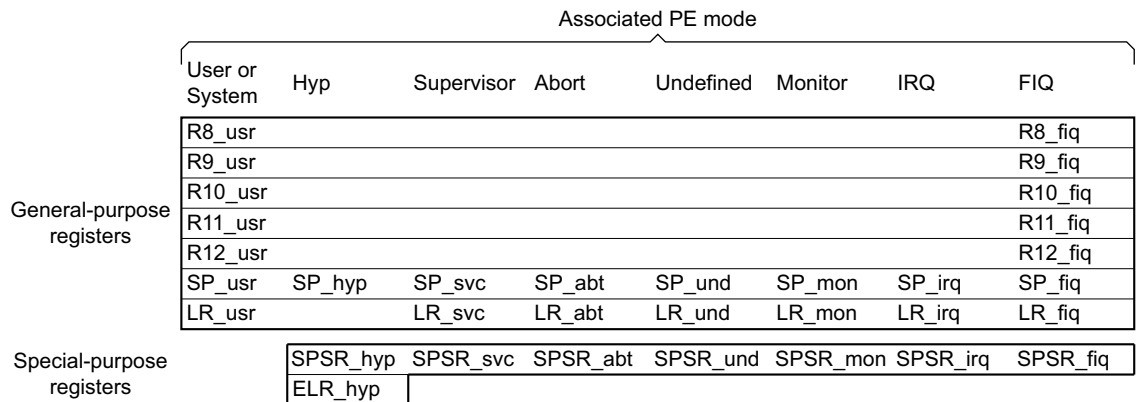

For the general-purpose registers, if no other register is shown, the *current mode register* is the `_usr` register. So, for example, the full set of current mode registers, including the registers that are not banked:

- For Hyp mode, is {R0_usr - R12_usr, SP_hyp, LR_usr, SPSR_hyp, ELR_hyp}.
- For Abort mode, is {R0_usr - R12_usr, SP_abt, LR_abt, SPSR_abt}.

Figure F5-1 Banking of general-purpose and Special-purpose registers

Figure F5-1 is based on Figure G1-2 on page G1-4325, that shows the complete set of general-purpose registers and Special-purpose registers accessible in each mode.

Note

- System mode uses the same set of registers as User mode. Neither of these modes can access an SPSR, except that System mode can use the MRS (Banked register) and MSR (Banked register) instructions to access some SPSRs, as described in [Usage restrictions on the Banked register transfer instructions on page F5-3675](#).
- General-purpose registers R0-R7, that are not Banked, cannot be accessed using the MRS (Banked register) and MSR (Banked register) instructions.
- In addition to the registers shown in Figure F5-1, the DLR and DSPSR are AArch32 System registers that map onto the AArch64 Special-purpose registers DLR_EL0 and DSPSR_EL0. However, DLR and DSPSR are not accessible using the MRS (Banked register) and MSR (Banked register) instructions.

Software using an MRS (Banked register) or MSR (Banked register) instruction specifies one of these registers using a name shown in Figure F5-1, or an alternative name for SP or LR. These registers can be grouped as follows:

R8-R12 Each of these registers has two Banked copies, `_usr` and `_fiq`, for example R8_usr and R8_fiq.

SP	There is a Banked copy of SP for every mode except System mode. For example, SP_svc is the SP for Supervisor mode.
LR	There is a Banked copy of LR for every mode except System mode and Hyp mode. For example, LR_svc is the LR for Supervisor mode.
SPSR	There is a Banked copy of SPSR for every mode except System mode and User mode.
ELR_hyp	Except for the operations provided by MRS (Banked register) and MSR (Banked register), ELR_hyp is accessible only from Hyp mode. It is not Banked.

F5.2.2 Usage restrictions on the Banked register transfer instructions

MRS (Banked register) and MSR (Banked register) instructions are **CONSTRAINED UNPREDICTABLE** if any of the following applies:

- The instruction is executed in User mode.
- The instruction accesses a Banked register that is not implemented, or that either:
 - Is not accessible from the current Privilege level and Security state.
 - Can be accessed from the current mode by using a different instruction.

[MSR/MRS Banked registers on page K1-6117](#) describes the permitted **CONSTRAINED UNPREDICTABLE** behavior.

An MRS (Banked register) or an MSR (Banked register) executed:

- At Non-secure EL1 cannot access any Hyp mode Banked registers.
- At Non-secure EL1 or EL2 cannot access any Monitor mode Banked registers.
- In a Secure mode other than Monitor mode cannot access any Hyp Banked registers.

This means that the Banked registers that MRS (Banked register) and MSR (Banked register) instructions cannot access are:

From Monitor mode

- The current mode registers R8_usr-R12_usr, SP_mon, LR_mon, and SPSR_mon.

From Hyp mode

- The Monitor mode registers SP_mon, LR_mon, and SPSR_mon.
- The current mode registers R8_usr-R12_usr, SP_hyp, LR_usr, and SPSR_hyp.

———— Note —————

MRS (Banked register) and MSR (Banked register) instructions can access the current mode register [ELR_hyp](#).

From FIQ mode

- From Non-secure EL1, the Monitor mode registers SP_mon, LR_mon, and SPSR_mon.
- The Hyp mode registers SP_hyp, SPSR_hyp, and [ELR_hyp](#).
- The current mode registers R8_fiq-R12_fiq, SP_fiq, LR_fiq, and SPSR_fiq.

From System mode

- From Non-secure EL1, the Monitor mode registers SP_mon, LR_mon, and SPSR_mon.
- The Hyp mode registers SP_hyp, SPSR_hyp, and [ELR_hyp](#).
- The current mode registers R8_usr-R12_usr, SP_usr, and LR_usr.

From Supervisor mode, Abort mode, Undefined mode, and IRQ mode

- From Non-secure EL1, the Monitor mode registers SP_mon, LR_mon, and SPSR_mon.
- The Hyp mode registers SP_hyp, SPSR_hyp, and [ELR_hyp](#).
- The current mode registers R8_usr-R12_usr, SP_<current_mode>, LR_<current_mode>, and SPSR_<current_mode>.

If EL3 is using AArch64, all MRS (Banked register) and MSR (Banked register) accesses to the Monitor mode registers from Secure EL1 modes are trapped to EL3. See *Traps to EL3 of Secure monitor functionality from Secure EL1 using AArch32* on page D1-1870.

For more information, see:

- [Encoding the register argument in the Banked register transfer instructions.](#)
- [Pseudocode support for the Banked register transfer instructions](#) on page F5-3677.
- [MRS \(Banked register\)](#) on page F5-3277.
- [MSR \(Banked register\)](#) on page F5-3281.

———— **Note** —————

CONSTRAINED UNPREDICTABLE behavior must not give access to registers that are not accessible from the current Privilege level and Security state.

F5.2.3 Encoding the register argument in the Banked register transfer instructions

The MRS (Banked register) and MSR (Banked register) instructions include a 5-bit field, SYSm, and an R bit, that together encode the register argument for the instruction.

When the R bit is set to 0, the argument is a register other than a Banked copy of the SPSR, and [Table F5-1](#) shows how the SYSm field defines the required register argument. In this table, CONST. UNPREDICTABLE indicates that behavior is CONSTRAINED UNPREDICTABLE.

Table F5-1 Banked register encodings when R==0

SYSm<2:0>	SYSm<4:3>			
	0b00	0b01	0b10	0b11
0b000	R8_usr	R8_fiq	LR_irq	CONST. UNPREDICTABLE
0b001	R9_usr	R9_fiq	SP_irq	CONST. UNPREDICTABLE
0b010	R10_usr	R10_fiq	LR_svc	CONST. UNPREDICTABLE
0b011	R11_usr	R11_fiq	SP_svc	CONST. UNPREDICTABLE
0b100	R12_usr	R12_fiq	LR_abt	LR_mon
0b101	SP_usr	SP_fiq	SP_abt	SP_mon
0b110	LR_usr	LR_fiq	LR_und	ELR_hyp
0b111	CONST. UNPREDICTABLE	CONST. UNPREDICTABLE	SP_und	SP_hyp

When the R bit is set to 1, the argument is a Banked copy of the SPSR, and [Table F5-2](#) shows how the SYSm field defines the required register argument. In this table, CONST. UNPREDICTABLE indicates that behavior is CONSTRAINED UNPREDICTABLE.

Table F5-2 Banked register encodings when R==1

SYSm<2:0>	SYSm<4:3>			
	0b00	0b01	0b10	0b11
0b000	CONST. UNPREDICTABLE	CONST. UNPREDICTABLE	SPSR_irq	CONST. UNPREDICTABLE
0b001	CONST. UNPREDICTABLE	CONST. UNPREDICTABLE	CONST. UNPREDICTABLE	CONST. UNPREDICTABLE
0b010	CONST. UNPREDICTABLE	CONST. UNPREDICTABLE	SPSR_svc	CONST. UNPREDICTABLE

Table F5-2 Banked register encodings when R==1 (continued)

SYSm<2:0>	SYSm<4:3>			
	0b00	0b01	0b10	0b11
0b011	CONST. UNPREDICTABLE	CONST. UNPREDICTABLE	CONST. UNPREDICTABLE	CONST. UNPREDICTABLE
0b100	CONST. UNPREDICTABLE	CONST. UNPREDICTABLE	SPSR_abt	SPSR_mon
0b101	CONST. UNPREDICTABLE	CONST. UNPREDICTABLE	CONST. UNPREDICTABLE	CONST. UNPREDICTABLE
0b110	CONST. UNPREDICTABLE	SPSR_fiq	SPSR_und	SPSR_hyp
0b111	CONST. UNPREDICTABLE	CONST. UNPREDICTABLE	CONST. UNPREDICTABLE	CONST. UNPREDICTABLE

F5.2.4 Pseudocode support for the Banked register transfer instructions

The pseudocode functions `BankedRegisterAccessValid()` and `SPSRAccessValid()` check the validity of MRS (Banked register) and MSR (Banked register) accesses. That is, they filter the accesses that are CONSTRAINED UNPREDICTABLE either because:

- They attempt to access a register that *Usage restrictions on the Banked register transfer instructions on page F5-3675* shows is not accessible.
- They use an SYSm<4:0> encoding that *Encoding the register argument in the Banked register transfer instructions on page F5-3676* shows as CONSTRAINED UNPREDICTABLE.

`BankedRegisterAccessValid()` applies to accesses to the banked general-purpose registers, or to `ELR_hyp`, and `SPSRAccessValid()` applies to accesses to the `SPSRs`.

Chapter F6

T32 and A32 Advanced SIMD and floating-point Instruction Descriptions

This chapter describes each instruction. It contains the following sections:

- [Alphabetical list of floating-point and Advanced SIMD instructions on page F6-3680.](#)

———— **Note** —————

Some headings in this chapter use the term *floating-point register*. This is an abbreviated description, and means a register in the Advanced SIMD and floating-point register file.

F6.1 Alphabetical list of floating-point and Advanced SIMD instructions

This section lists every floating-point and Advanced SIMD instruction in the T32 and A32 instruction sets. For details of the format used see [Format of instruction descriptions on page F2-2844](#).

This section is formatted so that each instruction description starts on a new page.

F6.1.1 AESD

AES single round decryption.

A1

31	30	29	28	27	26	25	24	23	22	21	20	19	18	17	16	15	12	11	10	9	8	7	6	5	4	3	0
1	1	1	1	0	0	1	1	1	D	1	1	size	0	0	Vd	0	0	1	1	0	1	M	0	Vm			

A1 variant

AESD.<dt> <Qd>, <Qm>

Decode for this encoding

```
if ! HaveCryptoExt() then UNDEFINED;
if size != '00' then UNDEFINED;
if Vd<0> == '1' || Vm<0> == '1' then UNDEFINED;
d = UInt(D:Vd); m = UInt(M:Vm);
```

T1

15	14	13	12	11	10	9	8	7	6	5	4	3	2	1	0	15	12	11	10	9	8	7	6	5	4	3	0
1	1	1	1	1	1	1	1	1	D	1	1	size	0	0	Vd	0	0	1	1	0	1	M	0	Vm			

T1 variant

AESD.<dt> <Qd>, <Qm>

Decode for this encoding

```
if ! HaveCryptoExt() then UNDEFINED;
if size != '00' then UNDEFINED;
if Vd<0> == '1' || Vm<0> == '1' then UNDEFINED;
d = UInt(D:Vd); m = UInt(M:Vm);
if InITBlock() then UNPREDICTABLE;
```

Notes for all encodings

For more information about the CONSTRAINED UNPREDICTABLE behavior of this instruction, see [Appendix K1 Architectural Constraints on UNPREDICTABLE behaviors](#).

Assembler symbols

<dt> Is the data type, encoded in the "size" field. It can have the following values:

8 when size = 00

The following encodings are reserved:

- size = 01.
- size = 1x.

<Qd> Is the 128-bit name of the SIMD&FP destination register, encoded in the "D:Vd" field as <Qd>*2.

<Qm> Is the 128-bit name of the SIMD&FP source register, encoded in the "M:Vm" field as <Qm>*2.

Operation for all encodings

```
if ConditionPassed() then
    EncodingSpecificOperations(); CheckCryptoEnabled32();
    op1 = Q[d>>1]; op2 = Q[m>>1];
    Q[d>>1] = AESInvSubBytes(AESInvShiftRows(op1 EOR op2));
```

F6.1.2 AESE

AES single round encryption.

A1

31	30	29	28	27	26	25	24	23	22	21	20	19	18	17	16	15	12	11	10	9	8	7	6	5	4	3	0
1	1	1	1	0	0	1	1	1	D	1	1	size	0	0	Vd	0	0	1	1	0	0	M	0	Vm			

A1 variant

AESE.<dt> <Qd>, <Qm>

Decode for this encoding

```
if ! HaveCryptoExt() then UNDEFINED;
if size != '00' then UNDEFINED;
if Vd<0> == '1' || Vm<0> == '1' then UNDEFINED;
d = UInt(D:Vd); m = UInt(M:Vm);
```

T1

15	14	13	12	11	10	9	8	7	6	5	4	3	2	1	0	15	12	11	10	9	8	7	6	5	4	3	0
1	1	1	1	1	1	1	1	1	D	1	1	size	0	0	Vd	0	0	1	1	0	0	M	0	Vm			

T1 variant

AESE.<dt> <Qd>, <Qm>

Decode for this encoding

```
if ! HaveCryptoExt() then UNDEFINED;
if size != '00' then UNDEFINED;
if Vd<0> == '1' || Vm<0> == '1' then UNDEFINED;
d = UInt(D:Vd); m = UInt(M:Vm);
if InITBlock() then UNPREDICTABLE;
```

Notes for all encodings

For more information about the CONSTRAINED UNPREDICTABLE behavior of this instruction, see [Appendix K1 Architectural Constraints on UNPREDICTABLE behaviors](#).

Assembler symbols

<dt> Is the data type, encoded in the "size" field. It can have the following values:

8 when size = 00

The following encodings are reserved:

- size = 01.
- size = 1x.

<Qd> Is the 128-bit name of the SIMD&FP destination register, encoded in the "D:Vd" field as <Qd>*2.

<Qm> Is the 128-bit name of the SIMD&FP source register, encoded in the "M:Vm" field as <Qm>*2.

Operation for all encodings

```
if ConditionPassed() then
    EncodingSpecificOperations(); CheckCryptoEnabled32();
    op1 = Q[d>>1]; op2 = Q[m>>1];
    Q[d>>1] = AESSubBytes(AESShiftRows(op1 EOR op2));
```

F6.1.3 AESIMC

AES inverse mix columns.

A1

31	30	29	28	27	26	25	24	23	22	21	20	19	18	17	16	15	12	11	10	9	8	7	6	5	4	3	0
1	1	1	1	0	0	1	1	1	D	1	1	size	0	0	Vd	0	0	1	1	1	1	M	0	Vm			

A1 variant

AESIMC.<dt> <Qd>, <Qm>

Decode for this encoding

```
if ! HaveCryptoExt() then UNDEFINED;
if size != '00' then UNDEFINED;
if Vd<0> == '1' || Vm<0> == '1' then UNDEFINED;
d = UInt(D:Vd); m = UInt(M:Vm);
```

T1

15	14	13	12	11	10	9	8	7	6	5	4	3	2	1	0	15	12	11	10	9	8	7	6	5	4	3	0
1	1	1	1	1	1	1	1	1	D	1	1	size	0	0	Vd	0	0	1	1	1	1	M	0	Vm			

T1 variant

AESIMC.<dt> <Qd>, <Qm>

Decode for this encoding

```
if ! HaveCryptoExt() then UNDEFINED;
if size != '00' then UNDEFINED;
if Vd<0> == '1' || Vm<0> == '1' then UNDEFINED;
d = UInt(D:Vd); m = UInt(M:Vm);
if InITBlock() then UNPREDICTABLE;
```

Assembler symbols

<dt> Is the data type, encoded in the "size" field. It can have the following values:

8 when size = 00

The following encodings are reserved:

- size = 01.
- size = 1x.

<Qd> Is the 128-bit name of the SIMD&FP destination register, encoded in the "D:Vd" field as <Qd>*2.

<Qm> Is the 128-bit name of the SIMD&FP source register, encoded in the "M:Vm" field as <Qm>*2.

Operation for all encodings

```
if ConditionPassed() then
    EncodingSpecificOperations(); CheckCryptoEnabled32();
    Q[d>>1] = AESInvMixColumns(Q[m>>1]);
```

F6.1.4 AESMC

AES mix columns.

A1

31	30	29	28	27	26	25	24	23	22	21	20	19	18	17	16	15	12	11	10	9	8	7	6	5	4	3	0
1	1	1	1	0	0	1	1	1	D	1	1	size	0	0	Vd	0	0	1	1	1	0	M	0	Vm			

A1 variant

AESMC.<dt> <Qd>, <Qm>

Decode for this encoding

```
if ! HaveCryptoExt() then UNDEFINED;
if size != '00' then UNDEFINED;
if Vd<0> == '1' || Vm<0> == '1' then UNDEFINED;
d = UInt(D:Vd); m = UInt(M:Vm);
```

T1

15	14	13	12	11	10	9	8	7	6	5	4	3	2	1	0	15	12	11	10	9	8	7	6	5	4	3	0
1	1	1	1	1	1	1	1	1	D	1	1	size	0	0	Vd	0	0	1	1	1	0	M	0	Vm			

T1 variant

AESMC.<dt> <Qd>, <Qm>

Decode for this encoding

```
if ! HaveCryptoExt() then UNDEFINED;
if size != '00' then UNDEFINED;
if Vd<0> == '1' || Vm<0> == '1' then UNDEFINED;
d = UInt(D:Vd); m = UInt(M:Vm);
if InITBlock() then UNPREDICTABLE;
```

Notes for all encodings

For more information about the CONSTRAINED UNPREDICTABLE behavior of this instruction, see [Appendix K1 Architectural Constraints on UNPREDICTABLE behaviors](#).

Assembler symbols

<dt> Is the data type, encoded in the "size" field. It can have the following values:

8 when size = 00

The following encodings are reserved:

- size = 01.
- size = 1x.

<Qd> Is the 128-bit name of the SIMD&FP destination register, encoded in the "D:Vd" field as <Qd>*2.

<Qm> Is the 128-bit name of the SIMD&FP source register, encoded in the "M:Vm" field as <Qm>*2.

Operation for all encodings

```
if ConditionPassed() then
    EncodingSpecificOperations(); CheckCryptoEnabled32();
    Q[d>>1] = AESMixColumns(Q[m>>1]);
```

F6.1.5 FLDM*X (FLDMDBX, FLDMIAX)

FLDMDBX is the Decrement Before variant of this instruction, and FLDMIAX is the Increment After variant. FLDM*X loads multiple SIMD&FP registers from consecutive locations in the Advanced SIMD and floating-point register file using an address from a general-purpose register.

ARM deprecates use of FLDMDBX and FLDMIAX, except for disassembly purposes, and reassembly of disassembled code.

Depending on settings in the CPACR, NSACR, and HCPTR registers, and the security state and mode in which the instruction is executed, an attempt to execute the instruction might be UNDEFINED, or trapped to Hyp mode. For more information see [Enabling Advanced SIMD and floating-point support on page G1-4413](#).

A1

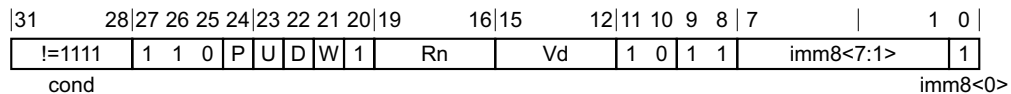

Decrement Before variant

Applies when P == 1 && U == 0 && W == 1.

FLDMDBX{<c>}{<q>} <Rn>!, <dreglist>

Increment After variant

Applies when P == 0 && U == 1.

FLDMIAX{<c>}{<q>} <Rn>{!}, <dreglist>

Decode for all variants of this encoding

```

if P == '0' && U == '0' && W == '0' then SEE "Related encodings";
if P == '1' && W == '0' then SEE VLDR;
if P == U && W == '1' then UNDEFINED;
// Remaining combinations are PUW = 010 (IA without !), 011 (IA with !), 101 (DB with !)
single_regs = FALSE; add = (U == '1'); wback = (W == '1');
d = UInt(D:Vd); n = UInt(Rn); imm32 = ZeroExtend(imm8:'00', 32);
regs = UInt(imm8) DIV 2; // If UInt(imm8) is odd, see "FLDM*X".
if n == 15 && (wback || CurrentInstrSet() != InstrSet_A32) then UNPREDICTABLE;
if regs == 0 || regs > 16 || (d+regs) > 32 then UNPREDICTABLE;
if imm8<0> == '1' && (d+regs) > 16 then UNPREDICTABLE;
    
```

CONSTRAINED UNPREDICTABLE behavior

If regs == 0, then one of the following behaviors must occur:

- The instruction is UNDEFINED.
- The instruction executes as NOP.
- The instruction operates as a VLDM with the same addressing mode but loads no registers.

If regs > 16 || (d+regs) > 16, then one of the following behaviors must occur:

- The instruction is UNDEFINED.
- The instruction executes as NOP.
- One or more of the SIMD and floating-point registers are UNKNOWN. If the instruction specifies writeback, the base register becomes UNKNOWN. This behavior does not affect any general-purpose registers.

T1

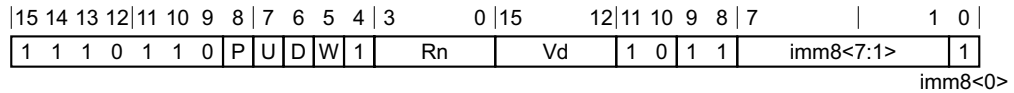

Decrement Before variant

Applies when P == 1 && U == 0 && W == 1.

FLDMDDBX{<c>}{<q>} <Rn>!, <dreglist>

Increment After variant

Applies when P == 0 && U == 1.

FLDMIAX{<c>}{<q>} <Rn>{!}, <dreglist>

Decode for all variants of this encoding

```

if P == '0' && U == '0' && W == '0' then SEE "Related encodings";
if P == '1' && W == '0' then SEE VLDR;
if P == U && W == '1' then UNDEFINED;
// Remaining combinations are PUW = 010 (IA without !), 011 (IA with !), 101 (DB with !)
single_regs = FALSE; add = (U == '1'); wback = (W == '1');
d = UInt(D:Vd); n = UInt(Rn); imm32 = ZeroExtend(imm8:'00', 32);
regs = UInt(imm8) DIV 2; // If UInt(imm8) is odd, see "FLDM*X".
if n == 15 && (wback || CurrentInstrSet() != InstrSet_A32) then UNPREDICTABLE;
if regs == 0 || regs > 16 || (d+regs) > 32 then UNPREDICTABLE;
if imm8<0> == '1' && (d+regs) > 16 then UNPREDICTABLE;
    
```

CONSTRAINED UNPREDICTABLE behavior

If regs == 0, then one of the following behaviors must occur:

- The instruction is UNDEFINED.
- The instruction executes as NOP.
- The instruction operates as a VLDM with the same addressing mode but loads no registers.

If regs > 16 || (d+regs) > 16, then one of the following behaviors must occur:

- The instruction is UNDEFINED.
- The instruction executes as NOP.
- One or more of the SIMD and floating-point registers are UNKNOWN. If the instruction specifies writeback, the base register becomes UNKNOWN. This behavior does not affect any general-purpose registers.

Notes for all encodings

For more information about the CONSTRAINED UNPREDICTABLE behavior of this instruction, see [Appendix K1 Architectural Constraints on UNPREDICTABLE behaviors](#).

Related encodings: See [Advanced SIMD and floating-point 64-bit move on page F3-2894](#) for the T32 instruction set, or [Advanced SIMD and floating-point 64-bit move on page F4-2973](#) for the A32 instruction set.

Assembler symbols

<c> See [Standard assembler syntax fields on page F2-2848](#).

<q> See [Standard assembler syntax fields on page F2-2848](#).

- <Rn> Is the general-purpose base register, encoded in the "Rn" field. If writeback is not specified, the PC can be used.
- ! Specifies base register writeback. Encoded in the "W" field as 1 if present, otherwise 0.
- <dreglist> Is the list of consecutively numbered 64-bit SIMD&FP registers to be transferred. The first register in the list is encoded in "D:Vd", and "imm8" is set to twice the number of registers in the list plus one. The list must contain at least one register, all registers must be in the range D0-D15, and must not contain more than 16 registers.

Operation for all encodings

```
if ConditionPassed() then
    EncodingSpecificOperations(); CheckVFPEnabled(TRUE);
    address = if add then R[n] else R[n]-imm32;
    for r = 0 to regs-1
        if single_regs then
            S[d+r] = MemA[address,4]; address = address+4;
        else
            word1 = MemA[address,4]; word2 = MemA[address+4,4]; address = address+8;
            // Combine the word-aligned words in the correct order for current endianness.
            D[d+r] = if BigEndian() then word1:word2 else word2:word1;
    if wback then R[n] = if add then R[n]+imm32 else R[n]-imm32;
```



F6.1.6 FSTMDBX, FSTMIAX

FSTMX stores multiple SIMD&FP registers from the Advanced SIMD and floating-point register file to consecutive locations in using an address from a general-purpose register.

ARM deprecates use of FLDMDBX and FLDMIAX, except for disassembly purposes, and reassembly of disassembled code.

Depending on settings in the CPACR, NSACR, HCPTR, and FPEXC registers, and the security state and mode in which the instruction is executed, an attempt to execute the instruction might be UNDEFINED, or trapped to Hyp mode. For more information see [Enabling Advanced SIMD and floating-point support on page G1-4413](#).

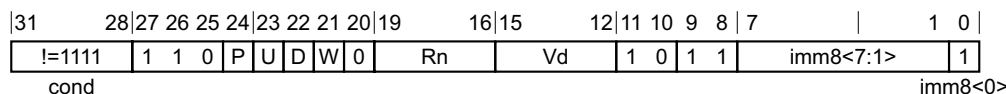
A1



Decrement Before variant

Applies when P == 1 && U == 0 && W == 1.

FSTMDBX{<c>}{<q>} <Rn>!, <dreglist>

Increment After variant

Applies when P == 0 && U == 1.

FSTMIAX{<c>}{<q>} <Rn>{!}, <dreglist>

Decode for all variants of this encoding

```

if P == '0' && U == '0' && W == '0' then SEE "Related encodings";
if P == '1' && W == '0' then SEE VSTR;
if P == U && W == '1' then UNDEFINED;
// Remaining combinations are PUW = 010 (IA without !), 011 (IA with !), 101 (DB with !)
single_regs = FALSE; add = (U == '1'); wback = (W == '1');
d = UInt(D:Vd); n = UInt(Rn); imm32 = ZeroExtend(imm8:'00', 32);
regs = UInt(imm8) DIV 2; // If UInt(imm8) is odd, see "FSTMX".
if n == 15 && (wback || CurrentInstrSet() != InstrSet_A32) then UNPREDICTABLE;
if regs == 0 || regs > 16 || (d+regs) > 32 then UNPREDICTABLE;
if imm8<0> == '1' && (d+regs) > 16 then UNPREDICTABLE;

```

CONSTRAINED UNPREDICTABLE behavior

If regs == 0, then one of the following behaviors must occur:

- The instruction is UNDEFINED.
- The instruction executes as NOP.
- The instruction operates as a VSTM with the same addressing mode but stores no registers.

If regs > 16 || (d+regs) > 16, then one of the following behaviors must occur:

- The instruction is UNDEFINED.
- The instruction executes as NOP.
- The memory locations specified by the instruction and the number of registers specified by the instruction if the register list had not gone out of range, become UNKNOWN. If the instruction specifies writeback, then that register becomes UNKNOWN. This behavior does not affect any other memory locations.

T1

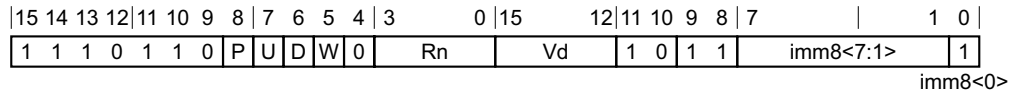

Decrement Before variant

Applies when P == 1 && U == 0 && W == 1.

FSTMDBX{<c>}{<q>} <Rn>!, <dreglist>

Increment After variant

Applies when P == 0 && U == 1.

FSTMIAX{<c>}{<q>} <Rn>{!}, <dreglist>

Decode for all variants of this encoding

```

if P == '0' && U == '0' && W == '0' then SEE "Related encodings";
if P == '1' && W == '0' then SEE VSTR;
if P == U && W == '1' then UNDEFINED;
// Remaining combinations are PUW = 010 (IA without !), 011 (IA with !), 101 (DB with !)
single_regs = FALSE; add = (U == '1'); wback = (W == '1');
d = UInt(D:Vd); n = UInt(Rn); imm32 = ZeroExtend(imm8:'00', 32);
regs = UInt(imm8) DIV 2; // If UInt(imm8) is odd, see "FSTMX".
if n == 15 && (wback || CurrentInstrSet() != InstrSet_A32) then UNPREDICTABLE;
if regs == 0 || regs > 16 || (d+regs) > 32 then UNPREDICTABLE;
if imm8<0> == '1' && (d+regs) > 16 then UNPREDICTABLE;
  
```

CONSTRAINED UNPREDICTABLE behavior

If regs == 0, then one of the following behaviors must occur:

- The instruction is UNDEFINED.
- The instruction executes as NOP.
- The instruction operates as a VSTM with the same addressing mode but stores no registers.

If regs > 16 || (d+regs) > 16, then one of the following behaviors must occur:

- The instruction is UNDEFINED.
- The instruction executes as NOP.
- The memory locations specified by the instruction and the number of registers specified by the instruction if the register list had not gone out of range, become UNKNOWN. If the instruction specifies writeback, then that register becomes UNKNOWN. This behavior does not affect any other memory locations.

Notes for all encodings

For more information about the CONSTRAINED UNPREDICTABLE behavior of this instruction, see [Appendix K1 Architectural Constraints on UNPREDICTABLE behaviors](#).

Related encodings: See [Advanced SIMD and floating-point 64-bit move on page F3-2894](#) for the T32 instruction set, or [Advanced SIMD and floating-point 64-bit move on page F4-2973](#) for the A32 instruction set.

Assembler symbols

<c> See [Standard assembler syntax fields on page F2-2848](#).

<q> See [Standard assembler syntax fields on page F2-2848](#).

- <Rn> Is the general-purpose base register, encoded in the "Rn" field. If writeback is not specified, the PC can be used. However, ARM deprecates use of the PC.
- ! Specifies base register writeback. Encoded in the "W" field as 1 if present, otherwise 0.
- <dreglist> Is the list of consecutively numbered 64-bit SIMD&FP registers to be transferred. The first register in the list is encoded in "D:Vd", and "imm8" is set to twice the number of registers in the list plus one. The list must contain at least one register, all registers must be in the range D0-D15, and must not contain more than 16 registers.

Operation for all encodings

```
if ConditionPassed() then
    EncodingSpecificOperations(); CheckVFPEnabled(TRUE);
    address = if add then R[n] else R[n]-imm32;
    for r = 0 to regs-1
        if single_regs then
            MemA[address,4] = S[d+r]; address = address+4;
        else
            // Store as two word-aligned words in the correct order for current endianness.
            MemA[address,4] = if BigEndian() then D[d+r]<63:32> else D[d+r]<31:0>;
            MemA[address+4,4] = if BigEndian() then D[d+r]<31:0> else D[d+r]<63:32>;
            address = address+8;
    if wback then R[n] = if add then R[n]+imm32 else R[n]-imm32;
```

F6.1.7 SHA1C

SHA1 hash update (choose).

A1

31	30	29	28	27	26	25	24	23	22	21	20	19	16	15	12	11	10	9	8	7	6	5	4	3	0
1	1	1	1	0	0	1	0	0	D	0	0	Vn	Vd	1	1	0	0	N	Q	M	0	Vm			

A1 variant

SHA1C.32 <Qd>, <Qn>, <Qm>

Decode for this encoding

```
if ! HaveCryptoExt() then UNDEFINED;
if Q != '1' then UNDEFINED;
if Vd<0> == '1' || Vn<0> == '1' || Vm<0> == '1' then UNDEFINED;
d = UInt(D:Vd); n = UInt(N:Vn); m = UInt(M:Vm);
```

T1

15	14	13	12	11	10	9	8	7	6	5	4	3	0	15	12	11	10	9	8	7	6	5	4	3	0
1	1	1	0	1	1	1	1	0	D	0	0	Vn	Vd	1	1	0	0	N	Q	M	0	Vm			

T1 variant

SHA1C.32 <Qd>, <Qn>, <Qm>

Decode for this encoding

```
if ! HaveCryptoExt() then UNDEFINED;
if Q != '1' then UNDEFINED;
if Vd<0> == '1' || Vn<0> == '1' || Vm<0> == '1' then UNDEFINED;
d = UInt(D:Vd); n = UInt(N:Vn); m = UInt(M:Vm);
if InITBlock() then UNPREDICTABLE;
```

Notes for all encodings

For more information about the CONSTRAINED UNPREDICTABLE behavior of this instruction, see [Appendix K1 Architectural Constraints on UNPREDICTABLE behaviors](#).

Assembler symbols

- <Qd> Is the 128-bit name of the SIMD&FP destination register, encoded in the "D:Vd" field as <Qd>*2.
- <Qn> Is the 128-bit name of the first SIMD&FP source register, encoded in the "N:Vn" field as <Qn>*2.
- <Qm> Is the 128-bit name of the second SIMD&FP source register, encoded in the "M:Vm" field as <Qm>*2.

Operation for all encodings

```
if ConditionPassed() then
    EncodingSpecificOperations(); CheckCryptoEnabled32();
    X = Q[d>>1];
    Y = Q[n>>1]<31:0>; // Note: 32 bits wide
```

```
W = Q[m>>1];  
for e = 0 to 3  
  t = SHChoose(X<63:32>, X<95:64>, X<127:96>);  
  Y = Y + ROL(X<31:0>, 5) + t + Elem[W, e, 32];  
  X<63:32> = ROL(X<63:32>, 30);  
  <Y, X> = ROL(Y:X, 32);  
Q[d>>1] = X;
```

F6.1.8 SHA1H

SHA1 fixed rotate.

A1

31	30	29	28	27	26	25	24	23	22	21	20	19	18	17	16	15	12	11	10	9	8	7	6	5	4	3	0
1	1	1	1	0	0	1	1	1	D	1	1	size	0	1	Vd	0	0	1	0	1	1	M	0	Vm			

A1 variant

SHA1H.32 <Qd>, <Qm>

Decode for this encoding

```
if ! HaveCryptoExt() then UNDEFINED;
if size != '10' then UNDEFINED;
if Vd<0> == '1' || Vm<0> == '1' then UNDEFINED;
d = UInt(D:Vd); m = UInt(M:Vm);
```

T1

15	14	13	12	11	10	9	8	7	6	5	4	3	2	1	0	15	12	11	10	9	8	7	6	5	4	3	0
1	1	1	1	1	1	1	1	1	D	1	1	size	0	1	Vd	0	0	1	0	1	1	M	0	Vm			

T1 variant

SHA1H.32 <Qd>, <Qm>

Decode for this encoding

```
if ! HaveCryptoExt() then UNDEFINED;
if size != '10' then UNDEFINED;
if Vd<0> == '1' || Vm<0> == '1' then UNDEFINED;
d = UInt(D:Vd); m = UInt(M:Vm);
if InITBlock() then UNPREDICTABLE;
```

Notes for all encodings

For more information about the CONSTRAINED UNPREDICTABLE behavior of this instruction, see [Appendix K1 Architectural Constraints on UNPREDICTABLE behaviors](#).

Assembler symbols

- <Qd> Is the 128-bit name of the SIMD&FP destination register, encoded in the "D:Vd" field as <Qd>*2.
- <Qm> Is the 128-bit name of the SIMD&FP source register, encoded in the "M:Vm" field as <Qm>*2.

Operation for all encodings

```
if ConditionPassed() then
    EncodingSpecificOperations(); CheckCryptoEnabled32();
    Q[d>>1] = ZeroExtend(ROL(Q[m>>1]<31:0>, 30), 128);
```

F6.1.9 SHA1M

SHA1 hash update (majority).

A1

31	30	29	28	27	26	25	24	23	22	21	20	19	16	15	12	11	10	9	8	7	6	5	4	3	0
1	1	1	1	0	0	1	0	0	D	1	0	Vn	Vd	1	1	0	0	N	Q	M	0	Vm			

A1 variant

SHA1M.32 <Qd>, <Qn>, <Qm>

Decode for this encoding

```
if ! HaveCryptoExt() then UNDEFINED;
if Q != '1' then UNDEFINED;
if Vd<0> == '1' || Vn<0> == '1' || Vm<0> == '1' then UNDEFINED;
d = UInt(D:Vd); n = UInt(N:Vn); m = UInt(M:Vm);
```

T1

15	14	13	12	11	10	9	8	7	6	5	4	3	0	15	12	11	10	9	8	7	6	5	4	3	0
1	1	1	0	1	1	1	1	0	D	1	0	Vn	Vd	1	1	0	0	N	Q	M	0	Vm			

T1 variant

SHA1M.32 <Qd>, <Qn>, <Qm>

Decode for this encoding

```
if ! HaveCryptoExt() then UNDEFINED;
if Q != '1' then UNDEFINED;
if Vd<0> == '1' || Vn<0> == '1' || Vm<0> == '1' then UNDEFINED;
d = UInt(D:Vd); n = UInt(N:Vn); m = UInt(M:Vm);
if InITBlock() then UNPREDICTABLE;
```

Notes for all encodings

For more information about the CONSTRAINED UNPREDICTABLE behavior of this instruction, see [Appendix K1 Architectural Constraints on UNPREDICTABLE behaviors](#).

Assembler symbols

- <Qd> Is the 128-bit name of the SIMD&FP destination register, encoded in the "D:Vd" field as <Qd>*2.
- <Qn> Is the 128-bit name of the first SIMD&FP source register, encoded in the "N:Vn" field as <Qn>*2.
- <Qm> Is the 128-bit name of the second SIMD&FP source register, encoded in the "M:Vm" field as <Qm>*2.

Operation for all encodings

```
if ConditionPassed() then
  EncodingSpecificOperations(); CheckCryptoEnabled32();
  X = Q[d>>1];
  Y = Q[n>>1]<31:0>; // Note: 32 bits wide
```

```
W = Q[m>>1];  
for e = 0 to 3  
  t = SHAmajority(X<63:32>, X<95:64>, X<127:96>);  
  Y = Y + ROL(X<31:0>, 5) + t + Elem[W, e, 32];  
  X<63:32> = ROL(X<63:32>, 30);  
  <Y, X> = ROL(Y:X, 32);  
Q[d>>1] = X;
```

F6.1.10 SHA1P

SHA1 hash update (parity).

A1

31	30	29	28	27	26	25	24	23	22	21	20	19	16	15	12	11	10	9	8	7	6	5	4	3	0
1	1	1	1	0	0	1	0	0	D	0	1	Vn	Vd	1	1	0	0	N	Q	M	0	Vm			

A1 variant

SHA1P.32 <Qd>, <Qn>, <Qm>

Decode for this encoding

```

if ! HaveCryptoExt() then UNDEFINED;
if Q != '1' then UNDEFINED;
if Vd<0> == '1' || Vn<0> == '1' || Vm<0> == '1' then UNDEFINED;
d = UInt(D:Vd); n = UInt(N:Vn); m = UInt(M:Vm);
    
```

T1

15	14	13	12	11	10	9	8	7	6	5	4	3	0	15	12	11	10	9	8	7	6	5	4	3	0
1	1	1	0	1	1	1	1	0	D	0	1	Vn	Vd	1	1	0	0	N	Q	M	0	Vm			

T1 variant

SHA1P.32 <Qd>, <Qn>, <Qm>

Decode for this encoding

```

if ! HaveCryptoExt() then UNDEFINED;
if Q != '1' then UNDEFINED;
if Vd<0> == '1' || Vn<0> == '1' || Vm<0> == '1' then UNDEFINED;
d = UInt(D:Vd); n = UInt(N:Vn); m = UInt(M:Vm);
if InITBlock() then UNPREDICTABLE;
    
```

Notes for all encodings

For more information about the CONSTRAINED UNPREDICTABLE behavior of this instruction, see [Appendix K1 Architectural Constraints on UNPREDICTABLE behaviors](#).

Assembler symbols

- <Qd> Is the 128-bit name of the SIMD&FP destination register, encoded in the "D:Vd" field as <Qd>*2.
- <Qn> Is the 128-bit name of the first SIMD&FP source register, encoded in the "N:Vn" field as <Qn>*2.
- <Qm> Is the 128-bit name of the second SIMD&FP source register, encoded in the "M:Vm" field as <Qm>*2.

Operation for all encodings

```

if ConditionPassed() then
    EncodingSpecificOperations(); CheckCryptoEnabled32();
    X = Q[d>>1];
    Y = Q[n>>1]<31:0>; // Note: 32 bits wide
    
```

```
W = Q[m>>1];  
for e = 0 to 3  
  t = SHAparity(X<63:32>, X<95:64>, X<127:96>);  
  Y = Y + ROL(X<31:0>, 5) + t + Elem[W, e, 32];  
  X<63:32> = ROL(X<63:32>, 30);  
  <Y, X> = ROL(Y:X, 32);  
Q[d>>1] = X;
```

F6.1.11 SHA1SU0

SHA1 schedule update 0.

A1

31	30	29	28	27	26	25	24	23	22	21	20	19	16	15	12	11	10	9	8	7	6	5	4	3	0
1	1	1	1	0	0	1	0	0	D	1	1	Vn	Vd	1	1	0	0	N	Q	M	0	Vm			

A1 variant

SHA1SU0.32 <Qd>, <Qn>, <Qm>

Decode for this encoding

```
if ! HaveCryptoExt() then UNDEFINED;
if Q != '1' then UNDEFINED;
if Vd<0> == '1' || Vn<0> == '1' || Vm<0> == '1' then UNDEFINED;
d = UInt(D:Vd); n = UInt(N:Vn); m = UInt(M:Vm);
```

T1

15	14	13	12	11	10	9	8	7	6	5	4	3	0	15	12	11	10	9	8	7	6	5	4	3	0
1	1	1	0	1	1	1	1	0	D	1	1	Vn	Vd	1	1	0	0	N	Q	M	0	Vm			

T1 variant

SHA1SU0.32 <Qd>, <Qn>, <Qm>

Decode for this encoding

```
if ! HaveCryptoExt() then UNDEFINED;
if Q != '1' then UNDEFINED;
if Vd<0> == '1' || Vn<0> == '1' || Vm<0> == '1' then UNDEFINED;
d = UInt(D:Vd); n = UInt(N:Vn); m = UInt(M:Vm);
if InITBlock() then UNPREDICTABLE;
```

Notes for all encodings

For more information about the CONSTRAINED UNPREDICTABLE behavior of this instruction, see [Appendix K1 Architectural Constraints on UNPREDICTABLE behaviors](#).

Assembler symbols

- <Qd> Is the 128-bit name of the SIMD&FP destination register, encoded in the "D:Vd" field as <Qd>*2.
- <Qn> Is the 128-bit name of the first SIMD&FP source register, encoded in the "N:Vn" field as <Qn>*2.
- <Qm> Is the 128-bit name of the second SIMD&FP source register, encoded in the "M:Vm" field as <Qm>*2.

Operation for all encodings

```
if ConditionPassed() then
    EncodingSpecificOperations(); CheckCryptoEnabled32();
    op1 = Q[d>>1]; op2 = Q[n>>1]; op3 = Q[m>>1];
    op2 = op2<63:0> : op1<127:64>;
    Q[d>>1] = op1 EOR op2 EOR op3;
```

F6.1.12 SHA1SU1

SHA1 schedule update 1.

A1

31	30	29	28	27	26	25	24	23	22	21	20	19	18	17	16	15	12	11	10	9	8	7	6	5	4	3	0
1	1	1	1	0	0	1	1	1	D	1	1	size	1	0	Vd	0	0	1	1	1	0	M	0	Vm			

A1 variant

SHA1SU1.32 <Qd>, <Qm>

Decode for this encoding

```
if ! HaveCryptoExt() then UNDEFINED;
if size != '10' then UNDEFINED;
if Vd<0> == '1' || Vm<0> == '1' then UNDEFINED;
d = UInt(D:Vd); m = UInt(M:Vm);
```

T1

15	14	13	12	11	10	9	8	7	6	5	4	3	2	1	0	15	12	11	10	9	8	7	6	5	4	3	0
1	1	1	1	1	1	1	1	1	D	1	1	size	1	0	Vd	0	0	1	1	1	0	M	0	Vm			

T1 variant

SHA1SU1.32 <Qd>, <Qm>

Decode for this encoding

```
if ! HaveCryptoExt() then UNDEFINED;
if size != '10' then UNDEFINED;
if Vd<0> == '1' || Vm<0> == '1' then UNDEFINED;
d = UInt(D:Vd); m = UInt(M:Vm);
if InITBlock() then UNPREDICTABLE;
```

Notes for all encodings

For more information about the CONSTRAINED UNPREDICTABLE behavior of this instruction, see [Appendix K1 Architectural Constraints on UNPREDICTABLE behaviors](#).

Assembler symbols

- <Qd> Is the 128-bit name of the SIMD&FP destination register, encoded in the "D:Vd" field as <Qd>*2.
- <Qm> Is the 128-bit name of the SIMD&FP source register, encoded in the "M:Vm" field as <Qm>*2.

Operation for all encodings

```
if ConditionPassed() then
  EncodingSpecificOperations(); CheckCryptoEnabled32();
  X = Q[d>>1]; Y = Q[m>>1];
  T = X EOR LSR(Y, 32);
  W0 = ROL(T<31:0>, 1);
  W1 = ROL(T<63:32>, 1);
```

```
W2 = ROL(T<95:64>, 1);  
W3 = ROL(T<127:96>, 1) EOR ROL(T<31:0>, 2);  
Q[d>>1] = W3:W2:W1:W0;
```

F6.1.13 SHA256H

SHA256 hash update part 1.

A1

31	30	29	28	27	26	25	24	23	22	21	20	19	16	15	12	11	10	9	8	7	6	5	4	3	0
1	1	1	1	0	0	1	1	0	D	0	0	Vn	Vd	1	1	0	0	N	Q	M	0	Vm			

A1 variant

SHA256H.32 <Qd>, <Qn>, <Qm>

Decode for this encoding

```
if ! HaveCryptoExt() then UNDEFINED;
if Q != '1' then UNDEFINED;
if Vd<0> == '1' || Vn<0> == '1' || Vm<0> == '1' then UNDEFINED;
d = UInt(D:Vd); n = UInt(N:Vn); m = UInt(M:Vm);
```

T1

15	14	13	12	11	10	9	8	7	6	5	4	3	0	15	12	11	10	9	8	7	6	5	4	3	0
1	1	1	1	1	1	1	1	0	D	0	0	Vn	Vd	1	1	0	0	N	Q	M	0	Vm			

T1 variant

SHA256H.32 <Qd>, <Qn>, <Qm>

Decode for this encoding

```
if ! HaveCryptoExt() then UNDEFINED;
if Q != '1' then UNDEFINED;
if Vd<0> == '1' || Vn<0> == '1' || Vm<0> == '1' then UNDEFINED;
d = UInt(D:Vd); n = UInt(N:Vn); m = UInt(M:Vm);
if InITBlock() then UNPREDICTABLE;
```

Notes for all encodings

For more information about the CONSTRAINED UNPREDICTABLE behavior of this instruction, see [Appendix K1 Architectural Constraints on UNPREDICTABLE behaviors](#).

Assembler symbols

- <Qd> Is the 128-bit name of the SIMD&FP destination register, encoded in the "D:Vd" field as <Qd>*2.
- <Qn> Is the 128-bit name of the first SIMD&FP source register, encoded in the "N:Vn" field as <Qn>*2.
- <Qm> Is the 128-bit name of the second SIMD&FP source register, encoded in the "M:Vm" field as <Qm>*2.

Operation for all encodings

```
if ConditionPassed() then
    EncodingSpecificOperations(); CheckCryptoEnabled32();
    X = Q[d>>1]; Y = Q[n>>1]; W = Q[m>>1]; part1 = TRUE;
    Q[d>>1] = SHA256hash(X, Y, W, part1);
```

F6.1.14 SHA256H2

SHA256 hash update part 2.

A1

31	30	29	28	27	26	25	24	23	22	21	20	19	16	15	12	11	10	9	8	7	6	5	4	3	0
1	1	1	1	0	0	1	1	0	D	0	1	Vn	Vd	1	1	0	0	N	Q	M	0	Vm			

A1 variant

SHA256H2.32 <Qd>, <Qn>, <Qm>

Decode for this encoding

```

if ! HaveCryptoExt() then UNDEFINED;
if Q != '1' then UNDEFINED;
if Vd<0> == '1' || Vn<0> == '1' || Vm<0> == '1' then UNDEFINED;
d = UInt(D:Vd); n = UInt(N:Vn); m = UInt(M:Vm);
    
```

T1

15	14	13	12	11	10	9	8	7	6	5	4	3	0	15	12	11	10	9	8	7	6	5	4	3	0
1	1	1	1	1	1	1	1	0	D	0	1	Vn	Vd	1	1	0	0	N	Q	M	0	Vm			

T1 variant

SHA256H2.32 <Qd>, <Qn>, <Qm>

Decode for this encoding

```

if ! HaveCryptoExt() then UNDEFINED;
if Q != '1' then UNDEFINED;
if Vd<0> == '1' || Vn<0> == '1' || Vm<0> == '1' then UNDEFINED;
d = UInt(D:Vd); n = UInt(N:Vn); m = UInt(M:Vm);
if InITBlock() then UNPREDICTABLE;
    
```

Notes for all encodings

For more information about the CONSTRAINED UNPREDICTABLE behavior of this instruction, see [Appendix K1 Architectural Constraints on UNPREDICTABLE behaviors](#).

Assembler symbols

- <Qd> Is the 128-bit name of the SIMD&FP destination register, encoded in the "D:Vd" field as <Qd>*2.
- <Qn> Is the 128-bit name of the first SIMD&FP source register, encoded in the "N:Vn" field as <Qn>*2.
- <Qm> Is the 128-bit name of the second SIMD&FP source register, encoded in the "M:Vm" field as <Qm>*2.

Operation for all encodings

```

if ConditionPassed() then
    EncodingSpecificOperations(); CheckCryptoEnabled32();
    X = Q[n>>1]; Y = Q[d>>1]; W = Q[m>>1]; part1 = FALSE;
    Q[d>>1] = SHA256hash(X, Y, W, part1);
    
```

F6.1.15 SHA256SU0

SHA256 schedule update 0.

A1

31	30	29	28	27	26	25	24	23	22	21	20	19	18	17	16	15	12	11	10	9	8	7	6	5	4	3	0
1	1	1	1	0	0	1	1	1	D	1	1	size	1	0	Vd	0	0	1	1	1	1	M	0	Vm			

A1 variant

SHA256SU0.32 <Qd>, <Qm>

Decode for this encoding

```
if ! HaveCryptoExt() then UNDEFINED;
if size != '10' then UNDEFINED;
if Vd<0> == '1' || Vm<0> == '1' then UNDEFINED;
d = UInt(D:Vd); m = UInt(M:Vm);
```

T1

15	14	13	12	11	10	9	8	7	6	5	4	3	2	1	0	15	12	11	10	9	8	7	6	5	4	3	0
1	1	1	1	1	1	1	1	1	D	1	1	size	1	0	Vd	0	0	1	1	1	1	M	0	Vm			

T1 variant

SHA256SU0.32 <Qd>, <Qm>

Decode for this encoding

```
if ! HaveCryptoExt() then UNDEFINED;
if size != '10' then UNDEFINED;
if Vd<0> == '1' || Vm<0> == '1' then UNDEFINED;
d = UInt(D:Vd); m = UInt(M:Vm);
if InITBlock() then UNPREDICTABLE;
```

Notes for all encodings

For more information about the CONSTRAINED UNPREDICTABLE behavior of this instruction, see [Appendix K1 Architectural Constraints on UNPREDICTABLE behaviors](#).

Assembler symbols

- <Qd> Is the 128-bit name of the SIMD&FP destination register, encoded in the "D:Vd" field as <Qd>*2.
- <Qm> Is the 128-bit name of the SIMD&FP source register, encoded in the "M:Vm" field as <Qm>*2.

Operation for all encodings

```
if ConditionPassed() then
    bits(128) result;
    EncodingSpecificOperations(); CheckCryptoEnabled32();
    X = Q[d>>1]; Y = Q[m>>1];
    T = Y<31:0> : X<127:32>;
    for e = 0 to 3
        e!t = Elem[T, e, 32];
```

```
e1t = ROR(e1t, 7) EOR ROR(e1t, 18) EOR LSR(e1t, 3);  
E1em[result, e, 32] = e1t + E1em[X, e, 32];  
Q[d>>1] = result;
```

F6.1.16 SHA256SU1

SHA256 schedule update 1.

A1

31	30	29	28	27	26	25	24	23	22	21	20	19	16	15	12	11	10	9	8	7	6	5	4	3	0
1	1	1	1	0	0	1	1	0	D	1	0	Vn	Vd	1	1	0	0	N	Q	M	0	Vm			

A1 variant

SHA256SU1.32 <Qd>, <Qn>, <Qm>

Decode for this encoding

```
if ! HaveCryptoExt() then UNDEFINED;
if Q != '1' then UNDEFINED;
if Vd<0> == '1' || Vn<0> == '1' || Vm<0> == '1' then UNDEFINED;
d = UInt(D:Vd); n = UInt(N:Vn); m = UInt(M:Vm);
```

T1

15	14	13	12	11	10	9	8	7	6	5	4	3	0	15	12	11	10	9	8	7	6	5	4	3	0
1	1	1	1	1	1	1	1	0	D	1	0	Vn	Vd	1	1	0	0	N	Q	M	0	Vm			

T1 variant

SHA256SU1.32 <Qd>, <Qn>, <Qm>

Decode for this encoding

```
if ! HaveCryptoExt() then UNDEFINED;
if Q != '1' then UNDEFINED;
if Vd<0> == '1' || Vn<0> == '1' || Vm<0> == '1' then UNDEFINED;
d = UInt(D:Vd); n = UInt(N:Vn); m = UInt(M:Vm);
if InITBlock() then UNPREDICTABLE;
```

Notes for all encodings

For more information about the CONSTRAINED UNPREDICTABLE behavior of this instruction, see [Appendix K1 Architectural Constraints on UNPREDICTABLE behaviors](#).

Assembler symbols

- <Qd> Is the 128-bit name of the SIMD&FP destination register, encoded in the "D:Vd" field as <Qd>*2.
- <Qn> Is the 128-bit name of the first SIMD&FP source register, encoded in the "N:Vn" field as <Qn>*2.
- <Qm> Is the 128-bit name of the second SIMD&FP source register, encoded in the "M:Vm" field as <Qm>*2.

Operation for all encodings

```
if ConditionPassed() then
    bits(128) result;
    EncodingSpecificOperations(); CheckCryptoEnabled32();
    X = Q[d>>1]; Y = Q[n>>1]; Z = Q[m>>1];
```

```
T0 = Z<31:0> : Y<127:32>;

T1 = Z<127:64>;
for e = 0 to 1
    elt = Elem[T1, e, 32];
    elt = ROR(elt, 17) EOR ROR(elt, 19) EOR LSR(elt, 10);
    elt = elt + Elem[X, e, 32] + Elem[T0, e, 32];
    Elem[result, e, 32] = elt;

T1 = result<63:0>;
for e = 2 to 3
    elt = Elem[T1, e - 2, 32];
    elt = ROR(elt, 17) EOR ROR(elt, 19) EOR LSR(elt, 10);
    elt = elt + Elem[X, e, 32] + Elem[T0, e, 32];
    Elem[result, e, 32] = elt;

Q[d>>1] = result;
```

F6.1.17 VABA

Vector Absolute Difference and Accumulate subtracts the elements of one vector from the corresponding elements of another vector, and accumulates the absolute values of the results into the elements of the destination vector.

Operand and result elements are all integers of the same length.

Depending on settings in the CPACR, NSACR, and HCPTR registers, and the security state and mode in which the instruction is executed, an attempt to execute the instruction might be UNDEFINED, or trapped to Hyp mode. For more information see [Enabling Advanced SIMD and floating-point support on page G1-4413](#).

A1

31	30	29	28	27	26	25	24	23	22	21	20	19	16	15	12	11	10	9	8	7	6	5	4	3	0
1	1	1	1	0	0	1	U	0	D	size	Vn	Vd	0	1	1	1	N	Q	M	1	Vm				

64-bit SIMD vector variant

Applies when Q == 0.

VABA{<c>}{<q>}.<dt> <Dd>, <Dn>, <Dm>

128-bit SIMD vector variant

Applies when Q == 1.

VABA{<c>}{<q>}.<dt> <Qd>, <Qn>, <Qm>

Decode for all variants of this encoding

```

if size == '11' then UNDEFINED;
if Q == '1' && (Vd<0> == '1' || Vn<0> == '1' || Vm<0> == '1') then UNDEFINED;
unsigned = (U == '1'); long_destination = FALSE;
esize = 8 << UInt(size); elements = 64 DIV esize;
d = UInt(D:Vd); n = UInt(N:Vn); m = UInt(M:Vm); regs = if Q == '0' then 1 else 2;
    
```

T1

15	14	13	12	11	10	9	8	7	6	5	4	3	0	15	12	11	10	9	8	7	6	5	4	3	0
1	1	1	U	1	1	1	1	0	D	size	Vn	Vd	0	1	1	1	N	Q	M	1	Vm				

64-bit SIMD vector variant

Applies when Q == 0.

VABA{<c>}{<q>}.<dt> <Dd>, <Dn>, <Dm>

128-bit SIMD vector variant

Applies when Q == 1.

VABA{<c>}{<q>}.<dt> <Qd>, <Qn>, <Qm>

Decode for all variants of this encoding

```

if size == '11' then UNDEFINED;
if Q == '1' && (Vd<0> == '1' || Vn<0> == '1' || Vm<0> == '1') then UNDEFINED;
unsigned = (U == '1'); long_destination = FALSE;
esize = 8 << UInt(size); elements = 64 DIV esize;
d = UInt(D:Vd); n = UInt(N:Vn); m = UInt(M:Vm); regs = if Q == '0' then 1 else 2;
    
```

Assembler symbols

<c>	For encoding A1: see <i>Standard assembler syntax fields</i> on page F2-2848. This encoding must be unconditional. For encoding T1: see <i>Standard assembler syntax fields</i> on page F2-2848.
<q>	See <i>Standard assembler syntax fields</i> on page F2-2848.
<dt>	Is the data type for the elements of the operands, encoded in the "U:size" field. It can have the following values: S8 when U = 0, size = 00 S16 when U = 0, size = 01 S32 when U = 0, size = 10 U8 when U = 1, size = 00 U16 when U = 1, size = 01 U32 when U = 1, size = 10
<Qd>	Is the 128-bit name of the SIMD&FP destination register, encoded in the "D:Vd" field as <Qd>*2.
<Qn>	Is the 128-bit name of the first SIMD&FP source register, encoded in the "N:Vn" field as <Qn>*2.
<Qm>	Is the 128-bit name of the second SIMD&FP source register, encoded in the "M:Vm" field as <Qm>*2.
<Dd>	Is the 64-bit name of the SIMD&FP destination register, encoded in the "D:Vd" field.
<Dn>	Is the 64-bit name of the first SIMD&FP source register, encoded in the "N:Vn" field.
<Dm>	Is the 64-bit name of the second SIMD&FP source register, encoded in the "M:Vm" field.

Operation for all encodings

```

if ConditionPassed() then
    EncodingSpecificOperations(); CheckAdvSIMDEnabled();
    for r = 0 to regs-1
        for e = 0 to elements-1
            op1 = Elem[Din[n+r],e,esize];
            op2 = Elem[Din[m+r],e,esize];
            absdiff = Abs(Int(op1,unsigned) - Int(op2,unsigned));
            if long_destination then
                Elem[Q[d>>1],e,2*esize] = Elem[Qin[d>>1],e,2*esize] + absdiff;
            else
                Elem[D[d+r],e,esize] = Elem[Din[d+r],e,esize] + absdiff;
  
```

F6.1.18 VABAL

Vector Absolute Difference and Accumulate Long subtracts the elements of one vector from the corresponding elements of another vector, and accumulates the absolute values of the results into the elements of the destination vector.

Operand elements are all integers of the same length, and the result elements are double the length of the operands.

Depending on settings in the CPACR, NSACR, and HCPTR registers, and the security state and mode in which the instruction is executed, an attempt to execute the instruction might be UNDEFINED, or trapped to Hyp mode. For more information see [Enabling Advanced SIMD and floating-point support on page G1-4413](#).

A1

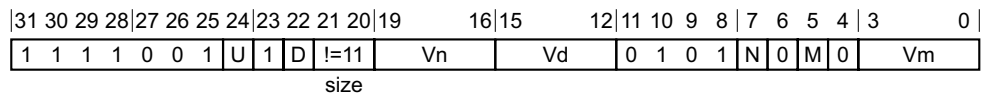

A1 variant

VABAL{<c>}{<q>}.<dt> <Qd>, <Dn>, <Dm>

Decode for this encoding

```

if size == '11' then SEE "Related encodings";
if Vd<0> == '1' then UNDEFINED;
unsigned = (U == '1'); long_destination = TRUE;
esize = 8 << UInt(size); elements = 64 DIV esize;
d = UInt(D:Vd); n = UInt(N:Vn); m = UInt(M:Vm); regs = 1;
    
```

T1

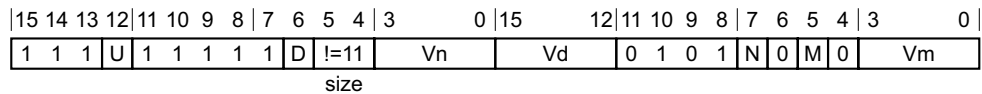

T1 variant

VABAL{<c>}{<q>}.<dt> <Qd>, <Dn>, <Dm>

Decode for this encoding

```

if size == '11' then SEE "Related encodings";
if Vd<0> == '1' then UNDEFINED;
unsigned = (U == '1'); long_destination = TRUE;
esize = 8 << UInt(size); elements = 64 DIV esize;
d = UInt(D:Vd); n = UInt(N:Vn); m = UInt(M:Vm); regs = 1;
    
```

Notes for all encodings

Related encodings: See [Advanced SIMD data-processing on page F3-2904](#) for the T32 instruction set, or [Advanced SIMD data-processing on page F4-2985](#) for the A32 instruction set.

Assembler symbols

- <c> For encoding A1: see [Standard assembler syntax fields on page F2-2848](#). This encoding must be unconditional.
- For encoding T1: see [Standard assembler syntax fields on page F2-2848](#).

- <q> See *Standard assembler syntax fields* on page F2-2848.
- <dt> Is the data type for the elements of the operands, encoded in the "U:size" field. It can have the following values:
- | | |
|-----|-----------------------|
| S8 | when U = 0, size = 00 |
| S16 | when U = 0, size = 01 |
| S32 | when U = 0, size = 10 |
| U8 | when U = 1, size = 00 |
| U16 | when U = 1, size = 01 |
| U32 | when U = 1, size = 10 |
- <Qd> Is the 128-bit name of the SIMD&FP destination register, encoded in the "D:Vd" field as <Qd>*2.
- <Dn> Is the 64-bit name of the first SIMD&FP source register, encoded in the "N:Vn" field.
- <Dm> Is the 64-bit name of the second SIMD&FP source register, encoded in the "M:Vm" field.

Operation for all encodings

```
if ConditionPassed() then
    EncodingSpecificOperations(); CheckAdvSIMDEnabled();
for r = 0 to regs-1
    for e = 0 to elements-1
        op1 = Elem[Din[n+r],e,esize];
        op2 = Elem[Din[m+r],e,esize];
        absdiff = Abs(Int(op1,unsigned) - Int(op2,unsigned));
        if long_destination then
            Elem[Q[d>>1],e,2*esize] = Elem[Qin[d>>1],e,2*esize] + absdiff;
        else
            Elem[D[d+r],e,esize] = Elem[Din[d+r],e,esize] + absdiff;
```

F6.1.19 VABD (floating-point)

Vector Absolute Difference (floating-point) subtracts the elements of one vector from the corresponding elements of another vector, and places the absolute values of the results in the elements of the destination vector.

Operand and result elements are floating-point numbers of the same size.

Depending on settings in the CPACR, NSACR, and HCPTR registers, and the security state and mode in which the instruction is executed, an attempt to execute the instruction might be UNDEFINED, or trapped to Hyp mode. For more information see [Enabling Advanced SIMD and floating-point support on page G1-4413](#).

A1

31	30	29	28	27	26	25	24	23	22	21	20	19	16	15	12	11	10	9	8	7	6	5	4	3	0
1	1	1	1	0	0	1	1	0	D	1	sz	Vn	Vd	1	1	0	1	N	Q	M	0	Vm			

64-bit SIMD vector variant

Applies when Q == 0.

VABD{<c>}{<q>}.<dt> {<Dd>, }<Dn>, <Dm>

128-bit SIMD vector variant

Applies when Q == 1.

VABD{<c>}{<q>}.<dt> {<Qd>, }<Qn>, <Qm>

Decode for all variants of this encoding

```

if Q == '1' && (Vd<0> == '1' || Vn<0> == '1' || Vm<0> == '1') then UNDEFINED;
if sz == '1' && !HaveFP16Ext() then UNDEFINED;
case sz of
    when '0' esize = 32; elements = 2;
    when '1' esize = 16; elements = 4;
d = UInt(D:Vd); n = UInt(N:Vn); m = UInt(M:Vm); regs = if Q == '0' then 1 else 2;
    
```

T1

15	14	13	12	11	10	9	8	7	6	5	4	3	0	15	12	11	10	9	8	7	6	5	4	3	0
1	1	1	1	1	1	1	1	0	D	1	sz	Vn	Vd	1	1	0	1	N	Q	M	0	Vm			

64-bit SIMD vector variant

Applies when Q == 0.

VABD{<c>}{<q>}.<dt> {<Dd>, }<Dn>, <Dm>

128-bit SIMD vector variant

Applies when Q == 1.

VABD{<c>}{<q>}.<dt> {<Qd>, }<Qn>, <Qm>

Decode for all variants of this encoding

```

if Q == '1' && (Vd<0> == '1' || Vn<0> == '1' || Vm<0> == '1') then UNDEFINED;
if sz == '1' && !HaveFP16Ext() then UNDEFINED;
if sz == '1' && InITBlock() then UNPREDICTABLE;
case sz of
    
```

```

    when '0' esize = 32; elements = 2;
    when '1' esize = 16; elements = 4;
    d = UInt(D:Vd); n = UInt(N:Vn); m = UInt(M:Vm); regs = if Q == '0' then 1 else 2;
  
```

CONSTRAINED UNPREDICTABLE behavior

If `sz == '1' && InITBlock()`, then one of the following behaviors must occur:

- The instruction is UNDEFINED.
- The instruction executes as if it passes the Condition code check.
- The instruction executes as NOP. This means it behaves as if it fails the Condition code check.

Assembler symbols

- <c> For encoding A1: see [Standard assembler syntax fields on page F2-2848](#). This encoding must be unconditional.
 For encoding T1: see [Standard assembler syntax fields on page F2-2848](#).
- <q> See [Standard assembler syntax fields on page F2-2848](#).
- <dt> Is the data type for the elements of the vectors, encoded in the "sz" field. It can have the following values:
 F32 when sz = 0
 F16 when sz = 1
- <Qd> Is the 128-bit name of the SIMD&FP destination register, encoded in the "D:Vd" field as <Qd>*2.
- <Qn> Is the 128-bit name of the first SIMD&FP source register, encoded in the "N:Vn" field as <Qn>*2.
- <Qm> Is the 128-bit name of the second SIMD&FP source register, encoded in the "M:Vm" field as <Qm>*2.
- <Dd> Is the 64-bit name of the SIMD&FP destination register, encoded in the "D:Vd" field.
- <Dn> Is the 64-bit name of the first SIMD&FP source register, encoded in the "N:Vn" field.
- <Dm> Is the 64-bit name of the second SIMD&FP source register, encoded in the "M:Vm" field.

Operation for all encodings

```

if ConditionPassed() then
  EncodingSpecificOperations(); CheckAdvSIMDEnabled();
  for r = 0 to regs-1
    for e = 0 to elements-1
      op1 = Elem[D[n+r],e,esize]; op2 = Elem[D[m+r],e,esize];
      Elem[D[d+r],e,esize] = FPAbs(FPSub(op1,op2,StandardFPSCRValue()));
  
```

F6.1.20 VABD (integer)

Vector Absolute Difference (integer) subtracts the elements of one vector from the corresponding elements of another vector, and places the absolute values of the results in the elements of the destination vector.

Operand and result elements are all integers of the same length.

Depending on settings in the CPACR, NSACR, and HCPTR registers, and the security state and mode in which the instruction is executed, an attempt to execute the instruction might be UNDEFINED, or trapped to Hyp mode. For more information see [Enabling Advanced SIMD and floating-point support on page G1-4413](#).

A1

31	30	29	28	27	26	25	24	23	22	21	20	19	16	15	12	11	10	9	8	7	6	5	4	3	0
1	1	1	1	0	0	1	U	0	D	size	Vn	Vd	0	1	1	1	N	Q	M	0	Vm				

64-bit SIMD vector variant

Applies when Q == 0.

VABD{<c>}{<q>}.<dt> {<Dd>, }<Dn>, <Dm>

128-bit SIMD vector variant

Applies when Q == 1.

VABD{<c>}{<q>}.<dt> {<Qd>, }<Qn>, <Qm>

Decode for all variants of this encoding

```

if size == '11' then UNDEFINED;
if Q == '1' && (Vd<0> == '1' || Vn<0> == '1' || Vm<0> == '1') then UNDEFINED;
unsigned = (U == '1'); long_destination = FALSE;
esize = 8 << UInt(size); elements = 64 DIV esize;
d = UInt(D:Vd); n = UInt(N:Vn); m = UInt(M:Vm); regs = if Q == '0' then 1 else 2;
  
```

T1

15	14	13	12	11	10	9	8	7	6	5	4	3	0	15	12	11	10	9	8	7	6	5	4	3	0
1	1	1	U	1	1	1	1	0	D	size	Vn	Vd	0	1	1	1	N	Q	M	0	Vm				

64-bit SIMD vector variant

Applies when Q == 0.

VABD{<c>}{<q>}.<dt> {<Dd>, }<Dn>, <Dm>

128-bit SIMD vector variant

Applies when Q == 1.

VABD{<c>}{<q>}.<dt> {<Qd>, }<Qn>, <Qm>

Decode for all variants of this encoding

```

if size == '11' then UNDEFINED;
if Q == '1' && (Vd<0> == '1' || Vn<0> == '1' || Vm<0> == '1') then UNDEFINED;
unsigned = (U == '1'); long_destination = FALSE;
esize = 8 << UInt(size); elements = 64 DIV esize;
d = UInt(D:Vd); n = UInt(N:Vn); m = UInt(M:Vm); regs = if Q == '0' then 1 else 2;
  
```

Assembler symbols

- <c> For encoding A1: see *Standard assembler syntax fields* on page F2-2848. This encoding must be unconditional.
For encoding T1: see *Standard assembler syntax fields* on page F2-2848.
- <q> See *Standard assembler syntax fields* on page F2-2848.
- <dt> Is the data type for the elements of the operands, encoded in the "U:size" field. It can have the following values:
- | | |
|-----|-----------------------|
| S8 | when U = 0, size = 00 |
| S16 | when U = 0, size = 01 |
| S32 | when U = 0, size = 10 |
| U8 | when U = 1, size = 00 |
| U16 | when U = 1, size = 01 |
| U32 | when U = 1, size = 10 |
- <Qd> Is the 128-bit name of the SIMD&FP destination register, encoded in the "D:Vd" field as <Qd>*2.
- <Qn> Is the 128-bit name of the first SIMD&FP source register, encoded in the "N:Vn" field as <Qn>*2.
- <Qm> Is the 128-bit name of the second SIMD&FP source register, encoded in the "M:Vm" field as <Qm>*2.
- <Dd> Is the 64-bit name of the SIMD&FP destination register, encoded in the "D:Vd" field.
- <Dn> Is the 64-bit name of the first SIMD&FP source register, encoded in the "N:Vn" field.
- <Dm> Is the 64-bit name of the second SIMD&FP source register, encoded in the "M:Vm" field.

Operation for all encodings

```
if ConditionPassed() then
    EncodingSpecificOperations(); CheckAdvSIMDEnabled();
    for r = 0 to regs-1
        for e = 0 to elements-1
            op1 = Elem[Din[n+r],e,esize];
            op2 = Elem[Din[m+r],e,esize];
            absdiff = Abs(Int(op1,unsigned) - Int(op2,unsigned));
            if long_destination then
                Elem[Q[d>>1],e,2*esize] = absdiff<2*esize-1:0>;
            else
                Elem[D[d+r],e,esize] = absdiff<esize-1:0>;
```

F6.1.21 VABDL (integer)

Vector Absolute Difference Long (integer) subtracts the elements of one vector from the corresponding elements of another vector, and places the absolute values of the results in the elements of the destination vector.

Operand elements are all integers of the same length, and the result elements are double the length of the operands.

Depending on settings in the CPACR, NSACR, and HCPTR registers, and the security state and mode in which the instruction is executed, an attempt to execute the instruction might be UNDEFINED, or trapped to Hyp mode. For more information see [Enabling Advanced SIMD and floating-point support on page G1-4413](#).

A1

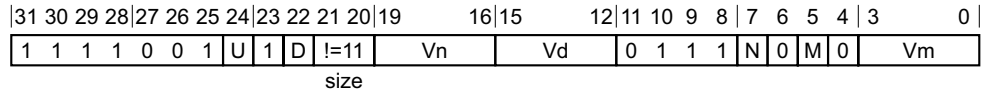

A1 variant

VABDL{<c>}{<q>}.<dt> <Qd>, <Dn>, <Dm>

Decode for this encoding

```
if size == '11' then SEE "Related encodings";
if Vd<0> == '1' then UNDEFINED;
unsigned = (U == '1'); long_destination = TRUE;
esize = 8 << UInt(size); elements = 64 DIV esize;
d = UInt(D:Vd); n = UInt(N:Vn); m = UInt(M:Vm); regs = 1;
```

T1

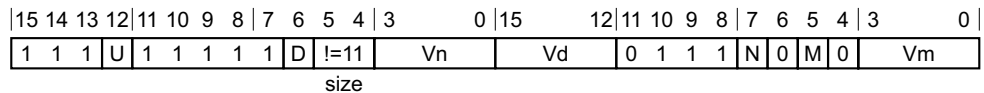

T1 variant

VABDL{<c>}{<q>}.<dt> <Qd>, <Dn>, <Dm>

Decode for this encoding

```
if size == '11' then SEE "Related encodings";
if Vd<0> == '1' then UNDEFINED;
unsigned = (U == '1'); long_destination = TRUE;
esize = 8 << UInt(size); elements = 64 DIV esize;
d = UInt(D:Vd); n = UInt(N:Vn); m = UInt(M:Vm); regs = 1;
```

Notes for all encodings

Related encodings: See [Advanced SIMD data-processing on page F3-2904](#) for the T32 instruction set, or [Advanced SIMD data-processing on page F4-2985](#) for the A32 instruction set.

Assembler symbols

- <c> For encoding A1: see [Standard assembler syntax fields on page F2-2848](#). This encoding must be unconditional.
 For encoding T1: see [Standard assembler syntax fields on page F2-2848](#).
- <q> See [Standard assembler syntax fields on page F2-2848](#).

- <dt> Is the data type for the elements of the operands, encoded in the "U:size" field. It can have the following values:
- S8 when U = 0, size = 00
 - S16 when U = 0, size = 01
 - S32 when U = 0, size = 10
 - U8 when U = 1, size = 00
 - U16 when U = 1, size = 01
 - U32 when U = 1, size = 10
- <Qd> Is the 128-bit name of the SIMD&FP destination register, encoded in the "D:Vd" field as <Qd>*2.
- <Dn> Is the 64-bit name of the first SIMD&FP source register, encoded in the "N:Vn" field.
- <Dm> Is the 64-bit name of the second SIMD&FP source register, encoded in the "M:Vm" field.

Operation for all encodings

```

if ConditionPassed() then
  EncodingSpecificOperations(); CheckAdvSIMDEnabled();
  for r = 0 to regs-1
    for e = 0 to elements-1
      op1 = Elem[Din[n+r],e,esize];
      op2 = Elem[Din[m+r],e,esize];
      absdiff = Abs(Int(op1,unsigned) - Int(op2,unsigned));
      if long_destination then
        Elem[Q[d>>1],e,2*esize] = absdiff<2*esize-1:0>;
      else
        Elem[D[d+r],e,esize] = absdiff<esize-1:0>;
  
```

F6.1.22 VABS

Vector Absolute takes the absolute value of each element in a vector, and places the results in a second vector. The floating-point version only clears the sign bit.

Depending on settings in the CPACR, NSACR, HCPTR, and FPEXC registers, and the security state and mode in which the instruction is executed, an attempt to execute the instruction might be UNDEFINED, or trapped to Hyp mode. For more information see [Enabling Advanced SIMD and floating-point support on page G1-4413](#).

A1

31	30	29	28	27	26	25	24	23	22	21	20	19	18	17	16	15	12	11	10	9	8	7	6	5	4	3	0
1	1	1	1	0	0	1	1	1	D	1	1	size	0	1	Vd	0	F	1	1	0	Q	M	0	Vm			

64-bit SIMD vector variant

Applies when Q == 0.

VABS{<c>}{<q>}.<dt> <Dd>, <Dm>

128-bit SIMD vector variant

Applies when Q == 1.

VABS{<c>}{<q>}.<dt> <Qd>, <Qm>

Decode for all variants of this encoding

```

if size == '11' then UNDEFINED;
if F == '1' && ((size == '01' && !HaveFP16Ext()) || size == '00') then UNDEFINED;
if Q == '1' && (Vd<0> == '1' || Vm<0> == '1') then UNDEFINED;
advsimd = TRUE; floating_point = (F == '1');
esize = 8 << UInt(size); elements = 64 DIV esize;
d = UInt(D:Vd); m = UInt(M:Vm); regs = if Q == '0' then 1 else 2;
    
```

A2

31	28	27	26	25	24	23	22	21	20	19	18	17	16	15	12	11	10	9	8	7	6	5	4	3	0
!=1111	1	1	1	0	1	D	1	1	0	0	0	0	Vd	1	0	size	1	1	M	0	Vm				

cond

Half-precision scalar variant

Applies when size == 01.

VABS{<c>}{<q>}.F16 <Sd>, <Sm>

Single-precision scalar variant

Applies when size == 10.

VABS{<c>}{<q>}.F32 <Sd>, <Sm>

Double-precision scalar variant

Applies when size == 11.

VABS{<c>}{<q>}.F64 <Dd>, <Dm>

Decode for all variants of this encoding

```

if FPSCR.Len != '000' || FPSCR.Stride != '00' then UNDEFINED;
if size == '00' || (size == '01' && !HaveFP16Ext()) then UNDEFINED;
if size == '01' && cond != '1110' then UNPREDICTABLE;
advsimd = FALSE;
case size of
    when '01' esize = 16; d = UInt(Vd:D); m = UInt(Vm:M);
    when '10' esize = 32; d = UInt(Vd:D); m = UInt(Vm:M);
    when '11' esize = 64; d = UInt(D:Vd); m = UInt(M:Vm);
    
```

CONSTRAINED UNPREDICTABLE behavior

If size == '01' && cond != '1110', then one of the following behaviors must occur:

- The instruction is UNDEFINED.
- The instruction executes as if it passes the Condition code check.
- The instruction executes as NOP. This means it behaves as if it fails the Condition code check.

T1

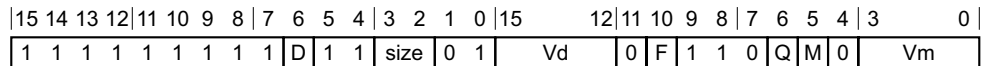

64-bit SIMD vector variant

Applies when Q == 0.

VABS{<c>}{<q>}.<dt> <Dd>, <Dm>

128-bit SIMD vector variant

Applies when Q == 1.

VABS{<c>}{<q>}.<dt> <Qd>, <Qm>

Decode for all variants of this encoding

```

if size == '11' then UNDEFINED;
if F == '1' && ((size == '01' && !HaveFP16Ext()) || size == '00') then UNDEFINED;
if F == '1' && size == '01' && InITBlock() then UNPREDICTABLE;
if Q == '1' && (Vd<0> == '1' || Vm<0> == '1') then UNDEFINED;
advsimd = TRUE; floating_point = (F == '1');
esize = 8 << UInt(size); elements = 64 DIV esize;
d = UInt(D:Vd); m = UInt(M:Vm); regs = if Q == '0' then 1 else 2;
    
```

CONSTRAINED UNPREDICTABLE behavior

If F == '1' && size == '01' && InITBlock(), then one of the following behaviors must occur:

- The instruction is UNDEFINED.
- The instruction executes as if it passes the Condition code check.
- The instruction executes as NOP. This means it behaves as if it fails the Condition code check.

T2

15	14	13	12	11	10	9	8	7	6	5	4	3	2	1	0	15	12	11	10	9	8	7	6	5	4	3	0
1	1	1	0	1	1	1	0	1	D	1	1	0	0	0	0	Vd	1	0	size	1	1	M	0	Vm			

Half-precision scalar variant

Applies when size == 01.

VABS{<c>}{<q>}.F16 <Sd>, <Sm>

Single-precision scalar variant

Applies when size == 10.

VABS{<c>}{<q>}.F32 <Sd>, <Sm>

Double-precision scalar variant

Applies when size == 11.

VABS{<c>}{<q>}.F64 <Dd>, <Dm>

Decode for all variants of this encoding

```

if FPSCR.Len != '000' || FPSCR.Stride != '00' then UNDEFINED;
if size == '00' || (size == '01' && !HaveFP16Ext()) then UNDEFINED;
if size == '01' && InITBlock() then UNPREDICTABLE;
advsimd = FALSE;
case size of
    when '01' esize = 16; d = UInt(Vd:D); m = UInt(Vm:M);
    when '10' esize = 32; d = UInt(Vd:D); m = UInt(Vm:M);
    when '11' esize = 64; d = UInt(D:Vd); m = UInt(M:Vm);
    
```

CONSTRAINED UNPREDICTABLE behavior

If size == '01' && InITBlock(), then one of the following behaviors must occur:

- The instruction is UNDEFINED.
- The instruction executes as if it passes the Condition code check.
- The instruction executes as NOP. This means it behaves as if it fails the Condition code check.

Assembler symbols

<c> For encoding A1: see [Standard assembler syntax fields on page F2-2848](#). This encoding must be unconditional.

For encoding A2, T1 and T2: see [Standard assembler syntax fields on page F2-2848](#).

<q> See [Standard assembler syntax fields on page F2-2848](#).

<dt> Is the data type for the elements of the vectors, encoded in the "F:size" field. It can have the following values:

S8	when F = 0, size = 00
S16	when F = 0, size = 01
S32	when F = 0, size = 10
F16	when F = 1, size = 01
F32	when F = 1, size = 10

- <Qd> Is the 128-bit name of the SIMD&FP destination register, encoded in the "D:Vd" field as <Qd>*2.
- <Qm> Is the 128-bit name of the SIMD&FP source register, encoded in the "M:Vm" field as <Qm>*2.
- <Dd> Is the 64-bit name of the SIMD&FP destination register, encoded in the "D:Vd" field.
- <Dm> Is the 64-bit name of the SIMD&FP source register, encoded in the "M:Vm" field.
- <Sd> Is the 32-bit name of the SIMD&FP destination register, encoded in the "Vd:D" field.
- <Sm> Is the 32-bit name of the SIMD&FP source register, encoded in the "Vm:M" field.

Operation for all encodings

```
if ConditionPassed() then
    EncodingSpecificOperations(); CheckAdvSIMDOrVFPEEnabled(TRUE, advsimd);
    if advsimd then // Advanced SIMD instruction
        for r = 0 to regs-1
            for e = 0 to elements-1
                if floating_point then
                    Elem[D[d+r],e,esize] = FPAbs(Elem[D[m+r],e,esize]);
                else
                    result = Abs(SInt(Elem[D[m+r],e,esize]));
                    Elem[D[d+r],e,esize] = result<esize-1:0>;
    else // VFP instruction
        case esize of
            when 16 S[d] = Zeros(16) : FPAbs(S[m]<15:0>);
            when 32 S[d] = FPAbs(S[m]);
            when 64 D[d] = FPAbs(D[m]);
```

F6.1.23 VACGE

Vector Absolute Compare Greater Than or Equal takes the absolute value of each element in a vector, and compares it with the absolute value of the corresponding element of a second vector. If the first is greater than or equal to the second, the corresponding element in the destination vector is set to all ones. Otherwise, it is set to all zeros.

The operands and result can be quadword or doubleword vectors. They must all be the same size.

The operand vector elements are floating-point numbers. The result vector elements are the same size as the operand vector elements.

Depending on settings in the CPACR, NSACR, and HCPTR registers, and the security state and mode in which the instruction is executed, an attempt to execute the instruction might be UNDEFINED, or trapped to Hyp mode. For more information see [Enabling Advanced SIMD and floating-point support on page G1-4413](#).

This instruction is used by the pseudo-instruction VACLE. The pseudo-instruction is never the preferred disassembly.

A1

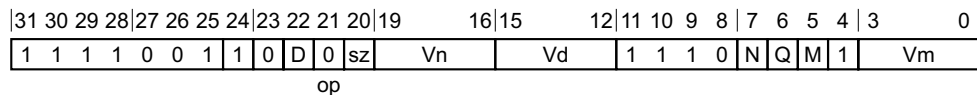

64-bit SIMD vector variant

Applies when Q == 0.

VACGE{<c>}{<q>}.<dt> {<Dd>, }<Dn>, <Dm>

128-bit SIMD vector variant

Applies when Q == 1.

VACGE{<c>}{<q>}.<dt> {<Qd>, }<Qn>, <Qm>

Decode for all variants of this encoding

```

if Q == '1' && (Vd<0> == '1' || Vn<0> == '1' || Vm<0> == '1') then UNDEFINED;
if sz == '1' && !HaveFP16Ext() then UNDEFINED;
or_equal = (op == '0');
case sz of
    when '0' esize = 32; elements = 2;
    when '1' esize = 16; elements = 4;
d = UInt(D:Vd); n = UInt(N:Vn); m = UInt(M:Vm); regs = if Q == '0' then 1 else 2;
    
```

T1

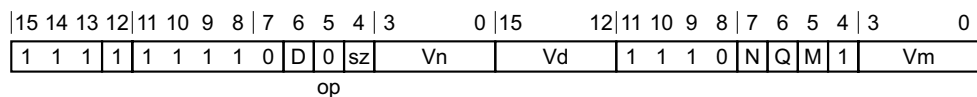

64-bit SIMD vector variant

Applies when Q == 0.

VACGE{<c>}{<q>}.<dt> {<Dd>, }<Dn>, <Dm>

128-bit SIMD vector variant

Applies when Q == 1.

VACGE{<c>}{<q>}.<dt> {<Qd>, }<Qn>, <Qm>

Decode for all variants of this encoding

```

if Q == '1' && (Vd<0> == '1' || Vn<0> == '1' || Vm<0> == '1') then UNDEFINED;
if sz == '1' && !HaveFP16Ext() then UNDEFINED;
if sz == '1' && InITBlock() then UNPREDICTABLE;
or_equal = (op == '0');
case sz of
  when '0' esize = 32; elements = 2;
  when '1' esize = 16; elements = 4;
d = UInt(D:Vd); n = UInt(N:Vn); m = UInt(M:Vm); regs = if Q == '0' then 1 else 2;
  
```

CONSTRAINED UNPREDICTABLE behavior

If sz == '1' && InITBlock(), then one of the following behaviors must occur:

- The instruction is UNDEFINED.
- The instruction executes as if it passes the Condition code check.
- The instruction executes as NOP. This means it behaves as if it fails the Condition code check.

Assembler symbols

<c>	For encoding A1: see Standard assembler syntax fields on page F2-2848 . This encoding must be unconditional. For encoding T1: see Standard assembler syntax fields on page F2-2848 .
<q>	See Standard assembler syntax fields on page F2-2848 .
<dt>	Is the data type for the elements of the vectors, encoded in the "sz" field. It can have the following values: F32 when sz = 0 F16 when sz = 1
<Qd>	Is the 128-bit name of the SIMD&FP destination register, encoded in the "D:Vd" field as <Qd>*2.
<Qn>	Is the 128-bit name of the first SIMD&FP source register, encoded in the "N:Vn" field as <Qn>*2.
<Qm>	Is the 128-bit name of the second SIMD&FP source register, encoded in the "M:Vm" field as <Qm>*2.
<Dd>	Is the 64-bit name of the SIMD&FP destination register, encoded in the "D:Vd" field.
<Dn>	Is the 64-bit name of the first SIMD&FP source register, encoded in the "N:Vn" field.
<Dm>	Is the 64-bit name of the second SIMD&FP source register, encoded in the "M:Vm" field.

Operation for all encodings

```

if ConditionPassed() then
  EncodingSpecificOperations(); CheckAdvSIMDEnabled();
  for r = 0 to regs-1
    for e = 0 to elements-1
      op1 = FPAbs(Elem[D[n+r],e,esize]); op2 = FPAbs(Elem[D[m+r],e,esize]);
      if or_equal then
        test_passed = FPCompareGE(op1, op2, StandardFPSCRValue());
      else
        test_passed = FPCompareGT(op1, op2, StandardFPSCRValue());
      Elem[D[d+r],e,esize] = if test_passed then Ones(esize) else Zeros(esize);
  
```

F6.1.24 VACLE

Vector Absolute Compare Less Than or Equal takes the absolute value of each element in a vector, and compares it with the absolute value of the corresponding element of a second vector. If the first is less than or equal to the second, the corresponding element in the destination vector is set to all ones. Otherwise, it is set to all zeros

This instruction is a pseudo-instruction of the [VACGE](#) instruction. This means that:

- The encodings in this description are named to match the encodings of [VACGE](#).
- The assembler syntax is used only for assembly, and is not used on disassembly.
- The description of [VACGE](#) gives the operational pseudocode for this instruction.

A1

31	30	29	28	27	26	25	24	23	22	21	20	19	16	15	12	11	10	9	8	7	6	5	4	3	0
1	1	1	1	0	0	1	1	0	D	0	sz	Vn	Vd	1	1	1	0	N	Q	M	1	Vm			

op

64-bit SIMD vector variant

Applies when Q == 0.

VACLE{<c>}{<q>}.<dt> {<Dd>, }<Dn>, <Dm>

is equivalent to

VACGE{<c>}{<q>}.<dt> <Dd>, <Dm>, <Dn>

and is never the preferred disassembly.

128-bit SIMD vector variant

Applies when Q == 1.

VACLE{<c>}{<q>}.<dt> {<Qd>, }<Qn>, <Qm>

is equivalent to

VACGE{<c>}{<q>}.<dt> <Qd>, <Qm>, <Qn>

and is never the preferred disassembly.

T1

15	14	13	12	11	10	9	8	7	6	5	4	3	0	15	12	11	10	9	8	7	6	5	4	3	0
1	1	1	1	1	1	1	1	0	D	0	sz	Vn	Vd	1	1	1	0	N	Q	M	1	Vm			

op

64-bit SIMD vector variant

Applies when Q == 0.

VACLE{<c>}{<q>}.<dt> {<Dd>, }<Dn>, <Dm>

is equivalent to

VACGE{<c>}{<q>}.<dt> <Dd>, <Dm>, <Dn>

and is never the preferred disassembly.

128-bit SIMD vector variant

Applies when Q == 1.

VACLE{<c>}{<q>}.<dt> {<Qd>, }<Qn>, <Qm>

is equivalent to

VACGE{<c>}{<q>}.<dt> <Qd>, <Qm>, <Qn>

and is never the preferred disassembly.

Assembler symbols

<Dm>	Is the 64-bit name of the second SIMD&FP source register, encoded in the "M:Vm" field.
<Dn>	Is the 64-bit name of the first SIMD&FP source register, encoded in the "N:Vn" field.
<Qm>	Is the 128-bit name of the second SIMD&FP source register, encoded in the "M:Vm" field as <Qm>*2.
<Qn>	Is the 128-bit name of the first SIMD&FP source register, encoded in the "N:Vn" field as <Qn>*2.
<c>	For encoding A1: see Standard assembler syntax fields on page F2-2848 . This encoding must be unconditional. For encoding T1: see Standard assembler syntax fields on page F2-2848 .
<q>	See Standard assembler syntax fields on page F2-2848 .
<dt>	Is the data type for the elements of the vectors, encoded in the "sz" field. It can have the following values: F32 when sz = 0 F16 when sz = 1
<Qd>	Is the 128-bit name of the SIMD&FP destination register, encoded in the "D:Vd" field as <Qd>*2.
<Dd>	Is the 64-bit name of the SIMD&FP destination register, encoded in the "D:Vd" field.

Operation for all encodings

The description of [VACGE](#) gives the operational pseudocode for this instruction.

F6.1.25 VACGT

Vector Absolute Compare Greater Than takes the absolute value of each element in a vector, and compares it with the absolute value of the corresponding element of a second vector. If the first is greater than the second, the corresponding element in the destination vector is set to all ones. Otherwise, it is set to all zeros.

The operands and result can be quadword or doubleword vectors. They must all be the same size.

The operand vector elements are floating-point numbers. The result vector elements are the same size as the operand vector elements.

Depending on settings in the CPACR, NSACR, and HCPTR registers, and the security state and mode in which the instruction is executed, an attempt to execute the instruction might be UNDEFINED, or trapped to Hyp mode. For more information see [Enabling Advanced SIMD and floating-point support on page G1-4413](#).

This instruction is used by the pseudo-instruction VACLT. The pseudo-instruction is never the preferred disassembly.

A1

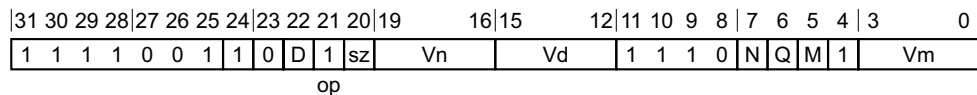

64-bit SIMD vector variant

Applies when Q == 0.

VACGT{<c>}{<q>}.<dt> {<Dd>, }<Dn>, <Dm>

128-bit SIMD vector variant

Applies when Q == 1.

VACGT{<c>}{<q>}.<dt> {<Qd>, }<Qn>, <Qm>

Decode for all variants of this encoding

```

if Q == '1' && (Vd<0> == '1' || Vn<0> == '1' || Vm<0> == '1') then UNDEFINED;
if sz == '1' && !HaveFP16Ext() then UNDEFINED;
or_equal = (op == '0');
case sz of
    when '0' esize = 32; elements = 2;
    when '1' esize = 16; elements = 4;
d = UInt(D:Vd); n = UInt(N:Vn); m = UInt(M:Vm); regs = if Q == '0' then 1 else 2;
    
```

T1

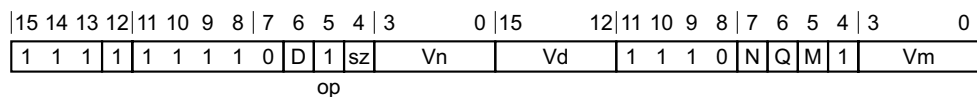

64-bit SIMD vector variant

Applies when Q == 0.

VACGT{<c>}{<q>}.<dt> {<Dd>, }<Dn>, <Dm>

128-bit SIMD vector variant

Applies when Q == 1.

VACGT{<c>}{<q>}.<dt> {<Qd>, }<Qn>, <Qm>

Decode for all variants of this encoding

```

if Q == '1' && (Vd<0> == '1' || Vn<0> == '1' || Vm<0> == '1') then UNDEFINED;
if sz == '1' && !HaveFP16Ext() then UNDEFINED;
if sz == '1' && InITBlock() then UNPREDICTABLE;
or_equal = (op == '0');
case sz of
  when '0' esize = 32; elements = 2;
  when '1' esize = 16; elements = 4;
d = UInt(D:Vd); n = UInt(N:Vn); m = UInt(M:Vm); regs = if Q == '0' then 1 else 2;
  
```

CONSTRAINED UNPREDICTABLE behavior

If sz == '1' && InITBlock(), then one of the following behaviors must occur:

- The instruction is UNDEFINED.
- The instruction executes as if it passes the Condition code check.
- The instruction executes as NOP. This means it behaves as if it fails the Condition code check.

Assembler symbols

<c>	For encoding A1: see Standard assembler syntax fields on page F2-2848 . This encoding must be unconditional. For encoding T1: see Standard assembler syntax fields on page F2-2848 .
<q>	See Standard assembler syntax fields on page F2-2848 .
<dt>	Is the data type for the elements of the vectors, encoded in the "sz" field. It can have the following values: F32 when sz = 0 F16 when sz = 1
<Qd>	Is the 128-bit name of the SIMD&FP destination register, encoded in the "D:Vd" field as <Qd>*2.
<Qn>	Is the 128-bit name of the first SIMD&FP source register, encoded in the "N:Vn" field as <Qn>*2.
<Qm>	Is the 128-bit name of the second SIMD&FP source register, encoded in the "M:Vm" field as <Qm>*2.
<Dd>	Is the 64-bit name of the SIMD&FP destination register, encoded in the "D:Vd" field.
<Dn>	Is the 64-bit name of the first SIMD&FP source register, encoded in the "N:Vn" field.
<Dm>	Is the 64-bit name of the second SIMD&FP source register, encoded in the "M:Vm" field.

Operation for all encodings

```

if ConditionPassed() then
  EncodingSpecificOperations(); CheckAdvSIMDEnabled();
  for r = 0 to regs-1
    for e = 0 to elements-1
      op1 = FPAbs(ELem[D[n+r],e,esize]); op2 = FPAbs(ELem[D[m+r],e,esize]);
      if or_equal then
        test_passed = FPCCompareGE(op1, op2, StandardFPSCRValue());
      else
        test_passed = FPCCompareGT(op1, op2, StandardFPSCRValue());
      ELem[D[d+r],e,esize] = if test_passed then Ones(esize) else Zeros(esize);
  
```



F6.1.26 VACLT

Vector Absolute Compare Less Than takes the absolute value of each element in a vector, and compares it with the absolute value of the corresponding element of a second vector. If the first is less than the second, the corresponding element in the destination vector is set to all ones. Otherwise, it is set to all zeros

This instruction is a pseudo-instruction of the [VACGT](#) instruction. This means that:

- The encodings in this description are named to match the encodings of [VACGT](#).
- The assembler syntax is used only for assembly, and is not used on disassembly.
- The description of [VACGT](#) gives the operational pseudocode for this instruction.

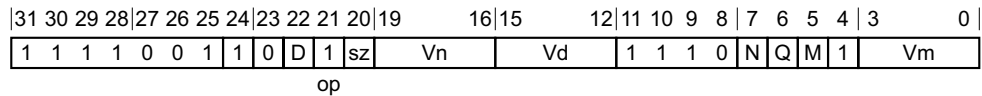
A1



64-bit SIMD vector variant

Applies when Q == 0.

VACLT{<c>}{<q>}.<dt> {<Dd>, }<Dn>, <Dm>

is equivalent to

VACGT{<c>}{<q>}.<dt> <Dd>, <Dm>, <Dn>

and is never the preferred disassembly.

128-bit SIMD vector variant

Applies when Q == 1.

VACLT{<c>}{<q>}.<dt> {<Qd>, }<Qn>, <Qm>

is equivalent to

VACGT{<c>}{<q>}.<dt> <Qd>, <Qm>, <Qn>

and is never the preferred disassembly.

T1

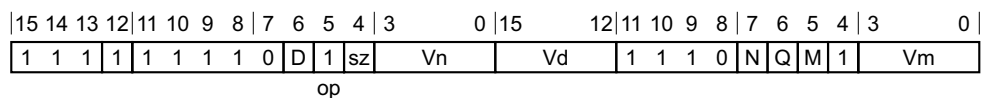

64-bit SIMD vector variant

Applies when Q == 0.

VACLT{<c>}{<q>}.<dt> {<Dd>, }<Dn>, <Dm>

is equivalent to

VACGT{<c>}{<q>}.<dt> <Dd>, <Dm>, <Dn>

and is never the preferred disassembly.

128-bit SIMD vector variant

Applies when Q == 1.

VACLT{<c>}{<q>}.<dt> {<Qd>, }<Qn>, <Qm>

is equivalent to

VACGT{<c>}{<q>}.<dt> <Qd>, <Qm>, <Qn>

and is never the preferred disassembly.

Assembler symbols

- <Dm> Is the 64-bit name of the second SIMD&FP source register, encoded in the "M:Vm" field.
- <Dn> Is the 64-bit name of the first SIMD&FP source register, encoded in the "N:Vn" field.
- <Qm> Is the 128-bit name of the second SIMD&FP source register, encoded in the "M:Vm" field as <Qm>*2.
- <Qn> Is the 128-bit name of the first SIMD&FP source register, encoded in the "N:Vn" field as <Qn>*2.
- <c> For encoding A1: see [Standard assembler syntax fields on page F2-2848](#). This encoding must be unconditional.
For encoding T1: see [Standard assembler syntax fields on page F2-2848](#).
- <q> See [Standard assembler syntax fields on page F2-2848](#).
- <dt> Is the data type for the elements of the vectors, encoded in the "sz" field. It can have the following values:
F32 when sz = 0
F16 when sz = 1
- <Qd> Is the 128-bit name of the SIMD&FP destination register, encoded in the "D:Vd" field as <Qd>*2.
- <Dd> Is the 64-bit name of the SIMD&FP destination register, encoded in the "D:Vd" field.

Operation for all encodings

The description of [VACGT](#) gives the operational pseudocode for this instruction.

F6.1.27 VADD (floating-point)

Vector Add (floating-point) adds corresponding elements in two vectors, and places the results in the destination vector.

Depending on settings in the CPACR, NSACR, HCPTR, and FPEXC registers, and the security state and mode in which the instruction is executed, an attempt to execute the instruction might be UNDEFINED, or trapped to Hyp mode. For more information see [Enabling Advanced SIMD and floating-point support on page G1-4413](#).

A1

31	30	29	28	27	26	25	24	23	22	21	20	19	16	15	12	11	10	9	8	7	6	5	4	3	0
1	1	1	1	0	0	1	0	0	D	0	sz	Vn	Vd	1	1	0	1	N	Q	M	0	Vm			

64-bit SIMD vector variant

Applies when Q == 0.

VADD{<c>}{<q>}.<dt> {<Dd>, }<Dn>, <Dm>

128-bit SIMD vector variant

Applies when Q == 1.

VADD{<c>}{<q>}.<dt> {<Qd>, }<Qn>, <Qm>

Decode for all variants of this encoding

```

if Q == '1' && (Vd<0> == '1' || Vn<0> == '1' || Vm<0> == '1') then UNDEFINED;
if sz == '1' && !HaveFP16Ext() then UNDEFINED;
advsimd = TRUE;
case sz of
    when '0' esize = 32; elements = 2;
    when '1' esize = 16; elements = 4;
d = UInt(D:Vd); n = UInt(N:Vn); m = UInt(M:Vm); regs = if Q == '0' then 1 else 2;
    
```

A2

31	28	27	26	25	24	23	22	21	20	19	16	15	12	11	10	9	8	7	6	5	4	3	0
I=1111	1	1	1	0	0	D	1	1	Vn	Vd	1	0	size	N	0	M	0	Vm					

cond

Half-precision scalar variant

Applies when size == 01.

VADD{<c>}{<q>}.F16 {<Sd>}, <Sn>, <Sm>

Single-precision scalar variant

Applies when size == 10.

VADD{<c>}{<q>}.F32 {<Sd>}, <Sn>, <Sm>

Double-precision scalar variant

Applies when size == 11.

VADD{<c>}{<q>}.F64 {<Dd>}, <Dn>, <Dm>

Decode for all variants of this encoding

```

if FPSCR.Len != '000' || FPSCR.Stride != '00' then UNDEFINED;
if size == '00' || (size == '01' && !HaveFP16Ext()) then UNDEFINED;
if size == '01' && cond != '1110' then UNPREDICTABLE;
advsimd = FALSE;
case size of
    when '01' esize = 16; d = UInt(Vd:D); n = UInt(Vn:N); m = UInt(Vm:M);
    when '10' esize = 32; d = UInt(Vd:D); n = UInt(Vn:N); m = UInt(Vm:M);
    when '11' esize = 64; d = UInt(D:Vd); n = UInt(N:Vn); m = UInt(M:Vm);
    
```

CONSTRAINED UNPREDICTABLE behavior

If size == '01' && cond != '1110', then one of the following behaviors must occur:

- The instruction is UNDEFINED.
- The instruction executes as if it passes the Condition code check.
- The instruction executes as NOP. This means it behaves as if it fails the Condition code check.

T1

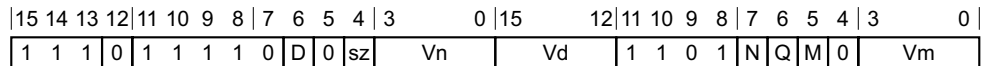

64-bit SIMD vector variant

Applies when Q == 0.

```
VADD{<c>}{<q>}.<dt> {<Dd>, }<Dn>, <Dm>
```

128-bit SIMD vector variant

Applies when Q == 1.

```
VADD{<c>}{<q>}.<dt> {<Qd>, }<Qn>, <Qm>
```

Decode for all variants of this encoding

```

if Q == '1' && (Vd<0> == '1' || Vn<0> == '1' || Vm<0> == '1') then UNDEFINED;
if sz == '1' && !HaveFP16Ext() then UNDEFINED;
if sz == '1' && InITBlock() then UNPREDICTABLE;
advsimd = TRUE;
case sz of
    when '0' esize = 32; elements = 2;
    when '1' esize = 16; elements = 4;
    d = UInt(D:Vd); n = UInt(N:Vn); m = UInt(M:Vm); regs = if Q == '0' then 1 else 2;
    
```

CONSTRAINED UNPREDICTABLE behavior

If sz == '1' && InITBlock(), then one of the following behaviors must occur:

- The instruction is UNDEFINED.
- The instruction executes as if it passes the Condition code check.
- The instruction executes as NOP. This means it behaves as if it fails the Condition code check.

T2

15	14	13	12	11	10	9	8	7	6	5	4	3	0	15	12	11	10	9	8	7	6	5	4	3	0
1	1	1	0	1	1	1	0	0	D	1	1	Vn	Vd	1	0	size	N	0	M	0	Vm				

Half-precision scalar variant

Applies when size == 01.

VADD{<c>}{<q>}.F16 {<Sd>}, <Sn>, <Sm>

Single-precision scalar variant

Applies when size == 10.

VADD{<c>}{<q>}.F32 {<Sd>}, <Sn>, <Sm>

Double-precision scalar variant

Applies when size == 11.

VADD{<c>}{<q>}.F64 {<Dd>}, <Dn>, <Dm>

Decode for all variants of this encoding

```

if FPSCR.Len != '000' || FPSCR.Stride != '00' then UNDEFINED;
if size == '00' || (size == '01' && !HaveFP16Ext()) then UNDEFINED;
if size == '01' && InITBlock() then UNPREDICTABLE;
advsimd = FALSE;
case size of
  when '01' esize = 16; d = UInt(Vd:D); n = UInt(Vn:N); m = UInt(Vm:M);
  when '10' esize = 32; d = UInt(Vd:D); n = UInt(Vn:N); m = UInt(Vm:M);
  when '11' esize = 64; d = UInt(D:Vd); n = UInt(N:Vn); m = UInt(M:Vm);

```

CONSTRAINED UNPREDICTABLE behavior

If size == '01' && InITBlock(), then one of the following behaviors must occur:

- The instruction is UNDEFINED.
- The instruction executes as if it passes the Condition code check.
- The instruction executes as NOP. This means it behaves as if it fails the Condition code check.

Assembler symbols

- <c> For encoding A1: see [Standard assembler syntax fields on page F2-2848](#). This encoding must be unconditional.
 For encoding A2, T1 and T2: see [Standard assembler syntax fields on page F2-2848](#).
- <q> See [Standard assembler syntax fields on page F2-2848](#).
- <dt> Is the data type for the elements of the vectors, encoded in the "sz" field. It can have the following values:
 F32 when sz = 0
 F16 when sz = 1
- <Qd> Is the 128-bit name of the SIMD&FP destination register, encoded in the "D:Vd" field as <Qd>*2.
- <Qn> Is the 128-bit name of the first SIMD&FP source register, encoded in the "N:Vn" field as <Qn>*2.

- <Qm> Is the 128-bit name of the second SIMD&FP source register, encoded in the "M:Vm" field as <Qm>*2.
- <Dd> Is the 64-bit name of the SIMD&FP destination register, encoded in the "D:Vd" field.
- <Dn> Is the 64-bit name of the first SIMD&FP source register, encoded in the "N:Vn" field.
- <Dm> Is the 64-bit name of the second SIMD&FP source register, encoded in the "M:Vm" field.
- <Sd> Is the 32-bit name of the SIMD&FP destination register, encoded in the "Vd:D" field.
- <Sn> Is the 32-bit name of the first SIMD&FP source register, encoded in the "Vn:N" field.
- <Sm> Is the 32-bit name of the second SIMD&FP source register, encoded in the "Vm:M" field.

Operation for all encodings

```

if ConditionPassed() then
  EncodingSpecificOperations(); CheckAdvSIMDorVFPEEnabled(TRUE, advsimd);
  if advsimd then // Advanced SIMD instruction
    for r = 0 to regs-1
      for e = 0 to elements-1
        Elem[D[d+r],e,esize] = FPAAdd(Elem[D[n+r],e,esize], Elem[D[m+r],e,esize],
                                     StandardFPSCRValue());
  else // VFP instruction
    case esize of
      when 16
        S[d] = Zeros(16) : FPAAdd(S[n]<15:0>, S[m]<15:0>, FPSCR);
      when 32
        S[d] = FPAAdd(S[n], S[m], FPSCR);
      when 64
        D[d] = FPAAdd(D[n], D[m], FPSCR);
  
```

F6.1.28 VADD (integer)

Vector Add (integer) adds corresponding elements in two vectors, and places the results in the destination vector.

Depending on settings in the CPACR, NSACR, and HCPTR registers, and the security state and mode in which the instruction is executed, an attempt to execute the instruction might be UNDEFINED, or trapped to Hyp mode. For more information see [Enabling Advanced SIMD and floating-point support on page G1-4413](#).

A1

31	30	29	28	27	26	25	24	23	22	21	20	19	16	15	12	11	10	9	8	7	6	5	4	3	0
1	1	1	1	0	0	1	0	0	D	size	Vn	Vd	1	0	0	0	N	Q	M	0	Vm				

64-bit SIMD vector variant

Applies when Q == 0.

VADD{<c>}{<q>}.<dt> {<Dd>, }<Dn>, <Dm>

128-bit SIMD vector variant

Applies when Q == 1.

VADD{<c>}{<q>}.<dt> {<Qd>, }<Qn>, <Qm>

Decode for all variants of this encoding

if Q == '1' && (Vd<0> == '1' || Vn<0> == '1' || Vm<0> == '1') then UNDEFINED;
 esize = 8 << UInt(size); elements = 64 DIV esize;
 d = UInt(D:Vd); n = UInt(N:Vn); m = UInt(M:Vm); regs = if Q == '0' then 1 else 2;

T1

15	14	13	12	11	10	9	8	7	6	5	4	3	0	15	12	11	10	9	8	7	6	5	4	3	0
1	1	1	0	1	1	1	1	0	D	size	Vn	Vd	1	0	0	0	N	Q	M	0	Vm				

64-bit SIMD vector variant

Applies when Q == 0.

VADD{<c>}{<q>}.<dt> {<Dd>, }<Dn>, <Dm>

128-bit SIMD vector variant

Applies when Q == 1.

VADD{<c>}{<q>}.<dt> {<Qd>, }<Qn>, <Qm>

Decode for all variants of this encoding

if Q == '1' && (Vd<0> == '1' || Vn<0> == '1' || Vm<0> == '1') then UNDEFINED;
 esize = 8 << UInt(size); elements = 64 DIV esize;
 d = UInt(D:Vd); n = UInt(N:Vn); m = UInt(M:Vm); regs = if Q == '0' then 1 else 2;

Assembler symbols

<c> For encoding A1: see [Standard assembler syntax fields on page F2-2848](#). This encoding must be unconditional.

For encoding T1: see *Standard assembler syntax fields* on page F2-2848.

- <q> See *Standard assembler syntax fields* on page F2-2848.
- <dt> Is the data type for the elements of the vectors, encoded in the "size" field. It can have the following values:
- | | |
|-----|----------------|
| I8 | when size = 00 |
| I16 | when size = 01 |
| I32 | when size = 10 |
| I64 | when size = 11 |
- <Qd> Is the 128-bit name of the SIMD&FP destination register, encoded in the "D:Vd" field as <Qd>*2.
- <Qn> Is the 128-bit name of the first SIMD&FP source register, encoded in the "N:Vn" field as <Qn>*2.
- <Qm> Is the 128-bit name of the second SIMD&FP source register, encoded in the "M:Vm" field as <Qm>*2.
- <Dd> Is the 64-bit name of the SIMD&FP destination register, encoded in the "D:Vd" field.
- <Dn> Is the 64-bit name of the first SIMD&FP source register, encoded in the "N:Vn" field.
- <Dm> Is the 64-bit name of the second SIMD&FP source register, encoded in the "M:Vm" field.

Operation for all encodings

```
if ConditionPassed() then
    EncodingSpecificOperations(); CheckAdvSIMDEnabled();
    for r = 0 to regs-1
        for e = 0 to elements-1
            Elem[D[d+r],e,esize] = Elem[D[n+r],e,esize] + Elem[D[m+r],e,esize];
```



F6.1.29 VADDHN

Vector Add and Narrow, returning High Half adds corresponding elements in two quadword vectors, and places the most significant half of each result in a doubleword vector. The results are truncated. For rounded results, see [VRADDHN](#).

The operand elements can be 16-bit, 32-bit, or 64-bit integers. There is no distinction between signed and unsigned integers.

Depending on settings in the [CPACR](#), [NSACR](#), and [HCPTR](#) registers, and the security state and mode in which the instruction is executed, an attempt to execute the instruction might be UNDEFINED, or trapped to Hyp mode. For more information see [Enabling Advanced SIMD and floating-point support on page G1-4413](#).

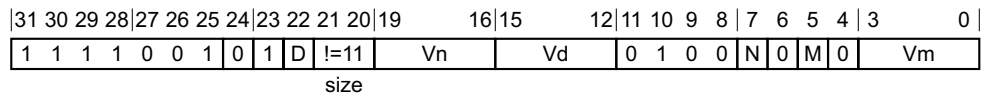
A1



A1 variant

VADDHN{<c>}{<q>}.<dt> <Dd>, <Qn>, <Qm>

Decode for this encoding

```
if size == '11' then SEE "Related encodings";
if Vn<0> == '1' || Vm<0> == '1' then UNDEFINED;
esize = 8 << UInt(size); elements = 64 DIV esize;
d = UInt(D:Vd); n = UInt(N:Vn); m = UInt(M:Vm);
```

T1

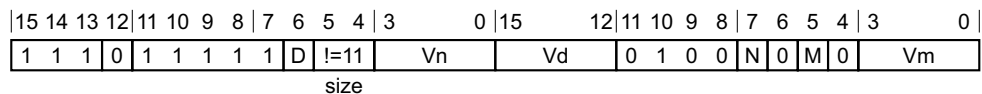

T1 variant

VADDHN{<c>}{<q>}.<dt> <Dd>, <Qn>, <Qm>

Decode for this encoding

```
if size == '11' then SEE "Related encodings";
if Vn<0> == '1' || Vm<0> == '1' then UNDEFINED;
esize = 8 << UInt(size); elements = 64 DIV esize;
d = UInt(D:Vd); n = UInt(N:Vn); m = UInt(M:Vm);
```

Notes for all encodings

Related encodings: See [Advanced SIMD data-processing on page F3-2904](#) for the T32 instruction set, or [Advanced SIMD data-processing on page F4-2985](#) for the A32 instruction set.

Assembler symbols

- <c> For encoding A1: see [Standard assembler syntax fields on page F2-2848](#). This encoding must be unconditional.
- For encoding T1: see [Standard assembler syntax fields on page F2-2848](#).
- <q> See [Standard assembler syntax fields on page F2-2848](#).

- <dt> Is the data type for the elements of the operands, encoded in the "size" field. It can have the following values:
- I16 when size = 00
 - I32 when size = 01
 - I64 when size = 10
- <Dd> Is the 64-bit name of the SIMD&FP destination register, encoded in the "D:Vd" field.
- <Qn> Is the 128-bit name of the first SIMD&FP source register, encoded in the "N:Vn" field as <Qn>*2.
- <Qm> Is the 128-bit name of the second SIMD&FP source register, encoded in the "M:Vm" field as <Qm>*2.

Operation for all encodings

```
if ConditionPassed() then
    EncodingSpecificOperations(); CheckAdvSIMDEnabled();
for e = 0 to elements-1
    result = Elem[Qin[n>>1],e,2*esize] + Elem[Qin[m>>1],e,2*esize];
    Elem[D[d],e,esize] = result<2*esize-1:esize>;
```

F6.1.30 VADDL

Vector Add Long adds corresponding elements in two doubleword vectors, and places the results in a quadword vector. Before adding, it sign-extends or zero-extends the elements of both operands.

Depending on settings in the CPACR, NSACR, and HCPTR registers, and the security state and mode in which the instruction is executed, an attempt to execute the instruction might be UNDEFINED, or trapped to Hyp mode. For more information see [Enabling Advanced SIMD and floating-point support on page G1-4413](#).

A1

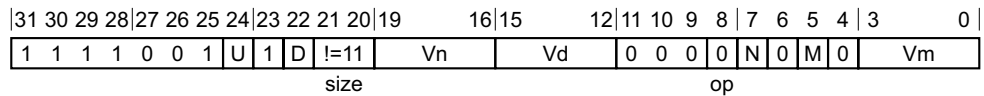

A1 variant

VADDL{<c>}{<q>}.<dt> <Qd>, <Dn>, <Dm>

Decode for this encoding

```
if size == '11' then SEE "Related encodings";
if Vd<0> == '1' || (op == '1' && Vn<0> == '1') then UNDEFINED;
unsigned = (U == '1');
esize = 8 << UInt(size); elements = 64 DIV esize; is_vaddw = (op == '1');
d = UInt(D:Vd); n = UInt(N:Vn); m = UInt(M:Vm);
```

T1

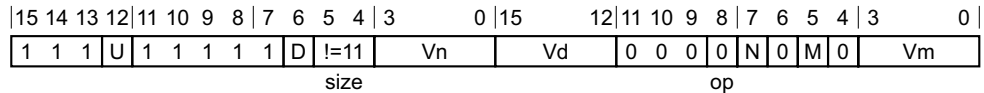

T1 variant

VADDL{<c>}{<q>}.<dt> <Qd>, <Dn>, <Dm>

Decode for this encoding

```
if size == '11' then SEE "Related encodings";
if Vd<0> == '1' || (op == '1' && Vn<0> == '1') then UNDEFINED;
unsigned = (U == '1');
esize = 8 << UInt(size); elements = 64 DIV esize; is_vaddw = (op == '1');
d = UInt(D:Vd); n = UInt(N:Vn); m = UInt(M:Vm);
```

Notes for all encodings

Related encodings: See [Advanced SIMD data-processing on page F3-2904](#) for the T32 instruction set, or [Advanced SIMD data-processing on page F4-2985](#) for the A32 instruction set.

Assembler symbols

- <c> For encoding A1: see [Standard assembler syntax fields on page F2-2848](#). This encoding must be unconditional.
- For encoding T1: see [Standard assembler syntax fields on page F2-2848](#).
- <q> See [Standard assembler syntax fields on page F2-2848](#).

- <dt> Is the data type for the elements of the second operand vector, encoded in the "U:size" field. It can have the following values:
- S8 when U = 0, size = 00
 - S16 when U = 0, size = 01
 - S32 when U = 0, size = 10
 - U8 when U = 1, size = 00
 - U16 when U = 1, size = 01
 - U32 when U = 1, size = 10
- <Qd> Is the 128-bit name of the SIMD&FP destination register, encoded in the "D:Vd" field as <Qd>*2.
- <Dn> Is the 64-bit name of the first SIMD&FP source register, encoded in the "N:Vn" field.
- <Dm> Is the 64-bit name of the second SIMD&FP source register, encoded in the "M:Vm" field.

Operation for all encodings

```
if ConditionPassed() then
    EncodingSpecificOperations(); CheckAdvSIMDEnabled();
    for e = 0 to elements-1
        if is_vaddw then
            op1 = Int(Elem[Qin[n>>1],e,2*esize], unsigned);
        else
            op1 = Int(Elem[Din[n],e,esize], unsigned);
        result = op1 + Int(Elem[Din[m],e,esize], unsigned);
        Elem[Q[d>>1],e,2*esize] = result<2*esize-1:0>;
```

F6.1.31 VADDW

Vector Add Wide adds corresponding elements in one quadword and one doubleword vector, and places the results in a quadword vector. Before adding, it sign-extends or zero-extends the elements of the doubleword operand.

Depending on settings in the CPACR, NSACR, and HCPTR registers, and the security state and mode in which the instruction is executed, an attempt to execute the instruction might be UNDEFINED, or trapped to Hyp mode. For more information see [Enabling Advanced SIMD and floating-point support on page G1-4413](#).

A1

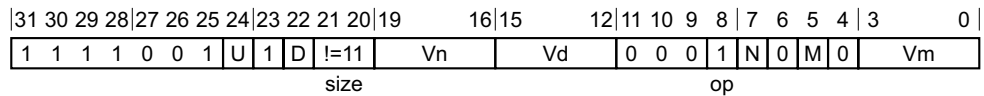

A1 variant

VADDW{<c>}{<q>}.<dt> {<Qd>}, <Qn>, <Dm>

Decode for this encoding

```
if size == '11' then SEE "Related encodings";
if Vd<0> == '1' || (op == '1' && Vn<0> == '1') then UNDEFINED;
unsigned = (U == '1');
esize = 8 << UInt(size); elements = 64 DIV esize; is_vaddw = (op == '1');
d = UInt(D:Vd); n = UInt(N:Vn); m = UInt(M:Vm);
```

T1

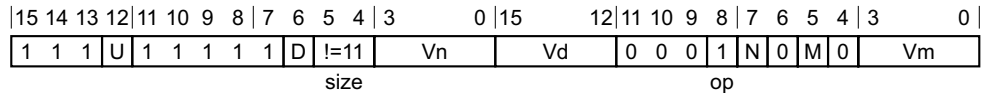

T1 variant

VADDW{<c>}{<q>}.<dt> {<Qd>}, <Qn>, <Dm>

Decode for this encoding

```
if size == '11' then SEE "Related encodings";
if Vd<0> == '1' || (op == '1' && Vn<0> == '1') then UNDEFINED;
unsigned = (U == '1');
esize = 8 << UInt(size); elements = 64 DIV esize; is_vaddw = (op == '1');
d = UInt(D:Vd); n = UInt(N:Vn); m = UInt(M:Vm);
```

Notes for all encodings

Related encodings: See [Advanced SIMD data-processing on page F3-2904](#) for the T32 instruction set, or [Advanced SIMD data-processing on page F4-2985](#) for the A32 instruction set.

Assembler symbols

- <c> For encoding A1: see [Standard assembler syntax fields on page F2-2848](#). This encoding must be unconditional.
- For encoding T1: see [Standard assembler syntax fields on page F2-2848](#).
- <q> See [Standard assembler syntax fields on page F2-2848](#).

- <dt> Is the data type for the elements of the second operand vector, encoded in the "U:size" field. It can have the following values:
- S8 when U = 0, size = 00
 - S16 when U = 0, size = 01
 - S32 when U = 0, size = 10
 - U8 when U = 1, size = 00
 - U16 when U = 1, size = 01
 - U32 when U = 1, size = 10
- <Qd> Is the 128-bit name of the SIMD&FP destination register, encoded in the "D:Vd" field as <Qd>*2.
- <Qn> Is the 128-bit name of the first SIMD&FP source register, encoded in the "N:Vn" field as <Qn>*2.
- <Dm> Is the 64-bit name of the second SIMD&FP source register, encoded in the "M:Vm" field.

Operation for all encodings

```
if ConditionPassed() then
    EncodingSpecificOperations(); CheckAdvSIMDEnabled();
    for e = 0 to elements-1
        if is_vaddw then
            op1 = Int(Elem[Qin[n>>1],e,2*esize], unsigned);
        else
            op1 = Int(Elem[Din[n],e,esize], unsigned);
        result = op1 + Int(Elem[Din[m],e,esize], unsigned);
        Elem[Q[d>>1],e,2*esize] = result<2*esize-1:0>;
```

F6.1.32 VAND (immediate)

Vector Bitwise AND (immediate) performs a bitwise AND between a register value and an immediate value, and returns the result into the destination vector

This instruction is a pseudo-instruction of the [VBIC \(immediate\)](#) instruction. This means that:

- The encodings in this description are named to match the encodings of [VBIC \(immediate\)](#).
- The assembler syntax is used only for assembly, and is not used on disassembly.
- The description of [VBIC \(immediate\)](#) gives the operational pseudocode for this instruction.

A1

31	30	29	28	27	26	25	24	23	22	21	20	19	18	16	15	12	11	8	7	6	5	4	3	0	
1	1	1	1	0	0	1	i	1	D	0	0	0	imm3	Vd	0	x	x	1	0	Q	1	1	imm4		
cmode																									

64-bit SIMD vector variant

Applies when Q == 0.

VAND{<c>}{<q>}.I16 {<Dd>}, <Dd>, #<imm>

is equivalent to

VBIC{<c>}{<q>}.I16 <Dd>, #~<imm>

and is never the preferred disassembly.

128-bit SIMD vector variant

Applies when Q == 1.

VAND{<c>}{<q>}.I16 {<Qd>}, <Qd>, #<imm>

is equivalent to

VBIC{<c>}{<q>}.I16 <Qd>, #~<imm>

and is never the preferred disassembly.

A2

31	30	29	28	27	26	25	24	23	22	21	20	19	18	16	15	12	11	8	7	6	5	4	3	0	
1	1	1	1	0	0	1	i	1	D	0	0	0	imm3	Vd	1	0	x	1	0	Q	1	1	imm4		
cmode																									

64-bit SIMD vector variant

Applies when Q == 0.

VAND{<c>}{<q>}.I32 {<Dd>}, <Dd>, #<imm>

is equivalent to

VBIC{<c>}{<q>}.I32 <Dd>, #~<imm>

and is never the preferred disassembly.

128-bit SIMD vector variant

Applies when Q == 1.

VAND{<c>}{<q>}.I32 {<Qd>}, <Qd>, #<imm>

is equivalent to

VBIC{<c>}{<q>}.I32 <Qd>, #~<imm>

and is never the preferred disassembly.

T1

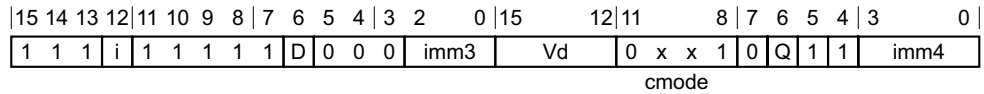

64-bit SIMD vector variant

Applies when Q == 0.

VAND{<c>}{<q>}.I16 {<Dd>}, <Dd>, #<imm>

is equivalent to

VBIC{<c>}{<q>}.I16 <Dd>, #~<imm>

and is never the preferred disassembly.

128-bit SIMD vector variant

Applies when Q == 1.

VAND{<c>}{<q>}.I16 {<Qd>}, <Qd>, #<imm>

is equivalent to

VBIC{<c>}{<q>}.I16 <Qd>, #~<imm>

and is never the preferred disassembly.

T2

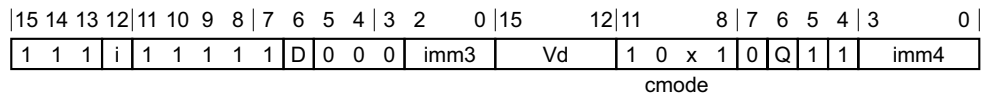

64-bit SIMD vector variant

Applies when Q == 0.

VAND{<c>}{<q>}.I32 {<Dd>}, <Dd>, #<imm>

is equivalent to

VBIC{<c>}{<q>}.I32 <Dd>, #~<imm>

and is never the preferred disassembly.

128-bit SIMD vector variant

Applies when Q == 1.

VAND{<c>}{<q>}.I32 {<Qd>}, <Qd>, #<imm>

is equivalent to

VBIC{<c>}{<q>}.I32 <Qd>, #~<imm>

and is never the preferred disassembly.

Assembler symbols

- <c> For encoding A1 and A2: see [Standard assembler syntax fields on page F2-2848](#). This encoding must be unconditional.
For encoding T1 and T2: see [Standard assembler syntax fields on page F2-2848](#).
- <q> See [Standard assembler syntax fields on page F2-2848](#).
- <Qd> Is the 128-bit name of the SIMD&FP destination register, encoded in the "D:Vd" field as <Qd>*2.
- <Dd> Is the 64-bit name of the SIMD&FP destination register, encoded in the "D:Vd" field.
- <imm> Is a constant of the specified type that is replicated to fill the destination register. For details of the range of constants available and the encoding of <imm>, see [Modified immediate constants in T32 and A32 Advanced SIMD instructions on page F2-2865](#).

Operation for all encodings

The description of [VBIC \(immediate\)](#) gives the operational pseudocode for this instruction.

F6.1.33 VAND (register)

Vector Bitwise AND (register) performs a bitwise AND operation between two registers, and places the result in the destination register.

Depending on settings in the CPACR, NSACR, and HCPTR registers, and the security state and mode in which the instruction is executed, an attempt to execute the instruction might be UNDEFINED, or trapped to Hyp mode. For more information see [Enabling Advanced SIMD and floating-point support on page G1-4413](#).

A1

31	30	29	28	27	26	25	24	23	22	21	20	19	16	15	12	11	10	9	8	7	6	5	4	3	0
1	1	1	1	0	0	1	0	0	D	0	0	Vn	Vd	0	0	0	1	N	Q	M	1	Vm			

64-bit SIMD vector variant

Applies when Q == 0.

VAND{<c>}{<q>}{.<dt>} {<Dd>}, <Dn>, <Dm>

128-bit SIMD vector variant

Applies when Q == 1.

VAND{<c>}{<q>}{.<dt>} {<Qd>}, <Qn>, <Qm>

Decode for all variants of this encoding

if Q == '1' && (Vd<0> == '1' || Vn<0> == '1' || Vm<0> == '1') then UNDEFINED;
 d = UInt(D:Vd); n = UInt(N:Vn); m = UInt(M:Vm); regs = if Q == '0' then 1 else 2;

T1

15	14	13	12	11	10	9	8	7	6	5	4	3	0	15	12	11	10	9	8	7	6	5	4	3	0
1	1	1	0	1	1	1	1	0	D	0	0	Vn	Vd	0	0	0	1	N	Q	M	1	Vm			

64-bit SIMD vector variant

Applies when Q == 0.

VAND{<c>}{<q>}{.<dt>} {<Dd>}, <Dn>, <Dm>

128-bit SIMD vector variant

Applies when Q == 1.

VAND{<c>}{<q>}{.<dt>} {<Qd>}, <Qn>, <Qm>

Decode for all variants of this encoding

if Q == '1' && (Vd<0> == '1' || Vn<0> == '1' || Vm<0> == '1') then UNDEFINED;
 d = UInt(D:Vd); n = UInt(N:Vn); m = UInt(M:Vm); regs = if Q == '0' then 1 else 2;

Assembler symbols

- <c> For encoding A1: see [Standard assembler syntax fields on page F2-2848](#). This encoding must be unconditional.
- For encoding T1: see [Standard assembler syntax fields on page F2-2848](#).

- <q> See *Standard assembler syntax fields* on page F2-2848.
- <dt> An optional data type. It is ignored by assemblers, and does not affect the encoding.
- <Qd> Is the 128-bit name of the SIMD&FP destination register, encoded in the "D:Vd" field as <Qd>*2.
- <Qn> Is the 128-bit name of the first SIMD&FP source register, encoded in the "N:Vn" field as <Qn>*2.
- <Qm> Is the 128-bit name of the second SIMD&FP source register, encoded in the "M:Vm" field as <Qm>*2.
- <Dd> Is the 64-bit name of the SIMD&FP destination register, encoded in the "D:Vd" field.
- <Dn> Is the 64-bit name of the first SIMD&FP source register, encoded in the "N:Vn" field.
- <Dm> Is the 64-bit name of the second SIMD&FP source register, encoded in the "M:Vm" field.

Operation for all encodings

```
if ConditionPassed() then
    EncodingSpecificOperations(); CheckAdvSIMDEnabled();
    for r = 0 to regs-1
        D[d+r] = D[n+r] AND D[m+r];
```

F6.1.34 VBIC (immediate)

Vector Bitwise Bit Clear (immediate) performs a bitwise AND between a register value and the complement of an immediate value, and returns the result into the destination vector.

Depending on settings in the CPACR, NSACR, and HCPTR registers, and the security state and mode in which the instruction is executed, an attempt to execute the instruction might be UNDEFINED, or trapped to Hyp mode. For more information see [Enabling Advanced SIMD and floating-point support on page G1-4413](#).

This instruction is used by the pseudo-instruction VAND (immediate). The pseudo-instruction is never the preferred disassembly.

A1

31	30	29	28	27	26	25	24	23	22	21	20	19	18	16	15	12	11	8	7	6	5	4	3	0
1	1	1	1	0	0	1	i	1	D	0	0	0	imm3	Vd	0	x	x	1	0	Q	1	1	imm4	
cmode																								

64-bit SIMD vector variant

Applies when Q == 0.

VBIC{<c>}{<q>}.I32 {<Dd>}, <Dd>, #<imm>

128-bit SIMD vector variant

Applies when Q == 1.

VBIC{<c>}{<q>}.I32 {<Qd>}, <Qd>, #<imm>

Decode for all variants of this encoding

```
if cmode<0> == '0' || cmode<3:2> == '11' then SEE "Related encodings";
if Q == '1' && Vd<0> == '1' then UNDEFINED;
imm64 = AdvSIMDExpandImm('1', cmode, i:imm3:imm4);
d = UInt(D:Vd); regs = if Q == '0' then 1 else 2;
```

A2

31	30	29	28	27	26	25	24	23	22	21	20	19	18	16	15	12	11	8	7	6	5	4	3	0
1	1	1	1	0	0	1	i	1	D	0	0	0	imm3	Vd	1	0	x	1	0	Q	1	1	imm4	
cmode																								

64-bit SIMD vector variant

Applies when Q == 0.

VBIC{<c>}{<q>}.I16 {<Dd>}, <Dd>, #<imm>

128-bit SIMD vector variant

Applies when Q == 1.

VBIC{<c>}{<q>}.I16 {<Qd>}, <Qd>, #<imm>

Decode for all variants of this encoding

```
if cmode<0> == '0' || cmode<3:2> == '11' then SEE "Related encodings";
if Q == '1' && Vd<0> == '1' then UNDEFINED;
imm64 = AdvSIMDExpandImm('1', cmode, i:imm3:imm4);
d = UInt(D:Vd); regs = if Q == '0' then 1 else 2;
```

T1

15	14	13	12	11	10	9	8	7	6	5	4	3	2	0	15	12	11	8	7	6	5	4	3	0
1	1	1	i	1	1	1	1	1	D	0	0	0	imm3	Vd	0	x	x	1	0	Q	1	1	imm4	

cmode

64-bit SIMD vector variant

Applies when Q == 0.

VBIC{<c>}{<q>}.I32 {<Dd>}, <Dd>, #<imm>

128-bit SIMD vector variant

Applies when Q == 1.

VBIC{<c>}{<q>}.I32 {<Qd>}, <Qd>, #<imm>

Decode for all variants of this encoding

```
if cmode<0> == '0' || cmode<3:2> == '11' then SEE "Related encodings";
if Q == '1' && Vd<0> == '1' then UNDEFINED;
imm64 = AdvSIMDExpandImm('1', cmode, i:imm3:imm4);
d = UInt(D:Vd); regs = if Q == '0' then 1 else 2;
```

T2

15	14	13	12	11	10	9	8	7	6	5	4	3	2	0	15	12	11	8	7	6	5	4	3	0
1	1	1	i	1	1	1	1	1	D	0	0	0	imm3	Vd	1	0	x	1	0	Q	1	1	imm4	

cmode

64-bit SIMD vector variant

Applies when Q == 0.

VBIC{<c>}{<q>}.I16 {<Dd>}, <Dd>, #<imm>

128-bit SIMD vector variant

Applies when Q == 1.

VBIC{<c>}{<q>}.I16 {<Qd>}, <Qd>, #<imm>

Decode for all variants of this encoding

```
if cmode<0> == '0' || cmode<3:2> == '11' then SEE "Related encodings";
if Q == '1' && Vd<0> == '1' then UNDEFINED;
imm64 = AdvSIMDExpandImm('1', cmode, i:imm3:imm4);
d = UInt(D:Vd); regs = if Q == '0' then 1 else 2;
```

Notes for all encodings

Related encodings: See *Advanced SIMD one register and modified immediate* on page F3-2912 for the T32 instruction set, or *Advanced SIMD one register and modified immediate* on page F4-2994 for the A32 instruction set.

Assembler symbols

<c> For encoding A1 and A2: see *Standard assembler syntax fields* on page F2-2848. This encoding must be unconditional.

For encoding T1 and T2: see *Standard assembler syntax fields* on page F2-2848.

- <q> See *Standard assembler syntax fields* on page F2-2848.
- <Qd> Is the 128-bit name of the SIMD&FP destination register, encoded in the "D:Vd" field as <Qd>*2.
- <Dd> Is the 64-bit name of the SIMD&FP destination register, encoded in the "D:Vd" field.
- <imm> Is a constant of the specified type that is replicated to fill the destination register. For details of the range of constants available and the encoding of <imm>, see *Modified immediate constants in T32 and A32 Advanced SIMD instructions* on page F2-2865.

The I8, I64, and F32 data types are permitted as pseudo-instructions, if the immediate can be represented by this instruction, and are encoded using a permitted encoding of the I16 or I32 data type.

Operation for all encodings

```
if ConditionPassed() then
    EncodingSpecificOperations(); CheckAdvSIMDEnabled();
    for r = 0 to regs-1
        D[d+r] = D[d+r] AND NOT(imm64);
```

F6.1.35 VBIC (register)

Vector Bitwise Bit Clear (register) performs a bitwise AND between a register value and the complement of a register value, and places the result in the destination register.

Depending on settings in the CPACR, NSACR, and HCPTR registers, and the security state and mode in which the instruction is executed, an attempt to execute the instruction might be UNDEFINED, or trapped to Hyp mode. For more information see [Enabling Advanced SIMD and floating-point support on page G1-4413](#).

A1

31	30	29	28	27	26	25	24	23	22	21	20	19	16	15	12	11	10	9	8	7	6	5	4	3	0
1	1	1	1	0	0	1	0	0	D	0	1	Vn	Vd	0	0	0	1	N	Q	M	1	Vm			

64-bit SIMD vector variant

Applies when Q == 0.

VBIC{<c>}{<q>}{.<dt>} {<Dd>}, <Dn>, <Dm>

128-bit SIMD vector variant

Applies when Q == 1.

VBIC{<c>}{<q>}{.<dt>} {<Qd>}, <Qn>, <Qm>

Decode for all variants of this encoding

if Q == '1' && (Vd<0> == '1' || Vn<0> == '1' || Vm<0> == '1') then UNDEFINED;
 d = UInt(D:Vd); n = UInt(N:Vn); m = UInt(M:Vm); regs = if Q == '0' then 1 else 2;

T1

15	14	13	12	11	10	9	8	7	6	5	4	3	0	15	12	11	10	9	8	7	6	5	4	3	0
1	1	1	0	1	1	1	1	0	D	0	1	Vn	Vd	0	0	0	1	N	Q	M	1	Vm			

64-bit SIMD vector variant

Applies when Q == 0.

VBIC{<c>}{<q>}{.<dt>} {<Dd>}, <Dn>, <Dm>

128-bit SIMD vector variant

Applies when Q == 1.

VBIC{<c>}{<q>}{.<dt>} {<Qd>}, <Qn>, <Qm>

Decode for all variants of this encoding

if Q == '1' && (Vd<0> == '1' || Vn<0> == '1' || Vm<0> == '1') then UNDEFINED;
 d = UInt(D:Vd); n = UInt(N:Vn); m = UInt(M:Vm); regs = if Q == '0' then 1 else 2;

Assembler symbols

- <c> For encoding A1: see [Standard assembler syntax fields on page F2-2848](#). This encoding must be unconditional.
 For encoding T1: see [Standard assembler syntax fields on page F2-2848](#).

<q>	See <i>Standard assembler syntax fields</i> on page F2-2848.
<dt>	An optional data type. It is ignored by assemblers, and does not affect the encoding.
<Qd>	Is the 128-bit name of the SIMD&FP destination register, encoded in the "D:Vd" field as <Qd>*2.
<Qn>	Is the 128-bit name of the first SIMD&FP source register, encoded in the "N:Vn" field as <Qn>*2.
<Qm>	Is the 128-bit name of the second SIMD&FP source register, encoded in the "M:Vm" field as <Qm>*2.
<Dd>	Is the 64-bit name of the SIMD&FP destination register, encoded in the "D:Vd" field.
<Dn>	Is the 64-bit name of the first SIMD&FP source register, encoded in the "N:Vn" field.
<Dm>	Is the 64-bit name of the second SIMD&FP source register, encoded in the "M:Vm" field.

Operation for all encodings

```
if ConditionPassed() then
    EncodingSpecificOperations(); CheckAdvSIMDEnabled();
    for r = 0 to regs-1
        D[d+r] = D[n+r] AND NOT(D[m+r]);
```

F6.1.36 VBIF

Vector Bitwise Insert if False inserts each bit from the first source register into the destination register if the corresponding bit of the second source register is 0, otherwise leaves the bit in the destination register unchanged.

Depending on settings in the CPACR, NSACR, and HCPTR registers, and the security state and mode in which the instruction is executed, an attempt to execute the instruction might be UNDEFINED, or trapped to Hyp mode. For more information see [Enabling Advanced SIMD and floating-point support on page G1-4413](#).

A1

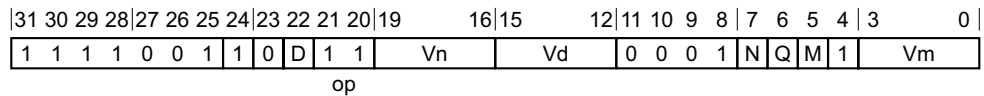

64-bit SIMD vector variant

Applies when Q == 0.

VBIF{<c>}{<q>}{.<dt>} {<Dd>}, <Dn>, <Dm>

128-bit SIMD vector variant

Applies when Q == 1.

VBIF{<c>}{<q>}{.<dt>} {<Qd>}, <Qn>, <Qm>

Decode for all variants of this encoding

```

if Q == '1' && (Vd<0> == '1' || Vn<0> == '1' || Vm<0> == '1') then UNDEFINED;
if op == '00' then SEE VEOR;
if op == '01' then operation = VBitOps_VBSL;
if op == '10' then operation = VBitOps_VBIT;
if op == '11' then operation = VBitOps_VBIF;
d = UInt(D:Vd); n = UInt(N:Vn); m = UInt(M:Vm); regs = if Q == '0' then 1 else 2;
    
```

T1

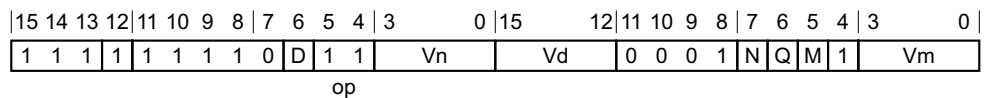

64-bit SIMD vector variant

Applies when Q == 0.

VBIF{<c>}{<q>}{.<dt>} {<Dd>}, <Dn>, <Dm>

128-bit SIMD vector variant

Applies when Q == 1.

VBIF{<c>}{<q>}{.<dt>} {<Qd>}, <Qn>, <Qm>

Decode for all variants of this encoding

```

if Q == '1' && (Vd<0> == '1' || Vn<0> == '1' || Vm<0> == '1') then UNDEFINED;
if op == '00' then SEE VEOR;
if op == '01' then operation = VBitOps_VBSL;
if op == '10' then operation = VBitOps_VBIT;
if op == '11' then operation = VBitOps_VBIF;
d = UInt(D:Vd); n = UInt(N:Vn); m = UInt(M:Vm); regs = if Q == '0' then 1 else 2;
    
```

Assembler symbols

<c>	For encoding A1: see <i>Standard assembler syntax fields</i> on page F2-2848. This encoding must be unconditional. For encoding T1: see <i>Standard assembler syntax fields</i> on page F2-2848.
<q>	See <i>Standard assembler syntax fields</i> on page F2-2848.
<dt>	An optional data type. It is ignored by assemblers, and does not affect the encoding.
<Qd>	Is the 128-bit name of the SIMD&FP destination register, encoded in the "D:Vd" field as <Qd>*2.
<Qn>	Is the 128-bit name of the first SIMD&FP source register, encoded in the "N:Vn" field as <Qn>*2.
<Qm>	Is the 128-bit name of the second SIMD&FP source register, encoded in the "M:Vm" field as <Qm>*2.
<Dd>	Is the 64-bit name of the SIMD&FP destination register, encoded in the "D:Vd" field.
<Dn>	Is the 64-bit name of the first SIMD&FP source register, encoded in the "N:Vn" field.
<Dm>	Is the 64-bit name of the second SIMD&FP source register, encoded in the "M:Vm" field.

Operation for all encodings

```
enumeration VBitOps {VBitOps_VBIF, VBitOps_VBIT, VBitOps_VBSL};  
  
if ConditionPassed() then  
    EncodingSpecificOperations(); CheckAdvSIMDEnabled();  
    for r = 0 to regs-1  
        case operation of  
            when VBitOps_VBIF D[d+r] = (D[d+r] AND D[m+r]) OR (D[n+r] AND NOT(D[m+r]));  
            when VBitOps_VBIT D[d+r] = (D[n+r] AND D[m+r]) OR (D[d+r] AND NOT(D[m+r]));  
            when VBitOps_VBSL D[d+r] = (D[n+r] AND D[d+r]) OR (D[m+r] AND NOT(D[d+r]));
```

F6.1.37 VBIT

Vector Bitwise Insert if True inserts each bit from the first source register into the destination register if the corresponding bit of the second source register is 1, otherwise leaves the bit in the destination register unchanged.

Depending on settings in the CPACR, NSACR, and HCPTR registers, and the security state and mode in which the instruction is executed, an attempt to execute the instruction might be UNDEFINED, or trapped to Hyp mode. For more information see [Enabling Advanced SIMD and floating-point support on page G1-4413](#).

A1

31	30	29	28	27	26	25	24	23	22	21	20	19	16	15	12	11	10	9	8	7	6	5	4	3	0
1	1	1	1	0	0	1	1	0	D	1	0	Vn	Vd	0	0	0	1	N	Q	M	1	Vm			

64-bit SIMD vector variant

Applies when Q == 0.

VBIT{<c>}{<q>}{.<dt>} {<Dd>}, <Dn>, <Dm>

128-bit SIMD vector variant

Applies when Q == 1.

VBIT{<c>}{<q>}{.<dt>} {<Qd>}, <Qn>, <Qm>

Decode for all variants of this encoding

```

if Q == '1' && (Vd<0> == '1' || Vn<0> == '1' || Vm<0> == '1') then UNDEFINED;
if op == '00' then SEE VEOR;
if op == '01' then operation = VBitOps_VBSL;
if op == '10' then operation = VBitOps_VBIT;
if op == '11' then operation = VBitOps_VBIF;
d = UInt(D:Vd); n = UInt(N:Vn); m = UInt(M:Vm); regs = if Q == '0' then 1 else 2;
    
```

T1

15	14	13	12	11	10	9	8	7	6	5	4	3	0	15	12	11	10	9	8	7	6	5	4	3	0
1	1	1	1	1	1	1	1	0	D	1	0	Vn	Vd	0	0	0	1	N	Q	M	1	Vm			

64-bit SIMD vector variant

Applies when Q == 0.

VBIT{<c>}{<q>}{.<dt>} {<Dd>}, <Dn>, <Dm>

128-bit SIMD vector variant

Applies when Q == 1.

VBIT{<c>}{<q>}{.<dt>} {<Qd>}, <Qn>, <Qm>

Decode for all variants of this encoding

```

if Q == '1' && (Vd<0> == '1' || Vn<0> == '1' || Vm<0> == '1') then UNDEFINED;
if op == '00' then SEE VEOR;
if op == '01' then operation = VBitOps_VBSL;
if op == '10' then operation = VBitOps_VBIT;
if op == '11' then operation = VBitOps_VBIF;
d = UInt(D:Vd); n = UInt(N:Vn); m = UInt(M:Vm); regs = if Q == '0' then 1 else 2;
    
```

Assembler symbols

<c>	For encoding A1: see <i>Standard assembler syntax fields</i> on page F2-2848. This encoding must be unconditional. For encoding T1: see <i>Standard assembler syntax fields</i> on page F2-2848.
<q>	See <i>Standard assembler syntax fields</i> on page F2-2848.
<dt>	An optional data type. It is ignored by assemblers, and does not affect the encoding.
<Qd>	Is the 128-bit name of the SIMD&FP destination register, encoded in the "D:Vd" field as <Qd>*2.
<Qn>	Is the 128-bit name of the first SIMD&FP source register, encoded in the "N:Vn" field as <Qn>*2.
<Qm>	Is the 128-bit name of the second SIMD&FP source register, encoded in the "M:Vm" field as <Qm>*2.
<Dd>	Is the 64-bit name of the SIMD&FP destination register, encoded in the "D:Vd" field.
<Dn>	Is the 64-bit name of the first SIMD&FP source register, encoded in the "N:Vn" field.
<Dm>	Is the 64-bit name of the second SIMD&FP source register, encoded in the "M:Vm" field.

Operation for all encodings

```
enumeration VBitOps {VBitOps_VBIF, VBitOps_VBIT, VBitOps_VBSL};  
  
if ConditionPassed() then  
    EncodingSpecificOperations(); CheckAdvSIMDEnabled();  
    for r = 0 to regs-1  
        case operation of  
            when VBitOps_VBIF D[d+r] = (D[d+r] AND D[m+r]) OR (D[n+r] AND NOT(D[m+r]));  
            when VBitOps_VBIT D[d+r] = (D[n+r] AND D[m+r]) OR (D[d+r] AND NOT(D[m+r]));  
            when VBitOps_VBSL D[d+r] = (D[n+r] AND D[d+r]) OR (D[m+r] AND NOT(D[d+r]));
```

F6.1.38 VBSL

Vector Bitwise Select sets each bit in the destination to the corresponding bit from the first source operand when the original destination bit was 1, otherwise from the second source operand.

Depending on settings in the CPACR, NSACR, and HCPTR registers, and the security state and mode in which the instruction is executed, an attempt to execute the instruction might be UNDEFINED, or trapped to Hyp mode. For more information see [Enabling Advanced SIMD and floating-point support on page G1-4413](#).

A1

31	30	29	28	27	26	25	24	23	22	21	20	19	16	15	12	11	10	9	8	7	6	5	4	3	0
1	1	1	1	0	0	1	1	0	D	0	1	Vn	Vd	0	0	0	1	N	Q	M	1	Vm			

64-bit SIMD vector variant

Applies when Q == 0.

VBSL{<c>}{<q>}{.<dt>} {<Dd>}, <Dn>, <Dm>

128-bit SIMD vector variant

Applies when Q == 1.

VBSL{<c>}{<q>}{.<dt>} {<Qd>}, <Qn>, <Qm>

Decode for all variants of this encoding

```

if Q == '1' && (Vd<0> == '1' || Vn<0> == '1' || Vm<0> == '1') then UNDEFINED;
if op == '00' then SEE VEOR;
if op == '01' then operation = VBitOps_VBSL;
if op == '10' then operation = VBitOps_VBIT;
if op == '11' then operation = VBitOps_VBIF;
d = UInt(D:Vd); n = UInt(N:Vn); m = UInt(M:Vm); regs = if Q == '0' then 1 else 2;
    
```

T1

15	14	13	12	11	10	9	8	7	6	5	4	3	0	15	12	11	10	9	8	7	6	5	4	3	0
1	1	1	1	1	1	1	0	D	0	1	Vn	Vd	0	0	0	1	N	Q	M	1	Vm				

64-bit SIMD vector variant

Applies when Q == 0.

VBSL{<c>}{<q>}{.<dt>} {<Dd>}, <Dn>, <Dm>

128-bit SIMD vector variant

Applies when Q == 1.

VBSL{<c>}{<q>}{.<dt>} {<Qd>}, <Qn>, <Qm>

Decode for all variants of this encoding

```

if Q == '1' && (Vd<0> == '1' || Vn<0> == '1' || Vm<0> == '1') then UNDEFINED;
if op == '00' then SEE VEOR;
if op == '01' then operation = VBitOps_VBSL;
if op == '10' then operation = VBitOps_VBIT;
if op == '11' then operation = VBitOps_VBIF;
d = UInt(D:Vd); n = UInt(N:Vn); m = UInt(M:Vm); regs = if Q == '0' then 1 else 2;
    
```

Assembler symbols

<c>	For encoding A1: see <i>Standard assembler syntax fields</i> on page F2-2848. This encoding must be unconditional. For encoding T1: see <i>Standard assembler syntax fields</i> on page F2-2848.
<q>	See <i>Standard assembler syntax fields</i> on page F2-2848.
<dt>	An optional data type. It is ignored by assemblers, and does not affect the encoding.
<Qd>	Is the 128-bit name of the SIMD&FP destination register, encoded in the "D:Vd" field as <Qd>*2.
<Qn>	Is the 128-bit name of the first SIMD&FP source register, encoded in the "N:Vn" field as <Qn>*2.
<Qm>	Is the 128-bit name of the second SIMD&FP source register, encoded in the "M:Vm" field as <Qm>*2.
<Dd>	Is the 64-bit name of the SIMD&FP destination register, encoded in the "D:Vd" field.
<Dn>	Is the 64-bit name of the first SIMD&FP source register, encoded in the "N:Vn" field.
<Dm>	Is the 64-bit name of the second SIMD&FP source register, encoded in the "M:Vm" field.

Operation for all encodings

```
enumeration VBitOps {VBitOps_VBIF, VBitOps_VBIT, VBitOps_VBSL};  
  
if ConditionPassed() then  
    EncodingSpecificOperations(); CheckAdvSIMDEnabled();  
    for r = 0 to regs-1  
        case operation of  
            when VBitOps_VBIF D[d+r] = (D[d+r] AND D[m+r]) OR (D[n+r] AND NOT(D[m+r]));  
            when VBitOps_VBIT D[d+r] = (D[n+r] AND D[m+r]) OR (D[d+r] AND NOT(D[m+r]));  
            when VBitOps_VBSL D[d+r] = (D[n+r] AND D[d+r]) OR (D[m+r] AND NOT(D[d+r]));
```

F6.1.39 VCEQ (immediate #0)

Vector Compare Equal to Zero takes each element in a vector, and compares it with zero. If it is equal to zero, the corresponding element in the destination vector is set to all ones. Otherwise, it is set to all zeros.

The operand vector elements are the same type, and are integers or floating-point numbers. The result vector elements are fields the same size as the operand vector elements.

Depending on settings in the CPACR, NSACR, and HCPTR registers, and the security state and mode in which the instruction is executed, an attempt to execute the instruction might be UNDEFINED, or trapped to Hyp mode. For more information see [Enabling Advanced SIMD and floating-point support on page G1-4413](#).

A1

31	30	29	28	27	26	25	24	23	22	21	20	19	18	17	16	15	12	11	10	9	8	7	6	5	4	3	0
1	1	1	1	0	0	1	1	1	D	1	1	size	0	1	Vd	0	F	0	1	0	Q	M	0	Vm			

64-bit SIMD vector variant

Applies when Q == 0.

VCEQ{<c>}{<q>}.<dt> {<Dd>}, <Dm>, #0

128-bit SIMD vector variant

Applies when Q == 1.

VCEQ{<c>}{<q>}.<dt> {<Qd>}, <Qm>, #0

Decode for all variants of this encoding

```

if size == '11' then UNDEFINED;
if F == '1' && ((size == '01' && !HaveFP16Ext()) || size == '00') then UNDEFINED;
if Q == '1' && (Vd<0> == '1' || Vm<0> == '1') then UNDEFINED;
floating_point = (F == '1');
esize = 8 << UInt(size); elements = 64 DIV esize;
d = UInt(D:Vd); m = UInt(M:Vm); regs = if Q == '0' then 1 else 2;
    
```

T1

15	14	13	12	11	10	9	8	7	6	5	4	3	2	1	0	15	12	11	10	9	8	7	6	5	4	3	0
1	1	1	1	1	1	1	1	1	D	1	1	size	0	1	Vd	0	F	0	1	0	Q	M	0	Vm			

64-bit SIMD vector variant

Applies when Q == 0.

VCEQ{<c>}{<q>}.<dt> {<Dd>}, <Dm>, #0

128-bit SIMD vector variant

Applies when Q == 1.

VCEQ{<c>}{<q>}.<dt> {<Qd>}, <Qm>, #0

Decode for all variants of this encoding

```

if size == '11' then UNDEFINED;
if F == '1' && ((size == '01' && !HaveFP16Ext()) || size == '00') then UNDEFINED;
if F == '1' && size == '01' && InITBlock() then UNPREDICTABLE;
    
```

```
if Q == '1' && (Vd<0> == '1' || Vm<0> == '1') then UNDEFINED;
floating_point = (F == '1');
esize = 8 << UInt(size); elements = 64 DIV esize;
d = UInt(D:Vd); m = UInt(M:Vm); regs = if Q == '0' then 1 else 2;
```

CONSTRAINED UNPREDICTABLE behavior

If `F == '1' && size == '01' && InITBlock()`, then one of the following behaviors must occur:

- The instruction is UNDEFINED.
- The instruction executes as if it passes the Condition code check.
- The instruction executes as NOP. This means it behaves as if it fails the Condition code check.

Assembler symbols

- <c> For encoding A1: see [Standard assembler syntax fields on page F2-2848](#). This encoding must be unconditional.
 For encoding T1: see [Standard assembler syntax fields on page F2-2848](#).
- <q> See [Standard assembler syntax fields on page F2-2848](#).
- <dt> Is the data type for the elements of the operands, encoded in the "F:size" field. It can have the following values:
- | | |
|-----|-----------------------|
| I8 | when F = 0, size = 00 |
| I16 | when F = 0, size = 01 |
| I32 | when F = 0, size = 10 |
| F16 | when F = 1, size = 01 |
| F32 | when F = 1, size = 10 |
- <Qd> Is the 128-bit name of the SIMD&FP destination register, encoded in the "D:Vd" field as <Qd>*2.
- <Qm> Is the 128-bit name of the SIMD&FP source register, encoded in the "M:Vm" field as <Qm>*2.
- <Dd> Is the 64-bit name of the SIMD&FP destination register, encoded in the "D:Vd" field.
- <Dm> Is the 64-bit name of the SIMD&FP source register, encoded in the "M:Vm" field.

Operation for all encodings

```
if ConditionPassed() then
  EncodingSpecificOperations(); CheckAdvSIMDEnabled();
  for r = 0 to regs-1
    for e = 0 to elements-1
      if floating_point then
        bits(esize) zero = FPZero('0');
        test_passed = FPCompareEQ(Elem[D[m+r],e,esize], zero, StandardFPSCRValue());
      else
        test_passed = (Elem[D[m+r],e,esize] == Zeros(esize));
      Elem[D[d+r],e,esize] = if test_passed then Ones(esize) else Zeros(esize);
```

F6.1.40 VCEQ (register)

Vector Compare Equal takes each element in a vector, and compares it with the corresponding element of a second vector. If they are equal, the corresponding element in the destination vector is set to all ones. Otherwise, it is set to all zeros.

The operand vector elements are the same type, and are integers or floating-point numbers. The result vector elements are fields the same size as the operand vector elements.

Depending on settings in the CPACR, NSACR, and HCPTR registers, and the security state and mode in which the instruction is executed, an attempt to execute the instruction might be UNDEFINED, or trapped to Hyp mode. For more information see [Enabling Advanced SIMD and floating-point support on page G1-4413](#).

A1

31	30	29	28	27	26	25	24	23	22	21	20	19	16	15	12	11	10	9	8	7	6	5	4	3	0
1	1	1	1	0	0	1	1	0	D	size	Vn	Vd	1	0	0	0	N	Q	M	1	Vm				

64-bit SIMD vector variant

Applies when Q == 0.

VCEQ{<c>}{<q>}.<dt> {<Dd>, }<Dn>, <Dm>

128-bit SIMD vector variant

Applies when Q == 1.

VCEQ{<c>}{<q>}.<dt> {<Qd>, }<Qn>, <Qm>

Decode for all variants of this encoding

```
if Q == '1' && (Vd<0> == '1' || Vn<0> == '1' || Vm<0> == '1') then UNDEFINED;
if size == '11' then UNDEFINED;
int_operation = TRUE; esize = 8 << UInt(size); elements = 64 DIV esize;
d = UInt(D:Vd); n = UInt(N:Vn); m = UInt(M:Vm); regs = if Q == '0' then 1 else 2;
```

A2

31	30	29	28	27	26	25	24	23	22	21	20	19	16	15	12	11	10	9	8	7	6	5	4	3	0
1	1	1	1	0	0	1	0	0	D	0	sz	Vn	Vd	1	1	1	0	N	Q	M	0	Vm			

64-bit SIMD vector variant

Applies when Q == 0.

VCEQ{<c>}{<q>}.<dt> {<Dd>, }<Dn>, <Dm>

128-bit SIMD vector variant

Applies when Q == 1.

VCEQ{<c>}{<q>}.<dt> {<Qd>, }<Qn>, <Qm>

Decode for all variants of this encoding

```
if Q == '1' && (Vd<0> == '1' || Vn<0> == '1' || Vm<0> == '1') then UNDEFINED;
if sz == '1' && !HaveFP16Ext() then UNDEFINED;
int_operation = FALSE;
```

```

case sz of
  when '0' esize = 32; elements = 2;
  when '1' esize = 16; elements = 4;
d = UInt(D:Vd); n = UInt(N:Vn); m = UInt(M:Vm); regs = if Q == '0' then 1 else 2;
  
```

T1

15	14	13	12	11	10	9	8	7	6	5	4	3	0	15	12	11	10	9	8	7	6	5	4	3	0
1	1	1	1	1	1	1	0	D	size	Vn	Vd	1	0	0	0	N	Q	M	1	Vm					

64-bit SIMD vector variant

Applies when Q == 0.

VCEQ{<c>}{<q>}.<dt> {<Dd>, }<Dn>, <Dm>

128-bit SIMD vector variant

Applies when Q == 1.

VCEQ{<c>}{<q>}.<dt> {<Qd>, }<Qn>, <Qm>

Decode for all variants of this encoding

```

if Q == '1' && (Vd<0> == '1' || Vn<0> == '1' || Vm<0> == '1') then UNDEFINED;
if size == '11' then UNDEFINED;
int_operation = TRUE; esize = 8 << UInt(size); elements = 64 DIV esize;
d = UInt(D:Vd); n = UInt(N:Vn); m = UInt(M:Vm); regs = if Q == '0' then 1 else 2;
  
```

T2

15	14	13	12	11	10	9	8	7	6	5	4	3	0	15	12	11	10	9	8	7	6	5	4	3	0
1	1	1	0	1	1	1	1	0	D	0	sz	Vn	Vd	1	1	1	0	N	Q	M	0	Vm			

64-bit SIMD vector variant

Applies when Q == 0.

VCEQ{<c>}{<q>}.<dt> {<Dd>, }<Dn>, <Dm>

128-bit SIMD vector variant

Applies when Q == 1.

VCEQ{<c>}{<q>}.<dt> {<Qd>, }<Qn>, <Qm>

Decode for all variants of this encoding

```

if Q == '1' && (Vd<0> == '1' || Vn<0> == '1' || Vm<0> == '1') then UNDEFINED;
if sz == '1' && !HaveFP16Ext() then UNDEFINED;
if sz == '1' && InITBlock() then UNPREDICTABLE;
int_operation = FALSE;
case sz of
  when '0' esize = 32; elements = 2;
  when '1' esize = 16; elements = 4;
d = UInt(D:Vd); n = UInt(N:Vn); m = UInt(M:Vm); regs = if Q == '0' then 1 else 2;
  
```

CONSTRAINED UNPREDICTABLE behavior

If `sz == '1' && InITBlock()`, then one of the following behaviors must occur:

- The instruction is UNDEFINED.
- The instruction executes as if it passes the Condition code check.
- The instruction executes as NOP. This means it behaves as if it fails the Condition code check.

Assembler symbols

- <c> For encoding A1 and A2: see [Standard assembler syntax fields on page F2-2848](#). This encoding must be unconditional.
 For encoding T1 and T2: see [Standard assembler syntax fields on page F2-2848](#).
- <q> See [Standard assembler syntax fields on page F2-2848](#).
- <dt> For encoding A1 and T1: is the data type for the elements of the vectors, encoded in the "size" field. It can have the following values:
 I8 when size = 00
 I16 when size = 01
 I32 when size = 10
 For encoding A2 and T2: is the data type for the elements of the vectors, encoded in the "sz" field. It can have the following values:
 F32 when sz = 0
 F16 when sz = 1
- <Qd> Is the 128-bit name of the SIMD&FP destination register, encoded in the "D:Vd" field as <Qd>*2.
- <Qn> Is the 128-bit name of the first SIMD&FP source register, encoded in the "N:Vn" field as <Qn>*2.
- <Qm> Is the 128-bit name of the second SIMD&FP source register, encoded in the "M:Vm" field as <Qm>*2.
- <Dd> Is the 64-bit name of the SIMD&FP destination register, encoded in the "D:Vd" field.
- <Dn> Is the 64-bit name of the first SIMD&FP source register, encoded in the "N:Vn" field.
- <Dm> Is the 64-bit name of the second SIMD&FP source register, encoded in the "M:Vm" field.

Operation for all encodings

```

if ConditionPassed() then
    EncodingSpecificOperations(); CheckAdvSIMDEnabled();
    for r = 0 to regs-1
        for e = 0 to elements-1
            op1 = Elem[D[n+r],e,esize]; op2 = Elem[D[m+r],e,esize];
            if int_operation then
                test_passed = (op1 == op2);
            else
                test_passed = FPCompareEQ(op1, op2, StandardFPSCRValue());
            Elem[D[d+r],e,esize] = if test_passed then Ones(esize) else Zeros(esize);
  
```

F6.1.41 VCGE (immediate #0)

Vector Compare Greater Than or Equal to Zero takes each element in a vector, and compares it with zero. If it is greater than or equal to zero, the corresponding element in the destination vector is set to all ones. Otherwise, it is set to all zeros.

The operand vector elements are the same type, and are signed integers or floating-point numbers. The result vector elements are fields the same size as the operand vector elements.

Depending on settings in the CPACR, NSACR, and HCPTR registers, and the security state and mode in which the instruction is executed, an attempt to execute the instruction might be UNDEFINED, or trapped to Hyp mode. For more information see [Enabling Advanced SIMD and floating-point support on page G1-4413](#).

A1

31	30	29	28	27	26	25	24	23	22	21	20	19	18	17	16	15	12	11	10	9	8	7	6	5	4	3	0
1	1	1	1	0	0	1	1	1	D	1	1	size	0	1	Vd	0	F	0	0	1	Q	M	0	Vm			

64-bit SIMD vector variant

Applies when Q == 0.

VCGE{<c>}{<q>}.<dt> {<Dd>}, <Dm>, #0

128-bit SIMD vector variant

Applies when Q == 1.

VCGE{<c>}{<q>}.<dt> {<Qd>}, <Qm>, #0

Decode for all variants of this encoding

```

if size == '11' then UNDEFINED;
if F == '1' && ((size == '01' && !HaveFP16Ext()) || size == '00') then UNDEFINED;
if Q == '1' && (Vd<0> == '1' || Vm<0> == '1') then UNDEFINED;
floating_point = (F == '1');
esize = 8 << UInt(size); elements = 64 DIV esize;
d = UInt(D:Vd); m = UInt(M:Vm); regs = if Q == '0' then 1 else 2;
    
```

T1

15	14	13	12	11	10	9	8	7	6	5	4	3	2	1	0	15	12	11	10	9	8	7	6	5	4	3	0
1	1	1	1	1	1	1	1	1	D	1	1	size	0	1	Vd	0	F	0	0	1	Q	M	0	Vm			

64-bit SIMD vector variant

Applies when Q == 0.

VCGE{<c>}{<q>}.<dt> {<Dd>}, <Dm>, #0

128-bit SIMD vector variant

Applies when Q == 1.

VCGE{<c>}{<q>}.<dt> {<Qd>}, <Qm>, #0

Decode for all variants of this encoding

```

if size == '11' then UNDEFINED;
if F == '1' && ((size == '01' && !HaveFP16Ext()) || size == '00') then UNDEFINED;
if F == '1' && size == '01' && InITBlock() then UNPREDICTABLE;
if Q == '1' && (Vd<0> == '1' || Vm<0> == '1') then UNDEFINED;
floating_point = (F == '1');
esize = 8 << UInt(size); elements = 64 DIV esize;
d = UInt(D:Vd); m = UInt(M:Vm); regs = if Q == '0' then 1 else 2;
  
```

CONSTRAINED UNPREDICTABLE behavior

If F == '1' && size == '01' && InITBlock(), then one of the following behaviors must occur:

- The instruction is UNDEFINED.
- The instruction executes as if it passes the Condition code check.
- The instruction executes as NOP. This means it behaves as if it fails the Condition code check.

Assembler symbols

- <c> For encoding A1: see [Standard assembler syntax fields on page F2-2848](#). This encoding must be unconditional.
 For encoding T1: see [Standard assembler syntax fields on page F2-2848](#).
- <q> See [Standard assembler syntax fields on page F2-2848](#).
- <dt> Is the data type for the elements of the operands, encoded in the "F:size" field. It can have the following values:

S8	when F = 0, size = 00
S16	when F = 0, size = 01
S32	when F = 0, size = 10
F16	when F = 1, size = 01
F32	when F = 1, size = 10
- <Qd> Is the 128-bit name of the SIMD&FP destination register, encoded in the "D:Vd" field as <Qd>*2.
- <Qm> Is the 128-bit name of the SIMD&FP source register, encoded in the "M:Vm" field as <Qm>*2.
- <Dd> Is the 64-bit name of the SIMD&FP destination register, encoded in the "D:Vd" field.
- <Dm> Is the 64-bit name of the SIMD&FP source register, encoded in the "M:Vm" field.

Operation for all encodings

```

if ConditionPassed() then
  EncodingSpecificOperations(); CheckAdvSIMDEnabled();
  for r = 0 to regs-1
    for e = 0 to elements-1
      if floating_point then
        bits(esize) zero = FPZero('0');
        test_passed = FPCompareGE(Elem[D[m+r],e,esize], zero, StandardFPSCRValue());
      else
        test_passed = (SInt(Elem[D[m+r],e,esize]) >= 0);
      Elem[D[d+r],e,esize] = if test_passed then Ones(esize) else Zeros(esize);
  
```

F6.1.42 VCGE (register)

Vector Compare Greater Than or Equal takes each element in a vector, and compares it with the corresponding element of a second vector. If the first is greater than or equal to the second, the corresponding element in the destination vector is set to all ones. Otherwise, it is set to all zeros.

The operand vector elements are the same type, and are signed integers, unsigned integers, or floating-point numbers. The result vector elements are fields the same size as the operand vector elements.

Depending on settings in the CPACR, NSACR, and HCPTR registers, and the security state and mode in which the instruction is executed, an attempt to execute the instruction might be UNDEFINED, or trapped to Hyp mode. For more information see [Enabling Advanced SIMD and floating-point support on page G1-4413](#).

This instruction is used by the pseudo-instruction VCLE (register). The pseudo-instruction is never the preferred disassembly.

A1

31	30	29	28	27	26	25	24	23	22	21	20	19	16	15	12	11	10	9	8	7	6	5	4	3	0
1	1	1	1	0	0	1	U	0	D	size	Vn	Vd	0	0	1	1	N	Q	M	1	Vm				

64-bit SIMD vector variant

Applies when Q == 0.

VCGE{<c>}{<q>}.<dt> {<Dd>, }<Dn>, <Dm>

128-bit SIMD vector variant

Applies when Q == 1.

VCGE{<c>}{<q>}.<dt> {<Qd>, }<Qn>, <Qm>

Decode for all variants of this encoding

```

if Q == '1' && (Vd<0> == '1' || Vn<0> == '1' || Vm<0> == '1') then UNDEFINED;
if size == '11' then UNDEFINED;
type = if U == '1' then VCGEtype_unsigned else VCGEtype_signed;
esize = 8 << UInt(size); elements = 64 DIV esize;
d = UInt(D:Vd); n = UInt(N:Vn); m = UInt(M:Vm); regs = if Q == '0' then 1 else 2;
    
```

A2

31	30	29	28	27	26	25	24	23	22	21	20	19	16	15	12	11	10	9	8	7	6	5	4	3	0
1	1	1	1	0	0	1	1	0	D	0	sz	Vn	Vd	1	1	1	0	N	Q	M	0	Vm			

64-bit SIMD vector variant

Applies when Q == 0.

VCGE{<c>}{<q>}.<dt> {<Dd>, }<Dn>, <Dm>

128-bit SIMD vector variant

Applies when Q == 1.

VCGE{<c>}{<q>}.<dt> {<Qd>, }<Qn>, <Qm>

Decode for all variants of this encoding

```

if Q == '1' && (Vd<0> == '1' || Vn<0> == '1' || Vm<0> == '1') then UNDEFINED;
if sz == '1' && !HaveFP16Ext() then UNDEFINED;
type = VCGEtype_fp;
case sz of
    when '0' esize = 32; elements = 2;
    when '1' esize = 16; elements = 4;
d = UInt(D:Vd); n = UInt(N:Vn); m = UInt(M:Vm); regs = if Q == '0' then 1 else 2;
    
```

T1

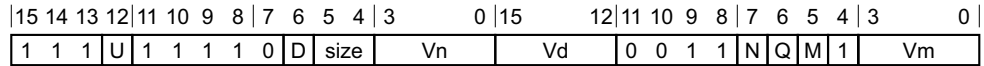

64-bit SIMD vector variant

Applies when Q == 0.

VCGE{<c>}{<q>}.<dt> {<Dd>, }<Dn>, <Dm>

128-bit SIMD vector variant

Applies when Q == 1.

VCGE{<c>}{<q>}.<dt> {<Qd>, }<Qn>, <Qm>

Decode for all variants of this encoding

```

if Q == '1' && (Vd<0> == '1' || Vn<0> == '1' || Vm<0> == '1') then UNDEFINED;
if size == '11' then UNDEFINED;
type = if U == '1' then VCGEtype_unsigned else VCGEtype_signed;
esize = 8 << UInt(size); elements = 64 DIV esize;
d = UInt(D:Vd); n = UInt(N:Vn); m = UInt(M:Vm); regs = if Q == '0' then 1 else 2;
    
```

T2

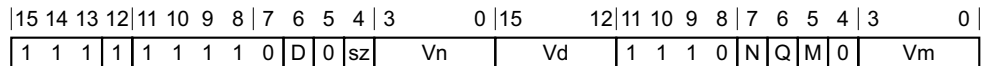

64-bit SIMD vector variant

Applies when Q == 0.

VCGE{<c>}{<q>}.<dt> {<Dd>, }<Dn>, <Dm>

128-bit SIMD vector variant

Applies when Q == 1.

VCGE{<c>}{<q>}.<dt> {<Qd>, }<Qn>, <Qm>

Decode for all variants of this encoding

```

if Q == '1' && (Vd<0> == '1' || Vn<0> == '1' || Vm<0> == '1') then UNDEFINED;
if sz == '1' && !HaveFP16Ext() then UNDEFINED;
if sz == '1' && InITBlock() then UNPREDICTABLE;
type = VCGEtype_fp;
case sz of
    
```

```

    when '0' esize = 32; elements = 2;
    when '1' esize = 16; elements = 4;
    d = UInt(D:Vd); n = UInt(N:Vn); m = UInt(M:Vm); regs = if Q == '0' then 1 else 2;
  
```

CONSTRAINED UNPREDICTABLE behavior

If `sz == '1' && InITBlock()`, then one of the following behaviors must occur:

- The instruction is UNDEFINED.
- The instruction executes as if it passes the Condition code check.
- The instruction executes as NOP. This means it behaves as if it fails the Condition code check.

Assembler symbols

- <c> For encoding A1 and A2: see *Standard assembler syntax fields on page F2-2848*. This encoding must be unconditional.
 For encoding T1 and T2: see *Standard assembler syntax fields on page F2-2848*.
- <q> See *Standard assembler syntax fields on page F2-2848*.
- <dt> For encoding A1 and T1: is the data type for the elements of the operands, encoded in the "U:size" field. It can have the following values:
 - S8 when U = 0, size = 00
 - S16 when U = 0, size = 01
 - S32 when U = 0, size = 10
 - U8 when U = 1, size = 00
 - U16 when U = 1, size = 01
 - U32 when U = 1, size = 10
 For encoding A2 and T2: is the data type for the elements of the vectors, encoded in the "sz" field. It can have the following values:
 - F32 when sz = 0
 - F16 when sz = 1
- <Qd> Is the 128-bit name of the SIMD&FP destination register, encoded in the "D:Vd" field as <Qd>*2.
- <Qn> Is the 128-bit name of the first SIMD&FP source register, encoded in the "N:Vn" field as <Qn>*2.
- <Qm> Is the 128-bit name of the second SIMD&FP source register, encoded in the "M:Vm" field as <Qm>*2.
- <Dd> Is the 64-bit name of the SIMD&FP destination register, encoded in the "D:Vd" field.
- <Dn> Is the 64-bit name of the first SIMD&FP source register, encoded in the "N:Vn" field.
- <Dm> Is the 64-bit name of the second SIMD&FP source register, encoded in the "M:Vm" field.

Operation for all encodings

```

enumeration VCGEType {VCGEType_signed, VCGEType_unsigned, VCGEType_fp};

if ConditionPassed() then
  EncodingSpecificOperations(); CheckAdvSIMDEnabled();
  for r = 0 to regs-1
    for e = 0 to elements-1
      op1 = Elem[D[n+r],e,esize]; op2 = Elem[D[m+r],e,esize];
      case type of
        when VCGEType_signed test_passed = (SInt(op1) >= SInt(op2));
  
```



```
when VCGEtype_unsigned test_passed = (UInt(op1) >= UInt(op2));  
when VCGEtype_fp       test_passed = FPCompareGE(op1, op2, StandardFPSCRValue());  
Elem[D[d+r],e,esize] = if test_passed then Ones(esize) else Zeros(esize);
```

F6.1.43 VCGT (immediate #0)

Vector Compare Greater Than Zero takes each element in a vector, and compares it with zero. If it is greater than zero, the corresponding element in the destination vector is set to all ones. Otherwise, it is set to all zeros.

The operand vector elements are the same type, and are signed integers or floating-point numbers. The result vector elements are fields the same size as the operand vector elements.

Depending on settings in the CPACR, NSACR, and HCPTR registers, and the security state and mode in which the instruction is executed, an attempt to execute the instruction might be UNDEFINED, or trapped to Hyp mode. For more information see [Enabling Advanced SIMD and floating-point support on page G1-4413](#).

A1

31	30	29	28	27	26	25	24	23	22	21	20	19	18	17	16	15	12	11	10	9	8	7	6	5	4	3	0
1	1	1	1	0	0	1	1	1	D	1	1	size	0	1	Vd	0	F	0	0	0	0	Q	M	0	Vm		

64-bit SIMD vector variant

Applies when Q == 0.

VCGT{<c>}{<q>}.<dt> {<Dd>}, <Dm>, #0

128-bit SIMD vector variant

Applies when Q == 1.

VCGT{<c>}{<q>}.<dt> {<Qd>}, <Qm>, #0

Decode for all variants of this encoding

```

if size == '11' then UNDEFINED;
if F == '1' && ((size == '01' && !HaveFP16Ext()) || size == '00') then UNDEFINED;
if Q == '1' && (Vd<0> == '1' || Vm<0> == '1') then UNDEFINED;
floating_point = (F == '1');
esize = 8 << UInt(size); elements = 64 DIV esize;
d = UInt(D:Vd); m = UInt(M:Vm); regs = if Q == '0' then 1 else 2;
    
```

T1

15	14	13	12	11	10	9	8	7	6	5	4	3	2	1	0	15	12	11	10	9	8	7	6	5	4	3	0
1	1	1	1	1	1	1	1	1	D	1	1	size	0	1	Vd	0	F	0	0	0	0	Q	M	0	Vm		

64-bit SIMD vector variant

Applies when Q == 0.

VCGT{<c>}{<q>}.<dt> {<Dd>}, <Dm>, #0

128-bit SIMD vector variant

Applies when Q == 1.

VCGT{<c>}{<q>}.<dt> {<Qd>}, <Qm>, #0

Decode for all variants of this encoding

```

if size == '11' then UNDEFINED;
if F == '1' && ((size == '01' && !HaveFP16Ext()) || size == '00') then UNDEFINED;
if F == '1' && size == '01' && InITBlock() then UNPREDICTABLE;
    
```

```
if Q == '1' && (Vd<0> == '1' || Vm<0> == '1') then UNDEFINED;
floating_point = (F == '1');
esize = 8 << UInt(size); elements = 64 DIV esize;
d = UInt(D:Vd); m = UInt(M:Vm); regs = if Q == '0' then 1 else 2;
```

CONSTRAINED UNPREDICTABLE behavior

If F == '1' && size == '01' && InITBlock(), then one of the following behaviors must occur:

- The instruction is UNDEFINED.
- The instruction executes as if it passes the Condition code check.
- The instruction executes as NOP. This means it behaves as if it fails the Condition code check.

Assembler symbols

- <c> For encoding A1: see [Standard assembler syntax fields on page F2-2848](#). This encoding must be unconditional.
 For encoding T1: see [Standard assembler syntax fields on page F2-2848](#).
- <q> See [Standard assembler syntax fields on page F2-2848](#).
- <dt> Is the data type for the elements of the operands, encoded in the "F:size" field. It can have the following values:
- | | |
|-----|-----------------------|
| S8 | when F = 0, size = 00 |
| S16 | when F = 0, size = 01 |
| S32 | when F = 0, size = 10 |
| F16 | when F = 1, size = 01 |
| F32 | when F = 1, size = 10 |
- <Qd> Is the 128-bit name of the SIMD&FP destination register, encoded in the "D:Vd" field as <Qd>*2.
- <Qm> Is the 128-bit name of the SIMD&FP source register, encoded in the "M:Vm" field as <Qm>*2.
- <Dd> Is the 64-bit name of the SIMD&FP destination register, encoded in the "D:Vd" field.
- <Dm> Is the 64-bit name of the SIMD&FP source register, encoded in the "M:Vm" field.

Operation for all encodings

```
if ConditionPassed() then
  EncodingSpecificOperations(); CheckAdvSIMDEnabled();
  for r = 0 to regs-1
    for e = 0 to elements-1
      if floating_point then
        bits(esize) zero = FPZero('0');
        test_passed = FPCompareGT(Elem[D[m+r],e,esize], zero, StandardFPSCRValue());
      else
        test_passed = (SInt(Elem[D[m+r],e,esize]) > 0);
      Elem[D[d+r],e,esize] = if test_passed then Ones(esize) else Zeros(esize);
```

F6.1.44 VCGT (register)

Vector Compare Greater Than takes each element in a vector, and compares it with the corresponding element of a second vector. If the first is greater than the second, the corresponding element in the destination vector is set to all ones. Otherwise, it is set to all zeros.

The operand vector elements are the same type, and are signed integers, unsigned integers, or floating-point numbers. The result vector elements are fields the same size as the operand vector elements.

Depending on settings in the CPACR, NSACR, and HCPTR registers, and the security state and mode in which the instruction is executed, an attempt to execute the instruction might be UNDEFINED, or trapped to Hyp mode. For more information see [Enabling Advanced SIMD and floating-point support on page G1-4413](#).

This instruction is used by the pseudo-instruction [VCLT \(register\)](#). The pseudo-instruction is never the preferred disassembly.

A1

31	30	29	28	27	26	25	24	23	22	21	20	19	16	15	12	11	10	9	8	7	6	5	4	3	0
1	1	1	1	0	0	0	1	U	0	D	size	Vn	Vd	0	0	1	1	N	Q	M	0	Vm			

64-bit SIMD vector variant

Applies when Q == 0.

VCGT{<c>}{<q>}.<dt> {<Dd>, }<Dn>, <Dm>

128-bit SIMD vector variant

Applies when Q == 1.

VCGT{<c>}{<q>}.<dt> {<Qd>, }<Qn>, <Qm>

Decode for all variants of this encoding

```

if Q == '1' && (Vd<0> == '1' || Vn<0> == '1' || Vm<0> == '1') then UNDEFINED;
if size == '11' then UNDEFINED;
type = if U == '1' then VCGTtype_unsigned else VCGTtype_signed;
esize = 8 << UInt(size); elements = 64 DIV esize;
d = UInt(D:Vd); n = UInt(N:Vn); m = UInt(M:Vm); regs = if Q == '0' then 1 else 2;
  
```

A2

31	30	29	28	27	26	25	24	23	22	21	20	19	16	15	12	11	10	9	8	7	6	5	4	3	0
1	1	1	1	0	0	0	1	1	0	D	1	sz	Vn	Vd	1	1	1	0	N	Q	M	0	Vm		

64-bit SIMD vector variant

Applies when Q == 0.

VCGT{<c>}{<q>}.<dt> {<Dd>, }<Dn>, <Dm>

128-bit SIMD vector variant

Applies when Q == 1.

VCGT{<c>}{<q>}.<dt> {<Qd>, }<Qn>, <Qm>

Decode for all variants of this encoding

```

if Q == '1' && (Vd<0> == '1' || Vn<0> == '1' || Vm<0> == '1') then UNDEFINED;
if sz == '1' && !HaveFP16Ext() then UNDEFINED;
type = VCGTtype_fp;
case sz of
    when '0' esize = 32; elements = 2;
    when '1' esize = 16; elements = 4;
d = UInt(D:Vd); n = UInt(N:Vn); m = UInt(M:Vm); regs = if Q == '0' then 1 else 2;
    
```

T1

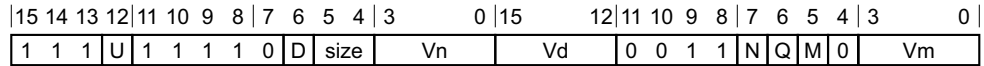

64-bit SIMD vector variant

Applies when Q == 0.

VCGT{<c>}{<q>}.<dt> {<Dd>, }<Dn>, <Dm>

128-bit SIMD vector variant

Applies when Q == 1.

VCGT{<c>}{<q>}.<dt> {<Qd>, }<Qn>, <Qm>

Decode for all variants of this encoding

```

if Q == '1' && (Vd<0> == '1' || Vn<0> == '1' || Vm<0> == '1') then UNDEFINED;
if size == '11' then UNDEFINED;
type = if U == '1' then VCGTtype_unsigned else VCGTtype_signed;
esize = 8 << UInt(size); elements = 64 DIV esize;
d = UInt(D:Vd); n = UInt(N:Vn); m = UInt(M:Vm); regs = if Q == '0' then 1 else 2;
    
```

T2

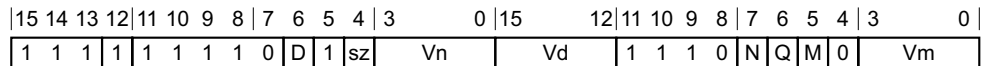

64-bit SIMD vector variant

Applies when Q == 0.

VCGT{<c>}{<q>}.<dt> {<Dd>, }<Dn>, <Dm>

128-bit SIMD vector variant

Applies when Q == 1.

VCGT{<c>}{<q>}.<dt> {<Qd>, }<Qn>, <Qm>

Decode for all variants of this encoding

```

if Q == '1' && (Vd<0> == '1' || Vn<0> == '1' || Vm<0> == '1') then UNDEFINED;
if sz == '1' && !HaveFP16Ext() then UNDEFINED;
if sz == '1' && InITBlock() then UNPREDICTABLE;
type = VCGTtype_fp;
case sz of
    
```

```

    when '0' esize = 32; elements = 2;
    when '1' esize = 16; elements = 4;
    d = UInt(D:Vd); n = UInt(N:Vn); m = UInt(M:Vm); regs = if Q == '0' then 1 else 2;
  
```

CONSTRAINED UNPREDICTABLE behavior

If `sz == '1' && InITBlock()`, then one of the following behaviors must occur:

- The instruction is UNDEFINED.
- The instruction executes as if it passes the Condition code check.
- The instruction executes as NOP. This means it behaves as if it fails the Condition code check.

Assembler symbols

- <c> For encoding A1 and A2: see [Standard assembler syntax fields on page F2-2848](#). This encoding must be unconditional.
 For encoding T1 and T2: see [Standard assembler syntax fields on page F2-2848](#).
- <q> See [Standard assembler syntax fields on page F2-2848](#).
- <dt> For encoding A1 and T1: is the data type for the elements of the operands, encoded in the "U:size" field. It can have the following values:
- | | |
|-----|-----------------------|
| S8 | when U = 0, size = 00 |
| S16 | when U = 0, size = 01 |
| S32 | when U = 0, size = 10 |
| U8 | when U = 1, size = 00 |
| U16 | when U = 1, size = 01 |
| U32 | when U = 1, size = 10 |
- For encoding A2 and T2: is the data type for the elements of the vectors, encoded in the "sz" field. It can have the following values:
- | | |
|-----|-------------|
| F32 | when sz = 0 |
| F16 | when sz = 1 |
- <Qd> Is the 128-bit name of the SIMD&FP destination register, encoded in the "D:Vd" field as <Qd>*2.
- <Qn> Is the 128-bit name of the first SIMD&FP source register, encoded in the "N:Vn" field as <Qn>*2.
- <Qm> Is the 128-bit name of the second SIMD&FP source register, encoded in the "M:Vm" field as <Qm>*2.
- <Dd> Is the 64-bit name of the SIMD&FP destination register, encoded in the "D:Vd" field.
- <Dn> Is the 64-bit name of the first SIMD&FP source register, encoded in the "N:Vn" field.
- <Dm> Is the 64-bit name of the second SIMD&FP source register, encoded in the "M:Vm" field.

Operation for all encodings

```

enumeration VCGTtype {VCGTtype_signed, VCGTtype_unsigned, VCGTtype_fp};

if ConditionPassed() then
    EncodingSpecificOperations(); CheckAdvSIMDEnabled();
    for r = 0 to regs-1
        for e = 0 to elements-1
            op1 = Elem[D[n+r],e,esize]; op2 = Elem[D[m+r],e,esize];
            case type of
                when VCGTtype_signed test_passed = (SInt(op1) > SInt(op2));
  
```

```
when VCGTtype_unsigned test_passed = (UInt(op1) > UInt(op2));  
when VCGTtype_fp       test_passed = FPCompareGT(op1, op2, StandardFPSCRValue());  
Elem[D[d+r],e,esize] = if test_passed then Ones(esize) else Zeros(esize);
```

F6.1.45 VCLE (immediate #0)

Vector Compare Less Than or Equal to Zero takes each element in a vector, and compares it with zero. If it is less than or equal to zero, the corresponding element in the destination vector is set to all ones. Otherwise, it is set to all zeros.

The operand vector elements are the same type, and are signed integers or floating-point numbers. The result vector elements are fields the same size as the operand vector elements.

Depending on settings in the CPACR, NSACR, and HCPTR registers, and the security state and mode in which the instruction is executed, an attempt to execute the instruction might be UNDEFINED, or trapped to Hyp mode. For more information see [Enabling Advanced SIMD and floating-point support on page G1-4413](#).

A1

31	30	29	28	27	26	25	24	23	22	21	20	19	18	17	16	15	12	11	10	9	8	7	6	5	4	3	0
1	1	1	1	0	0	1	1	1	D	1	1	size	0	1	Vd	0	F	0	1	1	Q	M	0	Vm			

64-bit SIMD vector variant

Applies when Q == 0.

VCLE{<c>}{<q>}.<dt> {<Dd>}, <Dm>, #0

128-bit SIMD vector variant

Applies when Q == 1.

VCLE{<c>}{<q>}.<dt> {<Qd>}, <Qm>, #0

Decode for all variants of this encoding

```

if size == '11' then UNDEFINED;
if F == '1' && ((size == '01' && !HaveFP16Ext()) || size == '00') then UNDEFINED;
if Q == '1' && (Vd<0> == '1' || Vm<0> == '1') then UNDEFINED;
floating_point = (F == '1');
esize = 8 << UInt(size); elements = 64 DIV esize;
d = UInt(D:Vd); m = UInt(M:Vm); regs = if Q == '0' then 1 else 2;
  
```

T1

15	14	13	12	11	10	9	8	7	6	5	4	3	2	1	0	15	12	11	10	9	8	7	6	5	4	3	0
1	1	1	1	1	1	1	1	1	D	1	1	size	0	1	Vd	0	F	0	1	1	Q	M	0	Vm			

64-bit SIMD vector variant

Applies when Q == 0.

VCLE{<c>}{<q>}.<dt> {<Dd>}, <Dm>, #0

128-bit SIMD vector variant

Applies when Q == 1.

VCLE{<c>}{<q>}.<dt> {<Qd>}, <Qm>, #0

Decode for all variants of this encoding

```

if size == '11' then UNDEFINED;
if F == '1' && ((size == '01' && !HaveFP16Ext()) || size == '00') then UNDEFINED;
if F == '1' && size == '01' && InITBlock() then UNPREDICTABLE;
if Q == '1' && (Vd<0> == '1' || Vm<0> == '1') then UNDEFINED;
floating_point = (F == '1');
esize = 8 << UInt(size); elements = 64 DIV esize;
d = UInt(D:Vd); m = UInt(M:Vm); regs = if Q == '0' then 1 else 2;
  
```

CONSTRAINED UNPREDICTABLE behavior

If F == '1' && size == '01' && InITBlock(), then one of the following behaviors must occur:

- The instruction is UNDEFINED.
- The instruction executes as if it passes the Condition code check.
- The instruction executes as NOP. This means it behaves as if it fails the Condition code check.

Assembler symbols

- <c> For encoding A1: see [Standard assembler syntax fields on page F2-2848](#). This encoding must be unconditional.
 For encoding T1: see [Standard assembler syntax fields on page F2-2848](#).
- <q> See [Standard assembler syntax fields on page F2-2848](#).
- <dt> Is the data type for the elements of the operands, encoded in the "F:size" field. It can have the following values:
- | | |
|-----|-----------------------|
| S8 | when F = 0, size = 00 |
| S16 | when F = 0, size = 01 |
| S32 | when F = 0, size = 10 |
| F16 | when F = 1, size = 01 |
| F32 | when F = 1, size = 10 |
- <Qd> Is the 128-bit name of the SIMD&FP destination register, encoded in the "D:Vd" field as <Qd>*2.
- <Qm> Is the 128-bit name of the SIMD&FP source register, encoded in the "M:Vm" field as <Qm>*2.
- <Dd> Is the 64-bit name of the SIMD&FP destination register, encoded in the "D:Vd" field.
- <Dm> Is the 64-bit name of the SIMD&FP source register, encoded in the "M:Vm" field.

Operation for all encodings

```

if ConditionPassed() then
  EncodingSpecificOperations(); CheckAdvSIMDEnabled();
  for r = 0 to regs-1
    for e = 0 to elements-1
      if floating_point then
        bits(esize) zero = FPZero('0');
        test_passed = FPCompareGE(zero, Elem[D[m+r],e,esize], StandardFPSCRValue());
      else
        test_passed = (SInt(Elem[D[m+r],e,esize]) <= 0);
      Elem[D[d+r],e,esize] = if test_passed then Ones(esize) else Zeros(esize);
  
```

F6.1.46 VCLE (register)

Vector Compare Less Than or Equal takes each element in a vector, and compares it with the corresponding element of a second vector. If the first is less than or equal to the second, the corresponding element in the destination vector is set to all ones. Otherwise, it is set to all zeros

This instruction is a pseudo-instruction of the [VCGE \(register\)](#) instruction. This means that:

- The encodings in this description are named to match the encodings of [VCGE \(register\)](#).
- The assembler syntax is used only for assembly, and is not used on disassembly.
- The description of [VCGE \(register\)](#) gives the operational pseudocode for this instruction.

A1

31	30	29	28	27	26	25	24	23	22	21	20	19	16	15	12	11	10	9	8	7	6	5	4	3	0
1	1	1	1	0	0	1	U	0	D	size	Vn	Vd	0	0	1	1	N	Q	M	1	Vm				

64-bit SIMD vector variant

Applies when Q == 0.

VCLE{<c>}{<q>}.<dt> {<Dd>, }<Dn>, <Dm>

is equivalent to

VCGE{<c>}{<q>}.<dt> <Dd>, <Dm>, <Dn>

and is never the preferred disassembly.

128-bit SIMD vector variant

Applies when Q == 1.

VCLE{<c>}{<q>}.<dt> {<Qd>, }<Qn>, <Qm>

is equivalent to

VCGE{<c>}{<q>}.<dt> <Qd>, <Qm>, <Qn>

and is never the preferred disassembly.

A2

31	30	29	28	27	26	25	24	23	22	21	20	19	16	15	12	11	10	9	8	7	6	5	4	3	0
1	1	1	1	0	0	1	1	0	D	0	sz	Vn	Vd	1	1	1	0	N	Q	M	0	Vm			

64-bit SIMD vector variant

Applies when Q == 0.

VCLE{<c>}{<q>}.<dt> {<Dd>, }<Dn>, <Dm>

is equivalent to

VCGE{<c>}{<q>}.<dt> <Dd>, <Dm>, <Dn>

and is never the preferred disassembly.

128-bit SIMD vector variant

Applies when Q == 1.

VCLE{<c>}{<q>}.<dt> {<Qd>, }<Qn>, <Qm>

is equivalent to

VCGE{<c>}{<q>}.<dt> <Qd>, <Qm>, <Qn>

and is never the preferred disassembly.

T1

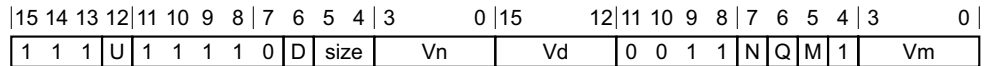

64-bit SIMD vector variant

Applies when Q == 0.

VCLE{<c>}{<q>}.<dt> {<Dd>, }<Dn>, <Dm>

is equivalent to

VCGE{<c>}{<q>}.<dt> <Dd>, <Dm>, <Dn>

and is never the preferred disassembly.

128-bit SIMD vector variant

Applies when Q == 1.

VCLE{<c>}{<q>}.<dt> {<Qd>, }<Qn>, <Qm>

is equivalent to

VCGE{<c>}{<q>}.<dt> <Qd>, <Qm>, <Qn>

and is never the preferred disassembly.

T2

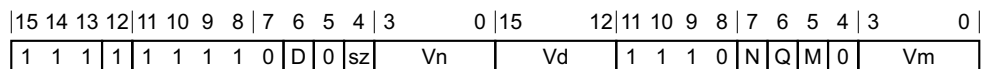

64-bit SIMD vector variant

Applies when Q == 0.

VCLE{<c>}{<q>}.<dt> {<Dd>, }<Dn>, <Dm>

is equivalent to

VCGE{<c>}{<q>}.<dt> <Dd>, <Dm>, <Dn>

and is never the preferred disassembly.

128-bit SIMD vector variant

Applies when Q == 1.

VCLE{<c>}{<q>}.<dt> {<Qd>, }<Qn>, <Qm>

is equivalent to

VCGE{<c>}{<q>}.<dt> <Qd>, <Qm>, <Qn>

and is never the preferred disassembly.

Assembler symbols

- <Dm> Is the 64-bit name of the second SIMD&FP source register, encoded in the "M:Vm" field.
- <Dn> Is the 64-bit name of the first SIMD&FP source register, encoded in the "N:Vn" field.
- <Qm> Is the 128-bit name of the second SIMD&FP source register, encoded in the "M:Vm" field as <Qm>*2.
- <Qn> Is the 128-bit name of the first SIMD&FP source register, encoded in the "N:Vn" field as <Qn>*2.
- <c> For encoding A1 and A2: see *Standard assembler syntax fields on page F2-2848*. This encoding must be unconditional.
For encoding T1 and T2: see *Standard assembler syntax fields on page F2-2848*.
- <q> See *Standard assembler syntax fields on page F2-2848*.
- <dt> For encoding A1 and T1: is the data type for the elements of the operands, encoded in the "U:size" field. It can have the following values:
- | | |
|-----|-----------------------|
| S8 | when U = 0, size = 00 |
| S16 | when U = 0, size = 01 |
| S32 | when U = 0, size = 10 |
| U8 | when U = 1, size = 00 |
| U16 | when U = 1, size = 01 |
| U32 | when U = 1, size = 10 |
- For encoding A2 and T2: is the data type for the elements of the vectors, encoded in the "sz" field. It can have the following values:
- | | |
|-----|-------------|
| F32 | when sz = 0 |
| F16 | when sz = 1 |
- <Qd> Is the 128-bit name of the SIMD&FP destination register, encoded in the "D:Vd" field as <Qd>*2.
- <Dd> Is the 64-bit name of the SIMD&FP destination register, encoded in the "D:Vd" field.

Operation for all encodings

The description of [VCGE \(register\)](#) gives the operational pseudocode for this instruction.

F6.1.47 VCLS

Vector Count Leading Sign Bits counts the number of consecutive bits following the topmost bit, that are the same as the topmost bit, in each element in a vector, and places the results in a second vector. The count does not include the topmost bit itself.

The operand vector elements can be any one of 8-bit, 16-bit, or 32-bit signed integers.

The result vector elements are the same data type as the operand vector elements.

Depending on settings in the CPACR, NSACR, and HCPTR registers, and the security state and mode in which the instruction is executed, an attempt to execute the instruction might be UNDEFINED, or trapped to Hyp mode. For more information see [Enabling Advanced SIMD and floating-point support on page G1-4413](#).

A1

31	30	29	28	27	26	25	24	23	22	21	20	19	18	17	16	15	12	11	10	9	8	7	6	5	4	3	0
1	1	1	1	0	0	1	1	1	D	1	1	size	0	0	Vd	0	1	0	0	0	Q	M	0	Vm			

64-bit SIMD vector variant

Applies when Q == 0.

VCLS{<c>}{<q>}.<dt> <Dd>, <Dm>

128-bit SIMD vector variant

Applies when Q == 1.

VCLS{<c>}{<q>}.<dt> <Qd>, <Qm>

Decode for all variants of this encoding

```
if size == '11' then UNDEFINED;
if Q == '1' && (Vd<0> == '1' || Vm<0> == '1') then UNDEFINED;
esize = 8 << UInt(size); elements = 64 DIV esize;
d = UInt(D:Vd); m = UInt(M:Vm); regs = if Q == '0' then 1 else 2;
```

T1

15	14	13	12	11	10	9	8	7	6	5	4	3	2	1	0	15	12	11	10	9	8	7	6	5	4	3	0
1	1	1	1	1	1	1	1	1	D	1	1	size	0	0	Vd	0	1	0	0	0	Q	M	0	Vm			

64-bit SIMD vector variant

Applies when Q == 0.

VCLS{<c>}{<q>}.<dt> <Dd>, <Dm>

128-bit SIMD vector variant

Applies when Q == 1.

VCLS{<c>}{<q>}.<dt> <Qd>, <Qm>

Decode for all variants of this encoding

```
if size == '11' then UNDEFINED;  
if Q == '1' && (Vd<0> == '1' || Vm<0> == '1') then UNDEFINED;  
esize = 8 << UInt(size); elements = 64 DIV esize;  
d = UInt(D:Vd); m = UInt(M:Vm); regs = if Q == '0' then 1 else 2;
```

Assembler symbols

- <c> For encoding A1: see [Standard assembler syntax fields on page F2-2848](#). This encoding must be unconditional.
For encoding T1: see [Standard assembler syntax fields on page F2-2848](#).
- <q> See [Standard assembler syntax fields on page F2-2848](#).
- <dt> Is the data type for the elements of the operands, encoded in the "size" field. It can have the following values:
S8 when size = 00
S16 when size = 01
S32 when size = 10
The encoding size = 11 is reserved.
- <Qd> Is the 128-bit name of the SIMD&FP destination register, encoded in the "D:Vd" field as <Qd>*2.
- <Qm> Is the 128-bit name of the SIMD&FP source register, encoded in the "M:Vm" field as <Qm>*2.
- <Dd> Is the 64-bit name of the SIMD&FP destination register, encoded in the "D:Vd" field.
- <Dm> Is the 64-bit name of the SIMD&FP source register, encoded in the "M:Vm" field.

Operation for all encodings

```
if ConditionPassed() then  
  EncodingSpecificOperations(); CheckAdvSIMDEnabled();  
  for r = 0 to regs-1  
    for e = 0 to elements-1  
      Elem[D[d+r],e,esize] = CountLeadingSignBits(ELem[D[m+r],e,esize])<esize-1:0>;
```

F6.1.48 VCLT (immediate #0)

Vector Compare Less Than Zero takes each element in a vector, and compares it with zero. If it is less than zero, the corresponding element in the destination vector is set to all ones. Otherwise, it is set to all zeros.

The operand vector elements are the same type, and are signed integers or floating-point numbers. The result vector elements are fields the same size as the operand vector elements.

Depending on settings in the CPACR, NSACR, and HCPTR registers, and the security state and mode in which the instruction is executed, an attempt to execute the instruction might be UNDEFINED, or trapped to Hyp mode. For more information see [Enabling Advanced SIMD and floating-point support on page G1-4413](#).

A1

31	30	29	28	27	26	25	24	23	22	21	20	19	18	17	16	15	12	11	10	9	8	7	6	5	4	3	0
1	1	1	1	0	0	1	1	1	D	1	1	size	0	1	Vd	0	F	1	0	0	Q	M	0	Vm			

64-bit SIMD vector variant

Applies when Q == 0.

VCLT{<c>}{<q>}.<dt> {<Dd>}, <Dm>, #0

128-bit SIMD vector variant

Applies when Q == 1.

VCLT{<c>}{<q>}.<dt> {<Qd>}, <Qm>, #0

Decode for all variants of this encoding

```

if size == '11' then UNDEFINED;
if F == '1' && ((size == '01' && !HaveFP16Ext()) || size == '00') then UNDEFINED;
if Q == '1' && (Vd<0> == '1' || Vm<0> == '1') then UNDEFINED;
floating_point = (F == '1');
esize = 8 << UInt(size); elements = 64 DIV esize;
d = UInt(D:Vd); m = UInt(M:Vm); regs = if Q == '0' then 1 else 2;
    
```

T1

15	14	13	12	11	10	9	8	7	6	5	4	3	2	1	0	15	12	11	10	9	8	7	6	5	4	3	0
1	1	1	1	1	1	1	1	1	D	1	1	size	0	1	Vd	0	F	1	0	0	Q	M	0	Vm			

64-bit SIMD vector variant

Applies when Q == 0.

VCLT{<c>}{<q>}.<dt> {<Dd>}, <Dm>, #0

128-bit SIMD vector variant

Applies when Q == 1.

VCLT{<c>}{<q>}.<dt> {<Qd>}, <Qm>, #0

Decode for all variants of this encoding

```

if size == '11' then UNDEFINED;
if F == '1' && ((size == '01' && !HaveFP16Ext()) || size == '00') then UNDEFINED;
if F == '1' && size == '01' && InITBlock() then UNPREDICTABLE;
    
```

```
if Q == '1' && (Vd<0> == '1' || Vm<0> == '1') then UNDEFINED;
floating_point = (F == '1');
esize = 8 << UInt(size); elements = 64 DIV esize;
d = UInt(D:Vd); m = UInt(M:Vm); regs = if Q == '0' then 1 else 2;
```

CONSTRAINED UNPREDICTABLE behavior

If `F == '1' && size == '01' && InITBlock()`, then one of the following behaviors must occur:

- The instruction is UNDEFINED.
- The instruction executes as if it passes the Condition code check.
- The instruction executes as NOP. This means it behaves as if it fails the Condition code check.

Assembler symbols

- <c> For encoding A1: see [Standard assembler syntax fields on page F2-2848](#). This encoding must be unconditional.
 For encoding T1: see [Standard assembler syntax fields on page F2-2848](#).
- <q> See [Standard assembler syntax fields on page F2-2848](#).
- <dt> Is the data type for the elements of the operands, encoded in the "F:size" field. It can have the following values:
- | | |
|-----|-----------------------|
| S8 | when F = 0, size = 00 |
| S16 | when F = 0, size = 01 |
| S32 | when F = 0, size = 10 |
| F16 | when F = 1, size = 01 |
| F32 | when F = 1, size = 10 |
- <Qd> Is the 128-bit name of the SIMD&FP destination register, encoded in the "D:Vd" field as <Qd>*2.
- <Qm> Is the 128-bit name of the SIMD&FP source register, encoded in the "M:Vm" field as <Qm>*2.
- <Dd> Is the 64-bit name of the SIMD&FP destination register, encoded in the "D:Vd" field.
- <Dm> Is the 64-bit name of the SIMD&FP source register, encoded in the "M:Vm" field.

Operation for all encodings

```
if ConditionPassed() then
  EncodingSpecificOperations(); CheckAdvSIMDEnabled();
  for r = 0 to regs-1
    for e = 0 to elements-1
      if floating_point then
        bits(esize) zero = FPZero('0');
        test_passed = FPCompareGT(zero, Elem[D[m+r],e,esize], StandardFPSCRValue());
      else
        test_passed = (SInt(Elem[D[m+r],e,esize]) < 0);
      Elem[D[d+r],e,esize] = if test_passed then Ones(esize) else Zeros(esize);
```

F6.1.49 VCLT (register)

Vector Compare Less Than takes each element in a vector, and compares it with the corresponding element of a second vector. If the first is less than the second, the corresponding element in the destination vector is set to all ones. Otherwise, it is set to all zeros

This instruction is a pseudo-instruction of the [VCGT \(register\)](#) instruction. This means that:

- The encodings in this description are named to match the encodings of [VCGT \(register\)](#).
- The assembler syntax is used only for assembly, and is not used on disassembly.
- The description of [VCGT \(register\)](#) gives the operational pseudocode for this instruction.

A1

31	30	29	28	27	26	25	24	23	22	21	20	19	16	15	12	11	10	9	8	7	6	5	4	3	0
1	1	1	1	0	0	1	U	0	D	size	Vn	Vd	0	0	1	1	N	Q	M	0	Vm				

64-bit SIMD vector variant

Applies when Q == 0.

VCLT{<c>}{<q>}.<dt> {<Dd>, }<Dn>, <Dm>

is equivalent to

VCGT{<c>}{<q>}.<dt> <Dd>, <Dm>, <Dn>

and is never the preferred disassembly.

128-bit SIMD vector variant

Applies when Q == 1.

VCLT{<c>}{<q>}.<dt> {<Qd>, }<Qn>, <Qm>

is equivalent to

VCGT{<c>}{<q>}.<dt> <Qd>, <Qm>, <Qn>

and is never the preferred disassembly.

A2

31	30	29	28	27	26	25	24	23	22	21	20	19	16	15	12	11	10	9	8	7	6	5	4	3	0
1	1	1	1	0	0	1	1	0	D	1	sz	Vn	Vd	1	1	1	0	N	Q	M	0	Vm			

64-bit SIMD vector variant

Applies when Q == 0.

VCLT{<c>}{<q>}.<dt> {<Dd>, }<Dn>, <Dm>

is equivalent to

VCGT{<c>}{<q>}.<dt> <Dd>, <Dm>, <Dn>

and is never the preferred disassembly.

128-bit SIMD vector variant

Applies when Q == 1.

VCLT{<c>}{<q>}.<dt> {<Qd>, }<Qn>, <Qm>

is equivalent to

VCGT{<c>}{<q>}.<dt> <Qd>, <Qm>, <Qn>

and is never the preferred disassembly.

T1

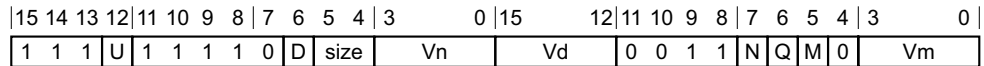

64-bit SIMD vector variant

Applies when Q == 0.

VCLT{<c>}{<q>}.<dt> {<Dd>, }<Dn>, <Dm>

is equivalent to

VCGT{<c>}{<q>}.<dt> <Dd>, <Dm>, <Dn>

and is never the preferred disassembly.

128-bit SIMD vector variant

Applies when Q == 1.

VCLT{<c>}{<q>}.<dt> {<Qd>, }<Qn>, <Qm>

is equivalent to

VCGT{<c>}{<q>}.<dt> <Qd>, <Qm>, <Qn>

and is never the preferred disassembly.

T2

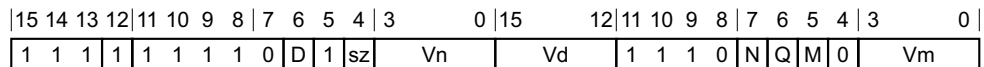

64-bit SIMD vector variant

Applies when Q == 0.

VCLT{<c>}{<q>}.<dt> {<Dd>, }<Dn>, <Dm>

is equivalent to

VCGT{<c>}{<q>}.<dt> <Dd>, <Dm>, <Dn>

and is never the preferred disassembly.

128-bit SIMD vector variant

Applies when Q == 1.

VCLT{<c>}{<q>}.<dt> {<Qd>, }<Qn>, <Qm>

is equivalent to

VCGT{<c>}{<q>}.<dt> <Qd>, <Qm>, <Qn>

and is never the preferred disassembly.

Assembler symbols

- <Dm> Is the 64-bit name of the second SIMD&FP source register, encoded in the "M:Vm" field.
- <Dn> Is the 64-bit name of the first SIMD&FP source register, encoded in the "N:Vn" field.
- <Qm> Is the 128-bit name of the second SIMD&FP source register, encoded in the "M:Vm" field as <Qm>*2.
- <Qn> Is the 128-bit name of the first SIMD&FP source register, encoded in the "N:Vn" field as <Qn>*2.
- <c> For encoding A1 and A2: see *Standard assembler syntax fields on page F2-2848*. This encoding must be unconditional.
For encoding T1 and T2: see *Standard assembler syntax fields on page F2-2848*.
- <q> See *Standard assembler syntax fields on page F2-2848*.
- <dt> For encoding A1 and T1: is the data type for the elements of the operands, encoded in the "U:size" field. It can have the following values:
- | | |
|-----|-----------------------|
| S8 | when U = 0, size = 00 |
| S16 | when U = 0, size = 01 |
| S32 | when U = 0, size = 10 |
| U8 | when U = 1, size = 00 |
| U16 | when U = 1, size = 01 |
| U32 | when U = 1, size = 10 |
- For encoding A2 and T2: is the data type for the elements of the vectors, encoded in the "sz" field. It can have the following values:
- | | |
|-----|-------------|
| F32 | when sz = 0 |
| F16 | when sz = 1 |
- <Qd> Is the 128-bit name of the SIMD&FP destination register, encoded in the "D:Vd" field as <Qd>*2.
- <Dd> Is the 64-bit name of the SIMD&FP destination register, encoded in the "D:Vd" field.

Operation for all encodings

The description of [VCGT \(register\)](#) gives the operational pseudocode for this instruction.

F6.1.50 VCLZ

Vector Count Leading Zeros counts the number of consecutive zeros, starting from the most significant bit, in each element in a vector, and places the results in a second vector.

The operand vector elements can be any one of 8-bit, 16-bit, or 32-bit integers. There is no distinction between signed and unsigned integers.

The result vector elements are the same data type as the operand vector elements.

Depending on settings in the CPACR, NSACR, and HCPTR registers, and the security state and mode in which the instruction is executed, an attempt to execute the instruction might be UNDEFINED, or trapped to Hyp mode. For more information see [Enabling Advanced SIMD and floating-point support on page G1-4413](#).

A1

31	30	29	28	27	26	25	24	23	22	21	20	19	18	17	16	15	12	11	10	9	8	7	6	5	4	3	0
1	1	1	1	0	0	1	1	1	D	1	1	size	0	0	Vd	0	1	0	0	1	Q	M	0	Vm			

64-bit SIMD vector variant

Applies when Q == 0.

VCLZ{<c>}{<q>}.<dt> <Dd>, <Dm>

128-bit SIMD vector variant

Applies when Q == 1.

VCLZ{<c>}{<q>}.<dt> <Qd>, <Qm>

Decode for all variants of this encoding

```
if size == '11' then UNDEFINED;
if Q == '1' && (Vd<0> == '1' || Vm<0> == '1') then UNDEFINED;
esize = 8 << UInt(size); elements = 64 DIV esize;
d = UInt(D:Vd); m = UInt(M:Vm); regs = if Q == '0' then 1 else 2;
```

T1

15	14	13	12	11	10	9	8	7	6	5	4	3	2	1	0	15	12	11	10	9	8	7	6	5	4	3	0
1	1	1	1	1	1	1	1	1	D	1	1	size	0	0	Vd	0	1	0	0	1	Q	M	0	Vm			

64-bit SIMD vector variant

Applies when Q == 0.

VCLZ{<c>}{<q>}.<dt> <Dd>, <Dm>

128-bit SIMD vector variant

Applies when Q == 1.

VCLZ{<c>}{<q>}.<dt> <Qd>, <Qm>

Decode for all variants of this encoding

```

if size == '11' then UNDEFINED;
if Q == '1' && (Vd<0> == '1' || Vm<0> == '1') then UNDEFINED;
esize = 8 << UInt(size); elements = 64 DIV esize;
d = UInt(D:Vd); m = UInt(M:Vm); regs = if Q == '0' then 1 else 2;
  
```

Assembler symbols

- <c> For encoding A1: see [Standard assembler syntax fields on page F2-2848](#). This encoding must be unconditional.
 For encoding T1: see [Standard assembler syntax fields on page F2-2848](#).
- <q> See [Standard assembler syntax fields on page F2-2848](#).
- <dt> Is the data type for the elements of the operands, encoded in the "size" field. It can have the following values:
 - I8 when size = 00
 - I16 when size = 01
 - I32 when size = 10
 The encoding size = 11 is reserved.
- <Qd> Is the 128-bit name of the SIMD&FP destination register, encoded in the "D:Vd" field as <Qd>*2.
- <Qm> Is the 128-bit name of the SIMD&FP source register, encoded in the "M:Vm" field as <Qm>*2.
- <Dd> Is the 64-bit name of the SIMD&FP destination register, encoded in the "D:Vd" field.
- <Dm> Is the 64-bit name of the SIMD&FP source register, encoded in the "M:Vm" field.

Operation for all encodings

```

if ConditionPassed() then
  EncodingSpecificOperations(); CheckAdvSIMDEnabled();
  for r = 0 to regs-1
    for e = 0 to elements-1
      Elem[D[d+r],e,esize] = CountLeadingZeroBits(Elem[M[m+r],e,esize])<esize-1:0>;
  
```

F6.1.51 VCOMP

Vector Compare compares two floating-point registers, or one floating-point register and zero. It writes the result to the **FPSCR** flags. These are normally transferred to the **PSTATE**.{N, Z, C, V} Condition flags by a subsequent **VMRS** instruction.

It raises an Invalid Operation exception only if either operand is a signaling NaN.

Depending on settings in the **CPACR**, **NSACR**, and **HCPTR** registers, and the security state and mode in which the instruction is executed, an attempt to execute the instruction might be **UNDEFINED**, or trapped to Hyp mode. For more information see *Enabling Advanced SIMD and floating-point support on page G1-4413*.

A1

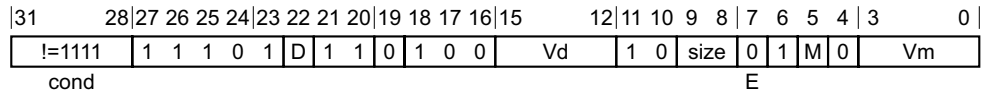

Half-precision scalar variant

Applies when size == 01.

`VCOMP{<c>}{<q>}.F16 <Sd>, <Sm>`

Single-precision scalar variant

Applies when size == 10.

`VCOMP{<c>}{<q>}.F32 <Sd>, <Sm>`

Double-precision scalar variant

Applies when size == 11.

`VCOMP{<c>}{<q>}.F64 <Dd>, <Dm>`

Decode for all variants of this encoding

```

if size == '00' || (size == '01' && !HaveFP16Ext()) then UNDEFINED;
if size == '01' && cond != '1110' then UNPREDICTABLE;
quiet_nan_exc = (E == '1'); with_zero = FALSE;
case size of
    when '01' esize = 16; d = UInt(Vd:D); m = UInt(Vm:M);
    when '10' esize = 32; d = UInt(Vd:D); m = UInt(Vm:M);
    when '11' esize = 64; d = UInt(D:Vd); m = UInt(M:Vm);
    
```

CONSTRAINED UNPREDICTABLE behavior

If size == '01' && cond != '1110', then one of the following behaviors must occur:

- The instruction is **UNDEFINED**.
- The instruction executes as if it passes the Condition code check.
- The instruction executes as **NOP**. This means it behaves as if it fails the Condition code check.

A2

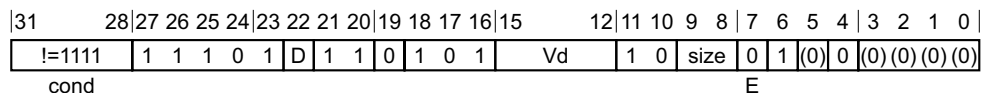

Half-precision scalar variant

Applies when size == 01.

VCMP{<c>}{<q>}.F16 <Sd>, #0.0

Single-precision scalar variant

Applies when size == 10.

VCMP{<c>}{<q>}.F32 <Sd>, #0.0

Double-precision scalar variant

Applies when size == 11.

VCMP{<c>}{<q>}.F64 <Dd>, #0.0

Decode for all variants of this encoding

```

if size == '00' || (size == '01' && !HaveFP16Ext()) then UNDEFINED;
if size == '01' && cond != '1110' then UNPREDICTABLE;
quiet_nan_exc = (E == '1'); with_zero = TRUE;
case size of
    when '01' esize = 16; d = UInt(Vd:D);
    when '10' esize = 32; d = UInt(Vd:D);
    when '11' esize = 64; d = UInt(D:Vd);
    
```

CONSTRAINED UNPREDICTABLE behavior

If size == '01' && cond != '1110', then one of the following behaviors must occur:

- The instruction is UNDEFINED.
- The instruction executes as if it passes the Condition code check.
- The instruction executes as NOP. This means it behaves as if it fails the Condition code check.

T1

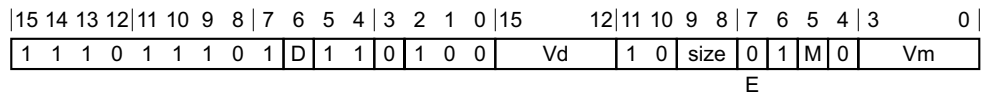

Half-precision scalar variant

Applies when size == 01.

VCMP{<c>}{<q>}.F16 <Sd>, <Sm>

Single-precision scalar variant

Applies when size == 10.

VCMP{<c>}{<q>}.F32 <Sd>, <Sm>

Double-precision scalar variant

Applies when size == 11.

VCMP{<c>}{<q>}.F64 <Dd>, <Dm>

Decode for all variants of this encoding

```

if size == '00' || (size == '01' && !HaveFP16Ext()) then UNDEFINED;
if size == '01' && InITBlock() then UNPREDICTABLE;
quiet_nan_exc = (E == '1'); with_zero = FALSE;
case size of
    when '01' esize = 16; d = UInt(Vd:D); m = UInt(Vm:M);
    when '10' esize = 32; d = UInt(Vd:D); m = UInt(Vm:M);
    when '11' esize = 64; d = UInt(D:Vd); m = UInt(M:Vm);
    
```

CONSTRAINED UNPREDICTABLE behavior

If size == '01' && InITBlock(), then one of the following behaviors must occur:

- The instruction is UNDEFINED.
- The instruction executes as if it passes the Condition code check.
- The instruction executes as NOP. This means it behaves as if it fails the Condition code check.

T2

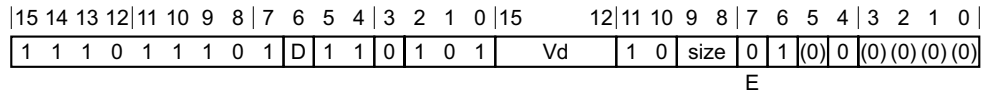

Half-precision scalar variant

Applies when size == 01.

VCMP{<c>}{<q>}.F16 <Sd>, #0.0

Single-precision scalar variant

Applies when size == 10.

VCMP{<c>}{<q>}.F32 <Sd>, #0.0

Double-precision scalar variant

Applies when size == 11.

VCMP{<c>}{<q>}.F64 <Dd>, #0.0

Decode for all variants of this encoding

```

if size == '00' || (size == '01' && !HaveFP16Ext()) then UNDEFINED;
if size == '01' && InITBlock() then UNPREDICTABLE;
quiet_nan_exc = (E == '1'); with_zero = TRUE;
case size of
    when '01' esize = 16; d = UInt(Vd:D);
    when '10' esize = 32; d = UInt(Vd:D);
    when '11' esize = 64; d = UInt(D:Vd);
    
```

CONSTRAINED UNPREDICTABLE behavior

If size == '01' && InITBlock(), then one of the following behaviors must occur:

- The instruction is UNDEFINED.
- The instruction executes as if it passes the Condition code check.
- The instruction executes as NOP. This means it behaves as if it fails the Condition code check.

Notes for all encodings

For more information about the CONSTRAINED UNPREDICTABLE behavior of this instruction, see [Appendix K1 Architectural Constraints on UNPREDICTABLE behaviors](#).

Assembler symbols

<c>	See <i>Standard assembler syntax fields</i> on page F2-2848.
<q>	See <i>Standard assembler syntax fields</i> on page F2-2848.
<Sd>	Is the 32-bit name of the SIMD&FP destination register, encoded in the "Vd:D" field.
<Sm>	Is the 32-bit name of the SIMD&FP source register, encoded in the "Vm:M" field.
<Dd>	Is the 64-bit name of the SIMD&FP destination register, encoded in the "D:Vd" field.
<Dm>	Is the 64-bit name of the SIMD&FP source register, encoded in the "M:Vm" field.

NaNs

The IEEE 754 standard specifies that the result of a comparison is precisely one of <, ==, > or unordered. If either or both of the operands are NaNs, they are unordered, and all three of (Operand1 < Operand2), (Operand1 == Operand2) and (Operand1 > Operand2) are false. This results in the FPSCR flags being set as N=0, Z=0, C=1 and V=1.

VMPE raises an Invalid Operation exception if either operand is any type of NaN, and is suitable for testing for <, <=, >, >=, and other predicates that raise an exception when the operands are unordered.

Operation for all encodings

```
if ConditionPassed() then
    EncodingSpecificOperations(); CheckVFPEnabled(TRUE);
case esize of
    when 16
        bits(16) op16 = if with_zero then FPZero('0') else S[m]<15:0>;
        FPSCR.<N,Z,C,V> = FPCompare(S[d]<15:0>, op16, quiet_nan_exc, FPSCR);
    when 32
        bits(32) op32 = if with_zero then FPZero('0') else S[m];
        FPSCR.<N,Z,C,V> = FPCompare(S[d], op32, quiet_nan_exc, FPSCR);
    when 64
        bits(64) op64 = if with_zero then FPZero('0') else D[m];
        FPSCR.<N,Z,C,V> = FPCompare(D[d], op64, quiet_nan_exc, FPSCR);
```

F6.1.52 VCMPE

Vector Compare, raising Invalid Operation on NaN compares two floating-point registers, or one floating-point register and zero. It writes the result to the FPSCR flags. These are normally transferred to the PSTATE.{N, Z, C, V} Condition flags by a subsequent VMRS instruction.

It raises an Invalid Operation exception if either operand is any type of NaN.

Depending on settings in the CPACR, NSACR, and HCPTR registers, and the security state and mode in which the instruction is executed, an attempt to execute the instruction might be UNDEFINED, or trapped to Hyp mode. For more information see *Enabling Advanced SIMD and floating-point support on page G1-4413*.

A1

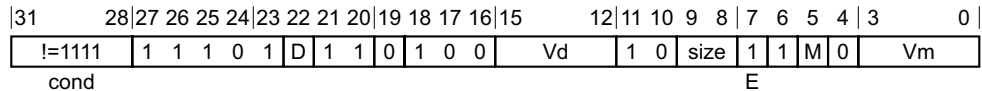

Half-precision scalar variant

Applies when size == 01.

VCMPE{<c>}{<q>}.F16 <Sd>, <Sm>

Single-precision scalar variant

Applies when size == 10.

VCMPE{<c>}{<q>}.F32 <Sd>, <Sm>

Double-precision scalar variant

Applies when size == 11.

VCMPE{<c>}{<q>}.F64 <Dd>, <Dm>

Decode for all variants of this encoding

```

if size == '00' || (size == '01' && !HaveFP16Ext()) then UNDEFINED;
if size == '01' && cond != '1110' then UNPREDICTABLE;
quiet_nan_exc = (E == '1'); with_zero = FALSE;
case size of
    when '01' esize = 16; d = UInt(Vd:D); m = UInt(Vm:M);
    when '10' esize = 32; d = UInt(Vd:D); m = UInt(Vm:M);
    when '11' esize = 64; d = UInt(D:Vd); m = UInt(M:Vm);
    
```

CONSTRAINED UNPREDICTABLE behavior

If size == '01' && cond != '1110', then one of the following behaviors must occur:

- The instruction is UNDEFINED.
- The instruction executes as if it passes the Condition code check.
- The instruction executes as NOP. This means it behaves as if it fails the Condition code check.

A2

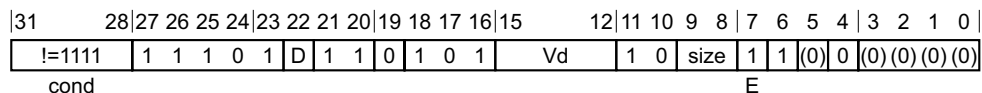

Half-precision scalar variant

Applies when size == 01.

VCMPE{<c>}{<q>}.F16 <Sd>, #0.0

Single-precision scalar variant

Applies when size == 10.

VCMPE{<c>}{<q>}.F32 <Sd>, #0.0

Double-precision scalar variant

Applies when size == 11.

VCMPE{<c>}{<q>}.F64 <Dd>, #0.0

Decode for all variants of this encoding

```
if size == '00' || (size == '01' && !HaveFP16Ext()) then UNDEFINED;
if size == '01' && cond != '1110' then UNPREDICTABLE;
quiet_nan_exc = (E == '1'); with_zero = TRUE;
case size of
    when '01' esize = 16; d = UInt(Vd:D);
    when '10' esize = 32; d = UInt(Vd:D);
    when '11' esize = 64; d = UInt(D:Vd);
```

CONSTRAINED UNPREDICTABLE behavior

If size == '01' && cond != '1110', then one of the following behaviors must occur:

- The instruction is UNDEFINED.
- The instruction executes as if it passes the Condition code check.
- The instruction executes as NOP. This means it behaves as if it fails the Condition code check.

T1

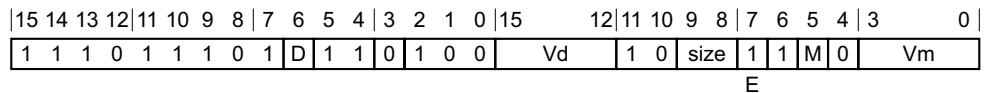

Half-precision scalar variant

Applies when size == 01.

VCMPE{<c>}{<q>}.F16 <Sd>, <Sm>

Single-precision scalar variant

Applies when size == 10.

VCMPE{<c>}{<q>}.F32 <Sd>, <Sm>

Double-precision scalar variant

Applies when size == 11.

VCMPE{<c>}{<q>}.F64 <Dd>, <Dm>

Decode for all variants of this encoding

```

if size == '00' || (size == '01' && !HaveFP16Ext()) then UNDEFINED;
if size == '01' && InITBlock() then UNPREDICTABLE;
quiet_nan_exc = (E == '1'); with_zero = FALSE;
case size of
    when '01' esize = 16; d = UInt(Vd:D); m = UInt(Vm:M);
    when '10' esize = 32; d = UInt(Vd:D); m = UInt(Vm:M);
    when '11' esize = 64; d = UInt(D:Vd); m = UInt(M:Vm);
    
```

CONSTRAINED UNPREDICTABLE behavior

If size == '01' && InITBlock(), then one of the following behaviors must occur:

- The instruction is UNDEFINED.
- The instruction executes as if it passes the Condition code check.
- The instruction executes as NOP. This means it behaves as if it fails the Condition code check.

T2

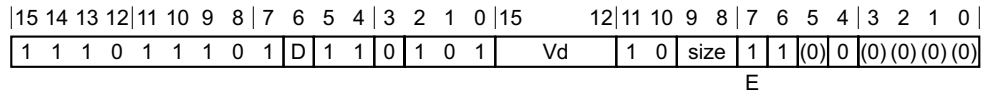

Half-precision scalar variant

Applies when size == 01.

VCMPE{<c>}{<q>}.F16 <Sd>, #0.0

Single-precision scalar variant

Applies when size == 10.

VCMPE{<c>}{<q>}.F32 <Sd>, #0.0

Double-precision scalar variant

Applies when size == 11.

VCMPE{<c>}{<q>}.F64 <Dd>, #0.0

Decode for all variants of this encoding

```

if size == '00' || (size == '01' && !HaveFP16Ext()) then UNDEFINED;
if size == '01' && InITBlock() then UNPREDICTABLE;
quiet_nan_exc = (E == '1'); with_zero = TRUE;
case size of
    when '01' esize = 16; d = UInt(Vd:D);
    when '10' esize = 32; d = UInt(Vd:D);
    when '11' esize = 64; d = UInt(D:Vd);
    
```

CONSTRAINED UNPREDICTABLE behavior

If size == '01' && InITBlock(), then one of the following behaviors must occur:

- The instruction is UNDEFINED.
- The instruction executes as if it passes the Condition code check.
- The instruction executes as NOP. This means it behaves as if it fails the Condition code check.

Notes for all encodings

For more information about the CONSTRAINED UNPREDICTABLE behavior of this instruction, see [Appendix K1 Architectural Constraints on UNPREDICTABLE behaviors](#).

Assembler symbols

<c>	See <i>Standard assembler syntax fields</i> on page F2-2848.
<q>	See <i>Standard assembler syntax fields</i> on page F2-2848.
<Sd>	Is the 32-bit name of the SIMD&FP destination register, encoded in the "Vd:D" field.
<Sm>	Is the 32-bit name of the SIMD&FP source register, encoded in the "Vm:M" field.
<Dd>	Is the 64-bit name of the SIMD&FP destination register, encoded in the "D:Vd" field.
<Dm>	Is the 64-bit name of the SIMD&FP source register, encoded in the "M:Vm" field.

NaNs

The IEEE 754 standard specifies that the result of a comparison is precisely one of <, ==, > or unordered. If either or both of the operands are NaNs, they are unordered, and all three of (Operand1 < Operand2), (Operand1 == Operand2) and (Operand1 > Operand2) are false. This results in the FPSCR flags being set as N=0, Z=0, C=1 and V=1.

VMPE raises an Invalid Operation exception if either operand is any type of NaN, and is suitable for testing for <, <=, >, >=, and other predicates that raise an exception when the operands are unordered.

Operation for all encodings

```
if ConditionPassed() then
    EncodingSpecificOperations(); CheckVFPEnabled(TRUE);
case esize of
    when 16
        bits(16) op16 = if with_zero then FPZero('0') else S[m]<15:0>;
        FPSCR.<N,Z,C,V> = FPCompare(S[d]<15:0>, op16, quiet_nan_exc, FPSCR);
    when 32
        bits(32) op32 = if with_zero then FPZero('0') else S[m];
        FPSCR.<N,Z,C,V> = FPCompare(S[d], op32, quiet_nan_exc, FPSCR);
    when 64
        bits(64) op64 = if with_zero then FPZero('0') else D[m];
        FPSCR.<N,Z,C,V> = FPCompare(D[d], op64, quiet_nan_exc, FPSCR);
```

F6.1.53 VCNT

Vector Count Set Bits counts the number of bits that are one in each element in a vector, and places the results in a second vector.

The operand vector elements must be 8-bit fields.

The result vector elements are 8-bit integers.

Depending on settings in the CPACR, NSACR, and HCPTR registers, and the security state and mode in which the instruction is executed, an attempt to execute the instruction might be UNDEFINED, or trapped to Hyp mode. For more information see [Enabling Advanced SIMD and floating-point support on page G1-4413](#).

A1

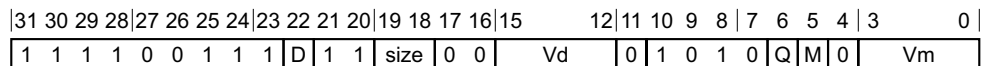

64-bit SIMD vector variant

Applies when Q == 0.

VCNT{<c>}{<q>}.8 <Dd>, <Dm> // Encoded as Q = 0

128-bit SIMD vector variant

Applies when Q == 1.

VCNT{<c>}{<q>}.8 <Qd>, <Qm> // Encoded as Q = 1

Decode for all variants of this encoding

```
if size != '00' then UNDEFINED;
if Q == '1' && (Vd<0> == '1' || Vm<0> == '1') then UNDEFINED;
esize = 8; elements = 8;
d = UInt(D:Vd); m = UInt(M:Vm); regs = if Q == '0' then 1 else 2;
```

T1

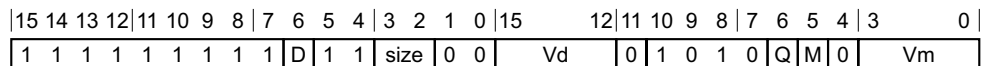

64-bit SIMD vector variant

Applies when Q == 0.

VCNT{<c>}{<q>}.8 <Dd>, <Dm> // Encoded as Q = 0

128-bit SIMD vector variant

Applies when Q == 1.

VCNT{<c>}{<q>}.8 <Qd>, <Qm> // Encoded as Q = 1

Decode for all variants of this encoding

```
if size != '00' then UNDEFINED;
if Q == '1' && (Vd<0> == '1' || Vm<0> == '1') then UNDEFINED;
esize = 8; elements = 8;
d = UInt(D:Vd); m = UInt(M:Vm); regs = if Q == '0' then 1 else 2;
```

Assembler symbols

- <c> For encoding A1: see *Standard assembler syntax fields* on page F2-2848. This encoding must be unconditional.
For encoding T1: see *Standard assembler syntax fields* on page F2-2848.
- <q> See *Standard assembler syntax fields* on page F2-2848.
- <Qd> Is the 128-bit name of the SIMD&FP destination register, encoded in the "D:Vd" field as <Qd>*2.
- <Qm> Is the 128-bit name of the SIMD&FP source register, encoded in the "M:Vm" field as <Qm>*2.
- <Dd> Is the 64-bit name of the SIMD&FP destination register, encoded in the "D:Vd" field.
- <Dm> Is the 64-bit name of the SIMD&FP source register, encoded in the "M:Vm" field.

Operation for all encodings

```
if ConditionPassed() then
    EncodingSpecificOperations(); CheckAdvSIMDEnabled();
    for r = 0 to regs-1
        for e = 0 to elements-1
            Elem[D[d+r],e,esize] = BitCount(Elem[D[m+r],e,esize])<esize-1:0>;
```

F6.1.54 VCVT (between double-precision and single-precision)

Convert between double-precision and single-precision does one of the following:

- Converts the value in a double-precision register to single-precision and writes the result to a single-precision register.
- Converts the value in a single-precision register to double-precision and writes the result to a double-precision register.

Depending on settings in the CPACR, NSACR, HCPTR, and FPEXC registers, and the security state and mode in which the instruction is executed, an attempt to execute the instruction might be UNDEFINED, or trapped to Hyp mode. For more information see [Enabling Advanced SIMD and floating-point support on page G1-4413](#).

A1

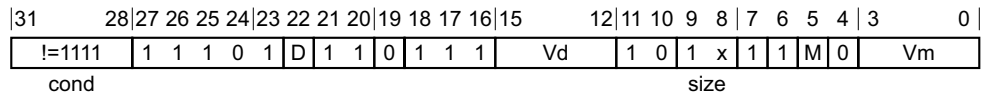

Single-precision to double-precision variant

Applies when size == 10.

VCVT{<c>}{<q>}.F64.F32 <Dd>, <Sm>

Double-precision to single-precision variant

Applies when size == 11.

VCVT{<c>}{<q>}.F32.F64 <Sd>, <Dm>

Decode for all variants of this encoding

```
double_to_single = (sz == '1');
d = if double_to_single then UInt(Vd:D) else UInt(D:Vd);
m = if double_to_single then UInt(M:Vm) else UInt(Vm:M);
```

T1

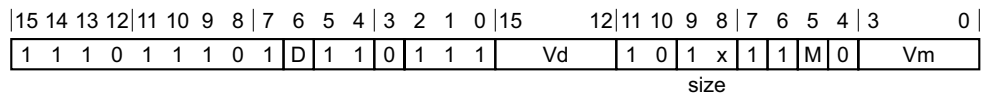

Single-precision to double-precision variant

Applies when size == 10.

VCVT{<c>}{<q>}.F64.F32 <Dd>, <Sm>

Double-precision to single-precision variant

Applies when size == 11.

VCVT{<c>}{<q>}.F32.F64 <Sd>, <Dm>

Decode for all variants of this encoding

```
double_to_single = (sz == '1');
d = if double_to_single then UInt(Vd:D) else UInt(D:Vd);
m = if double_to_single then UInt(M:Vm) else UInt(Vm:M);
```

Assembler symbols

- <c> See [Standard assembler syntax fields on page F2-2848](#).
- <q> See [Standard assembler syntax fields on page F2-2848](#).
- <Sd> Is the 32-bit name of the SIMD&FP destination register, encoded in the "Vd:D" field.
- <Dm> Is the 64-bit name of the SIMD&FP source register, encoded in the "M:Vm" field.
- <Dd> Is the 64-bit name of the SIMD&FP destination register, encoded in the "D:Vd" field.
- <Sm> Is the 32-bit name of the SIMD&FP source register, encoded in the "Vm:M" field.

Operation for all encodings

```
if ConditionPassed() then
    EncodingSpecificOperations(); CheckVFPEnabled(TRUE);
    if double_to_single then
        S[d] = FPConvert(D[m], FPSCR);
    else
        D[d] = FPConvert(S[m], FPSCR);
```

F6.1.55 VCVT (between half-precision and single-precision, Advanced SIMD)

Vector Convert between half-precision and single-precision converts each element in a vector from single-precision to half-precision floating-point, or from half-precision to single-precision, and places the results in a second vector.

Depending on settings in the CPACR, NSACR, and HCPTR registers, and the security state and mode in which the instruction is executed, an attempt to execute the instruction might be UNDEFINED, or trapped to Hyp mode. For more information see [Enabling Advanced SIMD and floating-point support on page G1-4413](#).

A1

31	30	29	28	27	26	25	24	23	22	21	20	19	18	17	16	15	12	11	10	9	8	7	6	5	4	3	0
1	1	1	1	0	0	1	1	1	D	1	1	size	1	0	Vd	0	1	1	op	0	0	M	0	Vm			

Half-precision to single-precision variant

Applies when op == 1.

VCVT{<c>}{<q>}.F32.F16 <Qd>, <Dm> // Encoded as op = 1

Single-precision to half-precision variant

Applies when op == 0.

VCVT{<c>}{<q>}.F16.F32 <Dd>, <Qm> // Encoded as op = 0

Decode for all variants of this encoding

```

if size != '01' then UNDEFINED;
half_to_single = (op == '1');
if half_to_single && Vd<0> == '1' then UNDEFINED;
if !half_to_single && Vm<0> == '1' then UNDEFINED;
esize = 16; elements = 4;
m = UInt(M:Vm); d = UInt(D:Vd);
    
```

T1

15	14	13	12	11	10	9	8	7	6	5	4	3	2	1	0	15	12	11	10	9	8	7	6	5	4	3	0
1	1	1	1	1	1	1	1	1	D	1	1	size	1	0	Vd	0	1	1	op	0	0	M	0	Vm			

Half-precision to single-precision variant

Applies when op == 1.

VCVT{<c>}{<q>}.F32.F16 <Qd>, <Dm> // Encoded as op = 1

Single-precision to half-precision variant

Applies when op == 0.

VCVT{<c>}{<q>}.F16.F32 <Dd>, <Qm> // Encoded as op = 0

Decode for all variants of this encoding

```

if size != '01' then UNDEFINED;
half_to_single = (op == '1');
if half_to_single && Vd<0> == '1' then UNDEFINED;
if !half_to_single && Vm<0> == '1' then UNDEFINED;
esize = 16; elements = 4;
m = UInt(M:Vm); d = UInt(D:Vd);
    
```

Assembler symbols

- <c> For encoding A1: see *Standard assembler syntax fields* on page F2-2848. This encoding must be unconditional.
For encoding T1: see *Standard assembler syntax fields* on page F2-2848.
- <q> See *Standard assembler syntax fields* on page F2-2848.
- <Qd> Is the 128-bit name of the SIMD&FP destination register, encoded in the "D:Vd" field as <Qd>*2.
- <Dm> Is the 64-bit name of the SIMD&FP source register, encoded in the "M:Vm" field.
- <Dd> Is the 64-bit name of the SIMD&FP destination register, encoded in the "D:Vd" field.
- <Qm> Is the 128-bit name of the SIMD&FP source register, encoded in the "M:Vm" field as <Qm>*2.

Operation for all encodings

```
if ConditionPassed() then
    EncodingSpecificOperations(); CheckAdvSIMDEnabled();
for e = 0 to elements-1
    if half_to_single then
        Elem[Q[d>>1],e,32] = FPConvert(Elem[Din[m],e,16], StandardFPSCRValue());
    else
        Elem[D[d],e,16] = FPConvert(Elem[Qin[m>>1],e,32], StandardFPSCRValue());
```

F6.1.56 VCVT (between floating-point and integer, Advanced SIMD)

Vector Convert between floating-point and integer converts each element in a vector from floating-point to integer, or from integer to floating-point, and places the results in a second vector.

The vector elements are the same type, and are floating-point numbers or integers. Signed and unsigned integers are distinct.

The floating-point to integer operation uses the Round towards Zero rounding mode. The integer to floating-point operation uses the Round to Nearest rounding mode.

Depending on settings in the CPACR, NSACR, and HCPTR registers, and the security state and mode in which the instruction is executed, an attempt to execute the instruction might be UNDEFINED, or trapped to Hyp mode. For more information see [Enabling Advanced SIMD and floating-point support on page G1-4413](#).

A1

31	30	29	28	27	26	25	24	23	22	21	20	19	18	17	16	15	12	11	10	9	8	7	6	5	4	3	0
1	1	1	1	0	0	1	1	1	D	1	1	size	1	1	Vd	0	1	1	op	Q	M	0	Vm				

64-bit SIMD vector variant

Applies when Q == 0.

VCVT{<c>}{<q>}.<dt1>.<dt2> <Dd>, <Dm>

128-bit SIMD vector variant

Applies when Q == 1.

VCVT{<c>}{<q>}.<dt1>.<dt2> <Qd>, <Qm>

Decode for all variants of this encoding

```

if Q == '1' && (Vd<0> == '1' || Vm<0> == '1') then UNDEFINED;
if (size == '01' && !HaveFP16Ext()) || size IN {'00', '11'} then UNDEFINED;
to_integer = (op<1> == '1'); unsigned = (op<0> == '1');
case size of
    when '01' esize = 16; elements = 4;
    when '10' esize = 32; elements = 2;
d = UInt(D:Vd); m = UInt(M:Vm); regs = if Q == '0' then 1 else 2;
    
```

T1

15	14	13	12	11	10	9	8	7	6	5	4	3	2	1	0	15	12	11	10	9	8	7	6	5	4	3	0
1	1	1	1	1	1	1	1	1	D	1	1	size	1	1	Vd	0	1	1	op	Q	M	0	Vm				

64-bit SIMD vector variant

Applies when Q == 0.

VCVT{<c>}{<q>}.<dt1>.<dt2> <Dd>, <Dm>

128-bit SIMD vector variant

Applies when Q == 1.

VCVT{<c>}{<q>}.<dt1>.<dt2> <Qd>, <Qm>

Decode for all variants of this encoding

```

if Q == '1' && (Vd<0> == '1' || Vm<0> == '1') then UNDEFINED;
if (size == '01' && !HaveFP16Ext()) || size IN {'00', '11'} then UNDEFINED;
if size == '01' && InITBlock() then UNPREDICTABLE;
to_integer = (op<1> == '1'); unsigned = (op<0> == '1');
case size of
  when '01' esize = 16; elements = 4;
  when '10' esize = 32; elements = 2;
d = UInt(D:Vd); m = UInt(M:Vm); regs = if Q == '0' then 1 else 2;
  
```

CONSTRAINED UNPREDICTABLE behavior

If size == '01' && InITBlock(), then one of the following behaviors must occur:

- The instruction is UNDEFINED.
- The instruction executes as if it passes the Condition code check.
- The instruction executes as NOP. This means it behaves as if it fails the Condition code check.

Assembler symbols

- <c> For encoding A1: see [Standard assembler syntax fields on page F2-2848](#). This encoding must be unconditional.
 For encoding T1: see [Standard assembler syntax fields on page F2-2848](#).
- <q> See [Standard assembler syntax fields on page F2-2848](#).
- <dt1> Is the data type for the elements of the destination vector, encoded in the "size:op" field. It can have the following values:
- | | |
|-----|-------------------------|
| F16 | when size = 01, op = 0x |
| S16 | when size = 01, op = 10 |
| U16 | when size = 01, op = 11 |
| F32 | when size = 10, op = 0x |
| S32 | when size = 10, op = 10 |
| U32 | when size = 10, op = 11 |
- <dt2> Is the data type for the elements of the source vector, encoded in the "size:op" field. It can have the following values:
- | | |
|-----|-------------------------|
| S16 | when size = 01, op = 00 |
| U16 | when size = 01, op = 01 |
| F16 | when size = 01, op = 1x |
| S32 | when size = 10, op = 00 |
| U32 | when size = 10, op = 01 |
| F32 | when size = 10, op = 1x |
- <Qd> Is the 128-bit name of the SIMD&FP destination register, encoded in the "D:Vd" field as <Qd>*2.
- <Qm> Is the 128-bit name of the SIMD&FP source register, encoded in the "M:Vm" field as <Qm>*2.
- <Dd> Is the 64-bit name of the SIMD&FP destination register, encoded in the "D:Vd" field.
- <Dm> Is the 64-bit name of the SIMD&FP source register, encoded in the "M:Vm" field.

Operation for all encodings

```
if ConditionPassed() then
    EncodingSpecificOperations(); CheckAdvSIMDEnabled();
    bits(esize) result;
    for r = 0 to regs-1
        for e = 0 to elements-1
            op1 = Elem[D[m+r],e,esize];
            if to_integer then
                result = FPToFixed(op1, 0, unsigned, StandardFPSCRValue(), FPRounding_ZERO);
            else
                result = FixedToFP(op1, 0, unsigned, StandardFPSCRValue(), FPRounding_TIEEVEN);
            Elem[D[d+r],e,esize] = result;
```

F6.1.57 VCVT (floating-point to integer, floating-point)

Convert floating-point to integer with Round towards Zero converts a value in a register from floating-point to a 32-bit integer, using the Round towards Zero rounding mode, and places the result in a second register.

[VCVT \(between floating-point and fixed-point, floating-point\)](#) describes conversions between floating-point and 16-bit integers.

Depending on settings in the [CPACR](#), [NSACR](#), [HCPTR](#), and [FPEXC](#) registers, and the security state and mode in which the instruction is executed, an attempt to execute the instruction might be UNDEFINED, or trapped to Hyp mode. For more information see [Enabling Advanced SIMD and floating-point support on page G1-4413](#).

A1

31	28	27	26	25	24	23	22	21	20	19	18	16	15	12	11	10	9	8	7	6	5	4	3	0		
!=1111				1	1	1	0	1	D	1	1	1	1	0	x	Vd	1	0	size	1	1	M	0	Vm		
cond				opc2								op														

Half-precision scalar variant

Applies when `opc2 == 100` && `size == 01`.

`VCVT{<c>}{<q>}.U32.F16 <Sd>, <Sm>`

Half-precision scalar variant

Applies when `opc2 == 101` && `size == 01`.

`VCVT{<c>}{<q>}.S32.F16 <Sd>, <Sm>`

Single-precision scalar variant

Applies when `opc2 == 100` && `size == 10`.

`VCVT{<c>}{<q>}.U32.F32 <Sd>, <Sm>`

Single-precision scalar variant

Applies when `opc2 == 101` && `size == 10`.

`VCVT{<c>}{<q>}.S32.F32 <Sd>, <Sm>`

Double-precision scalar variant

Applies when `opc2 == 100` && `size == 11`.

`VCVT{<c>}{<q>}.U32.F64 <Sd>, <Dm>`

Double-precision scalar variant

Applies when `opc2 == 101` && `size == 11`.

`VCVT{<c>}{<q>}.S32.F64 <Sd>, <Dm>`

Decode for all variants of this encoding

```

if opc2 != '000' && opc2 != '10x' then SEE "Related encodings";
if size == '00' || (size == '01' && !HaveFP16Ext()) then UNDEFINED;
if size == '01' && cond != '1110' then UNPREDICTABLE;
to_integer = (opc2<2> == '1');
if to_integer then
    unsigned = (opc2<0> == '0');
    rounding = if op == '1' then FPRounding_ZERO else FPRoundingMode(FPSCR);
    d = UInt(Vd:D);
    case size of
    
```

```

        when '01' esize = 16; m = UInt(Vm:M);
        when '10' esize = 32; m = UInt(Vm:M);
        when '11' esize = 64; m = UInt(M:Vm);
    else
        unsigned = (op == '0');
        rounding = FPRoundingMode(FPSCR);
        m = UInt(Vm:M);
        case size of
            when '01' esize = 16; d = UInt(Vd:D);
            when '10' esize = 32; d = UInt(Vd:D);
            when '11' esize = 64; d = UInt(D:Vd);
    
```

CONSTRAINED UNPREDICTABLE behavior

If size == '01' && cond != '1110', then one of the following behaviors must occur:

- The instruction is UNDEFINED.
- The instruction executes as if it passes the Condition code check.
- The instruction executes as NOP. This means it behaves as if it fails the Condition code check.

T1

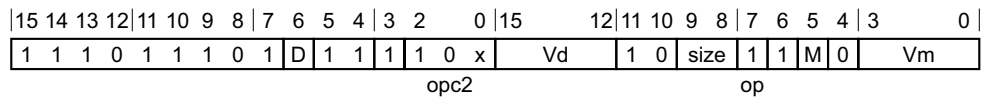

Half-precision scalar variant

Applies when opc2 == 100 && size == 01.

VCVT{<c>}{<q>}.U32.F16 <Sd>, <Sm>

Half-precision scalar variant

Applies when opc2 == 101 && size == 01.

VCVT{<c>}{<q>}.S32.F16 <Sd>, <Sm>

Single-precision scalar variant

Applies when opc2 == 100 && size == 10.

VCVT{<c>}{<q>}.U32.F32 <Sd>, <Sm>

Single-precision scalar variant

Applies when opc2 == 101 && size == 10.

VCVT{<c>}{<q>}.S32.F32 <Sd>, <Sm>

Double-precision scalar variant

Applies when opc2 == 100 && size == 11.

VCVT{<c>}{<q>}.U32.F64 <Sd>, <Dm>

Double-precision scalar variant

Applies when opc2 == 101 && size == 11.

VCVT{<c>}{<q>}.S32.F64 <Sd>, <Dm>

Decode for all variants of this encoding

```

if opc2 != '000' && opc2 != '10x' then SEE "Related encodings";
if size == '00' || (size == '01' && !HaveFP16Ext()) then UNDEFINED;
if size == '01' && InITBlock() then UNPREDICTABLE;
to_integer = (opc2<2> == '1');
if to_integer then
  unsigned = (opc2<0> == '0');
  rounding = if op == '1' then FPRounding_ZERO else FPRoundingMode(FPSCR);
  d = UInt(Vd:D);
  case size of
    when '01' esize = 16; m = UInt(Vm:M);
    when '10' esize = 32; m = UInt(Vm:M);
    when '11' esize = 64; m = UInt(M:Vm);
else
  unsigned = (op == '0');
  rounding = FPRoundingMode(FPSCR);
  m = UInt(Vm:M);
  case size of
    when '01' esize = 16; d = UInt(Vd:D);
    when '10' esize = 32; d = UInt(Vd:D);
    when '11' esize = 64; d = UInt(D:Vd);
  
```

CONSTRAINED UNPREDICTABLE behavior

If size == '01' && InITBlock(), then one of the following behaviors must occur:

- The instruction is UNDEFINED.
- The instruction executes as if it passes the Condition code check.
- The instruction executes as NOP. This means it behaves as if it fails the Condition code check.

Notes for all encodings

Related encodings: See [Floating-point data-processing on page F3-2898](#) for the T32 instruction set, or [Floating-point data-processing on page F4-2977](#) for the A32 instruction set.

Assembler symbols

- <c> See [Standard assembler syntax fields on page F2-2848](#).
- <q> See [Standard assembler syntax fields on page F2-2848](#).
- <Sd> Is the 32-bit name of the SIMD&FP destination register, encoded in the "Vd:D" field.
- <Sm> Is the 32-bit name of the SIMD&FP source register, encoded in the "Vm:M" field.
- <Dm> Is the 64-bit name of the SIMD&FP source register, encoded in the "M:Vm" field.

Operation for all encodings

```

if ConditionPassed() then
  EncodingSpecificOperations(); CheckVFPEnabled(TRUE);
  if to_integer then
    case esize of
      when 16
        S[d] = FPToFixed(S[m]<15:0>, 0, unsigned, FPSCR, rounding);
      when 32
        S[d] = FPToFixed(S[m], 0, unsigned, FPSCR, rounding);
      when 64
        S[d] = FPToFixed(D[m], 0, unsigned, FPSCR, rounding);
  else
    case esize of
      when 16
  
```

```
bits(16) fp16 = FixedToFP(S[m], 0, unsigned, FPSCR, rounding);  
S[d] = Zeros(16):fp16;  
when 32  
S[d] = FixedToFP(S[m], 0, unsigned, FPSCR, rounding);  
when 64  
D[d] = FixedToFP(S[m], 0, unsigned, FPSCR, rounding);
```

F6.1.58 VCVT (integer to floating-point, floating-point)

Convert integer to floating-point converts a 32-bit integer to floating-point using the rounding mode specified by the **FPSCR**, and places the result in a second register.

VCVT (between floating-point and fixed-point, floating-point) describes conversions between floating-point and 16-bit integers.

Depending on settings in the **CPACR**, **NSACR**, **HCPTR**, and **FPEXC** registers, and the security state and mode in which the instruction is executed, an attempt to execute the instruction might be **UNDEFINED**, or trapped to Hyp mode. For more information see *Enabling Advanced SIMD and floating-point support on page G1-4413*.

A1

31	28	27	26	25	24	23	22	21	20	19	18	16	15	12	11	10	9	8	7	6	5	4	3	0	
!=1111				1	1	1	0	1	D	1	1	1	0	0	0	Vd		1	0	size	op	1	M	0	Vm
cond																opc2									

Half-precision scalar variant

Applies when size == 01.

VCVT{<c>}{<q>}.F16.<dt> <Sd>, <Sm>

Single-precision scalar variant

Applies when size == 10.

VCVT{<c>}{<q>}.F32.<dt> <Sd>, <Sm>

Double-precision scalar variant

Applies when size == 11.

VCVT{<c>}{<q>}.F64.<dt> <Dd>, <Sm>

Decode for all variants of this encoding

```

if opc2 != '000' && opc2 != '10x' then SEE "Related encodings";
if size == '00' || (size == '01' && !HaveFP16Ext()) then UNDEFINED;
if size == '01' && cond != '1110' then UNPREDICTABLE;
to_integer = (opc2<2> == '1');
if to_integer then
    unsigned = (opc2<0> == '0');
    rounding = if op == '1' then FPRounding_ZERO else FPRoundingMode(FPSCR);
    d = UInt(Vd:D);
    case size of
        when '01' esize = 16; m = UInt(Vm:M);
        when '10' esize = 32; m = UInt(Vm:M);
        when '11' esize = 64; m = UInt(M:Vm);
else
    unsigned = (op == '0');
    rounding = FPRoundingMode(FPSCR);
    m = UInt(Vm:M);
    case size of
        when '01' esize = 16; d = UInt(Vd:D);
        when '10' esize = 32; d = UInt(Vd:D);
        when '11' esize = 64; d = UInt(D:Vd);
    
```

CONSTRAINED UNPREDICTABLE behavior

If size == '01' && cond != '1110', then one of the following behaviors must occur:

- The instruction is **UNDEFINED**.

- The instruction executes as if it passes the Condition code check.
- The instruction executes as NOP. This means it behaves as if it fails the Condition code check.

T1

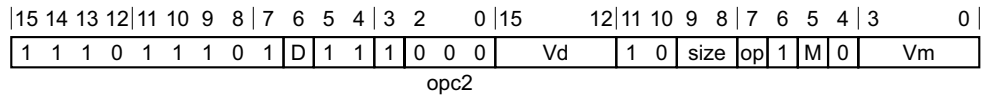

Half-precision scalar variant

Applies when size == 01.

VCVT{<c>}{<q>}.F16.<dt> <Sd>, <Sm>

Single-precision scalar variant

Applies when size == 10.

VCVT{<c>}{<q>}.F32.<dt> <Sd>, <Sm>

Double-precision scalar variant

Applies when size == 11.

VCVT{<c>}{<q>}.F64.<dt> <Dd>, <Sm>

Decode for all variants of this encoding

```

if opc2 != '000' && opc2 != '10x' then SEE "Related encodings";
if size == '00' || (size == '01' && !HaveFP16Ext()) then UNDEFINED;
if size == '01' && InITBlock() then UNPREDICTABLE;
to_integer = (opc2<2> == '1');
if to_integer then
    unsigned = (opc2<0> == '0');
    rounding = if op == '1' then FPRounding_ZERO else FPRoundingMode(FPSCR);
    d = UInt(Vd:D);
    case size of
        when '01' esize = 16; m = UInt(Vm:M);
        when '10' esize = 32; m = UInt(Vm:M);
        when '11' esize = 64; m = UInt(M:Vm);
    else
        unsigned = (op == '0');
        rounding = FPRoundingMode(FPSCR);
        m = UInt(Vm:M);
        case size of
            when '01' esize = 16; d = UInt(Vd:D);
            when '10' esize = 32; d = UInt(Vd:D);
            when '11' esize = 64; d = UInt(D:Vd);

```

CONSTRAINED UNPREDICTABLE behavior

If size == '01' && InITBlock(), then one of the following behaviors must occur:

- The instruction is UNDEFINED.
- The instruction executes as if it passes the Condition code check.
- The instruction executes as NOP. This means it behaves as if it fails the Condition code check.

Notes for all encodings

Related encodings: See [Floating-point data-processing on page F3-2898](#) for the T32 instruction set, or [Floating-point data-processing on page F4-2977](#) for the A32 instruction set.

Assembler symbols

- <c> See [Standard assembler syntax fields on page F2-2848](#).
- <q> See [Standard assembler syntax fields on page F2-2848](#).
- <dt> Is the data type for the operand, encoded in the "op" field. It can have the following values:
U32 when op = 0
S32 when op = 1
- <Sd> Is the 32-bit name of the SIMD&FP destination register, encoded in the "Vd:D" field.
- <Dd> Is the 64-bit name of the SIMD&FP destination register, encoded in the "D:Vd" field.
- <Sm> Is the 32-bit name of the SIMD&FP source register, encoded in the "Vm:M" field.

Operation for all encodings

```
if ConditionPassed() then
    EncodingSpecificOperations(); CheckVFPEnabled(TRUE);
    if to_integer then
        case esize of
            when 16
                S[d] = FPToFixed(S[m]<15:0>, 0, unsigned, FPSCR, rounding);
            when 32
                S[d] = FPToFixed(S[m], 0, unsigned, FPSCR, rounding);
            when 64
                S[d] = FPToFixed(D[m], 0, unsigned, FPSCR, rounding);
        else
            case esize of
                when 16
                    bits(16) fp16 = FixedToFP(S[m], 0, unsigned, FPSCR, rounding);
                    S[d] = Zeros(16):fp16;
                when 32
                    S[d] = FixedToFP(S[m], 0, unsigned, FPSCR, rounding);
                when 64
                    D[d] = FixedToFP(S[m], 0, unsigned, FPSCR, rounding);
```

F6.1.59 VCVT (between floating-point and fixed-point, Advanced SIMD)

Vector Convert between floating-point and fixed-point converts each element in a vector from floating-point to fixed-point, or from fixed-point to floating-point, and places the results in a second vector.

The vector elements are the same type, and are floating-point numbers or integers. Signed and unsigned integers are distinct.

The floating-point to fixed-point operation uses the Round towards Zero rounding mode. The fixed-point to floating-point operation uses the Round to Nearest rounding mode.

Depending on settings in the CPACR, NSACR, and HCPTR registers, and the security state and mode in which the instruction is executed, an attempt to execute the instruction might be UNDEFINED, or trapped to Hyp mode. For more information see [Enabling Advanced SIMD and floating-point support on page G1-4413](#).

A1

31	30	29	28	27	26	25	24	23	22	21	16	15	12	11	10	9	8	7	6	5	4	3	0
1	1	1	1	0	0	1	U	1	D	imm6	Vd	1	1	op	0	Q	M	1	Vm				

64-bit SIMD vector variant

Applies when imm6 != 000xxx && Q == 0.

VCVT{<c>}{<q>}.<dt1>.<dt2> <Dd>, <Dm>, #<fbits>

128-bit SIMD vector variant

Applies when imm6 != 000xxx && Q == 1.

VCVT{<c>}{<q>}.<dt1>.<dt2> <Qd>, <Qm>, #<fbits>

Decode for all variants of this encoding

```

if imm6 == '000xxx' then SEE "Related encodings";
if op<1> == '0' && !HaveFP16Ext() then UNDEFINED;
if op<1> == '0' && imm6 == '10xxxx' then UNDEFINED;
if imm6 == '0xxxxx' then UNDEFINED;
if Q == '1' && (Vd<0> == '1' || Vm<0> == '1') then UNDEFINED;
to_fixed = (op<0> == '1'); frac_bits = 64 - UInt(imm6);
unsigned = (U == '1');
case op<1> of
    when '0' esize = 16; elements = 4;
    when '1' esize = 32; elements = 2;
d = UInt(D:Vd); m = UInt(M:Vm); regs = if Q == '0' then 1 else 2;
    
```

T1

15	14	13	12	11	10	9	8	7	6	5	0	15	12	11	10	9	8	7	6	5	4	3	0
1	1	1	U	1	1	1	1	1	D	imm6	Vd	1	1	op	0	Q	M	1	Vm				

64-bit SIMD vector variant

Applies when imm6 != 000xxx && Q == 0.

VCVT{<c>}{<q>}.<dt1>.<dt2> <Dd>, <Dm>, #<fbits>

128-bit SIMD vector variant

Applies when imm6 != 000xxx && Q == 1.

VCVT{<c>}{<q>}.<dt1>.<dt2> <Qd>, <Qm>, #<fbits>

Decode for all variants of this encoding

```

if imm6 == '000xxx' then SEE "Related encodings";
if op<1> == '0' && !HaveFP16Ext() then UNDEFINED;
if op<1> == '0' && imm6 == '10xxxx' then UNDEFINED;
if imm6 == '0xxxxx' then UNDEFINED;
if Q == '1' && (Vd<0> == '1' || Vm<0> == '1') then UNDEFINED;
to_fixed = (op<0> == '1'); frac_bits = 64 - UInt(imm6);
unsigned = (U == '1');
case op<1> of
  when '0' esize = 16; elements = 4;
  when '1' esize = 32; elements = 2;
d = UInt(D:Vd); m = UInt(M:Vm); regs = if Q == '0' then 1 else 2;
  
```

Notes for all encodings

Related encodings: See *Advanced SIMD one register and modified immediate* on page F3-2912 for the T32 instruction set, or *Advanced SIMD one register and modified immediate* on page F4-2994 for the A32 instruction set.

Assembler symbols

- <c> For encoding A1: see *Standard assembler syntax fields* on page F2-2848. This encoding must be unconditional.
 For encoding T1: see *Standard assembler syntax fields* on page F2-2848.
- <q> See *Standard assembler syntax fields* on page F2-2848.
- <dt1> Is the data type for the elements of the destination vector, encoded in the "op:U" field. It can have the following values:
- | | |
|-----|---------------------|
| F16 | when op = 00, U = x |
| S16 | when op = 01, U = 0 |
| U16 | when op = 01, U = 1 |
| F32 | when op = 10, U = x |
| S32 | when op = 11, U = 0 |
| U32 | when op = 11, U = 1 |
- <dt2> Is the data type for the elements of the source vector, encoded in the "op:U" field. It can have the following values:
- | | |
|-----|---------------------|
| S16 | when op = 00, U = 0 |
| U16 | when op = 00, U = 1 |
| F16 | when op = 01, U = x |
| S32 | when op = 10, U = 0 |
| U32 | when op = 10, U = 1 |
| F32 | when op = 11, U = x |
- <Qd> Is the 128-bit name of the SIMD&FP destination register, encoded in the "D:Vd" field as <Qd>*2.
- <Qm> Is the 128-bit name of the SIMD&FP source register, encoded in the "M:Vm" field as <Qm>*2.
- <Dd> Is the 64-bit name of the SIMD&FP destination register, encoded in the "D:Vd" field.
- <Dm> Is the 64-bit name of the SIMD&FP source register, encoded in the "M:Vm" field.

<fbits> The number of fraction bits in the fixed point number, in the range 1 to 32 for 32-bit elements, or in the range 1 to 16 for 16-bit elements:

- (64 - <fbits>) is encoded in imm6.

An assembler can permit an <fbits> value of 0. This is encoded as floating-point to integer or integer to floating-point instruction, see [VCVT \(between floating-point and integer, Advanced SIMD\)](#).

Operation for all encodings

```
if ConditionPassed() then
    EncodingSpecificOperations(); CheckAdvSIMDEnabled();
bits(esize) result;
for r = 0 to regs-1
    for e = 0 to elements-1
        op1 = Elem[D[m+r],e,esize];
        if to_fixed then
            result = FPToFixed(op1, frac_bits, unsigned, StandardFPSCRValue(),
                               FPRounding_ZERO);
        else
            result = FixedToFP(op1, frac_bits, unsigned, StandardFPSCRValue(),
                               FPRounding_TIEEVEN);
        Elem[D[d+r],e,esize] = result;
```

F6.1.60 VCVT (between floating-point and fixed-point, floating-point)

Convert between floating-point and fixed-point converts a value in a register from floating-point to fixed-point, or from fixed-point to floating-point. Software can specify the fixed-point value as either signed or unsigned.

The fixed-point value can be 16-bit or 32-bit. Conversions from fixed-point values take their operand from the low-order bits of the source register and ignore any remaining bits. Signed conversions to fixed-point values sign-extend the result value to the destination register width. Unsigned conversions to fixed-point values zero-extend the result value to the destination register width.

The floating-point to fixed-point operation uses the Round towards Zero rounding mode. The fixed-point to floating-point operation uses the Round to Nearest rounding mode.

Depending on settings in the CPACR, NSACR, HCPTR, and FPEXC registers, and the security state and mode in which the instruction is executed, an attempt to execute the instruction might be UNDEFINED, or trapped to Hyp mode. For more information see *Enabling Advanced SIMD and floating-point support* on page G1-4413.

A1

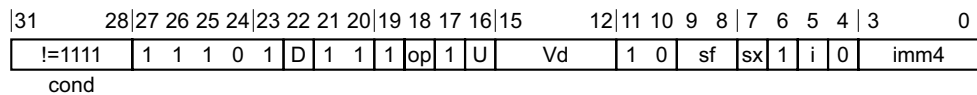

Half-precision scalar variant

Applies when `op == 0` && `sf == 01`.

VCVT{<c>}{<q>}.F16.<dt> <Sdm>, <Sdm>, #<fbits>

Half-precision scalar variant

Applies when `op == 1` && `sf == 01`.

VCVT{<c>}{<q>}.<dt>.F16 <Sdm>, <Sdm>, #<fbits>

Single-precision scalar variant

Applies when `op == 0` && `sf == 10`.

VCVT{<c>}{<q>}.F32.<dt> <Sdm>, <Sdm>, #<fbits>

Single-precision scalar variant

Applies when `op == 1` && `sf == 10`.

VCVT{<c>}{<q>}.<dt>.F32 <Sdm>, <Sdm>, #<fbits>

Double-precision scalar variant

Applies when `op == 0` && `sf == 11`.

VCVT{<c>}{<q>}.F64.<dt> <Ddm>, <Ddm>, #<fbits>

Double-precision scalar variant

Applies when `op == 1` && `sf == 11`.

VCVT{<c>}{<q>}.<dt>.F64 <Ddm>, <Ddm>, #<fbits>

Decode for all variants of this encoding

```
if sf == '00' || (sf == '01' && !HaveFP16Ext()) then UNDEFINED;
if sf == '01' && cond != '1110' then UNPREDICTABLE;
to_fixed = (op == '1'); unsigned = (U == '1');
```

```

size = if sx == '0' then 16 else 32;
frac_bits = size - UInt(imm4:i);
case sf of
    when '01' fp_size = 16; d = UInt(Vd:D);
    when '10' fp_size = 32; d = UInt(Vd:D);
    when '11' fp_size = 64; d = UInt(D:Vd);

if frac_bits < 0 then UNPREDICTABLE;
    
```

CONSTRAINED UNPREDICTABLE behavior

If frac_bits < 0, then one of the following behaviors must occur:

- The instruction is UNDEFINED.
- The instruction executes as NOP.
- The value in the destination register is UNKNOWN.

T1

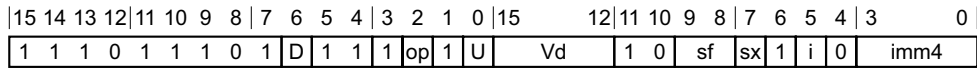

Half-precision scalar variant

Applies when op == 0 && sf == 01.

VCVT{<c>}{<q>}.F16.<dt> <Sdm>, <Sdm>, #<fbits>

Half-precision scalar variant

Applies when op == 1 && sf == 01.

VCVT{<c>}{<q>}.<dt>.F16 <Sdm>, <Sdm>, #<fbits>

Single-precision scalar variant

Applies when op == 0 && sf == 10.

VCVT{<c>}{<q>}.F32.<dt> <Sdm>, <Sdm>, #<fbits>

Single-precision scalar variant

Applies when op == 1 && sf == 10.

VCVT{<c>}{<q>}.<dt>.F32 <Sdm>, <Sdm>, #<fbits>

Double-precision scalar variant

Applies when op == 0 && sf == 11.

VCVT{<c>}{<q>}.F64.<dt> <Ddm>, <Ddm>, #<fbits>

Double-precision scalar variant

Applies when op == 1 && sf == 11.

VCVT{<c>}{<q>}.<dt>.F64 <Ddm>, <Ddm>, #<fbits>

Decode for all variants of this encoding

```

if sf == '00' || (sf == '01' && !HaveFP16Ext()) then UNDEFINED;
if sf == '01' && InITBlock() then UNPREDICTABLE;
to_fixed = (op == '1'); unsigned = (U == '1');
size = if sx == '0' then 16 else 32;
frac_bits = size - UInt(imm4:i);
case sf of
  when '01' fp_size = 16; d = UInt(Vd:D);
  when '10' fp_size = 32; d = UInt(Vd:D);
  when '11' fp_size = 64; d = UInt(D:Vd);

if frac_bits < 0 then UNPREDICTABLE;
  
```

CONSTRAINED UNPREDICTABLE behavior

If `frac_bits < 0`, then one of the following behaviors must occur:

- The instruction is UNDEFINED.
- The instruction executes as NOP.
- The value in the destination register is UNKNOWN.

Notes for all encodings

For more information about the CONSTRAINED UNPREDICTABLE behavior of this instruction, see [Appendix K1 Architectural Constraints on UNPREDICTABLE behaviors](#), and particularly *VCVT (between floating-point and fixed-point)* on page K1-6110.

Assembler symbols

- <c> See [Standard assembler syntax fields on page F2-2848](#).
- <q> See [Standard assembler syntax fields on page F2-2848](#).
- <dt> Is the data type for the fixed-point number, encoded in the "U:sx" field. It can have the following values:
- | | |
|-----|--------------------|
| S16 | when U = 0, sx = 0 |
| S32 | when U = 0, sx = 1 |
| U16 | when U = 1, sx = 0 |
| U32 | when U = 1, sx = 1 |
- <Sdm> Is the 32-bit name of the SIMD&FP destination and source register, encoded in the "Vd:D" field.
- <Ddm> Is the 64-bit name of the SIMD&FP destination and source register, encoded in the "D:Vd" field.
- <fbits> The number of fraction bits in the fixed-point number:
- If <dt> is S16 or U16, <fbits> must be in the range 0-16. (16 - <fbits>) is encoded in [imm4, i]
 - If <dt> is S32 or U32, <fbits> must be in the range 1-32. (32 - <fbits>) is encoded in [imm4, i].

Operation for all encodings

```

if ConditionPassed() then
  EncodingSpecificOperations(); CheckVFPEnabled(TRUE);
  if to_fixed then
    bits(size) result;
    case fp_size of
      when 16
        result = FPToFixed(S[d]<15:0>, frac_bits, unsigned, FPSCR, FPRounding_ZERO);
        S[d] = Extend(result, 32, unsigned);
      when 32
  
```

```
        result = FPToFixed(S[d], frac_bits, unsigned, FPSCR, FPRounding_ZERO);
        S[d] = Extend(result, 32, unsigned);
    when 64
        result = FPToFixed(D[d], frac_bits, unsigned, FPSCR, FPRounding_ZERO);
        D[d] = Extend(result, 64, unsigned);
else
    case fp_size of
    when 16
        bits(16) fp16 = FixedToFP(S[d]<size-1:0>, frac_bits, unsigned, FPSCR,
FPRounding_TIEEVEN);
        S[d] = Zeros(16):fp16;
    when 32
        S[d] = FixedToFP(S[d]<size-1:0>, frac_bits, unsigned, FPSCR, FPRounding_TIEEVEN);
    when 64
        D[d] = FixedToFP(D[d]<size-1:0>, frac_bits, unsigned, FPSCR, FPRounding_TIEEVEN);
```

F6.1.61 VCVTA (Advanced SIMD)

Vector Convert floating-point to integer with Round to Nearest with Ties to Away converts each element in a vector from floating-point to integer using the Round to Nearest with Ties to Away rounding mode, and places the results in a second vector.

The operand vector elements are floating-point numbers.

The result vector elements are 32-bit integers. Signed and unsigned integers are distinct.

Depending on settings in the CPACR, NSACR, HCPTR, and FPEXC registers, and the security state and mode in which the instruction is executed, an attempt to execute the instruction might be UNDEFINED, or trapped to Hyp mode. For more information see [Enabling Advanced SIMD and floating-point support on page G1-4413](#).

A1

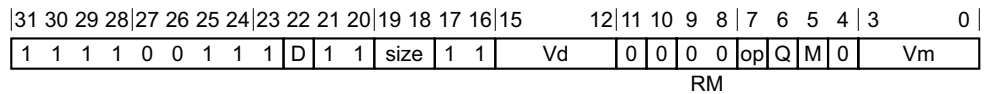

64-bit SIMD vector variant

Applies when Q == 0.

VCVTA{<q>}.<dt>.<dt2> <Dd>, <Dm>

128-bit SIMD vector variant

Applies when Q == 1.

VCVTA{<q>}.<dt>.<dt2> <Qd>, <Qm>

Decode for all variants of this encoding

```

if Q == '1' && (Vd<0> == '1' || Vm<0> == '1') then UNDEFINED;
if (size == '01' && !HaveFP16Ext()) || size IN {'00', '11'} then UNDEFINED;
rounding = FPDecodeRM(RM); unsigned = (op == '1');
case size of
  when '01' esize = 16; elements = 4;
  when '10' esize = 32; elements = 2;
d = UInt(D:Vd); m = UInt(M:Vm); regs = if Q == '0' then 1 else 2;
  
```

T1

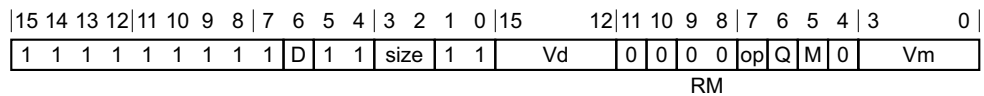

64-bit SIMD vector variant

Applies when Q == 0.

VCVTA{<q>}.<dt>.<dt2> <Dd>, <Dm>

128-bit SIMD vector variant

Applies when Q == 1.

VCVTA{<q>}.<dt>.<dt2> <Qd>, <Qm>

Decode for all variants of this encoding

```

if Q == '1' && (Vd<0> == '1' || Vm<0> == '1') then UNDEFINED;
if (size == '01' && !HaveFP16Ext()) || size IN {'00', '11'} then UNDEFINED;
rounding = FPDecodeRM(RM); unsigned = (op == '1');
case size of
  when '01' esize = 16; elements = 4;
  when '10' esize = 32; elements = 2;
d = UInt(D:Vd); m = UInt(M:Vm); regs = if Q == '0' then 1 else 2;
if InITBlock() then UNPREDICTABLE;
  
```

CONSTRAINED UNPREDICTABLE behavior

If InITBlock(), then one of the following behaviors must occur:

- The instruction is UNDEFINED.
- The instruction executes as if it passes the Condition code check.
- The instruction executes as NOP. This means it behaves as if it fails the Condition code check.

Assembler symbols

- <q> See *Standard assembler syntax fields on page F2-2848*.
- <dt> Is the data type for the elements of the destination, encoded in the "op" field. It can have the following values:
 S32 when op = 0
 U32 when op = 1
- <dt2> Is the data type for the elements of the source vector, encoded in the "size" field. It can have the following values:
 F16 when size = 01
 F32 when size = 10
- <Qd> Is the 128-bit name of the SIMD&FP destination register, encoded in the "D:Vd" field as <Qd>*2.
- <Qm> Is the 128-bit name of the SIMD&FP source register, encoded in the "M:Vm" field as <Qm>*2.
- <Dd> Is the 64-bit name of the SIMD&FP destination register, encoded in the "D:Vd" field.
- <Dm> Is the 64-bit name of the SIMD&FP source register, encoded in the "M:Vm" field.

Operation for all encodings

```

EncodingSpecificOperations(); CheckAdvSIMDEnabled();
bits(esize) result;
for r = 0 to regs-1
  for e = 0 to elements-1
    Elem[D[d+r],e,esize] = FPToFixed(Elem[D[m+r],e,esize], 0, unsigned,
      StandardFPSCRValue(), rounding);
  
```

F6.1.62 VCVTA (floating-point)

Convert floating-point to integer with Round to Nearest with Ties to Away converts a value in a register from floating-point to a 32-bit integer using the Round to Nearest with Ties to Away rounding mode, and places the result in a second register.

Depending on settings in the CPACR, NSACR, HCPTR, and FPEXC registers, and the security state and mode in which the instruction is executed, an attempt to execute the instruction might be UNDEFINED, or trapped to Hyp mode. For more information see [Enabling Advanced SIMD and floating-point support on page G1-4413](#).

A1

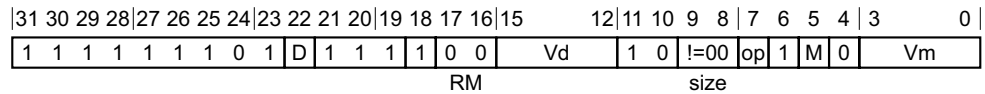

Half-precision scalar variant

Applies when size == 01.

VCVTA{<q>}.<dt>.F16 <Sd>, <Sm>

Single-precision scalar variant

Applies when size == 10.

VCVTA{<q>}.<dt>.F32 <Sd>, <Sm>

Double-precision scalar variant

Applies when size == 11.

VCVTA{<q>}.<dt>.F64 <Sd>, <Dm>

Decode for all variants of this encoding

```

if size == '00' || (size == '01' && !HaveFP16Ext()) then UNDEFINED;
rounding = FPDecodeRM(RM); unsigned = (op == '0');
d = UInt(Vd:D);
case size of
    when '01' esize = 16; m = UInt(Vm:M);
    when '10' esize = 32; m = UInt(Vm:M);
    when '11' esize = 64; m = UInt(M:Vm);
    
```

T1

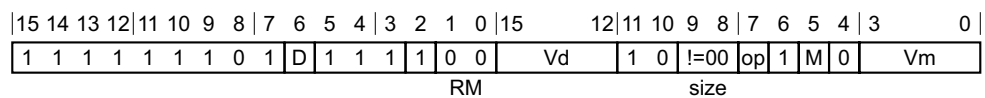

Half-precision scalar variant

Applies when size == 01.

VCVTA{<q>}.<dt>.F16 <Sd>, <Sm>

Single-precision scalar variant

Applies when size == 10.

VCVTA{<q>}.<dt>.F32 <Sd>, <Sm>

Double-precision scalar variant

Applies when size == 11.

VCVTA{<q>}.<dt>.F64 <Sd>, <Dm>

Decode for all variants of this encoding

```

if size == '00' || (size == '01' && !HaveFP16Ext()) then UNDEFINED;
rounding = FPDecodeRM(RM); unsigned = (op == '0');
d = UInt(Vd:D);
case esize of
    when '01' esize = 16; m = UInt(Vm:M);
    when '10' esize = 32; m = UInt(Vm:M);
    when '11' esize = 64; m = UInt(M:Vm);
if InITBlock() then UNPREDICTABLE;
    
```

CONSTRAINED UNPREDICTABLE behavior

If InITBlock(), then one of the following behaviors must occur:

- The instruction is UNDEFINED.
- The instruction executes as if it passes the Condition code check.
- The instruction executes as NOP. This means it behaves as if it fails the Condition code check.

Assembler symbols

<q>	See Standard assembler syntax fields on page F2-2848 .
<dt>	Is the data type for the elements of the destination, encoded in the "op" field. It can have the following values: U32 when op = 0 S32 when op = 1
<Sd>	Is the 32-bit name of the SIMD&FP destination register, encoded in the "Vd:D" field.
<Sm>	Is the 32-bit name of the SIMD&FP source register, encoded in the "Vm:M" field.
<Dm>	Is the 64-bit name of the SIMD&FP source register, encoded in the "M:Vm" field.

Operation for all encodings

```

EncodingSpecificOperations(); CheckVFPEnabled(TRUE);
case esize of
    when 16
        S[d] = FPToFixed(S[m]<15:0>, 0, unsigned, FPSCR, rounding);
    when 32
        S[d] = FPToFixed(S[m], 0, unsigned, FPSCR, rounding);
    when 64
        S[d] = FPToFixed(D[m], 0, unsigned, FPSCR, rounding);
    
```



F6.1.63 VCVTB

Convert to or from a half-precision value in the bottom half of a single-precision register does one of the following:

- Converts the half-precision value in the bottom half of a single-precision register to single-precision and writes the result to a single-precision register.
- Converts the half-precision value in the bottom half of a single-precision register to double-precision and writes the result to a double-precision register.
- Converts the single-precision value in a single-precision register to half-precision and writes the result into the bottom half of a single-precision register, preserving the other half of the destination register.
- Converts the double-precision value in a double-precision register to half-precision and writes the result into the bottom half of a single-precision register, preserving the other half of the destination register.

Depending on settings in the CPACR, NSACR, HCPTTR, and FPEXC registers, and the security state and mode in which the instruction is executed, an attempt to execute the instruction might be UNDEFINED, or trapped to Hyp mode. For more information see [Enabling Advanced SIMD and floating-point support on page G1-4413](#).

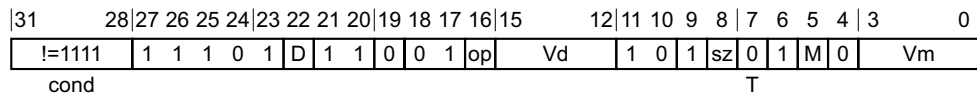
A1



Half-precision to single-precision variant

Applies when `op == 0` && `sz == 0`.

VCVTB{<c>}{<q>}.F32.F16 <Sd>, <Sm>

Half-precision to double-precision variant

Applies when `op == 0` && `sz == 1`.

VCVTB{<c>}{<q>}.F64.F16 <Dd>, <Sm>

Single-precision to half-precision variant

Applies when `op == 1` && `sz == 0`.

VCVTB{<c>}{<q>}.F16.F32 <Sd>, <Sm>

Double-precision to half-precision variant

Applies when `op == 1` && `sz == 1`.

VCVTB{<c>}{<q>}.F16.F64 <Sd>, <Dm>

Decode for all variants of this encoding

```

uses_double = (sz == '1'); convert_from_half = (op == '0');
lowbit = (if T == '1' then 16 else 0);
if uses_double then
    if convert_from_half then
        d = UInt(D:Vd); m = UInt(Vm:M);
    else
        d = UInt(Vd:D); m = UInt(M:Vm);
else
    d = UInt(Vd:D); m = UInt(Vm:M);
    
```

T1

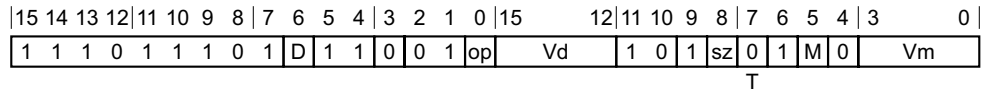

Half-precision to single-precision variant

Applies when `op == 0` && `sz == 0`.

`VCVTB{<c>}{<q>}.F32.F16 <Sd>, <Sm>`

Half-precision to double-precision variant

Applies when `op == 0` && `sz == 1`.

`VCVTB{<c>}{<q>}.F64.F16 <Dd>, <Sm>`

Single-precision to half-precision variant

Applies when `op == 1` && `sz == 0`.

`VCVTB{<c>}{<q>}.F16.F32 <Sd>, <Sm>`

Double-precision to half-precision variant

Applies when `op == 1` && `sz == 1`.

`VCVTB{<c>}{<q>}.F16.F64 <Sd>, <Dm>`

Decode for all variants of this encoding

```

uses_double = (sz == '1'); convert_from_half = (op == '0');
lowbit = (if T == '1' then 16 else 0);
if uses_double then
  if convert_from_half then
    d = UInt(D:Vd); m = UInt(Vm:M);
  else
    d = UInt(Vd:D); m = UInt(M:Vm);
else
  d = UInt(Vd:D); m = UInt(Vm:M);

```

Assembler symbols

- <c> See [Standard assembler syntax fields on page F2-2848](#).
- <q> See [Standard assembler syntax fields on page F2-2848](#).
- <Sd> Is the 32-bit name of the SIMD&FP destination register, encoded in the "Vd:D" field.
- <Dm> Is the 64-bit name of the SIMD&FP source register, encoded in the "M:Vm" field.
- <Dd> Is the 64-bit name of the SIMD&FP destination register, encoded in the "D:Vd" field.
- <Sm> Is the 32-bit name of the SIMD&FP source register, encoded in the "Vm:M" field.

Operation for all encodings

```

if ConditionPassed() then
  EncodingSpecificOperations(); CheckVFPEnabled(TRUE);
  bits(16) hp;
  if convert_from_half then
    hp = S[m]<lowbit+15:lowbit>;
  if uses_double then

```

```
        D[d] = FPConvert(hp, FPSCR);  
    else  
        S[d] = FPConvert(hp, FPSCR);  
else  
    if uses_double then  
        hp = FPConvert(D[m], FPSCR);  
    else  
        hp = FPConvert(S[m], FPSCR);  
S[d]<lowbit+15:lowbit> = hp;
```

F6.1.64 VCVTM (Advanced SIMD)

Vector Convert floating-point to integer with Round towards -Infinity converts each element in a vector from floating-point to integer using the Round towards -Infinity rounding mode, and places the results in a second vector.

The operand vector elements are floating-point numbers.

The result vector elements are 32-bit integers. Signed and unsigned integers are distinct.

Depending on settings in the CPACR, NSACR, HCPTR, and FPEXC registers, and the security state and mode in which the instruction is executed, an attempt to execute the instruction might be UNDEFINED, or trapped to Hyp mode. For more information see [Enabling Advanced SIMD and floating-point support on page G1-4413](#).

A1

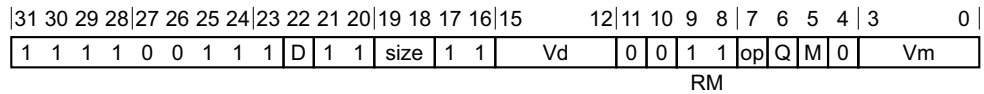

64-bit SIMD vector variant

Applies when Q == 0.

VCVTM{<q>}.<dt>.<dt2> <Dd>, <Dm>

128-bit SIMD vector variant

Applies when Q == 1.

VCVTM{<q>}.<dt>.<dt2> <Qd>, <Qm>

Decode for all variants of this encoding

```

if Q == '1' && (Vd<0> == '1' || Vm<0> == '1') then UNDEFINED;
if (size == '01' && !HaveFP16Ext()) || size IN {'00', '11'} then UNDEFINED;
rounding = FPDecodeRM(RM); unsigned = (op == '1');
case size of
    when '01' esize = 16; elements = 4;
    when '10' esize = 32; elements = 2;
d = UInt(D:Vd); m = UInt(M:Vm); regs = if Q == '0' then 1 else 2;
    
```

T1

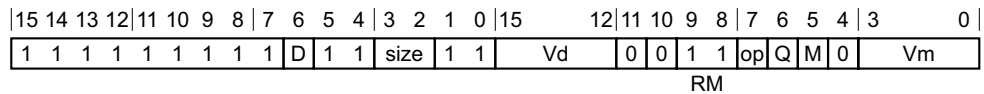

64-bit SIMD vector variant

Applies when Q == 0.

VCVTM{<q>}.<dt>.<dt2> <Dd>, <Dm>

128-bit SIMD vector variant

Applies when Q == 1.

VCVTM{<q>}.<dt>.<dt2> <Qd>, <Qm>

Decode for all variants of this encoding

```

if Q == '1' && (Vd<0> == '1' || Vm<0> == '1') then UNDEFINED;
if (size == '01' && !HaveFP16Ext()) || size IN {'00', '11'} then UNDEFINED;
rounding = FPDecodeRM(RM); unsigned = (op == '1');
case size of
  when '01' esize = 16; elements = 4;
  when '10' esize = 32; elements = 2;
d = UInt(D:Vd); m = UInt(M:Vm); regs = if Q == '0' then 1 else 2;
if InITBlock() then UNPREDICTABLE;
  
```

CONSTRAINED UNPREDICTABLE behavior

If InITBlock(), then one of the following behaviors must occur:

- The instruction is UNDEFINED.
- The instruction executes as if it passes the Condition code check.
- The instruction executes as NOP. This means it behaves as if it fails the Condition code check.

Assembler symbols

- <q> See [Standard assembler syntax fields on page F2-2848](#).
- <dt> Is the data type for the elements of the destination, encoded in the "op" field. It can have the following values:
- | | |
|-----|-------------|
| S32 | when op = 0 |
| U32 | when op = 1 |
- <dt2> Is the data type for the elements of the source vector, encoded in the "size" field. It can have the following values:
- | | |
|-----|----------------|
| F16 | when size = 01 |
| F32 | when size = 10 |
- <Qd> Is the 128-bit name of the SIMD&FP destination register, encoded in the "D:Vd" field as <Qd>*2.
- <Qm> Is the 128-bit name of the SIMD&FP source register, encoded in the "M:Vm" field as <Qm>*2.
- <Dd> Is the 64-bit name of the SIMD&FP destination register, encoded in the "D:Vd" field.
- <Dm> Is the 64-bit name of the SIMD&FP source register, encoded in the "M:Vm" field.

Operation for all encodings

```

EncodingSpecificOperations(); CheckAdvSIMDEnabled();
bits(esize) result;
for r = 0 to regs-1
  for e = 0 to elements-1
    Elem[D[d+r],e,esize] = FPToFixed(
      Elem[D[m+r],e,esize], 0, unsigned,
      StandardFPSCRValue(), rounding);
  
```

F6.1.65 VCVTM (floating-point)

Convert floating-point to integer with Round towards -Infinity converts a value in a register from floating-point to a 32-bit integer using the Round towards -Infinity rounding mode, and places the result in a second register.

Depending on settings in the CPACR, NSACR, HCPTR, and FPEXC registers, and the security state and mode in which the instruction is executed, an attempt to execute the instruction might be UNDEFINED, or trapped to Hyp mode. For more information see [Enabling Advanced SIMD and floating-point support on page G1-4413](#).

A1

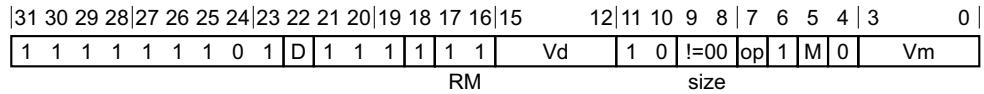

Half-precision scalar variant

Applies when size == 01.

VCVTM{<q>}.<dt>.F16 <Sd>, <Sm>

Single-precision scalar variant

Applies when size == 10.

VCVTM{<q>}.<dt>.F32 <Sd>, <Sm>

Double-precision scalar variant

Applies when size == 11.

VCVTM{<q>}.<dt>.F64 <Sd>, <Dm>

Decode for all variants of this encoding

```

if size == '00' || (size == '01' && !HaveFP16Ext()) then UNDEFINED;
rounding = FPDecodeRM(RM); unsigned = (op == '0');
d = UInt(Vd:D);
case size of
    when '01' esize = 16; m = UInt(Vm:M);
    when '10' esize = 32; m = UInt(Vm:M);
    when '11' esize = 64; m = UInt(M:Vm);
    
```

T1

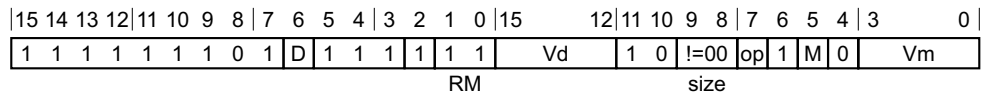

Half-precision scalar variant

Applies when size == 01.

VCVTM{<q>}.<dt>.F16 <Sd>, <Sm>

Single-precision scalar variant

Applies when size == 10.

VCVTM{<q>}.<dt>.F32 <Sd>, <Sm>

Double-precision scalar variant

Applies when size == 11.

VCVTM{<q>}.<dt>.F64 <Sd>, <Dm>

Decode for all variants of this encoding

```
if size == '00' || (size == '01' && !HaveFP16Ext()) then UNDEFINED;
rounding = FPDecodeRM(RM); unsigned = (op == '0');
d = UInt(Vd:D);
case size of
  when '01' esize = 16; m = UInt(Vm:M);
  when '10' esize = 32; m = UInt(Vm:M);
  when '11' esize = 64; m = UInt(M:Vm);
if InITBlock() then UNPREDICTABLE;
```

CONSTRAINED UNPREDICTABLE behavior

If InITBlock(), then one of the following behaviors must occur:

- The instruction is UNDEFINED.
- The instruction executes as if it passes the Condition code check.
- The instruction executes as NOP. This means it behaves as if it fails the Condition code check.

Assembler symbols

<q>	See Standard assembler syntax fields on page F2-2848 .
<dt>	Is the data type for the elements of the destination, encoded in the "op" field. It can have the following values: U32 when op = 0 S32 when op = 1
<Sd>	Is the 32-bit name of the SIMD&FP destination register, encoded in the "Vd:D" field.
<Sm>	Is the 32-bit name of the SIMD&FP source register, encoded in the "Vm:M" field.
<Dm>	Is the 64-bit name of the SIMD&FP source register, encoded in the "M:Vm" field.

Operation for all encodings

```
EncodingSpecificOperations(); CheckVFPEnabled(TRUE);
case esize of
  when 16
    S[d] = FPToFixed(S[m]<15:0>, 0, unsigned, FPSCR, rounding);
  when 32
    S[d] = FPToFixed(S[m], 0, unsigned, FPSCR, rounding);
  when 64
    S[d] = FPToFixed(D[m], 0, unsigned, FPSCR, rounding);
```

F6.1.66 VCVTN (Advanced SIMD)

Vector Convert floating-point to integer with Round to Nearest converts each element in a vector from floating-point to integer using the Round to Nearest rounding mode, and places the results in a second vector.

The operand vector elements are floating-point numbers.

The result vector elements are 32-bit integers. Signed and unsigned integers are distinct.

Depending on settings in the CPACR, NSACR, HCPTR, and FPEXC registers, and the security state and mode in which the instruction is executed, an attempt to execute the instruction might be UNDEFINED, or trapped to Hyp mode. For more information see [Enabling Advanced SIMD and floating-point support on page G1-4413](#).

A1

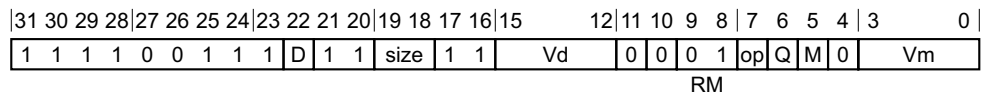

64-bit SIMD vector variant

Applies when Q == 0.

VCVTN{<q>}.<dt>.<dt2> <Dd>, <Dm>

128-bit SIMD vector variant

Applies when Q == 1.

VCVTN{<q>}.<dt>.<dt2> <Qd>, <Qm>

Decode for all variants of this encoding

```

if Q == '1' && (Vd<0> == '1' || Vm<0> == '1') then UNDEFINED;
if (size == '01' && !HaveFP16Ext()) || size IN {'00', '11'} then UNDEFINED;
rounding = FPDecodeRM(RM); unsigned = (op == '1');
case size of
    when '01' esize = 16; elements = 4;
    when '10' esize = 32; elements = 2;
d = UInt(D:Vd); m = UInt(M:Vm); regs = if Q == '0' then 1 else 2;
    
```

T1

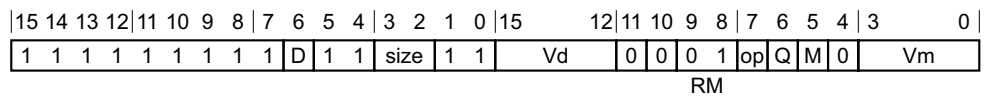

64-bit SIMD vector variant

Applies when Q == 0.

VCVTN{<q>}.<dt>.<dt2> <Dd>, <Dm>

128-bit SIMD vector variant

Applies when Q == 1.

VCVTN{<q>}.<dt>.<dt2> <Qd>, <Qm>

Decode for all variants of this encoding

```

if Q == '1' && (Vd<0> == '1' || Vm<0> == '1') then UNDEFINED;
if (size == '01' && !HaveFP16Ext()) || size IN {'00', '11'} then UNDEFINED;
rounding = FPDecodeRM(RM); unsigned = (op == '1');
case size of
  when '01' esize = 16; elements = 4;
  when '10' esize = 32; elements = 2;
d = UInt(D:Vd); m = UInt(M:Vm); regs = if Q == '0' then 1 else 2;
if InITBlock() then UNPREDICTABLE;
  
```

CONSTRAINED UNPREDICTABLE behavior

If InITBlock(), then one of the following behaviors must occur:

- The instruction is UNDEFINED.
- The instruction executes as if it passes the Condition code check.
- The instruction executes as NOP. This means it behaves as if it fails the Condition code check.

Assembler symbols

<q>	See Standard assembler syntax fields on page F2-2848 .
<dt>	Is the data type for the elements of the destination, encoded in the "op" field. It can have the following values: S32 when op = 0 U32 when op = 1
<dt2>	Is the data type for the elements of the source vector, encoded in the "size" field. It can have the following values: F16 when size = 01 F32 when size = 10
<Qd>	Is the 128-bit name of the SIMD&FP destination register, encoded in the "D:Vd" field as <Qd>*2.
<Qm>	Is the 128-bit name of the SIMD&FP source register, encoded in the "M:Vm" field as <Qm>*2.
<Dd>	Is the 64-bit name of the SIMD&FP destination register, encoded in the "D:Vd" field.
<Dm>	Is the 64-bit name of the SIMD&FP source register, encoded in the "M:Vm" field.

Operation for all encodings

```

EncodingSpecificOperations(); CheckAdvSIMDEnabled();
bits(esize) result;
for r = 0 to regs-1
  for e = 0 to elements-1
    Elem[D[d+r],e,esize] = FPToFixed(Elem[D[m+r],e,esize], 0, unsigned,
      StandardFPSCRValue(), rounding);
  
```

F6.1.67 VCVTN (floating-point)

Convert floating-point to integer with Round to Nearest converts a value in a register from floating-point to a 32-bit integer using the Round to Nearest rounding mode, and places the result in a second register.

Depending on settings in the CPACR, NSACR, HCPTR, and FPEXC registers, and the security state and mode in which the instruction is executed, an attempt to execute the instruction might be UNDEFINED, or trapped to Hyp mode. For more information see [Enabling Advanced SIMD and floating-point support on page G1-4413](#).

A1

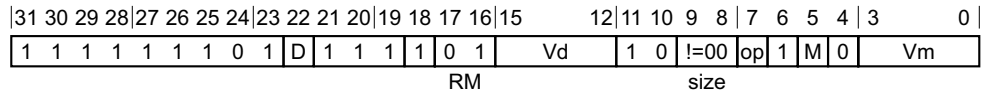

Half-precision scalar variant

Applies when size == 01.

VCVTN{<q>}.<dt>.F16 <Sd>, <Sm>

Single-precision scalar variant

Applies when size == 10.

VCVTN{<q>}.<dt>.F32 <Sd>, <Sm>

Double-precision scalar variant

Applies when size == 11.

VCVTN{<q>}.<dt>.F64 <Sd>, <Dm>

Decode for all variants of this encoding

```

if size == '00' || (size == '01' && !HaveFP16Ext()) then UNDEFINED;
rounding = FPDecodeRM(RM); unsigned = (op == '0');
d = UInt(Vd:D);
case size of
    when '01' esize = 16; m = UInt(Vm:M);
    when '10' esize = 32; m = UInt(Vm:M);
    when '11' esize = 64; m = UInt(M:Vm);
    
```

T1

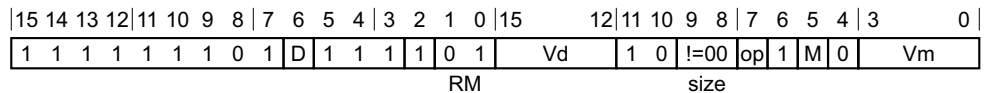

Half-precision scalar variant

Applies when size == 01.

VCVTN{<q>}.<dt>.F16 <Sd>, <Sm>

Single-precision scalar variant

Applies when size == 10.

VCVTN{<q>}.<dt>.F32 <Sd>, <Sm>

Double-precision scalar variant

Applies when size == 11.

VCVTN{<q>}.<dt>.F64 <Sd>, <Dm>

Decode for all variants of this encoding

```
if size == '00' || (size == '01' && !HaveFP16Ext()) then UNDEFINED;
rounding = FPDecodeRM(RM); unsigned = (op == '0');
d = UInt(Vd:D);
case size of
  when '01' esize = 16; m = UInt(Vm:M);
  when '10' esize = 32; m = UInt(Vm:M);
  when '11' esize = 64; m = UInt(M:Vm);
if InITBlock() then UNPREDICTABLE;
```

CONSTRAINED UNPREDICTABLE behavior

If InITBlock(), then one of the following behaviors must occur:

- The instruction is UNDEFINED.
- The instruction executes as if it passes the Condition code check.
- The instruction executes as NOP. This means it behaves as if it fails the Condition code check.

Assembler symbols

<q>	See Standard assembler syntax fields on page F2-2848 .
<dt>	Is the data type for the elements of the destination, encoded in the "op" field. It can have the following values: U32 when op = 0 S32 when op = 1
<Sd>	Is the 32-bit name of the SIMD&FP destination register, encoded in the "Vd:D" field.
<Sm>	Is the 32-bit name of the SIMD&FP source register, encoded in the "Vm:M" field.
<Dm>	Is the 64-bit name of the SIMD&FP source register, encoded in the "M:Vm" field.

Operation for all encodings

```
EncodingSpecificOperations(); CheckVFPEEnabled(TRUE);
case esize of
  when 16
    S[d] = FPToFixed(S[m]<15:0>, 0, unsigned, FPSCR, rounding);
  when 32
    S[d] = FPToFixed(S[m], 0, unsigned, FPSCR, rounding);
  when 64
    S[d] = FPToFixed(D[m], 0, unsigned, FPSCR, rounding);
```

F6.1.68 VCVTP (Advanced SIMD)

Vector Convert floating-point to integer with Round towards +Infinity converts each element in a vector from floating-point to integer using the Round towards +Infinity rounding mode, and places the results in a second vector.

The operand vector elements are floating-point numbers.

The result vector elements are 32-bit integers. Signed and unsigned integers are distinct.

Depending on settings in the CPACR, NSACR, HCPTR, and FPEXC registers, and the security state and mode in which the instruction is executed, an attempt to execute the instruction might be UNDEFINED, or trapped to Hyp mode. For more information see [Enabling Advanced SIMD and floating-point support on page G1-4413](#).

A1

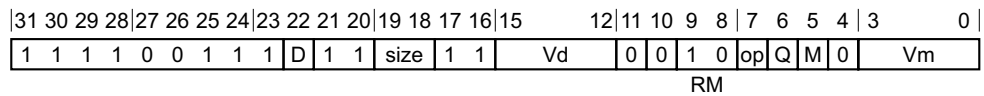

64-bit SIMD vector variant

Applies when Q == 0.

VCVTP{<q>}.<dt>.<dt2> <Dd>, <Dm>

128-bit SIMD vector variant

Applies when Q == 1.

VCVTP{<q>}.<dt>.<dt2> <Qd>, <Qm>

Decode for all variants of this encoding

```

if Q == '1' && (Vd<0> == '1' || Vm<0> == '1') then UNDEFINED;
if (size == '01' && !HaveFP16Ext()) || size IN {'00', '11'} then UNDEFINED;
rounding = FPDecodeRM(RM); unsigned = (op == '1');
case size of
    when '01' esize = 16; elements = 4;
    when '10' esize = 32; elements = 2;
d = UInt(D:Vd); m = UInt(M:Vm); regs = if Q == '0' then 1 else 2;
    
```

T1

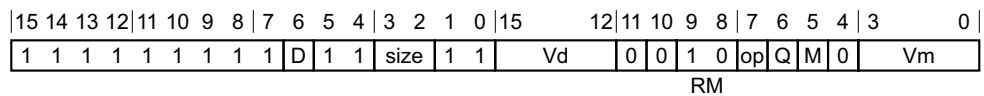

64-bit SIMD vector variant

Applies when Q == 0.

VCVTP{<q>}.<dt>.<dt2> <Dd>, <Dm>

128-bit SIMD vector variant

Applies when Q == 1.

VCVTP{<q>}.<dt>.<dt2> <Qd>, <Qm>

Decode for all variants of this encoding

```

if Q == '1' && (Vd<0> == '1' || Vm<0> == '1') then UNDEFINED;
if (size == '01' && !HaveFP16Ext()) || size IN {'00', '11'} then UNDEFINED;
rounding = FPDecodeRM(RM); unsigned = (op == '1');
case size of
  when '01' esize = 16; elements = 4;
  when '10' esize = 32; elements = 2;
d = UInt(D:Vd); m = UInt(M:Vm); regs = if Q == '0' then 1 else 2;
if InITBlock() then UNPREDICTABLE;
  
```

CONSTRAINED UNPREDICTABLE behavior

If InITBlock(), then one of the following behaviors must occur:

- The instruction is UNDEFINED.
- The instruction executes as if it passes the Condition code check.
- The instruction executes as NOP. This means it behaves as if it fails the Condition code check.

Assembler symbols

- <q> See [Standard assembler syntax fields on page F2-2848](#).
- <dt> Is the data type for the elements of the destination, encoded in the "op" field. It can have the following values:
- | | |
|-----|-------------|
| S32 | when op = 0 |
| U32 | when op = 1 |
- <dt2> Is the data type for the elements of the source vector, encoded in the "size" field. It can have the following values:
- | | |
|-----|----------------|
| F16 | when size = 01 |
| F32 | when size = 10 |
- <Qd> Is the 128-bit name of the SIMD&FP destination register, encoded in the "D:Vd" field as <Qd>*2.
- <Qm> Is the 128-bit name of the SIMD&FP source register, encoded in the "M:Vm" field as <Qm>*2.
- <Dd> Is the 64-bit name of the SIMD&FP destination register, encoded in the "D:Vd" field.
- <Dm> Is the 64-bit name of the SIMD&FP source register, encoded in the "M:Vm" field.

Operation for all encodings

```

EncodingSpecificOperations(); CheckAdvSIMDEnabled();
bits(esize) result;
for r = 0 to regs-1
  for e = 0 to elements-1
    Elem[D[d+r],e,esize] = FPToFixed(Elem[D[m+r],e,esize], 0, unsigned,
      StandardFPSCRValue(), rounding);
  
```

F6.1.69 VCVTP (floating-point)

Convert floating-point to integer with Round towards +Infinity converts a value in a register from floating-point to a 32-bit integer using the Round towards +Infinity rounding mode, and places the result in a second register.

Depending on settings in the CPACR, NSACR, HCPTR, and FPEXC registers, and the security state and mode in which the instruction is executed, an attempt to execute the instruction might be UNDEFINED, or trapped to Hyp mode. For more information see [Enabling Advanced SIMD and floating-point support on page G1-4413](#).

A1

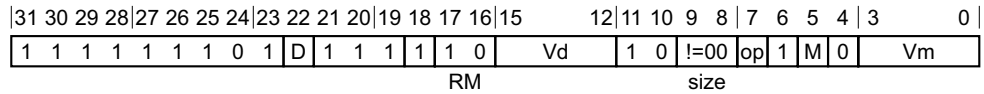

Half-precision scalar variant

Applies when size == 01.

VCVTP{<q>}.<dt>.F16 <Sd>, <Sm>

Single-precision scalar variant

Applies when size == 10.

VCVTP{<q>}.<dt>.F32 <Sd>, <Sm>

Double-precision scalar variant

Applies when size == 11.

VCVTP{<q>}.<dt>.F64 <Sd>, <Dm>

Decode for all variants of this encoding

```
if size == '00' || (size == '01' && !HaveFP16Ext()) then UNDEFINED;
rounding = FPDecodeRM(RM); unsigned = (op == '0');
d = UInt(Vd:D);
case size of
    when '01' esize = 16; m = UInt(Vm:M);
    when '10' esize = 32; m = UInt(Vm:M);
    when '11' esize = 64; m = UInt(M:Vm);
```

T1

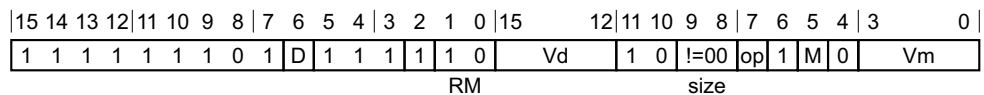

Half-precision scalar variant

Applies when size == 01.

VCVTP{<q>}.<dt>.F16 <Sd>, <Sm>

Single-precision scalar variant

Applies when size == 10.

VCVTP{<q>}.<dt>.F32 <Sd>, <Sm>

Double-precision scalar variant

Applies when size == 11.

VCVTP{<q>}.<dt>.F64 <Sd>, <Dm>

Decode for all variants of this encoding

```
if size == '00' || (size == '01' && !HaveFP16Ext()) then UNDEFINED;
rounding = FPDecodeRM(RM); unsigned = (op == '0');
d = UInt(Vd:D);
case size of
  when '01' esize = 16; m = UInt(Vm:M);
  when '10' esize = 32; m = UInt(Vm:M);
  when '11' esize = 64; m = UInt(M:Vm);
if InITBlock() then UNPREDICTABLE;
```

CONSTRAINED UNPREDICTABLE behavior

If InITBlock(), then one of the following behaviors must occur:

- The instruction is UNDEFINED.
- The instruction executes as if it passes the Condition code check.
- The instruction executes as NOP. This means it behaves as if it fails the Condition code check.

Assembler symbols

<q>	See Standard assembler syntax fields on page F2-2848 .
<dt>	Is the data type for the elements of the destination, encoded in the "op" field. It can have the following values: U32 when op = 0 S32 when op = 1
<Sd>	Is the 32-bit name of the SIMD&FP destination register, encoded in the "Vd:D" field.
<Sm>	Is the 32-bit name of the SIMD&FP source register, encoded in the "Vm:M" field.
<Dm>	Is the 64-bit name of the SIMD&FP source register, encoded in the "M:Vm" field.

Operation for all encodings

```
EncodingSpecificOperations(); CheckVFPEnabled(TRUE);
case esize of
  when 16
    S[d] = FPToFixed(S[m]<15:0>, 0, unsigned, FPSCR, rounding);
  when 32
    S[d] = FPToFixed(S[m], 0, unsigned, FPSCR, rounding);
  when 64
    S[d] = FPToFixed(D[m], 0, unsigned, FPSCR, rounding);
```

F6.1.70 VCVTR

Convert floating-point to integer converts a value in a register from floating-point to a 32-bit integer, using the rounding mode specified by the **FPSCR** and places the result in a second register.

VCVT (between floating-point and fixed-point, floating-point) describes conversions between floating-point and 16-bit integers.

Depending on settings in the **CPACR**, **NSACR**, **HCPTR**, and **FPEXC** registers, and the security state and mode in which the instruction is executed, an attempt to execute the instruction might be UNDEFINED, or trapped to Hyp mode. For more information see *Enabling Advanced SIMD and floating-point support on page G1-4413*.

A1

31	28	27	26	25	24	23	22	21	20	19	18	16	15	12	11	10	9	8	7	6	5	4	3	0
!=1111				1	1	1	0	1	D	1	1	1	1	0	x	Vd	1	0	size	0	1	M	0	Vm
cond				opc2								op												

Half-precision scalar variant

Applies when `opc2 == 100` && `size == 01`.

`VCVTR{<c>}{<q>}.U32.F16 <Sd>, <Sm>`

Half-precision scalar variant

Applies when `opc2 == 101` && `size == 01`.

`VCVTR{<c>}{<q>}.S32.F16 <Sd>, <Sm>`

Single-precision scalar variant

Applies when `opc2 == 100` && `size == 10`.

`VCVTR{<c>}{<q>}.U32.F32 <Sd>, <Sm>`

Single-precision scalar variant

Applies when `opc2 == 101` && `size == 10`.

`VCVTR{<c>}{<q>}.S32.F32 <Sd>, <Sm>`

Double-precision scalar variant

Applies when `opc2 == 100` && `size == 11`.

`VCVTR{<c>}{<q>}.U32.F64 <Sd>, <Dm>`

Double-precision scalar variant

Applies when `opc2 == 101` && `size == 11`.

`VCVTR{<c>}{<q>}.S32.F64 <Sd>, <Dm>`

Decode for all variants of this encoding

```

if opc2 != '000' && opc2 != '10x' then SEE "Related encodings";
if size == '00' || (size == '01' && !HaveFP16Ext()) then UNDEFINED;
if size == '01' && cond != '1110' then UNPREDICTABLE;
to_integer = (opc2<2> == '1');
if to_integer then
    unsigned = (opc2<0> == '0');
    rounding = if op == '1' then FPRounding_ZERO else FPRoundingMode(FPSCR);
    d = UInt(Vd:D);
    case size of
    
```



```

        when '01' esize = 16; m = UInt(Vm:M);
        when '10' esize = 32; m = UInt(Vm:M);
        when '11' esize = 64; m = UInt(M:Vm);
    else
        unsigned = (op == '0');
        rounding = FPRoundingMode(FPSCR);
        m = UInt(Vm:M);
        case size of
            when '01' esize = 16; d = UInt(Vd:D);
            when '10' esize = 32; d = UInt(Vd:D);
            when '11' esize = 64; d = UInt(D:Vd);
    
```

CONSTRAINED UNPREDICTABLE behavior

If size == '01' && cond != '1110', then one of the following behaviors must occur:

- The instruction is UNDEFINED.
- The instruction executes as if it passes the Condition code check.
- The instruction executes as NOP. This means it behaves as if it fails the Condition code check.

T1

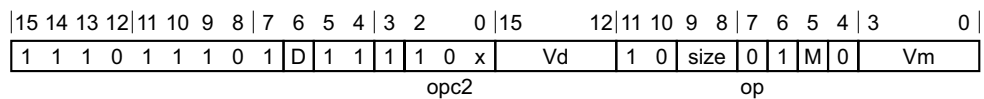

Half-precision scalar variant

Applies when opc2 == 100 && size == 01.

VCVTR{<c>}{<q>}.U32.F16 <Sd>, <Sm>

Half-precision scalar variant

Applies when opc2 == 101 && size == 01.

VCVTR{<c>}{<q>}.S32.F16 <Sd>, <Sm>

Single-precision scalar variant

Applies when opc2 == 100 && size == 10.

VCVTR{<c>}{<q>}.U32.F32 <Sd>, <Sm>

Single-precision scalar variant

Applies when opc2 == 101 && size == 10.

VCVTR{<c>}{<q>}.S32.F32 <Sd>, <Sm>

Double-precision scalar variant

Applies when opc2 == 100 && size == 11.

VCVTR{<c>}{<q>}.U32.F64 <Sd>, <Dm>

Double-precision scalar variant

Applies when opc2 == 101 && size == 11.

VCVTR{<c>}{<q>}.S32.F64 <Sd>, <Dm>

Decode for all variants of this encoding

```

if opc2 != '000' && opc2 != '10x' then SEE "Related encodings";
if size == '00' || (size == '01' && !HaveFP16Ext()) then UNDEFINED;
if size == '01' && InITBlock() then UNPREDICTABLE;
to_integer = (opc2<2> == '1');
if to_integer then
  unsigned = (opc2<0> == '0');
  rounding = if op == '1' then FPRounding_ZERO else FPRoundingMode(FPSCR);
  d = UInt(Vd:D);
  case size of
    when '01' esize = 16; m = UInt(Vm:M);
    when '10' esize = 32; m = UInt(Vm:M);
    when '11' esize = 64; m = UInt(M:Vm);
else
  unsigned = (op == '0');
  rounding = FPRoundingMode(FPSCR);
  m = UInt(Vm:M);
  case size of
    when '01' esize = 16; d = UInt(Vd:D);
    when '10' esize = 32; d = UInt(Vd:D);
    when '11' esize = 64; d = UInt(D:Vd);
  
```

CONSTRAINED UNPREDICTABLE behavior

If size == '01' && InITBlock(), then one of the following behaviors must occur:

- The instruction is UNDEFINED.
- The instruction executes as if it passes the Condition code check.
- The instruction executes as NOP. This means it behaves as if it fails the Condition code check.

Notes for all encodings

Related encodings: See [Floating-point data-processing on page F3-2898](#) for the T32 instruction set, or [Floating-point data-processing on page F4-2977](#) for the A32 instruction set.

Assembler symbols

- <c> See [Standard assembler syntax fields on page F2-2848](#).
- <q> See [Standard assembler syntax fields on page F2-2848](#).
- <Sd> Is the 32-bit name of the SIMD&FP destination register, encoded in the "Vd:D" field.
- <Sm> Is the 32-bit name of the SIMD&FP source register, encoded in the "Vm:M" field.
- <Dm> Is the 64-bit name of the SIMD&FP source register, encoded in the "M:Vm" field.

Operation for all encodings

```

if ConditionPassed() then
  EncodingSpecificOperations(); CheckVFPEnabled(TRUE);
  if to_integer then
    case esize of
      when 16
        S[d] = FPToFixed(S[m]<15:0>, 0, unsigned, FPSCR, rounding);
      when 32
        S[d] = FPToFixed(S[m], 0, unsigned, FPSCR, rounding);
      when 64
        S[d] = FPToFixed(D[m], 0, unsigned, FPSCR, rounding);
  else
    case esize of
      when 16
  
```

```
bits(16) fp16 = FixedToFP(S[m], 0, unsigned, FPSCR, rounding);  
S[d] = Zeros(16):fp16;  
when 32  
S[d] = FixedToFP(S[m], 0, unsigned, FPSCR, rounding);  
when 64  
D[d] = FixedToFP(S[m], 0, unsigned, FPSCR, rounding);
```

F6.1.71 VCVTT

Convert to or from a half-precision value in the top half of a single-precision register does one of the following:

- Converts the half-precision value in the top half of a single-precision register to single-precision and writes the result to a single-precision register.
- Converts the half-precision value in the top half of a single-precision register to double-precision and writes the result to a double-precision register.
- Converts the single-precision value in a single-precision register to half-precision and writes the result into the top half of a single-precision register, preserving the other half of the destination register.
- Converts the double-precision value in a double-precision register to half-precision and writes the result into the top half of a single-precision register, preserving the other half of the destination register.

Depending on settings in the CPACR, NSACR, HCPTR, and FPEXC registers, and the security state and mode in which the instruction is executed, an attempt to execute the instruction might be UNDEFINED, or trapped to Hyp mode. For more information see [Enabling Advanced SIMD and floating-point support on page G1-4413](#).

A1

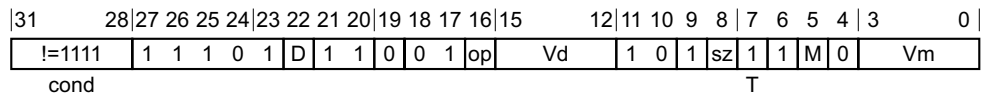

Half-precision to single-precision variant

Applies when `op == 0` && `sz == 0`.

`VCVTT{<c>}{<q>}.F32.F16 <Sd>, <Sm>`

Half-precision to double-precision variant

Applies when `op == 0` && `sz == 1`.

`VCVTT{<c>}{<q>}.F64.F16 <Dd>, <Sm>`

Single-precision to half-precision variant

Applies when `op == 1` && `sz == 0`.

`VCVTT{<c>}{<q>}.F16.F32 <Sd>, <Sm>`

Double-precision to half-precision variant

Applies when `op == 1` && `sz == 1`.

`VCVTT{<c>}{<q>}.F16.F64 <Sd>, <Dm>`

Decode for all variants of this encoding

```

uses_double = (sz == '1'); convert_from_half = (op == '0');
lowbit = (if T == '1' then 16 else 0);
if uses_double then
    if convert_from_half then
        d = UInt(D:Vd); m = UInt(Vm:M);
    else
        d = UInt(Vd:D); m = UInt(M:Vm);
else
    d = UInt(Vd:D); m = UInt(Vm:M);
    
```

T1

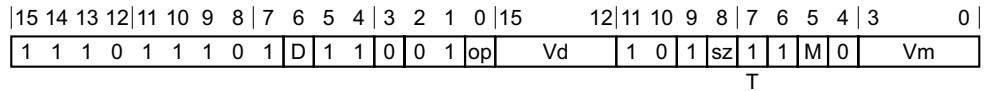

Half-precision to single-precision variant

Applies when `op == 0` && `sz == 0`.

`VCVTT{<c>}{<q>}.F32.F16 <Sd>, <Sm>`

Half-precision to double-precision variant

Applies when `op == 0` && `sz == 1`.

`VCVTT{<c>}{<q>}.F64.F16 <Dd>, <Sm>`

Single-precision to half-precision variant

Applies when `op == 1` && `sz == 0`.

`VCVTT{<c>}{<q>}.F16.F32 <Sd>, <Sm>`

Double-precision to half-precision variant

Applies when `op == 1` && `sz == 1`.

`VCVTT{<c>}{<q>}.F16.F64 <Sd>, <Dm>`

Decode for all variants of this encoding

```

uses_double = (sz == '1'); convert_from_half = (op == '0');
lowbit = (if T == '1' then 16 else 0);
if uses_double then
    if convert_from_half then
        d = UInt(D:Vd); m = UInt(Vm:M);
    else
        d = UInt(Vd:D); m = UInt(M:Vm);
else
    d = UInt(Vd:D); m = UInt(Vm:M);
    
```

Assembler symbols

- <c> See [Standard assembler syntax fields on page F2-2848](#).
- <q> See [Standard assembler syntax fields on page F2-2848](#).
- <Sd> Is the 32-bit name of the SIMD&FP destination register, encoded in the "Vd:D" field.
- <Dm> Is the 64-bit name of the SIMD&FP source register, encoded in the "M:Vm" field.
- <Dd> Is the 64-bit name of the SIMD&FP destination register, encoded in the "D:Vd" field.
- <Sm> Is the 32-bit name of the SIMD&FP source register, encoded in the "Vm:M" field.

Operation for all encodings

```

if ConditionPassed() then
    EncodingSpecificOperations(); CheckVFPEnabled(TRUE);
    bits(16) hp;
    if convert_from_half then
        hp = S[m]<lowbit+15:lowbit>;
    if uses_double then
    
```

```
        D[d] = FPConvert(hp, FPSCR);  
    else  
        S[d] = FPConvert(hp, FPSCR);  
else  
    if uses_double then  
        hp = FPConvert(D[m], FPSCR);  
    else  
        hp = FPConvert(S[m], FPSCR);  
S[d]<lowbit+15:lowbit> = hp;
```

F6.1.72 VDIV

VDIV divides one floating-point value by another floating-point value and writes the result to a third floating-point register.

Depending on settings in the CPACR, NSACR, HCPTR, and FPEXC registers, and the security state and mode in which the instruction is executed, an attempt to execute the instruction might be UNDEFINED, or trapped to Hyp mode. For more information see [Enabling Advanced SIMD and floating-point support on page G1-4413](#).

A1

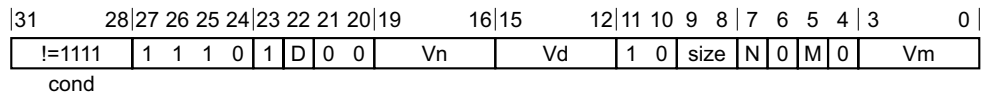

Half-precision scalar variant

Applies when size == 01.

VDIV{<c>}{<q>}.F16 {<Sd>}, <Sn>, <Sm>

Single-precision scalar variant

Applies when size == 10.

VDIV{<c>}{<q>}.F32 {<Sd>}, <Sn>, <Sm>

Double-precision scalar variant

Applies when size == 11.

VDIV{<c>}{<q>}.F64 {<Dd>}, <Dn>, <Dm>

Decode for all variants of this encoding

```

if FPSCR.Len != '000' || FPSCR.Stride != '00' then UNDEFINED;
if size == '00' || (size == '01' && !HaveFP16Ext()) then UNDEFINED;
if size == '01' && cond != '1110' then UNPREDICTABLE;
case size of
  when '01' esize = 16; d = UInt(Vd:D); n = UInt(Vn:N); m = UInt(Vm:M);
  when '10' esize = 32; d = UInt(Vd:D); n = UInt(Vn:N); m = UInt(Vm:M);
  when '11' esize = 64; d = UInt(D:Vd); n = UInt(N:Vn); m = UInt(M:Vm);
    
```

CONSTRAINED UNPREDICTABLE behavior

If size == '01' && cond != '1110', then one of the following behaviors must occur:

- The instruction is UNDEFINED.
- The instruction executes as if it passes the Condition code check.
- The instruction executes as NOP. This means it behaves as if it fails the Condition code check.

T1

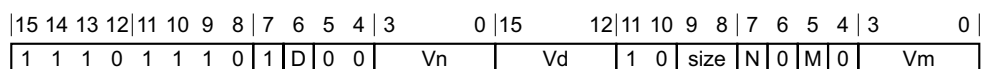

Half-precision scalar variant

Applies when size == 01.

VDIV{<c>}{<q>}.F16 {<Sd>}, <Sn>, <Sm>

Single-precision scalar variant

Applies when size == 10.

VDIV{<c>}{<q>}.F32 {<Sd>}, <Sn>, <Sm>

Double-precision scalar variant

Applies when size == 11.

VDIV{<c>}{<q>}.F64 {<Dd>}, <Dn>, <Dm>

Decode for all variants of this encoding

```
if FPSCR.Len != '000' || FPSCR.Stride != '00' then UNDEFINED;
if size == '00' || (size == '01' && !HaveFP16Ext()) then UNDEFINED;
if size == '01' && InITBlock() then UNPREDICTABLE;
case size of
  when '01' esize = 16; d = UInt(Vd:D); n = UInt(Vn:N); m = UInt(Vm:M);
  when '10' esize = 32; d = UInt(Vd:D); n = UInt(Vn:N); m = UInt(Vm:M);
  when '11' esize = 64; d = UInt(D:Vd); n = UInt(N:Vn); m = UInt(M:Vm);
```

CONSTRAINED UNPREDICTABLE behavior

If size == '01' && InITBlock(), then one of the following behaviors must occur:

- The instruction is UNDEFINED.
- The instruction executes as if it passes the Condition code check.
- The instruction executes as NOP. This means it behaves as if it fails the Condition code check.

Assembler symbols

<c>	See Standard assembler syntax fields on page F2-2848 .
<q>	See Standard assembler syntax fields on page F2-2848 .
<Sd>	Is the 32-bit name of the SIMD&FP destination register, encoded in the "Vd:D" field.
<Sn>	Is the 32-bit name of the first SIMD&FP source register, encoded in the "Vn:N" field.
<Sm>	Is the 32-bit name of the second SIMD&FP source register, encoded in the "Vm:M" field.
<Dd>	Is the 64-bit name of the SIMD&FP destination register, encoded in the "D:Vd" field.
<Dn>	Is the 64-bit name of the first SIMD&FP source register, encoded in the "N:Vn" field.
<Dm>	Is the 64-bit name of the second SIMD&FP source register, encoded in the "M:Vm" field.

Operation for all encodings

```
if ConditionPassed() then
  EncodingSpecificOperations(); CheckVFPEnabled(TRUE);
case esize of
  when 16
    S[d] = Zeros(16) : FPDiv(S[n]<15:0>, S[m]<15:0>, FPSCR);
  when 32
    S[d] = FPDiv(S[n], S[m], FPSCR);
  when 64
    D[d] = FPDiv(D[n], D[m], FPSCR);
```



F6.1.73 VDUP (general-purpose register)

Duplicate general-purpose register to vector duplicates an element from a general-purpose register into every element of the destination vector.

The destination vector elements can be 8-bit, 16-bit, or 32-bit fields. The source element is the least significant 8, 16, or 32 bits of the general-purpose register. There is no distinction between data types.

Depending on settings in the CPACR, NSACR, and HCPTR registers, and the security state and mode in which the instruction is executed, an attempt to execute the instruction might be UNDEFINED, or trapped to Hyp mode. For more information see [Enabling Advanced SIMD and floating-point support on page G1-4413](#).

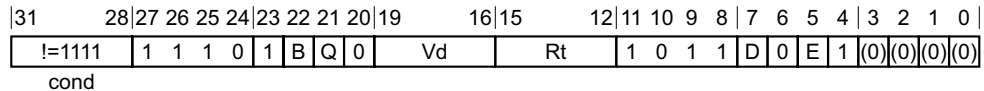
A1



A1 variant

VDUP{<c>}{<q>}.<size> <Qd>, <Rt> // Encoded as Q = 1
 VDUP{<c>}{<q>}.<size> <Dd>, <Rt> // Encoded as Q = 0

Decode for this encoding

```
if Q == '1' && Vd<0> == '1' then UNDEFINED;
d = UInt(D:Vd); t = UInt(Rt); regs = if Q == '0' then 1 else 2;
case B:E of
    when '00' esize = 32; elements = 2;
    when '01' esize = 16; elements = 4;
    when '10' esize = 8; elements = 8;
    when '11' UNDEFINED;
if t == 15 then UNPREDICTABLE; // ARMv8-A removes UNPREDICTABLE for R13
```

T1

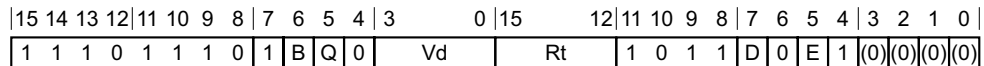

T1 variant

VDUP{<c>}{<q>}.<size> <Qd>, <Rt> // Encoded as Q = 1
 VDUP{<c>}{<q>}.<size> <Dd>, <Rt> // Encoded as Q = 0

Decode for this encoding

```
if Q == '1' && Vd<0> == '1' then UNDEFINED;
d = UInt(D:Vd); t = UInt(Rt); regs = if Q == '0' then 1 else 2;
case B:E of
    when '00' esize = 32; elements = 2;
    when '01' esize = 16; elements = 4;
    when '10' esize = 8; elements = 8;
    when '11' UNDEFINED;
if t == 15 then UNPREDICTABLE; // ARMv8-A removes UNPREDICTABLE for R13
```

Notes for all encodings

For more information about the CONSTRAINED UNPREDICTABLE behavior of this instruction, see [Appendix K1 Architectural Constraints on UNPREDICTABLE behaviors](#).

Assembler symbols

<c>	See Standard assembler syntax fields on page F2-2848 . ARM strongly recommends that any VDUP instruction is unconditional, see Conditional execution on page F2-2849 .
<q>	See Standard assembler syntax fields on page F2-2848 .
<size>	The data size for the elements of the destination vector. It must be one of: 8 Encoded as [b, e] = 0b10. 16 Encoded as [b, e] = 0b01. 32 Encoded as [b, e] = 0b00.
<Qd>	The destination vector for a quadword operation.
<Dd>	The destination vector for a doubleword operation.
<Rt>	The ARM source register.

Operation for all encodings

```
if ConditionPassed() then
    EncodingSpecificOperations(); CheckAdvSIMDEnabled();
    scalar = R[t]<esize-1:0>;
    for r = 0 to regs-1
        for e = 0 to elements-1
            Elem[D[d+r],e,esize] = scalar;
```

F6.1.74 VDUP (scalar)

Duplicate vector element to vector duplicates a single element of a vector into every element of the destination vector.

The scalar, and the destination vector elements, can be any one of 8-bit, 16-bit, or 32-bit fields. There is no distinction between data types.

For more information about scalars see *Advanced SIMD scalars* on page F2-2874.

Depending on settings in the CPACR, NSACR, and HCPTR registers, and the security state and mode in which the instruction is executed, an attempt to execute the instruction might be UNDEFINED, or trapped to Hyp mode. For more information see *Enabling Advanced SIMD and floating-point support* on page G1-4413.

A1

31	30	29	28	27	26	25	24	23	22	21	20	19	16	15	12	11	10	9	8	7	6	5	4	3	0
1	1	1	1	0	0	1	1	1	D	1	1	imm4	Vd	1	1	0	0	0	0	Q	M	0	Vm		

Encoding

Applies when Q == 0.

VDUP{<c>}{<q>}.<size> <Dd>, <Dm[x]>

Encoding

Applies when Q == 1.

VDUP{<c>}{<q>}.<size> <Qd>, <Dm[x]>

Decode for all variants of this encoding

```

if imm4 == 'x000' then UNDEFINED;
if Q == '1' && Vd<0> == '1' then UNDEFINED;
case imm4 of
  when 'xxx1' esize = 8; elements = 8; index = UInt(imm4<3:1>);
  when 'xx10' esize = 16; elements = 4; index = UInt(imm4<3:2>);
  when 'x100' esize = 32; elements = 2; index = UInt(imm4<3>);
d = UInt(D:Vd); m = UInt(M:Vm); regs = if Q == '0' then 1 else 2;
    
```

T1

15	14	13	12	11	10	9	8	7	6	5	4	3	0	15	12	11	10	9	8	7	6	5	4	3	0
1	1	1	1	1	1	1	1	1	D	1	1	imm4	Vd	1	1	0	0	0	0	Q	M	0	Vm		

Encoding

Applies when Q == 0.

VDUP{<c>}{<q>}.<size> <Dd>, <Dm[x]>

Encoding

Applies when Q == 1.

VDUP{<c>}{<q>}.<size> <Qd>, <Dm[x]>

Decode for all variants of this encoding

```
if imm4 == 'x000' then UNDEFINED;  
if Q == '1' && Vd<0> == '1' then UNDEFINED;  
case imm4 of  
  when 'xxx1' esize = 8; elements = 8; index = UInt(imm4<3:1>);  
  when 'xx10' esize = 16; elements = 4; index = UInt(imm4<3:2>);  
  when 'x100' esize = 32; elements = 2; index = UInt(imm4<3>);  
d = UInt(D:Vd); m = UInt(M:Vm); regs = if Q == '0' then 1 else 2;
```

Assembler symbols

- <c> For encoding A1: see [Standard assembler syntax fields on page F2-2848](#). This encoding must be unconditional.
For encoding T1: see [Standard assembler syntax fields on page F2-2848](#).
- <q> See [Standard assembler syntax fields on page F2-2848](#).
- <size> The data size. It must be one of:
8 Encoded as imm4<0> = '1'. imm4<3:1> encodes the index [x] of the scalar.
16 Encoded as imm4<1:0> = '10'. imm4<3:2> encodes the index [x] of the scalar.
32 Encoded as imm4<2:0> = '100'. imm4<3> encodes the index [x] of the scalar.
- <Qd> Is the 128-bit name of the SIMD&FP destination register, encoded in the "D:Vd" field as <Qd>*2.
- <Dd> Is the 64-bit name of the SIMD&FP destination register, encoded in the "D:Vd" field.
- <Dm[x]> The scalar. For details of how [x] is encoded, see the description of <size>.

Operation for all encodings

```
if ConditionPassed() then  
  EncodingSpecificOperations(); CheckAdvSIMDEnabled();  
  scalar = Elem[D[m],index,esize];  
  for r = 0 to regs-1  
    for e = 0 to elements-1  
      Elem[D[d+r],e,esize] = scalar;
```

F6.1.75 VEOR

Vector Bitwise Exclusive OR performs a bitwise Exclusive OR operation between two registers, and places the result in the destination register. The operand and result registers can be quadword or doubleword. They must all be the same size.

Depending on settings in the CPACR, NSACR, and HCPTR registers, and the security state and mode in which the instruction is executed, an attempt to execute the instruction might be UNDEFINED, or trapped to Hyp mode. For more information see [Enabling Advanced SIMD and floating-point support on page G1-4413](#).

A1

31	30	29	28	27	26	25	24	23	22	21	20	19	16	15	12	11	10	9	8	7	6	5	4	3	0
1	1	1	1	0	0	0	1	1	0	D	0	0	Vn	Vd	0	0	0	1	N	Q	M	1	Vm		

64-bit SIMD vector variant

Applies when Q == 0.

VEOR{<c>}{<q>}{.<dt>} {<Dd>}, <Dn>, <Dm>

128-bit SIMD vector variant

Applies when Q == 1.

VEOR{<c>}{<q>}{.<dt>} {<Qd>}, <Qn>, <Qm>

Decode for all variants of this encoding

if Q == '1' && (Vd<0> == '1' || Vn<0> == '1' || Vm<0> == '1') then UNDEFINED;
 d = UInt(D:Vd); n = UInt(N:Vn); m = UInt(M:Vm); regs = if Q == '0' then 1 else 2;

T1

15	14	13	12	11	10	9	8	7	6	5	4	3	0	15	12	11	10	9	8	7	6	5	4	3	0
1	1	1	1	1	1	1	1	0	D	0	0	Vn	Vd	0	0	0	1	N	Q	M	1	Vm			

64-bit SIMD vector variant

Applies when Q == 0.

VEOR{<c>}{<q>}{.<dt>} {<Dd>}, <Dn>, <Dm>

128-bit SIMD vector variant

Applies when Q == 1.

VEOR{<c>}{<q>}{.<dt>} {<Qd>}, <Qn>, <Qm>

Decode for all variants of this encoding

if Q == '1' && (Vd<0> == '1' || Vn<0> == '1' || Vm<0> == '1') then UNDEFINED;
 d = UInt(D:Vd); n = UInt(N:Vn); m = UInt(M:Vm); regs = if Q == '0' then 1 else 2;

Assembler symbols

<c> For encoding A1: see [Standard assembler syntax fields on page F2-2848](#). This encoding must be unconditional.

For encoding T1: see *Standard assembler syntax fields* on page F2-2848.

- <q> See *Standard assembler syntax fields* on page F2-2848.
- <dt> An optional data type. It is ignored by assemblers, and does not affect the encoding.
- <Qd> Is the 128-bit name of the SIMD&FP destination register, encoded in the "D:Vd" field as <Qd>*2.
- <Qn> Is the 128-bit name of the first SIMD&FP source register, encoded in the "N:Vn" field as <Qn>*2.
- <Qm> Is the 128-bit name of the second SIMD&FP source register, encoded in the "M:Vm" field as <Qm>*2.
- <Dd> Is the 64-bit name of the SIMD&FP destination register, encoded in the "D:Vd" field.
- <Dn> Is the 64-bit name of the first SIMD&FP source register, encoded in the "N:Vn" field.
- <Dm> Is the 64-bit name of the second SIMD&FP source register, encoded in the "M:Vm" field.

Operation for all encodings

```
if ConditionPassed() then
    EncodingSpecificOperations(); CheckAdvSIMDEnabled();
    for r = 0 to regs-1
        D[d+r] = D[n+r] EOR D[m+r];
```

F6.1.76 VEXT (byte elements)

Vector Extract extracts elements from the bottom end of the second operand vector and the top end of the first, concatenates them and places the result in the destination vector.

The elements of the vectors are treated as being 8-bit fields. There is no distinction between data types.

The following figure shows the operation of VEXT doubleword operation for $imm = 3$.

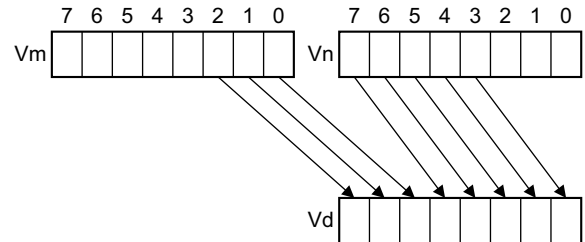

Depending on settings in the CPACR, NSACR, and HCPTR registers, and the security state and mode in which the instruction is executed, an attempt to execute the instruction might be UNDEFINED, or trapped to Hyp mode. For more information see [Enabling Advanced SIMD and floating-point support on page G1-4413](#).

This instruction is used by the pseudo-instruction **VEXT (multibyte elements)**. The pseudo-instruction is never the preferred disassembly.

A1

31	30	29	28	27	26	25	24	23	22	21	20	19	16	15	12	11	8	7	6	5	4	3	0
1	1	1	1	0	0	1	0	1	D	1	1	Vn	Vd	imm4	N	Q	M	0	Vm				

64-bit SIMD vector variant

Applies when $Q == 0$.

VEXT{<c>}{<q>}.8 {<Dd>}, <Dn>, <Dm>, #<imm>

128-bit SIMD vector variant

Applies when $Q == 1$.

VEXT{<c>}{<q>}.8 {<Qd>}, <Qn>, <Qm>, #<imm>

Decode for all variants of this encoding

```

if Q == '1' && (Vd<0> == '1' || Vn<0> == '1' || Vm<0> == '1') then UNDEFINED;
if Q == '0' && imm4<3> == '1' then UNDEFINED;
quadword_operation = (Q == '1'); position = 8 * UInt(imm4);
d = UInt(D:Vd); n = UInt(N:Vn); m = UInt(M:Vm);
    
```

T1

15	14	13	12	11	10	9	8	7	6	5	4	3	0	15	12	11	8	7	6	5	4	3	0
1	1	1	0	1	1	1	1	1	D	1	1	Vn	Vd	imm4	N	Q	M	0	Vm				

64-bit SIMD vector variant

Applies when $Q == 0$.

VEXT{<c>}{<q>}.8 {<Dd>}, <Dn>, <Dm>, #<imm>

128-bit SIMD vector variant

Applies when Q == 1.

VEXT{<c>}{<q>}.8 {<Qd>}, <Qn>, <Qm>, #<imm>

Decode for all variants of this encoding

```
if Q == '1' && (Vd<0> == '1' || Vn<0> == '1' || Vm<0> == '1') then UNDEFINED;
if Q == '0' && imm4<3> == '1' then UNDEFINED;
quadword_operation = (Q == '1'); position = 8 * UInt(imm4);
d = UInt(D:Vd); n = UInt(N:Vn); m = UInt(M:Vm);
```

Assembler symbols

- <c> For encoding A1: see [Standard assembler syntax fields on page F2-2848](#). This encoding must be unconditional.
For encoding T1: see [Standard assembler syntax fields on page F2-2848](#).
- <q> See [Standard assembler syntax fields on page F2-2848](#).
- <Qd> Is the 128-bit name of the SIMD&FP destination register, encoded in the "D:Vd" field as <Qd>*2.
- <Qn> Is the 128-bit name of the first SIMD&FP source register, encoded in the "N:Vn" field as <Qn>*2.
- <Qm> Is the 128-bit name of the second SIMD&FP source register, encoded in the "M:Vm" field as <Qm>*2.
- <Dd> Is the 64-bit name of the SIMD&FP destination register, encoded in the "D:Vd" field.
- <Dn> Is the 64-bit name of the first SIMD&FP source register, encoded in the "N:Vn" field.
- <Dm> Is the 64-bit name of the second SIMD&FP source register, encoded in the "M:Vm" field.
- <imm> For the 64-bit SIMD vector variant: is the location of the extracted result in the concatenation of the operands, as a number of bytes from the least significant end, in the range 0 to 7, encoded in the "imm4" field.
For the 128-bit SIMD vector variant: is the location of the extracted result in the concatenation of the operands, as a number of bytes from the least significant end, in the range 0 to 15, encoded in the "imm4" field.

Operation for all encodings

```
if ConditionPassed() then
  EncodingSpecificOperations(); CheckAdvSIMDEnabled();
  if quadword_operation then
    Q[d>>1] = (Q[m>>1]:Q[n>>1])<position+127:position>;
  else
    D[d] = (D[m]:D[n])<position+63:position>;
```

F6.1.77 VEXT (multibyte elements)

Vector Extract extracts elements from the bottom end of the second operand vector and the top end of the first, concatenates them and places the result in the destination vector

This instruction is a pseudo-instruction of the [VEXT \(byte elements\)](#) instruction. This means that:

- The encodings in this description are named to match the encodings of [VEXT \(byte elements\)](#).
- The assembler syntax is used only for assembly, and is not used on disassembly.
- The description of [VEXT \(byte elements\)](#) gives the operational pseudocode for this instruction.

A1

31	30	29	28	27	26	25	24	23	22	21	20	19	16	15	12	11	8	7	6	5	4	3	0
1	1	1	1	0	0	1	0	1	D	1	1	Vn	Vd	imm4	N	Q	M	0	Vm				

64-bit SIMD vector variant

Applies when Q == 0.

VEXT{<c>}{<q>}.<size> {<Dd>}, <Dn>, <Dm>, #<imm>

is equivalent to

VEXT{<c>}{<q>}.8 {<Dd>}, <Dn>, <Dm>, #<imm*(size/8)>

and is never the preferred disassembly.

128-bit SIMD vector variant

Applies when Q == 1.

VEXT{<c>}{<q>}.<size> {<Qd>}, <Qn>, <Qm>, #<imm>

is equivalent to

VEXT{<c>}{<q>}.8 {<Qd>}, <Qn>, <Qm>, #<imm*(size/8)>

and is never the preferred disassembly.

T1

15	14	13	12	11	10	9	8	7	6	5	4	3	0	15	12	11	8	7	6	5	4	3	0
1	1	1	0	1	1	1	1	1	D	1	1	Vn	Vd	imm4	N	Q	M	0	Vm				

64-bit SIMD vector variant

Applies when Q == 0.

VEXT{<c>}{<q>}.<size> {<Dd>}, <Dn>, <Dm>, #<imm>

is equivalent to

VEXT{<c>}{<q>}.8 {<Dd>}, <Dn>, <Dm>, #<imm*(size/8)>

and is never the preferred disassembly.

128-bit SIMD vector variant

Applies when Q == 1.

VEXT{<c>}{<q>}.<size> {<Qd>}, <Qn>, <Qm>, #<imm>

is equivalent to

VEXT{<c>}{<q>}.8 {<Qd>}, <Qn>, <Qm>, #<imm>*(size/8)>

and is never the preferred disassembly.

Assembler symbols

<c>	For encoding A1: see Standard assembler syntax fields on page F2-2848 . This encoding must be unconditional. For encoding T1: see Standard assembler syntax fields on page F2-2848 .
<q>	See Standard assembler syntax fields on page F2-2848 .
<size>	For the 64-bit SIMD vector variant: is the size of the operation, and can be one of 16 or 32. For the 128-bit SIMD vector variant: is the size of the operation, and can be one of 16, 32 or 64.
<Qd>	Is the 128-bit name of the SIMD&FP destination register, encoded in the "D:Vd" field as <Qd>*2.
<Qn>	Is the 128-bit name of the first SIMD&FP source register, encoded in the "N:Vn" field as <Qn>*2.
<Qm>	Is the 128-bit name of the second SIMD&FP source register, encoded in the "M:Vm" field as <Qm>*2.
<Dd>	Is the 64-bit name of the SIMD&FP destination register, encoded in the "D:Vd" field.
<Dn>	Is the 64-bit name of the first SIMD&FP source register, encoded in the "N:Vn" field.
<Dm>	Is the 64-bit name of the second SIMD&FP source register, encoded in the "M:Vm" field.
<imm>	For the 64-bit SIMD vector variant: is the location of the extracted result in the concatenation of the operands, as a number of bytes from the least significant end, in the range 0 to (128/<size>)-1. For the 128-bit SIMD vector variant: is the location of the extracted result in the concatenation of the operands, as a number of bytes from the least significant end, in the range 0 to (64/<size>)-1.

Operation for all encodings

The description of [VEXT \(byte elements\)](#) gives the operational pseudocode for this instruction.

F6.1.78 VFMA

Vector Fused Multiply Accumulate multiplies corresponding elements of two vectors, and accumulates the results into the elements of the destination vector. The instruction does not round the result of the multiply before the accumulation.

Depending on settings in the CPACR, NSACR, HCPTR, and FPEXC registers, and the security state and mode in which the instruction is executed, an attempt to execute the instruction might be UNDEFINED, or trapped to Hyp mode. For more information see [Enabling Advanced SIMD and floating-point support on page G1-4413](#).

A1

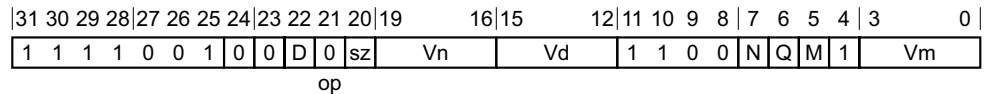

64-bit SIMD vector variant

Applies when Q == 0.

VFMA{<c>}{<q>}.<dt> <Dd>, <Dn>, <Dm>

128-bit SIMD vector variant

Applies when Q == 1.

VFMA{<c>}{<q>}.<dt> <Qd>, <Qn>, <Qm>

Decode for all variants of this encoding

```

if Q == '1' && (Vd<0> == '1' || Vn<0> == '1' || Vm<0> == '1') then UNDEFINED;
if sz == '1' && !HaveFP16Ext() then UNDEFINED;
advsimd = TRUE; op1_neg = (op == '1');
case sz of
    when '0' esize = 32; elements = 2;
    when '1' esize = 16; elements = 4;
d = UInt(D:Vd); n = UInt(N:Vn); m = UInt(M:Vm);
regs = if Q == '0' then 1 else 2;
    
```

A2

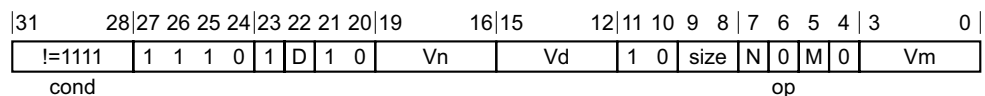

Half-precision scalar variant

Applies when size == 01.

VFMA{<c>}{<q>}.F16 <Sd>, <Sn>, <Sm>

Single-precision scalar variant

Applies when size == 10.

VFMA{<c>}{<q>}.F32 <Sd>, <Sn>, <Sm>

Double-precision scalar variant

Applies when size == 11.

VFMA{<c>}{<q>}.F64 <Dd>, <Dn>, <Dm>

Decode for all variants of this encoding

```

if FPSCR.Len != '000' || FPSCR.Stride != '00' then UNDEFINED;
if size == '00' || (size == '01' && !HaveFP16Ext()) then UNDEFINED;
if size == '01' && cond != '1110' then UNPREDICTABLE;
advsimd = FALSE; op1_neg = (op == '1');
case size of
  when '01' esize = 16; d = UInt(Vd:D); n = UInt(Vn:N); m = UInt(Vm:M);
  when '10' esize = 32; d = UInt(Vd:D); n = UInt(Vn:N); m = UInt(Vm:M);
  when '11' esize = 64; d = UInt(D:Vd); n = UInt(N:Vn); m = UInt(M:Vm);

```

CONSTRAINED UNPREDICTABLE behavior

If size == '01' && cond != '1110', then one of the following behaviors must occur:

- The instruction is UNDEFINED.
- The instruction executes as if it passes the Condition code check.
- The instruction executes as NOP. This means it behaves as if it fails the Condition code check.

T1

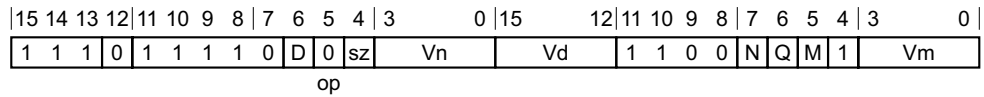

64-bit SIMD vector variant

Applies when Q == 0.

```
VFMA{<c>}{<q>}.<dt> <Dd>, <Dn>, <Dm>
```

128-bit SIMD vector variant

Applies when Q == 1.

```
VFMA{<c>}{<q>}.<dt> <Qd>, <Qn>, <Qm>
```

Decode for all variants of this encoding

```

if Q == '1' && (Vd<0> == '1' || Vn<0> == '1' || Vm<0> == '1') then UNDEFINED;
if sz == '1' && !HaveFP16Ext() then UNDEFINED;
if sz == '1' && InITBlock() then UNPREDICTABLE;
advsimd = TRUE; op1_neg = (op == '1');
case sz of
  when '0' esize = 32; elements = 2;
  when '1' esize = 16; elements = 4;
d = UInt(D:Vd); n = UInt(N:Vn); m = UInt(M:Vm);
regs = if Q == '0' then 1 else 2;

```

CONSTRAINED UNPREDICTABLE behavior

If sz == '1' && InITBlock(), then one of the following behaviors must occur:

- The instruction is UNDEFINED.
- The instruction executes as if it passes the Condition code check.
- The instruction executes as NOP. This means it behaves as if it fails the Condition code check.

T2

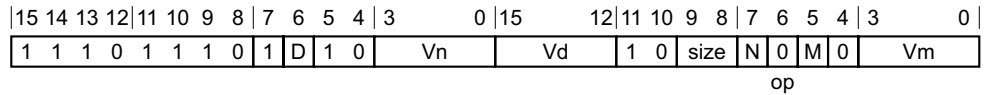

Half-precision scalar variant

Applies when size == 01.

VFMA{<c>}{<q>}.F16 <Sd>, <Sn>, <Sm>

Single-precision scalar variant

Applies when size == 10.

VFMA{<c>}{<q>}.F32 <Sd>, <Sn>, <Sm>

Double-precision scalar variant

Applies when size == 11.

VFMA{<c>}{<q>}.F64 <Dd>, <Dn>, <Dm>

Decode for all variants of this encoding

```

if FPSCR.Len != '000' || FPSCR.Stride != '00' then UNDEFINED;
if size == '00' || (size == '01' && !HaveFP16Ext()) then UNDEFINED;
if size == '01' && InITBlock() then UNPREDICTABLE;
advsimd = FALSE; op1_neg = (op == '1');
case size of
    when '01' esize = 16; d = UInt(Vd:D); n = UInt(Vn:N); m = UInt(Vm:M);
    when '10' esize = 32; d = UInt(Vd:D); n = UInt(Vn:N); m = UInt(Vm:M);
    when '11' esize = 64; d = UInt(D:Vd); n = UInt(N:Vn); m = UInt(M:Vm);
    
```

CONSTRAINED UNPREDICTABLE behavior

If size == '01' && InITBlock(), then one of the following behaviors must occur:

- The instruction is UNDEFINED.
- The instruction executes as if it passes the Condition code check.
- The instruction executes as NOP. This means it behaves as if it fails the Condition code check.

Assembler symbols

- <c> For encoding A1: see [Standard assembler syntax fields on page F2-2848](#). This encoding must be unconditional.
 For encoding A2, T1 and T2: see [Standard assembler syntax fields on page F2-2848](#).
- <q> See [Standard assembler syntax fields on page F2-2848](#).
- <dt> Is the data type for the elements of the vectors, encoded in the "sz" field. It can have the following values:
 F32 when sz = 0
 F16 when sz = 1
- <Qd> Is the 128-bit name of the SIMD&FP destination register, encoded in the "D:Vd" field as <Qd>*2.
- <Qn> Is the 128-bit name of the first SIMD&FP source register, encoded in the "N:Vn" field as <Qn>*2.

- <Qm> Is the 128-bit name of the second SIMD&FP source register, encoded in the "M:Vm" field as <Qm>*2.
- <Dd> Is the 64-bit name of the SIMD&FP destination register, encoded in the "D:Vd" field.
- <Dn> Is the 64-bit name of the first SIMD&FP source register, encoded in the "N:Vn" field.
- <Dm> Is the 64-bit name of the second SIMD&FP source register, encoded in the "M:Vm" field.
- <Sd> Is the 32-bit name of the SIMD&FP destination register, encoded in the "Vd:D" field.
- <Sn> Is the 32-bit name of the first SIMD&FP source register, encoded in the "Vn:N" field.
- <Sm> Is the 32-bit name of the second SIMD&FP source register, encoded in the "Vm:M" field.

Operation for all encodings

```

if ConditionPassed() then
    EncodingSpecificOperations();
    CheckAdvSIMDOrVFPEnabled(TRUE, advsimd);
    if advsimd then // Advanced SIMD instruction
        for r = 0 to regs-1
            for e = 0 to elements-1
                bits(eseize) op1 = Elem[D[n+r],e,eseize];
                if op1_neg then op1 = FPNeg(op1);
                Elem[D[d+r],e,eseize] = FPMu1Add(Elem[D[d+r],e,eseize],
                    op1, Elem[D[m+r],e,eseize], StandardFPSCRValue());
    else // VFP instruction
        case eseize of
            when 16
                op16 = if op1_neg then FPNeg(S[n]<15:0>) else S[n]<15:0>;
                S[d] = Zeros(16) : FPMu1Add(S[d]<15:0>, op16, S[m]<15:0>, FPSCR);
            when 32
                op32 = if op1_neg then FPNeg(S[n]) else S[n];
                S[d] = FPMu1Add(S[d], op32, S[m], FPSCR);
            when 64
                op64 = if op1_neg then FPNeg(D[n]) else D[n];
                D[d] = FPMu1Add(D[d], op64, D[m], FPSCR);
  
```

F6.1.79 VFMS

Vector Fused Multiply Subtract negates the elements of one vector and multiplies them with the corresponding elements of another vector, adds the products to the corresponding elements of the destination vector, and places the results in the destination vector. The instruction does not round the result of the multiply before the addition.

Depending on settings in the CPACR, NSACR, HCPTR, and FPEXC registers, and the security state and mode in which the instruction is executed, an attempt to execute the instruction might be UNDEFINED, or trapped to Hyp mode. For more information see [Enabling Advanced SIMD and floating-point support on page G1-4413](#).

A1

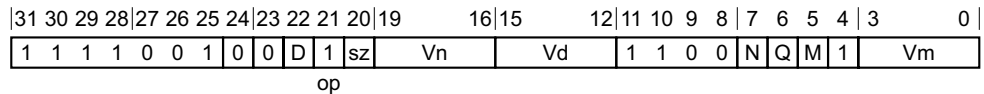

64-bit SIMD vector variant

Applies when Q == 0.

VFMS{<c>}{<q>}.<dt> <Dd>, <Dn>, <Dm>

128-bit SIMD vector variant

Applies when Q == 1.

VFMS{<c>}{<q>}.<dt> <Qd>, <Qn>, <Qm>

Decode for all variants of this encoding

```

if Q == '1' && (Vd<0> == '1' || Vn<0> == '1' || Vm<0> == '1') then UNDEFINED;
if sz == '1' && !HaveFP16Ext() then UNDEFINED;
advsimd = TRUE; op1_neg = (op == '1');
case sz of
    when '0' esize = 32; elements = 2;
    when '1' esize = 16; elements = 4;
d = UInt(D:Vd); n = UInt(N:Vn); m = UInt(M:Vm);
regs = if Q == '0' then 1 else 2;
    
```

A2

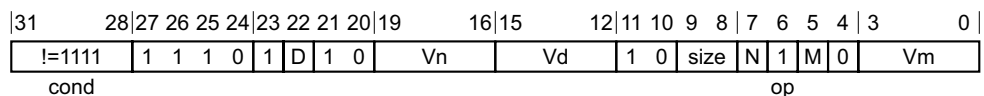

Half-precision scalar variant

Applies when size == 01.

VFMS{<c>}{<q>}.F16 <Sd>, <Sn>, <Sm>

Single-precision scalar variant

Applies when size == 10.

VFMS{<c>}{<q>}.F32 <Sd>, <Sn>, <Sm>

Double-precision scalar variant

Applies when size == 11.

VFMS{<c>}{<q>}.F64 <Dd>, <Dn>, <Dm>

Decode for all variants of this encoding

```

if FPSCR.Len != '000' || FPSCR.Stride != '00' then UNDEFINED;
if size == '00' || (size == '01' && !HaveFP16Ext()) then UNDEFINED;
if size == '01' && cond != '1110' then UNPREDICTABLE;
advsimd = FALSE; op1_neg = (op == '1');
case size of
  when '01' esize = 16; d = UInt(Vd:D); n = UInt(Vn:N); m = UInt(Vm:M);
  when '10' esize = 32; d = UInt(Vd:D); n = UInt(Vn:N); m = UInt(Vm:M);
  when '11' esize = 64; d = UInt(D:Vd); n = UInt(N:Vn); m = UInt(M:Vm);
  
```

CONSTRAINED UNPREDICTABLE behavior

If size == '01' && cond != '1110', then one of the following behaviors must occur:

- The instruction is UNDEFINED.
- The instruction executes as if it passes the Condition code check.
- The instruction executes as NOP. This means it behaves as if it fails the Condition code check.

T1

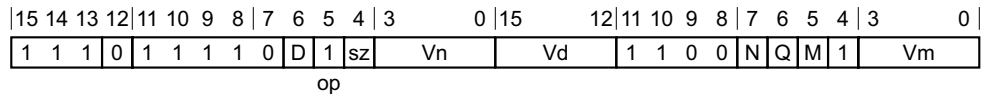

64-bit SIMD vector variant

Applies when Q == 0.

```
VFMS{<c>}{<q>}.<dt> <Dd>, <Dn>, <Dm>
```

128-bit SIMD vector variant

Applies when Q == 1.

```
VFMS{<c>}{<q>}.<dt> <Qd>, <Qn>, <Qm>
```

Decode for all variants of this encoding

```

if Q == '1' && (Vd<0> == '1' || Vn<0> == '1' || Vm<0> == '1') then UNDEFINED;
if sz == '1' && !HaveFP16Ext() then UNDEFINED;
if sz == '1' && InITBlock() then UNPREDICTABLE;
advsimd = TRUE; op1_neg = (op == '1');
case sz of
  when '0' esize = 32; elements = 2;
  when '1' esize = 16; elements = 4;
  d = UInt(D:Vd); n = UInt(N:Vn); m = UInt(M:Vm);
  regs = if Q == '0' then 1 else 2;
  
```

CONSTRAINED UNPREDICTABLE behavior

If sz == '1' && InITBlock(), then one of the following behaviors must occur:

- The instruction is UNDEFINED.
- The instruction executes as if it passes the Condition code check.
- The instruction executes as NOP. This means it behaves as if it fails the Condition code check.

T2

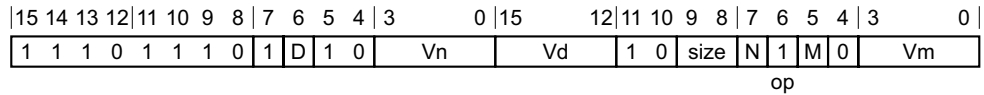

Half-precision scalar variant

Applies when size == 01.

VFMS{<c>}{<q>}.F16 <Sd>, <Sn>, <Sm>

Single-precision scalar variant

Applies when size == 10.

VFMS{<c>}{<q>}.F32 <Sd>, <Sn>, <Sm>

Double-precision scalar variant

Applies when size == 11.

VFMS{<c>}{<q>}.F64 <Dd>, <Dn>, <Dm>

Decode for all variants of this encoding

```

if FPSCR.Len != '000' || FPSCR.Stride != '00' then UNDEFINED;
if size == '00' || (size == '01' && !HaveFP16Ext()) then UNDEFINED;
if size == '01' && InITBlock() then UNPREDICTABLE;
advsimd = FALSE; op1_neg = (op == '1');
case size of
    when '01' esize = 16; d = UInt(Vd:D); n = UInt(Vn:N); m = UInt(Vm:M);
    when '10' esize = 32; d = UInt(Vd:D); n = UInt(Vn:N); m = UInt(Vm:M);
    when '11' esize = 64; d = UInt(D:Vd); n = UInt(N:Vn); m = UInt(M:Vm);
    
```

CONSTRAINED UNPREDICTABLE behavior

If size == '01' && InITBlock(), then one of the following behaviors must occur:

- The instruction is UNDEFINED.
- The instruction executes as if it passes the Condition code check.
- The instruction executes as NOP. This means it behaves as if it fails the Condition code check.

Assembler symbols

- <c> For encoding A1: see [Standard assembler syntax fields on page F2-2848](#). This encoding must be unconditional.
 For encoding A2, T1 and T2: see [Standard assembler syntax fields on page F2-2848](#).
- <q> See [Standard assembler syntax fields on page F2-2848](#).
- <dt> Is the data type for the elements of the vectors, encoded in the "sz" field. It can have the following values:
 F32 when sz = 0
 F16 when sz = 1
- <Qd> Is the 128-bit name of the SIMD&FP destination register, encoded in the "D:Vd" field as <Qd>*2.
- <Qn> Is the 128-bit name of the first SIMD&FP source register, encoded in the "N:Vn" field as <Qn>*2.

- <Qm> Is the 128-bit name of the second SIMD&FP source register, encoded in the "M:Vm" field as <Qm>*2.
- <Dd> Is the 64-bit name of the SIMD&FP destination register, encoded in the "D:Vd" field.
- <Dn> Is the 64-bit name of the first SIMD&FP source register, encoded in the "N:Vn" field.
- <Dm> Is the 64-bit name of the second SIMD&FP source register, encoded in the "M:Vm" field.
- <Sd> Is the 32-bit name of the SIMD&FP destination register, encoded in the "Vd:D" field.
- <Sn> Is the 32-bit name of the first SIMD&FP source register, encoded in the "Vn:N" field.
- <Sm> Is the 32-bit name of the second SIMD&FP source register, encoded in the "Vm:M" field.

Operation for all encodings

```

if ConditionPassed() then
    EncodingSpecificOperations(); CheckAdvSIMDOrVFPEnabled(TRUE, advsimd);
    if advsimd then // Advanced SIMD instruction
        for r = 0 to regs-1
            for e = 0 to elements-1
                bits(eseize) op1 = Elem[D[n+r],e,eseize];
                if op1_neg then op1 = FPNeg(op1);
                Elem[D[d+r],e,eseize] = FPMu1Add(Elem[D[d+r],e,eseize],
                    op1, Elem[D[m+r],e,eseize], StandardFPSCRValue());
    else // VFP instruction
        case esize of
            when 16
                op16 = if op1_neg then FPNeg(S[n]<15:0>) else S[n]<15:0>;
                S[d] = Zeros(16) : FPMu1Add(S[d]<15:0>, op16, S[m]<15:0>, FPSCR);
            when 32
                op32 = if op1_neg then FPNeg(S[n]) else S[n];
                S[d] = FPMu1Add(S[d], op32, S[m], FPSCR);
            when 64
                op64 = if op1_neg then FPNeg(D[n]) else D[n];
                D[d] = FPMu1Add(D[d], op64, D[m], FPSCR);
  
```

F6.1.80 VFNMA

Vector Fused Negate Multiply Accumulate negates one floating-point register value and multiplies it by another floating-point register value, adds the negation of the floating-point value in the destination register to the product, and writes the result back to the destination register. The instruction does not round the result of the multiply before the addition.

Depending on settings in the CPACR, NSACR, HCPTR, and FPEXC registers, and the security state and mode in which the instruction is executed, an attempt to execute the instruction might be UNDEFINED, or trapped to Hyp mode. For more information see [Enabling Advanced SIMD and floating-point support on page G1-4413](#).

A1

31	28	27	26	25	24	23	22	21	20	19	16	15	12	11	10	9	8	7	6	5	4	3	0	
!=1111				1	1	1	0	1	D	0	1	Vn	Vd	1	0	size	N	1	M	0	Vm			
cond												op												

Half-precision scalar variant

Applies when size == 01.

VFNMA{<c>}{<q>}.F16 <Sd>, <Sn>, <Sm>

Single-precision scalar variant

Applies when size == 10.

VFNMA{<c>}{<q>}.F32 <Sd>, <Sn>, <Sm>

Double-precision scalar variant

Applies when size == 11.

VFNMA{<c>}{<q>}.F64 <Dd>, <Dn>, <Dm>

Decode for all variants of this encoding

```

if FPSCR.Len != '000' || FPSCR.Stride != '00' then UNDEFINED;
if size == '00' || (size == '01' && !HaveFP16Ext()) then UNDEFINED;
if size == '01' && cond != '1110' then UNPREDICTABLE;
op1_neg = (op == '1');
case size of
    when '01' esize = 16; d = UInt(Vd:D); n = UInt(Vn:N); m = UInt(Vm:M);
    when '10' esize = 32; d = UInt(Vd:D); n = UInt(Vn:N); m = UInt(Vm:M);
    when '11' esize = 64; d = UInt(D:Vd); n = UInt(N:Vn); m = UInt(M:Vm);
    
```

CONSTRAINED UNPREDICTABLE behavior

If size == '01' && cond != '1110', then one of the following behaviors must occur:

- The instruction is UNDEFINED.
- The instruction executes as if it passes the Condition code check.
- The instruction executes as NOP. This means it behaves as if it fails the Condition code check.

T1

15	14	13	12	11	10	9	8	7	6	5	4	3	0	15	12	11	10	9	8	7	6	5	4	3	0
1	1	1	0	1	1	1	0	1	D	0	1	Vn	Vd	1	0	size	N	1	M	0	Vm				
												op													

Half-precision scalar variant

Applies when size == 01.

VFNMA{<c>}{<q>}.F16 <Sd>, <Sn>, <Sm>

Single-precision scalar variant

Applies when size == 10.

VFNMA{<c>}{<q>}.F32 <Sd>, <Sn>, <Sm>

Double-precision scalar variant

Applies when size == 11.

VFNMA{<c>}{<q>}.F64 <Dd>, <Dn>, <Dm>

Decode for all variants of this encoding

```

if FPSCR.Len != '000' || FPSCR.Stride != '00' then UNDEFINED;
if size == '00' || (size == '01' && !HaveFP16Ext()) then UNDEFINED;
if size == '01' && InITBlock() then UNPREDICTABLE;
op1_neg = (op == '1');
case size of
  when '01' esize = 16; d = UInt(Vd:D); n = UInt(Vn:N); m = UInt(Vm:M);
  when '10' esize = 32; d = UInt(Vd:D); n = UInt(Vn:N); m = UInt(Vm:M);
  when '11' esize = 64; d = UInt(D:Vd); n = UInt(N:Vn); m = UInt(M:Vm);

```

CONSTRAINED UNPREDICTABLE behavior

If size == '01' && InITBlock(), then one of the following behaviors must occur:

- The instruction is UNDEFINED.
- The instruction executes as if it passes the Condition code check.
- The instruction executes as NOP. This means it behaves as if it fails the Condition code check.

Assembler symbols

<c>	See Standard assembler syntax fields on page F2-2848 .
<q>	See Standard assembler syntax fields on page F2-2848 .
<Sd>	Is the 32-bit name of the SIMD&FP destination register, encoded in the "Vd:D" field.
<Sn>	Is the 32-bit name of the first SIMD&FP source register, encoded in the "Vn:N" field.
<Sm>	Is the 32-bit name of the second SIMD&FP source register, encoded in the "Vm:M" field.
<Dd>	Is the 64-bit name of the SIMD&FP destination register, encoded in the "D:Vd" field.
<Dn>	Is the 64-bit name of the first SIMD&FP source register, encoded in the "N:Vn" field.
<Dm>	Is the 64-bit name of the second SIMD&FP source register, encoded in the "M:Vm" field.

Operation for all encodings

```

if ConditionPassed() then
  EncodingSpecificOperations(); CheckVFPEabled(TRUE);
case esize of
  when 16
    op16 = if op1_neg then FPNeg(S[n]<15:0>) else S[n]<15:0>;
    S[d] = Zeros(16) : FPMu1Add(FPNeg(S[d]<15:0>), op16, S[m]<15:0>, FPSCR);
  when 32
    op32 = if op1_neg then FPNeg(S[n]) else S[n];

```

```
S[d] = FPMu1Add(FPNeg(S[d]), op32, S[m], FPSCR);  
when 64  
op64 = if op1_neg then FPNeg(D[n]) else D[n];  
D[d] = FPMu1Add(FPNeg(D[d]), op64, D[m], FPSCR);
```

F6.1.81 VFNMS

Vector Fused Negate Multiply Subtract multiplies together two floating-point register values, adds the negation of the floating-point value in the destination register to the product, and writes the result back to the destination register. The instruction does not round the result of the multiply before the addition.

Depending on settings in the CPACR, NSACR, HCPTR, and FPEXC registers, and the security state and mode in which the instruction is executed, an attempt to execute the instruction might be UNDEFINED, or trapped to Hyp mode. For more information see [Enabling Advanced SIMD and floating-point support on page G1-4413](#).

A1

31				28 27 26 25 24 23 22 21 20 19				16 15				12 11 10 9 8 7 6 5 4 3				0															
!=1111				1 1 1 0 1				D 0 1				Vn				Vd				1 0 size				N 0 M 0				Vm			
cond								op																							

Half-precision scalar variant

Applies when size == 01.

VFNMS{<c>}{<q>}.F16 <Sd>, <Sn>, <Sm>

Single-precision scalar variant

Applies when size == 10.

VFNMS{<c>}{<q>}.F32 <Sd>, <Sn>, <Sm>

Double-precision scalar variant

Applies when size == 11.

VFNMS{<c>}{<q>}.F64 <Dd>, <Dn>, <Dm>

Decode for all variants of this encoding

```

if FPSCR.Len != '000' || FPSCR.Stride != '00' then UNDEFINED;
if size == '00' || (size == '01' && !HaveFP16Ext()) then UNDEFINED;
if size == '01' && cond != '1110' then UNPREDICTABLE;
op_neg = (op == '1');
case size of
    when '01' esize = 16; d = UInt(Vd:D); n = UInt(Vn:N); m = UInt(Vm:M);
    when '10' esize = 32; d = UInt(Vd:D); n = UInt(Vn:N); m = UInt(Vm:M);
    when '11' esize = 64; d = UInt(D:Vd); n = UInt(N:Vn); m = UInt(M:Vm);
    
```

CONSTRAINED UNPREDICTABLE behavior

If size == '01' && cond != '1110', then one of the following behaviors must occur:

- The instruction is UNDEFINED.
- The instruction executes as if it passes the Condition code check.
- The instruction executes as NOP. This means it behaves as if it fails the Condition code check.

T1

15 14 13 12 11 10 9 8 7 6 5 4 3				0 15				12 11 10 9 8 7 6 5 4 3				0															
1 1 1 0 1 1 1 0 1				D 0 1				Vn				Vd				1 0 size				N 0 M 0				Vm			
op																											

Half-precision scalar variant

Applies when size == 01.

VFNMS{<c>}{<q>}.F16 <Sd>, <Sn>, <Sm>

Single-precision scalar variant

Applies when size == 10.

VFNMS{<c>}{<q>}.F32 <Sd>, <Sn>, <Sm>

Double-precision scalar variant

Applies when size == 11.

VFNMS{<c>}{<q>}.F64 <Dd>, <Dn>, <Dm>

Decode for all variants of this encoding

```

if FPSCR.Len != '000' || FPSCR.Stride != '00' then UNDEFINED;
if size == '00' || (size == '01' && !HaveFP16Ext()) then UNDEFINED;
if size == '01' && InITBlock() then UNPREDICTABLE;
op1_neg = (op == '1');
case size of
  when '01' esize = 16; d = UInt(Vd:D); n = UInt(Vn:N); m = UInt(Vm:M);
  when '10' esize = 32; d = UInt(Vd:D); n = UInt(Vn:N); m = UInt(Vm:M);
  when '11' esize = 64; d = UInt(D:Vd); n = UInt(N:Vn); m = UInt(M:Vm);
    
```

CONSTRAINED UNPREDICTABLE behavior

If size == '01' && InITBlock(), then one of the following behaviors must occur:

- The instruction is UNDEFINED.
- The instruction executes as if it passes the Condition code check.
- The instruction executes as NOP. This means it behaves as if it fails the Condition code check.

Assembler symbols

<c>	See Standard assembler syntax fields on page F2-2848 .
<q>	See Standard assembler syntax fields on page F2-2848 .
<Sd>	Is the 32-bit name of the SIMD&FP destination register, encoded in the "Vd:D" field.
<Sn>	Is the 32-bit name of the first SIMD&FP source register, encoded in the "Vn:N" field.
<Sm>	Is the 32-bit name of the second SIMD&FP source register, encoded in the "Vm:M" field.
<Dd>	Is the 64-bit name of the SIMD&FP destination register, encoded in the "D:Vd" field.
<Dn>	Is the 64-bit name of the first SIMD&FP source register, encoded in the "N:Vn" field.
<Dm>	Is the 64-bit name of the second SIMD&FP source register, encoded in the "M:Vm" field.

Operation for all encodings

```

if ConditionPassed() then
    EncodingSpecificOperations(); CheckVFPEnabled(TRUE);
case esize of
  when 16
    op16 = if op1_neg then FPNeg(S[n]<15:0>) else S[n]<15:0>;
    S[d] = Zeros(16) : FPMu1Add(FPNeg(S[d]<15:0>), op16, S[m]<15:0>, FPSCR);
  when 32
    op32 = if op1_neg then FPNeg(S[n]) else S[n];
    
```

```
S[d] = FPMu1Add(FPNeg(S[d]), op32, S[m], FPSCR);  
when 64  
op64 = if op1_neg then FPNeg(D[n]) else D[n];  
D[d] = FPMu1Add(FPNeg(D[d]), op64, D[m], FPSCR);
```

F6.1.82 VHADD

Vector Halving Add adds corresponding elements in two vectors of integers, shifts each result right one bit, and places the final results in the destination vector. The results of the halving operations are truncated. For rounded results, see [VRHADD](#)).

The operand and result elements are all the same type, and can be any one of:

- 8-bit, 16-bit, or 32-bit signed integers.
- 8-bit, 16-bit, or 32-bit unsigned integers.

Depending on settings in the [CPACR](#), [NSACR](#), and [HCPTR](#) registers, and the security state and mode in which the instruction is executed, an attempt to execute the instruction might be UNDEFINED, or trapped to Hyp mode. For more information see [Enabling Advanced SIMD and floating-point support on page G1-4413](#).

A1

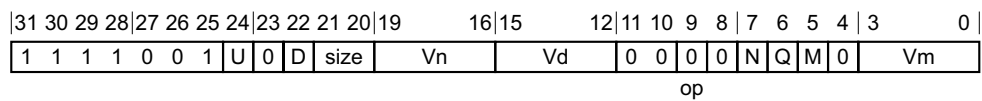

64-bit SIMD vector variant

Applies when Q == 0.

VHADD{<c>}{<q>}.<dt> {<Dd>, }<Dn>, <Dm>

128-bit SIMD vector variant

Applies when Q == 1.

VHADD{<c>}{<q>}.<dt> {<Qd>, }<Qn>, <Qm>

Decode for all variants of this encoding

```

if Q == '1' && (Vd<0> == '1' || Vn<0> == '1' || Vm<0> == '1') then UNDEFINED;
if size == '11' then UNDEFINED;
add = (op == '0'); unsigned = (U == '1');
esize = 8 << UInt(size); elements = 64 DIV esize;
d = UInt(D:Vd); n = UInt(N:Vn); m = UInt(M:Vm); regs = if Q == '0' then 1 else 2;
    
```

T1

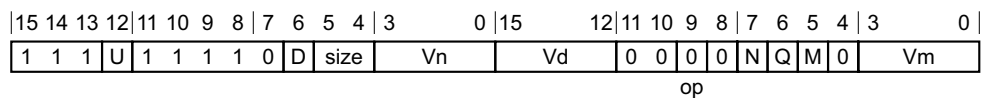

64-bit SIMD vector variant

Applies when Q == 0.

VHADD{<c>}{<q>}.<dt> {<Dd>, }<Dn>, <Dm>

128-bit SIMD vector variant

Applies when Q == 1.

VHADD{<c>}{<q>}.<dt> {<Qd>, }<Qn>, <Qm>

Decode for all variants of this encoding

```

if Q == '1' && (Vd<0> == '1' || Vn<0> == '1' || Vm<0> == '1') then UNDEFINED;
if size == '11' then UNDEFINED;
add = (op == '0'); unsigned = (U == '1');
esize = 8 << UInt(size); elements = 64 DIV esize;
d = UInt(D:Vd); n = UInt(N:Vn); m = UInt(M:Vm); regs = if Q == '0' then 1 else 2;
  
```

Assembler symbols

- <c> For encoding A1: see [Standard assembler syntax fields on page F2-2848](#). This encoding must be unconditional.
 For encoding T1: see [Standard assembler syntax fields on page F2-2848](#).
- <q> See [Standard assembler syntax fields on page F2-2848](#).
- <dt> Is the data type for the elements of the operands, encoded in the "U:size" field. It can have the following values:
 - S8 when U = 0, size = 00
 - S16 when U = 0, size = 01
 - S32 when U = 0, size = 10
 - U8 when U = 1, size = 00
 - U16 when U = 1, size = 01
 - U32 when U = 1, size = 10
- <Qd> Is the 128-bit name of the SIMD&FP destination register, encoded in the "D:Vd" field as <Qd>*2.
- <Qn> Is the 128-bit name of the first SIMD&FP source register, encoded in the "N:Vn" field as <Qn>*2.
- <Qm> Is the 128-bit name of the second SIMD&FP source register, encoded in the "M:Vm" field as <Qm>*2.
- <Dd> Is the 64-bit name of the SIMD&FP destination register, encoded in the "D:Vd" field.
- <Dn> Is the 64-bit name of the first SIMD&FP source register, encoded in the "N:Vn" field.
- <Dm> Is the 64-bit name of the second SIMD&FP source register, encoded in the "M:Vm" field.

Operation for all encodings

```

if ConditionPassed() then
  EncodingSpecificOperations(); CheckAdvSIMDEnabled();
  for r = 0 to regs-1
    for e = 0 to elements-1
      op1 = Int(Elem[D[n+r],e,esize], unsigned);
      op2 = Int(Elem[D[m+r],e,esize], unsigned);
      result = if add then op1+op2 else op1-op2;
      Elem[D[d+r],e,esize] = result<esize:1>;
  
```

F6.1.83 VHSUB

Vector Halving Subtract subtracts the elements of the second operand from the corresponding elements of the first operand, shifts each result right one bit, and places the final results in the destination vector. The results of the halving operations are truncated. There is no rounding version.

The operand and result elements are all the same type, and can be any one of:

- 8-bit, 16-bit, or 32-bit signed integers.
- 8-bit, 16-bit, or 32-bit unsigned integers.

Depending on settings in the CPACR, NSACR, and HCPTR registers, and the security state and mode in which the instruction is executed, an attempt to execute the instruction might be UNDEFINED, or trapped to Hyp mode. For more information see [Enabling Advanced SIMD and floating-point support on page G1-4413](#).

A1

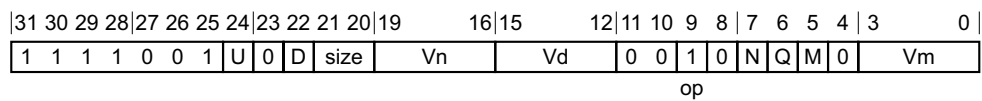

64-bit SIMD vector variant

Applies when Q == 0.

VHSUB{<c>}{<q>}.<dt> {<Dd>, }<Dn>, <Dm>

128-bit SIMD vector variant

Applies when Q == 1.

VHSUB{<c>}{<q>}.<dt> {<Qd>, }<Qn>, <Qm>

Decode for all variants of this encoding

```

if Q == '1' && (Vd<0> == '1' || Vn<0> == '1' || Vm<0> == '1') then UNDEFINED;
if size == '11' then UNDEFINED;
add = (op == '0'); unsigned = (U == '1');
esize = 8 << UInt(size); elements = 64 DIV esize;
d = UInt(D:Vd); n = UInt(N:Vn); m = UInt(M:Vm); regs = if Q == '0' then 1 else 2;
    
```

T1

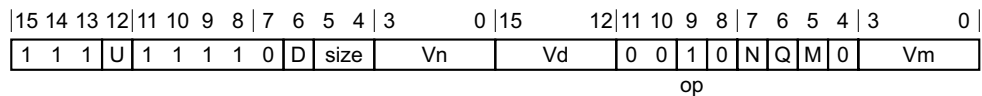

64-bit SIMD vector variant

Applies when Q == 0.

VHSUB{<c>}{<q>}.<dt> {<Dd>, }<Dn>, <Dm>

128-bit SIMD vector variant

Applies when Q == 1.

VHSUB{<c>}{<q>}.<dt> {<Qd>, }<Qn>, <Qm>

Decode for all variants of this encoding

```

if Q == '1' && (Vd<0> == '1' || Vn<0> == '1' || Vm<0> == '1') then UNDEFINED;
if size == '11' then UNDEFINED;
add = (op == '0'); unsigned = (U == '1');
esize = 8 << UInt(size); elements = 64 DIV esize;
d = UInt(D:Vd); n = UInt(N:Vn); m = UInt(M:Vm); regs = if Q == '0' then 1 else 2;
  
```

Assembler symbols

- <c> For encoding A1: see [Standard assembler syntax fields on page F2-2848](#). This encoding must be unconditional.
 For encoding T1: see [Standard assembler syntax fields on page F2-2848](#).
- <q> See [Standard assembler syntax fields on page F2-2848](#).
- <dt> Is the data type for the elements of the operands, encoded in the "U:size" field. It can have the following values:
 - S8 when U = 0, size = 00
 - S16 when U = 0, size = 01
 - S32 when U = 0, size = 10
 - U8 when U = 1, size = 00
 - U16 when U = 1, size = 01
 - U32 when U = 1, size = 10
- <Qd> Is the 128-bit name of the SIMD&FP destination register, encoded in the "D:Vd" field as <Qd>*2.
- <Qn> Is the 128-bit name of the first SIMD&FP source register, encoded in the "N:Vn" field as <Qn>*2.
- <Qm> Is the 128-bit name of the second SIMD&FP source register, encoded in the "M:Vm" field as <Qm>*2.
- <Dd> Is the 64-bit name of the SIMD&FP destination register, encoded in the "D:Vd" field.
- <Dn> Is the 64-bit name of the first SIMD&FP source register, encoded in the "N:Vn" field.
- <Dm> Is the 64-bit name of the second SIMD&FP source register, encoded in the "M:Vm" field.

Operation for all encodings

```

if ConditionPassed() then
  EncodingSpecificOperations(); CheckAdvSIMDEnabled();
  for r = 0 to regs-1
    for e = 0 to elements-1
      op1 = Int(Elem[D[n+r],e,esize], unsigned);
      op2 = Int(Elem[D[m+r],e,esize], unsigned);
      result = if add then op1+op2 else op1-op2;
      Elem[D[d+r],e,esize] = result<esize:1>;
  
```

F6.1.84 VINS

Vector move Insertion. This instruction copies the lower 16 bits of the 32-bit source SIMD&FP register into the upper 16 bits of the 32-bit destination SIMD&FP register, while preserving the values in the remaining bits.

Depending on settings in the CPACR, NSACR, HCPTR, and FPEXC registers, and the security state and mode in which the instruction is executed, an attempt to execute the instruction might be UNDEFINED, or trapped to Hyp mode. For more information see [Enabling Advanced SIMD and floating-point support on page G1-4413](#).

A1

ARMv8.2

31	30	29	28	27	26	25	24	23	22	21	20	19	18	17	16	15	12	11	10	9	8	7	6	5	4	3	0
1	1	1	1	1	1	1	0	1	D	1	1	0	0	0	0	Vd	1	0	1	0	1	1	M	0	Vm		

A1 variant

VINS{<q>}.F16 <Sd>, <Sm>

Decode for this encoding

```
if !HaveFP16Ext() then UNDEFINED;
if FPSCR.Len != '000' || FPSCR.Stride != '00' then UNDEFINED;
d = UInt(Vd:D); m = UInt(Vm:M);
```

T1

ARMv8.2

15	14	13	12	11	10	9	8	7	6	5	4	3	2	1	0	15	12	11	10	9	8	7	6	5	4	3	0
1	1	1	1	1	1	1	0	1	D	1	1	0	0	0	0	Vd	1	0	1	0	1	1	M	0	Vm		

T1 variant

VINS{<q>}.F16 <Sd>, <Sm>

Decode for this encoding

```
if !HaveFP16Ext() then UNDEFINED;
if FPSCR.Len != '000' || FPSCR.Stride != '00' then UNDEFINED;
if InITBlock() then UNPREDICTABLE;
d = UInt(Vd:D); m = UInt(Vm:M);
```

CONSTRAINED UNPREDICTABLE behavior

If InITBlock(), then one of the following behaviors must occur:

- The instruction is UNDEFINED.
- The instruction executes as if it passes the Condition code check.
- The instruction executes as NOP. This means it behaves as if it fails the Condition code check.

Assembler symbols

<q> See [Standard assembler syntax fields on page F2-2848](#).

<Sd> Is the 32-bit name of the SIMD&FP destination register, encoded in the "Vd:D" field.

<Sm> Is the 32-bit name of the SIMD&FP source register, encoded in the "Vm:M" field.

Operation for all encodings

```
if ConditionPassed() then
    EncodingSpecificOperations(); CheckVFPEnabled(TRUE);
    S[d] = S[m]<15:0> : S[d]<15:0>;
```

F6.1.85 VLD1 (single element to one lane)

Load single 1-element structure to one lane of one register loads one element from memory into one element of a register. Elements of the register that are not loaded are unchanged. For details of the addressing mode see *The Advanced SIMD addressing mode* on page F2-2869.

Depending on settings in the CPACR, NSACR, and HCPTR registers, and the security state and mode in which the instruction is executed, an attempt to execute the instruction might be UNDEFINED, or trapped to Hyp mode. For more information see *Enabling Advanced SIMD and floating-point support* on page G1-4413.

A1

31	30	29	28	27	26	25	24	23	22	21	20	19	16	15	12	11	10	9	8	7	4	3	0
1	1	1	1	0	1	0	0	1	D	1	0	Rn	Vd	0	0	0	0	index_align	Rm				
												size											

Offset variant

Applies when Rm == 1111.

VLD1{<c>}{<q>}.<size> <list>, [<Rn>{:<align>}]

Post-indexed variant

Applies when Rm == 1101.

VLD1{<c>}{<q>}.<size> <list>, [<Rn>{:<align>}]!

Post-indexed variant

Applies when Rm != 11x1.

VLD1{<c>}{<q>}.<size> <list>, [<Rn>{:<align>}], <Rm>

Decode for all variants of this encoding

```

if size == '11' then SEE VLD1 (single element to all lanes);
if index_align<0> != '0' then UNDEFINED;
ebytes = 1; index = UInt(index_align<3:1>); alignment = 1;
d = UInt(D:Vd); n = UInt(Rn); m = UInt(Rm);
wback = (m != 15); register_index = (m != 15 && m != 13);
if n == 15 then UNPREDICTABLE;
    
```

A2

31	30	29	28	27	26	25	24	23	22	21	20	19	16	15	12	11	10	9	8	7	4	3	0
1	1	1	1	0	1	0	0	1	D	1	0	Rn	Vd	0	1	0	0	index_align	Rm				
												size											

Offset variant

Applies when Rm == 1111.

VLD1{<c>}{<q>}.<size> <list>, [<Rn>{:<align>}]

Post-indexed variant

Applies when Rm == 1101.

VLD1{<c>}{<q>}.<size> <list>, [<Rn>{:<align>}]!

Post-indexed variant

Applies when Rm != 11x1.

VLD1{<c>}{<q>}.<size> <list>, [<Rn>{:<align>}], <Rm>

Decode for all variants of this encoding

```
if size == '11' then SEE VLD1 (single element to all lanes);
if index_align<1> != '0' then UNDEFINED;
ebytes = 2; index = UInt(index_align<3:2>);
alignment = if index_align<0> == '0' then 1 else 2;
d = UInt(D:Vd); n = UInt(Rn); m = UInt(Rm);
wback = (m != 15); register_index = (m != 15 && m != 13);
if n == 15 then UNPREDICTABLE;
```

A3

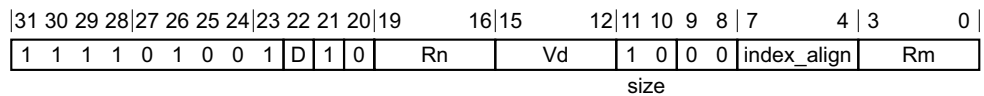

Offset variant

Applies when Rm == 1111.

VLD1{<c>}{<q>}.<size> <list>, [<Rn>{:<align>}]

Post-indexed variant

Applies when Rm == 1101.

VLD1{<c>}{<q>}.<size> <list>, [<Rn>{:<align>}]!

Post-indexed variant

Applies when Rm != 11x1.

VLD1{<c>}{<q>}.<size> <list>, [<Rn>{:<align>}], <Rm>

Decode for all variants of this encoding

```
if size == '11' then SEE VLD1 (single element to all lanes);
if index_align<2> != '0' then UNDEFINED;
if index_align<1:0> != '00' && index_align<1:0> != '11' then UNDEFINED;
ebytes = 4; index = UInt(index_align<3>);
alignment = if index_align<1:0> == '00' then 1 else 4;
d = UInt(D:Vd); n = UInt(Rn); m = UInt(Rm);
wback = (m != 15); register_index = (m != 15 && m != 13);
if n == 15 then UNPREDICTABLE;
```

T1

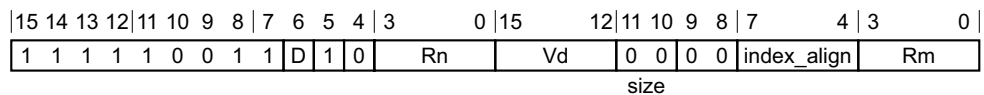

Offset variant

Applies when Rm == 1111.

VLD1{<c>}{<q>}.<size> <list>, [<Rn>{:<align>}]

Post-indexed variant

Applies when Rm == 1101.

VLD1{<c>}{<q>}.<size> <list>, [<Rn>{:<align>}]!

Post-indexed variant

Applies when Rm != 11x1.

VLD1{<c>}{<q>}.<size> <list>, [<Rn>{:<align>}], <Rm>

Decode for all variants of this encoding

```

if size == '11' then SEE VLD1 (single element to all lanes);
if index_align<0> != '0' then UNDEFINED;
ebytes = 1; index = UInt(index_align<3:1>); alignment = 1;
d = UInt(D:Vd); n = UInt(Rn); m = UInt(Rm);
wback = (m != 15); register_index = (m != 15 && m != 13);
if n == 15 then UNPREDICTABLE;
    
```

T2

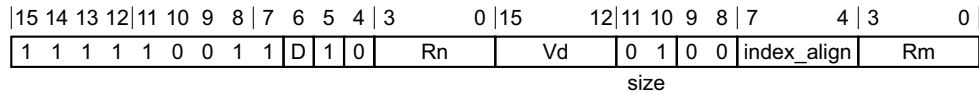

Offset variant

Applies when Rm == 1111.

VLD1{<c>}{<q>}.<size> <list>, [<Rn>{:<align>}]

Post-indexed variant

Applies when Rm == 1101.

VLD1{<c>}{<q>}.<size> <list>, [<Rn>{:<align>}]!

Post-indexed variant

Applies when Rm != 11x1.

VLD1{<c>}{<q>}.<size> <list>, [<Rn>{:<align>}], <Rm>

Decode for all variants of this encoding

```

if size == '11' then SEE VLD1 (single element to all lanes);
if index_align<1> != '0' then UNDEFINED;
ebytes = 2; index = UInt(index_align<3:2>);
alignment = if index_align<0> == '0' then 1 else 2;
d = UInt(D:Vd); n = UInt(Rn); m = UInt(Rm);
wback = (m != 15); register_index = (m != 15 && m != 13);
if n == 15 then UNPREDICTABLE;
    
```

T3

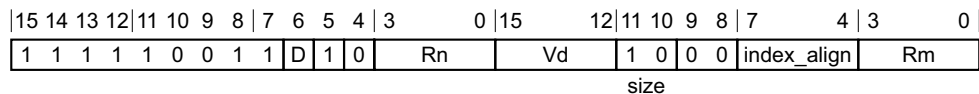

Offset variant

Applies when Rm == 1111.

VLD1{<c>}{<q>}.<size> <list>, [<Rn>{:<align>}]

Post-indexed variant

Applies when Rm == 1101.

VLD1{<c>}{<q>}.<size> <list>, [<Rn>{:<align>}]!

Post-indexed variant

Applies when Rm != 11x1.

VLD1{<c>}{<q>}.<size> <list>, [<Rn>{:<align>}], <Rm>

Decode for all variants of this encoding

```

if size == '11' then SEE VLD1 (single element to all lanes);
if index_align<2> != '0' then UNDEFINED;
if index_align<1:0> != '00' && index_align<1:0> != '11' then UNDEFINED;
ebytes = 4; index = UInt(index_align<3>);
alignment = if index_align<1:0> == '00' then 1 else 4;
d = UInt(D:Vd); n = UInt(Rn); m = UInt(Rm);
wback = (m != 15); register_index = (m != 15 && m != 13);
if n == 15 then UNPREDICTABLE;
  
```

Notes for all encodings

For more information about the CONSTRAINED UNPREDICTABLE behavior of this instruction, see [Appendix K1 Architectural Constraints on UNPREDICTABLE behaviors](#).

Assembler symbols

- <c> For encoding A1, A2 and A3: see [Standard assembler syntax fields on page F2-2848](#). This encoding must be unconditional.
 For encoding T1, T2 and T3: see [Standard assembler syntax fields on page F2-2848](#).
- <q> See [Standard assembler syntax fields on page F2-2848](#).
- <size> Is the data size, encoded in the "size" field. It can have the following values:
 - 8 when size = 00
 - 16 when size = 01
 - 32 when size = 10
- <list> Is a list containing the single 64-bit name of the SIMD&FP register holding the element.
 The list must be { <Dd>[<index>] }.
 The register <Dd> is encoded in the "D:Vd" field.
 The permitted values and encoding of <index> depend on <size>:
 - <size> == 8 <index> is in the range 0 to 7, encoded in the "index_align<3:1>" field.
 - <size> == 16 <index> is in the range 0 to 3, encoded in the "index_align<3:2>" field.
 - <size> == 32 <index> is 0 or 1, encoded in the "index_align<3>" field.
- <Rn> Is the general-purpose base register, encoded in the "Rn" field.
- <align> When <size> == 8, <align> must be omitted, otherwise it is the optional alignment.

Whenever <align> is omitted, the standard alignment is used, see [Unaligned data access on page E2-2777](#), and the encoding depends on <size>:

<size> == 8 Encoded in the "index_align<0>" field as 0.
<size> == 16 Encoded in the "index_align<1:0>" field as 0b00.
<size> == 32 Encoded in the "index_align<2:0>" field as 0b000.

Whenever <align> is present, the permitted values and encoding depend on <size>:

<size> == 16 <align> is 16, meaning 16-bit alignment, encoded in the
 "index_align<1:0>" field as 0b01.
<size> == 32 <align> is 32, meaning 32-bit alignment, encoded in the
 "index_align<2:0>" field as 0b011.

: is the preferred separator before the <align> value, but the alignment can be specified as @<align>, see [The Advanced SIMD addressing mode on page F2-2869](#).

<Rm> Is the general-purpose index register containing an offset applied after the access, encoded in the "Rm" field.

For more information about the variants of this instruction, see [The Advanced SIMD addressing mode on page F2-2869](#).

Operation for all encodings

```
if ConditionPassed() then
    EncodingSpecificOperations(); CheckAdvSIMDEnabled();
    address = R[n]; iswrite = FALSE;
    - = AArch32.CheckAlignment(address, alignment, AccType_VEC, iswrite);
    Elem[D[d],index] = MemU[address,ebytes];
if wback then
    if register_index then
        R[n] = R[n] + R[m];
    else
        R[n] = R[n] + ebytes;
```

F6.1.86 VLD1 (single element to all lanes)

Load single 1-element structure and replicate to all lanes of one register loads one element from memory into every element of one or two vectors. For details of the addressing mode see [The Advanced SIMD addressing mode on page F2-2869](#).

Depending on settings in the CPACR, NSACR, and HCPTR registers, and the security state and mode in which the instruction is executed, an attempt to execute the instruction might be UNDEFINED, or trapped to Hyp mode. For more information see [Enabling Advanced SIMD and floating-point support on page G1-4413](#).

A1

31	30	29	28	27	26	25	24	23	22	21	20	19	16	15	12	11	10	9	8	7	6	5	4	3	0
1	1	1	1	0	1	0	0	1	D	1	0	Rn	Vd	1	1	0	0	size	T	a	Rm				

Offset variant

Applies when Rm == 1111.

VLD1{<c>}{<q>}.<size> <list>, [<Rn>{:<align>}]

Post-indexed variant

Applies when Rm == 1101.

VLD1{<c>}{<q>}.<size> <list>, [<Rn>{:<align>}]!

Post-indexed variant

Applies when Rm != 11x1.

VLD1{<c>}{<q>}.<size> <list>, [<Rn>{:<align>}],<Rm>

Decode for all variants of this encoding

```
if size == '11' || (size == '00' && a == '1') then UNDEFINED;
ebytes = 1 << UInt(size); regs = if T == '0' then 1 else 2;
alignment = if a == '0' then 1 else ebytes;
d = UInt(D:Vd); n = UInt(Rn); m = UInt(Rm);
wback = (m != 15); register_index = (m != 15 && m != 13);
if n == 15 || d+regs > 32 then UNPREDICTABLE;
```

CONSTRAINED UNPREDICTABLE behavior

If d+regs > 32, then one of the following behaviors must occur:

- The instruction is UNDEFINED.
- The instruction executes as NOP.
- One or more of the SIMD and floating-point registers are UNKNOWN. If the instruction specifies writeback, the base register becomes UNKNOWN. This behavior does not affect any general-purpose registers.

T1

15	14	13	12	11	10	9	8	7	6	5	4	3	0	15	12	11	10	9	8	7	6	5	4	3	0
1	1	1	1	1	0	0	1	1	D	1	0	Rn	Vd	1	1	0	0	size	T	a	Rm				

Offset variant

Applies when Rm == 1111.

VLD1{<c>}{<q>}.<size> <list>, [<Rn>{:<align>}]

Post-indexed variant

Applies when Rm == 1101.

VLD1{<c>}{<q>}.<size> <list>, [<Rn>{:<align>}]!

Post-indexed variant

Applies when Rm != 11x1.

VLD1{<c>}{<q>}.<size> <list>, [<Rn>{:<align>}], <Rm>

Decode for all variants of this encoding

```
if size == '11' || (size == '00' && a == '1') then UNDEFINED;
ebytes = 1 << UInt(size); regs = if T == '0' then 1 else 2;
alignment = if a == '0' then 1 else ebytes;
d = UInt(D:Vd); n = UInt(Rn); m = UInt(Rm);
wback = (m != 15); register_index = (m != 15 && m != 13);
if n == 15 || d+regs > 32 then UNPREDICTABLE;
```

CONSTRAINED UNPREDICTABLE behavior

If d+regs > 32, then one of the following behaviors must occur:

- The instruction is UNDEFINED.
- The instruction executes as NOP.
- One or more of the SIMD and floating-point registers are UNKNOWN. If the instruction specifies writeback, the base register becomes UNKNOWN. This behavior does not affect any general-purpose registers.

Notes for all encodings

For more information about the CONSTRAINED UNPREDICTABLE behavior of this instruction, see [Appendix K1 Architectural Constraints on UNPREDICTABLE behaviors](#), and particularly *VLD1 (single element to all lanes)* on page K1-6110.

Assembler symbols

- <c> For encoding A1: see [Standard assembler syntax fields on page F2-2848](#). This encoding must be unconditional.
 For encoding T1: see [Standard assembler syntax fields on page F2-2848](#).
- <q> See [Standard assembler syntax fields on page F2-2848](#).
- <size> Is the data size, encoded in the "size" field. It can have the following values:

8	when size = 00
16	when size = 01
32	when size = 10

 The encoding size = 11 is reserved.
- <list> Is a list containing the 64-bit names of the SIMD&FP registers.
 The list must be one of:
 { <Dd>[] } Encoded in the "T" field as 0.

- { <Dd>[], <Dd+1>[] }Encoded in the "T" field as 1.
The register <Dd> is encoded in the "D:Vd" field.
- <Rn> Is the general-purpose base register, encoded in the "Rn" field.
- <align> When <size> == 8, <align> must be omitted, otherwise it is the optional alignment.
Whenever <align> is omitted, the standard alignment is used, see [Unaligned data access on page E2-2777](#), and is encoded in the "a" field as 0.
Whenever <align> is present, the permitted values and encoding depend on <size>:
<size> == 16 <align> is 16, meaning 16-bit alignment, encoded in the "a" field as 1.
<size> == 32 <align> is 32, meaning 32-bit alignment, encoded in the "a" field as 1.
: is the preferred separator before the <align> value, but the alignment can be specified as @<align>, see [The Advanced SIMD addressing mode on page F2-2869](#).
- <Rm> Is the general-purpose index register containing an offset applied after the access, encoded in the "Rm" field.

For more information about the variants of this instruction, see [The Advanced SIMD addressing mode on page F2-2869](#).

Operation for all encodings

```
if ConditionPassed() then
    EncodingSpecificOperations(); CheckAdvSIMDEnabled();
    address = R[n]; iswrite = FALSE;
    - = AArch32.CheckAlignment(address, alignment, AccType_VEC, iswrite);
    bits(64) replicated_element = Replicate(MemU[address,ebytes]);
    for r = 0 to regs-1
        D[d+r] = replicated_element;
    if wback then
        if register_index then
            R[n] = R[n] + R[m];
        else
            R[n] = R[n] + ebytes;
```

F6.1.87 VLD1 (multiple single elements)

Load multiple single 1-element structures to one, two, three, or four registers loads elements from memory into one, two, three, or four registers, without de-interleaving. Every element of each register is loaded. For details of the addressing mode see *The Advanced SIMD addressing mode on page F2-2869*.

Depending on settings in the CPACR, NSACR, and HCPTR registers, and the security state and mode in which the instruction is executed, an attempt to execute the instruction might be UNDEFINED, or trapped to Hyp mode. For more information see *Enabling Advanced SIMD and floating-point support on page G1-4413*.

A1

31	30	29	28	27	26	25	24	23	22	21	20	19	16	15	12	11	10	9	8	7	6	5	4	3	0
1	1	1	1	0	1	0	0	0	D	1	0	Rn	Vd	0	1	1	1	size	align	Rm					

Offset variant

Applies when Rm == 1111.

VLD1{<c>}{<q>}.<size> <list>, [<Rn>{:<align>}]

Post-indexed variant

Applies when Rm == 1101.

VLD1{<c>}{<q>}.<size> <list>, [<Rn>{:<align>}]!

Post-indexed variant

Applies when Rm != 11x1.

VLD1{<c>}{<q>}.<size> <list>, [<Rn>{:<align>}], <Rm>

Decode for all variants of this encoding

```
regs = 1; if align<1> == '1' then UNDEFINED;
alignment = if align == '00' then 1 else 4 << UInt(align);
ebytes = 1 << UInt(size); elements = 8 DIV ebytes;
d = UInt(D:Vd); n = UInt(Rn); m = UInt(Rm);
wback = (m != 15); register_index = (m != 15 && m != 13);
if n == 15 || d+regs > 32 then UNPREDICTABLE;
```

CONSTRAINED UNPREDICTABLE behavior

If d+regs > 32, then one of the following behaviors must occur:

- The instruction is UNDEFINED.
- The instruction executes as NOP.
- One or more of the SIMD and floating-point registers are UNKNOWN. If the instruction specifies writeback, the base register becomes UNKNOWN. This behavior does not affect any general-purpose registers.

A2

31	30	29	28	27	26	25	24	23	22	21	20	19	16	15	12	11	10	9	8	7	6	5	4	3	0
1	1	1	1	0	1	0	0	0	D	1	0	Rn	Vd	1	0	1	0	size	align	Rm					

Offset variant

Applies when Rm == 1111.

VLD1{<c>}{<q>}.<size> <list>, [<Rn>{:<align>}]

Post-indexed variant

Applies when Rm == 1101.

VLD1{<c>}{<q>}.<size> <list>, [<Rn>{:<align>}]!

Post-indexed variant

Applies when Rm != 11x1.

VLD1{<c>}{<q>}.<size> <list>, [<Rn>{:<align>}], <Rm>

Decode for all variants of this encoding

```
regs = 2; if align == '11' then UNDEFINED;
alignment = if align == '00' then 1 else 4 << UInt(align);
ebytes = 1 << UInt(size); elements = 8 DIV ebytes;
d = UInt(D:Vd); n = UInt(Rn); m = UInt(Rm);
wback = (m != 15); register_index = (m != 15 && m != 13);
if n == 15 || d+regs > 32 then UNPREDICTABLE;
```

CONSTRAINED UNPREDICTABLE behavior

If d+regs > 32, then one of the following behaviors must occur:

- The instruction is UNDEFINED.
- The instruction executes as NOP.
- One or more of the SIMD and floating-point registers are UNKNOWN. If the instruction specifies writeback, the base register becomes UNKNOWN. This behavior does not affect any general-purpose registers.

A3

31	30	29	28	27	26	25	24	23	22	21	20	19	16	15	12	11	10	9	8	7	6	5	4	3	0
1	1	1	1	0	1	0	0	0	D	1	0	Rn	Vd	0	1	1	0	size	align	Rm					

Offset variant

Applies when Rm == 1111.

VLD1{<c>}{<q>}.<size> <list>, [<Rn>{:<align>}]

Post-indexed variant

Applies when Rm == 1101.

VLD1{<c>}{<q>}.<size> <list>, [<Rn>{:<align>}]!

Post-indexed variant

Applies when Rm != 11x1.

VLD1{<c>}{<q>}.<size> <list>, [<Rn>{:<align>}], <Rm>

Decode for all variants of this encoding

```
regs = 3; if align<1> == '1' then UNDEFINED;
alignment = if align == '00' then 1 else 4 << UInt(align);
ebytes = 1 << UInt(size); elements = 8 DIV ebytes;
d = UInt(D:Vd); n = UInt(Rn); m = UInt(Rm);
wback = (m != 15); register_index = (m != 15 && m != 13);
if n == 15 || d+regs > 32 then UNPREDICTABLE;
```

CONSTRAINED UNPREDICTABLE behavior

If $d+regs > 32$, then one of the following behaviors must occur:

- The instruction is UNDEFINED.
- The instruction executes as NOP.
- One or more of the SIMD and floating-point registers are UNKNOWN. If the instruction specifies writeback, the base register becomes UNKNOWN. This behavior does not affect any general-purpose registers.

A4

31	30	29	28	27	26	25	24	23	22	21	20	19	16	15	12	11	10	9	8	7	6	5	4	3	0
1	1	1	1	0	0	1	0	0	0	D	1	0	Rn	Vd	0	0	1	0	size	align	Rm				

Offset variant

Applies when $Rm == 1111$.

$VLD1\{<c>\}\{<q>\}.<size> <list>, [<Rn>\{:<align>\}]$

Post-indexed variant

Applies when $Rm == 1101$.

$VLD1\{<c>\}\{<q>\}.<size> <list>, [<Rn>\{:<align>\}]!$

Post-indexed variant

Applies when $Rm != 11x1$.

$VLD1\{<c>\}\{<q>\}.<size> <list>, [<Rn>\{:<align>\}], <Rm>$

Decode for all variants of this encoding

```
regs = 4;
alignment = if align == '00' then 1 else 4 << UInt(align);
ebytes = 1 << UInt(size); elements = 8 DIV ebytes;
d = UInt(D:Vd); n = UInt(Rn); m = UInt(Rm);
wback = (m != 15); register_index = (m != 15 && m != 13);
if n == 15 || d+regs > 32 then UNPREDICTABLE;
```

CONSTRAINED UNPREDICTABLE behavior

If $d+regs > 32$, then one of the following behaviors must occur:

- The instruction is UNDEFINED.
- The instruction executes as NOP.
- One or more of the SIMD and floating-point registers are UNKNOWN. If the instruction specifies writeback, the base register becomes UNKNOWN. This behavior does not affect any general-purpose registers.

T1

15	14	13	12	11	10	9	8	7	6	5	4	3	0	15	12	11	10	9	8	7	6	5	4	3	0
1	1	1	1	1	0	0	1	0	D	1	0	Rn	Vd	0	1	1	1	size	align	Rm					

Offset variant

Applies when Rm == 1111.

VLD1{<c>}{<q>}.<size> <list>, [<Rn>{:<align>}]

Post-indexed variant

Applies when Rm == 1101.

VLD1{<c>}{<q>}.<size> <list>, [<Rn>{:<align>}]!

Post-indexed variant

Applies when Rm != 11x1.

VLD1{<c>}{<q>}.<size> <list>, [<Rn>{:<align>}], <Rm>

Decode for all variants of this encoding

```
regs = 1; if align<1> == '1' then UNDEFINED;
alignment = if align == '00' then 1 else 4 << UInt(align);
ebytes = 1 << UInt(size); elements = 8 DIV ebytes;
d = UInt(D:Vd); n = UInt(Rn); m = UInt(Rm);
wback = (m != 15); register_index = (m != 15 && m != 13);
if n == 15 || d+regs > 32 then UNPREDICTABLE;
```

CONSTRAINED UNPREDICTABLE behavior

If d+regs > 32, then one of the following behaviors must occur:

- The instruction is UNDEFINED.
- The instruction executes as NOP.
- One or more of the SIMD and floating-point registers are UNKNOWN. If the instruction specifies writeback, the base register becomes UNKNOWN. This behavior does not affect any general-purpose registers.

T2

15	14	13	12	11	10	9	8	7	6	5	4	3	0	15	12	11	10	9	8	7	6	5	4	3	0
1	1	1	1	1	0	0	1	0	D	1	0	Rn	Vd	1	0	1	0	size	align	Rm					

Offset variant

Applies when Rm == 1111.

VLD1{<c>}{<q>}.<size> <list>, [<Rn>{:<align>}]

Post-indexed variant

Applies when Rm == 1101.

VLD1{<c>}{<q>}.<size> <list>, [<Rn>{:<align>}]!

Post-indexed variant

Applies when Rm != 11x1.

VLD1{<c>}{<q>}.<size> <list>, [<Rn>{:<align>}], <Rm>

Decode for all variants of this encoding

```
regs = 2; if align == '11' then UNDEFINED;
alignment = if align == '00' then 1 else 4 << UInt(align);
ebytes = 1 << UInt(size); elements = 8 DIV ebytes;
d = UInt(D:Vd); n = UInt(Rn); m = UInt(Rm);
wback = (m != 15); register_index = (m != 15 && m != 13);
if n == 15 || d+regs > 32 then UNPREDICTABLE;
```

CONSTRAINED UNPREDICTABLE behavior

If d+regs > 32, then one of the following behaviors must occur:

- The instruction is UNDEFINED.
- The instruction executes as NOP.
- One or more of the SIMD and floating-point registers are UNKNOWN. If the instruction specifies writeback, the base register becomes UNKNOWN. This behavior does not affect any general-purpose registers.

T3

15	14	13	12	11	10	9	8	7	6	5	4	3	0	15	12	11	10	9	8	7	6	5	4	3	0
1	1	1	1	1	0	0	1	0	D	1	0	Rn	Vd	0	1	1	0	size	align	Rm					

Offset variant

Applies when Rm == 1111.

VLD1{<c>}{<q>}.<size> <list>, [<Rn>{:<align>}]

Post-indexed variant

Applies when Rm == 1101.

VLD1{<c>}{<q>}.<size> <list>, [<Rn>{:<align>}]!

Post-indexed variant

Applies when Rm != 11x1.

VLD1{<c>}{<q>}.<size> <list>, [<Rn>{:<align>}], <Rm>

Decode for all variants of this encoding

```
regs = 3; if align<1> == '1' then UNDEFINED;
alignment = if align == '00' then 1 else 4 << UInt(align);
ebytes = 1 << UInt(size); elements = 8 DIV ebytes;
d = UInt(D:Vd); n = UInt(Rn); m = UInt(Rm);
wback = (m != 15); register_index = (m != 15 && m != 13);
if n == 15 || d+regs > 32 then UNPREDICTABLE;
```

CONSTRAINED UNPREDICTABLE behavior

If d+regs > 32, then one of the following behaviors must occur:

- The instruction is UNDEFINED.

- The instruction executes as NOP.
- One or more of the SIMD and floating-point registers are UNKNOWN. If the instruction specifies writeback, the base register becomes UNKNOWN. This behavior does not affect any general-purpose registers.

T4

15	14	13	12	11	10	9	8	7	6	5	4	3	0	15	12	11	10	9	8	7	6	5	4	3	0
1	1	1	1	1	0	0	1	0	D	1	0	Rn	Vd	0	0	1	0	size	align	Rm					

Offset variant

Applies when Rm == 1111.

VLD1{<c>}{<q>}.<size> <list>, [<Rn>{:<align>}]

Post-indexed variant

Applies when Rm == 1101.

VLD1{<c>}{<q>}.<size> <list>, [<Rn>{:<align>}]!

Post-indexed variant

Applies when Rm != 11x1.

VLD1{<c>}{<q>}.<size> <list>, [<Rn>{:<align>}], <Rm>

Decode for all variants of this encoding

```
regs = 4;
alignment = if align == '00' then 1 else 4 << UInt(align);
ebytes = 1 << UInt(size); elements = 8 DIV ebytes;
d = UInt(D:Vd); n = UInt(Rn); m = UInt(Rm);
wback = (m != 15); register_index = (m != 15 && m != 13);
if n == 15 || d+regs > 32 then UNPREDICTABLE;
```

CONSTRAINED UNPREDICTABLE behavior

If d+regs > 32, then one of the following behaviors must occur:

- The instruction is UNDEFINED.
- The instruction executes as NOP.
- One or more of the SIMD and floating-point registers are UNKNOWN. If the instruction specifies writeback, the base register becomes UNKNOWN. This behavior does not affect any general-purpose registers.

Notes for all encodings

For more information about the CONSTRAINED UNPREDICTABLE behavior of this instruction, see [Appendix K1 Architectural Constraints on UNPREDICTABLE behaviors](#), and particularly *VLD1 (multiple single elements)* on page K1-6110.

Related encodings: See *Advanced SIMD element or structure load/store* on page F3-2922 for the T32 instruction set, or *Advanced SIMD element or structure load/store* on page F4-2997 for the A32 instruction set.

Assembler symbols

<c> For encoding A1, A2, A3 and A4: see [Standard assembler syntax fields](#) on page F2-2848. This encoding must be unconditional.

For encoding T1, T2, T3 and T4: see [Standard assembler syntax fields on page F2-2848](#).

<q> See [Standard assembler syntax fields on page F2-2848](#).

<size> Is the data size, encoded in the "size" field. It can have the following values:

8	when size = 00
16	when size = 01
32	when size = 10
64	when size = 11

<list> Is a list containing the 64-bit names of the SIMD&FP registers.

The list must be one of:

{ <Dd> }	Single register. Selects the A1 and T1 encodings of the instruction.
{ <Dd>, <Dd+1> }	Two single-spaced registers. Selects the A2 and T2 encodings of the instruction.
{ <Dd>, <Dd+1>, <Dd+2> }	Three single-spaced registers. Selects the A3 and T3 encodings of the instruction.
{ <Dd>, <Dd+1>, <Dd+2>, <Dd+3> }	Four single-spaced registers. Selects the A4 and T4 encodings of the instruction.

The register <Dd> is encoded in the "D:Vd" field.

<Rn> Is the general-purpose base register, encoded in the "Rn" field.

<align> Is the optional alignment.

Whenever <align> is omitted, the standard alignment is used, see [Unaligned data access on page E2-2777](#), and is encoded in the "align" field as 0b00.

Whenever <align> is present, the permitted values are:

64	64-bit alignment, encoded in the "align" field as 0b01.
128	128-bit alignment, encoded in the "align" field as 0b10. Available only if <list> contains two or four registers.
256	256-bit alignment, encoded in the "align" field as 0b11. Available only if <list> contains four registers.

: is the preferred separator before the <align> value, but the alignment can be specified as @<align>, see [The Advanced SIMD addressing mode on page F2-2869](#).

<Rm> Is the general-purpose index register containing an offset applied after the access, encoded in the "Rm" field.

For more information about the variants of this instruction, see [The Advanced SIMD addressing mode on page F2-2869](#).

Operation for all encodings

```

if ConditionPassed() then
    EncodingSpecificOperations(); CheckAdvSIMDEnabled();
    address = R[n]; iswrite = FALSE;
    - = AArch32.CheckAlignment(address, alignment, AccType_VEC, iswrite);
    for r = 0 to regs-1
        for e = 0 to elements-1
            bits(ebytes*8) data;
            if ebytes != 8 then
                data = MemU[address,ebytes];
            else
                - = AArch32.CheckAlignment(address, ebytes, AccType_NORMAL, iswrite);
  
```

```
        data<31:0> = if BigEndian() then MemU[address+4,4] else MemU[address,4];  
        data<63:32> = if BigEndian() then MemU[address,4] else MemU[address+4,4];  
    Elem[D[d+r],e] = data;  
    address = address + ebytes;  
if wback then  
    if register_index then  
        R[n] = R[n] + R[m];  
    else  
        R[n] = R[n] + 8*regs;
```

F6.1.88 VLD2 (single 2-element structure to one lane)

Load single 2-element structure to one lane of two registers loads one 2-element structure from memory into corresponding elements of two registers. Elements of the registers that are not loaded are unchanged. For details of the addressing mode see *The Advanced SIMD addressing mode on page F2-2869*.

Depending on settings in the CPACR, NSACR, and HCPTR registers, and the security state and mode in which the instruction is executed, an attempt to execute the instruction might be UNDEFINED, or trapped to Hyp mode. For more information see *Enabling Advanced SIMD and floating-point support on page G1-4413*.

A1

31	30	29	28	27	26	25	24	23	22	21	20	19	16	15	12	11	10	9	8	7	4	3	0
1	1	1	1	0	1	0	0	1	D	1	0	Rn	Vd	0	0	0	1	index_align	Rm				
												size											

Offset variant

Applies when Rm == 1111.

VLD2{<c>}{<q>}.<size> <list>, [<Rn>{:<align>}]

Post-indexed variant

Applies when Rm == 1101.

VLD2{<c>}{<q>}.<size> <list>, [<Rn>{:<align>}]!

Post-indexed variant

Applies when Rm != 11x1.

VLD2{<c>}{<q>}.<size> <list>, [<Rn>{:<align>}], <Rm>

Decode for all variants of this encoding

```
if size == '11' then SEE VLD2 (single 2-element structure to all lanes);
ebytes = 1; index = UInt(index_align<3:1>); inc = 1;
alignment = if index_align<0> == '0' then 1 else 2;
d = UInt(D:Vd); d2 = d + inc; n = UInt(Rn); m = UInt(Rm);
wback = (m != 15); register_index = (m != 15 && m != 13);
if n == 15 || d2 > 31 then UNPREDICTABLE;
```

CONSTRAINED UNPREDICTABLE behavior

If d2 > 31, then one of the following behaviors must occur:

- The instruction is UNDEFINED.
- The instruction executes as NOP.
- One or more of the SIMD and floating-point registers are UNKNOWN. If the instruction specifies writeback, the base register becomes UNKNOWN. This behavior does not affect any general-purpose registers.

A2

31	30	29	28	27	26	25	24	23	22	21	20	19	16	15	12	11	10	9	8	7	4	3	0
1	1	1	1	0	1	0	0	1	D	1	0	Rn	Vd	0	1	0	1	index_align	Rm				
												size											

Offset variant

Applies when Rm == 1111.

VLD2{<c>}{<q>}.<size> <list>, [<Rn>{:<align>}]

Post-indexed variant

Applies when Rm == 1101.

VLD2{<c>}{<q>}.<size> <list>, [<Rn>{:<align>}]!

Post-indexed variant

Applies when Rm != 11x1.

VLD2{<c>}{<q>}.<size> <list>, [<Rn>{:<align>}], <Rm>

Decode for all variants of this encoding

```
if size == '11' then SEE VLD2 (single 2-element structure to all lanes);
ebytes = 2; index = UInt(index_align<3:2>);
inc = if index_align<1> == '0' then 1 else 2;
alignment = if index_align<0> == '0' then 1 else 4;
d = UInt(D:Vd); d2 = d + inc; n = UInt(Rn); m = UInt(Rm);
wback = (m != 15); register_index = (m != 15 && m != 13);
if n == 15 || d2 > 31 then UNPREDICTABLE;
```

CONSTRAINED UNPREDICTABLE behavior

If d2 > 31, then one of the following behaviors must occur:

- The instruction is UNDEFINED.
- The instruction executes as NOP.
- One or more of the SIMD and floating-point registers are UNKNOWN. If the instruction specifies writeback, the base register becomes UNKNOWN. This behavior does not affect any general-purpose registers.

A3

31	30	29	28	27	26	25	24	23	22	21	20	19	16	15	12	11	10	9	8	7	4	3	0
1	1	1	1	0	0	1	0	0	1	D	1	0	Rn	Vd	1	0	0	1	index_align	Rm			

size

Offset variant

Applies when Rm == 1111.

VLD2{<c>}{<q>}.<size> <list>, [<Rn>{:<align>}]

Post-indexed variant

Applies when Rm == 1101.

VLD2{<c>}{<q>}.<size> <list>, [<Rn>{:<align>}]!

Post-indexed variant

Applies when Rm != 11x1.

VLD2{<c>}{<q>}.<size> <list>, [<Rn>{:<align>}], <Rm>

Decode for all variants of this encoding

```

if size == '11' then SEE VLD2 (single 2-element structure to all lanes);
if index_align<1> != '0' then UNDEFINED;
ebytes = 4; index = UInt(index_align<3>);
inc = if index_align<2> == '0' then 1 else 2;
alignment = if index_align<0> == '0' then 1 else 8;
d = UInt(D:Vd); d2 = d + inc; n = UInt(Rn); m = UInt(Rm);
wback = (m != 15); register_index = (m != 15 && m != 13);
if n == 15 || d2 > 31 then UNPREDICTABLE;
    
```

CONSTRAINED UNPREDICTABLE behavior

If $d2 > 31$, then one of the following behaviors must occur:

- The instruction is UNDEFINED.
- The instruction executes as NOP.
- One or more of the SIMD and floating-point registers are UNKNOWN. If the instruction specifies writeback, the base register becomes UNKNOWN. This behavior does not affect any general-purpose registers.

T1

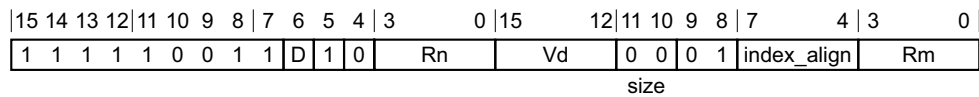

Offset variant

Applies when $Rm == 1111$.

VLD2{<c>}{<q>}.<size> <list>, [<Rn>{:<align>}]

Post-indexed variant

Applies when $Rm == 1101$.

VLD2{<c>}{<q>}.<size> <list>, [<Rn>{:<align>}]!

Post-indexed variant

Applies when $Rm != 11x1$.

VLD2{<c>}{<q>}.<size> <list>, [<Rn>{:<align>}], <Rm>

Decode for all variants of this encoding

```

if size == '11' then SEE VLD2 (single 2-element structure to all lanes);
ebytes = 1; index = UInt(index_align<3:1>); inc = 1;
alignment = if index_align<0> == '0' then 1 else 2;
d = UInt(D:Vd); d2 = d + inc; n = UInt(Rn); m = UInt(Rm);
wback = (m != 15); register_index = (m != 15 && m != 13);
if n == 15 || d2 > 31 then UNPREDICTABLE;
    
```

CONSTRAINED UNPREDICTABLE behavior

If $d2 > 31$, then one of the following behaviors must occur:

- The instruction is UNDEFINED.
- The instruction executes as NOP.
- One or more of the SIMD and floating-point registers are UNKNOWN. If the instruction specifies writeback, the base register becomes UNKNOWN. This behavior does not affect any general-purpose registers.

T2

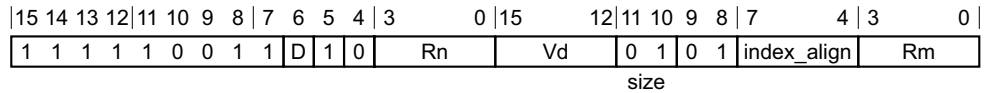

Offset variant

Applies when Rm == 1111.

VLD2{<c>}{<q>}.<size> <list>, [<Rn>{:<align>}]

Post-indexed variant

Applies when Rm == 1101.

VLD2{<c>}{<q>}.<size> <list>, [<Rn>{:<align>}]!

Post-indexed variant

Applies when Rm != 11x1.

VLD2{<c>}{<q>}.<size> <list>, [<Rn>{:<align>}], <Rm>

Decode for all variants of this encoding

```

if size == '11' then SEE VLD2 (single 2-element structure to all lanes);
ebytes = 2; index = UInt(index_align<3:2>);
inc = if index_align<1> == '0' then 1 else 2;
alignment = if index_align<0> == '0' then 1 else 4;
d = UInt(D:Vd); d2 = d + inc; n = UInt(Rn); m = UInt(Rm);
wback = (m != 15); register_index = (m != 15 && m != 13);
if n == 15 || d2 > 31 then UNPREDICTABLE;
    
```

CONSTRAINED UNPREDICTABLE behavior

If d2 > 31, then one of the following behaviors must occur:

- The instruction is UNDEFINED.
- The instruction executes as NOP.
- One or more of the SIMD and floating-point registers are UNKNOWN. If the instruction specifies writeback, the base register becomes UNKNOWN. This behavior does not affect any general-purpose registers.

T3

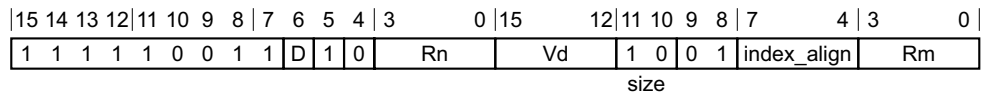

Offset variant

Applies when Rm == 1111.

VLD2{<c>}{<q>}.<size> <list>, [<Rn>{:<align>}]

Post-indexed variant

Applies when Rm == 1101.

VLD2{<c>}{<q>}.<size> <list>, [<Rn>{:<align>}]!

Post-indexed variant

Applies when $Rm \neq 11x1$.

$VLD2\{<c>\}\{<q>\}.<size> <list>, [<Rn>\{:<align>\}], <Rm>$

Decode for all variants of this encoding

```

if size == '11' then SEE VLD2 (single 2-element structure to all lanes);
if index_align<1> != '0' then UNDEFINED;
ebytes = 4; index = UInt(index_align<3>);
inc = if index_align<2> == '0' then 1 else 2;
alignment = if index_align<0> == '0' then 1 else 8;
d = UInt(D:Vd); d2 = d + inc; n = UInt(Rn); m = UInt(Rm);
wback = (m != 15); register_index = (m != 15 && m != 13);
if n == 15 || d2 > 31 then UNPREDICTABLE;
  
```

CONSTRAINED UNPREDICTABLE behavior

If $d2 > 31$, then one of the following behaviors must occur:

- The instruction is UNDEFINED.
- The instruction executes as NOP.
- One or more of the SIMD and floating-point registers are UNKNOWN. If the instruction specifies writeback, the base register becomes UNKNOWN. This behavior does not affect any general-purpose registers.

Notes for all encodings

For more information about the CONSTRAINED UNPREDICTABLE behavior of this instruction, see [Appendix K1 Architectural Constraints on UNPREDICTABLE behaviors](#), and particularly *VLD2 (single 2-element structure to one lane)* on page K1-6110.

Assembler symbols

$<c>$	For encoding A1, A2 and A3: see <i>Standard assembler syntax fields</i> on page F2-2848. This encoding must be unconditional. For encoding T1, T2 and T3: see <i>Standard assembler syntax fields</i> on page F2-2848.
$<q>$	See <i>Standard assembler syntax fields</i> on page F2-2848.
$<size>$	Is the data size, encoded in the "size" field. It can have the following values: 8 when size = 00 16 when size = 01 32 when size = 10
$<list>$	Is a list containing the 64-bit names of the two SIMD&FP registers holding the element. The list must be one of: { <Dd>[<index>], <Dd+1>[<index>] } Single-spaced registers, encoded as "spacing" = 0. { <Dd>[<index>], <Dd+2>[<index>] } Double-spaced registers, encoded as "spacing" = 1. Not permitted when $<size> == 8$. The encoding of "spacing" depends on $<size>$: $<size> == 16$ "spacing" is encoded in the "index_align<1>" field. $<size> == 32$ "spacing" is encoded in the "index_align<2>" field. The register <Dd> is encoded in the "D:Vd" field.

The permitted values and encoding of <index> depend on <size>:

- <size> == 8 <index> is in the range 0 to 7, encoded in the "index_align<3:1>" field.
- <size> == 16 <index> is in the range 0 to 3, encoded in the "index_align<3:2>" field.
- <size> == 32 <index> is 0 or 1, encoded in the "index_align<3>" field.

<Rn> Is the general-purpose base register, encoded in the "Rn" field.

<align> Is the optional alignment.

Whenever <align> is omitted, the standard alignment is used, see [Unaligned data access on page E2-2777](#), and the encoding depends on <size>:

- <size> == 8 Encoded in the "index_align<0>" field as 0.
- <size> == 16 Encoded in the "index_align<0>" field as 0.
- <size> == 32 Encoded in the "index_align<1:0>" field as 0b00.

Whenever <align> is present, the permitted values and encoding depend on <size>:

- <size> == 8 <align> is 16, meaning 16-bit alignment, encoded in the "index_align<0>" field as 1.
- <size> == 16 <align> is 32, meaning 32-bit alignment, encoded in the "index_align<0>" field as 1.
- <size> == 32 <align> is 64, meaning 64-bit alignment, encoded in the "index_align<1:0>" field as 0b01.

: is the preferred separator before the <align> value, but the alignment can be specified as @<align>, see [The Advanced SIMD addressing mode on page F2-2869](#).

<Rm> Is the general-purpose index register containing an offset applied after the access, encoded in the "Rm" field.

For more information about the variants of this instruction, see [The Advanced SIMD addressing mode on page F2-2869](#).

Operation for all encodings

```

if ConditionPassed() then
    EncodingSpecificOperations(); CheckAdvSIMDEnabled();
    address = R[n]; iswrite = FALSE;
    - = AArch32.CheckAlignment(address, alignment, AccType_VEC, iswrite);
    Elem[D[d], index] = MemU[address,ebytes];
    Elem[D[d2], index] = MemU[address+ebytes,ebytes];
    if wback then
        if register_index then
            R[n] = R[n] + R[m];
        else
            R[n] = R[n] + 2*ebytes;
  
```

F6.1.89 VLD2 (single 2-element structure to all lanes)

Load single 2-element structure and replicate to all lanes of two registers loads one 2-element structure from memory into all lanes of two registers. For details of the addressing mode see [The Advanced SIMD addressing mode on page F2-2869](#).

Depending on settings in the CPACR, NSACR, and HCPTR registers, and the security state and mode in which the instruction is executed, an attempt to execute the instruction might be UNDEFINED, or trapped to Hyp mode. For more information see [Enabling Advanced SIMD and floating-point support on page G1-4413](#).

A1

31	30	29	28	27	26	25	24	23	22	21	20	19	16	15	12	11	10	9	8	7	6	5	4	3	0
1	1	1	1	0	1	0	0	1	D	1	0	Rn	Vd	1	1	0	1	size	T	a	Rm				

Offset variant

Applies when Rm == 1111.

VLD2{<c>}{<q>}.<size> <list>, [<Rn>{:<align>}]

Post-indexed variant

Applies when Rm == 1101.

VLD2{<c>}{<q>}.<size> <list>, [<Rn>{:<align>}]!

Post-indexed variant

Applies when Rm != 11x1.

VLD2{<c>}{<q>}.<size> <list>, [<Rn>{:<align>}], <Rm>

Decode for all variants of this encoding

```

if size == '11' then UNDEFINED;
ebytes = 1 << UInt(size);
alignment = if a == '0' then 1 else 2*ebytes;
inc = if T == '0' then 1 else 2;
d = UInt(D:Vd); d2 = d + inc; n = UInt(Rn); m = UInt(Rm);
wback = (m != 15); register_index = (m != 15 && m != 13);
if n == 15 || d2 > 31 then UNPREDICTABLE;
    
```

CONSTRAINED UNPREDICTABLE behavior

If d2 > 31, then one of the following behaviors must occur:

- The instruction is UNDEFINED.
- The instruction executes as NOP.
- One or more of the SIMD and floating-point registers are UNKNOWN. If the instruction specifies writeback, the base register becomes UNKNOWN. This behavior does not affect any general-purpose registers.

T1

15	14	13	12	11	10	9	8	7	6	5	4	3	0	15	12	11	10	9	8	7	6	5	4	3	0
1	1	1	1	1	0	0	1	1	D	1	0	Rn	Vd	1	1	0	1	size	T	a	Rm				

Offset variant

Applies when Rm == 1111.

VLD2{<c>}{<q>}.<size> <list>, [<Rn>{:<align>}]

Post-indexed variant

Applies when Rm == 1101.

VLD2{<c>}{<q>}.<size> <list>, [<Rn>{:<align>}]!

Post-indexed variant

Applies when Rm != 11x1.

VLD2{<c>}{<q>}.<size> <list>, [<Rn>{:<align>}], <Rm>

Decode for all variants of this encoding

```
if size == '11' then UNDEFINED;
ebytes = 1 << UInt(size);
alignment = if a == '0' then 1 else 2*ebytes;
inc = if T == '0' then 1 else 2;
d = UInt(D:Vd); d2 = d + inc; n = UInt(Rn); m = UInt(Rm);
wback = (m != 15); register_index = (m != 15 && m != 13);
if n == 15 || d2 > 31 then UNPREDICTABLE;
```

CONSTRAINED UNPREDICTABLE behavior

If d2 > 31, then one of the following behaviors must occur:

- The instruction is UNDEFINED.
- The instruction executes as NOP.
- One or more of the SIMD and floating-point registers are UNKNOWN. If the instruction specifies writeback, the base register becomes UNKNOWN. This behavior does not affect any general-purpose registers.

Notes for all encodings

For more information about the CONSTRAINED UNPREDICTABLE behavior of this instruction, see [Appendix K1 Architectural Constraints on UNPREDICTABLE behaviors](#), and particularly *VLD2 (single 2-element structure to all lanes)* on page K1-6111.

Assembler symbols

<c> For encoding A1: see [Standard assembler syntax fields on page F2-2848](#). This encoding must be unconditional.

For encoding T1: see [Standard assembler syntax fields on page F2-2848](#).

<q> See [Standard assembler syntax fields on page F2-2848](#).

<size> Is the data size, encoded in the "size" field. It can have the following values:

8 when size = 00

16 when size = 01

32 when size = 10

The encoding size = 11 is reserved.

<list> Is a list containing the 64-bit names of two SIMD&FP registers.

The list must be one of:

{ <Dd>[], <Dd+1>[] } Single-spaced registers, encoded in the "T" field as 0.

{ <Dd>[], <Dd+2>[] } Double-spaced registers, encoded in the "T" field as 1.

The register <Dd> is encoded in the "D:Vd" field.

<Rn> Is the general-purpose base register, encoded in the "Rn" field.

<align> Is the optional alignment.

Whenever <align> is omitted, the standard alignment is used, see [Unaligned data access on page E2-2777](#), and is encoded in the "a" field as 0.

Whenever <align> is present, the permitted values and encoding depend on <size>:

<size> == 8 <align> is 16, meaning 16-bit alignment, encoded in the "a" field as 1.

<size> == 16 <align> is 32, meaning 32-bit alignment, encoded in the "a" field as 1.

<size> == 32 <align> is 64, meaning 64-bit alignment, encoded in the "a" field as 1.

: is the preferred separator before the <align> value, but the alignment can be specified as @<align>, see [The Advanced SIMD addressing mode on page F2-2869](#).

<Rm> Is the general-purpose index register containing an offset applied after the access, encoded in the "Rm" field.

For more information about the variants of this instruction, see [The Advanced SIMD addressing mode on page F2-2869](#).

Operation for all encodings

```
if ConditionPassed() then
    EncodingSpecificOperations(); CheckAdvSIMDEnabled();
    address = R[n]; iswrite = FALSE;
    - = AArch32.CheckAlignment(address, alignment, AccType_VEC, iswrite);
    D[d] = Replicate(MemU[address,ebytes]);
    D[d2] = Replicate(MemU[address+ebytes,ebytes]);
    if wback then
        if register_index then
            R[n] = R[n] + R[m];
        else
            R[n] = R[n] + 2*ebytes;
```

F6.1.90 VLD2 (multiple 2-element structures)

Load multiple 2-element structures to two or four registers loads multiple 2-element structures from memory into two or four registers, with de-interleaving. For more information, see *Element and structure load/store instructions on page F1-2829*. Every element of each register is loaded. For details of the addressing mode see *The Advanced SIMD addressing mode on page F2-2869*.

Depending on settings in the CPACR, NSACR, and HCPTR registers, and the security state and mode in which the instruction is executed, an attempt to execute the instruction might be UNDEFINED, or trapped to Hyp mode. For more information see *Enabling Advanced SIMD and floating-point support on page G1-4413*.

A1

31	30	29	28	27	26	25	24	23	22	21	20	19	16	15	12	11	8	7	6	5	4	3	0
1	1	1	1	0	1	0	0	0	D	1	0	Rn	Vd	1	0	0	x	size	align	Rm			
type																							

Offset variant

Applies when Rm == 1111.

VLD2{<c>}{<q>}.<size> <list>, [<Rn>{:<align>}]

Post-indexed variant

Applies when Rm == 1101.

VLD2{<c>}{<q>}.<size> <list>, [<Rn>{:<align>}]!

Post-indexed variant

Applies when Rm != 11x1.

VLD2{<c>}{<q>}.<size> <list>, [<Rn>{:<align>}], <Rm>

Decode for all variants of this encoding

```
regs = 1; if align == '11' then UNDEFINED;
if size == '11' then UNDEFINED;
inc = if type == '1001' then 2 else 1;
alignment = if align == '00' then 1 else 4 << UInt(align);
ebytes = 1 << UInt(size); elements = 8 DIV ebytes;
d = UInt(D:Vd); d2 = d + inc; n = UInt(Rn); m = UInt(Rm);
wback = (m != 15); register_index = (m != 15 && m != 13);
if n == 15 || d2+regs > 32 then UNPREDICTABLE;
```

CONSTRAINED UNPREDICTABLE behavior

If d2+regs > 32, then one of the following behaviors must occur:

- The instruction is UNDEFINED.
- The instruction executes as NOP.
- One or more of the SIMD and floating-point registers are UNKNOWN. If the instruction specifies writeback, the base register becomes UNKNOWN. This behavior does not affect any general-purpose registers.

A2

31	30	29	28	27	26	25	24	23	22	21	20	19	16	15	12	11	10	9	8	7	6	5	4	3	0
1	1	1	1	0	1	0	0	0	D	1	0	Rn	Vd	0	0	1	1	size	align	Rm					

Offset variant

Applies when Rm == 1111.

VLD2{<c>}{<q>}.<size> <list>, [<Rn>{:<align>}]

Post-indexed variant

Applies when Rm == 1101.

VLD2{<c>}{<q>}.<size> <list>, [<Rn>{:<align>}]!

Post-indexed variant

Applies when Rm != 11x1.

VLD2{<c>}{<q>}.<size> <list>, [<Rn>{:<align>}], <Rm>

Decode for all variants of this encoding

```
regs = 2; inc = 2;
if size == '11' then UNDEFINED;
alignment = if align == '00' then 1 else 4 << UInt(align);
ebytes = 1 << UInt(size); elements = 8 DIV ebytes;
d = UInt(D:Vd); d2 = d + inc; n = UInt(Rn); m = UInt(Rm);
wback = (m != 15); register_index = (m != 15 && m != 13);
if n == 15 || d2+regs > 32 then UNPREDICTABLE;
```

CONSTRAINED UNPREDICTABLE behavior

If $d2+regs > 32$, then one of the following behaviors must occur:

- The instruction is UNDEFINED.
- The instruction executes as NOP.
- One or more of the SIMD and floating-point registers are UNKNOWN. If the instruction specifies writeback, the base register becomes UNKNOWN. This behavior does not affect any general-purpose registers.

T1

15	14	13	12	11	10	9	8	7	6	5	4	3	0	15	12	11	8	7	6	5	4	3	0
1	1	1	1	1	0	0	1	0	D	1	0	Rn	Vd	1	0	0	x	size	align	Rm			

type

Offset variant

Applies when Rm == 1111.

VLD2{<c>}{<q>}.<size> <list>, [<Rn>{:<align>}]

Post-indexed variant

Applies when Rm == 1101.

VLD2{<c>}{<q>}.<size> <list>, [<Rn>{:<align>}]!

Post-indexed variant

Applies when Rm != 11x1.

VLD2{<c>}{<q>}.<size> <list>, [<Rn>{:<align>}], <Rm>

Decode for all variants of this encoding

```
regs = 1; if align == '11' then UNDEFINED;
if size == '11' then UNDEFINED;
inc = if type == '1001' then 2 else 1;
alignment = if align == '00' then 1 else 4 << UInt(align);
ebytes = 1 << UInt(size); elements = 8 DIV ebytes;
d = UInt(D:Vd); d2 = d + inc; n = UInt(Rn); m = UInt(Rm);
wback = (m != 15); register_index = (m != 15 && m != 13);
if n == 15 || d2+regs > 32 then UNPREDICTABLE;
```

CONSTRAINED UNPREDICTABLE behavior

If d2+regs > 32, then one of the following behaviors must occur:

- The instruction is UNDEFINED.
- The instruction executes as NOP.
- One or more of the SIMD and floating-point registers are UNKNOWN. If the instruction specifies writeback, the base register becomes UNKNOWN. This behavior does not affect any general-purpose registers.

T2

15	14	13	12	11	10	9	8	7	6	5	4	3	0	15	12	11	10	9	8	7	6	5	4	3	0
1	1	1	1	1	0	0	1	0	D	1	0	Rn	Vd	0	0	1	1	size	align	Rm					

Offset variant

Applies when Rm == 1111.

VLD2{<c>}{<q>}.<size> <list>, [<Rn>{:<align>}]

Post-indexed variant

Applies when Rm == 1101.

VLD2{<c>}{<q>}.<size> <list>, [<Rn>{:<align>}]!

Post-indexed variant

Applies when Rm != 11x1.

VLD2{<c>}{<q>}.<size> <list>, [<Rn>{:<align>}], <Rm>

Decode for all variants of this encoding

```
regs = 2; inc = 2;
if size == '11' then UNDEFINED;
alignment = if align == '00' then 1 else 4 << UInt(align);
ebytes = 1 << UInt(size); elements = 8 DIV ebytes;
d = UInt(D:Vd); d2 = d + inc; n = UInt(Rn); m = UInt(Rm);
wback = (m != 15); register_index = (m != 15 && m != 13);
if n == 15 || d2+regs > 32 then UNPREDICTABLE;
```

CONSTRAINED UNPREDICTABLE behavior

If $d2+regs > 32$, then one of the following behaviors must occur:

- The instruction is UNDEFINED.
- The instruction executes as NOP.
- One or more of the SIMD and floating-point registers are UNKNOWN. If the instruction specifies writeback, the base register becomes UNKNOWN. This behavior does not affect any general-purpose registers.

Notes for all encodings

For more information about the CONSTRAINED UNPREDICTABLE behavior of this instruction, see [Appendix K1 Architectural Constraints on UNPREDICTABLE behaviors](#), and particularly [VLD2 \(multiple 2-element structures\)](#) on page K1-6110.

Related encodings: See [Advanced SIMD element or structure load/store on page F3-2922](#) for the T32 instruction set, or [Advanced SIMD element or structure load/store on page F4-2997](#) for the A32 instruction set.

Assembler symbols

- <c> For encoding A1 and A2: see [Standard assembler syntax fields on page F2-2848](#). This encoding must be unconditional.
For encoding T1 and T2: see [Standard assembler syntax fields on page F2-2848](#).
- <q> See [Standard assembler syntax fields on page F2-2848](#).
- <size> Is the data size, encoded in the "size" field. It can have the following values:
8 when size = 00
16 when size = 01
32 when size = 10
The encoding size = 11 is reserved.
- <list> Is a list containing the 64-bit names of the SIMD&FP registers.
The list must be one of:
{ <Dd>, <Dd+1> } Two single-spaced registers. Selects the A1 and T1 encodings of the instruction, and encoded in the "type" field as 0b1000.
{ <Dd>, <Dd+2> } Two double-spaced registers. Selects the A1 and T1 encodings of the instruction, and encoded in the "type" field as 0b1001.
{ <Dd>, <Dd+1>, <Dd+2>, <Dd+3> } Three single-spaced registers. Selects the A2 and T2 encodings of the instruction.
The register <Dd> is encoded in the "D:Vd" field.
- <Rn> Is the general-purpose base register, encoded in the "Rn" field.
- <align> Is the optional alignment.
Whenever <align> is omitted, the standard alignment is used, see [Unaligned data access on page E2-2777](#), and is encoded in the "align" field as 0b00.
Whenever <align> is present, the permitted values are:
64 64-bit alignment, encoded in the "align" field as 0b01.
128 128-bit alignment, encoded in the "align" field as 0b10.
256 256-bit alignment, encoded in the "align" field as 0b11. Available only if <list> contains four registers.

: is the preferred separator before the <align> value, but the alignment can be specified as @<align>, see [The Advanced SIMD addressing mode on page F2-2869](#).

<Rm> Is the general-purpose index register containing an offset applied after the access, encoded in the "Rm" field.

For more information about the variants of this instruction, see [The Advanced SIMD addressing mode on page F2-2869](#).

Operation for all encodings

```
if ConditionPassed() then
    EncodingSpecificOperations(); CheckAdvSIMDEnabled();
    address = R[n]; iswrite = FALSE;
    - = AArch32.CheckAlignment(address, alignment, AccType_VEC, iswrite);
    for r = 0 to regs-1
        for e = 0 to elements-1
            Elem[D[d+r], e] = MemU[address, ebytes];
            Elem[D[d2+r], e] = MemU[address+ebytes, ebytes];
            address = address + 2*ebytes;
    if wback then
        if register_index then
            R[n] = R[n] + R[m];
        else
            R[n] = R[n] + 16*regs;
```

F6.1.91 VLD3 (single 3-element structure to one lane)

Load single 3-element structure to one lane of three registers loads one 3-element structure from memory into corresponding elements of three registers. Elements of the registers that are not loaded are unchanged. For details of the addressing mode see *The Advanced SIMD addressing mode on page F2-2869*.

Depending on settings in the CPACR, NSACR, and HCPTR registers, and the security state and mode in which the instruction is executed, an attempt to execute the instruction might be UNDEFINED, or trapped to Hyp mode. For more information see *Enabling Advanced SIMD and floating-point support on page G1-4413*.

A1

31	30	29	28	27	26	25	24	23	22	21	20	19	16	15	12	11	10	9	8	7	4	3	0
1	1	1	1	0	1	0	0	1	D	1	0	Rn	Vd	0	0	1	0	index_align	Rm				
												size											

Offset variant

Applies when Rm == 1111.

VLD3{<c>}{<q>}.<size> <list>, [<Rn>]

Post-indexed variant

Applies when Rm == 1101.

VLD3{<c>}{<q>}.<size> <list>, [<Rn>]!

Post-indexed variant

Applies when Rm != 11x1.

VLD3{<c>}{<q>}.<size> <list>, [<Rn>], <Rm>

Decode for all variants of this encoding

```

if size == '11' then SEE VLD3 (single 3-element structure to all lanes);
if index_align<0> != '0' then UNDEFINED;
ebytes = 1; index = UInt(index_align<3:1>); inc = 1;
d = UInt(D:Vd); d2 = d + inc; d3 = d2 + inc; n = UInt(Rn); m = UInt(Rm);
wback = (m != 15); register_index = (m != 15 && m != 13);
if n == 15 || d3 > 31 then UNPREDICTABLE;
    
```

CONSTRAINED UNPREDICTABLE behavior

If d3 > 31, then one of the following behaviors must occur:

- The instruction is UNDEFINED.
- The instruction executes as NOP.
- One or more of the SIMD and floating-point registers are UNKNOWN. If the instruction specifies writeback, the base register becomes UNKNOWN. This behavior does not affect any general-purpose registers.

A2

31	30	29	28	27	26	25	24	23	22	21	20	19	16	15	12	11	10	9	8	7	4	3	0
1	1	1	1	0	1	0	0	1	D	1	0	Rn	Vd	0	1	1	0	index_align	Rm				
												size											

Offset variant

Applies when Rm == 1111.

VLD3{<c>}{<q>}.<size> <list>, [<Rn>]

Post-indexed variant

Applies when Rm == 1101.

VLD3{<c>}{<q>}.<size> <list>, [<Rn>]!

Post-indexed variant

Applies when Rm != 11x1.

VLD3{<c>}{<q>}.<size> <list>, [<Rn>], <Rm>

Decode for all variants of this encoding

```

if size == '11' then SEE VLD3 (single 3-element structure to all lanes);
if index_align<0> != '0' then UNDEFINED;
ebytes = 2; index = UInt(index_align<3:2>);
inc = if index_align<1> == '0' then 1 else 2;
d = UInt(D:Vd); d2 = d + inc; d3 = d2 + inc; n = UInt(Rn); m = UInt(Rm);
wback = (m != 15); register_index = (m != 15 && m != 13);
if n == 15 || d3 > 31 then UNPREDICTABLE;
    
```

CONSTRAINED UNPREDICTABLE behavior

If d3 > 31, then one of the following behaviors must occur:

- The instruction is UNDEFINED.
- The instruction executes as NOP.
- One or more of the SIMD and floating-point registers are UNKNOWN. If the instruction specifies writeback, the base register becomes UNKNOWN. This behavior does not affect any general-purpose registers.

A3

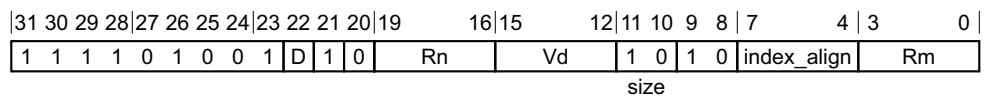

Offset variant

Applies when Rm == 1111.

VLD3{<c>}{<q>}.<size> <list>, [<Rn>]

Post-indexed variant

Applies when Rm == 1101.

VLD3{<c>}{<q>}.<size> <list>, [<Rn>]!

Post-indexed variant

Applies when Rm != 11x1.

VLD3{<c>}{<q>}.<size> <list>, [<Rn>], <Rm>

Decode for all variants of this encoding

```

if size == '11' then SEE VLD3 (single 3-element structure to all lanes);
if index_align<1:0> != '00' then UNDEFINED;
ebytes = 4; index = UInt(index_align<3>);
inc = if index_align<2> == '0' then 1 else 2;
d = UInt(D:Vd); d2 = d + inc; d3 = d2 + inc; n = UInt(Rn); m = UInt(Rm);
wback = (m != 15); register_index = (m != 15 && m != 13);
if n == 15 || d3 > 31 then UNPREDICTABLE;
    
```

CONSTRAINED UNPREDICTABLE behavior

If $d3 > 31$, then one of the following behaviors must occur:

- The instruction is UNDEFINED.
- The instruction executes as NOP.
- One or more of the SIMD and floating-point registers are UNKNOWN. If the instruction specifies writeback, the base register becomes UNKNOWN. This behavior does not affect any general-purpose registers.

T1

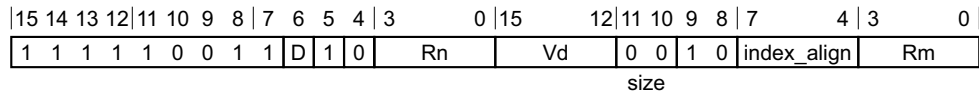

Offset variant

Applies when $Rm == 1111$.

VLD3{<c>}{<q>}.<size> <list>, [<Rn>]

Post-indexed variant

Applies when $Rm == 1101$.

VLD3{<c>}{<q>}.<size> <list>, [<Rn>]!

Post-indexed variant

Applies when $Rm != 11x1$.

VLD3{<c>}{<q>}.<size> <list>, [<Rn>], <Rm>

Decode for all variants of this encoding

```

if size == '11' then SEE VLD3 (single 3-element structure to all lanes);
if index_align<0> != '0' then UNDEFINED;
ebytes = 1; index = UInt(index_align<3:1>); inc = 1;
d = UInt(D:Vd); d2 = d + inc; d3 = d2 + inc; n = UInt(Rn); m = UInt(Rm);
wback = (m != 15); register_index = (m != 15 && m != 13);
if n == 15 || d3 > 31 then UNPREDICTABLE;
    
```

CONSTRAINED UNPREDICTABLE behavior

If $d3 > 31$, then one of the following behaviors must occur:

- The instruction is UNDEFINED.
- The instruction executes as NOP.
- One or more of the SIMD and floating-point registers are UNKNOWN. If the instruction specifies writeback, the base register becomes UNKNOWN. This behavior does not affect any general-purpose registers.

T2

15	14	13	12	11	10	9	8	7	6	5	4	3	0	15	12	11	10	9	8	7	4	3	0
1	1	1	1	1	0	0	1	1	D	1	0	Rn	Vd	0	1	1	0	index_align	Rm				
size																							

Offset variant

Applies when Rm == 1111.

VLD3{<c>}{<q>}.<size> <list>, [<Rn>]

Post-indexed variant

Applies when Rm == 1101.

VLD3{<c>}{<q>}.<size> <list>, [<Rn>]!

Post-indexed variant

Applies when Rm != 11x1.

VLD3{<c>}{<q>}.<size> <list>, [<Rn>], <Rm>

Decode for all variants of this encoding

```

if size == '11' then SEE VLD3 (single 3-element structure to all lanes);
if index_align<0> != '0' then UNDEFINED;
ebytes = 2; index = UInt(index_align<3:2>);
inc = if index_align<1> == '0' then 1 else 2;
d = UInt(D:Vd); d2 = d + inc; d3 = d2 + inc; n = UInt(Rn); m = UInt(Rm);
wback = (m != 15); register_index = (m != 15 && m != 13);
if n == 15 || d3 > 31 then UNPREDICTABLE;
    
```

CONSTRAINED UNPREDICTABLE behavior

If d3 > 31, then one of the following behaviors must occur:

- The instruction is UNDEFINED.
- The instruction executes as NOP.
- One or more of the SIMD and floating-point registers are UNKNOWN. If the instruction specifies writeback, the base register becomes UNKNOWN. This behavior does not affect any general-purpose registers.

T3

15	14	13	12	11	10	9	8	7	6	5	4	3	0	15	12	11	10	9	8	7	4	3	0
1	1	1	1	1	0	0	1	1	D	1	0	Rn	Vd	1	0	1	0	index_align	Rm				
size																							

Offset variant

Applies when Rm == 1111.

VLD3{<c>}{<q>}.<size> <list>, [<Rn>]

Post-indexed variant

Applies when Rm == 1101.

VLD3{<c>}{<q>}.<size> <list>, [<Rn>]!

Post-indexed variant

Applies when $Rm \neq 11x1$.

VLD3{<c>}{<q>}.<size> <list>, [<Rn>], <Rm>

Decode for all variants of this encoding

```

if size == '11' then SEE VLD3 (single 3-element structure to all lanes);
if index_align<1:0> != '00' then UNDEFINED;
ebytes = 4; index = UInt(index_align<3>);
inc = if index_align<2> == '0' then 1 else 2;
d = UInt(D:Vd); d2 = d + inc; d3 = d2 + inc; n = UInt(Rn); m = UInt(Rm);
wback = (m != 15); register_index = (m != 15 && m != 13);
if n == 15 || d3 > 31 then UNPREDICTABLE;
  
```

CONSTRAINED UNPREDICTABLE behavior

If $d3 > 31$, then one of the following behaviors must occur:

- The instruction is UNDEFINED.
- The instruction executes as NOP.
- One or more of the SIMD and floating-point registers are UNKNOWN. If the instruction specifies writeback, the base register becomes UNKNOWN. This behavior does not affect any general-purpose registers.

Notes for all encodings

For more information about the CONSTRAINED UNPREDICTABLE behavior of this instruction, see [Appendix K1 Architectural Constraints on UNPREDICTABLE behaviors](#), and particularly *VLD3 (single 3-element structure to one lane)* on page K1-6111.

Assembler symbols

<c>	For encoding A1, A2 and A3: see Standard assembler syntax fields on page F2-2848. This encoding must be unconditional. For encoding T1, T2 and T3: see Standard assembler syntax fields on page F2-2848.
<q>	See Standard assembler syntax fields on page F2-2848.
<size>	Is the data size, encoded in the "size" field. It can have the following values: 8 when size = 00 16 when size = 01 32 when size = 10
<list>	Is a list containing the 64-bit names of the three SIMD&FP registers holding the element. The list must be one of: { <Dd>[<index>], <Dd+1>[<index>], <Dd+2>[<index>] } Single-spaced registers, encoded as "spacing" = 0. { <Dd>[<index>], <Dd+2>[<index>], <Dd+4>[<index>] } Double-spaced registers, encoded as "spacing" = 1. Not permitted when <size> == 8. The encoding of "spacing" depends on <size>: <size> == 8 "spacing" is encoded in the "index_align<0>" field. <size> == 16 "spacing" is encoded in the "index_align<1>" field, and "index_align<0>" is set to 0. <size> == 32 "spacing" is encoded in the "index_align<2>" field, and "index_align<1:0>" is set to 0b00.

The register <Dd> is encoded in the "D:Vd" field.

The permitted values and encoding of <index> depend on <size>:

<size> == 8 <index> is in the range 0 to 7, encoded in the "index_align<3:1>" field.
<size> == 16 <index> is in the range 0 to 3, encoded in the "index_align<3:2>" field.
<size> == 32 <index> is 0 or 1, encoded in the "index_align<3>" field.

<Rn> Is the general-purpose base register, encoded in the "Rn" field.

<Rm> Is the general-purpose index register containing an offset applied after the access, encoded in the "Rm" field.

For more information about the variants of this instruction, see [The Advanced SIMD addressing mode on page F2-2869](#).

Alignment

Standard alignment rules apply, see [Alignment support on page B2-102](#).

Operation for all encodings

```
if ConditionPassed() then
    EncodingSpecificOperations(); CheckAdvSIMDEnabled();
    address = R[n];
    Elem[D[d], index] = MemU[address,ebytes];
    Elem[D[d2],index] = MemU[address+ebytes,ebytes];
    Elem[D[d3],index] = MemU[address+2*ebytes,ebytes];
    if wback then
        if register_index then
            R[n] = R[n] + R[m];
        else
            R[n] = R[n] + 3*ebytes;
```

F6.1.92 VLD3 (single 3-element structure to all lanes)

Load single 3-element structure and replicate to all lanes of three registers loads one 3-element structure from memory into all lanes of three registers. For details of the addressing mode see *The Advanced SIMD addressing mode* on page F2-2869.

Depending on settings in the CPACR, NSACR, and HCPTR registers, and the security state and mode in which the instruction is executed, an attempt to execute the instruction might be UNDEFINED, or trapped to Hyp mode. For more information see *Enabling Advanced SIMD and floating-point support* on page G1-4413.

A1

31	30	29	28	27	26	25	24	23	22	21	20	19	16	15	12	11	10	9	8	7	6	5	4	3	0
1	1	1	1	0	1	0	0	1	D	1	0	Rn	Vd	1	1	1	0	size	T	0	Rm				

a

Offset variant

Applies when Rm == 1111.

VLD3{<c>}{<q>}.<size> <list>, [<Rn>]

Post-indexed variant

Applies when Rm == 1101.

VLD3{<c>}{<q>}.<size> <list>, [<Rn>]!

Post-indexed variant

Applies when Rm != 11x1.

VLD3{<c>}{<q>}.<size> <list>, [<Rn>], <Rm>

Decode for all variants of this encoding

```

if size == '11' || a == '1' then UNDEFINED;
ebytes = 1 << UInt(size);
inc = if T == '0' then 1 else 2;
d = UInt(D:Vd); d2 = d + inc; d3 = d2 + inc; n = UInt(Rn); m = UInt(Rm);
wback = (m != 15); register_index = (m != 15 && m != 13);
if n == 15 || d3 > 31 then UNPREDICTABLE;
    
```

CONSTRAINED UNPREDICTABLE behavior

If d3 > 31, then one of the following behaviors must occur:

- The instruction is UNDEFINED.
- The instruction executes as NOP.
- One or more of the SIMD and floating-point registers are UNKNOWN. If the instruction specifies writeback, the base register becomes UNKNOWN. This behavior does not affect any general-purpose registers.

T1

15	14	13	12	11	10	9	8	7	6	5	4	3	0	15	12	11	10	9	8	7	6	5	4	3	0
1	1	1	1	1	0	0	1	1	D	1	0	Rn	Vd	1	1	1	0	size	T	0	Rm				

a

Offset variant

Applies when Rm == 1111.

VLD3{<c>}{<q>}.<size> <list>, [<Rn>]

Post-indexed variant

Applies when Rm == 1101.

VLD3{<c>}{<q>}.<size> <list>, [<Rn>]!

Post-indexed variant

Applies when Rm != 11x1.

VLD3{<c>}{<q>}.<size> <list>, [<Rn>], <Rm>

Decode for all variants of this encoding

```
if size == '11' || a == '1' then UNDEFINED;
ebytes = 1 << UInt(size);
inc = if T == '0' then 1 else 2;
d = UInt(D:Vd); d2 = d + inc; d3 = d2 + inc; n = UInt(Rn); m = UInt(Rm);
wback = (m != 15); register_index = (m != 15 && m != 13);
if n == 15 || d3 > 31 then UNPREDICTABLE;
```

CONSTRAINED UNPREDICTABLE behavior

If d3 > 31, then one of the following behaviors must occur:

- The instruction is UNDEFINED.
- The instruction executes as NOP.
- One or more of the SIMD and floating-point registers are UNKNOWN. If the instruction specifies writeback, the base register becomes UNKNOWN. This behavior does not affect any general-purpose registers.

Notes for all encodings

For more information about the CONSTRAINED UNPREDICTABLE behavior of this instruction, see [Appendix K1 Architectural Constraints on UNPREDICTABLE behaviors](#), and particularly *VLD3 (single 3-element structure to all lanes)* on page K1-6111.

Assembler symbols

- <c> For encoding A1: see [Standard assembler syntax fields on page F2-2848](#). This encoding must be unconditional.
 For encoding T1: see [Standard assembler syntax fields on page F2-2848](#).
- <q> See [Standard assembler syntax fields on page F2-2848](#).
- <size> Is the data size, encoded in the "size" field. It can have the following values:
 - 8 when size = 00
 - 16 when size = 01
 - 32 when size = 10
 The encoding size = 11 is reserved.
- <list> Is a list containing the 64-bit names of three SIMD&FP registers.
 The list must be one of:
 { <Dd>[], <Dd+1>[], <Dd+2>[] }
 Single-spaced registers, encoded in the "T" field as 0.

{ <Dd>[], <Dd+2>[], <Dd+4>[] }

Double-spaced registers, encoded in the "T" field as 1.

The register <Dd> is encoded in the "D:Vd" field.

<Rn> Is the general-purpose base register, encoded in the "Rn" field.

<Rm> Is the general-purpose index register containing an offset applied after the access, encoded in the "Rm" field.

For more information about the variants of this instruction, see [The Advanced SIMD addressing mode on page F2-2869](#).

Alignment

Standard alignment rules apply, see [Alignment support on page B2-102](#).

Operation for all encodings

```
if ConditionPassed() then
    EncodingSpecificOperations(); CheckAdvSIMDEnabled();
    address = R[n];
    D[d] = Replicate(MemU[address,ebytes]);
    D[d2] = Replicate(MemU[address+ebytes,ebytes]);
    D[d3] = Replicate(MemU[address+2*ebytes,ebytes]);
    if wback then
        if register_index then
            R[n] = R[n] + R[m];
        else
            R[n] = R[n] + 3*ebytes;
```

F6.1.93 VLD3 (multiple 3-element structures)

Load multiple 3-element structures to three registers loads multiple 3-element structures from memory into three registers, with de-interleaving. For more information, see *Element and structure load/store instructions* on page F1-2829. Every element of each register is loaded. For details of the addressing mode see *The Advanced SIMD addressing mode* on page F2-2869.

Depending on settings in the CPACR, NSACR, and HCPTR registers, and the security state and mode in which the instruction is executed, an attempt to execute the instruction might be UNDEFINED, or trapped to Hyp mode. For more information see *Enabling Advanced SIMD and floating-point support* on page G1-4413.

A1

31	30	29	28	27	26	25	24	23	22	21	20	19	16	15	12	11	8	7	6	5	4	3	0
1	1	1	1	0	1	0	0	0	D	1	0	Rn	Vd	0	1	0	x	size	align	Rm			

type

Offset variant

Applies when Rm == 1111.

VLD3{<c>}{<q>}.<size> <list>, [<Rn>{:<align>}]

Post-indexed variant

Applies when Rm == 1101.

VLD3{<c>}{<q>}.<size> <list>, [<Rn>{:<align>}]!

Post-indexed variant

Applies when Rm != 11x1.

VLD3{<c>}{<q>}.<size> <list>, [<Rn>{:<align>}], <Rm>

Decode for all variants of this encoding

```

case type of
  when '0100'
    inc = 1;
  when '0101'
    inc = 2;
  otherwise
    SEE "Related encodings";
if size == '11' || align<1> == '1' then UNDEFINED;
alignment = if align<0> == '0' then 1 else 8;
ebytes = 1 << UInt(size); elements = 8 DIV ebytes;
d = UInt(D:Vd); d2 = d + inc; d3 = d2 + inc; n = UInt(Rn); m = UInt(Rm);
wback = (m != 15); register_index = (m != 15 && m != 13);
if n == 15 || d3 > 31 then UNPREDICTABLE;
    
```

CONSTRAINED UNPREDICTABLE behavior

If d3 > 31, then one of the following behaviors must occur:

- The instruction is UNDEFINED.
- The instruction executes as NOP.
- One or more of the SIMD and floating-point registers are UNKNOWN. If the instruction specifies writeback, the base register becomes UNKNOWN. This behavior does not affect any general-purpose registers.

T1

15	14	13	12	11	10	9	8	7	6	5	4	3	0	15	12	11	8	7	6	5	4	3	0
1	1	1	1	1	0	0	1	0	D	1	0	Rn	Vd	0	1	0	x	size	align	Rm	type		

Offset variant

Applies when Rm == 1111.

VLD3{<c>}{<q>}.<size> <list>, [<Rn>{:<align>}]

Post-indexed variant

Applies when Rm == 1101.

VLD3{<c>}{<q>}.<size> <list>, [<Rn>{:<align>}]!

Post-indexed variant

Applies when Rm != 11x1.

VLD3{<c>}{<q>}.<size> <list>, [<Rn>{:<align>}], <Rm>

Decode for all variants of this encoding

```

case type of
  when '0100'
    inc = 1;
  when '0101'
    inc = 2;
  otherwise
    SEE "Related encodings";
if size == '11' || align<1> == '1' then UNDEFINED;
alignment = if align<0> == '0' then 1 else 8;
ebytes = 1 << UInt(size); elements = 8 DIV ebytes;
d = UInt(D:Vd); d2 = d + inc; d3 = d2 + inc; n = UInt(Rn); m = UInt(Rm);
wback = (m != 15); register_index = (m != 15 && m != 13);
if n == 15 || d3 > 31 then UNPREDICTABLE;
  
```

CONSTRAINED UNPREDICTABLE behavior

If d3 > 31, then one of the following behaviors must occur:

- The instruction is UNDEFINED.
- The instruction executes as NOP.
- One or more of the SIMD and floating-point registers are UNKNOWN. If the instruction specifies writeback, the base register becomes UNKNOWN. This behavior does not affect any general-purpose registers.

Notes for all encodings

For more information about the CONSTRAINED UNPREDICTABLE behavior of this instruction, see [Appendix K1 Architectural Constraints on UNPREDICTABLE behaviors](#), and particularly [VLD3 \(multiple 3-element structures\) on page K1-6111](#).

Related encodings: See [Advanced SIMD element or structure load/store on page F3-2922](#) for the T32 instruction set, or [Advanced SIMD element or structure load/store on page F4-2997](#) for the A32 instruction set.

Assembler symbols

- <c> For encoding A1: see [Standard assembler syntax fields on page F2-2848](#). This encoding must be unconditional.
 For encoding T1: see [Standard assembler syntax fields on page F2-2848](#).
- <q> See [Standard assembler syntax fields on page F2-2848](#).
- <size> Is the data size, encoded in the "size" field. It can have the following values:
 8 when size = 00
 16 when size = 01
 32 when size = 10
 The encoding size = 11 is reserved.
- <list> Is a list containing the 64-bit names of the SIMD&FP registers.
 The list must be one of:
 { <Dd>, <Dd+1>, <Dd+2> }
 Single-spaced registers, encoded in the "type" field as 0b0100.
 { <Dd>, <Dd+2>, <Dd+4> }
 Double-spaced registers, encoded in the "type" field as 0b0101.
 The register <Dd> is encoded in the "D:Vd" field.
- <Rn> Is the general-purpose base register, encoded in the "Rn" field.
- <align> Is the optional alignment.
 Whenever <align> is omitted, the standard alignment is used, see [Unaligned data access on page E2-2777](#), and is encoded in the "align" field as 0b00.
 Whenever <align> is present, the only permitted values is 64, meaning 64-bit alignment, encoded in the "align" field as 0b01.
 : is the preferred separator before the <align> value, but the alignment can be specified as @<align>, see [The Advanced SIMD addressing mode on page F2-2869](#).
- <Rm> Is the general-purpose index register containing an offset applied after the access, encoded in the "Rm" field.
- For more information about <Rn>, !, and <Rm>, see [The Advanced SIMD addressing mode on page F2-2869](#).

Operation for all encodings

```

if ConditionPassed() then
    EncodingSpecificOperations(); CheckAdvSIMDEnabled();
    address = R[n]; iswrite = FALSE;
    - = AArch32.CheckAlignment(address, alignment, AccType_VEC, iswrite);
    for e = 0 to elements-1
        Elem[D[d], e] = MemU[address,ebytes];
        Elem[D[d2],e] = MemU[address+ebytes,ebytes];
        Elem[D[d3],e] = MemU[address+2*ebytes,ebytes];
        address = address + 3*ebytes;
    if wback then
        if register_index then
            R[n] = R[n] + R[m];
        else
            R[n] = R[n] + 24;
  
```

F6.1.94 VLD4 (single 4-element structure to one lane)

Load single 4-element structure to one lane of four registers loads one 4-element structure from memory into corresponding elements of four registers. Elements of the registers that are not loaded are unchanged. For details of the addressing mode see *The Advanced SIMD addressing mode on page F2-2869*.

Depending on settings in the CPACR, NSACR, and HCPTR registers, and the security state and mode in which the instruction is executed, an attempt to execute the instruction might be UNDEFINED, or trapped to Hyp mode. For more information see *Enabling Advanced SIMD and floating-point support on page G1-4413*.

A1

31	30	29	28	27	26	25	24	23	22	21	20	19	16	15	12	11	10	9	8	7	4	3	0
1	1	1	1	0	1	0	0	1	D	1	0	Rn	Vd	0	0	1	1	index_align	Rm				
												size											

Offset variant

Applies when Rm == 1111.

VLD4{<c>}{<q>}.<size> <list>, [<Rn>{:<align>}]

Post-indexed variant

Applies when Rm == 1101.

VLD4{<c>}{<q>}.<size> <list>, [<Rn>{:<align>}]!

Post-indexed variant

Applies when Rm != 11x1.

VLD4{<c>}{<q>}.<size> <list>, [<Rn>{:<align>}], <Rm>

Decode for all variants of this encoding

```

if size == '11' then SEE VLD4 (single 4-element structure to all lanes);
ebytes = 1; index = UInt(index_align<3:1>); inc = 1;
alignment = if index_align<0> == '0' then 1 else 4;
d = UInt(D:Vd); d2 = d + inc; d3 = d2 + inc; d4 = d3 + inc; n = UInt(Rn); m = UInt(Rm);
wback = (m != 15); register_index = (m != 15 && m != 13);
if n == 15 || d4 > 31 then UNPREDICTABLE;
    
```

CONSTRAINED UNPREDICTABLE behavior

If d4 > 31, then one of the following behaviors must occur:

- The instruction is UNDEFINED.
- The instruction executes as NOP.
- One or more of the SIMD and floating-point registers are UNKNOWN. If the instruction specifies writeback, the base register becomes UNKNOWN. This behavior does not affect any general-purpose registers.

A2

31	30	29	28	27	26	25	24	23	22	21	20	19	16	15	12	11	10	9	8	7	4	3	0
1	1	1	1	0	1	0	0	1	D	1	0	Rn	Vd	0	1	1	1	index_align	Rm				
												size											

Offset variant

Applies when Rm == 1111.

VLD4{<c>}{<q>}.<size> <list>, [<Rn>{:<align>}]

Post-indexed variant

Applies when Rm == 1101.

VLD4{<c>}{<q>}.<size> <list>, [<Rn>{:<align>}]!

Post-indexed variant

Applies when Rm != 11x1.

VLD4{<c>}{<q>}.<size> <list>, [<Rn>{:<align>}], <Rm>

Decode for all variants of this encoding

```
if size == '11' then SEE VLD4 (single 4-element structure to all lanes);
ebytes = 2; index = UInt(index_align<3:2>);
inc = if index_align<1> == '0' then 1 else 2;
alignment = if index_align<0> == '0' then 1 else 8;
d = UInt(D:Vd); d2 = d + inc; d3 = d2 + inc; d4 = d3 + inc; n = UInt(Rn); m = UInt(Rm);
wback = (m != 15); register_index = (m != 15 && m != 13);
if n == 15 || d4 > 31 then UNPREDICTABLE;
```

CONSTRAINED UNPREDICTABLE behavior

If d4 > 31, then one of the following behaviors must occur:

- The instruction is UNDEFINED.
- The instruction executes as NOP.
- One or more of the SIMD and floating-point registers are UNKNOWN. If the instruction specifies writeback, the base register becomes UNKNOWN. This behavior does not affect any general-purpose registers.

A3

31	30	29	28	27	26	25	24	23	22	21	20	19	16	15	12	11	10	9	8	7	4	3	0
1	1	1	1	0	0	1	0	0	1	D	1	0	Rn	Vd	1	0	1	1	index_align	Rm			

size

Offset variant

Applies when Rm == 1111.

VLD4{<c>}{<q>}.<size> <list>, [<Rn>{:<align>}]

Post-indexed variant

Applies when Rm == 1101.

VLD4{<c>}{<q>}.<size> <list>, [<Rn>{:<align>}]!

Post-indexed variant

Applies when Rm != 11x1.

VLD4{<c>}{<q>}.<size> <list>, [<Rn>{:<align>}], <Rm>

Decode for all variants of this encoding

```

if size == '11' then SEE VLD4 (single 4-element structure to all lanes);
if index_align<1:0> == '11' then UNDEFINED;
ebytes = 4; index = UInt(index_align<3>);
inc = if index_align<2> == '0' then 1 else 2;
alignment = if index_align<1:0> == '00' then 1 else 4 << UInt(index_align<1:0>);
d = UInt(D:Vd); d2 = d + inc; d3 = d2 + inc; d4 = d3 + inc; n = UInt(Rn); m = UInt(Rm);
wback = (m != 15); register_index = (m != 15 && m != 13);
if n == 15 || d4 > 31 then UNPREDICTABLE;
    
```

CONSTRAINED UNPREDICTABLE behavior

If $d4 > 31$, then one of the following behaviors must occur:

- The instruction is UNDEFINED.
- The instruction executes as NOP.
- One or more of the SIMD and floating-point registers are UNKNOWN. If the instruction specifies writeback, the base register becomes UNKNOWN. This behavior does not affect any general-purpose registers.

T1

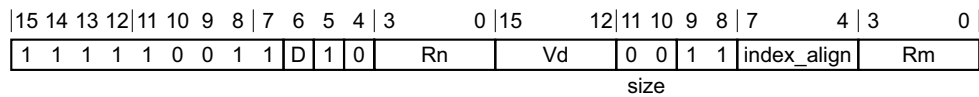

Offset variant

Applies when $Rm == 1111$.

VLD4{<c>}{<q>}.<size> <list>, [<Rn>{:<align>}]

Post-indexed variant

Applies when $Rm == 1101$.

VLD4{<c>}{<q>}.<size> <list>, [<Rn>{:<align>}]!

Post-indexed variant

Applies when $Rm != 11x1$.

VLD4{<c>}{<q>}.<size> <list>, [<Rn>{:<align>}], <Rm>

Decode for all variants of this encoding

```

if size == '11' then SEE VLD4 (single 4-element structure to all lanes);
ebytes = 1; index = UInt(index_align<3:1>); inc = 1;
alignment = if index_align<0> == '0' then 1 else 4;
d = UInt(D:Vd); d2 = d + inc; d3 = d2 + inc; d4 = d3 + inc; n = UInt(Rn); m = UInt(Rm);
wback = (m != 15); register_index = (m != 15 && m != 13);
if n == 15 || d4 > 31 then UNPREDICTABLE;
    
```

CONSTRAINED UNPREDICTABLE behavior

If $d4 > 31$, then one of the following behaviors must occur:

- The instruction is UNDEFINED.
- The instruction executes as NOP.
- One or more of the SIMD and floating-point registers are UNKNOWN. If the instruction specifies writeback, the base register becomes UNKNOWN. This behavior does not affect any general-purpose registers.

T2

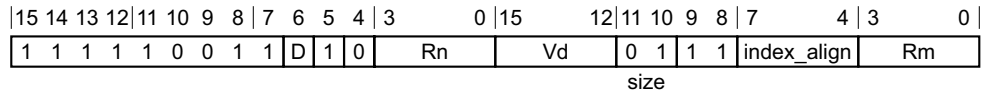

Offset variant

Applies when Rm == 1111.

VLD4{<c>}{<q>}.<size> <list>, [<Rn>{:<align>}]

Post-indexed variant

Applies when Rm == 1101.

VLD4{<c>}{<q>}.<size> <list>, [<Rn>{:<align>}]!

Post-indexed variant

Applies when Rm != 11x1.

VLD4{<c>}{<q>}.<size> <list>, [<Rn>{:<align>}], <Rm>

Decode for all variants of this encoding

```

if size == '11' then SEE VLD4 (single 4-element structure to all lanes);
ebytes = 2; index = UInt(index_align<3:2>);
inc = if index_align<1> == '0' then 1 else 2;
alignment = if index_align<0> == '0' then 1 else 8;
d = UInt(D:Vd); d2 = d + inc; d3 = d2 + inc; d4 = d3 + inc; n = UInt(Rn); m = UInt(Rm);
wback = (m != 15); register_index = (m != 15 && m != 13);
if n == 15 || d4 > 31 then UNPREDICTABLE;
    
```

CONSTRAINED UNPREDICTABLE behavior

If d4 > 31, then one of the following behaviors must occur:

- The instruction is UNDEFINED.
- The instruction executes as NOP.
- One or more of the SIMD and floating-point registers are UNKNOWN. If the instruction specifies writeback, the base register becomes UNKNOWN. This behavior does not affect any general-purpose registers.

T3

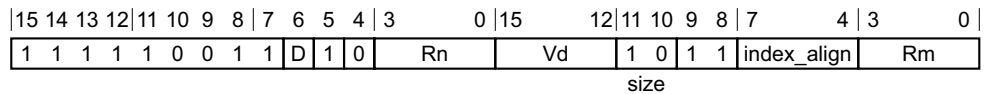

Offset variant

Applies when Rm == 1111.

VLD4{<c>}{<q>}.<size> <list>, [<Rn>{:<align>}]

Post-indexed variant

Applies when Rm == 1101.

VLD4{<c>}{<q>}.<size> <list>, [<Rn>{:<align>}]!

Post-indexed variant

Applies when $Rm \neq 11x1$.

$VLD4\{<c>\}\{<q>\}.<size> <list>, [<Rn\{:<align>\}], <Rm>$

Decode for all variants of this encoding

```

if size == '11' then SEE VLD4 (single 4-element structure to all lanes);
if index_align<1:0> == '11' then UNDEFINED;
ebytes = 4; index = UInt(index_align<3>);
inc = if index_align<2> == '0' then 1 else 2;
alignment = if index_align<1:0> == '00' then 1 else 4 << UInt(index_align<1:0>);
d = UInt(D:Vd); d2 = d + inc; d3 = d2 + inc; d4 = d3 + inc; n = UInt(Rn); m = UInt(Rm);
wback = (m != 15); register_index = (m != 15 && m != 13);
if n == 15 || d4 > 31 then UNPREDICTABLE;
  
```

CONSTRAINED UNPREDICTABLE behavior

If $d4 > 31$, then one of the following behaviors must occur:

- The instruction is UNDEFINED.
- The instruction executes as NOP.
- One or more of the SIMD and floating-point registers are UNKNOWN. If the instruction specifies writeback, the base register becomes UNKNOWN. This behavior does not affect any general-purpose registers.

Notes for all encodings

For more information about the CONSTRAINED UNPREDICTABLE behavior of this instruction, see [Appendix K1 Architectural Constraints on UNPREDICTABLE behaviors](#), and particularly *VLD4 (single 4-element structure to one lane)* on page K1-6111.

Assembler symbols

$<c>$	For encoding A1, A2 and A3: see <i>Standard assembler syntax fields</i> on page F2-2848. This encoding must be unconditional. For encoding T1, T2 and T3: see <i>Standard assembler syntax fields</i> on page F2-2848.
$<q>$	See <i>Standard assembler syntax fields</i> on page F2-2848.
$<size>$	Is the data size, encoded in the "size" field. It can have the following values: 8 when size = 00 16 when size = 01 32 when size = 10
$<list>$	Is a list containing the 64-bit names of the four SIMD&FP registers holding the element. The list must be one of: { <Dd>[<index>], <Dd+1>[<index>], <Dd+2>[<index>], <Dd+3>[<index>] } Single-spaced registers, encoded as "spacing" = 0. { <Dd>[<index>], <Dd+2>[<index>], <Dd+4>[<index>], <Dd+6>[<index>] } Double-spaced registers, encoded as "spacing" = 1. Not permitted when $<size> == 8$. The encoding of "spacing" depends on $<size>$: $<size> == 16$ "spacing" is encoded in the "index_align<1>" field. $<size> == 32$ "spacing" is encoded in the "index_align<2>" field. The register <Dd> is encoded in the "D:Vd" field.

The permitted values and encoding of <index> depend on <size>:

- <size> == 8 <index> is in the range 0 to 7, encoded in the "index_align<3:1>" field.
- <size> == 16 <index> is in the range 0 to 3, encoded in the "index_align<3:2>" field.
- <size> == 32 <index> is 0 or 1, encoded in the "index_align<3>" field.

<Rn> Is the general-purpose base register, encoded in the "Rn" field.

<align> Is the optional alignment.

Whenever <align> is omitted, the standard alignment is used, see [Unaligned data access on page E2-2777](#), and the encoding depends on <size>:

- <size> == 8 Encoded in the "index_align<0>" field as 0.
- <size> == 16 Encoded in the "index_align<0>" field as 0.
- <size> == 32 Encoded in the "index_align<1:0>" field as 0b00.

Whenever <align> is present, the permitted values and encoding depend on <size>:

- <size> == 8 <align> is 32, meaning 32-bit alignment, encoded in the "index_align<0>" field as 1.
- <size> == 16 <align> is 64, meaning 64-bit alignment, encoded in the "index_align<0>" field as 1.
- <size> == 32 <align> can be 64 or 128. 64-bit alignment is encoded in the "index_align<1:0>" field as 0b01, and 128-bit alignment is encoded in the "index_align<1:0>" field as 0b10.

: is the preferred separator before the <align> value, but the alignment can be specified as @<align>, see [The Advanced SIMD addressing mode on page F2-2869](#).

<Rm> Is the general-purpose index register containing an offset applied after the access, encoded in the "Rm" field.

For more information about the variants of this instruction, see [The Advanced SIMD addressing mode on page F2-2869](#).

Operation for all encodings

```

if ConditionPassed() then
    EncodingSpecificOperations(); CheckAdvSIMDEnabled();
    address = R[n]; iswrite = FALSE;
    - = AArch32.CheckAlignment(address, alignment, AccType_VEC, iswrite);
    Elem[D[d], index] = MemU[address,ebytes];
    Elem[D[d2], index] = MemU[address+ebytes,ebytes];
    Elem[D[d3], index] = MemU[address+2*ebytes,ebytes];
    Elem[D[d4], index] = MemU[address+3*ebytes,ebytes];
    if wback then
        if register_index then
            R[n] = R[n] + R[m];
        else
            R[n] = R[n] + 4*ebytes;
  
```

F6.1.95 VLD4 (single 4-element structure to all lanes)

Load single 4-element structure and replicate to all lanes of four registers loads one 4-element structure from memory into all lanes of four registers. For details of the addressing mode see *The Advanced SIMD addressing mode* on page F2-2869.

Depending on settings in the CPACR, NSACR, and HCPTR registers, and the security state and mode in which the instruction is executed, an attempt to execute the instruction might be UNDEFINED, or trapped to Hyp mode. For more information see *Enabling Advanced SIMD and floating-point support* on page G1-4413.

A1

31	30	29	28	27	26	25	24	23	22	21	20	19	16	15	12	11	10	9	8	7	6	5	4	3	0
1	1	1	1	0	1	0	0	1	D	1	0	Rn	Vd	1	1	1	1	size	T	a	Rm				

Offset variant

Applies when Rm == 1111.

VLD4{<c>}{<q>}.<size> <list>, [<Rn>{:<align>}]

Post-indexed variant

Applies when Rm == 1101.

VLD4{<c>}{<q>}.<size> <list>, [<Rn>{:<align>}]!

Post-indexed variant

Applies when Rm != 11x1.

VLD4{<c>}{<q>}.<size> <list>, [<Rn>{:<align>}],<Rm>

Decode for all variants of this encoding

```

if size == '11' && a == '0' then UNDEFINED;
if size == '11' then
    ebytes = 4; alignment = 16;
else
    ebytes = 1 << UInt(size);
    if size == '10' then
        alignment = if a == '0' then 1 else 8;
    else
        alignment = if a == '0' then 1 else 4*ebytes;
inc = if T == '0' then 1 else 2;
d = UInt(D:Vd); d2 = d + inc; d3 = d2 + inc; d4 = d3 + inc; n = UInt(Rn); m = UInt(Rm);
wback = (m != 15); register_index = (m != 15 && m != 13);
if n == 15 || d4 > 31 then UNPREDICTABLE;
    
```

CONSTRAINED UNPREDICTABLE behavior

If d4 > 31, then one of the following behaviors must occur:

- The instruction is UNDEFINED.
- The instruction executes as NOP.
- One or more of the SIMD and floating-point registers are UNKNOWN. If the instruction specifies writeback, the base register becomes UNKNOWN. This behavior does not affect any general-purpose registers.

T1

15	14	13	12	11	10	9	8	7	6	5	4	3	0	15	12	11	10	9	8	7	6	5	4	3	0
1	1	1	1	1	0	0	1	1	D	1	0	Rn	Vd	1	1	1	1	size	T	a	Rm				

Offset variant

Applies when Rm == 1111.

VLD4{<c>}{<q>}.<size> <list>, [<Rn>{:<align>}]

Post-indexed variant

Applies when Rm == 1101.

VLD4{<c>}{<q>}.<size> <list>, [<Rn>{:<align>}]!

Post-indexed variant

Applies when Rm != 11x1.

VLD4{<c>}{<q>}.<size> <list>, [<Rn>{:<align>}], <Rm>

Decode for all variants of this encoding

```

if size == '11' && a == '0' then UNDEFINED;
if size == '11' then
    ebytes = 4; alignment = 16;
else
    ebytes = 1 << UInt(size);
    if size == '10' then
        alignment = if a == '0' then 1 else 8;
    else
        alignment = if a == '0' then 1 else 4*ebytes;
inc = if T == '0' then 1 else 2;
d = UInt(D:Vd); d2 = d + inc; d3 = d2 + inc; d4 = d3 + inc; n = UInt(Rn); m = UInt(Rm);
wback = (m != 15); register_index = (m != 15 && m != 13);
if n == 15 || d4 > 31 then UNPREDICTABLE;
  
```

CONSTRAINED UNPREDICTABLE behavior

If d4 > 31, then one of the following behaviors must occur:

- The instruction is UNDEFINED.
- The instruction executes as NOP.
- One or more of the SIMD and floating-point registers are UNKNOWN. If the instruction specifies writeback, the base register becomes UNKNOWN. This behavior does not affect any general-purpose registers.

Notes for all encodings

For more information about the CONSTRAINED UNPREDICTABLE behavior of this instruction, see [Appendix K1 Architectural Constraints on UNPREDICTABLE behaviors](#), and particularly *VLD4 (single 4-element structure to all lanes)* on page K1-6112.

Assembler symbols

- <c> For encoding A1: see [Standard assembler syntax fields on page F2-2848](#). This encoding must be unconditional.
- For encoding T1: see [Standard assembler syntax fields on page F2-2848](#).

- <q> See [Standard assembler syntax fields on page F2-2848](#).
- <size> Is the data size, encoded in the "size" field. It can have the following values:
- | | |
|----|----------------|
| 8 | when size = 00 |
| 16 | when size = 01 |
| 32 | when size = 1x |
- <list> Is a list containing the 64-bit names of four SIMD&FP registers.
 The list must be one of:
- { <Dd>[], <Dd+1>[], <Dd+2>[], <Dd+3>[] }
 Single-spaced registers, encoded in the "T" field as 0.
- { <Dd>[], <Dd+2>[], <Dd+4>[], <Dd+6>[] }
 Double-spaced registers, encoded in the "T" field as 1.
- The register <Dd> is encoded in the "D:Vd" field.
- <Rn> Is the general-purpose base register, encoded in the "Rn" field.
- <align> Is the optional alignment.
 Whenever <align> is omitted, the standard alignment is used, see [Unaligned data access on page E2-2777](#), and is encoded in the "a" field as 0.
 Whenever <align> is present, the permitted values and encoding depend on <size>:
- | | |
|--------------|--|
| <size> == 8 | <align> is 32, meaning 32-bit alignment, encoded in the "a" field as 1. |
| <size> == 16 | <align> is 64, meaning 64-bit alignment, encoded in the "a" field as 1. |
| <size> == 32 | <align> can be 64 or 128. 64-bit alignment is encoded in the "a:size<0>" field as 0b10, and 128-bit alignment is encoded in the "a:size<0>" field as 0b11. |
- : is the preferred separator before the <align> value, but the alignment can be specified as @<align>, see [The Advanced SIMD addressing mode on page F2-2869](#).
- <Rm> Is the general-purpose index register containing an offset applied after the access, encoded in the "Rm" field.

For more information about the variants of this instruction, see [The Advanced SIMD addressing mode on page F2-2869](#).

Operation for all encodings

```

if ConditionPassed() then
    EncodingSpecificOperations(); CheckAdvSIMDEnabled();
    address = R[n]; iswrite = FALSE;
    - = AArch32.CheckAlignment(address, alignment, AccType_VEC, iswrite);
    D[d] = Replicate(MemU[address,ebytes]);
    D[d2] = Replicate(MemU[address+ebytes,ebytes]);
    D[d3] = Replicate(MemU[address+2*ebytes,ebytes]);
    D[d4] = Replicate(MemU[address+3*ebytes,ebytes]);
    if wback then
        if register_index then
            R[n] = R[n] + R[m];
        else
            R[n] = R[n] + 4*ebytes;
  
```

F6.1.96 VLD4 (multiple 4-element structures)

Load multiple 4-element structures to four registers loads multiple 4-element structures from memory into four registers, with de-interleaving. For more information, see [Element and structure load/store instructions on page F1-2829](#). Every element of each register is loaded. For details of the addressing mode see [The Advanced SIMD addressing mode on page F2-2869](#).

Depending on settings in the CPACR, NSACR, and HCPTR registers, and the security state and mode in which the instruction is executed, an attempt to execute the instruction might be UNDEFINED, or trapped to Hyp mode. For more information see [Enabling Advanced SIMD and floating-point support on page G1-4413](#).

A1

31	30	29	28	27	26	25	24	23	22	21	20	19	16	15	12	11	8	7	6	5	4	3	0
1	1	1	1	0	1	0	0	0	D	1	0	Rn	Vd	0	0	0	x	size	align			Rm	

type

Offset variant

Applies when Rm == 1111.

VLD4{<c>}{<q>}.<size> <list>, [<Rn>{:<align>}]

Post-indexed variant

Applies when Rm == 1101.

VLD4{<c>}{<q>}.<size> <list>, [<Rn>{:<align>}]!

Post-indexed variant

Applies when Rm != 11x1.

VLD4{<c>}{<q>}.<size> <list>, [<Rn>{:<align>}], <Rm>

Decode for all variants of this encoding

```

case type of
  when '0000'
    inc = 1;
  when '0001'
    inc = 2;
  otherwise
    SEE "Related encodings";
if size == '11' then UNDEFINED;
alignment = if align == '00' then 1 else 4 << UInt(align);
ebytes = 1 << UInt(size); elements = 8 DIV ebytes;
d = UInt(D:Vd); d2 = d + inc; d3 = d2 + inc; d4 = d3 + inc; n = UInt(Rn); m = UInt(Rm);
wback = (m != 15); register_index = (m != 15 && m != 13);
if n == 15 || d4 > 31 then UNPREDICTABLE;
    
```

CONSTRAINED UNPREDICTABLE behavior

If d4 > 31, then one of the following behaviors must occur:

- The instruction is UNDEFINED.
- The instruction executes as NOP.
- One or more of the SIMD and floating-point registers are UNKNOWN. If the instruction specifies writeback, the base register becomes UNKNOWN. This behavior does not affect any general-purpose registers.

T1

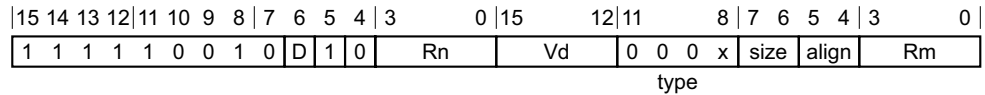

Offset variant

Applies when Rm == 1111.

VLD4{<c>}{<q>}.<size> <list>, [<Rn>{:<align>}]

Post-indexed variant

Applies when Rm == 1101.

VLD4{<c>}{<q>}.<size> <list>, [<Rn>{:<align>}]!

Post-indexed variant

Applies when Rm != 11x1.

VLD4{<c>}{<q>}.<size> <list>, [<Rn>{:<align>}], <Rm>

Decode for all variants of this encoding

```

case type of
  when '0000'
    inc = 1;
  when '0001'
    inc = 2;
  otherwise
    SEE "Related encodings";
if size == '11' then UNDEFINED;
alignment = if align == '00' then 1 else 4 << UInt(align);
ebytes = 1 << UInt(size); elements = 8 DIV ebytes;
d = UInt(D:Vd); d2 = d + inc; d3 = d2 + inc; d4 = d3 + inc; n = UInt(Rn); m = UInt(Rm);
wback = (m != 15); register_index = (m != 15 && m != 13);
if n == 15 || d4 > 31 then UNPREDICTABLE;
  
```

CONSTRAINED UNPREDICTABLE behavior

If $d4 > 31$, then one of the following behaviors must occur:

- The instruction is UNDEFINED.
- The instruction executes as NOP.
- One or more of the SIMD and floating-point registers are UNKNOWN. If the instruction specifies writeback, the base register becomes UNKNOWN. This behavior does not affect any general-purpose registers.

Notes for all encodings

For more information about the CONSTRAINED UNPREDICTABLE behavior of this instruction, see [Appendix K1 Architectural Constraints on UNPREDICTABLE behaviors](#), and particularly *VST4 (multiple 4-element structures)* on page K1-6113.

Related encodings: See *Advanced SIMD element or structure load/store* on page F3-2922 for the T32 instruction set, or *Advanced SIMD element or structure load/store* on page F4-2997 for the A32 instruction set.

Assembler symbols

- <c> For encoding A1: see [Standard assembler syntax fields on page F2-2848](#). This encoding must be unconditional.
 For encoding T1: see [Standard assembler syntax fields on page F2-2848](#).
- <q> See [Standard assembler syntax fields on page F2-2848](#).
- <size> Is the data size, encoded in the "size" field. It can have the following values:
 8 when size = 00
 16 when size = 01
 32 when size = 10
 The encoding size = 11 is reserved.
- <list> Is a list containing the 64-bit names of the SIMD&FP registers.
 The list must be one of:
 { <Dd>, <Dd+1>, <Dd+2>, <Dd+3> }
 Single-spaced registers, encoded in the "type" field as 0b0000.
 { <Dd>, <Dd+2>, <Dd+4>, <Dd+6> }
 Double-spaced registers, encoded in the "type" field as 0b0001.
 The register <Dd> is encoded in the "D:Vd" field.
- <Rn> Is the general-purpose base register, encoded in the "Rn" field.
- <align> Is the optional alignment.
 Whenever <align> is omitted, the standard alignment is used, see [Unaligned data access on page E2-2777](#), and is encoded in the "align" field as 0b00.
 Whenever <align> is present, the permitted values are:
 64 64-bit alignment, encoded in the "align" field as 0b01.
 128 128-bit alignment, encoded in the "align" field as 0b10.
 256 256-bit alignment, encoded in the "align" field as 0b11.
 : is the preferred separator before the <align> value, but the alignment can be specified as @<align>, see [The Advanced SIMD addressing mode on page F2-2869](#).
- <Rm> Is the general-purpose index register containing an offset applied after the access, encoded in the "Rm" field.

For more information about the variants of this instruction, see [The Advanced SIMD addressing mode on page F2-2869](#).

Operation for all encodings

```

if ConditionPassed() then
    EncodingSpecificOperations(); CheckAdvSIMDEnabled();
    address = R[n]; iswrite = FALSE;
    - = AArch32.CheckAlignment(address, alignment, AccType_VEC, iswrite);
    for e = 0 to elements-1
        Elem[D[d], e] = MemU[address,ebytes];
        Elem[D[d2],e] = MemU[address+ebytes,ebytes];
        Elem[D[d3],e] = MemU[address+2*ebytes,ebytes];
        Elem[D[d4],e] = MemU[address+3*ebytes,ebytes];
        address = address + 4*ebytes;
    if wback then
        if register_index then
            R[n] = R[n] + R[m];
        else
            R[n] = R[n] + 32;
  
```

F6.1.97 VLDM, VLDMDB, VLDMIA

Load Multiple SIMD&FP registers loads multiple registers from consecutive locations in the Advanced SIMD and floating-point register file using an address from a general-purpose register.

Depending on settings in the CPACR, NSACR, and HCPTR registers, and the security state and mode in which the instruction is executed, an attempt to execute the instruction might be UNDEFINED, or trapped to Hyp mode. For more information see [Enabling Advanced SIMD and floating-point support on page G1-4413](#).

This instruction is used by the alias VPOP. See [Alias conditions on page F6-3938](#) for details of when each alias is preferred.

A1

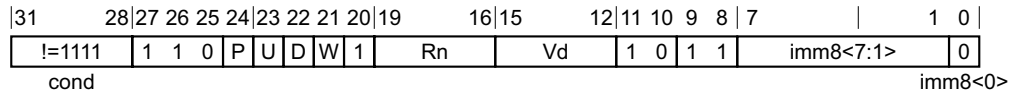

Decrement Before variant

Applies when P == 1 && U == 0 && W == 1.

VLDMDB{<c>}{<q>}{.<size>} <Rn>!, <dreglist>

Increment After variant

Applies when P == 0 && U == 1.

VLDM{<c>}{<q>}{.<size>} <Rn>{!}, <dreglist>

VLDMIA{<c>}{<q>}{.<size>} <Rn>{!}, <dreglist>

Decode for all variants of this encoding

```

if P == '0' && U == '0' && W == '0' then SEE "Related encodings";
if P == '1' && W == '0' then SEE VLDR;
if P == U && W == '1' then UNDEFINED;
// Remaining combinations are PUW = 010 (IA without !), 011 (IA with !), 101 (DB with !)
single_regs = FALSE; add = (U == '1'); wback = (W == '1');
d = UInt(D:Vd); n = UInt(Rn); imm32 = ZeroExtend(imm8:'00', 32);
regs = UInt(imm8) DIV 2; // If UInt(imm8) is odd, see "FLDM*X".
if n == 15 && (wback || CurrentInstrSet() != InstrSet_A32) then UNPREDICTABLE;
if regs == 0 || regs > 16 || (d+regs) > 32 then UNPREDICTABLE;
if imm8<0> == '1' && (d+regs) > 16 then UNPREDICTABLE;
    
```

CONSTRAINED UNPREDICTABLE behavior

If regs == 0, then one of the following behaviors must occur:

- The instruction is UNDEFINED.
- The instruction executes as NOP.
- The instruction operates as a VLDM with the same addressing mode but loads no registers.

If regs > 16 || (d+regs) > 32, then one of the following behaviors must occur:

- The instruction is UNDEFINED.
- The instruction executes as NOP.
- One or more of the SIMD and floating-point registers are UNKNOWN. If the instruction specifies writeback, the base register becomes UNKNOWN. This behavior does not affect any general-purpose registers.

A2

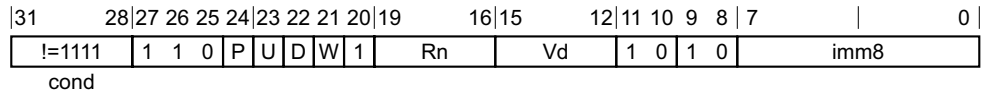

Decrement Before variant

Applies when $P == 1 \ \&\& \ U == 0 \ \&\& \ W == 1$.

VLDMDB{<c>}{<q>}{.<size>} <Rn>!, <sreglist>

Increment After variant

Applies when $P == 0 \ \&\& \ U == 1$.

VLDM{<c>}{<q>}{.<size>} <Rn>{!}, <sreglist>
 VLDMI{<c>}{<q>}{.<size>} <Rn>{!}, <sreglist>

Decode for all variants of this encoding

```
if P == '0' && U == '0' && W == '0' then SEE "Related encodings";
if P == '1' && W == '0' then SEE VLDR;
if P == U && W == '1' then UNDEFINED;
// Remaining combinations are PUW = 010 (IA without !), 011 (IA with !), 101 (DB with !)
single_regs = TRUE; add = (U == '1'); wback = (W == '1'); d = UInt(Vd:D); n = UInt(Rn);
imm32 = ZeroExtend(imm8:'00', 32); regs = UInt(imm8);
if n == 15 && (wback || CurrentInstrSet() != InstrSet_A32) then UNPREDICTABLE;
if regs == 0 || (d+regs) > 32 then UNPREDICTABLE;
```

CONSTRAINED UNPREDICTABLE behavior

If $regs == 0$, then one of the following behaviors must occur:

- The instruction is UNDEFINED.
- The instruction executes as NOP.
- The instruction operates as a VLDM with the same addressing mode but loads no registers.

If $(d+regs) > 32$, then one of the following behaviors must occur:

- The instruction is UNDEFINED.
- The instruction executes as NOP.
- One or more of the SIMD and floating-point registers are UNKNOWN. If the instruction specifies writeback, the base register becomes UNKNOWN. This behavior does not affect any general-purpose registers.

T1

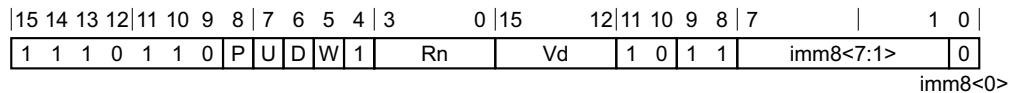

Decrement Before variant

Applies when $P == 1 \ \&\& \ U == 0 \ \&\& \ W == 1$.

VLDMDB{<c>}{<q>}{.<size>} <Rn>!, <dreglist>

Increment After variant

Applies when P == 0 && U == 1.

VLDM{<c>}{<q>}{.<size>} <Rn>{!}, <dreglist>
 VLDMIA{<c>}{<q>}{.<size>} <Rn>{!}, <dreglist>

Decode for all variants of this encoding

```
if P == '0' && U == '0' && W == '0' then SEE "Related encodings";
if P == '1' && W == '0' then SEE VLDR;
if P == U && W == '1' then UNDEFINED;
// Remaining combinations are PUW = 010 (IA without !), 011 (IA with !), 101 (DB with !)
single_regs = FALSE; add = (U == '1'); wback = (W == '1');
d = UInt(D:Vd); n = UInt(Rn); imm32 = ZeroExtend(imm8:'00', 32);
regs = UInt(imm8) DIV 2; // If UInt(imm8) is odd, see "FLDM*X".
if n == 15 && (wback || CurrentInstrSet() != InstrSet_A32) then UNPREDICTABLE;
if regs == 0 || regs > 16 || (d+regs) > 32 then UNPREDICTABLE;
if imm8<0> == '1' && (d+regs) > 16 then UNPREDICTABLE;
```

CONSTRAINED UNPREDICTABLE behavior

If regs == 0, then one of the following behaviors must occur:

- The instruction is UNDEFINED.
- The instruction executes as NOP.
- The instruction operates as a VLDM with the same addressing mode but loads no registers.

If regs > 16 || (d+regs) > 32, then one of the following behaviors must occur:

- The instruction is UNDEFINED.
- The instruction executes as NOP.
- One or more of the SIMD and floating-point registers are UNKNOWN. If the instruction specifies writeback, the base register becomes UNKNOWN. This behavior does not affect any general-purpose registers.

T2

15	14	13	12	11	10	9	8	7	6	5	4	3	0	15	12	11	10	9	8	7	0
1	1	1	0	1	1	0	P	U	D	W	1	Rn	Vd	1	0	1	0	imm8			

Decrement Before variant

Applies when P == 1 && U == 0 && W == 1.

VLDMDB{<c>}{<q>}{.<size>} <Rn>!, <sreglist>

Increment After variant

Applies when P == 0 && U == 1.

VLDM{<c>}{<q>}{.<size>} <Rn>{!}, <sreglist>
 VLDMIA{<c>}{<q>}{.<size>} <Rn>{!}, <sreglist>

Decode for all variants of this encoding

```
if P == '0' && U == '0' && W == '0' then SEE "Related encodings";
if P == '1' && W == '0' then SEE VLDR;
if P == U && W == '1' then UNDEFINED;
// Remaining combinations are PUW = 010 (IA without !), 011 (IA with !), 101 (DB with !)
single_regs = TRUE; add = (U == '1'); wback = (W == '1'); d = UInt(Vd:D); n = UInt(Rn);
```

```
imm32 = ZeroExtend(imm8:'00', 32); regs = UInt(imm8);
if n == 15 && (wback || CurrentInstrSet() != InstrSet_A32) then UNPREDICTABLE;
if regs == 0 || (d+regs) > 32 then UNPREDICTABLE;
```

CONSTRAINED UNPREDICTABLE behavior

If `regs == 0`, then one of the following behaviors must occur:

- The instruction is UNDEFINED.
- The instruction executes as NOP.
- The instruction operates as a VLDM with the same addressing mode but loads no registers.

If `(d+regs) > 32`, then one of the following behaviors must occur:

- The instruction is UNDEFINED.
- The instruction executes as NOP.
- One or more of the SIMD and floating-point registers are UNKNOWN. If the instruction specifies writeback, the base register becomes UNKNOWN. This behavior does not affect any general-purpose registers.

Notes for all encodings

For more information about the CONSTRAINED UNPREDICTABLE behavior of this instruction, see [Appendix K1 Architectural Constraints on UNPREDICTABLE behaviors](#), and particularly *VLDM* on page K1-6112.

Related encodings: See *Advanced SIMD and floating-point 64-bit move* on page F3-2894 for the T32 instruction set, or *Advanced SIMD and floating-point 64-bit move* on page F4-2973 for the A32 instruction set.

Alias conditions

Alias	is preferred when
VPOP	P == '0' && U == '1' && W == '1' && Rn == '1101'

Assembler symbols

- <c> See *Standard assembler syntax fields* on page F2-2848.
- <q> See *Standard assembler syntax fields* on page F2-2848.
- <size> An optional data size specifier. If present, it must be equal to the size in bits, 32 or 64, of the registers being transferred.
- <Rn> Is the general-purpose base register, encoded in the "Rn" field. If writeback is not specified, the PC can be used.
- ! Specifies base register writeback. Encoded in the "W" field as 1 if present, otherwise 0.
- <sreglist> Is the list of consecutively numbered 32-bit SIMD&FP registers to be transferred. The first register in the list is encoded in "Vd:D", and "imm8" is set to the number of registers in the list. The list must contain at least one register.
- <dreglist> Is the list of consecutively numbered 64-bit SIMD&FP registers to be transferred. The first register in the list is encoded in "D:Vd", and "imm8" is set to twice the number of registers in the list. The list must contain at least one register, and must not contain more than 16 registers.

Operation for all encodings

```
if ConditionPassed() then
    EncodingSpecificOperations(); CheckVFPEEnabled(TRUE);
    address = if add then R[n] else R[n]-imm32;
    for r = 0 to regs-1
        if single_regs then
            S[d+r] = MemA[address,4]; address = address+4;
        else
            word1 = MemA[address,4]; word2 = MemA[address+4,4]; address = address+8;
            // Combine the word-aligned words in the correct order for current endianness.
            D[d+r] = if BigEndian() then word1:word2 else word2:word1;
    if wback then R[n] = if add then R[n]+imm32 else R[n]-imm32;
```

F6.1.98 VLDR (immediate)

Load SIMD&FP register (immediate) loads a single register from the Advanced SIMD and floating-point register file, using an address from a general-purpose register, with an optional offset.

Depending on settings in the CPACR, NSACR, HCPTR, and FPEXC registers, and the security state and mode in which the instruction is executed, an attempt to execute the instruction might be UNDEFINED, or trapped to Hyp mode. For more information see [Enabling Advanced SIMD and floating-point support on page G1-4413](#).

A1

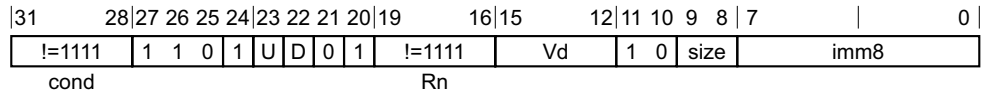

Half-precision scalar variant

Applies when size == 01.

VLDR{<c>}{<q>}.16 <Sd>, [<Rn> {, #<+/-><imm>}]

Single-precision scalar variant

Applies when size == 10.

VLDR{<c>}{<q>}.32 <Sd>, [<Rn> {, #<+/-><imm>}]

Double-precision scalar variant

Applies when size == 11.

VLDR{<c>}{<q>}.64 <Dd>, [<Rn> {, #<+/-><imm>}]

Decode for all variants of this encoding

```

if size == '00' || (size == '01' && !HaveFP16Ext()) then UNDEFINED;
if size == '01' && cond != '1110' then UNPREDICTABLE;
esize = 8 << UInt(size); add = (U == '1');
imm32 = if esize == 16 then ZeroExtend(imm8:'0', 32) else ZeroExtend(imm8:'00', 32);
d = UInt(D:Vd); n = UInt(Rn);
  
```

CONSTRAINED UNPREDICTABLE behavior

If size == '01' && cond != '1110', then one of the following behaviors must occur:

- The instruction is UNDEFINED.
- The instruction executes as if it passes the Condition code check.
- The instruction executes as NOP. This means it behaves as if it fails the Condition code check.

T1

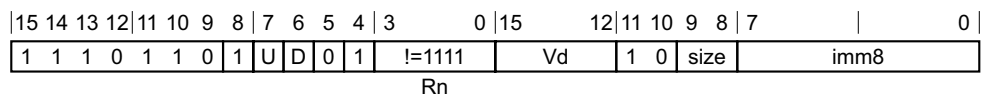

Half-precision scalar variant

Applies when size == 01.

VLDR{<c>}{<q>}.16 <Sd>, [<Rn> {, #<+/-><imm>}]

Single-precision scalar variant

Applies when size == 10.

```
VLDR{<c>}{<q>}{.32} <Sd>, [<Rn> {, #<+/-><imm>}]
```

Double-precision scalar variant

Applies when size == 11.

```
VLDR{<c>}{<q>}{.64} <Dd>, [<Rn> {, #<+/-><imm>}]
```

Decode for all variants of this encoding

```
if size == '00' || (size == '01' && !HaveFP16Ext()) then UNDEFINED;
if size == '01' && InITBlock() then UNPREDICTABLE;
esize = 8 << UInt(size); add = (U == '1');
imm32 = if esize == 16 then ZeroExtend(imm8:'0', 32) else ZeroExtend(imm8:'00', 32);
d = UInt(D:Vd); n = UInt(Rn);
```

CONSTRAINED UNPREDICTABLE behavior

If size == '01' && InITBlock(), then one of the following behaviors must occur:

- The instruction is UNDEFINED.
- The instruction executes as if it passes the Condition code check.
- The instruction executes as NOP. This means it behaves as if it fails the Condition code check.

Assembler symbols

<c>	See Standard assembler syntax fields on page F2-2848 .
<q>	See Standard assembler syntax fields on page F2-2848 .
.64	Is an optional data size specifier for 64-bit memory accesses that can be used in the assembler source code, but is otherwise ignored.
<Dd>	Is the 64-bit name of the SIMD&FP destination register, encoded in the "D:Vd" field.
.32	Is an optional data size specifier for 32-bit memory accesses that can be used in the assembler source code, but is otherwise ignored.
<Sd>	Is the 32-bit name of the SIMD&FP destination register, encoded in the "Vd:D" field.
<Rn>	Is the general-purpose base register, encoded in the "Rn" field.
+/-	Specifies the offset is added to or subtracted from the base register, defaulting to + if omitted and encoded in the "U" field. It can have the following values: <ul style="list-style-type: none"> - when U = 0 + when U = 1
<imm>	For encoding A1 or T1: is the optional unsigned immediate byte offset, a multiple of 2, in the range 0 to 510, defaulting to 0, and encoded in the "imm8" field as <imm>/2. For encoding A1, T1: is the optional unsigned immediate byte offset, a multiple of 4, in the range 0 to 1020, defaulting to 0, and encoded in the "imm8" field as <imm>/4.

Operation for all encodings

```
if ConditionPassed() then
  EncodingSpecificOperations(); CheckVFPEnabled(TRUE);
  base = if n == 15 then Align(PC,4) else R[n];
  address = if add then (base + imm32) else (base - imm32);
```

```
case esize of
  when 16
    S[d] = Zeros(16) : MemA[address,2];
  when 32
    S[d] = MemA[address,4];
  when 64
    word1 = MemA[address,4]; word2 = MemA[address+4,4];
    // Combine the word-aligned words in the correct order for current endianness.
    D[d] = if BigEndian() then word1:word2 else word2:word1;
```

F6.1.99 VLDR (literal)

Load SIMD&FP register (literal) loads a single register from the Advanced SIMD and floating-point register file, using an address from the PC value and an immediate offset.

Depending on settings in the CPACR, NSACR, HCPTR, and FPEXC registers, and the security state and mode in which the instruction is executed, an attempt to execute the instruction might be UNDEFINED, or trapped to Hyp mode. For more information see [Enabling Advanced SIMD and floating-point support on page G1-4413](#).

A1

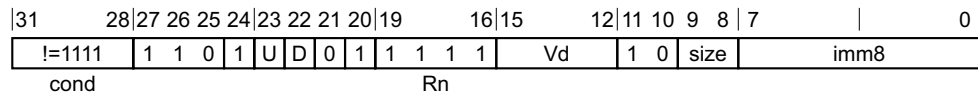

Half-precision scalar variant

Applies when size == 01.

VLDR{<c>}{<q>}.16 <Sd>, <label>
 VLDR{<c>}{<q>}.16 <Sd>, [PC, #{+/-}<imm>]

Single-precision scalar variant

Applies when size == 10.

VLDR{<c>}{<q>}.32 <Sd>, <label>
 VLDR{<c>}{<q>}.32 <Sd>, [PC, #{+/-}<imm>]

Double-precision scalar variant

Applies when size == 11.

VLDR{<c>}{<q>}.64 <Dd>, <label>
 VLDR{<c>}{<q>}.64 <Dd>, [PC, #{+/-}<imm>]

Decode for all variants of this encoding

```
if size == '00' || (size == '01' && !HaveFP16Ext()) then UNDEFINED;
if size == '01' && cond != '1110' then UNPREDICTABLE;
esize = 8 << UInt(size); add = (U == '1');
imm32 = if esize == 16 then ZeroExtend(imm8:'0', 32) else ZeroExtend(imm8:'00', 32);
d = UInt(D:Vd); n = UInt(Rn);
```

CONSTRAINED UNPREDICTABLE behavior

If size == '01' && cond != '1110', then one of the following behaviors must occur:

- The instruction is UNDEFINED.
- The instruction executes as if it passes the Condition code check.
- The instruction executes as NOP. This means it behaves as if it fails the Condition code check.

T1

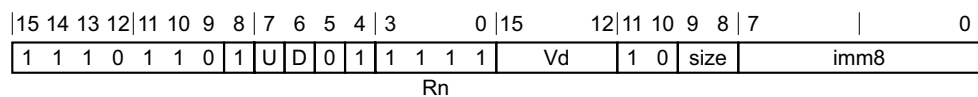

Half-precision scalar variant

Applies when size == 01.

```
VLDR{<c>}{<q>}.16 <Sd>, <label>
VLDR{<c>}{<q>}.16 <Sd>, [PC, #<+/-><imm>]
```

Single-precision scalar variant

Applies when size == 10.

```
VLDR{<c>}{<q>}.32 <Sd>, <label>
VLDR{<c>}{<q>}.32 <Sd>, [PC, #<+/-><imm>]
```

Double-precision scalar variant

Applies when size == 11.

```
VLDR{<c>}{<q>}.64 <Dd>, <label>
VLDR{<c>}{<q>}.64 <Dd>, [PC, #<+/-><imm>]
```

Decode for all variants of this encoding

```
if size == '00' || (size == '01' && !HaveFP16Ext()) then UNDEFINED;
if size == '01' && InITBlock() then UNPREDICTABLE;
esize = 8 << UInt(size); add = (U == '1');
imm32 = if esize == 16 then ZeroExtend(imm8:'0', 32) else ZeroExtend(imm8:'00', 32);
d = UInt(D:Vd); n = UInt(Rn);
```

CONSTRAINED UNPREDICTABLE behavior

If size == '01' && InITBlock(), then one of the following behaviors must occur:

- The instruction is UNDEFINED.
- The instruction executes as if it passes the Condition code check.
- The instruction executes as NOP. This means it behaves as if it fails the Condition code check.

Assembler symbols

<c>	See <i>Standard assembler syntax fields</i> on page F2-2848.
<q>	See <i>Standard assembler syntax fields</i> on page F2-2848.
.64	Is an optional data size specifier for 64-bit memory accesses that can be used in the assembler source code, but is otherwise ignored.
<Dd>	Is the 64-bit name of the SIMD&FP destination register, encoded in the "D:Vd" field.
.32	Is an optional data size specifier for 32-bit memory accesses that can be used in the assembler source code, but is otherwise ignored.
<Sd>	Is the 32-bit name of the SIMD&FP destination register, encoded in the "Vd:D" field.
<label>	The label of the literal data item to be loaded. The assembler calculates the required value of the offset from the <code>Align(PC, 4)</code> value of the instruction to this label. Permitted values are multiples of 4 in the range -1020 to 1020. If the offset is zero or positive, <code>imm32</code> is equal to the offset and <code>add == TRUE</code> . If the offset is negative, <code>imm32</code> is equal to minus the offset and <code>add == FALSE</code> .
+/-	Specifies the offset is added to or subtracted from the base register, defaulting to + if omitted and encoded in the "U" field. It can have the following values: - when U = 0

+ when U = 1

<imm> For encoding A1 or T1: is the optional unsigned immediate byte offset, a multiple of 2, in the range 0 to 510, defaulting to 0, and encoded in the "imm8" field as <imm>/2.

For encoding A1, T1: is the optional unsigned immediate byte offset, a multiple of 4, in the range 0 to 1020, defaulting to 0, and encoded in the "imm8" field as <imm>/4.

The alternative syntax permits the addition or subtraction of the offset and the immediate offset to be specified separately, including permitting a subtraction of 0 that cannot be specified using the normal syntax. For more information, see [Use of labels in UAL instruction syntax on page F1-2809](#).

Operation for all encodings

```
if ConditionPassed() then
    EncodingSpecificOperations(); CheckVFPEnabled(TRUE);
    base = if n == 15 then Align(PC,4) else R[n];
    address = if add then (base + imm32) else (base - imm32);
    case esize of
        when 16
            S[d] = Zeros(16) : MemA[address,2];
        when 32
            S[d] = MemA[address,4];
        when 64
            word1 = MemA[address,4]; word2 = MemA[address+4,4];
            // Combine the word-aligned words in the correct order for current endianness.
            D[d] = if BigEndian() then word1:word2 else word2:word1;
```

F6.1.100 VMAX (floating-point)

Vector Maximum compares corresponding elements in two vectors, and copies the larger of each pair into the corresponding element in the destination vector.

The operand vector elements are floating-point numbers.

Depending on settings in the CPACR, NSACR, and HCPTR registers, and the security state and mode in which the instruction is executed, an attempt to execute the instruction might be UNDEFINED, or trapped to Hyp mode. For more information see [Enabling Advanced SIMD and floating-point support on page G1-4413](#).

A1

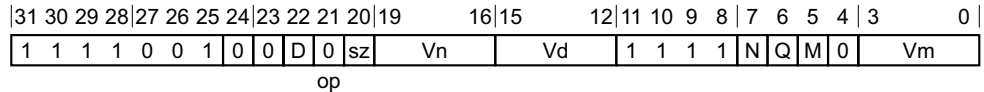

64-bit SIMD vector variant

Applies when Q == 0.

VMAX{<c>}{<q>}.<dt> {<Dd>, }<Dn>, <Dm>

128-bit SIMD vector variant

Applies when Q == 1.

VMAX{<c>}{<q>}.<dt> {<Qd>, }<Qn>, <Qm>

Decode for all variants of this encoding

```

if Q == '1' && (Vd<0> == '1' || Vn<0> == '1' || Vm<0> == '1') then UNDEFINED;
if sz == '1' && !HaveFP16Ext() then UNDEFINED;
maximum = (op == '0');
case sz of
    when '0' esize = 32; elements = 2;
    when '1' esize = 16; elements = 4;
d = UInt(D:Vd); n = UInt(N:Vn); m = UInt(M:Vm); regs = if Q == '0' then 1 else 2;
    
```

T1

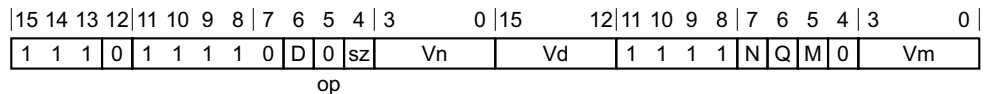

64-bit SIMD vector variant

Applies when Q == 0.

VMAX{<c>}{<q>}.<dt> {<Dd>, }<Dn>, <Dm>

128-bit SIMD vector variant

Applies when Q == 1.

VMAX{<c>}{<q>}.<dt> {<Qd>, }<Qn>, <Qm>

Decode for all variants of this encoding

```

if Q == '1' && (Vd<0> == '1' || Vn<0> == '1' || Vm<0> == '1') then UNDEFINED;
if sz == '1' && !HaveFP16Ext() then UNDEFINED;
if sz == '1' && InITBlock() then UNPREDICTABLE;
    
```



```

maximum = (op == '0');
case sz of
  when '0' esize = 32; elements = 2;
  when '1' esize = 16; elements = 4;
d = UInt(D:Vd); n = UInt(N:Vn); m = UInt(M:Vm); regs = if Q == '0' then 1 else 2;
  
```

CONSTRAINED UNPREDICTABLE behavior

If `sz == '1' && InITBlock()`, then one of the following behaviors must occur:

- The instruction is UNDEFINED.
- The instruction executes as if it passes the Condition code check.
- The instruction executes as NOP. This means it behaves as if it fails the Condition code check.

Assembler symbols

<c>	For encoding A1: see Standard assembler syntax fields on page F2-2848 . This encoding must be unconditional. For encoding T1: see Standard assembler syntax fields on page F2-2848 .
<q>	See Standard assembler syntax fields on page F2-2848 .
<dt>	Is the data type for the elements of the vectors, encoded in the "sz" field. It can have the following values: F32 when sz = 0 F16 when sz = 1
<Qd>	Is the 128-bit name of the SIMD&FP destination register, encoded in the "D:Vd" field as <Qd>*2.
<Qn>	Is the 128-bit name of the first SIMD&FP source register, encoded in the "N:Vn" field as <Qn>*2.
<Qm>	Is the 128-bit name of the second SIMD&FP source register, encoded in the "M:Vm" field as <Qm>*2.
<Dd>	Is the 64-bit name of the SIMD&FP destination register, encoded in the "D:Vd" field.
<Dn>	Is the 64-bit name of the first SIMD&FP source register, encoded in the "N:Vn" field.
<Dm>	Is the 64-bit name of the second SIMD&FP source register, encoded in the "M:Vm" field.

Floating-point maximum and minimum

- $\max(+0.0, -0.0) = +0.0$
- If any input is a NaN, the corresponding result element is the default NaN.

Operation for all encodings

```

if ConditionPassed() then
  EncodingSpecificOperations(); CheckAdvSIMDEnabled();
  for r = 0 to regs-1
    for e = 0 to elements-1
      op1 = Elem[D[n+r],e,esize]; op2 = Elem[D[m+r],e,esize];
      if maximum then
        Elem[D[d+r],e,esize] = FPMax(op1, op2, StandardFPSCRValue());
      else
        Elem[D[d+r],e,esize] = FPMin(op1, op2, StandardFPSCRValue());
  
```

F6.1.101 VMAX (integer)

Vector Maximum compares corresponding elements in two vectors, and copies the larger of each pair into the corresponding element in the destination vector.

The operand vector elements can be any one of:

- 8-bit, 16-bit, or 32-bit signed integers.
- 8-bit, 16-bit, or 32-bit unsigned integers.

The result vector elements are the same size as the operand vector elements.

Depending on settings in the CPACR, NSACR, and HCPTR registers, and the security state and mode in which the instruction is executed, an attempt to execute the instruction might be UNDEFINED, or trapped to Hyp mode. For more information see [Enabling Advanced SIMD and floating-point support on page G1-4413](#).

A1

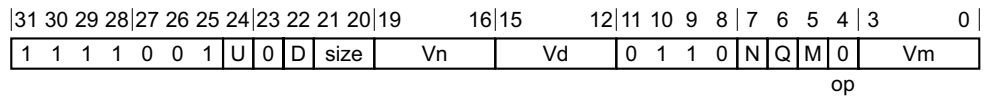

64-bit SIMD vector variant

Applies when Q == 0.

VMAX{<c>}{<q>}.<dt> {<Dd>, }<Dn>, <Dm>

128-bit SIMD vector variant

Applies when Q == 1.

VMAX{<c>}{<q>}.<dt> {<Qd>, }<Qn>, <Qm>

Decode for all variants of this encoding

```

if Q == '1' && (Vd<0> == '1' || Vn<0> == '1' || Vm<0> == '1') then UNDEFINED;
if size == '11' then UNDEFINED;
maximum = (op == '0'); unsigned = (U == '1');
esize = 8 << UInt(size); elements = 64 DIV esize;
d = UInt(D:Vd); n = UInt(N:Vn); m = UInt(M:Vm); regs = if Q == '0' then 1 else 2;
    
```

T1

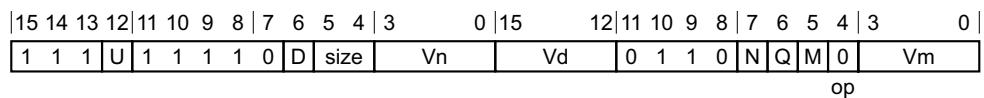

64-bit SIMD vector variant

Applies when Q == 0.

VMAX{<c>}{<q>}.<dt> {<Dd>, }<Dn>, <Dm>

128-bit SIMD vector variant

Applies when Q == 1.

VMAX{<c>}{<q>}.<dt> {<Qd>, }<Qn>, <Qm>

Decode for all variants of this encoding

```

if Q == '1' && (Vd<0> == '1' || Vn<0> == '1' || Vm<0> == '1') then UNDEFINED;
if size == '11' then UNDEFINED;
maximum = (op == '0'); unsigned = (U == '1');
esize = 8 << UInt(size); elements = 64 DIV esize;
d = UInt(D:Vd); n = UInt(N:Vn); m = UInt(M:Vm); regs = if Q == '0' then 1 else 2;
  
```

Assembler symbols

- <c> For encoding A1: see [Standard assembler syntax fields on page F2-2848](#). This encoding must be unconditional.
 For encoding T1: see [Standard assembler syntax fields on page F2-2848](#).
- <q> See [Standard assembler syntax fields on page F2-2848](#).
- <dt> Is the data type for the elements of the operands, encoded in the "U:size" field. It can have the following values:

S8	when U = 0, size = 00
S16	when U = 0, size = 01
S32	when U = 0, size = 10
U8	when U = 1, size = 00
U16	when U = 1, size = 01
U32	when U = 1, size = 10
- <Qd> Is the 128-bit name of the SIMD&FP destination register, encoded in the "D:Vd" field as <Qd>*2.
- <Qn> Is the 128-bit name of the first SIMD&FP source register, encoded in the "N:Vn" field as <Qn>*2.
- <Qm> Is the 128-bit name of the second SIMD&FP source register, encoded in the "M:Vm" field as <Qm>*2.
- <Dd> Is the 64-bit name of the SIMD&FP destination register, encoded in the "D:Vd" field.
- <Dn> Is the 64-bit name of the first SIMD&FP source register, encoded in the "N:Vn" field.
- <Dm> Is the 64-bit name of the second SIMD&FP source register, encoded in the "M:Vm" field.

Operation for all encodings

```

if ConditionPassed() then
  EncodingSpecificOperations(); CheckAdvSIMDEnabled();
  for r = 0 to regs-1
    for e = 0 to elements-1
      op1 = Int(Elem[D[n+r],e,esize], unsigned);
      op2 = Int(Elem[D[m+r],e,esize], unsigned);
      result = if maximum then Max(op1,op2) else Min(op1,op2);
      Elem[D[d+r],e,esize] = result<esize-1:0>;
  
```

F6.1.102 VMAXNM

This instruction determines the floating-point maximum number.

It handles NaNs in consistence with the IEEE754-2008 specification. It returns the numerical operand when one operand is numerical and the other is a quiet NaN, but otherwise the result is identical to floating-point VMAX.

This instruction is not conditional.

A1

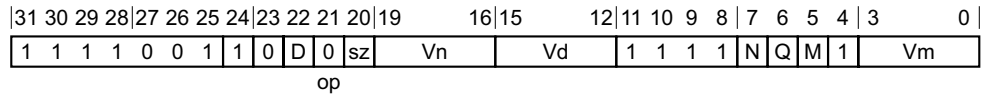

64-bit SIMD vector variant

Applies when Q == 0.

VMAXNM{<q>}.<dt> <Dd>, <Dn>, <Dm>

128-bit SIMD vector variant

Applies when Q == 1.

VMAXNM{<q>}.<dt> <Qd>, <Qn>, <Qm>

Decode for all variants of this encoding

```

if Q == '1' && (Vd<0> == '1' || Vn<0> == '1' || Vm<0> == '1') then UNDEFINED;
if sz == '1' && !HaveFP16Ext() then UNDEFINED;
maximum = (op == '0');
advsimd = TRUE;
case sz of
    when '0' esize = 32; elements = 2;
    when '1' esize = 16; elements = 4;
d = UInt(D:Vd); n = UInt(N:Vn); m = UInt(M:Vm); regs = if Q == '0' then 1 else 2;
    
```

A2

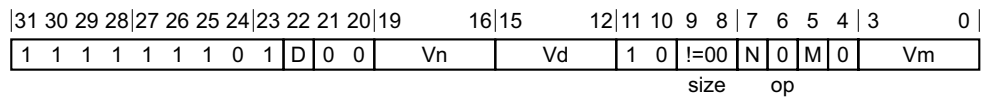

Half-precision scalar variant

Applies when size == 01.

VMAXNM{<q>}.F16 <Sd>, <Sn>, <Sm> // Cannot be conditional

Single-precision scalar variant

Applies when size == 10.

VMAXNM{<q>}.F32 <Sd>, <Sn>, <Sm> // Cannot be conditional

Double-precision scalar variant

Applies when size == 11.

VMAXNM{<q>}.F64 <Dd>, <Dn>, <Dm> // Cannot be conditional

Decode for all variants of this encoding

```

if size == '00' || (size == '01' && !HaveFP16Ext()) then UNDEFINED;
advsimd = FALSE;
maximum = (op == '0');
case size of
    when '01' esize = 16; d = UInt(Vd:D); n = UInt(Vn:N); m = UInt(Vm:M);
    when '10' esize = 32; d = UInt(Vd:D); n = UInt(Vn:N); m = UInt(Vm:M);
    when '11' esize = 64; d = UInt(D:Vd); n = UInt(N:Vn); m = UInt(M:Vm);
    
```

T1

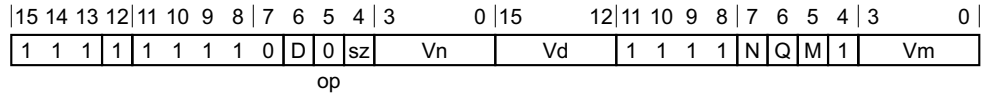

64-bit SIMD vector variant

Applies when Q == 0.

VMAXNM{<q>}.<dt> <Dd>, <Dn>, <Dm>

128-bit SIMD vector variant

Applies when Q == 1.

VMAXNM{<q>}.<dt> <Qd>, <Qn>, <Qm>

Decode for all variants of this encoding

```

if Q == '1' && (Vd<0> == '1' || Vn<0> == '1' || Vm<0> == '1') then UNDEFINED;
if sz == '1' && !HaveFP16Ext() then UNDEFINED;
maximum = (op == '0');
advsimd = TRUE;
case sz of
    when '0' esize = 32; elements = 2;
    when '1' esize = 16; elements = 4;
d = UInt(D:Vd); n = UInt(N:Vn); m = UInt(M:Vm); regs = if Q == '0' then 1 else 2;
if InITBlock() then UNPREDICTABLE;
    
```

CONSTRAINED UNPREDICTABLE behavior

If InITBlock(), then one of the following behaviors must occur:

- The instruction is UNDEFINED.
- The instruction executes as if it passes the Condition code check.
- The instruction executes as NOP. This means it behaves as if it fails the Condition code check.

T2

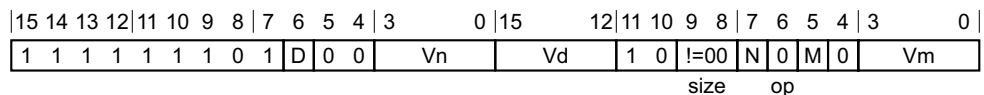

Half-precision scalar variant

Applies when size == 01.

VMAXNM{<q>}.F16 <Sd>, <Sn>, <Sm> // Not permitted in IT block

Single-precision scalar variant

Applies when size == 10.

VMAXNM{<q>}.F32 <Sd>, <Sn>, <Sm> // Not permitted in IT block

Double-precision scalar variant

Applies when size == 11.

VMAXNM{<q>}.F64 <Dd>, <Dn>, <Dm> // Not permitted in IT block

Decode for all variants of this encoding

```
if size == '00' || (size == '01' && !HaveFP16Ext()) then UNDEFINED;
advsimd = FALSE;
maximum = (op == '0');
case size of
  when '01' esize = 16; d = UInt(Vd:D); n = UInt(Vn:N); m = UInt(Vm:M);
  when '10' esize = 32; d = UInt(Vd:D); n = UInt(Vn:N); m = UInt(Vm:M);
  when '11' esize = 64; d = UInt(D:Vd); n = UInt(N:Vn); m = UInt(M:Vm);
if InITBlock() then UNPREDICTABLE;
```

CONSTRAINED UNPREDICTABLE behavior

If InITBlock(), then one of the following behaviors must occur:

- The instruction is UNDEFINED.
- The instruction executes as if it passes the Condition code check.
- The instruction executes as NOP. This means it behaves as if it fails the Condition code check.

Notes for all encodings

For more information about the CONSTRAINED UNPREDICTABLE behavior of this instruction, see [Appendix K1 Architectural Constraints on UNPREDICTABLE behaviors](#).

Assembler symbols

<q>	See Standard assembler syntax fields on page F2-2848 .
<dt>	Is the data type for the elements of the vectors, encoded in the "sz" field. It can have the following values: F32 when sz = 0 F16 when sz = 1
<Qd>	Is the 128-bit name of the SIMD&FP destination register, encoded in the "D:Vd" field as <Qd>*2.
<Qn>	Is the 128-bit name of the first SIMD&FP source register, encoded in the "N:Vn" field as <Qn>*2.
<Qm>	Is the 128-bit name of the second SIMD&FP source register, encoded in the "M:Vm" field as <Qm>*2.
<Dd>	Is the 64-bit name of the SIMD&FP destination register, encoded in the "D:Vd" field.
<Dn>	Is the 64-bit name of the first SIMD&FP source register, encoded in the "N:Vn" field.
<Dm>	Is the 64-bit name of the second SIMD&FP source register, encoded in the "M:Vm" field.
<Sd>	Is the 32-bit name of the SIMD&FP destination register, encoded in the "Vd:D" field.
<Sn>	Is the 32-bit name of the first SIMD&FP source register, encoded in the "Vn:N" field.
<Sm>	Is the 32-bit name of the second SIMD&FP source register, encoded in the "Vm:M" field.

Operation for all encodings

```

EncodingSpecificOperations(); CheckAdvSIMDorVFPEnabled(TRUE, advsimd);
if advsimd then // Advanced SIMD instruction
  for r = 0 to regs-1
    for e = 0 to elements-1
      op1 = Elem[D[n+r], e, esize]; op2 = Elem[D[m+r], e, esize];
      if maximum then
        Elem[D[d+r], e, esize] = FPMaXNum(op1, op2, StandardFPSCRValue());
      else
        Elem[D[d+r], e, esize] = FPMiNNum(op1, op2, StandardFPSCRValue());
else // VFP instruction
  case esize of
    when 16
      if maximum then
        S[d] = Zeros(16) : FPMaXNum(S[n]<15:0>, S[m]<15:0>, FPSCR);
      else
        S[d] = Zeros(16) : FPMiNNum(S[n]<15:0>, S[m]<15:0>, FPSCR);
    when 32
      if maximum then
        S[d] = FPMaXNum(S[n], S[m], FPSCR);
      else
        S[d] = FPMiNNum(S[n], S[m], FPSCR);
    when 64
      if maximum then
        D[d] = FPMaXNum(D[n], D[m], FPSCR);
      else
        D[d] = FPMiNNum(D[n], D[m], FPSCR);
  
```

F6.1.103 VMIN (floating-point)

Vector Minimum compares corresponding elements in two vectors, and copies the smaller of each pair into the corresponding element in the destination vector.

The operand vector elements are floating-point numbers.

Depending on settings in the CPACR, NSACR, and HCPTR registers, and the security state and mode in which the instruction is executed, an attempt to execute the instruction might be UNDEFINED, or trapped to Hyp mode. For more information see [Enabling Advanced SIMD and floating-point support on page G1-4413](#).

A1

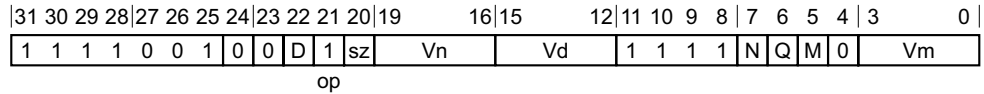

64-bit SIMD vector variant

Applies when Q == 0.

VMIN{<c>}{<q>}.<dt> {<Dd>, }<Dn>, <Dm>

128-bit SIMD vector variant

Applies when Q == 1.

VMIN{<c>}{<q>}.<dt> {<Qd>, }<Qn>, <Qm>

Decode for all variants of this encoding

```

if Q == '1' && (Vd<0> == '1' || Vn<0> == '1' || Vm<0> == '1') then UNDEFINED;
if sz == '1' && !HaveFP16Ext() then UNDEFINED;
maximum = (op == '0');
case sz of
    when '0' esize = 32; elements = 2;
    when '1' esize = 16; elements = 4;
d = UInt(D:Vd); n = UInt(N:Vn); m = UInt(M:Vm); regs = if Q == '0' then 1 else 2;
    
```

T1

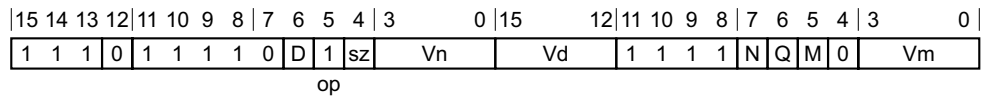

64-bit SIMD vector variant

Applies when Q == 0.

VMIN{<c>}{<q>}.<dt> {<Dd>, }<Dn>, <Dm>

128-bit SIMD vector variant

Applies when Q == 1.

VMIN{<c>}{<q>}.<dt> {<Qd>, }<Qn>, <Qm>

Decode for all variants of this encoding

```

if Q == '1' && (Vd<0> == '1' || Vn<0> == '1' || Vm<0> == '1') then UNDEFINED;
if sz == '1' && !HaveFP16Ext() then UNDEFINED;
if sz == '1' && InITBlock() then UNPREDICTABLE;
    
```



```

maximum = (op == '0');
case sz of
  when '0' esize = 32; elements = 2;
  when '1' esize = 16; elements = 4;
d = UInt(D:Vd); n = UInt(N:Vn); m = UInt(M:Vm); regs = if Q == '0' then 1 else 2;

```

CONSTRAINED UNPREDICTABLE behavior

If `sz == '1' && InITBlock()`, then one of the following behaviors must occur:

- The instruction is UNDEFINED.
- The instruction executes as if it passes the Condition code check.
- The instruction executes as NOP. This means it behaves as if it fails the Condition code check.

Assembler symbols

- <c> For encoding A1: see [Standard assembler syntax fields on page F2-2848](#). This encoding must be unconditional.
 For encoding T1: see [Standard assembler syntax fields on page F2-2848](#).
- <q> See [Standard assembler syntax fields on page F2-2848](#).
- <dt> Is the data type for the elements of the vectors, encoded in the "sz" field. It can have the following values:
 F32 when sz = 0
 F16 when sz = 1
- <Qd> Is the 128-bit name of the SIMD&FP destination register, encoded in the "D:Vd" field as <Qd>*2.
- <Qn> Is the 128-bit name of the first SIMD&FP source register, encoded in the "N:Vn" field as <Qn>*2.
- <Qm> Is the 128-bit name of the second SIMD&FP source register, encoded in the "M:Vm" field as <Qm>*2.
- <Dd> Is the 64-bit name of the SIMD&FP destination register, encoded in the "D:Vd" field.
- <Dn> Is the 64-bit name of the first SIMD&FP source register, encoded in the "N:Vn" field.
- <Dm> Is the 64-bit name of the second SIMD&FP source register, encoded in the "M:Vm" field.

Floating-point minimum

- $\min(+0.0, -0.0) = -0.0$
- If any input is a NaN, the corresponding result element is the default NaN.

Operation for all encodings

```

if ConditionPassed() then
  EncodingSpecificOperations(); CheckAdvSIMDEnabled();
  for r = 0 to regs-1
    for e = 0 to elements-1
      op1 = Elem[D[n+r],e,esize]; op2 = Elem[D[m+r],e,esize];
      if maximum then
        Elem[D[d+r],e,esize] = FPMax(op1, op2, StandardFPSCRValue());
      else
        Elem[D[d+r],e,esize] = FPMin(op1, op2, StandardFPSCRValue());

```

F6.1.104 VMIN (integer)

Vector Minimum compares corresponding elements in two vectors, and copies the smaller of each pair into the corresponding element in the destination vector.

The operand vector elements can be any one of:

- 8-bit, 16-bit, or 32-bit signed integers.
- 8-bit, 16-bit, or 32-bit unsigned integers.

The result vector elements are the same size as the operand vector elements.

Depending on settings in the CPACR, NSACR, and HCPTR registers, and the security state and mode in which the instruction is executed, an attempt to execute the instruction might be UNDEFINED, or trapped to Hyp mode. For more information see *Enabling Advanced SIMD and floating-point support on page G1-4413*.

A1

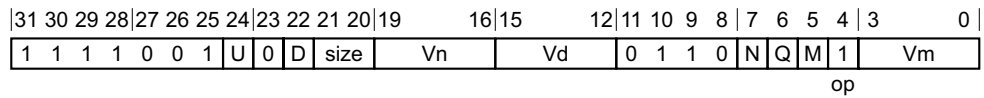

64-bit SIMD vector variant

Applies when Q == 0.

VMIN{<c>}{<q>}.<dt> {<Dd>, }<Dn>, <Dm>

128-bit SIMD vector variant

Applies when Q == 1.

VMIN{<c>}{<q>}.<dt> {<Qd>, }<Qn>, <Qm>

Decode for all variants of this encoding

```

if Q == '1' && (Vd<0> == '1' || Vn<0> == '1' || Vm<0> == '1') then UNDEFINED;
if size == '11' then UNDEFINED;
maximum = (op == '0'); unsigned = (U == '1');
esize = 8 << UInt(size); elements = 64 DIV esize;
d = UInt(D:Vd); n = UInt(N:Vn); m = UInt(M:Vm); regs = if Q == '0' then 1 else 2;
    
```

T1

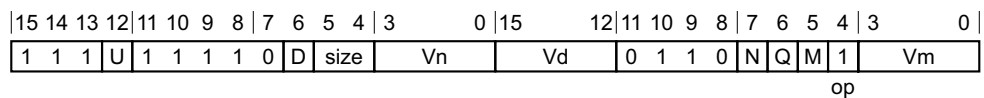

64-bit SIMD vector variant

Applies when Q == 0.

VMIN{<c>}{<q>}.<dt> {<Dd>, }<Dn>, <Dm>

128-bit SIMD vector variant

Applies when Q == 1.

VMIN{<c>}{<q>}.<dt> {<Qd>, }<Qn>, <Qm>

Decode for all variants of this encoding

```

if Q == '1' && (Vd<0> == '1' || Vn<0> == '1' || Vm<0> == '1') then UNDEFINED;
if size == '11' then UNDEFINED;
maximum = (op == '0'); unsigned = (U == '1');
esize = 8 << UInt(size); elements = 64 DIV esize;
d = UInt(D:Vd); n = UInt(N:Vn); m = UInt(M:Vm); regs = if Q == '0' then 1 else 2;
  
```

Assembler symbols

- <c> For encoding A1: see [Standard assembler syntax fields on page F2-2848](#). This encoding must be unconditional.
 For encoding T1: see [Standard assembler syntax fields on page F2-2848](#).
- <q> See [Standard assembler syntax fields on page F2-2848](#).
- <dt> Is the data type for the elements of the operands, encoded in the "U:size" field. It can have the following values:
- | | |
|-----|-----------------------|
| S8 | when U = 0, size = 00 |
| S16 | when U = 0, size = 01 |
| S32 | when U = 0, size = 10 |
| U8 | when U = 1, size = 00 |
| U16 | when U = 1, size = 01 |
| U32 | when U = 1, size = 10 |
- <Qd> Is the 128-bit name of the SIMD&FP destination register, encoded in the "D:Vd" field as <Qd>*2.
- <Qn> Is the 128-bit name of the first SIMD&FP source register, encoded in the "N:Vn" field as <Qn>*2.
- <Qm> Is the 128-bit name of the second SIMD&FP source register, encoded in the "M:Vm" field as <Qm>*2.
- <Dd> Is the 64-bit name of the SIMD&FP destination register, encoded in the "D:Vd" field.
- <Dn> Is the 64-bit name of the first SIMD&FP source register, encoded in the "N:Vn" field.
- <Dm> Is the 64-bit name of the second SIMD&FP source register, encoded in the "M:Vm" field.

Operation for all encodings

```

if ConditionPassed() then
  EncodingSpecificOperations(); CheckAdvSIMDEnabled();
  for r = 0 to regs-1
    for e = 0 to elements-1
      op1 = Int(Elem[D[n+r],e,esize], unsigned);
      op2 = Int(Elem[D[m+r],e,esize], unsigned);
      result = if maximum then Max(op1,op2) else Min(op1,op2);
      Elem[D[d+r],e,esize] = result<esize-1:0>;
  
```

F6.1.105 VMINNM

This instruction determines the floating point minimum number.

It handles NaNs in consistence with the IEEE754-2008 specification. It returns the numerical operand when one operand is numerical and the other is a quiet NaN, but otherwise the result is identical to floating-point VMIN.

This instruction is not conditional.

A1

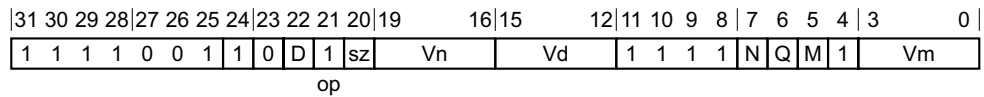

64-bit SIMD vector variant

Applies when Q == 0.

VMINNM{<q>}.<dt> <Dd>, <Dn>, <Dm>

128-bit SIMD vector variant

Applies when Q == 1.

VMINNM{<q>}.<dt> <Qd>, <Qn>, <Qm>

Decode for all variants of this encoding

```

if Q == '1' && (Vd<0> == '1' || Vn<0> == '1' || Vm<0> == '1') then UNDEFINED;
if sz == '1' && !HaveFP16Ext() then UNDEFINED;
maximum = (op == '0');
advsimd = TRUE;
case sz of
    when '0' esize = 32; elements = 2;
    when '1' esize = 16; elements = 4;
d = UInt(D:Vd); n = UInt(N:Vn); m = UInt(M:Vm); regs = if Q == '0' then 1 else 2;
    
```

A2

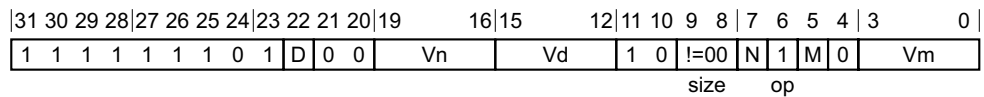

Half-precision scalar variant

Applies when size == 01.

VMINNM{<q>}.F16 <Sd>, <Sn>, <Sm> // Cannot be conditional

Single-precision scalar variant

Applies when size == 10.

VMINNM{<q>}.F32 <Sd>, <Sn>, <Sm> // Cannot be conditional

Double-precision scalar variant

Applies when size == 11.

VMINNM{<q>}.F64 <Dd>, <Dn>, <Dm> // Cannot be conditional

Decode for all variants of this encoding

```

if size == '00' || (size == '01' && !HaveFP16Ext()) then UNDEFINED;
advsimd = FALSE;
maximum = (op == '0');
case size of
    when '01' esize = 16; d = UInt(Vd:D); n = UInt(Vn:N); m = UInt(Vm:M);
    when '10' esize = 32; d = UInt(Vd:D); n = UInt(Vn:N); m = UInt(Vm:M);
    when '11' esize = 64; d = UInt(D:Vd); n = UInt(N:Vn); m = UInt(M:Vm);
    
```

T1

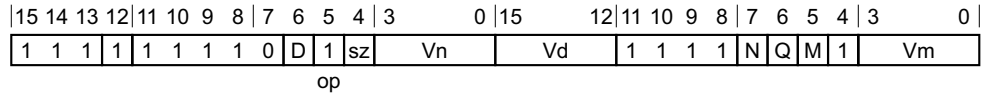

64-bit SIMD vector variant

Applies when Q == 0.

VMINNM{<q>}.<dt> <Dd>, <Dn>, <Dm>

128-bit SIMD vector variant

Applies when Q == 1.

VMINNM{<q>}.<dt> <Qd>, <Qn>, <Qm>

Decode for all variants of this encoding

```

if Q == '1' && (Vd<0> == '1' || Vn<0> == '1' || Vm<0> == '1') then UNDEFINED;
if sz == '1' && !HaveFP16Ext() then UNDEFINED;
maximum = (op == '0');
advsimd = TRUE;
case sz of
    when '0' esize = 32; elements = 2;
    when '1' esize = 16; elements = 4;
d = UInt(D:Vd); n = UInt(N:Vn); m = UInt(M:Vm); regs = if Q == '0' then 1 else 2;
if InITBlock() then UNPREDICTABLE;
    
```

CONSTRAINED UNPREDICTABLE behavior

If InITBlock(), then one of the following behaviors must occur:

- The instruction is UNDEFINED.
- The instruction executes as if it passes the Condition code check.
- The instruction executes as NOP. This means it behaves as if it fails the Condition code check.

T2

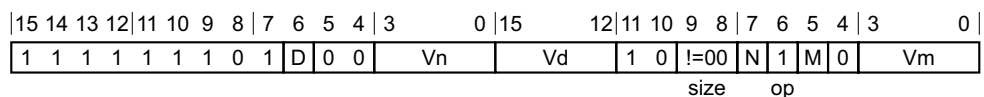

Half-precision scalar variant

Applies when size == 01.

VMINNM{<q>}.F16 <Sd>, <Sn>, <Sm> // Not permitted in IT block

Single-precision scalar variant

Applies when size == 10.

```
VMINNM{<q>}.F32 <Sd>, <Sn>, <Sm> // Not permitted in IT block
```

Double-precision scalar variant

Applies when size == 11.

```
VMINNM{<q>}.F64 <Dd>, <Dn>, <Dm> // Not permitted in IT block
```

Decode for all variants of this encoding

```
if size == '00' || (size == '01' && !HaveFP16Ext()) then UNDEFINED;
advsimd = FALSE;
maximum = (op == '0');
case size of
  when '01' esize = 16; d = UInt(Vd:D); n = UInt(Vn:N); m = UInt(Vm:M);
  when '10' esize = 32; d = UInt(Vd:D); n = UInt(Vn:N); m = UInt(Vm:M);
  when '11' esize = 64; d = UInt(D:Vd); n = UInt(N:Vn); m = UInt(M:Vm);
if InITBlock() then UNPREDICTABLE;
```

CONSTRAINED UNPREDICTABLE behavior

If InITBlock(), then one of the following behaviors must occur:

- The instruction is UNDEFINED.
- The instruction executes as if it passes the Condition code check.
- The instruction executes as NOP. This means it behaves as if it fails the Condition code check.

Notes for all encodings

For more information about the CONSTRAINED UNPREDICTABLE behavior of this instruction, see [Appendix K1 Architectural Constraints on UNPREDICTABLE behaviors](#).

Assembler symbols

<q>	See Standard assembler syntax fields on page F2-2848 .
<dt>	Is the data type for the elements of the vectors, encoded in the "sz" field. It can have the following values: F32 when sz = 0 F16 when sz = 1
<Qd>	Is the 128-bit name of the SIMD&FP destination register, encoded in the "D:Vd" field as <Qd>*2.
<Qn>	Is the 128-bit name of the first SIMD&FP source register, encoded in the "N:Vn" field as <Qn>*2.
<Qm>	Is the 128-bit name of the second SIMD&FP source register, encoded in the "M:Vm" field as <Qm>*2.
<Dd>	Is the 64-bit name of the SIMD&FP destination register, encoded in the "D:Vd" field.
<Dn>	Is the 64-bit name of the first SIMD&FP source register, encoded in the "N:Vn" field.
<Dm>	Is the 64-bit name of the second SIMD&FP source register, encoded in the "M:Vm" field.
<Sd>	Is the 32-bit name of the SIMD&FP destination register, encoded in the "Vd:D" field.
<Sn>	Is the 32-bit name of the first SIMD&FP source register, encoded in the "Vn:N" field.
<Sm>	Is the 32-bit name of the second SIMD&FP source register, encoded in the "Vm:M" field.

Operation for all encodings

```

EncodingSpecificOperations(); CheckAdvSIMDorVFPEnabled(TRUE, advsimd);
if advsimd then // Advanced SIMD instruction
  for r = 0 to regs-1
    for e = 0 to elements-1
      op1 = Elem[D[n+r], e, esize]; op2 = Elem[D[m+r], e, esize];
      if maximum then
        Elem[D[d+r], e, esize] = FMaxNum(op1, op2, StandardFPSCRValue());
      else
        Elem[D[d+r], e, esize] = FMinNum(op1, op2, StandardFPSCRValue());
else // VFP instruction
  case esize of
    when 16
      if maximum then
        S[d] = Zeros(16) : FMaxNum(S[n]<15:0>, S[m]<15:0>, FPSCR);
      else
        S[d] = Zeros(16) : FMinNum(S[n]<15:0>, S[m]<15:0>, FPSCR);
    when 32
      if maximum then
        S[d] = FMaxNum(S[n], S[m], FPSCR);
      else
        S[d] = FMinNum(S[n], S[m], FPSCR);
    when 64
      if maximum then
        D[d] = FMaxNum(D[n], D[m], FPSCR);
      else
        D[d] = FMinNum(D[n], D[m], FPSCR);
  
```

F6.1.106 VMLA (floating-point)

Vector Multiply Accumulate multiplies corresponding elements in two vectors, and accumulates the results into the elements of the destination vector.

Depending on settings in the CPACR, NSACR, HCPTR, and FPEXC registers, and the security state and mode in which the instruction is executed, an attempt to execute the instruction might be UNDEFINED, or trapped to Hyp mode. For more information see [Enabling Advanced SIMD and floating-point support on page G1-4413](#).

A1

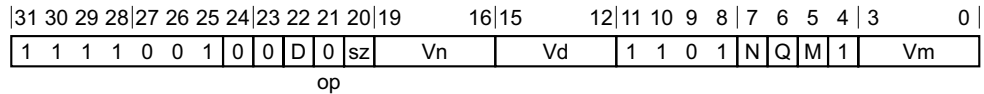

64-bit SIMD vector variant

Applies when Q == 0.

VMLA{<c>}{<q>}.<dt> <Dd>, <Dn>, <Dm>

128-bit SIMD vector variant

Applies when Q == 1.

VMLA{<c>}{<q>}.<dt> <Qd>, <Qn>, <Qm>

Decode for all variants of this encoding

```

if Q == '1' && (Vd<0> == '1' || Vn<0> == '1' || Vm<0> == '1') then UNDEFINED;
if sz == '1' && !HaveFP16Ext() then UNDEFINED;
advsimd = TRUE; add = (op == '0');
case sz of
  when '0' esize = 32; elements = 2;
  when '1' esize = 16; elements = 4;
d = UInt(D:Vd); n = UInt(N:Vn); m = UInt(M:Vm); regs = if Q == '0' then 1 else 2;
  
```

A2

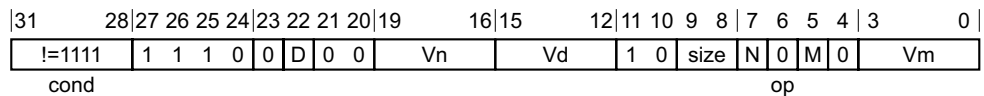

Half-precision scalar variant

Applies when size == 01.

VMLA{<c>}{<q>}.F16 <Sd>, <Sn>, <Sm>

Single-precision scalar variant

Applies when size == 10.

VMLA{<c>}{<q>}.F32 <Sd>, <Sn>, <Sm>

Double-precision scalar variant

Applies when size == 11.

VMLA{<c>}{<q>}.F64 <Dd>, <Dn>, <Dm>

Decode for all variants of this encoding

```

if size == '00' || (size == '01' && !HaveFP16Ext()) then UNDEFINED;
if size == '01' && cond != '1110' then UNPREDICTABLE;
if FPSCR.Len != '000' || FPSCR.Stride != '00' then UNDEFINED;
advsimd = FALSE; add = (op == '0');
case size of
    when '01' esize = 16; d = UInt(Vd:D); n = UInt(Vn:N); m = UInt(Vm:M);
    when '10' esize = 32; d = UInt(Vd:D); n = UInt(Vn:N); m = UInt(Vm:M);
    when '11' esize = 64; d = UInt(D:Vd); n = UInt(N:Vn); m = UInt(M:Vm);
    
```

CONSTRAINED UNPREDICTABLE behavior

If size == '01' && cond != '1110', then one of the following behaviors must occur:

- The instruction is UNDEFINED.
- The instruction executes as if it passes the Condition code check.
- The instruction executes as NOP. This means it behaves as if it fails the Condition code check.

T1

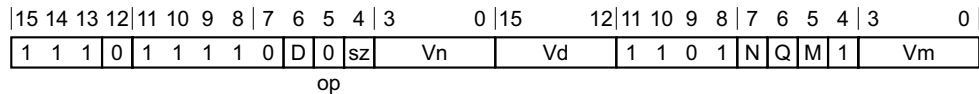

64-bit SIMD vector variant

Applies when Q == 0.

VMLA{<c>}{<q>}.<dt> <Dd>, <Dn>, <Dm>

128-bit SIMD vector variant

Applies when Q == 1.

VMLA{<c>}{<q>}.<dt> <Qd>, <Qn>, <Qm>

Decode for all variants of this encoding

```

if Q == '1' && (Vd<0> == '1' || Vn<0> == '1' || Vm<0> == '1') then UNDEFINED;
if sz == '1' && !HaveFP16Ext() then UNDEFINED;
if sz == '1' && InITBlock() then UNPREDICTABLE;
advsimd = TRUE; add = (op == '0');
case sz of
    when '0' esize = 32; elements = 2;
    when '1' esize = 16; elements = 4;
    d = UInt(D:Vd); n = UInt(N:Vn); m = UInt(M:Vm); regs = if Q == '0' then 1 else 2;
    
```

CONSTRAINED UNPREDICTABLE behavior

If sz == '1' && InITBlock(), then one of the following behaviors must occur:

- The instruction is UNDEFINED.
- The instruction executes as if it passes the Condition code check.
- The instruction executes as NOP. This means it behaves as if it fails the Condition code check.

T2

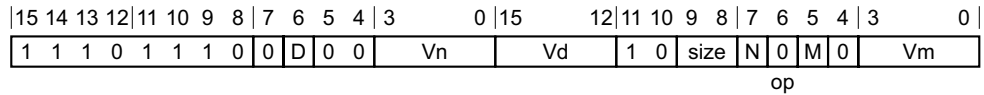

Half-precision scalar variant

Applies when size == 01.

VMLA{<c>}{<q>}.F16 <Sd>, <Sn>, <Sm>

Single-precision scalar variant

Applies when size == 10.

VMLA{<c>}{<q>}.F32 <Sd>, <Sn>, <Sm>

Double-precision scalar variant

Applies when size == 11.

VMLA{<c>}{<q>}.F64 <Dd>, <Dn>, <Dm>

Decode for all variants of this encoding

```

if size == '00' || (size == '01' && !HaveFP16Ext()) then UNDEFINED;
if size == '01' && InITBlock() then UNPREDICTABLE;
if FPSCR.Len != '000' || FPSCR.Stride != '00' then UNDEFINED;
advsimd = FALSE; add = (op == '0');
case size of
  when '01' esize = 16; d = UInt(Vd:D); n = UInt(Vn:N); m = UInt(Vm:M);
  when '10' esize = 32; d = UInt(Vd:D); n = UInt(Vn:N); m = UInt(Vm:M);
  when '11' esize = 64; d = UInt(D:Vd); n = UInt(N:Vn); m = UInt(M:Vm);

```

CONSTRAINED UNPREDICTABLE behavior

If size == '01' && InITBlock(), then one of the following behaviors must occur:

- The instruction is UNDEFINED.
- The instruction executes as if it passes the Condition code check.
- The instruction executes as NOP. This means it behaves as if it fails the Condition code check.

Assembler symbols

- <c> For encoding A1: see [Standard assembler syntax fields on page F2-2848](#). This encoding must be unconditional.
 For encoding A2, T1 and T2: see [Standard assembler syntax fields on page F2-2848](#).
- <q> See [Standard assembler syntax fields on page F2-2848](#).
- <dt> Is the data type for the elements of the vectors, encoded in the "sz" field. It can have the following values:
 F32 when sz = 0
 F16 when sz = 1
- <Qd> Is the 128-bit name of the SIMD&FP destination register, encoded in the "D:Vd" field as <Qd>*2.
- <Qn> Is the 128-bit name of the first SIMD&FP source register, encoded in the "N:Vn" field as <Qn>*2.

- <Qm> Is the 128-bit name of the second SIMD&FP source register, encoded in the "M:Vm" field as <Qm>*2.
- <Dd> Is the 64-bit name of the SIMD&FP destination register, encoded in the "D:Vd" field.
- <Dn> Is the 64-bit name of the first SIMD&FP source register, encoded in the "N:Vn" field.
- <Dm> Is the 64-bit name of the second SIMD&FP source register, encoded in the "M:Vm" field.
- <Sd> Is the 32-bit name of the SIMD&FP destination register, encoded in the "Vd:D" field.
- <Sn> Is the 32-bit name of the first SIMD&FP source register, encoded in the "Vn:N" field.
- <Sm> Is the 32-bit name of the second SIMD&FP source register, encoded in the "Vm:M" field.

Operation for all encodings

```

if ConditionPassed() then
    EncodingSpecificOperations(); CheckAdvSIMDOrVFPEEnabled(TRUE, advsimd);
    if advsimd then // Advanced SIMD instruction
        for r = 0 to regs-1
            for e = 0 to elements-1
                product = FPMu1(Elem[D[n+r],e,esize], Elem[D[m+r],e,esize], StandardFPSCRValue());
                addend = if add then product else FPNeg(product);
                Elem[D[d+r],e,esize] = FPAdd(Elem[D[d+r],e,esize], addend, StandardFPSCRValue());
            else // VFP instruction
                case esize of
                    when 16
                        addend16 = if add then FPMu1(S[n]<15:0>, S[m]<15:0>, FPSCR) else FPNeg(FPMu1(S[n]<15:0>,
S[m]<15:0>, FPSCR));
                        S[d] = Zeros(16) : FPAdd(S[d]<15:0>, addend16, FPSCR);
                    when 32
                        addend32 = if add then FPMu1(S[n], S[m], FPSCR) else FPNeg(FPMu1(S[n], S[m], FPSCR));
                        S[d] = FPAdd(S[d], addend32, FPSCR);
                    when 64
                        addend64 = if add then FPMu1(D[n], D[m], FPSCR) else FPNeg(FPMu1(D[n], D[m], FPSCR));
                        D[d] = FPAdd(D[d], addend64, FPSCR);

```

F6.1.107 VMLA (integer)

Vector Multiply Accumulate multiplies corresponding elements in two vectors, and adds the products to the corresponding elements of the destination vector.

Depending on settings in the CPACR, NSACR, and HCPTR registers, and the security state and mode in which the instruction is executed, an attempt to execute the instruction might be UNDEFINED, or trapped to Hyp mode. For more information see [Enabling Advanced SIMD and floating-point support on page G1-4413](#).

A1

31	30	29	28	27	26	25	24	23	22	21	20	19	16	15	12	11	10	9	8	7	6	5	4	3	0
1	1	1	1	0	0	1	0	0	D	size	Vn	Vd	1	0	0	1	N	Q	M	0	Vm				

op

64-bit SIMD vector variant

Applies when Q == 0.

VMLA{<c>}{<q>}.<type><size> <Dd>, <Dn>, <Dm> // Encoding T1/A1, encoded as Q = 0

128-bit SIMD vector variant

Applies when Q == 1.

VMLA{<c>}{<q>}.<type><size> <Qd>, <Qn>, <Qm> // Encoding T1/A1, encoded as Q = 1

Decode for all variants of this encoding

```

if size == '11' then UNDEFINED;
if Q == '1' && (Vd<0> == '1' || Vn<0> == '1' || Vm<0> == '1') then UNDEFINED;
add = (op == '0'); long_destination = FALSE;
unsigned = FALSE; // "Don't care" value: TRUE produces same functionality
esize = 8 << UInt(size); elements = 64 DIV esize;
d = UInt(D:Vd); n = UInt(N:Vn); m = UInt(M:Vm); regs = if Q == '0' then 1 else 2;
    
```

T1

15	14	13	12	11	10	9	8	7	6	5	4	3	0	15	12	11	10	9	8	7	6	5	4	3	0
1	1	1	0	1	1	1	1	0	D	size	Vn	Vd	1	0	0	1	N	Q	M	0	Vm				

op

64-bit SIMD vector variant

Applies when Q == 0.

VMLA{<c>}{<q>}.<type><size> <Dd>, <Dn>, <Dm> // Encoding T1/A1, encoded as Q = 0

128-bit SIMD vector variant

Applies when Q == 1.

VMLA{<c>}{<q>}.<type><size> <Qd>, <Qn>, <Qm> // Encoding T1/A1, encoded as Q = 1

Decode for all variants of this encoding

```

if size == '11' then UNDEFINED;
if Q == '1' && (Vd<0> == '1' || Vn<0> == '1' || Vm<0> == '1') then UNDEFINED;
add = (op == '0'); long_destination = FALSE;
unsigned = FALSE; // "Don't care" value: TRUE produces same functionality
esize = 8 << UInt(size); elements = 64 DIV esize;
d = UInt(D:Vd); n = UInt(N:Vn); m = UInt(M:Vm); regs = if Q == '0' then 1 else 2;
    
```

Assembler symbols

<c>	For encoding A1: see <i>Standard assembler syntax fields</i> on page F2-2848. This encoding must be unconditional. For encoding T1: see <i>Standard assembler syntax fields</i> on page F2-2848.
<q>	See <i>Standard assembler syntax fields</i> on page F2-2848.
<type>	The data type for the elements of the operands. It must be one of: S Optional in encoding T1/A1. Encoded as U = 0 in encoding T2/A2. U Optional in encoding T1/A1. Encoded as U = 1 in encoding T2/A2. I Available only in encoding T1/A1.
<size>	The data size for the elements of the operands. It must be one of: 8 Encoded as size = 0b00. 16 Encoded as size = 0b01. 32 Encoded as size = 0b10.
<Qd>	Is the 128-bit name of the SIMD&FP destination register, encoded in the "D:Vd" field as <Qd>*2.
<Qn>	Is the 128-bit name of the first SIMD&FP source register, encoded in the "N:Vn" field as <Qn>*2.
<Qm>	Is the 128-bit name of the second SIMD&FP source register, encoded in the "M:Vm" field as <Qm>*2.
<Dd>	Is the 64-bit name of the SIMD&FP destination register, encoded in the "D:Vd" field.
<Dn>	Is the 64-bit name of the first SIMD&FP source register, encoded in the "N:Vn" field.
<Dm>	Is the 64-bit name of the second SIMD&FP source register, encoded in the "M:Vm" field.

Operation for all encodings

```

if ConditionPassed() then
    EncodingSpecificOperations(); CheckAdvSIMDEnabled();
    for r = 0 to regs-1
        for e = 0 to elements-1
            product = Int(Elem[Din[n+r],e,esize],unsigned) * Int(Elem[Din[m+r],e,esize],unsigned);
            addend = if add then product else -product;
            if long_destination then
                Elem[Q[d>>1],e,2*esize] = Elem[Qin[d>>1],e,2*esize] + addend;
            else
                Elem[D[d+r],e,esize] = Elem[Din[d+r],e,esize] + addend;

```

F6.1.108 VMLA (by scalar)

Vector Multiply Accumulate multiplies elements of a vector by a scalar, and adds the products to corresponding elements of the destination vector.

For more information about scalars see [Advanced SIMD scalars on page F2-2874](#).

Depending on settings in the CPACR, NSACR, and HCPTR registers, and the security state and mode in which the instruction is executed, an attempt to execute the instruction might be UNDEFINED, or trapped to Hyp mode. For more information see [Enabling Advanced SIMD and floating-point support on page G1-4413](#).

A1

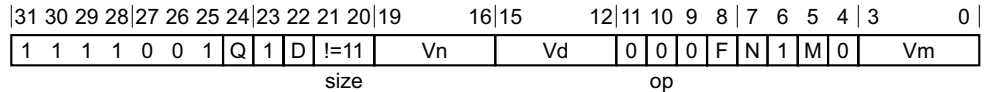

64-bit SIMD vector variant

Applies when Q == 0.

VMLA{<c>}{<q>}.<dt> <Dd>, <Dn>, <Dm[x]>

128-bit SIMD vector variant

Applies when Q == 1.

VMLA{<c>}{<q>}.<dt> <Qd>, <Qn>, <Dm[x]>

Decode for all variants of this encoding

```

if size == '11' then SEE "Related encodings";
if size == '00' || (F == '1' && size == '01' && !HaveFP16Ext()) then UNDEFINED;
if Q == '1' && (Vd<0> == '1' || Vn<0> == '1') then UNDEFINED;
unsigned = FALSE; // "Don't care" value: TRUE produces same functionality
add = (op == '0'); floating_point = (F == '1'); long_destination = FALSE;
d = UInt(D:Vd); n = UInt(N:Vn); regs = if Q == '0' then 1 else 2;
if size == '01' then esize = 16; elements = 4; m = UInt(Vm<2:0>); index = UInt(M:Vm<3>);
if size == '10' then esize = 32; elements = 2; m = UInt(Vm); index = UInt(M);
    
```

T1

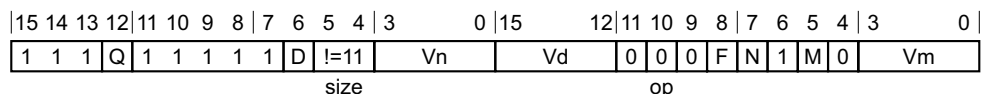

64-bit SIMD vector variant

Applies when Q == 0.

VMLA{<c>}{<q>}.<dt> <Dd>, <Dn>, <Dm[x]>

128-bit SIMD vector variant

Applies when Q == 1.

VMLA{<c>}{<q>}.<dt> <Qd>, <Qn>, <Dm[x]>

Decode for all variants of this encoding

```

if size == '11' then SEE "Related encodings";
if size == '00' || (F == '1' && size == '01' && !HaveFP16Ext()) then UNDEFINED;
if F == '1' && size == '01' && InITBlock() then UNPREDICTABLE;
if Q == '1' && (Vd<0> == '1' || Vn<0> == '1') then UNDEFINED;
unsigned = FALSE; // "Don't care" value: TRUE produces same functionality
add = (op == '0'); floating_point = (F == '1'); long_destination = FALSE;
d = UInt(D:Vd); n = UInt(N:Vn); regs = if Q == '0' then 1 else 2;
if size == '01' then esize = 16; elements = 4; m = UInt(Vm<2:0>); index = UInt(M:Vm<3>);
if size == '10' then esize = 32; elements = 2; m = UInt(Vm); index = UInt(M);
  
```

CONSTRAINED UNPREDICTABLE behavior

If `F == '1' && size == '01' && InITBlock()`, then one of the following behaviors must occur:

- The instruction is UNDEFINED.
- The instruction executes as if it passes the Condition code check.
- The instruction executes as NOP. This means it behaves as if it fails the Condition code check.

Notes for all encodings

Related encodings: See [Advanced SIMD data-processing on page F3-2904](#) for the T32 instruction set, or [Advanced SIMD data-processing on page F4-2985](#) for the A32 instruction set.

Assembler symbols

<c>	For encoding A1: see Standard assembler syntax fields on page F2-2848 . This encoding must be unconditional. For encoding T1: see Standard assembler syntax fields on page F2-2848 .								
<q>	See Standard assembler syntax fields on page F2-2848 .								
<dt>	Is the data type for the scalar and the elements of the operand vector, encoded in the "F:size" field. It can have the following values: <table> <tr> <td>I16</td> <td>when F = 0, size = 01</td> </tr> <tr> <td>I32</td> <td>when F = 0, size = 10</td> </tr> <tr> <td>F16</td> <td>when F = 1, size = 01</td> </tr> <tr> <td>F32</td> <td>when F = 1, size = 10</td> </tr> </table>	I16	when F = 0, size = 01	I32	when F = 0, size = 10	F16	when F = 1, size = 01	F32	when F = 1, size = 10
I16	when F = 0, size = 01								
I32	when F = 0, size = 10								
F16	when F = 1, size = 01								
F32	when F = 1, size = 10								
<Qd>	Is the 128-bit name of the SIMD&FP register holding the accumulate vector, encoded in the "D:Vd" field as <Qd>*2.								
<Qn>	Is the 128-bit name of the first SIMD&FP source register, encoded in the "N:Vn" field as <Qn>*2.								
<Dd>	Is the 64-bit name of the SIMD&FP register holding the accumulate vector, encoded in the "D:Vd" field.								
<Dn>	Is the 64-bit name of the first SIMD&FP source register, encoded in the "N:Vn" field.								
<Dm[x]>	Is the 64-bit name of the second SIMD&FP source register holding the scalar. If <dt> is I16 or F16, Dm is restricted to D0-D7. Dm is encoded in "Vm<2:0>", and x is encoded in "M:Vm<3>". If <dt> is I32 or F32, Dm is restricted to D0-D15. Dm is encoded in "Vm", and x is encoded in "M".								

Operation for all encodings

```

if ConditionPassed() then
  EncodingSpecificOperations(); CheckAdvSIMDEnabled();
  op2 = Elem[Din[m],index,esize]; op2val = Int(op2, unsigned);
  for r = 0 to regs-1
  
```

```
for e = 0 to elements-1
  op1 = Elem[Din[n+r],e,esize]; op1val = Int(op1, unsigned);
  if floating_point then
    fp_addend = if add then FPMul(op1,op2,StandardFPSCRValue()) else
FPNeg(FPMul(op1,op2,StandardFPSCRValue()));
    Elem[D[d+r],e,esize] = FPAdd(Elem[Din[d+r],e,esize], fp_addend, StandardFPSCRValue());
  else
    addend = if add then op1val*op2val else -op1val*op2val;
    if long_destination then
      Elem[Q[d>>1],e,2*esize] = Elem[Qin[d>>1],e,2*esize] + addend;
    else
      Elem[D[d+r],e,esize] = Elem[Din[d+r],e,esize] + addend;
```

F6.1.109 VMLAL (integer)

Vector Multiply Accumulate Long multiplies corresponding elements in two vectors, and add the products to the corresponding element of the destination vector. The destination vector element is twice as long as the elements that are multiplied.

Depending on settings in the CPACR, NSACR, and HCPTR registers, and the security state and mode in which the instruction is executed, an attempt to execute the instruction might be UNDEFINED, or trapped to Hyp mode. For more information see [Enabling Advanced SIMD and floating-point support on page G1-4413](#).

A1

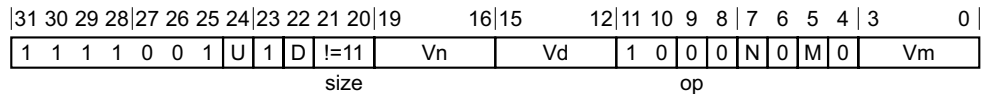

A1 variant

VMLAL{<c>}{<q>}.<type><size> <Qd>, <Dn>, <Dm> // Encoding T2/A2

Decode for this encoding

```

if size == '11' then SEE "Related encodings";
if Vd<0> == '1' then UNDEFINED;
add = (op == '0'); long_destination = TRUE; unsigned = (U == '1');
esize = 8 << UInt(size); elements = 64 DIV esize;
d = UInt(D:Vd); n = UInt(N:Vn); m = UInt(M:Vm); regs = 1;
  
```

T1

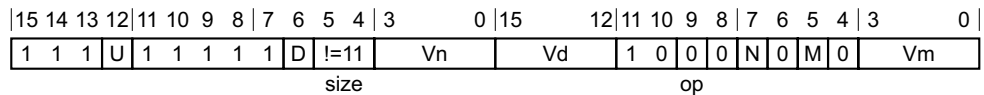

T1 variant

VMLAL{<c>}{<q>}.<type><size> <Qd>, <Dn>, <Dm> // Encoding T2/A2

Decode for this encoding

```

if size == '11' then SEE "Related encodings";
if Vd<0> == '1' then UNDEFINED;
add = (op == '0'); long_destination = TRUE; unsigned = (U == '1');
esize = 8 << UInt(size); elements = 64 DIV esize;
d = UInt(D:Vd); n = UInt(N:Vn); m = UInt(M:Vm); regs = 1;
  
```

Notes for all encodings

Related encodings: See [Advanced SIMD data-processing on page F3-2904](#) for the T32 instruction set, or [Advanced SIMD data-processing on page F4-2985](#) for the A32 instruction set.

Assembler symbols

- <c> For encoding A1: see [Standard assembler syntax fields on page F2-2848](#). This encoding must be unconditional.
- For encoding T1: see [Standard assembler syntax fields on page F2-2848](#).
- <q> See [Standard assembler syntax fields on page F2-2848](#).

<type>	The data type for the elements of the operands. It must be one of:
S	Optional in encoding T1/A1. Encoded as U = 0 in encoding T2/A2.
U	Optional in encoding T1/A1. Encoded as U = 1 in encoding T2/A2.
I	Available only in encoding T1/A1.
<size>	The data size for the elements of the operands. It must be one of:
8	Encoded as size = 0b00.
16	Encoded as size = 0b01.
32	Encoded as size = 0b10.
<Qd>	Is the 128-bit name of the SIMD&FP destination register, encoded in the "D:Vd" field as <Qd>*2.
<Dn>	Is the 64-bit name of the first SIMD&FP source register, encoded in the "N:Vn" field.
<Dm>	Is the 64-bit name of the second SIMD&FP source register, encoded in the "M:Vm" field.

Operation for all encodings

```

if ConditionPassed() then
    EncodingSpecificOperations(); CheckAdvSIMDEnabled();
    for r = 0 to regs-1
        for e = 0 to elements-1
            product = Int(Elem[Din[n+r],e,esize],unsigned) * Int(Elem[Din[m+r],e,esize],unsigned);
            addend = if add then product else -product;
            if long_destination then
                Elem[Q[d>>1],e,2*esize] = Elem[Qin[d>>1],e,2*esize] + addend;
            else
                Elem[D[d+r],e,esize] = Elem[Din[d+r],e,esize] + addend;
  
```

F6.1.110 VMLAL (by scalar)

Vector Multiply Accumulate Long multiplies elements of a vector by a scalar, and adds the products to corresponding elements of the destination vector. The destination vector elements are twice as long as the elements that are multiplied.

For more information about scalars see [Advanced SIMD scalars on page F2-2874](#).

Depending on settings in the CPACR, NSACR, and HCPTR registers, and the security state and mode in which the instruction is executed, an attempt to execute the instruction might be UNDEFINED, or trapped to Hyp mode. For more information see [Enabling Advanced SIMD and floating-point support on page G1-4413](#).

A1

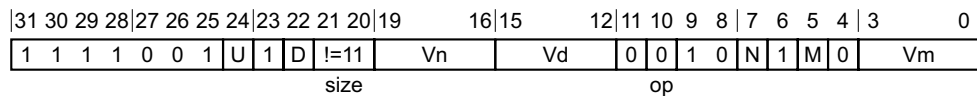

A1 variant

VMLAL{<c>}{<q>}.<dt> <Qd>, <Dn>, <Dm[x]>

Decode for this encoding

```

if size == '11' then SEE "Related encodings";
if size == '00' || Vd<0> == '1' then UNDEFINED;
unsigned = (U == '1'); add = (op == '0'); floating_point = FALSE; long_destination = TRUE;
d = UInt(D:Vd); n = UInt(N:Vn); regs = 1;
if size == '01' then esize = 16; elements = 4; m = UInt(Vm<2:0>); index = UInt(M:Vm<3>);
if size == '10' then esize = 32; elements = 2; m = UInt(Vm); index = UInt(M);
    
```

T1

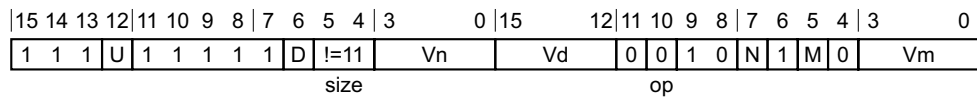

T1 variant

VMLAL{<c>}{<q>}.<dt> <Qd>, <Dn>, <Dm[x]>

Decode for this encoding

```

if size == '11' then SEE "Related encodings";
if size == '00' || Vd<0> == '1' then UNDEFINED;
unsigned = (U == '1'); add = (op == '0'); floating_point = FALSE; long_destination = TRUE;
d = UInt(D:Vd); n = UInt(N:Vn); regs = 1;
if size == '01' then esize = 16; elements = 4; m = UInt(Vm<2:0>); index = UInt(M:Vm<3>);
if size == '10' then esize = 32; elements = 2; m = UInt(Vm); index = UInt(M);
    
```

Notes for all encodings

Related encodings: See [Advanced SIMD data-processing on page F3-2904](#) for the T32 instruction set, or [Advanced SIMD data-processing on page F4-2985](#) for the A32 instruction set.

Assembler symbols

<c> For encoding A1: see [Standard assembler syntax fields on page F2-2848](#). This encoding must be unconditional.

For encoding T1: see *Standard assembler syntax fields* on page F2-2848.

- <q> See *Standard assembler syntax fields* on page F2-2848.
- <dt> Is the data type for the scalar and the elements of the operand vector, encoded in the "U:size" field. It can have the following values:
 - S16 when U = 0, size = 01
 - S32 when U = 0, size = 10
 - U16 when U = 1, size = 01
 - U32 when U = 1, size = 10
- <Qd> Is the 128-bit name of the SIMD&FP register holding the accumulate vector, encoded in the "D:Vd" field as <Qd>*2.
- <Dn> Is the 64-bit name of the first SIMD&FP source register, encoded in the "N:Vn" field.
- <Dm[x]> Is the 64-bit name of the second SIMD&FP source register holding the scalar. If <dt> is S16 or U16, Dm is restricted to D0-D7. Dm is encoded in "Vm<2:0>", and x is encoded in "M:Vm<3>". If <dt> is S32 or U32, Dm is restricted to D0-D15. Dm is encoded in "Vm", and x is encoded in "M".

Operation for all encodings

```

if ConditionPassed() then
  EncodingSpecificOperations(); CheckAdvSIMDEnabled();
  op2 = Elem[Din[m],index,esize]; op2val = Int(op2, unsigned);
  for r = 0 to regs-1
    for e = 0 to elements-1
      op1 = Elem[Din[n+r],e,esize]; op1val = Int(op1, unsigned);
      if floating_point then
        fp_addend = if add then FPMul(op1,op2,StandardFPSCRValue()) else
FPNeg(FPMul(op1,op2,StandardFPSCRValue()));
        Elem[D[d+r],e,esize] = FPAdd(Elem[Din[d+r],e,esize], fp_addend, StandardFPSCRValue());
      else
        addend = if add then op1val*op2val else -op1val*op2val;
        if long_destination then
          Elem[Q[d>>1],e,2*esize] = Elem[Qin[d>>1],e,2*esize] + addend;
        else
          Elem[D[d+r],e,esize] = Elem[Din[d+r],e,esize] + addend;
  
```

F6.1.111 VMLS (floating-point)

Vector Multiply Subtract multiplies corresponding elements in two vectors, subtracts the products from corresponding elements of the destination vector, and places the results in the destination vector.

———— Note ————

ARM recommends that software does not use the VMLS instruction in the Round towards Plus Infinity and Round towards Minus Infinity rounding modes, because the rounding of the product and of the sum can change the result of the instruction in opposite directions, defeating the purpose of these rounding modes.

Depending on settings in the CPACR, NSACR, HCPTR, and FPEXC registers, and the security state and mode in which the instruction is executed, an attempt to execute the instruction might be UNDEFINED, or trapped to Hyp mode. For more information see *Enabling Advanced SIMD and floating-point support on page G1-4413*.

A1

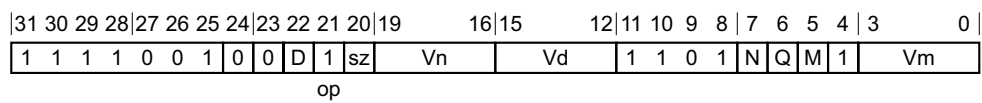

64-bit SIMD vector variant

Applies when Q == 0.

VMLS{<c>}{<q>}.<dt> <Dd>, <Dn>, <Dm>

128-bit SIMD vector variant

Applies when Q == 1.

VMLS{<c>}{<q>}.<dt> <Qd>, <Qn>, <Qm>

Decode for all variants of this encoding

```

if Q == '1' && (Vd<0> == '1' || Vn<0> == '1' || Vm<0> == '1') then UNDEFINED;
if sz == '1' && !HaveFP16Ext() then UNDEFINED;
advsimd = TRUE; add = (op == '0');
case sz of
    when '0' esize = 32; elements = 2;
    when '1' esize = 16; elements = 4;
d = UInt(D:Vd); n = UInt(N:Vn); m = UInt(M:Vm); regs = if Q == '0' then 1 else 2;
    
```

A2

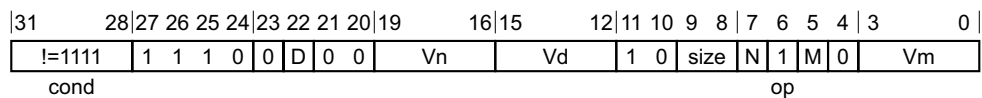

Half-precision scalar variant

Applies when size == 01.

VMLS{<c>}{<q>}.F16 <Sd>, <Sn>, <Sm>

Single-precision scalar variant

Applies when size == 10.

VMLS{<c>}{<q>}.F32 <Sd>, <Sn>, <Sm>

Double-precision scalar variant

Applies when size == 11.

VMLS{<c>}{<q>}.F64 <Dd>, <Dn>, <Dm>

Decode for all variants of this encoding

```

if size == '00' || (size == '01' && !HaveFP16Ext()) then UNDEFINED;
if size == '01' && cond != '1110' then UNPREDICTABLE;
if FPSCR.Len != '000' || FPSCR.Stride != '00' then UNDEFINED;
advsimd = FALSE; add = (op == '0');
case size of
    when '01' esize = 16; d = UInt(Vd:D); n = UInt(Vn:N); m = UInt(Vm:M);
    when '10' esize = 32; d = UInt(Vd:D); n = UInt(Vn:N); m = UInt(Vm:M);
    when '11' esize = 64; d = UInt(D:Vd); n = UInt(N:Vn); m = UInt(M:Vm);
    
```

CONSTRAINED UNPREDICTABLE behavior

If size == '01' && cond != '1110', then one of the following behaviors must occur:

- The instruction is UNDEFINED.
- The instruction executes as if it passes the Condition code check.
- The instruction executes as NOP. This means it behaves as if it fails the Condition code check.

T1

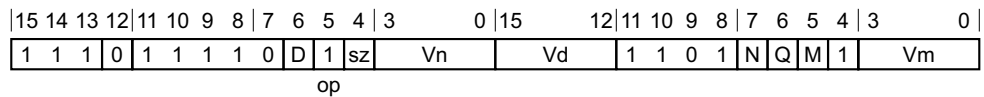

64-bit SIMD vector variant

Applies when Q == 0.

VMLS{<c>}{<q>}.<dt> <Dd>, <Dn>, <Dm>

128-bit SIMD vector variant

Applies when Q == 1.

VMLS{<c>}{<q>}.<dt> <Qd>, <Qn>, <Qm>

Decode for all variants of this encoding

```

if Q == '1' && (Vd<0> == '1' || Vn<0> == '1' || Vm<0> == '1') then UNDEFINED;
if sz == '1' && !HaveFP16Ext() then UNDEFINED;
if sz == '1' && InITBlock() then UNPREDICTABLE;
advsimd = TRUE; add = (op == '0');
case sz of
    when '0' esize = 32; elements = 2;
    when '1' esize = 16; elements = 4;
d = UInt(D:Vd); n = UInt(N:Vn); m = UInt(M:Vm); regs = if Q == '0' then 1 else 2;
    
```

CONSTRAINED UNPREDICTABLE behavior

If sz == '1' && InITBlock(), then one of the following behaviors must occur:

- The instruction is UNDEFINED.
- The instruction executes as if it passes the Condition code check.
- The instruction executes as NOP. This means it behaves as if it fails the Condition code check.

T2

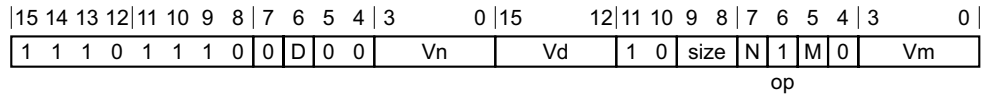

Half-precision scalar variant

Applies when size == 01.

VMLS{<c>}{<q>}.F16 <Sd>, <Sn>, <Sm>

Single-precision scalar variant

Applies when size == 10.

VMLS{<c>}{<q>}.F32 <Sd>, <Sn>, <Sm>

Double-precision scalar variant

Applies when size == 11.

VMLS{<c>}{<q>}.F64 <Dd>, <Dn>, <Dm>

Decode for all variants of this encoding

```

if size == '00' || (size == '01' && !HaveFP16Ext()) then UNDEFINED;
if size == '01' && InITBlock() then UNPREDICTABLE;
if FPSCR.Len != '000' || FPSCR.Stride != '00' then UNDEFINED;
advsimd = FALSE; add = (op == '0');
case size of
    when '01' esize = 16; d = UInt(Vd:D); n = UInt(Vn:N); m = UInt(Vm:M);
    when '10' esize = 32; d = UInt(Vd:D); n = UInt(Vn:N); m = UInt(Vm:M);
    when '11' esize = 64; d = UInt(D:Vd); n = UInt(N:Vn); m = UInt(M:Vm);
    
```

CONSTRAINED UNPREDICTABLE behavior

If size == '01' && InITBlock(), then one of the following behaviors must occur:

- The instruction is UNDEFINED.
- The instruction executes as if it passes the Condition code check.
- The instruction executes as NOP. This means it behaves as if it fails the Condition code check.

Assembler symbols

- <c> For encoding A1: see [Standard assembler syntax fields on page F2-2848](#). This encoding must be unconditional.
 For encoding A2, T1 and T2: see [Standard assembler syntax fields on page F2-2848](#).
- <q> See [Standard assembler syntax fields on page F2-2848](#).
- <dt> Is the data type for the elements of the vectors, encoded in the "sz" field. It can have the following values:
 F32 when sz = 0
 F16 when sz = 1
- <Qd> Is the 128-bit name of the SIMD&FP destination register, encoded in the "D:Vd" field as <Qd>*2.
- <Qn> Is the 128-bit name of the first SIMD&FP source register, encoded in the "N:Vn" field as <Qn>*2.

- <Qm> Is the 128-bit name of the second SIMD&FP source register, encoded in the "M:Vm" field as <Qm>*2.
- <Dd> Is the 64-bit name of the SIMD&FP destination register, encoded in the "D:Vd" field.
- <Dn> Is the 64-bit name of the first SIMD&FP source register, encoded in the "N:Vn" field.
- <Dm> Is the 64-bit name of the second SIMD&FP source register, encoded in the "M:Vm" field.
- <Sd> Is the 32-bit name of the SIMD&FP destination register, encoded in the "Vd:D" field.
- <Sn> Is the 32-bit name of the first SIMD&FP source register, encoded in the "Vn:N" field.
- <Sm> Is the 32-bit name of the second SIMD&FP source register, encoded in the "Vm:M" field.

Operation for all encodings

```

if ConditionPassed() then
    EncodingSpecificOperations(); CheckAdvSIMDOrVFPEEnabled(TRUE, advsimd);
    if advsimd then // Advanced SIMD instruction
        for r = 0 to regs-1
            for e = 0 to elements-1
                product = FPMu1(ElEm[D[n+r],e,esize], ElEm[D[m+r],e,esize], StandardFPSCRValue());
                addend = if add then product else FPNeg(product);
                ElEm[D[d+r],e,esize] = FPAdd(ElEm[D[d+r],e,esize], addend, StandardFPSCRValue());
            else // VFP instruction
                case esize of
                    when 16
                        addend16 = if add then FPMu1(S[n]<15:0>, S[m]<15:0>, FPSCR) else FPNeg(FPMu1(S[n]<15:0>,
S[m]<15:0>, FPSCR));
                        S[d] = Zeros(16) : FPAdd(S[d]<15:0>, addend16, FPSCR);
                    when 32
                        addend32 = if add then FPMu1(S[n], S[m], FPSCR) else FPNeg(FPMu1(S[n], S[m], FPSCR));
                        S[d] = FPAdd(S[d], addend32, FPSCR);
                    when 64
                        addend64 = if add then FPMu1(D[n], D[m], FPSCR) else FPNeg(FPMu1(D[n], D[m], FPSCR));
                        D[d] = FPAdd(D[d], addend64, FPSCR);

```

F6.1.112 VMLS (integer)

Vector Multiply Subtract multiplies corresponding elements in two vectors, and subtracts the products from the corresponding elements of the destination vector.

Depending on settings in the CPACR, NSACR, and HCPTR registers, and the security state and mode in which the instruction is executed, an attempt to execute the instruction might be UNDEFINED, or trapped to Hyp mode. For more information see [Enabling Advanced SIMD and floating-point support on page G1-4413](#).

A1

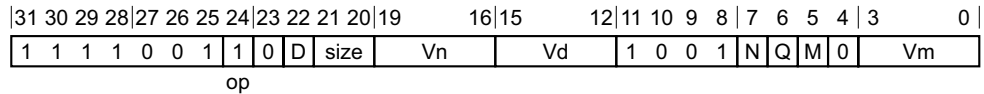

64-bit SIMD vector variant

Applies when Q == 0.

VMLS{<c>}{<q>}.<type><size> <Dd>, <Dn>, <Dm> // Encoding T1/A1, encoded as Q = 0

128-bit SIMD vector variant

Applies when Q == 1.

VMLS{<c>}{<q>}.<type><size> <Qd>, <Qn>, <Qm> // Encoding T1/A1, encoded as Q = 1

Decode for all variants of this encoding

```

if size == '11' then UNDEFINED;
if Q == '1' && (Vd<0> == '1' || Vn<0> == '1' || Vm<0> == '1') then UNDEFINED;
add = (op == '0'); long_destination = FALSE;
unsigned = FALSE; // "Don't care" value: TRUE produces same functionality
esize = 8 << UInt(size); elements = 64 DIV esize;
d = UInt(D:Vd); n = UInt(N:Vn); m = UInt(M:Vm); regs = if Q == '0' then 1 else 2;
    
```

T1

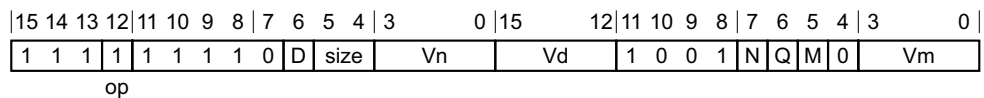

64-bit SIMD vector variant

Applies when Q == 0.

VMLS{<c>}{<q>}.<type><size> <Dd>, <Dn>, <Dm> // Encoding T1/A1, encoded as Q = 0

128-bit SIMD vector variant

Applies when Q == 1.

VMLS{<c>}{<q>}.<type><size> <Qd>, <Qn>, <Qm> // Encoding T1/A1, encoded as Q = 1

Decode for all variants of this encoding

```

if size == '11' then UNDEFINED;
if Q == '1' && (Vd<0> == '1' || Vn<0> == '1' || Vm<0> == '1') then UNDEFINED;
add = (op == '0'); long_destination = FALSE;
unsigned = FALSE; // "Don't care" value: TRUE produces same functionality
esize = 8 << UInt(size); elements = 64 DIV esize;
d = UInt(D:Vd); n = UInt(N:Vn); m = UInt(M:Vm); regs = if Q == '0' then 1 else 2;
    
```

Assembler symbols

<c>	For encoding A1: see <i>Standard assembler syntax fields</i> on page F2-2848. This encoding must be unconditional. For encoding T1: see <i>Standard assembler syntax fields</i> on page F2-2848.
<q>	See <i>Standard assembler syntax fields</i> on page F2-2848.
<type>	The data type for the elements of the operands. It must be one of: S Optional in encoding T1/A1. Encoded as U = 0 in encoding T2/A2. U Optional in encoding T1/A1. Encoded as U = 1 in encoding T2/A2. I Available only in encoding T1/A1.
<size>	The data size for the elements of the operands. It must be one of: 8 Encoded as size = 0b00. 16 Encoded as size = 0b01. 32 Encoded as size = 0b10.
<Qd>	Is the 128-bit name of the SIMD&FP destination register, encoded in the "D:Vd" field as <Qd>*2.
<Qn>	Is the 128-bit name of the first SIMD&FP source register, encoded in the "N:Vn" field as <Qn>*2.
<Qm>	Is the 128-bit name of the second SIMD&FP source register, encoded in the "M:Vm" field as <Qm>*2.
<Dd>	Is the 64-bit name of the SIMD&FP destination register, encoded in the "D:Vd" field.
<Dn>	Is the 64-bit name of the first SIMD&FP source register, encoded in the "N:Vn" field.
<Dm>	Is the 64-bit name of the second SIMD&FP source register, encoded in the "M:Vm" field.

Operation for all encodings

```

if ConditionPassed() then
    EncodingSpecificOperations(); CheckAdvSIMDEnabled();
    for r = 0 to regs-1
        for e = 0 to elements-1
            product = Int(Elem[Din[n+r],e,esize],unsigned) * Int(Elem[Din[m+r],e,esize],unsigned);
            addend = if add then product else -product;
            if long_destination then
                Elem[Q[d>>1],e,2*esize] = Elem[Qin[d>>1],e,2*esize] + addend;
            else
                Elem[D[d+r],e,esize] = Elem[Din[d+r],e,esize] + addend;
  
```

F6.1.113 VMLS (by scalar)

Vector Multiply Subtract multiplies elements of a vector by a scalar, and either subtracts the products from corresponding elements of the destination vector.

For more information about scalars see [Advanced SIMD scalars on page F2-2874](#).

Depending on settings in the CPACR, NSACR, and HCPTR registers, and the security state and mode in which the instruction is executed, an attempt to execute the instruction might be UNDEFINED, or trapped to Hyp mode. For more information see [Enabling Advanced SIMD and floating-point support on page G1-4413](#).

A1

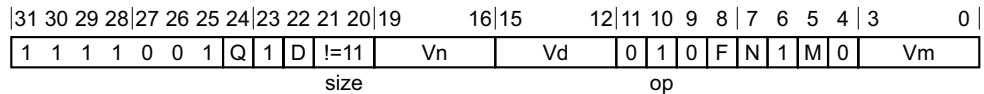

64-bit SIMD vector variant

Applies when Q == 0.

VMLS{<c>}{<q>}.<dt> <Dd>, <Dn>, <Dm[x]>

128-bit SIMD vector variant

Applies when Q == 1.

VMLS{<c>}{<q>}.<dt> <Qd>, <Qn>, <Dm[x]>

Decode for all variants of this encoding

```

if size == '11' then SEE "Related encodings";
if size == '00' || (F == '1' && size == '01' && !HaveFP16Ext()) then UNDEFINED;
if Q == '1' && (Vd<0> == '1' || Vn<0> == '1') then UNDEFINED;
unsigned = FALSE; // "Don't care" value: TRUE produces same functionality
add = (op == '0'); floating_point = (F == '1'); long_destination = FALSE;
d = UInt(D:Vd); n = UInt(N:Vn); regs = if Q == '0' then 1 else 2;
if size == '01' then esize = 16; elements = 4; m = UInt(Vm<2:0>); index = UInt(M:Vm<3>);
if size == '10' then esize = 32; elements = 2; m = UInt(Vm); index = UInt(M);
    
```

T1

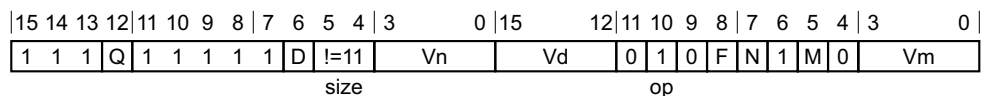

64-bit SIMD vector variant

Applies when Q == 0.

VMLS{<c>}{<q>}.<dt> <Dd>, <Dn>, <Dm[x]>

128-bit SIMD vector variant

Applies when Q == 1.

VMLS{<c>}{<q>}.<dt> <Qd>, <Qn>, <Dm[x]>

Decode for all variants of this encoding

```

if size == '11' then SEE "Related encodings";
if size == '00' || (F == '1' && size == '01' && !HaveFP16Ext()) then UNDEFINED;
if F == '1' && size == '01' && InITBlock() then UNPREDICTABLE;
if Q == '1' && (Vd<0> == '1' || Vn<0> == '1') then UNDEFINED;
unsigned = FALSE; // "Don't care" value: TRUE produces same functionality
add = (op == '0'); floating_point = (F == '1'); long_destination = FALSE;
d = UInt(D:Vd); n = UInt(N:Vn); regs = if Q == '0' then 1 else 2;
if size == '01' then esize = 16; elements = 4; m = UInt(Vm<2:0>); index = UInt(M:Vm<3>);
if size == '10' then esize = 32; elements = 2; m = UInt(Vm); index = UInt(M);
  
```

CONSTRAINED UNPREDICTABLE behavior

If F == '1' && size == '01' && InITBlock(), then one of the following behaviors must occur:

- The instruction is UNDEFINED.
- The instruction executes as if it passes the Condition code check.
- The instruction executes as NOP. This means it behaves as if it fails the Condition code check.

Notes for all encodings

Related encodings: See [Advanced SIMD data-processing on page F3-2904](#) for the T32 instruction set, or [Advanced SIMD data-processing on page F4-2985](#) for the A32 instruction set.

Assembler symbols

- <c> For encoding A1: see [Standard assembler syntax fields on page F2-2848](#). This encoding must be unconditional.
 For encoding T1: see [Standard assembler syntax fields on page F2-2848](#).
- <q> See [Standard assembler syntax fields on page F2-2848](#).
- <dt> Is the data type for the scalar and the elements of the operand vector, encoded in the "F:size" field. It can have the following values:
 - I16 when F = 0, size = 01
 - I32 when F = 0, size = 10
 - F16 when F = 1, size = 01
 - F32 when F = 1, size = 10
- <Qd> Is the 128-bit name of the SIMD&FP register holding the accumulate vector, encoded in the "D:Vd" field as <Qd>*2.
- <Qn> Is the 128-bit name of the first SIMD&FP source register, encoded in the "N:Vn" field as <Qn>*2.
- <Dd> Is the 64-bit name of the SIMD&FP register holding the accumulate vector, encoded in the "D:Vd" field.
- <Dn> Is the 64-bit name of the first SIMD&FP source register, encoded in the "N:Vn" field.
- <Dm[x]> Is the 64-bit name of the second SIMD&FP source register holding the scalar. If <dt> is I16 or F16, Dm is restricted to D0-D7. Dm is encoded in "Vm<2:0>", and x is encoded in "M:Vm<3>". If <dt> is I32 or F32, Dm is restricted to D0-D15. Dm is encoded in "Vm", and x is encoded in "M".

Operation for all encodings

```

if ConditionPassed() then
  EncodingSpecificOperations(); CheckAdvSIMDEnabled();
  op2 = Elem[Din[m],index,esize]; op2val = Int(op2, unsigned);
  for r = 0 to regs-1
  
```

```
for e = 0 to elements-1
  op1 = Elem[Din[n+r],e,esize]; op1val = Int(op1, unsigned);
  if floating_point then
    fp_addend = if add then FPMul(op1,op2,StandardFPSCRValue()) else
FPNeg(FPMul(op1,op2,StandardFPSCRValue()));
    Elem[D[d+r],e,esize] = FPAdd(Elem[Din[d+r],e,esize], fp_addend, StandardFPSCRValue());
  else
    addend = if add then op1val*op2val else -op1val*op2val;
    if long_destination then
      Elem[Q[d>>1],e,2*esize] = Elem[Qin[d>>1],e,2*esize] + addend;
    else
      Elem[D[d+r],e,esize] = Elem[Din[d+r],e,esize] + addend;
```

F6.1.114 VMLSL (integer)

Vector Multiply Subtract Long multiplies corresponding elements in two vectors, and subtract the products from the corresponding elements of the destination vector. The destination vector element is twice as long as the elements that are multiplied.

Depending on settings in the CPACR, NSACR, and HCPTR registers, and the security state and mode in which the instruction is executed, an attempt to execute the instruction might be UNDEFINED, or trapped to Hyp mode. For more information see [Enabling Advanced SIMD and floating-point support on page G1-4413](#).

A1

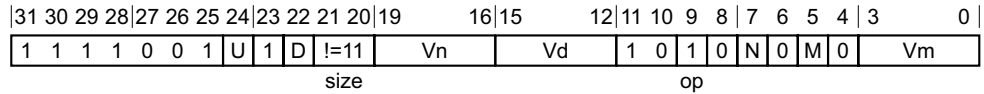

A1 variant

VMLSL{<c>}{<q>}.<type><size> <Qd>, <Dn>, <Dm> // Encoding T2/A2

Decode for this encoding

```

if size == '11' then SEE "Related encodings";
if Vd<0> == '1' then UNDEFINED;
add = (op == '0'); long_destination = TRUE; unsigned = (U == '1');
esize = 8 << UInt(size); elements = 64 DIV esize;
d = UInt(D:Vd); n = UInt(N:Vn); m = UInt(M:Vm); regs = 1;
    
```

T1

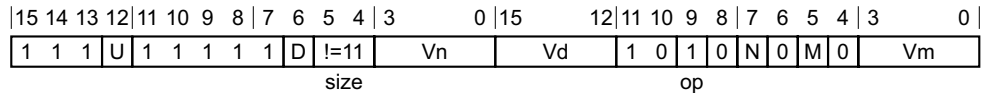

T1 variant

VMLSL{<c>}{<q>}.<type><size> <Qd>, <Dn>, <Dm> // Encoding T2/A2

Decode for this encoding

```

if size == '11' then SEE "Related encodings";
if Vd<0> == '1' then UNDEFINED;
add = (op == '0'); long_destination = TRUE; unsigned = (U == '1');
esize = 8 << UInt(size); elements = 64 DIV esize;
d = UInt(D:Vd); n = UInt(N:Vn); m = UInt(M:Vm); regs = 1;
    
```

Notes for all encodings

Related encodings: See [Advanced SIMD data-processing on page F3-2904](#) for the T32 instruction set, or [Advanced SIMD data-processing on page F4-2985](#) for the A32 instruction set.

Assembler symbols

- <c> For encoding A1: see [Standard assembler syntax fields on page F2-2848](#). This encoding must be unconditional.
- For encoding T1: see [Standard assembler syntax fields on page F2-2848](#).
- <q> See [Standard assembler syntax fields on page F2-2848](#).

<type>	The data type for the elements of the operands. It must be one of:
S	Optional in encoding T1/A1. Encoded as U = 0 in encoding T2/A2.
U	Optional in encoding T1/A1. Encoded as U = 1 in encoding T2/A2.
I	Available only in encoding T1/A1.
<size>	The data size for the elements of the operands. It must be one of:
8	Encoded as size = 0b00.
16	Encoded as size = 0b01.
32	Encoded as size = 0b10.
<Qd>	Is the 128-bit name of the SIMD&FP destination register, encoded in the "D:Vd" field as <Qd>*2.
<Dn>	Is the 64-bit name of the first SIMD&FP source register, encoded in the "N:Vn" field.
<Dm>	Is the 64-bit name of the second SIMD&FP source register, encoded in the "M:Vm" field.

Operation for all encodings

```

if ConditionPassed() then
    EncodingSpecificOperations(); CheckAdvSIMDEnabled();
    for r = 0 to regs-1
        for e = 0 to elements-1
            product = Int(Elem[Din[n+r],e,esize],unsigned) * Int(Elem[Din[m+r],e,esize],unsigned);
            addend = if add then product else -product;
            if long_destination then
                Elem[Q[d>>1],e,2*esize] = Elem[Qin[d>>1],e,2*esize] + addend;
            else
                Elem[D[d+r],e,esize] = Elem[Din[d+r],e,esize] + addend;
  
```

F6.1.115 VMLS (by scalar)

Vector Multiply Subtract Long multiplies elements of a vector by a scalar, and subtracts the products from corresponding elements of the destination vector. The destination vector elements are twice as long as the elements that are multiplied.

For more information about scalars see [Advanced SIMD scalars on page F2-2874](#).

Depending on settings in the CPACR, NSACR, and HCPTR registers, and the security state and mode in which the instruction is executed, an attempt to execute the instruction might be UNDEFINED, or trapped to Hyp mode. For more information see [Enabling Advanced SIMD and floating-point support on page G1-4413](#).

A1

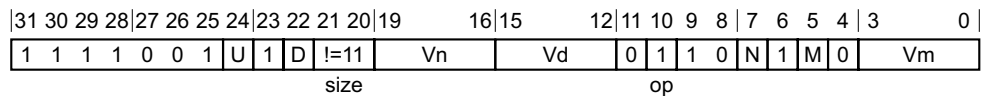

A1 variant

VMLS{<c>}{<q>}.<dt> <Qd>, <Dn>, <Dm[x]>

Decode for this encoding

```

if size == '11' then SEE "Related encodings";
if size == '00' || Vd<0> == '1' then UNDEFINED;
unsigned = (U == '1'); add = (op == '0'); floating_point = FALSE; long_destination = TRUE;
d = UInt(D:Vd); n = UInt(N:Vn); regs = 1;
if size == '01' then esize = 16; elements = 4; m = UInt(Vm<2:0>); index = UInt(M:Vm<3>);
if size == '10' then esize = 32; elements = 2; m = UInt(Vm); index = UInt(M);
  
```

T1

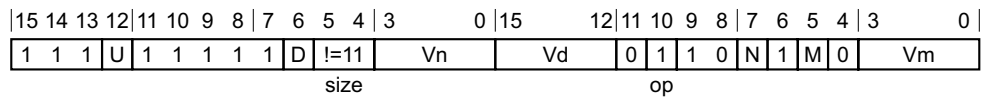

T1 variant

VMLS{<c>}{<q>}.<dt> <Qd>, <Dn>, <Dm[x]>

Decode for this encoding

```

if size == '11' then SEE "Related encodings";
if size == '00' || Vd<0> == '1' then UNDEFINED;
unsigned = (U == '1'); add = (op == '0'); floating_point = FALSE; long_destination = TRUE;
d = UInt(D:Vd); n = UInt(N:Vn); regs = 1;
if size == '01' then esize = 16; elements = 4; m = UInt(Vm<2:0>); index = UInt(M:Vm<3>);
if size == '10' then esize = 32; elements = 2; m = UInt(Vm); index = UInt(M);
  
```

Notes for all encodings

Related encodings: See [Advanced SIMD data-processing on page F3-2904](#) for the T32 instruction set, or [Advanced SIMD data-processing on page F4-2985](#) for the A32 instruction set.

Assembler symbols

<c> For encoding A1: see [Standard assembler syntax fields on page F2-2848](#). This encoding must be unconditional.

For encoding T1: see *Standard assembler syntax fields* on page F2-2848.

- <q> See *Standard assembler syntax fields* on page F2-2848.
- <dt> Is the data type for the scalar and the elements of the operand vector, encoded in the "U:size" field. It can have the following values:
- | | |
|-----|-----------------------|
| S16 | when U = 0, size = 01 |
| S32 | when U = 0, size = 10 |
| U16 | when U = 1, size = 01 |
| U32 | when U = 1, size = 10 |
- <Qd> Is the 128-bit name of the SIMD&FP register holding the accumulate vector, encoded in the "D:Vd" field as <Qd>*2.
- <Dn> Is the 64-bit name of the first SIMD&FP source register, encoded in the "N:Vn" field.
- <Dm[x]> Is the 64-bit name of the second SIMD&FP source register holding the scalar. If <dt> is S16 or U16, Dm is restricted to D0-D7. Dm is encoded in "Vm<2:0>", and x is encoded in "M:Vm<3>". If <dt> is S32 or U32, Dm is restricted to D0-D15. Dm is encoded in "Vm", and x is encoded in "M".

Operation for all encodings

```

if ConditionPassed() then
    EncodingSpecificOperations(); CheckAdvSIMDEnabled();
    op2 = Elem[Din[m],index,esize]; op2val = Int(op2, unsigned);
    for r = 0 to regs-1
        for e = 0 to elements-1
            op1 = Elem[Din[n+r],e,esize]; op1val = Int(op1, unsigned);
            if floating_point then
                fp_addend = if add then FPMul(op1,op2,StandardFPSCRValue()) else
                    FPNeg(FPMul(op1,op2,StandardFPSCRValue()));
                Elem[D[d+r],e,esize] = FPAdd(Elem[Din[d+r],e,esize], fp_addend, StandardFPSCRValue());
            else
                addend = if add then op1val*op2val else -op1val*op2val;
                if long_destination then
                    Elem[Q[d>>1],e,2*esize] = Elem[Qin[d>>1],e,2*esize] + addend;
                else
                    Elem[D[d+r],e,esize] = Elem[Din[d+r],e,esize] + addend;
  
```

F6.1.116 VMOV (between two general-purpose registers and a doubleword floating-point register)

Copy two general-purpose registers to or from a SIMD&FP register copies two words from two general-purpose registers into a doubleword register in the Advanced SIMD and floating-point register file, or from a doubleword register in the Advanced SIMD and floating-point register file to two general-purpose registers.

Depending on settings in the CPACR, NSACR, HCPTR, and FPEXC registers, and the security state and mode in which the instruction is executed, an attempt to execute the instruction might be UNDEFINED, or trapped to Hyp mode. For more information see [Enabling Advanced SIMD and floating-point support on page G1-4413](#).

A1

31				28 27 26 25 24 23 22 21 20 19				16 15				12 11 10 9 8 7 6 5 4 3				0															
!=1111				1 1 0 0 0 1 0				op				Rt2				Rt				1 0 1 1 0 0				M 1				Vm			
cond																															

From general-purpose registers variant

Applies when op == 0.

VMOV{<c>}{<q>} <Dm>, <Rt>, <Rt2>

To general-purpose registers variant

Applies when op == 1.

VMOV{<c>}{<q>} <Rt>, <Rt2>, <Dm>

Decode for all variants of this encoding

```
to_arm_registers = (op == '1'); t = UInt(Rt); t2 = UInt(Rt2); m = UInt(M:Vm);
if t == 15 || t2 == 15 then UNPREDICTABLE; // ARMv8-A removes UNPREDICTABLE for R13
if to_arm_registers && t == t2 then UNPREDICTABLE;
```

CONSTRAINED UNPREDICTABLE behavior

If to_arm_registers && t == t2, then one of the following behaviors must occur:

- The instruction is UNDEFINED.
- The instruction executes as NOP.
- The value in the destination register is UNKNOWN.

T1

15 14 13 12 11 10 9 8 7 6 5 4 3				0 15				12 11 10 9 8 7 6 5 4 3				0															
1 1 1 0 1 1 0 0 0 1 0				op				Rt2				Rt				1 0 1 1 0 0				M 1				Vm			

From general-purpose registers variant

Applies when op == 0.

VMOV{<c>}{<q>} <Dm>, <Rt>, <Rt2>

To general-purpose registers variant

Applies when op == 1.

VMOV{<c>}{<q>} <Rt>, <Rt2>, <Dm>

Decode for all variants of this encoding

```
to_arm_registers = (op == '1'); t = UInt(Rt); t2 = UInt(Rt2); m = UInt(M:Vm);  
if t == 15 || t2 == 15 then UNPREDICTABLE; // ARMv8-A removes UNPREDICTABLE for R13  
if to_arm_registers && t == t2 then UNPREDICTABLE;
```

CONSTRAINED UNPREDICTABLE behavior

If `to_arm_registers` && `t == t2`, then one of the following behaviors must occur:

- The instruction is UNDEFINED.
- The instruction executes as NOP.
- The value in the destination register is UNKNOWN.

Notes for all encodings

For more information about the CONSTRAINED UNPREDICTABLE behavior of this instruction, see [Appendix K1 Architectural Constraints on UNPREDICTABLE behaviors](#), and particularly *VMOV (between two general-purpose registers and a doubleword floating-point register)* on page K1-6112.

Assembler symbols

<Dm>	Is the 64-bit name of the SIMD&FP register to be transferred, encoded in the "M:Vm" field.
<Rt2>	Is the first general-purpose register that <Dm>[63:32] will be transferred to or from, encoded in the "Rt" field.
<Rt>	Is the first general-purpose register that <Dm>[31:0] will be transferred to or from, encoded in the "Rt" field.
<c>	See <i>Standard assembler syntax fields</i> on page F2-2848.
<q>	See <i>Standard assembler syntax fields</i> on page F2-2848.

Operation for all encodings

```
if ConditionPassed() then  
  EncodingSpecificOperations(); CheckVFPEnabled(TRUE);  
  if to_arm_registers then  
    R[t] = D[m]<31:0>;  
    R[t2] = D[m]<63:32>;  
  else  
    D[m]<31:0> = R[t];  
    D[m]<63:32> = R[t2];
```

F6.1.117 VMOV (between general-purpose register and half-precision)

Copy 16 bits of a general-purpose register to or from a 32-bit SIMD&FP register. This instruction transfers the value held in the bottom 16 bits of a 32-bit SIMD&FP register to the bottom 16 bits of a general-purpose register, or the value held in the bottom 16 bits of a general-purpose register to the bottom 16 bits of a 32-bit SIMD&FP register.

Depending on settings in the CPACR, NSACR, HCPTR, and FPEXC registers, and the security state and mode in which the instruction is executed, an attempt to execute the instruction might be UNDEFINED, or trapped to Hyp mode. For more information see [Enabling Advanced SIMD and floating-point support on page G1-4413](#).

A1

ARMv8.2

31				28 27 26 25 24 23 22 21 20 19				16 15		12 11 10 9 8 7 6 5 4 3 2 1 0													
!=1111				1 1 1 0 0 0 0				op		Vn		Rt		1 0 0 1		N		(0)(0)		1		(0)(0)(0)(0)	
cond																							

From general-purpose register variant

Applies when op == 0.

VMOV{<c>}{<q>}.F16 <Sn>, <Rt>

To general-purpose register variant

Applies when op == 1.

VMOV{<c>}{<q>}.F16 <Rt>, <Sn>

Decode for all variants of this encoding

```
if !HaveFP16Ext() then UNDEFINED;
if cond != '1110' then UNPREDICTABLE;
to_arm_register = (op == '1'); t = UInt(Rt); n = UInt(Vn:N);
if t == 15 then UNPREDICTABLE; // ARMv8-A removes UNPREDICTABLE for R13
```

CONSTRAINED UNPREDICTABLE behavior

If cond != '1110', then one of the following behaviors must occur:

- The instruction is UNDEFINED.
- The instruction executes as if it passes the Condition code check.
- The instruction executes as NOP. This means it behaves as if it fails the Condition code check.

T1

ARMv8.2

15 14 13 12 11 10 9 8 7 6 5 4 3				0 15		12 11 10 9 8 7 6 5 4 3 2 1 0													
1 1 1 0 1 1 1 0 0 0 0				op		Vn		Rt		1 0 0 1		N		(0)(0)		1		(0)(0)(0)(0)	

From general-purpose register variant

Applies when op == 0.

VMOV{<c>}{<q>}.F16 <Sn>, <Rt>

To general-purpose register variant

Applies when `op == 1`.

```
VMOV{<c>}{<q>}.F16 <Rt>, <Sn>
```

Decode for all variants of this encoding

```
if !HaveFP16Ext() then UNDEFINED;  
if InITBlock() then UNPREDICTABLE;  
to_arm_register = (op == '1'); t = UInt(Rt); n = UInt(Vn:N);  
if t == 15 then UNPREDICTABLE; // ARMv8-A removes UNPREDICTABLE for R13
```

CONSTRAINED UNPREDICTABLE behavior

If `InITBlock()`, then one of the following behaviors must occur:

- The instruction is UNDEFINED.
- The instruction executes as if it passes the Condition code check.
- The instruction executes as NOP. This means it behaves as if it fails the Condition code check.

Notes for all encodings

For more information about the CONSTRAINED UNPREDICTABLE behavior of this instruction, see [Appendix K1 Architectural Constraints on UNPREDICTABLE behaviors](#).

Assembler symbols

<Rt>	Is the general-purpose register that <Sn> will be transferred to or from, encoded in the "Rt" field.
<Sn>	Is the 32-bit name of the SIMD&FP register to be transferred, encoded in the "Vn:N" field.
<c>	See Standard assembler syntax fields on page F2-2848 .
<q>	See Standard assembler syntax fields on page F2-2848 .

Operation for all encodings

```
if ConditionPassed() then  
  EncodingSpecificOperations(); CheckVFPEnabled(TRUE);  
  if to_arm_register then  
    R[t] = Zeros(16) : S[n]<15:0>;  
  else  
    S[n] = Zeros(16) : R[t]<15:0>;
```

F6.1.118 VMOV (immediate)

Copy immediate value to a SIMD&FP register places an immediate constant into every element of the destination register.

Depending on settings in the CPACR, NSACR, HCPTR, and FPEXC registers, and the security state and mode in which the instruction is executed, an attempt to execute the instruction might be UNDEFINED, or trapped to Hyp mode. For more information see [Enabling Advanced SIMD and floating-point support on page G1-4413](#).

A1

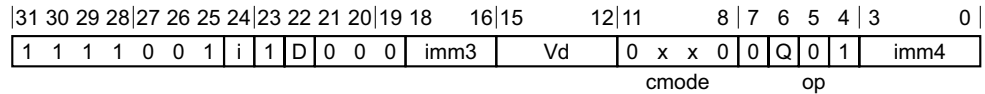

64-bit SIMD vector variant

Applies when Q == 0.

VMOV{<c>}{<q>}.I32 <Dd>, #<imm>

128-bit SIMD vector variant

Applies when Q == 1.

VMOV{<c>}{<q>}.I32 <Qd>, #<imm>

Decode for all variants of this encoding

```
if op == '0' && cmode<0> == '1' && cmode<3:2> != '11' then SEE VORR (immediate);
if op == '1' && cmode != '1110' then SEE "Related encodings";
if Q == '1' && Vd<0> == '1' then UNDEFINED;
single_register = FALSE; advsimd = TRUE; imm64 = AdvSIMDExpandImm(op, cmode, i:imm3:imm4);
d = UInt(D:Vd); regs = if Q == '0' then 1 else 2;
```

A2

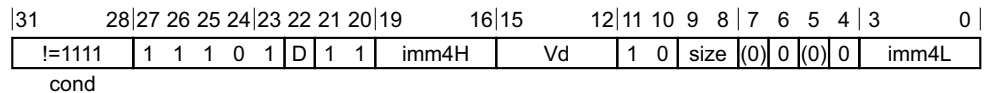

Half-precision scalar variant

Applies when size == 01.

VMOV{<c>}{<q>}.F16 <Sd>, #<imm>

Single-precision scalar variant

Applies when size == 10.

VMOV{<c>}{<q>}.F32 <Sd>, #<imm>

Double-precision scalar variant

Applies when size == 11.

VMOV{<c>}{<q>}.F64 <Dd>, #<imm>

Decode for all variants of this encoding

```

if FPSCR.Len != '000' || FPSCR.Stride != '00' then UNDEFINED;
if size == '00' || (size == '01' && !HaveFP16Ext()) then UNDEFINED;
if size == '01' && cond != '1110' then UNPREDICTABLE;
single_register = (size != '11'); advsimd = FALSE;
bits(16) imm16;
bits(32) imm32;
bits(64) imm64;
case size of
  when '01' d = UInt(Vd:D); imm16 = VFPEExpandImm(imm4H:imm4L); imm32 = Zeros(16) : imm16;
  when '10' d = UInt(Vd:D); imm32 = VFPEExpandImm(imm4H:imm4L);
  when '11' d = UInt(D:Vd); imm64 = VFPEExpandImm(imm4H:imm4L); regs = 1;
    
```

CONSTRAINED UNPREDICTABLE behavior

If size == '01' && cond != '1110', then one of the following behaviors must occur:

- The instruction is UNDEFINED.
- The instruction executes as if it passes the Condition code check.
- The instruction executes as NOP. This means it behaves as if it fails the Condition code check.

A3

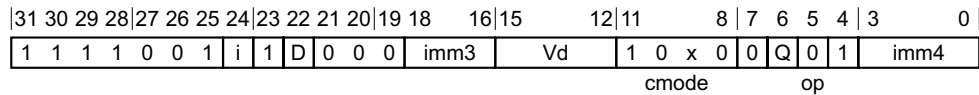

64-bit SIMD vector variant

Applies when Q == 0.

VMOV{<c>}{<q>}.I16 <Dd>, #<imm>

128-bit SIMD vector variant

Applies when Q == 1.

VMOV{<c>}{<q>}.I16 <Qd>, #<imm>

Decode for all variants of this encoding

```

if op == '0' && cmode<0> == '1' && cmode<3:2> != '11' then SEE VORR (immediate);
if op == '1' && cmode != '1110' then SEE "Related encodings";
if Q == '1' && Vd<0> == '1' then UNDEFINED;
single_register = FALSE; advsimd = TRUE; imm64 = AdvSIMDExpandImm(op, cmode, i:imm3:imm4);
d = UInt(D:Vd); regs = if Q == '0' then 1 else 2;
    
```

A4

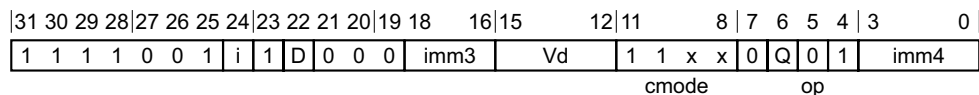

64-bit SIMD vector variant

Applies when Q == 0.

VMOV{<c>}{<q>}.<dt> <Dd>, #<imm>

128-bit SIMD vector variant

Applies when Q == 1.

VMOV{<c>}{<q>}.<dt> <Qd>, #<imm>

Decode for all variants of this encoding

```
if op == '0' && cmode<0> == '1' && cmode<3:2> != '11' then SEE VORR (immediate);
if op == '1' && cmode != '1110' then SEE "Related encodings";
if Q == '1' && Vd<0> == '1' then UNDEFINED;
single_register = FALSE; advsimd = TRUE; imm64 = AdvSIMDEExpandImm(op, cmode, i:imm3:imm4);
d = UInt(D:Vd); regs = if Q == '0' then 1 else 2;
```

A5

31	30	29	28	27	26	25	24	23	22	21	20	19	18	16	15	12	11	8	7	6	5	4	3	0
1	1	1	1	0	0	1	i	1	D	0	0	0	imm3	Vd	1	1	1	0	0	Q	1	1	imm4	
														cmode				op						

64-bit SIMD vector variant

Applies when Q == 0.

VMOV{<c>}{<q>}.I64 <Dd>, #<imm>

128-bit SIMD vector variant

Applies when Q == 1.

VMOV{<c>}{<q>}.I64 <Qd>, #<imm>

Decode for all variants of this encoding

```
if op == '0' && cmode<0> == '1' && cmode<3:2> != '11' then SEE VORR (immediate);
if op == '1' && cmode != '1110' then SEE "Related encodings";
if Q == '1' && Vd<0> == '1' then UNDEFINED;
single_register = FALSE; advsimd = TRUE; imm64 = AdvSIMDEExpandImm(op, cmode, i:imm3:imm4);
d = UInt(D:Vd); regs = if Q == '0' then 1 else 2;
```

T1

15	14	13	12	11	10	9	8	7	6	5	4	3	2	0	15	12	11	8	7	6	5	4	3	0
1	1	1	i	1	1	1	1	1	D	0	0	0	imm3	Vd	0	x	x	0	0	Q	0	1	imm4	
														cmode				op						

64-bit SIMD vector variant

Applies when Q == 0.

VMOV{<c>}{<q>}.I32 <Dd>, #<imm>

128-bit SIMD vector variant

Applies when Q == 1.

VMOV{<c>}{<q>}.I32 <Qd>, #<imm>

Decode for all variants of this encoding

```

if op == '0' && cmode<0> == '1' && cmode<3:2> != '11' then SEE VORR (immediate);
if op == '1' && cmode != '1110' then SEE "Related encodings";
if Q == '1' && Vd<0> == '1' then UNDEFINED;
single_register = FALSE; advsimd = TRUE; imm64 = AdvSIMDExpandImm(op, cmode, i:imm3:imm4);
d = UInt(D:Vd); regs = if Q == '0' then 1 else 2;
    
```

T2

15	14	13	12	11	10	9	8	7	6	5	4	3	0	15	12	11	10	9	8	7	6	5	4	3	0
1	1	1	0	1	1	1	0	1	D	1	1	imm4H	Vd	1	0	size	(0)	0	(0)	0	imm4L				

Half-precision scalar variant

Applies when size == 01.

VMOV{<c>}{<q>}.F16 <Sd>, #<imm>

Single-precision scalar variant

Applies when size == 10.

VMOV{<c>}{<q>}.F32 <Sd>, #<imm>

Double-precision scalar variant

Applies when size == 11.

VMOV{<c>}{<q>}.F64 <Dd>, #<imm>

Decode for all variants of this encoding

```

if FPSCR.Len != '000' || FPSCR.Stride != '00' then UNDEFINED;
if size == '00' || (size == '01' && !HaveFP16Ext()) then UNDEFINED;
if size == '01' && InITBlock() then UNPREDICTABLE;
single_register = (size != '11'); advsimd = FALSE;
bits(16) imm16;
bits(32) imm32;
bits(64) imm64;
case size of
    when '01' d = UInt(Vd:D); imm16 = VFPEExpandImm(imm4H:imm4L); imm32 = Zeros(16) : imm16;
    when '10' d = UInt(Vd:D); imm32 = VFPEExpandImm(imm4H:imm4L);
    when '11' d = UInt(D:Vd); imm64 = VFPEExpandImm(imm4H:imm4L); regs = 1;
    
```

CONSTRAINED UNPREDICTABLE behavior

If size == '01' && InITBlock(), then one of the following behaviors must occur:

- The instruction is UNDEFINED.
- The instruction executes as if it passes the Condition code check.
- The instruction executes as NOP. This means it behaves as if it fails the Condition code check.

T3

15	14	13	12	11	10	9	8	7	6	5	4	3	2	0	15	12	11	8	7	6	5	4	3	0
1	1	1	i	1	1	1	1	1	D	0	0	0	imm3	Vd	1	0	x	0	0	Q	0	1	imm4	
														cmode			op							

64-bit SIMD vector variant

Applies when Q == 0.

VMOV{<c>}{<q>}.I16 <Dd>, #<imm>

128-bit SIMD vector variant

Applies when Q == 1.

VMOV{<c>}{<q>}.I16 <Qd>, #<imm>

Decode for all variants of this encoding

```

if op == '0' && cmode<0> == '1' && cmode<3:2> != '11' then SEE VORR (immediate);
if op == '1' && cmode != '1110' then SEE "Related encodings";
if Q == '1' && Vd<0> == '1' then UNDEFINED;
single_register = FALSE; advsimd = TRUE; imm64 = AdvSIMDExpandImm(op, cmode, i:imm3:imm4);
d = UInt(D:Vd); regs = if Q == '0' then 1 else 2;
    
```

T4

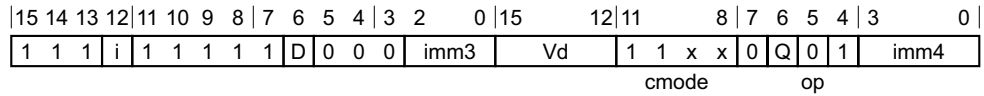

64-bit SIMD vector variant

Applies when Q == 0.

VMOV{<c>}{<q>}.<dt> <Dd>, #<imm>

128-bit SIMD vector variant

Applies when Q == 1.

VMOV{<c>}{<q>}.<dt> <Qd>, #<imm>

Decode for all variants of this encoding

```

if op == '0' && cmode<0> == '1' && cmode<3:2> != '11' then SEE VORR (immediate);
if op == '1' && cmode != '1110' then SEE "Related encodings";
if Q == '1' && Vd<0> == '1' then UNDEFINED;
single_register = FALSE; advsimd = TRUE; imm64 = AdvSIMDExpandImm(op, cmode, i:imm3:imm4);
d = UInt(D:Vd); regs = if Q == '0' then 1 else 2;
    
```

T5

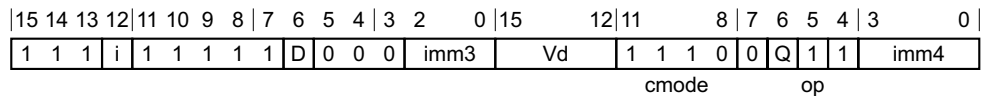

64-bit SIMD vector variant

Applies when Q == 0.

VMOV{<c>}{<q>}.I64 <Dd>, #<imm>

128-bit SIMD vector variant

Applies when Q == 1.

VMOV{<c>}{<q>}.I64 <Qd>, #<imm>

Decode for all variants of this encoding

```

if op == '0' && cmode<0> == '1' && cmode<3:2> != '11' then SEE VORR (immediate);
if op == '1' && cmode != '1110' then SEE "Related encodings";
if Q == '1' && Vd<0> == '1' then UNDEFINED;
single_register = FALSE; advsimd = TRUE; imm64 = AdvSIMDExpandImm(op, cmode, i:imm3:imm4);
d = UInt(D:Vd); regs = if Q == '0' then 1 else 2;
  
```

Notes for all encodings

Related encodings: See [Advanced SIMD one register and modified immediate on page F3-2912](#) for the T32 instruction set, or [Advanced SIMD one register and modified immediate on page F4-2994](#) for the A32 instruction set.

Assembler symbols

- <c> For encoding A1, A3, A4 and A5: see [Standard assembler syntax fields on page F2-2848](#). This encoding must be unconditional.
 For encoding A2, T1, T2, T3, T4 and T5: see [Standard assembler syntax fields on page F2-2848](#).
- <q> See [Standard assembler syntax fields on page F2-2848](#).
- <dt> The data type, encoded in the "cmode" field. It can have the following values:
 - I32 when cmode = 110x
 - I8 when cmode = 1110
 - F32 when cmode = 1111
- <Qd> Is the 128-bit name of the SIMD&FP destination register, encoded in the "D:Vd" field as <Qd>*2.
- <Dd> Is the 64-bit name of the SIMD&FP destination register, encoded in the "D:Vd" field.
- <Sd> Is the 32-bit name of the SIMD&FP destination register, encoded in the "Vd:D" field.
- <imm> For encoding A1, A3, A4, A5, T1, T3, T4 and T5: is a constant of the specified type that is replicated to fill the destination register. For details of the range of constants available and the encoding of <imm>, see [Modified immediate constants in T32 and A32 Advanced SIMD instructions on page F2-2865](#).
 For encoding A2 and T2: is a signed floating-point constant with 3-bit exponent and normalized 4 bits of precision, encoded in "imm4H:imm4L". For details of the range of constants available and the encoding of <imm>, see [Modified immediate constants in T32 and A32 floating-point instructions on page F2-2866](#).

Operation for all encodings

```

if ConditionPassed() then
  EncodingSpecificOperations(); CheckAdvSIMDorVFPEEnabled(TRUE, advsimd);
  if single_register then
    S[d] = imm32;
  else
    for r = 0 to regs-1
      D[d+r] = imm64;
  
```

F6.1.119 VMOV (register)

Copy between FP registers copies the contents of one FP register to another.

Depending on settings in the CPACR, NSACR, HCPTR, and FPEXC registers, and the security state and mode in which the instruction is executed, an attempt to execute the instruction might be UNDEFINED, or trapped to Hyp mode. For more information see [Enabling Advanced SIMD and floating-point support on page G1-4413](#).

A2

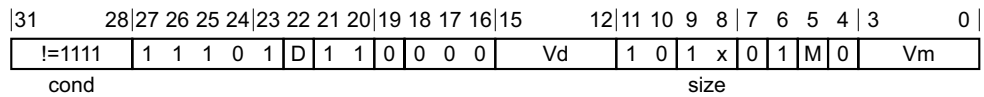

Single-precision scalar variant

Applies when size == 10.

VMOV{<c>}{<q>}.F32 <Sd>, <Sm>

Double-precision scalar variant

Applies when size == 11.

VMOV{<c>}{<q>}.F64 <Dd>, <Dm>

Decode for all variants of this encoding

```

if FPSCR.Len != '000' || FPSCR.Stride != '00' then UNDEFINED;
single_register = (sz == '0'); advsimd = FALSE;
if single_register then
    d = UInt(Vd:D); m = UInt(Vm:M);
else
    d = UInt(D:Vd); m = UInt(M:Vm); regs = 1;
    
```

T2

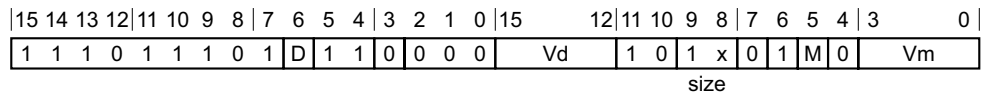

Single-precision scalar variant

Applies when size == 10.

VMOV{<c>}{<q>}.F32 <Sd>, <Sm>

Double-precision scalar variant

Applies when size == 11.

VMOV{<c>}{<q>}.F64 <Dd>, <Dm>

Decode for all variants of this encoding

```

if FPSCR.Len != '000' || FPSCR.Stride != '00' then UNDEFINED;
single_register = (sz == '0'); advsimd = FALSE;
if single_register then
    d = UInt(Vd:D); m = UInt(Vm:M);
else
    d = UInt(D:Vd); m = UInt(M:Vm); regs = 1;
    
```

Assembler symbols

- <c> See [Standard assembler syntax fields on page F2-2848](#).
- <q> See [Standard assembler syntax fields on page F2-2848](#).
- <Sd> Is the 32-bit name of the SIMD&FP destination register, encoded in the "Vd:D" field.
- <Sm> Is the 32-bit name of the SIMD&FP source register, encoded in the "Vm:M" field.
- <Dd> Is the 64-bit name of the SIMD&FP destination register, encoded in the "D:Vd" field.
- <Dm> Is the 64-bit name of the SIMD&FP source register, encoded in the "M:Vm" field.

Operation for all encodings

```
if ConditionPassed() then
    EncodingSpecificOperations(); CheckAdvSIMDorVFPEnabled(TRUE, advsimd);
    if single_register then
        S[d] = S[m];
    else
        for r = 0 to regs-1
            D[d+r] = D[m+r];
```

F6.1.120 VMOV (register, SIMD)

Copy between SIMD registers copies the contents of one SIMD register to another

This instruction is an alias of the [VORR \(register\)](#) instruction. This means that:

- The encodings in this description are named to match the encodings of [VORR \(register\)](#).
- The description of [VORR \(register\)](#) gives the operational pseudocode for this instruction.

A1

31	30	29	28	27	26	25	24	23	22	21	20	19	16	15	12	11	10	9	8	7	6	5	4	3	0
1	1	1	1	0	0	1	0	0	D	1	0	Vn	Vd	0	0	0	1	N	Q	M	1	Vm			

64-bit SIMD vector variant

Applies when Q == 0.

VMOV{<c>}{<q>}{. <dt>} <Dd>, <Dm>

is equivalent to

VORR{<c>}{<q>}{. <dt>} <Dd>, <Dm>, <Dm>

and is the preferred disassembly when N:Vn == M:Vm.

128-bit SIMD vector variant

Applies when Q == 1.

VMOV{<c>}{<q>}{. <dt>} <Qd>, <Qm>

is equivalent to

VORR{<c>}{<q>}{. <dt>} <Qd>, <Qm>, <Qm>

and is the preferred disassembly when N:Vn == M:Vm.

T1

15	14	13	12	11	10	9	8	7	6	5	4	3	0	15	12	11	10	9	8	7	6	5	4	3	0
1	1	1	0	1	1	1	1	0	D	1	0	Vn	Vd	0	0	0	1	N	Q	M	1	Vm			

64-bit SIMD vector variant

Applies when Q == 0.

VMOV{<c>}{<q>}{. <dt>} <Dd>, <Dm>

is equivalent to

VORR{<c>}{<q>}{. <dt>} <Dd>, <Dm>, <Dm>

and is the preferred disassembly when N:Vn == M:Vm.

128-bit SIMD vector variant

Applies when Q == 1.

VMOV{<c>}{<q>}{. <dt>} <Qd>, <Qm>

is equivalent to

VORR{<c>}{<q>}{.<dt>} <Qd>, <Qm>, <Qm>

and is the preferred disassembly when $N:Vn == M:Vm$.

Assembler symbols

- <c> For encoding A1: see [Standard assembler syntax fields on page F2-2848](#). This encoding must be unconditional.
For encoding T1: see [Standard assembler syntax fields on page F2-2848](#).
- <q> See [Standard assembler syntax fields on page F2-2848](#).
- <dt> An optional data type. <dt> must not be F64, but it is otherwise ignored.
- <Qd> Is the 128-bit name of the SIMD&FP destination register, encoded in the "D:Vd" field as <Qd>*2.
- <Qm> Is the 128-bit name of the SIMD&FP source register, encoded in the "N:Vn" and "M:Vm" field as <Qm>*2.
- <Dd> Is the 64-bit name of the SIMD&FP destination register, encoded in the "D:Vd" field.
- <Dm> Is the 64-bit name of the SIMD&FP source register, encoded in the "N:Vn" and "M:Vm" field.

Operation for all encodings

The description of [VORR \(register\)](#) gives the operational pseudocode for this instruction.

F6.1.121 VMOV (general-purpose register to scalar)

Copy a general-purpose register to a vector element copies a byte, halfword, or word from a general-purpose register into an Advanced SIMD scalar.

On a Floating-point-only system, this instruction transfers one word to the upper or lower half of a double-precision floating-point register from a general-purpose register. This is an identical operation to the Advanced SIMD single word transfer.

For more information about scalars see [Advanced SIMD scalars on page F2-2874](#).

Depending on settings in the CPACR, NSACR, HCPTR, and FPExc registers, and the security state and mode in which the instruction is executed, an attempt to execute the instruction might be UNDEFINED, or trapped to Hyp mode. For more information see [Enabling Advanced SIMD and floating-point support on page G1-4413](#).

A1

31	28	27	26	25	24	23	22	21	20	19	16	15	12	11	10	9	8	7	6	5	4	3	2	1	0
I=1111				1	1	1	0	0	opc1	0	Vd	Rt	1	0	1	1	D	opc2	1	(0)	(0)	(0)	(0)		
cond																									

A1 variant

VMOV{<c>}{<q>}{.<size>} <Dd[x]>, <Rt>

Decode for this encoding

```

case opc1:opc2 of
    when 'lxxx' advsimd = TRUE;  esize = 8;  index = UInt(opc1<0>:opc2);
    when '0xx1' advsimd = TRUE;  esize = 16; index = UInt(opc1<0>:opc2<1>);
    when '0x00' advsimd = FALSE; esize = 32; index = UInt(opc1<0>);
    when '0x10' UNDEFINED;
d = UInt(D:Vd);  t = UInt(Rt);
if t == 15 then UNPREDICTABLE; // ARMv8-A removes UNPREDICTABLE for R13
    
```

T1

15	14	13	12	11	10	9	8	7	6	5	4	3	0	15	12	11	10	9	8	7	6	5	4	3	2	1	0
1	1	1	0	1	1	1	0	0	opc1	0	Vd	Rt	1	0	1	1	D	opc2	1	(0)	(0)	(0)	(0)				

T1 variant

VMOV{<c>}{<q>}{.<size>} <Dd[x]>, <Rt>

Decode for this encoding

```

case opc1:opc2 of
    when 'lxxx' advsimd = TRUE;  esize = 8;  index = UInt(opc1<0>:opc2);
    when '0xx1' advsimd = TRUE;  esize = 16; index = UInt(opc1<0>:opc2<1>);
    when '0x00' advsimd = FALSE; esize = 32; index = UInt(opc1<0>);
    when '0x10' UNDEFINED;
d = UInt(D:Vd);  t = UInt(Rt);
if t == 15 then UNPREDICTABLE; // ARMv8-A removes UNPREDICTABLE for R13
    
```

Notes for all encodings

For more information about the CONSTRAINED UNPREDICTABLE behavior of this instruction, see [Appendix K1 Architectural Constraints on UNPREDICTABLE behaviors](#).

Assembler symbols

<c>	See Standard assembler syntax fields on page F2-2848 .
<q>	See Standard assembler syntax fields on page F2-2848 .
<size>	The data size. It must be one of: 8 Encoded as <code>opc1<1> = 1</code> . [x] is encoded in <code>opc1<0></code> , <code>opc2</code> . 16 Encoded as <code>opc1<1> = 0</code> , <code>opc2<0> = 1</code> . [x] is encoded in <code>opc1<0></code> , <code>opc2<1></code> . 32 Encoded as <code>opc1<1> = 0</code> , <code>opc2 = 0b00</code> . [x] is encoded in <code>opc1<0></code> . omitted Equivalent to 32.
<Dd[x]>	The scalar. The register <Dd> is encoded in D:Vd. For details of how [x] is encoded, see the description of <size>.
<Rt>	The source general-purpose register.

Operation for all encodings

```
if ConditionPassed() then
    EncodingSpecificOperations();
    Elem[D[d],index,esize] = R[t]<size-1:0>;
```

F6.1.122 VMOV (between general-purpose register and single-precision)

Copy a general-purpose register to or from a 32-bit SIMD&FP register. This instruction transfers the value held in a 32-bit SIMD&FP register to a general-purpose register, or the value held in a general-purpose register to a 32-bit SIMD&FP register.

Depending on settings in the CPACR, NSACR, HCPTR, and FPEXC registers, and the security state and mode in which the instruction is executed, an attempt to execute the instruction might be UNDEFINED, or trapped to Hyp mode. For more information see [Enabling Advanced SIMD and floating-point support on page G1-4413](#).

A1

31				28 27 26 25 24 23 22 21 20 19				16 15		12 11 10 9 8 7 6 5 4 3 2 1 0									
!=1111				1 1 1 0 0 0 0				op	Vn	Rt	1 0 1 0		N	(0)	(0)	1	(0)	(0)	(0)
cond																			

From general-purpose register variant

Applies when op == 0.

VMOV{<c>}{<q>} <Sn>, <Rt>

To general-purpose register variant

Applies when op == 1.

VMOV{<c>}{<q>} <Rt>, <Sn>

Decode for all variants of this encoding

```
to_arm_register = (op == '1'); t = UInt(Rt); n = UInt(Vn:N);
if t == 15 then UNPREDICTABLE; // ARMv8-A removes UNPREDICTABLE for R13
```

T1

15 14 13 12 11 10 9 8 7 6 5 4 3				0 15		12 11 10 9 8 7 6 5 4 3 2 1 0									
1 1 1 0 1 1 1 0 0 0 0				op	Vn	Rt	1 0 1 0		N	(0)	(0)	1	(0)	(0)	(0)

From general-purpose register variant

Applies when op == 0.

VMOV{<c>}{<q>} <Sn>, <Rt>

To general-purpose register variant

Applies when op == 1.

VMOV{<c>}{<q>} <Rt>, <Sn>

Decode for all variants of this encoding

```
to_arm_register = (op == '1'); t = UInt(Rt); n = UInt(Vn:N);
if t == 15 then UNPREDICTABLE; // ARMv8-A removes UNPREDICTABLE for R13
```

Notes for all encodings

For more information about the CONSTRAINED UNPREDICTABLE behavior of this instruction, see [Appendix K1 Architectural Constraints on UNPREDICTABLE behaviors](#).

Assembler symbols

- <Rt> Is the general-purpose register that <Sn> will be transferred to or from, encoded in the "Rt" field.
- <Sn> Is the 32-bit name of the SIMD&FP register to be transferred, encoded in the "Vn:N" field.
- <C> See [Standard assembler syntax fields on page F2-2848](#).
- <q> See [Standard assembler syntax fields on page F2-2848](#).

Operation for all encodings

```
if ConditionPassed() then
    EncodingSpecificOperations(); CheckVFPEnabled(TRUE);
    if to_arm_register then
        R[t] = S[n];
    else
        S[n] = R[t];
```

F6.1.123 VMOV (scalar to general-purpose register)

Copy a vector element to a general-purpose register with sign or zero extension copies a byte, halfword, or word from an Advanced SIMD scalar to a general-purpose register. Bytes and halfwords can be either zero-extended or sign-extended.

On a Floating-point-only system, this instruction transfers one word from the upper or lower half of a double-precision floating-point register to a general-purpose register. This is an identical operation to the Advanced SIMD single word transfer.

For more information about scalars see [Advanced SIMD scalars on page F2-2874](#).

Depending on settings in the CPACR, NSACR, HCPTR, and FPFXC registers, and the security state and mode in which the instruction is executed, an attempt to execute the instruction might be UNDEFINED, or trapped to Hyp mode. For more information see [Enabling Advanced SIMD and floating-point support on page G1-4413](#).

A1

31	28	27	26	25	24	23	22	21	20	19	16	15	12	11	10	9	8	7	6	5	4	3	2	1	0		
!=1111				1	1	1	0	U	opc1		1	Vn		Rt		1	0	1	1	N	opc2		1	(0)	(0)	(0)	(0)
cond																											

A1 variant

VMOV{<c>}{<q>}{.<dt>} <Rt>, <Dn[x]>

Decode for this encoding

```

case U:opc1:opc2 of
  when 'x1xxx' advsimd = TRUE; esize = 8; index = UInt(opc1<0>:opc2);
  when 'x0xx1' advsimd = TRUE; esize = 16; index = UInt(opc1<0>:opc2<1>);
  when '00x00' advsimd = FALSE; esize = 32; index = UInt(opc1<0>);
  when '10x00' UNDEFINED;
  when 'x0x10' UNDEFINED;
t = UInt(Rt); n = UInt(N:Vn); unsigned = (U == '1');
if t == 15 then UNPREDICTABLE; // ARMv8-A removes UNPREDICTABLE for R13
    
```

T1

15	14	13	12	11	10	9	8	7	6	5	4	3	0	15	12	11	10	9	8	7	6	5	4	3	2	1	0
1	1	1	0	1	1	1	0	U	opc1		1	Vn		Rt		1	0	1	1	N	opc2		1	(0)	(0)	(0)	(0)

T1 variant

VMOV{<c>}{<q>}{.<dt>} <Rt>, <Dn[x]>

Decode for this encoding

```

case U:opc1:opc2 of
  when 'x1xxx' advsimd = TRUE; esize = 8; index = UInt(opc1<0>:opc2);
  when 'x0xx1' advsimd = TRUE; esize = 16; index = UInt(opc1<0>:opc2<1>);
  when '00x00' advsimd = FALSE; esize = 32; index = UInt(opc1<0>);
  when '10x00' UNDEFINED;
  when 'x0x10' UNDEFINED;
t = UInt(Rt); n = UInt(N:Vn); unsigned = (U == '1');
if t == 15 then UNPREDICTABLE; // ARMv8-A removes UNPREDICTABLE for R13
    
```

Notes for all encodings

For more information about the CONSTRAINED UNPREDICTABLE behavior of this instruction, see [Appendix K1 Architectural Constraints on UNPREDICTABLE behaviors](#).

Assembler symbols

<c>	See <i>Standard assembler syntax fields</i> on page F2-2848.
<q>	See <i>Standard assembler syntax fields</i> on page F2-2848.
<dt>	The data type. It must be one of: S8 Encoded as U = 0, opc1<1> = 1. [x] is encoded in opc1<0>, opc2. S16 Encoded as U = 0, opc1<1> = 0, opc2<0> = 1. [x] is encoded in opc1<0>, opc2<1>. U8 Encoded as U = 1, opc1<1> = 1. [x] is encoded in opc1<0>, opc2. U16 Encoded as U = 1, opc1<1> = 0, opc2<0> = 1. [x] is encoded in opc1<0>, opc2<1>. 32 Encoded as U = 0, opc1<1> = 0, opc2 = 0b00. [x] is encoded in opc1<0>. omitted Equivalent to 32.
<Rt>	The destination general-purpose register.
<Dn[x]>	The scalar. For details of how [x] is encoded see the description of <dt>.

Operation for all encodings

```
if ConditionPassed() then
    EncodingSpecificOperations(); CheckAdvSIMDorVFPEnabled(TRUE, advsimd);
    if unsigned then
        R[t] = ZeroExtend(Elem[D[n], index, esize], 32);
    else
        R[t] = SignExtend(Elem[D[n], index, esize], 32);
```

F6.1.124 VMOV (between two general-purpose registers and two single-precision registers)

Copy two general-purpose registers to a pair of 32-bit SIMD&FP registers transfers the contents of two consecutively numbered single-precision Floating-point registers to two general-purpose registers, or the contents of two general-purpose registers to a pair of single-precision Floating-point registers. The general-purpose registers do not have to be contiguous.

Depending on settings in the CPACR, NSACR, HCPTR, and FPEXC registers, and the security state and mode in which the instruction is executed, an attempt to execute the instruction might be UNDEFINED, or trapped to Hyp mode. For more information see [Enabling Advanced SIMD and floating-point support on page G1-4413](#).

A1

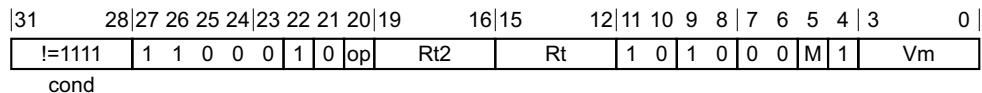

From general-purpose registers variant

Applies when op == 0.

VMOV{<c>}{<q>} <Sm>, <Sm1>, <Rt>, <Rt2>

To general-purpose registers variant

Applies when op == 1.

VMOV{<c>}{<q>} <Rt>, <Rt2>, <Sm>, <Sm1>

Decode for all variants of this encoding

```
to_arm_registers = (op == '1'); t = UInt(Rt); t2 = UInt(Rt2); m = UInt(Vm:M);
if t == 15 || t2 == 15 || m == 31 then UNPREDICTABLE;
if to_arm_registers && t == t2 then UNPREDICTABLE;
```

CONSTRAINED UNPREDICTABLE behavior

If to_arm_registers && t == t2, then one of the following behaviors must occur:

- The instruction is UNDEFINED.
- The instruction executes as NOP.
- The value in the destination register is UNKNOWN.

If m == 31, then one of the following behaviors must occur:

- The instruction is UNDEFINED.
- The instruction executes as NOP.
- One or more of the single-precision registers become UNKNOWN for a move to the single-precision register. The general-purpose registers listed in the instruction become UNKNOWN for a move from the single-precision registers. This behavior does not affect any other general-purpose registers.

T1

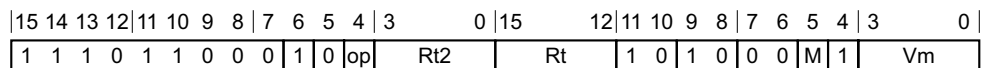

From general-purpose registers variant

Applies when `op == 0`.

`VMOV{<c>}{<q>} <Sm>, <Sm1>, <Rt>, <Rt2>`

To general-purpose registers variant

Applies when `op == 1`.

`VMOV{<c>}{<q>} <Rt>, <Rt2>, <Sm>, <Sm1>`

Decode for all variants of this encoding

```
to_arm_registers = (op == '1'); t = UInt(Rt); t2 = UInt(Rt2); m = UInt(Vm:M);
if t == 15 || t2 == 15 || m == 31 then UNPREDICTABLE;
if to_arm_registers && t == t2 then UNPREDICTABLE;
```

CONSTRAINED UNPREDICTABLE behavior

If `to_arm_registers && t == t2`, then one of the following behaviors must occur:

- The instruction is UNDEFINED.
- The instruction executes as NOP.
- The value in the destination register is UNKNOWN.

If `m == 31`, then one of the following behaviors must occur:

- The instruction is UNDEFINED.
- The instruction executes as NOP.
- One or more of the single-precision registers become UNKNOWN for a move to the single-precision register. The general-purpose registers listed in the instruction become UNKNOWN for a move from the single-precision registers. This behavior does not affect any other general-purpose registers.

Notes for all encodings

For more information about the CONSTRAINED UNPREDICTABLE behavior of this instruction, see [Appendix K1 Architectural Constraints on UNPREDICTABLE behaviors](#), and particularly *VMOV (between two general-purpose registers and two single-precision registers)* on page K1-6112.

Assembler symbols

<code><Rt2></code>	Is the second general-purpose register that <code><Sm1></code> will be transferred to or from, encoded in the "Rt" field.
<code><Rt></code>	Is the first general-purpose register that <code><Sm></code> will be transferred to or from, encoded in the "Rt" field.
<code><Sm1></code>	Is the 32-bit name of the second SIMD&FP register to be transferred. This is the next SIMD&FP register after <code><Sm></code> .
<code><Sm></code>	Is the 32-bit name of the first SIMD&FP register to be transferred, encoded in the "Vm:M" field.
<code><c></code>	See <i>Standard assembler syntax fields</i> on page F2-2848.
<code><q></code>	See <i>Standard assembler syntax fields</i> on page F2-2848.

Operation for all encodings

```
if ConditionPassed() then
  EncodingSpecificOperations(); CheckVFPEnabled(TRUE);
if to_arm_registers then
```

```
R[t] = S[m];  
R[t2] = S[m+1];  
else  
S[m] = R[t];  
S[m+1] = R[t2];
```

F6.1.125 VMOVL

Vector Move Long takes each element in a doubleword vector, sign or zero-extends them to twice their original length, and places the results in a quadword vector.

Depending on settings in the CPACR, NSACR, and HCPTR registers, and the security state and mode in which the instruction is executed, an attempt to execute the instruction might be UNDEFINED, or trapped to Hyp mode. For more information see [Enabling Advanced SIMD and floating-point support on page G1-4413](#).

A1

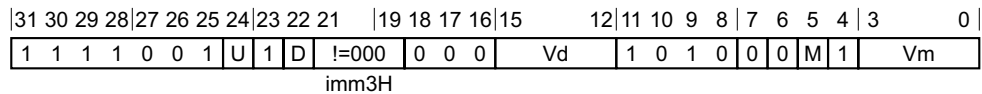

A1 variant

VMOVL{<c>}{<q>}.<dt> <Qd>, <Dm>

Decode for this encoding

```
if imm3H == '000' then SEE "Related encodings";
if imm3H != '001' && imm3H != '010' && imm3H != '100' then SEE VSHLL;
if Vd<0> == '1' then UNDEFINED;
esize = 8 * UInt(imm3H);
unsigned = (U == '1'); elements = 64 DIV esize;
d = UInt(D:Vd); m = UInt(M:Vm);
```

T1

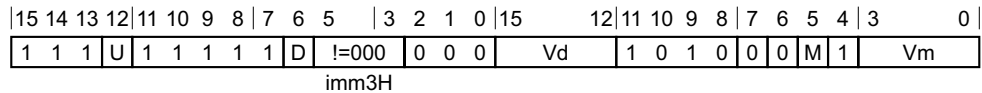

T1 variant

VMOVL{<c>}{<q>}.<dt> <Qd>, <Dm>

Decode for this encoding

```
if imm3H == '000' then SEE "Related encodings";
if imm3H != '001' && imm3H != '010' && imm3H != '100' then SEE VSHLL;
if Vd<0> == '1' then UNDEFINED;
esize = 8 * UInt(imm3H);
unsigned = (U == '1'); elements = 64 DIV esize;
d = UInt(D:Vd); m = UInt(M:Vm);
```

Notes for all encodings

Related encodings: See [Advanced SIMD one register and modified immediate on page F3-2912](#) for the T32 instruction set, or [Advanced SIMD one register and modified immediate on page F4-2994](#) for the A32 instruction set.

Assembler symbols

<c> For encoding A1: see [Standard assembler syntax fields on page F2-2848](#). This encoding must be unconditional.
 For encoding T1: see [Standard assembler syntax fields on page F2-2848](#).

- <q> See [Standard assembler syntax fields on page F2-2848](#).
- <dt> Is the data type for the elements of the operand, encoded in the "U:imm3H" field. It can have the following values:
- | | |
|-----|-------------------------|
| S8 | when U = 0, imm3H = 001 |
| S16 | when U = 0, imm3H = 010 |
| S32 | when U = 0, imm3H = 100 |
| U8 | when U = 1, imm3H = 001 |
| U16 | when U = 1, imm3H = 010 |
| U32 | when U = 1, imm3H = 100 |
- <Qd> Is the 128-bit name of the SIMD&FP destination register, encoded in the "D:Vd" field as <Qd>*2.
- <Dm> Is the 64-bit name of the SIMD&FP source register, encoded in the "M:Vm" field.

Operation for all encodings

```
if ConditionPassed() then
    EncodingSpecificOperations(); CheckAdvSIMDEnabled();
    for e = 0 to elements-1
        result = Int(Elem[Din[m],e,esize], unsigned);
        Elem[Q[d>1],e,2*esize] = result<2*esize-1:0>;
```

F6.1.126 VMOVN

Vector Move and Narrow copies the least significant half of each element of a quadword vector into the corresponding elements of a doubleword vector.

The operand vector elements can be any one of 16-bit, 32-bit, or 64-bit integers. There is no distinction between signed and unsigned integers.

Depending on settings in the CPACR, NSACR, and HCPTR registers, and the security state and mode in which the instruction is executed, an attempt to execute the instruction might be UNDEFINED, or trapped to Hyp mode. For more information see [Enabling Advanced SIMD and floating-point support on page G1-4413](#).

This instruction is used by the pseudo-instructions VRSHRN (zero) and VSHRN (zero). The pseudo-instruction is never the preferred disassembly.

A1

31	30	29	28	27	26	25	24	23	22	21	20	19	18	17	16	15	12	11	10	9	8	7	6	5	4	3	0
1	1	1	1	0	0	1	1	1	D	1	1	size	1	0	Vd	0	0	1	0	0	0	0	M	0	Vm		

A1 variant

VMOVN{<c>}{<q>}.<dt> <Dd>, <Qm>

Decode for this encoding

```
if size == '11' then UNDEFINED;
if Vm<0> == '1' then UNDEFINED;
esize = 8 << UInt(size); elements = 64 DIV esize;
d = UInt(D:Vd); m = UInt(M:Vm);
```

T1

15	14	13	12	11	10	9	8	7	6	5	4	3	2	1	0	15	12	11	10	9	8	7	6	5	4	3	0
1	1	1	1	1	1	1	1	1	D	1	1	size	1	0	Vd	0	0	1	0	0	0	0	M	0	Vm		

T1 variant

VMOVN{<c>}{<q>}.<dt> <Dd>, <Qm>

Decode for this encoding

```
if size == '11' then UNDEFINED;
if Vm<0> == '1' then UNDEFINED;
esize = 8 << UInt(size); elements = 64 DIV esize;
d = UInt(D:Vd); m = UInt(M:Vm);
```

Assembler symbols

- <c> For encoding A1: see [Standard assembler syntax fields on page F2-2848](#). This encoding must be unconditional.
 For encoding T1: see [Standard assembler syntax fields on page F2-2848](#).
- <q> See [Standard assembler syntax fields on page F2-2848](#).

- <dt> Is the data type for the elements of the operand, encoded in the "size" field. It can have the following values:
- I16 when size = 00
 - I32 when size = 01
 - I64 when size = 10
- The encoding size = 11 is reserved.
- <Dd> Is the 64-bit name of the SIMD&FP destination register, encoded in the "D:Vd" field.
- <Qm> Is the 128-bit name of the SIMD&FP source register, encoded in the "M:Vm" field as <Qm>*2.

Operation for all encodings

```
if ConditionPassed() then
    EncodingSpecificOperations(); CheckAdvSIMDEnabled();
    for e = 0 to elements-1
        Elem[D[d],e,esize] = Elem[Qin[m]>>1],e,2*esize]<esize-1:0>;
```

F6.1.127 VMOVX

Vector Move extraction. This instruction copies the upper 16 bits of the 32-bit source SIMD&FP register into the lower 16 bits of the 32-bit destination SIMD&FP register, while clearing the remaining bits to zero.

Depending on settings in the CPACR, NSACR, HCPTR, and FPEXC registers, and the security state and mode in which the instruction is executed, an attempt to execute the instruction might be UNDEFINED, or trapped to Hyp mode. For more information see [Enabling Advanced SIMD and floating-point support on page G1-4413](#).

A1

ARMv8.2

31	30	29	28	27	26	25	24	23	22	21	20	19	18	17	16	15	12	11	10	9	8	7	6	5	4	3	0
1	1	1	1	1	1	1	0	1	D	1	1	0	0	0	0	Vd	1	0	1	0	0	1	M	0	Vm		

A1 variant

VMOVX{<q>}.F16 <Sd>, <Sm>

Decode for this encoding

```
if !HaveFP16Ext() then UNDEFINED;
if FPSCR.Len != '000' || FPSCR.Stride != '00' then UNDEFINED;
d = UInt(Vd:D); m = UInt(Vm:M);
```

T1

ARMv8.2

15	14	13	12	11	10	9	8	7	6	5	4	3	2	1	0	15	12	11	10	9	8	7	6	5	4	3	0
1	1	1	1	1	1	1	0	1	D	1	1	0	0	0	0	Vd	1	0	1	0	0	1	M	0	Vm		

T1 variant

VMOVX{<q>}.F16 <Sd>, <Sm>

Decode for this encoding

```
if !HaveFP16Ext() then UNDEFINED;
if FPSCR.Len != '000' || FPSCR.Stride != '00' then UNDEFINED;
if InITBlock() then UNPREDICTABLE;
d = UInt(Vd:D); m = UInt(Vm:M);
```

CONSTRAINED UNPREDICTABLE behavior

If InITBlock(), then one of the following behaviors must occur:

- The instruction is UNDEFINED.
- The instruction executes as if it passes the Condition code check.
- The instruction executes as NOP. This means it behaves as if it fails the Condition code check.

Assembler symbols

<q> See [Standard assembler syntax fields on page F2-2848](#).

<Sd> Is the 32-bit name of the SIMD&FP destination register, encoded in the "Vd:D" field.

<Sm> Is the 32-bit name of the SIMD&FP source register, encoded in the "Vm:M" field.

Operation for all encodings

```
if ConditionPassed() then
    EncodingSpecificOperations(); CheckVFPEnabled(TRUE);
    S[d] = Zeros(16) : S[m]<31:16>;
```

F6.1.128 VMRS

Move SIMD&FP Special register to general-purpose register moves the value of an Advanced SIMD and floating-point System register to a general-purpose register. When the specified System register is the **FPSCR**, a form of the instruction transfers the **FPSCR**.{N, Z, C, V} condition flags to the **APSR**.{N, Z, C, V} condition flags.

Depending on settings in the **CPACR**, **NSACR**, **HCPTR**, and **FPEXC** registers, and the security state and mode in which the instruction is executed, an attempt to execute the instruction might be UNDEFINED, or trapped to Hyp mode. For more information see [Enabling Advanced SIMD and floating-point support on page G1-4413](#).

When these settings permit the execution of floating-point and Advanced SIMD instructions, if the specified floating-point System register is not the **FPSCR**, the instruction is UNDEFINED if executed in User mode.

In an implementation that includes EL2, when **HCR.TID0** is set to 1, any VMRS access to **FPSID** from a Non-secure EL1 mode that would be permitted if **HCR.TID0** was set to 0 generates a Hyp Trap exception. For more information, see [ID group 0, Primary device identification registers on page G1-4435](#).

For simplicity, the VMRS pseudocode does not show the possible trap to Hyp mode.

A1

31	28	27	26	25	24	23	22	21	20	19	16	15	12	11	10	9	8	7	6	5	4	3	2	1	0
!=1111	1	1	1	0	1	1	1	1	reg	Rt	1	0	1	0	(0)	(0)	(0)	1	(0)	(0)	(0)	(0)			
cond																									

A1 variant

VMRS{<c>}{<q>} <Rt>, <spec_reg>

Decode for this encoding

```
t = UInt(Rt);
if !(reg IN {'000x', '0101', '011x', '1000'}) then UNPREDICTABLE;
if t == 15 && reg != '0001' then UNPREDICTABLE; // ARMv8-A removes UNPREDICTABLE for R13
```

CONSTRAINED UNPREDICTABLE behavior

If !(reg IN {'000x', '0101', '011x', '1000'}), then one of the following behaviors must occur:

- The instruction is UNDEFINED.
- The instruction executes as NOP.
- The instruction transfers an UNKNOWN value to the specified target register. When the Rt field holds the value 0b1111, the specified target register is the **APSR**.{N, Z, C, V} bits, and these bits become UNKNOWN. Otherwise, the specified target register is the register specified by the Rt field, R0 - R14.

T1

15	14	13	12	11	10	9	8	7	6	5	4	3	0	15	12	11	10	9	8	7	6	5	4	3	2	1	0
1	1	1	0	1	1	1	0	1	1	1	1	reg	Rt	1	0	1	0	(0)	(0)	(0)	1	(0)	(0)	(0)	(0)		

T1 variant

VMRS{<c>}{<q>} <Rt>, <spec_reg>

Decode for this encoding

```
t = UInt(Rt);
if !(reg IN {'000x', '0101', '011x', '1000'}) then UNPREDICTABLE;
if t == 15 && reg != '0001' then UNPREDICTABLE; // ARMv8-A removes UNPREDICTABLE for R13
```

CONSTRAINED UNPREDICTABLE behavior

If !(reg IN {'000x', '0101', '011x', '1000'}), then one of the following behaviors must occur:

- The instruction is UNDEFINED.
- The instruction executes as NOP.
- The instruction transfers an UNKNOWN value to the specified target register. When the Rt field holds the value 0b1111, the specified target register is the [APSR](#).{N, Z, C, V} bits, and these bits become UNKNOWN. Otherwise, the specified target register is the register specified by the Rt field, R0 - R14.

Notes for all encodings

For more information about the CONSTRAINED UNPREDICTABLE behavior of this instruction, see [Appendix K1 Architectural Constraints on UNPREDICTABLE behaviors](#).

Assembler symbols

- <c> See [Standard assembler syntax fields on page F2-2848](#).
- <q> See [Standard assembler syntax fields on page F2-2848](#).
- <Rt> Is the general-purpose destination register, encoded in the "Rt" field. Is one of:
- | | |
|-----------|--|
| R0-R14 | General-purpose register. |
| APSR_nzcv | Permitted only when <spec_reg> is FPSCR. Encoded as 0b1111. The instruction transfers the FPSCR .{N, Z, C, V} condition flags to the APSR .{N, Z, C, V} condition flags. |
- <spec_reg> Is the source Advanced SIMD and floating-point System register, encoded in the "reg" field. It can have the following values:
- | | |
|-------|-----------------|
| FPSID | when reg = 0000 |
| FPSCR | when reg = 0001 |
| MVFR2 | when reg = 0101 |
| MVFR1 | when reg = 0110 |
| MVFR0 | when reg = 0111 |
| FPEXC | when reg = 1000 |
- The following encodings are UNPREDICTABLE:
- reg = 001x.
 - reg = 0100.
 - reg = 1001.
 - reg = 101x.
 - reg = 11xx.

Operation for all encodings

```
if ConditionPassed() then
  EncodingSpecificOperations();
if reg == '0001' then // FPSCR
  CheckVFPEabled(TRUE);
if t == 15 then
  PSTATE.<N,Z,C,V> = FPSR.<N,Z,C,V>;
```



```
else
    R[t] = FPSCR;
elseif PSTATE.EL == EL0 then
    UNDEFINED; // Non-FPSCR registers accessible only at PL1 or above
else
    CheckVFPEnabled(FALSE); // Non-FPSCR registers are not affected by FPEXC.EN
case reg of
    // Pseudocode does not consider possible HCR.TIDn Hyp Traps of Non-secure register reads
    when '0000' R[t] = FPSID;
    when '0101' R[t] = MVFR2;
    when '0110' R[t] = MVFR1;
    when '0111' R[t] = MVFR0;
    when '1000' R[t] = FPEXC;
    otherwise Unreachable(); // Dealt with above or in encoding-specific pseudocode
```

F6.1.129 VMSR

Move general-purpose register to SIMD&FP Special register moves the value of a general-purpose register to a floating-point System register.

Depending on settings in the CPACR, NSACR, HCPTR, and FPEXC registers, and the security state and mode in which the instruction is executed, an attempt to execute the instruction might be UNDEFINED, or trapped to Hyp mode. For more information see [Enabling Advanced SIMD and floating-point support on page G1-4413](#).

When these settings permit the execution of floating-point and Advanced SIMD instructions:

- If the specified floating-point System register is not the FPSCR, the instruction is UNDEFINED if executed in User mode.
- If the specified floating-point System register is the FPEXC and the instruction is executed in a mode other than User mode the instruction is ignored.

A1

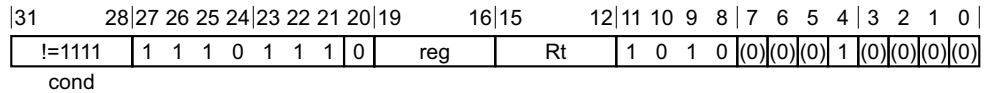

A1 variant

VMSR{<c>}{<q>} <spec_reg>, <Rt>

Decode for this encoding

```
t = UInt(Rt);
if reg != '000x' && reg != '1000' then UNPREDICTABLE;
if t == 15 then UNPREDICTABLE; // ARMv8-A removes UNPREDICTABLE for R13
```

CONSTRAINED UNPREDICTABLE behavior

If reg != '000x' && reg != '1000', then one of the following behaviors must occur:

- The instruction is UNDEFINED.
- The instruction executes as NOP.
- The instruction transfers the value in the general-purpose register to one of the allocated registers accessible using VMSR at the same Exception level.

T1

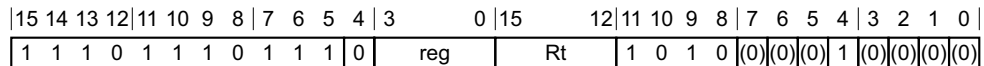

T1 variant

VMSR{<c>}{<q>} <spec_reg>, <Rt>

Decode for this encoding

```
t = UInt(Rt);
if reg != '000x' && reg != '1000' then UNPREDICTABLE;
if t == 15 then UNPREDICTABLE; // ARMv8-A removes UNPREDICTABLE for R13
```

CONSTRAINED UNPREDICTABLE behavior

If reg != '000x' && reg != '1000', then one of the following behaviors must occur:

- The instruction is UNDEFINED.
- The instruction executes as NOP.
- The instruction transfers the value in the general-purpose register to one of the allocated registers accessible using VMSR at the same Exception level.

Notes for all encodings

For more information about the CONSTRAINED UNPREDICTABLE behavior of this instruction, see [Appendix K1 Architectural Constraints on UNPREDICTABLE behaviors](#).

Assembler symbols

<c> See [Standard assembler syntax fields on page F2-2848](#).

<q> See [Standard assembler syntax fields on page F2-2848](#).

<spec_reg> Is the destination Advanced SIMD and floating-point System register, encoded in the "reg" field. It can have the following values:

FPSID when reg = 0000

FPSCR when reg = 0001

FPEXC when reg = 1000

The following encodings are UNPREDICTABLE:

- reg = 001x.
- reg = 01xx.
- reg = 1001.
- reg = 101x.
- reg = 11xx.

<Rt> Is the general-purpose source register, encoded in the "Rt" field.

Operation for all encodings

```

if ConditionPassed() then
    EncodingSpecificOperations();
    if reg == '0001' then // FPSCR
        CheckVFPEnabled(TRUE);
        FPSCR = R[t];
    elseif PSTATE.EL == EL0 then // Non-FPSCR registers accessible only at PL1 or above
        UNDEFINED;
    else
        CheckVFPEnabled(FALSE); // Non-FPSCR registers are not affected by FPEXC.EN
        case reg of
            when '0000' // VMSR access to FPSID is ignored
            when '1000' FPEXC = R[t];
            otherwise Unreachable(); // Dealt with above or in encoding-specific pseudocode

```

F6.1.130 VMUL (floating-point)

Vector Multiply multiplies corresponding elements in two vectors, and places the results in the destination vector.

Depending on settings in the CPACR, NSACR, HCPTR, and FPEXC registers, and the security state and mode in which the instruction is executed, an attempt to execute the instruction might be UNDEFINED, or trapped to Hyp mode. For more information see [Enabling Advanced SIMD and floating-point support on page G1-4413](#).

A1

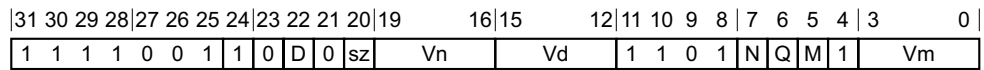

64-bit SIMD vector variant

Applies when Q == 0.

VMUL{<c>}{<q>}.<dt> {<Dd>, }<Dn>, <Dm>

128-bit SIMD vector variant

Applies when Q == 1.

VMUL{<c>}{<q>}.<dt> {<Qd>, }<Qn>, <Qm>

Decode for all variants of this encoding

```

if Q == '1' && (Vd<0> == '1' || Vn<0> == '1' || Vm<0> == '1') then UNDEFINED;
if sz == '1' && !HaveFP16Ext() then UNDEFINED;
advsimd = TRUE;
case sz of
    when '0' esize = 32; elements = 2;
    when '1' esize = 16; elements = 4;
d = UInt(D:Vd); n = UInt(N:Vn); m = UInt(M:Vm); regs = if Q == '0' then 1 else 2;
    
```

A2

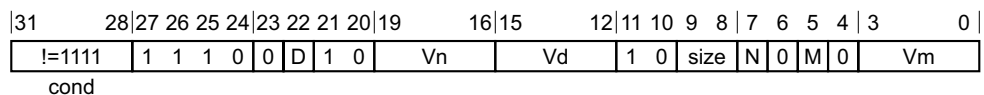

Half-precision scalar variant

Applies when size == 01.

VMUL{<c>}{<q>}.F16 {<Sd>, } <Sn>, <Sm>

Single-precision scalar variant

Applies when size == 10.

VMUL{<c>}{<q>}.F32 {<Sd>, } <Sn>, <Sm>

Double-precision scalar variant

Applies when size == 11.

VMUL{<c>}{<q>}.F64 {<Dd>, } <Dn>, <Dm>

Decode for all variants of this encoding

```

if FPSCR.Len != '000' || FPSCR.Stride != '00' then UNDEFINED;
if size == '00' || (size == '01' && !HaveFP16Ext()) then UNDEFINED;
if size == '01' && cond != '1110' then UNPREDICTABLE;
advsimd = FALSE;

case size of
  when '01' esize = 16; d = UInt(Vd:D); n = UInt(Vn:N); m = UInt(Vm:M);
  when '10' esize = 32; d = UInt(Vd:D); n = UInt(Vn:N); m = UInt(Vm:M);
  when '11' esize = 64; d = UInt(D:Vd); n = UInt(N:Vn); m = UInt(M:Vm);
  
```

CONSTRAINED UNPREDICTABLE behavior

If size == '01' && cond != '1110', then one of the following behaviors must occur:

- The instruction is UNDEFINED.
- The instruction executes as if it passes the Condition code check.
- The instruction executes as NOP. This means it behaves as if it fails the Condition code check.

T1

15	14	13	12	11	10	9	8	7	6	5	4	3	0	15	12	11	10	9	8	7	6	5	4	3	0
1	1	1	1	1	1	1	1	0	D	0	sz	Vn	Vd	1	1	0	1	N	Q	M	1	Vm			

64-bit SIMD vector variant

Applies when Q == 0.

VMUL{<c>}{<q>}.<dt> {<Dd>, }<Dn>, <Dm>

128-bit SIMD vector variant

Applies when Q == 1.

VMUL{<c>}{<q>}.<dt> {<Qd>, }<Qn>, <Qm>

Decode for all variants of this encoding

```

if Q == '1' && (Vd<0> == '1' || Vn<0> == '1' || Vm<0> == '1') then UNDEFINED;
if sz == '1' && !HaveFP16Ext() then UNDEFINED;
if sz == '1' && InITBlock() then UNPREDICTABLE;
advsimd = TRUE;
case sz of
  when '0' esize = 32; elements = 2;
  when '1' esize = 16; elements = 4;
d = UInt(D:Vd); n = UInt(N:Vn); m = UInt(M:Vm); regs = if Q == '0' then 1 else 2;
  
```

CONSTRAINED UNPREDICTABLE behavior

If sz == '1' && InITBlock(), then one of the following behaviors must occur:

- The instruction is UNDEFINED.
- The instruction executes as if it passes the Condition code check.
- The instruction executes as NOP. This means it behaves as if it fails the Condition code check.

T2

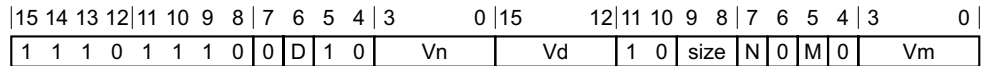

Half-precision scalar variant

Applies when size == 01.

VMUL{<c>}{<q>}.F16 {<Sd>}, <Sn>, <Sm>

Single-precision scalar variant

Applies when size == 10.

VMUL{<c>}{<q>}.F32 {<Sd>}, <Sn>, <Sm>

Double-precision scalar variant

Applies when size == 11.

VMUL{<c>}{<q>}.F64 {<Dd>}, <Dn>, <Dm>

Decode for all variants of this encoding

```
if FPSCR.Len != '000' || FPSCR.Stride != '00' then UNDEFINED;
if size == '00' || (size == '01' && !HaveFP16Ext()) then UNDEFINED;
if size == '01' && InITBlock() then UNPREDICTABLE;
advsimd = FALSE;
```

```
case size of
    when '01' esize = 16; d = UInt(Vd:D); n = UInt(Vn:N); m = UInt(Vm:M);
    when '10' esize = 32; d = UInt(Vd:D); n = UInt(Vn:N); m = UInt(Vm:M);
    when '11' esize = 64; d = UInt(D:Vd); n = UInt(N:Vn); m = UInt(M:Vm);
```

CONSTRAINED UNPREDICTABLE behavior

If size == '01' && InITBlock(), then one of the following behaviors must occur:

- The instruction is UNDEFINED.
- The instruction executes as if it passes the Condition code check.
- The instruction executes as NOP. This means it behaves as if it fails the Condition code check.

Assembler symbols

- <c> For encoding A1: see [Standard assembler syntax fields on page F2-2848](#). This encoding must be unconditional.
 For encoding A2, T1 and T2: see [Standard assembler syntax fields on page F2-2848](#).
- <q> See [Standard assembler syntax fields on page F2-2848](#).
- <dt> Is the data type for the elements of the vectors, encoded in the "sz" field. It can have the following values:
 F32 when sz = 0
 F16 when sz = 1
- <Qd> Is the 128-bit name of the SIMD&FP destination register, encoded in the "D:Vd" field as <Qd>*2.
- <Qn> Is the 128-bit name of the first SIMD&FP source register, encoded in the "N:Vn" field as <Qn>*2.

- <Qm> Is the 128-bit name of the second SIMD&FP source register, encoded in the "M:Vm" field as <Qm>*2.
- <Dd> Is the 64-bit name of the SIMD&FP destination register, encoded in the "D:Vd" field.
- <Dn> Is the 64-bit name of the first SIMD&FP source register, encoded in the "N:Vn" field.
- <Dm> Is the 64-bit name of the second SIMD&FP source register, encoded in the "M:Vm" field.
- <Sd> Is the 32-bit name of the SIMD&FP destination register, encoded in the "Vd:D" field.
- <Sn> Is the 32-bit name of the first SIMD&FP source register, encoded in the "Vn:N" field.
- <Sm> Is the 32-bit name of the second SIMD&FP source register, encoded in the "Vm:M" field.

Operation for all encodings

```

if ConditionPassed() then
    EncodingSpecificOperations(); CheckAdvSIMDorVFPEEnabled(TRUE, advsimd);
    if advsimd then // Advanced SIMD instruction
        for r = 0 to regs-1
            for e = 0 to elements-1
                Elem[D[d+r],e,esize] = FPMu1(Elem[D[n+r],e,esize], Elem[D[m+r],e,esize],
StandardFPSCRValue());
    else // VFP instruction
        case esize of
            when 16
                S[d] = Zeros(16) : FPMu1(S[n]<15:0>, S[m]<15:0>, FPSCR);
            when 32
                S[d] = FPMu1(S[n], S[m], FPSCR);
            when 64
                D[d] = FPMu1(D[n], D[m], FPSCR);
    
```

F6.1.131 VMUL (integer and polynomial)

Vector Multiply multiplies corresponding elements in two vectors.

For information about multiplying polynomials see *Polynomial arithmetic over {0, 1}* on page A1-47.

Depending on settings in the CPACR, NSACR, and HCPTR registers, and the security state and mode in which the instruction is executed, an attempt to execute the instruction might be UNDEFINED, or trapped to Hyp mode. For more information see *Enabling Advanced SIMD and floating-point support* on page G1-4413.

A1

31	30	29	28	27	26	25	24	23	22	21	20	19	16	15	12	11	10	9	8	7	6	5	4	3	0
1	1	1	1	0	0	1	op	0	D	size	Vn	Vd	1	0	0	1	N	Q	M	1	Vm				

64-bit SIMD vector variant

Applies when Q == 0.

VMUL{<c>}{<q>}.<dt> {<Dd>, }<Dn>, <Dm>

128-bit SIMD vector variant

Applies when Q == 1.

VMUL{<c>}{<q>}.<dt> {<Qd>, }<Qn>, <Qm>

Decode for all variants of this encoding

```
if size == '11' || (op == '1' && size != '00') then UNDEFINED;
if Q == '1' && (Vd<0> == '1' || Vn<0> == '1' || Vm<0> == '1') then UNDEFINED;
unsigned = FALSE; // "Don't care" value: TRUE produces same functionality
polynomial = (op == '1'); long_destination = FALSE;
esize = 8 << UInt(size); elements = 64 DIV esize;
d = UInt(D:Vd); n = UInt(N:Vn); m = UInt(M:Vm); regs = if Q == '0' then 1 else 2;
```

T1

15	14	13	12	11	10	9	8	7	6	5	4	3	0	15	12	11	10	9	8	7	6	5	4	3	0
1	1	1	op	1	1	1	1	0	D	size	Vn	Vd	1	0	0	1	N	Q	M	1	Vm				

64-bit SIMD vector variant

Applies when Q == 0.

VMUL{<c>}{<q>}.<dt> {<Dd>, }<Dn>, <Dm>

128-bit SIMD vector variant

Applies when Q == 1.

VMUL{<c>}{<q>}.<dt> {<Qd>, }<Qn>, <Qm>

Decode for all variants of this encoding

```
if size == '11' || (op == '1' && size != '00') then UNDEFINED;
if Q == '1' && (Vd<0> == '1' || Vn<0> == '1' || Vm<0> == '1') then UNDEFINED;
unsigned = FALSE; // "Don't care" value: TRUE produces same functionality
```



```

polynomial = (op == '1'); long_destination = FALSE;
esize = 8 << UInt(size); elements = 64 DIV esize;
d = UInt(D:Vd); n = UInt(N:Vn); m = UInt(M:Vm); regs = if Q == '0' then 1 else 2;
  
```

Notes for all encodings

For more information about the CONSTRAINED UNPREDICTABLE behavior of this instruction, see [Appendix K1 Architectural Constraints on UNPREDICTABLE behaviors](#).

Assembler symbols

- <c> For encoding A1: see [Standard assembler syntax fields on page F2-2848](#). This encoding must be unconditional.
 For encoding T1: see [Standard assembler syntax fields on page F2-2848](#).
- <q> See [Standard assembler syntax fields on page F2-2848](#).
- <dt> Is the data type for the elements of the operands, encoded in the "op:size" field. It can have the following values:
 - I8 when op = 0, size = 00
 - I16 when op = 0, size = 01
 - I32 when op = 0, size = 10
 - P8 when op = 1, size = 00
- <Qd> Is the 128-bit name of the SIMD&FP destination register, encoded in the "D:Vd" field as <Qd>*2.
- <Qn> Is the 128-bit name of the first SIMD&FP source register, encoded in the "N:Vn" field as <Qn>*2.
- <Qm> Is the 128-bit name of the second SIMD&FP source register, encoded in the "M:Vm" field as <Qm>*2.
- <Dd> Is the 64-bit name of the SIMD&FP destination register, encoded in the "D:Vd" field.
- <Dn> Is the 64-bit name of the first SIMD&FP source register, encoded in the "N:Vn" field.
- <Dm> Is the 64-bit name of the second SIMD&FP source register, encoded in the "M:Vm" field.

Operation for all encodings

```

if ConditionPassed() then
  EncodingSpecificOperations(); CheckAdvSIMDEnabled();
  for r = 0 to regs-1
    for e = 0 to elements-1
      op1 = Elem[Din[n+r],e,esize]; op1val = Int(op1, unsigned);
      op2 = Elem[Din[m+r],e,esize]; op2val = Int(op2, unsigned);
      if polynomial then
        product = PolynomialMult(op1,op2);
      else
        product = (op1val*op2val)<2*esize-1:0>;
      if long_destination then
        Elem[Q[d>>1],e,2*esize] = product;
      else
        Elem[D[d+r],e,esize] = product<esize-1:0>;
  
```

F6.1.132 VMUL (by scalar)

Vector Multiply multiplies each element in a vector by a scalar, and places the results in a second vector.

For more information about scalars see [Advanced SIMD scalars on page F2-2874](#).

Depending on settings in the CPACR, NSACR, and HCPTR registers, and the security state and mode in which the instruction is executed, an attempt to execute the instruction might be UNDEFINED, or trapped to Hyp mode. For more information see [Enabling Advanced SIMD and floating-point support on page G1-4413](#).

A1

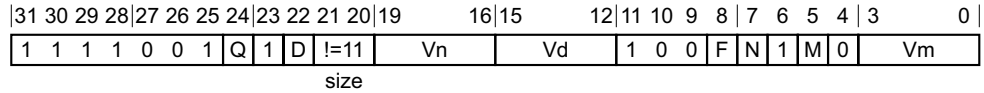

64-bit SIMD vector variant

Applies when Q == 0.

VMUL{<c>}{<q>}.<dt> {<Dd>}, <Dn>, <Dm>[<index>]

128-bit SIMD vector variant

Applies when Q == 1.

VMUL{<c>}{<q>}.<dt> {<Qd>}, <Qn>, <Dm>[<index>]

Decode for all variants of this encoding

```

if size == '11' then SEE "Related encodings";
if size == '00' || (F == '1' && size == '01' && !HaveFP16Ext()) then UNDEFINED;
if Q == '1' && (Vd<0> == '1' || Vn<0> == '1') then UNDEFINED;
unsigned = FALSE; // "Don't care" value: TRUE produces same functionality
floating_point = (F == '1'); long_destination = FALSE;
d = UInt(D:Vd); n = UInt(N:Vn); regs = if Q == '0' then 1 else 2;
if size == '01' then esize = 16; elements = 4; m = UInt(Vm<2:0>); index = UInt(M:Vm<3>);
if size == '10' then esize = 32; elements = 2; m = UInt(Vm); index = UInt(M);
    
```

T1

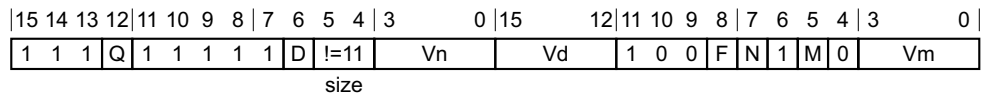

64-bit SIMD vector variant

Applies when Q == 0.

VMUL{<c>}{<q>}.<dt> {<Dd>}, <Dn>, <Dm>[<index>]

128-bit SIMD vector variant

Applies when Q == 1.

VMUL{<c>}{<q>}.<dt> {<Qd>}, <Qn>, <Dm>[<index>]

Decode for all variants of this encoding

```

if size == '11' then SEE "Related encodings";
if size == '00' || (F == '1' && size == '01' && !HaveFP16Ext()) then UNDEFINED;
if F == '1' && size == '01' && InITBlock() then UNPREDICTABLE;
    
```

```

if Q == '1' && (Vd<0> == '1' || Vn<0> == '1') then UNDEFINED;
unsigned = FALSE; // "Don't care" value: TRUE produces same functionality
floating_point = (F == '1'); long_destination = FALSE;
d = UInt(D:Vd); n = UInt(N:Vn); regs = if Q == '0' then 1 else 2;
if size == '01' then esize = 16; elements = 4; m = UInt(Vm<2:0>); index = UInt(M:Vm<3>);
if size == '10' then esize = 32; elements = 2; m = UInt(Vm); index = UInt(M);
  
```

CONSTRAINED UNPREDICTABLE behavior

If `F == '1' && size == '01' && InITBlock()`, then one of the following behaviors must occur:

- The instruction is UNDEFINED.
- The instruction executes as if it passes the Condition code check.
- The instruction executes as NOP. This means it behaves as if it fails the Condition code check.

Notes for all encodings

Related encodings: See [Advanced SIMD data-processing on page F3-2904](#) for the T32 instruction set, or [Advanced SIMD data-processing on page F4-2985](#) for the A32 instruction set.

Assembler symbols

<c>	For encoding A1: see Standard assembler syntax fields on page F2-2848 . This encoding must be unconditional. For encoding T1: see Standard assembler syntax fields on page F2-2848 .								
<q>	See Standard assembler syntax fields on page F2-2848 .								
<dt>	Is the data type for the scalar and the elements of the operand vector, encoded in the "F:size" field. It can have the following values: <table> <tr> <td>I16</td> <td>when F = 0, size = 01</td> </tr> <tr> <td>I32</td> <td>when F = 0, size = 10</td> </tr> <tr> <td>F16</td> <td>when F = 1, size = 01</td> </tr> <tr> <td>F32</td> <td>when F = 1, size = 10</td> </tr> </table>	I16	when F = 0, size = 01	I32	when F = 0, size = 10	F16	when F = 1, size = 01	F32	when F = 1, size = 10
I16	when F = 0, size = 01								
I32	when F = 0, size = 10								
F16	when F = 1, size = 01								
F32	when F = 1, size = 10								
<Qd>	Is the 128-bit name of the SIMD&FP destination register, encoded in the "D:Vd" field as <Qd>*2.								
<Qn>	Is the 128-bit name of the first SIMD&FP source register, encoded in the "N:Vn" field as <Qn>*2.								
<Dd>	Is the 64-bit name of the SIMD&FP destination register, encoded in the "D:Vd" field.								
<Dn>	Is the 64-bit name of the first SIMD&FP source register, encoded in the "N:Vn" field.								
<Dm>	Is the 64-bit name of the second SIMD&FP source register, encoded in the "Vm<2:0>" field when <dt> is I16, otherwise the "Vm" field.								
<index>	Is the element index in the range 0 to 3, encoded in the "M:Vm<3>" field when <dt> is I16, otherwise in range 0 to 1, encoded in the "M" field.								

Operation for all encodings

```

if ConditionPassed() then
  EncodingSpecificOperations(); CheckAdvSIMDEnabled();
  op2 = Elem[Din[m],index,esize]; op2val = Int(op2, unsigned);
  for r = 0 to regs-1
    for e = 0 to elements-1
      op1 = Elem[Din[n+r],e,esize]; op1val = Int(op1, unsigned);
      if floating_point then
        Elem[D[d+r],e,esize] = FPMul(op1, op2, StandardFPSCRValue());
      else
  
```

```
if long_destination then
    Elem[Q[d>>1],e,2*esize] = (op1val*op2val)<2*esize-1:0>;
else
    Elem[D[d+r],e,esize] = (op1val*op2val)<esize-1:0>;
```

F6.1.133 VMULL (integer and polynomial)

Vector Multiply Long multiplies corresponding elements in two vectors. The destination vector elements are twice as long as the elements that are multiplied.

For information about multiplying polynomials see [Polynomial arithmetic over {0, 1}](#) on page A1-47.

Depending on settings in the CPACR, NSACR, and HCPTR registers, and the security state and mode in which the instruction is executed, an attempt to execute the instruction might be UNDEFINED, or trapped to Hyp mode. For more information see [Enabling Advanced SIMD and floating-point support](#) on page G1-4413.

A1

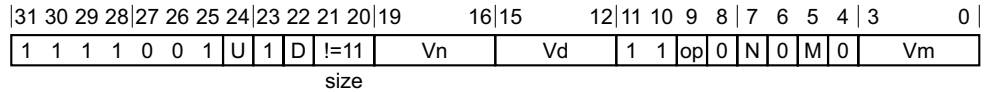

A1 variant

VMULL{<c>}{<q>}.<dt> <Qd>, <Dn>, <Dm>

Decode for this encoding

```

if size == '11' then SEE "Related encodings";
unsigned = (U == '1'); polynomial = (op == '1'); long_destination = TRUE;
esize = 8 << UInt(size); elements = 64 DIV esize;
if polynomial then
    if U == '1' || size == '01' then UNDEFINED;
    if size == '10' then // .p64
        if !HaveCryptoExt() then UNDEFINED;
        esize = 64; elements = 1;
if Vd<0> == '1' then UNDEFINED;
d = UInt(D:Vd); n = UInt(N:Vn); m = UInt(M:Vm); regs = 1;
    
```

T1

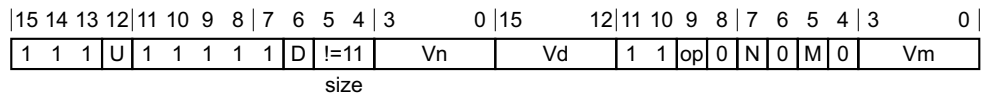

T1 variant

VMULL{<c>}{<q>}.<dt> <Qd>, <Dn>, <Dm>

Decode for this encoding

```

if size == '11' then SEE "Related encodings";
unsigned = (U == '1'); polynomial = (op == '1'); long_destination = TRUE;
esize = 8 << UInt(size); elements = 64 DIV esize;
if polynomial then
    if U == '1' || size == '01' then UNDEFINED;
    if size == '10' then // .p64
        if !HaveCryptoExt() then UNDEFINED;
        if InITBlock() then UNPREDICTABLE;
        esize = 64; elements = 1;
if Vd<0> == '1' then UNDEFINED;
d = UInt(D:Vd); n = UInt(N:Vn); m = UInt(M:Vm); regs = 1;
    
```

CONSTRAINED UNPREDICTABLE behavior

If `op == '1' && size == '10' && InITBlock()`, then one of the following behaviors must occur:

- The instruction is UNDEFINED.
- The instruction executes as if it passes the Condition code check.
- The instruction executes as NOP. This means it behaves as if it fails the Condition code check.

Notes for all encodings

For more information about the CONSTRAINED UNPREDICTABLE behavior of this instruction, see [Appendix K1 Architectural Constraints on UNPREDICTABLE behaviors](#).

Related encodings: See [Advanced SIMD data-processing on page F3-2904](#) for the T32 instruction set, or [Advanced SIMD data-processing on page F4-2985](#) for the A32 instruction set.

Assembler symbols

- <c> For encoding A1: see [Standard assembler syntax fields on page F2-2848](#). This encoding must be unconditional.
 For encoding T1: see [Standard assembler syntax fields on page F2-2848](#).
- <q> See [Standard assembler syntax fields on page F2-2848](#).
- <dt> Is the data type for the elements of the operands, encoded in the "op:U:size" field. It can have the following values:
- | | |
|-----|-------------------------------|
| S8 | when op = 0, U = 0, size = 00 |
| S16 | when op = 0, U = 0, size = 01 |
| S32 | when op = 0, U = 0, size = 10 |
| U8 | when op = 0, U = 1, size = 00 |
| U16 | when op = 0, U = 1, size = 01 |
| U32 | when op = 0, U = 1, size = 10 |
| P8 | when op = 1, U = 0, size = 00 |
| P64 | when op = 1, U = 0, size = 10 |
- <Qd> Is the 128-bit name of the SIMD&FP destination register, encoded in the "D:Vd" field as <Qd>*2.
- <Dn> Is the 64-bit name of the first SIMD&FP source register, encoded in the "N:Vn" field.
- <Dm> Is the 64-bit name of the second SIMD&FP source register, encoded in the "M:Vm" field.

Operation for all encodings

```

if ConditionPassed() then
    EncodingSpecificOperations(); CheckAdvSIMDEnabled();
    for r = 0 to regs-1
        for e = 0 to elements-1
            op1 = Elem[Din[n+r],e,esize]; op1val = Int(op1, unsigned);
            op2 = Elem[Din[m+r],e,esize]; op2val = Int(op2, unsigned);
            if polynomial then
                product = PolynomialMult(op1,op2);
            else
                product = (op1val*op2val)<2*esize-1:0>;
            if long_destination then
                Elem[Q[d>1],e,2*esize] = product;
            else
                Elem[D[d+r],e,esize] = product<esize-1:0>;
  
```

F6.1.134 VMULL (by scalar)

Vector Multiply Long multiplies each element in a vector by a scalar, and places the results in a second vector. The destination vector elements are twice as long as the elements that are multiplied.

For more information about scalars see [Advanced SIMD scalars](#) on page F2-2874.

Depending on settings in the CPACR, NSACR, and HCPTR registers, and the security state and mode in which the instruction is executed, an attempt to execute the instruction might be UNDEFINED, or trapped to Hyp mode. For more information see [Enabling Advanced SIMD and floating-point support](#) on page G1-4413.

A1

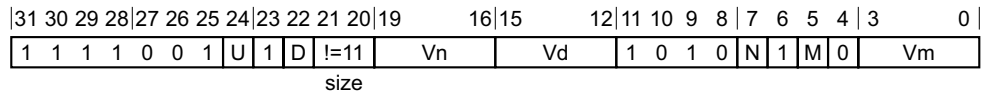

A1 variant

VMULL{<c>}{<q>}.<dt> <Qd>, <Dn>, <Dm>[<index>]

Decode for this encoding

```

if size == '11' then SEE "Related encodings";
if size == '00' || Vd<0> == '1' then UNDEFINED;
unsigned = (U == '1'); long_destination = TRUE; floating_point = FALSE;
d = UInt(D:Vd); n = UInt(N:Vn); regs = 1;
if size == '01' then esize = 16; elements = 4; m = UInt(Vm<2:0>); index = UInt(M:Vm<3>);
if size == '10' then esize = 32; elements = 2; m = UInt(Vm); index = UInt(M);
  
```

T1

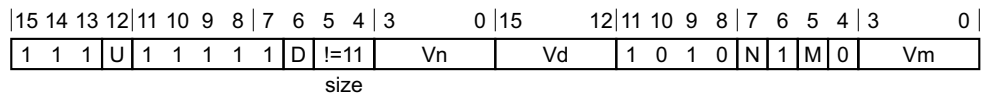

T1 variant

VMULL{<c>}{<q>}.<dt> <Qd>, <Dn>, <Dm>[<index>]

Decode for this encoding

```

if size == '11' then SEE "Related encodings";
if size == '00' || Vd<0> == '1' then UNDEFINED;
unsigned = (U == '1'); long_destination = TRUE; floating_point = FALSE;
d = UInt(D:Vd); n = UInt(N:Vn); regs = 1;
if size == '01' then esize = 16; elements = 4; m = UInt(Vm<2:0>); index = UInt(M:Vm<3>);
if size == '10' then esize = 32; elements = 2; m = UInt(Vm); index = UInt(M);
  
```

Notes for all encodings

Related encodings: See [Advanced SIMD data-processing](#) on page F3-2904 for the T32 instruction set, or [Advanced SIMD data-processing](#) on page F4-2985 for the A32 instruction set.

Assembler symbols

- <c> For encoding A1: see [Standard assembler syntax fields](#) on page F2-2848. This encoding must be unconditional.
- For encoding T1: see [Standard assembler syntax fields](#) on page F2-2848.

- <q> See *Standard assembler syntax fields* on page F2-2848.
- <dt> Is the data type for the scalar and the elements of the operand vector, encoded in the "U:size" field. It can have the following values:
- | | |
|-----|-----------------------|
| S16 | when U = 0, size = 01 |
| S32 | when U = 0, size = 10 |
| U16 | when U = 1, size = 01 |
| U32 | when U = 1, size = 10 |
- <Qd> Is the 128-bit name of the SIMD&FP destination register, encoded in the "D:Vd" field as <Qd>*2.
- <Dn> Is the 64-bit name of the first SIMD&FP source register, encoded in the "N:Vn" field.
- <Dm> Is the 64-bit name of the second SIMD&FP source register, encoded in the "Vm<2:0>" field when <dt> is S16 or U16, otherwise the "Vm" field.
- <index> Is the element index in the range 0 to 3, encoded in the "M:Vm<3>" field when <dt> is S16 or U16, otherwise in range 0 to 1, encoded in the "M" field.

Operation for all encodings

```

if ConditionPassed() then
    EncodingSpecificOperations(); CheckAdvSIMDEnabled();
    op2 = Elem[Din[m],index,esize]; op2val = Int(op2, unsigned);
    for r = 0 to regs-1
        for e = 0 to elements-1
            op1 = Elem[Din[n+r],e,esize]; op1val = Int(op1, unsigned);
            if floating_point then
                Elem[D[d+r],e,esize] = FPMul(op1, op2, StandardFPSCRValue());
            else
                if long_destination then
                    Elem[Q[d>>1],e,2*esize] = (op1val*op2val)<2*esize-1:0>;
                else
                    Elem[D[d+r],e,esize] = (op1val*op2val)<esize-1:0>;
  
```

F6.1.135 VMVN (immediate)

Vector Bitwise NOT (immediate) places the bitwise inverse of an immediate integer constant into every element of the destination register.

Depending on settings in the CPACR, NSACR, and HCPTR registers, and the security state and mode in which the instruction is executed, an attempt to execute the instruction might be UNDEFINED, or trapped to Hyp mode. For more information see [Enabling Advanced SIMD and floating-point support on page G1-4413](#).

A1

31	30	29	28	27	26	25	24	23	22	21	20	19	18	16	15	12	11	8	7	6	5	4	3	0
1	1	1	1	0	0	1	i	1	D	0	0	0	imm3	Vd	0	x	x	0	0	Q	1	1	imm4	

cmode

64-bit SIMD vector variant

Applies when Q == 0.

VMVN{<c>}{<q>}.I32 <Dd>, #<imm>

128-bit SIMD vector variant

Applies when Q == 1.

VMVN{<c>}{<q>}.I32 <Qd>, #<imm>

Decode for all variants of this encoding

```
if (cmode<0> == '1' && cmode<3:2> != '11') || cmode<3:1> == '111' then SEE "Related encodings";
if Q == '1' && Vd<0> == '1' then UNDEFINED;
imm64 = AdvSIMDExpandImm('1', cmode, i:imm3:imm4);
d = UInt(D:Vd); regs = if Q == '0' then 1 else 2;
```

A2

31	30	29	28	27	26	25	24	23	22	21	20	19	18	16	15	12	11	8	7	6	5	4	3	0
1	1	1	1	0	0	1	i	1	D	0	0	0	imm3	Vd	1	0	x	0	0	Q	1	1	imm4	

cmode

64-bit SIMD vector variant

Applies when Q == 0.

VMVN{<c>}{<q>}.I16 <Dd>, #<imm>

128-bit SIMD vector variant

Applies when Q == 1.

VMVN{<c>}{<q>}.I16 <Qd>, #<imm>

Decode for all variants of this encoding

```
if (cmode<0> == '1' && cmode<3:2> != '11') || cmode<3:1> == '111' then SEE "Related encodings";
if Q == '1' && Vd<0> == '1' then UNDEFINED;
imm64 = AdvSIMDExpandImm('1', cmode, i:imm3:imm4);
d = UInt(D:Vd); regs = if Q == '0' then 1 else 2;
```

A3

31	30	29	28	27	26	25	24	23	22	21	20	19	18	16	15	12	11	8	7	6	5	4	3	0
1	1	1	1	0	0	1	i	1	D	0	0	0	imm3	Vd	1	1	0	x	0	Q	1	1	imm4	

cmode

64-bit SIMD vector variant

Applies when Q == 0.

VMVN{<c>}{<q>}.I32 <Dd>, #<imm>

128-bit SIMD vector variant

Applies when Q == 1.

VMVN{<c>}{<q>}.I32 <Qd>, #<imm>

Decode for all variants of this encoding

```
if (cmode<0> == '1' && cmode<3:2> != '11') || cmode<3:1> == '111' then SEE "Related encodings";
if Q == '1' && Vd<0> == '1' then UNDEFINED;
imm64 = AdvSIMDEExpandImm('1', cmode, i:imm3:imm4);
d = UInt(D:Vd); regs = if Q == '0' then 1 else 2;
```

T1

15	14	13	12	11	10	9	8	7	6	5	4	3	2	0	15	12	11	8	7	6	5	4	3	0
1	1	1	i	1	1	1	1	1	D	0	0	0	imm3	Vd	0	x	x	0	0	Q	1	1	imm4	

cmode

64-bit SIMD vector variant

Applies when Q == 0.

VMVN{<c>}{<q>}.I32 <Dd>, #<imm>

128-bit SIMD vector variant

Applies when Q == 1.

VMVN{<c>}{<q>}.I32 <Qd>, #<imm>

Decode for all variants of this encoding

```
if (cmode<0> == '1' && cmode<3:2> != '11') || cmode<3:1> == '111' then SEE "Related encodings";
if Q == '1' && Vd<0> == '1' then UNDEFINED;
imm64 = AdvSIMDEExpandImm('1', cmode, i:imm3:imm4);
d = UInt(D:Vd); regs = if Q == '0' then 1 else 2;
```

T2

15	14	13	12	11	10	9	8	7	6	5	4	3	2	0	15	12	11	8	7	6	5	4	3	0
1	1	1	i	1	1	1	1	1	D	0	0	0	imm3	Vd	1	0	x	0	0	Q	1	1	imm4	

cmode

64-bit SIMD vector variant

Applies when Q == 0.

VMVN{<c>}{<q>}.I16 <Dd>, #<imm>

128-bit SIMD vector variant

Applies when Q == 1.

VMVN{<c>}{<q>}.I16 <Qd>, #<imm>

Decode for all variants of this encoding

```
if (cmode<0> == '1' && cmode<3:2> != '11') || cmode<3:1> == '111' then SEE "Related encodings";
if Q == '1' && Vd<0> == '1' then UNDEFINED;
imm64 = AdvSIMDExpandImm('1', cmode, i:imm3:imm4);
d = UInt(D:Vd); regs = if Q == '0' then 1 else 2;
```

T3

15	14	13	12	11	10	9	8	7	6	5	4	3	2	0	15	12	11	8	7	6	5	4	3	0
1	1	1	i	1	1	1	1	1	D	0	0	0	imm3	Vd	1	1	0	x	0	Q	1	1	imm4	

cmode

64-bit SIMD vector variant

Applies when Q == 0.

VMVN{<c>}{<q>}.I32 <Dd>, #<imm>

128-bit SIMD vector variant

Applies when Q == 1.

VMVN{<c>}{<q>}.I32 <Qd>, #<imm>

Decode for all variants of this encoding

```
if (cmode<0> == '1' && cmode<3:2> != '11') || cmode<3:1> == '111' then SEE "Related encodings";
if Q == '1' && Vd<0> == '1' then UNDEFINED;
imm64 = AdvSIMDExpandImm('1', cmode, i:imm3:imm4);
d = UInt(D:Vd); regs = if Q == '0' then 1 else 2;
```

Notes for all encodings

Related encodings: See *Advanced SIMD one register and modified immediate* on page F3-2912 for the T32 instruction set, or *Advanced SIMD one register and modified immediate* on page F4-2994 for the A32 instruction set.

Assembler symbols

- <c> For encoding A1, A2 and A3: see *Standard assembler syntax fields* on page F2-2848. This encoding must be unconditional.
For encoding T1, T2 and T3: see *Standard assembler syntax fields* on page F2-2848.
- <q> See *Standard assembler syntax fields* on page F2-2848.
- <Qd> Is the 128-bit name of the SIMD&FP destination register, encoded in the "D:Vd" field as <Qd>*2.
- <Dd> Is the 64-bit name of the SIMD&FP destination register, encoded in the "D:Vd" field.
- <imm> Is a constant of the specified type that is replicated to fill the destination register. For details of the range of constants available and the encoding of <imm>, see *Modified immediate constants in T32 and A32 Advanced SIMD instructions* on page F2-2865.

Operation for all encodings

```
if ConditionPassed() then
    EncodingSpecificOperations(); CheckAdvSIMDEnabled();
for r = 0 to regs-1
    D[d+r] = NOT(imm64);
```

F6.1.136 VMVN (register)

Vector Bitwise NOT (register) takes a value from a register, inverts the value of each bit, and places the result in the destination register. The registers can be either doubleword or quadword.

Depending on settings in the CPACR, NSACR, and HCPTR registers, and the security state and mode in which the instruction is executed, an attempt to execute the instruction might be UNDEFINED, or trapped to Hyp mode. For more information see [Enabling Advanced SIMD and floating-point support on page G1-4413](#).

A1

31	30	29	28	27	26	25	24	23	22	21	20	19	18	17	16	15	12	11	10	9	8	7	6	5	4	3	0
1	1	1	1	0	0	1	1	1	D	1	1	size	0	0	Vd	0	1	0	1	1	Q	M	0	Vm			

64-bit SIMD vector variant

Applies when Q == 0.

VMVN{<c>}{<q>}{.<dt>} <Dd>, <Dm>

128-bit SIMD vector variant

Applies when Q == 1.

VMVN{<c>}{<q>}{.<dt>} <Qd>, <Qm>

Decode for all variants of this encoding

```
if size != '00' then UNDEFINED;
if Q == '1' && (Vd<0> == '1' || Vm<0> == '1') then UNDEFINED;
d = UInt(D:Vd); m = UInt(M:Vm); regs = if Q == '0' then 1 else 2;
```

T1

15	14	13	12	11	10	9	8	7	6	5	4	3	2	1	0	15	12	11	10	9	8	7	6	5	4	3	0
1	1	1	1	1	1	1	1	1	D	1	1	size	0	0	Vd	0	1	0	1	1	Q	M	0	Vm			

64-bit SIMD vector variant

Applies when Q == 0.

VMVN{<c>}{<q>}{.<dt>} <Dd>, <Dm>

128-bit SIMD vector variant

Applies when Q == 1.

VMVN{<c>}{<q>}{.<dt>} <Qd>, <Qm>

Decode for all variants of this encoding

```
if size != '00' then UNDEFINED;
if Q == '1' && (Vd<0> == '1' || Vm<0> == '1') then UNDEFINED;
d = UInt(D:Vd); m = UInt(M:Vm); regs = if Q == '0' then 1 else 2;
```

Assembler symbols

<c> For encoding A1: see [Standard assembler syntax fields on page F2-2848](#). This encoding must be unconditional.

- For encoding T1: see [Standard assembler syntax fields on page F2-2848](#).
- <q> See [Standard assembler syntax fields on page F2-2848](#).
- <dt> An optional data type. It is ignored by assemblers, and does not affect the encoding.
- <Qd> Is the 128-bit name of the SIMD&FP destination register, encoded in the "D:Vd" field as <Qd>*2.
- <Qm> Is the 128-bit name of the SIMD&FP source register, encoded in the "M:Vm" field as <Qm>*2.
- <Dd> Is the 64-bit name of the SIMD&FP destination register, encoded in the "D:Vd" field.
- <Dm> Is the 64-bit name of the SIMD&FP source register, encoded in the "M:Vm" field.

Operation for all encodings

```
if ConditionPassed() then
    EncodingSpecificOperations(); CheckAdvSIMDEnabled();
    for r = 0 to regs-1
        D[d+r] = NOT(D[m+r]);
```

F6.1.137 VNEG

Vector Negate negates each element in a vector, and places the results in a second vector. The floating-point version only inverts the sign bit.

Depending on settings in the CPACR, NSACR, HCPTR, and FPEXC registers, and the security state and mode in which the instruction is executed, an attempt to execute the instruction might be UNDEFINED, or trapped to Hyp mode. For more information see [Enabling Advanced SIMD and floating-point support on page G1-4413](#).

A1

31	30	29	28	27	26	25	24	23	22	21	20	19	18	17	16	15	12	11	10	9	8	7	6	5	4	3	0
1	1	1	1	0	0	1	1	1	D	1	1	size	0	1	Vd	0	F	1	1	1	Q	M	0	Vm			

64-bit SIMD vector variant

Applies when Q == 0.

VNEG{<c>}{<q>}.<dt> <Dd>, <Dm>

128-bit SIMD vector variant

Applies when Q == 1.

VNEG{<c>}{<q>}.<dt> <Qd>, <Qm>

Decode for all variants of this encoding

```

if size == '11' then UNDEFINED;
if F == '1' && ((size == '01' && !HaveFP16Ext()) || size == '00') then UNDEFINED;
if Q == '1' && (Vd<0> == '1' || Vm<0> == '1') then UNDEFINED;
advsimd = TRUE; floating_point = (F == '1');
esize = 8 << UInt(size); elements = 64 DIV esize;
d = UInt(D:Vd); m = UInt(M:Vm); regs = if Q == '0' then 1 else 2;
    
```

A2

31	28	27	26	25	24	23	22	21	20	19	18	17	16	15	12	11	10	9	8	7	6	5	4	3	0
!=1111	1	1	1	0	1	D	1	1	0	0	0	1	Vd	1	0	size	0	1	M	0	Vm				

cond

Half-precision scalar variant

Applies when size == 01.

VNEG{<c>}{<q>}.F16 <Sd>, <Sm>

Single-precision scalar variant

Applies when size == 10.

VNEG{<c>}{<q>}.F32 <Sd>, <Sm>

Double-precision scalar variant

Applies when size == 11.

VNEG{<c>}{<q>}.F64 <Dd>, <Dm>

Decode for all variants of this encoding

```

if size == '00' || (size == '01' && !HaveFP16Ext()) then UNDEFINED;
if size == '01' && cond != '1110' then UNPREDICTABLE;
if FPSCR.Len != '000' || FPSCR.Stride != '00' then UNDEFINED;
advsimd = FALSE;
case size of
    when '01' esize = 16; d = UInt(Vd:D); m = UInt(Vm:M);
    when '10' esize = 32; d = UInt(Vd:D); m = UInt(Vm:M);
    when '11' esize = 64; d = UInt(D:Vd); m = UInt(M:Vm);
    
```

CONSTRAINED UNPREDICTABLE behavior

If size == '01' && cond != '1110', then one of the following behaviors must occur:

- The instruction is UNDEFINED.
- The instruction executes as if it passes the Condition code check.
- The instruction executes as NOP. This means it behaves as if it fails the Condition code check.

T1

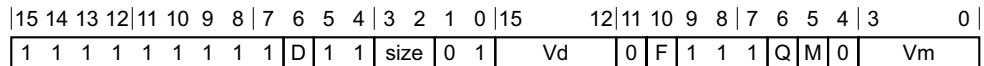

64-bit SIMD vector variant

Applies when Q == 0.

```
VNEG{<c>}{<q>}.<dt> <Dd>, <Dm>
```

128-bit SIMD vector variant

Applies when Q == 1.

```
VNEG{<c>}{<q>}.<dt> <Qd>, <Qm>
```

Decode for all variants of this encoding

```

if size == '11' then UNDEFINED;
if F == '1' && ((size == '01' && !HaveFP16Ext()) || size == '00') then UNDEFINED;
if F == '1' && size == '01' && InITBlock() then UNPREDICTABLE;
if Q == '1' && (Vd<0> == '1' || Vm<0> == '1') then UNDEFINED;
advsimd = TRUE; floating_point = (F == '1');
esize = 8 << UInt(size); elements = 64 DIV esize;
d = UInt(D:Vd); m = UInt(M:Vm); regs = if Q == '0' then 1 else 2;
    
```

CONSTRAINED UNPREDICTABLE behavior

If F == '1' && size == '01' && InITBlock(), then one of the following behaviors must occur:

- The instruction is UNDEFINED.
- The instruction executes as if it passes the Condition code check.
- The instruction executes as NOP. This means it behaves as if it fails the Condition code check.

T2

15	14	13	12	11	10	9	8	7	6	5	4	3	2	1	0	15	12	11	10	9	8	7	6	5	4	3	0
1	1	1	0	1	1	1	0	1	D	1	1	0	0	0	1	Vd	1	0	size	0	1	M	0	Vm			

Half-precision scalar variant

Applies when size == 01.

VNEG{<c>}{<q>}.F16 <Sd>, <Sm>

Single-precision scalar variant

Applies when size == 10.

VNEG{<c>}{<q>}.F32 <Sd>, <Sm>

Double-precision scalar variant

Applies when size == 11.

VNEG{<c>}{<q>}.F64 <Dd>, <Dm>

Decode for all variants of this encoding

```

if size == '00' || (size == '01' && !HaveFP16Ext()) then UNDEFINED;
if size == '01' && InITBlock() then UNPREDICTABLE;
if FPSCR.Len != '000' || FPSCR.Stride != '00' then UNDEFINED;
advsimd = FALSE;
case size of
    when '01' esize = 16; d = UInt(Vd:D); m = UInt(Vm:M);
    when '10' esize = 32; d = UInt(Vd:D); m = UInt(Vm:M);
    when '11' esize = 64; d = UInt(D:Vd); m = UInt(M:Vm);

```

CONSTRAINED UNPREDICTABLE behavior

If size == '01' && InITBlock(), then one of the following behaviors must occur:

- The instruction is UNDEFINED.
- The instruction executes as if it passes the Condition code check.
- The instruction executes as NOP. This means it behaves as if it fails the Condition code check.

Assembler symbols

<c> For encoding A1: see [Standard assembler syntax fields on page F2-2848](#). This encoding must be unconditional.

For encoding A2, T1 and T2: see [Standard assembler syntax fields on page F2-2848](#).

<q> See [Standard assembler syntax fields on page F2-2848](#).

<dt> Is the data type for the elements of the vectors, encoded in the "F:size" field. It can have the following values:

S8	when F = 0, size = 00
S16	when F = 0, size = 01
S32	when F = 0, size = 10
F16	when F = 1, size = 01
F32	when F = 1, size = 10

- <Qd> Is the 128-bit name of the SIMD&FP destination register, encoded in the "D:Vd" field as <Qd>*2.
- <Qm> Is the 128-bit name of the SIMD&FP source register, encoded in the "M:Vm" field as <Qm>*2.
- <Dd> Is the 64-bit name of the SIMD&FP destination register, encoded in the "D:Vd" field.
- <Dm> Is the 64-bit name of the SIMD&FP source register, encoded in the "M:Vm" field.
- <Sd> Is the 32-bit name of the SIMD&FP destination register, encoded in the "Vd:D" field.
- <Sm> Is the 32-bit name of the SIMD&FP source register, encoded in the "Vm:M" field.

Operation for all encodings

```
if ConditionPassed() then
    EncodingSpecificOperations(); CheckAdvSIMDOrVFPEnabled(TRUE, advsimd);
    if advsimd then // Advanced SIMD instruction
        for r = 0 to regs-1
            for e = 0 to elements-1
                if floating_point then
                    Elem[D[d+r],e,esize] = FPNeg(Elem[D[m+r],e,esize]);
                else
                    result = -SInt(Elem[D[m+r],e,esize]);
                    Elem[D[d+r],e,esize] = result<esize-1:0>;
    else // VFP instruction
        case esize of
            when 16 S[d] = Zeros(16) : FPNeg(S[m]<15:0>);
            when 32 S[d] = FPNeg(S[m]);
            when 64 D[d] = FPNeg(D[m]);
```

F6.1.138 VNMLA

Vector Negate Multiply Accumulate multiplies together two floating-point register values, adds the negation of the floating-point value in the destination register to the negation of the product, and writes the result back to the destination register.

———— Note —————

ARM recommends that software does not use the VNMLA instruction in the Round towards Plus Infinity and Round towards Minus Infinity rounding modes, because the rounding of the product and of the sum can change the result of the instruction in opposite directions, defeating the purpose of these rounding modes.

Depending on settings in the CPACR, NSACR, HCPTR, and FPEXC registers, and the security state and mode in which the instruction is executed, an attempt to execute the instruction might be UNDEFINED, or trapped to Hyp mode. For more information see *Enabling Advanced SIMD and floating-point support* on page G1-4413.

A1

31	28	27	26	25	24	23	22	21	20	19	16	15	12	11	10	9	8	7	6	5	4	3	0		
!=1111				1	1	1	0	0	D	0	1	Vn		Vd		1	0	size		N	1	M	0	Vm	
cond										op															

Half-precision scalar variant

Applies when size == 01.

VNMLA{<c>}{<q>}.F16 <Sd>, <Sn>, <Sm>

Single-precision scalar variant

Applies when size == 10.

VNMLA{<c>}{<q>}.F32 <Sd>, <Sn>, <Sm>

Double-precision scalar variant

Applies when size == 11.

VNMLA{<c>}{<q>}.F64 <Dd>, <Dn>, <Dm>

Decode for all variants of this encoding

```

if FPSCR.Len != '000' || FPSCR.Stride != '00' then UNDEFINED;
if size == '00' || (size == '01' && !HaveFP16Ext()) then UNDEFINED;
if size == '01' && cond != '1110' then UNPREDICTABLE;
type = if op == '1' then VFPNegMul_VNMLA else VFPNegMul_VNMMLS;
case size of
  when '01' esize = 16; d = UInt(Vd:D); n = UInt(Vn:N); m = UInt(Vm:M);
  when '10' esize = 32; d = UInt(Vd:D); n = UInt(Vn:N); m = UInt(Vm:M);
  when '11' esize = 64; d = UInt(D:Vd); n = UInt(N:Vn); m = UInt(M:Vm);
    
```

CONSTRAINED UNPREDICTABLE behavior

If size == '01' && cond != '1110', then one of the following behaviors must occur:

- The instruction is UNDEFINED.
- The instruction executes as if it passes the Condition code check.
- The instruction executes as NOP. This means it behaves as if it fails the Condition code check.

T1

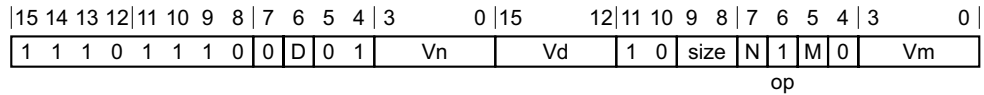

Half-precision scalar variant

Applies when size == 01.

VNMLA{<c>}{<q>}.F16 <Sd>, <Sn>, <Sm>

Single-precision scalar variant

Applies when size == 10.

VNMLA{<c>}{<q>}.F32 <Sd>, <Sn>, <Sm>

Double-precision scalar variant

Applies when size == 11.

VNMLA{<c>}{<q>}.F64 <Dd>, <Dn>, <Dm>

Decode for all variants of this encoding

```

if FPSCR.Len != '000' || FPSCR.Stride != '00' then UNDEFINED;
if size == '00' || (size == '01' && !HaveFP16Ext()) then UNDEFINED;
if size == '01' && InITBlock() then UNPREDICTABLE;
type = if op == '1' then VFPNegMul_VNMLA else VFPNegMul_VNMLS;
case size of
  when '01' esize = 16; d = UInt(Vd:D); n = UInt(Vn:N); m = UInt(Vm:M);
  when '10' esize = 32; d = UInt(Vd:D); n = UInt(Vn:N); m = UInt(Vm:M);
  when '11' esize = 64; d = UInt(D:Vd); n = UInt(N:Vn); m = UInt(M:Vm);
    
```

CONSTRAINED UNPREDICTABLE behavior

If size == '01' && InITBlock(), then one of the following behaviors must occur:

- The instruction is UNDEFINED.
- The instruction executes as if it passes the Condition code check.
- The instruction executes as NOP. This means it behaves as if it fails the Condition code check.

Assembler symbols

- <c> See [Standard assembler syntax fields on page F2-2848](#).
- <q> See [Standard assembler syntax fields on page F2-2848](#).
- <Sd> Is the 32-bit name of the SIMD&FP destination register, encoded in the "Vd:D" field.
- <Sn> Is the 32-bit name of the first SIMD&FP source register, encoded in the "Vn:N" field.
- <Sm> Is the 32-bit name of the second SIMD&FP source register, encoded in the "Vm:M" field.
- <Dd> Is the 64-bit name of the SIMD&FP destination register, encoded in the "D:Vd" field.
- <Dn> Is the 64-bit name of the first SIMD&FP source register, encoded in the "N:Vn" field.
- <Dm> Is the 64-bit name of the second SIMD&FP source register, encoded in the "M:Vm" field.

Operation for all encodings

```

enumeration VFPNegMul {VFPNegMul_VNMLA, VFPNegMul_VNMMLS, VFPNegMul_VNMUL};

if ConditionPassed() then
    EncodingSpecificOperations();
    CheckVFPEnabled(TRUE);
    case esize of
        when 16
            product16 = FPMu1(S[n]<15:0>, S[m]<15:0>, FPSCR);
            case type of
                when VFPNegMul_VNMLA S[d] = Zeros(16) : FAdd(FPNeg(S[d]<15:0>), FPNeg(product16),
FPSCR);
                when VFPNegMul_VNMMLS S[d] = Zeros(16) : FAdd(FPNeg(S[d]<15:0>), product16, FPSCR);
                when VFPNegMul_VNMUL S[d] = Zeros(16) : FPNeg(product16);
            when 32
                product32 = FPMu1(S[n], S[m], FPSCR);
                case type of
                    when VFPNegMul_VNMLA S[d] = FAdd(FPNeg(S[d]), FPNeg(product32), FPSCR);
                    when VFPNegMul_VNMMLS S[d] = FAdd(FPNeg(S[d]), product32, FPSCR);
                    when VFPNegMul_VNMUL S[d] = FPNeg(product32);
            when 64
                product64 = FPMu1(D[n], D[m], FPSCR);
                case type of
                    when VFPNegMul_VNMLA D[d] = FAdd(FPNeg(D[d]), FPNeg(product64), FPSCR);
                    when VFPNegMul_VNMMLS D[d] = FAdd(FPNeg(D[d]), product64, FPSCR);
                    when VFPNegMul_VNMUL D[d] = FPNeg(product64);
    
```

F6.1.139 VNMLS

Vector Negate Multiply Subtract multiplies together two floating-point register values, adds the negation of the floating-point value in the destination register to the product, and writes the result back to the destination register.

Depending on settings in the CPACR, NSACR, HCPTR, and FPEXC registers, and the security state and mode in which the instruction is executed, an attempt to execute the instruction might be UNDEFINED, or trapped to Hyp mode. For more information see [Enabling Advanced SIMD and floating-point support on page G1-4413](#).

A1

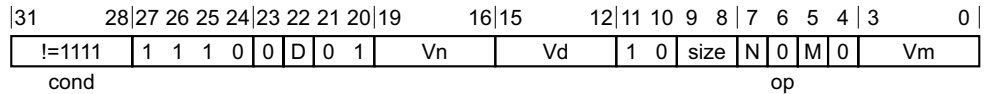

Half-precision scalar variant

Applies when size == 01.

VNMLS{<c>}{<q>}.F16 <Sd>, <Sn>, <Sm>

Single-precision scalar variant

Applies when size == 10.

VNMLS{<c>}{<q>}.F32 <Sd>, <Sn>, <Sm>

Double-precision scalar variant

Applies when size == 11.

VNMLS{<c>}{<q>}.F64 <Dd>, <Dn>, <Dm>

Decode for all variants of this encoding

```

if FPSCR.Len != '000' || FPSCR.Stride != '00' then UNDEFINED;
if size == '00' || (size == '01' && !HaveFP16Ext()) then UNDEFINED;
if size == '01' && cond != '1110' then UNPREDICTABLE;
type = if op == '1' then VFPNegMul_VNMLA else VFPNegMul_VNMLS;
case size of
    when '01' esize = 16; d = UInt(Vd:D); n = UInt(Vn:N); m = UInt(Vm:M);
    when '10' esize = 32; d = UInt(Vd:D); n = UInt(Vn:N); m = UInt(Vm:M);
    when '11' esize = 64; d = UInt(D:Vd); n = UInt(N:Vn); m = UInt(M:Vm);
    
```

CONSTRAINED UNPREDICTABLE behavior

If size == '01' && cond != '1110', then one of the following behaviors must occur:

- The instruction is UNDEFINED.
- The instruction executes as if it passes the Condition code check.
- The instruction executes as NOP. This means it behaves as if it fails the Condition code check.

T1

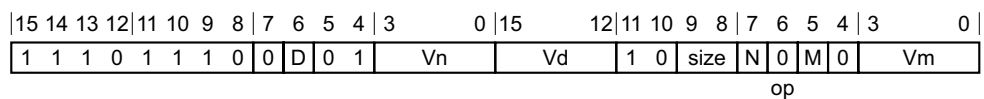

Half-precision scalar variant

Applies when size == 01.

VNMLS{<c>}{<q>}.F16 <Sd>, <Sn>, <Sm>

Single-precision scalar variant

Applies when size == 10.

VNMLS{<c>}{<q>}.F32 <Sd>, <Sn>, <Sm>

Double-precision scalar variant

Applies when size == 11.

VNMLS{<c>}{<q>}.F64 <Dd>, <Dn>, <Dm>

Decode for all variants of this encoding

```

if FPSCR.Len != '000' || FPSCR.Stride != '00' then UNDEFINED;
if size == '00' || (size == '01' && !HaveFP16Ext()) then UNDEFINED;
if size == '01' && InITBlock() then UNPREDICTABLE;
type = if op == '1' then VFPNegMul_VNMLA else VFPNegMul_VNMLS;
case size of
    when '01' esize = 16; d = UInt(Vd:D); n = UInt(Vn:N); m = UInt(Vm:M);
    when '10' esize = 32; d = UInt(Vd:D); n = UInt(Vn:N); m = UInt(Vm:M);
    when '11' esize = 64; d = UInt(D:Vd); n = UInt(N:Vn); m = UInt(M:Vm);
    
```

CONSTRAINED UNPREDICTABLE behavior

If size == '01' && InITBlock(), then one of the following behaviors must occur:

- The instruction is UNDEFINED.
- The instruction executes as if it passes the Condition code check.
- The instruction executes as NOP. This means it behaves as if it fails the Condition code check.

Assembler symbols

<c>	See <i>Standard assembler syntax fields</i> on page F2-2848.
<q>	See <i>Standard assembler syntax fields</i> on page F2-2848.
<Sd>	Is the 32-bit name of the SIMD&FP destination register, encoded in the "Vd:D" field.
<Sn>	Is the 32-bit name of the first SIMD&FP source register, encoded in the "Vn:N" field.
<Sm>	Is the 32-bit name of the second SIMD&FP source register, encoded in the "Vm:M" field.
<Dd>	Is the 64-bit name of the SIMD&FP destination register, encoded in the "D:Vd" field.
<Dn>	Is the 64-bit name of the first SIMD&FP source register, encoded in the "N:Vn" field.
<Dm>	Is the 64-bit name of the second SIMD&FP source register, encoded in the "M:Vm" field.

Operation for all encodings

```

enumeration VFPNegMul {VFPNegMul_VNMLA, VFPNegMul_VNMLS, VFPNegMul_VNMUL};

if ConditionPassed() then
    EncodingSpecificOperations(); CheckVFPEnabled(TRUE);
case esize of
    when 16
        product16 = FPMul(S[n]<15:0>, S[m]<15:0>, FPSCR);
    case type of
    
```

```

    when VFPNegMu1_VNMLA  S[d] = Zeros(16) : FAdd(FPNeg(S[d]<15:0>), FPNeg(product16),
FPSCR);
    when VFPNegMu1_VNMLS  S[d] = Zeros(16) : FAdd(FPNeg(S[d]<15:0>), product16, FPSCR);
    when VFPNegMu1_VNMUL  S[d] = Zeros(16) : FPNeg(product16);
  when 32
    product32 = FPMu1(S[n], S[m], FPSCR);
    case type of
      when VFPNegMu1_VNMLA  S[d] = FAdd(FPNeg(S[d]), FPNeg(product32), FPSCR);
      when VFPNegMu1_VNMLS  S[d] = FAdd(FPNeg(S[d]), product32, FPSCR);
      when VFPNegMu1_VNMUL  S[d] = FPNeg(product32);
  when 64
    product64 = FPMu1(D[n], D[m], FPSCR);
    case type of
      when VFPNegMu1_VNMLA  D[d] = FAdd(FPNeg(D[d]), FPNeg(product64), FPSCR);
      when VFPNegMu1_VNMLS  D[d] = FAdd(FPNeg(D[d]), product64, FPSCR);
      when VFPNegMu1_VNMUL  D[d] = FPNeg(product64);

```

F6.1.140 VNMUL

Vector Negate Multiply multiplies together two floating-point register values, and writes the negation of the result to the destination register.

Depending on settings in the CPACR, NSACR, HCPTR, and FPEXC registers, and the security state and mode in which the instruction is executed, an attempt to execute the instruction might be UNDEFINED, or trapped to Hyp mode. For more information see [Enabling Advanced SIMD and floating-point support on page G1-4413](#).

A1

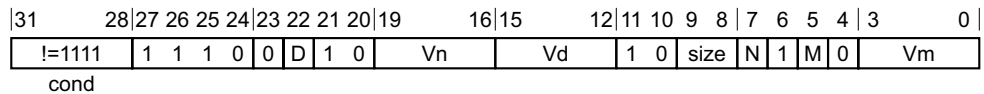

Half-precision scalar variant

Applies when size == 01.

VNMUL{<c>}{<q>}.F16 {<Sd>}, <Sn>, <Sm>

Single-precision scalar variant

Applies when size == 10.

VNMUL{<c>}{<q>}.F32 {<Sd>}, <Sn>, <Sm>

Double-precision scalar variant

Applies when size == 11.

VNMUL{<c>}{<q>}.F64 {<Dd>}, <Dn>, <Dm>

Decode for all variants of this encoding

```

if FPSCR.Len != '000' || FPSCR.Stride != '00' then UNDEFINED;
if size == '01' && !HaveFP16Ext() then UNDEFINED;
if size == '01' && cond != '1110' then UNPREDICTABLE;
type = VFPNegMul_VNMUL;
case size of
    when '01' esize = 16; d = UInt(Vd:D); n = UInt(Vn:N); m = UInt(Vm:M);
    when '10' esize = 32; d = UInt(Vd:D); n = UInt(Vn:N); m = UInt(Vm:M);
    when '11' esize = 64; d = UInt(D:Vd); n = UInt(N:Vn); m = UInt(M:Vm);
    
```

CONSTRAINED UNPREDICTABLE behavior

If size == '01' && cond != '1110', then one of the following behaviors must occur:

- The instruction is UNDEFINED.
- The instruction executes as if it passes the Condition code check.
- The instruction executes as NOP. This means it behaves as if it fails the Condition code check.

T1

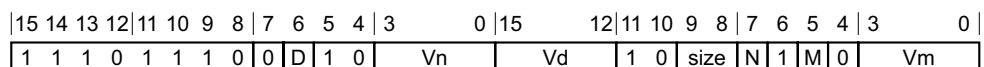

Half-precision scalar variant

Applies when size == 01.

VNMUL{<c>}{<q>}.F16 {<Sd>}, <Sn>, <Sm>

Single-precision scalar variant

Applies when size == 10.

VNMUL{<c>}{<q>}.F32 {<Sd>}, <Sn>, <Sm>

Double-precision scalar variant

Applies when size == 11.

VNMUL{<c>}{<q>}.F64 {<Dd>}, <Dn>, <Dm>

Decode for all variants of this encoding

```

if FPSCR.Len != '000' || FPSCR.Stride != '00' then UNDEFINED;
if size == '01' && !HaveFP16Ext() then UNDEFINED;
if size == '01' && InITBlock() then UNPREDICTABLE;
type = VFPNegMul_VNMUL;
case size of
  when '01' esize = 16; d = UInt(Vd:D); n = UInt(Vn:N); m = UInt(Vm:M);
  when '10' esize = 32; d = UInt(Vd:D); n = UInt(Vn:N); m = UInt(Vm:M);
  when '11' esize = 64; d = UInt(D:Vd); n = UInt(N:Vn); m = UInt(M:Vm);
  
```

CONSTRAINED UNPREDICTABLE behavior

If size == '01' && InITBlock(), then one of the following behaviors must occur:

- The instruction is UNDEFINED.
- The instruction executes as if it passes the Condition code check.
- The instruction executes as NOP. This means it behaves as if it fails the Condition code check.

Assembler symbols

<c>	See Standard assembler syntax fields on page F2-2848 .
<q>	See Standard assembler syntax fields on page F2-2848 .
<Sd>	Is the 32-bit name of the SIMD&FP destination register, encoded in the "Vd:D" field.
<Sn>	Is the 32-bit name of the first SIMD&FP source register, encoded in the "Vn:N" field.
<Sm>	Is the 32-bit name of the second SIMD&FP source register, encoded in the "Vm:M" field.
<Dd>	Is the 64-bit name of the SIMD&FP destination register, encoded in the "D:Vd" field.
<Dn>	Is the 64-bit name of the first SIMD&FP source register, encoded in the "N:Vn" field.
<Dm>	Is the 64-bit name of the second SIMD&FP source register, encoded in the "M:Vm" field.

Operation for all encodings

```

enumeration VFPNegMul {VFPNegMul_VNMLA, VFPNegMul_VNMLS, VFPNegMul_VNMUL};

if ConditionPassed() then
  EncodingSpecificOperations(); CheckVFPEnabled(TRUE);
case esize of
  when 16
    product16 = FPMul(S[n]<15:0>, S[m]<15:0>, FPSCR);
  case type of
  
```

```
FPSCR);
    when VFPNegMu1_VNMLA S[d] = Zeros(16) : FPAAdd(FPNeg(S[d]<15:0>), FPNeg(product16),
when 32
    product32 = FPMu1(S[n], S[m], FPSCR);
    case type of
        when VFPNegMu1_VNMLA S[d] = FPAAdd(FPNeg(S[d]), FPNeg(product32), FPSCR);
        when VFPNegMu1_VNMLS S[d] = FPAAdd(FPNeg(S[d]), product32, FPSCR);
        when VFPNegMu1_VNMUL S[d] = FPNeg(product32);
when 64
    product64 = FPMu1(D[n], D[m], FPSCR);
    case type of
        when VFPNegMu1_VNMLA D[d] = FPAAdd(FPNeg(D[d]), FPNeg(product64), FPSCR);
        when VFPNegMu1_VNMLS D[d] = FPAAdd(FPNeg(D[d]), product64, FPSCR);
        when VFPNegMu1_VNMUL D[d] = FPNeg(product64);
```

F6.1.141 VORN (immediate)

Vector Bitwise OR NOT (immediate) performs a bitwise OR between a register value and the complement of an immediate value, and returns the result into the destination vector

This instruction is a pseudo-instruction of the [VORR \(immediate\)](#) instruction. This means that:

- The encodings in this description are named to match the encodings of [VORR \(immediate\)](#).
- The assembler syntax is used only for assembly, and is not used on disassembly.
- The description of [VORR \(immediate\)](#) gives the operational pseudocode for this instruction.

A1

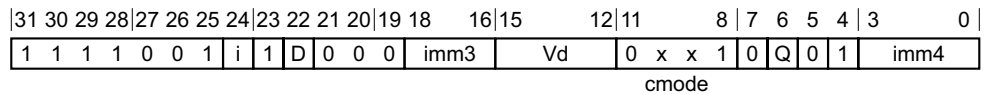

64-bit SIMD vector variant

Applies when Q == 0.

VORN{<c>}{<q>}.I16 {<Dd>}, <Dd>, #<imm>

is equivalent to

VORR{<c>}{<q>}.I16 <Dd>, #~<imm>

and is never the preferred disassembly.

128-bit SIMD vector variant

Applies when Q == 1.

VORN{<c>}{<q>}.I16 {<Qd>}, <Qd>, #<imm>

is equivalent to

VORR{<c>}{<q>}.I16 <Qd>, #~<imm>

and is never the preferred disassembly.

A2

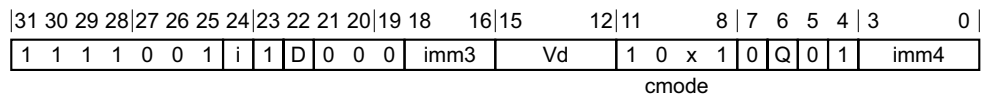

64-bit SIMD vector variant

Applies when Q == 0.

VORN{<c>}{<q>}.I32 {<Dd>}, <Dd>, #<imm>

is equivalent to

VORR{<c>}{<q>}.I32 <Dd>, #~<imm>

and is never the preferred disassembly.

128-bit SIMD vector variant

Applies when Q == 1.

VORN{<c>}{<q>}.I32 {<Qd>}, <Qd>, #<imm>

is equivalent to

VORR{<c>}{<q>}.I32 <Qd>, #~<imm>

and is never the preferred disassembly.

T1

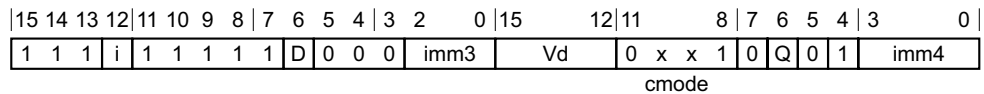

64-bit SIMD vector variant

Applies when Q == 0.

VORN{<c>}{<q>}.I16 {<Dd>}, <Dd>, #<imm>

is equivalent to

VORR{<c>}{<q>}.I16 <Dd>, #~<imm>

and is never the preferred disassembly.

128-bit SIMD vector variant

Applies when Q == 1.

VORN{<c>}{<q>}.I16 {<Qd>}, <Qd>, #<imm>

is equivalent to

VORR{<c>}{<q>}.I16 <Qd>, #~<imm>

and is never the preferred disassembly.

T2

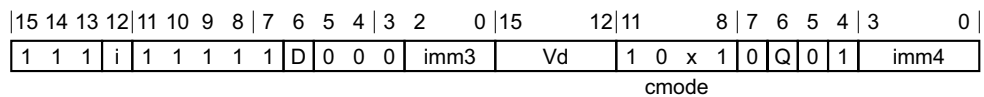

64-bit SIMD vector variant

Applies when Q == 0.

VORN{<c>}{<q>}.I32 {<Dd>}, <Dd>, #<imm>

is equivalent to

VORR{<c>}{<q>}.I32 <Dd>, #~<imm>

and is never the preferred disassembly.

128-bit SIMD vector variant

Applies when Q == 1.

VORN{<c>}{<q>}.I32 {<Qd>}, <Qd>, #<imm>

is equivalent to

VORR{<c>}{<q>}.I32 <Qd>, #~<imm>

and is never the preferred disassembly.

Assembler symbols

- <c> For encoding A1 and A2: see [Standard assembler syntax fields on page F2-2848](#). This encoding must be unconditional.
For encoding T1 and T2: see [Standard assembler syntax fields on page F2-2848](#).
- <q> See [Standard assembler syntax fields on page F2-2848](#).
- <Qd> Is the 128-bit name of the SIMD&FP destination register, encoded in the "D:Vd" field as <Qd>*2.
- <Dd> Is the 64-bit name of the SIMD&FP destination register, encoded in the "D:Vd" field.
- <imm> Is a constant of the specified type that is replicated to fill the destination register. For details of the range of constants available and the encoding of <imm>, see [Modified immediate constants in T32 and A32 Advanced SIMD instructions on page F2-2865](#).

Operation for all encodings

The description of [VORR \(immediate\)](#) gives the operational pseudocode for this instruction.

F6.1.142 VORN (register)

Vector bitwise OR NOT (register) performs a bitwise OR NOT operation between two registers, and places the result in the destination register. The operand and result registers can be quadword or doubleword. They must all be the same size.

Depending on settings in the CPACR, NSACR, and HCPTR registers, and the security state and mode in which the instruction is executed, an attempt to execute the instruction might be UNDEFINED, or trapped to Hyp mode. For more information see [Enabling Advanced SIMD and floating-point support on page G1-4413](#).

A1

31	30	29	28	27	26	25	24	23	22	21	20	19	16	15	12	11	10	9	8	7	6	5	4	3	0
1	1	1	1	0	0	0	1	0	0	D	1	1	Vn	Vd	0	0	0	1	N	Q	M	1	Vm		

64-bit SIMD vector variant

Applies when Q == 0.

VORN{<c>}{<q>}{.<dt>} {<Dd>}, <Dn>, <Dm>

128-bit SIMD vector variant

Applies when Q == 1.

VORN{<c>}{<q>}{.<dt>} {<Qd>}, <Qn>, <Qm>

Decode for all variants of this encoding

if Q == '1' && (Vd<0> == '1' || Vn<0> == '1' || Vm<0> == '1') then UNDEFINED;
 d = UInt(D:Vd); n = UInt(N:Vn); m = UInt(M:Vm); regs = if Q == '0' then 1 else 2;

T1

15	14	13	12	11	10	9	8	7	6	5	4	3	0	15	12	11	10	9	8	7	6	5	4	3	0
1	1	1	0	1	1	1	1	0	D	1	1	Vn	Vd	0	0	0	1	N	Q	M	1	Vm			

64-bit SIMD vector variant

Applies when Q == 0.

VORN{<c>}{<q>}{.<dt>} {<Dd>}, <Dn>, <Dm>

128-bit SIMD vector variant

Applies when Q == 1.

VORN{<c>}{<q>}{.<dt>} {<Qd>}, <Qn>, <Qm>

Decode for all variants of this encoding

if Q == '1' && (Vd<0> == '1' || Vn<0> == '1' || Vm<0> == '1') then UNDEFINED;
 d = UInt(D:Vd); n = UInt(N:Vn); m = UInt(M:Vm); regs = if Q == '0' then 1 else 2;

Assembler symbols

<c> For encoding A1: see [Standard assembler syntax fields on page F2-2848](#). This encoding must be unconditional.

- For encoding T1: see *Standard assembler syntax fields* on page F2-2848.
- <q> See *Standard assembler syntax fields* on page F2-2848.
- <dt> An optional data type. It is ignored by assemblers, and does not affect the encoding.
- <Qd> Is the 128-bit name of the SIMD&FP destination register, encoded in the "D:Vd" field as <Qd>*2.
- <Qn> Is the 128-bit name of the first SIMD&FP source register, encoded in the "N:Vn" field as <Qn>*2.
- <Qm> Is the 128-bit name of the second SIMD&FP source register, encoded in the "M:Vm" field as <Qm>*2.
- <Dd> Is the 64-bit name of the SIMD&FP destination register, encoded in the "D:Vd" field.
- <Dn> Is the 64-bit name of the first SIMD&FP source register, encoded in the "N:Vn" field.
- <Dm> Is the 64-bit name of the second SIMD&FP source register, encoded in the "M:Vm" field.

Operation for all encodings

```
if ConditionPassed() then
    EncodingSpecificOperations(); CheckAdvSIMDEnabled();
    for r = 0 to regs-1
        D[d+r] = D[n+r] OR NOT(D[m+r]);
```



F6.1.143 VORR (immediate)

Vector Bitwise OR (immediate) performs a bitwise OR between a register value and an immediate value, and returns the result into the destination vector.

Depending on settings in the CPACR, NSACR, and HCPTR registers, and the security state and mode in which the instruction is executed, an attempt to execute the instruction might be UNDEFINED, or trapped to Hyp mode. For more information see [Enabling Advanced SIMD and floating-point support on page G1-4413](#).

This instruction is used by the pseudo-instruction [VORN \(immediate\)](#). The pseudo-instruction is never the preferred disassembly.

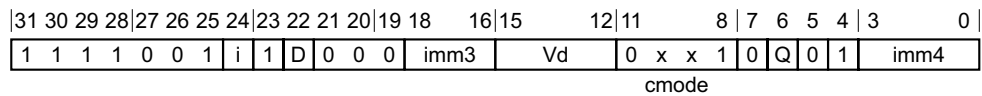
A1



64-bit SIMD vector variant

Applies when Q == 0.

VORR{<c>}{<q>}.I32 {<Dd>}, <Dd>, #<imm>

128-bit SIMD vector variant

Applies when Q == 1.

VORR{<c>}{<q>}.I32 {<Qd>}, <Qd>, #<imm>

Decode for all variants of this encoding

```
if cmode<0> == '0' || cmode<3:2> == '11' then SEE VMOV (immediate);
if Q == '1' && Vd<0> == '1' then UNDEFINED;
imm64 = AdvSIMDExpandImm('0', cmode, i:imm3:imm4);
d = UInt(D:Vd); regs = if Q == '0' then 1 else 2;
```

A2

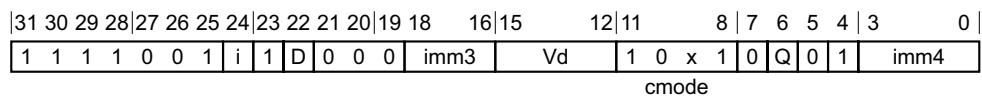

64-bit SIMD vector variant

Applies when Q == 0.

VORR{<c>}{<q>}.I16 {<Dd>}, <Dd>, #<imm>

128-bit SIMD vector variant

Applies when Q == 1.

VORR{<c>}{<q>}.I16 {<Qd>}, <Qd>, #<imm>

Decode for all variants of this encoding

```
if cmode<0> == '0' || cmode<3:2> == '11' then SEE VMOV (immediate);
if Q == '1' && Vd<0> == '1' then UNDEFINED;
imm64 = AdvSIMDExpandImm('0', cmode, i:imm3:imm4);
d = UInt(D:Vd); regs = if Q == '0' then 1 else 2;
```

T1

15	14	13	12	11	10	9	8	7	6	5	4	3	2	0	15	12	11	8	7	6	5	4	3	0
1	1	1	i	1	1	1	1	1	D	0	0	0	imm3	Vd	0	x	x	1	0	Q	0	1	imm4	

cmode

64-bit SIMD vector variant

Applies when Q == 0.

VORR{<c>}{<q>}.I32 {<Dd>}, <Dd>, #<imm>

128-bit SIMD vector variant

Applies when Q == 1.

VORR{<c>}{<q>}.I32 {<Qd>}, <Qd>, #<imm>

Decode for all variants of this encoding

```
if cmode<0> == '0' || cmode<3:2> == '11' then SEE VMOV (immediate);
if Q == '1' && Vd<0> == '1' then UNDEFINED;
imm64 = AdvSIMDExpandImm('0', cmode, i:imm3:imm4);
d = UInt(D:Vd); regs = if Q == '0' then 1 else 2;
```

T2

15	14	13	12	11	10	9	8	7	6	5	4	3	2	0	15	12	11	8	7	6	5	4	3	0
1	1	1	i	1	1	1	1	1	D	0	0	0	imm3	Vd	1	0	x	1	0	Q	0	1	imm4	

cmode

64-bit SIMD vector variant

Applies when Q == 0.

VORR{<c>}{<q>}.I16 {<Dd>}, <Dd>, #<imm>

128-bit SIMD vector variant

Applies when Q == 1.

VORR{<c>}{<q>}.I16 {<Qd>}, <Qd>, #<imm>

Decode for all variants of this encoding

```
if cmode<0> == '0' || cmode<3:2> == '11' then SEE VMOV (immediate);
if Q == '1' && Vd<0> == '1' then UNDEFINED;
imm64 = AdvSIMDExpandImm('0', cmode, i:imm3:imm4);
d = UInt(D:Vd); regs = if Q == '0' then 1 else 2;
```

Assembler symbols

- <c> For encoding A1 and A2: see [Standard assembler syntax fields on page F2-2848](#). This encoding must be unconditional.
For encoding T1 and T2: see [Standard assembler syntax fields on page F2-2848](#).
- <q> See [Standard assembler syntax fields on page F2-2848](#).
- <Qd> Is the 128-bit name of the SIMD&FP destination register, encoded in the "D:Vd" field as <Qd>*2.
- <Dd> Is the 64-bit name of the SIMD&FP destination register, encoded in the "D:Vd" field.

<imm> Is a constant of the specified type that is replicated to fill the destination register. For details of the range of constants available and the encoding of <imm>, see [Modified immediate constants in T32 and A32 Advanced SIMD instructions on page F2-2865](#).

The I8, I64, and F32 data types are permitted as pseudo-instructions, if the immediate can be represented by this instruction, and are encoded using a permitted encoding of the I16 or I32 data type.

Operation for all encodings

```
if ConditionPassed() then
    EncodingSpecificOperations(); CheckAdvSIMDEnabled();
    for r = 0 to regs-1
        D[d+r] = D[d+r] OR imm64;
```

F6.1.144 VORR (register)

Vector bitwise OR (register) performs a bitwise OR operation between two registers, and places the result in the destination register. The operand and result registers can be quadword or doubleword. They must all be the same size.

Depending on settings in the CPACR, NSACR, and HCPTR registers, and the security state and mode in which the instruction is executed, an attempt to execute the instruction might be UNDEFINED, or trapped to Hyp mode. For more information see [Enabling Advanced SIMD and floating-point support on page G1-4413](#).

This instruction is used by the pseudo-instructions VMOV (register, SIMD), VRSHR (zero), and VSHR (zero). The pseudo-instruction is never the preferred disassembly.

A1

31	30	29	28	27	26	25	24	23	22	21	20	19	16	15	12	11	10	9	8	7	6	5	4	3	0
1	1	1	1	0	0	1	0	0	D	1	0	Vn	Vd	0	0	0	1	N	Q	M	1	Vm			

64-bit SIMD vector variant

Applies when Q == 0.

VORR{<c>}{<q>}{.<dt>} {<Dd>}, <Dn>, <Dm>

128-bit SIMD vector variant

Applies when Q == 1.

VORR{<c>}{<q>}{.<dt>} {<Qd>}, <Qn>, <Qm>

Decode for all variants of this encoding

if Q == '1' && (Vd<0> == '1' || Vn<0> == '1' || Vm<0> == '1') then UNDEFINED;
 d = UInt(D:Vd); n = UInt(N:Vn); m = UInt(M:Vm); regs = if Q == '0' then 1 else 2;

T1

15	14	13	12	11	10	9	8	7	6	5	4	3	0	15	12	11	10	9	8	7	6	5	4	3	0
1	1	1	0	1	1	1	1	0	D	1	0	Vn	Vd	0	0	0	1	N	Q	M	1	Vm			

64-bit SIMD vector variant

Applies when Q == 0.

VORR{<c>}{<q>}{.<dt>} {<Dd>}, <Dn>, <Dm>

128-bit SIMD vector variant

Applies when Q == 1.

VORR{<c>}{<q>}{.<dt>} {<Qd>}, <Qn>, <Qm>

Decode for all variants of this encoding

if Q == '1' && (Vd<0> == '1' || Vn<0> == '1' || Vm<0> == '1') then UNDEFINED;
 d = UInt(D:Vd); n = UInt(N:Vn); m = UInt(M:Vm); regs = if Q == '0' then 1 else 2;

Alias conditions

Alias or pseudo-instruction	is preferred when
VMOV (register, SIMD)	N:Vn == M:Vm
VRSHR (zero)	Never
VSHR (zero)	Never

Assembler symbols

- <c> For encoding A1: see *Standard assembler syntax fields* on page F2-2848. This encoding must be unconditional.
 For encoding T1: see *Standard assembler syntax fields* on page F2-2848.
- <q> See *Standard assembler syntax fields* on page F2-2848.
- <dt> An optional data type. It is ignored by assemblers, and does not affect the encoding.
- <Qd> Is the 128-bit name of the SIMD&FP destination register, encoded in the "D:Vd" field as <Qd>*2.
- <Qn> Is the 128-bit name of the first SIMD&FP source register, encoded in the "N:Vn" field as <Qn>*2.
- <Qm> Is the 128-bit name of the second SIMD&FP source register, encoded in the "M:Vm" field as <Qm>*2.
- <Dd> Is the 64-bit name of the SIMD&FP destination register, encoded in the "D:Vd" field.
- <Dn> Is the 64-bit name of the first SIMD&FP source register, encoded in the "N:Vn" field.
- <Dm> Is the 64-bit name of the second SIMD&FP source register, encoded in the "M:Vm" field.

Operation for all encodings

```

if ConditionPassed() then
    EncodingSpecificOperations(); CheckAdvSIMDEnabled();
    for r = 0 to regs-1
        D[d+r] = D[n+r] OR D[m+r];
  
```

F6.1.145 VPADAL

Vector Pairwise Add and Accumulate Long adds adjacent pairs of elements of a vector, and accumulates the results into the elements of the destination vector.

The vectors can be doubleword or quadword. The operand elements can be 8-bit, 16-bit, or 32-bit integers. The result elements are twice the length of the operand elements.

The following figure shows the operation of VPADAL doubleword operation for data type S16.

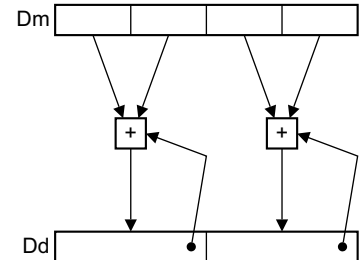

Depending on settings in the CPACR, NSACR, and HCPTR registers, and the security state and mode in which the instruction is executed, an attempt to execute the instruction might be UNDEFINED, or trapped to Hyp mode. For more information see *Enabling Advanced SIMD and floating-point support on page G1-4413*.

A1

31	30	29	28	27	26	25	24	23	22	21	20	19	18	17	16	15	12	11	10	9	8	7	6	5	4	3	0
1	1	1	1	0	0	1	1	1	D	1	1	size	0	0	Vd	0	1	1	0	op	Q	M	0	Vm			

64-bit SIMD vector variant

Applies when Q == 0.

VPADAL{<c>}{<q>}.<dt> <Dd>, <Dm>

128-bit SIMD vector variant

Applies when Q == 1.

VPADAL{<c>}{<q>}.<dt> <Qd>, <Qm>

Decode for all variants of this encoding

```

if size == '11' then UNDEFINED;
if Q == '1' && (Vd<0> == '1' || Vm<0> == '1') then UNDEFINED;
unsigned = (op == '1');
esize = 8 << UInt(size); elements = 64 DIV esize;
d = UInt(D:Vd); m = UInt(M:Vm); regs = if Q == '0' then 1 else 2;
    
```

T1

15	14	13	12	11	10	9	8	7	6	5	4	3	2	1	0	15	12	11	10	9	8	7	6	5	4	3	0
1	1	1	1	1	1	1	1	1	D	1	1	size	0	0	Vd	0	1	1	0	op	Q	M	0	Vm			

64-bit SIMD vector variant

Applies when Q == 0.

VPADAL{<c>}{<q>}.<dt> <Dd>, <Dm>

128-bit SIMD vector variant

Applies when Q == 1.

VPADAL{<c>}{<q>}.<dt> <Qd>, <Qm>

Decode for all variants of this encoding

```
if size == '11' then UNDEFINED;
if Q == '1' && (Vd<0> == '1' || Vm<0> == '1') then UNDEFINED;
unsigned = (op == '1');
esize = 8 << UInt(size); elements = 64 DIV esize;
d = UInt(D:Vd); m = UInt(M:Vm); regs = if Q == '0' then 1 else 2;
```

Assembler symbols

<c> For encoding A1: see [Standard assembler syntax fields on page F2-2848](#). This encoding must be unconditional.

For encoding T1: see [Standard assembler syntax fields on page F2-2848](#).

<q> See [Standard assembler syntax fields on page F2-2848](#).

<dt> Is the data type for the elements of the vectors, encoded in the "op:size" field. It can have the following values:

S8	when op = 0, size = 00
S16	when op = 0, size = 01
S32	when op = 0, size = 10
U8	when op = 1, size = 00
U16	when op = 1, size = 01
U32	when op = 1, size = 10

The following encodings are reserved:

- op = 0, size = 11.
- op = 1, size = 11.

<Qd> Is the 128-bit name of the SIMD&FP destination register, encoded in the "D:Vd" field as <Qd>*2.

<Qm> Is the 128-bit name of the SIMD&FP source register, encoded in the "M:Vm" field as <Qm>*2.

<Dd> Is the 64-bit name of the SIMD&FP destination register, encoded in the "D:Vd" field.

<Dm> Is the 64-bit name of the SIMD&FP source register, encoded in the "M:Vm" field.

Operation for all encodings

```
if ConditionPassed() then
  EncodingSpecificOperations(); CheckAdvSIMDEnabled();
  h = elements DIV 2;

  for r = 0 to regs-1
    for e = 0 to h-1
      op1 = Elem[D[m+r],2*e,esize]; op2 = Elem[D[m+r],2*e+1,esize];
      result = Int(op1, unsigned) + Int(op2, unsigned);
      Elem[D[d+r],e,2*esize] = Elem[D[d+r],e,2*esize] + result;
```

F6.1.146 VPADD (floating-point)

Vector Pairwise Add (floating-point) adds adjacent pairs of elements of two vectors, and places the results in the destination vector.

The operands and result are doubleword vectors.

The operand and result elements are floating-point numbers.

Depending on settings in the CPACR, NSACR, and HCPTR registers, and the security state and mode in which the instruction is executed, an attempt to execute the instruction might be UNDEFINED, or trapped to Hyp mode. For more information see [Enabling Advanced SIMD and floating-point support on page G1-4413](#).

A1

31	30	29	28	27	26	25	24	23	22	21	20	19	16	15	12	11	10	9	8	7	6	5	4	3	0
1	1	1	1	0	0	0	1	1	0	D	0	sz	Vn	Vd	1	1	0	1	N	Q	M	0	Vm		

A1 variant

VPADD{<c>}{<q>}.<dt> {<Dd>, }<Dn>, <Dm>

Decode for this encoding

```

if Q == '1' then UNDEFINED;
if sz == '1' && !HaveFP16Ext() then UNDEFINED;
case sz of
  when '0' esize = 32; elements = 2;
  when '1' esize = 16; elements = 4;
d = UInt(D:Vd); n = UInt(N:Vn); m = UInt(M:Vm);

```

T1

15	14	13	12	11	10	9	8	7	6	5	4	3	0	15	12	11	10	9	8	7	6	5	4	3	0
1	1	1	1	1	1	1	0	D	0	sz	Vn	Vd	1	1	0	1	N	Q	M	0	Vm				

T1 variant

VPADD{<c>}{<q>}.<dt> {<Dd>, }<Dn>, <Dm>

Decode for this encoding

```

if Q == '1' then UNDEFINED;
if sz == '1' && !HaveFP16Ext() then UNDEFINED;
if sz == '1' && InITBlock() then UNPREDICTABLE;
case sz of
  when '0' esize = 32; elements = 2;
  when '1' esize = 16; elements = 4;
d = UInt(D:Vd); n = UInt(N:Vn); m = UInt(M:Vm);

```

CONSTRAINED UNPREDICTABLE behavior

If sz == '1' && InITBlock(), then one of the following behaviors must occur:

- The instruction is UNDEFINED.
- The instruction executes as if it passes the Condition code check.
- The instruction executes as NOP. This means it behaves as if it fails the Condition code check.

Assembler symbols

- <c> For encoding A1: see *Standard assembler syntax fields* on page F2-2848. This encoding must be unconditional.
For encoding T1: see *Standard assembler syntax fields* on page F2-2848.
- <q> See *Standard assembler syntax fields* on page F2-2848.
- <dt> Is the data type for the elements of the vectors, encoded in the "sz" field. It can have the following values:
F32 when sz = 0
F16 when sz = 1
- <Dd> Is the 64-bit name of the SIMD&FP destination register, encoded in the "D:Vd" field.
- <Dn> Is the 64-bit name of the first SIMD&FP source register, encoded in the "N:Vn" field.
- <Dm> Is the 64-bit name of the second SIMD&FP source register, encoded in the "M:Vm" field.

Operation for all encodings

```
if ConditionPassed() then
    EncodingSpecificOperations(); CheckAdvSIMDEnabled();
    bits(64) dest;
    h = elements DIV 2;

    for e = 0 to h-1
        Elem[dest,e,esize] = FPAdd(Elem[D[n],2*e,esize], Elem[D[n],2*e+1,esize],
StandardFPSCRValue());
        Elem[dest,e+h,esize] = FPAdd(Elem[D[m],2*e,esize], Elem[D[m],2*e+1,esize],
StandardFPSCRValue());

    D[d] = dest;
```

F6.1.147 VPADD (integer)

Vector Pairwise Add (integer) adds adjacent pairs of elements of two vectors, and places the results in the destination vector.

The operands and result are doubleword vectors.

The operand and result elements must all be the same type, and can be 8-bit, 16-bit, or 32-bit integers. There is no distinction between signed and unsigned integers.

The following figure shows the operation of VPADD doubleword operation for data type I16.

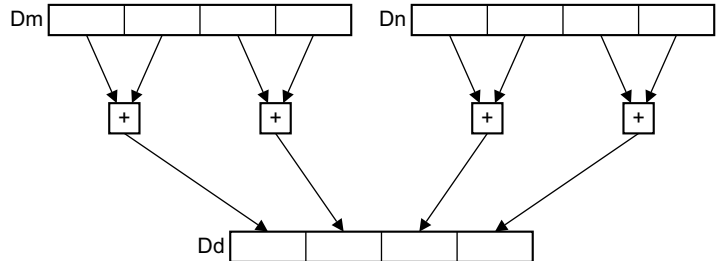

Depending on settings in the CPACR, NSACR, and HCPTR registers, and the security state and mode in which the instruction is executed, an attempt to execute the instruction might be UNDEFINED, or trapped to Hyp mode. For more information see [Enabling Advanced SIMD and floating-point support on page G1-4413](#).

A1

31	30	29	28	27	26	25	24	23	22	21	20	19	16	15	12	11	10	9	8	7	6	5	4	3	0
1	1	1	1	0	0	1	0	0	D	size	Vn	Vd	1	0	1	1	N	Q	M	1	Vm				

A1 variant

VPADD{<c>}{<q>}.<dt> {<Dd>, }<Dn>, <Dm>

Decode for this encoding

```
if size == '11' || Q == '1' then UNDEFINED;
esize = 8 << UInt(size); elements = 64 DIV esize;
d = UInt(D:Vd); n = UInt(N:Vn); m = UInt(M:Vm);
```

T1

15	14	13	12	11	10	9	8	7	6	5	4	3	0	15	12	11	10	9	8	7	6	5	4	3	0
1	1	1	0	1	1	1	1	0	D	size	Vn	Vd	1	0	1	1	N	Q	M	1	Vm				

T1 variant

VPADD{<c>}{<q>}.<dt> {<Dd>, }<Dn>, <Dm>

Decode for this encoding

```
if size == '11' || Q == '1' then UNDEFINED;
esize = 8 << UInt(size); elements = 64 DIV esize;
d = UInt(D:Vd); n = UInt(N:Vn); m = UInt(M:Vm);
```

Assembler symbols

- <c> For encoding A1: see *Standard assembler syntax fields* on page F2-2848. This encoding must be unconditional.
For encoding T1: see *Standard assembler syntax fields* on page F2-2848.
- <q> See *Standard assembler syntax fields* on page F2-2848.
- <dt> Is the data type for the elements of the vectors, encoded in the "size" field. It can have the following values:
I8 when size = 00
I16 when size = 01
I32 when size = 10
- <Dd> Is the 64-bit name of the SIMD&FP destination register, encoded in the "D:Vd" field.
- <Dn> Is the 64-bit name of the first SIMD&FP source register, encoded in the "N:Vn" field.
- <Dm> Is the 64-bit name of the second SIMD&FP source register, encoded in the "M:Vm" field.

Operation for all encodings

```
if ConditionPassed() then
    EncodingSpecificOperations(); CheckAdvSIMDEnabled();
    bits(64) dest;
    h = elements DIV 2;

    for e = 0 to h-1
        Elem[dest,e,esize] = Elem[D[n],2*e,esize] + Elem[D[n],2*e+1,esize];
        Elem[dest,e+h,esize] = Elem[D[m],2*e,esize] + Elem[D[m],2*e+1,esize];

    D[d] = dest;
```

F6.1.148 VPADDL

Vector Pairwise Add Long adds adjacent pairs of elements of two vectors, and places the results in the destination vector.

The vectors can be doubleword or quadword. The operand elements can be 8-bit, 16-bit, or 32-bit integers. The result elements are twice the length of the operand elements.

The following figure shows the operation of VPADDL doubleword operation for data type S16.

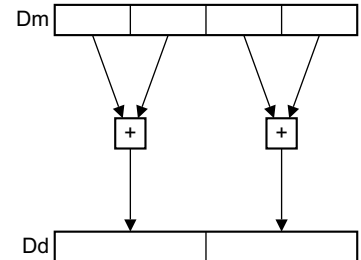

Depending on settings in the CPACR, NSACR, and HCPTR registers, and the security state and mode in which the instruction is executed, an attempt to execute the instruction might be UNDEFINED, or trapped to Hyp mode. For more information see [Enabling Advanced SIMD and floating-point support on page G1-4413](#).

A1

31	30	29	28	27	26	25	24	23	22	21	20	19	18	17	16	15	12	11	10	9	8	7	6	5	4	3	0
1	1	1	1	0	0	1	1	1	D	1	1	size	0	0	Vd	0	0	1	0	op	Q	M	0	Vm			

64-bit SIMD vector variant

Applies when Q == 0.

VPADDL{<c>}{<q>}.<dt> <Dd>, <Dm>

128-bit SIMD vector variant

Applies when Q == 1.

VPADDL{<c>}{<q>}.<dt> <Qd>, <Qm>

Decode for all variants of this encoding

```

if size == '11' then UNDEFINED;
if Q == '1' && (Vd<0> == '1' || Vm<0> == '1') then UNDEFINED;
unsigned = (op == '1');
esize = 8 << UInt(size); elements = 64 DIV esize;
d = UInt(D:Vd); m = UInt(M:Vm); regs = if Q == '0' then 1 else 2;
    
```

T1

15	14	13	12	11	10	9	8	7	6	5	4	3	2	1	0	15	12	11	10	9	8	7	6	5	4	3	0
1	1	1	1	1	1	1	1	1	D	1	1	size	0	0	Vd	0	0	1	0	op	Q	M	0	Vm			

64-bit SIMD vector variant

Applies when Q == 0.

VPADDL{<c>}{<q>}.<dt> <Dd>, <Dm>

128-bit SIMD vector variant

Applies when Q == 1.

VPADDL{<c>}{<q>}.<dt> <Qd>, <Qm>

Decode for all variants of this encoding

```
if size == '11' then UNDEFINED;
if Q == '1' && (Vd<0> == '1' || Vm<0> == '1') then UNDEFINED;
unsigned = (op == '1');
esize = 8 << UInt(size); elements = 64 DIV esize;
d = UInt(D:Vd); m = UInt(M:Vm); regs = if Q == '0' then 1 else 2;
```

Assembler symbols

- <c> For encoding A1: see [Standard assembler syntax fields on page F2-2848](#). This encoding must be unconditional.
- For encoding T1: see [Standard assembler syntax fields on page F2-2848](#).
- <q> See [Standard assembler syntax fields on page F2-2848](#).
- <dt> Is the data type for the elements of the vectors, encoded in the "op:size" field. It can have the following values:
- | | |
|-----|------------------------|
| S8 | when op = 0, size = 00 |
| S16 | when op = 0, size = 01 |
| S32 | when op = 0, size = 10 |
| U8 | when op = 1, size = 00 |
| U16 | when op = 1, size = 01 |
| U32 | when op = 1, size = 10 |
- The following encodings are reserved:
- op = 0, size = 11.
 - op = 1, size = 11.
- <Qd> Is the 128-bit name of the SIMD&FP destination register, encoded in the "D:Vd" field as <Qd>*2.
- <Qm> Is the 128-bit name of the SIMD&FP source register, encoded in the "M:Vm" field as <Qm>*2.
- <Dd> Is the 64-bit name of the SIMD&FP destination register, encoded in the "D:Vd" field.
- <Dm> Is the 64-bit name of the SIMD&FP source register, encoded in the "M:Vm" field.

Operation for all encodings

```
if ConditionPassed() then
  EncodingSpecificOperations(); CheckAdvSIMDEnabled();
  h = elements DIV 2;

  for r = 0 to regs-1
    for e = 0 to h-1
      op1 = Elem[D[m+r],2*e,esize]; op2 = Elem[D[m+r],2*e+1,esize];
      result = Int(op1, unsigned) + Int(op2, unsigned);
      Elem[D[d+r],e,2*esize] = result<2*esize-1:0>;
```

F6.1.149 VPMAX (floating-point)

Vector Pairwise Maximum compares adjacent pairs of elements in two doubleword vectors, and copies the larger of each pair into the corresponding element in the destination doubleword vector.

Depending on settings in the CPACR, NSACR, and HCPTR registers, and the security state and mode in which the instruction is executed, an attempt to execute the instruction might be UNDEFINED, or trapped to Hyp mode. For more information see [Enabling Advanced SIMD and floating-point support on page G1-4413](#).

A1

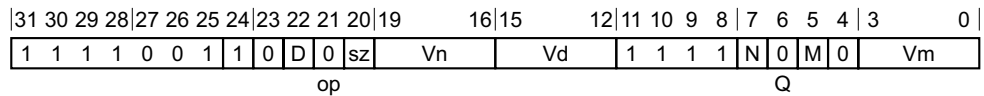

A1 variant

VPMAX{<c>}{<q>}.<dt> {<Dd>, }<Dn>, <Dm>

Decode for this encoding

```

if Q == '1' then UNDEFINED;
if sz == '1' && !HaveFP16Ext() then UNDEFINED;
maximum = (op == '0');
case sz of
    when '0' esize = 32; elements = 2;
    when '1' esize = 16; elements = 4;
d = UInt(D:Vd); n = UInt(N:Vn); m = UInt(M:Vm);
    
```

T1

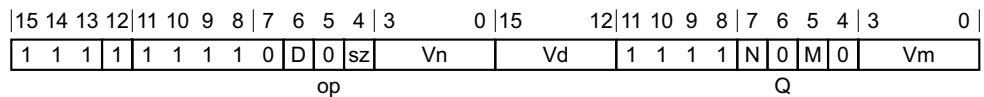

T1 variant

VPMAX{<c>}{<q>}.<dt> {<Dd>, }<Dn>, <Dm>

Decode for this encoding

```

if Q == '1' then UNDEFINED;
if sz == '1' && !HaveFP16Ext() then UNDEFINED;
if sz == '1' && InITBlock() then UNPREDICTABLE;
maximum = (op == '0');
case sz of
    when '0' esize = 32; elements = 2;
    when '1' esize = 16; elements = 4;
d = UInt(D:Vd); n = UInt(N:Vn); m = UInt(M:Vm);
    
```

CONSTRAINED UNPREDICTABLE behavior

If sz == '1' && InITBlock(), then one of the following behaviors must occur:

- The instruction is UNDEFINED.
- The instruction executes as if it passes the Condition code check.
- The instruction executes as NOP. This means it behaves as if it fails the Condition code check.

Assembler symbols

- <c> For encoding A1: see [Standard assembler syntax fields on page F2-2848](#). This encoding must be unconditional.
For encoding T1: see [Standard assembler syntax fields on page F2-2848](#).
- <q> See [Standard assembler syntax fields on page F2-2848](#).
- <dt> Is the data type for the elements of the vectors, encoded in the "sz" field. It can have the following values:
F32 when sz = 0
F16 when sz = 1
- <Dd> Is the 64-bit name of the SIMD&FP destination register, encoded in the "D:Vd" field.
- <Dn> Is the 64-bit name of the first SIMD&FP source register, encoded in the "N:Vn" field.
- <Dm> Is the 64-bit name of the second SIMD&FP source register, encoded in the "M:Vm" field.

Operation for all encodings

```
if ConditionPassed() then
    EncodingSpecificOperations(); CheckAdvSIMDEnabled();
    bits(64) dest;
    h = elements DIV 2;

    for e = 0 to h-1
        op1 = Elem[D[n],2*e,esize]; op2 = Elem[D[n],2*e+1,esize];
        Elem[dest,e,esize] = if maximum then FPMax(op1,op2,StandardFPSCRValue()) else
FPMIn(op1,op2,StandardFPSCRValue());
        op1 = Elem[D[m],2*e,esize]; op2 = Elem[D[m],2*e+1,esize];
        Elem[dest,e+h,esize] = if maximum then FPMax(op1,op2,StandardFPSCRValue()) else
FPMIn(op1,op2,StandardFPSCRValue());

    D[d] = dest;
```

F6.1.150 VPMAX (integer)

Vector Pairwise Maximum compares adjacent pairs of elements in two doubleword vectors, and copies the larger of each pair into the corresponding element in the destination doubleword vector.

The following figure shows the operation of VPMAX doubleword operation for data type S16 or U16.

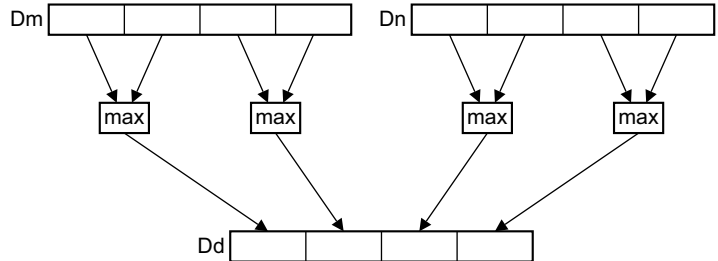

Depending on settings in the CPACR, NSACR, and HCPTR registers, and the security state and mode in which the instruction is executed, an attempt to execute the instruction might be UNDEFINED, or trapped to Hyp mode. For more information see [Enabling Advanced SIMD and floating-point support on page G1-4413](#).

A1

31	30	29	28	27	26	25	24	23	22	21	20	19	16	15	12	11	10	9	8	7	6	5	4	3	0
1	1	1	1	0	0	1	U	0	D	size	Vn	Vd	1	0	1	0	N	0	M	0	Q	op	Vm		

A1 variant

VPMAX{<c>}{<q>}.<dt> {<Dd>, }<Dn>, <Dm>

Decode for this encoding

```
if size == '11' || Q == '1' then UNDEFINED;
maximum = (op == '0'); unsigned = (U == '1');
esize = 8 << UInt(size); elements = 64 DIV esize;
d = UInt(D:Vd); n = UInt(N:Vn); m = UInt(M:Vm);
```

T1

15	14	13	12	11	10	9	8	7	6	5	4	3	0	15	12	11	10	9	8	7	6	5	4	3	0
1	1	1	U	1	1	1	1	0	D	size	Vn	Vd	1	0	1	0	N	0	M	0	Q	op	Vm		

T1 variant

VPMAX{<c>}{<q>}.<dt> {<Dd>, }<Dn>, <Dm>

Decode for this encoding

```
if size == '11' || Q == '1' then UNDEFINED;
maximum = (op == '0'); unsigned = (U == '1');
esize = 8 << UInt(size); elements = 64 DIV esize;
d = UInt(D:Vd); n = UInt(N:Vn); m = UInt(M:Vm);
```

Assembler symbols

<c> For encoding A1: see [Standard assembler syntax fields on page F2-2848](#). This encoding must be unconditional.
 For encoding T1: see [Standard assembler syntax fields on page F2-2848](#).

- <q> See *Standard assembler syntax fields* on page F2-2848.
- <dt> Is the data type for the elements of the operands, encoded in the "U:size" field. It can have the following values:
- S8 when U = 0, size = 00
 - S16 when U = 0, size = 01
 - S32 when U = 0, size = 10
 - U8 when U = 1, size = 00
 - U16 when U = 1, size = 01
 - U32 when U = 1, size = 10
- <Dd> Is the 64-bit name of the SIMD&FP destination register, encoded in the "D:Vd" field.
- <Dn> Is the 64-bit name of the first SIMD&FP source register, encoded in the "N:Vn" field.
- <Dm> Is the 64-bit name of the second SIMD&FP source register, encoded in the "M:Vm" field.

Operation for all encodings

```
if ConditionPassed() then
    EncodingSpecificOperations(); CheckAdvSIMDEnabled();
    bits(64) dest;
    h = elements DIV 2;

    for e = 0 to h-1
        op1 = Int(Elem[D[n],2*e,esize], unsigned);
        op2 = Int(Elem[D[n],2*e+1,esize], unsigned);
        result = if maximum then Max(op1,op2) else Min(op1,op2);
        Elem[dest,e,esize] = result<esize-1:0>;
        op1 = Int(Elem[D[m],2*e,esize], unsigned);
        op2 = Int(Elem[D[m],2*e+1,esize], unsigned);
        result = if maximum then Max(op1,op2) else Min(op1,op2);
        Elem[dest,e+h,esize] = result<esize-1:0>;

D[d] = dest;
```

F6.1.151 VPMIN (floating-point)

Vector Pairwise Minimum compares adjacent pairs of elements in two doubleword vectors, and copies the smaller of each pair into the corresponding element in the destination doubleword vector.

Depending on settings in the CPACR, NSACR, and HCPTR registers, and the security state and mode in which the instruction is executed, an attempt to execute the instruction might be UNDEFINED, or trapped to Hyp mode. For more information see [Enabling Advanced SIMD and floating-point support on page G1-4413](#).

A1

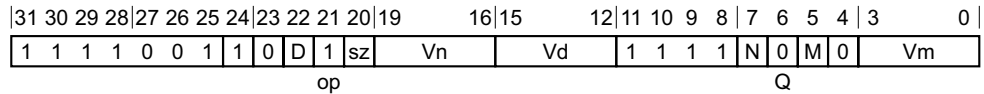

A1 variant

VPMIN{<c>}{<q>}.<dt> {<Dd>, }<Dn>, <Dm>

Decode for this encoding

```

if Q == '1' then UNDEFINED;
if sz == '1' && !HaveFP16Ext() then UNDEFINED;
maximum = (op == '0');
case sz of
    when '0' esize = 32; elements = 2;
    when '1' esize = 16; elements = 4;
d = UInt(D:Vd); n = UInt(N:Vn); m = UInt(M:Vm);
    
```

T1

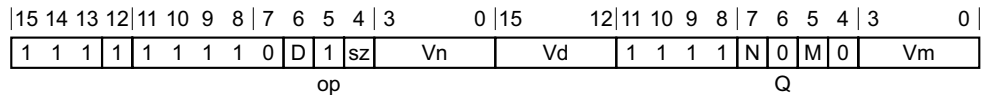

T1 variant

VPMIN{<c>}{<q>}.<dt> {<Dd>, }<Dn>, <Dm>

Decode for this encoding

```

if Q == '1' then UNDEFINED;
if sz == '1' && !HaveFP16Ext() then UNDEFINED;
if sz == '1' && InITBlock() then UNPREDICTABLE;
maximum = (op == '0');
case sz of
    when '0' esize = 32; elements = 2;
    when '1' esize = 16; elements = 4;
d = UInt(D:Vd); n = UInt(N:Vn); m = UInt(M:Vm);
    
```

CONSTRAINED UNPREDICTABLE behavior

If sz == '1' && InITBlock(), then one of the following behaviors must occur:

- The instruction is UNDEFINED.
- The instruction executes as if it passes the Condition code check.
- The instruction executes as NOP. This means it behaves as if it fails the Condition code check.

Assembler symbols

- <c> For encoding A1: see *Standard assembler syntax fields* on page F2-2848. This encoding must be unconditional.
For encoding T1: see *Standard assembler syntax fields* on page F2-2848.
- <q> See *Standard assembler syntax fields* on page F2-2848.
- <dt> Is the data type for the elements of the vectors, encoded in the "sz" field. It can have the following values:
F32 when sz = 0
F16 when sz = 1
- <Dd> Is the 64-bit name of the SIMD&FP destination register, encoded in the "D:Vd" field.
- <Dn> Is the 64-bit name of the first SIMD&FP source register, encoded in the "N:Vn" field.
- <Dm> Is the 64-bit name of the second SIMD&FP source register, encoded in the "M:Vm" field.

Operation for all encodings

```
if ConditionPassed() then
    EncodingSpecificOperations(); CheckAdvSIMDEnabled();
    bits(64) dest;
    h = elements DIV 2;

    for e = 0 to h-1
        op1 = Elem[D[n],2*e,esize]; op2 = Elem[D[n],2*e+1,esize];
        Elem[dest,e,esize] = if maximum then FPMax(op1,op2,StandardFPSCRValue()) else
FPMin(op1,op2,StandardFPSCRValue());
        op1 = Elem[D[m],2*e,esize]; op2 = Elem[D[m],2*e+1,esize];
        Elem[dest,e+h,esize] = if maximum then FPMax(op1,op2,StandardFPSCRValue()) else
FPMin(op1,op2,StandardFPSCRValue());

    D[d] = dest;
```

F6.1.152 VPMIN (integer)

Vector Pairwise Minimum compares adjacent pairs of elements in two doubleword vectors, and copies the smaller of each pair into the corresponding element in the destination doubleword vector.

Depending on settings in the CPACR, NSACR, and HCPTR registers, and the security state and mode in which the instruction is executed, an attempt to execute the instruction might be UNDEFINED, or trapped to Hyp mode. For more information see [Enabling Advanced SIMD and floating-point support on page G1-4413](#).

A1

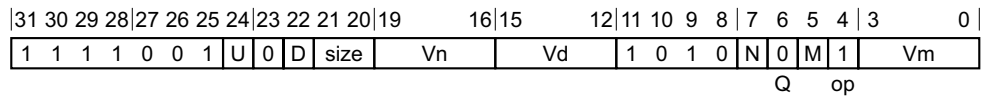

A1 variant

VPMIN{<c>}{<q>}.<dt> {<Dd>, }<Dn>, <Dm>

Decode for this encoding

```
if size == '11' || Q == '1' then UNDEFINED;
maximum = (op == '0'); unsigned = (U == '1');
esize = 8 << UInt(size); elements = 64 DIV esize;
d = UInt(D:Vd); n = UInt(N:Vn); m = UInt(M:Vm);
```

T1

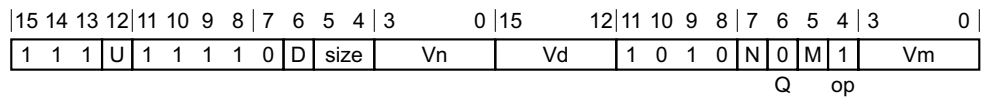

T1 variant

VPMIN{<c>}{<q>}.<dt> {<Dd>, }<Dn>, <Dm>

Decode for this encoding

```
if size == '11' || Q == '1' then UNDEFINED;
maximum = (op == '0'); unsigned = (U == '1');
esize = 8 << UInt(size); elements = 64 DIV esize;
d = UInt(D:Vd); n = UInt(N:Vn); m = UInt(M:Vm);
```

Assembler symbols

<c> For encoding A1: see [Standard assembler syntax fields on page F2-2848](#). This encoding must be unconditional.

For encoding T1: see [Standard assembler syntax fields on page F2-2848](#).

<q> See [Standard assembler syntax fields on page F2-2848](#).

<dt> Is the data type for the elements of the operands, encoded in the "U:size" field. It can have the following values:

- S8 when U = 0, size = 00
- S16 when U = 0, size = 01
- S32 when U = 0, size = 10
- U8 when U = 1, size = 00

- U16 when U = 1, size = 01
U32 when U = 1, size = 10
- <Dd> Is the 64-bit name of the SIMD&FP destination register, encoded in the "D:Vd" field.
- <Dn> Is the 64-bit name of the first SIMD&FP source register, encoded in the "N:Vn" field.
- <Dm> Is the 64-bit name of the second SIMD&FP source register, encoded in the "M:Vm" field.

Operation for all encodings

```
if ConditionPassed() then
    EncodingSpecificOperations(); CheckAdvSIMDEnabled();
    bits(64) dest;
    h = elements DIV 2;

    for e = 0 to h-1
        op1 = Int(Elem[D[n],2*e,esize], unsigned);
        op2 = Int(Elem[D[n],2*e+1,esize], unsigned);
        result = if maximum then Max(op1,op2) else Min(op1,op2);
        Elem[dest,e,esize] = result<esize-1:0>;
        op1 = Int(Elem[D[m],2*e,esize], unsigned);
        op2 = Int(Elem[D[m],2*e+1,esize], unsigned);
        result = if maximum then Max(op1,op2) else Min(op1,op2);
        Elem[dest,e+h,esize] = result<esize-1:0>;

D[d] = dest;
```

F6.1.153 VPOP

Pop SIMD&FP registers from Stack loads multiple consecutive Advanced SIMD and floating-point register file registers from the stack

This instruction is an alias of the [VLDM](#), [VLDMDB](#), [VLDMIA](#) instruction. This means that:

- The encodings in this description are named to match the encodings of [VLDM](#), [VLDMDB](#), [VLDMIA](#).
- The description of [VLDM](#), [VLDMDB](#), [VLDMIA](#) gives the operational pseudocode for this instruction.

A1

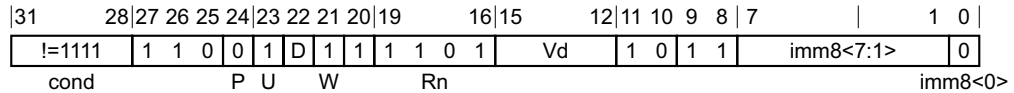

Increment After variant

VPOP{<c>}{<q>}{.<size>} <dreglist>

is equivalent to

VLDM{<c>}{<q>}{.<size>} SP!, <dreglist>

and is always the preferred disassembly.

A2

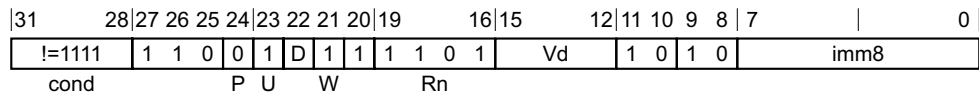

Increment After variant

VPOP{<c>}{<q>}{.<size>} <sreglist>

is equivalent to

VLDM{<c>}{<q>}{.<size>} SP!, <sreglist>

and is always the preferred disassembly.

T1

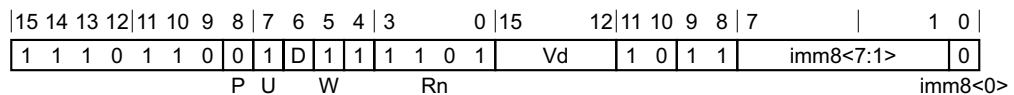

Increment After variant

VPOP{<c>}{<q>}{.<size>} <dreglist>

is equivalent to

VLDM{<c>}{<q>}{.<size>} SP!, <dreglist>

and is always the preferred disassembly.

T2

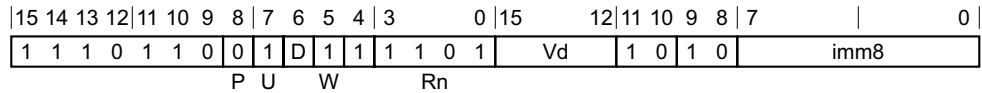

Increment After variant

VPOP{<c>}{<q>}{.<size>} <sreglist>

is equivalent to

VLDM{<c>}{<q>}{.<size>} SP!, <sreglist>

and is always the preferred disassembly.

Assembler symbols

<c> See [Standard assembler syntax fields on page F2-2848](#).

<q> See [Standard assembler syntax fields on page F2-2848](#).

<size> An optional data size specifier. If present, it must be equal to the size in bits, 32 or 64, of the registers being transferred.

<sreglist> Is the list of consecutively numbered 32-bit SIMD&FP registers to be transferred. The first register in the list is encoded in "Vd:D", and "imm8" is set to the number of registers in the list. The list must contain at least one register.

<dreglist> Is the list of consecutively numbered 64-bit SIMD&FP registers to be transferred. The first register in the list is encoded in "D:Vd", and "imm8" is set to twice the number of registers in the list. The list must contain at least one register, and must not contain more than 16 registers.

Operation for all encodings

The description of [VLDM](#), [VLDMDB](#), [VLDMIA](#) gives the operational pseudocode for this instruction.

F6.1.154 VPUSH

Push SIMD&FP registers to Stack stores multiple consecutive registers from the Advanced SIMD and floating-point register file to the stack

This instruction is an alias of the [VSTM](#), [VSTMDB](#), [VSTMIA](#) instruction. This means that:

- The encodings in this description are named to match the encodings of [VSTM](#), [VSTMDB](#), [VSTMIA](#).
- The description of [VSTM](#), [VSTMDB](#), [VSTMIA](#) gives the operational pseudocode for this instruction.

A1

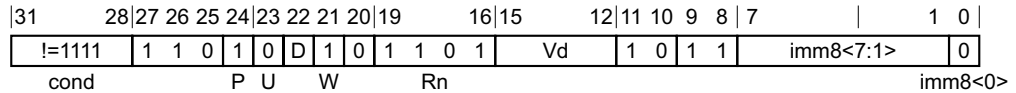

Decrement Before variant

VPUSH{<c>}{<q>}{.<size>} <dreglist>

is equivalent to

VSTMDB{<c>}{<q>}{.<size>} SP!, <dreglist>

and is always the preferred disassembly.

A2

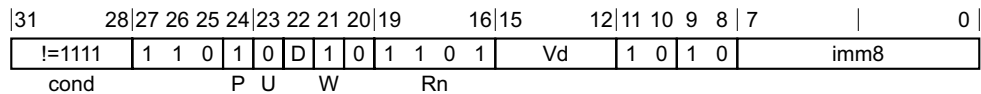

Decrement Before variant

VPUSH{<c>}{<q>}{.<size>} <sreglist>

is equivalent to

VSTMDB{<c>}{<q>}{.<size>} SP!, <sreglist>

and is always the preferred disassembly.

T1

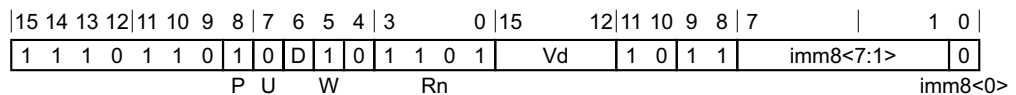

Decrement Before variant

VPUSH{<c>}{<q>}{.<size>} <dreglist>

is equivalent to

VSTMDB{<c>}{<q>}{.<size>} SP!, <dreglist>

and is always the preferred disassembly.

T2

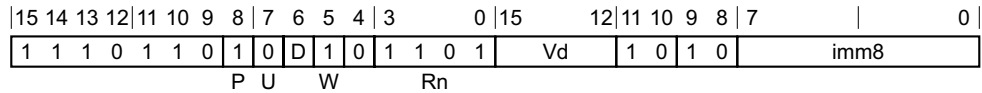

Decrement Before variant

VPUSH{<c>}{<q>}{.<size>} <sreglist>

is equivalent to

VSTMDB{<c>}{<q>}{.<size>} SP!, <sreglist>

and is always the preferred disassembly.

Assembler symbols

<c> See [Standard assembler syntax fields on page F2-2848](#).

<q> See [Standard assembler syntax fields on page F2-2848](#).

<size> An optional data size specifier. If present, it must be equal to the size in bits, 32 or 64, of the registers being transferred.

<sreglist> Is the list of consecutively numbered 32-bit SIMD&FP registers to be transferred. The first register in the list is encoded in "Vd:D", and "imm8" is set to the number of registers in the list. The list must contain at least one register.

<dreglist> Is the list of consecutively numbered 64-bit SIMD&FP registers to be transferred. The first register in the list is encoded in "D:Vd", and "imm8" is set to twice the number of registers in the list. The list must contain at least one register, and must not contain more than 16 registers.

Operation for all encodings

The description of [VSTM](#), [VSTMDB](#), [VSTMIA](#) gives the operational pseudocode for this instruction.

F6.1.155 VQABS

Vector Saturating Absolute takes the absolute value of each element in a vector, and places the results in the destination vector.

If any of the results overflow, they are saturated. The cumulative saturation bit, `FPSCR.QC`, is set if saturation occurs. For details see [Pseudocode description of saturation on page E1-2731](#).

Depending on settings in the `CPACR`, `NSACR`, and `HCPTR` registers, and the security state and mode in which the instruction is executed, an attempt to execute the instruction might be `UNDEFINED`, or trapped to Hyp mode. For more information see [Enabling Advanced SIMD and floating-point support on page G1-4413](#).

A1

31	30	29	28	27	26	25	24	23	22	21	20	19	18	17	16	15	12	11	10	9	8	7	6	5	4	3	0
1	1	1	1	0	0	1	1	1	D	1	1	size	0	0	Vd	0	1	1	1	0	Q	M	0	Vm			

64-bit SIMD vector variant

Applies when `Q == 0`.

`VQABS{<c>}{<q>}.<dt> <Dd>, <Dm>`

128-bit SIMD vector variant

Applies when `Q == 1`.

`VQABS{<c>}{<q>}.<dt> <Qd>, <Qm>`

Decode for all variants of this encoding

```

if size == '11' then UNDEFINED;
if Q == '1' && (Vd<0> == '1' || Vm<0> == '1') then UNDEFINED;
esize = 8 << UInt(size); elements = 64 DIV esize;
d = UInt(D:Vd); m = UInt(M:Vm); regs = if Q == '0' then 1 else 2;
    
```

T1

15	14	13	12	11	10	9	8	7	6	5	4	3	2	1	0	15	12	11	10	9	8	7	6	5	4	3	0
1	1	1	1	1	1	1	1	1	D	1	1	size	0	0	Vd	0	1	1	1	0	Q	M	0	Vm			

64-bit SIMD vector variant

Applies when `Q == 0`.

`VQABS{<c>}{<q>}.<dt> <Dd>, <Dm>`

128-bit SIMD vector variant

Applies when `Q == 1`.

`VQABS{<c>}{<q>}.<dt> <Qd>, <Qm>`

Decode for all variants of this encoding

```

if size == '11' then UNDEFINED;
if Q == '1' && (Vd<0> == '1' || Vm<0> == '1') then UNDEFINED;
esize = 8 << UInt(size); elements = 64 DIV esize;
d = UInt(D:Vd); m = UInt(M:Vm); regs = if Q == '0' then 1 else 2;
    
```

Assembler symbols

- <c> For encoding A1: see *Standard assembler syntax fields* on page F2-2848. This encoding must be unconditional.
For encoding T1: see *Standard assembler syntax fields* on page F2-2848.
- <q> See *Standard assembler syntax fields* on page F2-2848.
- <dt> Is the data type for the elements of the vectors, encoded in the "size" field. It can have the following values:
S8 when size = 00
S16 when size = 01
S32 when size = 10
The encoding size = 11 is reserved.
- <Qd> Is the 128-bit name of the SIMD&FP destination register, encoded in the "D:Vd" field as <Qd>*2.
- <Qm> Is the 128-bit name of the SIMD&FP source register, encoded in the "M:Vm" field as <Qm>*2.
- <Dd> Is the 64-bit name of the SIMD&FP destination register, encoded in the "D:Vd" field.
- <Dm> Is the 64-bit name of the SIMD&FP source register, encoded in the "M:Vm" field.

Operation for all encodings

```
if ConditionPassed() then
    EncodingSpecificOperations(); CheckAdvSIMDEnabled();
    for r = 0 to regs-1
        for e = 0 to elements-1
            result = Abs(SInt(Elem[D[m+r],e,esize]));
            (Elem[D[d+r],e,esize], sat) = SignedSatQ(result, esize);
            if sat then FPSCR.QC = '1';
```

F6.1.156 VQADD

Vector Saturating Add adds the values of corresponding elements of two vectors, and places the results in the destination vector.

If any of the results overflow, they are saturated. The cumulative saturation bit, `FPSCR.QC`, is set if saturation occurs. For details see [Pseudocode description of saturation on page E1-2731](#).

Depending on settings in the `CPACR`, `NSACR`, and `HCPTTR` registers, and the security state and mode in which the instruction is executed, an attempt to execute the instruction might be `UNDEFINED`, or trapped to Hyp mode. For more information see [Enabling Advanced SIMD and floating-point support on page G1-4413](#).

A1

31	30	29	28	27	26	25	24	23	22	21	20	19	16	15	12	11	10	9	8	7	6	5	4	3	0
1	1	1	1	0	0	1	U	0	D	size	Vn	Vd	0	0	0	0	N	Q	M	1	Vm				

64-bit SIMD vector variant

Applies when `Q == 0`.

`VQADD{<c>}{<q>}.<dt> {<Dd>}, <Dn>, <Dm>`

128-bit SIMD vector variant

Applies when `Q == 1`.

`VQADD{<c>}{<q>}.<dt> {<Qd>}, <Qn>, <Qm>`

Decode for all variants of this encoding

```
if Q == '1' && (Vd<0> == '1' || Vn<0> == '1' || Vm<0> == '1') then UNDEFINED;
unsigned = (U == '1');
esize = 8 << UInt(size); elements = 64 DIV esize;
d = UInt(D:Vd); n = UInt(N:Vn); m = UInt(M:Vm); regs = if Q == '0' then 1 else 2;
```

T1

15	14	13	12	11	10	9	8	7	6	5	4	3	0	15	12	11	10	9	8	7	6	5	4	3	0
1	1	1	U	1	1	1	1	0	D	size	Vn	Vd	0	0	0	0	N	Q	M	1	Vm				

64-bit SIMD vector variant

Applies when `Q == 0`.

`VQADD{<c>}{<q>}.<dt> {<Dd>}, <Dn>, <Dm>`

128-bit SIMD vector variant

Applies when `Q == 1`.

`VQADD{<c>}{<q>}.<dt> {<Qd>}, <Qn>, <Qm>`

Decode for all variants of this encoding

```
if Q == '1' && (Vd<0> == '1' || Vn<0> == '1' || Vm<0> == '1') then UNDEFINED;
unsigned = (U == '1');
esize = 8 << UInt(size); elements = 64 DIV esize;
d = UInt(D:Vd); n = UInt(N:Vn); m = UInt(M:Vm); regs = if Q == '0' then 1 else 2;
```

Assembler symbols

- <c> For encoding A1: see *Standard assembler syntax fields* on page F2-2848. This encoding must be unconditional.
 For encoding T1: see *Standard assembler syntax fields* on page F2-2848.
- <q> See *Standard assembler syntax fields* on page F2-2848.
- <dt> Is the data type for the elements of the vectors, encoded in the "U:size" field. It can have the following values:
- | | |
|-----|-----------------------|
| S8 | when U = 0, size = 00 |
| S16 | when U = 0, size = 01 |
| S32 | when U = 0, size = 10 |
| S64 | when U = 0, size = 11 |
| U8 | when U = 1, size = 00 |
| U16 | when U = 1, size = 01 |
| U32 | when U = 1, size = 10 |
| U64 | when U = 1, size = 11 |
- <Qd> Is the 128-bit name of the SIMD&FP destination register, encoded in the "D:Vd" field as <Qd>*2.
- <Qn> Is the 128-bit name of the first SIMD&FP source register, encoded in the "N:Vn" field as <Qn>*2.
- <Qm> Is the 128-bit name of the second SIMD&FP source register, encoded in the "M:Vm" field as <Qm>*2.
- <Dd> Is the 64-bit name of the SIMD&FP destination register, encoded in the "D:Vd" field.
- <Dn> Is the 64-bit name of the first SIMD&FP source register, encoded in the "N:Vn" field.
- <Dm> Is the 64-bit name of the second SIMD&FP source register, encoded in the "M:Vm" field.

Operation for all encodings

```

if ConditionPassed() then
    EncodingSpecificOperations(); CheckAdvSIMDEnabled();
    for r = 0 to regs-1
        for e = 0 to elements-1
            sum = Int(Elem[D[n+r],e,esize], unsigned) + Int(Elem[D[m+r],e,esize], unsigned);
            (Elem[D[d+r],e,esize], sat) = SatQ(sum, esize, unsigned);
            if sat then FPSCR.QC = '1';
  
```

F6.1.157 VQDMLAL

Vector Saturating Doubling Multiply Accumulate Long multiplies corresponding elements in two doubleword vectors, doubles the products, and accumulates the results into the elements of a quadword vector.

The second operand can be a scalar instead of a vector. For more information about scalars see *Advanced SIMD scalars* on page F2-2874.

If any of the results overflow, they are saturated. The cumulative saturation bit, `FPSCR.QC`, is set if saturation occurs. For details see *Pseudocode description of saturation* on page E1-2731.

Depending on settings in the `CPACR`, `NSACR`, and `HCPTR` registers, and the security state and mode in which the instruction is executed, an attempt to execute the instruction might be UNDEFINED, or trapped to Hyp mode. For more information see *Enabling Advanced SIMD and floating-point support* on page G1-4413.

A1

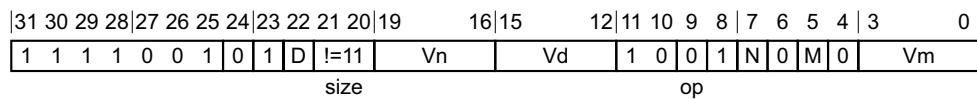

A1 variant

VQDMLAL{<c>}{<q>}.<dt> <Qd>, <Dn>, <Dm>

Decode for this encoding

```

if size == '11' then SEE "Related encodings";
if size == '00' || Vd<0> == '1' then UNDEFINED;
add = (op == '0');
scalar_form = FALSE; d = UInt(D:Vd); n = UInt(N:Vn); m = UInt(M:Vm);
esize = 8 << UInt(size); elements = 64 DIV esize;
    
```

A2

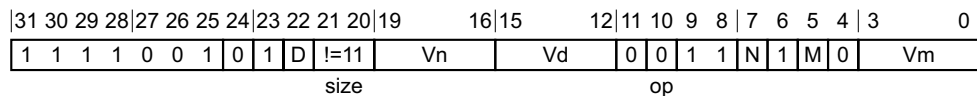

A2 variant

VQDMLAL{<c>}{<q>}.<dt> <Qd>, <Dn>, <Dm>[<index>]

Decode for this encoding

```

if size == '11' then SEE "Related encodings";
if size == '00' || Vd<0> == '1' then UNDEFINED;
add = (op == '0');
scalar_form = TRUE; d = UInt(D:Vd); n = UInt(N:Vn);
if size == '01' then esize = 16; elements = 4; m = UInt(Vm<2:0>); index = UInt(M:Vm<3>);
if size == '10' then esize = 32; elements = 2; m = UInt(Vm); index = UInt(M);
    
```

T1

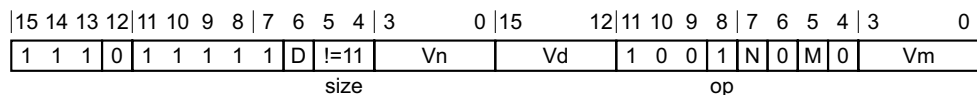

T1 variant

VQDMLAL{<c>}{<q>}.<dt> <Qd>, <Dn>, <Dm>

Decode for this encoding

```
if size == '11' then SEE "Related encodings";
if size == '00' || Vd<0> == '1' then UNDEFINED;
add = (op == '0');
scalar_form = FALSE; d = UInt(D:Vd); n = UInt(N:Vn); m = UInt(M:Vm);
esize = 8 << UInt(size); elements = 64 DIV esize;
```

T2

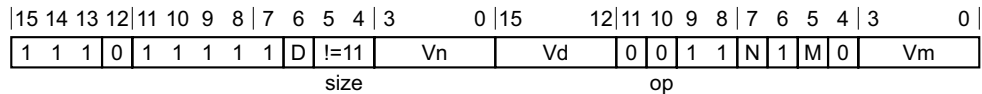

T2 variant

VQDMLAL{<c>}{<q>}.<dt> <Qd>, <Dn>, <Dm>[<index>]

Decode for this encoding

```
if size == '11' then SEE "Related encodings";
if size == '00' || Vd<0> == '1' then UNDEFINED;
add = (op == '0');
scalar_form = TRUE; d = UInt(D:Vd); n = UInt(N:Vn);
if size == '01' then esize = 16; elements = 4; m = UInt(Vm<2:0>); index = UInt(M:Vm<3>);
if size == '10' then esize = 32; elements = 2; m = UInt(Vm); index = UInt(M);
```

Notes for all encodings

Related encodings: See [Advanced SIMD data-processing on page F3-2904](#) for the T32 instruction set, or [Advanced SIMD data-processing on page F4-2985](#) for the A32 instruction set.

Assembler symbols

- <c> For encoding A1 and A2: see [Standard assembler syntax fields on page F2-2848](#). This encoding must be unconditional.
For encoding T1 and T2: see [Standard assembler syntax fields on page F2-2848](#).
- <q> See [Standard assembler syntax fields on page F2-2848](#).
- <dt> Is the data type for the elements of the operands, encoded in the "size" field. It can have the following values:
S16 when size = 01
S32 when size = 10
- <Qd> Is the 128-bit name of the SIMD&FP destination register, encoded in the "D:Vd" field as <Qd>*2.
- <Dn> Is the 64-bit name of the first SIMD&FP source register, encoded in the "N:Vn" field.
- <Dm> For encoding A1 and T1: is the 64-bit name of the second SIMD&FP source register, encoded in the "M:Vm" field.
For encoding A2 and T2: is the 64-bit name of the second SIMD&FP source register, encoded in the "Vm<2:0>" field when <dt> is S16, otherwise the "Vm" field.
- <index> Is the element index in the range 0 to 3, encoded in the "M:Vm<3>" field when <dt> is S16, otherwise in range 0 to 1, encoded in the "M" field.

Operation for all encodings

```
if ConditionPassed() then
    EncodingSpecificOperations(); CheckAdvSIMDEnabled();
    if scalar_form then op2 = SInt(Elem[Din[m],index,esize]);
    for e = 0 to elements-1
        if !scalar_form then op2 = SInt(Elem[Din[m],e,esize]);
        op1 = SInt(Elem[Din[n],e,esize]);
        // The following only saturates if both op1 and op2 equal -(2^(esize-1))
        (product, sat1) = SignedSatQ(2*op1*op2, 2*esize);
        if add then
            result = SInt(Elem[Qin[d>>1],e,2*esize]) + SInt(product);
        else
            result = SInt(Elem[Qin[d>>1],e,2*esize]) - SInt(product);
        (Elem[Q[d>>1],e,2*esize], sat2) = SignedSatQ(result, 2*esize);
        if sat1 || sat2 then FPSCR.QC = '1';
```

F6.1.158 VQDMLSL

Vector Saturating Doubling Multiply Subtract Long multiplies corresponding elements in two doubleword vectors, subtracts double the products from corresponding elements of a quadword vector, and places the results in the same quadword vector.

The second operand can be a scalar instead of a vector. For more information about scalars see *Advanced SIMD scalars* on page F2-2874.

If any of the results overflow, they are saturated. The cumulative saturation bit, `FPSCR.QC`, is set if saturation occurs. For details see *Pseudocode description of saturation* on page E1-2731.

Depending on settings in the `CPACR`, `NSACR`, and `HCPTR` registers, and the security state and mode in which the instruction is executed, an attempt to execute the instruction might be UNDEFINED, or trapped to Hyp mode. For more information see *Enabling Advanced SIMD and floating-point support* on page G1-4413.

A1

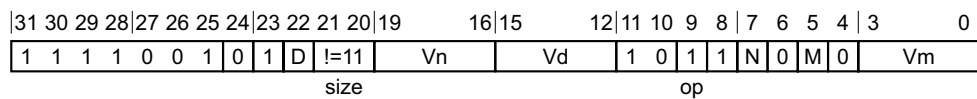

A1 variant

VQDMLSL{<c>}{<q>}.<dt> <Qd>, <Dn>, <Dm>

Decode for this encoding

```

if size == '11' then SEE "Related encodings";
if size == '00' || Vd<0> == '1' then UNDEFINED;
add = (op == '0');
scalar_form = FALSE; d = UInt(D:Vd); n = UInt(N:Vn); m = UInt(M:Vm);
esize = 8 << UInt(size); elements = 64 DIV esize;
    
```

A2

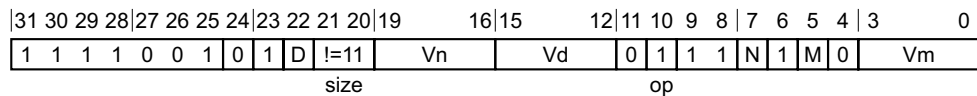

A2 variant

VQDMLSL{<c>}{<q>}.<dt> <Qd>, <Dn>, <Dm>[<index>]

Decode for this encoding

```

if size == '11' then SEE "Related encodings";
if size == '00' || Vd<0> == '1' then UNDEFINED;
add = (op == '0');
scalar_form = TRUE; d = UInt(D:Vd); n = UInt(N:Vn);
if size == '01' then esize = 16; elements = 4; m = UInt(Vm<2:0>); index = UInt(M:Vm<3>);
if size == '10' then esize = 32; elements = 2; m = UInt(Vm); index = UInt(M);
    
```

T1

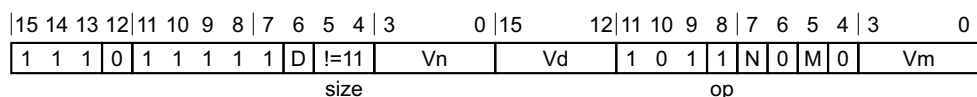

T1 variant

VQDMLSL{<c>}{<q>}.<dt> <Qd>, <Dn>, <Dm>

Decode for this encoding

```
if size == '11' then SEE "Related encodings";
if size == '00' || Vd<0> == '1' then UNDEFINED;
add = (op == '0');
scalar_form = FALSE; d = UInt(D:Vd); n = UInt(N:Vn); m = UInt(M:Vm);
esize = 8 << UInt(size); elements = 64 DIV esize;
```

T2

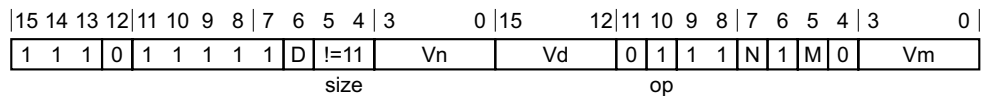

T2 variant

VQDMLSL{<c>}{<q>}.<dt> <Qd>, <Dn>, <Dm>[<index>]

Decode for this encoding

```
if size == '11' then SEE "Related encodings";
if size == '00' || Vd<0> == '1' then UNDEFINED;
add = (op == '0');
scalar_form = TRUE; d = UInt(D:Vd); n = UInt(N:Vn);
if size == '01' then esize = 16; elements = 4; m = UInt(Vm<2:0>); index = UInt(M:Vm<3>);
if size == '10' then esize = 32; elements = 2; m = UInt(Vm); index = UInt(M);
```

Notes for all encodings

Related encodings: See [Advanced SIMD data-processing on page F3-2904](#) for the T32 instruction set, or [Advanced SIMD data-processing on page F4-2985](#) for the A32 instruction set.

Assembler symbols

- <c> For encoding A1 and A2: see [Standard assembler syntax fields on page F2-2848](#). This encoding must be unconditional.
For encoding T1 and T2: see [Standard assembler syntax fields on page F2-2848](#).
- <q> See [Standard assembler syntax fields on page F2-2848](#).
- <dt> Is the data type for the elements of the operands, encoded in the "size" field. It can have the following values:
S16 when size = 01
S32 when size = 10
- <Qd> Is the 128-bit name of the SIMD&FP destination register, encoded in the "D:Vd" field as <Qd>*2.
- <Dn> Is the 64-bit name of the first SIMD&FP source register, encoded in the "N:Vn" field.
- <Dm> For encoding A1 and T1: is the 64-bit name of the second SIMD&FP source register, encoded in the "M:Vm" field.
For encoding A2 and T2: is the 64-bit name of the second SIMD&FP source register, encoded in the "Vm<2:0>" field when <dt> is S16, otherwise the "Vm" field.
- <index> Is the element index in the range 0 to 3, encoded in the "M:Vm<3>" field when <dt> is S16, otherwise in range 0 to 1, encoded in the "M" field.

Operation for all encodings

```
if ConditionPassed() then
    EncodingSpecificOperations(); CheckAdvSIMDEnabled();
    if scalar_form then op2 = SInt(Elem[Din[m],index,esize]);
    for e = 0 to elements-1
        if !scalar_form then op2 = SInt(Elem[Din[m],e,esize]);
        op1 = SInt(Elem[Din[n],e,esize]);
        // The following only saturates if both op1 and op2 equal -(2^(esize-1))
        (product, sat1) = SignedSatQ(2*op1*op2, 2*esize);
        if add then
            result = SInt(Elem[Qin[d>>1],e,2*esize]) + SInt(product);
        else
            result = SInt(Elem[Qin[d>>1],e,2*esize]) - SInt(product);
        (Elem[Q[d>>1],e,2*esize], sat2) = SignedSatQ(result, 2*esize);
        if sat1 || sat2 then FPSCR.QC = '1';
```

F6.1.159 VQDMULH

Vector Saturating Doubling Multiply Returning High Half multiplies corresponding elements in two vectors, doubles the results, and places the most significant half of the final results in the destination vector. The results are truncated, for rounded results see [VQRDMULH](#).

The second operand can be a scalar instead of a vector. For more information about scalars see [Advanced SIMD scalars on page F2-2874](#).

If any of the results overflow, they are saturated. The cumulative saturation bit, `FPSCR.QC`, is set if saturation occurs. For details see [Pseudocode description of saturation on page E1-2731](#).

Depending on settings in the `CPACR`, `NSACR`, and `HCPTR` registers, and the security state and mode in which the instruction is executed, an attempt to execute the instruction might be `UNDEFINED`, or trapped to Hyp mode. For more information see [Enabling Advanced SIMD and floating-point support on page G1-4413](#).

A1

31	30	29	28	27	26	25	24	23	22	21	20	19	16	15	12	11	10	9	8	7	6	5	4	3	0
1	1	1	1	0	0	1	0	0	D	size	Vn	Vd	1	0	1	1	N	Q	M	0	Vm				

64-bit SIMD vector variant

Applies when `Q == 0`.

`VQDMULH{<c>}{<q>}.<dt> {<Dd>, }<Dn>, <Dm>`

128-bit SIMD vector variant

Applies when `Q == 1`.

`VQDMULH{<c>}{<q>}.<dt> {<Qd>, }<Qn>, <Qm>`

Decode for all variants of this encoding

```

if Q == '1' && (Vd<0> == '1' || Vn<0> == '1' || Vm<0> == '1') then UNDEFINED;
if size == '00' || size == '11' then UNDEFINED;
scalar_form = FALSE; esize = 8 << UInt(size); elements = 64 DIV esize;
d = UInt(D:Vd); n = UInt(N:Vn); m = UInt(M:Vm); regs = if Q == '0' then 1 else 2;
    
```

A2

31	30	29	28	27	26	25	24	23	22	21	20	19	16	15	12	11	10	9	8	7	6	5	4	3	0
1	1	1	1	0	0	1	Q	1	D	!=11	Vn	Vd	1	1	0	0	N	1	M	0	Vm				

size

64-bit SIMD vector variant

Applies when `Q == 0`.

`VQDMULH{<c>}{<q>}.<dt> {<Dd>, } <Dn>, <Dm[x]>`

128-bit SIMD vector variant

Applies when `Q == 1`.

`VQDMULH{<c>}{<q>}.<dt> {<Qd>, } <Qn>, <Dm[x]>`

Decode for all variants of this encoding

```

if size == '11' then SEE "Related encodings";
if size == '00' then UNDEFINED;
if Q == '1' && (Vd<0> == '1' || Vn<0> == '1') then UNDEFINED;
scalar_form = TRUE; d = UInt(D:Vd); n = UInt(N:Vn); regs = if Q == '0' then 1 else 2;
if size == '01' then esize = 16; elements = 4; m = UInt(Vm<2:0>); index = UInt(M:Vm<3>);
if size == '10' then esize = 32; elements = 2; m = UInt(Vm); index = UInt(M);
    
```

T1

15	14	13	12	11	10	9	8	7	6	5	4	3	0	15	12	11	10	9	8	7	6	5	4	3	0
1	1	1	0	1	1	1	1	0	D	size	Vn	Vd	1	0	1	1	N	Q	M	0	Vm				

64-bit SIMD vector variant

Applies when Q == 0.

VQDMULH{<c>}{<q>}.<dt> {<Dd>, }<Dn>, <Dm>

128-bit SIMD vector variant

Applies when Q == 1.

VQDMULH{<c>}{<q>}.<dt> {<Qd>, }<Qn>, <Qm>

Decode for all variants of this encoding

```

if Q == '1' && (Vd<0> == '1' || Vn<0> == '1' || Vm<0> == '1') then UNDEFINED;
if size == '00' || size == '11' then UNDEFINED;
scalar_form = FALSE; esize = 8 << UInt(size); elements = 64 DIV esize;
d = UInt(D:Vd); n = UInt(N:Vn); m = UInt(M:Vm); regs = if Q == '0' then 1 else 2;
    
```

T2

15	14	13	12	11	10	9	8	7	6	5	4	3	0	15	12	11	10	9	8	7	6	5	4	3	0
1	1	1	Q	1	1	1	1	1	D	!=11	size	Vn	Vd	1	1	0	0	N	1	M	0	Vm			

64-bit SIMD vector variant

Applies when Q == 0.

VQDMULH{<c>}{<q>}.<dt> {<Dd>, }<Dn>, <Dm[x]>

128-bit SIMD vector variant

Applies when Q == 1.

VQDMULH{<c>}{<q>}.<dt> {<Qd>, }<Qn>, <Dm[x]>

Decode for all variants of this encoding

```

if size == '11' then SEE "Related encodings";
if size == '00' then UNDEFINED;
if Q == '1' && (Vd<0> == '1' || Vn<0> == '1') then UNDEFINED;
scalar_form = TRUE; d = UInt(D:Vd); n = UInt(N:Vn); regs = if Q == '0' then 1 else 2;
if size == '01' then esize = 16; elements = 4; m = UInt(Vm<2:0>); index = UInt(M:Vm<3>);
if size == '10' then esize = 32; elements = 2; m = UInt(Vm); index = UInt(M);
    
```

Notes for all encodings

Related encodings: See *Advanced SIMD data-processing* on page F3-2904 for the T32 instruction set, or *Advanced SIMD data-processing* on page F4-2985 for the A32 instruction set.

Assembler symbols

- <c> For encoding A1 and A2: see *Standard assembler syntax fields* on page F2-2848. This encoding must be unconditional.
For encoding T1 and T2: see *Standard assembler syntax fields* on page F2-2848.
- <q> See *Standard assembler syntax fields* on page F2-2848.
- <dt> Is the data type for the elements of the operands, encoded in the "size" field. It can have the following values:
S16 when size = 01
S32 when size = 10
- <Qd> Is the 128-bit name of the SIMD&FP destination register, encoded in the "D:Vd" field as <Qd>*2.
- <Qn> Is the 128-bit name of the first SIMD&FP source register, encoded in the "N:Vn" field as <Qn>*2.
- <Qm> Is the 128-bit name of the second SIMD&FP source register, encoded in the "M:Vm" field as <Qm>*2.
- <Dd> Is the 64-bit name of the SIMD&FP destination register, encoded in the "D:Vd" field.
- <Dn> Is the 64-bit name of the first SIMD&FP source register, encoded in the "N:Vn" field.
- <Dm[x]> Is the 64-bit name of the second SIMD&FP source register holding the scalar. If <dt> is S16, Dm is restricted to D0-D7. Dm is encoded in "Vm<2:0>", and x is encoded in "M:Vm<3>". If <dt> is S32, Dm is restricted to D0-D15. Dm is encoded in "Vm", and x is encoded in "M".
- <Qm> Is the 64-bit name of the second SIMD&FP source register, encoded in the "M:Vm" field.

Operation for all encodings

```
if ConditionPassed() then
    EncodingSpecificOperations(); CheckAdvSIMDEnabled();
    if scalar_form then op2 = SInt(Elem[D[m],index,esize]);
    for r = 0 to regs-1
        for e = 0 to elements-1
            if !scalar_form then op2 = SInt(Elem[D[m+r],e,esize]);
            op1 = SInt(Elem[D[n+r],e,esize]);
            // The following only saturates if both op1 and op2 equal -(2^(esize-1))
            (result, sat) = SignedSatQ((2*op1*op2) >> esize, esize);
            Elem[D[d+r],e,esize] = result;
            if sat then FPSCR.QC = '1';
```

F6.1.160 VQDMULL

Vector Saturating Doubling Multiply Long multiplies corresponding elements in two doubleword vectors, doubles the products, and places the results in a quadword vector.

The second operand can be a scalar instead of a vector. For more information about scalars see *Advanced SIMD scalars* on page F2-2874.

If any of the results overflow, they are saturated. The cumulative saturation bit, FPSCR.QC, is set if saturation occurs. For details see *Pseudocode description of saturation* on page E1-2731.

Depending on settings in the CPACR, NSACR, and HCPTR registers, and the security state and mode in which the instruction is executed, an attempt to execute the instruction might be UNDEFINED, or trapped to Hyp mode. For more information see *Enabling Advanced SIMD and floating-point support* on page G1-4413.

A1

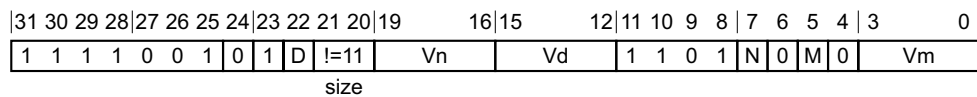

A1 variant

VQDMULL{<c>}{<q>}.<dt> <Qd>, <Dn>, <Dm>

Decode for this encoding

```
if size == '11' then SEE "Related encodings";
if size == '00' || Vd<0> == '1' then UNDEFINED;
scalar_form = FALSE; d = UInt(D:Vd); n = UInt(N:Vn); m = UInt(M:Vm);
esize = 8 << UInt(size); elements = 64 DIV esize;
```

A2

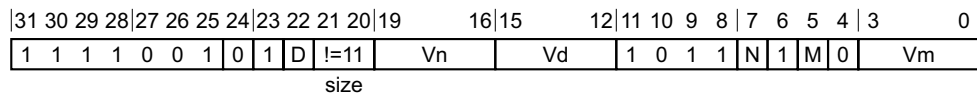

A2 variant

VQDMULL{<c>}{<q>}.<dt> <Qd>, <Dn>, <Dm[x]>

Decode for this encoding

```
if size == '11' then SEE "Related encodings";
if size == '00' || Vd<0> == '1' then UNDEFINED;
scalar_form = TRUE; d = UInt(D:Vd); n = UInt(N:Vn);
if size == '01' then esize = 16; elements = 4; m = UInt(Vm<2:0>); index = UInt(M:Vm<3>);
if size == '10' then esize = 32; elements = 2; m = UInt(Vm); index = UInt(M);
```

T1

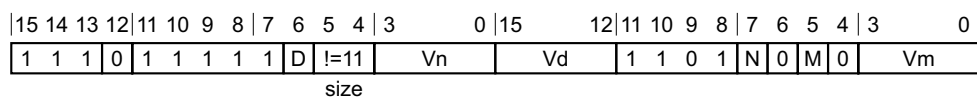

T1 variant

VQDMULL{<c>}{<q>}.<dt> <Qd>, <Dn>, <Dm>

Decode for this encoding

```
if size == '11' then SEE "Related encodings";
if size == '00' || Vd<0> == '1' then UNDEFINED;
scalar_form = FALSE; d = UInt(D:Vd); n = UInt(N:Vn); m = UInt(M:Vm);
esize = 8 << UInt(size); elements = 64 DIV esize;
```

T2

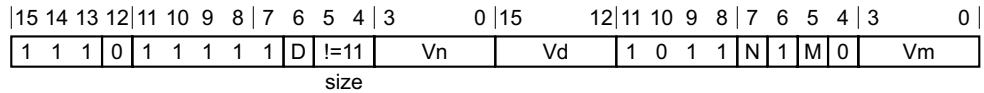

T2 variant

VQDMULL{<c>}{<q>}.<dt> <Qd>, <Dn>, <Dm[x]>

Decode for this encoding

```
if size == '11' then SEE "Related encodings";
if size == '00' || Vd<0> == '1' then UNDEFINED;
scalar_form = TRUE; d = UInt(D:Vd); n = UInt(N:Vn);
if size == '01' then esize = 16; elements = 4; m = UInt(Vm<2:0>); index = UInt(M:Vm<3>);
if size == '10' then esize = 32; elements = 2; m = UInt(Vm); index = UInt(M);
```

Notes for all encodings

Related encodings: See [Advanced SIMD data-processing on page F3-2904](#) for the T32 instruction set, or [Advanced SIMD data-processing on page F4-2985](#) for the A32 instruction set.

Assembler symbols

- <c> For encoding A1 and A2: see [Standard assembler syntax fields on page F2-2848](#). This encoding must be unconditional.
 For encoding T1 and T2: see [Standard assembler syntax fields on page F2-2848](#).
- <q> See [Standard assembler syntax fields on page F2-2848](#).
- <dt> Is the data type for the elements of the operands, encoded in the "size" field. It can have the following values:
 S16 when size = 01
 S32 when size = 10
- <Qd> Is the 128-bit name of the SIMD&FP destination register, encoded in the "D:Vd" field as <Qd>*2.
- <Dn> Is the 64-bit name of the first SIMD&FP source register, encoded in the "N:Vn" field.
- <Dm[x]> Is the 64-bit name of the second SIMD&FP source register holding the scalar. If <dt> is S16, Dm is restricted to D0-D7. Dm is encoded in "Vm<2:0>", and x is encoded in "M:Vm<3>". If <dt> is S32, Dm is restricted to D0-D15. Dm is encoded in "Vm", and x is encoded in "M".
- <Dm> Is the 64-bit name of the second SIMD&FP source register, encoded in the "M:Vm" field.

Operation for all encodings

```
if ConditionPassed() then
  EncodingSpecificOperations(); CheckAdvSIMDEnabled();
  if scalar_form then op2 = SInt(Elem[Din[m],index,esize]);
  for e = 0 to elements-1
    if !scalar_form then op2 = SInt(Elem[Din[m],e,esize]);
    op1 = SInt(Elem[Din[n],e,esize]);
    // The following only saturates if both op1 and op2 equal -(2^(esize-1))
    (product, sat) = SignedSatQ(2*op1*op2, 2*esize);
    Elem[Q[d>>1],e,2*esize] = product;
    if sat then FPSCR.QC = '1';
```

F6.1.161 VQMOVN, VQMOVUN

Vector Saturating Move and Narrow copies each element of the operand vector to the corresponding element of the destination vector.

The operand is a quadword vector. The elements can be any one of:

- 16-bit, 32-bit, or 64-bit signed integers.
- 16-bit, 32-bit, or 64-bit unsigned integers.

The result is a doubleword vector. The elements are half the length of the operand vector elements. If the operand is unsigned, the results are unsigned. If the operand is signed, the results can be signed or unsigned.

If any of the results overflow, they are saturated. The cumulative saturation bit, `FPSCR.QC`, is set if saturation occurs. For details see [Pseudocode description of saturation on page E1-2731](#).

Depending on settings in the `CPACR`, `NSACR`, and `HCPTR` registers, and the security state and mode in which the instruction is executed, an attempt to execute the instruction might be UNDEFINED, or trapped to Hyp mode. For more information see [Enabling Advanced SIMD and floating-point support on page G1-4413](#).

This instruction is used by the pseudo-instructions `VQRSHRN (zero)`, `VQRSHRUN (zero)`, `VQSHRN (zero)`, and `VQSHRUN (zero)`. The pseudo-instruction is never the preferred disassembly.

A1

31	30	29	28	27	26	25	24	23	22	21	20	19	18	17	16	15	12	11	10	9	8	7	6	5	4	3	0
1	1	1	1	0	0	1	1	1	D	1	1	size	1	0	Vd	0	0	1	0	op	M	0	Vm				

Signed result variant

Applies when `op == 1x`.

`VQMOVN{<c>}{<q>}.<dt> <Dd>, <Qm>`

Unsigned result variant

Applies when `op == 01`.

`VQMOVUN{<c>}{<q>}.<dt> <Dd>, <Qm>`

Decode for all variants of this encoding

```
if op == '00' then SEE VMOVN;
if size == '11' || Vm<0> == '1' then UNDEFINED;
src_unsigned = (op == '11'); dest_unsigned = (op<0> == '1');
esize = 8 << UInt(size); elements = 64 DIV esize;
d = UInt(D:Vd); m = UInt(M:Vm);
```

T1

15	14	13	12	11	10	9	8	7	6	5	4	3	2	1	0	15	12	11	10	9	8	7	6	5	4	3	0
1	1	1	1	1	1	1	1	1	D	1	1	size	1	0	Vd	0	0	1	0	op	M	0	Vm				

Signed result variant

Applies when `op == 1x`.

`VQMOVN{<c>}{<q>}.<dt> <Dd>, <Qm>`

Unsigned result variant

Applies when `op == 01`.

`VQMOVUN{<c>}{<q>}.<dt> <Dd>, <Qm>`

Decode for all variants of this encoding

```
if op == '00' then SEE VMOVN;
if size == '11' || Vm<0> == '1' then UNDEFINED;
src_unsigned = (op == '11'); dest_unsigned = (op<0> == '1');
esize = 8 << UInt(size); elements = 64 DIV esize;
d = UInt(D:Vd); m = UInt(M:Vm);
```

Assembler symbols

<c> For encoding A1: see [Standard assembler syntax fields on page F2-2848](#). This encoding must be unconditional.

For encoding T1: see [Standard assembler syntax fields on page F2-2848](#).

<q> See [Standard assembler syntax fields on page F2-2848](#).

<dt> For the signed result variant: is the data type for the elements of the operand, encoded in the "op<0>:size" field. It can have the following values:

S16	when op<0> = 0, size = 00
S32	when op<0> = 0, size = 01
S64	when op<0> = 0, size = 10
U16	when op<0> = 1, size = 00
U32	when op<0> = 1, size = 01
U64	when op<0> = 1, size = 10

The following encodings are reserved:

- op<0> = 0, size = 11.
- op<0> = 1, size = 11.

For the unsigned result variant: is the data type for the elements of the operand, encoded in the "size" field. It can have the following values:

S16	when size = 00
S32	when size = 01
S64	when size = 10

The encoding size = 11 is reserved.

<Dd> Is the 64-bit name of the SIMD&FP destination register, encoded in the "D:Vd" field.

<Qm> Is the 128-bit name of the SIMD&FP source register, encoded in the "M:Vm" field as <Qm>*2.

Operation for all encodings

```
if ConditionPassed() then
  EncodingSpecificOperations(); CheckAdvSIMDEnabled();
  for e = 0 to elements-1
    operand = Int(Elem[Qin[m>>1],e,2*esize], src_unsigned);
    (Elem[D[d],e,esize], sat) = SatQ(operand, esize, dest_unsigned);
    if sat then FPSCR.QC = '1';
```

F6.1.162 VQNEG

Vector Saturating Negate negates each element in a vector, and places the results in the destination vector.

If any of the results overflow, they are saturated. The cumulative saturation bit, `FPSCR.QC`, is set if saturation occurs. For details see [Pseudocode description of saturation on page E1-2731](#).

Depending on settings in the `CPACR`, `NSACR`, and `HCPTR` registers, and the security state and mode in which the instruction is executed, an attempt to execute the instruction might be UNDEFINED, or trapped to Hyp mode. For more information see [Enabling Advanced SIMD and floating-point support on page G1-4413](#).

A1

31	30	29	28	27	26	25	24	23	22	21	20	19	18	17	16	15	12	11	10	9	8	7	6	5	4	3	0
1	1	1	1	0	0	1	1	1	D	1	1	size	0	0	Vd	0	1	1	1	1	Q	M	0	Vm			

64-bit SIMD vector variant

Applies when `Q == 0`.

`VQNEG{<c>}{<q>}.<dt> <Dd>, <Dm>`

128-bit SIMD vector variant

Applies when `Q == 1`.

`VQNEG{<c>}{<q>}.<dt> <Qd>, <Qm>`

Decode for all variants of this encoding

```
if size == '11' then UNDEFINED;
if Q == '1' && (Vd<0> == '1' || Vm<0> == '1') then UNDEFINED;
esize = 8 << UInt(size); elements = 64 DIV esize;
d = UInt(D:Vd); m = UInt(M:Vm); regs = if Q == '0' then 1 else 2;
```

T1

15	14	13	12	11	10	9	8	7	6	5	4	3	2	1	0	15	12	11	10	9	8	7	6	5	4	3	0
1	1	1	1	1	1	1	1	1	D	1	1	size	0	0	Vd	0	1	1	1	1	Q	M	0	Vm			

64-bit SIMD vector variant

Applies when `Q == 0`.

`VQNEG{<c>}{<q>}.<dt> <Dd>, <Dm>`

128-bit SIMD vector variant

Applies when `Q == 1`.

`VQNEG{<c>}{<q>}.<dt> <Qd>, <Qm>`

Decode for all variants of this encoding

```
if size == '11' then UNDEFINED;
if Q == '1' && (Vd<0> == '1' || Vm<0> == '1') then UNDEFINED;
esize = 8 << UInt(size); elements = 64 DIV esize;
d = UInt(D:Vd); m = UInt(M:Vm); regs = if Q == '0' then 1 else 2;
```

Assembler symbols

- <c> For encoding A1: see *Standard assembler syntax fields* on page F2-2848. This encoding must be unconditional.
For encoding T1: see *Standard assembler syntax fields* on page F2-2848.
- <q> See *Standard assembler syntax fields* on page F2-2848.
- <dt> Is the data type for the elements of the vectors, encoded in the "size" field. It can have the following values:
S8 when size = 00
S16 when size = 01
S32 when size = 10
The encoding size = 11 is reserved.
- <Qd> Is the 128-bit name of the SIMD&FP destination register, encoded in the "D:Vd" field as <Qd>*2.
- <Qm> Is the 128-bit name of the SIMD&FP source register, encoded in the "M:Vm" field as <Qm>*2.
- <Dd> Is the 64-bit name of the SIMD&FP destination register, encoded in the "D:Vd" field.
- <Dm> Is the 64-bit name of the SIMD&FP source register, encoded in the "M:Vm" field.

Operation for all encodings

```
if ConditionPassed() then
    EncodingSpecificOperations(); CheckAdvSIMDEnabled();
    for r = 0 to regs-1
        for e = 0 to elements-1
            result = -SInt(Elem[D[m+r],e,esize]);
            (Elem[D[d+r],e,esize], sat) = SignedSatQ(result, esize);
            if sat then FPSCR.QC = '1';
```

F6.1.163 VQRDMLAH

Vector Saturating Rounding Doubling Multiply Accumulate Returning High Half. This instruction multiplies the vector elements of the first source SIMD&FP register with either the corresponding vector elements of the second source SIMD&FP register or the value of a vector element of the second source SIMD&FP register, without saturating the multiply results, doubles the results, and accumulates the most significant half of the final results with the vector elements of the destination SIMD&FP register. The results are rounded.

If any of the results overflow, they are saturated. The cumulative saturation bit, `FPSCR.QC`, is set if saturation occurs. For details see [Pseudocode description of saturation on page E1-2731](#).

Depending on settings in the `CPACR`, `NSACR`, and `HCPTR` registers, and the security state and mode in which the instruction is executed, an attempt to execute the instruction might be `UNDEFINED`, or trapped to Hyp mode. For more information see [Enabling Advanced SIMD and floating-point support on page G1-4413](#).

A1

ARMv8.1

31	30	29	28	27	26	25	24	23	22	21	20	19	16	15	12	11	10	9	8	7	6	5	4	3	0
1	1	1	1	0	0	1	1	0	D	size	Vn	Vd	1	0	1	1	N	Q	M	1	Vm				

64-bit SIMD vector variant

Applies when `Q == 0`.

`VQRDMLAH{<q>}.<dt> <Dd>, <Dn>, <Dm>`

128-bit SIMD vector variant

Applies when `Q == 1`.

`VQRDMLAH{<q>}.<dt> <Qd>, <Qn>, <Qm>`

Decode for all variants of this encoding

```
if !HaveQRDMLAHExt() then UNDEFINED;
if Q == '1' && (Vd<0> == '1' || Vn<0> == '1' || Vm<0> == '1') then UNDEFINED;
if size == '00' || size == '11' then UNDEFINED;
add = TRUE; scalar_form = FALSE; esize = 8 << UInt(size); elements = 64 DIV esize;
d = UInt(D:Vd); n = UInt(N:Vn); m = UInt(M:Vm); regs = if Q == '0' then 1 else 2;
```

A2

ARMv8.1

31	30	29	28	27	26	25	24	23	22	21	20	19	16	15	12	11	10	9	8	7	6	5	4	3	0
1	1	1	1	0	0	1	Q	1	D	!=11	Vn	Vd	1	1	1	0	N	1	M	0	Vm				

size

64-bit SIMD vector variant

Applies when `Q == 0`.

`VQRDMLAH{<q>}.<dt> <Dd>, <Dn>, <Dm[x]>`

128-bit SIMD vector variant

Applies when `Q == 1`.

`VQRDMLAH{<q>}.<dt> <Qd>, <Qn>, <Dm[x]>`

Decode for all variants of this encoding

```

if !HaveQRDMLAExt() then UNDEFINED;
if size == '11' then SEE "Related encodings";
if size == '00' then UNDEFINED;
if Q == '1' && (Vd<0> == '1' || Vn<0> == '1') then UNDEFINED;
add = TRUE; scalar_form = TRUE; d = UInt(D:Vd); n = UInt(N:Vn); regs = if Q == '0' then 1 else 2;
if size == '01' then esize = 16; elements = 4; m = UInt(Vm<2:0>); index = UInt(M:Vm<3>);
if size == '10' then esize = 32; elements = 2; m = UInt(Vm); index = UInt(M);
    
```

T1

ARMv8.1

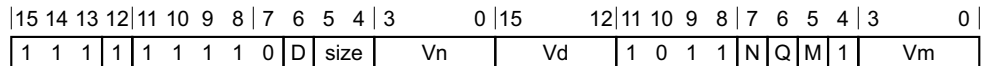

64-bit SIMD vector variant

Applies when Q == 0.

VQRDMLAH{<q>}.<dt> <Dd>, <Dn>, <Dm>

128-bit SIMD vector variant

Applies when Q == 1.

VQRDMLAH{<q>}.<dt> <Qd>, <Qn>, <Qm>

Decode for all variants of this encoding

```

if !HaveQRDMLAExt() then UNDEFINED;
if InITBlock() then UNPREDICTABLE;
if Q == '1' && (Vd<0> == '1' || Vn<0> == '1' || Vm<0> == '1') then UNDEFINED;
if size == '00' || size == '11' then UNDEFINED;
add = TRUE; scalar_form = FALSE; esize = 8 << UInt(size); elements = 64 DIV esize;
d = UInt(D:Vd); n = UInt(N:Vn); m = UInt(M:Vm); regs = if Q == '0' then 1 else 2;
    
```

CONSTRAINED UNPREDICTABLE behavior

If InITBlock(), then one of the following behaviors must occur:

- The instruction is UNDEFINED.
- The instruction executes as if it passes the Condition code check.
- The instruction executes as NOP. This means it behaves as if it fails the Condition code check.

T2

ARMv8.1

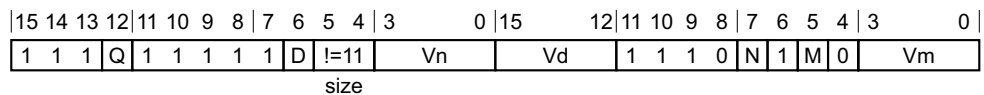

64-bit SIMD vector variant

Applies when Q == 0.

VQRDMLAH{<q>}.<dt> <Dd>, <Dn>, <Dm[x]>

128-bit SIMD vector variant

Applies when Q == 1.

VQRDMLAH{<q>}.<dt> <Qd>, <Qn>, <Dm[x]>

Decode for all variants of this encoding

```

if !HaveQRDMLAExt() then UNDEFINED;
if InITBlock() then UNPREDICTABLE;
if size == '11' then SEE "Related encodings";
if size == '00' then UNDEFINED;
if Q == '1' && (Vd<0> == '1' || Vn<0> == '1') then UNDEFINED;
add = TRUE; scalar_form = TRUE; d = UInt(D:Vd); n = UInt(N:Vn); regs = if Q == '0' then 1 else 2;
if size == '01' then esize = 16; elements = 4; m = UInt(Vm<2:0>); index = UInt(M:Vm<3>);
if size == '10' then esize = 32; elements = 2; m = UInt(Vm); index = UInt(M);
  
```

CONSTRAINED UNPREDICTABLE behavior

If InITBlock(), then one of the following behaviors must occur:

- The instruction is UNDEFINED.
- The instruction executes as if it passes the Condition code check.
- The instruction executes as NOP. This means it behaves as if it fails the Condition code check.

Notes for all encodings

Related encodings: See [Advanced SIMD data-processing on page F3-2904](#) for the T32 instruction set, or [Advanced SIMD data-processing on page F4-2985](#) for the A32 instruction set.

Assembler symbols

<q>	See Standard assembler syntax fields on page F2-2848 .
<dt>	Is the data type for the elements of the operands, encoded in the "size" field. It can have the following values: S16 when size = 01 S32 when size = 10
<Qd>	Is the 128-bit name of the SIMD&FP register holding the accumulate vector, encoded in the "D:Vd" field as <Qd>*2.
<Qn>	Is the 128-bit name of the first SIMD&FP source register, encoded in the "N:Vn" field as <Qn>*2.
<Qm>	Is the 128-bit name of the second SIMD&FP source register, encoded in the "M:Vm" field as <Qm>*2.
<Dd>	Is the 64-bit name of the SIMD&FP register holding the accumulate vector, encoded in the "D:Vd" field.
<Dn>	Is the 64-bit name of the first SIMD&FP source register, encoded in the "N:Vn" field.
<Dm[x]>	Is the 64-bit name of the second SIMD&FP source register holding the scalar. If <dt> is S16, Dm is restricted to D0-D7. Dm is encoded in "Vm<2:0>", and x is encoded in "M:Vm<3>". If <dt> is S32, Dm is restricted to D0-D15. Dm is encoded in "Vm", and x is encoded in "M".
<Dm>	Is the 64-bit name of the second SIMD&FP source register, encoded in the "M:Vm" field.

Operation for all encodings

```
EncodingSpecificOperations(); CheckAdvSIMDEnabled();
round_const = 1 << (esize-1);
if scalar_form then op2 = SInt(Elem[D[m],index,esize]);
for r = 0 to regs-1
  for e = 0 to elements-1
    op1 = SInt(Elem[D[n+r],e,esize]);
    op3 = SInt(Elem[D[d+r],e,esize]) << esize;
    if !scalar_form then op2 = SInt(Elem[D[m+r],e,esize]);
    (result, sat) = SignedSatQ((op3 + 2*(op1*op2) + round_const) >> esize, esize);
    Elem[D[d+r],e,esize] = result;
    if sat then FPSCR.QC = '1';
```

F6.1.164 VQRDMLSH

Vector Saturating Rounding Doubling Multiply Subtract Returning High Half. This instruction multiplies the vector elements of the first source SIMD&FP register with either the corresponding vector elements of the second source SIMD&FP register or the value of a vector element of the second source SIMD&FP register, without saturating the multiply results, doubles the results, and subtracts the most significant half of the final results from the vector elements of the destination SIMD&FP register. The results are rounded.

If any of the results overflow, they are saturated. The cumulative saturation bit, `FPSCR.QC`, is set if saturation occurs. For details see [Pseudocode description of saturation on page E1-2731](#).

Depending on settings in the `CPACR`, `NSACR`, and `HCPTR` registers, and the security state and mode in which the instruction is executed, an attempt to execute the instruction might be `UNDEFINED`, or trapped to Hyp mode. For more information see [Enabling Advanced SIMD and floating-point support on page G1-4413](#).

A1

ARMv8.1

31	30	29	28	27	26	25	24	23	22	21	20	19	16	15	12	11	10	9	8	7	6	5	4	3	0
1	1	1	1	0	0	1	1	0	D	size	Vn	Vd	1	1	0	0	N	Q	M	1	Vm				

64-bit SIMD vector variant

Applies when `Q == 0`.

`VQRDMLSH{<q>}.<dt> <Dd>, <Dn>, <Dm>`

128-bit SIMD vector variant

Applies when `Q == 1`.

`VQRDMLSH{<q>}.<dt> <Qd>, <Qn>, <Qm>`

Decode for all variants of this encoding

```

if !HaveQRDMLAHExt() then UNDEFINED;
if Q == '1' && (Vd<0> == '1' || Vn<0> == '1' || Vm<0> == '1') then UNDEFINED;
if size == '00' || size == '11' then UNDEFINED;
add = FALSE; scalar_form = FALSE; esize = 8 << UInt(size); elements = 64 DIV esize;
d = UInt(D:Vd); n = UInt(N:Vn); m = UInt(M:Vm); regs = if Q == '0' then 1 else 2;
    
```

A2

ARMv8.1

31	30	29	28	27	26	25	24	23	22	21	20	19	16	15	12	11	10	9	8	7	6	5	4	3	0
1	1	1	1	0	0	1	Q	1	D	!=11	Vn	Vd	1	1	1	1	N	1	M	0	Vm				

size

64-bit SIMD vector variant

Applies when `Q == 0`.

`VQRDMLSH{<q>}.<dt> <Dd>, <Dn>, <Dm[x]>`

128-bit SIMD vector variant

Applies when `Q == 1`.

`VQRDMLSH{<q>}.<dt> <Qd>, <Qn>, <Dm[x]>`

Decode for all variants of this encoding

```

if !HaveQRDMLAExt() then UNDEFINED;
if size == '11' then SEE "Related encodings";
if size == '00' then UNDEFINED;
if Q == '1' && (Vd<0> == '1' || Vn<0> == '1') then UNDEFINED;
add = FALSE; scalar_form = TRUE; d = UInt(D:Vd); n = UInt(N:Vn); regs = if Q == '0' then 1 else 2;
if size == '01' then esize = 16; elements = 4; m = UInt(Vm<2:0>); index = UInt(M:Vm<3>);
if size == '10' then esize = 32; elements = 2; m = UInt(Vm); index = UInt(M);
    
```

T1

ARMv8.1

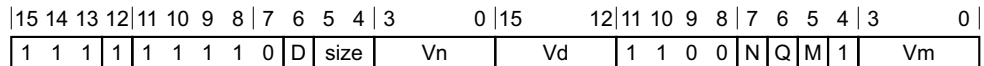

64-bit SIMD vector variant

Applies when Q == 0.

VQRDMLSH{<q>}.<dt> <Dd>, <Dn>, <Dm>

128-bit SIMD vector variant

Applies when Q == 1.

VQRDMLSH{<q>}.<dt> <Qd>, <Qn>, <Qm>

Decode for all variants of this encoding

```

if !HaveQRDMLAExt() then UNDEFINED;
if InITBlock() then UNPREDICTABLE;
if Q == '1' && (Vd<0> == '1' || Vn<0> == '1' || Vm<0> == '1') then UNDEFINED;
if size == '00' || size == '11' then UNDEFINED;
add = FALSE; scalar_form = FALSE; esize = 8 << UInt(size); elements = 64 DIV esize;
d = UInt(D:Vd); n = UInt(N:Vn); m = UInt(M:Vm); regs = if Q == '0' then 1 else 2;
    
```

CONSTRAINED UNPREDICTABLE behavior

If InITBlock(), then one of the following behaviors must occur:

- The instruction is UNDEFINED.
- The instruction executes as if it passes the Condition code check.
- The instruction executes as NOP. This means it behaves as if it fails the Condition code check.

T2

ARMv8.1

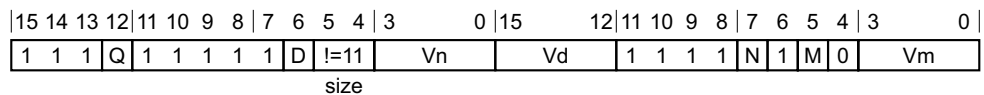

64-bit SIMD vector variant

Applies when Q == 0.

VQRDMLSH{<q>}.<dt> <Dd>, <Dn>, <Dm[x]>

128-bit SIMD vector variant

Applies when Q == 1.

VQRDMLSH{<q>}.<dt> <Qd>, <Qn>, <Dm[x]>

Decode for all variants of this encoding

```

if !HaveQRDMLAExt() then UNDEFINED;
if InITBlock() then UNPREDICTABLE;
if size == '11' then SEE "Related encodings";
if size == '00' then UNDEFINED;
if Q == '1' && (Vd<0> == '1' || Vn<0> == '1') then UNDEFINED;
add = FALSE; scalar_form = TRUE; d = UInt(D:Vd); n = UInt(N:Vn); regs = if Q == '0' then 1 else 2;
if size == '01' then esize = 16; elements = 4; m = UInt(Vm<2:0>); index = UInt(M:Vm<3>);
if size == '10' then esize = 32; elements = 2; m = UInt(Vm); index = UInt(M);
  
```

CONSTRAINED UNPREDICTABLE behavior

If InITBlock(), then one of the following behaviors must occur:

- The instruction is UNDEFINED.
- The instruction executes as if it passes the Condition code check.
- The instruction executes as NOP. This means it behaves as if it fails the Condition code check.

Notes for all encodings

Related encodings: See [Advanced SIMD data-processing on page F3-2904](#) for the T32 instruction set, or [Advanced SIMD data-processing on page F4-2985](#) for the A32 instruction set.

Assembler symbols

<q>	See Standard assembler syntax fields on page F2-2848 .
<dt>	Is the data type for the elements of the operands, encoded in the "size" field. It can have the following values: S16 when size = 01 S32 when size = 10
<Qd>	Is the 128-bit name of the SIMD&FP register holding the accumulate vector, encoded in the "D:Vd" field as <Qd>*2.
<Qn>	Is the 128-bit name of the first SIMD&FP source register, encoded in the "N:Vn" field as <Qn>*2.
<Qm>	Is the 128-bit name of the second SIMD&FP source register, encoded in the "M:Vm" field as <Qm>*2.
<Dd>	Is the 64-bit name of the SIMD&FP register holding the accumulate vector, encoded in the "D:Vd" field.
<Dn>	Is the 64-bit name of the first SIMD&FP source register, encoded in the "N:Vn" field.
<Dm[x]>	Is the 64-bit name of the second SIMD&FP source register holding the scalar. If <dt> is S16, Dm is restricted to D0-D7. Dm is encoded in "Vm<2:0>", and x is encoded in "M:Vm<3>". If <dt> is S32, Dm is restricted to D0-D15. Dm is encoded in "Vm", and x is encoded in "M".
<Dm>	Is the 64-bit name of the second SIMD&FP source register, encoded in the "M:Vm" field.

Operation for all encodings

```
EncodingSpecificOperations(); CheckAdvSIMDEnabled();
round_const = 1 << (esize-1);
if scalar_form then op2 = SInt(Elem[D[m],index,esize]);
for r = 0 to regs-1
  for e = 0 to elements-1
    op1 = SInt(Elem[D[n+r],e,esize]);
    op3 = SInt(Elem[D[d+r],e,esize]) << esize;
    if !scalar_form then op2 = SInt(Elem[D[m+r],e,esize]);
    (result, sat) = SignedSatQ((op3 - 2*(op1*op2) + round_const) >> esize, esize);
    Elem[D[d+r],e,esize] = result;
    if sat then FPSCR.QC = '1';
```

F6.1.165 VQRDMULH

Vector Saturating Rounding Doubling Multiply Returning High Half multiplies corresponding elements in two vectors, doubles the results, and places the most significant half of the final results in the destination vector. The results are rounded. For truncated results see [VQDMULH](#).

The second operand can be a scalar instead of a vector. For more information about scalars see [Advanced SIMD scalars on page F2-2874](#).

If any of the results overflow, they are saturated. The cumulative saturation bit, `FPSCR.QC`, is set if saturation occurs. For details see [Pseudocode description of saturation on page E1-2731](#).

Depending on settings in the `CPACR`, `NSACR`, and `HCPTR` registers, and the security state and mode in which the instruction is executed, an attempt to execute the instruction might be `UNDEFINED`, or trapped to Hyp mode. For more information see [Enabling Advanced SIMD and floating-point support on page G1-4413](#).

A1

31	30	29	28	27	26	25	24	23	22	21	20	19	16	15	12	11	10	9	8	7	6	5	4	3	0
1	1	1	1	0	0	1	1	0	D	size	Vn	Vd	1	0	1	1	N	Q	M	0	Vm				

64-bit SIMD vector variant

Applies when `Q == 0`.

`VQRDMULH{<c>}{<q>}.<dt> {<Dd>, }<Dn>, <Dm>`

128-bit SIMD vector variant

Applies when `Q == 1`.

`VQRDMULH{<c>}{<q>}.<dt> {<Qd>, }<Qn>, <Qm>`

Decode for all variants of this encoding

```

if Q == '1' && (Vd<0> == '1' || Vn<0> == '1' || Vm<0> == '1') then UNDEFINED;
if size == '00' || size == '11' then UNDEFINED;
scalar_form = FALSE; esize = 8 << UInt(size); elements = 64 DIV esize;
d = UInt(D:Vd); n = UInt(N:Vn); m = UInt(M:Vm); regs = if Q == '0' then 1 else 2;
    
```

A2

31	30	29	28	27	26	25	24	23	22	21	20	19	16	15	12	11	10	9	8	7	6	5	4	3	0
1	1	1	1	0	0	1	Q	1	D	!=11	Vn	Vd	1	1	0	1	N	1	M	0	Vm				

size

64-bit SIMD vector variant

Applies when `Q == 0`.

`VQRDMULH{<c>}{<q>}.<dt> {<Dd>, }<Dn>, <Dm[x]>`

128-bit SIMD vector variant

Applies when `Q == 1`.

`VQRDMULH{<c>}{<q>}.<dt> {<Qd>, }<Qn>, <Dm[x]>`

Decode for all variants of this encoding

```

if size == '11' then SEE "Related encodings";
if size == '00' then UNDEFINED;
if Q == '1' && (Vd<0> == '1' || Vn<0> == '1') then UNDEFINED;
scalar_form = TRUE; d = UInt(D:Vd); n = UInt(N:Vn); regs = if Q == '0' then 1 else 2;
if size == '01' then esize = 16; elements = 4; m = UInt(Vm<2:0>); index = UInt(M:Vm<3>);
if size == '10' then esize = 32; elements = 2; m = UInt(Vm); index = UInt(M);

```

T1

15	14	13	12	11	10	9	8	7	6	5	4	3	0	15	12	11	10	9	8	7	6	5	4	3	0
1	1	1	1	1	1	1	0	D	size	Vn	Vd	1	0	1	1	N	Q	M	0	Vm					

64-bit SIMD vector variant

Applies when Q == 0.

VQRDMULH{<c>}{<q>}.<dt> {<Dd>, }<Dn>, <Dm>

128-bit SIMD vector variant

Applies when Q == 1.

VQRDMULH{<c>}{<q>}.<dt> {<Qd>, }<Qn>, <Qm>

Decode for all variants of this encoding

```

if Q == '1' && (Vd<0> == '1' || Vn<0> == '1' || Vm<0> == '1') then UNDEFINED;
if size == '00' || size == '11' then UNDEFINED;
scalar_form = FALSE; esize = 8 << UInt(size); elements = 64 DIV esize;
d = UInt(D:Vd); n = UInt(N:Vn); m = UInt(M:Vm); regs = if Q == '0' then 1 else 2;

```

T2

15	14	13	12	11	10	9	8	7	6	5	4	3	0	15	12	11	10	9	8	7	6	5	4	3	0
1	1	1	Q	1	1	1	1	D	!=11	Vn	Vd	1	1	0	1	N	1	M	0	Vm					

size

64-bit SIMD vector variant

Applies when Q == 0.

VQRDMULH{<c>}{<q>}.<dt> {<Dd>, }<Dn>, <Dm[x]>

128-bit SIMD vector variant

Applies when Q == 1.

VQRDMULH{<c>}{<q>}.<dt> {<Qd>, }<Qn>, <Dm[x]>

Decode for all variants of this encoding

```

if size == '11' then SEE "Related encodings";
if size == '00' then UNDEFINED;
if Q == '1' && (Vd<0> == '1' || Vn<0> == '1') then UNDEFINED;
scalar_form = TRUE; d = UInt(D:Vd); n = UInt(N:Vn); regs = if Q == '0' then 1 else 2;
if size == '01' then esize = 16; elements = 4; m = UInt(Vm<2:0>); index = UInt(M:Vm<3>);
if size == '10' then esize = 32; elements = 2; m = UInt(Vm); index = UInt(M);

```

Notes for all encodings

Related encodings: See *Advanced SIMD data-processing* on page F3-2904 for the T32 instruction set, or *Advanced SIMD data-processing* on page F4-2985 for the A32 instruction set.

Assembler symbols

- <c> For encoding A1 and A2: see *Standard assembler syntax fields* on page F2-2848. This encoding must be unconditional.
 For encoding T1 and T2: see *Standard assembler syntax fields* on page F2-2848.
- <q> See *Standard assembler syntax fields* on page F2-2848.
- <dt> Is the data type for the elements of the operands, encoded in the "size" field. It can have the following values:
 S16 when size = 01
 S32 when size = 10
- <Qd> Is the 128-bit name of the SIMD&FP destination register, encoded in the "D:Vd" field as <Qd>*2.
- <Qn> Is the 128-bit name of the first SIMD&FP source register, encoded in the "N:Vn" field as <Qn>*2.
- <Qm> Is the 128-bit name of the second SIMD&FP source register, encoded in the "M:Vm" field as <Qm>*2.
- <Dd> Is the 64-bit name of the SIMD&FP destination register, encoded in the "D:Vd" field.
- <Dn> Is the 64-bit name of the first SIMD&FP source register, encoded in the "N:Vn" field.
- <Dm[x]> Is the 64-bit name of the second SIMD&FP source register holding the scalar. If <dt> is S16, Dm is restricted to D0-D7. Dm is encoded in "Vm<2:0>", and x is encoded in "M:Vm<3>". If <dt> is S32, Dm is restricted to D0-D15. Dm is encoded in "Vm", and x is encoded in "M".
- <Qm> Is the 64-bit name of the second SIMD&FP source register, encoded in the "M:Vm" field.

Operation for all encodings

```

if ConditionPassed() then
    EncodingSpecificOperations(); CheckAdvSIMDEnabled();
    round_const = 1 << (esize-1);
    if scalar_form then op2 = SInt(Elem[D[m],index,esize]);
    for r = 0 to regs-1
        for e = 0 to elements-1
            op1 = SInt(Elem[D[n+r],e,esize]);
            if !scalar_form then op2 = SInt(Elem[D[m+r],e,esize]);
            (result, sat) = SignedSatQ((2*op1*op2 + round_const) >> esize, esize);
            Elem[D[d+r],e,esize] = result;
            if sat then FPSCR.QC = '1';
  
```

F6.1.166 VQRSHL

Vector Saturating Rounding Shift Left takes each element in a vector, shifts them by a value from the least significant byte of the corresponding element of a second vector, and places the results in the destination vector. If the shift value is positive, the operation is a left shift. Otherwise, it is a right shift.

For truncated results see [VQSHL \(register\)](#).

The first operand and result elements are the same data type, and can be any one of:

- 8-bit, 16-bit, 32-bit, or 64-bit signed integers.
- 8-bit, 16-bit, 32-bit, or 64-bit unsigned integers.

The second operand is a signed integer of the same size.

If any of the results overflow, they are saturated. The cumulative saturation bit, [FPSCR.QC](#), is set if saturation occurs. For details see [Pseudocode description of saturation on page E1-2731](#).

Depending on settings in the [CPACR](#), [NSACR](#), and [HCPTR](#) registers, and the security state and mode in which the instruction is executed, an attempt to execute the instruction might be UNDEFINED, or trapped to Hyp mode. For more information see [Enabling Advanced SIMD and floating-point support on page G1-4413](#).

A1

31	30	29	28	27	26	25	24	23	22	21	20	19	16	15	12	11	10	9	8	7	6	5	4	3	0
1	1	1	1	0	0	1	U	0	D	size	Vn	Vd	0	1	0	1	N	Q	M	1	Vm				

64-bit SIMD vector variant

Applies when Q == 0.

VQRSHL{<c>}{<q>}.<dt> {<Dd>}, <Dm>, <Dn>

128-bit SIMD vector variant

Applies when Q == 1.

VQRSHL{<c>}{<q>}.<dt> {<Qd>}, <Qm>, <Qn>

Decode for all variants of this encoding

```
if Q == '1' && (Vd<0> == '1' || Vm<0> == '1' || Vn<0> == '1') then UNDEFINED;
unsigned = (U == '1');
esize = 8 << UInt(size); elements = 64 DIV esize;
d = UInt(D:Vd); m = UInt(M:Vm); n = UInt(N:Vn); regs = if Q == '0' then 1 else 2;
```

T1

15	14	13	12	11	10	9	8	7	6	5	4	3	0	15	12	11	10	9	8	7	6	5	4	3	0
1	1	1	U	1	1	1	1	0	D	size	Vn	Vd	0	1	0	1	N	Q	M	1	Vm				

64-bit SIMD vector variant

Applies when Q == 0.

VQRSHL{<c>}{<q>}.<dt> {<Dd>}, <Dm>, <Dn>

128-bit SIMD vector variant

Applies when Q == 1.

VQRSHL{<c>}{<q>}.<dt> {<Qd>}, <Qm>, <Qn>

Decode for all variants of this encoding

```
if Q == '1' && (Vd<0> == '1' || Vm<0> == '1' || Vn<0> == '1') then UNDEFINED;
unsigned = (U == '1');
esize = 8 << UInt(size); elements = 64 DIV esize;
d = UInt(D:Vd); m = UInt(M:Vm); n = UInt(N:Vn); regs = if Q == '0' then 1 else 2;
```

Assembler symbols

- <c> For encoding A1: see [Standard assembler syntax fields on page F2-2848](#). This encoding must be unconditional.
For encoding T1: see [Standard assembler syntax fields on page F2-2848](#).
- <q> See [Standard assembler syntax fields on page F2-2848](#).
- <dt> Is the data type for the elements of the vectors, encoded in the "U:size" field. It can have the following values:

S8	when U = 0, size = 00
S16	when U = 0, size = 01
S32	when U = 0, size = 10
S64	when U = 0, size = 11
U8	when U = 1, size = 00
U16	when U = 1, size = 01
U32	when U = 1, size = 10
U64	when U = 1, size = 11
- <Qd> Is the 128-bit name of the SIMD&FP destination register, encoded in the "D:Vd" field as <Qd>*2.
- <Qm> Is the 128-bit name of the second SIMD&FP source register, encoded in the "M:Vm" field as <Qm>*2.
- <Qn> Is the 128-bit name of the first SIMD&FP source register, encoded in the "N:Vn" field as <Qn>*2.
- <Dd> Is the 64-bit name of the SIMD&FP destination register, encoded in the "D:Vd" field.
- <Dm> Is the 64-bit name of the second SIMD&FP source register, encoded in the "M:Vm" field.
- <Dn> Is the 64-bit name of the first SIMD&FP source register, encoded in the "N:Vn" field.

Operation for all encodings

```
if ConditionPassed() then
  EncodingSpecificOperations(); CheckAdvSIMDEnabled();
  for r = 0 to regs-1
    for e = 0 to elements-1
      shift = SInt(Elem[D[n+r],e,esize]<7:0>);
      round_const = 1 << (-1-shift); // 0 for left shift, 2^(n-1) for right shift
      operand = Int(Elem[D[m+r],e,esize], unsigned);
      (result, sat) = SatQ((operand + round_const) << shift, esize, unsigned);
      Elem[D[d+r],e,esize] = result;
      if sat then FPSCR.QC = '1';
```

F6.1.167 VQRSHRN (zero)

Vector Saturating Rounding Shift Right, Narrow takes each element in a quadword vector of integers, right shifts them by an immediate value, and places the signed rounded results in a doubleword vector

This instruction is a pseudo-instruction of the [VQMOVN](#), [VQMOVUN](#) instruction. This means that:

- The encodings in this description are named to match the encodings of [VQMOVN](#), [VQMOVUN](#).
- The assembler syntax is used only for assembly, and is not used on disassembly.
- The description of [VQMOVN](#), [VQMOVUN](#) gives the operational pseudocode for this instruction.

A1

31	30	29	28	27	26	25	24	23	22	21	20	19	18	17	16	15	12	11	10	9	8	7	6	5	4	3	0
1	1	1	1	0	0	1	1	1	D	1	1	size	1	0	Vd	0	0	1	0	1	x	M	0	Vm			

op

Signed result variant

VQRSHRN{<c>}{<q>}.<dt> <Dd>, <Qm>, #0

is equivalent to

VQMOVN{<c>}{<q>}.<dt> <Dd>, <Qm>

and is never the preferred disassembly.

T1

15	14	13	12	11	10	9	8	7	6	5	4	3	2	1	0	15	12	11	10	9	8	7	6	5	4	3	0
1	1	1	1	1	1	1	1	1	D	1	1	size	1	0	Vd	0	0	1	0	1	x	M	0	Vm			

op

Signed result variant

VQRSHRN{<c>}{<q>}.<dt> <Dd>, <Qm>, #0

is equivalent to

VQMOVN{<c>}{<q>}.<dt> <Dd>, <Qm>

and is never the preferred disassembly.

Assembler symbols

<c> For encoding A1: see [Standard assembler syntax fields on page F2-2848](#). This encoding must be unconditional.

For encoding T1: see [Standard assembler syntax fields on page F2-2848](#).

<q> See [Standard assembler syntax fields on page F2-2848](#).

<dt> Is the data type for the elements of the operand, encoded in the "op<0>:size" field. It can have the following values:

S16	when op<0> = 0, size = 00
S32	when op<0> = 0, size = 01
S64	when op<0> = 0, size = 10
U16	when op<0> = 1, size = 00

U32 when $op<0> = 1$, size = 01

U64 when $op<0> = 1$, size = 10

The following encodings are reserved:

- $op<0> = 0$, size = 11.
- $op<0> = 1$, size = 11.

$<Dd>$ Is the 64-bit name of the SIMD&FP destination register, encoded in the "D:Vd" field.

$<Qm>$ Is the 128-bit name of the SIMD&FP source register, encoded in the "M:Vm" field as $<Qm>*2$.

Operation for all encodings

The description of [VQMOVN](#), [VQMOVUN](#) gives the operational pseudocode for this instruction.

F6.1.168 VQRSHRN, VQRSHRUN

Vector Saturating Rounding Shift Right, Narrow takes each element in a quadword vector of integers, right shifts them by an immediate value, and places the rounded results in a doubleword vector.

For truncated results, see [VQSHL \(register\)](#).

The operand elements must all be the same size, and can be any one of:

- 16-bit, 32-bit, or 64-bit signed integers.
- 16-bit, 32-bit, or 64-bit unsigned integers.

The result elements are half the width of the operand elements. If the operand elements are signed, the results can be either signed or unsigned. If the operand elements are unsigned, the result elements must also be unsigned.

If any of the results overflow, they are saturated. The cumulative saturation bit, [FPSCR.QC](#), is set if saturation occurs. For details see [Pseudocode description of saturation on page E1-2731](#).

Depending on settings in the [CPACR](#), [NSACR](#), and [HCPTR](#) registers, and the security state and mode in which the instruction is executed, an attempt to execute the instruction might be UNDEFINED, or trapped to Hyp mode. For more information see [Enabling Advanced SIMD and floating-point support on page G1-4413](#).

A1

31	30	29	28	27	26	25	24	23	22	21	16	15	12	11	10	9	8	7	6	5	4	3	0
1	1	1	1	0	0	1	U	1	D	imm6		Vd	1	0	0	op	0	1	M	1	Vm		

Signed result variant

Applies when $!(imm6 == 000xxx) \ \&\& \ op == 1$.

VQRSHRN{<c>}{<q>}.<type><size> <Dd>, <Qm>, #<imm>

Unsigned result variant

Applies when $U == 1 \ \&\& \ !(imm6 == 000xxx) \ \&\& \ op == 0$.

VQRSHRUN{<c>}{<q>}.<type><size> <Dd>, <Qm>, #<imm>

Decode for all variants of this encoding

```

if imm6 == '000xxx' then SEE "Related encodings";
if U == '0' && op == '0' then SEE VRSHRN;
if Vm<0> == '1' then UNDEFINED;
case imm6 of
  when '001xxx' esize = 8; elements = 8; shift_amount = 16 - UInt(imm6);
  when '01xxxx' esize = 16; elements = 4; shift_amount = 32 - UInt(imm6);
  when '1xxxxx' esize = 32; elements = 2; shift_amount = 64 - UInt(imm6);
src_unsigned = (U == '1' && op == '1'); dest_unsigned = (U == '1');
d = UInt(D:Vd); m = UInt(M:Vm);
  
```

T1

15	14	13	12	11	10	9	8	7	6	5	0	15	12	11	10	9	8	7	6	5	4	3	0
1	1	1	U	1	1	1	1	1	D	imm6		Vd	1	0	0	op	0	1	M	1	Vm		

Signed result variant

Applies when $!(imm6 == 000xxx) \ \&\& \ op == 1$.

VQRSHRN{<c>}{<q>}.<type><size> <Dd>, <Qm>, #<imm>

Unsigned result variant

Applies when $U == 1 \ \&\& \ !(imm6 == 000xxx) \ \&\& \ op == 0$.

VQRSHRUN{<c>}{<q>}.<type><size> <Dd>, <Qm>, #<imm>

Decode for all variants of this encoding

```

if imm6 == '000xxx' then SEE "Related encodings";
if U == '0' && op == '0' then SEE VRSHRN;
if Vm<0> == '1' then UNDEFINED;
case imm6 of
  when '001xxx' esize = 8; elements = 8; shift_amount = 16 - UInt(imm6);
  when '01xxxx' esize = 16; elements = 4; shift_amount = 32 - UInt(imm6);
  when '1xxxxx' esize = 32; elements = 2; shift_amount = 64 - UInt(imm6);
src_unsigned = (U == '1' && op == '1'); dest_unsigned = (U == '1');
d = UInt(D:Vd); m = UInt(M:Vm);

```

Notes for all encodings

Related encodings: See [Advanced SIMD one register and modified immediate on page F3-2912](#) for the T32 instruction set, or [Advanced SIMD one register and modified immediate on page F4-2994](#) for the A32 instruction set.

Assembler symbols

- <c> For encoding A1: see [Standard assembler syntax fields on page F2-2848](#). This encoding must be unconditional.
 For encoding T1: see [Standard assembler syntax fields on page F2-2848](#).
- <q> See [Standard assembler syntax fields on page F2-2848](#).
- <type> For the signed result variant: is the data type for the elements of the vectors, encoded in the "U" field. It can have the following values:
 S when U = 0
 U when U = 1
 For the unsigned result variant: is the data type for the elements of the vectors, encoded in the "U" field. It can have the following values:
 S when U = 1
- <size> Is the data size for the elements of the vectors, encoded in the "imm6<5:3>" field. It can have the following values:
 16 when imm6<5:3> = 001
 32 when imm6<5:3> = 01x
 64 when imm6<5:3> = 1xx
- <Dd> Is the 64-bit name of the SIMD&FP destination register, encoded in the "D:Vd" field.
- <Qm> Is the 128-bit name of the SIMD&FP source register, encoded in the "M:Vm" field as <Qm>*2.
- <imm> Is an immediate value, in the range 1 to <size>/2, encoded in the "imm6" field as <size>/2 - <imm>.

Operation for all encodings

```

if ConditionPassed() then
  EncodingSpecificOperations(); CheckAdvSIMDEnabled();
  round_const = 1 << (shift_amount - 1);
  for e = 0 to elements-1

```

```
operand = Int(Elem[Qin[m>>1],e,2*esize], src_unsigned);  
(result, sat) = SatQ((operand + round_const) >> shift_amount, esize, dest_unsigned);  
Elem[D[d],e,esize] = result;  
if sat then FPSCR.QC = '1';
```

F6.1.169 VQRSHRUN (zero)

Vector Saturating Rounding Shift Right, Narrow takes each element in a quadword vector of integers, right shifts them by an immediate value, and places the unsigned rounded results in a doubleword vector

This instruction is a pseudo-instruction of the [VQMOVN](#), [VQMOVUN](#) instruction. This means that:

- The encodings in this description are named to match the encodings of [VQMOVN](#), [VQMOVUN](#).
- The assembler syntax is used only for assembly, and is not used on disassembly.
- The description of [VQMOVN](#), [VQMOVUN](#) gives the operational pseudocode for this instruction.

A1

31	30	29	28	27	26	25	24	23	22	21	20	19	18	17	16	15	12	11	10	9	8	7	6	5	4	3	0
1	1	1	1	0	0	1	1	1	D	1	1	size	1	0	Vd	0	0	1	0	0	1	M	0	Vm			

op

Unsigned result variant

VQRSHRUN{<c>}{<q>}.<dt> <Dd>, <Qm>, #0

is equivalent to

VQMOVUN{<c>}{<q>}.<dt> <Dd>, <Qm>

and is never the preferred disassembly.

T1

15	14	13	12	11	10	9	8	7	6	5	4	3	2	1	0	15	12	11	10	9	8	7	6	5	4	3	0
1	1	1	1	1	1	1	1	1	D	1	1	size	1	0	Vd	0	0	1	0	0	1	M	0	Vm			

op

Unsigned result variant

VQRSHRUN{<c>}{<q>}.<dt> <Dd>, <Qm>, #0

is equivalent to

VQMOVUN{<c>}{<q>}.<dt> <Dd>, <Qm>

and is never the preferred disassembly.

Assembler symbols

<c> For encoding A1: see [Standard assembler syntax fields on page F2-2848](#). This encoding must be unconditional.

For encoding T1: see [Standard assembler syntax fields on page F2-2848](#).

<q> See [Standard assembler syntax fields on page F2-2848](#).

<dt> Is the data type for the elements of the operand, encoded in the "size" field. It can have the following values:

S16 when size = 00

S32 when size = 01

S64 when size = 10

The encoding size = 11 is reserved.

- <Dd> Is the 64-bit name of the SIMD&FP destination register, encoded in the "D:Vd" field.
- <Qm> Is the 128-bit name of the SIMD&FP source register, encoded in the "M:Vm" field as <Qm>*2.

Operation for all encodings

The description of [VQMOVN](#), [VQMOVUN](#) gives the operational pseudocode for this instruction.

F6.1.170 VQSHL, VQSHLU (immediate)

Vector Saturating Shift Left (immediate) takes each element in a vector of integers, left shifts them by an immediate value, and places the results in a second vector.

The operand elements must all be the same size, and can be any one of:

- 8-bit, 16-bit, 32-bit, or 64-bit signed integers.
- 8-bit, 16-bit, 32-bit, or 64-bit unsigned integers.

The result elements are the same size as the operand elements. If the operand elements are signed, the results can be either signed or unsigned. If the operand elements are unsigned, the result elements must also be unsigned.

If any of the results overflow, they are saturated. The cumulative saturation bit, `FPSCR.QC`, is set if saturation occurs. For details see [Pseudocode description of saturation on page E1-2731](#).

Depending on settings in the `CPACR`, `NSACR`, and `HCPTR` registers, and the security state and mode in which the instruction is executed, an attempt to execute the instruction might be UNDEFINED, or trapped to Hyp mode. For more information see [Enabling Advanced SIMD and floating-point support on page G1-4413](#).

A1

31	30	29	28	27	26	25	24	23	22	21							16	15					12	11	10	9	8	7	6	5	4	3	0
1	1	1	1	0	0	1	U	1	D	imm6						Vd		0 1 1				op	L	Q	M	1	Vm						

VQSHL, double, signed-result variant

Applies when `!(imm6 == 000xxx && L == 0) && op == 1 && Q == 0`.

`VQSHL{<c>}{<q>}.<type><size> {<Dd>}, <Dm>, #<imm>`

VQSHL, quad, signed-result variant

Applies when `!(imm6 == 000xxx && L == 0) && op == 1 && Q == 1`.

`VQSHL{<c>}{<q>}.<type><size> {<Qd>}, <Qm>, #<imm>`

VQSHLU, double, unsigned-result variant

Applies when `U == 1 && !(imm6 == 000xxx && L == 0) && op == 0 && Q == 0`.

`VQSHLU{<c>}{<q>}.<type><size> {<Dd>}, <Dm>, #<imm>`

VQSHLU, quad, unsigned-result variant

Applies when `U == 1 && !(imm6 == 000xxx && L == 0) && op == 0 && Q == 1`.

`VQSHLU{<c>}{<q>}.<type><size> {<Qd>}, <Qm>, #<imm>`

Decode for all variants of this encoding

```

if (L:imm6) == '0000xxx' then SEE "Related encodings";
if U == '0' && op == '0' then UNDEFINED;
if Q == '1' && (Vd<0> == '1' || Vm<0> == '1') then UNDEFINED;
case L:imm6 of
    when '0001xxx' esize = 8; elements = 8; shift_amount = UInt(imm6) - 8;
    when '001xxxx' esize = 16; elements = 4; shift_amount = UInt(imm6) - 16;
    when '01xxxxx' esize = 32; elements = 2; shift_amount = UInt(imm6) - 32;
    when '1xxxxxx' esize = 64; elements = 1; shift_amount = UInt(imm6);
src_unsigned = (U == '1' && op == '1'); dest_unsigned = (U == '1');
d = UInt(D:Vd); m = UInt(M:Vm); regs = if Q == '0' then 1 else 2;
    
```

T1

15	14	13	12	11	10	9	8	7	6	5	0	15	12	11	10	9	8	7	6	5	4	3	0
1	1	1	U	1	1	1	1	1	D	imm6	Vd	0	1	1	op	L	Q	M	1	Vm			

VQSHL, double, signed-result variant

Applies when $!(imm6 == 000xxx \ \&\& \ L == 0) \ \&\& \ op == 1 \ \&\& \ Q == 0$.

VQSHL{<c>}{<q>}.<type><size> {<Dd>}, <Dm>, #<imm>

VQSHL, quad, signed-result variant

Applies when $!(imm6 == 000xxx \ \&\& \ L == 0) \ \&\& \ op == 1 \ \&\& \ Q == 1$.

VQSHL{<c>}{<q>}.<type><size> {<Qd>}, <Qm>, #<imm>

VQSHLU, double, unsigned-result variant

Applies when $U == 1 \ \&\& \ !(imm6 == 000xxx \ \&\& \ L == 0) \ \&\& \ op == 0 \ \&\& \ Q == 0$.

VQSHLU{<c>}{<q>}.<type><size> {<Dd>}, <Dm>, #<imm>

VQSHLU, quad, unsigned-result variant

Applies when $U == 1 \ \&\& \ !(imm6 == 000xxx \ \&\& \ L == 0) \ \&\& \ op == 0 \ \&\& \ Q == 1$.

VQSHLU{<c>}{<q>}.<type><size> {<Qd>}, <Qm>, #<imm>

Decode for all variants of this encoding

```

if (L:imm6) == '0000xxx' then SEE "Related encodings";
if U == '0' && op == '0' then UNDEFINED;
if Q == '1' && (Vd<0> == '1' || Vm<0> == '1') then UNDEFINED;
case L:imm6 of
  when '0001xxx' esize = 8; elements = 8; shift_amount = UInt(imm6) - 8;
  when '001xxxx' esize = 16; elements = 4; shift_amount = UInt(imm6) - 16;
  when '01xxxxx' esize = 32; elements = 2; shift_amount = UInt(imm6) - 32;
  when '1xxxxxx' esize = 64; elements = 1; shift_amount = UInt(imm6);
src_unsigned = (U == '1' && op == '1'); dest_unsigned = (U == '1');
d = UInt(D:Vd); m = UInt(M:Vm); regs = if Q == '0' then 1 else 2;

```

Notes for all encodings

Related encodings: See [Advanced SIMD one register and modified immediate on page F3-2912](#) for the T32 instruction set, or [Advanced SIMD one register and modified immediate on page F4-2994](#) for the A32 instruction set.

Assembler symbols

- <c> For encoding A1: see [Standard assembler syntax fields on page F2-2848](#). This encoding must be unconditional.
For encoding T1: see [Standard assembler syntax fields on page F2-2848](#).
- <q> See [Standard assembler syntax fields on page F2-2848](#).
- <type> Is the data type for the elements of the vectors, encoded in the "U" field. It can have the following values:
 - S when U = 0
 - U when U = 1

<size>	Is the data size for the elements of the vectors, encoded in the "L:imm6<5:3>" field. It can have the following values: 8 when L = 0, imm6<5:3> = 001 16 when L = 0, imm6<5:3> = 01x 32 when L = 0, imm6<5:3> = 1xx 64 when L = 1, imm6<5:3> = xxx
<Qd>	Is the 128-bit name of the SIMD&FP destination register, encoded in the "D:Vd" field as <Qd>*2.
<Qm>	Is the 128-bit name of the SIMD&FP source register, encoded in the "M:Vm" field as <Qm>*2.
<Dd>	Is the 64-bit name of the SIMD&FP destination register, encoded in the "D:Vd" field.
<Dm>	Is the 64-bit name of the SIMD&FP source register, encoded in the "M:Vm" field.
<imm>	Is an immediate value, in the range 0 to <size>-1, encoded in the "imm6" field.

Operation for all encodings

```
if ConditionPassed() then
    EncodingSpecificOperations(); CheckAdvSIMDEnabled();
    for r = 0 to regs-1
        for e = 0 to elements-1
            operand = Int(Elem[D[m+r],e,esize], src_unsigned);
            (result, sat) = SatQ(operand << shift_amount, esize, dest_unsigned);
            Elem[D[d+r],e,esize] = result;
            if sat then FPSCR.QC = '1';
```

F6.1.171 VQSHL (register)

Vector Saturating Shift Left (register) takes each element in a vector, shifts them by a value from the least significant byte of the corresponding element of a second vector, and places the results in the destination vector. If the shift value is positive, the operation is a left shift. Otherwise, it is a right shift.

The results are truncated. For rounded results, see [VQRSHL](#).

The first operand and result elements are the same data type, and can be any one of:

- 8-bit, 16-bit, 32-bit, or 64-bit signed integers.
- 8-bit, 16-bit, 32-bit, or 64-bit unsigned integers.

The second operand is a signed integer of the same size.

If any of the results overflow, they are saturated. The cumulative saturation bit, [FPSCR.QC](#), is set if saturation occurs. For details see [Pseudocode description of saturation on page E1-2731](#).

Depending on settings in the [CPACR](#), [NSACR](#), and [HCPTR](#) registers, and the security state and mode in which the instruction is executed, an attempt to execute the instruction might be UNDEFINED, or trapped to Hyp mode. For more information see [Enabling Advanced SIMD and floating-point support on page G1-4413](#).

A1

31	30	29	28	27	26	25	24	23	22	21	20	19	16	15	12	11	10	9	8	7	6	5	4	3	0
1	1	1	1	0	0	1	U	0	D	size	Vn	Vd	0	1	0	0	N	Q	M	1	Vm				

64-bit SIMD vector variant

Applies when Q == 0.

VQSHL{<c>}{<q>}.<dt> {<Dd>}, <Dm>, <Dn>

128-bit SIMD vector variant

Applies when Q == 1.

VQSHL{<c>}{<q>}.<dt> {<Qd>}, <Qm>, <Qn>

Decode for all variants of this encoding

```
if Q == '1' && (Vd<0> == '1' || Vm<0> == '1' || Vn<0> == '1') then UNDEFINED;
unsigned = (U == '1');
esize = 8 << UInt(size); elements = 64 DIV esize;
d = UInt(D:Vd); m = UInt(M:Vm); n = UInt(N:Vn); regs = if Q == '0' then 1 else 2;
```

T1

15	14	13	12	11	10	9	8	7	6	5	4	3	0	15	12	11	10	9	8	7	6	5	4	3	0
1	1	1	U	1	1	1	1	0	D	size	Vn	Vd	0	1	0	0	N	Q	M	1	Vm				

64-bit SIMD vector variant

Applies when Q == 0.

VQSHL{<c>}{<q>}.<dt> {<Dd>}, <Dm>, <Dn>

128-bit SIMD vector variant

Applies when Q == 1.

VQSHL{<c>}{<q>}.<dt> {<Qd>}, <Qm>, <Qn>

Decode for all variants of this encoding

```
if Q == '1' && (Vd<0> == '1' || Vm<0> == '1' || Vn<0> == '1') then UNDEFINED;
unsigned = (U == '1');
esize = 8 << UInt(size); elements = 64 DIV esize;
d = UInt(D:Vd); m = UInt(M:Vm); n = UInt(N:Vn); regs = if Q == '0' then 1 else 2;
```

Assembler symbols

- <c> For encoding A1: see [Standard assembler syntax fields on page F2-2848](#). This encoding must be unconditional.
 For encoding T1: see [Standard assembler syntax fields on page F2-2848](#).
- <q> See [Standard assembler syntax fields on page F2-2848](#).
- <dt> Is the data type for the elements of the vectors, encoded in the "U:size" field. It can have the following values:
- | | |
|-----|-----------------------|
| S8 | when U = 0, size = 00 |
| S16 | when U = 0, size = 01 |
| S32 | when U = 0, size = 10 |
| S64 | when U = 0, size = 11 |
| U8 | when U = 1, size = 00 |
| U16 | when U = 1, size = 01 |
| U32 | when U = 1, size = 10 |
| U64 | when U = 1, size = 11 |
- <Qd> Is the 128-bit name of the SIMD&FP destination register, encoded in the "D:Vd" field as <Qd>*2.
- <Qm> Is the 128-bit name of the second SIMD&FP source register, encoded in the "M:Vm" field as <Qm>*2.
- <Qn> Is the 128-bit name of the first SIMD&FP source register, encoded in the "N:Vn" field as <Qn>*2.
- <Dd> Is the 64-bit name of the SIMD&FP destination register, encoded in the "D:Vd" field.
- <Dm> Is the 64-bit name of the second SIMD&FP source register, encoded in the "M:Vm" field.
- <Dn> Is the 64-bit name of the first SIMD&FP source register, encoded in the "N:Vn" field.

Operation for all encodings

```
if ConditionPassed() then
  EncodingSpecificOperations(); CheckAdvSIMDEnabled();
  for r = 0 to regs-1
    for e = 0 to elements-1
      shift = SInt(Elem[D[n+r],e,esize]<7:0>);
      operand = Int(Elem[D[m+r],e,esize], unsigned);
      (result,sat) = SatQ(operand << shift, esize, unsigned);
      Elem[D[d+r],e,esize] = result;
      if sat then FPSCR.QC = '1';
```

F6.1.172 VQSHRN (zero)

Vector Saturating Shift Right, Narrow takes each element in a quadword vector of integers, right shifts them by an immediate value, and places the signed truncated results in a doubleword vector

This instruction is a pseudo-instruction of the [VQMOVN](#), [VQMOVUN](#) instruction. This means that:

- The encodings in this description are named to match the encodings of [VQMOVN](#), [VQMOVUN](#).
- The assembler syntax is used only for assembly, and is not used on disassembly.
- The description of [VQMOVN](#), [VQMOVUN](#) gives the operational pseudocode for this instruction.

A1

31	30	29	28	27	26	25	24	23	22	21	20	19	18	17	16	15	12	11	10	9	8	7	6	5	4	3	0
1	1	1	1	0	0	1	1	1	D	1	1	size	1	0	Vd	0	0	1	0	1	x	M	0	Vm			

op

Signed result variant

VQSHRN{<c>}{<q>}.<dt> <Dd>, <Qm>, #0

is equivalent to

VQMOVN{<c>}{<q>}.<dt> <Dd>, <Qm>

and is never the preferred disassembly.

T1

15	14	13	12	11	10	9	8	7	6	5	4	3	2	1	0	15	12	11	10	9	8	7	6	5	4	3	0
1	1	1	1	1	1	1	1	1	D	1	1	size	1	0	Vd	0	0	1	0	1	x	M	0	Vm			

op

Signed result variant

VQSHRN{<c>}{<q>}.<dt> <Dd>, <Qm>, #0

is equivalent to

VQMOVN{<c>}{<q>}.<dt> <Dd>, <Qm>

and is never the preferred disassembly.

Assembler symbols

<c> For encoding A1: see [Standard assembler syntax fields on page F2-2848](#). This encoding must be unconditional.

For encoding T1: see [Standard assembler syntax fields on page F2-2848](#).

<q> See [Standard assembler syntax fields on page F2-2848](#).

<dt> Is the data type for the elements of the operand, encoded in the "op<0>:size" field. It can have the following values:

S16	when op<0> = 0, size = 00
S32	when op<0> = 0, size = 01
S64	when op<0> = 0, size = 10
U16	when op<0> = 1, size = 00

U32 when $op<0> = 1$, size = 01

U64 when $op<0> = 1$, size = 10

The following encodings are reserved:

- $op<0> = 0$, size = 11.
- $op<0> = 1$, size = 11.

$<Dd>$ Is the 64-bit name of the SIMD&FP destination register, encoded in the "D:Vd" field.

$<Qm>$ Is the 128-bit name of the SIMD&FP source register, encoded in the "M:Vm" field as $<Qm>*2$.

Operation for all encodings

The description of [VQMOVN](#), [VQMOVUN](#) gives the operational pseudocode for this instruction.

F6.1.173 VQSHRN, VQSHRUN

Vector Saturating Shift Right, Narrow takes each element in a quadword vector of integers, right shifts them by an immediate value, and places the truncated results in a doubleword vector.

For rounded results, see [VQRSHRN](#), [VQRSHRUN](#).

The operand elements must all be the same size, and can be any one of:

- 16-bit, 32-bit, or 64-bit signed integers.
- 16-bit, 32-bit, or 64-bit unsigned integers.

The result elements are half the width of the operand elements. If the operand elements are signed, the results can be either signed or unsigned. If the operand elements are unsigned, the result elements must also be unsigned.

If any of the results overflow, they are saturated. The cumulative saturation bit, [FPSCR.QC](#), is set if saturation occurs. For details see [Pseudocode description of saturation on page E1-2731](#).

Depending on settings in the [CPACR](#), [NSACR](#), and [HCPTR](#) registers, and the security state and mode in which the instruction is executed, an attempt to execute the instruction might be UNDEFINED, or trapped to Hyp mode. For more information see [Enabling Advanced SIMD and floating-point support on page G1-4413](#).

A1

31	30	29	28	27	26	25	24	23	22	21		16	15	12	11	10	9	8		7	6	5	4	3		0
1	1	1	1	0	0	1	U	1	D		imm6		Vd		1	0	0	op	0	0	M	1		Vm		

Signed result variant

Applies when $!(imm6 == 000xxx) \ \&\& \ op == 1$.

VQSHRN{<c>}{<q>}.<type><size> <Dd>, <Qm>, #<imm>

Unsigned result variant

Applies when $U == 1 \ \&\& \ !(imm6 == 000xxx) \ \&\& \ op == 0$.

VQSHRUN{<c>}{<q>}.<type><size> <Dd>, <Qm>, #<imm>

Decode for all variants of this encoding

```

if imm6 == '000xxx' then SEE "Related encodings";
if U == '0' && op == '0' then SEE VSHRN;
if Vm<0> == '1' then UNDEFINED;
case imm6 of
  when '001xxx' esize = 8; elements = 8; shift_amount = 16 - UInt(imm6);
  when '01xxxx' esize = 16; elements = 4; shift_amount = 32 - UInt(imm6);
  when '1xxxxx' esize = 32; elements = 2; shift_amount = 64 - UInt(imm6);
src_unsigned = (U == '1' && op == '1'); dest_unsigned = (U == '1');
d = UInt(D:Vd); m = UInt(M:Vm);
    
```

T1

15	14	13	12	11	10	9	8	7	6	5		0	15	12	11	10	9	8		7	6	5	4	3		0
1	1	1	U	1	1	1	1	1	D		imm6		Vd		1	0	0	op	0	0	M	1		Vm		

Signed result variant

Applies when $!(imm6 == 000xxx) \ \&\& \ op == 1$.

VQSHRN{<c>}{<q>}.<type><size> <Dd>, <Qm>, #<imm>

Unsigned result variant

Applies when U == 1 && !(imm6 == 000xxx) && op == 0.

VQSHRUN{<c>}{<q>}.<type><size> <Dd>, <Qm>, #<imm>

Decode for all variants of this encoding

```

if imm6 == '000xxx' then SEE "Related encodings";
if U == '0' && op == '0' then SEE VSHRN;
if Vm<0> == '1' then UNDEFINED;
case imm6 of
  when '001xxx' esize = 8; elements = 8; shift_amount = 16 - UInt(imm6);
  when '01xxxx' esize = 16; elements = 4; shift_amount = 32 - UInt(imm6);
  when '1xxxxx' esize = 32; elements = 2; shift_amount = 64 - UInt(imm6);
src_unsigned = (U == '1' && op == '1'); dest_unsigned = (U == '1');
d = UInt(D:Vd); m = UInt(M:Vm);
  
```

Notes for all encodings

Related encodings: See [Advanced SIMD one register and modified immediate on page F3-2912](#) for the T32 instruction set, or [Advanced SIMD one register and modified immediate on page F4-2994](#) for the A32 instruction set.

Assembler symbols

<code><c></code>	For encoding A1: see Standard assembler syntax fields on page F2-2848 . This encoding must be unconditional. For encoding T1: see Standard assembler syntax fields on page F2-2848 .
<code><q></code>	See Standard assembler syntax fields on page F2-2848 .
<code><type></code>	For the signed result variant: is the data type for the elements of the vectors, encoded in the "U" field. It can have the following values: S when U = 0 U when U = 1 For the unsigned result variant: is the data type for the elements of the vectors, encoded in the "U" field. It can have the following values: S when U = 1
<code><size></code>	Is the data size for the elements of the vectors, encoded in the "imm6<5:3>" field. It can have the following values: 16 when imm6<5:3> = 001 32 when imm6<5:3> = 01x 64 when imm6<5:3> = 1xx
<code><Dd></code>	Is the 64-bit name of the SIMD&FP destination register, encoded in the "D:Vd" field.
<code><Qm></code>	Is the 128-bit name of the SIMD&FP source register, encoded in the "M:Vm" field as <Qm>*2.
<code><imm></code>	Is an immediate value, in the range 1 to <size>/2, encoded in the "imm6" field as <size>/2 - <imm>.

Operation for all encodings

```

if ConditionPassed() then
  EncodingSpecificOperations(); CheckAdvSIMDEnabled();
  for e = 0 to elements-1
    operand = Int(Elem[Qin[m>>1],e,2*esize], src_unsigned);
  
```

```
(result, sat) = SatQ(operand >> shift_amount, esize, dest_unsigned);  
Elem[D[d],e,esize] = result;  
if sat then FPSCR.QC = '1';
```

F6.1.174 VQSHRUN (zero)

Vector Saturating Shift Right, Narrow takes each element in a quadword vector of integers, right shifts them by an immediate value, and places the unsigned truncated results in a doubleword vector

This instruction is a pseudo-instruction of the [VQMOVN](#), [VQMOVUN](#) instruction. This means that:

- The encodings in this description are named to match the encodings of [VQMOVN](#), [VQMOVUN](#).
- The assembler syntax is used only for assembly, and is not used on disassembly.
- The description of [VQMOVN](#), [VQMOVUN](#) gives the operational pseudocode for this instruction.

A1

31	30	29	28	27	26	25	24	23	22	21	20	19	18	17	16	15	12	11	10	9	8	7	6	5	4	3	0
1	1	1	1	0	0	1	1	1	D	1	1	size	1	0	Vd	0	0	1	0	0	1	M	0	Vm			

op

Unsigned result variant

VQSHRUN{<c>}{<q>}.<dt> <Dd>, <Qm>, #0

is equivalent to

VQMOVUN{<c>}{<q>}.<dt> <Dd>, <Qm>

and is never the preferred disassembly.

T1

15	14	13	12	11	10	9	8	7	6	5	4	3	2	1	0	15	12	11	10	9	8	7	6	5	4	3	0
1	1	1	1	1	1	1	1	1	D	1	1	size	1	0	Vd	0	0	1	0	0	1	M	0	Vm			

op

Unsigned result variant

VQSHRUN{<c>}{<q>}.<dt> <Dd>, <Qm>, #0

is equivalent to

VQMOVUN{<c>}{<q>}.<dt> <Dd>, <Qm>

and is never the preferred disassembly.

Assembler symbols

<c> For encoding A1: see [Standard assembler syntax fields on page F2-2848](#). This encoding must be unconditional.

For encoding T1: see [Standard assembler syntax fields on page F2-2848](#).

<q> See [Standard assembler syntax fields on page F2-2848](#).

<dt> Is the data type for the elements of the operand, encoded in the "size" field. It can have the following values:

S16 when size = 00

S32 when size = 01

S64 when size = 10

The encoding size = 11 is reserved.

- <Dd> Is the 64-bit name of the SIMD&FP destination register, encoded in the "D:Vd" field.
- <Qm> Is the 128-bit name of the SIMD&FP source register, encoded in the "M:Vm" field as <Qm>*2.

Operation for all encodings

The description of [VQMOVN](#), [VQMOVUN](#) gives the operational pseudocode for this instruction.

F6.1.175 VQSUB

Vector Saturating Subtract subtracts the elements of the second operand vector from the corresponding elements of the first operand vector, and places the results in the destination vector. Signed and unsigned operations are distinct.

The operand and result elements must all be the same type, and can be any one of:

- 8-bit, 16-bit, 32-bit, or 64-bit signed integers.
- 8-bit, 16-bit, 32-bit, or 64-bit unsigned integers.

If any of the results overflow, they are saturated. The cumulative saturation bit, `FPSCR.QC`, is set if saturation occurs. For details see [Pseudocode description of saturation on page E1-2731](#).

Depending on settings in the `CPACR`, `NSACR`, and `HCPTTR` registers, and the security state and mode in which the instruction is executed, an attempt to execute the instruction might be `UNDEFINED`, or trapped to Hyp mode. For more information see [Enabling Advanced SIMD and floating-point support on page G1-4413](#).

A1

31	30	29	28	27	26	25	24	23	22	21	20	19	16	15	12	11	10	9	8	7	6	5	4	3	0
1	1	1	1	0	0	1	U	0	D	size	Vn	Vd	0	0	1	0	N	Q	M	1	Vm				

64-bit SIMD vector variant

Applies when `Q == 0`.

`VQSUB{<c>}{<q>}.<dt> {<Dd>}, <Dn>, <Dm>`

128-bit SIMD vector variant

Applies when `Q == 1`.

`VQSUB{<c>}{<q>}.<dt> {<Qd>}, <Qn>, <Qm>`

Decode for all variants of this encoding

```
if Q == '1' && (Vd<0> == '1' || Vn<0> == '1' || Vm<0> == '1') then UNDEFINED;
unsigned = (U == '1');
esize = 8 << UInt(size); elements = 64 DIV esize;
d = UInt(D:Vd); n = UInt(N:Vn); m = UInt(M:Vm); regs = if Q == '0' then 1 else 2;
```

T1

15	14	13	12	11	10	9	8	7	6	5	4	3	0	15	12	11	10	9	8	7	6	5	4	3	0
1	1	1	U	1	1	1	1	0	D	size	Vn	Vd	0	0	1	0	N	Q	M	1	Vm				

64-bit SIMD vector variant

Applies when `Q == 0`.

`VQSUB{<c>}{<q>}.<dt> {<Dd>}, <Dn>, <Dm>`

128-bit SIMD vector variant

Applies when `Q == 1`.

`VQSUB{<c>}{<q>}.<dt> {<Qd>}, <Qn>, <Qm>`

Decode for all variants of this encoding

```
if Q == '1' && (Vd<0> == '1' || Vn<0> == '1' || Vm<0> == '1') then UNDEFINED;
unsigned = (U == '1');
esize = 8 << UInt(size); elements = 64 DIV esize;
d = UInt(D:Vd); n = UInt(N:Vn); m = UInt(M:Vm); regs = if Q == '0' then 1 else 2;
```

Assembler symbols

- <c> For encoding A1: see [Standard assembler syntax fields on page F2-2848](#). This encoding must be unconditional.
 For encoding T1: see [Standard assembler syntax fields on page F2-2848](#).
- <q> See [Standard assembler syntax fields on page F2-2848](#).
- <dt> Is the data type for the elements of the vectors, encoded in the "U:size" field. It can have the following values:
 - S8 when U = 0, size = 00
 - S16 when U = 0, size = 01
 - S32 when U = 0, size = 10
 - S64 when U = 0, size = 11
 - U8 when U = 1, size = 00
 - U16 when U = 1, size = 01
 - U32 when U = 1, size = 10
 - U64 when U = 1, size = 11
- <Qd> Is the 128-bit name of the SIMD&FP destination register, encoded in the "D:Vd" field as <Qd>*2.
- <Qn> Is the 128-bit name of the first SIMD&FP source register, encoded in the "N:Vn" field as <Qn>*2.
- <Qm> Is the 128-bit name of the second SIMD&FP source register, encoded in the "M:Vm" field as <Qm>*2.
- <Dd> Is the 64-bit name of the SIMD&FP destination register, encoded in the "D:Vd" field.
- <Dn> Is the 64-bit name of the first SIMD&FP source register, encoded in the "N:Vn" field.
- <Dm> Is the 64-bit name of the second SIMD&FP source register, encoded in the "M:Vm" field.

Operation for all encodings

```
if ConditionPassed() then
  EncodingSpecificOperations(); CheckAdvSIMDEnabled();
  for r = 0 to regs-1
    for e = 0 to elements-1
      diff = Int(Elem[D[n+r],e,esize], unsigned) - Int(Elem[D[m+r],e,esize], unsigned);
      (Elem[D[d+r],e,esize], sat) = SatQ(diff, esize, unsigned);
      if sat then FPSCR.QC = '1';
```

F6.1.176 VRADDHN

Vector Rounding Add and Narrow, returning High Half adds corresponding elements in two quadword vectors, and places the most significant half of each result in a doubleword vector. The results are rounded. For truncated results, see [VADDHN](#).

The operand elements can be 16-bit, 32-bit, or 64-bit integers. There is no distinction between signed and unsigned integers.

Depending on settings in the [CPACR](#), [NSACR](#), and [HCPTR](#) registers, and the security state and mode in which the instruction is executed, an attempt to execute the instruction might be UNDEFINED, or trapped to Hyp mode. For more information see [Enabling Advanced SIMD and floating-point support on page G1-4413](#).

A1

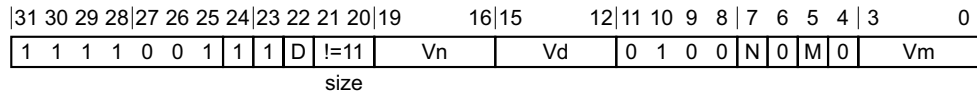

A1 variant

VRADDHN{<c>}{<q>}.<dt> <Dd>, <Qn>, <Qm>

Decode for this encoding

```
if size == '11' then SEE "Related encodings";
if Vn<0> == '1' || Vm<0> == '1' then UNDEFINED;
esize = 8 << UInt(size); elements = 64 DIV esize;
d = UInt(D:Vd); n = UInt(N:Vn); m = UInt(M:Vm);
```

T1

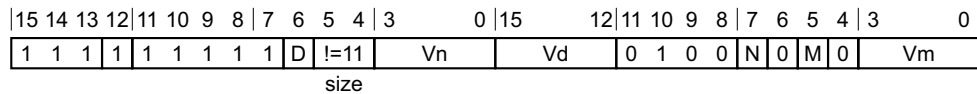

T1 variant

VRADDHN{<c>}{<q>}.<dt> <Dd>, <Qn>, <Qm>

Decode for this encoding

```
if size == '11' then SEE "Related encodings";
if Vn<0> == '1' || Vm<0> == '1' then UNDEFINED;
esize = 8 << UInt(size); elements = 64 DIV esize;
d = UInt(D:Vd); n = UInt(N:Vn); m = UInt(M:Vm);
```

Notes for all encodings

Related encodings: See [Advanced SIMD data-processing on page F3-2904](#) for the T32 instruction set, or [Advanced SIMD data-processing on page F4-2985](#) for the A32 instruction set.

Assembler symbols

- <c> For encoding A1: see [Standard assembler syntax fields on page F2-2848](#). This encoding must be unconditional.
- For encoding T1: see [Standard assembler syntax fields on page F2-2848](#).
- <q> See [Standard assembler syntax fields on page F2-2848](#).

- <dt> Is the data type for the elements of the operands, encoded in the "size" field. It can have the following values:
- I16 when size = 00
 - I32 when size = 01
 - I64 when size = 10
- <Dd> Is the 64-bit name of the SIMD&FP destination register, encoded in the "D:Vd" field.
- <Qn> Is the 128-bit name of the first SIMD&FP source register, encoded in the "N:Vn" field as <Qn>*2.
- <Qm> Is the 128-bit name of the second SIMD&FP source register, encoded in the "M:Vm" field as <Qm>*2.

Operation for all encodings

```
if ConditionPassed() then
    EncodingSpecificOperations(); CheckAdvSIMDEnabled();
    round_const = 1 << (esize-1);
    for e = 0 to elements-1
        result = Elem[Qin[n>>1],e,2*esize] + Elem[Qin[m>>1],e,2*esize] + round_const;
        Elem[D[d],e,esize] = result<2*esize-1:esize>;
```

F6.1.177 VRECPE

Vector Reciprocal Estimate finds an approximate reciprocal of each element in the operand vector, and places the results in the destination vector.

The operand and result elements are the same type, and can be floating-point numbers or unsigned integers.

For details of the operation performed by this instruction see *Floating-point reciprocal square root estimate and step* on page E1-2750.

Depending on settings in the CPACR, NSACR, and HCPTR registers, and the security state and mode in which the instruction is executed, an attempt to execute the instruction might be UNDEFINED, or trapped to Hyp mode. For more information see *Enabling Advanced SIMD and floating-point support* on page G1-4413.

A1

31	30	29	28	27	26	25	24	23	22	21	20	19	18	17	16	15	12	11	10	9	8	7	6	5	4	3	0
1	1	1	1	0	0	1	1	1	D	1	1	size	1	1	Vd	0	1	0	F	0	Q	M	0	Vm			

64-bit SIMD vector variant

Applies when Q == 0.

VRECPE{<c>}{<q>}.<dt> <Dd>, <Dm>

128-bit SIMD vector variant

Applies when Q == 1.

VRECPE{<c>}{<q>}.<dt> <Qd>, <Qm>

Decode for all variants of this encoding

```

if Q == '1' && (Vd<0> == '1' || Vm<0> == '1') then UNDEFINED;
if (size == '01' && !HaveFP16Ext()) || size IN {'00', '11'} then UNDEFINED;
floating_point = (F == '1');
case size of
  when '01' esize = 16; elements = 4;
  when '10' esize = 32; elements = 2;
d = UInt(D:Vd); m = UInt(M:Vm); regs = if Q == '0' then 1 else 2;
  
```

T1

15	14	13	12	11	10	9	8	7	6	5	4	3	2	1	0	15	12	11	10	9	8	7	6	5	4	3	0
1	1	1	1	1	1	1	1	1	D	1	1	size	1	1	Vd	0	1	0	F	0	Q	M	0	Vm			

64-bit SIMD vector variant

Applies when Q == 0.

VRECPE{<c>}{<q>}.<dt> <Dd>, <Dm>

128-bit SIMD vector variant

Applies when Q == 1.

VRECPE{<c>}{<q>}.<dt> <Qd>, <Qm>

Decode for all variants of this encoding

```

if Q == '1' && (Vd<0> == '1' || Vm<0> == '1') then UNDEFINED;
if (size == '01' && !HaveFP16Ext()) || size IN {'00', '11'} then UNDEFINED;
if size == '01' && InITBlock() then UNPREDICTABLE;
floating_point = (F == '1');
case size of
  when '01' esize = 16; elements = 4;
  when '10' esize = 32; elements = 2;
d = UInt(D:Vd); m = UInt(M:Vm); regs = if Q == '0' then 1 else 2;
  
```

CONSTRAINED UNPREDICTABLE behavior

If size == '01' && InITBlock(), then one of the following behaviors must occur:

- The instruction is UNDEFINED.
- The instruction executes as if it passes the Condition code check.
- The instruction executes as NOP. This means it behaves as if it fails the Condition code check.

Assembler symbols

- <c> For encoding A1: see [Standard assembler syntax fields on page F2-2848](#). This encoding must be unconditional.
 For encoding T1: see [Standard assembler syntax fields on page F2-2848](#).
- <q> See [Standard assembler syntax fields on page F2-2848](#).
- <dt> Is the data type for the elements of the vectors, encoded in the "F:size" field. It can have the following values:
- | | |
|-----|-----------------------|
| U32 | when F = 0, size = 10 |
| F16 | when F = 1, size = 01 |
| F32 | when F = 1, size = 10 |
- <Qd> Is the 128-bit name of the SIMD&FP destination register, encoded in the "D:Vd" field as <Qd>*2.
- <Qm> Is the 128-bit name of the SIMD&FP source register, encoded in the "M:Vm" field as <Qm>*2.
- <Dd> Is the 64-bit name of the SIMD&FP destination register, encoded in the "D:Vd" field.
- <Dm> Is the 64-bit name of the SIMD&FP source register, encoded in the "M:Vm" field.

Newton-Raphson iteration

For details of the operation performed and how it can be used in a Newton-Raphson iteration to calculate the reciprocal of a number, see [Floating-point reciprocal estimate and step on page E1-2749](#).

Operation for all encodings

```

if ConditionPassed() then
  EncodingSpecificOperations(); CheckAdvSIMDEnabled();
  for r = 0 to regs-1
    for e = 0 to elements-1
      if floating_point then
        Elem[D[d+r],e,esize] = FPRecipEstimate(Elem[D[m+r],e,esize], StandardFPSCRValue());
      else
        Elem[D[d+r],e,esize] = UnsignedRecipEstimate(Elem[D[m+r],e,esize]);
  
```

F6.1.178 VRECPS

Vector Reciprocal Step multiplies the elements of one vector by the corresponding elements of another vector, subtracts each of the products from 2.0, and places the results into the elements of the destination vector.

The operand and result elements are floating-point numbers.

For details of the operation performed by this instruction see [Floating-point reciprocal estimate and step on page E1-2749](#).

Depending on settings in the CPACR, NSACR, and HCPTR registers, and the security state and mode in which the instruction is executed, an attempt to execute the instruction might be UNDEFINED, or trapped to Hyp mode. For more information see [Enabling Advanced SIMD and floating-point support on page G1-4413](#).

A1

31	30	29	28	27	26	25	24	23	22	21	20	19	16	15	12	11	10	9	8	7	6	5	4	3	0
1	1	1	1	0	0	0	1	0	0	D	0	sz	Vn	Vd	1	1	1	1	N	Q	M	1	Vm		

64-bit SIMD vector variant

Applies when Q == 0.

VRECPS{<c>}{<q>}.<dt> {<Dd>, }<Dn>, <Dm>

128-bit SIMD vector variant

Applies when Q == 1.

VRECPS{<c>}{<q>}.<dt> {<Qd>, }<Qn>, <Qm>

Decode for all variants of this encoding

```

if Q == '1' && (Vd<0> == '1' || Vn<0> == '1' || Vm<0> == '1') then UNDEFINED;
if sz == '1' && !HaveFP16Ext() then UNDEFINED;
case sz of
    when '0' esize = 32; elements = 2;
    when '1' esize = 16; elements = 4;
d = UInt(D:Vd); n = UInt(N:Vn); m = UInt(M:Vm); regs = if Q == '0' then 1 else 2;
    
```

T1

15	14	13	12	11	10	9	8	7	6	5	4	3	0	15	12	11	10	9	8	7	6	5	4	3	0
1	1	1	0	1	1	1	1	0	D	0	sz	Vn	Vd	1	1	1	1	N	Q	M	1	Vm			

64-bit SIMD vector variant

Applies when Q == 0.

VRECPS{<c>}{<q>}.<dt> {<Dd>, }<Dn>, <Dm>

128-bit SIMD vector variant

Applies when Q == 1.

VRECPS{<c>}{<q>}.<dt> {<Qd>, }<Qn>, <Qm>

Decode for all variants of this encoding

```

if Q == '1' && (Vd<0> == '1' || Vn<0> == '1' || Vm<0> == '1') then UNDEFINED;
if sz == '1' && !HaveFP16Ext() then UNDEFINED;
if sz == '1' && InITBlock() then UNPREDICTABLE;
case sz of
  when '0' esize = 32; elements = 2;
  when '1' esize = 16; elements = 4;
d = UInt(D:Vd); n = UInt(N:Vn); m = UInt(M:Vm); regs = if Q == '0' then 1 else 2;
  
```

CONSTRAINED UNPREDICTABLE behavior

If size == '01' && InITBlock(), then one of the following behaviors must occur:

- The instruction is UNDEFINED.
- The instruction executes as if it passes the Condition code check.
- The instruction executes as NOP. This means it behaves as if it fails the Condition code check.

Assembler symbols

- <c> For encoding A1: see [Standard assembler syntax fields on page F2-2848](#). This encoding must be unconditional.
 For encoding T1: see [Standard assembler syntax fields on page F2-2848](#).
- <q> See [Standard assembler syntax fields on page F2-2848](#).
- <dt> Is the data type for the elements of the vectors, encoded in the "sz" field. It can have the following values:
 F32 when sz = 0
 F16 when sz = 1
- <Qd> Is the 128-bit name of the SIMD&FP destination register, encoded in the "D:Vd" field as <Qd>*2.
- <Qn> Is the 128-bit name of the first SIMD&FP source register, encoded in the "N:Vn" field as <Qn>*2.
- <Qm> Is the 128-bit name of the second SIMD&FP source register, encoded in the "M:Vm" field as <Qm>*2.
- <Dd> Is the 64-bit name of the SIMD&FP destination register, encoded in the "D:Vd" field.
- <Dn> Is the 64-bit name of the first SIMD&FP source register, encoded in the "N:Vn" field.
- <Dm> Is the 64-bit name of the second SIMD&FP source register, encoded in the "M:Vm" field.

Newton-Raphson iteration

For details of the operation performed and how it can be used in a Newton-Raphson iteration to calculate the reciprocal of a number, see [Floating-point reciprocal estimate and step on page E1-2749](#).

Operation for all encodings

```

if ConditionPassed() then
  EncodingSpecificOperations(); CheckAdvSIMDEnabled();
  for r = 0 to regs-1
    for e = 0 to elements-1
      Elem[D[d+r],e,esize] = FPRecipStep(Elem[D[n+r],e,esize], Elem[D[m+r],e,esize]);
  
```

F6.1.179 VREV16

Vector Reverse in halfwords reverses the order of 8-bit elements in each halfword of the vector, and places the result in the corresponding destination vector.

There is no distinction between data types, other than size.

The following figure shows the operation of VREV16 doubleword operation.

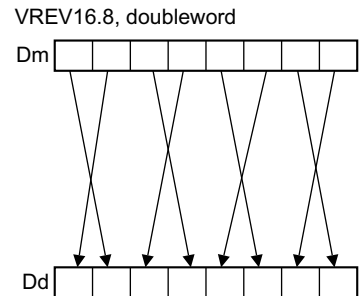

Depending on settings in the CPACR, NSACR, and HCPTR registers, and the security state and mode in which the instruction is executed, an attempt to execute the instruction might be UNDEFINED, or trapped to Hyp mode. For more information see [Enabling Advanced SIMD and floating-point support on page G1-4413](#).

A1

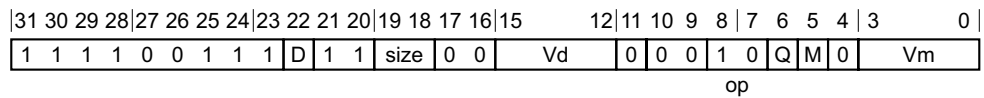

64-bit SIMD vector variant

Applies when Q == 0.

VREV16{<c>}{<q>}.<dt> <Dd>, <Dm>

128-bit SIMD vector variant

Applies when Q == 1.

VREV16{<c>}{<q>}.<dt> <Qd>, <Qm>

Decode for all variants of this encoding

```

if UInt(op)+UInt(size) >= 3 then UNDEFINED;
if Q == '1' && (Vd<0> == '1' || Vm<0> == '1') then UNDEFINED;

esize = 8 << UInt(size);
integer container_size;
case op of
  when '10' container_size = 16;
  when '01' container_size = 32;
  when '00' container_size = 64;
integer containers = 64 DIV container_size;
integer elements_per_container = container_size DIV esize;

d = UInt(D:Vd); m = UInt(M:Vm); regs = if Q == '0' then 1 else 2;
  
```

T1

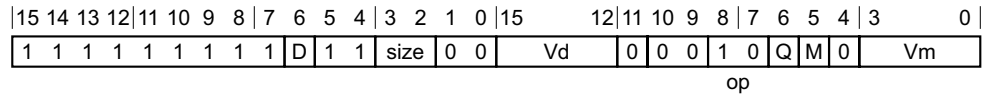

64-bit SIMD vector variant

Applies when Q == 0.

VREV16{<c>}{<q>}.<dt> <Dd>, <Dm>

128-bit SIMD vector variant

Applies when Q == 1.

VREV16{<c>}{<q>}.<dt> <Qd>, <Qm>

Decode for all variants of this encoding

```

if UInt(op)+UInt(size) >= 3 then UNDEFINED;
if Q == '1' && (Vd<0> == '1' || Vm<0> == '1') then UNDEFINED;

esize = 8 << UInt(size);
integer container_size;
case op of
    when '10' container_size = 16;
    when '01' container_size = 32;
    when '00' container_size = 64;
integer containers = 64 DIV container_size;
integer elements_per_container = container_size DIV esize;

d = UInt(D:Vd); m = UInt(M:Vm); regs = if Q == '0' then 1 else 2;
    
```

Assembler symbols

- <c> For encoding A1: see [Standard assembler syntax fields on page F2-2848](#). This encoding must be unconditional.
 For encoding T1: see [Standard assembler syntax fields on page F2-2848](#).
- <q> See [Standard assembler syntax fields on page F2-2848](#).
- <dt> Is the data type for the elements of the operand, encoded in the "size" field. It can have the following values:
 8 when size = 00
 The following encodings are reserved:
- size = 01.
 - size = 1x.
- <Qd> Is the 128-bit name of the SIMD&FP destination register, encoded in the "D:Vd" field as <Qd>*2.
- <Qm> Is the 128-bit name of the SIMD&FP source register, encoded in the "M:Vm" field as <Qm>*2.
- <Dd> Is the 64-bit name of the SIMD&FP destination register, encoded in the "D:Vd" field.
- <Dm> Is the 64-bit name of the SIMD&FP source register, encoded in the "M:Vm" field.

Operation for all encodings

```
if ConditionPassed() then
    EncodingSpecificOperations(); CheckAdvSIMDEnabled();

    bits(64) result;
    integer element;
    integer rev_element;
    for r = 0 to regs-1
        element = 0;
        for c = 0 to containers-1
            rev_element = element + elements_per_container - 1;
            for e = 0 to elements_per_container-1
                Elem[result, rev_element, esize] = Elem[D[m+r], element, esize];
                element = element + 1;
                rev_element = rev_element - 1;
            D[d+r] = result;
```

F6.1.180 VREV32

Vector Reverse in words reverses the order of 8-bit or 16-bit elements in each word of the vector, and places the result in the corresponding destination vector.

There is no distinction between data types, other than size.

The following figure shows the operation of VREV32 doubleword operations.

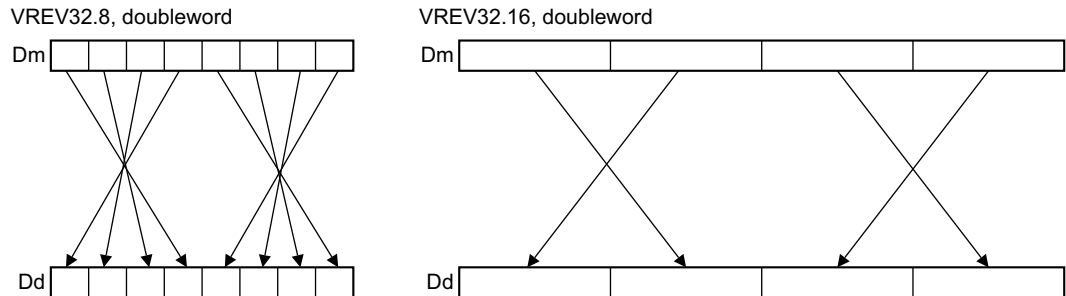

Depending on settings in the CPACR, NSACR, and HCPTR registers, and the security state and mode in which the instruction is executed, an attempt to execute the instruction might be UNDEFINED, or trapped to Hyp mode. For more information see [Enabling Advanced SIMD and floating-point support on page G1-4413](#).

A1

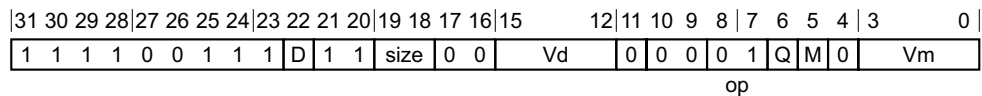

64-bit SIMD vector variant

Applies when Q == 0.

VREV32{<c>}{<q>}.<dt> <Dd>, <Dm>

128-bit SIMD vector variant

Applies when Q == 1.

VREV32{<c>}{<q>}.<dt> <Qd>, <Qm>

Decode for all variants of this encoding

```

if UInt(op)+UInt(size) >= 3 then UNDEFINED;
if Q == '1' && (Vd<0> == '1' || Vm<0> == '1') then UNDEFINED;

esize = 8 << UInt(size);
integer container_size;
case op of
    when '10' container_size = 16;
    when '01' container_size = 32;
    when '00' container_size = 64;
integer containers = 64 DIV container_size;
integer elements_per_container = container_size DIV esize;

d = UInt(D:Vd); m = UInt(M:Vm); regs = if Q == '0' then 1 else 2;
    
```

T1

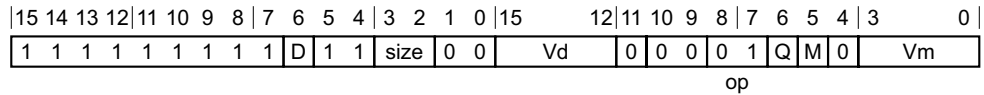

64-bit SIMD vector variant

Applies when Q == 0.

VREV32{<c>}{<q>}.<dt> <Dd>, <Dm>

128-bit SIMD vector variant

Applies when Q == 1.

VREV32{<c>}{<q>}.<dt> <Qd>, <Qm>

Decode for all variants of this encoding

```

if UInt(op)+UInt(size) >= 3 then UNDEFINED;
if Q == '1' && (Vd<0> == '1' || Vm<0> == '1') then UNDEFINED;

esize = 8 << UInt(size);
integer container_size;
case op of
  when '10' container_size = 16;
  when '01' container_size = 32;
  when '00' container_size = 64;
integer containers = 64 DIV container_size;
integer elements_per_container = container_size DIV esize;

d = UInt(D:Vd); m = UInt(M:Vm); regs = if Q == '0' then 1 else 2;
  
```

Assembler symbols

- <c> For encoding A1: see [Standard assembler syntax fields on page F2-2848](#). This encoding must be unconditional.
 For encoding T1: see [Standard assembler syntax fields on page F2-2848](#).
- <q> See [Standard assembler syntax fields on page F2-2848](#).
- <dt> Is the data type for the elements of the operand, encoded in the "size" field. It can have the following values:
 8 when size = 00
 16 when size = 01
 The encoding size = 1x is reserved.
- <Qd> Is the 128-bit name of the SIMD&FP destination register, encoded in the "D:Vd" field as <Qd>*2.
- <Qm> Is the 128-bit name of the SIMD&FP source register, encoded in the "M:Vm" field as <Qm>*2.
- <Dd> Is the 64-bit name of the SIMD&FP destination register, encoded in the "D:Vd" field.
- <Dm> Is the 64-bit name of the SIMD&FP source register, encoded in the "M:Vm" field.

Operation for all encodings

```

if ConditionPassed() then
  EncodingSpecificOperations(); CheckAdvSIMDEnabled();

  bits(64) result;
  
```

```
integer element;  
integer rev_element;  
for r = 0 to regs-1  
  element = 0;  
  for c = 0 to containers-1  
    rev_element = element + elements_per_container - 1;  
    for e = 0 to elements_per_container-1  
      Elem[result, rev_element, esize] = Elem[D[m+r], element, esize];  
      element = element + 1;  
      rev_element = rev_element - 1;  
    D[d+r] = result;
```

F6.1.181 VREV64

Vector Reverse in doublewords reverses the order of 8-bit, 16-bit, or 32-bit elements in each doubleword of the vector, and places the result in the corresponding destination vector.

There is no distinction between data types, other than size.

The following figure shows the operation of VREV64 doubleword operations.

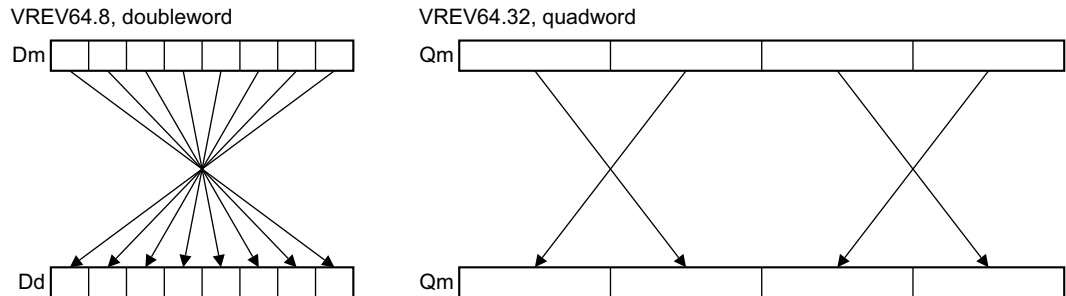

Depending on settings in the CPACR, NSACR, and HCPTR registers, and the security state and mode in which the instruction is executed, an attempt to execute the instruction might be UNDEFINED, or trapped to Hyp mode. For more information see [Enabling Advanced SIMD and floating-point support on page G1-4413](#).

A1

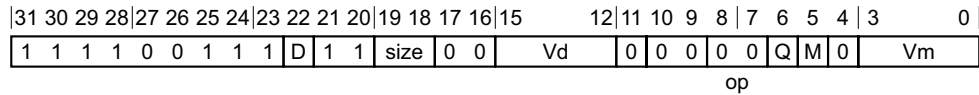

64-bit SIMD vector variant

Applies when Q == 0.

VREV64{<c>}{<q>}.<dt> <Dd>, <Dm>

128-bit SIMD vector variant

Applies when Q == 1.

VREV64{<c>}{<q>}.<dt> <Qd>, <Qm>

Decode for all variants of this encoding

```

if UInt(op)+UInt(size) >= 3 then UNDEFINED;
if Q == '1' && (Vd<0> == '1' || Vm<0> == '1') then UNDEFINED;

esize = 8 << UInt(size);
integer container_size;
case op of
    when '10' container_size = 16;
    when '01' container_size = 32;
    when '00' container_size = 64;
integer containers = 64 DIV container_size;
integer elements_per_container = container_size DIV esize;

d = UInt(D:Vd); m = UInt(M:Vm); regs = if Q == '0' then 1 else 2;
    
```

T1

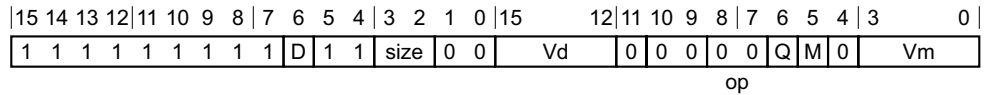

64-bit SIMD vector variant

Applies when Q == 0.

VREV64{<c>}{<q>}.<dt> <Dd>, <Dm>

128-bit SIMD vector variant

Applies when Q == 1.

VREV64{<c>}{<q>}.<dt> <Qd>, <Qm>

Decode for all variants of this encoding

```

if UInt(op)+UInt(size) >= 3 then UNDEFINED;
if Q == '1' && (Vd<0> == '1' || Vm<0> == '1') then UNDEFINED;

esize = 8 << UInt(size);
integer container_size;
case op of
  when '10' container_size = 16;
  when '01' container_size = 32;
  when '00' container_size = 64;
integer containers = 64 DIV container_size;
integer elements_per_container = container_size DIV esize;

d = UInt(D:Vd); m = UInt(M:Vm); regs = if Q == '0' then 1 else 2;
  
```

Assembler symbols

- <c> For encoding A1: see [Standard assembler syntax fields on page F2-2848](#). This encoding must be unconditional.
 For encoding T1: see [Standard assembler syntax fields on page F2-2848](#).
- <q> See [Standard assembler syntax fields on page F2-2848](#).
- <dt> Is the data type for the elements of the operand, encoded in the "size" field. It can have the following values:
 - 8 when size = 00
 - 16 when size = 01
 - 32 when size = 10
 The encoding size = 11 is reserved.
- <Qd> Is the 128-bit name of the SIMD&FP destination register, encoded in the "D:Vd" field as <Qd>*2.
- <Qm> Is the 128-bit name of the SIMD&FP source register, encoded in the "M:Vm" field as <Qm>*2.
- <Dd> Is the 64-bit name of the SIMD&FP destination register, encoded in the "D:Vd" field.
- <Dm> Is the 64-bit name of the SIMD&FP source register, encoded in the "M:Vm" field.

Operation for all encodings

```
if ConditionPassed() then
    EncodingSpecificOperations(); CheckAdvSIMDEnabled();

    bits(64) result;
    integer element;
    integer rev_element;
    for r = 0 to regs-1
        element = 0;
        for c = 0 to containers-1
            rev_element = element + elements_per_container - 1;
            for e = 0 to elements_per_container-1
                Elem[result, rev_element, esize] = Elem[D[m+r], element, esize];
                element = element + 1;
                rev_element = rev_element - 1;
            D[d+r] = result;
```

F6.1.182 VRHADD

Vector Rounding Halving Add adds corresponding elements in two vectors of integers, shifts each result right one bit, and places the final results in the destination vector.

The operand and result elements are all the same type, and can be any one of:

- 8-bit, 16-bit, or 32-bit signed integers.
- 8-bit, 16-bit, or 32-bit unsigned integers.

The results of the halving operations are rounded. For truncated results, see [VHADD](#).

Depending on settings in the [CPACR](#), [NSACR](#), and [HCPTR](#) registers, and the security state and mode in which the instruction is executed, an attempt to execute the instruction might be UNDEFINED, or trapped to Hyp mode. For more information see [Enabling Advanced SIMD and floating-point support on page G1-4413](#).

A1

31	30	29	28	27	26	25	24	23	22	21	20	19	16	15	12	11	10	9	8	7	6	5	4	3	0
1	1	1	1	0	0	1	U	0	D	size	Vn	Vd	0	0	0	1	N	Q	M	0	Vm				

64-bit SIMD vector variant

Applies when Q == 0.

VRHADD{<c>}{<q>}.<dt> {<Dd>, }<Dn>, <Dm>

128-bit SIMD vector variant

Applies when Q == 1.

VRHADD{<c>}{<q>}.<dt> {<Qd>, }<Qn>, <Qm>

Decode for all variants of this encoding

```

if Q == '1' && (Vd<0> == '1' || Vn<0> == '1' || Vm<0> == '1') then UNDEFINED;
if size == '11' then UNDEFINED;
unsigned = (U == '1');
esize = 8 << UInt(size); elements = 64 DIV esize;
d = UInt(D:Vd); n = UInt(N:Vn); m = UInt(M:Vm); regs = if Q == '0' then 1 else 2;
    
```

T1

15	14	13	12	11	10	9	8	7	6	5	4	3	0	15	12	11	10	9	8	7	6	5	4	3	0
1	1	1	U	1	1	1	1	0	D	size	Vn	Vd	0	0	0	1	N	Q	M	0	Vm				

64-bit SIMD vector variant

Applies when Q == 0.

VRHADD{<c>}{<q>}.<dt> {<Dd>, }<Dn>, <Dm>

128-bit SIMD vector variant

Applies when Q == 1.

VRHADD{<c>}{<q>}.<dt> {<Qd>, }<Qn>, <Qm>

Decode for all variants of this encoding

```

if Q == '1' && (Vd<0> == '1' || Vn<0> == '1' || Vm<0> == '1') then UNDEFINED;
if size == '11' then UNDEFINED;
unsigned = (U == '1');
esize = 8 << UInt(size); elements = 64 DIV esize;
d = UInt(D:Vd); n = UInt(N:Vn); m = UInt(M:Vm); regs = if Q == '0' then 1 else 2;
  
```

Assembler symbols

- <c> For encoding A1: see [Standard assembler syntax fields on page F2-2848](#). This encoding must be unconditional.
 For encoding T1: see [Standard assembler syntax fields on page F2-2848](#).
- <q> See [Standard assembler syntax fields on page F2-2848](#).
- <dt> Is the data type for the elements of the operands, encoded in the "U:size" field. It can have the following values:
 - S8 when U = 0, size = 00
 - S16 when U = 0, size = 01
 - S32 when U = 0, size = 10
 - U8 when U = 1, size = 00
 - U16 when U = 1, size = 01
 - U32 when U = 1, size = 10
- <Qd> Is the 128-bit name of the SIMD&FP destination register, encoded in the "D:Vd" field as <Qd>*2.
- <Qn> Is the 128-bit name of the first SIMD&FP source register, encoded in the "N:Vn" field as <Qn>*2.
- <Qm> Is the 128-bit name of the second SIMD&FP source register, encoded in the "M:Vm" field as <Qm>*2.
- <Dd> Is the 64-bit name of the SIMD&FP destination register, encoded in the "D:Vd" field.
- <Dn> Is the 64-bit name of the first SIMD&FP source register, encoded in the "N:Vn" field.
- <Dm> Is the 64-bit name of the second SIMD&FP source register, encoded in the "M:Vm" field.

Operation for all encodings

```

if ConditionPassed() then
  EncodingSpecificOperations(); CheckAdvSIMDEnabled();
  for r = 0 to regs-1
    for e = 0 to elements-1
      op1 = Int(Elem[D[n+r],e,esize], unsigned);
      op2 = Int(Elem[D[m+r],e,esize], unsigned);
      result = op1 + op2 + 1;
      Elem[D[d+r],e,esize] = result<esize:1>;
  
```

F6.1.183 VRINTA (Advanced SIMD)

Vector Round floating-point to integer towards Nearest with Ties to Away rounds a vector of floating-point values to integral floating-point values of the same size using the Round to Nearest with Ties to Away rounding mode. A zero input gives a zero result with the same sign, an infinite input gives an infinite result with the same sign, and a NaN is propagated as for normal arithmetic.

A1

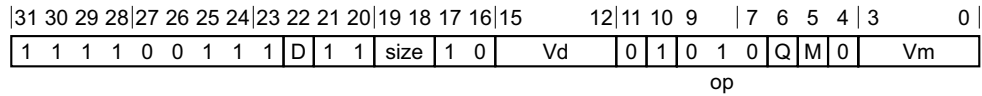

64-bit SIMD vector variant

Applies when Q == 0.

VRINTA{<q>}.<dt> <Dd>, <Dm>

128-bit SIMD vector variant

Applies when Q == 1.

VRINTA{<q>}.<dt> <Qd>, <Qm>

Decode for all variants of this encoding

```

if op<2> != op<0> then SEE "Related encodings";
if Q == '1' && (Vd<0> == '1' || Vm<0> == '1') then UNDEFINED;
if (size == '01' && !HaveFP16Ext()) || size IN {'00', '11'} then UNDEFINED;
// Rounding encoded differently from other VCVT and VRINT instructions
rounding = FPDecodeRM(op<2>:NOT(op<1>)); exact = FALSE;
case size of
    when '01' esize = 16; elements = 4;
    when '10' esize = 32; elements = 2;
d = UInt(D:Vd); m = UInt(M:Vm); regs = if Q == '0' then 1 else 2;
    
```

T1

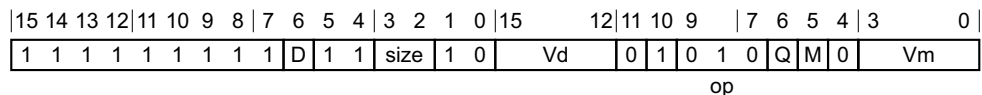

64-bit SIMD vector variant

Applies when Q == 0.

VRINTA{<q>}.<dt> <Dd>, <Dm>

128-bit SIMD vector variant

Applies when Q == 1.

VRINTA{<q>}.<dt> <Qd>, <Qm>

Decode for all variants of this encoding

```

if op<2> != op<0> then SEE "Related encodings";
if Q == '1' && (Vd<0> == '1' || Vm<0> == '1') then UNDEFINED;
if (size == '01' && !HaveFP16Ext()) || size IN {'00', '11'} then UNDEFINED;
// Rounding encoded differently from other VCVT and VRINT instructions
    
```

```
rounding = FPDecodeRM(op<2>:NOT(op<1>)); exact = FALSE;
case size of
  when '01' esize = 16; elements = 4;
  when '10' esize = 32; elements = 2;
d = UInt(D:Vd); m = UInt(M:Vm); regs = if Q == '0' then 1 else 2;
if InITBlock() then UNPREDICTABLE;
```

CONSTRAINED UNPREDICTABLE behavior

If InITBlock(), then one of the following behaviors must occur:

- The instruction is UNDEFINED.
- The instruction executes as if it passes the Condition code check.
- The instruction executes as NOP. This means it behaves as if it fails the Condition code check.

Notes for all encodings

Related encodings: See [Advanced SIMD two registers misc on page F3-2907](#) for the T32 instruction set, or [Advanced SIMD two registers misc on page F4-2989](#) for the A32 instruction set.

Assembler symbols

- <q> See [Standard assembler syntax fields on page F2-2848](#).
- <dt> Is the data type for the elements of the vectors, encoded in the "size" field. It can have the following values:
- | | |
|-----|----------------|
| F16 | when size = 01 |
| F32 | when size = 10 |
- <Qd> Is the 128-bit name of the SIMD&FP destination register, encoded in the "D:Vd" field as <Qd>*2.
- <Qm> Is the 128-bit name of the SIMD&FP source register, encoded in the "M:Vm" field as <Qm>*2.
- <Dd> Is the 64-bit name of the SIMD&FP destination register, encoded in the "D:Vd" field.
- <Dm> Is the 64-bit name of the SIMD&FP source register, encoded in the "M:Vm" field.

Operation for all encodings

```
EncodingSpecificOperations(); CheckAdvSIMDEnabled();
for r = 0 to regs-1
  for e = 0 to elements-1
    op1 = Elem[D[m+r],e,esize];
    result = FPRoundInt(op1, StandardFPSCRValue(), rounding, exact);
    Elem[D[d+r],e,esize] = result;
```

F6.1.184 VRINTA (floating-point)

Round floating-point to integer to Nearest with Ties to Away rounds a floating-point value to an integral floating-point value of the same size using the Round to Nearest with Ties to Away rounding mode. A zero input gives a zero result with the same sign, an infinite input gives an infinite result with the same sign, and a NaN is propagated as for normal arithmetic.

A1

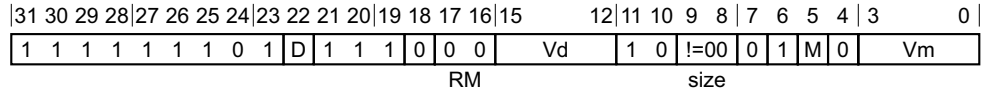

Half-precision scalar variant

Applies when size == 01.

VRINTA{<q>}.F16 <Sd>, <Sm>

Single-precision scalar variant

Applies when size == 10.

VRINTA{<q>}.F32 <Sd>, <Sm>

Double-precision scalar variant

Applies when size == 11.

VRINTA{<q>}.F64 <Dd>, <Dm>

Decode for all variants of this encoding

```

if size == '00' || (size == '01' && !HaveFP16Ext()) then UNDEFINED;
rounding = FPDecodeRM(RM); exact = FALSE;
case size of
    when '01' esize = 16; d = UInt(Vd:D); m = UInt(Vm:M);
    when '10' esize = 32; d = UInt(Vd:D); m = UInt(Vm:M);
    when '11' esize = 64; d = UInt(D:Vd); m = UInt(M:Vm);
    
```

T1

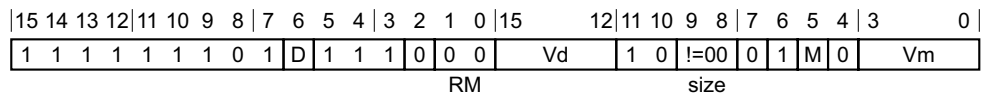

Half-precision scalar variant

Applies when size == 01.

VRINTA{<q>}.F16 <Sd>, <Sm>

Single-precision scalar variant

Applies when size == 10.

VRINTA{<q>}.F32 <Sd>, <Sm>

Double-precision scalar variant

Applies when size == 11.

VRINTA{<q>}.F64 <Dd>, <Dm>

Decode for all variants of this encoding

```
if size == '00' || (size == '01' && !HaveFP16Ext()) then UNDEFINED;
rounding = FPDecodeRM(RM); exact = FALSE;
case size of
  when '01' esize = 16; d = UInt(Vd:D); m = UInt(Vm:M);
  when '10' esize = 32; d = UInt(Vd:D); m = UInt(Vm:M);
  when '11' esize = 64; d = UInt(D:Vd); m = UInt(M:Vm);
if InITBlock() then UNPREDICTABLE;
```

CONSTRAINED UNPREDICTABLE behavior

If InITBlock(), then one of the following behaviors must occur:

- The instruction is UNDEFINED.
- The instruction executes as if it passes the Condition code check.
- The instruction executes as NOP. This means it behaves as if it fails the Condition code check.

Notes for all encodings

For more information about the CONSTRAINED UNPREDICTABLE behavior of this instruction, see [Appendix K1 Architectural Constraints on UNPREDICTABLE behaviors](#).

Assembler symbols

<q>	See Standard assembler syntax fields on page F2-2848 .
<Sd>	Is the 32-bit name of the SIMD&FP destination register, encoded in the "Vd:D" field.
<Sm>	Is the 32-bit name of the SIMD&FP source register, encoded in the "Vm:M" field.
<Dd>	Is the 64-bit name of the SIMD&FP destination register, encoded in the "D:Vd" field.
<Dm>	Is the 64-bit name of the SIMD&FP source register, encoded in the "M:Vm" field.

Operation for all encodings

```
EncodingSpecificOperations(); CheckVFPEnabled(TRUE);
case esize of
  when 16
    S[d] = Zeros(16) : FPRoundInt(S[m]<15:0>, FPSCR, rounding, exact);
  when 32
    S[d] = FPRoundInt(S[m], FPSCR, rounding, exact);
  when 64
    D[d] = FPRoundInt(D[m], FPSCR, rounding, exact);
```

F6.1.185 VRINTM (Advanced SIMD)

Vector Round floating-point to integer towards -Infinity rounds a vector of floating-point values to integral floating-point values of the same size, using the Round towards -Infinity rounding mode. A zero input gives a zero result with the same sign, an infinite input gives an infinite result with the same sign, and a NaN is propagated as for normal arithmetic.

A1

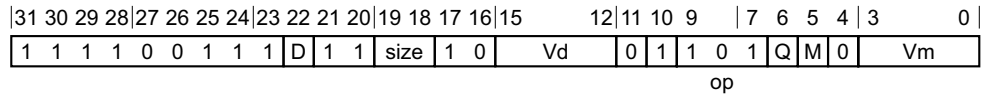

64-bit SIMD vector variant

Applies when Q == 0.

VRINTM{<q>}.<dt> <Dd>, <Dm>

128-bit SIMD vector variant

Applies when Q == 1.

VRINTM{<q>}.<dt> <Qd>, <Qm>

Decode for all variants of this encoding

```

if op<2> != op<0> then SEE "Related encodings";
if Q == '1' && (Vd<0> == '1' || Vm<0> == '1') then UNDEFINED;
if (size == '01' && !HaveFP16Ext()) || size IN {'00', '11'} then UNDEFINED;
// Rounding encoded differently from other VCVT and VRINT instructions
rounding = FPDecodeRM(op<2>:NOT(op<1>)); exact = FALSE;
case size of
    when '01' esize = 16; elements = 4;
    when '10' esize = 32; elements = 2;
d = UInt(D:Vd); m = UInt(M:Vm); regs = if Q == '0' then 1 else 2;
    
```

T1

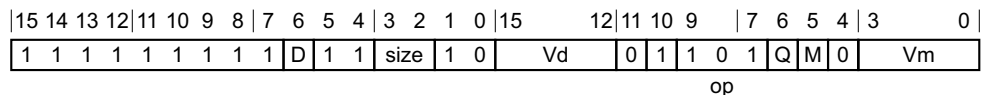

64-bit SIMD vector variant

Applies when Q == 0.

VRINTM{<q>}.<dt> <Dd>, <Dm>

128-bit SIMD vector variant

Applies when Q == 1.

VRINTM{<q>}.<dt> <Qd>, <Qm>

Decode for all variants of this encoding

```

if op<2> != op<0> then SEE "Related encodings";
if Q == '1' && (Vd<0> == '1' || Vm<0> == '1') then UNDEFINED;
if (size == '01' && !HaveFP16Ext()) || size IN {'00', '11'} then UNDEFINED;
// Rounding encoded differently from other VCVT and VRINT instructions
    
```

```
rounding = FPDecodeRM(op<2>:NOT(op<1>)); exact = FALSE;
case size of
  when '01' esize = 16; elements = 4;
  when '10' esize = 32; elements = 2;
d = UInt(D:Vd); m = UInt(M:Vm); regs = if Q == '0' then 1 else 2;
if InITBlock() then UNPREDICTABLE;
```

CONSTRAINED UNPREDICTABLE behavior

If InITBlock(), then one of the following behaviors must occur:

- The instruction is UNDEFINED.
- The instruction executes as if it passes the Condition code check.
- The instruction executes as NOP. This means it behaves as if it fails the Condition code check.

Notes for all encodings

Related encodings: See [Advanced SIMD two registers misc on page F3-2907](#) for the T32 instruction set, or [Advanced SIMD two registers misc on page F4-2989](#) for the A32 instruction set.

Assembler symbols

- <q> See [Standard assembler syntax fields on page F2-2848](#).
- <dt> Is the data type for the elements of the vectors, encoded in the "size" field. It can have the following values:
- | | |
|-----|----------------|
| F16 | when size = 01 |
| F32 | when size = 10 |
- <Qd> Is the 128-bit name of the SIMD&FP destination register, encoded in the "D:Vd" field as <Qd>*2.
- <Qm> Is the 128-bit name of the SIMD&FP source register, encoded in the "M:Vm" field as <Qm>*2.
- <Dd> Is the 64-bit name of the SIMD&FP destination register, encoded in the "D:Vd" field.
- <Dm> Is the 64-bit name of the SIMD&FP source register, encoded in the "M:Vm" field.

Operation for all encodings

```
EncodingSpecificOperations(); CheckAdvSIMDEnabled();
for r = 0 to regs-1
  for e = 0 to elements-1
    op1 = Elem[D[m+r],e,esize];
    result = FPRoundInt(op1, StandardFPSCRValue(), rounding, exact);
    Elem[D[d+r],e,esize] = result;
```

F6.1.186 VRINTM (floating-point)

Round floating-point to integer towards -Infinity rounds a floating-point value to an integral floating-point value of the same size using the Round towards -Infinity rounding mode. A zero input gives a zero result with the same sign, an infinite input gives an infinite result with the same sign, and a NaN is propagated as for normal arithmetic.

A1

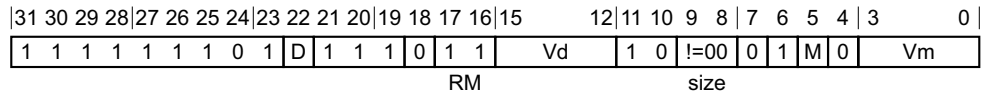

Half-precision scalar variant

Applies when size == 01.

VRINTM{<q>}.F16 <Sd>, <Sm>

Single-precision scalar variant

Applies when size == 10.

VRINTM{<q>}.F32 <Sd>, <Sm>

Double-precision scalar variant

Applies when size == 11.

VRINTM{<q>}.F64 <Dd>, <Dm>

Decode for all variants of this encoding

```
if size == '00' || (size == '01' && !HaveFP16Ext()) then UNDEFINED;
rounding = FPDecodeRM(RM); exact = FALSE;
case size of
    when '01' esize = 16; d = UInt(Vd:D); m = UInt(Vm:M);
    when '10' esize = 32; d = UInt(Vd:D); m = UInt(Vm:M);
    when '11' esize = 64; d = UInt(D:Vd); m = UInt(M:Vm);
```

T1

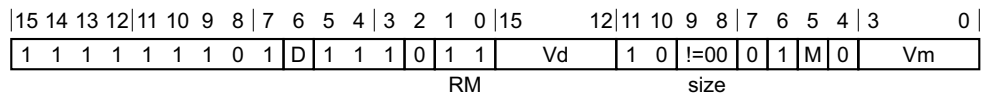

Half-precision scalar variant

Applies when size == 01.

VRINTM{<q>}.F16 <Sd>, <Sm>

Single-precision scalar variant

Applies when size == 10.

VRINTM{<q>}.F32 <Sd>, <Sm>

Double-precision scalar variant

Applies when size == 11.

VRINTM{<q>}.F64 <Dd>, <Dm>

Decode for all variants of this encoding

```
if size == '00' || (size == '01' && !HaveFP16Ext()) then UNDEFINED;
rounding = FPDecodeRM(RM); exact = FALSE;
case size of
  when '01' esize = 16; d = UInt(Vd:D); m = UInt(Vm:M);
  when '10' esize = 32; d = UInt(Vd:D); m = UInt(Vm:M);
  when '11' esize = 64; d = UInt(D:Vd); m = UInt(M:Vm);
if InITBlock() then UNPREDICTABLE;
```

CONSTRAINED UNPREDICTABLE behavior

If InITBlock(), then one of the following behaviors must occur:

- The instruction is UNDEFINED.
- The instruction executes as if it passes the Condition code check.
- The instruction executes as NOP. This means it behaves as if it fails the Condition code check.

Notes for all encodings

For more information about the CONSTRAINED UNPREDICTABLE behavior of this instruction, see [Appendix K1 Architectural Constraints on UNPREDICTABLE behaviors](#).

Assembler symbols

<q>	See Standard assembler syntax fields on page F2-2848 .
<Sd>	Is the 32-bit name of the SIMD&FP destination register, encoded in the "Vd:D" field.
<Sm>	Is the 32-bit name of the SIMD&FP source register, encoded in the "Vm:M" field.
<Dd>	Is the 64-bit name of the SIMD&FP destination register, encoded in the "D:Vd" field.
<Dm>	Is the 64-bit name of the SIMD&FP source register, encoded in the "M:Vm" field.

Operation for all encodings

```
EncodingSpecificOperations(); CheckVFPEnabled(TRUE);
case esize of
  when 16
    S[d] = Zeros(16) : FPRoundInt(S[m]<15:0>, FPSCR, rounding, exact);
  when 32
    S[d] = FPRoundInt(S[m], FPSCR, rounding, exact);
  when 64
    D[d] = FPRoundInt(D[m], FPSCR, rounding, exact);
```

F6.1.187 VRINTN (Advanced SIMD)

Vector Round floating-point to integer to Nearest rounds a vector of floating-point values to integral floating-point values of the same size using the Round to Nearest rounding mode. A zero input gives a zero result with the same sign, an infinite input gives an infinite result with the same sign, and a NaN is propagated as for normal arithmetic.

A1

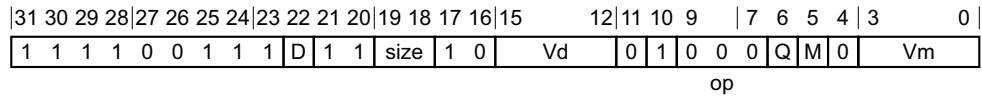

64-bit SIMD vector variant

Applies when Q == 0.

VRINTN{<q>}.<dt> <Dd>, <Dm>

128-bit SIMD vector variant

Applies when Q == 1.

VRINTN{<q>}.<dt> <Qd>, <Qm>

Decode for all variants of this encoding

```

if op<2> != op<0> then SEE "Related encodings";
if Q == '1' && (Vd<0> == '1' || Vm<0> == '1') then UNDEFINED;
if (size == '01' && !HaveFP16Ext()) || size IN {'00', '11'} then UNDEFINED;
// Rounding encoded differently from other VCVT and VRINT instructions
rounding = FPDecodeRM(op<2>:NOT(op<1>)); exact = FALSE;
case size of
    when '01' esize = 16; elements = 4;
    when '10' esize = 32; elements = 2;
d = UInt(D:Vd); m = UInt(M:Vm); regs = if Q == '0' then 1 else 2;

```

T1

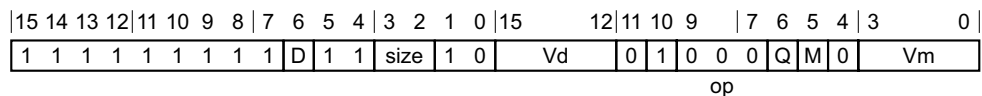

64-bit SIMD vector variant

Applies when Q == 0.

VRINTN{<q>}.<dt> <Dd>, <Dm>

128-bit SIMD vector variant

Applies when Q == 1.

VRINTN{<q>}.<dt> <Qd>, <Qm>

Decode for all variants of this encoding

```

if op<2> != op<0> then SEE "Related encodings";
if Q == '1' && (Vd<0> == '1' || Vm<0> == '1') then UNDEFINED;
if (size == '01' && !HaveFP16Ext()) || size IN {'00', '11'} then UNDEFINED;
// Rounding encoded differently from other VCVT and VRINT instructions
rounding = FPDecodeRM(op<2>:NOT(op<1>)); exact = FALSE;
case size of

```

```
    when '01' esize = 16; elements = 4;
    when '10' esize = 32; elements = 2;
d = UInt(D:Vd); m = UInt(M:Vm); regs = if Q == '0' then 1 else 2;
if InITBlock() then UNPREDICTABLE;
```

CONSTRAINED UNPREDICTABLE behavior

If InITBlock(), then one of the following behaviors must occur:

- The instruction is UNDEFINED.
- The instruction executes as if it passes the Condition code check.
- The instruction executes as NOP. This means it behaves as if it fails the Condition code check.

Notes for all encodings

Related encodings: See [Advanced SIMD two registers misc on page F3-2907](#) for the T32 instruction set, or [Advanced SIMD two registers misc on page F4-2989](#) for the A32 instruction set.

Assembler symbols

- <q> See [Standard assembler syntax fields on page F2-2848](#).
- <dt> Is the data type for the elements of the vectors, encoded in the "size" field. It can have the following values:
- | | |
|-----|----------------|
| F16 | when size = 01 |
| F32 | when size = 10 |
- <Qd> Is the 128-bit name of the SIMD&FP destination register, encoded in the "D:Vd" field as <Qd>*2.
- <Qm> Is the 128-bit name of the SIMD&FP source register, encoded in the "M:Vm" field as <Qm>*2.
- <Dd> Is the 64-bit name of the SIMD&FP destination register, encoded in the "D:Vd" field.
- <Dm> Is the 64-bit name of the SIMD&FP source register, encoded in the "M:Vm" field.

Operation for all encodings

```
EncodingSpecificOperations(); CheckAdvSIMDEnabled();
for r = 0 to regs-1
  for e = 0 to elements-1
    op1 = Elem[D[m+r],e,esize];
    result = FPRoundInt(op1, StandardFPSCRValue(), rounding, exact);
    Elem[D[d+r],e,esize] = result;
```

F6.1.188 VRINTN (floating-point)

Round floating-point to integer to Nearest rounds a floating-point value to an integral floating-point value of the same size using the Round to Nearest rounding mode. A zero input gives a zero result with the same sign, an infinite input gives an infinite result with the same sign, and a NaN is propagated as for normal arithmetic.

A1

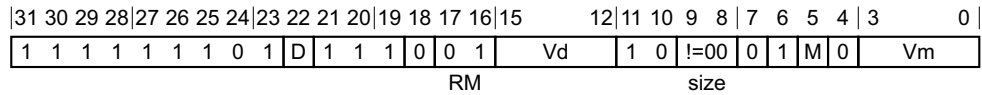

Half-precision scalar variant

Applies when size == 01.

VRINTN{<q>}.F16 <Sd>, <Sm>

Single-precision scalar variant

Applies when size == 10.

VRINTN{<q>}.F32 <Sd>, <Sm>

Double-precision scalar variant

Applies when size == 11.

VRINTN{<q>}.F64 <Dd>, <Dm>

Decode for all variants of this encoding

```

if size == '00' || (size == '01' && !HaveFP16Ext()) then UNDEFINED;
rounding = FPDecodeRM(RM); exact = FALSE;
case size of
    when '01' esize = 16; d = UInt(Vd:D); m = UInt(Vm:M);
    when '10' esize = 32; d = UInt(Vd:D); m = UInt(Vm:M);
    when '11' esize = 64; d = UInt(D:Vd); m = UInt(M:Vm);
    
```

T1

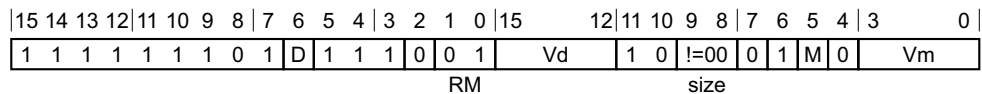

Half-precision scalar variant

Applies when size == 01.

VRINTN{<q>}.F16 <Sd>, <Sm>

Single-precision scalar variant

Applies when size == 10.

VRINTN{<q>}.F32 <Sd>, <Sm>

Double-precision scalar variant

Applies when size == 11.

VRINTN{<q>}.F64 <Dd>, <Dm>

Decode for all variants of this encoding

```
if size == '00' || (size == '01' && !HaveFP16Ext()) then UNDEFINED;
rounding = FPDecodeRM(RM); exact = FALSE;
case size of
  when '01' esize = 16; d = UInt(Vd:D); m = UInt(Vm:M);
  when '10' esize = 32; d = UInt(Vd:D); m = UInt(Vm:M);
  when '11' esize = 64; d = UInt(D:Vd); m = UInt(M:Vm);
if InITBlock() then UNPREDICTABLE;
```

CONSTRAINED UNPREDICTABLE behavior

If InITBlock(), then one of the following behaviors must occur:

- The instruction is UNDEFINED.
- The instruction executes as if it passes the Condition code check.
- The instruction executes as NOP. This means it behaves as if it fails the Condition code check.

Notes for all encodings

For more information about the CONSTRAINED UNPREDICTABLE behavior of this instruction, see [Appendix K1 Architectural Constraints on UNPREDICTABLE behaviors](#).

Assembler symbols

<q>	See Standard assembler syntax fields on page F2-2848 .
<Sd>	Is the 32-bit name of the SIMD&FP destination register, encoded in the "Vd:D" field.
<Sm>	Is the 32-bit name of the SIMD&FP source register, encoded in the "Vm:M" field.
<Dd>	Is the 64-bit name of the SIMD&FP destination register, encoded in the "D:Vd" field.
<Dm>	Is the 64-bit name of the SIMD&FP source register, encoded in the "M:Vm" field.

Operation for all encodings

```
EncodingSpecificOperations(); CheckVFPEnabled(TRUE);
case esize of
  when 16
    S[d] = Zeros(16) : FPRoundInt(S[m]<15:0>, FPSCR, rounding, exact);
  when 32
    S[d] = FPRoundInt(S[m], FPSCR, rounding, exact);
  when 64
    D[d] = FPRoundInt(D[m], FPSCR, rounding, exact);
```

F6.1.189 VRINTP (Advanced SIMD)

Vector Round floating-point to integer towards +Infinity rounds a vector of floating-point values to integral floating-point values of the same size using the Round towards +Infinity rounding mode. A zero input gives a zero result with the same sign, an infinite input gives an infinite result with the same sign, and a NaN is propagated as for normal arithmetic.

A1

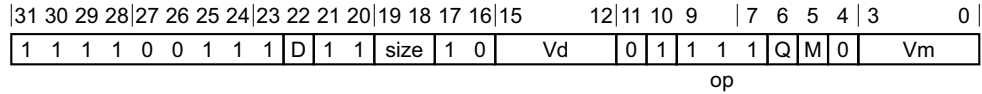

64-bit SIMD vector variant

Applies when Q == 0.

VRINTP{<q>}.<dt> <Dd>, <Dm>

128-bit SIMD vector variant

Applies when Q == 1.

VRINTP{<q>}.<dt> <Qd>, <Qm>

Decode for all variants of this encoding

```

if op<2> != op<0> then SEE "Related encodings";
if Q == '1' && (Vd<0> == '1' || Vm<0> == '1') then UNDEFINED;
if (size == '01' && !HaveFP16Ext()) || size IN {'00', '11'} then UNDEFINED;
// Rounding encoded differently from other VCVT and VRINT instructions
rounding = FPDecodeRM(op<2>:NOT(op<1>)); exact = FALSE;
case size of
    when '01' esize = 16; elements = 4;
    when '10' esize = 32; elements = 2;
d = UInt(D:Vd); m = UInt(M:Vm); regs = if Q == '0' then 1 else 2;
    
```

T1

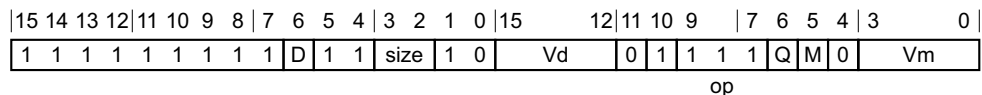

64-bit SIMD vector variant

Applies when Q == 0.

VRINTP{<q>}.<dt> <Dd>, <Dm>

128-bit SIMD vector variant

Applies when Q == 1.

VRINTP{<q>}.<dt> <Qd>, <Qm>

Decode for all variants of this encoding

```

if op<2> != op<0> then SEE "Related encodings";
if Q == '1' && (Vd<0> == '1' || Vm<0> == '1') then UNDEFINED;
if (size == '01' && !HaveFP16Ext()) || size IN {'00', '11'} then UNDEFINED;
// Rounding encoded differently from other VCVT and VRINT instructions
    
```

```
rounding = FPDecodeRM(op<2>:NOT(op<1>)); exact = FALSE;
case size of
  when '01' esize = 16; elements = 4;
  when '10' esize = 32; elements = 2;
d = UInt(D:Vd); m = UInt(M:Vm); regs = if Q == '0' then 1 else 2;
if InITBlock() then UNPREDICTABLE;
```

CONSTRAINED UNPREDICTABLE behavior

If InITBlock(), then one of the following behaviors must occur:

- The instruction is UNDEFINED.
- The instruction executes as if it passes the Condition code check.
- The instruction executes as NOP. This means it behaves as if it fails the Condition code check.

Notes for all encodings

Related encodings: See [Advanced SIMD two registers misc on page F3-2907](#) for the T32 instruction set, or [Advanced SIMD two registers misc on page F4-2989](#) for the A32 instruction set.

Assembler symbols

- <q> See [Standard assembler syntax fields on page F2-2848](#).
- <dt> Is the data type for the elements of the vectors, encoded in the "size" field. It can have the following values:
- | | |
|-----|----------------|
| F16 | when size = 01 |
| F32 | when size = 10 |
- <Qd> Is the 128-bit name of the SIMD&FP destination register, encoded in the "D:Vd" field as <Qd>*2.
- <Qm> Is the 128-bit name of the SIMD&FP source register, encoded in the "M:Vm" field as <Qm>*2.
- <Dd> Is the 64-bit name of the SIMD&FP destination register, encoded in the "D:Vd" field.
- <Dm> Is the 64-bit name of the SIMD&FP source register, encoded in the "M:Vm" field.

Operation for all encodings

```
EncodingSpecificOperations(); CheckAdvSIMDEnabled();
for r = 0 to regs-1
  for e = 0 to elements-1
    op1 = Elem[D[m+r],e,esize];
    result = FPRoundInt(op1, StandardFPSCRValue(), rounding, exact);
    Elem[D[d+r],e,esize] = result;
```

F6.1.190 VRINTP (floating-point)

Round floating-point to integer towards +Infinity rounds a floating-point value to an integral floating-point value of the same size using the Round towards +Infinity rounding mode. A zero input gives a zero result with the same sign, an infinite input gives an infinite result with the same sign, and a NaN is propagated as for normal arithmetic.

A1

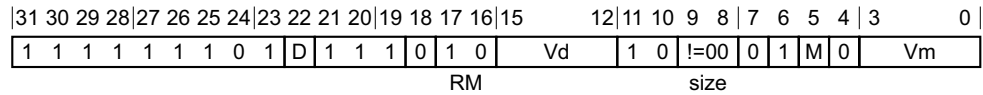

Half-precision scalar variant

Applies when size == 01.

VRINTP{<q>}.F16 <Sd>, <Sm>

Single-precision scalar variant

Applies when size == 10.

VRINTP{<q>}.F32 <Sd>, <Sm>

Double-precision scalar variant

Applies when size == 11.

VRINTP{<q>}.F64 <Dd>, <Dm>

Decode for all variants of this encoding

```
if size == '00' || (size == '01' && !HaveFP16Ext()) then UNDEFINED;
rounding = FPDecodeRM(RM); exact = FALSE;
case size of
    when '01' esize = 16; d = UInt(Vd:D); m = UInt(Vm:M);
    when '10' esize = 32; d = UInt(Vd:D); m = UInt(Vm:M);
    when '11' esize = 64; d = UInt(D:Vd); m = UInt(M:Vm);
```

T1

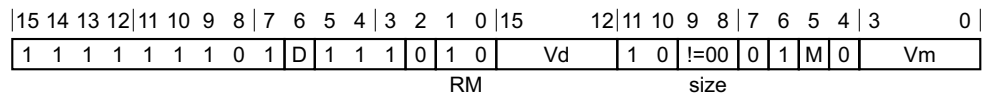

Half-precision scalar variant

Applies when size == 01.

VRINTP{<q>}.F16 <Sd>, <Sm>

Single-precision scalar variant

Applies when size == 10.

VRINTP{<q>}.F32 <Sd>, <Sm>

Double-precision scalar variant

Applies when size == 11.

VRINTP{<q>}.F64 <Dd>, <Dm>

Decode for all variants of this encoding

```
if size == '00' || (size == '01' && !HaveFP16Ext()) then UNDEFINED;
rounding = FPDecodeRM(RM); exact = FALSE;
case size of
  when '01' esize = 16; d = UInt(Vd:D); m = UInt(Vm:M);
  when '10' esize = 32; d = UInt(Vd:D); m = UInt(Vm:M);
  when '11' esize = 64; d = UInt(D:Vd); m = UInt(M:Vm);
if InITBlock() then UNPREDICTABLE;
```

CONSTRAINED UNPREDICTABLE behavior

If InITBlock(), then one of the following behaviors must occur:

- The instruction is UNDEFINED.
- The instruction executes as if it passes the Condition code check.
- The instruction executes as NOP. This means it behaves as if it fails the Condition code check.

Notes for all encodings

For more information about the CONSTRAINED UNPREDICTABLE behavior of this instruction, see [Appendix K1 Architectural Constraints on UNPREDICTABLE behaviors](#).

Assembler symbols

<q>	See Standard assembler syntax fields on page F2-2848 .
<Sd>	Is the 32-bit name of the SIMD&FP destination register, encoded in the "Vd:D" field.
<Sm>	Is the 32-bit name of the SIMD&FP source register, encoded in the "Vm:M" field.
<Dd>	Is the 64-bit name of the SIMD&FP destination register, encoded in the "D:Vd" field.
<Dm>	Is the 64-bit name of the SIMD&FP source register, encoded in the "M:Vm" field.

Operation for all encodings

```
EncodingSpecificOperations(); CheckVFPEnabled(TRUE);
case esize of
  when 16
    S[d] = Zeros(16) : FPRoundInt(S[m]<15:0>, FPSCR, rounding, exact);
  when 32
    S[d] = FPRoundInt(S[m], FPSCR, rounding, exact);
  when 64
    D[d] = FPRoundInt(D[m], FPSCR, rounding, exact);
```

F6.1.191 VRINTR

Round floating-point to integer rounds a floating-point value to an integral floating-point value of the same size using the rounding mode specified in the FPSCR. A zero input gives a zero result with the same sign, an infinite input gives an infinite result with the same sign, and a NaN is propagated as for normal arithmetic.

A1

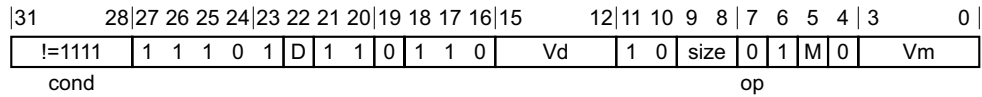

Half-precision scalar variant

Applies when size == 01.

VRINTR{<c>}{<q>}.F16 <Sd>, <Sm>

Single-precision scalar variant

Applies when size == 10.

VRINTR{<c>}{<q>}.F32 <Sd>, <Sm>

Double-precision scalar variant

Applies when size == 11.

VRINTR{<c>}{<q>}.F64 <Dd>, <Dm>

Decode for all variants of this encoding

```

if size == '00' || (size == '01' && !HaveFP16Ext()) then UNDEFINED;
if size == '01' && cond != '1110' then UNPREDICTABLE;
rounding = if op == '1' then FPRounding_ZERO else FPRoundingMode(FPSCR);
exact = FALSE;
case size of
    when '01' esize = 16; d = UInt(Vd:D); m = UInt(Vm:M);
    when '10' esize = 32; d = UInt(Vd:D); m = UInt(Vm:M);
    when '11' esize = 64; d = UInt(D:Vd); m = UInt(M:Vm);
    
```

T1

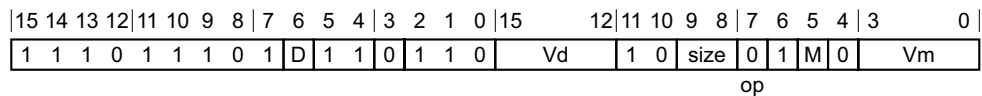

Half-precision scalar variant

Applies when size == 01.

VRINTR{<c>}{<q>}.F16 <Sd>, <Sm>

Single-precision scalar variant

Applies when size == 10.

VRINTR{<c>}{<q>}.F32 <Sd>, <Sm>

Double-precision scalar variant

Applies when size == 11.

VRINTR{<c>}{<q>}.F64 <Dd>, <Dm>

Decode for all variants of this encoding

```
if size == '00' || (size == '01' && !HaveFP16Ext()) then UNDEFINED;
if size == '01' && InITBlock() then UNPREDICTABLE;
rounding = if op == '1' then FPRounding_ZERO else FPRoundingMode(FPSCR);
exact = FALSE;
case size of
  when '01' esize = 16; d = UInt(Vd:D); m = UInt(Vm:M);
  when '10' esize = 32; d = UInt(Vd:D); m = UInt(Vm:M);
  when '11' esize = 64; d = UInt(D:Vd); m = UInt(M:Vm);
```

CONSTRAINED UNPREDICTABLE behavior

If InITBlock(), then one of the following behaviors must occur:

- The instruction is UNDEFINED.
- The instruction executes as if it passes the Condition code check.
- The instruction executes as NOP. This means it behaves as if it fails the Condition code check.

Assembler symbols

<c>	See Standard assembler syntax fields on page F2-2848 .
<q>	See Standard assembler syntax fields on page F2-2848 .
<Sd>	Is the 32-bit name of the SIMD&FP destination register, encoded in the "Vd:D" field.
<Sm>	Is the 32-bit name of the SIMD&FP source register, encoded in the "Vm:M" field.
<Dd>	Is the 64-bit name of the SIMD&FP destination register, encoded in the "D:Vd" field.
<Dm>	Is the 64-bit name of the SIMD&FP source register, encoded in the "M:Vm" field.

Operation for all encodings

```
if ConditionPassed() then
  EncodingSpecificOperations(); CheckVFPEnabled(TRUE);
case esize of
  when 16
    S[d] = Zeros(16) : FPRoundInt(S[m]<15:0>, FPSCR, rounding, exact);
  when 32
    S[d] = FPRoundInt(S[m], FPSCR, rounding, exact);
  when 64
    D[d] = FPRoundInt(D[m], FPSCR, rounding, exact);
```

F6.1.192 VRINTX (Advanced SIMD)

Vector round floating-point to integer inexact rounds a vector of floating-point values to integral floating-point values of the same size, using the Round to Nearest rounding mode, and raises the Inexact exception when the result value is not numerically equal to the input value. A zero input gives a zero result with the same sign, an infinite input gives an infinite result with the same sign, and a NaN is propagated as for normal arithmetic.

A1

31	30	29	28	27	26	25	24	23	22	21	20	19	18	17	16	15	12	11	10	9	8	7	6	5	4	3	0
1	1	1	1	0	0	1	1	1	D	1	1	size	1	0	Vd	0	1	0	0	1	Q	M	0	Vm			

64-bit SIMD vector variant

Applies when Q == 0.

VRINTX{<q>}.<dt> <Dd>, <Dm>

128-bit SIMD vector variant

Applies when Q == 1.

VRINTX{<q>}.<dt> <Qd>, <Qm>

Decode for all variants of this encoding

```

if Q == '1' && (Vd<0> == '1' || Vm<0> == '1') then UNDEFINED;
if (size == '01' && !HaveFP16Ext()) || size IN {'00', '11'} then UNDEFINED;
rounding = FPRounding_TIEEVEN; exact = TRUE;
case size of
    when '01' esize = 16; elements = 4;
    when '10' esize = 32; elements = 2;
d = UInt(D:Vd); m = UInt(M:Vm); regs = if Q == '0' then 1 else 2;
    
```

T1

15	14	13	12	11	10	9	8	7	6	5	4	3	2	1	0	15	12	11	10	9	8	7	6	5	4	3	0
1	1	1	1	1	1	1	1	1	D	1	1	size	1	0	Vd	0	1	0	0	1	Q	M	0	Vm			

64-bit SIMD vector variant

Applies when Q == 0.

VRINTX{<q>}.<dt> <Dd>, <Dm>

128-bit SIMD vector variant

Applies when Q == 1.

VRINTX{<q>}.<dt> <Qd>, <Qm>

Decode for all variants of this encoding

```

if Q == '1' && (Vd<0> == '1' || Vm<0> == '1') then UNDEFINED;
if (size == '01' && !HaveFP16Ext()) || size IN {'00', '11'} then UNDEFINED;
rounding = FPRounding_TIEEVEN; exact = TRUE;
case size of
    when '01' esize = 16; elements = 4;
    
```

```
    when '10' esize = 32; elements = 2;  
    d = UInt(D:Vd); m = UInt(M:Vm); regs = if Q == '0' then 1 else 2;  
    if InITBlock() then UNPREDICTABLE;
```

CONSTRAINED UNPREDICTABLE behavior

If InITBlock(), then one of the following behaviors must occur:

- The instruction is UNDEFINED.
- The instruction executes as if it passes the Condition code check.
- The instruction executes as NOP. This means it behaves as if it fails the Condition code check.

Notes for all encodings

For more information about the CONSTRAINED UNPREDICTABLE behavior of this instruction, see [Appendix K1 Architectural Constraints on UNPREDICTABLE behaviors](#).

Assembler symbols

- <q> See [Standard assembler syntax fields on page F2-2848](#).
- <dt> Is the data type for the elements of the vectors, encoded in the "size" field. It can have the following values:
F16 when size = 01
F32 when size = 10
- <Qd> Is the 128-bit name of the SIMD&FP destination register, encoded in the "D:Vd" field as <Qd>*2.
- <Qm> Is the 128-bit name of the SIMD&FP source register, encoded in the "M:Vm" field as <Qm>*2.
- <Dd> Is the 64-bit name of the SIMD&FP destination register, encoded in the "D:Vd" field.
- <Dm> Is the 64-bit name of the SIMD&FP source register, encoded in the "M:Vm" field.

Operation for all encodings

```
EncodingSpecificOperations(); CheckAdvSIMDEnabled();  
for r = 0 to regs-1  
  for e = 0 to elements-1  
    op1 = Elem[D[m+r],e,esize];  
    result = FPRoundInt(op1, StandardFPSCRValue(), rounding, exact);  
    Elem[D[d+r],e,esize] = result;
```

F6.1.193 VRINTX (floating-point)

Round floating-point to integer inexact rounds a floating-point value to an integral floating-point value of the same size, using the rounding mode specified in the FPSCR, and raises an Inexact exception when the result value is not numerically equal to the input value. A zero input gives a zero result with the same sign, an infinite input gives an infinite result with the same sign, and a NaN is propagated as for normal arithmetic.

A1

31	28	27	26	25	24	23	22	21	20	19	18	17	16	15	12	11	10	9	8	7	6	5	4	3	0
!=1111				1	1	1	0	1	D	1	1	0	1	1	1	Vd	1	0	size	0	1	M	0	Vm	
cond																									

Half-precision scalar variant

Applies when size == 01.

VRINTX{<c>}{<q>}.F16 <Sd>, <Sm>

Single-precision scalar variant

Applies when size == 10.

VRINTX{<c>}{<q>}.F32 <Sd>, <Sm>

Double-precision scalar variant

Applies when size == 11.

VRINTX{<c>}{<q>}.F64 <Dd>, <Dm>

Decode for all variants of this encoding

```

if size == '00' || (size == '01' && !HaveFP16Ext()) then UNDEFINED;
if size == '01' && cond != '1110' then UNPREDICTABLE;
exact = TRUE;
case size of
    when '01' esize = 16; d = UInt(Vd:D); m = UInt(Vm:M);
    when '10' esize = 32; d = UInt(Vd:D); m = UInt(Vm:M);
    when '11' esize = 64; d = UInt(D:Vd); m = UInt(M:Vm);
    
```

T1

15	14	13	12	11	10	9	8	7	6	5	4	3	2	1	0	15	12	11	10	9	8	7	6	5	4	3	0
1	1	1	0	1	1	1	0	1	D	1	1	0	1	1	1	Vd	1	0	size	0	1	M	0	Vm			

Half-precision scalar variant

Applies when size == 01.

VRINTX{<c>}{<q>}.F16 <Sd>, <Sm>

Single-precision scalar variant

Applies when size == 10.

VRINTX{<c>}{<q>}.F32 <Sd>, <Sm>

Double-precision scalar variant

Applies when size == 11.

VRINTX{<c>}{<q>}.F64 <Dd>, <Dm>

Decode for all variants of this encoding

```
if size == '00' || (size == '01' && !HaveFP16Ext()) then UNDEFINED;
if size == '01' && InITBlock() then UNPREDICTABLE;
exact = TRUE;
case size of
  when '01' esize = 16; d = UInt(Vd:D); m = UInt(Vm:M);
  when '10' esize = 32; d = UInt(Vd:D); m = UInt(Vm:M);
  when '11' esize = 64; d = UInt(D:Vd); m = UInt(M:Vm);
```

CONSTRAINED UNPREDICTABLE behavior

If InITBlock(), then one of the following behaviors must occur:

- The instruction is UNDEFINED.
- The instruction executes as if it passes the Condition code check.
- The instruction executes as NOP. This means it behaves as if it fails the Condition code check.

Assembler symbols

<c>	See Standard assembler syntax fields on page F2-2848 .
<q>	See Standard assembler syntax fields on page F2-2848 .
<Sd>	Is the 32-bit name of the SIMD&FP destination register, encoded in the "Vd:D" field.
<Sm>	Is the 32-bit name of the SIMD&FP source register, encoded in the "Vm:M" field.
<Dd>	Is the 64-bit name of the SIMD&FP destination register, encoded in the "D:Vd" field.
<Dm>	Is the 64-bit name of the SIMD&FP source register, encoded in the "M:Vm" field.

Operation for all encodings

```
if ConditionPassed() then
  EncodingSpecificOperations(); CheckVFPEnabled(TRUE);
  rounding = FPRoundingMode(FPSCR);
  case esize of
    when 16
      S[d] = Zeros(16) : FPRoundInt(S[m]<15:0>, FPSCR, rounding, exact);
    when 32
      S[d] = FPRoundInt(S[m], FPSCR, rounding, exact);
    when 64
      D[d] = FPRoundInt(D[m], FPSCR, rounding, exact);
```

F6.1.194 VRINTZ (Advanced SIMD)

Vector round floating-point to integer towards Zero rounds a vector of floating-point values to integral floating-point values of the same size, using the Round towards Zero rounding mode. A zero input gives a zero result with the same sign, an infinite input gives an infinite result with the same sign, and a NaN is propagated as for normal arithmetic.

A1

31	30	29	28	27	26	25	24	23	22	21	20	19	18	17	16	15	12	11	10	9	8	7	6	5	4	3	0
1	1	1	1	0	0	1	1	1	D	1	1	size	1	0	Vd	0	1	0	1	1	Q	M	0	Vm			

64-bit SIMD vector variant

Applies when Q == 0.

VRINTZ{<q>}.<dt> <Dd>, <Dm>

128-bit SIMD vector variant

Applies when Q == 1.

VRINTZ{<q>}.<dt> <Qd>, <Qm>

Decode for all variants of this encoding

```

if Q == '1' && (Vd<0> == '1' || Vm<0> == '1') then UNDEFINED;
if (size == '01' && !HaveFP16Ext()) || size IN {'00', '11'} then UNDEFINED;
rounding = FPRounding_ZERO; exact = FALSE;
case size of
    when '01' esize = 16; elements = 4;
    when '10' esize = 32; elements = 2;
d = UInt(D:Vd); m = UInt(M:Vm); regs = if Q == '0' then 1 else 2;
    
```

T1

15	14	13	12	11	10	9	8	7	6	5	4	3	2	1	0	15	12	11	10	9	8	7	6	5	4	3	0
1	1	1	1	1	1	1	1	1	D	1	1	size	1	0	Vd	0	1	0	1	1	Q	M	0	Vm			

64-bit SIMD vector variant

Applies when Q == 0.

VRINTZ{<q>}.<dt> <Dd>, <Dm>

128-bit SIMD vector variant

Applies when Q == 1.

VRINTZ{<q>}.<dt> <Qd>, <Qm>

Decode for all variants of this encoding

```

if Q == '1' && (Vd<0> == '1' || Vm<0> == '1') then UNDEFINED;
if (size == '01' && !HaveFP16Ext()) || size IN {'00', '11'} then UNDEFINED;
rounding = FPRounding_ZERO; exact = FALSE;
case size of
    when '01' esize = 16; elements = 4;
    
```

```
    when '10' esize = 32; elements = 2;  
    d = UInt(D:Vd); m = UInt(M:Vm); regs = if Q == '0' then 1 else 2;  
    if InITBlock() then UNPREDICTABLE;
```

CONSTRAINED UNPREDICTABLE behavior

If InITBlock(), then one of the following behaviors must occur:

- The instruction is UNDEFINED.
- The instruction executes as if it passes the Condition code check.
- The instruction executes as NOP. This means it behaves as if it fails the Condition code check.

Notes for all encodings

For more information about the CONSTRAINED UNPREDICTABLE behavior of this instruction, see [Appendix K1 Architectural Constraints on UNPREDICTABLE behaviors](#).

Assembler symbols

- <q> See [Standard assembler syntax fields on page F2-2848](#).
- <dt> Is the data type for the elements of the vectors, encoded in the "size" field. It can have the following values:
F16 when size = 01
F32 when size = 10
- <Qd> Is the 128-bit name of the SIMD&FP destination register, encoded in the "D:Vd" field as <Qd>*2.
- <Qm> Is the 128-bit name of the SIMD&FP source register, encoded in the "M:Vm" field as <Qm>*2.
- <Dd> Is the 64-bit name of the SIMD&FP destination register, encoded in the "D:Vd" field.
- <Dm> Is the 64-bit name of the SIMD&FP source register, encoded in the "M:Vm" field.

Operation for all encodings

```
EncodingSpecificOperations(); CheckAdvSIMDEnabled();  
for r = 0 to regs-1  
  for e = 0 to elements-1  
    op1 = Elem[D[m+r],e,esize];  
    result = FPRoundInt(op1, StandardFPSCRValue(), rounding, exact);  
    Elem[D[d+r],e,esize] = result;
```

F6.1.195 VRINTZ (floating-point)

Round floating-point to integer towards Zero rounds a floating-point value to an integral floating-point value of the same size, using the Round towards Zero rounding mode. A zero input gives a zero result with the same sign, an infinite input gives an infinite result with the same sign, and a NaN is propagated as for normal arithmetic.

A1

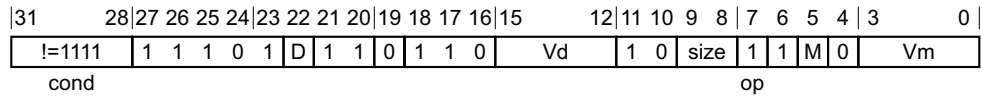

Half-precision scalar variant

Applies when size == 01.

VRINTZ{<c>}{<q>}.F16 <Sd>, <Sm>

Single-precision scalar variant

Applies when size == 10.

VRINTZ{<c>}{<q>}.F32 <Sd>, <Sm>

Double-precision scalar variant

Applies when size == 11.

VRINTZ{<c>}{<q>}.F64 <Dd>, <Dm>

Decode for all variants of this encoding

```

if size == '00' || (size == '01' && !HaveFP16Ext()) then UNDEFINED;
if size == '01' && cond != '1110' then UNPREDICTABLE;
rounding = if op == '1' then FPRounding_ZERO else FPRoundingMode(FPSCR);
exact = FALSE;
case size of
    when '01' esize = 16; d = UInt(Vd:D); m = UInt(Vm:M);
    when '10' esize = 32; d = UInt(Vd:D); m = UInt(Vm:M);
    when '11' esize = 64; d = UInt(D:Vd); m = UInt(M:Vm);
    
```

T1

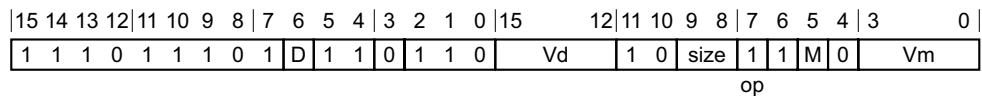

Half-precision scalar variant

Applies when size == 01.

VRINTZ{<c>}{<q>}.F16 <Sd>, <Sm>

Single-precision scalar variant

Applies when size == 10.

VRINTZ{<c>}{<q>}.F32 <Sd>, <Sm>

Double-precision scalar variant

Applies when size == 11.

VRINTZ{<c>}{<q>}.F64 <Dd>, <Dm>

Decode for all variants of this encoding

```
if size == '00' || (size == '01' && !HaveFP16Ext()) then UNDEFINED;
if size == '01' && InITBlock() then UNPREDICTABLE;
rounding = if op == '1' then FPRounding_ZERO else FPRoundingMode(FPSCR);
exact = FALSE;
case size of
  when '01' esize = 16; d = UInt(Vd:D); m = UInt(Vm:M);
  when '10' esize = 32; d = UInt(Vd:D); m = UInt(Vm:M);
  when '11' esize = 64; d = UInt(D:Vd); m = UInt(M:Vm);
```

CONSTRAINED UNPREDICTABLE behavior

If InITBlock(), then one of the following behaviors must occur:

- The instruction is UNDEFINED.
- The instruction executes as if it passes the Condition code check.
- The instruction executes as NOP. This means it behaves as if it fails the Condition code check.

Assembler symbols

<c>	See Standard assembler syntax fields on page F2-2848 .
<q>	See Standard assembler syntax fields on page F2-2848 .
<Sd>	Is the 32-bit name of the SIMD&FP destination register, encoded in the "Vd:D" field.
<Sm>	Is the 32-bit name of the SIMD&FP source register, encoded in the "Vm:M" field.
<Dd>	Is the 64-bit name of the SIMD&FP destination register, encoded in the "D:Vd" field.
<Dm>	Is the 64-bit name of the SIMD&FP source register, encoded in the "M:Vm" field.

Operation for all encodings

```
if ConditionPassed() then
  EncodingSpecificOperations(); CheckVFPEEnabled(TRUE);
case esize of
  when 16
    S[d] = Zeros(16) : FPRoundInt(S[m]<15:0>, FPSCR, rounding, exact);
  when 32
    S[d] = FPRoundInt(S[m], FPSCR, rounding, exact);
  when 64
    D[d] = FPRoundInt(D[m], FPSCR, rounding, exact);
```

F6.1.196 VRSHL

Vector Rounding Shift Left takes each element in a vector, shifts them by a value from the least significant byte of the corresponding element of a second vector, and places the results in the destination vector. If the shift value is positive, the operation is a left shift. If the shift value is negative, it is a rounding right shift. For a truncating shift, see VSHL.

The first operand and result elements are the same data type, and can be any one of:

- 8-bit, 16-bit, 32-bit, or 64-bit signed integers.
- 8-bit, 16-bit, 32-bit, or 64-bit unsigned integers.

The second operand is always a signed integer of the same size.

Depending on settings in the CPACR, NSACR, and HCPTR registers, and the security state and mode in which the instruction is executed, an attempt to execute the instruction might be UNDEFINED, or trapped to Hyp mode. For more information see [Enabling Advanced SIMD and floating-point support on page G1-4413](#).

A1

31	30	29	28	27	26	25	24	23	22	21	20	19	16	15	12	11	10	9	8	7	6	5	4	3	0
1	1	1	1	0	0	1	U	0	D	size	Vn	Vd	0	1	0	1	N	Q	M	0	Vm				

64-bit SIMD vector variant

Applies when Q == 0.

VRSHL{<c>}{<q>}.<dt> {<Dd>}, <Dm>, <Dn>

128-bit SIMD vector variant

Applies when Q == 1.

VRSHL{<c>}{<q>}.<dt> {<Qd>}, <Qm>, <Qn>

Decode for all variants of this encoding

```
if Q == '1' && (Vd<0> == '1' || Vm<0> == '1' || Vn<0> == '1') then UNDEFINED;
unsigned = (U == '1');
esize = 8 << UInt(size); elements = 64 DIV esize;
d = UInt(D:Vd); m = UInt(M:Vm); n = UInt(N:Vn); regs = if Q == '0' then 1 else 2;
```

T1

15	14	13	12	11	10	9	8	7	6	5	4	3	0	15	12	11	10	9	8	7	6	5	4	3	0
1	1	1	U	1	1	1	1	0	D	size	Vn	Vd	0	1	0	1	N	Q	M	0	Vm				

64-bit SIMD vector variant

Applies when Q == 0.

VRSHL{<c>}{<q>}.<dt> {<Dd>}, <Dm>, <Dn>

128-bit SIMD vector variant

Applies when Q == 1.

VRSHL{<c>}{<q>}.<dt> {<Qd>}, <Qm>, <Qn>

Decode for all variants of this encoding

```

if Q == '1' && (Vd<0> == '1' || Vm<0> == '1' || Vn<0> == '1') then UNDEFINED;
unsigned = (U == '1');
esize = 8 << UInt(size); elements = 64 DIV esize;
d = UInt(D:Vd); m = UInt(M:Vm); n = UInt(N:Vn); regs = if Q == '0' then 1 else 2;
  
```

Assembler symbols

- <c> For encoding A1: see [Standard assembler syntax fields on page F2-2848](#). This encoding must be unconditional.
 For encoding T1: see [Standard assembler syntax fields on page F2-2848](#).
- <q> See [Standard assembler syntax fields on page F2-2848](#).
- <dt> Is the data type for the elements of the vectors, encoded in the "U:size" field. It can have the following values:
- | | |
|-----|-----------------------|
| S8 | when U = 0, size = 00 |
| S16 | when U = 0, size = 01 |
| S32 | when U = 0, size = 10 |
| S64 | when U = 0, size = 11 |
| U8 | when U = 1, size = 00 |
| U16 | when U = 1, size = 01 |
| U32 | when U = 1, size = 10 |
| U64 | when U = 1, size = 11 |
- <Qd> Is the 128-bit name of the SIMD&FP destination register, encoded in the "D:Vd" field as <Qd>*2.
- <Qm> Is the 128-bit name of the second SIMD&FP source register, encoded in the "M:Vm" field as <Qm>*2.
- <Qn> Is the 128-bit name of the first SIMD&FP source register, encoded in the "N:Vn" field as <Qn>*2.
- <Dd> Is the 64-bit name of the SIMD&FP destination register, encoded in the "D:Vd" field.
- <Dm> Is the 64-bit name of the second SIMD&FP source register, encoded in the "M:Vm" field.
- <Dn> Is the 64-bit name of the first SIMD&FP source register, encoded in the "N:Vn" field.

Operation for all encodings

```

if ConditionPassed() then
  EncodingSpecificOperations(); CheckAdvSIMDEnabled();
  for r = 0 to regs-1
    for e = 0 to elements-1
      shift = SInt(Elem[D[n+r],e,esize]<7:0>);
      round_const = 1 << (-shift-1); // 0 for left shift, 2^(n-1) for right shift
      result = (Int(Elem[D[m+r],e,esize], unsigned) + round_const) << shift;
      Elem[D[d+r],e,esize] = result<esize-1:0>;
  
```

F6.1.197 VRSHR

Vector Rounding Shift Right takes each element in a vector, right shifts them by an immediate value, and places the rounded results in the destination vector. For truncated results, see [VSHR](#).

The operand and result elements must be the same size, and can be any one of:

- 8-bit, 16-bit, 32-bit, or 64-bit signed integers.
- 8-bit, 16-bit, 32-bit, or 64-bit unsigned integers.

Depending on settings in the [CPACR](#), [NSACR](#), and [HCPTR](#) registers, and the security state and mode in which the instruction is executed, an attempt to execute the instruction might be UNDEFINED, or trapped to Hyp mode. For more information see [Enabling Advanced SIMD and floating-point support on page G1-4413](#).

A1

31	30	29	28	27	26	25	24	23	22	21	16	15	12	11	10	9	8	7	6	5	4	3	0
1	1	1	1	0	0	1	U	1	D	imm6	Vd	0	0	1	0	L	Q	M	1	Vm			

64-bit SIMD vector variant

Applies when $!(imm6 == 000xxx \ \&\& \ L == 0) \ \&\& \ Q == 0$.

`VRSHR{<c>}{<q>}.<type><size> {<Dd>}, <Dm>, #<imm>`

128-bit SIMD vector variant

Applies when $!(imm6 == 000xxx \ \&\& \ L == 0) \ \&\& \ Q == 1$.

`VRSHR{<c>}{<q>}.<type><size> {<Qd>}, <Qm>, #<imm>`

Decode for all variants of this encoding

```

if (L:imm6) == '000xxx' then SEE "Related encodings";
if Q == '1' && (Vd<0> == '1' || Vm<0> == '1') then UNDEFINED;
case L:imm6 of
  when '0001xxx' esize = 8; elements = 8; shift_amount = 16 - UInt(imm6);
  when '001xxxx' esize = 16; elements = 4; shift_amount = 32 - UInt(imm6);
  when '01xxxxx' esize = 32; elements = 2; shift_amount = 64 - UInt(imm6);
  when '1xxxxxx' esize = 64; elements = 1; shift_amount = 64 - UInt(imm6);
unsigned = (U == '1'); d = UInt(D:Vd); m = UInt(M:Vm); regs = if Q == '0' then 1 else 2;
    
```

T1

15	14	13	12	11	10	9	8	7	6	5	0	15	12	11	10	9	8	7	6	5	4	3	0
1	1	1	U	1	1	1	1	1	D	imm6	Vd	0	0	1	0	L	Q	M	1	Vm			

64-bit SIMD vector variant

Applies when $!(imm6 == 000xxx \ \&\& \ L == 0) \ \&\& \ Q == 0$.

`VRSHR{<c>}{<q>}.<type><size> {<Dd>}, <Dm>, #<imm>`

128-bit SIMD vector variant

Applies when $!(imm6 == 000xxx \ \&\& \ L == 0) \ \&\& \ Q == 1$.

`VRSHR{<c>}{<q>}.<type><size> {<Qd>}, <Qm>, #<imm>`

Decode for all variants of this encoding

```

if (L:imm6) == '0000xxx' then SEE "Related encodings";
if Q == '1' && (Vd<0> == '1' || Vm<0> == '1') then UNDEFINED;
case L:imm6 of
  when '0001xxx' esize = 8; elements = 8; shift_amount = 16 - UInt(imm6);
  when '001xxxx' esize = 16; elements = 4; shift_amount = 32 - UInt(imm6);
  when '01xxxxx' esize = 32; elements = 2; shift_amount = 64 - UInt(imm6);
  when '1xxxxxx' esize = 64; elements = 1; shift_amount = 64 - UInt(imm6);
unsigned = (U == '1'); d = UInt(D:Vd); m = UInt(M:Vm); regs = if Q == '0' then 1 else 2;
  
```

Notes for all encodings

Related encodings: See *Advanced SIMD one register and modified immediate* on page F3-2912 for the T32 instruction set, or *Advanced SIMD one register and modified immediate* on page F4-2994 for the A32 instruction set.

Assembler symbols

- <c> For encoding A1: see *Standard assembler syntax fields* on page F2-2848. This encoding must be unconditional.
 For encoding T1: see *Standard assembler syntax fields* on page F2-2848.
- <q> See *Standard assembler syntax fields* on page F2-2848.
- <type> Is the data type for the elements of the vectors, encoded in the "U" field. It can have the following values:
 - S when U = 0
 - U when U = 1
- <size> Is the data size for the elements of the vectors, encoded in the "L:imm6<5:3>" field. It can have the following values:
 - 8 when L = 0, imm6<5:3> = 001
 - 16 when L = 0, imm6<5:3> = 01x
 - 32 when L = 0, imm6<5:3> = 1xx
 - 64 when L = 1, imm6<5:3> = xxx
- <Qd> Is the 128-bit name of the SIMD&FP destination register, encoded in the "D:Vd" field as <Qd>*2.
- <Qm> Is the 128-bit name of the SIMD&FP source register, encoded in the "M:Vm" field as <Qm>*2.
- <Dd> Is the 64-bit name of the SIMD&FP destination register, encoded in the "D:Vd" field.
- <Dm> Is the 64-bit name of the SIMD&FP source register, encoded in the "M:Vm" field.
- <imm> Is an immediate value, in the range 1 to <size>, encoded in the "imm6" field as <size> - <imm>.

Operation for all encodings

```

if ConditionPassed() then
  EncodingSpecificOperations(); CheckAdvSIMDEnabled();
  round_const = 1 << (shift_amount - 1);
  for r = 0 to regs-1
    for e = 0 to elements-1
      result = (Int(Elem[D[m+r],e,esize], unsigned) + round_const) >> shift_amount;
      Elem[D[d+r],e,esize] = result<esize-1:0>;
  
```

F6.1.198 VRSHR (zero)

Vector Rounding Shift Right copies the contents of one SIMD register to another

This instruction is a pseudo-instruction of the [VORR \(register\)](#) instruction. This means that:

- The encodings in this description are named to match the encodings of [VORR \(register\)](#).
- The assembler syntax is used only for assembly, and is not used on disassembly.
- The description of [VORR \(register\)](#) gives the operational pseudocode for this instruction.

A1

31	30	29	28	27	26	25	24	23	22	21	20	19	16	15	12	11	10	9	8	7	6	5	4	3	0
1	1	1	1	0	0	1	0	0	D	1	0	Vn	Vd	0	0	0	1	N	Q	M	1	Vm			

64-bit SIMD vector variant

Applies when Q == 0.

VRSHR{<c>}{<q>}.<dt> <Dd>, <Dm>, #0

is equivalent to

VORR{<c>}{<q>}{.dt} <Dd>, <Dm>, <Dm>

and is never the preferred disassembly.

128-bit SIMD vector variant

Applies when Q == 1.

VRSHR{<c>}{<q>}.<dt> <Qd>, <Qm>, #0

is equivalent to

VORR{<c>}{<q>}{.dt} <Qd>, <Qm>, <Qm>

and is never the preferred disassembly.

T1

15	14	13	12	11	10	9	8	7	6	5	4	3	0	15	12	11	10	9	8	7	6	5	4	3	0
1	1	1	0	1	1	1	1	0	D	1	0	Vn	Vd	0	0	0	1	N	Q	M	1	Vm			

64-bit SIMD vector variant

Applies when Q == 0.

VRSHR{<c>}{<q>}.<dt> <Dd>, <Dm>, #0

is equivalent to

VORR{<c>}{<q>}{.dt} <Dd>, <Dm>, <Dm>

and is never the preferred disassembly.

128-bit SIMD vector variant

Applies when Q == 1.

$\text{VRSHR}\{\langle c \rangle\}\{\langle q \rangle\}.\langle dt \rangle \langle Qd \rangle, \langle Qm \rangle, \#0$

is equivalent to

$\text{VORR}\{\langle c \rangle\}\{\langle q \rangle\}\{\langle dt \rangle\} \langle Qd \rangle, \langle Qm \rangle, \langle Qm \rangle$

and is never the preferred disassembly.

Assembler symbols

- $\langle c \rangle$ For encoding A1: see [Standard assembler syntax fields on page F2-2848](#). This encoding must be unconditional.
For encoding T1: see [Standard assembler syntax fields on page F2-2848](#).
- $\langle q \rangle$ See [Standard assembler syntax fields on page F2-2848](#).
- $\langle dt \rangle$ Is the data type for the elements of the vectors, and must be one of: S8, S16, S32, S64, U8, U16, U32 or U64.
- $\langle Qd \rangle$ Is the 128-bit name of the SIMD&FP destination register, encoded in the "D:Vd" field as $\langle Qd \rangle * 2$.
- $\langle Qm \rangle$ Is the 128-bit name of the SIMD&FP source register, encoded in the "N:Vn" and "M:Vm" field as $\langle Qm \rangle * 2$.
- $\langle Dd \rangle$ Is the 64-bit name of the SIMD&FP destination register, encoded in the "D:Vd" field.
- $\langle Dm \rangle$ Is the 64-bit name of the SIMD&FP source register, encoded in the "N:Vn" and "M:Vm" field.

Operation for all encodings

The description of [VORR \(register\)](#) gives the operational pseudocode for this instruction.

F6.1.199 VRSHRN

Vector Rounding Shift Right and Narrow takes each element in a vector, right shifts them by an immediate value, and places the rounded results in the destination vector. For truncated results, see [VSHRN](#).

The operand elements can be 16-bit, 32-bit, or 64-bit integers. There is no distinction between signed and unsigned integers. The destination elements are half the size of the source elements.

Depending on settings in the [CPACR](#), [NSACR](#), and [HCPTR](#) registers, and the security state and mode in which the instruction is executed, an attempt to execute the instruction might be UNDEFINED, or trapped to Hyp mode. For more information see [Enabling Advanced SIMD and floating-point support on page G1-4413](#).

A1

31	30	29	28	27	26	25	24	23	22	21		16	15	12	11	10	9	8		7	6	5	4	3		0
1	1	1	1	0	0	1	0	1	D		imm6		Vd		1	0	0	0	0		1	M	1		Vm	

A1 variant

Applies when `imm6 != 000xxx`.

`VRSHRN{<c>}{<q>}.I<size> <Dd>, <Qm>, #<imm>`

Decode for this encoding

```

if imm6 == '000xxx' then SEE "Related encodings";
if Vm<0> == '1' then UNDEFINED;
case imm6 of
    when '001xxx' esize = 8; elements = 8; shift_amount = 16 - UInt(imm6);
    when '01xxxx' esize = 16; elements = 4; shift_amount = 32 - UInt(imm6);
    when '1xxxxx' esize = 32; elements = 2; shift_amount = 64 - UInt(imm6);
d = UInt(D:Vd); m = UInt(M:Vm);
    
```

T1

15	14	13	12	11	10	9	8	7	6	5		0	15	12	11	10	9	8		7	6	5	4	3		0
1	1	1	0	1	1	1	1	1	D		imm6		Vd		1	0	0	0	0		1	M	1		Vm	

T1 variant

Applies when `imm6 != 000xxx`.

`VRSHRN{<c>}{<q>}.I<size> <Dd>, <Qm>, #<imm>`

Decode for this encoding

```

if imm6 == '000xxx' then SEE "Related encodings";
if Vm<0> == '1' then UNDEFINED;
case imm6 of
    when '001xxx' esize = 8; elements = 8; shift_amount = 16 - UInt(imm6);
    when '01xxxx' esize = 16; elements = 4; shift_amount = 32 - UInt(imm6);
    when '1xxxxx' esize = 32; elements = 2; shift_amount = 64 - UInt(imm6);
d = UInt(D:Vd); m = UInt(M:Vm);
    
```

Notes for all encodings

Related encodings: See [Advanced SIMD one register and modified immediate on page F3-2912](#) for the T32 instruction set, or [Advanced SIMD one register and modified immediate on page F4-2994](#) for the A32 instruction set.

Assembler symbols

- <c> For encoding A1: see *Standard assembler syntax fields* on page F2-2848. This encoding must be unconditional.
For encoding T1: see *Standard assembler syntax fields* on page F2-2848.
- <q> See *Standard assembler syntax fields* on page F2-2848.
- <size> Is the data size for the elements of the vectors, encoded in the "imm6<5:3>" field. It can have the following values:
16 when imm6<5:3> = 001
32 when imm6<5:3> = 01x
64 when imm6<5:3> = 1xx
- <Dd> Is the 64-bit name of the SIMD&FP destination register, encoded in the "D:Vd" field.
- <Qm> Is the 128-bit name of the SIMD&FP source register, encoded in the "M:Vm" field as <Qm>*2.
- <imm> Is an immediate value, in the range 1 to <size>/2, encoded in the "imm6" field as <size>/2 - <imm>.

Operation for all encodings

```
if ConditionPassed() then
    EncodingSpecificOperations(); CheckAdvSIMDEnabled();
    round_const = 1 << (shift_amount-1);
    for e = 0 to elements-1
        result = LSR(Elem[Qin[m]>>1],e,2*esize) + round_const, shift_amount);
        Elem[D[d],e,esize] = result<esize-1:0>;
```

F6.1.200 VRSHRN (zero)

Vector Rounding Shift Right and Narrow takes each element in a vector, right shifts them by an immediate value, and places the rounded results in the destination vector

This instruction is a pseudo-instruction of the [VMOVN](#) instruction. This means that:

- The encodings in this description are named to match the encodings of [VMOVN](#).
- The assembler syntax is used only for assembly, and is not used on disassembly.
- The description of [VMOVN](#) gives the operational pseudocode for this instruction.

A1

31	30	29	28	27	26	25	24	23	22	21	20	19	18	17	16	15	12	11	10	9	8	7	6	5	4	3	0
1	1	1	1	0	0	1	1	1	D	1	1	size	1	0	Vd	0	0	1	0	0	0	M	0	Vm			

A1 variant

VRSHRN{<c>}{<q>}.<dt> <Dd>, <Qm>, #0

is equivalent to

VMOVN{<c>}{<q>}.<dt> <Dd>, <Qm>

and is never the preferred disassembly.

T1

15	14	13	12	11	10	9	8	7	6	5	4	3	2	1	0	15	12	11	10	9	8	7	6	5	4	3	0
1	1	1	1	1	1	1	1	1	D	1	1	size	1	0	Vd	0	0	1	0	0	0	M	0	Vm			

T1 variant

VRSHRN{<c>}{<q>}.<dt> <Dd>, <Qm>, #0

is equivalent to

VMOVN{<c>}{<q>}.<dt> <Dd>, <Qm>

and is never the preferred disassembly.

Assembler symbols

<c> For encoding A1: see [Standard assembler syntax fields on page F2-2848](#). This encoding must be unconditional.

For encoding T1: see [Standard assembler syntax fields on page F2-2848](#).

<q> See [Standard assembler syntax fields on page F2-2848](#).

<dt> Is the data type for the elements of the operand, encoded in the "size" field. It can have the following values:

I16 when size = 00

I32 when size = 01

I64 when size = 10

The encoding size = 11 is reserved.

- <Dd> Is the 64-bit name of the SIMD&FP destination register, encoded in the "D:Vd" field.
- <Qm> Is the 128-bit name of the SIMD&FP source register, encoded in the "M:Vm" field as <Qm>*2.

Operation for all encodings

The description of [VMOVN](#) gives the operational pseudocode for this instruction.

F6.1.201 VRSQRTE

Vector Reciprocal Square Root Estimate finds an approximate reciprocal square root of each element in a vector, and places the results in a second vector.

The operand and result elements are the same type, and can be floating-point numbers or unsigned integers.

For details of the operation performed by this instruction see *Floating-point reciprocal estimate and step* on page E1-2749.

Depending on settings in the CPACR, NSACR, and HCPTR registers, and the security state and mode in which the instruction is executed, an attempt to execute the instruction might be UNDEFINED, or trapped to Hyp mode. For more information see *Enabling Advanced SIMD and floating-point support* on page G1-4413.

A1

31	30	29	28	27	26	25	24	23	22	21	20	19	18	17	16	15	12	11	10	9	8	7	6	5	4	3	0
1	1	1	1	0	0	1	1	1	D	1	1	size	1	1	Vd	0	1	0	F	1	Q	M	0	Vm			

64-bit SIMD vector variant

Applies when Q == 0.

VRSQRTE{<c>}{<q>}.<dt> <Dd>, <Dm>

128-bit SIMD vector variant

Applies when Q == 1.

VRSQRTE{<c>}{<q>}.<dt> <Qd>, <Qm>

Decode for all variants of this encoding

```

if Q == '1' && (Vd<0> == '1' || Vm<0> == '1') then UNDEFINED;
if (size == '01' && !HaveFP16Ext()) || size IN {'00', '11'} then UNDEFINED;
floating_point = (F == '1');
case size of
    when '01' esize = 16; elements = 4;
    when '10' esize = 32; elements = 2;
d = UInt(D:Vd); m = UInt(M:Vm); regs = if Q == '0' then 1 else 2;
    
```

T1

15	14	13	12	11	10	9	8	7	6	5	4	3	2	1	0	15	12	11	10	9	8	7	6	5	4	3	0
1	1	1	1	1	1	1	1	1	D	1	1	size	1	1	Vd	0	1	0	F	1	Q	M	0	Vm			

64-bit SIMD vector variant

Applies when Q == 0.

VRSQRTE{<c>}{<q>}.<dt> <Dd>, <Dm>

128-bit SIMD vector variant

Applies when Q == 1.

VRSQRTE{<c>}{<q>}.<dt> <Qd>, <Qm>

Decode for all variants of this encoding

```

if Q == '1' && (Vd<0> == '1' || Vm<0> == '1') then UNDEFINED;
if (size == '01' && !HaveFP16Ext()) || size IN {'00', '11'} then UNDEFINED;
if size == '01' && InITBlock() then UNPREDICTABLE;
floating_point = (F == '1');
case size of
  when '01' esize = 16; elements = 4;
  when '10' esize = 32; elements = 2;
d = UInt(D:Vd); m = UInt(M:Vm); regs = if Q == '0' then 1 else 2;
  
```

CONSTRAINED UNPREDICTABLE behavior

If size == '01' && InITBlock(), then one of the following behaviors must occur:

- The instruction is UNDEFINED.
- The instruction executes as if it passes the Condition code check.
- The instruction executes as NOP. This means it behaves as if it fails the Condition code check.

Assembler symbols

- <c> For encoding A1: see [Standard assembler syntax fields on page F2-2848](#). This encoding must be unconditional.
 For encoding T1: see [Standard assembler syntax fields on page F2-2848](#).
- <q> See [Standard assembler syntax fields on page F2-2848](#).
- <dt> Is the data type for the elements of the vectors, encoded in the "F:size" field. It can have the following values:
- | | |
|-----|-----------------------|
| U32 | when F = 0, size = 10 |
| F16 | when F = 1, size = 01 |
| F32 | when F = 1, size = 10 |
- <Qd> Is the 128-bit name of the SIMD&FP destination register, encoded in the "D:Vd" field as <Qd>*2.
- <Qm> Is the 128-bit name of the SIMD&FP source register, encoded in the "M:Vm" field as <Qm>*2.
- <Dd> Is the 64-bit name of the SIMD&FP destination register, encoded in the "D:Vd" field.
- <Dm> Is the 64-bit name of the SIMD&FP source register, encoded in the "M:Vm" field.

Newton-Raphson iteration

For details of the operation performed and how it can be used in a Newton-Raphson iteration to calculate the reciprocal of the square root of a number, see [Floating-point reciprocal estimate and step on page E1-2749](#).

Operation for all encodings

```

if ConditionPassed() then
  EncodingSpecificOperations(); CheckAdvSIMDEnabled();
  for r = 0 to regs-1
    for e = 0 to elements-1
      if floating_point then
        Elem[D[d+r],e,esize] = FPRsqrtEstimate(Elem[D[m+r],e,esize], StandardFPSCRValue());
      else
        Elem[D[d+r],e,esize] = UnsignedRSqrtEstimate(Elem[D[m+r],e,esize]);
  
```

F6.1.202 VRSQRTS

Vector Reciprocal Square Root Step multiplies the elements of one vector by the corresponding elements of another vector, subtracts each of the products from 3.0, divides these results by 2.0, and places the results into the elements of the destination vector.

The operand and result elements are floating-point numbers.

For details of the operation performed by this instruction see [Floating-point reciprocal estimate and step on page E1-2749](#).

Depending on settings in the CPACR, NSACR, and HCPTR registers, and the security state and mode in which the instruction is executed, an attempt to execute the instruction might be UNDEFINED, or trapped to Hyp mode. For more information see [Enabling Advanced SIMD and floating-point support on page G1-4413](#).

A1

31	30	29	28	27	26	25	24	23	22	21	20	19	16	15	12	11	10	9	8	7	6	5	4	3	0
1	1	1	1	0	0	1	0	0	D	1	sz	Vn	Vd	1	1	1	1	N	Q	M	1	Vm			

64-bit SIMD vector variant

Applies when Q == 0.

VRSQRTS{<c>}{<q>}.<dt> {<Dd>, }<Dn>, <Dm>

128-bit SIMD vector variant

Applies when Q == 1.

VRSQRTS{<c>}{<q>}.<dt> {<Qd>, }<Qn>, <Qm>

Decode for all variants of this encoding

```

if Q == '1' && (Vd<0> == '1' || Vn<0> == '1' || Vm<0> == '1') then UNDEFINED;
if sz == '1' && !HaveFP16Ext() then UNDEFINED;
case sz of
    when '0' esize = 32; elements = 2;
    when '1' esize = 16; elements = 4;
d = UInt(D:Vd); n = UInt(N:Vn); m = UInt(M:Vm); regs = if Q == '0' then 1 else 2;
    
```

T1

15	14	13	12	11	10	9	8	7	6	5	4	3	0	15	12	11	10	9	8	7	6	5	4	3	0
1	1	1	0	1	1	1	1	0	D	1	sz	Vn	Vd	1	1	1	1	N	Q	M	1	Vm			

64-bit SIMD vector variant

Applies when Q == 0.

VRSQRTS{<c>}{<q>}.<dt> {<Dd>, }<Dn>, <Dm>

128-bit SIMD vector variant

Applies when Q == 1.

VRSQRTS{<c>}{<q>}.<dt> {<Qd>, }<Qn>, <Qm>

Decode for all variants of this encoding

```

if Q == '1' && (Vd<0> == '1' || Vn<0> == '1' || Vm<0> == '1') then UNDEFINED;
if sz == '1' && !HaveFP16Ext() then UNDEFINED;
if sz == '1' && InITBlock() then UNPREDICTABLE;
case sz of
  when '0' esize = 32; elements = 2;
  when '1' esize = 16; elements = 4;
d = UInt(D:Vd); n = UInt(N:Vn); m = UInt(M:Vm); regs = if Q == '0' then 1 else 2;
  
```

CONSTRAINED UNPREDICTABLE behavior

If size == '01' && InITBlock(), then one of the following behaviors must occur:

- The instruction is UNDEFINED.
- The instruction executes as if it passes the Condition code check.
- The instruction executes as NOP. This means it behaves as if it fails the Condition code check.

Assembler symbols

- <c> For encoding A1: see [Standard assembler syntax fields on page F2-2848](#). This encoding must be unconditional.
 For encoding T1: see [Standard assembler syntax fields on page F2-2848](#).
- <q> See [Standard assembler syntax fields on page F2-2848](#).
- <dt> Is the data type for the elements of the vectors, encoded in the "sz" field. It can have the following values:
 F32 when sz = 0
 F16 when sz = 1
- <Qd> Is the 128-bit name of the SIMD&FP destination register, encoded in the "D:Vd" field as <Qd>*2.
- <Qn> Is the 128-bit name of the first SIMD&FP source register, encoded in the "N:Vn" field as <Qn>*2.
- <Qm> Is the 128-bit name of the second SIMD&FP source register, encoded in the "M:Vm" field as <Qm>*2.
- <Dd> Is the 64-bit name of the SIMD&FP destination register, encoded in the "D:Vd" field.
- <Dn> Is the 64-bit name of the first SIMD&FP source register, encoded in the "N:Vn" field.
- <Dm> Is the 64-bit name of the second SIMD&FP source register, encoded in the "M:Vm" field.

Newton-Raphson iteration

For details of the operation performed and how it can be used in a Newton-Raphson iteration to calculate the reciprocal of the square root of a number, see [Floating-point reciprocal estimate and step on page E1-2749](#).

Operation for all encodings

```

if ConditionPassed() then
  EncodingSpecificOperations(); CheckAdvSIMDEnabled();
  for r = 0 to regs-1
    for e = 0 to elements-1
      Elem[D[d+r],e,esize] = FPRSqrtStep(Elem[D[n+r],e,esize], Elem[D[m+r],e,esize]);
  
```

F6.1.203 VRSRA

Vector Rounding Shift Right and Accumulate takes each element in a vector, right shifts them by an immediate value, and accumulates the rounded results into the destination vector. For truncated results, see [VSRA](#).

The operand and result elements must all be the same type, and can be any one of:

- 8-bit, 16-bit, 32-bit, or 64-bit signed integers.
- 8-bit, 16-bit, 32-bit, or 64-bit unsigned integers.

Depending on settings in the [CPACR](#), [NSACR](#), and [HCPTR](#) registers, and the security state and mode in which the instruction is executed, an attempt to execute the instruction might be UNDEFINED, or trapped to Hyp mode. For more information see [Enabling Advanced SIMD and floating-point support on page G1-4413](#).

A1

31	30	29	28	27	26	25	24	23	22	21	16	15	12	11	10	9	8	7	6	5	4	3	0
1	1	1	1	0	0	1	U	1	D	imm6	Vd	0	0	1	1	L	Q	M	1	Vm			

64-bit SIMD vector variant

Applies when $!(imm6 == 000xxx \ \&\& \ L == 0) \ \&\& \ Q == 0$.

VRSRA{<c>}{<q>}.<type><size> {<Dd>}, <Dm>, #<imm>

128-bit SIMD vector variant

Applies when $!(imm6 == 000xxx \ \&\& \ L == 0) \ \&\& \ Q == 1$.

VRSRA{<c>}{<q>}.<type><size> {<Qd>}, <Qm>, #<imm>

Decode for all variants of this encoding

```

if (L:imm6) == '000xxx' then SEE "Related encodings";
if Q == '1' && (Vd<0> == '1' || Vm<0> == '1') then UNDEFINED;
case L:imm6 of
  when '0001xxx' esize = 8; elements = 8; shift_amount = 16 - UInt(imm6);
  when '001xxxx' esize = 16; elements = 4; shift_amount = 32 - UInt(imm6);
  when '01xxxxx' esize = 32; elements = 2; shift_amount = 64 - UInt(imm6);
  when '1xxxxxx' esize = 64; elements = 1; shift_amount = 64 - UInt(imm6);
unsigned = (U == '1'); d = UInt(D:Vd); m = UInt(M:Vm); regs = if Q == '0' then 1 else 2;
    
```

T1

15	14	13	12	11	10	9	8	7	6	5	0	15	12	11	10	9	8	7	6	5	4	3	0
1	1	1	U	1	1	1	1	1	D	imm6	Vd	0	0	1	1	L	Q	M	1	Vm			

64-bit SIMD vector variant

Applies when $!(imm6 == 000xxx \ \&\& \ L == 0) \ \&\& \ Q == 0$.

VRSRA{<c>}{<q>}.<type><size> {<Dd>}, <Dm>, #<imm>

128-bit SIMD vector variant

Applies when $!(imm6 == 000xxx \ \&\& \ L == 0) \ \&\& \ Q == 1$.

VRSRA{<c>}{<q>}.<type><size> {<Qd>}, <Qm>, #<imm>

Decode for all variants of this encoding

```

if (L:imm6) == '0000xxx' then SEE "Related encodings";
if Q == '1' && (Vd<0> == '1' || Vm<0> == '1') then UNDEFINED;
case L:imm6 of
  when '0001xxx' esize = 8; elements = 8; shift_amount = 16 - UInt(imm6);
  when '001xxxx' esize = 16; elements = 4; shift_amount = 32 - UInt(imm6);
  when '01xxxxx' esize = 32; elements = 2; shift_amount = 64 - UInt(imm6);
  when '1xxxxxx' esize = 64; elements = 1; shift_amount = 64 - UInt(imm6);
unsigned = (U == '1'); d = UInt(D:Vd); m = UInt(M:Vm); regs = if Q == '0' then 1 else 2;
  
```

Notes for all encodings

Related encodings: See *Advanced SIMD one register and modified immediate* on page F3-2912 for the T32 instruction set, or *Advanced SIMD one register and modified immediate* on page F4-2994 for the A32 instruction set.

Assembler symbols

- <c> For encoding A1: see *Standard assembler syntax fields* on page F2-2848. This encoding must be unconditional.
 For encoding T1: see *Standard assembler syntax fields* on page F2-2848.
- <q> See *Standard assembler syntax fields* on page F2-2848.
- <type> Is the data type for the elements of the vectors, encoded in the "U" field. It can have the following values:

S	when U = 0
U	when U = 1
- <size> Is the data size for the elements of the vectors, encoded in the "L:imm6<5:3>" field. It can have the following values:

8	when L = 0, imm6<5:3> = 001
16	when L = 0, imm6<5:3> = 01x
32	when L = 0, imm6<5:3> = 1xx
64	when L = 1, imm6<5:3> = xxx
- <Qd> Is the 128-bit name of the SIMD&FP destination register, encoded in the "D:Vd" field as <Qd>*2.
- <Qm> Is the 128-bit name of the SIMD&FP source register, encoded in the "M:Vm" field as <Qm>*2.
- <Dd> Is the 64-bit name of the SIMD&FP destination register, encoded in the "D:Vd" field.
- <Dm> Is the 64-bit name of the SIMD&FP source register, encoded in the "M:Vm" field.
- <imm> Is an immediate value, in the range 1 to <size>, encoded in the "imm6" field as <size> - <imm>.

Operation for all encodings

```

if ConditionPassed() then
  EncodingSpecificOperations(); CheckAdvSIMDEnabled();
  round_const = 1 << (shift_amount - 1);
  for r = 0 to regs-1
    for e = 0 to elements-1
      result = (Int(Elem[D[m+r],e,esize], unsigned) + round_const) >> shift_amount;
      Elem[D[d+r],e,esize] = Elem[D[d+r],e,esize] + result;
  
```

F6.1.204 VRSUBHN

Vector Rounding Subtract and Narrow, returning High Half subtracts the elements of one quadword vector from the corresponding elements of another quadword vector, takes the most significant half of each result, and places the final results in a doubleword vector. The results are rounded. For truncated results, see [VSUBHN](#).

The operand elements can be 16-bit, 32-bit, or 64-bit integers. There is no distinction between signed and unsigned integers.

Depending on settings in the [CPACR](#), [NSACR](#), and [HCPTR](#) registers, and the security state and mode in which the instruction is executed, an attempt to execute the instruction might be UNDEFINED, or trapped to Hyp mode. For more information see [Enabling Advanced SIMD and floating-point support on page G1-4413](#).

A1

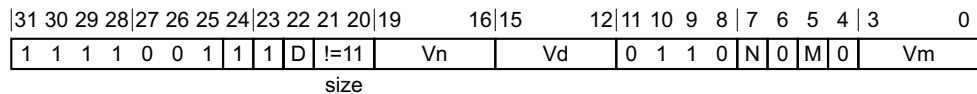

A1 variant

VRSUBHN{<c>}{<q>}.<dt> <Dd>, <Qn>, <Qm>

Decode for this encoding

```
if size == '11' then SEE "Related encodings";
if Vn<0> == '1' || Vm<0> == '1' then UNDEFINED;
esize = 8 << UInt(size); elements = 64 DIV esize;
d = UInt(D:Vd); n = UInt(N:Vn); m = UInt(M:Vm);
```

T1

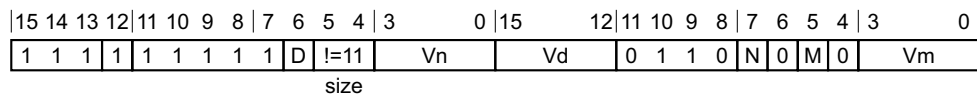

T1 variant

VRSUBHN{<c>}{<q>}.<dt> <Dd>, <Qn>, <Qm>

Decode for this encoding

```
if size == '11' then SEE "Related encodings";
if Vn<0> == '1' || Vm<0> == '1' then UNDEFINED;
esize = 8 << UInt(size); elements = 64 DIV esize;
d = UInt(D:Vd); n = UInt(N:Vn); m = UInt(M:Vm);
```

Notes for all encodings

Related encodings: See [Advanced SIMD data-processing on page F3-2904](#) for the T32 instruction set, or [Advanced SIMD data-processing on page F4-2985](#) for the A32 instruction set.

Assembler symbols

- <c> For encoding A1: see [Standard assembler syntax fields on page F2-2848](#). This encoding must be unconditional.
- For encoding T1: see [Standard assembler syntax fields on page F2-2848](#).
- <q> See [Standard assembler syntax fields on page F2-2848](#).

- <dt> Is the data type for the elements of the operands, encoded in the "size" field. It can have the following values:
- I16 when size = 00
 - I32 when size = 01
 - I64 when size = 10
- <Dd> Is the 64-bit name of the SIMD&FP destination register, encoded in the "D:Vd" field.
- <Qn> Is the 128-bit name of the first SIMD&FP source register, encoded in the "N:Vn" field as <Qn>*2.
- <Qm> Is the 128-bit name of the second SIMD&FP source register, encoded in the "M:Vm" field as <Qm>*2.

Operation for all encodings

```
if ConditionPassed() then
    EncodingSpecificOperations(); CheckAdvSIMDEnabled();
    round_const = 1 << (esize-1);
    for e = 0 to elements-1
        result = Elem[Qin[n>>1],e,2*esize] - Elem[Qin[m>>1],e,2*esize] + round_const;
        Elem[D[d],e,esize] = result<2*esize-1:esize>;
```

F6.1.205 VSELEQ, VSELGE, VSELGT, VSELVS

Floating-point conditional select allows the destination register to take the value in either one or the other source register according to the condition codes in the [APSR](#).

A1

31	30	29	28	27	26	25	24	23	22	21	20	19	16	15	12	11	10	9	8	7	6	5	4	3	0
1	1	1	1	1	1	1	0	0	D	cc	Vn	Vd	1	0	!=00	N	0	M	0	Vm					
size																									

VSELEQ, doubleprec variant

Applies when `cc == 00` && `size == 11`.

VSELEQ.F64 <Dd>, <Dn>, <Dm> // Cannot be conditional

VSELEQ, halfprec variant

Applies when `cc == 00` && `size == 01`.

VSELEQ.F16 <Sd>, <Sn>, <Sm> // Cannot be conditional

VSELEQ, singleprec variant

Applies when `cc == 00` && `size == 10`.

VSELEQ.F32 <Sd>, <Sn>, <Sm> // Cannot be conditional

VSELGE, doubleprec variant

Applies when `cc == 10` && `size == 11`.

VSELGE.F64 <Dd>, <Dn>, <Dm> // Cannot be conditional

VSELGE, halfprec variant

Applies when `cc == 10` && `size == 01`.

VSELGE.F16 <Sd>, <Sn>, <Sm> // Cannot be conditional

VSELGE, singleprec variant

Applies when `cc == 10` && `size == 10`.

VSELGE.F32 <Sd>, <Sn>, <Sm> // Cannot be conditional

VSELGT, doubleprec variant

Applies when `cc == 11` && `size == 11`.

VSELGT.F64 <Dd>, <Dn>, <Dm> // Cannot be conditional

VSELGT, halfprec variant

Applies when `cc == 11` && `size == 01`.

VSELGT.F16 <Sd>, <Sn>, <Sm> // Cannot be conditional

VSELGT, singleprec variant

Applies when `cc == 11` && `size == 10`.

VSELGT.F32 <Sd>, <Sn>, <Sm> // Cannot be conditional

VSELVS, doubleprec variant

Applies when cc == 01 && size == 11.
 VSELVS.F64 <Dd>, <Dn>, <Dm> // Cannot be conditional

VSELVS, halfprec variant

Applies when cc == 01 && size == 01.
 VSELVS.F16 <Sd>, <Sn>, <Sm> // Cannot be conditional

VSELVS, singleprec variant

Applies when cc == 01 && size == 10.
 VSELVS.F32 <Sd>, <Sn>, <Sm> // Cannot be conditional

Decode for all variants of this encoding

```
if size == '00' || (size == '01' && !HaveFP16Ext()) then UNDEFINED;
case size of
  when '01' esize = 16; d = UInt(Vd:D); n = UInt(Vn:N); m = UInt(Vm:M);
  when '10' esize = 32; d = UInt(Vd:D); n = UInt(Vn:N); m = UInt(Vm:M);
  when '11' esize = 64; d = UInt(D:Vd); n = UInt(N:Vn); m = UInt(M:Vm);
cond = cc:(cc<1> EOR cc<0>):'0';
```

T1

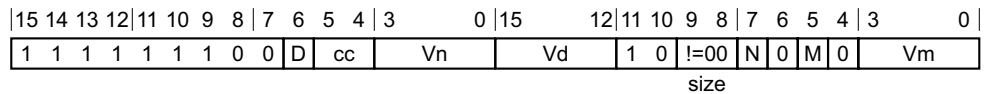

VSELEQ, doubleprec variant

Applies when cc == 00 && size == 11.
 VSELEQ.F64 <Dd>, <Dn>, <Dm> // Not permitted in IT block

VSELEQ, halfprec variant

Applies when cc == 00 && size == 01.
 VSELEQ.F16 <Sd>, <Sn>, <Sm> // Not permitted in IT block

VSELEQ, singleprec variant

Applies when cc == 00 && size == 10.
 VSELEQ.F32 <Sd>, <Sn>, <Sm> // Not permitted in IT block

VSELGE, doubleprec variant

Applies when cc == 10 && size == 11.
 VSELGE.F64 <Dd>, <Dn>, <Dm> // Not permitted in IT block

VSELGE, halfprec variant

Applies when cc == 10 && size == 01.
 VSELGE.F16 <Sd>, <Sn>, <Sm> // Not permitted in IT block

VSELGE, singleprec variant

Applies when cc == 10 && size == 10.

VSELGE.F32 <Sd>, <Sn>, <Sm> // Not permitted in IT block

VSELGT, doubleprec variant

Applies when cc == 11 && size == 11.

VSELGT.F64 <Dd>, <Dn>, <Dm> // Not permitted in IT block

VSELGT, halfprec variant

Applies when cc == 11 && size == 01.

VSELGT.F16 <Sd>, <Sn>, <Sm> // Not permitted in IT block

VSELGT, singleprec variant

Applies when cc == 11 && size == 10.

VSELGT.F32 <Sd>, <Sn>, <Sm> // Not permitted in IT block

VSELVS, doubleprec variant

Applies when cc == 01 && size == 11.

VSELVS.F64 <Dd>, <Dn>, <Dm> // Not permitted in IT block

VSELVS, halfprec variant

Applies when cc == 01 && size == 01.

VSELVS.F16 <Sd>, <Sn>, <Sm> // Not permitted in IT block

VSELVS, singleprec variant

Applies when cc == 01 && size == 10.

VSELVS.F32 <Sd>, <Sn>, <Sm> // Not permitted in IT block

Decode for all variants of this encoding

```
if size == '00' || (size == '01' && !HaveFP16Ext()) then UNDEFINED;
case size of
  when '01' esize = 16; d = UInt(Vd:D); n = UInt(Vn:N); m = UInt(Vm:M);
  when '10' esize = 32; d = UInt(Vd:D); n = UInt(Vn:N); m = UInt(Vm:M);
  when '11' esize = 64; d = UInt(D:Vd); n = UInt(N:Vn); m = UInt(M:Vm);
cond = cc:(cc<1> EOR cc<0>):'0';
if InITBlock() then UNPREDICTABLE;
```

CONSTRAINED UNPREDICTABLE behavior

If InITBlock(), then one of the following behaviors must occur:

- The instruction is UNDEFINED.
- The instruction executes as if it passes the Condition code check.
- The instruction executes as NOP. This means it behaves as if it fails the Condition code check.

Assembler symbols

<Dd> Is the 64-bit name of the SIMD&FP destination register, encoded in the "D:Vd" field.

<Dn> Is the 64-bit name of the first SIMD&FP source register, encoded in the "N:Vn" field.

- <Dm> Is the 64-bit name of the second SIMD&FP source register, encoded in the "M:Vm" field.
- <Sd> Is the 32-bit name of the SIMD&FP destination register, encoded in the "Vd:D" field.
- <Sn> Is the 32-bit name of the first SIMD&FP source register, encoded in the "Vn:N" field.
- <Sm> Is the 32-bit name of the second SIMD&FP source register, encoded in the "Vm:M" field.

Operation for all encodings

```
EncodingSpecificOperations(); CheckVFPEnabled(TRUE);
case esize of
  when 16
    S[d] = Zeros(16) : (if ConditionHolds(cond) then S[n] else S[m])<15:0>;
  when 32
    S[d] = if ConditionHolds(cond) then S[n] else S[m];
  when 64
    D[d] = if ConditionHolds(cond) then D[n] else D[m];
```

F6.1.206 VSHL (immediate)

Vector Shift Left (immediate) takes each element in a vector of integers, left shifts them by an immediate value, and places the results in the destination vector.

Bits shifted out of the left of each element are lost.

The elements must all be the same size, and can be 8-bit, 16-bit, 32-bit, or 64-bit integers. There is no distinction between signed and unsigned integers.

Depending on settings in the CPACR, NSACR, and HCPTR registers, and the security state and mode in which the instruction is executed, an attempt to execute the instruction might be UNDEFINED, or trapped to Hyp mode. For more information see [Enabling Advanced SIMD and floating-point support on page G1-4413](#).

A1

31	30	29	28	27	26	25	24	23	22	21		16	15	12	11	10	9	8		7	6	5	4	3		0
1	1	1	1	0	0	1	0	1	D		imm6		Vd		0	1	0	1	L	Q	M	1		Vm		

64-bit SIMD vector variant

Applies when $!(imm6 == 000xxx \ \&\& \ L == 0) \ \&\& \ Q == 0$.

VSHL{<c>}{<q>}.I<size> {<Dd>}, <Dm>, #<imm>

128-bit SIMD vector variant

Applies when $!(imm6 == 000xxx \ \&\& \ L == 0) \ \&\& \ Q == 1$.

VSHL{<c>}{<q>}.I<size> {<Qd>}, <Qm>, #<imm>

Decode for all variants of this encoding

```

if L:imm6 == '0001xxx' then SEE "Related encodings";
if Q == '1' && (Vd<0> == '1' || Vm<0> == '1') then UNDEFINED;
case L:imm6 of
  when '0001xxx' esize = 8; elements = 8; shift_amount = UInt(imm6) - 8;
  when '001xxxx' esize = 16; elements = 4; shift_amount = UInt(imm6) - 16;
  when '01xxxxx' esize = 32; elements = 2; shift_amount = UInt(imm6) - 32;
  when '1xxxxxx' esize = 64; elements = 1; shift_amount = UInt(imm6);
d = UInt(D:Vd); m = UInt(M:Vm); regs = if Q == '0' then 1 else 2;
    
```

T1

15	14	13	12	11	10	9	8	7	6	5		0	15	12	11	10	9	8		7	6	5	4	3		0
1	1	1	0	1	1	1	1	1	D		imm6		Vd		0	1	0	1	L	Q	M	1		Vm		

64-bit SIMD vector variant

Applies when $!(imm6 == 000xxx \ \&\& \ L == 0) \ \&\& \ Q == 0$.

VSHL{<c>}{<q>}.I<size> {<Dd>}, <Dm>, #<imm>

128-bit SIMD vector variant

Applies when $!(imm6 == 000xxx \ \&\& \ L == 0) \ \&\& \ Q == 1$.

VSHL{<c>}{<q>}.I<size> {<Qd>}, <Qm>, #<imm>

Decode for all variants of this encoding

```

if L:imm6 == '0000xxx' then SEE "Related encodings";
if Q == '1' && (Vd<0> == '1' || Vm<0> == '1') then UNDEFINED;
case L:imm6 of
  when '0001xxx' esize = 8; elements = 8; shift_amount = UInt(imm6) - 8;
  when '001xxxx' esize = 16; elements = 4; shift_amount = UInt(imm6) - 16;
  when '01xxxxx' esize = 32; elements = 2; shift_amount = UInt(imm6) - 32;
  when '1xxxxxx' esize = 64; elements = 1; shift_amount = UInt(imm6);
d = UInt(D:Vd); m = UInt(M:Vm); regs = if Q == '0' then 1 else 2;

```

Notes for all encodings

Related encodings: See *Advanced SIMD one register and modified immediate* on page F3-2912 for the T32 instruction set, or *Advanced SIMD one register and modified immediate* on page F4-2994 for the A32 instruction set.

Assembler symbols

- <c> For encoding A1: see *Standard assembler syntax fields* on page F2-2848. This encoding must be unconditional.
 For encoding T1: see *Standard assembler syntax fields* on page F2-2848.
- <q> See *Standard assembler syntax fields* on page F2-2848.
- <size> Is the data size for the elements of the vectors, encoded in the "L:imm6<5:3>" field. It can have the following values:

8	when L = 0, imm6<5:3> = 001
16	when L = 0, imm6<5:3> = 01x
32	when L = 0, imm6<5:3> = 1xx
64	when L = 1, imm6<5:3> = xxx
- <Qd> Is the 128-bit name of the SIMD&FP destination register, encoded in the "D:Vd" field as <Qd>*2.
- <Qm> Is the 128-bit name of the SIMD&FP source register, encoded in the "M:Vm" field as <Qm>*2.
- <Dd> Is the 64-bit name of the SIMD&FP destination register, encoded in the "D:Vd" field.
- <Dm> Is the 64-bit name of the SIMD&FP source register, encoded in the "M:Vm" field.
- <imm> Is an immediate value, in the range 0 to <size>-1, encoded in the "imm6" field.

Operation for all encodings

```

if ConditionPassed() then
  EncodingSpecificOperations(); CheckAdvSIMDEnabled();
  for r = 0 to regs-1
    for e = 0 to elements-1
      Elem[D[d+r],e,esize] = LSL(Elem[M[m+r],e,esize], shift_amount);

```

F6.1.207 VSHL (register)

Vector Shift Left (register) takes each element in a vector, shifts them by a value from the least significant byte of the corresponding element of a second vector, and places the results in the destination vector. If the shift value is positive, the operation is a left shift. If the shift value is negative, it is a truncating right shift.

For a rounding shift, see [VRSHL](#).

The first operand and result elements are the same data type, and can be any one of:

- 8-bit, 16-bit, 32-bit, or 64-bit signed integers.
- 8-bit, 16-bit, 32-bit, or 64-bit unsigned integers.

The second operand is always a signed integer of the same size.

Depending on settings in the [CPACR](#), [NSACR](#), and [HCPTR](#) registers, and the security state and mode in which the instruction is executed, an attempt to execute the instruction might be UNDEFINED, or trapped to Hyp mode. For more information see [Enabling Advanced SIMD and floating-point support on page G1-4413](#).

A1

31	30	29	28	27	26	25	24	23	22	21	20	19	16	15	12	11	10	9	8	7	6	5	4	3	0
1	1	1	1	0	0	0	1	U	0	D	size	Vn	Vd	0	1	0	0	N	Q	M	0	Vm			

64-bit SIMD vector variant

Applies when Q == 0.

VSHL{<c>}{<q>}.<dt> {<Dd>}, <Dm>, <Dn>

128-bit SIMD vector variant

Applies when Q == 1.

VSHL{<c>}{<q>}.<dt> {<Qd>}, <Qm>, <Qn>

Decode for all variants of this encoding

```
if Q == '1' && (Vd<0> == '1' || Vm<0> == '1' || Vn<0> == '1') then UNDEFINED;
unsigned = (U == '1');
esize = 8 << UInt(size); elements = 64 DIV esize;
d = UInt(D:Vd); m = UInt(M:Vm); n = UInt(N:Vn); regs = if Q == '0' then 1 else 2;
```

T1

15	14	13	12	11	10	9	8	7	6	5	4	3	0	15	12	11	10	9	8	7	6	5	4	3	0
1	1	1	U	1	1	1	1	0	D	size	Vn	Vd	0	1	0	0	N	Q	M	0	Vm				

64-bit SIMD vector variant

Applies when Q == 0.

VSHL{<c>}{<q>}.<dt> {<Dd>}, <Dm>, <Dn>

128-bit SIMD vector variant

Applies when Q == 1.

VSHL{<c>}{<q>}.<dt> {<Qd>}, <Qm>, <Qn>

Decode for all variants of this encoding

```

if Q == '1' && (Vd<0> == '1' || Vm<0> == '1' || Vn<0> == '1') then UNDEFINED;
unsigned = (U == '1');
esize = 8 << UInt(size); elements = 64 DIV esize;
d = UInt(D:Vd); m = UInt(M:Vm); n = UInt(N:Vn); regs = if Q == '0' then 1 else 2;
  
```

Assembler symbols

- <c> For encoding A1: see [Standard assembler syntax fields on page F2-2848](#). This encoding must be unconditional.
 For encoding T1: see [Standard assembler syntax fields on page F2-2848](#).
- <q> See [Standard assembler syntax fields on page F2-2848](#).
- <dt> Is the data type for the elements of the vectors, encoded in the "U:size" field. It can have the following values:
 - S8 when U = 0, size = 00
 - S16 when U = 0, size = 01
 - S32 when U = 0, size = 10
 - S64 when U = 0, size = 11
 - U8 when U = 1, size = 00
 - U16 when U = 1, size = 01
 - U32 when U = 1, size = 10
 - U64 when U = 1, size = 11
- <Qd> Is the 128-bit name of the SIMD&FP destination register, encoded in the "D:Vd" field as <Qd>*2.
- <Qm> Is the 128-bit name of the second SIMD&FP source register, encoded in the "M:Vm" field as <Qm>*2.
- <Qn> Is the 128-bit name of the first SIMD&FP source register, encoded in the "N:Vn" field as <Qn>*2.
- <Dd> Is the 64-bit name of the SIMD&FP destination register, encoded in the "D:Vd" field.
- <Dm> Is the 64-bit name of the second SIMD&FP source register, encoded in the "M:Vm" field.
- <Dn> Is the 64-bit name of the first SIMD&FP source register, encoded in the "N:Vn" field.

Operation for all encodings

```

if ConditionPassed() then
  EncodingSpecificOperations(); CheckAdvSIMDEnabled();
  for r = 0 to regs-1
    for e = 0 to elements-1
      shift = SInt(Elem[D[n+r],e,esize]<7:0>);
      result = Int(Elem[D[m+r],e,esize], unsigned) << shift;
      Elem[D[d+r],e,esize] = result<esize-1:0>;
  
```

F6.1.208 VSHLL

Vector Shift Left Long takes each element in a doubleword vector, left shifts them by an immediate value, and places the results in a quadword vector.

The operand elements can be:

- 8-bit, 16-bit, or 32-bit signed integers.
- 8-bit, 16-bit, or 32-bit unsigned integers.
- 8-bit, 16-bit, or 32-bit untyped integers, maximum shift only.

The result elements are twice the length of the operand elements.

Depending on settings in the CPACR, NSACR, and HCPTR registers, and the security state and mode in which the instruction is executed, an attempt to execute the instruction might be UNDEFINED, or trapped to Hyp mode. For more information see [Enabling Advanced SIMD and floating-point support on page G1-4413](#).

A1

31	30	29	28	27	26	25	24	23	22	21	16	15	12	11	10	9	8	7	6	5	4	3	0
1	1	1	1	0	0	1	U	1	D	imm6		Vd	1	0	1	0	0	0	M	1	Vm		

A1 variant

Applies when imm6 != 000xxx.

VSHLL{<c>}{<q>}.<type><size> <Qd>, <Dm>, #<imm>

Decode for this encoding

```

if imm6 == '000xxx' then SEE "Related encodings";
if Vd<0> == '1' then UNDEFINED;
case imm6 of
    when '001xxx' esize = 8; elements = 8; shift_amount = UInt(imm6) - 8;
    when '01xxxx' esize = 16; elements = 4; shift_amount = UInt(imm6) - 16;
    when '1xxxxx' esize = 32; elements = 2; shift_amount = UInt(imm6) - 32;
if shift_amount == 0 then SEE VMOVL;
unsigned = (U == '1'); d = UInt(D:Vd); m = UInt(M:Vm);
    
```

A2

31	30	29	28	27	26	25	24	23	22	21	20	19	18	17	16	15	12	11	10	9	8	7	6	5	4	3	0
1	1	1	1	0	0	1	1	1	D	1	1	size	1	0	Vd	0	0	1	1	0	0	M	0	Vm			

A2 variant

VSHLL{<c>}{<q>}.<type><size> <Qd>, <Dm>, #<imm>

Decode for this encoding

```

if size == '11' || Vd<0> == '1' then UNDEFINED;
esize = 8 << UInt(size); elements = 64 DIV esize; shift_amount = esize;
unsigned = FALSE; // Or TRUE without change of functionality
d = UInt(D:Vd); m = UInt(M:Vm);
    
```

T1

15	14	13	12	11	10	9	8	7	6	5	4	3	2	1	0	15	12	11	10	9	8	7	6	5	4	3	2	1	0
1	1	1	U	1	1	1	1	1	D	imm6					Vd	1	0	1	0	0	0	M	1	Vm					

T1 variant

Applies when imm6 != 000xxx.

VSHLL{<c>}{<q>}.<type><size> <Qd>, <Dm>, #<imm>

Decode for this encoding

```

if imm6 == '000xxx' then SEE "Related encodings";
if Vd<0> == '1' then UNDEFINED;
case imm6 of
  when '001xxx' esize = 8; elements = 8; shift_amount = UInt(imm6) - 8;
  when '01xxxx' esize = 16; elements = 4; shift_amount = UInt(imm6) - 16;
  when '1xxxxx' esize = 32; elements = 2; shift_amount = UInt(imm6) - 32;
if shift_amount == 0 then SEE VMOVL;
unsigned = (U == '1'); d = UInt(D:Vd); m = UInt(M:Vm);

```

T2

15	14	13	12	11	10	9	8	7	6	5	4	3	2	1	0	15	12	11	10	9	8	7	6	5	4	3	2	1	0
1	1	1	1	1	1	1	1	1	D	1	1	size	1	0	Vd	0	0	1	1	0	0	M	0	Vm					

T2 variant

VSHLL{<c>}{<q>}.<type><size> <Qd>, <Dm>, #<imm>

Decode for this encoding

```

if size == '11' || Vd<0> == '1' then UNDEFINED;
esize = 8 << UInt(size); elements = 64 DIV esize; shift_amount = esize;
unsigned = FALSE; // Or TRUE without change of functionality
d = UInt(D:Vd); m = UInt(M:Vm);

```

Notes for all encodings

Related encodings: See [Advanced SIMD one register and modified immediate](#) on page F3-2912 for the T32 instruction set, or [Advanced SIMD one register and modified immediate](#) on page F4-2994 for the A32 instruction set.

Assembler symbols

- <c> For encoding A1 and A2: see [Standard assembler syntax fields](#) on page F2-2848. This encoding must be unconditional.
 For encoding T1 and T2: see [Standard assembler syntax fields](#) on page F2-2848.
- <q> See [Standard assembler syntax fields](#) on page F2-2848.
- <type> The data type for the elements of the operand. It must be one of:
 - S Signed. In encoding T1/A1, encoded as U = 0.
 - U Unsigned. In encoding T1/A1, encoded as U = 1.
 - I Untyped integer, Available only in encoding T2/A2.

<size> The data size for the elements of the operand. The following table shows the permitted values and their encodings:

<size>	Encoding T1/A1	Encoding T2/A2
8	Encoded as imm6<5:3> = 0b001	Encoded as size = 0b00
16	Encoded as imm6<5:4> = 0b01	Encoded as size = 0b01
32	Encoded as imm6<5> = 1	Encoded as size = 0b10

<Qd> Is the 128-bit name of the SIMD&FP destination register, encoded in the "D:Vd" field as <Qd>*2.

<Dm> Is the 64-bit name of the SIMD&FP source register, encoded in the "M:Vm" field.

<imm> The immediate value. <imm> must lie in the range 1 to <size>, and:

- If <size> == <imm>, the encoding is T2/A2.
- Otherwise, the encoding is T1/A1, and:
 - If <size> == 8, <imm> is encoded in imm6<2:0>.
 - If <size> == 16, <imm> is encoded in imm6<3:0>.
 - If <size> == 32, <imm> is encoded in imm6<4:0>.

Operation for all encodings

```

if ConditionPassed() then
    EncodingSpecificOperations(); CheckAdvSIMDEnabled();
    for e = 0 to elements-1
        result = Int(Elem[Din[m],e,esize], unsigned) << shift_amount;
        Elem[Q[d>>1],e,2*esize] = result<2*esize-1:0>;
  
```

F6.1.209 VSHR

Vector Shift Right takes each element in a vector, right shifts them by an immediate value, and places the truncated results in the destination vector. For rounded results, see [VRSHR](#).

The operand and result elements must be the same size, and can be any one of:

- 8-bit, 16-bit, 32-bit, or 64-bit signed integers.
- 8-bit, 16-bit, 32-bit, or 64-bit unsigned integers.

Depending on settings in the [CPACR](#), [NSACR](#), and [HCPTR](#) registers, and the security state and mode in which the instruction is executed, an attempt to execute the instruction might be UNDEFINED, or trapped to Hyp mode. For more information see [Enabling Advanced SIMD and floating-point support on page G1-4413](#).

A1

31	30	29	28	27	26	25	24	23	22	21	16	15	12	11	10	9	8	7	6	5	4	3	0
1	1	1	1	0	0	1	U	1	D	imm6	Vd	0	0	0	0	L	Q	M	1	Vm			

64-bit SIMD vector variant

Applies when $!(imm6 == 000xxx \ \&\& \ L == 0) \ \&\& \ Q == 0$.

VSHR{<c>}{<q>}.<type><size> {<Dd>}, <Dm>, #<imm>

128-bit SIMD vector variant

Applies when $!(imm6 == 000xxx \ \&\& \ L == 0) \ \&\& \ Q == 1$.

VSHR{<c>}{<q>}.<type><size> {<Qd>}, <Qm>, #<imm>

Decode for all variants of this encoding

```

if (L:imm6) == '0001xxx' then SEE "Related encodings";
if Q == '1' && (Vd<0> == '1' || Vm<0> == '1') then UNDEFINED;
case L:imm6 of
  when '0001xxx' esize = 8; elements = 8; shift_amount = 16 - UInt(imm6);
  when '001xxxx' esize = 16; elements = 4; shift_amount = 32 - UInt(imm6);
  when '01xxxxx' esize = 32; elements = 2; shift_amount = 64 - UInt(imm6);
  when '1xxxxxx' esize = 64; elements = 1; shift_amount = 64 - UInt(imm6);
unsigned = (U == '1'); d = UInt(D:Vd); m = UInt(M:Vm); regs = if Q == '0' then 1 else 2;
    
```

T1

15	14	13	12	11	10	9	8	7	6	5	0	15	12	11	10	9	8	7	6	5	4	3	0
1	1	1	U	1	1	1	1	1	D	imm6	Vd	0	0	0	0	L	Q	M	1	Vm			

64-bit SIMD vector variant

Applies when $!(imm6 == 000xxx \ \&\& \ L == 0) \ \&\& \ Q == 0$.

VSHR{<c>}{<q>}.<type><size> {<Dd>}, <Dm>, #<imm>

128-bit SIMD vector variant

Applies when $!(imm6 == 000xxx \ \&\& \ L == 0) \ \&\& \ Q == 1$.

VSHR{<c>}{<q>}.<type><size> {<Qd>}, <Qm>, #<imm>

Decode for all variants of this encoding

```

if (L:imm6) == '0000xxx' then SEE "Related encodings";
if Q == '1' && (Vd<0> == '1' || Vm<0> == '1') then UNDEFINED;
case L:imm6 of
  when '0001xxx' esize = 8; elements = 8; shift_amount = 16 - UInt(imm6);
  when '001xxxx' esize = 16; elements = 4; shift_amount = 32 - UInt(imm6);
  when '01xxxxx' esize = 32; elements = 2; shift_amount = 64 - UInt(imm6);
  when '1xxxxxx' esize = 64; elements = 1; shift_amount = 64 - UInt(imm6);
unsigned = (U == '1'); d = UInt(D:Vd); m = UInt(M:Vm); regs = if Q == '0' then 1 else 2;
  
```

Notes for all encodings

Related encodings: See *Advanced SIMD one register and modified immediate* on page F3-2912 for the T32 instruction set, or *Advanced SIMD one register and modified immediate* on page F4-2994 for the A32 instruction set.

Assembler symbols

- <c> For encoding A1: see *Standard assembler syntax fields* on page F2-2848. This encoding must be unconditional.
 For encoding T1: see *Standard assembler syntax fields* on page F2-2848.
- <q> See *Standard assembler syntax fields* on page F2-2848.
- <type> Is the data type for the elements of the vectors, encoded in the "U" field. It can have the following values:
 - S when U = 0
 - U when U = 1
- <size> Is the data size for the elements of the vectors, encoded in the "L:imm6<5:3>" field. It can have the following values:
 - 8 when L = 0, imm6<5:3> = 001
 - 16 when L = 0, imm6<5:3> = 01x
 - 32 when L = 0, imm6<5:3> = 1xx
 - 64 when L = 1, imm6<5:3> = xxx
- <Qd> Is the 128-bit name of the SIMD&FP destination register, encoded in the "D:Vd" field as <Qd>*2.
- <Qm> Is the 128-bit name of the SIMD&FP source register, encoded in the "M:Vm" field as <Qm>*2.
- <Dd> Is the 64-bit name of the SIMD&FP destination register, encoded in the "D:Vd" field.
- <Dm> Is the 64-bit name of the SIMD&FP source register, encoded in the "M:Vm" field.
- <imm> Is an immediate value, in the range 1 to <size>, encoded in the "imm6" field as <size> - <imm>.

Operation for all encodings

```

if ConditionPassed() then
  EncodingSpecificOperations(); CheckAdvSIMDEnabled();
  for r = 0 to regs-1
    for e = 0 to elements-1
      result = Int(Elem[D[m+r],e,esize], unsigned) >> shift_amount;
      Elem[D[d+r],e,esize] = result<size-1:0>;
  
```

F6.1.210 VSHR (zero)

Vector Shift Right copies the contents of one SIMD register to another

This instruction is a pseudo-instruction of the [VORR \(register\)](#) instruction. This means that:

- The encodings in this description are named to match the encodings of [VORR \(register\)](#).
- The assembler syntax is used only for assembly, and is not used on disassembly.
- The description of [VORR \(register\)](#) gives the operational pseudocode for this instruction.

A1

31	30	29	28	27	26	25	24	23	22	21	20	19	16	15	12	11	10	9	8	7	6	5	4	3	0
1	1	1	1	0	0	0	1	0	0	D	1	0	Vn	Vd	0	0	0	1	N	Q	M	1	Vm		

64-bit SIMD vector variant

Applies when Q == 0.

VSHR{<c>}{<q>}.<dt> <Dd>, <Dm>, #0

is equivalent to

VORR{<c>}{<q>}{.dt} <Dd>, <Dm>, <Dm>

and is never the preferred disassembly.

128-bit SIMD vector variant

Applies when Q == 1.

VSHR{<c>}{<q>}.<dt> <Qd>, <Qm>, #0

is equivalent to

VORR{<c>}{<q>}{.dt} <Qd>, <Qm>, <Qm>

and is never the preferred disassembly.

T1

15	14	13	12	11	10	9	8	7	6	5	4	3	0	15	12	11	10	9	8	7	6	5	4	3	0
1	1	1	0	1	1	1	1	0	D	1	0	Vn	Vd	0	0	0	1	N	Q	M	1	Vm			

64-bit SIMD vector variant

Applies when Q == 0.

VSHR{<c>}{<q>}.<dt> <Dd>, <Dm>, #0

is equivalent to

VORR{<c>}{<q>}{.dt} <Dd>, <Dm>, <Dm>

and is never the preferred disassembly.

128-bit SIMD vector variant

Applies when Q == 1.

VSHR{<c>}{<q>}.<dt> <Qd>, <Qm>, #0

is equivalent to

VORR{<c>}{<q>}{. <dt>} <Qd>, <Qm>, <Qm>

and is never the preferred disassembly.

Assembler symbols

- <c> For encoding A1: see [Standard assembler syntax fields on page F2-2848](#). This encoding must be unconditional.
For encoding T1: see [Standard assembler syntax fields on page F2-2848](#).
- <q> See [Standard assembler syntax fields on page F2-2848](#).
- <dt> Is the data type for the elements of the vectors, and must be one of: S8, S16, S32, S64, U8, U16, U32 or U64.
- <Qd> Is the 128-bit name of the SIMD&FP destination register, encoded in the "D:Vd" field as <Qd>*2.
- <Qm> Is the 128-bit name of the SIMD&FP source register, encoded in the "N:Vn" and "M:Vm" field as <Qm>*2.
- <Dd> Is the 64-bit name of the SIMD&FP destination register, encoded in the "D:Vd" field.
- <Dm> Is the 64-bit name of the SIMD&FP source register, encoded in the "N:Vn" and "M:Vm" field.

Operation for all encodings

The description of [VORR \(register\)](#) gives the operational pseudocode for this instruction.

F6.1.211 VSHRN

Vector Shift Right Narrow takes each element in a vector, right shifts them by an immediate value, and places the truncated results in the destination vector. For rounded results, see [VRSHRN](#).

The operand elements can be 16-bit, 32-bit, or 64-bit integers. There is no distinction between signed and unsigned integers. The destination elements are half the size of the source elements.

Depending on settings in the [CPACR](#), [NSACR](#), and [HCPTR](#) registers, and the security state and mode in which the instruction is executed, an attempt to execute the instruction might be UNDEFINED, or trapped to Hyp mode. For more information see [Enabling Advanced SIMD and floating-point support on page G1-4413](#).

A1

31	30	29	28	27	26	25	24	23	22	21	16	15	12	11	10	9	8	7	6	5	4	3	0
1	1	1	1	0	0	1	0	1	D	imm6	Vd	1	0	0	0	0	0	M	1	Vm			

A1 variant

Applies when `imm6 != 000xxx`.

VSHRN{<c>}{<q>}.I<size> <Dd>, <Qm>, #<imm>

Decode for this encoding

```

if imm6 == '000xxx' then SEE "Related encodings";
if Vm<0> == '1' then UNDEFINED;
case imm6 of
    when '001xxx' esize = 8; elements = 8; shift_amount = 16 - UInt(imm6);
    when '01xxxx' esize = 16; elements = 4; shift_amount = 32 - UInt(imm6);
    when '1xxxxx' esize = 32; elements = 2; shift_amount = 64 - UInt(imm6);
d = UInt(D:Vd); m = UInt(M:Vm);
    
```

T1

15	14	13	12	11	10	9	8	7	6	5	0	15	12	11	10	9	8	7	6	5	4	3	0
1	1	1	0	1	1	1	1	D	imm6	Vd	1	0	0	0	0	0	M	1	Vm				

T1 variant

Applies when `imm6 != 000xxx`.

VSHRN{<c>}{<q>}.I<size> <Dd>, <Qm>, #<imm>

Decode for this encoding

```

if imm6 == '000xxx' then SEE "Related encodings";
if Vm<0> == '1' then UNDEFINED;
case imm6 of
    when '001xxx' esize = 8; elements = 8; shift_amount = 16 - UInt(imm6);
    when '01xxxx' esize = 16; elements = 4; shift_amount = 32 - UInt(imm6);
    when '1xxxxx' esize = 32; elements = 2; shift_amount = 64 - UInt(imm6);
d = UInt(D:Vd); m = UInt(M:Vm);
    
```

Notes for all encodings

Related encodings: See [Advanced SIMD one register and modified immediate on page F3-2912](#) for the T32 instruction set, or [Advanced SIMD one register and modified immediate on page F4-2994](#) for the A32 instruction set.

Assembler symbols

- <c> For encoding A1: see *Standard assembler syntax fields* on page F2-2848. This encoding must be unconditional.
For encoding T1: see *Standard assembler syntax fields* on page F2-2848.
- <q> See *Standard assembler syntax fields* on page F2-2848.
- <size> Is the data size for the elements of the vectors, encoded in the "imm6<5:3>" field. It can have the following values:
16 when imm6<5:3> = 001
32 when imm6<5:3> = 01x
64 when imm6<5:3> = 1xx
- <Dd> Is the 64-bit name of the SIMD&FP destination register, encoded in the "D:Vd" field.
- <Qm> Is the 128-bit name of the SIMD&FP source register, encoded in the "M:Vm" field as <Qm>*2.
- <imm> Is an immediate value, in the range 1 to <size>/2, encoded in the "imm6" field as <size>/2 - <imm>.

Operation for all encodings

```
if ConditionPassed() then
    EncodingSpecificOperations(); CheckAdvSIMDEnabled();
    for e = 0 to elements-1
        result = LSR(Elem[Qin[m>>1],e,2*esize], shift_amount);
        Elem[D[d],e,esize] = result<size-1:0>;
```

F6.1.212 VSHRN (zero)

Vector Shift Right Narrow takes each element in a vector, right shifts them by an immediate value, and places the truncated results in the destination vector

This instruction is a pseudo-instruction of the [VMOVN](#) instruction. This means that:

- The encodings in this description are named to match the encodings of [VMOVN](#).
- The assembler syntax is used only for assembly, and is not used on disassembly.
- The description of [VMOVN](#) gives the operational pseudocode for this instruction.

A1

31	30	29	28	27	26	25	24	23	22	21	20	19	18	17	16	15	12	11	10	9	8	7	6	5	4	3	0
1	1	1	1	0	0	1	1	1	D	1	1	size	1	0	Vd	0	0	1	0	0	0	M	0	Vm			

A1 variant

VSHRN{<c>}{<q>}.<dt> <Dd>, <Qm>, #0

is equivalent to

VMOVN{<c>}{<q>}.<dt> <Dd>, <Qm>

and is never the preferred disassembly.

T1

15	14	13	12	11	10	9	8	7	6	5	4	3	2	1	0	15	12	11	10	9	8	7	6	5	4	3	0
1	1	1	1	1	1	1	1	1	D	1	1	size	1	0	Vd	0	0	1	0	0	0	M	0	Vm			

T1 variant

VSHRN{<c>}{<q>}.<dt> <Dd>, <Qm>, #0

is equivalent to

VMOVN{<c>}{<q>}.<dt> <Dd>, <Qm>

and is never the preferred disassembly.

Assembler symbols

<c> For encoding A1: see [Standard assembler syntax fields on page F2-2848](#). This encoding must be unconditional.

For encoding T1: see [Standard assembler syntax fields on page F2-2848](#).

<q> See [Standard assembler syntax fields on page F2-2848](#).

<dt> Is the data type for the elements of the operand, encoded in the "size" field. It can have the following values:

I16 when size = 00

I32 when size = 01

I64 when size = 10

The encoding size = 11 is reserved.

- <Dd> Is the 64-bit name of the SIMD&FP destination register, encoded in the "D:Vd" field.
- <Qm> Is the 128-bit name of the SIMD&FP source register, encoded in the "M:Vm" field as <Qm>*2.

Operation for all encodings

The description of [VMOVN](#) gives the operational pseudocode for this instruction.

F6.1.213 VSLI

Vector Shift Left and Insert takes each element in the operand vector, left shifts them by an immediate value, and inserts the results in the destination vector. Bits shifted out of the left of each element are lost.

The elements must all be the same size, and can be 8-bit, 16-bit, 32-bit, or 64-bit. There is no distinction between data types.

Depending on settings in the CPACR, NSACR, and HCPTR registers, and the security state and mode in which the instruction is executed, an attempt to execute the instruction might be UNDEFINED, or trapped to Hyp mode. For more information see [Enabling Advanced SIMD and floating-point support on page G1-4413](#).

A1

31	30	29	28	27	26	25	24	23	22	21	16	15	12	11	10	9	8	7	6	5	4	3	0
1	1	1	1	0	0	1	1	1	D	imm6	Vd	0	1	0	1	L	Q	M	1	Vm			

64-bit SIMD vector variant

Applies when $!(imm6 == 000xxx \ \&\& \ L == 0) \ \&\& \ Q == 0$.

VSLI{<c>}{<q>}.<size> {<Dd>}, <Dm>, #<imm>

128-bit SIMD vector variant

Applies when $!(imm6 == 000xxx \ \&\& \ L == 0) \ \&\& \ Q == 1$.

VSLI{<c>}{<q>}.<size> {<Qd>}, <Qm>, #<imm>

Decode for all variants of this encoding

```

if (L:imm6) == '000xxx' then SEE "Related encodings";
if Q == '1' && (Vd<0> == '1' || Vm<0> == '1') then UNDEFINED;
case L:imm6 of
  when '0001xxx' esize = 8; elements = 8; shift_amount = UInt(imm6) - 8;
  when '001xxxx' esize = 16; elements = 4; shift_amount = UInt(imm6) - 16;
  when '01xxxxx' esize = 32; elements = 2; shift_amount = UInt(imm6) - 32;
  when '1xxxxxx' esize = 64; elements = 1; shift_amount = UInt(imm6);
d = UInt(D:Vd); m = UInt(M:Vm); regs = if Q == '0' then 1 else 2;
    
```

T1

15	14	13	12	11	10	9	8	7	6	5	0	15	12	11	10	9	8	7	6	5	4	3	0
1	1	1	1	1	1	1	1	1	D	imm6	Vd	0	1	0	1	L	Q	M	1	Vm			

64-bit SIMD vector variant

Applies when $!(imm6 == 000xxx \ \&\& \ L == 0) \ \&\& \ Q == 0$.

VSLI{<c>}{<q>}.<size> {<Dd>}, <Dm>, #<imm>

128-bit SIMD vector variant

Applies when $!(imm6 == 000xxx \ \&\& \ L == 0) \ \&\& \ Q == 1$.

VSLI{<c>}{<q>}.<size> {<Qd>}, <Qm>, #<imm>

Decode for all variants of this encoding

```

if (L:imm6) == '0000xxx' then SEE "Related encodings";
if Q == '1' && (Vd<0> == '1' || Vm<0> == '1') then UNDEFINED;
case L:imm6 of
  when '0001xxx' esize = 8; elements = 8; shift_amount = UInt(imm6) - 8;
  when '001xxxx' esize = 16; elements = 4; shift_amount = UInt(imm6) - 16;
  when '01xxxxx' esize = 32; elements = 2; shift_amount = UInt(imm6) - 32;
  when '1xxxxxx' esize = 64; elements = 1; shift_amount = UInt(imm6);
d = UInt(D:Vd); m = UInt(M:Vm); regs = if Q == '0' then 1 else 2;

```

Notes for all encodings

Related encodings: See *Advanced SIMD one register and modified immediate* on page F3-2912 for the T32 instruction set, or *Advanced SIMD one register and modified immediate* on page F4-2994 for the A32 instruction set.

Assembler symbols

- <c> For encoding A1: see *Standard assembler syntax fields* on page F2-2848. This encoding must be unconditional.
 For encoding T1: see *Standard assembler syntax fields* on page F2-2848.
- <q> See *Standard assembler syntax fields* on page F2-2848.
- <size> Is the data size for the elements of the vectors, encoded in the "L:imm6<5:3>" field. It can have the following values:

8	when L = 0, imm6<5:3> = 001
16	when L = 0, imm6<5:3> = 01x
32	when L = 0, imm6<5:3> = 1xx
64	when L = 1, imm6<5:3> = xxx
- <Qd> Is the 128-bit name of the SIMD&FP destination register, encoded in the "D:Vd" field as <Qd>*2.
- <Qm> Is the 128-bit name of the SIMD&FP source register, encoded in the "M:Vm" field as <Qm>*2.
- <Dd> Is the 64-bit name of the SIMD&FP destination register, encoded in the "D:Vd" field.
- <Dm> Is the 64-bit name of the SIMD&FP source register, encoded in the "M:Vm" field.
- <imm> Is an immediate value, in the range 0 to <size>-1, encoded in the "imm6" field.

Operation for all encodings

```

if ConditionPassed() then
  EncodingSpecificOperations(); CheckAdvSIMDEnabled();
  mask = LSL(Ones(esize), shift_amount);
  for r = 0 to regs-1
    for e = 0 to elements-1
      shifted_op = LSL(Elem[D[m+r],e,esize], shift_amount);
      Elem[D[d+r],e,esize] = (Elem[D[d+r],e,esize] AND NOT(mask)) OR shifted_op;

```

F6.1.214 VSQRT

Square Root calculates the square root of the value in a floating-point register and writes the result to another floating-point register.

Depending on settings in the CPACR, NSACR, HCPTR, and FPEXC registers, and the security state and mode in which the instruction is executed, an attempt to execute the instruction might be UNDEFINED, or trapped to Hyp mode. For more information see [Enabling Advanced SIMD and floating-point support on page G1-4413](#).

A1

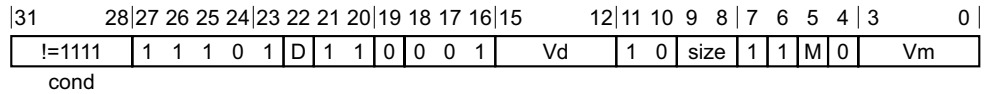

Half-precision scalar variant

Applies when size == 01.

VSQRT{<c>}{<q>}.F16 <Sd>, <Sm>

Single-precision scalar variant

Applies when size == 10.

VSQRT{<c>}{<q>}.F32 <Sd>, <Sm>

Double-precision scalar variant

Applies when size == 11.

VSQRT{<c>}{<q>}.F64 <Dd>, <Dm>

Decode for all variants of this encoding

```

if size == '00' || (size == '01' && !HaveFP16Ext()) then UNDEFINED;
if size == '01' && cond != '1110' then UNPREDICTABLE;
if FPSCR.Len != '000' || FPSCR.Stride != '00' then UNDEFINED;
case size of
    when '01' esize = 16; d = UInt(Vd:D); m = UInt(Vm:M);
    when '10' esize = 32; d = UInt(Vd:D); m = UInt(Vm:M);
    when '11' esize = 64; d = UInt(D:Vd); m = UInt(M:Vm);
    
```

CONSTRAINED UNPREDICTABLE behavior

If size == '01' && cond != '1110', then one of the following behaviors must occur:

- The instruction is UNDEFINED.
- The instruction executes as if it passes the Condition code check.
- The instruction executes as NOP. This means it behaves as if it fails the Condition code check.

T1

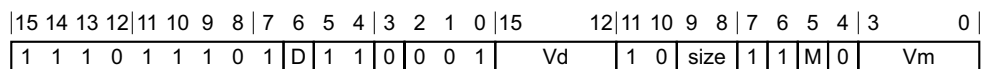

Half-precision scalar variant

Applies when size == 01.

VSQRT{<c>}{<q>}.F16 <Sd>, <Sm>

Single-precision scalar variant

Applies when size == 10.

VSQRT{<c>}{<q>}.F32 <Sd>, <Sm>

Double-precision scalar variant

Applies when size == 11.

VSQRT{<c>}{<q>}.F64 <Dd>, <Dm>

Decode for all variants of this encoding

```
if size == '00' || (size == '01' && !HaveFP16Ext()) then UNDEFINED;
if size == '01' && InITBlock() then UNPREDICTABLE;
if FPSCR.Len != '000' || FPSCR.Stride != '00' then UNDEFINED;
case size of
  when '01' esize = 16; d = UInt(Vd:D); m = UInt(Vm:M);
  when '10' esize = 32; d = UInt(Vd:D); m = UInt(Vm:M);
  when '11' esize = 64; d = UInt(D:Vd); m = UInt(M:Vm);
```

CONSTRAINED UNPREDICTABLE behavior

If size == '01' && InITBlock(), then one of the following behaviors must occur:

- The instruction is UNDEFINED.
- The instruction executes as if it passes the Condition code check.
- The instruction executes as NOP. This means it behaves as if it fails the Condition code check.

Assembler symbols

<c>	See Standard assembler syntax fields on page F2-2848 .
<q>	See Standard assembler syntax fields on page F2-2848 .
<Sd>	Is the 32-bit name of the SIMD&FP destination register, encoded in the "Vd:D" field.
<Sm>	Is the 32-bit name of the SIMD&FP source register, encoded in the "Vm:M" field.
<Dd>	Is the 64-bit name of the SIMD&FP destination register, encoded in the "D:Vd" field.
<Dm>	Is the 64-bit name of the SIMD&FP source register, encoded in the "M:Vm" field.

Operation for all encodings

```
if ConditionPassed() then
  EncodingSpecificOperations(); CheckVFPEnabled(TRUE);
case esize of
  when 16 S[d] = Zeros(16) : FPSqrt(S[m]<15:0>, FPSCR);
  when 32 S[d] = FPSqrt(S[m], FPSCR);
  when 64 D[d] = FPSqrt(D[m], FPSCR);
```

F6.1.215 VSRA

Vector Shift Right and Accumulate takes each element in a vector, right shifts them by an immediate value, and accumulates the truncated results into the destination vector. For rounded results, see [VRSRA](#).

The operand and result elements must all be the same type, and can be any one of:

- 8-bit, 16-bit, 32-bit, or 64-bit signed integers.
- 8-bit, 16-bit, 32-bit, or 64-bit unsigned integers.

Depending on settings in the [CPACR](#), [NSACR](#), and [HCPTR](#) registers, and the security state and mode in which the instruction is executed, an attempt to execute the instruction might be UNDEFINED, or trapped to Hyp mode. For more information see [Enabling Advanced SIMD and floating-point support on page G1-4413](#).

A1

31	30	29	28	27	26	25	24	23	22	21	16	15	12	11	10	9	8	7	6	5	4	3	0
1	1	1	1	0	0	1	U	1	D	imm6	Vd	0	0	0	1	L	Q	M	1	Vm			

64-bit SIMD vector variant

Applies when $!(imm6 == 000xxx \ \&\& \ L == 0) \ \&\& \ Q == 0$.

VSRA{<c>}{<q>}.<type><size> {<Dd>}, <Dm>, #<imm>

128-bit SIMD vector variant

Applies when $!(imm6 == 000xxx \ \&\& \ L == 0) \ \&\& \ Q == 1$.

VSRA{<c>}{<q>}.<type><size> {<Qd>}, <Qm>, #<imm>

Decode for all variants of this encoding

```

if (L:imm6) == '0001xxx' then SEE "Related encodings";
if Q == '1' && (Vd<0> == '1' || Vm<0> == '1') then UNDEFINED;
case L:imm6 of
  when '0001xxx' esize = 8; elements = 8; shift_amount = 16 - UInt(imm6);
  when '001xxxx' esize = 16; elements = 4; shift_amount = 32 - UInt(imm6);
  when '01xxxxx' esize = 32; elements = 2; shift_amount = 64 - UInt(imm6);
  when '1xxxxxx' esize = 64; elements = 1; shift_amount = 64 - UInt(imm6);
unsigned = (U == '1'); d = UInt(D:Vd); m = UInt(M:Vm); regs = if Q == '0' then 1 else 2;
    
```

T1

15	14	13	12	11	10	9	8	7	6	5	0	15	12	11	10	9	8	7	6	5	4	3	0
1	1	1	U	1	1	1	1	1	D	imm6	Vd	0	0	0	1	L	Q	M	1	Vm			

64-bit SIMD vector variant

Applies when $!(imm6 == 000xxx \ \&\& \ L == 0) \ \&\& \ Q == 0$.

VSRA{<c>}{<q>}.<type><size> {<Dd>}, <Dm>, #<imm>

128-bit SIMD vector variant

Applies when $!(imm6 == 000xxx \ \&\& \ L == 0) \ \&\& \ Q == 1$.

VSRA{<c>}{<q>}.<type><size> {<Qd>}, <Qm>, #<imm>

Decode for all variants of this encoding

```

if (L:imm6) == '0000xxx' then SEE "Related encodings";
if Q == '1' && (Vd<0> == '1' || Vm<0> == '1') then UNDEFINED;
case L:imm6 of
  when '0001xxx' esize = 8; elements = 8; shift_amount = 16 - UInt(imm6);
  when '001xxxx' esize = 16; elements = 4; shift_amount = 32 - UInt(imm6);
  when '01xxxxx' esize = 32; elements = 2; shift_amount = 64 - UInt(imm6);
  when '1xxxxxx' esize = 64; elements = 1; shift_amount = 64 - UInt(imm6);
unsigned = (U == '1'); d = UInt(D:Vd); m = UInt(M:Vm); regs = if Q == '0' then 1 else 2;
  
```

Notes for all encodings

Related encodings: See *Advanced SIMD one register and modified immediate* on page F3-2912 for the T32 instruction set, or *Advanced SIMD one register and modified immediate* on page F4-2994 for the A32 instruction set.

Assembler symbols

- <c> For encoding A1: see *Standard assembler syntax fields* on page F2-2848. This encoding must be unconditional.
 For encoding T1: see *Standard assembler syntax fields* on page F2-2848.
- <q> See *Standard assembler syntax fields* on page F2-2848.
- <type> Is the data type for the elements of the vectors, encoded in the "U" field. It can have the following values:
 - S when U = 0
 - U when U = 1
- <size> Is the data size for the elements of the vectors, encoded in the "L:imm6<5:3>" field. It can have the following values:
 - 8 when L = 0, imm6<5:3> = 001
 - 16 when L = 0, imm6<5:3> = 01x
 - 32 when L = 0, imm6<5:3> = 1xx
 - 64 when L = 1, imm6<5:3> = xxx
- <Qd> Is the 128-bit name of the SIMD&FP destination register, encoded in the "D:Vd" field as <Qd>*2.
- <Qm> Is the 128-bit name of the SIMD&FP source register, encoded in the "M:Vm" field as <Qm>*2.
- <Dd> Is the 64-bit name of the SIMD&FP destination register, encoded in the "D:Vd" field.
- <Dm> Is the 64-bit name of the SIMD&FP source register, encoded in the "M:Vm" field.
- <imm> Is an immediate value, in the range 1 to <size>, encoded in the "imm6" field as <size> - <imm>.

Operation for all encodings

```

if ConditionPassed() then
  EncodingSpecificOperations(); CheckAdvSIMDEnabled();
  for r = 0 to regs-1
    for e = 0 to elements-1
      result = Int(Elem[D[m+r],e,esize], unsigned) >> shift_amount;
      Elem[D[d+r],e,esize] = Elem[D[d+r],e,esize] + result;
  
```

F6.1.216 VSRI

Vector Shift Right and Insert takes each element in the operand vector, right shifts them by an immediate value, and inserts the results in the destination vector. Bits shifted out of the right of each element are lost.

The elements must all be the same size, and can be 8-bit, 16-bit, 32-bit, or 64-bit. There is no distinction between data types.

Depending on settings in the CPACR, NSACR, and HCPTR registers, and the security state and mode in which the instruction is executed, an attempt to execute the instruction might be UNDEFINED, or trapped to Hyp mode. For more information see [Enabling Advanced SIMD and floating-point support on page G1-4413](#).

A1

31	30	29	28	27	26	25	24	23	22	21	16	15	12	11	10	9	8	7	6	5	4	3	0
1	1	1	1	0	0	1	1	1	D	imm6	Vd	0	1	0	0	L	Q	M	1	Vm			

64-bit SIMD vector variant

Applies when $!(imm6 == 000xxx \ \&\& \ L == 0) \ \&\& \ Q == 0$.

VSRI{<c>}{<q>}.<size> {<Dd>}, <Dm>, #<imm>

128-bit SIMD vector variant

Applies when $!(imm6 == 000xxx \ \&\& \ L == 0) \ \&\& \ Q == 1$.

VSRI{<c>}{<q>}.<size> {<Qd>}, <Qm>, #<imm>

Decode for all variants of this encoding

```

if (L:imm6) == '000xxx' then SEE "Related encodings";
if Q == '1' && (Vd<0> == '1' || Vm<0> == '1') then UNDEFINED;
case L:imm6 of
  when '0001xxx' esize = 8; elements = 8; shift_amount = 16 - UInt(imm6);
  when '001xxxx' esize = 16; elements = 4; shift_amount = 32 - UInt(imm6);
  when '01xxxxx' esize = 32; elements = 2; shift_amount = 64 - UInt(imm6);
  when '1xxxxxx' esize = 64; elements = 1; shift_amount = 64 - UInt(imm6);
d = UInt(D:Vd); m = UInt(M:Vm); regs = if Q == '0' then 1 else 2;
    
```

T1

15	14	13	12	11	10	9	8	7	6	5	0	15	12	11	10	9	8	7	6	5	4	3	0
1	1	1	1	1	1	1	1	1	D	imm6	Vd	0	1	0	0	L	Q	M	1	Vm			

64-bit SIMD vector variant

Applies when $!(imm6 == 000xxx \ \&\& \ L == 0) \ \&\& \ Q == 0$.

VSRI{<c>}{<q>}.<size> {<Dd>}, <Dm>, #<imm>

128-bit SIMD vector variant

Applies when $!(imm6 == 000xxx \ \&\& \ L == 0) \ \&\& \ Q == 1$.

VSRI{<c>}{<q>}.<size> {<Qd>}, <Qm>, #<imm>

Decode for all variants of this encoding

```

if (L:imm6) == '0000xxx' then SEE "Related encodings";
if Q == '1' && (Vd<0> == '1' || Vm<0> == '1') then UNDEFINED;
case L:imm6 of
  when '0001xxx' esize = 8; elements = 8; shift_amount = 16 - UInt(imm6);
  when '001xxxx' esize = 16; elements = 4; shift_amount = 32 - UInt(imm6);
  when '01xxxxx' esize = 32; elements = 2; shift_amount = 64 - UInt(imm6);
  when '1xxxxxx' esize = 64; elements = 1; shift_amount = 64 - UInt(imm6);
d = UInt(D:Vd); m = UInt(M:Vm); regs = if Q == '0' then 1 else 2;
  
```

Notes for all encodings

Related encodings: See *Advanced SIMD one register and modified immediate* on page F3-2912 for the T32 instruction set, or *Advanced SIMD one register and modified immediate* on page F4-2994 for the A32 instruction set.

Assembler symbols

- <c> For encoding A1: see *Standard assembler syntax fields* on page F2-2848. This encoding must be unconditional.
 For encoding T1: see *Standard assembler syntax fields* on page F2-2848.
- <q> See *Standard assembler syntax fields* on page F2-2848.
- <size> Is the data size for the elements of the vectors, encoded in the "L:imm6<5:3>" field. It can have the following values:

8	when L = 0, imm6<5:3> = 001
16	when L = 0, imm6<5:3> = 01x
32	when L = 0, imm6<5:3> = 1xx
64	when L = 1, imm6<5:3> = xxx
- <Qd> Is the 128-bit name of the SIMD&FP destination register, encoded in the "D:Vd" field as <Qd>*2.
- <Qm> Is the 128-bit name of the SIMD&FP source register, encoded in the "M:Vm" field as <Qm>*2.
- <Dd> Is the 64-bit name of the SIMD&FP destination register, encoded in the "D:Vd" field.
- <Dm> Is the 64-bit name of the SIMD&FP source register, encoded in the "M:Vm" field.
- <imm> Is an immediate value, in the range 1 to <size>, encoded in the "imm6" field as <size> - <imm>.

Operation for all encodings

```

if ConditionPassed() then
  EncodingSpecificOperations(); CheckAdvSIMDEnabled();
  mask = LSR(Ones(esize), shift_amount);
  for r = 0 to regs-1
    for e = 0 to elements-1
      shifted_op = LSR(Elem[D[m+r],e,esize], shift_amount);
      Elem[D[d+r],e,esize] = (Elem[D[d+r],e,esize] AND NOT(mask)) OR shifted_op;
  
```

F6.1.217 VST1 (single element from one lane)

Store single element from one lane of one register stores one element to memory from one element of a register. For details of the addressing mode see *The Advanced SIMD addressing mode on page F2-2869*.

Depending on settings in the CPACR, NSACR, and HCPTR registers, and the security state and mode in which the instruction is executed, an attempt to execute the instruction might be UNDEFINED, or trapped to Hyp mode. For more information see *Enabling Advanced SIMD and floating-point support on page G1-4413*.

A1

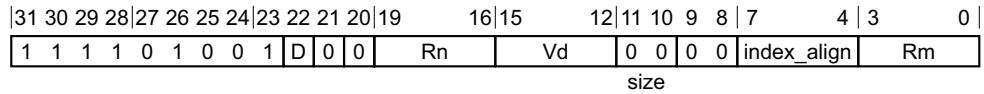

Offset variant

Applies when Rm == 1111.

VST1{<c>}{<q>}.<size> <list>, [<Rn>{:<align>}]

Post-indexed variant

Applies when Rm == 1101.

VST1{<c>}{<q>}.<size> <list>, [<Rn>{:<align>}]!

Post-indexed variant

Applies when Rm != 11x1.

VST1{<c>}{<q>}.<size> <list>, [<Rn>{:<align>}], <Rm>

Decode for all variants of this encoding

```

if size == '11' then UNDEFINED;
if index_align<0> != '0' then UNDEFINED;
ebytes = 1; index = UInt(index_align<3:1>); alignment = 1;
d = UInt(D:Vd); n = UInt(Rn); m = UInt(Rm);
wback = (m != 15); register_index = (m != 15 && m != 13);
if n == 15 then UNPREDICTABLE;
    
```

A2

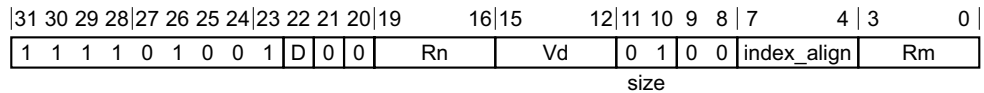

Offset variant

Applies when Rm == 1111.

VST1{<c>}{<q>}.<size> <list>, [<Rn>{:<align>}]

Post-indexed variant

Applies when Rm == 1101.

VST1{<c>}{<q>}.<size> <list>, [<Rn>{:<align>}]!

Post-indexed variant

Applies when Rm != 11x1.

VST1{<c>}{<q>}.<size> <list>, [<Rn>{:<align>}], <Rm>

Decode for all variants of this encoding

```

if size == '11' then UNDEFINED;
if index_align<1> != '0' then UNDEFINED;
ebytes = 2; index = UInt(index_align<3:2>);
alignment = if index_align<0> == '0' then 1 else 2;
d = UInt(D:Vd); n = UInt(Rn); m = UInt(Rm);
wback = (m != 15); register_index = (m != 15 && m != 13);
if n == 15 then UNPREDICTABLE;
    
```

A3

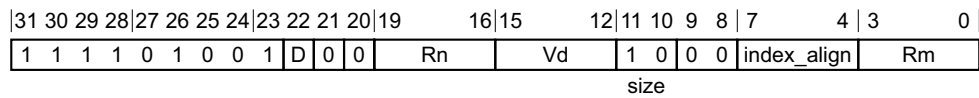

Offset variant

Applies when Rm == 1111.

VST1{<c>}{<q>}.<size> <list>, [<Rn>{:<align>}]

Post-indexed variant

Applies when Rm == 1101.

VST1{<c>}{<q>}.<size> <list>, [<Rn>{:<align>}]!

Post-indexed variant

Applies when Rm != 11x1.

VST1{<c>}{<q>}.<size> <list>, [<Rn>{:<align>}], <Rm>

Decode for all variants of this encoding

```

if size == '11' then UNDEFINED;
if index_align<2> != '0' then UNDEFINED;
if index_align<1:0> != '00' && index_align<1:0> != '11' then UNDEFINED;
ebytes = 4; index = UInt(index_align<3>);
alignment = if index_align<1:0> == '00' then 1 else 4;
d = UInt(D:Vd); n = UInt(Rn); m = UInt(Rm);
wback = (m != 15); register_index = (m != 15 && m != 13);
if n == 15 then UNPREDICTABLE;
    
```

T1

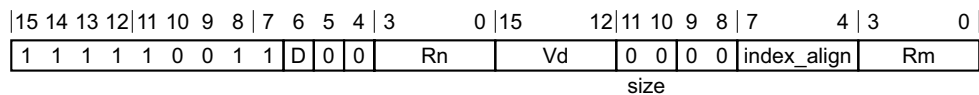

Offset variant

Applies when Rm == 1111.

VST1{<c>}{<q>}.<size> <list>, [<Rn>{:<align>}]

Post-indexed variant

Applies when Rm == 1101.

VST1{<c>}{<q>}.<size> <list>, [<Rn>{:<align>}]!

Post-indexed variant

Applies when Rm != 11x1.

VST1{<c>}{<q>}.<size> <list>, [<Rn>{:<align>}], <Rm>

Decode for all variants of this encoding

```

if size == '11' then UNDEFINED;
if index_align<0> != '0' then UNDEFINED;
ebytes = 1; index = UInt(index_align<3:1>); alignment = 1;
d = UInt(D:Vd); n = UInt(Rn); m = UInt(Rm);
wback = (m != 15); register_index = (m != 15 && m != 13);
if n == 15 then UNPREDICTABLE;
    
```

T2

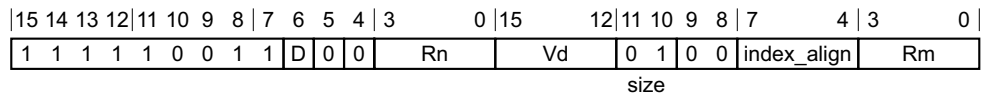

Offset variant

Applies when Rm == 1111.

VST1{<c>}{<q>}.<size> <list>, [<Rn>{:<align>}]

Post-indexed variant

Applies when Rm == 1101.

VST1{<c>}{<q>}.<size> <list>, [<Rn>{:<align>}]!

Post-indexed variant

Applies when Rm != 11x1.

VST1{<c>}{<q>}.<size> <list>, [<Rn>{:<align>}], <Rm>

Decode for all variants of this encoding

```

if size == '11' then UNDEFINED;
if index_align<1> != '0' then UNDEFINED;
ebytes = 2; index = UInt(index_align<3:2>);
alignment = if index_align<0> == '0' then 1 else 2;
d = UInt(D:Vd); n = UInt(Rn); m = UInt(Rm);
wback = (m != 15); register_index = (m != 15 && m != 13);
if n == 15 then UNPREDICTABLE;
    
```

T3

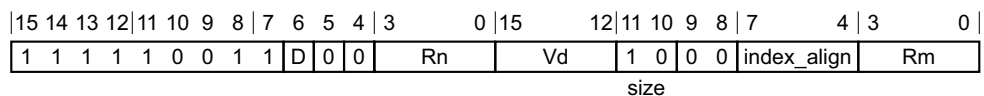

Offset variant

Applies when Rm == 1111.

VST1{<c>}{<q>}.<size> <list>, [<Rn>{:<align>}]

Post-indexed variant

Applies when Rm == 1101.

VST1{<c>}{<q>}.<size> <list>, [<Rn>{:<align>}]!

Post-indexed variant

Applies when Rm != 11x1.

VST1{<c>}{<q>}.<size> <list>, [<Rn>{:<align>}], <Rm>

Decode for all variants of this encoding

```

if size == '11' then UNDEFINED;
if index_align<2> != '0' then UNDEFINED;
if index_align<1:0> != '00' && index_align<1:0> != '11' then UNDEFINED;
ebytes = 4; index = UInt(index_align<3>);
alignment = if index_align<1:0> == '00' then 1 else 4;
d = UInt(D:Vd); n = UInt(Rn); m = UInt(Rm);
wback = (m != 15); register_index = (m != 15 && m != 13);
if n == 15 then UNPREDICTABLE;
  
```

Notes for all encodings

For more information about the CONSTRAINED UNPREDICTABLE behavior of this instruction, see [Appendix K1 Architectural Constraints on UNPREDICTABLE behaviors](#).

Assembler symbols

- <c> For encoding A1, A2 and A3: see [Standard assembler syntax fields on page F2-2848](#). This encoding must be unconditional.
- For encoding T1, T2 and T3: see [Standard assembler syntax fields on page F2-2848](#).
- <q> See [Standard assembler syntax fields on page F2-2848](#).
- <size> Is the data size, encoded in the "size" field. It can have the following values:
- | | |
|----|----------------|
| 8 | when size = 00 |
| 16 | when size = 01 |
| 32 | when size = 10 |
- <list> Is a list containing the single 64-bit name of the SIMD&FP register holding the element. The list must be { <Dd>[<index>] }.
- The register <Dd> is encoded in the "D:Vd" field.
- The permitted values and encoding of <index> depend on <size>:
- | | |
|--------------|--|
| <size> == 8 | <index> is in the range 0 to 7, encoded in the "index_align<3:1>" field. |
| <size> == 16 | <index> is in the range 0 to 3, encoded in the "index_align<3:2>" field. |
| <size> == 32 | <index> is 0 or 1, encoded in the "index_align<3>" field. |
- <Rn> Is the general-purpose base register, encoded in the "Rn" field.
- <align> When <size> == 8, <align> must be omitted, otherwise it is the optional alignment.

Whenever <align> is omitted, the standard alignment is used, see [Unaligned data access on page E2-2777](#), and the encoding depends on <size>:

<size> == 8 Encoded in the "index_align<0>" field as 0.
<size> == 16 Encoded in the "index_align<1:0>" field as 0b00.
<size> == 32 Encoded in the "index_align<2:0>" field as 0b000.

Whenever <align> is present, the permitted values and encoding depend on <size>:

<size> == 16 <align> is 16, meaning 16-bit alignment, encoded in the
 "index_align<1:0>" field as 0b01.
<size> == 32 <align> is 32, meaning 32-bit alignment, encoded in the
 "index_align<2:0>" field as 0b011.

: is the preferred separator before the <align> value, but the alignment can be specified as @<align>, see [The Advanced SIMD addressing mode on page F2-2869](#).

<Rm> Is the general-purpose index register containing an offset applied after the access, encoded in the "Rm" field.

For more information about the variants of this instruction, see [The Advanced SIMD addressing mode on page F2-2869](#).

Operation for all encodings

```
if ConditionPassed() then
    EncodingSpecificOperations(); CheckAdvSIMDEnabled();
    address = R[n]; iswrite = TRUE;
    - = AArch32.CheckAlignment(address, alignment, AccType_VEC, iswrite);
    MemU[address,ebytes] = Elem[D[d],index];
    if wback then
        if register_index then
            R[n] = R[n] + R[m];
        else
            R[n] = R[n] + ebytes;
```

F6.1.218 VST1 (multiple single elements)

Store multiple single elements from one, two, three, or four registers stores elements to memory from one, two, three, or four registers, without interleaving. Every element of each register is stored. For details of the addressing mode see *The Advanced SIMD addressing mode* on page F2-2869.

Depending on settings in the CPACR, NSACR, and HCPTR registers, and the security state and mode in which the instruction is executed, an attempt to execute the instruction might be UNDEFINED, or trapped to Hyp mode. For more information see *Enabling Advanced SIMD and floating-point support* on page G1-4413.

A1

31	30	29	28	27	26	25	24	23	22	21	20	19	16	15	12	11	10	9	8	7	6	5	4	3	0
1	1	1	1	0	1	0	0	0	D	0	0	Rn	Vd	0	1	1	1	size	align	Rm					

Offset variant

Applies when Rm == 1111.

VST1{<c>}{<q>}.<size> <list>, [<Rn>{:<align>}]

Post-indexed variant

Applies when Rm == 1101.

VST1{<c>}{<q>}.<size> <list>, [<Rn>{:<align>}]!

Post-indexed variant

Applies when Rm != 11x1.

VST1{<c>}{<q>}.<size> <list>, [<Rn>{:<align>}], <Rm>

Decode for all variants of this encoding

```
regs = 1; if align<1> == '1' then UNDEFINED;
alignment = if align == '00' then 1 else 4 << UInt(align);
ebytes = 1 << UInt(size); elements = 8 DIV ebytes;
d = UInt(D:Vd); n = UInt(Rn); m = UInt(Rm);
wback = (m != 15); register_index = (m != 15 && m != 13);
if n == 15 || d+regs > 32 then UNPREDICTABLE;
```

CONSTRAINED UNPREDICTABLE behavior

If d+regs > 32, then one of the following behaviors must occur:

- The instruction is UNDEFINED.
- The instruction executes as NOP.
- The memory locations specified by the instruction and the number of registers specified by the instruction if the register list had not gone out of range, become UNKNOWN. If the instruction specifies writeback, then that register becomes UNKNOWN. This behavior does not affect any other memory locations.

A2

31	30	29	28	27	26	25	24	23	22	21	20	19	16	15	12	11	10	9	8	7	6	5	4	3	0
1	1	1	1	0	1	0	0	0	D	0	0	Rn	Vd	1	0	1	0	size	align	Rm					

Offset variant

Applies when Rm == 1111.

VST1{<c>}{<q>}.<size> <list>, [<Rn>{:<align>}]

Post-indexed variant

Applies when Rm == 1101.

VST1{<c>}{<q>}.<size> <list>, [<Rn>{:<align>}]!

Post-indexed variant

Applies when Rm != 11x1.

VST1{<c>}{<q>}.<size> <list>, [<Rn>{:<align>}], <Rm>

Decode for all variants of this encoding

```
regs = 2; if align == '11' then UNDEFINED;
alignment = if align == '00' then 1 else 4 << UInt(align);
ebytes = 1 << UInt(size); elements = 8 DIV ebytes;
d = UInt(D:Vd); n = UInt(Rn); m = UInt(Rm);
wback = (m != 15); register_index = (m != 15 && m != 13);
if n == 15 || d+regs > 32 then UNPREDICTABLE;
```

CONSTRAINED UNPREDICTABLE behavior

If d+regs > 32, then one of the following behaviors must occur:

- The instruction is UNDEFINED.
- The instruction executes as NOP.
- The memory locations specified by the instruction and the number of registers specified by the instruction if the register list had not gone out of range, become UNKNOWN. If the instruction specifies writeback, then that register becomes UNKNOWN. This behavior does not affect any other memory locations.

A3

31	30	29	28	27	26	25	24	23	22	21	20	19	16	15	12	11	10	9	8	7	6	5	4	3	0
1	1	1	1	0	1	0	0	0	D	0	0	Rn	Vd	0	1	1	0	size	align	Rm					

Offset variant

Applies when Rm == 1111.

VST1{<c>}{<q>}.<size> <list>, [<Rn>{:<align>}]

Post-indexed variant

Applies when Rm == 1101.

VST1{<c>}{<q>}.<size> <list>, [<Rn>{:<align>}]!

Post-indexed variant

Applies when Rm != 11x1.

VST1{<c>}{<q>}.<size> <list>, [<Rn>{:<align>}], <Rm>

Decode for all variants of this encoding

```
regs = 3; if align<1> == '1' then UNDEFINED;
alignment = if align == '00' then 1 else 4 << UInt(align);
ebytes = 1 << UInt(size); elements = 8 DIV ebytes;
d = UInt(D:Vd); n = UInt(Rn); m = UInt(Rm);
wback = (m != 15); register_index = (m != 15 && m != 13);
if n == 15 || d+regs > 32 then UNPREDICTABLE;
```

CONSTRAINED UNPREDICTABLE behavior

If $d+regs > 32$, then one of the following behaviors must occur:

- The instruction is UNDEFINED.
- The instruction executes as NOP.
- The memory locations specified by the instruction and the number of registers specified by the instruction if the register list had not gone out of range, become UNKNOWN. If the instruction specifies writeback, then that register becomes UNKNOWN. This behavior does not affect any other memory locations.

A4

31	30	29	28	27	26	25	24	23	22	21	20	19	16	15	12	11	10	9	8	7	6	5	4	3	0
1	1	1	1	0	1	0	0	0	D	0	0	Rn	Vd	0	0	1	0	size	align	Rm					

Offset variant

Applies when $Rm == 1111$.

VST1{<c>}{<q>}.<size> <list>, [<Rn>{:<align>}]

Post-indexed variant

Applies when $Rm == 1101$.

VST1{<c>}{<q>}.<size> <list>, [<Rn>{:<align>}]!

Post-indexed variant

Applies when $Rm != 11x1$.

VST1{<c>}{<q>}.<size> <list>, [<Rn>{:<align>}], <Rm>

Decode for all variants of this encoding

```
regs = 4;
alignment = if align == '00' then 1 else 4 << UInt(align);
ebytes = 1 << UInt(size); elements = 8 DIV ebytes;
d = UInt(D:Vd); n = UInt(Rn); m = UInt(Rm);
wback = (m != 15); register_index = (m != 15 && m != 13);
if n == 15 || d+regs > 32 then UNPREDICTABLE;
```

CONSTRAINED UNPREDICTABLE behavior

If $d+regs > 32$, then one of the following behaviors must occur:

- The instruction is UNDEFINED.
- The instruction executes as NOP.

- The memory locations specified by the instruction and the number of registers specified by the instruction if the register list had not gone out of range, become UNKNOWN. If the instruction specifies writeback, then that register becomes UNKNOWN. This behavior does not affect any other memory locations.

T1

15	14	13	12	11	10	9	8	7	6	5	4	3	0	15	12	11	10	9	8	7	6	5	4	3	0
1	1	1	1	1	0	0	1	0	D	0	0	Rn	Vd	0	1	1	1	size	align	Rm					

Offset variant

Applies when Rm == 1111.

VST1{<c>}{<q>}.<size> <list>, [<Rn>{:<align>}]

Post-indexed variant

Applies when Rm == 1101.

VST1{<c>}{<q>}.<size> <list>, [<Rn>{:<align>}]!

Post-indexed variant

Applies when Rm != 11x1.

VST1{<c>}{<q>}.<size> <list>, [<Rn>{:<align>}], <Rm>

Decode for all variants of this encoding

```
regs = 1; if align<1> == '1' then UNDEFINED;
alignment = if align == '00' then 1 else 4 << UInt(align);
ebytes = 1 << UInt(size); elements = 8 DIV ebytes;
d = UInt(D:Vd); n = UInt(Rn); m = UInt(Rm);
wback = (m != 15); register_index = (m != 15 && m != 13);
if n == 15 || d+regs > 32 then UNPREDICTABLE;
```

CONSTRAINED UNPREDICTABLE behavior

If d+regs > 32, then one of the following behaviors must occur:

- The instruction is UNDEFINED.
- The instruction executes as NOP.
- The memory locations specified by the instruction and the number of registers specified by the instruction if the register list had not gone out of range, become UNKNOWN. If the instruction specifies writeback, then that register becomes UNKNOWN. This behavior does not affect any other memory locations.

T2

15	14	13	12	11	10	9	8	7	6	5	4	3	0	15	12	11	10	9	8	7	6	5	4	3	0
1	1	1	1	1	0	0	1	0	D	0	0	Rn	Vd	1	0	1	0	size	align	Rm					

Offset variant

Applies when Rm == 1111.

VST1{<c>}{<q>}.<size> <list>, [<Rn>{:<align>}]

Post-indexed variant

Applies when Rm == 1101.

VST1{<c>}{<q>}.<size> <list>, [<Rn>{:<align>}]!

Post-indexed variant

Applies when Rm != 11x1.

VST1{<c>}{<q>}.<size> <list>, [<Rn>{:<align>}], <Rm>

Decode for all variants of this encoding

```
regs = 2; if align == '11' then UNDEFINED;
alignment = if align == '00' then 1 else 4 << UInt(align);
ebytes = 1 << UInt(size); elements = 8 DIV ebytes;
d = UInt(D:Vd); n = UInt(Rn); m = UInt(Rm);
wback = (m != 15); register_index = (m != 15 && m != 13);
if n == 15 || d+regs > 32 then UNPREDICTABLE;
```

CONSTRAINED UNPREDICTABLE behavior

If d+regs > 32, then one of the following behaviors must occur:

- The instruction is UNDEFINED.
- The instruction executes as NOP.
- The memory locations specified by the instruction and the number of registers specified by the instruction if the register list had not gone out of range, become UNKNOWN. If the instruction specifies writeback, then that register becomes UNKNOWN. This behavior does not affect any other memory locations.

T3

15	14	13	12	11	10	9	8	7	6	5	4	3	0	15	12	11	10	9	8	7	6	5	4	3	0
1	1	1	1	1	0	0	1	0	D	0	0	Rn	Vd	0	1	1	0	size	align	Rm					

Offset variant

Applies when Rm == 1111.

VST1{<c>}{<q>}.<size> <list>, [<Rn>{:<align>}]

Post-indexed variant

Applies when Rm == 1101.

VST1{<c>}{<q>}.<size> <list>, [<Rn>{:<align>}]!

Post-indexed variant

Applies when Rm != 11x1.

VST1{<c>}{<q>}.<size> <list>, [<Rn>{:<align>}], <Rm>

Decode for all variants of this encoding

```
regs = 3; if align<1> == '1' then UNDEFINED;
alignment = if align == '00' then 1 else 4 << UInt(align);
ebytes = 1 << UInt(size); elements = 8 DIV ebytes;
d = UInt(D:Vd); n = UInt(Rn); m = UInt(Rm);
wback = (m != 15); register_index = (m != 15 && m != 13);
if n == 15 || d+regs > 32 then UNPREDICTABLE;
```

CONSTRAINED UNPREDICTABLE behavior

If $d+regs > 32$, then one of the following behaviors must occur:

- The instruction is UNDEFINED.
- The instruction executes as NOP.
- The memory locations specified by the instruction and the number of registers specified by the instruction if the register list had not gone out of range, become UNKNOWN. If the instruction specifies writeback, then that register becomes UNKNOWN. This behavior does not affect any other memory locations.

T4

15	14	13	12	11	10	9	8	7	6	5	4	3	0	15	12	11	10	9	8	7	6	5	4	3	0
1	1	1	1	1	0	0	1	0	D	0	0	Rn	Vd	0	0	1	0	size	align	Rm					

Offset variant

Applies when $Rm == 1111$.

$VST1\{<c>\}\{<q>\}.<size> <list>, [<Rn>\{:<align>\}]$

Post-indexed variant

Applies when $Rm == 1101$.

$VST1\{<c>\}\{<q>\}.<size> <list>, [<Rn>\{:<align>\}]!$

Post-indexed variant

Applies when $Rm != 11x1$.

$VST1\{<c>\}\{<q>\}.<size> <list>, [<Rn>\{:<align>\}], <Rm>$

Decode for all variants of this encoding

```
regs = 4;
alignment = if align == '00' then 1 else 4 << UInt(align);
ebytes = 1 << UInt(size); elements = 8 DIV ebytes;
d = UInt(D:Vd); n = UInt(Rn); m = UInt(Rm);
wback = (m != 15); register_index = (m != 15 && m != 13);
if n == 15 || d+regs > 32 then UNPREDICTABLE;
```

CONSTRAINED UNPREDICTABLE behavior

If $d+regs > 32$, then one of the following behaviors must occur:

- The instruction is UNDEFINED.
- The instruction executes as NOP.
- The memory locations specified by the instruction and the number of registers specified by the instruction if the register list had not gone out of range, become UNKNOWN. If the instruction specifies writeback, then that register becomes UNKNOWN. This behavior does not affect any other memory locations.

Notes for all encodings

For more information about the CONSTRAINED UNPREDICTABLE behavior of this instruction, see [Appendix K1 Architectural Constraints on UNPREDICTABLE behaviors](#), and particularly *VST1 (multiple single elements)* on page K1-6112.

Related encodings: See [Advanced SIMD element or structure load/store on page F3-2922](#) for the T32 instruction set, or [Advanced SIMD element or structure load/store on page F4-2997](#) for the A32 instruction set.

Assembler symbols

- <c> For encoding A1, A2, A3 and A4: see [Standard assembler syntax fields on page F2-2848](#). This encoding must be unconditional.
 For encoding T1, T2, T3 and T4: see [Standard assembler syntax fields on page F2-2848](#).
- <q> See [Standard assembler syntax fields on page F2-2848](#).
- <size> Is the data size, encoded in the "size" field. It can have the following values:
- | | |
|----|----------------|
| 8 | when size = 00 |
| 16 | when size = 01 |
| 32 | when size = 10 |
| 64 | when size = 11 |
- <list> Is a list containing the 64-bit names of the SIMD&FP registers.
 The list must be one of:
- | | |
|----------------------------------|--|
| { <Dd> } | Single register. Selects the A1 and T1 encodings of the instruction. |
| { <Dd>, <Dd+1> } | Two single-spaced registers. Selects the A2 and T2 encodings of the instruction. |
| { <Dd>, <Dd+1>, <Dd+2> } | Three single-spaced registers. Selects the A3 and T3 encodings of the instruction. |
| { <Dd>, <Dd+1>, <Dd+2>, <Dd+3> } | Four single-spaced registers. Selects the A4 and T4 encodings of the instruction. |
- The register <Dd> is encoded in the "D:Vd" field.
- <Rn> Is the general-purpose base register, encoded in the "Rn" field.
- <align> Is the optional alignment.
 Whenever <align> is omitted, the standard alignment is used, see [Unaligned data access on page E2-2777](#), and is encoded in the "align" field as 0b00.
 Whenever <align> is present, the permitted values are:
- | | |
|-----|---|
| 64 | 64-bit alignment, encoded in the "align" field as 0b01. |
| 128 | 128-bit alignment, encoded in the "align" field as 0b10. Available only if <list> contains two or four registers. |
| 256 | 256-bit alignment, encoded in the "align" field as 0b11. Available only if <list> contains four registers. |
- : is the preferred separator before the <align> value, but the alignment can be specified as @<align>, see [The Advanced SIMD addressing mode on page F2-2869](#).
- <Rm> Is the general-purpose index register containing an offset applied after the access, encoded in the "Rm" field.

For more information about <Rn>, !, and <Rm>, see [The Advanced SIMD addressing mode on page F2-2869](#).

Operation for all encodings

```
if ConditionPassed() then
    EncodingSpecificOperations(); CheckAdvSIMDEnabled();
    address = R[n]; iswrite = TRUE;
    - = AArch32.CheckAlignment(address, alignment, AccType_VEC, iswrite);
```

```
for r = 0 to regs-1
  for e = 0 to elements-1
    if ebytes != 8 then
      MemU[address,ebytes] = Elem[D[d+r],e];
    else
      - = AArch32.CheckAlignment(address, ebytes, AccType_NORMAL, iswrite);
      bits(64) data = Elem[D[d+r],e];
      MemU[address,4] = if BigEndian() then data<63:32> else data<31:0>;
      MemU[address+4,4] = if BigEndian() then data<31:0> else data<63:32>;
      address = address + ebytes;
  if wback then
    if register_index then
      R[n] = R[n] + R[m];
    else
      R[n] = R[n] + 8*regs;
```

F6.1.219 VST2 (single 2-element structure from one lane)

Store single 2-element structure from one lane of two registers stores one 2-element structure to memory from corresponding elements of two registers. For details of the addressing mode see *The Advanced SIMD addressing mode* on page F2-2869.

Depending on settings in the CPACR, NSACR, and HCPTR registers, and the security state and mode in which the instruction is executed, an attempt to execute the instruction might be UNDEFINED, or trapped to Hyp mode. For more information see *Enabling Advanced SIMD and floating-point support* on page G1-4413.

A1

31	30	29	28	27	26	25	24	23	22	21	20	19	16	15	12	11	10	9	8	7	4	3	0
1	1	1	1	0	1	0	0	1	D	0	0	Rn	Vd	0	0	0	1	index_align	Rm				
												size											

Offset variant

Applies when Rm == 1111.

VST2{<c>}{<q>}.<size> <list>, [<Rn>{:<align>}]

Post-indexed variant

Applies when Rm == 1101.

VST2{<c>}{<q>}.<size> <list>, [<Rn>{:<align>}]!

Post-indexed variant

Applies when Rm != 11x1.

VST2{<c>}{<q>}.<size> <list>, [<Rn>{:<align>}], <Rm>

Decode for all variants of this encoding

```

if size == '11' then UNDEFINED;
ebytes = 1; index = UInt(index_align<3:1>); inc = 1;
alignment = if index_align<0> == '0' then 1 else 2;
d = UInt(D:Vd); d2 = d + inc; n = UInt(Rn); m = UInt(Rm);
wback = (m != 15); register_index = (m != 15 && m != 13);
if n == 15 || d2 > 31 then UNPREDICTABLE;
    
```

CONSTRAINED UNPREDICTABLE behavior

If d2 > 31, then one of the following behaviors must occur:

- The instruction is UNDEFINED.
- The instruction executes as NOP.
- The memory locations specified by the instruction and the number of registers specified by the instruction if the register list had not gone out of range, become UNKNOWN. If the instruction specifies writeback, then that register becomes UNKNOWN. This behavior does not affect any other memory locations.

A2

31	30	29	28	27	26	25	24	23	22	21	20	19	16	15	12	11	10	9	8	7	4	3	0
1	1	1	1	0	1	0	0	1	D	0	0	Rn	Vd	0	1	0	1	index_align	Rm				
												size											

Offset variant

Applies when Rm == 1111.

VST2{<c>}{<q>}.<size> <list>, [<Rn>{:<align>}]

Post-indexed variant

Applies when Rm == 1101.

VST2{<c>}{<q>}.<size> <list>, [<Rn>{:<align>}]!

Post-indexed variant

Applies when Rm != 11x1.

VST2{<c>}{<q>}.<size> <list>, [<Rn>{:<align>}], <Rm>

Decode for all variants of this encoding

```

if size == '11' then UNDEFINED;
ebytes = 2; index = UInt(index_align<3:2>);
inc = if index_align<1> == '0' then 1 else 2;
alignment = if index_align<0> == '0' then 1 else 4;
d = UInt(D:Vd); d2 = d + inc; n = UInt(Rn); m = UInt(Rm);
wback = (m != 15); register_index = (m != 15 && m != 13);
if n == 15 || d2 > 31 then UNPREDICTABLE;
    
```

CONSTRAINED UNPREDICTABLE behavior

If d2 > 31, then one of the following behaviors must occur:

- The instruction is UNDEFINED.
- The instruction executes as NOP.
- The memory locations specified by the instruction and the number of registers specified by the instruction if the register list had not gone out of range, become UNKNOWN. If the instruction specifies writeback, then that register becomes UNKNOWN. This behavior does not affect any other memory locations.

A3

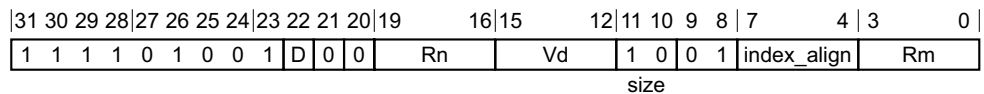

Offset variant

Applies when Rm == 1111.

VST2{<c>}{<q>}.<size> <list>, [<Rn>{:<align>}]

Post-indexed variant

Applies when Rm == 1101.

VST2{<c>}{<q>}.<size> <list>, [<Rn>{:<align>}]!

Post-indexed variant

Applies when Rm != 11x1.

VST2{<c>}{<q>}.<size> <list>, [<Rn>{:<align>}], <Rm>

Decode for all variants of this encoding

```

if size == '11' then UNDEFINED;
if index_align<1> != '0' then UNDEFINED;
ebytes = 4; index = UInt(index_align<3>);
inc = if index_align<2> == '0' then 1 else 2;
alignment = if index_align<0> == '0' then 1 else 8;
d = UInt(D:Vd); d2 = d + inc; n = UInt(Rn); m = UInt(Rm);
wback = (m != 15); register_index = (m != 15 && m != 13);
if n == 15 || d2 > 31 then UNPREDICTABLE;
    
```

CONSTRAINED UNPREDICTABLE behavior

If $d2 > 31$, then one of the following behaviors must occur:

- The instruction is UNDEFINED.
- The instruction executes as NOP.
- The memory locations specified by the instruction and the number of registers specified by the instruction if the register list had not gone out of range, become UNKNOWN. If the instruction specifies writeback, then that register becomes UNKNOWN. This behavior does not affect any other memory locations.

T1

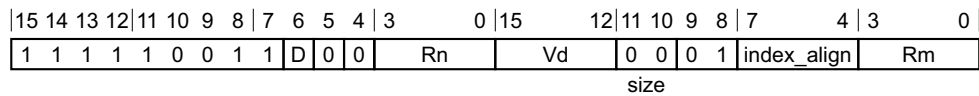

Offset variant

Applies when $Rm == 1111$.

VST2{<c>}{<q>}.<size> <list>, [<Rn>{:<align>}]

Post-indexed variant

Applies when $Rm == 1101$.

VST2{<c>}{<q>}.<size> <list>, [<Rn>{:<align>}]!

Post-indexed variant

Applies when $Rm != 11x1$.

VST2{<c>}{<q>}.<size> <list>, [<Rn>{:<align>}], <Rm>

Decode for all variants of this encoding

```

if size == '11' then UNDEFINED;
ebytes = 1; index = UInt(index_align<3:1>); inc = 1;
alignment = if index_align<0> == '0' then 1 else 2;
d = UInt(D:Vd); d2 = d + inc; n = UInt(Rn); m = UInt(Rm);
wback = (m != 15); register_index = (m != 15 && m != 13);
if n == 15 || d2 > 31 then UNPREDICTABLE;
    
```

CONSTRAINED UNPREDICTABLE behavior

If $d2 > 31$, then one of the following behaviors must occur:

- The instruction is UNDEFINED.
- The instruction executes as NOP.

- The memory locations specified by the instruction and the number of registers specified by the instruction if the register list had not gone out of range, become UNKNOWN. If the instruction specifies writeback, then that register becomes UNKNOWN. This behavior does not affect any other memory locations.

T2

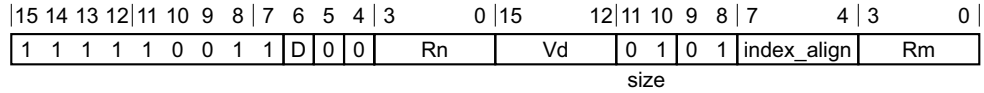

Offset variant

Applies when Rm == 1111.

VST2{<c>}{<q>}.<size> <list>, [<Rn>{:<align>}]

Post-indexed variant

Applies when Rm == 1101.

VST2{<c>}{<q>}.<size> <list>, [<Rn>{:<align>}]!

Post-indexed variant

Applies when Rm != 11x1.

VST2{<c>}{<q>}.<size> <list>, [<Rn>{:<align>}], <Rm>

Decode for all variants of this encoding

```

if size == '11' then UNDEFINED;
ebytes = 2; index = UInt(index_align<3:2>);
inc = if index_align<1> == '0' then 1 else 2;
alignment = if index_align<0> == '0' then 1 else 4;
d = UInt(D:Vd); d2 = d + inc; n = UInt(Rn); m = UInt(Rm);
wback = (m != 15); register_index = (m != 15 && m != 13);
if n == 15 || d2 > 31 then UNPREDICTABLE;
    
```

CONSTRAINED UNPREDICTABLE behavior

If d2 > 31, then one of the following behaviors must occur:

- The instruction is UNDEFINED.
- The instruction executes as NOP.
- The memory locations specified by the instruction and the number of registers specified by the instruction if the register list had not gone out of range, become UNKNOWN. If the instruction specifies writeback, then that register becomes UNKNOWN. This behavior does not affect any other memory locations.

T3

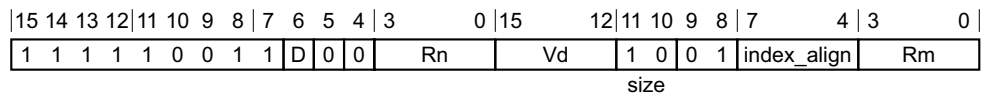

Offset variant

Applies when Rm == 1111.

VST2{<c>}{<q>}.<size> <list>, [<Rn>{:<align>}]

Post-indexed variant

Applies when $Rm == 1101$.

$VST2\{<c>\}\{<q>\}.<size> <list>, [<Rn>\{:<align>\}]!$

Post-indexed variant

Applies when $Rm != 11x1$.

$VST2\{<c>\}\{<q>\}.<size> <list>, [<Rn>\{:<align>\}], <Rm>$

Decode for all variants of this encoding

```

if size == '11' then UNDEFINED;
if index_align<1> != '0' then UNDEFINED;
ebytes = 4; index = UInt(index_align<3>);
inc = if index_align<2> == '0' then 1 else 2;
alignment = if index_align<0> == '0' then 1 else 8;
d = UInt(D:Vd); d2 = d + inc; n = UInt(Rn); m = UInt(Rm);
wback = (m != 15); register_index = (m != 15 && m != 13);
if n == 15 || d2 > 31 then UNPREDICTABLE;
  
```

CONSTRAINED UNPREDICTABLE behavior

If $d2 > 31$, then one of the following behaviors must occur:

- The instruction is UNDEFINED.
- The instruction executes as NOP.
- The memory locations specified by the instruction and the number of registers specified by the instruction if the register list had not gone out of range, become UNKNOWN. If the instruction specifies writeback, then that register becomes UNKNOWN. This behavior does not affect any other memory locations.

Notes for all encodings

For more information about the CONSTRAINED UNPREDICTABLE behavior of this instruction, see [Appendix K1 Architectural Constraints on UNPREDICTABLE behaviors](#), and particularly *VST2 (single 2-element structure from one lane)* on page K1-6113.

Assembler symbols

$<c>$ For encoding A1, A2 and A3: see *Standard assembler syntax fields* on page F2-2848. This encoding must be unconditional.

For encoding T1, T2 and T3: see *Standard assembler syntax fields* on page F2-2848.

$<q>$ See *Standard assembler syntax fields* on page F2-2848.

$<size>$ Is the data size, encoded in the "size" field. It can have the following values:

8	when size = 00
16	when size = 01
32	when size = 10

$<list>$ Is a list containing the 64-bit names of the two SIMD&FP registers holding the element.

The list must be one of:

{ $<Dd>[<index>], <Dd+1>[<index>]$ }

Single-spaced registers, encoded as "spacing" = 0.

{ $<Dd>[<index>], <Dd+2>[<index>]$ }

Double-spaced registers, encoded as "spacing" = 1. Not permitted when $<size> == 8$.

The encoding of "spacing" depends on <size>:

<size> == 16 "spacing" is encoded in the "index_align<1>" field.

<size> == 32 "spacing" is encoded in the "index_align<2>" field.

The register <Dd> is encoded in the "D:Vd" field.

The permitted values and encoding of <index> depend on <size>:

<size> == 8 <index> is in the range 0 to 7, encoded in the "index_align<3:1>" field.

<size> == 16 <index> is in the range 0 to 3, encoded in the "index_align<3:2>" field.

<size> == 32 <index> is 0 or 1, encoded in the "index_align<3>" field.

<Rn> Is the general-purpose base register, encoded in the "Rn" field.

<align> Is the optional alignment.

Whenever <align> is omitted, the standard alignment is used, see [Unaligned data access on page E2-2777](#), and the encoding depends on <size>:

<size> == 8 Encoded in the "index_align<0>" field as 0.

<size> == 16 Encoded in the "index_align<0>" field as 0.

<size> == 32 Encoded in the "index_align<1:0>" field as 0b00.

Whenever <align> is present, the permitted values and encoding depend on <size>:

<size> == 8 <align> is 16, meaning 16-bit alignment, encoded in the "index_align<0>" field as 1.

<size> == 16 <align> is 32, meaning 32-bit alignment, encoded in the "index_align<0>" field as 1.

<size> == 32 <align> is 64, meaning 64-bit alignment, encoded in the "index_align<1:0>" field as 0b01.

: is the preferred separator before the <align> value, but the alignment can be specified as @<align>, see [The Advanced SIMD addressing mode on page F2-2869](#).

<Rm> Is the general-purpose index register containing an offset applied after the access, encoded in the "Rm" field.

For more information about the variants of this instruction, see [The Advanced SIMD addressing mode on page F2-2869](#).

Operation for all encodings

```

if ConditionPassed() then
    EncodingSpecificOperations(); CheckAdvSIMDEnabled();
    address = R[n]; iswrite = TRUE;
    - = AArch32.CheckAlignment(address, alignment, AccType_VEC, iswrite);
    MemU[address, ebytes] = Elem[D[d], index];
    MemU[address+ebytes,ebytes] = Elem[D[d2],index];
    if wback then
        if register_index then
            R[n] = R[n] + R[m];
        else
            R[n] = R[n] + 2*ebytes;
  
```

F6.1.220 VST2 (multiple 2-element structures)

Store multiple 2-element structures from two or four registers stores multiple 2-element structures from two or four registers to memory, with interleaving. For more information, see *Element and structure load/store instructions* on page F1-2829. Every element of each register is saved. For details of the addressing mode see *The Advanced SIMD addressing mode* on page F2-2869.

Depending on settings in the CPACR, NSACR, and HCPTR registers, and the security state and mode in which the instruction is executed, an attempt to execute the instruction might be UNDEFINED, or trapped to Hyp mode. For more information see *Enabling Advanced SIMD and floating-point support* on page G1-4413.

A1

31	30	29	28	27	26	25	24	23	22	21	20	19	16	15	12	11	8	7	6	5	4	3	0
1	1	1	1	0	0	1	0	0	0	D	0	0	Rn	Vd	1	0	0	x	size	align	Rm		

type

Offset variant

Applies when Rm == 1111.

VST2{<c>}{<q>}.<size> <list>, [<Rn>{:<align>}]

Post-indexed variant

Applies when Rm == 1101.

VST2{<c>}{<q>}.<size> <list>, [<Rn>{:<align>}]!

Post-indexed variant

Applies when Rm != 11x1.

VST2{<c>}{<q>}.<size> <list>, [<Rn>{:<align>}], <Rm>

Decode for all variants of this encoding

```
regs = 1; if align == '11' then UNDEFINED;
if size == '11' then UNDEFINED;
inc = if type == '1001' then 2 else 1;
alignment = if align == '00' then 1 else 4 << UInt(align);
ebytes = 1 << UInt(size); elements = 8 DIV ebytes;
d = UInt(D:Vd); d2 = d + inc; n = UInt(Rn); m = UInt(Rm);
wback = (m != 15); register_index = (m != 15 && m != 13);
if n == 15 || d2+regs > 32 then UNPREDICTABLE;
```

CONSTRAINED UNPREDICTABLE behavior

If $d2+regs > 32$, then one of the following behaviors must occur:

- The instruction is UNDEFINED.
- The instruction executes as NOP.
- The memory locations specified by the instruction and the number of registers specified by the instruction if the register list had not gone out of range, become UNKNOWN. If the instruction specifies writeback, then that register becomes UNKNOWN. This behavior does not affect any other memory locations.

A2

31	30	29	28	27	26	25	24	23	22	21	20	19	16	15	12	11	10	9	8	7	6	5	4	3	0
1	1	1	1	0	1	0	0	0	D	0	0	Rn	Vd	0	0	1	1	size	align	Rm					

Offset variant

Applies when Rm == 1111.

VST2{<c>}{<q>}.<size> <list>, [<Rn>{:<align>}]

Post-indexed variant

Applies when Rm == 1101.

VST2{<c>}{<q>}.<size> <list>, [<Rn>{:<align>}]!

Post-indexed variant

Applies when Rm != 11x1.

VST2{<c>}{<q>}.<size> <list>, [<Rn>{:<align>}], <Rm>

Decode for all variants of this encoding

```
regs = 2; inc = 2;
if size == '11' then UNDEFINED;
alignment = if align == '00' then 1 else 4 << UInt(align);
ebytes = 1 << UInt(size); elements = 8 DIV ebytes;
d = UInt(D:Vd); d2 = d + inc; n = UInt(Rn); m = UInt(Rm);
wback = (m != 15); register_index = (m != 15 && m != 13);
if n == 15 || d2+regs > 32 then UNPREDICTABLE;
```

CONSTRAINED UNPREDICTABLE behavior

If d2+regs > 32, then one of the following behaviors must occur:

- The instruction is UNDEFINED.
- The instruction executes as NOP.
- The memory locations specified by the instruction and the number of registers specified by the instruction if the register list had not gone out of range, become UNKNOWN. If the instruction specifies writeback, then that register becomes UNKNOWN. This behavior does not affect any other memory locations.

T1

15	14	13	12	11	10	9	8	7	6	5	4	3	0	15	12	11	8	7	6	5	4	3	0
1	1	1	1	1	0	0	1	0	D	0	0	Rn	Vd	1	0	0	x	size	align	Rm			

type

Offset variant

Applies when Rm == 1111.

VST2{<c>}{<q>}.<size> <list>, [<Rn>{:<align>}]

Post-indexed variant

Applies when Rm == 1101.

VST2{<c>}{<q>}.<size> <list>, [<Rn>{:<align>}]!

Post-indexed variant

Applies when Rm != 11x1.

VST2{<c>}{<q>}.<size> <list>, [<Rn>{:<align>}], <Rm>

Decode for all variants of this encoding

```
regs = 1; if align == '11' then UNDEFINED;
if size == '11' then UNDEFINED;
inc = if type == '1001' then 2 else 1;
alignment = if align == '00' then 1 else 4 << UInt(align);
ebytes = 1 << UInt(size); elements = 8 DIV ebytes;
d = UInt(D:Vd); d2 = d + inc; n = UInt(Rn); m = UInt(Rm);
wback = (m != 15); register_index = (m != 15 && m != 13);
if n == 15 || d2+regs > 32 then UNPREDICTABLE;
```

CONSTRAINED UNPREDICTABLE behavior

If d2+regs > 32, then one of the following behaviors must occur:

- The instruction is UNDEFINED.
- The instruction executes as NOP.
- The memory locations specified by the instruction and the number of registers specified by the instruction if the register list had not gone out of range, become UNKNOWN. If the instruction specifies writeback, then that register becomes UNKNOWN. This behavior does not affect any other memory locations.

T2

15	14	13	12	11	10	9	8	7	6	5	4	3	0	15	12	11	10	9	8	7	6	5	4	3	0
1	1	1	1	1	0	0	1	0	D	0	0	Rn	Vd	0	0	1	1	size	align	Rm					

Offset variant

Applies when Rm == 1111.

VST2{<c>}{<q>}.<size> <list>, [<Rn>{:<align>}]

Post-indexed variant

Applies when Rm == 1101.

VST2{<c>}{<q>}.<size> <list>, [<Rn>{:<align>}]!

Post-indexed variant

Applies when Rm != 11x1.

VST2{<c>}{<q>}.<size> <list>, [<Rn>{:<align>}], <Rm>

Decode for all variants of this encoding

```
regs = 2; inc = 2;
if size == '11' then UNDEFINED;
alignment = if align == '00' then 1 else 4 << UInt(align);
ebytes = 1 << UInt(size); elements = 8 DIV ebytes;
d = UInt(D:Vd); d2 = d + inc; n = UInt(Rn); m = UInt(Rm);
wback = (m != 15); register_index = (m != 15 && m != 13);
if n == 15 || d2+regs > 32 then UNPREDICTABLE;
```

CONSTRAINED UNPREDICTABLE behavior

If $d2+regs > 32$, then one of the following behaviors must occur:

- The instruction is UNDEFINED.
- The instruction executes as NOP.
- The memory locations specified by the instruction and the number of registers specified by the instruction if the register list had not gone out of range, become UNKNOWN. If the instruction specifies writeback, then that register becomes UNKNOWN. This behavior does not affect any other memory locations.

Notes for all encodings

For more information about the CONSTRAINED UNPREDICTABLE behavior of this instruction, see [Appendix K1 Architectural Constraints on UNPREDICTABLE behaviors](#), and particularly *VST2 (multiple 2-element structures)* on page K1-6112.

Related encodings: See *Advanced SIMD element or structure load/store* on page F3-2922 for the T32 instruction set, or *Advanced SIMD element or structure load/store* on page F4-2997 for the A32 instruction set.

Assembler symbols

- <c> For encoding A1 and A2: see [Standard assembler syntax fields](#) on page F2-2848. This encoding must be unconditional.
For encoding T1 and T2: see [Standard assembler syntax fields](#) on page F2-2848.
- <q> See [Standard assembler syntax fields](#) on page F2-2848.
- <size> Is the data size, encoded in the "size" field. It can have the following values:
8 when size = 00
16 when size = 01
32 when size = 10
The encoding size = 11 is reserved.
- <list> Is a list containing the 64-bit names of the SIMD&FP registers.
The list must be one of:
{ <Dd>, <Dd+1> } Two single-spaced registers. Selects the A1 and T1 encodings of the instruction, and encoded in the "type" field as 0b1000.
{ <Dd>, <Dd+2> } Two double-spaced registers. Selects the A1 and T1 encodings of the instruction, and encoded in the "type" field as 0b1001.
{ <Dd>, <Dd+1>, <Dd+2>, <Dd+3> } Three single-spaced registers. Selects the A2 and T2 encodings of the instruction.
The register <Dd> is encoded in the "D:Vd" field.
- <Rn> Is the general-purpose base register, encoded in the "Rn" field.
- <align> Is the optional alignment.
Whenever <align> is omitted, the standard alignment is used, see [Unaligned data access](#) on page E2-2777, and is encoded in the "align" field as 0b00.
Whenever <align> is present, the permitted values are:
64 64-bit alignment, encoded in the "align" field as 0b01.
128 128-bit alignment, encoded in the "align" field as 0b10.
256 256-bit alignment, encoded in the "align" field as 0b11. Available only if <list> contains four registers.

: is the preferred separator before the <align> value, but the alignment can be specified as @<align>, see [The Advanced SIMD addressing mode on page F2-2869](#).

<Rm> Is the general-purpose index register containing an offset applied after the access, encoded in the "Rm" field.

For more information about the variants of this instruction, see [The Advanced SIMD addressing mode on page F2-2869](#).

Operation for all encodings

```
if ConditionPassed() then
    EncodingSpecificOperations(); CheckAdvSIMDEnabled();
    address = R[n]; iswrite = TRUE;
    - = AArch32.CheckAlignment(address, alignment, AccType_VEC, iswrite);
    for r = 0 to regs-1
        for e = 0 to elements-1
            MemU[address, ebytes] = Elem[D[d+r], e];
            MemU[address+ebytes, ebytes] = Elem[D[d2+r], e];
            address = address + 2*ebytes;
    if wback then
        if register_index then
            R[n] = R[n] + R[m];
        else
            R[n] = R[n] + 16*regs;
```

F6.1.221 VST3 (single 3-element structure from one lane)

Store single 3-element structure from one lane of three registers stores one 3-element structure to memory from corresponding elements of three registers. For details of the addressing mode see *The Advanced SIMD addressing mode* on page F2-2869.

Depending on settings in the CPACR, NSACR, and HCPTR registers, and the security state and mode in which the instruction is executed, an attempt to execute the instruction might be UNDEFINED, or trapped to Hyp mode. For more information see *Enabling Advanced SIMD and floating-point support* on page G1-4413.

A1

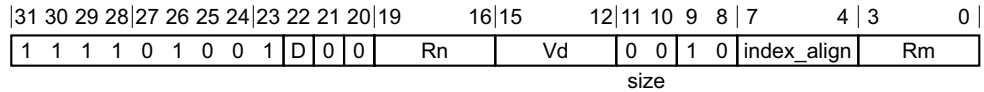

Offset variant

Applies when Rm == 1111.

VST3{<c>}{<q>}.<size> <list>, [<Rn>]

Post-indexed variant

Applies when Rm == 1101.

VST3{<c>}{<q>}.<size> <list>, [<Rn>]!

Post-indexed variant

Applies when Rm != 11x1.

VST3{<c>}{<q>}.<size> <list>, [<Rn>], <Rm>

Decode for all variants of this encoding

```

if size == '11' then UNDEFINED;
if index_align<0> != '0' then UNDEFINED;
ebytes = 1; index = UInt(index_align<3:1>); inc = 1;
d = UInt(D:Vd); d2 = d + inc; d3 = d2 + inc; n = UInt(Rn); m = UInt(Rm);
wback = (m != 15); register_index = (m != 15 && m != 13);
if n == 15 || d3 > 31 then UNPREDICTABLE;
    
```

CONSTRAINED UNPREDICTABLE behavior

If d3 > 31, then one of the following behaviors must occur:

- The instruction is UNDEFINED.
- The instruction executes as NOP.
- The memory locations specified by the instruction and the number of registers specified by the instruction if the register list had not gone out of range, become UNKNOWN. If the instruction specifies writeback, then that register becomes UNKNOWN. This behavior does not affect any other memory locations.

A2

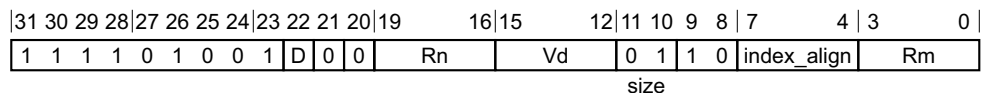

Offset variant

Applies when Rm == 1111.

VST3{<c>}{<q>}.<size> <list>, [<Rn>]

Post-indexed variant

Applies when Rm == 1101.

VST3{<c>}{<q>}.<size> <list>, [<Rn>]!

Post-indexed variant

Applies when Rm != 11x1.

VST3{<c>}{<q>}.<size> <list>, [<Rn>], <Rm>

Decode for all variants of this encoding

```

if size == '11' then UNDEFINED;
if index_align<0> != '0' then UNDEFINED;
ebytes = 2; index = UInt(index_align<3:2>);
inc = if index_align<1> == '0' then 1 else 2;
d = UInt(D:Vd); d2 = d + inc; d3 = d2 + inc; n = UInt(Rn); m = UInt(Rm);
wback = (m != 15); register_index = (m != 15 && m != 13);
if n == 15 || d3 > 31 then UNPREDICTABLE;
    
```

CONSTRAINED UNPREDICTABLE behavior

If d3 > 31, then one of the following behaviors must occur:

- The instruction is UNDEFINED.
- The instruction executes as NOP.
- The memory locations specified by the instruction and the number of registers specified by the instruction if the register list had not gone out of range, become UNKNOWN. If the instruction specifies writeback, then that register becomes UNKNOWN. This behavior does not affect any other memory locations.

A3

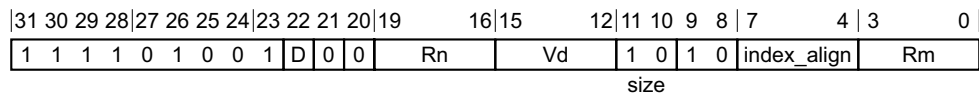

Offset variant

Applies when Rm == 1111.

VST3{<c>}{<q>}.<size> <list>, [<Rn>]

Post-indexed variant

Applies when Rm == 1101.

VST3{<c>}{<q>}.<size> <list>, [<Rn>]!

Post-indexed variant

Applies when Rm != 11x1.

VST3{<c>}{<q>}.<size> <list>, [<Rn>], <Rm>

Decode for all variants of this encoding

```

if size == '11' then UNDEFINED;
if index_align<1:0> != '00' then UNDEFINED;
ebytes = 4; index = UInt(index_align<3>);
inc = if index_align<2> == '0' then 1 else 2;
d = UInt(D:Vd); d2 = d + inc; d3 = d2 + inc; n = UInt(Rn); m = UInt(Rm);
wback = (m != 15); register_index = (m != 15 && m != 13);
if n == 15 || d3 > 31 then UNPREDICTABLE;
    
```

CONSTRAINED UNPREDICTABLE behavior

If $d3 > 31$, then one of the following behaviors must occur:

- The instruction is UNDEFINED.
- The instruction executes as NOP.
- The memory locations specified by the instruction and the number of registers specified by the instruction if the register list had not gone out of range, become UNKNOWN. If the instruction specifies writeback, then that register becomes UNKNOWN. This behavior does not affect any other memory locations.

T1

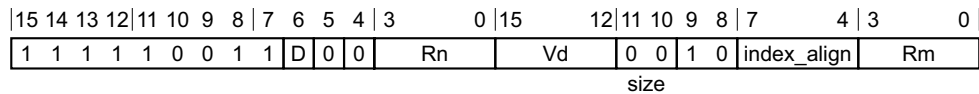

Offset variant

Applies when $Rm == 1111$.

```
VST3{<c>}{<q>}.<size> <list>, [<Rn>]
```

Post-indexed variant

Applies when $Rm == 1101$.

```
VST3{<c>}{<q>}.<size> <list>, [<Rn>]!
```

Post-indexed variant

Applies when $Rm != 11x1$.

```
VST3{<c>}{<q>}.<size> <list>, [<Rn>], <Rm>
```

Decode for all variants of this encoding

```

if size == '11' then UNDEFINED;
if index_align<0> != '0' then UNDEFINED;
ebytes = 1; index = UInt(index_align<3:1>); inc = 1;
d = UInt(D:Vd); d2 = d + inc; d3 = d2 + inc; n = UInt(Rn); m = UInt(Rm);
wback = (m != 15); register_index = (m != 15 && m != 13);
if n == 15 || d3 > 31 then UNPREDICTABLE;
    
```

CONSTRAINED UNPREDICTABLE behavior

If $d3 > 31$, then one of the following behaviors must occur:

- The instruction is UNDEFINED.
- The instruction executes as NOP.

- The memory locations specified by the instruction and the number of registers specified by the instruction if the register list had not gone out of range, become UNKNOWN. If the instruction specifies writeback, then that register becomes UNKNOWN. This behavior does not affect any other memory locations.

T2

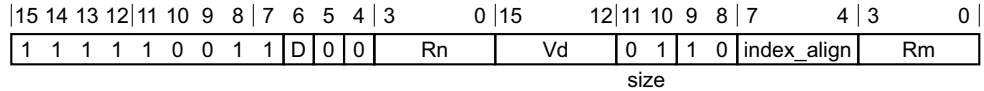

Offset variant

Applies when Rm == 1111.

VST3{<c>}{<q>}.<size> <list>, [<Rn>]

Post-indexed variant

Applies when Rm == 1101.

VST3{<c>}{<q>}.<size> <list>, [<Rn>]!

Post-indexed variant

Applies when Rm != 11x1.

VST3{<c>}{<q>}.<size> <list>, [<Rn>], <Rm>

Decode for all variants of this encoding

```

if size == '11' then UNDEFINED;
if index_align<0> != '0' then UNDEFINED;
ebytes = 2; index = UInt(index_align<3:2>);
inc = if index_align<1> == '0' then 1 else 2;
d = UInt(D:Vd); d2 = d + inc; d3 = d2 + inc; n = UInt(Rn); m = UInt(Rm);
wback = (m != 15); register_index = (m != 15 && m != 13);
if n == 15 || d3 > 31 then UNPREDICTABLE;
    
```

CONSTRAINED UNPREDICTABLE behavior

If d3 > 31, then one of the following behaviors must occur:

- The instruction is UNDEFINED.
- The instruction executes as NOP.
- The memory locations specified by the instruction and the number of registers specified by the instruction if the register list had not gone out of range, become UNKNOWN. If the instruction specifies writeback, then that register becomes UNKNOWN. This behavior does not affect any other memory locations.

T3

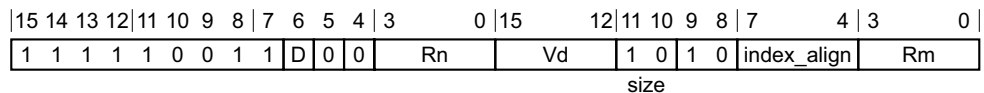

Offset variant

Applies when Rm == 1111.

VST3{<c>}{<q>}.<size> <list>, [<Rn>]

Post-indexed variant

Applies when $Rm == 1101$.

$VST3\{<c>\}\{<q>\}.<size> <list>, [<Rn>]!$

Post-indexed variant

Applies when $Rm != 11x1$.

$VST3\{<c>\}\{<q>\}.<size> <list>, [<Rn>], <Rm>$

Decode for all variants of this encoding

```
if size == '11' then UNDEFINED;
if index_align<1:0> != '00' then UNDEFINED;
ebytes = 4; index = UInt(index_align<3>);
inc = if index_align<2> == '0' then 1 else 2;
d = UInt(D:Vd); d2 = d + inc; d3 = d2 + inc; n = UInt(Rn); m = UInt(Rm);
wback = (m != 15); register_index = (m != 15 && m != 13);
if n == 15 || d3 > 31 then UNPREDICTABLE;
```

CONSTRAINED UNPREDICTABLE behavior

If $d3 > 31$, then one of the following behaviors must occur:

- The instruction is UNDEFINED.
- The instruction executes as NOP.
- The memory locations specified by the instruction and the number of registers specified by the instruction if the register list had not gone out of range, become UNKNOWN. If the instruction specifies writeback, then that register becomes UNKNOWN. This behavior does not affect any other memory locations.

Notes for all encodings

For more information about the CONSTRAINED UNPREDICTABLE behavior of this instruction, see [Appendix K1 Architectural Constraints on UNPREDICTABLE behaviors](#), and particularly *VST3 (single 3-element structure from one lane)* on page K1-6113.

Assembler symbols

<c>	For encoding A1, A2 and A3: see Standard assembler syntax fields on page F2-2848. This encoding must be unconditional. For encoding T1, T2 and T3: see Standard assembler syntax fields on page F2-2848.
<q>	See Standard assembler syntax fields on page F2-2848.
<size>	Is the data size, encoded in the "size" field. It can have the following values: 8 when size = 00 16 when size = 01 32 when size = 10
<list>	Is a list containing the 64-bit names of the three SIMD&FP registers holding the element. The list must be one of: { <Dd>[<index>], <Dd+1>[<index>], <Dd+2>[<index>] } Single-spaced registers, encoded as "spacing" = 0. { <Dd>[<index>], <Dd+2>[<index>], <Dd+4>[<index>] } Double-spaced registers, encoded as "spacing" = 1. Not permitted when <size> == 8.

The encoding of "spacing" depends on <size>:

- <size> == 8 "spacing" is encoded in the "index_align<0>" field.
- <size> == 16 "spacing" is encoded in the "index_align<1>" field, and "index_align<0>" is set to 0.
- <size> == 32 "spacing" is encoded in the "index_align<2>" field, and "index_align<1:0>" is set to 0b00.

The register <Dd> is encoded in the "D:Vd" field.

The permitted values and encoding of <index> depend on <size>:

- <size> == 8 <index> is in the range 0 to 7, encoded in the "index_align<3:1>" field.
- <size> == 16 <index> is in the range 0 to 3, encoded in the "index_align<3:2>" field.
- <size> == 32 <index> is 0 or 1, encoded in the "index_align<3>" field.

<Rn> Is the general-purpose base register, encoded in the "Rn" field.

<Rm> Is the general-purpose index register containing an offset applied after the access, encoded in the "Rm" field.

For more information about the variants of this instruction, see [The Advanced SIMD addressing mode on page F2-2869](#).

Alignment

Standard alignment rules apply, see [Alignment support on page B2-102](#).

Operation for all encodings

```

if ConditionPassed() then
    EncodingSpecificOperations(); CheckAdvSIMDEnabled();
    address = R[n];
    MemU[address, ebytes] = Elem[D[d], index];
    MemU[address+ebytes, ebytes] = Elem[D[d2], index];
    MemU[address+2*ebytes, ebytes] = Elem[D[d3], index];
    if wback then
        if register_index then
            R[n] = R[n] + R[m];
        else
            R[n] = R[n] + 3*ebytes;
  
```

F6.1.222 VST3 (multiple 3-element structures)

Store multiple 3-element structures from three registers stores multiple 3-element structures to memory from three registers, with interleaving. For more information, see [Element and structure load/store instructions on page F1-2829](#). Every element of each register is saved. For details of the addressing mode see [The Advanced SIMD addressing mode on page F2-2869](#).

Depending on settings in the CPACR, NSACR, and HCPTR registers, and the security state and mode in which the instruction is executed, an attempt to execute the instruction might be UNDEFINED, or trapped to Hyp mode. For more information see [Enabling Advanced SIMD and floating-point support on page G1-4413](#).

A1

31	30	29	28	27	26	25	24	23	22	21	20	19	16	15	12	11	8	7	6	5	4	3	0
1	1	1	1	0	1	0	0	0	D	0	0	Rn	Vd	0	1	0	x	size	align	Rm			

type

Offset variant

Applies when Rm == 1111.

VST3{<c>}{<q>}.<size> <list>, [<Rn>{:<align>}]

Post-indexed variant

Applies when Rm == 1101.

VST3{<c>}{<q>}.<size> <list>, [<Rn>{:<align>}]!

Post-indexed variant

Applies when Rm != 11x1.

VST3{<c>}{<q>}.<size> <list>, [<Rn>{:<align>}], <Rm>

Decode for all variants of this encoding

```

if size == '11' || align<1> == '1' then UNDEFINED;
case type of
  when '0100'
    inc = 1;
  when '0101'
    inc = 2;
  otherwise
    SEE "Related encodings";
alignment = if align<0> == '0' then 1 else 8;
ebytes = 1 << UInt(size); elements = 8 DIV ebytes;
d = UInt(D:Vd); d2 = d + inc; d3 = d2 + inc; n = UInt(Rn); m = UInt(Rm);
wback = (m != 15); register_index = (m != 15 && m != 13);
if n == 15 || d3 > 31 then UNPREDICTABLE;
    
```

CONSTRAINED UNPREDICTABLE behavior

If d3 > 31, then one of the following behaviors must occur:

- The instruction is UNDEFINED.
- The instruction executes as NOP.
- The memory locations specified by the instruction and the number of registers specified by the instruction if the register list had not gone out of range, become UNKNOWN. If the instruction specifies writeback, then that register becomes UNKNOWN. This behavior does not affect any other memory locations.

T1

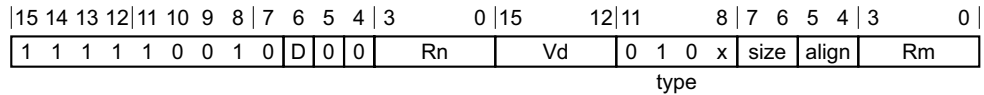

Offset variant

Applies when Rm == 1111.

VST3{<c>}{<q>}.<size> <list>, [<Rn>{:<align>}]

Post-indexed variant

Applies when Rm == 1101.

VST3{<c>}{<q>}.<size> <list>, [<Rn>{:<align>}]!

Post-indexed variant

Applies when Rm != 11x1.

VST3{<c>}{<q>}.<size> <list>, [<Rn>{:<align>}], <Rm>

Decode for all variants of this encoding

```

if size == '11' || align<1> == '1' then UNDEFINED;
case type of
  when '0100'
    inc = 1;
  when '0101'
    inc = 2;
  otherwise
    SEE "Related encodings";
alignment = if align<0> == '0' then 1 else 8;
ebytes = 1 << UInt(size); elements = 8 DIV ebytes;
d = UInt(D:Vd); d2 = d + inc; d3 = d2 + inc; n = UInt(Rn); m = UInt(Rm);
wback = (m != 15); register_index = (m != 15 && m != 13);
if n == 15 || d3 > 31 then UNPREDICTABLE;
    
```

CONSTRAINED UNPREDICTABLE behavior

If d3 > 31, then one of the following behaviors must occur:

- The instruction is UNDEFINED.
- The instruction executes as NOP.
- The memory locations specified by the instruction and the number of registers specified by the instruction if the register list had not gone out of range, become UNKNOWN. If the instruction specifies writeback, then that register becomes UNKNOWN. This behavior does not affect any other memory locations.

Notes for all encodings

For more information about the CONSTRAINED UNPREDICTABLE behavior of this instruction, see [Appendix K1 Architectural Constraints on UNPREDICTABLE behaviors](#), and particularly *VST3 (multiple 3-element structures)* on page K1-6113.

Related encodings: See *Advanced SIMD element or structure load/store* on page F3-2922 for the T32 instruction set, or *Advanced SIMD element or structure load/store* on page F4-2997 for the A32 instruction set.

Assembler symbols

- <c> For encoding A1: see [Standard assembler syntax fields on page F2-2848](#). This encoding must be unconditional.
 For encoding T1: see [Standard assembler syntax fields on page F2-2848](#).
- <q> See [Standard assembler syntax fields on page F2-2848](#).
- <size> Is the data size, encoded in the "size" field. It can have the following values:
 8 when size = 00
 16 when size = 01
 32 when size = 10
 The encoding size = 11 is reserved.
- <list> Is a list containing the 64-bit names of the SIMD&FP registers.
 The list must be one of:
 { <Dd>, <Dd+1>, <Dd+2> }
 Single-spaced registers, encoded in the "type" field as 0b0100.
 { <Dd>, <Dd+2>, <Dd+4> }
 Double-spaced registers, encoded in the "type" field as 0b0101.
 The register <Dd> is encoded in the "D:Vd" field.
- <Rn> Is the general-purpose base register, encoded in the "Rn" field.
- <align> Is the optional alignment.
 Whenever <align> is omitted, the standard alignment is used, see [Unaligned data access on page E2-2777](#), and is encoded in the "align" field as 0b00.
 Whenever <align> is present, the only permitted values is 64, meaning 64-bit alignment, encoded in the "align" field as 0b01.
 : is the preferred separator before the <align> value, but the alignment can be specified as @<align>, see [The Advanced SIMD addressing mode on page F2-2869](#).
- <Rm> Is the general-purpose index register containing an offset applied after the access, encoded in the "Rm" field.

For more information about the variants of this instruction, see [The Advanced SIMD addressing mode on page F2-2869](#).

Operation for all encodings

```

if ConditionPassed() then
    EncodingSpecificOperations(); CheckAdvSIMDEnabled();
    address = R[n]; iswrite = TRUE;
    - = AArch32.CheckAlignment(address, alignment, AccType_VEC, iswrite);
    for e = 0 to elements-1
        MemU[address, ebytes] = Elem[D[d], e];
        MemU[address+ebytes, ebytes] = Elem[D[d2], e];
        MemU[address+2*ebytes, ebytes] = Elem[D[d3], e];
        address = address + 3*ebytes;
    if wback then
        if register_index then
            R[n] = R[n] + R[m];
        else
            R[n] = R[n] + 24;
  
```

F6.1.223 VST4 (single 4-element structure from one lane)

Store single 4-element structure from one lane of four registers stores one 4-element structure to memory from corresponding elements of four registers. For details of the addressing mode see *The Advanced SIMD addressing mode* on page F2-2869.

Depending on settings in the CPACR, NSACR, and HCPTR registers, and the security state and mode in which the instruction is executed, an attempt to execute the instruction might be UNDEFINED, or trapped to Hyp mode. For more information see *Enabling Advanced SIMD and floating-point support* on page G1-4413.

A1

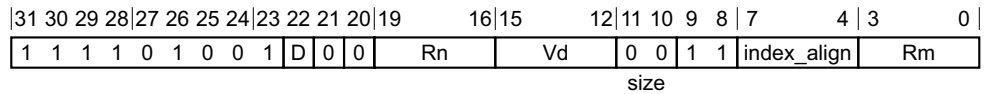

Offset variant

Applies when Rm == 1111.

VST4{<c>}{<q>}.<size> <list>, [<Rn>{:<align>}]

Post-indexed variant

Applies when Rm == 1101.

VST4{<c>}{<q>}.<size> <list>, [<Rn>{:<align>}]!

Post-indexed variant

Applies when Rm != 11x1.

VST4{<c>}{<q>}.<size> <list>, [<Rn>{:<align>}], <Rm>

Decode for all variants of this encoding

```

if size == '11' then UNDEFINED;
if size != '00' then SEE "Related encodings";
ebytes = 1; index = UInt(index_align<3:1>); inc = 1;
alignment = if index_align<0> == '0' then 1 else 4;
d = UInt(D:Vd); d2 = d + inc; d3 = d2 + inc; d4 = d3 + inc; n = UInt(Rn); m = UInt(Rm);
wback = (m != 15); register_index = (m != 15 && m != 13);
if n == 15 || d4 > 31 then UNPREDICTABLE;
    
```

CONSTRAINED UNPREDICTABLE behavior

If d4 > 31, then one of the following behaviors must occur:

- The instruction is UNDEFINED.
- The instruction executes as NOP.
- The memory locations specified by the instruction and the number of registers specified by the instruction if the register list had not gone out of range, become UNKNOWN. If the instruction specifies writeback, then that register becomes UNKNOWN. This behavior does not affect any other memory locations.

A2

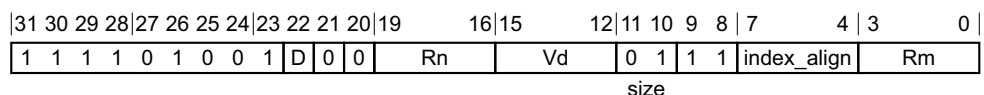

Offset variant

Applies when Rm == 1111.

VST4{<c>}{<q>}.<size> <list>, [<Rn>{:<align>}]

Post-indexed variant

Applies when Rm == 1101.

VST4{<c>}{<q>}.<size> <list>, [<Rn>{:<align>}]!

Post-indexed variant

Applies when Rm != 11x1.

VST4{<c>}{<q>}.<size> <list>, [<Rn>{:<align>}], <Rm>

Decode for all variants of this encoding

```

if size == '11' then UNDEFINED;
if size != '01' then SEE "Related encodings";
ebytes = 2; index = UInt(index_align<3:2>);
inc = if index_align<1> == '0' then 1 else 2;
alignment = if index_align<0> == '0' then 1 else 8;
d = UInt(D:Vd); d2 = d + inc; d3 = d2 + inc; d4 = d3 + inc; n = UInt(Rn); m = UInt(Rm);
wback = (m != 15); register_index = (m != 15 && m != 13);
if n == 15 || d4 > 31 then UNPREDICTABLE;
    
```

CONSTRAINED UNPREDICTABLE behavior

If d4 > 31, then one of the following behaviors must occur:

- The instruction is UNDEFINED.
- The instruction executes as NOP.
- The memory locations specified by the instruction and the number of registers specified by the instruction if the register list had not gone out of range, become UNKNOWN. If the instruction specifies writeback, then that register becomes UNKNOWN. This behavior does not affect any other memory locations.

A3

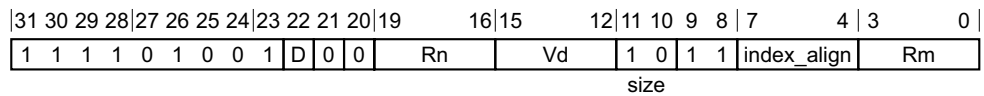

Offset variant

Applies when Rm == 1111.

VST4{<c>}{<q>}.<size> <list>, [<Rn>{:<align>}]

Post-indexed variant

Applies when Rm == 1101.

VST4{<c>}{<q>}.<size> <list>, [<Rn>{:<align>}]!

Post-indexed variant

Applies when Rm != 11x1.

VST4{<c>}{<q>}.<size> <list>, [<Rn>{:<align>}], <Rm>

Decode for all variants of this encoding

```

if size == '11' then UNDEFINED;
if size != '00' then SEE "Related encodings";
if index_align<1:0> == '11' then UNDEFINED;
ebytes = 4; index = UInt(index_align<3>);
inc = if index_align<2> == '0' then 1 else 2;
alignment = if index_align<1:0> == '00' then 1 else 4 << UInt(index_align<1:0>);
d = UInt(D:Vd); d2 = d + inc; d3 = d2 + inc; d4 = d3 + inc; n = UInt(Rn); m = UInt(Rm);
wback = (m != 15); register_index = (m != 15 && m != 13);
if n == 15 || d4 > 31 then UNPREDICTABLE;
    
```

CONSTRAINED UNPREDICTABLE behavior

If $d4 > 31$, then one of the following behaviors must occur:

- The instruction is UNDEFINED.
- The instruction executes as NOP.
- The memory locations specified by the instruction and the number of registers specified by the instruction if the register list had not gone out of range, become UNKNOWN. If the instruction specifies writeback, then that register becomes UNKNOWN. This behavior does not affect any other memory locations.

T1

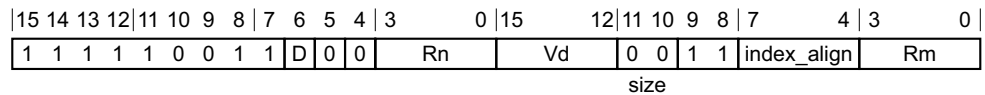

Offset variant

Applies when $Rm == 1111$.

VST4{<c>}{<q>}.<size> <list>, [<Rn>{:<align>}]

Post-indexed variant

Applies when $Rm == 1101$.

VST4{<c>}{<q>}.<size> <list>, [<Rn>{:<align>}]!

Post-indexed variant

Applies when $Rm != 11x1$.

VST4{<c>}{<q>}.<size> <list>, [<Rn>{:<align>}], <Rm>

Decode for all variants of this encoding

```

if size == '11' then UNDEFINED;
if size != '00' then SEE "Related encodings";
ebytes = 1; index = UInt(index_align<3:1>); inc = 1;
alignment = if index_align<0> == '0' then 1 else 4;
d = UInt(D:Vd); d2 = d + inc; d3 = d2 + inc; d4 = d3 + inc; n = UInt(Rn); m = UInt(Rm);
wback = (m != 15); register_index = (m != 15 && m != 13);
if n == 15 || d4 > 31 then UNPREDICTABLE;
    
```

CONSTRAINED UNPREDICTABLE behavior

If $d4 > 31$, then one of the following behaviors must occur:

- The instruction is UNDEFINED.
- The instruction executes as NOP.

- The memory locations specified by the instruction and the number of registers specified by the instruction if the register list had not gone out of range, become UNKNOWN. If the instruction specifies writeback, then that register becomes UNKNOWN. This behavior does not affect any other memory locations.

T2

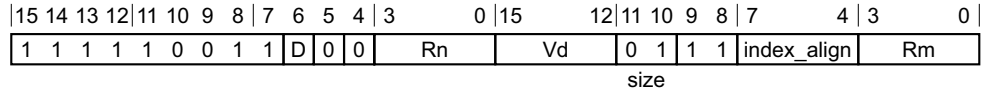

Offset variant

Applies when Rm == 1111.

VST4{<c>}{<q>}.<size> <list>, [<Rn>{:<align>}]

Post-indexed variant

Applies when Rm == 1101.

VST4{<c>}{<q>}.<size> <list>, [<Rn>{:<align>}]!

Post-indexed variant

Applies when Rm != 11x1.

VST4{<c>}{<q>}.<size> <list>, [<Rn>{:<align>}], <Rm>

Decode for all variants of this encoding

```

if size == '11' then UNDEFINED;
if size != '01' then SEE "Related encodings";
ebytes = 2; index = UInt(index_align<3:2>);
inc = if index_align<1> == '0' then 1 else 2;
alignment = if index_align<0> == '0' then 1 else 8;
d = UInt(D:Vd); d2 = d + inc; d3 = d2 + inc; d4 = d3 + inc; n = UInt(Rn); m = UInt(Rm);
wback = (m != 15); register_index = (m != 15 && m != 13);
if n == 15 || d4 > 31 then UNPREDICTABLE;
    
```

CONSTRAINED UNPREDICTABLE behavior

If d4 > 31, then one of the following behaviors must occur:

- The instruction is UNDEFINED.
- The instruction executes as NOP.
- The memory locations specified by the instruction and the number of registers specified by the instruction if the register list had not gone out of range, become UNKNOWN. If the instruction specifies writeback, then that register becomes UNKNOWN. This behavior does not affect any other memory locations.

T3

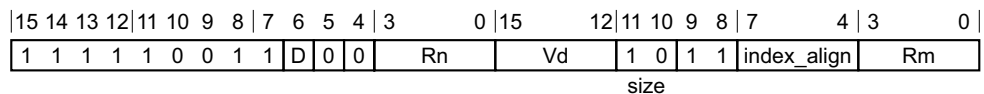

Offset variant

Applies when Rm == 1111.

VST4{<c>}{<q>}.<size> <list>, [<Rn>{:<align>}]

Post-indexed variant

Applies when Rm != 11x1.

VST4{<c>}{<q>}.<size> <list>, [<Rn>{:<align>}], <Rm>

Post-indexed variant

Applies when Rm == 1101.

VST4{<c>}{<q>}.<size> <list>, [<Rn>{:<align>}]!

Decode for all variants of this encoding

```
if size == '11' then UNDEFINED;
if size != '00' then SEE "Related encodings";
if index_align<1:0> == '11' then UNDEFINED;
ebytes = 4; index = UInt(index_align<3>);
inc = if index_align<2> == '0' then 1 else 2;
alignment = if index_align<1:0> == '00' then 1 else 4 << UInt(index_align<1:0>);
d = UInt(D:Vd); d2 = d + inc; d3 = d2 + inc; d4 = d3 + inc; n = UInt(Rn); m = UInt(Rm);
wback = (m != 15); register_index = (m != 15 && m != 13);
if n == 15 || d4 > 31 then UNPREDICTABLE;
```

CONSTRAINED UNPREDICTABLE behavior

If d4 > 31, then one of the following behaviors must occur:

- The instruction is UNDEFINED.
- The instruction executes as NOP.
- The memory locations specified by the instruction and the number of registers specified by the instruction if the register list had not gone out of range, become UNKNOWN. If the instruction specifies writeback, then that register becomes UNKNOWN. This behavior does not affect any other memory locations.

Notes for all encodings

For more information about the CONSTRAINED UNPREDICTABLE behavior of this instruction, see [Appendix K1 Architectural Constraints on UNPREDICTABLE behaviors](#), and particularly *VST4 (single 4-element structure from one lane)* on page K1-6113.

Assembler symbols

- <c> For encoding A1, A2 and A3: see [Standard assembler syntax fields](#) on page F2-2848. This encoding must be unconditional.
 For encoding T1, T2 and T3: see [Standard assembler syntax fields](#) on page F2-2848.
- <q> See [Standard assembler syntax fields](#) on page F2-2848.
- <size> Is the data size, encoded in the "size" field. It can have the following values:

8	when size = 00
16	when size = 01
32	when size = 10
- <list> Is a list containing the 64-bit names of the four SIMD&FP registers holding the element.
 The list must be one of:
 { <Dd>[<index>], <Dd+1>[<index>], <Dd+2>[<index>], <Dd+3>[<index>] }
 Single-spaced registers, encoded as "spacing" = 0.

{ <Dd>[<index>], <Dd+2>[<index>], <Dd+4>[<index>], <Dd+6>[<index>] }

Double-spaced registers, encoded as "spacing" = 1. Not permitted when <size> == 8.

The encoding of "spacing" depends on <size>:

<size> == 16 "spacing" is encoded in the "index_align<1>" field.

<size> == 32 "spacing" is encoded in the "index_align<2>" field.

The register <Dd> is encoded in the "D:Vd" field.

The permitted values and encoding of <index> depend on <size>:

<size> == 8 <index> is in the range 0 to 7, encoded in the "index_align<3:1>" field.

<size> == 16 <index> is in the range 0 to 3, encoded in the "index_align<3:2>" field.

<size> == 32 <index> is 0 or 1, encoded in the "index_align<3>" field.

<Rn> Is the general-purpose base register, encoded in the "Rn" field.

<align> Is the optional alignment.

Whenever <align> is omitted, the standard alignment is used, see [Unaligned data access on page E2-2777](#), and the encoding depends on <size>:

<size> == 8 Encoded in the "index_align<0>" field as 0.

<size> == 16 Encoded in the "index_align<0>" field as 0.

<size> == 32 Encoded in the "index_align<1:0>" field as 0b00.

Whenever <align> is present, the permitted values and encoding depend on <size>:

<size> == 8 <align> is 32, meaning 32-bit alignment, encoded in the "index_align<0>" field as 1.

<size> == 16 <align> is 64, meaning 64-bit alignment, encoded in the "index_align<0>" field as 1.

<size> == 32 <align> can be 64 or 128. 64-bit alignment is encoded in the "index_align<1:0>" field as 0b01, and 128-bit alignment is encoded in the "index_align<1:0>" field as 0b10.

: is the preferred separator before the <align> value, but the alignment can be specified as @<align>, see [The Advanced SIMD addressing mode on page F2-2869](#).

<Rm> Is the general-purpose index register containing an offset applied after the access, encoded in the "Rm" field.

For more information about the variants of this instruction, see [The Advanced SIMD addressing mode on page F2-2869](#).

Operation for all encodings

```

if ConditionPassed() then
    EncodingSpecificOperations(); CheckAdvSIMDEnabled();
    address = R[n]; iswrite = TRUE;
    - = AArch32.CheckAlignment(address, alignment, AccType_VEC, iswrite);
    MemU[address, ebytes] = Elem[D[d], index];
    MemU[address+ebytes, ebytes] = Elem[D[d2], index];
    MemU[address+2*ebytes, ebytes] = Elem[D[d3], index];
    MemU[address+3*ebytes, ebytes] = Elem[D[d4], index];
    if wback then
        if register_index then
            R[n] = R[n] + R[m];
        else
            R[n] = R[n] + 4*ebytes;
  
```

F6.1.224 VST4 (multiple 4-element structures)

Store multiple 4-element structures from four registers stores multiple 4-element structures to memory from four registers, with interleaving. For more information, see [Element and structure load/store instructions on page F1-2829](#). Every element of each register is saved. For details of the addressing mode see [The Advanced SIMD addressing mode on page F2-2869](#).

Depending on settings in the CPACR, NSACR, and HCPTR registers, and the security state and mode in which the instruction is executed, an attempt to execute the instruction might be UNDEFINED, or trapped to Hyp mode. For more information see [Enabling Advanced SIMD and floating-point support on page G1-4413](#).

A1

31	30	29	28	27	26	25	24	23	22	21	20	19	16	15	12	11	8	7	6	5	4	3	0
1	1	1	1	0	0	0	0	D	0	0		Rn		Vd		0	0	0	x	size	align		Rm

type

Offset variant

Applies when Rm == 1111.

VST4{<c>}{<q>}.<size> <list>, [<Rn>{:<align>}]

Post-indexed variant

Applies when Rm == 1101.

VST4{<c>}{<q>}.<size> <list>, [<Rn>{:<align>}]!

Post-indexed variant

Applies when Rm != 11x1.

VST4{<c>}{<q>}.<size> <list>, [<Rn>{:<align>}], <Rm>

Decode for all variants of this encoding

```

if size == '11' then UNDEFINED;
case type of
    when '0000'
        inc = 1;
    when '0001'
        inc = 2;
    otherwise
        SEE "Related encodings";
alignment = if align == '00' then 1 else 4 << UInt(align);
ebytes = 1 << UInt(size); elements = 8 DIV ebytes;
d = UInt(D:Vd); d2 = d + inc; d3 = d2 + inc; d4 = d3 + inc; n = UInt(Rn); m = UInt(Rm);
wback = (m != 15); register_index = (m != 15 && m != 13);
if n == 15 || d4 > 31 then UNPREDICTABLE;
    
```

CONSTRAINED UNPREDICTABLE behavior

If d4 > 31, then one of the following behaviors must occur:

- The instruction is UNDEFINED.
- The instruction executes as NOP.
- The memory locations specified by the instruction and the number of registers specified by the instruction if the register list had not gone out of range, become UNKNOWN. If the instruction specifies writeback, then that register becomes UNKNOWN. This behavior does not affect any other memory locations.

T1

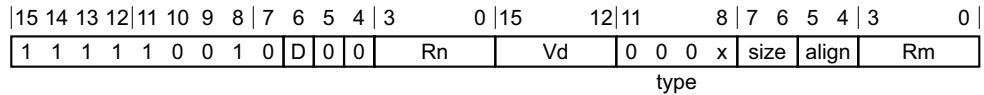

Offset variant

Applies when Rm == 1111.

VST4{<c>}{<q>}.<size> <list>, [<Rn>{:<align>}]

Post-indexed variant

Applies when Rm == 1101.

VST4{<c>}{<q>}.<size> <list>, [<Rn>{:<align>}]!

Post-indexed variant

Applies when Rm != 11x1.

VST4{<c>}{<q>}.<size> <list>, [<Rn>{:<align>}], <Rm>

Decode for all variants of this encoding

```

if size == '11' then UNDEFINED;
case type of
  when '0000'
    inc = 1;
  when '0001'
    inc = 2;
  otherwise
    SEE "Related encodings";
alignment = if align == '00' then 1 else 4 << UInt(align);
ebytes = 1 << UInt(size); elements = 8 DIV ebytes;
d = UInt(D:Vd); d2 = d + inc; d3 = d2 + inc; d4 = d3 + inc; n = UInt(Rn); m = UInt(Rm);
wback = (m != 15); register_index = (m != 15 && m != 13);
if n == 15 || d4 > 31 then UNPREDICTABLE;
    
```

CONSTRAINED UNPREDICTABLE behavior

If d4 > 31, then one of the following behaviors must occur:

- The instruction is UNDEFINED.
- The instruction executes as NOP.
- The memory locations specified by the instruction and the number of registers specified by the instruction if the register list had not gone out of range, become UNKNOWN. If the instruction specifies writeback, then that register becomes UNKNOWN. This behavior does not affect any other memory locations.

Notes for all encodings

For more information about the CONSTRAINED UNPREDICTABLE behavior of this instruction, see [Appendix K1 Architectural Constraints on UNPREDICTABLE behaviors](#), and particularly *VST4 (multiple 4-element structures)* on page K1-6113.

Related encodings: See *Advanced SIMD element or structure load/store* on page F3-2922 for the T32 instruction set, or *Advanced SIMD element or structure load/store* on page F4-2997 for the A32 instruction set.

Assembler symbols

- <c> For encoding A1: see [Standard assembler syntax fields on page F2-2848](#). This encoding must be unconditional.
 For encoding T1: see [Standard assembler syntax fields on page F2-2848](#).
- <q> See [Standard assembler syntax fields on page F2-2848](#).
- <size> Is the data size, encoded in the "size" field. It can have the following values:
 8 when size = 00
 16 when size = 01
 32 when size = 10
 The encoding size = 11 is reserved.
- <list> Is a list containing the 64-bit names of the SIMD&FP registers.
 The list must be one of:
 { <Dd>, <Dd+1>, <Dd+2>, <Dd+3> }
 Single-spaced registers, encoded in the "type" field as 0b0000.
 { <Dd>, <Dd+2>, <Dd+4>, <Dd+6> }
 Double-spaced registers, encoded in the "type" field as 0b0001.
 The register <Dd> is encoded in the "D:Vd" field.
- <Rn> Is the general-purpose base register, encoded in the "Rn" field.
- <align> Is the optional alignment.
 Whenever <align> is omitted, the standard alignment is used, see [Unaligned data access on page E2-2777](#), and is encoded in the "align" field as 0b00.
 Whenever <align> is present, the permitted values are:
 64 64-bit alignment, encoded in the "align" field as 0b01.
 128 128-bit alignment, encoded in the "align" field as 0b10.
 256 256-bit alignment, encoded in the "align" field as 0b11.
 : is the preferred separator before the <align> value, but the alignment can be specified as @<align>, see [The Advanced SIMD addressing mode on page F2-2869](#).
- <Rm> Is the general-purpose index register containing an offset applied after the access, encoded in the "Rm" field.

For more information about the variants of this instruction, see [The Advanced SIMD addressing mode on page F2-2869](#).

Operation for all encodings

```

if ConditionPassed() then
    EncodingSpecificOperations(); CheckAdvSIMDEnabled();
    address = R[n]; iswrite = TRUE;
    - = AArch32.CheckAlignment(address, alignment, AccType_VEC, iswrite);
    for e = 0 to elements-1
        MemU[address, ebytes] = E1em[D[d], e];
        MemU[address+ebytes, ebytes] = E1em[D[d2], e];
        MemU[address+2*ebytes, ebytes] = E1em[D[d3], e];
        MemU[address+3*ebytes, ebytes] = E1em[D[d4], e];
        address = address + 4*ebytes;
    if wback then
        if register_index then
            R[n] = R[n] + R[m];
        else
            R[n] = R[n] + 32;
  
```

F6.1.225 VSTM, VSTMDB, VSTMIA

Store multiple SIMD&FP registers stores multiple registers from the Advanced SIMD and floating-point register file to consecutive memory locations using an address from a general-purpose register.

Depending on settings in the CPACR, NSACR, HCPTR, and FPEXC registers, and the security state and mode in which the instruction is executed, an attempt to execute the instruction might be UNDEFINED, or trapped to Hyp mode. For more information see [Enabling Advanced SIMD and floating-point support on page G1-4413](#).

This instruction is used by the alias VPUSH. See [Alias conditions on page F6-4271](#) for details of when each alias is preferred.

A1

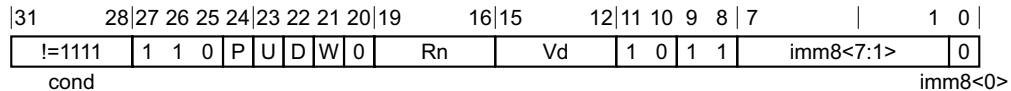

Decrement Before variant

Applies when P == 1 && U == 0 && W == 1.

VSTMDB{<c>}{<q>}{.<size>} <Rn>!, <dreglist>

Increment After variant

Applies when P == 0 && U == 1.

VSTM{<c>}{<q>}{.<size>} <Rn>{!}, <dreglist>

VSTMIA{<c>}{<q>}{.<size>} <Rn>{!}, <dreglist>

Decode for all variants of this encoding

```

if P == '0' && U == '0' && W == '0' then SEE "Related encodings";
if P == '1' && W == '0' then SEE VSTR;
if P == U && W == '1' then UNDEFINED;
// Remaining combinations are PUW = 010 (IA without !), 011 (IA with !), 101 (DB with !)
single_regs = FALSE; add = (U == '1'); wback = (W == '1');
d = UInt(D:Vd); n = UInt(Rn); imm32 = ZeroExtend(imm8:'00', 32);
regs = UInt(imm8) DIV 2; // If UInt(imm8) is odd, see "FSTMX".
if n == 15 && (wback || CurrentInstrSet() != InstrSet_A32) then UNPREDICTABLE;
if regs == 0 || regs > 16 || (d+regs) > 32 then UNPREDICTABLE;
if imm8<0> == '1' && (d+regs) > 16 then UNPREDICTABLE;
    
```

CONSTRAINED UNPREDICTABLE behavior

If regs == 0, then one of the following behaviors must occur:

- The instruction is UNDEFINED.
- The instruction executes as NOP.
- The instruction operates as a VSTM with the same addressing mode but stores no registers.

If regs > 16 || (d+regs) > 32, then one of the following behaviors must occur:

- The instruction is UNDEFINED.
- The instruction executes as NOP.
- The memory locations specified by the instruction and the number of registers specified by the instruction if the register list had not gone out of range, become UNKNOWN. If the instruction specifies writeback, then that register becomes UNKNOWN. This behavior does not affect any other memory locations.

A2

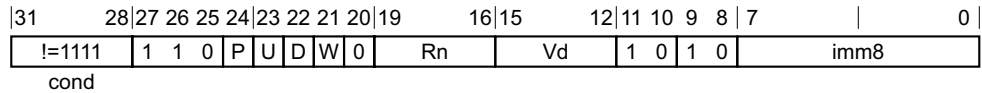

Decrement Before variant

Applies when P == 1 && U == 0 && W == 1.

VSTMDB{<c>}{<q>}{.<size>} <Rn>!, <sreglist>

Increment After variant

Applies when P == 0 && U == 1.

VSTM{<c>}{<q>}{.<size>} <Rn>{!}, <sreglist>
 VSTMIA{<c>}{<q>}{.<size>} <Rn>{!}, <sreglist>

Decode for all variants of this encoding

```

if P == '0' && U == '0' && W == '0' then SEE "Related encodings";
if P == '1' && W == '0' then SEE VSTR;
if P == U && W == '1' then UNDEFINED;
// Remaining combinations are PUW = 010 (IA without !), 011 (IA with !), 101 (DB with !)
single_regs = TRUE; add = (U == '1'); wback = (W == '1'); d = UInt(Vd:D); n = UInt(Rn);
imm32 = ZeroExtend(imm8:'00', 32); regs = UInt(imm8);
if n == 15 && (wback || CurrentInstrSet() != InstrSet_A32) then UNPREDICTABLE;
if regs == 0 || (d+regs) > 32 then UNPREDICTABLE;
    
```

CONSTRAINED UNPREDICTABLE behavior

If regs == 0, then one of the following behaviors must occur:

- The instruction is UNDEFINED.
- The instruction executes as NOP.
- The instruction operates as a VSTM with the same addressing mode but stores no registers.

If (d+regs) > 32, then one of the following behaviors must occur:

- The instruction is UNDEFINED.
- The instruction executes as NOP.
- The memory locations specified by the instruction and the number of registers specified by the instruction if the register list had not gone out of range, become UNKNOWN. If the instruction specifies writeback, then that register becomes UNKNOWN. This behavior does not affect any other memory locations.

T1

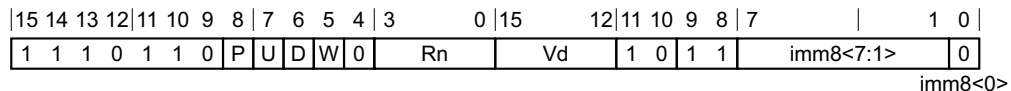

Decrement Before variant

Applies when P == 1 && U == 0 && W == 1.

VSTMDB{<c>}{<q>}{.<size>} <Rn>!, <dreglist>

Increment After variant

Applies when P == 0 && U == 1.

VSTM{<c>}{<q>}{.<size>} <Rn>{!}, <dreglist>
 VSTMIA{<c>}{<q>}{.<size>} <Rn>{!}, <dreglist>

Decode for all variants of this encoding

```

if P == '0' && U == '0' && W == '0' then SEE "Related encodings";
if P == '1' && W == '0' then SEE VSTR;
if P == U && W == '1' then UNDEFINED;
// Remaining combinations are PUW = 010 (IA without !), 011 (IA with !), 101 (DB with !)
single_regs = FALSE; add = (U == '1'); wback = (W == '1');
d = UInt(D:Vd); n = UInt(Rn); imm32 = ZeroExtend(imm8:'00', 32);
regs = UInt(imm8) DIV 2; // If UInt(imm8) is odd, see "FSTMX".
if n == 15 && (wback || CurrentInstrSet() != InstrSet_A32) then UNPREDICTABLE;
if regs == 0 || regs > 16 || (d+regs) > 32 then UNPREDICTABLE;
if imm8<0> == '1' && (d+regs) > 16 then UNPREDICTABLE;
    
```

CONSTRAINED UNPREDICTABLE behavior

If regs == 0, then one of the following behaviors must occur:

- The instruction is UNDEFINED.
- The instruction executes as NOP.
- The instruction operates as a VSTM with the same addressing mode but stores no registers.

If regs > 16 || (d+regs) > 32, then one of the following behaviors must occur:

- The instruction is UNDEFINED.
- The instruction executes as NOP.
- The memory locations specified by the instruction and the number of registers specified by the instruction if the register list had not gone out of range, become UNKNOWN. If the instruction specifies writeback, then that register becomes UNKNOWN. This behavior does not affect any other memory locations.

T2

15	14	13	12	11	10	9	8	7	6	5	4	3	0	15	12	11	10	9	8	7	0
1	1	1	0	1	1	0	P	U	D	W	0	Rn	Vd	1	0	1	0	imm8			

Decrement Before variant

Applies when P == 1 && U == 0 && W == 1.

VSTMDB{<c>}{<q>}{.<size>} <Rn>!, <sreglist>

Increment After variant

Applies when P == 0 && U == 1.

VSTM{<c>}{<q>}{.<size>} <Rn>{!}, <sreglist>
 VSTMIA{<c>}{<q>}{.<size>} <Rn>{!}, <sreglist>

Decode for all variants of this encoding

```

if P == '0' && U == '0' && W == '0' then SEE "Related encodings";
if P == '1' && W == '0' then SEE VSTR;
if P == U && W == '1' then UNDEFINED;
// Remaining combinations are PUW = 010 (IA without !), 011 (IA with !), 101 (DB with !)
    
```

```
single_regs = TRUE; add = (U == '1'); wback = (W == '1'); d = UInt(Vd:D); n = UInt(Rn);
imm32 = ZeroExtend(imm8:'00', 32); regs = UInt(imm8);
if n == 15 && (wback || CurrentInstrSet() != InstrSet_A32) then UNPREDICTABLE;
if regs == 0 || (d+regs) > 32 then UNPREDICTABLE;
```

CONSTRAINED UNPREDICTABLE behavior

If `regs == 0`, then one of the following behaviors must occur:

- The instruction is UNDEFINED.
- The instruction executes as NOP.
- The instruction operates as a VSTM with the same addressing mode but stores no registers.

If `(d+regs) > 32`, then one of the following behaviors must occur:

- The instruction is UNDEFINED.
- The instruction executes as NOP.
- The memory locations specified by the instruction and the number of registers specified by the instruction if the register list had not gone out of range, become UNKNOWN. If the instruction specifies writeback, then that register becomes UNKNOWN. This behavior does not affect any other memory locations.

Notes for all encodings

For more information about the CONSTRAINED UNPREDICTABLE behavior of this instruction, see [Appendix K1 Architectural Constraints on UNPREDICTABLE behaviors](#), and particularly *VSTM* on page K1-6113.

Related encodings: See *Advanced SIMD and floating-point 64-bit move* on page F3-2894 for the T32 instruction set, or *Advanced SIMD and floating-point 64-bit move* on page F4-2973 for the A32 instruction set.

Alias conditions

Alias	is preferred when
VPUSH	<code>P == '1' && U == '0' && W == '1' && Rn == '1101'</code>

Assembler symbols

<c>	See <i>Standard assembler syntax fields</i> on page F2-2848.
<q>	See <i>Standard assembler syntax fields</i> on page F2-2848.
<size>	An optional data size specifier. If present, it must be equal to the size in bits, 32 or 64, of the registers being transferred.
<Rn>	Is the general-purpose base register, encoded in the "Rn" field. If writeback is not specified, the PC can be used. However, ARM deprecates use of the PC.
!	Specifies base register writeback. Encoded in the "W" field as 1 if present, otherwise 0.
<sreglist>	Is the list of consecutively numbered 32-bit SIMD&FP registers to be transferred. The first register in the list is encoded in "Vd:D", and "imm8" is set to the number of registers in the list. The list must contain at least one register.
<dreglist>	Is the list of consecutively numbered 64-bit SIMD&FP registers to be transferred. The first register in the list is encoded in "D:Vd", and "imm8" is set to twice the number of registers in the list. The list must contain at least one register, and must not contain more than 16 registers.

Operation for all encodings

```
if ConditionPassed() then
    EncodingSpecificOperations(); CheckVFPEEnabled(TRUE);
    address = if add then R[n] else R[n]-imm32;
    for r = 0 to regs-1
        if single_regs then
            MemA[address,4] = S[d+r]; address = address+4;
        else
            // Store as two word-aligned words in the correct order for current endianness.
            MemA[address,4] = if BigEndian() then D[d+r]<63:32> else D[d+r]<31:0>;
            MemA[address+4,4] = if BigEndian() then D[d+r]<31:0> else D[d+r]<63:32>;
            address = address+8;
    if wback then R[n] = if add then R[n]+imm32 else R[n]-imm32;
```

F6.1.226 VSTR

Store SIMD&FP register stores a single register from the Advanced SIMD and floating-point register file to memory, using an address from a general-purpose register, with an optional offset.

Depending on settings in the CPACR, NSACR, HCPTR, and FPEXC registers, and the security state and mode in which the instruction is executed, an attempt to execute the instruction might be UNDEFINED, or trapped to Hyp mode. For more information see [Enabling Advanced SIMD and floating-point support on page G1-4413](#).

A1

31	28 27 26 25 24 23 22 21 20 19	16 15	12 11 10 9 8 7	0
!=1111	1 1 0 1 U D 0 0	Rn	Vd	1 0 size imm8
cond				

Half-precision scalar variant

Applies when size == 01.

VSTR{<c>}{<q>}.16 <Sd>, [<Rn>{, #<+/-><imm>}]

Single-precision scalar variant

Applies when size == 10.

VSTR{<c>}{<q>}.32 <Sd>, [<Rn>{, #<+/-><imm>}]

Double-precision scalar variant

Applies when size == 11.

VSTR{<c>}{<q>}.64 <Dd>, [<Rn>{, #<+/-><imm>}]

Decode for all variants of this encoding

```
if size == '00' || (size == '01' && !HaveFP16Ext()) then UNDEFINED;
if size == '01' && cond != '1110' then UNPREDICTABLE;
esize = 8 << UInt(size); add = (U == '1');
imm32 = if esize == 16 then ZeroExtend(imm8:'0', 32) else ZeroExtend(imm8:'00', 32);
d = UInt(D:Vd); n = UInt(Rn);
if n == 15 && CurrentInstrSet() != InstrSet_A32 then UNPREDICTABLE;
```

CONSTRAINED UNPREDICTABLE behavior

If size == '01' && cond != '1110', then one of the following behaviors must occur:

- The instruction is UNDEFINED.
- The instruction executes as if it passes the Condition code check.
- The instruction executes as NOP. This means it behaves as if it fails the Condition code check.

T1

15 14 13 12 11 10 9 8 7 6 5 4 3	0 15	12 11 10 9 8 7	0
1 1 1 0 1 1 0 1 U D 0 0	Rn	Vd	1 0 size imm8

Half-precision scalar variant

Applies when size == 01.

VSTR{<c>}{<q>}.16 <Sd>, [<Rn>{, #<+/-><imm>}]

Single-precision scalar variant

Applies when size == 10.

VSTR{<c>}{<q>}.32 <Sd>, [<Rn>{, #<+/-><imm>}]

Double-precision scalar variant

Applies when size == 11.

VSTR{<c>}{<q>}.64 <Dd>, [<Rn>{, #<+/-><imm>}]

Decode for all variants of this encoding

```
if size == '00' || (size == '01' && !HaveFP16Ext()) then UNDEFINED;
if size == '01' && InITBlock() then UNPREDICTABLE;
esize = 8 << UInt(size); add = (U == '1');
imm32 = if esize == 16 then ZeroExtend(imm8:'0', 32) else ZeroExtend(imm8:'00', 32);
d = UInt(D:Vd); n = UInt(Rn);
if n == 15 && CurrentInstrSet() != InstrSet_A32 then UNPREDICTABLE;
```

CONSTRAINED UNPREDICTABLE behavior

If size == '01' && InITBlock(), then one of the following behaviors must occur:

- The instruction is UNDEFINED.
- The instruction executes as if it passes the Condition code check.
- The instruction executes as NOP. This means it behaves as if it fails the Condition code check.

Notes for all encodings

For more information about the CONSTRAINED UNPREDICTABLE behavior of this instruction, see [Appendix K1 Architectural Constraints on UNPREDICTABLE behaviors](#).

Assembler symbols

<c>	See Standard assembler syntax fields on page F2-2848 .
<q>	See Standard assembler syntax fields on page F2-2848 .
.64	Is an optional data size specifier for 64-bit memory accesses that can be used in the assembler source code, but is otherwise ignored.
<Dd>	Is the 64-bit name of the SIMD&FP source register, encoded in the "D:Vd" field.
.32	Is an optional data size specifier for 32-bit memory accesses that can be used in the assembler source code, but is otherwise ignored.
<Sd>	Is the 32-bit name of the SIMD&FP source register, encoded in the "Vd:D" field.
<Rn>	Is the general-purpose base register, encoded in the "Rn" field. The PC can be used, but this is deprecated.
+/-	Specifies the offset is added to or subtracted from the base register, defaulting to + if omitted and encoded in the "U" field. It can have the following values: <ul style="list-style-type: none"> - when U = 0 + when U = 1
<imm>	For encoding A1 or T1: is the optional unsigned immediate byte offset, a multiple of 2, in the range 0 to 510, defaulting to 0, and encoded in the "imm8" field as <imm>/2.

For encoding A1, T1: is the optional unsigned immediate byte offset, a multiple of 4, in the range 0 to 1020, defaulting to 0, and encoded in the "imm8" field as <imm>/4.

Operation for all encodings

```
if ConditionPassed() then
    EncodingSpecificOperations(); CheckVFPEnabled(TRUE);
    address = if add then (R[n] + imm32) else (R[n] - imm32);
    case esize of
        when 16
            MemA[address,2] = S[d]<15:0>;
        when 32
            MemA[address,4] = S[d];
        when 64
            // Store as two word-aligned words in the correct order for current endianness.
            MemA[address,4] = if BigEndian() then D[d]<63:32> else D[d]<31:0>;
            MemA[address+4,4] = if BigEndian() then D[d]<31:0> else D[d]<63:32>;
```

F6.1.227 VSUB (floating-point)

Vector Subtract (floating-point) subtracts the elements of one vector from the corresponding elements of another vector, and places the results in the destination vector.

Depending on settings in the CPACR, NSACR, HCPTR, and FPEXC registers, and the security state and mode in which the instruction is executed, an attempt to execute the instruction might be UNDEFINED, or trapped to Hyp mode. For more information see [Enabling Advanced SIMD and floating-point support on page G1-4413](#).

A1

31	30	29	28	27	26	25	24	23	22	21	20	19	16	15	12	11	10	9	8	7	6	5	4	3	0
1	1	1	1	0	0	1	0	0	D	1	sz	Vn	Vd	1	1	0	1	N	Q	M	0	Vm			

64-bit SIMD vector variant

Applies when Q == 0.

VSUB{<c>}{<q>}.<dt> {<Dd>, }<Dn>, <Dm>

128-bit SIMD vector variant

Applies when Q == 1.

VSUB{<c>}{<q>}.<dt> {<Qd>, }<Qn>, <Qm>

Decode for all variants of this encoding

```

if Q == '1' && (Vd<0> == '1' || Vn<0> == '1' || Vm<0> == '1') then UNDEFINED;
if sz == '1' && !HaveFP16Ext() then UNDEFINED;
advsimd = TRUE;
case sz of
    when '0' esize = 32; elements = 2;
    when '1' esize = 16; elements = 4;
d = UInt(D:Vd); n = UInt(N:Vn); m = UInt(M:Vm); regs = if Q == '0' then 1 else 2;
    
```

A2

31	28	27	26	25	24	23	22	21	20	19	16	15	12	11	10	9	8	7	6	5	4	3	0
I=1111				1	1	1	0	0	D	1	1	Vn	Vd	1	0	size	N	1	M	0	Vm		
				cond																			

Half-precision scalar variant

Applies when size == 01.

VSUB{<c>}{<q>}.F16 {<Sd>}, <Sn>, <Sm>

Single-precision scalar variant

Applies when size == 10.

VSUB{<c>}{<q>}.F32 {<Sd>}, <Sn>, <Sm>

Double-precision scalar variant

Applies when size == 11.

VSUB{<c>}{<q>}.F64 {<Dd>}, <Dn>, <Dm>

Decode for all variants of this encoding

```

if FPSCR.Len != '000' || FPSCR.Stride != '00' then UNDEFINED;
if size == '00' || (size == '01' && !HaveFP16Ext()) then UNDEFINED;
if size == '01' && cond != '1110' then UNPREDICTABLE;
advsimd = FALSE;
case size of
    when '01' esize = 16; d = UInt(Vd:D); n = UInt(Vn:N); m = UInt(Vm:M);
    when '10' esize = 32; d = UInt(Vd:D); n = UInt(Vn:N); m = UInt(Vm:M);
    when '11' esize = 64; d = UInt(D:Vd); n = UInt(N:Vn); m = UInt(M:Vm);
    
```

CONSTRAINED UNPREDICTABLE behavior

If size == '01' && cond != '1110', then one of the following behaviors must occur:

- The instruction is UNDEFINED.
- The instruction executes as if it passes the Condition code check.
- The instruction executes as NOP. This means it behaves as if it fails the Condition code check.

T1

15	14	13	12	11	10	9	8	7	6	5	4	3	0	15	12	11	10	9	8	7	6	5	4	3	0
1	1	1	0	1	1	1	1	0	D	1	sz	Vn	Vd	1	1	0	1	N	Q	M	0	Vm			

64-bit SIMD vector variant

Applies when Q == 0.

VSUB{<c>}{<q>}.<dt> {<Dd>, }<Dn>, <Dm>

128-bit SIMD vector variant

Applies when Q == 1.

VSUB{<c>}{<q>}.<dt> {<Qd>, }<Qn>, <Qm>

Decode for all variants of this encoding

```

if Q == '1' && (Vd<0> == '1' || Vn<0> == '1' || Vm<0> == '1') then UNDEFINED;
if sz == '1' && !HaveFP16Ext() then UNDEFINED;
if sz == '1' && InITBlock() then UNPREDICTABLE;
advsimd = TRUE;
case sz of
    when '0' esize = 32; elements = 2;
    when '1' esize = 16; elements = 4;
    d = UInt(D:Vd); n = UInt(N:Vn); m = UInt(M:Vm); regs = if Q == '0' then 1 else 2;
    
```

CONSTRAINED UNPREDICTABLE behavior

If sz == '1' && InITBlock(), then one of the following behaviors must occur:

- The instruction is UNDEFINED.
- The instruction executes as if it passes the Condition code check.
- The instruction executes as NOP. This means it behaves as if it fails the Condition code check.

T2

15	14	13	12	11	10	9	8	7	6	5	4	3	0	15	12	11	10	9	8	7	6	5	4	3	0
1	1	1	0	1	1	1	0	0	D	1	1	Vn	Vd	1	0	size	N	1	M	0	Vm				

Half-precision scalar variant

Applies when size == 01.

VSUB{<c>}{<q>}.F16 {<Sd>}, <Sn>, <Sm>

Single-precision scalar variant

Applies when size == 10.

VSUB{<c>}{<q>}.F32 {<Sd>}, <Sn>, <Sm>

Double-precision scalar variant

Applies when size == 11.

VSUB{<c>}{<q>}.F64 {<Dd>}, <Dn>, <Dm>

Decode for all variants of this encoding

```

if FPSCR.Len != '000' || FPSCR.Stride != '00' then UNDEFINED;
if size == '00' || (size == '01' && !HaveFP16Ext()) then UNDEFINED;
if size == '01' && InITBlock() then UNPREDICTABLE;
advsimd = FALSE;
case size of
  when '01' esize = 16; d = UInt(Vd:D); n = UInt(Vn:N); m = UInt(Vm:M);
  when '10' esize = 32; d = UInt(Vd:D); n = UInt(Vn:N); m = UInt(Vm:M);
  when '11' esize = 64; d = UInt(D:Vd); n = UInt(N:Vn); m = UInt(M:Vm);

```

CONSTRAINED UNPREDICTABLE behavior

If size == '01' && InITBlock(), then one of the following behaviors must occur:

- The instruction is UNDEFINED.
- The instruction executes as if it passes the Condition code check.
- The instruction executes as NOP. This means it behaves as if it fails the Condition code check.

Assembler symbols

- <c> For encoding A1: see [Standard assembler syntax fields on page F2-2848](#). This encoding must be unconditional.
 For encoding A2, T1 and T2: see [Standard assembler syntax fields on page F2-2848](#).
- <q> See [Standard assembler syntax fields on page F2-2848](#).
- <dt> Is the data type for the elements of the vectors, encoded in the "sz" field. It can have the following values:
 F32 when sz = 0
 F16 when sz = 1
- <Qd> Is the 128-bit name of the SIMD&FP destination register, encoded in the "D:Vd" field as <Qd>*2.
- <Qn> Is the 128-bit name of the first SIMD&FP source register, encoded in the "N:Vn" field as <Qn>*2.

- <Qm> Is the 128-bit name of the second SIMD&FP source register, encoded in the "M:Vm" field as <Qm>*2.
- <Dd> Is the 64-bit name of the SIMD&FP destination register, encoded in the "D:Vd" field.
- <Dn> Is the 64-bit name of the first SIMD&FP source register, encoded in the "N:Vn" field.
- <Dm> Is the 64-bit name of the second SIMD&FP source register, encoded in the "M:Vm" field.
- <Sd> Is the 32-bit name of the SIMD&FP destination register, encoded in the "Vd:D" field.
- <Sn> Is the 32-bit name of the first SIMD&FP source register, encoded in the "Vn:N" field.
- <Sm> Is the 32-bit name of the second SIMD&FP source register, encoded in the "Vm:M" field.

Operation for all encodings

```

if ConditionPassed() then
    EncodingSpecificOperations(); CheckAdvSIMDorVFPEEnabled(TRUE, advsimd);
    if advsimd then // Advanced SIMD instruction
        for r = 0 to regs-1
            for e = 0 to elements-1
                Elem[D[d+r],e,esize] = FPSub(Elem[D[n+r],e,esize], Elem[D[m+r],e,esize],
StandardFPSCRValue());
    else // VFP instruction
        case esize of
            when 16
                S[d] = Zeros(16) : FPSub(S[n]<15:0>, S[m]<15:0>, FPSCR);
            when 32
                S[d] = FPSub(S[n], S[m], FPSCR);
            when 64
                D[d] = FPSub(D[n], D[m], FPSCR);
    
```

F6.1.228 VSUB (integer)

Vector Subtract (integer) subtracts the elements of one vector from the corresponding elements of another vector, and places the results in the destination vector.

Depending on settings in the CPACR, NSACR, and HCPTR registers, and the security state and mode in which the instruction is executed, an attempt to execute the instruction might be UNDEFINED, or trapped to Hyp mode. For more information see [Enabling Advanced SIMD and floating-point support on page G1-4413](#).

A1

31	30	29	28	27	26	25	24	23	22	21	20	19	16	15	12	11	10	9	8	7	6	5	4	3	0
1	1	1	1	0	0	1	1	0	D	size	Vn	Vd	1	0	0	0	N	Q	M	0	Vm				

64-bit SIMD vector variant

Applies when Q == 0.

VSUB{<c>}{<q>}.<dt> {<Dd>, }<Dn>, <Dm>

128-bit SIMD vector variant

Applies when Q == 1.

VSUB{<c>}{<q>}.<dt> {<Qd>, }<Qn>, <Qm>

Decode for all variants of this encoding

```
if Q == '1' && (Vd<0> == '1' || Vn<0> == '1' || Vm<0> == '1') then UNDEFINED;
esize = 8 << UInt(size); elements = 64 DIV esize;
d = UInt(D:Vd); n = UInt(N:Vn); m = UInt(M:Vm); regs = if Q == '0' then 1 else 2;
```

T1

15	14	13	12	11	10	9	8	7	6	5	4	3	0	15	12	11	10	9	8	7	6	5	4	3	0
1	1	1	1	1	1	1	1	0	D	size	Vn	Vd	1	0	0	0	N	Q	M	0	Vm				

64-bit SIMD vector variant

Applies when Q == 0.

VSUB{<c>}{<q>}.<dt> {<Dd>, }<Dn>, <Dm>

128-bit SIMD vector variant

Applies when Q == 1.

VSUB{<c>}{<q>}.<dt> {<Qd>, }<Qn>, <Qm>

Decode for all variants of this encoding

```
if Q == '1' && (Vd<0> == '1' || Vn<0> == '1' || Vm<0> == '1') then UNDEFINED;
esize = 8 << UInt(size); elements = 64 DIV esize;
d = UInt(D:Vd); n = UInt(N:Vn); m = UInt(M:Vm); regs = if Q == '0' then 1 else 2;
```

Assembler symbols

<c> For encoding A1: see [Standard assembler syntax fields on page F2-2848](#). This encoding must be unconditional.

For encoding T1: see *Standard assembler syntax fields* on page F2-2848.

<q> See *Standard assembler syntax fields* on page F2-2848.

<dt> Is the data type for the elements of the vectors, encoded in the "size" field. It can have the following values:

I8 when size = 00

I16 when size = 01

I32 when size = 10

I64 when size = 11

<Qd> Is the 128-bit name of the SIMD&FP destination register, encoded in the "D:Vd" field as <Qd>*2.

<Qn> Is the 128-bit name of the first SIMD&FP source register, encoded in the "N:Vn" field as <Qn>*2.

<Qm> Is the 128-bit name of the second SIMD&FP source register, encoded in the "M:Vm" field as <Qm>*2.

<Dd> Is the 64-bit name of the SIMD&FP destination register, encoded in the "D:Vd" field.

<Dn> Is the 64-bit name of the first SIMD&FP source register, encoded in the "N:Vn" field.

<Dm> Is the 64-bit name of the second SIMD&FP source register, encoded in the "M:Vm" field.

Operation for all encodings

```
if ConditionPassed() then
    EncodingSpecificOperations(); CheckAdvSIMDEnabled();
    for r = 0 to regs-1
        for e = 0 to elements-1
            Elem[D[d+r],e,esize] = Elem[D[n+r],e,esize] - Elem[D[m+r],e,esize];
```

F6.1.229 VSUBHN

Vector Subtract and Narrow, returning High Half subtracts the elements of one quadword vector from the corresponding elements of another quadword vector, takes the most significant half of each result, and places the final results in a doubleword vector. The results are truncated. For rounded results, see [VRSUBHN](#).

There is no distinction between signed and unsigned integers.

Depending on settings in the [CPACR](#), [NSACR](#), and [HCPTR](#) registers, and the security state and mode in which the instruction is executed, an attempt to execute the instruction might be UNDEFINED, or trapped to Hyp mode. For more information see [Enabling Advanced SIMD and floating-point support on page G1-4413](#).

A1

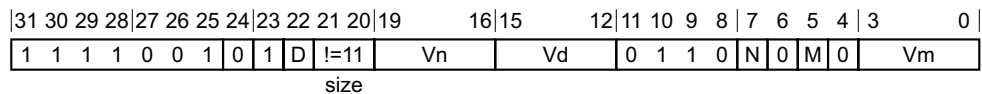

A1 variant

VSUBHN{<c>}{<q>}.<dt> <Dd>, <Qn>, <Qm>

Decode for this encoding

```
if size == '11' then SEE "Related encodings";
if Vn<0> == '1' || Vm<0> == '1' then UNDEFINED;
esize = 8 << UInt(size); elements = 64 DIV esize;
d = UInt(D:Vd); n = UInt(N:Vn); m = UInt(M:Vm);
```

T1

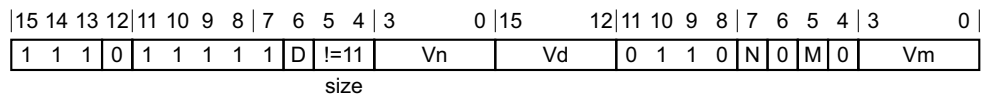

T1 variant

VSUBHN{<c>}{<q>}.<dt> <Dd>, <Qn>, <Qm>

Decode for this encoding

```
if size == '11' then SEE "Related encodings";
if Vn<0> == '1' || Vm<0> == '1' then UNDEFINED;
esize = 8 << UInt(size); elements = 64 DIV esize;
d = UInt(D:Vd); n = UInt(N:Vn); m = UInt(M:Vm);
```

Notes for all encodings

Related encodings: See [Advanced SIMD data-processing on page F3-2904](#) for the T32 instruction set, or [Advanced SIMD data-processing on page F4-2985](#) for the A32 instruction set.

Assembler symbols

- <c> For encoding A1: see [Standard assembler syntax fields on page F2-2848](#). This encoding must be unconditional.
- For encoding T1: see [Standard assembler syntax fields on page F2-2848](#).
- <q> See [Standard assembler syntax fields on page F2-2848](#).

- <dt> Is the data type for the elements of the operands, encoded in the "size" field. It can have the following values:
- I16 when size = 00
 - I32 when size = 01
 - I64 when size = 10
- <Dd> Is the 64-bit name of the SIMD&FP destination register, encoded in the "D:Vd" field.
- <Qn> Is the 128-bit name of the first SIMD&FP source register, encoded in the "N:Vn" field as <Qn>*2.
- <Qm> Is the 128-bit name of the second SIMD&FP source register, encoded in the "M:Vm" field as <Qm>*2.

Operation for all encodings

```
if ConditionPassed() then
    EncodingSpecificOperations(); CheckAdvSIMDEnabled();
for e = 0 to elements-1
    result = Elem[Qin[n>>1],e,2*esize] - Elem[Qin[m>>1],e,2*esize];
    Elem[D[d],e,esize] = result<2*esize-1:esize>;
```

F6.1.230 VSUBL

Vector Subtract Long subtracts the elements of one doubleword vector from the corresponding elements of another doubleword vector, and places the results in a quadword vector. Before subtracting, it sign-extends or zero-extends the elements of both operands.

Depending on settings in the CPACR, NSACR, and HCPTR registers, and the security state and mode in which the instruction is executed, an attempt to execute the instruction might be UNDEFINED, or trapped to Hyp mode. For more information see [Enabling Advanced SIMD and floating-point support on page G1-4413](#).

A1

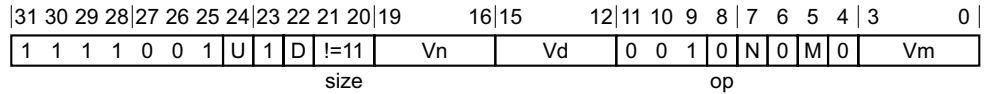

A1 variant

VSUBL{<c>}{<q>}.<dt> <Qd>, <Dn>, <Dm>

Decode for this encoding

```
if size == '11' then SEE "Related encodings";
if Vd<0> == '1' || (op == '1' && Vn<0> == '1') then UNDEFINED;
unsigned = (U == '1');
esize = 8 << UInt(size); elements = 64 DIV esize; is_vsubw = (op == '1');
d = UInt(D:Vd); n = UInt(N:Vn); m = UInt(M:Vm);
```

T1

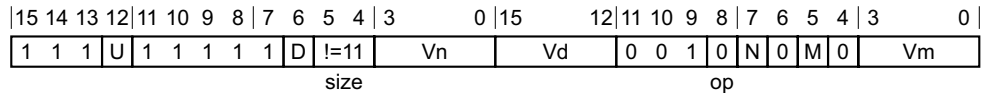

T1 variant

VSUBL{<c>}{<q>}.<dt> <Qd>, <Dn>, <Dm>

Decode for this encoding

```
if size == '11' then SEE "Related encodings";
if Vd<0> == '1' || (op == '1' && Vn<0> == '1') then UNDEFINED;
unsigned = (U == '1');
esize = 8 << UInt(size); elements = 64 DIV esize; is_vsubw = (op == '1');
d = UInt(D:Vd); n = UInt(N:Vn); m = UInt(M:Vm);
```

Notes for all encodings

Related encodings: See [Advanced SIMD data-processing on page F3-2904](#) for the T32 instruction set, or [Advanced SIMD data-processing on page F4-2985](#) for the A32 instruction set.

Assembler symbols

- <c> For encoding A1: see [Standard assembler syntax fields on page F2-2848](#). This encoding must be unconditional.
- For encoding T1: see [Standard assembler syntax fields on page F2-2848](#).
- <q> See [Standard assembler syntax fields on page F2-2848](#).

- <dt> Is the data type for the elements of the second operand vector, encoded in the "U:size" field. It can have the following values:
- S8 when U = 0, size = 00
 - S16 when U = 0, size = 01
 - S32 when U = 0, size = 10
 - U8 when U = 1, size = 00
 - U16 when U = 1, size = 01
 - U32 when U = 1, size = 10
- <Qd> Is the 128-bit name of the SIMD&FP destination register, encoded in the "D:Vd" field as <Qd>*2.
- <Dn> Is the 64-bit name of the first SIMD&FP source register, encoded in the "N:Vn" field.
- <Dm> Is the 64-bit name of the second SIMD&FP source register, encoded in the "M:Vm" field.

Operation for all encodings

```
if ConditionPassed() then
    EncodingSpecificOperations(); CheckAdvSIMDEnabled();
    for e = 0 to elements-1
        if is_vsubw then
            op1 = Int(Elem[Qin[n>>1],e,2*esize], unsigned);
        else
            op1 = Int(Elem[Din[n],e,esize], unsigned);
        result = op1 - Int(Elem[Din[m],e,esize], unsigned);
        Elem[Q[d>>1],e,2*esize] = result<2*esize-1:0>;
```

F6.1.231 VSUBW

Vector Subtract Wide subtracts the elements of a doubleword vector from the corresponding elements of a quadword vector, and places the results in another quadword vector. Before subtracting, it sign-extends or zero-extends the elements of the doubleword operand.

Depending on settings in the CPACR, NSACR, and HCPTR registers, and the security state and mode in which the instruction is executed, an attempt to execute the instruction might be UNDEFINED, or trapped to Hyp mode. For more information see [Enabling Advanced SIMD and floating-point support on page G1-4413](#).

A1

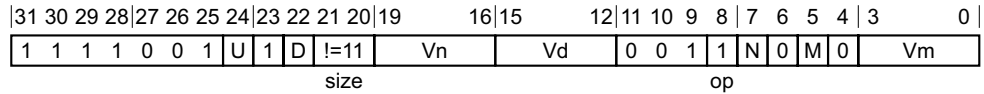

A1 variant

VSUBW{<c>}{<q>}.<dt> {<Qd>}, <Qn>, <Dm>

Decode for this encoding

```
if size == '11' then SEE "Related encodings";
if Vd<0> == '1' || (op == '1' && Vn<0> == '1') then UNDEFINED;
unsigned = (U == '1');
esize = 8 << UInt(size); elements = 64 DIV esize; is_vsubw = (op == '1');
d = UInt(D:Vd); n = UInt(N:Vn); m = UInt(M:Vm);
```

T1

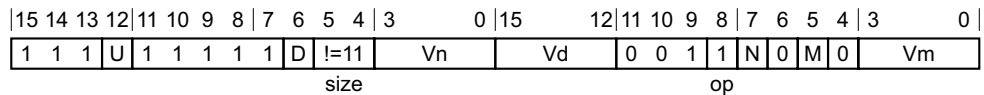

T1 variant

VSUBW{<c>}{<q>}.<dt> {<Qd>}, <Qn>, <Dm>

Decode for this encoding

```
if size == '11' then SEE "Related encodings";
if Vd<0> == '1' || (op == '1' && Vn<0> == '1') then UNDEFINED;
unsigned = (U == '1');
esize = 8 << UInt(size); elements = 64 DIV esize; is_vsubw = (op == '1');
d = UInt(D:Vd); n = UInt(N:Vn); m = UInt(M:Vm);
```

Notes for all encodings

Related encodings: See [Advanced SIMD data-processing on page F3-2904](#) for the T32 instruction set, or [Advanced SIMD data-processing on page F4-2985](#) for the A32 instruction set.

Assembler symbols

- <c> For encoding A1: see [Standard assembler syntax fields on page F2-2848](#). This encoding must be unconditional.
- For encoding T1: see [Standard assembler syntax fields on page F2-2848](#).
- <q> See [Standard assembler syntax fields on page F2-2848](#).

- <dt> Is the data type for the elements of the second operand vector, encoded in the "U:size" field. It can have the following values:
- S8 when U = 0, size = 00
 - S16 when U = 0, size = 01
 - S32 when U = 0, size = 10
 - U8 when U = 1, size = 00
 - U16 when U = 1, size = 01
 - U32 when U = 1, size = 10
- <Qd> Is the 128-bit name of the SIMD&FP destination register, encoded in the "D:Vd" field as <Qd>*2.
- <Qn> Is the 128-bit name of the first SIMD&FP source register, encoded in the "N:Vn" field as <Qn>*2.
- <Dm> Is the 64-bit name of the second SIMD&FP source register, encoded in the "M:Vm" field.

Operation for all encodings

```
if ConditionPassed() then
    EncodingSpecificOperations(); CheckAdvSIMDEnabled();
    for e = 0 to elements-1
        if is_vsubw then
            op1 = Int(Elem[Qin[n>>1],e,2*esize], unsigned);
        else
            op1 = Int(Elem[Din[n],e,esize], unsigned);
        result = op1 - Int(Elem[Din[m],e,esize], unsigned);
        Elem[Q[d>>1],e,2*esize] = result<2*esize-1:0>;
```

F6.1.232 VSWP

Vector Swap exchanges the contents of two vectors. The vectors can be either doubleword or quadword. There is no distinction between data types.

Depending on settings in the CPACR, NSACR, and HCPTR registers, and the security state and mode in which the instruction is executed, an attempt to execute the instruction might be UNDEFINED, or trapped to Hyp mode. For more information see [Enabling Advanced SIMD and floating-point support on page G1-4413](#).

A1

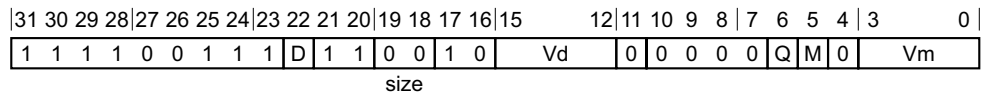

64-bit SIMD vector variant

Applies when Q == 0.

VSWP{<c>}{<q>}{.<dt>} <Dd>, <Dm>

128-bit SIMD vector variant

Applies when Q == 1.

VSWP{<c>}{<q>}{.<dt>} <Qd>, <Qm>

Decode for all variants of this encoding

```
if size != '00' then UNDEFINED;
if Q == '1' && (Vd<0> == '1' || Vm<0> == '1') then UNDEFINED;
d = UInt(D:Vd); m = UInt(M:Vm); regs = if Q == '0' then 1 else 2;
```

T1

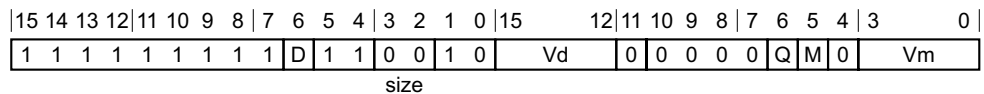

64-bit SIMD vector variant

Applies when Q == 0.

VSWP{<c>}{<q>}{.<dt>} <Dd>, <Dm>

128-bit SIMD vector variant

Applies when Q == 1.

VSWP{<c>}{<q>}{.<dt>} <Qd>, <Qm>

Decode for all variants of this encoding

```
if size != '00' then UNDEFINED;
if Q == '1' && (Vd<0> == '1' || Vm<0> == '1') then UNDEFINED;
d = UInt(D:Vd); m = UInt(M:Vm); regs = if Q == '0' then 1 else 2;
```

Assembler symbols

<c> For encoding A1: see [Standard assembler syntax fields on page F2-2848](#). This encoding must be unconditional.

For encoding T1: see *Standard assembler syntax fields* on page F2-2848.

<q> See *Standard assembler syntax fields* on page F2-2848.

<dt> An optional data type. It is ignored by assemblers, and does not affect the encoding.

<Qd> Is the 128-bit name of the SIMD&FP destination register, encoded in the "D:Vd" field as <Qd>*2.

<Qm> Is the 128-bit name of the SIMD&FP source register, encoded in the "M:Vm" field as <Qm>*2.

<Dd> Is the 64-bit name of the SIMD&FP destination register, encoded in the "D:Vd" field.

<Dm> Is the 64-bit name of the SIMD&FP source register, encoded in the "M:Vm" field.

Operation for all encodings

```
if ConditionPassed() then
    EncodingSpecificOperations(); CheckAdvSIMDEnabled();
for r = 0 to regs-1
    if d == m then
        D[d+r] = bits(64) UNKNOWN;
    else
        D[d+r] = Din[m+r];
        D[m+r] = Din[d+r];
```

F6.1.233 VTBL, VTBX

Vector Table Lookup uses byte indexes in a control vector to look up byte values in a table and generate a new vector. Indexes out of range return 0.

Vector Table Extension works in the same way, except that indexes out of range leave the destination element unchanged.

Depending on settings in the CPACR, NSACR, and HCPTR registers, and the security state and mode in which the instruction is executed, an attempt to execute the instruction might be UNDEFINED, or trapped to Hyp mode. For more information see [Enabling Advanced SIMD and floating-point support on page G1-4413](#).

A1

31	30	29	28	27	26	25	24	23	22	21	20	19	16	15	12	11	10	9	8	7	6	5	4	3	0
1	1	1	1	0	0	1	1	1	D	1	1	Vn	Vd	1	0	len	N	op	M	0	Vm				

VTBL variant

Applies when op == 0.

VTBL{<c>}{<q>}.8 <Dd>, <list>, <Dm>

VTBX variant

Applies when op == 1.

VTBX{<c>}{<q>}.8 <Dd>, <list>, <Dm>

Decode for all variants of this encoding

```
is_vtbl = (op == '0'); length = UInt(len)+1;
d = UInt(D:Vd); n = UInt(N:Vn); m = UInt(M:Vm);
if n+length > 32 then UNPREDICTABLE;
```

CONSTRAINED UNPREDICTABLE behavior

If n + length > 32, then one of the following behaviors must occur:

- The instruction is UNDEFINED.
- The instruction executes as NOP.
- One or more of the SIMD and floating-point registers are UNKNOWN. This behavior does not affect any general-purpose registers.

T1

15	14	13	12	11	10	9	8	7	6	5	4	3	0	15	12	11	10	9	8	7	6	5	4	3	0
1	1	1	1	1	1	1	1	1	D	1	1	Vn	Vd	1	0	len	N	op	M	0	Vm				

VTBL variant

Applies when op == 0.

VTBL{<c>}{<q>}.8 <Dd>, <list>, <Dm>

VTBX variant

Applies when op == 1.

VTBX{<c>}{<q>}.8 <Dd>, <list>, <Dm>

Decode for all variants of this encoding

```
is_vtbl = (op == '0'); length = UInt(len)+1;
d = UInt(D:Vd); n = UInt(N:Vn); m = UInt(M:Vm);
if n+length > 32 then UNPREDICTABLE;
```

CONSTRAINED UNPREDICTABLE behavior

If n + length > 32, then one of the following behaviors must occur:

- The instruction is UNDEFINED.
- The instruction executes as NOP.
- One or more of the SIMD and floating-point registers are UNKNOWN. This behavior does not affect any general-purpose registers.

Notes for all encodings

For more information about the CONSTRAINED UNPREDICTABLE behavior of this instruction, see [Appendix K1 Architectural Constraints on UNPREDICTABLE behaviors](#).

Assembler symbols

<c>	For encoding A1: see Standard assembler syntax fields on page F2-2848 . This encoding must be unconditional. For encoding T1: see Standard assembler syntax fields on page F2-2848 .
<q>	See Standard assembler syntax fields on page F2-2848 .
<Dd>	Is the 64-bit name of the SIMD&FP destination register, encoded in the "D:Vd" field.
<list>	The vectors containing the table. It must be one of: {<Dn>} Encoded as len = 0b00. {<Dn>, <Dn+1>} Encoded as len = 0b01. {<Dn>, <Dn+1>, <Dn+2>} Encoded as len = 0b10. {<Dn>, <Dn+1>, <Dn+2>, <Dn+3>} Encoded as len = 0b11.
<Dm>	Is the 64-bit name of the SIMD&FP source register holding the indices, encoded in the "M:Vm" field.

Operation for all encodings

```
if ConditionPassed() then
  EncodingSpecificOperations(); CheckAdvSIMDEnabled();

  // Create 256-bit = 32-byte table variable, with zeros in entries that will not be used.
  table3 = if length == 4 then D[n+3] else Zeros(64);
  table2 = if length >= 3 then D[n+2] else Zeros(64);
  table1 = if length >= 2 then D[n+1] else Zeros(64);
  table = table3 : table2 : table1 : D[n];

  for i = 0 to 7
    index = UInt(Elem[D[m],i,8]);
    if index < 8*length then
      Elem[D[d],i,8] = Elem[table,index,8];
```

```
else
  if is_vtbl then
    Elem[D[d],i,8] = Zeros(8);
  // else Elem[D[d],i,8] unchanged
```

F6.1.234 VTRN

Vector Transpose treats the elements of its operand vectors as elements of 2 x 2 matrices, and transposes the matrices.

The elements of the vectors can be 8-bit, 16-bit, or 32-bit. There is no distinction between data types.

The following figure shows the operation of VTRN doubleword operations.

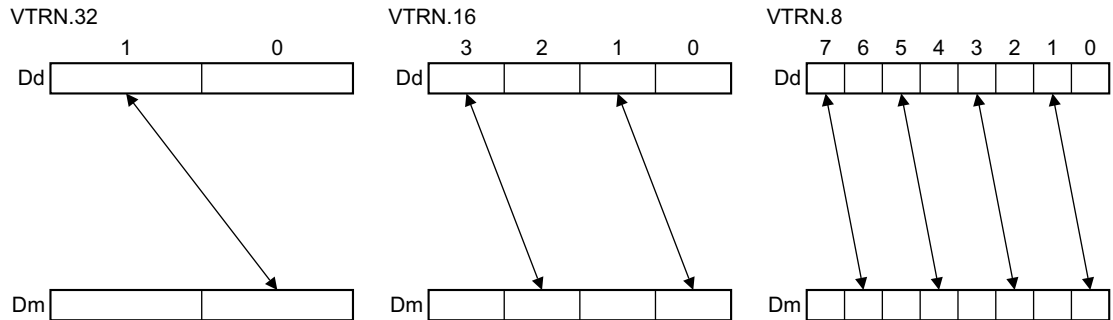

Depending on settings in the CPACR, NSACR, and HCPTR registers, and the security state and mode in which the instruction is executed, an attempt to execute the instruction might be UNDEFINED, or trapped to Hyp mode. For more information see [Enabling Advanced SIMD and floating-point support on page G1-4413](#).

This instruction is used by the pseudo-instructions VUZP (alias) and VZIP (alias). The pseudo-instruction is never the preferred disassembly.

A1

31	30	29	28	27	26	25	24	23	22	21	20	19	18	17	16	15	12	11	10	9	8	7	6	5	4	3	0
1	1	1	1	0	0	1	1	1	D	1	1	size	1	0	Vd	0	0	0	0	1	Q	M	0	Vm			

64-bit SIMD vector variant

Applies when Q == 0.

VTRN{<c>}{<q>}.<dt> <Dd>, <Dm>

128-bit SIMD vector variant

Applies when Q == 1.

VTRN{<c>}{<q>}.<dt> <Qd>, <Qm>

Decode for all variants of this encoding

```

if size == '11' then UNDEFINED;
if Q == '1' && (Vd<0> == '1' || Vm<0> == '1') then UNDEFINED;
esize = 8 << UInt(size); elements = 64 DIV esize;
d = UInt(D:Vd); m = UInt(M:Vm); regs = if Q == '0' then 1 else 2;
    
```

T1

15	14	13	12	11	10	9	8	7	6	5	4	3	2	1	0	15	12	11	10	9	8	7	6	5	4	3	0
1	1	1	1	1	1	1	1	1	D	1	1	size	1	0	Vd	0	0	0	0	1	Q	M	0	Vm			

64-bit SIMD vector variant

Applies when Q == 0.

VTRN{<c>}{<q>}.<dt> <Dd>, <Dm>

128-bit SIMD vector variant

Applies when Q == 1.

VTRN{<c>}{<q>}.<dt> <Qd>, <Qm>

Decode for all variants of this encoding

```

if size == '11' then UNDEFINED;
if Q == '1' && (Vd<0> == '1' || Vm<0> == '1') then UNDEFINED;
esize = 8 << UInt(size); elements = 64 DIV esize;
d = UInt(D:Vd); m = UInt(M:Vm); regs = if Q == '0' then 1 else 2;
  
```

Assembler symbols

- <c> For encoding A1: see [Standard assembler syntax fields on page F2-2848](#). This encoding must be unconditional.
 For encoding T1: see [Standard assembler syntax fields on page F2-2848](#).
- <q> See [Standard assembler syntax fields on page F2-2848](#).
- <dt> Is the data type for the elements of the vectors, encoded in the "size" field. It can have the following values:
 - 8 when size = 00
 - 16 when size = 01
 - 32 when size = 10
 The encoding size = 11 is reserved.
- <Qd> Is the 128-bit name of the SIMD&FP destination register, encoded in the "D:Vd" field as <Qd>*2.
- <Qm> Is the 128-bit name of the SIMD&FP source register, encoded in the "M:Vm" field as <Qm>*2.
- <Dd> Is the 64-bit name of the SIMD&FP destination register, encoded in the "D:Vd" field.
- <Dm> Is the 64-bit name of the SIMD&FP source register, encoded in the "M:Vm" field.

Operation for all encodings

```

if ConditionPassed() then
  EncodingSpecificOperations(); CheckAdvSIMDEnabled();
  h = elements DIV 2;

  for r = 0 to regs-1
    if d == m then
      D[d+r] = bits(64) UNKNOWN;
    else
      for e = 0 to h-1
        Elem[D[d+r],2*e+1,esize] = Elem[Din[m+r],2*e,esize];
        Elem[D[m+r],2*e,esize] = Elem[Din[d+r],2*e+1,esize];
  
```

F6.1.235 VTST

Vector Test Bits takes each element in a vector, and bitwise ANDs it with the corresponding element of a second vector. If the result is not zero, the corresponding element in the destination vector is set to all ones. Otherwise, it is set to all zeros.

The operand vector elements can be any one of:

- 8-bit, 16-bit, or 32-bit fields.

The result vector elements are fields the same size as the operand vector elements.

Depending on settings in the CPACR, NSACR, and HCPTR registers, and the security state and mode in which the instruction is executed, an attempt to execute the instruction might be UNDEFINED, or trapped to Hyp mode. For more information see [Enabling Advanced SIMD and floating-point support on page G1-4413](#).

A1

31	30	29	28	27	26	25	24	23	22	21	20	19	16	15	12	11	10	9	8	7	6	5	4	3	0
1	1	1	1	0	0	1	0	0	D	size	Vn	Vd	1	0	0	0	N	Q	M	1	Vm				

64-bit SIMD vector variant

Applies when Q == 0.

VTST{<c>}{<q>}.<dt> {<Dd>}, <Dn>, <Dm>

128-bit SIMD vector variant

Applies when Q == 1.

VTST{<c>}{<q>}.<dt> {<Qd>}, <Qn>, <Qm>

Decode for all variants of this encoding

```
if Q == '1' && (Vd<0> == '1' || Vn<0> == '1' || Vm<0> == '1') then UNDEFINED;
if size == '11' then UNDEFINED;
esize = 8 << UInt(size); elements = 64 DIV esize;
d = UInt(D:Vd); n = UInt(N:Vn); m = UInt(M:Vm); regs = if Q == '0' then 1 else 2;
```

T1

15	14	13	12	11	10	9	8	7	6	5	4	3	0	15	12	11	10	9	8	7	6	5	4	3	0
1	1	1	0	1	1	1	1	0	D	size	Vn	Vd	1	0	0	0	N	Q	M	1	Vm				

64-bit SIMD vector variant

Applies when Q == 0.

VTST{<c>}{<q>}.<dt> {<Dd>}, <Dn>, <Dm>

128-bit SIMD vector variant

Applies when Q == 1.

VTST{<c>}{<q>}.<dt> {<Qd>}, <Qn>, <Qm>

Decode for all variants of this encoding

```

if Q == '1' && (Vd<0> == '1' || Vn<0> == '1' || Vm<0> == '1') then UNDEFINED;
if size == '11' then UNDEFINED;
esize = 8 << UInt(size); elements = 64 DIV esize;
d = UInt(D:Vd); n = UInt(N:Vn); m = UInt(M:Vm); regs = if Q == '0' then 1 else 2;
  
```

Assembler symbols

- <c> For encoding A1: see [Standard assembler syntax fields on page F2-2848](#). This encoding must be unconditional.
 For encoding T1: see [Standard assembler syntax fields on page F2-2848](#).
- <q> See [Standard assembler syntax fields on page F2-2848](#).
- <dt> Is the data type for the elements of the operands, encoded in the "size" field. It can have the following values:
 - 8 when size = 00
 - 16 when size = 01
 - 32 when size = 10
- <Qd> Is the 128-bit name of the SIMD&FP destination register, encoded in the "D:Vd" field as <Qd>*2.
- <Qn> Is the 128-bit name of the first SIMD&FP source register, encoded in the "N:Vn" field as <Qn>*2.
- <Qm> Is the 128-bit name of the second SIMD&FP source register, encoded in the "M:Vm" field as <Qm>*2.
- <Dd> Is the 64-bit name of the SIMD&FP destination register, encoded in the "D:Vd" field.
- <Dn> Is the 64-bit name of the first SIMD&FP source register, encoded in the "N:Vn" field.
- <Dm> Is the 64-bit name of the second SIMD&FP source register, encoded in the "M:Vm" field.

Operation for all encodings

```

if ConditionPassed() then
  EncodingSpecificOperations(); CheckAdvSIMDEnabled();
  for r = 0 to regs-1
    for e = 0 to elements-1
      if !IsZero(Elem[D[n+r],e,esize] AND Elem[D[m+r],e,esize]) then
        Elem[D[d+r],e,esize] = Ones(esize);
      else
        Elem[D[d+r],e,esize] = Zeros(esize);
  
```

F6.1.236 VUZP

Vector Unzip de-interleaves the elements of two vectors.

The elements of the vectors can be 8-bit, 16-bit, or 32-bit. There is no distinction between data types.

The following figure shows the operation of VUZP doubleword operation for data type 8.

VUZP.8, doubleword

	Register state before operation								Register state after operation							
Dd	A7	A6	A5	A4	A3	A2	A1	A0	B6	B4	B2	B0	A6	A4	A2	A0
Dm	B7	B6	B5	B4	B3	B2	B1	B0	B7	B5	B3	B1	A7	A5	A3	A1

The following figure shows the operation of VUZP quadword operation for data type 32.

VUZP.32, quadword

	Register state before operation				Register state after operation			
Qd	A3	A2	A1	A0	B2	B0	A2	A0
Qm	B3	B2	B1	B0	B3	B1	A3	A1

Depending on settings in the CPACR, NSACR, and HCPTR registers, and the security state and mode in which the instruction is executed, an attempt to execute the instruction might be UNDEFINED, or trapped to Hyp mode. For more information see [Enabling Advanced SIMD and floating-point support on page G1-4413](#).

A1

31	30	29	28	27	26	25	24	23	22	21	20	19	18	17	16	15	12	11	10	9	8	7	6	5	4	3	0
1	1	1	1	0	0	1	1	1	D	1	1	size	1	0	Vd	0	0	0	1	0	Q	M	0	Vm			

64-bit SIMD vector variant

Applies when Q == 0.

VUZP{<c>}{<q>}.<dt> <Dd>, <Dm>

128-bit SIMD vector variant

Applies when Q == 1.

VUZP{<c>}{<q>}.<dt> <Qd>, <Qm>

Decode for all variants of this encoding

```
if size == '11' || (Q == '0' && size == '10') then UNDEFINED;
if Q == '1' && (Vd<0> == '1' || Vm<0> == '1') then UNDEFINED;
quadword_operation = (Q == '1'); esize = 8 << UInt(size);
d = UInt(D:Vd); m = UInt(M:Vm);
```

T1

15	14	13	12	11	10	9	8	7	6	5	4	3	2	1	0	15	12	11	10	9	8	7	6	5	4	3	0
1	1	1	1	1	1	1	1	1	D	1	1	size	1	0	Vd	0	0	0	1	0	Q	M	0	Vm			

64-bit SIMD vector variant

Applies when Q == 0.

VUZP{<c>}{<q>}.<dt> <Dd>, <Dm>

128-bit SIMD vector variant

Applies when Q == 1.

VUZP{<c>}{<q>}.<dt> <Qd>, <Qm>

Decode for all variants of this encoding

```
if size == '11' || (Q == '0' && size == '10') then UNDEFINED;
if Q == '1' && (Vd<0> == '1' || Vm<0> == '1') then UNDEFINED;
quadword_operation = (Q == '1'); esize = 8 << UInt(size);
d = UInt(D:Vd); m = UInt(M:Vm);
```

Assembler symbols

- <c> For encoding A1: see [Standard assembler syntax fields on page F2-2848](#). This encoding must be unconditional.
 For encoding T1: see [Standard assembler syntax fields on page F2-2848](#).
- <q> See [Standard assembler syntax fields on page F2-2848](#).
- <dt> For the 64-bit SIMD vector variant: is the data type for the elements of the vectors, encoded in the "size" field. It can have the following values:
 - 8 when size = 00
 - 16 when size = 01
 The encoding size = 1x is reserved.
 For the 128-bit SIMD vector variant: is the data type for the elements of the vectors, encoded in the "size" field. It can have the following values:
 - 8 when size = 00
 - 16 when size = 01
 - 32 when size = 10
 The encoding size = 11 is reserved.
- <Qd> Is the 128-bit name of the SIMD&FP destination register, encoded in the "D:Vd" field as <Qd>*2.
- <Qm> Is the 128-bit name of the SIMD&FP source register, encoded in the "M:Vm" field as <Qm>*2.
- <Dd> Is the 64-bit name of the SIMD&FP destination register, encoded in the "D:Vd" field.
- <Dm> Is the 64-bit name of the SIMD&FP source register, encoded in the "M:Vm" field.

Operation for all encodings

```
if ConditionPassed() then
  EncodingSpecificOperations(); CheckAdvSIMDEnabled();
  if quadword_operation then
    if d == m then
      Q[d>>1] = bits(128) UNKNOWN; Q[m>>1] = bits(128) UNKNOWN;
    else
      zipped_q = Q[m>>1]:Q[d>>1];
      for e = 0 to (128 DIV esize) - 1
        Elem[Q[d>>1],e,esize] = Elem[zipped_q,2*e,esize];
        Elem[Q[m>>1],e,esize] = Elem[zipped_q,2*e+1,esize];
  else
    if d == m then
      D[d] = bits(64) UNKNOWN; D[m] = bits(64) UNKNOWN;
    else
      zipped_d = D[m]:D[d];
      for e = 0 to (64 DIV esize) - 1
        Elem[D[d],e,esize] = Elem[zipped_d,2*e,esize];
        Elem[D[m],e,esize] = Elem[zipped_d,2*e+1,esize];
```

F6.1.237 VUZP (alias)

Vector Unzip de-interleaves the elements of two vectors

This instruction is a pseudo-instruction of the [VTRN](#) instruction. This means that:

- The encodings in this description are named to match the encodings of [VTRN](#).
- The assembler syntax is used only for assembly, and is not used on disassembly.
- The description of [VTRN](#) gives the operational pseudocode for this instruction.

A1

31	30	29	28	27	26	25	24	23	22	21	20	19	18	17	16	15	12	11	10	9	8	7	6	5	4	3	0
1	1	1	1	0	0	1	1	1	D	1	1	size	1	0	Vd	0	0	0	0	1	0	M	0	Vm			

Q

64-bit SIMD vector variant

VUZP{<c>}{<q>}.32 <Dd>, <Dm>

is equivalent to

VTRN{<c>}{<q>}.32 <Dd>, <Dm>

and is never the preferred disassembly.

T1

15	14	13	12	11	10	9	8	7	6	5	4	3	2	1	0	15	12	11	10	9	8	7	6	5	4	3	0
1	1	1	1	1	1	1	1	1	D	1	1	size	1	0	Vd	0	0	0	0	1	0	M	0	Vm			

Q

64-bit SIMD vector variant

VUZP{<c>}{<q>}.32 <Dd>, <Dm>

is equivalent to

VTRN{<c>}{<q>}.32 <Dd>, <Dm>

and is never the preferred disassembly.

Assembler symbols

<c> For encoding A1: see [Standard assembler syntax fields on page F2-2848](#). This encoding must be unconditional.

For encoding T1: see [Standard assembler syntax fields on page F2-2848](#).

<q> See [Standard assembler syntax fields on page F2-2848](#).

<Dd> Is the 64-bit name of the SIMD&FP destination register, encoded in the "D:Vd" field.

<Dm> Is the 64-bit name of the SIMD&FP source register, encoded in the "M:Vm" field.

Operation for all encodings

The description of [VTRN](#) gives the operational pseudocode for this instruction.

F6.1.238 VZIP

Vector Zip interleaves the elements of two vectors.

The elements of the vectors can be 8-bit, 16-bit, or 32-bit. There is no distinction between data types.

The following figure shows the operation of VZIP doubleword operation for data type 8.

VZIP.8, doubleword

	Register state before operation								Register state after operation							
Dd	A7	A6	A5	A4	A3	A2	A1	A0	B3	A3	B2	A2	B1	A1	B0	A0
Dm	B7	B6	B5	B4	B3	B2	B1	B0	B7	A7	B6	A6	B5	A5	B4	A4

The following figure shows the operation of VZIP quadword operation for data type 32.

VZIP.32, quadword

	Register state before operation				Register state after operation			
Qd	A3	A2	A1	A0	B1	A1	B0	A0
Qm	B3	B2	B1	B0	B3	A3	B2	A2

Depending on settings in the CPACR, NSACR, and HCPTR registers, and the security state and mode in which the instruction is executed, an attempt to execute the instruction might be UNDEFINED, or trapped to Hyp mode. For more information see [Enabling Advanced SIMD and floating-point support on page G1-4413](#).

A1

31	30	29	28	27	26	25	24	23	22	21	20	19	18	17	16	15	12	11	10	9	8	7	6	5	4	3	0
1	1	1	1	0	0	1	1	1	D	1	1	size	1	0	Vd	0	0	0	1	1	Q	M	0	Vm			

64-bit SIMD vector variant

Applies when Q == 0.

VZIP{<c>}{<q>}.<dt> <Dd>, <Dm>

128-bit SIMD vector variant

Applies when Q == 1.

VZIP{<c>}{<q>}.<dt> <Qd>, <Qm>

Decode for all variants of this encoding

```
if size == '11' || (Q == '0' && size == '10') then UNDEFINED;
if Q == '1' && (Vd<0> == '1' || Vm<0> == '1') then UNDEFINED;
quadword_operation = (Q == '1'); esize = 8 << UInt(size);
d = UInt(D:Vd); m = UInt(M:Vm);
```

T1

15	14	13	12	11	10	9	8	7	6	5	4	3	2	1	0	15	12	11	10	9	8	7	6	5	4	3	0
1	1	1	1	1	1	1	1	1	D	1	1	size	1	0	Vd	0	0	0	1	1	Q	M	0	Vm			

64-bit SIMD vector variant

Applies when Q == 0.

VZIP{<c>}{<q>}.<dt> <Dd>, <Dm>

128-bit SIMD vector variant

Applies when Q == 1.

VZIP{<c>}{<q>}.<dt> <Qd>, <Qm>

Decode for all variants of this encoding

```
if size == '11' || (Q == '0' && size == '10') then UNDEFINED;
if Q == '1' && (Vd<0> == '1' || Vm<0> == '1') then UNDEFINED;
quadword_operation = (Q == '1'); esize = 8 << UInt(size);
d = UInt(D:Vd); m = UInt(M:Vm);
```

Assembler symbols

- <c> For encoding A1: see [Standard assembler syntax fields on page F2-2848](#). This encoding must be unconditional.
 For encoding T1: see [Standard assembler syntax fields on page F2-2848](#).
- <q> See [Standard assembler syntax fields on page F2-2848](#).
- <dt> For the 64-bit SIMD vector variant: is the data type for the elements of the vectors, encoded in the "size" field. It can have the following values:
 - 8 when size = 00
 - 16 when size = 01
 The encoding size = 1x is reserved.
 For the 128-bit SIMD vector variant: is the data type for the elements of the vectors, encoded in the "size" field. It can have the following values:
 - 8 when size = 00
 - 16 when size = 01
 - 32 when size = 10
 The encoding size = 11 is reserved.
- <Qd> Is the 128-bit name of the SIMD&FP destination register, encoded in the "D:Vd" field as <Qd>*2.
- <Qm> Is the 128-bit name of the SIMD&FP source register, encoded in the "M:Vm" field as <Qm>*2.
- <Dd> Is the 64-bit name of the SIMD&FP destination register, encoded in the "D:Vd" field.
- <Dm> Is the 64-bit name of the SIMD&FP source register, encoded in the "M:Vm" field.

Operation for all encodings

```
if ConditionPassed() then
  EncodingSpecificOperations(); CheckAdvSIMDEnabled();
  if quadword_operation then
    if d == m then
      Q[d>>1] = bits(128) UNKNOWN; Q[m>>1] = bits(128) UNKNOWN;
    else
      bits(256) zipped_q;
      for e = 0 to (128 DIV esize) - 1
        Elem[zipped_q,2*e,esize] = Elem[Q[d>>1],e,esize];
        Elem[zipped_q,2*e+1,esize] = Elem[Q[m>>1],e,esize];
      Q[d>>1] = zipped_q<127:0>; Q[m>>1] = zipped_q<255:128>;
  else
    if d == m then
      D[d] = bits(64) UNKNOWN; D[m] = bits(64) UNKNOWN;
    else
      bits(128) zipped_d;
      for e = 0 to (64 DIV esize) - 1
```

```
Elem[zipped_d,2*e,esize] = Elem[D[d],e,esize];  
Elem[zipped_d,2*e+1,esize] = Elem[D[m],e,esize];  
D[d] = zipped_d<63:0>; D[m] = zipped_d<127:64>;
```

F6.1.239 VZIP (alias)

Vector Zip interleaves the elements of two vectors

This instruction is a pseudo-instruction of the [VTRN](#) instruction. This means that:

- The encodings in this description are named to match the encodings of [VTRN](#).
- The assembler syntax is used only for assembly, and is not used on disassembly.
- The description of [VTRN](#) gives the operational pseudocode for this instruction.

A1

31	30	29	28	27	26	25	24	23	22	21	20	19	18	17	16	15	12	11	10	9	8	7	6	5	4	3	0
1	1	1	1	0	0	1	1	1	D	1	1	size	1	0	Vd	0	0	0	0	1	0	M	0	Vm			

Q

64-bit SIMD vector variant

VZIP{<c>}{<q>}.32 <Dd>, <Dm>

is equivalent to

VTRN{<c>}{<q>}.32 <Dd>, <Dm>

and is never the preferred disassembly.

T1

15	14	13	12	11	10	9	8	7	6	5	4	3	2	1	0	15	12	11	10	9	8	7	6	5	4	3	0
1	1	1	1	1	1	1	1	1	D	1	1	size	1	0	Vd	0	0	0	0	1	0	M	0	Vm			

Q

64-bit SIMD vector variant

VZIP{<c>}{<q>}.32 <Dd>, <Dm>

is equivalent to

VTRN{<c>}{<q>}.32 <Dd>, <Dm>

and is never the preferred disassembly.

Assembler symbols

<c> For encoding A1: see [Standard assembler syntax fields on page F2-2848](#). This encoding must be unconditional.

For encoding T1: see [Standard assembler syntax fields on page F2-2848](#).

<q> See [Standard assembler syntax fields on page F2-2848](#).

<Dd> Is the 64-bit name of the SIMD&FP destination register, encoded in the "D:Vd" field.

<Dm> Is the 64-bit name of the SIMD&FP source register, encoded in the "M:Vm" field.

Operation for all encodings

The description of [VTRN](#) gives the operational pseudocode for this instruction.

Part G

The AArch32 System Level Architecture

Chapter G1

The AArch32 System Level Programmers' Model

This chapter gives a system level description of the programmers' model for execution in AArch32 state. It contains the following sections:

- *About the AArch32 System level programmers' model* on page G1-4308.
- *Exception levels* on page G1-4309.
- *Exception terminology* on page G1-4310.
- *Execution state* on page G1-4312.
- *Instruction Set state* on page G1-4314.
- *Security state* on page G1-4315.
- *Security state, Exception levels, and AArch32 execution privilege* on page G1-4318.
- *Virtualization* on page G1-4320.
- *AArch32 PE modes, and general-purpose and Special-purpose registers* on page G1-4322.
- *Process state, PSTATE* on page G1-4332.
- *Instruction set states* on page G1-4338.
- *Handling exceptions that are taken to an Exception level using AArch32* on page G1-4340.
- *Exception return to an Exception level using AArch32* on page G1-4360.
- *Asynchronous exception behavior for exceptions taken from AArch32 state* on page G1-4365.
- *AArch32 state exception descriptions* on page G1-4376.
- *Reset into AArch32 state* on page G1-4399.
- *Mechanisms for entering a low-power state* on page G1-4403.
- *The AArch32 System register interface* on page G1-4408.
- *Advanced SIMD and floating-point support* on page G1-4412.
- *Configurable instruction enables and disables, and trap controls* on page G1-4418.

G1.1 About the AArch32 System level programmers' model

An application programmer has only a restricted view of the system. The System level programmers' model supports this application level view of the system, and includes features that are required for one or both of an operating system (OS) and a hypervisor to provide the programming environment seen by an application. This chapter describes the System level programmers' model when executing at EL1 or higher in an Exception level that is using AArch32.

The system level programmers' model includes all of the system features required to support operating systems and to handle hardware events.

The following sections give a system level introduction to the basic concepts of the ARM architecture AArch32 state, and the terminology that is used for describing the architecture when executing in this state:

- [Exception levels on page G1-4309.](#)
- [Exception terminology on page G1-4310.](#)
- [Execution state on page G1-4312.](#)
- [Instruction Set state on page G1-4314.](#)
- [Security state on page G1-4315.](#)
- [Virtualization on page G1-4320.](#)

The rest of this chapter describes the system level programmers' model when executing in AArch32 state.

The other chapters in this part describe:

- The memory system architecture, as seen when executing in an Exception level that is using AArch32:
 - [Chapter G3 The AArch32 System Level Memory Model](#) describes the general features of the ARMv8 memory model, when executing in AArch32 state, that are not visible at the application level.

Note

[Chapter E2 The AArch32 Application Level Memory Model](#) describes the application level view of the memory model.

 - [Chapter G4 The AArch32 Virtual Memory System Architecture](#) describes the Virtual Memory System Architecture (VMSA) used in AArch32 state.
- The AArch32 System Registers, see [Chapter G6 AArch32 System Register Descriptions](#).

———— **Note** —————

The T32 and A32 instruction sets include instructions that provide system level functionality, such as returning from an exception. See for example, [ERET on page F5-3117](#).

G1.2 Exception levels

The ARMv8-A architecture defines a set of Exception levels, EL0 to EL3, where:

- If EL n is the Exception level, increased values of n indicate increased software execution privilege.
- Execution at EL0 is called *unprivileged execution*.
- EL2 provides support for virtualization of Non-secure operation.
- EL3 provides support for switching between two Security states, Secure state and Non-secure state.

An implementation might not include all of the Exception levels. All implementations must include EL0 and EL1. EL2 and EL3 are optional.

———— Note —————

A PE is not required to implement a contiguous set of Exception levels. For example, it is permissible for an implementation to include only EL0, EL1, and EL3.

[The effect of implementation choices on the programmers' model on page D1-1899](#) provides information on implementations.

When executing in AArch32 state, execution can move between Exception levels only on taking an exception or on returning from an exception:

- On taking an exception, the Exception level can only increase or remain the same.
- On returning from an exception, the Exception level can only decrease or remain the same.

The Exception level that execution changes to or remains in on taking an exception is called the *target Exception level* of the exception.

Each exception type has a target Exception level that is either:

- Implicit in the nature of the exception.
- Defined by configuration bits in the System registers.

An exception cannot target EL0.

Exception levels exist within *Security states*. [The ARMv8-A security model on page G1-4315](#) describes this. When executing at an Exception level, the PE can access both of the following:

- The resources that are available for the combination of the current Exception level and the current Security state.
- The resources that are available at all lower Exception levels, provided that those resources are available to the current Security state.

This means that if the implementation includes EL3, then because EL3 is only implemented in Secure state, execution at EL3 can access all resources available at all Exception levels, for both Security states.

Each Exception level other than EL0 has its own translation regime and associated control registers. For information on the translation regimes, see [Chapter G4 The AArch32 Virtual Memory System Architecture](#).

G1.2.1 Typical Exception level usage model

The architecture does not specify what software uses which Exception level. Such choices are outside the scope of the architecture. However, the following is a common usage model for the Exception levels:

EL0	Applications.
EL1	OS kernel and associated functions that are typically described as <i>privileged</i> .
EL2	Hypervisor.
EL3	Secure monitor.

G1.3 Exception terminology

The following subsections define the terms that are used when describing exceptions:

- [Terminology for taking an exception.](#)
- [Terminology for returning from an exception.](#)
- [Exception levels.](#)
- [Definition of a precise exception.](#)
- [Definitions of synchronous and asynchronous exceptions on page G1-4311.](#)

G1.3.1 Terminology for taking an exception

An exception is *generated* when the PE first responds to an exceptional condition. The PE state at this time is the state that the exception is *taken from*. The PE state immediately after taking the exception is the state that the exception is *taken to*.

G1.3.2 Terminology for returning from an exception

To return from an exception, the PE must execute an exception return instruction. The PE state when an exception return instruction is committed for execution is the state the exception *returns from*. The PE state immediately after the execution of that instruction is the state that the exception *returns to*.

G1.3.3 Exception levels

An Exception level, EL_n , with a larger value of n than another Exception level, is described as being a *higher* Exception level than the other Exception level. For example, EL_3 is a higher Exception level than EL_1 .

An Exception level with a smaller value of n than another Exception level is described as being a *lower* Exception level than the other Exception level. For example, EL_0 is a lower Exception level than EL_1 .

An Exception level is described as:

- *Using AArch64* when execution in that Exception level is in the AArch64 Execution state.
- *Using AArch32* when execution in that Exception level is in the AArch32 Execution state.

G1.3.4 Definition of a precise exception

An exception is described as *precise* when the exception handler receives the PE state and memory system state that is consistent with the PE having executed all of the instructions up to but not including the point in the instruction stream where the exception was taken, and none afterwards.

Other than the SError interrupt all exceptions that are taken to AArch32 state are required to be precise. For each occurrence of an SError interrupt, whether the interrupt is precise or imprecise is IMPLEMENTATION DEFINED.

Where a synchronous exception that is taken to AArch32 state is generated as part of an instruction that performs more than one single-copy atomic memory access, the definition of precise permits that the values in registers or memory affected by those instructions can be UNKNOWN, provided that:

- The accesses affecting those registers or memory locations do not, themselves, generate exceptions.
- The registers are not involved in the calculation of the memory address that is used by the instruction.

In AArch32 state, examples of instructions that perform more than one single-copy atomic memory access are the LDM and STM instructions.

———— **Note** —————

- For the definition of a single-copy atomic access, see [Properties of single-copy atomic accesses on page E2-2759.](#)
- The SError interrupt replaces the ARMv7 asynchronous abort.

G1.3.5 Definitions of synchronous and asynchronous exceptions

An exception is described as *synchronous* if all of the following apply:

- The exception is generated as a result of direct execution or attempted execution of an instruction.
- The return address presented to the exception handler is guaranteed to indicate the instruction that caused the exception.
- The exception is precise.

An exception is described as *asynchronous* if any of the following apply:

- The exception is not generated as a result of direct execution or attempted execution of the instruction stream.
- The return address presented to the exception handler is not guaranteed to indicate the instruction that caused the exception.
- The exception is imprecise.

For more information about exceptions, see [Handling exceptions that are taken to an Exception level using AArch32 on page G1-4340](#).

G1.4 Execution state

The Execution states are:

AArch64 The 64-bit Execution state.

AArch32 The 32-bit Execution state. Operation in this state is compatible with ARMv7-A operation.

[Execution state on page A1-34](#) gives more information about them.

Exception levels *use* Execution states. For example, EL0, EL1 and EL2 might all be using AArch32, under EL3 using AArch64.

This means that:

- Different software layers, such as an application, an operating system kernel, and a hypervisor, executing at different Exception levels, can execute in different Execution states.
- The PE can change Execution states only either:
 - At reset.
 - On a change of Exception level.

Note

- [Typical Exception level usage model on page G1-4309](#) shows which Exception levels different software layers might typically use.
- [The effect of implementation choices on the programmers' model on page D1-1899](#) gives information on supported configurations of Exception levels and Execution states.

The interaction between the AArch64 and AArch32 Execution states is called *interprocessing*. [Interprocessing on page D1-1887](#) describes this.

G1.4.1 About the AArch32 PE modes

AArch32 state provides a set of *PE modes* that support normal software execution and handle exceptions. The current mode determines the set of registers that are available, as described in [AArch32 general-purpose registers, the PC, and the Special-purpose registers on page G1-4327](#).

The AArch32 modes are:

- Monitor mode. This mode always executes at Secure EL3.
- Hyp mode. This mode always executes at Non-secure EL2.
- System, Supervisor, Abort, Undefined, IRQ and FIQ modes. The Exception level these modes execute at depends on the Security state, as described in [Security state on page G1-4315](#).
- User mode. This mode always executes at EL0.

Note

AArch64 state does not support modes. Modes are a concept that is specific to AArch32 state. Modes that execute at a particular Exception level are only implemented if that Exception level supports using AArch32.

For more information on modes see [AArch32 PE mode descriptions on page G1-4322](#).

The mode in use immediately before an exception is taken is described as the mode the exception is *taken from*. The mode that is used on taking the exception is described as the mode the exception is *taken to*.

All of the following define the mode that an exception is taken to:

- The type of exception.
- The mode the exception is taken from.
- Configuration settings defined at EL2 and EL3.

Monitor mode and Hyp mode can create system traps that cause exceptions to EL3 or EL2 respectively. There is an architected hierarchy where EL2 and EL3 configuration settings affect a common condition, for example interrupt routing. When no traps are enabled for a particular condition, the AArch32 mode an exception is taken to is called the *default mode* for that exception.

In AArch32 state, a number of different modes can exist at the same Exception level. All modes at a particular Exception level have the *execution privilege*, meaning they have the same access rights for accesses to memory and to System registers. However, the mapping of PE modes to Exception levels depends on the Security state, as described in [Security state on page G1-4315](#). [Security state, Exception levels, and AArch32 execution privilege on page G1-4318](#) gives more information about the PE modes, their associated execution privilege, and how this maps onto the Exception levels.

G1.5 Instruction Set state

In AArch32 state, the *Instruction Set state* determines the instruction set that the PE is executing. In an implementation that follows the ARM recommendations, the available Instruction Set states are:

T32 state The PE is executing T32 instructions.

A32 state The PE is executing A32 instructions.

———— **Note** —————

In previous versions of the ARM architecture:

- The T32 instruction set was called the Thumb instruction set.
- The A32 instruction set was called the ARM instruction set.

—————
For more information, see [Process state, PSTATE](#) on page E1-2734.

G1.6 Security state

The ARMv8-A architecture provides two Security states, each with an associated physical memory address space, as follows:

Secure state	When in this state, the PE can access both the Secure physical address space and the Non-secure physical address space.
Non-secure state	When in this state, the PE: <ul style="list-style-type: none"> • Can access only the Non-secure physical address space. • Cannot access the Secure system control resources.

For information on how virtual addresses translate onto Secure physical and Non-secure addresses, see [About VMSAv8-32 on page G4-4558](#).

G1.6.1 The ARMv8-A security model

The general principles of the ARMv8-A security model are:

- If the implementation includes EL3 then it has two Security states, Secure and Non-secure, and:
 - EL3 exists only in Secure state.
 - A change from Non-secure state to Secure state can only occur on taking an exception to EL3.
 - A change from Secure state to Non-secure state can only occur on an exception return from EL3.
 - If EL2 is implemented, it exists only in Non-secure state.
- If the implementation does not include EL3 it has one Security state, that is:
 - IMPLEMENTATION DEFINED, if the implementation does not include EL2.
 - Non-secure state if the implementation includes EL2.

The AArch32 security model, and execution privilege

The Exception level hierarchy of four Exception levels, EL0, EL1, EL2, and EL3, applies to execution in both Execution states. This section describes the mapping between Exception levels, AArch32 modes, and execution privilege.

The AArch32 modes Monitor, System, Supervisor, Abort, Undefined, IRQ, and FIQ all have the same execution privilege.

In Secure state:

- Monitor mode executes only at EL3, and is accessible only when EL3 is using AArch32.
- System mode, Supervisor mode, Abort mode, Undefined mode, IRQ mode, and FIQ mode all:
 - Execute at EL1 when EL3 is using AArch64.
 - Execute at EL3 when EL3 is using AArch32.

This means that there is a difference in the Secure state hierarchy that the PE is using, depending on which Execution state EL3 is using:

- If EL3 is using AArch64:
 - There is no support for Monitor mode.
 - If EL1 is using AArch32, System mode, Supervisor mode, Abort mode, Undefined mode, IRQ mode, and FIQ mode execute at Secure EL1.
- If EL3 is using AArch32:
 - Monitor mode is supported, and executes at Secure EL3
 - System mode, Supervisor mode, Abort mode, Undefined mode, IRQ mode, and FIQ mode execute at Secure EL3.
 - There is no support for a Secure EL1 Exception level.

See [Security behavior in Exception levels using AArch32 when EL3 is using AArch64 on page G1-4352](#) for more information about operation in a Secure EL1 mode when EL3 is using AArch64.

In Non-secure state, the PL1 modes System, Supervisor, Abort, Undefined, IRQ, and FIQ always execute at EL1. User mode always executes at EL0 and has the lowest possible execution privilege.

Hyp mode always executes in Non-secure state at EL2 and has higher execution privilege than all of:

- User mode.
- System mode, Supervisor mode, Abort mode, Undefined mode, IRQ mode, and FIQ mode.

[Limited use of Privilege level in ARMv8 AArch32 state on page G1-4319](#) describes how, in some contexts, the concept of *Privilege levels* can be used to represent the execution privilege hierarchy.

For more information about the modes see [About the AArch32 PE modes on page G1-4312](#).

Figure G1-1 shows the security model when EL3 is using AArch32, and shows the expected use of the different Exception levels, and which modes execute at which Exception levels.

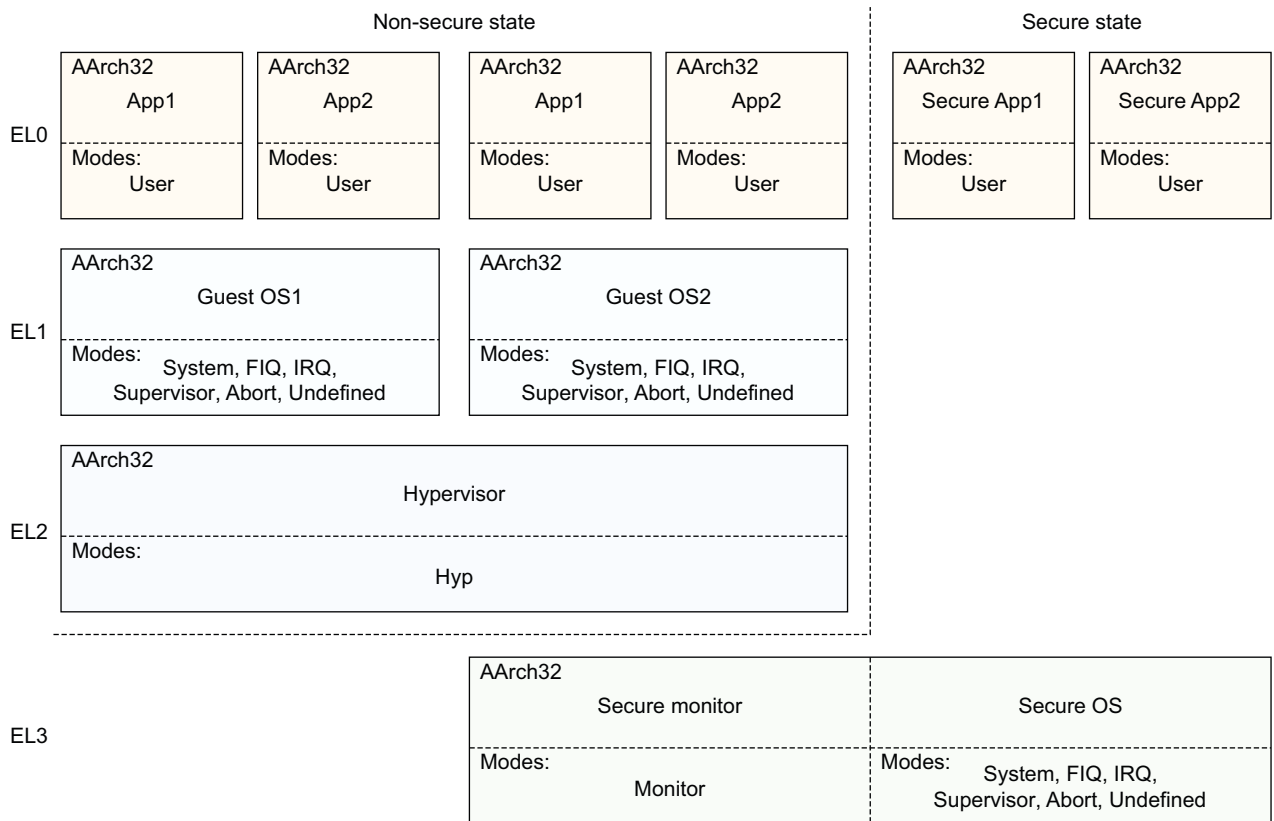

Figure G1-1 ARMv8-A Security model when EL3 is using AArch32

Note

For an overview of the Security models when EL3 is using AArch64:

- See [Figure G1-2 on page G1-4325](#) for the case where EL2, EL1, and EL0 are all using AArch32. This figure shows the implementation of the PE modes.
- See [Figure D1-1 on page D1-1781](#) for an overview of the set of possible implementations.

Figure G1-1 on page G1-4316 shows that when EL3 is using AArch32, the Exception levels and modes available in each Security state are as follows:

Secure state

- EL0** User mode.
- EL3** Any mode that is available in Secure state, other than User mode.

Non-secure state

- EL0** User mode.
- EL1** Any mode that is available in Non-secure state, other than Hyp mode and User mode.
- EL2** Hyp mode.

Execution at EL0 is described as *unprivileged execution*.

A mode associated with a particular Exception level, EL n , is described as an EL n mode.

Note

The Exception level defines the ability to access resources in the current Security state, and does not imply anything about the ability to access resources in the other Security state.

When EL3 is using AArch32, many AArch32 System registers accessible at PL1 are *banked* between the Secure and Non-secure states.

When EL3 is using AArch64 and Secure EL1 is using AArch32, System registers accessible at PL1 are not banked between the Non-secure and Secure states. Software running at EL3 is expected to switch the content of the PL1-accessible System registers between the Secure and Non-secure context, in a similar manner to switching the contents of general purpose registers. For information on the relationship between AArch64 and AArch32 System registers in an interprocessing environment, see [Mapping of the System registers between the Execution states on page D1-1890](#).

For more information on the System registers, see [The AArch32 System register interface on page G1-4408](#).

The *Secure Monitor Call* (SMC) instruction provides software with a system call to EL3. When executing at a privileged Exception level, SMC instructions generates exceptions. For more information, see [Secure Monitor Call \(SMC\) exception on page G1-4382](#) and [SMC on page F5-3429](#).

Note

For more information about the Privilege level terminology, see [Security state, Exception levels, and AArch32 execution privilege on page G1-4318](#).

Changing from Secure state to Non-secure state

Monitor mode is provided to support switching between Secure and Non-secure states. When executing in an Exception level that is using AArch32, except in Monitor mode and Hyp mode, the Security state is controlled:

- By the **SCR.NS** bit, when EL3 is using AArch32.
- By the **SCR_EL3.NS** bit, when EL3 is using AArch64.

The mapping of AArch32 privileged modes to the exception hierarchy means that it is possible when EL3 is using AArch32 to change from EL3 to Non-secure EL1 without an exception return. This can occur in one of the following ways:

- Using an MSR or CPS instruction to switch from Monitor mode to another privileged mode while **SCR.NS** is 1.
- Using an MCR instruction that writes **SCR.NS** to change from Secure to Non-secure state when in a privileged mode other than Monitor mode.

ARM strongly recommends that software executing at EL3 using AArch32 does not use either of these mechanisms to change from EL3 to Non-secure EL1 without an exception return. The use of both of these mechanisms is deprecated.

G1.7 Security state, Exception levels, and AArch32 execution privilege

In ARMv8, the hierarchy of software execution privilege, within a particular Security state, is defined by the Exception levels, with higher Exception level numbers indicating higher privilege. Table G1-1 shows this hierarchy for each Security state.

Table G1-1 Execution privilege and Exception levels, by Security state

Execution privilege	Secure state	Non-secure state	Typical use
Highest	EL3	– ^a	Secure monitor
-	– ^a	EL2	Hypervisor
-	EL1	EL1	Secure or Non-secure OS
Lowest, Unprivileged	EL0	EL0	Secure or Non-secure application

a. EL2 is never implemented in Secure state, and EL3 is never implemented in Non-secure state.

When executing in AArch32 state, within a given Security state, the current PE state, including the execution privilege, is primarily indicated by the current *PE mode*. In Secure state, how the PE modes map onto the Exception levels depends on whether EL3 is using AArch32 or is using AArch64, and:

- Figure G1-1 on page G1-4316 shows this mapping when EL3 is using AArch32.
- Figure G1-2 on page G1-4325 shows this mapping when EL3 is using AArch64.

Table G1-2 shows this mapping. In interpreting this table:

- Monitor mode is implemented only in Secure state, and only if EL3 is using AArch32.
- Hyp mode is implemented only in Non-secure state, and only if EL2 is using AArch32.
- System, FIQ, IRQ, Supervisor, Abort, and Undefined modes are implemented:
 - In Secure state** If either:
 - EL3 is using AArch32.
 - EL3 is using AArch64 and EL1 is using AArch32.
 - In Non-secure state** If EL1 is using AArch32.
- User mode is implemented if EL0 is using AArch32.

Table G1-2 Mapping of AArch32 PE modes to Exception levels

Exception level	PE modes in the given Security state, and EL3 Execution state		
	Secure state, EL3 using AArch32	Secure state, EL3 using AArch64	Non-secure state
EL3	Monitor, System, FIQ, IRQ, Supervisor, Abort, Undefined	-	-
EL2	-	-	Hyp
EL1	-	System, FIQ, IRQ, Supervisor, Abort, Undefined	System, FIQ, IRQ, Supervisor, Abort, Undefined
EL0	User	User	User

Because AArch32 behavior is described in terms of the PE modes, and transitions between PE modes, the Exception levels are implicit in most of the description of operation in AArch32 state.

G1.7.1 Limited use of Privilege level in ARMv8 AArch32 state

As described in *The VMSAv8-32 translation regimes on page G4-4560*, a *translation regime* maps a virtual address (VA) to the corresponding physical address (PA). The VMSAv8-64 translation regimes are defined by the Exception levels that use them. However, because the mapping between PE modes and Exception levels in Secure state depends on whether EL3 is using AArch32 or is using AArch64, as shown in [Table G1-2 on page G1-4318](#), the VMSAv8-32 translation regimes cannot be described simply in terms of either the Exception levels or the PE modes that use them.

To provide a consistent description of address translation as seen from AArch32 state, the VMSAv8-32 translation regimes are described in terms of the *Privilege levels* originally defined in the ARMv7 descriptions of AArch32 state. [Table G1-3](#) shows how the PE modes map to these Privilege levels:

Table G1-3 Mapping of PE modes to AArch32 Privilege levels

Privilege level	Secure state	Non-secure state
PL2	-	Hyp ^a
PL1	Monitor ^b , System, FIQ, IRQ, Supervisor, Abort, Undefined	System, FIQ, IRQ, Supervisor, Abort, Undefined
PL0	User	User

- a. Implemented only in Non-secure state, and only if EL2 is using AArch32
- b. Implemented only in Secure state, and only if EL3 is using AArch32.

Comparing [Table G1-3](#) with [Table G1-2 on page G1-4318](#) shows that:

In Non-secure state

Each privilege level maps to the corresponding Exception level. For example PL1 maps to EL1.

In Secure state

PL0 maps to EL0.

The mapping of PL1 depends on the Execution state being used by EL3, as follows:

EL3 using AArch64 Secure PL1 maps to Secure EL1. Monitor mode is not implemented.

EL3 using AArch32 Secure PL1 maps to Secure EL3. Monitor mode is implemented as one of the Secure PL1 modes.

G1.8 Virtualization

The support for virtualization described in this section applies only to an implementation that includes EL2. A PE is in *Hyp mode* when it is executing at EL2 in the AArch32 state. An exception return from Hyp mode to software running at EL1 or EL0 is performed using the ERET instruction.

EL2 provides a set of features that support virtualizing the Non-secure state of an ARMv8-A implementation. The basic model of a virtualized system involves:

- A hypervisor, running in EL2, that is responsible for switching between *virtual machines*. A virtual machine is comprised of Non-secure EL1 and Non-secure EL0.
- A number of Guest operating systems, that each run in Non-secure EL1, on a virtual machine.
- For each Guest operating system, applications, that usually run in Non-secure EL0, on a virtual machine.

———— **Note** ————

In some systems, a Guest OS is unaware that it is running on a virtual machine, and is unaware of any other Guest OS. In other systems, a hypervisor makes the Guest OS aware of these facts. The ARMv8-A architecture supports both of these models.

The hypervisor assigns a *virtual machine identifier* (VMID) to each virtual machine.

EL2 is implemented only in Non-secure state, to support Guest OS management. EL2 provides controls to:

- Provide virtual values for the contents of a small number of identification registers. A read of one of these registers by a Guest OS or the applications for a Guest OS returns the virtual value.
- *Trap* various operations, including memory management operations and accesses to many other registers. A trapped operation generates an exception that is taken to EL2.
- Route interrupts to the appropriate one of:
 - The current Guest OS.
 - A Guest OS that is not currently running.
 - The hypervisor.

In Non-secure state:

- The implementation provides an independent *translation regime* for memory accesses from EL2.
- For the PL1&0 translation regime, address translation occurs in two stages:
 - Stage 1 maps the *virtual address* (VA) to an *intermediate physical address* (IPA). This is managed at EL1, usually by a Guest OS. The Guest OS believes that the IPA is the *physical address* (PA).
 - Stage 2 maps the IPA to the PA. This is managed at EL2. The Guest OS might be completely unaware of this stage.

For more information on the translation regimes, see [Chapter G4 The AArch32 Virtual Memory System Architecture](#).

G1.8.1 The effect of implementing EL2 on the Exception model

An implementation that includes EL2 implements the following exceptions:

- Hypervisor Call (HVC) exception.
- Traps to EL2. [EL2 configurable controls on page G1-4427](#), describes these.
- All of the virtual interrupts:
 - Virtual SError.
 - Virtual IRQ.
 - Virtual FIQ.

HVC exceptions are always taken to EL2. All virtual interrupts are always taken to EL1, and can only be taken from Non-secure EL1 or EL0.

Each of the virtual interrupts can be independently enabled using controls at EL2.

Each of the virtual interrupts has a corresponding physical interrupt. See [Virtual interrupts](#).

When a virtual interrupt is enabled, its corresponding physical exception is taken to EL2, unless EL3 has configured that physical exception to be taken to EL3. For more information, see [Asynchronous exception behavior for exceptions taken from AArch32 state](#) on page G1-4365.

An implementation that includes EL2 also:

- Provides controls that can be used to route some synchronous exceptions, taken from Non-secure state, to EL2. For more information see:
 - [Routing exceptions from Non-secure EL0 to EL2](#) on page G1-4356.
 - [Routing debug exceptions to EL2 using AArch32](#) on page G1-4358.
- Provides mechanisms to trap PE operations to EL2. See [EL2 configurable controls](#) on page G1-4427.

When an operation is trapped to EL2, the hypervisor typically either:

 - Emulates the required operation. The application running in the Guest OS is unaware of the trap.
 - Returns an error to the Guest OS.

Virtual interrupts

The virtual interrupts have names that correspond to the physical interrupts, as shown in [Table G1-4](#).

Table G1-4 The virtual interrupts

Physical interrupt	Corresponding virtual interrupt
External SError	Virtual SError
IRQ	Virtual IRQ
FIQ	Virtual FIQ

Software executing at EL2 can use virtual interrupts to signal physical interrupts to Non-secure EL1 and Non-secure EL0. [Example G1-1](#) shows a usage model for virtual interrupts.

Example G1-1 Virtual interrupt usage model

A usage model is as follows:

1. Software executing at EL2 routes a physical interrupt to EL2.
2. When a physical interrupt of that type occurs, the exception handler executing in EL2 determines whether the interrupt can be handled in EL2 or requires routing to a Guest OS in EL1. If the interrupt requires routing to a Guest OS:
 - If the Guest OS is currently running, the hypervisor uses the appropriate virtual interrupt type to signal the physical interrupt to the Guest OS.
 - If the Guest OS is not currently running, the physical interrupt is marked as pending for the guest OS. When the hypervisor next switches to the virtual machine that is running that Guest OS, the hypervisor uses the appropriate virtual interrupt type to signal the physical interrupt to the Guest OS.

Non-secure EL1 and Non-secure EL0 modes cannot distinguish a virtual interrupt from the corresponding physical interrupt.

For more information see [Virtual exceptions when an implementation includes EL2](#) on page G1-4365.

G1.9 AArch32 PE modes, and general-purpose and Special-purpose registers

The following sections describe the AArch32 PE modes and the general-purpose registers and the PC:

- [AArch32 PE mode descriptions](#).
- [AArch32 general-purpose registers, the PC, and the Special-purpose registers on page G1-4327](#).
- [Saved Program Status Registers \(SPSRs\) on page G1-4329](#).
- [ELR_hyp on page G1-4331](#).

———— **Note** —————

The PC is included in the scope of this section because, in AArch32 state, it is defined as being part of the same register file as the general-purpose registers. That is, the AArch32 register file R0-R15 comprises:

- The general-purpose registers R0-R14.
- The PC, that can be described as R15.

G1.9.1 AArch32 PE mode descriptions

Table G1-5 shows the PE modes defined by the ARM architecture, for execution in AArch32 state. In this table:

- The *PE mode* column gives the name of each mode and the abbreviation used, for example, in the general-purpose register name suffixes used in [AArch32 general-purpose registers, the PC, and the Special-purpose registers on page G1-4327](#).
- The *Encoding* column gives the corresponding PSTATE.M field.
- The *Exception level* column gives the Exception level at which the mode is implemented, including dependencies on the current Security state and on whether EL3 is using AArch32, see [Exception levels on page G1-4309](#).

Table G1-5 AArch32 PE modes

PE mode	Encoding	Security state	Exception level	Implemented
User	usr 10000	Both	EL0	Always
FIQ	fiq 10001	Non-secure Secure	EL1 EL1 or EL3 ^a	Always
IRQ	irq 10010	Non-secure Secure	EL1 EL1 or EL3 ^a	Always
Supervisor	svc 10011	Non-secure Secure	EL1 EL1 or EL3 ^a	Always
Monitor	mon 10110	Secure	EL3	If EL3 implemented and using AArch32
Abort	abc 10111	Non-secure Secure	EL1 EL1 or EL3 ^a	Always
Hyp	hyp 11010	Non-secure	EL2	If EL2 implemented and using AArch32
Undefined	und 11011	Non-secure Secure	EL1 EL1 or EL3 ^a	Always
System	sys 11111	Non-secure Secure	EL1 EL1 or EL3 ^a	Always

a. EL3 if EL3 is using AArch32. EL1 if EL3 is using AArch64 and EL1 is using AArch32.

Mode changes can be made under software control, or can be caused by an external or internal exception.

Notes on the AArch32 PE modes

PE modes are defined only in AArch32 state. Because each mode is implemented as part of a particular Exception level that is using AArch32, the set of available modes depends on which Exception levels are implemented and using AArch32, as described in [Effect of the EL3 Execution state on the PE modes and Exception levels on page G1-4325](#).

This section gives more information about each of the modes, when it is implemented.

User mode Software executing in User mode executes at EL0. Execution in User mode is sometimes described as unprivileged execution. Application programs normally execute in User mode, and any program executed in User mode:

- Makes only unprivileged accesses to system resources, meaning it cannot access protected system resources.
- Makes only unprivileged access to memory.
- Cannot change mode except by causing an exception, see [Handling exceptions that are taken to an Exception level using AArch32 on page G1-4340](#).

System mode System mode is implemented at EL1 or EL3, see [Effect of the EL3 Execution state on the PE modes and Exception levels on page G1-4325](#).

System mode has the same registers available as User mode, and is not entered by any exception.

Supervisor mode

Supervisor mode is implemented at EL1 or EL3, see [Effect of the EL3 Execution state on the PE modes and Exception levels on page G1-4325](#).

Supervisor mode is the default mode to which a Supervisor Call exception is taken. Executing a SVC (Supervisor Call) instruction generates a Supervisor Call exception.

In an implementation where the highest implemented Exception level is using AArch32, if that Exception level is EL3 or EL1, a PE enters Supervisor mode on Reset.

Abort mode Abort mode is implemented at EL1 or EL3, see [Effect of the EL3 Execution state on the PE modes and Exception levels on page G1-4325](#).

Abort mode is the default mode to which a Data Abort exception or Prefetch Abort exception is taken.

Undefined mode

Undefined mode is implemented at EL1 or EL3, see [Effect of the EL3 Execution state on the PE modes and Exception levels on page G1-4325](#).

Undefined mode is the default mode to which an instruction-related exception, including any attempt to execute an UNDEFINED instruction, is taken.

FIQ mode FIQ mode is implemented at EL1 or EL3, see [Effect of the EL3 Execution state on the PE modes and Exception levels on page G1-4325](#).

FIQ mode is the default mode to which an FIQ interrupt is taken.

IRQ mode IRQ mode is implemented at EL1 or EL3, see [Effect of the EL3 Execution state on the PE modes and Exception levels on page G1-4325](#).

IRQ mode is the default mode to which an IRQ interrupt is taken.

Hyp mode Hyp mode is the Non-secure EL2 mode.

Hyp mode is entered on taking an exception from Non-secure state that must be taken to EL2.

In an implementation where the highest implemented Exception level is EL2 and EL2 uses AArch32 on reset, a PE enters Hyp mode on Reset.

The Hypervisor Call exception and Hyp Trap exception are implemented as part of EL2 and are always taken to Hyp mode.

———— **Note** —————

This means that Hypervisor Call and Hyp Trap exceptions cannot be taken from Secure state.

When the value of the Hypervisor Call enable bit, [SCR.HCE](#), is 1, executing an HVC (Hypervisor Call) instruction in a Non-secure EL1 mode generates a Hypervisor Call exception.

For more information, see [Hyp mode on page G1-4326](#).

Monitor mode

Monitor mode is the Secure EL3 mode. This means it is always in the Secure state, regardless of the value of the [SCR.NS](#) bit.

Monitor mode is the mode to which a Secure Monitor Call exception is taken. In a Non-secure EL1 mode, or a Secure EL3 mode, executing an SMC (Secure Monitor Call) instruction generates a Secure Monitor Call exception.

When EL3 is using AArch32, some exceptions that are taken to a different mode by default can be configured to be taken to EL3, see [PE mode for taking exceptions on page G1-4350](#).

When EL3 is using AArch32, software executing in Monitor mode:

- Has access to both the Secure and Non-secure copies of System registers.
- Can perform an exception return to Secure state, or to Non-secure state.

This means that, when EL3 is using AArch32, Monitor mode provides the only recommended method of changing between the Secure and Non-secure Security states.

Secure and Non-secure modes

In an implementation that includes EL3, the names of most implemented modes can be qualified as Secure or Non-secure, to indicate whether the PE is also in Secure state or Non-secure state. For example:

- If a PE is in Supervisor mode and Secure state, it is in *Secure Supervisor mode*.
- If a PE is in User mode and Non-secure state, it is in *Non-secure User mode*.

———— **Note** —————

As indicated in the appropriate Mode descriptions:

- Monitor mode is a Secure mode, meaning it is always in the Secure state.
- Hyp mode is a Non-secure mode, meaning it is accessible only in Non-secure state.

Effect of the EL3 Execution state on the PE modes and Exception levels

Figure G1-1 on page G1-4316 shows the PE modes, Exception levels, and Security states, for an implementation that includes all of the Exception levels, when EL3 is using AArch32. Figure G1-2 shows how the implemented modes change when EL3 is using AArch64.

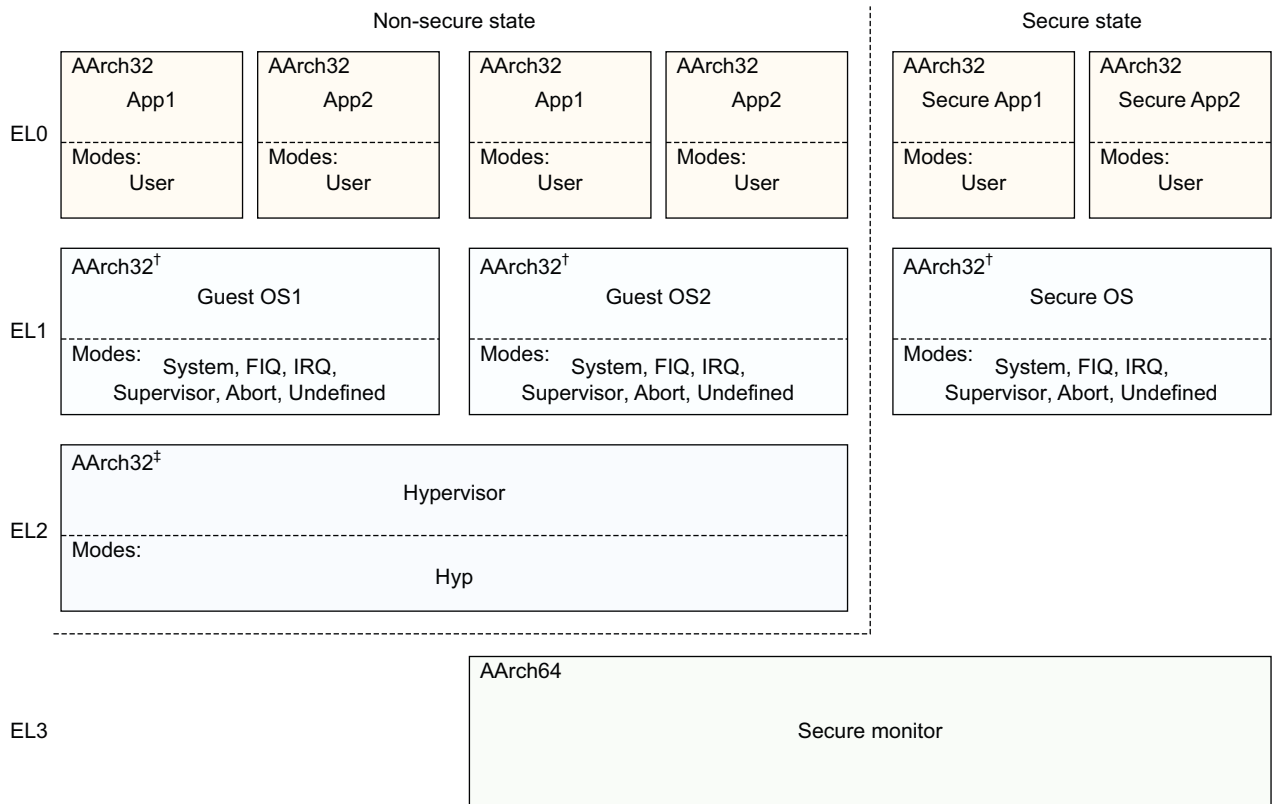

† When EL1 is using AArch64, System, FIQ, IRQ, Supervisor, Abort, and Undefined modes are not implemented

‡ When EL2 is using AArch64, Hyp mode is not implemented

Figure G1-2 ARMv8 Exception levels, and PE modes, when EL3 is using AArch64

Comparing Figure G1-1 on page G1-4316 and Figure G1-2 shows how, in Secure state only, the implementation of System, FIQ, IRQ, Supervisor, Abort, and Undefined mode depends on the Execution state that EL3 is using. That is, these modes are implemented as follows:

Non-secure state

If Non-secure EL1 is using AArch32 then System, FIQ, IRQ, Supervisor, Abort, and Undefined modes are implemented as part of EL1. Otherwise, these modes are not implemented in Non-secure state.

Secure state The implementation of these modes depends on the Execution state that EL3 is using, as follows:

EL3 using AArch64 If Secure EL1 is using AArch32 then System, FIQ, IRQ, Supervisor, Abort, and Undefined modes are implemented as part of EL1. Otherwise, these modes are not implemented in Secure state.

EL3 using AArch32 In Secure state, System, FIQ, IRQ, Supervisor, Abort, and Undefined modes are implemented as part of EL3, see Figure G1-1 on page G1-4316.

Hyp mode

Hyp mode is the Non-secure EL2 mode. When EL2 is using AArch32, it provides the usual method of controlling the virtualization of Non-secure execution at EL1 and EL0.

Note

The alternative method of controlling this functionality is by accessing the EL2 controls from EL3 with the [SCR_EL3.NS](#) or [SCR.NS](#) bit set to 1.

This section summarizes how Hyp mode differs from the other modes, and references where this part of the manual describes the features of Hyp mode in more detail:

- Software executing in Hyp mode executes at EL2, see [Figure G1-1 on page G1-4316](#).
- Hyp mode is accessible only in Non-secure state. In Secure state, an attempt by a CPS or an MSR instruction to change [PSTATE.M](#) to Hyp mode is an illegal change to [PSTATE.M](#), as described in [Illegal changes to PSTATE.M on page G1-4336](#).
- In Non-debug state, the only mechanisms for changing to Hyp mode are:
 - An exception taken from a Non-secure EL1 or EL0 mode.
 - When EL3 is using AArch32, an exception return from Secure Monitor mode.
 - When EL3 is using AArch64, an exception return from EL3.
- In Hyp mode, the only exception return is execution of an ERET instruction, see [ERET on page F5-3117](#).
- In Hyp mode, the [CPACR](#) has no effect on the execution of;
 - System register access instructions.
 - Advanced SIMD and floating-point instructions.The [HCPTR](#) controls execution of these instructions in Hyp mode.
- If software running in Hyp mode executes an SVC instruction, the Supervisor Call exception generated by the instruction is taken to Hyp mode, see [SVC on page F5-3575](#).
- An exception return with restored [PSTATE](#) specifying Hyp mode is an *illegal return event*, as described in [Illegal return events from AArch32 state on page G1-4361](#), if any of the following applies:
 - EL3 is using AArch64 and the value of [SCR_EL3.NS](#) is 0.
 - EL3 is using AArch32 and the value of [SCR.NS](#) is 0.
 - The return is from a Non-secure EL1 mode.
- The instructions described in the following sections are UNDEFINED if executed in Hyp mode:
 - SRS. See [SRS, SRSDA, SRSDDB, SRSIA, SRSIB on page F5-3464](#).
 - RFE. See [RFE, RFEDA, RFEDB, RFEIA, RFEIB on page F5-3363](#).
 - [LDM \(exception return\) on page F5-3148](#).
 - [LDM \(User registers\) on page F5-3150](#).
 - [STM \(User registers\) on page F5-3499](#).
 - The SUBS PC, LR forms of the instructions described in [SUB, SUBS \(immediate\) on page F5-3560](#).

Note

In T32 state, ERET is encoded as SUBS PC, LR, #0, and therefore this is a valid instruction.

- The exception return form of the instructions described in [MOV, MOVS \(register\) on page F5-3260](#).

In addition, deprecated forms of the A32 ADCS, ADDS, ANDS, BICS, EORS, MOVS, MVNS, ORRS, RSBS, RSCS, SBCS, and SUBS instructions with the PC as the destination register are UNDEFINED if executed in Hyp mode. The instruction descriptions identify these UNDEFINED cases.

- The Load unprivileged and Store unprivileged instructions LDRT, LDRSHT, LDRHT, LDRBT, STRT, STRHT, and STRBT, are CONSTRAINED UNPREDICTABLE if executed in Hyp mode, see *Execution of Load/Store unprivileged instructions in Hyp mode on page K1-6115*.

In an implementation that includes EL3, from reset, the HVC instruction is UNDEFINED in Non-secure EL1 modes, meaning entry to Hyp mode is disabled by default. To permit entry to Hyp mode using the Hypervisor Call exception, Secure software must enable use of the HVC instruction:

- By setting the `SCR_EL3.HCE` bit to 1, if EL3 is using AArch64.
- By setting the `SCR.HCE` bit to 1, if EL3 is using AArch32.

When the HVC instruction is UNDEFINED in Non-secure EL1 modes because of the value of the `SCR_EL3.HCE` or `SCR.HCE` bit, HVC is CONSTRAINED UNPREDICTABLE in Hyp mode.

Pseudocode description of mode operations

The `BadMode()` function tests whether a 5-bit mode number corresponds to one of the permitted modes.

The `BadMode()` function is defined in [Chapter J1 ARMv8 Pseudocode](#).

G1.9.2 AArch32 general-purpose registers, the PC, and the Special-purpose registers

The general-purpose registers, and the PC, in AArch32 state on page E1-2731 describes the application level view of the general-purpose registers, and the PC. This view provides:

- The general-purpose registers R0-R14, of which:
 - The preferred name for R13 is SP (*stack pointer*).
 - The preferred name for R14 is LR (*link register*).
- The PC (*program counter*), that can be described as R15.

These registers are selected from a larger set of registers, that includes *Banked* copies of some registers, with the current register selected by the execution mode. The implementation and banking of the general-purpose registers depends on whether or not the implementation includes EL2 and EL3, and whether those Exception levels are using AArch32. [Figure G1-3 on page G1-4328](#) shows the full set of Banked general-purpose registers, and the Special-purpose registers:

- The Program Status Registers `CPSR` and `SPSR`.
- `ELR_hyp`.

———— Note —————

The architecture uses system level register names, such as `R0_usr`, `R8_usr`, and `R8_fiq`, when it must identify a specific register. The application level names refer to the registers for the current mode, and usually are sufficient to identify a register.

Application level view		System level view							
	User	System	Hyp [†]	Supervisor	Abort	Undefined	Monitor [‡]	IRQ	FIQ
R0	R0_usr								
R1	R1_usr								
R2	R2_usr								
R3	R3_usr								
R4	R4_usr								
R5	R5_usr								
R6	R6_usr								
R7	R7_usr								
R8	R8_usr								R8_fiq
R9	R9_usr								R9_fiq
R10	R10_usr								R10_fiq
R11	R11_usr								R11_fiq
R12	R12_usr								R12_fiq
SP	SP_usr		SP_hyp	SP_svc	SP_abt	SP_und	SP_mon	SP_irq	SP_fiq
LR	LR_usr			LR_svc	LR_abt	LR_und	LR_mon	LR_irq	LR_fiq
PC	PC								
APSR	CPSR								
			SPSR_hyp	SPSR_svc	SPSR_abt	SPSR_und	SPSR_mon	SPSR_irq	SPSR_fiq
			ELR_hyp						

‡ Part of EL3. Exists only in Secure state, and only when EL3 is using AArch32.

† Part of EL2. Exists only in Non-secure state, and only when EL2 is using AArch32.

Cells with no entry indicate that the User mode register is used.

Figure G1-3 AArch32 general-purpose registers, PC, and Special-purpose registers, showing banking

As described in *PE mode for taking exceptions* on page G1-4350, on taking an exception the PE changes mode, unless it is already in the mode to which it must take the exception. Each mode that the PE might enter in this way has:

- A Banked copy of the stack pointer, for example SP_irq and SP_hyp.
- A register that holds a preferred return address for the exception. This is:
 - For the EL2 mode, Hyp mode, the Special-purpose register [ELR_hyp](#).
 - For the other privileged modes to which exceptions can be taken, a Banked copy of the link register, for example LR_und and LR_mon.
- A saved copy of **PSTATE**, made on exception entry, for example SPSR_irq and SPSR_hyp.

In addition FIQ mode has Banked copies of the general-purpose registers R8 to R12.

User mode and System mode share the same general-purpose registers.

User mode, System mode, and Hyp mode share the same LR.

For more information about the application level view of the SP, LR, and PC, and the alternative descriptions of them as R13, R14 and R15, see *The general-purpose registers, and the PC, in AArch32 state* on page E1-2731.

AArch32 Special-purpose registers

In AArch32 state, the Special-purpose registers are:

- The [CPSR](#) and its view as the [APSR](#).
- The [SPSR](#), including the banked copies [SPSR_abt](#), [SPSR_fiq](#), [SPSR_hyp](#), [SPSR_irq](#), [SPSR_mon](#), [SPSR_svc](#), and [SPSR_und](#).
- The [ELR_hyp](#).

Pseudocode description of general-purpose register and PC operations

The following pseudocode gives access to the general-purpose registers and the PC. These registers are an array, `_R[]`, indexed by parameter `n`. This array is common to AArch32 and AArch64 operation and therefore contains 31 64-bit registers. `_PC` is the program counter, and its definition is common to AArch32 and AArch64 operation and therefore its size is 64-bit.

`LookUpRIndex()` looks up the index value, `n`, for the specified register number and PE mode, using `RBankSelect()` to evaluate the result.

`R[]` accesses the specified general-purpose register in the current PE mode, using `Rmode[]` to access the register, accessing `_R[]` if necessary. `SP` accesses the stack pointer, `LR` accesses the link register, and `PC` accesses the program counter. Each function has a non-assignment form for register reads and an assignment form for register writes, other than `PC`, which has only a non-assignment form.

`BranchTo()` performs a branch to the specified address.

The `_R[]`, `_PC`, `LR`, `SP`, `LookUpRIndex()`, `RBankSelect()`, `Rmode[]`, and `BranchTo()` functions are defined in [Chapter J1 ARMv8 Pseudocode](#).

G1.9.3 Saved Program Status Registers (SPSRs)

The Saved Program Status Registers (SPSRs) are used to save PE state on taking exceptions. In AArch32 state, there is an SPSR for every mode that an exception can be taken to, as shown in [Figure G1-3 on page G1-4328](#). For example, the SPSR for Monitor mode is called `SPSR_mon`.

———— Note ————

Exceptions cannot be taken to EL0.

When the PE takes an exception, PE state is saved from `PSTATE` in the SPSR for the mode the exception is taken to. For example, if the PE takes an exception to Monitor mode, PE state is saved in `SPSR_mon`. For more information on `PSTATE`, see [Process state, PSTATE on page G1-4332](#).

———— Note ————

All `PSTATE` fields are saved, including those which have no direct read and write access.

Saving the `PSTATE` fields means the exception handler can:

- On return from the exception, restore the PE state to the values it had immediately before the exception was taken. When the PE returns from an exception, PE state is restored to the state stored in the SPSR of the mode the exception is returning from, if the exception return is made using one of:
 - `ERET`.
 - `LDM`.
 - The Exception return form of the instruction described in [MOV, MOVS \(register\) on page F5-3260](#).
 - The Exception return form of the instruction described in [SUB, SUBS \(immediate\) on page F5-3560](#).For example, on returning from Monitor mode, PE state is restored to the state stored in `SPSR_mon`. If the exception return is made using the `RFE` instruction, the PE restores the PE state from an SPSR valued read from memory.
- Examine the value that `PSTATE` had when the exception was taken, for example to determine the instruction set state and privilege level in which the instruction that caused an Undefined Instruction exception was executed.

The SPSRs are UNKNOWN on reset. Any operation in a Non-secure EL1 or EL0 mode makes `SPSR_hyp` UNKNOWN.

SPSR format for exceptions taken to AArch32 state

The SPSR bit assignments are:

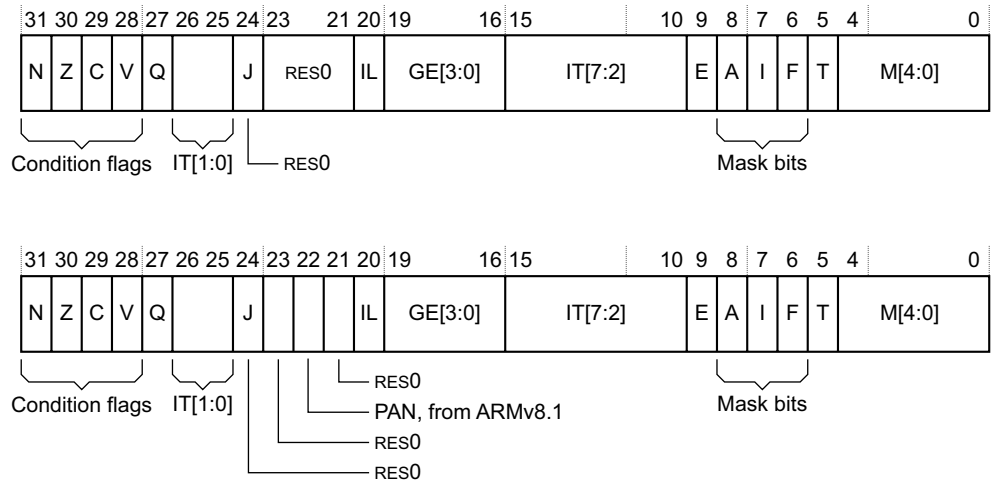

N, Z, C, V, Q, GE[3:0], bits[31:27, 19:16]

Shows the value of the **PSTATE**. {N, Z, C, V, Q, GE} flags immediately before the exception was taken.

IT[1:0], J, IL, IT[7:2], E, T, bits[26:24, 20, 15:9, 5]

Shows the values of the **PSTATE**. {IT[7:0], J, IL, E, T} PE state controls immediately before the exception was taken. The J bit is RES0.

Bit[23] Reserved, RES0.

Bit[22] In ARMv8.0, RES0.

In ARMv8.1, PAN. Shows the value of the **PSTATE**.PAN state bit immediately before the exception was taken.

Bit[21] Reserved, RES0.

A, I, F, M, bits[8:6, 4:0]

Shows the values of the **PSTATE**. {A, I, F} exception mask and **PSTATE**.M mode bits immediately before the exception was taken.

SPSR bits that are defined as RES0 on an exception taken from AArch32 state are ignored on any exception return to AArch32 state.

Pseudocode description of SPSR operations

The following pseudocode gives access to the SPSRs.

The `SPSR[]` function accesses the current SPSR and is common to AArch32 and AArch64 operation.

The `SPSRWriteByInstr()` function is used by the `MSR (register)` and `MSR (immediate)` instructions to update the current SPSR.

The `SPSR[]` and `SPSRWriteByInstr()` functions are defined in [Chapter J1 ARMv8 Pseudocode](#).

G1.9.4 ELR_hyp

Hyp mode does not provide its own Banked copy of LR. Instead, on taking an exception to Hyp mode, the preferred return address is stored in ELR_hyp, a 32-bit Special-purpose register implemented for this purpose.

ELR_hyp can be accessed explicitly only by executing:

- An MRS or MSR instruction that targets ELR_hyp, see:
 - [MRS \(Banked register\) on page F5-3277](#).
 - [MSR \(Banked register\) on page F5-3281](#).

The ERET instruction uses the value in ELR_hyp as the return address for the exception. For more information, see [ERET on page F5-3117](#).

Software execution in any Non-secure EL1 or EL0 mode makes ELR_hyp UNKNOWN.

G1.10 Process state, PSTATE

In the ARMv8-A architecture, Process state or PSTATE is an abstraction of process state information. All of the instruction sets provide instructions that operate on elements of PSTATE.

PSTATE includes all of the following:

- Fields that are meaningful only in AArch32 state.
- Fields that are meaningful only in AArch64 state.
- Fields that are meaningful in both Execution states.

PSTATE is defined in pseudocode as the PSTATE structure, of type `ProcState`. `ProcState` is defined in [Chapter J1 ARMv8 Pseudocode](#).

The PSTATE fields that are meaningful in AArch32 state are:

The Condition flags

N	Negative Condition flag.
Z	Zero Condition flag.
C	Carry Condition flag.
V	Overflow Condition flag.

[Process state, PSTATE on page E1-2734](#) gives more information about these.

The overflow or saturation flag

Q	See Process state, PSTATE on page E1-2734 .
----------	---

The greater than or equal flags

GE[3:0]	See Process state, PSTATE on page E1-2734 .
----------------	---

The PE state controls

J, T	Instruction set state. See Process state, PSTATE on page E1-2734 . J is RES0. On a reset to AArch32 state, T is set to an IMPLEMENTATION DEFINED value. On taking an exception to: <ul style="list-style-type: none">• A PL1 mode using AArch32, T is set to <code>SCTLR.TE</code>.• EL2 using AArch32, T is set to <code>HSCTLR.TE</code>.
IT[7:0]	IT block state bits. See Process state, PSTATE on page E1-2734 . On a reset or taking an exception to AArch32 state, these bits are set to 0.
E	Endianness of data accesses. See Process state, PSTATE on page E1-2734 . If an implementation provides both Big-endian and Little-endian support, then: <ul style="list-style-type: none">• On a reset to AArch32 state this bit is set to the IMPLEMENTATION DEFINED reset value of:<ul style="list-style-type: none">— <code>SCTLR.EE</code> if the highest implemented Exception level is not EL2.— <code>HSCTLR.EE</code> if the highest implemented Exception level is EL2.• On taking an exception to:<ul style="list-style-type: none">— A PL1 mode using AArch32, this bit is set to <code>SCTLR.EE</code>.— EL2 using AArch32, this bit is set to <code>HSCTLR.EE</code>.
IL	Illegal Execution state bit. See The Illegal Execution state exception on page G1-4363 . On a reset or taking an exception to AArch32 state, this bit is set to 0.

For information on how the J, T, IT[7:0], E, and IL fields can be accessed, see [Accessing the PE state controls and the Execution state bit on page G1-4335](#).

The asynchronous exception mask bits

A	SError interrupt mask bit.
I	IRQ interrupt mask bit.
F	FIQ interrupt mask bit.

For each bit, the values are:

- 0** Exception not masked.
- 1** Exception masked.

On a reset to AArch32 state, these bits are set to 1.

On taking an exception to AArch32 state, one or more of these bits are set to 1.

For more information, see both:

- [Asynchronous exception masking controls on page G1-4368.](#)
- [PE state on exception entry on page G1-4354.](#)

The mode bits

M[4:0] Current mode of the PE. [Table G1-5 on page G1-4322](#) lists the permitted values of this field. All other values are reserved. [Illegal changes to PSTATE.M on page G1-4336](#) describes the effect of setting M[4:0] to a reserved value.

M[4] is:

M[4], Execution state

The current Execution state:

- 0** AArch64 state.
- 1** AArch32 state.

———— Note ————

This is consistent with the use of M[4:0] in previous versions of the architecture.

On a reset to AArch32 state, M[4:0] is set to:

- **0b10011**, meaning Supervisor mode, if the highest implemented Exception level is not EL2.
- **0b11010**, meaning Hyp mode, if the highest implemented Exception level is EL2.

On taking an exception to AArch32 state, M[4:0] is set to the target mode for the exception type.

For more information about the PE modes, see:

- [AArch32 PE mode descriptions on page G1-4322.](#)
- [PE state on exception entry on page G1-4354.](#)

Access control bits, from ARMv8.1

PAN *Privileged Access Never* (PAN) state bit, see [About the PAN bit on page G4-4608.](#)

G1.10.1 Accessing PSTATE fields

The PSTATE fields can be accessed as described in the following subsections:

- [The Current Program Status Register, CPSR on page G1-4334.](#)
- [Accessing the PE state controls and the Execution state bit on page G1-4335.](#)
- [The CPS instruction on page G1-4335.](#)
- [The SETEND instruction on page G1-4336.](#)
- [The SETPAN instruction on page G1-4336.](#)

The Current Program Status Register, CPSR

Some **PSTATE** fields can be accessed using the Special-purpose *Current Program Status Register* (CPSR). The CPSR can be directly read using the **MRS** instruction, and directly written using the **MSR (register)** and **MSR (immediate)** instructions.

The CPSR bit assignments are:

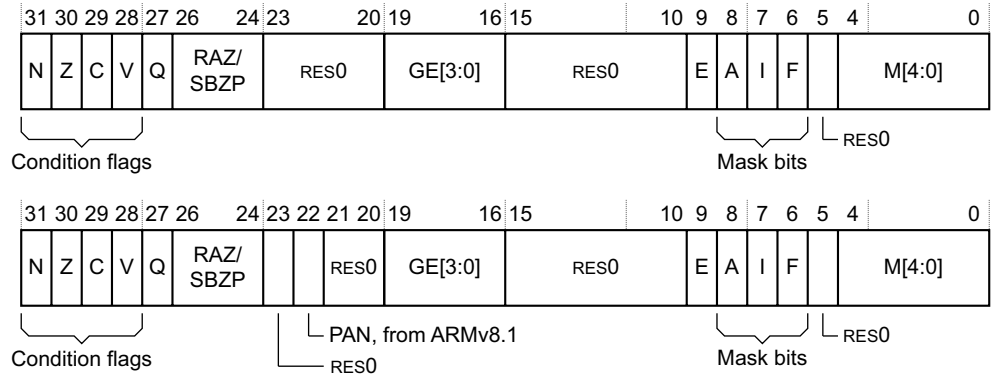

N, Z, C, V, bits [31:28]

The **PSTATE** Condition flags.

Q, bit [27] The **PSTATE** overflow or saturation flag.

Bits[26:24] Reserved, RAZ/SBZP. Software can use MSR instructions that write the top byte of the CPSR without using a read-modify-write sequence. If it does this, it must write zeros to bits[26:24].

Bits[23, 21:20, 15:10, 5]

Reserved, RES0.

Bit[22] In ARMv8.0, Reserved, RES0.

In ARMv8.1, *Privileged Access Never* (PAN) state bit, see [About the PAN bit on page G4-4608](#).

GE[3:0], bits [19:16]

The **PSTATE** greater than or equal flags.

E, bit [9] The **PSTATE** endianness bit.

A, I, F, bits [8:6]

The **PSTATE** asynchronous exception mask bits.

M[4:0], bits [4:0]

The **PSTATE** mode bits.

The other **PSTATE** fields cannot be accessed by using the CPSR. For information on how to access them, see [Accessing the PE state controls and the Execution state bit on page G1-4335](#).

The application level alias for the CPSR is the **APSR**. The **APSR** is a subset of the CPSR. See [The Application Program Status Register, APSR on page E1-2736](#).

Writes to the CPSR have side-effects on various aspects of PE operation. All of these side-effects, except side-effects on memory accesses associated with fetching instructions, are synchronous to the CPSR write. This means that they are guaranteed:

- Not to be visible to earlier instructions in the execution stream.
- To be visible to later instructions in the execution stream.

The privilege level and address space of memory accesses associated with fetching instructions depend on the current Exception level and Security state. Writes to `PSTATE.M` can change one or both of the Exception level and Security state. The effect, on memory accesses associated with fetching instructions, of a change of Exception level or Security state is:

- Synchronous to the change of Exception level or Security state, if that change is caused by an exception entry or exception return.
- Guaranteed not to be visible to any memory access caused by fetching an earlier instruction in the execution stream.
- Guaranteed to be visible to any memory access caused by fetching any instruction after the next *Context synchronization event* in the execution stream.
- Might or might not affect memory accesses caused by fetching instructions between the mode change instruction and the point where the mode change is guaranteed to be visible.

See *Exception return to an Exception level using AArch32* on page G1-4360 for the definition of exception return instructions.

Accessing the PE state controls and the Execution state bit

The PE state controls are the `PSTATE.{IL, IT[7:0], J, E, T}` fields. Software can read or write these in an `SPSR`.

In the `CPSR`:

- The PE state controls, other than `PSTATE.E`, are RAZ when read by an `MRS` instruction.
- Writes to the PE state controls, other than `PSTATE.E`, by `MSR (register)` or `MSR (immediate)`, are ignored in all modes.

Instructions other than `MRS`, `MSR (register)`, or `MSR (immediate)` that access the PE state controls can read and write them in any mode.

Unlike the other `PSTATE` PE state controls, `PSTATE.E` can be read by an `MRS` instruction and might be written by `MSR (register)` or `MSR (immediate)`. However, ARM deprecates `PSTATE.E` having a different value from the equivalent System register EE bit, see *Mixed-endian support* on page G3-4524.

————— Note —————

To determine the current endianness, software can use an `LDR` instruction to load a word from memory with a known value that differs if the endianness is reversed. For example, using an `LDR` instruction to load a word whose four bytes are `0x01`, `0x00`, `0x00`, and `0x00` in ascending order of memory address loads the destination register with:

- `0x00000001` if the current endianness is little-endian.
- `0x01000000` if the current endianness is big-endian.

The `PSTATE.M[4]` bit is the Execution state bit. When read by an `MRS` instruction in AArch32 state, this bit always reads as 1. When written by an `MSR (register)` instruction or `MSR (immediate)` instruction, writing a value other than 1 is an illegal change to the `PSTATE.M` field. See *Illegal changes to PSTATE.M* on page G1-4336.

The CPS instruction

The A32 and T32 instruction sets both include an instruction to manipulate `PSTATE.{A, I, F}` and `PSTATE.M`:

`CPSIE <i>flags</i> {, #<mode>}`
 Sets the specified `PSTATE.{A, I, F}` exception masks to 0, enabling the exception, and optionally changes to the specified mode.

`CPSID <i>flags</i> {, #<mode>}`
 Sets the specified `PSTATE.{A, I, F}` exception masks to 1, disabling the exception, and optionally changes to the specified mode.

`CPS #<mode>` Changes to the specified mode without affecting the `PSTATE.{A, I, F}` exception masks.

The CPS instruction is unconditional. For more information, see [CPS](#), [CPSID](#), [CPSIE](#) on page F5-3089.

The SETEND instruction

The A32 and T32 instruction sets both include an instruction to manipulate [PSTATE.E](#):

- SETEND BE Sets [PSTATE.E](#) to 1, for big-endian operation.
- SETEND LE Sets [PSTATE.E](#) to 0, for little-endian operation.

The SETEND instruction is unconditional. For more information, see [SETEND](#) on page F5-3411. ARM deprecates use of the SETEND instruction.

The SETPAN instruction

[ARMv8.1-PAN](#) adds the SETPAN instruction to the A32 and T32 instruction sets, to manipulate [PSTATE.PAN](#):

- SETPAN #0 Sets [PSTATE.PAN](#) to 0, disabling Privileged access-never operation.
- SETPAN #1 Sets [PSTATE.PAN](#) to 1, enabling Privileged access-never operation.

The SETPAN instruction is unconditional.

For more information see:

- [SETPAN](#) on page F5-3412.
- [About the PAN bit](#) on page G4-4608.

G1.10.2 The Saved Program Status Registers (SPSRs)

On taking an exception, [PSTATE](#) is preserved in the SPSR of the mode to which the exception is taken. The SPSRs are described in [Saved Program Status Registers \(SPSRs\)](#) on page G1-4329.

G1.10.3 Illegal changes to PSTATE.M

In AArch32 PE modes other than User mode, MSR and CPS instructions can explicitly change [PSTATE.M](#). The following changes to [PSTATE.M](#) by MSR or CPS instructions are illegal:

- A change to an encoding that [Table G1-5](#) on page G1-4322 does not show.
- A change to a mode that is not implemented.
- A change to a mode that is not accessible from the context the MRS or CPS instruction is executed in, as follows:
 - A change to a mode that would cause entry to a higher Exception level.
 - When executing in Non-secure state, a change to Monitor mode.
 - When executing in Secure EL1, a change to Monitor mode when EL3 is using AArch64.
 - A change to Hyp mode from any other mode.
 - A change from Hyp mode to any other mode.
 - When the value of [HCR.TGE](#) is 1, attempting to change from Monitor mode to a Non-secure PL1 mode, see [Trapping of general exceptions to Hyp mode](#) on page K1-6116.

On executing an instruction that attempts an illegal change to [PSTATE.M](#):

- [PSTATE.M](#) is unchanged, and the current mode remains unchanged.
- [PSTATE.IL](#) is set to 1.
- All other [PSTATE](#) fields are written to as normal.

———— Note —————

For the [PSTATE](#) fields that MSR and CPS instructions update, see the instruction descriptions:

- [MSR \(register\)](#) on page F5-3287.
- [MSR \(immediate\)](#) on page F5-3285.

- [CPS, CPSID, CPSIE on page F5-3089.](#)
-

When the value of [PSTATE.IL](#) is 1, any attempt to execute any instruction results in an Illegal Execution state exception. See [The Illegal Execution state exception on page G1-4363.](#)

———— **Note** —————

- The PE ignores writes to [PSTATE.M](#) when executing at PL0.
 - In ARMv7, an instruction that attempts to make an illegal change to [PSTATE.M](#) is UNPREDICTABLE.
-

G1.10.4 Pseudocode description of PSTATE operations

The [CPSRWriteByInstr\(\)](#) function is used by the [MSR \(register\)](#) and [MSR \(immediate\)](#) instructions to update [PSTATE](#).

The [SetPSTATEFromPSR\(\)](#) function updates [PSTATE](#) from a CPSR or SPSR.

[Chapter J1 ARMv8 Pseudocode](#) defines these functions.

G1.11 Instruction set states

The instruction set states are described in [Chapter E2 The AArch32 Application Level Memory Model](#) and application level operations on them are described there. This section supplies more information about how they interact with system level functionality, in the sections:

- [Exceptions and instruction set state](#).
- [Unimplemented instruction sets](#).

G1.11.1 Exceptions and instruction set state

If an exception is taken to an EL1 mode, the [SCTLR.TE](#) bit for the Security state the exception is taken to determines the instruction set state that handles the exception, and if necessary, the PE changes to this instruction set state on exception entry.

If the exception is taken to Hyp mode, the [HSCTLR.TE](#) bit determines the instruction set state that handles the exception, and if necessary, the PE changes to this instruction set state on exception entry.

On coming out of reset, if the highest implemented Exception level is using AArch32:

- If the highest implemented Exception level is EL2, the PE starts execution in Hyp mode, in the instruction set state determined by the reset value of [HSCTLR.TE](#).
- Otherwise, the PE starts execution in Supervisor mode, in the instruction set state determined by the reset value of [SCTLR.TE](#). If the implementation includes EL3, this execution is in Secure Supervisor mode.

For more information about exception entry, see [Overview of exception entry on page G1-4347](#).

G1.11.2 Unimplemented instruction sets

The [PSTATE.T](#) bit defines the current instruction set state, see [Process state, PSTATE on page E1-2734](#).

In the ARMv8 architecture there is no support for the hardware acceleration of Java bytecodes, and the Jazelle Instruction set state is obsolete. Every AArch32 implementation must support the Trivial Jazelle implementation described in [Trivial implementation of the Jazelle extension](#).

———— Note —————

In previous versions of the ARM architecture, the [PSTATE.{J, T}](#) bits determined the Instruction set state. In ARMv8, [PSTATE.J](#) is RES0.

Trivial implementation of the Jazelle extension

ARMv8 requires that the implementation of AArch32 state includes the trivial Jazelle implementation.

In a trivial implementation of the Jazelle extension:

- At EL1, EL2, or EL3, if the Exception level is using AArch32:
 - The [JMCR](#) and [JOSCR](#) are RAZ/WI.
 - The [JIDR](#) is a RAZ read-only register.
- At EL0 when EL0 is using AArch32:
 - It is IMPLEMENTATION DEFINED whether the [JMCR](#) and [JOSCR](#) are RAZ/WI or UNDEFINED.
 - It is IMPLEMENTATION DEFINED whether [JIDR](#) is RAZ or UNDEFINED.
- The [BXJ](#) instruction behaves identically to the [BX](#) instruction in all circumstances.

———— Note —————

This is consistent with the [JMCR.JE](#) bit being RAZ, and means that the A32 and T32 instruction sets do not provide any mechanism for attempting to enter Jazelle state.

- Jazelle state, as defined in previous versions of the ARM architecture, is an unimplemented instruction set state.

These requirements ensure that operating systems that support an EJVM execute correctly.

A trivial implementation is not required to extend the PC to 32 bits, that is, it can implement PC[0] as RAZ/WI.

———— **Note** —————

This is because the only way that PC[0] is visible in A32 or T32 state is as a result of an exception occurring during Jazelle state execution, and Jazelle state execution cannot occur on a trivial implementation.

G1.12 Handling exceptions that are taken to an Exception level using AArch32

An exception causes the PE to suspend program execution to handle an event, such as an externally generated interrupt or an attempt to execute an undefined instruction. Exceptions can be generated by internal and external sources.

Normally, when an exception is taken the PE state is preserved immediately, before handling the exception. This means that, when the event has been handled, the original state can be restored and program execution resumed from the point where the exception was taken.

More than one exception might be generated at the same time, and a new exception can be generated while the PE is handling an exception.

The following sections describe exception handling:

- [Exception vectors and the exception base address.](#)
- [Exception prioritization for exceptions taken to AArch32 state on page G1-4344.](#)
- [Overview of exception entry on page G1-4347.](#)
- [PE mode for taking exceptions on page G1-4350.](#)
- [PE state on exception entry on page G1-4354.](#)
- [Routing exceptions from Non-secure EL0 to EL2 on page G1-4356.](#)
- [Routing debug exceptions to EL2 using AArch32 on page G1-4358.](#)
- [Exception return to an Exception level using AArch32 on page G1-4360.](#)

[Asynchronous exception behavior for exceptions taken from AArch32 state on page G1-4365](#) gives a full description of asynchronous exception handling, for exceptions taken asynchronously from AArch32 state.

———— Note ————

Because of the common model for handling exceptions, the current section requires some understanding of the asynchronous exception behaviors described in [Asynchronous exception behavior for exceptions taken from AArch32 state on page G1-4365](#).

[AArch32 state exception descriptions on page G1-4376](#) then describes each exception.

G1.12.1 Exception vectors and the exception base address

When an exception is taken, PE execution is forced to an address that corresponds to the type of exception. This address is called the *exception vector* for that exception. The vectors for the different types of exception form a *vector table*.

———— Note ————

There are significant differences in the sets of exception vectors for exceptions taken to an Exception level that is using AArch32 and for exceptions taken to an Exception level that is using AArch64. This part of this manual describes only how exceptions are taken to an Exception level that is using AArch32. So, for example, when executing at EL1 or EL0, an exception might be generated that must be taken to EL3. In this case:

- If EL3 is using AArch32 then the exception is taken as described in this chapter, using the exception vectors described in this section.
- If EL3 is using AArch64 then the exception is taken as described in [Chapter D1 The AArch64 System Level Programmers' Model](#) using the exception vectors described in [Exception vectors on page D1-1800](#).

AArch32 state defines exception vector tables for exceptions taken to EL2 and EL3 when those Exception levels are using AArch32. Those vector tables are not used when the corresponding Exception levels are using AArch64.

A set of exception vectors for an Exception level that is using AArch32 comprises eight consecutive word-aligned memory addresses, starting at an *exception base address*. These eight vectors form an AArch32 *vector table*.

The number of possible exception base addresses, and therefore the number of vector tables, depends on the implemented Exception levels, as follows:

Implementation that does not include EL3

Any implementation that does not include EL3 must include the following AArch32 vector table if EL1 can use AArch32:

- An exception table for exceptions taken to EL1 modes other than System mode. This is the EL1 vector table, and is in the address space of the PL1&0 translation regime.

———— **Note** —————

Exceptions cannot be taken to System mode.

For this vector table, the **VBAR** holds the exception base address.

Implementation that includes EL2

Any implementation that includes EL2 must include the following additional AArch32 vector table if EL2 can use AArch32:

- An exception table for exceptions taken to Hyp mode. This is the Hyp vector table, and is in the address space of the Non-secure PL2 translation regime.

For this vector table, **HVBAR** holds the exception base address.

Implementation that includes EL3

Any implementation that includes EL3 must include the following AArch32 vector tables:

- If EL3 can use AArch32, a vector table for exceptions taken to Secure Monitor mode. This is the Monitor vector table, and is in the address space of the Secure PL1&0 translation regime.

For this vector table, **MVBAR** holds the exception base address.

- If Secure EL1 can use AArch32, a vector table for exceptions taken to Secure privileged modes other than Monitor mode and System mode. This is the Secure vector table, and is in the address space of the Secure PL1&0 translation regime.

For this vector table, the Secure **VBAR** holds the exception base address.

- If Non-secure EL1 can use AArch32, a vector table for exceptions taken to Non-secure PL1 modes. This is the Non-secure vector table, and is in the address space of the Non-secure PL1&0 translation regime.

For this vector table, the Non-secure **VBAR** holds the exception base address.

The following subsections give more information:

- [The vector tables and exception offsets.](#)
- [Pseudocode determination of the exception base address on page G1-4344.](#)

The vector tables and exception offsets

Table G1-6 on page G1-4342 defines the AArch32 vector table entries. In this table:

- The *Hyp mode* column defines the vector table entries for exceptions taken to Hyp mode.
- The *Monitor mode* column defines the vector table entries for exceptions taken to Monitor mode.
- The *Secure* and *Non-secure* columns define the Secure and Non-secure vector table entries, that are used for exceptions taken to modes other than Monitor mode, Hyp mode, System mode, and User mode. [Table G1-7 on page G1-4342](#) shows the mode to which each of these exceptions is taken. Each of these modes is described as the *default* mode for taking the corresponding exception.

———— **Note** —————

Exceptions cannot be taken to System mode or User mode.

For more information about determining the mode to which an exception is taken, see [PE mode for taking exceptions on page G1-4350](#).

When EL2 is using AArch32, it provides a number of additional exceptions, some of which are not shown explicitly in the vector tables. For more information, see [interrupt Offsets of AArch32 exceptions provided by EL2 on page G1-4343](#).

Table G1-6 The AArch32 vector tables

Offset	Vector tables			
	Hyp ^a	Monitor ^b	Secure ^c	Non-secure ^c
0x00	Not used	Not used	Not used ^d	Not used
0x04	Undefined Instruction, from Hyp mode	Monitor Trap	Undefined Instruction	Undefined Instruction
0x08	Hypervisor Call, from Hyp mode	Secure Monitor Call	Supervisor Call	Supervisor Call
0x0C	Prefetch Abort, from Hyp mode	Prefetch Abort	Prefetch Abort	Prefetch Abort
0x10	Data Abort, from Hyp mode	Data Abort	Data Abort	Data Abort
0x14	Hyp Trap, or Hyp mode entry ^e	Not used	Not used	Not used
0x18	IRQ interrupt	IRQ interrupt	IRQ interrupt	IRQ interrupt
0x1C	FIQ interrupt	FIQ interrupt	FIQ interrupt	FIQ interrupt

- a. Non-secure state only. Implemented only if the implementation includes EL2 and EL2 can use AArch32.
- b. Secure state only. Implemented only if the implementation includes EL3 and EL3 can use AArch32.
- c. If the implementation does not include EL3 then there is a single vector table for exceptions taken to EL1 when EL1 is using AArch32. That table holds the vectors shown in the Secure column of this table
- d. In previous versions of the architecture, this entry has been used for the Reset vector, meaning the address at which execution starts on coming out of reset. In ARMv8, the AArch32 Reset vector is IMPLEMENTATION DEFINED. An implementation might use this vector table entry to hold the Reset vector.
- e. See [Use of offset 0x14 in the Hyp vector table on page G1-4343](#).

Table G1-7 Modes for taking the exceptions shown in the Secure or Non-secure vector table

Exception	Mode taken to
Undefined Instruction	Undefined
Supervisor Call	Supervisor
Prefetch Abort	Abort
Data Abort	Abort
IRQ interrupt	IRQ
FIQ interrupt	FIQ

For more information about use of the vector tables see [Overview of exception entry on page G1-4347](#).

interrupt Offsets of AArch32 exceptions provided by EL2

EL2 provides the following exceptions. When EL2 is using AArch32, these exceptions are taken to Hyp mode, and the PE enters the handlers for these exceptions using the following vector table entries shown in [Table G1-6 on page G1-4342](#):

Hypervisor Call

If taken from Hyp mode, shown explicitly in the Hyp mode vector table. Otherwise, see [Use of offset 0x14 in the Hyp vector table](#).

Hyp Trap Shown explicitly in the Hyp mode vector table.

Virtual Abort Entered through the Data Abort vector in the Non-secure vector table.

Virtual IRQ Entered through the IRQ vector in the Non-secure vector table.

Virtual FIQ Entered through the FIQ vector in the Non-secure vector table.

———— **Note** —————

[Virtual exceptions when an implementation includes EL2 on page G1-4365](#) gives more information about the virtual exceptions.

Use of offset 0x14 in the Hyp vector table

The vector at offset 0x14 in the Hyp vector table is used for exceptions that cause entry to Hyp mode. This means it is:

- Always used for the Hyp Trap exception.
- Used for any Hypervisor Call exception that is taken from a mode other than Hyp mode.
- Used for any Supervisor Call exception that is taken from Non-secure User mode when the value of [HCR.TGE](#) is 1.
- Used for any Undefined Instruction that is taken from Non-secure User mode when the value of [HCR.TGE](#) is 1.
- Used for any Prefetch Abort exception that is:
 - Taken from Non-secure User mode when the value of [HCR.TGE](#) is 1.
 - Generated by a Debug exception from Non-secure state when the value of [HDCR.TDE](#) is 1.
 - Generated by a stage 2 abort on an address translation instruction.
- Used for any Data Abort exception that is:
 - Taken from Non-secure User mode when the value of [HCR.TGE](#) is 1.
 - Generated by an SError interrupt from Non-secure state when the value of [HCR.AMO](#) is 1.
 - Generated by a Watchpoint exception from Non-secure state when the value of [HDCR.TDE](#) is 1.
 - Generated by a stage 2 abort on an address translation operation.

———— **Note** —————

Offset 0x14 is never used for the following exceptions:

- IRQ exceptions.
- Virtual IRQ exceptions.
- FIQ exceptions.
- Virtual FIQ exceptions.

Virtual exceptions are never taken to Hyp mode.

For more information, see [PE mode for taking exceptions on page G1-4350](#).

Pseudocode determination of the exception base address

For an exception taken to a PL1 mode, the `ExcVectorBase()` function determines the exception base address.

The `ExcVectorBase()` function is defined in [Chapter J1 ARMv8 Pseudocode](#).

Note

The PL1 modes to which exceptions can be taken are Supervisor mode, Undefined mode, Abort mode, IRQ mode, and FIQ mode. In Non-secure state, and in Secure state when EL3 is using AArch64, these are EL1 modes. However, in Secure state when EL3 is using AArch32, these are EL3 modes. For more information see [Security state, Exception levels, and AArch32 execution privilege on page G1-4318](#).

G1.12.2 Exception prioritization for exceptions taken to AArch32 state

The following sections describe the ARMv8 requirements for the prioritization of synchronous exceptions, and the limits on when asynchronous exceptions can be taken:

- [Synchronous exception prioritization for exceptions taken to AArch32 state](#).
- [Architectural requirements for taking asynchronous exceptions on page G1-4346](#).

See also:

- [AArch32 state prioritization of synchronous aborts from a single stage of address translation on page G4-4660](#), for information about:
 - The prioritization of aborts on a single memory access in a VMSA implementation.
 - The prioritization of exceptions generated during address translation.
- [Debug state entry and debug event prioritization on page H2-5437](#) for information about the relative prioritization of exceptions and the debug events that cause entry to Debug state.

Synchronous exception prioritization for exceptions taken to AArch32 state

In principle, any single instruction can generate a number of different synchronous exceptions, between the fetching of the instruction, its decode, and eventual execution. This section describes the prioritization of such exceptions when they are taken to an Exception level that is using AArch32.

Note

- An exception that is taken to an Exception level that is using AArch32 must have been taken from an Exception level that is using AArch32.
 - The priority numbering in this list only shows the relative priorities of exceptions taken to an Exception level that is using AArch32. This numbering has no global significance and, for example, does not correlate with the equivalent AArch32 list in [Synchronous exception prioritization for exceptions taken to AArch64 on page D1-1827](#).
-

For an exception that is taken to an Exception level that is using AArch32, exceptions are prioritized as follows, where 1 is the highest priority.

1. PC alignment fault exceptions. A PC alignment fault exception can only be taken to an Exception level that is using AArch32 as a result of:
 - The CONSTRAINED UNPREDICTABLE handling of a branch to an unaligned address, see [Branching to an unaligned PC on page K1-6098](#).
 - Exiting from Debug state to AArch32 specifying an unaligned PC value, see [Exiting Debug state on page H2-5471](#).

A PC alignment fault exception that is taken to an Exception level that is using AArch32 is reported as a Prefetch Abort exception, see [Prefetch Abort exception reporting a PC alignment fault exception on page G1-4385](#).

2. Prefetch Abort exceptions. See [Prefetch Abort exception on page G1-4384](#) and [AArch32 state prioritization of synchronous aborts from a single stage of address translation on page G4-4660](#).
3. Breakpoint exceptions or Address Matching Vector Catch exceptions. See:
 - [Breakpoint exceptions on page G2-4470](#).
 - [Vector Catch exceptions on page G2-4510](#).

———— **Note** —————

An Exception Trapping Vector Catch exception is generated on exception entry for an exception that has been prioritized as described in this section. This means that it does not have its own entry in this list.

4. Illegal Execution state exceptions. See [The Illegal Execution state exception on page G1-4363](#).
5. Exceptions taken from EL1 to EL2 because of one of the following configuration settings:
 - [HSTR.Tn](#).
 - [HCR.TIDCP](#).
6. Undefined Instruction exceptions that occur as a result of one or more of the following:
 - An attempt to execute an unallocated instruction encoding, including an encoding for an instruction that is not implemented in the PE implementation.
 - An attempt to execute an instruction that is defined never to be accessible at the current Exception level regardless of any enables or traps.
 - Debug state execution of an instruction encoding that is unallocated in Debug state.
 - Non-debug state execution of an instruction encoding that is unallocated in Non-debug state.
 - Execution of an HVC instruction, when HVC instructions are disabled by [SCR.HCE](#) or [HCR.HCD](#).
 - Execution of an HLT instruction when HLT instructions are disabled by [EDSCR.HDE](#).
 - In Debug state:
 - Execution of a DCPS1 instruction in Non-secure EL0 when [HCR.TGE](#) is 1.
 - Execution of a DCPS2 instruction in EL1 or EL0 when [SCR.NS](#) is 0 or when EL2 is not implemented.
 - Execution of a DCPS3 instruction when [EDSCR.SDD](#) is 1 or when EL3 is not implemented.
 - When the value of [EDSCR.SDD](#) is 1, execution in EL2, EL1, or EL0 of an instruction that is trapped to EL3.
 - Execution of an instruction that is UNDEFINED as a result of any of:
 - Being in an IT block when [SCTLR.ITD](#) is 1, or when [HSCTLR.ITD](#) is 1.
 - Executing a SETEND instruction when [SCTLR.SED](#) is 1, or when [HSCTLR.SED](#) is 1.
 - Executing a [CP15DMB](#), [CP15DSB](#), or [CP15ISB](#) barrier instruction when [SCTLR.CP15BEN](#) is 0, or when [HSCTLR.CP15BEN](#) is 0.

See [Disabling or enabling PL0 and PL1 use of AArch32 deprecated functionality on page G1-4421](#) and [Disabling or enabling EL2 use of AArch32 deprecated functionality on page G1-4430](#).
 - Execution of an instruction that is UNDEFINED because at least one of [FPSCR](#).{Stride, Len} is nonzero, when programming these bits to nonzero values is supported. See [Floating-point exception traps on page G1-4416](#).
7. Exceptions taken to EL1, or taken to EL2 because the value of [HCR.TGE](#) is 1, that are generated because of configurable access to instructions, and that are not covered by any of priorities 1-6.
8. Exceptions taken from EL0 to EL2 because of one of the following configuration settings:
 - [HSTR.Tn](#).
 - [HCR.TIDCP](#).
9. Exceptions taken to EL2 because of configuration settings in the [HCPTR](#).

10. Exceptions taken to EL2 because of one of the following configuration settings:
 - Any setting in [HCR](#), other than the TIDCP bit.
 - Any setting in [CNTHCTL](#).
 - Any setting in [HDCR](#).
11. Exceptions taken to EL2 because of configurable access to instructions, and that are not covered by any of priorities [1 - 10](#).
12. Exceptions caused by the SMC instruction being UNDEFINED because the value of [SCR.SCD](#) is 1.
13. Exceptions caused by the execution of an Exception generating instruction, SVC, HVC, SMC, or BKPT.
14. Exceptions taken to EL3 because of configuration settings in the [SDCR](#). These might be taken from EL0, EL1, or EL2.
15. Exceptions taken to EL3 because of configurable access to instructions, and that are not covered by any of priorities [1 - 14](#).
16. Trapped floating-point exceptions, if supported. See [Floating-point exception traps on page G1-4416](#).
17. Data Abort exceptions other than a Data Abort exception generated by a Synchronous external abort that was not generated by a translation table walk. That is, any Data Abort exception that is not covered by item [19](#). See [Data Abort exception on page G1-4387](#) and [AArch32 state prioritization of synchronous aborts from a single stage of address translation on page G4-4660](#). It is IMPLEMENTATION DEFINED whether Synchronous external aborts are prioritized here or as item [19](#).
18. Watchpoint exceptions. See [Watchpoint exceptions on page G2-4496](#).
19. Data Abort exception generated by a Synchronous external abort that was not generated by a translation table walk, see [External aborts on page G3-4550](#). It is IMPLEMENTATION DEFINED whether Synchronous external aborts are prioritized here or as item [17](#).

For items [17 - 19](#), if an instruction results in more than one single-copy atomic memory access, the prioritization between synchronous exceptions generated on each of those different memory accesses is not defined by the architecture.

———— **Note** —————

Exceptions generated by a translation table walk are reported and prioritized as either a Prefetch Abort exception, priority [2](#) in this list, or a Data Abort exception, priority [17](#) in this list. See also [AArch32 state prioritization of synchronous aborts from a single stage of address translation on page G4-4660](#).

Architectural requirements for taking asynchronous exceptions

The ARM architecture does not define when asynchronous exceptions are taken. The prioritization of asynchronous exceptions, including virtual asynchronous exceptions, is IMPLEMENTATION DEFINED.

An asynchronous exception that is pending before one of the following context synchronizing events is taken before the first instruction after the context synchronizing event completes its execution, provided that the pending asynchronous event is not masked:

- Execution of an ISB instruction that does not fail its Condition code check.
- Exception entry.
- Exception return.
- Exit from Debug state.

Note

- If the first instruction after the context synchronizing event generates a synchronous exception, then the architecture does not define the order in which that synchronous exception and the asynchronous exception are taken.
- The [ISR](#) identifies any pending asynchronous exceptions.
- Interrupts are masked when the PE is in Debug state, and therefore this list of context synchronizing events does not include the DCPS and DRPS instructions.

In the absence of a specific requirement to take an asynchronous exception, the only requirement of the architecture is that an unmasked asynchronous exception is taken in finite time.

Note

The taking of an unmasked asynchronous exception in finite time must occur with all code sequences, including with a sequence that consists of unconditional loops.

If an unmasked interrupt was pending but is changed to not pending before it is taken, then the architecture permits the interrupt to be taken, but does not require this to happen. If the interrupt is taken then it must be taken before the first [Context synchronization event](#) after the interrupt was changed to not pending.

[PSTATE](#) includes a mask bit for each type of asynchronous exception. Setting one of these bits to 1 can prevent the corresponding asynchronous exception from being taken, although when the PE is in Non-secure state other controls can modify the effect of these bits. For more information, see [Asynchronous exception behavior for exceptions taken from AArch32 state on page G1-4365](#).

Taking an exception sets an exception-dependent subset of these mask bits.

Note

In some contexts, the [PSTATE](#).{A, I, F} bits mask the taking of asynchronous exceptions. The way these are set on exception entry, described in [PSTATE.{A, I, F, M} values on exception entry on page G1-4355](#), can prevent an exception handler being interrupted by an asynchronous exception.

G1.12.3 Overview of exception entry

There are some significant differences between the handling of exceptions taken to Hyp mode and exceptions taken to other modes. Because Hyp mode is the EL2 mode, this means that the following descriptions sometimes distinguish between the *EL2 mode* and the *non-EL2 modes*.

On taking an exception to an Exception level that is using AArch32:

1. The hardware determines the mode to which the exception must be taken, see [PE mode for taking exceptions on page G1-4350](#).
2. A link value, indicating the *preferred return address* for the exception, is saved. This is a possible return address for the exception handler, and depends on:
 - The exception type.
 - Whether the exception is taken to the EL2 mode or to a non-EL2 mode.
 - For some exceptions taken to non-EL2 modes, the instruction set state when the exception was taken.

Where the link value is saved depends on whether the exception is taken to the EL2 mode.

For more information see [Link values saved on exception entry on page G1-4349](#).

3. The value of [PSTATE](#) is saved in the [SPSR](#) for the mode to which the exception must be taken. The value saved in [SPSR.IT\[7:0\]](#) is always correct for the preferred return address.

4. In an implementation that includes EL3, when EL3 is using AArch32:
 - If the exception is taken from Monitor mode, **SCR.NS** is cleared to 0.
 - Otherwise, taking the exception leaves **SCR.NS** unchanged.
When EL3 is using AArch64, Monitor mode is not available.
5. **PSTATE** is updated with new context information for the exception handler. This includes:
 - Setting **PSTATE.M** to the PE mode to which the exception is taken.
 - Setting the appropriate **PSTATE** mask bits. This can disable the corresponding exceptions, preventing uncontrolled nesting of exception handlers.
 - Setting the instruction set state to the state required for exception entry.
 - Setting the endianness to the required value for exception entry.
 - Clearing the **PSTATE.IT[7:0]** bits to 0.
For more information, see *PE state on exception entry* on page G1-4354.
6. The appropriate exception vector is loaded into the PC, see *Exception vectors and the exception base address* on page G1-4340.
7. Execution continues from the address held in the PC.

For an exception taken to a non-EL2 mode, on exception entry, the exception handler can use the SRS instruction to store the return state onto the stack of any mode at the same Exception level and in the same Security state, and can use the CPS instruction to change mode. For more information about the instructions, see *SRS, SRSDA, SRSDB, SRSIA, SRSIB* on page F5-3464 and *CPS, CPSID, CPSIE* on page F5-3089.

Later sections of this chapter describe each of the possible exceptions, and each of these descriptions includes a pseudocode description of the PE state changes on taking that exception. [Table G1-8](#) gives an index to these descriptions:

Table G1-8 Pseudocode descriptions of exception entry for exceptions taken to AArch32 state

Exception	Description of exception entry
Reset	<i>Pseudocode descriptions of reset</i> on page G1-4402
Undefined Instruction	<i>Pseudocode description of taking the Undefined Instruction exception</i> on page G1-4378
Hyp Trap	<i>Pseudocode description of taking the Hyp Trap exception</i> on page G1-4380
Monitor Trap	<i>Pseudocode description of taking the Monitor Trap exception</i> on page G1-4379
Supervisor Call	<i>Pseudocode description of taking the Supervisor Call exception</i> on page G1-4381
Secure Monitor Call	<i>Pseudocode description of taking the Secure Monitor Call exception</i> on page G1-4382
Hypervisor Call	<i>Pseudocode description of taking the Hypervisor Call exception</i> on page G1-4383
Prefetch Abort	<i>Pseudocode description of taking the Prefetch Abort exception</i> on page G1-4387
Data Abort	<i>Pseudocode description of taking the Data Abort exception</i> on page G1-4390
Virtual Abort	<i>Pseudocode description of taking the Virtual SError interrupt exception</i> on page G1-4392
IRQ	<i>Pseudocode description of taking the physical IRQ exception</i> on page G1-4394
Virtual IRQ	<i>Pseudocode description of taking the Virtual IRQ exception</i> on page G1-4395
FIQ	<i>Pseudocode description of taking the FIQ exception</i> on page G1-4396
Virtual FIQ	<i>Pseudocode description of taking the Virtual FIQ exception</i> on page G1-4397

The following sections give more information about the PE state changes, for different architecture implementations. However, you must refer to the pseudocode for a full description of the state changes:

- [PE mode for taking exceptions on page G1-4350.](#)
- [PE state on exception entry on page G1-4354.](#)

Link values saved on exception entry

On exception entry, a link value for use on return from the exception, is saved. This link value is based on the preferred return address for the exception, as shown in [Table G1-9](#):

Table G1-9 Exception return addresses for exceptions taken to AArch32 state

Exception	Preferred return address	Taken to a mode at
Undefined Instruction	Address of the UNDEFINED instruction	Non-EL2 ^a , or EL2 ^c
Hyp Trap	Address of the trapped instruction	EL2 only ^c
Monitor Trap	Address of the trapped instruction	EL3 only
Supervisor Call	Address of the instruction after the SVC instruction	Non-EL2 ^a or EL2 ^c
Secure Monitor Call	Address of the instruction after the SMC instruction	EL3 ^b , and only in Secure state
Hypervisor Call	Address of the instruction after the HVC instruction	EL2 only ^c
Prefetch Abort	Address of aborted instruction fetch	Non-EL2 ^a or EL2 ^c
Data Abort	Address of instruction that generated the abort	Non-EL2 ^a or EL2 ^c
Virtual Abort	Address of next instruction to execute	EL1, and only in Non-secure state
IRQ or FIQ	Address of next instruction to execute	Non-EL2 ^a or EL2 ^c
Virtual IRQ or Virtual FIQ	Address of next instruction to execute	EL1, and only in Non-secure state

- EL1 if the exception is taken to a Non-secure mode, or is taken to a Secure mode when EL3 is using AArch64. EL3 if the exception is taken to a Secure mode when EL3 is using AArch64.
- A Secure Monitor Call exception is taken to EL3, and therefore is taken to AArch32 state only if EL3 is using AArch32, in which case it is taken to Monitor mode.
- EL2 is implemented only in Non-secure state. Therefore, an exception can be taken to EL2 mode only if it is taken from Non-secure state.

Note

- Although Reset is described as an exception, it differs significantly from other exceptions. The architecture has no concept of a return from a Reset and therefore it is not listed in this section.
- For each exception, the preferred return address is not affected by the Exception level from which the exception was taken.

The link value saved, and where it is saved, depend on whether the exception is taken to a non-EL2 mode, or to an EL2 mode, as follows:

Exception taken to a non-EL2 mode

The link value is saved in the LR for the mode to which the exception is taken.

The saved link value is the preferred return address for the exception, plus an offset that depends on the instruction set state when the exception was taken, as [Table G1-10](#) shows:

Table G1-10 Offsets applied to Link value for exceptions taken to non-EL2 modes

Exception	Offset, for PE state of:	
	A32	T32
Undefined Instruction	+4	+2
Monitor Trap	+4	+2
Supervisor Call	None	None
Secure Monitor Call	None	None
Prefetch Abort	+4	+4
Data Abort	+8	+8
Virtual Abort	+8	+8
IRQ or FIQ	+4	+4
Virtual IRQ or Virtual FIQ	+4	+4

Exception taken to an EL2 mode

The link value is saved in the [ELR_hyp](#) Special-purpose register.

The saved link value is the preferred return address for the exception, as shown in [Table G1-9 on page G1-4349](#), with no offset.

G1.12.4 PE mode for taking exceptions

The following principles determine the Exception level to which an exception is taken, and if that Exception level is using AArch32, the PE mode to which the exception is taken:

- An exception cannot be taken to the EL0 mode.
- An exception is taken either:
 - To the Exception level at which the PE was executing when it took the exception.
 - To a higher Exception level.

This means that, in Secure state:

- When EL3 is using AArch32, an exception is always taken to an EL3 mode.
- When EL3 is using AArch64, an exception that is taken to AArch32 state is taken to an EL1 mode.
- Configuration options and other features provided by EL2 and EL3 can determine the mode to which some exceptions are taken, as follows:

In an implementation that does not include EL2 or EL3

An exception is always taken to the default mode for that exception.

In an implementation that includes EL3

A Secure Monitor Call exception is always taken to EL3. This means:

- If EL3 is using AArch32 the exception is taken to Secure Monitor mode.
- If EL3 is using AArch64 then executing the instruction generates an exception that is taken to EL3, see *Execution of an SMC instruction from a privileged Exception level that is using AArch32* on page G1-4352.

IRQ, FIQ, and External abort exceptions can be configured to be taken to EL3. Therefore, if EL3 is using AArch32 the exceptions are taken to Secure Monitor mode.

When EL3 is using AArch32, a Monitor Trap exception is taken to Secure Monitor mode.

Any exception taken from Secure state that is not taken to Secure Monitor mode is taken to Secure state in the default mode for that exception. As described in *Security state, Exception levels, and AArch32 execution privilege* on page G1-4318, this means it is taken to:

- An EL3 mode other than Monitor mode if EL3 is using AArch32.
- An EL1 mode if EL3 is using AArch64.

If the implementation does not include EL2, any exception taken from Non-secure state that is not taken to Secure Monitor mode is taken to Non-secure state to the default mode for that exception. The default mode will be an EL1 mode.

In an implementation that includes EL2

An exception taken from Non-secure state that is not taken to Secure Monitor mode is taken to Non-secure state and:

- If the exception is taken from Hyp mode then it is taken to Hyp mode.
- Otherwise, the exception is either taken to Hyp mode, as described in *Exceptions taken to Hyp mode* on page G1-4352, or taken to the default mode for the exception.

————— Note —————

- Hyp mode is the EL2 mode. The other modes to which an exception can be taken in Non-secure state are EL1 modes.
- EL2 has no effect on the handling of exceptions taken from Secure state.

Table G1-7 on page G1-4342 shows the default mode to which each exception is taken.

Asynchronous exception routing controls on page G1-4367 describes the exception routing controls provided by EL2 and EL3.

Routing of aborts taken to AArch32 state on page G4-4649 gives more information about the modes to which memory aborts are taken.

The possible modes for taking each exception on page G1-4353 shows all modes to which each exception might be taken, in any implementation. That is, it applies to implementations:

- That include neither EL2 nor EL3.
- That include EL2 but not EL3
- That do not include EL2 but include EL3
- That include both EL2 and EL3.

Exceptions taken to Hyp mode

In an implementation that includes EL2 and EL3, when EL2 is using AArch32:

- Any exception taken from Hyp mode, that is not routed to EL3 by the controls described in *Asynchronous exception routing controls on page G1-4367*, is taken to Hyp mode.
- The following exceptions, if taken from Non-secure state, are taken to Hyp mode:
 - An abort that *Routing of aborts taken to AArch32 state on page G4-4649* identifies as taken to Hyp mode.
 - A Hyp Trap exception, see *EL2 configurable controls on page G1-4427*.
 - A Hypervisor Call exception. This is generated by executing an HVC instruction in a Non-secure mode.
 - An SError interrupt exception, IRQ exception or FIQ exception that is not routed to EL3 but is explicitly routed to Hyp mode, as described in *Asynchronous exception routing controls on page G1-4367*.
 - A synchronous external abort, Alignment fault, Undefined Instruction exception, or Supervisor Call exception taken from the Non-secure EL0 mode and explicitly routed to Hyp mode, as described in *Routing exceptions from Non-secure EL0 to EL2 on page G1-4356*.

———— **Note** —————

A synchronous external abort can be routed to Hyp mode only if it is not routed to EL3.

- A debug exception that is explicitly routed to Hyp mode as described in *Routing debug exceptions to EL2 using AArch32 on page G1-4358*.

———— **Note** —————

The virtual exceptions cannot be taken to Hyp mode. They are always taken to a Non-secure EL1 mode.

Security behavior in Exception levels using AArch32 when EL3 is using AArch64

As described in *The ARMv8-A security model on page G1-4315*, when EL3 is using AArch64, lower Exception levels, in either Security state, can be using AArch32. This means software executing in those Exception levels might try to access AArch32 security features that are not available. The following subsections describe the associated behaviors:

- *Execution of an SMC instruction from a privileged Exception level that is using AArch32*
- *Non-secure reads of the NSACR*
- *Secure EL1 operations when Secure EL1 is using AArch32 on page G1-4353*

Execution of an SMC instruction from a privileged Exception level that is using AArch32

When EL3 is using AArch64, an SMC instruction executed from Secure or Non-secure EL1 using AArch32, or from Non-secure EL2 using AArch32 when the value of HCR.TSC is 0, generates an exception that is taken to EL3. The exception syndrome is reported with an EC value of 0x13, SMC instruction executed in AArch32 state, see *Exception from SMC instruction execution in AArch32 state on page D1-1809*.

Non-secure reads of the NSACR

The NSACR is defined as being RO from Non-secure PE modes other than User mode. When EL3 is using AArch64, a read of the NSACR returns a fixed value of 0x00000C00 in the following cases:

- If the read is from a Non-secure EL1 mode when EL1 is using AArch32.
- If the read is from Hyp mode when EL2 is using AArch32.

Secure EL1 operations when Secure EL1 is using AArch32

When Secure EL1 is using AArch32 and EL3 is using AArch64:

- Any of the following operations performed in a Secure EL1 mode is trapped to Secure EL3:
 - A read or write of any of the [SCR](#), [NSACR](#), [MVBAR](#), and [SDCR](#).
 - Executing any of the [ATS12NSO**](#) instructions.
 - Executing an SRS instruction that would use [SP_mon](#), see [SRS](#), [SRSDA](#), [SRSDB](#), [SRSIA](#), [SRSIB](#) on [page F5-3464](#).
 - Executing an MRS (Banked register) or MSR (Banked register) instruction that would access [SPSR_mon](#), [SP_mon](#), or [LR_mon](#), see [MRS \(Banked register\)](#) on [page F5-3277](#) and [MSR \(Banked register\)](#) on [page F5-3281](#).

For more information about these traps, including the associated exception syndromes, see [Traps to EL3 of Secure monitor functionality from Secure EL1 using AArch32](#) on [page D1-1870](#).

- Writes to the [CNTFRQ](#) register are UNDEFINED.
- Any attempt to move into Monitor mode, either by an exception return or by executing a CPS or MSR instruction, is treated as an illegal operation and is handled as described in [Illegal return events from AArch32 state](#) on [page G1-4361](#).

———— Note —————

This functionality supports a usage model where:

- EL3 uses AArch64.
- Secure software executed in Secure EL1 using AArch32 and Secure EL0 using AArch32.
- The Non-secure state uses AArch64.

The possible modes for taking each exception

Each of the exception descriptions in [AArch32 state exception descriptions](#) on [page G1-4376](#) includes a subsection that describes the modes to which each exception can be taken. Those subsections are:

- [The PE mode to which the Undefined Instruction exception is taken](#) on [page G1-4377](#).
- [The PE mode to which the Hyp Trap exception is taken](#) on [page G1-4380](#).
- [The PE mode to which the Monitor Trap exception is taken](#) on [page G1-4379](#).
- [The PE mode to which the Supervisor Call exception is taken](#) on [page G1-4381](#).
- [The PE mode to which the Secure Monitor Call exception is taken](#) on [page G1-4382](#).
- [The PE mode to which the Hypervisor Call exception is taken](#) on [page G1-4383](#).
- [The PE mode to which the Prefetch Abort exception is taken](#) on [page G1-4386](#).
- [The PE mode to which the Data Abort exception is taken](#) on [page G1-4389](#).
- [The PE mode to which the Virtual SError interrupt exception is taken](#) on [page G1-4392](#).
- [The PE mode to which the physical IRQ exception is taken](#) on [page G1-4393](#).
- [The PE mode to which the Virtual IRQ exception is taken](#) on [page G1-4394](#).
- [The PE mode to which the physical FIQ exception is taken](#) on [page G1-4396](#).
- [The PE mode to which the Virtual FIQ exception is taken](#) on [page G1-4397](#).

These descriptions also show the vector offset for the exception entry for each mode. These descriptions assume that all Exception levels are using AArch32, meaning:

- [HCR](#), rather than [HCR_EL2](#), controls the routing of exceptions to EL2.
- [SCR](#), rather than [SCR_EL3](#), controls the routing of exceptions to EL3.

For more information about:

- Vector offsets, see [Exception vectors and the exception base address](#) on page G1-4340.
- The routing of synchronous external aborts or SError, IRQ, and FIQ interrupt exceptions, and the virtual exceptions, see [Asynchronous exception routing controls](#) on page G1-4367.

UNPREDICTABLE cases when the value of HCR.TGE is 1

When the value of HCR.TGE is 1, exceptions that would otherwise be taken to EL1 are, instead, routed to EL2, see [Routing exceptions from Non-secure EL0 to EL2](#) on page G1-4356. Related to this, when the value of HCR.TGE is 1, execution in a Non-secure EL1 mode is UNPREDICTABLE. ARMv8 does not constrain this UNPREDICTABLE behavior, but in ARMv8 software that follows the ARM recommendations cannot get to this state. When following the ARM recommendations, any attempt to move to a Non-secure EL1 mode when the value of HCR.TGE is 1 is either:

- An illegal exception return, see [Illegal return events from AArch32 state](#) on page G1-4361.
- An illegal PE mode change, see [Illegal changes to PSTATE.M](#) on page G1-4336.

G1.12.5 PE state on exception entry

The description of each exception includes a pseudocode description of entry to that exception, as [Table G1-8](#) on page G1-4348 shows. The following sections describe the PE state changes on entering an exception, for different implementations and operating states. However, you must always see the exception entry pseudocode for a full description of the state changes on exception entry:

- [Instruction set state on exception entry](#).
- [PSTATE.E value on exception entry](#) on page G1-4355.
- [PSTATE.{A, I, F, M} values on exception entry](#) on page G1-4355.

———— **Note** —————

The descriptions in these sections assume that EL2 and EL3, that control some aspects of the routing of exceptions taken from EL1 or EL0, are both using AArch32. If this is not the case:

- If EL2 is using AArch64:
 - Controls shown as provided by the HSCTLR are provided by the SCTLRL_EL2.
 - Controls shown as provided by the HCR are provided by the HCR_EL2.
- If EL3 is using AArch64, controls shown as provided by the SCR are provided by the SCR_EL3.

Instruction set state on exception entry

Exception handlers can execute in either T32 state or A32 state. On exception entry, PSTATE.T is set to the required value, as determined by SCTLRL.TE or HSCTLR.TE, depending on the mode the exception is taken to. [Table G1-11](#) shows this:

Table G1-11 PSTATE.T bit value on exception entry

Mode to which exception is taken	HSCTLR.TE	SCTLRL.TE	PSTATE.T	Exception handler state
Not Hyp mode	x	0	0	A32
		1	1	T32
Hyp mode	0	x	0	A32
	1	x	1	T32

When an implementation includes EL3 and EL3 is using AArch32, **SCTLR** is Banked for Secure and Non-secure states, and therefore the TE bit value might be different for Secure and Non-secure states. For an exception taken to a PE mode other than Hyp mode, the **SCTLR**.TE bit for the Security state to which the exception is taken determines the instruction set state for the exception handler. This means the instruction set state in which an exception handler might depending on the Security state to which the exception is taken.

PSTATE.E value on exception entry

PSTATE.E controls the load and store endianness for data handling. [Table G1-12](#) show the value to which this bit is set on exception entry:

Table G1-12 PSTATE.E value on exception entry

Exception mode	HSCTLR.EE	SCTLR.EE	Endianness for data loads and stores	PSTATE.E
Secure or Non-secure EL1	x	0	Little-endian	0
		1	Big-endian	1
Hyp	0	x	Little-endian	0
		1	Big-endian	1

For more information, see the bit description in *SPSR format for exceptions taken to AArch32 state on page G1-4330*.

PSTATE.{A, I, F, M} values on exception entry

On exception entry, **PSTATE.M** is set to the value for the mode to which the exception is taken, as described in *PE mode for taking exceptions on page G1-4350*.

[Table G1-13](#) shows the cases where **PSTATE**.{A, I, F} bits are set to 1 on an exception entry, and how this depends on the mode and Security state to which an exception is taken. If the table entry for a particular mode and Security state does not define a value for a **PSTATE**.{A, I, F} bit then that bit is unchanged by the exception entry. In this table:

- The *Exception mode* column is the mode to which the exception is taken.
- The *Non-secure, EL2 not implemented* column applies to exceptions taken to Non-secure state in an implementation that includes EL3 but does not include EL2.
- The *All others* column applies to:
 - Exceptions taken to Secure state.
 - Implementations that do not include the EL3.
 - Exceptions taken to Non-secure state in an implementation that includes EL2.

Table G1-13 PSTATE.{A, I, F} values on exception entry

PE mode exception is taken to	Security state	
	Non-secure	Secure
Hyp	If SCR.EA ==0 then PSTATE.A is set to 1 If SCR.IRQ ==0 then PSTATE.I is set to 1 If SCR.FIQ ==0 then PSTATE.F is set to 1	-
Monitor	-	PSTATE.A is set to 1 PSTATE.I is set to 1 PSTATE.F is set to 1

Table G1-13 PSTATE.{A, I, F} values on exception entry (continued)

PE mode exception is taken to	Security state	
	Non-secure	Secure
FIQ	PSTATE.A is set to 1 PSTATE.I is set to 1 PSTATE.F is set to 1	PSTATE.A is set to 1 PSTATE.I is set to 1 PSTATE.F is set to 1
IRQ, Abort	PSTATE.A is set to 1 PSTATE.I is set to 1	PSTATE.A is set to 1 PSTATE.I is set to 1
Undefined, Supervisor	PSTATE.I is set to 1	PSTATE.I is set to 1

Asynchronous exception behavior for exceptions taken from AArch32 state on page G1-4365 describes how, in some situations, the PSTATE.{A, I, F} bits mask the taking of SError interrupts, IRQ interrupts, and FIQ interrupts.

G1.12.6 Routing exceptions from Non-secure EL0 to EL2

———— **Note** ————

The routing control described in this section permits a Non-secure state usage model where applications execute in User mode under a hypervisor, that executes in Hyp mode, without a Guest OS running at Non-secure EL1. This control applies when the PE is executing in Non-secure EL0 using AArch32 and either:

- EL2 is using AArch32 and the value of HCR.TGE is 1.
- EL2 is using AArch64 and the value of HCR_EL2.TGE is 1.

In general, this section describes only the handling and reporting of exceptions that are taken to EL2 using AArch32 because the value of HCR.TGE is 1. *Exception entry on page D1-1799* describes the handling of exceptions that are taken to EL2 using AArch64 because the value of HCR_EL2.TGE is 1.

If the PE is in Non-secure User mode, any exception that would otherwise be taken to Non-secure EL1 is taken to EL2 if either:

- EL2 is using AArch32 and the value of HCR.TGE is 1.
 In this case the exception is taken to Hyp mode, instead of to the default Non-secure mode for handling the exception. For more information see *Exception reporting when HCR.TGE routes an exception to EL2 using AArch32 on page G1-4357*.
- EL2 is using AArch64 and the value of HCR_EL2.TGE is 1.
 In this case the exception is taken to EL2 using AArch64, see *Exception entry on page D1-1799*.

Any exception that is routed to Secure Monitor mode or to EL3 using AArch64 is unaffected by the value of HCR.TGE or HCR_EL2.TGE.

When the value of HCR.TGE is 1, meaning TGE routing from Non-secure EL0 using AArch32 to EL2 using AArch32 applies:

- The SCTL.R.M bit is treated as 0 for all purposes other than a direct read of the SCTL.R register.
- Each of the HCR.{FMO, IMO, AMO} bits is treated as 1 for all purposes other than a direct read of the HCR register
- Each of the HDCCR.{TDE, TDA, TDRA, TDOSA} bits is treated as 1 for all purposes other than a direct read of the HDCCR register.
- An exception return to Non-secure EL1 is treated as an illegal exception return, see *Illegal return events from AArch32 state on page G1-4361*.

- All virtual interrupts, including any IMPLEMENTATION DEFINED mechanisms for signaling virtual interrupts, are disabled.

Exception reporting when HCR.TGE routes an exception to EL2 using AArch32

The following sections give more information about the behavior of synchronous exceptions that are routed to Hyp mode because the value of HCR.TGE is 1:

- *Undefined Instruction exception, when the value of HCR.TGE is 1.*
- *Supervisor Call exception, when the value of HCR.TGE is 1.*
- *Abort exceptions, when the value of HCR.TGE is 1.*
- *Reporting of exceptions routed to EL2 using AArch32 because the value of HCR.TGE is 1 on page G1-4358.*

Undefined Instruction exception, when the value of HCR.TGE is 1

When HCR.TGE is set to 1, if the PE is executing in Non-secure User mode and attempts to execute an UNDEFINED instruction, it takes the Hyp Trap exception, instead of an Undefined Instruction exception. On taking the Hyp Trap exception, the HSR reports an unknown reason for the exception, using the EC value 0x00. For more information see *Use of the HSR on page G4-4677*.

Supervisor Call exception, when the value of HCR.TGE is 1

When HCR.TGE is set to 1, if the PE executes an SVC instruction in Non-secure User mode, the Supervisor Call exception generated by the instruction is taken to Hyp mode.

The HSR reports that entry to Hyp mode was because of a Supervisor Call exception, and:

- If the SVC is unconditional, takes for the imm16 value in the HSR:
 - A zero-extended 8-bit immediate value for the T32 SVC instruction.

————— **Note** —————

The only T32 encoding for SVC is a 16-bit instruction encoding.

- The bottom16 bits of the immediate value for the A32 SVC instruction.
- If the SVC is conditional, the imm16 value in the HSR is UNKNOWN.

If the SVC is conditional, the PE takes the exception only if the instruction passes its Condition code check.

The HSR reports the exception as a Supervisor Call exception taken to Hyp mode, using the EC value 0x11. For more information, see *Use of the HSR on page G4-4677*.

————— **Note** —————

The effect of setting HCR.TGE to 1 is to route the Supervisor Call exception to Hyp mode, not to trap the execution of the SVC instruction. This means that the preferred return address for the exception, when routed to Hyp mode in this way, is the instruction after the SVC instruction.

Abort exceptions, when the value of HCR.TGE is 1

When the value of HCR.TGE is 1, if the PE is executing in Non-secure User mode then any abort exception that is not routed to Secure Monitor mode or to EL3 using AArch64 generates an exception that is taken as a Hyp Trap exception. Where an attempt to execute an instruction causes an abort, on taking the Hyp Trap exception, the HSR indicates whether a Data Abort exception or a Prefetch Abort exception caused the Hyp Trap exception entry, and presents a valid syndrome in the HSR.

When SCR.EA is set to 1, external aborts and SError interrupts are routed to EL3, and this routing takes priority over the HCR.TGE routing. For more information, see *Asynchronous exception routing controls on page G1-4367*. The SCR.EA control described in that section applies to both synchronous external aborts and asynchronous SError interrupts.

An SError interrupt that is routed to Hyp mode because the value of HCR.TGE is 1 is reported as a Data Abort exception routed to Hyp mode.

The **HSR** reports the exception either:

- As a Prefetch Abort exception routed to Hyp mode, using the EC value 0x20.
- As a Data Abort exception routed to Hyp mode, using the EC value 0x24.

For more information about the exception reporting, see [Use of the HSR on page G4-4677](#).

Reporting of exceptions routed to EL2 using AArch32 because the value of HCR.TGE is 1

[PL1 configurable controls on page G1-4419](#) describes controls that, when the value of **HCR.TGE** is 0, can generate exceptions that are taken from Non-secure EL0 to EL1. When EL2 is using AArch32 and the value of **HCR.TGE** is 1, the exceptions generated by these controls are routed to Hyp mode. [Table G1-14](#) shows how these exceptions are then reported in the **HSR**.

Table G1-14 Syndrome reporting in HSR from HCR.TGE routing of traps, disables, and enables

Control provided by PL1	Control type ^a	Syndrome reporting in HSR
SCTLR .{nTWE, nTWI}	T	Uses EC value 0x00, Exception for an unknown reason
SCTLR .{SED, ITD}	D	Uses EC value 0x00, Exception for an unknown reason
SCTLR .CP15BEN	E	Uses EC value 0x00, Exception for an unknown reason
CPACR .TRCDIS	T	Uses EC value 0x00, Exception for an unknown reason
CPACR .{cp11, cp10}	E	Uses EC value 0x00, Exception for an unknown reason
FPEXC .EN	E	Uses EC value 0x00, Exception for an unknown reason
CPACR .ASEDIS	D	Uses EC value 0x00, Exception for an unknown reason
DBGDSCRExt .UDCCdis	T	Uses EC value 0x00, Exception for an unknown reason
CNTKCTL .{PL0PTEN, PL0VTEN, PL0PCTEN, PL0VCTEN}	T	Uses EC value 0x00, Exception for an unknown reason
PMUSERENR .{ER, CR, SW, EN}	T	Uses EC value 0x00, Exception for an unknown reason

a. T indicates a trap control, E indicates an instruction enable, and D indicates an instruction disable. For the definition of these terms, see the list that begins with [Instruction enables and instruction disables on page G1-4418](#).

G1.12.7 Routing debug exceptions to EL2 using AArch32

When the value of **HDCR.TDE** is 1, if the PE is executing in a Non-secure mode other than Hyp mode, any Debug exception is routed to Hyp mode. This means it generates a Hyp Trap exception. This applies to:

- Debug exceptions associated with an instruction fetch, that would otherwise generate a Prefetch Abort exception. These are the Breakpoint, Breakpoint Instruction, and Vector Catch exception, see [Chapter G2 AArch32 Self-hosted Debug](#).
- Watchpoint exceptions associated with data accesses, that would otherwise generate a Data Abort exception. See [Watchpoint exceptions on page G2-4496](#).

When the value of **HDCR.TDE** is 1, each of the **HDCR**.{TDRA, TDOSA, TDA} bits is treated as 1 for all purposes other than reading the **HDCR** register.

Note

- A Breakpoint or Watchpoint debug event that generates entry to Debug state cannot be trapped to Hyp mode. See [Breakpoint and Watchpoint debug events](#) on page H2-5436.
- When [HDCR.TDE](#) is set to 1, the Hyp Trap exception is generated instead of the Prefetch Abort exception or Data Abort exception that is otherwise generated by the Debug exception.
- Debug exceptions, other than Breakpoint Instruction exceptions, are never generated in Hyp mode.

When a Hyp Trap exception is generated because the value of [HDCR.TDE](#) is 1, The [HSR](#) reports the exception either:

- As a Prefetch Abort exception routed to Hyp mode, using the EC value 0x20.
- As a Data Abort exception routed to Hyp mode, using the EC value 0x24.

For more information see [Use of the HSR](#) on page G4-4677.

G1.13 Exception return to an Exception level using AArch32

In the ARM architecture, *exception return* to an Exception level that is using AArch32 requires the simultaneous restoration of the PC and **PSTATE** to values that are consistent with the desired state of execution on returning from the exception. Typically, exception return involves returning to one of:

- The instruction after the instruction boundary at which an asynchronous exception was taken.
- The instruction following an SVC, SMC, or HMC instruction, for an exception generated by one of those instructions.
- The instruction that caused the exception, after the reason for the exception has been removed.
- The subsequent instruction, if the instruction that caused the exception has been emulated in the exception handler.

The ARM architecture defines a *preferred return address* for each exception other than Reset, see [Link values saved on exception entry on page G1-4349](#). The values of the **SPSR.IT[7:0]** bits generated on exception entry are always correct for this preferred return address, but might require adjustment by the exception handler if returning elsewhere.

In some cases, to calculate the appropriate preferred return address for a return to an Exception level that is using AArch32, a subtraction must be performed on the link value saved on taking the exception. The description of each exception includes any value that must be subtracted from the link value, and other information about the required exception return.

On an exception return, the **PSTATE** takes either:

- The value loaded by the RFE instruction.
- If the exception return is not performed by executing an RFE instruction, the value of the current **SPSR** at the time of the exception return.

[Illegal return events from AArch32 state on page G1-4361](#) describes the behavior if the restored PE state would not be valid for the Exception level, PE mode, and Security state targeted by the exception return.

G1.13.1 Exception return instructions

The instructions that an exception handler can use to return from an exception depend on whether the exception was taken to an EL1 mode, or in an EL2 mode, see:

- [Return from an exception taken to a PE mode other than Hyp mode.](#)
- [Return from an exception taken to Hyp mode on page G1-4361.](#)

Return from an exception taken to a PE mode other than Hyp mode

For an exception taken to a PE mode other than Hyp mode, the ARM AArch32 architecture provides the following *exception return instructions*:

- From privileged modes other than System mode, the ERET instruction. After the exception return, execution resumes from the address held in the LR (R14) for the mode in which ERET is executed. See [ERET on page F5-3117](#).
- Data-processing instructions with the S bit set and the PC as a destination, see [MOV, MOVS \(register\) on page F5-3260](#) and [SUB, SUBS \(immediate\) on page F5-3560](#).

———— **Note** —————

The A32 instruction set includes other instructions that can be used for an exception return, but ARM deprecates any use of those instructions.

—————

Typically:

- A return where no subtraction is required uses SUBS with an operand of 0, or the equivalent MOVS instruction.
- A return requiring subtraction uses SUBS with a nonzero operand.
- The RFE instruction, see [RFE, RFEDA, RFEDB, RFEIA, RFEIB](#) on page F5-3363. If a subtraction is required, typically it is performed before saving the LR value to memory. After the exception return, execution resumes from the address held in the memory location indicated by the base register specified by the RFE instruction.
- In A32 state, a form of the LDM instruction in which the PC is one of the registers loaded, see [LDM \(exception return\)](#) on page F5-3148. If a subtraction is required, typically it is performed before saving the LR value to memory.

Return from an exception taken to Hyp mode

For an exception taken to Hyp mode, the ARM architecture provides the ERET instruction, see [ERET](#) on page F5-3117. An exception handler executing in Hyp mode must return using the ERET instruction.

Both Hyp mode and the ERET instruction are implemented only as part of EL2.

G1.13.2 Alignment of exception returns

The T bit of the value transferred to the [PSTATE](#) by an exception return controls the target instruction set of that return. The behavior of the hardware for exception returns for different values of the T bit is as follows:

T == 0 The target instruction set state is A32 state. Bits[1:0] of the address transferred to the PC are ignored by the hardware.

T == 1 The target instruction set state is T32 state:

- Bit[0] of the address transferred to the PC is ignored by the hardware.
- Bit[1] of the address transferred to the PC is part of the instruction address.

———— Note —————

In previous versions of the ARM architecture, the [PSTATE](#).{J, T} bits determined the Instruction set state. In ARMv8, [PSTATE](#).J is RES0.

ARM deprecates any dependence on the requirements that the hardware ignores bits of the address. ARM recommends that the address transferred to the PC for an exception return is correctly aligned for the target instruction set.

After an exception entry other than Reset, the LR value has the correct alignment for the instruction set indicated by the [SPSR](#).T bit. This means that if exception return instructions are used with the LR and [SPSR](#) values produced by such an exception entry, the only precaution software needs to take to ensure correct alignment is that any subtraction is of a multiple of four if returning to A32 state, or a multiple of two if returning to T32 state.

G1.13.3 Illegal return events from AArch32 state

Throughout this section:

Return In AArch32 state, refers to any of:

- Execution of any exception return instruction.
- Execution of a DRPS instruction in Debug state.
- Exit from Debug state.

If an exception or debug return from an Exception level using AArch32 triggers an illegal exception return, then bit[1] of the PC is either:

- Zero.
- The value of bit[1] of the return address for the exception or debug return.

The choice between these two alternatives is made by the implementation, and might differ from instance to instance of an illegal exception return.

———— **Note** ————

This means software must support both alternatives.

Saved process state value

In AArch32 state, refers to any of:

- The value held in the [SPSR](#) for any exception return other than an exception return made by executing an RFE instruction.
- The value read from memory that is to be restored to [PSTATE](#) by the execution of an RFE instruction.
- The value held in the [SPSR](#) for the execution of a DRPS instruction in Debug state.
- The value held in the [DSPSR](#) for a Debug state exit.

Link address In AArch32 state, refers to any of:

- The address held in the link register for any exception return other than an exception return made by executing an ERET, LDM, or RFE instruction.
- The address held in [ELR_hyp](#) for any exception return made by executing an ERET instruction.
- The address read from memory that is to be restored to the PC by the execution of an LDM or RFE instruction.
- The address held in the [DLR](#) for Debug state exit.

Configured from reset

Indicates the state determined on powerup or reset by a configuration input signal, or by another IMPLEMENTATION DEFINED mechanism.

The ARMv8 architecture has a generic mechanism for handling exception or debug returns to a mode or state that is illegal. In AArch32 state, this can occur as a result of any of the following situations:

- A return where the Exception level being returned to is higher than the current Exception level.
- A return where the mode being returned to is not implemented. For example:
 - A return to Hyp mode when EL2 is not implemented.
 - A return to Monitor mode, when EL3 is either not implemented or using AArch64 state.
- A return to EL2 when:
 - EL3 is implemented and using AArch64, and the value of the [SCR_EL3.NS](#) bit is 0.
 - EL3 is implemented and using AArch32, and the value of the [SCR.NS](#) bit is 0.
- A return to Non-secure EL1 when:
 - EL2 is implemented and using AArch64, and the value of the [HCR_EL2.TGE](#) bit is 1.
 - EL2 is implemented and using AArch32, and the value of the [HCR.TGE](#) bit is 1.
- A return where the value of the saved process state M[4:0] field is not a valid AArch32 PE mode for the implementation. [Table G1-5 on page G1-4322](#) shows the valid M[4:0] values for AArch32 PE modes.

In these cases:

- [PSTATE.IL](#) is set to 1, to indicate an illegal return.
- [PSTATE.M](#) is unchanged. This means the PE mode does not change.
- The SS bit is handled in the same way as any other exception or debug return, see [Software Step exceptions on page D2-1956](#).

- The following **PSTATE** bits are restored from the saved process state value:
 - The N, Z, C, V Condition flags.
 - The Q Overflow or saturation flag.
 - The GE Greater than or Equal flags.
 - The E Endianness mapping bit.
 - The A, I, F exception mask bits.
- The **PSTATE**.{IT, T} bits are each either:
 - Set to 0.
 - Copied from the saved process state in the **SPSR** for the PE mode in which the exception is handled.The choice between these two options is determined by an implementation, and might vary dynamically within an implementation. Correspondingly software must regard the value as being an UNKNOWN choice between the two values.
- The PC is restored from the link address, unless the illegal return is the execution of a DRPS instruction in Debug state.

When the value of the **PSTATE**.IL bit is 1, any attempt to execute any instruction results in an Illegal Execution state exception. See *The Illegal Execution state exception*.

All aspects of the illegal return, other than the effects described in this section, are the same as for a legal return.

G1.13.4 Legal returns that set **PSTATE**.IL to 1

In this section, return, saved process state value, and link address have the meaning that is defined in *Illegal return events from AArch32 state on page G1-4361*.

If the IL bit in the saved process state value is 1, then it is copied to **PSTATE** meaning that **PSTATE**.IL is set to 1. In this case, the **PSTATE**.{IT, T} bits are each either:

- Set to 0.
- Copied from the **SPSR**, or loaded from memory if the exception return was performed by executing an RFE instruction.

The choice between these two options is determined by an implementation, and might vary dynamically within the implementation. This means software must regard each value as being an UNKNOWN choice between the two permitted values.

Because the return sets the **PSTATE**.IL bit to 1, any attempt to execute any instruction results in an Illegal Execution state exception. See *The Illegal Execution state exception*.

G1.13.5 The Illegal Execution state exception

When the value of the **PSTATE**.IL bit is 1, any attempt to execute an instruction generates an Illegal Execution state exception. In AArch32 state, the **PSTATE**.IL bit can be set to 1 by one of the following:

- An illegal return, as described in *Illegal return events from AArch32 state on page G1-4361*.
- An illegal change to **PSTATE**.M, as described in *Illegal changes to PSTATE.M on page G1-4336*.
- A legal return that sets **PSTATE**.IL to 1, as described in *Legal returns that set PSTATE.IL to 1*.

An Illegal Execution state exception is taken in the same way as an Undefined Instruction exception in the current Exception level. If the current Exception level is EL2 using AArch32 state, the **HSR** provides additional syndrome information for the exception, see *Use of the HSR on page G4-4677*.

An Illegal Execution state exception has priority over any other Undefined Instruction exception that might arise from instruction execution.

Note

This section only describes the handling of an Illegal Execution state exception that is taken to an Exception level that is using AArch32 state. *The Illegal Execution state exception on page D1-1818* describes the cases where an Illegal Execution state exception is taken to an Exception level that is using AArch64 state.

On taking any exception to an Exception level that is using AArch32 state:

1. The value of the `PSTATE.IL` bit is 1 and this is copied to the `SPSR.IL` bit for the PE mode to which the exception is taken.
2. The `PSTATE.IL` bit is cleared to 0.

Note

This means that it is not possible for software to observe the value of `PSTATE.IL`.

Pseudocode description of exception return

The `AArch32.ExceptionReturn()` function transfers the return address to the PC and restores `PSTATE` to its saved value.

This function uses the function `SetPSTATEFromPSR()`.

The `IllegalExceptionReturn()` function checks for an Illegal Execution state exception.

[Chapter J1 ARMv8 Pseudocode](#) includes the definitions of these functions.

G1.14 Asynchronous exception behavior for exceptions taken from AArch32 state

In an implementation that does not include EL2 or EL3, the asynchronous exceptions behave as follows when EL1 and EL0 are both using AArch32:

- An SError interrupt is taken to Abort mode.
- An IRQ exception is taken to IRQ mode.
- An FIQ exception is taken to FIQ mode.

These are the *default PE modes* for taking these exceptions.

———— Note —————

The SError interrupt replaces the ARMv7 asynchronous abort. The new name better describes the nature of the exception.

However, the `PSTATE`.{A, I, F} bits *mask* the asynchronous exceptions, meaning that when the value of one of these `PSTATE` bits is 1, the corresponding exception is not taken.

If a masked asynchronous exceptions remains signaled, then the exception remains pending unless the value of the `PSTATE` bit is changed to 0.

EL2 and EL3 provide controls that affect:

- The routing of these exceptions, see [Asynchronous exception routing controls on page G1-4367](#).
- Masking of these exceptions in Non-secure state, see [Asynchronous exception masking controls on page G1-4368](#).

Similar register control bits are provided regardless of whether EL2 and EL3 are using AArch32 or AArch64:

- The EL2 controls are provided by the `HCR` when EL2 is using AArch32, and by the `HCR_EL2` when EL2 is using AArch64.
- The EL3 controls are provided by the `SCR` when EL3 is using AArch32, and by the `SCR_EL3` when EL3 is using AArch64.

Therefore, most references to the `HCR` or `SCR` in this section are to entries in [Table K11-1 on page K11-6282](#), that disambiguates between AArch32 registers and AArch64 registers. However, the Execution states used by EL2 and EL3 do affect some aspects of the routing and masking of the asynchronous exceptions, see [Asynchronous exception routing and masking with higher Exception levels using AArch64 on page G1-4370](#).

G1.14.1 Virtual exceptions when an implementation includes EL2

When implemented, EL2 provides the following virtual exceptions, that correspond to the physical asynchronous exceptions:

- Virtual SError, that corresponds to a physical external SError interrupt.
- Virtual IRQ, that corresponds to a physical IRQ.
- Virtual FIQ, that corresponds to a physical FIQ.

When the value of `HCR.TGE` is 0 and the value of an `HCR`.{AMO, IMO, FMO} routing control bit is 1, the corresponding virtual interrupt is enabled and a virtual exception is generated either:

- By setting the corresponding virtual interrupt pending bit, `HCR`.{VA, VI, VF}, to 1.
- For a Virtual IRQ or Virtual FIQ, by an IMPLEMENTATION DEFINED mechanism. This might be a signal from an interrupt controller. See, for example, the *ARM Generic Interrupt Controller Architecture Specification*.

When the value of `HCR_EL2.TGE` is 1 all virtual interrupts are disabled.

When a virtual interrupt is disabled:

- It cannot be taken.
- It cannot be seen in the `ISR`.

In AArch32 state, a virtual exception is taken only from a Non-secure EL1 or EL0 mode. In any other mode, if the exception is generated it is not taken.

A virtual exception is taken in Non-secure state to the default mode for the corresponding physical exception. This means:

- A Virtual SError is taken to Non-secure Abort mode.
- A Virtual IRQ is taken to Non-secure IRQ mode.
- A Virtual FIQ is taken to Non-secure FIQ mode.

Table G1-15 summarizes the HCR bits that route asynchronous exceptions to EL2, and the bits that generate the virtual exceptions.

Table G1-15 HCR bits controlling asynchronous exceptions

Exception	Routing the physical exception to EL2	Generating the virtual exception
SError	HCR.AMO	HCR.VA
IRQ	HCR.IMO	HCR.VI
FIQ	HCR.FMO	HCR.VF

The HCR.{VA, VI, VF} bits generate a virtual exception only if set to 1 when the value of the corresponding HCR.{AMO, IMO, FMO} is 1.

Similarly, if the implementation also includes EL3, the HCR.{AMO, IMO, FMO} bits route the corresponding physical exception to Hyp mode only if the physical exception is not routed to Monitor mode by the SCR.{EA, IRQ, FIQ} bit. For more information, see *Asynchronous exception routing controls* on page G1-4367.

When the value of an HCR.{AMO, IMO, FMO} control bit is 1, the corresponding mask bit in PSTATE:

- Does not mask the physical exception.
- Masks the virtual exception when the PE is executing in a Non-secure EL1 or EL0 mode.

Taking a Virtual Abort exception clears HCR.VA to zero. Taking a Virtual IRQ exception or a Virtual FIQ exception does not affect the value of HCR.VI or HCR.VF.

———— **Note** —————

This means that the exception handler for a Virtual IRQ exception or a Virtual FIQ exception must cause software that is executing at EL2 or EL3 to update the HCR to clear the appropriate virtual exception bit to 0.

See *WFE wake-up events* on page G1-4405 and *Wait For Interrupt* on page G1-4406 for information about how virtual exceptions affect wake up from power-saving states.

———— **Note** —————

A hypervisor can use virtual exceptions to signal exceptions to the current Guest OS. The Guest OS takes a virtual exception exactly as it would take the corresponding physical exception, and is unaware of any distinction between virtual exception and the corresponding physical exception.

Effects of the HCR.{AMO, IMO, FMO} bits

As described in this section, the HCR.{AMO, IMO, FMO} bits are part of the mechanism for enabling the virtual exceptions. In addition, for exceptions generated in Non-secure state:

- As mentioned in this section, affect the routing of the exceptions. See *Asynchronous exception routing controls* on page G1-4367.
- Affect the masking of the exceptions. See *Asynchronous exception masking controls* on page G1-4368.

G1.14.2 Asynchronous exception routing controls

Note

This section describes the behavior when all Exception levels are using AArch32. For the differences when this is not the case see [Asynchronous exception routing and masking with higher Exception levels using AArch64 on page G1-4370](#).

In an implementation that includes EL3 the following bits in the **SCR** control the routing of asynchronous exceptions, and also the routing of synchronous external aborts:

SCR.EA When the value of this bit is 1, any synchronous external abort or SError interrupt is taken to EL3.

Note

- Although this section describes the asynchronous exception routing controls, **SCR.EA** controls the routing of both synchronous external aborts and asynchronous SError interrupts.
- The other classes of abort cannot be routed to EL3. For more information about the classification of aborts, see [VMSAv8-32 memory aborts on page G4-4649](#).

SCR.FIQ When the value of this bit is 1, any FIQ exception is taken to EL3.

SCR.IRQ When the value of this bit is 1, any IRQ exception is taken to EL3.

When EL3 is using AArch32 and the value of one of the **SCR**.{EA, FIQ, IRQ} bits is 1, the exception is taken to Monitor mode.

Only Secure software can change the values of these bits.

In an implementation that includes EL2, the following bits in the **HCR** route asynchronous exceptions to EL2, for exceptions that are both:

- Taken from a Non-secure EL1 or EL0 mode.
- If the implementation also includes EL3, not configured, by the **SCR**.{EA, FIQ, IRQ} controls, to be taken to EL3.

HCR.AMO When the value of this bit is 1, an SError interrupt exception taken from a Non-secure EL1 or EL0 mode is taken to EL2, instead of to Non-secure Abort mode. If the implementation also includes EL3, this control applies only if the value of **SCR.EA** is 0. When the value of **SCR.EA** is 1, the value of the AMO bit is ignored.

HCR.FMO When the value of this bit is 1, an FIQ exception taken from a Non-secure EL1 or EL0 mode is taken to EL2, instead of to Non-secure FIQ mode. If the implementation also includes EL3, this control applies only if the value of **SCR.FIQ** is 0. When the value of **SCR.FIQ** is 1, the value of the FMO bit is ignored.

HCR.IMO When the value of this bit is 1, an IRQ exception taken from a Non-secure EL1 or EL0 mode is taken to EL2, instead of to Non-secure IRQ mode. If the implementation also includes EL3, this control applies only if the value of **SCR.IRQ** is 0. When the value of **SCR.IRQ** is 1, the value of the IMO bit is ignored.

When EL2 is using AArch32 and the value of one of the **HCR**.{AMO, FMO, IMO} bits is 1, the exception is taken to Hyp mode.

Only software executing in Hyp mode, or Secure software executing at EL3 with **SCR.NS** set to 1, can change the values of these bits. If EL3 is using AArch32, this requires the Secure software to be executing in Monitor mode.

The **HCR**.{AMO, FMO, IMO} bits also affect the masking of asynchronous exceptions in Non-secure state, as described in [Asynchronous exception masking controls on page G1-4368](#).

The **SCR**.{EA, FIQ, IRQ} and **HCR**.{AMO, FMO, IMO} bits have no effect on the routing of Virtual Abort, Virtual FIQ, and Virtual IRQ exceptions.

———— **Note** ————

When the PE is in Hyp mode:

- Physical asynchronous exceptions that are not routed to Monitor mode are taken to Hyp mode.
- Virtual exceptions are not signaled to the PE.

See also *Asynchronous exception behavior for exceptions taken from AArch32 state* on page G1-4365.

G1.14.3 Asynchronous exception masking controls

———— **Note** ————

This section describes the behavior when all Exception levels are using AArch32. For the differences when this is not the case see *Asynchronous exception routing and masking with higher Exception levels using AArch64* on page G1-4370.

The `PSTATE`.{A, I, F} bits can mask the taking of the corresponding exceptions from AArch32 state, as follows:

- `PSTATE`.A can mask SError interrupt exceptions.
- `PSTATE`.I can mask IRQ exceptions.
- `PSTATE`.F can mask FIQ exceptions.

In an implementation that does not include either of EL2 and EL3, setting one of these bits to 1 masks the corresponding exception, meaning the exception cannot be taken.

In an implementation that includes EL2, the `HCR`.{AMO, IMO, FMO} bits modify the masking of exceptions taken from Non-secure state.

Similarly, in an implementation that includes EL3, the `SCR`.{AW, FW} bits modify the masking of exceptions taken from Non-secure state by the `PSTATE`.{A, F} bits.

An implementation that includes only EL1 and EL0 does not provide any masking of the `PSTATE`.{A, I, F} bits. The following subsections describe the masking of these bits in other implementations:

- *Asynchronous exception masking in an implementation that includes EL2 but not EL3.*
- *Asynchronous exception masking in an implementation that includes EL3 but not EL2.*
- *Asynchronous exception masking in an implementation that includes both EL2 and EL3* on page G1-4369.
- *Summary of the asynchronous exception masking controls* on page G1-4369.

Asynchronous exception masking in an implementation that includes EL2 but not EL3

The `HCR`.{AMO, IMO, FMO} bits modify the effect of the `PSTATE`.{A, I, F} bits. When the value of an `HCR`.{AMO, IMO, FMO} mask override bit is 1, the value of the corresponding `PSTATE`.{A, I, F} bit is ignored when the exception is taken from a Non-secure mode other than Hyp mode.

Asynchronous exception masking in an implementation that includes EL3 but not EL2

The `SCR`.{AW, FW} bits modify the effect of the `PSTATE`.{A, F} bits. When the value of one of the `SCR`.{AW, FW} bits is 0, the corresponding `PSTATE` bit is ignored when both of the follow apply:

- The corresponding exception is taken from Non-secure state.
- The value of the corresponding `SCR`.{EA, FIQ} bit is 1, routing the exception to EL3. This means the exception is routed to Monitor mode if EL3 is using AArch32.

———— **Note** ————

Whenever the value of `PSTATE`.I is 1, IRQ exceptions are masked and cannot be taken.

Asynchronous exception masking in an implementation that includes both EL2 and EL3

When the value of an **HCR**.{AMO, IMO, FMO} mask override bit is 1, the value of the corresponding **PSTATE**.{A, I, F} bit is ignored when both of the following apply:

- The exception is taken from Non-secure state.
- Either:
 - The corresponding **SCR**.{EA, IRQ, FIQ} bit routes the exception to Monitor mode.
 - The exception is taken from a Non-secure mode other than Hyp mode.

In addition, when the value of an **SCR**.{AW, FW} bit is 0, the value of the corresponding **PSTATE**.{A, F} bit is ignored when all of the following apply:

- The exception is taken from Non-secure state.
- The corresponding **SCR**.{EA, FIQ} bit routes the exception to Monitor mode.
- The corresponding **HCR**.{AMO, FMO} mask override bit is set to 0.

Summary of the asynchronous exception masking controls

The tables in this section show the masking controls for each of the **PSTATE**.{A, I, F} bits. For an implementation that does not include all of the Exception levels:

If the implementation includes only EL1 and EL0

The **PSTATE** bits cannot be masked. The behavior is as shown in the *Secure* row of the tables.

If the implementation includes EL2 but not EL3

The behavior is as shown in the *Non-secure* table rows when the control bits in the **SCR** are both 0.

If the implementation includes EL3 but not EL2

The behavior is as shown in the table rows where the control bit in the **HCR** is 0.

Table G1-16 shows the controls of the masking of SError interrupt exceptions by **PSTATE**.A.

Table G1-16 Control of masking by **PSTATE.A**

Security state	HCR .AMO	SCR .EA	SCR .AW	Mode	PSTATE .A
Secure	x	x	x	x	Masks SError interrupt, when set to 1
Non-secure	0	0	x	x	Masks SError interrupt, when set to 1
			1	0	Ignored
		1	1	x	Masks SError interrupt, when set to 1
	1	x	x	Not Hyp	Ignored
			0	x	Hyp
		1	x	x	Ignored

Table G1-17 shows the controls of the masking of FIQ exceptions by **PSTATE.F**:

Table G1-17 Control of masking by **PSTATE.I**

Security state	HCR.IMO	SCR.IRQ	Mode	PSTATE.I
Secure	x	x	x	Masks IRQs, when set to 1
Non-secure	0	x	x	Masks IRQs, when set to 1
		1	Not Hyp	Ignored
	1	0	Hyp	Masks IRQs, when set to 1
		1	x	Ignored

Table G1-18 shows the controls of the masking of FIQ exceptions by **PSTATE.F**:

Table G1-18 Control of masking by **PSTATE.F**

Security state	HCR.FMO	SCR.FIQ	SCR.FW	Mode	PSTATE.F	
Secure	x	x	x	x	Masks FIQs, when set to 1	
Non-secure	0	0	x	x	Masks FIQs, when set to 1	
			1	0	x	Ignored
		1	x	x	Not Hyp	Ignored
	1	0	x	x	Hyp	Masks FIQs, when set to 1
			1	x	x	Ignored
		1	1	x	x	Ignored

G1.14.4 Asynchronous exception routing and masking with higher Exception levels using AArch64

Asynchronous exception routing controls on page G1-4367 and *Asynchronous exception masking controls* on page G1-4368 give full descriptions of the routing and masking of the asynchronous exceptions when all Exception levels are using AArch32. However, when EL0 and EL1 are using AArch32:

- As already described, the **SCR** and **HCR** controls might be from Exception levels that are using AArch64.
- If EL3 is using AArch64, or EL2 is using AArch64, there are some changes to the asynchronous exception behaviors.

Therefore, the following sections summarize the asynchronous exception behaviors, taking account of the Execution state being used at EL2 and EL3:

- *Summary of physical interrupt routing.*
- *Summary of physical interrupt masking on page G1-4372.*

Summary of physical interrupt routing

The following tables show the routing of physical interrupts. [Table G1-19 on page G1-4371](#) shows the routing of physical FIQ interrupts, [Table G1-20 on page G1-4371](#) shows the routing of physical IRQ interrupts, and [Table G1-21 on page G1-4372](#) shows the routing of physical SError interrupts.

In these tables, for exceptions that must be taken to an Exception level that is using AArch32, the table shows the target Exception level and PE mode. In these entries, *Mon* indicates Monitor mode, and *Abt* indicates Abort mode.

Table G1-19 Routing of physical FIQ exceptions

EL3 Execution state	Control bits			Target when take from:						
	SCR	HCR		Non-secure			Secure			
		FIQ	RW ^a	FMO ^b	EL0	EL1	EL2	EL0	EL1 ^c	EL3
AArch32	0	x	0	EL1 FIQ	EL1 FIQ	EL2 Hyp	EL3 FIQ	-	EL3 FIQ	
			1	EL2 Hyp	EL2 Hyp	EL2 Hyp	EL3 FIQ	-	EL3 FIQ	
	1	x	x	EL3 Mon	EL3 Mon	EL3 Mon	EL3 Mon	-	EL3 Mon	
AArch64	0	0	0	EL1 FIQ	EL1 FIQ	EL2 Hyp	EL1 FIQ	EL1 FIQ	p ^d	
			x	1	EL2 ^e	EL2 ^e	EL2 ^e	EL1 ^f	EL1 ^f	p ^d
			1	0	EL1	EL1	p ^d	EL1	EL1	p ^d
	1	x	x	EL3	EL3	EL3	EL3	EL3	EL3	

- a. **SCR_EL3.RW**. When 1, the next lower Exception level is using AArch64. This control is not present when EL3 is using AArch32.
- b. When the value of **HCR.TGE** is 1, the effective value of this bit is 1.
- c. When EL3 is using AArch32, the only Secure Exception levels are EL0 and EL3.
- d. Interrupt is not taken, but remains pending.
- e. If EL2 is using AArch32, taken to Hyp mode.
- f. If EL1 is using AArch32, taken to Abort mode.

Table G1-20 Routing of physical IRQ exceptions

EL3 Execution state	Control bits			Target when take from:						
	SCR	HCR		Non-secure			Secure			
		IRQ	RW ^a	IMO ^b	EL0	EL1	EL2	EL0	EL1 ^c	EL3
AArch32	0	x	0	EL1 IRQ	EL1 IRQ	EL2 Hyp	EL3 IRQ	-	EL3 IRQ	
			1	EL2 Hyp	EL2 Hyp	EL2 Hyp	EL3 IRQ	-	EL3 IRQ	
	1	x	x	EL3 Mon	EL3 Mon	EL3 Mon	EL3 Mon	-	EL3 Mon	
AArch64	0	0	0	EL1 IRQ	EL1 IRQ	EL2 Hyp	EL1 IRQ	EL1 IRQ	p ^d	
			x	1	EL2 ^e	EL2 ^e	EL2 ^e	EL1 ^f	EL1 ^f	p ^d
			1	0	EL1	EL1	p ^d	EL1	EL1	p ^d
	1	x	x	EL3	EL3	EL3	EL3	EL3	EL3	

- a. **SCR_EL3.RW**. When 1, the next lower Exception level is using AArch64. This control is not present when EL3 is using AArch32.
- b. When the value of **HCR.TGE** is 1, the effective value of this bit is 1.
- c. When EL3 is using AArch32, the only Secure Exception levels are EL0 and EL3.
- d. Interrupt is not taken, but remains pending.
- e. If EL2 is using AArch32, taken to Hyp mode.

f. If EL1 is using AArch32, taken to Abort mode.

Table G1-21 Routing of physical SError interrupts

EL3 Execution state	Control bits			Target when take from:					
	SCR EA	RW ^a	HCR AMO ^b	Non-secure			Secure		
				EL0	EL1	EL2	EL0	EL1 ^c	EL3
AArch32	0	x	0	EL1 Abt	EL1 Abt	EL2 Hyp	EL3 Abt	-	EL3 Abt
			1	EL2 Hyp	EL2 Hyp	EL2 Hyp	EL3 Abt	-	EL3 Abt
	1	x	x	EL3 Mon	EL3 Mon	EL3 Mon	EL3 Mon	-	EL3 Mon
AArch64	0	0	0	EL1 Abt	EL1 Abt	EL2 Hyp	EL1 Abt	EL1Abt	p ^d
		x	1	EL2 ^e	EL2 ^e	EL2 ^e	EL1 ^f	EL1 ^f	p ^d
		1	0	EL1	EL1	p ^d	EL1	EL1	p ^d
	1	x	x	EL3	EL3	EL3	EL3	EL3	EL3

- a. SCR_EL3.RW. When 1, the next lower Exception level is using AArch64. This control is not present when EL3 is using AArch32.
- b. When the value of HCR.TGE is 1, the effective value of this bit is 1.
- c. When EL3 is using AArch32, the only Secure Exception levels are EL0 and EL3.
- d. Interrupt is not taken, but remains pending.
- e. If EL2 is using AArch32, taken to Hyp mode.
- f. If EL1 is using AArch32, taken to Abort mode.

Summary of physical interrupt masking

The following tables show the masking of physical interrupts. [Table G1-22 on page G1-4373](#) shows the masking of physical FIQ interrupts, [Table G1-23 on page G1-4373](#) shows the masking of physical IRQ interrupts, and [Table G1-24 on page G1-4374](#) shows the masking of physical SError interrupts. In these tables:

- M** Indicates that the exception is masked when the value of the PSTATE mask bit is 1.
- T** Indicates that the exception is taken, regardless of the value of the PSTATE mask bit.
- P** Indicates that the exception is not taken but remains pending. The value of the PSTATE mask bit has no effect on this behavior.

Table G1-22 Masking of physical FIQ exceptions

EL3 Execution state	Control bits			Effect of PSTATE.F ^a mask in Exception level							
	SCR	HCR			Non-secure			Secure			
		FIQ	FW	RW ^b	FMO ^c	EL0	EL1	EL2	EL0	EL1 ^d	EL3
AArch32	0	x	x	0	M	M	M	M	-	M	
				1	T	T	M	M	-	M	
	1	0	x	0	T	T	T	M	-	M	
			1	x	0	M	M	M	M	-	M
		x	x	1	T	T	T	M	-	M	
			x	x	1	T	T	T	M	-	M
AArch64	0	x	0	0	M	M	M	M	M	P	
				1	T	T	M	M	M	P	
				1	0	M	M	P	M	M	P
					1	T	T	M	M	M	P
	1	x	x	x	T	T	T	T	T	M	
					T	T	T	T	T	M	

- In AArch32 state this is visible as **CPSR.F**.
- SCR_EL3** only, this control is not present when EL3 is using AArch32. When the value of RW is 1, the next lower Exception level is using AArch64.
- When the value of **HCR.TGE** is 1, the effective value of this bit is 1.
- When EL3 is using AArch32, the only Secure Exception levels are EL0 and EL3.

Table G1-23 Masking of physical IRQ exceptions

EL3 Execution state	Control bits			Effect of PSTATE.I ^a mask in Exception level						
	SCR	HCR		Non-secure			Secure			
		IRQ	RW ^b	IMO ^c	EL0	EL1	EL2	EL0	EL1 ^d	EL3
AArch32	0	x	0	M	M	M	M	-	M	
			1	T	T	M	M	-	M	
	1	x	0	M	M	M	M	-	M	
			1	T	T	T	M	-	M	
AArch64	0	0	0	M	M	M	M	M	P	
			1	T	T	M	M	M	P	
			1	0	M	M	P	M	M	P
				1	T	T	M	M	M	P
	1	x	x	T	T	T	T	T	M	

- a. In AArch32 state this is visible as **CPSR.I**.
- b. **SCR_EL3** only, this control is not present when EL3 is using AArch32. When the value of RW is 1, the next lower Exception level is using AArch64.
- c. When the value of **HCR.TGE** is 1, the effective value of this bit is 1.
- d. When EL3 is using AArch32, the only Secure Exception levels are EL0 and EL3.

Table G1-24 Masking of physical SError interrupts

EL3 Execution state	Control bits			Effect of PSTATE.A ^a mask in Exception level							
	SCR EA	AW	RW ^b	HCR	Non-secure			Secure			
				AMO ^c	EL0	EL1	EL2	EL0	EL1 ^d	EL3	
AArch32	0	x	x	0	M	M	M	M	-	M	
				1	T	T	M	M	-	M	
	1	0	x	0	T	T	T	M	-	M	
				1	M	M	M	M	-	M	
				x	T	T	T	M	-	M	
AArch64	0	x	0	0	M	M	M	M	M	P	
				1	T	T	M	M	M	P	
				1	0	M	M	P	M	M	P
					1	T	T	M	M	M	P
	1	x	x	x	T	T	T	T	T	M	

- a. In AArch32 state this is visible as **CPSR.A**.
- b. **SCR_EL3** only, this control is not present when EL3 is using AArch32. When the value of RW is 1, the next lower Exception level is using AArch64.
- c. When the value of **HCR.TGE** is 1, the effective value of this bit is 1.
- d. When EL3 is using AArch32, the only Secure Exception levels are EL0 and EL3.

G1.14.5 Taking an interrupt or other exception during a multiple-register load or store

In AArch32 state in ARMv8.0 and ARMv8.1, an interrupt cannot be taken during a sequence of memory accesses caused by a single load or store instruction.

When ARMv8.2-LSMAOC is implemented, an interrupt is permitted during a sequence of memory accesses generated by a LDM or STM instruction. Two control bits are added to HSCCLR and SCLLR to control this behavior. These are:

- The LSMAOE bit. This indicates that LDM and STM are permitted to be reordered or interrupted in any memory type.
- The nTlSMD bit. This causes LDM and STM instructions accessing Device memory to cause an Alignment fault.

When the LSMAOE bit is 0, if an interrupt is taken within the sequence of memory accesses generated by an LDM or STM instruction, then:

- For a load, any register being loaded by the instruction other than ones used in the generation of the address by the instruction, or PC, can contain an UNKNOWN value. Registers used in the generation of the address are restored to their initial value and the LR is set on the interrupt to a value consistent with returning to the instruction.
- For a store, any data location being stored to by the instruction can contain an UNKNOWN value.
- For either a load or store, if the instruction specifies writeback of the base address, then that register is restored to its initial value.

G1.15 AArch32 state exception descriptions

Handling exceptions that are taken to an Exception level using AArch32 on page G1-4340 gives general information about exception handling. This section describes each of the exceptions, in the following subsections:

- *Undefined Instruction exception.*
- *Monitor Trap exception on page G1-4379.*
- *Hyp Trap exception on page G1-4379.*
- *Supervisor Call (SVC) exception on page G1-4380.*
- *Secure Monitor Call (SMC) exception on page G1-4382.*
- *Hypervisor Call (HVC) exception on page G1-4383.*
- *Prefetch Abort exception on page G1-4384.*
- *Data Abort exception on page G1-4387.*
- *VirtualSError interrupt exception on page G1-4391.*
- *IRQ exception on page G1-4392.*
- *Virtual IRQ exception on page G1-4394.*
- *FIQ exception on page G1-4395.*
- *Virtual FIQ exception on page G1-4397.*

Additional pseudocode functions for exception handling on page G1-4398 gives additional pseudocode that is used in the pseudocode descriptions of a number of the exceptions.

G1.15.1 Undefined Instruction exception

An Undefined Instruction exception might be caused by:

- A System register access, floating-point, or Advanced SIMD instruction that is not accessible because of the settings in one or more of the CPACR, NSACR, HCPTR, and DBGDSCRExt.
- A System register access, floating-point, or Advanced SIMD instruction that is not implemented.
- A System register access, floating-point, or Advanced SIMD instruction that causes an exception during execution. This includes:
 - Trapped floating-point exceptions that are taken to AArch32, if an implementation supports these traps. See *Floating-point exceptions and exception traps on page E1-2743*.
 - Execution of certain floating-point instructions when one or both of the FPSCR.{Stride, Len} fields in nonzero, in an implementation in which those fields are RW. The description of FPEXC specifies the instructions to which this applies.
- An instruction that is UNDEFINED.

———— Note —————

The Undefined Instruction exception is taken using offset 0x04 in the Hyp, Secure, or Non-secure vector table. In the Monitor vector table this offset is used for the Monitor Trap exception. See *Monitor Trap exception on page G1-4379* and *The vector tables and exception offsets on page G1-4341*.

By default, an Undefined Instruction exception is taken to Undefined mode, but an Undefined Instruction exception can be taken to EL2, meaning it is taken to Hyp mode if EL2 is using AArch32, see *The PE mode to which the Undefined Instruction exception is taken on page G1-4377*.

The Undefined Instruction exception can provide:

- Signaling of an illegal instruction execution.
- *Lazy context switching* of System registers.

The preferred return address for an Undefined Instruction exception is the address of the instruction that generated the exception. For an exception taken to AArch32 state, this return is performed as follows:

- If returning from Secure or Non-secure Undefined mode, the exception return uses the **SPSR** and **LR_und** values generated by the exception entry, as follows:
 - If **SPSR.T** is 0, indicating that the exception occurred in A32 state, the return uses an exception return instruction with a subtraction of 4.
 - If **SPSR.T** is 1, indicating that the exception occurred in T32 state, the return uses an exception return instruction with a subtraction of 2.
- If returning from Hyp mode, the exception return is performed by an ERET instruction, using the **SPSR** and **ELR_hyp** values generated by the exception entry.

For more information, see *Exception return to an Exception level using AArch32* on page G1-4360.

Note

If handling the Undefined Instruction exception requires instruction emulation, followed by return to the next instruction after the instruction that caused the exception, the instruction emulator must use the instruction length to calculate the correct return address, and to calculate the updated values of the IT bits if necessary.

The PE mode to which the Undefined Instruction exception is taken

Figure G1-4 shows how the implementation, state, and configuration options determine the PE mode to which an Undefined Instruction exception is taken, when the exception is taken to an Exception level that is using AArch32.

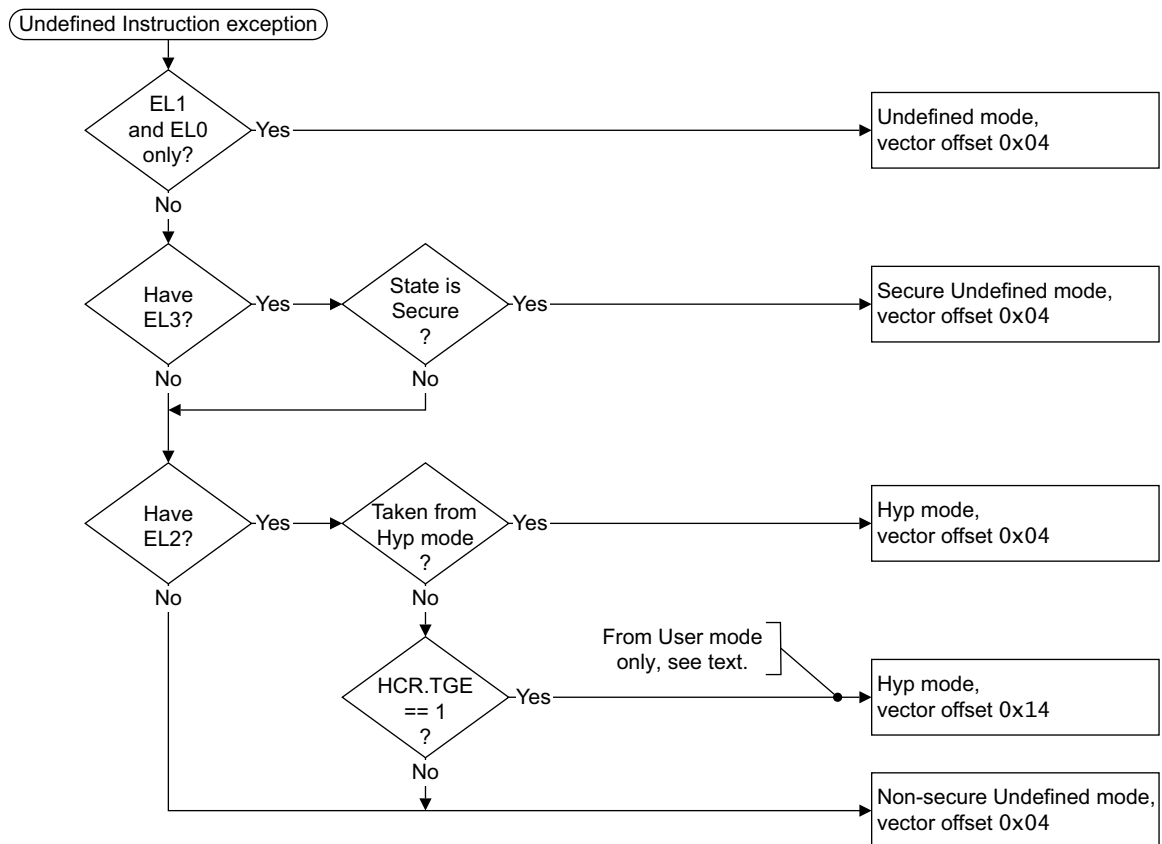

Figure G1-4 The PE mode an Undefined Instruction exception is taken to in AArch32 state

See also *UNPREDICTABLE cases when the value of HCR.TGE is 1* on page G1-4354.

Pseudocode description of taking the Undefined Instruction exception

The `AArch32.UndefinedFault()` pseudocode procedure determines whether the Undefined Instruction exception is taken to AArch32 state. If it is taken to AArch32 state, the `AArch32.TakeUndefInstrException()` pseudocode procedure describes how the PE takes the exception.

An Undefined Instruction exception is taken to an Exception level using AArch64 if either:

- It is generated in User mode when EL1 is using AArch64.
- It is generated in Non-secure User mode when EL2 is using AArch64 and the value of `HCR_EL2.TGE` is 1.

Conditional execution of undefined instructions

The conditional execution rules described in [Conditional execution on page F2-2849](#) apply to all instructions. This includes undefined instructions and other instructions that would cause entry to the Undefined Instruction exception.

If such an instruction fails its condition check, the behavior depends on the potential cause of entry to the Undefined Instruction exception, as follows:

- If the potential cause is the execution of the instruction itself and depends on data values used by the instruction, the instruction executes as a NOP and does not cause an Undefined Instruction exception.
- In the following cases, it is IMPLEMENTATION DEFINED whether the instruction executes as a NOP or causes an Undefined Instruction exception:
 - The potential cause is the execution of an earlier System register access instruction, floating-point instruction, or Advanced SIMD instruction.
 - The potential cause is the execution of the instruction itself without dependence on the data values used by the instruction.

An implementation must handle all such cases in the same way.

————— **Note** —————

Before ARMv7, all implementations executed any instruction that failed its condition check as a NOP, even if it would otherwise have caused an Undefined Instruction exception. An Undefined Instruction handler written for these implementations might assume without checking that the undefined instruction passed its condition check. Such an Undefined Instruction handler is likely to need rewriting, to check the condition is passed, before it functions correctly on all AArch32 implementations.

Interaction of UNDEFINED instruction behavior with UNPREDICTABLE or CONSTRAINED UNPREDICTABLE instruction behavior

If this manual describes an instruction as both:

- UNPREDICTABLE and UNDEFINED then the instruction is UNPREDICTABLE.
- CONSTRAINED UNPREDICTABLE and UNDEFINED then the instruction is CONSTRAINED UNPREDICTABLE.

————— **Note** —————

An example of this is where both:

- An instruction, or instruction class, is made UNDEFINED by some general principle, or by a configuration field.
- A particular encoding of that instruction or instruction class is specified as CONSTRAINED UNPREDICTABLE.

G1.15.2 Monitor Trap exception

The Monitor Trap exception is implemented only as part of EL3, and can be generated only if EL3 is using AArch32.

———— Note —————

The Monitor Trap exception is taken using offset 0x04 in the Monitor vector table. In the other vector tables, this offset is used for the Undefined Instruction exception. See [Undefined Instruction exception on page G1-4376](#) and [The vector tables and exception offsets on page G1-4341](#).

A Monitor Trap exception is generated if the PE is running in a mode other than Monitor mode, and commits for execution a WFI or WFE instruction that would otherwise cause suspension of execution when:

- In the case of the WFI instruction, the value of the `SCR.TWI` bit is 1.
- In the case of the WFE instruction, the value of the `SCR.TWE` bit is 1.

———— Note —————

Since a WFE or WFI can complete at any time, even without a Wakeup event, the traps on WFE or WFI are not guaranteed to be taken, even if the WFE or WFI is executed when there is no Wakeup event. The only guarantee is that if the instruction does not complete in finite time in the absence of a Wakeup event, the trap will be taken.

The preferred return address for a Monitor Trap exception is the address of the instruction that generated the exception. The exception return uses the `SPSR` and `LR_mon` values generated by the exception entry, as follows:

- If `SPSR.T` is 0, indicating that the exception occurred in A32 state, the return uses an exception return instruction with a subtraction of 4.
- If `SPSR.T` is 1, indicating that the exception occurred in T32 state, the return uses an exception return instruction with a subtraction of 2.

For more information, see [Exception return to an Exception level using AArch32 on page G1-4360](#).

The PE mode to which the Monitor Trap exception is taken

When EL3 is using AArch32, a Monitor Trap exception is taken to Monitor mode, using a vector offset of 0x04 from the Monitor exception base address.

Pseudocode description of taking the Monitor Trap exception

The `AArch32.TakeMonitorTrapException()` pseudocode procedure describes how the PE takes the exception.

G1.15.3 Hyp Trap exception

The Hyp Trap exception provides the standard mechanism for trapping Guest OS functions to the hypervisor.

The Hyp Trap exception is implemented only as part of EL2 and can be generated only if EL2 is using AArch32.

A Hyp Trap exception is generated if the PE is running in a Non-secure mode other than Hyp mode, and commits for execution an instruction that is trapped to Hyp mode. Instruction traps are enabled by setting bits to 1 in the `HCR`, `HCPTR`, `HDCR`, or `HSTR`. For more information see [EL2 configurable controls on page G1-4427](#).

Traps to Hyp mode never apply in Secure state, regardless of the value of the `SCR.NS` bit.

The preferred return address for a Hyp Trap exception is the address of the trapped instruction. The exception return is performed by an ERET instruction, using the `SPSR` and `ELR_hyp` values generated by the exception entry.

———— **Note** —————

The [SPSR](#) and [ELR_hyp](#) values generated on exception entry can be used, without modification, for an exception return to re-execute the trapped instruction. If the exception handler emulates the trapped instruction, and must return to the following instruction, the emulation of the instruction must include modifying [ELR_hyp](#), and possibly updating [SPSR_hyp](#).

When the PE enters the handler for a Hyp Trap exception, the [HSR](#) holds syndrome information for the exception. For more information see [Use of the HSR on page G4-4677](#).

The PE mode to which the Hyp Trap exception is taken

A Hyp Trap exception is taken to Hyp mode, using a vector offset of 0x14 from the Hyp exception base address.

Pseudocode description of taking the Hyp Trap exception

The [AArch32.TakeHypTrapException\(\)](#) pseudocode procedure describes how the PE takes the exception.

G1.15.4 Supervisor Call (SVC) exception

The Supervisor Call instruction, [SVC](#), requests a supervisor function, typically to request an operating system function. When EL1 is using AArch32, executing an [SVC](#) instruction causes the PE to enter Supervisor mode. For more information, see [SVC on page F5-3575](#).

———— **Note** —————

In an implementation that includes EL2, when EL2 is using AArch32:

- When an [SVC](#) instruction is executed in Hyp mode, the Supervisor Call exception is taken to Hyp mode. For more information see [SVC on page F5-3575](#).
- When the [HCR.TGE](#) bit is set to 1, the Supervisor Call exception generated by execution of an [SVC](#) instruction in Non-secure User mode is routed to Hyp mode. For more information, see [Supervisor Call exception, when the value of HCR.TGE is 1 on page G1-4357](#).

By default, a Supervisor Call exception that is taken to AArch32 state is taken to Supervisor mode, but a Supervisor Call exception can be taken to EL2, meaning it is taken to Hyp mode if EL2 is using AArch32, see [The PE mode to which the Supervisor Call exception is taken on page G1-4381](#).

The preferred return address for a Supervisor Call exception is the address of the next instruction after the [SVC](#) instruction. For an exception taken to AArch32 state, this return is performed as follows:

- If returning from Secure or Non-secure Supervisor mode, the exception return uses the [SPSR](#) and [LR_svc](#) values generated by the exception entry, in an exception return instruction without subtraction.
- If returning from Hyp mode, the exception return is performed by an [ERET](#) instruction, using the [SPSR](#) and [ELR_hyp](#) values generated by the exception entry.

For more information, see [Exception return to an Exception level using AArch32 on page G1-4360](#).

The PE mode to which the Supervisor Call exception is taken

Figure G1-5 shows how the implementation, state, and configuration options determine the PE mode to which a Supervisor Call exception is taken, when the exception is taken to an Exception level that is using AArch32.

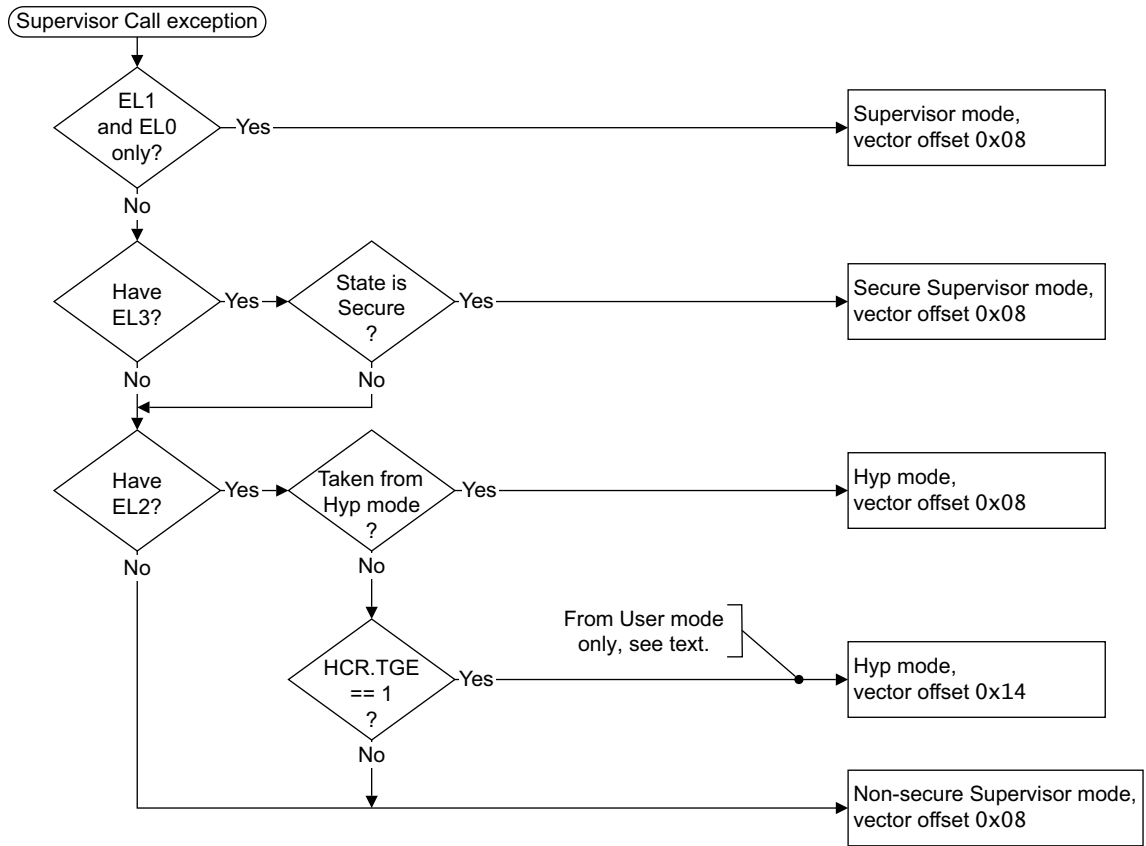

Figure G1-5 The PE mode the Supervisor Call exception is taken to in AArch32 state

See also *UNPREDICTABLE cases when the value of HCR.TGE is 1* on page G1-4354.

Pseudocode description of taking the Supervisor Call exception

The `AArch32.CallSupervisor()` pseudocode procedure determines whether the Supervisor Call exception is taken to AArch32 state. If it is taken to AArch32 state, the `AArch32.TakeSVCException()` pseudocode procedure describes how the PE takes the exception.

An Supervisor Call exception is taken to an Exception level using AArch64 if either:

- It is generated by executing an SVC instruction in User mode when EL1 is using AArch64.
- It is generated by executing an SVC instruction in Non-secure User mode when EL2 is using AArch64 and the value of `HCR_EL2.TGE` is 1.

G1.15.5 Secure Monitor Call (SMC) exception

The Secure Monitor Call exception is implemented only as part of EL3. When EL3 is using AArch32, the exception is taken to Monitor mode.

The Secure Monitor Call instruction, SMC, requests a Secure Monitor function. When EL3 is using AArch32, executing an SMC instruction causes the PE to enter Monitor mode. For more information, see [SMC on page F5-3429](#).

———— Note ————

- In an implementation that includes EL2, execution of an SMC instruction in a Non-secure EL1 mode can be trapped to EL2. When EL2 is using AArch32, this means that when HCR.TSC 1, execution of an SMC instruction in a Non-secure EL1 mode generates a Hyp Trap Exception that is taken to Hyp mode. For more information see [Traps to Hyp mode of Non-secure EL1 execution of SMC instructions on page G1-4434](#).
- The Operation pseudocode in the description of the AArch32 SMC instruction, in [SMC on page F5-3429](#), identifies cases where execution of the instruction generates an exception that is taken to EL3 using AArch64.

The preferred return address for a Secure Monitor Call exception is the address of the next instruction after the SMC instruction. For an exception taken to AArch32 state, this return is performed using the SPSR and LR_mon values generated by the exception entry, using an exception return instruction without a subtraction.

For more information, see [Exception return to an Exception level using AArch32 on page G1-4360](#).

———— Note ————

For an exception taken to AArch32 state, the exception handler can return to the SMC instruction itself by returning using a subtraction of 4, without any adjustment to the SPSR.IT[7:0] bits. If it does this, the return occurs, then asynchronous exceptions might occur and be handled, then the SMC instruction is re-executed and another Secure Monitor Call exception occurs.

This relies on:

- The SMC instruction being used correctly, either outside an IT block or as the last instruction in an IT block, so that the SPSR.IT[7:0] bits indicate unconditional execution.
- The Secure Monitor Call handler not changing the result of the original conditional execution test for the SMC instruction.

The PE mode to which the Secure Monitor Call exception is taken

The Secure Monitor Call exception is supported only as part of EL3. When EL3 is using AArch32, a Secure Monitor Call exception is taken to Monitor mode, using vector offset 0x08 from the Monitor exception base address.

———— Note ————

- An SMC instruction that is trapped to Hyp mode because HCR.TSC is set to 1 generates a Hyp Trap exception, see [The PE mode to which the Hyp Trap exception is taken on page G1-4380](#).
- If EL3 is using AArch64 then [Security behavior in Exception levels using AArch32 when EL3 is using AArch64 on page G1-4352](#) describes the effect of executing an SMC instruction at an Exception level that is using EL1.

Pseudocode description of taking the Secure Monitor Call exception

The [AArch32.TakeSMCException\(\)](#) pseudocode procedure describes how the PE takes the exception when the exception is taken to an Exception level that is using AArch32.

G1.15.6 Hypervisor Call (HVC) exception

The Hypervisor Call exception is implemented only as part of EL2.

The Hypervisor Call instruction, HVC, requests a hypervisor function. When EL2 is using AArch32, executing an HVC instruction generates a Hypervisor Call exception that is taken to Hyp mode. For more information, see [HVC on page F5-3123](#).

Note

- Execution of HVC instructions is disabled when the value of `SCR.HCE` is 0. Descriptions of HVC instruction execution elsewhere in this section assume the *Effective value* of `SCR.HCE` is 1.
- When EL2 is using AArch64 an HVC instruction executed in a Non-secure EL1 mode generates an exception that is taken to EL2 using AArch64. [Exception classes and the ESR_ELx syndrome registers on page D1-1801](#) describes how this exception is reported in `ESR_EL2`.

The preferred return address for a Hypervisor Call exception is the address of the next instruction after the HVC instruction. The exception return is performed by an ERET instruction, using the `SPSR` and `ELR_hyp` values generated by the exception entry.

For more information, see [Exception return to an Exception level using AArch32 on page G1-4360](#).

When EL2 is using AArch32, executing an HVC instruction transfers the immediate argument of the instruction to the `HSR`. The exception handler retrieves the argument from the `HSR`, and therefore does not have to access the original HVC instruction. For more information see [Use of the HSR on page G4-4677](#).

The PE mode to which the Hypervisor Call exception is taken

The Hypervisor Call exception is supported only as part of EL2. When EL2 is using AArch32, a Hypervisor Call exception is taken to Hyp mode, using a vector offset that depends on the mode from which the exception is taken, as [Figure G1-6](#) shows. This offset is from the Hyp exception base address.

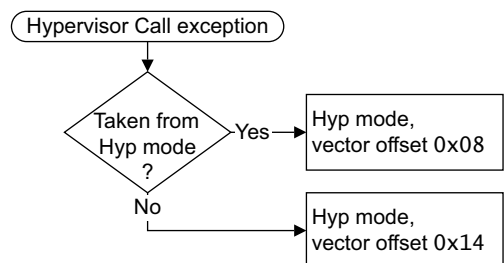

Figure G1-6 The PE mode the Hypervisor Call exception is taken to in AArch32 state

Pseudocode description of taking the Hypervisor Call exception

The `AArch32.CallHypervisor()` pseudocode procedure determines whether the valid execution of an HVC instruction in AArch32 state generates an exception that is taken to EL2 using AArch64, or generates a Hypervisor Call exception taken to Hyp mode. The `AArch32.TakeHVCException()` pseudocode procedure describes how the PE takes a Hypervisor Call exception.

G1.15.7 Prefetch Abort exception

A Prefetch Abort exception can be generated by:

- A synchronous memory abort on an instruction fetch.

———— **Note** —————

Asynchronous external aborts on instruction fetches are reported as SError interrupts using the Data Abort exception, see [Data Abort exception on page G1-4387](#).

A Prefetch Abort exception entry is synchronous to the instruction whose fetch aborted.

For more information about memory aborts see [VMSAv8-32 memory aborts on page G4-4649](#).

- A Breakpoint, Vector Catch or Breakpoint Instruction exception, see [Chapter G2 AArch32 Self-hosted Debug](#).

———— **Note** —————

If an implementation fetches instructions speculatively, it must handle a synchronous abort on such an instruction fetch by:

- Generating a Prefetch Abort exception only if the instruction would be executed in a simple sequential execution of the program.
- Ignoring the abort if the instruction would not be executed in a simple sequential execution of the program.

By default, when EL1 is using AArch32, a Prefetch Abort exception is taken to Abort mode, but a Prefetch Abort exception can be taken to:

- EL2, meaning it is taken to Hyp mode if EL2 is using AArch32.
- EL3, meaning it is taken to Monitor mode if EL3 is using AArch32.

For more information:

- About cases where the Prefetch Abort exception is taken to an Exception level that is using AArch32, see [The PE mode to which the Prefetch Abort exception is taken on page G1-4386](#).
- About cases where the Prefetch Abort generates an exception that is taken to an Exception level that is using AArch64, see [Pseudocode description of taking the Prefetch Abort exception on page G1-4387](#).

The preferred return address for a Prefetch Abort exception is the address of the aborted instruction. For an exception taken to AArch32 state this return is performed as follows:

- If returning from a mode other than Hyp mode, using the [SPSR](#) and [LR](#) values generated by the exception entry, using an exception return instruction with a subtraction of 4. This means using:
 - [SPSR_abt](#) and [LR_abt](#) if returning from Abort mode.
 - [SPSR_mon](#) and [LR_mon](#) if returning from Monitor mode.
- If returning from Hyp mode, using the [SPSR_hyp](#) and [ELR_hyp](#) values generated by the exception entry, using an ERET instruction.

For more information about the handling of Prefetch Abort exceptions in AArch32 state see [Exception return to an Exception level using AArch32 on page G1-4360](#).

Prefetch Abort exception reporting a PC alignment fault exception

A PC alignment fault exception that is taken to an Exception level that is using AArch32 is reported as a Prefetch Abort exception, and:

If the exception is taken to EL1 using AArch32 or EL3 using AArch32

- The IFSR indicates the cause of the exception:
 - If the value of `TTBCR.EAE` is 0, `IFSR.FS` takes the value `0b00001`.
 - If the value of `TTBCR.EAE` is 1, `IFSR.STATUS` takes the value `0b100001`.
- `IFAR` holds the value of the address that faulted, including the misaligned low order bit or bits.
- `R14_abt` holds the address that faulted, including the misaligned low order bit or bits, with the standard offset for a Prefetch Abort exception.

If the exception is taken to EL2 using AArch32

- `HSR.EC` takes the value `0b100010`.
- `HSR.IL` is UNKNOWN.
- `HSR.ISS` is RES0.
- `HIFAR` and `ELR_hyp` each hold the value of the address that faulted, including the misaligned low order bit or bits.

For a PC alignment fault exception taken to an Exception level that is using AArch32:

- If the exception occurred because of the CONstrained UNPREDICTABLE behavior of a branch to an unaligned PC value, as described in [Branching to an unaligned PC on page K1-6098](#), then bit[0] of the faulting address is forced to zero, and therefore the misalignment is because the value of bit[1] of this address is 1.
- If the exception occurred on an exit from Debug state, as described in [Exiting Debug state on page H2-5471](#), then it is CONstrained UNPREDICTABLE whether bit[0] of the faulting address is forced to zero.

The PE mode to which the Prefetch Abort exception is taken

Figure G1-7 shows how the implementation, state, and configuration options determine the PE mode to which a Prefetch Abort exception is taken, when the exception is taken to an Exception level that is using AArch32.

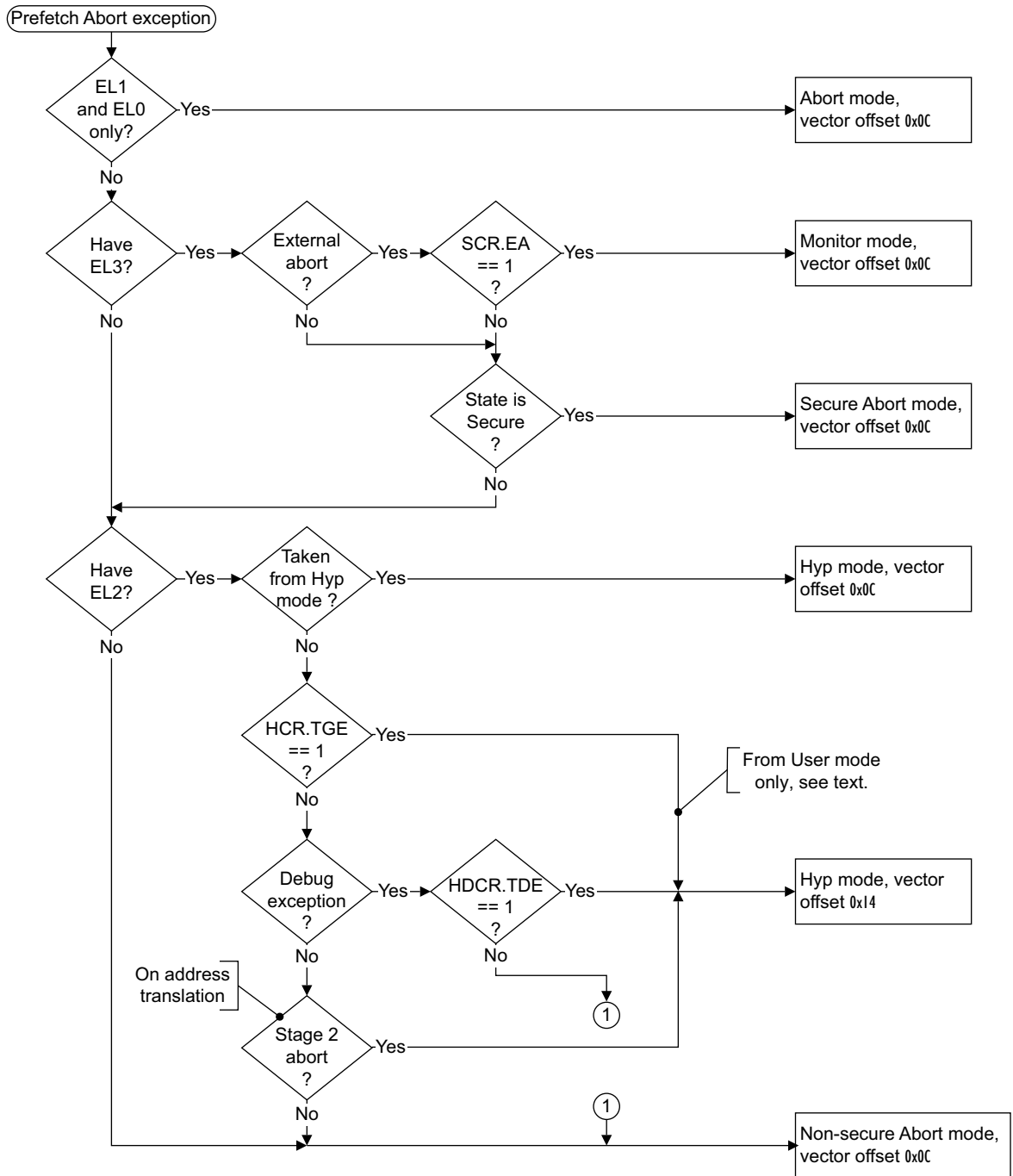

Figure G1-7 The PE mode the Prefetch Abort exception is taken to in AArch32 state

See also *UNPREDICTABLE cases when the value of HCR.TGE is 1* on page G1-4354.

Pseudocode description of taking the Prefetch Abort exception

The `AArch32.Abort()` pseudocode function determines whether the Prefetch Abort condition generates an exception that is taken to an Exception level that is using AArch64, or generates a Prefetch Abort exception that is taken in AArch32 state. When the exception is taken in AArch32 state, the `AArch32.TakePrefetchAbortException()` pseudocode procedure describes how the PE takes the exception.

The exception is taken to an Exception level using AArch64 if one of the following applies:

- The exception is generated in User mode when EL1 is using AArch64.
- The implementation includes EL2, EL2 is using AArch64, and one of the following applies:
 - The value of `HCR_EL2.TGE` is 1 and the exception is generated in Non-secure User mode.
 - The value of `MDCR_EL2.TDE` is 1 and the exception is generated by a Debug exception in a Non-secure EL1 or Non-secure EL0 mode.
 - The exception is generated by a stage 2 fault during a stage 1 translation table walk using the AArch32 Non-secure EL1&0 translation regime.
- The implementation includes EL3, EL3 is using AArch64, the value of `SCR_EL3.EA` is 1, and the exception is generated by an external abort in AArch32 state.

G1.15.8 Data Abort exception

In AArch32 state, a Data Abort exception can be generated by:

- A synchronous abort on a data read or write memory access. Exception entry is synchronous to the instruction that generated the memory access.
- An SError interrupt. The SError interrupt might be caused by an external abort on a memory access, which can be any of:
 - A data read or write access.
 - An instruction fetch.
 - In a VMSA memory system, a translation table access.

Exception entry occurs asynchronously.

As described in *Asynchronous exception masking controls* on page G1-4368, SError interrupts can be masked. When this happens, a generated SError interrupt is not taken until it is not masked.

- A watchpoint, see *Watchpoint exceptions* on page G2-4496.

By default, when EL1 is using AArch32 a Data Abort exception is taken to Abort mode, but a Data Abort exception can be taken to:

- EL2, meaning it is taken to Hyp mode if EL2 is using AArch32.
- EL3, meaning it is taken to Monitor mode if EL3 is using AArch32.

For more information:

- About cases where the Data Abort exception is taken to an Exception level that is using AArch32 see *The PE mode to which the Data Abort exception is taken* on page G1-4389.
- About memory aborts in AArch32 state see *VMSAv8-32 memory aborts* on page G4-4649.
- About cases where the Data Abort generates an exception that is taken to an Exception level that is using AArch64 see *Pseudocode description of taking the Data Abort exception* on page G1-4390.

The preferred return address for a Data Abort exception is the address of the instruction that generated the aborting memory access, or the address of the instruction following the instruction boundary at which an SError interrupt exception was taken. For an exception taken to AArch32 state, this return is performed as follows:

- If returning from a mode other than Hyp mode, using the [SPSR](#) and LR values generated by the exception entry, using an exception return instruction with a subtraction of 8. This means using:
 - [SPSR_abt](#) and [LR_abt](#) if returning from Abort mode.
 - [SPSR_mon](#) and [LR_mon](#) if returning from Monitor mode.
- If returning from Hyp mode, using the [SPSR_hyp](#) and [ELR_hyp](#) values generated by the exception entry, using an ERET instruction.

For more information about the handling of Data Abort exceptions in AArch32 state see [Exception return to an Exception level using AArch32](#) on page G1-4360.

The PE mode to which the Data Abort exception is taken

Figure G1-8 shows the determination of the mode to which a Data Abort exception is taken when the exception is taken to an Exception level that is using AArch32.

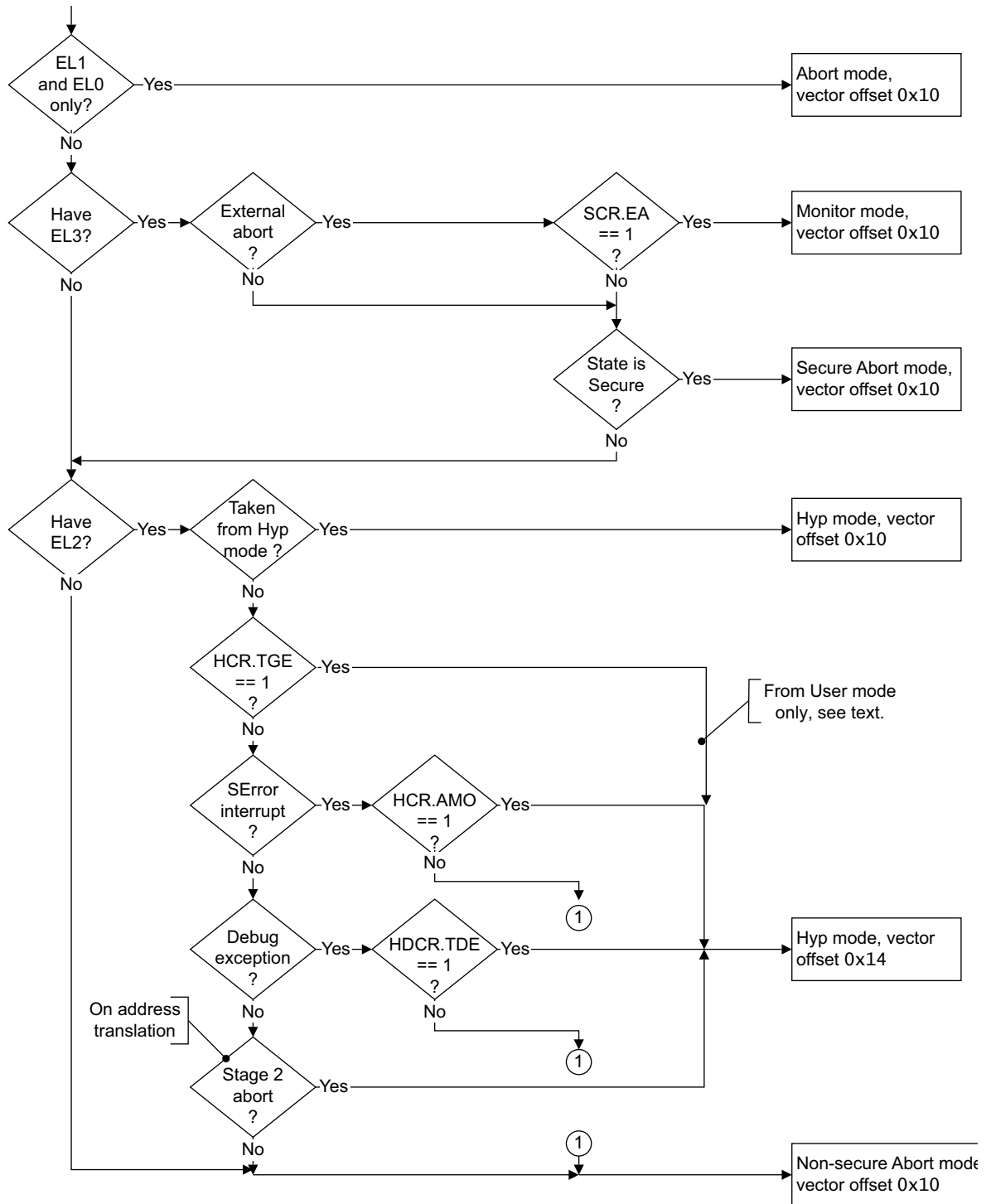

Figure G1-8 The PE mode the Data Abort exception is taken to in AArch32 state

See also *UNPREDICTABLE cases when the value of HCR.TGE is 1 on page G1-4354.*

Pseudocode description of taking the Data Abort exception

The `AArch32.Abort()` pseudocode function determines whether the Data Abort condition generates an exception that is taken to an Exception level that is using AArch64, or generates a Data Abort exception that is taken in AArch32 state. When the exception is taken in AArch32 state, the `AArch32.TakeDataAbortException()` pseudocode procedure describes how the PE takes the exception.

The exception is taken to an Exception level using AArch64 if one of the following applies:

- The exception is generated in User mode when EL1 is using AArch64.
- The implementation includes EL2, EL2 is using AArch64, and one of the following applies:
 - The value of `HCR_EL2.TGE` is 1 and the exception is generated in Non-secure User mode.
 - The value of `MDCR_EL2.TDE` is 1 and the exception is generated by a Debug exception in a Non-secure EL1 or Non-secure EL0 mode.
 - The exception is generated by a stage 2 fault during a stage 1 translation table walk using the AArch32 Non-secure EL1&0 translation regime.
- The implementation includes EL3, EL3 is using AArch64, the value of `SCR_EL3.EA` is 1, and the exception is generated by an external abort in AArch32 state.

Effects of data-aborted instructions

An instruction that accesses data memory can modify memory by storing one or more values. If the execution of such an instruction generates a Data Abort exception, or causes Debug state entry because of a watchpoint set on the instruction, the value of each memory location that the instruction stores to is:

- Unchanged for any location for which one of the following applies:
 - An MMU fault is generated.
 - A Watchpoint is generated.
 - An external abort is generated, if that external abort is taken synchronously.
- UNKNOWN for any location for which no exception and no debug event is generated.

If the access to a memory location generates an external abort that is taken asynchronously, it is outside the scope of the architecture to define the effect of the store on that memory location, because this depends on the system-specific nature of the external abort. However, in general, ARM recommends that such locations are unchanged.

For external aborts and Watchpoints, where in principle faulting could be identified at byte or halfword granularity, the size of a location in this definition is the size for which a memory access is single-copy atomic.

In AArch32 state, instructions that access data memory can modify registers in the following ways:

- By loading values into one or more of the general-purpose registers. The registers loaded can include the PC.
- By loading values into one or more of the registers in the Advanced SIMD and floating-point register file.
- By specifying *base register writeback*, in which the base register used in the address calculation has a modified value written to it. All instructions that support base register writeback have CONstrained UNPREDICTABLE results if base register writeback is specified with the PC as the base register. Only general-purpose registers can be modified reliably in this way.
- By a direct or indirect write to one or more System registers, for example:
 - An LDC instruction that writes to `DBGDTRXint` using a value read from memory is a *direct write* to the System register `DBGDTRXint`.
 - An STC instruction that reads `DBGDTRRXint` makes an *indirect write* to `DBGDSCRint.RXfull`.
- By modifying `PSTATE`.

If the execution of such an instruction generates a synchronous Data Abort exception, the following rules determine the values left in these registers:

- On entry to the Data Abort exception handler:
 - The PC value is the Data Abort vector address, see [Exception vectors and the exception base address on page G1-4340](#).
 - The LR_abt value is determined from the address of the aborted instruction. Neither value is affected by the results of any load specified by the instruction.
- The base register is restored to its original value if either:
 - The aborted instruction is a load and the list of registers to be loaded includes the base register.
 - The base register is being written back.
- If the instruction only loads one general-purpose register the value in that register is unchanged.
- If the instruction loads more than one general-purpose register, UNKNOWN values are left in destination registers other than the PC and the base register of the instruction.
- If the instruction affects any registers in the Advanced SIMD and floating-point register file, UNKNOWN values are left in the registers that are affected.
- [PSTATE](#) bits that are not defined as updated on exception entry retain their current value.
- If the instruction is a STREX, STREXB, STREXH, or STREXD, <Rd> is not updated.

After taking a Data Abort exception, the state of the Exclusives monitors is UNKNOWN. Therefore, ARM strongly recommends that the abort handler performs a CLREX instruction, or a dummy STREX instruction, to clear the Exclusives monitor state.

The ARM abort model

The abort model used by an ARM PE is described as a *Base Restored Abort Model*. This means that if a synchronous Data Abort exception is generated by executing an instruction that specifies base register writeback, the value in the base register is unchanged.

The abort model applies uniformly across all instructions.

G1.15.9 Virtual SError interrupt exception

The Virtual SError interrupt exception is implemented only as part of EL2.

A Virtual SError interrupt exception is generated in AArch32 state if all of the following apply:

- The PE is in a Non-secure mode other than Hyp mode.
- The value of [PSTATE.A](#) is 0.
- Either:
 - EL2 is using AArch32 and the values of the [HCR](#).{TGE, AMO, VA} bits are {0, 1, 1}.
 - EL2 is using AArch64 and the values of the [HCR_EL2](#).{TGE, AMO, VA} bits are {0, 1, 1}.

The conditions for generating a Virtual SError interrupt exception in AArch32 state mean the exception is:

- Taken from a Non-secure EL1 or EL0 mode.
- Taken to Non-secure Abort mode if EL1 is using AArch32.
- Taken to Non-secure EL1 using AArch64 if Non-secure EL0 is using AArch32 and Non-secure EL1 is using AArch64.

For more information see [Virtual exceptions when an implementation includes EL2 on page G1-4365](#).

Note

Because a Virtual SError interrupt exception taken to AArch32 state is always taken to Non-secure Abort mode, on exception entry the preferred return address is always saved to LR_abt.

The preferred return address for a Virtual SError interrupt exception is the address of the instruction immediately after the instruction boundary where the exception was taken. For an exception taken to AArch32 state, this return is performed using the [SPSR](#) and LR_abt values generated by the exception entry, using an exception return instruction without subtraction.

The PE mode to which the Virtual SError interrupt exception is taken

The Virtual SError interrupt exception is supported only as part of EL2. A Virtual SError interrupt exception is taken from a Non-secure EL1 or EL0 mode, and when taken to AArch32 state is taken to Non-secure Abort mode, using a vector offset of 0x10 from the Non-secure exception base address.

For more information about this exception see [Virtual exceptions when an implementation includes EL2 on page G1-4365](#).

Pseudocode description of taking the Virtual SError interrupt exception

The `AArch32.TakeVirtualSErrorException()` pseudocode procedure describes how the PE takes the exception. This procedure includes the case where in Non-secure state EL0 is using AArch32 and EL1 is using AArch64, and the exception is taken to EL1 using AArch64.

Note

This is the only case where the exception is taken from an Exception level using AArch32 to an Exception level using AArch64.

G1.15.10 IRQ exception

The IRQ exception is generated by IMPLEMENTATION DEFINED means. Typically this is by asserting an IRQ interrupt request input to the PE.

When an IRQ exception is taken, exception entry is precise to an instruction boundary.

As described in [Asynchronous exception masking controls on page G1-4368](#), IRQ exceptions can be masked. When this happens, a generated IRQ exception is not taken until it is not masked.

By default, when EL1 is using AArch32, an IRQ exception is taken to IRQ mode, but an IRQ exception can be taken to:

- EL2, meaning it is taken to Hyp mode if EL2 is using AArch32.
- EL3, meaning it is taken to Monitor mode if EL3 is using AArch32.

For more information:

- About cases where the exception is taken to an Exception level using AArch32 see [The PE mode to which the physical IRQ exception is taken on page G1-4393](#).
- About cases where the exception is taken to an Exception level using AArch64 see [Pseudocode description of taking the physical IRQ exception on page G1-4394](#).

The preferred return address for an IRQ exception is the address of the instruction following the instruction boundary at which the exception was taken. For an exception taken to AArch32 state this return is performed as follows:

- If returning from a mode other than Hyp mode, using the **SPSR** and LR values generated by the exception entry, using an exception return instruction with a subtraction of 4. This means using:
 - **SPSR_irq** and **LR_irq** if returning from IRQ mode.
 - **SPSR_mon** and **LR_mon** if returning from Monitor mode.
- If returning from Hyp mode, using the **SPSR_hyp** and **ELR_hyp** values generated by the exception entry, using an ERET instruction.

For more information, see [Exception return to an Exception level using AArch32](#) on page G1-4360.

The PE mode to which the physical IRQ exception is taken

Figure G1-9 shows how the implementation, state, and configuration options determine the mode to which an IRQ exception is taken when the exception is taken to an Exception level that is using AArch32.

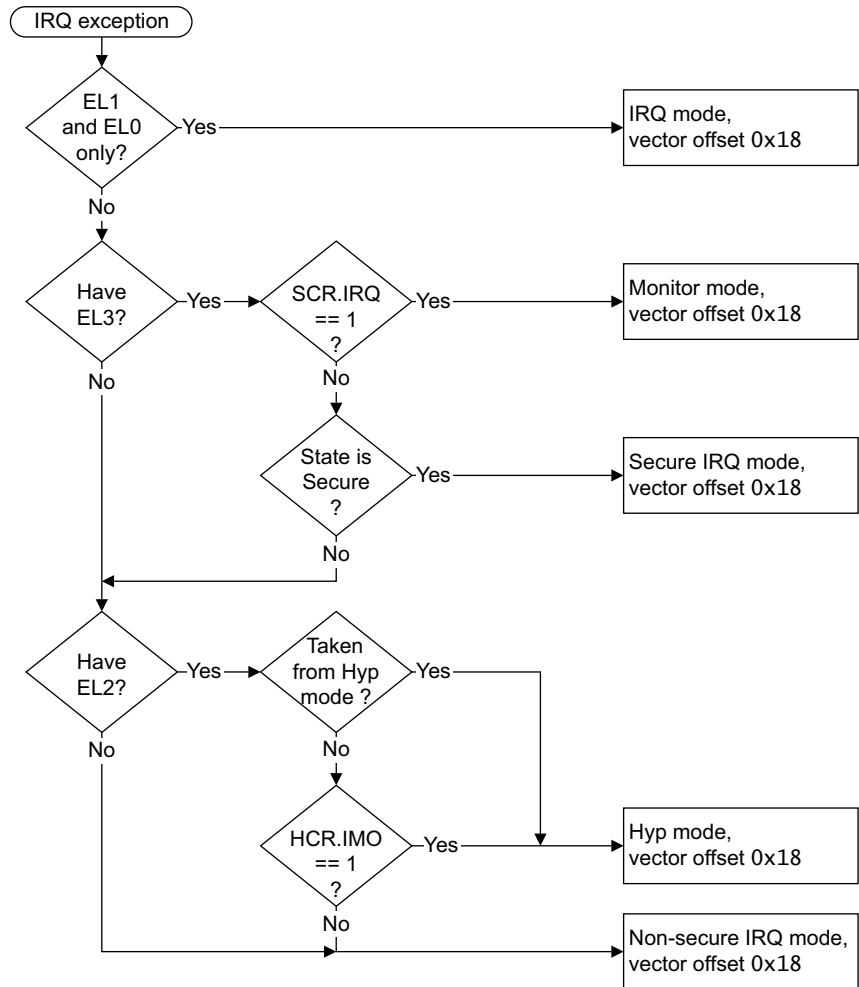

Figure G1-9 The PE mode the IRQ exception is taken to in AArch32 state

Pseudocode description of taking the physical IRQ exception

The [AArch32.TakePhysicalIRQException\(\)](#) pseudocode procedure describes how the PE takes the exception. This procedure includes the case where the exception is taken to an Exception level that is using AArch64. This happens if one of the following applies:

- The exception is taken from User mode and EL1 is using AArch64. The Exception is taken to EL1 using AArch64.
- The exception is taken from Non-secure User mode, EL2 is implemented and using AArch64, and the value of [HCR_EL2.TGE](#) is 1. The Exception is taken to EL2 using AArch64, in Non-secure state.
- The exception is taken from a Non-secure EL0 or EL1 mode, EL2 is implemented and using AArch64, and the value of [HCR_EL2.IMO](#) is 1. The Exception is taken to EL2 using AArch64, in Non-secure state.
- The exception is taken from a PE mode other than Monitor mode, EL3 is implemented and using AArch64, and the value of [SCR_EL3.IRQ](#) is 1. The Exception is taken to EL3 using AArch64.

G1.15.11 Virtual IRQ exception

The Virtual IRQ exception is implemented only as part of EL2.

A Virtual IRQ exception is generated in AArch32 state if all of the following apply:

- The PE is in a Non-secure mode other than Hyp mode.
- The value of [PSTATE.I](#) is 0.
- Either:
 - EL2 is using AArch32 and the value of [HCR.{TGE, IMO}](#) is {0, 1}.
 - EL2 is using AArch64 and the value of [HCR_EL2.{TGE, IMO}](#) is {0, 1}.
- One of the following applies:
 - EL2 is using AArch32 and the value of [HCR.VI](#) is 1.
 - EL2 is using AArch64 and the value of [HCR_EL2.VI](#) is 1.
 - A Virtual IRQ exception is generated by an IMPLEMENTATION DEFINED mechanism.

The conditions for generating a Virtual IRQ exception in AArch32 state mean the exception is:

- Taken from a Non-secure EL1 or EL0 mode.
- Taken to Non-secure IRQ mode if EL1 is using AArch32.
- Taken to Non-secure EL1 using AArch64 if Non-secure EL0 is using AArch32 and Non-secure EL1 is using AArch64.

For more information see [Virtual exceptions when an implementation includes EL2 on page G1-4365](#).

The preferred return address for a Virtual IRQ exception is the address of the instruction immediately after the instruction boundary where the exception was taken. For an exception taken to AArch32 state this return is performed using the [SPSR](#) and [LR_irq](#) values generated by the exception entry, using an exception return instruction with a subtraction of 4.

The PE mode to which the Virtual IRQ exception is taken

The Virtual IRQ exception is supported only as part of EL2. A Virtual IRQ exception is taken from a Non-secure EL1 or EL0 mode, and when taken to AArch32 state is taken to Non-secure IRQ mode, using a vector offset of 0x18 from the Non-secure exception base address.

For more information about this exception see [Virtual exceptions when an implementation includes EL2 on page G1-4365](#).

Pseudocode description of taking the Virtual IRQ exception

The `AArch32.TakeVirtualIRQException()` pseudocode procedure describes how the PE takes the exception. This procedure includes the case where, in Non-secure state, EL0 is using AArch32 and EL1 is using AArch64, and the exception is taken to Non-secure EL1 using AArch64.

———— Note —————

This is the only case where the exception is taken from an Exception level using AArch32 to an Exception level using AArch64.

G1.15.12 FIQ exception

The FIQ exception is generated by IMPLEMENTATION DEFINED means. Typically this is by asserting an FIQ interrupt request input to the PE.

When an FIQ exception is taken, exception entry is precise to an instruction boundary.

As described in *Asynchronous exception masking controls on page G1-4368*, FIQ exceptions can be masked. When this happens, a generated FIQ exception is not taken until it is not masked.

By default, an FIQ exception is taken to FIQ mode, but an FIQ exception can be taken to:

- EL2, meaning it is taken to Hyp mode if EL2 is using AArch32.
- EL3, meaning it is taken to Monitor mode if EL3 is using AArch32.

For more information:

- About cases where the exception is taken to an Exception level using AArch32 see *The PE mode to which the physical FIQ exception is taken on page G1-4396*.
- About cases where the exception is taken to an Exception level using AArch64 see *Pseudocode description of taking the FIQ exception on page G1-4396*.

The preferred return address for an FIQ exception is the address of the instruction following the instruction boundary at which the exception was taken. For an exception taken to AArch32 state this return is performed as follows:

- If returning from a mode other than Hyp mode, using the `SPSR` and `LR` values generated by the exception entry, using an exception return instruction with a subtraction of 4. This means using:
 - `SPSR_fiq` and `LR_fiq` if returning from FIQ mode.
 - `SPSR_mon` and `LR_mon` if returning from Monitor mode.
- If returning from Hyp mode, using the `SPSR_hyp` and `ELR_hyp` values generated by the exception entry, using an `ERET` instruction.

For more information see *Exception return to an Exception level using AArch32 on page G1-4360*.

The PE mode to which the physical FIQ exception is taken

Figure G1-9 on page G1-4393 shows how the implementation, state, and configuration options determine the PE mode to which an FIQ exception is taken when the exception is taken to an Exception level that is using AArch32.

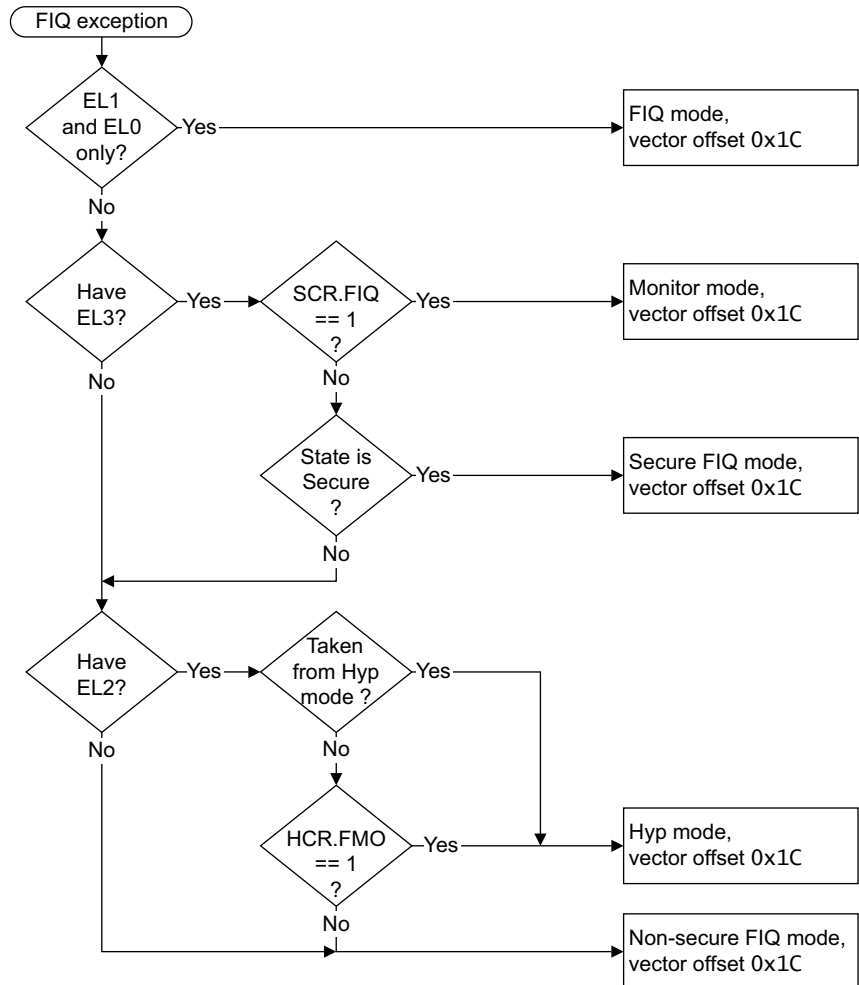

Figure G1-10 The PE mode the FIQ exception is taken to in AArch32 state

Pseudocode description of taking the FIQ exception

The `AArch32.TakePhysicalFIQException()` pseudocode procedure describes how the PE takes the exception. This procedure includes the case where the exception is taken to an Exception level that is using AArch64. This happens if one of the following applies:

- The exception is taken from User mode and EL1 is using AArch64. The Exception is taken to EL1 using AArch64.
- The exception is taken from Non-secure User mode, EL2 is implemented and using AArch64, and the value of `HCR_EL2.TGE` is 1. The Exception is taken to EL2 using AArch64, in Non-secure state.
- The exception is taken from a Non-secure EL0 or EL1 mode, EL2 is implemented and using AArch64, and the value of `HCR_EL2.FMO` is 1. The Exception is taken to EL2 using AArch64, in Non-secure state.
- The exception is taken from a PE mode other than Monitor mode, EL3 is implemented and using AArch64, and the value of `SCR_EL3.FIQ` is 1. The Exception is taken to EL3 using AArch64.

G1.15.13 Virtual FIQ exception

The Virtual FIQ exception is implemented only as part of EL2.

A Virtual FIQ exception is generated in AArch32 state if all of the following apply:

- The PE is in a Non-secure mode other than Hyp mode.
- The value of `PSTATE.F` is 0.
- Either:
 - EL2 is using AArch32 and the value of `HCR.{TGE, FMO}` is {0, 1}.
 - EL2 is using AArch64 and the value of `HCR_EL2.{TGE, FMO}` is {0, 1}.
- One of the following applies:
 - EL2 is using AArch32 and the value of `HCR.VF` is 1.
 - EL2 is using AArch64 and the value of `HCR_EL2.VF` is 1.
 - A Virtual FIQ exception is generated by an IMPLEMENTATION DEFINED mechanism.

The conditions for generating a Virtual FIQ exception in AArch32 state mean the exception is:

- Taken from a Non-secure EL1 or EL0 mode.
- Taken to Non-secure FIQ mode if EL1 is using AArch32.
- Taken to Non-secure EL1 using AArch64 if Non-secure EL0 is using AArch32 and Non-secure EL1 is using AArch64.

For more information see [Virtual exceptions when an implementation includes EL2](#) on page G1-4365.

The preferred return address for a Virtual FIQ exception is the address of the instruction immediately after the instruction boundary where the exception was taken. For an exception taken to AArch32 state this return is performed using the `SPSR` and `LR_irq` values generated by the exception entry, using an exception return instruction with a subtraction of 4.

The PE mode to which the Virtual FIQ exception is taken

The Virtual FIQ exception is supported only as part of EL2. A Virtual FIQ exception is taken from a Non-secure EL1 or EL0 mode, and when taken to AArch32 state is taken to Non-secure FIQ mode, using a vector offset of `0x1C` from the Non-secure exception base address.

For more information about this exception see [Virtual exceptions when an implementation includes EL2](#) on page G1-4365.

Pseudocode description of taking the Virtual FIQ exception

The `AArch32.TakeVirtualFIQException()` pseudocode procedure describes how the PE takes the exception. This procedure includes the case where, in Non-secure state, EL0 is using AArch32 and EL1 is using AArch64, and the exception is taken to Non-secure EL1 using AArch64.

———— Note —————

This is the only case where the exception is taken from an Exception level using AArch32 to an Exception level using AArch64.

G1.15.14 Additional pseudocode functions for exception handling

The `AArch32.EnterMonitorMode()` pseudocode function changes the PE mode to Monitor mode, with the required state changes.

The `AArch32.EnterHypMode()` pseudocode function changes the PE mode to Hyp mode, with the required state changes.

The `AArch32.EnterMode()` pseudocode function changes the PE mode to a PL1 mode, with the required state changes. It is used for all exceptions that are not routed to Hyp mode or Monitor mode.

The `AArch32.EnterMonitorMode()`, `AArch32.EnterHypMode()`, and `AArch32.EnterMode()` functions are described in [Chapter J1 ARMv8 Pseudocode](#).

G1.16 Reset into AArch32 state

[Reset on page D1-1795](#) describes the ARMv8 reset model, including the defined levels of reset. When reset is deasserted, the PE starts executing instructions in the highest implemented Exception level. If that Exception level is using AArch32, then it starts execution:

- In Secure state, if the implementation includes EL3.
- With interrupts disabled:
 - In Hyp mode, if the highest implemented Exception level is EL2.
 - In Supervisor mode, otherwise.

Note

- This section describes the architectural requirements for a reset into AArch32 state. It takes no account of whether ARM licenses any particular combination of Exception levels and Execution state. For more information about the licensed combinations see [Support for Exception levels and Execution states on page D1-1900](#).
- The Execution state in which the highest implemented Execution level starts executing instructions on coming out of reset might be determined by a configuration input signal.

Reset returns some PE state to architecturally-defined or IMPLEMENTATION DEFINED values, and makes other state UNKNOWN, as described in [PE state on reset into AArch32 state on page G1-4400](#). For more information about behavior when resetting into an Exception level using AArch32, see:

- [Behavior of caches at reset on page G3-4531](#).
- [Enabling stages of address translation on page G4-4569](#).
- [TLB behavior at reset on page G4-4629](#).
- [Reset and debug on page H6-5545](#).

When reset is deasserted, if the PE resets into an Exception level that is using AArch32, it is IMPLEMENTATION DEFINED whether execution starts:

- From an IMPLEMENTATION DEFINED address.
- If reset is into EL3 or EL1, from the low or high reset vector address, as determined by the reset value of the [SCTLR.V](#) bit. This reset value can be determined by an IMPLEMENTATION DEFINED configuration input signal.

Note

This option might be implemented for compatibility with earlier versions of the architecture.

Software might be able to identify the reset address:

- If reset is into EL3, by reading the reset value of [MVBAR](#). That is, after coming out of reset, by reading [MVBAR](#) before the boot software has updated it. It is IMPLEMENTATION DEFINED whether this discovery mechanism is supported.
- If reset is into EL2 or EL1, by reading [RVBAR](#). [RVBAR](#) can only be implemented at the highest implemented Exception level, and only if that Exception level is not EL3.

If [RVBAR](#) is not implemented, and at all Exception levels other than the highest implemented Exception level, the encoding for [RVBAR](#) is UNDEFINED.

The ARM architecture does not define any way of returning to a previous Execution state from a reset.

G1.16.1 PE state on reset into AArch32 state

———— **Note** —————

See the *ARM® Generic Interrupt Controller Architecture Specification, GIC architecture version 3.0 and version 4.0* for the reset requirements for GIC System registers.

Immediately after a reset, much of the PE state is UNKNOWN. However, some of the PE state is defined. If the PE resets to AArch32 state using either a Cold or a Warm reset, the PE state that is defined is as follows:

- If reset is into EL3 using AArch32 then all fields of the **SCR** reset to zero.

———— **Note** —————

This means **SCR.NS** correctly indicates that the PE is in Secure state.

- If reset is into EL2 using AArch32 then reset is into Hyp mode and **CPSR.M** resets to 0b1010, otherwise reset is into Supervisor mode and **CPSR.M** resets to 0b0011,
- **CPSR.IL** resets to 0.
- The **CPACR**.{cp11, cp10} fields reset to zero, and if **CPACR.ASEDIS** is implemented as an RW field it resets to zero.

———— **Note** —————

When **CPACR.TRCDIS** is a RW field, its reset value is architecturally UNKNOWN.

- **PSTATE** is reset to the values defined by the **AArch32.TakeReset()** pseudocode function, see *Pseudocode descriptions of reset on page G1-4402*.
- The **FPEXC.EN** field resets to 0.
- In the **SCTLR**:
 - The {AFE, TRE, UWXN, WXN, I, SED, ITD, C, A, M} fields reset to 0.
 - The {nTWE, nTWI, CP15BEN} fields reset to 1.
 - The {TE, EE, V} fields reset to IMPLEMENTATION DEFINED values, see the register description for more information.

When the reset is to EL3 using AArch32 then these reset values apply only to the Secure instance of the **SCTLR**, and the reset value of the Non-secure **SCTLR** is architecturally UNKNOWN.

- All field of the **TTBCR** reset to 0.
When the reset is to EL3 using AArch32 then:
 - All fields of the Secure **TTBCR** reset to 0.
 - In the Non-secure **TTBCR**, the EAE field resets to 0, and the reset values of all other fields are architecturally UNKNOWN.
- The **VBAR** resets to an IMPLEMENTATION DEFINED value.
When the reset is to EL3 using AArch32 then this reset value applies only to the Secure instance of the register, and the reset value of the Non-secure **VBAR** is architecturally UNKNOWN.
- All fields of the **DBGDCCINT** reset to 0.
- The **DBGDSCRExt**.{MDBGen, UDCCdis} fields reset to 0.
- The **DBGOSDLR**.DLK field resets to 0.

In addition:

If the reset is into EL1 using AArch32

- In the **RMR** register, the RR field resets to 0 on any warm or cold reset, and the AA64 field resets to 0 on a cold reset.

If the reset is into EL2 using AArch32

- In the **HRMR**, the RR field resets to 0 on any warm or cold reset, and the AA64 field resets to 0 on a cold reset.
- The **HSCTLR**.{I, C, M} fields all reset to 0, and the **HSCTLR**.EE field resets to an IMPLEMENTATION DEFINED value.

If the reset is into EL2 using AArch32 or into EL3 using AArch32

For a reset into EL3 using AArch32 these reset values apply only if the implementation includes EL2, see the register descriptions for more information.

- All fields of the **HCPTR** reset to zero.
- All fields of the **HCR** reset to zero.
- The **HCR2**.{ID, CD} fields reset to zero.
- All fields of the **HSTR** reset to zero.
- The **VMPIDR** resets to the value of the **MPIDR**, see the register description for more information.
- The **VPIDR** resets to the value of the **MIDR**, see the register description for more information.
- The **VTTBR**.VMID field resets to zero.
- In the **HDCR**:
 - The HPMN field resets to the IMPLEMENTATION DEFINED value of **PMCR**.N.
 - The reset value of the HPME field is architecturally UNKNOWN.
 - All other fields reset to 0.

If the reset is into EL3 using AArch32

- The **MVBAR** resets to an IMPLEMENTATION DEFINED value, see the register description for more information.
- If the **NSACR**.{NSTRCDIS, NSASEDIS} fields are RW fields then they reset to 0.
- In the **RMR** register, the RR field resets to 0 on any warm or cold reset, and the AA64 field resets to 0 on a cold reset.
- All fields of the **SCR** reset to zero.
- All fields of the **SDER** reset to 0.
- All fields of the **SDCR** reset to zero.

For either a warm or a cold reset

- The **EDPRSR**.SR field resets to 1.
- The **EDES**.{SS, RC, OSUC} fields reset to 0.

For a cold reset only

- The **EDSCR**.{RXO, TXU, INTdis, TDA, MA, HDE, ERR, RXfull, TXfull} fields reset to 0.
- The **EDECCR**.{NSE, SE} fields reset to 0.
- The **EDPRSR**.{SPMAD, SDAD} fields reset to 0, and the **EDPRSR**.SPD field resets to 1.
- The **DBGOSLSR**.OSLK field resets to 1.
- The **DBGPRCR**.CORENPDRQ field resets to the value of **EDPRCR**.COREPURQ.

An External Debug reset sets `EDPRCR.COREPURQ` to 0, see [External debug register resets on page H8-5572](#). If an External Debug reset and a cold reset coincide, both `DBGPRCR.CORENPRDRQ` and `EDPRCR.COREPURQ` are reset to 0.

- The debug CLAIM bits are reset to 0.

———— **Note** —————

These are the bits that are set to 1 by writing to `DBGCLAIMSET.CLAIM`, and reset to 0 by writing to `DBGCLAIMCLR.CLAIM`.

—————

G1.16.2 Pseudocode descriptions of reset

The `AArch32.TakeReset()` pseudocode procedure describes how the PE behaves when reset is deasserted.

The `AArch32.ResetGeneralRegisters()` pseudocode function resets the general-purpose registers.

The `AArch32.ResetSIMDFPRegisters()` pseudocode function resets the SIMD and floating-point registers.

The `AArch32.ResetSpecialRegisters()` pseudocode function resets the Special-purpose registers, and the debug System registers `DLR` and `DSPSR`, that are used for handling Debug exceptions.

The `AArch32.ResetSystemRegisters()` pseudocode function resets all System registers in the (coproc==0b111x) encoding space to their reset state as defined in the register descriptions in [Chapter G6 AArch32 System Register Descriptions](#).

———— **Note** —————

The `ResetSystemRegisters()` function only resets the System registers. It has no effect on memory-mapped registers.

—————

The `ResetExternalDebugRegisters()` pseudocode function resets all external debug registers to their reset state as defined in the register descriptions in [Chapter H9 External Debug Register Descriptions](#).

G1.17 Mechanisms for entering a low-power state

The following sections describe the architectural mechanisms that a PE can use to request entry to a low-power state:

- [Wait For Event and Send Event](#).
- [Wait For Interrupt](#) on page G1-4406.

G1.17.1 Wait For Event and Send Event

The Wait For Event (WFE) mechanism permits a PE to request entry to a low-power state, and, if the request succeeds, to remain in that state until an event is generated by a Send Event operation, or another WFE wake-up event occurs. [Example G1-2](#) describes how a spinlock implementation might use this mechanism to save energy.

Example G1-2 Spinlock as an example of using Wait For Event and Send Event

A multiprocessor operating system requires locking mechanisms to protect data structures from being accessed simultaneously by multiple PEs. These mechanisms prevent the data structures becoming inconsistent or corrupted if different PEs try to make conflicting changes. If a lock is busy, because a data structure is being used by one PE, it might not be practical for another PE to do anything except wait for the lock to be released. For example, if a PE is handling an interrupt from a device it might need to add data received from the device to a queue. If another PE is removing data from the queue, it will have locked the memory area that holds the queue. The first PE cannot add the new data until the queue is in a consistent state and the lock has been released. It cannot return from the interrupt handler until the data has been added to the queue, so it must wait.

Typically, a spin-lock mechanism is used in these circumstances:

- A PE requiring access to the protected data attempts to obtain the lock using single-copy atomic synchronization primitives such as the Load-Exclusive and Store-Exclusive operations described in [Synchronization and semaphores](#) on page E2-2795.
- If the PE obtains the lock it performs its memory operation and releases the lock.
- If the PE cannot obtain the lock, it reads the lock value repeatedly in a tight loop until the lock becomes available. At this point it again attempts to obtain the lock.

A spin-lock mechanism is not ideal for all situations:

- In a low-power system the tight read loop is undesirable because it uses energy to no effect.
- In a multithreaded implementation the execution of spin-locks by waiting threads can significantly degrade overall performance.

Using the Wait For Event and Send Event mechanism can improve the energy efficiency of a spinlock. In this situation, a PE that fails to obtain a lock can execute a Wait For Event instruction, WFE, to request entry to a low-power state. When a PE releases a lock, it must execute a Send Event instruction, SEV, causing any waiting PEs to wake up. Then, these PEs can attempt to gain the lock again.

The execution of a WFE instruction can cause suspension of execution only if all of the following are true:

- The instruction does not cause any other exception.
- When the instruction is executed:
 - The Event Register is not set.
 - There is not a pending WFE wakeup event.

For more information about the trap to EL2 see [Traps to Hyp mode of Non-secure EL0 and EL1 execution of WFE and WFI instructions](#) on page G1-4437.

The architecture does not define the exact nature of the low power state entered as a result of executing a WFE instruction, but the execution of a WFE instruction must not cause a loss of memory coherency.

———— **Note** —————

Although a complex operating system can contain thousands of distinct locks, the event sent by this mechanism does not indicate which lock has been released. If the event relates to a different lock, or if another PE acquires the lock more quickly, the PE fails to acquire the lock and can reenter the low-power state waiting for the next event.

The Wait For Event system relies on hardware and software working together to achieve energy saving:

- The hardware provides the mechanism to enter the Wait For Event low-power state.
- The operating system software is responsible for issuing:
 - A Wait For Event instruction, to request entry to the low-power state, used in the example when waiting for a spin-lock.
 - A Send Event instruction, required in the example when releasing a spin-lock.

The mechanism depends on the interaction of:

- WFE wake-up events, see [WFE wake-up events on page G1-4405](#).
- The Event Register, see [The Event Register](#).
- The Send Event instructions, see [The Send Event instructions on page G1-4405](#).
- The Wait For Event instruction, see [The Wait For Event instruction](#).

The Event Register

The Event Register is a single bit register for each PE. When set, an event register indicates that an event has occurred, since the register was last cleared, that might require some action by the PE. Therefore, the PE must not suspend operation on issuing a WFE instruction.

The reset value of the Event Register is UNKNOWN.

The Event Register for a PE is set by:

- The execution of an SEV instruction on any PE in the multiprocessor system.
- The execution of an SEVL instruction by the PE.
- An exception return.
- An event from a Generic Timer event stream, see [Event streams on page G5-4757](#).
- An event sent by some IMPLEMENTATION DEFINED mechanism.

As shown in this list, the Event Register might be set by IMPLEMENTATION DEFINED mechanisms.

The Event Register is cleared only by a Wait For Event instruction.

Software cannot read or write the value of the Event Register directly.

The Wait For Event instruction

The action of the Wait For Event instruction depends on the state of the Event Register:

- If the Event Register is set, the instruction clears the register and completes immediately. Normally, if this happens the software makes another attempt to claim the lock.
- If the Event Register is clear the PE can suspend execution, and hardware might enter a low-power state. The PE can remain suspended until a WFE wake-up event or a reset occurs. When a WFE wake-up event occurs, or earlier if the implementation chooses, the WFE instruction completes.

The execution in AArch32 state of a WFE instruction that would otherwise cause suspension of execution might be trapped, see:

- [Traps to Undefined mode of EL0 execution of WFE and WFI instructions on page G1-4421](#).
- [Traps to Hyp mode of Non-secure EL0 and EL1 execution of WFE and WFI instructions on page G1-4437](#).
- [Traps to Monitor mode of the execution of WFE and WFI instructions in modes other than Monitor mode on page G1-4447](#).

The Wait For Event instruction, WFE, is available at all privilege levels, see [WFE on page F5-3668](#).

Software using the Wait For Event mechanism must tolerate spurious wake-up events, including multiple wake ups.

WFE wake-up events

The following events are *WFE wake-up events*:

- The execution of an SEV instruction on any PE in the system.
- The execution of an SEVL instruction on the PE.
- A physical IRQ interrupt, unless masked by the [PSTATE.I](#) bit.
- A physical FIQ interrupt, unless masked by the [PSTATE.F](#) bit.
- A physical SError interrupt, unless masked by the [PSTATE.A](#) bit.
- In Non-secure state in any mode other than Hyp mode:
 - When [HCR.IMO](#) is set to 1, a virtual IRQ interrupt, unless masked by the [PSTATE.I](#) bit.
 - When [HCR.FMO](#) is set to 1, a virtual FIQ interrupt, unless masked by the [PSTATE.F](#) bit.
 - When [HCR.AMO](#) is set to 1, a virtual SError interrupt, unless masked by the [PSTATE.A](#) bit.
- An asynchronous External Debug Request debug event, if halting is allowed. For the definition of *halting is allowed* see [Halting allowed and halting prohibited on page H2-5435](#).
See also [External Debug Request debug event on page H3-5490](#).
- An event sent by the timer event stream, see [Event streams on page D6-2186](#).
- An event sent by some IMPLEMENTATION DEFINED mechanism.
- An event caused by the clearing of the global monitor associated with the PE.

In addition to the possible masking of WFE wake-up events shown in this list, when invasive debug is enabled and [EDSCR.HDE](#) is set to 1, [EDSCR.INTdis](#) can mask interrupts, including masking them acting as WFE wake-up events. For more information, see [EDSCR, External Debug Status and Control Register on page H9-5662](#).

As shown in the list of wake-up events, an implementation can include IMPLEMENTATION DEFINED hardware mechanisms to generate wake-up events.

———— Note —————

For more information about [PSTATE](#) masking see [Asynchronous exception masking controls on page G1-4368](#). If the configuration of the masking controls provided by EL2 and EL3 mean that a [PSTATE](#) mask bit cannot mask the corresponding exception, then the physical exception is a WFE wake-up event, regardless of the value of the [PSTATE](#) mask bit.

The Send Event instructions

The Send Event instructions are:

SEV, Send Event This causes an event to be signaled to all PEs in the multiprocessor system.

SEVL, Send Event Local

This must set the local Event Register. It might signal an event to other PEs, but is not required to do so.

The mechanism that signals an event to other PEs is IMPLEMENTATION DEFINED. The PE is not required to guarantee the ordering of this event with respect to the completion of memory accesses by instructions before the SEV instruction. Therefore, ARM recommends that software includes a DSB instruction before any SEV instruction.

———— Note —————

A DSB instruction ensures that no instruction, including any SEV instruction, that appears in program order after the DSB instruction, can execute until the DSB instruction has completed. For more information, see [Data Synchronization Barrier \(DSB\) on page E2-2769](#).

The SEVL instruction appears to execute in program order relative to any subsequent WFE instruction executed on the same PE, without the need for any explicit insertion of barrier instructions.

Execution of the Send Event instruction sets the Event Register.

The Send Event instructions are available at all privilege levels.

Pseudocode description of the Wait For Event mechanism

This section defines pseudocode functions that describe the operation of the Wait For Event mechanism.

The `ClearEventRegister()` pseudocode procedure clears the Event Register of the current PE.

The `IsEventRegisterSet()` pseudocode function returns TRUE if the Event Register of the current PE is set and FALSE if it is clear.

The `WaitForEvent()` pseudocode procedure optionally suspends execution until a WFE wake-up event or reset occurs, or until some earlier time if the implementation chooses. It is IMPLEMENTATION DEFINED whether restarting execution after the period of suspension causes a `ClearEventRegister()` to occur.

The `SendEvent()` pseudocode procedure sets the Event Register of every PE in the system.

G1.17.2 Wait For Interrupt

AArch32 state supports Wait For Interrupt through an instruction, WFI, that is provided in the A32 and T32 instruction sets. For more information, see [WFI on page F5-3670](#).

When a PE issues a WFI instruction, its execution can be suspended, and a low-power state can be entered.

The execution in AArch32 state of a WFI instruction that would otherwise cause suspension of execution might be trapped, see:

- [Traps to Undefined mode of EL0 execution of WFE and WFI instructions on page G1-4421](#).
- [Traps to Hyp mode of Non-secure EL0 and EL1 execution of WFE and WFI instructions on page G1-4437](#).
- [Traps to Monitor mode of the execution of WFE and WFI instructions in modes other than Monitor mode on page G1-4447](#).

The execution of a WFI instruction can cause suspension of execution only if both:

- The instruction does not cause any other exception.
- When the instruction is executed, there is not a pending WFI wakeup event.

WFI wake-up events

The PE can remain suspended in its WFI state until it is reset, or one of the following *WFI wake-up events* occurs:

- A physical IRQ interrupt, regardless of the value of the `PSTATE.I` bit.
- A physical FIQ interrupt, regardless of the value of the `PSTATE.F` bit.
- A physical SError interrupt, regardless of the value of the `PSTATE.A` bit.
- In Non-secure state in any mode other than Hyp mode:
 - When `HCR.IMO` is set to 1, a virtual IRQ interrupt, regardless of the value of the `PSTATE.I` bit.
 - When `HCR.FMO` is set to 1, a virtual FIQ interrupt, regardless of the value of the `PSTATE.F` bit.
 - When `HCR.AMO` is set to 1, a virtual SError interrupt, regardless of the value of the `PSTATE.A` bit.
- An asynchronous External Debug Request debug event, if halting is allowed. For the definition of *halting is allowed* see [Halting allowed and halting prohibited on page H2-5435](#).
See also [External Debug Request debug event on page H3-5490](#).

An implementation can include other IMPLEMENTATION DEFINED hardware mechanisms to generate WFI wake-up events.

When a WFI wake-up event is detected, or earlier if the implementation chooses, the WFI instruction completes.

WFI wake-up events cannot be masked by the mask bits in the `PSTATE`.

The architecture does not define the exact nature of the low power state, but the execution of a WFI instruction must not cause a loss of memory coherency.

Note

- Because debug events are WFI wake-up events, ARM strongly recommends that is used as part of an idle loop rather than waiting for a single specific interrupt event to occur and then moving forward. This ensures the intervention of debug while waiting does not significantly change the function of the program being debugged.
- In some previous implementations of Wait For Interrupt, the idle loop is followed by exit functions that must be executed before taking the interrupt. The operation of Wait For Interrupt remains consistent with this model, and therefore differs from the operation of Wait For Event.
- Some implementations of Wait For Interrupt drain down any pending memory activity before suspending execution. The ARM architecture does not require this operation, and software must not rely on Wait For Interrupt operating in this way.

Using WFI to indicate an idle state on bus interfaces

A common implementation practice is to complete any entry into powerdown routines with a WFI instruction.

Typically, the WFI instruction:

1. Forces the completion of execution of any instructions that are in progress, and of all associated bus activity.
2. Suspends the execution of instructions by the PE.

The control logic required to do this tracks the activity of the bus interfaces used by the PE. This means it can signal to an external power controller when there is no ongoing bus activity.

However, memory-mapped and external debug interface accesses to debug registers must continue to be processed while the PE is in the WFI state. The indication of idle state to the system normally only applies to the non-debug functional interfaces used by the PE, not the debug interfaces.

When the value of `DBGOSDLR.DLK`, the OS Double Lock status bit, is set to 1, this idle state must not be signaled to the PE unless the system can guarantee, also, that the debug interface is idle.

Note

When separate core and debug power domains are implemented, the debug interface referred to in this section is the interface between the core and debug power domains, since the signal to the power controller indicates that the core power domain is idle. For more information about the power domains see [Power domains and debug on page H6-5535](#).

The exact nature of this interface is IMPLEMENTATION DEFINED, but the use of Wait For Interrupt as the only architecturally-defined mechanism that completely suspends execution makes it very suitable as the preferred powerdown entry mechanism.

Pseudocode description of Wait For Interrupt

The `WaitForInterrupt()` pseudocode function optionally suspends execution until a WFI wake-up event or reset occurs, or until some earlier time if the implementation chooses.

G1.18 The AArch32 System register interface

In ARMv8, most system registers are accessed using the instructions described in [System register access instructions on page F1-2828](#). The System register interface provides access to those instructions, and:

- These registers are encoded using the parameters {coproc, opc1, CRn, CRm, opc2}, with permitted coproc values of 0b1110 and 0b1111.
- Some of these encodings provide the AArch32 System instructions summarized in:
 - [Cache maintenance instructions, functional group on page G4-4734](#).
 - [TLB maintenance instructions, functional group on page G4-4735](#).
 - [Address translation instructions, functional group on page G4-4737](#).
- To maintain compatibility with previous versions of the ARM architecture, the access controls for the AArch32 System registers include the access controls for AArch32 Advanced SIMD and floating-point functionality.

———— **Note** —————

See [Background to the System register interface on page G1-4410](#) for more information.

The following sections give more information about the AArch32 System register interface:

- [System registers in the coproc == 0b111x encoding space](#).
- [Access to System registers](#).
- [Access controls for Advanced SIMD and floating-point functionality on page G1-4409](#).
- [Pseudocode description of checking accesses to the System registers on page G1-4409](#).
- [Background to the System register interface on page G1-4410](#).

G1.18.1 System registers in the coproc == 0b111x encoding space

In AArch32 state:

- The coproc == 0b1110 encoding space is reserved for the configuration and control of:
 - Debug features, see [Debug registers on page G6-5239](#).
 - Trace features, see the [Embedded Trace Macrocell Architecture Specification](#).
 - Identification registers for the Trivial Jazelle implementation, see [Trivial implementation of the Jazelle extension on page G1-4338](#).
- The coproc == 0b1111 encoding space is reserved for the control and configuration of the PE, including architecture and feature identification. This means these encodings provide access to the System registers that control and return status information for PE operation.

For more information see [Chapter G6 AArch32 System Register Descriptions](#).

G1.18.2 Access to System registers

Most System registers are accessible only from EL1 or higher. For possible accesses from EL0:

- The register descriptions in [Chapter G6 AArch32 System Register Descriptions](#) indicate whether a register is accessible from EL0.
- [PL0 views of the System registers in the \(coproc==0b1111\) encoding space on page G4-4723](#) summarizes the permitted accesses to System registers in the coproc == 0b1111 encoding space from EL0.

G1.18.3 Access controls for Advanced SIMD and floating-point functionality

In ARMv8, the [CPACR](#) controls access to Advanced SIMD and floating-point functionality from software executing at PL1 or EL0 in AArch32 state:

- The {cp10, cp11} fields control access to all Advanced SIMD and floating-point functionality, and can:
 - Disable EL0 and PL1 access to this functionality.
 - Enable access to this functionality at PL1 only.
 - Enable access to this functionality at EL0 and PL1.
- The [ASEDIS](#) field controls access to Advanced SIMD instructions that are not also floating-point instructions.

Initially on powerup or reset into AArch32 state, all access to all Advanced SIMD and floating-point functionality from PL1 and EL0 is disabled.

———— **Note** —————

The [CPACR](#) has no effect on accesses from Hyp mode.

If an implementation includes EL3, the [NSACR](#) determines whether Advanced SIMD and floating-point functionality can be accessed from Non-secure state:

- The {cp10, cp11} fields control Non-secure access to all Advanced SIMD and floating-point functionality.
- The [NSASEDIS](#) field controls Non-secure access to Advanced SIMD instructions that are not also floating-point instructions.

If an implementation includes EL2, the [HCPTR](#) provides additional controls on Non-secure accesses to Advanced SIMD and floating-point functionality. For accesses that are otherwise permitted by the [CPACR](#) and [NSACR](#) settings, setting [HCPTR](#) bits to 1:

- Traps otherwise-permitted accesses from EL1 or EL0 to EL2. When EL2 is using AArch32, these accesses are trapped to Hyp mode.
- Makes accesses from EL2 mode UNDEFINED. When EL2 is using AArch32, this makes accesses from Hyp mode UNDEFINED.

In the [HCPTR](#):

- The {TCP10, TCP11} fields control access to all Advanced SIMD and floating-point functionality.
- The [TASE](#) field controls access to Advanced SIMD instructions that are not also floating-point instructions.
- The [TCPAC](#) field traps Non-secure EL1 accesses to the [CPACR](#) to Hyp mode.

For more information, see [General trapping to Hyp mode of Non-secure accesses to the SIMD and floating-point registers](#) on page G1-4437.

———— **Note** —————

Whenever a pair of fields control the access to the Advanced SIMD and floating-point functionality, the values of each field of the pair must be identical. In ARMv8, if these settings are not identical the behavior of the Advanced SIMD and floating-point functionality is CONstrained UNPREDICTABLE, see [Handling of System register control fields for Advanced SIMD and floating-point operation](#) on page K1-6102.

For more information about Advanced SIMD and floating-point support see [Advanced SIMD and floating-point support](#) on page G1-4412.

G1.18.4 Pseudocode description of checking accesses to the System registers

The [AArch32.CheckSystemAccess\(\)](#) function determines whether a System register access instruction that targets a System register in the (coproc == 0b111x) encoding space is accepted.

G1.18.5 Background to the System register interface

Note

This section is not part of the ARMv8 Architecture specification. It is included only to present the rationale of some aspects of the System register interface.

The interface to the System registers was originally defined as part of a generic *coprocessor* interface, that gave access to fifteen coprocessors, CP0 - CP15. Of these, CP8 - CP15 were reserved for use by ARM, while CP0 - CP7 were available for IMPLEMENTATION DEFINED coprocessors.

The coprocessors were accessed using coprocessor instructions. These instructions remain part of the T32 and A32 instruction sets, see [System register access instructions on page F1-2828](#).

In the ARM coprocessor model, a coprocessor included both:

- Primary and secondary coprocessor registers, that form part of the coprocessor interface.
- A number of internal registers.

When accessing a 32-bit internal coprocessor register, using an MCR or MRC instruction, the instruction specified:

- The target coprocessor, specified by the coproc parameter and taking a value between p0 for CP0 and p15 for CP15.
- The primary coprocessor register, specified by the CRn parameter and taking a value between c0 and c15.
- The secondary coprocessor register, specified by the CRm parameter and taking a value between c0 and c15.
- Up to two additional parameters, opc1 and opc2, taking values between 0 and 7.

Other instructions in the group described in [System register access instructions on page F1-2828](#) take a subset of these parameters:

- In the ARMv7 definitions, LDC and STC instructions take parameters {coproc, CRd}, where CRd is the primary coprocessor register.
- MCRR and MRRC instructions take parameters {coproc, opc1, CRm}, where CRm is the primary coprocessor register.

To maintain backwards compatibility, the arguments to an MCR or MRC instruction remain {coproc, opc1, CRn, CRm, opc2}. Correspondingly, the encoding of the AArch64 System registers is described using the parameters {op0, op1, CRn, CRm, op2}. However:

- The naming of these parameters no longer has any particular significance.
- While the coproc field is a 4-bit field, op0 is a 2-bit field.

Of the coprocessors reserved for use by ARM, in ARMv7 and earlier versions of the architecture:

- CP15 provided access to the System registers relating to non-debug operation, and was originally called the System control coprocessor. In ARMv8 these registers are described as being in the coproc == 0b1111 encoding space.
- CP14 provided access to additional System registers, including those relating to debug and trace. In ARMv8 these registers are described as being in the coproc == 0b1110 encoding space.
- CP10 and CP11 were used for Advanced SIMD and floating-point control, and many coprocessor instruction encodings targeting CP10 and CP11 were used as floating-point instruction encodings:
 - Generally ARMv8 does not relate these instructions to the coprocessor encoding space, but the naming of registers and register fields for Advanced SIMD and floating-point control reflects the historic coprocessor model.
 - Because the Advanced SIMD and floating-point functionality used both CP10 and CP11, some System register controls of this functionality have a pair of fields, for example NSACR.{cp10, cp11}. In these cases, both fields must be set to the same value. For more information see [Access controls for Advanced SIMD and floating-point functionality on page G1-4409](#).

In ARMv8:

- The AArch32 System registers include registers that were described as Special registers in ARMv7 and earlier versions of the architecture. This means that the ARMv8 System registers include registers that are outside the earlier coprocessor model.
- The ARMv7 AArch32 instruction encodings for LDC, STC, MCR, MRC, MCRR, and MRRC instructions with coproc field values other than {1010, 1011, 1110, 1111} are available for reuse. **ARMv8.2 re-uses some encodings in this way.**

G1.19 Advanced SIMD and floating-point support

[Advanced SIMD and floating-point instructions on page E1-2740](#) introduces:

- The scalar floating-point instructions in the A32 and T32 instruction sets.
- The Advanced SIMD integer and floating-point vector instructions in the A32 and T32 instruction sets.
- The SIMD and floating-point register file, that can be viewed as:
 - Singleword registers S0 - S31.
 - Doubleword registers D0 - D31.
 - Quadword registers Q0 - Q15.
- The *Floating-Point Status and Control Register (FPSCR)*.

For more information about the System registers for the Advanced SIMD and floating-point operation see [Advanced SIMD and floating-point System registers on page G1-4415](#). Software can interrogate these registers to discover the implemented Advanced SIMD and floating-point support.

[AArch32 implications of not including support for Advanced SIMD and floating-point](#) summarizes the effects of not supporting these instructions, and the following subsections give more information about the Advanced SIMD and Floating-point support:

- [Enabling Advanced SIMD and floating-point support on page G1-4413](#).
- [Advanced SIMD and floating-point System registers on page G1-4415](#).
- [Context switching when using Advanced SIMD and floating-point functionality on page G1-4415](#).
- [Floating-point exception traps on page G1-4416](#).

G1.19.1 AArch32 implications of not including support for Advanced SIMD and floating-point

As stated in [Implementations not including Advanced SIMD and floating-point instructions on page D1-1901](#), although ARMv8-A generally requires the inclusion of the Advanced SIMD and floating-point instructions in all instruction sets, for implementations targeting specialized markets, ARM might produce or license ARMv8-A implementations that do not provide any support for Advanced SIMD and floating-point instructions. In such an implementation, in AArch32 state:

- The **CPACR**.{ASEDIS, cp11, cp10} fields are RES0.
- The **NSACR**.{NSASEDIS, cp11, cp10} fields are RES0.
- The **HCPTR**.{TASE, TCP11, TCP10} fields are RES1.
- The **FPEXC**, **FPSCR**, **FPSID**, **MVFR0**, **MVFR1**, and **MVFR2** registers are not implemented and their encodings are UNDEFINED.
- Attempted accesses to Advanced SIMD and floating-point functionality are UNDEFINED. This means:
 - All Advanced SIMD and floating-point instructions are UNDEFINED.
 - Attempts to access the Advanced SIMD and floating-point System registers are UNDEFINED.

G1.19.2 Enabling Advanced SIMD and floating-point support

Software must ensure that the required access to the Advanced SIMD and floating-point features is enabled. Most of those controls are described in [Configurable instruction enables and disables, and trap controls on page G1-4418](#), and this section:

- Summarizes those controls.
- Provides additional information in the following subsections:
 - [FPFXC control of access to Advanced SIMD and floating-point functionality on page G1-4414](#).
 - [EL0 access to Advanced SIMD and floating-point functionality on page G1-4414](#).

Note

This section shows the controls when the controlling Exception levels are using AArch32. Similar controls are provided when the Exception levels are using AArch64, and then apply to lower Exception levels that are using AArch32.

The controls of access to Advanced SIMD and floating-point functionality are:

General {cp10, cp11} or {TCP10, TCP11} controls

This relates to the [CPACR](#).{cp10, cp11}, [NSACR](#).{cp10, cp11}, and [HCPTR](#).{TCP10, TCP11} controls.

Note

[Background to the System register interface on page G1-4410](#) explains the naming of these controls.

The {cp10, cp11} controls provide general control of the use of Advanced SIMD and floating-point functionality, as follows:

- [CPACR](#).{cp10, cp11} control access from PE modes other than Hyp mode. These fields have no effect on accesses to Advanced SIMD and floating-point functionality from Hyp mode.
- In an implementation that includes EL3, [NSACR](#).{cp10, cp11} control access from Non-secure state.
- In an implementation that includes EL2, if [NSACR](#).{cp10, cp11} permit Non-secure accesses, or if EL3 is not implemented, [HCPTR](#).{TCP10, TCP11} provide an additional control on those accesses.

In each case, the {cp10, cp11} controls must be programmed to the same value, otherwise operation is CONSTRAINED UNPREDICTABLE. The ARMv8 CONSTRAINED UNPREDICTABLE behavior is that, for all purposes other than reading the value of the register field, behavior is as if the cp11 field has the same value as the cp10 field. For more information see [Handling of System register control fields for Advanced SIMD and floating-point operation on page K1-6102](#).

For more information about these controls, see:

- [Enabling PL0 and PL1 accesses to the SIMD and floating-point registers on page G1-4423](#).
- [General trapping to Hyp mode of Non-secure accesses to the SIMD and floating-point registers on page G1-4437](#).
- [Enabling Non-secure access to SIMD and floating-point functionality on page G1-4449](#).

Control of accesses to the CPACR from Non-secure PL1 modes

As stated in [General {cp10, cp11} or {TCP10, TCP11} controls](#), the [CPACR](#) controls access to Advanced SIMD and floating-point functionality from PE modes other than Hyp mode. Accesses to the [CPACR](#) from Non-secure PL1 modes can be trapped to EL2, see [Traps to Hyp mode of Non-secure EL1 accesses to the CPACR on page G1-4439](#).

Additional controls of Advanced SIMD functionality

- If implemented as an RW field, [CPACR](#).ASEDIS can make all Advanced SIMD instructions UNDEFINED in all modes other than Hyp mode.

- In an implementation that includes EL3, when `CPACR.ASEDIS` permits use of the Advanced SIMD instructions or if the `CPACR.ASEDIS` control is not implemented, `NSACR.NSASEDIS` can make all Advanced SIMD instructions UNDEFINED in Non-secure state.
- In an implementation that includes EL2, when the `CPACR` and `NSACR` settings permit Non-secure use of the Advanced SIMD instructions, if `HCPTR.TASE` is implemented as an RW field it can make these instructions UNDEFINED in Hyp mode, and trap to Hyp mode any use of these instructions in a Non-secure PL0 or PL1 mode.

For more information about these controls, see:

- [Disabling PL0 and PL1 execution of Advanced SIMD instructions on page G1-4424.](#)
- [Traps to Hyp mode of Non-secure accesses to Advanced SIMD functionality on page G1-4438.](#)
- [Disabling Non-secure access to Advanced SIMD functionality on page G1-4450.](#)

[Pseudocode description of enabling SIMD and floating-point functionality on page G1-4451](#) provides links to the pseudocode descriptions of all of these controls.

FPEXC control of access to Advanced SIMD and floating-point functionality

In addition, `FPEXC.EN` is an enable bit for most Advanced SIMD and floating-point operations. When `FPEXC.EN` is 0, all Advanced SIMD and floating-point instructions are treated as UNDEFINED except for:

- A VMSR to the `FPEXC` or `FPSID` register.
- A VMRS from the `FPEXC`, `FPSID`, `MVFR0`, `MVFR1`, or `MVFR2` register.

These instructions can be executed only at EL1 or higher.

———— Note —————

- When the `FPSID` is accessible, any write access to the `FPSID` is ignored.
- When `FPEXC.EN` is 0, these operations are treated as UNDEFINED:
 - A VMSR to the `FPSCR`.
 - A VMRS from the `FPSCR`.

See [Enabling access to the SIMD and floating-point registers on page G1-4424](#) for more information about the scope of the `FPEXC.EN` control.

When executing at EL0, the PE behaves as if the value of `FPEXC.EN` is 1 if either:

- EL1 is using AArch64.
- Execution is in Non-secure state, EL2 is using AArch64. and the value of `HCR_EL2.TGE` is 1.

———— Note —————

In this state, if the value of `HCR_EL2.RW` is 0 then it is permitted for the value of `FPEXC32_EL2.EN` to control whether Advanced SIMD and floating-point functionality is enabled. However, ARM deprecates using the value of `FPEXC32_EL2.EN` to determine behavior.

EL0 access to Advanced SIMD and floating-point functionality

When the access controls summarized in this section permit EL0 access to the Advanced SIMD and floating-point functionality, this applies only to the subset of functionality that is available at EL0. In particular:

- Only Advanced SIMD and Floating-point System register that is accessible is the `FPSCR`.
- The Advanced SIMD and floating-point instructions are available.

Execution at EL0 corresponds to the application level view of the Advanced SIMD and floating-point functionality, as described in [Advanced SIMD and floating-point System registers on page E1-2742](#).

G1.19.3 Advanced SIMD and floating-point System registers

AArch32 state provides a common set of System registers for the Advanced SIMD and floating-point functionality. This section gives general information about this set of registers, and indicates where each register is described in detail. It contains the following subsections:

- [Register map of the Advanced SIMD and floating-point System registers.](#)
- [Accessing the Advanced SIMD and floating-point System registers.](#)

Register map of the Advanced SIMD and floating-point System registers

[Table G4-66 on page G4-4745](#) shows the register map of the Advanced SIMD and Floating-point registers. Each register is 32 bits wide. In an implementation that includes EL3, the Advanced SIMD and Floating-point registers are common registers, see [Common System registers on page G4-4698](#).

Accessing the Advanced SIMD and floating-point System registers

Software accesses the Advanced SIMD and floating-point System registers using the VMRS and VMSR instructions, see:

- [VMRS on page F6-4017.](#)
- [VMSR on page F6-4020.](#)

For example:

```
VMRS <Rt>, FPSID    ; Read Floating-Point System ID Register
VMRS <Rt>, MVFR1    ; Read Media and VFP Feature Register 1
VMSR FPSCR, <Rt>   ; Write Floating-Point System Control Register
```

Software can access the Advanced SIMD and floating-point System registers only if the access controls permit the access, see [Enabling Advanced SIMD and floating-point support on page G1-4413](#).

———— Note ————

All hardware ID information can be accessed only from EL1 or higher. This means:

The FPSID is accessible only from EL1 or higher.

This is a change introduced from VFPv3. Previously, the FPSID register can be accessed in all modes.

The MVFR registers are accessible only from EL1 or higher.

Unprivileged software must issue a system call to determine what features are supported.

G1.19.4 Context switching when using Advanced SIMD and floating-point functionality

When the Advanced SIMD and floating-point functionality is used by only a subset of processes, the operating system might implement lazy context switching of the Advanced SIMD and floating-point register file and System registers.

In the simplest lazy context switch implementation, the primary context switch software uses the CPACR. {cp10, cp11} controls to disable access to the Advanced SIMD and floating-point functionality, see [Enabling Advanced SIMD and floating-point support on page G1-4413](#). Subsequently, when a process or thread attempts to use an Advanced SIMD or floating-point instruction, it triggers an Undefined Instruction exception. The operating system responds by saving and restoring the Advanced SIMD and floating-point register file and System registers. Typically, it then re-executes the Advanced SIMD or floating-point instruction that generated the Undefined Instruction exception.

G1.19.5 Floating-point exception traps

Execution of a floating-point instruction can generate an exceptional condition, called a *floating-point exception*.

The ARMv8-A architecture supports synchronous exception generation in the event of any or all of the following floating-point floating-point exceptions:

- Input Denormal.
- Inexact.
- Underflow.
- Overflow.
- Divide by Zero.
- Invalid Operation.

———— **Note** —————

Do not confuse floating-point exceptions with the AArch32 architectural exceptions summarized in [AArch32 state exception descriptions on page G1-4376](#).

Whether an implementation includes synchronous exception generation for these floating-point exceptions is IMPLEMENTATION DEFINED:

- For an implementation that does provide this capability, **FPSCR**.{IDE, IXE, UFE, OFE, DZE, IOE} are the control bits that enable synchronous exception generation for each of the floating-point exceptions.
- For an implementation that does provide this capability, the **FPSCR**.{IDE, IXE, UFE, OFE, DZE, IOE} are RAZ/WI.

———— **Note** —————

The ARMv8-A architecture does not support asynchronous reporting of floating-point exceptions.

When generating synchronous exceptions for one or more floating-point exceptions is enabled, the synchronous exceptions generated by the floating-point exception traps are taken to the lowest Exception level that can handle such an exception, while adhering to the rule that an exception can never be taken to a lower Exception level. This means that trapped floating-point exceptions taken:

- From EL0 are taken to EL1, except for the following cases when they are taken from Non-secure EL0 to EL2:
 - EL2 is using AArch32 and the value of **HCR.TGE** is 1.
 - EL2 is using AArch64 and the value of **HCR_EL2.TGE** is 1
- From EL1 are taken to EL1.
- From EL2 are taken to EL2.
- From EL3 are taken to EL3.

If the exception is taken to an Exception level that is using AArch64 then it is reported in the **ELR_ELx** for the Exception level to which it is taken, as described in [Exception entry on page D1-1799](#).

If the exception is taken to an Exception level that is using AArch32 then it is taken as an Undefined Instruction exception, see [Undefined Instruction exception on page G1-4376](#). The **FPEXC** identifies the floating-point exceptions that occurred since the corresponding status bits in that register were last set to 0.

See also [Floating-point exceptions and exception traps on page E1-2743](#).

In an implementation that provides synchronous exception generation for floating-point exceptions:

- Synchronous exception generation applies to floating-point exceptions generated by scalar SIMD and floating-point instructions executed in AArch32 state.
- The registers that are presented to the exception handler are consistent with the state of the PE immediately before the instruction that caused the exception. An implementation is permitted not to restore the cumulative exception flags in the event of such an exception.

ARMv8 does not support the trapping of floating-point exceptions from Advanced SIMD instructions executed in AArch32 state,

The [AArch32.FPTrappedException\(\)](#) and [FPPProcessException\(\)](#) pseudocode functions describe the handling of trapped floating-point exceptions generated in AArch32 state.

The [AArch32.FPTrappedException\(\)](#) and [FPPProcessException\(\)](#) functions are described in [Chapter J1 ARMv8 Pseudocode](#).

G1.20 Configurable instruction enables and disables, and trap controls

This section describes the controls provided by AArch32 state for enabling, disabling, and trapping particular instructions. Each control is categorized as an *instruction enable*, an *instruction disable*, or a *trap control*:

Instruction enables and instruction disables

Enable or disable the use of one or more particular instructions at a particular Privilege level and Security state.

When an instruction is disabled as a result of an instruction enable or disable, it is UNDEFINED.

The exception generated by attempting to executed an UNDEFINED instruction is:

- Taken to EL1 if the UNDEFINED instruction was executed at EL0, unless the instruction was executed at Non-secure EL0 and is routed to EL2 by the control described in [Routing exceptions from Non-secure EL0 to EL2 on page G1-4356](#).

When the exception is taken to EL1 it is taken to Undefined mode.

- Otherwise, taken to the Exception level at which the UNDEFINED instruction was executed:
 - If the instruction was executed in Hyp mode the exception is taken to Hyp mode.
 - Otherwise, the exception is taken to Undefined mode.

Trap controls

Control whether one or more instructions, when executed at a particular Privilege level, are *trapped*.

———— Note —————

AArch32 trap controls are described in terms of Privilege levels, rather than Exception levels, because the PL1 traps apply at and are controlled from:

EL1 In Non-secure state, and in Secure state when EL3 is using AArch64.

EL3 In Secure state when EL3 is using AArch32.

For more information see [Security state, Exception levels, and AArch32 execution privilege on page G1-4318](#).

Trap controls are grouped as:

PL1, excluding Monitor mode

Trapped instructions generate Undefined Instruction exceptions that are taken to Undefined mode, unless the instruction was executed at Non-secure EL0 and is routed to EL2 by the control described in [Routing exceptions from Non-secure EL0 to EL2 on page G1-4356](#).

For more information about these traps see [PL1 configurable controls on page G1-4419](#).

Hyp mode (PL2)

These traps apply only to execution in Non-secure state. This section only describes the traps that apply when EL2 is using AArch32.

Trapped instructions generate:

- Hyp Trap exceptions, taken to Hyp mode, if trapped from a mode other than Hyp mode.
- Undefined Instruction exceptions taken to Hyp mode, if trapped from Hyp mode.

For more information about these traps see [EL2 configurable controls on page G1-4427](#). See also [Routing exceptions from Non-secure EL0 to EL2 on page G1-4356](#).

Monitor mode (Secure PL1)

This section only describes the traps that apply when EL3 is using AArch32.

Trapped instructions generate Monitor Trap exceptions, that are taken to Monitor mode.

For more information about these traps see [EL3 configurable controls on page G1-4446](#).

An exception generated as a result of an instruction enable or disable, or a trap control, is only taken if the instruction does not also generate a higher priority exception. [Exception prioritization for exceptions taken to AArch32 state on page G1-4344](#) defines the prioritization of different exceptions on the same instruction.

Exceptions generated as a result of these controls are synchronous exceptions.

For exceptions taken to an Exception level that is using AArch32, only exceptions that are taken to Hyp mode are reported in a syndrome register, the [HSR](#).

Note

- A particular control might have a mnemonic that suggests it is different type of control to the control type it is categorized as. For example, [CPACR.TRCDIS](#) is a trap control even though TRCDIS is a mnemonic for Trace Disable.
- An implementation might provide additional controls, in IMPLEMENTATION DEFINED registers, to provide control of trapping of IMPLEMENTATION DEFINED features.
- [Configurable instruction enables and disables, and trap controls on page D1-1842](#) describes controls provided by AArch64 state for enabling, disabling, and trapping instructions. Generally, where an AArch64 control applies to execution at lower Exception levels, it traps the equivalent functionality when that lower Exception level is using AArch32. See the AArch64 trap controls for more information.

This section is organized as follows:

- [Register access instructions](#).
- [PL1 configurable controls](#).
- [EL2 configurable controls on page G1-4427](#).
- [EL3 configurable controls on page G1-4446](#).
- [Pseudocode description of configurable instruction enables, disables, and traps on page G1-4451](#).

G1.20.1 Register access instructions

When an instruction is disabled or trapped, the exception is taken before execution of the instruction. This means that if the instruction is a register access instruction:

- No access is made before the exception is taken.
- Side-effects that are normally associated with the access do not occur before the exception is taken.

G1.20.2 PL1 configurable controls

In AArch32 state, each control is associated with a particular System register field that is accessible:

- When EL3 is using AArch64, or when an implementation does not include EL3, from EL1.
- When EL3 is using AArch32:
 - In Non-secure state, from EL1.
 - In Secure state, from EL3.

This means that the controls are described as PL1 controls, because PL1 is defined as being the Privilege level of software that is executing:

- At EL3, if the PE is executing in EL3 and EL3 is using AArch32.
- At EL1 under all other conditions.

Where there is an AArch64 control that is equivalent to an AArch32 PL1 control, the AArch64 control is an EL1 control.

Any exception that is generated because of an AArch32 PL1 control is taken to a PL1 mode.

Note

Any exception generated because of an AArch32 PL1 control is taken to AArch32 state.

Table G1-25 shows the AArch32 System registers that contain these controls.

Table G1-25 System registers that contain instruction enables and disables, and trap controls

Register name	Register description
SCTLR	System Control Register
FPEXC	Floating-point Exception Control Register
CPACR	Architectural Feature Access Control Register
DBGDSCRExt	Monitor System Debug Control Register
PMUSERENR	Performance Monitors User Enable Register

Table G1-26 summarizes these controls.

Table G1-26 Instruction enables and disables, and trap controls, for exceptions taken to Undefined mode

Control	Control type ^a	Description
SCTLR.{nTWE, nTWI}	T	Traps to Undefined mode of EL0 execution of WFE and WFI instructions on page G1-4421
SCTLR.{SED, ITD}	D	Disabling or enabling PL0 and PL1 use of AArch32 deprecated functionality on page G1-4421
SCTLR.CP15BEN	E	
CPACR.TRCDIS	T	Traps to Undefined mode of PL0 and PL1 System register accesses to trace registers on page G1-4422
CPACR.{cp11, cp10}	E	Enabling use of Advanced SIMD and floating-point functionality on page G1-4423
FPEXC.EN	E	
CPACR.ASEDIS	D	
DBGDSCRExt.UDCCdis	T	Traps to Undefined mode of EL0 accesses to the Debug Communications Channel (DCC) registers on page G1-4424
CNTKCTL.{PLOPTEN, PLOVTEN, PLOPCTEN, PLOVCTEN}	T	Traps to Undefined mode of EL0 accesses to the Generic Timer registers on page G1-4425
PMUSERENR.{ER, CR, SW, EN}	T	Traps to Undefined mode of EL0 accesses to Performance Monitors registers on page G1-4425

a. See Table G1-27.

Table G1-27 Control types, for exceptions taken to Undefined mode

Abbreviation	Type	See
D	Disable	Instruction enables and instruction disables on page G1-4418
E	Enable	Instruction enables and instruction disables on page G1-4418
T	Trap	Trap controls on page G1-4418

When generated in Non-secure User mode, exceptions generated by these controls can be routed to EL2, as described in *Routing exceptions from Non-secure EL0 to EL2* on page G1-4356.

Instructions that fail their Condition code check

See [Conditional execution of undefined instructions on page G1-4378](#).

Trapping to PL1 of instructions that are UNPREDICTABLE

For an instruction that is UNPREDICTABLE or CONSTRAINED UNPREDICTABLE, when the instruction is disabled or trapped then it is CONSTRAINED UNPREDICTABLE whether execution of the instruction generates an Undefined Instruction exception.

Traps to Undefined mode of EL0 execution of WFE and WFI instructions

SCTLR.{nTWE, nTWI} trap EL0 execution of WFE and WFI instructions to Undefined mode:

SCTLR.nTWE

- 1** This control has no effect on the EL0 execution of WFE instructions.
- 0** Any attempt to execute a WFE instruction at EL0 is trapped to Undefined mode, if the instruction would otherwise have caused the PE to enter a low-power state.

SCTLR.nTWI

- 1** This control has no effect on the EL0 execution of WFI instructions.
- 0** Any attempt to execute a WFI instruction at EL0 is trapped to Undefined mode, if the instruction would otherwise have caused the PE to enter a low-power state.

The attempted execution of a conditional WFE or WFI instruction is only trapped if the instruction passes its Condition code check.

———— **Note** —————

Since a WFE or WFI can complete at any time, even without a Wakeup event, the traps on WFE or WFI are not guaranteed to be taken, even if the WFE or WFI is executed when there is no Wakeup event. The only guarantee is that if the instruction does not complete in finite time in the absence of a Wakeup event, the trap will be taken.

When generated in Non-secure User mode, exceptions generated by these controls can be routed to EL2, as described in [Routing exceptions from Non-secure EL0 to EL2 on page G1-4356](#).

For more information about these instructions, and when they can cause the PE to enter a low-power state, see:

- [Wait For Event and Send Event on page G1-4403](#).
- [Wait For Interrupt on page G1-4406](#).

Disabling or enabling PL0 and PL1 use of AArch32 deprecated functionality

[Table G1-28 on page G1-4422](#) shows the deprecated AArch32 functionality that might have disable controls in the **SCTLR**:

- The SED control is always implemented.
- Whether each of the ITD or CP15BEN controls is implemented is IMPLEMENTATION DEFINED. If a control is not implemented then the associated functionality cannot be disabled.

When an instruction is disabled by one of these controls, it is UNDEFINED at PL0 and PL1. This means an attempt to execute the instruction at PL0 or PL1 generates an Undefined Instruction exception that is taken to Undefined mode, unless both of the following apply, in which case the attempted execution generates an exception that is taken to EL2, as described in [Routing exceptions from Non-secure EL0 to EL2 on page G1-4356](#):

- The instruction is executed at Non-secure EL0 using AArch32.
- Either:
 - EL2 is using AArch32 and the value of **HCR.TGE** is 1.
 - EL2 is using AArch64 and the value of **HCR_EL2.TGE** is 1.

Table G1-28 PL1 controls for disabling and enabling PL0 and PL1 use of AArch32 deprecated functionality

Deprecated AArch32 functionality	Instruction enable or disable in the SCTLR ^a	Disabled instructions
SETEND instructions	SED ^b	SETEND instructions
Some uses of IT instructions	ITD ^c	See the SCTLR.ITD description
Accesses to the CP15DMB , CP15DSB , and CP15ISB barrier instructions	CP15BEN ^d	MCR accesses to the CP15DMB , CP15DSB , and CP15ISB instructions

- a. The controls that are implemented in **SCTLR** are also implemented in **SCTLR_EL1**, and apply when PL1 is using AArch64 and PL0 is using AArch32.
- b. SETEND instruction disable. SETEND instructions are disabled when the value of this field is 1.
- c. IT instruction disable. If this control is implemented, some uses of IT instructions are disabled when the value of this field is 1.
- d. System register (coproc==0b1111) memory barrier enable. If this control is implemented, the specified register accesses are disabled when the value of CP15BEN is 0.

———— **Note** —————

The uses of the IT instruction, and use of the **CP15DMB**, **CP15DSB**, and **CP15ISB** barrier instructions, are deprecated for performance reasons.

Traps to Undefined mode of PL0 and PL1 System register accesses to trace registers

If implemented, the **CPACR.TRCDIS** control traps PL0 and PL1 System register accesses to the trace registers to Undefined mode, as follows:

- 1** PL0 and PL1 accesses to the System register interface to the trace macrocell are trapped to Undefined mode
- 0** This control has no effect on PL0 and PL1 accesses to the System register interface to the trace macrocell.

If the **CPACR.TRCDIS** control is not implemented, then the **CPACR.TRCDIS** field is RAZ/WI. This means the **CPACR** does not provide a trap to Undefined mode of PL1 and PL0 System register accesses to trace registers. See the register description for more information.

———— **Note** —————

- System register accesses to the trace macrocell use the (coproc==0b1110) encoding space.
- The ETMv4 architecture does not permit EL0 to access the trace registers. If the ARMv8-A architecture is implemented with an ETMv4 implementation, EL0 accesses to the trace System registers are UNDEFINED.
- The ARMv8-A architecture does not provide traps on trace register accesses through the optional memory-mapped external debug interface.

System register accesses to the trace System registers can have side-effects. When a System register access is trapped, no side-effects occur before the exception is taken, see *Register access instructions* on page G1-4419.

If EL3 is implemented and is using AArch32, and **NSACR.NSTRCDIS** is 1, **CPACR.TRCDIS** behaves as RAO/WI in Non-secure state. This behavior also applies if the **CPACR.TRCDIS** control is not implemented.

When generated in Non-secure User mode, an exception generated by this control can be routed to EL2, as described in *Routing exceptions from Non-secure EL0 to EL2* on page G1-4356.

Enabling use of Advanced SIMD and floating-point functionality

Table G1-29 summarizes the controls of Advanced SIMD and floating-point functionality.

Table G1-29 Controls of use of Advanced SIMD and floating-point functionality

Control	Type	Description, see
CPACR.{cp11, cp10}	E	<i>Enabling PL0 and PL1 accesses to the SIMD and floating-point registers</i>
FPEXC.EN	E	<i>Enabling access to the SIMD and floating-point registers on page G1-4424</i>
CPACR.ASEDIS	D	<i>Disabling PL0 and PL1 execution of Advanced SIMD instructions on page G1-4424</i>

If any of CPACR.{cp11, cp10}, FPEXC.EN, or for Advanced SIMD instructions, CPACR.ASEDIS, disable a floating-point or an Advanced SIMD instruction, the instruction is UNDEFINED. Support for the CPACR.ASEDIS control is optional, and if the control is not implemented behavior is as if the control permits the execution of Advanced SIMD instructions at PL1 and PL0.

When generated in Non-secure User mode, exceptions generated by these controls can be routed to EL2, as described in *Routing exceptions from Non-secure EL0 to EL2 on page G1-4356*.

Enabling PL0 and PL1 accesses to the SIMD and floating-point registers

CPACR.{cp11, cp10} enable PL0 and PL1 accesses to the SIMD and floating-point registers.

When CPACR.cp10 is:

00	PL0 and PL1 accesses to Advanced SIMD and floating-point registers or instructions are UNDEFINED.
01	PL0 accesses to Advanced SIMD and floating-point registers or instructions are UNDEFINED.
10	Reserved. The effect of programming this field to this value is CONSTRAINED UNPREDICTABLE.
11	This control permits full access to the Advanced SIMD and floating-point functionality from PL0 and PL1.

The value of CPACR.cp11 is ignored. If CPACR.cp11 is programmed with a different value to CPACR.cp10 then CPACR.cp11 is UNKNOWN on a direct read of the CPACR.

————— Note —————

- Software must set CPACR.cp11 and CPACR.cp10 to the same value.

Table G1-30 shows the registers for which accesses are enabled.

Table G1-30 Register accesses enabled at PL0 and PL1 by CPACR.{cp11, cp10}

Enabled at	Registers
PL0 and PL1, or PL0 only ^a	FPSCR, FPEXC, FPSID, MVFR0, MVFR1, MVFR2, and any of the SIMD and floating-point registers Q0-Q15, including their views as D0-D31 registers or S0-S31 registers ^b

a. Depending on the value of CPACR.{cp11, cp10}. See the register description for details.

b. Permitted VMSR accesses to the FPSID are ignored, but for the purposes of the {cp10, cp11} controls the architecture defines a VMSR accesses to the FPSID from EL1 or higher is an access to a SIMD and floating-point register.

If EL3 is implemented and is using AArch32, and NSACR.{cp11, cp10} are both set to 0, the functionality described in this section is disabled in Non-secure state, and CPACR.{cp11, cp10} are RAZ/WI in Non-secure state. See *Enabling Non-secure access to SIMD and floating-point functionality on page G1-4449*.

For more information about SIMD and floating-point support, see [Advanced SIMD and floating-point support on page G1-4412](#).

Enabling access to the SIMD and floating-point registers

FPEXC.EN enables accesses to the SIMD and floating-point registers at all Exception levels, but does not control the following:

- VMSR accesses to the FPEXC or FPSID.
- VMRS accesses from the FPEXC, FPSID, MVFR0, MVFR1, or MVFR2.

When FPEXC.EN is:

- 1** Accesses to the registers shown in [Table G1-31](#) are enabled at all Exception levels.
- 0** All accesses to the registers shown in [Table G1-31](#) are UNDEFINED.

[Table G1-31](#) shows the registers for which accesses are enabled, and for an exception taken to Hyp mode, how the exception is reported in HSR.

Table G1-31 Register accesses enabled when FPEXC.EN is 1

Enabled at	Registers	Syndrome reporting in HSR ^a
All Exception levels	FPCSR, and any of the SIMD and floating-point registers Q0-Q15, including their views as D0-D31 registers or S0-S31 registers.	Exception for an unknown reason, using EC value 0x00

a. Only for exceptions that are taken to Hyp mode.

For more information, see [Advanced SIMD and floating-point support on page G1-4412](#).

Disabling PL0 and PL1 execution of Advanced SIMD instructions

If implemented as an RW field, CPACR.ASEDIS can disable PL0 and PL1 execution of Advanced SIMD instructions, as follows:

- 1** Advanced SIMD instructions are UNDEFINED at PL0 and PL1.
- 0** Advanced SIMD instruction execution is enabled at PL0 and PL1.

The instructions that CPACR.ASEDIS disables are those described in [Controls of Advanced SIMD operation that do not apply to floating-point operation on page E1-2746](#).

When the control is not implemented, meaning the CPACR.ASEDIS field is RAZ/WI, behavior is as if the control permits execution of Advanced SIMD instructions at PL0 and PL1.

If EL3 is implemented and is using AArch32, and NSACR.NSASEDIS is 1, CPACR.ASEDIS is RAO/WI in Non-secure state. This also applies when the CPACR.ASEDIS control is not implemented.

Traps to Undefined mode of EL0 accesses to the Debug Communications Channel (DCC) registers

DBGDSCRext.UDCCdis traps EL0 accesses to the DCC registers to Undefined mode:

- 1** EL0 accesses to the DCC registers are trapped to Undefined mode
- 0** This control has no effect on EL0 accesses to the DCC registers.

Traps of EL0 accesses to the DBGDTRRXint and DBGDTRTXint are ignored in Debug state.

[Table G1-32](#) shows the registers for which accesses are trapped.

Table G1-32 Register accesses trapped to Undefined mode when DBGDSCRext.UDCCdis is 1

Traps from	Registers
EL0	DBGDSCRint, DBGDTRRXint, DBGDTRTXint, DBGDIDR, DBGDSAR, DBGDRAR

Note

All accesses to these registers are trapped, including LDC and STC accesses to [DBGDTRTXint](#) and [DBGDTRRXint](#), and MRRC accesses to [DBGDSAR](#) and [DBGDRAR](#).

When generated in Non-secure User mode, an exception generated by this control can be routed to EL2, as described in [Routing exceptions from Non-secure EL0 to EL2 on page G1-4356](#).

Traps to Undefined mode of EL0 accesses to the Generic Timer registers

[CNTKCTL](#).{[PL0PTEN](#), [PL0VTEN](#), [PL0PCTEN](#), [PL0VCTEN](#)} trap EL0 accesses to the Generic Timer registers to Undefined mode, as follows:

- [CNTKCTL](#).[PL0PTEN](#) traps EL0 accesses to the physical timer registers.
- [CNTKCTL](#).[PL0VTEN](#) traps EL0 accesses to the virtual timer registers.
- [CNTKCTL](#).[PL0PCTEN](#) traps EL0 accesses to the frequency register and physical counter register.
- [CNTKCTL](#).[PL0VCTEN](#) traps EL0 accesses to the frequency register and virtual counter register.

For all of these controls:

- 1** This control has no effect on EL0 accesses to the corresponding registers.
- 0** EL0 accesses to the corresponding registers are trapped to Undefined mode.

Accesses to the frequency register, [CNTFRQ](#), are only trapped if [CNTKCTL](#).[PL0PCTEN](#) and [CNTKCTL](#).[PL0VCTEN](#) are both 0.

[Table G1-33](#) shows the registers for which accesses are trapped.

Table G1-33 Register accesses trapped to Undefined mode by [CNTKCTL](#) trap controls

Traps from	Trap control	Registers
EL0	PL0PTEN	CNTP_CTL , CNTP_CVAL , CNTP_TVAL
	PL0VTEN	CNTV_CTL , CNTV_CVAL , CNTV_TVAL
	PL0PCTEN	CNTFRQ , CNTPCT
	PL0VCTEN	CNTFRQ , CNTVCT

When generated in Non-secure User mode, an exception generated by this control can be routed to EL2, as described in [Routing exceptions from Non-secure EL0 to EL2 on page G1-4356](#).

Traps to Undefined mode of EL0 accesses to Performance Monitors registers

[PMUSERENR](#).{[ER](#), [CR](#), [SW](#), [EN](#)} trap EL0 accesses to the Performance Monitors registers to Undefined mode.

For each of these controls:

- 1** This control has no effect on EL0 accesses to the corresponding registers.
- 0** EL0 accesses to the corresponding registers are trapped to Undefined mode.

For those Performance Monitors registers that more than one [PMUSERENR](#).{[ER](#), [CR](#), [SW](#), [EN](#)} control applies to, accesses are only trapped if all controls that apply are set to 0.

The accesses that these trap controls trap might be reads, writes, or both.

Note

- The architecture does not provide traps on Performance Monitors register accesses through the memory-mapped external debug interface.
- If the Performance Monitors Extension is not implemented, the Performance Monitors registers, including [PMUSERENR](#), are reserved.

Table G1-34 shows the registers for which EL0 accesses are trapped. For each register, the table shows the type of access trapped.

Table G1-34 Register accesses trapped to Undefined mode when disabled from EL0

Traps from	Trap control	Registers	Access type	
EL0	ER	PMXEVCNTR, PMEVCNTR<n>	R	
		PMSELR	RW	
	CR	PMCCNTR, accessed using an MRC	R	
	CR	PMCCNTR, accessed using an MRRC	R	
	SW	PMSWINC	W	
	EN	PMCNTENSET, PMCNTENCLR, PMCR, PMOVSr, PMSWINC, PMSELR, PMCEID0, PMCEID1, PMCCNTR, PMXEVTPER, PMXEVCNTR, PMOVSSET, PMEVCNTR<n>, PMEVTPER<n>, PMCCFILTR		RW

When generated in Non-secure User mode, an exception generated by this control can be routed to EL2, as described in *Routing exceptions from Non-secure EL0 to EL2* on page G1-4356.

G1.20.3 EL2 configurable controls

These controls are ignored in Secure state.

Table G1-35 shows the System registers that contain these controls.

Table G1-35 System registers that contain instruction enables and disables, and trap controls

Register name	Register description
FPEXC	Floating-point Exception Control Register
HCR	Hypervisor Configuration Register
HSTR	Hypervisor System Trap Register
HCPTR	Hyp Architectural Feature Trap Register
HDCR	Hyp Debug Control Register

Note

- FPEXC.EN is a control that is in a System register provided by PL1. However, some exceptions generated because the value of FPEXC.EN is 1 are taken to Hyp mode.
- For completeness, Table G1-36 includes the HCR.TGE routing control, that is described in *Routing exceptions from Non-secure EL0 to EL2 on page G1-4356*.

Table G1-36 summarizes the controls.

Table G1-36 Instruction enables and disables, and trap controls, for exceptions taken to Hyp mode

Control	Control type ^a	Description
HSCTLR.{SED, ITD} HSCTLR.CP15BEN	D E	<i>Disabling or enabling EL2 use of AArch32 deprecated functionality on page G1-4430</i>
HCR.{TRVM, TVM}	T	<i>Traps to Hyp mode of Non-secure EL1 accesses to virtual memory control registers on page G1-4430</i>
HCR.HCD	D	<i>Disabling Non-secure state execution of HVC instructions on page G1-4431</i>
HCR.TGE	R	<i>Routing exceptions from Non-secure EL0 to EL2 on page G1-4356</i>
HCR.TTLB	T	<i>Traps to Hyp mode of Non-secure EL1 execution of TLB maintenance instructions on page G1-4431</i>
HCR.{TSW, TPC, TPU}	T	<i>Traps to Hyp mode of Non-secure EL1 execution of cache maintenance instructions on page G1-4432</i>
HCR.TAC	T	<i>Traps to Hyp mode of Non-secure EL1 accesses to the Auxiliary Control Register on page G1-4432</i>
HCR.TIDCP	T	<i>Traps to Hyp mode of Non-secure EL0 and EL1 accesses to lockdown, DMA, and TCM operations on page G1-4433</i>
HCR.TSC	T	<i>Traps to Hyp mode of Non-secure EL1 execution of SMC instructions on page G1-4434</i>
HCR.{TID0, TID1, TID2, TID3}	T	<i>Traps to Hyp mode of Non-secure EL0 and EL1 accesses to the ID registers on page G1-4434</i>

Table G1-36 Instruction enables and disables, and trap controls, for exceptions taken to Hyp mode (continued)

Control	Control type ^a	Description
HCR.{TWI, TWE}	T	Traps to Hyp mode of Non-secure EL0 and EL1 execution of WFE and WFI instructions on page G1-4437
HCPTR.{TCP11, TCP10}	T	General trapping to Hyp mode of Non-secure accesses to the SIMD and floating-point registers on page G1-4437
FPEXC.EN	T	Enabling access to the SIMD and floating-point registers on page G1-4438
HCPTR.TASE	T	Traps to Hyp mode of Non-secure accesses to Advanced SIMD functionality on page G1-4438
HCPTR.TCPAC	T	Traps to Hyp mode of Non-secure EL1 accesses to the CPACR on page G1-4439
HCPTR.TTA	T	Traps to Hyp mode of Non-secure System register accesses to trace registers on page G1-4439
HSTR.{T0-T3, T5-T13, T15}	T	General trapping to Hyp mode of Non-secure EL0 and EL1 accesses to System registers in the (coproc == 0b1111) encoding space on page G1-4440
HDCR.{TDRA, TDOSA, TDA}	T	Traps to Hyp mode of Non-secure System register accesses to debug registers on page G1-4441
CNTHCTL.{PL1PCEN, PL1PCTEN}	T	Traps to Hyp mode of Non-secure EL0 and EL1 accesses to the Generic Timer registers on page G1-4443
HDCR.{TPM, TPMCR}	T	Traps to Hyp mode of Non-secure EL0 and EL1 accesses to Performance Monitors registers on page G1-4444

a. See Table G1-37.

Table G1-37 Control types, for exceptions taken to Hyp mode

Abbreviation	Type	See
D	Disable	Instruction enables and instruction disables on page G1-4418
E	Enable	Instruction enables and instruction disables on page G1-4418
R	Routing control	Routing exceptions from Non-secure EL0 to EL2 on page G1-4356
T	Trap	Trap controls on page G1-4418

Also see the following:

- Register access instructions on page G1-4419.
- Instructions that fail their Condition code check on page G1-4429.
- Trapping to EL2 of instructions that are UNPREDICTABLE on page G1-4429.

Instructions that fail their Condition code check

For UNDEFINED instructions that fail their Condition code check, see [Conditional execution of undefined instructions on page G1-4378](#).

For an instruction that has a Hyp trap set, that fails its Condition code check:

- Unless the trap description states otherwise, it is IMPLEMENTATION DEFINED whether the instruction:
 - Generates a Hyp Trap exception.
 - Executes as a NOP.

Any implementation must be consistent in its handling of instructions that fail their Condition code check. This means that:

- Whenever a Hyp trap is set on an instruction it must either:
 - Always generate a Hyp Trap exception.
 - Always treat the instruction as a NOP.
- The IMPLEMENTATION DEFINED part of the requirements of [Conditional execution of undefined instructions on page G1-4378](#) must be consistent with the handling of Hyp traps on instructions that fail their Condition code check. [Table G1-38](#) shows this:

Table G1-38 Consistent handling of instructions that fail their Condition code check

Behavior of conditional UNDEFINED instruction ^a	Hyp trap on instruction that fails its Condition code check ^b
Executes as a NOP	Executes as a NOP
Generates an Undefined Instruction exception	Generates a Hyp Trap exception

- a. As defined in [Conditional execution of undefined instructions on page G1-4378](#). In Non-secure EL0 and EL1 modes, this applies only if no Hyp trap is set for the instruction, otherwise see the behavior in the other column of the table.
- b. For a trapped instruction executed in a Non-secure EL1 or EL0 mode.

———— **Note** —————

Hyp traps on WFE and WFI instructions generate Hyp Trap exceptions only if the instruction passes its Condition code check. See [Traps to Hyp mode of Non-secure EL0 and EL1 execution of WFE and WFI instructions on page G1-4437](#).

Trapping to EL2 of instructions that are UNPREDICTABLE

For an instruction that is UNPREDICTABLE or CONSTRAINED UNPREDICTABLE, when the instruction is disabled or trapped then it is CONSTRAINED UNPREDICTABLE whether execution of the instruction generates a Hyp Trap exception.

———— **Note** —————

UNPREDICTABLE and CONSTRAINED UNPREDICTABLE behavior must not perform any function that cannot be performed at the current or lower Exception level using instructions that are not UNPREDICTABLE and are not CONSTRAINED UNPREDICTABLE. This means that disabling or trapping an instruction changes the set of instructions that might be executed in Non-secure state at EL1 or EL0. This indirectly affects the permitted behavior of UNPREDICTABLE and CONSTRAINED UNPREDICTABLE instructions.

If no instructions are trapped, the attempted execution of an UNPREDICTABLE instruction in a Non-secure EL1 or EL0 mode must not generate a Hyp Trap exception.

Disabling or enabling EL2 use of AArch32 deprecated functionality

Table G1-39 shows the deprecated AArch32 functionality that might have disable controls in the HSCTLR:

- The SED control is always implemented.
- Whether each of the ITD, CP15BEN controls is implemented is IMPLEMENTATION DEFINED. If a control is not implemented then the associated functionality cannot be disabled.

These HSCTLR controls apply only to execution at EL2 using AArch32. When an instruction is disabled by one of these controls, it is UNDEFINED at EL2, meaning it is undefined in Hyp mode.

Table G1-39 EL2 controls for disabling and enabling EL2 use of AArch32 deprecated functionality

Deprecated AArch32 functionality	Instruction enable or disable in the HSCTLR	Disabled instructions
SETEND instructions	SED ^a	SETEND instructions
Some uses of IT instructions	ITD ^b	See the HSCTLR.IT description
Accesses to the System register (coproc==0b1111) DMB, DSB, and ISB barrier operations	CP15BEN ^c	MCR accesses to the CP15DMB, CP15DSB, and CP15ISB

- SETEND instruction disable. SETEND instructions are disabled when the value of this field is 1.
- IT instruction disable. If this control is implemented, some uses of IT instructions are disabled when the value of this field is 1.
- System register (coproc==0b1111) memory barrier enable. If this control is implemented, the specified register accesses are disabled when the value of CP15BEN is 0.

Note

- These controls have no effect on instructions executed in any mode other than Hyp mode. The SCTLRR provides similar controls that apply to execution in other modes.
- The uses of the IT instruction, and use of the CP15DMB, CP15DSB, and CP15ISB barrier instructions, are deprecated for performance reasons.

Traps to Hyp mode of Non-secure EL1 accesses to virtual memory control registers

HCR.{TRVM, TVM} trap Non-secure EL1 accesses to the virtual memory control registers to Hyp mode:

HCR.TRVM, for read accesses:

- | | |
|----------|---|
| 1 | Non-secure EL1 reads of the virtual memory control registers are trapped to Hyp mode. |
| 0 | This control has no effect on Non-secure EL1 reads of the virtual memory control registers. |

HCR.TVM, for write access:

- | | |
|----------|--|
| 1 | Non-secure EL1 writes to the virtual memory control registers are trapped to Hyp mode. |
| 0 | This control has no effect on Non-secure EL1 writes to the virtual memory control registers. |

Table G1-40 on page G1-4431 shows the registers for which:

- Reads are trapped to Hyp mode when HCR.TRVM is 1.
- Writes are trapped to Hyp mode when HCR.TVM is 1.

The table also shows how the exceptions are reported in [HSR](#).

Table G1-40 Register read and write accesses trapped when [HCR](#).{TRVM, TVM} are 1

Traps from	Registers	Syndrome reporting in HSR
Non-secure EL1	SCTLR , TTBR0 , TTBR1 , TTBCR , TTBCR2 , DACR , DFSR , IFSR , DFAR , IFAR , ADFSR , AIFSR , PRRR , NMRR , MAIRO , MAIR1 , AMAIRO , AMAIR1 , CONTEXTIDR	Trapped MCR or MRC access (coproc==0b1111), using EC value 0x03 Trapped MCRR or MRRC access (coproc==0b1111), using EC value 0x04

———— **Note** —————

These registers are not accessible at EL0.

Disabling Non-secure state execution of HVC instructions

[HCR](#).HCD disables Non-secure state execution of HVC instructions:

- 1** HVC instructions are UNDEFINED at EL2 and Non-secure EL1. The Undefined Instruction exception is taken from the current Exception level to the current Exception level.
- 0** HVC instruction execution is enabled at EL2 and Non-secure EL1.

———— **Note** —————

HVC instructions are always UNDEFINED at EL0.

[HCR](#).HCD is only implemented if EL3 is not implemented. Otherwise, it is RES0. See the [HCR](#) register description.

[Table G1-41](#) shows how the exceptions are reported in [HSR](#).

Table G1-41 Instruction that causes exceptions when [HCR](#).HCD is 1

Attempted execution in	Disabled instruction	Syndrome reporting in HSR
Hyp mode	HVC	Exception for an unknown reason, using EC value 0x00
Mode other than Hyp mode	HVC	Not applicable

Traps to Hyp mode of Non-secure EL1 execution of TLB maintenance instructions

In the ARMv8-A architecture, the system instruction encoding space includes TLB maintenance instructions.

[HCR](#).TTLB traps Non-secure EL1 execution of TLB maintenance instructions to Hyp mode:

- 1** Any attempt to execute a TLBI instruction at Non-secure EL1 is trapped to Hyp mode.
- 0** This control has no effect on the Non-secure EL1 execution of TLBI instructions.

[Table G1-42](#) shows the instructions that are trapped, and how the exceptions are reported in [HSR](#).

Table G1-42 Instructions trapped to Hyp mode when [HCR](#).TTLB is 1

Traps from	Trapped instructions	Syndrome reporting in HSR
Non-secure EL1	TLBIALLIS , TLBIMVAIS , TLBIASIDIS , TLBIMVAAIS , TLBIMVALIS , TLBIMVAALIS , ITLBIALL , ITLBIMVA , ITLBIASID , DTLBIALL , DTLBIMVA , DTLBIASID , TLBIALL , TLBIMVA , TLBIASID , TLBIMVAA , TLBIMVAL , TLBIMVAAL .	Trapped MCR or MRC access (coproc==0b1111), using EC value 0x03

———— **Note** ————

These instructions are always UNDEFINED at EL0.

For more information about these instructions, see [The scope of TLB maintenance instructions on page G4-4641](#).

Traps to Hyp mode of Non-secure EL1 execution of cache maintenance instructions

[HCR.{TSW, TPC, TPU}](#) trap cache maintenance instructions to Hyp mode:

- 0** The control has no effect on the execution of cache maintenance instructions.
- 1** Any attempt to execute one of the cache maintenance instructions shown in [Table G1-44](#) at Non-secure EL1 is trapped to Hyp mode.

Table G1-43 Controls for trapping cache maintenance instructions to Hyp mode

Trap control	Trapped instructions
HCR.TSW	Data or unified cache maintenance by set/way
HCR.TPC	Data or unified cache maintenance to point of coherency
HCR.TPU	Cache maintenance to point of unification

[Table G1-44](#) shows the instructions that are trapped to Hyp mode, and how the exceptions are reported in [HSR](#).

Table G1-44 Instructions trapped to Hyp mode when [HCR.{TSW, TPC, TPU}](#) are 1

Traps from	Trap control	Trapped instructions	Syndrome reporting in HSR
Non-secure EL1	TSW	DCISW , DCCSW , DCCISW	Trapped MCR or MRC access (coproc==0b1111), using EC value 0x3
	TPC	DCIMVAC , DCCIMVAC , DCCMVAC	
	TPU	ICIMVAU , ICIALLU , ICIALLUIS , DCCMVAU	

———— **Note** ————

These instructions are always UNDEFINED at EL0.

For more information about these instructions, see [Cache maintenance instructions, functional group on page G4-4734](#).

Traps to Hyp mode of Non-secure EL1 accesses to the Auxiliary Control Register

[HCR.TAC](#) traps Non-secure EL1 accesses to the Auxiliary Control Registers to Hyp mode:

- 1** Non-secure EL1 accesses to the Auxiliary Control Registers are trapped to Hyp mode.
- 0** This control has no effect on Non-secure EL1 accesses to the Auxiliary Control Registers.

[Table G1-45](#) shows the registers for which accesses are trapped, and how the exceptions are reported in [HSR](#):

Table G1-45 Register accesses trapped to Hyp mode when [HCR.TAC](#) is 1

Traps from	Registers	Syndrome reporting in HSR
Non-secure EL1	ACTLR and, if implemented, ACTLR2 .	Trapped MCR or MRC access (coproc==0b1111) access, using EC value 0x03

———— **Note** —————

The [ACTLR](#) and [ACTLR2](#) are not accessible at EL0.

Traps to Hyp mode of Non-secure EL0 and EL1 accesses to lockdown, DMA, and TCM operations

The lockdown, DMA, and TCM features of the ARMv8-A architecture are IMPLEMENTATION DEFINED. The architecture reserves the encodings of a number of System registers for control of these features.

[HCR.TIDCP](#) traps the execution of System register access instructions that access these registers, as follows:

- 1** At Non-secure EL1, any attempt to execute an MCR or MRC instruction with a reserved register encoding shown in [Table G1-46](#) is trapped to Hyp mode.
- At Non-secure EL0, it is IMPLEMENTATION DEFINED whether attempts to execute MCR or MRC instructions with reserved register encodings are:
- Trapped to Hyp mode.
 - UNDEFINED, and the PE takes the Undefined Instruction exception to Non-secure Undefined mode.
- Any lockdown fault in the memory system caused by the use of these operations in Non-secure state generates a Data Abort exception that is taken to Hyp mode.
- 0** This control has no effect on Non-secure EL0 and EL1 System register access instructions with reserved register encodings shown in [Table G1-46](#).

———— **Note** —————

This means that a Hyp Trap exception taken from Non-secure EL1 to Hyp mode, generated because of a configuration setting in [HCR.TIDCP](#) is a higher priority exception than an Undefined Instruction exception generated because either the System register encoding is unallocated or because the register is never accessible at EL1. As [Synchronous exception prioritization for exceptions taken to AArch32 state on page G1-4344](#) shows, this is an exception to the general exception prioritization rules, that prioritize most Undefined Instruction exceptions taken to Undefined mode above traps to EL2.

[Table G1-46](#) shows the register encodings for which accesses are trapped to Hyp mode, and how the exceptions are reported in [HSR](#).

Table G1-46 Encodings trapped to Hyp mode when [HCR.TIDCP](#) is 1

Traps from	Register encodings	Syndrome reporting in HSR
Non-secure EL0 and EL1	An access to any of the following encodings: <ul style="list-style-type: none"> • CRn==c9, opc1=={0-7}, CRm=={c0-c2, c5-c8}, opc2=={0-7}. • CRn==c10, opc1=={0-7}, CRm=={c0, c1, c4, c8}, opc2=={0-7}. • CRn==c11, opc1=={0-7}, CRm=={c0-c8, c15}, opc2=={0-7}. 	Trapped MCR or MRC access (coproc==0b1111), using EC value 0x03

An implementation can also include IMPLEMENTATION DEFINED registers that provide additional controls, to give finer-grained control of the trapping of IMPLEMENTATION DEFINED features.

———— **Note** —————

ARM expects the trapping of Non-secure User mode accesses to these functions to Hyp mode to be unusual, and used only when the hypervisor is virtualizing User mode operation. ARM strongly recommends that unless the hypervisor must virtualize User mode operation, a Non-secure User mode access to any of these functions generates an Undefined Instruction exception, as it would if the implementation did not include EL2. The PE then takes this exception to Non-secure Undefined mode.

Traps to Hyp mode of Non-secure EL1 execution of SMC instructions

HCR.TSC traps Non-secure EL1 execution of SMC instructions to Hyp mode:

- 1** Any attempt to execute an SMC instruction at Non-secure EL1 is trapped to Hyp mode, regardless of the value of **SCR.SCD**.
- 0** This control has no effect on Non-secure EL1 execution of SMC instructions.

Table G1-47 shows how the exceptions are reported in **HSR**:

Table G1-47 SMC Instruction trapped to Hyp mode when **HCR.TSC is 1**

Traps from	Trapped instruction	Syndrome reporting in HSR
Non-secure EL1	SMC on page F5-3429	Trapped SMC instruction execution in AArch32 state, using EC value 0x13

The ARMv8-A architecture permits, but does not require, this trap to apply to conditional SMC instructions that fail their Condition code check, in the same way as with traps on other conditional instructions.

———— **Note** —————

- This trap is implemented only if the implementation includes EL3.
- SMC instructions are always UNDEFINED at EL0.
- **HCR.TSC** traps execution of the SMC instruction. It is not a routing control for the SMC exception. Hyp Trap and SMC exceptions have different preferred return addresses.

For more information about SMC instructions, see [SMC on page F5-3429](#).

Traps to Hyp mode of Non-secure EL0 and EL1 accesses to the ID registers

Other than the **MIDR**, **MPIDR**, and **PMCR.N**, the ID registers are divided into groups, with a trap control in the **HCR** for each group.

Table G1-48 ID register groups

Trap control	Register group
HCR.TID0	<i>ID group 0, Primary device identification registers on page G1-4435</i>
HCR.TID1	<i>ID group 1, Implementation identification registers on page G1-4436</i>
HCR.TID2	<i>ID group 2, Cache identification registers on page G1-4436</i>
HCR.TID3	<i>ID group 3, Detailed feature identification registers on page G1-4436</i>

These controls trap register accesses from Non-secure EL0 or EL1 to Hyp mode, as follows:

- HCR.TID0**
 - 0** This control has no effect on Non-secure EL1 reads of the ID group 0 registers.
 - 1** Any attempt at Non-secure EL0 or EL1 to read any register in ID group 0 is trapped to Hyp mode
- HCR.TID1**
 - 0** This control has no effect on Non-secure EL1 reads of the ID group 1 registers.
 - 1** Any attempt at Non-secure EL1 to read any register in ID group 1 is trapped to Hyp mode.
- HCR.TID2**
 - 0** This control has no effect on Non-secure EL1 and EL0 accesses to the ID group 2 registers.
 - 1** Any attempt at Non-secure EL0 or EL1 to read any register in ID group 2, and any attempt at Non-secure EL0 or EL1 to write to the **CSSELR**, is trapped to Hyp mode.

HCR.TID3	0	This control has no effect on Non-secure EL1 reads of the ID group 3 registers.
	1	Any attempt at Non-secure EL1 to read any register in ID group 3 is trapped to Hyp mode.

For the **MIDR** and **MPIDR**, and for **PMCR.N**, the architecture provides read/write aliases. The original register becomes accessible only from Hyp mode and Secure state, and a Non-secure EL0 or EL1 read of the original register returns the value of the read/write alias. This substitution is invisible to the EL0 or EL1 software reading the register.

Table G1-49 ID register substitution

Register	Original	Alias, EL2 using AArch32
Main ID	MIDR	VPIDR
Multiprocessor Affinity	MPIDR	VMPIDR
Performance Monitors Control Register	PMCR.N	HDCR.HPMN

Reads of the **MIDR**, **MPIDR**, or **PMCR.N** from Hyp mode or Secure state are unchanged by the implementation of EL2, and access the physical registers.

———— **Note** ————

- If the optional Performance Monitors Extension is not implemented, **HDCR.HPMN** is RES0 and **PMCR** is reserved.
- **HDCR.HPMN** also affects whether a Performance Monitors counter can be accessed from Non-secure EL1 or EL0. See the register description of **HDCR** for more information.
- **PMCR** contains other fields that identify the implementation. For more information about trapping accesses to the **PMCR**, see *Traps to Hyp mode of Non-secure EL0 and EL1 accesses to Performance Monitors registers on page G1-4444*.

A reset into AArch32 state sets **VPIDR** to the **MIDR** value, **VMPIDR** to the **MPIDR** value, and **HDCR.HPMN** to the **PMCR.N** value.

ID group 0, Primary device identification registers

These registers identify some top-level implementation choices.

Table G1-50 shows the registers that are in ID group 0 for traps to Hyp mode, and how the exceptions are reported in **HSR**.

Table G1-50 ID group 0 registers

Traps from	Group 0 registers	Syndrome reporting in HSR
Non-secure EL1	FPSID	Trapped VMRS access, for ID group traps, using EC value 0x08
Non-secure EL0 and EL1	JIDR	Trapped MCR or MRC access (coproc==0b1110), using EC value 0x05

———— **Note** ————

The **FPSID** is not accessible at EL0.

If **HCPTR**.{TCP11, TCP10} traps accesses to SIMD and floating-point functionality, then for a read of **FPSID**, that trap has priority over this trap.

When the **FPSID** is accessible, a VMSR **FPSID**, <Rt> instruction is permitted but is ignored. The execution of this VMSR instruction is not trapped by the ID group 0 trap.

ID group 1, Implementation identification registers

These registers often provide coarse-grained identification mechanisms for implementation-specific features.

Table G1-51 shows the registers that are in ID group 1 for traps to Hyp mode, and how the exceptions are reported in HSR.

Table G1-51 ID group 1 registers

Traps from	Group 1 registers	Syndrome reporting in HSR
Non-secure EL1	TCMTR, TLBTR, REVIDR, AIDR	Trapped MCR or MRC access (coproc==0b1111), using EC value 0x03

ID group 2, Cache identification registers

These registers describe and control the cache implementation.

Table G1-52 shows the registers that are in ID group 2 for traps to Hyp mode, and how the exceptions are reported in HSR.

Table G1-52 ID group 2 registers

Traps from	Group 2 registers	Syndrome reporting in HSR
Non-secure EL0 and EL1	CTR, CCSIDR, CLIDR, CSSELR	Trapped MCR or MRC access (coproc==0b1111), using EC value 0x03

ID group 3, Detailed feature identification registers

These registers provide detailed information about the features of the implementation.

———— **Note** —————

These registers are called the CPUID registers. There is no requirement for this trap to apply to those registers that the CPUID Identification Scheme defines as reserved. See *The CPUID identification scheme on page G4-4728*.

Table G1-53 shows the registers that are in ID group 3 for traps to Hyp mode, and how the exceptions are reported in HSR.

Table G1-53 ID group 3 registers

Traps from	Group 3 registers	Syndrome reporting in HSR
Non-secure EL1	MVFR0, MVFR1, MVFR2.	Trapped VMRS access for ID group traps, using EC value 0x08
	<p>ID_PFR0, ID_PFR1, ID_DFR0, ID_AFR0. ID_MMFR0, ID_MMFR1, ID_MMFR2, ID_MMFR3, and ID_MMFR4, except that if ID_MMFR4 is implemented as RAZ/WI then it is IMPLEMENTATION DEFINED whether reads of the register are trapped. ID_ISAR0, ID_ISAR1, ID_ISAR2, ID_ISAR3, ID_ISAR4, ID_ISAR5.</p> <p>Any MRC access to any of the following encodings when coproc==0b1111:</p> <ul style="list-style-type: none"> opc1 == 0, CRn == c0, CRm == {c3-c7}, opc2 == {0, 1}. opc1 == 0, CRn == c0, CRm == c3, opc2 == 2. opc1 == 0, CRn == c0, CRm == c5, opc2 == {4, 5}. <p>It is IMPLEMENTATION DEFINED whether HCR.TID3 traps MRC accesses with coproc==0b1111 to encodings in the following range that are not already mentioned in this table:</p> <ul style="list-style-type: none"> CRn == c0, opc1 == 0, CRm == {c2-c7}, opc2 == {0-7}. 	Trapped MCR or MRC access (coproc==0b1111), using EC value 0x03

If **HCPTR** traps accesses to SIMD and floating-point functionality, then for reads of **MVFR0**, **MVFR1**, and **MVFR2**, that trap has priority over this trap.

Traps to Hyp mode of Non-secure EL0 and EL1 execution of WFE and WFI instructions

HCR.{TWE, TWI} trap Non-secure EL0 and EL1 execution of WFE and WFI instructions to Hyp mode:

HCR.TWE:

- 1** Any attempt to execute a WFE instruction at Non-secure EL0 or EL1 is trapped to Hyp mode, if the instruction would otherwise have caused the PE to enter a low-power state.
- 0** This control has no effect on Non-secure EL0 or EL1 execution of WFE instructions.

HCR.TWI:

- 1** Any attempt to execute a WFI instruction at Non-secure EL0 or EL1 is trapped to Hyp mode, if the instruction would otherwise have caused the PE to enter a low-power state.
- 0** This control has no effect on Non-secure EL0 or EL1 execution of WFI instructions.

Table G1-54 shows how the exceptions are reported in **HSR**.

Table G1-54 Instructions trapped to Hyp mode when **HCR.{TWE, TWI} are 1**

Traps from	Trapped instructions	Syndrome reporting in HSR
Non-secure EL0 and EL1	WFE WFI	Trapped WFI or WFE instruction, using EC value 0x01

The attempted execution of a conditional WFE or WFI instruction is only trapped if the instruction passes its Condition code check.

———— **Note** ————

Since a WFE or WFI can complete at any time, even without a Wakeup event, the traps on WFE or WFI are not guaranteed to be taken, even if the WFE or WFI is executed when there is no Wakeup event. The only guarantee is that if the instruction does not complete in finite time in the absence of a Wakeup event, the trap will be taken.

For more information about these instructions, and when they can cause the PE to enter a low-power state, see:

- [Wait For Event and Send Event on page G1-4403](#).
- [Wait For Interrupt on page G1-4406](#).

General trapping to Hyp mode of Non-secure accesses to the SIMD and floating-point registers

HCPTR.{TCP11, TCP10} trap Non-secure accesses to the SIMD and floating-point registers to Hyp mode:

- 0b11** All Non-secure accesses to the SIMD and floating-point registers are trapped to Hyp mode. Trapped instructions generate:
 - Hyp Trap exceptions, if the exception is taken from Non-secure EL0 or EL1.
 - Undefined Instruction exceptions taken to Hyp mode, if the exception is taken from EL2.
- 0b00** This control has no effect on Non-secure accesses to the SIMD and floating-point registers.

———— **Note** ————

Software must set **HCPTR**.TCP11 and **HCPTR**.TCP10 to the same value.

Table G1-55 shows the registers for which accesses are trapped, and how the exceptions are reported in HSR.

Table G1-55 Register accesses trapped to Hyp mode when HCPTR.{TCP11, TCP10} are both 0b11

Traps from	Registers	Syndrome reporting in HSR
Non-secure state	FPSID, MVFR0, MVFR1, MVFR2, FPSCR, FPEXC, and any of the SIMD and floating-point registers Q0-Q15, including their views as D0-D31 registers or S0-S31 registers. See <i>Advanced SIMD and floating-point System registers</i> on page G1-4415.	Trapped access to SIMD and floating-point register, resulting from HCPTR, using EC value 0x07 ^a

- a. VMSR accesses to the FPSID are ignored, but for the purposes of this trap the architecture defines a VMSR access to the FPSID from EL1 or higher as an access to a SIMD and floating-point register.

If EL3 is implemented and is using AArch32, and NSACR.{cp11, cp10} are both set to 0, then HCPTR.{TCP11, TCP10} behave as RAO/WI, regardless of their actual value.

For more information about SIMD and floating-point support, see *Advanced SIMD and floating-point support* on page G1-4412.

Enabling access to the SIMD and floating-point registers

FPEXC.EN is an instruction enable that enables access to the SIMD and floating-point registers from all Exception levels, but does not control the following:

- VMSR accesses to the FPEXC or FPSID.
- VMRS accesses from the FPEXC, FPSID, MVFR0, MVFR1, or MVFR2.

FPEXC.EN is a PL1 control that also applies at EL2. See *Enabling access to the SIMD and floating-point registers* on page G1-4424.

Traps to Hyp mode of Non-secure accesses to Advanced SIMD functionality

If implemented as an RW field, HCPTR.TASE can trap Non-secure execution of Advanced SIMD instructions to Hyp mode, as follows. This trap applies only when HCPTR.{TCP11, TCP10} are both 0:

- 1** Any attempt to execute an Advanced SIMD instruction in Non-secure state is trapped to Hyp mode. Trapped instructions generate:
- Hyp Trap exceptions, if the exception is taken from Non-secure EL0 or EL1.
 - Undefined Instruction exceptions taken to Hyp mode, if the exception is taken from EL2.
- 0** This control has no effect on Non-secure execution of Advanced SIMD instructions.

When the control is not implemented, meaning the HCPTR.TASE field is RAZ/WI, the HCPTR does not provide a trap to Hyp mode of the Non-secure execution of Advanced SIMD instructions, other than the HCPTR.{TCP11, TCP10} trap that applies to Non-secure execution of both Advanced SIMD and floating-point instructions.

Table G1-30 on page G1-4423 shows the instructions that are trapped, and how the exceptions are reported in HSR.

Table G1-56 Instructions trapped to Hyp mode when HCPTR.TASE is set to 1

Traps from	Instructions	Syndrome reporting in HSR
Non-secure state	All Advanced SIMD instructions that are not also floating-point instructions. For more information see <i>Controls of Advanced SIMD operation that do not apply to floating-point operation</i> on page E1-2746.	Trapped access to SIMD and floating-point register, resulting from HCPTR, using EC value 0x07

If EL3 is implemented and is using AArch32, and NSACR.NSASEDIS is 1, then HCPTR.TASE behaves as RAO/WI, regardless of its actual value. This behavior also applies when the HCPTR.TASE control is not implemented.

Traps to Hyp mode of Non-secure EL1 accesses to the CPACR

HCPTR.TCPAC traps Non-secure EL1 accesses to the CPACR to Hyp mode:

- 1** Non-secure EL1 accesses to the CPACR are trapped to Hyp mode.
- 0** This control has no effect on Non-secure EL1 accesses to the CPACR.

Table G1-57 shows how the exceptions are reported in HSR:

Table G1-57 Register accesses trapped to Hyp mode when HCPTR.TCPAC is 1

Traps from	Register	Syndrome reporting in HSR
Non-secure EL1	CPACR	Trapped MCR or MRC access to System register with coproc==0b1111, using EC value 0x03

———— **Note** —————

- The CPACR is not accessible at EL0.
- In ARMv7 and earlier versions of the ARM architecture, one use of the CPACR is to identify what coprocessor, or conceptual coprocessor, functionality is implemented. Legacy software might use this identification mechanism. A hypervisor can use this trap to emulate this mechanism. See *Background to the System register interface* on page G1-4410 for more information about this functionality.

Traps to Hyp mode of Non-secure System register accesses to trace registers

If implemented, the HCPTR.TTA control traps System register accesses to the trace registers from Non-secure state to Hyp mode, as follows:

- 1** Non-secure System register accesses to the trace registers are trapped to Hyp mode. Trapped instructions generate:
 - Hyp Trap exceptions, if the exception is taken from Non-secure EL0 or EL1.
 - Undefined Instruction exceptions taken to Hyp mode, if the exception is taken from EL2.
- 0** This control has no effect on Non-secure System register accesses to the trace registers.

If the HCPTR.TTA control is not implemented, then HCPTR.TTA is RAO/WI. See the register description for more information.

———— **Note** —————

- System register accesses to the trace registers use the System register (coproc==0b1110) encoding space.
- The ETMv4 architecture does not permit EL0 to access the trace registers. If the ARMv8-A architecture is implemented with an ETMv4 implementation, EL0 accesses to the trace registers are UNDEFINED. A resulting Undefined Instruction exception is higher priority than an HCPTR.TTA Hyp Trap exception.
- EL2 does not provide traps on trace register accesses through the optional memory-mapped external debug interface.

System register accesses to the trace registers can have side-effects. When a System register access is trapped, no side-effects occur before the exception is taken, see *Register access instructions* on page G1-4419.

Table G1-58 shows the registers for which accesses are trapped to Hyp mode when `HCPTR.TTA` is 1, and how the exceptions are reported in `HSR`.

Table G1-58 Register accesses trapped to Hyp mode when `HCPTR.TTA` is 1

Traps from	Registers	Syndrome reporting in <code>HSR</code>
Non-secure state	System register accesses to all implemented trace registers	For accesses using: <ul style="list-style-type: none"> MCR or MRC instructions, trapped MCR or MRC access (<code>coproc==0b1110</code>), using EC value <code>0x05</code>. MCRR or MRRC instructions, trapped MCRR or MRRC access (<code>coproc==0b1110</code>), using EC value <code>0x0C</code>.

If EL3 is implemented and is using AArch32, and `NSACR.NSTRCDIS` is 1, then `HCPTR.TTA` behaves as RAO/WI, regardless of its actual value. This behavior applies, also, when the `HCPTR.TTA` control is not implemented.

General trapping to Hyp mode of Non-secure EL0 and EL1 accesses to System registers in the (`coproc==0b1111`) encoding space

`HSTR.{T0-T3, T5-T13, T15}` trap Non-secure EL0 and EL1 accesses, using MCR, MRC, MCRR, or MRRC instructions, to the System registers in the (`coproc==0b1111`) encoding space, by:

- The value of the `CRn` argument to the instruction, for MCR and MRC instructions.
- The value of the `CRm` argument to the instruction, for MCRR and MRRC instructions.

This applies for the set of `CRn`, or `CRm`, values {`c0-c3, c5-c13, c15`}.

When an `HSTR.Tn` trap control is:

- 1** Non-secure EL1 accesses to the corresponding System registers in the (`coproc==0b1111`) encoding space are trapped to Hyp mode.
 EL0 accesses to the corresponding System registers are trapped to Hyp mode if they would not be UNDEFINED if the bit was zero.
- 0** This control has no effect on Non-secure EL0 or EL1 accesses to System registers.

Note

This means that a Hyp Trap exception taken from EL1 to EL2, generated because of a configuration setting in `HSTR.Tn`, is a higher priority exception than an Undefined Instruction exception generated because either the System register encoding is unallocated or because a register is never accessible at Non-secure EL1. As *Synchronous exception prioritization for exceptions taken to AArch32 state on page G1-4344* shows, this is an exception to the general exception prioritization rules, that prioritize most Undefined Instruction exceptions taken to Undefined mode above traps to EL2. This prioritization includes any access from Non-secure EL1 to a register that is only accessible in Secure state. So, for example, an access to the `SCR` from Non-secure EL1:

- When the value of `HSTR.T1` is 0, generates an Undefined Instruction exception.
- When the value of `HSTR.T1` is 1, generates a Hyp Trap exception.

Table G1-59 shows the accesses that are trapped, and how the exceptions are reported in `HSR`.

Table G1-59 Accesses trapped to Hyp mode when an `HSTR.Tn` trap is enabled

Traps from	Trap control	Trapped accesses	Syndrome reporting in <code>HSR</code>
Non-secure EL0 and EL1 ^a	Tn	MCR and MRC instructions, with <code>coproc</code> set to <code>0b1111</code> and <code>CRn</code> set to <code>n</code>	Trapped MCR or MRC access (<code>coproc==0b1111</code>), using EC value <code>0x03</code>
		MCRR and MRRC instructions, with <code>coproc</code> set to <code>0b1111</code> and <code>CRm</code> set to <code>n</code>	Trapped MCRR or MRRC access (<code>coproc==0b1111</code>), using EC value <code>0x04</code>

- a. As described in this section, traps from EL1 apply whenever the value of `HSTR.Tn` is 1. Traps from EL0 apply only if the value of `HSTR.Tn` is 1 and the access would not be UNDEFINED if the value of `HSTR.Tn` was 0.

For example, when `HSTR.T7` is 1, considering only accesses from Non-secure EL1:

- Any 32-bit access from a Non-secure PL1 mode using an MRC or MCR instruction with `coproc` set to `0b1111` and `CRn` set to `c7`, is trapped to Hyp mode.
- Any 64-bit access from a Non-secure PL1 mode using an MRRC or MCRR instructions with `coproc` set to `0b1111` and `CRm` set to `c7`, is trapped to Hyp mode.

Note

- Bits[4,14] of the `HSTR` are reserved, RES0. Although the Generic Timer control registers are implemented in the `coproc == 0b1111` encoding space with `CRn == c14` for an MRC or MCR access, EL2 does not provide a trap on accesses to the Generic Timer System registers.
- An implementation might provide additional controls, in IMPLEMENTATION DEFINED registers, to provide finer-grained control of trapping of IMPLEMENTATION DEFINED features.

System registers in the (`coproc == 0b1111`) encoding space with IMPLEMENTATION DEFINED access permission from EL0

For a System register in the (`coproc == 0b1111`) encoding space, that is accessed using a `CRn` or `CRm` value that can be trapped by a `HSTR.Tn` control, if an access to the register from User mode is UNDEFINED when the value of the corresponding `HSTR.Tn` trap control is 0, then when that `HSTR.Tn` trap control is 1, it is IMPLEMENTATION DEFINED whether an access from Non-secure User mode generates:

- A Hyp Trap exception.
- An Undefined Instruction exception taken to Non-secure Undefined mode.

Note

ARM expects that trapping to Hyp mode of Non-secure User mode accesses to System register in the (`coproc == 0b1111`) encoding space will be unusual, and used only when the hypervisor must virtualize User mode operation. ARM recommends that, whenever possible, Non-secure User mode accesses to System register in the (`coproc == 0b1111`) encoding space behave as they would if the processor did not implement EL2, generating an Undefined Instruction exception taken to Non-secure Undefined mode if the architecture does not support the User mode access.

Traps to Hyp mode of Non-secure System register accesses to debug registers

`HDCR.{TDRA, TDOSA, TDA}` trap Non-secure System register accesses to debug registers to Hyp mode, as follows:

- `HDCR.(TDRA, TDA)` trap Non-secure EL0 and EL1 accesses.
- `HDCR.TDOSA` traps Non-secure EL1 accesses.

Note

EL2 does not provide traps of debug register accesses through the optional memory-mapped external debug interface.

System register accesses to the debug registers can have side-effects. When a System register access is trapped to Hyp mode, no side-effects occur before the exception is taken to Hyp mode. See [Register access instructions on page G1-4419](#).

Table G1-60 shows the subsections that list the accesses trapped. The subsections describe how the traps are reported in HSR.

Table G1-60 Traps of Non-secure EL0 and EL1 accesses to debug registers

Trap control	Subsection
HDCR.TDRA	<i>Trapping Non-secure System register accesses to Debug ROM registers</i>
HDCR.TDOSA	<i>Trapping Non-secure System register accesses to powerdown debug registers</i>
HDCR.TDA	<i>Trapping general Non-secure System register accesses to debug registers on page G1-4443</i>

———— **Note** ————

System register accesses to debug registers use the (coproc==0b1110) encoding space.

Trapping Non-secure System register accesses to Debug ROM registers

HDCR.TDRA traps Non-secure EL0 and EL1 System register accesses to the Debug ROM registers to Hyp mode:

- 1** Non-secure EL0 or EL1 System register accesses to the Debug ROM registers are trapped to Hyp mode.
- 0** This control has no effect on Non-secure EL0 and EL1 System register accesses to the Debug ROM registers.

Table G1-61 shows the register accesses that are trapped, and how the exceptions are reported in HSR:

Table G1-61 Register accesses trapped to Hyp mode when HDCR.TDRA is 1

Traps from	Registers	Syndrome reporting in HSR
Non-secure EL0 and EL1	DBGDRAR, DBGDSAR	For accesses using: <ul style="list-style-type: none"> • MCR or MRC instructions, trapped MCR or MRC access (coproc==0b1110), using EC value 0x05. • MRRC instructions, trapped MRRC access (coproc==0b1110), using EC value 0x0C.

If HDCR.TDE or HCR.TGE is 1, behavior is as if HDCR.TDRA is 1 other than for the purpose of a direct read.

Trapping Non-secure System register accesses to powerdown debug registers

HDCR.TDOSA traps Non-secure EL1 System register accesses to the powerdown debug registers to Hyp mode:

- 1** Non-secure EL1 System register accesses to the powerdown debug registers are trapped to Hyp mode.
- 0** This control has no effect on Non-secure EL1 System register accesses to the powerdown debug registers.

Table G1-62 shows the register accesses that are trapped, and how the exceptions are reported in HSR.

Table G1-62 Register accesses trapped to Hyp mode when HDCR.TDOSA is 1

Traps from	Registers	Syndrome reporting in HSR
Non-secure EL1	DBGOSLSR, DBGOSLAR, DBGOSDLR, DBGPRCR Any IMPLEMENTATION DEFINED integration registers. Any IMPLEMENTATION DEFINED register with similar functionality that the implementation specifies as trapped by HDCR.TDOSA.	Trapped MCR or MRC access (coproc==0b1110), using EC value 0x05

Note

These registers are not accessible at EL0.

If `HDCR.TDE` or `HCR.TGE` is 1, behavior is as if `HDCR.TDOSA` is 1 other than for the purpose of a direct read.

Trapping general Non-secure System register accesses to debug registers

`HDCR.TDA` traps Non-secure EL0 and EL1 System register accesses to the debug registers that are not mentioned in either of the following:

- [Traps to Hyp mode of Non-secure System register accesses to debug registers on page G1-4441.](#)
- [Trapping Non-secure System register accesses to powerdown debug registers on page G1-4442.](#)

This means that `HDCR.TDA` traps to Hyp mode Non-secure EL0 and EL1 System register accesses to all debug registers except the following:

- Non-secure System register accesses to `DBGDRAR` or `DBGDSAR`. The `HDCR.TDRA` trap traps these accesses.
- Non-secure System register access to `DBGOSLSR`, `DBGOSLAR`, `DBGOSDLR`, or `DBGPRCR`. The `HDCR.TDOSA` trap traps these accesses.

`HDCR.TDA` does not trap accesses to `DBGDTRRXint` or `DBGDTRRXint` when the PE is in Debug state.

When `HDCR.TDA` is:

- 1** Non-secure EL0 or EL1 System register accesses to any of the registers shown in [Table G1-63](#) are trapped to Hyp mode.
- 0** This control has no effect on Non-secure EL0 or EL1 System register accesses.

[Table G1-63](#) shows how the exceptions are reported in `HSR`.

Table G1-63 Accesses trapped to Hyp mode when `HDCR.TDA` is 1

Traps from	Trapped accesses	Syndrome reporting in <code>HSR</code>
Non-secure EL0 and EL1	Accesses to the <code>DBGDIDR</code> , <code>DBGDSCRint</code> , <code>DBGDCCINT</code> , <code>DBGDTRRXint</code> , <code>DBGDTRXint</code> , <code>DBGWFR</code> , <code>DBGVCR</code> , <code>DBGDSCRext</code> , <code>DBGDTRXext</code> , <code>DBGDTRRXext</code> , <code>DBGBVR<n></code> , <code>DBGBCR<n></code> , <code>DBGBXVR<n></code> , <code>DBGWCR<n></code> , <code>DBGWVR<n></code> , <code>DBGCLAIMSET</code> , <code>DBGCLAIMCLR</code> , <code>DBGAUTHSTATUS</code> , <code>DBGDEVID</code> , <code>DBGDEVID1</code> , <code>DBGDEVID2</code> , and <code>DBGOSECRR</code>	For accesses using MCR or MRC instructions, trapped MCR or MRC access (coproc == 0b1110), using EC value 0x05
	STC accesses to <code>DBGDTRRXint</code> .	Trapped LDC or STC access, using EC value 0x06
	LDC accesses to <code>DBGDTRXint</code> .	

If `HDCR.TDE` or `HCR.TGE` is 1, behavior is as if `HDCR.TDA` is 1 other than for the purpose of a direct read.

Traps to Hyp mode of Non-secure EL0 and EL1 accesses to the Generic Timer registers

`CNTHCTL`.{`PL1PCEN`, `PL1PCTEN`} trap Non-secure EL0 and EL1 accesses to the Generic Timer registers to Hyp mode, as follows:

- `CNTHCTL.PL1PCEN` traps Non-secure EL0 and EL1 accesses to the physical timer registers.
- `CNTHCTL.PL1PCTEN` traps Non-secure EL0 and EL1 accesses to the physical counter register.

For each of these controls:

- 1** This control has no effect on Non-secure EL0 and EL1 accesses to the registers shown in [Table G1-64 on page G1-4444.](#)

0 Non-secure EL0 and EL1 accesses are trapped to Hyp mode.

Table G1-64 shows the registers for which accesses are trapped, and how the exceptions are reported in HSR.

Table G1-64 Register accesses trapped to Hyp mode by CNTHCTL trap controls

Traps from	Trap control	Registers	Syndrome reporting in HSR
Non-secure EL0 and EL1	PL1PCEN	CNTP_CTL, CNTP_CVAL, CNTP_TVAL	For accesses using: <ul style="list-style-type: none"> MCR or MRC instructions, trapped MCR or MRC access (coproc==0b1111), using EC value 0x03 MCR or MRRC instructions, trapped MCR or MRRC access (coproc==0b1111), using EC value 0x04
	PL1PCTEN	CNTPCT	Trapped MCR or MRRC access (coproc==0b1110), using EC value 0x04

Traps to Hyp mode of Non-secure EL0 and EL1 accesses to Performance Monitors registers

If the Performance Monitors Extension is implemented, HDCR.{TPM, TPMCR} trap Non-secure EL0 and EL1 accesses to the Performance Monitors registers to Hyp mode:

HDCR.TPM:

- 1** Non-secure EL0 and EL1 accesses to all Performance Monitors registers are trapped to Hyp mode.
- 0** This control has no effect on Non-secure EL0 and EL1 accesses to the Performance Monitors registers.

HDCR.TPMCR:

- 1** Non-secure EL0 and EL1 accesses to the Performance Monitors Control Register are trapped to Hyp mode.

Note

The conditions for this trap are identical to those for the trap controlled by HDCR.TPM

- 0** This control has no effect on Non-secure EL0 and EL1 accesses to the Performance Monitors Control Registers.

Note

- EL2 does not provide traps on Performance Monitor register accesses through the optional memory-mapped external debug interface.
- If the Performance Monitors Extension is not implemented, HDCR.{TPM, TPMCR} are RES0.

Table G1-65 shows the registers for which accesses are trapped, and how the exceptions are reported in HSR.

Table G1-65 Register accesses trapped to Hyp mode when HDCR.{TPM, TPMCR} are 1

Traps from	Trap control	Registers	Syndrome reporting in HSR
Non-secure EL0 and EL1	TPM	PMCR, PMCNTENSET, PMCNTENCLR, PMOVSR, PMSWINC, PMSELR, PMCEID0, PMCEID1, PMCCNTR, PMXEVTYPER, PMXEVCNTR, PMUSERENR, PMINTENSET, PMINTENCLR, PMOVSSSET, PMEVCNTR<n>, PMEVTYPER<n>, PMCCFILTR	For accesses using: <ul style="list-style-type: none"> MCR or MRC instructions, trapped MCR or MRC access (coproc==0b1111), using EC value 0x03. MCR or MRRC instructions, trapped MCR or MRRC access (coproc==0b1111), using EC value 0x04.
	TPMCR	PMCR	Trapped MCR or MRC access (coproc==0b1111), using EC value 0x03

———— **Note** —————

HDCR.HPMN affects whether a counter can be accessed from Non-secure EL1 or EL0. See the register description of HDCR for more information.

G1.20.4 EL3 configurable controls

Table G1-66 shows the System registers that contain these controls.

Table G1-66 System registers that contain instruction enables and disables, and trap controls

Register name	Register description
SCR	Secure Configuration Register
NSACR	Non-secure Access Control Register

Table G1-67 summarizes the controls.

Table G1-67 EL3 Instruction enables and disables, and trap controls

Control	Type of control ^a	Trap
SCR.{TWE, TWI}	T	Traps to Monitor mode of the execution of WFE and WFI instructions in modes other than Monitor mode on page G1-4447
SCR.HCE	E	Enabling EL2 and Non-secure EL1 execution of HVC instructions on page G1-4448
SCR.SCD	D	Disabling SMC instructions on page G1-4448
NSACR.NSTRCDIS	D	Disabling Non-secure System register access to the trace registers on page G1-4449
NSACR.{cp11, cp10}	E	Enabling Non-secure access to SIMD and floating-point functionality on page G1-4449
NSACR.NSASEDIS	D	Disabling Non-secure access to Advanced SIMD functionality on page G1-4450

a. See Table G1-68.

Table G1-68 Control types, for AArch32 EL3 controls

Abbreviation	Type	See
D	Disable	Instruction enables and instruction disables on page G1-4418
E	Enable	Instruction enables and instruction disables on page G1-4418
T	Trap	Trap controls on page G1-4418

Also see the following:

- [Register access instructions on page G1-4419.](#)
- [Instructions that fail their Condition code check.](#)
- [Trapping to EL3 of instructions that are UNPREDICTABLE on page G1-4447.](#)

Instructions that fail their Condition code check

For UNDEFINED instructions that fail their Condition code check, see [Conditional execution of undefined instructions on page G1-4378.](#)

For an instruction that has a Monitor trap set, that fails its Condition code check:

- Unless the trap description states otherwise, it is IMPLEMENTATION DEFINED whether the instruction:
 - Generates a Monitor Trap exception.
 - Executes as a NOP.

Any implementation must be consistent in its handling of instructions that fail their Condition code check. This means that:

- Whenever a Monitor trap is set on such an instruction it must either:
 - Always generate a Monitor trap exception.
 - Always treat the instruction as a NOP.
- The IMPLEMENTATION DEFINED part of the requirements of *Conditional execution of undefined instructions* on page G1-4378 must be consistent with the handling of Monitor traps on instructions that fail their Condition code check. Table G1-69 shows this:

Table G1-69 Consistent handling of instructions that fail their Condition code check

Behavior of conditional UNDEFINED instruction ^a	Monitor trap on instruction that fails its Condition code check ^b
Executes as a NOP	Executes as a NOP
Generates an Undefined Instruction exception	Generates a Monitor trap exception

- a. As defined in *Conditional execution of undefined instructions* on page G1-4378. In Non-secure EL0 and EL1 modes, this applies only if no Monitor trap is set for the instruction, otherwise see the behavior in the other column of the table.
- b. For a trapped instruction executed in a Non-secure EL1 or EL0 mode.

———— **Note** ————

When `SCR{TWE, TWI}` is set so that conditional WFE and WFI instructions are trapped to Monitor mode, the attempted execution of a conditional WFE or WFI instruction is only trapped if the instruction passes its Condition code check. See *Traps to Monitor mode of the execution of WFE and WFI instructions in modes other than Monitor mode*.

Trapping to EL3 of instructions that are UNPREDICTABLE

For an instruction that is UNPREDICTABLE, when the instruction is disabled or trapped then it is CONSTRAINED UNPREDICTABLE whether execution of the instruction generates a Monitor Trap exception.

———— **Note** ————

UNPREDICTABLE and CONSTRAINED UNPREDICTABLE behavior must not perform any function that cannot be performed at the current or lower Exception level using instructions that are not UNPREDICTABLE and are not CONSTRAINED UNPREDICTABLE. This means that disabling or trapping an instruction changes the set of instructions that might be executed in modes other than Monitor mode. This affects, indirectly, the permitted behavior of UNPREDICTABLE and CONSTRAINED UNPREDICTABLE instructions.

If no instructions are trapped, the attempted execution of an UNPREDICTABLE instruction in a mode other than Monitor mode must not generate a Monitor Trap exception.

Traps to Monitor mode of the execution of WFE and WFI instructions in modes other than Monitor mode

`SCR{TWE, TWI}` trap WFE and WFI instructions to Monitor mode:

- | | | |
|----------------|----------|--|
| SCR.TWE | 1 | Any attempt to execute a WFE instruction in any mode other than Monitor mode is trapped to Monitor mode, if the instruction would otherwise have caused the PE to enter a low-power state. |
| | 0 | This control has no effect on the execution of WFE instructions. |

- SCR.TWI** **1** Any attempt to execute a WFI instruction in any mode other than Monitor mode is trapped to Monitor mode, if the instruction would otherwise have caused the PE to enter a low-power state.
- 0** This control has no effect on the execution of WFI instructions.

For PL0 and PL1, these traps apply to WFE and WFI instruction execution in both Security states.

The attempted execution of a conditional WFE or WFI instruction is only trapped if the instruction passes its Condition code check.

———— **Note** —————

Since a WFE or WFI can complete at any time, even without a Wakeup event, the traps on WFE or WFI are not guaranteed to be taken, even if the WFE or WFI is executed when there is no Wakeup event. The only guarantee is that if the instruction does not complete in finite time in the absence of a Wakeup event, the trap will be taken.

For more information about these instructions, and when they can cause the PE to enter a low-power state, see:

- [Wait For Event and Send Event on page G1-4403.](#)
- [Wait For Interrupt on page G1-4406.](#)

Enabling EL2 and Non-secure EL1 execution of HVC instructions

SCR.HCE enables EL2 and Non-secure EL1 execution of HVC instructions:

- 1** HVC instruction execution is enabled at EL2 and Non-secure EL1.
- 0** HVC instructions are:
- UNDEFINED at Non-secure EL1. The Undefined Instruction exception is taken to Undefined mode.
 - CONSTRAINED UNPREDICTABLE at EL2. The behavior must be one of the following:
 - The instruction is UNDEFINED.
 - The instruction executes as a NOP.

———— **Note** —————

- If EL2 is not implemented, **SCR.HCE** is RES0 and HVC is UNDEFINED.
- HVC instructions are always UNDEFINED at EL0 and in Secure state.

Disabling SMC instructions

SCR.SCD disables SMC instructions:

- 1** **In Non-secure state**
- SMC instructions are UNDEFINED. The Undefined Instruction exception is taken from the current Exception level to the current Exception level.
- In Secure state**
- Behavior is one of the following:
- The instruction is UNDEFINED.
 - The instruction executes as a NOP.
- 0** SMC instructions are enabled.

———— **Note** —————

- SMC instructions are always UNDEFINED at EL0.

- When the value of `HCR.TSC` is 1, any attempted execution of an SMC instruction at Non-secure EL1 is trapped to EL2, regardless of the value of `SCR.SCD`, see [Traps to Hyp mode of Non-secure EL1 execution of SMC instructions on page G1-4434](#). As [Synchronous exception prioritization for exceptions taken to AArch32 state on page G1-4344](#) shows, this is an exception to the general exception prioritization rules, that prioritize most Undefined Instruction exceptions taken to Undefined mode above traps to a higher Exception level.

Disabling Non-secure System register access to the trace registers

`NSACR.NSTRCDIS` disables Non-secure System register accesses to the trace registers, from all Privilege levels:

- 1** Non-secure state accesses are disabled. Secure state accesses are enabled. If the PE is in Non-secure state:
- `CPACR.TRCDIS` behaves as RAO/WI, regardless of its actual value. See [Traps to Undefined mode of PL0 and PL1 System register accesses to trace registers on page G1-4422](#). This behavior applies even if the `CPACR.TRCDIS` control is not implemented. See the referenced section for more information.
 - `HCPTR.TTA` behaves as RAO/WI, regardless of its actual value. See [Traps to Hyp mode of Non-secure System register accesses to trace registers on page G1-4439](#).
- 0** There is no effect on accesses to `CPACR.TRCDIS` and `HCPTR.TTA`.

Note

- System register accesses to the trace registers use the (coproc==0b1111) encoding space.
- `NSACR.NSTRCDIS` might be implemented as RAZ/WI. See the `NSACR` register description for more information.
- The ETMv4 architecture does not permit EL0 to access the trace registers. If the ARMv8-A architecture is implemented with an ETMv4 implementation, EL0 accesses to the trace registers are UNDEFINED.
- EL3 does not provide Non-secure access controls on trace register accesses through the optional memory-mapped external debug interface.

Enabling Non-secure access to SIMD and floating-point functionality

`NSACR.{cp11, cp10}` enable Non-secure access to the SIMD and floating-point registers, from all Privilege levels:

- 0b11** All accesses, from both Security states, are enabled.
- 0b00** Non-secure state accesses are disabled. Secure state accesses are enabled. If the PE is in Non-secure state:
- `CPACR.{cp11, cp10}` behave as RAZ/WI. See [Enabling PL0 and PL1 accesses to the SIMD and floating-point registers on page G1-4423](#).
 - `HCPTR.{TCP11, TCP10}` behave as RAO/WI. See [General trapping to Hyp mode of Non-secure accesses to the SIMD and floating-point registers on page G1-4437](#).

Note

Software must set `NSACR.cp11` and `NSACR.cp10` to the same value.

For more information about SIMD and floating-point support, see [Advanced SIMD and floating-point support on page G1-4412](#).

Disabling Non-secure access to Advanced SIMD functionality

[NSACR.NSASEDIS](#) disables Non-secure accesses to the Advanced SIMD functionality, from all Privilege levels:

- 1** Non-secure state accesses are disabled. Secure accesses are enabled. If the PE is in Non-secure state:
- [CPACR.ASEDIS](#) behaves as RAO/WI. See *Disabling PL0 and PL1 execution of Advanced SIMD instructions* on page G1-4424.
 - [HCPTR.TASE](#) behaves as RAO/WI. See *Traps to Hyp mode of Non-secure accesses to Advanced SIMD functionality* on page G1-4438.
- These behaviors apply even if one or both of the [CPACR.ASEDIS](#) and [HCPTR.TASE](#) controls is not implemented. See the referenced sections for more information.
- 0** There is no effect on [CPACR.ASEDIS](#) and [HCPTR.TASE](#).

G1.20.5 Pseudocode description of configurable instruction enables, disables, and traps

The pseudocode function `AArch32.CheckITEnabled()` checks whether the T32 IT instruction is enabled.

The pseudocode function `AArch32.CheckSETENDEnabled()` checks whether the SETEND instruction is disabled.

The pseudocode function for `AArch32.CheckForSMCTrap()` checks for traps on an SMC instruction.

The `AArch32.CheckForWfXTrap()` pseudocode function checks for traps on WFE and WFI instructions:

Pseudocode description of enabling SIMD and floating-point functionality

The `AArch32.CheckAdvSIMDorFPEEnabled()` and `AArch32.CheckFPAdvSIMDTrap()` pseudocode functions take appropriate action if an SIMD or floating-point instruction is used when the SIMD and floating-point functionality is not enabled or is trapped.

The `CheckAdvSIMDorVFPEEnabled()`, `CheckAdvSIMDEnabled()`, and `CheckVFPEEnabled()` wrapper functions support the `AArch32.CheckAdvSIMDorFPEEnabled()` and `AArch32.CheckFPAdvSIMDTrap()` functions.

The `AArch32.CheckAdvSIMDorFPEEnabled()`, `AArch32.CheckFPAdvSIMDTrap()`, `CheckAdvSIMDorVFPEEnabled()`, `CheckAdvSIMDEnabled()`, and `CheckVFPEEnabled()` functions are described in [Chapter J1 *ARMv8 Pseudocode*](#).

Chapter G2

AArch32 Self-hosted Debug

When the PE is using self-hosted debug, it generates *debug exceptions*. This chapter describes the AArch32 self-hosted debug exception model. It is organized as follows:

Introductory information

- [About self-hosted debug](#) on page G2-4454.
- [The debug exception enable controls](#) on page G2-4458.

The debug Exception model

- [Routing debug exceptions](#) on page G2-4459.
- [Enabling debug exceptions from the current Privilege level and Security state](#) on page G2-4461.
- [The effect of powerdown on debug exceptions](#) on page G2-4463.
- [Summary of permitted routing and enabling of debug exceptions](#) on page G2-4464.
- [Pseudocode description of debug exceptions](#) on page G2-4466.

The debug exceptions

- [Breakpoint Instruction exceptions](#) on page G2-4467.
- [Breakpoint exceptions](#) on page G2-4470.
- [Watchpoint exceptions](#) on page G2-4496.
- [Vector Catch exceptions](#) on page G2-4510.

Synchronization requirements

The behavior of self-hosted debug after changes to System registers, or after changes to the authentication interface, but before a *Context synchronization event* guarantees the effects of the changes:

- [Synchronization and debug exceptions](#) on page G2-4518.

G2.1 About self-hosted debug

Self-hosted debug supports debugging through the generation and handling of *debug exceptions*, that are taken using the exception model described in:

- [Chapter D1 The AArch64 System Level Programmers' Model](#), if the exception is taken to AArch64 state.
- [Chapter G1 The AArch32 System Level Programmers' Model](#), if the exception is taken to AArch32 state.

This section introduces some terms used in describing self-hosted debug, and then introduces the debug exceptions. See:

- [Definition of a debugger in the context of self-hosted debug](#).
- [Context ID and Process ID](#).

G2.1.1 Definition of a debugger in the context of self-hosted debug

Within this chapter, *debugger* means that part of an operating system, or higher level of system software, that handles debug exceptions and programs the debug System registers. An operating system with rich application environments might provide debug services that support a debugger user interface executing at EL0. From the architectural perspective, the debug services are the debugger.

G2.1.2 Context ID and Process ID

In AArch32 state, the [CONTEXTIDR](#) identifies the current *Context ID*, that is used by:

- The debug logic, for breakpoint and watchpoint matching.
- Implemented trace logic, to identify the current process.

When using the Long-descriptor translation table format, the [CONTEXTIDR](#) has a single field, PROCID, that is defined as the *Process Identifier* (Process ID). Therefore, in AArch64 state, the Context ID and Process ID are identical when using this translation table format.

When using the Short-descriptor translation table format:

- [CONTEXTIDR](#)[31:0] defines the Context ID, that is used for breakpoint and watchpoint matching.
- [CONTEXTIDR](#)[31:8] defines the Process ID.
- [CONTEXTIDR](#)[7:0] define the ASID. See [Global and process-specific translation table entries on page G4-4628](#). This means that, when using the Short-descriptor translation table format, the ASID is always bits[7:0] of the Context ID.

G2.1.3 About debug exceptions

Debug exceptions occur during normal program flow if a debugger has programmed the PE to generate them. For example, a software developer might use a debugger contained in an operating system to debug an application. To do this, the debugger might enable one or more debug exceptions. The debug exceptions that can be generated in an AArch32 stage 1 translation regime are:

- [Breakpoint Instruction exceptions on page G2-4455](#).
- [Breakpoint exceptions on page G2-4455](#), generated by hardware breakpoints.
- [Watchpoint exceptions on page G2-4456](#), generated by hardware watchpoints.
- [Vector Catch exceptions on page G2-4456](#).

———— **Note** —————

In addition, *Software Step exceptions* can be generated in stage 1 of an AArch32 translation regime. However, these are always taken to AArch64 state. [Software Step exceptions on page D2-1908](#) describes this.

The PE can only generate a particular debug exception when both:

1. Debug exceptions are enabled from the current Exception level and Security state.

See [Enabling debug exceptions from the current Privilege level and Security state on page G2-4461](#). Breakpoint Instruction exceptions are always enabled from the current Exception level and Security state.

2. A debugger has enabled that particular debug exception.
All of the debug exceptions except for Breakpoint Instruction exceptions have an enable control contained in the [DBGDSCRExt](#). See [The debug exception enable controls on page G2-4458](#).

———— **Note** ————

If *halting is allowed* and [EDSCR.HDE](#) is 1, hardware breakpoints and watchpoints cause entry to Debug state instead of causing debug exceptions. In Debug state, the PE is halted.

For the definition of halting is allowed, see [Halting allowed and halting prohibited on page H2-5435](#).

When a debug exception is taken to an Exception level that is using AArch32:

- If the debug exception is a Watchpoint exception, it is taken as a Data Abort exception.
- Otherwise, it is taken as a Prefetch Abort exception.

The following list summarizes each of the debug exceptions:

Breakpoint Instruction exceptions

Breakpoint instructions generate these. Breakpoint instructions are instructions that software developers can use to cause exceptions at particular points in the program flow.

The breakpoint instruction in the A32 and T32 instruction sets is `BKPT #<immediate>`. Whenever one of these is committed for execution, the PE takes a Breakpoint Instruction exception.

PE behavior

Breakpoint Instruction exceptions cannot be masked. The PE takes Breakpoint Instruction exceptions regardless of both of the following:

- The current Privilege level and AArch32 mode.
- The current Security state.

For more information, see [Breakpoint Instruction exceptions on page G2-4467](#).

Breakpoint exceptions

The ARMv8-A architecture provides 2-16 hardware breakpoints. These can be programmed to generate Breakpoint exceptions based on particular instruction addresses, or based on particular PE contexts, or both.

For example, a software developer might program a hardware breakpoint to generate a Breakpoint exception whenever the instruction with address `0x1000` is committed for execution.

The ARMv8-A architecture supports the following types of hardware breakpoint for use in stage 1 of an AArch32 translation regime:

- Address:
 - Address Match.
 - Address Mismatch.
 Comparisons are made with the virtual address of each instruction in the program flow.
- Context:
 - Context ID Match. Matches with the Context ID value held in the [CONTEXTIDR](#).
 - VMID Match. Matches with the VMID value held in the [VTTB](#).
 - Context ID and VMID Match. Matches with both the Context ID and the VMID value.

An Address breakpoint can link to a Context breakpoint, so that the Address breakpoint only generates a Breakpoint exception if the PE is in a particular context when the address match or mismatch occurs.

A breakpoint generates a Breakpoint exception whenever an instruction that causes a match is committed for execution.

PE behavior

If halting is allowed and `EDSCR.HDE` is 1, hardware breakpoints cause entry to Debug state. That is, they halt the PE. See [Chapter H2 Debug State](#).

Otherwise:

- If debug exceptions are enabled, hardware breakpoints cause Breakpoint exceptions.
- If debug exceptions are disabled, hardware breakpoints are ignored.

For more information, see [Breakpoint exceptions on page G2-4470](#).

Watchpoint exceptions

The ARMv8-A architecture provides 2-16 hardware watchpoints. These can be programmed to generate Watchpoint exceptions based on accesses to particular data addresses, or based on accesses to any address in a data address range.

For example, a software developer might program a hardware watchpoint to generate a Watchpoint exception on an access to any address in the data address range `0x1000 - 0x101F`.

A hardware watchpoint can link to a hardware breakpoint if the hardware breakpoint is a *Linked Context* type. In this case, the watchpoint only generates a Watchpoint exception if the PE is in a particular context when the data address match occurs.

The smallest data address size that a watchpoint can be programmed to match on is a byte. A single watchpoint can be programmed to match on one or more bytes.

A watchpoint generates a Watchpoint exception whenever an instruction that initiates an access that causes a match is committed for execution.

PE behavior

If halting is allowed and `EDSCR.HDE` is 1, hardware watchpoints cause entry to Debug state. That is, they halt the PE. See [Chapter H2 Debug State](#).

Otherwise:

- If debug exceptions are enabled, hardware watchpoints cause Watchpoint exceptions.
- If debug exceptions are disabled, hardware watchpoints are ignored.

For more information, see [Watchpoint exceptions on page G2-4496](#).

Vector Catch exceptions

These are used to trap exceptions. The ARMv8-A architecture provides two forms of vector catch, *address-matching* and *exception-trapping*. Only one form can be implemented.

Whichever form is implemented, a debugger must enable Vector Catch exceptions for one or more exception vectors by programming the `DBGVCR`. Generation of Vector Catch exceptions is then as follows:

- For the address-matching form, a Vector Catch exception is generated whenever the virtual address of an instruction matches a vector that Vector Catch exceptions are enabled for.
- For the Exception-trapping form, a Vector Catch exception is generated as part of exception entry for exception types that correspond to vectors that Vector Catch exceptions are enabled for.

PE behavior

If debug exceptions are:

- Enabled, Vector Catch exceptions can be generated.
- Disabled, vector catch is ignored.

For more information, see [Vector Catch exceptions on page G2-4510](#).

[Table G2-1 on page G2-4457](#) summarizes PE behavior and shows the location of the pseudocode for each of the debug exceptions.

Table G2-1 PE behavior and pseudocode for each of the debug exceptions

Debug exception	PE behavior if debug exceptions are:		Pseudocode
	Enabled	Disabled	
Breakpoint Instruction exception	Takes Prefetch Abort exception	Takes Prefetch Abort exception	AArch32.SoftwareBreakpoint()
Breakpoint exception	Takes Prefetch Abort exception ^a	Ignored	See <i>Pseudocode description of Breakpoint exceptions taken from AArch32 state</i> on page G2-4494
Watchpoint exception	Takes Data Abort exception ^a	Ignored	See <i>Pseudocode description of Watchpoint exceptions taken from AArch32 state</i> on page G2-4509
Vector Catch exception	Takes Prefetch Abort exception	Ignored	See <i>Pseudocode description of Vector Catch exceptions</i> on page G2-4517

- a. If halting is allowed and [EDSCR.HDE](#) is 1, hardware breakpoints and watchpoints cause the PE to enter Debug state instead of causing debug exceptions. See [Chapter H2 Debug State](#).

G2.2 The debug exception enable controls

The enable controls for each debug exception are as follows:

Breakpoint Instruction exceptions

None. Breakpoint Instruction exceptions are always enabled.

Breakpoint exceptions

[DBGDSCRExt.MDBGGen](#), plus an enable control for each breakpoint, [DBGBCR<n>.E](#).

Watchpoint exceptions

[DBGDSCRExt.MDBGGen](#), plus an enable control for each watchpoint, [DBGWCR<n>.E](#).

Vector Catch exceptions

[DBGDSCRExt.MDBGGen](#).

In addition, for all debug exceptions other than Breakpoint Instruction exceptions, software must configure the controls that enable debug exceptions from the current Exception level and Security state. See [Enabling debug exceptions from the current Privilege level and Security state on page G2-4461](#).

The PE cannot take a debug exception if debug exceptions are disabled from either the current Exception level or the current Security state.

Breakpoint Instruction exceptions are always enabled from the current Exception level and Security state.

G2.3 Routing debug exceptions

Debug exceptions are usually routed to Abort mode. However, if EL2 is implemented, the routing of debug exceptions taken from Non-secure state depends on the *Effective values* of `HDCR.TDE` and `HCR.TGE`:

If the *Effective value* of {`HDCR.TDE`, `HCR.TGE`} is not {0, 0}

Debug exceptions taken from Non-secure state are routed to Hyp mode.

Otherwise

In Non-secure state debug exceptions behave as follows:

- Debug exceptions taken from Non-secure EL1 and Non-secure EL0 are routed to Non-secure Abort mode.
- Breakpoint Instruction exceptions taken from Hyp mode are routed to Hyp mode.
- All other debug exceptions are disabled from Hyp mode.

———— **Note** —————

If EL2 is not implemented, the *Effective value* of `HCR.TGE` is 0 and the *Effective value* of `HDCR.TDE` is 0.

[Table G2-2](#), [Table G2-3](#), and [Table G2-4](#) show the routing of debug exceptions taken from an Exception level that is using AArch32 to an Exception level that is using AArch32. In these tables:

TDE Means the logical OR of `HDCR.TDE` and `HCR.TGE`.

(Hyp mode) Means:

- All debug exceptions other than Breakpoint Instruction exceptions are disabled from this Privilege level.
- Breakpoint Instruction exceptions taken from this Privilege level are taken to Hyp mode.

Table G2-2 Routing when both EL3 and EL2 are implemented

TDE	Target AArch32 mode when executing in:			
	Non-secure:			Secure state
	PL0	PL1	PL2	
0	Non-secure Abort mode	Non-secure Abort mode	(Hyp mode)	Secure Abort mode
1	Hyp mode	Hyp mode	(Hyp mode)	Secure Abort mode

Table G2-3 Routing when EL3 is implemented and EL2 is not implemented

Target AArch32 mode when executing in:	
Non-secure state	Secure state
Non-secure Abort mode	Secure Abort mode

Table G2-4 Routing when EL3 is not implemented and EL2 is implemented

TDE	Target AArch32 mode when executing in Non-secure:		
	PL0	PL1	PL2
0	Non-secure Abort mode	Non-secure Abort mode	(Hyp mode)
1	Hyp mode	Hyp mode	(Hyp mode)

G2.3.1 Pseudocode description of routing debug exceptions

[DebugTarget\(\)](#) returns the current debug target Exception level. [DebugTargetFrom\(\)](#) returns the debug target Exception level for the specified Security state.

G2.4 Enabling debug exceptions from the current Privilege level and Security state

A debug exception can only be taken if all of the following are true:

- The OS lock is unlocked.
- `DoubleLockStatus() == FALSE`.
- The debug exception is enabled from the current Privilege level.
- The debug exception is enabled from the current Security state.

Table G2-5 shows when debug exceptions are enabled from the current Privilege level.

Table G2-5 Whether debug exceptions are enabled from the current Privilege level

Current Privilege level	Breakpoint Instruction exceptions	All other debug exceptions
PL2	Enabled	Disabled
PL1	Enabled	Enabled
PL0		

Table G2-6 shows when debug exceptions are enabled from the current Security state.

Table G2-6 Whether debug exceptions are enabled from the current Security state

Current Security state	Breakpoint Instruction exceptions	All other debug exceptions
Non-secure	Enabled	Enabled from PL1 and PL0 only.
Secure	Enabled	Depends on <code>SDCR.SPD</code> and <code>SDER.SUIDEN</code> . See <i>Disabling debug exceptions from Secure state</i> .

G2.4.1 Disabling debug exceptions from Secure state

If EL3 is implemented, software executing at EL3 can enable or disable all debug exceptions taken from Secure PL1 other than Breakpoint Instruction exceptions, by using one of:

- The *Secure Privileged Debug* field, `SDCR.SPD`, if EL3 is using AArch32.
- The *AArch32 Secure Privileged Debug* field, `MDCR_EL3.SPD32`, if EL3 is using AArch64.

If debug exceptions are disabled from Secure PL1, software executing at Secure PL1 can set the *Secure User Invasive Debug Enable* bit, `SDER.SUIDEN`, to 1 to enable all debug exceptions taken from Secure PL0 other than Breakpoint Instruction exceptions.

———— **Note** ————

Breakpoint Instruction exceptions are always enabled.

The ARMv8-A architecture does not support disabling debug in Non-secure state.

———— **Note** ————

If the boot software that is executed when reset is deasserted programs `SUIDEN` and `SPD` so that all debug exceptions are disabled from Secure state, software operating at EL3 never has to switch any of the debug registers between the Security states.

G2.4.2 Pseudocode description of enabling debug exceptions

[AArch64.GenerateDebugExceptions\(\)](#) determines whether debug exceptions are enabled from the current Exception level and Security state. [AArch64.GenerateDebugExceptionsFrom\(\)](#) determines whether debug exceptions are enabled from the specified Exception level and Security state.

G2.5 The effect of powerdown on debug exceptions

Debug OS Save and Restore sequences on page H6-5541 describes the *powerdown save routine* and the *restore routine*.

When executing either routine, software must use the OS Lock to disable generation of all of the following:

- Breakpoint exceptions.
- Watchpoint exceptions.
- Vector Catch exceptions.

This is because the generation of these exceptions depends on the state of the debug registers, and the state of the debug registers might be lost over these routines.

Debug exceptions other than Breakpoint Instruction exceptions are enabled only if both the OS Lock is unlocked and `DoubleLockStatus() == FALSE`.

Breakpoint Instruction exceptions are enabled regardless of the state of the OS Lock and the OS Double Lock.

G2.6 Summary of permitted routing and enabling of debug exceptions

Behavior is as follows:

Breakpoint Instruction exceptions

These are always enabled, regardless of the current Privilege level and Security state. [Table G2-7](#) shows the routing of these. In the table, n/a means not applicable.

Table G2-7 Routing of Breakpoint Instruction exceptions

Current Security state	HDCR.TDE ^a :	Target when enabled from:		
		PL0	PL1	PL2
Secure	X	Secure Abort mode ^b	Secure Abort mode ^b	n/a
Non-secure	0	Non-secure Abort mode	Non-secure Abort mode	Hyp mode
	1	Hyp mode	Hyp mode	Hyp mode

- If EL2 is not implemented, behavior is as if the value of this bit is 0. Otherwise, if the value of HCR.TGE is 1, HDCR.TDE is treated as being 1 other than for a direct read of HDCR.
- If EL3 is implemented and is using AArch32, Secure Abort mode is at EL3. Otherwise, Secure Abort mode is at EL1.

All other debug exceptions

The enabling and permitted routing is controlled by all of the following:

- SDCR.SPD.
- SDER.SUIDEN.
- HDCR.TDE.
- The IMPLEMENTATION DEFINED authentication interface.

[Table G2-8](#) shows the valid combinations of the values of SDCR.SPD, SDER.SUIDEN, HDCR.TDE, and, in the *Auth* column, the input from the IMPLEMENTATION DEFINED authentication interface described by the pseudocode function `AArch32.SelfHostedSecurePrivilegedInvasiveDebugEnabled()`. For each combination, the table shows where debug exceptions are enabled from and where they are taken to.

In the table, n/a means not applicable and a dash, -, means that debug exceptions are disabled from that Exception level.

Table G2-8 Breakpoint, Watchpoint, and Vector Catch exceptions

Debug state	Lock ^a	Current Security state	SPD ^b	Auth ^c	SUIDEN	TDE ^d	Target AArch32 mode when enabled from:		
							PL0	PL1	PL2
Yes	X	X	0bXX	X	X	X	-	-	-
No	TRUE	X	0bXX	X	X	X	-	-	-
No	FALSE	Secure	0b00	FALSE	0	X	-	-	n/a
No	FALSE	Secure	0b00	FALSE	1	X	Secure Abort mode ^e	-	n/a
No	FALSE	Secure	0b00	TRUE	X	X	Secure Abort mode ^e	Secure Abort mode ^e	n/a
No	FALSE	Secure	0b10	X	0	X	-	-	n/a

Table G2-8 Breakpoint, Watchpoint, and Vector Catch exceptions (continued)

Debug state	Lock ^a	Current Security state	SPD ^b	Auth ^c	SUIDEN	TDE ^d	Target AArch32 mode when enabled from:		
							PL0	PL1	PL2
No	FALSE	Secure	0b10	X	1	X	Secure Abort mode ^e	-	n/a
No	FALSE	Secure	0b11	X	X	X	Secure Abort mode ^e	Secure Abort mode ^e	n/a
No	FALSE	Non-secure	0bXX	X	X	0	Non-secure Abort mode	Non-secure Abort mode	-
No	FALSE	Non-secure	0bXX	X	X	1	Hyp mode	Hyp mode	-

- a. The value of (OSLSR_EL1.OSLK == '1' || DoubleLockStatus()).
- b. If EL3 is not implemented, behavior is as if this is 0b11.
- c. See the text that introduces this table for an explanation of the [Auth on page G2-4464](#) column. An entry of TRUE indicates that the authentication mechanism permits the debug exceptions to be taken to their default target PE mode.
- d. If HCR.TGE is 1, this bit is treated as being 1 other than for a direct read of HDCR. If EL2 is not implemented, behavior is as if TDE is 0.
- e. If EL3 is implemented and is using AArch32, Secure Abort mode is at EL3. Otherwise, Secure Abort mode is at EL1

G2.7 Pseudocode description of debug exceptions

`AArch32.DebugFault()` returns a `FaultRecord()` that indicates that a memory access has generated a debug exception.

The `AArch32.Abort()` function processes `FaultRecord()`, as described in *Abort exceptions* on page G3-4555, and generates:

- Data Abort exceptions for watchpoints.
- Prefetch Abort exceptions for all other debug exceptions.

G2.8 Breakpoint Instruction exceptions

This section describes Breakpoint Instruction exceptions in an AArch32 translation regime.

Note

When the PE is executing in EL0 using AArch32 and EL1 is using AArch64, it is using the AArch64 EL1&0 translation regime. A T32 or A32 BKPT instruction executed at EL0 can generate a Breakpoint Instruction exception that is taken to an Exception level that is using AArch64. For more information about the handling of these exceptions, see [Breakpoint Instruction exceptions on page D2-1919](#).

It contains the following subsections:

- [About Breakpoint Instruction exceptions](#).
- [Breakpoint instruction in the A32 and T32 instruction sets](#).
- [BKPT instructions as the first instruction in an IT block on page G2-4468](#).
- [Exception syndrome information and preferred return address for a BKPT instruction on page G2-4468](#).
- [Pseudocode description of Breakpoint Instruction exceptions on page G2-4469](#).

G2.8.1 About Breakpoint Instruction exceptions

A *breakpoint* is an event that results from the execution of an instruction, based on either:

- The instruction address, the PE context, or both. This type of breakpoint is called a *hardware breakpoint*.
- The instruction itself. That is, the instruction is a *breakpoint instruction*. These can be included in the program that the PE executes. This type of breakpoint is called a *software breakpoint*.

Breakpoint Instruction exceptions, that this section describes, are software breakpoints. [Breakpoint exceptions on page G2-4470](#) describes hardware breakpoints.

There is no enable control for Breakpoint Instruction exceptions. They are always enabled, and cannot be masked.

A Breakpoint Instruction exception is generated whenever a breakpoint instruction is committed for execution, regardless of all of the following:

- The current Exception level.
- The current Security state.
- Whether the *debug target Exception level*, EL_D , is using AArch64 or AArch32.

Note

- EL_D is the Exception level that debug exceptions are targeting. See [Enabling debug exceptions from the current Privilege level and Security state on page G2-4461](#).
 - Debuggers using breakpoint instructions must be aware of the ARMv8 rules for concurrent modification and execution of instructions. See [Concurrent modification and execution of instructions on page B2-84](#).
-

G2.8.2 Breakpoint instruction in the A32 and T32 instruction sets

The breakpoint instruction, in both instruction sets, is:

- BKPT #<immediate>

For details of the instruction encoding, see [BKPT on page F5-3065](#).

About whether the BKPT instruction is conditional

In the T32 instruction set, BKPT instructions are always unconditional.

In the A32 instruction set:

- If the Condition code field is AL, the BKPT instruction is unconditional.

- If the Condition code field is anything other than AL, behavior is CONstrained UNPREDICTABLE, and is one of the following:
 - The instruction is UNDEFINED.
 - The instruction is treated as a NOP instruction.
 - The instruction is executed unconditionally.
 - The instruction is executed conditionally.

G2.8.3 BKPT instructions as the first instruction in an IT block

If the first instruction in an IT block is a T32 BKPT instruction, then in an implementation that supports the ITD control, if ITD field that applies to the current Exception level is:

- 0** The BKPT instruction generates a Breakpoint Instruction exception.
- 1** The combination of IT instruction and BKPT instruction is UNDEFINED. Either the IT instruction or the BKPT instruction generates an Undefined Instruction exception.

In such an implementation, to ensure consistent behavior when making the first instruction in one or more IT blocks a BKPT instruction, the debugger must replace the IT instruction.

An implementation that does not support the ITD control behaves as if the value of the ITD field is 0.

The ITD control fields are:

HSCTLR.ITD Applies to execution at EL2 when EL2 is using AArch32.

SCTLR.ITD Applies to execution at EL0 or EL1 when EL1 is using AArch32.

SCTLR_EL1.ITD

Applies to execution at EL0 using AArch32 when EL1 is using AArch64.

———— **Note** —————

T32 BKPT instructions are always unconditional, even when they are inside an IT block. See:

- [Disabling or enabling PL0 and PL1 use of AArch32 deprecated functionality on page G1-4421.](#)
- [Disabling or enabling EL2 use of AArch32 deprecated functionality on page G1-4430.](#)

G2.8.4 Exception syndrome information and preferred return address for a BKPT instruction

See the following:

- [Exception syndrome information for a Breakpoint Instruction exception.](#)
- [Preferred return address for a Breakpoint Instruction exception on page G2-4469.](#)

———— **Note** —————

Usually, the term *exception syndrome* is used only for exceptions taken to Hyp mode, or to AArch64 state. The referenced section uses the term more generally, to include exception information reported in the [IFSR](#).

Exception syndrome information for a Breakpoint Instruction exception

The PE takes a Breakpoint Instruction exception as either:

- A Prefetch Abort exception if it is taken to PL1. In this case, it is taken to Abort mode.
- A Hyp Trap exception, if it is taken to PL2 because either **HCR.TGE** or **HDCR.TDE** is 1. In this case, it is taken to Hyp mode.

If the exception is taken to:

PL1 Abort mode

The PE sets all of the following:

- **DBGDSCRExt.MOE** to 0b0011, to indicate a Breakpoint Instruction exception.

- [IFSR.FS](#) to the code for a debug, `0b00010`.
- The [IFAR](#) with an UNKNOWN value.

PL2 Hyp mode

The PE does all of the following:

- Records information about the exception in the *Hypervisor Syndrome Register*, [HSR](#). See [Table G2-9](#).
- Sets [DBGDSCRExt.MOE](#) to `0b0011`, to indicate a Breakpoint Instruction exception.
- Sets the [HIFAR](#) to an UNKNOWN value.

Table G2-9 Information recorded in the [HSR](#)

HSR field	Information recorded
<i>Exception Class, EC</i>	The PE sets this to the code for a Prefetch Abort exception routed to Hyp mode, <code>0x20</code> .
<i>Instruction Length, IL</i>	The PE sets this to: <ul style="list-style-type: none"> • 0 for a T32 BKPT instruction. • 1 for an A32 BKPT instruction.
<i>Instruction Specific Syndrome, ISS</i>	<p>ISS[24:10] RES0.</p> <p>ISS[9] <i>External Abort type (EA)</i>. The PE sets this to 0.</p> <p>ISS[8:6] RES0.</p> <p>ISS[5:0] <i>Instruction Fault Status Code (IFSC)</i>. The PE sets this to the code for a debug exception, <code>0b100010</code>.</p>

———— **Note** —————

For information about how debug exceptions can be routed to PL2, see [Routing debug exceptions on page G2-4459](#).

Preferred return address for a Breakpoint Instruction exception

The preferred return address is the address of the breakpoint instruction, not the next instruction. This is different to the behavior of other exception-generating instructions, like `SVC`.

G2.8.5 Pseudocode description of Breakpoint Instruction exceptions

`AArch32.SoftwareBreakpoint()` generates a Prefetch Abort exception that is taken from AArch32 state.

G2.9 Breakpoint exceptions

This section describes Breakpoint exceptions in stage 1 of an AArch32 translation regime.

The PE is using an AArch32 translation regime when it is executing either:

- At EL1 or higher in an Exception level that is using AArch32.
- At EL0 using AArch32 when EL1 is using AArch32.

This section contains the following subsections:

- [About Breakpoint exceptions](#).
- [Breakpoint types and linking of breakpoints on page G2-4471](#).
- [Execution conditions for which a breakpoint generates Breakpoint exceptions on page G2-4480](#).
- [Breakpoint instruction address comparisons on page G2-4482](#).
- [Breakpoint context comparisons on page G2-4487](#).
- [Using breakpoints on page G2-4488](#).
- [Exception syndrome information and preferred return address for a Breakpoint exception on page G2-4493](#).
- [Pseudocode description of Breakpoint exceptions taken from AArch32 state on page G2-4494](#).

G2.9.1 About Breakpoint exceptions

A *breakpoint* is an event that results from the execution of an instruction, based on either:

- The instruction address, the PE context, or both. This type of breakpoint is called a *hardware breakpoint*.
- The instruction itself. That is, the instruction is a *breakpoint instruction*. These can be included in the program that the PE executes. This type of breakpoint is called a *software breakpoint*.

Breakpoint exceptions are generated by *Breakpoint debug events*. Breakpoint debug events are generated by hardware breakpoints. Software breakpoints are described in [Breakpoint Instruction exceptions on page G2-4467](#).

An implementation can include between 2-16 hardware breakpoints. [DBGDIDR.BRPs](#) shows how many are implemented.

To use an implemented hardware breakpoint, a debugger programs the following registers for the breakpoint:

- The *Breakpoint Control Register*, [DBGBCR<n>](#). This contains controls for the breakpoint, for example an enable control.
- The *Breakpoint Value Register*, [DBGBVR<n>](#). This holds a value used for breakpoint matching, that is one of:
 - An instruction virtual address.
 - A Context ID.
- If EL2 is implemented, the *Breakpoint Extended Value Register*, [DBGBXVR<n>](#), that holds a VMID value used for breakpoint matching.

These registers are numbered, so that:

- [DBGBCR1](#), [DBGBVR1](#), and [DBGBXVR1](#) are for breakpoint number one.
- [DBGBCR2](#), [DBGBVR2](#), and [DBGBXVR2](#) are for breakpoint number two.
- ...
- ...
- [DBGBCR<n>](#), [DBGBVR<n>](#), and [DBGBXVR<n>](#) are for breakpoint number <n>.

A debugger can link a breakpoint that is programmed with an address and a breakpoint that is programmed with anything other than an address together, so that a Breakpoint debug event is only generated if both breakpoints match.

For each instruction in the program flow, all of the breakpoints are tested. When a breakpoint is tested, it generates a Breakpoint debug event if all of the following are true:

- The breakpoint is enabled. That is, the breakpoint enable control for it, `DBGBCR<n>.E`, is 1.
- The conditions specified in the `DBGBCR<n>` are met.
- The comparisons with the values held in one or both of the `DBGBVR<n>` and `DBGXVR<n>`, as applicable, are successful.
- If the breakpoint is linked to another breakpoint, the comparisons made by that other breakpoint are also successful.
- The instruction is committed for execution.

If all of these conditions are met, the breakpoint generates the Breakpoint debug event regardless of the following:

- Whether the instruction passes its Condition code check.
- The instruction type.

If halting is allowed and `EDSCR.HDE` is 1, Breakpoint debug events cause entry to Debug state.

Otherwise, if debug exceptions are

- Enabled, Breakpoint debug events generate Breakpoint exceptions
- Disabled, Breakpoint debug events are ignored.

———— **Note** —————

The remainder of this Breakpoint exceptions section, including all subsections, describes breakpoints as generating Breakpoint exceptions.

However, the behavior described also applies if breakpoints are causing entry to Debug state.

The debug exception enable controls on page G2-4458 describes the enable controls for Breakpoint debug events.

G2.9.2 Breakpoint types and linking of breakpoints

Each implemented breakpoint is one of the following:

- A *context-aware* breakpoint. This is a breakpoint that can be programmed to generate a Breakpoint exception on any one of the following:
 - An instruction address match.
 - An instruction address mismatch.
 - A Context ID match, with the value held in the `CONTEXTIDR`.
 - A VMID match, with the value held in the `VTTBR`.
 - Both a Context ID match and a VMID match.
- A breakpoint that is not context-aware. These can only be programmed to generate a Breakpoint exception on an instruction address match or an instruction address mismatch.

`DBGDIDR.CTX_CMPs` shows how many of the implemented breakpoints are context-aware breakpoints. At least one implemented breakpoint must be context-aware. The context-aware breakpoints are the highest numbered breakpoints.

Any breakpoint that is programmed to generate a Breakpoint exception on an instruction address match or mismatch is categorized as an *Address breakpoint*. Breakpoints that are programmed to match on anything else are categorized as *Context breakpoints*.

When a debugger programs a breakpoint to be an Address or a Context breakpoint, it must also program that breakpoint so that it is either:

- Used in isolation. In this case, the breakpoint is called an *Unlinked breakpoint*.
- Enabled for linking to another breakpoint. In this case, the breakpoint is called a *Linked breakpoint*.

By linking an Address breakpoint and a Context breakpoint together, the debugger can create a breakpoint pair that only generates a Breakpoint exception if the PE is in a particular context when an instruction address match or mismatch occurs. For example, a debugger might:

1. Program breakpoint number one to be a *Linked Address Match breakpoint*.
2. Program breakpoint number five to be a *Linked Context ID Match breakpoint*.
3. Link these two breakpoints together. A Breakpoint exception is only generated if both the instruction address matches and the Context ID matches.

The *Breakpoint Type* field for a breakpoint, `DBGBCR<n>.BT`, controls the breakpoint type and whether the breakpoint is enabled for linking. If `BT[0]` is 1, the breakpoint is enabled for linking.

Figure G2-1 shows all of the possible breakpoint types that stage 1 of an AArch32 translation regime supports, and their associated BT field values.

		Unlinked	Linked
Address breakpoints	Address Mismatch	BT == 0b0100 Unlinked Address Mismatch	BT == 0b0101 Linked Address Mismatch
	Address Match	BT == 0b0000 Unlinked Address Match	BT == 0b0001 Linked Address Match
Context breakpoints	Context ID Match	BT == 0b0010 Unlinked Context ID Match	BT == 0b0011 Linked Context ID Match
	VMID Match	BT == 0b1000 Unlinked VMID Match	BT == 0b1001 Linked VMID Match
	VMID and context ID Match	BT == 0b1010 Unlinked VMID and Context ID Match	BT == 0b1011 Linked VMID and Context ID Match

Figure G2-1 Breakpoint types and their associated BT field values

Address breakpoints can be programmed to generate Breakpoint exceptions on addresses that are halfword-aligned but not word-aligned. This makes it possible to breakpoint on T32 instructions. See [Specifying the halfword-aligned address that an Address breakpoint matches on on page G2-4482](#).

Rules for linking breakpoints

The rules for breakpoint linking are as follows:

- Only Linked breakpoint types can be linked.
- Any type of Linked Address breakpoint can link to any type of Linked Context breakpoint. The *Linked Breakpoint Number* field, `DBGBCR<n>.LBN`, for the Linked Address breakpoint specifies the particular Linked Context breakpoint that the Linked Address breakpoint links to, and:
 - `DBGBCR<n>.{SSC, HMC, PMC}` for the Linked Address breakpoint define the execution conditions that the breakpoint pair generates Breakpoint exceptions for. See *Execution conditions for which a breakpoint generates Breakpoint exceptions* on page G2-4480.
 - `DBGBCR<n>.{SSC, HMC, PMC}` for the Linked Context breakpoint are ignored.
- Linked Context breakpoint types can only be linked to. The LBN field for Context breakpoints is therefore ignored.
- Linked Address breakpoints cannot link to watchpoints. The LBN field can therefore only specify another breakpoint.
- If a Linked Address breakpoint links to a breakpoint that is not context-aware, the behavior of the Linked Address breakpoint is CONstrained UNPREDICTABLE. See *Other usage constraints for Address breakpoints* on page G2-4492.
- If a Linked Address breakpoint links to an Unlinked Context breakpoint, the Linked Address breakpoint never generates any Breakpoint exceptions.
- Multiple Linked Address breakpoints can link to a single Linked Context breakpoint.

———— **Note** —————

Multiple Linked watchpoints can also link to a single Linked Context breakpoint. *Watchpoint exceptions* on page G2-4496 describes watchpoints.

These rules mean that a single Linked Context breakpoint might be linked to by all, or any combination of, the following:

- Multiple Linked Address Match breakpoints.
- Multiple Linked Address Mismatch breakpoints.
- Multiple Linked watchpoints.

It is also possible that a Linked Context breakpoint might have no breakpoints or watchpoints linked to it.

[Figure G2-2 on page G2-4474](#) shows an example of permitted breakpoint and watchpoint linking.

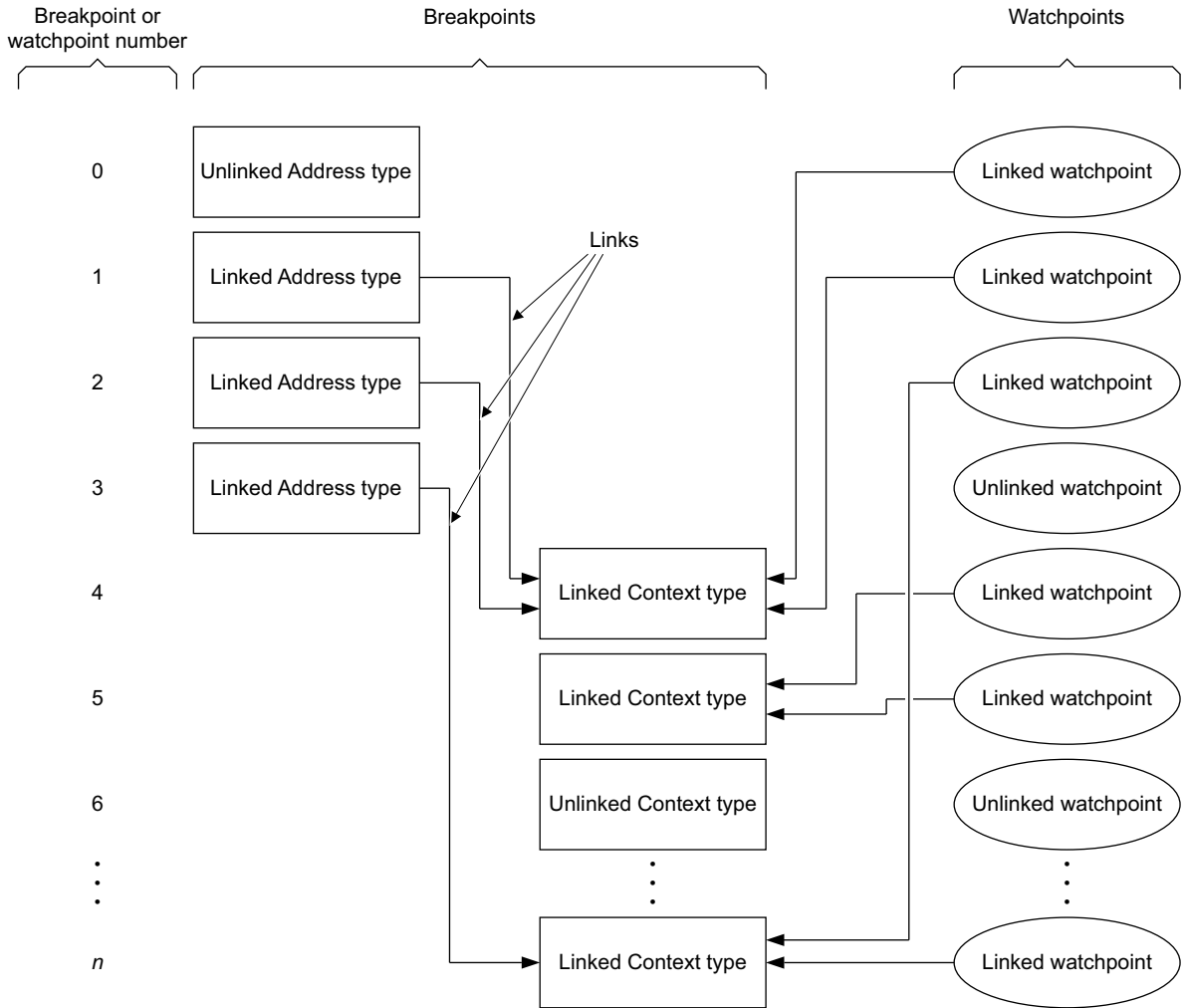

Figure G2-2 The role of linking in Breakpoint and Watchpoint exception generation

In [Figure G2-2](#), each Linked Address breakpoint can only generate a Breakpoint exception if the comparisons made by both it, and the Linked Context breakpoint that it links to, are successful. Similarly, each Linked watchpoint can only generate a Watchpoint exception if the comparisons made by both it, and the Linked Context breakpoint that it links to, are successful.

Breakpoint types defined by DBGBCRn.BT

The following list provides more detail about each breakpoint type:

0b0000, Unlinked Address Match breakpoint

Generation of a Breakpoint exception depends on both:

- [DBGBCR<n>.{SSC, HMC, PMC}](#). These define the execution conditions that the breakpoint generates Breakpoint exceptions for. See [Execution conditions for which a breakpoint generates Breakpoint exceptions](#) on page G2-4480.
- A successful address match, as described in [Breakpoint instruction address comparisons](#) on page G2-4482.

[DBGBCR<n>.LBN](#) for this breakpoint is ignored.

0b0001, Linked Address Match breakpoint

Generation of a Breakpoint exception depends on all of the following:

- **DBGBCR<n>**. {SSC, HMC, PMC} for this breakpoint. These define the execution conditions that the breakpoint generates Breakpoint exceptions for. See [Execution conditions for which a breakpoint generates Breakpoint exceptions on page G2-4480](#).
- A successful address match defined by this breakpoint, as described in [Breakpoint instruction address comparisons on page G2-4482](#).
- A successful context match defined by the Linked Context breakpoint that this breakpoint links to.

DBGBCR<n>.LBN for this breakpoint selects the Linked Context breakpoint that this breakpoint links to.

0b0010, Unlinked Context ID Match breakpoint

BT == 0b0010 is a reserved value if the breakpoint is not a context-aware breakpoint.

For context-aware breakpoints, generation of a Breakpoint exception depends on both:

- **DBGBCR<n>**. {SSC, HMC, PMC}. These define the execution conditions that the breakpoint generates Breakpoint exceptions for. See [Execution conditions for which a breakpoint generates Breakpoint exceptions on page G2-4480](#).
- A successful Context ID match, as described in [Breakpoint context comparisons on page G2-4487](#).

The value of **DBGBVR<n>**[31:0] is compared with the current Context ID. **CONTEXTIDR_EL2** holds the current Context ID when all of:

- The implementation includes the Virtualization Host Extensions.
- The PE is in Non-secure state.
- **HCR_EL2**.E2H is set to 1.
- The PE is executing at EL0 and **HCR_EL2**.TGE is 1, or PE is executing at EL2.

Otherwise, **CONTEXTIDR** holds the current Context ID.

DBGBCR<n>. {LBN, BAS} for this breakpoint are ignored

0b0011, Linked Context ID Match breakpoint

BT == 0b0011 is a reserved value if the breakpoint is not a context-aware breakpoint.

For context-aware breakpoints, either:

- This breakpoint does not generate any Breakpoint exceptions, if no Linked breakpoints or Linked watchpoints link to it.
- Generation of a Breakpoint exception depends on both:
 - A successful instruction address match, defined by a Linked Address breakpoint that links to this breakpoint, see [Breakpoint instruction address comparisons on page G2-4482](#).
 - A successful Context ID match defined by this breakpoint, as described in [Breakpoint context comparisons on page G2-4487](#).
- Generation of a Watchpoint exception depends on both:
 - A successful data address match, defined by a Linked watchpoint that links to this breakpoint, see [Watchpoint data address comparisons on page G2-4500](#).
 - A successful Context ID match defined by this breakpoint, as described in [Breakpoint context comparisons on page G2-4487](#).

The value of **DBGBVR<n>**[31:0] is compared with the current Context ID. **CONTEXTIDR_EL2** holds the current Context ID when all of:

- The implementation includes the Virtualization Host Extensions.
- The PE is in Non-secure state.
- **HCR_EL2**.E2H is set to 1.
- The PE is executing at EL0 and **HCR_EL2**.TGE is 1, or PE is executing at EL2.

Otherwise, `CONTEXTIDR` holds the current Context ID.

`DBGBCR<n>.{LBN, SSC, HMC, BAS PMC}` for this breakpoint are ignored.

0b0100, Unlinked Address Mismatch breakpoint

Generation of a Breakpoint exception depends on both:

- `DBGBCR<n>.{SSC, HMC, PMC}`. These define the execution conditions that the breakpoint generates Breakpoint exceptions for. See *Execution conditions for which a breakpoint generates Breakpoint exceptions* on page G2-4480.
- A successful address mismatch, as described in *Breakpoint instruction address comparisons* on page G2-4482.

`DBGBCR<n>.LBN` for this breakpoint is ignored.

0b0101, Linked Address Mismatch breakpoint

Generation of a Breakpoint exception depends on all of the following:

- `DBGBCR<n>.{SSC, HMC, PMC}`. These define the execution conditions that the breakpoint generates Breakpoint exceptions for. See *Execution conditions for which a breakpoint generates Breakpoint exceptions* on page G2-4480.
- A successful address mismatch defined by this breakpoint, as described in *Breakpoint instruction address comparisons* on page G2-4482.
- A successful context match defined by the Linked Context breakpoint that this breakpoint links to.

`DBGBCR<n>.LBN` for this breakpoint selects the Linked Context breakpoint that this breakpoint links to.

0b0110, Unlinked CONTEXTIDR_EL1 Match

`BT == 0b0110` is a reserved value if either:

- The breakpoint is not a context-aware breakpoint.
- The implementation does not include [ARMv8.1-VHE](#).

For context-aware breakpoints, generation of a Breakpoint exception depends on both:

- `DBGBCR<n>.{SSC, HMC, PMC}`. These define the execution conditions for which the breakpoint generates Breakpoint exceptions.
- A successful Context ID match defined by this breakpoint, as described in *Breakpoint context comparisons* on page G2-4487.

The Context ID check is made against the value in `CONTEXTIDR_EL1`. The value of `DBGBVR<n>.ContextID` is compared with the Context ID value held in `CONTEXTIDR_EL1`.

`DBGBCR<n>.{LBN, BAS}` for this breakpoint are ignored.

0b0111, Linked CONTEXTIDR_EL1 Match

`BT == 0b0111` is a reserved value if either:

- The breakpoint is not a context-aware breakpoint.
- The implementation does not include [ARMv8.1-VHE](#).

For context-aware breakpoints, one of the following applies:

- If no Linked breakpoints or Linked watchpoints link to this breakpoint, then the breakpoint does not generate any Breakpoint exceptions.
- Generation of a Breakpoint exception depends on both:
 - A successful instruction address match, defined by a Linked Address match breakpoint that links to this breakpoint, see *Breakpoint instruction address comparisons* on page G2-4482.
 - A successful Context ID match defined by this breakpoint, as described in *Breakpoint context comparisons* on page G2-4487.

- Generation of a Watchpoint exception depends on both:
 - A successful data address match, defined by a Linked watchpoint that links to this breakpoint, see [Watchpoint data address comparisons on page G2-4500](#).
 - A successful Context ID match defined by this breakpoint, as described in [Breakpoint context comparisons on page G2-4487](#).

The Context ID check is made against the value in `CONTEXTIDR_EL1`. The value of `DBGBVR<n>.ContextID` is compared with the Context ID value held in `CONTEXTIDR_EL1.DBGBCR<n>.{LBN, SSC, HMC, BAS, PMC}` for this breakpoint are ignored.

0b1000, Unlinked VMID Match breakpoint

`BT == 0b1000` is a reserved value if either:

- The breakpoint is not a context-aware breakpoint.
- EL2 is not implemented.

For context-aware breakpoints, generation of a Breakpoint exception depends on both:

- `DBGBCR<n>.{SSC, HMC, PMC}`. These define the execution conditions that the breakpoint generates Breakpoint exceptions for. See [Execution conditions for which a breakpoint generates Breakpoint exceptions on page G2-4480](#).
- A successful VMID match, as described in [Breakpoint context comparisons on page G2-4487](#).

`DBGBCR<n>.{LBN, BAS}` for this breakpoint are ignored.

0b1001, Linked VMID Match breakpoint

`BT == 0b1000` is a reserved value if either:

- The breakpoint is not a context-matching breakpoint.
- EL2 is not implemented.

For context-aware breakpoints, either:

- This breakpoint does not generate any Breakpoint exceptions, if no Linked breakpoints or Linked watchpoints link to it.
- Generation of a Breakpoint exception depends on both:
 - A successful instruction address match, defined by a Linked Address Match breakpoint that links to this breakpoint. See [Breakpoint instruction address comparisons on page G2-4482](#).
 - A successful VMID match defined by this breakpoint.
- Generation of a Watchpoint exception depends on both:
 - A successful data address match, defined by a Linked watchpoint that links to this breakpoint, see [Watchpoint data address comparisons on page G2-4500](#).
 - A successful VMID match defined by this breakpoint, as described in [Breakpoint context comparisons on page G2-4487](#).

`DBGBCR<n>.{LBN, SSC, HMC, BAS, PMC}` for this breakpoint are ignored.

0b1010, Unlinked Context ID and VMID Match breakpoint

`BT == 0b1010` is a reserved value if either:

- The breakpoint is not a context-matching breakpoint.
- EL2 is not implemented.

For context-matching breakpoints, generation of a Breakpoint exception depends on all of the following:

- `DBGBCR<n>.{SSC, HMC, PMC}`. These define the execution conditions that the breakpoint generates Breakpoint exceptions for. See [Execution conditions for which a breakpoint generates Breakpoint exceptions on page G2-4480](#).
- A successful Context ID match, as described in [Breakpoint context comparisons on page G2-4487](#).

- A successful VMID match.

The value of `DBGBVR<n>.ContextID` is compared with the current Context ID.

`CONTEXTIDR_EL2` holds the current Context ID when all of:

- The implementation includes [ARMv8.1-VHE](#).
- The PE is in Non-secure state.
- EL2 using AArch64 and `HCR_EL2.E2H` is set to 1.
- The PE is executing at EL0 and `HCR_EL2.TGE` is 1, or the PE is executing at EL2.

Otherwise, `CONTEXTIDR` holds the current Context ID.

[Breakpoint context comparisons on page G2-4487](#) describes the requirements for a successful Context ID match and a successful VMID match.

`DBGBCR<n>.{LBN, BAS}` for this breakpoint are ignored.

0b1011, Linked Context ID and VMID Match breakpoint

`BT == 0b1011` is a reserved value if either:

- The breakpoint is not a context-matching breakpoint.
- EL2 is not implemented.

For context-matching breakpoints, either:

- This breakpoint does not generate any Breakpoint exceptions, if no Linked breakpoints or Linked watchpoints link to it.
- Generation of a Breakpoint exception depends on all of the following:
 - A successful instruction address match, defined by a Linked Address breakpoint that links to this breakpoint, see [Breakpoint instruction address comparisons on page G2-4482](#).
 - A successful Context ID match defined by this breakpoint, as described in [Breakpoint context comparisons on page G2-4487](#).
 - A successful VMID match defined by this breakpoint.
- Generation of a Watchpoint exception depends on all of the following:
 - A successful data address match, defined by a Linked watchpoint that links to this breakpoint, see [Watchpoint data address comparisons on page G2-4500](#).
 - A successful Context ID match defined by this breakpoint, as described in [Breakpoint context comparisons on page G2-4487](#).
 - A successful VMID match defined by this breakpoint.

The value of `DBGBVR<n>.ContextID` is compared with the current Context ID.

`CONTEXTIDR_EL2` holds the current Context ID when all of:

- The implementation includes [ARMv8.1-VHE](#).
- The PE is in Non-secure state.
- EL2 using AArch64 and `HCR_EL2.E2H` is set to 1.
- The PE is executing at EL0 and `HCR_EL2.TGE` is 1, or the PE is executing at EL2.

Otherwise, `CONTEXTIDR` holds the current Context ID.

[Breakpoint context comparisons on page G2-4487](#) describes the requirements for a successful Context ID match and a successful VMID match by this breakpoint.

`DBGBCR<n>.{LBN, SSC, HMC, BAS, PMC}` for this breakpoint are ignored.

0b1100, Unlinked CONTEXTIDR_EL2 Match

`BT == 0b1100` is a reserved value if either:

- The breakpoint is not a context-aware breakpoint.
- The implementation does not include [ARMv8.1-VHE](#).

For context-aware breakpoints, generation of a Breakpoint exception depends on both:

- **DBGBCR<n>**.{SSC, HMC, PMC}. These define the execution conditions for which the breakpoint generates Breakpoint exceptions.
- A successful **CONTEXTIDR_EL2** match, as described in *Breakpoint context comparisons* on page G2-4487.

The Context ID check is made against the value in **CONTEXTIDR_EL2**. The value of check against **CONTEXTIDR_EL2** means this breakpoint can be generated only if execution is in Non-secure state and EL2 is using AArch64.

DBGBCR<n>.{LBN, BAS} for this breakpoint are ignored.

0b1101, Linked **CONTEXTIDR_EL2** Match

BT == 0b1101 is a reserved value if either:

- The breakpoint is not a context-aware breakpoint.
- The implementation does not include **ARMv8.1-VHE**.

For context-aware breakpoints, either:

- If no Linked breakpoints or Linked watchpoints link to this breakpoint, then the breakpoint does not generate any Breakpoint exceptions.
- Generation of a Breakpoint exception depends on both:
 - A successful instruction address match, defined by a Linked Address match breakpoint that links to this breakpoint, see *Breakpoint instruction address comparisons* on page G2-4482.
 - A successful **CONTEXTIDR_EL2** match, as described in *Breakpoint context comparisons* on page G2-4487.
- Generation of a Watchpoint exception depends on both:
 - A successful data address match, defined by a Linked watchpoint that links to this breakpoint, see *Watchpoint data address comparisons* on page G2-4500.
 - A successful **CONTEXTIDR_EL2** match, as described in *Breakpoint context comparisons* on page G2-4487.

The Context ID check is made against the value in **CONTEXTIDR_EL2**, regardless of the value of **HCR_EL2.E2H**. The check against the **CONTEXTIDR_EL2** means this breakpoint or watchpoint can be generated only if execution is in Non-secure state and EL2 is using AArch64.

DBGBCR<n>.{LBN, SSC, HMC, BAS, PMC} for this breakpoint are ignored.

0b1110, Unlinked Full Context ID Match

BT == 0b1110 is a reserved value if either:

- The breakpoint is not a context-aware breakpoint.
- The implementation does not include **ARMv8.1-VHE**.

For context-aware breakpoints, generation of a Breakpoint exception depends on both:

- **DBGBCR<n>**.{SSC, HMC, PMC}. These define the execution conditions for which the breakpoint generates Breakpoint exceptions.
- A successful Context ID match, as described in *Breakpoint context comparisons* on page G2-4487.

The Context ID check is made by checking the value of **DBGBVR<n>**.ContextID against the value in **CONTEXTIDR_EL1** and the value of **DBGBXVR<n>**.ContextID against the value in **CONTEXTIDR_EL2**. Both comparisons must match for the check to succeed.

- The check against the **CONTEXTIDR_EL2** means this breakpoint can be generated only if execution is in Non-secure state and EL2 is using AArch64.

DBGBCR<n>.{LBN, BAS} for this breakpoint are ignored.

0b1111, Linked Full Context ID Match

BT == 0b1111 is a reserved value if either:

- The breakpoint is not a context-aware breakpoint.
- The implementation does not include [ARMv8.1-VHE](#).

For context-aware breakpoints, one of the following applies:

- If no Linked breakpoints or Linked watchpoints link to this breakpoint, then the breakpoint does not generate any Breakpoint exceptions.
- Generation of a Breakpoint exception depends on both:
 - A successful instruction address match, defined by a Linked Address match breakpoint that links to this breakpoint, see [Breakpoint instruction address comparisons](#) on page G2-4482.
 - A successful Context ID match, as described in [Breakpoint context comparisons](#) on page G2-4487.
- Generation of a Watchpoint exception depends on both:
 - A successful data address match, defined by a Linked watchpoint that links to this breakpoint, see [Watchpoint data address comparisons](#) on page G2-4500.
 - A successful Context ID match, as described in [Breakpoint context comparisons](#) on page G2-4487.

The Context ID check is made by checking the value of `DBGBVR<n>.ContextID` against the value in `CONTEXTIDR_EL1` and the value of `DBGBXVR<n>.ContextID` against the value in `CONTEXTIDR_EL2`. Both comparisons must match for the check to succeed.

- The check against the `CONTEXTIDR_EL2` means this breakpoint or watchpoint can be generated only if execution is in Non-secure state and EL2 is using AArch64.

`DBGBCR<n>.{LBN, SSC, HMC, BAS, PMC}` for this breakpoint are ignored.

Note

See [Reserved `DBGBCR<n>.BT` values](#) on page G2-4490 for the behavior of breakpoints programmed with reserved BT values.

G2.9.3 Execution conditions for which a breakpoint generates Breakpoint exceptions

Each breakpoint can be programmed so that it only generates Breakpoint exceptions for certain execution conditions. For example, a breakpoint might be programmed to generate Breakpoint exceptions only when the PE is executing at PL0 in Secure state.

`DBGBCR<n>.{SSC, HMC, PMC}` define the execution conditions the breakpoint generates Breakpoint exceptions for, as follows:

Security State Control, SSC

Controls whether the breakpoint generates Breakpoint exceptions only in Secure state, only in Non-secure state, or in both Security states.

Note

This is determined by the Security state of the PE, not from the NS attribute returned by the translation of the virtual address on which the breakpoint is set.

Higher Mode Control, HMC, and Privileged Mode Control, PMC

HMC and PMC together control which AArch32 modes the breakpoint generates Breakpoint exceptions in.

[Table G2-10 on page G2-4481](#) shows the valid combinations of the values of HMC, SSC, and PMC, and for each combination shows which Privilege levels breakpoints generate Breakpoint exceptions in.

In the table:

- Y or -** Means that a breakpoint programmed with the values of HMC, SSC and PMC shown in that row:
Y Can generate Breakpoint exceptions in AArch32 modes at that Privilege level.
- Cannot generate Breakpoint exceptions in AArch32 modes at that Privilege level.
- Res** Means that the combination of HMC, SSC, and PMC is reserved. See *Reserved DBGBCR<n>.{SSC, HMC, PMC} values on page G2-4491*.

Table G2-10 Summary of breakpoint HMC, SSC, and PMC encodings

HMC	SSC	PMC	Security state the breakpoint is programmed to match in	PL2 ^a	PL1	PL0	Implementation	
							No EL3	No EL2 and no EL3
0	00	00	Both	-	Y ^b	Y ^b	-	-
0	00	01		-	Y	-	-	-
0	00	10		-	-	Y	-	-
0	00	11		-	Y	Y	-	-
0	01	00	Non-secure	-	Y ^b	Y ^b	Res	Res
0	01	01		-	Y	-	Res	Res
0	01	10		-	-	Y	Res	Res
0	01	11		-	Y	Y	Res	Res
0	10	00	Secure	-	Y ^b	Y ^b	Res	Res
0	10	01		-	Y	-	Res	Res
0	10	10		-	-	Y	Res	Res
0	10	11		-	Y	Y	Res	Res
1	00	01	Both	Y	Y	-	-	Res
1	00	11		Y	Y	Y	-	Res
1	01	01	Non-secure	Y	Y	-	Res	Res
1	01	11		Y	Y	Y	Res	Res
1	10	01	Secure	-	Y	-	Res	Res
1	10	11		-	Y	Y	Res	Res
1	11	00	Non-secure	Y	-	-	-	Res if no EL2 ^c

- a. Debug exceptions are not generated at PL2 using AArch32. This means that these combinations of HMC, SSC, and PMC are only relevant if breakpoints cause entry to Debug state. Self-hosted debuggers must avoid combinations of HMC, SSC, and PMC that generate Breakpoint exceptions at PL2 using AArch32.
- b. Only in User, System and Supervisor modes.
- c. This encoding is only reserved when EL2 is not implemented, regardless of whether EL3 is implemented.

All combinations of HMC, SSC, and PMC that this table does not show are reserved. See *Reserved HMC, SSC, and PMC combinations on page G2-4491*.

G2.9.4 Breakpoint instruction address comparisons

Address comparisons are made for each instruction in the program flow. The following subsections describe the criteria for a successful address comparison, for:

- [Address Match breakpoints](#).
- [Address Mismatch breakpoints](#).

Address Match breakpoints

An address match comparison is successful if both:

- Bits [31:2] of the current instruction virtual address are equal to [DBGBVR<n>](#)[31:2].
 - The word or halfword selected by [DBGBCR<n>](#).BAS matches. That is, either:
 - [DBGBCR<n>](#).BAS is programmed with 0b0011 or 0b1111, and the instruction is at a word-aligned address.
 - [DBGBCR<n>](#).BAS is programmed with 0b1100, and the instruction is not at a word-aligned address.
- See [Specifying the halfword-aligned address that an Address breakpoint matches on](#).

———— **Note** —————

[DBGBVR<n>](#)[1:0] are RES0 and are ignored.

Address Mismatch breakpoints

An address mismatch comparison is successful if either:

- Bits [31:2] of the current instruction virtual address are not equal to [DBGBVR<n>](#)[31:2].
 - The word or halfword selected by [DBGBCR<n>](#).BAS does not match. That is, either:
 - [DBGBCR<n>](#).BAS is programmed with 0b0011 or 0b1111, and the instruction is not at a word-aligned address.
 - [DBGBCR<n>](#).BAS is programmed with 0b1100, and the instruction is at a word-aligned address.
- See [Specifying the halfword-aligned address that an Address breakpoint matches on](#).

———— **Note** —————

- [DBGBVR<n>](#)[1:0] are RES0 and are ignored.
 - Address Mismatch breakpoints can be used to single-step through code. See [Using an Address Mismatch breakpoint to single-step an instruction on page G2-4488](#).
-

Specifying the halfword-aligned address that an Address breakpoint matches on

For an Address breakpoint, a debugger can use the *Byte Address Selection* field, [DBGBCR<n>](#).BAS, so that the address comparison is successful on one of:

- The whole word starting at address [DBGBVR<n>](#)[31:2]:00.
- The halfword starting at address [DBGBVR<n>](#)[31:2]:00.
- The halfword starting at address (([DBGBVR<n>](#)[31:2]:00) + 2).

———— **Note** —————

The address programmed into the [DBGBVR<n>](#) must be word-aligned.

`DBGBCR<n>.BAS` can be used in both Address Match breakpoints and Address Mismatch breakpoints, as follows:

- For an Address Match breakpoint, `DBGBCR<n>.BAS` selects which halfword-aligned address the breakpoint must generate a Breakpoint exception for. This means that an address comparison is successful only if both of the following match:
 - The instruction address held in bits [31:2] of the `DBGBVR<n>`.
 - The halfword defined by the BAS field.
 That is, a successful address comparison = `DBGBVR<n>[31:2]` match AND BAS match.
- For an Address Mismatch breakpoint, `DBGBCR<n>.BAS` selects which halfword-aligned address the breakpoint must not generate a Breakpoint exception for. This means that an address comparison is successful if either or both of the following do not match:
 - The instruction address held in bits [31:2] of the `DBGBVR<n>`.
 - The halfword defined by the BAS field.
 That is, a successful address comparison = NOT (`DBGBVR<n>[31:2]` match AND BAS match).

The following subsections show the supported BAS values:

- [Using the BAS field in Address Match breakpoints.](#)
- [Using the BAS field in Address Mismatch breakpoints on page G2-4485.](#)

For Context breakpoints, `DBGBCR<n>.BAS` is RES1 and is ignored.

Using the BAS field in Address Match breakpoints

The supported BAS values are:

- | | |
|---------------------|---|
| <code>0b0000</code> | <p>This value is reserved. Behavior is a CONSTRAINED UNPREDICTABLE choice of:</p> <ul style="list-style-type: none"> • The breakpoint is disabled. • The breakpoint behaves as if BAS is <code>0b0011</code>, <code>0b1100</code>, or <code>0b1111</code>. |
| <code>0b0011</code> | <p>The breakpoint generates a Breakpoint exception if an instruction with an address described as follows is committed for execution:</p> <ul style="list-style-type: none"> • Bits [31:2] of the address equals <code>DBGBVR<n>[31:2]</code>. • Bits [1:0] of the address are <code>0b00</code>. <p>This means that breakpoints programmed with this BAS value generate Breakpoint exceptions for all of the following:</p> <ul style="list-style-type: none"> • 32-bit T32 instructions at word-aligned addresses. • 16-bit T32 instructions at word-aligned addresses. • A32 instructions. These are always at word-aligned addresses. <p>However, ARM recommends that a debugger uses this BAS value only for T32 instructions.</p> <p>It is CONSTRAINED UNPREDICTABLE whether a breakpoint programmed with this BAS value generates a Breakpoint exception on the second halfword of a 32-bit T32 instruction starting at the halfword-aligned address (<code>(DBGBVR<n>[31:2]:00) - 2</code>).</p> |
| <code>0b1100</code> | <p>The breakpoint generates a Breakpoint exception if an instruction with an address described as follows is committed for execution:</p> <ul style="list-style-type: none"> • Bits [31:2] of the address equals <code>DBGBVR<n>[31:2]</code>. • Bits [1:0] of the address are <code>0b10</code>. <p>This means that breakpoints programmed with this BAS value generate Breakpoint exceptions for both of the following:</p> <ul style="list-style-type: none"> • 32-bit T32 instructions at addresses that are halfword-aligned but not word-aligned. • 16-bit T32 instructions at addresses that are halfword-aligned but not word-aligned. <p>It is CONSTRAINED UNPREDICTABLE whether a breakpoint programmed with this BAS value generates a Breakpoint exception on the second halfword of a 32-bit T32 or A32 instruction starting at a word-aligned address.</p> |

0b1111 The breakpoint generates a Breakpoint exception if an instruction with an address described as follows is committed for execution:

- Bits [31:2] of the address equals $DBGBVR\langle n \rangle[31:2]$.
- Bits [1:0] of the address are 0b00.

This means that breakpoints programmed with this BAS value generate Breakpoint exceptions for all of the following:

- 32-bit T32 instructions at word-aligned addresses.
- 16-bit T32 instructions at word-aligned addresses.
- A32 instructions. These are always at word-aligned addresses.

However, ARM recommends that a debugger uses this BAS value only for A32 instructions.

It is CONSTRAINED UNPREDICTABLE whether a breakpoint programmed with this BAS value generates a Breakpoint exception on the second halfword of a 32-bit T32 instruction starting at the halfword-aligned address $((DBGBVR\langle n \rangle[31:2]:00) - 2)$.

It is CONSTRAINED UNPREDICTABLE whether a breakpoint programmed with this BAS value generates a Breakpoint exception on a 32-bit T32 instruction or a 16-bit T32 instruction at the halfword-aligned address $((DBGBVR\langle n \rangle[31:2]:00) + 2)$.

All other BAS values are reserved. For these reserved other values, $DBGBCR\langle n \rangle.BAS[3,1]$ ignore writes and read the same values as $DBGBCR\langle n \rangle[2,0]$ respectively. This means that the smallest instruction size a debugger can program breakpoints to match on is a halfword.

Figure G2-3 on page G2-4485 shows a summary of when breakpoints programmed with particular BAS values generate Breakpoint exceptions.

The figure contains four parts:

- A column showing the row number, on the left.
- An instruction set and instruction size table.
- A location of instruction figure.
- A BAS field values table, on the right.

To use the figure, read across the rows. For example:

- Row 2 shows that a breakpoint with a BAS value of 0b1100 generates Breakpoint exceptions for 16-bit T32 instructions starting at the halfword-aligned address $((DBGBVR\langle n \rangle[31:2]:00) + 2)$.
- Row 6 shows that a breakpoint with a BAS value of either 0b0011 or 0b1111 generates Breakpoint exceptions for A32 instructions. A32 instructions are always at word-aligned addresses.

In the figure:

- Yes** Means that the breakpoint generates a Breakpoint exception.
- No** Means that the breakpoint does not generate a Breakpoint exception.
- UNP** Means that it is CONSTRAINED UNPREDICTABLE whether the breakpoint generates a Breakpoint exception. See *Other usage constraints for Address breakpoints on page G2-4492*.

	Instruction set	Size	Location of instruction ^a							BAS[3:0]			
			-2	-1	0	+1	+2	+3	+4	+5	0b0011	0b1100	0b1111
Row 1	T32	16-bit			■	■					Yes	No	Yes
Row 2		16-bit					■	■			No	Yes	UNP
Row 3	T32	32-bit	■	■	■	■					UNP	No	UNP
Row 4		32-bit			■	■	■	■			Yes	UNP	Yes
Row 5		32-bit						■	■	■	No	Yes	UNP
Row 6	A32	32-bit			■	■	■	■			Yes	UNP	Yes

- a. 0 means the word-aligned address held in the DBGBVRn. The other locations are as follows:
- -2 means ((DBGBVRn[31:2]:00) - 2).
 - -1 means ((DBGBVRn[31:2]:00) - 1).
 - ...
 - ...
 - +5 means ((DBGBVRn[31:2]:00) + 5).

The solid areas show the location of the instruction.

Figure G2-3 Summary of BAS field meanings for Address Match breakpoints

Using the BAS field in Address Mismatch breakpoints

An Address Mismatch breakpoint generates Breakpoint exceptions for all instructions committed for execution, except the instruction whose address the breakpoint is programmed to match.

The supported BAS values are:

0b0000 The breakpoint ignores the address held in the **DBGBVR<n>** and generates Breakpoint exceptions for all instruction addresses.

0b0011 The breakpoint does not generate a Breakpoint exception if an instruction with an address described as follows is committed for execution:

- Bits [31:2] of the address equals **DBGBVR<n>**[31:2].
- Bits [1:0] of the address are **0b00**.

This means that breakpoints programmed with this BAS value do not generate Breakpoint exceptions for any of the following:

- 32-bit T32 instructions at word-aligned addresses.
- 16-bit T32 instructions at word-aligned addresses.
- A32 instructions. These are always at word-aligned addresses.

However, ARM recommends that a debugger uses this BAS value only for T32 instructions.

It is **CONSTRAINED UNPREDICTABLE** whether a breakpoint programmed with this BAS value does not generate a Breakpoint exception on the second halfword of a 32-bit T32 instruction starting at the halfword-aligned address ((**DBGBVR<n>**[31:2]:00) - 2).

0b1100 The breakpoint does not generate a Breakpoint exception if an instruction with an address described as follows is committed for execution:

- Bits [31:2] equals **DBGBVR<n>**[31:2].
- Bits [1:0] of the address are **0b10**.

This means that breakpoints programmed with this BAS value do not generate Breakpoint exceptions for either of the following:

- 32-bit T32 instructions at addresses that are halfword-aligned but not word-aligned.
- 16-bit T32 instructions at addresses that are halfword-aligned but not word-aligned.

It is CONSTRAINED UNPREDICTABLE whether a breakpoint programmed with this BAS value does not generate a Breakpoint exception on the second halfword of a 32-bit T32 or A32 instruction at a word-aligned address.

0b1111 The breakpoint does not generate a Breakpoint exception if an instruction with an address described as follows is committed for execution:

- Bits [31:2] of the address equals `DBGBVR<n>[31:2]`.
- Bits [1:0] of the address are `0b00`.

This means that breakpoints programmed with this BAS value do not generate Breakpoint exceptions for any of the following:

- 32-bit T32 instructions at word-aligned addresses.
- 16-bit T32 instructions at word-aligned addresses.
- A32 instructions. These are always at word-aligned addresses.

However, ARM recommends that a debugger uses this BAS value only for A32 instructions.

It is CONSTRAINED UNPREDICTABLE whether a breakpoint programmed with this BAS value does not generate a Breakpoint exception on the second halfword of a 32-bit T32 instruction starting at the halfword-aligned address $((\text{DBGBVR}\langle n \rangle[31:2]:00) - 2)$.

It is CONSTRAINED UNPREDICTABLE whether a breakpoint programmed with this BAS value does not generate a Breakpoint exception on a 32-bit T32 instruction or a 16-bit T32 instruction at the halfword-aligned address $((\text{DBGBVR}\langle n \rangle[31:2]:00) + 2)$.

All other BAS values are reserved. For these reserved other values, `DBGBCR<n>.BAS[3,1]` ignore writes and read the same values as `DBGBCR<n>[2,0]` respectively. This means that the smallest instruction size that a breakpoint can never generate a Breakpoint exception for is a halfword.

[Figure G2-4 on page G2-4487](#) shows a summary of when breakpoints programmed with particular BAS values generate Breakpoint exceptions.

The figure contains four parts:

- A column showing the row number, on the left.
- An instruction set and instruction size table.
- A location of instruction figure.
- A BAS field values table, on the right.

To use the figure, read across the rows. For example:

- Row 1 shows that a breakpoint with a BAS value of `0b1100` generates Breakpoint exceptions for 16-bit T32 instructions starting at the word-aligned address held in the `DBGBVR<n>`.
- Row 5 shows that a breakpoint with a BAS value of `0b0011` generates Breakpoint exceptions for 32-bit T32 instructions starting at the halfword-aligned address immediately after the word aligned address held in the `DBGBVR<n>`.

In the figure:

Yes Means that the breakpoint does generate a Breakpoint exception.

No Means that the breakpoint does not generate a Breakpoint exception.

UNP Means that it is CONSTRAINED UNPREDICTABLE whether the breakpoint generates a Breakpoint exception. See [Other usage constraints for Address breakpoints on page G2-4492](#).

	Instruction set	Size	Location of instruction ^a								BAS[3:0]					
			-2	-1	0	+1	+2	+3	+4	+5	0b0000	0b0011	0b1100	0b1111		
Row 1	T32	16-bit			■	■							Yes	No	Yes	No
Row 2		16-bit			■		■	■					Yes	Yes	No	UNP
Row 3	T32	32-bit	■	■	■	■							Yes	UNP	Yes	UNP
Row 4		32-bit			■	■	■	■					Yes	No	UNP	No
Row 5		32-bit			■	■	■	■	■				Yes	Yes	No	UNP
Row 6	A32	32-bit			■	■	■	■					Yes	No	UNP	No

- a. 0 means the word-aligned address held in the DBGBVRn. The other locations are as follows:
- -2 means ((DBGBVRn[31:2]:00) - 2).
 - -1 means ((DBGBVRn[31:2]:00) - 1).
 - ...
 - ...
 - +5 means ((DBGBVRn[31:2]:00) + 5).

The solid areas show the location of the instruction.

Figure G2-4 Summary of BAS field meanings for Address Mismatch breakpoints

G2.9.5 Breakpoint context comparisons

The breakpoint type defined by `DBGBCR<n>.BT` determines what context comparison is required, if any. [Table G2-11](#) shows the BT values that require a comparison, and the match required for the comparison to be successful.

Table G2-11 Breakpoint context comparison tests

DBGBCR<n>.BT	Test required for successful context comparison
0b001x	When ARMv8.1-VHE is not implemented, <code>CONTEXTIDR</code> value matches <code>DBGBVR<n>.ContextID</code> value When ARMv8.1-VHE is implemented, <code>CONTEXTIDR_EL2</code> value matches <code>DBGXVR<n>.ContextID</code> value
0b011x	<code>CONTEXTIDR_EL1</code> value matches <code>DBGBVR<n>.ContextID</code> value
0b100x	<code>VTBR.VMID</code> value matches <code>DBGBVR<n>.VMID</code> value
0b101x	When ARMv8.1-VHE is not implemented, <code>CONTEXTIDR</code> value matches <code>DBGBVR<n>.ContextID</code> value and <code>VTBR.VMID</code> value matches <code>DBGBVR<n>.VMID</code> value When ARMv8.1-VHE is implemented, <code>CONTEXTIDR_EL2</code> value matches <code>DBGXVR<n>.ContextID</code> value and <code>VTBR.VMID</code> value matches <code>DBGBVR<n>.VMID</code> value
0b110x	<code>CONTEXTIDR_EL2</code> value matches <code>DBGXVR<n>.ContextID</code> value
0b111x	<code>CONTEXTIDR_EL1</code> value matches <code>DBGBVR<n>.ContextID</code> value and <code>CONTEXTIDR_EL2</code> value matches <code>DBGXVR<n>.ContextID</code> value

No context comparison is required for other valid `DBGBCR<n>.BT` values.

In ARMv8.0 only, context breakpoints do not generate Breakpoint exceptions when execution is at EL2.

Context breakpoints do not generate Breakpoint exceptions when any of:

- The comparison uses the value of `CONTEXTIDR_EL1` and any of:
 - The PE is executing at EL3 using AArch64.

- The PE is executing at EL2.
- The Virtualization Host Extensions are implemented, EL2 is using AArch64, the PE is executing in Non-secure state, and $HCR_EL2.\{E2H, TGE\} == \{1, 1\}$.
- The comparison uses the value of `CONTEXTIDR_EL2` and any of:
 - The Virtualization Host Extensions are not implemented.
 - The PE is in Secure state.
 - EL2 is using AArch32.
- The comparison uses the current VMID value and any of:
 - EL2 is not implemented.
 - The PE is in Secure state.
 - The PE is executing at EL2.
 - The Virtualization Host Extensions are implemented, EL2 is using AArch64, the PE is executing in Non-secure state, and $HCR_EL2.\{E2H, TGE\} == \{1, 1\}$.

The following Context breakpoint types do not generate Breakpoint exceptions in Secure state:

- VMID Match breakpoints.
- VMID and Context ID Match breakpoints.

———— **Note** —————

- For all Context breakpoints, `DBGBCR<n>.BAS` is RES1 and is ignored.
- For Linked Context breakpoints, `DBGBCR<n>.\{LBN, SSC, HMC, PMC\}` are RES0 and are ignored.

G2.9.6 Using breakpoints

This section contains the following:

- [Using an Address Mismatch breakpoint to single-step an instruction.](#)
- [ITD control effects on address breakpoints on the first instruction in an IT block on page G2-4489.](#)
- [Breakpoint usage constraints on page G2-4490.](#)

Using an Address Mismatch breakpoint to single-step an instruction

In execution conditions that an Address Mismatch breakpoint matches, defined by `DBGBCR<n>.\{LBN, SSC, PMC\}`, the breakpoint generates Breakpoint exceptions for all instructions committed for execution, except the instruction whose address the breakpoint is programmed with. [Figure G2-5](#) shows an example of Address Mismatch breakpoint operation, for an Address Mismatch breakpoint programmed with address `0x1014`.

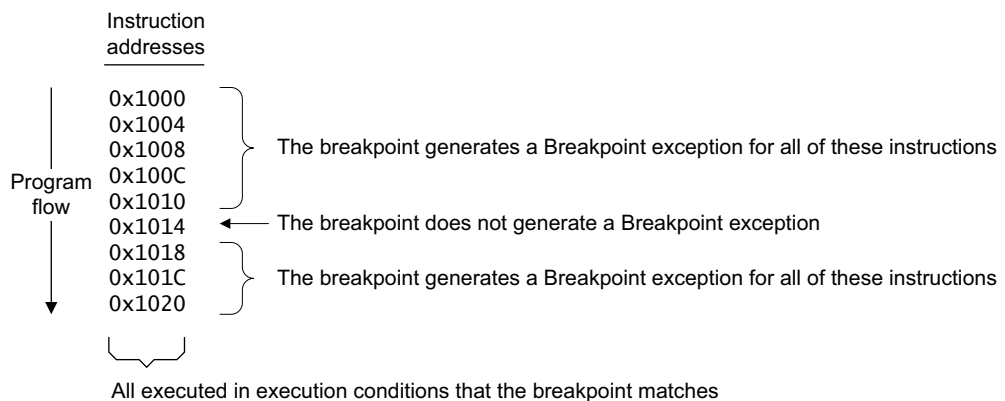

Figure G2-5 Operation of an Address Mismatch breakpoint

This means that an Address Mismatch breakpoint can be used to single-step an instruction.

In the example shown in [Figure G2-5 on page G2-4488](#):

- If the target of a branch is an instruction other than the instruction at address 0x1014, the breakpoint generates a Breakpoint exception when the instruction is committed for execution.
- If the target of a branch is the instruction at address 0x1014, the PE executes the instruction at 0x1014 and the breakpoint does not generate a Breakpoint exception until the instruction at address 0x1018 is committed for execution. The instruction at address 0x1014 is therefore single-stepped.

However, if the instruction at 0x1014 generates a synchronous exception, or if the PE takes an asynchronous exception while the instruction is being stepped, the breakpoint is evaluated again after taking the exception. This means that behavior is as follows:

- If the exception handler executes in execution conditions that the breakpoint matches, the breakpoint generates a Breakpoint exception for the exception vector, because the exception vector is not address 0x1014. This means that software execution steps into the exception.
- If the exception handler executes in execution conditions that the breakpoint does not match, the breakpoint does not generate any Breakpoint exceptions after the PE has taken the exception, until the exception handler completes and executes an exception return instruction. The effect is to step over the exception. Whether the instruction is stepped again depends on whether the target of the exception return instruction is the instruction at 0x1014 or the instruction at 0x1018.

If the instruction at 0x1014 is single-stepped and branches to itself, it is **CONSTRAINED UNPREDICTABLE** whether the breakpoint generates a Breakpoint exception after the PE has executed the branch.

This means that an instruction is only single-stepped if it is the target of a branch instruction and its address matches the address the breakpoint is programmed for. In the example shown in [Figure G2-5 on page G2-4488](#), this is 0x1014.

Usually this branch instruction is an exception return instruction that changes PE mode, branching from a PE mode in which the breakpoint does not generate a Breakpoint exception. A branch instruction that does not change PE mode would itself generate a Breakpoint exception. However, it might be a branch-to-self instruction as described above.

Because Address Mismatch breakpoints can single-step instructions, the behavior of an address mismatch Breakpoint exception is similar to the behavior of an AArch64 Software Step exception.

———— **Note** —————

- The example shown in [Figure G2-5 on page G2-4488](#) assumes an A32 instruction. The same behavior applies for both 32-bit and 16-bit T32 instructions.
- Software Step exceptions are the highest priority synchronous exception. Breakpoint exceptions are lower priority. See [Synchronous exception prioritization for exceptions taken to AArch64 on page D1-1827](#).

ITD control effects on address breakpoints on the first instruction in an IT block

In an implementation that supports the ITD control, if the value of the ITD field that applies to the current Exception level is 1, all of the following are true:

- An IT instruction can only be used to apply to one 16-bit T32 instruction.
- Only certain combinations of an IT instruction and second single 16-bit T32 instruction are permitted.
- For a permitted combination, it is **IMPLEMENTATION DEFINED** whether the implementation treats the combination as:
 - A pair of 16-bit instructions.
 - One 32-bit instruction.

If the implementation treats the combination as one 32-bit instruction, then as described in [Other usage constraints for Address breakpoints on page G2-4492](#), an Address breakpoint might not generate a Breakpoint exception for an address match only on the second halfword of the instruction.

For this reason, if the ITD bit associated with the current Exception level is 1, ARM recommends that a debugger that wants to program a breakpoint to match on the second T32 instruction programs it to match on the IT instruction instead.

However, if returning from an exception whose preferred return address is the address of the second T32 instruction, then because the debugger is aware that the implementation has treated the combination as a pair of 16-bit instructions, the debugger is permitted to program the breakpoint to match on the second T32 instruction.

The ITD control fields are:

HSCTLR.ITD Applies to execution at EL2 when EL2 is using AArch32.

SCTLR.ITD Applies to execution at EL0 or EL1 when EL1 is using AArch32.

SCTLR_EL1.ITD

Applies to execution at EL0 using AArch32 when EL1 is using AArch64.

An implementation that does not support the ITD control behaves as if the value of the ITD field is 0, and therefore the information in this section does not apply to such an implementation.

———— **Note** —————

Programming the breakpoint to match on the second T32 instruction might be necessary when using an Address Mismatch breakpoint for single stepping.

Breakpoint usage constraints

See the following sections:

- [Reserved DBGBCR<n>.BT values.](#)
- [Reserved DBGBCR<n>.{SSC, HMC, PMC} values on page G2-4491.](#)
- [Reserved DBGBCR<n>.BAS values on page G2-4491.](#)
- [Reserved DBGBCR<n>.LBN values on page G2-4492.](#)
- [Other usage constraints for Address breakpoints on page G2-4492.](#)
- [Other usage constraints for Context breakpoints on page G2-4493.](#)

Reserved DBGBCR<n>.BT values

Table G2-12 shows when particular DBGBCR<n>.BT values are reserved.

Table G2-12 Reserved BT values

BT value	Breakpoint type	Reserved
0b001x	Context ID Match	For non context-aware breakpoints
0b010x	Address Mismatch	If EDSCR.HDE is 1 and halting is allowed
0b011x	CONTEXTIDR_EL1 Match	When ARMv8.1-VHE is not implemented and breakpoints are not context-aware
0b100x	VMID Match	For non context-aware breakpoints, or if EL2 is not implemented
0b101x	Context ID and VMID Match	
0b110x	CONTEXTIDR_EL2 Match	When ARMv8.1-VHE is not implemented and breakpoints are not context-aware
0b111x	Full Context ID Match	

If a breakpoint is programmed with one of these reserved BT values:

- The breakpoint must behave as if it is either:
 - Disabled.

- Programmed with a BT value that is not reserved, other than for a direct or external read of [DBGBCR<n>](#).
- For a direct or external read of [DBGBCR<n>](#), if the reserved BT value:
 - Has no function for any execution conditions, the value read back is UNKNOWN.
 - Has a function for execution conditions other than the current execution conditions, the value read back is the value written. This permits software to save and restore the BT value so that the breakpoint functions for the other execution conditions.

The behavior of breakpoints with reserved BT values might change in future revisions of the architecture. For this reason, software must not rely on the behavior described here.

Reserved [DBGBCR<n>](#).{SSC, HMC, PMC} values

[Table G2-13](#) shows when particular combinations of [DBGBCR<n>](#).{SSC, HMC, PMC} are reserved in stage 1 of an AArch32 translation regime.

Table G2-13 Reserved HMC, SSC, and PMC combinations

HMC, SSC, and PMC combination	Reserved
All combinations with SSC set to 0b01 or 0b10.	When EL3 is not implemented and EL2 is implemented.
Any combination where HMC or SSC is nonzero, except for the combination with HMC set to 1, SSC set to 0b11, and PMC set to 0b00	When both of EL2 and EL3 are not implemented
The combination with HMC set to 1, SSC set to 0b11, and PMC set to 0b00	When EL2 is not implemented
Combinations not included in Table G2-10 on page G2-4481	Always

For all breakpoints except Linked Context breakpoints, if a breakpoint is programmed with one of these reserved combinations:

- If the reserved combination has a function for other execution conditions:
 - The breakpoint must behave as if it is disabled.
 - A direct or external read of [DBGBCR<n>](#).{SSC, HMC, PMC} returns the values written. This means that software can save and restore the combination so that the breakpoint can function for the other execution conditions.
- If the reserved combination does not have a function for other execution conditions:
 - It must behave either as if it is programmed with a combination that is not reserved or as if it is disabled.
 - A direct or external read of [DBGBCR<n>](#).{SSC, HMC, PMC} returns UNKNOWN values.

If the breakpoint is a Linked Context breakpoint, then:

- The values of HMC, SSC, and PMC are ignored.
- A direct or external read of [DBGBCR<n>](#).{SSC, HMC, PMC} returns UNKNOWN values

The behavior of breakpoints with reserved combinations of HMC, SSC, and PMC might change in future revisions of the architecture. For this reason, software must not rely on the behavior described here.

Reserved [DBGBCR<n>](#).BAS values

For all Context breakpoints

[DBGBCR<n>](#).BAS is RES1 and is ignored.

For all Address breakpoints

The supported values of the BAS field for the Address Match and Address Mismatch breakpoints are shown in [Specifying the halfword-aligned address that an Address breakpoint matches on on page G2-4482](#).

If a breakpoint is programmed with a reserved BAS value:

- The breakpoint must behave as if it is either:
 - Disabled.
 - Programmed with a BAS value that is not reserved, other than for a direct or external read of [DBGBCR<n>](#).
- A direct or external read of [DBGBCR<n>](#).BAS returns an UNKNOWN value.

Software must not rely on these properties as the behavior of reserved values might change in a future revision of the architecture.

Reserved [DBGBCR<n>](#).LBN values

For all Context breakpoints

[DBGBCR<n>](#).LBN reads UNKNOWN and its value is ignored.

For Linked Address breakpoints

A Linked Address breakpoint must link to a context-aware breakpoint. For a Linked Address breakpoint, any [DBGBCR<n>](#).LBN value that is not for a context-aware breakpoint is reserved.

If a Linked Address breakpoint links to a breakpoint that is not implemented, or that is not context-aware, then reads of [DBGBCR<n>](#).LBN return an UNKNOWN value and the behavior is CONSTRAINED UNPREDICTABLE. The Linked Address breakpoint behaves as if it is either:

- Disabled.
- Linked to an UNKNOWN context-aware breakpoint.

If a Linked Address breakpoint that links to a breakpoint that is implemented and that is context-aware, but that is either not enabled or not programmed as a Linked Context breakpoint, it behaves as if it is disabled.

For Unlinked Address breakpoints

[DBGBCR<n>](#).LBN reads UNKNOWN and its value is ignored.

Other usage constraints for Address breakpoints

For all Address breakpoints

- [DBGBVR<n>](#)[1:0] are RES0 and are ignored.
- The [DBGXVR<n>](#) is ignored.

For Address Match breakpoints

- For 32-bit instructions, if a breakpoint matches on the address of the second halfword but not the address of the first halfword, it is CONSTRAINED UNPREDICTABLE whether the breakpoint generates a Breakpoint exception.
- If [DBGBCR<n>](#).BAS is 0b1111, it is CONSTRAINED UNPREDICTABLE whether the breakpoint generates a Breakpoint exception for a T32 instruction starting at address $((\text{DBGBVR}\langle n \rangle[31:2]:00) + 2)$. For T32 instructions, ARM recommends that the debugger programs the BAS field with either 0b0011 or 0b1100.

For Address Mismatch breakpoints

The constraints are the same as those described in [For Address Match breakpoints](#), except that if two Address Mismatch breakpoints are programmed to match in the same Exception level and Security state, it is CONSTRAINED UNPREDICTABLE whether or not the instruction is stepped or a Breakpoint debug even is generated.

Other usage constraints for Context breakpoints

For all Context breakpoints

Any bits of `DBGBVR<n>` and `DBGBXVR<n>` that are not used to specify Context ID or VMID are RES0 and are ignored.

———— **Note** —————

This means that for Context ID Match breakpoints, the `DBGBXVR<n>` is RES0 and is ignored, and for VMID Match breakpoints, the `DBGBVR<n>` is RES0 and is ignored.

—————

For Linked Context breakpoints

If no Linked Address breakpoints or Linked Watchpoints link to a Linked Context breakpoint, the Linked Context breakpoint does not generate any Breakpoint exceptions.

G2.9.7 Exception syndrome information and preferred return address for a Breakpoint exception

See the following:

- [Exception syndrome information for a Breakpoint exception](#).
- [Preferred return address for a Breakpoint exception on page G2-4494](#).

———— **Note** —————

Usually, the term *exception syndrome* is used only for exceptions taken to Hyp mode, or to AArch64 state. The referenced section uses the term more generally, to include exception information reported in the [IFSR](#).

—————

Exception syndrome information for a Breakpoint exception

The PE takes a Breakpoint exception as either:

- A Prefetch Abort exception if it is taken to PL1. In this case, it is taken to Abort mode.
- A Hyp trap exception, if it is taken to PL2 because `HCR.TGE` or `HDCR.TDE` is 1. In this case, it is taken to Hyp mode.

If the exception is taken to:

Abort mode

The PE sets all of the following:

- `DBGDSCRExt.MOE` to 0b0001, to indicate a Breakpoint exception.
- `IFSR.FS` to the code for a debug exception, 0b00010.
- The [IFAR](#) with an UNKNOWN value.

Hyp mode

The PE does all of the following:

- Records information about the exception in the *Hypervisor Syndrome Register*, **HSR**. See [Table G2-14](#).
- Sets **DBGDSCRExt.MOE** to `0b0001`, to indicate a Breakpoint exception.
- Sets the **HIFAR** to an UNKNOWN value.

Table G2-14 Information recorded in the HSR

HSR field	Information recorded
<i>Exception Class</i> , EC	The PE sets this to the code for a Prefetch Abort exception routed to Hyp mode, <code>0x20</code> .
<i>Instruction Length</i> , IL	The PE sets this to 1.
<i>Instruction Specific Syndrome</i> , ISS	ISS[24:10] RES0. ISS[9] <i>External Abort type</i> (EA). The PE sets this to 0. ISS[8:6] RES0. ISS[5:0] <i>Instruction Fault Status Code</i> (IFSC). The PE sets this to the code for a debug exception, <code>0b100010</code> .

Note

For information about how debug exceptions can be routed to PL2, see [Routing debug exceptions on page G2-4459](#).

Preferred return address for a Breakpoint exception

The preferred return address of a Breakpoint exception is the address of the instruction that was not executed because the PE took the Breakpoint exception instead.

This means that the preferred return address is the address of the instruction that caused the exception.

G2.9.8 Pseudocode description of Breakpoint exceptions taken from AArch32 state

[AArch32.BreakpointValueMatch\(\)](#) returns a pair of results:

- A result for Address Match and Context breakpoints.
- A result for Address Mismatch breakpoints.

[AArch32.StateMatch\(\)](#) tests the values in **DBGBCR<n>**. {SSC, HMC, PMC} and, if the breakpoint links to a Linked Context breakpoint, also tests the Linked Context breakpoint.

[AArch32.BreakpointMatch\(\)](#) tests a committed instruction against all breakpoints.

[AArch32.CheckBreakpoint\(\)](#) generates a **FaultRecord**. A Breakpoint exception is taken if all of the following are true:

- **DBGDSCRExt.MDBGen** is 1.
- Debug exceptions are enabled from the current Exception level and Security state. See [Enabling debug exceptions from the current Privilege level and Security state on page G2-4461](#).
- All of the conditions required for Breakpoint exception generation are met. See [About Breakpoint exceptions on page G2-4470](#).

Note

[AArch32.CheckBreakpoint\(\)](#) might halt the PE and cause it to enter Debug state. External debug uses Debug state.

The `AArch32.Abort()` function processes the `FaultRecord` object returned by `AArch32.CheckBreakpoint()`, as described in *Abort exceptions on page G3-4555*. When a Breakpoint exception is taken to AArch32 state, the `AArch32.Abort()` function generates a Prefetch Abort exception.

G2.10 Watchpoint exceptions

This section describes Watchpoint exceptions in stage 1 of an AArch32 translation regime.

The PE is using an AArch32 translation regime when it is executing either:

- At EL1 or higher in an Exception level that is using AArch32.
- At EL0 using AArch32 when EL1 is using AArch32.

This section contains the following subsections:

- [About Watchpoint exceptions.](#)
- [Watchpoint types and linking of watchpoints on page G2-4498.](#)
- [Execution conditions for which a watchpoint generates Watchpoint exceptions on page G2-4499.](#)
- [Watchpoint data address comparisons on page G2-4500.](#)
- [Determining the memory location that caused a Watchpoint exception on page G2-4504.](#)
- [Watchpoint behavior on other instructions on page G2-4505.](#)
- [Usage constraints on page G2-4505.](#)
- [Exception syndrome information and preferred return address on page G2-4508.](#)
- [Pseudocode description of Watchpoint exceptions taken from AArch32 state on page G2-4509.](#)

G2.10.1 About Watchpoint exceptions

A *watchpoint* is an event that results from the execution of an instruction, based on a data address. Watchpoints are also known as *data breakpoints*.

A watchpoint operates as follows:

1. A debugger programs the watchpoint with a data address, or a data address range.
2. The watchpoint generates a *Watchpoint debug event* on an access to the address, or any address in the address range.

A watchpoint never generates a Watchpoint debug event on an instruction fetch.

An implementation can include between 2-16 watchpoints. In an implementation, [DBGDIDR.WRPs](#) shows how many are implemented.

To use an implemented watchpoint, a debugger programs the following registers for the watchpoint:

- The *Watchpoint Control Register*, [DBGWCR<n>](#). This holds control information for the watchpoint, for example an enable control.
- The *Watchpoint Value Register*, [DBGWVR<n>](#). This holds the data virtual address used for watchpoint matching.

The registers are numbered, so that:

- [DBGWCR1](#) and [DBGWVR1](#) are for watchpoint number one.
- [DBGWCR2](#) and [DBGWVR2](#) are for watchpoint number two.
- ...
- ...
- [DBGWCRn](#) and [DBGWVRn](#) are for watchpoint number n.

A watchpoint can:

- Be programmed to generate Watchpoint debug events on read accesses only, on write accesses only, or on both types of access.
- Link to a *Linked Context breakpoint*, so that a Watchpoint debug event is only generated if the PE is in a particular context when the address match occurs.

A single watchpoint can be programmed to match on one or more address bytes. A watchpoint generates a Watchpoint debug event on an access to any byte that it is watching. The number of bytes a watchpoint is watching is either:

- One to eight bytes, provided that these bytes are contiguous and that they are all in the same naturally-aligned doubleword. A debugger uses the *Byte Address Select* field, `DBGWCR<n>.BAS`, to select the bytes. See [Programming a watchpoint with eight bytes or fewer on page G2-4501](#).
- Eight bytes to 2GB, provided that both of the following are true:
 - The number of bytes is a power-of-two.
 - The range starts at an address that is aligned to the range size.
 A debugger uses the *MASK* field, `DBGWCR<n>.MASK`, to program a watchpoint with eight bytes to 2GB. See [Programming a watchpoint with eight or more bytes on page G2-4503](#).

A debugger must use either the *BAS* field or the *MASK* field. If it uses both, whether the watchpoint generates Watchpoint exceptions is `CONSTRAINED UNPREDICTABLE`. See [Programming dependencies of the *BAS* and *MASK* fields on page G2-4506](#).

For each memory access, all of the watchpoints are tested. When a watchpoint is tested, it generates a Watchpoint debug event if all of the following are true:

- The watchpoint is enabled. That is, the watchpoint enable control for it, `DBGWCR<n>.E`, is 1.
- The conditions specified in the `DBGWCR<n>` are met.
- The comparison with the address held in the `DBGWVR<n>` is successful.
- If the watchpoint links to a Linked Context breakpoint, the comparison or comparisons made by the Linked Context breakpoint are successful. See [on page G2-4474](#) shows this. See also [Breakpoint context comparisons on page G2-4487](#).
- The instruction that initiates the memory access is committed for execution.
- The instruction that initiates the memory access passes its Condition code check.

If halting is allowed and `EDSCR.HDE` is 1, Watchpoint debug events cause entry to Debug state.

Otherwise, if debug exceptions are:

- Enabled, Watchpoint debug events generate Watchpoint exceptions.
- Disabled, Watchpoint debug events are ignored.

———— **Note** —————

The remainder of this Watchpoint Exceptions section, including all subsections, describes watchpoints as generating Watchpoint exceptions.

However, the behavior described also applies if watchpoints are causing entry to Debug state.

[The debug exception enable controls on page G2-4458](#) describes the enable controls for Watchpoint debug events.

G2.10.2 Watchpoint types and linking of watchpoints

When a debugger programs a watchpoint, it must program that watchpoint so that it is either:

- Used in isolation. In this case, the watchpoint is called an *Unlinked watchpoint*.
- Enabled for linking to a Linked Context breakpoint. In this case, the watchpoint is called a *Linked watchpoint*.

When a Linked watchpoint links to a Linked Context breakpoint, the Linked watchpoint only generates a Watchpoint exception if the PE is in a particular context when the data address match occurs. For example, a debugger might:

1. Program watchpoint number one with a data address.
2. Program breakpoint number five to be a *Linked VMID Match breakpoint*.
3. Link the watchpoint and the breakpoint together. A Watchpoint exception is only generated if both the data address matches and the VMID matches.

The *Watchpoint Type* field for a watchpoint, `DBGWCR<n>.WT`, controls whether the watchpoint is enabled for linking. If `DBGWCR<n>.WT` is 1, the watchpoint is enabled for linking.

Rules for linking watchpoints

The rules for watchpoint linking are as follows:

- Only Linked watchpoints can be linked.
- A Linked watchpoint can link to any type of Linked Context breakpoint. The *Linked Breakpoint Number* field, `DBGWCR<n>.LBN`, for the Linked watchpoint specifies the particular Linked Context breakpoint that the Linked watchpoint links to, and:
 - `DBGWCR<n>.WT`. {SSC, HMC, PAC} for the Linked watchpoint define the execution conditions that the watchpoint generates Watchpoint exceptions for. See [Execution conditions for which a watchpoint generates Watchpoint exceptions on page G2-4499](#).
 - `DBGBCR<n>`. {SSC, HMC, PMC} for the Linked Context breakpoint are ignored.
- A Linked watchpoint cannot link to another watchpoint. The LBN field can therefore only specify a breakpoint.
- If a Linked watchpoint links to a breakpoint that is not context-aware, the behavior of the Linked watchpoint is CONSTRAINED UNPREDICTABLE. See [Usage constraints on page G2-4505](#).
- If a Linked watchpoint links to an Unlinked Context breakpoint, the Linked watchpoint never generates any Watchpoint exceptions.
- Multiple Linked watchpoints can link to a single Linked Context breakpoint.

———— **Note** —————

Multiple Address breakpoints can also link to a single Linked Context breakpoint. [Breakpoint exceptions on page G2-4470](#) describes breakpoints.

Figure G2-2 on page G2-4474 shows an example of permitted watchpoint linking.

G2.10.3 Execution conditions for which a watchpoint generates Watchpoint exceptions

Each watchpoint can be programmed so that it only generates Watchpoint exceptions for certain execution conditions. For example, a watchpoint might be programmed to generate Watchpoint exceptions only when the PE is executing at EL2.

`DBGWCR<n>.{SSC, HMC, PAC}` define the execution conditions a watchpoint generates Watchpoint exceptions for, as follows:

Security State Control, SSC

Controls whether the watchpoint generates Watchpoint exceptions only in Secure state, only in Non-secure state, or in both Security states.

———— **Note** —————

This is determined by the Security state of the PE, not from the NS attribute returned by the translation of the virtual address on which the watchpoint is set.

Higher Mode Control, HMC, and Privileged Access Control, PAC

HMC and PAC together control which Privilege level the watchpoint generates Watchpoint exceptions in.

The PAC control relates to the privilege of the memory access, not to the Exception level or Privilege level at which the access was made.

———— **Note** —————

This means that, if the PE executes a Load unprivileged or Store unprivileged instruction at PL1, the resulting data access triggers a watchpoint only if both:

- PAC is programmed to a value that generates watchpoints on PL0 accesses.
- All other conditions for generating the watchpoint are met.

Example A32/T32 Load unprivileged and Store unprivileged instructions are LDRT and STRT.

Table G2-15 on page G2-4500 shows the valid combinations of HMC, SSC, and PAC, and for each combination shows which Privilege levels watchpoints generate Watchpoint exceptions in.

In the table:

- Y or -** Means that a watchpoint programmed with the values of HMC, SSC, and PAC shown in that row:
- Y** Can generate Watchpoint exceptions at that Privilege level.
 - Cannot generate Watchpoint exceptions at that Privilege level.
- Res** Means that the combination of HMC, SSC, and PAC is reserved. See *Reserved DBGWCR<n>.{SSC, HMC, PAC} values* on page G2-4506.

Table G2-15 Summary of watchpoint HMC, SSC, and PAC encodings

HMC	SSC	PAC	Security state the watchpoint is programmed to match in	PL2 ^a	PL1	PL0	Implementation	
							No EL3	No EL2 and no EL3
0	00	01	Both	-	Y	-	-	-
0	00	10		-	-	Y	-	-
0	00	11		-	Y	Y	-	-
0	01	01	Non-secure	-	Y	-	Res	Res
0	01	10		-	-	Y	Res	Res
0	01	11		-	Y	Y	Res	Res
0	10	01	Secure	-	Y	-	Res	Res
0	10	10		-	-	Y	Res	Res
0	10	11		-	Y	Y	Res	Res
1	00	01	Both	Y	Y	-	-	Res
1	00	11		Y	Y	Y	-	Res
1	01	01	Non-secure	Y	Y	-	Res	Res
1	01	11		Y	Y	Y	Res	Res
1	10	01	Secure	-	Y	-	Res	Res
1	10	11		-	Y	Y	Res	Res
1	11	00	Non-secure	Y	-	-	-	Res if no EL2 ^b

- a. Debug exceptions are not generated at PL2 using AArch32. This means that these combinations of HMC, SSC, and PAC are only relevant if watchpoints cause entry to Debug state. Self-hosted debuggers must avoid combinations of HMC, SSC, and PAC that generate Watchpoint exceptions at PL2 using AArch32.
- b. This encoding is only reserved when EL2 is not implemented, regardless of whether EL3 is implemented.

All combinations of HMC, SSC, and PAC that this table does not show are reserved. See *Reserved DBGWCR<n>.{SSC, HMC, PAC} values on page G2-4506*.

G2.10.4 Watchpoint data address comparisons

An address comparison is successful if bits [31:2] of the current data virtual address are equal to `DBGWVR<n>[31:2]`, taking into account all of the following:

- The size of the access. See *Size of the data access on page G2-4501*.
- The bytes selected by `DBGWVR<n>.BAS`. See *Programming a watchpoint with eight bytes or fewer on page G2-4501*.
- Any address ranges indicated by `DBGWVR<n>.MASK`. See *Programming a watchpoint with eight or more bytes on page G2-4503*.

———— **Note** —————
`DBGWVR<n>[1:0]` are RES0 and are ignored.

Size of the data access

Because watchpoints can be programmed to generate Watchpoint exceptions on individual bytes, the size of each access must be taken into account. See [Example G2-1](#).

Example G2-1

1. A debugger programs a watchpoint to generate Watchpoint exceptions only when the byte at address 0x1009 is accessed.
2. The PE accesses the unaligned doubleword starting at address 0x1003.

In this scenario, the watchpoint must generate a Watchpoint exception.

The size of data accesses initiated by DCIMVAC instructions is an IMPLEMENTATION DEFINED size that is both:

- From the inclusive range between:
 - The size that [CTR.DminLine](#) defines.
 - 2KB.
- A power-of-two.

The lowest address accessed by a DCIMVAC instruction is the address supplied to the instruction, rounded down to the nearest multiple of the access size initiated by that instruction.

The highest address accessed is (size - 1) bytes above the lowest address accessed.

See also, [Watchpoint behavior on accesses by DCIMVAC instructions](#) on page G2-4505.

Programming a watchpoint with eight bytes or fewer

The Byte Address Select field, [DBGWCR<n>.BAS](#), selects which bytes in the doubleword starting at the address contained in the [DBGWVR<n>](#) the watchpoint generates Watchpoint exceptions for.

If the address programmed into the [DBGWVR<n>](#) is:

- Doubleword-aligned:
 - All eight bits of [DBGWCR<n>.BAS](#) are used, and the descriptions given in [Table G2-16](#) apply.
- Word-aligned but not doubleword-aligned:
 - Only [DBGWCR<n>.BAS\[3:0\]](#) are used, and the descriptions given in [Table G2-17 on page G2-4502](#) apply. In this case, [DBGWCR<n>.BAS\[7:4\]](#) are RES0.

Table G2-16 Supported BAS values when the DBGWVRn address alignment is doubleword

BAS value	Description
0b00000000	Watchpoint never generates a Watchpoint exception
BAS[0] == 1	Generates a Watchpoint exception if byte at address DBGWVR<n>[31:3]:000 is accessed
BAS[1] == 1	Generates a Watchpoint exception if byte at address DBGWVR<n>[31:3]:001 is accessed
BAS[2] == 1	Generates a Watchpoint exception if byte at address DBGWVR<n>[31:3]:010 is accessed
BAS[3] == 1	Generates a Watchpoint exception if byte at address DBGWVR<n>[31:3]:011 is accessed
BAS[4] == 1	Generates a Watchpoint exception if byte at address DBGWVR<n>[31:3]:100 is accessed

Table G2-16 Supported BAS values when the DBGWVRn address alignment is doubleword

BAS value	Description
BAS[5] == 1	Generates a Watchpoint exception if byte at address <code>DBGWVR<n>[31:3]:101</code> is accessed
BAS[6] == 1	Generates a Watchpoint exception if byte at address <code>DBGWVR<n>[31:3]:110</code> is accessed
BAS[7] == 1	Generates a Watchpoint exception if byte at address <code>DBGWVR<n>[31:3]:111</code> is accessed

Table G2-17 Supported BAS values when the DBGWVRn address alignment is word

BAS value ^a	Description
0b00000000	Watchpoint never generates a Watchpoint exception
BAS[0] == 1	Generates a Watchpoint exception if byte at address <code>DBGWVR<n>[31:2]:00</code> is accessed
BAS[1] == 1	Generates a Watchpoint exception if byte at address <code>DBGWVR<n>[31:2]:01</code> is accessed
BAS[2] == 1	Generates a Watchpoint exception if byte at address <code>DBGWVR<n>[31:2]:10</code> is accessed
BAS[3] == 1	Generates a Watchpoint exception if byte at address <code>DBGWVR<n>[31:2]:11</code> is accessed

a. `DBGWCR<n>.BAS[7:4]` are RES0.

If the BAS field is programmed with more than one byte, the bytes that it is programmed with must be contiguous. For watchpoint behavior when its BAS field is programmed with non-contiguous bytes, see *Other usage constraints on page G2-4507*.

When programming the BAS field with anything other than 0b11111111, a debugger must also program `DBGWCR<n>.MASK` to be 0b000000. See *Programming dependencies of the BAS and MASK fields on page G2-4506*.

A watchpoint generates a Watchpoint exception whenever a watched byte is accessed, even if:

- The access size is smaller or larger than the address region being watched.
- The access is misaligned, and the base address of the access is not in the doubleword or word of memory addressed by the `DBGWVR<n>[31:3]`. See *Example G2-1 on page G2-4501*.

The following are some example configurations of the BAS field:

- To program a watchpoint to generate a Watchpoint exception on the byte at address 0x1003, program:
 - `DBGWVR<n>` with 0x1000.
 - `DBGWCR<n>_EL1.BAS` to be 0b00001000.
- To program a watchpoint to generate a Watchpoint exception on the bytes at addresses 0x2003, 0x2004 and 0x2005, program:
 - `DBGWVR<n>` with 0x2000.
 - `DBGWCR<n>_EL1.BAS` to be 0b00111000.
- If the address programmed into the `DBGWVR<n>` is doubleword-aligned:
 - To generate a Watchpoint exception when any byte in the word starting at the doubleword-aligned address is accessed, program `DBGWCR<n>.BAS` to be 0b00001111.
 - To generate a Watchpoint exception when any byte in the word starting at address `DBGWVR<n>[31:3]:100` is accessed, program `DBGWCR<n>.BAS` to be 0b11110000.

Note

ARM deprecates programming a [DBGWVR<n>](#) with an address that is not doubleword-aligned.

Programming a watchpoint with eight or more bytes

A debugger can use the *MASK* field, [DBGWCR<n>.MASK](#), to program a single watchpoint with a data address range. The data address range must meet all of the following criteria:

- It is a size that is both:
 - A power-of-two.
 - A minimum of eight bytes.
 - A maximum of 2GB.
- It starts at an address that is aligned to the size.

The *MASK* field specifies the number of least significant data address bits that must be masked. Up to 31 least significant bits can be masked:

MASK	0b00000	No bits are masked.
	0b00001	Reserved.
	0b00010	Reserved.
	0b00011	Three least significant bits are masked.
	0b00100	Four least significant bits are masked.
	0b00101	Five least significant bits are masked.

	0b11111	31 least significant bits are masked.

If *n* least significant address bits are masked, the watchpoint generates a Watchpoint exception on all of the following:

- Address [DBGWVR<n>](#)[31:*n*]:000...
- Address [DBGWVR<n>](#)[31:*n*]:111...
- Any address between these two addresses.

For example, if the four least significant address bits are masked, Watchpoint exceptions are generated for all addresses between [DBGWVR<n>](#)[31:4]:0000 and [DBGWVR<n>](#)[31:4]:1111, including these addresses.

Note

- The most significant bit cannot be masked. This means that the full address cannot be masked.
 - For watchpoint behavior when its *MASK* field is programmed with a reserved value, see [Reserved DBGWCR<n>.MASK values on page G2-4507](#).
-

When masking address bits, a debugger must both:

- Program [DBGWCR<n>.BAS](#) to be 0b11111111. See [Programming dependencies of the BAS and MASK fields on page G2-4506](#).
- In the [DBGWVR<n>](#), set the masked address bits to 0. For watchpoint behavior when any of the masked address bits are not 0, see [Other usage constraints on page G2-4507](#).

G2.10.5 Determining the memory location that caused a Watchpoint exception

On a Watchpoint exception, the PE records an address in a *Fault Address Register* that the debugger can use to determine the memory location that triggered the watchpoint.

The Fault Address Register (FAR) used is either:

- [DFAR](#), if the exception is taken to PL1.
- [HDFAR](#), if the exception is taken to PL2.

In cases where one instruction triggers multiple watchpoints, only one address is recorded.

On entering Debug state on a Watchpoint debug event, the PE records the address in the [EDWAR](#).

Note

If Debug state was entered from AArch32 state, then [EDWAR](#)[63:32] is UNKNOWN and must be ignored by the debugger.

For more information, see the subsections that follow. These are:

- [Address recorded for Watchpoint exceptions generated by instructions other than Data Cache instructions.](#)
- [Address recorded for Watchpoint exceptions generated by Data Cache instructions on page G2-4505.](#)

Address recorded for Watchpoint exceptions generated by instructions other than Data Cache instructions

The address recorded must be both:

- From the inclusive range between:
 - The lowest address accessed by the memory access that triggered the watchpoint.
 - The highest *watchpointed address* accessed by the memory access. A watchpointed address is an address that the watchpoint is watching.
- Within a naturally-aligned block of memory that is all of the following:
 - A power-of-two size.
 - No larger than 2KB.
 - No larger than the block size used by the A64 [DC ZVA](#) instruction.

Note

There are no architectural means to discover the A64 [DC ZVA](#) instruction block size from AArch32 state.

- Contains a watchpointed address accessed by the memory access.

The size of the block is IMPLEMENTATION DEFINED. There is no architectural means of discovering the size.

Example G2-2 Address recorded for a watchpoint programmed on 0x8019

A debugger programs a watchpoint to generate a Watchpoint exception on any access to the byte 0x8019.

An A32 load multiple instruction then loads nine registers starting from address 0x8004 upwards. This triggers the watchpoint.

If the DC ZVA block size is:

- 32 bytes, the address that the PE records must be between 0x8004 and 0x8019 inclusive.
 - 16 bytes, the address that the PE records must be between 0x8010 and 0x8019 inclusive.
-

Address recorded for Watchpoint exceptions generated by Data Cache instructions

The address recorded is the address passed to the instruction. This means that the address recorded might be higher than the address of the location that triggered the watchpoint.

G2.10.6 Watchpoint behavior on other instructions

Under normal operating conditions, the following do not generate Watchpoint exceptions:

- Instruction cache maintenance instructions.
- Address translation instructions.
- TLB maintenance instructions.
- Preload instructions.
- All data cache maintenance instructions except DCIMVAC.

However, the debug architecture allows for IMPLEMENTATION DEFINED controls, such as those in ACTLR registers, to enable watchpoints on an IMPLEMENTATION DEFINED subset of these instructions. Whether a watchpoint treats the instruction as a load or a store, and the access size of instruction cache, address translation, and TLB operations are IMPLEMENTATION DEFINED.

The access size of the IMPLEMENTATION DEFINED instruction cache, address translation, and TLB operations which generate Watchpoint exceptions are IMPLEMENTATION DEFINED.

See also:

- [Watchpoint behavior on accesses by Store-Exclusive instructions.](#)
- [Watchpoint behavior on accesses by DCIMVAC instructions.](#)

Watchpoint behavior on accesses by Store-Exclusive instructions

If a watchpoint matches on a data access caused by a Store-Exclusive instruction, then:

- If the store fails because an Exclusives monitor does not permit it, it is IMPLEMENTATION DEFINED whether the watchpoint generates a Watchpoint exception.
- Otherwise, the watchpoint generates a Watchpoint exception.

Watchpoint behavior on accesses by DCIMVAC instructions

It is IMPLEMENTATION DEFINED whether DCIMVAC operations can generate Watchpoint exceptions. If they can, they are treated as data stores. This means that for a watchpoint to match on an access caused by a DCIMVAC instruction, the debugger must program `DBGWCR<n>.LSC` to be one of the following:

- 10** Match on data stores only.
- 11** Match on data stores and data loads.

———— Note —————

For the size of data accesses performed by DCIMVAC instructions, see [Watchpoint data address comparisons on page G2-4500](#). The size of all data accesses must be considered because watchpoints can be programmed to match on individual bytes.

G2.10.7 Usage constraints

See the following:

- [Reserved `DBGWCR<n>.{SSC, HMC, PAC}` values on page G2-4506.](#)
- [Reserved `DBGWCR<n>.LBN` values on page G2-4506.](#)
- [Programming dependencies of the `BAS` and `MASK` fields on page G2-4506.](#)
- [Reserved `DBGWCR<n>.BAS` values on page G2-4507.](#)
- [Reserved `DBGWCR<n>.MASK` values on page G2-4507.](#)
- [Other usage constraints on page G2-4507.](#)

Reserved DBGWCR<n>.{SSC, HMC, PAC} values

Table G2-18 shows when particular combinations of DBGWCR<n>.{SSC, HMC, PAC} are reserved.

Table G2-18 Reserved SSC, HMC, and PAC combinations

HMC, SSC, and PMC combination	Reserved
All combinations with SSC set to 0b01 or 0b10.	When EL3 is not implemented and EL2 is implemented.
All combinations where HMC or SSC is nonzero, except for the combination with HMC set to 1, SSC set to 0b11, and PMC set to 0b00.	When both of EL2 and EL3 are not implemented
The combination with HMC set to 1, SSC set to 0b11, and PMC set to 0b00.	When EL2 is not implemented
Combinations not included in Table G2-15 on page G2-4500.	Always

If a watchpoint is programmed with one of these reserved combinations:

- The watchpoint must behave as if it is either:
 - Disabled.
 - Programmed with a combination that is not reserved, other than for a direct or external read of DBGWCR<n>.
- For a direct or external read of DBGWCR<n>, if the reserved combination:
 - Has no function for any execution conditions, the value read back for each of SSC, HMC, and PMC is UNKNOWN.
 - Has a function for execution conditions other than the current execution conditions, the value read back is the value written. This permits software to save and restore the combination so that the watchpoint functions for the other execution conditions.

The behavior of watchpoints with reserved combinations of SSC, HMC, and PAC might change in future revisions of the architecture. For this reason, software must not rely on the behavior described here.

Reserved DBGWCR<n>.LBN values

For Linked watchpoints

A Linked watchpoint must link to a context-aware breakpoint. For a Linked watchpoint, any DBGWCR<n>.LBN value that is not for a context-aware breakpoint is reserved.

If a Linked watchpoint links to a breakpoint that is not implemented, or that is not context-aware, then reads of DBGWCR<n>.LBN return an UNKNOWN value and the behavior is CONSTRAINED UNPREDICTABLE. The Linked watchpoint behaves as if it is either:

- Disabled.
- Linked to an UNKNOWN context-aware breakpoint.

If a Linked watchpoint links to a breakpoint that is implemented and is context-aware, but that is either not enabled or not programmed as a Linked Context breakpoint, it behaves as if it is disabled.

For Unlinked watchpoints

For Unlinked watchpoints, DBGWCR<n>.LBN reads UNKNOWN and its value is ignored.

Programming dependencies of the BAS and MASK fields

When programming a watchpoint, a debugger must use either:

- The MASK field, to program the watchpoint with an address range that can be eight bytes to 2GB.
- The BAS field, to select which bytes in the doubleword or word starting at the address contained in the DBGWVR<n> the watchpoint must generate Watchpoint exceptions for.

If the debugger uses the:

- MASK field, it must program BAS to be 0b11111111, so that all bytes in the doubleword or word are selected.
- BAS field, it must program MASK to be 0b000000, so that the MASK field does not indicate any address ranges.

If an enabled watchpoint has a MASK field that is non-zero and a BAS field that is not set to 0b11111111, then for each byte in the address range, it is CONSTRAINED UNPREDICTABLE whether or not a Watchpoint exception is generated.

Reserved DBGWCR<n>.BAS values

The BAS field must be programmed with a value `Zeros(8-n-m):Ones(n):Zeros(m)`, where:

- n is a non-zero positive integer less-than-or-equal-to 8.
- m is a positive integer less-than 8.
- n+m is less-than-or-equal-to 8.

All other values are reserved.

———— Note —————

If x is zero, then `Zeros(x)` is an empty bitstring.

If `DBGWVR<n>[2]` is 1, `DBGWCR<n>.BAS[7:4]` are RES0 and are ignored.

If a watchpoint is programmed with a reserved BAS value:

- It is CONSTRAINED UNPREDICTABLE whether the watchpoint generates a Watchpoint exception for each byte in the doubleword or word of memory addressed by the `DBGWVR<n>`.
- A direct or external read of `DBGWCR<n>.BAS` returns an UNKNOWN value.

Software must not rely on these properties as the behavior of reserved values might change in a future revision of the architecture.

Reserved DBGWCR<n>.MASK values

If a watchpoint is programmed with a reserved MASK value:

- The watchpoint must behave as if it is either:
 - Disabled.
 - Programmed with an UNKNOWN value that is not reserved, that might be 0b000000, other than for a direct or external read of `DBGWCR<n>`.
- A direct or external read of `DBGWCR<n>.MASK` returns an UNKNOWN value.

Other usage constraints

For all watchpoints:

- `DBGWVR<n>[1:0]` are RES0 and are ignored.
- If `DBGWCR<n>.MASK` is nonzero, and any masked bits of `DBGWVR<n>` are not 0, it is CONSTRAINED UNPREDICTABLE whether the watchpoint generates a Watchpoint exception when the unmasked bits match.
- A watchpoint never generates any Watchpoint exceptions if `DBGWCR<n>.LSC` is 0b00.

G2.10.8 Exception syndrome information and preferred return address

See the following:

- [Exception syndrome information](#).
- [Preferred return address on page G2-4509](#).

Exception syndrome information

The PE takes a Watchpoint exception as either:

- A Data Abort exception, if it is taken to PL1. In this case, it is taken to Abort mode.
- A Hyp trap exception, if it is taken to PL2 because `HCR.TGE` or `HDCR.TDE` is 1. In this case, it is taken to Hyp mode.

If the exception is taken to:

Abort mode

The PE sets all of the following:

- `DBGDSCRExt.MOE` to `0b1010`, to indicate a Watchpoint exception.
- `DFSR.CM` to indicate whether a cache maintenance instruction caused the exception.
- `DFSR.WnR` to indicate whether the exception was generated on a read instruction or a write instruction.
- `DFAR` to an address that the debugger can use to determine the memory location that triggered the watchpoint. See [Determining the memory location that caused a Watchpoint exception on page G2-4504](#).

In addition, if using the:

- Short-descriptor format, the PE sets `DFSR.FS` to the code for a debug exception, `0b00010`, and `DFSR.Domain` to an UNKNOWN value.
- Long-descriptor format, the PE sets `DFSR.STATUS` to the code for a debug exception, `0b100010`.

Hyp mode

The PE does all of the following:

- Records information about the exception in the *Hypervisor Syndrome Register*, `HSR`. See [Table G2-19 on page G2-4509](#).
- Sets `DBGDSCRExt.MOE` to `0b1001`, to indicate a Watchpoint exception.
- Sets the `HDFAR` to an address that the debugger can use to determine the memory location that triggered the watchpoint. See [Determining the memory location that caused a Watchpoint exception on page G2-4504](#).

Table G2-19 Information recorded in the HSR

HSR field	Information recorded
<i>Exception Class</i> , EC	The PE sets this to the code for a Data Abort exception routed to Hyp mode, 0x24.
<i>Instruction Length</i> , IL	The PE sets this to 1.
<i>Instruction Specific Syndrome</i> , ISS	ISV[24] <i>Instruction Syndrome Valid</i> (ISV). The PE sets this to 0. ISS[23:10] RES0. ISS[9] <i>External Abort type</i> (EA). The PE sets this to 0. ISS[8] <i>Cache Maintenance</i> (CM). The PE sets this to indicate whether a cache maintenance instruction caused the exception. ISS[7] RES0. ISS[6] <i>Write not Read</i> (WnR). The PE sets this to indicate whether the exception was generated on a read instruction or a write instruction. ISS[5:0] <i>Data Fault Status Code</i> (DFSC). The PE sets this to the code for a debug exception, 0b100010.

Note

For information about how debug exceptions can be routed to PL2, see [Routing debug exceptions on page G2-4459](#).

Preferred return address

The preferred return address of a Watchpoint exception is the address of the instruction that was not executed because the PE took the Watchpoint exception instead.

This means that the preferred return address is the address of the instruction that caused the exception.

G2.10.9 Pseudocode description of Watchpoint exceptions taken from AArch32 state

`AArch32.WatchpointByteMatch()` tests an individual byte accessed by an operation.

`AArch32.StateMatch()` tests the values in `DBGWCR<n>`. {HMC, SSC, PAC}, and if the watchpoint is Linked, also tests the Linked Context breakpoint that the watchpoint links to.

`AArch32.WatchpointMatch()` tests the value in `DBGWVR<n>`.

`AArch32.CheckWatchpoint()` generates a `FaultRecord`. A Watchpoint exception is taken if all of the following are true:

- `DBGDSCExt.MDBGen` is 1.
- Debug exceptions are enabled from the current Exception level and Security state. See [Enabling debug exceptions from the current Privilege level and Security state on page G2-4461](#).
- All of the conditions required for Watchpoint exception generation are met. See [About Watchpoint exceptions on page G2-4496](#).

Note

`AArch32.CheckWatchpoint` might halt the PE and cause it to enter Debug state. External debug uses Debug state.

The `AArch32.Abort()` function processes the `FaultRecord` object returned by `AArch32.CheckWatchpoint()`, as described in [Abort exceptions on page G3-4555](#). If a Watchpoint exception is taken to AArch32 state, the `AArch32.Abort()` function generates a Data Abort exception.

G2.11 Vector Catch exceptions

ARM deprecates the use of vector catch.

This section describes Vector Catch exceptions in stage 1 of an AArch32 translation regime.

The PE is using an AArch32 translation regime when it is executing either:

- At EL1 or higher in an Exception level that is using AArch32.
- At EL0 using AArch32 when EL1 is using AArch32.

Note

Vector Catch exceptions cannot be generated when the PE is using an AArch64 translation regime.

This section contains the following subsections:

- [About Vector Catch exceptions.](#)
- [Exception vectors that Vector Catch exceptions can be enabled for on page G2-4512.](#)
- [Generation of Vector Catch exceptions on page G2-4513.](#)
- [Usage constraints on page G2-4515.](#)
- [Exception syndrome information and preferred return address for a Vector Catch exception on page G2-4516.](#)
- [Pseudocode description of Vector Catch exceptions on page G2-4517.](#)

G2.11.1 About Vector Catch exceptions

Whenever the PE takes an exception, execution is forced to an address that is the *exception vector* for that exception. Vector catch permits a debugger to trap exceptions based on the exception vector, or based on the exception type associated with the exception vector, as follows:

- If the *address-matching* form of vector catch is implemented, the debugger can trap exceptions based on the exception vector.
- If the *exception-trapping* form of vector catch is implemented, the debugger can trap exceptions based on the exception type associated with the exception vector.

The ARMv8-A architecture supports only these two forms of vector catch. Only one form can be implemented, and which is implemented is IMPLEMENTATION DEFINED. The [DBGDEVID](#) indicates which form is implemented.

Regardless of the form of vector catch implemented, a debugger enables Vector Catch exceptions for exception vectors or types by programming the [DBGVCR](#). This register contains *vector catch enable bits*. Each of these bits corresponds to a different vector. When a debugger sets a vector catch enable bit to 1, Vector Catch exceptions are enabled for the corresponding exception vector or type.

Note

EL2 using AArch64 or EL3 using AArch64 can enable Vector Catch exceptions for vectors by programming the [DBGVCR32_EL2](#). The [DBGVCR32_EL2](#) is architecturally mapped to the [DBGVCR](#).

When Vector Catch exceptions are enabled for an exception vector, this is called an *enabled vector catch*. The set of exception vectors that Vector Catch exceptions are enabled for is called the *enabled vector catch set*.

If the form of vector catch implemented is the:

Address-matching form:

The PE compares the virtual address of each instruction in the program flow with a subset of the enabled vector catch set.

If an address match occurs, a Vector Catch exception is generated when the instruction that caused the match is committed for execution.

Exception-trapping form

Whenever the PE takes an exception, if the vector the exception is taken to is included in a subset of the enabled vector catch set, a Vector Catch exception is generated.

The Vector Catch exception is generated as part of entry to the exception, and must be taken before the PE either executes any instructions or takes any further exceptions.

The addresses that comprise the subset depend on whether EL3 is implemented and, for the:

- Address-matching form, the current Security state.
- Exception-trapping form, the Security state that the exception is handled in.

See [Generation of Vector Catch exceptions on page G2-4513](#).

[Table G2-20](#) summarizes the differences between the address-matching and exception-trapping forms.

Table G2-20 Differences in behavior of the address-matching and exception-trapping forms of vector catch

Address-matching	Exception-trapping
<p>An enabled vector catch generates a Vector Catch exception when an instruction that is fetched from the vector is committed for execution.</p> <p>This means that spurious Vector Catch exceptions might occur, where the Vector Catch exception does not result from an exception entry, but is instead caused by a branch to the vector.</p> <p>A branch to the vector might occur, for example, on a return from a nested exception or when simulating an exception entry.</p>	<p>An enabled vector catch generates a Vector Catch exception immediately after the PE takes the exception that is associated with the vector.</p> <p>This means that Vector Catch exceptions always result from exception entry, and not from branches to exception vectors.</p>
<p>A Vector Catch exception is generated as a result of an instruction fetch. This means that the Vector Catch exception has a priority relative to the other synchronous exceptions that result from an instruction fetch.</p> <p>Synchronous exception prioritization for exceptions taken to AArch64 on page D1-1827 describes this prioritization.</p>	<p>A Vector Catch exception is generated as a result of an exception entry. This means that the Vector Catch exception is part of the exception that caused the Vector Catch exception. Therefore, the Vector Catch exception has no priority associated with it.</p> <p>For this reason, Vector Catch exceptions are outside the scope of the prioritization that Synchronous exception prioritization for exceptions taken to AArch64 on page D1-1827 describes.</p>
<p>A Vector Catch exception can be preempted by another exception. If this happens, the Vector Catch exception is generated again when the exception handler branches back to the vector.</p>	<p>Vector Catch exceptions must be taken before other exceptions.</p>
<p>A Vector Catch exception can be generated as a result of an instruction fetch executed in any AArch32 mode except Hyp mode, including User mode.</p>	<p>Because a Vector Catch exception is generated as the result of an exception entry, the Vector Catch exception is only generated when the PE is in the AArch32 exception handling mode.</p>
<p>If <code>HCR.TGE</code> is 1, Vector Catch exceptions can be generated for User mode instruction fetches from Non-secure PL1 vectors.</p>	<p>If <code>HCR.TGE</code> is 1, Vector Catch exceptions are never generated in Non-secure state, because:</p> <ul style="list-style-type: none"> • Exceptions are routed away from Non-secure PL1 vectors, to PL2. • The architecture does not provide vector catch enable bits for the Hyp exception vectors.

Depending on the implementation, some vector catch enable bits in the `DBGVCR` might be RES0. For example, if EL3 is not implemented or is implemented but is using AArch64, Monitor mode is not implemented, and so the enable bits for exception vectors for exceptions taken to Monitor mode are RES0. See [Exception vectors that Vector Catch exceptions can be enabled for on page G2-4512](#) for the vector catch enable bits that exist for different implementations.

[The debug exception enable controls on page G2-4458](#) describes the enable controls for Vector Catch exceptions.

G2.11.2 Exception vectors that Vector Catch exceptions can be enabled for

When the PE takes an exception, the exception vector is contained in a *vector table* at the Privilege level the exception is taken to.

Depending on the Security state and AArch32 mode the exception is taken to, when the exception is taken, the vector table used is the table that contains one of:

- *Local exception vectors.*
- *Non-secure Local exception vectors.*
- *Secure Local exception vectors.*
- *Hyp exception vectors.*
- *Monitor exception vectors.*

Table G2-21 shows which vector tables are implemented for different implementations. In the table:

- A dash, -, means that the Exception level is not implemented.
- 64 means that the Exception level is using AArch64.
- 32 means that the Exception level is using AArch32.

Table G2-21 Vector tables implemented for different implementations

Implementation				Vector table or tables implemented
EL0	EL1	EL2	EL3	
32	32	-	-	Local exception vectors.
		64	-	Non-secure Local exception vectors.
		32	-	Non-secure Local exception vectors. Hyp exception vectors.
		-	64	Secure Local exception vectors. Non-secure Local exception vectors.
		-	32	Secure Local exception vectors. Non-secure Local exception vectors. Monitor exception vectors.
		64	64	Secure Local exception vectors. Non-secure Local exception vectors.
		32	64	Secure Local exception vectors. Non-secure Local exception vectors. Hyp exception vectors.
		32	32	Secure Local exception vectors. Non-secure Local exception vectors. Hyp exception vectors. Monitor exception vectors.

For example, in an AArch32-only implementation that includes EL0, EL1, and EL3, when the PE takes an exception to Monitor mode, it uses the vector table containing Monitor exception vectors.

The tables that follow show the vectors that Vector Catch exceptions can be enabled for, and their corresponding vector catch enable bits in the **DBGVCR**:

- [Table G2-22](#) shows the Local exception vectors, Secure Local exception vectors, and Non-secure Local exception vectors that Vector Catch exceptions can be enabled for.
- [Table G2-23](#) shows the Monitor exception vectors that Vector Catch exceptions can be enabled for.

The ARMv8-A architecture does not provide vector catch enable bits for the Hyp exception vectors.

Table G2-22 Local exception vectors, Secure Local exception vectors, and Non-secure Local exception vectors that Vector Catch exceptions can be enabled for

Vector catch enable bit		Exception type	Local exception vectors	
Local or Secure Local exception vectors	Non-secure Local exception vectors		Normal. SCTLR.V is 0. ^a	High. SCTLR.V is 1.
SF	NSF	FIQ interrupt	VBAR + 0x0000001C	0xFFFF001C
SI	NSI	IRQ interrupt	VBAR + 0x00000018	0xFFFF0018
SD	NSD	Data Abort	VBAR + 0x00000010	0xFFFF0010
SP	NSP	Prefetch Abort	VBAR + 0x0000000C	0xFFFF000C
SS	NSS	Supervisor Call	VBAR + 0x00000008	0xFFFF0008
SU	NSU	Undefined Instruction	VBAR + 0x00000004	0xFFFF0004

a. If EL3 is implemented and is using AArch32, **VBAR** is banked. The Secure Local exception vectors use **VBAR_S** and the Non-secure Local Exception vectors use **VBAR_{NS}**.

Table G2-23 Monitor exception vectors that Vector Catch exceptions can be enabled for

Vector catch enable bit	Exception type	Monitor exception vectors
MF	FIQ interrupt	MVBAR + 0x0000001C
MI	IRQ interrupt	MVBAR + 0x00000018
MD	Data Abort	MVBAR + 0x00000010
MP	Prefetch Abort	MVBAR + 0x0000000C
MS	Secure Monitor Call	MVBAR + 0x00000008

Note

There is no vector catch enable bit for Monitor trap exceptions.

G2.11.3 Generation of Vector Catch exceptions

How Vector Catch exceptions are generated depends on which form is implemented:

- [Address-matching form on page G2-4514.](#)
- [Exception-trapping form on page G2-4514.](#)

Address-matching form

The PE compares the virtual address of each instruction in the program flow is with some or all of the addresses in the enabled vector catch set, as follows:

- If EL3 is not implemented, the enabled vector catch set contains only Local exception vectors. The PE compares the virtual address of each instruction in the program flow, including those executed at EL0, with all addresses in the enabled vector catch set.
- If EL3 is implemented, the enabled vector catch set might contain one or more of the following:
 - Monitor exception vectors, if EL3 is using AArch32.
 - Secure Local exception vectors.
 - Non-secure Local exception vectors.

In this case, [Table G2-24](#) shows which addresses, in the enabled vector catch set, the virtual address of each instruction in the program flow is compared with.

Table G2-24 Comparisons made if the implementation includes EL3

EL3 is using	For exceptions taken to:	
	Secure PL1 modes	Non-secure PL1 modes
AArch64	Secure Local exception vectors	Non-secure Local exception vectors
AArch32	Secure Local exception vectors and Monitor exception vectors	

For example, for exceptions taken to a Secure PL1 mode when EL3 is using AArch64, the virtual address of each instruction in the program flow is compared with each Secure Local exception vector in the enabled vector catch set.

For each instruction in the program flow, the PE tests for any possible Vector Catch exceptions before executing the instruction. If a match occurs, a Vector Catch exception is generated when the instruction is committed for execution, regardless of all of the following:

- Whether the instruction passes its Condition code check.
- Whether the instruction is executed as part of exception entry.
- If EL2 is implemented, what [HCR](#). {IMO, FMO, AMO} are set to.
- If EL3 is implemented, what [SCR](#). {IRQ, FIQ, EA} are set to.

Exception-trapping form

When the PE takes an exception, it tests whether the exception is by branching to an exception vector in a subset of the enabled vector catch set, as follows:

- If EL3 is not implemented, the enabled vector catch set contains only Local exception vectors. The PE tests whether the exception is by branching to any address in the enabled vector catch set.
- If EL3 is implemented, the enabled vector catch set might contain one or more of the following:
 - Monitor exception vectors, if EL3 is using AArch32.
 - Secure Local exception vectors.
 - Non-secure Local exception vectors.

In this case, the PE tests whether the exception is by branching to a vector in one of the subsets that [Table G2-25](#) shows. In the table, n/a means not applicable.

Table G2-25 Subsets that the PE tests within if EL3 is implemented

EL3 is using	For exceptions taken to:		
	Monitor mode	Other Secure PL1 modes	Non-secure PL1 modes
AArch64	n/a	Secure Local exception vectors	Non-secure Local exception vectors
AArch32	Monitor exception vectors		

For example, for an exception taken to a Secure PL1 mode when EL3 is using AArch64, the PE tests whether the exception is by branching to any of the Secure Local exception vectors in the enabled vector address set.

If the exception is by branching to a vector in the subset, a Vector Catch exception is generated as part of exception entry. That is, a Vector Catch exception is generated instead of the exception handler executing its first instruction.

G2.11.4 Usage constraints

See the following subsections:

- [Usage constraints that apply to both forms of vector catch.](#)
- [Usage constraints that apply only to the address-matching form.](#)

Usage constraints that apply to both forms of vector catch

For Vector Catch exceptions enabled for either the Prefetch Abort exception vector or the Data Abort exception vector, if one of these exception types is taken to the Exception level that debug exceptions are targeting, behavior is CONSTRAINED UNPREDICTABLE. Either:

- Vector catch is ignored, therefore a Vector Catch exception is not generated.
- Vector catch generates a Prefetch Abort debug exception. For Vector Catch exceptions enabled for the Prefetch Abort exception vector, the PE might enter a recursive loop of Prefetch Abort exceptions causing Vector Catch exceptions and Vector Catch exceptions causing Prefetch Abort exceptions.

———— Note —————

The Exception level that debug exceptions are targeting is called the *debug target Exception level*, EL_D . [Routing debug exceptions on page G2-4459](#) describes how EL_D is derived.

Usage constraints that apply only to the address-matching form

Exception vectors are at word-aligned addresses, and:

- It is CONSTRAINED UNPREDICTABLE whether an enabled vector catch generates a Vector Catch exception for a 32-bit T32 instruction starting at the halfword-aligned address immediately prior to the vector address.
- T32 instructions that start at the halfword-aligned address immediately after the exception vector do not generate Vector Catch exceptions.

For the address-matching form, Vector Catch exceptions have the same priority as Breakpoint exceptions. If a single instruction causes both a Vector Catch exception and a Breakpoint exception, it is CONSTRAINED UNPREDICTABLE which of these debug exceptions the PE takes.

G2.11.5 Exception syndrome information and preferred return address for a Vector Catch exception

See the following:

- [Exception syndrome information for a Vector Catch exception.](#)
- [Preferred return address for a Vector Catch exception on page G2-4517.](#)

———— Note ————

Usually, the term *exception syndrome* is used only for exceptions taken to Hyp mode, or to AArch64 state. The referenced section uses the term more generally, to include exception information reported in the [IFSR](#).

Exception syndrome information for a Vector Catch exception

The PE takes a Vector Catch exception as either:

- A Prefetch Abort exception if it is taken to PL1. In this case, it is taken to Abort mode.
- A Hyp trap exception, if it is taken to PL2 because [HCR.TGE](#) or [HDCR.TDE](#) is 1. In this case, it is taken to Hyp mode.

If the exception is taken to:

PL1 Abort mode

The PE sets all of the following:

- [IFSR.FS](#) to the code for a debug exception, `0b00010`.
- [DBGDSCRExt.MOE](#) to `0b0101`, to indicate a Vector Catch exception.
- The [IFAR](#) with an UNKNOWN value.

PL2 Hyp mode

The PE does all of the following:

- Records information about the exception in the *Hypervisor Syndrome Register*, [HSR](#). See [Table G2-26](#).
- Sets [DBGDSCRExt.MOE](#) to `0b0101`, to indicate a Vector Catch exception.
- Sets the [HIFAR](#) to an unknown value.

Table G2-26 Information recorded in the [HSR](#)

HSR field	Information recorded
<i>Exception Class, EC</i>	The PE sets this to the code for a Prefetch Abort exception routed to Hyp mode, <code>0x20</code> .
<i>Instruction Length, IL</i>	The PE sets this to 1.
<i>Instruction Specific Syndrome, ISS</i>	ISS[24:10] RES0. ISS[9] <i>External Abort type (EA)</i> . The PE sets this to 0. ISS[8:6] RES0. ISS[5:0] <i>Instruction Fault Status Code (IFSC)</i> . The PE sets this to the code for a debug exception, <code>0b100010</code> .

———— Note ————

For information about how debug exceptions can be routed to PL2, see [Routing debug exceptions on page G2-4459](#).

Preferred return address for a Vector Catch exception

The preferred return address of a Vector Catch exceptions is the address of the instruction that was not executed because the PE took the Vector Catch exception instead.

This means that the preferred return address is the exception vector. This is true regardless of whether the address-matching form or the exception trapping form is implemented.

G2.11.6 Pseudocode description of Vector Catch exceptions

The `AArch32.VCRMatch()` pseudocode function checks whether the instruction at address generates a Vector Catch exception. It therefore shows the address-matching form of vector catch.

The `AArch32.CheckVectorCatch()` pseudocode function uses `AArch32.VCRMatch()` to test whether the instruction generates a Vector Catch exception, and if `AArch32.VCRMatch()` returns TRUE it generates that event.

The `AArch32.Abort()` function processes the Faultrecord object returned by `AArch32.CheckVectorCatch()`, as described in *Abort exceptions on page G3-4555*. If there is a Vector Catch exception, the `AArch32.Abort()` function generates a Prefetch Abort exception.

G2.12 Synchronization and debug exceptions

The behavior of debug depends on all of the following:

- The state of the external debug authentication interface.
- Indirect reads of:
 - External debug registers.
 - System registers, including system debug registers.
 - Special-purpose registers.

If a change is made to any of these, the effect of that change on debug exception generation cannot be relied on until after a *Context synchronization event* has occurred.

For any instructions executed between the time when the change is made and the time when the next *Context synchronization event* occurs, it is CONSTRAINED UNPREDICTABLE whether debug uses the state of the PE before the change, or the state of the PE after the change.

Example G2-3

1. Software changes `DBGDSCRExt.MDBGGen` from 0 to 1.
2. An instruction is executed, that would cause a Breakpoint exception if self-hosted debug uses the state of the PE after the change.
3. A *Context synchronization event* occurs.

In this case, it is CONSTRAINED UNPREDICTABLE whether the instruction generates a Breakpoint exception.

Example G2-4

1. Software unlocks the OS lock.
2. The PE executes some instructions.
3. A *Context synchronization event* occurs.

During the time when the PE is executing some instructions, step 2, it is CONSTRAINED UNPREDICTABLE whether debug exceptions other than Breakpoint Instruction exceptions can be generated.

Note

Some register updates are self-synchronizing. Others require an explicit *Context synchronization event*. For more information, see:

- [Synchronization of changes to AArch32 System registers](#) on page G6-4768.
 - [Accessing PSTATE fields](#) on page G1-4333.
 - [Synchronization of changes to the external debug registers](#) on page H8-5554.
-

G2.12.1 State and mode changes without explicit context synchronization events

Most changes to the Exception level, and most changes to the Security state if EL3 is implemented, happen as a result of operations that are an explicit *Context synchronization event*. This is because taking an exception and returning from an exception are both explicit *Context synchronization events*, and the Privilege level and Security state can only change as a result of taking or returning from an exception.

However, some Security state and AArch32 mode changes can happen because of operations that are not an explicit *Context synchronization event*. These are:

- AArch32 mode changes caused by MSR and CPS instructions. A mode change might be to a mode at a lower Privilege level.
- If EL3 is using AArch32, a Security state change caused by a direct write to the SCR in a privileged mode other than Monitor mode, to set SCR.NS to 1.

Chapter G3

The AArch32 System Level Memory Model

This chapter provides a system level view of the general features of the memory system. It contains the following sections:

- *About the memory system architecture on page G3-4522.*
- *Address space on page G3-4523.*
- *Mixed-endian support on page G3-4524.*
- *AArch32 cache and branch predictor support on page G3-4525.*
- *System register support for IMPLEMENTATION DEFINED memory features on page G3-4549.*
- *External aborts on page G3-4550.*
- *Memory barrier instructions on page G3-4552.*
- *Pseudocode description of general memory system instructions on page G3-4553.*

G3.1 About the memory system architecture

The ARM architecture supports different implementation choices for the memory system microarchitecture and memory hierarchy, depending on the requirements of the system being implemented. In this respect, the memory system architecture describes a design space in which an implementation is made. The architecture does not prescribe a particular form for the memory systems. Key concepts are abstracted in a way that permits implementation choices to be made while enabling the development of common software routines that do not have to be specific to a particular microarchitectural form of the memory system. For more information about the concept of a hierarchical memory system see [Memory hierarchy on page E2-2772](#).

G3.1.1 Form of the memory system architecture

The ARMv8 A-profile architecture includes a *Virtual Memory System Architecture* (VMSA). [Chapter G4 The AArch32 Virtual Memory System Architecture](#) describes the AArch32 view of the VMSA.

G3.1.2 Memory attributes

[Memory types and attributes on page E2-2782](#) describes the memory attributes, including how different memory types have different attributes. Each location in memory has a set of memory attributes, and the translation tables define the virtual memory locations, and the attributes for each location.

[Table G3-1](#) shows the memory attributes that are visible at the system level.

Table G3-1 Memory attribute summary

Memory type	Shareability	Cacheability
Device ^a	Outer Shareable	Non-cacheable.
Normal	One of: <ul style="list-style-type: none">• Non-shareable.• Inner Shareable.• Outer Shareable.	One of ^b : <ul style="list-style-type: none">• Non-cacheable.• Write-Through Cacheable.• Write-Back Cacheable.

a. Takes additional attributes, see [Device memory on page E2-2786](#).

b. See also [Cacheability, cache allocation hints, and cache transient hints on page G3-4528](#).

For more information on Cacheability and Shareability see [The Cacheability and Shareability memory attributes on page E2-2773](#), [Non-shareable Normal memory on page E2-2784](#), and [Caches and memory hierarchy on page E2-2772](#).

G3.2 Address space

The ARMv8 architecture is designed to support a wide range of applications with different memory requirements. It supports a range of *physical address* (PA) sizes, and provides associated control and identification mechanisms. For more information, see [About VMSAv8-32 on page G4-4558](#).

G3.2.1 Address space overflow or underflow

This subsection describes address space overflow or underflow:

Instruction address space overflow

When a PE performs a normal, sequential execution of instructions, it calculates:

$$(\text{address_of_current_instruction}) + (\text{size_of_executed_instruction})$$

This calculation is performed after each instruction to determine which instruction to execute next.

If the address calculation performed after executing an A32 or T32 instruction overflows `0xFFFF FFFF`, the program counter becomes UNKNOWN.

If the PE executes an instruction for which the instruction address, size, and alignment mean that it contains the bytes `0xFFFFFFFF` and `0x00000000`, the bytes that apparently from `0x00000000` onwards come from an UNKNOWN address.

Data address space overflow and underflow

If the PE executes a load or store instruction for which the computed address, total access size, and alignment mean that it accesses bytes `0xFFFFFFFF` and `0x00000000`, then the bytes that apparently come from `0x00000000` onwards come from UNKNOWN addresses.

G3.3 Mixed-endian support

Table G3-2 shows the endianness of explicit data accesses and translation table walks.

Table G3-2 Endianness support

Exception level	Explicit data accesses	Stage 1 translation table walks	Stage 2 translation table walks
EL0	PSTATE.E	SCTLR(S/NS).EE	HSCTLR.EE
EL1	PSTATE.E	SCTLR(S/NS).EE	HSCTLR.EE
EL2	PSTATE.E	HSCTLR.EE	N/A
EL3	PSTATE.E	SCTLR(S).EE	N/A

AArch32 state provides the following options for endianness support:

- All Exception levels support mixed-endianness:
 - SCTLR(S/NS).EE, HSCTLR.EE, and PSTATE.E are RW.
- Only EL0 supports mixed-endianness and EL1, EL2, and EL3 support only little-endianness:
 - SCTLR(S/NS).EE and HSCTLR.EE are RES0. PSTATE.E is RW when in EL0 and RES0 when in EL1, EL2, or EL3. SPSR.E is also RES0 when not returning to EL0.
- Only EL0 supports mixed-endianness and EL1, EL2, and EL3 support only big-endianness:
 - SCTLR(S/NS).EE and HSCTLR.EE are RES1. PSTATE.E is RW when in EL0 and RES1 when in EL1, EL2, or EL3. SPSR.E is also RES1 when not returning to EL0.
- All Exception levels support only little-endianness:
 - Each of SCTLR(S/NS).EE, HSCTLR.EE, PSTATE.E, and SPSR.E is RES0.
- All Exception levels support only big-endianness:
 - Each of SCTLR(S/NS).EE, HSCTLR.EE, PSTATE.E, and SPSR.E is RES1.

If mixed endian support is implemented for an Exception level using AArch32, endianness is controlled by PSTATE.E. For exception returns to AArch32 state, PSTATE.E is copied from SPSR_ELx.E. If the target Exception level supports only little-endian accesses, SPSR_ELx.E is RES0. If the target Exception level supports only big-endian accesses, SPSR_ELx.E is RES1.

———— **Note** —————

- When using AArch32, ARM deprecates PSTATE.E having a different value from the equivalent System register EE bit when in EL1, EL2 or EL3. The use of the SETEND instruction is also deprecated.
- If the higher Exception levels are using AArch64, the corresponding registers are:
 - SCTLR_EL1 for SCTLR(NS).
 - SCTLR_EL2 for HSCTLR.
 - SCTLR_EL3 for SCTLR(S).

The `BigEndian()` function determines whether the current Exception level and Execution state is using big-endian data.

For more information about endianness in the ARM architecture see [Endian support on page E2-2779](#).

G3.4 AArch32 cache and branch predictor support

The following sections describe the support for caches and branch predictors in AArch32 state:

- [General behavior of the caches.](#)
- [Cache identification on page G3-4527.](#)
- [Cacheability, cache allocation hints, and cache transient hints on page G3-4528.](#)
- [Enabling and disabling the caching of memory accesses in AArch32 state on page G3-4529.](#)
- [Behavior of caches at reset on page G3-4531.](#)
- [AArch32 cache and branch predictor maintenance instructions on page G3-4535.](#)
- [About cache maintenance in AArch32 state on page G3-4531.](#)
- [AArch32 cache and branch predictor maintenance instructions on page G3-4535.](#)
- [Cache lockdown on page G3-4546.](#)
- [System level caches on page G3-4547.](#)

See also [Chapter G4 The AArch32 Virtual Memory System Architecture](#), and in particular [Caches in VMSAv8-32 on page G4-4646](#).

———— Note —————

- Branch predictors typically use a form of cache to hold branch target data. Therefore, they are included in this section.
- In the instruction mnemonics, MVA is a synonym for VA.

G3.4.1 General behavior of the caches

When a memory location is marked with a Normal Cacheable memory attribute, determining whether a copy of the memory location is held in a cache still depends on many aspects of the implementation. The following non-exhaustive list of factors might be involved:

- The size, line length, and associativity of the cache.
- The cache allocation algorithm.
- Activity by other elements of the system that can access the memory.
- Speculative instruction fetching algorithms.
- Speculative data fetching algorithms.
- Interrupt behaviors.

Given this range of factors, and the large variety of cache systems that might be implemented, the architecture cannot guarantee whether:

- A memory location present in the cache remains in the cache.
- A memory location not present in the cache is brought into the cache.

Instead, the following principles apply to the behavior of caches:

- The architecture has a concept of an entry locked down in the cache. How lockdown is achieved is IMPLEMENTATION DEFINED, and lockdown might not be supported by:
 - A particular implementation.
 - Some memory attributes.
- An unlocked entry in a cache might not remain in that cache. The architecture does not guarantee that an unlocked cache entry remains in the cache or remains incoherent with the rest of memory. Software must not assume that an unlocked item that remains in the cache remains dirty.

- A locked entry in a cache is guaranteed to remain in that cache. The architecture does not guarantee that a locked cache entry remains incoherent with the rest of memory, that is, it might not remain dirty.

———— **Note** —————

For more information, see [The interaction of cache lockdown with cache maintenance instructions on page G3-4546](#).

- Any memory location that has a Normal Cacheable attribute at either the current Exception level or at a higher Exception level can be allocated to a cache at any time.
- It is guaranteed that no memory location that does not have a Normal Cacheable attribute is allocated into the cache.
- It is guaranteed that no memory location is allocated to the cache if it has a Normal Non-cacheable attribute or any type of Device memory attribute in both:
 - The translation regime at the current Exception level.
 - The translation regime at any higher Exception level.
- For data accesses, any memory location with a Normal Inner Shareable or Normal Outer Shareable attribute is guaranteed to be coherent with all masters in its Shareability domain.
- Any memory location is not guaranteed to remain incoherent with the rest of memory.
- The eviction of a cache entry from a cache level can overwrite memory that has been written by another observer only if the entry contains a memory location that has been written to by an observer in the Shareability domain of that memory location. The maximum size of the memory that can be overwritten is called the *Cache Write-back Granule*. In some implementations the CTR identifies the Cache Write-back Granule, see [CTR, Cache Type Register on page G6-4843](#).
- The allocation of a memory location into a cache cannot cause the most recent value of that memory location to become invisible to an observer, if it was previously visible to that observer.

———— **Note** —————

The Cacheability attribute of an address is determined by the applicable translation table entry for that address, as modified by any applicable System register Cacheability controls, such as the [SCTLR](#). {I, C} controls.

For the purpose of these principles, a cache entry covers at least 16 bytes and no more than 2KB of contiguous address space, aligned to the size of the cache entry.

G3.4.2 Cache identification

The ARMv8 cache identification consists of a set of registers that describe the implemented caches that are affected by cache maintenance instructions executed on the PE. This includes cache maintenance instructions that:

- Affect the entire cache, for example [ICIALLUIS](#).
- Operate by VA, for example [ICIMVAU](#).
- Operate by set/way, for example [DCISW](#).

The cache identification registers are:

- A single Cache Type Register, [CTR](#), that defines:
 - The minimum line length of any of the instruction caches affected by the instruction cache maintenance instructions.
 - The minimum line length of any of the data or unified caches, affected by the data cache maintenance instructions.
 - The cache indexing and tagging policy of the Level 1 instruction cache.

———— **Note** —————

It is IMPLEMENTATION DEFINED whether caches beyond the PoC will be reported by this mechanism, and because of the possible existence of system caches some caches before the PoC might not be reported. For more information about system caches see [System level caches on page G3-4547](#).

- A single Cache Level ID Register, [CLIDR](#), that defines:
 - The type of cache that is implemented and can be maintained using the architected cache maintenance instructions that operate by set/way or operate on the entire cache at each cache level, up to the maximum of seven levels.
 - The *Level of Unification Inner Shareable* (LoUIS), *Level of Coherence* (LoC) and the *Level of Unification* (LoU) for the caches. See [Terms used in describing the cache maintenance instructions on page G3-4532](#) for a definition of these terms.
 - An optional ICB field to indicate the boundary between the caches use for caching Inner Cacheable memory regions and those used only for caching Outer Cacheable regions.
- A single Cache Size Selection Register, [CSSELR](#), that selects the cache level and cache type of the current Cache Size Identification Register.
- For each implemented cache that is identifiable by this mechanism, across all the levels of caching, a Cache Size Identification Register, [CCSIDR](#), that defines:
 - Whether the cache supports Write-Through, Write-Back, Read-Allocate and Write-Allocate.
 - The number of sets, associativity and line length of the cache. See [Terms used in describing the cache maintenance instructions on page G3-4532](#) for a definition of these terms.

To determine the cache topology associated with a PE:

1. Read the Cache Type Register to find the indexing and tagging policy used for the Level 1 instruction cache. This register also provides the size of the smallest cache lines used for the instruction caches, and for the data and unified caches. These values are used in cache maintenance instructions.
2. Read the Cache Level ID Register to find what caches are implemented. The register includes seven Cache type fields, for cache levels 1 to 7. Scanning these fields, starting from Level 1, identifies the instruction, data or unified caches implemented at each level. This scan ends when it reaches a level at which no caches are defined. The Cache Level ID Register also specifies the Level of Unification (LoU) and the Level of Coherence (LoC) for the cache implementation.

3. For each cache identified at stage 2:
 - Write to the Cache Size Selection Register to select the required cache. A cache is identified by its level, and whether it is:
 - An instruction cache.
 - A data or unified cache.
 - Read the Cache Size ID Register to find details of the cache.

G3.4.3 Cacheability, cache allocation hints, and cache transient hints

Cacheability only applies to Normal memory, and is defined independently for Inner and Outer cache locations. All types of Device memory are always treated as Non-cacheable.

As described in [Memory types and attributes on page E2-2782](#), the memory attributes include a cacheability attribute that is one of:

- Non-cacheable.
- Write-Through cacheable.
- Write-Back cacheable.

In ARMv8, Cacheability attributes other than Non-cacheable can be complemented by a *cache allocation hint*. This is an indication to the memory system of whether allocating a value to a cache is likely to improve performance. In addition, it is IMPLEMENTATION DEFINED whether a *cache transient hint* is supported, see [Transient cacheability hint](#).

The cache allocation hints are assigned independently for read and write accesses, and therefore when the Transient hit is supported the following cache allocation hints can be used:

For read accesses: Read-Allocate, Transient Read-Allocate, or No Read-Allocate.

For write accesses: Write-Allocate, Transient Write-Allocate, or No Write-Allocate.

———— Note —————

- A Cacheable location with both No Read-Allocate and No Write-Allocate hints is not the same as a Non-cacheable location. A Non-cacheable location has coherency guarantees for all observers within the system that do not apply for a location that is Cacheable, No Read-Allocate, No Write-Allocate.
- Implementations can use the cache allocation hints to limit cache pollution to a part of a cache, such as to a subset of ways.
- For VMSAv8-32 translation table walks using the Long-descriptor translation table format, the appropriate [TCR.{IRGNn, ORGNn}](#) fields define the memory attributes of the translation tables, including the cacheability. However, this assignment supports only a subset of the cacheability attributes described in this section.

The architecture does not require an implementation to make any use of cache allocation hints. This means an implementation might not make any distinction between memory locations with attributes that differ only in their cache allocation hint.

Transient cacheability hint

In ARMv8, it is IMPLEMENTATION DEFINED whether a Transient hint is supported for the VMSAv8-32 translation scheme when using the Long-descriptor translation table format. In an implementation that supports the Transient hint, the Transient hint is a qualifier of the cache allocation hints, and indicates that the benefit of caching is for a relatively short period. It indicates that it might be better to restrict allocation of transient entries, to avoid possibly casting-out other, less transient, entries.

———— Note —————

The architecture does not specify what is meant by a *relatively short period*.

When using the Short-descriptor translation table format, VMSAv8-32 cannot support the Transient hint.

The description of the [MAIRO](#), [MAIR1](#), [HMAIRO](#), and [HMAIR1](#) registers includes the assignment of the Transient attribute in an implementation that supports this option. In this assignment:

- The Transient hint is defined independently for Inner Cacheable and Outer Cacheable memory regions.
- A single Transient hint applies to both read and write accesses to a memory region.

G3.4.4 Enabling and disabling the caching of memory accesses in AArch32 state

In ARMv8, Cacheability control fields can force all memory locations with the Normal memory type to be treated as Non-cacheable, regardless of their assigned Cacheability attribute. Independent controls are provided for each stage of address translation, with separate controls for:

- Data accesses. These controls also apply to accesses to the translation tables.
- Instruction accesses.

———— **Note** —————

These Cacheability controls replace the cache enable controls provided in previous versions of the ARM architecture.

In AArch32 state, the Cacheability control fields and their effects are as follows:

For the Non-secure PL1&0 translation regime

The Non-secure instance of [SCTLR](#) holds the EL1 controls that affect cacheability:

- When the value of [SCTLR.C](#) is 0:
 - All stage 1 translations for data accesses to Normal memory are Non-cacheable.
 - All accesses to the PL1&0 stage 1 translation tables are Non-cacheable.
- When the value of [SCTLR.I](#) is 0:
 - All stage 1 translations for instruction accesses to Normal memory are Non-cacheable.
- When the value of [HCR2.CD](#) is 1:
 - All stage 2 translations for data accesses to Normal memory are Non-cacheable.
 - All accesses to the PL1&0 stage 2 translation tables are Non-cacheable.
- When the value of [HCR2.ID](#) is 1:
 - All stage 2 translations for instruction accesses to Normal memory are Non-cacheable.
- When the value of [HCR.DC](#) is 1, all Non-secure stage 1 translations and all accesses to the Non-secure EL1&0 stage 1 translation tables, are treated as accesses to Normal Non-shareable Inner Write-Back Cacheable Read-Allocate Write-Allocate, Outer Write-Back Cacheable Read-Allocate Write-Allocate memory, regardless of the value of [SCTLR.C](#). This applies to translations for both data and instruction accesses.

In addition, when the value of [SCTLR.M](#) is 0, indicating that the stage 1 translations are disabled for the translation regime, then if EL2 is using AArch32 and the value of [HCR.DC](#) is 0 or if EL2 is using AArch64 and the value of [HCR_EL2.DC](#) is 0, then:

- If the value of [SCTLR.I](#) is 0, instruction accesses to Normal memory from stage 1 of the translation regime are Outer Shareable, Inner Non-cacheable, Outer Non-cacheable.
- If the value of [SCTLR.I](#) is 1, instruction accesses to Normal memory from stage 1 of the translation regime are Outer Shareable, Inner Write-Through cacheable, Outer Write-Through cacheable.

Note

- In Non-secure state, the stage 1 and stage 2 cacheability attributes are combined as described in *Combining the Cacheability attribute on page G4-4626*.
 - The Non-secure `SCTLR.{C, I}` and `HCR.DC` fields have no effect on the Secure PL1&0 and EL2 translation regimes.
 - The `HCR2.{ID, CD}` fields affect only stage 2 of the Non-secure PL1&0 translation regime.
 - In Non-secure state, the PL1&0 translation regime can be described as the Non-secure EL1&0 translation regime. This is consistent with the equivalent AArch64 descriptions.
-

For the Secure PL1&0 translation regime

The Secure instance of `SCTLR` holds the controls that determine cacheability:

- When the value of `SCTLR.C` is 0:
 - All data accesses to Normal memory using the Secure PL1&0 translation regime are Non-cacheable.
 - All accesses to the Secure PL1&0 translation tables are Non-cacheable.
- When the value of `SCTLR.I` is 0:
 - All instruction accesses to Normal memory using the Secure PL1&0 translation regime are Non-cacheable.

In addition, when the value of `SCTLR.M` is 0, indicating that stage 1 translations are disabled, then:

- If the value of `SCTLR.I` is 0, instruction accesses to Normal memory from stage 1 of the translation regime are Outer Shareable, Inner Non-cacheable, Outer Non-cacheable.
- If the value of `SCTLR.I` is 1, instruction accesses to Normal memory from stage 1 of the translation regime are Outer Shareable, Inner Write-Through cacheable, Outer Write-Through cacheable.

Note

The Secure `SCTLR.{I, C, M}` fields have no effect on the Non-secure PL1&0 and EL2 translation regimes.

For the EL2 translation regime

- When the value of `HSCTLR.C` is 0:
 - All data accesses to Normal memory using the EL2 translation regime are Non-cacheable.
 - All accesses to the EL2 translation tables are Non-cacheable.
- When the value of `HSCTLR.I` is 0:
 - All instruction accesses to Normal memory using the EL2 translation regime are Non-cacheable.

In addition, when the value of `HSCTLR.M` is 0, indicating that stage 1 translations are disabled, then:

- If the value of `HSCTLR.I` is 0, instruction accesses to Normal memory from stage 1 of the translation regime are Outer Shareable, Inner Non-cacheable, Outer Non-cacheable.
- If the value of `HSCTLR.I` is 1, instruction accesses to Normal memory from stage 1 of the translation regime are Outer Shareable, Inner Write-Through cacheable, Outer Write-Through cacheable.

Note

The `HSCTLR.{I, C, M}` fields have no effect on the PL1&0 and EL3 translation regimes.

The effect of the `SCTLR.C` or `HSCTLR.C` and `HCR2.CD` bits is reflected in the result of the address translation instructions in the PAR.

Note

- The requirements in this section mean the architecturally required effects of [SCTLR.I](#) and [HSCTLR.I](#) are limited to their effects on caching instruction accesses in unified caches.
- This specification can give rise to different cacheability attributes between instruction and data accesses to the same location. Where this occurs, the measures for mismatch memory attributes described in [Mismatched memory attributes on page E2-2792](#) must be followed to manage the corresponding loss of coherency.

G3.4.5 Behavior of caches at reset

In ARMv8:

- All caches reset to IMPLEMENTATION DEFINED states that might be UNKNOWN.
- The Cacheability control fields described in [Enabling and disabling the caching of memory accesses in AArch32 state on page G3-4529](#) reset to values that force all memory locations to be treated as Non-cacheable.

Note

This applies only to the controls that apply to the Translation regime that is used by the Exception level, PE mode, and Security state entered on reset.

- An implementation can require the use of a specific cache initialization routine to invalidate its storage array before caching is enabled. The exact form of any required initialization routine is IMPLEMENTATION DEFINED, and the routine must be documented clearly as part of the documentation of the device.
- If an implementation permits cache hits when the Cacheability control fields force all memory locations to be treated as Non-cacheable then the cache initialization routine must:
 - Provide a mechanism to ensure the correct initialization of the caches.
 - Be documented clearly as part of the documentation of the device.In particular, if an implementation permits cache hits when the Cacheability controls force all memory locations to be treated as Non-cacheable, and the cache contents are not invalidated at reset, the initialization routine must avoid any possibility of running from an uninitialized cache. It is acceptable for an initialization routine to require a fixed instruction sequence to be placed in a restricted range of memory.
- ARM recommends that whenever an invalidation routine is required, it is based on the ARMv8 cache maintenance instructions.

Similar rules apply to:

- Branch predictor behavior, see [Behavior of the branch predictors at reset on page G3-4539](#).
- TLB behavior, see [TLB behavior at reset on page G4-4629](#).

G3.4.6 About cache maintenance in AArch32 state

The following sections give general information about cache maintenance in ARMv8:

- [Terms used in describing the cache maintenance instructions on page G3-4532](#).
- [The ARMv8 abstraction of the cache hierarchy on page G3-4534](#).

The following sections describe the AArch32 state cache maintenance instructions:

- [AArch32 instruction cache maintenance instructions \(IC*\) on page G3-4536](#).
- [AArch32 data cache maintenance instructions \(DC*\) on page G3-4537](#).

Note

Some descriptions of the cache maintenance instructions refer to the Cacheability of the address on which the instruction operates. The Cacheability of an address is determined by the applicable translation table entry for that address, as modified by any applicable System register Cacheability controls, such as the [SCTLR.{I, C}](#) controls.

Terms used in describing the cache maintenance instructions

Cache maintenance instructions are defined to act on particular memory locations. Instructions can be defined:

- By the virtual address of the memory location to be maintained, referred to as operating *by VA*.
- By a mechanism that describes the location in the hardware of the cache, referred to as operating *by set/way*.

In addition, for instruction caches and branch predictors, there are instructions that invalidate all entries.

The following subsections define the terms used in the descriptions of the cache maintenance instructions:

- [Terminology for cache maintenance instructions operating by set/way](#).
- [Terminology for Clean, Invalidate, and Clean and Invalidate instructions](#).

Note

There is no terminology specific to cache maintenance instructions that operate by VA. When all applicable stages of translation are disabled, the VA used is identical to the PA. For more information about memory system behavior when address translation is disabled, see [The effects of disabling address translation stages on VMSAv8-32 behavior on page G4-4567](#).

Terminology for cache maintenance instructions operating by set/way

Cache maintenance instructions that operate by set/way refer to the particular structures in a cache. Three parameters describe the location in a cache hierarchy that an instruction works on. These parameters are:

- Level** The cache level of the hierarchy. The number of levels of cache is IMPLEMENTATION DEFINED. The cache levels that can be managed using the architected cache maintenance instructions that operate by set/way can be determined from the [CLIDR](#).
- In the ARM architecture, the lower numbered cache levels are those closest to the PE. See [Memory hierarchy on page E2-2772](#).
- Set** Each level of a cache is split up into a number of *sets*. Each set is a set of locations in a cache level to which an address can be assigned. Usually, the set number is an IMPLEMENTATION DEFINED function of an address.
- In the ARM architecture, sets are numbered from 0.
- Way** The associativity of a cache is the number of locations in a set to which a specific address can be assigned. The *way* number specifies one of these locations.
- In the ARM architecture, ways are numbered from 0.

Note

Because the allocation of a memory address to a cache location is entirely IMPLEMENTATION DEFINED, ARM expects that most portable software will use only the cache maintenance instructions by set/way as single steps in a routine to perform maintenance on the entire cache.

Terminology for Clean, Invalidate, and Clean and Invalidate instructions

Caches introduce coherency problems in two possible directions:

1. An update to a memory location by a PE that accesses a cache might not be visible to other observers that can access memory. This can occur because new updates are still in the cache and are not visible yet to the other observers that do not access that cache.
2. Updates to memory locations by other observers that can access memory might not be visible to a PE that accesses a cache. This can occur when the cache contains an old, or *stale*, copy of the memory location that has been updated.

The *Clean* and *Invalidate* instructions address these two issues. The definitions of these instructions are:

Clean A cache clean instruction ensures that updates made by an observer that controls the cache are made visible to other observers that can access memory at the point to which the instruction is performed. Once the Clean has completed, the new memory values are guaranteed to be visible to the point to which the instruction is performed, for example to the Point of Unification.

The cleaning of a cache entry from a cache can overwrite memory that has been written by another observer only if the entry contains a location that has been written to by an observer in the Shareability domain of that memory location.

Invalidate A cache invalidate instruction ensures that updates made visible by observers that access memory at the point to which the invalidate is defined, are made visible to an observer that controls the cache. This might result in the loss of updates to the locations affected by the invalidate instruction that have been written by observers that access the cache, if those updates have not been cleaned from the cache since they were made.

If the address of an entry on which the invalidate instruction operates is Normal, Non-cacheable or any type of Device memory then an invalidate instruction also ensures that this address is not present in the cache.

———— **Note** —————

Entries for addresses that are Normal Cacheable can be allocated to the cache at any time, and so the cache invalidate instruction cannot ensure that the address is not present in a cache.

Clean and Invalidate

A cache *clean and invalidate* instruction behaves as the execution of a clean instruction followed immediately by an invalidate instruction. Both instructions are performed to the same location.

The points to which a cache maintenance instruction can be defined differ depending on whether the instruction operates by VA or by set/way:

- For instructions operating by set/way, the point is defined to be to the next level of caching. For the All operations, the point is defined as the Point of Unification for each location held in the cache.
- For instruction operating by VA, two conceptual points are defined:

Point of Coherency (PoC)

The point at which all agents that can access memory are guaranteed to see the same copy of a memory location for accesses of any memory type or cacheability attribute. In many cases this is effectively the main system memory, although the architecture does not prohibit the implementation of caches beyond the PoC that have no effect on the coherency between memory system agents.

———— **Note** —————

The presence of system caches can affect the determination of the point of coherency as described in [System level caches on page G3-4547](#).

Point of Unification (PoU)

The PoU for a PE is the point by which the instruction and data caches and the translation table walks of that PE are guaranteed to see the same copy of a memory location. In many cases, the Point of Unification is the point in a uniprocessor memory system by which the instruction and data caches and the translation table walks have merged.

The PoU for an Inner Shareable Shareability domain is the point by which the instruction and data caches and the translation table walks of all the PEs in that Inner Shareable Shareability domain are guaranteed to see the same copy of a memory location. Defining this point permits self-modifying software to ensure future instruction fetches are associated with the modified version of the software by using the standard correctness policy of:

1. Clean data cache entry by address.
2. Invalidate instruction cache entry by address.

The following fields in the [CLIDR](#) relate to these conceptual points:

LoC, Level of Coherence

This field defines the last level of cache that must be cleaned or invalidated when cleaning or invalidating to the Point of Coherency. The LoC value is a cache level, so, for example, if LoC contains the value 3:

- A clean to the Point of Coherency operation requires the level 1, level 2 and level 3 caches to be cleaned.
- Level 4 cache is the first level that does not have to be maintained.

If the LoC field value is $0x0$, this means that no levels of cache need to be cleaned or invalidated when cleaning or invalidating to the Point of Coherency.

If the LoC field value is a nonzero value that corresponds to a level that is not implemented, this indicates that all implemented caches are before the Point of Coherency.

LoUU, Level of Unification, uniprocessor

This field defines the last level of cache that must be cleaned or invalidated when cleaning or invalidating to the Point of Unification for the PE. As with LoC, the LoUU value is a cache level.

If the LoUU field value is $0x0$, this means that no levels of cache need to be cleaned or invalidated when cleaning or invalidating to the Point of Unification.

If the LoUU field value is a nonzero value that corresponds to a level that is not implemented, this indicates that all implemented caches are before the Point of Unification.

LoUIS, Level of Unification, Inner Shareable

In any implementation:

- This field defines the last level of cache that must be cleaned or invalidated when cleaning or invalidating to the Point of Unification for the Inner Shareable Shareability domain. As with LoC, the LoUIS value is a cache level.
- If the LoUIS field value is $0x0$, this means that no levels of cache need to be cleaned or invalidated when cleaning or invalidating to the Point of Unification for the Inner Shareable Shareability domain.
- If the LoUIS field value is a nonzero value that corresponds to a level that is not implemented, this indicates that all implemented caches are before the Point of Unification.

For more information, see [CLIDR, Cache Level ID Register on page G6-4823](#).

The ARMv8 abstraction of the cache hierarchy

The following subsections describe the ARMv8 abstraction of the cache hierarchy:

- [Cache maintenance instructions that operate by VA](#).
- [Cache maintenance instructions that operate by set/way on page G3-4535](#).

Cache maintenance instructions that operate by VA

The VA-based cache maintenance instructions are described as operating by VA. Each of these instructions is always qualified as being either:

- Performed to the Point of Coherency.
- Performed to the Point of Unification.

See [Terms used in describing the cache maintenance instructions on page G3-4532](#) for definitions of Point of Coherency and Point of Unification, and more information about possible meanings of VA.

[AArch32 cache and branch predictor maintenance instructions on page G3-4535](#) lists the VA-based maintenance instructions.

The **CTR** holds minimum line length values for:

- The instruction caches.
- The data and unified caches.

These values support efficient invalidation of a range of addresses, because this value is the most efficient address stride to use to apply a sequence of VA-based maintenance instructions to a range of VAs.

For the Invalidate data or unified cache line by VA instruction, the Cache Write-back Granule field of the CTR defines the maximum granule that a single invalidate instruction can invalidate. This meaning of the Cache Write-back Granule is in addition to its defining the maximum size that can be written back.

Cache maintenance instructions that operate by set/way

AArch32 cache and branch predictor maintenance instructions lists the set/way-based maintenance instructions. Some encodings of these instructions include a required field that specifies the cache level for the instruction:

- A clean instruction cleans from the level of cache specified through to at least the next level of cache, moving further from the PE.
- An invalidate instruction invalidates only at the level specified.

G3.4.7 AArch32 cache and branch predictor maintenance instructions

The instruction and data cache maintenance instructions have the same functionality in AArch32 state and in AArch64 state. [Table G3-3](#) shows the AArch32 system instructions. Instructions that take an argument include Rt in the instruction description.

AArch32 state also provides branch predictor maintenance instructions.

————— Note —————

- In [Table G3-3](#) the Point of Unification is the Point of Unification of the PE executing the cache maintenance instruction.
- In AArch32 state, all of the maintenance instructions are available from EL1 or higher.
- In AArch64 state, branch predictors are always invisible to software, and therefore AArch64 state does not provide any branch predictor maintenance instructions.

Table G3-3 AArch32 System instructions for cache maintenance

Register	Instruction
Instruction cache maintenance instructions	
ICIALLUIS	Invalidate all to Point of Unification, Inner Shareable
ICIALLU	Invalidate all to Point of Unification
ICIMVAU, Rt	Invalidate by virtual address to Point of Unification
Data cache maintenance instructions	
DCIMVAC, Rt	Invalidate by virtual address to Point of Coherency
DCISW, Rt	Invalidate by set/way
DCCMVAC, Rt	Clean by virtual address to Point of Coherency
DCCSW, Rt	Clean by set/way
DCCMVAU, Rt	Clean by virtual address to Point of Unification
DCCIMVAC, Rt	Clean and invalidate by virtual address to Point of Coherency
DCCISW, Rt	Clean and invalidate by set/way

Table G3-3 AArch32 System instructions for cache maintenance (continued)

Register	Instruction
Branch prediction maintenance instructions	
BPIMVA, Rt	Invalidate the virtual address from the branch predictors
BPIALLIS, Rt	Invalidate all entries from branch predictors, Inner Shareable
BPIALL, Rt	Invalidate all entries from branch predictors

A DSB or DMB instruction intended to ensure the completion of cache or branch predictor maintenance instructions must have an access type of both loads and stores.

In an implementation where the branch predictors are architecturally invisible, the BPIMVA, BPIALLIS, and BPIALL instructions can execute as NOPs.

The following subsections give more information about these instructions:

- [AArch32 instruction cache maintenance instructions \(IC*\)](#).
- [AArch32 data cache maintenance instructions \(DC*\)](#) on page G3-4537.
- [Branch predictors](#) on page G3-4538.
- [General requirements for the scope of cache and branch predictor maintenance instructions](#) on page G3-4539.
- [Effects of instructions that operate by VA to the Point of Coherency](#) on page G3-4540.
- [Effects of instructions that operate by VA but not to the Point of Coherency](#) on page G3-4540.
- [Effects of All and set/way maintenance instructions](#) on page G3-4541.
- [Effects of virtualization and security on the AArch32 cache maintenance instructions](#) on page G3-4541.
- [Boundary conditions for cache maintenance instructions](#) on page G3-4543.
- [Ordering of cache and branch predictor maintenance instructions](#) on page G3-4543.
- [Performing cache maintenance instructions](#) on page G3-4545.

AArch32 instruction cache maintenance instructions (IC*)

Where an address argument for these instructions is required, it takes the form of a 32-bit register that holds the virtual address argument. No alignment restrictions apply for this address.

Any cache maintenance instruction operating by VA includes as part of any required VA to PA translation:

- For an instruction executed at EL1, the current system *Address Space Identifier*, ASID.
- The current Security state.
- Whether the instruction was performed from Hyp mode, or from Non-secure EL1 state.
- For an instruction executed from a Non-secure EL1 state, the *Virtual Machine Identifier*, VMID.

For an instruction cache maintenance instruction that operates by VA:

- It is IMPLEMENTATION DEFINED whether the operation can generate a Data Abort exception for a Translation fault or an Access flag fault.
- The operation cannot generate a Data Abort exception for a Domain fault or a Permission fault, except for the Permission fault case described in [Stage 2 fault on a stage 1 translation table walk](#) on page G4-4656.

For more information about these possible faults on an instruction that operates by VA see [MMU faults in AArch32 state](#) on page G4-4657.

An instruction cache maintenance instruction can complete at any time after it is executed, but is only guaranteed to be complete, and its effects visible to other observers, following a DSB instruction executed by the PE that executed the cache maintenance instruction.

See also [Ordering of cache and branch predictor maintenance instructions on page G3-4543](#).

AArch32 data cache maintenance instructions (DC*)

Data cache maintenance instructions that take a set/way/level argument take a 32-bit register.

If a data cache maintenance by set/way instruction specifies a set, way, or level argument that is larger than the value supported by the implementation then the instruction is CONSTRAINED UNPREDICTABLE, see [Out of range values of the Set/Way/Index fields in cache maintenance instructions on page K1-6107](#) or the instruction description.

DCISW instructions executed at EL1 perform a clean and invalidate, meaning they execute as a DCCISW instruction, if all of the following apply:

- EL2 is implemented.
- Either:
 - EL2 is using AArch32 and the value of HCR.SWIO is 1.
 - EL2 is using AArch64 and the value of HCR_EL2.SWIO is 1.
- EL3 is not implemented, or either:
 - EL3 is using AArch32 and the value of SCR.NS is 1.
 - EL3 is using AArch64 and the value of SCR_EL3.NS is 1.

Where an address argument for these instructions is required, it takes the form of a 32-bit register that holds the virtual address argument. No alignment restrictions apply for this address.

Any cache maintenance instruction operating by VA includes as part of any required VA to PA translation:

- For an instruction executed at EL1, the current system *Address Space Identifier*, ASID.
- The current Security state.
- Whether the instruction was performed from Hyp mode, or from Non-secure EL1 state.
- For an instruction executed from a Non-secure EL1 state, the *Virtual Machine Identifier*, VMID.

A data or unified cache maintenance instruction that operates by VA cannot generate a Data Abort exception for a Domain fault, and cannot generate a Data Abort exception for a Permission fault, except for the Permission fault described in [Stage 2 fault on a stage 1 translation table walk on page G4-4656](#).

For more information about the possible faults on an instruction that operates by VA see [MMU faults in AArch32 state on page G4-4657](#).

DCIMVAC and DCISW instructions executed at EL1 perform a clean and invalidate, meaning they execute as a DCCIMVAC or DCCISW instruction, if all of the following apply:

- EL2 is implemented.
- PL1&0 stage two address translation is enabled, meaning either:
 - EL2 is using AArch32 and the value of HCR.VM is 1.
 - EL2 is using AArch64 and the value of HCR_EL2.VM is 1.
- EL3 is not implemented, or either:
 - EL3 is using AArch32 and the value of SCR.NS is 1.
 - EL3 is using AArch64 and the value of SCR_EL3.NS is 1.

If a memory fault that sets FAR for the translation regime applicable for the cache maintenance instruction is generated from a data cache maintenance instruction, the FAR holds the address specified in the register argument of the instruction.

See also [Ordering of cache and branch predictor maintenance instructions on page G3-4543](#).

Branch predictors

In AArch32 state it is IMPLEMENTATION DEFINED whether branch prediction is architecturally visible. This means that under some circumstances software must perform branch predictor maintenance to avoid incorrect execution caused by out-of-date entries in the branch predictor. For example, to ensure correct operation it might be necessary to invalidate branch predictor entries on a change to instruction memory, or a change of instruction address mapping. For more information, see [Specific requirements for branch predictor maintenance instructions](#).

In an implementation where the branch predictors are architecturally invisible, the branch predictor maintenance instructions can execute as NOPs.

An invalidate all operation on the branch predictor ensures that any location held in the branch predictor has no functional effect on execution. An invalidate branch predictor by VA instruction operates on the address of the branch instruction, but can affect other branch predictor entries.

———— Note —————

The architecture does not make visible the range of addresses in a branch predictor to which the invalidate operation applies. This means the address used in the invalidate by VA operation must be the address of the branch to be invalidated.

If branch prediction is architecturally visible, an instruction cache invalidate all operation also invalidates all branch predictors.

See also [Ordering of cache and branch predictor maintenance instructions on page G3-4543](#).

Specific requirements for branch predictor maintenance instructions

If, for a given translation regime and a given ASID and VMID as appropriate, the instructions at any virtual address change, then branch predictor maintenance instructions must be performed to invalidate entries in the branch predictor, to ensure that the change is visible to subsequent execution. This maintenance is required when writing new values to instruction locations. It can also be required as a result of any of the following situations that change the translation of a virtual address to a physical address, if, as a result of the change to the translation, the instructions at the virtual addresses change:

- For any translation regime other than the Non-secure PL1&0 translation regime, enabling or disabling stage 1 translations.
- For the Non-secure PL1&0 translation regime:
 - When stage 2 translations are enabled, enabling or disabling stage 1 translations unless accompanied by a change of VMID.
 - When stage 2 translations are disabled, enabling or disabling stage 1 translations.
 - Enabling or disabling stage 2 translations.
- Writing new mappings to the translation tables.
- Any change to the [TTBR0](#), [TTBR1](#), or [TTBCR](#) registers, unless:
 - For a change to the Secure PL1&0 translation regime, the change is accompanied by a change to the ASID.
 - For a change to the stage 1 translations of the Non-secure PL1&0 translation regime, the change is accompanied by a change to the ASID or a change to the VMID.
- Any change to the [VTTBR](#) or [VTCR](#) registers, unless accompanied by a change to the VMID.

Note

Invalidation is not required if the changes to the translations are such that the instructions associated with the non-faulting translations of a virtual address, for a given translation regime and a given ASID and VMID, as appropriate, remain unchanged throughout the sequence of changes to the translations. Examples of translation changes to which this applies are:

- Changing a valid translation to a translation that generates an MMU fault.
- Changing a translation that generates an MMU fault to a valid translation.

Failure to invalidate entries might give CONSTRAINED UNPREDICTABLE results, caused by the execution of old branches. For more information, see [Ordering of cache and branch predictor maintenance instructions on page G3-4543](#).

Note

- In ARMv8, there is no requirement to use the branch predictor maintenance operations to invalidate the branch predictor after:
 - Changing the ContextID or VMID.
 - A cache maintenance instruction that is identified as also flushing the branch predictors, see [AArch32 cache and branch predictor maintenance instructions on page G3-4535](#).

[Cache maintenance instructions, functional group on page G4-4734](#) shows the branch predictor maintenance operations in a VMSA implementation.

Behavior of the branch predictors at reset

In AArch32 state:

- If branch predictors are not architecturally invisible:
 - The branch predictors reset to an IMPLEMENTATION DEFINED state that might be UNKNOWN.
 - The branch predictors are disabled at reset.
- An implementation can require the use of a specific branch predictor initialization routine to invalidate the branch predictor storage array before it is enabled. The exact form of any required initialization routine is IMPLEMENTATION DEFINED, but the routine must be documented clearly as part of the documentation of the device.
- ARM recommends that whenever an invalidation routine is required, it is based on the AArch32 branch predictor maintenance operations.

Similar rules apply:

- To cache behavior, see [Behavior of caches at reset on page G3-4531](#).
- To TLB behavior, see [TLB behavior at reset on page G4-4629](#).

General requirements for the scope of cache and branch predictor maintenance instructions

The ARMv8 specification of the cache maintenance and branch predictor instructions describes what each instruction is guaranteed to do in a system. It does not limit other behaviors that might occur, provided they are consistent with the requirements described in [General behavior of the caches on page G3-4525](#), [Behavior of caches at reset on page G3-4531](#), and [Preloading caches on page E2-2775](#).

This means that as a side-effect of a cache maintenance instruction:

- Any location in the cache might be cleaned.
- Any unlocked location in the cache might be cleaned and invalidated.

As a side-effect of a branch predictor maintenance instruction, any entry in the branch predictor might be invalidated.

———— **Note** ————

ARM recommends that, for best performance, such side-effects are kept to a minimum. ARM strongly recommends that the side-effects of operations performed in Non-secure state do not have a significant performance impact on execution in Secure state.

Effects of instructions that operate by VA to the Point of Coherency

For Normal memory that is not Inner Non-cacheable, Outer Non-cacheable, these instructions must affect the caches of other PEs in the Shareability domain described by the Shareability attributes of the VA supplied with the instruction.

For Device memory and Normal memory that is Inner Non-cacheable, Outer Non-cacheable, these instructions must affect the caches of all PEs in the Outer Shareable Shareability domain of the PE on which the instruction is operating.

In all cases, for any affected PE, these instructions affect all data and unified caches to the Point of Coherency.

Table G3-4 PEs affected by cache maintenance instructions to the Point of Coherency

Shareability	PEs affected	Effective to
Non-shareable	The PE performing the operation	The Point of Coherency of the entire system
Inner Shareable	All PEs in the same Inner Shareable Shareability domain as the PE performing the operation	The Point of Coherency of the entire system
Outer Shareable	All PEs in the same Outer Shareable Shareability domain as the PE performing the operation	The Point of Coherency of the entire system

Effects of instructions that operate by VA but not to the Point of Coherency

The following instruction operate by VA but not to the Point of Coherency:

- Clean data or unified cache line by MVA to the Point of Unification, [DCCMVAU](#).
- Invalidate instruction cache line by MVA to Point of Unification, [ICIMVAU](#).
- Invalidate by MVA from branch predictors, [BPIMVA](#).

For these instructions, [Table G3-5](#) shows how, for a VA in a Normal or Device memory location, the Shareability attribute of the VA determines the minimum set of PEs affected, and the point to which the instruction must be effective.

Table G3-5 PEs affected by cache maintenance instructions to the Point of Unification

Shareability	PEs affected	Effective to
Non-shareable	The PE executing the instruction	The Point of Unification of instruction cache fills, data cache fills and write-backs, and translation table walks, on the PE executing the instruction
Inner Shareable or Outer Shareable	All PEs in the same Inner Shareable Shareability domain as the PE executing the instruction	The Point of Unification of instruction cache fills, data cache fills and write-backs, and translation table walks, of all PEs in the same Inner Shareable Shareability domain as the PE executing the instruction

———— **Note** ————

The set of PEs guaranteed to be affected is never greater than the PEs in the Inner Shareable Shareability domain containing the PE executing the instruction.

Effects of All and set/way maintenance instructions

The **ICIALLU**, **BPIALL** and DC* set/way instructions apply only to the caches and branch predictors of the PE that performs the instruction. If the branch predictors are architecturally-visible, **ICIALLU** also performs a **BPIALL** operation.

The **ICIALLUIS** and **BPIALLIS** instructions can affect the caches and branch predictors of all PEs in the same Inner Shareable Shareability domain as the PE that performs the instruction. If the branch predictors are architecturally-visible, **ICIALLUIS** also performs a **BPIALLIS** operation. These instructions have an effect to the Point of Unification of instruction cache fills, data cache fills, and write-backs, and translation table walks, of all PEs in the same Inner Shareable Shareability domain.

———— Note —————

The possible presence of system caches, as described in *System level caches on page G3-4547*, means architecture does not guarantee that all levels of cache can be maintained using set/way instructions.

Effects of virtualization and security on the AArch32 cache maintenance instructions

Each Security state has its own physical address space, and therefore cache entries are associated with physical address space. In addition, cache maintenance and branch predictor instructions performed in Non-secure state have to take account of:

- Whether the instruction was performed at EL1 or at EL2.
- For instructions that operate by VA, the current VMID.

Table G3-6 shows the effects of virtualization and security on these maintenance instructions.

Table G3-6 Effects of virtualization and security on the AArch32 cache maintenance instructions

Cache maintenance instructions	Security state	Specified entry
Data or unified cache maintenance instructions		
Invalidate, Clean, or Clean and Invalidate by VA: DCIMVAC , DCCMVAC , DCCMVAU , DCCIMVAC	Either	All lines that hold the PA that, in the current translation regime, are mapped to by the combination of all of: <ul style="list-style-type: none"> • The specified VA. • For an instruction executed at EL1, the current ASID if the location is mapped to by a non-global page. • For an instruction executed at Non-secure EL1, the current VMID^a.
	Non-secure	Line specified by set/way provided that the entry comes from the Non-secure PA space.
Invalidate, Clean, or Clean and Invalidate by set/way: DCISW , DCCSW , DCCISW	Secure	Line specified by set/way regardless of the PA space that the entry has come from.

Table G3-6 Effects of virtualization and security on the AArch32 cache maintenance instructions (continued)

Cache maintenance instructions	Security state	Specified entry
Instruction cache maintenance instructions		
Invalidate by VA: ICIMVAU	Either	All lines corresponding to the specified VA ^b in the current translation regime and: <ul style="list-style-type: none"> For an instruction executed at EL1 or EL0, the current ASID. For an instruction executed at Non-secure EL1 or Non-secure EL0, the current VMID^a.
Invalidate All: ICIALLU , ICIALUIS		<ul style="list-style-type: none"> Can invalidate any unlocked entry in the instruction cache. Are required to invalidate any entries relevant to the software component that executed it. The Non-secure and Secure descriptions give more information: <p>Non-secure</p> <p>An instruction executed at EL1 must operate on all instruction cache lines that contain entries associated with the current virtual machine, meaning any entry with the current VMID.^a</p> <p>An instruction executed at EL2 must operate on all instruction cache lines that contain entries that can be accessed from Non-secure state.</p> <p>Secure</p> <p>The instruction must invalidate all instruction cache lines.</p>
Branch predictor instructions ^c		
Invalidate by VA: BPIMVA	Either	All lines that, in the current translation regime, are mapped to by the combination of: all of: <ul style="list-style-type: none"> The specified VA. For an instruction executed at EL1 or EL0, the current ASID if the location is mapped to by a non-global page. For an instruction executed at Non-secure EL1 or EL0, the current VMID^a.
Invalidate all: BPIALL , BPIALLIS		<ul style="list-style-type: none"> Can invalidate any unlocked entry in the branch predictor. Are required to invalidate any entries relevant to the software component that executed it. The Non-secure and Secure descriptions give more information.

- a. Dependencies on the VMID apply even when [HCR_EL2.VM](#) is set to 0. However, [VTTBR_EL2.VMID](#) resets to zero, meaning there is a valid VMID from reset.
- b. The type of instruction cache used affects the interpretation of the specified entries in this table such that:
 - For a PIPT instruction cache, the cache maintenance applies to all entries whose physical address corresponds to the specified address.
 - For a VIPT instruction cache, the cache maintenance applies to entries whose virtual index and physical tag corresponds to the specified address.
For information of types of instruction cache, see [Instruction caches on page G4-4647](#).
- c. In an implementation where the branch predictors are architecturally invisible, these instructions can execute as NOPs.

For locked entries and entries that might be locked, the behavior of cache maintenance instructions described in [The interaction of cache lockdown with cache maintenance instructions on page G3-4546](#) applies.

With an implementation that generates aborts if entries are locked or might be locked in the cache, when the use of lockdown aborts is enabled, these aborts can occur on any cache maintenance instructions.

In an implementation that includes EL2:

- The architecture does not require cache cleaning when switching between virtual machines. Cache invalidation by set/way must not present an opportunity for one virtual machine to corrupt state associated with a second virtual machine. To ensure this requirement is met, Non-secure clean by set/way instructions can, instead, perform a clean and invalidate by set/way.

- The AArch32 Data cache invalidate instructions **DCIMVAC** and **DCISW**, perform a cache clean as well as a cache invalidate, meaning **DCIMVAC** performs the same invalidation as a **DCCIMVAC** instruction, and **DCISW** performs the same invalidation as a **DCCISW** instruction, if both of the following apply:
 - The value of **HCR.VM** is 1.
 - The instruction is executed in Non-secure state, or EL3 is not implemented.
- The AArch32 Data cache invalidate by set/way instruction **DCISW** performs a cache clean as well as a cache invalidate, meaning it performs the same invalidation as a **DCCISW** instruction, if both of the following apply:
 - The value of **HCR.SWIO** is 1.
 - The instruction is executed in Non-secure state, or EL3 is not implemented.
- When the value of **HCR.FB** is 1, TLB and instruction cache invalidate instructions executed in the Non-secure EL1 Exception level are broadcast across the Inner Shareable domain. When Non-secure EL1 is using AArch32, this applies to the **TLBIMVA**, **TLBIASID**, **TLBIMVAA**, **TLBIMVAL**, **TLBIMVAAL**, and **ICIALLU** instructions. This means the instruction performs the invalidation that would be performed by the corresponding Inner Shareable instruction, for example **ICIALLU** performs the invalidation that would be performed by **ICIALLUIS**, and **BPIALL** performs the invalidation that would be performed by **BPIALLIS**.

For more information about the cache maintenance instructions, see [About cache maintenance in AArch32 state on page G3-4531](#), [AArch32 cache and branch predictor maintenance instructions on page G3-4535](#), and [Chapter G4 The AArch32 Virtual Memory System Architecture](#).

Boundary conditions for cache maintenance instructions

Cache maintenance instructions operate on the caches regardless of whether the System register Cacheability controls force all memory accesses to be Non-cacheable.

For VA-based cache maintenance instructions, the instructions operate on the caches regardless of the memory type and cacheability attributes marked for the memory address in the VMSA translation table entries. This means that the effects of the cache maintenance instructions can apply regardless of:

- Whether the address accessed:
 - Is Normal memory or Device memory.
 - Has the Cacheable attribute or the Non-cacheable attribute.
- Any applicable domain control of the address accessed.
- The access permissions for the address accessed, other than the effect of the stage two write permission on data or unified cache invalidation instructions.

Ordering of cache and branch predictor maintenance instructions

The following rules describe the effect of the memory order model on the cache and branch predictor maintenance instructions:

- All cache and branch predictor maintenance instructions that do not specify an address execute, relative to each other, in program order.
 - All cache and branch predictor instructions that specify an address:
 - Execute in program order relative to all cache and branch predictor operations that do not specify an address.
 - Execute in program order relative to all cache and branch predictor operations that specify the same address.
 - Can execute in any order relative to cache and branch predictor operations that specify a different address.
- Where a cache maintenance or branch predictor instruction appears in program order before a change to the translation tables, the architecture guarantees that the cache or branch predictor maintenance instruction uses the translations that were visible before the change to the translation tables.

- Where a change of the translation tables appears in program order before a cache maintenance or branch predictor instruction, software must execute the sequence outlined in [Ordering and completion of TLB maintenance instructions on page G4-4635](#) before performing the cache or branch predictor maintenance instruction, to ensure that the maintenance operation uses the new translations.
- A DMB instruction causes the effect of all data or unified cache maintenance instructions appearing in program order before the DMB to be visible to all explicit load and store operations appearing in program order after the DMB.

Also, a DMB instruction ensures that the effects of any data or unified cache maintenance instruction appearing in program order before the DMB are observable by any observer in the same required Shareability domain before any data or unified cache maintenance or explicit memory operations appearing in program order after the DMB are observed by the same observer. Completion of the DMB does not guarantee the visibility of all data to other observers. For example, all data might not be visible to a translation table walk, or to instruction fetches.
- A DSB is required to guarantee the completion of all cache maintenance instruction that appear in program order before the DSB instruction.
- A [Context synchronization event](#) is required to guarantee the effects of any branch predictor maintenance operation. This means a [Context synchronization event](#) causes the effect of all completed branch predictor maintenance operations appearing in program order before the [Context synchronization event](#) to be visible to all instructions after the [Context synchronization event](#).

This means that, if a branch instruction appears after an invalidate branch predictor operation and before any [Context synchronization event](#), it is CONSTRAINED UNPREDICTABLE whether the branch instruction is affected by the invalidate. Software must avoid this ordering of instructions, because it might cause CONSTRAINED UNPREDICTABLE behavior.
- Any data or unified cache maintenance instruction by VA must be executed in program order relative to any explicit load or store on the same PE to an address covered by the VA of the cache instruction if that load or store is to Normal Cacheable memory. The order of memory accesses that result from the cache maintenance instruction, relative to any other memory accesses to Normal Cacheable memory, are subject to the memory ordering rules. For more information, see [Definition of the ARMv8 memory model on page E2-2762](#).

Any data or unified cache maintenance instruction by VA can be executed in any order relative to any explicit load or store on the same PE to an address covered by the VA of the cache maintenance instruction if that load or store is not to Normal Cacheable memory.
- There is no restriction on the ordering of data or unified cache maintenance instruction by VA relative to any explicit load or store on the same PE where the address of the explicit load or store is not covered by the VA of the cache instruction. Where the ordering must be restricted, a DMB instruction must be inserted to enforce ordering.
- There is no restriction on the ordering of a data or unified cache maintenance instruction by set/way relative to any explicit load or store on the same PE. Where the ordering must be restricted, a DMB instruction must be inserted to enforce ordering.
- Software must execute a [Context synchronization event](#) after the completion of an instruction cache maintenance instruction, to guarantee that the effect of the maintenance instruction is visible to any instruction fetch.

A DSB or DMB instruction intended to ensure the completion of cache maintenance instructions or branch predictor instructions must have an access type of both loads and stores.

The scope of instruction cache maintenance depends on the type of the instruction cache. For more information see [Instruction caches on page G4-4647](#).

Example G3-1 Cache cleaning operations for self-modifying code

The sequence of cache cleaning operations for a line of self-modifying code on a uniprocessor system is:

; Coherency example for data and instruction accesses within the same Inner Shareable domain.

```

; Enter this code with <Rt> containing a new 32-bit instruction,
; to be held in Cacheable space at a location pointed to by Rn. Use STRH in the first line
; instead of STR for a 16-bit instruction.
STR Rt, [Rn]
DCCMVAU Rn      ; Clean data cache by MVA to point of unification (PoU)
DSB             ; Ensure visibility of the data cleaned from cache
ICIMVAU Rn     ; Invalidate instruction cache by MVA to PoU
BPIMVA Rn      ; Invalidate branch predictor by MVA to PoU
DSB            ; Ensure completion of the invalidations
ISB            ; Synchronize the fetched instruction stream

```

Performing cache maintenance instructions

To ensure all cache lines in a block of address space are maintained through all levels of cache ARM strongly recommends that software:

- For data or unified cache maintenance, uses the `CTR.DMinLine` value to determine the loop increment size for a loop of data cache maintenance by VA instructions.
- For instruction cache maintenance, uses the `CTR.IMinLine` value to determine the loop increment size for a loop of instruction cache maintenance by VA instructions.

Example code for cache maintenance instructions

The cache maintenance instructions by set/way can be used to clean or invalidate, or both, the entirety of one or more levels of cache attached to a PE. However, unless all PEs attached to the caches regard all memory locations as Non-cacheable, it is not possible to prevent locations being allocated into the cache during such a sequence of the cache maintenance instructions.

———— Note ————

Because the set/way instructions operate only locally, there is no guarantee of the atomicity of cache maintenance between different PEs, even if those different PEs are each executing the same cache maintenance instructions at the same time. Because any cacheable line can be allocated into the cache at any time, it is possible for a cache line to migrate from an entry in the cache of one PE to the cache of a different PE in a way that means the cache line is not affected by set/way based cache maintenance. Therefore, ARM strongly discourages the use of set/way instructions to manage coherency in coherent systems. The expected use of the cache maintenance instructions that operate by set/way is limited to the cache maintenance associated with the powerdown and powerup of caches, if this is required by the implementation.

The limitations of cache maintenance by set/way mean maintenance by set/way does not happen on multiple PEs, and cannot be made to happen atomically for each address on each PE. Therefore in multiprocessor or multithreaded systems, the use of cache maintenance by set/way to clean, or clean and invalidate, the entire cache for coherency management with very large buffers or with buffers with unknown address can fail to provide the expected coherency results because of speculation by other PEs, or possibly by other threads. The only way that these instructions can be used in this way is to first ensure that all PEs that might cause speculative accesses to caches that need to be maintained are not capable of generating speculative accesses. This can be achieved by ensuring that those PEs have no memory locations with a Normal Cacheable attribute. Such an approach can have very large system performance effects, and ARM advises implementers to use hardware coherency mechanisms in systems where this will be an issue.

[System level caches on page G3-4547](#) refers to other limitations of cache maintenance by set/way.

The following example code for cleaning a data or unified cache to the Point of Coherency illustrates a generic mechanism for cleaning the entire data or unified cache to the Point of Coherency.

```

MRC p15, 1, R0, c0, c0, 1 ; Read CLIDR into R0
ANDS R3, R0, #0x07000000
MOV R3, R3, LSR #23      ; Cache level value (naturally aligned)
BEQ Finished
MOV R10, #0
Loop1

```



```
ADD R2, R10, R10, LSR #1 ; Work out 3 x cache level
MOV R1, R0, LSR R2 ; bottom 3 bits are the Cache type for this level
AND R1, R1, #7 ; get those 3 bits alone
CMP R1, #2
BLT Skip ; no cache or only instruction cache at this level
MCR p15, 2, R10, c0, c0, 0 ; write CSSELR from R10
ISB ; ISB to sync the change to the CCSIDR
MRC p15, 1, R1, c0, c0, 0 ; read current CCSIDR to R1
AND R2, R1, #7 ; extract the line length field
ADD R2, R2, #4 ; add 4 for the line length offset (log2 16 bytes)
MOV R4, #0x3FF
ANDS R4, R4, R1, LSR #3 ; R4 is the max number on the way size (right aligned)
CLZ R5, R4 ; R5 is the bit position of the way size increment
MOV R9, R4 ; R9 working copy of the max way size (right aligned)
Loop2
MOV R7, #0x00007FFF
ANDS R7, R7, R1, LSR #13 ; R7 is the max number of the index size (right aligned)
Loop3
ORR R11, R10, R9, LSL R5 ; factor in the way number and cache number into R11
ORR R11, R11, R7, LSL R2 ; factor in the index number
MCR p15, 0, R11, c7, c10, 2 ; DCCSW, clean by set/way
SUBS R7, R7, #1 ; decrement the index
BGE Loop3
SUBS R9, R9, #1 ; decrement the way number
BGE Loop2
Skip
ADD R10, R10, #2 ; increment the cache number
CMP R3, R10
DSB ; ensure completion of previous cache maintenance instruction
BGT Loop1
Finished
```

Similar approaches can be used for all cache maintenance instructions.

G3.4.8 Cache lockdown

The concept of an entry locked in a cache is allowed, but not architecturally defined. How lockdown is achieved is IMPLEMENTATION DEFINED and might not be supported by:

- An implementation.
- Some memory attributes.

An unlocked entry in a cache might not remain in that cache. The architecture does not guarantee that an unlocked cache entry remains in the cache or remains incoherent with the rest of memory. Software must not assume that an unlocked item that remains in the cache remains dirty.

A locked entry in a cache is guaranteed to remain in that cache. The architecture does not guarantee that a locked cache entry remains incoherent with the rest of memory, that is, it might not remain dirty.

The interaction of cache lockdown with cache maintenance instructions

The interaction of cache lockdown and cache maintenance instructions is IMPLEMENTATION DEFINED. However, an architecturally-defined cache maintenance instruction on a locked cache line must comply with the following general rules:

- The effect of the following instructions on locked cache entries is IMPLEMENTATION DEFINED:
 - Cache clean by set/way, [DCCSW](#).
 - Cache invalidate by set/way, [DCISW](#).
 - Cache clean and invalidate by set/way, [DCISW](#).
 - Instruction cache invalidate all, [ICIALLU](#) and [ICIALUIS](#).

However, one of the following approaches must be adopted in all these cases:

1. If the instruction specified an invalidation, a locked entry is not invalidated from the cache.
2. If the instruction specified a clean it is IMPLEMENTATION DEFINED whether locked entries are cleaned.

3. If an entry is locked down, or could be locked down, an IMPLEMENTATION DEFINED Data Abort exception is generated, using the Fault status code defined for this purpose. See [Data Abort exception on page G1-4387](#).

This permits a usage model for cache invalidate routines to operate on a large range of addresses by performing the required operation on the entire cache, without having to consider whether any cache entries are locked.

The effect of the following instructions is IMPLEMENTATION DEFINED:

- Cache clean by virtual address, [DCCMVAC](#) and [DCCMVAU](#).
- Cache invalidate by virtual address, [DCIMVAC](#).
- Cache clean and invalidate by virtual address, [DCCIMVAC](#).

However, one of the following approaches must be adopted in all these cases:

1. If the instruction specified an invalidation, a locked entry is invalidated from the cache. For the clean and invalidate instructions, the entry must be cleaned before it is invalidated.
2. If the instruction specified an invalidation, a locked entry is not invalidated from the cache. If the instruction specified a clean it is IMPLEMENTATION DEFINED whether locked entries are cleaned.
3. If an entry is locked down, or could be locked down, an IMPLEMENTATION DEFINED Data Abort exception is generated, using the Fault status code defined for this purpose. See [DFSR](#) or [HSR](#).

In an implementation that includes EL2, if [HCR.TIDCP](#) is set to 1, any exception relating to lockdown of an entry associated with Non-secure memory is routed to EL2.

———— **Note** —————

An implementation that uses an abort mechanism for entries that can be locked down but are not actually locked down must:

- Document the IMPLEMENTATION DEFINED instruction sequences that perform the required operations on entries that are not locked down.
- Implement one of the other permitted alternatives for the locked entries.

ARM recommends that, when possible, such IMPLEMENTATION DEFINED instruction sequences use architecturally-defined instructions. This minimizes the number of customized instructions required.

In addition, an implementation that uses an abort to handle cache maintenance instructions for entries that might be locked must provide a mechanism that ensures that no entries are locked in the cache.

The reset setting of the cache must be that no cache entries are locked.

Additional cache functions for the implementation of lockdown

An implementation can add additional cache maintenance functions for the handling of lockdown in the IMPLEMENTATION DEFINED space. See [IMPLEMENTATION DEFINED registers, functional group on page G4-4744](#).

G3.4.9 System level caches

The ARM Architecture defines a *system cache* as a cache that is not described in the PE Cache Identification registers, [CCSIDR](#) and [CLIDR](#), and for which the set/way cache maintenance instructions do not apply.

Conceptually, three classes of system cache can be envisaged:

1. System caches which lie before the point of coherency and cannot be managed by cache maintenance instructions. Such systems fundamentally undermine the concept of cache maintenance instructions operating to the point of coherency, as they imply the use of non-architecture mechanisms to manage coherency. The use of such systems in the ARM architecture is explicitly prohibited.

2. System caches which lie before the point of coherency and can be managed by cache maintenance by address instructions that apply to the point of coherency, but cannot be managed by cache maintenance by set/way instructions. Where maintenance of the entire system cache must be performed, as is the case for power management, it must be performed using non-architectural mechanisms.
3. System caches which lie beyond the point of coherency and so are invisible to software. The management of such caches is outside the scope of architecture.

G3.5 System register support for IMPLEMENTATION DEFINED memory features

The VMSAv8-32 defines the following registers for describing IMPLEMENTATION DEFINED features of the memory system:

- The TCM Type Register, **TCMTR** must be implemented. The following conditions apply to this register:
 - If no TCMs are implemented, the **TCMTR** indicates zero-size TCMs.
 - If bits[31:29] are 0b100, the format of the rest of the register is IMPLEMENTATION DEFINED. This value indicates that the implementation includes TCMs that do not follow the legacy usage model. Other fields in the register might give more information about the TCMs.
- The System register encoding space with {coproc==0b1111, CRn==c9, CRm=={c0-c2, c5-c7}} is IMPLEMENTATION DEFINED for all values of opc2 and opc1. This space is reserved for branch predictor, cache and TCM functionality, for example maintenance, override behaviors and lockdown.
- In a VMSAv8-32 implementation, part of the System register encoding space with {coproc==0b1111, CRn==c10} is IMPLEMENTATION DEFINED and reserved for TLB functionality, see [TLB lockdown on page G4-4630](#).
- The System register encoding space with {coproc==0b1111, CRn==c11, CRm=={c0-c8, c15}} is IMPLEMENTATION DEFINED for all values of opc2 and opc1. This space is reserved for DMA operations to and from the TCMs.

In addition, the System register encoding space with {coproc==0b1111, CRn==c15} is reserved for IMPLEMENTATION DEFINED registers, and can provide additional registers for the memory system. For more information, see [Reserved encodings in the VMSAv8-32 System register \(coproc==0b1111\) space on page G4-4709](#).

G3.6 External aborts

The ARM architecture defines external aborts as errors that occur in the memory system, other than those that are detected by the MMU or Debug hardware. External aborts include parity or ECC errors detected by the caches or other parts of the memory system. For example, an uncorrectable parity or ECC failure on a Level 2 memory structure might generate an external abort.

An external abort is one of:

- Synchronous.
- Precise asynchronous.
- Imprecise asynchronous.

For more information, see [Exception terminology on page G1-4310](#).

The ARM architecture does not provide any method to distinguish between precise asynchronous and imprecise asynchronous external aborts.

VMSAv8-32 permits external aborts on data accesses, translation table walks, and instruction fetches to be either synchronous or asynchronous. The reported fault code identifies whether the external abort is synchronous or asynchronous.

It is IMPLEMENTATION DEFINED which external aborts, if any, are supported. Asynchronous external aborts are taken as SError interrupt exceptions.

In AArch32 state:

- SError interrupts are taken as asynchronous Data Abort exceptions.
- Synchronous external aborts:
 - On data accesses are taken as synchronous Data Abort exceptions.
 - On instruction fetches, or prefetches, are taken as synchronous Prefetch Abort exceptions.

See also:

- [External abort on a translation table walk on page G4-4659](#).
- [Handling exceptions that are taken to an Exception level using AArch32 on page G1-4340](#).

Normally, external aborts are rare. An imprecise asynchronous external abort is likely to be fatal to the process that is running. ARM recommends that implementations make external aborts precise wherever possible.

The following subsections give more information about possible external aborts:

- [External abort on instruction fetch](#).
- [External abort on data read or write](#).
- [Provision for classification of external aborts on page G3-4551](#).
- [Parity or ECC error reporting on page G3-4551](#).

The section [Exception reporting in a VMSAv8-32 implementation on page G4-4663](#) describes the reporting of external aborts.

G3.6.1 External abort on instruction fetch

An external abort on an instruction fetch can be either synchronous or asynchronous. A synchronous external abort on an instruction fetch is taken precisely.

An implementation can report the external abort asynchronously from the instruction that it applies to. In such an implementation these aborts behave essentially as interrupts. The aborts are masked when `PSTATE.A` is set to 1, otherwise they are reported using the Data Abort exception.

G3.6.2 External abort on data read or write

Externally-generated errors during a data read or write can be either synchronous or asynchronous.

An implementation can report the external abort asynchronously from the instruction that generated the access. In such an implementation these aborts behave essentially as interrupts. The aborts are masked when `PSTATE.A` is set to 1, otherwise they are reported using the Data Abort exception.

G3.6.3 Provision for classification of external aborts

For a synchronous external abort taken to a privileged mode other than Hyp mode, an implementation can use the `DFSR.ExT` and `IFSR.ExT` bits to provide more information about synchronous external aborts:

- `DFSR.ExT` provides an IMPLEMENTATION DEFINED classification of synchronous external aborts on data accesses.
- `IFSR.ExT` provides an IMPLEMENTATION DEFINED classification of synchronous external aborts on instruction accesses.

For a synchronous external abort taken to Hyp mode, the `HSR.EA`, `ISS[9]` bit, provides an IMPLEMENTATION DEFINED classification of external aborts.

For all aborts other than synchronous external aborts these bits return a value of 0.

G3.6.4 Parity or ECC error reporting

The ARM architecture supports the reporting of both synchronous and asynchronous parity or ECC errors from the cache systems. It is IMPLEMENTATION DEFINED what parity or ECC errors in the cache systems, if any, result in synchronous or asynchronous parity or ECC errors.

A fault code is defined for reporting parity or ECC errors, see [Exception reporting in a VMSAv8-32 implementation on page G4-4663](#). However when parity or ECC error reporting is implemented it is IMPLEMENTATION DEFINED whether a parity or ECC error is reported using the assigned fault code, or using another appropriate encoding.

For all purposes other than the Fault status encoding, parity or ECC errors are treated as external aborts.

G3.7 Memory barrier instructions

[Memory barriers on page E2-2768](#) describes the memory barrier instructions. This section describes the system level controls of those instructions.

G3.7.1 EL2 control of the Shareability of data barrier instructions executed at EL0 or EL1

In an implementation that includes EL2 and supports Shareability limitations on the data barrier instructions, the [HCR.BSU](#) field can modify the required Shareability of an instruction that is executed at EL0 or EL1 in Non-secure state. [Table G3-7](#) shows the encoding of this field:

Table G3-7 EL2 control of Shareability of barrier instructions executed at EL0 or EL1

HCR.BSU	Minimum Shareability of barrier instructions
00	No effect, Shareability is as specified by the instruction
01	Inner Shareable
10	Outer Shareable
11	Full system

For an instruction executed at EL0 or EL1 in Non-secure state, [Table G3-8](#) shows how the [HCR.BSU](#) is combined with the Shareability specified by the argument of the DMB or DSB instruction to give the scope of the instruction:

Table G3-8 Effect of the [HCR_EL2.BSU](#) on barrier instructions executed at Non-secure EL1 or EL1

Shareability specified by the DMB or DSB argument	HCR.BSU	Resultant Shareability
Full system	Any	Full system
	00, 01, or 10	Outer Shareable
Outer Shareable	11, Full system	Full system
	00 or 01	Inner Shareable
	10, Outer Shareable	Outer Shareable
Inner Shareable	11, Full system	Full system
	00, No effect	Non-shareable
	01, Inner Shareable	Inner Shareable
Non-shareable	10, Outer Shareable	Outer Shareable
	11, Full system	Full system
	11, Full system	Full system

G3.8 Pseudocode description of general memory system instructions

This section lists the pseudocode describing general memory operations:

- [Memory data type definitions](#).
- [Basic memory access](#).
- [Aligned memory access](#) on page G3-4554.
- [Unaligned memory access](#) on page G3-4554.
- [Exclusives monitors operations](#) on page G3-4554.
- [Access permission checking](#) on page G3-4555.
- [Abort exceptions](#) on page G3-4555.
- [Memory barriers](#) on page G3-4555.

G3.8.1 Memory data type definitions

This section lists the memory data types.

The memory data types are:

- Address descriptor, defined by the [AddressDescriptor](#) type.
- Full address, defined by the [FullAddress](#) type.
- Memory attributes, defined by the [MemoryAttributes](#) type.
- Memory type, defined by the [MemType](#) enumeration.
- Device memory type, defined by the [DeviceType](#) enumeration.
- Normal memory attributes, defined by the [MemAttrHints](#) type.
- Cacheability attributes, defined by the [MemAttr_NC](#), [MemAttr_WT](#), and [MemAttr_WB](#) constants.
- Allocation hints, defined by the [MemHint_No](#), [MemHint_WA](#), [MemHint_RA](#), and [MemHint_RWA](#) constants.
- Access permissions, defined by the [Permissions](#) type.

G3.8.2 Basic memory access

The two forms of the `_Mem[]` accessor, non-assignment (memory read) `_Mem[]` and assignment (memory write) `_Mem[]`, are the operations that perform single-copy atomic, aligned, little-endian memory accesses of size bytes to or from the underlying physical memory array of bytes.

The functions address the array using `desc.paddress`, that supplies:

- The physical address.
- An NS bit that selects between the Secure and Non-secure parts of the array.

The attributes in `desc.memattrs` are used by the memory system to determine caching and ordering behaviors as described in [Memory types and attributes](#) on page E2-2782, [Definition of the ARMv8 memory model](#) on page E2-2762, and [Atomicity in the ARM architecture](#) on page E2-2758.

An additional parameter to the `_Mem[]` accessor defines the access type, for example normal, exclusive, or ordered, and whether the access is made as part of a translation table walk.

The actual implemented array of memory might be smaller than the maximum address size that can be accessed from AArch32 state. In this case the scheme for aliasing is IMPLEMENTATION DEFINED, or some parts of the address space might give rise to external aborts or a System Error.

`PAMax()` returns the IMPLEMENTATION DEFINED size of the physical address.

———— Note —————

A stage of address translation using VMSAv8-32 cannot generate an output address of more than 40 bits.

G3.8.3 Aligned memory access

The `AArch32.MemSingle[]` functions make atomic, little-endian accesses of size bytes.

G3.8.4 Unaligned memory access

See *Unaligned data access on page E2-2777* for details of the `SCTLR.A` and `HSCTLR.A` controls on the generation of alignment faults. The `HSCTLR` control applies to Normal memory accesses from Hyp mode, and the `SCTLR` control applies to Normal memory accesses from all other modes.

The `Mem_with_type[]` functions make an access of the required type. If that access is naturally aligned, each form of the function performs an atomic access by making a single call to `AArch32.MemSingle[]`. If that access is not aligned but passes the `AArch32.CheckAlignment()` checks, each form of the function synthesizes the required access from multiple calls to `AArch32.MemSingle[]`. It also reverses the byte order if the access is big-endian.

G3.8.5 Exclusives monitors operations

The `AArch32.SetExclusiveMonitors()` function sets the Exclusives monitors for a Load-Exclusive instruction, for a block of bytes. The size of the blocks is determined by `size`, at the VA address. The `ExclusiveMonitorsPass()` function checks whether a Store-Exclusive instruction still has possession of the Exclusives monitors and therefore completes successfully.

The `AArch32.ExclusiveMonitorsPass()` function checks whether a Store-Exclusive instruction still has possession of the Exclusives monitors, by checking whether the Exclusives monitors are set to include the location of the memory block specified by `size`, at the virtual address defined by `address`. The atomic write that follows after the Exclusives monitors have been set must be to the same physical address. It is permitted, but not required, for this function to return `FALSE` if the virtual address is not the same as that used in the previous call to `AArch32.SetExclusiveMonitors()`.

The `ExclusiveMonitorsStatus()` function returns 0 if the previous atomic write was to the same physical memory locations selected by `ExclusiveMonitorsPass()` and therefore succeeded. Otherwise the function returns 1, indicating that the address translation delivered a different physical address.

The `MarkExclusiveGlobal()` procedure takes as arguments a `FullAddress.address`, the PE identifier `processorid` and the size of the transfer. The procedure records that the PE `processorid` has requested exclusive access covering at least `size` bytes from address `address`. The size of the location marked as exclusive is IMPLEMENTATION DEFINED, up to a limit of 2KB and no smaller than two words, and aligned in the address space to the size of the location. It is CONstrained UNPREDICTABLE whether this causes any previous request for exclusive access to any other address by the same PE to be cleared.

The `MarkExclusiveLocal()` procedure takes as arguments a `FullAddress.address`, the PE identifier `processorid` and the size of the transfer. The procedure records in a local record that PE `processorid` has requested exclusive access to an address covering at least `size` bytes from address `address`. The size of the location marked as exclusive is IMPLEMENTATION DEFINED, and can at its largest cover the whole of memory but is no smaller than two words, and is aligned in the address space to the size of the location. It is IMPLEMENTATION DEFINED whether this procedure also performs a `MarkExclusiveGlobal()` using the same parameters.

The `IsExclusiveGlobal()` function takes as arguments a `FullAddress.address`, the PE identifier `processorid` and the size of the transfer. The function returns `TRUE` if the PE `processorid` has marked in a global record an address range as exclusive access requested that covers at least `size` bytes from address `address`. It is IMPLEMENTATION DEFINED whether it returns `TRUE` or `FALSE` if a global record has marked a different address as exclusive access requested. If no address is marked in a global record as exclusive access, `IsExclusiveGlobal()` returns `FALSE`.

The `IsExclusiveLocal()` function takes as arguments a `FullAddress.address`, the PE identifier `processorid` and the size of the transfer. The function returns `TRUE` if the PE `processorid` has marked an address range as exclusive access requested that covers at least the `size` bytes from address `address`. It is IMPLEMENTATION DEFINED whether this function returns `TRUE` or `FALSE` if the address marked as exclusive access requested does not cover all of `size` bytes from address `address`. If no address is marked as exclusive access requested, then this function returns `FALSE`. It is IMPLEMENTATION DEFINED whether this result is ANDed with the result of `IsExclusiveGlobal()` with the same parameters.

The `ClearExclusiveByAddress()` procedure takes as arguments a `FullAddress` address, the PE identifier `processorid` and the size of the transfer. The procedure clears the global records of all PEs, other than `processorid`, for which an address region including any of `size` bytes starting from `paddress` has had a request for an exclusive access. It is IMPLEMENTATION DEFINED whether the equivalent global record of the PE `processorid` is also cleared if any of `size` bytes starting from `paddress` has had a request for an exclusive access, or if any other address has had a request for an exclusive access.

The `ClearExclusiveLocal()` procedure takes as arguments the PE identifier `processorid`. The procedure clears the local record of PE `processorid` for which an address has had a request for an exclusive access. It is IMPLEMENTATION DEFINED whether this operation also clears the global record of PE `processorid` that an address has had a request for an exclusive access.

G3.8.6 Access permission checking

The function `AArch32.CheckPermission()` is used by the architecture to perform access permission checking based on attributes derived from the translation tables or location descriptors.

The interpretation of access permission is shown in *Memory access control* on page G4-4605.

G3.8.7 Abort exceptions

The function `AArch32.Abort()` generates a Data Abort exception or a Prefetch Abort exception by calling the `AArch32.TakeDataAbortException()` or `AArch32.TakePrefetchAbortException()` function.

The `FaultRecord` type describes a fault. Functions that check for faults return a record of this type appropriate to the type of fault. *Pseudocode description of VMSAv8-32 memory system operations* on page G4-4748 provides a number of wrappers to generate a `FaultRecord`.

The function `AArch32.NoFault()` returns a null record that indicates no fault. The `IsFault()` function tests whether a `FaultRecord` contains a fault.

G3.8.8 Memory barriers

The definition for the memory barrier functions is given by the enumerations `MBReqDomain` and `MBReqTypes`.

These enumerations define the required Shareability domains and required access types used as arguments for DMB and DSB instructions.

The procedures `DataMemoryBarrier()`, `DataSynchronizationBarrier()`, and `InstructionSynchronizationBarrier()` perform the memory barriers.

Chapter G4

The AArch32 Virtual Memory System Architecture

This chapter describes the ARMv8-A AArch32 Virtual Memory System Architecture (VMSA), that is backwards-compatible with VMSAv7. It includes the following sections:

- *About VMSAv8-32 on page G4-4558.*
- *The effects of disabling address translation stages on VMSAv8-32 behavior on page G4-4567.*
- *Translation tables on page G4-4571.*
- *The VMSAv8-32 Short-descriptor translation table format on page G4-4576.*
- *The VMSAv8-32 Long-descriptor translation table format on page G4-4585.*
- *Memory access control on page G4-4605.*
- *Memory region attributes on page G4-4616.*
- *Translation Lookaside Buffers (TLBs) on page G4-4628.*
- *TLB maintenance requirements on page G4-4632.*
- *Caches in VMSAv8-32 on page G4-4646.*
- *VMSAv8-32 memory aborts on page G4-4649.*
- *Exception reporting in a VMSAv8-32 implementation on page G4-4663.*
- *Address translation instructions on page G4-4682.*
- *About the System registers for VMSAv8-32 on page G4-4689.*
- *VMSAv8-32 organization of registers in the (coproc == 0b1110) encoding space on page G4-4704.*
- *VMSAv8-32 organization of registers in the (coproc == 0b1111) encoding space on page G4-4707.*
- *Functional grouping of VMSAv8-32 System registers on page G4-4726.*
- *Pseudocode description of VMSAv8-32 memory system operations on page G4-4748.*

Note

This chapter must be read with [Chapter G3 The AArch32 System Level Memory Model](#).

G4.1 About VMSAv8-32

Note

- This chapter describes the ARMv8 VMSA for AArch32 state, VMSAv8-32. This is generally equivalent to VMSAv7 for an implementation that includes all of the Security Extensions, the Multiprocessing Extensions, the Large Physical Address Extension, and the Virtualization Extensions.
- This chapter describes the control of the VMSA by Exception levels that are using AArch32. [Security state, Exception levels, and AArch32 execution privilege on page G1-4318](#) summarizes how the AArch32 PE modes map onto the Exception levels.
[Chapter D4 The AArch64 Virtual Memory System Architecture](#) describes the control of the VMSA by Exception levels that are using AArch64.
- For details of the VMSA differences in previous versions of the ARM architecture see the *ARM® Architecture Reference Manual, ARMv7-A and ARMv7-R edition*.

The main function of the VMSA is to perform address translation, and access permissions and memory attribute determination and checking, for memory accesses made by the PE. Address translation, and permissions and attribute determination and checking, is performed by a *stage* of address translation.

In VMSAv8-32, the *Memory Management Unit* (MMU) provides a number of stages of address translation. This chapter describes only the stages that are visible from Exception levels that are using AArch32, which are as follows:

For operation in Secure state

A single stage of address translation, for use when executing at PL1 or PL0. This is the *Secure PL1&0 stage 1* address translation stage.

For operation in Non-secure state

- A single stage of address translation for use when executing at PL2. This is the *Non-secure PL2 stage 1* address translation stage.
- Two stages of address translation for use when executing at PL1 or PL0. These are:
 - The *Non-secure PL1&0 stage 1* address translation stage.
 - The *Non-secure PL1&0 stage 2* address translation stage.

The System registers provide independent control of each supported stage of address translation, including a control to disable that stage of translation.

However, if the PE is executing at EL0 using AArch32 when EL1 is using AArch64 then it is using the VMSAv8-64 EL1&0 translation regime, described in [Chapter D4 The AArch64 Virtual Memory System Architecture](#).

These features mean the VMSAv8-32 can support a hierarchy of software supervision, for example an Operating System and a hypervisor.

Each stage of address translation uses address translations and associated memory properties held in memory mapped tables called *translation tables*.

For information about how the MMU features differ if an implementation does not include all of the Exception levels, see [About address translation for VMSAv8-32 on page G4-4562](#).

The translation tables define the following properties:

Access to the Secure or Non-secure address map

The translation table entries determine whether an access from Secure state accesses the Secure or the Non-secure address map. Any access from Non-secure state accesses the Non-secure address map.

Memory access permission control

This controls whether a program is permitted to access a memory region. For instruction and data access, the possible settings are:

- No access.
- Read-only.
- Write-only. This is possible only in a translation regime with two stages of translation.
- Read/write.

For instruction accesses, additional controls determine whether instructions can be fetched and executed from the memory region.

If a PE attempts an access that is not permitted, a memory fault is signaled to the PE.

Memory region attributes

These describe the properties of a memory region. The top-level attribute, the Memory type, is one of Normal, or a type of Device memory, as follows:

- Both translation table formats support the following Device memory types:
 - Device-nGnRnE
 - Device-nGnRE
- The Long-descriptor translation table format supports, in addition, the following Device memory types:
 - Device-nGRE
 - Device-GRE

Note

ARMv8 added the Device-nGRE and Device-GRE memory types. Also, in versions of the ARM architecture before ARMv8:

- Device-nGnRnE memory is described as Strongly-ordered memory.
- Device-nGnRE memory is described as Device memory.

Normal memory regions can have additional attributes.

For more information, see [Memory types and attributes on page E2-2782](#).

Address translation mappings

An address translation maps an *input address* to an *output address*.

A stage 1 translation takes the address of an explicit data access or instruction fetch, a *virtual address* (VA), as the input address, and translates it to a different output address:

- If only one stage of translation is provided, this output address is the *physical address* (PA).
- If two stages of address translation are provided, the output address of the stage 1 translation is an *intermediate physical address* (IPA).

Note

In the ARMv8-32 architecture, a software agent, such as an Operating System, that uses or defines stage 1 memory translations, might be unaware of the distinction between IPA and PA.

A stage 2 translation translates the IPA to a PA.

The possible Security states and privilege levels of memory accesses define a set of *translation regimes*, where a translation regime maps an input VA to the corresponding PA, using one or two stages of translation. See [The VMSAv8-32 translation regimes on page G4-4560](#).

System registers control VMSAv8-32, including defining the location of the translation tables, and enabling and configuring the MMU, including enabling and disabling the different address translation stages. Also, they report any faults that occur on a memory access. For more information, see [Functional grouping of VMSAv8-32 System registers on page G4-4726](#).

The following sections give an overview of VMSAv8-32, and of the implementation options for VMSAv8-32:

- [The VMSAv8-32 translation regimes.](#)
- [Address types used in a VMSAv8-32 description on page G4-4561.](#)
- [Address spaces in VMSAv8-32 on page G4-4561.](#)
- [About address translation for VMSAv8-32 on page G4-4562.](#)

The remainder of the chapter fully describes the VMSA, including the different implementation options, as summarized in [Organization of the remainder of this chapter on page G4-4565.](#)

G4.1.1 The VMSAv8-32 translation regimes

As introduced in [Address translation mappings on page G4-4559](#), a translation regime maps an input VA to the corresponding PA, using one or two stages of translation. [Figure G4-1](#) shows the VMSAv8-32 translation regimes, and their associated translation stages and the Exception levels from which they are controlled.

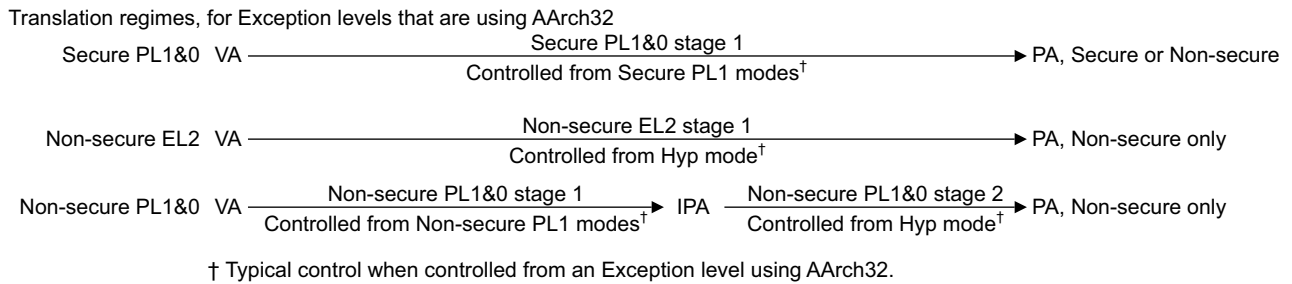

Figure G4-1 VMSAv8-32 translation regimes, and associated control

———— **Note** ————

Conceptually, a translation regime that has only a stage 1 address translation is equivalent to a regime with a fixed, flat stage 2 mapping from IPA to PA.

[Limited use of Privilege level in ARMv8 AArch32 state on page G1-4319](#) describes the mapping between the PE modes and the Privilege levels (PLs).

Alternative descriptions of the PL1&0 translation regime

The PL1&0 is described in terms of Privilege level because of the way the AArch32 PE modes map onto the Exception levels, as described in [Limited use of Privilege level in ARMv8 AArch32 state on page G1-4319](#). The description of this translation regime in terms of the Exception levels using depends on the current state of the PE, as follows:

- In Non-secure state, PL1 always maps to EL1, and therefore the Non-secure PL1&0 translation regime could be described as the Non-secure EL1&0 translation regime.
- In Secure state:
 - When EL3 is using AArch32, PL1 maps to EL3, and therefore under these conditions the Secure PL1&0 translation regime could be described as the Secure EL3&0 translation regime,
 - When EL3 is using AArch64, Secure PL1 maps to Secure EL1, and therefore under these conditions the Secure PL1&0 translation regime could be described as the Secure EL1&0 translation regime,

However, these descriptions all refer to the same translation regime, with the same System registers that are associated with its stage 1 translations. Therefore, the regime is generally referred to as the PL1&0 translation regime.

———— **Note** ————

As [Figure G4-1](#) shows, Stage 2 translation is supported only in Non-secure state.

G4.1.2 Address types used in a VMSAv8-32 description

A description of VMSAv8-32 refers to the following address types.

———— Note ————

These descriptions relate to a VMSAv8-32 description and therefore sometimes differ from the generic definitions given in the Glossary.

Virtual address (VA)

An address that is used in an instruction, as a data or instruction address, is a virtual address (VA).

An address that is held in the PC, LR, or SP, is a VA.

The VA map runs from zero to the size of the VA space. For AArch32 state, the maximum VA space is 4GB, giving a maximum VA range of 0x00000000-0xFFFFFFFF.

Intermediate physical address (IPA)

In a translation regime that provides two stages of address translation, the IPA is the address after the stage 1 translation, and is the input address for the stage 2 translation.

In a translation regime that provides only one stage of address translation, the IPA is identical to the PA.

A VMSAv8-32 implementation provides only one stage of address translation:

- If the implementation does not include EL2.
- When executing in Secure state.
- When executing in Hyp mode.

Physical address (PA)

The address of a location in the Secure or Non-secure memory map. That is, an output address from the PE to the memory system.

G4.1.3 Address spaces in VMSAv8-32

For execution in AArch32 state, the ARMv8 architecture supports:

- A VA space of up to 32 bits. The actual width is IMPLEMENTATION DEFINED.
- An IPA space of up to 40 bits. The translation tables and associated System registers define the width of the implemented address space.

———— Note ————

AArch32 defines two translation table formats. The *Long-descriptor* format gives access to the full 40-bit IPA or PA space at a granularity of 4KB. The *Short-descriptor* format:

- Gives access to a 32-bit PA space at 4KB granularity.
- Gives access to a 40-bit PA space, but only at 16MB granularity, by the use of Supersections.

If an implementation includes EL3, the address maps are defined independently for Secure and Non-secure operation, providing two independent 40-bit address spaces, where:

- A VA accessed from Non-secure state can only be translated to the Non-secure address map.
- A VA accessed from Secure state can be translated to either the Secure or the Non-secure address map.

G4.1.4 About address translation for VMSAv8-32

Address translation is the process of mapping one address type to another, for example, mapping VAs to IPAs, or mapping VAs to PAs. A *translation table* defines the mapping from one address type to another, and a *Translation table base register (TTBR)* indicates the start of a translation table. Each implemented stage of address translation shown in [Figure G4-1 on page G4-4560](#) requires its own translation tables.

For PL1&0 stage 1 translations, the mapping can be split between two tables, one controlling the lower part of the VA space, and the other controlling the upper part of the VA space. This can be used, for example, so that:

- One table defines the mapping for operating system and I/O addresses, that do not change on a context switch.
- A second table defines the mapping for application-specific addresses, and therefore might require updating on a context switch.

The VMSAv8-32 implementation options determine the supported address translation stages. The following descriptions apply when all implemented Exception levels are using AArch32:

VMSAv8-32 without EL2 or EL3

Supports only a single PL1&0 stage 1 address translation. Translation of this stage of address translation can be split between two sets of translation tables, with base addresses defined by [TTBR0](#) and [TTBR1](#), and controlled by [TTBCR](#).

VMSAv8-32 with EL3 but without EL2

Supports only the Secure PL1&0 stage 1 address translation and the Non-secure PL1&0 stage 1 address translation. In each Security state, this stage of translation can be split between two sets of translation tables, with base addresses defined by the Secure and Non-secure copies of [TTBR0](#) and [TTBR1](#), and controlled by the Secure and Non-secure copies of [TTBCR](#).

VMSAv8-32 with EL2 but without EL3

The implementation supports the following stages of address translation:

Non-secure PL2 stage 1 address translation

The [HTTBR](#) defines the base address of the translation table for this stage of address translation, controlled by [HTCR](#).

Non-secure PL1&0 stage 1 address translation

Translation of this stage of address translation can be split between two sets of translation tables, with base addresses defined by the Non-secure copies of [TTBR0](#) and [TTBR1](#) and controlled by the Non-secure instance of [TTBCR](#).

Non-secure PL1&0 stage 2 address translation

The [VTTBR](#) defines the base address of the translation table for this stage of address translation, controlled by [VTCR](#).

VMSAv8-32 with EL2 and EL3

The implementation supports all the stages of address translation, as follows:

Secure PL1&0 stage 1 address translation

Translation of this stage of address translation can be split between two sets of translation tables, with base addresses defined by the Secure copies of [TTBR0](#) and [TTBR1](#), and controlled by the Secure instance of [TTBCR](#).

Non-secure PL2 stage 1 address translation

The [HTTBR](#) defines the base address of the translation table for this stage of address translation, controlled by [HTCR](#).

Non-secure PL1&0 stage 1 address translation

Translation of this stage of address translation can be split between two sets of translation tables, with base addresses defined by the Non-secure copies of [TTBR0](#) and [TTBR1](#) and controlled by the Non-secure instance of [TTBCR](#).

Non-secure PL1&0 stage 2 address translation

The **VTTBR** defines the base address of the translation table for this stage of address translation, controlled by **VTCR**.

Figure G4-2 shows the translation regimes and stages in a VMSAv8-32 implementation that includes all the Exception levels, and indicates the PE mode that, typically, defines each set of translation tables, if that stage of address translation is controlled by a Privilege level that is using AArch32:

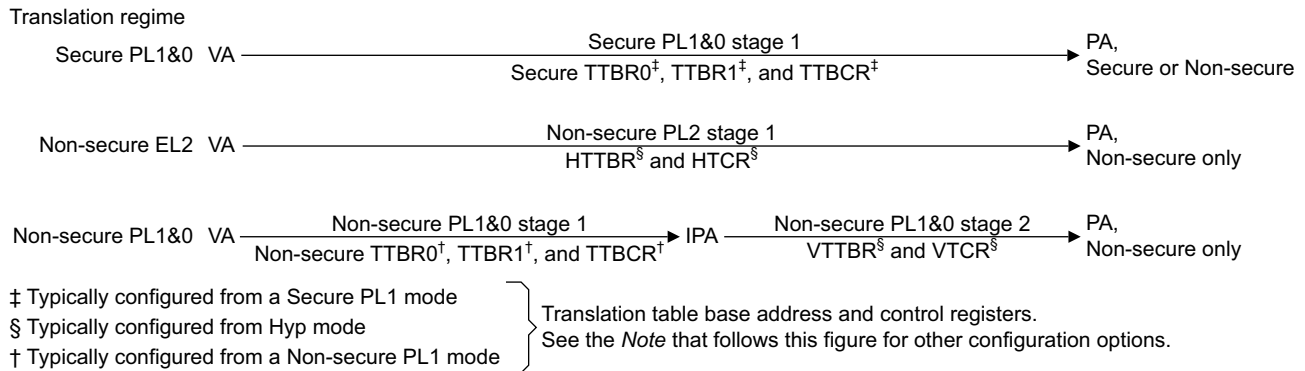

Figure G4-2 VMSAv8-32 address translation summary

————— Note —————

The term *Typically configured* is used in Figure G4-2 to indicate the expected software usage. However, stages of address translation used in AArch32 state can also be configured:

- From an Exception level higher than the Exception level of the configuring PE mode shown in Figure G4-2, regardless of whether that Exception level is using AArch32 or is using AArch64, except that a Non-secure Exception level can never configure a stage of address translation that is used in Secure state.
- From an Exception level that is using AArch64 and is higher than the level at which the translation stage is being used. For example, if Non-secure EL0 is the only Non-secure Exception level that is using AArch32, then the Non-secure PL1&0 stage of address translation is configured from Non-secure EL1, that is using AArch64.

In general:

- The translation from VA to PA can require multiple *stages* of address translation, as Figure G4-2 shows.
- A single stage of address translation takes an *input address* and translates it to an *output address*.

A full translation table lookup is called a *translation table walk*. It is performed automatically by hardware, and can have a significant cost in execution time. To support fine granularity of the VA to PA mapping, a single input address to output address translation can require multiple accesses to the translation tables, with each access giving finer granularity. Each access is described as a *level* of address lookup. The final level of the lookup defines:

- The required output address.
- The *attributes* and *access permissions* of the addressed memory.

Translation Lookaside Buffers (TLBs) reduce the average cost of a memory access by caching the results of translation table walks. TLBs behave as caches of the translation table information, and VMSAv8-32 provides TLB maintenance instructions for the management of TLB contents.

————— Note —————

The ARM architecture permits TLBs to hold any translation table entry that does not directly cause a Translation fault, an Address size fault, or an Access flag fault.

To reduce the software overhead of TLB maintenance, for the PL1&0 translation regimes VMSAv8-32 distinguishes between *Global pages* and *Process-specific pages*. The *Address Space Identifier* (ASID) identifies pages that are associated with a specific process and provides a mechanism for changing process-specific tables without having to maintain the TLB structures.

If an implementation includes EL2, the *virtual machine identifier* (VMID) identifies the current virtual machine, with its own independent ASID space. The TLB entries include this VMID information, meaning TLBs do not require explicit invalidation when changing from one virtual machine to another, if the virtual machines have different VMIDs. For stage 2 translations, all translations are associated with the current VMID. There is no mechanism to associate a particular stage 2 translation with multiple virtual machines.

Atomicity of register changes on changing virtual machine

From the viewpoint of software executing at Non-secure PL1 or PL0, when there is a switch from one virtual machine to another, the registers that control or affect address translation must be changed atomically. This rule applies to the registers for the Non-secure PL1&0 translation regime. This means that all of the following registers must change atomically:

- The registers that are associated with the stage 1 translations:
 - MAIR0, MAIR1, AMAIR0, and AMAIR1.
 - TTBR0, TTBR1, TTBCR, TTBCR2, and CONTEXTIDR.
 - SCTLR.
- The registers that are associated with the stage 2 translations:
 - VTTBR and VTCR.
 - HSCTLR.

———— Note ————

Only some fields of SCTLR affect the stage 1 translation, and only some fields of HSCTLR affect the stage 2 translation. However, in each case, changing these fields requires a write to the register, and that write must be atomic with the other register updates.

These registers apply to execution using the Non-secure PL1&0 translation regime. However, when updated as part of a switch of virtual machines they are updated by software executing at EL2. This means the registers are out of context when they are updated, and no synchronization precautions are required.

Use of out-of-context translation regimes

The architecture requires that:

- When executing at EL3 or EL2, the PE must not use the registers that are associated with the Non-secure PL1&0 translation regime for speculative memory accesses.
- When executing at EL3 the PE must not use the registers that are associated with the EL2 translation regime for speculative memory accesses.
- When executing at EL3, EL2, or Non-secure EL1, the PE must not use the registers that are associated with the Secure PL1&0 translation regime for speculative memory accesses.

When entering an Exception level on completion of a DSB instruction, no new memory accesses using any translation table entries from a translation regime of an Exception level lower than the Exception level that has been entered, will be observed by any observers to the extent that those accesses are required to be observed, as determined by the Shareability and Cacheability of those translation table entries.

———— Note ————

- This does not require that speculative memory accesses cannot be performed using those entries if it is impossible to tell that those memory accesses have been observed by the observers.

- This requirement does not imply that, on taking an exception to a higher Exception level, any translation table walks started before the exception was taken will be completed by the time the higher Exception level is entered, and therefore memory accesses required for such a translation table walk might, in effect, be performed speculatively. However, the execution of a DSB on entry to the higher Exception level ensures that these accesses are complete.

G4.1.5 Organization of the remainder of this chapter

The remainder of this chapter is organized as follows.

The next part of the chapter describes address translation and the associated memory properties held in the translation table entries, in the following sections:

- *The effects of disabling address translation stages on VMSAv8-32 behavior* on page G4-4567.
- *Translation tables* on page G4-4571.
- *Secure and Non-secure address spaces* on page G4-4574.
- *The VMSAv8-32 Short-descriptor translation table format* on page G4-4576.
- *The VMSAv8-32 Long-descriptor translation table format* on page G4-4585.
- *Memory access control* on page G4-4605.
- *Memory region attributes* on page G4-4616.
- *Translation Lookaside Buffers (TLBs)* on page G4-4628.
- *TLB maintenance requirements* on page G4-4632.

Caches in VMSAv8-32 on page G4-4646 describes VMSAv8-32-specific cache requirements.

The following sections then describe aborts on VMSAv8-32 memory accesses, and how these and other faults are reported:

- *VMSAv8-32 memory aborts* on page G4-4649.
- *Exception reporting in a VMSAv8-32 implementation* on page G4-4663.

Address translation instructions on page G4-4682 then describes these operations, and how they relate to address translation.

A number of sections then describe the System registers for VMSAv8-32. The following sections give general information about the System registers, and the organization of the registers in the primary encoding spaces, (coproc==0b1110) and (coproc==0b1111) for these registers:

- *About the System registers for VMSAv8-32* on page G4-4689.
- *VMSAv8-32 organization of registers in the (coproc==0b1110) encoding space* on page G4-4704.
- *VMSAv8-32 organization of registers in the (coproc==0b1111) encoding space* on page G4-4707.
- *Functional grouping of VMSAv8-32 System registers* on page G4-4726.

The following sections then describe each of the functional groups of the System registers in the (coproc==0b1111) encoding space, including a full description of each register in the group:

- *Identification registers, functional group* on page G4-4727.
- *Virtual memory control registers, functional group* on page G4-4729.
- *Exception and fault handling registers, functional group* on page G4-4733.
- *General system control registers, functional group* on page G4-4728.
- *Lockdown, DMA, and TCM features, functional group* on page G4-4738.
- *Cache maintenance instructions, functional group* on page G4-4734.
- *TLB maintenance instructions, functional group* on page G4-4735.
- *Address translation instructions, functional group* on page G4-4737.
- *Legacy feature registers, functional group* on page G4-4744.
- *Performance Monitors Extension registers, functional group* on page G4-4738.
- *Security registers, functional group* on page G4-4732.
- *Virtualization registers, functional group* on page G4-4730.
- *IMPLEMENTATION DEFINED registers, functional group* on page G4-4744.

———— **Note** —————

The System registers in the (coproc==0b1110) encoding space provide the following functionality:

- Self-hosted debug. These registers are described in [Debug registers on page G6-5239](#).
- The System register interface to a trace macrocell. These registers are not described in this manual.
- Jazelle registers. These registers are summarized in [Legacy feature registers, functional group on page G4-4744](#).

Therefore, there is no summary of these registers by functional groups.

[Pseudocode description of VMSAv8-32 memory system operations on page G4-4748](#) then summarizes the pseudocode functions that describe many features of VMSAv8-32 operation.

G4.2 The effects of disabling address translation stages on VMSAv8-32 behavior

About VMSAv8-32 on page G4-4558 defines the translation regimes and the associated stages of address translation, each of which has its own System registers for control and configuration. VMSAv8-32 includes an enable bit for each stage of address translation, as follows:

- **SCTLR.M**, in the Secure instance of the register, controls Secure PL1&0 stage 1 address translation.
- **SCTLR.M**, in the Non-secure instance of the register, controls Non-secure PL1&0 stage 1 address translation.
- **HCR.VM** controls Non-secure PL1&0 stage 2 address translation.
- **HSCTLR.M** controls Non-secure PL2 stage 1 address translation.

Note

- The descriptions throughout this chapter describe address translation as seen by Exception levels that are using AArch32. However, for the Non-secure PL1&0 translation regime, the stage 2 translation:
 - Is controlled by the **HCR** if EL2 is using AArch32.
 - Is controlled by the **HCR_EL2** if EL2 is using AArch64.For this reason, links to the **HCR** link to a table that disambiguates between the AArch32 **HCR** and the AArch64 **HCR_EL2**.
- If EL2 is using AArch64, then the equivalent of the Non-secure PL2 translation regime is described in *Chapter D4 The AArch64 Virtual Memory System Architecture*, not in this chapter.

The following sections describe the effect on VMSAv8-32 behavior of disabling each stage of translation:

- *VMSAv8-32 behavior when stage 1 address translation is disabled.*
- *VMSAv8-32 behavior when stage 2 address translation is disabled on page G4-4569.*
- *Behavior of instruction fetches when all associated address translations are disabled on page G4-4569.*

Enabling stages of address translation on page G4-4569 gives more information about each stage of address translation, in particular after a reset on an implementation that includes EL3.

G4.2.1 VMSAv8-32 behavior when stage 1 address translation is disabled

When stage 1 address translation is disabled, memory accesses that would otherwise be translated by that stage of address translation are treated as follows:

Non-secure PL1 and PL0 accesses when EL2 is implemented and HCR.DC is set to 1

In an implementation that includes EL2, for an access from a Non-secure PL1 or PL0 mode when **HCR.DC** is set to 1, the stage 1 translation assigns the Normal Non-shareable, Inner Write-Back Read-Allocate Write-Allocate, Outer Write-Back Read-Allocate Write-Allocate memory attributes.

See also *Effect of the HCR.DC field on page G4-4568*.

All other accesses

For all other accesses, when a stage 1 address translation is disabled, the assigned attributes depend on whether the access is a data access or an instruction access, as follows:

Data access

The stage 1 translation assigns the Device-nGnRnE memory type.

Instruction access

The stage 1 translation assigns Normal memory attribute, with the Cacheability and Shareability attributes determined by the value of:

- The Secure instance of **SCTLR.I** for the Secure PL1&0 translation regime.
- The Non-secure instance of **SCTLR.I** for the Non-secure PL1&0 translation regime.
- **HSCTLR.I** for the Non-secure PL2 translation regime.

In these cases, the meaning of the I field is as follows:

When I is set to 0

The stage 1 translation assigns the attributes Outer Shareable, Non-cacheable.

When I is set to 1

The stage 1 translation assigns the attributes Inner Write-Through Read-Allocate No Write-Allocate, Outer Write-Through Read-Allocate No Write-Allocate Cacheable.

———— **Note** —————

On some implementations, if the [SCTLR.TRE](#) field is set to 0 then this behavior can be changed by the remap settings in the memory remap registers. The details of TEX remap when [SCTLR.TRE](#) is set to 0 are IMPLEMENTATION DEFINED, see [SCTLR.TRE](#), [SCTLR.M](#), and the effect of the TEX remap registers on page G4-4621.

For this stage of translation, no memory access permission checks are performed, and therefore no MMU faults relating to this stage of translation can be generated.

———— **Note** —————

Alignment checking is performed, and therefore Alignment faults can occur.

For every access, when stage 1 translation is disabled, the output address of the stage 1 translation is equal to the input address. This is called a flat address mapping. If the implementation supports output addresses of more than 32 bits then the output address bits above bit[31] are zero. For example, for a VA to PA translation on an implementation that supports 40-bit PAs, PA[39:32] is 0x00.

For a Non-secure PL1 or PL0 access, if the PL1&0 stage 2 address translation is enabled, the stage 1 memory attribute assignments and output address can be modified by the stage 2 translation.

See also [Behavior of instruction fetches when all associated address translations are disabled](#) on page G4-4569.

Effect of the HCR.DC field

The [HCR.DC](#) field determines the default memory attributes assigned for the first stage of the Non-secure PL1&0 translation regime when that stage of translation is disabled.

When executing in a Non-secure PL1 or PL0 mode with [HCR.DC](#) set to 1:

- For all purposes other than reading the value of the [SCTLR](#), the PE behaves as if the value of the [SCTLR.M](#) field is 0. This means Non-secure PL1&0 stage 1 address translation is disabled.
- For all purposes other than reading the value of the [HCR](#), the PE behaves as if the value of the [HCR.VM](#) field is 1. This means Non-secure PL1&0 stage 2 address translation is enabled.

The effect of [HCR.DC](#) might be held in TLB entries associated with a particular VMID. Therefore, if software executing at EL2 changes the [HCR.DC](#) value without also changing the current VMID, it must also invalidate all TLB entries associated with the current VMID. Otherwise, the behavior of Non-secure software executing at EL1 or EL0 is CONstrained UNPREDICTABLE, see [CONstrained UNPREDICTABLE behaviors due to caching of control or data values](#) on page K1-6101.

Effect of disabling translation on maintenance and address translation instructions

Cache maintenance instructions act on the target cache whether address translation is enabled or not, and regardless of the values of the memory attributes. However, if a stage of translation is disabled, they use the flat address mapping for that stage, and all mappings are considered global.

TLB invalidate operations act on the target TLB whether address translation is enabled or not.

When the Non-secure PL1&0 stage 1 address translation is disabled, any [ATS1C**](#) or [ATS12NSO**](#) address translation instruction that accesses the Non-secure state translation reflects the effect of the [HCR.DC](#) field.

G4.2.2 VMSAv8-32 behavior when stage 2 address translation is disabled

When stage 2 address translation is disabled:

- The IPA output from the stage 1 translation maps flat to the PA
- The memory attributes and permissions from the stage 1 translation apply to the PA.

If the stage 1 address translation and the stage 2 address translation are both disabled, see [Behavior of instruction fetches when all associated address translations are disabled](#).

G4.2.3 Behavior of instruction fetches when all associated address translations are disabled

The information in this section applies to memory accesses:

- From Secure PL1 and PL0 modes, when the Secure PL1&0 stage 1 address translation is disabled
- From Hyp mode, when the Non-secure PL2 stage 1 address translation is disabled
- From Non-secure PL1 and PL0 modes, when all of the following apply:
 - The Non-secure PL1&0 stage 1 address translation is disabled.
 - The Non-secure PL1&0 stage 2 address translation is disabled.
 - [HCR.DC](#) is set to 0.

In these cases, when execution is in AArch32 state a memory location might be accessed as a result of an instruction fetch if either:

- The memory location is in the same 4KB block of memory, aligned to 4KB, as an instruction which a simple sequential execution of the program either requires to be fetched now or has required to be fetched since the last reset, or is in the 4KB block immediately following such a block.
- The memory location is the target of a direct branch that a simple sequential execution of the program would have taken since the most recent of:
 - The last reset.
 - If the branch predictor is architecturally invisible, the last synchronization of instruction cache maintenance targeting the address of the branch instruction.
 - If the branch predictor is not architecturally invisible, the last synchronization of branch predictor maintenance targeting the address of the branch instruction.

These accesses can be caused by speculative instruction fetches, regardless of whether the prefetched instruction is committed for execution.

———— Note —————

To ensure architectural compliance, software must ensure that both of the following apply:

- Instructions that will be executed when address translation is disabled are located in 4KB blocks of the address space that contain only memory that is tolerant to speculative accesses.
- Each 4KB block of the address space that immediately follows a 4KB block that holds instructions that will be executed when address translation is disabled also contains only memory that is tolerant to speculative accesses.

G4.2.4 Enabling stages of address translation

On powerup or reset, only the [SCTLR.M](#) field for the Exception level and Security state entered on reset is reset to 0, disabling address translation for the initial state of the PE. All other [SCTLR.M](#) and [HSCTLR.M](#) fields that are implemented are UNKNOWN after the reset.

This means, on powerup or reset:

- On an implementation that includes EL3, where EL3 is using AArch32:
 - The PL1&0 stage 1 address translation enable bit, [SCTLR.M](#), is Banked, meaning there are separate enables for operation in Secure and Non-secure state.
 - If EL3 is using AArch32, only the Secure instance of the [SCTLR.M](#) field resets to 0, disabling the Secure state PL1&0 stage 1 address translation. The reset value of the Non-secure instance of [SCTLR.M](#) is UNKNOWN.
- On an implementation that includes EL2, where EL2 is using AArch32, the [HSCTLR.M](#) field, that controls the Non-secure PL2 stage 1 address translation:
 - If the implementation does not include EL3, resets to 0.
 - Otherwise, is UNKNOWN.
- On an implementation that does not include either EL2 or EL3, there is a single stage of translation. This is controlled by [SCTLR.M](#), that resets to 0.

———— **Note** —————

If, for the software that enables or disables a stage of address translation, the input address of a stage 1 translation differs from the output address of that stage 1 translation, and the software is running in translation regime that is affected by that stage of translation, then the requirement to synchronize changes to the System registers means it is uncertain where in the instruction stream the change of the translation takes place. For this reason, ARM strongly recommends that the input address and the output address are identical in this situation.

G4.3 Translation tables

VMSAv8-32 defines two alternative translation table formats:

Short-descriptor format

It uses 32-bit descriptor entries in the translation tables, and provides:

- Up to two levels of address lookup.
- 32-bit input addresses.
- Output addresses of up to 40 bits.
- Support for PAs of more than 32 bits by use of supersections, with 16MB granularity.
- Support for No access, Client, and Manager domains.

Long-descriptor format

It uses 64-bit descriptor entries in the translation tables, and provides:

- Up to three levels of address lookup.
- Input addresses of up to 40 bits, when used for stage 2 translations.
- Output addresses of up to 40 bits.
- 4KB assignment granularity across the entire PA range.
- No support for domains, all memory regions are treated as in a Client domain.
- Fixed 4KB table size, unless truncated by the size of the input address space.

Note

- Translation with a 40-bit input address range requires two concatenated 4KB top-level tables, aligned to 8KB.
- The VMSAv8-64 Long-descriptor translation table format is generally similar to this format, but supports input and output addresses of up to 48 bits, and has an assignment granularity and table size defined by its *translation granule*. This can be 4KB, 16KB, or 64KB. See [The VMSAv8-64 translation table format on page D4-2042](#).

In all implementations, of the possible address translations shown in [Figure G4-2 on page G4-4563](#), for stages of address translation that are using AArch32:

- In a particular Security state, the translation tables for the PL1&0 stage 1 translations can use either translation table format, and the `TTBCR.EAE` field indicates the current translation table format.
- The translation tables for the Non-secure PL2 stage 1 translations, and for the Non-secure PL1&0 stage 2 translations, must use the Long-descriptor translation table format.

Many aspects of performing a translation table walk depend on the current translation table format. Therefore, the following sections describe the two formats, including how the MMU performs a translation table walk for each format:

- [The VMSAv8-32 Short-descriptor translation table format on page G4-4576](#).
- [The VMSAv8-32 Long-descriptor translation table format on page G4-4585](#).

The following subsections describe aspects of the translation tables and translation table walks, for memory accesses from AArch32 state, that are independent of the translation table format:

- [Translation table walks for memory accesses using VMSAv8-32 translation regimes on page G4-4572](#).
- [Information returned by a translation table lookup on page G4-4572](#).
- [Determining the translation table base address in the VMSAv8-32 translation regimes on page G4-4573](#).
- [Control of translation table walks on a TLB miss on page G4-4574](#).
- [Access to the Secure or Non-secure physical address map on page G4-4574](#).

See also [TLB maintenance requirements on page G4-4632](#).

G4.3.1 Translation table walks for memory accesses using VMSAv8-32 translation regimes

A translation table walk occurs as the result of a TLB miss, and starts with a read of the appropriate starting-level translation table. The result of that read determines whether additional translation table reads are required, for this stage of translation, as described in either:

- [Translation table walks, when using the VMSAv8-32 Short-descriptor translation table format on page G4-4582.](#)
- [Translation table walks, when using the VMSAv8-32 Long-descriptor translation table format on page G4-4600.](#)

———— **Note** —————

When using the Short-descriptor translation table format, the starting level for a translation table walk is always a level 1 lookup. However, with the Long-descriptor translation table format, the starting-level can be either a level 1 or a level 2 lookup.

For the PL1&0 stage 1 translations, [SCTLR.EE](#) determines the endianness of the translation table lookups. [SCTLR](#) is Banked, and therefore the endianness is determined independently for each Security state.

[HSCTLR.EE](#) defines the endianness for the Non-secure PL2 stage 1 and Non-secure PL1&0 stage 2 translations.

———— **Note** —————

Dynamically changing translation table endianness

Because any change to [SCTLR.EE](#) or [HSCTLR.EE](#) requires synchronization before it is visible to subsequent operations, ARM strongly recommends that:

- [SCTLR.EE](#) is changed only when either:
 - Executing in a mode that does not use the translation tables affected by [SCTLR.EE](#).
 - Executing with [SCTLR.M](#) set to 0.
 - [HSCTLR.EE](#) is changed only when either:
 - Executing in a mode that does not use the translation tables affected by [HSCTLR.EE](#).
 - Executing with [HSCTLR.M](#) set to 0.
-

The physical address of the base of the starting-level translation table is determined from the appropriate [TTBR](#), see [Determining the translation table base address in the VMSAv8-32 translation regimes on page G4-4573.](#)

For more information, see [Ordering and completion of TLB maintenance instructions on page G4-4635.](#)

Translation table walks must access data or unified caches, or data and unified caches, of other agents participating in the coherency protocol, according to the Shareability attributes described in the [TTBR](#). These Shareability attributes must be consistent with the Shareability attributes for the translation tables themselves.

G4.3.2 Information returned by a translation table lookup

When an associated stage of address translation is enabled, a memory access requires one or more translation table lookups. If the required translation table descriptor is not held in a TLB, a translation table walk is performed to obtain the descriptor. A lookup, whether from the TLB or as the result of a translation table walk, returns both:

- An output address that corresponds to the input address for the lookup.
- A set of properties that correspond to that output address.

The returned properties are classified as providing *address map control*, *access controls*, or *region attributes*. This classification determines how the descriptions of the properties are grouped. The classification is based on the following model:

Address map control

Memory accesses from Secure state can access either the Secure or the Non-secure address map, as summarized in [Access to the Secure or Non-secure physical address map on page G4-4574.](#)

Memory accesses from Non-secure state can only access the Non-secure address map.

Access controls

Determine whether the PE, in its current state, can access the output address that corresponds to the given input address. If not, an MMU fault is generated and there is no memory access.

Memory access control on page G4-4605 describes the properties in this group.

Attributes Are valid only for an output address that the PE, in its current state, can access. The attributes define aspects of the required behavior of accesses to the target memory region.

Memory region attributes on page G4-4616 describes the properties in this group.

G4.3.3 Determining the translation table base address in the VMSAv8-32 translation regimes

On a TLB miss, the VMSA must perform a translation table walk, and therefore must find the base address of the translation table to use for its lookup. A TTBR holds this address. As [Figure G4-2 on page G4-4563](#) shows:

- For a Non-secure PL2 stage 1 translation, the [HTTBR](#) holds the required base address. The [HTCR](#) is the control register for these translations.
- For a Non-secure PL1&0 stage 2 translation, the [VTTBR](#) holds the required base address. The [VTCTCR](#) is the control register for these translations.
- For a PL1&0 stage 1 translation, either [TTBR0](#) or [TTBR1](#) holds the required base address. The [TTBCR](#) is the control register for these translations.

The Non-secure copies of [TTBR0](#), [TTBR1](#), and [TTBCR](#), relate to the Non-secure PL1&0 stage 1 translation. The Secure copies of [TTBR0](#), [TTBR1](#), and [TTBCR](#), relate to the Secure PL1&0 stage 1 translation.

For the PL1&0 translation table walks:

- [TTBR0](#) can be configured to describe the translation of VAs in the entire address map, or to describe only the translation of VAs in the lower part of the address map.
- If [TTBR0](#) is configured to describe the translation of VAs in the lower part of the address map, [TTBR1](#) is configured to describe the translation of VAs in the upper part of the address map.

The contents of the appropriate instance of the [TTBCR](#) determine whether the address map is separated into two parts, and where the separation occurs. The details of the separation depend on the current translation table format, see:

- *Selecting between TTBR0 and TTBR1, VMSAv8-32 Short-descriptor translation table format* on page G4-4581.
- *Selecting between TTBR0 and TTBR1, VMSAv8-32 Long-descriptor translation table format* on page G4-4594.

[Example G4-1](#) shows a typical use of the two sets of translation tables:

Example G4-1 Example use of TTBR0 and TTBR1

An example of using the two TTBRs for PL1&0 stage 1 address translations is:

TTBR0 Used for process-specific addresses.

Each process maintains a separate level 1 translation table. On a context switch:

- [TTBR0](#) is updated to point to the level 1 translation table for the new context.
- [TTBCR](#) is updated if this change changes the size of the translation table.
- The [CONTEXTIDR](#) is updated.

[TTBCR](#) can be programmed so that all translations use [TTBR0](#) in a manner compatible with architecture versions before ARMv6.

TTBR1 Used for operating system and I/O addresses, that do not change on a context switch.

G4.3.4 Control of translation table walks on a TLB miss

Two fields in the [TCR](#) for the translation stage required by a memory access control whether a translation table walk is performed on a TLB miss. These two fields are the:

- PD0 and PD1 fields, on a PE using the Short-descriptor translation table format.
- EPD0 and EPD1 fields, on a PE using the Long-descriptor translation table format.

———— **Note** ————

For the VMSAv8-32 translation regimes, the different field names are because the fields are in different positions in [TTBCR](#), depending on the translation table format.

The effect of these fields is:

{E}PDx == 0 If a TLB miss occurs based on [TTBRx](#), a translation table walk is performed. The current Security state determines whether the memory access is Secure or Non-secure.

{E}PDx == 1 If a TLB miss occurs based on [TTBRx](#), a level 1 Translation fault is returned, and no translation table walk is performed.

G4.3.5 Access to the Secure or Non-secure physical address map

As stated in [Address spaces in VMSAv8-32 on page G4-4561](#), a PE can access independent Secure and Non-secure address maps. When the PL1 Exception level is using AArch32, these are defined by the translation tables identified by the Secure [TTBR0](#) and [TTBR1](#). In both translation table formats in the Secure translation map, the NS field in a descriptor indicates whether the descriptor refers to the Secure or the Non-secure address map:

NS == 0 Access the Secure physical address space.

NS == 1 Access the Non-secure physical address space.

———— **Note** ————

In the Non-secure translation tables, the corresponding field is SBZ. Non-secure accesses always access the Non-secure physical address space, regardless of the value of this field.

The Long-descriptor translation table format extends this control, adding an NSTable field to the Secure translation tables, as described in [Hierarchical control of Secure or Non-secure memory accesses, Long-descriptor format on page G4-4593](#). In the Non-secure translation tables, the corresponding field is SBZ, and Non-secure accesses ignore the value of this field.

The following sections describe the address map controls in the two implementations:

- [Control of Secure or Non-secure memory access, VMSAv8-32 Short-descriptor format on page G4-4581](#).
- [Control of Secure or Non-secure memory access, VMSAv8-32 Long-descriptor format on page G4-4593](#).

The following subsection gives more information.

Secure and Non-secure address spaces

EL3 provides two physical address spaces, a Secure physical address space and a Non-secure physical address space.

As described in [Access to the Secure or Non-secure physical address map](#), for the PL1&0 stage 1 translations when controlled from an Exception level using AArch32, the registers that control the stage of translation, [TTBR0](#), [TTBR1](#), [TTBCR](#), and [TTBCR2](#) are Banked to provide independent Secure and Non-secure instances of the registers, and the Security state of the PE when it performs a memory access whether the Secure or Non-secure instances are used. This means that for stage 1 of the PL1&0 translation regime there are independent Secure and Non-secure translation tables, and translation table walks are made to the physical address space corresponding to the Security state of the translation tables used.

For a translation table walk caused by a memory access from Non-secure state, all memory accesses are to the Non-secure address space.

For a translation table walk caused by a memory access from Secure state:

- When address translation is using the Long-descriptor translation table format:
 - The initial lookup performed must access the Secure address space.
 - If a table descriptor read from the Secure address space has the NSTable field set to 0, then the next level of lookup is from the Secure address space.
 - If a table descriptor read from the Secure address space has the NSTable field set to 1, then the next level of lookup, and any subsequent level of lookup, is from the Non-secure address space.

For more information, see [Control of Secure or Non-secure memory access, VMSAv8-32 Long-descriptor format on page G4-4593](#).

- Otherwise, all memory accesses are to the Secure address space.

Note

- When executing in Non-secure state, additional translations are supported. For memory accesses from AArch32 state these are:
 - Non-secure PL2 stage 1 translation.
 - Non-secure PL1&0 stage 2 translation.These translations can access only the Non-secure address space.
 - A system implementation can alias parts of the Secure physical address space to the Non-secure physical address space in an implementation-specific way. As with any other aliasing of physical memory, the use of aliases in this way can require the use of cache maintenance instructions to ensure that changes to memory made using one alias of the physical memory are visible to accesses to the other alias of the physical memory.
-

G4.4 The VMSAv8-32 Short-descriptor translation table format

The Short-descriptor translation table format supports a memory map based on memory sections or pages:

Supersections Consist of 16MB blocks of memory. Support for Supersections is optional, except that an implementation that supports more than 32 bits of physical address must also support Supersections to provide access to the entire physical address space.

Sections Consist of 1MB blocks of memory.

Large pages Consist of 64KB blocks of memory.

Small pages Consist of 4KB blocks of memory.

Supersections, Sections and Large pages map large regions of memory using only a single TLB entry.

———— Note —————

Whether a VMSAv8-32 implementation of the Short-descriptor format translation tables supports supersections is IMPLEMENTATION DEFINED.

When using the Short-descriptor translation table format, two levels of translation tables are held in memory:

Level 1 table

Holds *level 1 descriptors* that contain the base address and

- Translation properties for a Section and Supersection.
- Translation properties and pointers to a level 2 table for a Large page or a Small page.

Level 2 tables

Hold *level 2 descriptors* that contain the base address and translation properties for a Small page or a Large page. With the Short-descriptor format, level 2 tables can be referred to as *Page tables*.

A level 2 table requires 1KB of memory.

In the translation tables, in general, a descriptor is one of:

- An invalid or fault entry.
- A Page table entry, that points to a next-level translation table.
- A page or section entry, that defines the memory properties for the access.
- A reserved format.

Bits[1:0] of the descriptor give the primary indication of the descriptor type.

[Figure G4-3 on page G4-4577](#) gives a general view of address translation when using the Short-descriptor translation table format.

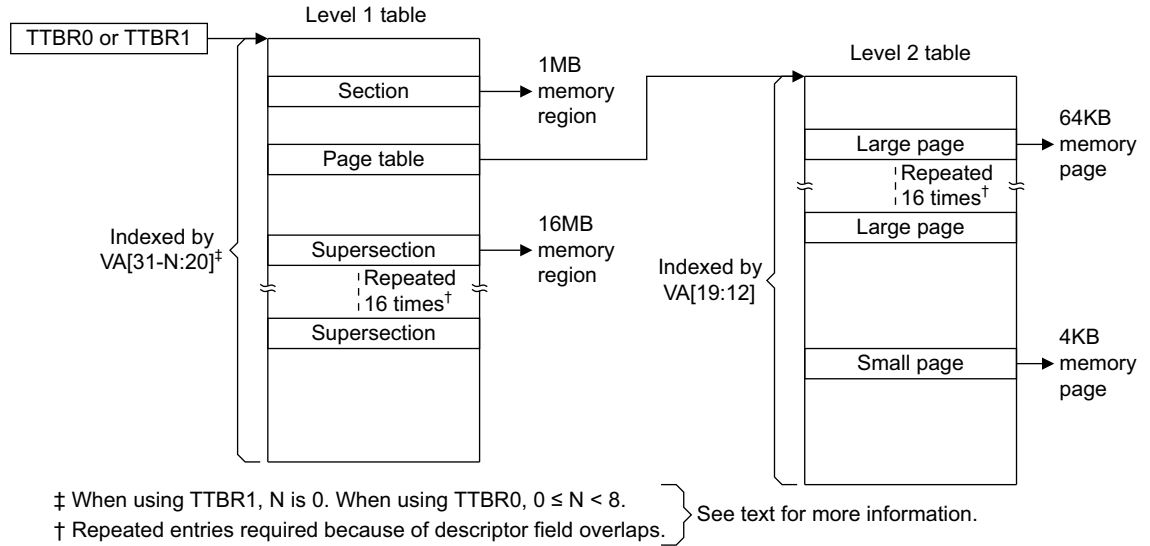

Figure G4-3 General view of address translation using VMSAv8-32 Short-descriptor format translation tables

Additional requirements for Short-descriptor format translation tables on page G4-4580 describes why, when using the Short-descriptor format, Supersection and Large page entries must be repeated 16 times, as shown in *Figure G4-3*.

VMSAv8-32 Short-descriptor translation table format descriptors, Memory attributes in the VMSAv8-32 Short-descriptor translation table format descriptors on page G4-4580, and Control of Secure or Non-secure memory access, VMSAv8-32 Short-descriptor format on page G4-4581 describe the format of the descriptors in the Short-descriptor format translation tables.

The following sections then describe the use of this translation table format:

- *Selecting between TTBR0 and TTBR1, VMSAv8-32 Short-descriptor translation table format on page G4-4581.*
- *Translation table walks, when using the VMSAv8-32 Short-descriptor translation table format on page G4-4582.*

G4.4.1 VMSAv8-32 Short-descriptor translation table format descriptors

The following sections describe the formats of the entries in the Short-descriptor translation tables:

- *Short-descriptor translation table level 1 descriptor formats on page G4-4578.*
- *Short-descriptor translation table level 2 descriptor formats on page G4-4579.*

For more information about level 2 translation tables see *Additional requirements for Short-descriptor format translation tables on page G4-4580*.

————— **Note** —————

Previous versions of the *ARM Architecture Reference Manual*, and some other documentation, describes the AP[2] bit in the translation table entries as the APX bit.

Information returned by a translation table lookup on page G4-4572 describes the classification of the non-address fields in the descriptors as address map control, access control, or attribute fields.

Short-descriptor translation table level 1 descriptor formats

Each entry in the level 1 table describes the mapping of the associated 1MB VA range.

Figure G4-4 shows the possible level 1 descriptor formats.

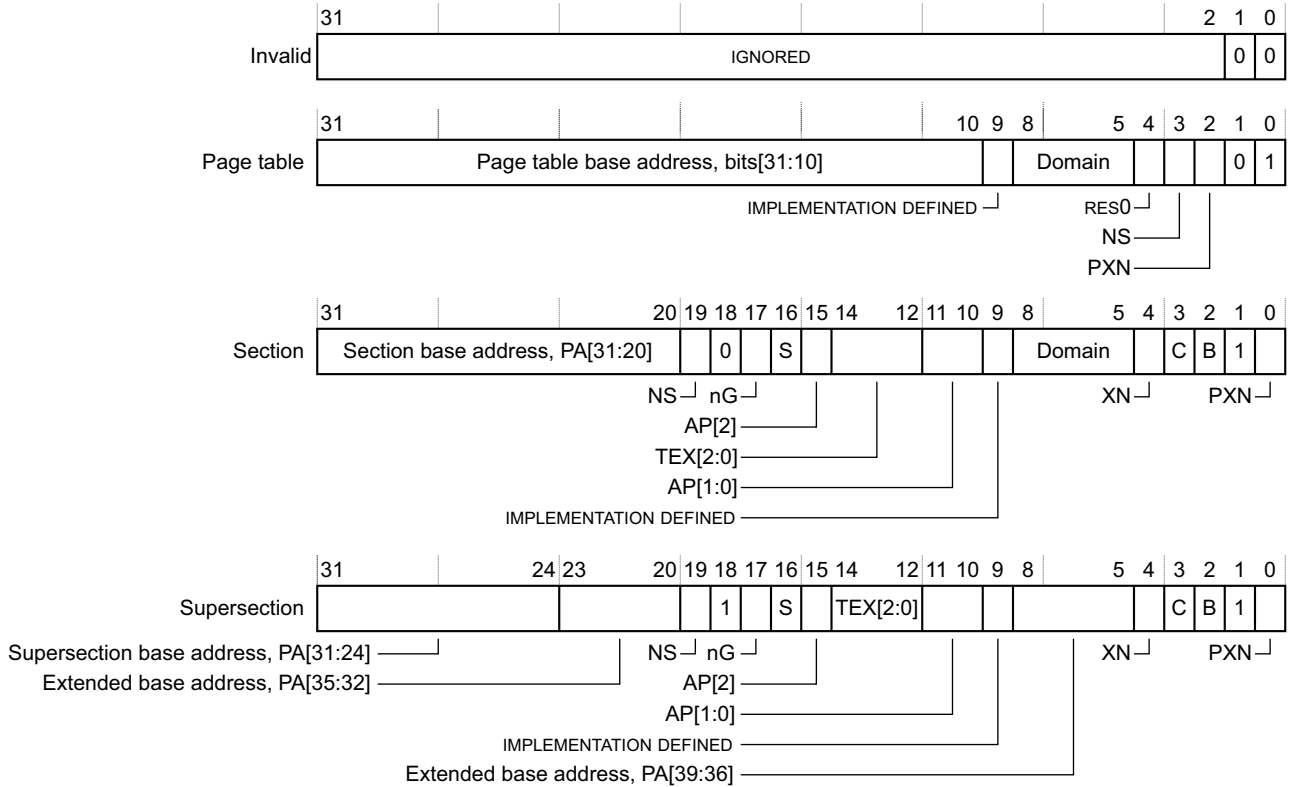

Figure G4-4 VMSAv8-32 Short-descriptor level 1 descriptor formats

Descriptor bits[1:0] identify the descriptor type. The encoding of these bits is:

0b00, Invalid entry

The associated VA is unmapped, and any attempt to access it generates a Translation fault.

Bits[31:2] of the descriptor are IGNORED, see *IGNORED* on page Glossary-6341. This means software can use these bits for its own purposes.

0b01, Page table

The descriptor gives the address of a level 2 translation table, that specifies the mapping of the associated 1MByte VA range.

0b10, Section or Supersection

The descriptor gives the base address of the Section or Supersection. Bit[18] determines whether the entry describes a Section or a Supersection.

This encoding also defines the PXN field as 0.

0b11, Section or Supersection, if the implementation supports the PXN attribute

This encoding is identical to 0b10, except that it defines the PXN field as 1.

Note

A VMSAv8-32 implementation can use the Short-descriptor translation table format for the PL1&0 stage 1 translations, by setting `TTBCR.EAE` to 0.

The address information in the level 1 descriptors is:

- Page table** Bits[31:10] of the descriptor are bits[31:10] of the address of a Page table.
- Section** Bits[31:20] of the descriptor are bits[31:20] of the address of the Section.
- Supersection** Bits[31:24] of the descriptor are bits[31:24] of the address of the Supersection.
 Optionally, bits[8:5, 23:20] of the descriptor are bits[39:32] of the extended Supersection address.

For the Non-secure PL1&0 translation tables, the address in the descriptor is the IPA of the Page table, Section, or Supersection. Otherwise, the address is the PA of the Page table, Section, or Supersection.

For descriptions of the other fields in the descriptors, see *Memory attributes in the VMSAv8-32 Short-descriptor translation table format descriptors* on page G4-4580.

Short-descriptor translation table level 2 descriptor formats

Figure G4-5 shows the possible formats of a level 2 descriptor.

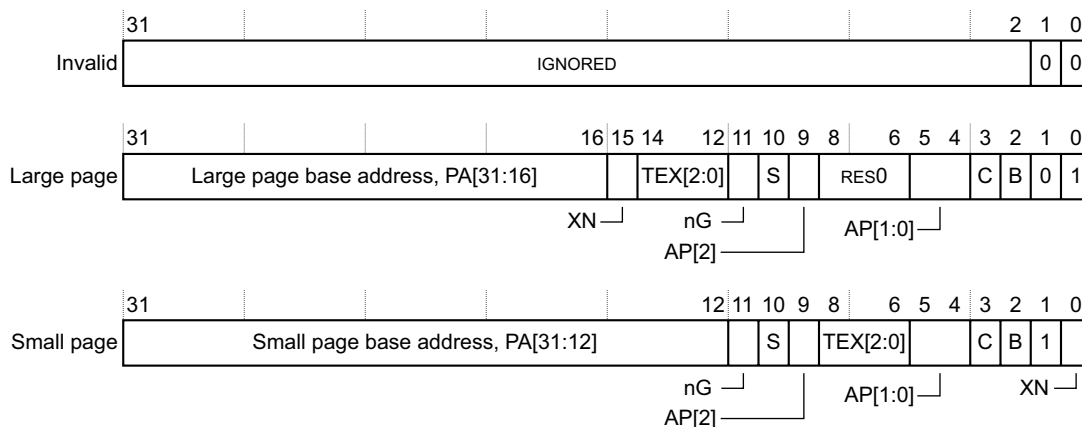

Figure G4-5 Short-descriptor level 2 descriptor formats

Descriptor bits[1:0] identify the descriptor type. The encoding of these bits is:

0b00, Invalid entry

The associated VA is unmapped, and attempting to access it generates a Translation fault.

Bits[31:2] of the descriptor are *IGNORED*, see *IGNORED* on page Glossary-6341. This means software can use these bits for its own purposes.

0b01, Large page

The descriptor gives the base address and properties of the Large page.

0b1x, Small page

The descriptor gives the base address and properties of the Small page.

In this descriptor format, bit[0] of the descriptor is the XN field.

The address information in the level 2 descriptors is:

- Large page** Bits[31:16] of the descriptor are bits[31:16] of the address of the Large page.
- Small page** Bits[31:12] of the descriptor are bits[31:12] of the address of the Small page.

For the Non-secure PL1&0 translation tables, the address in the descriptor is the IPA of the Page table, Section, or Supersection. Otherwise, the address is the PA of the Page table, Section, or Supersection.

For descriptions of the other fields in the descriptors, see [Memory attributes in the VMSAv8-32 Short-descriptor translation table format descriptors](#).

Additional requirements for Short-descriptor format translation tables

When using Supersection or Large page descriptors in the Short-descriptor translation table format, the input address field that defines the Supersection or Large page descriptor address overlaps the table address field. In each case, the size of the overlap is 4 bits. The following diagrams show these overlaps:

- [Figure K6-14 on page K6-6194](#) for the level 1 translation table entry for a Supersection.
- [Figure K6-16 on page K6-6196](#) for the level 2 translation table entry for a Large page.

Considering the case of using Large page descriptors in a level 2 translation table, this overlap means that for any specific Large page, the bottom four bits of the level 2 translation table entry might take any value from 0b0000 to 0b1111. Therefore, each of these sixteen index values must point to a separate copy of the same descriptor.

This means that each Large page or Supersection descriptor must:

- Occur first on a sixteen-word boundary.
- Be repeated in 16 consecutive memory locations.

G4.4.2 Memory attributes in the VMSAv8-32 Short-descriptor translation table format descriptors

This section describes the descriptor fields other than the descriptor type field and the address field:

TEX[2:0], C, B

Memory region attribute fields, see [Memory region attributes on page G4-4616](#).

These fields are not present in a descriptor for a Page table.

XN bit The Execute-never bit. Determines whether the PE can execute software from the addressed region, see [Access permissions for instruction execution on page G4-4609](#).

This bit is not present in a descriptor for a Page table.

PXN bit The Privileged execute-never bit. Determines whether the PE can execute software from the region when executing at PL1, see [Access permissions for instruction execution on page G4-4609](#).

————— Note —————

Memory accesses by software executing at EL2 always use the Long-descriptor translation table format.

When this bit is set to 1 in the descriptor for a Page table, it indicates that all memory pages described in the corresponding Page table are Privileged execute-never.

NS bit Non-secure bit. Specifies whether the translated PA is in the Secure or Non-secure address map, see [Control of Secure or Non-secure memory access, VMSAv8-32 Short-descriptor format on page G4-4581](#).

This bit is not present in level 2 descriptors. The value of the NS bit in a level 1 descriptor for a Page table applies to all entries in the corresponding level 2 translation table.

Domain Domain field, see [Domains, Short-descriptor format only on page G4-4612](#).

This field is not present in a Supersection entry. Memory described by Supersections is in domain 0.

This bit is not present in level 2 descriptors. The value of the Domain field in the level 1 descriptor for a Page table applies to all entries in the corresponding level 2 translation table.

An IMPLEMENTATION DEFINED bit

This bit is not present in level 2 descriptors.

AP[2], AP[1:0]

Access Permissions bits, see *Memory access control* on page G4-4605.

AP[0] can be configured as the *Access flag*, see *The Access flag* on page G4-4613.

These bits are not present in a descriptor for a Page table.

S bit

Shareable bit. Used in determining the Shareability of the addressed region, see *Memory region attributes* on page G4-4616.

———— **Note** —————

The naming of this bit as the *Shareable* bit is carried forward from early versions of the ARM architecture. This name is no longer an adequate description of the interpretation of the bit.

This bit is not present in a descriptor for a Page table.

nG bit

The not global bit. If a lookup using this descriptor is cached in a TLB, determines whether the TLB entry applies to all ASID values, or only to the current ASID value. See *Global and process-specific translation table entries* on page G4-4628.

This bit is not present in a descriptor for a Page table.

Bit[18], when bits[1:0] indicate a Section or Supersection descriptor

- | | |
|----------|-----------------------------------|
| 0 | Descriptor is for a Section. |
| 1 | Descriptor is for a Supersection. |

G4.4.3 Control of Secure or Non-secure memory access, VMSAv8-32 Short-descriptor format

Access to the Secure or Non-secure physical address map on page G4-4574 describes how the NS bit in the translation table entries:

- For accesses from Secure state, determines whether the access is to Secure or Non-secure memory.
- Is ignored by accesses from Non-secure state.

In the Short-descriptor translation table format, the NS bit is defined only in the level 1 translation tables. This means that, in a level 1 descriptor for a Page table, the NS bit defines the physical address map, Secure or Non-secure, for all of the Large pages and Small pages of memory described by that table.

The NS bit of a level 1 descriptor for a Page table has no effect on the physical address map in which that translation table is held. As stated in *Secure and Non-secure address spaces* on page G4-4574, the physical address of that translation table is in:

- The Secure address map if the translation table walk is in Secure state.
- The Non-secure address map if the translation table walk is in Non-secure state.

This means the granularity of the Secure and Non-secure memory maps is 1MB. However, in these memory maps, table entries can define physical memory regions with a granularity of 4KB.

G4.4.4 Selecting between TTBR0 and TTBR1, VMSAv8-32 Short-descriptor translation table format

As described in *Determining the translation table base address in the VMSAv8-32 translation regimes* on page G4-4573, two sets of translation tables can be defined for each of the PL1&0 stage 1 translations, and TTBR0 and TTBR1 hold the base addresses for the two sets of tables. When using the Short-descriptor translation table format, the value of TTBCR.N indicates the number of most significant bits of the input VA that determine whether TTBR0 or TTBR1 holds the required translation table base address, as follows:

- If N == 0 then use TTBR0. Setting TTBCR.N to zero disables use of a second set of translation tables.
- If N > 0 then:
 - If bits[31:32-N] of the input VA are all zero then use TTBR0.
 - Otherwise use TTBR1.

Table G4-1 shows how the value of N determines the lowest address translated using TTBR1, and the size of the level 1 translation table addressed by TTBR0.

Table G4-1 Effect of TTBCR.N on address translation, Short-descriptor format

TTBCR.N	First address translated with TTBR1	TTBR0 table	
		Size	Index range
0b000	TTBR1 not used	16KB	VA[31:20]
0b001	0x80000000	8KB	VA[30:20]
0b010	0x40000000	4KB	VA[29:20]
0b011	0x20000000	2KB	VA[28:20]
0b100	0x10000000	1KB	VA[27:20]
0b101	0x08000000	512 bytes	VA[26:20]
0b110	0x04000000	256 bytes	VA[25:20]
0b111	0x02000000	128 bytes	VA[24:20]

Whenever TTBCR.N is nonzero, the size of the translation table addressed by TTBR1 is 16KB.

Figure G4-6 shows how the value of TTBCR.N controls the boundary between VAs that are translated using TTBR0, and VAs that are translated using TTBR1.

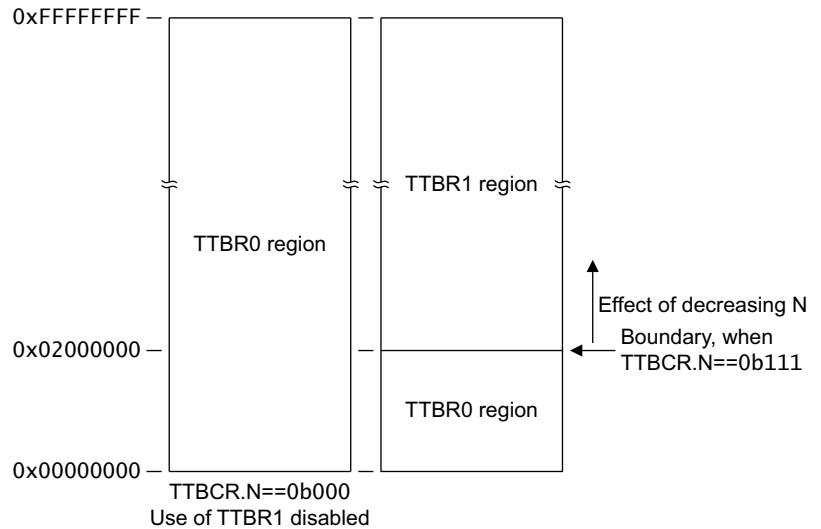

Figure G4-6 How TTBCR.N controls the boundary between the TTBRs, Short-descriptor format

In the selected TTBR, bits RGN, S and IRGN[1:0] define the memory region attributes for the translation table walk.

Translation table walks, when using the VMSAv8-32 Short-descriptor translation table format describes the translation.

G4.4.5 Translation table walks, when using the VMSAv8-32 Short-descriptor translation table format

When using the Short-descriptor translation table format, and a memory access requires a translation table walk:

- A section-mapped access only requires a read of the level 1 translation table.
- A page-mapped access also requires a read of the level 2 translation table.

Reading a level 1 translation table describes how either **TTBR1** or **TTBR0** is used, with the accessed VA, to determine the address of the level 1 descriptor.

Reading a level 1 translation table shows the output address as A[39:0]:

- For a Non-secure PL1&0 stage 1 translation, this is the IPA of the required descriptor. A Non-secure PL1&0 stage 2 translation of this address is performed to obtain the PA of the descriptor.
- Otherwise, this address is the PA of the required descriptor.

The full translation flow for Sections, Supersections, Small pages and Large pages on page G4-4584 then shows the complete translation flow for each valid memory access.

Reading a level 1 translation table

When performing a fetch based on **TTBR0**:

- The address bits taken from **TTBR0** vary between bits[31:14] and bits[31:7].
- The address bits taken from the VA, that is the input address for the translation, vary between bits[31:20] and bits[24:20].

The width of the **TTBR0** and VA fields depend on the value of **TTBCR.N**, as [Figure G4-7](#) shows.

When performing a fetch based on **TTBR1**, Bits **TTBR1**[31:14] are concatenated with bits[31:20] of the VA. This makes the fetch equivalent to that shown in [Figure G4-7](#), with $N=0$.

————— **Note** —————

See *The address and Properties fields shown in the translation flows* on page K6-6198 for more information about the *Properties* label used in this and other figures.

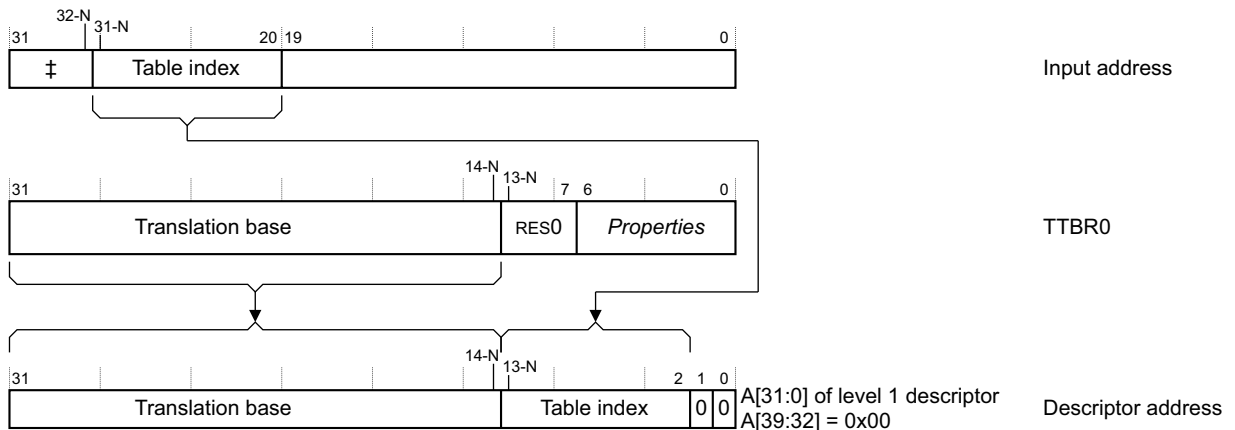

‡ This field is absent if N is 0
 N is the value of **TTBCR.N**
 For details of the *Properties* field, see the register description

Figure G4-7 Accessing level 1 translation table based on TTBR0, Short-descriptor format

Regardless of which register is used as the base for the fetch, the resulting output address selects a four-byte translation table entry that is one of:

- A level 1 descriptor for a Section or Supersection.
- A descriptor for a *Page table*, that points to a level 2 translation table. In this case:
 - A second fetch is performed to retrieve a level 2 descriptor.
 - The descriptor also contains some attributes for the access, see [Figure G4-4](#) on page G4-4578.
- A faulting entry.

The full translation flow for Sections, Supersections, Small pages and Large pages

In a translation table walk, only the initial lookup uses the translation table base address from the appropriate [TTBR](#). Subsequent lookups use a combination of address information from:

- The table descriptor read in the previous lookup.
- The input address.

Address translation examples using the VMSAv8-32 Short descriptor translation table format on page K6-6193 shows the full translation flow for each of the memory section and page options. As described in VMSAv8-32 Short-descriptor translation table format descriptors on page G4-4577, these options are:

Supersection A 16MB memory region, see *Translation flow for a Supersection on page K6-6194*.

Section A 1MB memory region, see *Translation flow for a Section on page K6-6195*.

Large page A 64KB memory region, described by the combination of:

- A level 1 translation table entry that indicates the address of a level 2 Page table.
- A level 2 descriptor that indicates a Large page.

See *Translation flow for a Large page on page K6-6196*.

Small page A 4KB memory region, described by the combination of:

- A level 1 translation table entry that indicates the address of a level 2 Page table.
- A level 2 descriptor that indicates a Small page.

See *Translation flow for a Small page on page K6-6197*.

G4.5 The VMSAv8-32 Long-descriptor translation table format

The VMSAv8-32 Long-descriptor translation table format supports the assignment of memory attributes to memory Pages, at a granularity of 4KB, across the complete input address range. It also supports the assignment of memory attributes to *blocks* of memory, where a block can be 2MB or 1GB.

———— **Note** —————

- Although the VMSAv8-32 Long-descriptor format is limited to three levels of address lookup, its design and naming conventions support extension to additional levels, to support a larger input address range.
- Similarly, while the VMSAv8-32 implementation limits the output address range to 40 bits, its design supports extension to a larger output address range.

Figure G4-2 on page G4-4563 shows the different address translation stages. The Long-descriptor translation table format:

- Is used for:
 - The Non-secure PL2 stage 1 translation.
 - The Non-secure PL1&0 stage 2 translation.
- Can be used for the Secure and Non-secure PL1&0 translations.

When used for a stage 1 translation, the translation tables support an input address of up to 32 bits, corresponding to the VA address range of the PE.

When used for a stage 2 translation, the translation tables support an input address range of up to 40 bits, to support the translation from IPA to PA. If the input address for the stage 2 translation is a 32-bit address then this address is zero-extended to 40 bits.

———— **Note** —————

When the Short-descriptor translation table format is used for the Non-secure stage 1 translations, this generates 32-bit IPAs. These are zero-extended to 40 bits to provide the input address for the stage 2 translation.

Overview of VMSAv8-32 address translation using Long-descriptor translation tables on page G4-4586 summarizes address translation from AArch32 state when using the Long-descriptor format translation tables.

The following sections then describe the format of the descriptors in the Long-descriptor format translation tables:

- *VMSAv8-32 Long-descriptor translation table format descriptors* on page G4-4586.
- *Memory attribute fields in the VMSAv8-32 Long-descriptor translation table format descriptors* on page G4-4589.
- *Control of Secure or Non-secure memory access, VMSAv8-32 Long-descriptor format* on page G4-4593.

The following sections then describe this translation table format:

- *Selecting between TTBR0 and TTBR1, VMSAv8-32 Long-descriptor translation table format* on page G4-4594.
- *VMSAv8-32 Long-descriptor translation table format address lookup levels* on page G4-4597.
- *Translation table walks, when using the VMSAv8-32 Long-descriptor translation table format* on page G4-4600.
- *The algorithm for finding the translation table entries, VMSAv8-32 Long-descriptor format* on page G4-4603.

G4.5.1 Overview of VMSAv8-32 address translation using Long-descriptor translation tables

Figure G4-8 gives a general view of VMSAv8-32 stage 1 address translation when using the Long-descriptor translation table format.

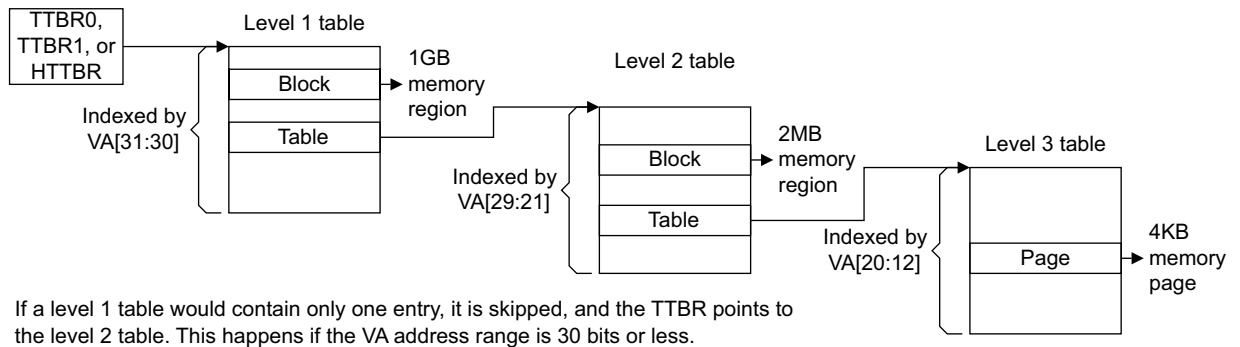
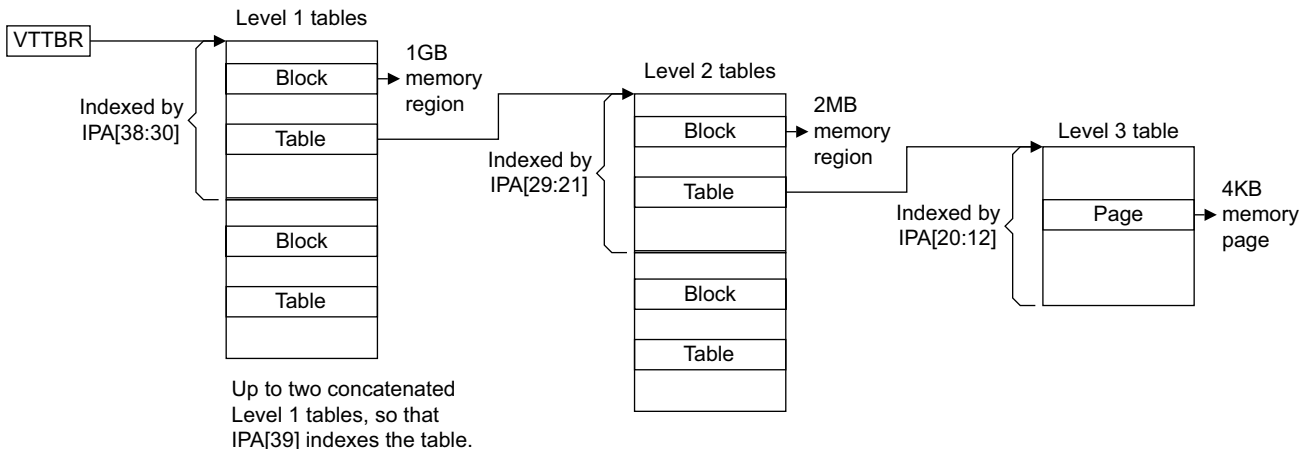

Figure G4-8 General view of VMSAv8-32 stage 1 address translation using Long-descriptor format

Figure G4-9 gives a general view of VMSAv8-32 stage 2 address translation. Stage 2 translation always uses the Long-descriptor translation table format.



If a level 1 table would contain 16 entries or fewer, level 1 lookup can be omitted. If so, VTTBR points to the start of a block of concatenated level 2 tables. See text for more information.

Figure G4-9 General view of VMSAv8-32 stage 2 address translation, Long-descriptor translation table format

Use of concatenated translation tables for the initial stage 2 lookup on page G4-4597 describes how using concatenated level 2 tables means lookup can start at level 2, as referred to in Figure G4-9.

G4.5.2 VMSAv8-32 Long-descriptor translation table format descriptors

As described in *VMSAv8-32 Long-descriptor translation table format address lookup levels* on page G4-4597, the Long-descriptor translation table format provides up to three levels of address lookup. A translation table walk starts either at level 1 or level 2 of the address lookup.

In general, a descriptor is one of:

- An invalid or fault entry.
- A table entry, that points to the next-level translation table.
- A block entry, that defines the memory properties for the access.
- A reserved format.

Bit[1] of the descriptor indicates the descriptor type, and bit[0] indicates whether the descriptor is valid.

The following sections describe the Long-descriptor translation table descriptor formats:

- [VMSAv8-32 Long-descriptor level 1 and level 2 descriptor formats.](#)
- [VMSAv8-32 Long-descriptor translation table level 3 descriptor formats on page G4-4588.](#)

[Information returned by a translation table lookup on page G4-4572](#) describes the classification of the non-address fields in the descriptors between *address map control*, *access controls*, and *region attributes*.

VMSAv8-32 Long-descriptor level 1 and level 2 descriptor formats

In the Long-descriptor translation tables, the formats of the level 1 and level 2 descriptors differ only in the size of the block of memory addressed by the block descriptor. A block entry:

- In a level 1 table describes the mapping of the associated 1GB input address range.
- In a level 2 table describes the mapping of the associated 2MB input address range.

Figure G4-10 shows the Long-descriptor level 1 and level 2 descriptor formats:

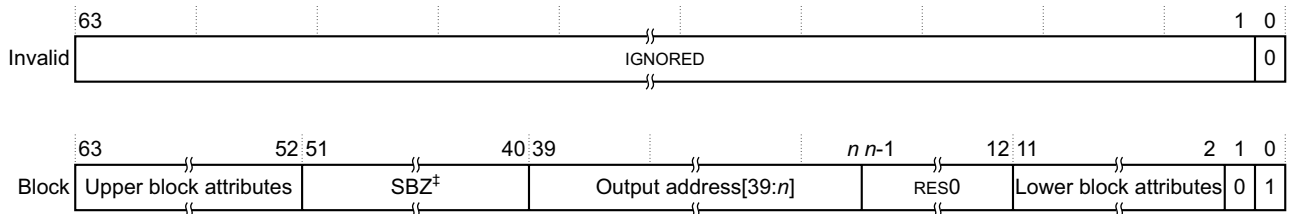

For the level 1 descriptor, n is 30. For the level 2 descriptor, n is 21.

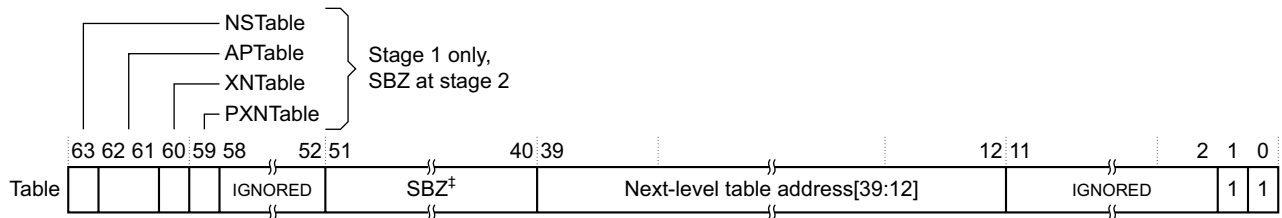

The level 1 descriptor returns the address of the level 2 table.
 The level 2 descriptor returns the address of the level 3 table.

[‡] See the descriptions of the address fields for more information about bits[47:40] of the Block and Table descriptors.

Figure G4-10 VMSAv8-32 Long-descriptor level 1 and level 2 descriptor formats

Descriptor encodings, Long-descriptor level 1 and level 2 formats

Descriptor bit[0] identifies whether the descriptor is valid, and is 1 for a valid descriptor. If a lookup returns an invalid descriptor, the associated input address is unmapped, and any attempt to access it generates a Translation fault.

Descriptor bit[1] identifies the descriptor type, and is encoded as:

- 0, Block** The descriptor gives the base address of a block of memory, and the attributes for that memory region.
- 1, Table** The descriptor gives the address of the next level of translation table, and for a stage 1 translation, some attributes for that translation.

The other fields in the valid descriptors are:

Block descriptor

Gives the base address and attributes of a block of memory:

- For a level 1 Block descriptor, bits[39:30] are bits[39:30] of the output address that specifies a 1GB block of memory.
- For a level 2 Block descriptor, bits[39:21] are bits[39:21] of the output address that specifies a 2MB block of memory.

In both cases, if bits[47:40] of the descriptor are not zero then a translation that uses the descriptor will generate an Address size fault, see [Address size fault on page G4-4658](#).

Bits[63:52, 11:2] provide attributes for the target memory block, see [Memory attribute fields in the VMSAv8-32 Long-descriptor translation table format descriptors on page G4-4589](#). The position and contents of these bits is identical in the level 2 block descriptor and in the level 3 page descriptor.

Table descriptor

Bits[39:m] are bits[39:m] of the address of the required next-level table. Bits[m-1:0] of the table address are zero:

- For a level 1 Table descriptor, this is the address of a level 2 table.
- For a level 2 Table descriptor, this is the address of a level 3 table.

In both cases, if bits[47:40] of the descriptor are not zero then a translation that uses the descriptor will generate an Address size fault, see [Address size fault on page G4-4658](#).

For a stage 1 translation only, bits[63:59] provide attributes for the next-level lookup, see [Memory attribute fields in the VMSAv8-32 Long-descriptor translation table format descriptors on page G4-4589](#).

If the translation table defines the Non-secure PL1&0 stage 1 translations, then the output address in the descriptor is the IPA of the target block or table. Otherwise, it is the PA of the target block or table.

VMSAv8-32 Long-descriptor translation table level 3 descriptor formats

Each entry in a level 3 table describes the mapping of the associated 4KB input address range.

Figure G4-11 shows the Long-descriptor level 3 descriptor formats.

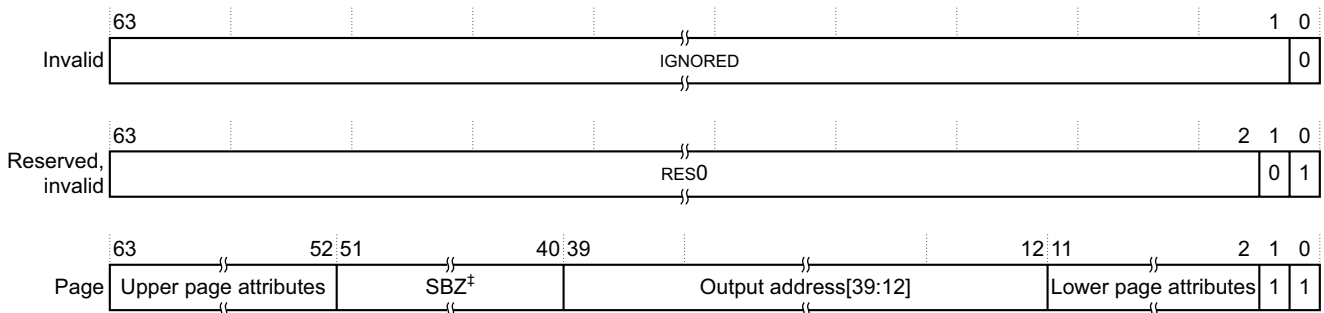

† See the description of the address field for more information about bits[47:40] of the Page descriptor.

Figure G4-11 VMSAv8-32 Long-descriptor level 3 descriptor formats

Descriptor bit[0] identifies whether the descriptor is valid, and is 1 for a valid descriptor. If a lookup returns an invalid descriptor, the associated input address is unmapped, and any attempt to access it generates a Translation fault.

Descriptor bit[1] identifies the descriptor type, and is encoded as:

0, Reserved, invalid

Behaves identically to encodings with bit[0] set to 0.

This encoding must not be used in level 3 translation tables.

1, Page Gives the address and attributes of a 4KB page of memory.

At this level, the only valid format is the Page descriptor. The other fields in the Page descriptor are:

Page descriptor

Bits[39:12] are bits[39:12] of the output address for a page of memory.

If bits[47:40] of the descriptor are not zero then a translation that uses the descriptor will generate an Address size fault, see [Address size fault on page G4-4658](#).

Bits[63:52, 11:2] provide attributes for the target memory page, see [Memory attribute fields in the VMSAv8-32 Long-descriptor translation table format descriptors](#). The position and contents of these bits are identical in the level 1 block descriptor and in the level 2 block descriptor.

If the translation table defines the Non-secure PL1&0 stage 1 translations, then the output address in the descriptor is the IPA of the target page. Otherwise, it is the PA of the target page.

G4.5.3 Memory attribute fields in the VMSAv8-32 Long-descriptor translation table format descriptors

The memory attributes in the VMSAv8-32 Long-descriptor translation tables are based on those in the Short-descriptor translation table format, with some extensions. [Memory region attributes on page G4-4616](#) describes these attributes. In the Long-descriptor translation table format:

- Table entries for stage 1 translations define attributes for the next level of lookup, see [Next-level attributes in VMSAv8-32 Long-descriptor stage 1 Table descriptors](#)
The hierarchical attributes in the translation tables, APTable, XNTable, and PXNTable, permit subtrees of the translation tables to be used by different agents. Not all operating systems use this functionality, and so ARMv8.2-AA32HPD adds a facility to disable these bits.
This ability to disable hierarchical attribute bits has no effect on the NSTable bit.
- Block and Page entries define memory attributes for the target block or page of memory. Stage 1 and stage 2 translations have some differences in these attributes, see:
 - [Attribute fields in VMSAv8-32 Long-descriptor stage 1 Block and Page descriptors on page G4-4590](#).
 - [Attribute fields in VMSAv8-32 Long-descriptor stage 2 Block and Page descriptors on page G4-4592](#).

Next-level attributes in VMSAv8-32 Long-descriptor stage 1 Table descriptors

In a Table descriptor for a stage 1 translation, bits[63:59] of the descriptor define the following attributes for the next-level translation table access:

- NSTable, bit[63]** For memory accesses from Secure state, specifies the Security state for subsequent levels of lookup, see [Hierarchical control of Secure or Non-secure memory accesses, Long-descriptor format on page G4-4593](#).
For memory accesses from Non-secure state, this bit is ignored.
- APTable, bits[62:61]** Access permissions limit for subsequent levels of lookup, see [Hierarchical control of access permissions, Long-descriptor format on page G4-4607](#).
APTable[0] is reserved, SBZ, in the Non-secure PL2 stage 1 translation tables.
From ARMv8.2, when ARMv8.2-AA32HPD is implemented, this field can be disabled.

When the value of TTBCR2.HPD0 or TTBCR2.HPD1 is 1, and the value of TTBCR.T2E is also 1:

- The value of the corresponding APTable field is IGNORED by hardware, allowing the field to be used by software.
- The behavior of the system is as if the value of the corresponding APTable field is 0, that is to say, the APTable field has an *Effective value* of 0.

XNTable, bit[60] XN limit for subsequent levels of lookup, see *Hierarchical control of instruction fetching, Long-descriptor format* on page G4-4611.

From ARMv8.2, when ARMv8.2-AA32HPD is implemented, this field can be disabled.

When the value of TTBCR2.HPD0 or TTBCR2.HPD1 is 1, and the value of TTBCR.T2E is also 1:

- The value of the corresponding XNTable field is IGNORED by hardware, allowing the field to be used by software.
- The behavior of the system is as if the value of the corresponding XNTable field is 0, that is to say, the XNTable field has an *Effective value* of 0.

PXNTable, bit[59] PXN limit for subsequent levels of lookup, see *Hierarchical control of instruction fetching, Long-descriptor format* on page G4-4611.

This bit is RES0 in the Non-secure PL2 stage 1 translation tables.

From ARMv8.2, when ARMv8.2-AA32HPD is implemented, this field can be disabled.

When the value of TTBCR2.HPD0 or TTBCR2.HPD1 is 1 and the value of TTBCR.T2E is also 1:

- The value of the corresponding PXNTable field is IGNORED by hardware, allowing the field to be used by software.
- The behavior of the system is as if the value of the corresponding PXNTable field is 0, that is to say, the PXNTable field has an *Effective value* of 0.

Attribute fields in VMSAv8-32 Long-descriptor stage 1 Block and Page descriptors

In Block and Page descriptors, the memory attributes are split into an upper block and a lower block as shown for a stage 1 translation:

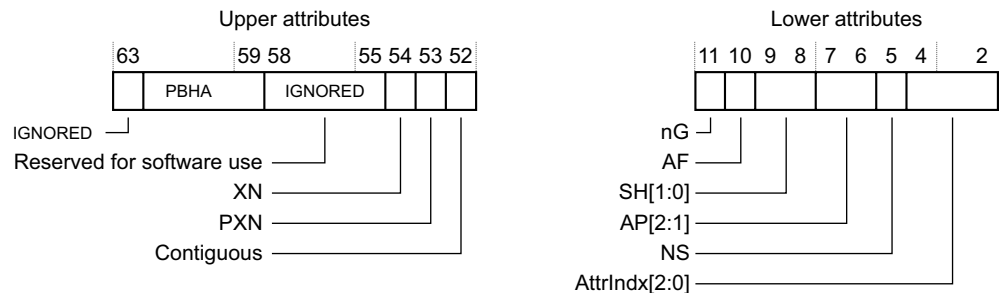

For a stage 1 descriptor, the attributes are:

PBHA, bits[62:59]

Page based hardware attributes bits.

These bits are IGNORED in descriptors at any level above level 3, and are IGNORED in level 3 descriptors in an implementation that does not include ARMv8.2-TTPBHA.

In an implementation that includes ARMv8.2-TTPBHA, the HTCR and the TTBCR2 registers both contain a control bit for each PBHA bit in the translation tables that they control. When the value of that control bit is 1, and the value of the corresponding Hierarchical permission disables bit is 1, hardware can use that PBHA bit for IMPLEMENTATION DEFINED purposes.

The control bits for this feature are:

For a Non-secure PL2 translation regime:

HTCR.HWU_{nn}

Controls whether level 3 descriptor bit[*nn*] can be used by hardware.
 These controls apply only when the value of HTCR.HPD is 1.

For a PL1&0 translation regime:

TTBCR2.HWU_{1nn}

For the translation tables indicated by TTBR1, controls whether level 3 descriptor bit[*nn*] can be used by hardware.
 These controls apply only when the value of TTBCR2.HPD1 is 1 and the value of TTBCR.T2E is 1.

TTBCR2.HWU_{0nn}

For the translation tables indicated by TTBR0, controls whether level 3 descriptor bit[*nn*] can be used by hardware.
 These controls apply only when the value of TTBCR2.HPD0 is 1 and the value of TTBCR.T2E is 1.

Implementation of ARMv8.2-TTPBHA requires the implementation of ARMv8.2-AA32HPD, which provides the Hierarchical permission disables bits. If ARMv8.2-AA32HPD is implemented but ARMv8.2-TTPBHA is not implemented, then the control bits are RAZ/WI but other aspects of ARMv8.2-AA32HPD functionality are implemented. If neither feature is implemented, then:

- The control bits are RAZ/WI.
- The ARMv8.2-AA32HPD identification registers indicate that the functionality is not supported, see *ARMv8.2-AA32HPD* on page A1-61.
- The TTBCR2 register encoding is treated as unallocated.

- XN, bit[54]** The Execute-never bit. Determines whether the region is executable, see *Access permissions for instruction execution* on page G4-4609.
- PXN, bit[53]** The Privileged execute-never bit. Determines whether the region is executable at EL1, see *Access permissions for instruction execution* on page G4-4609.
 This bit is RES0 in the Non-secure PL2 stage 1 translation tables.
- Contiguous, bit[52]**
 Indicates that 16 adjacent translation table entries point to contiguous memory regions, see *Contiguous bit* on page G4-4623.
- nG, bit[11]** The not global bit. Determines how the translation is marked in the TLB, see *Global and process-specific translation table entries* on page G4-4628.
 This bit is RES0 in the Non-secure PL2 stage 1 translation tables.
- AF, bit[10]** The Access flag, see *The Access flag* on page G4-4613.
- SH, bits[9:8]** Shareability field, see *Memory region attributes* on page G4-4616.
- AP[2:1], bits[7:6]**
 Access Permissions bits, see *Memory access control* on page G4-4605.
- **Note** —————
 For consistency with the Short-descriptor translation table formats, the Long-descriptor format defines AP[2:1] as the Access Permissions bits, and does not define an AP[0] bit.
- AP[1] is RES1 in the Non-secure PL2 stage 1 translation tables.
- NS, bit[5]** Non-secure bit. For memory accesses from Secure state, specifies whether the output address is in Secure or Non-secure memory, see *Control of Secure or Non-secure memory access, VMSAv8-32 Long-descriptor format* on page G4-4593.

For memory accesses from Non-secure state, this bit is RES0 and is ignored by the PE.

AttrIndx[2:0], bits[4:2]

Stage 1 memory attributes index field, for the indicated Memory Attribute Indirection Register, see [VMSAv8-32 Long-descriptor format memory region attributes on page G4-4622](#).

The definition of IGNORED means the architecture guarantees that the PE makes no use of the field, see [IGNORED on page Glossary-6341](#). For more information about these fields see [Other fields in the Long-descriptor translation table format descriptors on page G4-4623](#).

Attribute fields in VMSAv8-32 Long-descriptor stage 2 Block and Page descriptors

In Block and Page descriptors, the memory attributes are split into an upper block and a lower block as shown for a stage 2 translation:

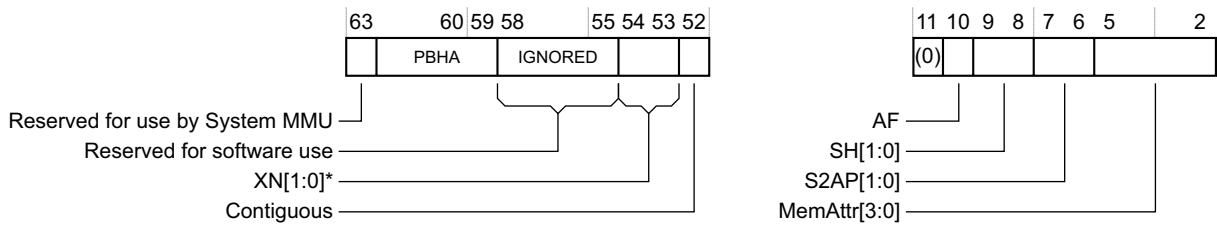

* RES0 before ARMv8.2

For a stage 2 descriptor, the attributes are:

PBHA, bits[62:59]

Page based hardware attributes bits.

These bits are IGNORED in descriptors at any level above level 3, and are IGNORED in level 3 descriptors in an implementation that does not include ARMv8.2-TTPBHA.

In an implementation that includes ARMv8.2-TTPBHA, the VTCR register contains a control bit for each PBHA bit in the translation tables that it controls. When the value of that control bit, VTCR.HWU_{nn}, is 1, hardware can use the corresponding level 3 descriptor bit[nn] for IMPLEMENTATION DEFINED purposes.

Implementation of ARMv8.2-TTPBHA requires the implementation of ARMv8.2-AA32HPD. If neither feature is implemented, or if ARMv8.2-AA32HPD is implemented but ARMv8.2-TTPBHA is not implemented, then the VTCR control bits are RAZ/WI.

XN[1:0], bits[54:53]

The Execute-never field. Determines whether the region is executable.

For more information, see [Access permissions for instruction execution on page G4-4609](#).

In an implementation that does not support ARMv8.2-TTS2UXN, bit[53] is RES0.

Contiguous, bit[52]

Indicates that 16 adjacent translation table entries point to contiguous memory regions, see [Contiguous bit on page G4-4623](#).

AF, bit[10] The Access flag, see [The Access flag on page G4-4613](#).

SH, bits[9:8] Shareability field, see [EL2 control of Non-secure memory region attributes on page G4-4624](#).

S2AP, bits[7:6]

Stage 2 Access Permissions bits, see [Hyp mode control of Non-secure access permissions on page G4-4614](#).

———— **Note** ————

In the original VMSAv7-32 Long-descriptor attribute definition, this field was called HAP[2:1], for consistency with the AP[2:1] field in the stage 1 descriptors and despite there being no HAP[0] bit. ARMv8 renames the field for greater clarity.

MemAttr, bits[5:2]

Stage 2 memory attributes, see *EL2 control of Non-secure memory region attributes* on page G4-4624.

The definition of IGNORED means the architecture guarantees that the PE makes no use of the field, see *IGNORED* on page Glossary-6341. For more information about these fields see *Other fields in the Long-descriptor translation table format descriptors* on page G4-4623.

G4.5.4 Control of Secure or Non-secure memory access, VMSAv8-32 Long-descriptor format

Access to the Secure or Non-secure physical address map on page G4-4574 describes how the NS bit in the translation table entries:

- For accesses from Secure state, determines whether the access is to Secure or Non-secure memory.
- Is ignored by accesses from Non-secure state.

In the Long-descriptor format:

- The NS bit relates only to the memory block or page at the output address defined by the descriptor.
- The descriptors also include an NSTable bit, see *Hierarchical control of Secure or Non-secure memory accesses, Long-descriptor format*.

The NS and NSTable bits are valid only for memory accesses from Secure state. Memory accesses from Non-secure state ignore the values of these bits.

Hierarchical control of Secure or Non-secure memory accesses, Long-descriptor format

For Long-descriptor format table descriptors for stage 1 translations, the descriptor includes an NSTable bit, that indicates whether the table identified in the descriptor is in Secure or Non-secure memory. For accesses from Secure state, the meaning of the NSTable bit is:

NSTable == 0 The defined table address is in the Secure physical address map. In the descriptors in that translation table, NS bits and NSTable bits have their defined meanings.

NSTable == 1 The defined table address is in the Non-secure physical address map. Because this table is fetched from the Non-secure address map, the NS and NSTable bits in the descriptors in this table must be ignored. This means that, for this table:

- The value of the NS bit in any block or page descriptor is ignored. The block or page address refers to Non-secure memory.
- The value of the NSTable bit in any table descriptor is ignored, and the table address refers to Non-secure memory. When this table is accessed, the NS bit in any block or page descriptor is ignored, and all descriptors in the table refer to Non-secure memory.

In addition, an entry fetched in Secure state is treated as non-global if it is read from Non-secure memory. That is, these entries must be treated as if nG==1, regardless of the value of the nG bit. For more information about the nG bit, see *Global and process-specific translation table entries* on page G4-4628.

The effect of NSTable applies to later entries in the translation table walk, and so its effects can be held in one or more TLB entries. Therefore, a change to NSTable requires coarse-grained invalidation of the TLB to ensure that the effect of the change is visible to subsequent memory transactions.

Note

- When using the Long-descriptor format, table descriptors are defined only for the level 1 and level 2 of lookup.
- Stage 2 translations are performed only for operations in Non-secure state, that can access only the Non-secure address map. Therefore, the stage 2 descriptors do not include NS or NSTable bits.

G4.5.5 Selecting between TTBR0 and TTBR1, VMSAv8-32 Long-descriptor translation table format

As described in *Determining the translation table base address in the VMSAv8-32 translation regimes on page G4-4573*, two sets of translation tables can be defined for each of the PL1&0 stage 1 translations, and **TTBR0** and **TTBR1** hold the base addresses for the two sets of tables. The Long-descriptor translation table format provides more flexibility in defining the boundary between using **TTBR0** and using **TTBR1**. When a PL1&0 stage 1 address translation is enabled, **TTBR0** is always used. If **TTBR1** is also used then:

- **TTBR1** is used for the top part of the input address range.
- **TTBR0** is used for the bottom part of the input address range.

The **TTBCR.T0SZ** and **TTBCR.T1SZ** size fields control the use of **TTBR0** and **TTBR1**, as *Table G4-2* shows.

Table G4-2 Use of TTBR0 and TTBR1, Long-descriptor format

TTBCR		Input address range using:	
T0SZ	T1SZ	TTBR0	TTBR1
0b000	0b000	All addresses	Not used
M ^a	0b000	Zero to (2 ^(32-M) -1)	2 ^{32-M} to maximum input address
0b000	N ^a	Zero to (2 ^{32-2(32-N)} -1)	2 ^{32-2(32-N)} to maximum input address
M ^a	N ^a	Zero to (2 ^(32-M) -1)	2 ^{32-2(32-N)} to maximum input address

a. M, N must be greater than 0. The maximum possible value for each of T0SZ and T1SZ is 7.

For stage 1 translations, the input address is always a VA, and the maximum possible VA is (2³²-1).

When address translation is using the Long-descriptor translation table format:

- *Figure G4-12* shows how, when **TTBCR.T1SZ** is zero, the value of **TTBCR.T0SZ** controls the boundary between VAs that are translated using **TTBR0**, and VAs that are translated using **TTBR1**.

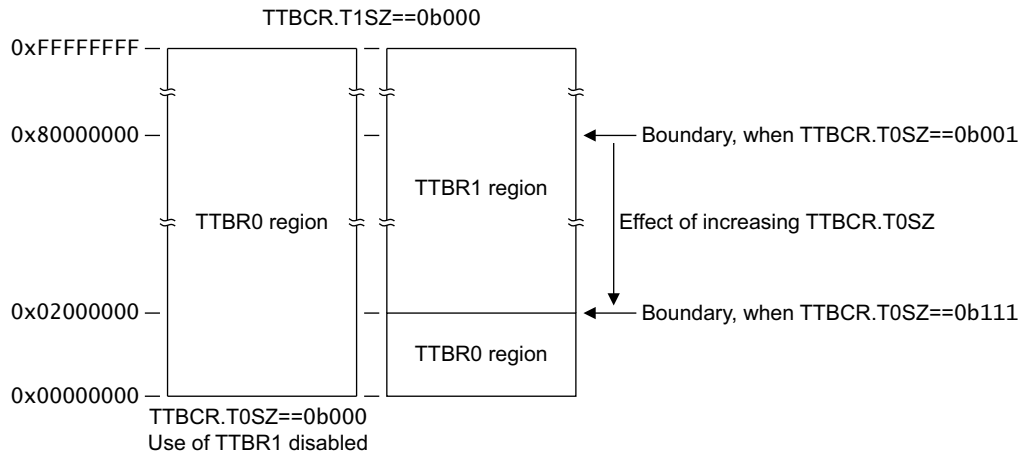

Figure G4-12 Control of TTBR boundary, when TTBCR.T1SZ is zero

- [Figure G4-13](#) shows how, when `TTBCR.T1SZ` is nonzero, the values of `TTBCR.T0SZ` and `TTBCR.T1SZ` control the boundaries between VAs that are translated using `TTBR0`, and VAs that are translated using `TTBR1`.

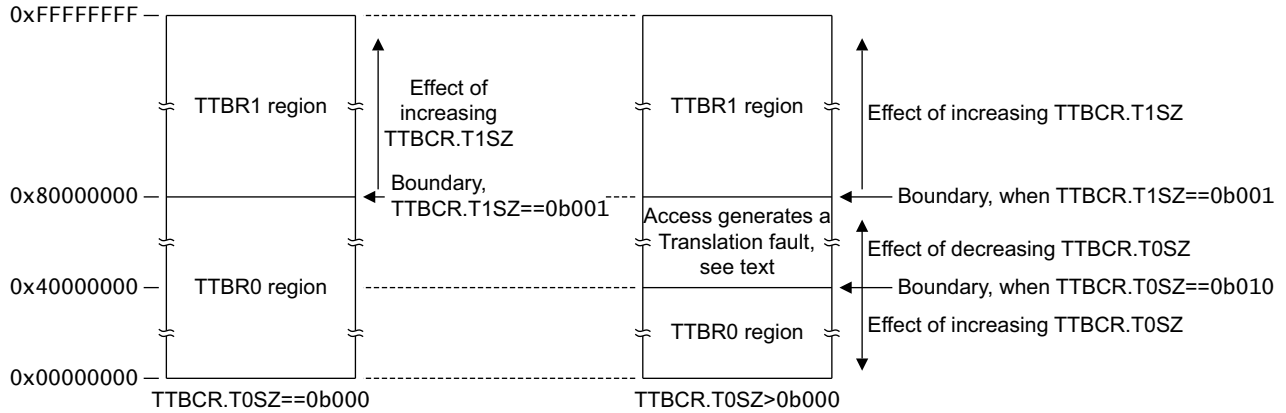

Figure G4-13 Control of TTBR boundaries, when `TTBCR.T1SZ` is nonzero

When `T0SZ` and `T1SZ` are both nonzero:

- If both fields are set to `0b001`, the boundary between the two regions is `0x80000000`. This is identical to having `T0SZ` set to `0b000` and `T1SZ` set to `0b001`.
- Otherwise, the `TTBR0` and `TTBR1` regions are non-contiguous. In this case, any attempt to access an address that is in that gap between the `TTBR0` and `TTBR1` regions generates a Translation fault.

Note

The handling of the Contiguous bit can mean that the boundary between the translation regions defined by the `TCR_EL1.TnSZ` values and the region for which an access generates a Translation fault is wider than shown in [Figure G4-13](#). That is, if the descriptor for an access to the region shown as generating a fault has the Contiguous bit set to 1, the access might not generate a fault. [Possible errors in programming the translation table registers](#) describes this possibility.

When using the Long-descriptor translation table format:

- The `TTBCR` contains fields that define memory region attributes for the translation table walk, for each `TTBR`. These are the `SH0`, `ORGN0`, `IRGN0`, `SH1`, `ORGN1`, and `IRGN1` bits.
- `TTBR0` and `TTBR1` each contain an ASID field, and the `TTBCR.A1` field selects which ASID to use.

For this translation table format, [VMSAv8-32 Long-descriptor translation table format address lookup levels](#) on page G4-4597 summarizes the lookup levels, and [Translation table walks, when using the VMSAv8-32 Long-descriptor translation table format](#) on page G4-4600 describes the possible translations.

Possible errors in programming the translation table registers

In all the descriptions in this subsection, the *size of the input address* supported for a PL1&0 stage 1 translation refers to the size specified by a `TTBCR.TxSZ` field.

Note

For a PL1&0 stage 1 translation, the input address range can be split so that the lower addresses are translated by `TTBR0` and the higher addresses are translated by `TTBR1`. In this case, each of input address sizes specified by `TTBCR.{T0SZ, T1SZ}` is smaller than the total address size supported by the stage of translation.

The following are possible errors in the programming of **TTBR0**, **TTBR1**, and **TTBCR**. For the translation of a particular address at a particular stage of translation, either:

- The block size being used to translate the address is larger than the size of the input address supported at a stage of translation used in performing the required translation. This can occur only for the PL1&0 stage 1 translations, and only when either **TTBCR.T0SZ** or **TTBCR.T1SZ** is zero, meaning there is no gap between the address range translated by **TTBR0** and the range translated by **TTBR1**. In this case, this programming error occurs if a block translated from the region that has **TxSZ** set to zero straddles the boundary between the two address ranges. [Example G4-2](#) shows an example of this mis-programming.
- The address range translated by a set of blocks marked as contiguous, by use of the contiguous bit, is larger than the size of the input address supported at a stage of translation used in performing the required translation.

Example G4-2 Error in programming the translation table registers

If **TTBCR.T0SZ** is programmed to 0 and **TTBCR.T1SZ** is programmed to 7, this means:

- **TTBR0** translates addresses in the range 0x00000000-0xFDFFFFFF.
- **TTBR1** translates addresses in the range 0xFE000000-0xFFFFFFFF.

The translation table indicated by **TTBR0** might be programmed with a block entry for a 1GB region starting at 0xC0000000. This covers the address range 0xC0000000-0xFFFFFFFF, that overlaps the **TTBR1** address range. This means this block size is larger than the input address size supported for translations using **TTBR0**, and therefore this is a programming error.

To understand why this must be a programming error, consider a memory access to address 0xFFFF0000. According to the **TTBCR**.{**T0SZ**, **T1SZ**} values, this must be translated using **TTBR1**. However, the access matches a TLB entry for the translation, using **TTBR0**, of the block at 0xC0000000. Hardware is not required to detect that the access to 0xFFFF0000 is being translated incorrectly.

In these cases, an implementation might use one of the following approaches:

- Treat such a block as causing a Translation fault, even though the block is valid, and the address accessed within that block is within the size of the input address supported at a stage of translation.
The block might be a block within a contiguous set of blocks.
- Treat such a block as not causing a Translation fault, even though the address accessed within that block is outside the size of the input address supported at a stage of translation, provided that both of the following apply:
 - The block is valid.
 - At least one address within the block, or contiguous set of blocks, is within the size of the input address supported at a stage of translation.

The block might be a block within a contiguous set of blocks.

Additional constraints apply to programming the **VTCR**, see [Determining the required initial lookup level for stage 2 translations on page G4-4602](#).

G4.5.6 VMSAv8-32 Long-descriptor translation table format address lookup levels

As stated at the start of this section, because the Long-descriptor translation table format is used for the Non-secure PL1&0 stage 2 translations, the format must support input addresses of up to 40 bits.

Table G4-3 summarizes the properties of the different levels of address lookup when using this format.

Table G4-3 Properties of the three levels of address lookup with VMSAv8-32 Long-descriptor translation tables

Level	Input address		Output address ^a		Number of entries
	Size	Address range ^b	Size	Address range	
First	Up to 512GB	Up to Address[38:0]	1GB	Address[39:30]	Up to 512
Second	Up to 1GB	Up to Address[29:0]	2MB	Address[39:21]	Up to 512
Third	2MB	Address[20:0]	4KB	Address[39:12]	512

- a. Output address when an entry addresses a block of memory or a memory page. If an entry addresses the next level of address lookup it specifies Address[39:12] for the next-level translation table.
- b. Input address range for the translation table. See *Use of concatenated level 1 translation tables* on page G4-4598 for details of support for additional bits of address at a given level, including possible support of a 40-bit input address range for stage 2 translations at level 1. For stage 1 translations at level 1 the input address range is limited to the VA size of [31:0].

For level 1 and level 2 tables, reducing the input address range reduces the number of addresses in the table and therefore reduces the table size. The appropriate Translation Table Control Register specifies the input address range.

Stage 1 translations require an input address range of up to 32 bits, corresponding to VA[31:0]. For these translations:

- For a memory access from a mode other than Hyp mode, the Secure or Non-secure **TTBR0** or **TTBR1** holds the translation table base address, and the Secure or Non-secure **TTBCR** is the control register.
- For a memory access from Hyp mode, **HTTBR** holds the translation table base address, and **HTCR** is the control register.

Note

For translations controlled by **TTBR0** and **TTBR1**, if neither **TTBR** has an input address range larger than 1GB, then translation starts at level 2. Together, **TTBR0** and **TTBR1** can still cover the 32-bit VA input address range.

Stage 2 translations require an input address range of up to 40 bits, corresponding to IPA[39:0], and the supported input address size is configurable in the range 25-40 bits. Table G4-3 indicates a requirement for the translation mechanism to support a 39-bit input address range, Address[38:0]. *Use of concatenated translation tables for the initial stage 2 lookup* describes how a 40-bit IPA address range is supported. For stage 2 translations:

- **VTTBR** holds the translation table base address, and **VTCR** is the control register.
- If a supplied input address is larger than the configured input address size, a Translation fault is generated.

Use of concatenated translation tables for the initial stage 2 lookup

If a stage 2 translation would require 16 entries or fewer in its top-level translation table, that stage of translation can, instead, be configured so that:

- It requires the corresponding number of concatenated translation tables at the next translation level, aligned to the size of the block of concatenated translation tables.
- The stage 2 translation starts at that next translation level.

Note

Stage 2 translations always use the Long-descriptor translation table format.

This use of concatenated translation tables is:

- Required when the stage 2 translation supports a 40-bit input address range, see [Use of concatenated level 1 translation tables](#).
- Supported for a stage 2 translation with an input address range of 31-34 bits, see [Use of concatenated level 2 translation tables](#).

The use of concatenated translation tables requires the software that is defining the translation to:

- Define the concatenated translation tables with the required overall alignment.
- Program [VTTBR](#) to hold the address of the first of the concatenated translation tables.
- Program [VTCR](#) to indicate the required input address range and initial lookup level.

Note

The use of concatenated translation tables avoids the overhead of an additional level of translation

Use of concatenated level 1 translation tables

The Long-descriptor format translation tables provide 9 bits of address resolution at each level of lookup. However, a 40-bit input address range with a translation granularity of 4KB requires a total of 28 bits of address resolution. Therefore, a stage 2 translation that supports a 40-bit input address range requires two concatenated level 1 translation tables, together aligned to 8KB, where:

- The table at the address with $PA[12:0] == 0b0_0000_0000_0000$ defines the translations for input addresses with $bit[39] == 0$.
- The table at the address with $PA[12:0] == 0b1_0000_0000_0000$ defines the translations for input addresses with $bit[39] == 1$.
- The 8KB alignment requirement means that both tables have the same value for $PA[39:13]$.

Use of concatenated level 2 translation tables

A stage 2 translation with an input address range of 31-34 bits can start the translation either:

- With a level 1 lookup, accessing a level 1 translation table with 2-16 entries.
- With a level 2 lookup, accessing a set of concatenated level 2 translation tables.

[Table G4-4 on page G4-4599](#) shows these options, for each of the input address ranges that can use this scheme.

Note

Because these are stage 2 translations, the input address range is an IPA range.

Table G4-4 Possible uses of concatenated translation tables for level 2 lookup

Input address range		Lookup starts at level 1	Lookup starts at level 2	
IPA range	Size	Required level 1 entries	Number of concatenated tables	Required alignment ^a
IPA[30:0]	2 ³¹ bytes	2	2	8KB
IPA[31:0]	2 ³² bytes	4	4	16KB
IPA[32:0]	2 ³³ bytes	8	8	32KB
IPA[33:0]	2 ³⁴ bytes	16	16	64KB

a. Required alignment of the set of concatenated level 2 tables.

See also [Determining the required initial lookup level for stage 2 translations on page G4-4602](#).

G4.5.7 Translation table walks, when using the VMSAv8-32 Long-descriptor translation table format

Figure G4-2 on page G4-4563 shows the possible address translations. If a stage of translation is controlled from an Exception level that is using AArch32, the input and output address constraints and the registers that control the translation are as follows:

Stage 1 translations

For all stage 1 translations:

- The input address range is up to 32 bits, as determined by either:
 - `TTBCR.T0SZ` or `TTBCR.T1SZ`, for a PL1&0 stage 1 translation.
 - `HTCR.T0SZ`, for a PL2 stage 1 translation.
- The output address range is 40 bits.

The stage 1 translations are:

Non-secure PL1&0 stage 1 translation

The stage 1 translation for memory accesses from Non-secure modes other than Hyp mode. This translates a VA to an IPA. For this translation, when Non-secure EL1 is using AArch32:

- Non-secure `TTBR0` or `TTBR1` holds the translation table base address.
- Non-secure `TTBCR` determines which TTBR is used.

Non-secure PL2 stage 1 translation

The stage 1 translation for memory accesses from Hyp mode, translates a VA to a PA. For this translation, when EL2 is using AArch32, `HTTBR` holds the translation table base address.

Secure PL1&0 stage 1 translation

The stage 1 translation for memory accesses from Secure modes, translates a VA to a PA. For this translation, when the Secure PL1 modes are using AArch32:

- Secure `TTBR0` or `TTBR1` holds the translation table base address.
- Secure `TTBCR` determines which TTBR is used.

Stage 2 translation

Non-secure PL1&0 stage 2 translation

The stage 2 translation for memory accesses from Non-secure modes other than Hyp mode, and translates an IPA to a PA. For this translation, when EL2 is using AArch32:

- The input address range is 40 bits, and `VTCR.T0SZ` determines the input address size.
- The output address range depends on the implemented memory system, and is up to 40 bits.
- `VTTBR` holds the translation table base address.
- `VTCR` specifies the required input address range, and whether the initial lookup is at level 1 or at level 2.

The descriptions of the VMSAv8-32 translation stages state that the maximum output address size is 40 bits. However, the register and Long-descriptor format descriptor fields that hold these addresses are 48 bits wide. If bits[47:40] of an output address are not all zero then the address generates an Address size fault.

The Long-descriptor translation table format provides up to three levels of address lookup, as described in [VMSAv8-32 Long-descriptor translation table format address lookup levels on page G4-4597](#), and the initial lookup, in which the MMU reads the translation table base address, is at either level 1 or level 2. The following determines the level of the initial lookup:

- For a stage 1 translation, the required input address range. For more information see [Determining the required initial lookup level for stage 1 translations on page G4-4602](#).
- For a stage 2 translation, the level specified by the `VTCR.SL0` field. For more information see [Determining the required initial lookup level for stage 2 translations on page G4-4602](#).

Note

For a stage 2 translation, the size of the required input address range constrains the `VTCCR.SL0` value.

Figure G4-14 shows how the descriptor address for the initial lookup for a translation using the Long-descriptor translation table format is determined from the input address and the `TTBR` value. This figure shows the lookup for a translation that starts with a level 1 lookup, that translates bits[39:30] of the input address, zero extended if necessary.

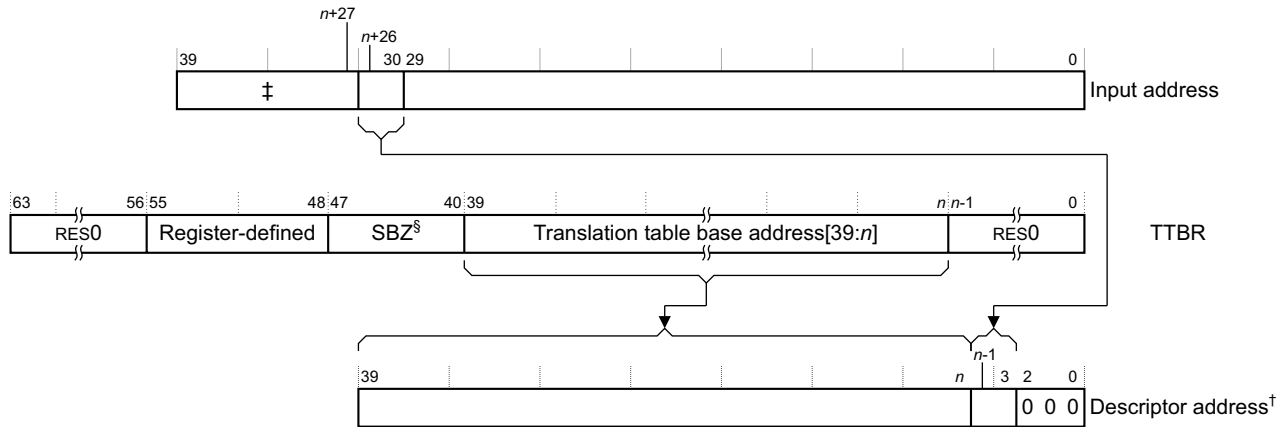

See text for more information about the translation table base register used, and the value of n .

‡ This field is absent if n is 13.

† For a Non-secure PL1&0 stage 1 translation, the IPA of the descriptor. Otherwise, the PA of the descriptor.

§ See the lookup description for more information about bits[40:47] of the TTBR

Figure G4-14 VMSAv8-32 Long-descriptor initial lookup, starting at level 1

If bits[47:40] of the `TTBR` are not zero then the initial lookup will generate an Address size fault, see [Address size fault on page G4-4658](#).

For a translation that starts with a level 1 lookup, as shown in [Figure G4-14](#):

For a stage 1 translation

n is in the range 4-5 and:

- For a memory access from Hyp mode:
 - `HTTBR` is the `TTBR`.
 - $n=5-(HTCR.TOSZ)$.
- For other accesses:
 - The Secure or Non-secure instance of `TTBR0` or `TTBR1` is the `TTBR`.
 - $n=(5-TTBCR.TxSZ)$, where x is 0 when using `TTBR0`, and 1 when using `TTBR1`.

For a stage 2 translation

n is in the range 4-13 and:

- `VTTBR` is the `TTBR`.
- $n=5-(VTCCR.TOSZ)$.

For a translation that starts with a level 2 lookup, the descriptor address is obtained in the same way, except that bits[(n+17):21] of the input address provide bits[(n-1):3] of the descriptor address, where:

For a stage 1 translation

n is in the range 7-12. As [Determining the required initial lookup level for stage 1 translations](#) shows, for a stage 1 translation to start with a level 2 lookup, the corresponding T0SZ or T1SZ field must be 2 or more. This means:

- For a memory access from Hyp mode, $n=14-HTCR.T0SZ$.
- For other memory accesses, $n=14-(TTBCR.TxSZ)$, where *x* is 0 when using **TTBR0**, and 1 when using **TTBR1**.

For a stage 2 translation

n is in the range 7-16. For a stage 2 translation to start with a level 2 lookup, **VTCR.SL0** is 0b00, and $n=14-(VTCR.T0SZ)$.

The following sections describe how the level of the initial lookup is determined:

- [Determining the required initial lookup level for stage 1 translations](#).
- [Determining the required initial lookup level for stage 2 translations](#).

[Address translation examples using the VMSAv8-32 Long descriptor translation table format on page K6-6198](#) shows examples of full translation flows, to an entry for a 4KB memory page, for lookups starting at level 1 and lookups starting at level 2.

Determining the required initial lookup level for stage 1 translations

For a stage 1 translation, the required input address range, indicated by a T0SZ or T1SZ field in a translation table control register, determines the initial lookup level. The size of this input address region is $2^{(32-TxSZ)}$ bytes, and if this size is:

- Less than or equal to 2^{30} bytes, the required start is at level 2, and translation requires two levels of table to map to 4KB pages. This corresponds to a TxSZ value of 2 or more.
- More than 2^{30} bytes, the required start is at level 1, and translation requires three levels of table to map to 4KB pages. This corresponds to a TxSZ value that is less than 2.

For the PL1&0 stage 1 translations, the **TTBCR**:

- Splits the 32-bit VA input address range between **TTBR0** and **TTBR1**, see [Selecting between TTBR0 and TTBR1, VMSAv8-32 Long-descriptor translation table format on page G4-4594](#).
- Holds the input address range sizes for **TTBR0** and **TTBR1**, in the **TTBCR.T0SZ** and **TTBCR.T1SZ** fields.

For the PL2 stage 1 translations, **HTCR.T0SZ** indicates the size of the required input address range. For example, if this field is 0b000, it indicates a 32-bit VA input address range, and translation lookup must start at level 1.

Determining the required initial lookup level for stage 2 translations

For a PL1&0 stage 2 translation, the output address range from the PL1&0 stage 1 translations determines the required input address range for the stage 2 translation.

VTCR.SL0 indicates the starting level for the lookup. The permitted SL0 values are:

- 0b00 Stage 2 translation lookup must start at level 2.
- 0b01 Stage 2 translation lookup must start at level 1.

In addition, **VTCR.T0SZ** must indicate the required input address range. The size of the input address region is $2^{(32-T0SZ)}$ bytes.

———— **Note** —————

VTCR.T0SZ holds a four-bit signed integer value, meaning it supports values from -8 to 7. This is different from the other translation control registers, where **TnSZ** holds a three-bit unsigned integer, supporting values from 0 to 7.

The programming of **VTCR** must follow the constraints shown in [Table G4-5](#), otherwise any attempt to perform a translation table walk that uses the stage 2 address translation generates a stage 2 level 1 Translation Fault. The table also shows how the **VTCR.SL0** and **VTCR.T0SZ** values determine the **VTBTR.BADDR** field width.

———— **Note** —————

If **VTCR.SL0** is programmed to a reserved value then the constraints shown in [Table G4-5](#) are not met, and a translation table walk that uses stage 2 translation generates a stage 2 level 1 Translation fault.

Table G4-5 Input address range constraints on programming **VTCR**

VTCR.SL0	VTCR.T0SZ	Input address range, R	Initial lookup level	BADDR[39:x] width ^a
0b00	2 to 7	$R \leq 2^{30}$ bytes	Level 2	[39:12] to [39:7]
0b00	-2 to 1	$2^{30} < R \leq 2^{34}$ bytes	Level 2	[39:16] to [39:13]
0b01	-2 to 1		Level 1	[39:7] to [39:4]
0b01	-8 to -3	$2^{34} < R$	Level 1	[39:13] to [39:8]

a. The first range corresponds to the first T0SZ value, the second range to the second T0SZ value.

In addition, **VTCR.S** must be programmed to the value of **T0SZ[3]**, otherwise behavior is **CONSTRAINED UNPREDICTABLE** with the resulting behavior being that **VTCR.T0SZ** is treated as an **UNKNOWN** value.

———— **Note** —————

VTCR.T0SZ being treated as an **UNKNOWN** value results in a stage 2 level 1 Translation Fault if that **UNKNOWN** value is not consistent with the programmed value of **VTCR.SL0**.

CONSTRAINED UNPREDICTABLE behaviors associated with the VTCR on page K1-6114 describes these **CONSTRAINED UNPREDICTABLE** behaviors.

Where necessary, the initial lookup level provides multiple concatenated translation tables, as described in *Use of concatenated level 2 translation tables on page G4-4598*. This section also gives more information about the alternatives, shown in [Table G4-5](#), when **R** is in the range $2^{31} - 2^{34}$.

G4.5.8 The algorithm for finding the translation table entries, VMSAv8-32 Long-descriptor format

This section gives the algorithm for finding the translation table entry that corresponds to a given IA, for each required level of lookup. The algorithm encodes the descriptions of address translation given earlier in this section. The VMSAv8-32 Long-descriptor format uses a 4KB translation granule.

The description uses the following terms:

- BaseAddr** The base address for the level of lookup, as defined by:
- For the initial lookup level, the **TTBR.BADDR** base address field in the appropriate **TTBR**, see the description of *TnSZ* on page G4-4604.
 - Otherwise, the translation table address returned by the previous level of lookup.
- IA** The supplied IA for this stage of translation.

- TnSZ** The translation table size for this stage of translation:
- For PL1&0 stage 1** Either:
- **TTBCR.T0SZ** if the translation is using **TTBR0**.
 - **TTBCR.T1SZ** if the translation is using **TTBR1**.
- For PL1&0 stage 2** **VTCR.T0SZ**. The translation uses **VTTBR**.
- For PL2 stage 1** **HTCR.T0SZ**. The translation uses **HTTBR**.
- SL0** **VTCR.SL0**. Applies to the Non-secure PL1&0 stage 2 translation only.

Table G4-6 shows the translation table descriptor address, for each level of lookup. The table shows only architecturally-valid programming of the **TCR**. See also *Possible errors in programming the translation table registers* on page G4-4595.

Table G4-6 Translation table entry addresses, VMSAv8-32 using Long-descriptor format

Lookup level	Entry address and conditions		General conditions
	Stage 1 translation	Stage 2 translation	
One	BaseAddr[39:x]:IA[y:30]:0b000 if ^a $0 \leq TnSZ \leq 1$ then $x = (5 - TnSZ)$	BaseAddr[39:x]:IA[y:30]:0b000 if $SL0^b = 1$ then if ^a $-8 \leq T0SZ \leq 1$ then $x = (5 - T0SZ)$	$y = (x + 26)$
Two	BaseAddr[39:x]:IA[y:21]:0b000 if ^a $2 \leq TnSZ \leq 7$ then $x = (14 - TnSZ)$ else ^c $x = 12$	BaseAddr[39:x]:IA[y:21]:0b000 if $SL0 = 0$ then if ^a $-2 \leq T0SZ \leq 7$ then $x = (14 - T0SZ)$ elsif ^c $SL0^b = 1$ then $x = 12$	$y = (x + 17)$
Three	BaseAddr[39:12]:IA[20:12]:0b000	BaseAddr[39:12]:IA[20:12]:0b000	-

- a. This line indicates the range of permitted values for **TnSZ**, for a lookup that starts at this level, see *Use of concatenated translation tables for the initial stage 2 lookup* on page G4-4597.
- b. $SL0 = 0$ if the initial lookup is level 2, $SL0 = 1$ if the initial lookup is level 1.
- c. This is the case where this level of lookup is not the initial level of lookup.

G4.6 Memory access control

In addition to an output address, a translation table entry that refers to page or region of memory includes fields that define properties of the target memory region. [Information returned by a translation table lookup on page G4-4572](#) describes the classification of those fields as address map control, access control, and memory attribute fields. The access control fields, described in this section, determine whether the PE, in its current state, is permitted to perform the required access to the output address given in the translation table descriptor. If a translation stage does not permit the access then an MMU fault is generated for that translation stage, and no memory access is performed.

The following sections describe the memory access controls:

- [About access permissions.](#)
- [About the PAN bit on page G4-4608.](#)
- [Access permissions for instruction execution on page G4-4609.](#)
- [Domains, Short-descriptor format only on page G4-4612.](#)
- [The Access flag on page G4-4613.](#)
- [Hyp mode control of Non-secure access permissions on page G4-4614.](#)

G4.6.1 About access permissions

The translation table descriptors include fields that define access permissions for data accesses and for instruction fetches. This section introduces those fields. In addition:

- System register controls can prevent execution from writeable locations, see [Preventing execution from writeable locations on page G4-4612.](#)
- In ARMv8.1, the `PSTATE.PAN` can affect the access permissions for privileged data accesses, see [About the PAN bit on page G4-4608.](#)

———— Note —————

This section gives a general description of memory access permissions. Software executing at PL1 in Non-secure state can see only the access permissions defined by the Non-secure PL1&0 stage 1 translations. However, software executing at PL2 can modify these permissions, as described in [Hyp mode control of Non-secure access permissions on page G4-4614.](#) This modification is invisible to Non-secure software executing at EL1 or EL0.

Access permission bits in a translation table descriptor control access to the corresponding memory region. The details of this control depend on the translation table format, as follows:

Short-descriptor format

This format supports two options for defining the access permissions:

- Three bits, `AP[2:0]`, define the access permissions.
- Two bits, `AP[2:1]`, define the access permissions, and `AP[0]` can be used as an Access flag.

`SCTLR.AFE` selects the access permissions option. Setting this bit to 1, to enable the Access flag, also selects use of `AP[2:1]` to define access permissions.

ARM deprecates any use of the `AP[2:0]` scheme for defining access permissions.

Long-descriptor format

`AP[2:1]` to control the access permissions, and the descriptors provide an `AF` bit for use as an Access flag. This means VMSAv8-32 behaves as if the value of `SCTLR.AFE` is 1, regardless of the value that software has written to this bit.

———— Note —————

When use of the Long-descriptor format is enabled, `SCTLR.AFE` is UNK/SBOP.

[The Access flag on page G4-4613](#) describes the Access flag, for both translation table formats.

The `XN` and `PXN` bits provide additional access controls for instruction fetches, see [Access permissions for instruction execution on page G4-4609.](#)

An attempt to perform a memory access that the translation table access permission bits do not permit generates a Permission fault, for the corresponding stage of translation. However, when using the Short-descriptor translation table format, it generates the fault only if the access is to memory in the Client domain, see [Domains, Short-descriptor format only on page G4-4612](#).

———— **Note** —————

For the Non-secure PL1&0 translation regime, memory accesses are subject to two stages of translation. Each stage of translation has its own, independent, fault checking. Fault handling is different for the two stages, see [Exception reporting in a VMSEA8-32 implementation on page G4-4663](#).

The following sections describe the two access permissions models:

- [AP\[2:1\] access permissions model](#).
- [AP\[2:0\] access permissions control, Short-descriptor format only on page G4-4607](#). This section includes some information on access permission control in earlier versions of the ARM VMSEA.

AP[2:1] access permissions model

———— **Note** —————

ARM recommends that this model is always used, even where the AP[2:0] model is permitted. Some documentation describes the AP[2:1] model as the *simplified access permissions* model.

This access permissions model is used if the translation is either:

- Using the Long-descriptor translation table format.
- Using Short-descriptor translation table format, and the `SCTLR.AFE` bit is set to 1.

In this model:

- One bit, AP[2], selects between read-only and read/write access.
- A second bit, AP[1], selects between Application level (PL0) and System level (PL1) control. For the Non-secure PL2 stage 1 translations, AP[1] is SBO.

This provides four access combinations:

- Read-only at all privilege levels.
- Read/write at all privilege levels.
- Read-only at PL1, no access by software executing at PL0.
- Read/write at PL1, no access by software executing at PL0.

[Table G4-7](#) shows this access control model.

Table G4-7 VMSEA8-32 AP[2:1] access permissions model

AP[2], disable write access	AP[1], enable unprivileged access	Access
0	0 ^a	Read/write, only at PL1
0	1	Read/write, at any privilege level
1	0 ^a	Read-only, only at PL1
1	1	Read-only, at any privilege level

a. Not valid for Non-secure PL2 stage 1 translation tables. AP[1] is SBO in these tables.

Hierarchical control of access permissions, Long-descriptor format

The Long-descriptor translation table format introduces a mechanism that entries at one level of translation table lookup can use to set limits on the permitted entries at subsequent levels of lookup. This rule applies to the access permissions, and also to the restrictions on instruction fetching described in [Hierarchical control of instruction fetching, Long-descriptor format on page G4-4611](#).

The restrictions apply only to subsequent levels of lookup at the same stage of translation. The APTable[1:0] field restricts the access permissions, as [Table G4-8](#) shows.

However, in an implementation that includes ARMv8.2-AA32HPD, when hierarchical control of data access permissions is disabled for a translation regime, the information in this subsection does not apply. See [Memory attribute fields in the VM8-32 Long-descriptor translation table format descriptors on page G4-4589](#).

As stated in the table footnote, for the Non-secure PL2 stage 1 translation tables, APTable[0] is reserved, SBZ.

Table G4-8 Effect of APTable[1:0] on subsequent levels of lookup

APTable[1:0]	Effect
00	No effect on permissions in subsequent levels of lookup.
01 ^a	Access at PL0 not permitted, regardless of permissions in subsequent levels of lookup.
10	Write access not permitted, at any Exception level, regardless of permissions in subsequent levels of lookup.
11 ^a	Regardless of permissions in subsequent levels of lookup: <ul style="list-style-type: none"> • Write access not permitted, at any Exception level. • Read access not permitted at PL0.

a. Not valid for the Non-secure PL2 stage 1 translation tables. In those tables, APTable[0] is SBZ.

———— Note —————

The APTable[1:0] settings are combined with the translation table access permissions in the translation table descriptors accessed in subsequent levels of lookup. They do not restrict or change the values entered in those descriptors.

The Long-descriptor format provides APTable[1:0] control only for the stage 1 translations. The corresponding bits are SBZ in the stage 2 translation table descriptors.

The effect of APTable applies to later entries in the translation table walk, and so its effects can be held in one or more TLB entries. Therefore, a change to APTable requires coarse-grained invalidation of the TLB to ensure that the effect of the change is visible to subsequent memory transactions.

AP[2:0] access permissions control, Short-descriptor format only

This access permissions model applies when using the Short-descriptor translation tables format, and the SCTLRAFE bit is set to 0. ARM deprecates any use of this access permissions model.

When SCTLRAFE is set to 0, ensuring that the AP[0] bit is always set to 1 effectively changes the access model to the simpler model described in [AP\[2:1\] access permissions model on page G4-4606](#).

Table G4-9 shows the full AP[2:0] access permissions model:

Table G4-9 VMSAv8-32 MMU access permissions

AP[2]	AP[1:0]	PL1 access	Unprivileged access	Description
0	00	No access	No access	All accesses generate Permission faults
	01	Read/write	No access	Access only at PL1
	10	Read/write	Read-only	Writes at PL0 generate Permission faults
	11	Read/write	Read/write	Full access
1	00	-	-	Reserved
	01	Read-only	No access	Read-only, only at PL1
	10	Read-only	Read-only	Read-only at any Exception level, deprecated ^a
	11	Read-only	Read-only	Read-only at any Exception level ^b

a. From VMSAv7, ARM strongly recommends use of the 0b11 encoding for Read-only at any Exception level.

b. This mapping was introduced in VMSAv7, and is reserved in earlier versions of the VMSA.

———— **Note** ————

- VMSAv8-32 supports the full set of access permissions shown in Table G4-9 only when `SCTLR.AFE` is set to 0. When `SCTLR.AFE` is set to 1, the only supported access permissions are those described in [AP\[2:1\] access permissions model on page G4-4606](#).
- Some old documentation describes the AP[2] bit in the translation table entries as the APX bit.

G4.6.2 About the PAN bit

When the value of `PSTATE.PAN` is 1, any privileged data access from PL1 or EL2 to a virtual memory address that is accessible at EL0 generates a Permission fault.

When the value of `PSTATE.PAN` is 0, the translation system is the same as in ARMv8.0.

A corresponding PAN bit is added to `CPSR` and `SPSR` for exception returns, and `DSPSR` for entry to and exit from Debug state.

A new SPAN bit is added to `SCTLR` that controls whether the PAN state bit is set on taking an exception to EL1 from either Secure or Non-secure state, or to EL3 from Secure state when EL3 is using AArch32.

`CPSR.PAN` bit can be written using an MSR instruction at PL1 or higher. Data writes to `CPSR.PAN` using an MSR instruction at EL0 are ignored. The value that is returned for an MRS instruction of `CPSR` from EL0 is UNKNOWN. In keeping with all other writes to the `CPSR`, other than for instruction fetches, the effect of the PAN state bit does not need to be explicitly synchronized.

The PAN state bit has no effect on:

- Data Cache instructions.
- Address translation instructions, other than `ATS1CPRP` and `ATS1CPWP` when [ARMv8.2-ATS1E1](#) is implemented.
- Unprivileged instructions, `LDRBT`, `LDRHT`, `LDRT`, `LDRSBT`, `LDRSHT`, `STRBT`, `STRHT`, `STRT`, `STRSBT`, and `STRSHT`, unless `HCR_EL2.{E2H, TGE} == {1, 0}`.
- Instruction accesses.
- Manager domains.

If access is disabled, then the access will give rise to a stage 1 Permission fault.

On an exception taken from AArch32:

- **CPSR.PAN** is copied to **SPSR_ELx.PAN**, when the target Exception level is AArch64.
- **CPSR.PAN** is copied to **SPSR.PAN**, when the target Exception level is AArch32.

On an exception return from AArch32 to AArch32, **SPSR.PAN** is copied to **CPSR.PAN**.

On entry to Debug state, **CPSR.PAN** is copied to **DSPSR.PAN**.

On exit from Debug state, **DSPSR.PAN** is copied to **CPSR.PAN**.

The **CPSR.PAN** bit is not an Execution state bit.

———— **Note** —————

A debugger can use the **DRPS** instruction to modify the PAN state bit.

G4.6.3 Access permissions for instruction execution

Execute-never controls provide an additional level of control on memory accesses permitted by the access permissions settings. These controls are:

XN, Execute-never

Descriptor bit[54], defined as XN for:

- Stage 1 of any translation regime.
- Stage 2 of the Non-secure PL1&0 translation regime when **ARMv8.2-TTS2UXN** is not implemented.

———— **Note** —————

XN[1:0], Execute-never, for stage 2 control describes the stage 2 control when ARMv8.2-TTS2UXN is implemented.

A value of 0 indicates that this control permits execution.

PXN, Privileged execute-never

Descriptor bit[53], used only for stage 1 of any translation regime that applies to EL0 and a higher Exception level:

- For stage 1 of a translation regime that applies to only a single Exception level the descriptors define a PXN field that is RES0, meaning it is ignored by hardware.

———— **Note** —————

For stage 2 of the Non-secure PL1&0 translation regime when ARMv8.2-TTS2UXN is not implemented, descriptor bit[53] is RES0, meaning it is ignored by hardware.

A value of 0 indicates that this control permits execution.

XN[1:0], Execute-never, for stage 2 control

Descriptor bits[54:53], defined as XN[1:0] for:

- Stage 2 of the PL1&0 translation regime in an implementation where **ARMv8.2-TTS2UXN** is supported.

Table G4-10 on page G4-4610 shows the operation of this control.

———— **Note** —————

Because the stage 2 controls apply only in Non-secure state, PL1 always corresponds to EL1 and the controls are described in terms of instruction execution at EL1 and EL0.

Table G4-10 XN[1:0] stage 2 access permissions model

XN[1]	XN[0]	Access
0	0	The stage 2 control permits execution at EL1 and EL0 if read access is permitted
0	1	The stage 2 control does not permit execution at EL1, but permits execution at EL0 if read access is permitted
1	0	The stage 2 control does not permit execution at EL1 or at EL0
1	1	The stage 2 control permits execution at EL1 if read access is permitted, but does not permit execution at EL0

Executing an instruction at PLx generates a Permission fault unless all of the follow are true for the instruction address:

- The stage 1 execute-never control that applies to execution at PLx permits execution.
- For PL0 or PL1, the stage 2 execute-never control that applies to execution at PLx permits execution.
- Read access is permitted.

However, when using the Short-descriptor translation table format, the Permission fault is generated only if the access is to memory in the Client domain, see [Domains, Short-descriptor format only on page G4-4612](#).

See also [Hyp mode control of Non-secure access permissions on page G4-4614](#).

In addition, System register controls can enforce execute-never restrictions, regardless of the settings in the translation table XN and PXN fields, see:

- [Restriction on Secure instruction fetch on page G4-4612](#).
- [Preventing execution from writeable locations on page G4-4612](#).

The execute-never controls apply also to speculative instruction fetching. This means a speculative instruction fetch from a memory region that is execute-never at the current level of privilege is prohibited.

The execute-never controls means that, when the stage of address translation is enabled, the PE can fetch, or speculatively fetch, an instruction from a memory location only if all of the following apply:

- If using the Short-descriptor translation table format, the translation table descriptor for the location does not indicate that it is in a No access domain.
- If using the Long-descriptor translation table format, or using the Short descriptor format and the descriptor indicates that the location is in a Client domain, in the descriptor for the location the following apply:
 - The stage 1 execute-never control for the Exception level at which the instruction is executed permits execution.
 - For a translation regime with two stages of address translation, the stage 2 execute-never control that applies to the Exception level at which the instruction is executed permits execution.
 - The access permissions permit a read access from the current PE mode.
- No other Prefetch Abort condition exists.

Note

- The PXN control applies to the PE privilege when it attempts to execute the instruction. In an implementation that fetches instructions speculatively, this might not be the privilege when the instruction was prefetched. Therefore, the architecture does not require the PXN control to prevent instruction fetching.
- Although the XN control applies to speculative fetching, on a speculative instruction fetch from an XN location, no Permission fault is generated unless the PE attempts to execute the instruction that would have been fetched from that location. This means that, if a speculative fetch from an XN location is attempted, but there is no attempt to execute the corresponding instruction, a Permission fault is not generated.

- The software that defines a translation table must mark any region of memory that is read-sensitive as XN, to avoid the possibility of a speculative fetch accessing the memory region. This means it must mark any memory region that corresponds to a read-sensitive peripheral as XN. Hardware does not prevent speculative accesses to a region of any Device memory type unless that region is also marked as execute-never for all Exception levels from which it can be accessed.
- When using the Short-descriptor translation table format, the XN attribute is not checked for domains marked as Manager. Therefore, the system must not include read-sensitive memory in domains marked as Manager, because the XN field does not prevent speculative fetches from a Manager domain.

When no stage of address translation for the translation regime is enabled, memory regions cannot have XN or PXN attributes assigned. *Behavior of instruction fetches when all associated address translations are disabled* on page G4-4569 describes how disabling all MMUs affects instruction fetching.

Hierarchical control of instruction fetching, Long-descriptor format

The Long-descriptor translation table format introduces a mechanism that means entries at one level of translation tables lookup can set limits on the permitted entries at subsequent levels of lookup. This rule applies to the restrictions on instruction fetching, and also to the access permissions described in *Hierarchical control of access permissions, Long-descriptor format* on page G4-4607.

Note

Similar hierarchical controls apply to data accesses, see *Hierarchical control of access permissions, Long-descriptor format* on page G4-4607.

However, in an implementation that includes ARMv8.2-HPD, when hierarchical control of instruction fetching is disabled for a translation regime, the information in this subsection does not apply. See *Memory attribute fields in the VMSAv8-32 Long-descriptor translation table format descriptors* on page G4-4589.

The restrictions apply only to subsequent levels of lookup at the same stage of translation, and:

- **XNTable** restricts the XN control:
 - When **XNTable** is set to 1, the XN field is treated as 1 in all subsequent levels of lookup, regardless of the actual value of the field.
 - When **XNTable** is set to 0 it has no effect.
- **PXNTable** restricts the PXN control:
 - When **PXNTable** is set to 1, the PXN field is treated as 1 in all subsequent levels of lookup, regardless of the actual value of the field.
 - When **PXNTable** is set to 0 it has no effect.

Note

The **XNTable** and **PXNTable** settings are combined with the XN and PXN fields in the translation table descriptors accessed at subsequent levels of lookup. They do not restrict or change the values entered in those descriptors.

The **XNTable** and **PXNTable** controls are provided only in the Long-descriptor translation table format, and only for stage 1 translations. The corresponding bits are SBZ in the stage 2 translation table descriptors.

The effect of **XNTable** or **PXNTable** applies to later entries in the translation table walk, and so its effects can be held in one or more TLB entries. Therefore, a change to **XNTable** or **PXNTable** requires coarse-grained invalidation of the TLB to ensure that the effect of the change is visible to subsequent memory transactions.

Preventing execution from writeable locations

ARMv8 provides control bits that, when the corresponding stage 1 address translation is enabled, force writeable memory to be treated as **XN** or **PXN**, regardless of the value of the **XN** or **PXN** field. When the translation stages are controlled by an Exception level that is using AArch32:

- For PL1&0 stage 1 translations, when **SCTLR.WXN** is set to 1, all regions that are writeable at stage 1 of the address translation are treated as XN.
- For PL1&0 stage 1 translations, when **SCTLR.UWXN** is set to 1, an instruction fetch is treated as accessing a PXN region if it accesses a region that software executing at PL0 can write to.
- For Non-secure PL2 stage 1 translations, when **HSCTLR.WXN** is set to 1, all regions that are writeable at stage 1 of the address translation are treated as XN.

Note

- The **SCTLR.WXN** controls are intended to be used in systems with very high security requirements.
- Setting a **WXN** or **UWXN** bit to 1 changes the interpretation of the translation table entry, overriding a zero value of an **XN** or **PXN** field. It does not cause any change to the translation table entry.

For any given virtual machine, ARM expects **WXN** and **UWXN** to remain static in normal operation. In particular, it is IMPLEMENTATION DEFINED whether TLB entries associated with a particular VMID reflect the effect of the values of these fields. A generic sequence to ensure synchronization of a change to these fields, when that change is made without a corresponding change of VMID, is:

```
Change the WXN or UWXN bit
ISB                               ; This ensures synchronization of the change
Invalidate entire TLB of associated entries
DSB                               ; This completes the TLB Invalidation
ISB                               ; This ensures instruction synchronization
```

As with all Permission fault checking, if the stage 1 translation is using the Short-descriptor translation table format, the permission checks are performed only for Client domains. For more information, see [About access permissions on page G4-4605](#).

For more information about address translation, see [About address translation for VMSEA8-32 on page G4-4562](#).

Restriction on Secure instruction fetch

EL3 provides a Secure instruction fetch bit, **SCR.SIF**. When this bit is to 1, any attempt in Secure state to execute an instruction fetched from Non-secure physical memory causes a Permission fault. As with all Permission fault checking, when using the Short-descriptor format translation tables the check applies only to Client domains, see [About access permissions on page G4-4605](#).

ARM expects **SCR.SIF** to be static during normal operation. In particular, whether the TLB holds the effect of the **SIF** bit is IMPLEMENTATION DEFINED. The generic sequence to ensure visibility of a change to the **SIF** bit is:

```
Change the SCR.SIF bit
ISB                               ; This ensures synchronization of the change
Invalidate entire TLB
DSB                               ; This completes the TLB Invalidation
ISB                               ; This ensures instruction synchronization
```

G4.6.4 Domains, Short-descriptor format only

A domain is a collection of memory regions. The Short-descriptor translation table format supports 16 domains, and requires the software that defines a translation table to assign each VMSEA8-32 memory region to a domain. When using the Short-descriptor format:

- Level 1 translation table entries for Page tables and Sections include a domain field.

- Translation table entries for Supersections do not include a domain field. The Short-descriptor format defines Supersections as being in domain 0.
- Level 2 translation table entries inherit a domain setting from the parent level 1 Page table descriptor.
- Each TLB entry includes a domain field.

The domain field specifies which of the 16 domains the entry is in, and a two-bit field in the [DACR](#) defines the permitted access for each domain. The possible settings for each domain are:

No access Any access using the translation table descriptor generates a Domain fault.

Clients On an access using the translation table descriptor, the access permission attributes are checked. Therefore, the access might generate a Permission fault.

Managers On an access using the translation table descriptor, the access permission attributes are not checked. Therefore, the access cannot generate a Permission fault.

See [The MMU fault-checking sequence on page G4-4652](#) for more information about how, when using the Short-descriptor translation table format, the Domain attribute affects the checking of the other attributes in the translation table descriptor.

———— **Note** —————

A single program might:

- Be a Client of some domains.
- Be a Manager of some other domains.
- Have no access to the remaining domains.

The Long-descriptor translation table format does not support domains. When a stage of translation is using this format, all memory is treated as being in a Client domain, and the settings in the [DACR](#) are ignored.

G4.6.5 The Access flag

The Access flag indicates when a page or section of memory is accessed for the first time since the Access flag in the corresponding translation table descriptor was set to 0:

- If address translation is using the Short-descriptor translation table format, it must set [SCTLR.AFE](#) to 1 to enable use of the Access flag. Setting this bit to 1 redefines the AP[0] bit in the translation table descriptors as an Access flag, and limits the access permissions information in the translation table descriptors to AP[2:1], as described in [AP\[2:1\] access permissions model on page G4-4606](#).
- The Long-descriptor format always supports an Access flag bit in the translation table descriptors, and address translation using this format behaves as if [SCTLR.AFE](#) is set to 1, regardless of the value of that bit.

In ARMv8.0, the Access flag is managed by software as described in [Software management of the Access flag](#).

———— **Note** —————

Previous version of the ARM architecture optionally supported hardware management of the Access flag. ARMv8.0 obsoletes this option.

Software management of the Access flag

ARMv8.0 requires that software manages the Access flag. This means an Access flag fault is generated whenever an attempt is made to read into the TLB a translation table descriptor entry for which the value of the Access flag is 0.

Note

When using the Short-descriptor translation table format, Access flag faults are generated only if `SCTLR.AFE` is set to 1, to enable use of a translation table descriptor bit as an Access flag.

The Access flag mechanism expects that, when an Access flag fault occurs, software resets the Access flag to 1 in the translation table entry that caused the fault. This prevents the fault occurring the next time that memory location is accessed. Entries with the Access flag set to 0 are never held in the TLB, meaning software does not have to flush the entry from the TLB after setting the flag.

Note

If a system incorporates components that can autonomously update translation table entries that are shared with the ARM PE, then the software must be aware of the possibility that such components can update the access flag autonomously.

In such a system, system software should perform any changes of translation table entries with an Access flag of 0, other than changes to the Access flag value, by using an Load-Exclusive/Store-Exclusive loop, to allow for the possibility of simultaneous updates.

G4.6.6 Hyp mode control of Non-secure access permissions

When EL2 is using AArch32, Non-secure software executing in Hyp mode controls two sets of translation tables, both of which use the Long-descriptor translation table format:

- The translation tables that control the Non-secure PL2 stage 1 translations. These map VAs to PAs, for memory accesses made when executing in Non-secure state in Hyp mode, and are indicated and controlled by the `HTTBR` and `HTCR`.

These translations have similar access controls to other Non-secure stage 1 translations using the Long-descriptor translation table format, as described in:

- [AP\[2:1\] access permissions model on page G4-4606](#).
- [Access permissions for instruction execution on page G4-4609](#).

The differences from the Non-secure stage 1 translations are that:

- The `APTable[0]`, `PXNTable`, and `PXN` bits are reserved, `SBZ`.
- `AP[1]` is reserved, `SBO`.
- The translation tables that control the Non-secure PL1&0 stage 2 translations. These map the IPAs from the stage 1 translation onto PAs, for memory accesses made when executing in Non-secure state at PL1 or PL0, and are indicated and controlled by the `VTTBR` and `VTCR`.

The descriptors in the virtualization translation tables define stage 2 access permissions, that are combined with the permissions defined in the stage 1 translation. This section describes this combining of access permissions.

Note

The level 2 access permissions mean a hypervisor can define additional access restrictions to those defined by a Guest OS in the stage 1 translation tables. For a particular access, the actual access permission is the more restrictive of the permissions defined by:

- The Guest OS, in the stage 1 translation tables.
- The hypervisor, in the stage 2 translation tables.

The stage 2 access controls defined from Hyp mode:

- Affect only the Non-secure stage 1 access permissions settings.
- Take no account of whether the accesses are from a Non-secure PL1 mode or a Non-secure PL0 mode.
- Permit software executing in Hyp mode to assign a write-only attribute to a memory region.

The S2AP field in the stage 2 descriptors define the stage 2 access permissions, as [Table G4-11](#) shows:

Table G4-11 Stage 2 control of access permissions

S2AP	Access permission
00	No access permitted
01	Read-only. Writes to the region are not permitted, regardless of the stage 1 permissions.
10	Write-only. Reads from the region are not permitted, regardless of the stage 1 permissions.
11	Read/write. The stage 1 permissions determine the access permissions for the region.

For more information about the S2AP field see [Attribute fields in VMSEA8-32 Long-descriptor stage 2 Block and Page descriptors on page G4-4592](#).

If the stage 2 permissions cause a Permission fault, this is a stage 2 MMU fault. Stage 2 MMU faults are taken to Hyp mode, and reported in the [HSR](#) using an EC code of 0x20 or 0x24. For more information, see [Use of the HSR on page G4-4677](#).

———— **Note** —————

In the [HSR](#), the combination of the EC code and the DFSC or IFSC value in the ISS indicate that the fault is a stage 2 MMU fault.

The stage 2 permissions include an XN attribute. If this is set to 1, execution from the region is not permitted, regardless of the value of the XN attribute in the stage 1 translation. If a Permission fault is generated because the stage 2 XN bit is set to 1, this is reported as a stage 2 MMU fault.

[AArch32 state prioritization of synchronous aborts from a single stage of address translation on page G4-4660](#) describes the abort prioritization if both stages of a translation generate a fault.

G4.7 Memory region attributes

In addition to an output address, a translation table entry that refers to a page or region of memory includes fields that define properties of that target memory region. [Information returned by a translation table lookup on page G4-4572](#) describes the classification of those fields as address map control, access control, and memory attribute fields. The memory region attribute fields control the memory type, Cacheability, and Shareability of the region.

The following sections describe the assignment of memory region attributes for stage 1 translations:

- [Overview of memory region attributes for stage 1 translations.](#)
- [Short-descriptor format memory region attributes, without TEX remap on page G4-4617.](#)
- [Short-descriptor format memory region attributes, with TEX remap on page G4-4619.](#)
- [VMSAv8-32 Long-descriptor format memory region attributes on page G4-4622.](#)

For an implementation that is operating in Secure state, or in Hyp mode, these assignments define the memory attributes of the accessed region.

For an implementation that is operating in a Non-secure PL1 or PL0 mode, the Non-secure PL1&0 stage 2 translation can modify the memory attributes assigned by the stage 1 translation. [EL2 control of Non-secure memory region attributes on page G4-4624](#) describes these stage 2 assignments.

G4.7.1 Overview of memory region attributes for stage 1 translations

The description of the memory region attributes in a translation descriptor divides into:

Memory type and attributes

These are described either:

- Directly, by bits in the translation table descriptor.
- Indirectly, by registers referenced by bits in the table descriptor. This is described as *remapping* the memory type and attribute description.

The Short-descriptor translation table format can use either of these approaches, selected by the `SCTLR.TRE` bit:

TRE == 0 Remap disabled. The `TEX[2:0]`, `C`, and `B` bits in the translation table descriptor define the memory region attributes. [Short-descriptor format memory region attributes, without TEX remap on page G4-4617](#) describes this encoding.

———— Note —————

With the Short-descriptor format, remapping is called *TEX remap*, and the `SCTLR.TRE` bit is the *TEX remap enabled* bit.

The description of the `TRE == 0` encoding includes information about the encoding in previous versions of the architecture.

TRE == 1 Remap enabled. The `TEX[0]`, `C`, and `B` bits in the translation table descriptor are index bits to the remap registers, that define the memory region attributes:

- The Primary Region Remap Register, `PRRR`.
- The Normal Memory Remap Register, `NMRR`.

[Short-descriptor format memory region attributes, with TEX remap on page G4-4619](#) describes this encoding scheme.

This scheme reassigns translation table descriptor bits `TEX[2:1]` for use as bits managed by the operating system.

The Long-descriptor translation table format always uses remapping. This means that when the value of `TTBCR.EAE` is 1, enabling use of the Long-descriptor translation table format, `SCTLR.TRE` is `RES1`.

[VMSAv8-32 Long-descriptor format memory region attributes on page G4-4622](#) describes this encoding.

Shareability In the Short-descriptor translation table format, the S bit in the translation table descriptor is used in determining the Shareability of the region. How the S bit is interpreted depends on whether TEX remap is enabled, see:

- [Shareability and the S bit, without TEX remap on page G4-4618.](#)
- [Determining the Shareability, with TEX remap on page G4-4620.](#)

In the Long-descriptor translation table format, the SH[1:0] field in the translation table descriptor encodes the Shareability of the region, see [Shareability, Long-descriptor format on page G4-4622.](#)

———— **Note** —————

Shareability is one of Non-shareable, Inner Shareable, and Outer Shareable. However, when using the Short-descriptor translation table format without TEX remap, VMSAv8-32 does not support any distinction between Inner Shareable and Outer Shareable memory, and a memory region is either Non-shareable or Outer Shareable.

G4.7.2 Short-descriptor format memory region attributes, without TEX remap

When using the Short-descriptor translation table formats, TEX remap is disabled when the value of `SCTLR.TRE` is 0.

———— **Note** —————

- The Short-descriptor format scheme without TEX remap is the scheme used in VMSAv6.
- The B (Bufferable), C (Cacheable), and TEX (Type extension) bit names are inherited from earlier versions of the architecture. These names no longer adequately describe the function of the B, C, and TEX bits.

[Table G4-12](#) shows the C, B, and TEX[2:0] encodings when TEX remap is disabled. In the [Page Shareability](#) column, an entry of *S bit* indicates that the S bit in the translation table descriptor determines the Shareability, see [Shareability and the S bit, without TEX remap on page G4-4618.](#)

Table G4-12 TEX, C, and B encodings when TRE == 0

TEX[2:0]	C	B	Description	Memory type	Page Shareability
000	0	0	Device-nGnRnE	Device-nGnRnE	Outer Shareable
		1	Device-nGnRE ^a	Device-nGnRE	Outer Shareable ^a
	1	0	Outer and Inner Write-Through, Read-Allocate No Write-Allocate	Normal	S bit
		1	Outer and Inner Write-Back, Read-Allocate No Write-Allocate	Normal	S bit
001	0	0	Outer and Inner Non-cacheable	Normal	Outer Shareable ^b
		1	Reserved	-	-
	1	0	IMPLEMENTATION DEFINED	IMPLEMENTATION DEFINED	IMPLEMENTATION DEFINED
		1	Outer and Inner Write-Back, Read-Allocate Write-Allocate	Normal	S bit
010	0	0	Device-nGnRE ^a	Device-nGnRE	Outer Shareable ^a
		1	Reserved	-	-
	1	x	Reserved	-	-

Table G4-12 TEX, C, and B encodings when TRE == 0 (continued)

TEX[2:0]	C	B	Description	Memory type	Page Shareability
011	x	x	Reserved	-	-
1BB	A	A	Cacheable memory: AA = Inner attribute ^c BB = Outer attribute	Normal	S bit

- In ARMv8, all Device memory types are Outer Shareable. For the Device-nGnRE memory type this is a change from previous versions of the architecture. This is why Device-nGnRE memory has two entries in this table. For compatibility with ARMv7 software should use the {TEX, C, B} values {000, 0, 1}.
- In ARMv8, Normal Inner Non-cacheable, Outer Non-cacheable memory is always Outer Shareable. This is a change from previous versions of the architecture, where the S bit determined the Shareability. For compatibility with ARMv7 software should set S to 1.
- For more information, see *Cacheability attributes, without TEX remap*.

See *Memory types and attributes on page E2-2782* for an explanation of Normal memory, and the types of Device memory, and of the Shareability attribute.

Cacheability attributes, without TEX remap

When the value of TEX[2] is 0, the same Cacheability attribute applies to Inner Cacheable and Outer Cacheable memory regions, and the {TEX[1:0], C, B} values identify this attribute, as [Table G4-12 on page G4-4617](#) shows.

When the value of TEX[2] is 1, the memory described by the translation table entry is cacheable, and the rest of the encoding defines the Inner Cacheability and Outer Cacheability attributes:

- TEX[1:0]** Define the Outer Cacheability attribute.
- C, B** Define the Inner Cacheability attribute.

The translation table entries use the same encoding for the Outer and Inner Cacheability attributes, as [Table G4-13](#) shows.

Table G4-13 Inner and Outer Cacheability attribute encoding

Encoding	Cacheability attribute
00	Non-cacheable
01	Write-Back, Read-Allocate Write-Allocate
10	Write-Through, Read Allocate No Write-Allocate
11	Write-Back, Read Allocate No Write-Allocate

Shareability and the S bit, without TEX remap

The Short-descriptor format translation table entries include an S bit. This bit:

- Is ignored if the entry refers to any type of Device memory, or to Normal memory that is Inner Non-cacheable, Outer Non-cacheable.
- For Normal memory that is not Inner Non-cacheable, Outer Non-cacheable, determines whether the memory region is Outer Shareable or Non-shareable:
 - S == 0** Normal memory region is Non-shareable.
 - S == 1** Normal memory region is Outer Shareable.

Without TEX remapping there is no distinction between Inner Shareable and Outer Shareable memory, meaning the S bit determines whether the region is Non-shareable or Outer Shareable.

G4.7.3 Short-descriptor format memory region attributes, with TEX remap

When using the Short-descriptor translation table formats, TEX remap is enabled when the value of `SCTLR.TRE` is 1. In this configuration:

- The software that defines the translation tables must program the `PRRR` and `NMRR` to define seven possible memory region attributes.
- The `TEX[0]`, `C`, and `B` bits of the translation table descriptors define the memory region attributes, by indexing `PRRR` and `NMRR`.
- Hardware makes no use of `TEX[2:1]`, see *The OS managed translation table bits* on page G4-4621.

When TEX remap is enabled:

- For seven of the eight possible combinations of the `TEX[0]`, `C` and `B` bits, fields in the `PRRR` and `NMRR` define the region attributes, as described in this section.
- The meaning of the eighth combination for the `TEX[0]`, `C` and `B` bits is IMPLEMENTATION DEFINED.
- If the `TEX[0]`, `C` and `B` bits determine that the region is a Device memory type, or is Normal Inner Non-cacheable, Outer Non-cacheable, then the region is Outer Shareable. Otherwise, the Shareability is determined by the combination of:
 - The `S` bit from the translation table descriptor.
 - The value of the `PRRR.NS0` or `PRRR.NS1` bit.
 - The value of the appropriate `PRRR.NOSn` bit, as shown in Table G4-14.

For more information, see *Determining the Shareability, with TEX remap* on page G4-4620.

For each of the possible encodings of the `TEX[0]`, `C`, and `B` bits in a translation table entry, Table G4-14 shows which fields of the `PRRR` and `NMRR` registers describe the memory region attributes.

Table G4-14 TEX, C, and B encodings when TRE == 1

Encoding TEX[0]	C	B	Memory type ^a	Cache attributes ^{a, b} :		Outer Shareable attribute ^{a, c}
				Inner cacheability	Outer cacheability	
0	0	0	<code>PRRR.TR0</code>	<code>NMRR.IR0</code>	<code>NMRR.OR0</code>	<code>NOT(PRRR.NOS0)</code>
		1	<code>PRRR.TR1</code>	<code>NMRR.IR1</code>	<code>NMRR.OR1</code>	<code>NOT(PRRR.NOS1)</code>
	1	0	<code>PRRR.TR2</code>	<code>NMRR.IR2</code>	<code>NMRR.OR2</code>	<code>NOT(PRRR.NOS2)</code>
		1	<code>PRRR.TR3</code>	<code>NMRR.IR3</code>	<code>NMRR.OR3</code>	<code>NOT(PRRR.NOS3)</code>
1	0	0	<code>PRRR.TR4</code>	<code>NMRR.IR4</code>	<code>NMRR.OR4</code>	<code>NOT(PRRR.NOS4)</code>
		1	<code>PRRR.TR5</code>	<code>NMRR.IR5</code>	<code>NMRR.OR5</code>	<code>NOT(PRRR.NOS5)</code>
	1	0	IMPLEMENTATION DEFINED			
		1	<code>PRRR.TR7</code>	<code>NMRR.IR7</code>	<code>NMRR.OR7</code>	<code>NOT(PRRR.NOS7)</code>

a. For details of the *Memory type* and *Outer Shareable* encodings see the description of the `PRRR`. For details of the *Cache attributes* encodings the description of the `NMRR`.

b. Applies only if the memory type for the region is mapped as Normal memory.

c. Applies only if both of the following apply:

- The memory type for the region is mapped as Normal memory that is not Inner Non-cacheable and Outer Non-cacheable.
- The region is not Non-shareable.

See *Determining the Shareability, with TEX remap* on page G4-4620.

As [Table G4-14 on page G4-4619](#) shows, when TEX remap is enabled, for a given set of {TEX[0], C, B} bits from a translation table descriptor:

1. The primary mapping, to memory type, is given by the **PRRR.TR_n** field as shown in the [Memory type](#) column.
2. For any region that the **PRRR.TR_n** maps as Normal memory, **NMRR.IR_n** determines the Inner cacheability attribute, and **NMRR.OR_n** determines the Outer cacheability attribute.
3. For a region that **PRRR.TR_n** maps as Normal memory, if **NMRR**.{IR_n, OR_n} do not map the region as Inner Non-cacheable, Outer Non-cacheable, **PRRR**.{NS0, NS1} and **PRRR.NOS_n** are used to determine the Shareability of the region, see [Determining the Shareability, with TEX remap](#).

The TEX remap registers and the **SCTLR.TRE** bit are Banked between the Secure and Non-secure Security states. For more information, see [The effect of EL3 on TEX remap on page G4-4622](#).

The TEX remap registers must be static during normal operation. In particular, when the remap registers are changed:

- It is IMPLEMENTATION DEFINED when the changes take effect.
- It is CONSTRAINED UNPREDICTABLE whether the TLB caches the effect of the TEX remap on translation tables, see [CONSTRAINED UNPREDICTABLE behaviors due to caching of control or data values on page K1-6101](#).

The software sequence to ensure the synchronization of changes to the TEX remap registers is:

1. Execute a DSB instruction. This ensures any memory accesses using the old mapping have completed.
2. Write the TEX remap registers or **SCTLR.TRE** bit.
3. Execute an ISB instruction. This ensures synchronization of the register updates.
4. Invalidate the entire TLB.
5. Execute a DSB instruction. This ensures completion of the entire TLB operation.
6. Clean and invalidate all caches. This removes any cached information associated with the old mapping.
7. Execute a DSB instruction. This ensures completion of the cache maintenance.
8. Execute an ISB instruction. This ensures instruction synchronization.

This extends the standard rules for the synchronization of changes to System registers described in [Synchronization of changes to AArch32 System registers on page G6-4768](#), and provides implementation freedom as to whether or not the effect of the TEX remap is cached.

Determining the Shareability, with TEX remap

The memory type of a region, as indicated in the [Memory type](#) column of [Table G4-14 on page G4-4619](#), provides the first level of control of the Shareability of the region:

- If the memory is any type of Device memory, then the region is Outer Shareable, and any Shareability attributes in the translation table descriptor and **PRRR** for that region are ignored.
This rule applies also to a Normal memory region that the **NMRR** attributes identify as Inner Non-cacheable and Outer Non-cacheable,
- If using the Short descriptor translation table format then the Shareability of the region is determined using the value of the S bit in the translation table descriptor to index one of the **PRRR**.{NS1, NS0} bits, as described in this section.

[Table G4-15](#) shows how the translation table S bit indexes into the **PRRR**:

Table G4-15 Determining the Shareability attribute, with TEX remap

Memory type	Remapping when S == 0	Remapping when S == 1
Device or Normal Inner Non-cacheable, Outer Non-cacheable	Outer Shareable	Outer Shareable
Normal, not Inner Non-cacheable, Outer Non-cacheable	PRRR .NS0	PRRR .NS1

For a Normal memory region that is not Inner Non-cacheable, Outer Non-cacheable, the appropriate bit of the **PRRR** indicates whether the region is Non-shareable, as follows:

- PRRR.NSn==0** Non-shareable.
PRRR.{NOS7:NOS0} are ignored.
- PRRR.NSn==1** The appropriate **PRRR.NOSm** field, as shown in [Table G4-14 on page G4-4619](#), indicates whether the region is Inner Shareable or Outer Shareable:
- PRRR.NOSm==0** Region is Outer Shareable.
 - PRRR.NOSm==1** Region is Inner Shareable.

———— **Note** —————

This means that TEX remapping can map a translation table entry with $S == 0$ as shareable memory.

SCTLR.TRE, SCTLR.M, and the effect of the TEX remap registers

When TEX remap is disabled, because the value of the **SCTLR.TRE** bit is 0:

- The effect of the **PRRR** and **NMRR** registers can be IMPLEMENTATION DEFINED.
- The interpretation of the fields of the **PRRR** and **NMRR** registers can differ from the description given earlier in this section. One implication of this is that the implementation can provide an IMPLEMENTATION DEFINED mechanism to interpret the **PRRR**.{NOS7:NOS0} fields.

VMSAv8-32 requires that the effect of these registers is limited to remapping the attributes of memory locations. These registers must not change whether any cache hardware or stages of address translation are enabled. The mechanism by which the TEX remap registers have an effect when the value of the **SCTLR.TRE** bit is 0 is IMPLEMENTATION DEFINED. The AArch32 architecture requires that from reset, if the IMPLEMENTATION DEFINED mechanism has not been invoked:

- If the PL1&0 stage 1 address translation is enabled and is using the Short-descriptor format translation tables, the architecturally-defined behavior of the TEX[2:0], C, and B bits must apply, without reference to the TEX remap functionality. In other words, memory attribute assignment must comply with the scheme described in *Short-descriptor format memory region attributes, without TEX remap on page G4-4617*.
- If the PL1&0 stage 1 address translation is disabled, then the architecturally-defined behavior of VMSAv8-32 with address translation disabled must apply, without reference to the TEX remap functionality. See *The effects of disabling address translation stages on VMSAv8-32 behavior on page G4-4567*.

Possible mechanisms for enabling the IMPLEMENTATION DEFINED effect of the TEX remap registers when the value of **SCTLR.TRE** is 0 include:

- A control bit in the **ACTLR**, or in an IMPLEMENTATION DEFINED System register.
- Changing the behavior when the **PRRR** and **NMRR** registers are changed from their IMPLEMENTATION DEFINED reset values.

In addition, if the stage of address translation is disabled and the value of the **SCTLR.TRE** bit is 1, the architecturally-defined behavior of the VMSAv8-32 with the stage of address translation disabled must apply without reference to the TEX remap functionality.

In an implementation that includes EL3, the IMPLEMENTATION DEFINED effect of these registers must only take effect in the Security state of the registers. See also *The effect of EL3 on TEX remap on page G4-4622*.

The OS managed translation table bits

When TEX remap is enabled, the TEX[2:1] bits in the translation table descriptors are available as two bits that can be managed by the operating system. In VMSAv8-32, as long as the **SCTLR.TRE** bit is set to 1, the values of the TEX[2:1] bits are IGNORED by the PE. Software can write any value to these bits in the translation tables.

The effect of EL3 on TEX remap

In an implementation that includes EL3, when EL3 is using AArch32, the TEX remap registers are Banked between the Secure and Non-secure Security states. When EL3 is using AArch32, write accesses to the Secure register for the current Security state apply to all PL1&0 stage 1 translation table lookups in that state. The `SCTLR.TRE` bit is Banked in the Secure and Non-secure copies of the register, and the appropriate version of this bit determines whether TEX remap is applied to translation table lookups in the current Security state.

Write accesses to the Secure copies of the TEX remap registers are disabled when the `CP15SDISABLE` input is asserted HIGH, meaning the MCR operations to access these registers are UNDEFINED. For more information, see [The CP15SDISABLE input signal on page G4-4699](#).

G4.7.4 VMSAv8-32 Long-descriptor format memory region attributes

When a PE is using the VMSAv8-32 Long-descriptor translation table format, the `AttrIdx[2:0]` field in a block or page translation table descriptor for a stage 1 translation indicates the 8-bit field, in the appropriate MAIR register, that specifies the attributes for the corresponding memory region, as follows:

- `AttrIdx[2]` indicates the MAIR register to be used:
 - `AttrIdx[2] == 0` Use `MAIR0`.
 - `AttrIdx[2] == 1` Use `MAIR1`.
- `AttrIdx[2:0]` indicates the required `Attr` field, `Attrn`, where $n = \text{AttrIdx}[2:0]$.

Each `AttrIdx` field defines, for the corresponding memory region:

- The memory type, Normal or a type of Device memory.
- For Normal memory:
 - The Inner cacheability and Outer cacheability attributes, each of which is one of Non-cacheable, Write-Through Cacheable, or Write-Back Cacheable.
 - For Write-Through Cacheable and Write-Back Cacheable regions, the Read-Allocate and Write-Allocate policy hints, each of which is *Allocate* or *No allocate*.

For more information about the `AttrIdx[2:0]` descriptor field, see [Attribute fields in VMSAv8-32 Long-descriptor stage 1 Block and Page descriptors on page G4-4590](#).

Shareability, Long-descriptor format

When a PE is using the Long-descriptor translation table format, the `SH[1:0]` field in a block or page translation table descriptor specifies the Shareability attributes of the corresponding memory region, if the MAIR entry for that region identifies it as Normal memory that is not both Inner Non-cacheable and Outer Non-cacheable. [Table G4-16](#) shows the encoding of this field.

Table G4-16 SH[1:0] field encoding for Normal memory, Long-descriptor format

SH[1:0]	Normal memory
00	Non-shareable
01	Reserved, CONSTRAINED UNPREDICTABLE, see Reserved values in System and memory-mapped registers and translation table entries on page K1-6117 for the permitted behavior.
10	Outer Shareable
11	Inner Shareable

See [Combining the Shareability attribute on page G4-4627](#) for constraints on the Shareability attributes of a Normal memory region that is Inner Non-cacheable, Outer Non-cacheable.

For any type of Device memory, and for Normal Inner Non-cacheable, Outer Non-cacheable memory, the value of the SH[1:0] field of the translation table descriptor is ignored.

Other fields in the Long-descriptor translation table format descriptors

The following subsections describe the other fields in the translation table block and page descriptors when a PE is using the Long-descriptor translation table format:

- *Contiguous bit*
- *IGNORED fields.*
- *Field reserved for software use*

Contiguous bit

The Long-descriptor translation table format descriptors contain a Contiguous bit. Setting this bit to 1 indicates that 16 adjacent translation table entries point to a *contiguous output address range*. These 16 entries must be aligned in the translation table so that the top five bits of their input addresses, that index their position in the translation table, are the same. For example, to use this bit for a block of 16 entries in the level 3 translation table, bits[20:16] of the input addresses for the 16 entries must be the same.

The contiguous output address range must be aligned to size of 16 translation table entries at the same translation table level.

Use of this bit means that the TLB can cache a single entry to cover the 16 translation table entries.

This bit acts as a hint. The architecture does not require a PE to cache TLB entries in this way. To avoid TLB coherency issues, any TLB maintenance by address must not assume any optimization of the TLB tables that might result from use of this bit.

———— **Note** —————

The use of the contiguous bit is similar to the approach used, in the Short-descriptor translation table format, for optimized caching of Large Pages and Supersections in the TLB. However, an important difference in the contiguous bit capability is that TLB maintenance must be performed based on the size of the underlying translation table entries, to avoid TLB coherency issues. That is, any use of the contiguous bit has no effect on the minimum size of entry that must be invalidated from the TLB.

IGNORED fields

For stage 1 and stage 2 Block and Page descriptors, the architecture defines bits[63:59] and bits[58:55] as IGNORED fields, meaning the architecture guarantees that a PE makes no use of these fields. In addition:

- Bits[58:55] are reserved for software use, see *Field reserved for software use*.
- In the stage 2 Block and Page descriptors, bits[63:60] are reserved for use by a System MMU.

———— **Note** —————

The definition of IGNORED means there is no need to invalidate the TLB if these bits are changed.

Field reserved for software use

The architecture reserves a 4-bit field in the Block and Page table descriptors, bits[58:55], for software use. In considering migration from using the Short-descriptor format to the Long-descriptor format, this field is an extension of the Short-descriptor field described in *The OS managed translation table bits on page G4-4621*.

———— **Note** —————

The definition of IGNORED means there is no need to invalidate the TLB if these bits are changed.

G4.7.5 EL2 control of Non-secure memory region attributes

Software executing at EL2 controls two sets of translation tables, both of which use the Long-descriptor translation table format. These are:

- The translation tables that control Non-secure PL2 stage 1 translations. These map VAs to PAs, and when EL2 is using AArch32 they are indicated and controlled by the [HTTBR](#) and [HTCR](#).
 These translations have exactly the same memory region attribute controls as any other stage 1 translations, as described in [VMSAv8-32 Long-descriptor format memory region attributes on page G4-4622](#).
- The translation tables that control Non-secure PL1&0 stage 2 translations. These map the IPAs from the stage 1 translation onto PAs, and are indicated and when EL2 is using AArch32 they are controlled by the [VTTBR](#) and [VTCR](#).
 The descriptors in the virtualization translation tables define level 2 memory region attributes, that are combined with the attributes defined in the stage 1 translation. This section describes this combining of attributes.

[VMSAv8-32 Long-descriptor translation table format descriptors on page G4-4586](#) describes the format of the entries in these tables.

———— **Note** —————

In a virtualization implementation, a hypervisor might usefully:

- Reduce the permitted Cacheability of a region.
- Increase the required Shareability of a region.

The combining of attributes from stage 1 and stage 2 translations supports both of these options.

In the stage 2 translation table descriptors for memory regions and pages, the MemAttr[3:0] and SH[1:0] fields describe the stage 2 memory region attributes:

- The definition of the stage 2 SH[1:0] field is identical to the same field for a stage 1 translation, see [Shareability, Long-descriptor format on page G4-4622](#).
- MemAttr[3:2] give a top-level definition of the memory type, and of the cacheability of a Normal memory region, as [Table G4-17](#) shows:

Table G4-17 Long-descriptor MemAttr[3:2] encoding, stage 2 translation

MemAttr[3:2]	Memory type	Cacheability
00	Device, of type determined by MemAttr[1:0]	Not applicable
01	Normal, Inner cacheability determined by MemAttr[1:0]	Outer Non-cacheable
10		Outer Write-Through Cacheable
11		Outer Write-Back Cacheable

The encoding of MemAttr[1:0] depends on the Memory type indicated by MemAttr[3:2]:

- When MemAttr[3:2]==0b00, indicating a type of Device memory, [Table G4-18](#) shows the encoding of MemAttr[1:0]:

Table G4-18 MemAttr[1:0] encoding for the types of Device memory

MemAttr[1:0]	Meaning when MemAttr[3:2] == 0b00
00	Region is Device-nGnRnE memory
01	Region is Device-nGnRE memory
10	Region is Device-nGRE memory
11	Region is Device-GRE memory

- When MemAttr[3:2]!=0b00, indicating Normal memory, [Table G4-19](#) shows the encoding of MemAttr[1:0]:

Table G4-19 MemAttr[1:0] encoding for Normal memory

MemAttr[1:0]	Meaning when MemAttr[3:2] != 0b00
00	Reserved, CONSTRAINED UNPREDICTABLE, See Reserved values in System and memory-mapped registers and translation table entries on page K1-6117 for the permitted behavior.
01	Inner Non-cacheable
10	Inner Write-Through Cacheable
11	Inner Write-Back Cacheable

———— **Note** —————

The stage 2 translation does not assign any allocation hints.

The following sections describe how the memory type attributes assigned at stage 2 of the translation are combined with those assigned at stage 1:

- [Combining the memory type attribute on page G4-4626.](#)
- [Combining the Cacheability attribute on page G4-4626.](#)
- [Combining the Shareability attribute on page G4-4627.](#)

———— **Note** —————

- The following stage 2 translation table attribute settings leave the stage 1 settings unchanged:
 - MemAttr[3:2] == 0b11, Normal memory, Outer Write-Back Cacheable.
 - MemAttr[1:0] == 0b11, Inner Write-Back Cacheable.
- In addition to the attribute combinations described in this section, [Access permissions for instruction execution on page G4-4609](#) describes how the stage 1 and stage 1 XN permission fields are combined, so that a region is execute-never if the value of the XN field is 1 in at least one stage of translation.

Combining the memory type attribute

Table G4-20 shows how the stage 1 and stage 2 memory type assignments are combined:

Table G4-20 Combining the stage 1 and stage 2 memory type assignments

Assignment in stage 1	Assignment in stage 2	Resultant type
Device-nGnRnE	Any	Device-nGnRnE
Device-nGnRE	Device-nGnRnE	Device-nGnRnE
	Not Device-nGnRnE	Device-nGnRE
Device-nGRE	Device-nGnRnE	Device-nGnRnE
	Device-nGnRE	Device-nGnRE
	Not (Device-nGnRnE or Device-nGnRE)	Device-nGRE
Device-GRE	Device-nGnRnE	Device-nGnRnE
	Device-nGnRE	Device-nGnRE
	Device-nGRE	Device-nGRE
	Device-GRE or Normal	Device-GRE
Normal	Any type of Device	Device type assigned at stage 2
	Normal	Normal

See [Combining the Shareability attribute on page G4-4627](#) for information about the Shareability of:

- A region for which the resultant type is any Device type.
- A region with a resultant type of Normal for which the resultant cacheability, described in [Combining the Cacheability attribute](#), is Inner Non-cacheable, Outer Non-cacheable.

The combining of the memory type attribute means a translation table walk for a stage 1 translation can be made to a type of Device memory. If this occurs, then:

- If the value of HCR.PTW is 0, then the translation table walk occurs as if it is to Normal Non-cacheable memory. This means it can be done speculatively.
- If the value of HCR.PTW is 1, then the memory access generates a stage 2 Permission fault.

Combining the Cacheability attribute

For a Normal memory region, Table G4-21 shows how the stage 1 and stage 2 Cacheability assignments are combined. This combination applies, independently, for the Inner Cacheability and Outer Cacheability attributes:

Table G4-21 Combining the stage 1 and stage 2 cacheability assignments

Assignment in stage 1	Assignment in stage 2	Resultant cacheability
Non-cacheable	Any	Non-cacheable
Any	Non-cacheable	Non-cacheable

Table G4-21 Combining the stage 1 and stage 2 cacheability assignments (continued)

Assignment in stage 1	Assignment in stage 2	Resultant cacheability
Write-Through Cacheable	Write-Through or Write-Back Cacheable	Write-Through Cacheable
Write-Through or Write-Back Cacheable	Write-Through Cacheable	Write-Through Cacheable
Write-Back Cacheable	Write-Back Cacheable	Write-Back Cacheable

———— **Note** —————

Only Normal memory has a Cacheability attribute.

Combining the Shareability attribute

In the following cases, a memory region is treated as Outer Shareable, regardless of any shareability assignments at either stage of translation:

- The resultant memory type attribute, described in [Combining the memory type attribute on page G4-4626](#), is any type of Device memory.
- The resultant memory type attribute is Normal memory, and the resultant Cacheability, described in [Combining the Cacheability attribute on page G4-4626](#), is Inner Non-cacheable Outer Non-cacheable.

For a memory region with a resultant memory type attribute of Normal that is not Inner Non-cacheable Outer Non-cacheable, [Table G4-22](#) shows how the stage 1 and stage 2 shareability assignments are combined:

Table G4-22 Combining the stage 1 and stage 2 Shareability assignments

Assignment in stage 1	Assignment in stage 2	Resultant Shareability
Outer Shareable	Any	Outer Shareable
Inner Shareable	Outer Shareable	Outer Shareable
Inner Shareable	Inner Shareable	Inner Shareable
Inner Shareable	Non-shareable	Inner Shareable
Non-shareable	Outer Shareable	Outer Shareable
Non-shareable	Inner Shareable	Inner Shareable
Non-shareable	Non-shareable	Non-shareable

G4.8 Translation Lookaside Buffers (TLBs)

Translation Lookaside Buffers (TLBs) are an implementation technique that caches translations or translation table entries. TLBs avoid the requirement to perform a translation table walk in memory for every memory access. The ARM architecture does not specify the exact form of the TLB structures for any design. In a similar way to the requirements for caches, the architecture only defines certain principles for TLBs:

- The architecture has a concept of an entry locked down in the TLB. The method by which lockdown is achieved is IMPLEMENTATION DEFINED, and an implementation might not support lockdown.
- The architecture does not guarantee that an unlocked TLB entry remains in the TLB.
- The architecture guarantees that a locked TLB entry remains in the TLB. However, a locked TLB entry might be updated by subsequent updates to the translation tables. Therefore, when a change is made to the translation tables, the architecture does not guarantee that a locked TLB entry remains incoherent with an entry in the translation table.
- The architecture guarantees that a translation table entry that generates a Translation fault, an Address size fault, or an Access flag fault is not held in the TLB. However a translation table entry that generates a Domain fault or a Permission fault might be held in the TLB.
- When address translation is enabled, any translation table entry that does not generate a Translation fault, an Address size fault, or an Access flag fault and is not from a translation regime for an Exception level that is lower than the current Exception level can be allocated to a TLB at any time. The only translation table entries guaranteed not to be held in the TLB are those that generate a Translation fault, an Address size fault, or an Access flag fault.

———— **Note** ————

A TLB can hold translation table entries that do not generate a Translation fault but point to subsequent tables in the translation table walk. This can be referred to as *intermediate caching* of TLB entries.

- Software can rely on the fact that between disabling and re-enabling a stage of address translation, entries in the TLB relating to that stage of translation have not been corrupted to give incorrect translations.

The following sections give more information about TLB implementation:

- [Global and process-specific translation table entries](#).
- [TLB matching on page G4-4629](#).
- [TLB behavior at reset on page G4-4629](#).
- [TLB lockdown on page G4-4630](#).
- [TLB conflict aborts on page G4-4630](#).

See also [TLB maintenance requirements on page G4-4632](#).

G4.8.1 Global and process-specific translation table entries

For VMSAv8-32, system software can divide a virtual memory map used by memory accesses at PL1 and PL0 into global and non-global regions, indicated by the nG bit in the translation table descriptors:

nG == 0 The translation is global, meaning the region is available for all processes.

nG == 1 The translation is non-global, or process-specific, meaning it relates to the current ASID, as defined by:

- [TTBR0.ASID](#) or [TTBR1.ASID](#), if using the Long-descriptor translation table format. In this case, [TTBCR.A1](#) selects which ASID is current.
- [CONTEXTIDR.ASID](#), if using the Short-descriptor translation table format.

Each non-global region has an associated ASID. These identifiers mean different translation table mappings can co-exist in a caching structure such as a TLB. This means that software can create a new mapping of a non-global memory region without removing previous mappings.

For a symmetric multiprocessor cluster where a single operating system is running on the set of PEs, the architecture requires all ASID values to be assigned uniquely within any single Inner Shareable domain. In other words, each ASID value must have the same meaning to all PEs in the system.

The translation regime used for accesses made at PL2 does not support ASIDs, and all pages are treated as global.

When a PE is using the Long-descriptor translation table format, and is in Secure state, a translation must be treated as non-global, regardless of the value of the nG bit, if NSTable is set to 1 at any level of the translation table walk.

For more information see *Control of Secure or Non-secure memory access, VMSAv8-32 Long-descriptor format* on page G4-4593.

G4.8.2 TLB matching

A TLB is a hardware caching structure for translation table information. Like other hardware caching structures, it is mostly invisible to software. However, there are some situations where it can become visible. These are associated with coherency problems caused by an update to the translation table that has not been reflected in the TLB. Use of the TLB maintenance instructions described in *TLB maintenance requirements* on page G4-4632 can prevent any TLB incoherency becoming a problem.

A particular case where the presence of the TLB can become visible is if the translation table entries that are in use under a particular ASID and VMID are changed without suitable invalidation of the TLB. This can occur only if the architecturally-required break-before-make sequence described in *Using break-before-make when updating translation table entries* on page G4-4633 is not used. If the break-before make sequence is not used, the TLB can hold two mappings for the same address, and this:

- Might generate an exception that is reported using the TLB Conflict fault code, see *TLB conflict aborts* on page G4-4630.
- Might lead to CONSTRAINED UNPREDICTABLE behavior. In this case, behavior will be consistent with one of the mappings held in the TLB, or with some amalgamation of the values held in the TLB, but cannot give access to regions of memory with permissions or attributes that could not be assigned by valid translation table entries in the translation regime being used for the access. See *CONSTRAINED UNPREDICTABLE behaviors due to caching of control or data values* on page K1-6101.

G4.8.3 TLB behavior at reset

The ARM architecture does not require a reset to invalidate the TLBs, and recognizes that an implementation might require caches, including TLBs, to maintain context over a system reset. Possible reasons for doing so include power management and debug requirements.

Therefore, for ARMv8:

- All TLBs reset to an IMPLEMENTATION DEFINED state that might be UNKNOWN.
- All TLBs are disabled from reset. All stages of address translation that are used from the PE state entered on coming out of reset are disabled from reset, and the contents of the TLBs have no effect on address translation. For more information see *Enabling stages of address translation* on page G4-4569.
- An implementation can require the use of a specific TLB invalidation routine, to invalidate the TLB arrays before they are enabled after a reset. The exact form of this routine is IMPLEMENTATION DEFINED, but if an invalidation routine is required it must be documented clearly as part of the documentation of the device.

ARM recommends that if an invalidation routine is required for this purpose, and the PE resets into AArch32 state, the routine is based on the AArch32 TLB maintenance instructions described in *The scope of TLB maintenance instructions* on page G4-4641.

Similar rules apply:

- To cache behavior, see *Behavior of caches at reset* on page G3-4531.
- To branch predictor behavior, see *Behavior of the branch predictors at reset* on page G3-4539.

G4.8.4 TLB lockdown

The ARM architecture recognizes that any TLB lockdown scheme is heavily dependent on the microarchitecture, making it inappropriate to define a common mechanism across all implementations. This means that:

- The architecture does not require TLB lockdown support.
- If TLB lockdown support is implemented, the lockdown mechanism is IMPLEMENTATION DEFINED. However, key properties of the interaction of lockdown with the architecture must be documented as part of the implementation documentation.

This means that:

- The TLB Type Register, [TLBTR](#), does not define the lockdown scheme in use.
- In AArch32 state, a region of the {coproc==0b1111, CRn==c10} encodings is reserved for IMPLEMENTATION DEFINED TLB functions, such as TLB lockdown functions. The reserved encodings are those with:
 - <CRm> == {c0, c1, c4, c8}.
 - All values of <opc2> and <opc1>.

An implementation might use some of the {coproc==0b1111, CRn==c10} encodings that are reserved for IMPLEMENTATION DEFINED TLB functions to implement additional TLB control functions. These functions might include:

- Unlock all locked TLB entries.
- Preload into a specific level of TLB. This is beyond the scope of the PLI and PLD hint instructions.

The inclusion of EL2 in an implementation does not affect the TLB lockdown requirements. However, in an implementation that includes EL2, exceptions generated as a result of TLB lockdown when executing in a Non-secure PL1 mode or in Non-secure User mode can be routed to either:

- Non-secure Abort mode, using the Non-secure Data Abort exception vector.
- Hyp mode, using the Hyp Trap exception vector.

For more information, see [Traps to Hyp mode of Non-secure EL0 and EL1 accesses to lockdown, DMA, and TCM operations on page G1-4433](#).

G4.8.5 TLB conflict aborts

If an address matches multiple entries in the TLB, it is IMPLEMENTATION DEFINED whether a TLB conflict abort is generated.

An implementation can generate TLB conflict aborts on either or both instruction fetches and data accesses. A TLB conflict abort is classified as an MMU fault, see [MMU faults in AArch32 state on page G4-4657](#). This means:

- A TLB conflict abort on an instruction fetch is reported as a Prefetch Abort exception,
- A TLB conflict abort on a data access is reported as a Data Abort exception,

Fault status codes for TLB conflict aborts are defined for both the Short-descriptor and Long-descriptor translation table formats, see:

- [PL1 fault reporting with the Short-descriptor translation table format on page G4-4668](#)
- [PL1 fault reporting with the Long-descriptor translation table format on page G4-4670](#).

On a TLB conflict abort, the fault address register returns the address that generated the fault. That is, it returns the address that was being looked up in the TLB.

It is IMPLEMENTATION DEFINED whether a TLB conflict abort is a stage 1 abort or a stage 2 abort.

———— **Note** —————

- An address can hit multiple entries in the TLB if the TLB has been invalidated inappropriately, for example if TLB invalidation required by this manual has not been performed.
- A stage 2 abort cannot be generated if the Non-secure PL1&0 stage 2 address translation is disabled.

The priority of the TLB conflict abort is IMPLEMENTATION DEFINED, because it depends on the form of any TLB that can generate the abort. However, the TLB conflict abort must have higher priority than any abort that depends on a value held in the TLB.

If an address matches multiple entries in the TLB and no TLB conflict abort not generated, the resulting behavior is CONSTRAINED UNPREDICTABLE, see [CONSTRAINED UNPREDICTABLE behaviors due to caching of control or data values on page K1-6101](#). The CONSTRAINED UNPREDICTABLE behavior must not permit access to regions of memory with permissions or attributes that mean they cannot be accessed in the current Security state at the current Privilege level.

G4.9 TLB maintenance requirements

[Translation Lookaside Buffers \(TLBs\) on page G4-4628](#) describes the ARM architectural provision for TLBs. Although the ARM architecture does not specify the form of any TLB structures, it does define the mechanisms by which TLBs can be maintained. The following sections describe the VMSAv8-32 TLB maintenance instructions:

- [General TLB maintenance requirements](#).
- [Maintenance requirements on changing System register values on page G4-4637](#).
- [Atomicity of register changes on changing virtual machine on page G4-4638](#).
- [Synchronization of changes of ASID and TTBR on page G4-4639](#).
- [The scope of TLB maintenance instructions on page G4-4641](#).

G4.9.1 General TLB maintenance requirements

TLB maintenance instructions provide a mechanism to invalidate entries from a TLB. As [Translation Lookaside Buffers \(TLBs\) on page G4-4628](#) describes, when address translation is enabled translation table entries can be allocated to a TLB at any time. This means that software must perform TLB maintenance between updating translation table entries that apply in a particular context and accessing memory locations whose translation is determined by those entries in that context.

———— Note ————

This requirement applies to any translation table entry at any level of the translation tables, including an entry that points to further levels of the tables, provided that the entry in that level of the tables does not cause a Translation fault, an Address size fault, or an Access flag fault.

In addition to any TLB maintenance requirement, when changing the cacheability attributes of an area of memory, software must ensure that any cached copies of affected locations are removed from the caches. For more information see [Cache maintenance requirement created by changing translation table attributes on page G4-4648](#).

Because a TLB never holds any translation table entry that generates a Translation fault, an Address size fault, or an Access flag fault, a change from a translation table entry that causes a Translation, Address size, or Access flag fault to one that does not fault, does not require any TLB or branch predictor invalidation.

Special considerations apply to translation table updates that change the memory type, cacheability, or output address of an entry, see [Using break-before-make when updating translation table entries on page G4-4633](#).

In addition, software must perform TLB maintenance after updating the System registers if the update means that the TLB might hold information that applies to a current translation context, but is no longer valid for that context. [Maintenance requirements on changing System register values on page G4-4637](#) gives more information about this maintenance requirement.

Each of the translation regimes defined in [Figure G4-1 on page G4-4560](#) is a different context, and:

- For the Non-secure PL1&0 regime, a change in the VMID or ASID value changes the context.
- For the Secure PL1&0 regime, a change in the ASID value changes the context.

For operation in Non-secure PL1 or PL0 modes, a change of `HCR.VM`, unless made at the same time as a change of VMID, requires the invalidation of all TLB entries for the Non-secure PL1&0 translation regime that apply to the current VMID. Otherwise, there is no guarantee that the effect of the change of `HCR.VM` is visible to software executing in the Non-secure PL1 and PL0 modes.

Any TLB maintenance instruction can affect any other TLB entries that are not locked down.

AArch32 state defines `{coproc==0b1111, CRn==c8}` System instructions for TLB maintenance instructions, and supports the following operations:

- Invalidate all unlocked entries in the TLB.
- Invalidate a single TLB entry, by VA, or VA and ASID for a non-global entry.
- Invalidate all TLB entries that match a specified ASID.
- Invalidate all TLB entries that match a specified VA, regardless of the ASID.
- Operations that apply across multiprocessors in the same Inner Shareable domain.

———— **Note** ————

An address-based TLB maintenance instruction that applies to the Inner Shareable domain does so regardless of the Shareability attributes of the address supplied as an argument to the instruction.

A TLB maintenance instruction that specifies a virtual address that would generate any MMU fault, including a virtual address that is not in the range of virtual addresses that can be translated, does not generate an abort.

EL2 provides additional TLB maintenance instructions for use in AArch32 state at PL2, and has some implications for the effect of the other TLB maintenance instructions, see [The scope of TLB maintenance instructions on page G4-4641](#).

In an implementation that includes EL3, the TLB maintenance instructions take account of the current Security state, as part of the address translation required for the TLB maintenance instruction.

Some TLB maintenance instructions are defined as operating only on instruction TLBs, or only on data TLBs. ARMv8 AArch32 state includes these instructions for backwards compatibility. However, more recent TLB maintenance instructions do not support this distinction. From the introduction of ARMv7, ARM deprecates any use of Instruction TLB maintenance instructions, or of Data TLB maintenance instructions, and developers must not rely on this distinction being maintained in future revisions of the ARM architecture.

The ARM architecture does not dictate the form in which the TLB stores translation table entries. However, for TLB invalidate instructions, the minimum size of the table entry that is invalidated from the TLB must be at least the size that appears in the translation table entry.

[The scope of TLB maintenance instructions on page G4-4641](#) describes the TLB maintenance instructions. The following subsections give more information about the general requirements for TLB maintenance:

- [Using break-before-make when updating translation table entries.](#)
- [The interaction of TLB lockdown with TLB maintenance instructions on page G4-4634.](#)
- [Ordering and completion of TLB maintenance instructions on page G4-4635.](#)
- [Use of ASIDs and VMIDs to reduce TLB maintenance requirements on page G4-4636.](#)

Using break-before-make when updating translation table entries

To avoid possibly creating multiple TLB entries for the same address, and to avoid the effects of TLB caching possibly breaking coherency, ordering guarantees or uniprocessor semantics, or possibly failing to clear the Exclusives monitors, the architecture requires the use of a break-before-make sequence when changing translation table entries whenever multiple threads of execution can use the same translation tables and the change to the translation table entries involves any of:

- A change of the memory type.
- A change of the cacheability attributes.
- A change of the output address (OA), if the OA of at least one of the old translation table entries and the new translation table entry is writeable.
- A change to the size of block used by the translation system. This rule applies both:
 - When changing from a smaller size to a larger size, for example by replacing a table mapping with a block mapping in a stage 2 translation table.
 - When changing from a larger size to a smaller size, for example by replacing a block mapping with a table mapping in a stage 2 translation table.
- Creating a global entry when there might be non-global entries in a TLB that overlap with that global entry.

A break-before-make sequence on changing from an old translation table entry to a new translation table entry requires the following steps:

1. Replace the old translation table entry with an invalid entry, and execute a DSB instruction.
2. Invalidate the translation table entry with a broadcast TLB invalidation instruction, and execute a DSB instruction to ensure the completion of that invalidation.
3. Write the new translation table entry, and execute a DSB instruction to ensure that the new entry is visible.

This sequence ensures that at no time are both the old and new entries simultaneously visible to different threads of execution, and therefore the problems described at the start of this subsection cannot arise.

The interaction of TLB lockdown with TLB maintenance instructions

The precise interaction of TLB lockdown with the TLB maintenance instructions is IMPLEMENTATION DEFINED. However, the architecturally-defined TLB maintenance instructions must comply with these rules:

- The effect on locked entry of a TLB invalidate all unlocked entries instruction or a TLB invalidate by VA all ASID instruction that would invalidate that entry if the entry was not locked must be one of the following, and it is IMPLEMENTATION DEFINED which behavior applies:
 - The instructions have no effect on entries that are locked down.
 - The instructions generate an IMPLEMENTATION DEFINED Data Abort exception if an entry is locked down, or might be locked down. For an invalidate instruction performed in AArch32 state, the {coproc==0b1111, CRn==c5} fault status register definitions include a Fault status code for cache and TLB lockdown faults, see [Table G4-25 on page G4-4668](#) for the codes used with the Short-descriptor translation table formats, or [Table G4-26 on page G4-4670](#) for the codes used with the Long-descriptor translation table formats.

In an implementation that includes EL2, if EL2 is using AArch32 and the value of HCR.TIDCP is 1, any such exceptions taken from a Non-secure PL1 mode are routed to Hyp mode, see [Traps to Hyp mode of Non-secure EL0 and EL1 accesses to lockdown, DMA, and TCM operations on page G1-4433](#).

This permits a usage model for TLB invalidate routines, where the routine invalidates a large range of addresses, without considering whether any entries are locked in the TLB.

- The effect on a locked TLB entry of a TLB invalidate by VA instruction or a TLB invalidate by ASID match instruction that would invalidate that entry if the entry was not locked must be one of the following, and it is IMPLEMENTATION DEFINED which behavior applies:
 - A locked entry is invalidated in the TLB.
 - The instruction has no effect on a locked entry in the TLB. In the case of the Invalidate single entry by VA, this means the PE treats the instruction as a NOP.
 - The instruction generates an IMPLEMENTATION DEFINED Data Abort exception if it operates on an entry that is locked down, or might be locked down. For an invalidate instruction performed in AArch32 state, the {coproc==0b1111, CRn==c5} fault status register definitions include a Fault status code for cache and TLB lockdown faults, see [Table G4-25 on page G4-4668](#) and [Table G4-26 on page G4-4670](#).

———— Note —————

Any implementation that uses an abort mechanism for entries that can be locked down but are not actually locked down must:

- Document the IMPLEMENTATION DEFINED instruction sequences that perform the required invalidation on entries that are not locked down.
- Implement one of the other specified alternatives for the locked entries.

ARM recommends that, when possible, such IMPLEMENTATION DEFINED instruction sequences use the architecturally-defined maintenance instructions. This minimizes the number of customized maintenance operations required.

In addition, an implementation that uses an abort mechanism for handling TLB maintenance instructions on entries that can be locked down but are not actually locked down must also provide a mechanism that ensures that no TLB entries are locked.

Similar rules apply to cache lockdown, see [The interaction of cache lockdown with cache maintenance instructions on page G3-4546](#).

The architecture does not guarantee that any unlocked entry in the TLB remains in the TLB. This means that, as a side-effect of a TLB maintenance instruction, any unlocked entry in the TLB might be invalidated.

Ordering and completion of TLB maintenance instructions

The following rules describe the relations between the memory order model and the TLB maintenance instructions:

- A TLB invalidate instruction is complete when all memory accesses using the invalidated TLB entries have been observed by all observers, to the extent that those accesses must be observed. The Shareability and Cacheability of the accessed memory locations determine the extent to which the accesses must be observed.

———— **Note** —————

For a TLB invalidate instruction that affects other PEs, the set of memory accesses that have been observed when the TLB maintenance instruction is complete must include the memory accesses from those processes that used the invalidated TLB entries.

After the TLB invalidate instruction is complete, no new memory accesses using the invalidated TLB entries will be observed by those observers.

———— **Note** —————

This requirement does not mean that speculative memory accesses cannot be performed using those entries if it is impossible to tell that those memory accesses have been observed by the observers.

- A TLB maintenance instruction is only guaranteed to be complete after the execution of a DSB instruction.
- An ISB instruction, or a return from an exception, causes the effect of all completed TLB maintenance instructions that appear in program order before the ISB or return from exception to be visible to all subsequent instructions, including the instruction fetches for those instructions.
- An exception causes all completed TLB maintenance instructions, that appear in the instruction stream before the point where the exception is taken, to be visible to all subsequent instructions, including the instruction fetches for those instructions.
- All TLB maintenance instructions are executed in program order relative to each other.
- The execution of a Data or Unified TLB maintenance instruction is only guaranteed to be visible to a subsequent explicit load or store instruction after both:
 - The execution of a DSB instruction to ensure the completion of the TLB maintenance instruction.
 - Execution of a subsequent [Context synchronization event](#).
- The execution of an Instruction or Unified TLB maintenance instruction is only guaranteed to be visible to a subsequent instruction fetch after both:
 - The execution of a DSB instruction to ensure the completion of the TLB maintenance instruction.
 - Execution of a subsequent [Context synchronization event](#).

In all cases in this section where a DMB or DSB is referred to, it refers to a DMB or DSB whose required access type is both loads and stores. A DSB NSH is sufficient to ensure completion of TLB maintenance instructions that apply to a single PE. A DSB ISH is sufficient to ensure completion of TLB maintenance instructions that apply to PEs in the same Inner Shareable domain.

The following rules apply when writing translation table entries. They ensure that the updated entries are visible to subsequent accesses and cache maintenance instructions.

For TLB maintenance, the translation table walk is treated as a separate observer. This means:

- A write to the translation tables is only guaranteed to be seen by a translation table walk caused by an explicit load or store after the execution of both a DSB and an ISB.

However, the architecture guarantees that any writes to the translation tables are not seen by any explicit memory access that occurs in program order before the write to the translation tables.

- A write to the translation tables is only guaranteed to be seen by a translation table walk caused by the instruction fetch of an instruction that follows the write to the translation tables after both a DSB and an ISB.

Therefore, in a uniprocessor system, an example instruction sequence for writing a translation table entry, covering changes to the instruction or data mappings is:

```
STR rx, [Translation table entry] ; write new entry to the translation table
DSB ; ensures visibility of the new entry
Invalidate TLB entry by VA (and ASID if non-global) [page address]
Invalidate BTC
DSB ; ensure completion of the Invalidate TLB instruction
ISB ; ensure table changes visible to instruction fetch
```

Use of ASIDs and VMIDs to reduce TLB maintenance requirements

To reduce the need for TLB maintenance on context switches, the lookups from some translation regimes can be associated with an ASID, or with an ASID and a VMID.

————— Note —————

The use of ASIDs and VMIDs in VMSAv8-32 is generally similar to their use in VMSAv8-64, see [Use of ASIDs and VMIDs to reduce TLB maintenance requirements on page D4-2113](#).

For more information about the use of ASIDs in VMSAv8-32 see [Global and process-specific translation table entries on page G4-4628](#).

Common not private translations in VMSAv8-32

In an implementation that includes ARMv8.2-TTCNP, multiple PEs in the same Inner Shareable domain can use the same translation table entries for a given stage of address translation in a particular translation regime. This sharing is enabled by the TTBR.CnP field for the stage of address translation.

When the value of a TTBR.CnP field is 1, translation table entries pointed to by that TTBR are shared with all other PEs in the Inner Shareable domain for which the following conditions are met:

- The corresponding TTBR.CnP field has the value 1.
- That TTBR is using the Long-descriptor translation table format.
- If an ASID applies to the stage of translation corresponding to that TTBR then the current ASID value must be the same for all of the PEs that are sharing entries.
- If a VMID applies to the stage of translation corresponding to that TTBR then the current VMID value must be the same for all of the PEs that are sharing entries.

————— Note —————

In an implementation that includes EL3, the Secure instances of TTBR0 and TTBR1 relate to the Secure PL1&0 translation regime, and the Non-secure instances of TTBR0 and TTBR1 relate to the Non-secure PL1&0 translation regime.

Where a TLB combines information from stage 1 and stage 2 translation table entries into a single entry, this entry can be shared between different PEs only if the value of the TTBR.CnP bit is 1 for both stage 1 and stage 2 of the translation table walk.

The TTBR.CnP bit can be cached in a TLB.

For a given TTBR, if the value of TTBR.CnP is 1 on multiple PEs in the same Inner Shareable domain, and those PEs meet the other conditions for sharing translation table entries as defined in this section, but those TTBRs do not point to the same translation table entries, then the system is misconfigured, and performing an address translation using that TTBR:

- Might generate multiple hits in the TLB, and as a result generate an exception that is reported using the TLB conflict fault code, see *TLB conflict aborts* on page G4-4630.
- Otherwise, has a **CONSTRAINED UNPREDICTABLE** result, as described in *CONSTRAINED UNPREDICTABLE behaviors due to caching of control or data values* on page K1-6101.

G4.9.2 Maintenance requirements on changing System register values

The TLB contents can be influenced by control bits in a number of System registers. This means the TLB must be invalidated after any changes to these bits, unless the changes are accompanied by a change to the VMID or ASID that defines the context to which the bits apply. The general form of the required invalidation sequence is as follows:

```
; Change control bits in System registers
ISB          ; Synchronize changes to the control bits
; Perform TLB invalidation of all entries that might be affected by the changed control bits
```

The System register changes that this applies to are:

- Any change to the **NMRR**, **PRRR**, **MAIR0**, **MAIR1**, **HMAIR0** or **HMAIR1** registers.
- Any change to the **SCTLR.AFE** bit, see *Changing the Access flag enable*.
- Any change to any of the **SCTLR**.{TRE, WXN, UWXN} bits.
- Any change to the Translation table base 0 address in **TTBR0**.
- Any change to the Translation table base 1 address in **TTBR1**.
- Any change to **HTTBR.BADDR**.
- Any change to **VTTBR.BADDR**.
- Changing **TTBCR.EAE**, see *Changing the current Translation table format* on page G4-4638.
- In an implementation that includes EL3, any change to the **SCR.SIF** bit.
- In an implementation that includes EL2:
 - Any change to the **HCR.VM** bit.
 - Any change to **HCR.PTW** bit, see *Changing HCR.PTW* on page G4-4638.
- When using the Short-descriptor translation table format:
 - Any change to the RGN, IRGN, S, or NOS fields in **TTBR0** or **TTBR1**.
 - Any change to the N, EAE, PD0 or PD1 fields in **TTBCR**
- When using the Long-descriptor translation table format:
 - Any change to the EAE, TnSZ, ORGNn, IRGNn, SHn, or EPDn fields in the **TTBCR**, where n is 0 or 1.
 - **Any change to the TTBCR2.**
 - Any change to the T0SZ, ORGN0, IRGN0, or SH0 fields in the **HTCR**.
 - Any change to the T0SZ, ORGN0, IRGN0, or SH0 fields in the **VTCR**.

Changing the Access flag enable

In a PE that is using the Short-descriptor translation table format, it is **CONSTRAINED UNPREDICTABLE** whether the TLB caches the effect of the **SCTLR.AFE** bit on translation tables. This means that, after changing the **SCTLR.AFE** bit software must invalidate the TLB before it relies on the effect of the new value of the **SCTLR.AFE** bit, otherwise behavior is **CONSTRAINED UNPREDICTABLE**, see *CONSTRAINED UNPREDICTABLE behaviors due to caching of control or data values* on page K1-6101.

————— **Note** —————

There is no enable bit for use of the Access flag when using the Long-descriptor translation table format.

Changing HCR.PTW

When EL2 is using AArch32 and the value of the Protected table walk bit, **HCR.PTW**, is 1, a stage 1 translation table access in the Non-secure PL1&0 translation regime, to an address that is mapped to any type of Device memory by its stage 2 translation, generates a stage 2 Permission fault. A TLB associated with a particular VMID might hold entries that depend on the effect of **HCR.PTW**. Therefore, if the value of **HCR.PTW** is changed without a change to the VMID value, all TLB entries associated with the current VMID must be invalidated before executing software in a Non-secure PL1 or PL0 mode. If this is not done, behavior is **CONSTRAINED UNPREDICTABLE**, see [CONSTRAINED UNPREDICTABLE behaviors due to caching of control or data values on page K1-6101](#).

Changing the current Translation table format

The effect of changing **TTBCR.EAE** when executing in the translation regime affected by **TTBCR.EAE** with any stage of address translation for that translation regime enabled is **CONSTRAINED UNPREDICTABLE**. This means that, when **TTBCR.EAE** is changed for a given context, the TLB must be invalidated before resuming execution in that context, otherwise the effect is **CONSTRAINED UNPREDICTABLE**, see [CONSTRAINED UNPREDICTABLE behaviors due to caching of control or data values on page K1-6101](#).

G4.9.3 Atomicity of register changes on changing virtual machine

From the viewpoint of software executing in a Non-secure PL1 or PL0 mode, when there is a switch from one virtual machine to another, the registers that control or affect address translation must be changed atomically. This rule applies to the registers for:

- Non-secure PL1&0 stage 1 address translations. This means that all of the following registers must change atomically:
 - **PRRR** and **NMRR**, if using the Short-descriptor translation table format.
 - **MAIR0** and **MAIR1**, if using the Long-descriptor translation table format.
 - **TTBR0**, **TTBR1**, **TTBCR**, **TTBCR2**, **DACR**, and **CONTEXTIDR**.
 - The **SCTLR**.
- Non-secure PL1&0 stage 2 address translations. When EL2 is using AArch32, this means that all of the following registers and register fields must change atomically:
 - **VTTBR** and **VTCR**.
 - **HMAIR0** and **HMAIR1**.
 - The **HSCTLR**.

———— Note —————

Only some bits of **SCTLR** affect the stage 1 translation, and only some bits of **HSCTLR** affect the stage 2 translation. However, in each case, changing these bits requires a write to the register, and that write must be atomic with the other register updates.

These registers apply to execution in Non-secure PL1&0 modes. However, when updated as part of a switch of virtual machines they are updated by software executing in Hyp mode. This means the registers are *out of context* when they are updated, and no synchronization precautions are required.

———— Note —————

By contrast, a translation table change associated with a change of ASID, made by software executing at PL1, can require changes to registers that are *in context*. [Synchronization of changes of ASID and TTBR on page G4-4639](#) describes appropriate precautions for such a change.

Software executing in Hyp mode, or in Secure state, must not use the registers that are associated with the Non-secure PL1&0 translation regime for speculative memory accesses.

G4.9.4 Synchronization of changes of ASID and TTBR

A common virtual memory management requirement is to change the ASID and TTBR together to associate the new ASID with different translation tables, without any change to the current translation regime. When using the Short-descriptor translation table format, different registers hold the ASID and the translation table base address, meaning these two values cannot be updated atomically. Since a PE can perform a speculative memory access at any time, this lack of atomicity is a problem that software must address. Such a change is complicated by:

- The depth of speculative fetch being IMPLEMENTATION DEFINED.
- The use of branch prediction.

When using the Short-descriptor translation table format, the virtual memory management operations must ensure the synchronization of changes of the ContextID and the translation table registers. For example, some or all of the TLBs, branch predictors, and other caching of ASID and translation information might become corrupt with invalid translations. Synchronization is required to avoid either:

- The old ASID being associated with translation table walks from the new translation tables.
- The new ASID being associated with translation table walks from the old translation tables.

There are a number of possible solutions to this problem, and the most appropriate approach depends on the system. [Example G4-3](#), [Example G4-4](#), and [Example G4-5 on page G4-4640](#) describe three possible approaches.

Note

Another instance of the synchronization problem occurs if a branch is encountered between changing the ASID and performing the synchronization. In this case the value in the branch predictor might be associated with the incorrect ASID. Software can address this possibility using any of these approaches, but instead software might be written in a way that avoids such branches.

Example G4-3 Using a reserved ASID to synchronize ASID and TTBR changes

In this approach, a particular ASID value is reserved for use by the operating system, and is used only for the synchronization of the ASID and TTBR. This example uses the value of 0 for this purpose, but any value could be used.

This approach can be used only when the size of the mapping for any given virtual address is the same in the old and new translation tables.

The maintenance software uses the following sequence, that must be executed from memory marked as global:

```
Change ASID to 0
ISB
Change TTBR
ISB
Change ASID to new value
```

This approach ensures that any non-global pages fetched at a time when it is uncertain whether the old or new translation tables are being accessed are associated with the unused ASID value of 0. Since the ASID value of 0 is not used for any normal operations these entries cannot cause corruption of execution.

Example G4-4 Using translation tables containing only global mappings when changing the ASID

A second approach involves switching the translation tables to a set of translation tables that only contain global mappings while switching the ASID.

The maintenance software uses the following sequence, that must be executed from memory marked as global:

```
Change TTBR to the global-only mappings
ISB
```

```
Change ASID to new value
ISB
Change TTBR to new value
```

This approach ensures that no non-global pages can be fetched at a time when it is uncertain whether the old or new ASID value will be used.

This approach works without the need for TLB invalidations in systems that have caching of intermediate levels of translation tables, as described in [General TLB maintenance requirements on page G4-4632](#), provided that the translation tables containing only global mappings have only level 1 translation table entries of the following kinds:

- Entries that are global.
- Pointers to level 2 tables that hold only global entries, and that are the same level 2 tables that are used for accessing global entries by both:
 - The set of translation tables that were used under the old ASID value.
 - The set of translation tables that will be used with the new ASID value.
- Invalid level 1 entries.

In addition, all sets of translation tables in this example should have the same Shareability and Cacheability attributes, as held in the `TTBR0`.{ORGN, IRGN} or `TTBR1`.{ORGN, IRGN} fields.

If these rules are not followed, then the implementation might cache level 1 translation table entries that require explicit invalidation.

Example G4-5 Disabling non-global mappings when changing the ASID

In systems where only the translation tables indexed by `TTBR0` hold non-global mappings, maintenance software can use the `TTBCR.PD0` field to disable use of `TTBR0` during the change of ASID. This means the system does not require a set of global-only mappings.

The maintenance software uses the following sequence, that must be executed from a memory region with a translation that is accessed using the base address in the `TTBR1` register, and is marked as global:

```
Set TTBCR.PD0 = 1
ISB
Change ASID to new value
Change TTBR to new value
ISB
Set TTBCR.PD0 = 0
```

This approach ensures that no non-global pages can be fetched at a time when it is uncertain whether the old or new ASID value will be used.

When using the Long-descriptor translation table format, `TTBCR.A1` holds the number, 0 or 1, of the TTBR that holds the current ASID. This means the current `TTBR` can also hold the current ASID, and the current translation table base address and ASID can be updated atomically when:

- `TTBR0` is the only `TTBR` being used. `TTBCR.A1` must be set to 0.
- `TTBR0` points to the only translation tables that hold non-global entries, and `TTBCR.A1` is set to 0.
- `TTBR1` points to the only translation tables that hold non-global entries, and `TTBCR.A1` is set to 1.

In these cases, software can update the current translation table base address and ASID atomically, by updating the appropriate `TTBR`, and does not require a specific routine to ensure synchronization of the change of ASID and base address.

However, in all other cases using the Long-descriptor format, the synchronization requirements are identical to those when using the Short-descriptor formats, and the examples in this section indicate how synchronization might be achieved.

Note

When using the Long-descriptor translation table format, `CONTEXTIDR.ASID` has no significance for address translation, and is only an extension of the Context ID value.

G4.9.5 The scope of TLB maintenance instructions

TLB maintenance instructions provide a mechanism for invalidating entries from TLB caching structures, to ensure that changes to the translation tables are reflected correctly in the TLB caching structures. To support TLB maintenance in multiprocessor systems, there are maintenance operations that apply to the TLBs of all PEs in the same Inner Shareable domain.

The architecture permits the caching of any translation table entry that has been returned from memory without a fault and that does not, itself, cause a Translation Fault, an Address size fault, or an Access Flag fault. This means the TLB:

- Cannot hold an entry that, when used for a translation table lookup, causes a Translation fault, an Address size fault, or an Access Flag fault.
- Can hold an entry for a translation table lookup for a translation that causes a Translation Fault, an Address size fault, or an Access Flag fault at a subsequent level of translation table lookup. For example, it can hold an entry for the level 1 lookup of a translation that causes a Translation fault, an Address size fault, or an Access Flag fault at level 2 or level 3 of lookup.

This means that entries cached in the TLB can include:

- Translation table entries that point to a subsequent table to be used in the current stage of translation.
- In an implementation that includes EL2:
 - Stage 2 translation table entries that are used as part of a stage 1 translation table walk.
 - Stage 2 translation table entries for translating the output address of a stage 1 translation.

Such entries might be held in intermediate TLB caching structures that are distinct from the data caches, in that they are not required to be invalidated as the result of writes of the data. The architecture makes no restriction on the form of these intermediate TLB caching structures.

The architecture does not intend to restrict the form of TLB caching structures used for holding translation table entries. In particular for translation regimes that involve two stages of translation, it recognizes that such caching structures might contain:

- At any level of the translation table walk, entries containing information from stage 1 translation table entries.
- In an implementation that includes EL2:
 - At any level of the translation table walk, entries containing information from stage 2 translation table entries.
 - At any level of the translation table walk, entries combining information from both stage 1 and stage 2 translation table entries.

Note

For the purpose of TLB maintenance, the term *TLB entry* denotes any structure, including temporary working registers in translation table walk hardware, that holds a translation table entry.

For the TLB maintenance instructions:

- If a TLB maintenance instruction is required to apply to stage 1 entries then it must apply to any cached entry in the caching structures that includes any stage 1 information that would be used to translate the address being invalidated, including any entry that combines information from both stage 1 and stage 2 translation table entries.

Note

- Where stage 1 information has been cached in multiple TLB entries, as could occur from splintering a page when caching in the TLB, then the invalidation must apply to each cached entry containing stage 1 information from the page that is used to translate the address being invalidated, regardless of whether or not that cached entry would be used to translate the address being invalidated.
- As stated in *Global and process-specific translation table entries* on page G4-4628, translation table entries from levels of translation other than the final level are treated as being non-global. ARM expects that, in at least some implementations, cached copies of levels of the translation table walk other than the last level are tagged with their ASID, regardless of whether the final level is global. This means that TLB invalidations that involve the ASID require the ASID to match such entries to perform the required invalidation.

-
- If a TLB maintenance instruction is required to apply to stage 2 entries only, then:
 - It is not required to apply to caching structures that combine stage 1 and stage 2 translation table entries.
 - It must apply to caching structures that contain information only from stage 2 translation table entries.
 - If a TLB maintenance instruction is required to apply to both stage 1 and stage 2 entries, then it must apply to any entry in the caching structures that includes information from either a stage 1 translation table entry or a stage 2 translation table entry, including any entry that combines information from both stage 1 and stage 2 translation table entries.

Table G4-23 on page G4-4643 summarizes the required effect of the AArch32 TLB maintenance instructions, that operate only on TLBs on the PE that executes the instruction. Additional TLB maintenance instructions that:

- Apply across all PEs in the same Inner Shareable domain. Each instruction shown in the table has an Inner Shareable equivalent, identified by an IS suffix. For example, the Inner Shareable equivalent of `TLBIALL` is `TLBIALLIS`. See also *EL2 forced broadcasting of TLB maintenance instructions* on page G4-4644.
- Can apply to separate Instruction or Data TLBs. These instructions are indicated by a footnote to the table. ARM deprecates any use of these instructions.

Note

- The architecture permits a TLB invalidation instruction to affect any unlocked entry in the TLB. Table G4-23 on page G4-4643 defines only the entries that each instruction must invalidate.
- All TLB instructions, including those that operate on a VA match, operate as described regardless of the value of `SCTLR.M`.

When interpreting the table:

Related operations Each instruction description applies also to any equivalent instruction that either:

- Applies to all PEs in the same Inner Shareable domain.
- Applies only to a data TLB, or only to an instruction TLB.

So, for example, the `TLBIALL` instruction description applies also to `TLBIALLIS`, `ITLBIALL`, and `DTLBIALL`.

TLB maintenance instructions, functional group on page G4-4735 lists all of the TLB maintenance instructions.

Matches the VA Means the VA argument for the instruction must match the VA value in the TLB entry.

Matches the ASID Means the ASID argument for the instruction must match the ASID in use when the TLB entry was assigned.

Matches the current VMID

Means the current VMID must match the VMID in use when the TLB entry was assigned.

The dependency on the VMID applies even when the value of `HCR.VM` is 0, including situations where there is no use of virtualization. However, `VTTBR.VMID` resets to zero, meaning there is a valid VMID from reset.

Execution at PL2 Descriptions of operations at PL2 apply only to implementations that include EL2.

For the definitions of the translation regimes referred to in the table see *About VMSAv8-32 on page G4-4558*.

Table G4-23 Effect of the TLB maintenance instructions

Instruction	Executed from		Effect, must invalidate any entry that matches all stated conditions
	State	Mode	
TLBIALL ^a	Secure	PL1	All entries for the Secure PL1&0 translation regime. That is, all entries that were allocated in Secure state.
	Non-secure	PL1	All entries for stage 1 of the Non-secure PL1&0 translation regime that match the current VMID.
		Hyp	All entries for stage 1 or stage 2 of the Non-secure PL1&0 translation regime that match the current VMID.
TLBIMVA ^a	Secure	PL1	Any entry for the Secure PL1&0 translation regime that both: <ul style="list-style-type: none"> Matches the VA argument. Matches the ASID argument, or is global.
	Non-secure	PL1 or Hyp	Any entry for stage 1 of the Non-secure PL1&0 translation regime to which all of the following apply. The entry: <ul style="list-style-type: none"> Matches the VA argument. Matches the ASID argument, or is global. Matches the current VMID.
TLBIASID ^a	Secure	PL1	Any entry for the Secure PL1&0 translation regime that matches the specified ASID and either: <ul style="list-style-type: none"> Is from a level of lookup above the final level. Is a non-global entry from the final level of lookup.
	Non-secure	PL1 or Hyp	Any entry for stage 1 of the Non-secure PL1&0 translation regime that both: <ul style="list-style-type: none"> Matches the specified ASID and either: <ul style="list-style-type: none"> Is from a level of lookup above the final level. Is a non-global entry from the final level of lookup. Matches the current VMID.
TLBIMVAA	Secure	PL1	Any entry for the Secure PL1&0 translation regime that matches the VA argument.
	Non-secure	PL1 or Hyp	Any entry for stage 1 of the Non-secure PL1&0 translation regime that both: <ul style="list-style-type: none"> Matches the VA argument. Matches the current VMID.
TLBIALLNSNH ^b	Secure	Monitor	All entries for stage 1 or stage 2 of the Non-secure PL1&0 translation regime, regardless of the associated VMID.
	Non-secure	Hyp	
TLBIALLH ^b	Secure	Monitor	All entries for the Non-secure PL2 translation regime. That is, any entry that was allocated in Non-secure state from Hyp mode.
	Non-secure	Hyp	

Table G4-23 Effect of the TLB maintenance instructions (continued)

Instruction	Executed from		Effect, must invalidate any entry that matches all stated conditions
	State	Mode	
TLBIMVAL	Secure	PL1	Any entry for stage 1 of the Secure PL1&0 translation regime that is from the last level of the translation table walk and both: <ul style="list-style-type: none"> Matches the VA argument. Matches the ASID argument, or is global.
	Non-secure	PL1 or Hyp	Any entry for stage 1 of the Non-secure PL1&0 translation regime that is from the last level of the translation table walk and to which all of the following apply. The entry: <ul style="list-style-type: none"> Matches the VA argument. Matches the ASID argument, or is global. Matches the current VMID.
TLBIMVAAL	Secure	PL1	Any entry for stage 1 of the Secure PL1&0 translation regime that is from the last level of the translation table walk and matches the VA argument.
	Non-secure	PL1 or Hyp	Any entry for stage 1 of the Non-secure PL1&0 translation regime that is from the last level of the translation table walk and both: <ul style="list-style-type: none"> Matches the VA argument. Matches the current VMID.
TLBIMVAH ^b	Secure	Monitor	Any entry for the Non-secure PL2 translation regime that matches the VA argument.
	Non-secure	Hyp	
TLBIMVALH ^b	Secure	Monitor	Any entry for the Non-secure PL2 translation regime that is from the last level of the translation table walk and matches the VA argument.
	Non-secure	Hyp	
TLBIIPAS2 ^{b, c}	Secure	Monitor ^d	Any entry for stage 2 of the PL1&0 translation regime that both: <ul style="list-style-type: none"> Matches the IPA argument. Matches the current VMID.
	Non-secure	Hyp	
TLBIIPAS2L ^{b, c}	Secure	Monitor ^d	Any entry for stage 2 of the PL1&0 translation regime that is from the last level of translation and both: <ul style="list-style-type: none"> Matches the IPA argument. Matches the current VMID.
	Non-secure	Hyp	

- a. The architecture defines variants of these instructions that apply only to instruction TLBs, and only to data TLBs. ARM deprecates any use of these variants. For more information, see the referenced description of the operation.
- b. Available only in an implementation that includes EL2. See also [EL2 forced broadcasting of TLB maintenance instructions](#).
- c. This instruction is CONSTRAINED UNPREDICTABLE if executed in any AArch32 Secure privileged mode, see [Hyp mode TLB maintenance instructions on page K1-6116](#).
- d. This instruction executes as a NOP when SCR.NS == 0.

EL2 forced broadcasting of TLB maintenance instructions

In an implementation that includes EL2, when the value of HCR.FB is 1, the TLB maintenance instructions that are not broadcast across the Inner Shareable domain are forced to operate across the Inner Shareable domain when executed in a Non-secure PL1 mode. For example, when the value of HCR.FB is 1, a TLBIMVA instruction executed in a Non-secure PL1 mode performs the same invalidation as the invalidation performed by a TLBIMVAIS instruction.

TLB maintenance with different translation granule sizes

If a TLB maintenance instruction specifying a virtual address affecting the PL2 translation regime is broadcast from a PE using AArch32 to a PE using AArch64 using a translation granule size that is different from the AArch32 translation granule size for that same translation regime, the TLB maintenance instruction is not required to perform any invalidation on the recipient PE.

If a TLB maintenance instruction specifying a virtual address affecting the PL1 translation regime is broadcast from a PE using AArch32 using one translation granule size for that translation regime for a particular ASID, VMID (if applicable), and Security state, to a PE using AArch64 where EL1 for the same ASID, VMID (if applicable), and Security state, is using a translation granule size that is different from the AArch32 translation granule size, the TLB maintenance instruction is not required to perform any invalidation on the recipient PE.

G4.10 Caches in VMSAv8-32

The ARM architecture describes the required behavior of an implementation of the architecture. As far as possible it does not restrict the implemented microarchitecture, or the implementation techniques that might achieve the required behavior.

Maintaining this level of abstraction is difficult when describing the relationship between memory address translation and caches, especially regarding the indexing and tagging policy of caches. This section:

- Summarizes the architectural requirements for the interaction between caches and memory translation.
- Gives some information about the likely implementation impact of the required behavior.

The following sections give this information:

- [Data and unified caches](#).
- [Instruction caches on page G4-4647](#).

In addition [Cache maintenance requirement created by changing translation table attributes on page G4-4648](#) describes the cache maintenance required after updating the translation tables to change the attributes of an area of memory.

For more information about cache maintenance see:

- [AArch32 cache and branch predictor support on page G3-4525](#). This section describes the ARM cache maintenance instructions.
- [Cache maintenance instructions, functional group on page G4-4734](#). This section summarizes the System register encodings used for these operations when executing in AArch32 state.

G4.10.1 Data and unified caches

For data and unified caches, the use of memory address translation is entirely transparent to any data access other than as described in [Mismatched memory attributes on page E2-2792](#).

This means that the behavior of accesses from the same observer to different VAs, that are translated to the same PA with the same memory attributes, is fully coherent. This means these accesses behave as follows, regardless of which VA is accessed:

- Two writes to the same PA occur in program order.
- A read of a PA returns the value of the last successful write to that PA.
- A write to a PA that occurs, in program order, after a read of that PA, has no effect on the value returned by that read.

The memory system behaves in this way without any requirement to use barrier or cache maintenance instructions.

In addition, if cache maintenance is performed on a memory location, the effect of that cache maintenance is visible to all aliases of that physical memory location.

These properties are consistent with implementing all caches that can handle data accesses as *Physically-indexed, physically-tagged* (PIPT) caches.

G4.10.2 Instruction caches

In the ARM architecture, an instruction cache is a cache that is accessed only as a result of an instruction fetch. Therefore, an instruction cache is never written to by any load or store instruction executed by the PE.

The ARM architecture permits different behaviors for instruction caches. These are identified by descriptions of the associated expected implementation. The following subsections describe the behavior associated with these cache types, including any occasions where explicit cache maintenance is required to make the use of memory address translation transparent to the instruction cache:

- [PIPT \(Physically-indexed, physically-tagged\) instruction caches](#).
- [VPIPT \(VMID-aware PIPT\) instruction caches](#).
- [VIPT \(Virtually-indexed, physically-tagged\) instruction caches on page G4-4648](#).
- [The IVIPT architecture Extension on page G4-4648](#).

In AArch32 state, the `CTR.LIIP` field identifies the form of the instruction caches.

———— Note ————

For software to be portable between implementations that might use any of PIPT instruction caches, [VPIPT instruction caches](#), or [VIPT instruction caches](#), software must invalidate the instruction cache whenever any condition occurs that would require instruction cache maintenance for at least one of the instruction cache types.

PIPT (Physically-indexed, physically-tagged) instruction caches

For a PIPT instruction cache:

- The use of memory address translation is entirely transparent to all instruction fetches other than as described in [Mismatched memory attributes on page E2-2792](#).
- If cache maintenance is performed on a memory location, the effect of that cache maintenance is visible to all aliases of that physical memory location.

An implementation that provides PIPT instruction caches implements the IVIPT Extension, see [The IVIPT architecture Extension on page G4-4648](#).

VPIPT (VMID-aware PIPT) instruction caches

An implementation that includes ARMv8.2-VPIPT can implement VPIPT instruction caches.

For a VPIPT instruction cache:

- Instruction fetches from Non-secure EL1 and Non-secure EL0 are only permitted to hit in the cache if the instruction fetch is made using the VMID that was used when the entry in the instruction cache was fetched.
- An instruction cache maintenance instruction executed at Non-secure EL0 or at Non-secure EL1 is required to have an effect on entries in the instruction cache only if those entries were fetched using the VMID that is current when the cache maintenance instruction is executed.

All other requirements for the use of cache maintenance instructions are the same as for [PIPT \(Physically-indexed, physically-tagged\) instruction caches](#).

An implementation that provides VPIPT instruction caches implements the IVIPT Extension, see [The IVIPT architecture Extension on page G4-4648](#).

VIPT (*Virtually-indexed, physically-tagged*) instruction caches

For a VIPT instruction cache:

- The use of memory address translation is transparent to all instruction fetches other than for the effect of memory address translation on instruction cache invalidate by address operations or as described in [Mismatched memory attributes on page E2-2792](#).

———— **Note** ————

Cache invalidation is the only cache maintenance instruction that can be performed on an instruction cache.

- If instruction cache invalidation by address is performed on a memory location, the effect of that invalidation is visible only to the virtual address supplied with the operation. The effect of the invalidation might not be visible to any other virtual address aliases of that physical memory location.

The only architecturally-guaranteed way to invalidate all aliases of a physical address from a VIPT instruction cache is to invalidate the entire instruction cache.

An implementation that provides VIPT instruction caches implements the IVIPT Extension, see [The IVIPT architecture Extension](#).

The IVIPT architecture Extension

In ARMv8, any permitted instruction cache implementation can be described as implementing the *IVIPT Extension* to the ARM architecture.

The formal definition of the ARM IVIPT Extension is that it reduces the instruction cache maintenance requirement to the following condition:

- Instruction cache maintenance is required only after writing new data to a physical address that holds an instruction.

———— **Note** ————

Previous versions of the ARM architecture have permitted an instruction cache option that does not implement the ARM IVIPT Extension.

G4.10.3 Cache maintenance requirement created by changing translation table attributes

Any change to the translation tables to change the attributes of an area of memory can require maintenance of the translation tables, as described in [General TLB maintenance requirements on page G4-4632](#). If the change affects the cacheability attributes of the area of memory, including any change between Write-Through and Write-Back attributes, software must ensure that any cached copies of affected locations are removed from the caches, typically by cleaning and invalidating the locations from the levels of cache that might hold copies of the locations affected by the attribute change. Any of the following changes to the inner cacheability or outer cacheability attribute creates this maintenance requirement:

- Write-Back to Write-Through.
- Write-Back to Non-cacheable.
- Write-Through to Non-cacheable.
- Write-Through to Write-Back.

The cache clean and invalidate avoids any possible coherency errors caused by mismatched memory attributes.

Similarly, to avoid possible coherency errors caused by mismatched memory attributes, the following sequence must be followed when changing the Shareability attributes of a cacheable memory location:

1. Make the memory location Non-cacheable, Outer Shareable.
2. Clean and invalidate the location from them cache.
3. Change the Shareability attributes to the required new values.

G4.11 VMSAv8-32 memory aborts

In a VMSAv8-32 implementation, the following mechanisms cause a PE to take an exception on a failed memory access:

Debug exception	An exception caused by the debug configuration, see Chapter G2 AArch32 Self-hosted Debug .
Alignment fault	An Alignment fault is generated if the address used for a memory access does not have the required alignment for the operation. For more information see Unaligned data access on page E2-2777 and Alignment faults on page G4-4656 .
MMU fault	An MMU fault is a fault generated by the fault checking sequence for the current translation regime. See MMU faults in AArch32 state on page G4-4657 .
External abort	Any memory system fault other than a Debug exception, an Alignment fault, or an MMU fault.

Collectively, these mechanisms are called *aborts*. [Chapter G2 AArch32 Self-hosted Debug](#) and [Chapter H3 Halting Debug Events](#) describe Debug exceptions, and the remainder of this section describes Alignment faults, MMU faults, and External aborts.

The exception generated on a synchronous memory abort:

- On an instruction fetch is called the Prefetch Abort exception.
- On a data access is called the Data Abort exception.

———— Note ————

The Prefetch Abort exception applies to any synchronous memory abort on an instruction fetch. It is not restricted to speculative instruction fetches.

In AArch32 state, asynchronous memory aborts are a type of External abort, and are treated as a type of Data Abort exception.

The following sections describe the abort mechanisms:

- [Routing of aborts taken to AArch32 state](#).
- [VMSAv8-32 MMU fault terminology on page G4-4652](#).
- [The MMU fault-checking sequence on page G4-4652](#).
- [Alignment faults on page G4-4656](#).
- [MMU faults in AArch32 state on page G4-4657](#).
- [External abort on a translation table walk on page G4-4659](#).
- [AArch32 state prioritization of synchronous aborts from a single stage of address translation on page G4-4660](#).

An access that causes an abort is said to be aborted. On an abort, System registers are used to record context information. For more information see [Exception reporting in a VMSAv8-32 implementation on page G4-4663](#).

G4.11.1 Routing of aborts taken to AArch32 state

A memory abort is either a Data Abort exception or a Prefetch Abort exception. When executing in AArch32 state, depending on the cause of the abort, and possibly on configuration settings, an abort is taken either:

- To the Exception level of the PE mode from which the abort is taken. In this case the abort is taken to AArch32 state.
- To a higher Exception level. In this case the Exception level to which the abort is taken is either:
 - Using AArch32. In this case, this chapter describes how the abort is handled.
 - Using AArch64. In this case, [Chapter D4 The AArch64 Virtual Memory System Architecture](#) describes how the abort is handled.

For an abort taken to an Exception level that is using AArch32, the mode to which a memory abort is taken depends on the reason for the exception, the mode the PE is in when it takes the exception, and configuration settings, as follows:

Memory aborts taken to Monitor mode

If an implementation includes EL3, when the value of `SCR.EA` is 1, all External aborts are taken to EL3, and if EL3 is using AArch32 they are taken to Monitor mode. This rule applies to aborts taken from Secure modes and from Non-secure modes. For more information see [Asynchronous exception routing controls on page G1-4367](#).

———— Note —————

- Although the referenced section mostly describes the routing of asynchronous exceptions, it includes the `SCR.EA` control that applies to both synchronous external aborts and SError interrupts.
- The `SCR` is implemented only as part of EL3.

Memory aborts taken to Secure Abort mode

If an implementation includes EL3, when the PE is executing in Secure state, all memory aborts that are not routed to EL3 are taken to Secure Abort mode.

———— Note —————

The only memory aborts that can be routed to Monitor mode are External aborts.

Memory aborts taken to Hyp mode

If an implementation includes EL2, when the PE is executing in Non-secure state, the following aborts are taken to EL2. If EL2 is using AArch32 this means they are taken to Hyp mode:

- Alignment faults taken:
 - When the PE is in Hyp mode.
 - When the PE is in a Non-secure PL1 or PL0 mode and the exception is generated because the Non-secure PL1&0 stage 2 translation identifies the target of an unaligned access as any type of Device memory.
 - When the PE is in Non-secure User mode and `HCR.TGE` is set to 1. For more information see [Abort exceptions, when the value of HCR.TGE is 1 on page G1-4357](#).
- When the PE is using the Non-secure PL1&0 translation regime:
 - MMU faults from stage 2 translations, for which the stage 1 translation did not cause an MMU fault.
 - Any abort taken during the stage 2 translation of an address accessed in a stage 1 translation table walk that is not routed to Secure Monitor mode, see [Stage 2 fault on a stage 1 translation table walk on page G4-4656](#).
- When the PE is using the Non-secure PL2 translation regime, MMU faults from stage 1 translations.

———— Note —————

The Non-secure PL2 translation regime has only one stage of translation.

- External aborts, if `SCR.EA` is set to 0 and any of the following applies:
 - The PE was executing in Hyp mode when it took the exception.
 - The PE was executing in a Non-secure PL0 or PL1 mode when it took the exception, the abort is asynchronous, and `HCR.AMO` is set to 1. For more information see [Asynchronous exception routing controls on page G1-4367](#).
 - The PE was executing in the Non-secure User mode when it took the exception, the abort is synchronous, and `HCR.TGE` is set to 1. For more information see [Abort exceptions, when the value of HCR.TGE is 1 on page G1-4357](#).
 - The abort occurred on a stage 2 translation table walk.
- Debug exceptions, if `HDCR.TDE` is set to 1. For more information, see [Routing debug exceptions to EL2 using AArch32 on page G1-4358](#).

Memory aborts taken to Non-secure Abort mode

In an implementation that does not include EL3, all memory aborts that are taken to an Exception level that is using AArch32 are taken to Abort mode.

Otherwise, when the PE is executing in Non-secure state, the following aborts are taken to Non-secure Abort mode:

- When the PE is in a Non-secure PL1 or PL0 mode, Alignment faults taken for any of the following reasons:
 - `SCTLR.A` is set to 1.
 - An instruction that does not support unaligned accesses is committed for execution, and the instruction accesses an unaligned address.
 - The PL1&0 stage 1 translation identifies the target of an unaligned access as any type of Device memory.

Note

In an implementation that does not include EL2, this case results in a `CONSTRAINED UNPREDICTABLE` memory access, see [Cases where unaligned accesses are CONSTRAINED UNPREDICTABLE on page E2-2778](#) and [Loads and Stores to unaligned locations on page K1-6098](#).

If an implementation includes EL2 and the PE is in Non-secure User mode, these exceptions are taken to Abort mode only if the value of `HCR.TGE` is 0.

- When the PE is using the Non-secure PL1&0 translation regime, an MMU fault from a stage 1 translation.
- External aborts, if all of the following apply:
 - The abort is not on a stage 2 translation table walk.
 - The PE is not in Hyp mode.
 - The value of `SCR.EA` is 0.
 - The abort is asynchronous, and `HCR.AMO` is set to 0.
 - The abort is synchronous, and `HCR.TGE` is set to 0.
- Virtual Aborts, see [Virtual exceptions when an implementation includes EL2 on page G1-4365](#).
- When the value of `HDCR.TDE` is 0, Debug exceptions. For more information, see [Routing debug exceptions to EL2 using AArch32 on page G1-4358](#).

Note

If EL0 is using AArch32 and EL1 is using AArch64 then any of these memory aborts taken from User mode are taken to EL1 as described in [Chapter D4 The AArch64 Virtual Memory System Architecture](#).

Memory aborts with IMPLEMENTATION DEFINED behavior

In addition, a PE can generate an abort for an IMPLEMENTATION DEFINED reason associated with lockdown. In an implementation that includes EL2, whether such an abort is taken to Non-secure Abort mode or is taken to EL2 is IMPLEMENTATION DEFINED, and an implementation might include a mechanism to select whether the abort is routed to Non-secure Abort mode or to EL2.

When the PE is in a Non-secure mode other than Hyp mode, if multiple factors cause an Alignment fault, the abort is taken to Non-secure Abort mode if any of the factors require the abort to be taken to Abort mode. For example, if the SCTLRA bit is set to 1, and the access is an unaligned access to an address that the stage 2 translation tables mark as Device-nGnRnE, then the abort is taken to Non-secure Abort mode.

For more information see [Handling exceptions that are taken to an Exception level using AArch32 on page G1-4340](#).

G4.11.2 VMSAv8-32 MMU fault terminology

The ARMv7 Large Physical Address Extension introduced new terminology for faults on a stage of address translation, to provide consistent terminology across all implementations. Table G4-24 shows the terminology used in this manual for an MMU faults, compared with older ARM documentation. The current terms are the same for faults that occur with the Short-descriptor translation table format and with the Long-descriptor format, and also apply to faults in a level 3 lookup when using the Long-descriptor translation table format.

Table G4-24 MMU fault terminology

Current term	Old term	Note
Level 1 Translation fault	Section Translation fault	-
Level 2 Translation fault	Page Translation fault	-
Level 3 Translation fault	-	Long-descriptor translation table format only.
Level 1 Access flag fault	Section Access flag fault	-
Level 2 Access flag fault	Page Access flag fault	-
Level 3 Access flag fault	-	Long-descriptor translation table format only.
Level 1 Domain fault	Section Domain fault	Short-descriptor translation table format only, except for reporting faults on address translation instructions in the 64-bit PAR, see Determining the PAR format on page G4-4686 . Cannot occur at level 3.
Level 2 Domain fault	Page Domain fault	
Level 1 Permission fault	Section Permission fault	-
Level 2 Permission fault	Page Permission fault	-
Level 3 Permission fault	-	Long-descriptor translation table format only.

In an implementation that includes EL2, MMU faults are also classified by the translation stage at which the fault is generated. This means that a memory access from a Non-secure PL1 or PL0 mode can generate:

- A stage 1 MMU fault, for example, a stage 1 Translation fault.
- A stage 2 MMU fault, for example, a stage 2 Translation fault.

G4.11.3 The MMU fault-checking sequence

This section describes the MMU checks made for the memory accesses required for instruction fetches and for explicit memory accesses:

- If an instruction fetch faults, it generates a Prefetch Abort exception.
- If an data memory access faults, it generates a Data Abort exception.

For more information about Prefetch Abort exceptions and Data Abort exceptions see [Handling exceptions that are taken to an Exception level using AArch32](#) on page G1-4340.

In VMSAv8-32, all memory accesses require VA to PA translation. Therefore, when a corresponding stage of address translation is enabled, each access requires a lookup of the translation table descriptor for the accessed VA. For more information, see [Translation tables on page G4-4571](#) and subsequent sections of this chapter. MMU fault checking is performed for each level of translation table lookup. If an implementation includes EL2 and is operating in Non-secure state, MMU fault checking is performed for each stage of address translation.

———— **Note** —————

In an implementation that includes EL2, if a PE is executing in Non-secure state, the operating system or similar Non-secure system software defines the stage 1 translation tables in the IPA address map, and typically is unaware of the stage 2 translation from IPA to PA. However, each Non-secure stage 1 translation table access is subject to stage 2 address translation, and might be faulted at that stage.

The MMU fault checking sequence is largely independent of the translation table format, as the figures in this section show. The differences are:

When using the Short-descriptor format

- There are one or two levels of lookup.
- Lookup always starts at level 1.
- The final level of lookup checks the Domain field of the descriptor and:
 - Faults if there is no access to the Domain.
 - Checks the access permissions only for Client domains.

When using the Long-descriptor format

- There are one, two, or three levels of lookup.
- Lookup starts at either level 1 or level 2.
- Domains are not supported. All accesses are treated as Client domain accesses.

The fault-checking sequence shows a translation from an Input address to an Output address. For more information about this terminology, see [About address translation for VMSAv8-32](#) on page G4-4562.

———— **Note** —————

The descriptions in this section do not include the possibility that the attempted address translation generates a TLB conflict abort, as described in [TLB conflict aborts on page G4-4630](#).

[MMU faults in AArch32 state on page G4-4657](#) describes the faults that an MMU fault-checking sequence can report.

[Figure G4-15 on page G4-4654](#) shows the process of fetching a descriptor from the translation table. For the top-level fetch for any translation, the descriptor is fetched only if the input address passes any required alignment check. As the figure shows, in an implementation that includes EL2, if the translation is stage 1 of the Non-secure PL1&0 translation regime, then the descriptor address is in the IPA address map, and is subject to a stage 2 translation to obtain the required PA. This stage 2 translation requires a recursive entry to the fault checking sequence.

———— **Note** —————

[Figure G4-15 on page G4-4654](#) and [Figure G4-16 on page G4-4655](#) give an overview of the fault checking performed by the MMU. See [AArch32 state prioritization of synchronous aborts from a single stage of address translation on page G4-4660](#) for the complete set of possible faults and their prioritization.

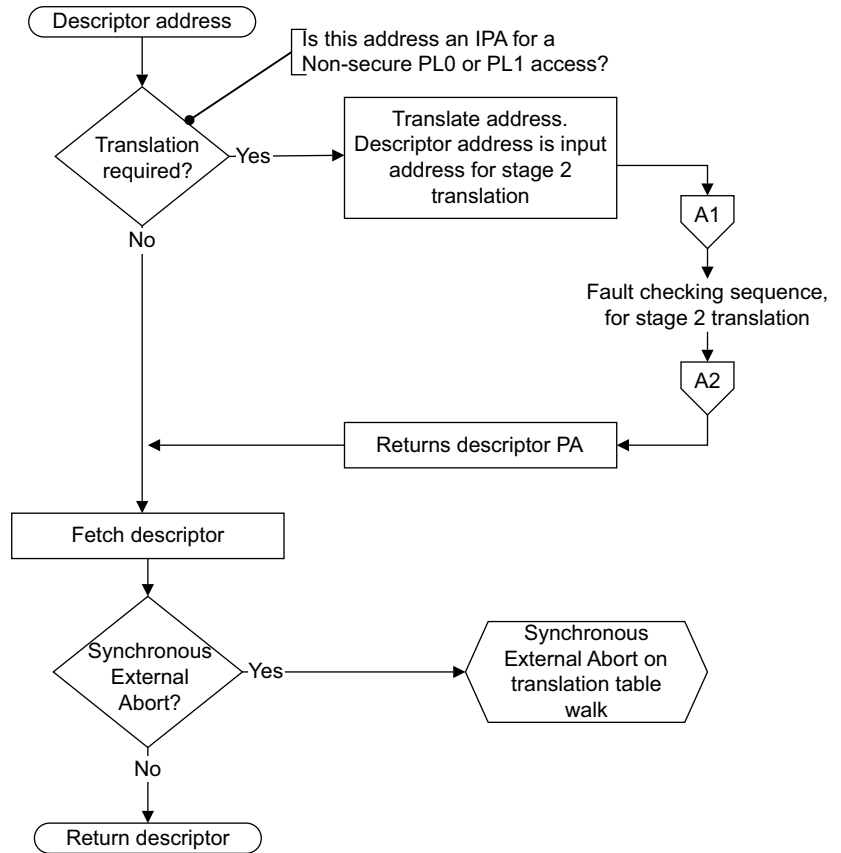

Figure G4-15 Fetching the descriptor in a VMSAv8-32 translation table walk

Figure G4-16 shows the full VMSAv8-32 fault checking sequence, including the alignment check on the initial access.

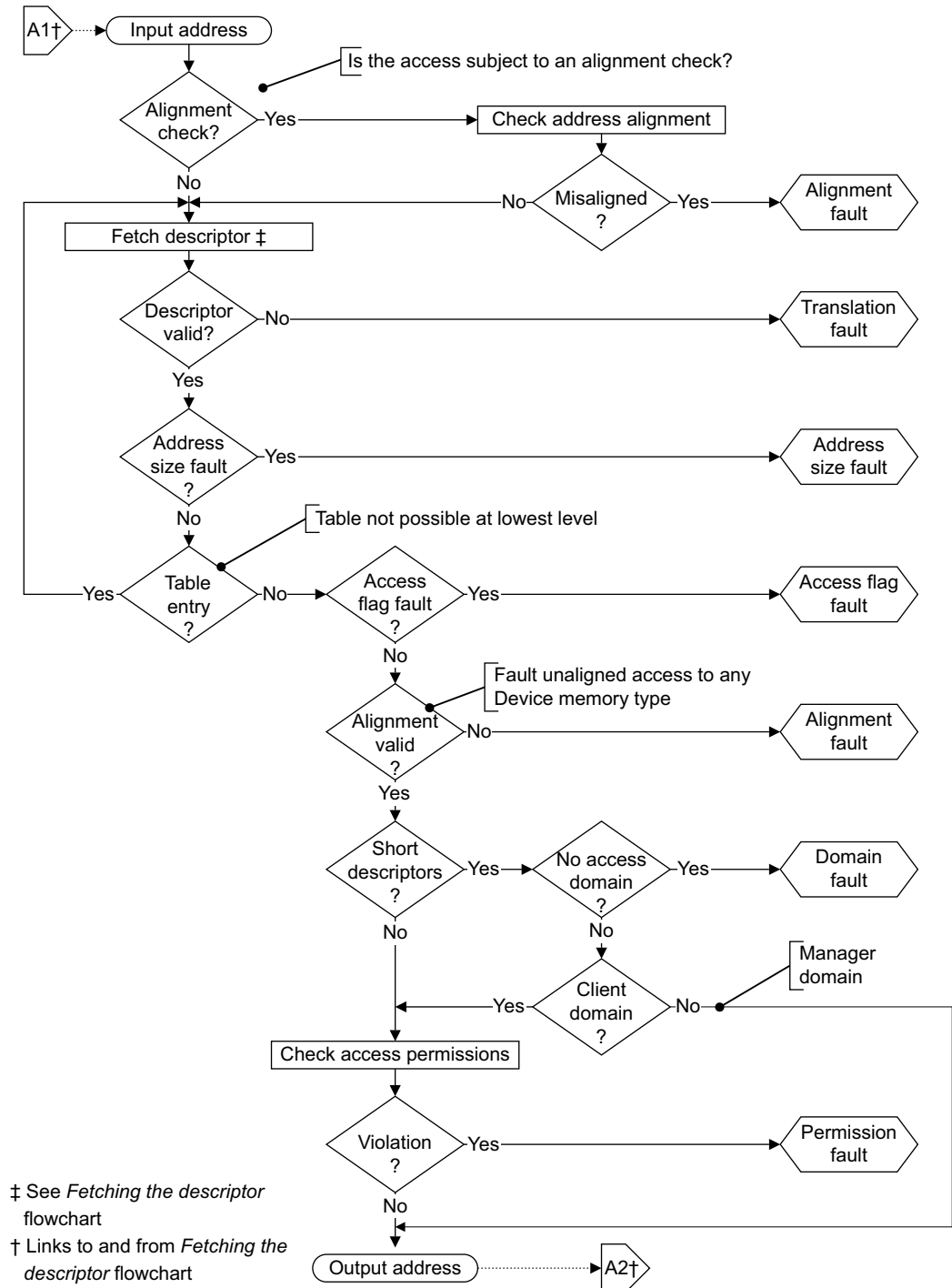

Figure G4-16 VMSAv8-32 fault checking sequence

Stage 2 fault on a stage 1 translation table walk

When an implementation that includes EL2 is operating in a Non-secure PL1 or PL0 mode, any memory access goes through two stages of translation:

- Stage 1, from VA to IPA.
- Stage 2, from IPA to PA.

Note

In a virtualized system that is using AArch32, typically, a Guest OS operating in a Non-secure PL1 mode defines the translation tables and translation table register entries controlling the Non-secure PL1&0 stage 1 translations. A Guest OS has no awareness of the stage 2 address translation, and therefore believes it is specifying translation table addresses in the physical address map. However, it actually specifies these addresses in its IPA map. Therefore, to support virtualization, translation table addresses for the Non-secure PL1&0 stage 1 translations are always defined in the IPA address map.

On performing a translation table walk for the stage 1 translations, the descriptor addresses must be translated from IPA to PA, using a stage 2 translation. This means that a memory access made as part of a stage 1 translation table lookup might generate, on a stage 2 translation:

- A Translation fault, Access flag fault, or Permission fault.
- A synchronous external abort on the memory access.

If **SCR.EA** is set to 1, a synchronous external abort is taken to EL3, and if EL3 is using AArch32 it is taken to Secure Monitor mode. Otherwise, these faults are reported as stage 2 memory aborts. When EL2 is using AArch32, **HSR.ISS[7]** is set to 1, to indicate a stage 2 fault during a stage 1 translation table walk, and the part of the ISS field that might contain details of the instruction is invalid. For more information see [Use of the HSR on page G4-4677](#).

Alternatively, a memory access made as part of a stage 1 translation table lookup might target an area of memory with the any type of Device memory attribute assigned on the stage 2 translation of the address accessed. When the value of the **HCR.PTW** bit is 1, such an access generates a stage 2 Permission fault.

Note

- On most systems, such a mapping to a Device memory type on the stage 2 translation is likely to indicate a Guest OS error, where the stage 1 translation table is corrupted. Therefore, it is appropriate to trap this access to the hypervisor.

A TLB might hold entries that depend on the effect of **HCR.PTW**. Therefore, if **HCR.PTW** is changed without changing the current VMID, the TLBs must be invalidated before executing in a Non-secure PL1 or PL0 mode. For more information see [Changing HCR.PTW on page G4-4638](#).

A cache maintenance instruction executed at Non-secure PL1 can cause a stage 1 translation table walk that might generate a stage 2 Permission fault, as described in this section. This is an exception to the general rule that a cache maintenance instruction cannot generate a Permission fault. If the Point of Coherency is before any level of cache, it is IMPLEMENTATION DEFINED whether a cache maintenance by VA instruction can generate a Permission fault in this way.

If the Point of Unification is before any level of data cache, it is IMPLEMENTATION DEFINED whether a data or unified cache clean by VA to the Point of Unification instruction can generate a Permission fault in this way.

G4.11.4 Alignment faults

The ARM memory architecture requires support for strict alignment checking. This checking is controlled by **SCTLR.A**. In addition, some instructions do not support unaligned accesses, regardless of the value of **SCTLR.A**. [Unaligned data access on page E2-2777](#) defines when Alignment faults are generated, for both values of **SCTLR.A**.

An Alignment fault can occur on an access for which the stage of address translation is disabled.

Any unaligned access to memory region with any Device memory type attribute generates an Alignment fault.

[Routing of aborts taken to AArch32 state on page G4-4649](#) defines the mode to which an Alignment fault is taken.

The prioritization of Alignment faults depends on whether the fault was generated because of an access to a Device memory type, or for another reason. For more information see [AArch32 state prioritization of synchronous aborts from a single stage of address translation](#) on page G4-4660.

G4.11.5 MMU faults in AArch32 state

This section describes the faults that might be detected during one of the fault-checking sequences described in [The MMU fault-checking sequence](#) on page G4-4652. Unless indicated otherwise, information in this section applies to the fault checking sequences for both the Short-descriptor translation table format and the Long-descriptor translation table format.

MMU faults are always synchronous.

When an MMU fault generates an abort for a region of memory, no memory access is made if that region is or could be marked as any type of Device memory.

The following subsections describe the MMU faults that might be detected during a fault checking sequence:

- [Permission fault](#).
- [Translation fault](#) on page G4-4658.
- [Address size fault](#) on page G4-4658.
- [Access flag fault](#) on page G4-4659.
- [Domain fault, Short-descriptor format translation tables only](#) on page G4-4659.
- [TLB conflict aborts](#) on page G4-4630.

See also [External abort on a translation table walk](#) on page G4-4659.

Note

- Although the TLB conflict abort is classified as an MMU fault, it is described in the section [Translation Lookaside Buffers \(TLBs\)](#) on page G4-4628.
- In VMSAv8-64 an external abort on a translation table walk is classified as an MMU fault. However, in VMSAv8-32, for consistency with earlier versions of the architecture these aborts are not classified as MMU faults.

Permission fault

A Permission fault can be generated at any level of lookup, and the reported fault code identifies the lookup level. See [About access permissions](#) on page G4-4605 for information about conditions that cause a Permission fault.

Note

When using the Short-descriptor translation table format, the translation table descriptors are checked for Permission faults only for accesses to memory regions in Client domains.

A TLB might hold a translation table entry that cause a Permission fault. Therefore, if the handling of a Permission fault results in an update to the associated translation tables, the software that updates the translation tables must invalidate the appropriate TLB entry, to prevent the stale information in the TLB being used on a subsequent memory access. For more information, see the translation table entry update examples in [Ordering and completion of TLB maintenance instructions](#) on page G4-4635.

Note

In an implementation that includes EL2, this maintenance requirement applies to Permission faults in both stage 1 and stage 2 translations.

Cache or branch predictor maintenance operations cannot cause a Permission fault, except that:

- A stage 1 translation table walk performed as part of a cache or branch predictor maintenance operation can generate a stage 2 Permission fault as described in *Stage 2 fault on a stage 1 translation table walk on page G4-4656*.
- A DCIMVAC issued in Non-secure state that attempts to update a location for which it does not have stage 2 write access can generate a stage 2 Permission fault, as described in *AArch32 data cache maintenance instructions (DC*) on page G3-4537*.

Translation fault

A Translation fault can be generated at any level of lookup, and the reported fault code identifies the lookup level. A Translation fault is generated if bits[1:0] of a translation table descriptor identify the descriptor as either a Fault encoding or a reserved encoding. For more information see:

- *VMSAv8-32 Short-descriptor translation table format descriptors on page G4-4577*.
- *VMSAv8-32 Long-descriptor translation table format descriptors on page G4-4586*.

In addition, a Translation fault is generated if the input address for a translation either does not map onto an address range of a TTBR, or the TTBR range that it maps onto is disabled. In these cases the fault is reported as a level 1 Translation fault on the translation stage at which the mapping to a region described by a TTBR failed.

The architecture guarantees that any translation table entry that causes a Translation fault is not cached, meaning the TLB never holds such an entry. Therefore, when a Translation fault occurs, the fault handler does not have to perform any TLB maintenance instructions to remove the faulting entry.

A data or unified cache maintenance instruction by VA can generate a Translation fault. It is IMPLEMENTATION DEFINED whether an instruction cache invalidate by VA operation can generate a Translation fault.

A data or unified cache maintenance by VA instruction can generate a Translation fault. If the Point of Coherency is before any level of cache, it is IMPLEMENTATION DEFINED whether a data or unified cache maintenance by VA instruction can generate a Translation fault. It is IMPLEMENTATION DEFINED whether an instruction cache invalidate by VA operation can generate a Translation fault.

If the Point of Unification is before any level of data cache, it is IMPLEMENTATION DEFINED whether a data or unified cache clean by VA to the Point of Unification instruction can generate a Translation fault.

It is IMPLEMENTATION DEFINED whether a branch predictor maintenance operation can generate a Translation fault.

Address size fault

An Address size fault can be generated at any level of lookup, and the reported fault code identifies the lookup level.

An Address size fault is generated if the translation table entries or the TTBR for the stage of translation have nonzero address bits above the most significant bit of the maximum output address size. Because VMSAv8-32 supports a maximum PA and IPA size of 40 bits, this means any case where a translation table entry or the TTBR holds an address for which A[47:40] is nonzero generates an Address size fault.

A data or unified cache maintenance by VA instruction can generate an Address size fault. If the Point of Coherency is before any level of cache, it is IMPLEMENTATION DEFINED whether a data or unified cache maintenance by VA instruction can generate an Address size fault. It is IMPLEMENTATION DEFINED whether an instruction cache invalidate by VA operation can generate an Address size fault.

If the Point of Unification is before any level of data cache, it is IMPLEMENTATION DEFINED whether a data or unified cache clean by VA to the Point of Unification instruction can generate an Address size fault.

It is IMPLEMENTATION DEFINED whether a branch predictor maintenance operation can generate an Address size fault.

The architecture guarantees that any translation table entry that causes an Address size fault is not cached, meaning the TLB never holds such an entry. Therefore, when an Address size fault occurs, the fault handler does not have to perform any TLB maintenance instructions to remove the faulting entry.

Access flag fault

An Access flag fault can be generated at any level of lookup, and the reported fault code identifies the lookup level. An Access flag fault is generated only if all of the following apply:

- The translation tables support an Access flag bit:
 - The Short-descriptor format supports an Access flag only when `SCTLR.AFE` is set to 1.
 - The Long-descriptor format always supports an Access flag.
- A translation table descriptor with the Access flag bit set to 0 is loaded.

For more information about the Access flag bit see:

- [VMSAv8-32 Short-descriptor translation table format descriptors on page G4-4577](#)
- [VMSAv8-32 Long-descriptor translation table format descriptors on page G4-4586](#).

The architecture guarantees that any translation table entry that causes an Access flag fault is not cached, meaning the TLB never holds such an entry. Therefore, when an Access flag fault occurs, the fault handler does not have to perform any TLB maintenance instructions to remove the faulting entry.

Whether any cache maintenance instruction by VA can generate Access flag faults is IMPLEMENTATION DEFINED.

Whether branch predictor invalidate by VA operations can generate Access flag faults is IMPLEMENTATION DEFINED.

For more information, see [The Access flag on page G4-4613](#).

Domain fault, Short-descriptor format translation tables only

When using the Short-descriptor translation table format, a Domain fault can be generated at level 1 or level 2 of lookup. The reported fault code identifies the lookup level. The conditions for generating a Domain fault are:

- Level 1** When a level 1 descriptor fetch returns a valid Section level 1 descriptor, the domain field of that descriptor is checked against the `DACR`. A level 1 Domain fault is generated if this check fails.
- Level 2** When a level 2 descriptor fetch returns a valid level 2 descriptor, the domain field of the level 1 descriptor that required the level 2 fetch is checked against the `DACR`, and a level 2 Domain fault is generated if this check fails.

For more information, see [Domains, Short-descriptor format only on page G4-4612](#).

Domain faults cannot occur on cache or branch predictor maintenance operations.

A TLB might hold a translation table entry that cause a Domain fault. Therefore, if the handling of a Domain fault results in an update to the associated translation tables, the software that updates the translation tables must invalidate the appropriate TLB entry, to prevent the stale information in the TLB being used on a subsequent memory access. For more information, see the translation table entry update examples in [Ordering and completion of TLB maintenance instructions on page G4-4635](#).

Any change to the `DACR` must be synchronized by a [Context synchronization event](#). For more information see [Synchronization of changes to AArch32 System registers on page G6-4768](#).

G4.11.6 External abort on a translation table walk

An external abort on a translation table walk can be either synchronous or asynchronous. For more information on external aborts, see [External aborts on page G3-4550](#).

An external abort on a translation table walk is reported:

- If the external abort is synchronous, using:
 - A synchronous Prefetch Abort exception if the translation table walk is for an instruction fetch.
 - A synchronous Data Abort exception if the translation table walk is for a data access.
- If the external abort is asynchronous, using an SError interrupt, which is taken as an asynchronous Data Abort exception.

If an implementation reports the error in the translation table walk asynchronously from executing the instruction whose instruction fetch or memory access caused the translation table walk, these aborts behave essentially as interrupts. The aborts are masked when `PSTATE.A` is set to 1, otherwise they are reported using the Data Abort exception.

Behavior of external aborts on a translation table walk caused by address translation instructions

The address translation instructions summarized in [Address translation instructions, functional group on page G4-4737](#) require translation table walks. An external abort can occur in the translation table walk. The abort generates a Data Abort exception, and can be synchronous or asynchronous. For more information, see [Handling of faults and aborts during an address translation instruction on page G4-4686](#).

G4.11.7 AArch32 state prioritization of synchronous aborts from a single stage of address translation

[Exception prioritization for exceptions taken to AArch32 state on page G1-4344](#) describes the prioritization of exceptions taken from an Exception level that is using AArch32. This section gives additional information about the prioritization of MMU faults from VMSAv8-32 translation regimes.

If a single instruction generates aborts on more than one memory access, the architecture does not define any prioritization between those aborts.

In general, the ARM architecture does not define when asynchronous events are taken, and therefore the prioritization of asynchronous events is IMPLEMENTATION DEFINED.

———— Note —————

The priority numbering in this list only shows the relative priorities of aborts from a single stage of address translation in a VMSAv8-32 translation regime. This numbering has no global significance and, for example, does not correlate with the equivalent AArch64 list in [AArch64 state prioritization of synchronous aborts from a single stage of address translation on page D4-2110](#).

For a single stage of translation in a VMSAv8-32 translation regime, the following numbered list shows the priority of the possible memory management faults on a memory access. In this list:

- For memory accesses that undergo two stages of translation, the *italic entries show where the faults from the stage 2 translation can occur*. A stage 2 fault within a stage 1 translation table walk follows the same prioritization of faults.
- For synchronous external aborts from translation table walks see also [Synchronous external abort errors from address translation caching structures on page G4-4661](#).

The priority order, from highest priority to lowest priority, is:

1. Alignment fault not caused by memory type. This is possible for a stage 1 translation only.
2. Translation fault due to the input address being out of the address range to be translated or requiring an AArch32 `TTBR` that is disabled. This includes `VTCR.SL0` being inconsistent with `VTCR.T0SZ` or programmed to a reserved value.
3. Address size fault on an AArch32 `TTBR` caused by the physical address being out of the range implemented.
4. *Second stage abort on a level 1 lookup of a a stage 1 table walk. When stage 2 address translation is enabled this includes an Address size fault caused by the physical address being out of the range implemented.* This is second stage abort during a first stage translation table walk.
5. Synchronous parity or ECC error on a level 1 lookup of a translation table walk.
6. Synchronous external abort on a level 1 lookup level of a translation table walk.
7. Translation fault on a level 1 translation table entry.

8. Address size fault on a level 1 lookup translation table entry caused by the output address being out of the range implemented.
9. *Second stage abort on a level 2 lookup of a stage 1 table walk. When stage 2 address translation is enabled this includes an Address size fault caused by the physical address being out of the range implemented. This is second stage abort during a first stage translation table walk.*
10. Synchronous parity or ECC error on a level 2 lookup of a translation table walk.
11. Synchronous external abort on a level 2 lookup level of a translation table walk.
12. Translation fault on a level 2 translation table entry.
13. Address size fault on a level 2 lookup translation table entry caused by the output address being out of the range implemented.
14. *Second stage abort on a level 3 lookup of a stage 1 table walk. When stage 2 address translation is enabled this includes an Address size fault caused by the physical address being out of the range implemented. This is second stage abort during a first stage translation table walk.*
15. Synchronous parity or ECC error on a level 3 lookup of a translation table walk.
16. Synchronous external abort on a level 3 lookup level of a translation table walk.
17. Translation fault on a level 3 translation table entry.
18. Address size fault on a level 3 lookup translation table entry caused by the output address being out of the range implemented.
19. Access Flag fault.
20. Alignment fault caused by the memory type.
21. Domain fault.

———— **Note** ————

Domain faults are possible only when using the VMSAv8-32 Short-descriptor translation table format, see [Domain fault, Short-descriptor format translation tables](#) only on page G4-4659.

22. Permission fault.
23. *A fault from the stage 2 translation of the memory access. When stage 2 address translation is enabled this includes an Address size fault caused by the physical address being out of the range implemented.*
24. Synchronous parity or ECC error on the memory access.
25. Synchronous External Abort on the memory access.

———— **Note** ————

- The prioritization of TLB Conflict aborts is IMPLEMENTATION DEFINED, as the exact cause of these aborts depends on the form of TLBs implemented. However, the TLB conflict abort must have higher priority than any abort that depends on a value held in the TLB.
- The prioritization of IMPLEMENTATION DEFINED MMU faults for a Load-Exclusive or Store-Exclusive to an unsupported memory type is IMPLEMENTATION DEFINED.

See also [The MMU fault-checking sequence](#) on page G4-4652.

Synchronous external abort errors from address translation caching structures

A caching structure used for caching translation table walks might support:

- An arbitrary number of levels of translation table lookup.

- One or more stages of translation, that might not correspond to the stages of an address translation lookup.

This might mean that, on a synchronous external abort arising from the caching structure, such as from a parity or ECC error, the PE cannot precisely determine one or both of the translation stage and level of lookup at which the error occurred. In this case:

- If the PE cannot determine precisely the translation stage at which the error occurred, it is reported and prioritized as a stage 1 error.
- If the PE cannot determine precisely the lookup level at which the error occurred, the level is reported and prioritized as either:
 - The lowest-numbered level that could have given rise to the error.
 - Level 1 if it the PE cannot determine any information about the level.

G4.12 Exception reporting in a VMSAv8-32 implementation

This section describes exception reporting, in AArch32 state, in a VMSAv8-32 implementation. That is, it describes only the reporting of exceptions that are taken to an Exception level that is using AArch32. EL2 provides an enhanced reporting mechanism for exceptions taken to the Non-secure EL2 mode, Hyp mode. This means that, for VMSAv8-32, the exception reporting depends on the mode to which the exception is taken.

Note

The enhanced reporting mechanism for exceptions that are taken to Hyp mode is generally similar to the reporting of exceptions that are taken to an Exception level that is using AArch64.

About exception reporting introduces the general approach to exception reporting, and the following sections then describe exception reporting at different privilege levels:

- *Reporting exceptions taken to PL1 modes on page G4-4664.*
- *Fault reporting in PL1 modes on page G4-4667.*
- *Summary of register updates on faults taken to PL1 modes on page G4-4671.*
- *Reporting exceptions taken to Hyp mode on page G4-4673.*
- *Use of the HSR on page G4-4677.*
- *Summary of register updates on exceptions taken to Hyp mode on page G4-4680.*

Note

The registers used for exception reporting also report information about debug exceptions. For more information see:

- *Data Abort exceptions, taken to a PL1 mode on page G4-4665.*
 - *Prefetch Abort exceptions, taken to a PL1 mode on page G4-4667.*
 - *Reporting exceptions taken to Hyp mode on page G4-4673.*
-

G4.12.1 About exception reporting

In an implementation that includes EL2 and EL3, exceptions can be taken to:

- Monitor mode, if EL3 is using AArch32.
- Hyp mode, if EL2 is using AArch32.
- A Secure or Non-secure PL1 mode.

Monitor mode is a PL1 mode, but:

- It is accessible only when EL3 is using AArch32.
- It is present only in Secure state.
- When EL3 is using AArch32, System register controls route some exceptions from Non-secure state to Monitor mode. These are the only cases where taking an exception to an Exception level that is using AArch32 changes the Security state of the PE.

Exception reporting in Hyp mode differs significantly from that in the other modes, but in general, exception reporting returns:

- Information about the exception:
 - On taking an exception to Hyp mode, the *Hyp Syndrome Register*, **HSR**, returns syndrome information.
 - On taking an exception to any other mode, a *Fault Status Register* (FSR) returns status information.
- For synchronous exceptions, one or more addresses associated with the exceptions, returned in *Fault Address Registers* (FARs). For a permitted exception to this requirement see *Fault address reporting on synchronous external aborts on page G4-4664*.

In all modes, additional IMPLEMENTATION DEFINED registers can provide additional information about exceptions.

Note

- [PE mode for taking exceptions on page G1-4350](#) describes how the mode to which an exception is taken is determined.
 - EL2 provides:
 - Specific exception types, that can only be taken from Non-secure PL1 and PL0 modes, and are always taken to Hyp mode.
 - Routing controls that can route some exceptions from Non-secure PL1 and PL0 modes to Hyp mode.These exceptions are reported using the same mechanism as the Hyp mode reporting of VMSAv8-32 memory aborts, as described in this section.
-

Memory system faults generate either a Data Abort exception or a Prefetch Abort exception, as summarized in:

- [Reporting exceptions taken to PL1 modes.](#)
- [Memory fault reporting in Hyp mode on page G4-4675.](#)

On an access that might have multiple aborts, the MMU fault checking sequence and the prioritization of aborts determine which abort occurs. For more information, see [The MMU fault-checking sequence on page G4-4652](#) and [AArch32 state prioritization of synchronous aborts from a single stage of address translation on page G4-4660](#).

Fault address reporting on synchronous external aborts

The general architectural requirement is that, on a synchronous abort, the faulting address is recorded in a *Fault Address Register* (FAR). This requirement is relaxed for the case of a synchronous external abort that is not a synchronous external abort on a translation table walk. In this case only:

- It is IMPLEMENTATION DEFINED whether the faulting address is recorded in a FAR.
- A bit in a fault reporting register, the FnV bit, indicates whether a valid address is recorded.

For exceptions taken to an Exception level that is using AArch32, the details of this reporting depend on whether the exception is taken to:

- A PL1 mode, as described in [Reporting exceptions taken to PL1 modes.](#)
- Hyp mode, as described in [Reporting exceptions taken to Hyp mode on page G4-4673.](#)

G4.12.2 Reporting exceptions taken to PL1 modes

The following sections give general information about the reporting of exceptions when they are taken to a Secure or Non-secure PL1 mode:

- [Registers used for reporting exceptions taken to PL1 modes on page G4-4665.](#)
- [Data Abort exceptions, taken to a PL1 mode on page G4-4665.](#)
- [Prefetch Abort exceptions, taken to a PL1 mode on page G4-4667.](#)

[Fault reporting in PL1 modes on page G4-4667](#) then describes the fault reporting in these modes, including the encodings used for reporting the faults.

Note

[Security state, Exception levels, and AArch32 execution privilege on page G1-4318](#) describes how the Secure and Non-secure PL1 modes map onto the Exception levels.

Registers used for reporting exceptions taken to PL1 modes

AArch32 state defines the following registers, and register encodings, for exceptions taken to PL1 modes:

- The **DFSR** holds information about a Data Abort exception.
- The **DFAR** holds the faulting address for some synchronous Data Abort exceptions.
- The **IFSR** holds information about a Prefetch Abort exception.
- The **IFAR** holds the faulting address for some synchronous Prefetch Abort exceptions.

In addition, if implemented, the optional ADFSR and AIFSR can provide additional fault information, see *Auxiliary Fault Status Registers*.

Auxiliary Fault Status Registers

AArch32 state defines the following Auxiliary Fault Status Registers:

- The Auxiliary Data Fault Status Register, **ADFSR**.
- The Auxiliary Instruction Fault Status Register, **AIFSR**.

The position of these registers is architecturally-defined, but the content and use of the registers is IMPLEMENTATION DEFINED. An implementation can use these registers to return additional fault status information. An example use of these registers is to return more information for diagnosing parity or ECC errors.

An implementation that does not need to report additional fault information must implement these registers as UNK/SBZP. This ensures that an attempt to access these registers from software executing at PL1 does not cause an Undefined Instruction exception.

Data Abort exceptions, taken to a PL1 mode

On taking a Data Abort exception to a PL1 mode:

- If the exception is on an instruction cache or branch predictor maintenance operation by VA, its reporting depends on the value of **TTBCR.EAE**. For more information about the registers used when reporting the exception, see *Data Abort on an instruction cache or branch predictor maintenance instruction by VA on page G4-4666*.
- Otherwise, the **DFSR** is updated with details of the fault, including the appropriate Fault status code. If the Data Abort exception is synchronous, **DFSR.WnR** is updated to indicate whether the faulted instruction was a read or a write. However, if the fault is on a cache maintenance instruction, or on an address translation instruction, **WnR** is set to 1, to indicate a fault on a write instruction, and the **CM** bit is set to 1.

See the register description for more information about the returned fault information. See also *Data Abort on a Watchpoint exception on page G4-4666*.

If the Data Abort exception is

- Synchronous, the **DFAR** is updated with the VA that caused the exception, but see *Fault address reporting on synchronous external aborts on page G4-4664* for a permitted exception to this requirement.
- Asynchronous, the **DFAR** becomes UNKNOWN.

DFSR.WnR and **DFSR.CM** are UNKNOWN on an asynchronous Data Abort exception.

For all Data Abort exceptions, if the implementation includes EL3, the Security state of the PE in the mode to which the Data Abort exception is taken determines whether the Secure or Non-secure **DFSR** and **DFAR** are updated.

Data Abort on an instruction cache or branch predictor maintenance instruction by VA

If an instruction cache invalidation by VA or branch predictor invalidation by VA operation generates a Data Abort exception that is taken to a PL1 mode, the **DFAR** is updated to hold the faulting VA. However, the reporting of the fault depends on the value of **TTBCR.EAE**:

TTBCR.EAE == 0

When the value of **TTBCR.EAE** is 0, it is IMPLEMENTATION DEFINED which of the following is used when reporting the fault:

- The **DFSR** indicates an Instruction cache maintenance instruction fault, and the **IFSR** is valid and indicates the cause of the fault, a Translation fault or Access flag fault.
- The **DFSR** indicates the cause of the fault, a Translation fault or Access flag fault. The **IFSR** is UNKNOWN.

In either case:

- **DFSR.WnR** is set to 1.
- **DFSR.CM** is set to 1, to indicate a fault on a cache maintenance instruction.

TTBCR.EAE == 1

When the value of **TTBCR.EAE** is 1:

- **DFSR.CM** is set to 1, to indicate a fault on a cache maintenance instruction.
- **DFSR.STATUS** indicates the cause of the fault, a Translation or Access flag fault.
- **DFSR.WnR** is set to 1.
- The **IFSR** is UNKNOWN.

Data Abort on a Watchpoint exception

On taking a Data Abort exception caused by a watchpoint:

- **DFSR.FS** is updated to indicate a debug exception.
- **DFSR**.{WnR, Domain} are UNKNOWN.
- **DFAR** is set to the address that generated the watchpoint

Note

- **LR_abt** indicates the address of the instruction that triggered the watchpoint.
- In some ARMv7 AArch32 implementations, the **DBGWFAR** is set to the address of the instruction that triggered the watchpoint. In ARMv8 this register is **RES0**.

A watchpointed address can be any byte-aligned address. The address reported in **DFAR** might not be the watchpointed address, and:

- For a watchpoint due to an operation other than a Data Cache maintenance instruction, can be any address between and including:
 - The lowest address accessed by the instruction that triggered the watchpoint.
 - The highest watchpointed address accessed by that instruction.

If multiple watchpoints are set in this range, there is no guarantee of which watchpoint is generated.

The address must also be within a naturally-aligned block of memory of an IMPLEMENTATION DEFINED power-of-two size, containing a watchpoint address accessed by that location.

Note

- In particular, there is no guarantee of generating the watchpoint with the lowest address in the range.
- The IMPLEMENTATION DEFINED power-of-two size must be no larger than the block size of the AArch64 **DC ZVA** operation.

- For a watchpoint due to a Data Cache operation, the address is the address passed to the instruction. This might be an address that is above the watchpointed location.

Prefetch Abort exceptions, taken to a PL1 mode

For a Prefetch Abort exception generated by an instruction fetch, the Prefetch Abort exception is taken synchronously with the instruction that the abort is reported on. This means:

- If the PE attempts to execute the instruction a Prefetch Abort exception is generated.
- If an instruction fetch is issued but the PE does not attempt to execute the prefetched instruction, no Prefetch Abort exception is generated for that instruction. For example, if the execution flow branches round a prefetched instruction, no Prefetch Abort exception is generated.

In addition, Breakpoint Instruction, Breakpoint, and Vector Catch exceptions, generate a Prefetch Abort exception, see the following for more information:

- [Exception syndrome information and preferred return address for a BKPT instruction on page G2-4468.](#)
- [Exception syndrome information and preferred return address for a Breakpoint exception on page G2-4493.](#)
- [Exception syndrome information and preferred return address for a Vector Catch exception on page G2-4516.](#)

Note

Usually, the term *exception syndrome* is used only for exceptions taken to Hyp mode, or to AArch64 state. The referenced sections use the term more generally, to include exception information reported in the [IFSR](#).

On taking a Prefetch Abort exception to a PL1 mode:

- The [IFSR](#) is updated with details of the fault, including the appropriate fault code. If appropriate, the fault code indicates that the exception was generated by a debug exception.
See the register description for more information about the returned fault information.
- For a Prefetch Abort exception generated by an instruction fetch, the [IFAR](#) is updated with the VA that caused the exception, but see [Fault address reporting on synchronous external aborts on page G4-4664](#) for a permitted exception to this requirement.
- For a Prefetch Abort exception generated by a debug exception, the [IFAR](#) is UNKNOWN.

If the implementation includes EL3, the Security state of the PE in the mode to which it takes the Prefetch Abort exception determines whether the exception updates the Secure or Non-secure [IFSR](#) and [IFAR](#).

G4.12.3 Fault reporting in PL1 modes

The FSRs provide fault information, including an indication of the fault that occurred. The following subsections describe fault reporting in PL1 modes for each of the translation table formats:

- [PL1 fault reporting with the Short-descriptor translation table format on page G4-4668.](#)
- [PL1 fault reporting with the Long-descriptor translation table format on page G4-4670.](#)

[Reserved encoding in the IFSR and DFSR encodings tables on page G4-4671](#) gives some additional information about the encodings for both formats.

[Summary of register updates on faults taken to PL1 modes on page G4-4671](#) shows which registers are updated on each of the reported faults.

[Reporting of External aborts taken from Non-secure state to Monitor mode on page G4-4668](#) describes how the fault status register format is determined for those aborts. For all other aborts, the current translation table format determines the format of the fault status registers.

Reporting of External aborts taken from Non-secure state to Monitor mode

When an External abort is taken from Non-secure state to Monitor mode:

- For a Data Abort exception, the Secure [DFSR](#) and [DFAR](#) hold information about the abort.
- For a Prefetch Abort exception, the Secure [IFSR](#) and [IFAR](#) hold information about the abort.
- The abort does not affect the contents of the Non-secure copies of the fault reporting registers.

Normally, the current translation table format determines the format of the [DFSR](#) and [IFSR](#). However, when [SCR.EA](#) is set to 1, to route external aborts to Monitor mode, and an external abort is taken from Non-secure state, this section defines the [DFSR](#) and [IFSR](#) format.

For an External abort taken from Non-secure state to Monitor mode, the [DFSR](#) or [IFSR](#) uses the format associated with the Long-descriptor translation table format, as described in [PL1 fault reporting with the Long-descriptor translation table format on page G4-4670](#), if any of the following applies:

- The Secure [TTBCR.EAE](#) bit is set to 1.
- The External abort is synchronous and either:
 - It is taken from Hyp mode.
 - It is taken from a Non-secure PL1 or PL0 mode, and the Non-secure [TTBCR.EAE](#) bit is set to 1.

Otherwise, the [DFSR](#) or [IFSR](#) uses the format associated with the Short-descriptor translation table format, as described in [PL1 fault reporting with the Short-descriptor translation table format](#).

PL1 fault reporting with the Short-descriptor translation table format

This subsection describes the fault reporting for a fault taken to a PL1 when address translation is using the Short-descriptor translation table format.

On taking an exception, bit[9] of the FSR is RAZ, or set to 0, if the PE is using this FSR format.

An FSR encodes the fault in a 5-bit FS field, that comprises FSR[10, 3:0]. [Table G4-25](#) shows the encoding of that field. [Summary of register updates on faults taken to PL1 modes on page G4-4671](#) shows:

- Whether the corresponding FAR is updated on the fault. That is:
 - For a fault reported in the [IFSR](#), whether the [IFAR](#) holds a valid address.
 - For a fault reported in the [DFSR](#), whether the [DFAR](#) holds a valid address.
- For faults that update [DFSR](#), whether [DFSR.Domain](#) is valid

When reading [Table G4-25](#):

- FS values not shown in the table are reserved.
- FS values shown as [DFSR](#) only are reserved for the [IFSR](#).

Table G4-25 FSR encodings when using the Short-description translation table format

FS	Source		Notes
00001	Alignment fault		DFSR only. Fault on initial lookup
00100	Fault on instruction cache maintenance		DFSR only
01100	Synchronous external abort on translation table walk ^a	Level 1	-
01110		Level 2	
11100	Synchronous parity or ECC error on translation table walk ^a	Level 1	-
11110		Level 2	
00101	Translation fault ^a	Level 1	MMU fault
00111		Level 2	

Table G4-25 FSR encodings when using the Short-description translation table format (continued)

FS	Source		Notes
00011 b 00110	Access flag fault ^a	Level 1 Level 2	MMU fault
01001 01011	Domain fault ^a	Level 1 Level 2	MMU fault
01101 01111	Permission fault ^a	Level 1 Level 2	MMU fault
00010	Debug exception		See Chapter G2 AArch32 Self-hosted Debug
01000	Synchronous external abort		-
10000	TLB conflict abort		See TLB conflict aborts on page G4-4630
10100	IMPLEMENTATION DEFINED		Lockdown
10101	IMPLEMENTATION DEFINED		Unsupported Exclusive access
11001	Synchronous parity or ECC error on memory access		-
10110	SError interrupt ^c		DFSR only
11000	SError interrupt ^c from a parity or ECC error on memory access		DFSR only

- See [The level associated with MMU faults on a Short-descriptor translation table lookup](#).
- Previously, this encoding was a deprecated encoding for Alignment fault. The extensive changes in the memory model in VMSAv8-32 mean there should be no possibility of confusing the new use of this encoding with its previous use
- Including asynchronous external abort on a data access, a translation table walk, or an instruction fetch.

The level associated with MMU faults on a Short-descriptor translation table lookup

The lookup level associated with a fault is:

- For a fault generated on a translation table walk, the lookup level of the walk being performed.
- For a Translation fault, the lookup level of the translation table that gave the fault. If a fault occurs because a stage of address translation is disabled, or because the input address is outside the range specified by the appropriate base address register or registers, the fault is reported as a level 1 fault.
- For an Access flag fault, Permission fault, or Domain fault, the lookup level of the final level of translation table accessed for the translation. That is, the lookup level of the translation table that returned a Supersection, Section, or Page descriptor.

Also see [Synchronous external abort errors from address translation caching structures on page G4-4661](#).

The Domain field in the DFSR

The DFSR includes a Domain field. This is inherited from previous versions of the VMSA. The IFSR does not include a Domain field. [Summary of register updates on faults taken to PL1 modes on page G4-4671](#) describes when DFSR.Domain is valid.

ARM deprecates any use of the Domain field in the DFSR. The Long-descriptor translation table format does not support a Domain field, and future versions of the ARM architecture might not support a Domain field in the Short-descriptor translation table format. ARM strongly recommends that new software does not use this field.

For both Data Abort exceptions and Prefetch Abort exceptions, software can find the domain information by performing a translation table read for the faulting address and extracting the Domain field from the translation table entry.

PL1 fault reporting with the Long-descriptor translation table format

This subsection describes the fault reporting for a fault taken to a PL1 mode when address translation is using the Long-descriptor translation table format.

When the PE takes an exception, bit[9] of the FSR is set to 1 if the PE is using this FSR format.

The FSRs encode the fault in a 6-bit STATUS field, that comprises FSR[5:0]. [Table G4-26](#) shows the encoding of that field. In addition:

- For a fault taken to a PL1 mode, [Summary of register updates on faults taken to PL1 modes on page G4-4671](#) shows whether the corresponding FAR is updated on the fault. That is:
 - For a fault reported in the **IFSR**, whether the **IFAR** holds a valid address.
 - For a fault reported in the **DFSR**, whether the **DFAR** holds a valid address.
- For a fault taken to the Hyp mode, [Summary of register updates on exceptions taken to Hyp mode on page G4-4680](#) shows what registers are updated on the fault.

Table G4-26 FSR encodings when using the Long-descriptor translation table format

STATUS ^a	Source	Notes
0000LL	Address size fault. LL bits indicate level ^b .	MMU fault
0001LL	Translation fault. LL bits indicate level ^b .	MMU fault
0010LL	Access flag fault. LL bits indicate level ^b .	MMU fault
0011LL	Permission fault. LL bits indicate level ^b .	MMU fault
010000	Synchronous external abort.	-
011000	Synchronous parity or ECC error on memory access.	-
010001	SError interrupt ^c .	DFSR only
011001	SError interrupt ^c from a parity or ECC error on memory access.	DFSR only
0101LL	Synchronous external abort on translation table walk. LL bits indicate level ^b .	-
0111LL	Synchronous parity or ECC error on memory access on translation table walk. LL bits indicate level ^b .	-
100001	Alignment fault.	Fault on initial lookup
100010	Debug exception.	See Chapter G2 AArch32 Self-hosted Debug
110000	TLB conflict abort.	See TLB conflict aborts on page G4-4630
110100	IMPLEMENTATION DEFINED.	Lockdown, DFSR only
110101	IMPLEMENTATION DEFINED.	Unsupported Exclusive access
1111LL	Domain fault. LL bits indicate level ^b .	MMU fault. 64-bit PAR only, level 1 or level 2 only. Never used in DFSR , IFSR , or HSR ^d

a. STATUS values not shown in this table are reserved. STATUS values not supported in the **IFSR** or **DFSR** are reserved for the register or registers in which they are not supported.

b. See [The level associated with MMU faults on a Long-descriptor translation table lookup on page G4-4671](#).

c. Including asynchronous external abort on a data access, a translation table walk, or an instruction fetch.

d. A Domain fault can be reported using the Long-descriptor STATUS encodings only as a result of a fault on an address translation instruction. For more information see [MMU fault on an address translation instruction on page G4-4686](#).

The level associated with MMU faults on a Long-descriptor translation table lookup

For MMU faults, [Table G4-27](#) shows how the LL bits in the xFSR.STATUS field encode the lookup level associated with the fault.

Table G4-27 Use of LL bits to encode the lookup level at which the fault occurred

LL bits	Meaning
00	Address size fault Address size fault in TTBR0 or TTBR1 . All other faults Reserved.
01	Level 1.
10	Level 2.
11	Level 3. When xFSR.STATUS indicates a Domain fault, this value is reserved.

The lookup level associated with a fault is:

- For a fault generated on a translation table walk, the lookup level of the walk being performed.
- For a Translation fault, the lookup level of the translation table that gave the fault. If a fault occurs because a stage of address translation is disabled, or because the input address is outside the range specified by the appropriate base address register or registers, the fault is reported as a level 1 fault.
- For an Access flag fault, the lookup level of the translation table that gave the fault.
- For a Permission fault, including a Permission fault caused by hierarchical permissions, the lookup level of the final level of translation table accessed for the translation. That is, the lookup level of the translation table that returned a Block or Page descriptor.

Also see [Synchronous external abort errors from address translation caching structures](#) on page G4-4661.

Reserved encoding in the IFSR and DFSR encodings tables

With both the Short-descriptor and the Long-descriptor FSR format, the fault encodings reserve a single encoding for Cache and TLB lockdown faults. The details of these faults and any associated subsidiary registers are IMPLEMENTATION DEFINED.

G4.12.4 Summary of register updates on faults taken to PL1 modes

For faults that generate exceptions that are taken to a PL1 mode, [Table G4-28 on page G4-4672](#) shows the registers affected by each fault. In this table:

- Yes indicates that the register is updated.
- UNK indicates that the fault makes the register value UNKNOWN.
- A null entry, -, indicates that the fault does not affect the register.

For faults that update the **DFSR** using the Short-descriptor format FSR encodings, [Table G4-29 on page G4-4673](#) shows whether **DFSR.Domain** is valid.

Table G4-28 Effect of a fault taken to a PL1 mode on the reporting registers

Fault		IFSR	IFAR	DFSR	DFAR
Faults reported as Prefetch Abort exceptions:					
MMU fault, always synchronous		Yes	Yes	-	-
Synchronous external abort on translation table walk		Yes	Yes	-	-
Synchronous parity or ECC error on translation table walk		Yes	Yes	-	-
Synchronous external abort		Yes	IMP DEF ^a	-	-
Synchronous parity or ECC error on memory access		Yes	Yes	-	-
TLB conflict abort		Yes	Yes	-	-
Fault reported as Data Abort exception:					
Alignment fault, always synchronous		-	-	Yes	Yes
MMU fault, always synchronous		-	-	Yes	Yes
Fault on instruction cache maintenance, when using Long-descriptor translation table format ^b		UNK	-	Yes	Yes
Fault on instruction cache maintenance, when using Short descriptor translation table format ^c	<i>either</i>	Yes	-	Yes	Yes
	<i>or</i>	UNK	-	Yes	Yes
Synchronous external abort on translation table walk		-	-	Yes	Yes
Synchronous parity or ECC error on translation table walk		-	-	Yes	Yes
Synchronous external abort		-	-	Yes	IMP DEF ^a
Synchronous parity or ECC error on memory access		-	-	Yes	Yes
SError interrupt		-	-	Yes	UNK
SError interrupt from a parity or ECC error on memory access		-	-	Yes	UNK
TLB conflict abort		-	-	Yes	Yes
Debug exceptions:					
Breakpoint, Breakpoint Instruction, or Vector Catch ^d		Yes	UNK	-	-
Watchpoint ^e		-	-	Yes	Yes

a. IMPLEMENTATION DEFINED. The **IFSR.FnV** or **DFSR.FnV** bit indicates whether the register holds a valid address. See [Fault address reporting on synchronous external aborts on page G4-4664](#).

b. When using the Long-descriptor translation table format, there is not a specific fault code for a fault on an instruction cache maintenance instruction. For more information see [Data Abort on an instruction cache or branch predictor maintenance instruction by VA on page G4-4666](#).

c. The two lines of this entry show the alternative ways of reporting the fault when using the Short-descriptor translation table format. It is IMPLEMENTATION DEFINED which methods is used, see [Data Abort on an instruction cache or branch predictor maintenance instruction by VA on page G4-4666](#).

d. Generates a Prefetch Abort exception.

e. Generates a Data Abort exception.

For those faults for which [Table G4-28 on page G4-4672](#) shows that the **DFSR** is updated, if the fault is reported using the Short-descriptor FSR encodings, [Table G4-29](#) shows whether **DFSR.Domain** is valid. In this table, UNK indicates that the fault makes **DFSR.Domain** UNKNOWN.

Table G4-29 Validity of Domain field on faults that update the **DFSR when using the Short-descriptor encodings**

DFSR.FS	Source		DFSR.Domain	Notes
00001	Alignment fault		UNK	-
00100	Fault on instruction cache maintenance instruction		UNK	-
01100	Synchronous external abort on translation table walk	Level 1	UNK	-
01110		Level 2	Valid	
11100	Synchronous parity or ECC error on translation table walk	Level 1	UNK	-
11110		Level 2	Valid	
00101	Translation fault	Level 1	UNK	MMU fault
00111		Level 2	Valid	
00011 ^a	Access flag fault	Level 1	UNK	MMU fault
00110		Level 2	Valid	
01001	Domain fault	Level 1	Valid	MMU fault
01011		Level 2	Valid	
01101	Permission fault	Level 1	UNK	MMU fault
01111		Level 2	UNK	
01000	Synchronous external abort		UNK	-
10000	TLB conflict abort		UNK	-
11001	Synchronous parity or ECC error on memory access		UNK	-
10110	SError interrupt ^b		UNK	-
11000	SError interrupt ^b from a parity or ECC error on memory access		UNK	-
00010	Watchpoint		UNK	

- a. Previously, this encoding was a deprecated encoding for Alignment fault. The extensive changes in the memory model in VMSAv8-32 mean there should be no possibility of confusing the new use of this encoding with its previous use
- b. Including asynchronous external abort on a data access, a translation table walk, or an instruction fetch.

G4.12.5 Reporting exceptions taken to Hyp mode

Hyp mode is the Non-secure EL2 mode. It is entered by taking an exception to Hyp mode.

————— **Note** —————

Software executing in Monitor mode, or at EL3 when EL3 is using AArch64, can perform an exception return to Hyp mode. This means Hyp mode can be entered either by taking an exception, or by a permitted exception return.

When EL2 is using AArch32, the following exceptions are taken to Hyp mode:

- SError interrupt exceptions, IRQ exceptions, and FIQ exceptions, from Non-secure PL0 and PL1 modes, if not routed to Secure Monitor mode, and if configured by the AMO, FMO or IMO bits. For more information see [Asynchronous exception routing controls on page G1-4367](#).
- When **HCR.TGE** is set to 1, all exceptions that would be routed to Non-secure PL1 modes.

For more information, see [Routing exceptions from Non-secure EL0 to EL2 on page G1-4356](#).

- When `HDCR.TDE` is set to 1, any debug exception that would otherwise be taken to a Non-secure PL1 mode, see [Routing debug exceptions to EL2 using AArch32 on page G1-4358](#).
- The privilege rules for taking exceptions mean that any exception taken from Hyp mode, if not routed to EL3, must be taken to Hyp mode.
- Hypervisor Call exceptions, and Hyp Trap exceptions, are always taken to Hyp mode. These exceptions are supported only as part of EL2.

When EL2 is implemented, various operations from Non-secure PL0 and PL1 modes can be *trapped* to Hyp mode, using the Hyp Trap exception. For more information, see [EL2 configurable controls on page G1-4427](#).

These exceptions include any memory system fault that occurs:

- On a memory access from Hyp mode.
- On memory access from a Non-secure PL0 or PL1 mode:
 - On a stage 2 translation, from IPA to PA.
 - On the stage 2 translation of an address accessed in performing a stage 1 translation table walk.

[Memory fault reporting in Hyp mode on page G4-4675](#) gives more information about these faults.

The following exceptions provide *syndrome* information in the `HSR`:

- Any synchronous exception taken to Hyp mode.
- Some exceptions taken from Debug state that would be taken to Hyp mode if the PE was in Non-debug state, see [Exceptions in Debug state on page H2-5465](#).

———— **Note** —————

- In Debug state, the PE does not change mode on taking an exception.
- As [Exceptions in Debug state on page H2-5465](#) describes, some other exceptions taken from Debug state make the `HSR` UNKNOWN.

The syndrome information in the `HSR` includes the Fault status code otherwise provided by the fault status register, and extends the fault reporting compared to that available for an exception taken to a PL1 mode. For more information, see [Use of the HSR on page G4-4677](#).

In addition, for a Debug exception taken to Hyp mode, `DBGDSCRint.MOE` or `DBGDTRRExt.MOE` shows what caused the Debug exception. This bit is valid regardless of whether the Debug exception was taken from Hyp mode or from another Non-secure mode.

[Registers used for reporting exceptions taken to Hyp mode](#) lists all of the registers used for exception reporting in Hyp mode.

Registers used for reporting exceptions taken to Hyp mode

The following registers are used for reporting exceptions taken to Hyp mode:

- The `HSR` holds syndrome information for the exception.
- The `HDFAR` holds the VA associated with a Data Abort exception.
- The `HIFAR` holds the VA associated with a Prefetch Abort exception.
- The `HPFAR` holds bits[39:12] of the IPA associated with some aborts on stage 2 address translations.

In addition, if implemented, the optional `HADFSR` and `HAIFSR` can provide additional fault information, see [Hyp Auxiliary Fault Syndrome Registers](#).

Hyp Auxiliary Fault Syndrome Registers

EL2 also defines encodings for the following Hyp Auxiliary Fault Syndrome Registers:

- The Hyp Auxiliary Data Fault Syndrome Register, `HADFSR`.
- The Hyp Auxiliary Instruction Fault Syndrome Register, `HAIFSR`.

An implementation can use these registers to return additional fault status information for aborts taken to Hyp mode. They are the Hyp mode equivalents of the registers described in *Auxiliary Fault Status Registers* on page G4-4665. An example use of these registers is to return more information for diagnosing parity or ECC errors.

The architectural requirements for the [HADFSR](#) and [HAIFSR](#) are:

- The position of these registers is architecturally-defined, but the content and use of the registers is IMPLEMENTATION DEFINED.
- An implementation with no requirement for additional fault reporting can implement these registers as UNK/SBZP, but the architecture does not require it to do so.

Memory fault reporting in Hyp mode

Prefetch Abort and Data Abort exceptions taken to Hyp mode report memory faults. For these aborts, the [HSR](#) contains the following fault status information:

- The [HSR.EC](#) field indicates the type of abort, as [Table G4-30](#) shows.
- The [HSR.ISS](#) field holds more information about the abort. In particular:
 - Bits[5:0] of this field hold the STATUS field for the abort, using the encodings defined in *PL1 fault reporting with the Long-descriptor translation table format* on page G4-4670.
 - Other subfields of the ISS give more information about the exception, equivalent to the information returned in the FSR for a memory fault reported at PL1.

See the descriptions of the ISS fields for the memory faults, referenced from the *Syndrome description* column of [Table G4-30](#), for information about the returned fault information.

Table G4-30 HSR.EC encodings for aborts taken to Hyp mode

HSR.EC	Abort	Syndrome description
0x20	Prefetch Abort taken from Non-secure PL0 or PL1 mode	<i>ISS encoding for an exception from a Prefetch Abort on page G6-4958</i>
0x21	Prefetch Abort taken from Hyp mode	
0x24	Data Abort taken from Non-secure PL0 or PL1 mode	<i>ISS encoding for an exception from a Data Abort on page G6-4960</i>
0x25	Data Abort taken from Hyp mode	

For more information, see *Use of the HSR* on page G4-4677.

A Prefetch Abort exception is taken synchronously with the instruction that the abort is reported on. This means:

- If the PE attempts to execute the instruction a Prefetch Abort exception is generated.
- If an instruction fetch is issued but the PE does not attempt to execute the prefetched instruction, no Prefetch Abort exception is generated for that instruction. For example, if the execution flow branches round a prefetched instruction that would abort if the PE attempted to execute it, no Prefetch Abort exception is generated.

Register updates on exception reporting in Hyp mode

The use of the [HSR](#), and of the other registers listed in *Registers used for reporting exceptions taken to Hyp mode* on page G4-4674, depends on the cause of the Abort. In reporting these faults, in general:

- If the fault generates a synchronous Data Abort exception, the [HDFAR](#) holds the associated VA, but see *Fault address reporting on synchronous external aborts* on page G4-4664 for a permitted exception to this requirement.
- If the fault generates a Prefetch Abort exception, the [HIFAR](#) holds the associated VA, but see *Fault address reporting on synchronous external aborts* on page G4-4664 for a permitted exception to this requirement.

- In the following cases, the **HPFAR** holds the faulting IPA:
 - A Translation or Access flag fault on a stage 2 translation.
 - A Translation, Access flag, or Permission fault on the stage 2 translation of an address accessed in a stage 1 translation table walk.
 - A stage 2 Address size fault.

In all other cases, the **HPFAR** is UNKNOWN.

- On a Data Abort exception that is taken to Hyp mode, the **HIFAR** is UNKNOWN.
- On a Prefetch Abort exception that is taken to Hyp mode, the **HDFAR** is UNKNOWN.

In addition, the reporting of particular aborts is as follows:

Abort on the stage 1 translation for a memory access from Hyp mode

The **HDFAR** or **HIFAR** holds the VA that caused the fault. The STATUS subfield of **HSR.ISS** indicates the type of fault, Translation, Address size, Access flag, or Permission. The **HPFAR** is UNKNOWN.

Abort on the stage 2 translation for a memory access from a Non-secure PL1 or PL0 mode

This includes aborts on the stage 2 translation of a memory access made as part of a translation table walk for a stage 1 translation. The **HDFAR** or **HIFAR** holds the VA that caused the fault. The STATUS subfield of **HSR.ISS** indicates the type of fault, Translation, Address size, Access flag, or Permission.

For any Access flag fault or Translation fault, and also for any Permission fault on the stage 2 translation of a memory access made as part of a translation table walk for a stage 1 translation, the **HPFAR** holds the IPA that caused the fault. Otherwise, the **HPFAR** is UNKNOWN.

Abort caused by a synchronous external abort, or synchronous parity or ECC error, and taken to Hyp mode

The **HDFAR** or **HIFAR** holds the VA that caused the fault, but see *Fault address reporting on synchronous external aborts on page G4-4664* for a permitted exception to this requirement. The **HPFAR** is UNKNOWN.

Data Abort caused by a Watchpoint exception and routed to Hyp mode because HDCR.TDE is set to 1

When **HDCR.TDE** is set to 1, a Watchpoint exception generated in a Non-secure PL1 or PL0 mode, that would otherwise generate a Data Abort exception, is routed to Hyp mode and generates a Hyp Trap exception.

HDFAR is set to the address that generated the watchpoint.

Note

ELR_hyp indicates the address of the instruction that triggered the watchpoint.

A watchpointed address can be any byte-aligned address. The address reported in **HDFAR** might not be the watchpointed address, and, for a watchpoint due to an operation other than a Data Cache maintenance instruction, can be any address between and including:

- The lowest address accessed by the instruction that triggered the watchpoint.
- The highest watchpointed address accessed by that instruction.

If multiple watchpoints are set in this range, there is no guarantee of which watchpoint is generated.

Note

In particular, there is no guarantee of generating the watchpoint with the lowest address in the range.

The address must also be within a naturally-aligned block of memory of an IMPLEMENTATION DEFINED power-of-two size, containing a watchpoint address accessed by that location.

Note

The IMPLEMENTATION DEFINED power-of-two size must be no larger than the block size of the AArch64 DC ZVA operation.

See also [Watchpoint exceptions](#) on page G2-4496.

In all cases, HPFAR is UNKNOWN.

Prefetch Abort caused by a Breakpoint Instruction exception and taken to Hyp mode

This abort is generated if a BKPT instruction is executed in Hyp mode. The abort leaves the HIFAR and HPFAR UNKNOWN.

See also [Breakpoint Instruction exceptions](#) on page G2-4467.

Prefetch Abort caused by a Breakpoint Instruction, Breakpoint, or Vector Catch exception, and routed to Hyp mode because HDCR.TDE is set to 1

When HDCR.TDE is set to 1, a debug exception, generated in a Non-secure PL1 or PL0 mode, that would otherwise generate a Prefetch Abort exception, is routed to Hyp mode and generates a Hyp Trap exception.

The abort leaves the HIFAR and HPFAR UNKNOWN. This is identical to the reporting of a Prefetch Abort exception caused by a Debug exception on a BKPT instruction that is executed in Hyp mode.

Note

The difference between these two cases is:

- The Debug exception on a BKPT instruction executed in Hyp mode generates a Prefetch Abort exception, taken to Hyp mode, and reported in the HSR using EC value 0x21.
- Aborts generated because HDCR.TDE is set to 1 generate a Hyp Trap exception, and are reported in the HSR using EC value 0x20.

Use of the HSR

The HSR holds syndrome information for any synchronous exception taken to Hyp mode. Compared with the reporting of exceptions taken to PL1 modes, the HSR:

- Always provides details of the fault. The DFSR and IFSR are not used.
- Provides more extensive information, for a wider range of exceptions.

Note

IRQ and FIQ exceptions taken to Hyp mode do not report any syndrome information in the HSR.

[HSR, Hyp Syndrome Register](#) on page G6-4945 describes the HSR, this section summarizes the general form of the register, to show how it encodes exception syndrome information. The register comprises:

- A 6-bit Exception class field, EC, that indicates the cause of the exception.
- An instruction length bit, IL. When an exception is caused by trapping an instruction to Hyp mode, this bit indicates the length of the trapped instruction, as follows:

0	16-bit instruction trapped.
1	32-bit instruction trapped.

In other cases the IL field is not valid and is RES1.
- An instruction specific syndrome field, ISS. Architecturally, this field could be defined independently for each defined Exception class (EC), but in practice several ISS formats are common to more than one EC.

The format of the HSR depends on the value of the EC field, as follows:

0b000000 < EC ≤ 0b001100

The ISS part of the returned value includes the CV and COND fields described in [Encoding of ISS\[24:20\] when 0b000000 < EC ≤ 0b001100](#). Figure G4-17 shows the HSR format in this case.

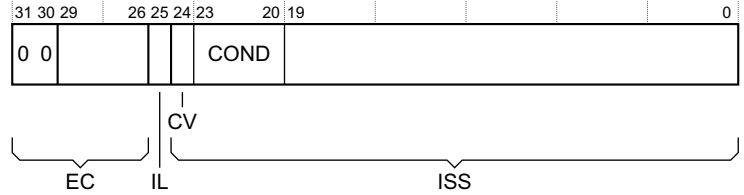

Figure G4-17 HSR format when the ISS includes CV and COND fields

EC == 0b000000 or EC 0b001100 There are no generic fields within the ISS. Figure G4-18 shows the HSR format in this case.

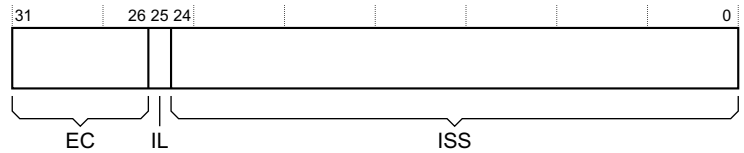

Figure G4-18 HSR format when the ISS does not include a COND field

Encoding of ISS[24:20] when 0b000000 < EC ≤ 0b001100

For EC values that are nonzero and less than or equal to 0b001100, ISS[24:20] provides the Condition code field for the trapped instruction, together with a valid flag for this field. The encoding of this part of the ISS field is:

- CV, ISS[24]** Condition code valid. Possible values of this bit are:
 - 0** The COND field is not valid.
 - 1** The COND field is valid

COND, ISS[23:20]

The Condition code for the trapped instruction. This field is valid only when CV is set to 1. If CV is set to 0, this field is UNK/SBZP.

The full descriptions of the HSR.ISS formats give more information about the CV field.

———— Note ————

In some circumstances, it is IMPLEMENTATION DEFINED whether a conditional instruction that fails its Condition code check generates an Undefined Instruction exception, see [Conditional execution of undefined instructions on page G1-4378](#).

HSR exception classes

Table G4-31 shows the encoding of the HSR exception class field, EC. Values of EC not shown in the table are reserved. For each EC value, the table references a subsection of the description of the HSR that describes the associated ISS format and gives information about the cause of the exception, for example the configuration required to enable the associated trap.

Table G4-31 HSR.EC field encoding

EC	Exception class	ISS description, or notes
0b000000	Unknown reason	<i>ISS encoding for exceptions with an unknown reason on page G6-4947.</i>
0b000001	Trapped WFI or WFE instruction	<i>ISS encoding for an exception from a WFI or WFE instruction on page G6-4948.</i>
0b000011	Trapped MCR or MRC access with (coproc==0b1111)	<i>ISS encoding for an exception from an MCR or MRC access on page G6-4949.</i>
0b000100	Trapped MCRR or MRRC access with (coproc==0b1111)	<i>ISS encoding for an exception from an MCRR or MRRC access on page G6-4951.</i>
0b000101	Trapped MCR or MRC access with (coproc==0b1110)	<i>ISS encoding for an exception from an MCR or MRC access on page G6-4949.</i>
0b000110	Trapped LDC or STC access	<i>ISS encoding for an exception from an LDC or STC instruction on page G6-4953.</i>
0b000111	Advanced SIMD or floating-point functionality trapped by a HCPTR. {TASE, TCP10} control	<i>ISS encoding for an exception from an access to SIMD or floating-point functionality, resulting from HCPTR on page G6-4955.</i>
0b001000	Trapped VMRS access, from ID group traps, that is not reported using EC 0b000111	<i>ISS encoding for an exception from an MCR or MRC access on page G6-4949.</i> This trap is not taken if the HCPTR settings trap the access.
0b001100	Trapped MRRC access with (coproc==0b1110)	<i>ISS encoding for an exception from an MCRR or MRRC access on page G6-4951.</i>
0b001110	Illegal exception return to AArch32 state	<i>ISS encoding for an exception from an Illegal state or PC alignment fault on page G6-4959.</i>
0b010001	Exception on SVC execution in AArch32 state routed to EL2	<i>ISS encoding for an exception from HVC or SVC instruction execution on page G6-4956.</i>
0b010010	HVC instruction execution in AArch32 state, when HVC is not disabled	
0b010011	Trapped execution of SMC instruction in AArch32 state	<i>ISS encoding for an exception from SMC instruction execution on page G6-4957.</i>
0b100000	Prefetch Abort from a lower Exception level	<i>ISS encoding for an exception from a Prefetch Abort on page G6-4958.</i>
0b100001	Prefetch Abort taken without a change in Exception level	
0b100010	PC alignment exception.	<i>ISS encoding for an exception from an Illegal state or PC alignment fault on page G6-4959.</i>
0b100100	Data Abort from a lower Exception level	<i>ISS encoding for an exception from a Data Abort on page G6-4960.</i>
0b100101	Data Abort taken without a change in Exception level	

All EC encodings not shown in Table G4-30 on page G4-4675 are reserved by ARM.

G4.12.6 Summary of register updates on exceptions taken to Hyp mode

For memory system faults that generate exceptions that are taken to Hyp mode, [Table G4-32](#) shows the registers affected by each fault. In this table:

- Yes indicates that the register is updated.
- UNK indicates that the fault makes the register value UNKNOWN.
- A null entry, -, indicates that the fault does not affect the register.

———— **Note** —————

For a list of the MMU faults see [MMU faults in AArch32 state on page G4-4657](#).

Table G4-32 Effect of an exception taken to Hyp mode on the reporting registers

Fault	HSR	HIFAR	HDFAR	HPFAR
Faults reported as Prefetch Abort exceptions:				
MMU fault ^a at stage 1.	Yes	Yes	UNK	UNK
Translation or Access flag MMU fault ^a at stage 2.	Yes	Yes	UNK	Yes
Other ^b MMU fault ^a at stage 2.	Yes	Yes	UNK	UNK
Stage 2 MMU fault ^a on a stage 1 translation.	Yes	Yes	UNK	Yes
Synchronous external abort on translation table walk.	Yes	Yes	UNK	UNK
Synchronous parity or ECC error on translation table walk.	Yes	Yes	UNK	UNK
Synchronous external abort.	Yes	IMP DEF ^c	UNK	UNK
Synchronous parity or ECC error on memory access.	Yes	Yes	UNK	UNK
Fault reported as Data Abort exception:				
MMU fault ^a at stage 1.	Yes	UNK	Yes	UNK
Translation or Access flag MMU fault ^a at stage 2.	Yes	UNK	Yes	Yes
Other ^b MMU fault ^a at stage 2.	Yes	UNK	Yes	UNK
Stage 2 MMU fault ^a on a stage 1 translation.	Yes	UNK	Yes	Yes
Synchronous external abort on translation table walk.	Yes	UNK	Yes	UNK
Synchronous parity or ECC error on translation table walk.	Yes	UNK	Yes	UNK
Synchronous external abort.	Yes	UNK	IMP DEF ^c	UNK
Synchronous parity or ECC error on memory access.	Yes	UNK	Yes	UNK
SError interrupt	Yes	UNK	UNK	UNK
SError interrupt from a parity or ECC error on memory access.	Yes	UNK	UNK	UNK
Debug exception:				
Breakpoint Instruction ^d , generates a Prefetch Abort exception.	Yes	UNK	-	UNK

Table G4-32 Effect of an exception taken to Hyp mode on the reporting registers (continued)

Fault	HSR	HIFAR	HDFAR	HPFAR
Debug exception routed to Hyp mode because HDCCR.TDE is set to 1. Generates a Hyp Trap exception.				
Breakpoint Breakpoint Instruction or Vector Catch	Yes	UNK	-	UNK
Watchpoint	Yes	-	Yes	UNK

- a. For more information see [Classification of MMU faults taken to Hyp mode](#)
- b. MMU fault other than a Translation fault or an Access flag fault.
- c. IMPLEMENTATION DEFINED. The FnV bit in the HSR.ISS field indicates whether the register holds a valid address. See [Fault address reporting on synchronous external aborts on page G4-4664](#).
- d. All other debug exceptions are not permitted in Hyp mode.

———— **Note** —————

Unlike [Table G4-28 on page G4-4672](#), the Hyp mode fault reporting table does not include an entry for a fault on an instruction cache maintenance instruction. That is because, when the fault is taken to Hyp mode, the reporting indicates the cause of the fault, for example a Translation fault, and ISS.CM is set to 1 to indicate that the fault was on a cache maintenance instruction, see [ISS encoding for an exception from a Data Abort on page G6-4960](#).

Classification of MMU faults taken to Hyp mode

This subsection gives more information about the MMU faults shown in [Table G4-32 on page G4-4680](#).

———— **Note** —————

All MMU faults are synchronous.

The table uses the following descriptions for MMU faults taken to Hyp mode:

MMU fault at stage 1

This is an MMU fault generated on a stage 1 translation performed in the Non-secure PL2 translation regime.

MMU fault at stage 2

This is an MMU fault generated on a stage 2 translation performed in the Non-secure PL1&0 translation regime.

As the table shows, for the faults in this group:

- Translation and Access flag faults update the [HPFAR](#)
- Permission faults leave the [HPFAR](#) UNKNOWN.

MMU stage 2 fault on a stage 1 translation

This is an MMU fault generated on the stage 2 translation of an address accessed in a stage 1 translation table walk performed in the Non-secure PL1&0 translation regime. For more information about these faults see [Stage 2 fault on a stage 1 translation table walk on page G4-4656](#).

[Figure G4-1 on page G4-4560](#) shows the different translation regimes and associated stages of translation.

G4.13 Address translation instructions

The System register encoding space includes encodings for instructions that either:

- Translate a *virtual address* (VA) to a *physical address* (PA).
- Translate a *virtual address* (VA) to an *intermediate physical address* (IPA).

[Address translation instructions, functional group on page G4-4737](#) summarizes these instructions.

When using the Short-descriptor translation table format, all translations performed by these instructions take account of TEX remap when this is enabled, see [Short-descriptor format memory region attributes, with TEX remap on page G4-4619](#).

An address translation instruction that executes successfully returns the output address, a PA or an IPA, in the PAR. This is a 64-bit register, that can hold addresses of up to 40 bits.

It is IMPLEMENTATION DEFINED whether the address translation instructions return the values held in a TLB or the result of a translation table walk. Therefore, ARM recommends that these instructions are not used at a time when the TLB entries might be different from the underlying translation tables held in memory.

The following sections give more information about these instructions:

- [Address translation instruction naming and operation summary](#).
- [Encoding and availability of the address translation instructions on page G4-4684](#).
- [Determining the PAR format on page G4-4686](#).
- [Handling of faults and aborts during an address translation instruction on page G4-4686](#).

G4.13.1 Address translation instruction naming and operation summary

Some older documentation uses the original names for the address translation instructions that were included in the original ARMv7 documentation. [Table G4-33](#) summarizes the instructions that are available in AArch32 state, and relates the old instruction names to the current names.

Table G4-33 Naming of address translation instructions

Name	Old name	Description
ATS1CPR , ATS1CPW , ATS1CUR , ATS1CUW	V2PCWPR, V2PCWPW, V2PCWUR, V2PCWUW	See ATS1C** , Address translation stage 1, current Security state on page G4-4683
ATS12NSOPR , ATS12NSOPW , ATS12NSOUR , ATS12NSOUW	V2POWPR, V2POWPW, V2POWUR, V2POWUW	See ATS12NSO** , Address translation stages 1 and 2, Non-secure state only on page G4-4683
ATS1HR , ATS1HW	Not applicable ^a	See ATS1H* , Address translation stage 1, Hyp mode on page G4-4684

a. Instructions are part of EL2 and have no equivalent in the older descriptions.

In an implementation that does not include EL2, there is no distinction between stage 1 translations and stage 1 and 2 combined translations.

For the *stage 1 current state* and *stages 1 and 2 Non-secure state only* instructions, the meanings of the last two letters of the names are:

PR	PL1 mode, read operation.
PW	PL1 mode, write operation.
UR	User mode, read operation.
UW	User mode, write operation.

———— **Note** —————

User mode can be described as the unprivileged mode. It is the only PL0 mode.

For the *stage 1 Hyp mode* instructions, the last letter of the instruction name is **R** for the read operation and **W** for the write operation.

See also [Encoding and availability of the address translation instructions on page G4-4684](#).

ATS1C**, Address translation stage 1, current Security state

Any VMSAv8-32 implementation supports the ATS1C** instructions. They can be executed by any software executing at PL1 or higher, in either Security state.

The ATS1C** instructions are [ATS1CPR](#), [ATS1CPW](#), [ATS1CUR](#), and [ATS1CUW](#) and, when [ARMv8.2-ATS1E1 is implemented](#), [ATS1CPRP](#) and [ATS1CPWP](#). These instructions perform the address translations of the PL1&0 translation regime.

In an implementation that includes EL2, when executed in Non-secure state, these instructions return the IPA that is the output address of the stage 1 translation. [Figure G4-1 on page G4-4560](#) shows the different translation regimes.

———— Note ————

The Non-secure PL1 and PL0 modes have no visibility of the stage 2 address translations, that can be defined only at PL2, and translate IPAs to be PAs.

See [Determining the PAR format on page G4-4686](#) for the format used when returning the result of these instructions.

ATS12NSO**, Address translation stages 1 and 2, Non-secure state only

A VMSAv8-32 implementation supports the ATS12NSO** instructions only if it includes EL2. In an implementation that includes EL2, in AArch32 state, they can be executed:

- By software executing in Non-secure state at EL2. This means by software executing in Hyp mode.
- If the implementation includes EL3, when EL3 is using AArch32, by software executing in Secure state at PL1.

The ATS12NSO** instructions are [ATS12NSOPR](#), [ATS12NSOPW](#), [ATS12NSOUR](#), and [ATS12NSOUW](#).

In an implementation that includes EL3, when EL3 is using AArch64 and EL1 is using AArch32, any execution of an ATS12NSO** instruction at Secure EL1 is trapped as an exception that is taken to EL3.

In an implementation that does not include EL2, but includes EL3, when EL3 is using AArch32 these instructions are not UNDEFINED but each instruction behaves in the same way as the equivalent [ATS1C**](#) instruction.

If an implementation does not include EL2 and does not include EL3 then these instructions are CONSTRAINED UNPREDICTABLE, with the permitted behavior that the instructions are UNDEFINED, see [Unallocated System register access instructions on page K1-6100](#).

ARM deprecates use of these instructions from any Secure PL1 mode other than Monitor mode.

In Secure state and in Non-secure Hyp mode these instructions perform the translations made by the Non-secure PL1&0 translation regime.

These instructions always return the PA and final attributes generated by the translation. That is, for an implementation that includes EL2, they return:

- The result of the two stages of address translation for the specified Non-secure input address.
- The memory attributes obtained by the combination of the stage 1 and stage 2 attributes.

———— **Note** —————

From Hyp mode, the **ATS1C**** and **ATS12NSO**** instructions both return the results of address translations that would be performed in the Non-secure modes other than Hyp mode. The difference is:

- The **ATS1C**** instructions return the Non-secure PL1 view of the associated address translation. That is, they return the IPA output address corresponding to the VA input address.
- The **ATS12NSO**** instructions return the EL2, or Hyp mode, view of the associated address translation. That is, they return the PA output address corresponding to the VA input address, generated by two stages of translation.

See [Determining the PAR format on page G4-4686](#) for the format used when returning the result of these instructions.

ATS1H*, Address translation stage 1, Hyp mode

A VMSAv8-32 implementation supports the **ATS1H*** instructions only if it includes EL2. They can be executed by:

- Software executing in Non-secure state at PL2. This means by software executing in Hyp mode.
- Software executing in Secure state in Monitor mode.

The **ATS1H*** instructions are **ATS1HR** and **ATS1HW**. In an implementation that includes EL3, these instructions are **CONSTRAINED UNPREDICTABLE** if executed in a Secure PL1 mode other than Monitor mode, see [Hyp mode VA to PA address translation instructions on page K1-6116](#).

If an implementation does not include EL2 then these instructions are **CONSTRAINED UNPREDICTABLE**, with the permitted behavior that the instructions are **UNDEFINED**, see [Unallocated System register access instructions on page K1-6100](#).

These instructions perform the translations made by the Non-secure EL2 translation regime. The instruction takes a VA input address and returns a PA output address.

These instructions always return a result in a 64-bit format **PAR**.

G4.13.2 Encoding and availability of the address translation instructions

Software executing at PL0 never has any visibility of the address translation instructions, but software executing at PL1 or higher can use the unprivileged address translation instructions to find the address translations used for memory accesses by software executing at PL0 and PL1.

———— **Note** —————

For information about translations when the stage of address translation is disabled see [The effects of disabling address translation stages on VMSAv8-32 behavior on page G4-4567](#).

[Table G4-34](#) shows the encodings for the address translation instructions, and their availability in different implementations in different PE modes and states.

Table G4-34 Address translation instructions in AArch32 state

opc1	CRm	opc2	Name	Type	Description
All VMSAv8-32 implementations, in all modes, at PL1 or higher, see ATS1C**, Address translation stage 1, current Security state on page G4-4683					

Table G4-34 Address translation instructions in AArch32 state (continued)

opc1	CRm	opc2	Name	Type	Description
0	c8	0	ATS1CPR	WO	PL1 stage 1 read translation, current state
		1	ATS1CPW	WO	PL1 stage 1 write translation, current state
		2	ATS1CUR	WO	Unprivileged stage 1 read translation, current state
		3	ATS1CUW	WO	Unprivileged stage 1 write translation, current state
c9	0	0	ATS1CPR^a	WO	PL1 stage 1 read translation, current state, PSTATE.PAN ^a
		1	ATS1CPW^a	WO	PL1 stage 1 write translation, current state, PSTATE.PAN ^a
Implementation includes EL2, in Non-secure Hyp mode and Secure PL1 modes, see ATS12NSO** , Address translation stages 1 and 2, Non-secure state only on page G4-4683					
0	c8	4	ATS12NSOPR	WO	Non-secure PL1 stage 1 and 2 read translation
		5	ATS12NSOPW	WO	Non-secure PL1 stage 1 and 2 write translation
		6	ATS12NSOUR	WO	Non-secure unprivileged stage 1 and 2 read translation
		7	ATS12NSOUW	WO	Non-secure unprivileged stage 1 and 2 write translation
Implementation includes EL2, in Non-secure Hyp mode and Secure Monitor mode, see ATS1H* , Address translation stage 1, Hyp mode on page G4-4684					
4	c8	0	ATS1HR	WO	Hyp mode stage 1 read translation
		1	ATS1HW	WO	Hyp mode stage 1 write translation

a. **Instruction only supported when ARMv8.2-ATS1E1 is implemented.**

The result of an instruction is always returned in the [PAR](#). The [PAR](#) is a RW register and:

- In all implementations, the 32-bit format [PAR](#) is accessed using an MCR or MRC instruction with CRn set to c7, CRm set to c4, and opc1 and opc2 both set to 0.
- The 64-bit format [PAR](#) is accessed using an MCRR or MRRC instruction with CRm set to c7, and opc1 set to 0.

Address translation instructions that are not available in a particular implementation are reserved and CONSTRAINED UNPREDICTABLE. For example:

- In an implementation that does not include EL2, the encodings with an opc1 value of 4 are reserved and CONSTRAINED UNPREDICTABLE. These are the [ATS1H*](#) instructions.
- In an implementation that does not include either EL2 or EL3, the encodings with opc2 values of 4-7 are reserved and CONSTRAINED UNPREDICTABLE. These are the [ATS12NSO**](#) instructions.

The CONSTRAINED UNPREDICTABLE behavior of these encodings is that they are UNDEFINED, see [Unallocated System register access instructions on page K1-6100](#).

G4.13.3 Determining the PAR format

The PAR is a 64-bit register, that supports both 32-bit and 64-bit PAR formats. This section describes how the PAR format is determined, for returning a result from each of the groups of address translation instructions. The returned result might be the translated address, or might indicate a fault on the translation, see *Handling of faults and aborts during an address translation instruction*.

ATSIC** instructions

Address translations for the current state. From modes other than Hyp mode:

- TTBCR.EAE determines whether the result is returned using the 32-bit or the 64-bit PAR format.
- If the implementation includes EL3, the translation performed is for the current Security state and, depending on that state:
 - The Secure or Non-secure TTBCR.EAE determines the PAR format.
 - The result is returned to the Secure or Non-secure instance of the PAR

Instructions executed in Hyp mode always return a result to the Non-secure PAR, using the 64-bit format.

ATS12NSO** instructions

Address translations for the Non-secure PL1 and PL0 modes. These instructions return a result using the 64-bit PAR format if at least one of the following is true:

- The Non-secure TTBCR.EAE bit is set to 1.
- The implementation includes EL2, and the value of HCR.VM is 1.

Otherwise, the instruction returns a result using the 32-bit PAR format.

Instructions executed in a Secure PL1 mode return a result to the Secure PAR. Instructions executed in Hyp mode return a result to the Non-secure PAR.

ATS1H* instructions

Address translations from Hyp mode. These instructions always return a result using the 64-bit PAR format.

Instructions executed in Secure Monitor mode return a result to the Secure PAR. Instructions executed in Non-secure Hyp mode return a result to the Non-secure PAR.

G4.13.4 Handling of faults and aborts during an address translation instruction

When a stage of address translation is enabled, any corresponding address translation instruction requires a translation table lookup, and this might require a translation table walk. However, the input address for the translation might be a faulting address, either because:

- The translation table entries used for the translation indicate a fault.
- A stage 2 fault or an external abort occurs on the required translation table walk.

VMSAv8-32 memory aborts on page G4-4649 describes the faults that might occur on a translation table walk in AArch32 state.

How the fault is handled, and whether it generates an exception, depends on the cause of the fault, as described in:

- *MMU fault on an address translation instruction*.
- *External abort during an address translation instruction on page G4-4687*.
- *Stage 2 fault on a current state address translation instruction on page G4-4688*.

MMU fault on an address translation instruction

In the following cases, an MMU fault on an address translation is reported in the PAR, and no abort is taken. This rule applies:

- To a faulting address translation instruction executed in Hyp mode, or in a Secure PL1 mode.

- To a faulting address translation instruction executed in a Non-secure PL1 mode, for cases where the fault would generate a stage 1 abort if it occurred on the equivalent load or store operation.

Using the PAR to report a fault on an address translation instruction gives more information about how these faults are reported.

Note

- The Domain fault encodings shown in [Table G4-26 on page G4-4670](#) are used only for reporting a fault on an address translation instruction that uses the 64-bit PAR format. That is, they are used only in an implementation that includes EL2, and are used for reporting a Domain fault on either:
 - An *ATS1C*** instruction executed in Hyp mode.
 - An *ATS12NSO*** instruction executed when the value of HCR.VM is 1.These encodings are never used for fault reporting in the *DFSR*, *IFSR*, or *HSR*.
- For an address translation instruction executed in a Non-secure PL1 mode, for a fault that would generate a stage 2 abort if it occurred on the equivalent load or store operation, the stage 2 abort is generated as described in *Stage 2 fault on a current state address translation instruction on page G4-4688*.

Using the PAR to report a fault on an address translation instruction

For a fault on an address translation instruction for which no abort is taken, the PAR is updated with the following information, to indicate the fault:

- The fault code, that would normally be written to the Fault status register. The code used depends on the current translation table format, as described in either:
 - *PL1 fault reporting with the Short-descriptor translation table format on page G4-4668*.
 - *PL1 fault reporting with the Long-descriptor translation table format on page G4-4670*.See also the Note at the start of *Determining the PAR format on page G4-4686* about the Domain fault encodings shown in [Table G4-26 on page G4-4670](#).
- A status bit, that indicates that the translation operation failed.

The fault does not update any Fault Address Register.

External abort during an address translation instruction

As stated in *External abort on a translation table walk on page G4-4659*, an external abort on a translation table walk generates a Data Abort exception. The abort can be synchronous or asynchronous, and behaves as follows:

Synchronous external abort on a translation table walk

The fault status and fault address registers of the Security state to which the abort is taken are updated. The fault status register indicates the appropriate external abort on a Translation fault, and the fault address register indicates the input address for the translation.

The PAR is UNKNOWN.

Asynchronous external abort on a translation table walk

The fault status register of the Security state to which the abort is taken is updated, to indicate the asynchronous external abort. No fault address registers are updated.

The PAR is UNKNOWN.

Stage 2 fault on a current state address translation instruction

If the PE is in a Non-secure PL1 mode and executes one of the [ATS1C**](#) instructions, then a fault in the stage 2 translation of an address accessed in a stage 1 translation table lookup generates an exception. This is equivalent to the case described in [Stage 2 fault on a stage 1 translation table walk](#) on page G4-4656. When this fault occurs on an [ATS1C**](#) address translation instruction:

- A Hyp Trap exception is taken to Hyp mode.
- The [PAR](#) is UNKNOWN.
- The [HSR](#) indicates that:
 - The fault occurred on a translation table walk.
 - The operation that faulted was a cache maintenance instruction.
- The [HPFAR](#) holds the IPA that faulted.
- The [HDFAR](#) holds the VA that the executing software supplied to the address translation instruction.

G4.14 About the System registers for VMSAv8-32

The System registers and System instructions that are accessible in AArch32 state are almost all in the encoding space described in *The AArch32 System register interface* on page G1-4408. This section gives general information about these registers, which comprise:

- Registers in the (coproc==0b1111) encoding space, that provide control and status information for the PE in Non-debug state.
- Registers in the (coproc==0b1110) encoding space, including:
 - Debug registers.
 - Trace registers.
 - Legacy execution environment registers.

VMSAv8-32 organization of registers in the (coproc==0b1110) encoding space on page G4-4704 summarizes the registers in the (coproc==0b1110) encoding space, and indicates where these registers are described, either in this manual or in other architecture specifications.

VMSAv8-32 organization of registers in the (coproc==0b1111) encoding space on page G4-4707 summarizes the registers in the (coproc==0b1111) encoding space, and indicates where in this manual these registers are described.

This section gives general information about the AArch32 System registers, and the conventions used in describing these registers.

———— Note —————

Many implementations include other interfaces to some System registers, for example a memory-mapped interface to some debug System registers. These are described in the appropriate sections of this manual.

This section is organized as follows:

- *About AArch32 System register accesses.*
- *Classification of System registers* on page G4-4692.
- *Synchronization of changes to AArch32 System registers* on page G6-4768.
- *Fixed values in register diagrams* on page G4-4701.
- *Principles of the ID scheme for fields in ID registers* on page G4-4701.

G4.14.1 About AArch32 System register accesses

The following subsections give more information about accesses to the AArch32 System registers:

- *Ordering of reads of System registers.*
- *Accessing 32-bit System registers* on page G4-4690.
- *Accessing 64-bit System registers* on page G4-4691.

Ordering of reads of System registers

Reads of the System registers can occur out of order with respect to earlier instructions executed on the same PE, provided that both:

- Any data dependencies between the instructions, as specified in *Synchronization of changes to AArch32 System registers* on page G6-4768, including read-after-read dependencies, are respected.
- The reads to the register do not occur earlier than the most recent *Context synchronization event* to its architectural position in the instruction stream.

———— Note —————

In particular, the values read from System registers that hold self-incrementing counts, such as the Performance Monitors counters or the Generic Timer counter or timers, could be accessed from any time after the previous *Context synchronization event*. For example, where a memory access is used to communicate a read of such

counters, an ISB must be inserted between the read of the memory location that is known to have returned its data, either as a result of a condition on that data or of the write being completed, and the read of the Generic Timer counter, if it is necessary that the Generic Timer counter returns a count value after the memory communication.

Accessing 32-bit System registers

Software accesses most 32-bit System registers using the generic MCR and MRC System register access instructions, specifying some or all of the parameters {coproc, CRn, opc1, CRm, opc2}, where:

coproc	Identifies the primary region of the System register encoding space. Takes one of the values: p14 Encoded as 0b1110. p15 Encoded as 0b1111.
CRn	Takes a value in the range c0-c15, encoded the corresponding 4-bit binary value, 0b0000-0b1111. In the (coproc==0b1110) encoding space, the opc1 value identifies the System register functional group, and CRn is the most significant identifier for the required register within that group. In the (coproc==0b1111) encoding space, CRn is the most significant identifier for the required register.
opc1	Takes a value in the range 0-7, encoded as its 3-bit binary value. In the (coproc==0b1110) encoding space, the opc1 value identifies the System register functional group, and can take the following values: 0 Debug System registers. 1 Trace System registers. 7 Legacy Jazelle System registers. In the (coproc==0b1111) encoding space, opc1 can take any value in the range 0-7.
CRm	Takes a value in the range c0-c15, encoded the corresponding 4-bit binary value, 0b0000-0b1111.
opc2	Takes a value in the range 0-7, encoded as its 3-bit binary value. opc2 is optional in the MCR and MRC instruction syntax, and if no value is specified the encoding defaults to 0b000.
Rt	A general-purpose register to hold a 32-bit value to transfer to or from the System register. Takes a value in the range R0-R14, encoded as the corresponding 4-bit binary value, 0b0000-0b1110.

This means an MCR or MRC access to a specific 32-bit System register uses:

- A unique combination of coproc, CRn, opc1, CRm, and opc2, to specify the required System register.
- A general-purpose register, Rt, for the transferred 32-bit value.

See also:

- [MCR on page F5-3249](#).
- [MRC on page F5-3271](#).

A small number of AArch32 debug System registers are accessed using LDC or STC instructions. In these cases, the register to be accessed is identified in the instruction syntax by the use of p14, c5 where:

p14	Identifies that the access is to the (coproc==0b1110) encoding space.
c5	Identifies the target debug System register.

See the instruction descriptions:

- [LDC \(immediate\) on page F5-3140](#).
- [LDC \(literal\) on page F5-3142](#).
- [STC on page F5-3478](#).

The only uses of LDC and STC permitted in ARMv8-A are:

- An LDC access to load data from memory to `DBGDTRTXint`, see [LDC \(immediate\) on page F5-3140](#) and [LDC \(literal\) on page F5-3142](#).
- An STC access to store data to memory from `DBGDTRRXint`, see [STC on page F5-3478](#).

A small number of AArch32 System registers are accessed using MRS, MSR, VMRS, or VMSR instructions, see the appropriate register and instruction description for more information, see:

- [MRS on page F5-3275](#).
- [MSR \(immediate\) on page F5-3285](#),
- [MSR \(register\) on page F5-3287](#).
- [VMRS on page F6-4017](#).
- [VMSR on page F6-4020](#).

Note

- For example:
 - The [APSR](#), [CPSR](#), and [SPSR](#) are accessed using MRS or MSR instructions.
 - The [MVFR0](#), [MVFR1](#), and [MVFR2](#) are accessed using VMRS or VMSR instructions.
 - In addition, the banked register forms of the MRS and MSR instructions can be used to access some System registers that are associated with PE modes other than the mode in which the PE is currently executing, see [MRS \(Banked register\) on page F5-3277](#) and [MSR \(Banked register\) on page F5-3281](#).
-

Accessing 64-bit System registers

Software accesses a 64-bit System register using the generic MCRR and MRRC System register access instructions, specifying the parameters {coproc, CRm, opc1}, where:

coproc	Identifies the primary region of the System register encoding space. Takes one of the values: p14 Encoded as 0b1110. p15 Encoded as 0b1111.
CRm	Takes a value in the range c0-c15, encoded the corresponding 4-bit binary value, 0b0000-0b1111. In the (coproc==0b1110) encoding space, the opc1 value identifies the System register functional group, and CRm is the most significant identifier for the required register within that group. In the (coproc==0b1111) encoding space, CRm is the most significant identifier for the required register.
opc1	Takes a value in the range 0-15, encoded as its 3-bit binary value. In the (coproc==0b1110) encoding space, the opc1 value identifies the System register functional group, and can take the following values: 0 Debug System registers. 1 Trace System registers. In the (coproc==0b1111) encoding space, opc1 can take any value in the range 0-15.
Rt	A general-purpose register to hold bits[31:0] of the value to transfer to or from the System register. Takes a value in the range R0-R14, encoded as the corresponding 4-bit binary value, 0b0000-0b1110.
Rt2	A general-purpose register to hold bits[63:32] of the value to transfer to or from the System register. Takes a value in the range R0-R14, encoded as the corresponding 4-bit binary value, 0b0000-0b1110.

This means an MCRR or MRRC access to a specific 64-bit System register uses:

- A unique combination of coproc, CRm and opc1, to specify the required 64-bit System register.
- Two general-purpose registers, each holding 32 bits of the value to transfer.

This means a PE can access a 64-bit System register using:

- An MCRR instruction to write to a System register, see [MCRR on page F5-3251](#).
- An MRRC instruction to read a System register, see [MRRC on page F5-3251](#).

When using an MCRR or MRRC instruction the System register access is 64-bit atomic.

Some 64-bit registers also have an MCR and MRC encoding. The MCR and MRC encodings for these registers access the least significant 32 bits of the register. For example, to access the [PAR](#), software can:

- Use the following instructions to access all 64 bits of the register:
MRRC p15, 0, <Rt>, <Rt2>, c7 ; Read 64-bit PAR into Rt (low word) and Rt2 (high word)
MCRR p15, 0, <Rt>, <Rt2>, c7 ; Write Rt (low word) and Rt2 (high word) to 64-bit PAR

- Use the following instructions to access the least significant 32 bits of the register:
 MRC p15, 0, <Rt>, c7, c4, 0 ; Read PAR[31:0] into Rt
 MCR p15, 0, <Rt>, c7, c4, 0 ; Write Rt to PAR[31:0]

G4.14.2 Classification of System registers

Features provided by EL3 and EL2 integrate with many features of the architecture. Therefore, the descriptions of the individual System registers include information about how these Exception levels affect the register. This section:

- Summarizes how EL3 and EL2 affect the implementation of the System registers, and the classification of those registers.
- Summarizes how EL3 controls access to the System registers.
- Describes an EL3 signal that can control access to some registers in the (coproc==0b1111) encoding space.

It contains the following subsections:

- [Banked System registers](#).
- [Restricted access System registers on page G4-4694](#).
- [Configurable access System registers on page G4-4694](#).
- [EL2-mode System registers on page G4-4695](#).
- [Common System registers on page G4-4698](#).
- [The CP15SDISABLE input signal on page G4-4699](#).
- [Access to registers from Monitor mode on page G4-4700](#).

———— Note ————

EL3 defines the register classifications of Banked, Restricted access, Configurable, and Common. EL2 defines the EL2-mode classification.

It is IMPLEMENTATION DEFINED whether each IMPLEMENTATION DEFINED register is Banked, Restricted access, Configurable, EL2-mode, or Common.

Banked System registers

In an implementation that includes EL3 using AArch32, some System registers are Banked. Banked System registers have two copies, one Secure and one Non-secure. The SCR.NS bit selects the Secure or Non-secure instance of the register. [Table G4-35](#) shows which registers in the (coproc==0b1111) encoding space are Banked in this way, and the permitted access to each register. No registers in the (coproc==0b1110) encoding space are Banked.

Table G4-35 Banked (coproc==0b1110) System registers

Banked register	Permitted accesses ^a
ACTLR , Auxiliary Control Register	Read/write only at PL1 or higher
ACTLR2 , Auxiliary Control Register 2	Read/write only at PL1 or higher.
ADFSR , Auxiliary Data Fault Status Register	Read/write only at PL1 or higher
AIFSR , Auxiliary Instruction Fault Status Register	Read/write only at PL1 or higher
AMAIR0 , Auxiliary Memory Attribute Indirection Register 0	Read/write only at PL1 or higher
AMAIR1 , Auxiliary Memory Attribute Indirection Register 1	Read/write only at PL1 or higher
CNTP_CTL , Counter-timer Physical Timer Control register	Read/write only at PL0 or higher ^b
CNTP_CVAL , Counter-timer Physical Timer CompareValue register	Read/write at PL0 or higher ^b
CNTP_TVAL , Counter-timer Physical Timer TimerValue register	Read/write at PL0 or higher ^b

Table G4-35 Banked (coproc==0b1110) System registers (continued)

Banked register	Permitted accesses^a
CONTEXTIDR , Context ID Register	Read/write only at PL1 or higher
CSSELR , Cache Size Selection Register	Read/write only at PL1 or higher
DACR , Domain Access Control Register	Read/write only at PL1 or higher
DFAR , Data Fault Address Register	Read/write only at PL1 or higher
DFSR , Data Fault Status Register	Read/write only at PL1 or higher
IFAR , Instruction Fault Address Register	Read/write only at PL1 or higher
IFSR , Instruction Fault Status Register	Read/write only at PL1 or higher
MAIR0 , Memory Attribute Indirection Register 0	Read/write only at PL1 or higher
MAIR1 , Memory Attribute Indirection Register 1	Read/write only at PL1 or higher
NMRR , Normal Memory Remap Register	Read/write only at PL1 or higher
PAR , Physical Address Register	Read/write only at PL1 or higher
PRRR , Primary Region Remap Register	Read/write only at PL1 or higher
SCTLR , System Control Register ^c	Read/write only at PL1 or higher
TPIDRPRW , EL1 only Thread ID	Read/write only at PL1 or higher
TPIDRURO , User Read-only Thread ID	Read-only at PL0 Read/write at PL1 or higher
TPIDRURW , User Read/Write Thread ID	Read/write at PL0 or higher
TTBCR , Translation Table Base Control	Read/write only at PL1 or higher
TTBCR2 , Translation Table Base Control 2	Read/write only at PL1 or higher
TTBR0 , Translation Table Base 0	Read/write only at PL1 or higher
TTBR1 , Translation Table Base 1	Read/write only at PL1 or higher
VBAR , Vector Base Address Register	Read/write only at PL1 or higher

- a. Any attempt to execute an access that is not permitted results in an Undefined Instruction exception.
- b. PL0 access is configurable, see the register description for more information.
- c. Some bits are common to the Secure and the Non-secure copies of the register, see [SCTLR, System Control Register](#) on page G6-5106.

A Banked System register can contain a mixture of:

- Fields that are Banked.
- Fields that are read-only in Non-secure PL1 or PL2 modes but read/write in the Secure state.

The System Control Register [SCTLR](#) is an example of a register of that contains this mixture of fields.

The Secure copies of the Banked System registers are sometimes referred to as the Secure Banked System registers. The Non-secure copies of the Banked System registers are sometimes referred to as the Non-secure Banked System registers.

Restricted access System registers

In an implementation that includes EL3, some System registers are present only in Secure state. These are called *Restricted access* registers, and their read/write access permissions are:

- In Non-secure state, software cannot modify Restricted access registers.
- For the **NSACR**, in Non-secure state:
 - Software running at PL1 or higher can read the register.
 - Unprivileged software, meaning software running at PL0, cannot read the register.

This means that Non-secure software running at PL1 or higher can read the access permissions for System registers that have Configurable access.

If EL3 is using AArch64 then any read of the **NSACR** from Non-secure EL2 using AArch32, or Non-secure EL1 using AArch32, returns the value `0x00000C00`.
- For all other Restricted access registers, Non-secure software cannot read the register.

In an implementation that does not include EL3:

- **SDER** is implemented only in Secure state.
- Any read of the **NSACR** returns the value `0x00000C00`.
- All other accesses to Restricted access System registers are UNDEFINED.

Table G4-36 shows the Restricted access System registers in the (coproc==0b1111) encoding space. There are no Restricted access registers in the (coproc==0b1110) encoding space.

Table G4-36 Restricted access (coproc==0b1111) System registers

Register	Permitted accesses ^a
SCR , Secure Configuration	Read/write in Secure PL1 modes
SDCR , Secure Debug Configuration Register	Read/write in Secure PL1 modes
SDER , Secure Debug Enable	Read/write in Secure PL1 modes
NSACR , Non-Secure Access Control	Read/write in Secure PL1 modes Read-only in Non-secure PL1 and PL2 modes
MVBAR , Monitor Vector Base Address	Read/write in Secure PL1 modes

a. Any attempt to execute an access that is not permitted results in an Undefined Instruction exception.

Configurable access System registers

Secure software can configure the access to some System registers. These registers are called Configurable access registers, and the control can be:

- A bit in the control register determines whether the register is:
 - Accessible from Secure state only.
 - Accessible from both Secure and Non-secure states.
- A bit in the control register changes the accessibility of a register bit or field. For example, setting a bit in the control register might mean that a RW field behaves as RAZ/WI when accessed from Non-secure state.

Bits in the **NSACR** control access.

In an AArch32 implementation that includes EL3:

- There are no Configurable access System registers in the (coproc==0b1110) encoding space.
- The only required Configurable access register in the (coproc==0b1111) encoding space is the **CPACR**.
- The following Advanced SIMD and floating point System registers are Configurable access:
 - Floating-point Status and Control Register, **FPSCR**

- Floating-point Exception register, [FPEXC](#).
- Floating-point System ID register, [FPSID](#).
- Media and VFP Feature Register 0, [MVFR0](#).
- Media and VFP Feature Register 1, [MVFR1](#).
- Media and VFP Feature Register 2, [MVFR2](#).

EL2-mode System registers

In an implementation that includes EL2, if EL2 can use AArch32, the implementation provides a number of registers for use in the EL2 mode, Hyp mode. As with other System register encodings, some of these register encodings provide write-only operations. When the implementation includes EL3 and EL3 is using AArch32, these registers are also accessible from Monitor mode when the value of [SCR.NS](#) is 1.

The following subsections describe the EL2-mode registers:

- [Hyp mode read/write registers in the \(coproc==0b1111\) encoding space](#).
- [Hyp mode encodings for shared \(coproc==0b1111\) System registers on page G4-4696](#).
- [Hyp mode \(coproc==0b1111\) write-only System instructions on page G4-4697](#).

There are no EL2-mode registers in the (coproc==0b1110) encoding space.

Hyp mode read/write registers in the (coproc==0b1111) encoding space

These registers are implemented only in Non-secure state, and in Non-secure state they are accessible only from Hyp mode.

Except for accesses to [CNTVOFF](#) in an implementation that includes EL3 but not EL2, the behavior of accesses to these registers is as follows:

- In Secure state, the registers can be accessed from EL3 when [SCR.NS](#) is set to 1, see [Access to registers from Monitor mode on page G4-4700](#).
- The following accesses are UNDEFINED:
 - Accesses from Non-secure PL1 modes.
 - Accesses in Secure state when [SCR.NS](#) is set to 0.

In an implementation that includes EL3 but not EL2, the behavior of accesses to [CNTVOFF](#) is as follows:

- Any access from Secure Monitor mode is CONSTRAINED UNPREDICTABLE, regardless of the value of [SCR.NS](#). The CONSTRAINED UNPREDICTABLE behavior is that the access is UNDEFINED, see [Unallocated System register access instructions on page K1-6100](#).
- All other accesses are UNDEFINED.

———— **Note** ————

Except for [CNTVOFF](#), the Hyp mode registers are part of EL2, meaning they are implemented only if the implementation includes EL2. However, conceptually, [CNTVOFF](#) is part of any implementation of the Generic Timer, see [Status of the CNTVOFF register on page G5-4757](#). This means the behavior of [CNTVOFF](#) in an implementation that does not include EL2 is not covered by the general definition of the behavior of the Hyp mode (coproc==0b1111) read/write registers.

Table G4-37 shows the Hyp mode read/write System registers, in the (coproc==0b1111) encoding space:

Table G4-37 Hyp mode (coproc==0b1111) read/write System registers

Register	Width	Permitted accesses ^a
VPIDR	32-bit	Read/write. In Non-secure state, accessible only from Hyp mode
VMPIDR	32-bit	Read/write. In Non-secure state, accessible only from Hyp mode
HSCTLR	32-bit	Read/write. In Non-secure state, accessible only from Hyp mode
HACTLR	32-bit	Read/write. In Non-secure state, accessible only from Hyp mode
HACTLR2	32-bit	Read/write. In Non-secure state, accessible only from Hyp mode.
HCR	32-bit	Read/write. In Non-secure state, accessible only from Hyp mode
HDCCR	32-bit	Read/write. In Non-secure state, accessible only from Hyp mode
HCPTR	32-bit	Read/write. In Non-secure state, accessible only from Hyp mode
HSTR	32-bit	Read/write. In Non-secure state, accessible only from Hyp mode
HACR	32-bit	Read/write. In Non-secure state, accessible only from Hyp mode
HTCR	32-bit	Read/write. In Non-secure state, accessible only from Hyp mode
VTCR	32-bit	Read/write. In Non-secure state, accessible only from Hyp mode
HTTBR	64-bit	Read/write. In Non-secure state, accessible only from Hyp mode
VTTBR	64-bit	Read/write. In Non-secure state, accessible only from Hyp mode
HADFSR	32-bit	Read/write. In Non-secure state, accessible only from Hyp mode
HAIFSR	32-bit	Read/write. In Non-secure state, accessible only from Hyp mode
HSR	32-bit	Read/write. In Non-secure state, accessible only from Hyp mode
HPFAR	32-bit	Read/write. In Non-secure state, accessible only from Hyp mode
HMAIR0	32-bit	Read/write. In Non-secure state, accessible only from Hyp mode
HMAIR1	32-bit	Read/write. In Non-secure state, accessible only from Hyp mode
HAMAIR0	32-bit	Read/write. In Non-secure state, accessible only from Hyp mode
HAMAIR1	32-bit	Read/write. In Non-secure state, accessible only from Hyp mode
HVBAR	32-bit	Read/write. In Non-secure state, accessible only from Hyp mode
HTPIDR	32-bit	Read/write. In Non-secure state, accessible only from Hyp mode
CNTVOFF ^b	64-bit	Read/write. In Non-secure state, accessible only from Hyp mode

a. Any attempt to execute an access that is not permitted results in an Undefined Instruction exception.

b. Implemented in any implementation of the Generic Timer. See, also, the Note earlier in this section.

Hyp mode encodings for shared (coproc==0b1111) System registers

Some Hyp mode registers share the Secure instance of an existing Banked register. In this case the implementation includes an encoding for the register that is accessible only in Hyp mode, or in Monitor mode when `SCR.NS` is set to 1.

For these registers, the following accesses are UNDEFINED:

- Accesses from Non-secure PL1 modes.
- Accesses in Secure state when `SCR.NS` is set to 0.

Table G4-38 lists the Hyp mode encodings for shared registers.

Table G4-38 Hyp mode (coproc==0b1111) System register encodings for shared registers

Register	Permitted accesses ^a	Shared register
HDFAR	Read/write. Accessible from Hyp mode, or from Monitor mode when <code>SCR.NS</code> is set to 1.	Secure DFAR
HIFAR	Read/write. Accessible from Hyp mode, or from Monitor mode when <code>SCR.NS</code> is set to 1.	Secure IFAR

a. Any attempt to execute an access that is not permitted results in an Undefined Instruction exception.

In Monitor mode, the Secure copies of these registers can be accessed either:

- Using the [DFAR](#) or [IFAR](#) encoding with `SCR.NS` set to 0.
- Using the [HDFAR](#) or [HIFAR](#) encoding with `SCR.NS` set to 1.

However, between accessing a register using one alias and accessing the register using the other alias, a *Context synchronization event* is required to ensure the ordering of the accesses.

Hyp mode (coproc==0b1111) write-only System instructions

Architecturally, these encodings are an extension of the Banked register encodings described in *Banked System registers on page G4-4692*, where:

- The implementation does not implement the operation in Secure state.
- In Non-secure state, the operation is accessible only at EL2, that is, only from Hyp mode.

In Secure state:

- These instructions can be accessed from Monitor mode regardless of the value of `SCR.NS`, see *Access to registers from Monitor mode on page G4-4700*.
- Accesses to these instructions are CONstrained UNPREDICTABLE if executed in a Secure mode other than Monitor mode, see *Hyp mode TLB maintenance instructions on page K1-6116* and *Hyp mode VA to PA address translation instructions on page K1-6116*.

Accesses to these instructions are UNDEFINED if accessed from a Non-secure PL1 mode.

Table G4-39 shows the EL2-mode write-only instructions in the (coproc==0b1111) encoding space:

Table G4-39 Hyp mode (coproc==0b1111) write-only System instructions

Register	Width	Permitted accesses ^a
ATS1HR	32-bit	Write-only. Accessible only from Hyp mode and Monitor mode
ATS1HW	32-bit	Write-only. Accessible only from Hyp mode and Monitor mode
TLBIALLHIS	32-bit	Write-only. Accessible only from Hyp mode and Monitor mode
TLBIMVAHIS	32-bit	Write-only. Accessible only from Hyp mode and Monitor mode
TLBIALLNSNHIS	32-bit	Write-only. Accessible only from Hyp mode and Monitor mode
TLBIALLH	32-bit	Write-only. Accessible only from Hyp mode and Monitor mode
TLBIMVAH	32-bit	Write-only. Accessible only from Hyp mode and Monitor mode
TLBIALLNSNH	32-bit	Write-only. Accessible only from Hyp mode and Monitor mode

- a. This section describes the behavior of write accesses that are not permitted. See also *Read-only and write-only register encodings* on page G6-4766.

Common System registers

Some System registers and operations are common to the Secure and Non-secure Security states. These are described as the *Common access* registers, or simply as the *Common* registers. These registers include:

- Read-only registers that hold configuration information.
- Register encodings used for various memory system operations, rather than to access registers.
- The *ISR*.
- All System registers in the (coproc==0b1110) encoding space.

Table G4-40 shows the Common System registers in the (coproc==0b1111) encoding space. These registers are not affected by whether EL3 is implemented.

Table G4-40 Common (coproc==0b1111) System registers

Register	Permitted accesses ^a
<i>MIDR</i> , Main ID Register	Read-only, only at EL1 or higher
<i>CTR</i> , Cache Type Register	Read-only, only at EL1 or higher
<i>TCMTR</i> , TCM Type Register ^b	Read-only, only at EL1 or higher
<i>TLBTR</i> , TLB Type Register ^b	Read-only, only at EL1 or higher
<i>MPIDR</i> , Multiprocessor Affinity Register	Read-only, only at EL1 or higher
<i>REVIDR</i> , Revision ID	Read-only, only at EL1 or higher
<i>ID_PFR0</i> , <i>ID_PFR1</i> , Processor Feature Registers	Read-only, only at EL1 or higher
<i>ID_DFR0</i> , Debug Feature Register 0	Read-only, only at EL1 or higher
<i>ID_AFR0</i> , Auxiliary Feature Register 0	Read-only, only at EL1 or higher
<i>ID_MMFR0</i> - <i>ID_MMFR4</i> , Memory Model Feature Registers	Read-only, only at EL1 or higher
<i>ID_ISAR0</i> - <i>ID_ISAR5</i> , Instruction Set Attribute Registers	Read-only, only at EL1 or higher
<i>CCSIDR</i> , Cache Size ID Register	Read-only, only at EL1 or higher
<i>CLIDR</i> , Cache Level ID Register	Read-only, only at EL1 or higher
<i>AIDR</i> , Auxiliary ID Register ^b	Read-only, only at EL1 or higher
<i>FCSEIDR</i> , FCSE PID Register	Read/write, only at EL1 or higher
Cache and branch predictor maintenance instruction	See <i>Cache maintenance instructions, functional group</i> on page G4-4734
Address translation instructions	See <i>Address translation instructions, functional group</i> on page G4-4737
<i>CP15DMB</i> , <i>CP15DSB</i> , <i>CP15ISB</i> memory barrier operations ^c	Write-only at all privilege levels, including EL0
TLB maintenance instructions	Write-only, only at EL1 or higher, see <i>TLB maintenance instructions, functional group</i> on page G4-4735
Performance monitors	See <i>Access permissions</i> on page D5-2176
<i>ISR</i> , Interrupt Status Register	Read-only, only at EL1 or higher

- a. Any attempt to execute an access that is not permitted results in an Undefined Instruction exception.
- b. Register or operation details are IMPLEMENTATION DEFINED.
- c. For performance reasons, ARM deprecates any use of these memory barrier operations.

Secure System registers for the (coproc==0b1111) encoding space

The Secure System registers in the (coproc==0b1111) encoding space comprise:

- The Secure copies of the Banked System registers in the (coproc==0b1111) encoding space.
- The Restricted access System registers in the (coproc==0b1111) encoding space.
- The Configurable access System registers in the (coproc==0b1111) encoding space that are configured to be accessible only from Secure state.

In an implementation that includes EL3, the Non-secure System registers are the System registers other than the Secure System registers.

The CP15SDISABLE input signal

When EL3 is using AArch32, it provides an input signal, **CP15SDISABLE**, that disables write access to some of the Secure registers when asserted HIGH. The **CP15SDISABLE** signal has no effect on:

- Register accesses from AArch64 state.
- Register accesses from Secure EL1 when EL3 is using AArch64 and EL1 is using AArch32.

————— **Note** —————

When EL3 is using AArch32, the interaction between **CP15SDISABLE** and any IMPLEMENTATION DEFINED register is IMPLEMENTATION DEFINED.

Table G4-41 shows the registers and operations affected.

Table G4-41 Secure registers affected by CP15SDISABLE

Register name	Affected operation
SCTLR, System Control Register	MCR p15, 0, <Rt>, c1, c0, 0
TTBR0, Translation Table Base Register 0	MCR p15, 0, <Rt>, c2, c0, 0
TTBCR, Translation Table Base Control Register	MCR p15, 0, <Rt>, c2, c0, 2
TTBCR2, Translation Table Base Control Register 2	MCR p15, 0, <Rt>, c2, c0, 3
DACR, Domain Access Control Register	MCR p15, 0, <Rt>, c3, c0, 0
PRRR, Primary Region Remap Register	MCR p15, 0, <Rt>, c10, c2, 0
NMRR, Normal Memory Remap Register	MCR p15, 0, <Rt>, c10, c2, 1
AMAIR0, Auxiliary Memory Attribute Indirection Register 0	MCR p15, 0, <Rt>, c10, c3, 0
AMAIR1, Auxiliary Memory Attribute Indirection Register 1	MCR p15, 0, <Rt>, c10, c3, 1
VBAR, Vector Base Address Register	MCR p15, 0, <Rt>, c12, c0, 0
MVBAR, Monitor Vector Base Address Register	MCR p15, 0, <Rt>, c12, c0, 1

On a reset by the external system that resets the PE into EL3 using AArch32, the **CP15SDISABLE** input signal must be taken LOW. This permits the Reset code to set up the configuration of EL3 features. When the input is asserted HIGH, any attempt to write to the Secure registers shown in [Table G4-41 on page G4-4699](#) results in an Undefined Instruction exception.

The **CP15SDISABLE** input does not affect reading Secure registers, or reading or writing Non-secure registers. It is IMPLEMENTATION DEFINED how the input is changed and when changes to this input are reflected in the PE, and an implementation might not provide any mechanism for driving the **CP15SDISABLE** input HIGH. However, in an implementation in which the **CP15SDISABLE** input can be driven HIGH, changes in the state of **CP15SDISABLE** must be reflected as quickly as possible. Any change must occur before completion of an Instruction Synchronization Barrier operation, issued after the change, is visible to the PE with respect to instruction execution boundaries. Software must perform an Instruction Synchronization Barrier operation meeting the above conditions to ensure all subsequent instructions are affected by the change to **CP15SDISABLE**.

When EL3 is using AArch32, use of **CP15SDISABLE** means key Secure features that are accessible only at PL1 can be locked in a known state. This provides an additional level of overall system security. ARM expects control of **CP15SDISABLE** to reside in the system, in a block dedicated to security.

Access to registers from Monitor mode

When the PE is in Monitor mode, the PE is in Secure state regardless of the value of the **SCR.NS** bit. In Monitor mode, the **SCR.NS** bit determines whether, for System registers in the (coproc==0b1111) encoding space, valid uses of the MRC, MCR, MRRC and MCRR instructions access the Secure Banked System registers or the Non-secure Banked System registers. That is, when:

NS == 0 Common, Restricted access, and Secure Banked System registers are accessed by MRC, MCR, MRRC and MCRR instructions that target the (coproc==0b1111) encoding space.

If the implementation includes EL2, the registers listed in [Hyp mode read/write registers in the \(coproc==0b1111\) encoding space on page G4-4695](#) and [Hyp mode encodings for shared \(coproc==0b1111\) System registers on page G4-4696](#) are not accessible, and any attempt to access them generates an Undefined Instruction exception.

———— **Note** ————

The operations listed in [Hyp mode \(coproc==0b1111\) write-only System instructions on page G4-4697](#) are accessible in Monitor mode regardless of the value of **SCR.NS**.

System instructions in the (coproc==0b1111) encoding space use the Security state to determine all resources used, that is, all operations performed by these instructions are performed in Secure state.

NS == 1 Common, Restricted access and Non-secure Banked System registers are accessed by MRC, MCR, MRRC and MCRR instructions that target the (coproc==0b1111) encoding space.

If the implementation includes EL2, all the registers and operations listed in the subsections of [EL2-mode System registers on page G4-4695](#) are accessible, using the MRC, MCR, MRRC, or MCRR instructions required to access them from Hyp mode.

System instructions in the (coproc==0b1111) encoding space use the Security state to determine all resources used, that is, all operations by these instructions are performed in Secure state.

The Security state determines whether the Secure or Non-secure Banked registers determine the control state.

———— **Note** ————

Where the contents of a register select the value accessed by an MRC or MCR access to a different register, then the register that is used for selection is being used as control state. For example, **CSSELR** selects the current **CCSIDR**, and therefore **CSSELR** is used as control state. Therefore, in Monitor mode:

- **SCR.NS** determines whether the Secure or Non-secure **CSSELR** is accessible.
- Because the PE is in Secure state, the Secure **CSSELR** selects the current **CCSIDR**.

G4.14.3 Fixed values in register diagrams

In register diagrams, a fixed bit can be indicated by one of 0, (0), 1, or (1), with the following meanings:

- 0** In any implementation:
 - The bit must read as 0.
 - Writes to the bit must be ignored.
 - Software:
 - Can rely on the bit reading as 0.
 - Must use an SBZP policy to write to the bit.
- (0)** The bit should-be-zero. In AArch32 state there are a small number of cases where a bit is (0) in some contexts, and has a different defined behavior in other contexts. See [RES0](#).
- 1** In any implementation:
 - The bit must read as 1.
 - Writes to the bit must be ignored.
 - Software:
 - Can rely on the bit reading as 1.
 - Must use an SBOP policy to write to the bit.
- (1)** The bit is should-be-one. In AArch32 state there are a small number of cases where a bit is (1) in some contexts, and has a different defined behavior in other contexts. See [RES1](#).

———— **Note** —————

In register diagrams, (0) is a synonym for RES0, and (1) is a synonym for RES1, where RES0 and RES1 are defined in the [Glossary](#). However, when used in an instruction encoding diagram, (0) and (1) have the narrower definition that behavior is UNPREDICTABLE or CONSTRAINED UNPREDICTABLE if either:

- A bit marked as (0) has the value 1.
- A bit marked as (1) has the value 0.

—————

G4.14.4 Principles of the ID scheme for fields in ID registers

The ARM architecture specifies a number of *ID registers* that are characterized as comprising a set of 4-bit *ID fields*. Each ID field identifies the presence, and possibly the level of support for, a particular feature in an implementation of the architecture. These fields follow an architectural model that aids their use by software and provides future compatibility. This section describes that model. [AArch32 ID registers to which this scheme applies on page G4-4702](#) identifies the set of ID registers that are accessible from AArch32 state.

———— **Note** —————

These fields are distinct from register fields that enumerate the number of resources, such as the number of breakpoints, watchpoints, or performance monitors, or the amount of memory.

—————

———— **Note** —————

The presence of an ID register field for a feature does not imply that the feature is optional.

—————

To provide forward compatibility, software can rely on the features of these fields that are described in this section.

The ID fields, which are either signed or unsigned, use increasing numerical values to indicate increases in functionality. Therefore, if a value of 0x1 indicates the presence of some instructions, then the value 0x2 will indicate the presence of those instructions plus some additional instructions or functionality. This means software can be written in the form:

```
if (value >= number) {
    // do something that relies on the value of the feature
}
```

For ID fields where the value 0x0 defines that a feature is not present, the field holds an unsigned value. This covers the vast majority of such fields.

In a few cases, the architecture has been changed to permit implementations to exclude a feature that has previously been required and for which no ID field has been defined. In these cases, a new ID field is defined and:

- The field holds a signed value.
- The field value 0xF indicates that the feature is not implemented.
- The field value 0x0 indicates that the feature is implemented.
- Software that depends on the feature can use the test:

```
if value >= 0 {  
    // Software features that depend on the presence of the hardware feature  
}
```

In some cases, it has been decided retrospectively that the increase in functionality between two consecutive numerical values is too great, and it is desirable to permit an intermediate degree of functionality, and the means to discover this. This is done by the introduction of a *fractional* field that both:

- Is referred to in the definition of the original field.
- Applies only when the original field is at the lower value of the step.

In principle a fractional field can be used for two different fractional steps, with different meanings associated with each of these steps. For this reason, a fractional field must be interpreted in the context of the field to which it relates and the value of that field. [Example G4-6](#) shows the use of such a field.

Example G4-6 Example of the use of a fractional field

For a field describing some class of functionality:

- The value 0x1 was defined as indicating that item A is present.
- The value 0x2 was defined as indicating that items B and C are present, in addition to item A.

Subsequently, it might be necessary to introduce a second ID field to indicate that A and B only are present. This new field is a fractional field, and might be defined as having the value 0x1 when A and B only are present. This fractional field is valid only when the original ID field has the value 0x1.

This approach means that:

- Software that depends on the test if (value >= 0x2) can rely on features A, B, and C being present,
- Software that depends on the test if (value >= 0x1) can rely on feature A being present.
- If new software needs to check only that features A and B are present then it can test:

```
if (value >= 0x2 || (value == 0x1 && fractional_value >= 0x1)) {  
    // Software features that depend on A and B only  
}
```

A fractional field uses the same approach of increasing numerical values indicating increasing functionality, and the fractional approach can also be applied recursively to fractional fields.

Unused ID fields, and fractional fields that are not applicable, are RES0 to allow their future use when features, or fractional implementation options, are added.

AArch32 ID registers to which this scheme applies

This scheme applies to the following AArch32 system registers:

- The Auxiliary Feature register [ID_AFR0](#).
- The Processor Feature registers [ID_PFR0](#) and [ID_PFR1](#).
- The Debug Feature register [ID_DFR0](#).
- The Memory Model Feature registers [ID_MMFR0](#), [ID_MMFR1](#), [ID_MMFR2](#), [ID_MMFR3](#), and [ID_MMFR4](#).

- The Instruction Set Attribute registers [ID_ISAR0](#), [ID_ISAR1](#), [ID_ISAR2](#), [ID_ISAR3](#), [ID_ISAR4](#), and [ID_ISAR5](#).
- The Media and VFP Feature registers [MVFR0](#), [MVFR1](#), and [MVFR2](#).

———— **Note** —————

Principles of the ID scheme for fields in ID registers on page D7-2195 includes information about the AArch64 System registers and the memory-mapped registers to which this scheme applies.

G4.15 VMSAv8-32 organization of registers in the (coproc==0b1110) encoding space

The System registers in the (coproc==0b1110) encoding space provide a number of distinct control functions, covering:

- Debug.
- Trace.
- Execution environment control, for identification of the trivial Jazelle implementation.

Because these functions are distinct, the descriptions of these registers are distributed, as follows:

- In this manual [Debug registers on page G6-5239](#) describes the Debug registers.
- [The Embedded Trace Macrocell Architecture Specification](#) describes the Trace registers.

This section summarizes the allocation of the System registers in the (coproc==0b1110) encoding space between these different functions, and the register encodings in this space that are reserved.

The 32-bit System register encodings are classified by the {opc1, CRn, opc2, CRm} values required to access them using an MCR or an MRC instruction. The 64-bit System register encodings are classified by the {opc1, CRm} values required to access them using an MCRR or an MRRC instruction. For the registers in the (coproc==0b1110) encoding space, the opc1 value determines the primary allocation of these registers, as follows:

opc1==0 Debug registers.

opc1==1 Trace registers.

opc1==7 Jazelle registers. Jazelle registers are implemented as required for a trivial Jazelle implementation.

Other opc1 values

Reserved.

———— Note ————

Primary allocation of (coproc==0b1110) register function by opc1 value differs from the allocation of (coproc==0b1111) registers, where primary allocation is by CRn value for 32-bit register accesses, or CRm value for 64-bit register accesses.

For the Debug and Jazelle registers, [Table G4-42 on page G4-4705](#) defines:

- The {opc1, CRn, opc2, CRm} values used for accessing the 32-bit registers using the MRC and MCR instructions.
- The {opc1, CRm} values used for accessing the 64-bit register using the MRRC instruction.

Some Debug registers can also be accessed using the LDC and STC instructions. [Table G4-43 on page G4-4706](#) defines the CRn values used for accessing the registers using these instructions.

———— Note ————

The only permitted uses of the LDC and STC instructions are:

- An LDC access to load data from memory to [DBGDTRXint](#).
- An STC access to store data to memory from [DBGDTRRXint](#).

In the LDC and STC syntax descriptions in this Manual, the required coproc value of p14 and CRn value of c5 are given explicitly.

G4.15.1 Register access instruction arguments, (coproc==0b1110) registers

Table G4-42 shows the MCR, MRC, and MRRC instruction arguments required for accesses to each register that can be visible in the System register interface in the (coproc==0b1110) encoding.

Table G4-42 Mapping of (coproc==0b1110) MCR, MRC, and MRRC instruction arguments to System registers

opc1	CRn	opc2	CRm	Name	Width	Description		
0	c0	0	c0	DBGDIDR	32-bit	Debug ID, or unallocated ^a		
			c1	DBGDSCRint	32-bit	Debug Status and Control Register, Internal View		
			c2	DBGDCCINT	32-bit	DCC Interrupt Enable Register		
			c5	DBGDTRRXint	32-bit	Debug Data Transfer Register, Receive, Internal View		
			c5	DBGDTRTXint	32-bit	Debug Data Transfer Register, Transmit, Internal View		
			c6	-	32-bit	Legacy DBGWFAR , RES0		
			c7	DBGVCR	32-bit	Debug Vector Catch Register		
	2	c0	-	c0	DBGDTRRXext	32-bit	Debug Data Transfer Register, Receive, External View	
				c2	DBGDSCRExt	32-bit	Debug Status and Control Register, External View	
				c3	DBGDTRTXext	32-bit	Debug Data Transfer Register, Transmit, External View	
				c6	DBGOSECCR	32-bit	Debug OS Lock Exception Catch Register	
				4	c0-15 ^b	DBGBVR<n>	32-bit	Debug Breakpoint Value Registers, n = 0-15
				5	c0-15 ^b	DBGBCR<n>	32-bit	Debug Breakpoint Control Registers, n = 0-15
				6	c0-15 ^b	DBGWVR<n>	32-bit	Debug Watchpoint Value Registers, n = 0-15
7	c0-15 ^b	DBGWCR<n>	32-bit	Debug Watchpoint Control Registers, n = 0-15				
c1	0	c0	c0	DBGDRAR	32-bit	Debug ROM Address Register		
			c1	-	64-bit	-		
c1	1	4	c0-15 ^b	DBGBXVR<n>	32-bit	Debug Breakpoint Extended Value Registers n = 0-15		
			c0	DBGOSLAR	32-bit	Debug OS Lock Access Register		
			c1	DBGOSLSR	32-bit	Debug OS Lock Status Register		
			c3	DBGOSDLR	32-bit	Debug OS Double Lock Register		
			c4	DBGPRCR	32-bit	Debug Power Control Register		
c2	0	c0	c0	DBGDSAR	32-bit	Debug Self Address Register or unallocated ^a		
			c2	-	64-bit	-		
c4	0-3	c0-15	-	-	-	IMPLEMENTATION DEFINED		

Table G4-42 Mapping of (coproc==0b1110) MCR, MRC, and MRRC instruction arguments to System registers (continued)

opc1	CRn	opc2	CRm	Name	Width	Description
0	c7	6	c8	DBGCLAIMSET	32-bit	Debug CLAIM Tag Set register
			c9	DBGCLAIMCLR	32-bit	Debug CLAIM Tag Clear register
			c14	DBGAUTHSTATUS	32-bit	Debug Authentication Status register
	7		c0	DBGDEVID2	32-bit	Debug Device ID register 2
			c1	DBGDEVID1	32-bit	Debug Device ID register 1
			c2	DBGDEVID	32-bit	Debug Device ID register
1	c0-c7	0-7	c0-c15	-	32-bit	Reserved for OPTIONAL Trace extension
7	c0	0	c0	JIDR	32-bit	Jazelle ID Register ^c
	c1	0	c0	JOSCR	32-bit	Jazelle OS Control Register ^c
	c2	0	c0	JMCR	32-bit	Jazelle Main Configuration Register ^c
All other encodings				-	32-bit	Unallocated

- a. If EL1 cannot use AArch32 this register is OPTIONAL and deprecated. See the register description for details.
- b. Not implemented breakpoint and watchpoint register access instructions are unallocated. If EL2 is not implemented or breakpoint *n* is not context-aware, [DBGXVR<n>](#) is unallocated. CRm encodes <*n*>, the breakpoint or watchpoint number.
- c. Legacy register, see [Legacy feature registers, functional group on page G4-4744](#).

[Table G4-43](#) shows the LDC and STC instruction arguments required for accesses to the Debug registers that can be accessed using these instructions.

Table G4-43 Mapping of LDC and STC instruction arguments to System registers

CRn	Instruction	Name	Width	Description
c5	LDC	DBGDTRTXint	32-bit	Debug Data Transfer Register, Transmit, Internal View
c5	STC	DBGDTRRXint	32-bit	Debug Data Transfer Register, Receive, Internal View

———— **Note** —————

In the instruction syntax descriptions for the LDC and STC instructions, the required coproc and CRn values are given explicitly as coproc==p14, CRn==c5.

G4.16 VMSAv8-32 organization of registers in the (coproc==0b1111) encoding space

For 32-bit accesses to the System registers in the (coproc==0b1111) encoding space, the ordered set of parameters {CRn, opc1, CRm, opc2} determine the register order. Within this ordering, the CRn value originally provided a functional grouping of these registers. As the number of System registers has increased this ordering has become less appropriate.

This document now:

- Groups the ARMv8.0 System registers in the (coproc==0b1111) encoding space by functional group, see [Functional grouping of VMSAv8-32 System registers on page G4-4726](#).
- Describes all of the ARMv8.0 System registers for VMSAv8-32, in [Chapter G6 AArch32 System Register Descriptions](#).
- Gives additional information about the organization of the VMSAv8-32 System registers in the (coproc==0b1111) encoding space, in the remainder of this section.

Note

Not all System registers introduced by architectural extensions to ARMv8.0 are described in [Chapter G6 AArch32 System Register Descriptions](#). For information about the System registers introduced by architectural extensions to ARMv8.0, see [ARMv8 architecture extensions on page A1-55](#).

This section presents information as follows:

Register ordering by {CRn, opc1, CRm, opc2}

See:

- [System register summary for \(coproc==0b1111\) encodings by CRn value on page G4-4708](#).
- [Full list of VMSAv8-32 System registers in the \(coproc==0b1111\) encoding space on page G4-4710](#).

Note

The ordered listing of (coproc==0b1111) registers by the {CRn, opc1, CRm, opc2} encoding of the 32-bit registers is most likely to be useful to those implementing AArch32 state, and to those validating such implementations. However, otherwise, the grouping of registers by function is more logical.

Views of the registers, that depend on the current state of the PE

See [AArch32 views of the System registers in the \(coproc==0b1111\) encoding space on page G4-4723](#).

Note

The different register views are particularly significant in implementations that include EL2.

In addition, the indexes in [Appendix K11 Registers Index](#) include all of the System registers.

G4.16.1 System register summary for (coproc==0b1111) encodings by CRn value

Figure G4-19 summarizes the grouping of the System registers in the (coproc==0b1111) encoding space, for a VMSAv8-32 implementation, by the value of CRn used for a 32-bit access to the register.

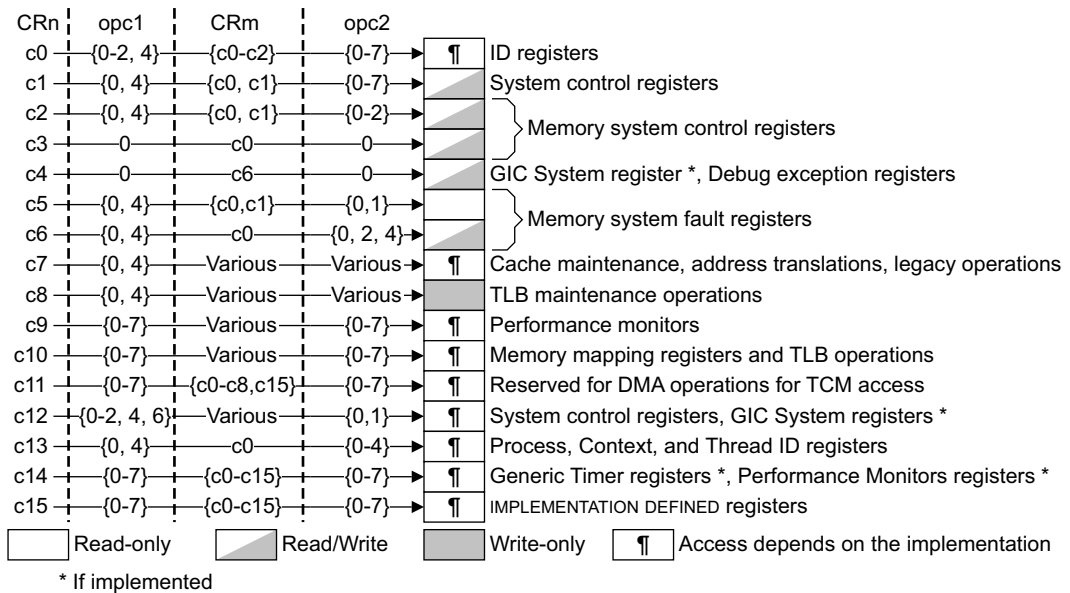

Figure G4-19 System register groupings for (coproc==0b1111), for 32-bit registers

Note

For the System registers in the (coproc==0b1111) encoding space, Figure G4-19 gives only an overview of the assigned encodings for 32-bit registers for each of the CRn values c0-c15. For more information, see:

- The full list of registers in the (coproc==0b1111) encoding space, in *Full list of VMSAv8-32 System registers in the (coproc==0b1111) encoding space* on page G4-4710, for the definition of the assigned and unassigned encodings for that register.
- The register definitions in *Chapter G6 AArch32 System Register Descriptions* for any dependencies on the implemented Exception levels.

In general, System register accesses using an unallocated set of {CRn, opc1, CRm, opc2} values are UNDEFINED. *Behavior of VMSAv8-32 32-bit System registers with (coproc==0b1111, CRn==c0)* on page G4-4709 described the only exceptions to this rule.

The 32-bit System registers with (coproc==0b1111, CRn==c15), and the corresponding 64-bit System registers, are reserved for implementation defined registers. For more information see *Reserved encodings in the VMSAv8-32 System register (coproc==0b1111) space* on page G4-4709.

The HSTR.Tn trap on (coproc==0b1111) System registers

As *General trapping to Hyp mode of Non-secure EL0 and EL1 accesses to System registers in the (coproc==0b1111) encoding space* on page G1-4440 describes, when the value of HSTR.Tn is 1, Non-secure PL1 accesses to System registers in the (coproc==0b1111) encoding space using a CRn or CRm value that corresponds to the value of Tn are trapped to PL2, even if the encoding is UNDEFINED when the value of HSTR.Tn is 0. This rule applies:

- For 32 bit register accesses when the value of Rn in the MCR or MRC instruction corresponds to Tn.
- For 64 bit register accesses when the value of Rm in the MCRR or MRRC instruction corresponds to Tn.

If there are matching System register encodings that are accessible from Non-secure PL0 then those accesses are also trapped to PL2 when the value of HSTR.Tn is 1.

Behavior of VMSAv8-32 32-bit System registers with (coproc==0b1111, CRn==c0)

In the (coproc==0b1111) encoding space, the 32-bit System registers with (CRn==c0) provide device and feature identification. That is, they provide registers in the functional group described in *Identification registers, functional group* on page G4-4727.

Table G4-44 on page G4-4711 shows all of the architecturally required System registers with {coproc==0b1111, CRn==c0}. The behavior of 32-bit System register encodings in this group that are not shown in the table, and encodings that are part of an unimplemented Exception level, depends on the value of opc1, and possibly on the value of CRm and opc2, as follows:

- opc1 == 0 All write accesses to the encodings are UNDEFINED.
For read accesses:
- The following encodings return an UNKNOWN value:
 - CRm==3, opc2=={0, 1, 2}.
 - CRm=={4, 6, 7}, opc2=={0, 1}.
 - CRm==5, opc2=={0, 1, 4, 5}.
 - All other encodings are RES0.
- opc1 > 0 All accesses to the encodings are UNDEFINED.

See also *Accesses to unallocated encodings in the (coproc==0b111x) encoding space* on page G6-4765.

———— Note ————

Some of these registers were previously described as being part of the CPUID identification scheme, see *The CPUID identification scheme* on page G4-4728.

Reserved encodings in the VMSAv8-32 System register (coproc==0b1111) space

AArch32 state reserves a number of regions in the (coproc==0b1111) encoding space for IMPLEMENTATION DEFINED System registers. These reservations are defined in terms of the encoding of 32-bit accesses to the System register encoding space. That is, they are defined by the reserved 32-bit {CRn, opc1, CRm, opc2} encodings.

In ARMv8, reserved encodings that do not have an IMPLEMENTATION DEFINED function are UNDEFINED.

The following subsections give more information about these reserved encodings:

- Reserved 32-bit encodings with {coproc==0b1111, CRn==c9}.*
- Reserved 32-bit encodings with {coproc==0b1111, CRn==c10} on page G4-4710.*
- Reserved 32-bit encodings with {coproc==0b1111, CRn==c11} on page G4-4710.*
- Reserved 32-bit encodings with {coproc==0b1111, CRn==c15} on page G4-4710.*

Reserved 32-bit encodings with {coproc==0b1111, CRn==c9}

In the AArch32 encoding space, for 32-bit encodings with {coproc==0b1111, CRn==c9}, the following encodings are reserved for IMPLEMENTATION DEFINED purposes:

- Encodings with {coproc==0b1111, CRn==c9, opc=={0-7}, CRm=={c0-c2, c5-c8}} are reserved for IMPLEMENTATION DEFINED branch predictor, cache, and TCM operations.
- Encodings with {coproc==0b1111, CRn==c9, opc=={0-7}, CRm==c15} are reserved for IMPLEMENTATION DEFINED performance monitors.

———— Note ————

These are distinct from the OPTIONAL ARM Performance Monitors Extension, the registers for which use the encoding space {coproc==0b1111, CRn==c9, opc=={0-7}, CRm=={c12-c14}}.

Reserved 32-bit encodings with {coproc==0b1111, CRn==c10}

In the AArch32 encoding space, for 32-bit encodings with {coproc==0b1111, CRn==c10}, the following encodings are reserved for IMPLEMENTATION DEFINED purposes:

- Encodings with {coproc==0b1111, CRn==c10, opc=={0-7}, CRm=={c0, c1, c4, c8}} are reserved for IMPLEMENTATION DEFINED TLB lockdown operations.

Reserved 32-bit encodings with {coproc==0b1111, CRn==c11}

In the AArch32 encoding space, for 32-bit encodings with {coproc==0b1111, CRn==c11}, the following encodings are reserved for IMPLEMENTATION DEFINED purposes:

- Encodings with {coproc==0b1111, CRn==c11, opc=={0-7}, CRm=={c0-c8, c15}} are reserved for IMPLEMENTATION DEFINED DMA operations for TCM access.

In ARMv8, the remainder of the AArch32 {coproc==0b1111, CRn==c11} encoding space is UNDEFINED.

Reserved 32-bit encodings with {coproc==0b1111, CRn==c15}

ARMv8 reserves the AArch32 System register encodings with (coproc==0b1111, CRn==c15) for IMPLEMENTATION DEFINED purposes, and does not impose any restrictions on the use of these encodings. The documentation of the ARM implementation must describe fully any registers implemented in the {coproc==0b1111, CRn==c15} encoding space. Normally, for processor implementations by ARM, this information is included in the *Technical Reference Manual* for the processor.

Typically, an implementation uses the {coproc==0b1111, CRn==c15} encodings to provide test features, and any required configuration options that are not covered by this Manual.

This reservation means that the AArch32 64-bit encodings with {coproc==0b1111, CRm==c15} are also reserved for IMPLEMENTATION DEFINED purposes, without any restrictions on the use of these encodings.

G4.16.2 Full list of VMSAv8-32 System registers in the (coproc==0b1111) encoding space

Table G4-44 on page G4-4711 shows the System registers in the (coproc==0b1111) encoding space in VMSAv8-32, in the order of the {CRn, opc1, CRm, opc2} parameter values used in MCR or MRC accesses to the 32-bit registers:

- For MCR or MRC accesses to the 32-bit registers, CRn is the primary identifier of the target System register for the access. This rule applies, also, to MCR or MRC instructions that provide 32-bit accesses to a single word of a 64-bit System register.
- For MCRR or MRRC accesses to the 64-bit registers, CRm is the primary identifier of the target System register for the access. Table G4-44 on page G4-4711 orders the 64-bit registers with the 32-bit registers accessed using the same primary register identifier. For example, the 64-bit encoding of TTBR0, that is accessed with (CRm==c2), is listed with the 32-bit registers that are accessed with (CRn==c2).

Table G4-44 VMSAv8-32 (coproc==0b1111) register summary, in MCR/MRC parameter order

CRn	opc1	CRm	opc2	Name	Width	Description
c0	0	c0	0	MIDR	32-bit	Main ID Register
			1	CTR	32-bit	Cache Type Register
			2	TCMTR	32-bit	TCM Type Register
			3	TLBTR	32-bit	TLB Type Register
			4, 6 ^a , 7	MIDR	32-bit	Aliases of Main ID Register
			5	MPIDR	32-bit	Multiprocessor Affinity Register
			6 ^a	REVIDR	32-bit	Revision ID Register
		c1	0	ID_PFR0	32-bit	Processor Feature Register 0
			1	ID_PFR1	32-bit	Processor Feature Register 1
			2	ID_DFR0	32-bit	Debug Feature Register 0
			3	ID_AFR0	32-bit	Auxiliary Feature Register 0
			4	ID_MMFR0	32-bit	Memory Model Feature Register 0
			5	ID_MMFR1	32-bit	Memory Model Feature Register 1
			6	ID_MMFR2	32-bit	Memory Model Feature Register 2
c2	7	ID_MMFR3	32-bit	Memory Model Feature Register 3		
	0	ID_ISAR0	32-bit	Instruction Set Attribute Register 0		
	1	ID_ISAR1	32-bit	Instruction Set Attribute Register 1		
	2	ID_ISAR2	32-bit	Instruction Set Attribute Register 2		
	3	ID_ISAR3	32-bit	Instruction Set Attribute Register 3		
	4	ID_ISAR4	32-bit	Instruction Set Attribute Register 4		
	5	ID_ISAR5	32-bit	Instruction Set Attribute Register 5		
1	c0	0	CCSIDR	32-bit	Cache Size ID Registers	
		1	CLIDR	32-bit	Cache Level ID Register	
		7	AIDR	32-bit	Auxiliary ID Register	
2	c0	0	CSSELR	32-bit	Cache Size Selection Register	
4	c0	0	VPIDR ^b	32-bit	Virtualization Processor ID Register	
		5	VMPIDR ^b	32-bit	Virtualization Multiprocessor ID Register	

Table G4-44 VMSAv8-32 (coproc==0b1111) register summary, in MCR/MRC parameter order (continued)

CRn	opc1	CRm	opc2	Name	Width	Description	
c1	0	c0	0	SCTLR	32-bit	System Control Register	
			1	ACTLR	32-bit	Auxiliary Control Register	
			2	CPACR	32-bit	Architectural Feature Access Control Register	
			3	ACTLR2	32-bit	Auxiliary Control Register 2	
	c1	0	0	SCR ^c	32-bit	Secure Configuration Register	
			1	SDER ^c	32-bit	Secure Debug Enable Register	
			2	NSACR ^c	32-bit	Non-Secure Access Control Register	
	c3	1	SDCR ^d	32-bit	Secure Debug Configuration Register		
	c1	4	c0	0	HSCTLR ^b	32-bit	Hyp System Control Register
				1	HACTLR ^b	32-bit	Hyp Auxiliary Control Register
3				HACTLR2 ^b	32-bit	Hyp Auxiliary Control Register 2	
c1		0	0	HCR ^b	32-bit	Hyp Configuration Register	
			1	HDCCR ^b	32-bit	Hyp Debug Configuration Register	
			2	HCPTR ^b	32-bit	Hyp Architectural Feature Trap Register	
			3	HSTR ^b	32-bit	Hyp System Trap Register	
			4	HCR2 ^{b, d}	32-bit	Hyp Configuration Register 2	
			7	HACR ^b	32-bit	Hyp Auxiliary Configuration Register	
			c2	0	c0	0	TTBR0
-	0	c2	-	TTBR0	64-bit		
c2	0	c0	1	TTBR1	32-bit	Translation Table Base Register 1	
-	1	c2	-	TTBR1	64-bit		
c2	0	c0	2	TTBCR	32-bit	Translation Table Base Control Register	
			3	TTBCR2	32-bit	Translation Table Base Control Register 2	
	4	c0	2	HTCR ^b	32-bit	Hyp Translation Control Register	
		c1	2	VTCTCR ^b	32-bit	Virtualization Translation Control Register	
-	4	c2	-	HTTBR ^b	64-bit	Hyp Translation Table Base Register	
-	6	c2	-	VTTBR ^b	64-bit	Virtualization Translation Table Base Register	
c3	0	c0	0	DACR	32-bit	Domain Access Control Register	
c4	0	c6	0	ICC_PMR ^e ICV_PMR ^e	32-bit	Interrupt Controller Interrupt Priority Mask Register Interrupt Controller Virtual Priority Mask Register	
			3	c5	0	DSPSR ^d	32-bit
				1	DLR ^d	32-bit	Debug Link Register ^f

Table G4-44 VMSAv8-32 (coproc==0b1111) register summary, in MCR/MRC parameter order (continued)

CRn	opc1	CRm	opc2	Name	Width	Description
c5	0	c0	0	DFSR	32-bit	Data Fault Status Register
			1	IFSR	32-bit	Instruction Fault Status Register
		c1	0	ADFSR	32-bit	Auxiliary Data Fault Status Register
			1	AIFSR	32-bit	Auxiliary Instruction Fault Status Register
		c3	0-1	RAS registers	32-bit	RAS Extension ^g
		c4	0-5, 7			
c5	0, 1, 4, 5					
4		c1	0	HADFSR ^b	32-bit	Hyp Auxiliary Data Fault Syndrome Register
			1	HAIFSR	32-bit	Hyp Auxiliary Instruction Fault Syndrome Register
		c2	0	HSR ^b	32-bit	Hyp Syndrome Register
			3	RAS register	32-bit	RAS Extension ^g
c6	0	c0	0	DFAR	32-bit	Data Fault Address Register
			2	IFAR	32-bit	Instruction Fault Address Register
	4	c0	0	HDFAR ^b	32-bit	Hyp Data Fault Address Register
			2	HIFAR ^b	32-bit	Hyp Instruction Fault Address Register
			4	HPFAR ^b	32-bit	Hyp IPA Fault Address Register
c7	0	c1	0	ICIALLUIS	32-bit	See <i>Cache maintenance instructions, functional group</i> on page G4-4734
			6	BPIALLIS	32-bit	
		c4	0	PAR	32-bit	Physical Address Register
-	0	c7	-	PAR	64-bit	

Table G4-44 VMSAv8-32 (coproc==0b1111) register summary, in MCR/MRC parameter order (continued)

CRn	opc1	CRm	opc2	Name	Width	Description		
c7	0	c5	0	ICIALLU	32-bit	See <i>Cache maintenance instructions, functional group</i> on page G4-4734		
			1	ICIMVAU	32-bit			
			4	CP15ISB	32-bit		See <i>Memory barriers</i> on page E2-2768 ^h	
			6	BPIALL	32-bit		See <i>Cache maintenance instructions, functional group</i> on page G4-4734	
			7	BPIMVA	32-bit			
		c6	1	DCIMVAC	32-bit	See <i>Cache maintenance instructions, functional group</i> on page G4-4734		
			2	DCISW	32-bit			
		c8	0	c8	0	ATS1CPR	32-bit	See <i>Address translation instructions</i> on page G4-4682
					1	ATS1CPW	32-bit	
					2	ATS1CUR	32-bit	
					3	ATS1CUW	32-bit	
					4	ATS12NSOPR ^c	32-bit	
					5	ATS12NSOPW ^c	32-bit	
					6	ATS12NSOUR ^c	32-bit	
7	ATS12NSOUW ^c				32-bit			
c7	0	c10	1	DCCMVAC	32-bit	See <i>Cache maintenance instructions, functional group</i> on page G4-4734		
			2	DCCSW	32-bit			
			4	CP15DSB	32-bit		See <i>Memory barriers</i> on page E2-2768 ^h	
			5	CP15DMB	32-bit			
			0	c11	1		DCCMVAU	32-bit
	c14	1	DCCIMVAC	32-bit	See <i>Cache maintenance instructions, functional group</i> on page G4-4734			
		2	DCCISW	32-bit				
	4	c8	c8	0	ATS1HR ^b	32-bit	See <i>Address translation instructions</i> on page G4-4682	
				1	ATS1HW ^b	32-bit		

Table G4-44 VMSAv8-32 (coproc==0b1111) register summary, in MCR/MRC parameter order (continued)

CRn	opc1	CRm	opc2	Name	Width	Description	
c8	0	c3	0	TLBIALLIS	32-bit	See <i>The scope of TLB maintenance instructions</i> on page G4-4641	
			1	TLBIMVAIS	32-bit		
			2	TLBIASIDIS	32-bit		
			3	TLBIMVAAIS	32-bit		
			5	TLBIMVALIS ^d	32-bit		
			7	TLBIMVAALIS ^d	32-bit		
			c5	0	ITLBIALL		32-bit
	1	ITLBIMVA		32-bit			
	2	ITLBIASID		32-bit			
	c6	0	DTLBIALL	32-bit	See <i>The scope of TLB maintenance instructions</i> on page G4-4641		
		1	DTLBIMVA	32-bit			
		2	DTLBIASID	32-bit			
	c7	0	c7	0	TLBIALL	32-bit	See <i>The scope of TLB maintenance instructions</i> on page G4-4641
				1	TLBIMVA	32-bit	
				2	TLBIASID	32-bit	
				3	TLBIMVAA	32-bit	
				5	TLBIMVAL ^d	32-bit	
				7	TLBIMVAAL ^d	32-bit	
				4	c0	1	
	5	TLBIIPAS2LIS ^d	32-bit				
	c8	4	c3	0	TLBIALLHIS ^b	32-bit	See <i>The scope of TLB maintenance instructions</i> on page G4-4641
1				TLBIMVAHIS ^b	32-bit		
4				TLBIALLNSNHIS ^b	32-bit		
5				TLBIMVALHIS ^d	32-bit		
4				c4	1	TLBIIPAS2 ^d	
5		TLBIIPAS2L ^d	32-bit				
c7		0	c7	0	TLBIALLH ^b	32-bit	See <i>The scope of TLB maintenance instructions</i> on page G4-4641
				1	TLBIMVAH ^b	32-bit	
				4	TLBIALLNSNH ^b	32-bit	
				5	TLBIMVALH ^d	32-bit	

Table G4-44 VMSAv8-32 (coproc==0b1111) register summary, in MCR/MRC parameter order (continued)

CRn	opc1	CRm	opc2	Name	Width	Description
c9	0-7	c0- c2	0-7	-	32-bit	Reserved for IMPLEMENTATION DEFINED branch predictor, cache, and TCM operations
		c5- c8	0-7	-	32-bit	Reserved for IMPLEMENTATION DEFINED branch predictor, cache, and TCM operations
0	c12	0	0	PMCR	32-bit	Performance Monitors Control Register
			1	PMCNTENSET	32-bit	Performance Monitors Count Enable Set register
			2	PMCNTENCLR	32-bit	Performance Monitors Count Enable Clear register
			3	PMOVSr	32-bit	Performance Monitors Overflow Flag Status Register
			4	PMSWINC	32-bit	Performance Monitors Software Increment register
			5	PMSELR	32-bit	Performance Monitors Event Counter Selection Register
			6	PMCEID0	32-bit	Performance Monitors Common Event Identification register 0
			7	PMCEID1	32-bit	Performance Monitors Common Event Identification register 1
0	c13	0	PMCCNTR	32-bit	Performance Monitors Cycle Count Register	
-	0	c9	-	PMCCNTR_EL0	64-bit	Performance Monitors Cycle Count Register
c9	0	c13	1	PMXEVTYPER	32-bit	Performance Monitors Event Type Select Register
			2	PMXEVCNTR	32-bit	Performance Monitors Event Count Register
0	c14	0	0	PMUSERENR	32-bit	Performance Monitors User Enable Register
			1	PMINTENSET	32-bit	Performance Monitors Interrupt Enable Set register
			2	PMINTENCLR	32-bit	Performance Monitors Interrupt Enable Clear register
			3	PMOVSSET^b	32-bit	Performance Monitors Overflow Flag Status Set register
0-7	c15	0-7	-	32-bit	Reserved for IMPLEMENTATION DEFINED performance monitors	

Table G4-44 VMSAv8-32 (coproc==0b1111) register summary, in MCR/MRC parameter order (continued)

CRn	opc1	CRm	opc2	Name	Width	Description			
c10	0	c0- c1	0-7	-	32-bit	Reserved for IMPLEMENTATION DEFINED TLB lockdown operations			
				c2	0	PRRRⁱ	32-bit	Primary Region Remap Register	
						MAIR0ⁱ	32-bit	Memory Attribute Indirection Register 0	
				1	NMRRⁱ	32-bit	Normal Memory Remap Register		
					MAIR1ⁱ	32-bit	Memory Attribute Indirection Register 1		
				c3	0	AMAIR0	32-bit	Auxiliary Memory Attribute Indirection Register 0	
					1	AMAIR1	32-bit	Auxiliary Memory Attribute Indirection Register 1	
				c4, c8	0-7	-	32-bit	Reserved for IMPLEMENTATION DEFINED TLB lockdown operations	
		1-3		c0, c1, c4, c8	0-7	-	32-bit	Reserved for IMPLEMENTATION DEFINED TLB lockdown operations	
4		c0, c1	0-7	-	32-bit	Reserved for IMPLEMENTATION DEFINED TLB lockdown operations			
				c2	0	HMAIR0^b	32-bit	Hyp Memory Attribute Indirection Register 0	
					1	HMAIR1^b	32-bit	Hyp Memory Attribute Indirection Register 1	
				c3	0	HAMAIR0^b	32-bit	Hyp Auxiliary Memory Attribute Indirection Register 0	
					1	HAMAIR1^b	32-bit	Hyp Auxiliary Memory Attribute Indirection Register 1	
				c4, c8	0-7	-	32-bit	Reserved for IMPLEMENTATION DEFINED TLB lockdown operations	
				5-7	c0, c1, c4, c8	0-7	-	32-bit	Reserved for IMPLEMENTATION DEFINED TLB lockdown operations
		c11	0-7	c0-c8	0-7	-	32-bit	Reserved for IMPLEMENTATION DEFINED DMA operations for TCM access.	
c15	0-7					-	32-bit		
-	0	c12	-	ICC_SGI1R^e	64-bit	Interrupt Controller SGI group 1 Register			
c12	0	c0	0	VBAR	32-bit	Vector Base Address Register			
			1	MVBAR^c	32-bit	Monitor Vector Base Address Register			
				RVBAR	32-bit	Reset Vector Base Address Register			
			2	RMR^j	32-bit	Reset Management Register			
		c1	0	ISR^c	32-bit	Interrupt Status Register			
			1	RAS register	32-bit	RAS Extension^g			
4	c1	1							

Table G4-44 VMSAv8-32 (coproc==0b1111) register summary, in MCR/MRC parameter order (continued)

CRn	opc1	CRm	opc2	Name	Width	Description
c12	0	c8	0	ICC_IAR0 ^e ICV_IAR0 ^e	32-bit	Interrupt Controller Interrupt Acknowledge Register 0 Interrupt Controller Virtual Acknowledge Register 0
			1	ICC_EOIR0 ^e ICV_EOIR0 ^e	32-bit	Interrupt Controller End Of Interrupt Register 0 Interrupt Controller Virtual End Of Interrupt Register 0
		2	ICC_HPPIR0 ^e ICV_HPPIR0 ^e	32-bit	Interrupt Controller Highest Priority Pending Interrupt Register 0 Interrupt Controller Virtual Highest Priority Pending Interrupt Register 0	
		3	ICC_BPR0 ^e ICV_BPR0 ^e	32-bit	Interrupt Controller Binary Point Register 0 Interrupt Controller Virtual Binary Point Register 0	
		4	ICC_AP0R0 ^e ICV_AP0R0 ^e	32-bit	Interrupt Controller Active Priorities Register (0,0) Interrupt Controller Virtual Active Priorities Register (0,0)	
		5	ICC_AP0R1 ^e ICV_AP0R1 ^e	32-bit	Interrupt Controller Active Priorities Register (0,1) Interrupt Controller Virtual Active Priorities Register (0,1)	
		6	ICC_AP0R1 ^e ICV_AP0R1 ^e	32-bit	Interrupt Controller Active Priorities Register (0,2) Interrupt Controller Virtual Active Priorities Register (0,2)	
		7	ICC_AP0R3 ^e ICV_AP0R3 ^e	32-bit	Interrupt Controller Active Priorities Register (0,3) Interrupt Controller Virtual Active Priorities Register (0,3)	
		c9	0	ICC_AP1R0 ^e ICV_AP1R0 ^e	32-bit	Interrupt Controller Active Priorities Register (1,0) Interrupt Controller Virtual Active Priorities Register (1,0)
			1	ICC_AP1R1 ^e ICV_AP1R1 ^e	32-bit	Interrupt Controller Active Priorities Register (1,1) Interrupt Controller Virtual Active Priorities Register (1,1)
			2	ICC_AP1R2 ^e ICV_AP1R2 ^e	32-bit	Interrupt Controller Active Priorities Register (1,2) Interrupt Controller Virtual Active Priorities Register (1,2)
			3	ICC_AP1R3 ^e ICV_AP1R3 ^e	32-bit	Interrupt Controller Active Priorities Register (1,3) Interrupt Controller Virtual Active Priorities Register (1,3)
		c11	1	ICC_DIR ^e ICV_DIR ^e	32-bit	Interrupt Controller Deactivate Interrupt Register Interrupt Controller Deactivate Virtual Interrupt Register
			3	ICC_RPR ^e ICV_RPR ^e	32-bit	Interrupt Controller Running Priority Register Interrupt Controller Virtual Running Priority Register

Table G4-44 VMSAv8-32 (coproc==0b1111) register summary, in MCR/MRC parameter order (continued)

CRn	opc1	CRm	opc2	Name	Width	Description
c12	0	c12	0	ICC_IAR1 ^e	32-bit	Interrupt Controller Interrupt Acknowledge Register 1
				ICV_IAR1 ^e		Interrupt Controller Virtual Interrupt Acknowledge Register 1
			1	ICC_EOIR1 ^e	32-bit	Interrupt Controller End Of Interrupt Register 1
				ICV_EOIR1 ^e		Interrupt Controller Virtual End Of Interrupt Register 1
			2	ICC_HPPIR1 ^e	32-bit	Interrupt Controller Highest Priority Pending Interrupt Register 1
				ICV_HPPIR1 ^e		Interrupt Controller Virtual Highest Priority Pending Interrupt Register 1
			3	ICC_BPR1 ^e	32-bit	Interrupt Controller Binary Point Register 1
				ICV_BPR1 ^e		Interrupt Controller Virtual Binary Point Register 1
4	ICC_CTLR ^e	32-bit	Interrupt Controller Control Register			
	ICV_CTLR ^e		Interrupt Controller Virtual Control Register			
5	ICC_SRE ^e	32-bit	Interrupt Controller System Register Enable Register			
6	ICC_IGRPEN0 ^e	32-bit	Interrupt Controller Interrupt Group 0 Enable Register			
	ICV_IGRPEN0 ^e		Interrupt Controller Virtual Interrupt Group 0 Enable Register			
7	ICC_IGRPEN1 ^e	32-bit	Interrupt Controller Interrupt Group 1 Enable Register			
	ICV_IGRPEN1 ^e		Interrupt Controller Virtual Interrupt Group 1 Enable Register			
-	1	c12	-	ICC_ASGI1R ^e	64 bit	Interrupt Controller Alias SGI group 1 Register
-	2	c12	-	ICC_SGI0R ^e	64 bit	Interrupt Controller SGI group 0 Register
c12	4	c0	0	HVBAR ^{b,c}	32-bit	Hyp Vector Base Address Register
				HRMR ^j		Hyp Reset Management Register
	c8	0	0	ICH_AP0R0 ^e	32-bit	Interrupt Controller Hyp Active Priorities Register (0,0)
				ICH_AP0R1 ^e		Interrupt Controller Hyp Active Priorities Register (0,1)
				ICH_AP0R2 ^e		Interrupt Controller Hyp Active Priorities Register (0,2)
				ICH_AP0R3 ^e		Interrupt Controller Hyp Active Priorities Register (0,3)
	c9	0	0	ICH_AP1R0 ^e	32-bit	Interrupt Controller Hyp Active Priorities Register (1,0)
				ICH_AP1R1 ^e		Interrupt Controller Hyp Active Priorities Register (1,1)
				ICH_AP1R2 ^e		Interrupt Controller Hyp Active Priorities Register (1,2)
				ICH_AP1R3 ^e		Interrupt Controller Hyp Active Priorities Register (1,3)
				ICC_HSRE ^e		Interrupt Controller Hyp System Register Enable register

Table G4-44 VMSAv8-32 (coproc==0b1111) register summary, in MCR/MRC parameter order (continued)

CRn	opc1	CRm	opc2	Name	Width	Description
c12	4	c11	0	ICH_HCR ^e	32-bit	Interrupt Controller Hyp Control Register
			1	ICH_VTR ^e	32-bit	Interrupt Controller VGIC Type Register
			2	ICH_MISR ^e	32-bit	Interrupt Controller Maintenance Interrupt State Register
			3	ICH_EISR ^e	32-bit	Interrupt Controller End of Interrupt Status Register
			5	ICH_ELRSR ^e	32-bit	Interrupt Controller Empty List Register Status Register
			7	ICH_VMCR ^e	32-bit	Interrupt Controller Virtual Machine Control Register
			c12	0-7	ICH_LR<n>, for n==0 to 7 ^e	32-bit
	c13	0-7	ICH_LR<n>, for n==8 to 15 ^e	32-bit	Interrupt Controller List Registers 8 to 15	
	c14	0-7	ICH_LRC<n>, for n==0 to 7 ^e	32-bit	Interrupt Controller List Registers 0 to 7, continuation	
	c15	0-7	ICH_LRC<n>, for n==8 to 15 ^e	32-bit	Interrupt Controller List Registers 8 to 15, continuation	
6	c12	4	ICC_MCTLR ^e	32-bit	Interrupt Controller Monitor Control Register	
		5	ICC_MSRE ^e	32-bit	Interrupt Controller Monitor System Register Enable register	
		7	ICC_MGRPEN1 ^e	32-bit	Interrupt Controller Monitor Interrupt Group 1 Enable register	
c13	0	c0	0	FCSEIDR	32-bit	FCSE Process ID Register
			1	CONTEXTIDR	32-bit	Context ID Register
			2	TPIDRURW	32-bit	User Read/Write Thread ID Register
			3	TPIDRURO	32-bit	User Read-Only Thread ID Register
			4	TPIDRPRW	32-bit	EL1 only Thread ID Register
4	c0	2	HTPIDR ^b	32-bit	Hyp Software Thread ID Register	
-	0	c14	-	CNTPCT ^k	64-bit	Physical Count register
c14	0	c0	0	CNTFRQ ^k	32-bit	Counter Frequency register
			c1	0	CNTKCTL ^k	32-bit
		c2	0	CNTP_TVAL ^k	32-bit	EL1 Physical TimerValue register
			1	CNTP_CTL ^k	32-bit	EL1 Physical Timer Control register
		c3	0	CNTV_TVAL ^k	32-bit	Virtual TimerValue register
			1	CNTV_CTL ^k	32-bit	Virtual Timer Control register

Table G4-44 VMSAv8-32 (coproc==0b1111) register summary, in MCR/MRC parameter order (continued)

CRn	opc1	CRm	opc2	Name	Width	Description
c14	0	c8	0-7	PMEVCNTR<n> , for n==0 to 7 ^d	32-bit	Performance Monitors Event Count Registers, 0-7
		c9	0-7	PMEVCNTR<n> , for n==8 to 15 ^d	32-bit	Performance Monitors Event Count Registers, 8-15
		c10	0-7	PMEVCNTR<n> , for n==16 to 23 ^d	32-bit	Performance Monitors Event Count Registers, 16-23
		c11	0-6	PMEVCNTR<n> , for n==24 to 30 ^d	32-bit	Performance Monitors Event Count Registers, 24-30
		c12	0-7	PMEVTYPER<n> , for n==0 to 7 ^d	32-bit	Performance Monitors Event Type Registers, 0-7
		c13	0-7	PMEVTYPER<n> , for n==8 to 15 ^d	32-bit	Performance Monitors Event Type Registers, 8-15
		c14	0-7	PMEVTYPER<n> , for n==16 to 23 ^d	32-bit	Performance Monitors Event Type Registers, 16-23
		c15	0-6	PMEVTYPER<n> , for n==17 to 30 ^d	32-bit	Performance Monitors Event Type Registers, 24-30
		c15	7	PMCCFILTR ^d	32-bit	Performance Monitors Cycle Count Filter Register
-	1	c14	-	CNTVCT ^k	64-bit	Virtual Count register
-	2	c14	-	CNTP_CVAL ^k	64-bit	EL1 Physical Timer CompareValue register
-	3	c14	-	CNTV_CVAL ^k	64-bit	Virtual Timer CompareValue register
-	4	c14	-	CNTVOFF ^l	64-bit	Virtual Offset register
c14	4	c1	0	CNTHCTL	32-bit	Timer EL2 Control register
		c2	0	CNTHP_TVAL	32-bit	EL2 Physical TimerValue register
			1	CNTHP_CTL	32-bit	EL2 Physical Timer Control register
-	6	c14	-	CNTHP_CVAL	64-bit	EL2 Physical Timer CompareValue register
c15	0-7	c0-c15	0-7	-	32-bit	See <i>Reserved 32-bit encodings with {coproc==0b1111, CRn==c15}</i> on page G4-4710

- a. [REVIDR](#) is an optional register. If it is not implemented, the encoding with opc2 set to 6 is an alias of [MIDR](#).
- b. Implemented only as part of EL2, when EL2 is using AArch32. Otherwise, encoding is unallocated and CONSTRAINED UNPREDICTABLE, see *Accesses to unallocated encodings in the (coproc==0b111x) encoding space on page G6-4765*.
- c. Implemented only as part of the EL3, when EL3 is using AArch32. Otherwise, as described in *Accesses to unallocated encodings in the (coproc==0b111x) encoding space on page G6-4765*, encoding is unallocated and:
- UNDEFINED, for the registers accessed using CRn set to c12.
 - CONSTRAINED UNPREDICTABLE, for the register accessed using CRn values other than c12.
- d. Introduced in ARMv8.
- e. Introduced in ARMv8. Implemented only if the implementation includes the GIC System registers. For information see *Generic Interrupt Controller System registers, functional groups on page G4-4740*. As that subsection describes, each ICV_* register uses the same encoding as the corresponding ICC_* register
- f. This register is only accessible in Debug state.
- g. *RAS System registers, see The Reliability, Availability, and Serviceability (RAS) Extension on page A1-63.*

- h. For performance reasons, ARM deprecates any use of these memory barrier operations.
- i. When an implementation is using the Long descriptor translation table format these encodings access the [MAIRO](#) and [MAIR1](#) registers. Otherwise, they access the [PRRR](#) and [NMRR](#).
- j. Introduced in ARMv8. Only one of [RMR](#) and [HRMR](#) is implemented, corresponding to the highest implemented Exception level, and the register is implemented only if that Exception level is using AArch32.
- k. Implemented as part of the Generic Timer.
- l. Implemented as RW as part of the Generic Timer on an implementation that includes EL2 and when EL2 is using AArch32. For more information see [Status of the CNTVOFF register on page G5-4757](#).

G4.16.3 AArch32 views of the System registers in the (coproc==0b1111) encoding space

The following sections summarize the different software views of the System registers in the (coproc==0b1111) encoding space, for VMSAv8-32:

- [PL0 views of the System registers in the \(coproc==0b1111\) encoding space.](#)
- [PL1 views of the System registers in the in the \(coproc==0b1111\) encoding space on page G4-4725.](#)
- [Non-secure PL2 view of the System registers in the \(coproc==0b1111\) encoding space on page G4-4725.](#)

———— **Note** ————

In previous versions of the ARM architecture, the behavior of accesses to the System registers in the (coproc==0b1111) encoding space were described in relation to the PE modes. In Secure state, the Exception level of the privileged PE modes depends on whether EL3 is using AArch32, or is using AArch64. This means it is simpler to describe the views of the registers in terms of *privilege levels*, PL0-PL2, rather than the *Exception levels* EL1-EL3. This is because each AArch32 PE mode is associated with a particular privilege level, but in Secure state its Exception level can depend on the EL3 Execution state. For more information see [Security state, Exception levels, and AArch32 execution privilege on page G1-4318.](#)

PL0 views of the System registers in the (coproc==0b1111) encoding space

Software executing at PL0, unprivileged, can access only a small subset of the System registers in the (coproc==0b1111) encoding space, as [Table G4-45](#) shows. This table excludes possible PL0 access to the following registers:

- The Performance Monitors Extension, see [Possible PL0 access to the Performance Monitors Extension System registers on page G4-4724.](#)
- The Generic Timer registers, see [Possible PL0 access to the Generic Timer System registers on page G4-4724.](#)

Table G4-45 System registers in the (coproc==0b1111) encoding space accessible from PL0

Name	Access	Description	Note
CP15ISB	WO	Memory barriers on page E2-2768	ARM deprecates use of these operations
CP15DSB	WO		
CP15DMB	WO		
TPIDRURW	RW	TPIDRURW, PL0 Read/Write Software Thread ID Register on page G6-5201	-
TPIDRURO	RO	TPIDRURO, PL0 Read-Only Software Thread ID Register on page G6-5199	RW at PL1

Possible PL0 access to the Performance Monitors Extension System registers

In a VMSAv8-32 implementation that includes the Performance Monitors Extension, when using the System register interface to the Performance Monitors:

- The [PMUSERENR](#) is RO from PL0.
- When:
 - The value of [PMUSERENR.EN](#) is 1, [PMCNTENSET](#), [PMCNTENCLR](#), [PMOVSr](#), [PMSWINC](#), [PMSELR](#), [PMCEID0](#), [PMCEID1](#), [PMCCNTR](#), [PMXEVTYPER](#), [PMXEVCNTR](#), [PMUSERENR](#), [PMOVSSET](#), [PMEVCNTR<n>](#), [PMEVTYPER<n>](#), and [PMCCFILTR](#) are accessible by reads and writes from PL0.
 - The value of [PMUSERENR.ER](#) is 1, [PMXEVCNTR](#) and [PMEVCNTR<n>](#) are accessible by reads and from PL0, and [PMSELR](#) is accessible by reads and writes from PL0.
 - The value of [PMUSERENR.CR](#) is 1, [PMCCNTR](#) is accessible by reads from PL0.
 - The value of [PMUSERENR.SW](#) is 1, [PMSWINC](#) is accessible by writes from PL0.

In general, when the value of a [PMUSERENR](#).{EN, ER, CR, SW} bit is 1, the enabled registers have the same access permissions from PL0 as they do from PL1.

For more information, see:

- [Traps to EL1 of EL0 accesses to Performance Monitors registers on page D1-1850](#).
- [Chapter D5 The Performance Monitors Extension](#), in particular [Access permissions on page D5-2176](#).

Possible PL0 access to the Generic Timer System registers

In a VMSAv8-32 implementation, when using the System register interface to the Generic Timer registers:

- If [CNTKCTL.PL0PCTEN](#) is set to 1, then if the physical counter register [CNTPCT](#) is accessible from PL1 it is also accessible from PL0. For more information see [Accessing the physical counter on page D6-2184](#).
- If [CNTKCTL.PL0PVTEN](#) is set to 1, the virtual counter register [CNTVCT](#) is accessible from PL0. For more information, see [Accessing the virtual counter on page D6-2185](#).
- If at least one of [CNTKCTL](#).{[PL0PCTEN](#), [PL0PVTEN](#)} is set to 1, the [CNTFRQ](#) register is RO from PL0.
- If:
 - [CNTKCTL.PL0PTEN](#) is set to 1, the physical timer registers [CNTP_CTL](#), [CNTP_CVAL](#), and [CNTP_TVAL](#) are accessible from PL0.
 - [CNTKCTL.PL0VTEN](#) is set to 1, the virtual timer registers [CNTV_CTL](#), [CNTV_CVAL](#), and [CNTV_TVAL](#), are accessible from PL0.

For more information, see [Accessing the timer registers on page G5-4759](#).

PL1 views of the System registers in the in the (coproc==0b1111) encoding space

Software executing at PL1 can access all System registers in the (coproc==0b1111) encoding space, with the following exceptions:

Non-secure PL1 software

EL3 restricts or prevents access to some registers by Non-secure PL1 software. In particular:

- The Restricted access System registers are either not accessible to Non-secure PL1 software, or are read-only to Non-secure PL1 software, see *Restricted access System registers on page G4-4694*.
- Configuration settings determine whether Non-secure PL1 software can access the Configurable access System registers, see *Configurable access System registers on page G4-4694*.

The individual register descriptions identify these access restrictions.

In an implementation that includes EL2, Non-secure PL1 software has no visibility of the PL2-mode registers summarized in *Hyp mode read/write registers in the (coproc==0b1111) encoding space on page G4-4695*. The individual register descriptions identify these registers as EL2-mode registers.

Secure PL1 software

In general, Secure PL1 software has access to all System registers. However:

- When EL3 is using AArch32, the **CP15SDISABLE** signal disables write access to a number of Secure registers, see *The CP15SDISABLE input signal on page G4-4699*.
- The PL2-mode registers are accessible from Secure state only if EL3 is using AArch32. When this is the case, Secure PL1 software can access these registers by moving into Monitor mode, and setting **SCR.NS** to 1. *Hyp mode read/write registers in the (coproc==0b1111) encoding space on page G4-4695* summarizes these registers.

The individual register descriptions identify:

- The registers affected by the **CP15SDISABLE** signal.
- The PL2-mode registers.

Non-secure PL2 view of the System registers in the (coproc==0b1111) encoding space

Non-secure software executing at PL2 can access:

- The registers that are accessible to Non-secure software executing at PL1, as defined in *PL1 views of the System registers in the in the (coproc==0b1111) encoding space*. Access permissions for these registers are identical to those for Non-secure software executing at EL1.
- The PL2-mode registers summarized in *Hyp mode read/write registers in the (coproc==0b1111) encoding space on page G4-4695*, and described in *Virtualization registers, functional group on page G4-4730*.

G4.17 Functional grouping of VMSAv8-32 System registers

This section describes how the System registers in an VMSAv8-32 implementation divide into functional groups.

[Chapter G6 AArch32 System Register Descriptions](#) describes each of these registers.

Note

- [Table G4-44 on page G4-4711](#) lists all of the VMSAv8-32 System registers in the (coproc==0b1111) encoding space, ordered by:
 1. The CRn primary register used when using a 32-bit access to the register.
For 64-bit register accesses using an MCRR or MRRC instruction, the instruction arguments that identify the target register are {coproc, Rm, opc1}. The value of Rm determines where these registers appear in [Table G4-44 on page G4-4711](#), so that these registers appear with the 32-bit registers accessed using that value for CRn. So, for example, the 64-bit access to [TTBR0](#), that uses (CRn==c2), appears with the 32-bit access to [TTBR0](#), that uses (CRn==c2).
 2. The opc1 value used when accessing the register.
 3. For 32-bit registers, the {CRm, opc2} values used when accessing the register.
- The functional groups defined in this section mainly consist of the VMSAv8-32 System registers, but include some additional System registers.
- Some registers belong to more than one functional group.

For other related information see:

- [The AArch32 System register interface on page G1-4408](#) for general information about the access to the AArch32 System registers, including the main register access instructions MRC and MCR.
- [About the System registers for VMSAv8-32 on page G4-4689](#).
- [VMSAv8-32 organization of registers in the \(coproc==0b1110\) encoding space on page G4-4704](#).
- [VMSAv8-32 organization of registers in the \(coproc==0b1111\) encoding space on page G4-4707](#).
- [About the AArch32 System registers on page G6-4764](#).

The remainder of this chapter, and the register descriptions in [Chapter G6 AArch32 System Register Descriptions](#), assume you are familiar with these sections, and use conventions and other information from them without any explanation.

Each of the following sections summarizes a functional group of VMSAv8-32 System registers:

- [Identification registers, functional group on page G4-4727](#).
- [General system control registers, functional group on page G4-4728](#).
- [Virtual memory control registers, functional group on page G4-4729](#).
- [Virtualization registers, functional group on page G4-4730](#).
- [Security registers, functional group on page G4-4732](#).
- [Exception and fault handling registers, functional group on page G4-4733](#).
- [Reset management registers, functional group on page G4-4734](#).
- [Thread and process ID registers, functional group on page G4-4734](#).
- [Cache maintenance instructions, functional group on page G4-4734](#).
- [TLB maintenance instructions, functional group on page G4-4735](#).
- [Address translation instructions, functional group on page G4-4737](#).
- [Lockdown, DMA, and TCM features, functional group on page G4-4738](#).
- [Performance Monitors Extension registers, functional group on page G4-4738](#).
- [Generic Timer registers, functional group on page G4-4740](#).
- [Generic Interrupt Controller System registers, functional groups on page G4-4740](#).
- [Legacy feature registers, functional group on page G4-4744](#).

- *IMPLEMENTATION DEFINED registers, functional group on page G4-4744.*
- *Advanced SIMD and floating-point registers, functional group on page G4-4745.*
- *Debug registers, functional group on page G4-4745.*

G4.17.1 Identification registers, functional group

Table G4-46 shows the VMSAv8-32 System registers in the (coproc==0b1111) encoding space that are in the Identification registers functional group.

Table G4-46 Identification registers, VMSAv8-32

Name	CRn	opc1	CRm	opc2	Width	Type	Description
AIDR	c0	1	c0	7	32-bit	RO	Auxiliary ID Register
CCSIDR	c0	1	c0	0	32-bit	RO	Cache Size ID Registers
CLIDR	c0	1	c0	1	32-bit	RO	Cache Level ID Register
CSSELR	c0	2	c0	0	32-bit	RW	Cache Size Selection Register
CTR	c0	0	c0	1	32-bit	RO	Cache Type Register
ID_AFR0	c0	0	c1	3	32-bit	RO	Auxiliary Feature Register 0 ^a
ID_DFR0	c0	0	c1	2	32-bit	RO	Debug Feature Register 0 ^a
ID_ISAR0	c0	0	c2	0	32-bit	RO	Instruction Set Attribute Register 0 ^a
ID_ISAR1	c0	0	c2	1	32-bit	RO	Instruction Set Attribute Register 1 ^a
ID_ISAR2	c0	0	c2	2	32-bit	RO	Instruction Set Attribute Register 2 ^a
ID_ISAR3	c0	0	c2	3	32-bit	RO	Instruction Set Attribute Register 3 ^a
ID_ISAR4	c0	0	c2	4	32-bit	RO	Instruction Set Attribute Register 4 ^a
ID_ISAR5	c0	0	c2	5	32-bit	RO	Instruction Set Attribute Register 5 ^a
ID_MMFR0	c0	0	c1	4	32-bit	RO	Memory Model Feature Register 0 ^a
ID_MMFR1	c0	0	c1	5	32-bit	RO	Memory Model Feature Register 1 ^a
ID_MMFR2	c0	0	c1	6	32-bit	RO	Memory Model Feature Register 2 ^a
ID_MMFR3	c0	0	c1	7	32-bit	RO	Memory Model Feature Register 3 ^a
ID_MMFR4	c0	0	c2	6	32-bit	RO	Memory Model Feature Register 4 ^a
ID_PFR0	c0	0	c1	0	32-bit	RO	Processor Feature Register 0 ^a
ID_PFR1	c0	0	c1	1	32-bit	RO	Processor Feature Register 1 ^a
MIDR	c0	0	c0	0	32-bit	RO	Main ID Register
MPIDR	c0	0	c0	5	32-bit	RO	Multiprocessor Affinity Register
REVIDR	c0	0	c0	6	32-bit	RO	Revision ID Register
TCMTR	c0	0	c0	2	32-bit	RO	TCM Type Register

Table G4-46 Identification registers, VMSAv8-32 (continued)

Name	CRn	opc1	CRm	opc2	Width	Type	Description
TLBTR	c0	0	c0	3	32-bit	RO	TLB Type Register
VMPIDR	c0	4	c0	5	32-bit	RW	Virtualization Multiprocessor ID Register
VPIDR	c0	4	c0	5	32-bit	RW	Virtualization Processor ID Register

a. CPUID register, see [The CPUID identification scheme](#).

The other registers in this group are the [FPSID](#), [MVFR0](#), [MVFR1](#), and [MVFR2](#).

The [JIDR](#) holds legacy identification information.

The CPUID identification scheme

The ID_* registers were originally called the CPUID identification scheme registers. A footnote to [Table G4-46 on page G4-4727](#) identifies these registers. However, functionally, there is no value in separating these registers from the slightly larger Identification registers functional group.

G4.17.2 General system control registers, functional group

[Table G4-47](#) shows the VMSAv8-32 System registers in the (coproc==0b1111) encoding space that are in the General system control registers functional group.

Table G4-47 General system control registers, VMSAv8-32

Name	CRn	opc1	CRm	opc2	Width	Type	Description
ACTLR	c1	0	c0	1	32-bit	RW	Auxiliary Control Register
ACTLR2	c1	0	c0	3	32-bit	RW	Auxiliary Control Register 2
CPACR	c1	0	c0	2	32-bit	RW	Architectural Feature Access Control Register
HACTLR	c1	4	c0	0	32-bit	RW	Hyp Auxiliary System Control Register
HACTLR2	c1	4	c0	3	32-bit	RW	Hyp Auxiliary System Control Register 2
HSCTLR	c1	4	c0	0	32-bit	RW	Hyp System Control Register
SCTLR	c1	0	c0	0	32-bit	RW	System Control Register

The following sections summarize the System registers added by the corresponding Exception levels:

- [Security registers, functional group on page G4-4732](#).
- [Virtualization registers, functional group on page G4-4730](#).

G4.17.3 Virtual memory control registers, functional group

Table G4-48 shows the VMSAv8-32 System registers in the (coproc==0b1111) encoding space that are in the Virtual memory control registers functional group.

Table G4-48 Virtual memory control registers

Name	CRn	opc1	CRm	opc2	Width	Type	Description
AMAIRO	c10	0	c3	0	32-bit	RW	Auxiliary Memory Attribute Indirection Register 0
AMAIR1	c10	0	c3	1	32-bit	RW	Auxiliary Memory Attribute Indirection Register 1
CONTEXTIDR	c13	0	c0	1	32-bit	RW	Context ID Register
DACR	c3	0	c0	0	32-bit	RW	Domain Access Control Register
HAMAIRO	c10	4	c3	0	32-bit	RW	Hyp Auxiliary Memory Attribute Indirection Register 0
HAMAIR1	c10	4	c3	1	32-bit	RW	Hyp Auxiliary Memory Attribute Indirection Register 1
HMAIRO	c10	4	c2	0	32-bit	RW	Hyp Memory Attribute Indirection Register 0
HMAIR1	c10	4	c2	1	32-bit	RW	Hyp Memory Attribute Indirection Register 1
HTCR	c2	4	c0	2	32-bit	RW	Hyp Translation Control Register
HTTBR	-	4	c2	-	64-bit	RW	Hyp Translation Table Base Register
MAIRO	c10	0	c2	0	32-bit	RW	Memory Attribute Indirection Register 0
MAIR1	c10	0	c2	1	32-bit	RW	Memory Attribute Indirection Register 1
NMRR	c10	0	c2	1	32-bit	RW	Normal Memory Remap Register
PRRR	c10	0	c2	0	32-bit	RW	Primary Region Remap Register
SCTLR	c1	0	c0	0	32-bit	RW	System Control Register
TTBCR	c2	0	c0	2	32-bit	RW	Translation Table Base Control Register
TTBCR2	c2	0	c0	3	32-bit	RW	Translation Table Base Control Register 2
TTBR0	c2	0	c0	0	32-bit	RW	Translation Table Base Register 0
TTBR0	-	0	c2	-	64-bit	RW	Translation Table Base Register 0
TTBR1	c2	0	c0	1	32-bit	RW	Translation Table Base Register 1
TTBR1	-	1	c2	-	64-bit	RW	Translation Table Base Register 1
VTCTCR	c2	4	c1	2	32-bit	RW	Virtualization Translation Control Register
VTTBR	-	6	c2	-	64-bit	RW	Virtualization Translation Table Base Register

The ACTLR and, if implemented, ACTLR2, might provide additional virtual memory control.

G4.17.4 Virtualization registers, functional group

Table G4-49 shows the VMSAv8-32 System registers in the (coproc==0b1111) encoding space that are in the Virtualization registers functional group, excluding the System instructions in this group.

Table G4-49 Virtualization registers, excluding System instructions

Name	CRn	opc1	CRm	opc2	Width	Type	Description
CNTHCTL	c14	4	c1	0	32-bit	RW	Counter-timer Hyp Control register
CNTHP_CTL	c14	4	c2	1	32-bit	RW	Counter-timer Hyp Physical Timer Control register
CNTHP_CVAL	-	6	c14	-	64-bit	RW	Counter-timer Hyp Physical Compare Value register
CNTHP_TVAL	c14	4	c2	0	32-bit	RW	Counter-timer Hyp Physical Timer Timer Value register
CNTVOFF	-	4	c14	-	64-bit	RW	Counter-timer Virtual Offset register
HACR	c1	4	c1	7	32-bit	RW	Hyp Auxiliary Configuration Register
HACTLR	c1	4	c0	1	32-bit	RW	Hyp Auxiliary Control Register
HACTLR2	c1	4	c0	3	32-bit	RW	Hyp Auxiliary Control Register 2
HADFSR	c5	4	c1	0	32-bit	RW	Hyp Auxiliary Data Fault Status Register
HAIFSR	c5	4	c1	1	32-bit	RW	Hyp Auxiliary Instruction Fault Status Register
HAMAIR0	c10	4	c3	0	32-bit	RW	Hyp Auxiliary Memory Attribute Indirection Register 0
HAMAIR1	c10	4	c3	1	32-bit	RW	Hyp Auxiliary Memory Attribute Indirection Register 1
HCPTR	c1	4	c1	2	32-bit	RW	Hyp Architectural Feature Trap Register
HCR	c1	4	c1	0	32-bit	RW	Hyp Configuration Register
HCR2	c1	4	c1	4	32-bit	RW	Hyp Configuration Register 2
HDCR	c1	4	c1	1	32-bit	RW	Hyp Debug Configuration Register
HDFAR	c6	4	c0	0	32-bit	RW	Hyp Data Fault Address Register
HIFAR	c6	4	c0	2	32-bit	RW	Hyp Instruction Fault Address Register
HMAIR0	c10	4	c2	0	32-bit	RW	Hyp Memory Attribute Indirection Register 0
HMAIR1	c10	4	c2	1	32-bit	RW	Hyp Memory Attribute Indirection Register 1
HPFAR	c6	4	c0	4	32-bit	RW	Hyp IPA Fault Address Register
HRMR	c12	4	c0	2	32-bit	RW	Hyp Reset Management Register
HSCTLR	c1	4	c0	0	32-bit	RW	Hyp System Control Register
HSR	c5	4	c2	0	32-bit	RW	Hyp Syndrome Register
HSTR	c1	4	c1	3	32-bit	RW	Hyp System Trap Register
HTCR	c2	4	c0	2	32-bit	RW	Hyp Translation Control Register
HTPIDR	c13	4	c0	2	32-bit	RW	Hyp Thread and Process ID Register
HTTBR	-	4	c2	-	64-bit	RW	Hyp Translation Table Base Register
HVBAR	c12	4	c0	0	32-bit	RW	Hyp Vector Base Address Register

Table G4-49 Virtualization registers, excluding System instructions (continued)

Name	CRn	opc1	CRm	opc2	Width	Type	Description
ICC_HSRE ^a	c12	4	c9	5	32-bit	RW	Interrupt Controller Hyp System Register Enable register
ICH_AP0R0 ^a	c12	4	c8	0	32-bit	RW	Interrupt Controller Hyp Active Priorities Register (0,0)
ICH_AP0R1 ^a	c12	4	c8	1	32-bit	RW	Interrupt Controller Hyp Active Priorities Register (0,1)
ICH_AP0R2 ^a	c12	4	c8	2	32-bit	RW	Interrupt Controller Hyp Active Priorities Register (0,2)
ICH_AP0R3 ^a	c12	4	c8	3	32-bit	RW	Interrupt Controller Hyp Active Priorities Register (0,3)
ICH_AP1R0 ^a	c12	4	c9	0	32-bit	RW	Interrupt Controller Hyp Active Priorities Register (1,0)
ICH_AP1R1 ^a	c12	4	c9	1	32-bit	RW	Interrupt Controller Hyp Active Priorities Register (1,1)
ICH_AP1R2 ^a	c12	4	c9	2	32-bit	RW	Interrupt Controller Hyp Active Priorities Register (1,2)
ICH_AP1R3 ^a	c12	4	c9	3	32-bit	RW	Interrupt Controller Hyp Active Priorities Register (1,3)
ICH_EISR ^a	c12	4	c11	3	32-bit	RO	Interrupt Controller End of Interrupt Status Register
ICH_ELRSR ^a	c12	4	c11	5	32-bit	RO	Interrupt Controller Empty List Register Status Register
ICH_HCR ^a	c12	4	c11	0	32-bit	RW	Interrupt Controller Hyp Control Register
ICH_LR<n>, n==0-7 ^a	c12	4	c12	0-7	32-bit	RW	Interrupt Controller List Registers, 0-7
ICH_LR<n>, n==8-15 ^a	c12	4	c13	0-7	32-bit	RW	Interrupt Controller List Registers, 8-15
ICH_LRC<n>, n==0-7 ^a	c12	4	c14	0-7	32-bit	RW	Interrupt Controller List Registers Continuation, 0-7
ICH_LRC<n>, n==8-15 ^a	c12	4	c15	0-7	32-bit	RW	Interrupt Controller List Registers Continuation, 8-15
ICH_MISR ^a	c12	4	c11	2	32-bit	RO	Interrupt Controller Maintenance Interrupt State Register
ICH_VMCR ^a	c12	4	c11	7	32-bit	RW	Interrupt Controller Virtual Machine Control Register
ICH_VTR ^a	c12	4	c11	1	32-bit	RO	Interrupt Controller VGIC Type Register
VMPIDR	c0	4	c0	5	32-bit	RW	Virtualization Multiprocessor ID Register
VPIDR	c0	4	c0	0	32-bit	RW	Virtualization Processor ID Register
VTCR	c2	4	c1	2	32-bit	RW	Virtualization Translation Control Register
VTTBR	-	6	c2	-	64-bit	RW	Virtualization Translation Table Base Register

a. For more information about these registers see *Generic Interrupt Controller System registers, functional groups* on page G4-4740. As that section describes, each ICV_* register uses the same encoding as the corresponding ICC_* register.

Table G4-50 shows the Hyp mode System instructions, in the (coproc==0b1111) encoding space, that are part of this functional group. See also Table G4-49 on page G4-4730.

Table G4-50 Hyp mode System instructions

Name	CRn	opc1	CRm	opc2	Width	Type	Description
ATS1HR	c7	4	c8	0	32-bit	WO	Address Translate Stage 1 Hyp mode Read
ATS1HW	c7	4	c8	1	32-bit	WO	Address Translate Stage 1 Hyp mode Write
TLBIALLH^a	c8	4	c7	0	32-bit	WO	Invalidate entire Hyp unified TLB
TLBIALLHIS^a	c8	4	c3	0	32-bit	WO	Invalidate entire Hyp unified TLB
TLBIALLNSNH^a	c8	4	c7	4	32-bit	WO	Invalidate entire Non-secure Non-Hyp unified TLB
TLBIALLNSNHIS^a	c8	4	c3	4	32-bit	WO	Invalidate entire Non-secure Non-Hyp unified TLB
TLBIIPAS2^a	c8	4	c4	1	32-bit	WO	TLB Invalidate entry by IPA, Stage 2
TLBIIPAS2IS^a	c8	4	c0	1	32-bit	WO	TLB Invalidate entry by IPA, Stage 2, Inner Shareable
TLBIIPAS2L^a	c8	4	c4	5	32-bit	WO	TLB Invalidate entry by IPA, Stage 2, Last level
TLBIIPAS2LIS^a	c8	4	c0	5	32-bit	WO	TLB Invalidate entry by IPA, Stage 2, Last level, Inner Shareable
TLBIMVAH^a	c8	4	c7	1	32-bit	WO	Invalidate Hyp unified TLB by VA
TLBIMVAHIS^a	c8	4	c3	1	32-bit	WO	Invalidate Hyp unified TLB by VA
TLBIMVALH^a	c8	4	c7	5	32-bit	WO	TLB Invalidate entry by MVA, Last level, Hyp mode
TLBIMVALHIS^a	c8	4	c3	5	32-bit	WO	TLB Invalidate entry by MVA, Last level, Hyp mode, Inner Shareable

a. These links are to a summary of the operation, and [The scope of TLB maintenance instructions on page G4-4641](#) describes the operation.

All the encodings shown in [Table G4-49 on page G4-4730](#) and [Table G4-50](#) are unallocated and CONstrained UNPREDICTABLE on an implementation that does not include EL2, see [Accesses to unallocated encodings in the \(coproc==0b111x\) encoding space on page G6-4765](#).

G4.17.5 Security registers, functional group

Table G4-51 shows the VMSAv8-32 System registers in the (coproc==0b1111) encoding space that are in the Security registers functional group.

Table G4-51 Security registers

Name	CRn	opc1	CRm	opc2	Width	Type	Description
ICC_MCTLR^a	c12	6	c12	4	32-bit	RW	Interrupt Controller Monitor Control Register
ICC_MGRPEN1^a	c12	6	c12	7	32-bit	RW	Interrupt Controller Monitor Interrupt Group 1 Enable register
ICC_MSRE^a	c12	6	c12	5	32-bit	RW	Interrupt Controller Monitor System Register Enable register
MVBAR	c12	0	c0	1	32-bit	RW	Monitor Vector Base Address Register

Table G4-51 Security registers (continued)

Name	CRn	opc1	CRm	opc2	Width	Type	Description
NSACR	c1	0	c1	2	32-bit	RW	Non-Secure Access Control Register
RMR	c12	0	c0	2	32-bit	RW	Reset Management Register
SCR	c1	0	c1	0	32-bit	RW	Secure Configuration Register
SDER	c1	0	c1	1	32-bit	RW	Secure Debug Enable Register

a. For information about these registers see the *ARM® Generic Interrupt Controller Architecture Specification, GIC architecture version 3.0 and version 4.0*.

All the encodings shown in [Table G4-51 on page G4-4732](#) are unallocated and CONSTRAINED UNPREDICTABLE on an implementation that does not include EL3, see [Accesses to unallocated encodings in the \(coproc==0b111x\) encoding space on page G6-4765](#).

G4.17.6 Exception and fault handling registers, functional group

[Table G4-52](#) shows the VMSAv8-32 System registers in the (coproc==0b1111) encoding space that are in the Exception and fault handling registers functional group.

Table G4-52 Exception and fault handling registers

Name	CRn	opc1	CRm	opc2	Width	Type	Description
ADFSR	c5	0	c1	0	32-bit	RW	Auxiliary Data Fault Status Register
AIFSR	c5	0	c1	1	32-bit	RW	Auxiliary Instruction Fault Status Register
DFAR	c6	0	c0	0	32-bit	RW	Data Fault Address Register
DFSR	c5	0	c0	0	32-bit	RW	Data Fault Status Register
HADFSR	c5	4	c1	0	32-bit	RW	Hyp Auxiliary Data Fault Status Register
HAIFSR	c5	4	c1	1	32-bit	RW	Hyp Auxiliary Instruction Fault Status Register
HDFAR	c6	4	c0	0	32-bit	RW	Hyp Data Fault Address Register
HIFAR	c6	4	c0	2	32-bit	RW	Hyp Instruction Fault Address Register
HPFAR	c6	4	c0	4	32-bit	RW	Hyp IPA Fault Address Register
HSR	c5	4	c2	0	32-bit	RW	Hyp Syndrome Register
HVBAR	c12	4	c0	1	32-bit	RW	Hyp Vector Base Address Register
IFAR	c6	0	c0	2	32-bit	RW	Instruction Fault Address Register
IFSR	c5	0	c0	1	32-bit	RW	Instruction Fault Status Register
ISR	c12	0	c1	0	32-bit	RO	Interrupt Status Register
MVBAR	c12	0	c0	1	32-bit	RW	Monitor Vector Base Address Register
RVBAR	c12	0	c0	1	32-bit	RW	Reset Vector Base Address Register
VBAR	c12	0	c0	0	32-bit	RW	Vector Base Address Register

The PE returns fault information using the fault status registers and the fault address registers. For details of how these registers are used see [Exception reporting in a VMSAv8-32 implementation on page G4-4663](#).

———— **Note** ————

These registers also report information about debug exceptions. For more information see:

- [Data Abort exceptions, taken to a PL1 mode on page G4-4665.](#)
- [Prefetch Abort exceptions, taken to a PL1 mode on page G4-4667.](#)
- [Reporting exceptions taken to Hyp mode on page G4-4673.](#)

G4.17.7 Reset management registers, functional group

Table G4-53 shows the VMSAv8-32 System registers in the (coproc==0b1111) encoding space that are in the Reset management registers functional group.

Table G4-53 Reset management registers

Name	CRn	opc1	CRm	opc2	Width	Type	Description
HRMR	c12	4	c0	2	32-bit	RW	Hyp Reset Management Register
RMR	c12	0	c0	2	32-bit	RW	Reset Management Register

G4.17.8 Thread and process ID registers, functional group

Table G4-54 shows the VMSAv8-32 System registers in the (coproc==0b1111) encoding space that are in the Thread and process ID registers functional group.

Table G4-54 VMSAv8-32 Thread and process ID registers

Name	CRn	opc1	CRm	opc2	Width	Type ^a	Description
HTPIDR^b	c13	4	c0	2	32-bit	RW	Hyp Software Thread ID Register
TPIDRPRW	c13	0	c0	4	32-bit	RW	PL1 Software Thread ID Register
TPIDRURO	c13	0	c0	3	32-bit	RW, PL0	PL0 Read-Only Software Thread ID Register
TPIDRURW	c13	0	c0	2	32-bit	RW, PL0	PL0 Read/Write Software Thread ID Register

- PL0 in a Type description indicates that the encoding is accessible by software executing at PL0. See the register description for more information.
- Implemented only as part of EL2. Otherwise, encoding is unallocated and CONSTRAINED UNPREDICTABLE, see [Accesses to unallocated encodings in the \(coproc==0b111x\) encoding space on page G6-4765.](#)

G4.17.9 Cache maintenance instructions, functional group

Table G4-55 shows the VMSAv8-32 System instructions in the (coproc==0b1111) encoding space that are in the Cache and branch predictor maintenance instructions functional group.

Table G4-55 Cache and branch predictor maintenance instructions

Name	CRn	opc1	CRm	opc2	Width	Type	Description	Limits ^a
BPIALL^b	c7	0	c5	6	32-bit	WO	Branch predictor invalidate all	-
BPIALLIS^b	c7	0	c1	6	32-bit	WO	Branch predictor invalidate all	IS
BPIMVA^b	c7	0	c5	7	32-bit	WO	Branch predictor invalidate by VA	-
DCCIMVAC^b	c7	0	c14	1	32-bit	WO	Data cache clean and invalidate by VA	PoC

Table G4-55 Cache and branch predictor maintenance instructions (continued)

Name	CRn	opc1	CRm	opc2	Width	Type	Description	Limits ^a
DCCISW^b	c7	0	c14	2	32-bit	WO	Data cache clean and invalidate by set/way	-
DCCMVAC^b	c7	0	c10	1	32-bit	WO	Data cache clean by VA	PoC
DCCMVAU^b	c7	0	c11	1	32-bit	WO	Data cache clean by VA	PoU
DCCSW^b	c7	0	c10	2	32-bit	WO	Data cache clean by set/way	-
DCIMVAC^b	c7	0	c6	1	32-bit	WO	Data cache invalidate by VA	PoC
DCISW^b	c7	0	c6	2	32-bit	WO	Data cache invalidate by set/way	-
ICIALLU^b	c7	0	c5	0	32-bit	WO	Instruction cache invalidate all	PoU
ICIALLUIS^b	c7	0	c1	0	32-bit	WO	Instruction cache invalidate all	PoU, IS
ICIMVAU^b	c7	0	c5	1	32-bit	WO	Instruction cache invalidate by VA	PoU

- a. PoU = to Point of Unification, PoC = to Point of Coherency, IS = Inner Shareable.
b. The links in this column are to a summary of the operation, see [AArch32 cache and branch predictor maintenance instructions on page G3-4535](#).

G4.17.10 TLB maintenance instructions, functional group

Table G4-56 shows the VMSAv8-32 System instructions in the (coproc==0b1111) encoding space that are in the TLB maintenance instructions functional group. *The scope of TLB maintenance instructions on page G4-4641* describes the operations.

Table G4-56 TLB maintenance instructions

Name ^a	CRn	opc1	CRm	opc2	Width	Type	Description	Limits ^b
DTLBIALL^c	c8	0	c6	0	32-bit	WO	Invalidate entire data TLB	-
DTLBIASID^c	c8	0	c6	2	32-bit	WO	Invalidate data TLB by ASID	-
DTLBMVA^c	c8	0	c6	1	32-bit	WO	Invalidate data TLB entry by VA	-
ITLBIALL^c	c8	0	c5	0	32-bit	WO	Invalidate entire instruction TLB	-
ITLBIASID^c	c8	0	c5	2	32-bit	WO	Invalidate instruction TLB by ASID	-
ITLBMVA^c	c8	0	c5	1	32-bit	WO	Invalidate instruction TLB by VA	-
TLBIALL^d	c8	0	c7	0	32-bit	WO	Invalidate entire unified TLB	-
TLBIALLH	c8	4	c7	0	32-bit	WO	Invalidate entire Hyp unified TLB	-
TLBIALLHIS	c8	4	c3	0	32-bit	WO	Invalidate entire Hyp unified TLB	IS
TLBIALLIS	c8	0	c3	0	32-bit	WO	Invalidate entire unified TLB	IS
TLBIALLNSNH	c8	4	c7	4	32-bit	WO	Invalidate entire Non-secure Non-Hyp unified TLB	-
TLBIALLNSNHIS	c8	4	c3	4	32-bit	WO	Invalidate entire Non-secure Non-Hyp unified TLB	IS
TLBIASID	c8	0	c7	2	32-bit	WO	Invalidate unified TLB by ASID	-

Table G4-56 TLB maintenance instructions (continued)

Name ^a	CRn	opc1	CRm	opc2	Width	Type	Description	Limits ^b
TLBIASIDIS	c8	0	c3	2	32-bit	WO	Invalidate unified TLB by ASID	IS
TLBIIPAS2	c8	4	c4	1	32-bit	WO	TLB Invalidate entry by IPA, Stage 2	-
TLBIIPAS2IS	c8	4	c0	1	32-bit	WO	TLB Invalidate entry by IPA, Stage 2, Inner Shareable	IS
TLBIIPAS2L	c8	4	c4	5	32-bit	WO	TLB Invalidate entry by IPA, Stage 2, Last level	-
TLBIIPAS2LIS	c8	4	c0	5	32-bit	WO	TLB Invalidate entry by IPA, Stage 2, Last level, Inner Shareable	IS
TLBIMVAA	c8	0	c7	3	32-bit	WO	Invalidate unified TLB by VA, all ASID	-
TLBIMVAAIS	c8	0	c3	3	32-bit	WO	Invalidate unified TLB by VA, all ASID	IS
TLBIMVAAL	c8	0	c7	7	32-bit	WO	TLB Invalidate entry by MVA, All ASID, Last level	-
TLBIMVAALIS	c8	0	c3	7	32-bit	WO	TLB Invalidate entry by MVA, All ASID, Last level, Inner Shareable	IS
TLBIMVA	c8	0	c7	1	32-bit	WO	Invalidate unified TLB by VA	-
TLBIMVAH	c8	4	c7	1	32-bit	WO	Invalidate Hyp unified TLB by VA	-
TLBIMVAHIS	c8	4	c3	1	32-bit	WO	Invalidate Hyp unified TLB by VA	IS
TLBIMVAIS	c8	0	c3	1	32-bit	WO	Invalidate unified TLB by VA	IS
TLBIMVAL	c8	0	c7	5	32-bit	WO	TLB Invalidate entry by MVA, Last level	-
TLBIMVALH	c8	4	c7	5	32-bit	WO	TLB Invalidate entry by MVA, Last level, Hyp mode	-
TLBIMVALHIS	c8	4	c3	5	32-bit	WO	TLB Invalidate entry by MVA, Last level, Hyp mode, Inner Shareable	IS
TLBIMVALIS	c8	0	c3	5	32-bit	WO	TLB Invalidate entry by MVA, Last level	IS

- a. These links are to a summary of the operation, and [The scope of TLB maintenance instructions on page G4-4641](#) describes the operation.
- b. IS = Inner Shareable.
- c. Deprecated. ARM deprecates use of operations that operate only on an Instruction TLB, or only on a Data TLB.
- d. The mnemonics for the operations with CRm==c7, opc2=={0, 1, 2} were previously UTLBIALL, UTLBIMVA and UTLBIMASID.

G4.17.11 Address translation instructions, functional group

Table G4-57 shows the VMSAv8-32 System instructions in the (coproc==0b1111) encoding space that are in the Address translation instructions functional group.

Table G4-57 Address translation instructions

Name	CRn	opc1	CRm	opc2	Width	Type	Description
ATS12NSOPR ^{a, c}	c7	0	c8	4	32-bit	WO	Stages 1 and 2 Non-secure only EL1 read
ATS12NSOPW ^{a, c}	c7	0	c8	5	32-bit	WO	Stages 1 and 2 Non-secure only EL1 write
ATS12NSOUR ^{a, c}	c7	0	c8	6	32-bit	WO	Stages 1 and 2 Non-secure only unprivileged read
ATS12NSOUW ^{a, c}	c7	0	c8	7	32-bit	WO	Stages 1 and 2 Non-secure only unprivileged write
ATS1CPR ^c	c7	0	c8	0	32-bit	WO	Stage 1 Current state EL1 read
ATS1CPW ^c	c7	0	c8	1	32-bit	WO	Stage 1 Current state EL1 write
ATS1CUR ^c	c7	0	c8	2	32-bit	WO	Stage 1 Current state unprivileged read
ATS1CUW ^c	c7	0	c8	3	32-bit	WO	Stage 1 Current state unprivileged write
ATS1HR ^{b, c}	c7	4	c8	0	32-bit	WO	Stage 1 Hyp mode read
ATS1HW ^{b, c}	c7	4	c8	1	32-bit	WO	Stage 1 Hyp mode write
PAR	c7	0	c4	0	32-bit	RW	Physical Address Register
	-	0	c7	-	64-bit	RW	

- a. Implemented only as part of EL3. Otherwise, encoding is unallocated and CONSTRAINED UNPREDICTABLE, see [Accesses to unallocated encodings in the \(coproc==0b111x\) encoding space on page G6-4765](#).
- b. Implemented only as part of EL2. Otherwise, encoding is unallocated and CONSTRAINED UNPREDICTABLE, see [Accesses to unallocated encodings in the \(coproc==0b111x\) encoding space on page G6-4765](#).
- c. These links are to a summary of the operation.

[Address translation instructions on page G4-4682](#) describes these operations.

G4.17.12 Lockdown, DMA, and TCM features, functional group

Table G4-58 shows the VMSAv8-32 reserved encodings in the (coproc==0b1111) encoding space that provide the Lockdown, DMA, and TCM features registers functional group.

Table G4-58 Lockdown, DMA, and TCM features, VMSAv8-32

Name	CRn	opc1	CRm	Width	opc2	Type	Description
IMPLEMENTATION DEFINED	c9	0-7	c0-c2	32-bit	0-7	a	Reserved for IMPLEMENTATION DEFINED branch predictor, cache, and TCM operations.
			c5-c8	32-bit	0-7	a	
	c10	0-7	c0-c1	32-bit	0-7	a	Reserved for IMPLEMENTATION DEFINED TLB lockdown operations
			c4	32-bit	0-7	a	
c8			32-bit	0-7	a		
c11	0-7	c0-c8	32-bit	0-7	a	Reserved for IMPLEMENTATION DEFINED DMA operations to and from TCMs	
		c15	32-bit	0-7	a		

a. Access depends on the register or operation, and is IMPLEMENTATION DEFINED.

G4.17.13 Performance Monitors Extension registers, functional group

Table G4-59 shows the VMSAv8-32 System registers in the (coproc==0b1111) encoding space that are the Performance Monitors Extension registers functional group. See also *IMPLEMENTATION DEFINED performance monitors* on page G4-4739.

Table G4-59 Performance Monitors Extension registers

Name	CRn	opc1	CRm	opc2	Width	Description
PMCCFILTR	c14	0	c15	7	32-bit	Performance Monitors Cycle Count Filter Register
PMCCNTR	c9	0	c13	0	32-bit	Performance Monitors Cycle Count Register
PMCEID0	c9	0	c12	6	32-bit	Performance Monitors Common Event Identification register 0
PMCEID1	c9	0	c12	7	32-bit	Performance Monitors Common Event Identification register 1
PMCNTENCLR	c9	0	c12	2	32-bit	Performance Monitors Count Enable Clear register
PMCNTENSET	c9	0	c12	1	32-bit	Performance Monitors Count Enable Set register
PMCR	c9	0	c12	0	32-bit	Performance Monitors Control Register
PMEVCNTR<n>, for n==0 to 7	c14	0	c8	0-7	32-bit	Performance Monitors Event Count Registers, 0-7
PMEVCNTR<n>, for n==16 to 23	c14	0	c10	0-7	32-bit	Performance Monitors Event Count Registers, 16-23
PMEVCNTR<n>, for n==24 to 30	c14	0	c11	0-6	32-bit	Performance Monitors Event Count Registers, 24-30
PMEVCNTR<n>, for n==8 to 15	c14	0	c9	0-7	32-bit	Performance Monitors Event Count Registers, 8-15

Table G4-59 Performance Monitors Extension registers (continued)

Name	CRn	opc1	CRm	opc2	Width	Description
PMEVTYPER<n> , for n==0 to 7	c14	0	c12	0-7	32-bit	Performance Monitors Event Type Registers, 0-7
PMEVTYPER<n> , for n==16 to 23	c14	0	c14	0-7	32-bit	Performance Monitors Event Type Registers, 16-23
PMEVTYPER<n> , for n==17 to 30	c14	0	c15	0-6	32-bit	Performance Monitors Event Type Registers, 24-30
PMEVTYPER<n> , for n==8 to 15	c14	0	c13	0-7	32-bit	Performance Monitors Event Type Registers, 8-15
PMINTENCLR	c9	0	c14	2	32-bit	Performance Monitors Interrupt Enable Clear register
PMINTENSET	c9	0	c14	1	32-bit	Performance Monitors Interrupt Enable Set register
PMOVSr	c9	0	c12	3	32-bit	Performance Monitors Overflow Flag Status Register
PMOVSSET	c9	0	c14	3	32-bit	Performance Monitors Overflow Flag Status Set register
PMSELR	c9	0	c12	5	32-bit	Performance Monitors Event Counter Selection Register
PMSWINC	c9	0	c12	4	32-bit	Performance Monitors Software Increment register
PMUSERENR	c9	0	c14	0	32-bit	Performance Monitors User Enable Register
PMXEVCNTR	c9	0	c13	2	32-bit	Performance Monitors Event Count Register
PMXEVTYPER	c9	0	c13	1	32-bit	Performance Monitors Event Type Select Register

IMPLEMENTATION DEFINED performance monitors

VMSAv8-32 reserves some additional System register encodings in the (coproc==0b1111) encoding space for optional additional IMPLEMENTATION DEFINED performance monitors. [Table G4-60](#) shows the allocation of these encodings:

Table G4-60 Performance Monitors System register encoding allocations

CRn	opc1	CRm	opc2	Name	Width	Type
c9	0-7	c12-c14	0-7	Performance Monitors Extension registers, see Table G4-59 on page G4-4738	32-bit	RW or RO ^a
		c15	0-7	IMPLEMENTATION DEFINED	32-bit	b

a. The table referenced in the *Name* entry shows the type of each of the OPTIONAL Performance Monitors Extension registers.

b. Access depends on the register or operation, and is IMPLEMENTATION DEFINED.

G4.17.14 Generic Timer registers, functional group

Table G4-61 shows the VMSAv8-32 System registers in the (coproc==0b1111) encoding space that are the Generic Time registers functional group.

Table G4-61 Generic Timer registers

Name	CRn	opc1	CRm	opc2	Width	Type ^a	Description
CNTRQ	c14	0	c0	0	32-bit	RW	Counter Frequency register
CNTHCTL	c14	4	c1	0	32-bit	RW	Timer EL2 Control register
CNTHP_CTL	c14	4	c2	1	32-bit	RW	EL2 Physical Timer Control register
CNTHP_CVAL	-	6	c14	-	64-bit	RW	EL2 Physical Timer CompareValue register
CNTHP_TVAL	c14	4	c2	0	32-bit	RW	EL2 Physical TimerValue register
CNTKCTL	c14	0	c1	0	32-bit	RW	Timer EL1 Control register
CNTP_CTL	c14	0	c2	1	32-bit	RW	EL1 Physical Timer Control register
CNTP_CVAL	-	2	c14	-	64-bit	RW	EL1 Physical Timer CompareValue register
CNTP_TVAL	c14	0	c2	0	32-bit	RW	EL1 Physical TimerValue register
CNTPCT	-	0	c14	-	64-bit	RW	Physical Count register
CNTV_CTL	c14	0	c3	1	32-bit	RW	Virtual Timer Control register
CNTV_CVAL	-	3	c14	-	64-bit	RW	Virtual Timer CompareValue register
CNTV_TVAL	c14	0	c3	0	32-bit	RW	Virtual TimerValue register
CNTVCT	-	1	c14	-	64-bit	RO	Virtual Count register
CNTVOFF ^b	-	4	c14	-	64-bit	RW	Virtual Offset register

- a. See the register descriptions for more information. Accessibility can depend on configuration settings as well as on the current Exception level.
- b. Implemented as RW as part of the Generic Timer on an implementation that includes EL2 and when EL2 is using AArch32. For more information see *Status of the CNTVOFF register* on page G5-4757.

G4.17.15 Generic Interrupt Controller System registers, functional groups

From version 3.0 of the GIC architecture specification, the specification defines three groups of System registers, identified by the prefix of the register name:

- ICC_** GIC physical CPU interface System registers.
- ICH_** GIC virtual interface control System registers.
- ICV_** GIC Virtual CPU interface System registers.

———— **Note** —————

These registers are in addition to the GIC memory-mapped register groups GICC_, GICD_, GICH_, GICR_, GICV_, and GITS_.

In VMSAv8-32, the GIC System registers are all in the (coproc==0b1111) encoding space with (CRn==c12). The ICV_* registers have the same {CRn, opc1, CRm, op2} encodings as the corresponding ICC_* registers. For these encodings, GIC register configuration fields determine which register is accessed.

For more information see the *ARM® Generic Interrupt Controller Architecture Specification, GIC architecture version 3.0 and version 4.0*.

Table G4-62 shows the functional groups of GIC System registers.

Table G4-62 Generic Interrupt Controller System registers

Name	CRn	opc1	CRm	opc2	Width	Type	Description
ICC_AP0R0 ^a ICV_AP0R0 ^a	c12	0	c8	4	32-bit	RW	Interrupt Controller Active Priorities Register (0,0) Interrupt Controller Virtual Active Priorities Register (0,0)
ICC_AP0R1 ^a ICV_AP0R1 ^a	c12	0	c8	5	32-bit	RW	Interrupt Controller Active Priorities Register (0,1) Interrupt Controller Virtual Active Priorities Register (0,1)
ICC_AP0R2 ^a ICV_AP0R2 ^a	c12	0	c8	6	32-bit	RW	Interrupt Controller Active Priorities Register (0,2) Interrupt Controller Virtual Active Priorities Register (0,2)
ICC_AP0R3 ^a ICV_AP0R3 ^a	c12	0	c8	7	32-bit	RW	Interrupt Controller Active Priorities Register (0,3) Interrupt Controller Virtual Active Priorities Register (0,3)
ICC_AP1R0 ^a ICV_AP1R0 ^a	c12	0	c9	0	32-bit	RW	Interrupt Controller Active Priorities Register (1,0) Interrupt Controller Virtual Active Priorities Register (1,0)
ICC_AP1R1 ^a ICV_AP1R1 ^a	c12	0	c9	1	32-bit	RW	Interrupt Controller Active Priorities Register (1,1) Interrupt Controller Virtual Active Priorities Register (1,1)
ICC_AP1R2 ^a ICV_AP1R2 ^a	c12	0	c9	2	32-bit	RW	Interrupt Controller Active Priorities Register (1,2) Interrupt Controller Virtual Active Priorities Register (1,2)
ICC_AP1R3 ^a ICV_AP1R3 ^a	c12	0	c9	3	32-bit	RW	Interrupt Controller Active Priorities Register (1,3) Interrupt Controller Virtual Active Priorities Register (1,3)
ICC_ASGI1R	-	1	c12	-	64-bit	WO	Interrupt Controller Alias Software Generated Interrupt group 1 Register
ICC_BPR0 ^a ICV_BPR0 ^a	c12	0	c8	3	32-bit	RW	Interrupt Controller Binary Point Register 0 Interrupt Controller Virtual Binary Point Register 0
ICC_BPR1 ^a ICV_BPR1 ^a	c12	0	c12	3	32-bit	RW	Interrupt Controller Binary Point Register 1 Interrupt Controller Virtual Binary Point Register 1
ICC_CTLR ^a ICV_CTLR ^a	c12	0	c12	4	32-bit	RW	Interrupt Controller Control Register Interrupt Controller Virtual Control Register
ICC_DIR ^a ICV_DIR ^a	c12	0	c11	1	32-bit	WO	Interrupt Controller Deactivate Interrupt Register Interrupt Controller Deactivate Virtual Interrupt Register
ICC_EOIR0 ^a ICV_EOIR0 ^a	c12	0	c8	1	32-bit	WO	Interrupt Controller End Of Interrupt Register 0 Interrupt Controller Virtual End Of Interrupt Register 0

Table G4-62 Generic Interrupt Controller System registers (continued)

Name	CRn	opc1	CRm	opc2	Width	Type	Description
ICC_EOIR1 ^a ICV_EOIR1 ^a	c12	0	c12	1	32-bit	WO	Interrupt Controller End Of Interrupt Register 1 Interrupt Controller Virtual End Of Interrupt Register 1
ICC_HPPIR0 ^a ICV_HPPIR0 ^a	c12	0	c8	2	32-bit	RO	Interrupt Controller Highest Priority Pending Interrupt Register 0 Interrupt Controller Virtual Highest Priority Pending Interrupt Register 0
ICC_HPPIR1 ^a ICV_HPPIR1 ^a	c12	0	c12	2	32-bit	RO	Interrupt Controller Highest Priority Pending Interrupt Register 1 Interrupt Controller Virtual Highest Priority Pending Interrupt Register 1
ICC_HSRE	c12	4	c9	5	32-bit	RW	Interrupt Controller Hyp System Register Enable register
ICC_IAR0 ^a ICV_IAR0 ^a	c12	0	c8	0	32-bit	RO	Interrupt Controller Interrupt Acknowledge Register 0 Interrupt Controller Virtual Interrupt Acknowledge Register 0
ICC_IAR1 ^a ICV_IAR1 ^a	c12	0	c12	0	32-bit	RO	Interrupt Controller Interrupt Acknowledge Register 1 Interrupt Controller Virtual Interrupt Acknowledge Register 1
ICC_IGRPENR0 ^a ICV_IGRPENR0 ^a	c12	0	c12	6	32-bit	RW	Interrupt Controller Interrupt Group 0 Enable register Interrupt Controller Virtual Interrupt Group 0 Enable register
ICC_IGRPENR1 ^a ICV_IGRPENR1 ^a	c12	0	c12	7	32-bit	RW	Interrupt Controller Interrupt Group 1 Enable register Interrupt Controller Virtual Interrupt Group 1 Enable register
ICC_MCTLR	c12	6	c12	4	32-bit	RW	Interrupt Controller Monitor Control Register
ICC_MGRPEN1	c12	6	c12	7	32-bit	RW	Interrupt Controller Monitor Interrupt Group 1 Enable register
ICC_MSRE	c12	6	c12	5	32-bit	RW	Interrupt Controller Monitor System Register Enable register
ICC_PMR ^a ICV_PMR ^a	c4	0	c6	0	32-bit	RW	Interrupt Controller Interrupt Priority Mask Register Interrupt Controller Virtual Interrupt Priority Mask Register
ICC_RPR ^a ICV_RPR ^a	c12	0	c11	3	32-bit	RO	Interrupt Controller Running Priority Register Interrupt Controller Virtual Running Priority Register
ICC_SGIOR	-	2	c12	-	64-bit	WO	Interrupt Controller Software Generated Interrupt group 0 Register
ICC_SGIIR	-	0	c12	-	64-bit	WO	Interrupt Controller Software Generated Interrupt group 1 Register
ICC_SRE	c12	0	c12	5	32-bit	RW	Interrupt Controller System Register Enable register

Table G4-62 Generic Interrupt Controller System registers (continued)

Name	CRn	opc1	CRm	opc2	Width	Type	Description
ICH_AP0R0	c12	4	c8	0	32-bit	RW	Interrupt Controller Hyp Active Priorities Register (0,0)
ICH_AP0R1	c12	4	c8	1	32-bit	RW	Interrupt Controller Hyp Active Priorities Register (0,1)
ICH_AP0R2	c12	4	c8	2	32-bit	RW	Interrupt Controller Hyp Active Priorities Register (0,2)
ICH_AP0R3	c12	4	c8	3	32-bit	RW	Interrupt Controller Hyp Active Priorities Register (0,3)
ICH_AP1R0	c12	4	c9	0	32-bit	RW	Interrupt Controller Hyp Active Priorities Register (1,0)
ICH_AP1R1	c12	4	c9	1	32-bit	RW	Interrupt Controller Hyp Active Priorities Register (1,1)
ICH_AP1R2	c12	4	c9	2	32-bit	RW	Interrupt Controller Hyp Active Priorities Register (1,2)
ICH_AP1R3	c12	4	c9	3	32-bit	RW	Interrupt Controller Hyp Active Priorities Register (1,3)
ICH_EISR	c12	4	c11	3	32-bit	RO	Interrupt Controller End of Interrupt Status Register
ICH_ELRSR	c12	4	c11	5	32-bit	RO	Interrupt Controller Empty List Register Status Register
ICH_HCR	c12	4	c11	0	32-bit	RW	Interrupt Controller Hyp Control Register
ICH_LR<n>, n==0-7	c12	4	c12	0-7	32-bit	RW	Interrupt Controller List Registers, 0-7
ICH_LR<n>, n==8-15	c12	4	c13	0-7	32-bit	RW	Interrupt Controller List Registers, 8-15
ICH_LRC<n>, n==0-7	c12	4	c14	0-7	32-bit	RW	Interrupt Controller List Registers Continuation, 0-7
ICH_LRC<n>, n==8-15	c12	4	c15	0-7	32-bit	RW	Interrupt Controller List Registers Continuation, 8-15
ICH_MISR	c12	4	c11	2	32-bit	RO	Interrupt Controller Maintenance Interrupt State Register
ICH_VMCR	c12	4	c11	7	32-bit	RW	Interrupt Controller Virtual Machine Control Register
ICH_VTR	c12	4	c11	1	32-bit	RO	Interrupt Controller VGIC Type Register

a. As described in this section, these ICC_* and ICV_* registers use the same encodings.

G4.17.16 Legacy feature registers, functional group

Table G4-63 shows the VMSAv8-32 System registers in the (coproc==0b1111) encoding space that are in the Legacy features registers functional group.

Table G4-63 Legacy features System registers in the (coproc==0b1111) encoding space

Name	CRn	opc1	CRm	opc2	Width	Type ^a	Description
CP15DMB	c7	0	c10	5	32-bit	WO, PL0	<i>Memory barriers on page E2-2768^b</i>
CP15DSB	c7	0	c10	4	32-bit	WO, PL0	
CP15ISB	c7	0	c5	4	32-bit	WO, PL0	
FCSEIDR	c13	0	c0	0	32-bit	RW ^c	FCSE Process ID Register

- a. PL0 in a Type description indicates that the encoding is accessible by software executing at PL0. See the register description for more information.
- b. For performance reasons, ARM deprecates any use of these memory barrier operations.
- c. In ARMv8, the PE does not implement the FCSEIDR, and therefore the register is RAZ/WI. See the register description for more information.

Table G4-64 shows the VMSAv8-32 System registers in the (coproc==0b1110) encoding space that are in the Legacy features registers functional group.

Table G4-64 Legacy features registers in the (coproc==0b1110) encoding space

Name	CRn	opc1	CRm	opc2	Width	Type	Description
JIDR	c0	7	c0	0	32-bit	RO	Jazelle ID Register
JMCR	c2	7	c0	0	32-bit	RW	Jazelle Main Configuration Register
JOSCR	c1	7	c0	0	32-bit	RW	Jazelle OS Control Register

G4.17.17 IMPLEMENTATION DEFINED registers, functional group

VMSAv8-32 defines some encodings for registers with content that is entirely IMPLEMENTATION DEFINED.

Table G4-65 shows these registers in the (coproc==0b1111) encoding space.

Table G4-65 Architectural encodings for registers with IMPLEMENTATION DEFINED content

Name	CRn	opc1	CRm	opc2	Width	Type	Description
ACTLR	c1	0	c0	1	32-bit	RW	Auxiliary Control Register
ACTLR2	c1	0	c0	3	32-bit	RW	Auxiliary Control Register 2
ADFSR	c5	0	c1	0	32-bit	RW	Auxiliary Data Fault Status Register
AIDR	c0	1	c0	7	32-bit	RO	Auxiliary ID Register
AIFSR	c5	0	c1	1	32-bit	RW	Auxiliary Instruction Fault Status Register
AMAIRO	c10	0	c3	0	32-bit	RW	Auxiliary Memory Attribute Indirection Register 0
AMAIR1	c10	0	c3	1	32-bit	RW	Auxiliary Memory Attribute Indirection Register 1
HACR	c1	4	c1	7	32-bit	RW	Hyp Auxiliary Configuration Register
HACTLR	c1	4	c0	0	32-bit	RW	Hyp Auxiliary System Control Register

Table G4-65 Architectural encodings for registers with IMPLEMENTATION DEFINED content (continued)

Name	CRn	opc1	CRm	opc2	Width	Type	Description
HACTLR2	c1	4	c0	3	32-bit	RW	Hyp Auxiliary System Control Register 2
HADFSR	c5	4	c1	0	32-bit	RW	Hyp Auxiliary Data Fault Status Register
HAIFSR	c5	4	c1	1	32-bit	RW	Hyp Auxiliary Instruction Fault Status Register
HAMAIRO	c10	4	c3	0	32-bit	RW	Hyp Auxiliary Memory Attribute Indirection Register 0
HAMAIRI	c10	4	c3	1	32-bit	RW	Hyp Auxiliary Memory Attribute Indirection Register 1
REVIDR	c0	0	c0	6	32-bit	RO	Revision ID Register
TCMTR	c0	0	c0	2	32-bit	RO	TCM Type Register

See also *IMPLEMENTATION DEFINED performance monitors* on page G4-4739.

G4.17.18 Advanced SIMD and floating-point registers, functional group

[Table G4-66](#) shows the VMSAv8-32 System registers in the Advanced SIMD and floating-point registers functional group. These registers are accessed using VMRS and VMSR instructions, see the register descriptions for more information.

Table G4-66 Floating-point registers

Name	Width	Type	Description
FPEXC	32-bit	RW	Floating-Point Exception Control register
FPSCR	32-bit	RW	Floating-Point Status and Control Register
FPSID	32-bit	RW ^a	Floating-Point System ID register
MVFR0	32-bit	RO	Media and VFP Feature Register 0
MVFR1	32-bit	RO	Media and VFP Feature Register 1
MVFR2	32-bit	RO	Media and VFP Feature Register 2

a. When the [FPSID](#) is accessible, VMSR accesses to the [FPSID](#) are ignored.

G4.17.19 Debug registers, functional group

In AArch32 state, most Debug registers that are accessible through the System registers interface use {coproc==0b1110, opc1==0} encodings. [Table G4-67](#) shows these registers.

Table G4-67 System register {coproc == 0b1110, opc1 == 0} encodings of Debug registers

Name	CRn	opc2	CRm	Width	Type	Description
DBGAUTHSTATUS	c7	6	c14	32-bit	RO	Authentication Status
DBGBCR<n>	c0	5	c0-c15	32-bit	RW	Breakpoint Control
DBGBVR<n>	c0	4	c0-c15	32-bit	RW	Breakpoint Value
DBGXBVR<n>	c1	1	c0-c15	32-bit	RW	Breakpoint Extended Value
DBGCLAIMCLR	c7	6	c9	32-bit	RW	CLAIM Tag Clear

Table G4-67 System register {coproc == 0b1110, opc1 == 0} encodings of Debug registers (continued)

Name	CRn	opc2	CRm	Width	Type	Description
DBGCLAIMSET	c7	6	c8	32-bit	RW	CLAIM Tag Set
DBGDCCINT	c0	0	c2	32-bit	RW	Debug Communications Channel Interrupt Enable Register
DBGDEVID	c7	7	c2	32-bit	RO	Device ID 0
DBGDEVID1	c7	7	c1	32-bit	RO	Device ID 1
DBGDEVID2	c7	7	c0	32-bit	RO	Reserved, UNK
DBGDIDR	c0	0	c0	32-bit	RO	Debug ID
DBGDRAR	-	-	c1	64-bit	RO	Debug ROM Address
	c1	0	c0	32-bit		
DBGDSAR	-	-	c2	64-bit	RO	Debug Self Address Offset
	c2	0	c0	32-bit		
DBGDSCRExt	c0	2	c2	32-bit	RW	Debug Status and Control external
DBGDSCRint	c0	0	c1	32-bit	RO	Debug Status and Control internal
DBGDTRRExt	c0	2	c0	32-bit	RW	Host to Target Data Transfer external
DBGDTRRint	c0	0	c5	32-bit	RO	Host to Target Data Transfer internal
DBGDTRTExt	c0	2	c3	32-bit	RW	Target to Host Data Transfer external
DBGDTRTint	c0	0	c5	32-bit	WO	Target to Host Data Transfer internal
DBGOSDLR	c1	4	c3	32-bit	RW	OS Double Lock
DBGOSECCR	c0	2	c6	32-bit	RW	OS Lock Exception Catch Control Register
DBGOSLAR	c1	4	c0	32-bit	WO	OS Lock Access
DBGOSLSR	c1	4	c1	32-bit	RO	OS Lock Status
DBGPRCR	c1	4	c4	32-bit	RW	Device Powerdown and Reset Control
DBGVCR	c0	0	c7	32-bit	RW	Vector Catch
DBGWCR<n>	c0	7	c0-c15	32-bit	RW	Watchpoint Control
DBGWFAR	c0	0	c6	32-bit	RW	Watchpoint Fault Address
DBGWVR<n>	c0	6	c0-c15	32-bit	RW	Watchpoint Value
-	c4	0-3	c0-c15	32-bit	IMP DEF	IMPLEMENTATION DEFINED
-	c7	2-3	c0-c15	32-bit	IMP DEF	Integration registers
		4	c0	32-bit		

In AArch32 state, some Debug registers that are accessible through the System registers interface using (coproc==0b1110) encodings. [Table G4-68 on page G4-4747](#) shows these registers.

Table G4-68 System register (coproc==0b1110) encodings of Debug registers

Name	CRn	opc1	CRm	opc2	Width	Type	Description
DLR	c4	3	c5	1	32-bit	RW	Debug Link Register
DPSR	c4	3	c5	0	32-bit	RW	Debug Saved Program Status Register
HDCR	c1	4	c1	1	32-bit	RW	Hyp Debug Control Register
SDCR	c1	0	c3	1	32-bit	RW	Secure Debug Configuration Register
SDER	c1	0	c1	1	32-bit	RW	Secure Debug Enable Register

G4.18 Pseudocode description of VMSAv8-32 memory system operations

This section contains a list of pseudocode functions describing VMSAv8-32 memory operations. The following subsections describe the pseudocode functions:

- [Alignment fault.](#)
- [Address translation.](#)
- [Domain checking.](#)
- [TLB operations.](#)
- [Translation table walk.](#)
- [Reporting syndrome information on page G4-4749.](#)
- [Memory access decode when TEX remap is enabled on page G4-4749.](#)

See also the descriptions of pseudocode for general memory system operations in [Pseudocode description of general memory system instructions on page G3-4553.](#)

G4.18.1 Alignment fault

The `AArch32.AlignmentFault()` pseudocode function describes the generation of an Alignment fault Data Abort exception.

See also [Abort exceptions on page G3-4555.](#)

G4.18.2 Address translation

The `AArch32.TranslateAddress()` and `AArch32.FullTranslate()` pseudocode functions describe a VMSAv8-32 address translation.

The `AArch32.FullTranslate()` function calls either:

- The function described in [Address translation when the stage 1 address translation is disabled.](#)
- One of the functions described in [Translation table walk.](#)

See also [Stage 2 translation table walk on page G4-4749.](#)

Address translation when the stage 1 address translation is disabled

The `AArch32.TranslateAddressS10ff()` pseudocode function describes the address translation performed when the stage 1 address translation is disabled.

G4.18.3 Domain checking

The `AArch32.CheckDomain()` pseudocode function describes domain checking.

G4.18.4 TLB operations

The `TLBRecord` type represents the contents of a TLB entry:

G4.18.5 Translation table walk

Because of the complexity of a translation table walk, the following sections describe the different cases:

- [Translation table walk using the Short-descriptor translation table format for stage 1.](#)
- [Translation table walk using the Long-descriptor translation table format for stage 1 on page G4-4749.](#)
- [Stage 2 translation table walk on page G4-4749.](#)

Translation table walk using the Short-descriptor translation table format for stage 1

The `AArch32.TranslationTableWalkSD()` pseudocode function describes the translation table walk when the stage 1 translation tables use the Short-descriptor format. It calls the function described in [Stage 2 translation table walk on page G4-4749](#) if necessary.

The `ShortConvertAttrHints()` pseudocode function converts the Normal memory cacheability attribute, from the TTBR or the translation table TEX field, into the separate cacheability attribute and cache allocation hint defined in a Long-descriptor translation table descriptor.

Translation table walk using the Long-descriptor translation table format for stage 1

The `AArch32.TranslationTableWalkLD()` pseudocode function describes the translation table walk when the stage 1 translation tables use the Long-descriptor format. It calls the function described in *Stage 2 translation table walk* if necessary.

`AArch32.TranslationTableWalkLD()` calls the `ConvertAttrHints()` pseudocode function that is defined in *Translation table walk using the Short-descriptor translation table format for stage 1* on page G4-4748.

The `AArch32.S1AttrDecode()` pseudocode function uses the MAIR0 and MAIR1 registers to decode the Attr[2:0] value from a stage 1 translation table descriptor.

The `S2AttrDecode()` pseudocode function decodes the Attr[3:0] value from a stage 2 translation table descriptor.

Stage 2 translation table walk

In the Non-secure EL1&0 translation regime, a descriptor address returned by stage 1 lookup is in the IPA address map, and must be mapped to a PA by a stage 2 translation. When EL2 is using AArch32, function `AArch32.SecondStageWalk()` performs this translation, by calling the `AArch32.SecondStageTranslate()` function. When called from `AArch32.SecondStageWalk()`, the `AArch32.SecondStageTranslate()` function performs a second stage translation, from IPA to PA, of the supplied address, including checking that the access has read permission at the second stage. If the access does not have second stage read permission it generates a second stage Permission fault on the first stage translation table walk. The second stage translation might hit in a TLB, or might involve a translation table walk, which will use the algorithm described in this section. Stage 2 translations tables always use the Long-descriptor translation table format.

The `AArch32.CheckPermission()` pseudocode function checks the access permissions for the stage 1 translation.

The `AArch32.CheckS2Permission()` pseudocode function checks the access permissions for the stage 2 translation.

The `CombineS1S2Desc()` pseudocode function combines the stage 1 and stage 2 access descriptors:

G4.18.6 Reporting syndrome information

The `AArch32.ReportHypEntry()`, `AArch32.ReportDataAbort()`, and `AArch32.ReportPrefetchAbort()` pseudocode functions write syndrome value information to the appropriate registers for the current mode.

G4.18.7 Memory access decode when TEX remap is enabled

When using the Short-descriptor translation table format, the function `AArch32.RemappedTEXDecode()` decodes the texcb and S attributes derived from the translation tables when TEX remap is enabled. *Short-descriptor format memory region attributes, with TEX remap* on page G4-4619 shows the interpretation of the arguments.

Chapter G5

The Generic Timer in AArch32 state

This chapter describes the implementation of the ARM Generic Timer as an extension to an ARMv8 implementation. It includes an overview of the AArch32 System register interface to an ARM Generic Timer.

It contains the following sections:

- [About the Generic Timer in AArch32 state on page G5-4752.](#)
- [The AArch32 view of the Generic Timer on page G5-4756.](#)

[Chapter D6 The Generic Timer in AArch64 state](#) describes the AArch64 view of the Generic Timer, including an additional timer that can be implemented in AArch64 state, and [Chapter I1 System Level Implementation of the Generic Timer](#) describes the system level implementation of the Generic Timer.

G5.1 About the Generic Timer in AArch32 state

Figure G5-1 shows an example system-on-chip that uses the Generic Timer as a system timer. In this figure:

- This manual defines the architecture of the individual PEs in the multiprocessor blocks.
- The *ARM Generic Interrupt Controller Architecture Specification* defines a possible architecture for the interrupt controllers.
- Generic Timer functionality is distributed across multiple components.

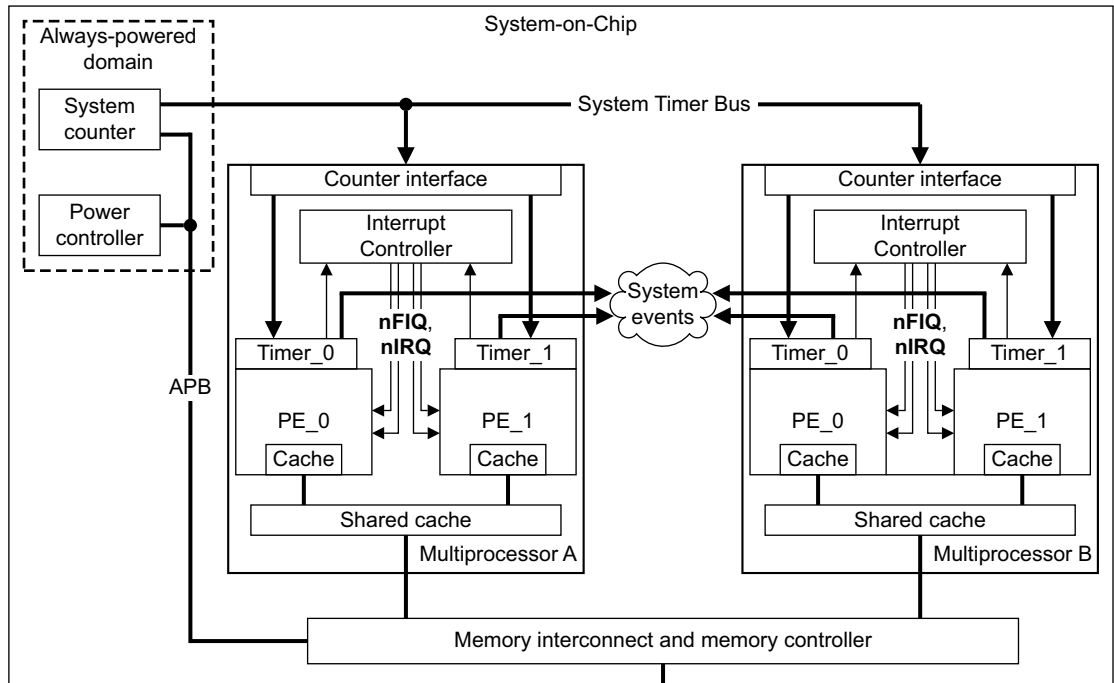

Figure G5-1 Generic Timer example

The Generic Timer:

- Provides a system counter, that measures the passing of time in real-time.

———— **Note** ————

The Generic Timer can also provide other components at a system level, but Figure G5-1 does not show any such components.

- Supports *virtual counters* that measure the passing of virtual-time. That is, a virtual counter can measure the passing of time on a particular virtual machine.
- Timers, that can trigger events after a period of time has passed. The timers:
 - Can be used as count-up or as count-down timers.
 - Can operate in real-time or in virtual-time.

This chapter describes an instance of the Generic Timer component that Figure G5-1 shows as Timer_0 or Timer_1 within the Multiprocessor A or Multiprocessor B block. This component can be accessed from AArch64 state or AArch32 state, and this chapter describes access from AArch32 state. Chapter D6 *The Generic Timer in AArch64 state* describes access to this component from AArch64 state.

———— **Note** ————

The reset requirements of Generic Timer registers are more strict when they are accessed from AArch32 state than when they are accessed from AArch64 state.

A Generic Timer implementation must also include a memory-mapped system component, see [The full set of Generic Timer components](#).

G5.1.1 The full set of Generic Timer components

Within a system that might include multiple PEs, a full set of Generic Timer components is as follows:

The system counter

This provides a uniform view of system time, see [The system counter on page G5-4754](#). Because this must be implemented at the system level, it is accessed through [The system level memory-mapped implementation of the Generic Timer](#). However, during initialization, a status register in each implemented timer in the system must be programmed with the frequency of the system counter, so that software can read this frequency.

PE implementations of the Generic Timer

Each PE implementation of the Generic Timer provides the following components:

- A physical counter, that gives access to the count value of the system counter.
- A virtual counter, that gives access to virtual time. In AArch32 state, the `CNTVOFF` register defines the offset between physical time, as defined by the value of the system counter, and virtual time.
- A number of timers. In an implementation where all Exception levels are implemented and can use AArch32 state, the timers that are accessible from AArch64 state are:
 - A Secure PL1 physical timer.
 - A Non-secure EL1 physical timer.
 - An EL2 physical timer.
 - A virtual timer.

Note

The Secure PL1 physical timer uses the Secure banked instances of the `CNTP_CTL`, `CNTP_CVAL`, and `CNTP_TVAL` registers, and the Non-secure EL1 physical timer uses the Non-secure instances of the same registers.

[The AArch32 view of the Generic Timer on page G5-4756](#) describes these components.

The system level memory-mapped implementation of the Generic Timer

The memory-mapped registers that control the components of the system level implementation of the Generic Timer are grouped into *frames*. The Generic Timer architecture defines the offset of each register within its frame, but the base address of each frame is IMPLEMENTATION DEFINED, and defined by the system.

Each system level component has one or two register frames. The possible system level components are:

The memory-mapped counter module, required

This module controls the system counter. It has two frames:

- A control frame, `CNTControlBase`.
- A status frame, `CNTReadBase`.

The memory-mapped timer control module, required

The system level implementation of the Generic Timer can provide up to eight timers, and the memory-mapped timer control module identifies:

- Which timers are implemented.
- The features of each implemented timer.

This module has a single frame, `CNTCTLBase`.

Memory-mapped timers, optional

An implemented memory-mapped timer:

- Must provide a privileged view of the timer, in the `CNTBaseN` frame.

- Optionally, provides an unprivileged view of the timer in the CNTEL0BaseN frame.

N is the timer number, and the corresponding frame number, in the range 0-7.

[Chapter 11 System Level Implementation of the Generic Timer](#) describes these components.

G5.1.2 The system counter

The Generic Timer provides a system counter with the following specification:

Width	At least 56 bits wide. The value returned by any 64-bit read of the counter is zero-extended to 64 bits.
Frequency	Increments at a fixed frequency, typically in the range 1-50MHz. Can support one or more alternative operating modes in which it increments by larger amounts at a lower frequency, typically for power-saving.
Roll-over	Roll-over time of not less than 40 years.
Accuracy	ARM does not specify a required accuracy, but recommends that the counter does not gain or lose more than ten seconds in a 24-hour period. Use of lower-frequency modes must not affect the implemented accuracy.
Start-up	Starts operating from zero.

The system counter, once configured and running, must provide a uniform view of system time. More precisely, it must be impossible for the following sequence of events to show system time going backwards:

1. Device A reads the time from the system counter.
2. Device A communicates with another agent in the system, Device B.
3. After recognizing the communication from Device A, Device B reads the time from the system counter.

The system counter must be implemented in an always-on power domain.

To support lower-power operating modes, the counter can increment by larger amounts at a lower frequency. For example, a 10MHz system counter might either increment:

- By 1 at 10MHz.
- By 500 at 20kHz, when the system lowers the clock frequency, to reduce power consumption.

In this case, the counter must support transitions between high-frequency, high-precision operation, and lower-frequency, lower-precision operation, without any impact on the required accuracy of the counter.

The **CNTFRQ** register is intended to hold a copy of the current clock frequency to allow fast reference to this frequency by software running on the PE. For more information see [Initializing and reading the system counter frequency](#).

The mechanism by which the count from the system counter is distributed to system components is IMPLEMENTATION DEFINED, but each PE with a System register interface to the system counter must have a counter input that can capture each increment of the counter.

———— Note —————

So that the system counter can be clocked independently from the PE hardware, the count value might be distributed using a Gray code sequence. [Gray-count scheme for timer distribution scheme on page I1-5736](#) gives more information about this possibility.

Initializing and reading the system counter frequency

The **CNTFRQ** register must be programmed to the clock frequency of the system counter. Typically, this is done only during the system boot process, by using the System register interface to write the system counter frequency to the **CNTFRQ** register. Only software executing at the highest implemented Exception level can write to **CNTFRQ**.

Note

The [CNTFRQ](#) register is UNKNOWN at reset, and therefore the counter frequency must be set as part of the system boot process.

Software can read the [CNTFRQ](#) register, to determine the current system counter frequency, in the following states and modes:

- Hyp mode.
- Secure PL1 modes and Non-secure EL1 modes.
- When [CNTKCTL.PL0PCTEN](#) is set to 1, Secure and Non-secure EL0 modes.

Memory-mapped controls of the system counter

Some system counter controls are accessible only through the memory-mapped interface to the system counter. These controls are:

- Enabling and disabling the counter.
- Setting the counter value.
- Changing the operating mode, to change the update frequency and increment value.
- Enabling Halt-on-debug, that a debugger can then use to suspend counting.

For descriptions of these controls, see [Chapter 11 System Level Implementation of the Generic Timer](#).

G5.2 The AArch32 view of the Generic Timer

The following sections describe the components and features of a PE implementation of the Generic Timer, as seen from AArch32 state:

- [The physical counter](#).
- [The virtual counter](#).
- [Event streams on page G5-4757](#).
- [Timers on page G5-4758](#).

G5.2.1 The physical counter

The PE includes a physical counter that contains the count value of the system counter. The `CNTPCT` register holds the current physical counter value.

Accessing the physical counter

Software with sufficient privilege can read `CNTPCT` using a 64-bit System register read.

`CNTPCT`:

- Is always accessible from Secure PL1 modes and from Non-secure Hyp mode.
- Is accessible from Non-secure EL1 modes when the value of `CNTHCTL.PL1PCTEN` is 1. When the value of `CNTHCTL.PL1PCTEN` is 0, any attempt to access `CNTPCT` from Non-secure EL1 modes is trapped to Hyp mode.
- Is accessible from Secure User mode when the value of `CNTKCTL.PL0PCTEN` is 1. When the value of `CNTKCTL.PL0PCTEN` is 0, any attempt to access `CNTPCT` generates an UNDEFINED exception.
- Is accessible from Non-secure User mode when the value of `CNTHCTL.PL1PCTEN` is 1 and the value of `CNTKCTL.PL0PCTEN` is 1. Otherwise:
 - When the value of `CNTKCTL.PL0PCTEN` is 0, any attempt to access `CNTPCT` from Non-secure User mode generates an UNDEFINED exception.
 - When the value of `CNTKCTL.PL0PCTEN` is 1 and the value of `CNTHCTL.PL1PCTEN` is 0, any attempt to access `CNTPCT` from Non-secure User mode is trapped to Hyp mode.

Reads of `CNTPCT` can occur speculatively and out of order relative to other instructions executed on the same PE.

For example, if a read from memory is used to obtain a signal from another agent that indicates that `CNTPCT` must be read, an ISB is used to ensure that the read of `CNTPCT` occurs after the signal has been read from memory, as shown in the following code sequence:

```
loop                ; polling for some communication to indicate a requirement to read the timer
  LDR R1, [R2]
  CMP R1, #1
  BNE loop
  ISB                ; without this, the CNTPCT could be read before the memory location in [R2]
                    ; has had the value 1 written to it
  MRS R1, CNTPCT
```

G5.2.2 The virtual counter

An implementation of the Generic Timer always includes a virtual counter, that indicates virtual time.

The virtual counter contains the value of the physical counter minus a 64-bit virtual offset. When executing in a Non-secure EL1 or EL0 mode, the virtual offset value relates to the current virtual machine.

The `CNTVOFF` register contains the virtual offset. `CNTVOFF` is only accessible:

- From Hyp mode.
- From Monitor mode only when `SCR.NS` is set to 1.

For more information see [Status of the CNTVOFF register on page G5-4757](#).

The `CNTVCT` register holds the current virtual counter value.

Accessing the virtual counter

Software with sufficient privilege can read `CNTVCT` using a 64-bit System register read.

`CNTVCT` is always accessible from Secure PL1 modes and from Non-secure EL1 and EL2 modes.

In addition, when `CNTKCTL.PL0VCTEN` is set to 1, `CNTVCT` is accessible from EL0.

When `CNTKCTL.PL0VCTEN` is set to 0, any attempt to access `CNTVCT` from EL0 is UNDEFINED.

Reads of `CNTVCT` can occur speculatively and out of order relative to other instructions executed on the same PE.

For example, if a read from memory is used to obtain a signal from another agent that indicates that `CNTVCT` must be read, an ISB is used to ensure that the read of `CNTVCT` occurs after the signal has been read from memory, as shown in the following code sequence:

```
loop           ; polling for some communication to indicate a requirement to read the timer
  LDR R1, [R2]
  CMP R1, #1
  BNE loop
  ISB          ; without this, the CNTVCT could be read before the memory location in [R2]
               ; has had the value 1 written to it
  MRS R1, CNTVCT
```

Status of the CNTVOFF register

All implementations of the Generic Timer include the virtual counter. Therefore, conceptually, all implementations include the `CNTVOFF` register that defines the *virtual offset* between the physical count and the virtual count. `CNTVOFF` is only accessible at EL2 or above. If EL2 is not implemented, the virtual counter uses a fixed virtual offset of zero.

G5.2.3 Event streams

Any implementation of the Generic Timer can use the system counter to generate one or more *event streams*, to generate periodic wake-up events as part of the mechanism described in [Wait for Event mechanism and Send event on page D1-1879](#).

————— Note —————

An event stream might be used:

- To impose a time-out on a Wait For Event polling loop.
- To safeguard against any programming error that means an expected event is not generated.

An event stream is configured by:

- Selecting which bit, from the bottom 16 bits of a counter, triggers the event. This determines the frequency of the events in the stream.
- Selecting whether the event is generated on each 0 to 1 transition, or each 1 to 0 transition, of the selected counter bit.

The `CNTKCTL`.{EVNTEN, EVNTDIR, EVNTI} fields define an event stream that is generated from the virtual counter.

In all implementations the `CNTHCTL`.{EVNTEN, EVNTDIR, EVNTI} fields define an event stream that is generated from the physical counter.

The operation of an event stream is as follows:

- The pseudocode variables PreviousCNTVCT and PreviousCNTPCT are initialized as:

```
// Variables used for generation of the timer event stream.
```

```
bits(64) PreviousCNTVCT = bits(64) UNKNOWN;
bits(64) PreviousCNTPCT = bits(64) UNKNOWN;
```

- The pseudocode functions TestEventCNTV() and TestEventCNTP() are called on each cycle of the PE clock.
- The TestEventCNTx() pseudocode template defines the functions TestEventCNTV() and TestEventCNTP():

```
// TestEventCNTx()
// =====

// Template for the TestEventCNTV() and TestEventCNTP() functions
// Describes operation when all Exception Levels are using AArch32:
// CNTxCT      is CNTVCT      or CNTPCT      64-bit count value
// CNTx_CTL    is CNTV_CTL    or CNTP_CTL    Control register
// PreviousCNTxCT is PreviousCNTVCT or PreviousCNTPCT

TestEventCNTx()
    if CNTx_CTL.EVNTEN == '1' then
        n = UInt(CNTx_CTL.EVNTI);
        SampleBit = CNTxCT<n>;
        PreviousBit = PreviousCNTxCT<n>;

        if CNTx_CTL.EVNTDIR == '0' then
            if PreviousBit == '0' && SampleBit == '1' then EventRegisterSet();
        else
            if PreviousBit == '1' && SampleBit == '0' then EventRegisterSet();

        PreviousCNTxCT = CNTxCT;

    return;
```

G5.2.4 Timers

In an implementation that includes EL3, in any implementation of the Generic Timer, the following timers are accessible from AArch32 state, provided the appropriate Exception level can use AArch32:

- A Non-secure EL1 physical timer. A Non-secure EL1 control determines whether this register is accessible from Non-secure EL0.
- A Secure PL1 physical timer. This timer:
 - Is accessible from Secure EL1 using AArch32 when EL3 is using AArch64.
 - Is accessible from Secure EL3 when EL3 is using AArch32.
A Secure PL1 control determines whether this register is accessible from Secure EL0.
- A Non-secure EL2 physical timer.
- A virtual timer.

The output of each implemented timer:

- Provides an output signal to the system.
- If the PE interfaces to a *Generic Interrupt Controller* (GIC), signals a *Private Peripheral Interrupt* (PPI) to that GIC. In a multiprocessor implementation, each PE must use the same interrupt number for each timer.

Each timer:

- Is based around a 64-bit CompareValue that provides a 64-bit unsigned upcounter.
- Provides an alternative view of the CompareValue, called the TimerValue, that appears to operate as a 32-bit downcounter.
- Has, in addition, a 32-bit Control register.

In all implementations, the AArch32 System registers for the EL1 (or PL1) physical timer are Banked, to provide the Secure and Non-secure implementations of the timer. [Table G5-1](#) shows the Timer registers.

Table G5-1 Timer registers summary for the Generic Timer

Timer register	Secure PL1 or Non-secure EL1 physical timer	EL2 physical timer	Virtual timer
CompareValue register	CNTP_CVAL ^a	CNTHP_CVAL	CNTV_CVAL
TimerValue register	CNTP_TVAL ^a	CNTHP_TVAL	CNTV_TVAL
Control register	CNTP_CTL ^a	CNTHP_CTL	CNTV_CTL

a. In AArch32 state, these registers are Banked to provide the Non-secure EL1 physical timer and the Secure PL1 physical timer.

The following sections describe:

- [Accessing the timer registers](#)
- [Operation of the CompareValue views of the timers on page G5-4760](#)
- [Operation of the TimerValue views of the timers on page G5-4760.](#)

Accessing the timer registers

For each timer, all timer registers have the same access permissions, as follows:

Secure PL1 and Non-secure EL1 physical timer

The Secure PL1 physical timer is accessible from Secure PL1 modes.

Non-secure software executing at EL2 controls access to the Non-secure EL1 physical timer from Non-secure EL1 modes. The Non-secure EL1 physical timer is accessible from Monitor mode when the value of [SCR.NS](#) is 1.

When access from PL1 or EL1 modes is permitted, [CNTKCTL.PLOPTEN](#) determines whether the registers are accessible from EL0. If an access is not permitted because [CNTKCTL.PLOPTEN](#) is set to 0, an attempted access from EL0 is UNDEFINED.

In all implementations:

- Except for accesses from Monitor mode, accesses are to the registers for the current Security state.
- For accesses from Monitor mode, the value of [SCR.NS](#) determines whether accesses are to the Secure or the Non-secure registers.

————— Note —————

Monitor mode is present only when EL3 is using AArch32.

- The Non-secure registers are accessible from Hyp mode.
- [CNTHCTL.PL1PCEN](#) determines whether the Non-secure registers are accessible from Non-secure EL1 modes. If this bit is set to 1, to enable access from Non-secure EL1 modes, [CNTKCTL.PLOPTEN](#) determines whether the registers are accessible from Non-secure EL0.

If an access is not permitted because [CNTHCTL.PL1PCEN](#) is set to 0, an attempted access from a Non-secure EL1 or EL0 mode generates a Hyp Trap exception. However, if [CNTKCTL.PLOPTEN](#) is set to 0, this control takes priority, and an attempted access from EL0 is UNDEFINED.

EL2 physical timer Accessible from Hyp mode, and from Secure Monitor mode when [SCR_EL3.NS](#) is set to 1.

Virtual timer Accessible from Secure PL1 modes and Non-secure EL1 modes, and from Hyp mode.
CNTKCTL.PLOVTEN determines whether the registers are accessible from EL0 modes. If an access is not permitted because **CNTKCTL.PLOVTEN** is set to 0, an attempted access from EL0 is UNDEFINED.

Operation of the CompareValue views of the timers

The CompareValue view of a timer operates as a 64-bit upcounter. The timer condition is met when the appropriate counter reaches the value programmed into its CompareValue register. When the timer condition is met an interrupt is generated if the interrupt is not masked in the corresponding timer control register, **CNTP_CTL**, **CNTHP_CTL**, or **CNTV_CTL**. For **CNTP_CTL**, the interrupt is the same as the interrupt asserted by the Non-secure instance of the AArch64 register **CNTP_CTL_ELO**.

The operation of this view of a timer is:

$$\text{TimerConditionMet} = (((\text{Counter}[63:0] - \text{Offset}[63:0])[63:0] - \text{CompareValue}[63:0]) \geq 0)$$

Where:

TimerConditionMet Is TRUE if the timer condition for this counter is met, and FALSE otherwise.

Counter The physical counter value, that can be read from the **CNTPCT** register.

———— **Note** —————

The virtual counter value, that can be read from the **CNTVCT** register, is the value:

$$\frac{(\text{Counter} - \text{Offset})}{}$$

Offset For a physical timer it is zero, and for the virtual timer it is the virtual offset, held in the **CNTVOFF** register.

CompareValue The value of the appropriate CompareValue register, **CNTP_CVAL**, **CNTHP_CVAL**, or **CNTV_CVAL**.

In this view of a timer, Counter, Offset, and CompareValue are all 64-bit unsigned values.

———— **Note** —————

This means that a timer with a CompareValue of, or close to, 0xFFFF_FFFF_FFFF_FFFF might never meet its timer condition. However, there is no practical requirement to use values close to the counter wrap value.

Operation of the TimerValue views of the timers

The TimerValue view of a timer appears to operate as a signed 32-bit downcounter. A TimerValue register is programmed with a count value. This value decrements on each increment of the appropriate counter, and the timer condition is met when the value reaches zero. When the timer condition is met, an interrupt is generated if the interrupt is not masked in the corresponding timer control register, **CNTP_CTL**, **CNTHP_CTL**, or **CNTV_CTL**.

This view of a timer depends on the following behavior of accesses to TimerValue registers:

Reads $\text{TimerValue} = (\text{CompareValue} - (\text{Counter} - \text{Offset})) [31:0]$

Writes $\text{CompareValue} = ((\text{Counter} - \text{Offset}) [63:0] + \text{SignExtend}(\text{TimerValue})) [63:0]$

Where the arguments other than TimerValue have the definitions used in *Operation of the CompareValue views of the timers*, and in addition:

TimerValue The value of a TimerValue register, **CNTP_TVAL**, **CNTHP_TVAL**, or **CNTV_TVAL**.

In this view of a timer, values are signed, in standard two's complement form.

A read of a TimerValue register after the timer condition has been met indicates the time since the timer condition was met.

Note

- *Operation of the CompareValue views of the timers on page G5-4760* gives a strict definition of TimerConditionMet. However, provided that the TimerValue is not expected to wrap as a 32-bit signed value when decremented from 0x80000000, the TimerValue view can be used as giving an effect equivalent to:
TimerConditionMet = (TimerValue ≤ 0)
 - Programming TimerValue to a negative number with magnitude greater than (Counter–Offset) can lead to an arithmetic overflow that causes the CompareValue to be an extremely large positive value. This potentially delays meeting the timer condition for an extremely long period of time.
-

Chapter G6

AArch32 System Register Descriptions

This chapter describes each of the AArch32 System registers.

It contains the following sections:

- *About the AArch32 System registers* on page G6-4764.
- *General system control registers* on page G6-4774.
- *Debug registers* on page G6-5239.
- *Performance Monitors registers* on page G6-5331.
- *Generic Timer registers* on page G6-5383.

G6.1 About the AArch32 System registers

For general information about the AArch32 System registers, see:

- [About the System registers for VMSAv8-32 on page G4-4689.](#)
- [VMSAv8-32 organization of registers in the \(coproc == 0b1110\) encoding space on page G4-4704.](#)
- [VMSAv8-32 organization of registers in the \(coproc == 0b1111\) encoding space on page G4-4707.](#)
- [Functional grouping of VMSAv8-32 System registers on page G4-4726.](#)

The remainder of this chapter describes the AArch32 System registers, in the following sections:

- [General system control registers on page G6-4774.](#)
- [Debug registers on page G6-5239.](#)
- [Performance Monitors registers on page G6-5331.](#)
- [Generic Timer registers on page G6-5383.](#)

G6.1.1 General behavior of System registers

Except where indicated, System registers are 32-bits wide. As stated in [About the System registers for VMSAv8-32 on page G4-4689](#), there are some 64-bit registers, and these include cases where software can access either a 32-bit view or a 64-bit view of a register. The register summaries, and the individual register descriptions, identify the 64-bit registers and how they can be accessed.

The following sections give information about the general behavior of these registers. Unless otherwise indicated, information applies to all AArch32 System registers:

- [Register names.](#)
- [Read-only bits in read/write registers.](#)
- [UNPREDICTABLE, CONSTRAINED UNPREDICTABLE, and UNDEFINED behavior for AArch32 System register accesses.](#)
- [Read-only and write-only register encodings on page G6-4766.](#)
- [Reset behavior of AArch32 System registers on page G6-4767.](#)

See also [About AArch32 System register accesses on page G4-4689](#) and [Fixed values in register diagrams on page G4-4701](#).

Register names

The ARM architecture guarantees not to define any register name prefixed with *IMP_* as part of the standard ARM architecture.

———— Note —————

ARM strongly recommends that any register names created in the IMPLEMENTATION DEFINED register spaces be prefixed with *IMP_*, where appropriate.

Read-only bits in read/write registers

Some read/write registers include bits that are read-only. These bits ignore writes.

An example of this is the [SCTLR.NMFI bit, SCTLR\[27\]](#).

UNPREDICTABLE, CONSTRAINED UNPREDICTABLE, and UNDEFINED behavior for AArch32 System register accesses

This section defines UNPREDICTABLE and UNDEFINED behaviors for accesses to System registers, including those cases where the ARMv8 behavior is CONSTRAINED UNPREDICTABLE.

In AArch32 state the following operations are UNDEFINED:

- All LDC and STC accesses, except for the LDC access to [DBGDTRTXint](#) and the STC access to [DBGDTRRXint](#) specified in [Table G4-43 on page G4-4706](#).
- All MCRR and MRRC operations to the (coproc==0b111x) encoding space, except for those explicitly defined as accessing 64-bit System registers specified in [Table G4-42 on page G4-4705](#) and [Table G4-44 on page G4-4711](#).

Unless otherwise indicated in the individual register descriptions:

- Reserved fields in registers are RES0.
- Assigning a reserved value to a field has a CONSTRAINED UNPREDICTABLE effect, see [Reserved values in System and memory-mapped registers and translation table entries on page K1-6117](#).

The following subsections give more information about UNPREDICTABLE, CONSTRAINED UNPREDICTABLE, and UNDEFINED behavior for accesses to the (coproc==0b111x) encoding space:

- [Accesses to unallocated encodings in the \(coproc==0b111x\) encoding space](#).
- [Additional rules for MCR and MRC accesses to System registers](#).
- [Effects of EL3 and EL2 on System register accesses](#).

Accesses to unallocated encodings in the (coproc==0b111x) encoding space

In ARMv8-A, accesses to unallocated register encodings in the (coproc==0b111x) encoding space are UNDEFINED, see [Unallocated System register access instructions on page K1-6100](#).

Additional rules for MCR and MRC accesses to System registers

The following operations are CONSTRAINED UNPREDICTABLE for all encodings in the (coproc==0b111x) encoding space:

- All MCR operations from the PC.
- All MRC operations to APSR_nzcv, except for the (coproc==0b1110) MRC operation to APSR_nzcv from [DBGDSCRint](#).

The CONSTRAINED UNPREDICTABLE behavior of these operations is that they are UNDEFINED, see [Unallocated System register access instructions on page K1-6100](#).

For registers and operations that are accessible from a particular Privilege level, any attempt to access those registers from a lower Privilege level is UNDEFINED.

Some individual registers can be made inaccessible by setting configuration bits, possibly including IMPLEMENTATION DEFINED configuration bits, to disable access to the register. The effects of the architecturally-defined configuration bits are defined individually in this manual. Unless explicitly stated otherwise in this manual, setting a configuration bit to disable access to a register results in the register becoming UNDEFINED for MRC and MCR accesses.

See also [Read-only and write-only register encodings on page G6-4766](#).

Effects of EL3 and EL2 on System register accesses

EL2 and EL3 introduce classes of System registers, described in [Classification of System registers on page G4-4692](#). Some of these classes of register are either:

- Accessible only from certain modes or states.
- Accessible from certain modes or states only when configuration settings permit the access.

Accesses to these registers that are not permitted are UNDEFINED, meaning execution of the register access instruction generates an Undefined Instruction exception.

Note

This section applies only to registers that are accessible from some modes and states. That is, it applies only to register access instructions using an encoding that, under some circumstances, would perform a valid register access.

The following register classes restrict access in this way:

Restricted access System registers

This register class is defined in any implementation that includes EL3.

Restricted access registers other than the [NSACR](#) are accessible only from Secure EL3 modes. All other accesses to these registers are UNDEFINED.

The [NSACR](#) is a special case of a Restricted access register and:

- The [NSACR](#) is:
 - Read/write accessible from Secure PL1 modes.
 - Is Read-only accessible from Non-secure PL2 and PL1 modes.
- All other accesses to the [NSACR](#) are UNDEFINED.

For more information, including behavior when EL3 is using AArch64 or is not implemented, see [Restricted access System registers on page G4-4694](#).

Configurable access System registers

This register class is defined in any implementation that includes EL3.

Most Configurable access registers are accessible from Non-secure state only if control bits in the [NSACR](#) permit Non-secure access to the register. Otherwise, a Non-secure access to the register is UNDEFINED.

For other Configurable access registers, control bits in the [NSACR](#) control the behavior of bits or fields in the register when it is accessed from Non-secure state. That is, Non-secure accesses to the register are permitted, but the [NSACR](#) controls how they behave. The only architecturally-defined register of this type is the [CPACR](#).

For more information, see [Configurable access System registers on page G4-4694](#).

EL2-mode System registers

This register class is defined only in an implementation that includes EL2.

EL2-mode registers are accessible only from:

- The Non-secure EL2 mode, Hyp mode.
- Secure Monitor mode when [SCR.NS](#) is set to 1.

All other accesses to these registers are UNDEFINED.

For more information, see [Hyp mode read/write registers in the \(coproc == 0b1111\) encoding space on page G4-4695](#) and [Hyp mode encodings for shared \(coproc == 0b1111\) System registers on page G4-4696](#).

EL2-mode write-only operations

This register class is defined only in an implementation that includes EL2.

EL2-mode write-only operations are accessible only from:

- The Non-secure EL2 mode, Hyp mode.
- Secure Monitor mode, regardless of the value of [SCR.NS](#).

Write accesses to these operations are:

- CONSTRAINED UNPREDICTABLE in Secure EL3 modes other than Monitor mode.
- UNDEFINED in Non-secure modes other than Hyp mode.

For more information, see [Hyp mode \(coproc == 0b1111\) write-only System instructions on page G4-4697](#).

In addition, in any implementation that includes EL3, when EL3 is using AArch32, if write access to a register is disabled by the [CP15SSDISABLE](#) signal then any MCR access to that register is UNDEFINED.

Read-only and write-only register encodings

Some System registers are *read-only* (RO) or *write-only* (WO). For example:

- Most identification registers are read-only.

- Most encodings that perform an operation, such as a cache maintenance instruction, are write-only.

If a particular Privilege level defines a register to be:

- RO, then any attempt to write to that register, at that Privilege level, is UNDEFINED. This means that any access to that register with $L == 0$ is UNDEFINED.
- WO, then any attempt to read from that register, at that Privilege level, is UNDEFINED. This means that any access to that register with $L == 1$ is UNDEFINED.

For IMPLEMENTATION DEFINED encoding spaces, the treatment of the encodings is IMPLEMENTATION DEFINED.

Note

This section applies only to registers that this manual defines as RO or WO. It does not apply to registers for which other access permissions are explicitly defined.

Reset behavior of AArch32 System registers

Reset values apply only to RW registers and fields, however:

- Some RO registers or fields, including feature ID registers and some status registers or register fields, always return a known value.
- Some RW and RO registers or register fields return status information about the PE. Unless the register description indicates that the value is UNKNOWN on reset, a read of the register immediately after a reset returns valid information.
- Some RW and RO registers and fields are aliases of other registers or fields. In these cases, the reset behavior of the aliased register or field determines the value returned by a read of the register immediately after a reset.
- WO registers that only have an effect on writes do not have meaningful reset values. However, an access to a WO register might affect underlying state, and that state might have a defined reset value.
- IMPLEMENTATION DEFINED registers have IMPLEMENTATION DEFINED reset behavior.

After a reset, only a limited subset of the PE state is guaranteed to be set to defined values. Also, for debug and trace System registers, reset requirements must take account of different levels of reset. For more information about the reset behavior of System registers when the PE resets into an Exception level that is using AArch32, see:

- [PE state on reset into AArch32 state on page G1-4400](#).
- The appropriate Trace architecture specification, for the Trace System registers.

When the PE resets into an Exception level that is using AArch64, PE state that relates to execution in AArch32 state, including the System register values, is UNKNOWN. The only exception to this is state that applies to execution in both AArch64 state and AArch32 state and that has a defined reset value on the reset into AArch64 state. An example of such PE state is the [EDPRSR.SR](#) bit.

For a PE reset into an Exception level that is using AArch32, the architecture defines which AArch32 System registers have a defined reset value, and when that defined reset value applies. The register descriptions include this information, and [PE state on reset into AArch32 state on page G1-4400](#) summarizes these architectural requirements. Otherwise, RW registers reset to an architecturally unknown value.

Note

In an implementation that includes EL3, unless this manual explicitly states otherwise, only the Secure instance of a Banked register is reset to the defined value. This means that software must program the Non-secure instance of the register with the required values. Typically, this programming is part of the PE boot sequence.

Pseudocode description of resetting System registers

The [AArch32.ResetControlRegisters\(\)](#) pseudocode function resets all System registers, and register fields, that have defined reset values, as described in this section and [PE state on reset into AArch32 state on page G1-4400](#).

Note

For debug and trace System registers, this function resets registers as defined for the appropriate level of reset.

Synchronization of changes to AArch32 System registers

In this section, *this PE* means the PE on which accesses are being synchronized.

Note

See [Definitions of direct and indirect reads and writes and their side-effects on page G6-4772](#) for definitions of the terms *direct write*, *direct read*, *indirect write*, and *indirect read*.

A *direct write* to a System register might become visible at any point after the change to the register, but without a [Context synchronization event](#) there is no guarantee that the change becomes visible.

Any direct write to a System register is guaranteed not to affect any instruction that appears, in program order, before the instruction that performed the direct write, and any direct write to a System register must be synchronized before any instruction that appears after the direct write, in program order, can rely on the effect of that write. The only exceptions to this are:

- All direct writes to the same register, using the same encoding, are guaranteed to occur in program order.
- All direct writes to a register are guaranteed to occur in program order relative to all direct reads of the same register using the same encoding.
- Any System register access that an ARM *Architecture Specification* or equivalent specification defines as not requiring synchronization.
- If an instruction that appears in program order before the direct write performs a memory access, such as a memory-mapped register access, that causes an indirect read or write to a register, that memory access is subject to the memory order model. In this case, if permitted by the memory order model, the instruction that appears in program order before the direct write can be affected by the direct write. For information about the memory order model, see [Definition of the ARMv8 memory model on page E2-2762](#).

These rules mean that an instruction that writes to one of the address translation instructions described in [Address translation instructions on page G4-4682](#) must be explicitly synchronized to guarantee that the result of the address translation instruction is visible in the [PAR](#).

Note

In this case, the direct write to the encoding of the address translation instruction causes an *indirect write* to the [PAR](#). Without a [Context synchronization event](#) after the direct write, there is no guarantee that the indirect write to the [PAR](#) is visible.

Conceptually, the explicit synchronization occurs as the first step of any [Context synchronization event](#). This means that if the operation uses the state that had been changed but not synchronized before the operation occurred, the operation is guaranteed to use the state as if it had been synchronized.

Note

- This explicit synchronization is applied as the first step of the execution of any instruction that causes the synchronization operation. This means it does not synchronize any effect of changes to the System registers that might affect the fetch and decode of the instructions that cause the operation, such as breakpoints or changes to translation tables.
 - For a synchronous exception, the control state in use at the time the exception is generated determines the exception syndrome information, and this syndrome information is not changed by this synchronization at the start of taking the exception.
-

Except for the register reads listed in *Registers with some architectural guarantee of ordering or observability* on page G6-4771, if no *Context synchronization event* is performed, direct reads of System registers can occur in any order.

Table G6-1 shows the synchronization requirement between two reads or writes that access the same System register. In the column headings, *First* and *Second* refer to:

- Program order, for any read or write caused by the execution of an instruction by this PE, other than a read or write caused by a memory access made by that instruction.
- The order of arrival of asynchronous reads or writes made by this PE relative to the execution of instructions by this PE.

In addition:

- For indirect reads or writes caused by an external agent, such as a debugger, the mechanism that determines the order of the reads or writes is defined by that external agent. The external agent can provide mechanisms that ensure that any read or write it makes arrives at the PE. These indirect reads and writes are asynchronous to software execution on the PE.
- For indirect reads or writes caused by memory-mapped reads or writes made by this PE, the ordering of the memory accesses is subject to the memory order model, including the effect of the memory type of the accessed memory address. This applies, for example, if this PE reads or writes one of its registers in a memory-mapped register interface.

The mechanism for ensuring completion of these memory accesses, including ensuring the arrival of the asynchronous read or write at the PE, is defined by the system.

———— **Note** —————

Such accesses are likely to be given a Device memory attribute, but requiring this is outside the scope of the architecture.

- For indirect reads or writes caused by autonomous asynchronous events that are counted, for example events caused by the passage of time, the events are ordered so that:
 - Counts progress monotonically.
 - The events arrive at the PE in finite time and without undue delay.

Table G6-1 Synchronization requirements for updates to System registers

First read or write	Second read or write	<i>Context synchronization event</i> required
Direct read	Direct read	No
	Direct write	No
	Indirect read	No ^a
	Indirect write	No ^a , but see text in this section for exceptions
Direct write	Direct read	No
	Direct write	No
	Indirect read	Yes ^a
	Indirect write	No, but see text in this section for exceptions

Table G6-1 Synchronization requirements for updates to System registers (continued)

First read or write	Second read or write	<i>Context synchronization event</i> required
Indirect read	Direct read	No
	Direct write	No
	Indirect read	No
	Indirect write	No
Indirect write	Direct read	Yes, but see text in this section for exceptions
	Direct write	No, but see text in this section for exceptions
	Indirect read	Yes, but see text in this section for exceptions
	Indirect write	No, but see text in this section for exceptions

- a. Although no synchronization is required between a Direct write and a Direct read, or between a Direct read and an Indirect write, this does not imply that a Direct read causes synchronization of a previous Direct write. This means that the sequence Direct write followed by Direct read followed by Indirect read, with no intervening context synchronization, does not guarantee that the Indirect read observes the result of the Direct write.

If the indirect write is to a register that [Registers with some architectural guarantee of ordering or observability on page G6-4771](#) shows as having some guarantee of the visibility of an indirect write, synchronization might not be required.

If a direct read or a direct write to a register is followed by an indirect write to that register that is caused by an external agent, or by an autonomous asynchronous event, or as a result of a memory-mapped write, then synchronization is required to guarantee the ordering of the indirect write relative to the direct read or direct write.

If an indirect write caused by a direct write is followed by an indirect write caused by an external agent, or by an autonomous asynchronous event, or as a result of a memory-mapped write, then synchronization is required to guarantee the ordering of the two indirect writes.

If a direct read causes an indirect write, synchronization is required to guarantee that the indirect write is visible to subsequent direct or indirect reads or writes. This synchronization must be performed after the direct read, before any subsequent direct or indirect read or write.

If a direct write causes an indirect write, synchronization is required to guarantee that the indirect write is visible to subsequent direct or indirect reads or writes. This synchronization must be performed after the direct write, before any subsequent direct or indirect read or write.

———— **Note** —————

Where a register has more than one encoding, a direct write to the register using a particular encoding is not an indirect write to the same register with a different encoding.

Where an indirect write is caused by the action of an external agent, such as a debugger, or by a memory-mapped read or write by the PE, then an indirect write by that agent to a register using a particular access mechanism, followed by an indirect read by that agent to the same register using the same access mechanism and address does not need synchronization.

For information about the additional synchronization requirements for memory-mapped registers, see [Synchronization requirements for AArch64 System registers on page D7-2191](#).

To guarantee the visibility of changes to some registers, additional operations might be required before the *Context synchronization event*. For such a register, the definition of the register identifies these additional requirements.

In this manual, unless the context indicates otherwise:

- *Accessing* a System register refers to a direct read or write of the register.
- *Using* a System register refers to an indirect read or write of the register.

Registers with some architectural guarantee of ordering or observability

For the registers for which [Table G6-2](#) shows that the ordering of direct reads is guaranteed, multiple direct reads of a single register, using the same encoding, occur in program order without any explicit ordering.

For the registers for which [Table G6-2](#) shows that some observability of indirect writes is guaranteed, an indirect write to the register caused by an external agent, an autonomous asynchronous event, or as a result of a memory-mapped write, is both:

- Observable to direct reads of the register, in finite time, without explicit synchronization.
- Observable to subsequent indirect reads of the register without explicit synchronization.

These two sets of registers are similar, as [Table G6-2](#) shows:

Table G6-2 Registers with a guarantee of ordering or observability, VMSAv8-32

Register	Ordering of direct reads	Observability of indirect writes	Notes
ISR	Guaranteed	Guaranteed	Interrupt Status Register
DBGCLAIMCLR	Guaranteed	Guaranteed	Debug CLAIM registers
DBGCLAIMSET	-	Guaranteed	
DBGDTRRXint	Guaranteed	Guaranteed	Debug Communication Channel registers
DBGDTRTXint	-	Guaranteed	
The DCC flags in DBGDSCRint	Guaranteed	Guaranteed	
CNTPCT	Guaranteed	Guaranteed	Generic Timer registers
CNTP_TVAL	Guaranteed	Guaranteed	
CNTVCT	Guaranteed	Guaranteed	
CNTV_TVAL	Guaranteed	Guaranteed	
CNTHP_TVAL	Guaranteed	Guaranteed	
PMCCNTR	Guaranteed	Guaranteed	
PMEVCNTR<n>	Guaranteed	Guaranteed	
PMXVCNTR	Guaranteed	Guaranteed	
PMOVSSET	Guaranteed	Guaranteed	
PMOVSRR	Guaranteed	Guaranteed	
EDSCR .PipeAdv and the DCC flags in EDSCR	-	Guaranteed	Fields of the External Debug Status and Control Register

In addition to the requirements shown in [Table G6-2](#):

- Indirect writes to the following registers as a result of memory-mapped writes, including accesses by external agents, are required to be observable to the indirect read made in determining the response to a subsequent memory-mapped access without explicit synchronization:

- [OSLAR_EL1](#). [OSLAR_EL1](#) is indirectly read to determine whether the subsequent access is permitted.

———— **Note** —————

[OSLAR_EL1](#) maps to the AArch32 System register [DBGOSLAR](#).

- [EDLAR](#), if implemented. [EDLAR](#) is indirectly read to determine whether a subsequent write or side-effect of an access is ignored.

———— **Note** —————

This requirement is stricter than the general requirement for the observability of indirect writes.

- When the PE is in Debug state, there are synchronization requirements for the Debug Communication Channel and Instruction Transfer registers. See [DCC and ITR access in Debug state](#) on page H4-5513.

The possibility that direct reads can occur *early*, in the absence of context synchronization, described in [Ordering of reads of System registers](#) on page G4-4689, still applies to the registers listed in [Table G6-2](#) on page G6-4771.

Definitions of direct and indirect reads and writes and their side-effects

Direct and indirect reads and writes are defined as follows:

Direct read Is a read of a register, using an MRC, MRRC, or STC instruction, that the architecture permits for the current PE state.

If a direct read of a register has a side-effect of changing the value of a register, the effect of a direct read on that register is defined to be an *indirect write*, and has the synchronization requirements of an indirect write. This means the indirect write is guaranteed to have occurred, and to be visible to subsequent direct or indirect reads and writes only if synchronization is performed after the direct read.

———— **Note** —————

The indirect write described here can affect either the register written to by the direct write, or some other register. The synchronization requirement is the same in both cases.

Direct write Is a write to a register, using an MCR, MCRR, or LDC instruction, that the architecture permits for the current PE state.

In the following cases, the side-effect of the direct write is defined to be an indirect write of the affected register, and has the synchronization requirements of an indirect write:

- If the direct write has a side-effect of changing the value of a register other than the register accessed by the direct write.
- If the direct write has a side-effect of changing the value of the register accessed by the direct write, so that the value in that register might not be the value that the direct write wrote to the register.

In both cases, this means that the indirect write is not guaranteed to be visible to subsequent direct or indirect reads and writes unless synchronization is performed after the direct write.

———— **Note** —————

- As an example of a direct write to a register having an effect that is an indirect write of that register, writing 1 to a [PMCNTENCLR.Px](#) bit is also an indirect write, because if the Px bit had the value 1 before the direct write, the side-effect of the write changes the value of that bit to 0.
- The indirect write described here can affect either the register written to by the direct write, or some other register. The synchronization requirement is the same in both cases.
For example, writing 1 to a [PMCNTENCLR.Px](#) bit that is set to 1 also changes the corresponding [PMCNTENSET.Px](#) bit from 1 to 0. This means that the direct write to the [PMCNTENCLR](#) defines indirect writes to both itself and to the [PMCNTENSET](#).

Indirect read Is a use of the register by an instruction to establish the operating conditions for the instruction. Examples of operating conditions that might be determined by an indirect read are the translation table base address, or whether memory accesses are forced to be Non-cacheable.

Indirect reads include situations where the value of one register determines what value is returned by a second register. This means that any read of the second register is an indirect read of the register that determines what value is returned.

Indirect reads also include:

- Reads of the System registers by external agents, such as debuggers, as described in [Debug registers on page G6-5239](#).
- Memory-mapped reads of the System registers made by the PE on which the System registers are implemented.

Where an indirect read of a register has a side-effect of changing the value of a register, that change is defined to be an indirect write, and has the synchronization requirements of an indirect write.

Indirect write Is an update to the value of a register as a consequence of either:

- An exception, operation, or execution of an instruction that is not a direct write to that register.
- The asynchronous operation of an external agent.

This can include:

- The passage of time, as seen in counters or timers, including performance counters.
- The assertion of an interrupt.
- A write from an external agent, such as a debugger.

However, for some registers, the architecture gives some guarantee of visibility without any explicit synchronization, see [Registers with some architectural guarantee of ordering or observability on page G6-4771](#).

———— **Note** —————

Taking an exception is a context-synchronizing operation. Therefore, any indirect write performed as part of an exception entry does not require additional synchronization. This includes the indirect writes to the registers that report the exception, as described in [Exception reporting in a VMSAv8-32 implementation on page G4-4663](#).

G6.2 General system control registers

This section lists the System registers in AArch32 state that are not part of one of the other listed groups.

G6.2.1 ACTLR, Auxiliary Control Register

The ACTLR characteristics are:

Purpose

Provides IMPLEMENTATION DEFINED configuration and control options for execution at EL1 and EL0.

Configurations

AArch32 System register ACTLR is architecturally mapped to AArch64 System register [ACTLR_EL1](#)[31:0].

Some bits might define global configuration settings, and be common to the Secure and Non-secure instances of the register.

RW fields in this register reset to architecturally UNKNOWN values.

Attributes

ACTLR is a 32-bit register.

Field descriptions

The ACTLR bit assignments are:



IMPLEMENTATION DEFINED, bits [31:0]

IMPLEMENTATION DEFINED.

Accessing the ACTLR

This register can be read using MRC with the following syntax:

MRC <syntax>

This register can be written using MCR with the following syntax:

MCR <syntax>

This syntax is encoded with the following settings in the instruction encoding:

<syntax>	opc1	opc2	CRn	coproc	CRm
p15, 0, <Rt>, c1, c0, 1	000	001	0001	1111	0000

Accessibility

The register is accessible in software as follows:

Configuration	Control			Accessibility				Instance
	E2H	TGE	NS	EL0	EL1	EL2	EL3	
EL3 is using AArch32.	x	x	0	-	n/a	n/a	RW	ACTLR_s
EL3 is using AArch32.	x	0	1	-	RW	RW	RW	ACTLR_ns
EL3 is using AArch32.	x	1	1	-	n/a	RW	RW	ACTLR_ns
EL3 is not implemented.	x	x	0	-	RW	n/a	n/a	ACTLR
EL3 is not implemented.	x	0	1	-	RW	RW	n/a	ACTLR
EL3 is not implemented.	x	1	1	-	n/a	RW	n/a	ACTLR
EL3 is using AArch64.	x	x	0	-	RW	n/a	n/a	ACTLR
EL3 is using AArch64.	x	0	1	-	RW	RW	n/a	ACTLR
EL3 is using AArch64.	x	1	1	-	n/a	RW	n/a	ACTLR

Traps and Enables

For a description of the prioritization of any generated exceptions, see [Synchronous exception prioritization for exceptions taken to AArch32 state on page G1-4344](#) for exceptions taken to AArch32 state and [Synchronous exception prioritization for exceptions taken to AArch64 on page D1-1827](#) for exceptions taken to AArch64 state. Subject to the prioritization rules:

- When EL2 is implemented and is using AArch64 and (SCR_EL3.NS == 1) && (HCR_EL2.E2H == 0):
 - If HCR_EL2.TACR==1, Non-secure accesses to this register from EL1 are trapped to EL2 using AArch64.
 - If HSTR_EL2.T1==1, Non-secure accesses to this register from EL1 are trapped to EL2.
- When EL2 is implemented and is using AArch64 and (SCR_EL3.NS == 1) && (HCR_EL2.E2H == 1) && (HCR_EL2.TGE == 0):
 - If HCR_EL2.TACR==1, Non-secure accesses to this register from EL1 are trapped to EL2 using AArch64.
 - If HSTR_EL2.T1==1, Non-secure accesses to this register from EL1 are trapped to EL2.
- When EL2 is implemented and is using AArch32 and SCR_EL3.NS == 1:
 - If HCR.TAC==1, Non-secure accesses to this register from EL1 are trapped to Hyp mode.
 - If HSTR.T1==1, Non-secure accesses to this register from EL1 are trapped to Hyp mode.

G6.2.2 ACTLR2, Auxiliary Control Register 2

The ACTLR2 characteristics are:

Purpose

Provides additional space to the ACTLR register to hold IMPLEMENTATION DEFINED trap functionality for execution at EL1 and EL0.

Configurations

AArch32 System register ACTLR2 is architecturally mapped to AArch64 System register [ACTLR_EL1](#)[63:32].

In ARMv8.0 and ARMv8.1, it is IMPLEMENTATION DEFINED whether this register is implemented, or whether it causes UNDEFINED exceptions when accessed. The implementation of this register can be detected by examining [ID_MMFR4.AC2](#).

From ARMv8.2 this register must be implemented.

RW fields in this register reset to architecturally UNKNOWN values.

Attributes

ACTLR2 is a 32-bit register.

Field descriptions

The ACTLR2 bit assignments are:



IMPLEMENTATION DEFINED, bits [31:0]

IMPLEMENTATION DEFINED.

Accessing the ACTLR2

This register can be read using MRC with the following syntax:

MRC <syntax>

This register can be written using MCR with the following syntax:

MCR <syntax>

This syntax is encoded with the following settings in the instruction encoding:

<syntax>	opc1	opc2	CRn	coproc	CRm
p15, 0, <Rt>, c1, c0, 3	000	011	0001	1111	0000

Accessibility

The register is accessible in software as follows:

Configuration	Control			Accessibility				Instance
	E2H	TGE	NS	EL0	EL1	EL2	EL3	
EL3 is not implemented.	x	x	0	-	RW	n/a	n/a	ACTLR2
EL3 is not implemented.	x	0	1	-	RW	RW	n/a	ACTLR2
EL3 is not implemented.	x	1	1	-	n/a	RW	n/a	ACTLR2
EL3 is using AArch64.	x	x	0	-	RW	n/a	n/a	ACTLR2
EL3 is using AArch64.	x	0	1	-	RW	RW	n/a	ACTLR2
EL3 is using AArch64.	x	1	1	-	n/a	RW	n/a	ACTLR2
EL3 is using AArch32.	x	x	0	-	n/a	n/a	RW	ACTLR2_s
EL3 is using AArch32.	x	0	1	-	RW	RW	RW	ACTLR2_ns
EL3 is using AArch32.	x	1	1	-	n/a	RW	RW	ACTLR2_ns

Traps and Enables

For a description of the prioritization of any generated exceptions, see [Synchronous exception prioritization for exceptions taken to AArch32 state on page G1-4344](#) for exceptions taken to AArch32 state and [Synchronous exception prioritization for exceptions taken to AArch64 on page D1-1827](#) for exceptions taken to AArch64 state. Subject to the prioritization rules:

- When EL2 is implemented and is using AArch64 and (SCR_EL3.NS == 1) && (HCR_EL2.E2H == 0):
 - If HCR_EL2.TACR==1, Non-secure accesses to this register from EL1 are trapped to EL2 using AArch64.
 - If HSTR_EL2.T1==1, Non-secure accesses to this register from EL1 are trapped to EL2.
- When EL2 is implemented and is using AArch64 and (SCR_EL3.NS == 1) && (HCR_EL2.E2H == 1) && (HCR_EL2.TGE == 0):
 - If HCR_EL2.TACR==1, Non-secure accesses to this register from EL1 are trapped to EL2 using AArch64.
 - If HSTR_EL2.T1==1, Non-secure accesses to this register from EL1 are trapped to EL2.
- When EL2 is implemented and is using AArch32 and SCR_EL3.NS == 1:
 - If HCR.TAC==1, Non-secure accesses to this register from EL1 are trapped to Hyp mode.
 - If HSTR.T1==1, Non-secure accesses to this register from EL1 are trapped to Hyp mode.

G6.2.3 ADFSR, Auxiliary Data Fault Status Register

The ADFSR characteristics are:

Purpose

Provides additional IMPLEMENTATION DEFINED fault status information for Data Abort exceptions taken to EL1 modes, and EL3 modes when EL3 is implemented and is using AArch32.

Configurations

AArch32 System register ADFSR is architecturally mapped to AArch64 System register [AFSR0_EL1](#).

RW fields in this register reset to architecturally UNKNOWN values.

Attributes

ADFSR is a 32-bit register.

Field descriptions

The ADFSR bit assignments are:



IMPLEMENTATION DEFINED, bits [31:0]

IMPLEMENTATION DEFINED.

Accessing the ADFSR

This register can be read using MRC with the following syntax:

MRC <syntax>

This register can be written using MCR with the following syntax:

MCR <syntax>

This syntax is encoded with the following settings in the instruction encoding:

<syntax>	opc1	opc2	CRn	coproc	CRm
p15, 0, <Rt>, c5, c1, 0	000	000	0101	1111	0001

Accessibility

The register is accessible in software as follows:

Configuration	Control			Accessibility				Instance
	E2H	TGE	NS	EL0	EL1	EL2	EL3	
EL3 is not implemented.	x	x	0	-	RW	n/a	n/a	ADFSR
EL3 is not implemented.	x	0	1	-	RW	RW	n/a	ADFSR
EL3 is not implemented.	x	1	1	-	n/a	RW	n/a	ADFSR
EL3 is using AArch64.	x	x	0	-	RW	n/a	n/a	ADFSR
EL3 is using AArch64.	x	0	1	-	RW	RW	n/a	ADFSR
EL3 is using AArch64.	x	1	1	-	n/a	RW	n/a	ADFSR
EL3 is using AArch32.	x	x	0	-	n/a	n/a	RW	ADFSR_s
EL3 is using AArch32.	x	0	1	-	RW	RW	RW	ADFSR_ns
EL3 is using AArch32.	x	1	1	-	n/a	RW	RW	ADFSR_ns

Traps and Enables

For a description of the prioritization of any generated exceptions, see [Synchronous exception prioritization for exceptions taken to AArch32 state on page G1-4344](#) for exceptions taken to AArch32 state and [Synchronous exception prioritization for exceptions taken to AArch64 on page D1-1827](#) for exceptions taken to AArch64 state. Subject to the prioritization rules:

- When EL2 is implemented and is using AArch64 and (SCR_EL3.NS == 1) && (HCR_EL2.E2H == 0):
 - If HCR_EL2.TVM==1, Non-secure write accesses to this register from EL1 are trapped to EL2.
 - If HCR_EL2.TRVM==1, Non-secure read accesses to this register from EL1 are trapped to EL2.
 - If HSTR_EL2.T5==1, Non-secure accesses to this register from EL1 are trapped to EL2.
- When EL2 is implemented and is using AArch64 and (SCR_EL3.NS == 1) && (HCR_EL2.E2H == 1) && (HCR_EL2.TGE == 0):
 - If HCR_EL2.TVM==1, Non-secure write accesses to this register from EL1 are trapped to EL2.
 - If HCR_EL2.TRVM==1, Non-secure read accesses to this register from EL1 are trapped to EL2.
 - If HSTR_EL2.T5==1, Non-secure accesses to this register from EL1 are trapped to EL2.
- When EL2 is implemented and is using AArch32 and SCR_EL3.NS == 1:
 - If HCR.TVM==1, Non-secure write accesses to this register from EL1 are trapped to Hyp mode.
 - If HCR.TRVM==1, Non-secure read accesses to this register from EL1 are trapped to Hyp mode.
 - If HSTR.T5==1, Non-secure accesses to this register from EL1 are trapped to Hyp mode.

G6.2.4 AIDR, Auxiliary ID Register

The AIDR characteristics are:

Purpose

Provides IMPLEMENTATION DEFINED identification information.

The value of this register must be used in conjunction with the value of [MIDR](#).

Configurations

There is one instance of this register that is used in both Secure and Non-secure states.

AArch32 System register AIDR is architecturally mapped to AArch64 System register [AIDR_EL1](#).

Attributes

AIDR is a 32-bit register.

Field descriptions

The AIDR bit assignments are:



IMPLEMENTATION DEFINED, bits [31:0]

IMPLEMENTATION DEFINED.

Accessing the AIDR

This register can be read using MRC with the following syntax:

MRC <syntax>

This syntax is encoded with the following settings in the instruction encoding:

<syntax>	opc1	opc2	CRn	coproc	CRm
p15, 1, <Rt>, c0, c0, 7	001	111	0000	1111	0000

Accessibility

The register is accessible in software as follows:

Control			Accessibility			
E2H	TGE	NS	EL0	EL1	EL2	EL3
x	x	0	-	RO	n/a	RO
x	0	1	-	RO	RO	RO
x	1	1	-	n/a	RO	RO

Traps and Enables

For a description of the prioritization of any generated exceptions, see *Synchronous exception prioritization for exceptions taken to AArch32 state* on page G1-4344 for exceptions taken to AArch32 state and *Synchronous exception prioritization for exceptions taken to AArch64* on page D1-1827 for exceptions taken to AArch64 state. Subject to the prioritization rules:

- When EL2 is implemented and is using AArch64 and $(SCR_EL3.NS == 1) \ \&\& \ (HCR_EL2.E2H == 0)$:
 - If $HCR_EL2.TID1 == 1$, Non-secure read accesses to this register from EL1 are trapped to EL2.
 - If $HSTR_EL2.T0 == 1$, Non-secure read accesses to this register from EL1 are trapped to EL2.
- When EL2 is implemented and is using AArch64 and $(SCR_EL3.NS == 1) \ \&\& \ (HCR_EL2.E2H == 1) \ \&\& \ (HCR_EL2.TGE == 0)$:
 - If $HCR_EL2.TID1 == 1$, Non-secure read accesses to this register from EL1 are trapped to EL2.
 - If $HSTR_EL2.T0 == 1$, Non-secure read accesses to this register from EL1 are trapped to EL2.
- When EL2 is implemented and is using AArch32 and $SCR_EL3.NS == 1$:
 - If $HCR.TID1 == 1$, Non-secure read accesses to this register from EL1 are trapped to Hyp mode.
 - If $HSTR.T0 == 1$, Non-secure read accesses to this register from EL1 are trapped to Hyp mode.

G6.2.5 AIFSR, Auxiliary Instruction Fault Status Register

The AIFSR characteristics are:

Purpose

Provides additional IMPLEMENTATION DEFINED fault status information for Prefetch Abort exceptions taken to EL1 modes, and EL3 modes when EL3 is implemented and is using AArch32.

Configurations

AArch32 System register AIFSR is architecturally mapped to AArch64 System register [AFSR1_EL1](#).

RW fields in this register reset to architecturally UNKNOWN values.

Attributes

AIFSR is a 32-bit register.

Field descriptions

The AIFSR bit assignments are:



IMPLEMENTATION DEFINED, bits [31:0]

IMPLEMENTATION DEFINED.

Accessing the AIFSR

This register can be read using MRC with the following syntax:

MRC <syntax>

This register can be written using MCR with the following syntax:

MCR <syntax>

This syntax is encoded with the following settings in the instruction encoding:

<syntax>	opc1	opc2	CRn	coproc	CRm
p15, 0, <Rt>, c5, c1, 1	000	001	0101	1111	0001

Accessibility

The register is accessible in software as follows:

Configuration	Control			Accessibility				Instance
	E2H	TGE	NS	EL0	EL1	EL2	EL3	
EL3 is using AArch32.	x	x	0	-	n/a	n/a	RW	AIFSR_s
EL3 is not implemented.	x	x	0	-	RW	n/a	n/a	AIFSR
EL3 is not implemented.	x	0	1	-	RW	RW	n/a	AIFSR

Configuration	Control			Accessibility				Instance
	E2H	TGE	NS	EL0	EL1	EL2	EL3	
EL3 is not implemented.	x	1	1	-	n/a	RW	n/a	AIFSR
EL3 is using AArch64.	x	x	0	-	RW	n/a	n/a	AIFSR
EL3 is using AArch64.	x	0	1	-	RW	RW	n/a	AIFSR
EL3 is using AArch64.	x	1	1	-	n/a	RW	n/a	AIFSR
EL3 is using AArch32.	x	0	1	-	RW	RW	RW	AIFSR_ns
EL3 is using AArch32.	x	1	1	-	n/a	RW	RW	AIFSR_ns

Traps and Enables

For a description of the prioritization of any generated exceptions, see [Synchronous exception prioritization for exceptions taken to AArch32 state on page G1-4344](#) for exceptions taken to AArch32 state and [Synchronous exception prioritization for exceptions taken to AArch64 on page D1-1827](#) for exceptions taken to AArch64 state. Subject to the prioritization rules:

- When EL2 is implemented and is using AArch64 and (SCR_EL3.NS == 1) && (HCR_EL2.E2H == 0):
 - If HCR_EL2.TVM==1, Non-secure write accesses to this register from EL1 are trapped to EL2.
 - If HCR_EL2.TRVM==1, Non-secure read accesses to this register from EL1 are trapped to EL2.
 - If HSTR_EL2.T5==1, Non-secure accesses to this register from EL1 are trapped to EL2.
- When EL2 is implemented and is using AArch64 and (SCR_EL3.NS == 1) && (HCR_EL2.E2H == 1) && (HCR_EL2.TGE == 0):
 - If HCR_EL2.TVM==1, Non-secure write accesses to this register from EL1 are trapped to EL2.
 - If HCR_EL2.TRVM==1, Non-secure read accesses to this register from EL1 are trapped to EL2.
 - If HSTR_EL2.T5==1, Non-secure accesses to this register from EL1 are trapped to EL2.
- When EL2 is implemented and is using AArch32 and SCR_EL3.NS == 1:
 - If HCR.TVM==1, Non-secure write accesses to this register from EL1 are trapped to Hyp mode.
 - If HCR.TRVM==1, Non-secure read accesses to this register from EL1 are trapped to Hyp mode.
 - If HSTR.T5==1, Non-secure accesses to this register from EL1 are trapped to Hyp mode.

G6.2.6 AMAIR0, Auxiliary Memory Attribute Indirection Register 0

The AMAIR0 characteristics are:

Purpose

When using the Long-descriptor format translation tables for stage 1 translations, provides IMPLEMENTATION DEFINED memory attributes for the memory regions specified by [MAIR0](#).

Configurations

AArch32 System register AMAIR0 is architecturally mapped to AArch64 System register [AMAIR_EL1](#)[31:0].

When EL3 is using AArch32, write access to AMAIR0(S) is disabled when the CP15SDISABLE signal is asserted HIGH.

RW fields in this register reset to architecturally UNKNOWN values.

Attributes

AMAIR0 is a 32-bit register.

Field descriptions

The AMAIR0 bit assignments are:



This register is RES0 in the following cases:

- When an implementation does not provide any IMPLEMENTATION DEFINED memory attributes.
- When the Long-descriptor translation table format is not used.

If EL3 is implemented and is using AArch32:

- AMAIR0(S) gives the value for memory accesses from Secure state.
- AMAIR0(NS) gives the value for memory accesses from Non-secure states other than Hyp mode.

Any IMPLEMENTATION DEFINED memory attributes are additional qualifiers for the memory locations and must not change the architected behavior specified by [MAIR0](#) and [MAIR1](#).

In a typical implementation, AMAIR0 and [AMAIR1](#) split into eight one-byte fields, corresponding to the MAIRn.Attr<n> fields, but the architecture does not require them to do so.

IMPLEMENTATION DEFINED, bits [31:0]

IMPLEMENTATION DEFINED.

Accessing the AMAIR0

This register can be read using MRC with the following syntax:

MRC <syntax>

This register can be written using MCR with the following syntax:

MCR <syntax>

This syntax is encoded with the following settings in the instruction encoding:

<syntax>	opc1	opc2	CRn	coproc	CRm
p15, 0, <Rt>, c10, c3, 0	000	000	1010	1111	0011

Accessibility

The register is accessible in software as follows:

Configuration	Control			Accessibility				Instance
	E2H	TGE	NS	EL0	EL1	EL2	EL3	
EL3 is not implemented.	x	x	0	-	RW	n/a	n/a	AMAIRO
EL3 is not implemented.	x	0	1	-	RW	RW	n/a	AMAIRO
EL3 is not implemented.	x	1	1	-	n/a	RW	n/a	AMAIRO
EL3 is using AArch64.	x	x	0	-	RW	n/a	n/a	AMAIRO
EL3 is using AArch64.	x	0	1	-	RW	RW	n/a	AMAIRO
EL3 is using AArch64.	x	1	1	-	n/a	RW	n/a	AMAIRO
EL3 is using AArch32.	x	0	1	-	RW	RW	RW	AMAIRO_ns
EL3 is using AArch32.	x	1	1	-	n/a	RW	RW	AMAIRO_ns
EL3 is using AArch32.	x	x	0	-	n/a	n/a	RW	AMAIRO_s

When EL3 is using AArch32, write access to AMAIRO_s is UNDEFINED when the CP15SSDISABLE signal is asserted HIGH.

Traps and Enables

For a description of the prioritization of any generated exceptions, see [Synchronous exception prioritization for exceptions taken to AArch32 state on page G1-4344](#) for exceptions taken to AArch32 state and [Synchronous exception prioritization for exceptions taken to AArch64 on page D1-1827](#) for exceptions taken to AArch64 state. Subject to the prioritization rules:

- When EL2 is implemented and is using AArch64 and (SCR_EL3.NS == 1) && (HCR_EL2.E2H == 0):
 - If HCR_EL2.TVM==1, Non-secure write accesses to this register from EL1 are trapped to EL2.
 - If HCR_EL2.TRVM==1, Non-secure read accesses to this register from EL1 are trapped to EL2.
 - If HSTR_EL2.T10==1, Non-secure accesses to this register from EL1 are trapped to EL2.
- When EL2 is implemented and is using AArch64 and (SCR_EL3.NS == 1) && (HCR_EL2.E2H == 1) && (HCR_EL2.TGE == 0):
 - If HCR_EL2.TVM==1, Non-secure write accesses to this register from EL1 are trapped to EL2.
 - If HCR_EL2.TRVM==1, Non-secure read accesses to this register from EL1 are trapped to EL2.
 - If HSTR_EL2.T10==1, Non-secure accesses to this register from EL1 are trapped to EL2.
- When EL2 is implemented and is using AArch32 and SCR_EL3.NS == 1:
 - If HCR.TVM==1, Non-secure write accesses to this register from EL1 are trapped to Hyp mode.
 - If HCR.TRVM==1, Non-secure read accesses to this register from EL1 are trapped to Hyp mode.
 - If HSTR.T10==1, Non-secure accesses to this register from EL1 are trapped to Hyp mode.

G6.2.7 AMAIR1, Auxiliary Memory Attribute Indirection Register 1

The AMAIR1 characteristics are:

Purpose

When using the Long-descriptor format translation tables for stage 1 translations, provides IMPLEMENTATION DEFINED memory attributes for the memory regions specified by MAIR1.

Configurations

AArch32 System register AMAIR1 is architecturally mapped to AArch64 System register AMAIR_EL1[63:32].

When EL3 is using AArch32, write access to AMAIR1(S) is disabled when the CP15SDISABLE signal is asserted HIGH.

RW fields in this register reset to architecturally UNKNOWN values.

Attributes

AMAIR1 is a 32-bit register.

Field descriptions

The AMAIR1 bit assignments are:



This register is RES0 in the following cases:

- When an implementation does not provide any IMPLEMENTATION DEFINED memory attributes.
- When the Long-descriptor translation table format is not used.

If EL3 is implemented and is using AArch32:

- AMAIR1(S) gives the value for memory accesses from Secure state.
- AMAIR1(NS) gives the value for memory accesses from Non-secure states other than Hyp mode.

Any IMPLEMENTATION DEFINED memory attributes are additional qualifiers for the memory locations and must not change the architected behavior specified by MAIR0 and MAIR1.

In a typical implementation, AMAIR0 and AMAIR1 split into eight one-byte fields, corresponding to the MAIRn.Attr<n> fields, but the architecture does not require them to do so.

IMPLEMENTATION DEFINED, bits [31:0]

IMPLEMENTATION DEFINED.

Accessing the AMAIR1

This register can be read using MRC with the following syntax:

MRC <syntax>

This register can be written using MCR with the following syntax:

MCR <syntax>

This syntax is encoded with the following settings in the instruction encoding:

<syntax>	opc1	opc2	CRn	coproc	CRm
p15, 0, <Rt>, c10, c3, 1	000	001	1010	1111	0011

Accessibility

The register is accessible in software as follows:

Configuration	Control			Accessibility				Instance
	E2H	TGE	NS	EL0	EL1	EL2	EL3	
EL3 is not implemented.	x	x	0	-	RW	n/a	n/a	AMAIR1
EL3 is not implemented.	x	0	1	-	RW	RW	n/a	AMAIR1
EL3 is not implemented.	x	1	1	-	n/a	RW	n/a	AMAIR1
EL3 is using AArch64.	x	x	0	-	RW	n/a	n/a	AMAIR1
EL3 is using AArch64.	x	0	1	-	RW	RW	n/a	AMAIR1
EL3 is using AArch64.	x	1	1	-	n/a	RW	n/a	AMAIR1
EL3 is using AArch32.	x	0	1	-	RW	RW	RW	AMAIR1_ns
EL3 is using AArch32.	x	1	1	-	n/a	RW	RW	AMAIR1_ns
EL3 is using AArch32.	x	x	0	-	n/a	n/a	RW	AMAIR1_s

When EL3 is using AArch32, write access to AMAIR1_s is UNDEFINED when the CP15SSDISABLE signal is asserted HIGH.

Traps and Enables

For a description of the prioritization of any generated exceptions, see [Synchronous exception prioritization for exceptions taken to AArch32 state on page G1-4344](#) for exceptions taken to AArch32 state and [Synchronous exception prioritization for exceptions taken to AArch64 on page D1-1827](#) for exceptions taken to AArch64 state. Subject to the prioritization rules:

- When EL2 is implemented and is using AArch64 and (SCR_EL3.NS == 1) && (HCR_EL2.E2H == 0):
 - If HCR_EL2.TVM==1, Non-secure write accesses to this register from EL1 are trapped to EL2.
 - If HCR_EL2.TRVM==1, Non-secure read accesses to this register from EL1 are trapped to EL2.
 - If HSTR_EL2.T10==1, Non-secure accesses to this register from EL1 are trapped to EL2.
- When EL2 is implemented and is using AArch64 and (SCR_EL3.NS == 1) && (HCR_EL2.E2H == 1) && (HCR_EL2.TGE == 0):
 - If HCR_EL2.TVM==1, Non-secure write accesses to this register from EL1 are trapped to EL2.
 - If HCR_EL2.TRVM==1, Non-secure read accesses to this register from EL1 are trapped to EL2.
 - If HSTR_EL2.T10==1, Non-secure accesses to this register from EL1 are trapped to EL2.
- When EL2 is implemented and is using AArch32 and SCR_EL3.NS == 1:
 - If HCR.TVM==1, Non-secure write accesses to this register from EL1 are trapped to Hyp mode.
 - If HCR.TRVM==1, Non-secure read accesses to this register from EL1 are trapped to Hyp mode.
 - If HSTR.T10==1, Non-secure accesses to this register from EL1 are trapped to Hyp mode.

G6.2.8 APSR, Application Program Status Register

The APSR characteristics are:

Purpose

Hold program status and control information.

Configurations

There is one instance of this register that is used in both Secure and Non-secure states.

Attributes

APSR is a 32-bit register.

Field descriptions

The APSR bit assignments are:

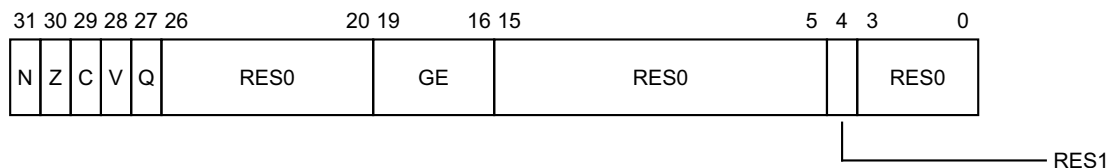

N, bit [31]

Negative condition flag. Set to bit[31] of the result of the last flag-setting instruction. If the result is regarded as a two's complement signed integer, then N is set to 1 if the result was negative, and N is set to 0 if the result was positive or zero.

Z, bit [30]

Zero condition flag. Set to 1 if the result of the last flag-setting instruction was zero, and to 0 otherwise. A result of zero often indicates an equal result from a comparison.

C, bit [29]

Carry condition flag. Set to 1 if the last flag-setting instruction resulted in a carry condition, for example an unsigned overflow on an addition.

V, bit [28]

Overflow condition flag. Set to 1 if the last flag-setting instruction resulted in an overflow condition, for example a signed overflow on an addition.

Q, bit [27]

Cumulative saturation bit. Set to 1 to indicate that overflow or saturation occurred in some instructions.

Bits [26:20]

Reserved, RES0.

GE, bits [19:16]

Greater than or Equal flags, for parallel addition and subtraction.

Bits [15:5]

Reserved, RES0.

Bit [4]

Reserved, RES1.

Bits [3:0]

Reserved, RES0.

G6.2.9 ATS12NSOPR, Address Translate Stages 1 and 2 Non-secure Only PL1 Read

The ATS12NSOPR characteristics are:

Purpose

Performs stage 1 and 2 address translations as defined for PL1 and the Non-secure state, with permissions as if reading from the given virtual address.

Configurations

There are no configuration notes.

Attributes

ATS12NSOPR is a 32-bit System instruction.

Field descriptions

The ATS12NSOPR input value bit assignments are:

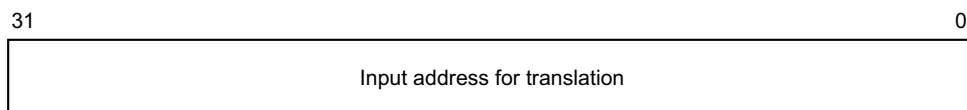

Bits [31:0]

Input address for translation. The resulting address can be read from the [PAR](#).

This instruction takes a VA as input. The resulting address is the PA that is the output address of the stage 2 translation.

Executing the ATS12NSOPR instruction

This instruction is executed using MCR with the following syntax:

MCR <syntax>

This syntax uses the following encoding in the System instruction encoding space:

<syntax>	opc1	opc2	CRn	coproc	CRm
p15, 0, <Rt>, c7, c8, 4	000	100	0111	1111	1000

Accessibility

The instruction is executable as follows:

Control			Accessibility			
E2H	TGE	NS	EL0	EL1	EL2	EL3
x	x	0	-	-	n/a	WO
x	0	1	-	-	WO	WO
x	1	1	-	n/a	WO	WO

If EL3 is implemented and is using AArch64, execution of ATS12NSOPR in Secure EL1 using AArch32 is trapped as an exception to EL3.

Traps and Enables

For a description of the prioritization of any generated exceptions, see *Synchronous exception prioritization for exceptions taken to AArch32 state* on page G1-4344 for exceptions taken to AArch32 state and *Synchronous exception prioritization for exceptions taken to AArch64* on page D1-1827 for exceptions taken to AArch64 state. Subject to the prioritization rules:

- When EL2 is implemented and is using AArch64 and $(SCR_EL3.NS == 1) \&\& (HCR_EL2.E2H == 0)$:
 - If $HSTR_EL2.T7 == 1$, Non-secure execution of this instruction at EL1 is trapped to EL2.
- When EL2 is implemented and is using AArch64 and $(SCR_EL3.NS == 1) \&\& (HCR_EL2.E2H == 1) \&\& (HCR_EL2.TGE == 0)$:
 - If $HSTR_EL2.T7 == 1$, Non-secure execution of this instruction at EL1 is trapped to EL2.
- When EL2 is implemented and is using AArch32 and $SCR_EL3.NS == 1$:
 - If $HSTR.T7 == 1$, Non-secure execution of this instruction at EL1 is trapped to Hyp mode.

G6.2.10 ATS12NSOPW, Address Translate Stages 1 and 2 Non-secure Only PL1 Write

The ATS12NSOPW characteristics are:

Purpose

Performs stage 1 and 2 address translations as defined for PL1 and the Non-secure state, with permissions as if writing to the given virtual address.

Configurations

There are no configuration notes.

Attributes

ATS12NSOPW is a 32-bit System instruction.

Field descriptions

The ATS12NSOPW input value bit assignments are:

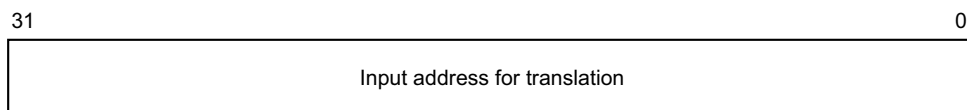

Bits [31:0]

Input address for translation. The resulting address can be read from the [PAR](#).

This instruction takes a VA as input. The resulting address is the PA that is the output address of the stage 2 translation.

Executing the ATS12NSOPW instruction

This instruction is executed using MCR with the following syntax:

MCR <syntax>

This syntax uses the following encoding in the System instruction encoding space:

<syntax>	opc1	opc2	CRn	coproc	CRm
p15, 0, <Rt>, c7, c8, 5	000	101	0111	1111	1000

Accessibility

The instruction is executable as follows:

Control			Accessibility			
E2H	TGE	NS	EL0	EL1	EL2	EL3
x	x	0	-	-	n/a	WO
x	0	1	-	-	WO	WO
x	1	1	-	n/a	WO	WO

If EL3 is implemented and is using AArch64, execution of ATS12NSOPW in Secure EL1 using AArch32 is trapped as an exception to EL3.

Traps and Enables

For a description of the prioritization of any generated exceptions, see *Synchronous exception prioritization for exceptions taken to AArch32 state* on page G1-4344 for exceptions taken to AArch32 state and *Synchronous exception prioritization for exceptions taken to AArch64* on page D1-1827 for exceptions taken to AArch64 state. Subject to the prioritization rules:

- When EL2 is implemented and is using AArch64 and $(SCR_EL3.NS == 1) \&\& (HCR_EL2.E2H == 0)$:
 - If $HSTR_EL2.T7 == 1$, Non-secure execution of this instruction at EL1 is trapped to EL2.
- When EL2 is implemented and is using AArch64 and $(SCR_EL3.NS == 1) \&\& (HCR_EL2.E2H == 1) \&\& (HCR_EL2.TGE == 0)$:
 - If $HSTR_EL2.T7 == 1$, Non-secure execution of this instruction at EL1 is trapped to EL2.
- When EL2 is implemented and is using AArch32 and $SCR_EL3.NS == 1$:
 - If $HSTR.T7 == 1$, Non-secure execution of this instruction at EL1 is trapped to Hyp mode.

G6.2.11 ATS12NSOUR, Address Translate Stages 1 and 2 Non-secure Only Unprivileged Read

The ATS12NSOUR characteristics are:

Purpose

Performs stage 1 and 2 address translations as defined for PL0 and the Non-secure state, with permissions as if reading from the given virtual address.

Configurations

There are no configuration notes.

Attributes

ATS12NSOUR is a 32-bit System instruction.

Field descriptions

The ATS12NSOUR input value bit assignments are:

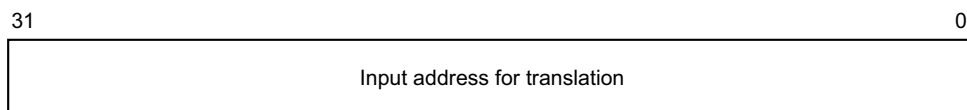

Bits [31:0]

Input address for translation. The resulting address can be read from the [PAR](#).

This instruction takes a VA as input. The resulting address is the PA that is the output address of the stage 2 translation.

Executing the ATS12NSOUR instruction

This instruction is executed using MCR with the following syntax:

MCR <syntax>

This syntax uses the following encoding in the System instruction encoding space:

<syntax>	opc1	opc2	CRn	coproc	CRm
p15, 0, <Rt>, c7, c8, 6	000	110	0111	1111	1000

Accessibility

The instruction is executable as follows:

Control			Accessibility			
E2H	TGE	NS	EL0	EL1	EL2	EL3
x	x	0	-	-	n/a	WO
x	0	1	-	-	WO	WO
x	1	1	-	n/a	WO	WO

If EL3 is implemented and is using AArch64, execution of ATS12NSOUR in Secure EL1 using AArch32 is trapped as an exception to EL3.

Traps and Enables

For a description of the prioritization of any generated exceptions, see *Synchronous exception prioritization for exceptions taken to AArch32 state* on page G1-4344 for exceptions taken to AArch32 state and *Synchronous exception prioritization for exceptions taken to AArch64* on page D1-1827 for exceptions taken to AArch64 state. Subject to the prioritization rules:

- When EL2 is implemented and is using AArch64 and $(SCR_EL3.NS == 1) \&\& (HCR_EL2.E2H == 0)$:
 - If $HSTR_EL2.T7 == 1$, Non-secure execution of this instruction at EL1 is trapped to EL2.
- When EL2 is implemented and is using AArch64 and $(SCR_EL3.NS == 1) \&\& (HCR_EL2.E2H == 1) \&\& (HCR_EL2.TGE == 0)$:
 - If $HSTR_EL2.T7 == 1$, Non-secure execution of this instruction at EL1 is trapped to EL2.
- When EL2 is implemented and is using AArch32 and $SCR_EL3.NS == 1$:
 - If $HSTR.T7 == 1$, Non-secure execution of this instruction at EL1 is trapped to Hyp mode.

G6.2.12 ATS12NSOUW, Address Translate Stages 1 and 2 Non-secure Only Unprivileged Write

The ATS12NSOUW characteristics are:

Purpose

Performs stage 1 and 2 address translations as defined for PL0 and the Non-secure state, with permissions as if writing to the given virtual address.

Configurations

There are no configuration notes.

Attributes

ATS12NSOUW is a 32-bit System instruction.

Field descriptions

The ATS12NSOUW input value bit assignments are:

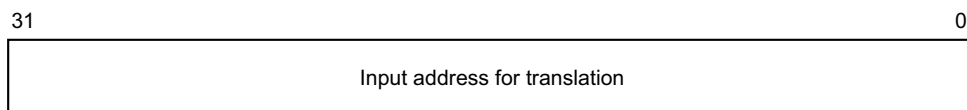

Bits [31:0]

Input address for translation. The resulting address can be read from the [PAR](#).

This instruction takes a VA as input. The resulting address is the PA that is the output address of the stage 2 translation.

Executing the ATS12NSOUW instruction

This instruction is executed using MCR with the following syntax:

MCR <syntax>

This syntax uses the following encoding in the System instruction encoding space:

<syntax>	opc1	opc2	CRn	coproc	CRm
p15, 0, <Rt>, c7, c8, 7	000	111	0111	1111	1000

Accessibility

The instruction is executable as follows:

Control			Accessibility			
E2H	TGE	NS	EL0	EL1	EL2	EL3
x	x	0	-	-	n/a	WO
x	0	1	-	-	WO	WO
x	1	1	-	n/a	WO	WO

If EL3 is implemented and is using AArch64, execution of ATS12NSOUW in Secure EL1 using AArch32 is trapped as an exception to EL3.

Traps and Enables

For a description of the prioritization of any generated exceptions, see *Synchronous exception prioritization for exceptions taken to AArch32 state* on page G1-4344 for exceptions taken to AArch32 state and *Synchronous exception prioritization for exceptions taken to AArch64* on page D1-1827 for exceptions taken to AArch64 state. Subject to the prioritization rules:

- When EL2 is implemented and is using AArch64 and $(SCR_EL3.NS == 1) \ \&\& \ (HCR_EL2.E2H == 0)$:
 - If $HSTR_EL2.T7 == 1$, Non-secure execution of this instruction at EL1 is trapped to EL2.
- When EL2 is implemented and is using AArch64 and $(SCR_EL3.NS == 1) \ \&\& \ (HCR_EL2.E2H == 1) \ \&\& \ (HCR_EL2.TGE == 0)$:
 - If $HSTR_EL2.T7 == 1$, Non-secure execution of this instruction at EL1 is trapped to EL2.
- When EL2 is implemented and is using AArch32 and $SCR_EL3.NS == 1$:
 - If $HSTR.T7 == 1$, Non-secure execution of this instruction at EL1 is trapped to Hyp mode.

G6.2.13 ATS1CPR, Address Translate Stage 1 Current state PL1 Read

The ATS1CPR characteristics are:

Purpose

Performs stage 1 address translation as defined for PL1 and the current Security state, with permissions as if reading from the given virtual address.

Configurations

There are no configuration notes.

Attributes

ATS1CPR is a 32-bit System instruction.

Field descriptions

The ATS1CPR input value bit assignments are:

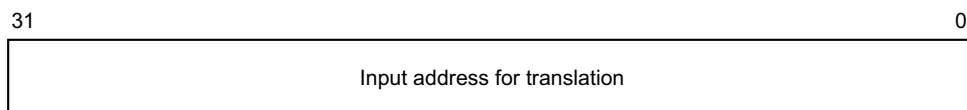

Bits [31:0]

Input address for translation. The resulting address can be read from the [PAR](#).

This instruction takes a VA as input. In an implementation that includes EL2, when executed in Non-secure state, the resulting address is the IPA that is the output address of the stage 1 translation. Otherwise, the resulting address is a PA.

Executing the ATS1CPR instruction

This instruction is executed using MCR with the following syntax:

MCR <syntax>

This syntax uses the following encoding in the System instruction encoding space:

<syntax>	opc1	opc2	CRn	coproc	CRm
p15, 0, <Rt>, c7, c8, 0	000	000	0111	1111	1000

Accessibility

The instruction is executable as follows:

Control			Accessibility			
E2H	TGE	NS	EL0	EL1	EL2	EL3
x	x	0	-	WO	n/a	WO
x	0	1	-	WO	WO	WO
x	1	1	-	n/a	WO	WO

Traps and Enables

For a description of the prioritization of any generated exceptions, see *Synchronous exception prioritization for exceptions taken to AArch32 state* on page G1-4344 for exceptions taken to AArch32 state and *Synchronous exception prioritization for exceptions taken to AArch64* on page D1-1827 for exceptions taken to AArch64 state. Subject to the prioritization rules:

- When EL2 is implemented and is using AArch64 and $(SCR_EL3.NS == 1) \&\& (HCR_EL2.E2H == 0)$:
 - If $HSTR_EL2.T7 == 1$, Non-secure execution of this instruction at EL1 is trapped to EL2.
- When EL2 is implemented and is using AArch64 and $(SCR_EL3.NS == 1) \&\& (HCR_EL2.E2H == 1) \&\& (HCR_EL2.TGE == 0)$:
 - If $HSTR_EL2.T7 == 1$, Non-secure execution of this instruction at EL1 is trapped to EL2.
- When EL2 is implemented and is using AArch32 and $SCR_EL3.NS == 1$:
 - If $HSTR.T7 == 1$, Non-secure execution of this instruction at EL1 is trapped to Hyp mode.

G6.2.14 ATS1CPRP, Address Translate Stage 1 Current state PL1 Read PAN

The ATS1CPRP characteristics are:

Purpose

When [ARMv8.2-ATS1E1](#) is implemented, performs a stage 1 address translation at PL1 and in the current Security state, where the value of PSTATE.PAN determines if a read from a location will generate a permission fault for a privileged access.

Configurations

This instruction is introduced in ARMv8.2.

Attributes

ATS1CPRP is a 32-bit System instruction.

Field descriptions

The ATS1CPRP input value bit assignments are:

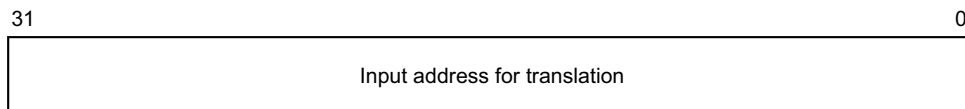

Bits [31:0]

Input address for translation. The resulting address can be read from the [PAR](#).

This instruction takes a VA as input. In an implementation that includes EL2, when executed in Non-secure state, the resulting address is the IPA that is the output address of the stage 1 translation. Otherwise, the resulting address is a PA.

Executing the ATS1CPRP instruction

This instruction is executed using MCR with the following syntax:

MCR <syntax>

This syntax uses the following encoding in the System instruction encoding space:

<syntax>	opc1	opc2	CRn	coproc	CRm
p15, 0, <Rt>, c7, c9, 0	000	000	0111	1111	1001

Accessibility

The instruction is executable as follows:

Control			Accessibility			
E2H	TGE	NS	EL0	EL1	EL2	EL3
x	x	0	-	WO	n/a	WO
x	0	1	-	WO	WO	WO
x	1	1	-	n/a	WO	WO

Traps and Enables

For a description of the prioritization of any generated exceptions, see *Synchronous exception prioritization for exceptions taken to AArch32 state* on page G1-4344 for exceptions taken to AArch32 state and *Synchronous exception prioritization for exceptions taken to AArch64* on page D1-1827 for exceptions taken to AArch64 state. Subject to the prioritization rules:

- When EL2 is implemented and is using AArch64 and $(SCR_EL3.NS == 1) \ \&\& \ (HCR_EL2.E2H == 0)$:
 - If $HSTR_EL2.T7 == 1$, Non-secure execution of this instruction at EL1 is trapped to EL2.
- When EL2 is implemented and is using AArch64 and $(SCR_EL3.NS == 1) \ \&\& \ (HCR_EL2.E2H == 1) \ \&\& \ (HCR_EL2.TGE == 0)$:
 - If $HSTR_EL2.T7 == 1$, Non-secure execution of this instruction at EL1 is trapped to EL2.
- When EL2 is implemented and is using AArch32 and $SCR_EL3.NS == 1$:
 - If $HSTR.T7 == 1$, Non-secure execution of this instruction at EL1 is trapped to Hyp mode.

G6.2.15 ATS1CPW, Address Translate Stage 1 Current state PL1 Write

The ATS1CPW characteristics are:

Purpose

Performs stage 1 address translation as defined for PL1 and the current Security state, with permissions as if writing to the given virtual address.

Configurations

There are no configuration notes.

Attributes

ATS1CPW is a 32-bit System instruction.

Field descriptions

The ATS1CPW input value bit assignments are:

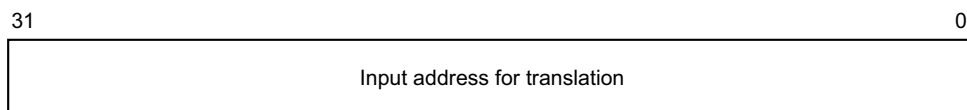

Bits [31:0]

Input address for translation. The resulting address can be read from the [PAR](#).

This instruction takes a VA as input. In an implementation that includes EL2, when executed in Non-secure state, the resulting address is the IPA that is the output address of the stage 1 translation. Otherwise, the resulting address is a PA.

Executing the ATS1CPW instruction

This instruction is executed using MCR with the following syntax:

MCR <syntax>

This syntax uses the following encoding in the System instruction encoding space:

<syntax>	opc1	opc2	CRn	coproc	CRm
p15, 0, <Rt>, c7, c8, 1	000	001	0111	1111	1000

Accessibility

The instruction is executable as follows:

Control			Accessibility			
E2H	TGE	NS	EL0	EL1	EL2	EL3
x	x	0	-	WO	n/a	WO
x	0	1	-	WO	WO	WO
x	1	1	-	n/a	WO	WO

Traps and Enables

For a description of the prioritization of any generated exceptions, see *Synchronous exception prioritization for exceptions taken to AArch32 state* on page G1-4344 for exceptions taken to AArch32 state and *Synchronous exception prioritization for exceptions taken to AArch64* on page D1-1827 for exceptions taken to AArch64 state. Subject to the prioritization rules:

- When EL2 is implemented and is using AArch64 and $(SCR_EL3.NS == 1) \&\& (HCR_EL2.E2H == 0)$:
 - If $HSTR_EL2.T7 == 1$, Non-secure execution of this instruction at EL1 is trapped to EL2.
- When EL2 is implemented and is using AArch64 and $(SCR_EL3.NS == 1) \&\& (HCR_EL2.E2H == 1) \&\& (HCR_EL2.TGE == 0)$:
 - If $HSTR_EL2.T7 == 1$, Non-secure execution of this instruction at EL1 is trapped to EL2.
- When EL2 is implemented and is using AArch32 and $SCR_EL3.NS == 1$:
 - If $HSTR.T7 == 1$, Non-secure execution of this instruction at EL1 is trapped to Hyp mode.

G6.2.16 ATS1CPWP, Address Translate Stage 1 Current state PL1 Write PAN

The ATS1CPWP characteristics are:

Purpose

When [ARMv8.2-ATS1E1](#) is implemented, performs a stage 1 address translation at PL1 and in the current Security state, where the value of PSTATE.PAN determines if a write to the location will generate a permission fault for a privileged access.

Configurations

This instruction is introduced in ARMv8.2.

Attributes

ATS1CPWP is a 32-bit System instruction.

Field descriptions

The ATS1CPWP input value bit assignments are:

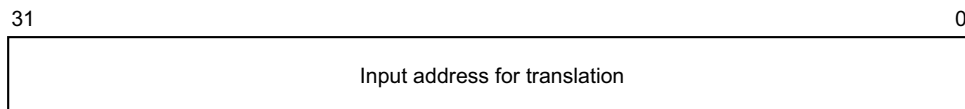

Bits [31:0]

Input address for translation. The resulting address can be read from the [PAR](#).

This instruction takes a VA as input. In an implementation that includes EL2, when executed in Non-secure state, the resulting address is the IPA that is the output address of the stage 1 translation. Otherwise, the resulting address is a PA.

Executing the ATS1CPWP instruction

This instruction is executed using MCR with the following syntax:

MCR <syntax>

This syntax uses the following encoding in the System instruction encoding space:

<syntax>	opc1	opc2	CRn	coproc	CRm
p15, 0, <Rt>, c7, c9, 1	000	001	0111	1111	1001

Accessibility

The instruction is executable as follows:

Control			Accessibility			
E2H	TGE	NS	EL0	EL1	EL2	EL3
x	x	0	-	WO	n/a	WO
x	0	1	-	WO	WO	WO
x	1	1	-	n/a	WO	WO

Traps and Enables

For a description of the prioritization of any generated exceptions, see *Synchronous exception prioritization for exceptions taken to AArch32 state* on page G1-4344 for exceptions taken to AArch32 state and *Synchronous exception prioritization for exceptions taken to AArch64* on page D1-1827 for exceptions taken to AArch64 state. Subject to the prioritization rules:

- When EL2 is implemented and is using AArch64 and $(SCR_EL3.NS == 1) \&\& (HCR_EL2.E2H == 0)$:
 - If $HSTR_EL2.T7 == 1$, Non-secure execution of this instruction at EL1 is trapped to EL2.
- When EL2 is implemented and is using AArch64 and $(SCR_EL3.NS == 1) \&\& (HCR_EL2.E2H == 1) \&\& (HCR_EL2.TGE == 0)$:
 - If $HSTR_EL2.T7 == 1$, Non-secure execution of this instruction at EL1 is trapped to EL2.
- When EL2 is implemented and is using AArch32 and $SCR_EL3.NS == 1$:
 - If $HSTR.T7 == 1$, Non-secure execution of this instruction at EL1 is trapped to Hyp mode.

G6.2.17 ATS1CUR, Address Translate Stage 1 Current state Unprivileged Read

The ATS1CUR characteristics are:

Purpose

Performs stage 1 address translation as defined for PL0 and the current Security state, with permissions as if reading from the given virtual address.

Configurations

There are no configuration notes.

Attributes

ATS1CUR is a 32-bit System instruction.

Field descriptions

The ATS1CUR input value bit assignments are:

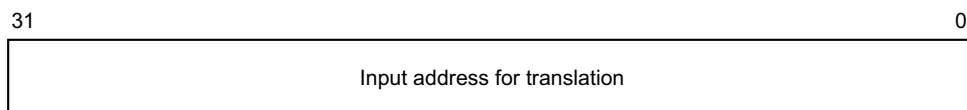

Bits [31:0]

Input address for translation. The resulting address can be read from the [PAR](#).

This instruction takes a VA as input. In an implementation that includes EL2, when executed in Non-secure state, the resulting address is the IPA that is the output address of the stage 1 translation. Otherwise, the resulting address is a PA.

Executing the ATS1CUR instruction

This instruction is executed using MCR with the following syntax:

MCR <syntax>

This syntax uses the following encoding in the System instruction encoding space:

<syntax>	opc1	opc2	CRn	coproc	CRm
p15, 0, <Rt>, c7, c8, 2	000	010	0111	1111	1000

Accessibility

The instruction is executable as follows:

Control			Accessibility			
E2H	TGE	NS	EL0	EL1	EL2	EL3
x	x	0	-	WO	n/a	WO
x	0	1	-	WO	WO	WO
x	1	1	-	n/a	WO	WO

Traps and Enables

For a description of the prioritization of any generated exceptions, see *Synchronous exception prioritization for exceptions taken to AArch32 state* on page G1-4344 for exceptions taken to AArch32 state and *Synchronous exception prioritization for exceptions taken to AArch64* on page D1-1827 for exceptions taken to AArch64 state. Subject to the prioritization rules:

- When EL2 is implemented and is using AArch64 and $(SCR_EL3.NS == 1) \ \&\& \ (HCR_EL2.E2H == 0)$:
 - If $HSTR_EL2.T7 == 1$, Non-secure execution of this instruction at EL1 is trapped to EL2.
- When EL2 is implemented and is using AArch64 and $(SCR_EL3.NS == 1) \ \&\& \ (HCR_EL2.E2H == 1) \ \&\& \ (HCR_EL2.TGE == 0)$:
 - If $HSTR_EL2.T7 == 1$, Non-secure execution of this instruction at EL1 is trapped to EL2.
- When EL2 is implemented and is using AArch32 and $SCR_EL3.NS == 1$:
 - If $HSTR.T7 == 1$, Non-secure execution of this instruction at EL1 is trapped to Hyp mode.

G6.2.18 ATS1CUW, Address Translate Stage 1 Current state Unprivileged Write

The ATS1CUW characteristics are:

Purpose

Performs stage 1 address translation as defined for PL0 and the current Security state, with permissions as if writing to the given virtual address.

Configurations

There are no configuration notes.

Attributes

ATS1CUW is a 32-bit System instruction.

Field descriptions

The ATS1CUW input value bit assignments are:

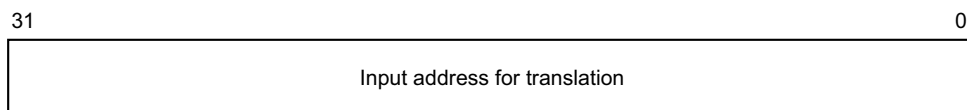

Bits [31:0]

Input address for translation. The resulting address can be read from the [PAR](#).

This instruction takes a VA as input. In an implementation that includes EL2, when executed in Non-secure state, the resulting address is the IPA that is the output address of the stage 1 translation. Otherwise, the resulting address is a PA.

Executing the ATS1CUW instruction

This instruction is executed using MCR with the following syntax:

MCR <syntax>

This syntax uses the following encoding in the System instruction encoding space:

<syntax>	opc1	opc2	CRn	coproc	CRm
p15, 0, <Rt>, c7, c8, 3	000	011	0111	1111	1000

Accessibility

The instruction is executable as follows:

Control			Accessibility			
E2H	TGE	NS	EL0	EL1	EL2	EL3
x	x	0	-	WO	n/a	WO
x	0	1	-	WO	WO	WO
x	1	1	-	n/a	WO	WO

Traps and Enables

For a description of the prioritization of any generated exceptions, see *Synchronous exception prioritization for exceptions taken to AArch32 state* on page G1-4344 for exceptions taken to AArch32 state and *Synchronous exception prioritization for exceptions taken to AArch64* on page D1-1827 for exceptions taken to AArch64 state. Subject to the prioritization rules:

- When EL2 is implemented and is using AArch64 and $(SCR_EL3.NS == 1) \ \&\& \ (HCR_EL2.E2H == 0)$:
 - If $HSTR_EL2.T7 == 1$, Non-secure execution of this instruction at EL1 is trapped to EL2.
- When EL2 is implemented and is using AArch64 and $(SCR_EL3.NS == 1) \ \&\& \ (HCR_EL2.E2H == 1) \ \&\& \ (HCR_EL2.TGE == 0)$:
 - If $HSTR_EL2.T7 == 1$, Non-secure execution of this instruction at EL1 is trapped to EL2.
- When EL2 is implemented and is using AArch32 and $SCR_EL3.NS == 1$:
 - If $HSTR.T7 == 1$, Non-secure execution of this instruction at EL1 is trapped to Hyp mode.

G6.2.19 ATS1HR, Address Translate Stage 1 Hyp mode Read

The ATS1HR characteristics are:

Purpose

Performs stage 1 address translation as defined for PL2 and the Non-secure state, with permissions as if reading from the given virtual address.

Configurations

There are no configuration notes.

Attributes

ATS1HR is a 32-bit System instruction.

Field descriptions

The ATS1HR input value bit assignments are:

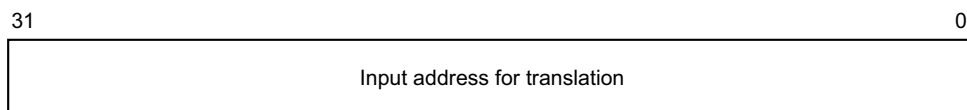

Bits [31:0]

Input address for translation. The resulting address can be read from the [PAR](#).

This instruction takes a VA as input. The resulting address is the PA that is the output address of the translation.

Executing the ATS1HR instruction

This instruction is executed using MCR with the following syntax:

MCR <syntax>

This syntax uses the following encoding in the System instruction encoding space:

<syntax>	opc1	opc2	CRn	coproc	CRm
p15, 4, <Rt>, c7, c8, 0	100	000	0111	1111	1000

Accessibility

The instruction is executable as follows:

Control			Accessibility			
E2H	TGE	NS	EL0	EL1	EL2	EL3
x	x	0	-	-	n/a	WO
x	0	1	-	-	WO	WO
x	1	1	-	n/a	WO	WO

If this instruction is executed in a Secure privileged mode other than Monitor mode, then the behavior is CONSTRAINED UNPREDICTABLE, and one of the following behaviors must occur:

- The instruction is UNDEFINED.
- The instruction is treated as a NOP.
- The instruction executes as if it had been executed in Monitor mode.

Traps and Enables

For a description of the prioritization of any generated exceptions, see *Synchronous exception prioritization for exceptions taken to AArch32 state* on page G1-4344 for exceptions taken to AArch32 state and *Synchronous exception prioritization for exceptions taken to AArch64* on page D1-1827 for exceptions taken to AArch64 state. Subject to the prioritization rules:

- When EL2 is implemented and is using AArch64 and $(SCR_EL3.NS == 1) \ \&\& \ (HCR_EL2.E2H == 0)$:
 - If $HSTR_EL2.T7 == 1$, Non-secure execution of this instruction at EL1 is trapped to EL2.
- When EL2 is implemented and is using AArch64 and $(SCR_EL3.NS == 1) \ \&\& \ (HCR_EL2.E2H == 1) \ \&\& \ (HCR_EL2.TGE == 0)$:
 - If $HSTR_EL2.T7 == 1$, Non-secure execution of this instruction at EL1 is trapped to EL2.
- When EL2 is implemented and is using AArch32 and $SCR_EL3.NS == 1$:
 - If $HSTR.T7 == 1$, Non-secure execution of this instruction at EL1 is trapped to Hyp mode.

G6.2.20 ATS1HW, Address Translate Stage 1 Hyp mode Write

The ATS1HW characteristics are:

Purpose

Performs stage 1 address translation as defined for PL2 and the Non-secure state, with permissions as if writing to the given virtual address.

Configurations

There are no configuration notes.

Attributes

ATS1HW is a 32-bit System instruction.

Field descriptions

The ATS1HW input value bit assignments are:

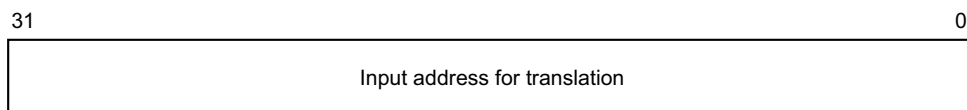

Bits [31:0]

Input address for translation. The resulting address can be read from the [PAR](#).

This instruction takes a VA as input. The resulting address is the PA that is the output address of the translation.

Executing the ATS1HW instruction

This instruction is executed using MCR with the following syntax:

MCR <syntax>

This syntax uses the following encoding in the System instruction encoding space:

<syntax>	opc1	opc2	CRn	coproc	CRm
p15, 4, <Rt>, c7, c8, 1	100	001	0111	1111	1000

Accessibility

The instruction is executable as follows:

Control			Accessibility			
E2H	TGE	NS	EL0	EL1	EL2	EL3
x	x	0	-	-	n/a	WO
x	0	1	-	-	WO	WO
x	1	1	-	n/a	WO	WO

If this instruction is executed in a Secure privileged mode other than Monitor mode, then the behavior is CONSTRAINED UNPREDICTABLE, and one of the following behaviors must occur:

- The instruction is UNDEFINED.
- The instruction is treated as a NOP.
- The instruction executes as if it had been executed in Monitor mode.

Traps and Enables

For a description of the prioritization of any generated exceptions, see *Synchronous exception prioritization for exceptions taken to AArch32 state* on page G1-4344 for exceptions taken to AArch32 state and *Synchronous exception prioritization for exceptions taken to AArch64* on page D1-1827 for exceptions taken to AArch64 state. Subject to the prioritization rules:

- When EL2 is implemented and is using AArch64 and $(SCR_EL3.NS == 1) \ \&\& \ (HCR_EL2.E2H == 0)$:
 - If $HSTR_EL2.T7 == 1$, Non-secure execution of this instruction at EL1 is trapped to EL2.
- When EL2 is implemented and is using AArch64 and $(SCR_EL3.NS == 1) \ \&\& \ (HCR_EL2.E2H == 1) \ \&\& \ (HCR_EL2.TGE == 0)$:
 - If $HSTR_EL2.T7 == 1$, Non-secure execution of this instruction at EL1 is trapped to EL2.
- When EL2 is implemented and is using AArch32 and $SCR_EL3.NS == 1$:
 - If $HSTR.T7 == 1$, Non-secure execution of this instruction at EL1 is trapped to Hyp mode.

G6.2.21 BPIALL, Branch Predictor Invalidate All

The BPIALL characteristics are:

Purpose

Invalidate all entries from branch predictors.

Configurations

In an implementation where the branch predictors are architecturally invisible, this instruction can execute as a NOP.

Attributes

BPIALL is a 32-bit System instruction.

Field descriptions

BPIALL ignores the value in the register specified by the instruction. Software does not have to write a value to the register before issuing this instruction.

Executing the BPIALL instruction

This instruction is executed using MCR with the following syntax:

MCR <syntax>

This syntax uses the following encoding in the System instruction encoding space:

<syntax>	opc1	opc2	CRn	coproc	CRm
p15, 0, <Rt>, c7, c5, 6	000	110	0111	1111	0101

The PE ignores the value of <Rt>. Software does not have to write a value to this register before issuing this instruction.

Accessibility

The instruction is executable as follows:

Control			Accessibility			
E2H	TGE	NS	EL0	EL1	EL2	EL3
x	x	0	-	WO	n/a	WO
x	0	1	-	WO	WO	WO
x	1	1	-	n/a	WO	WO

When [HCR.FB](#) is 1, at Non-secure EL1 this instruction executes as a [BPIALLIS](#).

Traps and Enables

For a description of the prioritization of any generated exceptions, see *Synchronous exception prioritization for exceptions taken to AArch32 state* on page G1-4344 for exceptions taken to AArch32 state and *Synchronous exception prioritization for exceptions taken to AArch64* on page D1-1827 for exceptions taken to AArch64 state. Subject to the prioritization rules:

- When EL2 is implemented and is using AArch64 and $(SCR_EL3.NS == 1) \ \&\& \ (HCR_EL2.E2H == 0)$:
 - If $HSTR_EL2.T7 == 1$, Non-secure execution of this instruction at EL1 is trapped to EL2.
- When EL2 is implemented and is using AArch64 and $(SCR_EL3.NS == 1) \ \&\& \ (HCR_EL2.E2H == 1) \ \&\& \ (HCR_EL2.TGE == 0)$:
 - If $HSTR_EL2.T7 == 1$, Non-secure execution of this instruction at EL1 is trapped to EL2.
- When EL2 is implemented and is using AArch32 and $SCR_EL3.NS == 1$:
 - If $HSTR.T7 == 1$, Non-secure execution of this instruction at EL1 is trapped to Hyp mode.

G6.2.22 BPIALLIS, Branch Predictor Invalidate All, Inner Shareable

The BPIALLIS characteristics are:

Purpose

Invalidate all entries from branch predictors Inner Shareable.

Configurations

In an implementation where the branch predictors are architecturally invisible, this instruction can execute as a NOP.

Attributes

BPIALLIS is a 32-bit System instruction.

Field descriptions

BPIALLIS ignores the value in the register specified by the instruction. Software does not have to write a value to the register before issuing this instruction.

Executing the BPIALLIS instruction

This instruction is executed using MCR with the following syntax:

MCR <syntax>

This syntax uses the following encoding in the System instruction encoding space:

<syntax>	opc1	opc2	CRn	coproc	CRm
p15, 0, <Rt>, c7, c1, 6	000	110	0111	1111	0001

The PE ignores the value of <Rt>. Software does not have to write a value to this register before issuing this instruction.

Accessibility

The instruction is executable as follows:

Control			Accessibility			
E2H	TGE	NS	EL0	EL1	EL2	EL3
x	x	0	-	WO	n/a	WO
x	0	1	-	WO	WO	WO
x	1	1	-	n/a	WO	WO

Traps and Enables

For a description of the prioritization of any generated exceptions, see [Synchronous exception prioritization for exceptions taken to AArch32 state on page G1-4344](#) for exceptions taken to AArch32 state and [Synchronous exception prioritization for exceptions taken to AArch64 on page D1-1827](#) for exceptions taken to AArch64 state. Subject to the prioritization rules:

- When EL2 is implemented and is using AArch64 and (SCR_EL3.NS == 1) && (HCR_EL2.E2H == 0):
 - If HSTR_EL2.T7==1, Non-secure execution of this instruction at EL1 is trapped to EL2.

- When EL2 is implemented and is using AArch64 and (SCR_EL3.NS == 1) && (HCR_EL2.E2H == 1) && (HCR_EL2.TGE == 0):
 - If [HSTR_EL2.T7](#)==1, Non-secure execution of this instruction at EL1 is trapped to EL2.
- When EL2 is implemented and is using AArch32 and SCR_EL3.NS == 1:
 - If [HSTR.T7](#)==1, Non-secure execution of this instruction at EL1 is trapped to Hyp mode.

G6.2.23 BPIMVA, Branch Predictor Invalidate by VA

The BPIMVA characteristics are:

Purpose

Invalidate virtual address from branch predictors.

Configurations

In an implementation where the branch predictors are architecturally invisible, this instruction can execute as a NOP.

Attributes

BPIMVA is a 32-bit System instruction.

Field descriptions

The BPIMVA input value bit assignments are:

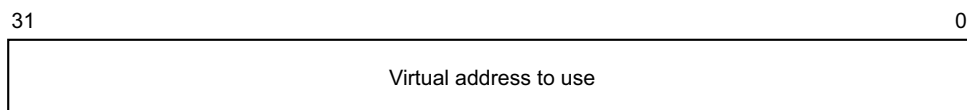

Bits [31:0]

Virtual address to use.

Executing the BPIMVA instruction

This instruction is executed using MCR with the following syntax:

MCR <syntax>

This syntax uses the following encoding in the System instruction encoding space:

<syntax>	opc1	opc2	CRn	coproc	CRm
p15, 0, <Rt>, c7, c5, 7	000	111	0111	1111	0101

Accessibility

The instruction is executable as follows:

Control			Accessibility			
E2H	TGE	NS	EL0	EL1	EL2	EL3
x	x	0	-	WO	n/a	WO
x	0	1	-	WO	WO	WO
x	1	1	-	n/a	WO	WO

Traps and Enables

For a description of the prioritization of any generated exceptions, see *Synchronous exception prioritization for exceptions taken to AArch32 state* on page G1-4344 for exceptions taken to AArch32 state and *Synchronous exception prioritization for exceptions taken to AArch64* on page D1-1827 for exceptions taken to AArch64 state. Subject to the prioritization rules:

- When EL2 is implemented and is using AArch64 and $(SCR_EL3.NS == 1) \ \&\& \ (HCR_EL2.E2H == 0)$:
 - If $HSTR_EL2.T7 == 1$, Non-secure execution of this instruction at EL1 is trapped to EL2.
- When EL2 is implemented and is using AArch64 and $(SCR_EL3.NS == 1) \ \&\& \ (HCR_EL2.E2H == 1) \ \&\& \ (HCR_EL2.TGE == 0)$:
 - If $HSTR_EL2.T7 == 1$, Non-secure execution of this instruction at EL1 is trapped to EL2.
- When EL2 is implemented and is using AArch32 and $SCR_EL3.NS == 1$:
 - If $HSTR.T7 == 1$, Non-secure execution of this instruction at EL1 is trapped to Hyp mode.

G6.2.24 CCSIDR, Current Cache Size ID Register

The CCSIDR characteristics are:

Purpose

Provides information about the architecture of the currently selected cache.

Configurations

There is one instance of this register that is used in both Secure and Non-secure states.

AArch32 System register CCSIDR is architecturally mapped to AArch64 System register [CCSIDR_EL1](#).

The implementation includes one CCSIDR for each cache that it can access. [CSSELR](#) and the Security state select which Cache Size ID Register is accessible.

Attributes

CCSIDR is a 32-bit register.

Field descriptions

The CCSIDR bit assignments are:

31	28 27	13 12	3 2 0
UNKNOWN	NumSets	Associativity	LineSize

UNKNOWN, bits [31:28]

Reserved, UNKNOWN.

NumSets, bits [27:13]

(Number of sets in cache) - 1, therefore a value of 0 indicates 1 set in the cache. The number of sets does not have to be a power of 2.

Associativity, bits [12:3]

(Associativity of cache) - 1, therefore a value of 0 indicates an associativity of 1. The associativity does not have to be a power of 2.

LineSize, bits [2:0]

($\text{Log}_2(\text{Number of bytes in cache line})$) - 4. For example:

For a line length of 16 bytes: $\text{Log}_2(16) = 4$, LineSize entry = 0. This is the minimum line length.

For a line length of 32 bytes: $\text{Log}_2(32) = 5$, LineSize entry = 1.

————— Note —————

The parameters NumSets, Associativity, and LineSize in these registers define the architecturally visible parameters that are required for the cache maintenance by Set/Way instructions. They are not guaranteed to represent the actual microarchitectural features of a design. You cannot make any inference about the actual sizes of caches based on these parameters.

Accessing the CCSIDR

This register can be read using MRC with the following syntax:

MRC <syntax>

This syntax is encoded with the following settings in the instruction encoding:

<syntax>	opc1	opc2	CRn	coproc	CRm
p15, 1, <Rt>, c0, c0, 0	001	000	0000	1111	0000

Accessibility

The register is accessible in software as follows:

Control			Accessibility			
E2H	TGE	NS	EL0	EL1	EL2	EL3
x	x	0	-	RO	n/a	RO
x	0	1	-	RO	RO	RO
x	1	1	-	n/a	RO	RO

If **CSSELR.Level** is programmed to a cache level that is not implemented, then on a read of the CCSIDR the behavior is CONstrained UNPREDICTABLE, and can be one of the following:

- The CCSIDR read is treated as NOP.
- The CCSIDR read is UNDEFINED.
- The CCSIDR read returns an UNKNOWN value.

Traps and Enables

For a description of the prioritization of any generated exceptions, see [Synchronous exception prioritization for exceptions taken to AArch32 state on page G1-4344](#) for exceptions taken to AArch32 state and [Synchronous exception prioritization for exceptions taken to AArch64 on page D1-1827](#) for exceptions taken to AArch64 state. Subject to the prioritization rules:

- When EL2 is implemented and is using AArch64 and (SCR_EL3.NS == 1) && (HCR_EL2.E2H == 0):
 - If **HCR_EL2.TID2**==1, Non-secure read accesses to this register from EL1 are trapped to EL2.
 - If **HSTR_EL2.T0**==1, Non-secure read accesses to this register from EL1 are trapped to EL2.
- When EL2 is implemented and is using AArch64 and (SCR_EL3.NS == 1) && (HCR_EL2.E2H == 1) && (HCR_EL2.TGE == 0):
 - If **HCR_EL2.TID2**==1, Non-secure read accesses to this register from EL1 are trapped to EL2.
 - If **HSTR_EL2.T0**==1, Non-secure read accesses to this register from EL1 are trapped to EL2.
- When EL2 is implemented and is using AArch32 and SCR_EL3.NS == 1:
 - If **HCR.TID2**==1, Non-secure read accesses to this register from EL1 are trapped to Hyp mode.
 - If **HSTR.T0**==1, Non-secure read accesses to this register from EL1 are trapped to Hyp mode.

G6.2.25 CLIDR, Cache Level ID Register

The CLIDR characteristics are:

Purpose

Identifies the type of cache, or caches, that are implemented at each level and can be managed using the architected cache maintenance instructions that operate by set/way, up to a maximum of seven levels. Also identifies the Level of Coherence (LoC) and Level of Unification (LoU) for the cache hierarchy.

Configurations

There is one instance of this register that is used in both Secure and Non-secure states.

AArch32 System register CLIDR is architecturally mapped to AArch64 System register [CLIDR_EL1](#).

Attributes

CLIDR is a 32-bit register.

Field descriptions

The CLIDR bit assignments are:

31	30	29	27	26	24	23	21	20	18	17	15	14	12	11	9	8	6	5	3	2	0
ICB	LoUU	LoC	LoUIS	Ctype7	Ctype6	Ctype5	Ctype4	Ctype3	Ctype2	Ctype1											

ICB, bits [31:30]

Inner cache boundary. This field indicates the boundary for caching Inner Cacheable memory regions.

The possible values are:

00	Not disclosed by this mechanism.
01	L1 cache is the highest Inner Cacheable level.
10	L2 cache is the highest Inner Cacheable level.
11	L3 cache is the highest Inner Cacheable level.

LoUU, bits [29:27]

Level of Unification Uniprocessor for the cache hierarchy.

LoC, bits [26:24]

Level of Coherence for the cache hierarchy.

LoUIS, bits [23:21]

Level of Unification Inner Shareable for the cache hierarchy.

Ctype<n>, bits [3(n-1)+2:3(n-1)], for n = 1 to 7

Cache Type fields. Indicate the type of cache that is implemented and can be managed using the architected cache maintenance instructions that operate by set/way at each level, from Level 1 up to a maximum of seven levels of cache hierarchy. Possible values of each field are:

000	No cache.
001	Instruction cache only.
010	Data cache only.
011	Separate instruction and data caches.

100 Unified cache.

All other values are reserved.

If software reads the Cache Type fields from Ctype1 upwards, once it has seen a value of 000, no caches that can be managed using the architected cache maintenance instructions that operate by set/way exist at further-out levels of the hierarchy. So, for example, if Ctype3 is the first Cache Type field with a value of 000, the values of Ctype4 to Ctype7 must be ignored.

Accessing the CLIDR

This register can be read using MRC with the following syntax:

MRC <syntax>

This syntax is encoded with the following settings in the instruction encoding:

<syntax>	opc1	opc2	CRn	coproc	CRm
p15, 1, <Rt>, c0, c0, 1	001	001	0000	1111	0000

Accessibility

The register is accessible in software as follows:

Control			Accessibility			
E2H	TGE	NS	EL0	EL1	EL2	EL3
x	x	0	-	RO	n/a	RO
x	0	1	-	RO	RO	RO
x	1	1	-	n/a	RO	RO

Traps and Enables

For a description of the prioritization of any generated exceptions, see [Synchronous exception prioritization for exceptions taken to AArch32 state on page G1-4344](#) for exceptions taken to AArch32 state and [Synchronous exception prioritization for exceptions taken to AArch64 on page D1-1827](#) for exceptions taken to AArch64 state. Subject to the prioritization rules:

- When EL2 is implemented and is using AArch64 and (SCR_EL3.NS == 1) && (HCR_EL2.E2H == 0):
 - If HCR_EL2.TID2==1, Non-secure read accesses to this register from EL1 are trapped to EL2.
 - If HSTR_EL2.T0==1, Non-secure read accesses to this register from EL1 are trapped to EL2.
- When EL2 is implemented and is using AArch64 and (SCR_EL3.NS == 1) && (HCR_EL2.E2H == 1) && (HCR_EL2.TGE == 0):
 - If HCR_EL2.TID2==1, Non-secure read accesses to this register from EL1 are trapped to EL2.
 - If HSTR_EL2.T0==1, Non-secure read accesses to this register from EL1 are trapped to EL2.
- When EL2 is implemented and is using AArch32 and SCR_EL3.NS == 1:
 - If HCR.TID2==1, Non-secure read accesses to this register from EL1 are trapped to Hyp mode.
 - If HSTR.T0==1, Non-secure read accesses to this register from EL1 are trapped to Hyp mode.

G6.2.26 CONTEXTIDR, Context ID Register

The CONTEXTIDR characteristics are:

Purpose

Identifies the current Process Identifier and, when using the Short-descriptor translation table format, the Address Space Identifier.

The value of the whole of this register is called the Context ID and is used by:

- The debug logic, for Linked and Unlinked Context ID matching.
- The trace logic, to identify the current process.

The significance of this register is for debug and trace use only.

Configurations

AArch32 System register CONTEXTIDR is architecturally mapped to AArch64 System register [CONTEXTIDR_ELI](#).

The register format depends on whether address translation is using the Long-descriptor or the Short-descriptor translation table format.

RW fields in this register reset to architecturally UNKNOWN values.

Attributes

CONTEXTIDR is a 32-bit register.

Field descriptions

The CONTEXTIDR bit assignments are:

When *TTBCR.EAE*==0:

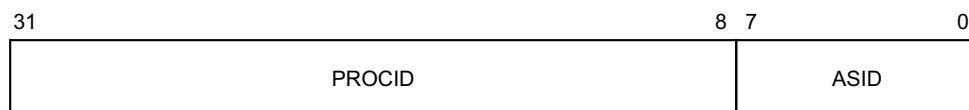

PROCID, bits [31:8]

Process Identifier. This field must be programmed with a unique value that identifies the current process.

ASID, bits [7:0]

Address Space Identifier. This field is programmed with the value of the current ASID.

When *TTBCR.EAE*==1:

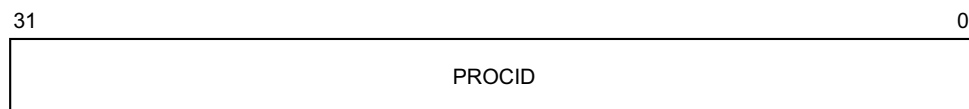

PROCID, bits [31:0]

Process Identifier. This field must be programmed with a unique value that identifies the current process.

Accessing the CONTEXTIDR

This register can be read using MRC with the following syntax:

MCR <syntax>

This register can be written using MCR with the following syntax:

MCR <syntax>

This syntax is encoded with the following settings in the instruction encoding:

<syntax>	opc1	opc2	CRn	coproc	CRm
p15, 0, <Rt>, c13, c0, 1	000	001	1101	1111	0000

Accessibility

The register is accessible in software as follows:

Configuration	Control			Accessibility				Instance
	E2H	TGE	NS	EL0	EL1	EL2	EL3	
EL3 is using AArch32.	x	0	1	-	RW	RW	RW	CONTEXTIDR_ns
EL3 is using AArch32.	x	1	1	-	n/a	RW	RW	CONTEXTIDR_ns
EL3 is using AArch32.	x	x	0	-	n/a	n/a	RW	CONTEXTIDR_s
EL3 is not implemented.	x	x	0	-	RW	n/a	n/a	CONTEXTIDR
EL3 is not implemented.	x	0	1	-	RW	RW	n/a	CONTEXTIDR
EL3 is not implemented.	x	1	1	-	n/a	RW	n/a	CONTEXTIDR
EL3 is using AArch64.	x	x	0	-	RW	n/a	n/a	CONTEXTIDR
EL3 is using AArch64.	x	0	1	-	RW	RW	n/a	CONTEXTIDR
EL3 is using AArch64.	x	1	1	-	n/a	RW	n/a	CONTEXTIDR

Traps and Enables

For a description of the prioritization of any generated exceptions, see [Synchronous exception prioritization for exceptions taken to AArch32 state on page G1-4344](#) for exceptions taken to AArch32 state and [Synchronous exception prioritization for exceptions taken to AArch64 on page D1-1827](#) for exceptions taken to AArch64 state. Subject to the prioritization rules:

- When EL2 is implemented and is using AArch64 and (SCR_EL3.NS == 1) && (HCR_EL2.E2H == 0):
 - If HCR_EL2.TVM==1, Non-secure write accesses to this register from EL1 are trapped to EL2.
 - If HCR_EL2.TRVM==1, Non-secure read accesses to this register from EL1 are trapped to EL2.
 - If HSTR_EL2.T13==1, Non-secure accesses to this register from EL1 are trapped to EL2.
- When EL2 is implemented and is using AArch64 and (SCR_EL3.NS == 1) && (HCR_EL2.E2H == 1) && (HCR_EL2.TGE == 0):
 - If HCR_EL2.TVM==1, Non-secure write accesses to this register from EL1 are trapped to EL2.
 - If HCR_EL2.TRVM==1, Non-secure read accesses to this register from EL1 are trapped to EL2.
 - If HSTR_EL2.T13==1, Non-secure accesses to this register from EL1 are trapped to EL2.
- When EL2 is implemented and is using AArch32 and SCR_EL3.NS == 1:
 - If HCR.TVM==1, Non-secure write accesses to this register from EL1 are trapped to Hyp mode.
 - If HCR.TRVM==1, Non-secure read accesses to this register from EL1 are trapped to Hyp mode.

- If `HSTR.T13==1`, Non-secure accesses to this register from EL1 are trapped to Hyp mode.

G6.2.27 CP15DMB, Data Memory Barrier System instruction

The CP15DMB characteristics are:

Purpose

Performs a Data Memory Barrier.

ARM deprecates any use of this operation, and strongly recommends that software use the [DMB](#) instruction instead.

Configurations

There are no configuration notes.

Attributes

CP15DMB is a 32-bit System instruction.

Field descriptions

CP15DMB ignores the value in the register specified by the instruction. Software does not have to write a value to the register before issuing this instruction.

Executing the CP15DMB instruction

This instruction is executed using MCR with the following syntax:

MCR <syntax>

This syntax uses the following encoding in the System instruction encoding space:

<syntax>	opc1	opc2	CRn	coproc	CRm
p15, 0, <Rt>, c7, c10, 5	000	101	0111	1111	1010

Accessibility

The instruction is executable as follows:

Control			Accessibility			
E2H	TGE	NS	EL0	EL1	EL2	EL3
x	x	0	WO	WO	n/a	WO
x	0	1	WO	WO	WO	WO
x	1	1	WO	n/a	WO	WO

Traps and Enables

For a description of the prioritization of any generated exceptions, see [Synchronous exception prioritization for exceptions taken to AArch32 state on page G1-4344](#) for exceptions taken to AArch32 state and [Synchronous exception prioritization for exceptions taken to AArch64 on page D1-1827](#) for exceptions taken to AArch64 state. Subject to the prioritization rules:

- In both security states, and not dependent on other bits:
 - If [SCTLR.CP15BEN](#)==0, execution of this instruction at PL0 and PL1 is UNDEFINED.
 - If [SCTLR_EL1.CP15BEN](#)==0, execution of this instruction at PL0 is UNDEFINED.
 - If [HSCTLR.CP15BEN](#)==0, execution of this instruction at PL2 is UNDEFINED.

- When EL2 is implemented and is using AArch64 and $(SCR_EL3.NS == 1) \ \&\& \ (HCR_EL2.E2H == 0)$:
 - If $HSTR_EL2.T7 == 1$, Non-secure execution of this instruction at EL0 and EL1 is trapped to EL2.
- When EL2 is implemented and is using AArch64 and $(SCR_EL3.NS == 1) \ \&\& \ (HCR_EL2.E2H == 1) \ \&\& \ (HCR_EL2.TGE == 0)$:
 - If $HSTR_EL2.T7 == 1$, Non-secure execution of this instruction at EL0 and EL1 is trapped to EL2.
- When EL2 is implemented and is using AArch32 and $SCR_EL3.NS == 1$:
 - If $HSTR.T7 == 1$, Non-secure execution of this instruction at EL0 and EL1 is trapped to Hyp mode.

G6.2.28 CP15DSB, Data Synchronization Barrier System instruction

The CP15DSB characteristics are:

Purpose

Performs a Data Synchronization Barrier.

ARM deprecates any use of this operation, and strongly recommends that software use the [DSB](#) instruction instead.

Configurations

There are no configuration notes.

Attributes

CP15DSB is a 32-bit System instruction.

Field descriptions

CP15DSB ignores the value in the register specified by the instruction. Software does not have to write a value to the register before issuing this instruction.

Executing the CP15DSB instruction

This instruction is executed using MCR with the following syntax:

MCR <syntax>

This syntax uses the following encoding in the System instruction encoding space:

<syntax>	opc1	opc2	CRn	coproc	CRm
p15, 0, <Rt>, c7, c10, 4	000	100	0111	1111	1010

Accessibility

The instruction is executable as follows:

Control			Accessibility			
E2H	TGE	NS	EL0	EL1	EL2	EL3
x	x	0	WO	WO	n/a	WO
x	0	1	WO	WO	WO	WO
x	1	1	WO	n/a	WO	WO

Traps and Enables

For a description of the prioritization of any generated exceptions, see [Synchronous exception prioritization for exceptions taken to AArch32 state on page G1-4344](#) for exceptions taken to AArch32 state and [Synchronous exception prioritization for exceptions taken to AArch64 on page D1-1827](#) for exceptions taken to AArch64 state. Subject to the prioritization rules:

- In both security states, and not dependent on other bits:
 - If `SCTLR.CP15BEN==0`, execution of this instruction at PL0 and PL1 is UNDEFINED.
 - If `SCTLR_EL1.CP15BEN==0`, execution of this instruction at PL0 is UNDEFINED.
 - If `HSCTLR.CP15BEN==0`, execution of this instruction at PL2 is UNDEFINED.

- When EL2 is implemented and is using AArch64 and $(SCR_EL3.NS == 1) \ \&\& \ (HCR_EL2.E2H == 0)$:
 - If $HSTR_EL2.T7 == 1$, Non-secure execution of this instruction at EL0 and EL1 is trapped to EL2.
- When EL2 is implemented and is using AArch64 and $(SCR_EL3.NS == 1) \ \&\& \ (HCR_EL2.E2H == 1) \ \&\& \ (HCR_EL2.TGE == 0)$:
 - If $HSTR_EL2.T7 == 1$, Non-secure execution of this instruction at EL0 and EL1 is trapped to EL2.
- When EL2 is implemented and is using AArch32 and $SCR_EL3.NS == 1$:
 - If $HSTR.T7 == 1$, Non-secure execution of this instruction at EL0 and EL1 is trapped to Hyp mode.

G6.2.29 CP15ISB, Instruction Synchronization Barrier System instruction

The CP15ISB characteristics are:

Purpose

Performs an Instruction Synchronization Barrier.

ARM deprecates any use of this operation, and strongly recommends that software use the [ISB](#) instruction instead.

Configurations

There are no configuration notes.

Attributes

CP15ISB is a 32-bit System instruction.

Field descriptions

CP15ISB ignores the value in the register specified by the instruction. Software does not have to write a value to the register before issuing this instruction.

Executing the CP15ISB instruction

This instruction is executed using MCR with the following syntax:

MCR <syntax>

This syntax uses the following encoding in the System instruction encoding space:

<syntax>	opc1	opc2	CRn	coproc	CRm
p15, 0, <Rt>, c7, c5, 4	000	100	0111	1111	0101

Accessibility

The instruction is executable as follows:

Control			Accessibility			
E2H	TGE	NS	EL0	EL1	EL2	EL3
x	x	0	WO	WO	n/a	WO
x	0	1	WO	WO	WO	WO
x	1	1	WO	n/a	WO	WO

Traps and Enables

For a description of the prioritization of any generated exceptions, see [Synchronous exception prioritization for exceptions taken to AArch32 state on page G1-4344](#) for exceptions taken to AArch32 state and [Synchronous exception prioritization for exceptions taken to AArch64 on page D1-1827](#) for exceptions taken to AArch64 state. Subject to the prioritization rules:

- In both security states, and not dependent on other bits:
 - If `SCTLR.CP15BEN==0`, execution of this instruction at PL0 and PL1 is UNDEFINED.
 - If `SCTLR_EL1.CP15BEN==0`, execution of this instruction at PL0 is UNDEFINED.
 - If `HSCTLR.CP15BEN==0`, execution of this instruction at PL2 is UNDEFINED.

- When EL2 is implemented and is using AArch64 and $(SCR_EL3.NS == 1) \ \&\& \ (HCR_EL2.E2H == 0)$:
 - If $HSTR_EL2.T7 == 1$, Non-secure execution of this instruction at EL0 and EL1 is trapped to EL2.
- When EL2 is implemented and is using AArch64 and $(SCR_EL3.NS == 1) \ \&\& \ (HCR_EL2.E2H == 1) \ \&\& \ (HCR_EL2.TGE == 0)$:
 - If $HSTR_EL2.T7 == 1$, Non-secure execution of this instruction at EL0 and EL1 is trapped to EL2.
- When EL2 is implemented and is using AArch32 and $SCR_EL3.NS == 1$:
 - If $HSTR.T7 == 1$, Non-secure execution of this instruction at EL0 and EL1 is trapped to Hyp mode.

G6.2.30 CPACR, Architectural Feature Access Control Register

The CPACR characteristics are:

Purpose

Controls access to trace, and to Advanced SIMD and floating-point functionality from EL0, EL1, and EL3.

In an implementation that includes EL2, the CPACR has no effect on instructions executed at EL2.

Configurations

There is one instance of this register that is used in both Secure and Non-secure states.

AArch32 System register CPACR is architecturally mapped to AArch64 System register [CPACR_EL1](#).

Bits in the [NSACR](#) control Non-secure access to the CPACR fields. See the field descriptions for more information.

———— Note ————

In the register field descriptions, controls are described as applying at specified Privilege levels. This is because, in Secure state, a PL1 control:

- Applies to execution in a Secure EL3 mode when EL3 is using AArch32.
- Applies to execution in a Secure EL1 mode when EL3 is using AArch64.

See [Security state, Exception levels, and AArch32 execution privilege on page G1-4318](#).

Some or all RW fields of this register have defined reset values. These apply only if the PE resets into an Exception level that is using AArch32. Otherwise, RW fields in this register reset to architecturally UNKNOWN values.

Attributes

CPACR is a 32-bit register.

Field descriptions

The CPACR bit assignments are:

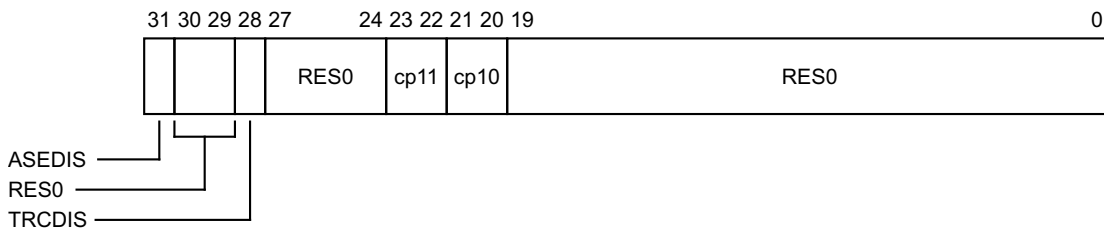

ASEDIS, bit [31]

Disables PL0 and PL1 execution of Advanced SIMD instructions.

0 This control permits execution of Advanced SIMD instructions at PL0 and PL1.

1 All instruction encodings that are Advanced SIMD instruction encodings, but are not also floating-point instruction encodings, are UNDEFINED at PL0 and PL1.

If the implementation does not include Advanced SIMD and floating-point functionality, this field is RES0. Otherwise, it is IMPLEMENTATION DEFINED whether this field is implemented as a RW field. If it is not implemented as a RW field, it is RAZ/WI.

If EL3 is implemented and is using AArch32, and the value of [NSACR.NSASEDIS](#) is 1, this field behaves as RAO/WI in Non-secure state, regardless of its actual value. This applies even if the field is implemented as RAZ/WI.

For the list of instructions affected by this field, see *Controls of Advanced SIMD operation that do not apply to floating-point operation* on page E1-2746.

See the description of CPACR.cp10 for a list of other controls that can disable or trap execution of Advanced SIMD instructions in AArch32 state.

When this register has an architecturally-defined reset value, if this field is implemented as an RW field, it resets to 0.

Bits [30:29]

Reserved, RES0.

TRCDIS, bit [28]

Traps PL0 and PL1 System register accesses to all implemented trace registers to Undefined mode.

- | | |
|---|--|
| 0 | This control has no effect on PL0 and PL1 System register accesses to trace registers. |
| 1 | PL0 and PL1 System register accesses to all implemented trace registers are trapped to Undefined mode. |

If the implementation does not include a trace macrocell, or does not include a System register interface to the trace macrocell registers, this field is RES0. Otherwise, it is IMPLEMENTATION DEFINED whether this field is implemented as a RW field. If it is not implemented as a RW field, it is RAZ/WI.

If EL3 is implemented and is using AArch32, and the value of NSACR.NSTRCDIS is 1, this field behaves as RAO/WI in Non-secure state, regardless of its actual value. This applies even if the field is implemented as RAZ/WI.

Note

- The ETMv4 architecture does not permit EL0 to access the trace registers. If the implementation includes an ETMv4 implementation, EL0 accesses to the trace registers are UNDEFINED.
- The architecture does not provide traps on trace register accesses through the optional memory-mapped external debug interface.

System register accesses to the trace registers can have side-effects. When a System register access is trapped, any side-effects that are normally associated with the access do not occur before the exception is taken.

If this field is implemented as an RW field, it resets to a value that is architecturally UNKNOWN.

Bits [27:24]

Reserved, RES0.

cp11, bits [23:22]

The value of this field is ignored. If this field is programmed with a different value to the cp10 field then this field is UNKNOWN on a direct read of the CPACR.

If the implementation does not include Advanced SIMD and floating-point functionality, this field is RES0.

In Non-secure state, if EL3 is implemented and is using AArch32, when the value of NSACR.cp10 is 0, this field behaves as RAZ/WI, regardless of its actual value.

When this register has an architecturally-defined reset value, if this field is implemented as an RW field, it resets to 0.

cp10, bits [21:20]

Defines the access rights for the floating-point and Advanced SIMD functionality. Possible values of the field are:

- | | |
|----|---|
| 00 | PL0 and PL1 accesses to floating-point and Advanced SIMD registers or instructions are UNDEFINED. |
|----|---|

- 01 PL0 accesses to floating-point and Advanced SIMD registers or instructions are UNDEFINED.
- 10 Reserved. The effect of programming this field to this value is CONSTRAINED UNPREDICTABLE. See *Reserved values in System and memory-mapped registers and translation table entries* on page K1-6117.
- 11 This control permits full access to the floating-point and Advanced SIMD functionality from PL0 and PL1.

The floating-point and Advanced SIMD features controlled by these fields are:

- Execution of any floating-point or Advanced SIMD instruction.
- Any access to the Advanced SIMD and floating-point registers D0-D31 and their views as S0-S31 and Q0-Q15.
- Any access to the [FPSCR](#), [FPSID](#), [MVFRO](#), [MVFRI](#), [MVFR2](#), or [FPEXC](#) System registers.

———— **Note** ————

The [CPACR](#) has no effect on floating-point and Advanced SIMD accesses from PL2. These can be disabled by the [HCPTR.TCP10](#) field.

If the implementation does not include Advanced SIMD and floating-point functionality, this field is RES0.

In Non-secure state, if EL3 is implemented and is using AArch32, when the value of [NSACR.cp10](#) is 0, this field behaves as RAZ/WI, regardless of its actual value.

Execution of floating-point and Advanced SIMD instructions in AArch32 state can be disabled or trapped by the following controls:

- [CPACR.cp10](#), or, if executing at EL0, [CPACR_EL1.FPEN](#).
- [FPEXC.EN](#).
- If executing in Non-secure state:
 - [HCPTR.TCP10](#), or if EL2 is using AArch64, [CPTR_EL2.TFP](#).
 - [NSACR.cp10](#), or if EL3 is using AArch64, [CPTR_EL3.TFP](#).
- For Advanced SIMD instructions only:
 - [CPACR.ASEDIS](#).
 - If executing in Non-secure state, [HCPTR.TASE](#) and [NSACR.NSTRCDIS](#).

See the descriptions of the controls for more information.

When this register has an architecturally-defined reset value, if this field is implemented as an RW field, it resets to 0.

Bits [19:0]

Reserved, RES0.

Accessing the CPACR

This register can be read using MRC with the following syntax:

MRC <syntax>

This register can be written using MCR with the following syntax:

MCR <syntax>

This syntax is encoded with the following settings in the instruction encoding:

<syntax>	opc1	opc2	CRn	coproc	CRm
p15, 0, <Rt>, c1, c0, 2	000	010	0001	1111	0000

Accessibility

The register is accessible in software as follows:

Control			Accessibility			
E2H	TGE	NS	EL0	EL1	EL2	EL3
x	x	0	-	RW	n/a	RW
x	0	1	-	RW	RW	RW
x	1	1	-	n/a	RW	RW

Traps and Enables

For a description of the prioritization of any generated exceptions, see [Synchronous exception prioritization for exceptions taken to AArch32 state on page G1-4344](#) for exceptions taken to AArch32 state and [Synchronous exception prioritization for exceptions taken to AArch64 on page D1-1827](#) for exceptions taken to AArch64 state. Subject to the prioritization rules:

- When EL2 is implemented and is using AArch64 and $(SCR_EL3.NS == 1) \ \&\& \ (HCR_EL2.E2H == 0)$:
 - If $CPTR_EL2.TCPAC == 1$, Non-secure accesses to this register from EL1 are trapped to EL2.
 - If $HSTR_EL2.T1 == 1$, Non-secure accesses to this register from EL1 are trapped to EL2.
- When EL2 is implemented and is using AArch64 and $(SCR_EL3.NS == 1) \ \&\& \ (HCR_EL2.E2H == 1) \ \&\& \ (HCR_EL2.TGE == 0)$:
 - If $CPTR_EL2.TCPAC == 1$, Non-secure accesses to this register from EL1 are trapped to EL2.
 - If $HSTR_EL2.T1 == 1$, Non-secure accesses to this register from EL1 are trapped to EL2.
- When EL2 is implemented and is using AArch32 and $SCR_EL3.NS == 1$:
 - If $HCPTR.TCPAC == 1$, Non-secure accesses to this register from EL1 are trapped to Hyp mode.
 - If $HSTR.T1 == 1$, Non-secure accesses to this register from EL1 are trapped to Hyp mode.
- When EL3 is implemented and is using AArch64:
 - If $CPTR_EL3.TCPAC == 1$, accesses to this register from EL1 and EL2 are trapped to EL3.

G6.2.31 CPSR, Current Program Status Register

The CPSR characteristics are:

Purpose

Holds PE status and control information.

Configurations

There is one instance of this register that is used in both Secure and Non-secure states.

Attributes

CPSR is a 32-bit register.

Field descriptions

The CPSR bit assignments are:

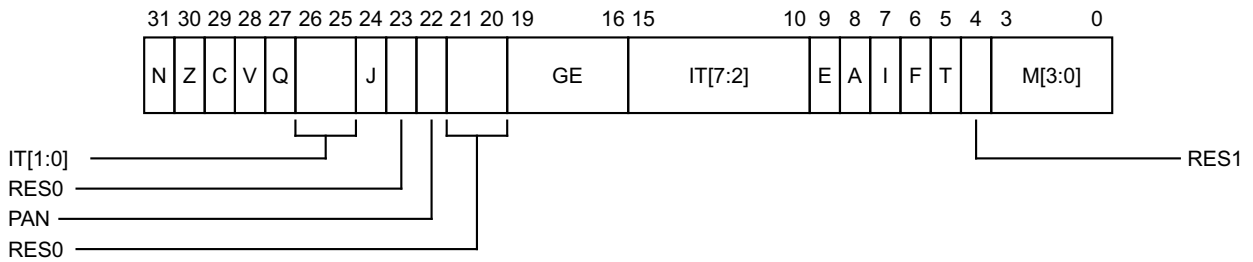

N, bit [31]

Negative condition flag. Set to bit[31] of the result of the last flag-setting instruction. If the result is regarded as a two's complement signed integer, then N is set to 1 if the result was negative, and N is set to 0 if the result was positive or zero.

Z, bit [30]

Zero condition flag. Set to 1 if the result of the last flag-setting instruction was zero, and to 0 otherwise. A result of zero often indicates an equal result from a comparison.

C, bit [29]

Carry condition flag. Set to 1 if the last flag-setting instruction resulted in a carry condition, for example an unsigned overflow on an addition.

V, bit [28]

Overflow condition flag. Set to 1 if the last flag-setting instruction resulted in an overflow condition, for example a signed overflow on an addition.

Q, bit [27]

Cumulative saturation bit. Set to 1 to indicate that overflow or saturation occurred in some instructions.

IT[1:0], bits [26:25]

IT block state bits for the T32 IT (If-Then) instruction. See IT[7:2] for explanation of this field.

J, bit [24]

RES0.

In previous versions of the architecture, the {J, T} bits determined the AArch32 Instruction set state. ARMv8 does not support either Jazelle state or T32EE state, and the T bit determines the Instruction set state.

Bit [23]

Reserved, RES0.

PAN, bit [22]

In ARMv8.2 and ARMv8.1

Privileged Access Never. When [ARMv8.1-PAN](#) is implemented, defined values are:

- 0 The translation system is the same as ARMv8.0.
- 1 Disables privileged read and write accesses to addresses accessible at EL0.

The value of this bit is usually preserved on taking an exception, except in the following situations:

- When the target of the exception is EL1, and the value of the [SCTLR.SPAN](#) bit for the current Security state is 0, this bit is set to 1.
- When the target of the exception is EL3, from Secure state, and the value of the Secure [SCTLR.SPAN](#) is 0, this bit is set to 1.
- When the target of the exception is EL3, from Non-secure state, this bit is set to 0 regardless of the value of the Secure [SCTLR.SPAN](#) bit.

When [ARMv8.1-PAN](#) is not implemented, this bit is RES0.

In ARMv8.0.

Reserved, RES0.

Bits [21:20]

Reserved, RES0.

GE, bits [19:16]

Greater than or Equal flags, for parallel addition and subtraction.

IT[7:2], bits [15:10]

IT block state bits for the T32 IT (If-Then) instruction. This field must be interpreted in two parts.

- IT[7:5] holds the base condition for the IT block. The base condition is the top 3 bits of the condition code specified by the first condition field of the IT instruction.
- IT[4:0] encodes the size of the IT block, which is the number of instructions that are to be conditionally executed, by the position of the least significant 1 in this field. It also encodes the value of the least significant bit of the condition code for each instruction in the block.

The IT field is 0b00000000 when no IT block is active.

E, bit [9]

Endianness state bit. Controls the load and store endianness for data accesses:

- 0 Little-endian operation
- 1 Big-endian operation.

Instruction fetches ignore this bit.

When the reset value of the [SCTLR.EE](#) bit is defined by a configuration input signal, that value also applies to the [CPSR.E](#) bit on reset, and therefore applies to software execution from reset.

If an implementation does not provide Big-endian support, this bit is RES0. If it does not provide Little-endian support, this bit is RES1.

If an implementation provides Big-endian support but only at EL0, this bit is RES0 for an exception return to any Exception level other than EL0.

Likewise, if it provides Little-endian support only at EL0, this bit is RES1 for an exception return to any Exception level other than EL0.

A, bit [8]

SERror interrupt mask bit. The possible values of this bit are:

- 0 Exception not masked.

1 Exception masked.

I, bit [7]

IRQ mask bit. The possible values of this bit are:

0 Exception not masked.
 1 Exception masked.

F, bit [6]

FIQ mask bit. The possible values of this bit are:

0 Exception not masked.
 1 Exception masked.

T, bit [5]

T32 Instruction set state bit. Indicates the AArch32 instruction set state. Possible values of this bit are:

0 A32 state.
 1 T32 state.

Bit [4]

Reserved, RES1.

M[3:0], bits [3:0]

Current PE mode. Possible values are:

M[3:0]	Mode
0b0000	User
0b0001	FIQ
0b0010	IRQ
0b0011	Supervisor
0b0110	Monitor
0b0111	Abort
0b1010	Hyp
0b1011	Undefined
0b1111	System

Other values are reserved.

G6.2.32 CSSELR, Cache Size Selection Register

The CSSELR characteristics are:

Purpose

Selects the current Cache Size ID Register, [CCSIDR](#), by specifying the required cache level and the cache type (either instruction or data cache).

Configurations

AArch32 System register CSSELR is architecturally mapped to AArch64 System register [CSSELR_EL1](#).

RW fields in this register reset to architecturally UNKNOWN values.

Attributes

CSSELR is a 32-bit register.

Field descriptions

The CSSELR bit assignments are:

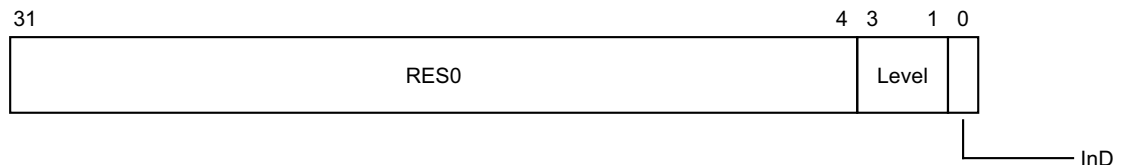

Bits [31:4]

Reserved, RES0.

Level, bits [3:1]

Cache level of required cache. Permitted values are:

000	Level 1 cache
001	Level 2 cache
010	Level 3 cache
011	Level 4 cache
100	Level 5 cache
101	Level 6 cache
110	Level 7 cache

All other values are reserved.

If CSSELR.Level is programmed to a cache level that is not implemented, then the value for this field on a read of CSSELR is UNKNOWN.

InD, bit [0]

Instruction not Data bit. Permitted values are:

0	Data or unified cache.
1	Instruction cache.

If CSSELR.Level is programmed to a cache level that is not implemented, then the value for this field on a read of CSSELR is UNKNOWN.

Accessing the CSSELR

This register can be read using MRC with the following syntax:

MCR <syntax>

This register can be written using MCR with the following syntax:

MCR <syntax>

This syntax is encoded with the following settings in the instruction encoding:

<syntax>	opc1	opc2	CRn	coproc	CRm
p15, 2, <Rt>, c0, c0, 0	010	000	0000	1111	0000

Accessibility

The register is accessible in software as follows:

Configuration	Control			Accessibility				Instance
	E2H	TGE	NS	EL0	EL1	EL2	EL3	
EL3 is not implemented.	x	x	0	-	RW	n/a	n/a	CSSELR
EL3 is not implemented.	x	0	1	-	RW	RW	n/a	CSSELR
EL3 is not implemented.	x	1	1	-	n/a	RW	n/a	CSSELR
EL3 is using AArch64.	x	x	0	-	RW	n/a	n/a	CSSELR
EL3 is using AArch64.	x	0	1	-	RW	RW	n/a	CSSELR
EL3 is using AArch64.	x	1	1	-	n/a	RW	n/a	CSSELR
EL3 is using AArch32.	x	x	0	-	n/a	n/a	RW	CSSELR_s
EL3 is using AArch32.	x	0	1	-	RW	RW	RW	CSSELR_ns
EL3 is using AArch32.	x	1	1	-	n/a	RW	RW	CSSELR_ns

Traps and Enables

For a description of the prioritization of any generated exceptions, see [Synchronous exception prioritization for exceptions taken to AArch32 state on page G1-4344](#) for exceptions taken to AArch32 state and [Synchronous exception prioritization for exceptions taken to AArch64 on page D1-1827](#) for exceptions taken to AArch64 state. Subject to the prioritization rules:

- When EL2 is implemented and is using AArch64 and (SCR_EL3.NS == 1) && (HCR_EL2.E2H == 0):
 - If HCR_EL2.TID2==1, Non-secure accesses to this register from EL1 are trapped to EL2.
 - If HSTR_EL2.T0==1, Non-secure accesses to this register from EL1 are trapped to EL2.
- When EL2 is implemented and is using AArch64 and (SCR_EL3.NS == 1) && (HCR_EL2.E2H == 1) && (HCR_EL2.TGE == 0):
 - If HCR_EL2.TID2==1, Non-secure accesses to this register from EL1 are trapped to EL2.
 - If HSTR_EL2.T0==1, Non-secure accesses to this register from EL1 are trapped to EL2.
- When EL2 is implemented and is using AArch32 and SCR_EL3.NS == 1:
 - If HCR.TID2==1, Non-secure accesses to this register from EL1 are trapped to Hyp mode.
 - If HSTR.T0==1, Non-secure accesses to this register from EL1 are trapped to Hyp mode.

G6.2.33 CTR, Cache Type Register

The CTR characteristics are:

Purpose

Provides information about the architecture of the caches.

Configurations

There is one instance of this register that is used in both Secure and Non-secure states.

AArch32 System register CTR is architecturally mapped to AArch64 System register [CTR_EL0](#).

Attributes

CTR is a 32-bit register.

Field descriptions

The CTR bit assignments are:

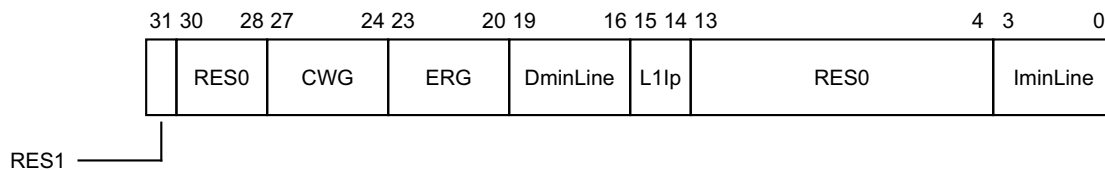

Bit [31]

Reserved, RES1.

Bits [30:28]

Reserved, RES0.

CWG, bits [27:24]

Cache writeback granule. \log_2 of the number of words of the maximum size of memory that can be overwritten as a result of the eviction of a cache entry that has had a memory location in it modified.

A value of `0b0000` indicates that this register does not provide Cache writeback granule information and either:

- The architectural maximum of 512 words (2KB) must be assumed.
- The Cache writeback granule can be determined from maximum cache line size encoded in the Cache Size ID Registers.

Values greater than `0b1001` are reserved.

ARM recommends that an implementation that does not support cache write-back implements this field as `0b0001`. This applies, for example, to an implementation that supports only write-through caches.

ERG, bits [23:20]

Exclusives reservation granule. \log_2 of the number of words of the maximum size of the reservation granule that has been implemented for the Load-Exclusive and Store-Exclusive instructions.

A value of `0b0000` indicates that this register does not provide Exclusives reservation granule information and the architectural maximum of 512 words (2KB) must be assumed.

Values greater than `0b1001` are reserved.

DminLine, bits [19:16]

\log_2 of the number of words in the smallest cache line of all the data caches and unified caches that are controlled by the PE.

L1Ip, bits [15:14]

Level 1 instruction cache policy. Indicates the indexing and tagging policy for the L1 instruction cache. Possible values of this field are:

- 00 VMID aware Physical Index, Physical tag (VPIPT)
- 01 ASID-tagged Virtual Index, Virtual Tag (AIVIVT)
- 10 Virtual Index, Physical Tag (VIPT)
- 11 Physical Index, Physical Tag (PIPT)

The value 0b01 is reserved in ARMv8.

Bits [13:4]

Reserved, RES0.

IminLine, bits [3:0]

Log₂ of the number of words in the smallest cache line of all the instruction caches that are controlled by the PE.

Accessing the CTR

This register can be read using MRC with the following syntax:

MRC <syntax>

This syntax is encoded with the following settings in the instruction encoding:

<syntax>	opc1	opc2	CRn	coproc	CRm
p15, 0, <Rt>, c0, c0, 1	000	001	0000	1111	0000

Accessibility

The register is accessible in software as follows:

Control			Accessibility			
E2H	TGE	NS	EL0	EL1	EL2	EL3
x	x	0	-	RO	n/a	RO
x	0	1	-	RO	RO	RO
x	1	1	-	n/a	RO	RO

Traps and Enables

For a description of the prioritization of any generated exceptions, see *Synchronous exception prioritization for exceptions taken to AArch32 state* on page G1-4344 for exceptions taken to AArch32 state and *Synchronous exception prioritization for exceptions taken to AArch64* on page D1-1827 for exceptions taken to AArch64 state. Subject to the prioritization rules:

- When EL2 is implemented and is using AArch64 and (SCR_EL3.NS == 1) && (HCR_EL2.E2H == 0):
 - If HCR_EL2.TID2==1, Non-secure read accesses to this register from EL1 are trapped to EL2.
 - If HSTR_EL2.T0==1, Non-secure read accesses to this register from EL1 are trapped to EL2.

- When EL2 is implemented and is using AArch64 and (SCR_EL3.NS == 1) && (HCR_EL2.E2H == 1) && (HCR_EL2.TGE == 0):
 - If HCR_EL2.TID2==1, Non-secure read accesses to this register from EL1 are trapped to EL2.
 - If HSTR_EL2.T0==1, Non-secure read accesses to this register from EL1 are trapped to EL2.
- When EL2 is implemented and is using AArch32 and SCR_EL3.NS == 1:
 - If HCR.TID2==1, Non-secure read accesses to this register from EL1 are trapped to Hyp mode.
 - If HSTR.T0==1, Non-secure read accesses to this register from EL1 are trapped to Hyp mode.

G6.2.34 DACR, Domain Access Control Register

The DACR characteristics are:

Purpose

Defines the access permission for each of the sixteen memory domains.

Configurations

AArch32 System register DACR is architecturally mapped to AArch64 System register [DACR32_EL2](#).

When EL3 is using AArch32, write access to DACR(S) is disabled when the CP15SDISABLE signal is asserted HIGH.

This register has no function when [TTBCR.EAE](#) is set to 1, to select the Long-descriptor translation table format.

RW fields in this register reset to architecturally UNKNOWN values.

Attributes

DACR is a 32-bit register.

Field descriptions

The DACR bit assignments are:

31	30	29	28	27	26	25	24	23	22	21	20	19	18	17	16	15	14	13	12	11	10	9	8	7	6	5	4	3	2	1	0
D15	D14	D13	D12	D11	D10	D9	D8	D7	D6	D5	D4	D3	D2	D1	D0																

D<n>, bits [2n+1:2n], for n = 0 to 15

Domain n access permission, where n = 0 to 15. Permitted values are:

- 00 No access. Any access to the domain generates a Domain fault.
 - 01 Client. Accesses are checked against the permission bits in the translation tables.
 - 11 Manager. Accesses are not checked against the permission bits in the translation tables.
- The value 10 is reserved.

Accessing the DACR

This register can be read using MRC with the following syntax:

MRC <syntax>

This register can be written using MCR with the following syntax:

MCR <syntax>

This syntax is encoded with the following settings in the instruction encoding:

<syntax>	opc1	opc2	CRn	coproc	CRm
p15, 0, <Rt>, c3, c0, 0	000	000	0011	1111	0000

Accessibility

The register is accessible in software as follows:

Configuration	Control			Accessibility				Instance
	E2H	TGE	NS	EL0	EL1	EL2	EL3	
EL3 is not implemented.	x	x	0	-	RW	n/a	n/a	DACR
EL3 is not implemented.	x	0	1	-	RW	RW	n/a	DACR
EL3 is not implemented.	x	1	1	-	n/a	RW	n/a	DACR
EL3 is using AArch64.	x	x	0	-	RW	n/a	n/a	DACR
EL3 is using AArch64.	x	0	1	-	RW	RW	n/a	DACR
EL3 is using AArch64.	x	1	1	-	n/a	RW	n/a	DACR
EL3 is using AArch32.	x	x	0	-	n/a	n/a	RW	DACR_s
EL3 is using AArch32.	x	0	1	-	RW	RW	RW	DACR_ns
EL3 is using AArch32.	x	1	1	-	n/a	RW	RW	DACR_ns

When EL3 is using AArch32, write access to DACR_s is UNDEFINED when the CP15SDISABLE signal is asserted HIGH.

Traps and Enables

For a description of the prioritization of any generated exceptions, see [Synchronous exception prioritization for exceptions taken to AArch32 state on page G1-4344](#) for exceptions taken to AArch32 state and [Synchronous exception prioritization for exceptions taken to AArch64 on page D1-1827](#) for exceptions taken to AArch64 state. Subject to the prioritization rules:

- When EL2 is implemented and is using AArch64 and (SCR_EL3.NS == 1) && (HCR_EL2.E2H == 0):
 - If HCR_EL2.TVM==1, Non-secure write accesses to this register from EL1 are trapped to EL2.
 - If HCR_EL2.TRVM==1, Non-secure read accesses to this register from EL1 are trapped to EL2.
 - If HSTR_EL2.T3==1, Non-secure accesses to this register from EL1 are trapped to EL2.
- When EL2 is implemented and is using AArch64 and (SCR_EL3.NS == 1) && (HCR_EL2.E2H == 1) && (HCR_EL2.TGE == 0):
 - If HCR_EL2.TVM==1, Non-secure write accesses to this register from EL1 are trapped to EL2.
 - If HCR_EL2.TRVM==1, Non-secure read accesses to this register from EL1 are trapped to EL2.
 - If HSTR_EL2.T3==1, Non-secure accesses to this register from EL1 are trapped to EL2.
- When EL2 is implemented and is using AArch32 and SCR_EL3.NS == 1:
 - If HCR.TVM==1, Non-secure write accesses to this register from EL1 are trapped to Hyp mode.
 - If HCR.TRVM==1, Non-secure read accesses to this register from EL1 are trapped to Hyp mode.
 - If HSTR.T3==1, Non-secure accesses to this register from EL1 are trapped to Hyp mode.

G6.2.35 DCCIMVAC, Data Cache line Clean and Invalidate by VA to PoC

The DCCIMVAC characteristics are:

Purpose

Clean and Invalidate data or unified cache line by virtual address to PoC.

Configurations

AArch32 System instruction DCCIMVAC performs the same function as AArch64 System instruction [DC CIVAC](#).

Attributes

DCCIMVAC is a 32-bit System instruction.

Field descriptions

The DCCIMVAC input value bit assignments are:

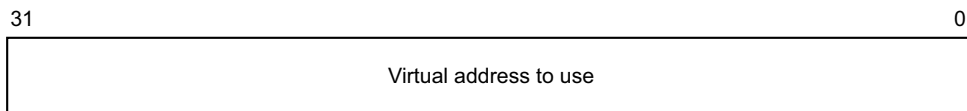

Bits [31:0]

Virtual address to use.

Executing the DCCIMVAC instruction

This instruction is executed using MCR with the following syntax:

MCR <syntax>

This syntax uses the following encoding in the System instruction encoding space:

<syntax>	opc1	opc2	CRn	coproc	CRm
p15, 0, <Rt>, c7, c14, 1	000	001	0111	1111	1110

Accessibility

The instruction is executable as follows:

Control			Accessibility			
E2H	TGE	NS	EL0	EL1	EL2	EL3
x	x	0	-	WO	n/a	WO
x	0	1	-	WO	WO	WO
x	1	1	-	n/a	WO	WO

Traps and Enables

For a description of the prioritization of any generated exceptions, see *Synchronous exception prioritization for exceptions taken to AArch32 state* on page G1-4344 for exceptions taken to AArch32 state and *Synchronous exception prioritization for exceptions taken to AArch64* on page D1-1827 for exceptions taken to AArch64 state. Subject to the prioritization rules:

- When EL2 is implemented and is using AArch64 and $(SCR_EL3.NS == 1) \&\& (HCR_EL2.E2H == 0)$:
 - If $HCR_EL2.TPC == 1$, Non-secure execution of this instruction at EL1 is trapped to EL2.
 - If $HSTR_EL2.T7 == 1$, Non-secure execution of this instruction at EL1 is trapped to EL2.
- When EL2 is implemented and is using AArch64 and $(SCR_EL3.NS == 1) \&\& (HCR_EL2.E2H == 1) \&\& (HCR_EL2.TGE == 0)$:
 - If $HCR_EL2.TPC == 1$, Non-secure execution of this instruction at EL1 is trapped to EL2.
 - If $HSTR_EL2.T7 == 1$, Non-secure execution of this instruction at EL1 is trapped to EL2.
- When EL2 is implemented and is using AArch32 and $SCR_EL3.NS == 1$:
 - If $HCR.TPC == 1$, Non-secure execution of this instruction at EL1 is trapped to Hyp mode.
 - If $HSTR.T7 == 1$, Non-secure execution of this instruction at EL1 is trapped to Hyp mode.

G6.2.36 DCCISW, Data Cache line Clean and Invalidate by Set/Way

The DCCISW characteristics are:

Purpose

Clean and Invalidate data or unified cache line by set/way.

Configurations

AArch32 System instruction DCCISW performs the same function as AArch64 System instruction [DC C1SW](#).

Attributes

DCCISW is a 32-bit System instruction.

Field descriptions

The DCCISW input value bit assignments are:

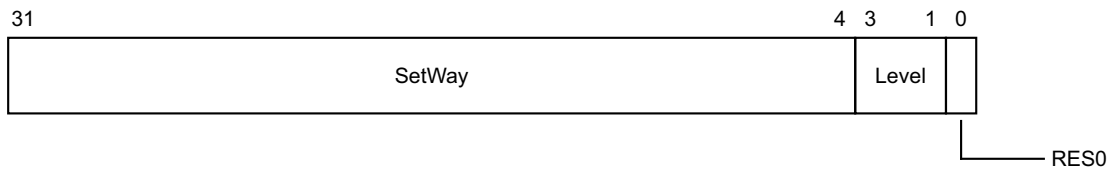

SetWay, bits [31:4]

Contains two fields:

- Way, bits[31:32-A], the number of the way to operate on.
- Set, bits[B-1:L], the number of the set to operate on.

Bits[L-1:4] are RES0.

$A = \text{Log}_2(\text{ASSOCIATIVITY})$, $L = \text{Log}_2(\text{LINELEN})$, $B = (L + S)$, $S = \text{Log}_2(\text{NSETS})$.

ASSOCIATIVITY, LINELEN (line length, in bytes), and NSETS (number of sets) have their usual meanings and are the values for the cache level being operated on. The values of A and S are rounded up to the next integer.

Level, bits [3:1]

Cache level to operate on, minus 1. For example, this field is 0 for operations on L1 cache, or 1 for operations on L2 cache.

Bit [0]

Reserved, RES0.

Executing the DCCISW instruction

This instruction is executed using MCR with the following syntax:

MCR <syntax>

This syntax uses the following encoding in the System instruction encoding space:

<syntax>	opc1	opc2	CRn	coproc	CRm
p15, 0, <Rt>, c7, c14, 2	000	010	0111	1111	1110

Accessibility

The instruction is executable as follows:

Control			Accessibility			
E2H	TGE	NS	EL0	EL1	EL2	EL3
x	x	0	-	WO	n/a	WO
x	0	1	-	WO	WO	WO
x	1	1	-	n/a	WO	WO

If this instruction is executed with a set, way or level argument that is larger than the value supported by the implementation then the behavior is CONstrained UNPREDICTABLE and one of the following occurs:

- The instruction is UNDEFINED
- The instruction performs cache maintenance on one of:
 - No cache lines.
 - A single arbitrary cache line.
 - Multiple arbitrary cache lines.

Traps and Enables

For a description of the prioritization of any generated exceptions, see [Synchronous exception prioritization for exceptions taken to AArch32 state on page G1-4344](#) for exceptions taken to AArch32 state and [Synchronous exception prioritization for exceptions taken to AArch64 on page D1-1827](#) for exceptions taken to AArch64 state. Subject to the prioritization rules:

- When EL2 is implemented and is using AArch64 and (SCR_EL3.NS == 1) && (HCR_EL2.E2H == 0):
 - If HCR_EL2.TSW==1, Non-secure execution of this instruction at EL1 is trapped to EL2.
 - If HSTR_EL2.T7==1, Non-secure execution of this instruction at EL1 is trapped to EL2.
- When EL2 is implemented and is using AArch64 and (SCR_EL3.NS == 1) && (HCR_EL2.E2H == 1) && (HCR_EL2.TGE == 0):
 - If HCR_EL2.TSW==1, Non-secure execution of this instruction at EL1 is trapped to EL2.
 - If HSTR_EL2.T7==1, Non-secure execution of this instruction at EL1 is trapped to EL2.
- When EL2 is implemented and is using AArch32 and SCR_EL3.NS == 1:
 - If HCR.TSW==1, Non-secure execution of this instruction at EL1 is trapped to Hyp mode.
 - If HSTR.T7==1, Non-secure execution of this instruction at EL1 is trapped to Hyp mode.

G6.2.37 DCCMVAC, Data Cache line Clean by VA to PoC

The DCCMVAC characteristics are:

Purpose

Clean data or unified cache line by virtual address to PoC.

Configurations

AArch32 System instruction DCCMVAC performs the same function as AArch64 System instruction [DC CVAC](#).

Attributes

DCCMVAC is a 32-bit System instruction.

Field descriptions

The DCCMVAC input value bit assignments are:

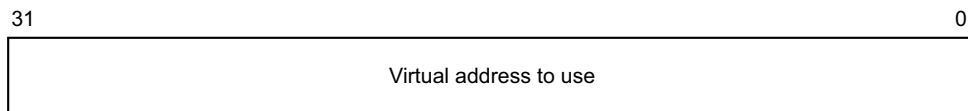

Bits [31:0]

Virtual address to use.

Executing the DCCMVAC instruction

This instruction is executed using MCR with the following syntax:

MCR <syntax>

This syntax uses the following encoding in the System instruction encoding space:

<syntax>	opc1	opc2	CRn	coproc	CRm
p15, 0, <Rt>, c7, c10, 1	000	001	0111	1111	1010

Accessibility

The instruction is executable as follows:

Control			Accessibility			
E2H	TGE	NS	EL0	EL1	EL2	EL3
x	x	0	-	WO	n/a	WO
x	0	1	-	WO	WO	WO
x	1	1	-	n/a	WO	WO

Traps and Enables

For a description of the prioritization of any generated exceptions, see *Synchronous exception prioritization for exceptions taken to AArch32 state* on page G1-4344 for exceptions taken to AArch32 state and *Synchronous exception prioritization for exceptions taken to AArch64* on page D1-1827 for exceptions taken to AArch64 state. Subject to the prioritization rules:

- When EL2 is implemented and is using AArch64 and $(SCR_EL3.NS == 1) \&\& (HCR_EL2.E2H == 0)$:
 - If $HCR_EL2.TPC == 1$, Non-secure execution of this instruction at EL1 is trapped to EL2.
 - If $HSTR_EL2.T7 == 1$, Non-secure execution of this instruction at EL1 is trapped to EL2.
- When EL2 is implemented and is using AArch64 and $(SCR_EL3.NS == 1) \&\& (HCR_EL2.E2H == 1) \&\& (HCR_EL2.TGE == 0)$:
 - If $HCR_EL2.TPC == 1$, Non-secure execution of this instruction at EL1 is trapped to EL2.
 - If $HSTR_EL2.T7 == 1$, Non-secure execution of this instruction at EL1 is trapped to EL2.
- When EL2 is implemented and is using AArch32 and $SCR_EL3.NS == 1$:
 - If $HCR.TPC == 1$, Non-secure execution of this instruction at EL1 is trapped to Hyp mode.
 - If $HSTR.T7 == 1$, Non-secure execution of this instruction at EL1 is trapped to Hyp mode.

G6.2.38 DCCMVAU, Data Cache line Clean by VA to PoU

The DCCMVAU characteristics are:

Purpose

Clean data or unified cache line by virtual address to PoU.

Configurations

AArch32 System instruction DCCMVAU performs the same function as AArch64 System instruction [DC CVAU](#).

Attributes

DCCMVAU is a 32-bit System instruction.

Field descriptions

The DCCMVAU input value bit assignments are:

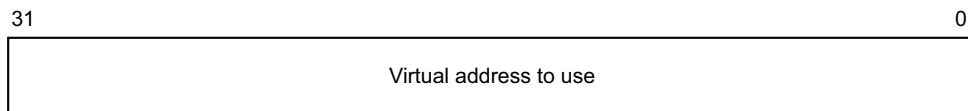

Bits [31:0]

Virtual address to use.

Executing the DCCMVAU instruction

This instruction is executed using MCR with the following syntax:

MCR <syntax>

This syntax uses the following encoding in the System instruction encoding space:

<syntax>	opc1	opc2	CRn	coproc	CRm
p15, 0, <Rt>, c7, c11, 1	000	001	0111	1111	1011

Accessibility

The instruction is executable as follows:

Control			Accessibility			
E2H	TGE	NS	EL0	EL1	EL2	EL3
x	x	0	-	WO	n/a	WO
x	0	1	-	WO	WO	WO
x	1	1	-	n/a	WO	WO

Traps and Enables

For a description of the prioritization of any generated exceptions, see *Synchronous exception prioritization for exceptions taken to AArch32 state* on page G1-4344 for exceptions taken to AArch32 state and *Synchronous exception prioritization for exceptions taken to AArch64* on page D1-1827 for exceptions taken to AArch64 state. Subject to the prioritization rules:

- When EL2 is implemented and is using AArch64 and $(SCR_EL3.NS == 1) \&\& (HCR_EL2.E2H == 0)$:
 - If $HCR_EL2.TPU == 1$, Non-secure execution of this instruction at EL1 is trapped to EL2.
 - If $HSTR_EL2.T7 == 1$, Non-secure execution of this instruction at EL1 is trapped to EL2.
- When EL2 is implemented and is using AArch64 and $(SCR_EL3.NS == 1) \&\& (HCR_EL2.E2H == 1) \&\& (HCR_EL2.TGE == 0)$:
 - If $HCR_EL2.TPU == 1$, Non-secure execution of this instruction at EL1 is trapped to EL2.
 - If $HSTR_EL2.T7 == 1$, Non-secure execution of this instruction at EL1 is trapped to EL2.
- When EL2 is implemented and is using AArch32 and $SCR_EL3.NS == 1$:
 - If $HCR.TPU == 1$, Non-secure execution of this instruction at EL1 is trapped to Hyp mode.
 - If $HSTR.T7 == 1$, Non-secure execution of this instruction at EL1 is trapped to Hyp mode.

G6.2.39 DCCSW, Data Cache line Clean by Set/Way

The DCCSW characteristics are:

Purpose

Clean data or unified cache line by set/way.

Configurations

AArch32 System instruction DCCSW performs the same function as AArch64 System instruction [DC CSW](#).

Attributes

DCCSW is a 32-bit System instruction.

Field descriptions

The DCCSW input value bit assignments are:

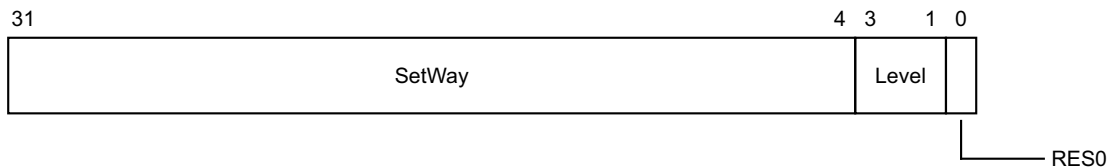

SetWay, bits [31:4]

Contains two fields:

- Way, bits[31:32-A], the number of the way to operate on.
- Set, bits[B-1:L], the number of the set to operate on.

Bits[L-1:4] are RES0.

$A = \text{Log}_2(\text{ASSOCIATIVITY})$, $L = \text{Log}_2(\text{LINELEN})$, $B = (L + S)$, $S = \text{Log}_2(\text{NSETS})$.

ASSOCIATIVITY, LINELEN (line length, in bytes), and NSETS (number of sets) have their usual meanings and are the values for the cache level being operated on. The values of A and S are rounded up to the next integer.

Level, bits [3:1]

Cache level to operate on, minus 1. For example, this field is 0 for operations on L1 cache, or 1 for operations on L2 cache.

Bit [0]

Reserved, RES0.

Executing the DCCSW instruction

This instruction is executed using MCR with the following syntax:

MCR <syntax>

This syntax uses the following encoding in the System instruction encoding space:

<syntax>	opc1	opc2	CRn	coproc	CRm
p15, 0, <Rt>, c7, c10, 2	000	010	0111	1111	1010

Accessibility

The instruction is executable as follows:

Control			Accessibility			
E2H	TGE	NS	EL0	EL1	EL2	EL3
x	x	0	-	WO	n/a	WO
x	0	1	-	WO	WO	WO
x	1	1	-	n/a	WO	WO

If this instruction is executed with a set, way or level argument that is larger than the value supported by the implementation then the behavior is CONstrained UNPREDICTABLE and one of the following occurs:

- The instruction is UNDEFINED
- The instruction performs cache maintenance on one of:
 - No cache lines.
 - A single arbitrary cache line.
 - Multiple arbitrary cache lines.

Traps and Enables

For a description of the prioritization of any generated exceptions, see [Synchronous exception prioritization for exceptions taken to AArch32 state on page G1-4344](#) for exceptions taken to AArch32 state and [Synchronous exception prioritization for exceptions taken to AArch64 on page D1-1827](#) for exceptions taken to AArch64 state. Subject to the prioritization rules:

- When EL2 is implemented and is using AArch64 and (SCR_EL3.NS == 1) && (HCR_EL2.E2H == 0):
 - If HCR_EL2.TSW==1, Non-secure execution of this instruction at EL1 is trapped to EL2.
 - If HSTR_EL2.T7==1, Non-secure execution of this instruction at EL1 is trapped to EL2.
- When EL2 is implemented and is using AArch64 and (SCR_EL3.NS == 1) && (HCR_EL2.E2H == 1) && (HCR_EL2.TGE == 0):
 - If HCR_EL2.TSW==1, Non-secure execution of this instruction at EL1 is trapped to EL2.
 - If HSTR_EL2.T7==1, Non-secure execution of this instruction at EL1 is trapped to EL2.
- When EL2 is implemented and is using AArch32 and SCR_EL3.NS == 1:
 - If HCR.TSW==1, Non-secure execution of this instruction at EL1 is trapped to Hyp mode.
 - If HSTR.T7==1, Non-secure execution of this instruction at EL1 is trapped to Hyp mode.

G6.2.40 DCIMVAC, Data Cache line Invalidate by VA to PoC

The DCIMVAC characteristics are:

Purpose

Invalidate data or unified cache line by virtual address to PoC.

Configurations

AArch32 System instruction DCIMVAC performs the same function as AArch64 System instruction [DC IVAC](#).

Attributes

DCIMVAC is a 32-bit System instruction.

Field descriptions

The DCIMVAC input value bit assignments are:

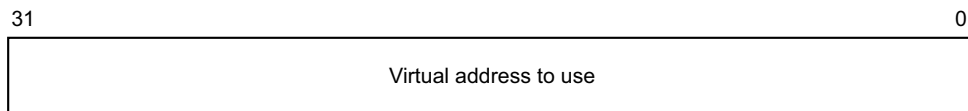

Bits [31:0]

Virtual address to use.

Executing the DCIMVAC instruction

This instruction is executed using MCR with the following syntax:

MCR <syntax>

This syntax uses the following encoding in the System instruction encoding space:

<syntax>	opc1	opc2	CRn	coproc	CRm
p15, 0, <Rt>, c7, c6, 1	000	001	0111	1111	0110

It is IMPLEMENTATION DEFINED whether, when this instruction is executed, it can generate a watchpoint. If this instruction can generate a watchpoint this is prioritized in the same way as other watchpoints.

Accessibility

The instruction is executable as follows:

Control			Accessibility			
E2H	TGE	NS	EL0	EL1	EL2	EL3
x	x	0	-	WO	n/a	WO
x	0	1	-	WO	WO	WO
x	1	1	-	n/a	WO	WO

At EL1, this instruction performs a cache clean and invalidate, meaning it performs the same invalidation as a [DCCIMVAC](#) instruction, if all of the following apply:

- EL2 is implemented and either:
 - EL2 is using AArch64 and the value of [HCR_EL2.VM](#) is 1.
 - EL2 is using AArch32 and the value of [HCR.VM](#) is 1.
- Execution is in Non-secure state, or EL3 is not implemented.

Traps and Enables

For a description of the prioritization of any generated exceptions, see [Synchronous exception prioritization for exceptions taken to AArch32 state on page G1-4344](#) for exceptions taken to AArch32 state and [Synchronous exception prioritization for exceptions taken to AArch64 on page D1-1827](#) for exceptions taken to AArch64 state. Subject to the prioritization rules:

- When EL2 is implemented and is using AArch64 and $(SCR_EL3.NS == 1) \&\& (HCR_EL2.E2H == 0)$:
 - If [HCR_EL2.TPC](#)==1, Non-secure execution of this instruction at EL1 is trapped to EL2.
 - If [HSTR_EL2.T7](#)==1, Non-secure execution of this instruction at EL1 is trapped to EL2.
- When EL2 is implemented and is using AArch64 and $(SCR_EL3.NS == 1) \&\& (HCR_EL2.E2H == 1) \&\& (HCR_EL2.TGE == 0)$:
 - If [HCR_EL2.TPC](#)==1, Non-secure execution of this instruction at EL1 is trapped to EL2.
 - If [HSTR_EL2.T7](#)==1, Non-secure execution of this instruction at EL1 is trapped to EL2.
- When EL2 is implemented and is using AArch32 and $SCR_EL3.NS == 1$:
 - If [HCR.TPC](#)==1, Non-secure execution of this instruction at EL1 is trapped to Hyp mode.
 - If [HSTR.T7](#)==1, Non-secure execution of this instruction at EL1 is trapped to Hyp mode.

G6.2.41 DCISW, Data Cache line Invalidate by Set/Way

The DCISW characteristics are:

Purpose

Invalidate data or unified cache line by set/way.

Configurations

AArch32 System instruction DCISW performs the same function as AArch64 System instruction [DC ISW](#).

Attributes

DCISW is a 32-bit System instruction.

Field descriptions

The DCISW input value bit assignments are:

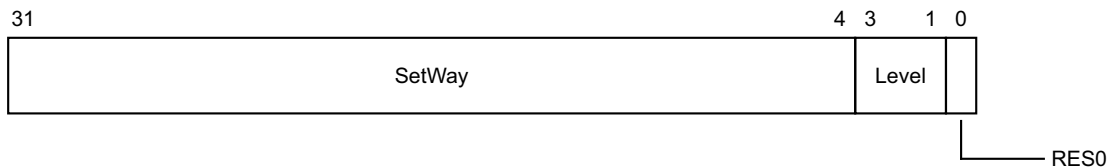

SetWay, bits [31:4]

Contains two fields:

- Way, bits[31:32-A], the number of the way to operate on.
- Set, bits[B-1:L], the number of the set to operate on.

Bits[L-1:4] are RES0.

$A = \text{Log}_2(\text{ASSOCIATIVITY})$, $L = \text{Log}_2(\text{LINELEN})$, $B = (L + S)$, $S = \text{Log}_2(\text{NSETS})$.

ASSOCIATIVITY, LINELEN (line length, in bytes), and NSETS (number of sets) have their usual meanings and are the values for the cache level being operated on. The values of A and S are rounded up to the next integer.

Level, bits [3:1]

Cache level to operate on, minus 1. For example, this field is 0 for operations on L1 cache, or 1 for operations on L2 cache.

Bit [0]

Reserved, RES0.

Executing the DCISW instruction

This instruction is executed using MCR with the following syntax:

MCR <syntax>

This syntax uses the following encoding in the System instruction encoding space:

<syntax>	opc1	opc2	CRn	coproc	CRm
p15, 0, <Rt>, c7, c6, 2	000	010	0111	1111	0110

Accessibility

The instruction is executable as follows:

Control			Accessibility			
E2H	TGE	NS	EL0	EL1	EL2	EL3
x	x	0	-	WO	n/a	WO
x	0	1	-	WO	WO	WO
x	1	1	-	n/a	WO	WO

At EL1, this instruction performs a cache clean and invalidate, meaning it performs the same invalidation as a [DCCISW](#) instruction, if all of the following apply:

- EL2 is implemented and either:
 - EL2 is using AArch64 and the value of [HCR_EL2](#).{SWIO, VM} is not {0, 0}.
 - EL2 is using AArch32 and the value of [HCR](#).{SWIO, VM} is not {0, 0}.
- Execution is in Non-secure state, or EL3 is not implemented.

If this instruction is executed with a set, way or level argument that is larger than the value supported by the implementation then the behavior is CONstrained UNPREDICTABLE and one of the following occurs:

- The instruction is UNDEFINED
- The instruction performs cache maintenance on one of:
 - No cache lines.
 - A single arbitrary cache line.
 - Multiple arbitrary cache lines.

Traps and Enables

For a description of the prioritization of any generated exceptions, see [Synchronous exception prioritization for exceptions taken to AArch32 state on page G1-4344](#) for exceptions taken to AArch32 state and [Synchronous exception prioritization for exceptions taken to AArch64 on page D1-1827](#) for exceptions taken to AArch64 state. Subject to the prioritization rules:

- When EL2 is implemented and is using AArch64 and (SCR_EL3.NS == 1) && (HCR_EL2.E2H == 0):
 - If [HCR_EL2](#).TSW==1, Non-secure execution of this instruction at EL1 is trapped to EL2.
 - If [HSTR_EL2](#).T7==1, Non-secure execution of this instruction at EL1 is trapped to EL2.
- When EL2 is implemented and is using AArch64 and (SCR_EL3.NS == 1) && (HCR_EL2.E2H == 1) && (HCR_EL2.TGE == 0):
 - If [HCR_EL2](#).TSW==1, Non-secure execution of this instruction at EL1 is trapped to EL2.
 - If [HSTR_EL2](#).T7==1, Non-secure execution of this instruction at EL1 is trapped to EL2.
- When EL2 is implemented and is using AArch32 and SCR_EL3.NS == 1:
 - If [HCR](#).TSW==1, Non-secure execution of this instruction at EL1 is trapped to Hyp mode.
 - If [HSTR](#).T7==1, Non-secure execution of this instruction at EL1 is trapped to Hyp mode.

G6.2.42 DFAR, Data Fault Address Register

The DFAR characteristics are:

Purpose

Holds the virtual address of the faulting address that caused a synchronous Data Abort exception.

Configurations

AArch32 System register DFAR(NS) is architecturally mapped to AArch64 System register [FAR_EL1](#)[31:0].

AArch32 System register DFAR(S) is architecturally mapped to AArch32 System register [HDFAR](#) when EL2 is implemented.

AArch32 System register DFAR(S) is architecturally mapped to AArch64 System register [FAR_EL2](#)[31:0] when EL2 is implemented.

RW fields in this register reset to architecturally UNKNOWN values.

Attributes

DFAR is a 32-bit register.

Field descriptions

The DFAR bit assignments are:

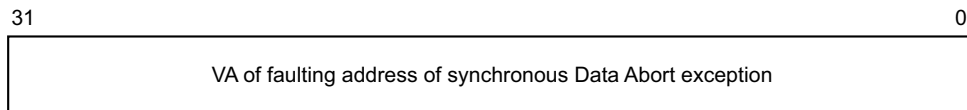

Bits [31:0]

VA of faulting address of synchronous Data Abort exception.

Accessing the DFAR

This register can be read using MRC with the following syntax:

MRC <syntax>

This register can be written using MCR with the following syntax:

MCR <syntax>

This syntax is encoded with the following settings in the instruction encoding:

<syntax>	opc1	opc2	CRn	coproc	CRm
p15, 0, <Rt>, c6, c0, 0	000	000	0110	1111	0000

Accessibility

The register is accessible in software as follows:

Configuration	Control			Accessibility				Instance
	E2H	TGE	NS	EL0	EL1	EL2	EL3	
EL3 is using AArch32.	x	x	0	-	n/a	n/a	RW	DFAR_s
EL3 is not implemented.	x	x	0	-	RW	n/a	n/a	DFAR
EL3 is not implemented.	x	0	1	-	RW	RW	n/a	DFAR
EL3 is not implemented.	x	1	1	-	n/a	RW	n/a	DFAR
EL3 is using AArch64.	x	x	0	-	RW	n/a	n/a	DFAR
EL3 is using AArch64.	x	0	1	-	RW	RW	n/a	DFAR
EL3 is using AArch64.	x	1	1	-	n/a	RW	n/a	DFAR
EL3 is using AArch32.	x	0	1	-	RW	RW	RW	DFAR_ns
EL3 is using AArch32.	x	1	1	-	n/a	RW	RW	DFAR_ns

Traps and Enables

For a description of the prioritization of any generated exceptions, see [Synchronous exception prioritization for exceptions taken to AArch32 state on page G1-4344](#) for exceptions taken to AArch32 state and [Synchronous exception prioritization for exceptions taken to AArch64 on page D1-1827](#) for exceptions taken to AArch64 state. Subject to the prioritization rules:

- When EL2 is implemented and is using AArch64 and (SCR_EL3.NS == 1) && (HCR_EL2.E2H == 0):
 - If HCR_EL2.TVM==1, Non-secure write accesses to this register from EL1 are trapped to EL2.
 - If HCR_EL2.TRVM==1, Non-secure read accesses to this register from EL1 are trapped to EL2.
 - If HSTR_EL2.T6==1, Non-secure accesses to this register from EL1 are trapped to EL2.
- When EL2 is implemented and is using AArch64 and (SCR_EL3.NS == 1) && (HCR_EL2.E2H == 1) && (HCR_EL2.TGE == 0):
 - If HCR_EL2.TVM==1, Non-secure write accesses to this register from EL1 are trapped to EL2.
 - If HCR_EL2.TRVM==1, Non-secure read accesses to this register from EL1 are trapped to EL2.
 - If HSTR_EL2.T6==1, Non-secure accesses to this register from EL1 are trapped to EL2.
- When EL2 is implemented and is using AArch32 and SCR_EL3.NS == 1:
 - If HCR.TVM==1, Non-secure write accesses to this register from EL1 are trapped to Hyp mode.
 - If HCR.TRVM==1, Non-secure read accesses to this register from EL1 are trapped to Hyp mode.
 - If HSTR.T6==1, Non-secure accesses to this register from EL1 are trapped to Hyp mode.

G6.2.43 DFSR, Data Fault Status Register

The DFSR characteristics are:

Purpose

Holds status information about the last data fault.

Configurations

AArch32 System register DFSR is architecturally mapped to AArch64 System register [ESR_EL1](#).

The current translation table format determines which format of the register is used.

RW fields in this register reset to architecturally UNKNOWN values.

Attributes

DFSR is a 32-bit register.

Field descriptions

The DFSR bit assignments are:

When *TTBCR.EAE*==0:

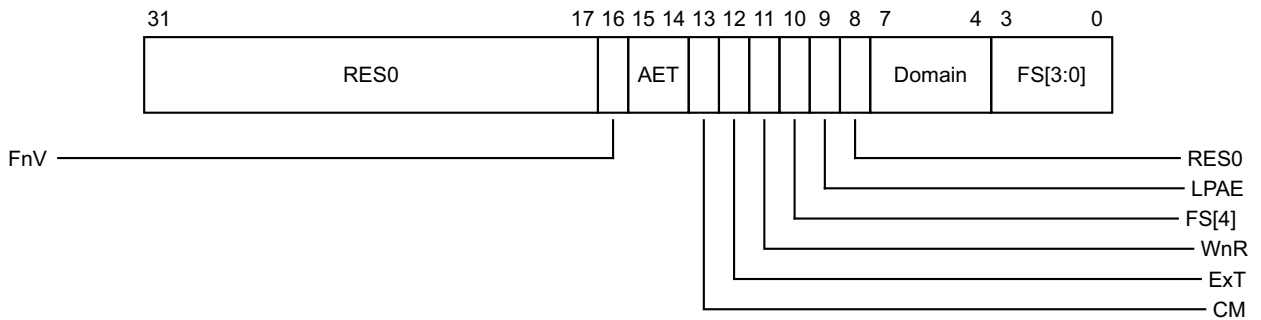

Bits [31:17]

Reserved, RES0.

FnV, bit [16]

FAR not Valid, for a Synchronous external abort other than a Synchronous external abort on a translation table walk.

- 0 [DFAR](#) is valid.
- 1 [DFAR](#) is not valid, and holds an UNKNOWN value.

This field is only valid for a Synchronous external abort other than a Synchronous external abort on a translation table walk. It is RES0 for all other Data Abort exceptions.

AET, bits [15:14]

Asynchronous Error Type. When the RAS Extension is implemented, this field describes the state of the PE after taking an asynchronous Data Abort exception. Possible values are:

- 00 Uncontainable error (UC) or uncategorized.
- 01 Unrecoverable error (UEU).
- 10 Restartable error (UEO) or Corrected error (CE).
- 11 Recoverable error (UER).

When the RAS Extension is not implemented, or on a synchronous Data Abort, this field is RES0.

———— **Note** —————

ARMv8.2 requires the implementation of the RAS Extension.

In the event of multiple errors taken as a single SError interrupt exception, the overall state of the PE is reported.

———— **Note** —————

Software can use this information to determine what recovery might be possible. The recovery software must also examine any implemented fault records to determine the location and extent of the error.

CM, bit [13]

Cache maintenance fault. For synchronous faults, this bit indicates whether a cache maintenance instruction generated the fault. The possible values of this bit are:

- 0 Abort not caused by execution of a cache maintenance instruction.
- 1 Abort caused by execution of a cache maintenance instruction.

On a synchronous Data Abort on a translation table walk, this bit is UNKNOWN.

On an asynchronous fault, this bit is UNKNOWN.

Ext, bit [12]

External abort type. This bit can be used to provide an IMPLEMENTATION DEFINED classification of external aborts.

In an implementation that does not provide any classification of external aborts, this bit is RES0.

For aborts other than external aborts this bit always returns 0.

WnR, bit [11]

Write not Read bit. Indicates whether the abort was caused by a write or a read instruction. The possible values of this bit are:

- 0 Abort caused by a read instruction.
- 1 Abort caused by a write instruction.

For faults on the cache maintenance and address translation System instructions in the (coproc==1111) encoding space this bit always returns a value of 1.

FS[4], bit [10]

See FS[3:0], bits [3:0] for description of the FS field.

LPAE, bit [9]

On taking a Data Abort exception, this bit is set as follows:

- 0 Using the Short-descriptor translation table formats.
- 1 Using the Long-descriptor translation table formats.

Hardware does not interpret this bit to determine the behavior of the memory system, and therefore software can set this bit to 0 or 1 without affecting operation.

Bit [8]

Reserved, RES0.

Domain, bits [7:4]

The domain of the fault address.

ARM deprecates any use of this field, see [The Domain field in the DFSR on page G4-4669](#).

This field is UNKNOWN for certain faults where the DFSR is updated and reported using the Short-descriptor FSR encodings, see [Table G4-29 on page G4-4673](#).

FS[3:0], bits [3:0]

Fault status bits. Interpreted with bit [10]. Possible values of FS[4:0] are:

- 00001 Alignment fault
- 00010 Debug exception
- 00011 Access flag fault, level 1
- 00100 Fault on instruction cache maintenance
- 00101 Translation fault, level 1
- 00110 Access flag fault, level 2
- 00111 Translation fault, level 2
- 01000 Synchronous external abort, not on translation table walk
- 01001 Domain fault, level 1
- 01011 Domain fault, level 2
- 01100 Synchronous external abort, on translation table walk, level 1
- 01101 Permission fault, level 1
- 01110 Synchronous external abort, on translation table walk, level 2
- 01111 Permission fault, level 2
- 10000 TLB conflict abort
- 10100 IMPLEMENTATION DEFINED fault (Lockdown fault)
- 10101 IMPLEMENTATION DEFINED fault (Unsupported Exclusive access fault)
- 10110 SError interrupt
- 11000 SError interrupt, from a parity or ECC error on memory access
- 11001 Synchronous parity or ECC error on memory access, not on translation table walk
- 11100 Synchronous parity or ECC error on translation table walk, level 1
- 11110 Synchronous parity or ECC error on translation table walk, level 2

All other values are reserved.

When the RAS Extension is implemented, 11000, 11001, 11100, and 11110 are reserved.

For more information about the lookup level associated with a fault, see [The level associated with MMU faults on a Short-descriptor translation table lookup](#) on page G4-4669.

When TTBCR.EAE==1:

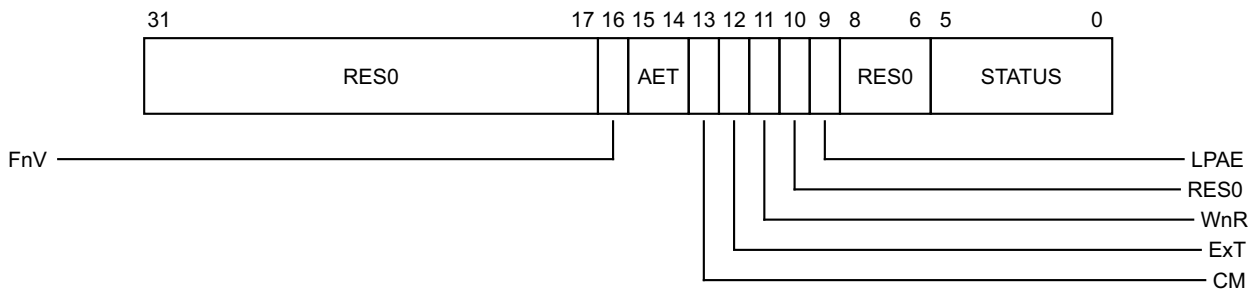

Bits [31:17]

Reserved, RES0.

FnV, bit [16]

FAR not Valid, for a Synchronous external abort other than a Synchronous external abort on a translation table walk.

- 0 DFAR is valid.
- 1 DFAR is not valid, and holds an UNKNOWN value.

This field is only valid for a Synchronous external abort other than a Synchronous external abort on a translation table walk. It is RES0 for all other Data Abort exceptions.

AET, bits [15:14]

Asynchronous Error Type. When the RAS Extension is implemented, this field describes the state of the PE after taking an asynchronous Data Abort exception. Possible values are:

- 00 Uncontainable error (UC) or uncategorized.
- 01 Unrecoverable error (UEU).
- 10 Restartable error (UEO) or Corrected error (CE).
- 11 Recoverable error (UER).

When the RAS Extension is not implemented, or on a synchronous Data Abort, this field is RES0.

Note

ARMv8.2 requires the implementation of the RAS Extension.

In the event of multiple errors taken as a single SError interrupt exception, the overall state of the PE is reported.

Note

Software can use this information to determine what recovery might be possible. The recovery software must also examine any implemented fault records to determine the location and extent of the error.

CM, bit [13]

Cache maintenance fault. For synchronous faults, this bit indicates whether a cache maintenance instruction generated the fault. The possible values of this bit are:

- 0 Abort not caused by execution of a cache maintenance instruction.
- 1 Abort caused by execution of a cache maintenance instruction.

On a synchronous Data Abort on a translation table walk, this bit is UNKNOWN.

On an asynchronous fault, this bit is UNKNOWN.

ExT, bit [12]

External abort type. This bit can be used to provide an IMPLEMENTATION DEFINED classification of external aborts.

In an implementation that does not provide any classification of external aborts, this bit is RES0.

For aborts other than external aborts this bit always returns 0.

WnR, bit [11]

Write not Read bit. Indicates whether the abort was caused by a write or a read instruction. The possible values of this bit are:

- 0 Abort caused by a read instruction.
- 1 Abort caused by a write instruction.

For faults on the cache maintenance and address translation System instructions in the (coproc==1111) encoding space this bit always returns a value of 1.

Bit [10]

Reserved, RES0.

LPAAE, bit [9]

On taking a Data Abort exception, this bit is set as follows:

- 0 Using the Short-descriptor translation table formats.
- 1 Using the Long-descriptor translation table formats.

Hardware does not interpret this bit to determine the behavior of the memory system, and therefore software can set this bit to 0 or 1 without affecting operation.

Bits [8:6]

Reserved, RES0.

STATUS, bits [5:0]

Fault status bits. Possible values of this field are:

- 000000 Address size fault in [TTBR0](#) or [TTBR1](#)
- 000001 Address size fault, level 1
- 000010 Address size fault, level 2
- 000011 Address size fault, level 3
- 000101 Translation fault, level 1
- 000110 Translation fault, level 2
- 000111 Translation fault, level 3
- 001001 Access flag fault, level 1
- 001010 Access flag fault, level 2
- 001011 Access flag fault, level 3
- 001101 Permission fault, level 1
- 001110 Permission fault, level 2
- 001111 Permission fault, level 3
- 010000 Synchronous external abort, not on translation table walk
- 010001 SError interrupt
- 010101 Synchronous external abort, on translation table walk, level 1
- 010110 Synchronous external abort, on translation table walk, level 2
- 010111 Synchronous external abort, on translation table walk, level 3
- 011000 Synchronous parity or ECC error on memory access, not on translation table walk
- 011001 SError interrupt, from a parity or ECC error on memory access
- 011101 Synchronous parity or ECC error on memory access on translation table walk, level 1
- 011110 Synchronous parity or ECC error on memory access on translation table walk, level 2
- 011111 Synchronous parity or ECC error on memory access on translation table walk, level 3
- 100001 Alignment fault
- 100010 Debug exception
- 110000 TLB conflict abort
- 110100 IMPLEMENTATION DEFINED fault (Lockdown fault)
- 110101 IMPLEMENTATION DEFINED fault (Unsupported Exclusive access fault)

All other values are reserved.

When the RAS Extension is implemented, 011000, 011001, 011101, 011110, and 011111 are reserved.

For more information about the lookup level associated with a fault, see *The level associated with MMU faults on a Long-descriptor translation table lookup* on page G4-4671.

Accessing the DFSR

This register can be read using MRC with the following syntax:

MRC <syntax>

This register can be written using MCR with the following syntax:

MCR <syntax>

This syntax is encoded with the following settings in the instruction encoding:

<syntax>	opc1	opc2	CRn	coproc	CRm
p15, 0, <Rt>, c5, c0, 0	000	000	0101	1111	0000

Accessibility

The register is accessible in software as follows:

Configuration	Control			Accessibility				Instance
	E2H	TGE	NS	EL0	EL1	EL2	EL3	
EL3 is not implemented.	x	x	0	-	RW	n/a	n/a	DFSR
EL3 is not implemented.	x	0	1	-	RW	RW	n/a	DFSR
EL3 is not implemented.	x	1	1	-	n/a	RW	n/a	DFSR
EL3 is using AArch64.	x	x	0	-	RW	n/a	n/a	DFSR
EL3 is using AArch64.	x	0	1	-	RW	RW	n/a	DFSR
EL3 is using AArch64.	x	1	1	-	n/a	RW	n/a	DFSR
EL3 is using AArch32.	x	x	0	-	n/a	n/a	RW	DFSR_s
EL3 is using AArch32.	x	0	1	-	RW	RW	RW	DFSR_ns
EL3 is using AArch32.	x	1	1	-	n/a	RW	RW	DFSR_ns

Traps and Enables

For a description of the prioritization of any generated exceptions, see *Synchronous exception prioritization for exceptions taken to AArch32 state* on page G1-4344 for exceptions taken to AArch32 state and *Synchronous exception prioritization for exceptions taken to AArch64* on page D1-1827 for exceptions taken to AArch64 state. Subject to the prioritization rules:

- When EL2 is implemented and is using AArch64 and (SCR_EL3.NS == 1) && (HCR_EL2.E2H == 0):
 - If HCR_EL2.TVM==1, Non-secure write accesses to this register from EL1 are trapped to EL2.
 - If HCR_EL2.TRVM==1, Non-secure read accesses to this register from EL1 are trapped to EL2.
 - If HSTR_EL2.T5==1, Non-secure accesses to this register from EL1 are trapped to EL2.
- When EL2 is implemented and is using AArch64 and (SCR_EL3.NS == 1) && (HCR_EL2.E2H == 1) && (HCR_EL2.TGE == 0):
 - If HCR_EL2.TVM==1, Non-secure write accesses to this register from EL1 are trapped to EL2.

- If `HCR_EL2.TRVM==1`, Non-secure read accesses to this register from EL1 are trapped to EL2.
- If `HSTR_EL2.T5==1`, Non-secure accesses to this register from EL1 are trapped to EL2.
- When EL2 is implemented and is using AArch32 and `SCR_EL3.NS == 1`:
 - If `HCR.TVM==1`, Non-secure write accesses to this register from EL1 are trapped to Hyp mode.
 - If `HCR.TRVM==1`, Non-secure read accesses to this register from EL1 are trapped to Hyp mode.
 - If `HSTR.T5==1`, Non-secure accesses to this register from EL1 are trapped to Hyp mode.

G6.2.44 DTLBIALL, Data TLB Invalidate All

The DTLBIALL characteristics are:

Purpose

Invalidate all cached copies of translation table entries from data TLBs that are from any level of the translation table walk. The entries that are invalidated are as follows:

- If executed at Secure EL1 when EL3 is using AArch64, all entries that would be required for the Secure EL1&0 translation regime.
- If executed in Secure state when EL3 is using AArch32, all entries that would be required for the Secure PL1&0 translation regime.
- If executed at Non-secure EL1, all stage 1 translation table entries that would be required for the Non-secure PL1&0 translation regime and, if EL2 is implemented, they must match the current VMID.
- If executed at EL2, the stage 1 or stage 2 translation table entries that would be required for the Non-secure PL1&0 translation regime and matches the current VMID.

The invalidation only applies to the PE that executes this instruction.

ARM deprecates the use of this instruction. It is only provided for backwards compatibility with earlier versions of the ARM architecture.

Configurations

There are no configuration notes.

Attributes

DTLBIALL is a 32-bit System instruction.

Field descriptions

DTLBIALL ignores the value in the register specified by the instruction. Software does not have to write a value to the register before issuing this instruction.

Executing the DTLBIALL instruction

This instruction is executed using MCR with the following syntax:

MCR <syntax>

This syntax uses the following encoding in the System instruction encoding space:

<syntax>	opc1	opc2	CRn	coproc	CRm
p15, 0, <Rt>, c8, c6, 0	000	000	1000	1111	0110

Accessibility

The instruction is executable as follows:

Control			Accessibility			
E2H	TGE	NS	EL0	EL1	EL2	EL3
x	x	0	-	WO	n/a	WO
x	0	1	-	WO	WO	WO
x	1	1	-	n/a	WO	WO

When `HCR.FB` is 1, at Non-secure EL1 this instruction executes as a `TLBIALLS` operating on data TLBs only.

Traps and Enables

For a description of the prioritization of any generated exceptions, see *Synchronous exception prioritization for exceptions taken to AArch32 state* on page G1-4344 for exceptions taken to AArch32 state and *Synchronous exception prioritization for exceptions taken to AArch64* on page D1-1827 for exceptions taken to AArch64 state. Subject to the prioritization rules:

- When EL2 is implemented and is using AArch64 and `(SCR_EL3.NS == 1) && (HCR_EL2.E2H == 0)`:
 - If `HCR_EL2.TTLB==1`, Non-secure execution of this instruction at EL1 is trapped to EL2.
 - If `HSTR_EL2.T8==1`, Non-secure execution of this instruction at EL1 is trapped to EL2.
- When EL2 is implemented and is using AArch64 and `(SCR_EL3.NS == 1) && (HCR_EL2.E2H == 1) && (HCR_EL2.TGE == 0)`:
 - If `HCR_EL2.TTLB==1`, Non-secure execution of this instruction at EL1 is trapped to EL2.
 - If `HSTR_EL2.T8==1`, Non-secure execution of this instruction at EL1 is trapped to EL2.
- When EL2 is implemented and is using AArch32 and `SCR_EL3.NS == 1`:
 - If `HCR.TTLB==1`, Non-secure execution of this instruction at EL1 is trapped to Hyp mode.
 - If `HSTR.T8==1`, Non-secure execution of this instruction at EL1 is trapped to Hyp mode.

G6.2.45 DTLBIASID, Data TLB Invalidate by ASID match

The DTLBIASID characteristics are:

Purpose

Invalidate all cached copies of translation table entries from data TLBs that meet the following requirements:

- The entry is a stage 1 translation table entry.
- The entry would be used for the specified ASID, and either:
 - Is from a level of lookup above the final level.
 - Is a non-global entry from the final level of lookup.
- If EL2 is implemented, the entry would be used with the current VMID.

From the entries that match these requirement, the entries that are invalidated are required for the following translation regime:

- If executed at Secure EL1 when EL3 is using AArch64, the Secure EL1&0 translation regime.
- If executed in Secure state when EL3 is using AArch32, the Secure PL1&0 translation regime.
- If executed in Non-secure state, the Non-secure PL1&0 translation regime.

The invalidation only applies to the PE that executes this instruction.

ARM deprecates the use of this instruction. It is only provided for backwards compatibility with earlier versions of the ARM architecture.

Configurations

There are no configuration notes.

Attributes

DTLBIASID is a 32-bit System instruction.

Field descriptions

The DTLBIASID input value bit assignments are:

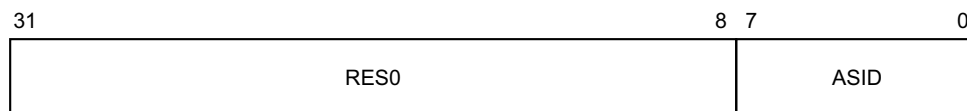

Bits [31:8]

Reserved, RES0.

ASID, bits [7:0]

ASID value to match. Any TLB entries for non-global pages that match the ASID values will be affected by this operation.

Executing the DTLBIASID instruction

This instruction is executed using MCR with the following syntax:

MCR <syntax>

This syntax uses the following encoding in the System instruction encoding space:

<syntax>	opc1	opc2	CRn	coproc	CRm
p15, 0, <Rt>, c8, c6, 2	000	010	1000	1111	0110

Accessibility

The instruction is executable as follows:

Control			Accessibility			
E2H	TGE	NS	EL0	EL1	EL2	EL3
x	x	0	-	WO	n/a	WO
x	0	1	-	WO	WO	WO
x	1	1	-	n/a	WO	WO

When `HCR.FB` is 1, at Non-secure EL1 this instruction executes as a `TLBIASIDIS` operating on data TLBs only.

Traps and Enables

For a description of the prioritization of any generated exceptions, see *Synchronous exception prioritization for exceptions taken to AArch32 state* on page G1-4344 for exceptions taken to AArch32 state and *Synchronous exception prioritization for exceptions taken to AArch64* on page D1-1827 for exceptions taken to AArch64 state. Subject to the prioritization rules:

- When EL2 is implemented and is using AArch64 and `(SCR_EL3.NS == 1) && (HCR_EL2.E2H == 0)`:
 - If `HCR_EL2.TTLB==1`, Non-secure execution of this instruction at EL1 is trapped to EL2.
 - If `HSTR_EL2.T8==1`, Non-secure execution of this instruction at EL1 is trapped to EL2.
- When EL2 is implemented and is using AArch64 and `(SCR_EL3.NS == 1) && (HCR_EL2.E2H == 1) && (HCR_EL2.TGE == 0)`:
 - If `HCR_EL2.TTLB==1`, Non-secure execution of this instruction at EL1 is trapped to EL2.
 - If `HSTR_EL2.T8==1`, Non-secure execution of this instruction at EL1 is trapped to EL2.
- When EL2 is implemented and is using AArch32 and `SCR_EL3.NS == 1`:
 - If `HCR.TTLB==1`, Non-secure execution of this instruction at EL1 is trapped to Hyp mode.
 - If `HSTR.T8==1`, Non-secure execution of this instruction at EL1 is trapped to Hyp mode.

G6.2.46 DTLBIMVA, Data TLB Invalidate by VA

The DTLBIMVA characteristics are:

Purpose

Invalidate all cached copies of translation table entries from data TLBs that meet the following requirements:

- The entry is a stage 1 translation table entry.
- The entry would be used to translate the specified address, and one of the following applies:
 - The entry is from a level of lookup above the final level and matches the specified ASID.
 - The entry is a global entry from the final level of lookup.
 - The entry is a non-global entry from the final level of lookup that matches the specified ASID.
- If EL2 is implemented, the entry would be used with the current VMID.

From the entries that match these requirement, the entries that are invalidated are required for the following translation regime:

- If executed at Secure EL1 when EL3 is using AArch64, the Secure EL1&0 translation regime.
- If executed in Secure state when EL3 is using AArch32, the Secure PL1&0 translation regime.
- If executed in Non-secure state, the Non-secure PL1&0 translation regime.

The invalidation only applies to the PE that executes this instruction.

ARM deprecates the use of this instruction. It is only provided for backwards compatibility with earlier versions of the ARM architecture.

Configurations

There are no configuration notes.

Attributes

DTLBIMVA is a 32-bit System instruction.

Field descriptions

The DTLBIMVA input value bit assignments are:

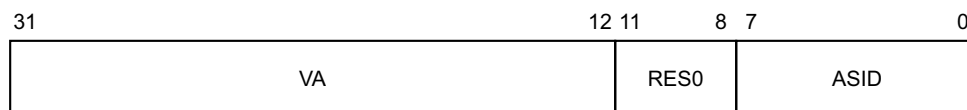

VA, bits [31:12]

Virtual address to match. Any TLB entries that match the ASID value and VA value will be affected by this operation.

Bits [11:8]

Reserved, RES0.

ASID, bits [7:0]

ASID value to match. Any TLB entries that match the ASID value and VA value will be affected by this operation.

Global TLB entries that match the VA value will be affected by this operation, regardless of the value of the ASID field.

Executing the DTLBIMVA instruction

This instruction is executed using MCR with the following syntax:

MCR <syntax>

This syntax uses the following encoding in the System instruction encoding space:

<syntax>	opc1	opc2	CRn	coproc	CRm
p15, 0, <Rt>, c8, c6, 1	000	001	1000	1111	0110

Accessibility

The instruction is executable as follows:

Control			Accessibility			
E2H	TGE	NS	EL0	EL1	EL2	EL3
x	x	0	-	WO	n/a	WO
x	0	1	-	WO	WO	WO
x	1	1	-	n/a	WO	WO

When [HCR.FB](#) is 1, at Non-secure EL1 this instruction executes as a [TLBIMVAIS](#) operating on data TLBs only.

Traps and Enables

For a description of the prioritization of any generated exceptions, see [Synchronous exception prioritization for exceptions taken to AArch32 state on page G1-4344](#) for exceptions taken to AArch32 state and [Synchronous exception prioritization for exceptions taken to AArch64 on page D1-1827](#) for exceptions taken to AArch64 state. Subject to the prioritization rules:

- When EL2 is implemented and is using AArch64 and (SCR_EL3.NS == 1) && (HCR_EL2.E2H == 0):
 - If [HCR_EL2.TTLB](#)==1, Non-secure execution of this instruction at EL1 is trapped to EL2.
 - If [HSTR_EL2.T8](#)==1, Non-secure execution of this instruction at EL1 is trapped to EL2.
- When EL2 is implemented and is using AArch64 and (SCR_EL3.NS == 1) && (HCR_EL2.E2H == 1) && (HCR_EL2.TGE == 0):
 - If [HCR_EL2.TTLB](#)==1, Non-secure execution of this instruction at EL1 is trapped to EL2.
 - If [HSTR_EL2.T8](#)==1, Non-secure execution of this instruction at EL1 is trapped to EL2.
- When EL2 is implemented and is using AArch32 and SCR_EL3.NS == 1:
 - If [HCR.TTLB](#)==1, Non-secure execution of this instruction at EL1 is trapped to Hyp mode.
 - If [HSTR.T8](#)==1, Non-secure execution of this instruction at EL1 is trapped to Hyp mode.

G6.2.47 ELR_hyp, Exception Link Register (Hyp mode)

The ELR_hyp characteristics are:

Purpose

When taking an exception to Hyp mode, holds the address to return to.

Configurations

AArch32 System register ELR_hyp is architecturally mapped to AArch64 System register [ELR_EL2](#).

On a reset into an Exception level that is using AArch32 ELR_hyp is UNKNOWN.

Attributes

ELR_hyp is a 32-bit register.

Field descriptions

The ELR_hyp bit assignments are:

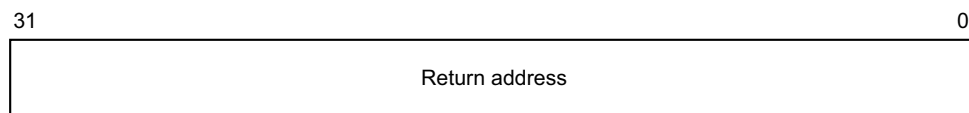

Bits [31:0]

Return address.

Accessing the ELR_hyp

This register can be read using MRS (banked register) with the following syntax:

MRS <Rd>, <banked_reg>

This register can be written using MSR (banked register) with the following syntax:

MSR <banked_reg>, <Rd>

This syntax is encoded with the following settings in the instruction encoding:

<banked_reg>	R	M	M1
ELR_hyp	0	1	1110

Accessibility

The register is accessible in software as follows:

Control			Accessibility			
E2H	TGE	NS	EL0	EL1	EL2	EL3
x	x	0	-	-	n/a	-
x	0	1	-	-	RW	RW
x	1	1	-	n/a	RW	RW

G6.2.48 FCSEIDR, FCSE Process ID register

The FCSEIDR characteristics are:

Purpose

Identifies whether the Fast Context Switch Extension (FCSE) is implemented.

In ARMv8, the FCSE is not implemented, so this register is RAZ/WI. Software can access this register to determine that the implementation does not include the FCSE.

Configurations

There is one instance of this register that is used in both Secure and Non-secure states.

Attributes

FCSEIDR is a 32-bit register.

Field descriptions

The FCSEIDR bit assignments are:

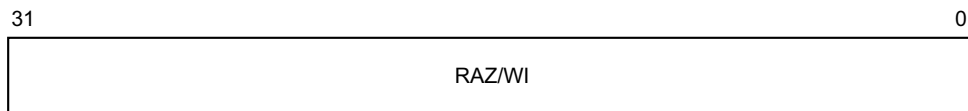

Bits [31:0]

Reserved, RAZ/WI. Hardware must implement this as RAZ/WI. Software must not rely on this property as the behavior of reserved values might change in a future revision of the architecture.

Accessing the FCSEIDR

This register can be read using MRC with the following syntax:

MRC <syntax>

This register can be written using MCR with the following syntax:

MCR <syntax>

This syntax is encoded with the following settings in the instruction encoding:

<syntax>	opc1	opc2	CRn	coproc	CRm
p15, 0, <Rt>, c13, c0, 0	000	000	1101	1111	0000

Accessibility

The register is accessible in software as follows:

Control			Accessibility			
E2H	TGE	NS	EL0	EL1	EL2	EL3
x	x	0	-	RW	n/a	RW
x	0	1	-	RW	RW	RW
x	1	1	-	n/a	RW	RW

Traps and Enables

For a description of the prioritization of any generated exceptions, see *Synchronous exception prioritization for exceptions taken to AArch32 state* on page G1-4344 for exceptions taken to AArch32 state and *Synchronous exception prioritization for exceptions taken to AArch64* on page D1-1827 for exceptions taken to AArch64 state. Subject to the prioritization rules:

- When EL2 is implemented and is using AArch64 and $(SCR_EL3.NS == 1) \ \&\& \ (HCR_EL2.E2H == 0)$:
 - If $HSTR_EL2.T13 == 1$, Non-secure accesses to this register from EL1 are trapped to EL2.
- When EL2 is implemented and is using AArch64 and $(SCR_EL3.NS == 1) \ \&\& \ (HCR_EL2.E2H == 1) \ \&\& \ (HCR_EL2.TGE == 0)$:
 - If $HSTR_EL2.T13 == 1$, Non-secure accesses to this register from EL1 are trapped to EL2.
- When EL2 is implemented and is using AArch32 and $SCR_EL3.NS == 1$:
 - If $HSTR.T13 == 1$, Non-secure accesses to this register from EL1 are trapped to Hyp mode.

G6.2.49 FPEXC, Floating-Point Exception Control register

The FPEXC characteristics are:

Purpose

Provides a global enable for the implemented Advanced SIMD and floating-point functionality, and reports floating-point status information.

Configurations

There is one instance of this register that is used in both Secure and Non-secure states.

AArch32 System register FPEXC is architecturally mapped to AArch64 System register [FPEXC32_EL2](#).

Implemented only if the implementation includes the Advanced SIMD and floating-point functionality.

Some or all RW fields of this register have defined reset values. These apply only if the PE resets into an Exception level that is using AArch32. Otherwise, RW fields in this register reset to architecturally UNKNOWN values.

Attributes

FPEXC is a 32-bit register.

Field descriptions

The FPEXC bit assignments are:

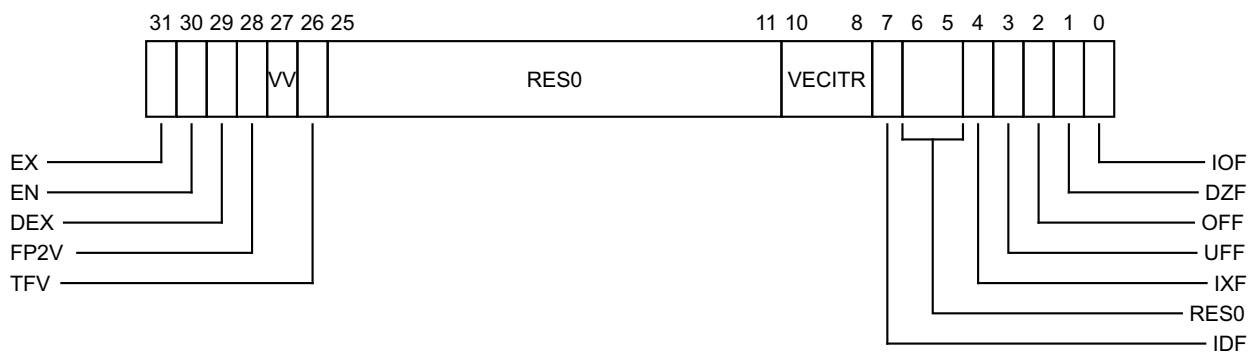

EX, bit [31]

Exception bit. In ARMv8, this bit is RAZ/WI.

EN, bit [30]

Enables access to the Advanced SIMD and floating-point functionality from all Exception levels, except that setting this field to 0 does not disable the following:

- VMRS accesses to the [FPEXC](#) or [FPSID](#).
- VMRS accesses from the [FPEXC](#), [FPSID](#), [MVFR0](#), [MVFR1](#), or [MVFR2](#).

0 Accesses to the [FPSCR](#), and any of the SIMD and floating-point registers Q0-Q15, including their views as D0-D31 registers or S0-S31 registers, are UNDEFINED at all Exception levels.

1 This control permits access to the Advanced SIMD and floating-point functionality at all Exception levels.

Execution of floating-point and Advanced SIMD instructions in AArch32 state can be disabled or trapped by the following controls:

- [CPACR.cp10](#), or, if executing at EL0, [CPACR_EL1.FPEN](#).

- FPEXC.EN.
- If executing in Non-secure state:
 - `HCPTTR.TCP10`, or if EL2 is using AArch64, `CPTR_EL2.TFP`.
 - `NSACR.cp10`, or if EL3 is using AArch64, `CPTR_EL3.TFP`.
- For Advanced SIMD instructions only:
 - `CPACR.ASEDIS`.
 - If executing in Non-secure state, `HCPTTR.TASE` and `NSACR.NSTRCDIS`.

See the descriptions of the controls for more information.

———— **Note** —————

When executing at EL0 using AArch32:

- If EL1 is using AArch64 then behavior is as if the value of FPEXC.EN is 1.
- In Non-secure state, if EL2 is using AArch64 and the value of `HCR_EL2`.{RW, TGE} is {1, 1} then behavior is as if the value of FPEXC.EN is 1.
- In Non-secure state, if EL2 is using AArch64 and the value of `HCR_EL2`.{RW, TGE} is {0, 1} then it is IMPLEMENTATION DEFINED whether the behavior is:
 - As if the value of FPEXC.EN is 1.
 - Determined by the value of FPEXC.EN, as described in this field description.
ARM deprecates using the value of FPEXC.EN to determine behavior.

When this register has an architecturally-defined reset value, this field resets to 0.

DEX, bit [29]

Defined synchronous exception on floating-point execution.

This field identifies whether a synchronous exception generated by the attempted execution of an instruction was generated by an unallocated encoding. The instruction must be in the encoding space that is identified by the pseudocode function `ExecutingCP10or11Instr()` returning TRUE. This field also indicates whether the FPEXC.TFV field is valid.

The meaning of this bit is:

- | | |
|---|---|
| 0 | The exception was generated by the attempted execution of an unallocated instruction in the encoding space that is identified by the pseudocode function <code>ExecutingCP10or11Instr()</code> . If FPEXC.TFV is RW then it is invalid and UNKNOWN. If FPEXC.{IDF, IXF, UFF, OFF, DZF, IOF} are RW then they are invalid and UNKNOWN. |
| 1 | The exception was generated during the execution of an unallocated encoding. FPEXC.TFV is valid and indicates the cause of the exception. |

On an exception that sets this bit to 1 the exception-handling routine must clear this bit to 0.

On an implementation that both does not support trapping of floating-point exceptions and implements the `FPSCR`.{Stride, Len} fields as RAZ, this bit is RES0.

If this field is implemented as an RW field, it resets to a value that is architecturally UNKNOWN.

FP2V, bit [28]

FPINST2 instruction valid bit. In ARMv8, this bit is RES0.

VV, bit [27]

VECITR valid bit. In ARMv8, this bit is RES0.

TFV, bit [26]

Trapped Fault Valid bit. Valid only when the value of FPEXC.DEX is 1. When valid, it indicates the cause of the exception and therefore whether the FPEXC.{IDF, IXF, UFF, OFF, DZF, IOF} bits are valid.

- 0 The exception was caused by the execution of a floating-point VABS, VADD, VDIV, VFMA, VFMS, VFNMA, VFNMS, VMLA, VMLS, VMOV, VMUL, VNEG, VNMLA, VNMLS, VNMUL, VSQRT, or VSUB instruction when one or both of FPSCR.{Stride, Len} was non-zero. If the FPEXC.{IDF, IXF, UFF, OFF, DZF, IOF} bits are RW then they are invalid and UNKNOWN.
- 1 FPEXC.{IDF, IXF, UFF, OFF, DZF, IOF} indicate the presence of trapped floating-point exceptions that had occurred at the time of the exception. Bits are set for all trapped exceptions that had occurred at the time of the exception.

This bit returns a status value and ignores writes.

When the value of FPEXC.DEX is 0 and this bit is RW, this bit is invalid and UNKNOWN.

On an implementation that does not support the trapping of floating-point exceptions this bit is RAZ/WI.

On an implementation that supports the trapping of floating-point exceptions and implements FPSCR.{Stride, Len} as RAZ, this bit is RAO/WI.

Bits [25:11]

Reserved, RES0.

VECITR, bits [10:8]

Vector iteration count. In ARMv8, this field is RES1.

IDF, bit [7]

Input Denormal trapped exception bit. Valid only when the value of FPEXC.TFV is 1. When valid, it indicates whether an Input Denormal exception occurred while FPSCR.IDE was 1:

- 0 Input denormal exception has not occurred.
- 1 Input denormal exception has occurred.

Input Denormal exceptions can occur only when FPSCR.FZ is 1.

This bit must be cleared to 0 by the exception-handling routine.

When the value of FPEXC.TFV is 0 and this bit is RW, this bit is invalid and UNKNOWN.

On an implementation that does not support the trapping of floating-point exceptions this bit is RAZ/WI.

If this field is implemented as an RW field, it resets to a value that is architecturally UNKNOWN.

Bits [6:5]

Reserved, RES0.

IXF, bit [4]

Inexact trapped exception bit. Valid only when the value of FPEXC.TFV is 1. When valid, it indicates whether an Inexact exception occurred while FPSCR.IXE was 1:

- 0 Inexact exception has not occurred.
- 1 Inexact exception has occurred.

This bit must be cleared to 0 by the exception-handling routine.

When the value of FPEXC.TFV is 0 and this bit is RW, this bit is invalid and UNKNOWN.

On an implementation that does not support the trapping of floating-point exceptions this bit is RAZ/WI.

If this field is implemented as an RW field, it resets to a value that is architecturally UNKNOWN.

UFF, bit [3]

Underflow trapped exception bit. Valid only when the value of FPEXC.TFV is 1. When valid, it indicates whether an Underflow exception occurred while FPSCR.UFE was 1:

- 0 Underflow exception has not occurred.
- 1 Underflow exception has occurred.

Underflow trapped exceptions can occur only when FPSCR.FZ is 0.

This bit must be cleared to 0 by the exception-handling routine.

When the value of FPEXC.TFV is 0 and this bit is RW, this bit is invalid and UNKNOWN.

On an implementation that does not support the trapping of floating-point exceptions this bit is RAZ/WI.

If this field is implemented as an RW field, it resets to a value that is architecturally UNKNOWN.

OFF, bit [2]

Overflow trapped exception bit. Valid only when the value of FPEXC.TFV is 1. When valid, it indicates whether an Overflow exception occurred while FPSCR.OFE was 1:

- 0 Overflow exception has not occurred.
- 1 Overflow exception has occurred.

This bit must be cleared to 0 by the exception-handling routine.

When the value of FPEXC.TFV is 0 and this bit is RW, this bit is invalid and UNKNOWN.

On an implementation that does not support the trapping of floating-point exceptions this bit is RAZ/WI.

If this field is implemented as an RW field, it resets to a value that is architecturally UNKNOWN.

DZF, bit [1]

Divide by Zero trapped exception bit. Valid only when the value of FPEXC.TFV is 1. When valid, it indicates whether a Divide by Zero exception occurred while FPSCR.DZE was 1:

- 0 Divide by Zero exception has not occurred.
- 1 Divide by Zero exception has occurred.

This bit must be cleared to 0 by the exception-handling routine.

When the value of FPEXC.TFV is 0 and this bit is RW, this bit is invalid and UNKNOWN.

On an implementation that does not support the trapping of floating-point exceptions this bit is RAZ/WI.

If this field is implemented as an RW field, it resets to a value that is architecturally UNKNOWN.

IOF, bit [0]

Invalid Operation trapped exception bit. Valid only when the value of FPEXC.TFV is 1. When valid, it indicates whether an Invalid Operation exception occurred while FPSCR.IOE was 1:

- 0 Invalid Operation exception has not occurred.
- 1 Invalid Operation exception has occurred.

This bit must be cleared to 0 by the exception-handling routine.

When the value of FPEXC.TFV is 0 and this bit is RW, this bit is invalid and UNKNOWN.

On an implementation that does not support the trapping of floating-point exceptions this bit is RAZ/WI.

If this field is implemented as an RW field, it resets to a value that is architecturally UNKNOWN.

Accessing the FPEXC

This register can be read using VMRS with the following syntax:

```
VMRS <Rt>, <spec_reg>
```

This register can be written using VMSR with the following syntax:

VMSR <spec_reg>, <Rt>

This syntax is encoded with the following settings in the instruction encoding:

<spec_reg>	reg
FPEXC	1000

Accessibility

The register is accessible in software as follows:

Control			Accessibility			
E2H	TGE	NS	EL0	EL1	EL2	EL3
x	x	0	-	RW	n/a	RW
x	0	1	-	RW	RW	RW
x	1	1	-	n/a	RW	RW

Traps and Enables

For a description of the prioritization of any generated exceptions, see [Synchronous exception prioritization for exceptions taken to AArch32 state on page G1-4344](#) for exceptions taken to AArch32 state and [Synchronous exception prioritization for exceptions taken to AArch64 on page D1-1827](#) for exceptions taken to AArch64 state. Subject to the prioritization rules:

- When $HCR_EL2.E2H == 0$:
 - If $CPACR.cp10 == 00$, accesses to this register from PL1 are UNDEFINED.
- When EL2 is implemented and is using AArch64 and $(SCR_EL3.NS == 1) \&\& (HCR_EL2.E2H == 0)$:
 - If $CPTR_EL2.TFP == 1$, Non-secure accesses to this register from EL1 are trapped to EL2.
- When EL2 is implemented and is using AArch64 and $(SCR_EL3.NS == 1) \&\& (HCR_EL2.E2H == 1) \&\& (HCR_EL2.TGE == 0)$:
 - If $CPTR_EL2.FPEN == 00$, Non-secure accesses to this register from EL1 are trapped to EL2.
 - If $CPTR_EL2.FPEN == 10$, Non-secure accesses to this register from EL1 are trapped to EL2.
- When EL2 is implemented and is using AArch32 and $SCR_EL3.NS == 1$:
 - If $HCPTR.TCP10 == 1$, Non-secure accesses to this register from EL1 are trapped to Hyp mode.
 - If $HCPTR.TCP10 == 1$, Non-secure accesses to this register from EL2 are UNDEFINED.
- When EL3 is implemented and is using AArch32 and $SCR_EL3.NS == 1$:
 - If $NSACR.cp10 == 0$, Non-secure accesses to this register from EL1 and EL2 are UNDEFINED.
- When EL3 is implemented and is using AArch64:
 - If $CPTR_EL3.TFP == 1$, accesses to this register from EL1 and EL2 are trapped to EL3.

G6.2.50 FPSCR, Floating-Point Status and Control Register

The FPSCR characteristics are:

Purpose

Provides floating-point system status information and control.

Configurations

There is one instance of this register that is used in both Secure and Non-secure states.

The named fields in this register map to the equivalent fields in the AArch64 [FPCR](#) and [FPSR](#).

It is IMPLEMENTATION DEFINED whether the Len and Stride fields can be programmed to non-zero values, which will cause some AArch32 floating-point instruction encodings to be UNDEFINED, or whether these fields are RAZ.

Implemented only if the implementation includes the Advanced SIMD and floating-point functionality.

RW fields in this register reset to architecturally UNKNOWN values.

Attributes

FPSCR is a 32-bit register.

Field descriptions

The FPSCR bit assignments are:

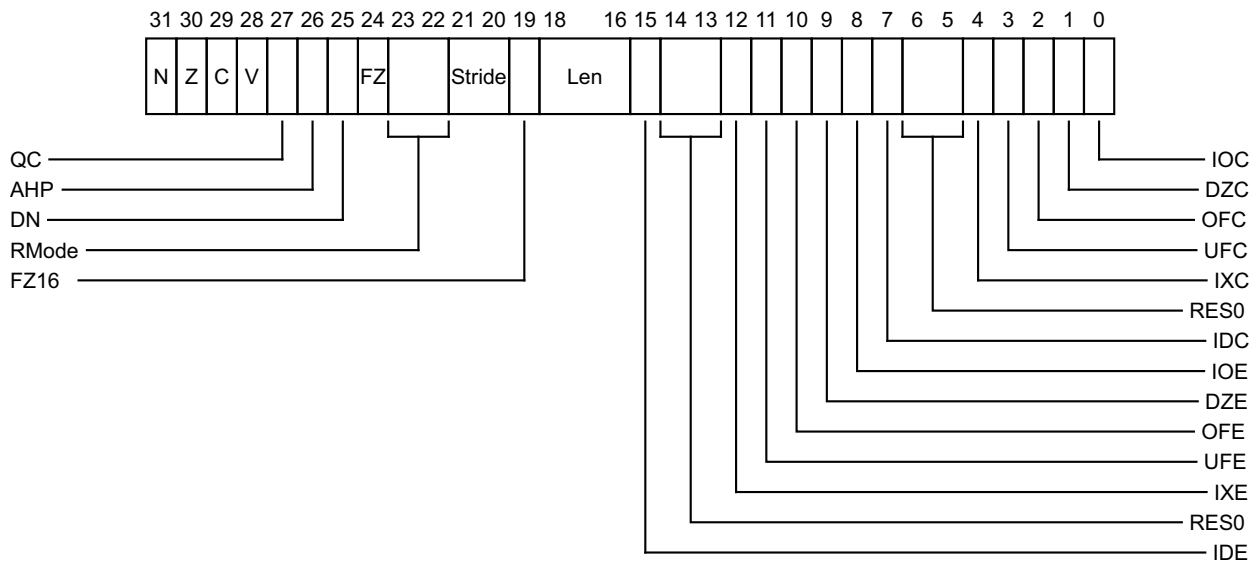

N, bit [31]

Negative condition flag. This is updated by floating-point comparison operations.

Z, bit [30]

Zero condition flag. This is updated by floating-point comparison operations.

C, bit [29]

Carry condition flag. This is updated by floating-point comparison operations.

V, bit [28]

Overflow condition flag. This is updated by floating-point comparison operations.

QC, bit [27]

Cumulative saturation bit, Advanced SIMD only. This bit is set to 1 to indicate that an Advanced SIMD integer operation has saturated since 0 was last written to this bit.

AHP, bit [26]

Alternative half-precision control bit:

- 0 IEEE half-precision format selected.
- 1 Alternative half-precision format selected.

This bit is only used for conversions between half-precision floating-point and other floating-point formats.

The data-processing instructions added as part of the [ARMv8.2-FP16](#) extension always use the IEEE half-precision format, and ignore the value of this bit.

DN, bit [25]

Default NaN mode control bit:

- 0 NaN operands propagate through to the output of a floating-point operation.
- 1 Any operation involving one or more NaNs returns the Default NaN.

The value of this bit only controls scalar floating-point arithmetic. Advanced SIMD arithmetic always uses the Default NaN setting, regardless of the value of the DN bit.

FZ, bit [24]

Flush-to-zero mode control bit:

- 0 Flush-to-zero mode disabled. Behavior of the floating-point system is fully compliant with the IEEE 754 standard.
- 1 Flush-to-zero mode enabled.

The value of this bit only controls scalar floating-point arithmetic. Advanced SIMD arithmetic always uses the Flush-to-zero setting, regardless of the value of the FZ bit.

This bit has no effect on half-precision calculations.

RMode, bits [23:22]

Rounding Mode control field. The encoding of this field is:

- 00 Round to Nearest (RN) mode
- 01 Round towards Plus Infinity (RP) mode
- 10 Round towards Minus Infinity (RM) mode
- 11 Round towards Zero (RZ) mode.

The specified rounding mode is used by almost all scalar floating-point instructions. Advanced SIMD arithmetic always uses the Round to Nearest setting, regardless of the value of the RMode bits.

Stride, bits [21:20]

It is IMPLEMENTATION DEFINED whether this field is RW or RAZ.

If this field is RW and is set to a value other than zero, some floating-point instruction encodings are UNDEFINED. The instruction pseudocode identifies these instructions.

ARM strongly recommends that software never sets this field to a value other than zero.

The value of this field is ignored when processing Advanced SIMD instructions.

FZ16, bit [19]

In ARMv8.2

When [ARMv8.2-FP16](#) is implemented, flush-to-zero mode control bit on half-precision data-processing instructions:

- 0 Flush-to-zero mode disabled. Behavior of the floating-point system is fully compliant with the IEEE 754 standard.
- 1 Flush-to-zero mode enabled.

The value of this bit applies to both scalar and Advanced SIMD floating-point half-precision calculations.

When [ARMv8.2-FP16](#) is not implemented, this bit is RES0.

In ARMv8.1 and ARMv8.0.

Reserved, RES0.

Len, bits [18:16]

It is IMPLEMENTATION DEFINED whether this field is RW or RAZ.

If this field is RW and is set to a value other than zero, some floating-point instruction encodings are UNDEFINED. The instruction pseudocode identifies these instructions.

ARM strongly recommends that software never sets this field to a value other than zero.

The value of this field is ignored when processing Advanced SIMD instructions.

IDE, bit [15]

Input Denormal floating-point exception trap enable. Possible values are:

- 0 Untrapped exception handling selected. If the floating-point exception occurs then the IDC bit is set to 1.
- 1 Trapped exception handling selected. If the floating-point exception occurs, the PE does not update the IDC bit. The trap handling software can decide whether to set the IDC bit to 1.

This bit is RW only if the implementation supports the trapping of floating-point exceptions. In an implementation that does not support floating-point exception trapping, this bit is RES0.

When this bit is RW, it applies only to floating-point operations. Advanced SIMD operations always use untrapped floating-point exception handling in AArch32 state.

Bits [14:13]

Reserved, RES0.

IXE, bit [12]

Inexact floating-point exception trap enable. Possible values are:

- 0 Untrapped exception handling selected. If the floating-point exception occurs then the IXC bit is set to 1.
- 1 Trapped exception handling selected. If the floating-point exception occurs, the PE does not update the IXC bit. The trap handling software can decide whether to set the IXC bit to 1.

This bit is RW only if the implementation supports the trapping of floating-point exceptions. In an implementation that does not support floating-point exception trapping, this bit is RES0.

When this bit is RW, it applies only to floating-point operations. Advanced SIMD operations always use untrapped floating-point exception handling in AArch32 state.

UFE, bit [11]

Underflow floating-point exception trap enable. Possible values are:

- 0 Untrapped exception handling selected. If the floating-point exception occurs then the UFC bit is set to 1.
- 1 Trapped exception handling selected. If the floating-point exception occurs, the PE does not update the UFC bit. The trap handling software can decide whether to set the UFC bit to 1.

This bit is RW only if the implementation supports the trapping of floating-point exceptions. In an implementation that does not support floating-point exception trapping, this bit is RES0.

When this bit is RW, it applies only to floating-point operations. Advanced SIMD operations always use untrapped floating-point exception handling in AArch32 state.

OFE, bit [10]

Overflow floating-point exception trap enable. Possible values are:

- 0 Untrapped exception handling selected. If the floating-point exception occurs then the OFC bit is set to 1.
- 1 Trapped exception handling selected. If the floating-point exception occurs, the PE does not update the OFC bit. The trap handling software can decide whether to set the OFC bit to 1.

This bit is RW only if the implementation supports the trapping of floating-point exceptions. In an implementation that does not support floating-point exception trapping, this bit is RES0.

When this bit is RW, it applies only to floating-point operations. Advanced SIMD operations always use untrapped floating-point exception handling in AArch32 state.

DZE, bit [9]

Divide by Zero floating-point exception trap enable. Possible values are:

- 0 Untrapped exception handling selected. If the floating-point exception occurs then the DZC bit is set to 1.
- 1 Trapped exception handling selected. If the floating-point exception occurs, the PE does not update the DZC bit. The trap handling software can decide whether to set the DZC bit to 1.

This bit is RW only if the implementation supports the trapping of floating-point exceptions. In an implementation that does not support floating-point exception trapping, this bit is RES0.

When this bit is RW, it applies only to floating-point operations. Advanced SIMD operations always use untrapped floating-point exception handling in AArch32 state.

IOE, bit [8]

Invalid Operation floating-point exception trap enable. Possible values are:

- 0 Untrapped exception handling selected. If the floating-point exception occurs then the IOC bit is set to 1.
- 1 Trapped exception handling selected. If the floating-point exception occurs, the PE does not update the IOC bit. The trap handling software can decide whether to set the IOC bit to 1.

This bit is RW only if the implementation supports the trapping of floating-point exceptions. In an implementation that does not support floating-point exception trapping, this bit is RES0.

When this bit is RW, it applies only to floating-point operations. Advanced SIMD operations always use untrapped floating-point exception handling in AArch32 state.

IDC, bit [7]

Input Denormal cumulative floating-point exception bit. This bit is set to 1 to indicate that the Input Denormal floating-point exception has occurred since 0 was last written to this bit.

How VFP instructions update this bit depends on the value of the IDE bit.

Advanced SIMD instructions set this bit if the Input Denormal floating-point exception occurs in one or more of the floating-point calculations performed by the instruction, regardless of the value of the IDE bit.

Bits [6:5]

Reserved, RES0.

IXC, bit [4]

Inexact cumulative floating-point exception bit. This bit is set to 1 to indicate that the Inexact floating-point exception has occurred since 0 was last written to this bit.

How VFP instructions update this bit depends on the value of the IXE bit.

Advanced SIMD instructions set this bit if the Inexact floating-point exception occurs in one or more of the floating-point calculations performed by the instruction, regardless of the value of the IXE bit.

UFC, bit [3]

Underflow cumulative floating-point exception bit. This bit is set to 1 to indicate that the Underflow floating-point exception has occurred since 0 was last written to this bit.

How VFP instructions update this bit depends on the value of the UFE bit.

Advanced SIMD instructions set this bit if the Underflow floating-point exception occurs in one or more of the floating-point calculations performed by the instruction, regardless of the value of the UFE bit.

OFC, bit [2]

Overflow cumulative floating-point exception bit. This bit is set to 1 to indicate that the Overflow floating-point exception has occurred since 0 was last written to this bit.

How VFP instructions update this bit depends on the value of the OFE bit.

Advanced SIMD instructions set this bit if the Overflow floating-point exception occurs in one or more of the floating-point calculations performed by the instruction, regardless of the value of the OFE bit.

DZC, bit [1]

Divide by Zero cumulative floating-point exception bit. This bit is set to 1 to indicate that the Divide by Zero floating-point exception has occurred since 0 was last written to this bit.

How VFP instructions update this bit depends on the value of the DZE bit.

Advanced SIMD instructions set this bit if the Divide by Zero floating-point exception occurs in one or more of the floating-point calculations performed by the instruction, regardless of the value of the DZE bit.

IOC, bit [0]

Invalid Operation cumulative floating-point exception bit. This bit is set to 1 to indicate that the Invalid Operation floating-point exception has occurred since 0 was last written to this bit.

How VFP instructions update this bit depends on the value of the IOE bit.

Advanced SIMD instructions set this bit if the Invalid Operation floating-point exception occurs in one or more of the floating-point calculations performed by the instruction, regardless of the value of the IOE bit.

Accessing the FPSCR

This register can be read using VMRS with the following syntax:

```
VMRS <Rt>, <spec_reg>
```

This register can be written using VMSR with the following syntax:

```
VMSR <spec_reg>, <Rt>
```

This syntax is encoded with the following settings in the instruction encoding:

<spec_reg>	reg
FPSCR	0001

Accessibility

The register is accessible in software as follows:

Control			Accessibility			
E2H	TGE	NS	EL0	EL1	EL2	EL3
x	x	0	RW	RW	n/a	RW
x	0	1	RW	RW	RW	RW
x	1	1	RW	n/a	RW	RW

Traps and Enables

For a description of the prioritization of any generated exceptions, see [Synchronous exception prioritization for exceptions taken to AArch32 state on page G1-4344](#) for exceptions taken to AArch32 state and [Synchronous exception prioritization for exceptions taken to AArch64 on page D1-1827](#) for exceptions taken to AArch64 state. Subject to the prioritization rules:

- When $HCR_EL2.E2H == 0$:
 - If $CPACR.cp10 == 00$, accesses to this register from PL0 and PL1 are UNDEFINED.
 - If $CPACR.cp10 == 01$, accesses to this register from PL0 are UNDEFINED.
 - If $CPACR_EL1.FPEN == 00$, accesses to this register from PL0 are trapped to EL1.
 - If $CPACR_EL1.FPEN == 01$, accesses to this register from PL0 are trapped to EL1.
 - If $CPACR_EL1.FPEN == 10$, accesses to this register from PL0 are trapped to EL1.
- When EL2 is implemented and is using AArch64 and $(SCR_EL3.NS == 1) \&\& (HCR_EL2.E2H == 0)$:
 - If $CPTR_EL2.TFP == 1$, Non-secure accesses to this register from EL0 and EL1 are trapped to EL2.
- When EL2 is implemented and is using AArch64 and $(SCR_EL3.NS == 1) \&\& (HCR_EL2.E2H == 1) \&\& (HCR_EL2.TGE == 0)$:
 - If $CPACR_EL1.FPEN == 00$, Non-secure accesses to this register from EL0 are trapped to EL1.
 - If $CPACR_EL1.FPEN == 01$, Non-secure accesses to this register from EL0 are trapped to EL1.
 - If $CPACR_EL1.FPEN == 10$, Non-secure accesses to this register from EL0 are trapped to EL1.
 - If $CPTR_EL2.FPEN == 00$, Non-secure accesses to this register from EL0 and EL1 are trapped to EL2.
 - If $CPTR_EL2.FPEN == 10$, Non-secure accesses to this register from EL0 and EL1 are trapped to EL2.
- When EL2 is implemented and is using AArch64 and $(SCR_EL3.NS == 1) \&\& (HCR_EL2.E2H == 1) \&\& (HCR_EL2.TGE == 1)$:
 - If $CPTR_EL2.FPEN == 00$, Non-secure accesses to this register from EL0 are trapped to EL2.
 - If $CPTR_EL2.FPEN == 01$, Non-secure accesses to this register from EL0 are trapped to EL2.
 - If $CPTR_EL2.FPEN == 10$, Non-secure accesses to this register from EL0 are trapped to EL2.
- When EL2 is implemented and is using AArch32 and $SCR_EL3.NS == 1$:
 - If $HCPTR.TCP10 == 1$, Non-secure accesses to this register from EL0 and EL1 are trapped to Hyp mode.
 - If $HCPTR.TCP10 == 1$, Non-secure accesses to this register from EL2 are UNDEFINED.
- When EL3 is implemented and is using AArch32 and $SCR_EL3.NS == 1$:
 - If $NSACR.cp10 == 0$, Non-secure accesses to this register from EL0, EL1, and EL2 are UNDEFINED.

- When EL3 is implemented and is using AArch64:
 - If [CPTR_EL3.TFP](#)==1, accesses to this register from EL0, EL1, and EL2 are trapped to EL3.

G6.2.51 FPSID, Floating-Point System ID register

The FPSID characteristics are:

Purpose

Provides top-level information about the floating-point implementation.

This register largely duplicates information held in the [MIDR](#). ARM deprecates use of it.

Configurations

There is one instance of this register that is used in both Secure and Non-secure states.

Implemented only if the implementation includes the Advanced SIMD and floating-point functionality.

Attributes

FPSID is a 32-bit register.

Field descriptions

The FPSID bit assignments are:

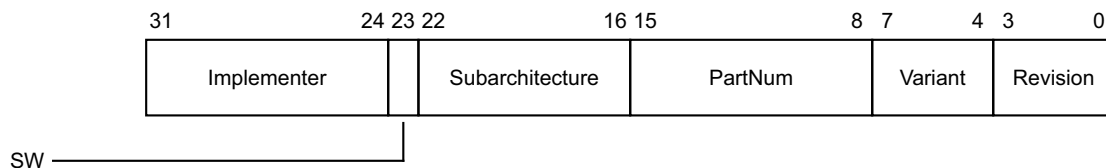

Implementer, bits [31:24]

Implementer codes are the same as those used for the [MIDR](#).

For an implementation by ARM this field is 0x41, the ASCII code for A.

SW, bit [23]

Software bit. Defined values are:

0 The implementation provides a hardware implementation of the floating-point instructions.

1 The implementation supports only software emulation of the floating-point instructions.

In ARMv8-A the only permitted value is 0.

Subarchitecture, bits [22:16]

Subarchitecture version number. For an implementation by ARM, defined values are:

0000000 VFPv1 architecture with an IMPLEMENTATION DEFINED subarchitecture.

0000001 VFPv2 architecture with Common VFP subarchitecture v1.

0000010 VFPv3 architecture, or later, with Common VFP subarchitecture v2. The VFP architecture version is indicated by the [MVFR0](#) and [MVFR1](#) registers.

0000011 VFPv3 architecture, or later, with Null subarchitecture. The entire floating-point implementation is in hardware, and no software support code is required. The VFP architecture version is indicated by the [MVFR0](#) and [MVFR1](#) registers. This value can be used only by an implementation that does not support the trap enable bits in the [FPSCR](#).

0000100 VFPv3 architecture, or later, with Common VFP subarchitecture v3, and support for trap enable bits in [FPSCR](#). The VFP architecture version is indicated by the [MVFR0](#) and [MVFR1](#) registers.

For a subarchitecture designed by ARM the most significant bit of this field, register bit[22], is 0. Values with a most significant bit of 0 that are not listed here are reserved.

When the subarchitecture designer is not ARM, the most significant bit of this field, register bit[22], must be 1. Each implementer must maintain its own list of subarchitectures it has designed, starting at subarchitecture version number 0x40.

In ARMv8-A the permitted values are 0000011 and 0000100.

PartNum, bits [15:8]

An IMPLEMENTATION DEFINED part number for the floating-point implementation, assigned by the implementer.

Variant, bits [7:4]

An IMPLEMENTATION DEFINED variant number. Typically, this field distinguishes between different production variants of a single product.

Revision, bits [3:0]

An IMPLEMENTATION DEFINED revision number for the floating-point implementation.

Accessing the FPSID

This register can be read using VMRS with the following syntax:

```
VMRS <Rt>, <spec_reg>
```

This register can be written using VMSR with the following syntax:

```
VMSR <spec_reg>, <Rt>
```

This syntax is encoded with the following settings in the instruction encoding:

<spec_reg>	reg
FPSID	0000

Accessibility

The register is accessible in software as follows:

Control			Accessibility			
E2H	TGE	NS	EL0	EL1	EL2	EL3
x	x	0	-	RW	n/a	RW
x	0	1	-	RW	RW	RW
x	1	1	-	n/a	RW	RW

When access to this register is permitted, write accesses are ignored.

Traps and Enables

For a description of the prioritization of any generated exceptions, see *Synchronous exception prioritization for exceptions taken to AArch32 state* on page G1-4344 for exceptions taken to AArch32 state and *Synchronous exception prioritization for exceptions taken to AArch64* on page D1-1827 for exceptions taken to AArch64 state. Subject to the prioritization rules:

- When $\text{HCR_EL2.E2H} == 0$:
 - If $\text{CPACR.cp10} == 0$, accesses to this register from PL1 are UNDEFINED.
- When EL2 is implemented and is using AArch64 and $(\text{SCR_EL3.NS} == 1) \ \&\& \ (\text{HCR_EL2.E2H} == 0)$:
 - If $\text{CPTR_EL2.TFP} == 1$, Non-secure accesses to this register from EL1 are trapped to EL2.
 - If $\text{HCR_EL2.TID0} == 1$, Non-secure read accesses to this register from EL1 are trapped to EL2.
- When EL2 is implemented and is using AArch64 and $(\text{SCR_EL3.NS} == 1) \ \&\& \ (\text{HCR_EL2.E2H} == 1) \ \&\& \ (\text{HCR_EL2.TGE} == 0)$:
 - If $\text{CPTR_EL2.FPEN} == 0$, Non-secure accesses to this register from EL1 are trapped to EL2.
 - If $\text{CPTR_EL2.FPEN} == 1$, Non-secure accesses to this register from EL1 are trapped to EL2.
 - If $\text{HCR_EL2.TID0} == 1$, Non-secure read accesses to this register from EL1 are trapped to EL2.
- When EL2 is implemented and is using AArch32 and $\text{SCR_EL3.NS} == 1$:
 - If $\text{HCPTR.TCP10} == 1$, Non-secure accesses to this register from EL1 are trapped to Hyp mode.
 - If $\text{HCPTR.TCP10} == 0$, Non-secure accesses to this register from EL2 are UNDEFINED.
 - If $\text{HCR.TID0} == 1$, Non-secure read accesses to this register from EL1 are trapped to Hyp mode.
- When EL3 is implemented and is using AArch32 and $\text{SCR_EL3.NS} == 1$:
 - If $\text{NSACR.cp10} == 0$, Non-secure accesses to this register from EL1 and EL2 are UNDEFINED.
- When EL3 is implemented and is using AArch64:
 - If $\text{CPTR_EL3.TFP} == 1$, accesses to this register from EL1 and EL2 are trapped to EL3.

G6.2.52 HACR, Hyp Auxiliary Configuration Register

The HACR characteristics are:

Purpose

Controls trapping to Hyp mode of IMPLEMENTATION DEFINED aspects of Non-secure EL1 or EL0 operation.

Configurations

AArch32 System register HACR is architecturally mapped to AArch64 System register [HACR_EL2](#).

If EL2 is not implemented, this register is RES0 from EL3.

RW fields in this register reset to architecturally UNKNOWN values.

Attributes

HACR is a 32-bit register.

Field descriptions

The HACR bit assignments are:



IMPLEMENTATION DEFINED, bits [31:0]

IMPLEMENTATION DEFINED.

Accessing the HACR

This register can be read using MRC with the following syntax:

MRC <syntax>

This register can be written using MCR with the following syntax:

MCR <syntax>

This syntax is encoded with the following settings in the instruction encoding:

<syntax>	opc1	opc2	CRn	coproc	CRm
p15, 4, <Rt>, c1, c1, 7	100	111	0001	1111	0001

Accessibility

The register is accessible in software as follows:

Control			Accessibility			
E2H	TGE	NS	EL0	EL1	EL2	EL3
x	x	0	-	-	n/a	-
x	0	1	-	-	RW	RW
x	1	1	-	n/a	RW	RW

Traps and Enables

For a description of the prioritization of any generated exceptions, see [Synchronous exception prioritization for exceptions taken to AArch32 state on page G1-4344](#) for exceptions taken to AArch32 state and [Synchronous exception prioritization for exceptions taken to AArch64 on page D1-1827](#) for exceptions taken to AArch64 state. Subject to the prioritization rules:

- When EL2 is implemented and is using AArch64 and $(SCR_EL3.NS == 1) \ \&\& \ (HCR_EL2.E2H == 0)$:
 - If $HSTR_EL2.T1 == 1$, Non-secure accesses to this register from EL1 are trapped to EL2.
- When EL2 is implemented and is using AArch64 and $(SCR_EL3.NS == 1) \ \&\& \ (HCR_EL2.E2H == 1) \ \&\& \ (HCR_EL2.TGE == 0)$:
 - If $HSTR_EL2.T1 == 1$, Non-secure accesses to this register from EL1 are trapped to EL2.
- When EL2 is implemented and is using AArch32 and $SCR_EL3.NS == 1$:
 - If $HSTR.T1 == 1$, Non-secure accesses to this register from EL1 are trapped to Hyp mode.

G6.2.53 HACTLR, Hyp Auxiliary Control Register

The HACTLR characteristics are:

Purpose

Controls IMPLEMENTATION DEFINED features of Hyp mode operation.

Configurations

AArch32 System register HACTLR is architecturally mapped to AArch64 System register [ACTLR_EL2](#)[31:0].

If EL2 is not implemented, this register is RES0 from EL3.

RW fields in this register reset to architecturally UNKNOWN values.

Attributes

HACTLR is a 32-bit register.

Field descriptions

The HACTLR bit assignments are:



IMPLEMENTATION DEFINED, bits [31:0]

IMPLEMENTATION DEFINED.

Accessing the HACTLR

This register can be read using MRC with the following syntax:

MRC <syntax>

This register can be written using MCR with the following syntax:

MCR <syntax>

This syntax is encoded with the following settings in the instruction encoding:

<syntax>	opc1	opc2	CRn	coproc	CRm
p15, 4, <Rt>, c1, c0, 1	100	001	0001	1111	0000

Accessibility

The register is accessible in software as follows:

Control			Accessibility			
E2H	TGE	NS	EL0	EL1	EL2	EL3
x	x	0	-	-	n/a	-
x	0	1	-	-	RW	RW
x	1	1	-	n/a	RW	RW

Traps and Enables

For a description of the prioritization of any generated exceptions, see *Synchronous exception prioritization for exceptions taken to AArch32 state* on page G1-4344 for exceptions taken to AArch32 state and *Synchronous exception prioritization for exceptions taken to AArch64* on page D1-1827 for exceptions taken to AArch64 state. Subject to the prioritization rules:

- When EL2 is implemented and is using AArch64 and $(SCR_EL3.NS == 1) \ \&\& \ (HCR_EL2.E2H == 0)$:
 - If $HSTR_EL2.T1 == 1$, Non-secure accesses to this register from EL1 are trapped to EL2.
- When EL2 is implemented and is using AArch64 and $(SCR_EL3.NS == 1) \ \&\& \ (HCR_EL2.E2H == 1) \ \&\& \ (HCR_EL2.TGE == 0)$:
 - If $HSTR_EL2.T1 == 1$, Non-secure accesses to this register from EL1 are trapped to EL2.
- When EL2 is implemented and is using AArch32 and $SCR_EL3.NS == 1$:
 - If $HSTR.T1 == 1$, Non-secure accesses to this register from EL1 are trapped to Hyp mode.

G6.2.54 HACTLR2, Hyp Auxiliary Control Register 2

The HACTLR2 characteristics are:

Purpose

Provides additional space to the HACTLR register to hold IMPLEMENTATION DEFINED trap functionality.

Configurations

AArch32 System register HACTLR2 is architecturally mapped to AArch64 System register [ACTLR_EL2](#)[63:32].

In ARMv8.0 and ARMv8.1, it is IMPLEMENTATION DEFINED whether this register is implemented, or whether it causes UNDEFINED exceptions when accessed. The implementation of this register can be detected by examining [ID_MMFR4.AC2](#).

From ARMv8.2 this register must be implemented.

RW fields in this register reset to architecturally UNKNOWN values.

Attributes

HACTLR2 is a 32-bit register.

Field descriptions

The HACTLR2 bit assignments are:



IMPLEMENTATION DEFINED, bits [31:0]

IMPLEMENTATION DEFINED.

Accessing the HACTLR2

This register can be read using MRC with the following syntax:

MRC <syntax>

This register can be written using MCR with the following syntax:

MCR <syntax>

This syntax is encoded with the following settings in the instruction encoding:

<syntax>	opc1	opc2	CRn	coproc	CRm
p15, 4, <Rt>, c1, c0, 3	100	011	0001	1111	0000

Accessibility

The register is accessible in software as follows:

Control			Accessibility			
E2H	TGE	NS	EL0	EL1	EL2	EL3
x	x	0	-	-	n/a	-
x	0	1	-	-	RW	RW
x	1	1	-	n/a	RW	RW

Traps and Enables

For a description of the prioritization of any generated exceptions, see [Synchronous exception prioritization for exceptions taken to AArch32 state on page G1-4344](#) for exceptions taken to AArch32 state and [Synchronous exception prioritization for exceptions taken to AArch64 on page D1-1827](#) for exceptions taken to AArch64 state. Subject to the prioritization rules:

- When EL2 is implemented and is using AArch64 and (SCR_EL3.NS == 1) && (HCR_EL2.E2H == 0):
 - If [HSTR_EL2.T1](#)==1, Non-secure accesses to this register from EL1 are trapped to EL2.
- When EL2 is implemented and is using AArch64 and (SCR_EL3.NS == 1) && (HCR_EL2.E2H == 1) && (HCR_EL2.TGE == 0):
 - If [HSTR_EL2.T1](#)==1, Non-secure accesses to this register from EL1 are trapped to EL2.
- When EL2 is implemented and is using AArch32 and SCR_EL3.NS == 1:
 - If [HSTR.T1](#)==1, Non-secure accesses to this register from EL1 are trapped to Hyp mode.

G6.2.55 HADFSR, Hyp Auxiliary Data Fault Status Register

The HADFSR characteristics are:

Purpose

Provides additional IMPLEMENTATION DEFINED syndrome information for Data Abort exceptions taken to Hyp mode.

Configurations

AArch32 System register HADFSR is architecturally mapped to AArch64 System register [AFSR0_EL2](#).

This is an optional register. An implementation that does not require this register can implement it as RES0.

If EL2 is not implemented, this register is RES0 from EL3.

RW fields in this register reset to architecturally UNKNOWN values.

Attributes

HADFSR is a 32-bit register.

Field descriptions

The HADFSR bit assignments are:



IMPLEMENTATION DEFINED, bits [31:0]

IMPLEMENTATION DEFINED.

Accessing the HADFSR

This register can be read using MRC with the following syntax:

MRC <syntax>

This register can be written using MCR with the following syntax:

MCR <syntax>

This syntax is encoded with the following settings in the instruction encoding:

<syntax>	opc1	opc2	CRn	coproc	CRm
p15, 4, <Rt>, c5, c1, 0	100	000	0101	1111	0001

Accessibility

The register is accessible in software as follows:

Control			Accessibility			
E2H	TGE	NS	EL0	EL1	EL2	EL3
x	x	0	-	-	n/a	-
x	0	1	-	-	RW	RW
x	1	1	-	n/a	RW	RW

Traps and Enables

For a description of the prioritization of any generated exceptions, see [Synchronous exception prioritization for exceptions taken to AArch32 state on page G1-4344](#) for exceptions taken to AArch32 state and [Synchronous exception prioritization for exceptions taken to AArch64 on page D1-1827](#) for exceptions taken to AArch64 state. Subject to the prioritization rules:

- When EL2 is implemented and is using AArch64 and (SCR_EL3.NS == 1) && (HCR_EL2.E2H == 0):
 - If [HSTR_EL2.T5](#)==1, Non-secure accesses to this register from EL1 are trapped to EL2.
- When EL2 is implemented and is using AArch64 and (SCR_EL3.NS == 1) && (HCR_EL2.E2H == 1) && (HCR_EL2.TGE == 0):
 - If [HSTR_EL2.T5](#)==1, Non-secure accesses to this register from EL1 are trapped to EL2.
- When EL2 is implemented and is using AArch32 and SCR_EL3.NS == 1:
 - If [HSTR.T5](#)==1, Non-secure accesses to this register from EL1 are trapped to Hyp mode.

G6.2.56 HAIFSR, Hyp Auxiliary Instruction Fault Status Register

The HAIFSR characteristics are:

Purpose

Provides additional IMPLEMENTATION DEFINED syndrome information for Prefetch Abort exceptions taken to Hyp mode.

Configurations

AArch32 System register HAIFSR is architecturally mapped to AArch64 System register [AFSR1_EL2](#).

This is an optional register. An implementation that does not require this register can implement it as RES0.

If EL2 is not implemented, this register is RES0 from EL3.

RW fields in this register reset to architecturally UNKNOWN values.

Attributes

HAIFSR is a 32-bit register.

Field descriptions

The HAIFSR bit assignments are:



IMPLEMENTATION DEFINED, bits [31:0]

IMPLEMENTATION DEFINED.

Accessing the HAIFSR

This register can be read using MRC with the following syntax:

MRC <syntax>

This register can be written using MCR with the following syntax:

MCR <syntax>

This syntax is encoded with the following settings in the instruction encoding:

<syntax>	opc1	opc2	CRn	coproc	CRm
p15, 4, <Rt>, c5, c1, 1	100	001	0101	1111	0001

Accessibility

The register is accessible in software as follows:

Control			Accessibility			
E2H	TGE	NS	EL0	EL1	EL2	EL3
x	x	0	-	-	n/a	-
x	0	1	-	-	RW	RW
x	1	1	-	n/a	RW	RW

Traps and Enables

For a description of the prioritization of any generated exceptions, see [Synchronous exception prioritization for exceptions taken to AArch32 state on page G1-4344](#) for exceptions taken to AArch32 state and [Synchronous exception prioritization for exceptions taken to AArch64 on page D1-1827](#) for exceptions taken to AArch64 state. Subject to the prioritization rules:

- When EL2 is implemented and is using AArch64 and (SCR_EL3.NS == 1) && (HCR_EL2.E2H == 0):
 - If [HSTR_EL2.T5](#)==1, Non-secure accesses to this register from EL1 are trapped to EL2.
- When EL2 is implemented and is using AArch64 and (SCR_EL3.NS == 1) && (HCR_EL2.E2H == 1) && (HCR_EL2.TGE == 0):
 - If [HSTR_EL2.T5](#)==1, Non-secure accesses to this register from EL1 are trapped to EL2.
- When EL2 is implemented and is using AArch32 and SCR_EL3.NS == 1:
 - If [HSTR.T5](#)==1, Non-secure accesses to this register from EL1 are trapped to Hyp mode.

G6.2.57 HMAIR0, Hyp Auxiliary Memory Attribute Indirection Register 0

The HMAIR0 characteristics are:

Purpose

Provides IMPLEMENTATION DEFINED memory attributes for the memory attribute encodings defined by [HMAIR0](#). These IMPLEMENTATION DEFINED attributes can only provide additional qualifiers for the memory attribute encodings, and cannot change the memory attributes defined in [HMAIR0](#).

Configurations

AArch32 System register HMAIR0 is architecturally mapped to AArch64 System register [AMAIR_EL2](#)[31:0].

If EL2 is not implemented, this register is RES0 from EL3.

RW fields in this register reset to architecturally UNKNOWN values.

Attributes

HMAIR0 is a 32-bit register.

Field descriptions

The HMAIR0 bit assignments are:



If an implementation does not provide any IMPLEMENTATION DEFINED memory attributes, this register is RES0.

IMPLEMENTATION DEFINED, bits [31:0]

IMPLEMENTATION DEFINED.

Accessing the HMAIR0

This register can be read using MRC with the following syntax:

MRC <syntax>

This register can be written using MCR with the following syntax:

MCR <syntax>

This syntax is encoded with the following settings in the instruction encoding:

<syntax>	opc1	opc2	CRn	coproc	CRm
p15, 4, <Rt>, c10, c3, 0	100	000	1010	1111	0011

Accessibility

The register is accessible in software as follows:

Control			Accessibility			
E2H	TGE	NS	EL0	EL1	EL2	EL3
x	x	0	-	-	n/a	-
x	0	1	-	-	RW	RW
x	1	1	-	n/a	RW	RW

Traps and Enables

For a description of the prioritization of any generated exceptions, see [Synchronous exception prioritization for exceptions taken to AArch32 state on page G1-4344](#) for exceptions taken to AArch32 state and [Synchronous exception prioritization for exceptions taken to AArch64 on page D1-1827](#) for exceptions taken to AArch64 state. Subject to the prioritization rules:

- When EL2 is implemented and is using AArch64 and $(SCR_EL3.NS == 1) \ \&\& \ (HCR_EL2.E2H == 0)$:
 - If $HSTR_EL2.T10 == 1$, Non-secure accesses to this register from EL1 are trapped to EL2.
- When EL2 is implemented and is using AArch64 and $(SCR_EL3.NS == 1) \ \&\& \ (HCR_EL2.E2H == 1) \ \&\& \ (HCR_EL2.TGE == 0)$:
 - If $HSTR_EL2.T10 == 1$, Non-secure accesses to this register from EL1 are trapped to EL2.
- When EL2 is implemented and is using AArch32 and $SCR_EL3.NS == 1$:
 - If $HSTR.T10 == 1$, Non-secure accesses to this register from EL1 are trapped to Hyp mode.

G6.2.58 HMAIR1, Hyp Auxiliary Memory Attribute Indirection Register 1

The HMAIR1 characteristics are:

Purpose

Provides IMPLEMENTATION DEFINED memory attributes for the memory attribute encodings defined by [HMAIR1](#). These IMPLEMENTATION DEFINED attributes can only provide additional qualifiers for the memory attribute encodings, and cannot change the memory attributes defined in [HMAIR1](#).

Configurations

AArch32 System register HMAIR1 is architecturally mapped to AArch64 System register [AMAIR_EL2](#)[63:32].

If EL2 is not implemented, this register is RES0 from EL3.

RW fields in this register reset to architecturally UNKNOWN values.

Attributes

HMAIR1 is a 32-bit register.

Field descriptions

The HMAIR1 bit assignments are:



If an implementation does not provide any IMPLEMENTATION DEFINED memory attributes, this register is RES0.

IMPLEMENTATION DEFINED, bits [31:0]

IMPLEMENTATION DEFINED.

Accessing the HMAIR1

This register can be read using MRC with the following syntax:

MRC <syntax>

This register can be written using MCR with the following syntax:

MCR <syntax>

This syntax is encoded with the following settings in the instruction encoding:

<syntax>	opc1	opc2	CRn	coproc	CRm
p15, 4, <Rt>, c10, c3, 1	100	001	1010	1111	0011

Accessibility

The register is accessible in software as follows:

Control			Accessibility			
E2H	TGE	NS	EL0	EL1	EL2	EL3
x	x	0	-	-	n/a	-
x	0	1	-	-	RW	RW
x	1	1	-	n/a	RW	RW

Traps and Enables

For a description of the prioritization of any generated exceptions, see [Synchronous exception prioritization for exceptions taken to AArch32 state on page G1-4344](#) for exceptions taken to AArch32 state and [Synchronous exception prioritization for exceptions taken to AArch64 on page D1-1827](#) for exceptions taken to AArch64 state. Subject to the prioritization rules:

- When EL2 is implemented and is using AArch64 and (SCR_EL3.NS == 1) && (HCR_EL2.E2H == 0):
 - If [HSTR_EL2.T10==1](#), Non-secure accesses to this register from EL1 are trapped to EL2.
- When EL2 is implemented and is using AArch64 and (SCR_EL3.NS == 1) && (HCR_EL2.E2H == 1) && (HCR_EL2.TGE == 0):
 - If [HSTR_EL2.T10==1](#), Non-secure accesses to this register from EL1 are trapped to EL2.
- When EL2 is implemented and is using AArch32 and SCR_EL3.NS == 1:
 - If [HSTR.T10==1](#), Non-secure accesses to this register from EL1 are trapped to Hyp mode.

G6.2.59 HCPTR, Hyp Architectural Feature Trap Register

The HCPTR characteristics are:

Purpose

Controls:

- Trapping to Hyp mode of Non-secure access, at EL1 or EL0, to trace, and to Advanced SIMD and floating-point functionality.
- Hyp mode access to trace, and to Advanced SIMD and floating-point functionality.

———— Note ————

Accesses to this functionality:

- From Non-secure modes other than Hyp mode are also affected by settings in the [CPACR](#) and [NSACR](#).
- From Hyp mode are also affected by settings in the [NSACR](#).

Exceptions generated by the [CPACR](#) and [NSACR](#) controls are higher priority than those generated by the HCPTR controls.

Configurations

AArch32 System register HCPTR is architecturally mapped to AArch64 System register [CPTR_EL2](#).

If EL2 is not implemented, this register is RES0 from EL3.

Some or all RW fields of this register have defined reset values. These apply only if the PE resets into EL2 with EL2 using AArch32, or into EL3 with EL3 using AArch32. Otherwise, RW fields in this register reset to architecturally UNKNOWN values.

Attributes

HCPTR is a 32-bit register.

Field descriptions

The HCPTR bit assignments are:

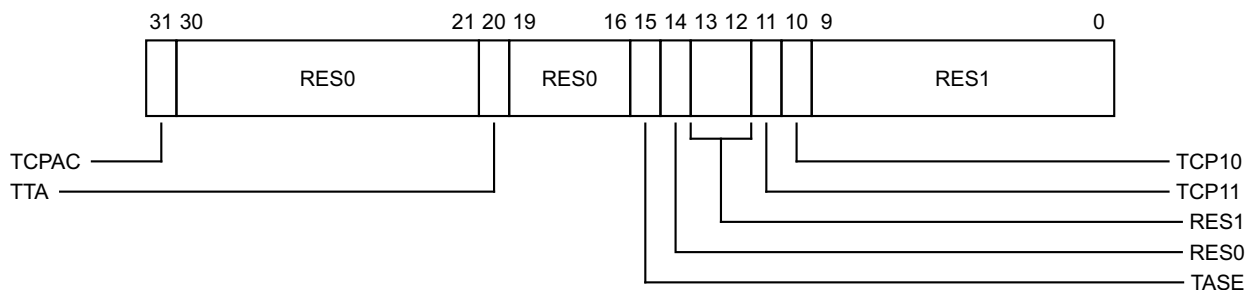

TCPAC, bit [31]

Traps Non-secure EL1 accesses to the [CPACR](#) to Hyp mode.

0 This control does not cause any instructions to be trapped.

1 Non-secure EL1 accesses to the [CPACR](#) are trapped to Hyp mode.

———— Note ————

The [CPACR](#) is not accessible at EL0.

When this register has an architecturally-defined reset value, this field resets to 0.

Bits [30:21]

Reserved, RES0.

TTA, bit [20]

Traps Non-secure System register accesses to all implemented trace registers to Hyp mode.

- 0 This control does not cause any instructions to be trapped.
- 1 Any Non-secure System register access to an implemented trace register is trapped to Hyp mode, unless the access is trapped to EL1 by a **CPACR** or **NSACR** control, or the access is from Non-secure EL0 and the definition of the register in the appropriate trace architecture specification indicates that the register is not accessible from EL0. A trapped instruction generates:
- A Hyp Trap exception, if the exception is taken from Non-secure EL0 or EL1.
 - An Undefined Instruction exception taken to Hyp mode, if the exception is taken from Hyp mode.

If the implementation does not include a trace macrocell, or does not include a System register interface to the trace macrocell registers, it is IMPLEMENTATION DEFINED whether this bit:

- Is RES0.
- Is RES1.
- Can be written from Hyp mode, and from Secure Monitor mode when **SCR.NS** is 1.

If EL3 is implemented and is using AArch32, and the value of **NSACR.NSTRCDIS** is 1, in Non-secure state this field behaves as RAO/WI, regardless of its actual value.

Note

- The ETMv4 architecture does not permit EL0 to access the trace registers. If the implementation includes an ETMv4 implementation, EL0 accesses to the trace registers are UNDEFINED, and a resulting Undefined Instruction exception is higher priority than a HCPTR.TTA Hyp Trap exception.
- The architecture does not provide traps on trace register accesses through the optional memory-mapped external debug interface.

System register accesses to the trace registers can have side-effects. When a System register access is trapped, any side-effects that are normally associated with the access do not occur before the exception is taken.

When this register has an architecturally-defined reset value, if this field is implemented as an RW field, it resets to 0.

Bits [19:16]

Reserved, RES0.

TASE, bit [15]

Traps Non-secure execution of Advanced SIMD instructions to Hyp mode when the value of HCPTR.TCP10 is 0.

- 0 This control does not cause any instructions to be trapped.
- 1 When the value of HCPTR.TCP10 is 0, any attempt to execute an Advanced SIMD instruction in Non-secure state is trapped to Hyp mode, unless it is trapped to EL1 by a **CPACR** or **NSACR** control. A trapped instruction generates:
- A Hyp Trap exception, if the exception is taken from Non-secure EL0 or EL1.
 - An Undefined Instruction exception taken to Hyp mode, if the exception is taken from Hyp mode.

When the value of HCPTR.TCP10 is 1, the value of this field is ignored.

If the implementation does not include Advanced SIMD and floating-point functionality, this field is RES1. Otherwise, it is IMPLEMENTATION DEFINED whether this field is implemented as a RW field. If it is not implemented as a RW field, then it is RAZ/WI.

If EL3 is implemented and is using AArch32, and the value of **NSACR.NSASEDIS** is 1, in Non-secure state this field behaves as RAO/WI, regardless of its actual value. This applies even if the field is implemented as RAZ/WI.

For the list of instructions affected by this field, see *Controls of Advanced SIMD operation that do not apply to floating-point operation* on page E1-2746.

When this register has an architecturally-defined reset value, if this field is implemented as an RW field, it resets to 0.

Bit [14]

Reserved, RES0.

Bits [13:12]

Reserved, RES1.

TCP11, bit [11]

The value of this field is ignored. If this field is programmed with a different value to the TCP10 bit then this field is UNKNOWN on a direct read of the HCPTR.

If the implementation does not include Advanced SIMD and floating-point functionality, this field is RES1.

If EL3 is implemented and is using AArch32, and the value of **NSACR.cp10** is 0, in Non-secure state this field behaves as RAO/WI, regardless of its actual value.

When this register has an architecturally-defined reset value, if this field is implemented as an RW field, it resets to 0.

TCP10, bit [10]

Trap Non-secure accesses to Advanced SIMD and floating-point functionality to Hyp mode:

- | | |
|---|--|
| 0 | This control does not cause any instructions to be trapped. |
| 1 | Any attempted access to Advanced SIMD and floating-point functionality from Non-secure state is trapped to Hyp mode, unless it is trapped to EL1 by a CPACR or NSACR control. A trapped instruction generates: <ul style="list-style-type: none"> • A Hyp Trap exception, if the exception is taken from Non-secure EL0 or EL1. • An Undefined Instruction exception taken to Hyp mode, if the exception is taken from Hyp mode. |

The Advanced SIMD and floating-point features controlled by these fields are:

- Execution of any floating-point or Advanced SIMD instruction.
- Any access to the Advanced SIMD and floating-point registers D0-D31 and their views as S0-S31 and Q0-Q15.
- Any access to the **FPSCR**, **FPSID**, **MVFR0**, **MVFR1**, **MVFR2**, or **FPEXC** System registers.

If the implementation does not include Advanced SIMD and floating-point functionality, this field is RES1.

If EL3 is implemented and is using AArch32, and the value of **NSACR.cp10** is 0, in Non-secure state this field behaves as RAO/WI, regardless of its actual value.

When this register has an architecturally-defined reset value, if this field is implemented as an RW field, it resets to 0.

Bits [9:0]

Reserved, RES1.

Accessing the HCPTR

This register can be read using MRC with the following syntax:

MRC <syntax>

This register can be written using MCR with the following syntax:

MCR <syntax>

This syntax is encoded with the following settings in the instruction encoding:

<syntax>	opc1	opc2	CRn	coproc	CRm
p15, 4, <Rt>, c1, c1, 2	100	010	0001	1111	0001

Accessibility

The register is accessible in software as follows:

Control			Accessibility			
E2H	TGE	NS	EL0	EL1	EL2	EL3
x	x	0	-	-	n/a	-
x	0	1	-	-	RW	RW
x	1	1	-	n/a	RW	RW

Traps and Enables

For a description of the prioritization of any generated exceptions, see [Synchronous exception prioritization for exceptions taken to AArch32 state on page G1-4344](#) for exceptions taken to AArch32 state and [Synchronous exception prioritization for exceptions taken to AArch64 on page D1-1827](#) for exceptions taken to AArch64 state. Subject to the prioritization rules:

- When EL3 is implemented and is using AArch64:
 - If `CPTR_EL3.TCPAC==1`, accesses to this register from EL2 are trapped to EL3.
- When EL2 is implemented and is using AArch64 and `(SCR_EL3.NS == 1) && (HCR_EL2.E2H == 0)`:
 - If `HSTR_EL2.T1==1`, Non-secure accesses to this register from EL1 are trapped to EL2.
- When EL2 is implemented and is using AArch64 and `(SCR_EL3.NS == 1) && (HCR_EL2.E2H == 1) && (HCR_EL2.TGE == 0)`:
 - If `HSTR_EL2.T1==1`, Non-secure accesses to this register from EL1 are trapped to EL2.
- When EL2 is implemented and is using AArch32 and `SCR_EL3.NS == 1`:
 - If `HSTR.T1==1`, Non-secure accesses to this register from EL1 are trapped to Hyp mode.

G6.2.60 HCR, Hyp Configuration Register

The HCR characteristics are:

Purpose

Provides configuration controls for virtualization, including defining whether various Non-secure operations are trapped to Hyp mode.

Configurations

AArch32 System register HCR is architecturally mapped to AArch64 System register [HCR_EL2](#)[31:0].

If EL2 is not implemented, this register is RES0 from EL3.

Some or all RW fields of this register have defined reset values. These apply only if the PE resets into EL2 with EL2 using AArch32, or into EL3 with EL3 using AArch32. Otherwise, RW fields in this register reset to architecturally UNKNOWN values.

Attributes

HCR is a 32-bit register.

Field descriptions

The HCR bit assignments are:

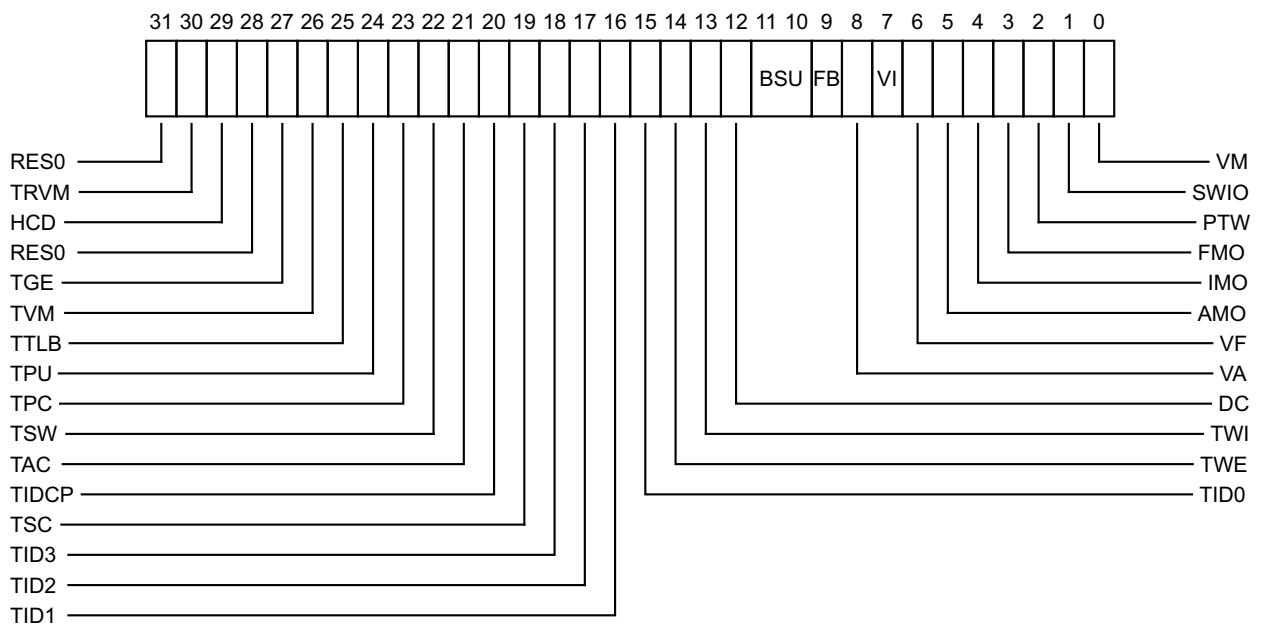

Bit [31]

Reserved, RES0.

TRVM, bit [30]

Trap Reads of Virtual Memory controls. Traps Non-secure EL1 reads of the virtual memory control registers to Hyp mode. The registers for which read accesses are trapped are as follows:

[SCTLR](#), [TTBR0](#), [TTBR1](#), [TTBCR](#), [TTBCR2](#), [DACR](#), [DFSR](#), [IFSR](#), [DFAR](#), [IFAR](#), [ADFSR](#), [AIFSR](#), [PRRR](#), [NMRR](#), [MAIR0](#), [MAIR1](#), [AMAIRO](#), [AMAIR1](#), [CONTEXTIDR](#).

0 This control does not cause any instructions to be trapped.

- 1 Non-secure EL1 read accesses to the specified Virtual Memory controls are trapped to Hyp mode.

When this register has an architecturally-defined reset value, this field resets to 0.

HCD, bit [29]

HVC instruction disable. Disables Non-secure state execution of HVC instructions.

- 0 HVC instruction execution is enabled at EL2 and Non-secure EL1.
- 1 HVC instructions are UNDEFINED at EL2 and Non-secure EL1. The Undefined Instruction exception is taken to the Exception level at which the HVC instruction is executed.

———— Note —————

HVC instructions are always UNDEFINED at EL0.

This bit is only implemented if EL3 is not implemented. Otherwise, it is RES0.

When this register has an architecturally-defined reset value, if this field is implemented as an RW field, it resets to 0.

Bit [28]

Reserved, RES0.

TGE, bit [27]

Trap General Exceptions, from Non-secure EL0.

- 0 This control has no effect on execution at EL0.
- 1 When the value of [SCR.NS](#) is 0, this control has no effect on execution at EL0. When the value of [SCR.NS](#) is 1, then:
- All exceptions that would be routed to EL1 are routed to EL2.
 - The [SCTLR.M](#) bit is treated as being 0 for all purposes other than returning the result of a direct read of [SCTLR](#).
 - The [HCR.{FMO, IMO, AMO}](#) bits are treated as being 1 for all purposes other than returning the result of a direct read of [HCR](#).
 - All virtual interrupts are disabled.
 - Any IMPLEMENTATION DEFINED mechanisms for signaling virtual interrupts are disabled.
 - An exception return to EL1 is treated as an illegal exception return.
 - Monitor mode execution of an MSR or CPS instruction that changes [CPSR.M](#) to a Non-secure EL1 mode is an illegal change to [PSTATE.M](#). For more information see [Illegal changes to PSTATE.M on page G1-4336](#).

Also, when [HCR.TGE](#) is 1:

- If EL3 is using AArch32, an attempt to change from a Secure PL1 mode to a Non-secure EL1 mode by changing [SCR.NS](#) from 0 to 1 results in [SCR.NS](#) remaining as 0.
- The [HDCR.{TDRA, TDOSA, TDA, TDE}](#) bits are ignored and treated as being 1 other than for the purpose of a direct read of [HDCR](#).

In the following cases the field resets to 0:

- The PE resets into EL3 with EL3 using AArch32.
- The PE resets into EL2 with EL2 using AArch32.

Otherwise, the field reset value is architecturally UNKNOWN.

When this register has an architecturally-defined reset value, this field resets to 0.

TVM, bit [26]

Trap Virtual Memory controls. Traps Non-secure EL1 writes to the virtual memory control registers to Hyp mode. The registers for which write accesses are trapped are as follows:

[SCTLR](#), [TTBR0](#), [TTBR1](#), [TTBCR](#), [TTBCR2](#), [DACR](#), [DFSR](#), [IFSR](#), [DFAR](#), [IFAR](#), [ADFSR](#), [AIFSR](#), [PRRR](#), [NMRR](#), [MAIRO](#), [MAIR1](#), [AMAIRO](#), [AMAIR1](#), [CONTEXTIDR](#).

- 0 This control does not cause any instructions to be trapped.
- 1 Non-secure EL1 write accesses to EL1 virtual memory control registers are trapped to Hyp mode.

When this register has an architecturally-defined reset value, this field resets to 0.

TTLB, bit [25]

Trap TLB maintenance instructions. Traps Non-secure EL1 execution of a TLBI instruction to Hyp mode. This applies to the following instructions:

[TLBIALLIS](#), [TLBIMVAIS](#), [TLBIASIDIS](#), [TLBIMVAAIS](#), [TLBIMVALIS](#), [TLBIMVAALIS](#), [ITLBIALL](#), [ITLBIMVA](#), [ITLBIASID](#), [DTLBIALL](#), [DTLBIMVA](#), [DTLBIASID](#), [TLBIALL](#), [TLBIMVA](#), [TLBIASID](#), [TLBIMVAA](#), [TLBIMVAL](#), [TLBIMVAAL](#)

- 0 This control does not cause any instructions to be trapped.
- 1 Non-secure EL1 accesses to TLB maintenance instructions are trapped to Hyp mode.

When this register has an architecturally-defined reset value, this field resets to 0.

TPU, bit [24]

Trap cache maintenance instructions that operate to the Point of Unification. Traps Non-secure EL1 execution of those cache maintenance instructions to Hyp mode. This applies to the following instructions:

[ICIMVAU](#), [ICIALLU](#), [ICIALUIS](#), [DCCMVAU](#).

———— **Note** —————

An Undefined Instruction exception generated at EL0 is higher priority than this trap to EL2, and these instructions are always UNDEFINED at EL0.

- 0 This control does not cause any instructions to be trapped.
- 1 Non-secure EL1 execution of the specified instructions is trapped to Hyp mode.

When this register has an architecturally-defined reset value, this field resets to 0.

TPC, bit [23]

Trap data or unified cache maintenance instructions that operate to the Point of Coherency. Traps Non-secure EL1 execution of those cache maintenance instructions to Hyp mode. This applies to the following instructions:

[DCIMVAC](#), [DCCIMVAC](#), [DCCMVAC](#).

———— **Note** —————

An Undefined Instruction exception generated at EL0 is higher priority than this trap to EL2, and these instructions are always UNDEFINED at EL0.

- 0 This control does not cause any instructions to be trapped.
- 1 Non-secure execution of the specified instructions is trapped to Hyp mode.

When this register has an architecturally-defined reset value, this field resets to 0.

TSW, bit [22]

Trap data or unified cache maintenance instructions that operate by Set/Way. Traps Non-secure EL1 execution of those cache maintenance instructions by set/way to Hyp mode. This applies to the following instructions:

[DCISW](#), [DCCSW](#), [DCCISW](#).

———— **Note** ————

An Undefined Instruction exception generated at EL0 is higher priority than this trap to EL2, and these instructions are always UNDEFINED at EL0.

- 0 This control does not cause any instructions to be trapped.
1 Non-secure execution of the specified instructions is trapped to Hyp mode.

When this register has an architecturally-defined reset value, this field resets to 0.

TAC, bit [21]

Trap Auxiliary Control Registers. Traps Non-secure EL1 accesses to the Auxiliary Control Registers to Hyp mode, from both Execution states. This applies to the following register accesses: [ACTLR](#) and, if implemented, [ACTLR2](#).

- 0 This control does not cause any instructions to be trapped.
1 Non-secure EL1 accesses to the specified registers are trapped to Hyp mode.

When this register has an architecturally-defined reset value, this field resets to 0.

TIDCP, bit [20]

Trap IMPLEMENTATION DEFINED functionality. Traps Non-secure EL1 accesses to the encodings for IMPLEMENTATION DEFINED System Registers to Hyp mode.

MCR and MRC instructions accessing the following encodings:

- All coproc==p15, CRn==c9, Opcode1 = {0-7}, CRm == {c0-c2, c5-c8}, opcode2 == {0-7}.
- All coproc==p15, CRn==c10, Opcode1 =={0-7}, CRm == {c0, c1, c4, c8}, opcode2 == {0-7}.
- All coproc==p15, CRn==c11, Opcode1=={0-7}, CRm == {c0-c8, c15}, opcode2 == {0-7}.

When HCR.TIDCP is set to 1, it is IMPLEMENTATION DEFINED whether any of this functionality accessed from Non-secure EL0 is trapped to Hyp mode. If it is not, it is UNDEFINED, and the PE takes an Undefined Instruction exception to Non-secure Undefined mode.

- 0 This control does not cause any instructions to be trapped.
1 Non-secure EL1 accesses to the specified System register encodings for IMPLEMENTATION DEFINED functionality are trapped to Hyp mode.

When this register has an architecturally-defined reset value, this field resets to 0.

TSC, bit [19]

Trap SMC instructions. Traps Non-secure EL1 execution of SMC instructions to Hyp mode.

- 0 This control does not cause any instructions to be trapped.
1 Any attempt to execute an SMC instruction at Non-secure EL1 is trapped to Hyp mode, regardless of the value of [SCR.SCD](#).

The ARMv8-A architecture permits, but does not require, this trap to apply to conditional SMC instructions that fail their condition code check, in the same way as with traps on other conditional instructions.

———— **Note** ————

- This trap is only implemented if the implementation includes EL3.
- SMC instructions are always UNDEFINED at PL0.
- This bit traps execution of the SMC instruction. It is not a routing control for the SMC exception. Hyp Trap exceptions and SMC exceptions have different preferred return addresses.

When this register has an architecturally-defined reset value, this field resets to 0.

TID3, bit [18]

Trap ID group 3. Traps Non-secure EL1 reads of the following registers to Hyp mode:

[ID_PFR0](#), [ID_PFR1](#), [ID_DFR0](#), [ID_AFR0](#), [ID_MMFR0](#), [ID_MMFR1](#), [ID_MMFR2](#), [ID_MMFR3](#), [ID_ISAR0](#), [ID_ISAR1](#), [ID_ISAR2](#), [ID_ISAR3](#), [ID_ISAR4](#), [ID_ISAR5](#), [MVFR0](#), [MVFR1](#), [MVFR2](#), and [ID_MMFR4](#), except that if [ID_MMFR4](#) is implemented as RAZ/WI then it is IMPLEMENTATION DEFINED whether accesses to [ID_MMFR4](#) are trapped.

Also an MRC access to any of the following encodings:

- coproc==p15, opc1 == 0, CRn == c0, CRm == {c3-c7}, opc2 == {0,1}.
- coproc==p15, opc1 == 0, CRn == c0, CRm == c3, opc2 == 2.
- coproc==p15, opc1 == 0, CRn == c0, CRm == c5, opc2 == {4,5}.

It is IMPLEMENTATION DEFINED whether this bit traps MRC accesses to the following encodings:

- coproc==p15, opc1 == 0, CRn == c0, CRm == c2, opc2 == 7.
- coproc==p15, opc1 == 0, CRn == c0, CRm == c3, opc2 == {3-7}.
- coproc==p15, opc1 == 0, CRn == c0, CRm == {c4, c6, c7}, opc2 == {2-7}.
- coproc==p15, opc1 == 0, CRn == c0, CRm == c5, opc2 == {2, 3, 6, 7}.

0 This control does not cause any instructions to be trapped.

1 The specified Non-secure EL1 read accesses to ID group 3 registers are trapped to Hyp mode.

When this register has an architecturally-defined reset value, this field resets to 0.

TID2, bit [17]

Trap ID group 2. Traps the following register accesses to Hyp mode:

- Non-secure EL1 and EL0 reads of the [CTR](#), [CCSIDR](#), [CLIDR](#), and [CSSELR](#).
- Non-secure EL1 and EL0 writes to the [CSSELR](#).

0 This control does not cause any instructions to be trapped.

1 The specified Non-secure EL1 and EL0 accesses to ID group 2 registers are trapped to Hyp mode.

When this register has an architecturally-defined reset value, this field resets to 0.

TID1, bit [16]

Trap ID group 1. Traps Non-secure EL1 reads of the following registers to Hyp mode:

[TCMTR](#), [TLBTR](#), [REVIDR](#), [AIDR](#).

0 This control does not cause any instructions to be trapped.

1 The specified Non-secure EL1 read accesses to ID group 1 registers are trapped to Hyp mode.

When this register has an architecturally-defined reset value, this field resets to 0.

TID0, bit [15]

Trap ID group 0. Traps the following register accesses to Hyp mode:

- Non-secure EL1 reads of the [JIDR](#) and [FPSID](#).
- If the [JIDR](#) is RAZ from Non-secure EL0, Non-secure EL0 reads of the [JIDR](#).

————— Note —————

- It is IMPLEMENTATION DEFINED whether the [JIDR](#) is RAZ or UNDEFINED at EL0. If it is UNDEFINED at EL0 then the Undefined Instruction exception takes precedence over this trap.
- The [FPSID](#) is not accessible at EL0.
- Writes to the [FPSID](#) are ignored, and not trapped by this control.

0 This control does not cause any instructions to be trapped.

- 1 The specified Non-secure EL1 read accesses to ID group 0 registers are trapped to Hyp mode.

When this register has an architecturally-defined reset value, this field resets to 0.

TWE, bit [14]

Traps Non-secure EL0 and EL1 execution of WFE instructions to Hyp mode:

- 0 This control does not cause any instructions to be trapped.
- 1 Any attempt to execute a WFE instruction at Non-secure EL0 or EL1 is trapped to Hyp mode, if the instruction would otherwise have caused the PE to enter a low-power state and it is not trapped by `SCTLR.nTWE`.

The attempted execution of a conditional WFE instruction is only trapped if the instruction passes its condition code check.

———— Note ————

Since a WFE can complete at any time, even without a Wakeup event, the traps on WFE are not guaranteed to be taken, even if the WFE is executed when there is no Wakeup event. The only guarantee is that if the instruction does not complete in finite time in the absence of a Wakeup event, the trap will be taken.

When this register has an architecturally-defined reset value, this field resets to 0.

TWI, bit [13]

Traps Non-secure EL0 and EL1 execution of WFI instructions to Hyp mode.

- 0 This control does not cause any instructions to be trapped.
- 1 Any attempt to execute a WFI instruction at Non-secure EL0 or EL1 is trapped to Hyp mode, if the instruction would otherwise have caused the PE to enter a low-power state and it is not trapped by `SCTLR.nTWI`.

The attempted execution of a conditional WFI instruction is only trapped if the instruction passes its condition code check.

———— Note ————

Since a WFI can complete at any time, even without a Wakeup event, the traps on WFI are not guaranteed to be taken, even if the WFI is executed when there is no Wakeup event. The only guarantee is that if the instruction does not complete in finite time in the absence of a Wakeup event, the trap will be taken.

When this register has an architecturally-defined reset value, this field resets to 0.

DC, bit [12]

Default Cacheability.

- 0 This control has no effect on the Non-secure EL1&0 translation regime.
- 1 In Non-secure state:
- The `SCTLR.M` field behaves as 0 for all purposes other than a direct read of the value of the field.
 - The `HCR.VM` field behaves as 1 for all purposes other than a direct read of the value of the field.
 - The memory type produced by the first stage of the EL1&0 translation regime is Normal Non-Shareable, Inner Write-Back Read-Allocate Write-Allocate, Outer Write-Back Read-Allocate Write-Allocate.

This field has no effect on the EL2 and EL3 translation regimes.

This field is permitted to be cached in a TLB.

When this register has an architecturally-defined reset value, this field resets to 0.

BSU, bits [11:10]

Barrier Shareability upgrade. This field determines the minimum shareability domain that is applied to any barrier instruction executed from Non-secure EL1 or Non-secure EL0:

00	No effect
01	Inner Shareable
10	Outer Shareable
11	Full system

This value is combined with the specified level of the barrier held in its instruction, using the same principles as combining the shareability attributes from two stages of address translation.

When this register has an architecturally-defined reset value, this field resets to 0.

FB, bit [9]

Force broadcast. Causes the following instructions to be broadcast within the Inner Shareable domain when executed from Non-secure EL1:

[BPIALL](#), [TLBIALL](#), [TLBIMVA](#), [TLBIASID](#), [DTLBIALL](#), [DTLBIMVA](#), [DTLBIASID](#), [ITLBIALL](#), [ITLBIMVA](#), [ITLBIASID](#), [TLBIMVAA](#), [ICIALLU](#), [TLBIMVAL](#), [TLBIMVAAL](#).

0	This field has no effect on the operation of the specified instructions.
1	When one of the specified instruction is executed at Non-secure EL1, the instruction is broadcast within the Inner Shareable shareability domain.

When this register has an architecturally-defined reset value, this field resets to 0.

VA, bit [8]

Virtual SError interrupt exception.

0	This mechanism is not making a virtual SError interrupt pending.
1	A virtual SError interrupt is pending because of this mechanism.

The virtual SError interrupt is enabled only when the value of HCR.{TGE, AMO} is {0, 1}.

The Guest OS cannot distinguish the virtual exception from the corresponding physical exception.

When this register has an architecturally-defined reset value, this field resets to 0.

VI, bit [7]

Virtual IRQ exception.

0	This mechanism is not making a virtual IRQ pending.
1	A virtual IRQ is pending because of this mechanism.

The virtual IRQ is enabled only when the value of HCR.{TGE, IMO} is {0, 1}.

The Guest OS cannot distinguish the virtual exception from the corresponding physical exception.

When this register has an architecturally-defined reset value, this field resets to 0.

VF, bit [6]

Virtual FIQ exception.

0	This mechanism is not making a virtual FIQ pending.
1	A virtual FIQ is pending because of this mechanism.

The virtual FIQ is enabled only when the value of HCR.{TGE, FMO} is {0, 1}.

The Guest OS cannot distinguish the virtual exception from the corresponding physical exception.

When this register has an architecturally-defined reset value, this field resets to 0.

AMO, bit [5]

SError interrupt Mask Override. When this bit is set to 1, it overrides the effect of [CPSR.A](#), and enables virtual exception signaling by the VA bit.

If the value of HCR.TGE is 0, then Virtual SError Interrupts are enabled in Non-secure state.

If the value of HCR.TGE is 1, then in Non-secure state the HCR.AMO bit behaves as 1 for all purposes other than a direct read of the value of the bit.

When this register has an architecturally-defined reset value, this field resets to 0.

IMO, bit [4]

IRQ Mask Override. When this bit is set to 1, it overrides the effect of CPSR.I, and enables virtual exception signaling by the VI bit.

If the value of HCR.TGE is 0, then Virtual IRQ interrupts are enabled in the Non-secure state.

If the value of HCR.TGE is 1, then in Non-secure state the HCR.IMO bit behaves as 1 for all purposes other than a direct read of the value of the bit.

When this register has an architecturally-defined reset value, this field resets to 0.

FMO, bit [3]

FIQ Mask Override. When this bit is set to 1, it overrides the effect of CPSR.F, and enables virtual exception signaling by the VF bit.

If the value of HCR.TGE is 0, then Virtual FIQ interrupts are enabled in the Non-secure state.

If the value of HCR.TGE is 1, then in Non-secure state the HCR.FMO bit behaves as 1 for all purposes other than a direct read of the value of the bit.

When this register has an architecturally-defined reset value, this field resets to 0.

PTW, bit [2]

Protected Table Walk. In the Non-secure PL1&0 translation regime, a translation table access made as part of a stage 1 translation table walk is subject to a stage 2 translation. The combining of the memory type attributes from the two stages of translation means the access might be made to a type of Device memory. If this occurs then the value of this bit determines the behavior:

0 The translation table walk occurs as if it is to Normal Non-cacheable memory. This means it can be made speculatively.

1 The memory access generates a stage 2 Permission fault.

This field is permitted to be cached in a TLB.

When this register has an architecturally-defined reset value, this field resets to 0.

SWIO, bit [1]

Set/Way Invalidation Override. Causes Non-secure EL1 execution of the data cache invalidate by set/way instructions to perform a data cache clean and invalidate by set/way.

0 This control has no effect on the operation of data cache invalidate by set/way instructions.

1 Data cache invalidate by set/way instructions perform a data cache clean and invalidate by set/way.

When this bit is set to 1, DCISW performs the same invalidation as a DCCISW instruction.

As a result of changes to the behavior of DCISW, this bit is redundant in ARMv8. This bit can be implemented as RES1.

When this register has an architecturally-defined reset value, if this field is implemented as an RW field, it resets to 0.

VM, bit [0]

Virtualization enable. Enables stage 2 address translation for the Non-secure EL1&0 translation regime. Possible values of this bit are:

0 Non-secure EL1&0 stage 2 address translation disabled.

1 Non-secure EL1&0 stage 2 address translation enabled.

If the HCR.DC bit is set to 1, then the behavior of the PE when executing in a Non-secure mode other than Hyp mode is consistent with HCR.VM being 1, regardless of the actual value of HCR.VM, other than the value returned by an explicit read of HCR.VM.

When the value of this bit is 1, data cache invalidate instructions executed at Non-secure EL1 perform a data cache clean and invalidate. For the invalidate by set/way instruction this behavior applies regardless of the value of the HCR.SWIO bit.

This bit is permitted to be cached in a TLB.

When this register has an architecturally-defined reset value, this field resets to 0.

Accessing the HCR

This register can be read using MRC with the following syntax:

MRC <syntax>

This register can be written using MCR with the following syntax:

MCR <syntax>

This syntax is encoded with the following settings in the instruction encoding:

<syntax>	opc1	opc2	CRn	coproc	CRm
p15, 4, <Rt>, c1, c1, 0	100	000	0001	1111	0001

Accessibility

The register is accessible in software as follows:

Control			Accessibility			
E2H	TGE	NS	EL0	EL1	EL2	EL3
x	x	0	-	-	n/a	-
x	0	1	-	-	RW	RW
x	1	1	-	n/a	RW	RW

Traps and Enables

For a description of the prioritization of any generated exceptions, see [Synchronous exception prioritization for exceptions taken to AArch32 state on page G1-4344](#) for exceptions taken to AArch32 state and [Synchronous exception prioritization for exceptions taken to AArch64 on page D1-1827](#) for exceptions taken to AArch64 state. Subject to the prioritization rules:

- When EL2 is implemented and is using AArch64 and (SCR_EL3.NS == 1) && (HCR_EL2.E2H == 0):
 - If HSTR_EL2.T1==1, Non-secure accesses to this register from EL1 are trapped to EL2.
- When EL2 is implemented and is using AArch64 and (SCR_EL3.NS == 1) && (HCR_EL2.E2H == 1) && (HCR_EL2.TGE == 0):
 - If HSTR_EL2.T1==1, Non-secure accesses to this register from EL1 are trapped to EL2.
- When EL2 is implemented and is using AArch32 and SCR_EL3.NS == 1:
 - If HSTR.T1==1, Non-secure accesses to this register from EL1 are trapped to Hyp mode.

G6.2.61 HCR2, Hyp Configuration Register 2

The HCR2 characteristics are:

Purpose

Provides additional configuration controls for virtualization.

Configurations

AArch32 System register HCR2 is architecturally mapped to AArch64 System register [HCR_EL2](#)[63:32].

If EL2 is not implemented, this register is RES0 from EL3.

Some or all RW fields of this register have defined reset values. These apply only if the PE resets into EL2 with EL2 using AArch32, or into EL3 with EL3 using AArch32. Otherwise, RW fields in this register reset to architecturally UNKNOWN values.

Attributes

HCR2 is a 32-bit register.

Field descriptions

The HCR2 bit assignments are:

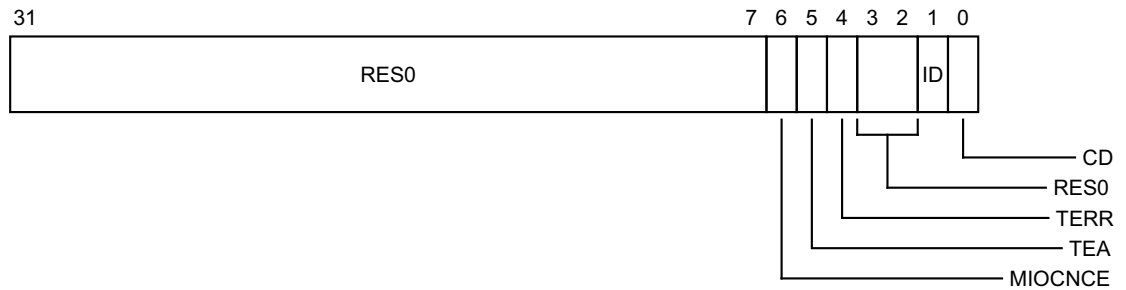

Bits [31:7]

Reserved, RES0.

MIOCNCNE, bit [6]

Mismatched Inner/Outer Cacheable Non-Coherency Enable, for the Non-secure PL1&0 translation regime.

- 0 For the Non-secure PL1&0 translation regime, for permitted accesses to a memory location that use a common definition of the Shareability and Cacheability of the location, there must be no loss of coherency if the Inner Cacheability attribute for those accesses differs from the Outer Cacheability attribute.
- 1 For the Non-secure PL1&0 translation regime, for permitted accesses to a memory location that use a common definition of the Shareability and Cacheability of the location, there might be a loss of coherency if the Inner Cacheability attribute for those accesses differs from the Outer Cacheability attribute.

For more information see [Mismatched memory attributes](#) on page E2-2792.

The value of this field has no effect on translation regimes other than the Non-secure PL1&0 translation regime.

This field can be implemented as RAZ/WI.

If this field is implemented as an RW field, it resets to a value that is architecturally UNKNOWN.

TEA, bit [5]

Route synchronous External Abort exceptions to EL2. If the RAS Extension is implemented, the possible values of this bit are:

- 0 Do not route synchronous External Abort exceptions from Non-secure EL0 and EL1 to EL2.
- 1 Route synchronous External Abort exceptions from Non-secure EL0 and EL1 to EL2, if not routed to EL3.

This bit resets to zero on a Warm reset into AArch32 state.

When the RAS Extension is not implemented, this field is RES0.

When this register has an architecturally-defined reset value, this field resets to 0.

TERR, bit [4]

Trap Error record accesses. If the RAS Extension is implemented, the possible values of this bit are:

- 0 Do not trap accesses to error record registers from Non-secure EL1 to EL2.
- 1 Accesses to the ER* registers from Non-secure EL1 generate a Trap exception to EL2.

This bit resets to zero on a Warm reset into AArch32 state.

When the RAS Extension is not implemented, this field is RES0.

When this register has an architecturally-defined reset value, this field resets to 0.

Bits [3:2]

Reserved, RES0.

ID, bit [1]

Stage 2 Instruction access cacheability disable. For the Non-secure PL1&0 translation regime, when `HCR.VM==1`, this control forces all stage 2 translations for instruction accesses to Normal memory to be Non-cacheable.

- 0 This control has no effect on stage 2 of the Non-secure PL1&0 translation regime.
- 1 For the Non-secure PL1&0 translation regime, forces all stage 2 translations for instruction accesses to Normal memory to be Non-cacheable.

This bit has no effect on the EL2 translation regime.

When this register has an architecturally-defined reset value, this field resets to 0.

CD, bit [0]

Stage 2 Data access cacheability disable. When `HCR.VM==1`, this forces all stage 2 translations for data accesses and translation table walks to Normal memory to be Non-cacheable for the Non-secure PL1&0 translation regime.

- 0 This control has no effect on stage 2 of the Non-secure PL1&0 translation regime for data accesses and translation table walks.
- 1 For the Non-secure PL1&0 translation regime, forces all stage 2 translations for data accesses and translation table walks to Normal memory to be Non-cacheable.

This bit has no effect on the EL2 translation regime.

When this register has an architecturally-defined reset value, this field resets to 0.

Accessing the HCR2

This register can be read using MRC with the following syntax:

```
MRC <syntax>
```

This register can be written using MCR with the following syntax:

```
MCR <syntax>
```

This syntax is encoded with the following settings in the instruction encoding:

<syntax>	opc1	opc2	CRn	coproc	CRm
p15, 4, <Rt>, c1, c1, 4	100	100	0001	1111	0001

Accessibility

The register is accessible in software as follows:

Control			Accessibility			
E2H	TGE	NS	EL0	EL1	EL2	EL3
x	x	0	-	-	n/a	-
x	0	1	-	-	RW	RW
x	1	1	-	n/a	RW	RW

Traps and Enables

For a description of the prioritization of any generated exceptions, see [Synchronous exception prioritization for exceptions taken to AArch32 state on page G1-4344](#) for exceptions taken to AArch32 state and [Synchronous exception prioritization for exceptions taken to AArch64 on page D1-1827](#) for exceptions taken to AArch64 state. Subject to the prioritization rules:

- When EL2 is implemented and is using AArch64 and (SCR_EL3.NS == 1) && (HCR_EL2.E2H == 0):
 - If HSTR_EL2.T1==1, Non-secure accesses to this register from EL1 are trapped to EL2.
- When EL2 is implemented and is using AArch64 and (SCR_EL3.NS == 1) && (HCR_EL2.E2H == 1) && (HCR_EL2.TGE == 0):
 - If HSTR_EL2.T1==1, Non-secure accesses to this register from EL1 are trapped to EL2.
- When EL2 is implemented and is using AArch32 and SCR_EL3.NS == 1:
 - If HSTR.T1==1, Non-secure accesses to this register from EL1 are trapped to Hyp mode.

G6.2.62 HDFAR, Hyp Data Fault Address Register

The HDFAR characteristics are:

Purpose

Holds the virtual address of the faulting address that caused a synchronous Data Abort exception that is taken to Hyp mode.

Configurations

AArch32 System register HDFAR is architecturally mapped to AArch64 System register [FAR_EL2](#)[31:0].

AArch32 System register HDFAR is architecturally mapped to AArch32 System register [DFAR](#) (S) when EL2 is implemented.

If EL2 is not implemented, this register is RES0 from EL3.

RW fields in this register reset to architecturally UNKNOWN values.

Attributes

HDFAR is a 32-bit register.

Field descriptions

The HDFAR bit assignments are:

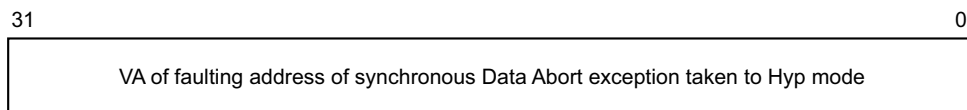

Bits [31:0]

VA of faulting address of synchronous Data Abort exception taken to Hyp mode.

On a Prefetch Abort exception, this register is UNKNOWN.

Any execution in a Non-secure EL1 or Non-secure EL0 mode makes this register UNKNOWN.

Accessing the HDFAR

This register can be read using MRC with the following syntax:

MRC <syntax>

This register can be written using MCR with the following syntax:

MCR <syntax>

This syntax is encoded with the following settings in the instruction encoding:

<syntax>	opc1	opc2	CRn	coproc	CRm
p15, 4, <Rt>, c6, c0, 0	100	000	0110	1111	0000

Accessibility

The register is accessible in software as follows:

Control			Accessibility			
E2H	TGE	NS	EL0	EL1	EL2	EL3
x	x	0	-	-	n/a	-
x	0	1	-	-	RW	RW
x	1	1	-	n/a	RW	RW

Traps and Enables

For a description of the prioritization of any generated exceptions, see [Synchronous exception prioritization for exceptions taken to AArch32 state on page G1-4344](#) for exceptions taken to AArch32 state and [Synchronous exception prioritization for exceptions taken to AArch64 on page D1-1827](#) for exceptions taken to AArch64 state. Subject to the prioritization rules:

- When EL2 is implemented and is using AArch64 and (SCR_EL3.NS == 1) && (HCR_EL2.E2H == 0):
 - If [HSTR_EL2.T6](#)==1, Non-secure accesses to this register from EL1 are trapped to EL2.
- When EL2 is implemented and is using AArch64 and (SCR_EL3.NS == 1) && (HCR_EL2.E2H == 1) && (HCR_EL2.TGE == 0):
 - If [HSTR_EL2.T6](#)==1, Non-secure accesses to this register from EL1 are trapped to EL2.
- When EL2 is implemented and is using AArch32 and SCR_EL3.NS == 1:
 - If [HSTR.T6](#)==1, Non-secure accesses to this register from EL1 are trapped to Hyp mode.

G6.2.63 HIFAR, Hyp Instruction Fault Address Register

The HIFAR characteristics are:

Purpose

Holds the virtual address of the faulting address that caused a synchronous Prefetch Abort exception that is taken to Hyp mode.

Configurations

AArch32 System register HIFAR is architecturally mapped to AArch64 System register [FAR_EL2](#)[63:32].

AArch32 System register HIFAR is architecturally mapped to AArch32 System register [IFAR](#) (S) when EL2 is implemented.

If EL2 is not implemented, this register is RES0 from EL3.

RW fields in this register reset to architecturally UNKNOWN values.

Attributes

HIFAR is a 32-bit register.

Field descriptions

The HIFAR bit assignments are:

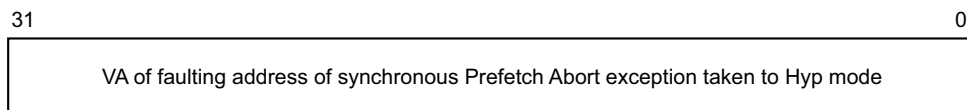

Bits [31:0]

VA of faulting address of synchronous Prefetch Abort exception taken to Hyp mode.

On a Data Abort exception, this register is UNKNOWN.

Any execution in a Non-secure EL1 or Non-secure EL0 mode makes this register UNKNOWN.

Accessing the HIFAR

This register can be read using MRC with the following syntax:

MRC <syntax>

This register can be written using MCR with the following syntax:

MCR <syntax>

This syntax is encoded with the following settings in the instruction encoding:

<syntax>	opc1	opc2	CRn	coproc	CRm
p15, 4, <Rt>, c6, c0, 2	100	010	0110	1111	0000

Accessibility

The register is accessible in software as follows:

Control			Accessibility			
E2H	TGE	NS	EL0	EL1	EL2	EL3
x	x	0	-	-	n/a	-
x	0	1	-	-	RW	RW
x	1	1	-	n/a	RW	RW

Traps and Enables

For a description of the prioritization of any generated exceptions, see [Synchronous exception prioritization for exceptions taken to AArch32 state on page G1-4344](#) for exceptions taken to AArch32 state and [Synchronous exception prioritization for exceptions taken to AArch64 on page D1-1827](#) for exceptions taken to AArch64 state. Subject to the prioritization rules:

- When EL2 is implemented and is using AArch64 and (SCR_EL3.NS == 1) && (HCR_EL2.E2H == 0):
 - If [HSTR_EL2.T6](#)==1, Non-secure accesses to this register from EL1 are trapped to EL2.
- When EL2 is implemented and is using AArch64 and (SCR_EL3.NS == 1) && (HCR_EL2.E2H == 1) && (HCR_EL2.TGE == 0):
 - If [HSTR_EL2.T6](#)==1, Non-secure accesses to this register from EL1 are trapped to EL2.
- When EL2 is implemented and is using AArch32 and SCR_EL3.NS == 1:
 - If [HSTR.T6](#)==1, Non-secure accesses to this register from EL1 are trapped to Hyp mode.

G6.2.64 HMAIR0, Hyp Memory Attribute Indirection Register 0

The HMAIR0 characteristics are:

Purpose

Along with [HMAIR1](#), provides the memory attribute encodings corresponding to the possible AttrIdx values in a Long-descriptor format translation table entry for stage 1 translations for memory accesses from Hyp mode.

AttrIdx[2] indicates the HMAIR register to be used:

- When AttrIdx[2] is 0, HMAIR0 is used.
- When AttrIdx[2] is 1, [HMAIR1](#) is used.

Configurations

AArch32 System register HMAIR0 is architecturally mapped to AArch64 System register [MAIR_EL2](#)[31:0].

If EL2 is not implemented, this register is RES0 from EL3.

RW fields in this register reset to architecturally UNKNOWN values.

Attributes

HMAIR0 is a 32-bit register.

Field descriptions

The HMAIR0 bit assignments are:

When *TTBCR.EAE*==1:

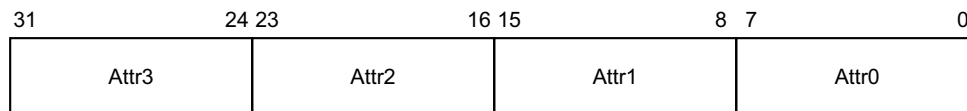

Attr<n>, bits [8n+7:8n], for n = 0 to 3

The memory attribute encoding for an AttrIdx[2:0] entry in a Long descriptor format translation table entry, where:

- AttrIdx[2:0] gives the value of <n> in Attr<n>.
- AttrIdx[2] defines which MAIR to access. Attr7 to Attr4 are in MAIR1, and Attr3 to Attr0 are in MAIR0.

Bits [7:4] are encoded as follows:

Attr<n>[7:4]	Meaning
0000	Device memory. See encoding of Attr<n>[3:0] for the type of Device memory.
00RW, RW not 00	Normal memory, Outer Write-Through Transient
0100	Normal memory, Outer Non-cacheable
01RW, RW not 00	Normal memory, Outer Write-Back Transient
10RW	Normal memory, Outer Write-Through Non-transient
11RW	Normal memory, Outer Write-Back Non-transient

R = Outer Read-Allocate policy, W = Outer Write-Allocate policy.

The meaning of bits [3:0] depends on the value of bits [7:4]:

Attr<n>[3:0]	Meaning when Attr<n>[7:4] is 0000	Meaning when Attr<n>[7:4] is not 0000
0000	Device-nGnRnE memory	UNPREDICTABLE
00RW, RW not 00	UNPREDICTABLE	Normal memory, Inner Write-Through Transient
0100	Device-nGnRE memory	Normal memory, Inner Non-cacheable
01RW, RW not 00	UNPREDICTABLE	Normal memory, Inner Write-Back Transient
1000	Device-nGRE memory	Normal memory, Inner Write-Through Non-transient (RW=00)
10RW, RW not 00	UNPREDICTABLE	Normal memory, Inner Write-Through Non-transient
1100	Device-GRE memory	Normal memory, Inner Write-Back Non-transient (RW=00)
11RW, RW not 00	UNPREDICTABLE	Normal memory, Inner Write-Back Non-transient

R = Inner Read-Allocate policy, W = Inner Write-Allocate policy.

The R and W bits in some Attr<n> fields have the following meanings:

R or W	Meaning
0	No Allocate
1	Allocate

Accessing the HMAIR0

This register can be read using MRC with the following syntax:

MRC <syntax>

This register can be written using MCR with the following syntax:

MCR <syntax>

This syntax is encoded with the following settings in the instruction encoding:

<syntax>	opc1	opc2	CRn	coproc	CRm
p15, 4, <Rt>, c10, c2, 0	100	000	1010	1111	0010

Accessibility

The register is accessible in software as follows:

Control			Accessibility			
E2H	TGE	NS	EL0	EL1	EL2	EL3
x	x	0	-	-	n/a	-
x	0	1	-	-	RW	RW
x	1	1	-	n/a	RW	RW

Traps and Enables

For a description of the prioritization of any generated exceptions, see *Synchronous exception prioritization for exceptions taken to AArch32 state* on page G1-4344 for exceptions taken to AArch32 state and *Synchronous exception prioritization for exceptions taken to AArch64* on page D1-1827 for exceptions taken to AArch64 state. Subject to the prioritization rules:

- When EL2 is implemented and is using AArch64 and $(SCR_EL3.NS == 1) \ \&\& \ (HCR_EL2.E2H == 0)$:
 - If $HSTR_EL2.T10 == 1$, Non-secure accesses to this register from EL1 are trapped to EL2.
- When EL2 is implemented and is using AArch64 and $(SCR_EL3.NS == 1) \ \&\& \ (HCR_EL2.E2H == 1) \ \&\& \ (HCR_EL2.TGE == 0)$:
 - If $HSTR_EL2.T10 == 1$, Non-secure accesses to this register from EL1 are trapped to EL2.
- When EL2 is implemented and is using AArch32 and $SCR_EL3.NS == 1$:
 - If $HSTR.T10 == 1$, Non-secure accesses to this register from EL1 are trapped to Hyp mode.

G6.2.65 HMAIR1, Hyp Memory Attribute Indirection Register 1

The HMAIR1 characteristics are:

Purpose

Along with [HMAIR0](#), provides the memory attribute encodings corresponding to the possible AttrIdx values in a Long-descriptor format translation table entry for stage 1 translations for memory accesses from Hyp mode.

AttrIdx[2] indicates the HMAIR register to be used:

- When AttrIdx[2] is 0, [HMAIR0](#) is used.
- When AttrIdx[2] is 1, HMAIR1 is used.

Configurations

AArch32 System register HMAIR1 is architecturally mapped to AArch64 System register [MAIR_EL2](#)[63:32].

If EL2 is not implemented, this register is RES0 from EL3.

RW fields in this register reset to architecturally UNKNOWN values.

Attributes

HMAIR1 is a 32-bit register.

Field descriptions

The HMAIR1 bit assignments are:

When *TTBCR.EAE*==1:

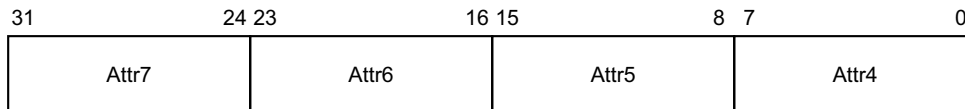

Attr<n>, bits [8(n-4)+7:8(n-4)], for n = 4 to 7

The memory attribute encoding for an AttrIdx[2:0] entry in a Long descriptor format translation table entry, where:

- AttrIdx[2:0] gives the value of <n> in Attr<n>.
- AttrIdx[2] defines which MAIR to access. Attr7 to Attr4 are in MAIR1, and Attr3 to Attr0 are in MAIR0.

Bits [7:4] are encoded as follows:

Attr<n>[7:4]	Meaning
0000	Device memory. See encoding of Attr<n>[3:0] for the type of Device memory.
00RW, RW not 00	Normal memory, Outer Write-Through Transient
0100	Normal memory, Outer Non-cacheable
01RW, RW not 00	Normal memory, Outer Write-Back Transient
10RW	Normal memory, Outer Write-Through Non-transient
11RW	Normal memory, Outer Write-Back Non-transient

R = Outer Read-Allocate policy, W = Outer Write-Allocate policy.

The meaning of bits [3:0] depends on the value of bits [7:4]:

Attr<n>[3:0]	Meaning when Attr<n>[7:4] is 0000	Meaning when Attr<n>[7:4] is not 0000
0000	Device-nGnRnE memory	UNPREDICTABLE
00RW, RW not 00	UNPREDICTABLE	Normal memory, Inner Write-Through Transient
0100	Device-nGnRE memory	Normal memory, Inner Non-cacheable
01RW, RW not 00	UNPREDICTABLE	Normal memory, Inner Write-Back Transient
1000	Device-nGRE memory	Normal memory, Inner Write-Through Non-transient (RW=00)
10RW, RW not 00	UNPREDICTABLE	Normal memory, Inner Write-Through Non-transient
1100	Device-GRE memory	Normal memory, Inner Write-Back Non-transient (RW=00)
11RW, RW not 00	UNPREDICTABLE	Normal memory, Inner Write-Back Non-transient

R = Inner Read-Allocate policy, W = Inner Write-Allocate policy.

The R and W bits in some Attr<n> fields have the following meanings:

R or W	Meaning
0	No Allocate
1	Allocate

Accessing the HMAIR1

This register can be read using MRC with the following syntax:

MRC <syntax>

This register can be written using MCR with the following syntax:

MCR <syntax>

This syntax is encoded with the following settings in the instruction encoding:

<syntax>	opc1	opc2	CRn	coproc	CRm
p15, 4, <Rt>, c10, c2, 1	100	001	1010	1111	0010

Accessibility

The register is accessible in software as follows:

Control			Accessibility			
E2H	TGE	NS	EL0	EL1	EL2	EL3
x	x	0	-	-	n/a	-
x	0	1	-	-	RW	RW
x	1	1	-	n/a	RW	RW

Traps and Enables

For a description of the prioritization of any generated exceptions, see *Synchronous exception prioritization for exceptions taken to AArch32 state* on page G1-4344 for exceptions taken to AArch32 state and *Synchronous exception prioritization for exceptions taken to AArch64* on page D1-1827 for exceptions taken to AArch64 state. Subject to the prioritization rules:

- When EL2 is implemented and is using AArch64 and $(SCR_EL3.NS == 1) \ \&\& \ (HCR_EL2.E2H == 0)$:
 - If $HSTR_EL2.T10 == 1$, Non-secure accesses to this register from EL1 are trapped to EL2.
- When EL2 is implemented and is using AArch64 and $(SCR_EL3.NS == 1) \ \&\& \ (HCR_EL2.E2H == 1) \ \&\& \ (HCR_EL2.TGE == 0)$:
 - If $HSTR_EL2.T10 == 1$, Non-secure accesses to this register from EL1 are trapped to EL2.
- When EL2 is implemented and is using AArch32 and $SCR_EL3.NS == 1$:
 - If $HSTR.T10 == 1$, Non-secure accesses to this register from EL1 are trapped to Hyp mode.

G6.2.66 HPFAR, Hyp IPA Fault Address Register

The HPFAR characteristics are:

Purpose

Holds the faulting IPA for some aborts on a stage 2 translation taken to Hyp mode.

Configurations

AArch32 System register HPFAR is architecturally mapped to AArch64 System register [HPFAR_EL2](#)[31:0].

If EL2 is not implemented, this register is RES0 from EL3.

RW fields in this register reset to architecturally UNKNOWN values.

Attributes

HPFAR is a 32-bit register.

Field descriptions

The HPFAR bit assignments are:

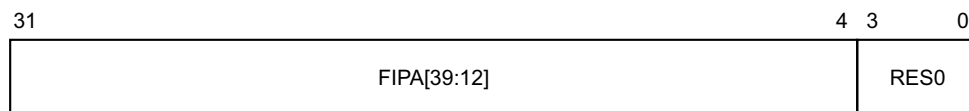

Execution in any Non-secure mode other than Hyp mode makes this register UNKNOWN.

FIPA[39:12], bits [31:4]

Bits [39:12] of the faulting intermediate physical address.

Bits [3:0]

Reserved, RES0.

Accessing the HPFAR

This register can be read using MRC with the following syntax:

MRC <syntax>

This register can be written using MCR with the following syntax:

MCR <syntax>

This syntax is encoded with the following settings in the instruction encoding:

<syntax>	opc1	opc2	CRn	coproc	CRm
p15, 4, <Rt>, c6, c0, 4	100	100	0110	1111	0000

Accessibility

The register is accessible in software as follows:

Control			Accessibility			
E2H	TGE	NS	EL0	EL1	EL2	EL3
x	x	0	-	-	n/a	-
x	0	1	-	-	RW	RW
x	1	1	-	n/a	RW	RW

Traps and Enables

For a description of the prioritization of any generated exceptions, see [Synchronous exception prioritization for exceptions taken to AArch32 state on page G1-4344](#) for exceptions taken to AArch32 state and [Synchronous exception prioritization for exceptions taken to AArch64 on page D1-1827](#) for exceptions taken to AArch64 state. Subject to the prioritization rules:

- When EL2 is implemented and is using AArch64 and (SCR_EL3.NS == 1) && (HCR_EL2.E2H == 0):
 - If [HSTR_EL2.T6](#)==1, Non-secure accesses to this register from EL1 are trapped to EL2.
- When EL2 is implemented and is using AArch64 and (SCR_EL3.NS == 1) && (HCR_EL2.E2H == 1) && (HCR_EL2.TGE == 0):
 - If [HSTR_EL2.T6](#)==1, Non-secure accesses to this register from EL1 are trapped to EL2.
- When EL2 is implemented and is using AArch32 and SCR_EL3.NS == 1:
 - If [HSTR.T6](#)==1, Non-secure accesses to this register from EL1 are trapped to Hyp mode.

G6.2.67 HRMR, Hyp Reset Management Register

The HRMR characteristics are:

Purpose

If EL2 is the highest implemented Exception level and this register is implemented:

- A write to the register at EL2 can request a Warm reset.
- If EL2 can use AArch32 and AArch64, this register specifies the Execution state that the PE boots into on a Warm reset.

Configurations

AArch32 System register HRMR is architecturally mapped to AArch64 System register [RMR_EL2](#).

Only implemented if EL2 is the highest implemented Exception level. In this case:

- If EL2 can use AArch32 and AArch64 then this register must be implemented.
- If EL2 cannot use AArch64 then it is IMPLEMENTATION DEFINED whether the register is implemented.

See the field descriptions for the reset values. These apply whenever the register is implemented.

Attributes

HRMR is a 32-bit register.

Field descriptions

The HRMR bit assignments are:

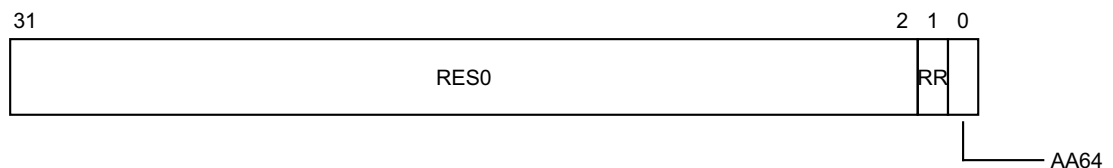

Bits [31:2]

Reserved, RES0.

RR, bit [1]

Reset Request. Setting this bit to 1 requests a Warm reset.

This field resets to 0 on a Warm or Cold reset.

AA64, bit [0]

When EL2 can use AArch64, determines which Execution state the PE boots into after a Warm reset:

- 0 AArch32.
- 1 AArch64.

On coming out of the Warm reset, execution starts at the IMPLEMENTATION DEFINED reset vector address of the specified Execution state.

If EL2 cannot use AArch64 this bit is RAZ/WI.

When implemented as a RW field, this field resets to 0 on a Cold reset.

Accessing the HRMR

This register can be read using MRC with the following syntax:

MCR <syntax>

This register can be written using MCR with the following syntax:

MCR <syntax>

This syntax is encoded with the following settings in the instruction encoding:

<syntax>	opc1	opc2	CRn	coproc	CRm
p15, 4, <Rt>, c12, c0, 2	100	010	1100	1111	0000

Accessibility

The register is accessible in software as follows:

Configuration	Control			Accessibility			
	E2H	TGE	NS	EL0	EL1	EL2	EL3
EL2 is the highest implemented Exception level.	x	0	1	-	-	RW	n/a
EL2 is the highest implemented Exception level.	x	1	1	-	n/a	RW	n/a

When HRMR is not implemented, the encoding for this register is UNDEFINED.

Traps and Enables

For a description of the prioritization of any generated exceptions, see [Synchronous exception prioritization for exceptions taken to AArch32 state on page G1-4344](#) for exceptions taken to AArch32 state and [Synchronous exception prioritization for exceptions taken to AArch64 on page D1-1827](#) for exceptions taken to AArch64 state. Subject to the prioritization rules:

- When EL2 is implemented and is using AArch64 and (SCR_EL3.NS == 1) && (HCR_EL2.E2H == 0):
 - If HSTR_EL2.T12==1, Non-secure accesses to this register from EL1 are trapped to EL2.
- When EL2 is implemented and is using AArch64 and (SCR_EL3.NS == 1) && (HCR_EL2.E2H == 1) && (HCR_EL2.TGE == 0):
 - If HSTR_EL2.T12==1, Non-secure accesses to this register from EL1 are trapped to EL2.
- When EL2 is implemented and is using AArch32 and SCR_EL3.NS == 1:
 - If HSTR.T12==1, Non-secure accesses to this register from EL1 are trapped to Hyp mode.

G6.2.68 HSCTLR, Hyp System Control Register

The HSCTLR characteristics are:

Purpose

Provides top level control of the system operation in Hyp mode.

Configurations

AArch32 System register HSCTLR is architecturally mapped to AArch64 System register [SCTLR_EL2](#).

If EL2 is not implemented, this register is RES0 from EL3.

Some or all RW fields of this register have defined reset values. These apply only if the PE resets into EL2 with EL2 using AArch32. Otherwise, RW fields in this register reset to architecturally UNKNOWN values.

Attributes

HSCTLR is a 32-bit register.

Field descriptions

The HSCTLR bit assignments are:

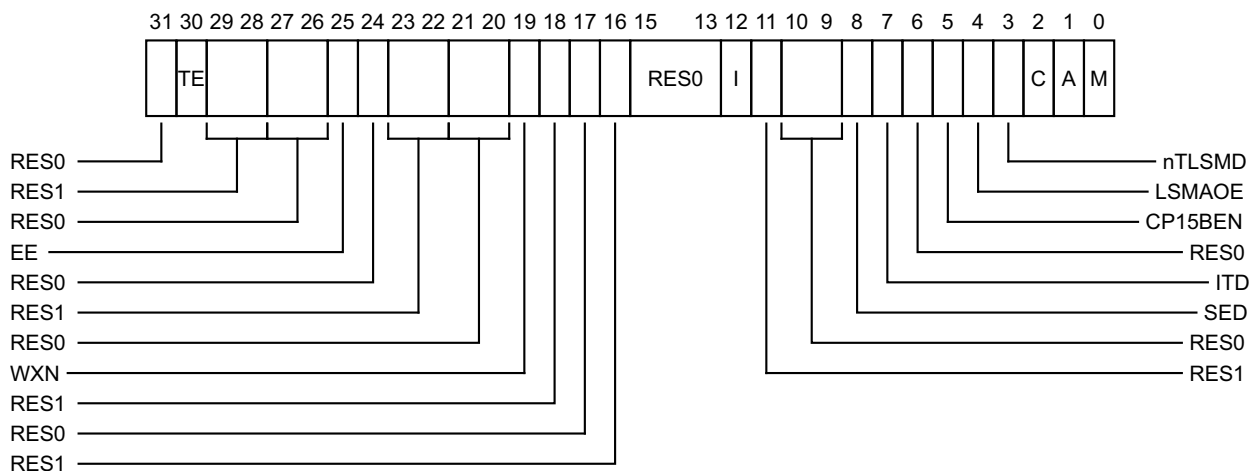

Bit [31]

Reserved, RES0.

TE, bit [30]

T32 Exception Enable. This bit controls whether exceptions to EL2 are taken to A32 or T32 state:

0 Exceptions, including reset, taken to A32 state.

1 Exceptions, including reset, taken to T32 state.

This field resets to a value that is architecturally UNKNOWN.

Bits [29:28]

Reserved, RES1.

Bits [27:26]

Reserved, RES0.

EE, bit [25]

The value of the PSTATE.E bit on entry to Hyp mode, the endianness of stage 1 translation table walks in the EL2 translation regime, and the endianness of stage 2 translation table walks in the PL1&0 translation regime.

The possible values of this bit are:

- 0 Little-endian. PSTATE.E is cleared to 0 on entry to Hyp mode. Stage 1 translation table walks in the EL2 translation regime, and stage 2 translation table walks in the PL1&0 translation regime are little-endian.
- 1 Big-endian. PSTATE.E is set to 1 on entry to Hyp mode. Stage 1 translation table walks in the EL2 translation regime, and stage 2 translation table walks in the PL1&0 translation regime are big-endian.

If an implementation does not provide Big-endian support at Exception Levels higher than EL0, this bit is RES0.

If an implementation does not provide Little-endian support at Exception Levels higher than EL0, this bit is RES1.

When this register has an architecturally-defined reset value, if this field is implemented as an RW field, it resets to an IMPLEMENTATION DEFINED value.

Bit [24]

Reserved, RES0.

Bits [23:22]

Reserved, RES1.

Bits [21:20]

Reserved, RES0.

WXN, bit [19]

Write permission implies XN (Execute-never). For the EL2 translation regime, this bit can force all memory regions that are writable to be treated as XN. The possible values of this bit are:

- 0 This control has no effect on memory access permissions.
- 1 Any region that is writable in the EL2 translation regime is forced to XN for accesses from software executing at EL2.

The WXN bit is permitted to be cached in a TLB.

This field resets to a value that is architecturally UNKNOWN.

Bit [18]

Reserved, RES1.

Bit [17]

Reserved, RES0.

Bit [16]

Reserved, RES1.

Bits [15:13]

Reserved, RES0.

I, bit [12]

Instruction access Cacheability control, for accesses at EL2:

- 0 All instruction access to Normal memory from EL2 are Non-cacheable for all levels of instruction and unified cache.

If the value of HSCTLR.M is 0, instruction accesses from stage 1 of the EL2 translation regime are to Normal, Outer Shareable, Inner Non-cacheable, Outer Non-cacheable memory.

- 1 All instruction access to Normal memory from EL2 can be cached at all levels of instruction and unified cache.
- If the value of HSCTLR.M is 0, instruction accesses from stage 1 of the EL2 translation regime are to Normal, Outer Shareable, Inner Write-Through, Outer Write-Through memory.

This bit has no effect on the PL1&0 translation regime.

When this register has an architecturally-defined reset value, this field resets to 0.

Bit [11]

Reserved, RES1.

Bits [10:9]

Reserved, RES0.

SED, bit [8]

SETEND instruction disable. Disables SETEND instructions at EL2.

- 0 SETEND instruction execution is enabled at EL2.
- 1 SETEND instructions are UNDEFINED at EL2.

If the implementation does not support mixed-endian operation at EL2, this bit is RES1.

If this field is implemented as an RW field, it resets to a value that is architecturally UNKNOWN.

ITD, bit [7]

IT Disable. Disables some uses of IT instructions at EL2.

- 0 All IT instruction functionality is enabled at EL2.
- 1 Any attempt at EL2 to execute any of the following is UNDEFINED:
- All encodings of the IT instruction with hw1[3:0] != 1000.
 - All encodings of the subsequent instruction with the following values for hw1:
 - 11xxxxxxxxxxxxx
All 32-bit instructions, and the 16-bit instructions B, UDF, SVC, LDM, and STM.
 - 1011xxxxxxxxxxxxx
All instructions in *Miscellaneous 16-bit instructions on page F3-2883*.
 - 10100xxxxxxxxxxxx
ADD Rd, PC, #imm
 - 01001xxxxxxxxxxxx
LDR Rd, [PC, #imm]
 - 0100x1xxx1111xxx
ADD Rdn, PC; CMP Rn, PC; MOV Rd, PC; BX PC; BLX PC.
 - 010001xx1xxxx111
ADD PC, Rm; CMP PC, Rm; MOV PC, Rm. This pattern also covers UNPREDICTABLE cases with BLX Rn.

These instructions are always UNDEFINED, regardless of whether they would pass or fail the condition code check that applies to them as a result of being in an IT block.

It is IMPLEMENTATION DEFINED whether the IT instruction is treated as:

- A 16-bit instruction, that can only be followed by another 16-bit instruction.
- The first half of a 32-bit instruction.

This means that, for the situations that are UNDEFINED, either the second 16-bit instruction or the 32-bit instruction is UNDEFINED.

An implementation might vary dynamically as to whether IT is treated as a 16-bit instruction or the first half of a 32-bit instruction.

If an instruction in an active IT block that would be disabled by this field sets this field to 1 then behavior is CONSTRAINED UNPREDICTABLE. For more information see [Changes to an ITD control by an instruction in an IT block on page E1-2738](#)

ITD is optional, but if it is implemented in the SCTLR then it must also be implemented in the HSCTLR. If it is not implemented then this bit is RAZ/WI.

If this field is implemented as an RW field, it resets to a value that is architecturally UNKNOWN.

Bit [6]

Reserved, RES0.

CP15BEN, bit [5]

System instruction memory barrier enable. Enables accesses to the DMB, DSB, and ISB System instructions in the (coproc==1111) encoding space from EL2:

- 0 EL2 execution of the [CP15DMB](#), [CP15DSB](#), and [CP15ISB](#) instructions is UNDEFINED.
- 1 EL2 execution of the [CP15DMB](#), [CP15DSB](#), and [CP15ISB](#) instructions is enabled.

CP15BEN is optional, but if it is implemented in the SCTLR then it must also be implemented in the HSCTLR. If it is not implemented then this bit is RAO/WI.

If this field is implemented as an RW field, it resets to a value that is architecturally UNKNOWN.

LSMAOE, bit [4]

In ARMv8.2

Load Multiple and Store Multiple Atomicity and Ordering Enable. When the OPTIONAL feature [ARMv8.2-LSMAOC](#) is implemented, defined values are:

- 0 For all memory accesses at EL2, A32 and T32 Load Multiple and Store Multiple can have an interrupt taken during the sequence memory accesses, and the memory accesses are not required to be ordered.
- 1 The ordering and interrupt behavior of A32 and T32 Load Multiple and Store Multiple at EL2 is as defined for ARMv8.0.

This bit is permitted to be cached in a TLB.

If this bit is not implemented, it is RES1.

When this register has an architecturally-defined reset value, this field resets to 1.

In ARMv8.1 and ARMv8.0.

Reserved, RES1.

nTLSMD, bit [3]

In ARMv8.2

No Trap Load Multiple and Store Multiple to Device-nGRE/Device-nGnRE/Device-nGnRnE memory. When the OPTIONAL feature [ARMv8.2-LSMAOC](#) is implemented, defined values are:

- 0 All memory accesses by A32 and T32 Load Multiple and Store Multiple at EL2 that are marked at stage 1 as Device-nGRE/Device-nGnRE/Device-nGnRnE memory are trapped and generate a stage 1 Alignment fault.
- 1 All memory accesses by A32 and T32 Load Multiple and Store Multiple at EL2 that are marked at stage 1 as Device-nGRE/Device-nGnRE/Device-nGnRnE memory are not trapped.

This bit is permitted to be cached in a TLB.

If this bit is not implemented, it is RES1.

When this register has an architecturally-defined reset value, this field resets to 1.

In ARMv8.1 and ARMv8.0.

Reserved, RES1.

C, bit [2]

Cacheability control, for data accesses at EL2:

- 0 All data access to Normal memory from EL2, and all accesses to the EL2 translation tables, are Non-cacheable for all levels of data and unified cache.
- 1 All data access to Normal memory from EL2, and all accesses to the EL2 translation tables, can be cached at all levels of data and unified cache.

This bit has no effect on the PL1&0 translation regime.

When this register has an architecturally-defined reset value, this field resets to 0.

A, bit [1]

Alignment check enable. This is the enable bit for Alignment fault checking at EL2:

- 0 Alignment fault checking disabled when executing at EL2.
Instructions that load or store one or more registers, other than load/store exclusive and load-acquire/store-release, do not check that the address being accessed is aligned to the size of the data element or data elements being accessed.
- 1 Alignment fault checking enabled when executing at EL2.
All instructions that load or store one or more registers have an alignment check that the address being accessed is aligned to the size of the data element or data elements being accessed. If this check fails it causes an Alignment fault, which is taken as a Data Abort exception.

Load/store exclusive and load-acquire/store-release instructions have an alignment check regardless of the value of the A bit.

This field resets to a value that is architecturally UNKNOWN.

M, bit [0]

MMU enable for EL2 stage 1 address translation. Possible values of this bit are:

- 0 EL2 stage 1 address translation disabled.
See the HSCTLR.I field for the behavior of instruction accesses to Normal memory.
- 1 EL2 stage 1 address translation enabled.

When this register has an architecturally-defined reset value, this field resets to 0.

Accessing the HSCTLR

This register can be read using MRC with the following syntax:

MRC <syntax>

This register can be written using MCR with the following syntax:

MCR <syntax>

This syntax is encoded with the following settings in the instruction encoding:

<syntax>	opc1	opc2	CRn	coproc	CRm
p15, 4, <Rt>, c1, c0, 0	100	000	0001	1111	0000

Accessibility

The register is accessible in software as follows:

Control			Accessibility			
E2H	TGE	NS	EL0	EL1	EL2	EL3
x	x	0	-	-	n/a	-
x	0	1	-	-	RW	RW
x	1	1	-	n/a	RW	RW

Traps and Enables

For a description of the prioritization of any generated exceptions, see [Synchronous exception prioritization for exceptions taken to AArch32 state on page G1-4344](#) for exceptions taken to AArch32 state and [Synchronous exception prioritization for exceptions taken to AArch64 on page D1-1827](#) for exceptions taken to AArch64 state. Subject to the prioritization rules:

- When EL2 is implemented and is using AArch64 and (SCR_EL3.NS == 1) && (HCR_EL2.E2H == 0):
 - If [HSTR_EL2.T1](#)==1, Non-secure accesses to this register from EL1 are trapped to EL2.
- When EL2 is implemented and is using AArch64 and (SCR_EL3.NS == 1) && (HCR_EL2.E2H == 1) && (HCR_EL2.TGE == 0):
 - If [HSTR_EL2.T1](#)==1, Non-secure accesses to this register from EL1 are trapped to EL2.
- When EL2 is implemented and is using AArch32 and SCR_EL3.NS == 1:
 - If [HSTR.T1](#)==1, Non-secure accesses to this register from EL1 are trapped to Hyp mode.

G6.2.69 HSR, Hyp Syndrome Register

The HSR characteristics are:

Purpose

Holds syndrome information for an exception taken to Hyp mode.

Configurations

AArch32 System register HSR is architecturally mapped to AArch64 System register [ESR_EL2](#).

If EL2 is not implemented, this register is RES0 from EL3.

RW fields in this register reset to architecturally UNKNOWN values.

Attributes

HSR is a 32-bit register.

Field descriptions

The HSR bit assignments are:

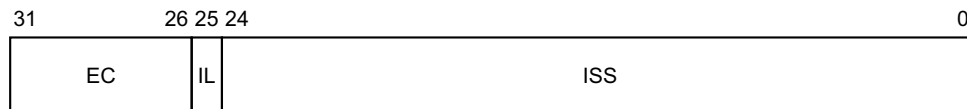

Execution in any Non-secure PE mode other than Hyp mode makes this register UNKNOWN.

When an UNPREDICTABLE instruction is treated as UNDEFINED, and the exception is taken to EL2, the value of HSR is UNKNOWN. The value written to HSR must be consistent with a value that could be created as a result of an exception from the same Exception level that generated the exception as a result of a situation that is not UNPREDICTABLE at that Exception level, in order to avoid the possibility of a privilege violation.

EC, bits [31:26]

Exception Class. Indicates the reason for the exception that this register holds information about. Possible values of this field are:

EC == 000000

Unknown reason.

See [ISS encoding for exceptions with an unknown reason](#).

EC == 000001

Trapped WFI or WFE instruction execution.

Conditional WFE and WFI instructions that fail their condition code check do not cause an exception.

See [ISS encoding for an exception from a WFI or WFE instruction](#).

EC == 000011

Trapped MCR or MRC access with (coproc==1111) that is not reported using EC 0b000000.

See [ISS encoding for an exception from an MCR or MRC access](#).

EC == 000100

Trapped MCRR or MRRC access with (coproc==1111) that is not reported using EC 0b000000.

See [ISS encoding for an exception from an MCRR or MRRC access](#).

EC == 000101

Trapped MCR or MRC access with (coproc==1110).

See [ISS encoding for an exception from an MCR or MRC access](#).

EC == 000110

Trapped LDC or STC access.

The only architected uses of these instructions are:

- An STC to write data to memory from [DBGDTRRXint](#).
- An LDC to read data from memory to [DBGDTRTXint](#).

See [ISS encoding for an exception from an LDC or STC instruction](#).

EC == 000111

Access to Advanced SIMD or floating-point functionality trapped by a [HCPTR](#). {TASE, TCP10} control.

Excludes exceptions generated because Advanced SIMD and floating-point are not implemented. These are reported with EC value `0b000000`.

See [ISS encoding for an exception from an access to SIMD or floating-point functionality, resulting from HCPTR](#).

EC == 001000

Trapped VMRS access, from ID group trap, that is not reported using EC `0b000111`.

See [ISS encoding for an exception from an MCR or MRC access](#).

EC == 001100

Trapped MRRC access with (coproc==1110).

See [ISS encoding for an exception from an MCRR or MRRC access](#).

EC == 001110

Illegal exception return to AArch32 state.

See [ISS encoding for an exception from an Illegal state or PC alignment fault](#).

EC == 010001

Exception on SVC instruction execution in AArch32 state routed to EL2.

See [ISS encoding for an exception from HVC or SVC instruction execution](#).

EC == 010010

HVC instruction execution in AArch32 state, when HVC is not disabled.

See [ISS encoding for an exception from HVC or SVC instruction execution](#).

EC == 010011

Trapped execution of SMC instruction in AArch32 state.

See [ISS encoding for an exception from SMC instruction execution](#).

EC == 100000

Prefetch Abort from a lower Exception level.

See [ISS encoding for an exception from a Prefetch Abort](#).

EC == 100001

Prefetch Abort taken without a change in Exception level.

See [ISS encoding for an exception from a Prefetch Abort](#).

EC == 100010

PC alignment fault exception.

See [ISS encoding for an exception from an Illegal state or PC alignment fault](#).

EC == 100100

Data Abort from a lower Exception level.

See [ISS encoding for an exception from a Data Abort](#).

EC == 100101

Data Abort taken without a change in Exception level.

See [ISS encoding for an exception from a Data Abort](#).

All other EC values are reserved by ARM, and:

- Unused values in the range `0b000000 - 0b101100` (`0x00 - 0x2C`) are reserved for future use for synchronous exceptions.

- Unused values in the range 0b101101 - 0b111111 (0x2D - 0x3F) are reserved for future use, and might be used for synchronous or asynchronous exceptions.

The effect of programming this field to a reserved value is that behavior is CONstrained UNPREDICTABLE, as described in *Reserved values in System and memory-mapped registers and translation table entries* on page K1-6133.

IL, bit [25]

Instruction length bit. Indicates the size of the instruction that has been trapped to Hyp mode. When this bit is valid, possible values of this bit are:

- 0 16-bit instruction trapped.
- 1 32-bit instruction trapped.

This field is RES1 and not valid for the following cases:

- When the EC field is 0b000000, indicating an exception with an unknown reason.
- Prefetch Aborts.
- Data Aborts for which the HSR.ISS.ISV field is 0.
- When the EC value is 0b001110, indicating an Illegal state exception.

———— Note ————

This is a change from the behavior in ARMv7, where the IL field is UNK/SBZP for the corresponding cases.

The IL field is not valid and is UNKNOWN on an exception from a PC alignment fault.

ISS, bits [24:0]

Instruction Specific Syndrome. Architecturally, this field can be defined independently for each defined Exception class. However, in practice, some ISS encodings are used for more than one Exception class.

The following subsections describe each ISS format.

ISS encoding for exceptions with an unknown reason

This encoding is used by:

- Unknown reason.

The ISS encoding for these exceptions is:

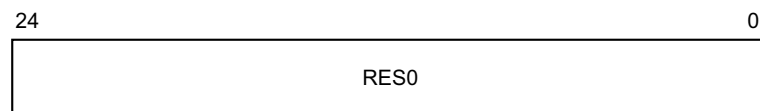

Bits [24:0]

Reserved, RES0.

This EC code is used for all exceptions that are not covered by any other EC value. This includes exceptions that are generated in the following situations:

- The attempted execution of an instruction bit pattern that has no allocated instruction in the current PE mode in the current Security state, including:
 - A read access using a System register encoding pattern that is not allocated for reads at the current Exception level and Security state.
 - A write access using a System register encoding pattern that is not allocated for writes at the current Exception level and Security state.
 - Instruction encodings for instructions not implemented in the implementation.

- In Debug state, the attempted execution of an instruction bit pattern that is unallocated in Debug state.
- In Non-debug state, the attempted execution of an instruction bit pattern that is unallocated in Non-debug state.
- The attempted execution of a short vector floating-point instruction.
- In an implementation that does not include Advanced SIMD and floating-point functionality, an attempted access to Advanced SIMD or floating-point functionality under conditions where that access would be permitted if that functionality was present. This includes the attempted execution of an Advanced SIMD or floating-point instruction, and attempted accesses to Advanced SIMD and floating-point System registers.
- An exception generated because of the value of one of the `SCTLR`.{ITD, SED, CP15BEN} control bits.
- Attempted execution of:
 - An HVC instruction when disabled by `HCR.HCD`, `SCR.HCE`, or `SCR_EL3.HCE`.
 - An SMC instruction when disabled by `SCR.SCD` or `SCR_EL3.SMD`.
 - An HLT instruction when disabled by `EDSCR.HDE`.
- An exception generated because of the attempted execution of an MSR (Banked register) or MRS (Banked register) instruction that would access a Banked register that is not accessible from the Security state and PE mode at which the instruction was executed.

———— **Note** —————

An exception is generated only if the CONSTRAINED UNPREDICTABLE behavior of the instruction is that it is UNDEFINED, see *MSR/MRS Banked registers on page K1-6117*.

- Attempted execution, in Debug state, of:
 - A DCPS1 instruction in Non-secure state from EL0 when EL2 is using AArch32 and the value of `HCR.TGE` is 1.
 - A DCPS2 instruction at EL1 or EL0 when EL2 is not implemented, or when EL3 is using AArch32 and the value of `SCR.NS` is 0, or when EL3 is using AArch64 and the value of `SCR_EL3.NS` is 0.
 - A DCPS3 instruction when EL3 is not implemented, or when the value of `EDSCR.SDD` is 1.
- In Debug state when the value of `EDSCR.SDD` is 1, the attempted execution at EL2, EL1, or EL0 of an instruction that is configured to trap to EL3.

Undefined Instruction exception, when the value of `HCR.TGE` is 1 on page G1-4357 describes the configuration settings for a trap that returns an `HSR.EC` value of `0b000000`.

ISS encoding for an exception from a WFI or WFE instruction

This encoding is used by:

- Trapped WFI or WFE instruction execution.
Conditional WFE and WFI instructions that fail their condition code check do not cause an exception.

The ISS encoding for these exceptions is:

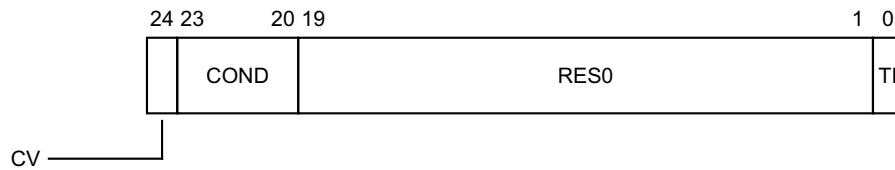

CV, bit [24]

Condition code valid. Possible values of this bit are:

- 0 The COND field is not valid.
- 1 The COND field is valid.

When an A32 instruction is trapped, CV is set to 1.

When a T32 instruction is trapped, it is IMPLEMENTATION DEFINED whether CV is set to 1 or set to 0. See the description of the COND field for more information.

COND, bits [23:20]

The condition code for the trapped instruction.

When an A32 instruction is trapped, CV is set to 1 and:

- If the instruction is conditional, COND is set to the condition code field value from the instruction.
- If the instruction is unconditional, COND is set to 0b1110.

A conditional A32 instruction that is known to pass its condition code check can be presented either:

- With COND set to 0b1110, the value for unconditional.
- With the COND value held in the instruction.

When a T32 instruction is trapped, it is IMPLEMENTATION DEFINED whether:

- CV is set to 0 and COND is set to an UNKNOWN value. Software must examine the SPSR.IT field to determine the condition, if any, of the T32 instruction.
- CV is set to 1 and COND is set to the condition code for the condition that applied to the instruction.

For an implementation that, for both A32 and T32 instructions, takes an exception on a trapped conditional instruction only if the instruction passes its condition code check, these definitions mean that when CV is set to 1 it is IMPLEMENTATION DEFINED whether the COND field is set to 0b1110, or to the value of any condition that applied to the instruction.

Bits [19:1]

Reserved, RES0.

TI, bit [0]

Trapped instruction. Possible values of this bit are:

- 0 WFI trapped.
- 1 WFE trapped.

[Traps to Hyp mode of Non-secure EL0 and EL1 execution of WFE and WFI instructions on page G1-4437](#) describes the configuration settings for this trap.

ISS encoding for an exception from an MCR or MRC access

This encoding is used by:

- Trapped MCR or MRC access with (coproc==1111) that is not reported using EC 0b000000.
- Trapped MCR or MRC access with (coproc==1110).

- Trapped VMRS access, from ID group trap, that is not reported using EC 0b000111.

The ISS encoding for these exceptions is:

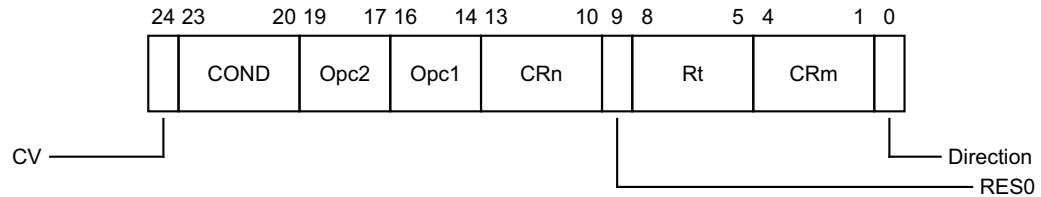

CV, bit [24]

Condition code valid. Possible values of this bit are:

- 0 The COND field is not valid.
- 1 The COND field is valid.

When an A32 instruction is trapped, CV is set to 1.

When a T32 instruction is trapped, it is IMPLEMENTATION DEFINED whether CV is set to 1 or set to 0. See the description of the COND field for more information.

COND, bits [23:20]

The condition code for the trapped instruction.

When an A32 instruction is trapped, CV is set to 1 and:

- If the instruction is conditional, COND is set to the condition code field value from the instruction.
- If the instruction is unconditional, COND is set to 0b1110.

A conditional A32 instruction that is known to pass its condition code check can be presented either:

- With COND set to 0b1110, the value for unconditional.
- With the COND value held in the instruction.

When a T32 instruction is trapped, it is IMPLEMENTATION DEFINED whether:

- CV is set to 0 and COND is set to an UNKNOWN value. Software must examine the SPSR.IT field to determine the condition, if any, of the T32 instruction.
- CV is set to 1 and COND is set to the condition code for the condition that applied to the instruction.

For an implementation that, for both A32 and T32 instructions, takes an exception on a trapped conditional instruction only if the instruction passes its condition code check, these definitions mean that when CV is set to 1 it is IMPLEMENTATION DEFINED whether the COND field is set to 0b1110, or to the value of any condition that applied to the instruction.

Opc2, bits [19:17]

The Opc2 value from the issued instruction.

For a trapped VMRS access, holds the value 0b000.

Opc1, bits [16:14]

The Opc1 value from the issued instruction.

For a trapped VMRS access, holds the value 0b111.

CRn, bits [13:10]

The CRn value from the issued instruction.

For a trapped VMRS access, holds the reg field from the VMRS instruction encoding.

Bit [9]

Reserved, RES0.

Rt, bits [8:5]

The Rt value from the issued instruction, the general-purpose register used for the transfer.

CRm, bits [4:1]

The CRm value from the issued instruction.

For a trapped VMRS access, holds the value 0b0000.

Direction, bit [0]

Indicates the direction of the trapped instruction. The possible values of this bit are:

- | | |
|---|---|
| 0 | Write to System register space. MCR instruction. |
| 1 | Read from System register space. MRC or VMRS instruction. |

The following sections describe configuration settings for traps that are reported using EC value 0b000011:

- [Traps to Hyp mode of Non-secure EL0 and EL1 accesses to the ID registers on page G1-4434.](#)
- [Traps to Hyp mode of Non-secure EL0 and EL1 accesses to lockdown, DMA, and TCM operations on page G1-4433.](#)
- [Traps to Hyp mode of Non-secure EL1 execution of cache maintenance instructions on page G1-4432.](#)
- [Traps to Hyp mode of Non-secure EL1 execution of TLB maintenance instructions on page G1-4431.](#)
- [Traps to Hyp mode of Non-secure EL1 accesses to the Auxiliary Control Register on page G1-4432.](#)
- [Traps to Hyp mode of Non-secure EL0 and EL1 accesses to Performance Monitors registers on page G1-4444.](#)
- [Traps to Hyp mode of Non-secure EL1 accesses to the CPACR on page G1-4439.](#)
- [Traps to Hyp mode of Non-secure EL1 accesses to virtual memory control registers on page G1-4430.](#)
- [General trapping to Hyp mode of Non-secure EL0 and EL1 accesses to System registers in the \(coproc==0b1111\) encoding space on page G1-4440.](#)

The following sections describe configuration settings for traps that are reported using EC value 0b000101:

- [ID group 0, Primary device identification registers on page G1-4435.](#)
- [Traps to Hyp mode of Non-secure System register accesses to trace registers on page G1-4439.](#)
- [Trapping Non-secure System register accesses to Debug ROM registers on page G1-4442.](#)
- [Trapping Non-secure System register accesses to powerdown debug registers on page G1-4442.](#)
- [Trapping general Non-secure System register accesses to debug registers on page G1-4443.](#)

The following sections describes configuration settings for traps that are reported using EC value 0b001000:

- [ID group 0, Primary device identification registers on page G1-4435.](#)
- [ID group 3, Detailed feature identification registers on page G1-4436.](#)

ISS encoding for an exception from an MCRR or MRRC access

This encoding is used by:

- Trapped MCRR or MRRC access with (coproc==1111) that is not reported using EC 0b000000.
- Trapped MRRC access with (coproc==1110).

The ISS encoding for these exceptions is:

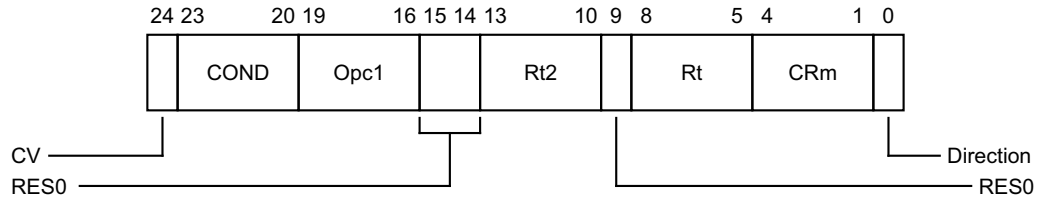

CV, bit [24]

Condition code valid. Possible values of this bit are:

- 0 The COND field is not valid.
- 1 The COND field is valid.

When an A32 instruction is trapped, CV is set to 1.

When a T32 instruction is trapped, it is IMPLEMENTATION DEFINED whether CV is set to 1 or set to 0. See the description of the COND field for more information.

COND, bits [23:20]

The condition code for the trapped instruction.

When an A32 instruction is trapped, CV is set to 1 and:

- If the instruction is conditional, COND is set to the condition code field value from the instruction.
- If the instruction is unconditional, COND is set to 0b1110.

A conditional A32 instruction that is known to pass its condition code check can be presented either:

- With COND set to 0b1110, the value for unconditional.
- With the COND value held in the instruction.

When a T32 instruction is trapped, it is IMPLEMENTATION DEFINED whether:

- CV is set to 0 and COND is set to an UNKNOWN value. Software must examine the SPSR.IT field to determine the condition, if any, of the T32 instruction.
- CV is set to 1 and COND is set to the condition code for the condition that applied to the instruction.

For an implementation that, for both A32 and T32 instructions, takes an exception on a trapped conditional instruction only if the instruction passes its condition code check, these definitions mean that when CV is set to 1 it is IMPLEMENTATION DEFINED whether the COND field is set to 0b1110, or to the value of any condition that applied to the instruction.

Opc1, bits [19:16]

The Opc1 value from the issued instruction.

Bits [15:14]

Reserved, RES0.

Rt2, bits [13:10]

The Rt2 value from the issued instruction, the second general-purpose register used for the transfer.

Bit [9]

Reserved, RES0.

Rt, bits [8:5]

The Rt value from the issued instruction, the first general-purpose register used for the transfer.

CRm, bits [4:1]

The CRm value from the issued instruction.

Direction, bit [0]

Indicates the direction of the trapped instruction. The possible values of this bit are:

- 0 Write to System register space. MCRR instruction.
- 1 Read from System register space. MRRC instruction.

The following sections describe configuration settings for traps that are reported using EC value 0b000100:

- [Traps to Hyp mode of Non-secure EL1 accesses to virtual memory control registers on page G1-4430.](#)
- [General trapping to Hyp mode of Non-secure EL0 and EL1 accesses to System registers in the \(coproc == 0b1111\) encoding space on page G1-4440.](#)

The following sections describe configuration settings for traps that are reported using EC value 0b001100:

- [Traps to Hyp mode of Non-secure System register accesses to trace registers on page G1-4439.](#)
- [Trapping Non-secure System register accesses to Debug ROM registers on page G1-4442.](#)

ISS encoding for an exception from an LDC or STC instruction

This encoding is used by:

- Trapped LDC or STC access.
The only architected uses of these instructions are:
 - An STC to write data to memory from [DBGDTRRXint](#).
 - An LDC to read data from memory to [DBGDTRTXint](#).

The ISS encoding for these exceptions is:

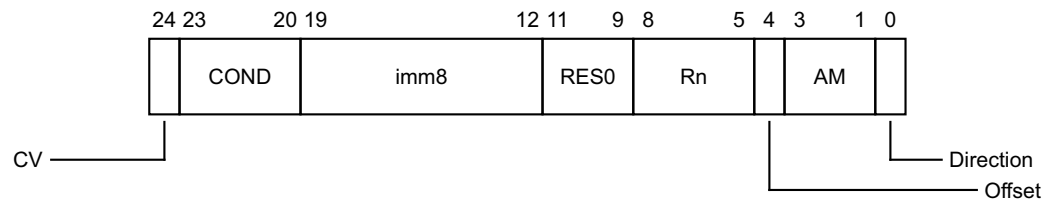

CV, bit [24]

Condition code valid. Possible values of this bit are:

- 0 The COND field is not valid.
- 1 The COND field is valid.

When an A32 instruction is trapped, CV is set to 1.

When a T32 instruction is trapped, it is IMPLEMENTATION DEFINED whether CV is set to 1 or set to 0. See the description of the COND field for more information.

COND, bits [23:20]

The condition code for the trapped instruction.

When an A32 instruction is trapped, CV is set to 1 and:

- If the instruction is conditional, COND is set to the condition code field value from the instruction.
- If the instruction is unconditional, COND is set to 0b1110.

A conditional A32 instruction that is known to pass its condition code check can be presented either:

- With COND set to 0b1110, the value for unconditional.

- With the COND value held in the instruction.

When a T32 instruction is trapped, it is IMPLEMENTATION DEFINED whether:

- CV is set to 0 and COND is set to an UNKNOWN value. Software must examine the SPSR.IT field to determine the condition, if any, of the T32 instruction.
- CV is set to 1 and COND is set to the condition code for the condition that applied to the instruction.

For an implementation that, for both A32 and T32 instructions, takes an exception on a trapped conditional instruction only if the instruction passes its condition code check, these definitions mean that when CV is set to 1 it is IMPLEMENTATION DEFINED whether the COND field is set to 0b1110, or to the value of any condition that applied to the instruction.

imm8, bits [19:12]

The immediate value from the issued instruction.

Bits [11:9]

Reserved, RES0.

Rn, bits [8:5]

The Rn value from the issued instruction. Valid only when AM[2] is 0, indicating an immediate form of the LDC or STC instruction.

When AM[2] is 1, indicating a literal form of the LDC or STC instruction, this field is UNKNOWN.

Offset, bit [4]

Indicates whether the offset is added or subtracted:

- | | |
|---|------------------|
| 0 | Subtract offset. |
| 1 | Add offset. |

This bit corresponds to the U bit in the instruction encoding.

AM, bits [3:1]

Addressing mode. The permitted values of this field are:

- | | |
|-----|---|
| 000 | Immediate unindexed. |
| 001 | Immediate post-indexed. |
| 010 | Immediate offset. |
| 011 | Immediate pre-indexed. |
| 100 | Literal unindexed.
LDC instruction in A32 instruction set only.
For a trapped STC instruction or a trapped T32 LDC instruction this encoding is reserved. |
| 110 | Literal offset.
LDC instruction only.
For a trapped STC instruction, this encoding is reserved. |

The values 0b101 and 0b111 are reserved. The effect of programming this field to a reserved value is that behavior is CONSTRAINED UNPREDICTABLE, as described in [Reserved values in System and memory-mapped registers and translation table entries on page K1-6117](#).

Bit [2] in this subfield indicates the instruction form, immediate or literal.

Bits [1:0] in this subfield correspond to the bits {P, W} in the instruction encoding.

Direction, bit [0]

Indicates the direction of the trapped instruction. The possible values of this bit are:

- | | |
|---|------------------------------------|
| 0 | Write to memory. STC instruction. |
| 1 | Read from memory. LDC instruction. |

[Trapping general Non-secure System register accesses to debug registers on page G1-4443](#) describes the configuration settings for the trap that is reported using EC value 0b000110.

ISS encoding for an exception from an access to SIMD or floating-point functionality, resulting from HCPTR

This encoding is used by:

- Access to Advanced SIMD or floating-point functionality trapped by a HCPTR. {TASE, TCP10} control. Excludes exceptions generated because Advanced SIMD and floating-point are not implemented. These are reported with EC value 0b000000.

The ISS encoding for these exceptions is:

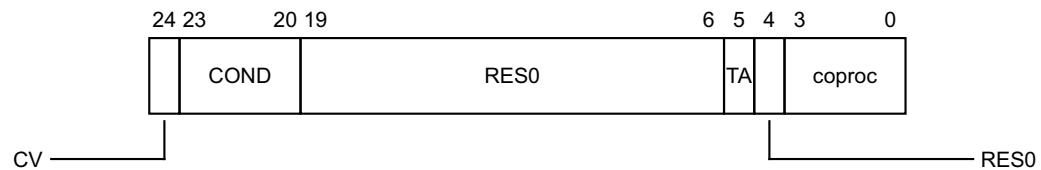

Excludes exceptions that occur because Advanced SIMD and floating-point functionality is not implemented, or because the value of HCR.TGE or HCR_EL2.TGE is 1. These are reported with EC value 0b000000.

CV, bit [24]

Condition code valid. Possible values of this bit are:

- 0 The COND field is not valid.
- 1 The COND field is valid.

When an A32 instruction is trapped, CV is set to 1.

When a T32 instruction is trapped, it is IMPLEMENTATION DEFINED whether CV is set to 1 or set to 0. See the description of the COND field for more information.

COND, bits [23:20]

The condition code for the trapped instruction.

When an A32 instruction is trapped, CV is set to 1 and:

- If the instruction is conditional, COND is set to the condition code field value from the instruction.
- If the instruction is unconditional, COND is set to 0b1110.

A conditional A32 instruction that is known to pass its condition code check can be presented either:

- With COND set to 0b1110, the value for unconditional.
- With the COND value held in the instruction.

When a T32 instruction is trapped, it is IMPLEMENTATION DEFINED whether:

- CV is set to 0 and COND is set to an UNKNOWN value. Software must examine the SPSR.IT field to determine the condition, if any, of the T32 instruction.
- CV is set to 1 and COND is set to the condition code for the condition that applied to the instruction.

For an implementation that, for both A32 and T32 instructions, takes an exception on a trapped conditional instruction only if the instruction passes its condition code check, these definitions mean that when CV is set to 1 it is IMPLEMENTATION DEFINED whether the COND field is set to 0b1110, or to the value of any condition that applied to the instruction.

Bits [19:6]

Reserved, RES0.

TA, bit [5]

Indicates trapped use of Advanced SIMD functionality. The possible values of this bit are:

- 0 Exception was not caused by trapped use of Advanced SIMD functionality.
- 1 Exception was caused by trapped use of Advanced SIMD functionality.

Any use of an Advanced SIMD instruction that is not also a floating-point instruction that is trapped to Hyp mode because of a trap configured in the **HCPTR** sets this bit to 1.

For a list of these instructions, see *Controls of Advanced SIMD operation that do not apply to floating-point operation* on page E1-2746.

Bit [4]

Reserved, RES0.

coproc, bits [3:0]

When the TA field returns the value 1, this field returns the value 1010, otherwise this field is RES0.

The following sections describe the configuration settings for the traps that are reported using EC value 0b000111:

- *General trapping to Hyp mode of Non-secure accesses to the SIMD and floating-point registers* on page G1-4437.
- *Traps to Hyp mode of Non-secure accesses to Advanced SIMD functionality* on page G1-4438.

ISS encoding for an exception from HVC or SVC instruction execution

This encoding is used by:

- Exception on SVC instruction execution in AArch32 state routed to EL2.
- HVC instruction execution in AArch32 state, when HVC is not disabled.

The ISS encoding for these exceptions is:

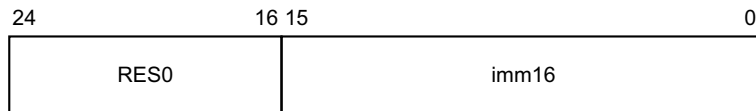

Bits [24:16]

Reserved, RES0.

imm16, bits [15:0]

The value of the immediate field from the HVC or SVC instruction.

For an HVC instruction, this is the value of the imm16 field of the issued instruction.

For an SVC instruction:

- If the instruction is unconditional, then:
 - For the T32 instruction, this field is zero-extended from the imm8 field of the instruction.
 - For the A32 instruction, this field is the bottom 16 bits of the imm24 field of the instruction.
- If the instruction is conditional, this field is UNKNOWN.

The HVC instruction is unconditional, and a conditional SVC instruction generates an exception only if it passes its condition code check. Therefore, the syndrome information for these exceptions does not require conditionality information.

Supervisor Call exception, when the value of HCR.TGE is 1 on page G1-4357 describes the configuration settings for the trap reported with EC value 0b010001.

ISS encoding for an exception from SMC instruction execution

This encoding is used by:

- Trapped execution of SMC instruction in AArch32 state.

The ISS encoding for these exceptions is:

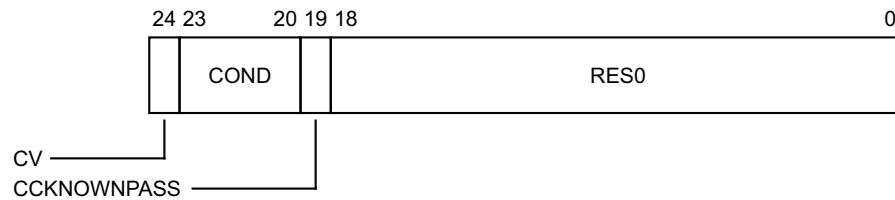

CV, bit [24]

Condition code valid. Possible values of this bit are:

- 0 The COND field is not valid.
- 1 The COND field is valid.

When an A32 instruction is trapped, CV is set to 1.

When a T32 instruction is trapped, it is IMPLEMENTATION DEFINED whether CV is set to 1 or set to 0. See the description of the COND field for more information.

This field is only valid if CCKNOWNPASS is 1, otherwise it is RES0.

COND, bits [23:20]

The condition code for the trapped instruction.

When an A32 instruction is trapped, CV is set to 1 and:

- If the instruction is conditional, COND is set to the condition code field value from the instruction.
- If the instruction is unconditional, COND is set to 0b1110.

A conditional A32 instruction that is known to pass its condition code check can be presented either:

- With COND set to 0b1110, the value for unconditional.
- With the COND value held in the instruction.

When a T32 instruction is trapped, it is IMPLEMENTATION DEFINED whether:

- CV is set to 0 and COND is set to an UNKNOWN value. Software must examine the SPSR.IT field to determine the condition, if any, of the T32 instruction.
- CV is set to 1 and COND is set to the condition code for the condition that applied to the instruction.

For an implementation that, for both A32 and T32 instructions, takes an exception on a trapped conditional instruction only if the instruction passes its condition code check, these definitions mean that when CV is set to 1 it is IMPLEMENTATION DEFINED whether the COND field is set to 0b1110, or to the value of any condition that applied to the instruction.

This field is only valid if CCKNOWNPASS is 1, otherwise it is RES0.

CCKNOWNPASS, bit [19]

Indicates whether the instruction might have failed its condition code check.

- 0 The instruction was unconditional, or was conditional and passed its condition code check.
- 1 The instruction was conditional, and might have failed its condition code check.

Bits [18:0]

Reserved, RES0.

[Traps to Hyp mode of Non-secure EL1 execution of SMC instructions on page G1-4434](#) describes the configuration settings for this trap, for instructions executed in Non-secure PL1 modes.

ISS encoding for an exception from a Prefetch Abort

This encoding is used by:

- Prefetch Abort from a lower Exception level.
- Prefetch Abort taken without a change in Exception level.

The ISS encoding for these exceptions is:

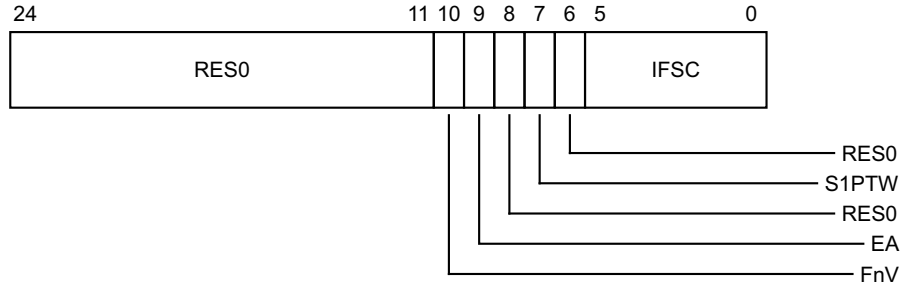

Bits [24:11]

Reserved, RES0.

FnV, bit [10]

FAR not Valid, for a Synchronous external abort other than a Synchronous external abort on a translation table walk.

- 0 HIFAR is valid.
- 1 HIFAR is not valid, and holds an UNKNOWN value.

This field is only valid if the IFSC code is 010000. It is RES0 for all other aborts.

EA, bit [9]

External abort type. This bit can provide an IMPLEMENTATION DEFINED classification of External aborts.

For any abort other than an External abort this bit returns a value of 0.

Bit [8]

Reserved, RES0.

S1PTW, bit [7]

For a stage 2 fault, indicates whether the fault was a stage 2 fault on an access made for a stage 1 translation table walk:

- 0 Fault not on a stage 2 translation for a stage 1 translation table walk.
- 1 Fault on the stage 2 translation of an access for a stage 1 translation table walk.

For any abort other than a stage 2 fault this bit is RES0.

Bit [6]

Reserved, RES0.

IFSC, bits [5:0]

Instruction Fault Status Code. Possible values of this field are:

- 000000 Address size fault, translation table base register
- 000001 Address size fault, level 1

000010	Address size fault, level 2
000011	Address size fault, level 3
000101	Translation fault, level 1
000110	Translation fault, level 2
000111	Translation fault, level 3
001001	Access flag fault, level 1
001010	Access flag fault, level 2
001011	Access flag fault, level 3
001101	Permission fault, level 1
001110	Permission fault, level 2
001111	Permission fault, level 3
010000	Synchronous external abort, not on translation table walk
011000	Synchronous parity or ECC error on memory access, not on translation table walk
010101	Synchronous external abort, on translation table walk, level 1
010110	Synchronous external abort, on translation table walk, level 2
010111	Synchronous external abort, on translation table walk, level 3
011101	Synchronous parity or ECC error on memory access on translation table walk, level 1
011110	Synchronous parity or ECC error on memory access on translation table walk, level 2
011111	Synchronous parity or ECC error on memory access on translation table walk, level 3
100010	Debug exception, only when the EC value is 0b100001
110000	TLB conflict abort

All other values are reserved.

When the RAS Extension is implemented, 011000, 011101, 011110 and 011111 are reserved.

———— **Note** ————

ARMv8.2 requires the implementation of the RAS Extension.

For more information about the lookup level associated with a fault, see [The level associated with MMU faults on a Long-descriptor translation table lookup on page G4-4671](#).

The following sections describe cases where Prefetch Abort exceptions can be routed to Hyp mode, generating exceptions that are reported in the HSR with EC value 0b100000:

- [Abort exceptions, when the value of HCR.TGE is 1 on page G1-4357](#).
- [Routing debug exceptions to EL2 using AArch32 on page G1-4358](#).

ISS encoding for an exception from an Illegal state or PC alignment fault

This encoding is used by:

- Illegal exception return to AArch32 state.
- PC alignment fault exception.

The ISS encoding for these exceptions is:

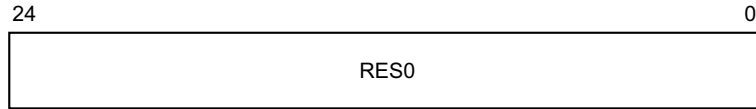

Bits [24:0]

Reserved, RES0.

For more information about the Illegal state exception, see:

- [Illegal changes to PSTATE.M](#) on page G1-4336.
- [Illegal return events from AArch32 state](#) on page G1-4361.
- [Legal returns that set PSTATE.IL to 1](#) on page G1-4363.
- [The Illegal Execution state exception](#) on page G1-4363.

For more information about the PC alignment fault exception, see [Branching to an unaligned PC](#) on page K1-6098.

ISS encoding for an exception from a Data Abort

This encoding is used by:

- Data Abort from a lower Exception level.
- Data Abort taken without a change in Exception level.

The ISS encoding for these exceptions is:

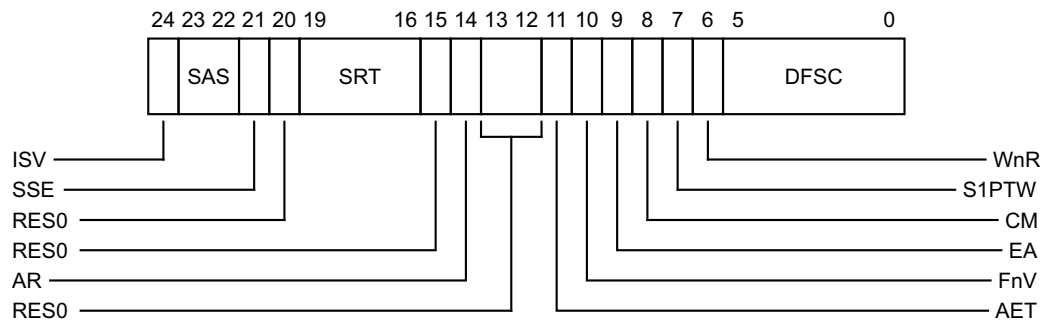

ISV, bit [24]

Instruction syndrome valid. Indicates whether the syndrome information in ISS[23:14] is valid.

0 No valid instruction syndrome. ISS[23:14] are RES0.

1 ISS[23:14] hold a valid instruction syndrome.

This bit is 0 for all faults except Data Aborts generated by stage 2 address translations for which all the following apply to the instruction that generated the Data Abort exception:

- The instruction is an LDR, LDA, LDRT, LDRSH, LDRSHT, LDRH, LDAH, LDRHT, LDRSB, LDRSBT, LDRB, LDAB, LDRBT, STR, STL, STRT, STRH, STLH, STRHT, STRB, STLB, or STRBT instruction.
- The instruction is not performing register writeback.
- The instruction is not using the PC as a source or destination register.

For these cases, ISV is UNKNOWN if the exception was generated in Debug state in memory access mode, as described in [Data Aborts in Memory access mode](#) on page H4-5504, and otherwise indicates whether ISS[23:14] hold a valid syndrome.

———— **Note** ————

In the A32 instruction set, LDR*T and STR*T instructions always perform register writeback and therefore never return a valid instruction syndrome.

When the RAS Extension is implemented, ISV is 0 for any Synchronous external abort.

ISV is set to 0 on a stage 2 abort on a stage 1 translation table walk.

When the RAS Extension is not implemented, it is IMPLEMENTATION DEFINED whether ISV is set to 1 or 0 on a Synchronous external abort on stage 2 translation table walk.

SAS, bits [23:22]

Syndrome Access Size. When ISV is 1, indicates the size of the access attempted by the faulting operation.

00	Byte
01	Halfword
10	Word
11	Doubleword

This field is UNKNOWN when the value of ISV is UNKNOWN.

This field is RES0 when the value of ISV is 0.

SSE, bit [21]

Syndrome Sign Extend. When ISV is 1, for a byte, halfword, or word load operation, indicates whether the data item must be sign extended. For these cases, the possible values of this bit are:

0	Sign-extension not required.
1	Data item must be sign-extended.

For all other operations this bit is 0.

This field is UNKNOWN when the value of ISV is UNKNOWN.

This field is RES0 when the value of ISV is 0.

Bit [20]

Reserved, RES0.

SRT, bits [19:16]

Syndrome Register transfer. When ISV is 1, the register number of the Rt operand of the faulting instruction.

This field is UNKNOWN when the value of ISV is UNKNOWN.

This field is RES0 when the value of ISV is 0.

Bit [15]

Reserved, RES0.

AR, bit [14]

Acquire/Release. When ISV is 1, the possible values of this bit are:

0	Instruction did not have acquire/release semantics.
1	Instruction did have acquire/release semantics.

This field is UNKNOWN when the value of ISV is UNKNOWN.

This field is RES0 when the value of ISV is 0.

Bits [13:12]

Reserved, RES0.

AET, bit [11:10]

Asynchronous Error Type.

When the RAS Extension is implemented and the value returned in the DFSC field is 010001, describes the state of the PE after taking the SError interrupt exception. The possible values of this field are:

00	Uncontainable error (UC) or uncategorized.
01	Unrecoverable error (UEU).
10	Restartable error (UEO) or Corrected error (CE).
11	Recoverable error (UER).

On a synchronous Data Abort, this field is RES0.

If multiple errors are taken as a single SError interrupt exception, the overall state of the PE is reported. For example, if both a Recoverable and Unrecoverable error occurred, the state is Unrecoverable.

———— Note —————

Software can use this information to determine what recovery might be possible. The recovery software must also examine any implemented fault records to determine the location and extent of the error.

When RAS Extension is not implemented, or when DFSC is not 010001:

- Bit[11] is RES0.
- Bit[10] forms the FnV field.

———— Note —————

ARMv8.2 requires the implementation of the RAS Extension.

FnV, bit [10]

FAR not Valid, for a Synchronous external abort other than a Synchronous external abort on a translation table walk.

0	HDFAR is valid.
1	HDFAR is not valid, and holds an UNKNOWN value.

When the RAS Extension is not implemented, this field is valid only if DFSC is 010000. It is RES0 for all other aborts.

When the RAS Extension is implemented:

- If DFSC is 010000, this field is valid.
- If DFSC is 010001, this bit forms part of the AET field.
- This field is RES0 for all other aborts.

———— Note —————

ARMv8.2 requires the implementation of the RAS Extension.

EA, bit [9]

External abort type. This bit can provide an IMPLEMENTATION DEFINED classification of External aborts.

For any abort other than an External abort this bit returns a value of 0.

CM, bit [8]

Cache maintenance. For a synchronous fault, identifies fault that comes from a cache maintenance or address translation instruction. For synchronous faults, the possible values of this bit are:

0	Fault not generated by a cache maintenance or address translation instruction.
---	--

1 Fault generated by a cache maintenance or address translation instruction.

For an asynchronous Data Abort exception, this bit is 0.

S1PTW, bit [7]

For a stage 2 fault, indicates whether the fault was a stage 2 fault on an access made for a stage 1 translation table walk:

0 Fault not on a stage 2 translation for a stage 1 translation table walk.

1 Fault on the stage 2 translation of an access for a stage 1 translation table walk.

For any abort other than a stage 2 fault this bit is RES0.

———— Note —————

ARMv8.2 requires the implementation of the RAS Extension.

WnR, bit [6]

Write not Read. Indicates whether a synchronous abort was caused by a write instruction or a read instruction. The possible values of this bit are:

0 Abort caused by a read instruction.

1 Abort caused by a write instruction.

For faults on cache maintenance and address translation instructions, this bit always returns a value of 1.

On an asynchronous Data Abort:

- When the RAS Extension is not implemented this bit is UNKNOWN.
- When the RAS Extension is implemented this bit is RES0.

———— Note —————

ARMv8.2 requires the implementation of the RAS Extension.

DFSC, bits [5:0]

Data Fault Status Code. Possible values of this field are:

000000 Address size fault, translation table base register

000001 Address size fault, level 1

000010 Address size fault, level 2

000011 Address size fault, level 3

000101 Translation fault, level 1

000110 Translation fault, level 2

000111 Translation fault, level 3

001001 Access flag fault, level 1

001010 Access flag fault, level 2

001011 Access flag fault, level 3

001101 Permission fault, level 1

001110 Permission fault, level 2

001111 Permission fault, level 3

010000 Synchronous external abort, not on translation table walk

011000 Synchronous parity or ECC error on memory access, not on translation table walk

010001 SError interrupt

011001 SError interrupt from a parity or ECC error on memory access

010101 Synchronous external abort, on translation table walk, level 1

010110	Synchronous external abort, on translation table walk, level 2
010111	Synchronous external abort, on translation table walk, level 3
011101	Synchronous parity or ECC error on memory access on translation table walk, level 1
011110	Synchronous parity or ECC error on memory access on translation table walk, level 2
011111	Synchronous parity or ECC error on memory access on translation table walk, level 3
100001	Alignment fault
100010	Debug exception, only when the EC value is 0b100100
110000	TLB conflict abort
110100	IMPLEMENTATION DEFINED fault (Lockdown fault)
110101	IMPLEMENTATION DEFINED fault (Unsupported Exclusive access fault)

All other values are reserved.

When the RAS Extension is implemented, 011000, 011001, 011101, 011110, and 011111 are reserved.

For more information about the lookup level associated with a fault, see [The level associated with MMU faults on a Long-descriptor translation table lookup on page G4-4671](#).

The following describe cases where Data Abort exceptions can be routed to Hyp mode, generating exceptions that are reported in the HSR with EC value 0b100100:

- [Abort exceptions, when the value of HCR.TGE is 1 on page G1-4357](#).
- [Routing debug exceptions to EL2 using AArch32 on page G1-4358](#).

The following describe cases that can cause a Data Abort exception that is taken to Hyp mode, and reported in the HSR with EC value of 0b100000 or 0b100100:

- [Hyp mode control of Non-secure access permissions on page G4-4614](#).
- [Memory fault reporting in Hyp mode on page G4-4675](#).

Accessing the HSR

This register can be read using MRC with the following syntax:

MRC <syntax>

This register can be written using MCR with the following syntax:

MCR <syntax>

This syntax is encoded with the following settings in the instruction encoding:

<syntax>	opc1	opc2	CRn	coproc	CRm
p15, 4, <Rt>, c5, c2, 0	100	000	0101	1111	0010

Accessibility

The register is accessible in software as follows:

Control			Accessibility			
E2H	TGE	NS	EL0	EL1	EL2	EL3
x	x	0	-	-	n/a	-
x	0	1	-	-	RW	RW
x	1	1	-	n/a	RW	RW

Traps and Enables

For a description of the prioritization of any generated exceptions, see [Synchronous exception prioritization for exceptions taken to AArch32 state](#) on page G1-4344 for exceptions taken to AArch32 state and [Synchronous exception prioritization for exceptions taken to AArch64](#) on page D1-1827 for exceptions taken to AArch64 state. Subject to the prioritization rules:

- When EL2 is implemented and is using AArch64 and $(SCR_EL3.NS == 1) \ \&\& \ (HCR_EL2.E2H == 0)$:
 - If $HSTR_EL2.T5 == 1$, Non-secure accesses to this register from EL1 are trapped to EL2.
- When EL2 is implemented and is using AArch64 and $(SCR_EL3.NS == 1) \ \&\& \ (HCR_EL2.E2H == 1) \ \&\& \ (HCR_EL2.TGE == 0)$:
 - If $HSTR_EL2.T5 == 1$, Non-secure accesses to this register from EL1 are trapped to EL2.
- When EL2 is implemented and is using AArch32 and $SCR_EL3.NS == 1$:
 - If $HSTR.T5 == 1$, Non-secure accesses to this register from EL1 are trapped to Hyp mode.

G6.2.70 HSTR, Hyp System Trap Register

The HSTR characteristics are:

Purpose

Controls trapping to Hyp mode of Non-secure accesses, at EL1 or lower, to the System register in the coproc == 1111 encoding space, by the CRn value used to access the register using MCR or MRC instruction. When the register is accessible using an MCRR or MRRC instruction, this is the CRm value used to access the register.

Configurations

AArch32 System register HSTR is architecturally mapped to AArch64 System register [HSTR_EL2](#).

If EL2 is not implemented, this register is RES0 from EL3.

Some or all RW fields of this register have defined reset values. These apply only if the PE resets into EL2 with EL2 using AArch32, or into EL3 with EL3 using AArch32. Otherwise, RW fields in this register reset to architecturally UNKNOWN values.

Attributes

HSTR is a 32-bit register.

Field descriptions

The HSTR bit assignments are:

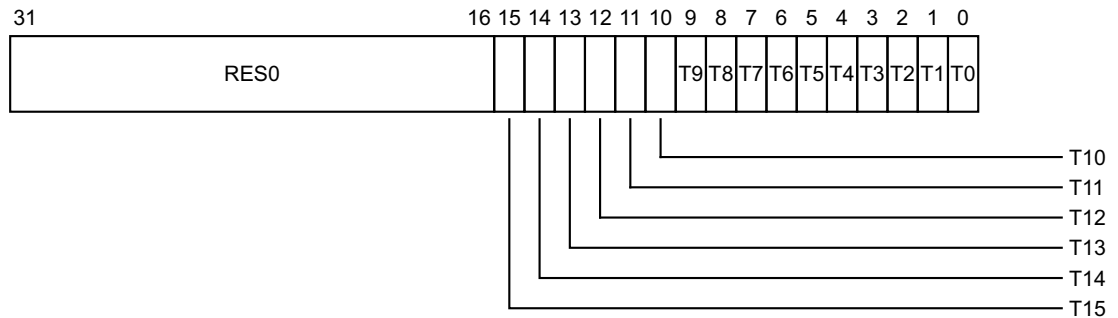

Bits [31:16]

Reserved, RES0.

T<n>, bit [n], for n = 0 to 15

Fields T14 and T4 are RES0.

The remaining fields control whether Non-secure EL0 and EL1 accesses, using MCR, MRC, MCRR, and MRRC instructions, to the System registers in the coproc == 1111 encoding space are trapped to Hyp mode:

- 0 This control has no effect on Non-secure EL0 or EL1 accesses to System registers.
- 1 Any Non-secure EL1 MCR, MRC access with coproc == 1111 and CRn == <n> is trapped to Hyp mode if the access is not UNDEFINED when the value of this field is 0.
Any Non-secure EL1 MCRR, MRRC access with coproc == 1111 and CRm == <n> is trapped to Hyp mode if the access is not UNDEFINED when the value of this field is 0.

For example, when HSTR.T7 is 1:

- Any 32-bit access from a Non-secure EL1 mode, using an MCR or MRC instruction with coproc set to 1111 and <CRn> set to c7, and that is not UNDEFINED when HSTR.T7 is 0, is trapped to Hyp mode.

- Any 64-bit access from a Non-secure EL1 mode, using an MCRR or MRRC instruction with coproc set to 1111 and <CRm> set to c7, and that is not UNDEFINED when HSTR.T7 is 0, is trapped to Hyp mode.

When this register has an architecturally-defined reset value, this field resets to 0.

Accessing the HSTR

This register can be read using MRC with the following syntax:

MRC <syntax>

This register can be written using MCR with the following syntax:

MCR <syntax>

This syntax is encoded with the following settings in the instruction encoding:

<syntax>	opc1	opc2	CRn	coproc	CRm
p15, 4, <Rt>, c1, c1, 3	100	011	0001	1111	0001

Accessibility

The register is accessible in software as follows:

Control			Accessibility			
E2H	TGE	NS	EL0	EL1	EL2	EL3
x	x	0	-	-	n/a	-
x	0	1	-	-	RW	RW
x	1	1	-	n/a	RW	RW

Traps and Enables

For a description of the prioritization of any generated exceptions, see [Synchronous exception prioritization for exceptions taken to AArch32 state on page G1-4344](#) for exceptions taken to AArch32 state and [Synchronous exception prioritization for exceptions taken to AArch64 on page D1-1827](#) for exceptions taken to AArch64 state. Subject to the prioritization rules:

- When EL2 is implemented and is using AArch64 and (SCR_EL3.NS == 1) && (HCR_EL2.E2H == 0):
 - If HSTR_EL2.T1==1, Non-secure accesses to this register from EL1 are trapped to EL2.
- When EL2 is implemented and is using AArch64 and (SCR_EL3.NS == 1) && (HCR_EL2.E2H == 1) && (HCR_EL2.TGE == 0):
 - If HSTR_EL2.T1==1, Non-secure accesses to this register from EL1 are trapped to EL2.
- When EL2 is implemented and is using AArch32 and SCR_EL3.NS == 1:
 - If HSTR.T1==1, Non-secure accesses to this register from EL1 are trapped to Hyp mode.

G6.2.71 HTCR, Hyp Translation Control Register

The HTCR characteristics are:

Purpose

The control register for stage 1 of the EL2 translation regime.

Note

This stage of translation always uses the Long-descriptor translation table format.

Configurations

AArch32 System register HTCR is architecturally mapped to AArch64 System register [TCR_EL2](#).

If EL2 is not implemented, this register is RES0 from EL3.

RW fields in this register reset to architecturally UNKNOWN values.

Attributes

HTCR is a 32-bit register.

Field descriptions

The HTCR bit assignments are:

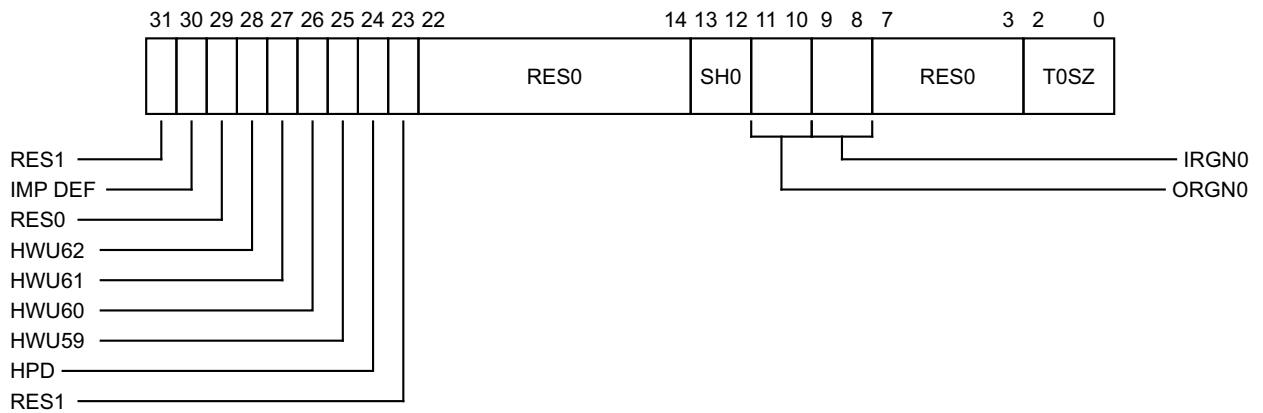

Bit [31]

Reserved, RES1.

IMP DEF, bit [30]

IMPLEMENTATION DEFINED.

Bit [29]

Reserved, RES0.

HWU62, bit [28]

In ARMv8.2

Hardware Use. Indicates IMPLEMENTATION DEFINED hardware use of bit[62] of the stage 1 translation table block or level 3 entry if the HTCR.HPD value is 1.

Defined values are:

- 0 The stage 1 translation table entry block or level 3 bit cannot be interpreted by hardware for an IMPLEMENTATION DEFINED purpose.

- 1 The stage 1 translation table entry block or level 3 bit can be interpreted by hardware for an IMPLEMENTATION DEFINED purpose if the HTCR.HPD value is 1.

This bit is RES0 if [ARMv8.2-TTPBHA](#) is not implemented.

In ARMv8.1 and ARMv8.0.

Reserved, RES0.

HWU61, bit [27]

In ARMv8.2

Hardware Use. Indicates IMPLEMENTATION DEFINED hardware use of bit[61] of the stage 1 translation table block or level 3 entry if the HTCR.HPD value is 1.

Defined values are:

- 0 The stage 1 translation table entry block or level 3 bit cannot be interpreted by hardware for an IMPLEMENTATION DEFINED purpose.
- 1 The stage 1 translation table entry block or level 3 bit can be interpreted by hardware for an IMPLEMENTATION DEFINED purpose if HTCR.HPD bit value is 1.

This bit is RES0 if [ARMv8.2-TTPBHA](#) is not implemented.

In ARMv8.1 and ARMv8.0.

Reserved, RES0.

HWU60, bit [26]

In ARMv8.2

Hardware Use. Indicates IMPLEMENTATION DEFINED hardware use of bit[60] of the stage 1 translation table block or level 3 entry.

Defined values are:

- 0 The stage 1 translation table entry block or level 3 bit cannot be interpreted by hardware for an IMPLEMENTATION DEFINED purpose.
- 1 The stage 1 translation table entry block or level 3 bit can be interpreted by hardware for an IMPLEMENTATION DEFINED purpose if the HTCR.HPD bit value is 1.

This bit is RES0 if [ARMv8.2-TTPBHA](#) is not implemented.

In ARMv8.1 and ARMv8.0.

Reserved, RES0.

HWU59, bit [25]

In ARMv8.2

Hardware Use. Indicates IMPLEMENTATION DEFINED hardware use of bit[59] of the stage 1 translation table block or level 3 entry.

Defined values are:

- 0 The stage 1 translation table entry block or level 3 bit cannot be interpreted by hardware for an IMPLEMENTATION DEFINED purpose.
- 1 The stage 1 translation table entry block or level 3 bit can be interpreted by hardware for an IMPLEMENTATION DEFINED purpose if the HTCR.HPD bit value is 1.

This bit is RES0 if [ARMv8.2-TTPBHA](#) is not implemented.

In ARMv8.1 and ARMv8.0.

Reserved, RES0.

HPD, bit [24]

In ARMv8.2

Hierarchical Permission Disables. This affects the hierarchical control bits, APTable, XNTable, and PXNTable, in the PL2 translation regime.

Defined values are:

- 0 Hierarchical permissions are enabled.
- 1 Hierarchical permissions are disabled.

When disabled, the permissions are treated as if the bits are zero.

This bit is RES0 if [ARMv8.2-AA32HPD](#) is not implemented.

In ARMv8.1 and ARMv8.0.

Reserved, RES0.

Bit [23]

Reserved, RES1.

Bits [22:14]

Reserved, RES0.

SH0, bits [13:12]

Shareability attribute for memory associated with translation table walks using [HTTBR](#).

- 00 Non-shareable
- 10 Outer Shareable
- 11 Inner Shareable

Other values are reserved. The effect of programming this field to a Reserved value is that behavior is CONstrained UNPREDICTABLE, as described in [Reserved values in System and memory-mapped registers and translation table entries on page K1-6117](#).

ORGN0, bits [11:10]

Outer cacheability attribute for memory associated with translation table walks using [HTTBR](#).

- 00 Normal memory, Outer Non-cacheable
- 01 Normal memory, Outer Write-Back Read-Allocate Write-Allocate Cacheable
- 10 Normal memory, Outer Write-Through Read-Allocate No Write-Allocate Cacheable
- 11 Normal memory, Outer Write-Back Read-Allocate No Write-Allocate Cacheable

IRGN0, bits [9:8]

Inner cacheability attribute for memory associated with translation table walks using [HTTBR](#).

- 00 Normal memory, Inner Non-cacheable
- 01 Normal memory, Inner Write-Back Read-Allocate Write-Allocate Cacheable
- 10 Normal memory, Inner Write-Through Read-Allocate No Write-Allocate Cacheable
- 11 Normal memory, Inner Write-Back Read-Allocate No Write-Allocate Cacheable

Bits [7:3]

Reserved, RES0.

T0SZ, bits [2:0]

The size offset of the memory region addressed by [HTTBR](#). The region size is $2^{(32-T0SZ)}$ bytes.

Accessing the HTCR

This register can be read using MRC with the following syntax:

MRC <syntax>

This register can be written using MCR with the following syntax:

MCR <syntax>

This syntax is encoded with the following settings in the instruction encoding:

<syntax>	opc1	opc2	CRn	coproc	CRm
p15, 4, <Rt>, c2, c0, 2	100	010	0010	1111	0000

Accessibility

The register is accessible in software as follows:

Control			Accessibility			
E2H	TGE	NS	EL0	EL1	EL2	EL3
x	x	0	-	-	n/a	-
x	0	1	-	-	RW	RW
x	1	1	-	n/a	RW	RW

Traps and Enables

For a description of the prioritization of any generated exceptions, see [Synchronous exception prioritization for exceptions taken to AArch32 state on page G1-4344](#) for exceptions taken to AArch32 state and [Synchronous exception prioritization for exceptions taken to AArch64 on page D1-1827](#) for exceptions taken to AArch64 state. Subject to the prioritization rules:

- When EL2 is implemented and is using AArch64 and (SCR_EL3.NS == 1) && (HCR_EL2.E2H == 0):
 - If HSTR_EL2.T2==1, Non-secure accesses to this register from EL1 are trapped to EL2.
- When EL2 is implemented and is using AArch64 and (SCR_EL3.NS == 1) && (HCR_EL2.E2H == 1) && (HCR_EL2.TGE == 0):
 - If HSTR_EL2.T2==1, Non-secure accesses to this register from EL1 are trapped to EL2.
- When EL2 is implemented and is using AArch32 and SCR_EL3.NS == 1:
 - If HSTR.T2==1, Non-secure accesses to this register from EL1 are trapped to Hyp mode.

G6.2.72 HTPIDR, Hyp Software Thread ID Register

The HTPIDR characteristics are:

Purpose

Provides a location where software running in Hyp mode can store thread identifying information that is not visible to Non-secure software executing at EL0 or EL1, for hypervisor management purposes.

The PE makes no use of this register.

Configurations

AArch32 System register HTPIDR is architecturally mapped to AArch64 System register [TPIDR_EL2](#)[31:0].

If EL2 is not implemented, this register is RES0 from EL3.

The PE never updates this register. This means the register is always UNKNOWN on reset.

Attributes

HTPIDR is a 32-bit register.

Field descriptions

The HTPIDR bit assignments are:

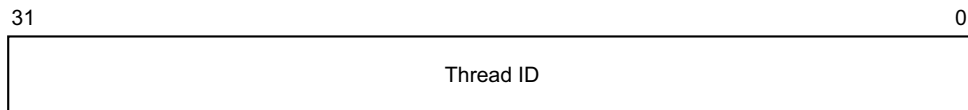

Bits [31:0]

Thread ID. Thread identifying information stored by software running at this Exception level.

Accessing the HTPIDR

This register can be read using MRC with the following syntax:

MRC <syntax>

This register can be written using MCR with the following syntax:

MCR <syntax>

This syntax is encoded with the following settings in the instruction encoding:

<syntax>	opc1	opc2	CRn	coproc	CRm
p15, 4, <Rt>, c13, c0, 2	100	010	1101	1111	0000

Accessibility

The register is accessible in software as follows:

Control			Accessibility			
E2H	TGE	NS	EL0	EL1	EL2	EL3
x	x	0	-	-	n/a	-
x	0	1	-	-	RW	RW
x	1	1	-	n/a	RW	RW

Traps and Enables

For a description of the prioritization of any generated exceptions, see [Synchronous exception prioritization for exceptions taken to AArch32 state on page G1-4344](#) for exceptions taken to AArch32 state and [Synchronous exception prioritization for exceptions taken to AArch64 on page D1-1827](#) for exceptions taken to AArch64 state. Subject to the prioritization rules:

- When EL2 is implemented and is using AArch64 and $(SCR_EL3.NS == 1) \ \&\& \ (HCR_EL2.E2H == 0)$:
 - If $HSTR_EL2.T13 == 1$, Non-secure accesses to this register from EL1 are trapped to EL2.
- When EL2 is implemented and is using AArch64 and $(SCR_EL3.NS == 1) \ \&\& \ (HCR_EL2.E2H == 1) \ \&\& \ (HCR_EL2.TGE == 0)$:
 - If $HSTR_EL2.T13 == 1$, Non-secure accesses to this register from EL1 are trapped to EL2.
- When EL2 is implemented and is using AArch32 and $SCR_EL3.NS == 1$:
 - If $HSTR.T13 == 1$, Non-secure accesses to this register from EL1 are trapped to Hyp mode.

G6.2.73 HTTBR, Hyp Translation Table Base Register

The HTTBR characteristics are:

Purpose

Holds the base address of the translation table for the initial lookup for stage 1 of an address translation in the EL2 translation regime, and other information for this translation regime.

Configurations

AArch32 System register HTTBR is architecturally mapped to AArch64 System register [TTBR0_EL2](#).

If EL2 is not implemented, this register is RES0 from EL3.

RW fields in this register reset to architecturally UNKNOWN values.

Attributes

HTTBR is a 64-bit register.

Field descriptions

The HTTBR bit assignments are:

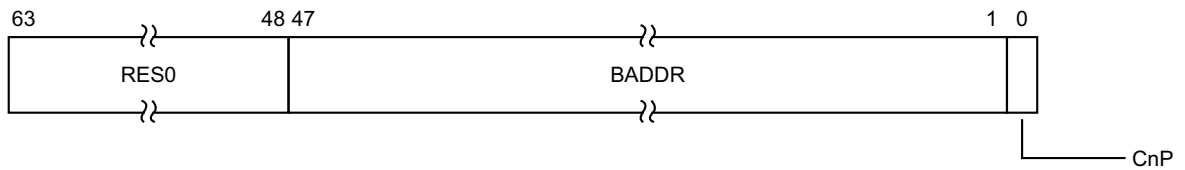

Bits [63:48]

Reserved, RES0.

BADDR, bits [47:1]

Translation table base address, bits[47:x], Bits [x-1:1] are RES0, with the additional requirement that if bits[x-1:3] are not all zero, this is a misaligned translation table base address, with effects that are CONstrained UNPREDICTABLE, and must be one of the following:

- Register bits [x-1:3] are treated as if all the bits are zero. The value read back from these bits is either the value written or zero.
- The result of the calculation of an address for a translation table walk using this register can be corrupted in those bits that are nonzero.

x is determined from the value of [HTCR.TOSZ](#) as follows:

- If [HTCR.TOSZ](#) is 0 or 1, $x = 5 - \text{HTCR.TOSZ}$.
- If [HTCR.TOSZ](#) is greater than 1, $x = 14 - \text{HTCR.TOSZ}$.

If bits[47:40] of the translation table base address are not zero, an Address size fault is generated.

CnP, bit [0]

In ARMv8.2

Common not Private. In an implementation that includes [ARMv8.2-TTCNP](#), indicates whether each entry that is pointed to by HTTBR is a member of a common set that can be used by every PE in the Inner Shareable domain for which the value of HTTBR.CnP is 1.

- 0 The translation table entries pointed to by HTTBR are permitted to differ from corresponding entries for HTTBR for other PEs in the Inner Shareable domain. This is not affected by the value of HTTBR.CnP on those other PEs.

- 1 The translation table entries pointed to by HTTBR are the same as the translation table entries pointed to by HTTBR on every other PE in the Inner Shareable domain for which the value of HTTBR.CnP is 1.

Note

If the value of the HTTBR.CnP bit is 1 on multiple PEs in the same Inner Shareable domain and those HTTBRs do not point to the same translation table entries when the other conditions specified for the case when the value of CnP is 1 apply, then the results of translations are *CONSTRAINED UNPREDICTABLE*, see *CONSTRAINED UNPREDICTABLE behaviors due to caching of control or data values on page K1-6101*.

In an implementation that does not include [ARMv8.2-TTCNP](#) this field is RES0.

In ARMv8.1 and ARMv8.0.

Reserved, RES0.

Accessing the HTTBR

This register can be read using MRRC with the following syntax:

MRRC <syntax>

This register can be written using MCRR with the following syntax:

MCRR <syntax>

This syntax is encoded with the following settings in the instruction encoding:

<syntax>	opc1	coproc	CRm
p15, 4, <Rt>, <Rt2>, c2	0100	1111	0010

Accessibility

The register is accessible in software as follows:

Control			Accessibility			
E2H	TGE	NS	EL0	EL1	EL2	EL3
x	x	0	-	-	n/a	-
x	0	1	-	-	RW	RW
x	1	1	-	n/a	RW	RW

Traps and Enables

For a description of the prioritization of any generated exceptions, see *Synchronous exception prioritization for exceptions taken to AArch32 state on page G1-4344* for exceptions taken to AArch32 state and *Synchronous exception prioritization for exceptions taken to AArch64 on page D1-1827* for exceptions taken to AArch64 state. Subject to the prioritization rules:

- When EL2 is implemented and is using AArch64 and (SCR_EL3.NS == 1) && (HCR_EL2.E2H == 0):
 - If `HSTR_EL2.T2==1`, Non-secure accesses to this register from EL1 are trapped to EL2.
- When EL2 is implemented and is using AArch64 and (SCR_EL3.NS == 1) && (HCR_EL2.E2H == 1) && (HCR_EL2.TGE == 0):
 - If `HSTR_EL2.T2==1`, Non-secure accesses to this register from EL1 are trapped to EL2.

- When EL2 is implemented and is using AArch32 and SCR_EL3.NS == 1:
 - If [HSTR.T2](#)==1, Non-secure accesses to this register from EL1 are trapped to Hyp mode.

G6.2.74 HVBAR, Hyp Vector Base Address Register

The HVBAR characteristics are:

Purpose

Holds the vector base address for any exception that is taken to Hyp mode.

Configurations

AArch32 System register HVBAR is architecturally mapped to AArch64 System register [VBAR_EL2](#)[31:0].

If EL2 is not implemented, this register is RES0 from EL3.

RW fields in this register reset to architecturally UNKNOWN values.

Attributes

HVBAR is a 32-bit register.

Field descriptions

The HVBAR bit assignments are:

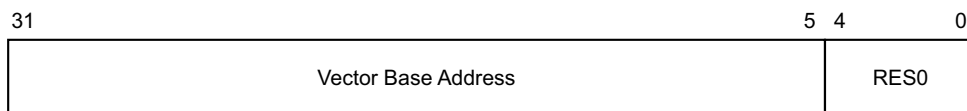

Bits [31:5]

Vector Base Address. Bits[31:5] of the base address of the exception vectors for exceptions taken to this Exception level. Bits[4:0] of an exception vector are the exception offset.

Bits [4:0]

Reserved, RES0.

Accessing the HVBAR

This register can be read using MRC with the following syntax:

MRC <syntax>

This register can be written using MCR with the following syntax:

MCR <syntax>

This syntax is encoded with the following settings in the instruction encoding:

<syntax>	opc1	opc2	CRn	coproc	CRm
p15, 4, <Rt>, c12, c0, 0	100	000	1100	1111	0000

Accessibility

The register is accessible in software as follows:

Control			Accessibility			
E2H	TGE	NS	EL0	EL1	EL2	EL3
x	x	0	-	-	n/a	-
x	0	1	-	-	RW	RW
x	1	1	-	n/a	RW	RW

Traps and Enables

For a description of the prioritization of any generated exceptions, see [Synchronous exception prioritization for exceptions taken to AArch32 state on page G1-4344](#) for exceptions taken to AArch32 state and [Synchronous exception prioritization for exceptions taken to AArch64 on page D1-1827](#) for exceptions taken to AArch64 state. Subject to the prioritization rules:

- When EL2 is implemented and is using AArch64 and (SCR_EL3.NS == 1) && (HCR_EL2.E2H == 0):
 - If [HSTR_EL2.T12==1](#), Non-secure accesses to this register from EL1 are trapped to EL2.
- When EL2 is implemented and is using AArch64 and (SCR_EL3.NS == 1) && (HCR_EL2.E2H == 1) && (HCR_EL2.TGE == 0):
 - If [HSTR_EL2.T12==1](#), Non-secure accesses to this register from EL1 are trapped to EL2.
- When EL2 is implemented and is using AArch32 and SCR_EL3.NS == 1:
 - If [HSTR.T12==1](#), Non-secure accesses to this register from EL1 are trapped to Hyp mode.

G6.2.75 ICIALLU, Instruction Cache Invalidate All to PoU

The ICIALLU characteristics are:

Purpose

Invalidate all instruction caches to PoU. If branch predictors are architecturally visible, also flush branch predictors.

Configurations

AArch32 System instruction ICIALLU performs the same function as AArch64 System instruction [IC IALLU](#).

Attributes

ICIALLU is a 32-bit System instruction.

Field descriptions

ICIALLU ignores the value in the register specified by the instruction. Software does not have to write a value to the register before issuing this instruction.

Executing the ICIALLU instruction

This instruction is executed using MCR with the following syntax:

MCR <syntax>

This syntax uses the following encoding in the System instruction encoding space:

<syntax>	opc1	opc2	CRn	coproc	CRm
p15, 0, <Rt>, c7, c5, 0	000	000	0111	1111	0101

The PE ignores the value of <Rt>. Software does not have to write a value to this register before issuing this instruction.

Accessibility

The instruction is executable as follows:

Control			Accessibility			
E2H	TGE	NS	EL0	EL1	EL2	EL3
x	x	0	-	WO	n/a	WO
x	0	1	-	WO	WO	WO
x	1	1	-	n/a	WO	WO

When [HCR.FB](#) is 1, at Non-secure EL1 this instruction executes as a [ICIALUIS](#).

Traps and Enables

For a description of the prioritization of any generated exceptions, see *Synchronous exception prioritization for exceptions taken to AArch32 state* on page G1-4344 for exceptions taken to AArch32 state and *Synchronous exception prioritization for exceptions taken to AArch64* on page D1-1827 for exceptions taken to AArch64 state. Subject to the prioritization rules:

- When EL2 is implemented and is using AArch64 and $(SCR_EL3.NS == 1) \&\& (HCR_EL2.E2H == 0)$:
 - If $HCR_EL2.TPU == 1$, Non-secure execution of this instruction at EL1 is trapped to EL2.
 - If $HSTR_EL2.T7 == 1$, Non-secure execution of this instruction at EL1 is trapped to EL2.
- When EL2 is implemented and is using AArch64 and $(SCR_EL3.NS == 1) \&\& (HCR_EL2.E2H == 1) \&\& (HCR_EL2.TGE == 0)$:
 - If $HCR_EL2.TPU == 1$, Non-secure execution of this instruction at EL1 is trapped to EL2.
 - If $HSTR_EL2.T7 == 1$, Non-secure execution of this instruction at EL1 is trapped to EL2.
- When EL2 is implemented and is using AArch32 and $SCR_EL3.NS == 1$:
 - If $HCR.TPU == 1$, Non-secure execution of this instruction at EL1 is trapped to Hyp mode.
 - If $HSTR.T7 == 1$, Non-secure execution of this instruction at EL1 is trapped to Hyp mode.

G6.2.76 ICIALLUIS, Instruction Cache Invalidate All to PoU, Inner Shareable

The ICIALLUIS characteristics are:

Purpose

Invalidate all instruction caches Inner Shareable to PoU. If branch predictors are architecturally visible, also flush branch predictors.

Configurations

AArch32 System instruction ICIALLUIS performs the same function as AArch64 System instruction [IC IALLUIS](#).

Attributes

ICIALLUIS is a 32-bit System instruction.

Field descriptions

ICIALLUIS ignores the value in the register specified by the instruction. Software does not have to write a value to the register before issuing this instruction.

Executing the ICIALLUIS instruction

This instruction is executed using MCR with the following syntax:

MCR <syntax>

This syntax uses the following encoding in the System instruction encoding space:

<syntax>	opc1	opc2	CRn	coproc	CRm
p15, 0, <Rt>, c7, c1, 0	000	000	0111	1111	0001

The PE ignores the value of <Rt>. Software does not have to write a value to this register before issuing this instruction.

Accessibility

The instruction is executable as follows:

Control			Accessibility			
E2H	TGE	NS	EL0	EL1	EL2	EL3
x	x	0	-	WO	n/a	WO
x	0	1	-	WO	WO	WO
x	1	1	-	n/a	WO	WO

Traps and Enables

For a description of the prioritization of any generated exceptions, see [Synchronous exception prioritization for exceptions taken to AArch32 state on page G1-4344](#) for exceptions taken to AArch32 state and [Synchronous exception prioritization for exceptions taken to AArch64 on page D1-1827](#) for exceptions taken to AArch64 state. Subject to the prioritization rules:

- When EL2 is implemented and is using AArch64 and (SCR_EL3.NS == 1) && (HCR_EL2.E2H == 0):
 - If HCR_EL2.TPU==1, Non-secure execution of this instruction at EL1 is trapped to EL2.

- If `HSTR_EL2.T7==1`, Non-secure execution of this instruction at EL1 is trapped to EL2.
- When EL2 is implemented and is using AArch64 and `(SCR_EL3.NS == 1) && (HCR_EL2.E2H == 1) && (HCR_EL2.TGE == 0)`:
 - If `HCR_EL2.TPU==1`, Non-secure execution of this instruction at EL1 is trapped to EL2.
 - If `HSTR_EL2.T7==1`, Non-secure execution of this instruction at EL1 is trapped to EL2.
- When EL2 is implemented and is using AArch32 and `SCR_EL3.NS == 1`:
 - If `HCR.TPU==1`, Non-secure execution of this instruction at EL1 is trapped to Hyp mode.
 - If `HSTR.T7==1`, Non-secure execution of this instruction at EL1 is trapped to Hyp mode.

G6.2.77 ICIMVAU, Instruction Cache line Invalidate by VA to PoU

The ICIMVAU characteristics are:

Purpose

Invalidate instruction cache line by virtual address to PoU.

Configurations

AArch32 System instruction ICIMVAU performs the same function as AArch64 System instruction [IC IVAU](#).

Attributes

ICIMVAU is a 32-bit System instruction.

Field descriptions

The ICIMVAU input value bit assignments are:

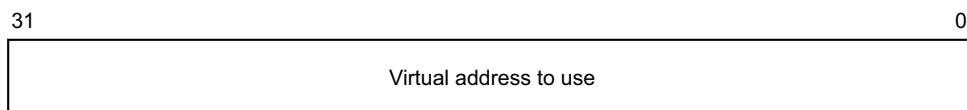

Bits [31:0]

Virtual address to use.

Executing the ICIMVAU instruction

This instruction is executed using MCR with the following syntax:

MCR <syntax>

This syntax uses the following encoding in the System instruction encoding space:

<syntax>	opc1	opc2	CRn	coproc	CRm
p15, 0, <Rt>, c7, c5, 1	000	001	0111	1111	0101

Accessibility

The instruction is executable as follows:

Control			Accessibility			
E2H	TGE	NS	EL0	EL1	EL2	EL3
x	x	0	-	WO	n/a	WO
x	0	1	-	WO	WO	WO
x	1	1	-	n/a	WO	WO

Traps and Enables

For a description of the prioritization of any generated exceptions, see *Synchronous exception prioritization for exceptions taken to AArch32 state* on page G1-4344 for exceptions taken to AArch32 state and *Synchronous exception prioritization for exceptions taken to AArch64* on page D1-1827 for exceptions taken to AArch64 state. Subject to the prioritization rules:

- When EL2 is implemented and is using AArch64 and $(SCR_EL3.NS == 1) \&\& (HCR_EL2.E2H == 0)$:
 - If $HCR_EL2.TPU == 1$, Non-secure execution of this instruction at EL1 is trapped to EL2.
 - If $HSTR_EL2.T7 == 1$, Non-secure execution of this instruction at EL1 is trapped to EL2.
- When EL2 is implemented and is using AArch64 and $(SCR_EL3.NS == 1) \&\& (HCR_EL2.E2H == 1) \&\& (HCR_EL2.TGE == 0)$:
 - If $HCR_EL2.TPU == 1$, Non-secure execution of this instruction at EL1 is trapped to EL2.
 - If $HSTR_EL2.T7 == 1$, Non-secure execution of this instruction at EL1 is trapped to EL2.
- When EL2 is implemented and is using AArch32 and $SCR_EL3.NS == 1$:
 - If $HCR.TPU == 1$, Non-secure execution of this instruction at EL1 is trapped to Hyp mode.
 - If $HSTR.T7 == 1$, Non-secure execution of this instruction at EL1 is trapped to Hyp mode.

G6.2.78 ID_AFR0, Auxiliary Feature Register 0

The ID_AFR0 characteristics are:

Purpose

Provides information about the IMPLEMENTATION DEFINED features of the PE in AArch32 state.

Must be interpreted with the Main ID Register, [MIDR](#).

For general information about the interpretation of the ID registers see [Principles of the ID scheme for fields in ID registers on page G4-4701](#).

Configurations

There is one instance of this register that is used in both Secure and Non-secure states.

AArch32 System register ID_AFR0 is architecturally mapped to AArch64 System register [ID_AFR0_EL1](#).

Attributes

ID_AFR0 is a 32-bit register.

Field descriptions

The ID_AFR0 bit assignments are:

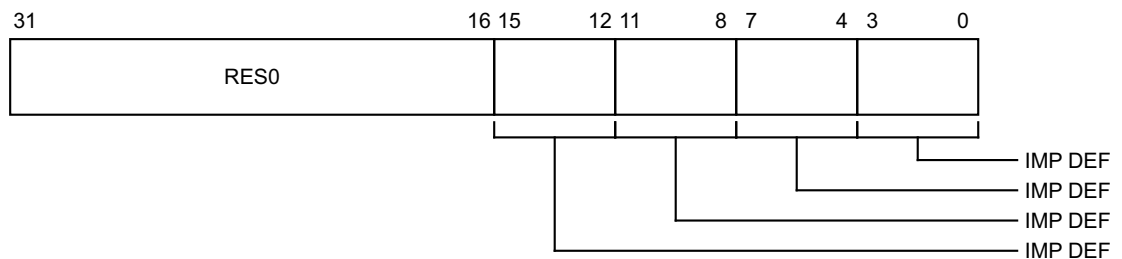

Bits [31:16]

Reserved, RES0.

IMPLEMENTATION DEFINED, bits [15:12]

IMPLEMENTATION DEFINED.

IMPLEMENTATION DEFINED, bits [11:8]

IMPLEMENTATION DEFINED.

IMPLEMENTATION DEFINED, bits [7:4]

IMPLEMENTATION DEFINED.

IMPLEMENTATION DEFINED, bits [3:0]

IMPLEMENTATION DEFINED.

Accessing the ID_AFR0

This register can be read using MRC with the following syntax:

MRC <syntax>

This syntax is encoded with the following settings in the instruction encoding:

<syntax>	opc1	opc2	CRn	coproc	CRm
p15, 0, <Rt>, c0, c1, 3	000	011	0000	1111	0001

Accessibility

The register is accessible in software as follows:

Control			Accessibility			
E2H	TGE	NS	EL0	EL1	EL2	EL3
x	x	0	-	RO	n/a	RO
x	0	1	-	RO	RO	RO
x	1	1	-	n/a	RO	RO

Traps and Enables

For a description of the prioritization of any generated exceptions, see [Synchronous exception prioritization for exceptions taken to AArch32 state on page G1-4344](#) for exceptions taken to AArch32 state and [Synchronous exception prioritization for exceptions taken to AArch64 on page D1-1827](#) for exceptions taken to AArch64 state. Subject to the prioritization rules:

- When EL2 is implemented and is using AArch64 and (SCR_EL3.NS == 1) && (HCR_EL2.E2H == 0):
 - If HCR_EL2.TID3==1, Non-secure read accesses to this register from EL1 are trapped to EL2.
 - If HSTR_EL2.T0==1, Non-secure read accesses to this register from EL1 are trapped to EL2.
- When EL2 is implemented and is using AArch64 and (SCR_EL3.NS == 1) && (HCR_EL2.E2H == 1) && (HCR_EL2.TGE == 0):
 - If HCR_EL2.TID3==1, Non-secure read accesses to this register from EL1 are trapped to EL2.
 - If HSTR_EL2.T0==1, Non-secure read accesses to this register from EL1 are trapped to EL2.
- When EL2 is implemented and is using AArch32 and SCR_EL3.NS == 1:
 - If HCR.TID3==1, Non-secure read accesses to this register from EL1 are trapped to Hyp mode.
 - If HSTR.T0==1, Non-secure read accesses to this register from EL1 are trapped to Hyp mode.

G6.2.79 ID_DFR0, Debug Feature Register 0

The ID_DFR0 characteristics are:

Purpose

Provides top level information about the debug system in AArch32 state.

Must be interpreted with the Main ID Register, [MIDR](#).

For general information about the interpretation of the ID registers see [Principles of the ID scheme for fields in ID registers on page G4-4701](#).

Configurations

There is one instance of this register that is used in both Secure and Non-secure states.

AArch32 System register ID_DFR0 is architecturally mapped to AArch64 System register [ID_DFR0_EL1](#).

Attributes

ID_DFR0 is a 32-bit register.

Field descriptions

The ID_DFR0 bit assignments are:

31	28 27	24 23	20 19	16 15	12 11	8 7	4 3	0
RES0	PerfMon	MProfDbg	MMapTrc	CopTrc	MMapDbg	CopSDBG	CopDbg	

Bits [31:28]

Reserved, RES0.

PerfMon, bits [27:24]

Performance Monitors. Support for System registers-based ARM Performance Monitors Extension, using registers in the coproc == 1111 encoding space, for A and R profile processors. Defined values are:

0000	Performance Monitors Extension System registers not implemented.
0001	Support for Performance Monitors Extension version 1 (PMUv1) System registers.
0010	Support for Performance Monitors Extension version 2 (PMUv2) System registers.
0011	Support for Performance Monitors Extension version 3 (PMUv3) System registers.
0100	Support for Performance Monitors Extension version 3 (PMUv3) System registers, with a 16-bit evtCount field.
1111	IMPLEMENTATION DEFINED form of Performance Monitors System registers supported. PMUv3 not supported.

All other values are reserved.

In ARMv8.0 the permitted values are 0000, 0011, and 1111.

From ARMv8.1 the permitted values are 0000, 0100, and 1111.

In ARMv7, the value 0000 can mean that PMUv1 is implemented. PMUv1 is not permitted in an ARMv8 implementation.

MProfDbg, bits [23:20]

M Profile Debug. Support for memory-mapped debug model for M profile processors. Defined values are:

0000	Not supported.
------	----------------

0001 Support for M profile Debug architecture, with memory-mapped access.
All other values are reserved.
In ARMv8-A the only permitted value is 0000.

MMapTrc, bits [19:16]

Memory Mapped Trace. Support for memory-mapped trace model. Defined values are:
0000 Not supported.
0001 Support for ARM trace architecture, with memory-mapped access.
All other values are reserved.
In ARMv8-A the permitted values are 0000 and 0001.
In the Trace registers, the ETMIDR gives more information about the implementation.

CopTrc, bits [15:12]

Support for System registers-based trace model, using registers in the coproc == 1110 encoding space. Defined values are:
0000 Not supported.
0001 Support for ARM trace architecture, with System registers access.
All other values are reserved.
In ARMv8-A the permitted values are 0000 and 0001.
In the Trace registers, the ETMIDR gives more information about the implementation.

MMapDbg, bits [11:8]

Memory Mapped Debug. Support for v7 memory-mapped debug model, for A and R profile processors.
In ARMv8-A this field is RES0.
The optional memory map defined by ARMv8 is not compatible with ARMv7.

CopSDBG, bits [7:4]

Support for a System registers-based Secure debug model, using registers in the coproc = 1110 encoding space, for an A profile processor that includes EL3.
If EL3 is not implemented and the implemented Security state is Non-Secure state, this field is RES0.
Otherwise, this field reads the same as bits [3:0].

CopDbg, bits [3:0]

Support for System registers-based debug model, using registers in the coproc == 1110 encoding space, for A and R profile processors. Defined values are:
0000 Not supported.
0010 Support for ARMv6, v6 Debug architecture, with System registers access.
0011 Support for ARMv6, v6.1 Debug architecture, with System registers access.
0100 Support for ARMv7, v7 Debug architecture, with System registers access.
0101 Support for ARMv7, v7.1 Debug architecture, with System registers access.
0110 Support for ARMv8 debug architecture, with System registers access.
0111 Support for ARMv8 debug architecture, with System registers access, and Virtualization Host extensions.
1000 Support for ARMv8.2 debug architecture.
All other values are reserved.
In an ARMv8.0 implementation, the only permitted value is 0b0110.
In an ARMv8.1 implementation that does not include ARMv8.1-VHE, the permitted values are 0b0110 and 0b0111.

In an ARMv8.1 implementation that includes ARMv8.1-VHE, the only permitted value is 0b0111.

In an ARMv8.2 implementation, the only permitted value is 0b1000.

Accessing the ID_DFR0

This register can be read using MRC with the following syntax:

MRC <syntax>

This syntax is encoded with the following settings in the instruction encoding:

<syntax>	opc1	opc2	CRn	coproc	CRm
p15, 0, <Rt>, c0, c1, 2	000	010	0000	1111	0001

Accessibility

The register is accessible in software as follows:

Control			Accessibility			
E2H	TGE	NS	EL0	EL1	EL2	EL3
x	x	0	-	RO	n/a	RO
x	0	1	-	RO	RO	RO
x	1	1	-	n/a	RO	RO

Traps and Enables

For a description of the prioritization of any generated exceptions, see [Synchronous exception prioritization for exceptions taken to AArch32 state on page G1-4344](#) for exceptions taken to AArch32 state and [Synchronous exception prioritization for exceptions taken to AArch64 on page D1-1827](#) for exceptions taken to AArch64 state. Subject to the prioritization rules:

- When EL2 is implemented and is using AArch64 and (SCR_EL3.NS == 1) && (HCR_EL2.E2H == 0):
 - If HCR_EL2.TID3==1, Non-secure read accesses to this register from EL1 are trapped to EL2.
 - If HSTR_EL2.T0==1, Non-secure read accesses to this register from EL1 are trapped to EL2.
- When EL2 is implemented and is using AArch64 and (SCR_EL3.NS == 1) && (HCR_EL2.E2H == 1) && (HCR_EL2.TGE == 0):
 - If HCR_EL2.TID3==1, Non-secure read accesses to this register from EL1 are trapped to EL2.
 - If HSTR_EL2.T0==1, Non-secure read accesses to this register from EL1 are trapped to EL2.
- When EL2 is implemented and is using AArch32 and SCR_EL3.NS == 1:
 - If HCR.TID3==1, Non-secure read accesses to this register from EL1 are trapped to Hyp mode.
 - If HSTR.T0==1, Non-secure read accesses to this register from EL1 are trapped to Hyp mode.

G6.2.80 ID_ISAR0, Instruction Set Attribute Register 0

The ID_ISAR0 characteristics are:

Purpose

Provides information about the instruction sets implemented by the PE in AArch32 state.

Must be interpreted with ID_ISAR1, ID_ISAR2, ID_ISAR3, ID_ISAR4, and ID_ISAR5.

For general information about the interpretation of the ID registers see *Principles of the ID scheme for fields in ID registers* on page G4-4701.

Configurations

There is one instance of this register that is used in both Secure and Non-secure states.

AArch32 System register ID_ISAR0 is architecturally mapped to AArch64 System register ID_ISAR0_EL1.

Attributes

ID_ISAR0 is a 32-bit register.

Field descriptions

The ID_ISAR0 bit assignments are:

31	28 27	24 23	20 19	16 15	12 11	8 7	4 3	0
RES0	Divide	Debug	Coprocc	CmpBranch	BitField	BitCount	Swap	

Bits [31:28]

Reserved, RES0.

Divide, bits [27:24]

Indicates the implemented Divide instructions. Defined values are:

0000 None implemented.

0001 Adds SDIV and UDIV in the T32 instruction set.

0010 As for 0001, and adds SDIV and UDIV in the A32 instruction set.

All other values are reserved.

In ARMv8-A the only permitted value is 0010.

Debug, bits [23:20]

Indicates the implemented Debug instructions. Defined values are:

0000 None implemented.

0001 Adds BKPT.

All other values are reserved.

In ARMv8-A the only permitted value is 0001.

Coprocc, bits [19:16]

Indicates the implemented System register access instructions. Defined values are:

0000 None implemented, except for instructions separately attributed by the architecture to provide access to AArch32 System registers and System instructions.

0001 Adds generic CDP, LDC, MCR, MRC, and STC.

0010 As for 0001, and adds generic CDP2, LDC2, MCR2, MRC2, and STC2.

0011 As for 0010, and adds generic MCRR and MRRC.

0100 As for 0011, and adds generic MCRR2 and MRRC2.
All other values are reserved.
In ARMv8-A the only permitted value is 0000.

CmpBranch, bits [15:12]

Indicates the implemented combined Compare and Branch instructions in the T32 instruction set.
Defined values are:
0000 None implemented.
0001 Adds CBNZ and CBZ.
All other values are reserved.
In ARMv8-A the only permitted value is 0001.

BitField, bits [11:8]

Indicates the implemented BitField instructions. Defined values are:
0000 None implemented.
0001 Adds BFC, BFI, SBFX, and UBFX.
All other values are reserved.
In ARMv8-A the only permitted value is 0001.

BitCount, bits [7:4]

Indicates the implemented Bit Counting instructions. Defined values are:
0000 None implemented.
0001 Adds CLZ.
All other values are reserved.
In ARMv8-A the only permitted value is 0001.

Swap, bits [3:0]

Indicates the implemented Swap instructions in the A32 instruction set. Defined values are:
0000 None implemented.
0001 Adds SWP and SWPB.
All other values are reserved.
In ARMv8-A the only permitted value is 0000.

Accessing the ID_ISAR0

This register can be read using MRC with the following syntax:

MRC <syntax>

This syntax is encoded with the following settings in the instruction encoding:

<syntax>	opc1	opc2	CRn	coproc	CRm
p15, 0, <Rt>, c0, c2, 0	000	000	0000	1111	0010

Accessibility

The register is accessible in software as follows:

Control			Accessibility			
E2H	TGE	NS	EL0	EL1	EL2	EL3
x	x	0	-	RO	n/a	RO
x	0	1	-	RO	RO	RO
x	1	1	-	n/a	RO	RO

Traps and Enables

For a description of the prioritization of any generated exceptions, see [Synchronous exception prioritization for exceptions taken to AArch32 state on page G1-4344](#) for exceptions taken to AArch32 state and [Synchronous exception prioritization for exceptions taken to AArch64 on page D1-1827](#) for exceptions taken to AArch64 state. Subject to the prioritization rules:

- When EL2 is implemented and is using AArch64 and (SCR_EL3.NS == 1) && (HCR_EL2.E2H == 0):
 - If HCR_EL2.TID3==1, Non-secure read accesses to this register from EL1 are trapped to EL2.
 - If HSTR_EL2.T0==1, Non-secure read accesses to this register from EL1 are trapped to EL2.
- When EL2 is implemented and is using AArch64 and (SCR_EL3.NS == 1) && (HCR_EL2.E2H == 1) && (HCR_EL2.TGE == 0):
 - If HCR_EL2.TID3==1, Non-secure read accesses to this register from EL1 are trapped to EL2.
 - If HSTR_EL2.T0==1, Non-secure read accesses to this register from EL1 are trapped to EL2.
- When EL2 is implemented and is using AArch32 and SCR_EL3.NS == 1:
 - If HCR.TID3==1, Non-secure read accesses to this register from EL1 are trapped to Hyp mode.
 - If HSTR.T0==1, Non-secure read accesses to this register from EL1 are trapped to Hyp mode.

G6.2.81 ID_ISAR1, Instruction Set Attribute Register 1

The ID_ISAR1 characteristics are:

Purpose

Provides information about the instruction sets implemented by the PE in AArch32 state.

Must be interpreted with ID_ISAR0, ID_ISAR2, ID_ISAR3, ID_ISAR4, and ID_ISAR5.

For general information about the interpretation of the ID registers see *Principles of the ID scheme for fields in ID registers* on page G4-4701.

Configurations

There is one instance of this register that is used in both Secure and Non-secure states.

AArch32 System register ID_ISAR1 is architecturally mapped to AArch64 System register ID_ISAR1_EL1.

Attributes

ID_ISAR1 is a 32-bit register.

Field descriptions

The ID_ISAR1 bit assignments are:

31	28 27	24 23	20 19	16 15	12 11	8 7	4 3	0
Jazelle	Interwork	Immediate	IfThen	Extend	Except_AR	Except	Endian	

Jazelle, bits [31:28]

Indicates the implemented Jazelle extension instructions. Defined values are:

0000 No support for Jazelle.

0001 Adds the BXJ instruction, and the J bit in the PSR. This setting might indicate a trivial implementation of the Jazelle extension.

All other values are reserved.

In ARMv8-A the only permitted value is 0001.

Interwork, bits [27:24]

Indicates the implemented Interworking instructions. Defined values are:

0000 None implemented.

0001 Adds the BX instruction, and the T bit in the PSR.

0010 As for 0001, and adds the BLX instruction. PC loads have BX-like behavior.

0011 As for 0010, and guarantees that data-processing instructions in the A32 instruction set with the PC as the destination and the S bit clear have BX-like behavior.

All other values are reserved.

In ARMv8-A the only permitted value is 0011.

Immediate, bits [23:20]

Indicates the implemented data-processing instructions with long immediates. Defined values are:

0000 None implemented.

0001 Adds:

- The MOVT instruction.
- The MOV instruction encodings with zero-extended 16-bit immediates.

- The T32 ADD and SUB instruction encodings with zero-extended 12-bit immediates, and the other ADD, ADR, and SUB encodings cross-referenced by the pseudocode for those encodings.

All other values are reserved.

In ARMv8-A the only permitted value is 0001.

IfThen, bits [19:16]

Indicates the implemented If-Then instructions in the T32 instruction set. Defined values are:

0000 None implemented.

0001 Adds the IT instructions, and the IT bits in the PSRs.

All other values are reserved.

In ARMv8-A the only permitted value is 0001.

Extend, bits [15:12]

Indicates the implemented Extend instructions. Defined values are:

0000 No scalar sign-extend or zero-extend instructions are implemented, where scalar instructions means non-Advanced SIMD instructions.

0001 Adds the SXTB, SXTB16, UXTB, and UXTH instructions.

0010 As for 0001, and adds the SXTB16, SXTAB, SXTAB16, SXTAH, UXTB16, UXTAB, UXTAB16, and UXTAH instructions.

All other values are reserved.

In ARMv8-A the only permitted value is 0010.

Except_AR, bits [11:8]

Indicates the implemented A and R profile exception-handling instructions. Defined values are:

0000 None implemented.

0001 Adds the SRS and RFE instructions, and the A and R profile forms of the CPS instruction.

All other values are reserved.

In ARMv8-A the only permitted value is 0001.

Except, bits [7:4]

Indicates the implemented exception-handling instructions in the ARM instruction set. Defined values are:

0000 Not implemented. This indicates that the User bank and Exception return forms of the LDM and STM instructions are not implemented.

0001 Adds the LDM (exception return), LDM (user registers), and STM (user registers) instruction versions.

All other values are reserved.

In ARMv8-A the only permitted value is 0001.

Endian, bits [3:0]

Indicates the implemented Endian instructions. Defined values are:

0000 None implemented.

0001 Adds the SETEND instruction, and the E bit in the PSRs.

All other values are reserved.

In ARMv8-A the permitted values are 0000 and 0001.

Accessing the ID_ISAR1

This register can be read using MRC with the following syntax:

MRC <syntax>

This syntax is encoded with the following settings in the instruction encoding:

<syntax>	opc1	opc2	CRn	coproc	CRm
p15, 0, <Rt>, c0, c2, 1	000	001	0000	1111	0010

Accessibility

The register is accessible in software as follows:

Control			Accessibility			
E2H	TGE	NS	EL0	EL1	EL2	EL3
x	x	0	-	RO	n/a	RO
x	0	1	-	RO	RO	RO
x	1	1	-	n/a	RO	RO

Traps and Enables

For a description of the prioritization of any generated exceptions, see [Synchronous exception prioritization for exceptions taken to AArch32 state on page G1-4344](#) for exceptions taken to AArch32 state and [Synchronous exception prioritization for exceptions taken to AArch64 on page D1-1827](#) for exceptions taken to AArch64 state. Subject to the prioritization rules:

- When EL2 is implemented and is using AArch64 and (SCR_EL3.NS == 1) && (HCR_EL2.E2H == 0):
 - If HCR_EL2.TID3==1, Non-secure read accesses to this register from EL1 are trapped to EL2.
 - If HSTR_EL2.T0==1, Non-secure read accesses to this register from EL1 are trapped to EL2.
- When EL2 is implemented and is using AArch64 and (SCR_EL3.NS == 1) && (HCR_EL2.E2H == 1) && (HCR_EL2.TGE == 0):
 - If HCR_EL2.TID3==1, Non-secure read accesses to this register from EL1 are trapped to EL2.
 - If HSTR_EL2.T0==1, Non-secure read accesses to this register from EL1 are trapped to EL2.
- When EL2 is implemented and is using AArch32 and SCR_EL3.NS == 1:
 - If HCR.TID3==1, Non-secure read accesses to this register from EL1 are trapped to Hyp mode.
 - If HSTR.T0==1, Non-secure read accesses to this register from EL1 are trapped to Hyp mode.

G6.2.82 ID_ISAR2, Instruction Set Attribute Register 2

The ID_ISAR2 characteristics are:

Purpose

Provides information about the instruction sets implemented by the PE in AArch32 state.

Must be interpreted with ID_ISAR0, ID_ISAR1, ID_ISAR3, ID_ISAR4, and ID_ISAR5.

For general information about the interpretation of the ID registers see *Principles of the ID scheme for fields in ID registers* on page G4-4701.

Configurations

There is one instance of this register that is used in both Secure and Non-secure states.

AArch32 System register ID_ISAR2 is architecturally mapped to AArch64 System register ID_ISAR2_EL1.

Attributes

ID_ISAR2 is a 32-bit register.

Field descriptions

The ID_ISAR2 bit assignments are:

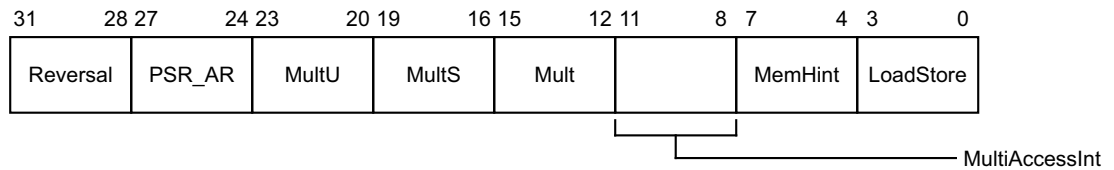

Reversal, bits [31:28]

Indicates the implemented Reversal instructions. Defined values are:

- 0000 None implemented.
- 0001 Adds the REV, REV16, and REVSH instructions.
- 0010 As for 0001, and adds the RBIT instruction.

All other values are reserved.

In ARMv8-A the only permitted value is 0010.

PSR_AR, bits [27:24]

Indicates the implemented A and R profile instructions to manipulate the PSR. Defined values are:

- 0000 None implemented.
- 0001 Adds the MRS and MSR instructions, and the exception return forms of data-processing instructions.

All other values are reserved.

In ARMv8-A the only permitted value is 0001.

The exception return forms of the data-processing instructions are:

- In the A32 instruction set, data-processing instructions with the PC as the destination and the S bit set. These instructions might be affected by the WithShifts attribute.
- In the T32 instruction set, the SUBS PC,LR,#N instruction.

MultU, bits [23:20]

Indicates the implemented advanced unsigned Multiply instructions. Defined values are:

- 0000 None implemented.
- 0001 Adds the UMULL and UMLAL instructions.
- 0010 As for 0001, and adds the UMAAL instruction.

All other values are reserved.

In ARMv8-A the only permitted value is 0010.

MultS, bits [19:16]

Indicates the implemented advanced signed Multiply instructions. Defined values are:

- 0000 None implemented.
- 0001 Adds the SMULL and SMLAL instructions.
- 0010 As for 0001, and adds the SMLABB, SMLABT, SMLALBB, SMLALBT, SMLALTB, SMLALTT, SMLATB, SMLATT, SMLAWB, SMLAWT, SMULBB, SMULBT, SMULTB, SMULTT, SMULWB, and SMULWT instructions. Also adds the Q bit in the PSRs.
- 0011 As for 0010, and adds the SMLAD, SMLADX, SMLALD, SMLALDX, SMLSD, SMLSDX, SMLSLD, SMLSLDX, SMMLA, SMMLAR, SMMLS, SMMLSR, SMMUL, SMMULR, SMUAD, SMUADX, SMUSD, and SMUSDX instructions.

All other values are reserved.

In ARMv8-A the only permitted value is 0011.

Mult, bits [15:12]

Indicates the implemented additional Multiply instructions. Defined values are:

- 0000 No additional instructions implemented. This means only MUL is implemented.
- 0001 Adds the MLA instruction.
- 0010 As for 0001, and adds the MLS instruction.

All other values are reserved.

In ARMv8-A the only permitted value is 0010.

MultiAccessInt, bits [11:8]

Indicates the support for interruptible multi-access instructions. Defined values are:

- 0000 No support. This means the LDM and STM instructions are not interruptible.
- 0001 LDM and STM instructions are restartable.
- 0010 LDM and STM instructions are continuable.

All other values are reserved.

In ARMv8-A the only permitted value is 0000.

MemHint, bits [7:4]

Indicates the implemented Memory Hint instructions. Defined values are:

- 0000 None implemented.
- 0001 Adds the PLD instruction.
- 0010 Adds the PLD instruction. (0001 and 0010 have identical effects.)
- 0011 As for 0001 (or 0010), and adds the PLI instruction.
- 0100 As for 0011, and adds the PLDW instruction.

All other values are reserved.

In ARMv8-A the only permitted value is 0100.

LoadStore, bits [3:0]

Indicates the implemented additional load/store instructions. Defined values are:

- 0000 No additional load/store instructions implemented.
- 0001 Adds the LDRD and STRD instructions.
- 0010 As for 0001, and adds the Load Acquire (LDAB, LDAH, LDA, LDAEXB, LDAEXH, LDAEX, LDAEXD) and Store Release (STLB, STLH, STL, STLEXB, STLEXH, STLEX, STLEXD) instructions.

All other values are reserved.

In ARMv8-A the only permitted value is 0010.

Accessing the ID_ISAR2

This register can be read using MRC with the following syntax:

MRC <syntax>

This syntax is encoded with the following settings in the instruction encoding:

<syntax>	opc1	opc2	CRn	coproc	CRm
p15, 0, <Rt>, c0, c2, 2	000	010	0000	1111	0010

Accessibility

The register is accessible in software as follows:

Control			Accessibility			
E2H	TGE	NS	EL0	EL1	EL2	EL3
x	x	0	-	RO	n/a	RO
x	0	1	-	RO	RO	RO
x	1	1	-	n/a	RO	RO

Traps and Enables

For a description of the prioritization of any generated exceptions, see [Synchronous exception prioritization for exceptions taken to AArch32 state on page G1-4344](#) for exceptions taken to AArch32 state and [Synchronous exception prioritization for exceptions taken to AArch64 on page D1-1827](#) for exceptions taken to AArch64 state. Subject to the prioritization rules:

- When EL2 is implemented and is using AArch64 and (SCR_EL3.NS == 1) && (HCR_EL2.E2H == 0):
 - If HCR_EL2.TID3==1, Non-secure read accesses to this register from EL1 are trapped to EL2.
 - If HSTR_EL2.T0==1, Non-secure read accesses to this register from EL1 are trapped to EL2.
- When EL2 is implemented and is using AArch64 and (SCR_EL3.NS == 1) && (HCR_EL2.E2H == 1) && (HCR_EL2.TGE == 0):
 - If HCR_EL2.TID3==1, Non-secure read accesses to this register from EL1 are trapped to EL2.
 - If HSTR_EL2.T0==1, Non-secure read accesses to this register from EL1 are trapped to EL2.
- When EL2 is implemented and is using AArch32 and SCR_EL3.NS == 1:
 - If HCR.TID3==1, Non-secure read accesses to this register from EL1 are trapped to Hyp mode.
 - If HSTR.T0==1, Non-secure read accesses to this register from EL1 are trapped to Hyp mode.

G6.2.83 ID_ISAR3, Instruction Set Attribute Register 3

The ID_ISAR3 characteristics are:

Purpose

Provides information about the instruction sets implemented by the PE in AArch32 state.

Must be interpreted with ID_ISAR0, ID_ISAR1, ID_ISAR2, ID_ISAR4, and ID_ISAR5.

For general information about the interpretation of the ID registers see *Principles of the ID scheme for fields in ID registers* on page G4-4701.

Configurations

There is one instance of this register that is used in both Secure and Non-secure states.

AArch32 System register ID_ISAR3 is architecturally mapped to AArch64 System register ID_ISAR3_EL1.

Attributes

ID_ISAR3 is a 32-bit register.

Field descriptions

The ID_ISAR3 bit assignments are:

31	28 27	24 23	20 19	16 15	12 11	8 7	4 3	0
T32EE	TrueNOP	T32Copy	TabBranch	SynchPrim	SVC	SIMD	Saturate	

T32EE, bits [31:28]

Indicates the implemented T32EE instructions. Defined values are:

0000 None implemented.

0001 Adds the ENTERX and LEAVEX instructions, and modifies the load behavior to include null checking.

All other values are reserved.

In ARMv8-A the only permitted value is 0000.

TrueNOP, bits [27:24]

Indicates the implemented true NOP instructions. Defined values are:

0000 None implemented. This means there are no NOP instructions that do not have any register dependencies.

0001 Adds true NOP instructions in both the T32 and A32 instruction sets. This also permits additional NOP-compatible hints.

All other values are reserved.

In ARMv8-A the only permitted value is 0001.

T32Copy, bits [23:20]

Indicates the support for T32 non flag-setting MOV instructions. Defined values are:

0000 Not supported. This means that in the T32 instruction set, encoding T1 of the MOV (register) instruction does not support a copy from a low register to a low register.

0001 Adds support for T32 instruction set encoding T1 of the MOV (register) instruction, copying from a low register to a low register.

All other values are reserved.

In ARMv8-A the only permitted value is 0001.

TabBranch, bits [19:16]

Indicates the implemented Table Branch instructions in the T32 instruction set. Defined values are:

- 0000 None implemented.
- 0001 Adds the TBB and TBH instructions.

All other values are reserved.

In ARMv8-A the only permitted value is 0001.

SynchPrim, bits [15:12]

Used in conjunction with ID_ISAR4.SynchPrim_frac to indicate the implemented Synchronization Primitive instructions. Defined values are:

- 0000 If SynchPrim_frac == 0000, no Synchronization Primitives implemented.
- 0001 If SynchPrim_frac == 0000, adds the LDREX and STREX instructions.
If SynchPrim_frac == 0011, also adds the CLREX, LDREXB, STREXB, and STREXH instructions.
- 0010 If SynchPrim_frac == 0000, as for [0001, 0011] and also adds the LDREXD and STREXD instructions.

All other combinations of SynchPrim and SynchPrim_frac are reserved.

In ARMv8-A the only permitted value is 0010.

SVC, bits [11:8]

Indicates the implemented SVC instructions. Defined values are:

- 0000 Not implemented.
- 0001 Adds the SVC instruction.

All other values are reserved.

In ARMv8-A the only permitted value is 0001.

SIMD, bits [7:4]

Indicates the implemented SIMD instructions. Defined values are:

- 0000 None implemented.
- 0001 Adds the SSAT and USAT instructions, and the Q bit in the PSRs.
- 0011 As for 0001, and adds the PKHBT, PKHTB, QADD16, QADD8, QASX, QSUB16, QSUB8, QSAX, SADD16, SADD8, SASX, SEL, SHADD16, SHADD8, SHASX, SHSUB16, SHSUB8, SHSAX, SSAT16, SSUB16, SSUB8, SSAX, SXTAB16, SXTB16, UADD16, UADD8, UASX, UHADD16, UHADD8, UHASX, UHSUB16, UHSUB8, UHSAX, UQADD16, UQADD8, UQASX, UQSUB16, UQSUB8, UQSAX, USAD8, USADA8, USAT16, USUB16, USUB8, USAX, UXTAB16, and UXTB16 instructions. Also adds support for the GE[3:0] bits in the PSRs.

All other values are reserved.

In ARMv8-A the only permitted value is 0011.

The SIMD field relates only to implemented instructions that perform SIMD operations on the general-purpose registers. In an implementation that supports floating-point and Advanced SIMD instructions, [MVFR0](#), [MVFR1](#), and [MVFR2](#) give information about the implemented Advanced SIMD instructions.

Saturate, bits [3:0]

Indicates the implemented Saturate instructions. Defined values are:

- 0000 None implemented. This means no non-Advanced SIMD saturate instructions are implemented.
- 0001 Adds the QADD, QDADD, QDSUB, and QSUB instructions, and the Q bit in the PSRs.

All other values are reserved.

In ARMv8-A the only permitted value is 0001.

Accessing the ID_ISAR3

This register can be read using MRC with the following syntax:

MRC <syntax>

This syntax is encoded with the following settings in the instruction encoding:

<syntax>	opc1	opc2	CRn	coproc	CRm
p15, 0, <Rt>, c0, c2, 3	000	011	0000	1111	0010

Accessibility

The register is accessible in software as follows:

Control			Accessibility			
E2H	TGE	NS	EL0	EL1	EL2	EL3
x	x	0	-	RO	n/a	RO
x	0	1	-	RO	RO	RO
x	1	1	-	n/a	RO	RO

Traps and Enables

For a description of the prioritization of any generated exceptions, see [Synchronous exception prioritization for exceptions taken to AArch32 state on page G1-4344](#) for exceptions taken to AArch32 state and [Synchronous exception prioritization for exceptions taken to AArch64 on page D1-1827](#) for exceptions taken to AArch64 state. Subject to the prioritization rules:

- When EL2 is implemented and is using AArch64 and (SCR_EL3.NS == 1) && (HCR_EL2.E2H == 0):
 - If HCR_EL2.TID3==1, Non-secure read accesses to this register from EL1 are trapped to EL2.
 - If HSTR_EL2.T0==1, Non-secure read accesses to this register from EL1 are trapped to EL2.
- When EL2 is implemented and is using AArch64 and (SCR_EL3.NS == 1) && (HCR_EL2.E2H == 1) && (HCR_EL2.TGE == 0):
 - If HCR_EL2.TID3==1, Non-secure read accesses to this register from EL1 are trapped to EL2.
 - If HSTR_EL2.T0==1, Non-secure read accesses to this register from EL1 are trapped to EL2.
- When EL2 is implemented and is using AArch32 and SCR_EL3.NS == 1:
 - If HCR.TID3==1, Non-secure read accesses to this register from EL1 are trapped to Hyp mode.
 - If HSTR.T0==1, Non-secure read accesses to this register from EL1 are trapped to Hyp mode.

G6.2.84 ID_ISAR4, Instruction Set Attribute Register 4

The ID_ISAR4 characteristics are:

Purpose

Provides information about the instruction sets implemented by the PE in AArch32 state.

Must be interpreted with ID_ISAR0, ID_ISAR1, ID_ISAR2, ID_ISAR3, and ID_ISAR5.

For general information about the interpretation of the ID registers see *Principles of the ID scheme for fields in ID registers* on page G4-4701.

Configurations

There is one instance of this register that is used in both Secure and Non-secure states.

AArch32 System register ID_ISAR4 is architecturally mapped to AArch64 System register ID_ISAR4_EL1.

Attributes

ID_ISAR4 is a 32-bit register.

Field descriptions

The ID_ISAR4 bit assignments are:

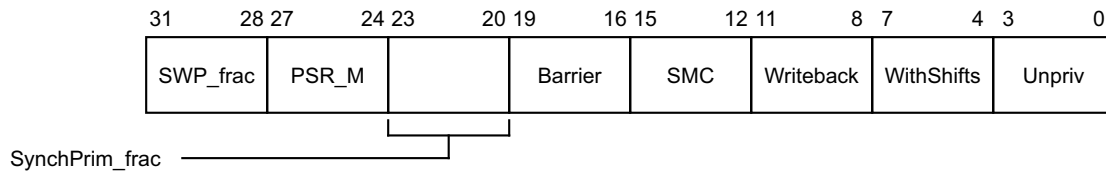

SWP_frac, bits [31:28]

Indicates support for the memory system locking the bus for SWP or SWPB instructions. Defined values are:

0000 SWP or SWPB instructions not implemented.

0001 SWP or SWPB implemented but only in a uniprocessor context. SWP and SWPB do not guarantee whether memory accesses from other masters can come between the load memory access and the store memory access of the SWP or SWPB.

All other values are reserved. This field is valid only if the ID_ISAR0.Swap_insts field is 0000.

In ARMv8-A the only permitted value is 0000.

PSR_M, bits [27:24]

Indicates the implemented M profile instructions to modify the PSRs. Defined values are:

0000 None implemented.

0001 Adds the M profile forms of the CPS, MRS, and MSR instructions.

All other values are reserved.

In ARMv8-A the only permitted value is 0000.

SynchPrim_frac, bits [23:20]

Used in conjunction with ID_ISAR3.SynchPrim to indicate the implemented Synchronization Primitive instructions. Possible values are:

0000 If SynchPrim == 0000, no Synchronization Primitives implemented. If SynchPrim == 0001, adds the LDREX and STREX instructions. If SynchPrim == 0010, also adds the CLREX, LDREXB, LDREXH, STREXB, STREXH, LDREXD, and STREXD instructions.

0011 If SynchPrim == 0001, adds the LDREX, STREX, CLREX, LDREXB, LDREXH, STREXB, and STREXH instructions.

All other combinations of SynchPrim and SynchPrim_frac are reserved.

In ARMv8-A the only permitted value is 0000.

Barrier, bits [19:16]

Indicates the implemented Barrier instructions in the A32 and T32 instruction sets. Defined values are:

0000 None implemented. Barrier operations are provided only as System instructions in the (coproc==1111) encoding space.

0001 Adds the DMB, DSB, and ISB barrier instructions.

All other values are reserved.

In ARMv8-A the only permitted value is 0001.

SMC, bits [15:12]

Indicates the implemented SMC instructions. Defined values are:

0000 None implemented.

0001 Adds the SMC instruction.

All other values are reserved.

In ARMv8-A the only permitted value is 0001.

Writeback, bits [11:8]

Indicates the support for Writeback addressing modes. Defined values are:

0000 Basic support. Only the LDM, STM, PUSH, POP, SRS, and RFE instructions support writeback addressing modes. These instructions support all of their writeback addressing modes.

0001 Adds support for all of the writeback addressing modes.

All other values are reserved.

In ARMv8-A the only permitted value is 0001.

WithShifts, bits [7:4]

Indicates the support for instructions with shifts. Defined values are:

0000 Nonzero shifts supported only in MOV and shift instructions.

0001 Adds support for shifts of loads and stores over the range LSL 0-3.

0011 As for 0001, and adds support for other constant shift options, both on load/store and other instructions.

0100 As for 0011, and adds support for register-controlled shift options.

All other values are reserved.

In ARMv8-A the only permitted value is 0100.

Unpriv, bits [3:0]

Indicates the implemented unprivileged instructions. Defined values are:

0000 None implemented. No T variant instructions are implemented.

0001 Adds the LDRBT, LDRT, STRBT, and STRT instructions.

0010 As for 0001, and adds the LDRHT, LDRSBT, LDRSHT, and STRHT instructions.

All other values are reserved.

In ARMv8-A the only permitted value is 0010.

Accessing the ID_ISAR4

This register can be read using MRC with the following syntax:

MRC <syntax>

This syntax is encoded with the following settings in the instruction encoding:

<syntax>	opc1	opc2	CRn	coproc	CRm
p15, 0, <Rt>, c0, c2, 4	000	100	0000	1111	0010

Accessibility

The register is accessible in software as follows:

Control			Accessibility			
E2H	TGE	NS	EL0	EL1	EL2	EL3
x	x	0	-	RO	n/a	RO
x	0	1	-	RO	RO	RO
x	1	1	-	n/a	RO	RO

Traps and Enables

For a description of the prioritization of any generated exceptions, see [Synchronous exception prioritization for exceptions taken to AArch32 state on page G1-4344](#) for exceptions taken to AArch32 state and [Synchronous exception prioritization for exceptions taken to AArch64 on page D1-1827](#) for exceptions taken to AArch64 state. Subject to the prioritization rules:

- When EL2 is implemented and is using AArch64 and (SCR_EL3.NS == 1) && (HCR_EL2.E2H == 0):
 - If HCR_EL2.TID3==1, Non-secure read accesses to this register from EL1 are trapped to EL2.
 - If HSTR_EL2.T0==1, Non-secure read accesses to this register from EL1 are trapped to EL2.
- When EL2 is implemented and is using AArch64 and (SCR_EL3.NS == 1) && (HCR_EL2.E2H == 1) && (HCR_EL2.TGE == 0):
 - If HCR_EL2.TID3==1, Non-secure read accesses to this register from EL1 are trapped to EL2.
 - If HSTR_EL2.T0==1, Non-secure read accesses to this register from EL1 are trapped to EL2.
- When EL2 is implemented and is using AArch32 and SCR_EL3.NS == 1:
 - If HCR.TID3==1, Non-secure read accesses to this register from EL1 are trapped to Hyp mode.
 - If HSTR.T0==1, Non-secure read accesses to this register from EL1 are trapped to Hyp mode.

G6.2.85 ID_ISAR5, Instruction Set Attribute Register 5

The ID_ISAR5 characteristics are:

Purpose

Provides information about the instruction sets implemented by the PE in AArch32 state.

Must be interpreted with ID_ISAR0, ID_ISAR1, ID_ISAR2, ID_ISAR3, and ID_ISAR4.

For general information about the interpretation of the ID registers see *Principles of the ID scheme for fields in ID registers* on page G4-4701.

Configurations

There is one instance of this register that is used in both Secure and Non-secure states.

AArch32 System register ID_ISAR5 is architecturally mapped to AArch64 System register ID_ISAR5_EL1.

Attributes

ID_ISAR5 is a 32-bit register.

Field descriptions

The ID_ISAR5 bit assignments are:

31	28 27	24 23	20 19	16 15	12 11	8 7	4 3	0
RES0	RDM	RES0	CRC32	SHA2	SHA1	AES	SEVL	

Bits [31:28]

Reserved, RES0.

RDM, bits [27:24]

In ARMv8.2 and ARMv8.1

Indicates whether the VQRDMLAH and VQRDMLSH instructions are implemented in AArch32 state. Defined values are:

0000 No VQRDMLAH and VQRDMLSH instructions implemented.

0001 VQRDMLAH and VQRDMLSH instructions implemented.

All other values are reserved.

In ARMv8.0 the only permitted value is 0000.

From ARMv8.1 the only permitted value is 0001. This feature is identified by the name [ARMv8.1-SIMD](#).

In ARMv8.0.

Reserved, RES0.

Bits [23:20]

Reserved, RES0.

CRC32, bits [19:16]

Indicates whether the CRC32 instructions are implemented in AArch32 state.

0000 No CRC32 instructions implemented.

0001 CRC32B, CRC32H, CRC32W, CRC32CB, CRC32CH, and CRC32CW instructions implemented.

All other values are reserved.

In ARMv8.0 the permitted values are 0000 and 0001.

From ARMv8.1 the only permitted value is 0001.

SHA2, bits [15:12]

Indicates whether the SHA2 instructions are implemented in AArch32 state.

0000 No SHA2 instructions implemented.

0001 SHA256H, SHA256H2, SHA256SU0, and SHA256SU1 implemented.

All other values are reserved.

In ARMv8-A the permitted values are 0000 and 0001.

SHA1, bits [11:8]

Indicates whether the SHA1 instructions are implemented in AArch32 state.

0000 No SHA1 instructions implemented.

0001 SHA1C, SHA1P, SHA1M, SHA1H, SHA1SU0, and SHA1SU1 implemented.

All other values are reserved.

In ARMv8-A the permitted values are 0000 and 0001.

AES, bits [7:4]

Indicates whether the AES instructions are implemented in AArch32 state.

0000 No AES instructions implemented.

0001 AESE, AESD, AESMC, and AESIMC implemented.

0010 As for 0001, plus PMULL/PMULL2 instructions operating on 64-bit data quantities.

All other values are reserved.

In ARMv8-A the permitted values are 0000 and 0010.

SEVL, bits [3:0]

Indicates whether the SEVL instruction is implemented in AArch32 state.

0000 SEVL is implemented as a NOP.

0001 SEVL is implemented as Send Event Local.

All other values are reserved.

In ARMv8-A the only permitted value is 0001.

Accessing the ID_ISAR5

This register can be read using MRC with the following syntax:

MRC <syntax>

This syntax is encoded with the following settings in the instruction encoding:

<syntax>	opc1	opc2	CRn	coproc	CRm
p15, 0, <Rt>, c0, c2, 5	000	101	0000	1111	0010

Accessibility

The register is accessible in software as follows:

Control			Accessibility			
E2H	TGE	NS	EL0	EL1	EL2	EL3
x	x	0	-	RO	n/a	RO
x	0	1	-	RO	RO	RO
x	1	1	-	n/a	RO	RO

Traps and Enables

For a description of the prioritization of any generated exceptions, see [Synchronous exception prioritization for exceptions taken to AArch32 state on page G1-4344](#) for exceptions taken to AArch32 state and [Synchronous exception prioritization for exceptions taken to AArch64 on page D1-1827](#) for exceptions taken to AArch64 state. Subject to the prioritization rules:

- When EL2 is implemented and is using AArch64 and (SCR_EL3.NS == 1) && (HCR_EL2.E2H == 0):
 - If HCR_EL2.TID3==1, Non-secure read accesses to this register from EL1 are trapped to EL2.
 - If HSTR_EL2.T0==1, Non-secure read accesses to this register from EL1 are trapped to EL2.
- When EL2 is implemented and is using AArch64 and (SCR_EL3.NS == 1) && (HCR_EL2.E2H == 1) && (HCR_EL2.TGE == 0):
 - If HCR_EL2.TID3==1, Non-secure read accesses to this register from EL1 are trapped to EL2.
 - If HSTR_EL2.T0==1, Non-secure read accesses to this register from EL1 are trapped to EL2.
- When EL2 is implemented and is using AArch32 and SCR_EL3.NS == 1:
 - If HCR.TID3==1, Non-secure read accesses to this register from EL1 are trapped to Hyp mode.
 - If HSTR.T0==1, Non-secure read accesses to this register from EL1 are trapped to Hyp mode.

G6.2.86 ID_MMFR0, Memory Model Feature Register 0

The ID_MMFR0 characteristics are:

Purpose

Provides information about the implemented memory model and memory management support in AArch32 state.

Must be interpreted with ID_MMFR1, ID_MMFR2, ID_MMFR3, and ID_MMFR4.

For general information about the interpretation of the ID registers see *Principles of the ID scheme for fields in ID registers* on page G4-4701.

Configurations

There is one instance of this register that is used in both Secure and Non-secure states.

AArch32 System register ID_MMFR0 is architecturally mapped to AArch64 System register ID_MMFR0_EL1.

Attributes

ID_MMFR0 is a 32-bit register.

Field descriptions

The ID_MMFR0 bit assignments are:

31	28 27	24 23	20 19	16 15	12 11	8 7	4 3	0
InnerShr	FCSE	AuxReg	TCM	ShareLvl	OuterShr	PMSA	VMSA	

InnerShr, bits [31:28]

Innermost Shareability. Indicates the innermost shareability domain implemented. Defined values are:

- 0000 Implemented as Non-cacheable.
- 0001 Implemented with hardware coherency support.
- 1111 Shareability ignored.

All other values are reserved.

In ARMv8 the permitted values are 0000, 0001, and 1111.

This field is valid only if the implementation supports two levels of shareability, as indicated by ID_MMFR0.ShareLvl having the value 0001.

When ID_MMFR0.ShareLvl is zero, this field is UNK.

FCSE, bits [27:24]

Indicates whether the implementation includes the FCSE. Defined values are:

- 0000 Not supported.
- 0001 Support for FCSE.

All other values are reserved.

In ARMv8 the only permitted value is 0000.

AuxReg, bits [23:20]

Auxiliary Registers. Indicates support for Auxiliary registers. Defined values are:

- 0000 None supported.
- 0001 Support for Auxiliary Control Register only.

0010 Support for Auxiliary Fault Status Registers (**AIFSR** and **ADFSR**) and Auxiliary Control Register.

All other values are reserved.

In ARMv8 the only permitted value is 0010.

———— **Note** ————

Accesses to unimplemented Auxiliary registers are UNDEFINED.

TCM, bits [19:16]

Indicates support for TCMs and associated DMAs. Defined values are:

0000 Not supported.

0001 Support is IMPLEMENTATION DEFINED. ARMv7 requires this setting.

0010 Support for TCM only, ARMv6 implementation.

0011 Support for TCM and DMA, ARMv6 implementation.

All other values are reserved.

In ARMv8-A the only permitted value is 0000.

ShareLvl, bits [15:12]

Shareability Levels. Indicates the number of shareability levels implemented. Defined values are:

0000 One level of shareability implemented.

0001 Two levels of shareability implemented.

All other values are reserved.

In ARMv8 the only permitted value is 0001.

OuterShr, bits [11:8]

Outermost Shareability. Indicates the outermost shareability domain implemented. Defined values are:

0000 Implemented as Non-cacheable.

0001 Implemented with hardware coherency support.

1111 Shareability ignored.

All other values are reserved.

In ARMv8 the permitted values are 0000, 0001, and 1111.

PMSA, bits [7:4]

Indicates support for a PMSA. Defined values are:

0000 Not supported.

0001 Support for IMPLEMENTATION DEFINED PMSA.

0010 Support for PMSAv6, with a Cache Type Register implemented.

0011 Support for PMSAv7, with support for memory subsections. ARMv7-R profile.

All other values are reserved.

In ARMv8-A the only permitted value is 0000.

VMSA, bits [3:0]

Indicates support for a VMSA. Defined values are:

0000 Not supported.

0001 Support for IMPLEMENTATION DEFINED VMSA.

0010 Support for VMSAv6, with Cache and TLB Type Registers implemented.

- 0011 Support for VMSAv7, with support for remapping and the Access flag. ARMv7-A profile.
 - 0100 As for 0011, and adds support for the PXN bit in the Short-descriptor translation table format descriptors.
 - 0101 As for 0100, and adds support for the Long-descriptor translation table format.
- All other values are reserved.
- In ARMv8-A the only permitted value is 0101.

Accessing the ID_MMFR0

This register can be read using MRC with the following syntax:

MRC <syntax>

This syntax is encoded with the following settings in the instruction encoding:

<syntax>	opc1	opc2	CRn	coproc	CRm
p15, 0, <Rt>, c0, c1, 4	000	100	0000	1111	0001

Accessibility

The register is accessible in software as follows:

Control			Accessibility			
E2H	TGE	NS	EL0	EL1	EL2	EL3
x	x	0	-	RO	n/a	RO
x	0	1	-	RO	RO	RO
x	1	1	-	n/a	RO	RO

Traps and Enables

For a description of the prioritization of any generated exceptions, see [Synchronous exception prioritization for exceptions taken to AArch32 state on page G1-4344](#) for exceptions taken to AArch32 state and [Synchronous exception prioritization for exceptions taken to AArch64 on page D1-1827](#) for exceptions taken to AArch64 state. Subject to the prioritization rules:

- When EL2 is implemented and is using AArch64 and (SCR_EL3.NS == 1) && (HCR_EL2.E2H == 0):
 - If HCR_EL2.TID3==1, Non-secure read accesses to this register from EL1 are trapped to EL2.
 - If HSTR_EL2.T0==1, Non-secure read accesses to this register from EL1 are trapped to EL2.
- When EL2 is implemented and is using AArch64 and (SCR_EL3.NS == 1) && (HCR_EL2.E2H == 1) && (HCR_EL2.TGE == 0):
 - If HCR_EL2.TID3==1, Non-secure read accesses to this register from EL1 are trapped to EL2.
 - If HSTR_EL2.T0==1, Non-secure read accesses to this register from EL1 are trapped to EL2.
- When EL2 is implemented and is using AArch32 and SCR_EL3.NS == 1:
 - If HCR.TID3==1, Non-secure read accesses to this register from EL1 are trapped to Hyp mode.
 - If HSTR.T0==1, Non-secure read accesses to this register from EL1 are trapped to Hyp mode.

G6.2.87 ID_MMFR1, Memory Model Feature Register 1

The ID_MMFR1 characteristics are:

Purpose

Provides information about the implemented memory model and memory management support in AArch32 state.

Must be interpreted with [ID_MMFR0](#), [ID_MMFR2](#), [ID_MMFR3](#), and [ID_MMFR4](#).

For general information about the interpretation of the ID registers see *Principles of the ID scheme for fields in ID registers* on page G4-4701.

Configurations

There is one instance of this register that is used in both Secure and Non-secure states.

AArch32 System register ID_MMFR1 is architecturally mapped to AArch64 System register [ID_MMFR1_EL1](#).

Attributes

ID_MMFR1 is a 32-bit register.

Field descriptions

The ID_MMFR1 bit assignments are:

31	28 27	24 23	20 19	16 15	12 11	8 7	4 3	0
BPred	L1TstCln	L1Uni	L1Hvd	L1UniSW	L1HvdSW	L1UniVA	L1HvdVA	

BPred, bits [31:28]

Branch Predictor. Indicates branch predictor management requirements. Defined values are:

0000 No branch predictor, or no MMU present. Implies a fixed MPU configuration.

0001 Branch predictor requires flushing on:

- Enabling or disabling a stage of address translation.
- Writing new data to instruction locations.
- Writing new mappings to the translation tables.
- Changes to the [TTBR0](#), [TTBR1](#), or [TTBCR](#) registers.
- Changes to the ContextID or ASID, or to the FCSE ProcessID if this is supported.

0010 Branch predictor requires flushing on:

- Enabling or disabling a stage of address translation.
- Writing new data to instruction locations.
- Writing new mappings to the translation tables.
- Any change to the [TTBR0](#), [TTBR1](#), or [TTBCR](#) registers without a change to the corresponding ContextID or ASID, or FCSE ProcessID if this is supported.

0011 Branch predictor requires flushing only on writing new data to instruction locations.

0100 For execution correctness, branch predictor requires no flushing at any time.

All other values are reserved.

In ARMv8-A the permitted values are 0010, 0011, or 0100. For values other than 0000 and 0100 the ARM Architecture Reference Manual, or the product documentation, might give more information about the required maintenance.

L1TstCln, bits [27:24]

Level 1 cache Test and Clean. Indicates the supported Level 1 data cache test and clean operations, for Harvard or unified cache implementations. Defined values are:

- 0000 None supported.
- 0001 Supported Level 1 data cache test and clean operations are:
- Test and clean data cache.
- 0010 As for 0001, and adds:
- Test, clean, and invalidate data cache.

All other values are reserved.

In ARMv8-A the only permitted value is 0000.

L1Uni, bits [23:20]

Level 1 Unified cache. Indicates the supported entire Level 1 cache maintenance operations for a unified cache implementation. Defined values are:

- 0000 None supported.
- 0001 Supported entire Level 1 cache operations are:
- Invalidate cache, including branch predictor if appropriate.
 - Invalidate branch predictor, if appropriate.
- 0010 As for 0001, and adds:
- Clean cache, using a recursive model that uses the cache dirty status bit.
 - Clean and invalidate cache, using a recursive model that uses the cache dirty status bit.

All other values are reserved.

In ARMv8-A the only permitted value is 0000.

L1Hvd, bits [19:16]

Level 1 Harvard cache. Indicates the supported entire Level 1 cache maintenance operations for a Harvard cache implementation. Defined values are:

- 0000 None supported.
- 0001 Supported entire Level 1 cache operations are:
- Invalidate instruction cache, including branch predictor if appropriate.
 - Invalidate branch predictor, if appropriate.
- 0010 As for 0001, and adds:
- Invalidate data cache.
 - Invalidate data cache and instruction cache, including branch predictor if appropriate.
- 0011 As for 0010, and adds:
- Clean data cache, using a recursive model that uses the cache dirty status bit.
 - Clean and invalidate data cache, using a recursive model that uses the cache dirty status bit.

All other values are reserved.

In ARMv8-A the only permitted value is 0000.

L1UniSW, bits [15:12]

Level 1 Unified cache by Set/Way. Indicates the supported Level 1 cache line maintenance operations by set/way, for a unified cache implementation. Defined values are:

- 0000 None supported.

0001 Supported Level 1 unified cache line maintenance operations by set/way are:

- Clean cache line by set/way.

0010 As for 0001, and adds:

- Clean and invalidate cache line by set/way.

0011 As for 0010, and adds:

- Invalidate cache line by set/way.

All other values are reserved.

In ARMv8-A the only permitted value is 0000.

L1HvdSW, bits [11:8]

Level 1 Harvard cache by Set/Way. Indicates the supported Level 1 cache line maintenance operations by set/way, for a Harvard cache implementation. Defined values are:

0000 None supported.

0001 Supported Level 1 Harvard cache line maintenance operations by set/way are:

- Clean data cache line by set/way.
- Clean and invalidate data cache line by set/way.

0010 As for 0001, and adds:

- Invalidate data cache line by set/way.

0011 As for 0010, and adds:

- Invalidate instruction cache line by set/way.

All other values are reserved.

In ARMv8-A the only permitted value is 0000.

L1UniVA, bits [7:4]

Level 1 Unified cache by Virtual Address. Indicates the supported Level 1 cache line maintenance operations by VA, for a unified cache implementation. Defined values are:

0000 None supported.

0001 Supported Level 1 unified cache line maintenance operations by VA are:

- Clean cache line by VA.
- Invalidate cache line by VA.
- Clean and invalidate cache line by VA.

0010 As for 0001, and adds:

- Invalidate branch predictor by VA, if branch predictor is implemented.

All other values are reserved.

In ARMv8-A the only permitted value is 0000.

L1HvdVA, bits [3:0]

Level 1 Harvard cache by Virtual Address. Indicates the supported Level 1 cache line maintenance operations by VA, for a Harvard cache implementation. Defined values are:

0000 None supported.

0001 Supported Level 1 Harvard cache line maintenance operations by VA are:

- Clean data cache line by VA.
- Invalidate data cache line by VA.
- Clean and invalidate data cache line by VA.
- Clean instruction cache line by VA.

0010 As for 0001, and adds:

- Invalidate branch predictor by VA, if branch predictor is implemented.

All other values are reserved.
 In ARMv8-A the only permitted value is 0000.

Accessing the ID_MMFR1

This register can be read using MRC with the following syntax:

MRC <syntax>

This syntax is encoded with the following settings in the instruction encoding:

<syntax>	opc1	opc2	CRn	coproc	CRm
p15, 0, <Rt>, c0, c1, 5	000	101	0000	1111	0001

Accessibility

The register is accessible in software as follows:

Control			Accessibility			
E2H	TGE	NS	EL0	EL1	EL2	EL3
x	x	0	-	RO	n/a	RO
x	0	1	-	RO	RO	RO
x	1	1	-	n/a	RO	RO

Traps and Enables

For a description of the prioritization of any generated exceptions, see [Synchronous exception prioritization for exceptions taken to AArch32 state on page G1-4344](#) for exceptions taken to AArch32 state and [Synchronous exception prioritization for exceptions taken to AArch64 on page D1-1827](#) for exceptions taken to AArch64 state. Subject to the prioritization rules:

- When EL2 is implemented and is using AArch64 and (SCR_EL3.NS == 1) && (HCR_EL2.E2H == 0):
 - If HCR_EL2.TID3==1, Non-secure read accesses to this register from EL1 are trapped to EL2.
 - If HSTR_EL2.T0==1, Non-secure read accesses to this register from EL1 are trapped to EL2.
- When EL2 is implemented and is using AArch64 and (SCR_EL3.NS == 1) && (HCR_EL2.E2H == 1) && (HCR_EL2.TGE == 0):
 - If HCR_EL2.TID3==1, Non-secure read accesses to this register from EL1 are trapped to EL2.
 - If HSTR_EL2.T0==1, Non-secure read accesses to this register from EL1 are trapped to EL2.
- When EL2 is implemented and is using AArch32 and SCR_EL3.NS == 1:
 - If HCR.TID3==1, Non-secure read accesses to this register from EL1 are trapped to Hyp mode.
 - If HSTR.T0==1, Non-secure read accesses to this register from EL1 are trapped to Hyp mode.

G6.2.88 ID_MMFR2, Memory Model Feature Register 2

The ID_MMFR2 characteristics are:

Purpose

Provides information about the implemented memory model and memory management support in AArch32 state.

Must be interpreted with ID_MMFR0, ID_MMFR1, ID_MMFR3, and ID_MMFR4.

For general information about the interpretation of the ID registers see *Principles of the ID scheme for fields in ID registers* on page G4-4701.

Configurations

There is one instance of this register that is used in both Secure and Non-secure states.

AArch32 System register ID_MMFR2 is architecturally mapped to AArch64 System register ID_MMFR2_EL1.

Attributes

ID_MMFR2 is a 32-bit register.

Field descriptions

The ID_MMFR2 bit assignments are:

31	28 27	24 23	20 19	16 15	12 11	8 7	4 3	0
HWAccFlg	WFIStall	MemBarr	UniTLB	HvdTLB	L1HvdRng	L1HvdBG	L1HvdFG	

HWAccFlg, bits [31:28]

Hardware Access Flag. In earlier versions of the ARM Architecture, this field indicates support for a Hardware Access flag, as part of the VMSAv7 implementation. Defined values are:

0000 Not supported.

0001 Support for VMSAv7 Access flag, updated in hardware.

All other values are reserved.

In ARMv8 the only permitted value is 0000.

WFIStall, bits [27:24]

Wait For Interrupt Stall. Indicates the support for Wait For Interrupt (WFI) stalling. Defined values are:

0000 Not supported.

0001 Support for WFI stalling.

All other values are reserved.

In ARMv8 the permitted values are 0000 and 0001.

MemBarr, bits [23:20]

Memory Barrier. Indicates the supported memory barrier System instructions in the (coproc==1111) encoding space:

0000 None supported.

0001 Supported memory barrier System instructions are:

- Data Synchronization Barrier (DSB).

0010 As for 0001, and adds:

- Instruction Synchronization Barrier (ISB).

- Data Memory Barrier (DMB).

All other values are reserved.

In ARMv8 the only permitted value is 0010.

ARM deprecates the use of these operations. ID_ISAR4.Barrier_instrs indicates the level of support for the preferred barrier instructions.

UniTLB, bits [19:16]

Unified TLB. Indicates the supported TLB maintenance operations, for a unified TLB implementation. Defined values are:

- | | |
|------|---|
| 0000 | Not supported. |
| 0001 | Supported unified TLB maintenance operations are: <ul style="list-style-type: none">• Invalidate all entries in the TLB.• Invalidate TLB entry by VA. |
| 0010 | As for 0001, and adds: <ul style="list-style-type: none">• Invalidate TLB entries by ASID match. |
| 0011 | As for 0010, and adds: <ul style="list-style-type: none">• Invalidate instruction TLB and data TLB entries by VA All ASID. This is a shared unified TLB operation. |
| 0100 | As for 0011, and adds: <ul style="list-style-type: none">• Invalidate Hyp mode unified TLB entry by VA.• Invalidate entire Non-secure PL1&0 unified TLB.• Invalidate entire Hyp mode unified TLB. |
| 0101 | As for 0100, and adds the following operations: TLBIMVALIS , TLBIMVAALIS , TLBIMVALHIS , TLBIMVAL , TLBIMVAAL , TLBIMVALH . |
| 0110 | As for 0101, and adds the following operations: TLBIIPAS2IS , TLBIIPAS2LIS , TLBIIPAS2 , TLBIIPAS2L . |

All other values are reserved.

In ARMv8-A the only permitted value is 0110.

HvdTLB, bits [15:12]

If the Unified TLB field (UniTLB, bits [19:16]) is not 0000, then the meaning of this field is IMPLEMENTATION DEFINED. ARM deprecates the use of this field by software.

L1HvdRng, bits [11:8]

Level 1 Harvard cache Range. Indicates the supported Level 1 cache maintenance range operations, for a Harvard cache implementation. Defined values are:

- | | |
|------|---|
| 0000 | Not supported. |
| 0001 | Supported Level 1 Harvard cache maintenance range operations are: <ul style="list-style-type: none">• Invalidate data cache range by VA.• Invalidate instruction cache range by VA.• Clean data cache range by VA.• Clean and invalidate data cache range by VA. |

All other values are reserved.

In ARMv8 the only permitted value is 0000.

L1HvdBG, bits [7:4]

Level 1 Harvard cache Background fetch. Indicates the supported Level 1 cache background fetch operations, for a Harvard cache implementation. When supported, background fetch operations are non-blocking operations. Defined values are:

0000 Not supported.

0001 Supported Level 1 Harvard cache background fetch operations are:

- Fetch instruction cache range by VA.
- Fetch data cache range by VA.

All other values are reserved.

In ARMv8 the only permitted value is 0000.

L1HvdFG, bits [3:0]

Level 1 Harvard cache Foreground fetch. Indicates the supported Level 1 cache foreground fetch operations, for a Harvard cache implementation. When supported, foreground fetch operations are blocking operations. Defined values are:

0000 Not supported.

0001 Supported Level 1 Harvard cache foreground fetch operations are:

- Fetch instruction cache range by VA.
- Fetch data cache range by VA.

All other values are reserved.

In ARMv8 the only permitted value is 0000.

Accessing the ID_MMFR2

This register can be read using MRC with the following syntax:

MRC <syntax>

This syntax is encoded with the following settings in the instruction encoding:

<syntax>	opc1	opc2	CRn	coproc	CRm
p15, 0, <Rt>, c0, c1, 6	000	110	0000	1111	0001

Accessibility

The register is accessible in software as follows:

Control			Accessibility			
E2H	TGE	NS	EL0	EL1	EL2	EL3
x	x	0	-	RO	n/a	RO
x	0	1	-	RO	RO	RO
x	1	1	-	n/a	RO	RO

Traps and Enables

For a description of the prioritization of any generated exceptions, see *Synchronous exception prioritization for exceptions taken to AArch32 state* on page G1-4344 for exceptions taken to AArch32 state and *Synchronous exception prioritization for exceptions taken to AArch64* on page D1-1827 for exceptions taken to AArch64 state. Subject to the prioritization rules:

- When EL2 is implemented and is using AArch64 and $(SCR_EL3.NS == 1) \&\& (HCR_EL2.E2H == 0)$:
 - If $HCR_EL2.TID3 == 1$, Non-secure read accesses to this register from EL1 are trapped to EL2.
 - If $HSTR_EL2.T0 == 1$, Non-secure read accesses to this register from EL1 are trapped to EL2.
- When EL2 is implemented and is using AArch64 and $(SCR_EL3.NS == 1) \&\& (HCR_EL2.E2H == 1) \&\& (HCR_EL2.TGE == 0)$:
 - If $HCR_EL2.TID3 == 1$, Non-secure read accesses to this register from EL1 are trapped to EL2.
 - If $HSTR_EL2.T0 == 1$, Non-secure read accesses to this register from EL1 are trapped to EL2.
- When EL2 is implemented and is using AArch32 and $SCR_EL3.NS == 1$:
 - If $HCR.TID3 == 1$, Non-secure read accesses to this register from EL1 are trapped to Hyp mode.
 - If $HSTR.T0 == 1$, Non-secure read accesses to this register from EL1 are trapped to Hyp mode.

G6.2.89 ID_MMFR3, Memory Model Feature Register 3

The ID_MMFR3 characteristics are:

Purpose

Provides information about the implemented memory model and memory management support in AArch32 state.

Must be interpreted with ID_MMFR0, ID_MMFR1, ID_MMFR2, and ID_MMFR4.

For general information about the interpretation of the ID registers see *Principles of the ID scheme for fields in ID registers* on page G4-4701.

Configurations

There is one instance of this register that is used in both Secure and Non-secure states.

AArch32 System register ID_MMFR3 is architecturally mapped to AArch64 System register ID_MMFR3_EL1.

Attributes

ID_MMFR3 is a 32-bit register.

Field descriptions

The ID_MMFR3 bit assignments are:

31	28 27	24 23	20 19	16 15	12 11	8 7	4 3	0
Supersec	CMemSz	CohWalk	PAN	MaintBcst	BPMaint	CMaintSW	CMaintVA	

Supersec, bits [31:28]

Supersections. On a VMSA implementation, indicates whether Supersections are supported.

Defined values are:

0000 Supersections supported.

1111 Supersections not supported.

All other values are reserved.

In ARMv8-A the permitted values are 0000 and 1111.

CMemSz, bits [27:24]

Cached Memory Size. Indicates the physical memory size supported by the caches. Defined values are:

0000 4GB, corresponding to a 32-bit physical address range.

0001 64GB, corresponding to a 36-bit physical address range.

0010 1TB or more, corresponding to a 40-bit or larger physical address range.

All other values are reserved.

In ARMv8-A the permitted values are 0000, 0001, and 0010.

CohWalk, bits [23:20]

Coherent Walk. Indicates whether Translation table updates require a clean to the point of unification. Defined values are:

0000 Updates to the translation tables require a clean to the point of unification to ensure visibility by subsequent translation table walks.

0001 Updates to the translation tables do not require a clean to the point of unification to ensure visibility by subsequent translation table walks.

All other values are reserved.
In ARMv8-A the only permitted value is 0001.

PAN, bits [19:16]

In ARMv8.2 and ARMv8.1

Privileged Access Never. Indicates support for the PAN bit in [CPSR](#), [SPSR](#), and [DSPSR](#) in AArch32. Defined values are:

- 0000 PAN not supported.
- 0001 PAN supported.
- 0010 PAN supported and [ATS1CPRP](#) and [ATS1CPWP](#) instructions supported.

All other values are reserved.

In ARMv8.0 the only permitted value is 0000.

In ARMv8.1 the only permitted value is 0001. This feature is identified by the name [ARMv8.1-PAN](#).

From ARMv8.2, the only permitted value is 0010. This feature is identified by the name [ARMv8.2-ATS1E1](#).

In ARMv8.0.

Reserved, RES0.

MaintBcst, bits [15:12]

Maintenance Broadcast. Indicates whether Cache, TLB, and branch predictor operations are broadcast. Defined values are:

- 0000 Cache, TLB, and branch predictor operations only affect local structures.
- 0001 Cache and branch predictor operations affect structures according to shareability and defined behavior of instructions. TLB operations only affect local structures.
- 0010 Cache, TLB, and branch predictor operations affect structures according to shareability and defined behavior of instructions.

All other values are reserved.

In ARMv8-A the only permitted value is 0010.

BPMaint, bits [11:8]

Branch Predictor Maintenance. Indicates the supported branch predictor maintenance operations in an implementation with hierarchical cache maintenance operations. Defined values are:

- 0000 None supported.
- 0001 Supported branch predictor maintenance operations are:
 - Invalidate all branch predictors.
- 0010 As for 0001, and adds:
 - Invalidate branch predictors by VA.

All other values are reserved.

In ARMv8-A the only permitted value is 0010.

CMaintSW, bits [7:4]

Cache Maintenance by Set/Way. Indicates the supported cache maintenance operations by set/way, in an implementation with hierarchical caches. Defined values are:

- 0000 None supported.
- 0001 Supported hierarchical cache maintenance instructions by set/way are:
 - Invalidate data cache by set/way.
 - Clean data cache by set/way.
 - Clean and invalidate data cache by set/way.

All other values are reserved.

In ARMv8-A the only permitted value is 0001.

In a unified cache implementation, the data cache maintenance operations apply to the unified caches.

CMaintVA, bits [3:0]

Cache Maintenance by Virtual Address. Indicates the supported cache maintenance operations by VA, in an implementation with hierarchical caches. Defined values are:

- 0000 None supported.
- 0001 Supported hierarchical cache maintenance operations by VA are:
 - Invalidate data cache by VA.
 - Clean data cache by VA.
 - Clean and invalidate data cache by VA.
 - Invalidate instruction cache by VA.
 - Invalidate all instruction cache entries.

All other values are reserved.

In ARMv8-A the only permitted value is 0001.

In a unified cache implementation, data cache maintenance operations apply to the unified caches, and the instruction cache maintenance instructions are not implemented.

Accessing the ID_MMFR3

This register can be read using MRC with the following syntax:

MRC <syntax>

This syntax is encoded with the following settings in the instruction encoding:

<syntax>	opc1	opc2	CRn	coproc	CRm
p15, 0, <Rt>, c0, c1, 7	000	111	0000	1111	0001

Accessibility

The register is accessible in software as follows:

Control			Accessibility			
E2H	TGE	NS	EL0	EL1	EL2	EL3
x	x	0	-	RO	n/a	RO
x	0	1	-	RO	RO	RO
x	1	1	-	n/a	RO	RO

Traps and Enables

For a description of the prioritization of any generated exceptions, see [Synchronous exception prioritization for exceptions taken to AArch32 state on page G1-4344](#) for exceptions taken to AArch32 state and [Synchronous exception prioritization for exceptions taken to AArch64 on page D1-1827](#) for exceptions taken to AArch64 state. Subject to the prioritization rules:

- When EL2 is implemented and is using AArch64 and (SCR_EL3.NS == 1) && (HCR_EL2.E2H == 0):
 - If HCR_EL2.TID3==1, Non-secure read accesses to this register from EL1 are trapped to EL2.

- If `HSTR_EL2.T0==1`, Non-secure read accesses to this register from EL1 are trapped to EL2.
- When EL2 is implemented and is using AArch64 and `(SCR_EL3.NS == 1) && (HCR_EL2.E2H == 1) && (HCR_EL2.TGE == 0)`:
 - If `HCR_EL2.TID3==1`, Non-secure read accesses to this register from EL1 are trapped to EL2.
 - If `HSTR_EL2.T0==1`, Non-secure read accesses to this register from EL1 are trapped to EL2.
- When EL2 is implemented and is using AArch32 and `SCR_EL3.NS == 1`:
 - If `HCR.TID3==1`, Non-secure read accesses to this register from EL1 are trapped to Hyp mode.
 - If `HSTR.T0==1`, Non-secure read accesses to this register from EL1 are trapped to Hyp mode.

G6.2.90 ID_MMFR4, Memory Model Feature Register 4

The ID_MMFR4 characteristics are:

Purpose

Provides information about the implemented memory model and memory management support in AArch32 state.

Must be interpreted with [ID_MMFR0](#), [ID_MMFR1](#), [ID_MMFR2](#), and [ID_MMFR3](#).

For general information about the interpretation of the ID registers see *Principles of the ID scheme for fields in ID registers* on page G4-4701.

Configurations

There is one instance of this register that is used in both Secure and Non-secure states.

AArch32 System register ID_MMFR4 is architecturally mapped to AArch64 System register [ID_MMFR4_EL1](#).

In an implementation that does not include [ACTLR2](#) and [HACTLR2](#) this register is RAZ.

Attributes

ID_MMFR4 is a 32-bit register.

Field descriptions

The ID_MMFR4 bit assignments are:

31	24 23	20 19	16 15	12 11	8 7	4 3	0
RAZ	LSM	HPDS	CnP	XNX	AC2	SpecSEI	

Bits [31:24]

Reserved, RAZ.

LSM, bits [23:20]

In ARMv8.2

Indicates support for LSMAOE and nTLSMD bits in [HSCTLR](#) and [SCTLR](#). Defined values are:

0000 LSMAOE and nTLSMD bits not supported.

0001 LSMAOE and nTLSMD bits supported.

All other values are reserved.

In ARMv8.0 and ARMv8.1 the only permitted value is 0000.

From ARMv8.2, the permitted values are 0000 and 0001. This feature is identified by the name [ARMv8.2-LSMAOC](#).

In ARMv8.1 and ARMv8.0.

Reserved, RAZ.

HPDS, bits [19:16]

In ARMv8.2

Hierarchical permission disables bits in translation tables. Defined values are:

0000 Disabling of hierarchical controls not supported.

0001 Supports disabling of hierarchical controls using the [TTBCR2.HPD0](#), [TTBCR2.HPD1](#), and [HTCR.HPD](#) bits.

0010 Supports disabling of hierarchical controls using the [TTBCR2.HPD0](#), [TTBCR2.HPD1](#), and [HTCR.HPD](#) bits, and hardware allocation of bits[62:59] of the last level page table descriptor for IMPLEMENTATION DEFINED use.

All other values are reserved.

In ARMv8.0 and ARMv8.1 the only permitted value is 0000.

From ARMv8.2, the permitted values are 0000, 0001 and 0010. This feature is identified by the name [ARMv8.2-AA32HPD](#).

———— **Note** —————

The encoding 0000 implies that the encoding for [TTBCR2](#) is unallocated.

In ARMv8.1 and ARMv8.0.

Reserved, RAZ.

CnP, bits [15:12]

In ARMv8.2

Common not Private translations. Defined values are:

0000 Common not Private translations not supported.

0001 Common not Private translations supported.

All other values are reserved.

In ARMv8.0 and ARMv8.1 the only permitted value is 0000.

From ARMv8.2, the only permitted value is 0001. This feature is identified by the name [ARMv8.2-TTCNP](#).

In ARMv8.1 and ARMv8.0.

Reserved, RAZ.

XNX, bits [11:8]

In ARMv8.2

Support for execute never control distinction at stage 2 bit. Defined values are:

0000 Distinction between EL0 and EL1 execute permission at stage 2 not supported.

0001 Distinction between EL0 and EL1 execute permission at stage 2 supported.

All other values are reserved.

In ARMv8.0 and ARMv8.1 the only permitted value is 0000.

From ARMv8.2, the only permitted value is 0001. This feature is identified by the name [ARMv8.2-TTS2UXN](#).

In ARMv8.1 and ARMv8.0.

Reserved, RAZ.

AC2, bits [7:4]

Indicates the extension of the [ACTLR](#) and [HACTLR](#) registers using [ACTLR2](#) and [HACTLR2](#).

Defined values are:

0000 [ACTLR2](#) and [HACTLR2](#) are not implemented.

0001 [ACTLR2](#) and [HACTLR2](#) are implemented.

All other values are reserved.

In ARMv8.0 and ARMv8.1 the permitted values are 0000 and 0001.

From ARMv8.2, the only permitted value is 0001.

SpecSEI, bits [3:0]

Describes whether the PE can generate SError interrupt exceptions from speculative reads of memory, including speculative instruction fetches. The defined values of this field are:

- 0000 The PE never generates an SError interrupt due to an external abort on a speculative read.
 - 0001 The PE might generate an SError interrupt due to an external abort on a speculative read.
- All other values are reserved.

When the RAS Extension is not implemented, this field is RAZ.

Accessing the ID_MMFR4

This register can be read using MRC with the following syntax:

MRC <syntax>

This syntax is encoded with the following settings in the instruction encoding:

<syntax>	opc1	opc2	CRn	coproc	CRm
p15, 0, <Rt>, c0, c2, 6	000	110	0000	1111	0010

Accessibility

The register is accessible in software as follows:

Control			Accessibility			
E2H	TGE	NS	EL0	EL1	EL2	EL3
x	x	0	-	RO	n/a	RO
x	0	1	-	RO	RO	RO
x	1	1	-	n/a	RO	RO

Traps and Enables

For a description of the prioritization of any generated exceptions, see [Synchronous exception prioritization for exceptions taken to AArch32 state on page G1-4344](#) for exceptions taken to AArch32 state and [Synchronous exception prioritization for exceptions taken to AArch64 on page D1-1827](#) for exceptions taken to AArch64 state. Subject to the prioritization rules:

- If EL2 is using AArch32 and `HCR.TID3==1`, then:
 - If this register is not RAZ/WI then Non-secure EL1 read accesses to this register are trapped to Hyp mode.
 - Otherwise, it is IMPLEMENTATION DEFINED whether Non-secure EL1 read accesses to this register are trapped to Hyp mode.
- If EL2 is using AArch64 and `HCR_EL2.TID3==1`, then:
 - If this register is not RAZ/WI then Non-secure EL1 read accesses to this register are trapped to EL2.
 - Otherwise, it is IMPLEMENTATION DEFINED whether Non-secure EL1 read accesses to this register are trapped to EL2.
- If `HSTR.T0==1`, Non-secure read accesses to this register from EL1 are trapped to Hyp mode.
- If `HSTR_EL2.T0==1`, Non-secure read accesses to this register from EL1 are trapped to EL2.

G6.2.91 ID_PFR0, Processor Feature Register 0

The ID_PFR0 characteristics are:

Purpose

Gives top-level information about the instruction sets supported by the PE in AArch32 state.

Must be interpreted with ID_PFR1.

For general information about the interpretation of the ID registers see *Principles of the ID scheme for fields in ID registers* on page G4-4701.

Configurations

There is one instance of this register that is used in both Secure and Non-secure states.

AArch32 System register ID_PFR0 is architecturally mapped to AArch64 System register ID_PFR0_EL1.

Attributes

ID_PFR0 is a 32-bit register.

Field descriptions

The ID_PFR0 bit assignments are:

31	28 27	16 15	12 11	8 7	4 3	0
RAS	RES0	State3	State2	State1	State0	

RAS, bits [31:28]

RAS Extension version. The defined values of this field are:

0000 No RAS Extension.

0001 Version 1 of the RAS Extension present.

All other values are reserved.

Bits [27:16]

Reserved, RES0.

State3, bits [15:12]

T32EE instruction set support. Defined values are:

0000 Not implemented.

0001 T32EE instruction set implemented.

All other values are reserved.

In ARMv8-A the only permitted value is 0000.

State2, bits [11:8]

Jazelle extension support. Defined values are:

0000 Not implemented.

0001 Jazelle extension implemented, without clearing of JOSCR.CV on exception entry.

0010 Jazelle extension implemented, with clearing of JOSCR.CV on exception entry.

All other values are reserved.

In ARMv8-A the only permitted value is 0001.

State1, bits [7:4]

T32 instruction set support. Defined values are:

- 0000 T32 instruction set not implemented.
- 0001 T32 encodings before the introduction of Thumb-2 technology implemented:
- All instructions are 16-bit.
 - A BL or BLX is a pair of 16-bit instructions.
 - 32-bit instructions other than BL and BLX cannot be encoded.
- 0011 T32 encodings after the introduction of Thumb-2 technology implemented, for all 16-bit and 32-bit T32 basic instructions.

All other values are reserved.

In ARMv8-A the only permitted value is 0011.

State0, bits [3:0]

A32 instruction set support. Defined values are:

- 0000 A32 instruction set not implemented.
- 0001 A32 instruction set implemented.

All other values are reserved.

In ARMv8-A the only permitted value is 0001.

Accessing the ID_PFR0

This register can be read using MRC with the following syntax:

MRC <syntax>

This syntax is encoded with the following settings in the instruction encoding:

<syntax>	opc1	opc2	CRn	coproc	CRm
p15, 0, <Rt>, c0, c1, 0	000	000	0000	1111	0001

Accessibility

The register is accessible in software as follows:

Control			Accessibility			
E2H	TGE	NS	EL0	EL1	EL2	EL3
x	x	0	-	RO	n/a	RO
x	0	1	-	RO	RO	RO
x	1	1	-	n/a	RO	RO

Traps and Enables

For a description of the prioritization of any generated exceptions, see *Synchronous exception prioritization for exceptions taken to AArch32 state* on page G1-4344 for exceptions taken to AArch32 state and *Synchronous exception prioritization for exceptions taken to AArch64* on page D1-1827 for exceptions taken to AArch64 state. Subject to the prioritization rules:

- When EL2 is implemented and is using AArch64 and $(SCR_EL3.NS == 1) \ \&\& \ (HCR_EL2.E2H == 0)$:
 - If $HCR_EL2.TID3 == 1$, Non-secure read accesses to this register from EL1 are trapped to EL2.
 - If $HSTR_EL2.T0 == 1$, Non-secure read accesses to this register from EL1 are trapped to EL2.
- When EL2 is implemented and is using AArch64 and $(SCR_EL3.NS == 1) \ \&\& \ (HCR_EL2.E2H == 1) \ \&\& \ (HCR_EL2.TGE == 0)$:
 - If $HCR_EL2.TID3 == 1$, Non-secure read accesses to this register from EL1 are trapped to EL2.
 - If $HSTR_EL2.T0 == 1$, Non-secure read accesses to this register from EL1 are trapped to EL2.
- When EL2 is implemented and is using AArch32 and $SCR_EL3.NS == 1$:
 - If $HCR.TID3 == 1$, Non-secure read accesses to this register from EL1 are trapped to Hyp mode.
 - If $HSTR.T0 == 1$, Non-secure read accesses to this register from EL1 are trapped to Hyp mode.

G6.2.92 ID_PFR1, Processor Feature Register 1

The ID_PFR1 characteristics are:

Purpose

Gives information about the AArch32 programmers' model.

Must be interpreted with ID_PFR0.

For general information about the interpretation of the ID registers see *Principles of the ID scheme for fields in ID registers* on page G4-4701.

Configurations

There is one instance of this register that is used in both Secure and Non-secure states.

AArch32 System register ID_PFR1 is architecturally mapped to AArch64 System register ID_PFR1_EL1.

Attributes

ID_PFR1 is a 32-bit register.

Field descriptions

The ID_PFR1 bit assignments are:

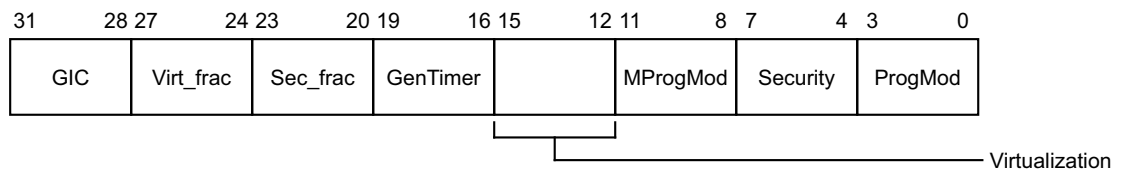

GIC, bits [31:28]

System register GIC CPU interface. Defined values are:

- 0000 No System register interface to the GIC CPU interface is supported.
 - 0001 System register interface to versions 3.0 and 4.0 of the GIC CPU interface is supported.
- All other values are reserved.

Virt_frac, bits [27:24]

Virtualization fractional field. When the Virtualization field is 0000, determines the support for features from the ARMv7 Virtualization Extensions. Defined values are:

- 0000 No features from the ARMv7 Virtualization Extensions are implemented.
- 0001 The following features of the ARMv7 Virtualization Extensions are implemented:
 - The SCR.SIF bit, if EL3 is implemented.
 - The modifications to the SCR.AW and SCR.FW bits described in the Virtualization Extensions, if EL3 is implemented.
 - The MSR (Banked register) and MRS (Banked register) instructions.
 - The ERET instruction.

All other values are reserved.

In ARMv8-A the permitted values are:

- 0000 when EL2 is implemented.
- 0001 when EL2 is not implemented.

This field is only valid when the value of ID_PFR1.Virtualization is 0, otherwise it holds the value 0000.

———— **Note** —————

The ID_ISAR registers do not identify whether the instructions added by the ARMv7 Virtualization Extensions are implemented.

Sec_frac, bits [23:20]

Security fractional field. When the Security field is 0000, determines the support for features from the ARMv7 Security Extensions. Defined values are:

- 0000 No features from the ARMv7 Security Extensions are implemented.
- 0001 The following features from the ARMv7 Security Extensions are implemented:
 - The VBAR register.
 - The TTBCR.PD0 and TTBCR.PD1 bits.
- 0010 As for 0001, plus the ability to access Secure or Non-secure physical memory is supported.

All other values are reserved.

In ARMv8-A the permitted values are:

- 0000 when EL3 is implemented.
- 0001 or 0010 when EL3 is not implemented.

This field is only valid when the value of ID_PFR1.Security is 0, otherwise it holds the value 0000.

GenTimer, bits [19:16]

Generic Timer support. Defined values are:

- 0000 Not implemented.
- 0001 Generic Timer implemented.

All other values are reserved.

In ARMv8-A the only permitted value is 0001.

Virtualization, bits [15:12]

Virtualization support. Defined values are:

- 0000 EL2, Hyp mode, and the HVC instruction not implemented.
- 0001 EL2, Hyp mode, the HVC instruction, and all the features described by Virt_frac == 0001 implemented.

All other values are reserved.

In ARMv8-A the permitted values are:

- 0000 when EL2 is not implemented.
- 0001 when EL2 is implemented.

In an implementation that includes EL2, if EL2 cannot use AArch32 but EL1 can use AArch32 then this field has the value 0001.

———— **Note** —————

The ID_ISARs do not identify whether the HVC instruction is implemented.

MProgMod, bits [11:8]

M profile programmers' model support. Defined values are:

- 0000 Not supported.
- 0010 Support for two-stack programmers' model.

All other values are reserved.

In ARMv8-A the only permitted value is 0000.

Security, bits [7:4]

Security support. Defined values are:

- 0000 EL3, Monitor mode, and the SMC instruction not implemented.
- 0001 EL3, Monitor mode, the SMC instruction, and all the features described by Sec_frac == 0001 implemented.
- 0010 As for 0001, and adds the ability to set the NSACR.RFR bit. Not permitted in ARMv8 as the NSACR.RFR bit is RES0.

All other values are reserved.

In ARMv8-A the permitted values are:

- 0000 when EL3 is not implemented.
- 0001 when EL3 is implemented.

In an implementation that includes EL3, if EL3 cannot use AArch32 but EL1 can use AArch32 then this field has the value 0001.

ProgMod, bits [3:0]

Support for the standard programmers' model for ARMv4 and later. Model must support User, FIQ, IRQ, Supervisor, Abort, Undefined, and System modes. Defined values are:

- 0000 Not supported.
- 0001 Supported.

All other values are reserved.

In ARMv8-A the only permitted value is 0001.

Accessing the ID_PFR1

This register can be read using MRC with the following syntax:

MRC <syntax>

This syntax is encoded with the following settings in the instruction encoding:

<syntax>	opc1	opc2	CRn	coproc	CRm
p15, 0, <Rt>, c0, c1, 1	000	001	0000	1111	0001

Accessibility

The register is accessible in software as follows:

Control			Accessibility			
E2H	TGE	NS	EL0	EL1	EL2	EL3
x	x	0	-	RO	n/a	RO
x	0	1	-	RO	RO	RO
x	1	1	-	n/a	RO	RO

Traps and Enables

For a description of the prioritization of any generated exceptions, see *Synchronous exception prioritization for exceptions taken to AArch32 state* on page G1-4344 for exceptions taken to AArch32 state and *Synchronous exception prioritization for exceptions taken to AArch64* on page D1-1827 for exceptions taken to AArch64 state. Subject to the prioritization rules:

- When EL2 is implemented and is using AArch64 and $(SCR_EL3.NS == 1) \&\& (HCR_EL2.E2H == 0)$:
 - If $HCR_EL2.TID3 == 1$, Non-secure read accesses to this register from EL1 are trapped to EL2.
 - If $HSTR_EL2.T0 == 1$, Non-secure read accesses to this register from EL1 are trapped to EL2.
- When EL2 is implemented and is using AArch64 and $(SCR_EL3.NS == 1) \&\& (HCR_EL2.E2H == 1) \&\& (HCR_EL2.TGE == 0)$:
 - If $HCR_EL2.TID3 == 1$, Non-secure read accesses to this register from EL1 are trapped to EL2.
 - If $HSTR_EL2.T0 == 1$, Non-secure read accesses to this register from EL1 are trapped to EL2.
- When EL2 is implemented and is using AArch32 and $SCR_EL3.NS == 1$:
 - If $HCR.TID3 == 1$, Non-secure read accesses to this register from EL1 are trapped to Hyp mode.
 - If $HSTR.T0 == 1$, Non-secure read accesses to this register from EL1 are trapped to Hyp mode.

G6.2.93 IFAR, Instruction Fault Address Register

The IFAR characteristics are:

Purpose

Holds the virtual address of the faulting address that caused a synchronous Prefetch Abort exception.

Configurations

AArch32 System register IFAR(NS) is architecturally mapped to AArch64 System register [FAR_EL1](#)[63:32].

AArch32 System register IFAR(S) is architecturally mapped to AArch32 System register [HIFAR](#) when EL2 is implemented.

AArch32 System register IFAR(S) is architecturally mapped to AArch64 System register [FAR_EL2](#)[63:32] when EL2 is implemented.

RW fields in this register reset to architecturally UNKNOWN values.

Attributes

IFAR is a 32-bit register.

Field descriptions

The IFAR bit assignments are:

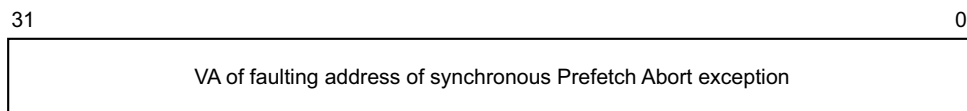

Bits [31:0]

VA of faulting address of synchronous Prefetch Abort exception.

Accessing the IFAR

This register can be read using MRC with the following syntax:

MRC <syntax>

This register can be written using MCR with the following syntax:

MCR <syntax>

This syntax is encoded with the following settings in the instruction encoding:

<syntax>	opc1	opc2	CRn	coproc	CRm
p15, 0, <Rt>, c6, c0, 2	000	010	0110	1111	0000

Accessibility

The register is accessible in software as follows:

Configuration	Control			Accessibility				Instance
	E2H	TGE	NS	EL0	EL1	EL2	EL3	
EL3 is using AArch32.	x	x	0	-	n/a	n/a	RW	IFAR_s
EL3 is not implemented.	x	x	0	-	RW	n/a	n/a	IFAR
EL3 is not implemented.	x	0	1	-	RW	RW	n/a	IFAR
EL3 is not implemented.	x	1	1	-	n/a	RW	n/a	IFAR
EL3 is using AArch64.	x	x	0	-	RW	n/a	n/a	IFAR
EL3 is using AArch64.	x	0	1	-	RW	RW	n/a	IFAR
EL3 is using AArch64.	x	1	1	-	n/a	RW	n/a	IFAR
EL3 is using AArch32.	x	0	1	-	RW	RW	RW	IFAR_ns
EL3 is using AArch32.	x	1	1	-	n/a	RW	RW	IFAR_ns

Traps and Enables

For a description of the prioritization of any generated exceptions, see [Synchronous exception prioritization for exceptions taken to AArch32 state on page G1-4344](#) for exceptions taken to AArch32 state and [Synchronous exception prioritization for exceptions taken to AArch64 on page D1-1827](#) for exceptions taken to AArch64 state. Subject to the prioritization rules:

- When EL2 is implemented and is using AArch64 and (SCR_EL3.NS == 1) && (HCR_EL2.E2H == 0):
 - If HCR_EL2.TVM==1, Non-secure write accesses to this register from EL1 are trapped to EL2.
 - If HCR_EL2.TRVM==1, Non-secure read accesses to this register from EL1 are trapped to EL2.
 - If HSTR_EL2.T6==1, Non-secure accesses to this register from EL1 are trapped to EL2.
- When EL2 is implemented and is using AArch64 and (SCR_EL3.NS == 1) && (HCR_EL2.E2H == 1) && (HCR_EL2.TGE == 0):
 - If HCR_EL2.TVM==1, Non-secure write accesses to this register from EL1 are trapped to EL2.
 - If HCR_EL2.TRVM==1, Non-secure read accesses to this register from EL1 are trapped to EL2.
 - If HSTR_EL2.T6==1, Non-secure accesses to this register from EL1 are trapped to EL2.
- When EL2 is implemented and is using AArch32 and SCR_EL3.NS == 1:
 - If HCR.TVM==1, Non-secure write accesses to this register from EL1 are trapped to Hyp mode.
 - If HCR.TRVM==1, Non-secure read accesses to this register from EL1 are trapped to Hyp mode.
 - If HSTR.T6==1, Non-secure accesses to this register from EL1 are trapped to Hyp mode.

G6.2.94 IFSR, Instruction Fault Status Register

The IFSR characteristics are:

Purpose

Holds status information about the last instruction fault.

Configurations

AArch32 System register IFSR is architecturally mapped to AArch64 System register [IFSR32_EL2](#).

The current translation table format determines which format of the register is used.

RW fields in this register reset to architecturally UNKNOWN values.

Attributes

IFSR is a 32-bit register.

Field descriptions

The IFSR bit assignments are:

When *TTBCR.EAE*==0:

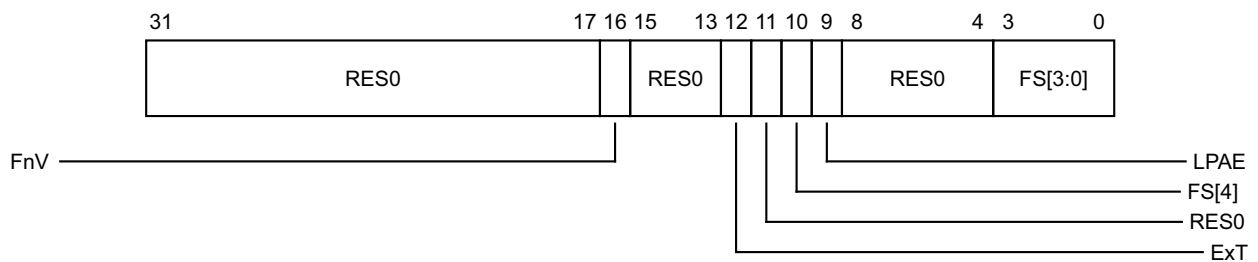

Bits [31:17]

Reserved, RES0.

FnV, bit [16]

FAR not Valid, for a Synchronous external abort other than a Synchronous external abort on a translation table walk.

0 [IFAR](#) is valid.

1 [IFAR](#) is not valid, and holds an UNKNOWN value.

This field is only valid for a Synchronous external abort other than a Synchronous external abort on a translation table walk. It is RES0 for all other Prefetch Abort exceptions.

Bits [15:13]

Reserved, RES0.

ExT, bit [12]

External abort type. This bit can be used to provide an IMPLEMENTATION DEFINED classification of external aborts.

In an implementation that does not provide any classification of external aborts, this bit is RES0.

For aborts other than external aborts this bit always returns 0.

Bit [11]

Reserved, RES0.

FS[4], bit [10]

See FS[3:0], bits [3:0] for description of the FS field.

LPAE, bit [9]

On taking a Data Abort exception, this bit is set as follows:

- 0 Using the Short-descriptor translation table formats.
- 1 Using the Long-descriptor translation table formats.

Hardware does not interpret this bit to determine the behavior of the memory system, and therefore software can set this bit to 0 or 1 without affecting operation.

Bits [8:4]

Reserved, RES0.

FS[3:0], bits [3:0]

Fault status bits. Interpreted with bit [10]. Possible values of FS[4:0] are:

- 00001 PC alignment fault
- 00010 Debug exception
- 00011 Access flag fault, level 1
- 00101 Translation fault, level 1
- 00110 Access flag fault, level 2
- 00111 Translation fault, level 2
- 01000 Synchronous external abort, not on translation table walk
- 01001 Domain fault, level 1
- 01011 Domain fault, level 2
- 01100 Synchronous external abort, on translation table walk, level 1
- 01101 Permission fault, level 1
- 01110 Synchronous external abort, on translation table walk, level 2
- 01111 Permission fault, level 2
- 10000 TLB conflict abort
- 10100 IMPLEMENTATION DEFINED fault (Lockdown fault)
- 11001 Synchronous parity or ECC error on memory access, not on translation table walk
- 11100 Synchronous parity or ECC error on translation table walk, level 1
- 11110 Synchronous parity or ECC error on translation table walk, level 2

All other values are reserved.

When the RAS Extension is implemented, 11001, 11100, and 11110 are reserved.

For more information about the lookup level associated with a fault, see [The level associated with MMU faults on a Short-descriptor translation table lookup](#) on page G4-4669.

When TTBCR.EAE==1:

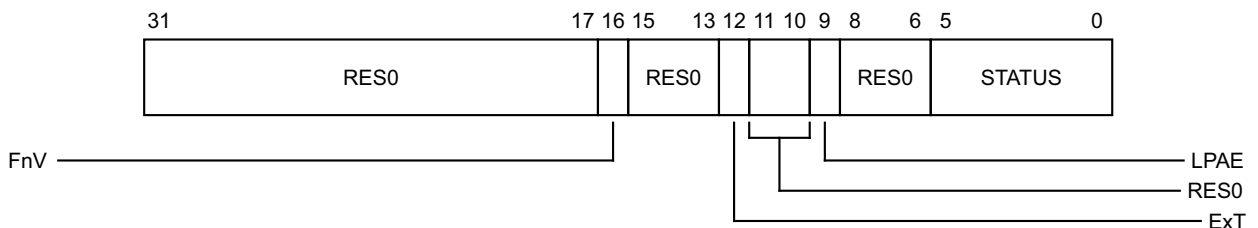

Bits [31:17]

Reserved, RES0.

FnV, bit [16]

FAR not Valid, for a Synchronous external abort other than a Synchronous external abort on a translation table walk.

0 **IFAR** is valid.

1 **IFAR** is not valid, and holds an UNKNOWN value.

This field is only valid for a Synchronous external abort other than a Synchronous external abort on a translation table walk. It is RES0 for all other Prefetch Abort exceptions.

Bits [15:13]

Reserved, RES0.

ExT, bit [12]

External abort type. This bit can be used to provide an IMPLEMENTATION DEFINED classification of external aborts.

In an implementation that does not provide any classification of external aborts, this bit is RES0.

For aborts other than external aborts this bit always returns 0.

Bits [11:10]

Reserved, RES0.

LPAE, bit [9]

On taking a Data Abort exception, this bit is set as follows:

0 Using the Short-descriptor translation table formats.

1 Using the Long-descriptor translation table formats.

Hardware does not interpret this bit to determine the behavior of the memory system, and therefore software can set this bit to 0 or 1 without affecting operation.

Bits [8:6]

Reserved, RES0.

STATUS, bits [5:0]

Fault status bits. Possible values of this field are:

000000	Address size fault in TTBR0 or TTBR1
000001	Address size fault, level 1
000010	Address size fault, level 2
000011	Address size fault, level 3
000101	Translation fault, level 1
000110	Translation fault, level 2
000111	Translation fault, level 3
001001	Access flag fault, level 1
001010	Access flag fault, level 2
001011	Access flag fault, level 3
001101	Permission fault, level 1
001110	Permission fault, level 2
001111	Permission fault, level 3
010000	Synchronous external abort, not on translation table walk
010101	Synchronous external abort, on translation table walk, level 1

- 010110 Synchronous external abort, on translation table walk, level 2
- 010111 Synchronous external abort, on translation table walk, level 3
- 011000 Synchronous parity or ECC error on memory access, not on translation table walk
- 011101 Synchronous parity or ECC error on memory access on translation table walk, level 1
- 011110 Synchronous parity or ECC error on memory access on translation table walk, level 2
- 011111 Synchronous parity or ECC error on memory access on translation table walk, level 3
- 100001 PC alignment fault
- 100010 Debug exception
- 110000 TLB conflict abort

All other values are reserved.

When the RAS Extension is implemented, 011000, 011101, 011110, and 011111 are reserved.

For more information about the lookup level associated with a fault, see [The level associated with MMU faults on a Long-descriptor translation table lookup on page G4-4671](#).

Accessing the IFSR

This register can be read using MRC with the following syntax:

MRC <syntax>

This register can be written using MCR with the following syntax:

MCR <syntax>

This syntax is encoded with the following settings in the instruction encoding:

<syntax>	opc1	opc2	CRn	coproc	CRm
p15, 0, <Rt>, c5, c0, 1	000	001	0101	1111	0000

Accessibility

The register is accessible in software as follows:

Configuration	Control			Accessibility				Instance
	E2H	TGE	NS	EL0	EL1	EL2	EL3	
EL3 is not implemented.	x	x	0	-	RW	n/a	n/a	IFSR
EL3 is not implemented.	x	0	1	-	RW	RW	n/a	IFSR
EL3 is not implemented.	x	1	1	-	n/a	RW	n/a	IFSR
EL3 is using AArch64.	x	x	0	-	RW	n/a	n/a	IFSR
EL3 is using AArch64.	x	0	1	-	RW	RW	n/a	IFSR
EL3 is using AArch64.	x	1	1	-	n/a	RW	n/a	IFSR
EL3 is using AArch32.	x	x	0	-	n/a	n/a	RW	IFSR_s
EL3 is using AArch32.	x	0	1	-	RW	RW	RW	IFSR_ns
EL3 is using AArch32.	x	1	1	-	n/a	RW	RW	IFSR_ns

Traps and Enables

For a description of the prioritization of any generated exceptions, see *Synchronous exception prioritization for exceptions taken to AArch32 state* on page G1-4344 for exceptions taken to AArch32 state and *Synchronous exception prioritization for exceptions taken to AArch64* on page D1-1827 for exceptions taken to AArch64 state. Subject to the prioritization rules:

- When EL2 is implemented and is using AArch64 and $(SCR_EL3.NS == 1) \ \&\& \ (HCR_EL2.E2H == 0)$:
 - If $HCR_EL2.TVM == 1$, Non-secure write accesses to this register from EL1 are trapped to EL2.
 - If $HCR_EL2.TRVM == 1$, Non-secure read accesses to this register from EL1 are trapped to EL2.
 - If $HSTR_EL2.T5 == 1$, Non-secure accesses to this register from EL1 are trapped to EL2.
- When EL2 is implemented and is using AArch64 and $(SCR_EL3.NS == 1) \ \&\& \ (HCR_EL2.E2H == 1) \ \&\& \ (HCR_EL2.TGE == 0)$:
 - If $HCR_EL2.TVM == 1$, Non-secure write accesses to this register from EL1 are trapped to EL2.
 - If $HCR_EL2.TRVM == 1$, Non-secure read accesses to this register from EL1 are trapped to EL2.
 - If $HSTR_EL2.T5 == 1$, Non-secure accesses to this register from EL1 are trapped to EL2.
- When EL2 is implemented and is using AArch32 and $SCR_EL3.NS == 1$:
 - If $HCR.TVM == 1$, Non-secure write accesses to this register from EL1 are trapped to Hyp mode.
 - If $HCR.TRVM == 1$, Non-secure read accesses to this register from EL1 are trapped to Hyp mode.
 - If $HSTR.T5 == 1$, Non-secure accesses to this register from EL1 are trapped to Hyp mode.

G6.2.95 ISR, Interrupt Status Register

The ISR characteristics are:

Purpose

Shows whether any IRQ, FIQ, or external abort is pending. In an implementation that includes EL2, when the register is accessed from Non-secure EL1, a pending interrupt might be a physical interrupt or a virtual interrupt, and the architecture does not provide any mechanism that software executing at Non-secure EL1 can use to determine whether a pending interrupt is physical or virtual. For all other accesses, any indicated interrupt must be a physical interrupt.

Configurations

There is one instance of this register that is used in both Secure and Non-secure states.

AArch32 System register ISR is architecturally mapped to AArch64 System register [ISR_EL1](#).

Attributes

ISR is a 32-bit register.

Field descriptions

The ISR bit assignments are:

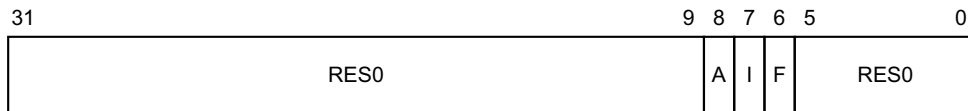

Bits [31:9]

Reserved, RES0.

A, bit [8]

Asynchronous external abort pending bit:

0 No pending asynchronous external abort.

1 An asynchronous external abort is pending.

I, bit [7]

IRQ pending bit. Indicates whether an IRQ interrupt is pending:

0 No pending IRQ.

1 An IRQ interrupt is pending.

F, bit [6]

FIQ pending bit. Indicates whether an FIQ interrupt is pending.

0 No pending FIQ.

1 An FIQ interrupt is pending.

Bits [5:0]

Reserved, RES0.

Accessing the ISR

This register can be read using MRC with the following syntax:

MRC <syntax>

This syntax is encoded with the following settings in the instruction encoding:

<syntax>	opc1	opc2	CRn	coproc	CRm
p15, 0, <Rt>, c12, c1, 0	000	000	1100	1111	0001

Accessibility

The register is accessible in software as follows:

Control			Accessibility			
E2H	TGE	NS	EL0	EL1	EL2	EL3
x	x	0	-	RO	n/a	RO
x	0	1	-	RO	RO	RO
x	1	1	-	n/a	RO	RO

Traps and Enables

For a description of the prioritization of any generated exceptions, see [Synchronous exception prioritization for exceptions taken to AArch32 state on page G1-4344](#) for exceptions taken to AArch32 state and [Synchronous exception prioritization for exceptions taken to AArch64 on page D1-1827](#) for exceptions taken to AArch64 state. Subject to the prioritization rules:

- When EL2 is implemented and is using AArch64 and (SCR_EL3.NS == 1) && (HCR_EL2.E2H == 0):
 - If HSTR_EL2.T12==1, Non-secure read accesses to this register from EL1 are trapped to EL2.
- When EL2 is implemented and is using AArch64 and (SCR_EL3.NS == 1) && (HCR_EL2.E2H == 1) && (HCR_EL2.TGE == 0):
 - If HSTR_EL2.T12==1, Non-secure read accesses to this register from EL1 are trapped to EL2.
- When EL2 is implemented and is using AArch32 and SCR_EL3.NS == 1:
 - If HSTR.T12==1, Non-secure read accesses to this register from EL1 are trapped to Hyp mode.

G6.2.96 ITLBIALL, Instruction TLB Invalidate All

The ITLBIALL characteristics are:

Purpose

Invalidate all cached copies of translation table entries from instruction TLBs that are from any level of the translation table walk. The entries that are invalidated are as follows:

- If executed at Secure EL1 when EL3 is using AArch64, all entries that would be required for the Secure EL1&0 translation regime.
- If executed in Secure state when EL3 is using AArch32, all entries that would be required for the Secure PL1&0 translation regime.
- If executed at Non-secure EL1, all stage 1 translation table entries that would be required for the Non-secure PL1&0 translation regime and, if EL2 is implemented, they must match the current VMID.
- If executed at EL2, the stage 1 or stage 2 translation table entries that would be required for the Non-secure PL1&0 translation regime and matches the current VMID.

The invalidation only applies to the PE that executes this instruction.

ARM deprecates the use of this instruction. It is only provided for backwards compatibility with earlier versions of the ARM architecture.

Configurations

There are no configuration notes.

Attributes

ITLBIALL is a 32-bit System instruction.

Field descriptions

ITLBIALL ignores the value in the register specified by the instruction. Software does not have to write a value to the register before issuing this instruction.

Executing the ITLBIALL instruction

This instruction is executed using MCR with the following syntax:

MCR <syntax>

This syntax uses the following encoding in the System instruction encoding space:

<syntax>	opc1	opc2	CRn	coproc	CRm
p15, 0, <Rt>, c8, c5, 0	000	000	1000	1111	0101

Accessibility

The instruction is executable as follows:

Control			Accessibility			
E2H	TGE	NS	EL0	EL1	EL2	EL3
x	x	0	-	WO	n/a	WO
x	0	1	-	WO	WO	WO
x	1	1	-	n/a	WO	WO

When `HCR.FB` is 1, at Non-secure EL1 this instruction executes as a `TLBIALLS` operating on instruction TLBs only.

Traps and Enables

For a description of the prioritization of any generated exceptions, see *Synchronous exception prioritization for exceptions taken to AArch32 state* on page G1-4344 for exceptions taken to AArch32 state and *Synchronous exception prioritization for exceptions taken to AArch64* on page D1-1827 for exceptions taken to AArch64 state. Subject to the prioritization rules:

- When EL2 is implemented and is using AArch64 and `(SCR_EL3.NS == 1) && (HCR_EL2.E2H == 0)`:
 - If `HCR_EL2.TTLB==1`, Non-secure execution of this instruction at EL1 is trapped to EL2.
 - If `HSTR_EL2.T8==1`, Non-secure execution of this instruction at EL1 is trapped to EL2.
- When EL2 is implemented and is using AArch64 and `(SCR_EL3.NS == 1) && (HCR_EL2.E2H == 1) && (HCR_EL2.TGE == 0)`:
 - If `HCR_EL2.TTLB==1`, Non-secure execution of this instruction at EL1 is trapped to EL2.
 - If `HSTR_EL2.T8==1`, Non-secure execution of this instruction at EL1 is trapped to EL2.
- When EL2 is implemented and is using AArch32 and `SCR_EL3.NS == 1`:
 - If `HCR.TTLB==1`, Non-secure execution of this instruction at EL1 is trapped to Hyp mode.
 - If `HSTR.T8==1`, Non-secure execution of this instruction at EL1 is trapped to Hyp mode.

G6.2.97 ITLBIASID, Instruction TLB Invalidate by ASID match

The ITLBIASID characteristics are:

Purpose

Invalidate all cached copies of translation table entries from instruction TLBs that meet the following requirements:

- The entry is a stage 1 translation table entry.
- The entry would be used for the specified ASID, and either:
 - Is from a level of lookup above the final level.
 - Is a non-global entry from the final level of lookup.
- If EL2 is implemented, the entry would be used with the current VMID.

From the entries that match these requirement, the entries that are invalidated are required for the following translation regime:

- If executed at Secure EL1 when EL3 is using AArch64, the Secure EL1&0 translation regime.
- If executed in Secure state when EL3 is using AArch32, the Secure PL1&0 translation regime.
- If executed in Non-secure state, the Non-secure PL1&0 translation regime.

The invalidation only applies to the PE that executes this instruction.

ARM deprecates the use of this instruction. It is only provided for backwards compatibility with earlier versions of the ARM architecture.

Configurations

There are no configuration notes.

Attributes

ITLBIASID is a 32-bit System instruction.

Field descriptions

The ITLBIASID input value bit assignments are:

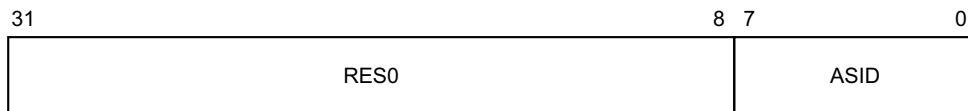

Bits [31:8]

Reserved, RES0.

ASID, bits [7:0]

ASID value to match. Any TLB entries for non-global pages that match the ASID values will be affected by this operation.

Executing the ITLBIASID instruction

This instruction is executed using MCR with the following syntax:

MCR <syntax>

This syntax uses the following encoding in the System instruction encoding space:

<syntax>	opc1	opc2	CRn	coproc	CRm
p15, 0, <Rt>, c8, c5, 2	000	010	1000	1111	0101

Accessibility

The instruction is executable as follows:

Control			Accessibility			
E2H	TGE	NS	EL0	EL1	EL2	EL3
x	x	0	-	WO	n/a	WO
x	0	1	-	WO	WO	WO
x	1	1	-	n/a	WO	WO

When `HCR.FB` is 1, at Non-secure EL1 this instruction executes as a `TLBIASIDIS` operating on instruction TLBs only.

Traps and Enables

For a description of the prioritization of any generated exceptions, see *Synchronous exception prioritization for exceptions taken to AArch32 state* on page G1-4344 for exceptions taken to AArch32 state and *Synchronous exception prioritization for exceptions taken to AArch64* on page D1-1827 for exceptions taken to AArch64 state. Subject to the prioritization rules:

- When EL2 is implemented and is using AArch64 and $(SCR_EL3.NS == 1) \ \&\& \ (HCR_EL2.E2H == 0)$:
 - If `HCR_EL2.TTLB==1`, Non-secure execution of this instruction at EL1 is trapped to EL2.
 - If `HSTR_EL2.T8==1`, Non-secure execution of this instruction at EL1 is trapped to EL2.
- When EL2 is implemented and is using AArch64 and $(SCR_EL3.NS == 1) \ \&\& \ (HCR_EL2.E2H == 1) \ \&\& \ (HCR_EL2.TGE == 0)$:
 - If `HCR_EL2.TTLB==1`, Non-secure execution of this instruction at EL1 is trapped to EL2.
 - If `HSTR_EL2.T8==1`, Non-secure execution of this instruction at EL1 is trapped to EL2.
- When EL2 is implemented and is using AArch32 and $SCR_EL3.NS == 1$:
 - If `HCR.TTLB==1`, Non-secure execution of this instruction at EL1 is trapped to Hyp mode.
 - If `HSTR.T8==1`, Non-secure execution of this instruction at EL1 is trapped to Hyp mode.

G6.2.98 ITLBIMVA, Instruction TLB Invalidate by VA

The ITLBIMVA characteristics are:

Purpose

Invalidate all cached copies of translation table entries from instruction TLBs that meet the following requirements:

- The entry is a stage 1 translation table entry.
- The entry would be used to translate the specified address, and one of the following applies:
 - The entry is from a level of lookup above the final level and matches the specified ASID.
 - The entry is a global entry from the final level of lookup.
 - The entry is a non-global entry from the final level of lookup that matches the specified ASID.
- If EL2 is implemented, the entry would be used with the current VMID.

From the entries that match these requirement, the entries that are invalidated are required for the following translation regime:

- If executed at Secure EL1 when EL3 is using AArch64, the Secure EL1&0 translation regime.
- If executed in Secure state when EL3 is using AArch32, the Secure PL1&0 translation regime.
- If executed in Non-secure state, the Non-secure PL1&0 translation regime.

The invalidation only applies to the PE that executes this instruction.

ARM deprecates the use of this instruction. It is only provided for backwards compatibility with earlier versions of the ARM architecture.

Configurations

There are no configuration notes.

Attributes

ITLBIMVA is a 32-bit System instruction.

Field descriptions

The ITLBIMVA input value bit assignments are:

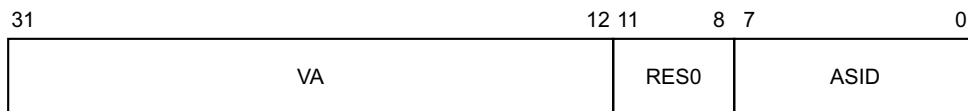

VA, bits [31:12]

Virtual address to match. Any TLB entries that match the ASID value and VA value will be affected by this operation.

Bits [11:8]

Reserved, RES0.

ASID, bits [7:0]

ASID value to match. Any TLB entries that match the ASID value and VA value will be affected by this operation.

Global TLB entries that match the VA value will be affected by this operation, regardless of the value of the ASID field.

Executing the ITLBIMVA instruction

This instruction is executed using MCR with the following syntax:

MCR <syntax>

This syntax uses the following encoding in the System instruction encoding space:

<syntax>	opc1	opc2	CRn	coproc	CRm
p15, 0, <Rt>, c8, c5, 1	000	001	1000	1111	0101

Accessibility

The instruction is executable as follows:

Control			Accessibility			
E2H	TGE	NS	EL0	EL1	EL2	EL3
x	x	0	-	WO	n/a	WO
x	0	1	-	WO	WO	WO
x	1	1	-	n/a	WO	WO

When `HCR.FB` is 1, at Non-secure EL1 this instruction executes as a `TLBIMVAIS` operating on instruction TLBs only.

Traps and Enables

For a description of the prioritization of any generated exceptions, see *Synchronous exception prioritization for exceptions taken to AArch32 state* on page G1-4344 for exceptions taken to AArch32 state and *Synchronous exception prioritization for exceptions taken to AArch64* on page D1-1827 for exceptions taken to AArch64 state. Subject to the prioritization rules:

- When EL2 is implemented and is using AArch64 and $(SCR_EL3.NS == 1) \ \&\& \ (HCR_EL2.E2H == 0)$:
 - If $HCR_EL2.TTLB == 1$, Non-secure execution of this instruction at EL1 is trapped to EL2.
 - If $HSTR_EL2.T8 == 1$, Non-secure execution of this instruction at EL1 is trapped to EL2.
- When EL2 is implemented and is using AArch64 and $(SCR_EL3.NS == 1) \ \&\& \ (HCR_EL2.E2H == 1) \ \&\& \ (HCR_EL2.TGE == 0)$:
 - If $HCR_EL2.TTLB == 1$, Non-secure execution of this instruction at EL1 is trapped to EL2.
 - If $HSTR_EL2.T8 == 1$, Non-secure execution of this instruction at EL1 is trapped to EL2.
- When EL2 is implemented and is using AArch32 and $SCR_EL3.NS == 1$:
 - If $HCR.TTLB == 1$, Non-secure execution of this instruction at EL1 is trapped to Hyp mode.
 - If $HSTR.T8 == 1$, Non-secure execution of this instruction at EL1 is trapped to Hyp mode.

G6.2.99 JIDR, Jazelle ID Register

The JIDR characteristics are:

Purpose

A Jazelle register, which identified the Jazelle architecture version.

Configurations

There is one instance of this register that is used in both Secure and Non-secure states.

Attributes

JIDR is a 32-bit register.

Field descriptions

The JIDR bit assignments are:

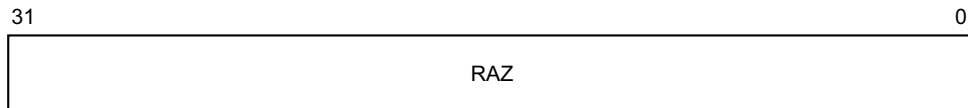

Bits [31:0]

RAZ.

Accessing the JIDR

This register can be read using MRC with the following syntax:

MRC <syntax>

This syntax is encoded with the following settings in the instruction encoding:

<syntax>	opc1	opc2	CRn	coproc	CRm
p14, 7, <Rt>, c0, c0, 0	111	000	0000	1110	0000

Accessibility

The register is accessible in software as follows:

Control			Accessibility			
E2H	TGE	NS	EL0	EL1	EL2	EL3
x	x	0	IMPLEMENTATION DEFINED	RO	n/a	RO
x	0	1	IMPLEMENTATION DEFINED	RO	RO	RO
x	1	1	IMPLEMENTATION DEFINED	n/a	RO	RO

For accesses from EL0 it is IMPLEMENTATION DEFINED whether the register is RO or UNDEFINED.

Traps and Enables

For a description of the prioritization of any generated exceptions, see *Synchronous exception prioritization for exceptions taken to AArch32 state* on page G1-4344 for exceptions taken to AArch32 state and *Synchronous exception prioritization for exceptions taken to AArch64* on page D1-1827 for exceptions taken to AArch64 state. Subject to the prioritization rules:

- When EL2 is implemented and is using AArch64 and $(SCR_EL3.NS == 1) \&\& (HCR_EL2.E2H == 0)$:
 - If $HCR_EL2.TID0 == 1$, Non-secure read accesses to this register from EL0 and EL1 are trapped to EL2.
- When EL2 is implemented and is using AArch64 and $(SCR_EL3.NS == 1) \&\& (HCR_EL2.E2H == 1) \&\& (HCR_EL2.TGE == 0)$:
 - If $HCR_EL2.TID0 == 1$, Non-secure read accesses to this register from EL0 and EL1 are trapped to EL2.
- When EL2 is implemented and is using AArch32 and $SCR_EL3.NS == 1$:
 - If $HCR.TID0 == 1$, Non-secure read accesses to this register from EL0 and EL1 are trapped to Hyp mode.

G6.2.100 JMCR, Jazelle Main Configuration Register

The JMCR characteristics are:

Purpose

A Jazelle register, which provides control of the Jazelle extension.

Configurations

There is one instance of this register that is used in both Secure and Non-secure states.

Attributes

JMCR is a 32-bit register.

Field descriptions

The JMCR bit assignments are:

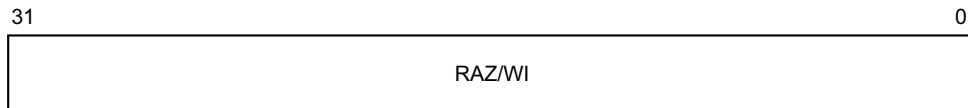

Bits [31:0]

RAZ/WI.

Accessing the JMCR

This register can be read using MRC with the following syntax:

MRC <syntax>

This register can be written using MCR with the following syntax:

MCR <syntax>

This syntax is encoded with the following settings in the instruction encoding:

<syntax>	opc1	opc2	CRn	coproc	CRm
p14, 7, <Rt>, c2, c0, 0	111	000	0010	1110	0000

Accessibility

The register is accessible in software as follows:

Control			Accessibility			
E2H	TGE	NS	EL0	EL1	EL2	EL3
x	x	0	IMPLEMENTATION DEFINED	RW	n/a	RW
x	0	1	IMPLEMENTATION DEFINED	RW	RW	RW
x	1	1	IMPLEMENTATION DEFINED	n/a	RW	RW

For accesses from EL0 it is IMPLEMENTATION DEFINED whether the register is RW or UNDEFINED.

G6.2.101 JOSCR, Jazelle OS Control Register

The JOSCR characteristics are:

Purpose

A Jazelle register, which provides operating system control of the Jazelle Extension.

Configurations

There is one instance of this register that is used in both Secure and Non-secure states.

Attributes

JOSCR is a 32-bit register.

Field descriptions

The JOSCR bit assignments are:

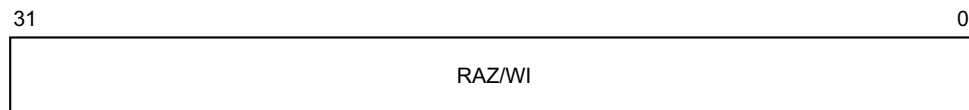

Bits [31:0]

RAZ/WI.

Accessing the JOSCR

This register can be read using MRC with the following syntax:

MRC <syntax>

This register can be written using MCR with the following syntax:

MCR <syntax>

This syntax is encoded with the following settings in the instruction encoding:

<syntax>	opc1	opc2	CRn	coproc	CRm
p14, 7, <Rt>, c1, c0, 0	111	000	0001	1110	0000

Accessibility

The register is accessible in software as follows:

Control			Accessibility			
E2H	TGE	NS	EL0	EL1	EL2	EL3
x	x	0	IMPLEMENTATION DEFINED	RW	n/a	RW
x	0	1	IMPLEMENTATION DEFINED	RW	RW	RW
x	1	1	IMPLEMENTATION DEFINED	n/a	RW	RW

For accesses from EL0 it is IMPLEMENTATION DEFINED whether the register is RW or UNDEFINED.

G6.2.102 MAIRO, Memory Attribute Indirection Register 0

The MAIRO characteristics are:

Purpose

Along with MAIR1, provides the memory attribute encodings corresponding to the possible AttrIdx values in a Long-descriptor format translation table entry for stage 1 translations.

AttrIdx[2] indicates the MAIR register to be used:

- When AttrIdx[2] is 0, MAIRO is used.
- When AttrIdx[2] is 1, MAIR1 is used.

Configurations

AArch32 System register MAIRO is architecturally mapped to AArch64 System register MAIR_ELI[31:0].

MAIRO and PRRR are the same register, with a different view depending on the value of TTBCR.EAE:

- When it is set to 0, the register is as described in PRRR.
- When it is set to 1, the register is as described in MAIRO.

When EL3 is using AArch32, write access to MAIRO(S) is disabled when the CP15SSDISABLE signal is asserted HIGH.

RW fields in this register reset to architecturally UNKNOWN values.

Attributes

MAIRO is a 32-bit register.

Field descriptions

The MAIRO bit assignments are:

When TTBCR.EAE==1:

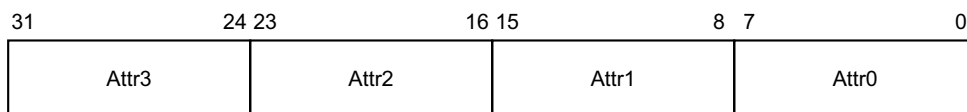

Attr<n>, bits [8n+7:8n], for n = 0 to 3

The memory attribute encoding for an AttrIdx[2:0] entry in a Long descriptor format translation table entry, where:

- AttrIdx[2:0] gives the value of <n> in Attr<n>.
- AttrIdx[2] defines which MAIR to access. Attr7 to Attr4 are in MAIR1, and Attr3 to Attr0 are in MAIRO.

Bits [7:4] are encoded as follows:

Attr<n>[7:4]	Meaning
0000	Device memory. See encoding of Attr<n>[3:0] for the type of Device memory.
00RW, RW not 00	Normal memory, Outer Write-Through Transient
0100	Normal memory, Outer Non-cacheable

Attr<n>[7:4]	Meaning
01RW, RW not 00	Normal memory, Outer Write-Back Transient
10RW	Normal memory, Outer Write-Through Non-transient
11RW	Normal memory, Outer Write-Back Non-transient

R = Outer Read-Allocate policy, W = Outer Write-Allocate policy.

The meaning of bits [3:0] depends on the value of bits [7:4]:

Attr<n>[3:0]	Meaning when Attr<n>[7:4] is 0000	Meaning when Attr<n>[7:4] is not 0000
0000	Device-nGnRnE memory	UNPREDICTABLE
00RW, RW not 00	UNPREDICTABLE	Normal memory, Inner Write-Through Transient
0100	Device-nGnRE memory	Normal memory, Inner Non-cacheable
01RW, RW not 00	UNPREDICTABLE	Normal memory, Inner Write-Back Transient
1000	Device-nGRE memory	Normal memory, Inner Write-Through Non-transient (RW=00)
10RW, RW not 00	UNPREDICTABLE	Normal memory, Inner Write-Through Non-transient
1100	Device-GRE memory	Normal memory, Inner Write-Back Non-transient (RW=00)
11RW, RW not 00	UNPREDICTABLE	Normal memory, Inner Write-Back Non-transient

R = Inner Read-Allocate policy, W = Inner Write-Allocate policy.

The R and W bits in some Attr<n> fields have the following meanings:

R or W	Meaning
0	No Allocate
1	Allocate

Accessing the MAIR0

This register can be read using MRC with the following syntax:

MRC <syntax>

This register can be written using MCR with the following syntax:

MCR <syntax>

This syntax is encoded with the following settings in the instruction encoding:

<syntax>	opc1	opc2	CRn	coproc	CRm
p15, 0, <Rt>, c10, c2, 0	000	000	1010	1111	0010

Accessibility

The register is accessible in software as follows:

Configuration	Control			Accessibility				Instance
	E2H	TGE	NS	EL0	EL1	EL2	EL3	
EL3 is using AArch32.	x	x	0	-	n/a	n/a	RW	MAIR0_s
EL3 is not implemented.	x	x	0	-	RW	n/a	n/a	MAIR0
EL3 is not implemented.	x	0	1	-	RW	RW	n/a	MAIR0
EL3 is not implemented.	x	1	1	-	n/a	RW	n/a	MAIR0
EL3 is using AArch64.	x	x	0	-	RW	n/a	n/a	MAIR0
EL3 is using AArch64.	x	0	1	-	RW	RW	n/a	MAIR0
EL3 is using AArch64.	x	1	1	-	n/a	RW	n/a	MAIR0
EL3 is using AArch32.	x	0	1	-	RW	RW	RW	MAIR0_ns
EL3 is using AArch32.	x	1	1	-	n/a	RW	RW	MAIR0_ns

When EL3 is using AArch32, write access to MAIR0_s is UNDEFINED when the CP15SSDISABLE signal is asserted HIGH.

Traps and Enables

For a description of the prioritization of any generated exceptions, see [Synchronous exception prioritization for exceptions taken to AArch32 state on page G1-4344](#) for exceptions taken to AArch32 state and [Synchronous exception prioritization for exceptions taken to AArch64 on page D1-1827](#) for exceptions taken to AArch64 state. Subject to the prioritization rules:

- When EL2 is implemented and is using AArch64 and (SCR_EL3.NS == 1) && (HCR_EL2.E2H == 0):
 - If HCR_EL2.TVM==1, Non-secure write accesses to this register from EL1 are trapped to EL2.
 - If HCR_EL2.TRVM==1, Non-secure read accesses to this register from EL1 are trapped to EL2.
 - If HSTR_EL2.T10==1, Non-secure accesses to this register from EL1 are trapped to EL2.
- When EL2 is implemented and is using AArch64 and (SCR_EL3.NS == 1) && (HCR_EL2.E2H == 1) && (HCR_EL2.TGE == 0):
 - If HCR_EL2.TVM==1, Non-secure write accesses to this register from EL1 are trapped to EL2.
 - If HCR_EL2.TRVM==1, Non-secure read accesses to this register from EL1 are trapped to EL2.
 - If HSTR_EL2.T10==1, Non-secure accesses to this register from EL1 are trapped to EL2.
- When EL2 is implemented and is using AArch32 and SCR_EL3.NS == 1:
 - If HCR.TVM==1, Non-secure write accesses to this register from EL1 are trapped to Hyp mode.
 - If HCR.TRVM==1, Non-secure read accesses to this register from EL1 are trapped to Hyp mode.
 - If HSTR.T10==1, Non-secure accesses to this register from EL1 are trapped to Hyp mode.

G6.2.103 MAIR1, Memory Attribute Indirection Register 1

The MAIR1 characteristics are:

Purpose

Along with MAIR0, provides the memory attribute encodings corresponding to the possible AttrIdx values in a Long-descriptor format translation table entry for stage 1 translations.

AttrIdx[2] indicates the MAIR register to be used:

- When AttrIdx[2] is 0, MAIR0 is used.
- When AttrIdx[2] is 1, MAIR1 is used.

Configurations

AArch32 System register MAIR1 is architecturally mapped to AArch64 System register MAIR_EL1[63:32].

MAIR1 and NMRR are the same register, with a different view depending on the value of TTBCR.EAE:

- When it is set to 0, the register is as described in NMRR.
- When it is set to 1, the register is as described in MAIR1.

When EL3 is using AArch32, write access to MAIR1(S) is disabled when the CP15SSDISABLE signal is asserted HIGH.

RW fields in this register reset to architecturally UNKNOWN values.

Attributes

MAIR1 is a 32-bit register.

Field descriptions

The MAIR1 bit assignments are:

When TTBCR.EAE==1:

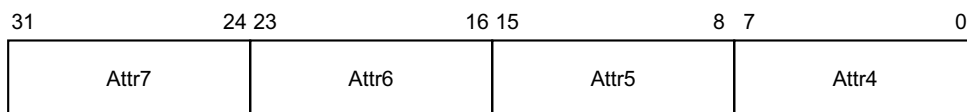

Attr<n>, bits [8(n-4)+7:8(n-4)], for n = 4 to 7

The memory attribute encoding for an AttrIdx[2:0] entry in a Long descriptor format translation table entry, where:

- AttrIdx[2:0] gives the value of <n> in Attr<n>.
- AttrIdx[2] defines which MAIR to access. Attr7 to Attr4 are in MAIR1, and Attr3 to Attr0 are in MAIR0.

Bits [7:4] are encoded as follows:

Attr<n>[7:4]	Meaning
0000	Device memory. See encoding of Attr<n>[3:0] for the type of Device memory.
00RW, RW not 00	Normal memory, Outer Write-Through Transient
0100	Normal memory, Outer Non-cacheable

Attr<n>[7:4]	Meaning
01RW, RW not 00	Normal memory, Outer Write-Back Transient
10RW	Normal memory, Outer Write-Through Non-transient
11RW	Normal memory, Outer Write-Back Non-transient

R = Outer Read-Allocate policy, W = Outer Write-Allocate policy.

The meaning of bits [3:0] depends on the value of bits [7:4]:

Attr<n>[3:0]	Meaning when Attr<n>[7:4] is 0000	Meaning when Attr<n>[7:4] is not 0000
0000	Device-nGnRnE memory	UNPREDICTABLE
00RW, RW not 00	UNPREDICTABLE	Normal memory, Inner Write-Through Transient
0100	Device-nGnRE memory	Normal memory, Inner Non-cacheable
01RW, RW not 00	UNPREDICTABLE	Normal memory, Inner Write-Back Transient
1000	Device-nGRE memory	Normal memory, Inner Write-Through Non-transient (RW=00)
10RW, RW not 00	UNPREDICTABLE	Normal memory, Inner Write-Through Non-transient
1100	Device-GRE memory	Normal memory, Inner Write-Back Non-transient (RW=00)
11RW, RW not 00	UNPREDICTABLE	Normal memory, Inner Write-Back Non-transient

R = Inner Read-Allocate policy, W = Inner Write-Allocate policy.

The R and W bits in some Attr<n> fields have the following meanings:

R or W	Meaning
0	No Allocate
1	Allocate

Accessing the MAIR1

This register can be read using MRC with the following syntax:

MRC <syntax>

This register can be written using MCR with the following syntax:

MCR <syntax>

This syntax is encoded with the following settings in the instruction encoding:

<syntax>	opc1	opc2	CRn	coproc	CRm
p15, 0, <Rt>, c10, c2, 1	000	001	1010	1111	0010

Accessibility

The register is accessible in software as follows:

Configuration	Control			Accessibility				Instance
	E2H	TGE	NS	EL0	EL1	EL2	EL3	
EL3 is using AArch32.	x	x	0	-	n/a	n/a	RW	MAIR1_s
EL3 is using AArch32.	x	0	1	-	RW	RW	RW	MAIR1_ns
EL3 is using AArch32.	x	1	1	-	n/a	RW	RW	MAIR1_ns
EL3 is not implemented.	x	x	0	-	RW	n/a	n/a	MAIR1
EL3 is not implemented.	x	0	1	-	RW	RW	n/a	MAIR1
EL3 is not implemented.	x	1	1	-	n/a	RW	n/a	MAIR1
EL3 is using AArch64.	x	x	0	-	RW	n/a	n/a	MAIR1
EL3 is using AArch64.	x	0	1	-	RW	RW	n/a	MAIR1
EL3 is using AArch64.	x	1	1	-	n/a	RW	n/a	MAIR1

When EL3 is using AArch32, write access to MAIR1_s is UNDEFINED when the CP15SSDISABLE signal is asserted HIGH.

Traps and Enables

For a description of the prioritization of any generated exceptions, see [Synchronous exception prioritization for exceptions taken to AArch32 state on page G1-4344](#) for exceptions taken to AArch32 state and [Synchronous exception prioritization for exceptions taken to AArch64 on page D1-1827](#) for exceptions taken to AArch64 state. Subject to the prioritization rules:

- When EL2 is implemented and is using AArch64 and (SCR_EL3.NS == 1) && (HCR_EL2.E2H == 0):
 - If HCR_EL2.TVM==1, Non-secure write accesses to this register from EL1 are trapped to EL2.
 - If HCR_EL2.TRVM==1, Non-secure read accesses to this register from EL1 are trapped to EL2.
 - If HSTR_EL2.T10==1, Non-secure accesses to this register from EL1 are trapped to EL2.
- When EL2 is implemented and is using AArch64 and (SCR_EL3.NS == 1) && (HCR_EL2.E2H == 1) && (HCR_EL2.TGE == 0):
 - If HCR_EL2.TVM==1, Non-secure write accesses to this register from EL1 are trapped to EL2.
 - If HCR_EL2.TRVM==1, Non-secure read accesses to this register from EL1 are trapped to EL2.
 - If HSTR_EL2.T10==1, Non-secure accesses to this register from EL1 are trapped to EL2.
- When EL2 is implemented and is using AArch32 and SCR_EL3.NS == 1:
 - If HCR.TVM==1, Non-secure write accesses to this register from EL1 are trapped to Hyp mode.
 - If HCR.TRVM==1, Non-secure read accesses to this register from EL1 are trapped to Hyp mode.
 - If HSTR.T10==1, Non-secure accesses to this register from EL1 are trapped to Hyp mode.

G6.2.104 MIDR, Main ID Register

The MIDR characteristics are:

Purpose

Provides identification information for the PE, including an implementer code for the device and a device ID number.

Configurations

There is one instance of this register that is used in both Secure and Non-secure states.

AArch32 System register MIDR is architecturally mapped to AArch64 System register [MIDR_EL1](#).

AArch32 System register MIDR is architecturally mapped to External register [MIDR_EL1](#).

Some fields of the MIDR are IMPLEMENTATION DEFINED. For details of the values of these fields for a particular ARMv8 implementation, and any implementation-specific significance of these values, see the product documentation.

Attributes

MIDR is a 32-bit register.

Field descriptions

The MIDR bit assignments are:

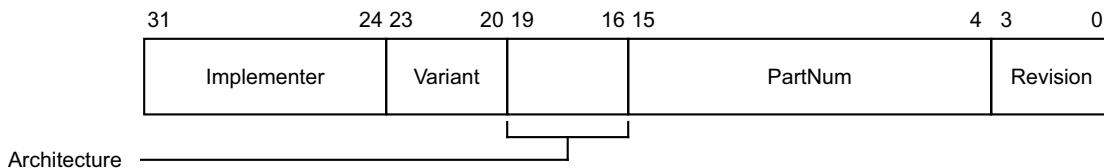

Implementer, bits [31:24]

The Implementer code. This field must hold an implementer code that has been assigned by ARM. Assigned codes include the following:

Hex representation	ASCII representation	Implementer
0x41	A	ARM Limited
0x42	B	Broadcom Corporation
0x43	C	Cavium Inc.
0x44	D	Digital Equipment Corporation
0x49	I	Infineon Technologies AG
0x4D	M	Motorola or Freescale Semiconductor Inc.
0x4E	N	NVIDIA Corporation
0x50	P	Applied Micro Circuits Corporation
0x51	Q	Qualcomm Inc.
0x56	V	Marvell International Ltd.
0x69	i	Intel Corporation

ARM can assign codes that are not published in this manual. All values not assigned by ARM are reserved and must not be used.

Variant, bits [23:20]

An IMPLEMENTATION DEFINED variant number. Typically, this field is used to distinguish between different product variants, or major revisions of a product.

Architecture, bits [19:16]

The permitted values of this field are:

0001	ARMv4
0010	ARMv4T
0011	ARMv5 (obsolete)
0100	ARMv5T
0101	ARMv5TE
0110	ARMv5TEJ
0111	ARMv6
1111	Architectural features are individually identified in the ID_* registers, see <i>Identification registers, functional group</i> on page G4-4727.

All other values are reserved.

PartNum, bits [15:4]

An IMPLEMENTATION DEFINED primary part number for the device.

On processors implemented by ARM, if the top four bits of the primary part number are 0x0 or 0x7, the variant and architecture are encoded differently.

Revision, bits [3:0]

An IMPLEMENTATION DEFINED revision number for the device.

Accessing the MIDR

This register can be read using MRC with the following syntax:

MRC <syntax>

This syntax is encoded with the following settings in the instruction encoding:

<syntax>	opc1	opc2	CRn	coproc	CRm
p15, 0, <Rt>, c0, c0, 0	000	000	0000	1111	0000

Accessibility

The register is accessible in software as follows:

Control			Accessibility			
E2H	TGE	NS	EL0	EL1	EL2	EL3
x	x	0	-	RO	n/a	RO
x	0	1	-	RO	RO	RO
x	1	1	-	n/a	RO	RO

Traps and Enables

For a description of the prioritization of any generated exceptions, see *Synchronous exception prioritization for exceptions taken to AArch32 state* on page G1-4344 for exceptions taken to AArch32 state and *Synchronous exception prioritization for exceptions taken to AArch64* on page D1-1827 for exceptions taken to AArch64 state. Subject to the prioritization rules:

- When EL2 is implemented and is using AArch64 and $(SCR_EL3.NS == 1) \ \&\& \ (HCR_EL2.E2H == 0)$:
 - If $HSTR_EL2.T0 == 1$, Non-secure read accesses to this register from EL1 are trapped to EL2.
- When EL2 is implemented and is using AArch64 and $(SCR_EL3.NS == 1) \ \&\& \ (HCR_EL2.E2H == 1) \ \&\& \ (HCR_EL2.TGE == 0)$:
 - If $HSTR_EL2.T0 == 1$, Non-secure read accesses to this register from EL1 are trapped to EL2.
- When EL2 is implemented and is using AArch32 and $SCR_EL3.NS == 1$:
 - If $HSTR.T0 == 1$, Non-secure read accesses to this register from EL1 are trapped to Hyp mode.

G6.2.105 MPIDR, Multiprocessor Affinity Register

The MPIDR characteristics are:

Purpose

In a multiprocessor system, provides an additional PE identification mechanism for scheduling purposes.

Configurations

There is one instance of this register that is used in both Secure and Non-secure states.

AArch32 System register MPIDR is architecturally mapped to AArch64 System register [MPIDR_EL1](#).

The assigned value of the MPIDR. {Aff2, Aff1, Aff0} or [MPIDR_EL1](#). {Aff3, Aff2, Aff1, Aff0} set of fields of each PE must be unique within the system as a whole.

In a uniprocessor system ARM recommends that each Aff<n> field of this register returns a value of 0.

Attributes

MPIDR is a 32-bit register.

Field descriptions

The MPIDR bit assignments are:

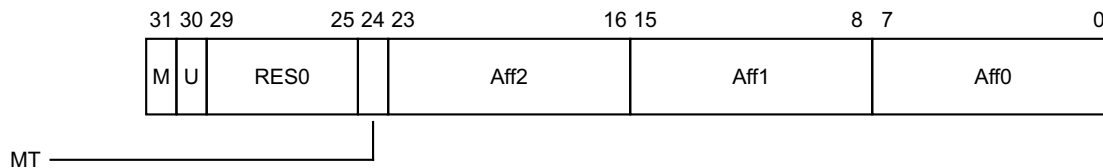

M, bit [31]

Indicates whether this implementation includes the functionality introduced by the ARMv7 Multiprocessing Extensions. The possible values of this bit are:

- 0 This implementation does not include the ARMv7 Multiprocessing Extensions functionality.
- 1 This implementation includes the ARMv7 Multiprocessing Extensions functionality.

In ARMv8 this bit is RES1.

U, bit [30]

Indicates a Uniprocessor system, as distinct from PE 0 in a multiprocessor system. The possible values of this bit are:

- 0 Processor is part of a multiprocessor system.
- 1 Processor is part of a uniprocessor system.

Bits [29:25]

Reserved, RES0.

MT, bit [24]

Indicates whether the lowest level of affinity consists of logical PEs that are implemented using a multithreading type approach. The possible values of this bit are:

- 0 Performance of PEs at the lowest affinity level is largely independent.
- 1 Performance of PEs at the lowest affinity level is very interdependent.

Aff2, bits [23:16]

Affinity level 2. The least significant affinity level field, for this PE in the system.

Aff1, bits [15:8]

Affinity level 1. The intermediate affinity level field, for this PE in the system.

Aff0, bits [7:0]

Affinity level 0. The most significant affinity level field, for this PE in the system.

Accessing the MPIDR

This register can be read using MRC with the following syntax:

MRC <syntax>

This syntax is encoded with the following settings in the instruction encoding:

<syntax>	opc1	opc2	CRn	coproc	CRm
p15, 0, <Rt>, c0, c0, 5	000	101	0000	1111	0000

Accessibility

The register is accessible in software as follows:

Control			Accessibility			
E2H	TGE	NS	EL0	EL1	EL2	EL3
x	x	0	-	RO	n/a	RO
x	0	1	-	RO	RO	RO
x	1	1	-	n/a	RO	RO

Traps and Enables

For a description of the prioritization of any generated exceptions, see [Synchronous exception prioritization for exceptions taken to AArch32 state on page G1-4344](#) for exceptions taken to AArch32 state and [Synchronous exception prioritization for exceptions taken to AArch64 on page D1-1827](#) for exceptions taken to AArch64 state. Subject to the prioritization rules:

- When EL2 is implemented and is using AArch64 and (SCR_EL3.NS == 1) && (HCR_EL2.E2H == 0):
 - If HSTR_EL2.T0==1, Non-secure read accesses to this register from EL1 are trapped to EL2.
- When EL2 is implemented and is using AArch64 and (SCR_EL3.NS == 1) && (HCR_EL2.E2H == 1) && (HCR_EL2.TGE == 0):
 - If HSTR_EL2.T0==1, Non-secure read accesses to this register from EL1 are trapped to EL2.
- When EL2 is implemented and is using AArch32 and SCR_EL3.NS == 1:
 - If HSTR.T0==1, Non-secure read accesses to this register from EL1 are trapped to Hyp mode.

G6.2.106 MVBAR, Monitor Vector Base Address Register

The MVBAR characteristics are:

Purpose

When EL3 is implemented and can use AArch32, holds the vector base address for any exception that is taken to Monitor mode.

Secure software must program the MVBAR with the required initial value as part of the PE boot sequence.

Configurations

This register is only accessible in Secure state.

It is IMPLEMENTATION DEFINED whether MVBAR[0] has a fixed value and ignored writes, or takes the last value written to it.

Write access to MVBAR is disabled when the CP15SSDISABLE signal is asserted HIGH.

On a reset into EL3 using AArch32, the reset value of MVBAR is an IMPLEMENTATION DEFINED choice between:

- MVBAR[31:5] = an IMPLEMENTATION DEFINED value, which might be UNKNOWN.
- MVBAR[4:1] = RES0.
- MVBAR[0] = 0.

And:

- MVBAR[31:1] = an IMPLEMENTATION DEFINED value that is bits[31:1] of the AArch32 reset address.
- MVBAR[0] = 1.

Attributes

MVBAR is a 32-bit register.

Field descriptions

The MVBAR bit assignments are:

When programmed with a vector base address:

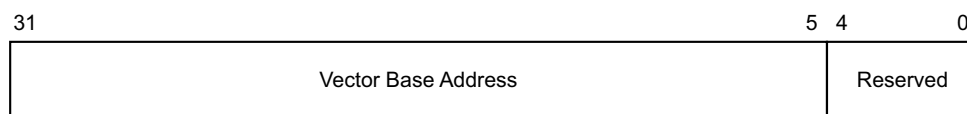

Bits [31:5]

Vector Base Address. Bits[31:5] of the base address of the exception vectors for exceptions taken to this Exception level. Bits[4:0] of an exception vector are the exception offset.

Reserved, bits [4:0]

Reserved, see Configurations.

Accessing the MVBAR

This register can be read using MRC with the following syntax:

MRC <syntax>

This register can be written using MCR with the following syntax:

MCR <syntax>

This syntax is encoded with the following settings in the instruction encoding:

<syntax>	opc1	opc2	CRn	coproc	CRm
p15, 0, <Rt>, c12, c0, 1	000	001	1100	1111	0000

Accessibility

The register is accessible in software as follows:

Control			Accessibility			
E2H	TGE	NS	EL0	EL1	EL2	EL3
x	x	0	-	-	n/a	RW
x	0	1	-	-	-	RW
x	1	1	-	n/a	-	RW

When EL3 is using AArch32, write access to MVBAR is UNDEFINED when the CP15SSDISABLE signal is asserted HIGH.

If EL3 is implemented and is using AArch64, any read or write to MVBAR from Secure EL1 using AArch32 is trapped as an exception to EL3.

Traps and Enables

For a description of the prioritization of any generated exceptions, see [Synchronous exception prioritization for exceptions taken to AArch32 state on page G1-4344](#) for exceptions taken to AArch32 state and [Synchronous exception prioritization for exceptions taken to AArch64 on page D1-1827](#) for exceptions taken to AArch64 state. Subject to the prioritization rules:

- When EL2 is implemented and is using AArch64 and (SCR_EL3.NS == 1) && (HCR_EL2.E2H == 0):
 - If HSTR_EL2.T12==1, Non-secure accesses to this register from EL1 are trapped to EL2.
- When EL2 is implemented and is using AArch64 and (SCR_EL3.NS == 1) && (HCR_EL2.E2H == 1) && (HCR_EL2.TGE == 0):
 - If HSTR_EL2.T12==1, Non-secure accesses to this register from EL1 are trapped to EL2.
- When EL2 is implemented and is using AArch32 and SCR_EL3.NS == 1:
 - If HSTR.T12==1, Non-secure accesses to this register from EL1 are trapped to Hyp mode.

G6.2.107 MVFR0, Media and VFP Feature Register 0

The MVFR0 characteristics are:

Purpose

Describes the features provided by the AArch32 Advanced SIMD and Floating-point implementation.

Must be interpreted with [MVFR1](#) and [MVFR2](#).

For general information about the interpretation of the ID registers see [Principles of the ID scheme for fields in ID registers on page G4-4701](#).

Configurations

There is one instance of this register that is used in both Secure and Non-secure states.

AArch32 System register MVFR0 is architecturally mapped to AArch64 System register [MVFR0_EL1](#).

Implemented only if the implementation includes Advanced SIMD and floating-point instructions.

Attributes

MVFR0 is a 32-bit register.

Field descriptions

The MVFR0 bit assignments are:

31	28 27	24 23	20 19	16 15	12 11	8 7	4 3	0
FPRound	FPShVec	FPSqrt	FPDivide	FPTrap	FPDP	FPSP	SIMDReg	

FPRound, bits [31:28]

Floating-Point Rounding modes. Indicates whether the floating-point implementation provides support for rounding modes. Defined values are:

0000 Not implemented, or only Round to Nearest mode supported, except that Round towards Zero mode is supported for VCVT instructions that always use that rounding mode regardless of the [FPSCR](#) setting.

0001 All rounding modes supported.

All other values are reserved.

In ARMv8-A the permitted values are 0000 and 0001.

FPShVec, bits [27:24]

Short Vectors. Indicates whether the floating-point implementation provides support for the use of short vectors. Defined values are:

0000 Short vectors not supported.

0001 Short vector operation supported.

All other values are reserved.

In ARMv8-A the only permitted value is 0000.

FPSqrt, bits [23:20]

Square Root. Indicates whether the floating-point implementation provides support for the ARMv6 VFP square root operations. Defined values are:

0000 Not supported in hardware.

0001 Supported.

All other values are reserved.

In ARMv8-A the permitted values are 0000 and 0001.

The VSQRT.F32 instruction also requires the single-precision floating-point attribute, bits [7:4], and the VSQRT.F64 instruction also requires the double-precision floating-point attribute, bits [11:8].

FPDivide, bits [19:16]

Indicates whether the floating-point implementation provides support for VFP divide operations. Defined values are:

0000 Not supported in hardware.

0001 Supported.

All other values are reserved.

In ARMv8-A the permitted values are 0000 and 0001.

The VDIV.F32 instruction also requires the single-precision floating-point attribute, bits [7:4], and the VDIV.F64 instruction also requires the double-precision floating-point attribute, bits [11:8].

FPTrap, bits [15:12]

Floating Point Exception Trapping. Indicates whether the floating-point implementation provides support for exception trapping. Defined values are:

0000 Not supported.

0001 Supported.

All other values are reserved.

A value of 0001 indicates that, when the corresponding trap is enabled, a floating-point exception generates an exception.

FPDP, bits [11:8]

Double Precision. Indicates whether the floating-point implementation provides support for double-precision operations. Defined values are:

0000 Not supported in hardware.

0001 Supported, VFPv2.

0010 Supported, VFPv3, VFPv4, or ARMv8. VFPv3 and ARMv8 add an instruction to load a double-precision floating-point constant, and conversions between double-precision and fixed-point values.

All other values are reserved.

In ARMv8-A the permitted values are 0000 and 0010.

A value of 0b0001 or 0b0010 indicates support for all VFP double-precision instructions in the supported version of VFP, except that, in addition to this field being nonzero:

- VSQRT.F64 is only available if the Square root field is 0001.
- VDIV.F64 is only available if the Divide field is 0001.
- Conversion between double-precision and single-precision is only available if the single-precision field is nonzero.

FPSP, bits [7:4]

Single Precision. Indicates whether the floating-point implementation provides support for single-precision operations. Defined values are:

0000 Not supported in hardware.

0001 Supported, VFPv2.

0010 Supported, VFPv3 or VFPv4. VFPv3 adds an instruction to load a single-precision floating-point constant, and conversions between single-precision and fixed-point values.

All other values are reserved.

In ARMv8-A the permitted values are 0000 and 0010.

A value of 0b0001 or 0b0010 indicates support for all VFP single-precision instructions in the supported version of VFP, except that, in addition to this field being nonzero:

- VSQRT.F32 is only available if the Square root field is 0001.
- VDIV.F32 is only available if the Divide field is 0001.
- Conversion between double-precision and single-precision is only available if the double-precision field is nonzero.

SIMDReg, bits [3:0]

Advanced SIMD registers. Indicates whether the Advanced SIMD and floating-point implementation provides support for the Advanced SIMD and floating-point register bank. Defined values are:

- 0000 The implementation has no Advanced SIMD and floating-point support.
- 0001 The implementation includes floating-point support with 16 x 64-bit registers.
- 0010 The implementation includes Advanced SIMD and floating-point support with 32 x 64-bit registers.

All other values are reserved.

In ARMv8-A the permitted values are 0000 and 0010.

Accessing the MVFR0

This register can be read using VMRS with the following syntax:

VMRS <Rt>, <spec_reg>

This syntax is encoded with the following settings in the instruction encoding:

<spec_reg>	reg
MVFR0	0111

Accessibility

The register is accessible in software as follows:

Control			Accessibility			
E2H	TGE	NS	EL0	EL1	EL2	EL3
x	x	0	-	RO	n/a	RO
x	0	1	-	RO	RO	RO
x	1	1	-	n/a	RO	RO

Traps and Enables

For a description of the prioritization of any generated exceptions, see *Synchronous exception prioritization for exceptions taken to AArch32 state* on page G1-4344 for exceptions taken to AArch32 state and *Synchronous exception prioritization for exceptions taken to AArch64* on page D1-1827 for exceptions taken to AArch64 state. Subject to the prioritization rules:

- When $\text{HCR_EL2.E2H} == 0$:
 - If $\text{CPACR.cp10} == 0$, read accesses to this register from PL1 are UNDEFINED.
- When EL2 is implemented and is using AArch64 and $(\text{SCR_EL3.NS} == 1) \ \&\& \ (\text{HCR_EL2.E2H} == 0)$:
 - If $\text{CPTR_EL2.TFP} == 1$, Non-secure read accesses to this register from EL1 are trapped to EL2.
 - If $\text{HCR_EL2.TID3} == 1$, Non-secure read accesses to this register from EL1 are trapped to EL2.
- When EL2 is implemented and is using AArch64 and $(\text{SCR_EL3.NS} == 1) \ \&\& \ (\text{HCR_EL2.E2H} == 1) \ \&\& \ (\text{HCR_EL2.TGE} == 0)$:
 - If $\text{CPTR_EL2.FPEN} == 0$, Non-secure read accesses to this register from EL1 are trapped to EL2.
 - If $\text{CPTR_EL2.FPEN} == 1$, Non-secure read accesses to this register from EL1 are trapped to EL2.
 - If $\text{HCR_EL2.TID3} == 1$, Non-secure read accesses to this register from EL1 are trapped to EL2.
- When EL2 is implemented and is using AArch32 and $\text{SCR_EL3.NS} == 1$:
 - If $\text{HCPTR.TCP10} == 1$, Non-secure read accesses to this register from EL1 are trapped to Hyp mode.
 - If $\text{HCPTR.TCP10} == 0$, Non-secure read accesses to this register from EL2 are UNDEFINED.
 - If $\text{HCR.TID3} == 1$, Non-secure read accesses to this register from EL1 are trapped to Hyp mode.
- When EL3 is implemented and is using AArch32 and $\text{SCR_EL3.NS} == 1$:
 - If $\text{NSACR.cp10} == 0$, Non-secure read accesses to this register from EL1 and EL2 are UNDEFINED.
- When EL3 is implemented and is using AArch64:
 - If $\text{CPTR_EL3.TFP} == 1$, read accesses to this register from EL1 and EL2 are trapped to EL3.

G6.2.108 MVFR1, Media and VFP Feature Register 1

The MVFR1 characteristics are:

Purpose

Describes the features provided by the AArch32 Advanced SIMD and Floating-point implementation.

Must be interpreted with [MVFR0](#) and [MVFR2](#).

For general information about the interpretation of the ID registers see [Principles of the ID scheme for fields in ID registers on page G4-4701](#).

Configurations

There is one instance of this register that is used in both Secure and Non-secure states.

AArch32 System register MVFR1 is architecturally mapped to AArch64 System register [MVFR1_EL1](#).

Implemented only if the implementation includes Advanced SIMD and floating-point instructions.

Attributes

MVFR1 is a 32-bit register.

Field descriptions

The MVFR1 bit assignments are:

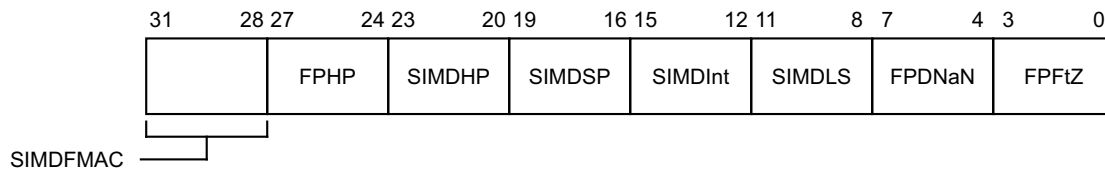

SIMDFMAC, bits [31:28]

Advanced SIMD Fused Multiply-Accumulate. Indicates whether the Advanced SIMD implementation provides fused multiply accumulate instructions. Defined values are:

0000 Not implemented.

0001 Implemented.

All other values are reserved.

In ARMv8-A the permitted values are 0000 and 0001.

The Advanced SIMD and floating-point implementations must provide the same level of support for these instructions.

FPHP, bits [27:24]

Floating Point Half Precision. Indicates the level of half-precision floating-point support. Defined values are:

0000 Not supported.

0001 Floating-point half-precision conversion instructions are supported for conversion between single-precision and half-precision.

0010 Floating-point half-precision conversion instructions are supported for conversion between single-precision and half-precision and between double-precision and half-precision.

0011 As for 0010, and also includes support for half-precision floating-point arithmetic.

All other values are reserved.

The permitted values are:

- 0000 in an implementation without floating-point support.
- 0010 in an implementation with floating-point support, that does not include the [ARMv8.2-FP16](#) extension.
- 0011 in an implementation with floating-point support, that includes the [ARMv8.2-FP16](#) extension.

SIMDHP, bits [23:20]

Advanced SIMD Half Precision. Indicates the level of half-precision floating-point support. Defined values are:

- | | |
|------|---|
| 0000 | Not supported. |
| 0001 | SIMD half-precision conversion instructions are supported for conversion between single-precision and half-precision. |
| 0010 | As for 0010, and also includes support for half-precision floating-point arithmetic. |

All other values are reserved.

The permitted values are:

- 0000 in an implementation without SIMD floating-point support.
- 0001 in an implementation with SIMD floating-point support, that does not include the [ARMv8.2-FP16](#) extension.
- 0010 in an implementation with SIMD floating-point support, that includes the [ARMv8.2-FP16](#) extension.

SIMDSP, bits [19:16]

Advanced SIMD Single Precision. Indicates whether the Advanced SIMD and floating-point implementation provides single-precision floating-point instructions. Defined values are:

- | | |
|------|---|
| 0000 | Not implemented. |
| 0001 | Implemented. This value is permitted only if the SIMDInt field is 0001. |

All other values are reserved.

In ARMv8-A the permitted values are 0000 and 0001.

SIMDInt, bits [15:12]

Advanced SIMD Integer. Indicates whether the Advanced SIMD and floating-point implementation provides integer instructions. Defined values are:

- | | |
|------|------------------|
| 0000 | Not implemented. |
| 0001 | Implemented. |

All other values are reserved.

In ARMv8-A the permitted values are 0000 and 0001.

SIMDLS, bits [11:8]

Advanced SIMD Load/Store. Indicates whether the Advanced SIMD and floating-point implementation provides load/store instructions. Defined values are:

- | | |
|------|------------------|
| 0000 | Not implemented. |
| 0001 | Implemented. |

All other values are reserved.

In ARMv8-A the permitted values are 0000 and 0001.

FPDNaN, bits [7:4]

Default NaN mode. Indicates whether the floating-point implementation provides support only for the Default NaN mode. Defined values are:

- | | |
|------|--|
| 0000 | Not implemented, or hardware supports only the Default NaN mode. |
|------|--|

0001 Hardware supports propagation of NaN values.
All other values are reserved.
In ARMv8-A the permitted values are 0000 and 0001.

FPFtZ, bits [3:0]

Flush to Zero mode. Indicates whether the floating-point implementation provides support only for the Flush-to-Zero mode of operation. Defined values are:

0000 Not implemented, or hardware supports only the Flush-to-Zero mode of operation.
0001 Hardware supports full denormalized number arithmetic.
All other values are reserved.
In ARMv8-A the permitted values are 0000 and 0001.

Accessing the MVFR1

This register can be read using VMRS with the following syntax:

VMRS <Rt>, <spec_reg>

This syntax is encoded with the following settings in the instruction encoding:

<spec_reg>	reg
MVFR1	0110

Accessibility

The register is accessible in software as follows:

Control			Accessibility			
E2H	TGE	NS	EL0	EL1	EL2	EL3
x	x	0	-	RO	n/a	RO
x	0	1	-	RO	RO	RO
x	1	1	-	n/a	RO	RO

Traps and Enables

For a description of the prioritization of any generated exceptions, see [Synchronous exception prioritization for exceptions taken to AArch32 state on page G1-4344](#) for exceptions taken to AArch32 state and [Synchronous exception prioritization for exceptions taken to AArch64 on page D1-1827](#) for exceptions taken to AArch64 state. Subject to the prioritization rules:

- When $HCR_EL2.E2H == 0$:
 - If $CPACR.cp10 == 00$, read accesses to this register from PL1 are UNDEFINED.
- When EL2 is implemented and is using AArch64 and $(SCR_EL3.NS == 1) \&\& (HCR_EL2.E2H == 0)$:
 - If $CPTR_EL2.TFP == 1$, Non-secure read accesses to this register from EL1 are trapped to EL2.
 - If $HCR_EL2.TID3 == 1$, Non-secure read accesses to this register from EL1 are trapped to EL2.
- When EL2 is implemented and is using AArch64 and $(SCR_EL3.NS == 1) \&\& (HCR_EL2.E2H == 1) \&\& (HCR_EL2.TGE == 0)$:
 - If $CPTR_EL2.FPEN == 00$, Non-secure read accesses to this register from EL1 are trapped to EL2.

- If `CPTR_EL2.FPEN==10`, Non-secure read accesses to this register from EL1 are trapped to EL2.
- If `HCR_EL2.TID3==1`, Non-secure read accesses to this register from EL1 are trapped to EL2.
- When EL2 is implemented and is using AArch32 and `SCR_EL3.NS == 1`:
 - If `HCPTR.TCP10==1`, Non-secure read accesses to this register from EL1 are trapped to Hyp mode.
 - If `HCPTR.TCP10==1`, Non-secure read accesses to this register from EL2 are UNDEFINED.
 - If `HCR.TID3==1`, Non-secure read accesses to this register from EL1 are trapped to Hyp mode.
- When EL3 is implemented and is using AArch32 and `SCR_EL3.NS == 1`:
 - If `NSACR.cp10==0`, Non-secure read accesses to this register from EL1 and EL2 are UNDEFINED.
- When EL3 is implemented and is using AArch64:
 - If `CPTR_EL3.TFP==1`, read accesses to this register from EL1 and EL2 are trapped to EL3.

G6.2.109 MVFR2, Media and VFP Feature Register 2

The MVFR2 characteristics are:

Purpose

Describes the features provided by the AArch32 Advanced SIMD and Floating-point implementation.

Must be interpreted with [MVFR0](#) and [MVFR1](#).

For general information about the interpretation of the ID registers see [Principles of the ID scheme for fields in ID registers on page G4-4701](#).

Configurations

There is one instance of this register that is used in both Secure and Non-secure states.

AArch32 System register MVFR2 is architecturally mapped to AArch64 System register [MVFR2_EL1](#).

Implemented only if the implementation includes Advanced SIMD and floating-point instructions.

Attributes

MVFR2 is a 32-bit register.

Field descriptions

The MVFR2 bit assignments are:

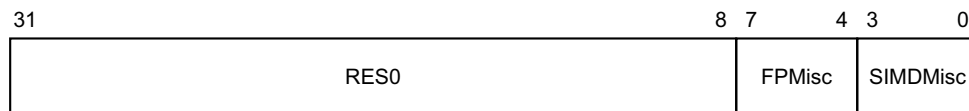

Bits [31:8]

Reserved, RES0.

FPMisc, bits [7:4]

Indicates whether the floating-point implementation provides support for miscellaneous VFP features.

0000 Not implemented, or no support for miscellaneous features.

0001 Support for Floating-point selection.

0010 As 0001, and Floating-point Conversion to Integer with Directed Rounding modes.

0011 As 0010, and Floating-point Round to Integer Floating-point.

0100 As 0011, and Floating-point MaxNum and MinNum.

All other values are reserved.

In ARMv8-A the permitted values are 0000 and 0100.

SIMDMisc, bits [3:0]

Indicates whether the Advanced SIMD implementation provides support for miscellaneous Advanced SIMD features.

0000 Not implemented, or no support for miscellaneous features.

0001 Floating-point Conversion to Integer with Directed Rounding modes.

0010 As 0001, and Floating-point Round to Integer Floating-point.

0011 As 0010, and Floating-point MaxNum and MinNum.

All other values are reserved.

In ARMv8-A the permitted values are 0000 and 0011.

Accessing the MVFR2

This register can be read using VMRS with the following syntax:

VMRS <Rt>, <spec_reg>

This syntax is encoded with the following settings in the instruction encoding:

<spec_reg>	reg
MVFR2	0101

Accessibility

The register is accessible in software as follows:

Control			Accessibility			
E2H	TGE	NS	EL0	EL1	EL2	EL3
x	x	0	-	RO	n/a	RO
x	0	1	-	RO	RO	RO
x	1	1	-	n/a	RO	RO

Traps and Enables

For a description of the prioritization of any generated exceptions, see [Synchronous exception prioritization for exceptions taken to AArch32 state on page G1-4344](#) for exceptions taken to AArch32 state and [Synchronous exception prioritization for exceptions taken to AArch64 on page D1-1827](#) for exceptions taken to AArch64 state. Subject to the prioritization rules:

- When $HCR_EL2.E2H == 0$:
 - If $CPACR.cp10 == 00$, read accesses to this register from PL1 are UNDEFINED.
- When EL2 is implemented and is using AArch64 and $(SCR_EL3.NS == 1) \&\& (HCR_EL2.E2H == 0)$:
 - If $CPTR_EL2.TFP == 1$, Non-secure read accesses to this register from EL1 are trapped to EL2.
 - If $HCR_EL2.TID3 == 1$, Non-secure read accesses to this register from EL1 are trapped to EL2.
- When EL2 is implemented and is using AArch64 and $(SCR_EL3.NS == 1) \&\& (HCR_EL2.E2H == 1) \&\& (HCR_EL2.TGE == 0)$:
 - If $CPTR_EL2.FPEN == 00$, Non-secure read accesses to this register from EL1 are trapped to EL2.
 - If $CPTR_EL2.FPEN == 10$, Non-secure read accesses to this register from EL1 are trapped to EL2.
 - If $HCR_EL2.TID3 == 1$, Non-secure read accesses to this register from EL1 are trapped to EL2.
- When EL2 is implemented and is using AArch32 and $SCR_EL3.NS == 1$:
 - If $HCPTR.TCP10 == 1$, Non-secure read accesses to this register from EL1 are trapped to Hyp mode.
 - If $HCPTR.TCP10 == 1$, Non-secure read accesses to this register from EL2 are UNDEFINED.
 - If $HCR.TID3 == 1$, Non-secure read accesses to this register from EL1 are trapped to Hyp mode.
- When EL3 is implemented and is using AArch32 and $SCR_EL3.NS == 1$:
 - If $NSACR.cp10 == 0$, Non-secure read accesses to this register from EL1 and EL2 are UNDEFINED.

- When EL3 is implemented and is using AArch64:
 - If `CPTR_EL3.TFP==1`, read accesses to this register from EL1 and EL2 are trapped to EL3.

G6.2.110 NMRR, Normal Memory Remap Register

The NMRR characteristics are:

Purpose

Provides additional mapping controls for memory regions that are mapped as Normal memory by their entry in the [PRRR](#).

Used in conjunction with the [PRRR](#).

Configurations

AArch32 System register NMRR is architecturally mapped to AArch64 System register [MAIR_EL1](#)[63:32].

[MAIR1](#) and NMRR are the same register, with a different view depending on the value of [TTBCR.EAE](#):

- When it is set to 0, the register is as described in NMRR.
- When it is set to 1, the register is as described in [MAIR1](#).

When EL3 is using AArch32, write access to NMRR(S) is disabled when the CP15SSDISABLE signal is asserted HIGH.

RW fields in this register reset to architecturally UNKNOWN values.

Attributes

NMRR is a 32-bit register.

Field descriptions

The NMRR bit assignments are:

When [TTBCR.EAE](#)==0:

31	30	29	28	27	26	25	24	23	22	21	20	19	18	17	16	15	14	13	12	11	10	9	8	7	6	5	4	3	2	1	0
OR7	OR6	OR5	OR4	OR3	OR2	OR1	OR0	IR7	IR6	IR5	IR4	IR3	IR2	IR1	IR0																

OR<n>, bits [2n+17:2n+16], for n = 0 to 7

Outer Cacheable property mapping for memory attributes n, if the region is mapped as Normal memory by the [PRRR.TR<n>](#) entry. n is the value of the [TEX\[0\]](#), C, and B bits concatenated. The possible values of this field are:

- 00 Region is Non-cacheable.
- 01 Region is Write-Back, Write-Allocate.
- 10 Region is Write-Through, no Write-Allocate.
- 11 Region is Write-Back, no Write-Allocate.

The meaning of the field with n = 6 is IMPLEMENTATION DEFINED and might differ from the meaning given here. This is because the meaning of the attribute combination {[TEX\[0\]](#) = 1, C = 1, B = 0} is IMPLEMENTATION DEFINED.

IR<n>, bits [2n+1:2n], for n = 0 to 7

Inner Cacheable property mapping for memory attributes n, if the region is mapped as Normal memory by the [PRRR.TR<n>](#) entry. n is the value of the [TEX\[0\]](#), C, and B bits concatenated. The possible values of this field are:

- 00 Region is Non-cacheable.
- 01 Region is Write-Back, Write-Allocate.

10 Region is Write-Through, no Write-Allocate.

11 Region is Write-Back, no Write-Allocate.

The meaning of the field with $n = 6$ is IMPLEMENTATION DEFINED and might differ from the meaning given here. This is because the meaning of the attribute combination $\{TEX[0] = 1, C = 1, B = 0\}$ is IMPLEMENTATION DEFINED.

Accessing the NMRR

This register can be read using MRC with the following syntax:

MRC <syntax>

This register can be written using MCR with the following syntax:

MCR <syntax>

This syntax is encoded with the following settings in the instruction encoding:

<syntax>	opc1	opc2	CRn	coproc	CRm
p15, 0, <Rt>, c10, c2, 1	000	001	1010	1111	0010

Accessibility

The register is accessible in software as follows:

Configuration	Control			Accessibility				Instance
	E2H	TGE	NS	EL0	EL1	EL2	EL3	
EL3 is using AArch32.	x	x	0	-	n/a	n/a	RW	NMRR_s
EL3 is not implemented.	x	x	0	-	RW	n/a	n/a	NMRR
EL3 is not implemented.	x	0	1	-	RW	RW	n/a	NMRR
EL3 is not implemented.	x	1	1	-	n/a	RW	n/a	NMRR
EL3 is using AArch64.	x	x	0	-	RW	n/a	n/a	NMRR
EL3 is using AArch64.	x	0	1	-	RW	RW	n/a	NMRR
EL3 is using AArch64.	x	1	1	-	n/a	RW	n/a	NMRR
EL3 is using AArch32.	x	0	1	-	RW	RW	RW	NMRR_ns
EL3 is using AArch32.	x	1	1	-	n/a	RW	RW	NMRR_ns

When EL3 is using AArch32, write access to NMRR_s is UNDEFINED when the CP15SSDISABLE signal is asserted HIGH.

Traps and Enables

For a description of the prioritization of any generated exceptions, see [Synchronous exception prioritization for exceptions taken to AArch32 state on page G1-4344](#) for exceptions taken to AArch32 state and [Synchronous exception prioritization for exceptions taken to AArch64 on page D1-1827](#) for exceptions taken to AArch64 state. Subject to the prioritization rules:

- When EL2 is implemented and is using AArch64 and $(SCR_EL3.NS == 1) \ \&\& \ (HCR_EL2.E2H == 0)$:
 - If $HCR_EL2.TVM == 1$, Non-secure write accesses to this register from EL1 are trapped to EL2.

- If `HCR_EL2.TRVM==1`, Non-secure read accesses to this register from EL1 are trapped to EL2.
- If `HSTR_EL2.T10==1`, Non-secure accesses to this register from EL1 are trapped to EL2.
- When EL2 is implemented and is using AArch64 and `(SCR_EL3.NS == 1) && (HCR_EL2.E2H == 1) && (HCR_EL2.TGE == 0)`:
 - If `HCR_EL2.TVM==1`, Non-secure write accesses to this register from EL1 are trapped to EL2.
 - If `HCR_EL2.TRVM==1`, Non-secure read accesses to this register from EL1 are trapped to EL2.
 - If `HSTR_EL2.T10==1`, Non-secure accesses to this register from EL1 are trapped to EL2.
- When EL2 is implemented and is using AArch32 and `SCR_EL3.NS == 1`:
 - If `HCR.TVM==1`, Non-secure write accesses to this register from EL1 are trapped to Hyp mode.
 - If `HCR.TRVM==1`, Non-secure read accesses to this register from EL1 are trapped to Hyp mode.
 - If `HSTR.T10==1`, Non-secure accesses to this register from EL1 are trapped to Hyp mode.

G6.2.111 NSACR, Non-Secure Access Control Register

The NSACR characteristics are:

Purpose

When EL3 is implemented and can use AArch32, defines the Non-secure access permissions to Trace, Advanced SIMD and floating-point functionality. Also includes IMPLEMENTATION DEFINED bits that can define Non-secure access permissions for IMPLEMENTATION DEFINED functionality.

Configurations

There is one instance of this register that is used in both Secure and Non-secure states.

———— Note ————

In AArch64 state, the NSACR controls are replaced by controls in [CPTR_EL3](#).

Some or all RW fields of this register have defined reset values. These apply whenever the register is accessible. This means they apply when the PE resets into EL3 using AArch32.

Attributes

NSACR is a 32-bit register.

Field descriptions

The NSACR bit assignments are:

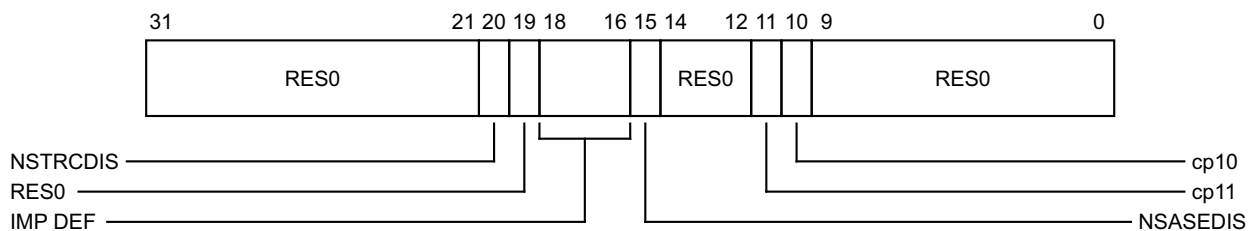

If EL3 is implemented and is using AArch64 then:

- Any read of the NSACR from Non-secure EL2 or Non-secure EL1 returns a value of `0x0000C00`.
- Any read or write to NSACR from Secure EL1 is trapped as an exception to EL3.

If EL3 is not implemented, then any read of the NSACR from EL2 or EL1 returns a value of `0x0000C00`.

Bits [31:21]

Reserved, RES0.

NSTRCDIS, bit [20]

Disables Non-secure System register accesses to all implemented trace registers.

0 This control has no effect on:

- System register access to implemented trace registers.
- The behavior of [CPACR.TRCDIS](#) and [HCPTR.TTA](#).

1 Non-secure System register accesses to all implemented trace registers are disabled, meaning:

- [CPACR.TRCDIS](#) behaves as RAO/WI in Non-secure state, regardless of its actual value.
- [HCPTR.TTA](#) behaves as RAO/WI, regardless of its actual value.

The implementation of this field must correspond to the implementation of the [CPACR.TRCDIS](#) field:

- If [CPACR.TRCDIS](#) is RAZ/WI, this field is RAZ/WI.
- If [CPACR.TRCDIS](#) is RW, this field is RW.

———— **Note** ————

- The ETMv4 architecture does not permit EL0 to access the trace registers. If the implementation includes an ETMv4 implementation, EL0 accesses to the trace registers are UNDEFINED.
- The architecture does not provide Non-secure access controls on trace register accesses through the optional memory-mapped external debug interface.

System register accesses to the trace registers can have side-effects. When a System register access is trapped, any side-effects that are normally associated with the access do not occur before the exception is taken.

When this register has an architecturally-defined reset value, if this field is implemented as an RW field, it resets to 0.

Bit [19]

Reserved, RES0.

IMPLEMENTATION DEFINED, bits [18:16]

IMPLEMENTATION DEFINED.

NSASEDIS, bit [15]

Disables Non-secure access to the Advanced SIMD functionality.

0 This control has no effect on:

- Non-secure access to Advanced SIMD functionality.
- The behavior of [CPACR.ASEDIS](#) and [HCPTR.TASE](#).

1 Non-secure access to the Advanced SIMD functionality is disabled, meaning:

- [CPACR.ASEDIS](#) behaves as RAO/WI in Non-secure state, regardless of its actual value.
- [HCPTR.TASE](#) behaves as RAO/WI, regardless of its actual value.

The implementation of this field must correspond to the implementation of the [CPACR.ASEDIS](#) field:

- If [CPACR.ASEDIS](#) is RES0, this field is RES0. If the implementation does not include Advanced SIMD and floating-point functionality, this field is RES0.
- If [CPACR.ASEDIS](#) is RAZ/WI, this field is RAZ/WI.
- If [CPACR.ASEDIS](#) is RW, this field is RW.

When this register has an architecturally-defined reset value, if this field is implemented as an RW field, it resets to 0.

Bits [14:12]

Reserved, RES0.

cp11, bit [11]

The value of this field is ignored. If this field is programmed with a different value to the cp10 field then this field is UNKNOWN on a direct read of the NSACR.

If the implementation does not include Advanced SIMD and floating-point functionality, this field is RES0.

If this field is implemented as an RW field, it resets to a value that is architecturally UNKNOWN.

cp10, bit [10]

Enable Non-secure access to the Advanced SIMD and floating-point features. Possible values of the fields are:

0 Advanced SIMD and floating-point features can be accessed only from Secure state. Any attempt to access this functionality from Non-secure state is UNDEFINED.

When the PE is in Non-secure state:

- The **CPACR**.{cp11, cp10} fields ignore writes and read as 0b00, access denied.
- The **HCPTR**.{TCP11, TCP10} fields behave as RAO/WI, regardless of their actual values.

1 Advanced SIMD and floating-point features can be accessed from both Security states.

If Non-secure access to the Advanced SIMD and floating-point functionality is enabled, the **CPACR** must be checked to determine the level of access that is permitted.

The Advanced SIMD and floating-point features controlled by these fields are:

- Execution of any floating-point or Advanced SIMD instruction.
- Any access to the Advanced SIMD and floating-point registers D0-D31 and their views as S0-S31 and Q0-Q15.
- Any access to the **FPSCR**, **FPSID**, **MVFR0**, **MVFR1**, **MVFR2**, or **FPEXC** System registers.

If the implementation does not include Advanced SIMD and floating-point functionality, this field is RES0.

If this field is implemented as an RW field, it resets to a value that is architecturally UNKNOWN.

Bits [9:0]

Reserved, RES0.

Accessing the NSACR

This register can be read using MRC with the following syntax:

MRC <syntax>

This register can be written using MCR with the following syntax:

MCR <syntax>

This syntax is encoded with the following settings in the instruction encoding:

<syntax>	opc1	opc2	CRn	coproc	CRm
p15, 0, <Rt>, c1, c1, 2	000	010	0001	1111	0001

Accessibility

The register is accessible in software as follows:

Control			Accessibility			
E2H	TGE	NS	EL0	EL1	EL2	EL3
x	x	0	-	-	n/a	RW
x	0	1	-	RO	RO	RW
x	1	1	-	n/a	RO	RW

If EL3 is implemented and is using AArch64, any read from or write to NSACR from Secure EL1 is trapped as an exception to EL3.

Traps and Enables

For a description of the prioritization of any generated exceptions, see [Synchronous exception prioritization for exceptions taken to AArch32 state on page G1-4344](#) for exceptions taken to AArch32 state and [Synchronous exception prioritization for exceptions taken to AArch64 on page D1-1827](#) for exceptions taken to AArch64 state. Subject to the prioritization rules:

- When EL2 is implemented and is using AArch64 and $(SCR_EL3.NS == 1) \ \&\& \ (HCR_EL2.E2H == 0)$:
 - If $HSTR_EL2.T1 == 1$, Non-secure read accesses to this register from EL1 are trapped to EL2.
- When EL2 is implemented and is using AArch64 and $(SCR_EL3.NS == 1) \ \&\& \ (HCR_EL2.E2H == 1) \ \&\& \ (HCR_EL2.TGE == 0)$:
 - If $HSTR_EL2.T1 == 1$, Non-secure read accesses to this register from EL1 are trapped to EL2.
- When EL2 is implemented and is using AArch32 and $SCR_EL3.NS == 1$:
 - If $HSTR.T1 == 1$, Non-secure read accesses to this register from EL1 are trapped to Hyp mode.

G6.2.112 PAR, Physical Address Register

The PAR characteristics are:

Purpose

Returns the output address (OA) from an address translation instruction that executed successfully, or fault information if the instruction did not execute successfully.

Configurations

AArch32 System register PAR is architecturally mapped to AArch64 System register [PAR_EL1](#).

The PAR returns a 32-bit value:

- When the PE is not in Hyp mode and is using the Short-descriptor translation table format.
- When the PE is in Hyp mode and executes an [ATS12NSOPR](#), [ATS12NSOPW](#), [ATS12NSOUR](#), or [ATS12NSOUW](#) instruction when the value of [HCR.VM](#) is 0 and the value of [TTBCR.EAE](#) is 0.

In these cases, PAR[63:32] is RES0.

Otherwise, the PAR returns a 64-bit value. This means it returns a 64-bit value in the following cases:

- When using the Long-descriptor translation table format.
- If the stage 1 address translation is disabled and [TTBCR.EAE](#) is set to 1.
- In an implementation that includes EL2, for the result of an [ATS1Cxx](#) instruction performed from Hyp mode.

For PL1&0 stage 1 translations, [TTBCR.EAE](#) selects the translation table format.

RW fields in this register reset to architecturally UNKNOWN values.

Attributes

PAR is a 64-bit register that can also be accessed as a 32-bit value. If it is accessed as a 32-bit register, accesses read and write bits[31:0] and do not modify bits[63:32].

The Configurations section specifies the cases where each PAR format is used.

Field descriptions

The PAR bit assignments are:

For all register layouts:

F, bit [0]

Indicates whether the instruction performed a successful address translation.

- | | |
|---|---|
| 0 | Address translation completed successfully. |
| 1 | Address translation aborted. |

When the instruction returned a 32-bit value to the PAR, PAR.F==0:

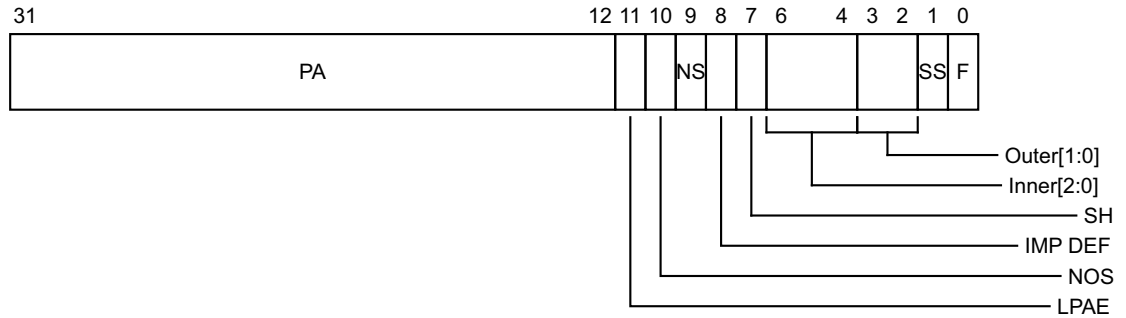

This section describes the register value returned by the successful execution of an Address translation instruction. Software might subsequently write a different value to the register, and that write does not affect the operation of the PE.

On a successful conversion, the PAR can return a value that indicates the resulting attributes, rather than the values that appear in the translation table descriptors. More precisely:

- Memory attribute fields are permitted to report the resulting attributes, as determined by any permitted implementation choices and any applicable configuration bits, instead of reporting the values that appear in the translation table descriptors. This applies to the NOS, SH, Inner, and Outer fields.
- See the NS bit description for constraints on the value it returns.

PA, bits [31:12]

Output address. The output address (OA) corresponding to the supplied input address. This field returns address bits[31:12].

LPAE, bit [11]

When updating the PAR with the result of the translation operation, this bit is set as follows:

- 0 Short-descriptor translation table format used. This means the PAR returned a 32-bit value.

NOS, bit [10]

Not Outer Shareable. When the returned value of PAR.SH is 1, indicates the Shareability attribute for the physical memory region:

- 0 Memory region is Outer Shareable.
- 1 Memory region is Inner Shareable.

When the returned value of PAR.SH is 0 the value returned to this field is UNKNOWN.

The value returned in this field can be the resulting attribute, as determined by any permitted implementation choices and any applicable configuration bits, instead of the value that appears in the translation table descriptor.

NS, bit [9]

Non-secure. The NS attribute for a translation table entry from a Secure translation regime.

For a result from a Secure translation regime, this bit reflects the Security state of the physical address space of the translation. This means it reflects the effect of the NSTable bits of earlier levels of the translation table walk if those NSTable bits have an effect on the translation.

For a result from a Non-secure translation regime, this bit is UNKNOWN.

IMP DEF, bit [8]

IMPLEMENTATION DEFINED.

SH, bit [7]

Shareability. Indicates whether the physical memory region is Non-shareable:

- | | |
|---|--|
| 0 | Memory is Non-shareable. |
| 1 | Memory is shareable, and PAR.NOS indicates whether the region is Outer Shareable or Inner Shareable. |

The value returned in this field can be the resulting attribute, as determined by any permitted implementation choices and any applicable configuration bits, instead of the value that appears in the translation table descriptor.

Inner[2:0], bits [6:4]

Inner cacheability attribute for the region. Permitted values are:

- | | |
|-----|--------------------------------|
| 000 | Non-cacheable. |
| 001 | Device-nGnRnE. |
| 011 | Device-nGnRE. |
| 101 | Write-Back, Write-Allocate. |
| 110 | Write-Through. |
| 111 | Write-Back, no Write-Allocate. |

The values 010 and 100 are reserved.

The value returned in this field can be the resulting attribute, as determined by any permitted implementation choices and any applicable configuration bits, instead of the value that appears in the translation table descriptor.

Outer[1:0], bits [3:2]

Outer cacheability attribute for the region. Permitted values are:

- | | |
|----|-----------------------------------|
| 00 | Non-cacheable. |
| 01 | Write-Back, Write-Allocate. |
| 10 | Write-Through, no Write-Allocate. |
| 11 | Write-Back, no Write-Allocate. |

The value returned in this field can be the resulting attribute, as determined by any permitted implementation choices and any applicable configuration bits, instead of the value that appears in the translation table descriptor.

SS, bit [1]

Supersection. Used to indicate if the result is a Supersection:

- | | |
|---|--|
| 0 | Result is not a Supersection. PAR[31:12] contains OA[31:12]. |
| 1 | Result is a Supersection, and: <ul style="list-style-type: none">• PAR[31:24] contains OA[31:24].• PAR[23:16] contains OA[39:32].• PAR[15:12] contains 0b0000. |

If an implementation supports less than 40 bits of physical address, the bits in the PAR field that correspond to physical address bits that are not implemented are UNKNOWN.

F, bit [0]

Indicates whether the instruction performed a successful address translation.

- | | |
|---|---|
| 0 | Address translation completed successfully. |
|---|---|

When the instruction returned a 32-bit value to the PAR, PAR.F==1:

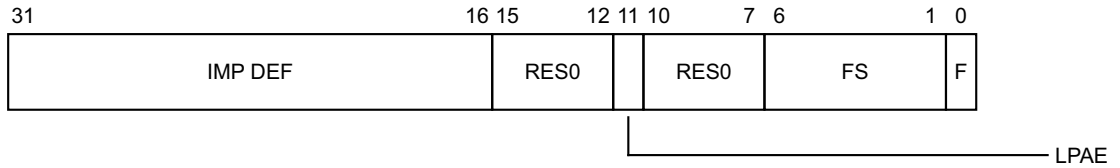

This section describes the register value returned by a fault on the execution of an Address translation instruction. Software might subsequently write a different value to the register, and that write does not affect the operation of the PE.

IMP DEF, bits [31:16]

IMPLEMENTATION DEFINED.

Bits [15:12]

Reserved, RES0.

LPAE, bit [11]

When updating the PAR with the result of the translation operation, this bit is set as follows:

0 Short-descriptor translation table format used. This means the PAR returned a 32-bit value.

Bits [10:7]

Reserved, RES0.

FS, bits [6:1]

Fault status bits. Bits [12,10,3:0] from the [DFSR](#), indicating the source of the abort.

F, bit [0]

Indicates whether the instruction performed a successful address translation.

1 Address translation aborted.

When the instruction returned a 64-bit value to the PAR, PAR.F==0:

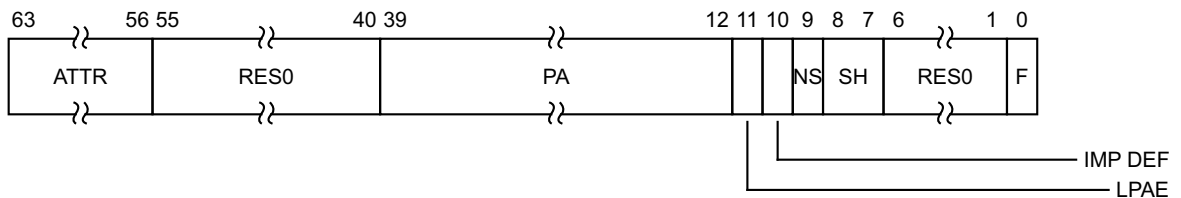

This section describes the register value returned by the successful execution of an Address translation instruction. Software might subsequently write a different value to the register, and that write does not affect the operation of the PE.

On a successful conversion, the PAR can return a value that indicates the resulting attributes, rather than the values that appear in the translation table descriptors. More precisely:

- Memory attribute fields are permitted to report the resulting attributes, as determined by any permitted implementation choices and any applicable configuration bits, instead of reporting the values that appear in the translation table descriptors. This applies to the ATTR and SH fields.

- See the NS bit description for constraints on the value it returns.

ATTR, bits [63:56]

Memory attributes for the returned output address. This field uses the same encoding as the Attr<n> fields in MAIRO and MAIR1.

The value returned in this field can be the resulting attribute, as determined by any permitted implementation choices and any applicable configuration bits, instead of the value that appears in the translation table descriptor.

Bits [55:40]

Reserved, RES0.

PA, bits [39:12]

Output address. The output address (OA) corresponding to the supplied input address. This field returns address bits[39:12].

LPAE, bit [11]

When updating the PAR with the result of the translation operation, this bit is set as follows:

- 1 Long-descriptor translation table format used. This means the PAR returned a 64-bit value.

IMP DEF, bit [10]

IMPLEMENTATION DEFINED.

NS, bit [9]

Non-secure. The NS attribute for a translation table entry from a Secure translation regime.

For a result from a Secure translation regime, this bit reflects the Security state of the physical address space of the translation. This means it reflects the effect of the NSTable bits of earlier levels of the translation table walk if those NSTable bits have an effect on the translation.

For a result from a Non-secure translation regime, this bit is UNKNOWN.

SH, bits [8:7]

Shareability attribute, for the returned output address. Permitted values are:

- 00 Non-shareable.
- 10 Outer Shareable.
- 11 Inner Shareable.

The value 01 is reserved.

———— **Note** —————

This field returns the value 10 for:

- Any type of Device memory.
- Normal memory with both Inner Non-cacheable and Outer Non-cacheable attributes.

The value returned in this field can be the resulting attribute, as determined by any permitted implementation choices and any applicable configuration bits, instead of the value that appears in the translation table descriptor.

Bits [6:1]

Reserved, RES0.

F, bit [0]

Indicates whether the instruction performed a successful address translation.

- 0 Address translation completed successfully.

When the instruction returned a 64-bit value to the PAR, PAR.F==1:

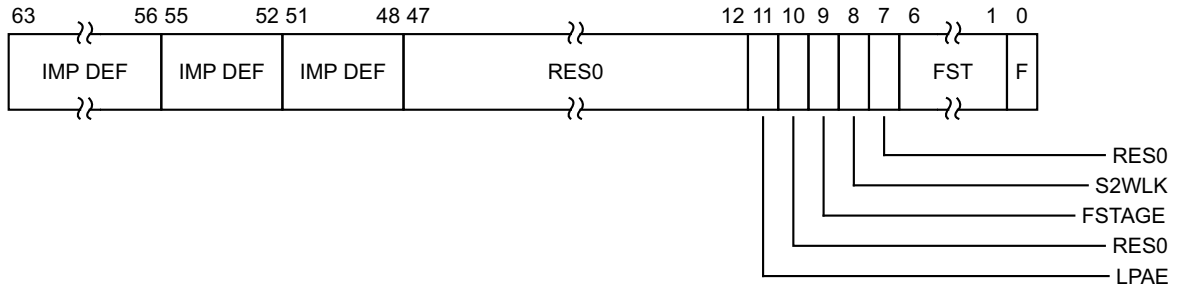

This section describes the register value returned by a fault on the execution of an Address translation instruction. Software might subsequently write a different value to the register, and that write does not affect the operation of the PE.

IMP DEF, bits [63:56]

IMPLEMENTATION DEFINED.

IMP DEF, bits [55:52]

IMPLEMENTATION DEFINED.

IMP DEF, bits [51:48]

IMPLEMENTATION DEFINED.

Bits [47:12]

Reserved, RES0.

LPAAE, bit [11]

When updating the PAR with the result of the translation operation, this bit is set as follows:

- 1 Long-descriptor translation table format used. This means the PAR returned a 64-bit value.

Bit [10]

Reserved, RES0.

FSTAGE, bit [9]

Indicates the translation stage at which the translation aborted:

- 0 Translation aborted because of a fault in the stage 1 translation.
- 1 Translation aborted because of a fault in the stage 2 translation.

S2WLK, bit [8]

If this bit is set to 1, it indicates the translation aborted because of a stage 2 fault during a stage 1 translation table walk.

Bit [7]

Reserved, RES0.

FST, bits [6:1]

Fault status field. Values are as in the [DFSR.STATUS](#) and [IFSR.STATUS](#) fields when using the Long-descriptor translation table format.

F, bit [0]

Indicates whether the instruction performed a successful address translation.

- 1 Address translation aborted.

Accessing the PAR

This register can be read using MRC with the following syntax:

MRC <syntax>

This register can be written using MCR with the following syntax:

MCR <syntax>

This syntax is encoded with the following settings in the instruction encoding:

<syntax>	opc1	opc2	CRn	coproc	CRm
p15, 0, <Rt>, c7, c4, 0	000	000	0111	1111	0100

This register can be read using MRRC with the following syntax:

MRRC <syntax>

This register can be written using MCRR with the following syntax:

MCRR <syntax>

This syntax is encoded with the following settings in the instruction encoding:

<syntax>	opc1	coproc	CRm
p15, 0, <Rt>, <Rt2>, c7	0000	1111	0111

Accessibility

The register is accessible in software as follows:

Configuration	Control			Accessibility				Instance
	E2H	TGE	NS	EL0	EL1	EL2	EL3	
EL3 is not implemented.	x	x	0	-	RW	n/a	n/a	PAR
EL3 is not implemented.	x	0	1	-	RW	RW	n/a	PAR
EL3 is not implemented.	x	1	1	-	n/a	RW	n/a	PAR
EL3 is using AArch64.	x	x	0	-	RW	n/a	n/a	PAR
EL3 is using AArch64.	x	0	1	-	RW	RW	n/a	PAR
EL3 is using AArch64.	x	1	1	-	n/a	RW	n/a	PAR
EL3 is using AArch32.	x	0	1	-	RW	RW	RW	PAR_ns
EL3 is using AArch32.	x	1	1	-	n/a	RW	RW	PAR_ns
EL3 is using AArch32.	x	x	0	-	n/a	n/a	RW	PAR_s

Traps and Enables

For a description of the prioritization of any generated exceptions, see *Synchronous exception prioritization for exceptions taken to AArch32 state* on page G1-4344 for exceptions taken to AArch32 state and *Synchronous exception prioritization for exceptions taken to AArch64* on page D1-1827 for exceptions taken to AArch64 state. Subject to the prioritization rules:

- When EL2 is implemented and is using AArch64 and $(SCR_EL3.NS == 1) \ \&\& \ (HCR_EL2.E2H == 0)$:
 - If $HSTR_EL2.T7 == 1$, Non-secure accesses to this register from EL1 are trapped to EL2.
- When EL2 is implemented and is using AArch64 and $(SCR_EL3.NS == 1) \ \&\& \ (HCR_EL2.E2H == 1) \ \&\& \ (HCR_EL2.TGE == 0)$:
 - If $HSTR_EL2.T7 == 1$, Non-secure accesses to this register from EL1 are trapped to EL2.
- When EL2 is implemented and is using AArch32 and $SCR_EL3.NS == 1$:
 - If $HSTR.T7 == 1$, Non-secure accesses to this register from EL1 are trapped to Hyp mode.

G6.2.113 PRRR, Primary Region Remap Register

The PRRR characteristics are:

Purpose

Controls the top level mapping of the TEX[0], C, and B memory region attributes.

Configurations

AArch32 System register PRRR is architecturally mapped to AArch64 System register [MAIR_EL1](#)[31:0].

[MAIRO](#) and PRRR are the same register, with a different view depending on the value of [TTBCR.EAE](#):

- When it is set to 0, the register is as described in PRRR.
- When it is set to 1, the register is as described in [MAIRO](#).

When EL3 is using AArch32, write access to PRRR(S) is disabled when the CP15SDISABLE signal is asserted HIGH.

RW fields in this register reset to architecturally UNKNOWN values.

Attributes

PRRR is a 32-bit register.

Field descriptions

The PRRR bit assignments are:

When *TTBCR.EAE*==0:

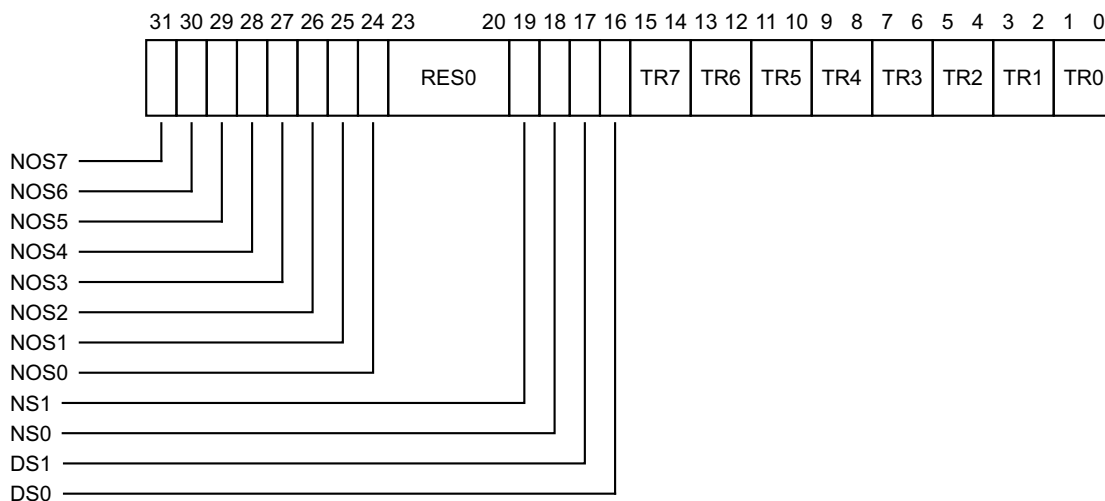

NOS<n>, bit [n+24], for n = 0 to 7

Not Outer Shareable. NOS<n> is the Outer Shareable property for memory attributes n, if the region is mapped as Normal memory that is not Inner Non-cacheable, Outer Non-cacheable, and the appropriate PRRR. {NS0, NS1} field identifies the region as shareable. n is the value of the concatenation of the {TEX[0], C, B} bits from the translation table descriptor. The possible values of each NOS<n> field other than NOS6 are:

- 0 Memory region is Outer Shareable.
- 1 Memory region is Inner Shareable.

The value of this bit is ignored if the region is:

- Device memory
- Normal memory that is at least one of:
 - Inner Non-cacheable, Outer Non-cacheable.
 - Identified by the appropriate PRRR.{NS0, NS1} field as Non-shareable.

The meaning of the NOS6 field is IMPLEMENTATION DEFINED.

Bits [23:20]

Reserved, RES0.

NS1, bit [19]

Mapping of S = 1 attribute for Normal memory regions. This field is used in determining the Shareability of a memory region that is mapped to Normal memory and both:

- Is not Inner Non-cacheable, Outer Non-cacheable.
- Has the S bit in the translation table descriptor set to 1.

The possible values of this bit are:

- | | |
|---|--|
| 0 | Region is Non-shareable. |
| 1 | Region is shareable. The value of the appropriate PRRR.NOS<n> field determines whether the region is Inner Shareable or Outer Shareable. |

NS0, bit [18]

Mapping of S = 0 attribute for Normal memory regions. This field is used in determining the Shareability of a memory region that is mapped to Normal memory and both:

- Is not Inner Non-cacheable, Outer Non-cacheable.
- Has the S bit in the translation table descriptor set to 0.

The possible values of this bit are:

- | | |
|---|--|
| 0 | Region is Non-shareable. |
| 1 | Region is shareable. The value of the appropriate PRRR.NOS<n> field determines whether the region is Inner Shareable or Outer Shareable. |

DS1, bit [17]

Mapping of S = 1 attribute for Device memory. In ARMv8, all types of Device memory are Outer Shareable, and therefore this bit is RES1.

DS0, bit [16]

Mapping of S = 0 attribute for Device memory. In ARMv8, all types of Device memory are Outer Shareable, and therefore this bit is RES1.

TR<n>, bits [2n+1:2n], for n = 0 to 7

TR<n> is the primary TEX mapping for memory attributes n, and defines the mapped memory type for a region with attributes n. n is the value of the concatenation of the {TEX[0], C, B} bits from the translation table descriptor. The possible values for each field other than TR6 are:

- | | |
|----|----------------------|
| 00 | Device-nGnRnE memory |
| 01 | Device-nGnRE memory |
| 10 | Normal memory |

The value 11 is reserved. The effect of programming a field to 11 is CONSTRAINED UNPREDICTABLE, see [Reserved values in System and memory-mapped registers and translation table entries on page K1-6117](#).

The meaning of the TR6 field is IMPLEMENTATION DEFINED.

Accessing the PRRR

This register can be read using MRC with the following syntax:

MRC <syntax>

This register can be written using MCR with the following syntax:

MCR <syntax>

This syntax is encoded with the following settings in the instruction encoding:

<syntax>	opc1	opc2	CRn	coproc	CRm
p15, 0, <Rt>, c10, c2, 0	000	000	1010	1111	0010

Accessibility

The register is accessible in software as follows:

Configuration	Control			Accessibility				Instance
	E2H	TGE	NS	EL0	EL1	EL2	EL3	
EL3 is not implemented.	x	x	0	-	RW	n/a	n/a	PRRR
EL3 is not implemented.	x	0	1	-	RW	RW	n/a	PRRR
EL3 is not implemented.	x	1	1	-	n/a	RW	n/a	PRRR
EL3 is using AArch64.	x	x	0	-	RW	n/a	n/a	PRRR
EL3 is using AArch64.	x	0	1	-	RW	RW	n/a	PRRR
EL3 is using AArch64.	x	1	1	-	n/a	RW	n/a	PRRR
EL3 is using AArch32.	x	x	0	-	n/a	n/a	RW	PRRR_s
EL3 is using AArch32.	x	0	1	-	RW	RW	RW	PRRR_ns
EL3 is using AArch32.	x	1	1	-	n/a	RW	RW	PRRR_ns

When EL3 is using AArch32, write access to PRRR_s is UNDEFINED when the CP15SDISABLE signal is asserted HIGH.

Traps and Enables

For a description of the prioritization of any generated exceptions, see [Synchronous exception prioritization for exceptions taken to AArch32 state on page G1-4344](#) for exceptions taken to AArch32 state and [Synchronous exception prioritization for exceptions taken to AArch64 on page D1-1827](#) for exceptions taken to AArch64 state. Subject to the prioritization rules:

- When EL2 is implemented and is using AArch64 and (SCR_EL3.NS == 1) && (HCR_EL2.E2H == 0):
 - If HCR_EL2.TVM==1, Non-secure write accesses to this register from EL1 are trapped to EL2.
 - If HCR_EL2.TRVM==1, Non-secure read accesses to this register from EL1 are trapped to EL2.
 - If HSTR_EL2.T10==1, Non-secure accesses to this register from EL1 are trapped to EL2.
- When EL2 is implemented and is using AArch64 and (SCR_EL3.NS == 1) && (HCR_EL2.E2H == 1) && (HCR_EL2.TGE == 0):
 - If HCR_EL2.TVM==1, Non-secure write accesses to this register from EL1 are trapped to EL2.

- If `HCR_EL2.TRVM==1`, Non-secure read accesses to this register from EL1 are trapped to EL2.
- If `HSTR_EL2.T10==1`, Non-secure accesses to this register from EL1 are trapped to EL2.
- When EL2 is implemented and is using AArch32 and `SCR_EL3.NS == 1`:
 - If `HCR.TVM==1`, Non-secure write accesses to this register from EL1 are trapped to Hyp mode.
 - If `HCR.TRVM==1`, Non-secure read accesses to this register from EL1 are trapped to Hyp mode.
 - If `HSTR.T10==1`, Non-secure accesses to this register from EL1 are trapped to Hyp mode.

G6.2.114 REVIDR, Revision ID Register

The REVIDR characteristics are:

Purpose

Provides implementation-specific minor revision information.

Configurations

There is one instance of this register that is used in both Secure and Non-secure states.

AArch32 System register REVIDR is architecturally mapped to AArch64 System register [REVIDR_EL1](#).

If REVIDR has the same value as [MIDR](#), then its contents have no significance.

Attributes

REVIDR is a 32-bit register.

Field descriptions

The REVIDR bit assignments are:



IMPLEMENTATION DEFINED, bits [31:0]

IMPLEMENTATION DEFINED.

Accessing the REVIDR

This register can be read using MRC with the following syntax:

MRC <syntax>

This syntax is encoded with the following settings in the instruction encoding:

<syntax>	opc1	opc2	CRn	coproc	CRm
p15, 0, <Rt>, c0, c0, 6	000	110	0000	1111	0000

Accessibility

The register is accessible in software as follows:

Control			Accessibility			
E2H	TGE	NS	EL0	EL1	EL2	EL3
x	x	0	-	RO	n/a	RO
x	0	1	-	RO	RO	RO
x	1	1	-	n/a	RO	RO

Traps and Enables

For a description of the prioritization of any generated exceptions, see *Synchronous exception prioritization for exceptions taken to AArch32 state* on page G1-4344 for exceptions taken to AArch32 state and *Synchronous exception prioritization for exceptions taken to AArch64* on page D1-1827 for exceptions taken to AArch64 state. Subject to the prioritization rules:

- When EL2 is implemented and is using AArch64 and $(SCR_EL3.NS == 1) \&\& (HCR_EL2.E2H == 0)$:
 - If $HCR_EL2.TID1 == 1$, Non-secure read accesses to this register from EL1 are trapped to EL2.
 - If $HSTR_EL2.T0 == 1$, Non-secure read accesses to this register from EL1 are trapped to EL2.
- When EL2 is implemented and is using AArch64 and $(SCR_EL3.NS == 1) \&\& (HCR_EL2.E2H == 1) \&\& (HCR_EL2.TGE == 0)$:
 - If $HCR_EL2.TID1 == 1$, Non-secure read accesses to this register from EL1 are trapped to EL2.
 - If $HSTR_EL2.T0 == 1$, Non-secure read accesses to this register from EL1 are trapped to EL2.
- When EL2 is implemented and is using AArch32 and $SCR_EL3.NS == 1$:
 - If $HCR.TID1 == 1$, Non-secure read accesses to this register from EL1 are trapped to Hyp mode.
 - If $HSTR.T0 == 1$, Non-secure read accesses to this register from EL1 are trapped to Hyp mode.

G6.2.115 RMR, Reset Management Register

The RMR characteristics are:

Purpose

If EL1 or EL3 is the highest implemented Exception level and this register is implemented:

- A write to the register at the highest implemented Exception level can request a Warm reset.
- If the highest implemented Exception level can use AArch32 and AArch64, this register specifies the Execution state that the PE boots into on a Warm reset.

Configurations

There is one instance of this register that is used in both Secure and Non-secure states.

AArch32 System register RMR is architecturally mapped to AArch64 System register [RMR_EL1](#) when EL1 is highest implemented Exception level.

AArch32 System register RMR is architecturally mapped to AArch64 System register [RMR_EL3](#) when EL3 is implemented.

Only implemented if EL1 or EL3 is the highest implemented Exception level. In this case:

- If the highest implemented Exception level can use AArch32 and AArch64 then this register must be implemented.
- If the highest implemented Exception level cannot use AArch64 then it is IMPLEMENTATION DEFINED whether the register is implemented.

See the field descriptions for the reset values. These apply whenever the register is implemented.

Attributes

RMR is a 32-bit register.

Field descriptions

The RMR bit assignments are:

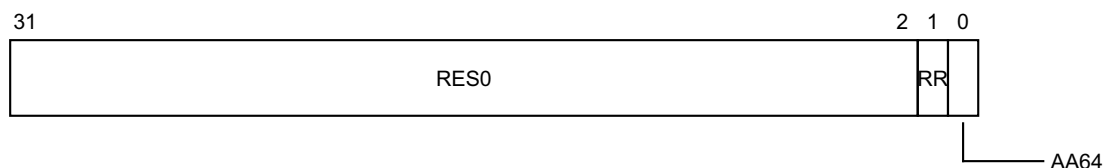

Bits [31:2]

Reserved, RES0.

RR, bit [1]

Reset Request. Setting this bit to 1 requests a Warm reset.

This field resets to 0 on a Warm or Cold reset.

AA64, bit [0]

When the highest implemented Exception level can use AArch64, determines which Execution state the PE boots into after a Warm reset:

- 0 AArch32.
- 1 AArch64.

On coming out of the Warm reset, execution starts at the IMPLEMENTATION DEFINED reset vector address of the specified Execution state.

If the highest implemented Exception level cannot use AArch64 this bit is RAZ/WI.

When implemented as a RW field, this field resets to 0 on a Cold reset.

Accessing the RMR

This register can be read using MRC with the following syntax:

MRC <syntax>

This register can be written using MCR with the following syntax:

MCR <syntax>

This syntax is encoded with the following settings in the instruction encoding:

<syntax>	opc1	opc2	CRn	coproc	CRm
p15, 0, <Rt>, c12, c0, 2	000	010	1100	1111	0000

Accessibility

The register is accessible in software as follows:

Configuration	Control			Accessibility			
	E2H	TGE	NS	EL0	EL1	EL2	EL3
EL1 is the highest implemented Exception level.	x	x	x	-	RW	n/a	n/a
EL2 is the highest implemented Exception level.	x	0	1	-	-	-	n/a
EL2 is the highest implemented Exception level.	x	1	1	-	n/a	-	n/a
EL3 is the highest implemented Exception level.	x	x	0	-	-	n/a	RW
EL3 is the highest implemented Exception level.	x	0	1	-	-	-	RW
EL3 is the highest implemented Exception level.	x	1	1	-	n/a	-	RW

The encoding for this register is UNDEFINED:

- If the RMR is not implemented.
- At all Exception levels other than the highest implemented Exception level.

When EL3 is implemented, ARM deprecates accessing this register from any PE mode other than Monitor mode.

G6.2.116 RVBAR, Reset Vector Base Address Register

The RVBAR characteristics are:

Purpose

If EL3 is not implemented, contains the IMPLEMENTATION DEFINED address that execution starts from after reset when executing in AArch32 state.

Configurations

There is one instance of this register that is used in both Secure and Non-secure states.

This register is only implemented if the highest Exception level implemented is capable of using AArch32, and is not EL3.

Attributes

RVBAR is a 32-bit register.

Field descriptions

The RVBAR bit assignments are:

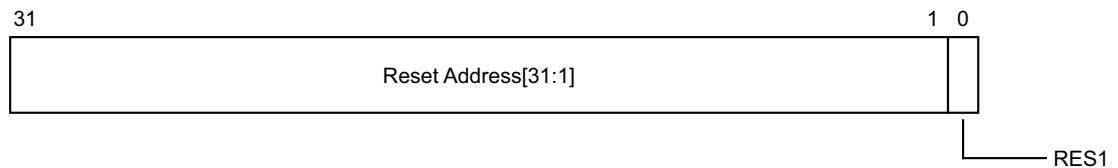

Bits [31:1]

Reset Address[31:1]. Bits [31:1] of the IMPLEMENTATION DEFINED address that execution starts from after reset when executing in 32-bit state.

Bit [0]

Reserved, RES1.

Accessing the RVBAR

This register can be read using MRC with the following syntax:

MRC <syntax>

This syntax is encoded with the following settings in the instruction encoding:

<syntax>	opc1	opc2	CRn	coproc	CRm
p15, 0, <Rt>, c12, c0, 1	000	001	1100	1111	0000

Accessibility

The register is accessible in software as follows:

Configuration	Control			Accessibility			
	E2H	TGE	NS	EL0	EL1	EL2	EL3
EL1 is the highest implemented Exception level.	x	x	x	-	RO	n/a	n/a
EL2 is the highest implemented Exception level.	x	0	1	-	-	RO	n/a
EL2 is the highest implemented Exception level.	x	1	1	-	n/a	RO	n/a
EL3 is the highest implemented Exception level.	x	x	0	-	-	n/a	-
EL3 is the highest implemented Exception level.	x	0	1	-	-	-	-
EL3 is the highest implemented Exception level.	x	1	1	-	n/a	-	-

Traps and Enables

For a description of the prioritization of any generated exceptions, see [Synchronous exception prioritization for exceptions taken to AArch32 state on page G1-4344](#) for exceptions taken to AArch32 state and [Synchronous exception prioritization for exceptions taken to AArch64 on page D1-1827](#) for exceptions taken to AArch64 state. Subject to the prioritization rules:

- When EL2 is implemented and is using AArch64 and (SCR_EL3.NS == 1) && (HCR_EL2.E2H == 0):
 - If HSTR_EL2.T12==1, Non-secure accesses to this register from EL1 are trapped to EL2.
- When EL2 is implemented and is using AArch64 and (SCR_EL3.NS == 1) && (HCR_EL2.E2H == 1) && (HCR_EL2.TGE == 0):
 - If HSTR_EL2.T12==1, Non-secure accesses to this register from EL1 are trapped to EL2.
- When EL2 is implemented and is using AArch32 and SCR_EL3.NS == 1:
 - If HSTR.T12==1, Non-secure accesses to this register from EL1 are trapped to Hyp mode.

G6.2.117 SCR, Secure Configuration Register

The SCR characteristics are:

Purpose

When EL3 is implemented and can use AArch32, defines the configuration of the current Security state. It specifies:

- The Security state, either Secure or Non-secure.
- What mode the PE branches to if an IRQ, FIQ, or External Abort occurs.
- Whether the CPSR.F or CPSR.A bits can be modified when SCR.NS==1.

Configurations

This register is only accessible in Secure state.

AArch32 System register SCR can be mapped to AArch64 System register [SCR_EL3](#), but this is not architecturally mandated.

Some or all RW fields of this register have defined reset values. These apply whenever the register is accessible. This means they apply when the PE resets into EL3 using AArch32.

Attributes

SCR is a 32-bit register.

Field descriptions

The SCR bit assignments are:

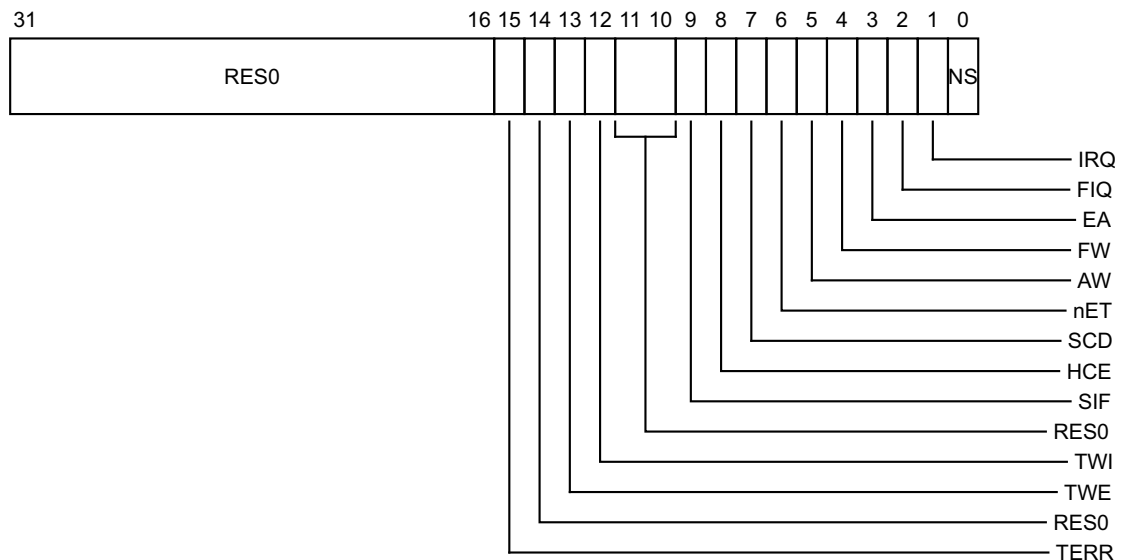

Bits [31:16]

Reserved, RES0.

TERR, bit [15]

Trap Error record accesses. If the RAS Extension is implemented, the possible values of this bit are:

- 0 Do not trap accesses to record registers from EL1 and EL2 to EL3.
- 1 Accesses to the ER* registers from EL1 and EL2 generate a Trap exception to EL3.

This bit resets to 0 on Warm reset.

When the RAS Extension is not implemented, this field is RES0.

Bit [14]

Reserved, RES0.

TWE, bit [13]

Traps WFE instructions to Monitor mode.

- 0 This control does not cause any instructions to be trapped.
- 1 Any attempt to execute a WFE instruction in any mode other than Monitor mode is trapped to Monitor mode, if the instruction would otherwise have caused the PE to enter a low-power state and the attempted execution does not generate an exception that is taken to EL1 or EL2 by [SCTLR.nTWE](#) or [HCR.TWE](#).
Any exception that is taken to EL1 or to EL2 has priority over this trap.

The attempted execution of a conditional WFE instruction is only trapped if the instruction passes its condition code check.

———— Note ————

Since a WFE or WFI can complete at any time, even without a Wakeup event, the traps on WFE of WFI are not guaranteed to be taken, even if the WFE or WFI is executed when there is no Wakeup event. The only guarantee is that if the instruction does not complete in finite time in the absence of a Wakeup event, the trap will be taken.

When this register has an architecturally-defined reset value, this field resets to 0.

TWI, bit [12]

Traps WFI instructions to Monitor mode.

- 0 This control does not cause any instructions to be trapped.
- 1 Any attempt to execute a WFI instruction in any mode other than Monitor mode is trapped to Monitor mode, if the instruction would otherwise have caused the PE to enter a low-power state and the attempted execution does not generate an exception that is taken to EL1 or EL2 by [SCTLR.nTWI](#) or [HCR.TWI](#).
Any exception that is taken to EL1 or to EL2 has priority over this trap.

The attempted execution of a conditional WFI instruction is only trapped if the instruction passes its condition code check.

———— Note ————

Since a WFE or WFI can complete at any time, even without a Wakeup event, the traps on WFE of WFI are not guaranteed to be taken, even if the WFE or WFI is executed when there is no Wakeup event. The only guarantee is that if the instruction does not complete in finite time in the absence of a Wakeup event, the trap will be taken.

When this register has an architecturally-defined reset value, this field resets to 0.

Bits [11:10]

Reserved, RES0.

SIF, bit [9]

Secure instruction fetch. When the PE is in Secure state, this bit disables instruction fetch from Non-secure memory. The possible values for this bit are:

- 0 Secure state instruction fetches from Non-secure memory are permitted.
- 1 Secure state instruction fetches from Non-secure memory are not permitted.

This bit is permitted to be cached in a TLB.

When this register has an architecturally-defined reset value, this field resets to 0.

HCE, bit [8]

Hypervisor Call instruction enable. Enables EL2 and Non-secure EL1 execution of HVC instructions.

- 0 HVC instructions are:
- UNDEFINED at Non-secure EL1. The Undefined Instruction exception is taken from PL1 to PL1.
 - UNPREDICTABLE at EL2. Behavior is one of the following:
 - The instruction is UNDEFINED.
 - The instruction executes as a NOP.
- 1 HVC instructions are enabled at EL2 and Non-secure EL1.

———— **Note** ————

HVC instructions are always UNDEFINED at EL0 and in Secure state.

If EL2 is not implemented, this bit is RES0 and HVC is UNDEFINED.

When this register has an architecturally-defined reset value, if this field is implemented as an RW field, it resets to 0.

SCD, bit [7]

Secure Monitor Call disable. Disables SMC instructions.

- 0 SMC instructions are enabled.
- 1 In Non-secure state, SMC instructions are UNDEFINED. The Undefined Instruction exception is taken from the current Exception level to the current Exception level. In Secure state, behavior is one of the following:
- The instruction is UNDEFINED.
 - The instruction executes as a NOP.

———— **Note** ————

SMC instructions are always UNDEFINED at PL0.

When this register has an architecturally-defined reset value, this field resets to 0.

nET, bit [6]

Not Early Termination. This bit disables early termination. The possible values of this bit are:

- 0 Early termination permitted. Execution time of data operations can depend on the data values.
- 1 Disable early termination. The number of cycles required for data operations is forced to be independent of the data values.

This IMPLEMENTATION DEFINED mechanism can disable data dependent timing optimizations from multiplies and data operations. It can provide system support against information leakage that might be exploited by timing correlation types of attack.

On implementations that do not support early termination or do not support disabling early termination, this bit is RES0.

When this register has an architecturally-defined reset value, if this field is implemented as an RW field, it resets to 0.

AW, bit [5]

When the value of SCR.EA is 1 and the value of HCR.AMO is 0, this bit controls whether CPSR.A masks an external abort taken from Non-secure state, and the possible values of this bit are:

- 0 External aborts taken from Non-secure state are not masked by CPSR.A, and are taken to EL3.
External aborts taken from Secure state are masked by CPSR.A.

1 External aborts taken from either Security state are masked by **CPSR.A**. When **CPSR.A** is 0, the abort is taken to EL3.

When **SCR.EA** is 0 or **HCR.AMO** is 1, this bit has no effect.

When this register has an architecturally-defined reset value, this field resets to 0.

FW, bit [4]

When the value of **SCR.FIQ** is 1 and the value of **HCR.FMO** is 0, this bit controls whether **CPSR.F** masks an FIQ interrupt taken from Non-secure state, and the possible values of this bit are:

0 An FIQ taken from Non-secure state is not masked by **CPSR.F**, and is taken to EL3.
An FIQ taken from Secure state is masked by **CPSR.F**.

1 An FIQ taken from either Security state is masked by **CPSR.F**. When **CPSR.F** is 0, the FIQ is taken to EL3.

When **SCR.FIQ** is 0 or **HCR.FMO** is 1, this bit has no effect.

When this register has an architecturally-defined reset value, this field resets to 0.

EA, bit [3]

External Abort handler. This bit controls which mode takes external aborts. The possible values of this bit are:

0 External aborts taken to Abort mode.

1 External aborts taken to Monitor mode.

When this register has an architecturally-defined reset value, this field resets to 0.

FIQ, bit [2]

FIQ handler. This bit controls which mode takes FIQ exceptions. The possible values of this bit are:

0 FIQs taken to FIQ mode.

1 FIQs taken to Monitor mode.

When this register has an architecturally-defined reset value, this field resets to 0.

IRQ, bit [1]

IRQ handler. This bit controls which mode takes IRQ exceptions. The possible values of this bit are:

0 IRQs taken to IRQ mode.

1 IRQs taken to Monitor mode.

When this register has an architecturally-defined reset value, this field resets to 0.

NS, bit [0]

Non-secure bit. Except when the PE is in Monitor mode, this bit determines the Security state of the PE:

0 PE is in Secure state.

1 PE is in Non-secure state.

If the **HCR.TGE** bit is set, an attempt to change from a Secure PL1 mode to a Non-secure EL1 mode by changing the **SCR.NS** bit from 0 to 1 results in the **SCR.NS** bit remaining as 0.

When this register has an architecturally-defined reset value, this field resets to 0.

Accessing the SCR

This register can be read using MRC with the following syntax:

```
MRC <syntax>
```

This register can be written using MCR with the following syntax:

```
MCR <syntax>
```

This syntax is encoded with the following settings in the instruction encoding:

<syntax>	opc1	opc2	CRn	coproc	CRm
p15, 0, <Rt>, c1, c1, 0	000	000	0001	1111	0001

Accessibility

The register is accessible in software as follows:

Control			Accessibility			
E2H	TGE	NS	EL0	EL1	EL2	EL3
x	x	0	-	-	n/a	RW
x	0	1	-	-	-	RW
x	1	1	-	n/a	-	RW

If EL3 is implemented and is using AArch64, any read or write to SCR from Secure EL1 using AArch32 is trapped as an exception to EL3.

Traps and Enables

For a description of the prioritization of any generated exceptions, see [Synchronous exception prioritization for exceptions taken to AArch32 state on page G1-4344](#) for exceptions taken to AArch32 state and [Synchronous exception prioritization for exceptions taken to AArch64 on page D1-1827](#) for exceptions taken to AArch64 state. Subject to the prioritization rules:

- When EL2 is implemented and is using AArch64 and (SCR_EL3.NS == 1) && (HCR_EL2.E2H == 0):
 - If HSTR_EL2.T1==1, Non-secure accesses to this register from EL1 are trapped to EL2.
- When EL2 is implemented and is using AArch64 and (SCR_EL3.NS == 1) && (HCR_EL2.E2H == 1) && (HCR_EL2.TGE == 0):
 - If HSTR_EL2.T1==1, Non-secure accesses to this register from EL1 are trapped to EL2.
- When EL2 is implemented and is using AArch32 and SCR_EL3.NS == 1:
 - If HSTR.T1==1, Non-secure accesses to this register from EL1 are trapped to Hyp mode.

G6.2.118 SCTLR, System Control Register

The SCTLR characteristics are:

Purpose

Provides the top level control of the system, including its memory system.

Configurations

AArch32 System register SCTLR is architecturally mapped to AArch64 System register [SCTLR_EL1](#).

When EL3 is using AArch32, write access to SCTLR(S) is disabled when the CP15SDISABLE signal is asserted HIGH.

Some bits in the register are read-only. These bits relate to non-configurable features of an implementation, and are provided for compatibility with previous versions of the architecture.

Some or all RW fields of this register have defined reset values. These apply only if the PE resets into an Exception level that is using AArch32. If the PE resets into EL3 using AArch32 they apply only to the Secure instance of the register. Otherwise, RW fields in this register reset to architecturally UNKNOWN values.

Attributes

SCTLR is a 32-bit register.

Field descriptions

The SCTLR bit assignments are:

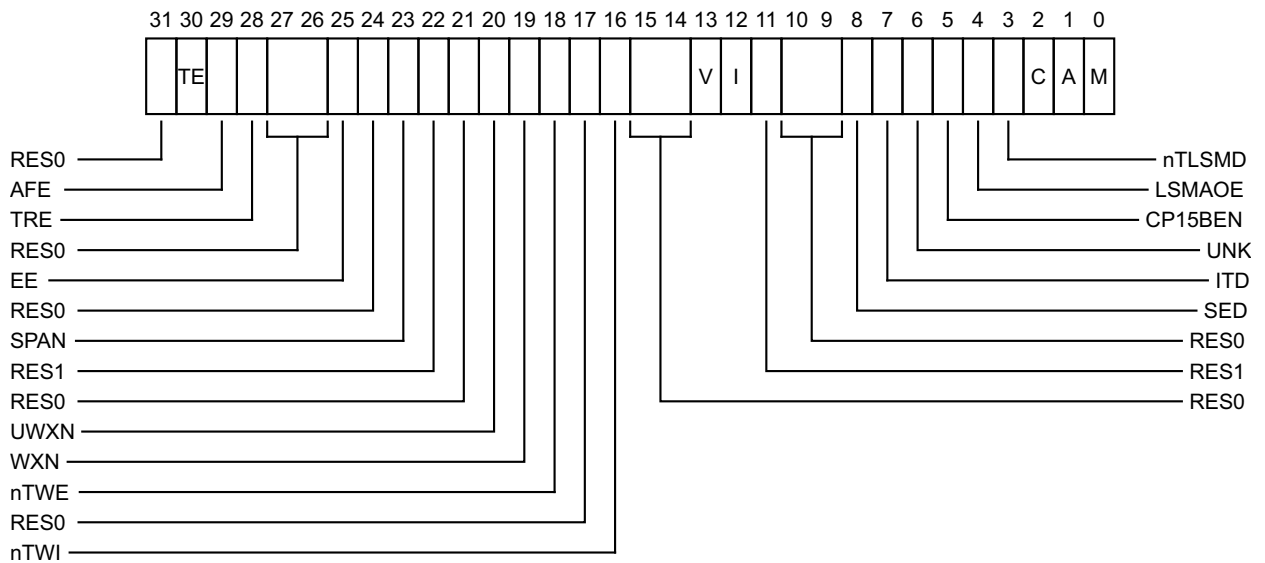

Bit [31]

Reserved, RES0.

TE, bit [30]

T32 Exception Enable. This bit controls whether exceptions to an Exception Level that is executing at PL1 are taken to A32 or T32 state:

- 0 Exceptions, including reset, taken to A32 state.
- 1 Exceptions, including reset, taken to T32 state.

When this register has an architecturally-defined reset value, this field resets to an IMPLEMENTATION DEFINED choice between:

- 0.
- A value determined by an input configuration signal.

AFE, bit [29]

Access Flag Enable. When using the Short-descriptor translation table format for the PL1&0 translation regime, this bit enables use of the AP[0] bit in the translation descriptors as the Access flag, and restricts access permissions in the translation descriptors to the simplified model. The possible values of this bit are:

- | | |
|---|---|
| 0 | In the translation table descriptors, AP[0] is an access permissions bit. The full range of access permissions is supported. No Access flag is implemented. |
| 1 | In the translation table descriptors, AP[0] is the Access flag. Only the simplified model for access permissions is supported. |

When using the Long-descriptor translation table format, the VMSA behaves as if this bit is set to 1, regardless of the value of this bit.

The AFE bit is permitted to be cached in a TLB.

When this register has an architecturally-defined reset value, this field resets to 0.

TRE, bit [28]

TEX remap enable. This bit enables remapping of the TEX[2:1] bits in the PL1&0 translation regime for use as two translation table bits that can be managed by the operating system. Enabling this remapping also changes the scheme used to describe the memory region attributes in the VMSA. The possible values of this bit are:

- | | |
|---|--|
| 0 | TEX remap disabled. TEX[2:0] are used, with the C and B bits, to describe the memory region attributes. |
| 1 | TEX remap enabled. TEX[2:1] are reassigned for use as bits managed by the operating system. The TEX[0], C, and B bits are used to describe the memory region attributes, with the MMU remap registers. |

When the value of [TTBCR.EAE](#) is 1, this bit is RES1.

The TRE bit is permitted to be cached in a TLB.

When this register has an architecturally-defined reset value, this field resets to 0.

Bits [27:26]

Reserved, RES0.

EE, bit [25]

The value of the PSTATE.E bit on branch to an exception vector or coming out of reset, and the endianness of stage 1 translation table walks in the PL1&0 translation regime.

The possible values of this bit are:

- | | |
|---|---|
| 0 | Little-endian. PSTATE.E is cleared to 0 on taking an exception or coming out of reset. Stage 1 translation table walks in the PL1&0 translation regime are little-endian. |
| 1 | Big-endian. PSTATE.E is cleared to 0 on taking an exception or coming out of reset. Stage 1 translation table walks in the PL1&0 translation regime are big-endian. |

If an implementation does not provide Big-endian support for data accesses at Exception Levels higher than EL0, this bit is RES0.

If an implementation does not provide Little-endian support for data accesses at Exception Levels higher than EL0, this bit is RES1.

When this register has an architecturally-defined reset value, if this field is implemented as an RW field, it resets to an IMPLEMENTATION DEFINED choice between:

- 0.
- A value determined by an input configuration signal.

Bit [24]

Reserved, RES0.

SPAN, bit [23]

In ARMv8.2 and ARMv8.1

Set Privileged Access Never, on taking an exception to EL1 from either Secure or Non-secure state, or to EL3 from Secure state when EL3 is using AArch32.

0 **CPSR.PAN** is set to 1 in the following situations:

- In Non-secure state, on taking an exception to EL1.
- In Secure state, when EL3 is using AArch64, on taking an exception to EL1.
- In Secure state, when EL3 is using AArch32, on taking an exception to EL3.

1 The value of **CPSR.PAN** is left unchanged on taking an exception.

In ARMv8.0.

Reserved, RES1.

Bit [22]

Reserved, RES1.

Bit [21]

Reserved, RES0.

UWXN, bit [20]

Unprivileged write permission implies PL1 XN (Execute-never). This bit can force all memory regions that are writable at PL0 to be treated as XN for accesses from software executing at PL1. The possible values of this bit are:

0 This control has no effect on memory access permissions.

1 Any region that is writable at PL0 forced to XN for accesses from software executing at PL1.

The UWXN bit is permitted to be cached in a TLB.

When this register has an architecturally-defined reset value, this field resets to 0.

WXN, bit [19]

Write permission implies XN (Execute-never). For the PL1&0 translation regime, this bit can force all memory regions that are writable to be treated as XN. The possible values of this bit are:

0 This control has no effect on memory access permissions.

1 Any region that is writable in the PL1&0 translation regime is forced to XN for accesses from software executing at PL1 or PL0.

The WXN bit is permitted to be cached in a TLB.

When this register has an architecturally-defined reset value, this field resets to 0.

nTWE, bit [18]

Traps EL0 execution of WFE instructions to Undefined mode.

0 Any attempt to execute a WFE instruction at EL0 is trapped to Undefined mode, if the instruction would otherwise have caused the PE to enter a low-power state.

1 This control does not cause any instructions to be trapped.

The attempted execution of a conditional WFE instruction is only trapped if the instruction passes its condition code check.

———— **Note** ————

Since a WFE or WFI can complete at any time, even without a Wakeup event, the traps on WFE of WFI are not guaranteed to be taken, even if the WFE or WFI is executed when there is no Wakeup event. The only guarantee is that if the instruction does not complete in finite time in the absence of a Wakeup event, the trap will be taken.

When this register has an architecturally-defined reset value, this field resets to 1.

Bit [17]

Reserved, RES0.

nTWI, bit [16]

Traps EL0 execution of WFI instructions to Undefined mode.

- 0 Any attempt to execute a WFI instruction at EL0 is trapped to Undefined mode, if the instruction would otherwise have caused the PE to enter a low-power state.
- 1 This control does not cause any instructions to be trapped.

The attempted execution of a conditional WFI instruction is only trapped if the instruction passes its condition code check.

———— **Note** ————

Since a WFE or WFI can complete at any time, even without a Wakeup event, the traps on WFE of WFI are not guaranteed to be taken, even if the WFE or WFI is executed when there is no Wakeup event. The only guarantee is that if the instruction does not complete in finite time in the absence of a Wakeup event, the trap will be taken.

When this register has an architecturally-defined reset value, this field resets to 1.

Bits [15:14]

Reserved, RES0.

V, bit [13]

Vectors bit. This bit selects the base address of the exception vectors for exceptions taken to a PE mode other than Monitor mode or Hyp mode:

- 0 Normal exception vectors. Base address is held in [VBAR](#).
- 1 High exception vectors (Hivecs), base address 0xFFFF0000. This base address cannot be remapped.

When this register has an architecturally-defined reset value, this field resets to an IMPLEMENTATION DEFINED choice between:

- 0.
- A value determined by an input configuration signal.

I, bit [12]

Instruction access Cacheability control, for accesses at EL1 and EL0:

- 0 All instruction access to Normal memory from PL1 and PL0 are Non-cacheable for all levels of instruction and unified cache.
If the value of SCTL.R.M is 0, instruction accesses from stage 1 of the PL1&0 translation regime are to Normal, Outer Shareable, Inner Non-cacheable, Outer Non-cacheable memory.
- 1 All instruction access to Normal memory from PL1 and PL0 can be cached at all levels of instruction and unified cache.
If the value of SCTL.R.M is 0, instruction accesses from stage 1 of the PL1&0 translation regime are to Normal, Outer Shareable, Inner Write-Through, Outer Write-Through memory.

Instruction accesses to Normal memory from Non-secure EL1 and Non-secure EL0 are Cacheable regardless of the value of the SCTLR.I bit if either:

- EL2 is using AArch32 and the value of HCR.DC is 1.
- EL2 is using AArch64 and the value of HCR_EL2.DC is 1.

When this register has an architecturally-defined reset value, this field resets to 0.

Bit [11]

Reserved, RES1.

Bits [10:9]

Reserved, RES0.

SED, bit [8]

SETEND instruction disable. Disables SETEND instructions at PL0 and PL1.

- 0 SETEND instruction execution is enabled at PL0 and PL1.
- 1 SETEND instructions are UNDEFINED at PL0 and PL1.

If the implementation does not support mixed-endian operation at any Exception level, this bit is RES1.

When this register has an architecturally-defined reset value, if this field is implemented as an RW field, it resets to 0.

ITD, bit [7]

IT Disable. Disables some uses of IT instructions at PL1 and PL0.

- 0 All IT instruction functionality is enabled at PL1 and PL0.
- 1 Any attempt at PL1 or PL0 to execute any of the following is UNDEFINED:
 - All encodings of the IT instruction with hw1[3:0] != 1000.
 - All encodings of the subsequent instruction with the following values for hw1:
 - 11xxxxxxxxxxxx
All 32-bit instructions, and the 16-bit instructions B, UDF, SVC, LDM, and STM.
 - 1011xxxxxxxxxxxx
All instructions in *Miscellaneous 16-bit instructions on page F3-2883*.
 - 1010xxxxxxxxxxxx
ADD Rd, PC, #imm
 - 01001xxxxxxxxxxx
LDR Rd, [PC, #imm]
 - 0100x1xxx1111xxx
ADD Rdn, PC; CMP Rn, PC; MOV Rd, PC; BX PC; BLX PC.
 - 010001xx1xxxx111
ADD PC, Rm; CMP PC, Rm; MOV PC, Rm. This pattern also covers UNPREDICTABLE cases with BLX Rn.

These instructions are always UNDEFINED, regardless of whether they would pass or fail the condition code check that applies to them as a result of being in an IT block.

It is IMPLEMENTATION DEFINED whether the IT instruction is treated as:

- A 16-bit instruction, that can only be followed by another 16-bit instruction.
- The first half of a 32-bit instruction.

This means that, for the situations that are UNDEFINED, either the second 16-bit instruction or the 32-bit instruction is UNDEFINED.

An implementation might vary dynamically as to whether IT is treated as a 16-bit instruction or the first half of a 32-bit instruction.

If an instruction in an active IT block that would be disabled by this field sets this field to 1 then behavior is CONSTRAINED UNPREDICTABLE. For more information see [Changes to an ITD control by an instruction in an IT block on page E1-2738](#).

ITD is optional, but if it is implemented in the SCTLR then it must also be implemented in the [SCTLR_EL1](#). If it is not implemented then this bit is RAZ/WI.

When this register has an architecturally-defined reset value, if this field is implemented as an RW field, it resets to 0.

UNK, bit [6]

Writes to this bit are IGNORED. Reads of this bit return an UNKNOWN value.

CP15BEN, bit [5]

System instruction memory barrier enable. Enables accesses to the DMB, DSB, and ISB System instructions in the (coproc==1111) encoding space from PL1 and PL0:

- | | |
|---|---|
| 0 | PL0 and PL1 execution of the CP15DMB , CP15DSB , and CP15ISB instructions is UNDEFINED. |
| 1 | PL0 and PL1 execution of the CP15DMB , CP15DSB , and CP15ISB instructions is enabled. |

CP15BEN is optional, but if it is implemented in the SCTLR then it must also be implemented in the [SCTLR_EL1](#). If it is not implemented then this bit is RAO/WI.

When this register has an architecturally-defined reset value, if this field is implemented as an RW field, it resets to 1.

LSMAOE, bit [4]

In ARMv8.2

Load Multiple and Store Multiple Atomicity and Ordering Enable. When the OPTIONAL feature [ARMv8.2-LSMAOC](#) is implemented, defined values are:

- | | |
|---|--|
| 0 | For all memory accesses at EL1 or EL0, A32 and T32 Load Multiple and Store Multiple can have an interrupt taken during the sequence memory accesses, and the memory accesses are not required to be ordered. |
| 1 | The ordering and interrupt behavior of A32 and T32 Load Multiple and Store Multiple at EL1 or EL0 is as defined for ARMv8.0. |

This bit is permitted to be cached in a TLB.

If this bit is not implemented, it is RES1.

When this register has an architecturally-defined reset value, this field resets to 1.

In ARMv8.1 and ARMv8.0.

Reserved, RES1.

nTLSMD, bit [3]

In ARMv8.2

No Trap Load Multiple and Store Multiple to Device-nGRE/Device-nGnRE/Device-nGnRnE memory. When the OPTIONAL feature [ARMv8.2-LSMAOC](#) is implemented, defined values are:

- | | |
|---|---|
| 0 | All memory accesses by A32 and T32 Load Multiple and Store Multiple at EL1 or EL0 that are marked at stage 1 as Device-nGRE/Device-nGnRE/Device-nGnRnE memory are trapped and generate a stage 1 Alignment fault. |
| 1 | All memory accesses by A32 and T32 Load Multiple and Store Multiple at EL1 or EL0 that are marked at stage 1 as Device-nGRE/Device-nGnRE/Device-nGnRnE memory are not trapped. |

This bit is permitted to be cached in a TLB.

If this bit is not implemented, it is RES1.

When this register has an architecturally-defined reset value, this field resets to 1.

In ARMv8.1 and ARMv8.0.

Reserved, RES1.

C, bit [2]

Cacheability control, for data accesses at EL1 and EL0:

- | | |
|---|--|
| 0 | All data access to Normal memory from PL1 and PL0, and all accesses to the PL1&0 stage 1 translation tables, are Non-cacheable for all levels of data and unified cache. |
| 1 | All data access to Normal memory from PL1 and PL0, and all accesses to the PL1&0 stage 1 translation tables, can be cached at all levels of data and unified cache. |

The PE ignores SCLTR.C for Non-secure state and data accesses to Normal memory from EL1 and EL0 are Cacheable if either:

- EL2 is using AArch32 and the value of HCR.DC is 1.
- EL2 is using AArch64 and the value of HCR_EL2.DC is 1.

When this register has an architecturally-defined reset value, this field resets to 0.

A, bit [1]

Alignment check enable. This is the enable bit for Alignment fault checking at PL1 and PL0:

- | | |
|---|---|
| 0 | Alignment fault checking disabled when executing at PL1 or PL0.
Instructions that load or store one or more registers, other than load/store exclusive and load-acquire/store-release, do not check that the address being accessed is aligned to the size of the data element(s) being accessed. |
| 1 | Alignment fault checking enabled when executing at PL1 or PL0.
All instructions that load or store one or more registers have an alignment check that the address being accessed is aligned to the size of the data element(s) being accessed. If this check fails it causes an Alignment fault, which is taken as a Data Abort exception. |

Load/store exclusive and load-acquire/store-release instructions have an alignment check regardless of the value of the A bit.

When this register has an architecturally-defined reset value, this field resets to 0.

M, bit [0]

MMU enable for EL1 and EL0 stage 1 address translation. Possible values of this bit are:

- | | |
|---|---|
| 0 | EL1 and EL0 stage 1 address translation disabled.
See the SCLTR.I field for the behavior of instruction accesses to Normal memory. |
| 1 | EL1 and EL0 stage 1 address translation enabled. |

In the Non-secure state the PE behaves as if the value of the SCLTR.M field is 0 for all purposes other than returning the value of a direct read of the field if either:

- EL2 is using AArch32 and the value of HCR.{DC, TGE} is not {0, 0}.
- EL2 is using AArch64 and the value of HCR_EL2.{DC, TGE} is not {0, 0}.

When this register has an architecturally-defined reset value, this field resets to 0.

Accessing the SCLTR

This register can be read using MRC with the following syntax:

MRC <syntax>

This register can be written using MCR with the following syntax:

MCR <syntax>

This syntax is encoded with the following settings in the instruction encoding:

<syntax>	opc1	opc2	CRn	coproc	CRm
p15, 0, <Rt>, c1, c0, 0	000	000	0001	1111	0000

Accessibility

The register is accessible in software as follows:

Configuration	Control			Accessibility				Instance
	E2H	TGE	NS	EL0	EL1	EL2	EL3	
EL3 is not implemented.	x	x	0	-	RW	n/a	n/a	SCTLR
EL3 is not implemented.	x	0	1	-	RW	RW	n/a	SCTLR
EL3 is not implemented.	x	1	1	-	n/a	RW	n/a	SCTLR
EL3 is using AArch64.	x	x	0	-	RW	n/a	n/a	SCTLR
EL3 is using AArch64.	x	0	1	-	RW	RW	n/a	SCTLR
EL3 is using AArch64.	x	1	1	-	n/a	RW	n/a	SCTLR
EL3 is using AArch32.	x	x	0	-	n/a	n/a	RW	SCTLR_s
EL3 is using AArch32.	x	0	1	-	RW	RW	RW	SCTLR_ns
EL3 is using AArch32.	x	1	1	-	n/a	RW	RW	SCTLR_ns

When EL3 is using AArch32, write access to SCTLR_s is UNDEFINED when the CP15SSDISABLE signal is asserted HIGH.

Traps and Enables

For a description of the prioritization of any generated exceptions, see [Synchronous exception prioritization for exceptions taken to AArch32 state on page G1-4344](#) for exceptions taken to AArch32 state and [Synchronous exception prioritization for exceptions taken to AArch64 on page D1-1827](#) for exceptions taken to AArch64 state. Subject to the prioritization rules:

- When EL2 is implemented and is using AArch64 and (SCR_EL3.NS == 1) && (HCR_EL2.E2H == 0):
 - If HCR_EL2.TVM==1, Non-secure write accesses to this register from EL1 are trapped to EL2.
 - If HCR_EL2.TRVM==1, Non-secure read accesses to this register from EL1 are trapped to EL2.
 - If HSTR_EL2.T1==1, Non-secure accesses to this register from EL1 are trapped to EL2.
- When EL2 is implemented and is using AArch64 and (SCR_EL3.NS == 1) && (HCR_EL2.E2H == 1) && (HCR_EL2.TGE == 0):
 - If HCR_EL2.TVM==1, Non-secure write accesses to this register from EL1 are trapped to EL2.
 - If HCR_EL2.TRVM==1, Non-secure read accesses to this register from EL1 are trapped to EL2.
 - If HSTR_EL2.T1==1, Non-secure accesses to this register from EL1 are trapped to EL2.
- When EL2 is implemented and is using AArch32 and SCR_EL3.NS == 1:
 - If HCR.TVM==1, Non-secure write accesses to this register from EL1 are trapped to Hyp mode.
 - If HCR.TRVM==1, Non-secure read accesses to this register from EL1 are trapped to Hyp mode.
 - If HSTR.T1==1, Non-secure accesses to this register from EL1 are trapped to Hyp mode.

G6.2.119 SPSR, Saved Program Status Register

The SPSR characteristics are:

Purpose

Holds the saved process state for the current mode.

Configurations

There is one instance of this register that is used in both Secure and Non-secure states.

Attributes

SPSR is a 32-bit register.

Field descriptions

The SPSR bit assignments are:

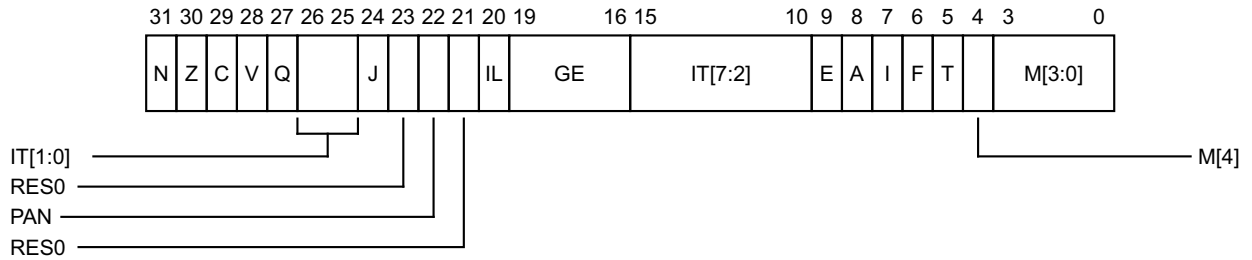

N, bit [31]

Set to the value of **CPSR.N** on taking an exception to the current mode, and copied to **CPSR.N** on executing an exception return operation in the current mode.

Z, bit [30]

Set to the value of **CPSR.Z** on taking an exception to the current mode, and copied to **CPSR.Z** on executing an exception return operation in the current mode.

C, bit [29]

Set to the value of **CPSR.C** on taking an exception to the current mode, and copied to **CPSR.C** on executing an exception return operation in the current mode.

V, bit [28]

Set to the value of **CPSR.V** on taking an exception to the current mode, and copied to **CPSR.V** on executing an exception return operation in the current mode.

Q, bit [27]

Set to the value of **CPSR.Q** on taking an exception to the current mode, and copied to **CPSR.Q** on executing an exception return operation in the current mode.

IT[1:0], bits [26:25]

IT block state bits for the T32 IT (If-Then) instruction. See IT[7:2] for explanation of this field.

J, bit [24]

RES0.

In previous versions of the architecture, the {J, T} bits determined the AArch32 Instruction set state. ARMv8 does not support either Jazelle state or T32EE state, and the T bit determines the Instruction set state.

Bit [23]

Reserved, RES0.

PAN, bit [22]

In ARMv8.2 and ARMv8.1

When [ARMv8.1-PAN](#) is implemented, set to the value of [CPSR.PAN](#) on taking an exception to the current mode, and copied to [CPSR.PAN](#) on executing an exception return operation in the current mode.

When [ARMv8.1-PAN](#) is not implemented, this bit is RES0.

In ARMv8.0.

Reserved, RES0.

Bit [21]

Reserved, RES0.

IL, bit [20]

Illegal Execution state bit. Shows the value of [PSTATE.IL](#) immediately before the exception was taken.

GE, bits [19:16]

Greater than or Equal flags, for parallel addition and subtraction.

IT[7:2], bits [15:10]

IT block state bits for the T32 IT (If-Then) instruction. This field must be interpreted in two parts.

- IT[7:5] holds the base condition for the IT block. The base condition is the top 3 bits of the condition code specified by the first condition field of the IT instruction.
- IT[4:0] encodes the size of the IT block, which is the number of instructions that are to be conditionally executed, by the position of the least significant 1 in this field. It also encodes the value of the least significant bit of the condition code for each instruction in the block.

The IT field is `0b00000000` when no IT block is active.

E, bit [9]

Endianness state bit. Controls the load and store endianness for data accesses:

0 Little-endian operation

1 Big-endian operation.

Instruction fetches ignore this bit.

When the reset value of the [SCTLR.EE](#) bit is defined by a configuration input signal, that value also applies to the [CPSR.E](#) bit on reset, and therefore applies to software execution from reset.

If an implementation does not provide Big-endian support, this bit is RES0. If it does not provide Little-endian support, this bit is RES1.

If an implementation provides Big-endian support but only at EL0, this bit is RES0 for an exception return to any Exception level other than EL0.

Likewise, if it provides Little-endian support only at EL0, this bit is RES1 for an exception return to any Exception level other than EL0.

A, bit [8]

SError interrupt mask bit. The possible values of this bit are:

0 Exception not masked.

1 Exception masked.

I, bit [7]

IRQ mask bit. The possible values of this bit are:

- 0 Exception not masked.
- 1 Exception masked.

F, bit [6]

FIQ mask bit. The possible values of this bit are:

- 0 Exception not masked.
- 1 Exception masked.

T, bit [5]

T32 Instruction set state bit. Determines the AArch32 instruction set state that the exception was taken from. Possible values of this bit are:

- 0 Taken from A32 state.
- 1 Taken from T32 state.

M[4], bit [4]

Execution state that the exception was taken from. Possible values of this bit are:

- 1 Exception taken from AArch32.

M[3:0], bits [3:0]

AArch32 mode that an exception was taken from. The possible values are:

M[3:0]	Mode
0b0000	User
0b0001	FIQ
0b0010	IRQ
0b0011	Supervisor
0b0110	Monitor (only valid in Secure state, if EL3 is implemented and can use AArch32)
0b0111	Abort
0b1010	Hyp
0b1011	Undefined
0b1111	System

Other values are reserved.

G6.2.120 SPSR_abt, Saved Program Status Register (Abort mode)

The SPSR_abt characteristics are:

Purpose

Holds the saved process state when an exception is taken to Abort mode.

Configurations

There is one instance of this register that is used in both Secure and Non-secure states.

AArch32 System register SPSR_abt is architecturally mapped to AArch64 System register [SPSR_abt](#).

Attributes

SPSR_abt is a 32-bit register.

Field descriptions

The SPSR_abt bit assignments are:

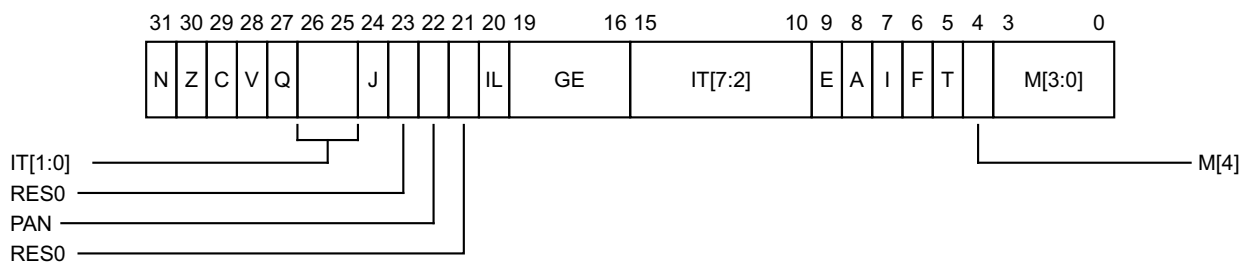

N, bit [31]

Set to the value of [CPSR.N](#) on taking an exception to Abort mode, and copied to [CPSR.N](#) on executing an exception return operation in Abort mode.

Z, bit [30]

Set to the value of [CPSR.Z](#) on taking an exception to Abort mode, and copied to [CPSR.Z](#) on executing an exception return operation in Abort mode.

C, bit [29]

Set to the value of [CPSR.C](#) on taking an exception to Abort mode, and copied to [CPSR.C](#) on executing an exception return operation in Abort mode.

V, bit [28]

Set to the value of [CPSR.V](#) on taking an exception to Abort mode, and copied to [CPSR.V](#) on executing an exception return operation in Abort mode.

Q, bit [27]

Set to the value of [CPSR.Q](#) on taking an exception to Abort mode, and copied to [CPSR.Q](#) on executing an exception return operation in Abort mode.

IT[1:0], bits [26:25]

IT block state bits for the T32 IT (If-Then) instruction. See IT[7:2] for explanation of this field.

J, bit [24]

RES0.

In previous versions of the architecture, the {J, T} bits determined the AArch32 Instruction set state. ARMv8 does not support either Jazelle state or T32EE state, and the T bit determines the Instruction set state.

Bit [23]

Reserved, RES0.

PAN, bit [22]

In ARMv8.2 and ARMv8.1

When [ARMv8.1-PAN](#) is implemented, set to the value of [CPSR.PAN](#) on taking an exception to Abort mode, and copied to [CPSR.PAN](#) on executing an exception return operation in Abort mode.

When [ARMv8.1-PAN](#) is not implemented, this bit is RES0.

In ARMv8.0.

Reserved, RES0.

Bit [21]

Reserved, RES0.

IL, bit [20]

Illegal Execution state bit. Shows the value of [PSTATE.IL](#) immediately before the exception was taken.

GE, bits [19:16]

Greater than or Equal flags, for parallel addition and subtraction.

IT[7:2], bits [15:10]

IT block state bits for the T32 IT (If-Then) instruction. This field must be interpreted in two parts.

- IT[7:5] holds the base condition for the IT block. The base condition is the top 3 bits of the condition code specified by the first condition field of the IT instruction.
- IT[4:0] encodes the size of the IT block, which is the number of instructions that are to be conditionally executed, by the position of the least significant 1 in this field. It also encodes the value of the least significant bit of the condition code for each instruction in the block.

The IT field is `0b00000000` when no IT block is active.

E, bit [9]

Endianness state bit. Controls the load and store endianness for data accesses:

0 Little-endian operation

1 Big-endian operation.

Instruction fetches ignore this bit.

When the reset value of the [SCTLR.EE](#) bit is defined by a configuration input signal, that value also applies to the [CPSR.E](#) bit on reset, and therefore applies to software execution from reset.

If an implementation does not provide Big-endian support, this bit is RES0. If it does not provide Little-endian support, this bit is RES1.

If an implementation provides Big-endian support but only at EL0, this bit is RES0 for an exception return to any Exception level other than EL0.

Likewise, if it provides Little-endian support only at EL0, this bit is RES1 for an exception return to any Exception level other than EL0.

A, bit [8]

SError interrupt mask bit. The possible values of this bit are:

0 Exception not masked.

1 Exception masked.

I, bit [7]

IRQ mask bit. The possible values of this bit are:

- 0 Exception not masked.
- 1 Exception masked.

F, bit [6]

FIQ mask bit. The possible values of this bit are:

- 0 Exception not masked.
- 1 Exception masked.

T, bit [5]

T32 Instruction set state bit. Determines the AArch32 instruction set state that the exception was taken from. Possible values of this bit are:

- 0 Taken from A32 state.
- 1 Taken from T32 state.

M[4], bit [4]

Execution state that the exception was taken from. Possible values of this bit are:

- 1 Exception taken from AArch32.

M[3:0], bits [3:0]

AArch32 mode that an exception was taken from. The possible values are:

M[3:0]	Mode
0b0000	User
0b0001	FIQ
0b0010	IRQ
0b0011	Supervisor
0b0110	Monitor (only valid in Secure state, if EL3 is implemented and can use AArch32)
0b0111	Abort
0b1011	Undefined
0b1111	System

Other values are reserved. The effect of programming this field to a Reserved value is that behavior is **CONSTRAINED UNPREDICTABLE**, as described in *Reserved values in System and memory-mapped registers and translation table entries* on page K1-6117.

Accessing the SPSR_abt

This register can be read using MRS (banked register) with the following syntax:

MRS <Rd>, <banked_reg>

This register can be written using MSR (banked register) with the following syntax:

MSR <banked_reg>, <Rd>

This syntax is encoded with the following settings in the instruction encoding:

<banked_reg>	R	M	M1
SPSR_abt	1	1	0100

Accessibility

The register is accessible in software as follows:

Control			Accessibility			
E2H	TGE	NS	EL0	EL1	EL2	EL3
x	x	0	-	RW	n/a	RW
x	0	1	-	RW	RW	RW
x	1	1	-	n/a	RW	RW

Using MRS (banked register) and MSR (banked register) instructions, at PL1 this register is only accessible from PE modes other than Abort mode. In Abort mode, it is accessible as the current SPSR.

G6.2.121 SPSR_fiq, Saved Program Status Register (FIQ mode)

The SPSR_fiq characteristics are:

Purpose

Holds the saved process state when an exception is taken to FIQ mode.

Configurations

There is one instance of this register that is used in both Secure and Non-secure states.

AArch32 System register SPSR_fiq is architecturally mapped to AArch64 System register [SPSR_fiq](#).

Attributes

SPSR_fiq is a 32-bit register.

Field descriptions

The SPSR_fiq bit assignments are:

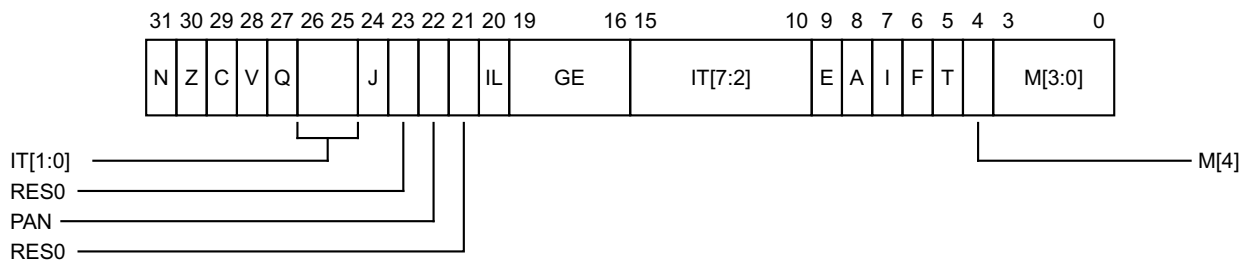

N, bit [31]

Set to the value of [CPSR.N](#) on taking an exception to FIQ mode, and copied to [CPSR.N](#) on executing an exception return operation in FIQ mode.

Z, bit [30]

Set to the value of [CPSR.Z](#) on taking an exception to FIQ mode, and copied to [CPSR.Z](#) on executing an exception return operation in FIQ mode.

C, bit [29]

Set to the value of [CPSR.C](#) on taking an exception to FIQ mode, and copied to [CPSR.C](#) on executing an exception return operation in FIQ mode.

V, bit [28]

Set to the value of [CPSR.V](#) on taking an exception to FIQ mode, and copied to [CPSR.V](#) on executing an exception return operation in FIQ mode.

Q, bit [27]

Set to the value of [CPSR.Q](#) on taking an exception to FIQ mode, and copied to [CPSR.Q](#) on executing an exception return operation in FIQ mode.

IT[1:0], bits [26:25]

IT block state bits for the T32 IT (If-Then) instruction. See IT[7:2] for explanation of this field.

J, bit [24]

RES0.

In previous versions of the architecture, the {J, T} bits determined the AArch32 Instruction set state. ARMv8 does not support either Jazelle state or T32EE state, and the T bit determines the Instruction set state.

Bit [23]

Reserved, RES0.

PAN, bit [22]

In ARMv8.2 and ARMv8.1

When [ARMv8.1-PAN](#) is implemented, set to the value of [CPSR.PAN](#) on taking an exception to FIQ mode, and copied to [CPSR.PAN](#) on executing an exception return operation in FIQ mode.

When [ARMv8.1-PAN](#) is not implemented, this bit is RES0.

In ARMv8.0.

Reserved, RES0.

Bit [21]

Reserved, RES0.

IL, bit [20]

Illegal Execution state bit. Shows the value of [PSTATE.IL](#) immediately before the exception was taken.

GE, bits [19:16]

Greater than or Equal flags, for parallel addition and subtraction.

IT[7:2], bits [15:10]

IT block state bits for the T32 IT (If-Then) instruction. This field must be interpreted in two parts.

- IT[7:5] holds the base condition for the IT block. The base condition is the top 3 bits of the condition code specified by the first condition field of the IT instruction.
- IT[4:0] encodes the size of the IT block, which is the number of instructions that are to be conditionally executed, by the position of the least significant 1 in this field. It also encodes the value of the least significant bit of the condition code for each instruction in the block.

The IT field is `0b00000000` when no IT block is active.

E, bit [9]

Endianness state bit. Controls the load and store endianness for data accesses:

0 Little-endian operation

1 Big-endian operation.

Instruction fetches ignore this bit.

When the reset value of the [SCTLR.EE](#) bit is defined by a configuration input signal, that value also applies to the [CPSR.E](#) bit on reset, and therefore applies to software execution from reset.

If an implementation does not provide Big-endian support, this bit is RES0. If it does not provide Little-endian support, this bit is RES1.

If an implementation provides Big-endian support but only at EL0, this bit is RES0 for an exception return to any Exception level other than EL0.

Likewise, if it provides Little-endian support only at EL0, this bit is RES1 for an exception return to any Exception level other than EL0.

A, bit [8]

SError interrupt mask bit. The possible values of this bit are:

0 Exception not masked.

1 Exception masked.

I, bit [7]

IRQ mask bit. The possible values of this bit are:

- 0 Exception not masked.
- 1 Exception masked.

F, bit [6]

FIQ mask bit. The possible values of this bit are:

- 0 Exception not masked.
- 1 Exception masked.

T, bit [5]

T32 Instruction set state bit. Determines the AArch32 instruction set state that the exception was taken from. Possible values of this bit are:

- 0 Taken from A32 state.
- 1 Taken from T32 state.

M[4], bit [4]

Execution state that the exception was taken from. Possible values of this bit are:

- 1 Exception taken from AArch32.

M[3:0], bits [3:0]

AArch32 mode that an exception was taken from. The possible values are:

M[3:0]	Mode
0b0000	User
0b0001	FIQ
0b0010	IRQ
0b0011	Supervisor
0b0110	Monitor (only valid in Secure state, if EL3 is implemented and can use AArch32)
0b0111	Abort
0b1011	Undefined
0b1111	System

Other values are reserved. The effect of programming this field to a Reserved value is that behavior is **CONSTRAINED UNPREDICTABLE**, as described in *Reserved values in System and memory-mapped registers and translation table entries* on page K1-6117.

Accessing the SPSR_fiq

This register can be read using MRS (banked register) with the following syntax:

MRS <Rd>, <banked_reg>

This register can be written using MSR (banked register) with the following syntax:

MSR <banked_reg>, <Rd>

This syntax is encoded with the following settings in the instruction encoding:

<banked_reg>	R	M	M1
SPSR_fiq	1	0	1110

Accessibility

The register is accessible in software as follows:

Control			Accessibility			
E2H	TGE	NS	EL0	EL1	EL2	EL3
x	x	0	-	RW	n/a	RW
x	0	1	-	RW	RW	RW
x	1	1	-	n/a	RW	RW

Using MRS (banked register) and MSR (banked register) instructions, at PL1 this register is only accessible from PE modes other than FIQ mode. In FIQ mode, it is accessible as the current SPSR.

G6.2.122 SPSR_hyp, Saved Program Status Register (Hyp mode)

The SPSR_hyp characteristics are:

Purpose

Holds the saved process state when an exception is taken to Hyp mode.

Configurations

There is one instance of this register that is used in both Secure and Non-secure states.

AArch32 System register SPSR_hyp is architecturally mapped to AArch64 System register [SPSR_EL2](#).

Attributes

SPSR_hyp is a 32-bit register.

Field descriptions

The SPSR_hyp bit assignments are:

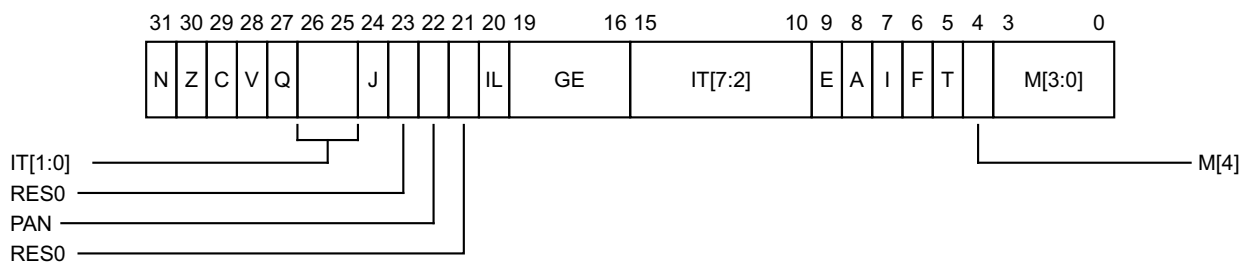

N, bit [31]

Set to the value of [CPSR.N](#) on taking an exception to Hyp mode, and copied to [CPSR.N](#) on executing an exception return operation in Hyp mode.

Z, bit [30]

Set to the value of [CPSR.Z](#) on taking an exception to Hyp mode, and copied to [CPSR.Z](#) on executing an exception return operation in Hyp mode.

C, bit [29]

Set to the value of [CPSR.C](#) on taking an exception to Hyp mode, and copied to [CPSR.C](#) on executing an exception return operation in Hyp mode.

V, bit [28]

Set to the value of [CPSR.V](#) on taking an exception to Hyp mode, and copied to [CPSR.V](#) on executing an exception return operation in Hyp mode.

Q, bit [27]

Set to the value of [CPSR.Q](#) on taking an exception to Hyp mode, and copied to [CPSR.Q](#) on executing an exception return operation in Hyp mode.

IT[1:0], bits [26:25]

IT block state bits for the T32 IT (If-Then) instruction. See IT[7:2] for explanation of this field.

J, bit [24]

RES0.

In previous versions of the architecture, the {J, T} bits determined the AArch32 Instruction set state. ARMv8 does not support either Jazelle state or T32EE state, and the T bit determines the Instruction set state.

Bit [23]

Reserved, RES0.

PAN, bit [22]

In ARMv8.2 and ARMv8.1

When [ARMv8.1-PAN](#) is implemented, set to the value of [CPSR.PAN](#) on taking an exception to Hyp mode, and copied to [CPSR.PAN](#) on executing an exception return operation in Hyp mode.

When [ARMv8.1-PAN](#) is not implemented, this bit is RES0.

In ARMv8.0.

Reserved, RES0.

Bit [21]

Reserved, RES0.

IL, bit [20]

Illegal Execution state bit. Shows the value of [PSTATE.IL](#) immediately before the exception was taken.

GE, bits [19:16]

Greater than or Equal flags, for parallel addition and subtraction.

IT[7:2], bits [15:10]

IT block state bits for the T32 IT (If-Then) instruction. This field must be interpreted in two parts.

- IT[7:5] holds the base condition for the IT block. The base condition is the top 3 bits of the condition code specified by the first condition field of the IT instruction.
- IT[4:0] encodes the size of the IT block, which is the number of instructions that are to be conditionally executed, by the position of the least significant 1 in this field. It also encodes the value of the least significant bit of the condition code for each instruction in the block.

The IT field is `0b00000000` when no IT block is active.

E, bit [9]

Endianness state bit. Controls the load and store endianness for data accesses:

0 Little-endian operation

1 Big-endian operation.

Instruction fetches ignore this bit.

When the reset value of the [SCTLR.EE](#) bit is defined by a configuration input signal, that value also applies to the [CPSR.E](#) bit on reset, and therefore applies to software execution from reset.

If an implementation does not provide Big-endian support, this bit is RES0. If it does not provide Little-endian support, this bit is RES1.

If an implementation provides Big-endian support but only at EL0, this bit is RES0 for an exception return to any Exception level other than EL0.

Likewise, if it provides Little-endian support only at EL0, this bit is RES1 for an exception return to any Exception level other than EL0.

A, bit [8]

SError interrupt mask bit. The possible values of this bit are:

0 Exception not masked.

1 Exception masked.

I, bit [7]

IRQ mask bit. The possible values of this bit are:

- 0 Exception not masked.
- 1 Exception masked.

F, bit [6]

FIQ mask bit. The possible values of this bit are:

- 0 Exception not masked.
- 1 Exception masked.

T, bit [5]

T32 Instruction set state bit. Determines the AArch32 instruction set state that the exception was taken from. Possible values of this bit are:

- 0 Taken from A32 state.
- 1 Taken from T32 state.

M[4], bit [4]

Execution state that the exception was taken from. Possible values of this bit are:

- 1 Exception taken from AArch32.

M[3:0], bits [3:0]

AArch32 mode that an exception was taken from. The possible values are:

M[3:0]	Mode
0b0000	User
0b0001	FIQ
0b0010	IRQ
0b0011	Supervisor
0b0111	Abort
0b1010	Hyp
0b1011	Undefined
0b1111	System

Other values are reserved. The effect of programming this field to a Reserved value is that behavior is **CONSTRAINED UNPREDICTABLE**, as described in *Reserved values in System and memory-mapped registers and translation table entries* on page K1-6117.

Accessing the SPSR_hyp

This register can be read using MRS (banked register) with the following syntax:

MRS <Rd>, <banked_reg>

This register can be written using MSR (banked register) with the following syntax:

MSR <banked_reg>, <Rd>

This syntax is encoded with the following settings in the instruction encoding:

<banked_reg>	R	M	M1
SPSR_hyp	1	1	1110

Accessibility

The register is accessible in software as follows:

Control			Accessibility			
E2H	TGE	NS	EL0	EL1	EL2	EL3
x	x	0	-	-	n/a	RW
x	0	1	-	-	-	RW
x	1	1	-	n/a	-	RW

Using MRS (banked register) and MSR (banked register) instructions, this register is only accessible from Monitor mode. In Hyp mode, this register is accessible as the current SPSR.

G6.2.123 SPSR_irq, Saved Program Status Register (IRQ mode)

The SPSR_irq characteristics are:

Purpose

Holds the saved process state when an exception is taken to IRQ mode.

Configurations

There is one instance of this register that is used in both Secure and Non-secure states.

AArch32 System register SPSR_irq is architecturally mapped to AArch64 System register [SPSR_irq](#).

Attributes

SPSR_irq is a 32-bit register.

Field descriptions

The SPSR_irq bit assignments are:

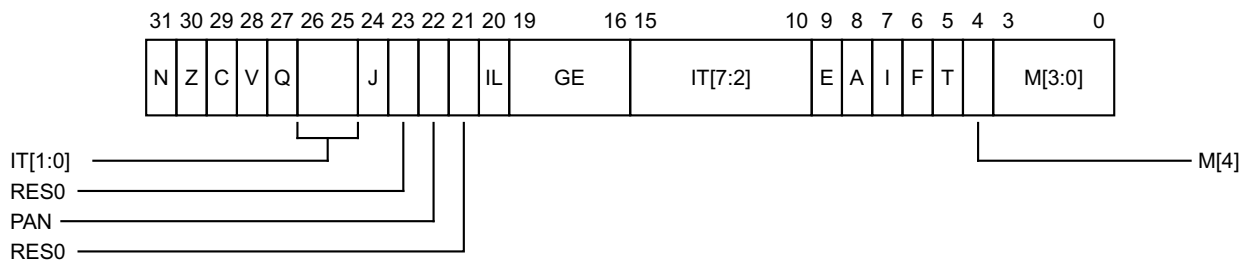

N, bit [31]

Set to the value of [CPSR.N](#) on taking an exception to IRQ mode, and copied to [CPSR.N](#) on executing an exception return operation in IRQ mode.

Z, bit [30]

Set to the value of [CPSR.Z](#) on taking an exception to IRQ mode, and copied to [CPSR.Z](#) on executing an exception return operation in IRQ mode.

C, bit [29]

Set to the value of [CPSR.C](#) on taking an exception to IRQ mode, and copied to [CPSR.C](#) on executing an exception return operation in IRQ mode.

V, bit [28]

Set to the value of [CPSR.V](#) on taking an exception to IRQ mode, and copied to [CPSR.V](#) on executing an exception return operation in IRQ mode.

Q, bit [27]

Set to the value of [CPSR.Q](#) on taking an exception to IRQ mode, and copied to [CPSR.Q](#) on executing an exception return operation in IRQ mode.

IT[1:0], bits [26:25]

IT block state bits for the T32 IT (If-Then) instruction. See IT[7:2] for explanation of this field.

J, bit [24]

RES0.

In previous versions of the architecture, the {J, T} bits determined the AArch32 Instruction set state. ARMv8 does not support either Jazelle state or T32EE state, and the T bit determines the Instruction set state.

Bit [23]

Reserved, RES0.

PAN, bit [22]

In ARMv8.2 and ARMv8.1

When [ARMv8.1-PAN](#) is implemented, set to the value of [CPSR.PAN](#) on taking an exception to IRQ mode, and copied to [CPSR.PAN](#) on executing an exception return operation in IRQ mode.

When [ARMv8.1-PAN](#) is not implemented, this bit is RES0.

In ARMv8.0.

Reserved, RES0.

Bit [21]

Reserved, RES0.

IL, bit [20]

Illegal Execution state bit. Shows the value of [PSTATE.IL](#) immediately before the exception was taken.

GE, bits [19:16]

Greater than or Equal flags, for parallel addition and subtraction.

IT[7:2], bits [15:10]

IT block state bits for the T32 IT (If-Then) instruction. This field must be interpreted in two parts.

- IT[7:5] holds the base condition for the IT block. The base condition is the top 3 bits of the condition code specified by the first condition field of the IT instruction.
- IT[4:0] encodes the size of the IT block, which is the number of instructions that are to be conditionally executed, by the position of the least significant 1 in this field. It also encodes the value of the least significant bit of the condition code for each instruction in the block.

The IT field is `0b00000000` when no IT block is active.

E, bit [9]

Endianness state bit. Controls the load and store endianness for data accesses:

0 Little-endian operation

1 Big-endian operation.

Instruction fetches ignore this bit.

When the reset value of the [SCTLR.EE](#) bit is defined by a configuration input signal, that value also applies to the [CPSR.E](#) bit on reset, and therefore applies to software execution from reset.

If an implementation does not provide Big-endian support, this bit is RES0. If it does not provide Little-endian support, this bit is RES1.

If an implementation provides Big-endian support but only at EL0, this bit is RES0 for an exception return to any Exception level other than EL0.

Likewise, if it provides Little-endian support only at EL0, this bit is RES1 for an exception return to any Exception level other than EL0.

A, bit [8]

SError interrupt mask bit. The possible values of this bit are:

0 Exception not masked.

1 Exception masked.

I, bit [7]

IRQ mask bit. The possible values of this bit are:

- 0 Exception not masked.
- 1 Exception masked.

F, bit [6]

FIQ mask bit. The possible values of this bit are:

- 0 Exception not masked.
- 1 Exception masked.

T, bit [5]

T32 Instruction set state bit. Determines the AArch32 instruction set state that the exception was taken from. Possible values of this bit are:

- 0 Taken from A32 state.
- 1 Taken from T32 state.

M[4], bit [4]

Execution state that the exception was taken from. Possible values of this bit are:

- 1 Exception taken from AArch32.

M[3:0], bits [3:0]

AArch32 mode that an exception was taken from. The possible values are:

M[3:0]	Mode
0b0000	User
0b0001	FIQ
0b0010	IRQ
0b0011	Supervisor
0b0110	Monitor (only valid in Secure state, if EL3 is implemented and can use AArch32)
0b0111	Abort
0b1011	Undefined
0b1111	System

Other values are reserved. The effect of programming this field to a Reserved value is that behavior is **CONSTRAINED UNPREDICTABLE**, as described in [Reserved values in System and memory-mapped registers and translation table entries on page K1-6117](#).

Accessing the SPSR_irq

This register can be read using MRS (banked register) with the following syntax:

MRS <Rd>, <banked_reg>

This register can be written using MSR (banked register) with the following syntax:

MSR <banked_reg>, <Rd>

This syntax is encoded with the following settings in the instruction encoding:

<banked_reg>	R	M	M1
SPSR_irq	1	1	0000

Accessibility

The register is accessible in software as follows:

Control			Accessibility			
E2H	TGE	NS	EL0	EL1	EL2	EL3
x	x	0	-	RW	n/a	RW
x	0	1	-	RW	RW	RW
x	1	1	-	n/a	RW	RW

Using MRS (banked register) and MSR (banked register) instructions, at PL1 this register is only accessible from PE modes other than IRQ mode. In IRQ mode, it is accessible as the current SPSR.

G6.2.124 SPSR_mon, Saved Program Status Register (Monitor mode)

The SPSR_mon characteristics are:

Purpose

Holds the saved process state when an exception is taken to Monitor mode.

Configurations

This register is only accessible in Secure state.

AArch32 System register SPSR_mon can be mapped to AArch64 System register [SPSR_EL3](#), but this is not architecturally mandated.

Attributes

SPSR_mon is a 32-bit register.

Field descriptions

The SPSR_mon bit assignments are:

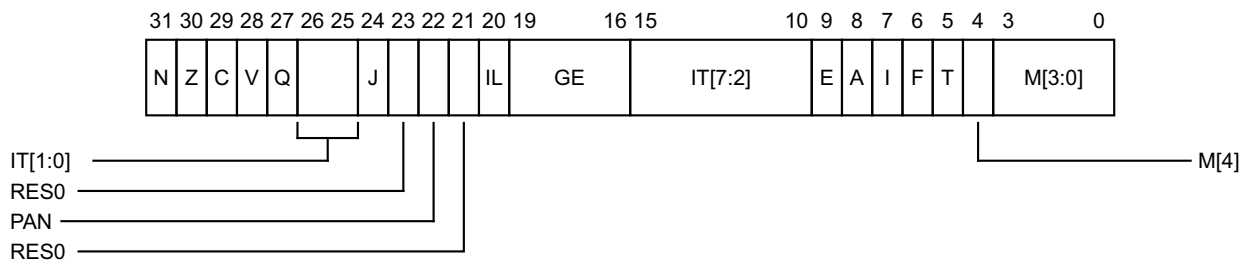

N, bit [31]

Set to the value of [CPSR.N](#) on taking an exception to Monitor mode, and copied to [CPSR.N](#) on executing an exception return operation in Monitor mode.

Z, bit [30]

Set to the value of [CPSR.Z](#) on taking an exception to Monitor mode, and copied to [CPSR.Z](#) on executing an exception return operation in Monitor mode.

C, bit [29]

Set to the value of [CPSR.C](#) on taking an exception to Monitor mode, and copied to [CPSR.C](#) on executing an exception return operation in Monitor mode.

V, bit [28]

Set to the value of [CPSR.V](#) on taking an exception to Monitor mode, and copied to [CPSR.V](#) on executing an exception return operation in Monitor mode.

Q, bit [27]

Set to the value of [CPSR.Q](#) on taking an exception to Monitor mode, and copied to [CPSR.Q](#) on executing an exception return operation in Monitor mode.

IT[1:0], bits [26:25]

IT block state bits for the T32 IT (If-Then) instruction. See [IT\[7:2\]](#) for explanation of this field.

J, bit [24]

RES0.

In previous versions of the architecture, the {J, T} bits determined the AArch32 Instruction set state. ARMv8 does not support either Jazelle state or T32EE state, and the T bit determines the Instruction set state.

Bit [23]

Reserved, RES0.

PAN, bit [22]

In ARMv8.2 and ARMv8.1

When [ARMv8.1-PAN](#) is implemented, set to the value of [CPSR.PAN](#) on taking an exception to Monitor mode, and copied to [CPSR.PAN](#) on executing an exception return operation in Monitor mode.

When [ARMv8.1-PAN](#) is not implemented, this bit is RES0.

In ARMv8.0.

Reserved, RES0.

Bit [21]

Reserved, RES0.

IL, bit [20]

Illegal Execution state bit. Shows the value of [PSTATE.IL](#) immediately before the exception was taken.

GE, bits [19:16]

Greater than or Equal flags, for parallel addition and subtraction.

IT[7:2], bits [15:10]

IT block state bits for the T32 IT (If-Then) instruction. This field must be interpreted in two parts.

- IT[7:5] holds the base condition for the IT block. The base condition is the top 3 bits of the condition code specified by the first condition field of the IT instruction.
- IT[4:0] encodes the size of the IT block, which is the number of instructions that are to be conditionally executed, by the position of the least significant 1 in this field. It also encodes the value of the least significant bit of the condition code for each instruction in the block.

The IT field is 0b00000000 when no IT block is active.

E, bit [9]

Endianness state bit. Controls the load and store endianness for data accesses:

- | | |
|---|-------------------------|
| 0 | Little-endian operation |
| 1 | Big-endian operation. |

Instruction fetches ignore this bit.

When the reset value of the [SCTLR.EE](#) bit is defined by a configuration input signal, that value also applies to the [CPSR.E](#) bit on reset, and therefore applies to software execution from reset.

If an implementation does not provide Big-endian support, this bit is RES0. If it does not provide Little-endian support, this bit is RES1.

If an implementation provides Big-endian support but only at EL0, this bit is RES0 for an exception return to any Exception level other than EL0.

Likewise, if it provides Little-endian support only at EL0, this bit is RES1 for an exception return to any Exception level other than EL0.

A, bit [8]

SError interrupt mask bit. The possible values of this bit are:

- | | |
|---|-----------------------|
| 0 | Exception not masked. |
| 1 | Exception masked. |

I, bit [7]

IRQ mask bit. The possible values of this bit are:

- 0 Exception not masked.
- 1 Exception masked.

F, bit [6]

FIQ mask bit. The possible values of this bit are:

- 0 Exception not masked.
- 1 Exception masked.

T, bit [5]

T32 Instruction set state bit. Determines the AArch32 instruction set state that the exception was taken from. Possible values of this bit are:

- 0 Taken from A32 state.
- 1 Taken from T32 state.

M[4], bit [4]

Execution state that the exception was taken from. Possible values of this bit are:

- 1 Exception taken from AArch32.

M[3:0], bits [3:0]

AArch32 mode that an exception was taken from. The possible values are:

M[3:0]	Mode
0b0000	User
0b0001	FIQ
0b0010	IRQ
0b0011	Supervisor
0b0110	Monitor (only valid in Secure state, if EL3 is implemented and can use AArch32)
0b0111	Abort
0b1010	Hyp
0b1011	Undefined
0b1111	System

Other values are reserved. The effect of programming this field to a Reserved value is that behavior is CONstrained UNPREDICTABLE, as described in [Reserved values in System and memory-mapped registers and translation table entries on page K1-6117](#).

Accessing the SPSR_mon

This register can be read using MRS (banked register) with the following syntax:

MRS <Rd>, <banked_reg>

This register can be written using MSR (banked register) with the following syntax:

MSR <banked_reg>, <Rd>

This syntax is encoded with the following settings in the instruction encoding:

<banked_reg>	R	M	M1
SPSR_mon	1	1	1100

Accessibility

The register is accessible in software as follows:

Control			Accessibility			
E2H	TGE	NS	EL0	EL1	EL2	EL3
x	x	0	-	-	n/a	RW
x	0	1	-	-	-	RW
x	1	1	-	n/a	-	RW

Using MRS (banked register) and MSR (banked register) instructions, this register is only accessible from EL3 modes other than Monitor mode. In Monitor mode, it is accessible as the current SPSR.

G6.2.125 SPSR_svc, Saved Program Status Register (Supervisor mode)

The SPSR_svc characteristics are:

Purpose

Holds the saved process state when an exception is taken to Supervisor mode.

Configurations

There is one instance of this register that is used in both Secure and Non-secure states.

AArch32 System register SPSR_svc is architecturally mapped to AArch64 System register [SPSR_EL1](#).

Attributes

SPSR_svc is a 32-bit register.

Field descriptions

The SPSR_svc bit assignments are:

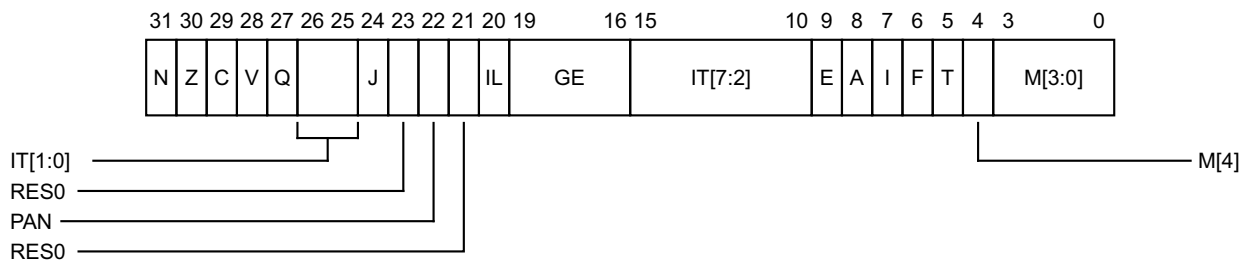

N, bit [31]

Set to the value of [CPSR.N](#) on taking an exception to Supervisor mode, and copied to [CPSR.N](#) on executing an exception return operation in Supervisor mode.

Z, bit [30]

Set to the value of [CPSR.Z](#) on taking an exception to Supervisor mode, and copied to [CPSR.Z](#) on executing an exception return operation in Supervisor mode.

C, bit [29]

Set to the value of [CPSR.C](#) on taking an exception to Supervisor mode, and copied to [CPSR.C](#) on executing an exception return operation in Supervisor mode.

V, bit [28]

Set to the value of [CPSR.V](#) on taking an exception to Supervisor mode, and copied to [CPSR.V](#) on executing an exception return operation in Supervisor mode.

Q, bit [27]

Set to the value of [CPSR.Q](#) on taking an exception to Supervisor mode, and copied to [CPSR.Q](#) on executing an exception return operation in Supervisor mode.

IT[1:0], bits [26:25]

IT block state bits for the T32 IT (If-Then) instruction. See [IT\[7:2\]](#) for explanation of this field.

J, bit [24]

RES0.

In previous versions of the architecture, the {J, T} bits determined the AArch32 Instruction set state. ARMv8 does not support either Jazelle state or T32EE state, and the T bit determines the Instruction set state.

Bit [23]

Reserved, RES0.

PAN, bit [22]

In ARMv8.2 and ARMv8.1

When [ARMv8.1-PAN](#) is implemented, set to the value of [CPSR.PAN](#) on taking an exception to Supervisor mode, and copied to [CPSR.PAN](#) on executing an exception return operation in Supervisor mode.

When [ARMv8.1-PAN](#) is not implemented, this bit is RES0.

In ARMv8.0.

Reserved, RES0.

Bit [21]

Reserved, RES0.

IL, bit [20]

Illegal Execution state bit. Shows the value of [PSTATE.IL](#) immediately before the exception was taken.

GE, bits [19:16]

Greater than or Equal flags, for parallel addition and subtraction.

IT[7:2], bits [15:10]

IT block state bits for the T32 IT (If-Then) instruction. This field must be interpreted in two parts.

- IT[7:5] holds the base condition for the IT block. The base condition is the top 3 bits of the condition code specified by the first condition field of the IT instruction.
- IT[4:0] encodes the size of the IT block, which is the number of instructions that are to be conditionally executed, by the position of the least significant 1 in this field. It also encodes the value of the least significant bit of the condition code for each instruction in the block.

The IT field is 0b00000000 when no IT block is active.

E, bit [9]

Endianness state bit. Controls the load and store endianness for data accesses:

- | | |
|---|-------------------------|
| 0 | Little-endian operation |
| 1 | Big-endian operation. |

Instruction fetches ignore this bit.

When the reset value of the [SCTLR.EE](#) bit is defined by a configuration input signal, that value also applies to the [CPSR.E](#) bit on reset, and therefore applies to software execution from reset.

If an implementation does not provide Big-endian support, this bit is RES0. If it does not provide Little-endian support, this bit is RES1.

If an implementation provides Big-endian support but only at EL0, this bit is RES0 for an exception return to any Exception level other than EL0.

Likewise, if it provides Little-endian support only at EL0, this bit is RES1 for an exception return to any Exception level other than EL0.

A, bit [8]

SError interrupt mask bit. The possible values of this bit are:

- | | |
|---|-----------------------|
| 0 | Exception not masked. |
| 1 | Exception masked. |

I, bit [7]

IRQ mask bit. The possible values of this bit are:

- 0 Exception not masked.
- 1 Exception masked.

F, bit [6]

FIQ mask bit. The possible values of this bit are:

- 0 Exception not masked.
- 1 Exception masked.

T, bit [5]

T32 Instruction set state bit. Determines the AArch32 instruction set state that the exception was taken from. Possible values of this bit are:

- 0 Taken from A32 state.
- 1 Taken from T32 state.

M[4], bit [4]

Execution state that the exception was taken from. Possible values of this bit are:

- 1 Exception taken from AArch32.

M[3:0], bits [3:0]

AArch32 mode that an exception was taken from. The possible values are:

M[3:0]	Mode
0b0000	User
0b0001	FIQ
0b0010	IRQ
0b0011	Supervisor
0b0110	Monitor (only valid in Secure state, if EL3 is implemented and can use AArch32)
0b0111	Abort
0b1011	Undefined
0b1111	System

Other values are reserved. The effect of programming this field to a Reserved value is that behavior is **CONSTRAINED UNPREDICTABLE**, as described in *Reserved values in System and memory-mapped registers and translation table entries* on page K1-6117.

Accessing the SPSR_svc

This register can be read using MRS (banked register) with the following syntax:

MRS <Rd>, <banked_reg>

This register can be written using MSR (banked register) with the following syntax:

MSR <banked_reg>, <Rd>

This syntax is encoded with the following settings in the instruction encoding:

<banked_reg>	R	M	M1
SPSR_svc	1	1	0010

Accessibility

The register is accessible in software as follows:

Control			Accessibility			
E2H	TGE	NS	EL0	EL1	EL2	EL3
x	x	0	-	RW	n/a	RW
x	0	1	-	RW	RW	RW
x	1	1	-	n/a	RW	RW

Using MRS (banked register) and MSR (banked register) instructions, at PL1 this register is only accessible from PE modes other than Supervisor mode. In Supervisor mode, it is accessible as the current SPSR.

G6.2.126 SPSR_und, Saved Program Status Register (Undefined mode)

The SPSR_und characteristics are:

Purpose

Holds the saved process state when an exception is taken to Undefined mode.

Configurations

There is one instance of this register that is used in both Secure and Non-secure states.

AArch32 System register SPSR_und is architecturally mapped to AArch64 System register [SPSR_und](#).

Attributes

SPSR_und is a 32-bit register.

Field descriptions

The SPSR_und bit assignments are:

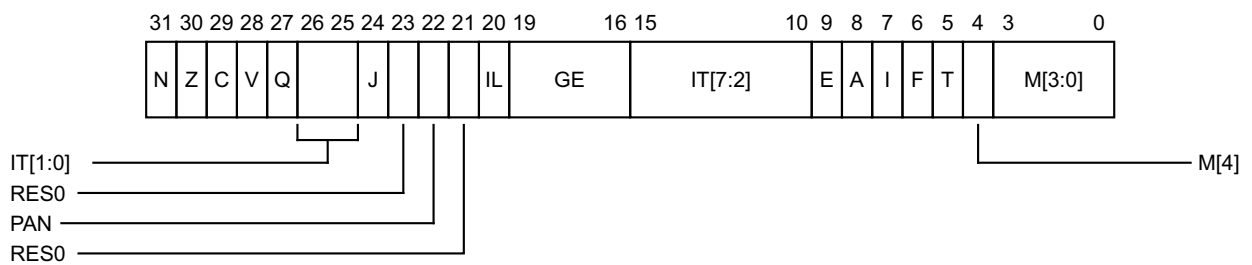

N, bit [31]

Set to the value of [CPSR.N](#) on taking an exception to Undefined mode, and copied to [CPSR.N](#) on executing an exception return operation in Undefined mode.

Z, bit [30]

Set to the value of [CPSR.Z](#) on taking an exception to Undefined mode, and copied to [CPSR.Z](#) on executing an exception return operation in Undefined mode.

C, bit [29]

Set to the value of [CPSR.C](#) on taking an exception to Undefined mode, and copied to [CPSR.C](#) on executing an exception return operation in Undefined mode.

V, bit [28]

Set to the value of [CPSR.V](#) on taking an exception to Undefined mode, and copied to [CPSR.V](#) on executing an exception return operation in Undefined mode.

Q, bit [27]

Set to the value of [CPSR.Q](#) on taking an exception to Undefined mode, and copied to [CPSR.Q](#) on executing an exception return operation in Undefined mode.

IT[1:0], bits [26:25]

IT block state bits for the T32 IT (If-Then) instruction. See [IT\[7:2\]](#) for explanation of this field.

J, bit [24]

RES0.

In previous versions of the architecture, the {J, T} bits determined the AArch32 Instruction set state. ARMv8 does not support either Jazelle state or T32EE state, and the T bit determines the Instruction set state.

Bit [23]

Reserved, RES0.

PAN, bit [22]

In ARMv8.2 and ARMv8.1

When [ARMv8.1-PAN](#) is implemented, set to the value of [CPSR.PAN](#) on taking an exception to Undefined mode, and copied to [CPSR.PAN](#) on executing an exception return operation in Undefined mode.

When [ARMv8.1-PAN](#) is not implemented, this bit is RES0.

In ARMv8.0.

Reserved, RES0.

Bit [21]

Reserved, RES0.

IL, bit [20]

Illegal Execution state bit. Shows the value of [PSTATE.IL](#) immediately before the exception was taken.

GE, bits [19:16]

Greater than or Equal flags, for parallel addition and subtraction.

IT[7:2], bits [15:10]

IT block state bits for the T32 IT (If-Then) instruction. This field must be interpreted in two parts.

- IT[7:5] holds the base condition for the IT block. The base condition is the top 3 bits of the condition code specified by the first condition field of the IT instruction.
- IT[4:0] encodes the size of the IT block, which is the number of instructions that are to be conditionally executed, by the position of the least significant 1 in this field. It also encodes the value of the least significant bit of the condition code for each instruction in the block.

The IT field is 0b00000000 when no IT block is active.

E, bit [9]

Endianness state bit. Controls the load and store endianness for data accesses:

- | | |
|---|-------------------------|
| 0 | Little-endian operation |
| 1 | Big-endian operation. |

Instruction fetches ignore this bit.

When the reset value of the [SCTLR.EE](#) bit is defined by a configuration input signal, that value also applies to the [CPSR.E](#) bit on reset, and therefore applies to software execution from reset.

If an implementation does not provide Big-endian support, this bit is RES0. If it does not provide Little-endian support, this bit is RES1.

If an implementation provides Big-endian support but only at EL0, this bit is RES0 for an exception return to any Exception level other than EL0.

Likewise, if it provides Little-endian support only at EL0, this bit is RES1 for an exception return to any Exception level other than EL0.

A, bit [8]

SError interrupt mask bit. The possible values of this bit are:

- | | |
|---|-----------------------|
| 0 | Exception not masked. |
| 1 | Exception masked. |

I, bit [7]

IRQ mask bit. The possible values of this bit are:

- 0 Exception not masked.
- 1 Exception masked.

F, bit [6]

FIQ mask bit. The possible values of this bit are:

- 0 Exception not masked.
- 1 Exception masked.

T, bit [5]

T32 Instruction set state bit. Determines the AArch32 instruction set state that the exception was taken from. Possible values of this bit are:

- 0 Taken from A32 state.
- 1 Taken from T32 state.

M[4], bit [4]

Execution state that the exception was taken from. Possible values of this bit are:

- 1 Exception taken from AArch32.

M[3:0], bits [3:0]

AArch32 mode that an exception was taken from. The possible values are:

M[3:0]	Mode
0b0000	User
0b0001	FIQ
0b0010	IRQ
0b0011	Supervisor
0b0110	Monitor (only valid in Secure state, if EL3 is implemented and can use AArch32)
0b0111	Abort
0b1011	Undefined
0b1111	System

Other values are reserved. The effect of programming this field to a Reserved value is that behavior is **CONSTRAINED UNPREDICTABLE**, as described in *Reserved values in System and memory-mapped registers and translation table entries* on page K1-6117.

Accessing the SPSR_und

This register can be read using MRS (banked register) with the following syntax:

MRS <Rd>, <banked_reg>

This register can be written using MSR (banked register) with the following syntax:

MSR <banked_reg>, <Rd>

This syntax is encoded with the following settings in the instruction encoding:

<banked_reg>	R	M	M1
SPSR_und	1	1	0110

Accessibility

The register is accessible in software as follows:

Control			Accessibility			
E2H	TGE	NS	EL0	EL1	EL2	EL3
x	x	0	-	RW	n/a	RW
x	0	1	-	RW	RW	RW
x	1	1	-	n/a	RW	RW

Using MRS (banked register) and MSR (banked register) instructions, at PL1 this register is only accessible from PE modes other than Undefined mode. In Undefined mode, it is accessible as the current SPSR.

G6.2.127 TCMTR, TCM Type Register

The TCMTR characteristics are:

Purpose

Provides information about the implementation of the TCM.

Configurations

There is one instance of this register that is used in both Secure and Non-secure states.

Attributes

TCMTR is a 32-bit register.

Field descriptions

The TCMTR bit assignments are:



IMPLEMENTATION DEFINED, bits [31:0]

IMPLEMENTATION DEFINED.

Accessing the TCMTR

This register can be read using MRC with the following syntax:

MRC <syntax>

This syntax is encoded with the following settings in the instruction encoding:

<syntax>	opc1	opc2	CRn	coproc	CRm
p15, 0, <Rt>, c0, c0, 2	000	010	0000	1111	0000

Accessibility

The register is accessible in software as follows:

Control			Accessibility			
E2H	TGE	NS	EL0	EL1	EL2	EL3
x	x	0	-	RO	n/a	RO
x	0	1	-	RO	RO	RO
x	1	1	-	n/a	RO	RO

Traps and Enables

For a description of the prioritization of any generated exceptions, see *Synchronous exception prioritization for exceptions taken to AArch32 state* on page G1-4344 for exceptions taken to AArch32 state and *Synchronous exception prioritization for exceptions taken to AArch64* on page D1-1827 for exceptions taken to AArch64 state. Subject to the prioritization rules:

- When EL2 is implemented and is using AArch64 and $(SCR_EL3.NS == 1) \&\& (HCR_EL2.E2H == 0)$:
 - If $HCR_EL2.TID1 == 1$, Non-secure read accesses to this register from EL1 are trapped to EL2.
 - If $HSTR_EL2.T0 == 1$, Non-secure read accesses to this register from EL1 are trapped to EL2.
- When EL2 is implemented and is using AArch64 and $(SCR_EL3.NS == 1) \&\& (HCR_EL2.E2H == 1) \&\& (HCR_EL2.TGE == 0)$:
 - If $HCR_EL2.TID1 == 1$, Non-secure read accesses to this register from EL1 are trapped to EL2.
 - If $HSTR_EL2.T0 == 1$, Non-secure read accesses to this register from EL1 are trapped to EL2.
- When EL2 is implemented and is using AArch32 and $SCR_EL3.NS == 1$:
 - If $HCR.TID1 == 1$, Non-secure read accesses to this register from EL1 are trapped to Hyp mode.
 - If $HSTR.T0 == 1$, Non-secure read accesses to this register from EL1 are trapped to Hyp mode.

G6.2.128 TLBIALL, TLB Invalidate All

The TLBIALL characteristics are:

Purpose

Invalidate all cached copies of translation table entries from TLBs that are from any level of the translation table walk. The entries that are invalidated are as follows:

- If executed at Secure EL1 when EL3 is using AArch64, all entries that would be required for the Secure EL1&0 translation regime.
- If executed in Secure state when EL3 is using AArch32, all entries that would be required for the Secure PL1&0 translation regime.
- If executed at Non-secure EL1, all stage 1 translation table entries that would be required for the Non-secure PL1&0 translation regime and, if EL2 is implemented, they must match the current VMID.
- If executed at EL2, the stage 1 or stage 2 translation table entries that would be required for the Non-secure PL1&0 translation regime and matches the current VMID.

The invalidation only applies to the PE that executes this instruction.

Configurations

There are no configuration notes.

Attributes

TLBIALL is a 32-bit System instruction.

Field descriptions

TLBIALL ignores the value in the register specified by the instruction. Software does not have to write a value to the register before issuing this instruction.

Executing the TLBIALL instruction

This instruction is executed using MCR with the following syntax:

MCR <syntax>

This syntax uses the following encoding in the System instruction encoding space:

<syntax>	opc1	opc2	CRn	coproc	CRm
p15, 0, <Rt>, c8, c7, 0	000	000	1000	1111	0111

Accessibility

The instruction is executable as follows:

Control			Accessibility			
E2H	TGE	NS	EL0	EL1	EL2	EL3
x	x	0	-	WO	n/a	WO
x	0	1	-	WO	WO	WO
x	1	1	-	n/a	WO	WO

When [HCR.FB](#) is 1, at Non-secure EL1 this instruction executes as a [TLBIALLIS](#).

Traps and Enables

For a description of the prioritization of any generated exceptions, see *Synchronous exception prioritization for exceptions taken to AArch32 state* on page G1-4344 for exceptions taken to AArch32 state and *Synchronous exception prioritization for exceptions taken to AArch64* on page D1-1827 for exceptions taken to AArch64 state. Subject to the prioritization rules:

- When EL2 is implemented and is using AArch64 and $(SCR_EL3.NS == 1) \&\& (HCR_EL2.E2H == 0)$:
 - If $HCR_EL2.TTLB == 1$, Non-secure execution of this instruction at EL1 is trapped to EL2.
 - If $HSTR_EL2.T8 == 1$, Non-secure execution of this instruction at EL1 is trapped to EL2.
- When EL2 is implemented and is using AArch64 and $(SCR_EL3.NS == 1) \&\& (HCR_EL2.E2H == 1) \&\& (HCR_EL2.TGE == 0)$:
 - If $HCR_EL2.TTLB == 1$, Non-secure execution of this instruction at EL1 is trapped to EL2.
 - If $HSTR_EL2.T8 == 1$, Non-secure execution of this instruction at EL1 is trapped to EL2.
- When EL2 is implemented and is using AArch32 and $SCR_EL3.NS == 1$:
 - If $HCR.TTLB == 1$, Non-secure execution of this instruction at EL1 is trapped to Hyp mode.
 - If $HSTR.T8 == 1$, Non-secure execution of this instruction at EL1 is trapped to Hyp mode.

G6.2.129 TLBIALLH, TLB Invalidate All, Hyp mode

The TLBIALLH characteristics are:

Purpose

If EL2 is implemented, invalidate all cached copies of translation table entries from TLBs that are from any level of the translation table walk that would be required for the Non-secure EL2 translation regime.

The invalidation only applies to the PE that executes this instruction.

Configurations

There are no configuration notes.

Attributes

TLBIALLH is a 32-bit System instruction.

Field descriptions

TLBIALLH ignores the value in the register specified by the instruction. Software does not have to write a value to the register before issuing this instruction.

Executing the TLBIALLH instruction

This instruction is executed using MCR with the following syntax:

MCR <syntax>

This syntax uses the following encoding in the System instruction encoding space:

<syntax>	opc1	opc2	CRn	coproc	CRm
p15, 4, <Rt>, c8, c7, 0	100	000	1000	1111	0111

Accessibility

The instruction is executable as follows:

Control			Accessibility			
E2H	TGE	NS	EL0	EL1	EL2	EL3
x	x	0	-	-	n/a	WO
x	0	1	-	-	WO	WO
x	1	1	-	n/a	WO	WO

If EL2 is not implemented, this instruction is UNDEFINED.

If this instruction is executed in a Secure privileged mode other than Monitor mode, then the behavior is CONSTRAINED UNPREDICTABLE, and one of the following behaviors must occur:

- The instruction is UNDEFINED.
- The instruction is treated as a NOP.
- The instruction executes as if it had been executed in Monitor mode.

Traps and Enables

For a description of the prioritization of any generated exceptions, see *Synchronous exception prioritization for exceptions taken to AArch32 state* on page G1-4344 for exceptions taken to AArch32 state and *Synchronous exception prioritization for exceptions taken to AArch64* on page D1-1827 for exceptions taken to AArch64 state. Subject to the prioritization rules:

- When EL2 is implemented and is using AArch64 and $(SCR_EL3.NS == 1) \ \&\& \ (HCR_EL2.E2H == 0)$:
 - If $HSTR_EL2.T8 == 1$, Non-secure execution of this instruction at EL1 is trapped to EL2.
- When EL2 is implemented and is using AArch64 and $(SCR_EL3.NS == 1) \ \&\& \ (HCR_EL2.E2H == 1) \ \&\& \ (HCR_EL2.TGE == 0)$:
 - If $HSTR_EL2.T8 == 1$, Non-secure execution of this instruction at EL1 is trapped to EL2.
- When EL2 is implemented and is using AArch32 and $SCR_EL3.NS == 1$:
 - If $HSTR.T8 == 1$, Non-secure execution of this instruction at EL1 is trapped to Hyp mode.

G6.2.130 TLBIALLHIS, TLB Invalidate All, Hyp mode, Inner Shareable

The TLBIALLHIS characteristics are:

Purpose

If EL2 is implemented, invalidate all cached copies of translation table entries from TLBs that are from any level of the translation table walk that would be required for the Non-secure EL2 translation regime.

The invalidation applies to all PEs in the same Inner Shareable shareability domain as the PE that executes this instructions.

Configurations

There are no configuration notes.

Attributes

TLBIALLHIS is a 32-bit System instruction.

Field descriptions

TLBIALLHIS ignores the value in the register specified by the instruction. Software does not have to write a value to the register before issuing this instruction.

Executing the TLBIALLHIS instruction

This instruction is executed using MCR with the following syntax:

MCR <syntax>

This syntax uses the following encoding in the System instruction encoding space:

<syntax>	opc1	opc2	CRn	coproc	CRm
p15, 4, <Rt>, c8, c3, 0	100	000	1000	1111	0011

Accessibility

The instruction is executable as follows:

Control			Accessibility			
E2H	TGE	NS	EL0	EL1	EL2	EL3
x	x	0	-	-	n/a	WO
x	0	1	-	-	WO	WO
x	1	1	-	n/a	WO	WO

If EL2 is not implemented, this instruction is UNDEFINED.

If this instruction is executed in a Secure privileged mode other than Monitor mode, then the behavior is CONSTRAINED UNPREDICTABLE, and one of the following behaviors must occur:

- The instruction is UNDEFINED.
- The instruction is treated as a NOP.
- The instruction executes as if it had been executed in Monitor mode.

Traps and Enables

For a description of the prioritization of any generated exceptions, see *Synchronous exception prioritization for exceptions taken to AArch32 state* on page G1-4344 for exceptions taken to AArch32 state and *Synchronous exception prioritization for exceptions taken to AArch64* on page D1-1827 for exceptions taken to AArch64 state. Subject to the prioritization rules:

- When EL2 is implemented and is using AArch64 and $(SCR_EL3.NS == 1) \ \&\& \ (HCR_EL2.E2H == 0)$:
 - If $HSTR_EL2.T8 == 1$, Non-secure execution of this instruction at EL1 is trapped to EL2.
- When EL2 is implemented and is using AArch64 and $(SCR_EL3.NS == 1) \ \&\& \ (HCR_EL2.E2H == 1) \ \&\& \ (HCR_EL2.TGE == 0)$:
 - If $HSTR_EL2.T8 == 1$, Non-secure execution of this instruction at EL1 is trapped to EL2.
- When EL2 is implemented and is using AArch32 and $SCR_EL3.NS == 1$:
 - If $HSTR.T8 == 1$, Non-secure execution of this instruction at EL1 is trapped to Hyp mode.

G6.2.131 TLBIALLIS, TLB Invalidate All, Inner Shareable

The TLBIALLIS characteristics are:

Purpose

Invalidate all cached copies of translation table entries from TLBs that are from any level of the translation table walk. The entries that are invalidated are as follows:

- If executed at Secure EL1 when EL3 is using AArch64, all entries that would be required for the Secure EL1&0 translation regime.
- If executed in Secure state when EL3 is using AArch32, all entries that would be required for the Secure PL1&0 translation regime.
- If executed at Non-secure EL1, all stage 1 translation table entries that would be required for the Non-secure PL1&0 translation regime and, if EL2 is implemented, they must match the current VMID.
- If executed at EL2, the stage 1 or stage 2 translation table entries that would be required for the Non-secure PL1&0 translation regime and matches the current VMID.

The invalidation applies to all PEs in the same Inner Shareable shareability domain as the PE that executes this instructions.

Configurations

There are no configuration notes.

Attributes

TLBIALLIS is a 32-bit System instruction.

Field descriptions

TLBIALLIS ignores the value in the register specified by the instruction. Software does not have to write a value to the register before issuing this instruction.

Executing the TLBIALLIS instruction

This instruction is executed using MCR with the following syntax:

MCR <syntax>

This syntax uses the following encoding in the System instruction encoding space:

<syntax>	opc1	opc2	CRn	coproc	CRm
p15, 0, <Rt>, c8, c3, 0	000	000	1000	1111	0011

Accessibility

The instruction is executable as follows:

Control			Accessibility			
E2H	TGE	NS	EL0	EL1	EL2	EL3
x	x	0	-	WO	n/a	WO
x	0	1	-	WO	WO	WO
x	1	1	-	n/a	WO	WO

Traps and Enables

For a description of the prioritization of any generated exceptions, see *Synchronous exception prioritization for exceptions taken to AArch32 state* on page G1-4344 for exceptions taken to AArch32 state and *Synchronous exception prioritization for exceptions taken to AArch64* on page D1-1827 for exceptions taken to AArch64 state. Subject to the prioritization rules:

- When EL2 is implemented and is using AArch64 and $(SCR_EL3.NS == 1) \&\& (HCR_EL2.E2H == 0)$:
 - If $HCR_EL2.TTLB == 1$, Non-secure execution of this instruction at EL1 is trapped to EL2.
 - If $HSTR_EL2.T8 == 1$, Non-secure execution of this instruction at EL1 is trapped to EL2.
- When EL2 is implemented and is using AArch64 and $(SCR_EL3.NS == 1) \&\& (HCR_EL2.E2H == 1) \&\& (HCR_EL2.TGE == 0)$:
 - If $HCR_EL2.TTLB == 1$, Non-secure execution of this instruction at EL1 is trapped to EL2.
 - If $HSTR_EL2.T8 == 1$, Non-secure execution of this instruction at EL1 is trapped to EL2.
- When EL2 is implemented and is using AArch32 and $SCR_EL3.NS == 1$:
 - If $HCR.TTLB == 1$, Non-secure execution of this instruction at EL1 is trapped to Hyp mode.
 - If $HSTR.T8 == 1$, Non-secure execution of this instruction at EL1 is trapped to Hyp mode.

G6.2.132 TLBIALLNSNH, TLB Invalidate All, Non-Secure Non-Hyp

The TLBIALLNSNH characteristics are:

Purpose

If EL2 is implemented, invalidate all cached copies of translation table entries from TLBs that are from any level of the translation table walk that would be required for stage 1 or stage 2 of the Non-secure PL1&0 translation regime, regardless of the associated VMID.

The invalidation only applies to the PE that executes this instruction.

Configurations

There are no configuration notes.

Attributes

TLBIALLNSNH is a 32-bit System instruction.

Field descriptions

TLBIALLNSNH ignores the value in the register specified by the instruction. Software does not have to write a value to the register before issuing this instruction.

Executing the TLBIALLNSNH instruction

This instruction is executed using MCR with the following syntax:

MCR <syntax>

This syntax uses the following encoding in the System instruction encoding space:

<syntax>	opc1	opc2	CRn	coproc	CRm
p15, 4, <Rt>, c8, c7, 4	100	100	1000	1111	0111

Accessibility

The instruction is executable as follows:

Control			Accessibility			
E2H	TGE	NS	EL0	EL1	EL2	EL3
x	x	0	-	-	n/a	WO
x	0	1	-	-	WO	WO
x	1	1	-	n/a	WO	WO

If EL2 is not implemented, this instruction is UNDEFINED.

If this instruction is executed in a Secure privileged mode other than Monitor mode, then the behavior is CONSTRAINED UNPREDICTABLE, and one of the following behaviors must occur:

- The instruction is UNDEFINED.
- The instruction is treated as a NOP.
- The instruction executes as if it had been executed in Monitor mode.

Traps and Enables

For a description of the prioritization of any generated exceptions, see *Synchronous exception prioritization for exceptions taken to AArch32 state* on page G1-4344 for exceptions taken to AArch32 state and *Synchronous exception prioritization for exceptions taken to AArch64* on page D1-1827 for exceptions taken to AArch64 state. Subject to the prioritization rules:

- When EL2 is implemented and is using AArch64 and $(SCR_EL3.NS == 1) \&\& (HCR_EL2.E2H == 0)$:
 - If $HSTR_EL2.T8 == 1$, Non-secure execution of this instruction at EL1 is trapped to EL2.
- When EL2 is implemented and is using AArch64 and $(SCR_EL3.NS == 1) \&\& (HCR_EL2.E2H == 1) \&\& (HCR_EL2.TGE == 0)$:
 - If $HSTR_EL2.T8 == 1$, Non-secure execution of this instruction at EL1 is trapped to EL2.
- When EL2 is implemented and is using AArch32 and $SCR_EL3.NS == 1$:
 - If $HSTR.T8 == 1$, Non-secure execution of this instruction at EL1 is trapped to Hyp mode.

G6.2.133 TLBIALLNSNHIS, TLB Invalidate All, Non-Secure Non-Hyp, Inner Shareable

The TLBIALLNSNHIS characteristics are:

Purpose

If EL2 is implemented, invalidate all cached copies of translation table entries from TLBs that are from any level of the translation table walk that would be required for stage 1 or stage 2 of the Non-secure PL1&0 translation regime, regardless of the associated VMID.

The invalidation applies to all PEs in the same Inner Shareable shareability domain as the PE that executes this instructions.

Configurations

There are no configuration notes.

Attributes

TLBIALLNSNHIS is a 32-bit System instruction.

Field descriptions

TLBIALLNSNHIS ignores the value in the register specified by the instruction. Software does not have to write a value to the register before issuing this instruction.

Executing the TLBIALLNSNHIS instruction

This instruction is executed using MCR with the following syntax:

MCR <syntax>

This syntax uses the following encoding in the System instruction encoding space:

<syntax>	opc1	opc2	CRn	coproc	CRm
p15, 4, <Rt>, c8, c3, 4	100	100	1000	1111	0011

Accessibility

The instruction is executable as follows:

Control			Accessibility			
E2H	TGE	NS	EL0	EL1	EL2	EL3
x	x	0	-	-	n/a	WO
x	0	1	-	-	WO	WO
x	1	1	-	n/a	WO	WO

If EL2 is not implemented, this instruction is UNDEFINED.

If this instruction is executed in a Secure privileged mode other than Monitor mode, then the behavior is CONSTRAINED UNPREDICTABLE, and one of the following behaviors must occur:

- The instruction is UNDEFINED.
- The instruction is treated as a NOP.
- The instruction executes as if it had been executed in Monitor mode.

Traps and Enables

For a description of the prioritization of any generated exceptions, see *Synchronous exception prioritization for exceptions taken to AArch32 state* on page G1-4344 for exceptions taken to AArch32 state and *Synchronous exception prioritization for exceptions taken to AArch64* on page D1-1827 for exceptions taken to AArch64 state. Subject to the prioritization rules:

- When EL2 is implemented and is using AArch64 and $(SCR_EL3.NS == 1) \&\& (HCR_EL2.E2H == 0)$:
 - If $HSTR_EL2.T8 == 1$, Non-secure execution of this instruction at EL1 is trapped to EL2.
- When EL2 is implemented and is using AArch64 and $(SCR_EL3.NS == 1) \&\& (HCR_EL2.E2H == 1) \&\& (HCR_EL2.TGE == 0)$:
 - If $HSTR_EL2.T8 == 1$, Non-secure execution of this instruction at EL1 is trapped to EL2.
- When EL2 is implemented and is using AArch32 and $SCR_EL3.NS == 1$:
 - If $HSTR.T8 == 1$, Non-secure execution of this instruction at EL1 is trapped to Hyp mode.

G6.2.134 TLBIASID, TLB Invalidate by ASID match

The TLBIASID characteristics are:

Purpose

Invalidate all cached copies of translation table entries from TLBs that meet the following requirements:

- The entry is a stage 1 translation table entry.
- The entry would be used for the specified ASID, and either:
 - Is from a level of lookup above the final level.
 - Is a non-global entry from the final level of lookup.
- If EL2 is implemented, the entry would be used with the current VMID.

From the entries that match these requirement, the entries that are invalidated are required for the following translation regime:

- If executed at Secure EL1 when EL3 is using AArch64, the Secure EL1&0 translation regime.
- If executed in Secure state when EL3 is using AArch32, the Secure PL1&0 translation regime.
- If executed in Non-secure state, the Non-secure PL1&0 translation regime.

The invalidation only applies to the PE that executes this instruction.

Configurations

There are no configuration notes.

Attributes

TLBIASID is a 32-bit System instruction.

Field descriptions

The TLBIASID input value bit assignments are:

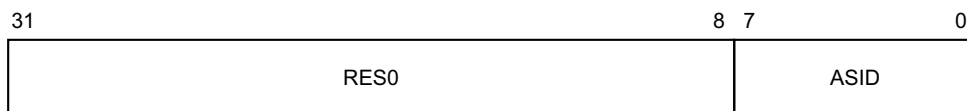

Bits [31:8]

Reserved, RES0.

ASID, bits [7:0]

ASID value to match. Any TLB entries for non-global pages that match the ASID values will be affected by this operation.

Executing the TLBIASID instruction

This instruction is executed using MCR with the following syntax:

MCR <syntax>

This syntax uses the following encoding in the System instruction encoding space:

<syntax>	opc1	opc2	CRn	coproc	CRm
p15, 0, <Rt>, c8, c7, 2	000	010	1000	1111	0111

Accessibility

The instruction is executable as follows:

Control			Accessibility			
E2H	TGE	NS	EL0	EL1	EL2	EL3
x	x	0	-	WO	n/a	WO
x	0	1	-	WO	WO	WO
x	1	1	-	n/a	WO	WO

When `HCR.FB` is 1, at Non-secure EL1 this instruction executes as a `TLBIASIDIS`.

Traps and Enables

For a description of the prioritization of any generated exceptions, see *Synchronous exception prioritization for exceptions taken to AArch32 state* on page G1-4344 for exceptions taken to AArch32 state and *Synchronous exception prioritization for exceptions taken to AArch64* on page D1-1827 for exceptions taken to AArch64 state. Subject to the prioritization rules:

- When EL2 is implemented and is using AArch64 and $(SCR_EL3.NS == 1) \ \&\& \ (HCR_EL2.E2H == 0)$:
 - If $HCR_EL2.TTLB == 1$, Non-secure execution of this instruction at EL1 is trapped to EL2.
 - If $HSTR_EL2.T8 == 1$, Non-secure execution of this instruction at EL1 is trapped to EL2.
- When EL2 is implemented and is using AArch64 and $(SCR_EL3.NS == 1) \ \&\& \ (HCR_EL2.E2H == 1) \ \&\& \ (HCR_EL2.TGE == 0)$:
 - If $HCR_EL2.TTLB == 1$, Non-secure execution of this instruction at EL1 is trapped to EL2.
 - If $HSTR_EL2.T8 == 1$, Non-secure execution of this instruction at EL1 is trapped to EL2.
- When EL2 is implemented and is using AArch32 and $SCR_EL3.NS == 1$:
 - If $HCR.TTLB == 1$, Non-secure execution of this instruction at EL1 is trapped to Hyp mode.
 - If $HSTR.T8 == 1$, Non-secure execution of this instruction at EL1 is trapped to Hyp mode.

G6.2.135 TLBIASIDIS, TLB Invalidate by ASID match, Inner Shareable

The TLBIASIDIS characteristics are:

Purpose

Invalidate all cached copies of translation table entries from TLBs that meet the following requirements:

- The entry is a stage 1 translation table entry.
- The entry would be used for the specified ASID, and either:
 - Is from a level of lookup above the final level.
 - Is a non-global entry from the final level of lookup.
- If EL2 is implemented, the entry would be used with the current VMID.

From the entries that match these requirement, the entries that are invalidated are required for the following translation regime:

- If executed at Secure EL1 when EL3 is using AArch64, the Secure EL1&0 translation regime.
- If executed in Secure state when EL3 is using AArch32, the Secure PL1&0 translation regime.
- If executed in Non-secure state, the Non-secure PL1&0 translation regime.

The invalidation applies to all PEs in the same Inner Shareable shareability domain as the PE that executes this instructions.

Configurations

There are no configuration notes.

Attributes

TLBIASIDIS is a 32-bit System instruction.

Field descriptions

The TLBIASIDIS input value bit assignments are:

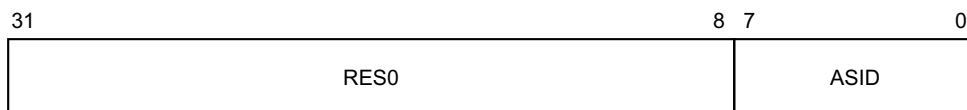

Bits [31:8]

Reserved, RES0.

ASID, bits [7:0]

ASID value to match. Any TLB entries for non-global pages that match the ASID values will be affected by this operation.

Executing the TLBIASIDIS instruction

This instruction is executed using MCR with the following syntax:

MCR <syntax>

This syntax uses the following encoding in the System instruction encoding space:

<syntax>	opc1	opc2	CRn	coproc	CRm
p15, 0, <Rt>, c8, c3, 2	000	010	1000	1111	0011

Accessibility

The instruction is executable as follows:

Control			Accessibility			
E2H	TGE	NS	EL0	EL1	EL2	EL3
x	x	0	-	WO	n/a	WO
x	0	1	-	WO	WO	WO
x	1	1	-	n/a	WO	WO

Traps and Enables

For a description of the prioritization of any generated exceptions, see [Synchronous exception prioritization for exceptions taken to AArch32 state on page G1-4344](#) for exceptions taken to AArch32 state and [Synchronous exception prioritization for exceptions taken to AArch64 on page D1-1827](#) for exceptions taken to AArch64 state. Subject to the prioritization rules:

- When EL2 is implemented and is using AArch64 and (SCR_EL3.NS == 1) && (HCR_EL2.E2H == 0):
 - If HCR_EL2.TTLB==1, Non-secure execution of this instruction at EL1 is trapped to EL2.
 - If HSTR_EL2.T8==1, Non-secure execution of this instruction at EL1 is trapped to EL2.
- When EL2 is implemented and is using AArch64 and (SCR_EL3.NS == 1) && (HCR_EL2.E2H == 1) && (HCR_EL2.TGE == 0):
 - If HCR_EL2.TTLB==1, Non-secure execution of this instruction at EL1 is trapped to EL2.
 - If HSTR_EL2.T8==1, Non-secure execution of this instruction at EL1 is trapped to EL2.
- When EL2 is implemented and is using AArch32 and SCR_EL3.NS == 1:
 - If HCR.TTLB==1, Non-secure execution of this instruction at EL1 is trapped to Hyp mode.
 - If HSTR.T8==1, Non-secure execution of this instruction at EL1 is trapped to Hyp mode.

G6.2.136 TLBIIPAS2, TLB Invalidate by Intermediate Physical Address, Stage 2

The TLBIIPAS2 characteristics are:

Purpose

If EL2 is implemented, invalidate all cached copies of translation table entries from TLBs that meet the following requirements:

- The entry is a stage 2 only translation table entry, from any level of the translation table walk.
- SCR.NS is 1.
- The entry would be used for the specified IPA.
- The entry would be used with the current VMID.
- The entry would be required for the PL1&0 translation regime.

The invalidation is not required to apply to caching structures that combine stage 1 and stage 2 translation table entries.

The invalidation only applies to the PE that executes this instruction.

Configurations

———— Note ————

This System instruction is not implemented in architecture versions before ARMv8.

Attributes

TLBIIPAS2 is a 32-bit System instruction.

Field descriptions

The TLBIIPAS2 input value bit assignments are:

31	28 27	0
RES0	IPA[39:12]	

Bits [31:28]

Reserved, RES0.

IPA[39:12], bits [27:0]

Bits[39:12] of the intermediate physical address to match.

Executing the TLBIIPAS2 instruction

This instruction is executed using MCR with the following syntax:

MCR <syntax>

This syntax uses the following encoding in the System instruction encoding space:

<syntax>	opc1	opc2	CRn	coproc	CRm
p15, 4, <Rt>, c8, c4, 1	100	001	1000	1111	0100

Accessibility

The instruction is executable as follows:

Control			Accessibility			
E2H	TGE	NS	EL0	EL1	EL2	EL3
x	x	0	-	-	n/a	WO
x	0	1	-	-	WO	WO
x	1	1	-	n/a	WO	WO

If EL2 is not implemented, this instruction is UNDEFINED.

If SCR.NS is 0, this instruction is a NOP.

If this instruction is executed in a Secure privileged mode other than Monitor mode, then the behavior is CONSTRAINED UNPREDICTABLE, and one of the following behaviors must occur:

- The instruction is UNDEFINED.
- The instruction is treated as a NOP.
- The instruction executes as if it had been executed in Monitor mode.

Traps and Enables

For a description of the prioritization of any generated exceptions, see [Synchronous exception prioritization for exceptions taken to AArch32 state on page G1-4344](#) for exceptions taken to AArch32 state and [Synchronous exception prioritization for exceptions taken to AArch64 on page D1-1827](#) for exceptions taken to AArch64 state. Subject to the prioritization rules:

- When EL2 is implemented and is using AArch64 and (SCR_EL3.NS == 1) && (HCR_EL2.E2H == 0):
 - If HSTR_EL2.T8==1, Non-secure execution of this instruction at EL1 is trapped to EL2.
- When EL2 is implemented and is using AArch64 and (SCR_EL3.NS == 1) && (HCR_EL2.E2H == 1) && (HCR_EL2.TGE == 0):
 - If HSTR_EL2.T8==1, Non-secure execution of this instruction at EL1 is trapped to EL2.
- When EL2 is implemented and is using AArch32 and SCR_EL3.NS == 1:
 - If HSTR.T8==1, Non-secure execution of this instruction at EL1 is trapped to Hyp mode.

G6.2.137 TLBIIPAS2IS, TLB Invalidate by Intermediate Physical Address, Stage 2, Inner Shareable

The TLBIIPAS2IS characteristics are:

Purpose

If EL2 is implemented, invalidate all cached copies of translation table entries from TLBs that meet the following requirements:

- The entry is a stage 2 only translation table entry, from any level of the translation table walk.
- SCR.NS is 1.
- The entry would be used for the specified IPA.
- The entry would be used with the current VMID.
- The entry would be required for the PL1&0 translation regime.

The invalidation is not required to apply to caching structures that combine stage 1 and stage 2 translation table entries.

The invalidation applies to all PEs in the same Inner Shareable shareability domain as the PE that executes this instructions.

Configurations

———— Note ————

This System instruction is not implemented in architecture versions before ARMv8.

Attributes

TLBIIPAS2IS is a 32-bit System instruction.

Field descriptions

The TLBIIPAS2IS input value bit assignments are:

31	28 27	0
RES0	IPA[39:12]	

Bits [31:28]

Reserved, RES0.

IPA[39:12], bits [27:0]

Bits[39:12] of the intermediate physical address to match.

Executing the TLBIIPAS2IS instruction

This instruction is executed using MCR with the following syntax:

MCR <syntax>

This syntax uses the following encoding in the System instruction encoding space:

<syntax>	opc1	opc2	CRn	coproc	CRm
p15, 4, <Rt>, c8, c0, 1	100	001	1000	1111	0000

Accessibility

The instruction is executable as follows:

Control			Accessibility			
E2H	TGE	NS	EL0	EL1	EL2	EL3
x	x	0	-	-	n/a	WO
x	0	1	-	-	WO	WO
x	1	1	-	n/a	WO	WO

If EL2 is not implemented, this instruction is UNDEFINED.

If SCR.NS is 0, this instruction is a NOP.

If this instruction is executed in a Secure privileged mode other than Monitor mode, then the behavior is CONSTRAINED UNPREDICTABLE, and one of the following behaviors must occur:

- The instruction is UNDEFINED.
- The instruction is treated as a NOP.
- The instruction executes as if it had been executed in Monitor mode.

Traps and Enables

For a description of the prioritization of any generated exceptions, see [Synchronous exception prioritization for exceptions taken to AArch32 state on page G1-4344](#) for exceptions taken to AArch32 state and [Synchronous exception prioritization for exceptions taken to AArch64 on page D1-1827](#) for exceptions taken to AArch64 state. Subject to the prioritization rules:

- When EL2 is implemented and is using AArch64 and (SCR_EL3.NS == 1) && (HCR_EL2.E2H == 0):
 - If HSTR_EL2.T8==1, Non-secure execution of this instruction at EL1 is trapped to EL2.
- When EL2 is implemented and is using AArch64 and (SCR_EL3.NS == 1) && (HCR_EL2.E2H == 1) && (HCR_EL2.TGE == 0):
 - If HSTR_EL2.T8==1, Non-secure execution of this instruction at EL1 is trapped to EL2.
- When EL2 is implemented and is using AArch32 and SCR_EL3.NS == 1:
 - If HSTR.T8==1, Non-secure execution of this instruction at EL1 is trapped to Hyp mode.

G6.2.138 TLBIIPAS2L, TLB Invalidate by Intermediate Physical Address, Stage 2, Last level

The TLBIIPAS2L characteristics are:

Purpose

If EL2 is implemented, invalidate all cached copies of translation table entries from TLBs that meet the following requirements:

- The entry is a stage 2 only translation table entry, from the final level of the translation table walk.
- SCR.NS is 1.
- The entry would be used for the specified IPA.
- The entry would be used with the current VMID.
- The entry would be required for the PL1&0 translation regime.

The invalidation is not required to apply to caching structures that combine stage 1 and stage 2 translation table entries.

The invalidation only applies to the PE that executes this instruction.

Configurations

———— Note ————

This System instruction is not implemented in architecture versions before ARMv8.

Attributes

TLBIIPAS2L is a 32-bit System instruction.

Field descriptions

The TLBIIPAS2L input value bit assignments are:

31	28 27	0
RES0	IPA[39:12]	

Bits [31:28]

Reserved, RES0.

IPA[39:12], bits [27:0]

Bits[39:12] of the intermediate physical address to match.

Executing the TLBIIPAS2L instruction

This instruction is executed using MCR with the following syntax:

MCR <syntax>

This syntax uses the following encoding in the System instruction encoding space:

<syntax>	opc1	opc2	CRn	coproc	CRm
p15, 4, <Rt>, c8, c4, 5	100	101	1000	1111	0100

Accessibility

The instruction is executable as follows:

Control			Accessibility			
E2H	TGE	NS	EL0	EL1	EL2	EL3
x	x	0	-	-	n/a	WO
x	0	1	-	-	WO	WO
x	1	1	-	n/a	WO	WO

If EL2 is not implemented, this instruction is UNDEFINED.

If SCR.NS is 0, this instruction is a NOP.

If this instruction is executed in a Secure privileged mode other than Monitor mode, then the behavior is CONSTRAINED UNPREDICTABLE, and one of the following behaviors must occur:

- The instruction is UNDEFINED.
- The instruction is treated as a NOP.
- The instruction executes as if it had been executed in Monitor mode.

Traps and Enables

For a description of the prioritization of any generated exceptions, see [Synchronous exception prioritization for exceptions taken to AArch32 state on page G1-4344](#) for exceptions taken to AArch32 state and [Synchronous exception prioritization for exceptions taken to AArch64 on page D1-1827](#) for exceptions taken to AArch64 state. Subject to the prioritization rules:

- When EL2 is implemented and is using AArch64 and (SCR_EL3.NS == 1) && (HCR_EL2.E2H == 0):
 - If HSTR_EL2.T8==1, Non-secure execution of this instruction at EL1 is trapped to EL2.
- When EL2 is implemented and is using AArch64 and (SCR_EL3.NS == 1) && (HCR_EL2.E2H == 1) && (HCR_EL2.TGE == 0):
 - If HSTR_EL2.T8==1, Non-secure execution of this instruction at EL1 is trapped to EL2.
- When EL2 is implemented and is using AArch32 and SCR_EL3.NS == 1:
 - If HSTR.T8==1, Non-secure execution of this instruction at EL1 is trapped to Hyp mode.

G6.2.139 TLBIIPAS2LIS, TLB Invalidate by Intermediate Physical Address, Stage 2, Last level, Inner Shareable

The TLBIIPAS2LIS characteristics are:

Purpose

If EL2 is implemented, invalidate all cached copies of translation table entries from TLBs that meet the following requirements:

- The entry is a stage 2 only translation table entry, from the final level of the translation table walk.
- SCR.NS is 1.
- The entry would be used for the specified IPA.
- The entry would be used with the current VMID.
- The entry would be required for the PL1&0 translation regime.

The invalidation is not required to apply to caching structures that combine stage 1 and stage 2 translation table entries.

The invalidation applies to all PEs in the same Inner Shareable shareability domain as the PE that executes this instructions.

Configurations

Note

This System instruction is not implemented in architecture versions before ARMv8.

Attributes

TLBIIPAS2LIS is a 32-bit System instruction.

Field descriptions

The TLBIIPAS2LIS input value bit assignments are:

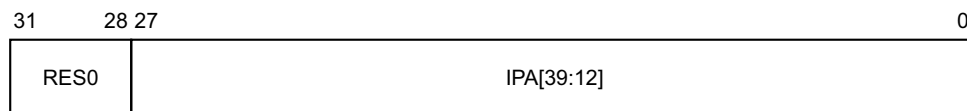

Bits [31:28]

Reserved, RES0.

IPA[39:12], bits [27:0]

Bits[39:12] of the intermediate physical address to match.

Executing the TLBIIPAS2LIS instruction

This instruction is executed using MCR with the following syntax:

MCR <syntax>

This syntax uses the following encoding in the System instruction encoding space:

<syntax>	opc1	opc2	CRn	coproc	CRm
p15, 4, <Rt>, c8, c0, 5	100	101	1000	1111	0000

Accessibility

The instruction is executable as follows:

Control			Accessibility			
E2H	TGE	NS	EL0	EL1	EL2	EL3
x	x	0	-	-	n/a	WO
x	0	1	-	-	WO	WO
x	1	1	-	n/a	WO	WO

If EL2 is not implemented, this instruction is UNDEFINED.

If SCR.NS is 0, this instruction is a NOP.

If this instruction is executed in a Secure privileged mode other than Monitor mode, then the behavior is CONSTRAINED UNPREDICTABLE, and one of the following behaviors must occur:

- The instruction is UNDEFINED.
- The instruction is treated as a NOP.
- The instruction executes as if it had been executed in Monitor mode.

Traps and Enables

For a description of the prioritization of any generated exceptions, see [Synchronous exception prioritization for exceptions taken to AArch32 state on page G1-4344](#) for exceptions taken to AArch32 state and [Synchronous exception prioritization for exceptions taken to AArch64 on page D1-1827](#) for exceptions taken to AArch64 state. Subject to the prioritization rules:

- When EL2 is implemented and is using AArch64 and (SCR_EL3.NS == 1) && (HCR_EL2.E2H == 0):
 - If HSTR_EL2.T8==1, Non-secure execution of this instruction at EL1 is trapped to EL2.
- When EL2 is implemented and is using AArch64 and (SCR_EL3.NS == 1) && (HCR_EL2.E2H == 1) && (HCR_EL2.TGE == 0):
 - If HSTR_EL2.T8==1, Non-secure execution of this instruction at EL1 is trapped to EL2.
- When EL2 is implemented and is using AArch32 and SCR_EL3.NS == 1:
 - If HSTR.T8==1, Non-secure execution of this instruction at EL1 is trapped to Hyp mode.

G6.2.140 TLBIMVA, TLB Invalidate by VA

The TLBIMVA characteristics are:

Purpose

Invalidate all cached copies of translation table entries from TLBs that meet the following requirements:

- The entry is a stage 1 translation table entry.
- The entry would be used to translate the specified address, and one of the following applies:
 - The entry is from a level of lookup above the final level and matches the specified ASID.
 - The entry is a global entry from the final level of lookup.
 - The entry is a non-global entry from the final level of lookup that matches the specified ASID.
- If EL2 is implemented, the entry would be used with the current VMID.

From the entries that match these requirement, the entries that are invalidated are required for the following translation regime:

- If executed at Secure EL1 when EL3 is using AArch64, the Secure EL1&0 translation regime.
- If executed in Secure state when EL3 is using AArch32, the Secure PL1&0 translation regime.
- If executed in Non-secure state, the Non-secure PL1&0 translation regime.

The invalidation only applies to the PE that executes this instruction.

Configurations

There are no configuration notes.

Attributes

TLBIMVA is a 32-bit System instruction.

Field descriptions

The TLBIMVA input value bit assignments are:

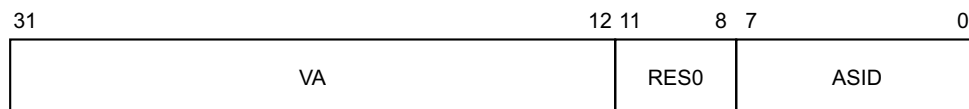

VA, bits [31:12]

Virtual address to match. Any TLB entries that match the ASID value and VA value will be affected by this operation.

Bits [11:8]

Reserved, RES0.

ASID, bits [7:0]

ASID value to match. Any TLB entries that match the ASID value and VA value will be affected by this operation.

Global TLB entries that match the VA value will be affected by this operation, regardless of the value of the ASID field.

Executing the TLBIMVA instruction

This instruction is executed using MCR with the following syntax:

MCR <syntax>

This syntax uses the following encoding in the System instruction encoding space:

<syntax>	opc1	opc2	CRn	coproc	CRm
p15, 0, <Rt>, c8, c7, 1	000	001	1000	1111	0111

Accessibility

The instruction is executable as follows:

Control			Accessibility			
E2H	TGE	NS	EL0	EL1	EL2	EL3
x	x	0	-	WO	n/a	WO
x	0	1	-	WO	WO	WO
x	1	1	-	n/a	WO	WO

When [HCR.FB](#) is 1, at Non-secure EL1 this instruction executes as a [TLBIMVAIS](#).

Traps and Enables

For a description of the prioritization of any generated exceptions, see [Synchronous exception prioritization for exceptions taken to AArch32 state on page G1-4344](#) for exceptions taken to AArch32 state and [Synchronous exception prioritization for exceptions taken to AArch64 on page D1-1827](#) for exceptions taken to AArch64 state. Subject to the prioritization rules:

- When EL2 is implemented and is using AArch64 and (SCR_EL3.NS == 1) && (HCR_EL2.E2H == 0):
 - If [HCR_EL2.TTLB](#)==1, Non-secure execution of this instruction at EL1 is trapped to EL2.
 - If [HSTR_EL2.T8](#)==1, Non-secure execution of this instruction at EL1 is trapped to EL2.
- When EL2 is implemented and is using AArch64 and (SCR_EL3.NS == 1) && (HCR_EL2.E2H == 1) && (HCR_EL2.TGE == 0):
 - If [HCR_EL2.TTLB](#)==1, Non-secure execution of this instruction at EL1 is trapped to EL2.
 - If [HSTR_EL2.T8](#)==1, Non-secure execution of this instruction at EL1 is trapped to EL2.
- When EL2 is implemented and is using AArch32 and SCR_EL3.NS == 1:
 - If [HCR.TTLB](#)==1, Non-secure execution of this instruction at EL1 is trapped to Hyp mode.
 - If [HSTR.T8](#)==1, Non-secure execution of this instruction at EL1 is trapped to Hyp mode.

G6.2.141 TLBIMVAA, TLB Invalidate by VA, All ASID

The TLBIMVAA characteristics are:

Purpose

Invalidate all cached copies of translation table entries from TLBs that meet the following requirements:

- The entry is a stage 1 translation table entry, from any level of the translation table walk.
- The entry would be used to translate the specified address.
- If EL2 is implemented, the entry would be used with the current VMID.

From the entries that match these requirement, the entries that are invalidated are required for the following translation regime:

- If executed at Secure EL1 when EL3 is using AArch64, the Secure EL1&0 translation regime.
- If executed in Secure state when EL3 is using AArch32, the Secure PL1&0 translation regime.
- If executed in Non-secure state, the Non-secure PL1&0 translation regime.

The invalidation only applies to the PE that executes this instruction.

Configurations

There are no configuration notes.

Attributes

TLBIMVAA is a 32-bit System instruction.

Field descriptions

The TLBIMVAA input value bit assignments are:

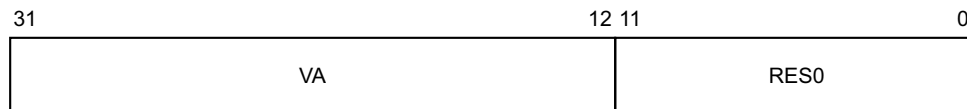

VA, bits [31:12]

Virtual address to match. Any unlocked TLB entries that match the VA will be affected by this operation, regardless of the ASID.

Bits [11:0]

Reserved, RES0.

Executing the TLBIMVAA instruction

This instruction is executed using MCR with the following syntax:

MCR <syntax>

This syntax uses the following encoding in the System instruction encoding space:

<syntax>	opc1	opc2	CRn	coproc	CRm
p15, 0, <Rt>, c8, c7, 3	000	011	1000	1111	0111

Accessibility

The instruction is executable as follows:

Control			Accessibility			
E2H	TGE	NS	EL0	EL1	EL2	EL3
x	x	0	-	WO	n/a	WO
x	0	1	-	WO	WO	WO
x	1	1	-	n/a	WO	WO

When [HCR.FB](#) is 1, at Non-secure EL1 this instruction executes as a [TLBIMVAAIS](#).

Traps and Enables

For a description of the prioritization of any generated exceptions, see [Synchronous exception prioritization for exceptions taken to AArch32 state on page G1-4344](#) for exceptions taken to AArch32 state and [Synchronous exception prioritization for exceptions taken to AArch64 on page D1-1827](#) for exceptions taken to AArch64 state. Subject to the prioritization rules:

- When EL2 is implemented and is using AArch64 and $(SCR_EL3.NS == 1) \ \&\& \ (HCR_EL2.E2H == 0)$:
 - If $HCR_EL2.TTLB == 1$, Non-secure execution of this instruction at EL1 is trapped to EL2.
 - If $HSTR_EL2.T8 == 1$, Non-secure execution of this instruction at EL1 is trapped to EL2.
- When EL2 is implemented and is using AArch64 and $(SCR_EL3.NS == 1) \ \&\& \ (HCR_EL2.E2H == 1) \ \&\& \ (HCR_EL2.TGE == 0)$:
 - If $HCR_EL2.TTLB == 1$, Non-secure execution of this instruction at EL1 is trapped to EL2.
 - If $HSTR_EL2.T8 == 1$, Non-secure execution of this instruction at EL1 is trapped to EL2.
- When EL2 is implemented and is using AArch32 and $SCR_EL3.NS == 1$:
 - If $HCR.TTLB == 1$, Non-secure execution of this instruction at EL1 is trapped to Hyp mode.
 - If $HSTR.T8 == 1$, Non-secure execution of this instruction at EL1 is trapped to Hyp mode.

G6.2.142 TLBIMVAAIS, TLB Invalidate by VA, All ASID, Inner Shareable

The TLBIMVAAIS characteristics are:

Purpose

Invalidate all cached copies of translation table entries from TLBs that meet the following requirements:

- The entry is a stage 1 translation table entry, from any level of the translation table walk.
- The entry would be used to translate the specified address.
- If EL2 is implemented, the entry would be used with the current VMID.

From the entries that match these requirement, the entries that are invalidated are required for the following translation regime:

- If executed at Secure EL1 when EL3 is using AArch64, the Secure EL1&0 translation regime.
- If executed in Secure state when EL3 is using AArch32, the Secure PL1&0 translation regime.
- If executed in Non-secure state, the Non-secure PL1&0 translation regime.

The invalidation applies to all PEs in the same Inner Shareable shareability domain as the PE that executes this instructions.

Configurations

There are no configuration notes.

Attributes

TLBIMVAAIS is a 32-bit System instruction.

Field descriptions

The TLBIMVAAIS input value bit assignments are:

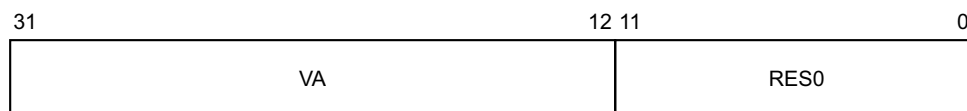

VA, bits [31:12]

Virtual address to match. Any unlocked TLB entries that match the VA will be affected by this operation, regardless of the ASID.

Bits [11:0]

Reserved, RES0.

Executing the TLBIMVAAIS instruction

This instruction is executed using MCR with the following syntax:

MCR <syntax>

This syntax uses the following encoding in the System instruction encoding space:

<syntax>	opc1	opc2	CRn	coproc	CRm
p15, 0, <Rt>, c8, c3, 3	000	011	1000	1111	0011

Accessibility

The instruction is executable as follows:

Control			Accessibility			
E2H	TGE	NS	EL0	EL1	EL2	EL3
x	x	0	-	WO	n/a	WO
x	0	1	-	WO	WO	WO
x	1	1	-	n/a	WO	WO

Traps and Enables

For a description of the prioritization of any generated exceptions, see [Synchronous exception prioritization for exceptions taken to AArch32 state on page G1-4344](#) for exceptions taken to AArch32 state and [Synchronous exception prioritization for exceptions taken to AArch64 on page D1-1827](#) for exceptions taken to AArch64 state. Subject to the prioritization rules:

- When EL2 is implemented and is using AArch64 and (SCR_EL3.NS == 1) && (HCR_EL2.E2H == 0):
 - If HCR_EL2.TTLB==1, Non-secure execution of this instruction at EL1 is trapped to EL2.
 - If HSTR_EL2.T8==1, Non-secure execution of this instruction at EL1 is trapped to EL2.
- When EL2 is implemented and is using AArch64 and (SCR_EL3.NS == 1) && (HCR_EL2.E2H == 1) && (HCR_EL2.TGE == 0):
 - If HCR_EL2.TTLB==1, Non-secure execution of this instruction at EL1 is trapped to EL2.
 - If HSTR_EL2.T8==1, Non-secure execution of this instruction at EL1 is trapped to EL2.
- When EL2 is implemented and is using AArch32 and SCR_EL3.NS == 1:
 - If HCR.TTLB==1, Non-secure execution of this instruction at EL1 is trapped to Hyp mode.
 - If HSTR.T8==1, Non-secure execution of this instruction at EL1 is trapped to Hyp mode.

G6.2.143 TLBIMVAAL, TLB Invalidate by VA, All ASID, Last level

The TLBIMVAAL characteristics are:

Purpose

Invalidate all cached copies of translation table entries from TLBs that meet the following requirements:

- The entry is a stage 1 translation table entry, from the final level of the translation table walk.
- The entry would be used to translate the specified address.
- If EL2 is implemented, the entry would be used with the current VMID.

From the entries that match these requirement, the entries that are invalidated are required for the following translation regime:

- If executed at Secure EL1 when EL3 is using AArch64, the Secure EL1&0 translation regime.
- If executed in Secure state when EL3 is using AArch32, the Secure PL1&0 translation regime.
- If executed in Non-secure state, the Non-secure PL1&0 translation regime.

The invalidation only applies to the PE that executes this instruction.

Configurations

———— Note ————

This System instruction is not implemented in architecture versions before ARMv8.

Attributes

TLBIMVAAL is a 32-bit System instruction.

Field descriptions

The TLBIMVAAL input value bit assignments are:

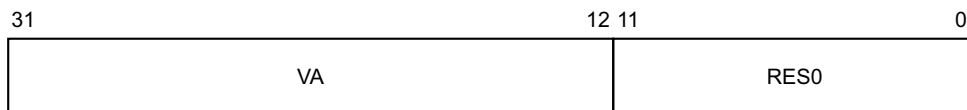

VA, bits [31:12]

Virtual address to match. Any unlocked TLB entries that match the VA will be affected by this operation, regardless of the ASID.

Bits [11:0]

Reserved, RES0.

Executing the TLBIMVAAL instruction

This instruction is executed using MCR with the following syntax:

MCR <syntax>

This syntax uses the following encoding in the System instruction encoding space:

<syntax>	opc1	opc2	CRn	coproc	CRm
p15, 0, <Rt>, c8, c7, 7	000	111	1000	1111	0111

Accessibility

The instruction is executable as follows:

Control			Accessibility			
E2H	TGE	NS	EL0	EL1	EL2	EL3
x	x	0	-	WO	n/a	WO
x	0	1	-	WO	WO	WO
x	1	1	-	n/a	WO	WO

When `HCR.FB` is 1, at Non-secure EL1 this instruction executes as a `TLBIMVAALIS`.

Traps and Enables

For a description of the prioritization of any generated exceptions, see *Synchronous exception prioritization for exceptions taken to AArch32 state* on page G1-4344 for exceptions taken to AArch32 state and *Synchronous exception prioritization for exceptions taken to AArch64* on page D1-1827 for exceptions taken to AArch64 state. Subject to the prioritization rules:

- When EL2 is implemented and is using AArch64 and $(SCR_EL3.NS == 1) \ \&\& \ (HCR_EL2.E2H == 0)$:
 - If $HCR_EL2.TTLB == 1$, Non-secure execution of this instruction at EL1 is trapped to EL2.
 - If $HSTR_EL2.T8 == 1$, Non-secure execution of this instruction at EL1 is trapped to EL2.
- When EL2 is implemented and is using AArch64 and $(SCR_EL3.NS == 1) \ \&\& \ (HCR_EL2.E2H == 1) \ \&\& \ (HCR_EL2.TGE == 0)$:
 - If $HCR_EL2.TTLB == 1$, Non-secure execution of this instruction at EL1 is trapped to EL2.
 - If $HSTR_EL2.T8 == 1$, Non-secure execution of this instruction at EL1 is trapped to EL2.
- When EL2 is implemented and is using AArch32 and $SCR_EL3.NS == 1$:
 - If $HCR.TTLB == 1$, Non-secure execution of this instruction at EL1 is trapped to Hyp mode.
 - If $HSTR.T8 == 1$, Non-secure execution of this instruction at EL1 is trapped to Hyp mode.

G6.2.144 TLBIMVAALIS, TLB Invalidate by VA, All ASID, Last level, Inner Shareable

The TLBIMVAALIS characteristics are:

Purpose

Invalidate all cached copies of translation table entries from TLBs that meet the following requirements:

- The entry is a stage 1 translation table entry, from the final level of the translation table walk.
- The entry would be used to translate the specified address.
- If EL2 is implemented, the entry would be used with the current VMID.

From the entries that match these requirement, the entries that are invalidated are required for the following translation regime:

- If executed at Secure EL1 when EL3 is using AArch64, the Secure EL1&0 translation regime.
- If executed in Secure state when EL3 is using AArch32, the Secure PL1&0 translation regime.
- If executed in Non-secure state, the Non-secure PL1&0 translation regime.

The invalidation applies to all PEs in the same Inner Shareable shareability domain as the PE that executes this instructions.

Configurations

———— **Note** —————

This System instruction is not implemented in architecture versions before ARMv8.

Attributes

TLBIMVAALIS is a 32-bit System instruction.

Field descriptions

The TLBIMVAALIS input value bit assignments are:

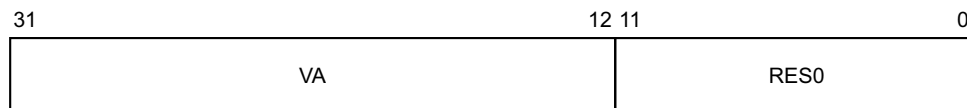

VA, bits [31:12]

Virtual address to match. Any unlocked TLB entries that match the VA will be affected by this operation, regardless of the ASID.

Bits [11:0]

Reserved, RES0.

Executing the TLBIMVAALIS instruction

This instruction is executed using MCR with the following syntax:

MCR <syntax>

This syntax uses the following encoding in the System instruction encoding space:

<syntax>	opc1	opc2	CRn	coproc	CRm
p15, 0, <Rt>, c8, c3, 7	000	111	1000	1111	0011

Accessibility

The instruction is executable as follows:

Control			Accessibility			
E2H	TGE	NS	EL0	EL1	EL2	EL3
x	x	0	-	WO	n/a	WO
x	0	1	-	WO	WO	WO
x	1	1	-	n/a	WO	WO

Traps and Enables

For a description of the prioritization of any generated exceptions, see [Synchronous exception prioritization for exceptions taken to AArch32 state on page G1-4344](#) for exceptions taken to AArch32 state and [Synchronous exception prioritization for exceptions taken to AArch64 on page D1-1827](#) for exceptions taken to AArch64 state. Subject to the prioritization rules:

- When EL2 is implemented and is using AArch64 and (SCR_EL3.NS == 1) && (HCR_EL2.E2H == 0):
 - If HCR_EL2.TTLB==1, Non-secure execution of this instruction at EL1 is trapped to EL2.
 - If HSTR_EL2.T8==1, Non-secure execution of this instruction at EL1 is trapped to EL2.
- When EL2 is implemented and is using AArch64 and (SCR_EL3.NS == 1) && (HCR_EL2.E2H == 1) && (HCR_EL2.TGE == 0):
 - If HCR_EL2.TTLB==1, Non-secure execution of this instruction at EL1 is trapped to EL2.
 - If HSTR_EL2.T8==1, Non-secure execution of this instruction at EL1 is trapped to EL2.
- When EL2 is implemented and is using AArch32 and SCR_EL3.NS == 1:
 - If HCR.TTLB==1, Non-secure execution of this instruction at EL1 is trapped to Hyp mode.
 - If HSTR.T8==1, Non-secure execution of this instruction at EL1 is trapped to Hyp mode.

G6.2.145 TLBIMVAH, TLB Invalidate by VA, Hyp mode

The TLBIMVAH characteristics are:

Purpose

If EL2 is implemented, invalidate all cached copies of translation table entries from TLBs that are from any level of the translation table walk that would be required for the Non-secure EL2 translation regime and used to translate the specified address.

The invalidation only applies to the PE that executes this instruction.

Configurations

There are no configuration notes.

Attributes

TLBIMVAH is a 32-bit System instruction.

Field descriptions

The TLBIMVAH input value bit assignments are:

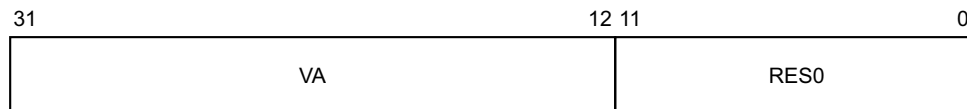

VA, bits [31:12]

Virtual address to match. Any TLB entries that match the ASID value and VA value will be affected by this operation.

Bits [11:0]

Reserved, RES0.

Executing the TLBIMVAH instruction

This instruction is executed using MCR with the following syntax:

MCR <syntax>

This syntax uses the following encoding in the System instruction encoding space:

<syntax>	opc1	opc2	CRn	coproc	CRm
p15, 4, <Rt>, c8, c7, 1	100	001	1000	1111	0111

Accessibility

The instruction is executable as follows:

Control			Accessibility			
E2H	TGE	NS	EL0	EL1	EL2	EL3
x	x	0	-	-	n/a	WO
x	0	1	-	-	WO	WO
x	1	1	-	n/a	WO	WO

If EL2 is not implemented, this instruction is UNDEFINED.

If this instruction is executed in a Secure privileged mode other than Monitor mode, then the behavior is CONSTRAINED UNPREDICTABLE, and one of the following behaviors must occur:

- The instruction is UNDEFINED.
- The instruction is treated as a NOP.
- The instruction executes as if it had been executed in Monitor mode.

Traps and Enables

For a description of the prioritization of any generated exceptions, see [Synchronous exception prioritization for exceptions taken to AArch32 state on page G1-4344](#) for exceptions taken to AArch32 state and [Synchronous exception prioritization for exceptions taken to AArch64 on page D1-1827](#) for exceptions taken to AArch64 state. Subject to the prioritization rules:

- When EL2 is implemented and is using AArch64 and (SCR_EL3.NS == 1) && (HCR_EL2.E2H == 0):
 - If [HSTR_EL2.T8](#)==1, Non-secure execution of this instruction at EL1 is trapped to EL2.
- When EL2 is implemented and is using AArch64 and (SCR_EL3.NS == 1) && (HCR_EL2.E2H == 1) && (HCR_EL2.TGE == 0):
 - If [HSTR_EL2.T8](#)==1, Non-secure execution of this instruction at EL1 is trapped to EL2.
- When EL2 is implemented and is using AArch32 and SCR_EL3.NS == 1:
 - If [HSTR.T8](#)==1, Non-secure execution of this instruction at EL1 is trapped to Hyp mode.

G6.2.146 TLBIMVAHIS, TLB Invalidate by VA, Hyp mode, Inner Shareable

The TLBIMVAHIS characteristics are:

Purpose

If EL2 is implemented, invalidate all cached copies of translation table entries from TLBs that are from any level of the translation table walk that would be required for the Non-secure EL2 translation regime and used to translate the specified address.

The invalidation applies to all PEs in the same Inner Shareable shareability domain as the PE that executes this instructions.

Configurations

There are no configuration notes.

Attributes

TLBIMVAHIS is a 32-bit System instruction.

Field descriptions

The TLBIMVAHIS input value bit assignments are:

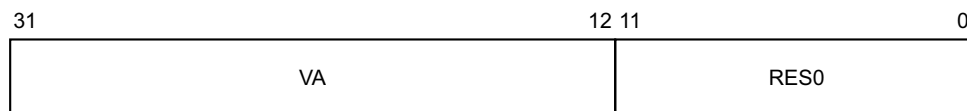

VA, bits [31:12]

Virtual address to match. Any TLB entries that match the ASID value and VA value will be affected by this operation.

Bits [11:0]

Reserved, RES0.

Executing the TLBIMVAHIS instruction

This instruction is executed using MCR with the following syntax:

MCR <syntax>

This syntax uses the following encoding in the System instruction encoding space:

<syntax>	opc1	opc2	CRn	coproc	CRm
p15, 4, <Rt>, c8, c3, 1	100	001	1000	1111	0011

Accessibility

The instruction is executable as follows:

Control			Accessibility			
E2H	TGE	NS	EL0	EL1	EL2	EL3
x	x	0	-	-	n/a	WO
x	0	1	-	-	WO	WO
x	1	1	-	n/a	WO	WO

If EL2 is not implemented, this instruction is UNDEFINED.

If this instruction is executed in a Secure privileged mode other than Monitor mode, then the behavior is CONSTRAINED UNPREDICTABLE, and one of the following behaviors must occur:

- The instruction is UNDEFINED.
- The instruction is treated as a NOP.
- The instruction executes as if it had been executed in Monitor mode.

Traps and Enables

For a description of the prioritization of any generated exceptions, see *Synchronous exception prioritization for exceptions taken to AArch32 state* on page G1-4344 for exceptions taken to AArch32 state and *Synchronous exception prioritization for exceptions taken to AArch64* on page D1-1827 for exceptions taken to AArch64 state. Subject to the prioritization rules:

- When EL2 is implemented and is using AArch64 and (SCR_EL3.NS == 1) && (HCR_EL2.E2H == 0):
 - If HSTR_EL2.T8==1, Non-secure execution of this instruction at EL1 is trapped to EL2.
- When EL2 is implemented and is using AArch64 and (SCR_EL3.NS == 1) && (HCR_EL2.E2H == 1) && (HCR_EL2.TGE == 0):
 - If HSTR_EL2.T8==1, Non-secure execution of this instruction at EL1 is trapped to EL2.
- When EL2 is implemented and is using AArch32 and SCR_EL3.NS == 1:
 - If HSTR.T8==1, Non-secure execution of this instruction at EL1 is trapped to Hyp mode.

G6.2.147 TLBIMVAIS, TLB Invalidate by VA, Inner Shareable

The TLBIMVAIS characteristics are:

Purpose

Invalidate all cached copies of translation table entries from TLBs that meet the following requirements:

- The entry is a stage 1 translation table entry.
- The entry would be used to translate the specified address, and one of the following applies:
 - The entry is from a level of lookup above the final level and matches the specified ASID.
 - The entry is a global entry from the final level of lookup.
 - The entry is a non-global entry from the final level of lookup that matches the specified ASID.
- If EL2 is implemented, the entry would be used with the current VMID.

From the entries that match these requirement, the entries that are invalidated are required for the following translation regime:

- If executed at Secure EL1 when EL3 is using AArch64, the Secure EL1&0 translation regime.
- If executed in Secure state when EL3 is using AArch32, the Secure PL1&0 translation regime.
- If executed in Non-secure state, the Non-secure PL1&0 translation regime.

The invalidation applies to all PEs in the same Inner Shareable shareability domain as the PE that executes this instructions.

Configurations

There are no configuration notes.

Attributes

TLBIMVAIS is a 32-bit System instruction.

Field descriptions

The TLBIMVAIS input value bit assignments are:

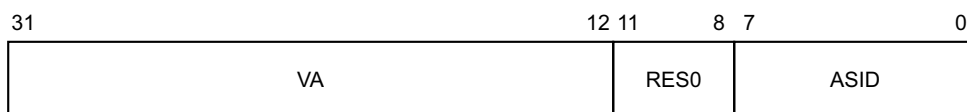

VA, bits [31:12]

Virtual address to match. Any TLB entries that match the ASID value and VA value will be affected by this operation.

Bits [11:8]

Reserved, RES0.

ASID, bits [7:0]

ASID value to match. Any TLB entries that match the ASID value and VA value will be affected by this operation.

Global TLB entries that match the VA value will be affected by this operation, regardless of the value of the ASID field.

Executing the TLBIMVAIS instruction

This instruction is executed using MCR with the following syntax:

MCR <syntax>

This syntax uses the following encoding in the System instruction encoding space:

<syntax>	opc1	opc2	CRn	coproc	CRm
p15, 0, <Rt>, c8, c3, 1	000	001	1000	1111	0011

Accessibility

The instruction is executable as follows:

Control			Accessibility			
E2H	TGE	NS	EL0	EL1	EL2	EL3
x	x	0	-	WO	n/a	WO
x	0	1	-	WO	WO	WO
x	1	1	-	n/a	WO	WO

Traps and Enables

For a description of the prioritization of any generated exceptions, see [Synchronous exception prioritization for exceptions taken to AArch32 state on page G1-4344](#) for exceptions taken to AArch32 state and [Synchronous exception prioritization for exceptions taken to AArch64 on page D1-1827](#) for exceptions taken to AArch64 state. Subject to the prioritization rules:

- When EL2 is implemented and is using AArch64 and (SCR_EL3.NS == 1) && (HCR_EL2.E2H == 0):
 - If HCR_EL2.TTLB==1, Non-secure execution of this instruction at EL1 is trapped to EL2.
 - If HSTR_EL2.T8==1, Non-secure execution of this instruction at EL1 is trapped to EL2.
- When EL2 is implemented and is using AArch64 and (SCR_EL3.NS == 1) && (HCR_EL2.E2H == 1) && (HCR_EL2.TGE == 0):
 - If HCR_EL2.TTLB==1, Non-secure execution of this instruction at EL1 is trapped to EL2.
 - If HSTR_EL2.T8==1, Non-secure execution of this instruction at EL1 is trapped to EL2.
- When EL2 is implemented and is using AArch32 and SCR_EL3.NS == 1:
 - If HCR.TTLB==1, Non-secure execution of this instruction at EL1 is trapped to Hyp mode.
 - If HSTR.T8==1, Non-secure execution of this instruction at EL1 is trapped to Hyp mode.

G6.2.148 TLBIMVAL, TLB Invalidate by VA, Last level

The TLBIMVAL characteristics are:

Purpose

Invalidate all cached copies of translation table entries from TLBs that meet the following requirements:

- The entry is a stage 1 translation table entry.
- The entry would be used to translate the specified address, and one of the following applies:
 - The entry is a global entry from the final level of lookup.
 - The entry is a non-global entry from the final level of lookup that matches the specified ASID.
- If EL2 is implemented, the entry would be used with the current VMID.

From the entries that match these requirements, the entries that are invalidated are required for the following translation regime:

- If executed at Secure EL1 when EL3 is using AArch64, the Secure EL1&0 translation regime.
- If executed in Secure state when EL3 is using AArch32, the Secure PL1&0 translation regime.
- If executed in Non-secure state, the Non-secure PL1&0 translation regime.

The invalidation only applies to the PE that executes this instruction.

Configurations

This System instruction is not implemented in architecture versions before ARMv8.

Attributes

TLBIMVAL is a 32-bit System instruction.

Field descriptions

The TLBIMVAL input value bit assignments are:

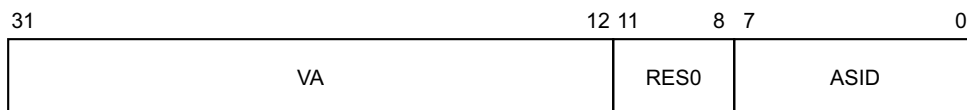

VA, bits [31:12]

Virtual address to match. Any TLB entries that match the ASID value and VA value will be affected by this operation.

Bits [11:8]

Reserved, RES0.

ASID, bits [7:0]

ASID value to match. Any TLB entries that match the ASID value and VA value will be affected by this operation.

Global TLB entries that match the VA value will be affected by this operation, regardless of the value of the ASID field.

Executing the TLBIMVAL instruction

This instruction is executed using MCR with the following syntax:

MCR <syntax>

This syntax uses the following encoding in the System instruction encoding space:

<syntax>	opc1	opc2	CRn	coproc	CRm
p15, 0, <Rt>, c8, c7, 5	000	101	1000	1111	0111

Accessibility

The instruction is executable as follows:

Control			Accessibility			
E2H	TGE	NS	EL0	EL1	EL2	EL3
x	x	0	-	WO	n/a	WO
x	0	1	-	WO	WO	WO
x	1	1	-	n/a	WO	WO

When [HCR.FB](#) is 1, at Non-secure EL1 this instruction executes as a [TLBIMVALIS](#).

Traps and Enables

For a description of the prioritization of any generated exceptions, see [Synchronous exception prioritization for exceptions taken to AArch32 state on page G1-4344](#) for exceptions taken to AArch32 state and [Synchronous exception prioritization for exceptions taken to AArch64 on page D1-1827](#) for exceptions taken to AArch64 state. Subject to the prioritization rules:

- When EL2 is implemented and is using AArch64 and (SCR_EL3.NS == 1) && (HCR_EL2.E2H == 0):
 - If [HCR_EL2.TTLB](#)==1, Non-secure execution of this instruction at EL1 is trapped to EL2.
 - If [HSTR_EL2.T8](#)==1, Non-secure execution of this instruction at EL1 is trapped to EL2.
- When EL2 is implemented and is using AArch64 and (SCR_EL3.NS == 1) && (HCR_EL2.E2H == 1) && (HCR_EL2.TGE == 0):
 - If [HCR_EL2.TTLB](#)==1, Non-secure execution of this instruction at EL1 is trapped to EL2.
 - If [HSTR_EL2.T8](#)==1, Non-secure execution of this instruction at EL1 is trapped to EL2.
- When EL2 is implemented and is using AArch32 and SCR_EL3.NS == 1:
 - If [HCR.TTLB](#)==1, Non-secure execution of this instruction at EL1 is trapped to Hyp mode.
 - If [HSTR.T8](#)==1, Non-secure execution of this instruction at EL1 is trapped to Hyp mode.

G6.2.149 TLBINVALH, TLB Invalidate by VA, Last level, Hyp mode

The TLBINVALH characteristics are:

Purpose

If EL2 is implemented, invalidate all cached copies of translation table entries from TLBs that are from the final level of the translation table walk that would be required for the Non-secure EL2 translation regime and used to translate the specified address.

The invalidation only applies to the PE that executes this instruction.

Configurations

This System instruction is not implemented in architecture versions before ARMv8.

Attributes

TLBINVALH is a 32-bit System instruction.

Field descriptions

The TLBINVALH input value bit assignments are:

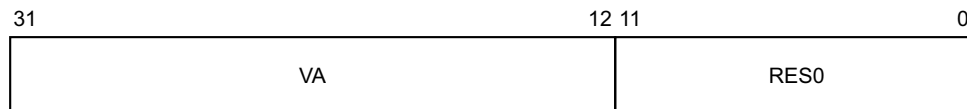

VA, bits [31:12]

Virtual address to match. Any TLB entries that match the ASID value and VA value will be affected by this operation.

Bits [11:0]

Reserved, RES0.

Executing the TLBINVALH instruction

This instruction is executed using MCR with the following syntax:

MCR <syntax>

This syntax uses the following encoding in the System instruction encoding space:

<syntax>	opc1	opc2	CRn	coproc	CRm
p15, 4, <Rt>, c8, c7, 5	100	101	1000	1111	0111

Accessibility

The instruction is executable as follows:

Control			Accessibility			
E2H	TGE	NS	EL0	EL1	EL2	EL3
x	x	0	-	-	n/a	WO
x	0	1	-	-	WO	WO
x	1	1	-	n/a	WO	WO

If this instruction is executed in a Secure privileged mode other than Monitor mode, then the behavior is CONSTRAINED UNPREDICTABLE, and one of the following behaviors must occur:

- The instruction is UNDEFINED.
- The instruction is treated as a NOP.
- The instruction executes as if it had been executed in Monitor mode.

Traps and Enables

For a description of the prioritization of any generated exceptions, see [Synchronous exception prioritization for exceptions taken to AArch32 state on page G1-4344](#) for exceptions taken to AArch32 state and [Synchronous exception prioritization for exceptions taken to AArch64 on page D1-1827](#) for exceptions taken to AArch64 state. Subject to the prioritization rules:

- When EL2 is implemented and is using AArch64 and (SCR_EL3.NS == 1) && (HCR_EL2.E2H == 0):
 - If HSTR_EL2.T8==1, Non-secure execution of this instruction at EL1 is trapped to EL2.
- When EL2 is implemented and is using AArch64 and (SCR_EL3.NS == 1) && (HCR_EL2.E2H == 1) && (HCR_EL2.TGE == 0):
 - If HSTR_EL2.T8==1, Non-secure execution of this instruction at EL1 is trapped to EL2.
- When EL2 is implemented and is using AArch32 and SCR_EL3.NS == 1:
 - If HSTR.T8==1, Non-secure execution of this instruction at EL1 is trapped to Hyp mode.

G6.2.150 TLBINVALHIS, TLB Invalidate by VA, Last level, Hyp mode, Inner Shareable

The TLBINVALHIS characteristics are:

Purpose

If EL2 is implemented, invalidate all cached copies of translation table entries from TLBs that are from the final level of the translation table walk that would be required for the Non-secure EL2 translation regime and used to translate the specified address.

The invalidation applies to all PEs in the same Inner Shareable shareability domain as the PE that executes this instructions.

Configurations

This System instruction is not implemented in architecture versions before ARMv8.

Attributes

TLBINVALHIS is a 32-bit System instruction.

Field descriptions

The TLBINVALHIS input value bit assignments are:

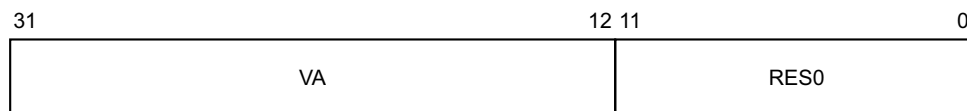

VA, bits [31:12]

Virtual address to match. Any TLB entries that match the ASID value and VA value will be affected by this operation.

Bits [11:0]

Reserved, RES0.

Executing the TLBINVALHIS instruction

This instruction is executed using MCR with the following syntax:

MCR <syntax>

This syntax uses the following encoding in the System instruction encoding space:

<syntax>	opc1	opc2	CRn	coproc	CRm
p15, 4, <Rt>, c8, c3, 5	100	101	1000	1111	0011

Accessibility

The instruction is executable as follows:

Control			Accessibility			
E2H	TGE	NS	EL0	EL1	EL2	EL3
x	x	0	-	-	n/a	WO
x	0	1	-	-	WO	WO
x	1	1	-	n/a	WO	WO

If EL2 is not implemented, this instruction is UNDEFINED.

If this instruction is executed in a Secure privileged mode other than Monitor mode, then the behavior is CONSTRAINED UNPREDICTABLE, and one of the following behaviors must occur:

- The instruction is UNDEFINED.
- The instruction is treated as a NOP.
- The instruction executes as if it had been executed in Monitor mode.

Traps and Enables

For a description of the prioritization of any generated exceptions, see *Synchronous exception prioritization for exceptions taken to AArch32 state* on page G1-4344 for exceptions taken to AArch32 state and *Synchronous exception prioritization for exceptions taken to AArch64* on page D1-1827 for exceptions taken to AArch64 state. Subject to the prioritization rules:

- When EL2 is implemented and is using AArch64 and (SCR_EL3.NS == 1) && (HCR_EL2.E2H == 0):
 - If HSTR_EL2.T8==1, Non-secure execution of this instruction at EL1 is trapped to EL2.
- When EL2 is implemented and is using AArch64 and (SCR_EL3.NS == 1) && (HCR_EL2.E2H == 1) && (HCR_EL2.TGE == 0):
 - If HSTR_EL2.T8==1, Non-secure execution of this instruction at EL1 is trapped to EL2.
- When EL2 is implemented and is using AArch32 and SCR_EL3.NS == 1:
 - If HSTR.T8==1, Non-secure execution of this instruction at EL1 is trapped to Hyp mode.

G6.2.151 TLBINVALIS, TLB Invalidate by VA, Last level, Inner Shareable

The TLBINVALIS characteristics are:

Purpose

Invalidate all cached copies of translation table entries from TLBs that meet the following requirements:

- The entry is a stage 1 translation table entry.
- The entry would be used to translate the specified address, and one of the following applies:
 - The entry is a global entry from the final level of lookup.
 - The entry is a non-global entry from the final level of lookup that matches the specified ASID.
- If EL2 is implemented, the entry would be used with the current VMID.

From the entries that match these requirements, the entries that are invalidated are required for the following translation regime:

- If executed at Secure EL1 when EL3 is using AArch64, the Secure EL1&0 translation regime.
- If executed in Secure state when EL3 is using AArch32, the Secure PL1&0 translation regime.
- If executed in Non-secure state, the Non-secure PL1&0 translation regime.

The invalidation applies to all PEs in the same Inner Shareable shareability domain as the PE that executes this instructions.

Configurations

This System instruction is not implemented in architecture versions before ARMv8.

Attributes

TLBINVALIS is a 32-bit System instruction.

Field descriptions

The TLBINVALIS input value bit assignments are:

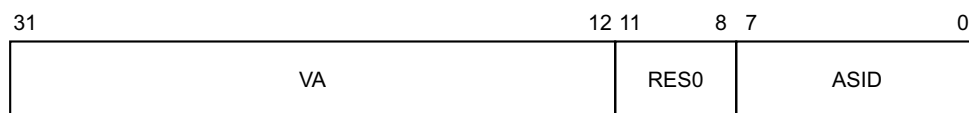

VA, bits [31:12]

Virtual address to match. Any TLB entries that match the ASID value and VA value will be affected by this operation.

Bits [11:8]

Reserved, RES0.

ASID, bits [7:0]

ASID value to match. Any TLB entries that match the ASID value and VA value will be affected by this operation.

Global TLB entries that match the VA value will be affected by this operation, regardless of the value of the ASID field.

Executing the TLBIMVALIS instruction

This instruction is executed using MCR with the following syntax:

MCR <syntax>

This syntax uses the following encoding in the System instruction encoding space:

<syntax>	opc1	opc2	CRn	coproc	CRm
p15, 0, <Rt>, c8, c3, 5	000	101	1000	1111	0011

Accessibility

The instruction is executable as follows:

Control			Accessibility			
E2H	TGE	NS	EL0	EL1	EL2	EL3
x	x	0	-	WO	n/a	WO
x	0	1	-	WO	WO	WO
x	1	1	-	n/a	WO	WO

Traps and Enables

For a description of the prioritization of any generated exceptions, see [Synchronous exception prioritization for exceptions taken to AArch32 state on page G1-4344](#) for exceptions taken to AArch32 state and [Synchronous exception prioritization for exceptions taken to AArch64 on page D1-1827](#) for exceptions taken to AArch64 state. Subject to the prioritization rules:

- When EL2 is implemented and is using AArch64 and (SCR_EL3.NS == 1) && (HCR_EL2.E2H == 0):
 - If HCR_EL2.TTLB==1, Non-secure execution of this instruction at EL1 is trapped to EL2.
 - If HSTR_EL2.T8==1, Non-secure execution of this instruction at EL1 is trapped to EL2.
- When EL2 is implemented and is using AArch64 and (SCR_EL3.NS == 1) && (HCR_EL2.E2H == 1) && (HCR_EL2.TGE == 0):
 - If HCR_EL2.TTLB==1, Non-secure execution of this instruction at EL1 is trapped to EL2.
 - If HSTR_EL2.T8==1, Non-secure execution of this instruction at EL1 is trapped to EL2.
- When EL2 is implemented and is using AArch32 and SCR_EL3.NS == 1:
 - If HCR.TTLB==1, Non-secure execution of this instruction at EL1 is trapped to Hyp mode.
 - If HSTR.T8==1, Non-secure execution of this instruction at EL1 is trapped to Hyp mode.

G6.2.152 TLBTR, TLB Type Register

The TLBTR characteristics are:

Purpose

Provides information about the TLB implementation. The register must define whether the implementation provides separate instruction and data TLBs, or a unified TLB. Normally, the IMPLEMENTATION DEFINED information in this register includes the number of lockable entries in the TLB.

Configurations

There is one instance of this register that is used in both Secure and Non-secure states.

Attributes

TLBTR is a 32-bit register.

Field descriptions

The TLBTR bit assignments are:



IMPLEMENTATION DEFINED, bits [31:1]

IMPLEMENTATION DEFINED.

nU, bit [0]

Not Unified TLB. Indicates whether the implementation has a unified TLB:

- 0 Unified TLB.
- 1 Separate Instruction and Data TLBs.

Accessing the TLBTR

This register can be read using MRC with the following syntax:

MRC <syntax>

This syntax is encoded with the following settings in the instruction encoding:

<syntax>	opc1	opc2	CRn	coproc	CRm
p15, 0, <Rt>, c0, c0, 3	000	011	0000	1111	0000

Accessibility

The register is accessible in software as follows:

Control			Accessibility			
E2H	TGE	NS	EL0	EL1	EL2	EL3
x	x	0	-	RO	n/a	RO
x	0	1	-	RO	RO	RO
x	1	1	-	n/a	RO	RO

Traps and Enables

For a description of the prioritization of any generated exceptions, see [Synchronous exception prioritization for exceptions taken to AArch32 state on page G1-4344](#) for exceptions taken to AArch32 state and [Synchronous exception prioritization for exceptions taken to AArch64 on page D1-1827](#) for exceptions taken to AArch64 state. Subject to the prioritization rules:

- When EL2 is implemented and is using AArch64 and (SCR_EL3.NS == 1) && (HCR_EL2.E2H == 0):
 - If HCR_EL2.TID1==1, Non-secure read accesses to this register from EL1 are trapped to EL2.
 - If HSTR_EL2.T0==1, Non-secure read accesses to this register from EL1 are trapped to EL2.
- When EL2 is implemented and is using AArch64 and (SCR_EL3.NS == 1) && (HCR_EL2.E2H == 1) && (HCR_EL2.TGE == 0):
 - If HCR_EL2.TID1==1, Non-secure read accesses to this register from EL1 are trapped to EL2.
 - If HSTR_EL2.T0==1, Non-secure read accesses to this register from EL1 are trapped to EL2.
- When EL2 is implemented and is using AArch32 and SCR_EL3.NS == 1:
 - If HCR.TID1==1, Non-secure read accesses to this register from EL1 are trapped to Hyp mode.
 - If HSTR.T0==1, Non-secure read accesses to this register from EL1 are trapped to Hyp mode.

G6.2.153 TPIDRPRW, PL1 Software Thread ID Register

The TPIDRPRW characteristics are:

Purpose

Provides a location where software executing at EL1 or higher can store thread identifying information that is not visible to software executing at EL0, for OS management purposes.

The PE makes no use of this register.

Configurations

AArch32 System register TPIDRPRW is architecturally mapped to AArch64 System register [TPIDR_EL1](#)[31:0].

The PE never updates this register. This means the register is always UNKNOWN on reset.

Attributes

TPIDRPRW is a 32-bit register.

Field descriptions

The TPIDRPRW bit assignments are:

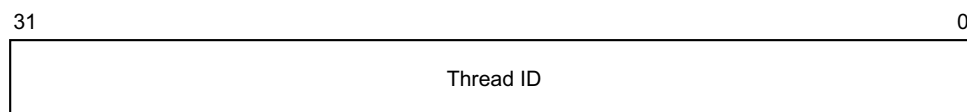

Bits [31:0]

Thread ID. Thread identifying information stored by software running at this Exception level.

Accessing the TPIDRPRW

This register can be read using MRC with the following syntax:

MRC <syntax>

This register can be written using MCR with the following syntax:

MCR <syntax>

This syntax is encoded with the following settings in the instruction encoding:

<syntax>	opc1	opc2	CRn	coproc	CRm
p15, 0, <Rt>, c13, c0, 4	000	100	1101	1111	0000

Accessibility

The register is accessible in software as follows:

Configuration	Control			Accessibility				Instance
	E2H	TGE	NS	EL0	EL1	EL2	EL3	
EL3 is using AArch32.	x	x	0	-	n/a	n/a	RW	TPIDRPRW_s
EL3 is not implemented.	x	x	0	-	RW	n/a	n/a	TPIDRPRW
EL3 is not implemented.	x	0	1	-	RW	RW	n/a	TPIDRPRW
EL3 is not implemented.	x	1	1	-	n/a	RW	n/a	TPIDRPRW
EL3 is using AArch64.	x	x	0	-	RW	n/a	n/a	TPIDRPRW
EL3 is using AArch64.	x	0	1	-	RW	RW	n/a	TPIDRPRW
EL3 is using AArch64.	x	1	1	-	n/a	RW	n/a	TPIDRPRW
EL3 is using AArch32.	x	0	1	-	RW	RW	RW	TPIDRPRW_ns
EL3 is using AArch32.	x	1	1	-	n/a	RW	RW	TPIDRPRW_ns

Traps and Enables

For a description of the prioritization of any generated exceptions, see [Synchronous exception prioritization for exceptions taken to AArch32 state on page G1-4344](#) for exceptions taken to AArch32 state and [Synchronous exception prioritization for exceptions taken to AArch64 on page D1-1827](#) for exceptions taken to AArch64 state. Subject to the prioritization rules:

- When EL2 is implemented and is using AArch64 and (SCR_EL3.NS == 1) && (HCR_EL2.E2H == 0):
 - If HSTR_EL2.T13==1, Non-secure accesses to this register from EL1 are trapped to EL2.
- When EL2 is implemented and is using AArch64 and (SCR_EL3.NS == 1) && (HCR_EL2.E2H == 1) && (HCR_EL2.TGE == 0):
 - If HSTR_EL2.T13==1, Non-secure accesses to this register from EL1 are trapped to EL2.
- When EL2 is implemented and is using AArch32 and SCR_EL3.NS == 1:
 - If HSTR.T13==1, Non-secure accesses to this register from EL1 are trapped to Hyp mode.

G6.2.154 TPIDRURO, PL0 Read-Only Software Thread ID Register

The TPIDRURO characteristics are:

Purpose

Provides a location where software executing at EL1 or higher can store thread identifying information that is visible to software executing at EL0, for OS management purposes.

The PE makes no use of this register.

Configurations

AArch32 System register TPIDRURO is architecturally mapped to AArch64 System register [TPIDRRO_EL0](#)[31:0].

The PE never updates this register. This means the register is always UNKNOWN on reset.

Attributes

TPIDRURO is a 32-bit register.

Field descriptions

The TPIDRURO bit assignments are:

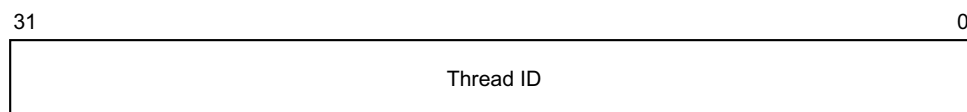

Bits [31:0]

Thread ID. Thread identifying information stored by software running at this Exception level.

Accessing the TPIDRURO

This register can be read using MRC with the following syntax:

MRC <syntax>

This register can be written using MCR with the following syntax:

MCR <syntax>

This syntax is encoded with the following settings in the instruction encoding:

<syntax>	opc1	opc2	CRn	coproc	CRm
p15, 0, <Rt>, c13, c0, 3	000	011	1101	1111	0000

Accessibility

The register is accessible in software as follows:

Configuration	Control			Accessibility				Instance
	E2H	TGE	NS	EL0	EL1	EL2	EL3	
EL3 is using AArch32.	x	x	0	RO	n/a	n/a	RW	TPIDRURO_s
EL3 is using AArch32.	x	0	1	RO	RW	RW	RW	TPIDRURO_ns
EL3 is using AArch32.	x	1	1	RO	n/a	RW	RW	TPIDRURO_ns
EL3 is not implemented.	x	x	0	RO	RW	n/a	n/a	TPIDRURO
EL3 is not implemented.	x	0	1	RO	RW	RW	n/a	TPIDRURO
EL3 is not implemented.	x	1	1	RO	n/a	RW	n/a	TPIDRURO
EL3 is using AArch64.	x	x	0	RO	RW	n/a	n/a	TPIDRURO
EL3 is using AArch64.	x	0	1	RO	RW	RW	n/a	TPIDRURO
EL3 is using AArch64.	x	1	1	RO	n/a	RW	n/a	TPIDRURO

Traps and Enables

For a description of the prioritization of any generated exceptions, see [Synchronous exception prioritization for exceptions taken to AArch32 state on page G1-4344](#) for exceptions taken to AArch32 state and [Synchronous exception prioritization for exceptions taken to AArch64 on page D1-1827](#) for exceptions taken to AArch64 state. Subject to the prioritization rules:

- When EL2 is implemented and is using AArch64 and (SCR_EL3.NS == 1) && (HCR_EL2.E2H == 0):
 - If HSTR_EL2.T13==1, Non-secure accesses to this register from EL0 and EL1 are trapped to EL2.
- When EL2 is implemented and is using AArch64 and (SCR_EL3.NS == 1) && (HCR_EL2.E2H == 1) && (HCR_EL2.TGE == 0):
 - If HSTR_EL2.T13==1, Non-secure accesses to this register from EL0 and EL1 are trapped to EL2.
- When EL2 is implemented and is using AArch32 and SCR_EL3.NS == 1:
 - If HSTR.T13==1, Non-secure accesses to this register from EL0 and EL1 are trapped to Hyp mode.

G6.2.155 TPIDRURW, PL0 Read/Write Software Thread ID Register

The TPIDRURW characteristics are:

Purpose

Provides a location where software executing at EL0 can store thread identifying information, for OS management purposes.

The PE makes no use of this register.

Configurations

AArch32 System register TPIDRURW is architecturally mapped to AArch64 System register [TPIDR_EL0](#)[31:0].

The PE never updates this register. This means the register is always UNKNOWN on reset.

Attributes

TPIDRURW is a 32-bit register.

Field descriptions

The TPIDRURW bit assignments are:

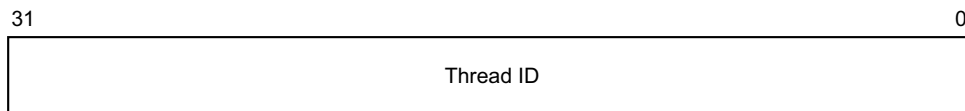

Bits [31:0]

Thread ID. Thread identifying information stored by software running at this Exception level.

Accessing the TPIDRURW

This register can be read using MRC with the following syntax:

MRC <syntax>

This register can be written using MCR with the following syntax:

MCR <syntax>

This syntax is encoded with the following settings in the instruction encoding:

<syntax>	opc1	opc2	CRn	coproc	CRm
p15, 0, <Rt>, c13, c0, 2	000	010	1101	1111	0000

Accessibility

The register is accessible in software as follows:

Configuration	Control			Accessibility				Instance
	E2H	TGE	NS	EL0	EL1	EL2	EL3	
EL3 is using AArch32.	x	x	0	RW	n/a	n/a	RW	TPIDRURW_s
EL3 is using AArch32.	x	0	1	RW	RW	RW	RW	TPIDRURW_ns
EL3 is using AArch32.	x	1	1	RW	n/a	RW	RW	TPIDRURW_ns
EL3 is not implemented.	x	x	0	RW	RW	n/a	n/a	TPIDRURW
EL3 is not implemented.	x	0	1	RW	RW	RW	n/a	TPIDRURW
EL3 is not implemented.	x	1	1	RW	n/a	RW	n/a	TPIDRURW
EL3 is using AArch64.	x	x	0	RW	RW	n/a	n/a	TPIDRURW
EL3 is using AArch64.	x	0	1	RW	RW	RW	n/a	TPIDRURW
EL3 is using AArch64.	x	1	1	RW	n/a	RW	n/a	TPIDRURW

Traps and Enables

For a description of the prioritization of any generated exceptions, see [Synchronous exception prioritization for exceptions taken to AArch32 state on page G1-4344](#) for exceptions taken to AArch32 state and [Synchronous exception prioritization for exceptions taken to AArch64 on page D1-1827](#) for exceptions taken to AArch64 state. Subject to the prioritization rules:

- When EL2 is implemented and is using AArch64 and (SCR_EL3.NS == 1) && (HCR_EL2.E2H == 0):
 - If HSTR_EL2.T13==1, Non-secure accesses to this register from EL0 and EL1 are trapped to EL2.
- When EL2 is implemented and is using AArch64 and (SCR_EL3.NS == 1) && (HCR_EL2.E2H == 1) && (HCR_EL2.TGE == 0):
 - If HSTR_EL2.T13==1, Non-secure accesses to this register from EL0 and EL1 are trapped to EL2.
- When EL2 is implemented and is using AArch32 and SCR_EL3.NS == 1:
 - If HSTR.T13==1, Non-secure accesses to this register from EL0 and EL1 are trapped to Hyp mode.

G6.2.156 TTBCR, Translation Table Base Control Register

The TTBCR characteristics are:

Purpose

The control register for stage 1 of the PL1&0 translation regime. Its controls include:

- Where the VA range is split between addresses translated using [TTBR0](#) and addresses translated using [TTBR1](#).
- The translation table format used by this stage of translation.

In ARMv8.2, when the value of TTBCR.{EAE, T2E} is {1,1}, TTBCR is used with [TTBCR2](#).

Configurations

AArch32 System register TTBCR is architecturally mapped to AArch64 System register [TCR_EL1](#)[31:0].

The current translation table format determines which format of the register is used.

When EL3 is using AArch32, write access to TTBCR(S) is disabled when the CP15SDISABLE signal is asserted HIGH.

Some RW fields of this register have defined reset values. These apply only if the PE resets into an Exception level that is using AArch32. If the PE resets into EL3 using AArch32 then:

- The EAE bit resets to 0 in both the Secure and the Non-secure instances of the register.
- Other reset values apply only to the Secure instance of the register.

Attributes

TTBCR is a 32-bit register.

Field descriptions

The TTBCR bit assignments are:

For all register layouts:

EAE, bit [31]

Extended Address Enable. The meanings of the possible values of this bit are:

- | | |
|---|--|
| 0 | Use the VMSAv8-32 translation system with the Short-descriptor translation table format. |
| 1 | Use the VMSAv8-32 translation system with the Long-descriptor translation table format. |

When TTBCR.EAE==0:

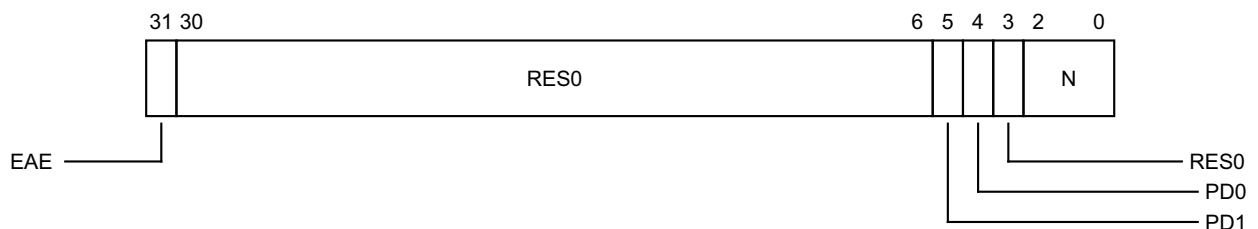

EAE, bit [31]

Extended Address Enable. The meanings of the possible values of this bit are:

- | | |
|---|--|
| 0 | Use the VMSAv8-32 translation system with the Short-descriptor translation table format. |
|---|--|

When this register has an architecturally-defined reset value, this field resets to 0.

Bits [30:6]

Reserved, RES0.

PD1, bit [5]

Translation table walk disable for translations using **TTBR1**. This bit controls whether a translation table walk is performed on a TLB miss, for an address that is translated using **TTBR1**. The encoding of this bit is:

- 0 Perform translation table walks using **TTBR1**.
- 1 A TLB miss on an address that is translated using **TTBR1** generates a Translation fault. No translation table walk is performed.

When this register has an architecturally-defined reset value, this field resets to 0.

PD0, bit [4]

Translation table walk disable for translations using **TTBR0**. This bit controls whether a translation table walk is performed on a TLB miss for an address that is translated using **TTBR0**. The encoding of this bit is:

- 0 Perform translation table walks using **TTBR0**.
- 1 A TLB miss on an address that is translated using **TTBR0** generates a Translation fault. No translation table walk is performed.

When this register has an architecturally-defined reset value, this field resets to 0.

Bit [3]

Reserved, RES0.

N, bits [2:0]

Indicate the width of the base address held in **TTBR0**. In **TTBR0**, the base address field is bits[31:14-N]. The value of N also determines:

- Whether **TTBR0** or **TTBR1** is used as the base address for translation table walks.
- The size of the translation table pointed to by **TTBR0**.

N can take any value from 0 to 7, that is, from 0b000 to 0b111.

When N has its reset value of 0, the translation table base is compatible with ARMv5 and ARMv6.

When this register has an architecturally-defined reset value, this field resets to 0.

When TTBCR.EAE==1:

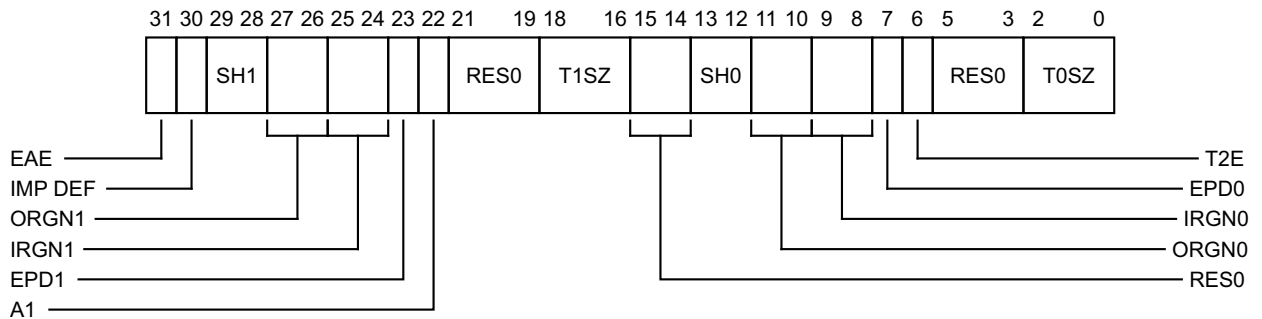

EAE, bit [31]

Extended Address Enable. The meanings of the possible values of this bit are:

- 1 Use the VMSAv8-32 translation system with the Long-descriptor translation table format.

When this register has an architecturally-defined reset value, this field resets to 0.

IMP DEF, bit [30]

IMPLEMENTATION DEFINED.

When this register has an architecturally-defined reset value, this field resets to 0.

SH1, bits [29:28]

Shareability attribute for memory associated with translation table walks using [TTBR1](#). Defined values are:

00	Non-shareable
10	Outer Shareable
11	Inner Shareable

Other values are reserved. The effect of programming this field to a Reserved value is that behavior is CONstrained UNPREDICTABLE, as described in [Reserved values in System and memory-mapped registers and translation table entries on page K1-6117](#).

When this register has an architecturally-defined reset value, this field resets to 0.

ORGN1, bits [27:26]

Outer cacheability attribute for memory associated with translation table walks using [TTBR1](#).

00	Normal memory, Outer Non-cacheable
01	Normal memory, Outer Write-Back Read-Allocate Write-Allocate Cacheable
10	Normal memory, Outer Write-Through Read-Allocate No Write-Allocate Cacheable
11	Normal memory, Outer Write-Back Read-Allocate No Write-Allocate Cacheable

When this register has an architecturally-defined reset value, this field resets to 0.

IRGN1, bits [25:24]

Inner cacheability attribute for memory associated with translation table walks using [TTBR1](#).

00	Normal memory, Inner Non-cacheable
01	Normal memory, Inner Write-Back Read-Allocate Write-Allocate Cacheable
10	Normal memory, Inner Write-Through Read-Allocate No Write-Allocate Cacheable
11	Normal memory, Inner Write-Back Read-Allocate No Write-Allocate Cacheable

When this register has an architecturally-defined reset value, this field resets to 0.

EPD1, bit [23]

Translation table walk disable for translations using [TTBR1](#). This bit controls whether a translation table walk is performed on a TLB miss, for an address that is translated using [TTBR1](#). The encoding of this bit is:

0	Perform translation table walks using TTBR1 .
1	A TLB miss on an address that is translated using TTBR1 generates a Translation fault. No translation table walk is performed.

When this register has an architecturally-defined reset value, this field resets to 0.

A1, bit [22]

Selects whether [TTBR0](#) or [TTBR1](#) defines the ASID. The encoding of this bit is:

0	TTBR0 .ASID defines the ASID.
1	TTBR1 .ASID defines the ASID.

When this register has an architecturally-defined reset value, this field resets to 0.

Bits [21:19]

Reserved, RES0.

T1SZ, bits [18:16]

See [Selecting between TTBR0 and TTBR1, VMSAv8-32 Long-descriptor translation table format on page G4-4594](#) for how TTBCR.{T1SZ, T0SZ} determine the input address ranges and memory region sizes translated using TTBR0 and TTBR1.

When this register has an architecturally-defined reset value, this field resets to 0.

Bits [15:14]

Reserved, RES0.

SH0, bits [13:12]

Shareability attribute for memory associated with translation table walks using TTBR0.

00	Non-shareable
10	Outer Shareable
11	Inner Shareable

Other values are reserved. The effect of programming this field to a Reserved value is that behavior is CONSTRAINED UNPREDICTABLE, as described in [Reserved values in System and memory-mapped registers and translation table entries on page K1-6117](#).

When this register has an architecturally-defined reset value, this field resets to 0.

ORGN0, bits [11:10]

Outer cacheability attribute for memory associated with translation table walks using TTBR0.

00	Normal memory, Outer Non-cacheable
01	Normal memory, Outer Write-Back Read-Allocate Write-Allocate Cacheable
10	Normal memory, Outer Write-Through Read-Allocate No Write-Allocate Cacheable
11	Normal memory, Outer Write-Back Read-Allocate No Write-Allocate Cacheable

When this register has an architecturally-defined reset value, this field resets to 0.

IRGN0, bits [9:8]

Inner cacheability attribute for memory associated with translation table walks using TTBR0.

00	Normal memory, Inner Non-cacheable
01	Normal memory, Inner Write-Back Read-Allocate Write-Allocate Cacheable
10	Normal memory, Inner Write-Through Read-Allocate No Write-Allocate Cacheable
11	Normal memory, Inner Write-Back Read-Allocate No Write-Allocate Cacheable

When this register has an architecturally-defined reset value, this field resets to 0.

EPD0, bit [7]

Translation table walk disable for translations using TTBR0. This bit controls whether a translation table walk is performed on a TLB miss, for an address that is translated using TTBR0. The encoding of this bit is:

0	Perform translation table walks using TTBR0.
1	A TLB miss on an address that is translated using TTBR0 generates a Translation fault. No translation table walk is performed.

When this register has an architecturally-defined reset value, this field resets to 0.

T2E, bit [6]

In ARMv8.2

TTBCR2 Enable.

Defined values are:

0	TTBCR2 is disabled. The contents of TTBCR2 are treated as 0 for all purposes other than reading or writing the register.
---	--

1 [TTBCR2](#) is enabled.

If `TTBCR.EAE==0`, then the behavior is as if the bit is 0.

This bit is RES0 if [ARMv8.2-AA32HPD](#) is not implemented.

In ARMv8.1 and ARMv8.0.

Reserved, RES0.

Bits [5:3]

Reserved, RES0.

T0SZ, bits [2:0]

See [Selecting between TTBR0 and TTBR1, VMSAv8-32 Long-descriptor translation table format on page G4-4594](#) for how `TTBCR`.{`T1SZ`, `T0SZ`} determine the input address ranges and memory region sizes translated using `TTBR0` and `TTBR1`.

When this register has an architecturally-defined reset value, this field resets to 0.

Accessing the TTBCR

This register can be read using MRC with the following syntax:

MRC <syntax>

This register can be written using MCR with the following syntax:

MCR <syntax>

This syntax is encoded with the following settings in the instruction encoding:

<syntax>	opc1	opc2	CRn	coproc	CRm
p15, 0, <Rt>, c2, c0, 2	000	010	0010	1111	0000

Accessibility

The register is accessible in software as follows:

Configuration	Control			Accessibility				Instance
	E2H	TGE	NS	EL0	EL1	EL2	EL3	
EL3 is not implemented.	x	x	0	-	RW	n/a	n/a	TTBCR
EL3 is not implemented.	x	0	1	-	RW	RW	n/a	TTBCR
EL3 is not implemented.	x	1	1	-	n/a	RW	n/a	TTBCR
EL3 is using AArch64.	x	x	0	-	RW	n/a	n/a	TTBCR
EL3 is using AArch64.	x	0	1	-	RW	RW	n/a	TTBCR
EL3 is using AArch64.	x	1	1	-	n/a	RW	n/a	TTBCR
EL3 is using AArch32.	x	0	1	-	RW	RW	RW	TTBCR_ns
EL3 is using AArch32.	x	1	1	-	n/a	RW	RW	TTBCR_ns
EL3 is using AArch32.	x	x	0	-	n/a	n/a	RW	TTBCR_s

When EL3 is using AArch32, write access to `TTBCR_s` is UNDEFINED when the `CP15SSDISABLE` signal is asserted HIGH.

Traps and Enables

For a description of the prioritization of any generated exceptions, see *Synchronous exception prioritization for exceptions taken to AArch32 state* on page G1-4344 for exceptions taken to AArch32 state and *Synchronous exception prioritization for exceptions taken to AArch64* on page D1-1827 for exceptions taken to AArch64 state. Subject to the prioritization rules:

- When EL2 is implemented and is using AArch64 and $(SCR_EL3.NS == 1) \ \&\& \ (HCR_EL2.E2H == 0)$:
 - If $HCR_EL2.TVM == 1$, Non-secure write accesses to this register from EL1 are trapped to EL2.
 - If $HCR_EL2.TRVM == 1$, Non-secure read accesses to this register from EL1 are trapped to EL2.
 - If $HSTR_EL2.T2 == 1$, Non-secure accesses to this register from EL1 are trapped to EL2.
- When EL2 is implemented and is using AArch64 and $(SCR_EL3.NS == 1) \ \&\& \ (HCR_EL2.E2H == 1) \ \&\& \ (HCR_EL2.TGE == 0)$:
 - If $HCR_EL2.TVM == 1$, Non-secure write accesses to this register from EL1 are trapped to EL2.
 - If $HCR_EL2.TRVM == 1$, Non-secure read accesses to this register from EL1 are trapped to EL2.
 - If $HSTR_EL2.T2 == 1$, Non-secure accesses to this register from EL1 are trapped to EL2.
- When EL2 is implemented and is using AArch32 and $SCR_EL3.NS == 1$:
 - If $HCR.TVM == 1$, Non-secure write accesses to this register from EL1 are trapped to Hyp mode.
 - If $HCR.TRVM == 1$, Non-secure read accesses to this register from EL1 are trapped to Hyp mode.
 - If $HSTR.T2 == 1$, Non-secure accesses to this register from EL1 are trapped to Hyp mode.

G6.2.157 TTBCR2, Translation Table Base Control Register 2

The TTBCR2 characteristics are:

Purpose

The second control register for stage 1 of the PL1&0 translation regime.

If ARMv8.2-AA32HPD is not implemented and ARMv8.2-TTPBHA is not implemented, then this register is not implemented and its encoding is unallocated. Otherwise:

- When the value of `TTBCR.{EAE, T2E}` is not `{1, 1}`, the contents of TTBCR2 are treated as zero for all purposes other than reading or writing the register.
- When the value of `TTBCR.{EAE, T2E}` is `{1, 1}`, TTBCR2 is used with `TTBCR`.

Configurations

AArch32 System register TTBCR2 is architecturally mapped to AArch64 System register `TCR_EL1[63:32]`.

When EL3 is using AArch32, write access to TTBCR2(S) is disabled when the CP15SDISABLE signal is asserted HIGH.

RW fields in this register reset to architecturally UNKNOWN values.

This register is introduced in ARMv8.2.

Attributes

TTBCR2 is a 32-bit register.

Field descriptions

The TTBCR2 bit assignments are:

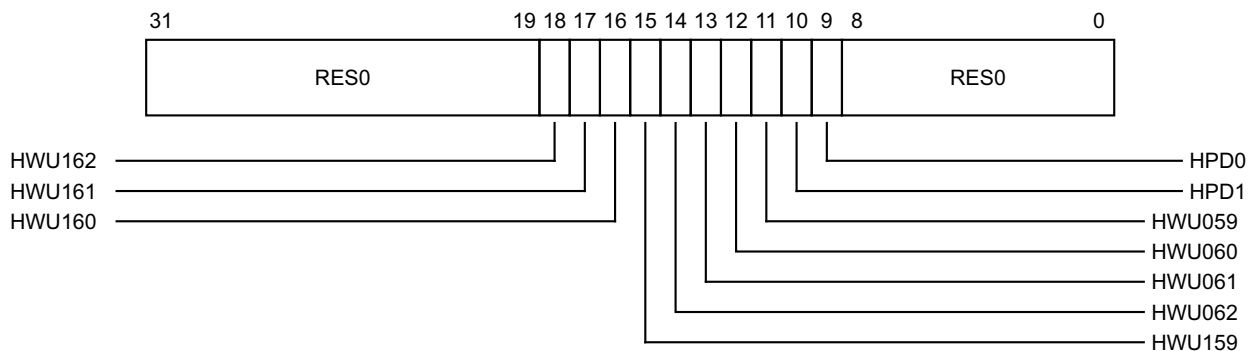

Bits [31:19]

Reserved, RES0.

HWU162, bit [18]

Hardware Use. Indicates IMPLEMENTATION DEFINED hardware use of bit[62] of the stage 1 translation table block or level 3 entry for pages pointed to by `TTBR1` if `TTBCR2.HPD1==1` and `TTBCR.T2E==1`.

Defined values are:

- 0 The stage 1 translation table entry block or level 3 bit cannot be interpreted by hardware for an IMPLEMENTATION DEFINED purpose.
- 1 The stage 1 translation table entry block or level 3 bit can be interpreted by hardware for an IMPLEMENTATION DEFINED purpose if the TTBCR2.HPD1 value is 1.

This bit is RES0 if `ARMv8.2-TTPBHA` is not implemented.

HWU161, bit [17]

Hardware Use. Indicates IMPLEMENTATION DEFINED hardware use of bit[61] of the stage 1 translation table block or level 3 entry for pages pointed to by [TTBR1](#) if `TTBCR2.HPD1==1` and `TTBCR.T2E==1`.

Defined values are:

- 0 The stage 1 translation table entry block or level 3 bit cannot be interpreted by hardware for an IMPLEMENTATION DEFINED purpose.
- 1 The stage 1 translation table entry block or level 3 bit can be interpreted by hardware for an IMPLEMENTATION DEFINED purpose if the `TTBCR2.HPD1` value is 1.

This bit is RES0 if [ARMv8.2-TTPBHA](#) is not implemented.

HWU160, bit [16]

Hardware Use. Indicates IMPLEMENTATION DEFINED hardware use of bit[60] of the stage 1 translation table block or level 3 entry for pages pointed to by [TTBR1](#) if `TTBCR2.HPD1==1` and `TTBCR.T2E==1`.

Defined values are:

- 0 The stage 1 translation table entry block or level 3 bit cannot be interpreted by hardware for an IMPLEMENTATION DEFINED purpose.
- 1 The stage 1 translation table entry block or level 3 bit can be interpreted by hardware for an IMPLEMENTATION DEFINED purpose if the `TTBCR2.HPD1` value is 1.

This bit is RES0 if [ARMv8.2-TTPBHA](#) is not implemented.

HWU159, bit [15]

Hardware Use. Indicates IMPLEMENTATION DEFINED hardware use of bit[59] of the stage 1 translation table block or level 3 entry for pages pointed to by [TTBR1](#) if `TTBCR2.HPD1==1` and `TTBCR.T2E==1`.

Defined values are:

- 0 The stage 1 translation table entry block or level 3 bit cannot be interpreted by hardware for an IMPLEMENTATION DEFINED purpose.
- 1 The stage 1 translation table entry block or level 3 bit can be interpreted by hardware for an IMPLEMENTATION DEFINED purpose if the `TTBCR2.HPD1` value is 1.

This bit is RES0 if [ARMv8.2-TTPBHA](#) is not implemented.

HWU062, bit [14]

Hardware Use. Indicates IMPLEMENTATION DEFINED hardware use of bit[62] of the stage 1 translation table block or level 3 entry for pages pointed to by [TTBR0](#) if `TTBCR2.HPD0==1` and `TTBCR.T2E==1`.

Defined values are:

- 0 The stage 1 translation table entry block or level 3 bit cannot be interpreted by hardware for an IMPLEMENTATION DEFINED purpose.
- 1 The stage 1 translation table entry block or level 3 bit can be interpreted by hardware for an IMPLEMENTATION DEFINED purpose if the `TTBCR2.HPD0` value is 1.

This bit is RES0 if [ARMv8.2-TTPBHA](#) is not implemented.

HWU061, bit [13]

Hardware Use. Indicates IMPLEMENTATION DEFINED hardware use of bit[61] of the stage 1 translation table block or level 3 entry for pages pointed to by [TTBR0](#) if `TTBCR2.HPD0==1` and `TTBCR.T2E==1`.

Defined values are:

- 0 The stage 1 translation table entry block or level 3 bit cannot be interpreted by hardware for an IMPLEMENTATION DEFINED purpose.

- 1 The stage 1 translation table entry block or level 3 bit can be interpreted by hardware for an IMPLEMENTATION DEFINED purpose if the TTBCR2.HPD0 value is 1.

This bit is RES0 if [ARMv8.2-TTPBHA](#) is not implemented.

HWU060, bit [12]

Hardware Use. Indicates IMPLEMENTATION DEFINED hardware use of bit[60] of the stage 1 translation table block or level 3 entry for pages pointed to by [TTBR0](#) if TTBCR2.HPD0==1 and [TTBCR.T2E](#)==1.

Defined values are:

- 0 The stage 1 translation table entry block or level 3 bit cannot be interpreted by hardware for an IMPLEMENTATION DEFINED purpose.
- 1 The stage 1 translation table entry block or level 3 bit can be interpreted by hardware for an IMPLEMENTATION DEFINED purpose if the TTBCR2.HPD0 value is 1.

This bit is RES0 if [ARMv8.2-TTPBHA](#) is not implemented.

HWU059, bit [11]

Hardware Use. Indicates IMPLEMENTATION DEFINED hardware use of bit[59] of the stage 1 translation table block or level 3 entry for pages pointed to by [TTBR0](#) if TTBCR2.HPD0==1 and [TTBCR.T2E](#)==1.

Defined values are:

- 0 The stage 1 translation table entry block or level 3 bit cannot be interpreted by hardware for an IMPLEMENTATION DEFINED purpose.
- 1 The stage 1 translation table entry block or level 3 bit can be interpreted by hardware for an IMPLEMENTATION DEFINED purpose if the TTBCR2.HPD0 value is 1.

This bit is RES0 if [ARMv8.2-TTPBHA](#) is not implemented.

HPD1, bit [10]

Hierarchical Permission Disables. This affects the hierarchical control bits, APTable, XNTable, and PXNTable, in the translation tables pointed to by [TTBR1](#).

Defined values are:

- 0 Hierarchical permissions are enabled.
- 1 Hierarchical permissions are disabled if [TTBCR.T2E](#) == 1.

When disabled, the permissions are treated as if the bits are 0.

If [TTBCR.T2E](#) == 0, the hierarchical permissions are enabled.

This bit is RES0 if [ARMv8.2-AA32HPD](#) is not implemented.

HPD0, bit [9]

Hierarchical Permission Disables. This affects the hierarchical control bits, APTable, XNTable, and PXNTable, in the translation tables pointed to by [TTBR0](#).

Defined values are:

- 0 Hierarchical permissions are enabled.
- 1 Hierarchical permissions are disabled if [TTBCR.T2E](#) == 1.

When disabled, the permissions are treated as if the bits are 0.

If [TTBCR.T2E](#) == 0, the hierarchical permissions are enabled.

This bit is RES0 if [ARMv8.2-AA32HPD](#) is not implemented.

Bits [8:0]

Reserved, RES0.

Accessing the TTBCR2

This register can be read using MRC with the following syntax:

MRC <syntax>

This register can be written using MCR with the following syntax:

MCR <syntax>

This syntax is encoded with the following settings in the instruction encoding:

<syntax>	opc1	opc2	CRn	coproc	CRm
p15, 0, <Rt>, c2, c0, 3	000	011	0010	1111	0000

Accessibility

The register is accessible in software as follows:

Configuration	Control			Accessibility				Instance
	E2H	TGE	NS	EL0	EL1	EL2	EL3	
EL3 is using AArch32.	x	0	1	-	RW	RW	RW	TTBCR2_ns
EL3 is using AArch32.	x	1	1	-	n/a	RW	RW	TTBCR2_ns
EL3 is not implemented.	x	x	0	-	RW	n/a	n/a	TTBCR2
EL3 is not implemented.	x	0	1	-	RW	RW	n/a	TTBCR2
EL3 is not implemented.	x	1	1	-	n/a	RW	n/a	TTBCR2
EL3 is using AArch64.	x	x	0	-	RW	n/a	n/a	TTBCR2
EL3 is using AArch64.	x	0	1	-	RW	RW	n/a	TTBCR2
EL3 is using AArch64.	x	1	1	-	n/a	RW	n/a	TTBCR2
EL3 is using AArch32.	x	x	0	-	n/a	n/a	RW	TTBCR2_s

When EL3 is using AArch32, write access to TTBCR2_s is UNDEFINED when the CP15SDISABLE signal is asserted HIGH.

Traps and Enables

For a description of the prioritization of any generated exceptions, see [Synchronous exception prioritization for exceptions taken to AArch32 state on page G1-4344](#) for exceptions taken to AArch32 state and [Synchronous exception prioritization for exceptions taken to AArch64 on page D1-1827](#) for exceptions taken to AArch64 state. Subject to the prioritization rules:

- When EL2 is implemented and is using AArch64 and (SCR_EL3.NS == 1) && (HCR_EL2.E2H == 0):
 - If HCR_EL2.TVM==1, Non-secure write accesses to this register from EL1 are trapped to EL2.
 - If HCR_EL2.TRVM==1, Non-secure read accesses to this register from EL1 are trapped to EL2.
 - If HSTR_EL2.T2==1, Non-secure accesses to this register from EL1 are trapped to EL2.
- When EL2 is implemented and is using AArch64 and (SCR_EL3.NS == 1) && (HCR_EL2.E2H == 1) && (HCR_EL2.TGE == 0):
 - If HCR_EL2.TVM==1, Non-secure write accesses to this register from EL1 are trapped to EL2.

- If `HCR_EL2.TRVM==1`, Non-secure read accesses to this register from EL1 are trapped to EL2.
- If `HSTR_EL2.T2==1`, Non-secure accesses to this register from EL1 are trapped to EL2.
- When EL2 is implemented and is using AArch32 and `SCR_EL3.NS == 1`:
 - If `HCR.TVM==1`, Non-secure write accesses to this register from EL1 are trapped to Hyp mode.
 - If `HCR.TRVM==1`, Non-secure read accesses to this register from EL1 are trapped to Hyp mode.
 - If `HSTR.T2==1`, Non-secure accesses to this register from EL1 are trapped to Hyp mode.

G6.2.158 TTBR0, Translation Table Base Register 0

The TTBR0 characteristics are:

Purpose

Holds the base address of the translation table for the initial lookup for stage 1 of the translation of an address from the lower VA range in the PL1&0 translation regime, and other information for this translation regime.

Configurations

AArch32 System register TTBR0 is architecturally mapped to AArch64 System register [TTBR0_EL1](#).

[TTBCR.EAE](#) determines which TTBR0 format is used:

EAE==0 32-bit format is used. TTBR0[63:32] are ignored.

EAE==1 64-bit format is used.

When EL3 is using AArch32, write access to TTBR0(S) is disabled when the CP15SSDISABLE signal is asserted HIGH.

Used in conjunction with the [TTBCR](#). When the 64-bit TTBR0 format is used, cacheability and shareability information is held in the [TTBCR](#), not in TTBR0.

RW fields in this register reset to architecturally UNKNOWN values.

Attributes

TTBR0 is a 64-bit register that can also be accessed as a 32-bit value. If it is accessed as a 32-bit register, accesses read and write bits [31:0] and do not modify bits [63:32].

Field descriptions

The TTBR0 bit assignments are:

When [TTBCR.EAE](#)==0:

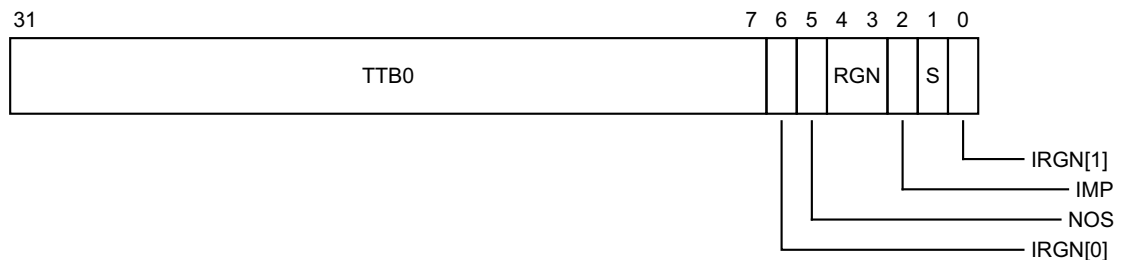

TTBR0, bits [31:7]

Translation table base address, bits[31:x], where x is 14-([TTBCR.N](#)). Register bits [x-1:7] are RES0, with the additional requirement that if these bits are not all zero, this is a misaligned translation table base address, with effects that are CONstrained UNPREDICTABLE, and must be one of the following:

- Register bits [x-1:7] are treated as if all the bits are zero. The value read back from these bits is either the value written or zero.
- The result of the calculation of an address for a translation table walk using this register can be corrupted in those bits that are nonzero.

IRGN[0], bit [6]

See the [IRGN\[1\]](#) description.

NOS, bit [5]

Not Outer Shareable. When the value of TTBR0.S is 1, indicates whether the memory associated with a translation table walk is Inner Shareable or Outer Shareable:

- 0 Memory is Outer Shareable.
- 1 Memory is Inner Shareable.

This bit is ignored when the value of TTBR0.S is 0.

RGN, bits [4:3]

Region bits. Indicates the Outer cacheability attributes for the memory associated with the translation table walks:

- 00 Normal memory, Outer Non-cacheable.
- 01 Normal memory, Outer Write-Back Write-Allocate Cacheable.
- 10 Normal memory, Outer Write-Through Cacheable.
- 11 Normal memory, Outer Write-Back no Write-Allocate Cacheable.

IMP, bit [2]

The effect of this bit is IMPLEMENTATION DEFINED. If the translation table implementation does not include any IMPLEMENTATION DEFINED features this bit is UNK/SBZP.

S, bit [1]

Shareable. Indicates whether the memory associated with the translation table walks is Non-shareable:

- 0 Memory is Non-shareable.
- 1 Memory is shareable. The TTBR0.NOS field indicates whether the memory is Inner Shareable or Outer Shareable.

IRGN[1], bit [0]

Inner region bits. IRGN[1:0] indicate the Inner Cacheability attributes for the memory associated with the translation table walks. The possible values of IRGN[1:0] are:

- 00 Normal memory, Inner Non-cacheable.
- 01 Normal memory, Inner Write-Back Write-Allocate Cacheable.
- 10 Normal memory, Inner Write-Through Cacheable.
- 11 Normal memory, Inner Write-Back no Write-Allocate Cacheable.

Note

The encoding of the IRGN bits is counter-intuitive, with register bit[6] being IRGN[0] and register bit[0] being IRGN[1]. This encoding is chosen to give a consistent encoding of memory region types and to ensure that software written for ARMv7 without the Multiprocessing Extensions can run unmodified on an implementation that includes the functionality introduced by the ARMv7 Multiprocessing Extensions.

When TTBCR.EAE==1:

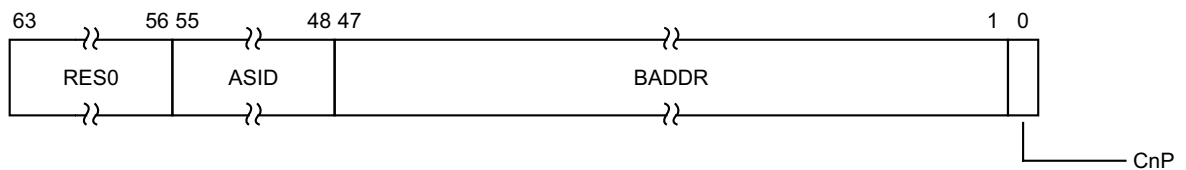

Bits [63:56]

Reserved, RES0.

ASID, bits [55:48]

An ASID for the translation table base address. The [TTBCR.A1](#) field selects either [TTBR0.ASID](#) or [TTBR1.ASID](#).

BADDR, bits [47:1]

Translation table base address, bits[47:x], Bits [x-1:1] are RES0, with the additional requirement that if bits[x-1:3] are not all zero, this is a misaligned translation table base address, with effects that are *CONSTRAINED UNPREDICTABLE*, and must be one of the following:

- Register bits [x-1:3] are treated as if all the bits are zero. The value read back from these bits is either the value written or zero.
- The result of the calculation of an address for a translation table walk using this register can be corrupted in those bits that are nonzero.

x is determined from the value of [TTBCR.TOSZ](#) as follows:

- If [TTBCR.TOSZ](#) is 0 or 1, $x = 5 - \text{TTBCR.TOSZ}$.
- If [TTBCR.TOSZ](#) is greater than 1, $x = 14 - \text{TTBCR.TOSZ}$.

If bits[47:40] of the translation table base address are not zero, an Address size fault is generated.

CnP, bit [0]

In ARMv8.2

Common not Private. In an implementation that includes [ARMv8.2-TTCNP](#), when [TTBCR.EAE](#) ==1, indicates whether each entry that is pointed to by [TTBR0](#) is a member of a common set that can be used by every PE in the Inner Shareable domain for which the value of [TTBR0.CnP](#) is 1.

0 The translation table entries pointed to by this instance of [TTBR0](#), for the current ASID, are permitted to differ from corresponding entries for this instance of [TTBR0](#) for other PEs in the Inner Shareable domain. This is not affected by:

- The value of [TTBR0.CnP](#) on those other PEs.
- The value of [TTBCR.EAE](#) on those other PEs.
- The value of the current ASID or, for the Non-secure instance of [TTBR0](#), the value of the current VMID.

1 The translation table entries pointed to by this instance of [TTBR0](#) are the same as the translation table entries for every other PE in the Inner Shareable domain for which the value of [TTBR0.CnP](#) is 1 for this instance of [TTBR0](#) and all of the following apply:

- The translation table entries are pointed to by this instance of [TTBR0](#).
- The value of the applicable [TTBCR.EAE](#) field is 1.
- The ASID is the same as the current ASID.
- For the Non-secure instance of [TTBR0](#), the VMID is the same as the current VMID.

When a TLB combines entries from stage 1 translation and stage 2 translation into a single entry, that entry can only be shared between different PEs if the value of the CnP bit is 1 for both stage 1 and stage 2.

———— Note ————

If the value of the [TTBR0.CnP](#) bit is 1 on multiple PEs in the same Inner Shareable domain and those [TTBR0](#)s do not point to the same translation table entries when the other conditions specified for the case when the value of CnP is 1 apply, then the results of translations are *CONSTRAINED UNPREDICTABLE*, see [CONSTRAINED UNPREDICTABLE behaviors due to caching of control or data values on page K1-6101](#).

In an implementation that does not include [ARMv8.2-TTCNP](#) this field is RES0.

In ARMv8.1 and ARMv8.0.

Reserved, RES0.

Accessing the TTBR0

This register can be read using MRC with the following syntax:

MRC <syntax>

This register can be written using MCR with the following syntax:

MCR <syntax>

This syntax is encoded with the following settings in the instruction encoding:

<syntax>	opc1	opc2	CRn	coproc	CRm
p15, 0, <Rt>, c2, c0, 0	000	000	0010	1111	0000

This register can be read using MRRC with the following syntax:

MRRC <syntax>

This register can be written using MCRR with the following syntax:

MCRR <syntax>

This syntax is encoded with the following settings in the instruction encoding:

<syntax>	opc1	coproc	CRm
p15, 0, <Rt>, <Rt2>, c2	0000	1111	0010

Accessibility

The register is accessible in software as follows:

Configuration	Control			Accessibility				Instance
	E2H	TGE	NS	EL0	EL1	EL2	EL3	
EL3 is not implemented.	x	x	0	-	RW	n/a	n/a	TTBR0
EL3 is not implemented.	x	0	1	-	RW	RW	n/a	TTBR0
EL3 is not implemented.	x	1	1	-	n/a	RW	n/a	TTBR0
EL3 is using AArch64.	x	x	0	-	RW	n/a	n/a	TTBR0
EL3 is using AArch64.	x	0	1	-	RW	RW	n/a	TTBR0
EL3 is using AArch64.	x	1	1	-	n/a	RW	n/a	TTBR0
EL3 is using AArch32.	x	x	0	-	n/a	n/a	RW	TTBR0_s
EL3 is using AArch32.	x	0	1	-	RW	RW	RW	TTBR0_ns
EL3 is using AArch32.	x	1	1	-	n/a	RW	RW	TTBR0_ns

When EL3 is using AArch32, write access to TTBR0_s is UNDEFINED when the CP15SSDISABLE signal is asserted HIGH.

Traps and Enables

For a description of the prioritization of any generated exceptions, see *Synchronous exception prioritization for exceptions taken to AArch32 state* on page G1-4344 for exceptions taken to AArch32 state and *Synchronous exception prioritization for exceptions taken to AArch64* on page D1-1827 for exceptions taken to AArch64 state. Subject to the prioritization rules:

- When EL2 is implemented and is using AArch64 and $(SCR_EL3.NS == 1) \ \&\& \ (HCR_EL2.E2H == 0)$:
 - If $HCR_EL2.TVM == 1$, Non-secure write accesses to this register from EL1 are trapped to EL2.
 - If $HCR_EL2.TRVM == 1$, Non-secure read accesses to this register from EL1 are trapped to EL2.
 - If $HSTR_EL2.T2 == 1$, Non-secure accesses to this register from EL1 are trapped to EL2.
- When EL2 is implemented and is using AArch64 and $(SCR_EL3.NS == 1) \ \&\& \ (HCR_EL2.E2H == 1) \ \&\& \ (HCR_EL2.TGE == 0)$:
 - If $HCR_EL2.TVM == 1$, Non-secure write accesses to this register from EL1 are trapped to EL2.
 - If $HCR_EL2.TRVM == 1$, Non-secure read accesses to this register from EL1 are trapped to EL2.
 - If $HSTR_EL2.T2 == 1$, Non-secure accesses to this register from EL1 are trapped to EL2.
- When EL2 is implemented and is using AArch32 and $SCR_EL3.NS == 1$:
 - If $HCR.TVM == 1$, Non-secure write accesses to this register from EL1 are trapped to Hyp mode.
 - If $HCR.TRVM == 1$, Non-secure read accesses to this register from EL1 are trapped to Hyp mode.
 - If $HSTR.T2 == 1$, Non-secure accesses to this register from EL1 are trapped to Hyp mode.

G6.2.159 TTBR1, Translation Table Base Register 1

The TTBR1 characteristics are:

Purpose

Holds the base address of the translation table for the initial lookup for stage 1 of the translation of an address from the higher VA range in the PL1&0 translation regime, and other information for this translation regime.

Configurations

AArch32 System register TTBR1 is architecturally mapped to AArch64 System register [TTBR1_EL1](#).

[TTBCR.EAE](#) determines which TTBR1 format is used:

EAE==0 32-bit format is used. TTBR1[63:32] are ignored.

EAE==1 64-bit format is used.

Used in conjunction with the [TTBCR](#). When the 64-bit TTBR1 format is used, cacheability and shareability information is held in the [TTBCR](#), not in TTBR1.

RW fields in this register reset to architecturally UNKNOWN values.

Attributes

TTBR1 is a 64-bit register that can also be accessed as a 32-bit value. If it is accessed as a 32-bit register, accesses read and write bits [31:0] and do not modify bits [63:32].

Field descriptions

The TTBR1 bit assignments are:

When [TTBCR.EAE](#)==0:

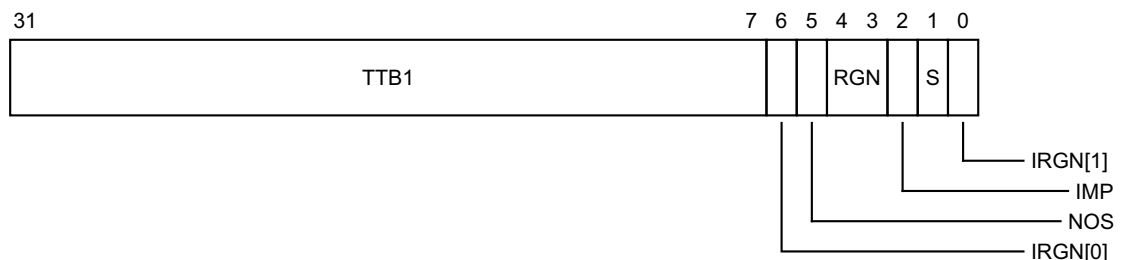

TTB1, bits [31:7]

Translation table base address, bits[31:14]. Register bits [13:7] are RES0, with the additional requirement that if these bits are not all zero, this is a misaligned translation table base address, with effects that are CONstrained UNPREDICTABLE, and must be one of the following:

- Register bits [13:7] are treated as if all the bits are zero. The value read back from these bits is either the value written or zero.
- The result of the calculation of an address for a translation table walk using this register can be corrupted in those bits that are nonzero.

IRGN[0], bit [6]

See the [IRGN\[1\]](#) description.

NOS, bit [5]

Not Outer Shareable. When the value of TTBR1.S is 1, indicates whether the memory associated with a translation table walk is Inner Shareable or Outer Shareable:

- 0 Memory is Outer Shareable.
- 1 Memory is Inner Shareable.

This bit is ignored when the value of TTBR1.S is 0.

RGN, bits [4:3]

Region bits. Indicates the Outer cacheability attributes for the memory associated with the translation table walks:

- 00 Normal memory, Outer Non-cacheable.
- 01 Normal memory, Outer Write-Back Write-Allocate Cacheable.
- 10 Normal memory, Outer Write-Through Cacheable.
- 11 Normal memory, Outer Write-Back no Write-Allocate Cacheable.

IMP, bit [2]

The effect of this bit is IMPLEMENTATION DEFINED. If the translation table implementation does not include any IMPLEMENTATION DEFINED features this bit is UNK/SBZP.

S, bit [1]

Shareable. Indicates whether the memory associated with the translation table walks is Non-shareable:

- 0 Memory is Non-shareable.
- 1 Memory is shareable. The TTBR1.NOS field indicates whether the memory is Inner Shareable or Outer Shareable.

IRGN[1], bit [0]

Inner region bits. IRGN[1:0] indicate the Inner Cacheability attributes for the memory associated with the translation table walks. The possible values of IRGN[1:0] are:

- 00 Normal memory, Inner Non-cacheable.
- 01 Normal memory, Inner Write-Back Write-Allocate Cacheable.
- 10 Normal memory, Inner Write-Through Cacheable.
- 11 Normal memory, Inner Write-Back no Write-Allocate Cacheable.

Note

The encoding of the IRGN bits is counter-intuitive, with register bit[6] being IRGN[0] and register bit[0] being IRGN[1]. This encoding is chosen to give a consistent encoding of memory region types and to ensure that software written for ARMv7 without the Multiprocessing Extensions can run unmodified on an implementation that includes the functionality introduced by the ARMv7 Multiprocessing Extensions.

When TTBCR.EAE==1:

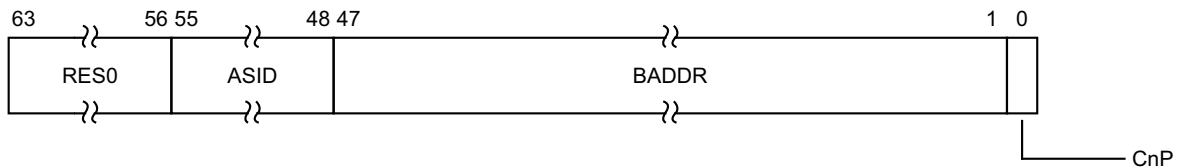

Bits [63:56]

Reserved, RES0.

ASID, bits [55:48]

An ASID for the translation table base address. The [TTBCR.A1](#) field selects either [TTBR0.ASID](#) or [TTBR1.ASID](#).

BADDR, bits [47:1]

Translation table base address, bits[47:x], Bits [x-1:1] are RES0, with the additional requirement that if bits[x-1:3] are not all zero, this is a misaligned translation table base address, with effects that are *CONSTRAINED UNPREDICTABLE*, and must be one of the following:

- Register bits [x-1:3] are treated as if all the bits are zero. The value read back from these bits is either the value written or zero.
- The result of the calculation of an address for a translation table walk using this register can be corrupted in those bits that are nonzero.

x is determined from the value of [TTBCR.T1SZ](#) as follows:

- If [TTBCR.T1SZ](#) is 0 or 1, $x = 5 - \text{TTBCR.T1SZ}$.
- If [TTBCR.T1SZ](#) is greater than 1, $x = 14 - \text{TTBCR.T1SZ}$.

If bits[47:40] of the translation table base address are not zero, an Address size fault is generated.

CnP, bit [0]

In ARMv8.2

Common not Private. In an implementation that includes [ARMv8.2-TTCNP](#), when [TTBCR.EAE](#) ==1, indicates whether each entry that is pointed to by [TTBR1](#) is a member of a common set that can be used by every PE in the Inner Shareable domain for which the value of [TTBR1.CnP](#) is 1.

0 The translation table entries pointed to by this instance of [TTBR1](#), for the current ASID, are permitted to differ from corresponding entries for this instance of [TTBR1](#) for other PEs in the Inner Shareable domain. This is not affected by:

- The value of [TTBR1.CnP](#) on those other PEs.
- The value of [TTBCR.EAE](#) on those other PEs.
- The value of the current ASID or, for the Non-secure instance of [TTBR1](#), the value of the current VMID.

1 The translation table entries pointed to by this instance of [TTBR1](#) are the same as the translation table entries for every other PE in the Inner Shareable domain for which the value of [TTBR1.CnP](#) is 1 for this instance of [TTBR1](#) and all of the following apply:

- The translation table entries are pointed to by this instance of [TTBR1](#).
- The value of the applicable [TTBCR.EAE](#) field is 1.
- The ASID is the same as the current ASID.
- For the Non-secure instance of [TTBR1](#), the VMID is the same as the current VMID.

When a TLB combines entries from stage 1 translation and stage 2 translation into a single entry, that entry can only be shared between different PEs if the value of the CnP bit is 1 for both stage 1 and stage 2.

———— **Note** ————

If the value of the [TTBR1.CnP](#) bit is 1 on multiple PEs in the same Inner Shareable domain and those [TTBR1](#)s do not point to the same translation table entries when the other conditions specified for the case when the value of CnP is 1 apply, then the results of translations are *CONSTRAINED UNPREDICTABLE*, see *CONSTRAINED UNPREDICTABLE behaviors due to caching of control or data values on page K1-6101*.

In an implementation that does not include [ARMv8.2-TTCNP](#) this field is RES0.

In ARMv8.1 and ARMv8.0.

Reserved, RES0.

Accessing the TTBR1

This register can be read using MRC with the following syntax:

MRC <syntax>

This register can be written using MCR with the following syntax:

MCR <syntax>

This syntax is encoded with the following settings in the instruction encoding:

<syntax>	opc1	opc2	CRn	coproc	CRm
p15, 0, <Rt>, c2, c0, 1	000	001	0010	1111	0000

This register can be read using MRRC with the following syntax:

MRRC <syntax>

This register can be written using MCRR with the following syntax:

MCRR <syntax>

This syntax is encoded with the following settings in the instruction encoding:

<syntax>	opc1	coproc	CRm
p15, 1, <Rt>, <Rt2>, c2	0001	1111	0010

Accessibility

The register is accessible in software as follows:

Configuration	Control			Accessibility				Instance
	E2H	TGE	NS	EL0	EL1	EL2	EL3	
EL3 is not implemented.	x	x	0	-	RW	n/a	n/a	TTBR1
EL3 is not implemented.	x	0	1	-	RW	RW	n/a	TTBR1
EL3 is not implemented.	x	1	1	-	n/a	RW	n/a	TTBR1
EL3 is using AArch64.	x	x	0	-	RW	n/a	n/a	TTBR1
EL3 is using AArch64.	x	0	1	-	RW	RW	n/a	TTBR1
EL3 is using AArch64.	x	1	1	-	n/a	RW	n/a	TTBR1
EL3 is using AArch32.	x	0	1	-	RW	RW	RW	TTBR1_ns
EL3 is using AArch32.	x	1	1	-	n/a	RW	RW	TTBR1_ns
EL3 is using AArch32.	x	x	0	-	n/a	n/a	RW	TTBR1_s

Traps and Enables

For a description of the prioritization of any generated exceptions, see *Synchronous exception prioritization for exceptions taken to AArch32 state* on page G1-4344 for exceptions taken to AArch32 state and *Synchronous exception prioritization for exceptions taken to AArch64* on page D1-1827 for exceptions taken to AArch64 state. Subject to the prioritization rules:

- When EL2 is implemented and is using AArch64 and $(SCR_EL3.NS == 1) \&\& (HCR_EL2.E2H == 0)$:
 - If $HCR_EL2.TVM == 1$, Non-secure write accesses to this register from EL1 are trapped to EL2.
 - If $HCR_EL2.TRVM == 1$, Non-secure read accesses to this register from EL1 are trapped to EL2.
 - If $HSTR_EL2.T2 == 1$, Non-secure accesses to this register from EL1 are trapped to EL2.
- When EL2 is implemented and is using AArch64 and $(SCR_EL3.NS == 1) \&\& (HCR_EL2.E2H == 1) \&\& (HCR_EL2.TGE == 0)$:
 - If $HCR_EL2.TVM == 1$, Non-secure write accesses to this register from EL1 are trapped to EL2.
 - If $HCR_EL2.TRVM == 1$, Non-secure read accesses to this register from EL1 are trapped to EL2.
 - If $HSTR_EL2.T2 == 1$, Non-secure accesses to this register from EL1 are trapped to EL2.
- When EL2 is implemented and is using AArch32 and $SCR_EL3.NS == 1$:
 - If $HCR.TVM == 1$, Non-secure write accesses to this register from EL1 are trapped to Hyp mode.
 - If $HCR.TRVM == 1$, Non-secure read accesses to this register from EL1 are trapped to Hyp mode.
 - If $HSTR.T2 == 1$, Non-secure accesses to this register from EL1 are trapped to Hyp mode.

G6.2.160 VBAR, Vector Base Address Register

The VBAR characteristics are:

Purpose

When high exception vectors are not selected, holds the vector base address for exceptions that are not taken to Monitor mode or to Hyp mode.

Software must program VBAR(NS) with the required initial value as part of the PE boot sequence.

Configurations

AArch32 System register VBAR is architecturally mapped to AArch64 System register [VBAR_EL1](#)[31:0].

When EL3 is using AArch32, write access to VBAR(S) is disabled when the CP15SDISABLE signal is asserted HIGH.

Some or all RW fields of this register have defined reset values. These apply only if the PE resets into an Exception level that is using AArch32. If the PE resets into EL3 using AArch32 they apply only to the Secure instance of the register. Otherwise, RW fields in this register reset to architecturally UNKNOWN values.

Attributes

VBAR is a 32-bit register.

Field descriptions

The VBAR bit assignments are:



Bits [31:5]

Vector Base Address. Bits[31:5] of the base address of the exception vectors for exceptions taken to this Exception level. Bits[4:0] of an exception vector are the exception offset.

When this register has an architecturally-defined reset value, this field resets to an IMPLEMENTATION DEFINED value.

Bits [4:0]

Reserved, RES0.

Accessing the VBAR

This register can be read using MRC with the following syntax:

MRC <syntax>

This register can be written using MCR with the following syntax:

MCR <syntax>

This syntax is encoded with the following settings in the instruction encoding:

<syntax>	opc1	opc2	CRn	coproc	CRm
p15, 0, <Rt>, c12, c0, 0	000	000	1100	1111	0000

Accessibility

The register is accessible in software as follows:

Configuration	Control			Accessibility				Instance
	E2H	TGE	NS	EL0	EL1	EL2	EL3	
EL3 is using AArch32.	x	x	0	-	n/a	n/a	RW	VBAR_s
EL3 is using AArch32.	x	0	1	-	RW	RW	RW	VBAR_ns
EL3 is using AArch32.	x	1	1	-	n/a	RW	RW	VBAR_ns
EL3 is not implemented.	x	x	0	-	RW	n/a	n/a	VBAR
EL3 is not implemented.	x	0	1	-	RW	RW	n/a	VBAR
EL3 is not implemented.	x	1	1	-	n/a	RW	n/a	VBAR
EL3 is using AArch64.	x	x	0	-	RW	n/a	n/a	VBAR
EL3 is using AArch64.	x	0	1	-	RW	RW	n/a	VBAR
EL3 is using AArch64.	x	1	1	-	n/a	RW	n/a	VBAR

When EL3 is using AArch32, write access to VBAR_s is UNDEFINED when the CP15SDISABLE signal is asserted HIGH.

Traps and Enables

For a description of the prioritization of any generated exceptions, see [Synchronous exception prioritization for exceptions taken to AArch32 state on page G1-4344](#) for exceptions taken to AArch32 state and [Synchronous exception prioritization for exceptions taken to AArch64 on page D1-1827](#) for exceptions taken to AArch64 state. Subject to the prioritization rules:

- When EL2 is implemented and is using AArch64 and (SCR_EL3.NS == 1) && (HCR_EL2.E2H == 0):
 - If HSTR_EL2.T12==1, Non-secure accesses to this register from EL1 are trapped to EL2.
- When EL2 is implemented and is using AArch64 and (SCR_EL3.NS == 1) && (HCR_EL2.E2H == 1) && (HCR_EL2.TGE == 0):
 - If HSTR_EL2.T12==1, Non-secure accesses to this register from EL1 are trapped to EL2.
- When EL2 is implemented and is using AArch32 and SCR_EL3.NS == 1:
 - If HSTR.T12==1, Non-secure accesses to this register from EL1 are trapped to Hyp mode.

G6.2.161 VMPIDR, Virtualization Multiprocessor ID Register

The VMPIDR characteristics are:

Purpose

Holds the value of the Virtualization Multiprocessor ID. This is the value returned by Non-secure EL1 reads of [MPIDR](#).

Configurations

AArch32 System register VMPIDR is architecturally mapped to AArch64 System register [VMPIDR_EL2](#)[31:0].

If EL2 is not implemented but EL3 is implemented, this register takes the value of the [MPIDR](#).

Some or all RW fields of this register have defined reset values. These apply only if the PE resets into EL2 with EL2 using AArch32, or into EL3 with EL3 using AArch32. Otherwise, RW fields in this register reset to architecturally UNKNOWN values.

Attributes

VMPIDR is a 32-bit register.

Field descriptions

The VMPIDR bit assignments are:

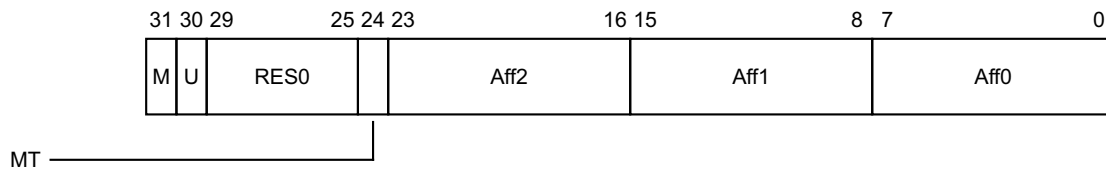

M, bit [31]

Indicates whether this implementation includes the functionality introduced by the ARMv7 Multiprocessing Extensions. The possible values of this bit are:

- 0 This implementation does not include the ARMv7 Multiprocessing Extensions functionality.
 - 1 This implementation includes the ARMv7 Multiprocessing Extensions functionality.
- In ARMv8 this bit is RES1.

U, bit [30]

Indicates a Uniprocessor system, as distinct from PE 0 in a multiprocessor system. The possible values of this bit are:

- 0 Processor is part of a multiprocessor system.
- 1 Processor is part of a uniprocessor system.

When this register has an architecturally-defined reset value, this field resets to the value of [MPIDR.U](#).

Bits [29:25]

Reserved, RES0.

MT, bit [24]

Indicates whether the lowest level of affinity consists of logical PEs that are implemented using a multithreading type approach. The possible values of this bit are:

- 0 Performance of PEs at the lowest affinity level is largely independent.
- 1 Performance of PEs at the lowest affinity level is very interdependent.

When this register has an architecturally-defined reset value, this field resets to the value of [MPIDR.MT](#).

Aff2, bits [23:16]

Affinity level 2. The least significant affinity level field, for this PE in the system.

When this register has an architecturally-defined reset value, this field resets to the value of [MPIDR.Aff2](#).

Aff1, bits [15:8]

Affinity level 1. The intermediate affinity level field, for this PE in the system.

When this register has an architecturally-defined reset value, this field resets to the value of [MPIDR.Aff1](#).

Aff0, bits [7:0]

Affinity level 0. The most significant affinity level field, for this PE in the system.

When this register has an architecturally-defined reset value, this field resets to the value of [MPIDR.Aff0](#).

Accessing the VMPIDR

This register can be read using MRC with the following syntax:

MRC <syntax>

This register can be written using MCR with the following syntax:

MCR <syntax>

This syntax is encoded with the following settings in the instruction encoding:

<syntax>	opc1	opc2	CRn	coproc	CRm
p15, 4, <Rt>, c0, c0, 5	100	101	0000	1111	0000

Accessibility

The register is accessible in software as follows:

Control			Accessibility			
E2H	TGE	NS	EL0	EL1	EL2	EL3
x	x	0	-	-	n/a	-
x	0	1	-	-	RW	RW
x	1	1	-	n/a	RW	RW

Traps and Enables

For a description of the prioritization of any generated exceptions, see [Synchronous exception prioritization for exceptions taken to AArch32 state on page G1-4344](#) for exceptions taken to AArch32 state and [Synchronous exception prioritization for exceptions taken to AArch64 on page D1-1827](#) for exceptions taken to AArch64 state. Subject to the prioritization rules:

- When EL2 is implemented and is using AArch64 and (SCR_EL3.NS == 1) && (HCR_EL2.E2H == 0):
 - If [HSTR_EL2.T0](#)==1, Non-secure accesses to this register from EL1 are trapped to EL2.

- When EL2 is implemented and is using AArch64 and (SCR_EL3.NS == 1) && (HCR_EL2.E2H == 1) && (HCR_EL2.TGE == 0):
 - If [HSTR_EL2.T0](#)==1, Non-secure accesses to this register from EL1 are trapped to EL2.
- When EL2 is implemented and is using AArch32 and SCR_EL3.NS == 1:
 - If [HSTR.T0](#)==1, Non-secure accesses to this register from EL1 are trapped to Hyp mode.

G6.2.162 VPIDR, Virtualization Processor ID Register

The VPIDR characteristics are:

Purpose

Holds the value of the Virtualization Processor ID. This is the value returned by Non-secure EL1 reads of [MIDR](#).

Configurations

AArch32 System register VPIDR is architecturally mapped to AArch64 System register [VPIDR_EL2](#).

If EL2 is not implemented but EL3 is implemented, this register takes the value of the [MIDR](#).

Some or all RW fields of this register have defined reset values. These apply only if the PE resets into EL2 with EL2 using AArch32, or into EL3 with EL3 using AArch32. Otherwise, RW fields in this register reset to architecturally UNKNOWN values.

Attributes

VPIDR is a 32-bit register.

Field descriptions

The VPIDR bit assignments are:

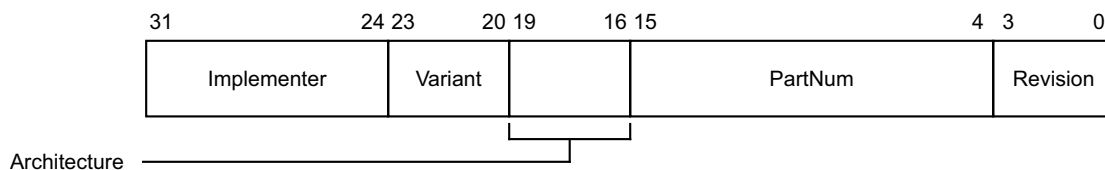

Implementer, bits [31:24]

The Implementer code. This field must hold an implementer code that has been assigned by ARM. Assigned codes include the following:

Hex representation	ASCII representation	Implementer
0x41	A	ARM Limited
0x42	B	Broadcom Corporation
0x43	C	Cavium Inc.
0x44	D	Digital Equipment Corporation
0x49	I	Infineon Technologies AG
0x4D	M	Motorola or Freescale Semiconductor Inc.
0x4E	N	NVIDIA Corporation
0x50	P	Applied Micro Circuits Corporation
0x51	Q	Qualcomm Inc.
0x56	V	Marvell International Ltd.
0x69	i	Intel Corporation

ARM can assign codes that are not published in this manual. All values not assigned by ARM are reserved and must not be used.

When this register has an architecturally-defined reset value, this field resets to the value of [MIDR.Implementer](#).

Variant, bits [23:20]

An IMPLEMENTATION DEFINED variant number. Typically, this field is used to distinguish between different product variants, or major revisions of a product.

When this register has an architecturally-defined reset value, this field resets to the value of [MIDR.Variant](#).

Architecture, bits [19:16]

The permitted values of this field are:

- 0001 ARMv4
- 0010 ARMv4T
- 0011 ARMv5 (obsolete)
- 0100 ARMv5T
- 0101 ARMv5TE
- 0110 ARMv5TEJ
- 0111 ARMv6
- 1111 Architectural features are individually identified in the ID_* registers, see [Identification registers, functional group on page G4-4727](#).

All other values are reserved.

When this register has an architecturally-defined reset value, this field resets to the value of [MIDR.Architecture](#).

PartNum, bits [15:4]

An IMPLEMENTATION DEFINED primary part number for the device.

On processors implemented by ARM, if the top four bits of the primary part number are 0x0 or 0x7, the variant and architecture are encoded differently.

When this register has an architecturally-defined reset value, this field resets to the value of [MIDR.PartNum](#).

Revision, bits [3:0]

An IMPLEMENTATION DEFINED revision number for the device.

When this register has an architecturally-defined reset value, this field resets to the value of [MIDR.Revision](#).

Accessing the VPIDR

This register can be read using MRC with the following syntax:

MRC <syntax>

This register can be written using MCR with the following syntax:

MCR <syntax>

This syntax is encoded with the following settings in the instruction encoding:

<syntax>	opc1	opc2	CRn	coproc	CRm
p15, 4, <Rt>, c0, c0, 0	100	000	0000	1111	0000

Accessibility

The register is accessible in software as follows:

Control			Accessibility			
E2H	TGE	NS	EL0	EL1	EL2	EL3
x	x	0	-	-	n/a	-
x	0	1	-	-	RW	RW
x	1	1	-	n/a	RW	RW

Traps and Enables

For a description of the prioritization of any generated exceptions, see [Synchronous exception prioritization for exceptions taken to AArch32 state on page G1-4344](#) for exceptions taken to AArch32 state and [Synchronous exception prioritization for exceptions taken to AArch64 on page D1-1827](#) for exceptions taken to AArch64 state. Subject to the prioritization rules:

- When EL2 is implemented and is using AArch64 and $(SCR_EL3.NS == 1) \ \&\& \ (HCR_EL2.E2H == 0)$:
 - If $HSTR_EL2.T0 == 1$, Non-secure accesses to this register from EL1 are trapped to EL2.
- When EL2 is implemented and is using AArch64 and $(SCR_EL3.NS == 1) \ \&\& \ (HCR_EL2.E2H == 1) \ \&\& \ (HCR_EL2.TGE == 0)$:
 - If $HSTR_EL2.T0 == 1$, Non-secure accesses to this register from EL1 are trapped to EL2.
- When EL2 is implemented and is using AArch32 and $SCR_EL3.NS == 1$:
 - If $HSTR.T0 == 1$, Non-secure accesses to this register from EL1 are trapped to Hyp mode.

G6.2.163 VTCR, Virtualization Translation Control Register

The VTCR characteristics are:

Purpose

The control register for stage 2 of the Non-secure PL1&0 translation regime.

Note

This stage of translation always uses the Long-descriptor translation table format.

Configurations

AArch32 System register VTCR is architecturally mapped to AArch64 System register [VTCR_EL2](#).

If EL2 is not implemented, this register is RES0 from EL3.

RW fields in this register reset to architecturally UNKNOWN values.

Attributes

VTCR is a 32-bit register.

Field descriptions

The VTCR bit assignments are:

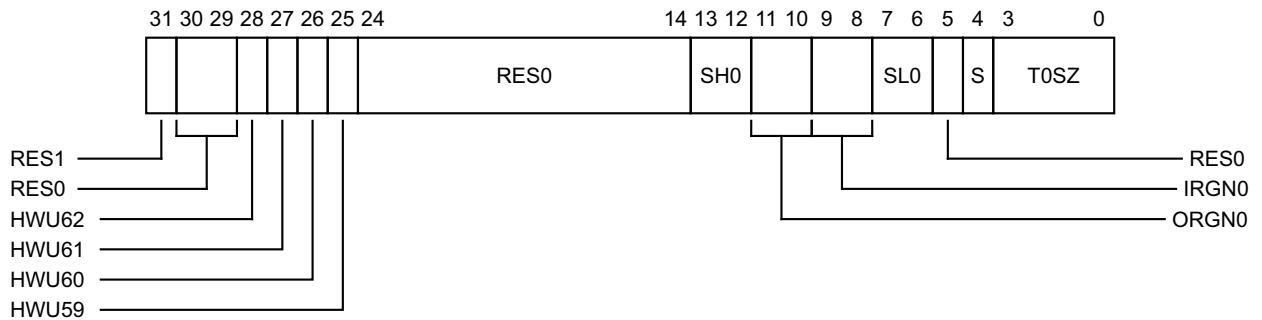

Bit [31]

Reserved, RES1.

Bits [30:29]

Reserved, RES0.

HWU62, bit [28]

In ARMv8.2

Hardware Use. Indicates IMPLEMENTATION DEFINED hardware use of bit[62] of the stage 2 translation table block or level 3 entry.

Defined values are:

- 0 The stage 2 translation table entry block or level 3 entry cannot be interpreted by hardware for an IMPLEMENTATION DEFINED purpose.
- 1 The stage 2 translation table entry block or level 3 entry can be interpreted by hardware for an IMPLEMENTATION DEFINED purpose.

This bit is RES0 if [ARMv8.2-TTPBHA](#) is not implemented.

In ARMv8.1 and ARMv8.0.

Reserved, RES0.

HWU61, bit [27]

In ARMv8.2

Hardware Use. Indicates IMPLEMENTATION DEFINED hardware use of bit[61] of the stage 2 translation table block or level 3 entry.

Defined values are:

- 0 The stage 2 translation table entry block or level 3 entry cannot be interpreted by hardware for an IMPLEMENTATION DEFINED purpose.
- 1 The stage 2 translation table entry block or level 3 entry can be interpreted by hardware for an IMPLEMENTATION DEFINED purpose.

This bit is RES0 if [ARMv8.2-TTPBHA](#) is not implemented.

In ARMv8.1 and ARMv8.0.

Reserved, RES0.

HWU60, bit [26]

In ARMv8.2

Hardware Use. Indicates IMPLEMENTATION DEFINED hardware use of bit[60] of the stage 2 translation table block or level 3 entry.

Defined values are:

- 0 The stage 2 translation table entry block or level 3 entry cannot be interpreted by hardware for an IMPLEMENTATION DEFINED purpose.
- 1 The stage 2 translation table entry block or level 3 entry can be interpreted by hardware for an IMPLEMENTATION DEFINED purpose.

This bit is RES0 if [ARMv8.2-TTPBHA](#) is not implemented.

In ARMv8.1 and ARMv8.0.

Reserved, RES0.

HWU59, bit [25]

In ARMv8.2

Hardware Use. Indicates IMPLEMENTATION DEFINED hardware use of bit[59] of the stage 2 translation table block or level 3 entry.

Defined values are:

- 0 The stage 2 translation table entry block or level 3 entry cannot be interpreted by hardware for an IMPLEMENTATION DEFINED purpose.
- 1 The stage 2 translation table entry block or level 3 entry can be interpreted by hardware for an IMPLEMENTATION DEFINED purpose.

This bit is RES0 if [ARMv8.2-TTPBHA](#) is not implemented.

In ARMv8.1 and ARMv8.0.

Reserved, RES0.

Bits [24:14]

Reserved, RES0.

SH0, bits [13:12]

Shareability attribute for memory associated with translation table walks using [VTTBR](#).

- 00 Non-shareable
- 10 Outer Shareable
- 11 Inner Shareable

Other values are reserved. The effect of programming this field to a Reserved value is that behavior is CONstrained UNPREDICTABLE, as described in [Reserved values in System and memory-mapped registers and translation table entries](#) on page K1-6117.

ORGN0, bits [11:10]

Outer cacheability attribute for memory associated with translation table walks using [VTTBR](#).

00	Normal memory, Outer Non-cacheable
01	Normal memory, Outer Write-Back Read-Allocate Write-Allocate Cacheable
10	Normal memory, Outer Write-Through Read-Allocate No Write-Allocate Cacheable
11	Normal memory, Outer Write-Back Read-Allocate No Write-Allocate Cacheable

IRGN0, bits [9:8]

Inner cacheability attribute for memory associated with translation table walks using [VTTBR](#).

00	Normal memory, Inner Non-cacheable
01	Normal memory, Inner Write-Back Read-Allocate Write-Allocate Cacheable
10	Normal memory, Inner Write-Through Read-Allocate No Write-Allocate Cacheable
11	Normal memory, Inner Write-Back Read-Allocate No Write-Allocate Cacheable

SL0, bits [7:6]

Starting level for translation table walks using [VTTBR](#).

00	Start at level 2
01	Start at level 1

All other values are reserved. If this field is programmed to a reserved value, or to a value that is not consistent with the programming of T0SZ, then a stage 2 level 1 Translation fault is generated.

Bit [5]

Reserved, RES0.

S, bit [4]

Sign extension bit. This bit must be programmed to the value of T0SZ[3]. If it is not, then the behavior is **CONSTRAINED UNPREDICTABLE** and the stage 2 T0SZ value is treated as an UNKNOWN value, see [Misprogramming VTCR.S on page K1-6114](#).

T0SZ, bits [3:0]

The size offset of the memory region addressed by [VTTBR](#). The region size is $2^{(32-T0SZ)}$ bytes.

This field holds a four-bit signed integer value, meaning it supports values from -8 to 7.

———— Note —————

This is different from the other translation control registers, where TnSZ holds a three-bit unsigned integer, supporting values from 0 to 7.

If this field is programmed to a value that is not consistent with the programming of SL0 then a stage 2 level 1 Translation fault is generated.

Accessing the VTCR

This register can be read using MRC with the following syntax:

```
MRC <syntax>
```

This register can be written using MCR with the following syntax:

```
MCR <syntax>
```

This syntax is encoded with the following settings in the instruction encoding:

<syntax>	opc1	opc2	CRn	coproc	CRm
p15, 4, <Rt>, c2, c1, 2	100	010	0010	1111	0001

Accessibility

The register is accessible in software as follows:

Control			Accessibility			
E2H	TGE	NS	EL0	EL1	EL2	EL3
x	x	0	-	-	n/a	-
x	0	1	-	-	RW	RW
x	1	1	-	n/a	RW	RW

Traps and Enables

For a description of the prioritization of any generated exceptions, see [Synchronous exception prioritization for exceptions taken to AArch32 state on page G1-4344](#) for exceptions taken to AArch32 state and [Synchronous exception prioritization for exceptions taken to AArch64 on page D1-1827](#) for exceptions taken to AArch64 state. Subject to the prioritization rules:

- When EL2 is implemented and is using AArch64 and (SCR_EL3.NS == 1) && (HCR_EL2.E2H == 0):
 - If HSTR_EL2.T2==1, Non-secure accesses to this register from EL1 are trapped to EL2.
- When EL2 is implemented and is using AArch64 and (SCR_EL3.NS == 1) && (HCR_EL2.E2H == 1) && (HCR_EL2.TGE == 0):
 - If HSTR_EL2.T2==1, Non-secure accesses to this register from EL1 are trapped to EL2.
- When EL2 is implemented and is using AArch32 and SCR_EL3.NS == 1:
 - If HSTR.T2==1, Non-secure accesses to this register from EL1 are trapped to Hyp mode.

G6.2.164 VTTBR, Virtualization Translation Table Base Register

The VTTBR characteristics are:

Purpose

Holds the base address of the translation table for the initial lookup for stage 2 of an address translation in the Non-secure PL1&0 translation regime, and other information for this translation regime.

Configurations

AArch32 System register VTTBR is architecturally mapped to AArch64 System register [VTTBR_EL2](#).

If EL2 is not implemented, this register is RES0 from EL3.

Some or all RW fields of this register have defined reset values. These apply only if the PE resets into EL2 with EL2 using AArch32, or into EL3 with EL3 using AArch32. Otherwise, RW fields in this register reset to architecturally UNKNOWN values.

Attributes

VTTBR is a 64-bit register.

Field descriptions

The VTTBR bit assignments are:

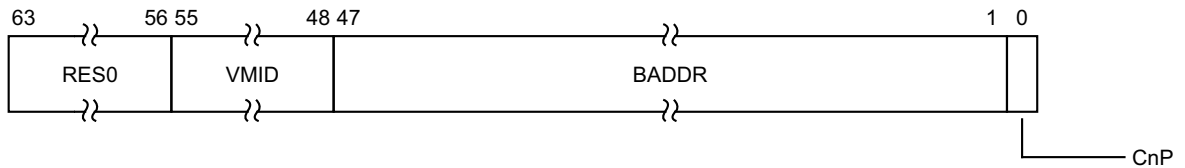

Bits [63:56]

Reserved, RES0.

VMID, bits [55:48]

The VMID for the translation table.

When this register has an architecturally-defined reset value, this field resets to 0.

BADDR, bits [47:1]

Translation table base address, bits[47:x], Bits [x-1:1] are RES0, with the additional requirement that if bits[x-1:3] are not all zero, this is a misaligned translation table base address, with effects that are CONstrained UNPREDICTABLE, and must be one of the following:

- Register bits [x-1:3] are treated as if all the bits are zero. The value read back from these bits is either the value written or zero.
- The result of the calculation of an address for a translation table walk using this register can be corrupted in those bits that are nonzero.

x is determined from the value of [VTCR.SL0](#) and [VTCR.T0SZ](#) as follows:

- If [VTCR.SL0](#) is 00, meaning that lookup starts at level 2, then x is 14 - [VTCR.T0SZ](#).
- If [VTCR.SL0](#) is 01, meaning that lookup starts at level 1, then x is 5 - [VTCR.T0SZ](#).
- If [VTCR.SL0](#) is either 10 or 11 then a stage 2 level 1 Translation fault is generated.

If bits[47:40] of the translation table base address are not zero, an Address size fault is generated.

This field resets to a value that is architecturally UNKNOWN.

CnP, bit [0]

In ARMv8.2

Common not Private. In an implementation that includes [ARMv8.2-TTCNP](#), indicates whether each entry that is pointed to by VTTBR is a member of a common set that can be used by every PE in the Inner Shareable domain for which the value of VTTBR.CnP is 1.

- 0 The translation table entries pointed to by VTTBR are permitted to differ from the entries for VTTBR for other PEs in the Inner Shareable domain. This is not affected by the value of the current VMID.
- 1 The translation table entries pointed to by VTTBR are the same as the translation table entries for every other PE in the Inner Shareable domain for which the value of VTTBR.CnP is 1 and the VMID is the same as the current VMID.

When a TLB combines entries from stage 1 translation and stage 2 translation into a single entry, that entry can only be shared between different PEs if the value of the CnP bit is 1 for both stage 1 and stage 2.

Note

If the value of the VTTBR.CnP bit is 1 on multiple PEs in the same Inner Shareable domain and those VTTBRs do not point to the same translation table entries when the VMID value is the same as the current VMID, then the results of translations are *CONSTRAINED UNPREDICTABLE*, see [CONSTRAINED UNPREDICTABLE behaviors due to caching of control or data values on page K1-6101](#).

In an implementation that does not include [ARMv8.2-TTCNP](#) this field is RES0.

In ARMv8.1 and ARMv8.0.

Reserved, RES0.

Accessing the VTTBR

This register can be read using MRRC with the following syntax:

MRRC <syntax>

This register can be written using MCRR with the following syntax:

MCRR <syntax>

This syntax is encoded with the following settings in the instruction encoding:

<syntax>	opc1	coproc	CRm
p15, 6, <Rt>, <Rt2>, c2	0110	1111	0010

Accessibility

The register is accessible in software as follows:

Control			Accessibility			
E2H	TGE	NS	EL0	EL1	EL2	EL3
x	x	0	-	-	n/a	-
x	0	1	-	-	RW	RW
x	1	1	-	n/a	RW	RW

Traps and Enables

For a description of the prioritization of any generated exceptions, see *Synchronous exception prioritization for exceptions taken to AArch32 state* on page G1-4344 for exceptions taken to AArch32 state and *Synchronous exception prioritization for exceptions taken to AArch64* on page D1-1827 for exceptions taken to AArch64 state. Subject to the prioritization rules:

- When EL2 is implemented and is using AArch64 and $(SCR_EL3.NS == 1) \ \&\& \ (HCR_EL2.E2H == 0)$:
 - If $HSTR_EL2.T2 == 1$, Non-secure accesses to this register from EL1 are trapped to EL2.
- When EL2 is implemented and is using AArch64 and $(SCR_EL3.NS == 1) \ \&\& \ (HCR_EL2.E2H == 1) \ \&\& \ (HCR_EL2.TGE == 0)$:
 - If $HSTR_EL2.T2 == 1$, Non-secure accesses to this register from EL1 are trapped to EL2.
- When EL2 is implemented and is using AArch32 and $SCR_EL3.NS == 1$:
 - If $HSTR.T2 == 1$, Non-secure accesses to this register from EL1 are trapped to Hyp mode.

G6.3 Debug registers

This section lists the Debug System registers in AArch32 state, in alphabetic order.

G6.3.1 DBGAUTHSTATUS, Debug Authentication Status register

The DBGAUTHSTATUS characteristics are:

Purpose

Provides information about the state of the IMPLEMENTATION DEFINED authentication interface for debug.

Configurations

There is one instance of this register that is used in both Secure and Non-secure states.

AArch32 System register DBGAUTHSTATUS is architecturally mapped to AArch64 System register [DBGAUTHSTATUS_EL1](#).

AArch32 System register DBGAUTHSTATUS is architecturally mapped to External register [DBGAUTHSTATUS_EL1](#).

This register is required in all implementations.

Attributes

DBGAUTHSTATUS is a 32-bit register.

Field descriptions

The DBGAUTHSTATUS bit assignments are:

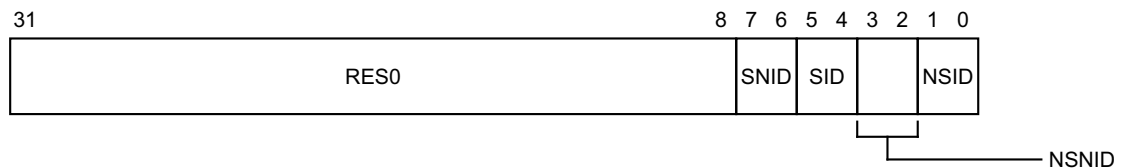

Bits [31:8]

Reserved, RES0.

SNID, bits [7:6]

Secure non-invasive debug. Possible values of this field are:

- 00 Not implemented. EL3 is not implemented and the implemented Security state is Non-secure state.
- 10 Implemented and disabled. ExternalSecureNoninvasiveDebugEnabled() == FALSE.
- 11 Implemented and enabled. ExternalSecureNoninvasiveDebugEnabled() == TRUE.

Other values are reserved.

SID, bits [5:4]

Secure invasive debug. Possible values of this field are:

- 00 Not implemented. EL3 is not implemented and the implemented Security state is Non-secure state.
- 10 Implemented and disabled. ExternalSecureInvasiveDebugEnabled() == FALSE.
- 11 Implemented and enabled. ExternalSecureInvasiveDebugEnabled() == TRUE.

Other values are reserved.

NSNID, bits [3:2]

Non-secure non-invasive debug. Possible values of this field are:

- 00 Not implemented. EL3 is not implemented and the implemented Security state is Secure state.

- 10 Implemented and disabled. ExternalNoninvasiveDebugEnabled() == FALSE.
 - 11 Implemented and enabled. ExternalNoninvasiveDebugEnabled() == TRUE.
- Other values are reserved.

NSID, bits [1:0]

Non-secure invasive debug. Possible values of this field are:

- 00 Not implemented. EL3 is not implemented and the implemented Security state is Secure state.
 - 10 Implemented and disabled. ExternalInvasiveDebugEnabled() == FALSE.
 - 11 Implemented and enabled. ExternalInvasiveDebugEnabled() == TRUE.
- Other values are reserved.

Accessing the DBGAUTHSTATUS

This register can be read using MRC with the following syntax:

MRC <syntax>

This syntax is encoded with the following settings in the instruction encoding:

<syntax>	opc1	opc2	CRn	coproc	CRm
p14, 0, <Rt>, c7, c14, 6	000	110	0111	1110	1110

Accessibility

The register is accessible in software as follows:

Control			Accessibility			
E2H	TGE	NS	EL0	EL1	EL2	EL3
x	x	0	-	RO	n/a	RO
x	0	1	-	RO	RO	RO
x	1	1	-	n/a	RO	RO

Traps and Enables

For a description of the prioritization of any generated exceptions, see [Synchronous exception prioritization for exceptions taken to AArch32 state on page G1-4344](#) for exceptions taken to AArch32 state and [Synchronous exception prioritization for exceptions taken to AArch64 on page D1-1827](#) for exceptions taken to AArch64 state. Subject to the prioritization rules:

- When EL2 is implemented and is using AArch64 and SCR_EL3.NS == 1:
 - If MDCR_EL2.TDA==1, Non-secure read accesses to this register from EL1 are trapped to EL2.
- When EL2 is implemented and is using AArch32 and SCR_EL3.NS == 1:
 - If HDCR.TDA==1, Non-secure read accesses to this register from EL1 are trapped to Hyp mode.
- When EL3 is implemented and is using AArch64:
 - If MDCR_EL3.TDA==1, read accesses to this register from EL1 and EL2 are trapped to EL3.

G6.3.2 DBGBCR<n>, Debug Breakpoint Control Registers, n = 0 - 15

The DBGBCR<n> characteristics are:

Purpose

Holds control information for a breakpoint. Forms breakpoint n together with value register [DBGBVR<n>](#). If EL2 is implemented and this breakpoint supports Context matching, [DBGBVR<n>](#) can be associated with a Breakpoint Extended Value Register [DBGBXVR<n>](#) for VMID matching.

Configurations

There is one instance of this register that is used in both Secure and Non-secure states.

AArch32 System register DBGBCR<n> is architecturally mapped to AArch64 System register [DBGBCR<n>_EL1](#).

AArch32 System register DBGBCR<n> is architecturally mapped to External register [DBGBCR<n>_EL1](#).

If breakpoint n is not implemented then this register is unallocated.

This register is in the Cold reset domain. On a Cold reset RW fields in this register reset to architecturally UNKNOWN values. The register is not affected by a Warm reset.

Attributes

DBGBCR<n> is a 32-bit register.

Field descriptions

The DBGBCR<n> bit assignments are:

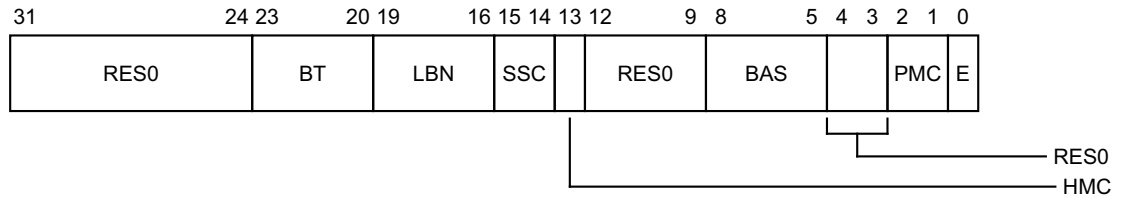

When the E field is zero, all the other fields in the register are ignored.

Bits [31:24]

Reserved, RES0.

BT, bits [23:20]

Breakpoint Type. Possible values are:

- 0000 Unlinked instruction address match.
- 0001 Linked instruction address match.
- 0010 Unlinked Context ID match.
- 0011 Linked Context ID match.
- 0100 Unlinked instruction address mismatch.
- 0101 Linked instruction address mismatch.
- 0110 Unlinked [CONTEXTIDR_EL1](#) match (introduced in ARMv8.1).
- 0111 Linked [CONTEXTIDR_EL1](#) match (introduced in ARMv8.1).
- 1000 Unlinked VMID match.
- 1001 Linked VMID match.

1010	Unlinked VMID and Context ID match.
1011	Linked VMID and Context ID match.
1100	Unlinked <code>CONTEXTIDR_EL2</code> match (introduced in ARMv8.1).
1101	Linked <code>CONTEXTIDR_EL2</code> match (introduced in ARMv8.1).
1110	Unlinked Full Context ID match (introduced in ARMv8.1).
1111	Linked Full Context ID match (introduced in ARMv8.1).

The field breaks down as follows:

- `BT[3:1]`: Base type.

000	Match address. <code>DBGVVR<n></code> is the address of an instruction.
001	Match Context ID. <code>DBGVVR<n>.ContextID</code> is a Context ID compared against <code>CONTEXTIDR</code> when <code>ARMv8.1-VHE</code> is not implemented, or not in a Host OS or a Host Application. When <code>ARMv8.1-VHE</code> is implemented, and in a Host OS or Host Application, the Context ID is compared against <code>CONTEXTIDR_EL2</code> .
010	Mismatch address. <code>DBGVVR<n></code> is the address of an instruction to be stepped.
011	Match <code>CONTEXTIDR_EL1</code> . <code>DBGVVR<n>.ContextID</code> is a Context ID compared against <code>CONTEXTIDR</code> .
100	Match VMID. <code>DBGXVVR<n>.VMID</code> is a VMID compared against <code>VTTBR.VMID</code> .
101	Match VMID and Context ID. <code>DBGVVR<n>.ContextID</code> is a Context ID compared against <code>CONTEXTIDR</code> , and <code>DBGXVVR<n>.VMID</code> is a VMID compared against <code>VTTBR.VMID</code> .
110	Match <code>CONTEXTIDR_EL2</code> . <code>DBGXVVR<n>.ContextID2</code> is a Context ID compared against <code>CONTEXTIDR_EL2</code> .
111	Match Full Context ID. <code>DBGVVR<n>.ContextID</code> is compared against <code>CONTEXTIDR_EL1</code> , and <code>DBGXVVR<n>.ContextID2</code> is compared against <code>CONTEXTIDR_EL2</code> .
- `BT[0]`: Enable linking.

Constraints on breakpoint programming mean some values are reserved under certain conditions. For more information, see [Reserved `DBGBCR<n>.BT` values on page G2-4490](#).

This field resets to a value that is architecturally UNKNOWN.

LBN, bits [19:16]

Linked breakpoint number. For Linked address matching breakpoints, this specifies the index of the Context-matching breakpoint linked to.

For all other breakpoint types this field is ignored and reads of the register return an UNKNOWN value.

This field is ignored when the value of `DBGBCR<n>.E` is 0.

This field resets to a value that is architecturally UNKNOWN.

SSC, bits [15:14]

Security state control. Determines the Security states under which a Breakpoint debug event for breakpoint `n` is generated. This field must be interpreted along with the HMC and PMC fields, and there are constraints on the permitted values of the {HMC, SSC, PMC} fields. For more information, including the effect of programming the fields to a reserved set of values, see [Breakpoint usage constraints on page G2-4490](#).

For more information on the operation of the SSC, HMC, and PMC fields, see [Execution conditions for which a breakpoint generates Breakpoint exceptions on page G2-4480](#).

This field resets to a value that is architecturally UNKNOWN.

HMC, bit [13]

Higher mode control. Determines the debug perspective for deciding when a Breakpoint debug event for breakpoint n is generated. This field must be interpreted along with the SSC and PMC fields, and there are constraints on the permitted values of the {HMC, SSC, PMC} fields. For more information see the SSC, bits [15:14] description.

For more information on the operation of the SSC, HMC, and PMC fields, see [Execution conditions for which a breakpoint generates Breakpoint exceptions on page G2-4480](#).

This field resets to a value that is architecturally UNKNOWN.

Bits [12:9]

Reserved, RES0.

BAS, bits [8:5]

Byte address select. Defines which half-words an address-matching breakpoint matches, regardless of the instruction set and Execution state.

The permitted values depend on the breakpoint type.

For Address match breakpoints, the permitted values are:

BAS	Match instruction at	Constraint for debuggers
0011	DBGBVR<n>	Use for T32 instructions.
1100	DBGBVR<n>+2	Use for T32 instructions.
1111	DBGBVR<n>	Use for A32 instructions.

All other values are reserved. For more information, see [Reserved DBGBCR<n>.{SSC, HMC, PMC} values on page G2-4491](#).

For more information on using the BAS field in Address Match breakpoints, see [Using the BAS field in Address Match breakpoints on page G2-4483](#).

For Address mismatch breakpoints in an AArch32 stage 1 translation regime, the permitted values are:

BAS	Step instruction at	Constraint for debuggers
0000	-	Use for a match anywhere breakpoint.
0011	DBGBVR<n>	Use for stepping T32 instructions.
1100	DBGBVR<n>+2	Use for stepping T32 instructions.
1111	DBGBVR<n>	Use for stepping A32 instructions.

All other values are reserved. For more information, see [Reserved DBGBCR<n>.{SSC, HMC, PMC} values on page G2-4491](#).

For more information on using the BAS field in address mismatch breakpoints, see [Using the BAS field in Address Match breakpoints on page G2-4483](#).

For Context matching breakpoints, this field is RES1 and ignored.

If this field is implemented as an RW field, it resets to a value that is architecturally UNKNOWN.

Bits [4:3]

Reserved, RES0.

PMC, bits [2:1]

Privilege mode control. Determines the Exception level or levels at which a Breakpoint debug event for breakpoint n is generated. This field must be interpreted along with the SSC and HMC fields, and there are constraints on the permitted values of the {HMC, SSC, PMC} fields. For more information see the DBGBCR<n>.SSC description.

For more information on the operation of the SSC, HMC, and PMC fields, see [Execution conditions for which a breakpoint generates Breakpoint exceptions on page G2-4480](#).

This field resets to a value that is architecturally UNKNOWN.

E, bit [0]

Enable breakpoint DBGBVR<n>. Possible values are:

- 0 Breakpoint disabled.
- 1 Breakpoint enabled.

This field resets to a value that is architecturally UNKNOWN.

Accessing the DBGBCR<n>

This register can be read using MRC with the following syntax:

MRC <syntax>

This register can be written using MCR with the following syntax:

MCR <syntax>

This syntax is encoded with the following settings in the instruction encoding:

<syntax>	opc1	opc2	CRn	coproc	CRm
p14, 0, <Rt>, c0, <CRm>, 5	000	101	0000	1110	n<3:0>

- <CRm> is in the range c0 - c15.

Accessibility

The register is accessible in software as follows:

Control			Accessibility			
E2H	TGE	NS	EL0	EL1	EL2	EL3
x	x	0	-	RW	n/a	RW
x	0	1	-	RW	RW	RW
x	1	1	-	n/a	RW	RW

Traps and Enables

For a description of the prioritization of any generated exceptions, see:

- [Synchronous exception prioritization for exceptions taken to AArch32 state on page G1-4344](#) for exceptions taken to AArch32 state.
- [Synchronous exception prioritization for exceptions taken to AArch64 on page D1-1827](#) for exceptions taken to AArch64 state.
- [Software Access debug event on page H3-5493](#) for accesses to this register taken to Debug state.

Subject to the prioritization rules:

- In both security states, and not dependent on other bits:
 - If `EDSCR.TDA==1`, `DBGOSLSR.OSLK==0`, and halting is allowed, accesses to this register from EL1 and EL2 generate a Software Access debug event.
- When EL2 is implemented and is using AArch64 and `SCR_EL3.NS == 1`:
 - If `MDCR_EL2.TDA==1`, Non-secure accesses to this register from EL1 are trapped to EL2.
- When EL2 is implemented and is using AArch32 and `SCR_EL3.NS == 1`:
 - If `HDCR.TDA==1`, Non-secure accesses to this register from EL1 are trapped to Hyp mode.
- When EL3 is implemented and is using AArch64:
 - If `MDCR_EL3.TDA==1`, accesses to this register from EL1 and EL2 are trapped to EL3.

G6.3.3 DBGBVR<n>, Debug Breakpoint Value Registers, n = 0 - 15

The DBGBVR<n> characteristics are:

Purpose

Holds a value for use in breakpoint matching, either the virtual address of an instruction or a context ID. Forms breakpoint n together with control register [DBGBCR<n>](#). If EL2 is implemented and this breakpoint supports Context matching, DBGBVR<n> can be associated with a Breakpoint Extended Value Register [DBGXVR<n>](#) for VMID matching.

Configurations

There is one instance of this register that is used in both Secure and Non-secure states.

AArch32 System register DBGBVR<n> is architecturally mapped to AArch64 System register [DBGBVR<n>_EL1](#)[31:0].

AArch32 System register DBGBVR<n> is architecturally mapped to External register [DBGBVR<n>_EL1](#)[31:0].

If breakpoint n is not implemented then this register is unallocated.

This register is in the Cold reset domain. On a Cold reset RW fields in this register reset to architecturally UNKNOWN values. The register is not affected by a Warm reset.

———— Note ————

Writes to DBGBVR<n> do not modify [DBGBVR<n>_EL1](#)[63:32].

Attributes

How this register is interpreted depends on the value of [DBGBCR<n>.BT](#).

- When [DBGBCR<n>.BT](#) is 0b0x0x, this register holds a virtual address.
- When [DBGBCR<n>.BT](#) is 0b001x, 0b101x, or 0b111x, this register holds a Context ID.

For other values of [DBGBCR<n>.BT](#), this register is RES0.

Some breakpoints might not support Context ID comparison. For more information, see the description of the [DBGDIDR.CTX_CMPs](#) field.

Field descriptions

The DBGBVR<n> bit assignments are:

When [DBGBCR<n>.BT==0b0x0x](#):

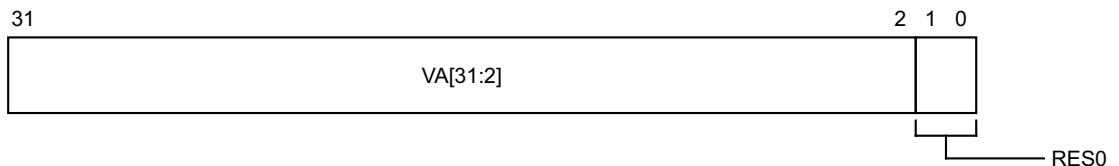

VA[31:2], bits [31:2]

Bits[31:2] of the address value for comparison.

This field resets to a value that is architecturally UNKNOWN.

Bits [1:0]

Reserved, RES0.

When $DBGBCR<n>.BT==0b001x$:

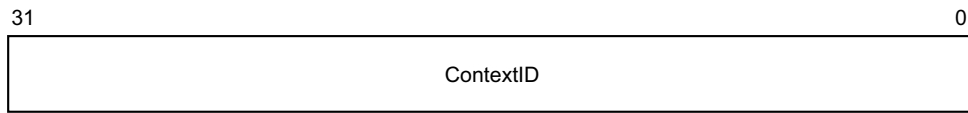

ContextID, bits [31:0]

Context ID value for comparison.

The value is compared against [CONTEXTIDR](#) in the following cases:

- The PE is in Secure state.
- EL2 is using AArch32.
- When [ARMv8.1-VHE](#) is not implemented.
- When [ARMv8.1-VHE](#) is implemented, EL2 is using AArch64, and [HCR_EL2.E2H](#) is 0.
- When [ARMv8.1-VHE](#) is implemented, EL2 is using AArch64, [HCR_EL2](#).{E2H, TGE} is {1, 0}, and the PE is in Non-secure EL0 or EL1.

When [ARMv8.1-VHE](#) is implemented, EL2 is using AArch64, [HCR_EL2](#).{E2H, TGE} is {1, 1} and the PE is in Non-secure EL0, the value is compared against [CONTEXTIDR_EL2](#).

This field resets to a value that is architecturally UNKNOWN.

When $DBGBCR<n>.BT==0b101x$ and EL2 implemented:

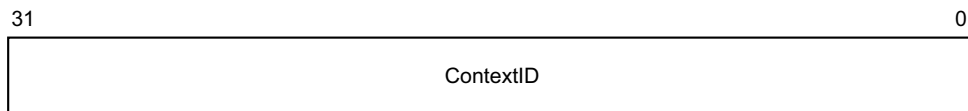

ContextID, bits [31:0]

Context ID value for comparison against [CONTEXTIDR](#).

This field resets to a value that is architecturally UNKNOWN.

When $DBGBCR<n>.BT==0b111x$ and EL2 implemented:



ContextID, bits [31:0]

Context ID value for comparison against [CONTEXTIDR_EL2](#).

This field resets to a value that is architecturally UNKNOWN.

Accessing the $DBGBVR<n>$

This register can be read using MRC with the following syntax:

MRC <syntax>

This register can be written using MCR with the following syntax:

MCR <syntax>

This syntax is encoded with the following settings in the instruction encoding:

<syntax>	opc1	opc2	CRn	coproc	CRm
p14, 0, <Rt>, c0, <CRm>, 4	000	100	0000	1110	n<3:0>

- <CRm> is in the range c0 - c15.

Accessibility

The register is accessible in software as follows:

Control			Accessibility			
E2H	TGE	NS	EL0	EL1	EL2	EL3
x	x	0	-	RW	n/a	RW
x	0	1	-	RW	RW	RW
x	1	1	-	n/a	RW	RW

Traps and Enables

For a description of the prioritization of any generated exceptions, see:

- [Synchronous exception prioritization for exceptions taken to AArch32 state on page G1-4344](#) for exceptions taken to AArch32 state.
- [Synchronous exception prioritization for exceptions taken to AArch64 on page D1-1827](#) for exceptions taken to AArch64 state.
- [Software Access debug event on page H3-5493](#) for accesses to this register taken to Debug state.

Subject to the prioritization rules:

- In both security states, and not dependent on other bits:
 - If `EDSCR.TDA==1`, `DBGOSLSR.OSLK==0`, and halting is allowed, accesses to this register from EL1 and EL2 generate a Software Access debug event.
- When EL2 is implemented and is using AArch64 and `SCR_EL3.NS == 1`:
 - If `MDCR_EL2.TDA==1`, Non-secure accesses to this register from EL1 are trapped to EL2.
- When EL2 is implemented and is using AArch32 and `SCR_EL3.NS == 1`:
 - If `HDCR.TDA==1`, Non-secure accesses to this register from EL1 are trapped to Hyp mode.
- When EL3 is implemented and is using AArch64:
 - If `MDCR_EL3.TDA==1`, accesses to this register from EL1 and EL2 are trapped to EL3.

G6.3.4 DBGBXVR<n>, Debug Breakpoint Extended Value Registers, n = 0 - 15

The DBGBXVR<n> characteristics are:

Purpose

Holds a value for use in breakpoint matching, to support VMID matching. Used in conjunction with a control register [DBGBCR<n>](#) and a value register [DBGBVR<n>](#), where EL2 is implemented and breakpoint n supports Context matching.

Configurations

There is one instance of this register that is used in both Secure and Non-secure states.

AArch32 System register DBGBXVR<n> is architecturally mapped to AArch64 System register [DBGBVR<n>_EL1](#)[63:32].

AArch32 System register DBGBXVR<n> is architecturally mapped to External register [DBGBVR<n>_EL1](#)[63:32].

Note

Writes to DBGBXVR<n> do not modify [DBGBVR<n>_EL1](#)[31:0].

This register is unallocated in any of the following cases:

- Breakpoint n is not implemented.
- Breakpoint n does not support Context matching.
- EL2 is not implemented.

For more information, see the description of the [DBGDIDR.CTX_CMPs](#) field.

This register is in the Cold reset domain. On a Cold reset RW fields in this register reset to architecturally UNKNOWN values. The register is not affected by a Warm reset.

Attributes

How this register is interpreted depends on the value of [DBGBCR<n>.BT](#).

- When [DBGBCR<n>.BT](#) is 0b10xx, this register holds a VMID.
- When [DBGBCR<n>.BT](#) is 0b11xx, this register holds a Context ID.

For other values of [DBGBCR<n>.BT](#), this register is RES0.

Field descriptions

The DBGBXVR<n> bit assignments are:

When [DBGBCR<n>.BT](#)==0b10xx and EL2 implemented:

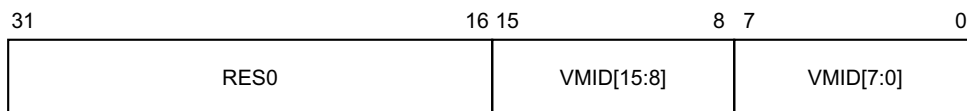

Bits [31:16]

Reserved, RES0.

VMID[15:8], bits [15:8]

In ARMv8.2 and ARMv8.1

Extension to VMID[7:0]. See VMID[7:0] for more details.

This field resets to a value that is architecturally UNKNOWN.

In ARMv8.0.

Reserved, RES0.

VMID[7:0], bits [7:0]

VMID value for comparison.

The VMID is 8 bits in the following cases.

- EL2 is using AArch32.
- [ARMv8.1-VMID16](#) is not implemented.

When [ARMv8.1-VMID16](#) is implemented and EL2 is using AArch64, it is IMPLEMENTATION DEFINED whether the VMID is 8 bits or 16 bits.

VMID[15:8] is RES0 if any of the following applies:

- The implementation has an 8-bit VMID.
- [VTCCR_EL2.VS](#) has a value of 0.
- EL2 is using AArch32.

This field resets to a value that is architecturally UNKNOWN.

When $DBGBCR\langle n \rangle.BT == 0b11xx$ and EL2 implemented:

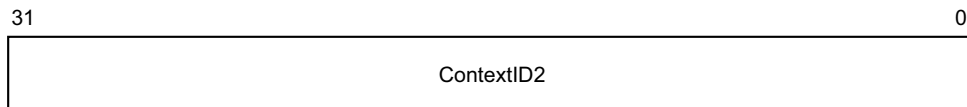

ContextID2, bits [31:0]

Context ID value for comparison against [CONTEXTIDR_EL2](#).

This field resets to a value that is architecturally UNKNOWN.

Accessing the $DBGXVR\langle n \rangle$

This register can be read using MRC with the following syntax:

MRC <syntax>

This register can be written using MCR with the following syntax:

MCR <syntax>

This syntax is encoded with the following settings in the instruction encoding:

<syntax>	opc1	opc2	CRn	coproc	CRm
p14, 0, <Rt>, c1, <CRm>, 1	000	001	0001	1110	n<3:0>

- <CRm> is in the range c0 - c15.

Accessibility

The register is accessible in software as follows:

Control			Accessibility			
E2H	TGE	NS	EL0	EL1	EL2	EL3
x	x	0	-	RW	n/a	RW
x	0	1	-	RW	RW	RW
x	1	1	-	n/a	RW	RW

Traps and Enables

For a description of the prioritization of any generated exceptions, see:

- [Synchronous exception prioritization for exceptions taken to AArch32 state on page G1-4344](#) for exceptions taken to AArch32 state.
- [Synchronous exception prioritization for exceptions taken to AArch64 on page D1-1827](#) for exceptions taken to AArch64 state.
- [Software Access debug event on page H3-5493](#) for accesses to this register taken to Debug state.

Subject to the prioritization rules:

- In both security states, and not dependent on other bits:
 - If `EDSCR.TDA==1`, `DBGOSLSR.OSLK==0`, and halting is allowed, accesses to this register from EL1 and EL2 generate a Software Access debug event.
- When EL2 is implemented and is using AArch64 and `SCR_EL3.NS == 1`:
 - If `MDCR_EL2.TDA==1`, Non-secure accesses to this register from EL1 are trapped to EL2.
- When EL2 is implemented and is using AArch32 and `SCR_EL3.NS == 1`:
 - If `HDCR.TDA==1`, Non-secure accesses to this register from EL1 are trapped to Hyp mode.
- When EL3 is implemented and is using AArch64:
 - If `MDCR_EL3.TDA==1`, accesses to this register from EL1 and EL2 are trapped to EL3.

G6.3.5 DBGCLAIMCLR, Debug Claim Tag Clear register

The DBGCLAIMCLR characteristics are:

Purpose

Used by software to read the values of the CLAIM tag bits, and to clear these bits to 0.
The architecture does not define any functionality for the CLAIM tag bits.

———— Note —————

CLAIM tags are typically used for communication between the debugger and target software.

Used in conjunction with the [DBGCLAIMSET](#) register.

Configurations

There is one instance of this register that is used in both Secure and Non-secure states.

AArch32 System register DBGCLAIMCLR is architecturally mapped to AArch64 System register [DBGCLAIMCLR_EL1](#).

AArch32 System register DBGCLAIMCLR is architecturally mapped to External register [DBGCLAIMCLR_EL1](#).

An implementation must include 8 CLAIM tag bits.

This register is in the Cold reset domain. See the CLAIM field description for the effect of a Cold reset on the value returned by this register. This register is not affected by a Warm reset.

Attributes

DBGCLAIMCLR is a 32-bit register.

Field descriptions

The DBGCLAIMCLR bit assignments are:

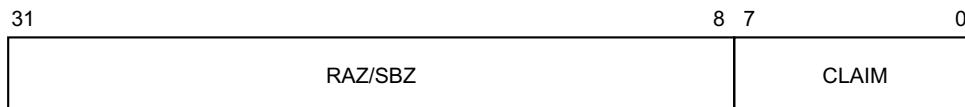

Bits [31:8]

Reserved, RAZ/SBZ. Software can rely on these bits reading as zero, and must use a should-be-zero policy on writes. Implementations must ignore writes.

CLAIM, bits [7:0]

Read or clear CLAIM tag bits. Reading this field returns the current value of the CLAIM tag bits.

Writing a 1 to one of these bits clears the corresponding CLAIM tag bit to 0. This is an indirect write to the CLAIM tag bits. A single write operation can clear multiple CLAIM tag bits to 0.

Writing 0 to one of these bits has no effect.

A cold reset clears the CLAIM tag bits to 0.

Accessing the DBGCLAIMCLR

This register can be read using MRC with the following syntax:

```
MRC <syntax>
```

This register can be written using MCR with the following syntax:

```
MCR <syntax>
```

This syntax is encoded with the following settings in the instruction encoding:

<syntax>	opc1	opc2	CRn	coproc	CRm
p14, 0, <Rt>, c7, c9, 6	000	110	0111	1110	1001

Accessibility

The register is accessible in software as follows:

Control			Accessibility			
E2H	TGE	NS	EL0	EL1	EL2	EL3
x	x	0	-	RW	n/a	RW
x	0	1	-	RW	RW	RW
x	1	1	-	n/a	RW	RW

Traps and Enables

For a description of the prioritization of any generated exceptions, see [Synchronous exception prioritization for exceptions taken to AArch32 state on page G1-4344](#) for exceptions taken to AArch32 state and [Synchronous exception prioritization for exceptions taken to AArch64 on page D1-1827](#) for exceptions taken to AArch64 state. Subject to the prioritization rules:

- When EL2 is implemented and is using AArch64 and SCR_EL3.NS == 1:
 - If MDCR_EL2.TDA==1, Non-secure accesses to this register from EL1 are trapped to EL2.
- When EL2 is implemented and is using AArch32 and SCR_EL3.NS == 1:
 - If HDCR.TDA==1, Non-secure accesses to this register from EL1 are trapped to Hyp mode.
- When EL3 is implemented and is using AArch64:
 - If MDCR_EL3.TDA==1, accesses to this register from EL1 and EL2 are trapped to EL3.

G6.3.6 DBGCLAIMSET, Debug Claim Tag Set register

The DBGCLAIMSET characteristics are:

Purpose

Used by software to set the CLAIM tag bits to 1.

The architecture does not define any functionality for the CLAIM tag bits.

———— Note —————

CLAIM tags are typically used for communication between the debugger and target software.

Used in conjunction with the [DBGCLAIMCLR](#) register.

Configurations

There is one instance of this register that is used in both Secure and Non-secure states.

AArch32 System register DBGCLAIMSET is architecturally mapped to AArch64 System register [DBGCLAIMSET_EL1](#).

AArch32 System register DBGCLAIMSET is architecturally mapped to External register [DBGCLAIMSET_EL1](#).

An implementation must include 8 CLAIM tag bits.

Attributes

DBGCLAIMSET is a 32-bit register.

Field descriptions

The DBGCLAIMSET bit assignments are:

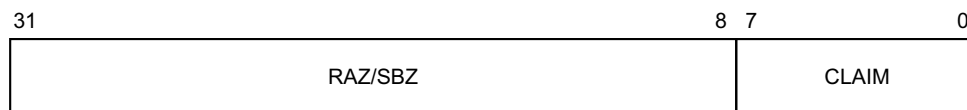

Bits [31:8]

Reserved, RAZ/SBZ. Software can rely on these bits reading as zero, and must use a should-be-zero policy on writes. Implementations must ignore writes.

CLAIM, bits [7:0]

Set CLAIM tag bits. RAO.

Writing a 1 to one of these bits sets the corresponding CLAIM tag bit to 1. This is an indirect write to the CLAIM tag bits. A single write operation can set multiple CLAIM tag bits to 1.

Writing 0 to one of these bits has no effect.

A cold reset clears the CLAIM tag bits to 0.

Accessing the DBGCLAIMSET

This register can be read using MRC with the following syntax:

MRC <syntax>

This register can be written using MCR with the following syntax:

MCR <syntax>

This syntax is encoded with the following settings in the instruction encoding:

<syntax>	opc1	opc2	CRn	coproc	CRm
p14, 0, <Rt>, c7, c8, 6	000	110	0111	1110	1000

Accessibility

The register is accessible in software as follows:

Control			Accessibility			
E2H	TGE	NS	EL0	EL1	EL2	EL3
x	x	0	-	RW	n/a	RW
x	0	1	-	RW	RW	RW
x	1	1	-	n/a	RW	RW

Traps and Enables

For a description of the prioritization of any generated exceptions, see [Synchronous exception prioritization for exceptions taken to AArch32 state on page G1-4344](#) for exceptions taken to AArch32 state and [Synchronous exception prioritization for exceptions taken to AArch64 on page D1-1827](#) for exceptions taken to AArch64 state. Subject to the prioritization rules:

- When EL2 is implemented and is using AArch64 and SCR_EL3.NS == 1:
 - If MDCR_EL2.TDA==1, Non-secure accesses to this register from EL1 are trapped to EL2.
- When EL2 is implemented and is using AArch32 and SCR_EL3.NS == 1:
 - If HDCR.TDA==1, Non-secure accesses to this register from EL1 are trapped to Hyp mode.
- When EL3 is implemented and is using AArch64:
 - If MDCR_EL3.TDA==1, accesses to this register from EL1 and EL2 are trapped to EL3.

G6.3.7 DBGDCCINT, DCC Interrupt Enable Register

The DBGDCCINT characteristics are:

Purpose

Enables interrupt requests to be signaled based on the DCC status flags.

Configurations

There is one instance of this register that is used in both Secure and Non-secure states.

AArch32 System register DBGDCCINT is architecturally mapped to AArch64 System register [MDCCINT_EL1](#).

This register is in the Warm reset domain. Some or all RW fields of this register have defined reset values. On a Warm or Cold reset these apply only if the PE resets into an Exception level that is using AArch32. Otherwise, on a Warm or Cold reset RW fields in this register reset to architecturally UNKNOWN values.

Attributes

DBGDCCINT is a 32-bit register.

Field descriptions

The DBGDCCINT bit assignments are:

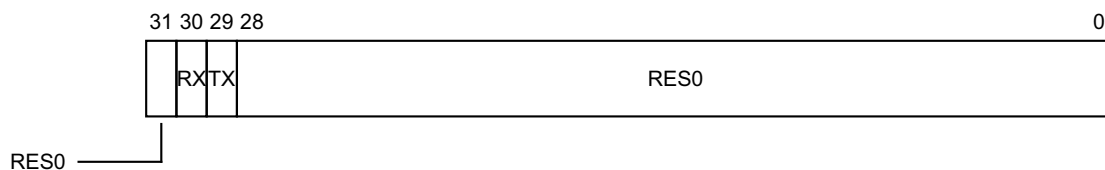

Bit [31]

Reserved, RES0.

RX, bit [30]

DCC interrupt request enable control for DTRRX. Enables a common COMMIRQ interrupt request to be signaled based on the DCC status flags.

0 No interrupt request generated by DTRRX.

1 Interrupt request will be generated on RXfull == 1.

If legacy COMMRX and COMMTX signals are implemented, then these are not affected by the value of this bit.

When this register has an architecturally-defined reset value, this field resets to 0.

TX, bit [29]

DCC interrupt request enable control for DTRTX. Enables a common COMMIRQ interrupt request to be signaled based on the DCC status flags.

0 No interrupt request generated by DTRTX.

1 Interrupt request will be generated on TXfull == 0.

If legacy COMMRX and COMMTX signals are implemented, then these are not affected by the value of this bit.

When this register has an architecturally-defined reset value, this field resets to 0.

Bits [28:0]

Reserved, RES0.

Accessing the DBGDCCINT

This register can be read using MRC with the following syntax:

MRC <syntax>

This register can be written using MCR with the following syntax:

MCR <syntax>

This syntax is encoded with the following settings in the instruction encoding:

<syntax>	opc1	opc2	CRn	coproc	CRm
p14, 0, <Rt>, c0, c2, 0	000	000	0000	1110	0010

Accessibility

The register is accessible in software as follows:

Control			Accessibility			
E2H	TGE	NS	EL0	EL1	EL2	EL3
x	x	0	-	RW	n/a	RW
x	0	1	-	RW	RW	RW
x	1	1	-	n/a	RW	RW

Traps and Enables

For a description of the prioritization of any generated exceptions, see [Synchronous exception prioritization for exceptions taken to AArch32 state on page G1-4344](#) for exceptions taken to AArch32 state and [Synchronous exception prioritization for exceptions taken to AArch64 on page D1-1827](#) for exceptions taken to AArch64 state. Subject to the prioritization rules:

- When EL2 is implemented and is using AArch64 and SCR_EL3.NS == 1:
 - If MDCR_EL2.TDA==1, Non-secure accesses to this register from EL1 are trapped to EL2.
- When EL2 is implemented and is using AArch32 and SCR_EL3.NS == 1:
 - If HDCR.TDA==1, Non-secure accesses to this register from EL1 are trapped to Hyp mode.
- When EL3 is implemented and is using AArch64:
 - If MDCR_EL3.TDA==1, accesses to this register from EL1 and EL2 are trapped to EL3.

G6.3.8 DBGDEVID, Debug Device ID register 0

The DBGDEVID characteristics are:

Purpose

Adds to the information given by the [DBGDIDR](#) by describing other features of the debug implementation.

Configurations

There is one instance of this register that is used in both Secure and Non-secure states.

This register is required in all implementations.

Attributes

DBGDEVID is a 32-bit register.

Field descriptions

The DBGDEVID bit assignments are:

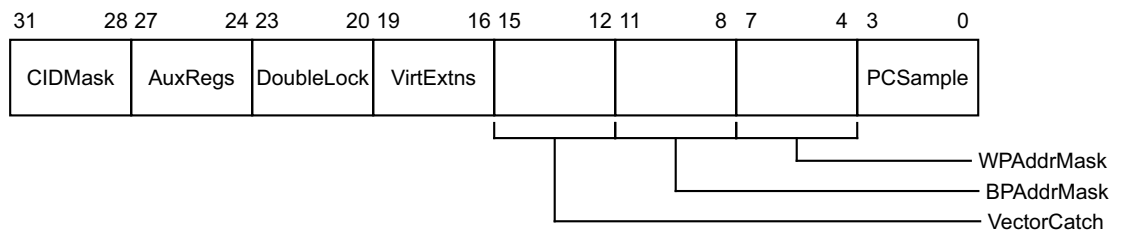

CIDMask, bits [31:28]

Indicates the level of support for the Context ID matching breakpoint masking capability. Permitted values of this field are:

0000 Context ID masking is not implemented.

0001 Context ID masking is implemented.

All other values are reserved. The value of this for ARMv8 is 0000.

AuxRegs, bits [27:24]

Indicates support for Auxiliary registers. Permitted values for this field are:

0000 None supported.

0001 Support for External Debug Auxiliary Control Register, [EDACR](#).

All other values are reserved.

DoubleLock, bits [23:20]

Indicates the presence of the [DBGOSDLR](#), OS Double Lock Register. Permitted values of this field are:

0000 The [DBGOSDLR](#) is not present.

0001 The [DBGOSDLR](#) is present.

All other values are reserved. The value of this for ARMv8 is 0001.

VirtExtns, bits [19:16]

Indicates whether EL2 is implemented. Permitted values of this field are:

0000 EL2 is not implemented.

0001 EL2 is implemented.

All other values are reserved.

VectorCatch, bits [15:12]

Defines the form of Vector Catch exception implemented. Permitted values of this field are:

- 0000 Address matching Vector Catch exception implemented.
 - 0001 Exception matching Vector Catch exception implemented.
- All other values are reserved.

BPAddrMask, bits [11:8]

Indicates the level of support for the instruction address matching breakpoint masking capability. Permitted values of this field are:

- 0000 Breakpoint address masking might be implemented. If not implemented, [DBGBCR<n>](#)[28:24] is RAZ/WI.
 - 0001 Breakpoint address masking is implemented.
 - 1111 Breakpoint address masking is not implemented. [DBGBCR<n>](#)[28:24] is RES0.
- All other values are reserved. The value of this for ARMv8 is 1111.

WPAAddrMask, bits [7:4]

Indicates the level of support for the data address matching watchpoint masking capability. Permitted values of this field are:

- 0000 Watchpoint address masking might be implemented. If not implemented, [DBGWCR<n>](#).MASK (Address mask) is RAZ/WI.
- 0001 Watchpoint address masking is implemented.
- 1111 Watchpoint address masking is not implemented. [DBGWCR<n>](#).MASK (Address mask) is RES0.

All other values are reserved. The value of this for ARMv8 is 0001.

PCSample, bits [3:0]

Indicates the level of PC Sample-based Profiling support using external debug registers. Permitted values of this field are:

- 0000 Architecture-defined form of PC Sample-based Profiling not implemented using external debug registers.
- 0010 Only [EDPCSR](#) and [EDCIDSR](#) are implemented. This option is only permitted if EL3 and EL2 are not implemented.
- 0011 [EDPCSR](#), [EDCIDSR](#), and [EDVIDSR](#) are implemented.

All other values are reserved.

From ARMv8.2 onwards, the only permitted value is 0b0000. The architecture defines the functionality in a different set of registers, see [PMDEVID](#).

Accessing the DBGDEVID

This register can be read using MRC with the following syntax:

MRC <syntax>

This syntax is encoded with the following settings in the instruction encoding:

<syntax>	opc1	opc2	CRn	coproc	CRm
p14, 0, <Rt>, c7, c2, 7	000	111	0111	1110	0010

Accessibility

The register is accessible in software as follows:

Control			Accessibility			
E2H	TGE	NS	EL0	EL1	EL2	EL3
x	x	0	-	RO	n/a	RO
x	0	1	-	RO	RO	RO
x	1	1	-	n/a	RO	RO

Traps and Enables

For a description of the prioritization of any generated exceptions, see [Synchronous exception prioritization for exceptions taken to AArch32 state on page G1-4344](#) for exceptions taken to AArch32 state and [Synchronous exception prioritization for exceptions taken to AArch64 on page D1-1827](#) for exceptions taken to AArch64 state. Subject to the prioritization rules:

- When EL2 is implemented and is using AArch64 and SCR_EL3.NS == 1:
 - If MDCR_EL2.TDA==1, Non-secure read accesses to this register from EL1 are trapped to EL2.
- When EL2 is implemented and is using AArch32 and SCR_EL3.NS == 1:
 - If HDCR.TDA==1, Non-secure read accesses to this register from EL1 are trapped to Hyp mode.
- When EL3 is implemented and is using AArch64:
 - If MDCR_EL3.TDA==1, read accesses to this register from EL1 and EL2 are trapped to EL3.

G6.3.9 DBGDEVID1, Debug Device ID register 1

The DBGDEVID1 characteristics are:

Purpose

Adds to the information given by the [DBGDIDR](#) by describing other features of the debug implementation.

Configurations

There is one instance of this register that is used in both Secure and Non-secure states. This register is required in all implementations.

Attributes

DBGDEVID1 is a 32-bit register.

Field descriptions

The DBGDEVID1 bit assignments are:

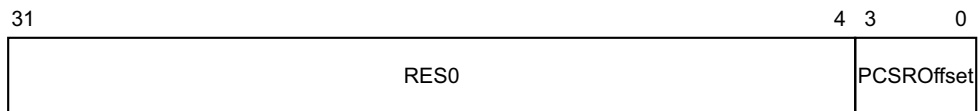

Bits [31:4]

Reserved, RES0.

PCSROffset, bits [3:0]

This field indicates the offset applied to PC samples returned by reads of [EDPCSR](#). Permitted values of this field in ARMv8 are:

- 0000 [EDPCSR](#) not implemented.
- 0010 [EDPCSR](#) implemented. Samples have no offset applied and do not sample the instruction set state in AArch32 state.

Note

In ARMv7, a PCSROffset value of 0000 has an alternative meaning that [EDPCSR](#) is implemented and returns values that have an offset applied and indicate the Instruction set state. This implementation option is not permitted in ARMv8.

From ARMv8.2 onwards, the only permitted value is 0b0000. The architecture defines the functionality in a different set of registers, see [PMDEVID](#).

Accessing the DBGDEVID1

This register can be read using MRC with the following syntax:

MRC <syntax>

This syntax is encoded with the following settings in the instruction encoding:

<syntax>	opc1	opc2	CRn	coproc	CRm
p14, 0, <Rt>, c7, c1, 7	000	111	0111	1110	0001

Accessibility

The register is accessible in software as follows:

Control			Accessibility			
E2H	TGE	NS	EL0	EL1	EL2	EL3
x	x	0	-	RO	n/a	RO
x	0	1	-	RO	RO	RO
x	1	1	-	n/a	RO	RO

Traps and Enables

For a description of the prioritization of any generated exceptions, see [Synchronous exception prioritization for exceptions taken to AArch32 state on page G1-4344](#) for exceptions taken to AArch32 state and [Synchronous exception prioritization for exceptions taken to AArch64 on page D1-1827](#) for exceptions taken to AArch64 state. Subject to the prioritization rules:

- When EL2 is implemented and is using AArch64 and SCR_EL3.NS == 1:
 - If MDCR_EL2.TDA==1, Non-secure read accesses to this register from EL1 are trapped to EL2.
- When EL2 is implemented and is using AArch32 and SCR_EL3.NS == 1:
 - If HDCR.TDA==1, Non-secure read accesses to this register from EL1 are trapped to Hyp mode.
- When EL3 is implemented and is using AArch64:
 - If MDCR_EL3.TDA==1, read accesses to this register from EL1 and EL2 are trapped to EL3.

G6.3.10 DBGDEVID2, Debug Device ID register 2

The DBGDEVID2 characteristics are:

Purpose

Reserved for future descriptions of features of the debug implementation.

Configurations

There is one instance of this register that is used in both Secure and Non-secure states.

Attributes

DBGDEVID2 is a 32-bit register.

Field descriptions

The DBGDEVID2 bit assignments are:

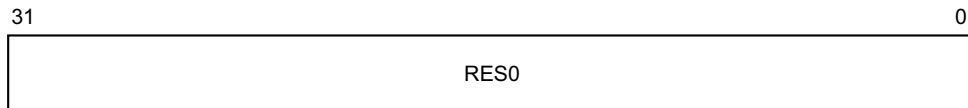

Bits [31:0]

Reserved, RES0.

Accessing the DBGDEVID2

This register can be read using MRC with the following syntax:

MRC <syntax>

This syntax is encoded with the following settings in the instruction encoding:

<syntax>	opc1	opc2	CRn	coproc	CRm
p14, 0, <Rt>, c7, c0, 7	000	111	0111	1110	0000

Accessibility

The register is accessible in software as follows:

Control			Accessibility			
E2H	TGE	NS	EL0	EL1	EL2	EL3
x	x	0	-	RO	n/a	RO
x	0	1	-	RO	RO	RO
x	1	1	-	n/a	RO	RO

Traps and Enables

For a description of the prioritization of any generated exceptions, see *Synchronous exception prioritization for exceptions taken to AArch32 state* on page G1-4344 for exceptions taken to AArch32 state and *Synchronous exception prioritization for exceptions taken to AArch64* on page D1-1827 for exceptions taken to AArch64 state. Subject to the prioritization rules:

- When EL2 is implemented and is using AArch64 and $SCR_EL3.NS == 1$:
 - If $MDCR_EL2.TDA == 1$, Non-secure read accesses to this register from EL1 are trapped to EL2.
- When EL2 is implemented and is using AArch32 and $SCR_EL3.NS == 1$:
 - If $HDCR.TDA == 1$, Non-secure read accesses to this register from EL1 are trapped to Hyp mode.
- When EL3 is implemented and is using AArch64:
 - If $MDCR_EL3.TDA == 1$, read accesses to this register from EL1 and EL2 are trapped to EL3.

G6.3.11 DBGDIDR, Debug ID Register

The DBGDIDR characteristics are:

Purpose

Specifies which version of the Debug architecture is implemented, and some features of the debug implementation.

Configurations

There is one instance of this register that is used in both Secure and Non-secure states.

If EL1 cannot use AArch32 then the implementation of this register is OPTIONAL and deprecated.

Attributes

DBGDIDR is a 32-bit register.

Field descriptions

The DBGDIDR bit assignments are:

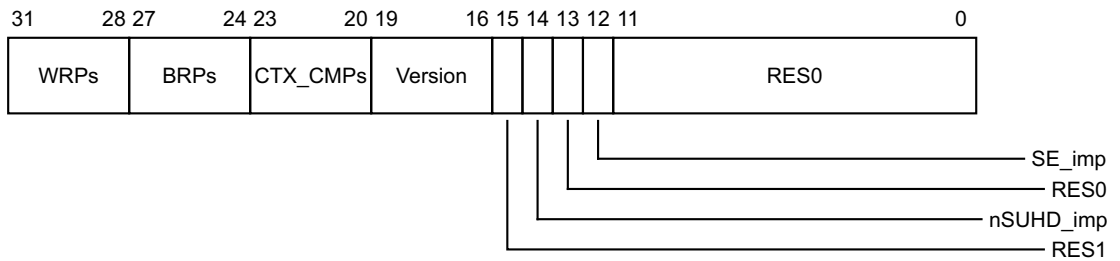

WRPs, bits [31:28]

The number of watchpoints implemented, minus 1.

Permitted values of this field are from 0b0001 for 2 implemented watchpoints, to 0b1111 for 16 implemented watchpoints.

The value of 0b0000 is reserved.

If AArch64 is implemented, this field has the same value as [ID_AA64DFR0_EL1.WRPs](#).

BRPs, bits [27:24]

The number of breakpoints implemented, minus 1.

Permitted values of this field are from 0b0001 for 2 implemented breakpoint, to 0b1111 for 16 implemented breakpoints.

The value of 0b0000 is reserved.

If AArch64 is implemented, this field has the same value as [ID_AA64DFR0_EL1.BRPs](#).

CTX_CMPs, bits [23:20]

The number of breakpoints that can be used for Context matching, minus 1.

Permitted values of this field are from 0b0000 for 1 Context matching breakpoint, to 0b1111 for 16 Context matching breakpoints.

The Context matching breakpoints must be the highest addressed breakpoints. For example, if six breakpoints are implemented and two are Context matching breakpoints, they must be breakpoints 4 and 5.

If AArch64 is implemented, this field has the same value as [ID_AA64DFR0_EL1.CTX_CMPs](#).

Version, bits [19:16]

The Debug architecture version. Defined values are:

0001	ARMv6, v6 Debug architecture.
0010	ARMv6, v6.1 Debug architecture.
0011	ARMv7, v7 Debug architecture, with baseline CP14 registers implemented.
0100	ARMv7, v7 Debug architecture, with all CP14 registers implemented.
0101	ARMv7, v7.1 Debug architecture.
0110	ARMv8, v8 Debug architecture.
0111	ARMv8.1, v8 Debug architecture, with Virtualization Host Extensions.
1000	ARMv8.2, v8.2 Debug architecture.

All other values are reserved.

- In an ARMv8.0 implementation, the only permitted value is 0110.
- In an ARMv8.1 implementation that includes [ARMv8.1-VHE](#), the only permitted value is 0111.
- In an ARMv8.1 implementation that does not include [ARMv8.1-VHE](#), the permitted values are 0110 and 0111.
- In an ARMv8.2 implementation, the only permitted value is 1000.

Bit [15]

Reserved, RES1.

nSUHD_imp, bit [14]

In ARMv7-A, was Secure User Halting Debug not implemented.

The value of this bit must match the value of the SE_imp bit.

Bit [13]

Reserved, RES0.

SE_imp, bit [12]

EL3 implemented. The meanings of the values of this bit are:

0	EL3 not implemented.
1	EL3 implemented.

The value of this bit must match the value of the nSUHD_imp bit.

Bits [11:0]

Reserved, RES0.

Accessing the DBGDIDR

This register can be read using MRC with the following syntax:

MRC <syntax>

This syntax is encoded with the following settings in the instruction encoding:

<syntax>	opc1	opc2	CRn	coproc	CRm
p14, 0, <Rt>, c0, c0, 0	000	000	0000	1110	0000

Accessibility

The register is accessible in software as follows:

Control			Accessibility			
E2H	TGE	NS	EL0	EL1	EL2	EL3
x	x	0	RO	RO	n/a	RO
x	0	1	RO	RO	RO	RO
x	1	1	RO	n/a	RO	RO

ARM deprecates any access to this register from EL0.

Traps and Enables

For a description of the prioritization of any generated exceptions, see [Synchronous exception prioritization for exceptions taken to AArch32 state on page G1-4344](#) for exceptions taken to AArch32 state and [Synchronous exception prioritization for exceptions taken to AArch64 on page D1-1827](#) for exceptions taken to AArch64 state. Subject to the prioritization rules:

- In both security states, and not dependent on other bits:
 - If `DBGDSCRExt.UDCCdis==1`, read accesses to this register from EL0 are trapped to Undefined mode.
 - If `MDSCR_EL1.TDCC==1`, read accesses to this register from EL0 are trapped to EL1.
- When EL2 is implemented and is using AArch64 and `SCR_EL3.NS == 1`:
 - If `MDCR_EL2.TDA==1`, Non-secure read accesses to this register from EL0 and EL1 are trapped to EL2.
- When EL2 is implemented and is using AArch32 and `SCR_EL3.NS == 1`:
 - If `HDCR.TDA==1`, Non-secure read accesses to this register from EL0 and EL1 are trapped to Hyp mode.
- When EL3 is implemented and is using AArch64:
 - If `MDCR_EL3.TDA==1`, read accesses to this register from EL0, EL1, and EL2 are trapped to EL3.

G6.3.12 DBGDRAR, Debug ROM Address Register

The DBGDRAR characteristics are:

Purpose

Defines the base physical address of a 4KB-aligned memory-mapped debug component, usually a ROM table that locates and describes the memory-mapped debug components in the system. ARMv8 deprecates any use of this register.

Configurations

There is one instance of this register that is used in both Secure and Non-secure states.

AArch32 System register DBGDRAR is architecturally mapped to AArch64 System register [MDRAR_EL1](#).

If EL1 cannot use AArch32 then the implementation of this register is OPTIONAL and deprecated.

Attributes

DBGDRAR is a 64-bit register that can also be accessed as a 32-bit value. If it is accessed as a 32-bit register, bits [31:0] are read.

Field descriptions

The DBGDRAR bit assignments are:

When accessing as a 32-bit register:

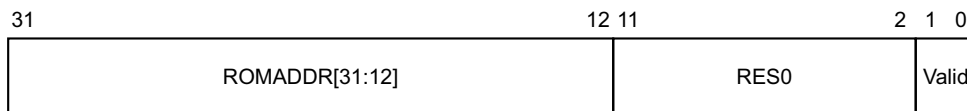

ROMADDR[31:12], bits [31:12]

Bits[31:12] of the ROM table physical address. Bits [11:0] of the address are zero.

In an implementation that includes EL3, ROMADDR is an address in Non-secure memory. It is IMPLEMENTATION DEFINED whether the ROM table is also accessible in Secure memory.

Bits [11:2]

Reserved, RES0.

Valid, bits [1:0]

This field indicates whether the ROM Table address is valid. The permitted values of this field are:

00 ROM Table address is not valid. Software must ignore ROMADDR.

11 ROM Table address is valid.

Other values are reserved.

When accessing as a 64-bit register:

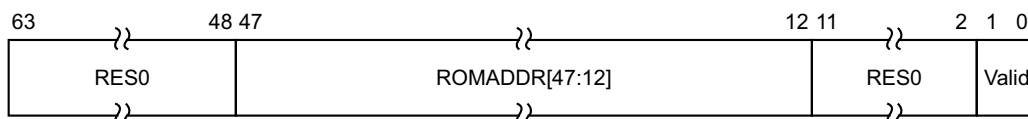

Bits [63:48]

Reserved, RES0.

ROMADDR[47:12], bits [47:12]

Bits[47:12] of the ROM table physical address.

If the physical address size in bits (PAsize) is less than 48 then the register bits corresponding to ROMADDR [47:PAsize] are RES0.

Bits [11:0] of the ROM table physical address are zero.

ARM strongly recommends that bits ROMADDR[(PAsize-1):32] are zero in any system that supports AArch32 at the highest implemented Exception level.

In an implementation that includes EL3, ROMADDR is an address in Non-secure memory. It is IMPLEMENTATION DEFINED whether the ROM table is also accessible in Secure memory.

Bits [11:2]

Reserved, RES0.

Valid, bits [1:0]

This field indicates whether the ROM Table address is valid. The permitted values of this field are:

00 ROM Table address is not valid. Software must ignore ROMADDR.

11 ROM Table address is valid.

Other values are reserved.

Accessing the DBGDRAR

This register can be read using MRC with the following syntax:

MRC <syntax>

This syntax is encoded with the following settings in the instruction encoding:

<syntax>	opc1	opc2	CRn	coproc	CRm
p14, 0, <Rt>, c1, c0, 0	000	000	0001	1110	0000

This register can be read using MRRC with the following syntax:

MRRC <syntax>

This syntax is encoded with the following settings in the instruction encoding:

<syntax>	opc1	coproc	CRm
p14, 0, <Rt>, <Rt2>, c1	0000	1110	0001

Accessibility

The register is accessible in software as follows:

Control			Accessibility			
E2H	TGE	NS	EL0	EL1	EL2	EL3
x	x	0	RO	RO	n/a	RO
x	0	1	RO	RO	RO	RO
x	1	1	RO	n/a	RO	RO

Traps and Enables

For a description of the prioritization of any generated exceptions, see *Synchronous exception prioritization for exceptions taken to AArch32 state* on page G1-4344 for exceptions taken to AArch32 state and *Synchronous exception prioritization for exceptions taken to AArch64* on page D1-1827 for exceptions taken to AArch64 state. Subject to the prioritization rules:

- In both security states, and not dependent on other bits:
 - If `DBGDSCRExt.UDCCdis`==1, read accesses to this register from EL0 are trapped to Undefined mode.
 - If `MDSCR_EL1.TDCC`==1, read accesses to this register from EL0 are trapped to EL1.
- When EL2 is implemented and is using AArch64 and `SCR_EL3.NS` == 1:
 - If `MDCR_EL2.TDRA`==1, Non-secure read accesses to this register from EL0 and EL1 are trapped to EL2.
- When EL2 is implemented and is using AArch32 and `SCR_EL3.NS` == 1:
 - If `HDCR.TDRA`==1, Non-secure read accesses to this register from EL0 and EL1 are trapped to Hyp mode.

G6.3.13 DBGDSAR, Debug Self Address Register

The DBGDSAR characteristics are:

Purpose

In earlier versions of the ARM Architecture, this register defines the offset from the base address defined in [DBGDRAR](#) of the physical base address of the debug registers for the PE. ARMv8 deprecates any use of this register.

Configurations

There is one instance of this register that is used in both Secure and Non-secure states.

If EL1 cannot use AArch32 then the implementation of this register is OPTIONAL and deprecated.

Attributes

DBGDSAR is a 64-bit register that can also be accessed as a 32-bit value. If it is accessed as a 32-bit register, bits [31:0] are read.

Field descriptions

The DBGDSAR bit assignments are:

When accessing as a 32-bit register:



Offset, bits [31:0]

This register value is RAZ.

When accessing as a 64-bit register:

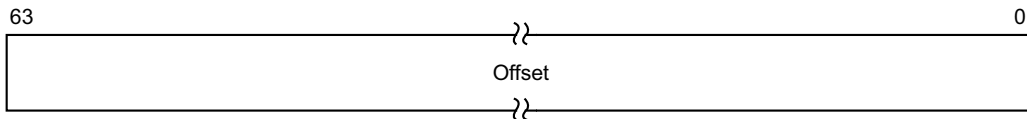

Offset, bits [63:0]

This register value is RAZ.

Accessing the DBGDSAR

This register can be read using MRC with the following syntax:

MRC <syntax>

This syntax is encoded with the following settings in the instruction encoding:

<syntax>	opc1	opc2	CRn	coproc	CRm
p14, 0, <Rt>, c2, c0, 0	000	000	0010	1110	0000

This register can be read using MRRC with the following syntax:

MRRC <syntax>

This syntax is encoded with the following settings in the instruction encoding:

<syntax>	opc1	coproc	CRm
p14, 0, <Rt>, <Rt2>, c2	0000	1110	0010

Accessibility

The register is accessible in software as follows:

Control			Accessibility			
E2H	TGE	NS	EL0	EL1	EL2	EL3
x	x	0	RO	RO	n/a	RO
x	0	1	RO	RO	RO	RO
x	1	1	RO	n/a	RO	RO

Traps and Enables

For a description of the prioritization of any generated exceptions, see [Synchronous exception prioritization for exceptions taken to AArch32 state on page G1-4344](#) for exceptions taken to AArch32 state and [Synchronous exception prioritization for exceptions taken to AArch64 on page D1-1827](#) for exceptions taken to AArch64 state. Subject to the prioritization rules:

- In both security states, and not dependent on other bits:
 - If `DBGDSCRExt.UDCCdis==1`, read accesses to this register from EL0 are trapped to Undefined mode.
 - If `MDSR_EL1.TDCC==1`, read accesses to this register from EL0 are trapped to EL1.
- When EL2 is implemented and is using AArch64 and `SCR_EL3.NS == 1`:
 - If `MDCR_EL2.TDRA==1`, Non-secure read accesses to this register from EL0 and EL1 are trapped to EL2.
- When EL2 is implemented and is using AArch32 and `SCR_EL3.NS == 1`:
 - If `HDCR.TDRA==1`, Non-secure read accesses to this register from EL0 and EL1 are trapped to Hyp mode.
- When EL3 is implemented and is using AArch64:
 - If `MDCR_EL3.TDA==1`, read accesses to this register from EL0, EL1, and EL2 are trapped to EL3.

G6.3.14 DBGDSCRext, Debug Status and Control Register, External View

The DBGDSCRext characteristics are:

Purpose

Main control register for the debug implementation.

Configurations

There is one instance of this register that is used in both Secure and Non-secure states.

AArch32 System register DBGDSCRext is architecturally mapped to AArch64 System register [MDSR_EL1](#).

This register is required in all implementations.

This register is in the Warm reset domain. Some or all RW fields of this register have defined reset values. On a Warm or Cold reset these apply only if the PE resets into an Exception level that is using AArch32. Otherwise, on a Warm or Cold reset RW fields in this register reset to architecturally UNKNOWN values.

Attributes

DBGDSCRext is a 32-bit register.

Field descriptions

The DBGDSCRext bit assignments are:

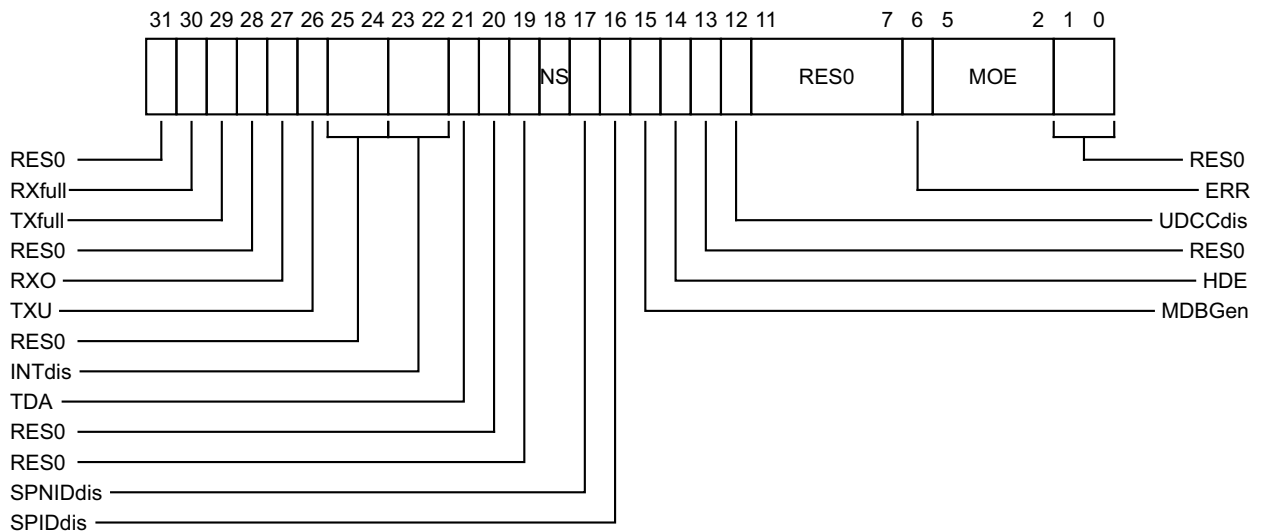

Bit [31]

Reserved, RES0.

RXfull, bit [30]

DTRRX full. Used for save/restore of [EDSCR.RXfull](#).

When [DBGOSLSR.OSLK](#) == 0 (the OS lock is unlocked), this bit is RO, and software must treat it as UNK/SBZP.

When [DBGOSLSR.OSLK](#) == 1 (the OS lock is locked), this bit is RW and holds the value of [EDSCR.RXfull](#).

ARM deprecates use of this bit other than for save/restore. Use [DBGDSCRint](#) to access the DTRRX full status.

Reads and writes of this bit are indirect accesses to [EDSCR.RXfull](#).

The architected behavior of this field determines the value it returns after a reset.

TXfull, bit [29]

DTRTX full. Used for save/restore of [EDSCR.TXfull](#).

When [DBGOSLSR.OSLK](#) == 0 (the OS lock is unlocked), this bit is RO, and software must treat it as UNK/SBZP.

When [DBGOSLSR.OSLK](#) == 1 (the OS lock is locked), this bit is RW and holds the value of [EDSCR.TXfull](#).

ARM deprecates use of this bit other than for save/restore. Use [DBGDSCRint](#) to access the DTRTX full status.

Reads and writes of this bit are indirect accesses to [EDSCR.TXfull](#).

The architected behavior of this field determines the value it returns after a reset.

Bit [28]

Reserved, RES0.

RXO, bit [27]

Used for save/restore of [EDSCR.RXO](#).

When [DBGOSLSR.OSLK](#) == 0 (the OS lock is unlocked), this bit is RO, and software must treat it as UNK/SBZP.

When [DBGOSLSR.OSLK](#) == 1 (the OS lock is locked), this bit is RW and holds the value of [EDSCR.RXO](#).

Reads and writes of this bit are indirect accesses to [EDSCR.RXO](#).

The architected behavior of this field determines the value it returns after a reset.

TXU, bit [26]

Used for save/restore of [EDSCR.TXU](#).

When [DBGOSLSR.OSLK](#) == 0 (the OS lock is unlocked), this bit is RO, and software must treat it as UNK/SBZP.

When [DBGOSLSR.OSLK](#) == 1 (the OS lock is locked), this bit is RW and holds the value of [EDSCR.TXU](#).

Reads and writes of this bit are indirect accesses to [EDSCR.TXU](#).

The architected behavior of this field determines the value it returns after a reset.

Bits [25:24]

Reserved, RES0.

INTdis, bits [23:22]

Used for save/restore of [EDSCR.INTdis](#).

When [DBGOSLSR.OSLK](#) == 0 (the OS lock is unlocked), this field is RO, and software must treat it as UNK/SBZP.

When [DBGOSLSR.OSLK](#) == 1 (the OS lock is locked), this field is RW and holds the value of [EDSCR.INTdis](#).

Reads and writes of this field are indirect accesses to [EDSCR.INTdis](#).

The architected behavior of this field determines the value it returns after a reset.

TDA, bit [21]

Used for save/restore of [EDSCR.TDA](#).

When [DBGOSLSR.OSLK](#) == 0 (the OS lock is unlocked), this bit is RO, and software must treat it as UNK/SBZP.

When [DBGOSLSR.OSLK](#) == 1 (the OS lock is locked), this bit is RW and holds the value of [EDSCR.TDA](#).

Reads and writes of this bit are indirect accesses to [EDSCR.TDA](#).
The architected behavior of this field determines the value it returns after a reset.

Bit [20]

Reserved, RES0.

SC2, bit [19]

In ARMv8.1

Used for save/restore of [EDSCR.SC2](#).

When [DBGOSLSR.OSLK](#) == 0 (the OS lock is unlocked), this bit is RO, and software must treat it as UNK/SBZP.

When [DBGOSLSR.OSLK](#) == 1 (the OS lock is locked), this bit is RW and holds the value of [EDSCR.SC2](#).

Reads and writes of this bit are indirect accesses to [EDSCR.SC2](#).

If the PC Sample-based Profiling Extension is not implemented, then this field is RES0.

In ARMv8.2 and ARMv8.0.

Reserved, RES0.

NS, bit [18]

Non-secure status. Returns the inverse of `IsSecure()`. This bit is RO.

ARM deprecates use of this field.

SPNIDdis, bit [17]

Secure privileged profiling disabled status bit. This bit is RO. Permitted values are:

- 0 If EL3 is implemented, profiling allowed in Secure privileged modes.
- 1 If EL3 is implemented, profiling prohibited in Secure privileged modes.

This field is RES0 if EL3 is not implemented.

- This field is RES1 if either:
 - EL3 is using AArch64 and the Effective value of [SCR_EL3.NS](#) is 1.
 - EL3 is using AArch32 and the Effective value of [SCR.NS](#) is 1.
- Otherwise, the field is RES0 if any of the following applies, and RES1 otherwise:
 - [ARMv8.2-Debug](#) is not implemented and `ExternalSecureNoninvasiveDebugEnabled()` returns TRUE.
 - EL3 is using AArch32 and the value of [SDCR.SPME](#) is 1.
 - EL3 is using AArch64 and the value of [MDCR_EL3.SPME](#) is 1.

ARM deprecates use of this field.

SPIDdis, bit [16]

Secure privileged AArch32 invasive self-hosted debug disabled status bit. This bit is RO and depends on the value of [SDCR.SPD](#) and the pseudocode function `AArch32.SelfHostedSecurePrivilegedInvasiveDebugEnabled()`. Permitted values are:

- 0 Self-hosted debug enabled in Secure privileged AArch32 modes.
- 1 Self-hosted debug disabled in Secure privileged AArch32 modes.

This bit reads as 1 if any of the following is true and reads as 0 otherwise:

- [SDCR.SPD](#) has the value 10.
- [SDCR.SPD](#) has the value 00 and `AArch32.SelfHostedSecurePrivilegedInvasiveDebugEnabled()` returns FALSE.

ARM deprecates use of this field.

MDBGen, bit [15]

Monitor debug events enable. Enable Breakpoint, Watchpoint, and Vector Catch exceptions.

0 Breakpoint, Watchpoint, and Vector Catch exceptions disabled.

1 Breakpoint, Watchpoint, and Vector Catch exceptions enabled.

When this register has an architecturally-defined reset value, this field resets to 0.

HDE, bit [14]

Used for save/restore of [EDSCR.HDE](#).

When [DBGOSLSR.OSLK](#) == 0 (the OS lock is unlocked), this bit is RO, and software must treat it as UNK/SBZP.

When [DBGOSLSR.OSLK](#) == 1 (the OS lock is locked), this bit is RW and holds the value of [EDSCR.HDE](#).

Reads and writes of this bit are indirect accesses to [EDSCR.HDE](#).

The architected behavior of this field determines the value it returns after a reset.

Bit [13]

Reserved, RES0.

UDCCdis, bit [12]

Traps EL0 accesses to the DCC registers to Undefined mode.

0 This control does not cause any instructions to be trapped.

1 EL0 accesses to the [DBGDSCRint](#), [DBGDTRRXint](#), [DBGDTRTXint](#), [DBGDIDR](#), [DBGDSAR](#), and [DBGDRAR](#) are trapped to Undefined mode.

———— Note ————

All accesses to these registers are trapped, including LDC and STC accesses to [DBGDTRTXint](#) and [DBGDTRRXint](#), and MRRC accesses to [DBGDSAR](#) and [DBGDRAR](#).

Traps of EL0 accesses to the [DBGDTRRXint](#) and [DBGDTRTXint](#) are ignored in Debug state.

When this register has an architecturally-defined reset value, this field resets to 0.

Bits [11:7]

Reserved, RES0.

ERR, bit [6]

Used for save/restore of [EDSCR.ERR](#).

When [DBGOSLSR.OSLK](#) == 0 (the OS lock is unlocked), this bit is RO, and software must treat it as UNK/SBZP.

When [DBGOSLSR.OSLK](#) == 1 (the OS lock is locked), this bit is RW and holds the value of [EDSCR.ERR](#).

Reads and writes of this bit are indirect accesses to [EDSCR.ERR](#).

The architected behavior of this field determines the value it returns after a reset.

MOE, bits [5:2]

Method of Entry for debug exception. When a debug exception is taken to an Exception level using AArch32, this field is set to indicate the event that caused the exception:

0001 Breakpoint

0011 Software breakpoint (BKPT) instruction

0101 Vector catch

1010 Watchpoint

This field resets to a value that is architecturally UNKNOWN.

Bits [1:0]

Reserved, RES0.

Accessing the DBGDSCRExt

This register can be read using MRC with the following syntax:

MRC <syntax>

This register can be written using MCR with the following syntax:

MCR <syntax>

This syntax is encoded with the following settings in the instruction encoding:

<syntax>	opc1	opc2	CRn	coproc	CRm
p14, 0, <Rt>, c0, c2, 2	000	010	0000	1110	0010

Accessibility

The register is accessible in software as follows:

Control			Accessibility			
E2H	TGE	NS	EL0	EL1	EL2	EL3
x	x	0	-	RW	n/a	RW
x	0	1	-	RW	RW	RW
x	1	1	-	n/a	RW	RW

Individual fields within this register might have restricted accessibility when `DBGOSLSR.OSLK == 0` (the OS lock is unlocked.) See the field descriptions for more detail.

Traps and Enables

For a description of the prioritization of any generated exceptions, see *Synchronous exception prioritization for exceptions taken to AArch32 state* on page G1-4344 for exceptions taken to AArch32 state and *Synchronous exception prioritization for exceptions taken to AArch64* on page D1-1827 for exceptions taken to AArch64 state. Subject to the prioritization rules:

- When EL2 is implemented and is using AArch64 and `SCR_EL3.NS == 1`:
 - If `MDCR_EL2.TDA==1`, Non-secure accesses to this register from EL1 are trapped to EL2.
- When EL2 is implemented and is using AArch32 and `SCR_EL3.NS == 1`:
 - If `HDCR.TDA==1`, Non-secure accesses to this register from EL1 are trapped to Hyp mode.
- When EL3 is implemented and is using AArch64:
 - If `MDCR_EL3.TDA==1`, accesses to this register from EL1 and EL2 are trapped to EL3.

G6.3.15 DBGDSCRint, Debug Status and Control Register, Internal View

The DBGDSCRint characteristics are:

Purpose

Main control register for the debug implementation. This is an internal, read-only view.

Configurations

There is one instance of this register that is used in both Secure and Non-secure states.

This register is required in all implementations.

DBGDSCRint.{NS, SPNIDdis, SPIDdis, MDBGen, UDCCdis, MOE} are UNKNOWN when the register is accessed at EL0. However, although these values are not accessible at EL0 by instructions that are neither UNPREDICTABLE nor return UNKNOWN values, it is permissible for an implementation to return the values of DBGDSCRext.{NS, SPNIDdis, SPIDdis, MDBGen, UDCCdis, MOE} for these fields at EL0.

It is also permissible for an implementation to return the same values as defined for a read of DBGDSCRint at EL1 or above. (This is the case even if the implementation does not support AArch32 at EL1 or above.)

Attributes

DBGDSCRint is a 32-bit register.

Field descriptions

The DBGDSCRint bit assignments are:

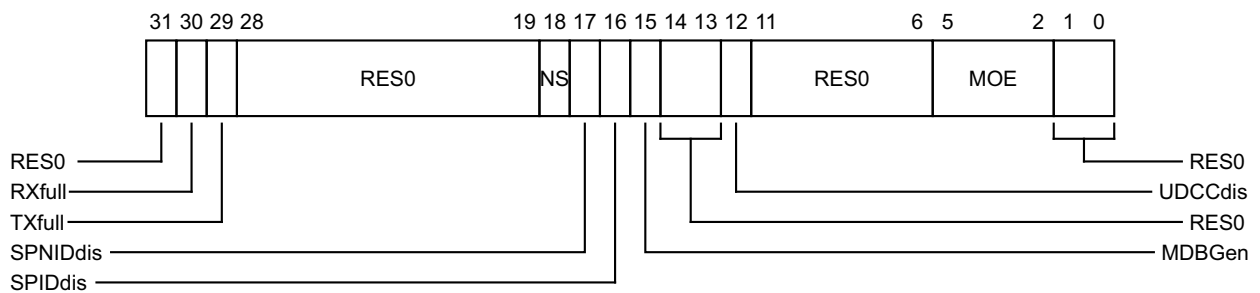

Bit [31]

Reserved, RES0.

RXfull, bit [30]

DTRRX full. Read-only view of the equivalent bit in the [EDSCR](#).

TXfull, bit [29]

DTRTX full. Read-only view of the equivalent bit in the [EDSCR](#).

Bits [28:19]

Reserved, RES0.

NS, bit [18]

Non-secure status.

Read-only view of the equivalent bit in the [DBGDSCRext](#). ARM deprecates use of this field.

SPNIDdis, bit [17]

Secure privileged non-invasive debug disable.

Read-only view of the equivalent bit in the [DBGDSCRext](#). ARM deprecates use of this field.

SPIDdis, bit [16]

Secure privileged invasive debug disable.

Read-only view of the equivalent bit in the [DBGDSCRext](#). ARM deprecates use of this field.

MDBGGen, bit [15]

Monitor debug events enable.

Read-only view of the equivalent bit in the [DBGDSCRext](#).

Bits [14:13]

Reserved, RES0.

UDCCdis, bit [12]

User mode access to Debug Communications Channel disable.

Read-only view of the equivalent bit in the [DBGDSCRext](#). ARM deprecates use of this field.

Bits [11:6]

Reserved, RES0.

MOE, bits [5:2]

Method of Entry for debug exception. When a debug exception is taken to an Exception level using AArch32, this field is set to indicate the event that caused the exception:

- 0001 Breakpoint
- 0011 Software breakpoint (BKPT) instruction
- 0101 Vector catch
- 1010 Watchpoint

Read-only view of the equivalent bit in the [DBGDSCRext](#).

Bits [1:0]

Reserved, RES0.

Accessing the DBGDSCRint

This register can be read using MRC with the following syntax:

MRC <syntax>

This syntax is encoded with the following settings in the instruction encoding:

<syntax>	opc1	opc2	CRn	coproc	CRm
p14, 0, <Rt>, c0, c1, 0	000	000	0000	1110	0001

Accessibility

The register is accessible in software as follows:

Control			Accessibility			
E2H	TGE	NS	EL0	EL1	EL2	EL3
x	x	0	RO	RO	n/a	RO
x	0	1	RO	RO	RO	RO
x	1	1	RO	n/a	RO	RO

Traps and Enables

For a description of the prioritization of any generated exceptions, see [Synchronous exception prioritization for exceptions taken to AArch32 state on page G1-4344](#) for exceptions taken to AArch32 state and [Synchronous exception prioritization for exceptions taken to AArch64 on page D1-1827](#) for exceptions taken to AArch64 state. Subject to the prioritization rules:

- In both security states, and not dependent on other bits:
 - If `DBGDSCRExt.UDCCdis==1`, read accesses to this register from EL0 are trapped to Undefined mode.
 - If `MDSCR_EL1.TDCC==1`, read accesses to this register from EL0 are trapped to EL1.
- When EL2 is implemented and is using AArch64 and `SCR_EL3.NS == 1`:
 - If `MDCR_EL2.TDA==1`, Non-secure read accesses to this register from EL0 and EL1 are trapped to EL2.
- When EL2 is implemented and is using AArch32 and `SCR_EL3.NS == 1`:
 - If `HDCR.TDA==1`, Non-secure read accesses to this register from EL0 and EL1 are trapped to Hyp mode.
- When EL3 is implemented and is using AArch64:
 - If `MDCR_EL3.TDA==1`, read accesses to this register from EL0, EL1, and EL2 are trapped to EL3.

G6.3.16 DBGDTRRText, Debug OS Lock Data Transfer Register, Receive, External View

The DBGDTRRText characteristics are:

Purpose

Used for save/restore of [DBGDTRRXint](#). It is a component of the Debug Communications Channel.

Configurations

There is one instance of this register that is used in both Secure and Non-secure states.

AArch32 System register DBGDTRRText is architecturally mapped to AArch64 System register [OSDTRRX_EL1](#).

Attributes

DBGDTRRText is a 32-bit register.

Field descriptions

The DBGDTRRText bit assignments are:

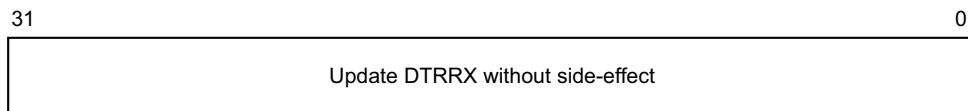

Bits [31:0]

Update DTRRX without side-effect.

Writes to this register update the value in DTRRX and do not change RXfull.

Reads of this register return the last value written to DTRRX and do not change RXfull.

For the full behavior of the Debug Communications Channel, see [Chapter H4 The Debug Communication Channel and Instruction Transfer Register](#).

This field resets to a value that is architecturally UNKNOWN.

Accessing the DBGDTRRText

This register can be read using MRC with the following syntax:

MRC <syntax>

This register can be written using MCR with the following syntax:

MCR <syntax>

This syntax is encoded with the following settings in the instruction encoding:

<syntax>	opc1	opc2	CRn	coproc	CRm
p14, 0, <Rt>, c0, c0, 2	000	010	0000	1110	0000

Accessibility

The register is accessible in software as follows:

Control			Accessibility			
E2H	TGE	NS	EL0	EL1	EL2	EL3
x	x	0	-	RW	n/a	RW
x	0	1	-	RW	RW	RW
x	1	1	-	n/a	RW	RW

ARM deprecates reads and writes of DBGDTRRXext through the System register interface when the OS lock is unlocked.

Traps and Enables

For a description of the prioritization of any generated exceptions, see [Synchronous exception prioritization for exceptions taken to AArch32 state on page G1-4344](#) for exceptions taken to AArch32 state and [Synchronous exception prioritization for exceptions taken to AArch64 on page D1-1827](#) for exceptions taken to AArch64 state. Subject to the prioritization rules:

- When EL2 is implemented and is using AArch64 and SCR_EL3.NS == 1:
 - If MDCR_EL2.TDA==1, Non-secure accesses to this register from EL1 are trapped to EL2.
- When EL2 is implemented and is using AArch32 and SCR_EL3.NS == 1:
 - If HDCR.TDA==1, Non-secure accesses to this register from EL1 are trapped to Hyp mode.
- When EL3 is implemented and is using AArch64:
 - If MDCR_EL3.TDA==1, accesses to this register from EL1 and EL2 are trapped to EL3.

G6.3.17 DBGDTRRXint, Debug Data Transfer Register, Receive

The DBGDTRRXint characteristics are:

Purpose

Transfers data from an external debugger to the PE. For example, it is used by a debugger transferring commands and data to a debug target. It is a component of the Debug Communications Channel.

Configurations

There is one instance of this register that is used in both Secure and Non-secure states.

AArch32 System register DBGDTRRXint is architecturally mapped to AArch64 System register [DBGDTRRX_ELO](#).

AArch32 System register DBGDTRRXint is architecturally mapped to External register [DBGDTRRX_ELO](#).

This register is in the Cold reset domain. On a Cold reset RW fields in this register reset to architecturally UNKNOWN values. The register is not affected by a Warm reset.

Attributes

DBGDTRRXint is a 32-bit register.

Field descriptions

The DBGDTRRXint bit assignments are:



Bits [31:0]

Update DTRRX.

If RXfull is set to 1, then reads of this register return the last value written to DTRRX and clear RXfull to 0.

For the full behavior of the Debug Communications Channel, see [Chapter H4 The Debug Communication Channel and Instruction Transfer Register](#).

This field resets to a value that is architecturally UNKNOWN.

Accessing the DBGDTRRXint

This register can be read using MRC with the following syntax:

MRC <syntax>

This syntax is encoded with the following settings in the instruction encoding:

<syntax>	opc1	opc2	CRn	coproc	CRm
p14, 0, <Rt>, c0, c5, 0	000	000	0000	1110	0101

Data can be stored to memory from this register using [STC](#).

Accessibility

The register is accessible in software as follows:

Control			Accessibility			
E2H	TGE	NS	EL0	EL1	EL2	EL3
x	x	0	RO	RO	n/a	RO
x	0	1	RO	RO	RO	RO
x	1	1	RO	n/a	RO	RO

Traps and Enables

For a description of the prioritization of any generated exceptions, see *Synchronous exception prioritization for exceptions taken to AArch32 state* on page G1-4344 for exceptions taken to AArch32 state and *Synchronous exception prioritization for exceptions taken to AArch64* on page D1-1827 for exceptions taken to AArch64 state. Subject to the prioritization rules, in Non-debug state:

- In both security states, and not dependent on other bits:
 - If `DBGDSCRExt.UDCCdis==1`, read accesses to this register from EL0 are trapped to Undefined mode.
 - If `MDSCR_EL1.TDCC==1`, read accesses to this register from EL0 are trapped to EL1.
- When EL2 is implemented and is using AArch64 and `SCR_EL3.NS == 1`:
 - If `MDCR_EL2.TDA==1`, Non-secure read accesses to this register from EL0 and EL1 are trapped to EL2.
- When EL2 is implemented and is using AArch32 and `SCR_EL3.NS == 1`:
 - If `HDCR.TDA==1`, Non-secure read accesses to this register from EL0 and EL1 are trapped to Hyp mode.
- When EL3 is implemented and is using AArch64:
 - If `MDCR_EL3.TDA==1`, read accesses to this register from EL0, EL1, and EL2 are trapped to EL3.

———— **Note** —————

Read accesses to this register are not trapped in Debug state.

G6.3.18 DBGDTRTXext, Debug OS Lock Data Transfer Register, Transmit

The DBGDTRTXext characteristics are:

Purpose

Used for save/restore of [DBGDTRTXint](#). It is a component of the Debug Communication Channel.

Configurations

There is one instance of this register that is used in both Secure and Non-secure states.

AArch32 System register DBGDTRTXext is architecturally mapped to AArch64 System register [OSDTRTX_EL1](#).

Attributes

DBGDTRTXext is a 32-bit register.

Field descriptions

The DBGDTRTXext bit assignments are:

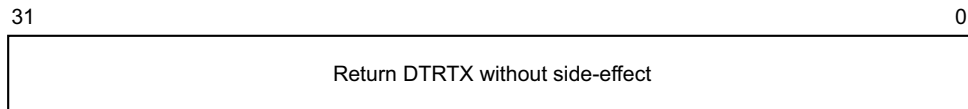

Bits [31:0]

Return DTRTX without side-effect.

Reads of this register return the value in DTRTX and do not change TXfull.

Writes of this register update the value in DTRTX and do not change TXfull.

For the full behavior of the Debug Communications Channel, see [Chapter H4 The Debug Communication Channel and Instruction Transfer Register](#).

This field resets to a value that is architecturally UNKNOWN.

Accessing the DBGDTRTXext

This register can be read using MRC with the following syntax:

MRC <syntax>

This register can be written using MCR with the following syntax:

MCR <syntax>

This syntax is encoded with the following settings in the instruction encoding:

<syntax>	opc1	opc2	CRn	coproc	CRm
p14, 0, <Rt>, c0, c3, 2	000	010	0000	1110	0011

Accessibility

The register is accessible in software as follows:

Control			Accessibility			
E2H	TGE	NS	EL0	EL1	EL2	EL3
x	x	0	-	RW	n/a	RW
x	0	1	-	RW	RW	RW
x	1	1	-	n/a	RW	RW

ARM deprecates reads and writes of DBGDTRTXext through the System register interface when the OS lock is unlocked.

Traps and Enables

For a description of the prioritization of any generated exceptions, see [Synchronous exception prioritization for exceptions taken to AArch32 state on page G1-4344](#) for exceptions taken to AArch32 state and [Synchronous exception prioritization for exceptions taken to AArch64 on page D1-1827](#) for exceptions taken to AArch64 state. Subject to the prioritization rules:

- When EL2 is implemented and is using AArch64 and SCR_EL3.NS == 1:
 - If MDCR_EL2.TDA==1, Non-secure accesses to this register from EL1 are trapped to EL2.
- When EL2 is implemented and is using AArch32 and SCR_EL3.NS == 1:
 - If HDCR.TDA==1, Non-secure accesses to this register from EL1 are trapped to Hyp mode.
- When EL3 is implemented and is using AArch64:
 - If MDCR_EL3.TDA==1, accesses to this register from EL1 and EL2 are trapped to EL3.

G6.3.19 DBGDTRTXint, Debug Data Transfer Register, Transmit

The DBGDTRTXint characteristics are:

Purpose

Transfers data from the PE to an external debugger. For example, it is used by a debug target to transfer data to the debugger. It is a component of the Debug Communication Channel.

Configurations

There is one instance of this register that is used in both Secure and Non-secure states.

AArch32 System register DBGDTRTXint is architecturally mapped to AArch64 System register [DBGDTRTX_ELO](#).

AArch32 System register DBGDTRTXint is architecturally mapped to External register [DBGDTRTX_ELO](#).

This register is in the Cold reset domain. On a Cold reset RW fields in this register reset to architecturally UNKNOWN values. The register is not affected by a Warm reset.

Attributes

DBGDTRTXint is a 32-bit register.

Field descriptions

The DBGDTRTXint bit assignments are:

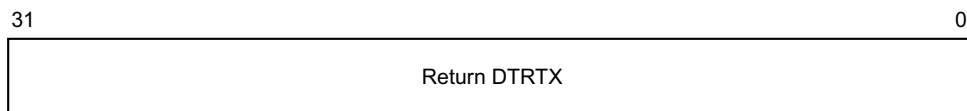

Bits [31:0]

Return DTRTX.

If TXfull is set to 0, then writes of this register update the value in DTRTX and set TXfull to 1.

For the full behavior of the Debug Communications Channel, see [Chapter H4 The Debug Communication Channel and Instruction Transfer Register](#).

This field resets to a value that is architecturally UNKNOWN.

Accessing the DBGDTRTXint

This register can be written using MCR with the following syntax:

MCR <syntax>

This syntax is encoded with the following settings in the instruction encoding:

<syntax>	opc1	opc2	CRn	coproc	CRm
p14, 0, <Rt>, c0, c5, 0	000	000	0000	1110	0101

Data can be loaded from memory into this register using [LDC \(immediate\)](#) and [LDC \(literal\)](#).

Accessibility

The register is accessible in software as follows:

Control			Accessibility			
E2H	TGE	NS	EL0	EL1	EL2	EL3
x	x	0	WO	WO	n/a	WO
x	0	1	WO	WO	WO	WO
x	1	1	WO	n/a	WO	WO

Traps and Enables

For a description of the prioritization of any generated exceptions, see *Synchronous exception prioritization for exceptions taken to AArch32 state* on page G1-4344 for exceptions taken to AArch32 state and *Synchronous exception prioritization for exceptions taken to AArch64* on page D1-1827 for exceptions taken to AArch64 state. Subject to the prioritization rules, in Non-debug state:

- In both security states, and not dependent on other bits:
 - If `DBGDSCRExt.UDCCdis==1`, write accesses to this register from EL0 are trapped to Undefined mode.
 - If `MDSCR_EL1.TDCC==1`, write accesses to this register from EL0 are trapped to EL1.
- When EL2 is implemented and is using AArch64 and `SCR_EL3.NS == 1`:
 - If `MDCR_EL2.TDA==1`, Non-secure write accesses to this register from EL0 and EL1 are trapped to EL2.
- When EL2 is implemented and is using AArch32 and `SCR_EL3.NS == 1`:
 - If `HDCR.TDA==1`, Non-secure write accesses to this register from EL0 and EL1 are trapped to Hyp mode.
- When EL3 is implemented and is using AArch64:
 - If `MDCR_EL3.TDA==1`, write accesses to this register from EL0, EL1, and EL2 are trapped to EL3.

———— **Note** —————

Write accesses to this register are not trapped in Debug state.

G6.3.20 DBGOSDLR, Debug OS Double Lock Register

The DBGOSDLR characteristics are:

Purpose

Locks out the external debug interface.

Configurations

There is one instance of this register that is used in both Secure and Non-secure states.

AArch32 System register DBGOSDLR is architecturally mapped to AArch64 System register [OSDLR_EL1](#).

This register is in the Warm reset domain. Some or all RW fields of this register have defined reset values. On a Warm or Cold reset these apply only if the PE resets into an Exception level that is using AArch32. Otherwise, on a Warm or Cold reset RW fields in this register reset to architecturally UNKNOWN values.

Attributes

DBGOSDLR is a 32-bit register.

Field descriptions

The DBGOSDLR bit assignments are:

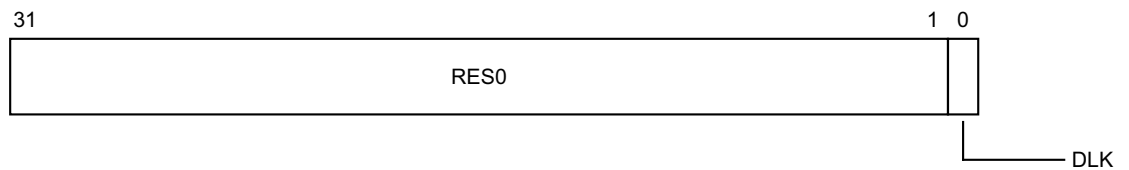

Bits [31:1]

Reserved, RES0.

DLK, bit [0]

OS Double Lock control bit. Possible values are:

- 0 OS Double Lock unlocked.
- 1 OS Double Lock locked, if [DBGPRCR.CORENPDRQ](#) (Core no powerdown request) bit is set to 0 and the PE is in Non-debug state.

When this register has an architecturally-defined reset value, this field resets to 0.

Accessing the DBGOSDLR

This register can be read using MRC with the following syntax:

MRC <syntax>

This register can be written using MCR with the following syntax:

MCR <syntax>

This syntax is encoded with the following settings in the instruction encoding:

<syntax>	opc1	opc2	CRn	coproc	CRm
p14, 0, <Rt>, c1, c3, 4	000	100	0001	1110	0011

Accessibility

The register is accessible in software as follows:

Control			Accessibility			
E2H	TGE	NS	EL0	EL1	EL2	EL3
x	x	0	-	RW	n/a	RW
x	0	1	-	RW	RW	RW
x	1	1	-	n/a	RW	RW

Traps and Enables

For a description of the prioritization of any generated exceptions, see [Synchronous exception prioritization for exceptions taken to AArch32 state](#) on page G1-4344 for exceptions taken to AArch32 state and [Synchronous exception prioritization for exceptions taken to AArch64](#) on page D1-1827 for exceptions taken to AArch64 state. Subject to the prioritization rules:

- When EL2 is implemented and is using AArch64 and SCR_EL3.NS == 1:
 - If MDCR_EL2.TDOSA==1, Non-secure accesses to this register from EL1 are trapped to EL2.
- When EL2 is implemented and is using AArch32 and SCR_EL3.NS == 1:
 - If HDCR.TDOSA==1, Non-secure accesses to this register from EL1 are trapped to Hyp mode.
- When EL3 is implemented and is using AArch64:
 - If MDCR_EL3.TDOSA==1, accesses to this register from EL1 and EL2 are trapped to EL3.

G6.3.21 DBGOSECCR, Debug OS Lock Exception Catch Control Register

The DBGOSECCR characteristics are:

Purpose

Provides a mechanism for an operating system to access the contents of [EDECCR](#) that are otherwise invisible to software, so it can save/restore the contents of [EDECCR](#) over powerdown on behalf of the external debugger.

Configurations

There is one instance of this register that is used in both Secure and Non-secure states.

AArch32 System register DBGOSECCR is architecturally mapped to AArch64 System register [OSECCR_EL1](#).

AArch32 System register DBGOSECCR is architecturally mapped to External register [EDECCR](#).

If `OSLSR.OSLK == 0` then DBGOSECCR returns an UNKNOWN value on reads and ignores writes.

Attributes

DBGOSECCR is a 32-bit register.

Field descriptions

The DBGOSECCR bit assignments are:

When `OSLSR.OSLK==1`:

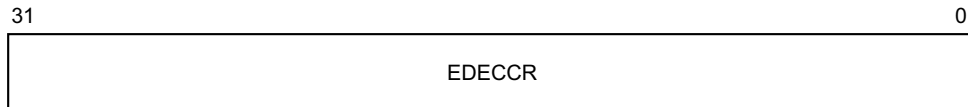

EDECCR, bits [31:0]

Used for save/restore to [EDECCR](#) over powerdown.

Reads or writes to this field are indirect accesses to [EDECCR](#).

Accessing the DBGOSECCR

This register can be read using MRC with the following syntax:

MRC <syntax>

This register can be written using MCR with the following syntax:

MCR <syntax>

This syntax is encoded with the following settings in the instruction encoding:

<syntax>	opc1	opc2	CRn	coproc	CRm
p14, 0, <Rt>, c0, c6, 2	000	010	0000	1110	0110

Accessibility

The register is accessible in software as follows:

Control			Accessibility			
E2H	TGE	NS	EL0	EL1	EL2	EL3
x	x	0	-	RW	n/a	RW
x	0	1	-	RW	RW	RW
x	1	1	-	n/a	RW	RW

Traps and Enables

For a description of the prioritization of any generated exceptions, see [Synchronous exception prioritization for exceptions taken to AArch32 state](#) on page G1-4344 for exceptions taken to AArch32 state and [Synchronous exception prioritization for exceptions taken to AArch64](#) on page D1-1827 for exceptions taken to AArch64 state. Subject to the prioritization rules:

- When EL2 is implemented and is using AArch64 and SCR_EL3.NS == 1:
 - If MDCR_EL2.TDA==1, Non-secure accesses to this register from EL1 are trapped to EL2.
- When EL2 is implemented and is using AArch32 and SCR_EL3.NS == 1:
 - If HDCR.TDA==1, Non-secure accesses to this register from EL1 are trapped to Hyp mode.
- When EL3 is implemented and is using AArch64:
 - If MDCR_EL3.TDA==1, accesses to this register from EL1 and EL2 are trapped to EL3.

G6.3.22 DBGOSLAR, Debug OS Lock Access Register

The DBGOSLAR characteristics are:

Purpose

Provides a lock for the debug registers. The OS lock also disables some Software debug events.

Configurations

There is one instance of this register that is used in both Secure and Non-secure states.

AArch32 System register DBGOSLAR is architecturally mapped to AArch64 System register [OSLAR_EL1](#).

AArch32 System register DBGOSLAR is architecturally mapped to External register [OSLAR_EL1](#).

Attributes

DBGOSLAR is a 32-bit register.

Field descriptions

The DBGOSLAR bit assignments are:

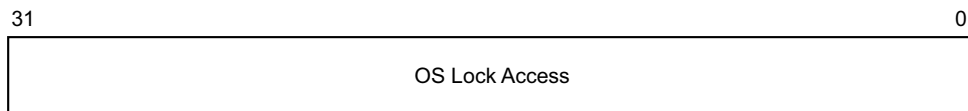

Bits [31:0]

OS Lock Access. Writing the value 0xC5ACCE55 to the DBGOSLAR sets the OS lock to 1. Writing any other value sets the OS lock to 0.

Use [DBGOSLSR.OSLK](#) to check the current status of the lock.

Accessing the DBGOSLAR

This register can be written using MCR with the following syntax:

MCR <syntax>

This syntax is encoded with the following settings in the instruction encoding:

<syntax>	opc1	opc2	CRn	coproc	CRm
p14, 0, <Rt>, c1, c0, 4	000	100	0001	1110	0000

Accessibility

The register is accessible in software as follows:

Control			Accessibility			
E2H	TGE	NS	EL0	EL1	EL2	EL3
x	x	0	-	WO	n/a	WO
x	0	1	-	WO	WO	WO
x	1	1	-	n/a	WO	WO

Traps and Enables

For a description of the prioritization of any generated exceptions, see *Synchronous exception prioritization for exceptions taken to AArch32 state* on page G1-4344 for exceptions taken to AArch32 state and *Synchronous exception prioritization for exceptions taken to AArch64* on page D1-1827 for exceptions taken to AArch64 state. Subject to the prioritization rules:

- When EL2 is implemented and is using AArch64 and SCR_EL3.NS == 1:
 - If MDCR_EL2.TDOSA==1, Non-secure write accesses to this register from EL1 are trapped to EL2 using AArch64.
- When EL2 is implemented and is using AArch32 and SCR_EL3.NS == 1:
 - If HDCR.TDOSA==1, Non-secure write accesses to this register from EL1 are trapped to Hyp mode.
- When EL3 is implemented and is using AArch64:
 - If MDCR_EL3.TDOSA==1, write accesses to this register from EL1 and EL2 are trapped to EL3 using AArch64.

G6.3.23 DBGOSLSR, Debug OS Lock Status Register

The DBGOSLSR characteristics are:

Purpose

Provides status information for the OS lock.

Configurations

There is one instance of this register that is used in both Secure and Non-secure states.

AArch32 System register DBGOSLSR is architecturally mapped to AArch64 System register [OSLSR_EL1](#).

The OS lock status is also visible in the external debug interface through EDPRSR.

This register is in the Cold reset domain. Some or all RW fields of this register have defined reset values. On a Cold reset these apply only if the PE resets into an Exception level that is using AArch32. Otherwise, on a Cold reset RW fields in this register reset to architecturally UNKNOWN values. The register is not affected by a Warm reset.

Attributes

DBGOSLSR is a 32-bit register.

Field descriptions

The DBGOSLSR bit assignments are:

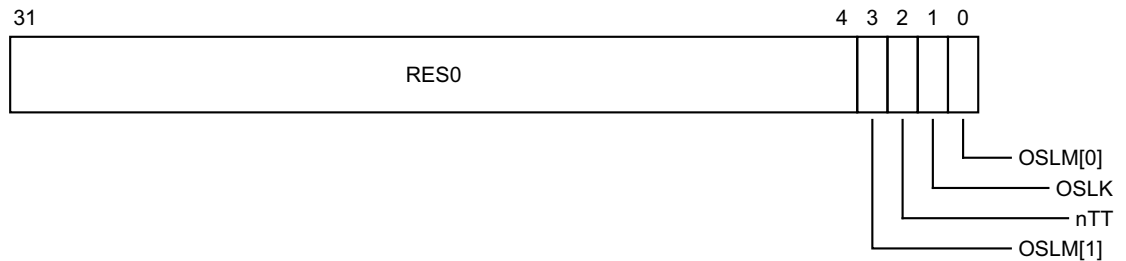

Bits [31:4]

Reserved, RES0.

OSLM[1], bit [3]

See below for description of the OSLM field.

nTT, bit [2]

Not 32-bit access. This bit is always RAZ. It indicates that a 32-bit access is needed to write the key to the OS Lock Access Register.

OSLK, bit [1]

OS Lock Status. The possible values are:

- 0 OS lock unlocked.
- 1 OS lock locked.

The OS lock is locked and unlocked by writing to the OS Lock Access Register.

When this register has an architecturally-defined reset value, this field resets to 1.

OSLM[0], bit [0]

OS lock model implemented. Identifies the form of OS save and restore mechanism implemented. In ARMv8 these bits are as follows:

10 OS lock implemented. DBGOSSRR not implemented.

All other values are reserved.

Accessing the DBGOSLSR

This register can be read using MRC with the following syntax:

MRC <syntax>

This syntax is encoded with the following settings in the instruction encoding:

<syntax>	opc1	opc2	CRn	coproc	CRm
p14, 0, <Rt>, c1, c1, 4	000	100	0001	1110	0001

Accessibility

The register is accessible in software as follows:

Control			Accessibility			
E2H	TGE	NS	EL0	EL1	EL2	EL3
x	x	0	-	RO	n/a	RO
x	0	1	-	RO	RO	RO
x	1	1	-	n/a	RO	RO

Traps and Enables

For a description of the prioritization of any generated exceptions, see [Synchronous exception prioritization for exceptions taken to AArch32 state on page G1-4344](#) for exceptions taken to AArch32 state and [Synchronous exception prioritization for exceptions taken to AArch64 on page D1-1827](#) for exceptions taken to AArch64 state. Subject to the prioritization rules:

- When EL2 is implemented and is using AArch64 and SCR_EL3.NS == 1:
 - If MDCR_EL2.TDOSA==1, Non-secure read accesses to this register from EL1 are trapped to EL2.
- When EL2 is implemented and is using AArch32 and SCR_EL3.NS == 1:
 - If HDCR.TDOSA==1, Non-secure read accesses to this register from EL1 are trapped to Hyp mode.
- When EL3 is implemented and is using AArch64:
 - If MDCR_EL3.TDOSA==1, read accesses to this register from EL1 and EL2 are trapped to EL3.

G6.3.24 DBGPRCR, Debug Power Control Register

The DBGPRCR characteristics are:

Purpose

Controls behavior of the PE on powerdown request.

Configurations

There is one instance of this register that is used in both Secure and Non-secure states.

AArch32 System register DBGPRCR is architecturally mapped to AArch64 System register [DBGPRCR_EL1](#).

Bit [0] of this register is mapped to [EDPRCR.CORENPDRQ](#), bit [0] of the external view of this register.

The other bits in these registers are not mapped to each other.

This register is in the Cold reset domain. On a Cold reset RW fields in this register reset to architecturally UNKNOWN values. The register is not affected by a Warm reset.

Attributes

DBGPRCR is a 32-bit register.

Field descriptions

The DBGPRCR bit assignments are:

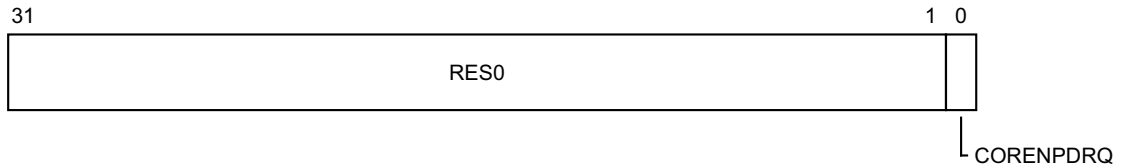

Bits [31:1]

Reserved, RES0.

CORENPDRQ, bit [0]

Core no powerdown request. Requests emulation of powerdown. Possible values of this bit are:

- 0 If the system responds to a powerdown request, it powers down Core power domain.
- 1 If the system responds to a powerdown request, it does not powerdown the Core power domain, but instead emulates a powerdown of that domain.

Writes to this bit are permitted regardless of the state of the IMPLEMENTATION DEFINED authentication interface. This means that a debugger can request Core no powerdown regardless of whether invasive debug is permitted.

It is IMPLEMENTATION DEFINED whether this bit is reset to the value of [EDPRCR.COREPURQ](#) on exit from an IMPLEMENTATION DEFINED software-visible retention state.

Accessing the DBGPRCR

This register can be read using MRC with the following syntax:

MRC <syntax>

This register can be written using MCR with the following syntax:

MCR <syntax>

This syntax is encoded with the following settings in the instruction encoding:

<syntax>	opc1	opc2	CRn	coproc	CRm
p14, 0, <Rt>, c1, c4, 4	000	100	0001	1110	0100

Accessibility

The register is accessible in software as follows:

Control			Accessibility			
E2H	TGE	NS	EL0	EL1	EL2	EL3
x	x	0	-	RW	n/a	RW
x	0	1	-	RW	RW	RW
x	1	1	-	n/a	RW	RW

Traps and Enables

For a description of the prioritization of any generated exceptions, see [Synchronous exception prioritization for exceptions taken to AArch32 state on page G1-4344](#) for exceptions taken to AArch32 state and [Synchronous exception prioritization for exceptions taken to AArch64 on page D1-1827](#) for exceptions taken to AArch64 state. Subject to the prioritization rules:

- When EL2 is implemented and is using AArch64 and SCR_EL3.NS == 1:
 - If MDCR_EL2.TDOSA==1, Non-secure accesses to this register from EL1 are trapped to EL2.
- When EL2 is implemented and is using AArch32 and SCR_EL3.NS == 1:
 - If HDCR.TDOSA==1, Non-secure accesses to this register from EL1 are trapped to Hyp mode.
- When EL3 is implemented and is using AArch64:
 - If MDCR_EL3.TDOSA==1, accesses to this register from EL1 and EL2 are trapped to EL3.

G6.3.25 DBGVCR, Debug Vector Catch Register

The DBGVCR characteristics are:

Purpose

Controls Vector Catch debug events.

Configurations

There is one instance of this register that is used in both Secure and Non-secure states.

AArch32 System register DBGVCR is architecturally mapped to AArch64 System register [DBGVCR32_EL2](#).

This register is required in all implementations.

This register is in the Warm reset domain. On a Warm or Cold reset RW fields in this register reset to architecturally UNKNOWN values.

Attributes

DBGVCR is a 32-bit register.

Field descriptions

The DBGVCR bit assignments are:

When EL3 implemented and using AArch32:

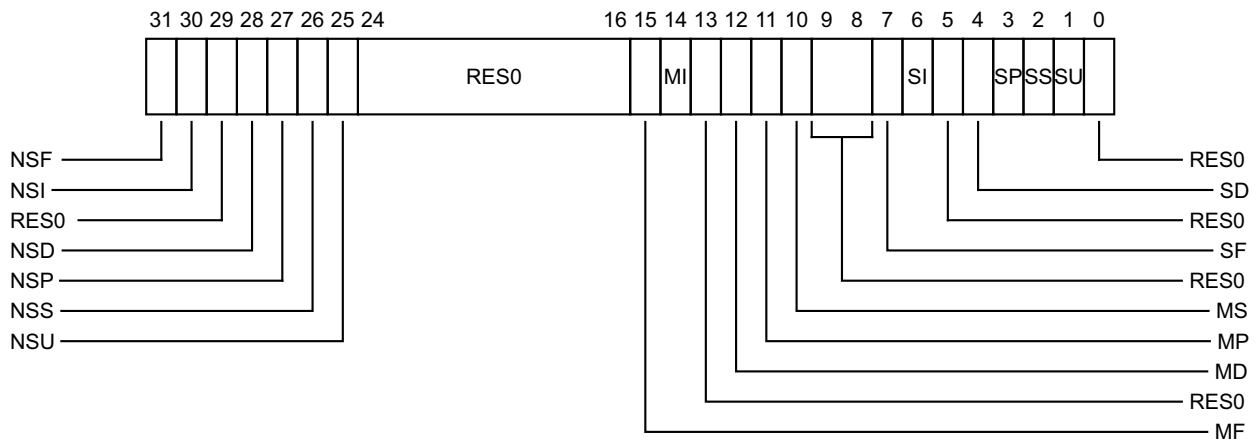

NSF, bit [31]

FIQ vector catch enable in Non-secure state.

The exception vector offset is 0x1C.

This field resets to a value that is architecturally UNKNOWN.

NSI, bit [30]

IRQ vector catch enable in Non-secure state.

The exception vector offset is 0x18.

This field resets to a value that is architecturally UNKNOWN.

Bit [29]

Reserved, RES0.

NSD, bit [28]

Data Abort vector catch enable in Non-secure state.

The exception vector offset is $0x10$.
This field resets to a value that is architecturally UNKNOWN.

NSP, bit [27]

Prefetch Abort vector catch enable in Non-secure state.
The exception vector offset is $0x0C$.
This field resets to a value that is architecturally UNKNOWN.

NSS, bit [26]

Supervisor Call (SVC) vector catch enable in Non-secure state.
The exception vector offset is $0x08$.
This field resets to a value that is architecturally UNKNOWN.

NSU, bit [25]

Undefined Instruction vector catch enable in Non-secure state.
The exception vector offset is $0x04$.
This field resets to a value that is architecturally UNKNOWN.

Bits [24:16]

Reserved, RES0.

MF, bit [15]

FIQ vector catch enable in Monitor mode.
The exception vector offset is $0x1C$.
This field resets to a value that is architecturally UNKNOWN.

MI, bit [14]

IRQ vector catch enable in Monitor mode.
The exception vector offset is $0x18$.
This field resets to a value that is architecturally UNKNOWN.

Bit [13]

Reserved, RES0.

MD, bit [12]

Data Abort vector catch enable in Monitor mode.
The exception vector offset is $0x10$.
This field resets to a value that is architecturally UNKNOWN.

MP, bit [11]

Prefetch Abort vector catch enable in Monitor mode.
The exception vector offset is $0x0C$.
This field resets to a value that is architecturally UNKNOWN.

MS, bit [10]

Secure Monitor Call (SMC) vector catch enable in Monitor mode.
The exception vector offset is $0x08$.
This field resets to a value that is architecturally UNKNOWN.

Bits [9:8]

Reserved, RES0.

SF, bit [7]

FIQ vector catch enable in Secure state.
 The exception vector offset is 0x1C.
 This field resets to a value that is architecturally UNKNOWN.

SI, bit [6]

IRQ vector catch enable in Secure state.
 The exception vector offset is 0x18.
 This field resets to a value that is architecturally UNKNOWN.

Bit [5]

Reserved, RES0.

SD, bit [4]

Data Abort vector catch enable in Secure state.
 The exception vector offset is 0x10.
 This field resets to a value that is architecturally UNKNOWN.

SP, bit [3]

Prefetch Abort vector catch enable in Secure state.
 The exception vector offset is 0x0C.
 This field resets to a value that is architecturally UNKNOWN.

SS, bit [2]

Supervisor Call (SVC) vector catch enable in Secure state.
 The exception vector offset is 0x08.
 This field resets to a value that is architecturally UNKNOWN.

SU, bit [1]

Undefined Instruction vector catch enable in Secure state.
 The exception vector offset is 0x04.
 This field resets to a value that is architecturally UNKNOWN.

Bit [0]

Reserved, RES0.

When EL3 implemented and using AArch64:

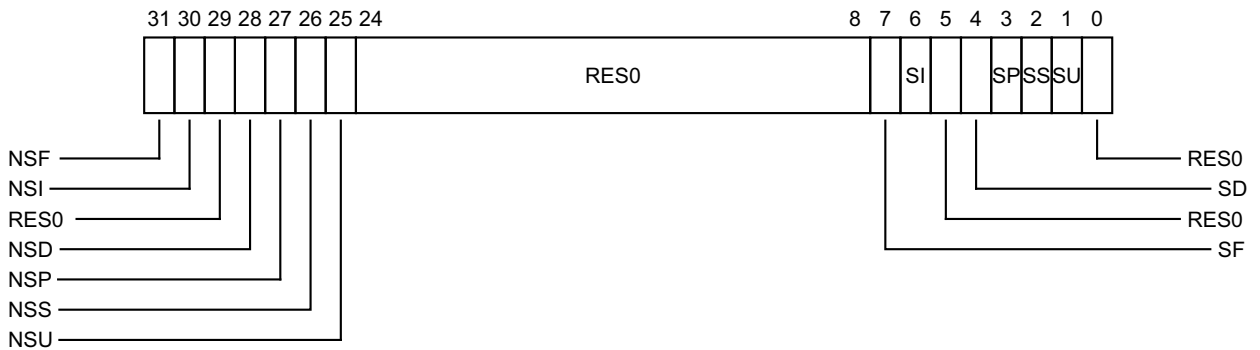

NSF, bit [31]

FIQ vector catch enable in Non-secure state.
The exception vector offset is 0x1C.
This field resets to a value that is architecturally UNKNOWN.

NSI, bit [30]

IRQ vector catch enable in Non-secure state.
The exception vector offset is 0x18.
This field resets to a value that is architecturally UNKNOWN.

Bit [29]

Reserved, RES0.

NSD, bit [28]

Data Abort vector catch enable in Non-secure state.
The exception vector offset is 0x10.
This field resets to a value that is architecturally UNKNOWN.

NSP, bit [27]

Prefetch Abort vector catch enable in Non-secure state.
The exception vector offset is 0x0C.
This field resets to a value that is architecturally UNKNOWN.

NSS, bit [26]

Supervisor Call (SVC) vector catch enable in Non-secure state.
The exception vector offset is 0x08.
This field resets to a value that is architecturally UNKNOWN.

NSU, bit [25]

Undefined Instruction vector catch enable in Non-secure state.
The exception vector offset is 0x04.
This field resets to a value that is architecturally UNKNOWN.

Bits [24:8]

Reserved, RES0.

SF, bit [7]

FIQ vector catch enable in Secure state.
The exception vector offset is 0x1C.
This field resets to a value that is architecturally UNKNOWN.

SI, bit [6]

IRQ vector catch enable in Secure state.
The exception vector offset is 0x18.
This field resets to a value that is architecturally UNKNOWN.

Bit [5]

Reserved, RES0.

SD, bit [4]

Data Abort vector catch enable in Secure state.
The exception vector offset is 0x10.

This field resets to a value that is architecturally UNKNOWN.

SP, bit [3]

Prefetch Abort vector catch enable in Secure state.

The exception vector offset is 0x0C.

This field resets to a value that is architecturally UNKNOWN.

SS, bit [2]

Supervisor Call (SVC) vector catch enable in Secure state.

The exception vector offset is 0x08.

This field resets to a value that is architecturally UNKNOWN.

SU, bit [1]

Undefined Instruction vector catch enable in Secure state.

The exception vector offset is 0x04.

This field resets to a value that is architecturally UNKNOWN.

Bit [0]

Reserved, RES0.

When EL3 not implemented:

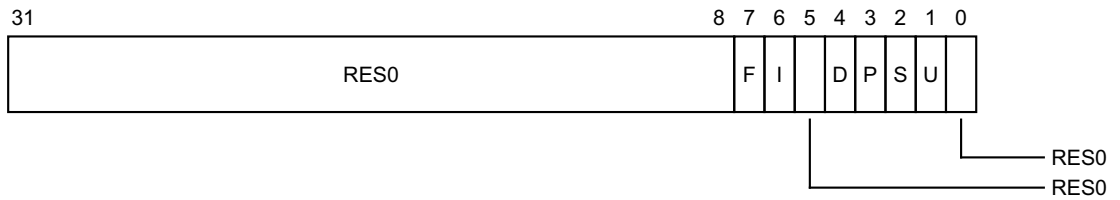

Bits [31:8]

Reserved, RES0.

F, bit [7]

FIQ vector catch enable.

The exception vector offset is 0x1C.

This field resets to a value that is architecturally UNKNOWN.

I, bit [6]

IRQ vector catch enable.

The exception vector offset is 0x18.

This field resets to a value that is architecturally UNKNOWN.

Bit [5]

Reserved, RES0.

D, bit [4]

Data Abort vector catch enable.

The exception vector offset is 0x10.

This field resets to a value that is architecturally UNKNOWN.

P, bit [3]

Prefetch Abort vector catch enable.

The exception vector offset 0x0C.
This field resets to a value that is architecturally UNKNOWN.

S, bit [2]

Supervisor Call (SVC) vector catch enable.
The exception vector offset is 0x08.
This field resets to a value that is architecturally UNKNOWN.

U, bit [1]

Undefined Instruction vector catch enable.
The exception vector offset is 0x04.
This field resets to a value that is architecturally UNKNOWN.

Bit [0]

Reserved, RES0.

Accessing the DBGVCR

This register can be read using MRC with the following syntax:

MRC <syntax>

This register can be written using MCR with the following syntax:

MCR <syntax>

This syntax is encoded with the following settings in the instruction encoding:

<syntax>	opc1	opc2	CRn	coproc	CRm
p14, 0, <Rt>, c0, c7, 0	000	000	0000	1110	0111

Accessibility

The register is accessible in software as follows:

Control			Accessibility			
E2H	TGE	NS	EL0	EL1	EL2	EL3
x	x	0	-	RW	n/a	RW
x	0	1	-	RW	RW	RW
x	1	1	-	n/a	RW	RW

Traps and Enables

For a description of the prioritization of any generated exceptions, see [Synchronous exception prioritization for exceptions taken to AArch32 state on page G1-4344](#) for exceptions taken to AArch32 state and [Synchronous exception prioritization for exceptions taken to AArch64 on page D1-1827](#) for exceptions taken to AArch64 state. Subject to the prioritization rules:

- When EL2 is implemented and is using AArch64 and SCR_EL3.NS == 1:
 - If MDCR_EL2.TDA==1, Non-secure accesses to this register from EL1 are trapped to EL2.

- When EL2 is implemented and is using AArch32 and SCR_EL3.NS == 1:
 - If [HDCR.TDA](#)==1, Non-secure accesses to this register from EL1 are trapped to Hyp mode.
- When EL3 is implemented and is using AArch64:
 - If [MDCR_EL3.TDA](#)==1, accesses to this register from EL1 and EL2 are trapped to EL3.

G6.3.26 DBGWCR<n>, Debug Watchpoint Control Registers, n = 0 - 15

The DBGWCR<n> characteristics are:

Purpose

Holds control information for a watchpoint. Forms watchpoint n together with value register [DBGWVR<n>](#).

Configurations

There is one instance of this register that is used in both Secure and Non-secure states.

AArch32 System register DBGWCR<n> is architecturally mapped to AArch64 System register [DBGWCR<n>_EL1](#).

AArch32 System register DBGWCR<n> is architecturally mapped to External register [DBGWCR<n>_EL1](#).

If breakpoint n is not implemented then this register is unallocated.

This register is in the Cold reset domain. On a Cold reset RW fields in this register reset to architecturally UNKNOWN values. The register is not affected by a Warm reset.

Attributes

DBGWCR<n> is a 32-bit register.

Field descriptions

The DBGWCR<n> bit assignments are:

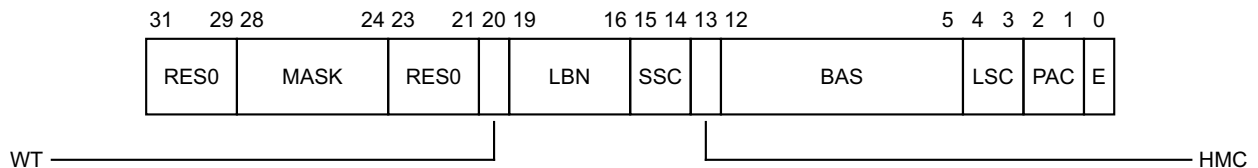

When the E field is zero, all the other fields in the register are ignored.

Bits [31:29]

Reserved, RES0.

MASK, bits [28:24]

Address mask. Only objects up to 2GB can be watched using a single mask.

00000	No mask.
00001	Reserved.
00010	Reserved.

If programmed with a reserved value, a watchpoint must behave as if either:

- MASK has been programmed with a defined value, which might be 0 (no mask), other than for a direct read of [DBGWCRn_EL1](#).
- The watchpoint is disabled.

Software must not rely on this property because the behavior of reserved values might change in a future revision of the architecture.

Other values mask the corresponding number of address bits, from 0b00011 masking 3 address bits (0x00000007 mask for address) to 0b11111 masking 31 address bits (0xFFFFFFFF mask for address).

This field resets to a value that is architecturally UNKNOWN.

Bits [23:21]

Reserved, RES0.

WT, bit [20]

Watchpoint type. Possible values are:

- 0 Unlinked data address match.
- 1 Linked data address match.

This field resets to a value that is architecturally UNKNOWN.

LBN, bits [19:16]

Linked breakpoint number. For Linked data address watchpoints, this specifies the index of the Context-matching breakpoint linked to.

This field resets to a value that is architecturally UNKNOWN.

SSC, bits [15:14]

Security state control. Determines the Security states under which a Watchpoint debug event for watchpoint n is generated. This field must be interpreted along with the HMC and PAC fields.

For more information on the operation of the SSC, HMC, and PAC fields, see [Execution conditions for which a watchpoint generates Watchpoint exceptions on page G2-4499](#).

This field resets to a value that is architecturally UNKNOWN.

HMC, bit [13]

Higher mode control. Determines the debug perspective for deciding when a Watchpoint debug event for watchpoint n is generated. This field must be interpreted along with the SSC and PAC fields.

For more information on the operation of the SSC, HMC, and PAC fields, see [Execution conditions for which a watchpoint generates Watchpoint exceptions on page G2-4499](#).

This field resets to a value that is architecturally UNKNOWN.

BAS, bits [12:5]

Byte address select. Each bit of this field selects whether a byte from within the word or double-word addressed by `DBGWVR<n>` is being watched.

BAS	Description
xxxxxxx1	Match byte at <code>DBGWVR<n></code>
xxxxxx1x	Match byte at <code>DBGWVR<n>+1</code>
xxxxx1xx	Match byte at <code>DBGWVR<n>+2</code>
xxxx1xxx	Match byte at <code>DBGWVR<n>+3</code>

In cases where `DBGWVR<n>` addresses a double-word:

BAS	Description, if <code>DBGWVR<n>[2] == 0</code>
xxx1xxxx	Match byte at <code>DBGWVR<n>+4</code>
xx1xxxxx	Match byte at <code>DBGWVR<n>+5</code>
x1xxxxxx	Match byte at <code>DBGWVR<n>+6</code>
1xxxxxxx	Match byte at <code>DBGWVR<n>+7</code>

If `DBGWVR<n>[2] == 1`, only `BAS[3:0]` are used and `BAS[7:4]` are ignored. ARM deprecates setting `DBGWVR<n>[2] == 1`.

The valid values for `BAS` are non-zero binary numbers all of whose set bits are contiguous. All other values are reserved and must not be used by software. See [Reserved `DBGWCR<n>.BAS` values on page G2-4507](#)

This field resets to a value that is architecturally UNKNOWN.

LSC, bits [4:3]

Load/store control. This field enables watchpoint matching on the type of access being made. Possible values of this field are:

- 01 Match instructions that load from a watchpointed address.
- 10 Match instructions that store to a watchpointed address.
- 11 Match instructions that load from or store to a watchpointed address.

All other values are reserved, but must behave as if the watchpoint is disabled. Software must not rely on this property as the behavior of reserved values might change in a future revision of the architecture.

This field resets to a value that is architecturally UNKNOWN.

PAC, bits [2:1]

Privilege of access control. Determines the Exception level or levels at which a Watchpoint debug event for watchpoint `n` is generated. This field must be interpreted along with the `SSC` and `HMC` fields.

For more information on the operation of the `SSC`, `HMC`, and `PAC` fields, see [Execution conditions for which a watchpoint generates Watchpoint exceptions on page G2-4499](#).

This field resets to a value that is architecturally UNKNOWN.

E, bit [0]

Enable watchpoint `n`. Possible values are:

- 0 Watchpoint disabled.
- 1 Watchpoint enabled.

This field resets to a value that is architecturally UNKNOWN.

Accessing the `DBGWCR<n>`

This register can be read using `MRC` with the following syntax:

`MRC <syntax>`

This register can be written using `MCR` with the following syntax:

`MCR <syntax>`

This syntax is encoded with the following settings in the instruction encoding:

<code><syntax></code>	<code>opc1</code>	<code>opc2</code>	<code>CRn</code>	<code>coproc</code>	<code>CRm</code>
<code>p14, 0, <Rt>, c0, <CRm>, 7</code>	000	111	0000	1110	<code>n<3:0></code>

- `<CRm>` is in the range `c0 - c15`.

Accessibility

The register is accessible in software as follows:

Control			Accessibility			
E2H	TGE	NS	EL0	EL1	EL2	EL3
x	x	0	-	RW	n/a	RW
x	0	1	-	RW	RW	RW
x	1	1	-	n/a	RW	RW

Traps and Enables

For a description of the prioritization of any generated exceptions, see:

- [Synchronous exception prioritization for exceptions taken to AArch32 state on page G1-4344](#) for exceptions taken to AArch32 state.
- [Synchronous exception prioritization for exceptions taken to AArch64 on page D1-1827](#) for exceptions taken to AArch64 state.
- [Software Access debug event on page H3-5493](#) for accesses to this register taken to Debug state.

Subject to the prioritization rules:

- In both security states, and not dependent on other bits:
 - If `EDSCR.TDA==1`, `DBGOSLSR.OSLK==0`, and halting is allowed, accesses to this register from EL1 and EL2 generate a Software Access debug event.
- When EL2 is implemented and is using AArch64 and `SCR_EL3.NS == 1`:
 - If `MDCR_EL2.TDA==1`, Non-secure accesses to this register from EL1 are trapped to EL2.
- When EL2 is implemented and is using AArch32 and `SCR_EL3.NS == 1`:
 - If `HDCR.TDA==1`, Non-secure accesses to this register from EL1 are trapped to Hyp mode.
- When EL3 is implemented and is using AArch64:
 - If `MDCR_EL3.TDA==1`, accesses to this register from EL1 and EL2 are trapped to EL3.

G6.3.27 DBGWFAR, Debug Watchpoint Fault Address Register

The DBGWFAR characteristics are:

Purpose

Previously returned information about the address of the instruction that accessed a watchpointed address. Is now deprecated and RES0.

Configurations

There is one instance of this register that is used in both Secure and Non-secure states.

Attributes

DBGWFAR is a 32-bit register.

Field descriptions

The DBGWFAR bit assignments are:

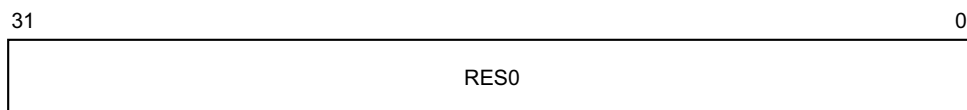

Bits [31:0]

Reserved, RES0.

Accessing the DBGWFAR

This register can be read using MRC with the following syntax:

MRC <syntax>

This register can be written using MCR with the following syntax:

MCR <syntax>

This syntax is encoded with the following settings in the instruction encoding:

<syntax>	opc1	opc2	CRn	coproc	CRm
p14, 0, <Rt>, c0, c6, 0	000	000	0000	1110	0110

Accessibility

The register is accessible in software as follows:

Control			Accessibility			
E2H	TGE	NS	EL0	EL1	EL2	EL3
x	x	0	-	RW	n/a	RW
x	0	1	-	RW	RW	RW
x	1	1	-	n/a	RW	RW

Traps and Enables

For a description of the prioritization of any generated exceptions, see *Synchronous exception prioritization for exceptions taken to AArch32 state* on page G1-4344 for exceptions taken to AArch32 state and *Synchronous exception prioritization for exceptions taken to AArch64* on page D1-1827 for exceptions taken to AArch64 state. Subject to the prioritization rules:

- When EL2 is implemented and is using AArch64 and $SCR_EL3.NS == 1$:
 - If $MDCR_EL2.TDA == 1$, Non-secure accesses to this register from EL1 are trapped to EL2.
- When EL2 is implemented and is using AArch32 and $SCR_EL3.NS == 1$:
 - If $HDCR.TDA == 1$, Non-secure accesses to this register from EL1 are trapped to Hyp mode.
- When EL3 is implemented and is using AArch64:
 - If $MDCR_EL3.TDA == 1$, accesses to this register from EL1 and EL2 are trapped to EL3.

G6.3.28 DBGWVR<n>, Debug Watchpoint Value Registers, n = 0 - 15

The DBGWVR<n> characteristics are:

Purpose

Holds a data address value for use in watchpoint matching. Forms watchpoint n together with control register [DBGWCR<n>](#).

Configurations

There is one instance of this register that is used in both Secure and Non-secure states.

AArch32 System register DBGWVR<n> is architecturally mapped to AArch64 System register [DBGWVR<n>_EL1](#)[31:0].

AArch32 System register DBGWVR<n> is architecturally mapped to External register [DBGWVR<n>_EL1](#)[31:0].

If breakpoint n is not implemented then this register is unallocated.

This register is in the Cold reset domain. On a Cold reset RW fields in this register reset to architecturally UNKNOWN values. The register is not affected by a Warm reset.

Attributes

DBGWVR<n> is a 32-bit register.

Field descriptions

The DBGWVR<n> bit assignments are:

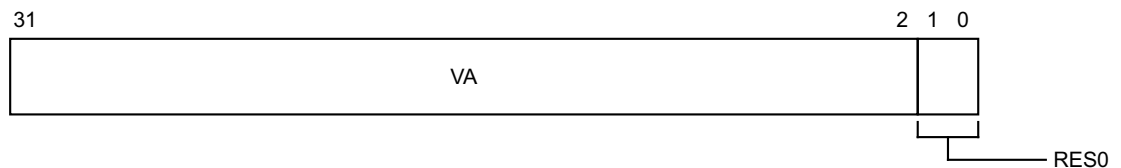

VA, bits [31:2]

Bits[31:2] of the address value for comparison.

ARM deprecates setting [DBGWVR<n>](#)[2] == 1.

This field resets to a value that is architecturally UNKNOWN.

Bits [1:0]

Reserved, RES0.

Accessing the DBGWVR<n>

This register can be read using MRC with the following syntax:

```
MRC <syntax>
```

This register can be written using MCR with the following syntax:

```
MCR <syntax>
```

This syntax is encoded with the following settings in the instruction encoding:

<syntax>	opc1	opc2	CRn	coproc	CRm
p14, 0, <Rt>, c0, <CRm>, 6	000	110	0000	1110	n<3:0>

- <CRm> is in the range c0 - c15.

Accessibility

The register is accessible in software as follows:

Control			Accessibility			
E2H	TGE	NS	EL0	EL1	EL2	EL3
x	x	0	-	RW	n/a	RW
x	0	1	-	RW	RW	RW
x	1	1	-	n/a	RW	RW

Traps and Enables

For a description of the prioritization of any generated exceptions, see:

- [Synchronous exception prioritization for exceptions taken to AArch32 state on page G1-4344](#) for exceptions taken to AArch32 state.
- [Synchronous exception prioritization for exceptions taken to AArch64 on page D1-1827](#) for exceptions taken to AArch64 state.
- [Software Access debug event on page H3-5493](#) for accesses to this register taken to Debug state.

Subject to the prioritization rules:

- In both security states, and not dependent on other bits:
 - If `EDSCR.TDA==1`, `DBGOSLSR.OSLK==0`, and halting is allowed, accesses to this register from EL1 and EL2 generate a Software Access debug event.
- When EL2 is implemented and is using AArch64 and `SCR_EL3.NS == 1`:
 - If `MDCR_EL2.TDA==1`, Non-secure accesses to this register from EL1 are trapped to EL2.
- When EL3 is implemented and is using AArch64:
 - If `MDCR_EL3.TDA==1`, accesses to this register from EL1 and EL2 are trapped to EL3.

G6.3.29 DLR, Debug Link Register

The DLR characteristics are:

Purpose

In Debug state, holds the address to restart from.

Configurations

There is one instance of this register that is used in both Secure and Non-secure states. AArch32 System register DLR is architecturally mapped to AArch64 System register [DLR_EL0](#)[31:0].

Attributes

DLR is a 32-bit register.

Field descriptions

The DLR bit assignments are:

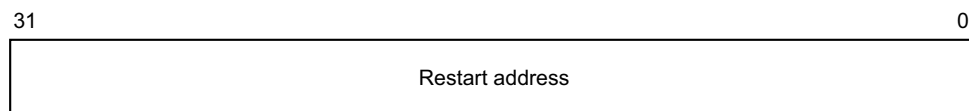

Bits [31:0]

Restart address.

Accessing the DLR

This register can be read using MRC with the following syntax:

MRC <syntax>

This register can be written using MCR with the following syntax:

MCR <syntax>

This syntax is encoded with the following settings in the instruction encoding:

<syntax>	opc1	opc2	CRn	coproc	CRm
p15, 3, <Rt>, c4, c5, 1	011	001	0100	1111	0101

Accessibility

The register is accessible in software as follows:

Control			Accessibility			
E2H	TGE	NS	EL0	EL1	EL2	EL3
x	x	0	RW	RW	n/a	RW
x	0	1	RW	RW	RW	RW
x	1	1	RW	n/a	RW	RW

Access to this register is from Debug state only. During normal execution this register is unallocated.

G6.3.30 DSPSR, Debug Saved Program Status Register

The DSPSR characteristics are:

Purpose

Holds the saved process state on entry to Debug state.

Configurations

There is one instance of this register that is used in both Secure and Non-secure states.

AArch32 System register DSPSR is architecturally mapped to AArch64 System register [DSPSR_EL0](#).

Attributes

DSPSR is a 32-bit register.

Field descriptions

The DSPSR bit assignments are:

When entering Debug state from AArch32 and exiting Debug state to AArch32:

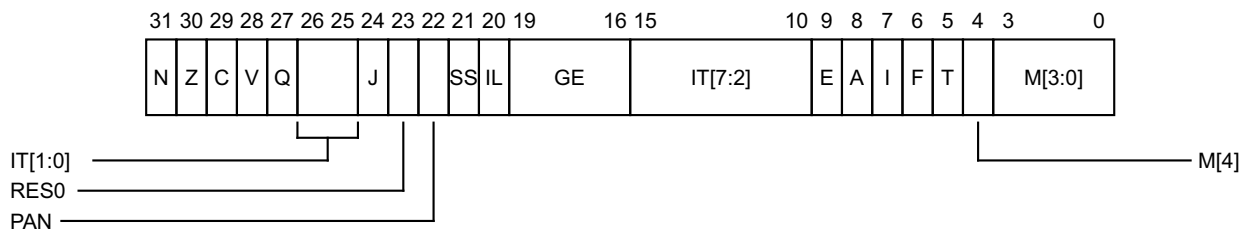

N, bit [31]

Set to the value of [CPSR.N](#) on entering Debug state, and copied to [CPSR.N](#) on exiting Debug state.

Z, bit [30]

Set to the value of [CPSR.Z](#) on entering Debug state, and copied to [CPSR.Z](#) on exiting Debug state.

C, bit [29]

Set to the value of [CPSR.C](#) on entering Debug state, and copied to [CPSR.C](#) on exiting Debug state.

V, bit [28]

Set to the value of [CPSR.V](#) on entering Debug state, and copied to [CPSR.V](#) on exiting Debug state.

Q, bit [27]

Set to the value of [CPSR.Q](#) on entering Debug state, and copied to [CPSR.Q](#) on exiting Debug state.

IT[1:0], bits [26:25]

IT block state bits for the T32 IT (If-Then) instruction. See [IT\[7:2\]](#) for explanation of this field.

J, bit [24]

RES0.

In previous versions of the architecture, the {J, T} bits determined the AArch32 Instruction set state. ARMv8 does not support either Jazelle state or T32EE state, and the T bit determines the Instruction set state.

Bit [23]

Reserved, RES0.

PAN, bit [22]

In ARMv8.2 and ARMv8.1

When **ARMv8.1-PAN** is implemented, set to the value of **CPSR.PAN** on entering Debug state, and copied to **CPSR.PAN** on exiting Debug state.

When **ARMv8.1-PAN** is not implemented, this bit is RES0.

In ARMv8.0.

Reserved, RES0.

SS, bit [21]

Software step. Shows the value of **PSTATE.SS** immediately before Debug state was entered.

IL, bit [20]

Illegal Execution state bit. Shows the value of **PSTATE.IL** immediately before Debug state was entered.

GE, bits [19:16]

Greater than or Equal flags, for parallel addition and subtraction.

IT[7:2], bits [15:10]

IT block state bits for the T32 IT (If-Then) instruction. This field must be interpreted in two parts.

- **IT[7:5]** holds the base condition for the IT block. The base condition is the top 3 bits of the condition code specified by the first condition field of the IT instruction.
- **IT[4:0]** encodes the size of the IT block, which is the number of instructions that are to be conditionally executed, by the position of the least significant 1 in this field. It also encodes the value of the least significant bit of the condition code for each instruction in the block.

The IT field is **0b00000000** when no IT block is active.

E, bit [9]

Endianness state bit. Controls the load and store endianness for data accesses:

- | | |
|---|-------------------------|
| 0 | Little-endian operation |
| 1 | Big-endian operation. |

Instruction fetches ignore this bit.

When the reset value of the **SCTLR.EE** bit is defined by a configuration input signal, that value also applies to the **CPSR.E** bit on reset, and therefore applies to software execution from reset.

If an implementation does not provide Big-endian support, this bit is RES0. If it does not provide Little-endian support, this bit is RES1.

If an implementation provides Big-endian support but only at EL0, this bit is RES0 for an exception return to any Exception level other than EL0.

Likewise, if it provides Little-endian support only at EL0, this bit is RES1 for an exception return to any Exception level other than EL0.

A, bit [8]

SError interrupt mask bit. The possible values of this bit are:

- | | |
|---|-----------------------|
| 0 | Exception not masked. |
| 1 | Exception masked. |

I, bit [7]

IRQ mask bit. The possible values of this bit are:

- | | |
|---|-----------------------|
| 0 | Exception not masked. |
| 1 | Exception masked. |

F, bit [6]

FIQ mask bit. The possible values of this bit are:

- 0 Exception not masked.
- 1 Exception masked.

T, bit [5]

T32 Instruction set state bit. Determines the AArch32 instruction set state that the Debug state entry was taken from. Possible values of this bit are:

- 0 Taken from A32 state.
- 1 Taken from T32 state.

M[4], bit [4]

Execution state that Debug state was entered from. Possible values of this bit are:

- 1 Exception taken from AArch32.

M[3:0], bits [3:0]

AArch32 mode that Debug state was entered from. The possible values are:

M[3:0]	Mode
0b0000	User
0b0001	FIQ
0b0010	IRQ
0b0011	Supervisor
0b0110	Monitor (only valid in Secure state, if EL3 is implemented and can use AArch32)
0b0111	Abort
0b1010	Hyp
0b1011	Undefined
0b1111	System

Other values are reserved. The effect of programming this field to a Reserved value is that behavior is CONstrained UNPREDICTABLE, as described in *Reserved values in System and memory-mapped registers and translation table entries* on page K1-6117.

Accessing the DSPSR

This register can be read using MRC with the following syntax:

MRC <syntax>

This register can be written using MCR with the following syntax:

MCR <syntax>

This syntax is encoded with the following settings in the instruction encoding:

<syntax>	opc1	opc2	CRn	coproc	CRm
p15, 3, <Rt>, c4, c5, 0	011	000	0100	1111	0101

Accessibility

The register is accessible in software as follows:

Control			Accessibility			
E2H	TGE	NS	EL0	EL1	EL2	EL3
x	x	0	RW	RW	n/a	RW
x	0	1	RW	RW	RW	RW
x	1	1	RW	n/a	RW	RW

Access to this register is from Debug state only. During normal execution this register is unallocated.

G6.3.31 HDCR, Hyp Debug Control Register

The HDCR characteristics are:

Purpose

Controls the trapping to Hyp mode of Non-secure accesses, at EL1 or lower, to functions provided by the debug and trace architectures and the Performance Monitors Extension.

Configurations

AArch32 System register HDCR is architecturally mapped to AArch64 System register [MDCR_EL2](#).

If EL2 is not implemented, this register is RES0 from EL3.

This register is in the Warm reset domain. Some or all RW fields of this register have defined reset values. On a Warm or Cold reset these apply only if the PE resets into an Exception level that is using AArch32. Otherwise, on a Warm or Cold reset RW fields in this register reset to architecturally UNKNOWN values.

Attributes

HDCR is a 32-bit register.

Field descriptions

The HDCR bit assignments are:

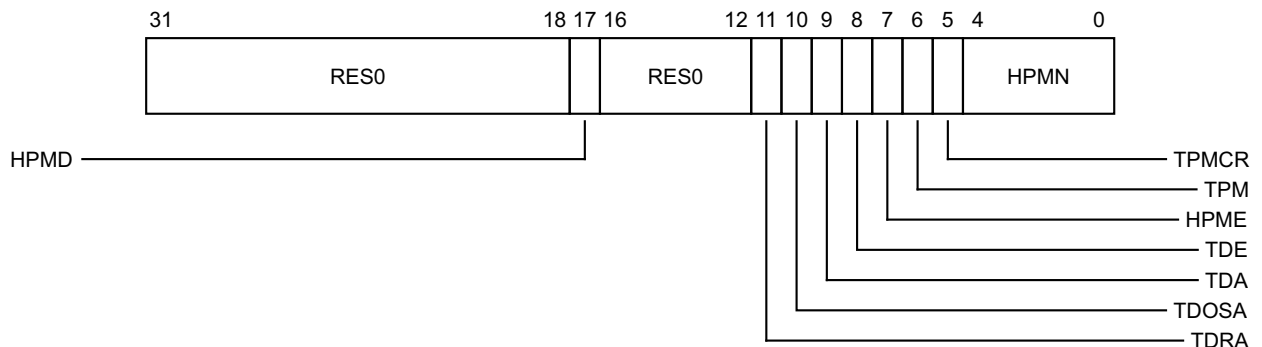

Bits [31:18]

Reserved, RES0.

HPMD, bit [17]

In ARMv8.2 and ARMv8.1

Guest Performance Monitors Disable. This control prohibits event counting at EL2. Permitted values are:

- 0 Event counting allowed in Hyp mode.
- 1 Event counting prohibited in Hyp mode.

In an ARMv8.1 implementation, event counting is prohibited unless enabled by the IMPLEMENTATION DEFINED authentication interface `ExternalSecureNoninvasiveDebugEnabled()`.

This control applies only to:

- The event counters in the range `[0..(HPMN-1)]`.
- If `PMCR.DP` is set to 1, `PMCCNTR`.

The other event counters are unaffected. When `PMCR.DP` is set to 0, `PMCCNTR` is unaffected.

When this register has an architecturally-defined reset value, this field resets to 0.

In ARMv8.0.

Reserved, RES0.

Bits [16:12]

Reserved, RES0.

TDRA, bit [11]

Trap Debug ROM Address register access. Traps Non-secure EL0 and EL1 System register accesses to the Debug ROM registers to Hyp mode.

0 This control does not cause any instructions to be trapped.

1 Non-secure EL0 and EL1 System register accesses to the [DBGDRAR](#) or [DBGDSAR](#) are trapped to Hyp mode, unless it is trapped by [DBGDSCRExt.UDCCdis](#).

If [HCR.TGE](#) or [HDCR.TDE](#) is 1, behavior is as if this bit is 1 other than for the purpose of a direct read.

When this register has an architecturally-defined reset value, this field resets to 0.

TDOSA, bit [10]

Trap debug OS-related register access. Traps Non-secure EL1 System register accesses to the powerdown debug registers to Hyp mode.

0 This control does not cause any instructions to be trapped.

1 Non-secure EL1 System register accesses to the powerdown debug registers are trapped to Hyp mode.

The registers for which accesses are trapped are as follows:

- [DBGOSLSR](#), [DBGOSLAR](#), [DBGOSDLR](#), and the [DBGPRCR](#).
- Any IMPLEMENTATION DEFINED register with similar functionality that the implementation specifies as trapped by this bit.

———— **Note** ————

These registers are not accessible at EL0.

If [HCR.TGE](#) or [HDCR.TDE](#) is 1, behavior is as if this bit is 1 other than for the purpose of a direct read.

When this register has an architecturally-defined reset value, this field resets to 0.

TDA, bit [9]

Trap debug access. Traps Non-secure EL0 and EL1 System register accesses to those debug System registers in the (coproc==1110) encoding space that are not trapped by either of the following:

- [HDCR.TDRA](#).
- [HDCR.TDOSA](#).

0 This control does not cause any instructions to be trapped.

1 Non-secure EL0 or EL1 System register accesses to the debug registers, other than the registers trapped by [HDCR.TDRA](#) and [HDCR.TDOSA](#), are trapped to Hyp mode, unless it is trapped by [DBGDSCRExt.UDCCdis](#).

Traps of AArch32 accesses to [DBGDTRRXint](#) and [DBGDTRTXint](#) are ignored in Debug state.

If [HCR.TGE](#) or [HDCR.TDE](#) is 1, behavior is as if this bit is 1 other than for the purpose of a direct read.

When this register has an architecturally-defined reset value, this field resets to 0.

TDE, bit [8]

Trap Debug exceptions. The possible values of this bit are:

0 This control has no effect on the routing of debug exceptions, and has no effect on Non-secure accesses to debug registers.

- 1 In Non-secure state:
- Debug exceptions generated at EL1 or EL0 are routed to EL2.
 - The HDCR.{TDRA, TDOSA, TDA} fields are treated as being 1 for all purposes other than returning the result of a direct read of the register.

When `HCR.TGE == 1`, the PE behaves as if the value of this field is 1 for all purposes other than returning the value of a direct read of the register.

When this register has an architecturally-defined reset value, this field resets to 0.

HPME, bit [7]

Hypervisor Performance Monitors Counters Enable. The possible values of this bit are:

- 0 Hyp mode Performance Monitors counters disabled.
- 1 Hyp mode Performance Monitors counters enabled.

When the value of this bit is 1, the Performance Monitors counters that are reserved for use from Hyp mode or Secure state are enabled. For more information see the description of the HPMN field.

If the Performance Monitors Extension is not implemented, this field is RES0.

If this field is implemented as an RW field, it resets to a value that is architecturally UNKNOWN.

TPM, bit [6]

Trap Performance Monitors accesses. Traps Non-secure EL0 and EL1 accesses to all Performance Monitors registers to Hyp mode.

- 0 This control does not cause any instructions to be trapped.
- 1 Non-secure EL0 and EL1 accesses to all Performance Monitors registers are trapped to Hyp mode.

———— Note —————

EL2 does not provide traps on Performance Monitor register accesses through the optional memory-mapped external debug interface.

If the Performance Monitors Extension is not implemented, this field is RES0.

When this register has an architecturally-defined reset value, if this field is implemented as an RW field, it resets to 0.

TPMCR, bit [5]

Trap `PMCR` accesses. Traps Non-secure EL0 and EL1 accesses to the `PMCR` to Hyp mode.

- 0 This control does not cause any instructions to be trapped.
- 1 Non-secure EL0 and EL1 accesses to the `PMCR` are trapped to Hyp mode, unless it is trapped by `PMUSERENR.EN`.

———— Note —————

EL2 does not provide traps on Performance Monitor register accesses through the optional memory-mapped external debug interface.

If the Performance Monitors Extension is not implemented, this field is RES0.

When this register has an architecturally-defined reset value, if this field is implemented as an RW field, it resets to 0.

HPMN, bits [4:0]

Defines the number of Performance Monitors counters that are accessible from Non-secure EL1 modes, and from Non-secure EL0 modes if unprivileged access is enabled.

If the Performance Monitors Extension is not implemented, this field is RES0.

In Non-secure state, HPMN divides the Performance Monitors counters as follows. If software is accessing Performance Monitors counter n then, in Non-secure state:

- If n is in the range $0 \leq n < \text{HPMN}$, the counter is accessible from EL1 and EL2, and from EL0 if unprivileged access to the counters is enabled. **PMCR.E** enables the operation of counters in this range.
- If n is in the range $\text{HPMN} \leq n < \text{PMCR.N}$, the counter is accessible only from EL2 and from Secure state. **HDCR.HPME** enables the operation of counters in this range.

If this field is set to 0, or to a value larger than **PMCR.N**, then the following **CONSTRAINED UNPREDICTABLE** behavior applies:

- The value returned by a direct read of **HDCR.HPMN** is **UNKNOWN**.
- Either:
 - An **UNKNOWN** number of counters are reserved for EL2 use. That is, the PE behaves as if **HDCR.HPMN** is set to an **UNKNOWN** non-zero value less than **PMCR.N**.
 - All counters are reserved for EL2 use, meaning no counters are accessible from Non-secure EL1 and Non-secure EL0.

When this register has an architecturally-defined reset value, if this field is implemented as an **RW** field, it resets to the value of **PMCR.N**.

Accessing the HDCR

This register can be read using **MRC** with the following syntax:

MRC <syntax>

This register can be written using **MCR** with the following syntax:

MCR <syntax>

This syntax is encoded with the following settings in the instruction encoding:

<syntax>	opc1	opc2	CRn	coproc	CRm
p15, 4, <Rt>, c1, c1, 1	100	001	0001	1111	0001

Accessibility

The register is accessible in software as follows:

Control			Accessibility			
E2H	TGE	NS	EL0	EL1	EL2	EL3
x	x	0	-	-	n/a	-
x	0	1	-	-	RW	RW
x	1	1	-	n/a	RW	RW

Traps and Enables

For a description of the prioritization of any generated exceptions, see *Synchronous exception prioritization for exceptions taken to AArch32 state* on page G1-4344 for exceptions taken to AArch32 state and *Synchronous exception prioritization for exceptions taken to AArch64* on page D1-1827 for exceptions taken to AArch64 state. Subject to the prioritization rules:

- When EL2 is implemented and is using AArch64 and (SCR_EL3.NS == 1) && (HCR_EL2.E2H == 0):
 - If HSTR_EL2.T1==1, Non-secure accesses to this register from EL1 are trapped to EL2.
- When EL2 is implemented and is using AArch64 and (SCR_EL3.NS == 1) && (HCR_EL2.E2H == 1) && (HCR_EL2.TGE == 0):
 - If HSTR_EL2.T1==1, Non-secure accesses to this register from EL1 are trapped to EL2.
- When EL2 is implemented and is using AArch32 and SCR_EL3.NS == 1:
 - If HSTR.T1==1, Non-secure accesses to this register from EL1 are trapped to Hyp mode.
- When EL3 is implemented and is using AArch64:
 - If MDCR_EL3.TDA==1, accesses to this register from EL2 are trapped to EL3 using AArch64.

G6.3.32 SDCR, Secure Debug Control Register

The SDCR characteristics are:

Purpose

When EL3 is implemented and can use AArch32, controls debug and performance monitors functionality in Secure state.

Configurations

This register is only accessible in Secure state.

AArch32 System register SDCR can be mapped to AArch64 System register [MDCR_EL3](#), but this is not architecturally mandated.

This register is in the Warm reset domain. Some or all RW fields of this register have defined reset values. On a Warm or Cold reset these apply only if the PE resets into an Exception level that is using AArch32. Otherwise, on a Warm or Cold reset RW fields in this register reset to architecturally UNKNOWN values.

Attributes

SDCR is a 32-bit register.

Field descriptions

The SDCR bit assignments are:

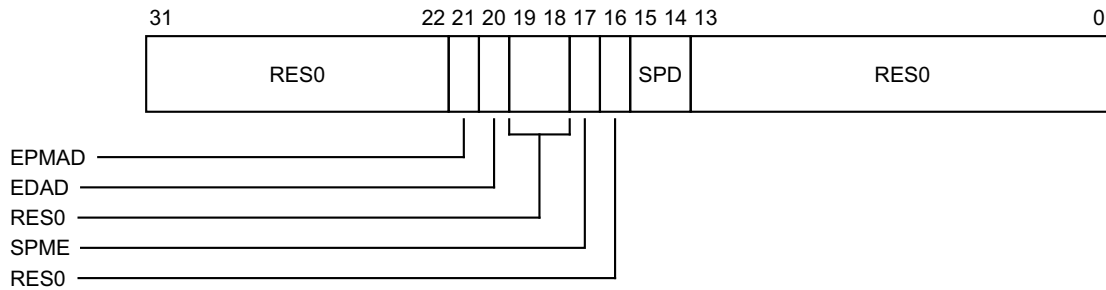

Bits [31:22]

Reserved, RES0.

EPMAD, bit [21]

External debug interface Performance Monitors registers disable. This disables access to these registers by an external debugger:

- 0 Access to Performance Monitors registers from external debugger is permitted.
- 1 Access to Performance Monitors registers from external debugger is disabled, unless overridden by the IMPLEMENTATION DEFINED authentication interface.

If the Performance Monitors Extension is not implemented or does not support external debug interface accesses this bit is RES0.

When this register has an architecturally-defined reset value, if this field is implemented as an RW field, it resets to 0.

EDAD, bit [20]

External debug interface breakpoint and watchpoint register access disable. This disables access to these registers by an external debugger:

- 0 Access to breakpoint and watchpoint registers from external debugger is permitted.

- 1 Access to breakpoint and watchpoint registers from external debugger is disabled, unless overridden by the IMPLEMENTATION DEFINED authentication interface.

When this register has an architecturally-defined reset value, this field resets to 0.

Bits [19:18]

Reserved, RES0.

SPME, bit [17]

Secure Performance Monitors enable. This allows event counting in Secure state:

- 0 Event counting prohibited in Secure state.
In an ARMv8.0 or ARMv8.1 implementation, event counting is prohibited unless ExternalSecureNoninvasiveDebugEnabled() is TRUE, meaning this control is overridden by the IMPLEMENTATION DEFINED authentication interface.
- 1 Event counting allowed in Secure state.

If the Performance Monitors Extension is not implemented, this field is RES0.

When this register has an architecturally-defined reset value, this field resets to 0.

Bit [16]

Reserved, RES0.

SPD, bits [15:14]

AArch32 Secure privileged debug. Enables or disables debug exceptions from Secure state, other than Breakpoint Instruction exceptions. Valid values for this field are:

- 00 Legacy mode. Debug exceptions from Secure EL1 are enabled by the authentication interface.
- 10 Secure privileged debug disabled. Debug exceptions from Secure EL1 are disabled.
- 11 Secure privileged debug enabled. Debug exceptions from Secure EL1 are enabled.

Other values are reserved, and have the CONSTRAINED UNPREDICTABLE behavior that they must have the same behavior as 0b00. Software must not rely on this property as the behavior of reserved values might change in a future revision of the architecture.

If debug exceptions from Secure EL1 are enabled, then debug exceptions from Secure EL0 are also enabled.

Otherwise, debug exceptions from Secure EL0 are enabled only if `SDER32_EL3.SUIDEN == 1`.

Ignored in Non-secure state. Debug exceptions from Breakpoint Instruction exceptions are always enabled.

When this register has an architecturally-defined reset value, this field resets to 0.

Bits [13:0]

Reserved, RES0.

Accessing the SDCR

This register can be read using MRC with the following syntax:

MRC <syntax>

This register can be written using MCR with the following syntax:

MCR <syntax>

This syntax is encoded with the following settings in the instruction encoding:

<syntax>	opc1	opc2	CRn	coproc	CRm
p15, 0, <Rt>, c1, c3, 1	000	001	0001	1111	0011

Accessibility

The register is accessible in software as follows:

Control			Accessibility			
E2H	TGE	NS	EL0	EL1	EL2	EL3
x	x	0	-	-	n/a	RW
x	0	1	-	-	-	RW
x	1	1	-	n/a	-	RW

If EL3 is implemented and is using AArch64, any read or write to SDCR from Secure EL1 using AArch32 is trapped as an exception to EL3.

Traps and Enables

For a description of the prioritization of any generated exceptions, see [Synchronous exception prioritization for exceptions taken to AArch32 state on page G1-4344](#) for exceptions taken to AArch32 state and [Synchronous exception prioritization for exceptions taken to AArch64 on page D1-1827](#) for exceptions taken to AArch64 state. Subject to the prioritization rules:

- When EL2 is implemented and is using AArch64 and $(SCR_EL3.NS == 1) \ \&\& \ (HCR_EL2.E2H == 0)$:
 - If $HSTR_EL2.T1 == 1$, Non-secure accesses to this register from EL1 are trapped to EL2.
- When EL2 is implemented and is using AArch64 and $(SCR_EL3.NS == 1) \ \&\& \ (HCR_EL2.E2H == 1) \ \&\& \ (HCR_EL2.TGE == 0)$:
 - If $HSTR_EL2.T1 == 1$, Non-secure accesses to this register from EL1 are trapped to EL2.
- When EL2 is implemented and is using AArch32 and $SCR_EL3.NS == 1$:
 - If $HSTR.T1 == 1$, Non-secure accesses to this register from EL1 are trapped to Hyp mode.

G6.3.33 SDER, Secure Debug Enable Register

The SDER characteristics are:

Purpose

Controls invasive and non-invasive debug in the Secure EL0 mode.

Configurations

This register is only accessible in Secure state.

AArch32 System register SDER is architecturally mapped to AArch64 System register [SDER32_EL3](#).

If EL3 is not implemented and EL1 supports AArch32, SDER is implemented only if the implemented Security state is Secure state.

This register is in the Warm reset domain. Some or all RW fields of this register have defined reset values. On a Warm or Cold reset these apply only if the PE resets into an Exception level that is using AArch32. Otherwise, on a Warm or Cold reset RW fields in this register reset to architecturally UNKNOWN values.

Attributes

SDER is a 32-bit register.

Field descriptions

The SDER bit assignments are:

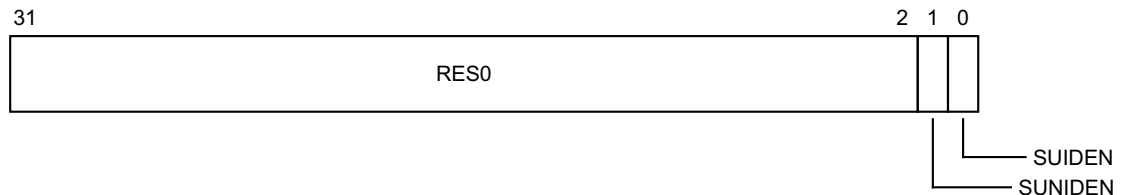

Bits [31:2]

Reserved, RES0.

SUNIDEN, bit [1]

Secure User Non-Invasive Debug Enable:

- 0 Performance Monitors event counting prohibited in Secure EL0 unless allowed by [MDCR_EL3.SPME](#), [SDCR.SPME](#).
In an ARMv8.0 or ARMv8.1 implementation, event counting can also be allowed using the IMPLEMENTATION DEFINED authentication interface `ExternalSecureNoninvasiveDebugEnabled()`.
- 1 Performance Monitors event counting allowed in Secure EL0.

When this register has an architecturally-defined reset value, this field resets to 0.

SUIDEN, bit [0]

Secure User Invasive Debug Enable:

- 0 Debug exceptions other than Breakpoint Instruction exceptions from Secure EL0 are disabled, unless enabled by [MDCR_EL3.SPD32](#) or [SDCR.SPD](#).
- 1 Debug exceptions from Secure EL0 are enabled.

When this register has an architecturally-defined reset value, this field resets to 0.

Accessing the SDER

This register can be read using MRC with the following syntax:

MRC <syntax>

This register can be written using MCR with the following syntax:

MCR <syntax>

This syntax is encoded with the following settings in the instruction encoding:

<syntax>	opc1	opc2	CRn	coproc	CRm
p15, 0, <Rt>, c1, c1, 1	000	001	0001	1111	0001

Accessibility

The register is accessible in software as follows:

Configuration	Control			Accessibility			
	E2H	TGE	NS	EL0	EL1	EL2	EL3
EL3 is not implemented.	x	x	0	-	RW	n/a	n/a
EL3 is not implemented.	x	0	1	-	-	-	n/a
EL3 is not implemented.	x	1	1	-	n/a	-	n/a
EL3 is using AArch64.	x	x	0	-	RW	n/a	n/a
EL3 is using AArch64.	x	0	1	-	-	-	n/a
EL3 is using AArch64.	x	1	1	-	n/a	-	n/a
EL3 is using AArch32.	x	x	0	-	n/a	n/a	RW
EL3 is using AArch32.	x	0	1	-	-	-	RW
EL3 is using AArch32.	x	1	1	-	n/a	-	RW

Traps and Enables

For a description of the prioritization of any generated exceptions, see [Synchronous exception prioritization for exceptions taken to AArch32 state on page G1-4344](#) for exceptions taken to AArch32 state and [Synchronous exception prioritization for exceptions taken to AArch64 on page D1-1827](#) for exceptions taken to AArch64 state. Subject to the prioritization rules:

- When EL2 is implemented and is using AArch64 and (SCR_EL3.NS == 1) && (HCR_EL2.E2H == 0):
 - If HSTR_EL2.T1==1, Non-secure accesses to this register from EL1 are trapped to EL2.
- When EL2 is implemented and is using AArch64 and (SCR_EL3.NS == 1) && (HCR_EL2.E2H == 1) && (HCR_EL2.TGE == 0):
 - If HSTR_EL2.T1==1, Non-secure accesses to this register from EL1 are trapped to EL2.
- When EL2 is implemented and is using AArch32 and SCR_EL3.NS == 1:
 - If HSTR.T1==1, Non-secure accesses to this register from EL1 are trapped to Hyp mode.

G6.4 Performance Monitors registers

This section lists the Performance Monitors registers in AArch32.

G6.4.1 PMCCFILTR, Performance Monitors Cycle Count Filter Register

The PMCCFILTR characteristics are:

Purpose

Determines the modes in which the Cycle Counter, [PMCCNTR](#), increments.

Configurations

There is one instance of this register that is used in both Secure and Non-secure states.

AArch32 System register PMCCFILTR is architecturally mapped to AArch64 System register [PMCCFILTR_ELO](#).

AArch32 System register PMCCFILTR is architecturally mapped to External register [PMCCFILTR_ELO](#).

This register is in the Warm reset domain. Some or all RW fields of this register have defined reset values. On a Warm or Cold reset these apply only if the PE resets into an Exception level that is using AArch32. Otherwise, on a Warm or Cold reset RW fields in this register reset to architecturally UNKNOWN values.

Attributes

PMCCFILTR is a 32-bit register.

Field descriptions

The PMCCFILTR bit assignments are:

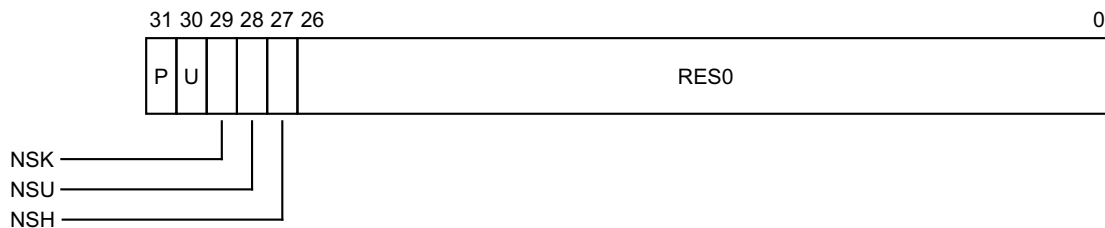

P, bit [31]

Privileged filtering bit. Controls counting in EL1. If EL3 is implemented, then counting in Non-secure EL1 is further controlled by the NSK bit. The possible values of this bit are:

- 0 Count cycles in EL1.
- 1 Do not count cycles in EL1.

When this register has an architecturally-defined reset value, this field resets to 0.

U, bit [30]

User filtering bit. Controls counting in EL0. If EL3 is implemented, then counting in Non-secure EL0 is further controlled by the NSU bit. The possible values of this bit are:

- 0 Count cycles in EL0.
- 1 Do not count cycles in EL0.

When this register has an architecturally-defined reset value, this field resets to 0.

NSK, bit [29]

Non-secure EL1 (kernel) modes filtering bit. Controls counting in Non-secure EL1. If EL3 is not implemented, this bit is RES0.

If the value of this bit is equal to the value of P, cycles in Non-secure EL1 are counted.

Otherwise, cycles in Non-secure EL1 are not counted.

When this register has an architecturally-defined reset value, if this field is implemented as an RW field, it resets to 0.

NSU, bit [28]

Non-secure EL0 (Unprivileged) filtering. Controls counting in Non-secure EL0. If EL3 is not implemented, this bit is RES0.

If the value of this bit is equal to the value of U, cycles in Non-secure EL0 are counted.

Otherwise, cycles in Non-secure EL0 are not counted.

When this register has an architecturally-defined reset value, if this field is implemented as an RW field, it resets to 0.

NSH, bit [27]

Non-secure EL2 (Hyp mode) filtering bit. Controls counting in Non-secure EL2. If EL2 is not implemented, this bit is RES0.

0 Do not count cycles in EL2.

1 Count cycles in EL2.

When this register has an architecturally-defined reset value, if this field is implemented as an RW field, it resets to 0.

Bits [26:0]

Reserved, RES0.

Accessing the PMCCFILTR

This register can be read using MRC with the following syntax:

MRC <syntax>

This register can be written using MCR with the following syntax:

MCR <syntax>

This syntax is encoded with the following settings in the instruction encoding:

<syntax>	opc1	opc2	CRn	coproc	CRm
p15, 0, <Rt>, c14, c15, 7	000	111	1110	1111	1111

PMCCFILTR can also be accessed by using [PMXEVTYPER](#) with [PMSELR](#).SEL set to 0b11111.

Accessibility

The register is accessible in software as follows:

Control			Accessibility			
E2H	TGE	NS	EL0	EL1	EL2	EL3
x	x	0	RW	RW	n/a	RW
x	0	1	RW	RW	RW	RW
x	1	1	RW	n/a	RW	RW

Traps and Enables

For a description of the prioritization of any generated exceptions, see *Synchronous exception prioritization for exceptions taken to AArch32 state* on page G1-4344 for exceptions taken to AArch32 state and *Synchronous exception prioritization for exceptions taken to AArch64* on page D1-1827 for exceptions taken to AArch64 state. Subject to the prioritization rules:

- In both security states, and not dependent on other bits:
 - If `PMUSERENR.EN==0`, accesses to this register from EL0 are trapped to Undefined mode.
 - If `PMUSERENR_EL0.EN==0`, accesses to this register from EL0 are trapped to EL1.
- When EL2 is implemented and is using AArch64 and `SCR_EL3.NS == 1`:
 - If `MDCR_EL2.TPM==1`, Non-secure accesses to this register from EL0 and EL1 are trapped to EL2.
- When EL2 is implemented and is using AArch32 and `SCR_EL3.NS == 1`:
 - If `HDCR.TPM==1`, Non-secure accesses to this register from EL0 and EL1 are trapped to Hyp mode.
- When EL3 is implemented and is using AArch64:
 - If `MDCR_EL3.TPM==1`, accesses to this register from EL0, EL1, and EL2 are trapped to EL3.

G6.4.2 PMCCNTR, Performance Monitors Cycle Count Register

The PMCCNTR characteristics are:

Purpose

Holds the value of the processor Cycle Counter, CCNT, that counts processor clock cycles. See [Time as measured by the Performance Monitors cycle counter on page D5-2139](#) for more information.

[PMCCFILTR](#) determines the modes and states in which the PMCCNTR can increment.

Configurations

There is one instance of this register that is used in both Secure and Non-secure states.

AArch32 System register PMCCNTR is architecturally mapped to AArch64 System register [PMCCNTR_ELO](#).

AArch32 System register PMCCNTR is architecturally mapped to External register [PMCCNTR_ELO](#).

All counters are subject to any changes in clock frequency, including clock stopping caused by the WFI and WFE instructions. This means that it is CONstrained UNPREDICTABLE whether or not PMCCNTR continues to increment when clocks are stopped by WFI and WFE instructions.

This register is in the Warm reset domain. On a Warm or Cold reset RW fields in this register reset to architecturally UNKNOWN values.

Attributes

PMCCNTR is a 64-bit register that can also be accessed as a 32-bit value. If it is accessed as a 32-bit register, accesses read and write bits [31:0] and do not modify bits [63:32].

Field descriptions

The PMCCNTR bit assignments are:

When accessing as a 32-bit register:

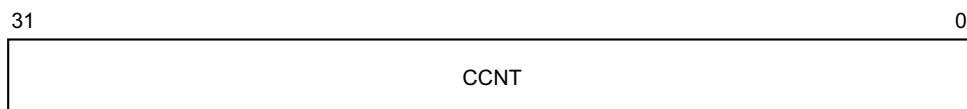

CCNT, bits [31:0]

Cycle count. Depending on the values of [PMCR](#).{LC,D}, this field increments in one of the following ways:

- Every processor clock cycle.
- Every 64th processor clock cycle.

Writing 1 to [PMCR.C](#) sets this field to 0.

When accessing as a 64-bit register:

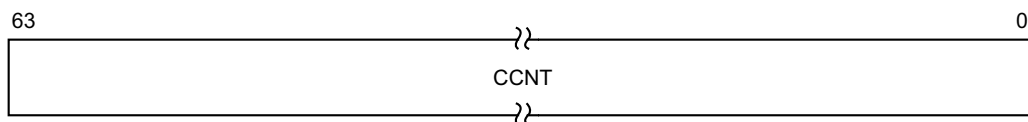

CCNT, bits [63:0]

Cycle count. Depending on the values of **PMCR**.{LC,D}, this field increments in one of the following ways:

- Every processor clock cycle.
- Every 64th processor clock cycle.

Writing 1 to **PMCR.C** sets this field to 0.

Accessing the PMCCNTR

This register can be read using MRC with the following syntax:

MRC <syntax>

This register can be written using MCR with the following syntax:

MCR <syntax>

This syntax is encoded with the following settings in the instruction encoding:

<syntax>	opc1	opc2	CRn	coproc	CRm
p15, 0, <Rt>, c9, c13, 0	000	000	1001	1111	1101

This register can be read using MRRC with the following syntax:

MRRC <syntax>

This register can be written using MCRR with the following syntax:

MCRR <syntax>

This syntax is encoded with the following settings in the instruction encoding:

<syntax>	opc1	coproc	CRm
p15, 0, <Rt>, <Rt2>, c9	0000	1111	1001

Accessibility

The register is accessible in software as follows:

Control			Accessibility			
E2H	TGE	NS	EL0	EL1	EL2	EL3
x	x	0	RW	RW	n/a	RW
x	0	1	RW	RW	RW	RW
x	1	1	RW	n/a	RW	RW

Traps and Enables

For a description of the prioritization of any generated exceptions, see *Synchronous exception prioritization for exceptions taken to AArch32 state* on page G1-4344 for exceptions taken to AArch32 state and *Synchronous exception prioritization for exceptions taken to AArch64* on page D1-1827 for exceptions taken to AArch64 state. Subject to the prioritization rules:

- In both security states, and not dependent on other bits:
 - If `PMUSERENR.CR==0`, and `PMUSERENR.EN==0`, read accesses to this register from EL0 are trapped to Undefined mode.
 - If `PMUSERENR_EL0.CR==0`, and `PMUSERENR_EL0.EN==0`, read accesses to this register from EL0 are trapped to EL1.
 - If `PMUSERENR.EN==0`, write accesses to this register from EL0 are trapped to Undefined mode.
 - If `PMUSERENR_EL0.EN==0`, write accesses to this register from EL0 are trapped to EL1.
- When EL2 is implemented and is using AArch64 and `(SCR_EL3.NS == 1) && (HCR_EL2.E2H == 0)`:
 - If `HSTR_EL2.T9==1`, Non-secure accesses to this register from EL0 and EL1 are trapped to EL2.
- When EL2 is implemented and is using AArch64 and `SCR_EL3.NS == 1`:
 - If `MDCR_EL2.TPM==1`, Non-secure accesses to this register from EL0 and EL1 are trapped to EL2.
- When EL2 is implemented and is using AArch64 and `(SCR_EL3.NS == 1) && (HCR_EL2.E2H == 1) && (HCR_EL2.TGE == 0)`:
 - If `HSTR_EL2.T9==1`, Non-secure write accesses to this register from EL0 and EL1 are trapped to EL2.
- When EL2 is implemented and is using AArch32 and `SCR_EL3.NS == 1`:
 - If `HDCR.TPM==1`, Non-secure accesses to this register from EL0 and EL1 are trapped to Hyp mode.
 - If `HSTR.T9==1`, Non-secure accesses to this register from EL0 and EL1 are trapped to Hyp mode.
- When EL3 is implemented and is using AArch64:
 - If `MDCR_EL3.TPM==1`, accesses to this register from EL0, EL1, and EL2 are trapped to EL3.

G6.4.3 PMCEID0, Performance Monitors Common Event Identification register 0

The PMCEID0 characteristics are:

Purpose

Defines which common architectural and common microarchitectural feature events in the range 0x000 to 0x01F are implemented. If a particular bit is set to 1, then the event for that bit is implemented.

Configurations

There is one instance of this register that is used in both Secure and Non-secure states.

AArch32 System register PMCEID0 is architecturally mapped to AArch64 System register [PMCEID0_EL0](#)[31:0].

AArch32 System register PMCEID0 is architecturally mapped to External register [PMCEID0](#)[31:0].

Attributes

PMCEID0 is a 32-bit register.

Field descriptions

The PMCEID0 bit assignments are:

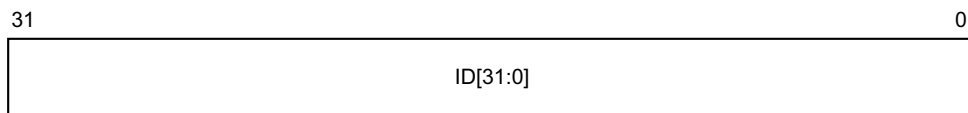

ID[31:0], bits [31:0]

PMCEID0[n] maps to event n. For a list of event numbers and descriptions, see [Events, event numbers, and mnemonics on page D5-2152](#).

For each bit:

0 The common event is not implemented.

1 The common event is implemented.

Bits that map to reserved event numbers are reserved to identify events that might be defined in future revisions to the architecture.

Events that do not require additional features in the PMU can be defined retrospectively, meaning that they can be implemented as part of a PMUv3 implementation.

Accessing the PMCEID0

This register can be read using MRC with the following syntax:

MRC <syntax>

This syntax is encoded with the following settings in the instruction encoding:

<syntax>	opc1	opc2	CRn	coproc	CRm
p15, 0, <Rt>, c9, c12, 6	000	110	1001	1111	1100

Accessibility

The register is accessible in software as follows:

Control			Accessibility			
E2H	TGE	NS	EL0	EL1	EL2	EL3
x	x	0	RO	RO	n/a	RO
x	0	1	RO	RO	RO	RO
x	1	1	RO	n/a	RO	RO

Traps and Enables

For a description of the prioritization of any generated exceptions, see [Synchronous exception prioritization for exceptions taken to AArch32 state on page G1-4344](#) for exceptions taken to AArch32 state and [Synchronous exception prioritization for exceptions taken to AArch64 on page D1-1827](#) for exceptions taken to AArch64 state. Subject to the prioritization rules:

- In both security states, and not dependent on other bits:
 - If `PMUSERENR.EN==0`, read accesses to this register from EL0 are trapped to Undefined mode.
 - If `PMUSERENR_EL0.EN==0`, read accesses to this register from EL0 are trapped to EL1.
- When EL2 is implemented and is using AArch64 and `(SCR_EL3.NS == 1) && (HCR_EL2.E2H == 0)`:
 - If `HSTR_EL2.T9==1`, Non-secure read accesses to this register from EL0 and EL1 are trapped to EL2.
- When EL2 is implemented and is using AArch64 and `SCR_EL3.NS == 1`:
 - If `MDCR_EL2.TPM==1`, Non-secure read accesses to this register from EL0 and EL1 are trapped to EL2.
- When EL2 is implemented and is using AArch32 and `SCR_EL3.NS == 1`:
 - If `HDCR.TPM==1`, Non-secure read accesses to this register from EL0 and EL1 are trapped to Hyp mode.
 - If `HSTR.T9==1`, Non-secure read accesses to this register from EL0 and EL1 are trapped to Hyp mode.
- When EL3 is implemented and is using AArch64:
 - If `MDCR_EL3.TPM==1`, read accesses to this register from EL0, EL1, and EL2 are trapped to EL3.

G6.4.4 PMCEID1, Performance Monitors Common Event Identification register 1

The PMCEID1 characteristics are:

Purpose

Defines which common architectural and common microarchitectural feature events in the range 0x020 to 0x03F are implemented. If a particular bit is set to 1, then the event for that bit is implemented.

Configurations

There is one instance of this register that is used in both Secure and Non-secure states.

AArch32 System register PMCEID1 is architecturally mapped to AArch64 System register [PMCEID1_EL0](#)[31:0].

AArch32 System register PMCEID1 is architecturally mapped to External register [PMCEID1](#)[31:0].

Attributes

PMCEID1 is a 32-bit register.

Field descriptions

The PMCEID1 bit assignments are:

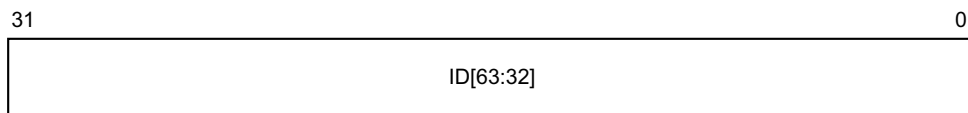

ID[63:32], bits [31:0]

PMCEID1[n] maps to event (n + 32). For a list of event numbers and descriptions, see [Events, event numbers, and mnemonics on page D5-2152](#).

For each bit:

0 The common event is not implemented.

1 The common event is implemented.

Bits that map to reserved event numbers are reserved to identify events that might be defined in future revisions to the architecture.

Events that do not require additional features in the PMU can be defined retrospectively, meaning that they can be implemented as part of a PMUv3 implementation.

Accessing the PMCEID1

This register can be read using MRC with the following syntax:

MRC <syntax>

This syntax is encoded with the following settings in the instruction encoding:

<syntax>	opc1	opc2	CRn	coproc	CRm
p15, 0, <Rt>, c9, c12, 7	000	111	1001	1111	1100

Accessibility

The register is accessible in software as follows:

Control			Accessibility			
E2H	TGE	NS	EL0	EL1	EL2	EL3
x	x	0	RO	RO	n/a	RO
x	0	1	RO	RO	RO	RO
x	1	1	RO	n/a	RO	RO

Traps and Enables

For a description of the prioritization of any generated exceptions, see [Synchronous exception prioritization for exceptions taken to AArch32 state on page G1-4344](#) for exceptions taken to AArch32 state and [Synchronous exception prioritization for exceptions taken to AArch64 on page D1-1827](#) for exceptions taken to AArch64 state. Subject to the prioritization rules:

- In both security states, and not dependent on other bits:
 - If `PMUSERENR.EN==0`, read accesses to this register from EL0 are trapped to Undefined mode.
 - If `PMUSERENR_EL0.EN==0`, read accesses to this register from EL0 are trapped to EL1.
- When EL2 is implemented and is using AArch64 and `(SCR_EL3.NS == 1) && (HCR_EL2.E2H == 0)`:
 - If `HSTR_EL2.T9==1`, Non-secure read accesses to this register from EL0 and EL1 are trapped to EL2.
- When EL2 is implemented and is using AArch64 and `SCR_EL3.NS == 1`:
 - If `MDCR_EL2.TPM==1`, Non-secure read accesses to this register from EL0 and EL1 are trapped to EL2.
- When EL2 is implemented and is using AArch32 and `SCR_EL3.NS == 1`:
 - If `HDCR.TPM==1`, Non-secure read accesses to this register from EL0 and EL1 are trapped to Hyp mode.
 - If `HSTR.T9==1`, Non-secure read accesses to this register from EL0 and EL1 are trapped to Hyp mode.
- When EL3 is implemented and is using AArch64:
 - If `MDCR_EL3.TPM==1`, read accesses to this register from EL0, EL1, and EL2 are trapped to EL3.

G6.4.5 PMCEID2, Performance Monitors Common Event Identification register 2

The PMCEID2 characteristics are:

Purpose

Defines which common architectural and common microarchitectural feature events in the range 0x4000 to 0x401F are implemented. If a particular bit is set to 1, then the event for that bit is implemented.

Configurations

There is one instance of this register that is used in both Secure and Non-secure states.

AArch32 System register PMCEID2 is architecturally mapped to AArch64 System register [PMCEID0_EL0](#)[63:32].

AArch32 System register PMCEID2 is architecturally mapped to External register [PMCEID2](#)[63:32].

This register is introduced in ARMv8.1.

Attributes

PMCEID2 is a 32-bit register.

Field descriptions

The PMCEID2 bit assignments are:

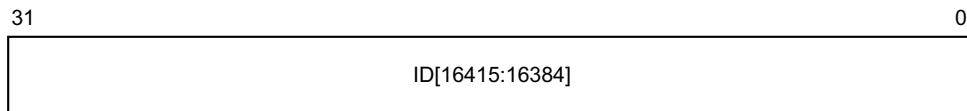

ID[16415:16384], bits [31:0]

PMCEID2[31:0] maps to common events 0x4000 to 0x401F. For a list of event numbers and descriptions, see [Events, event numbers, and mnemonics on page D5-2152](#).

For each bit:

0 The common event is not implemented.

1 The common event is implemented.

Bits that map to reserved event numbers are reserved to identify events that might be defined in future revisions to the architecture.

Events that do not require additional features in the PMU can be defined retrospectively, meaning that they can be implemented as part of a PMUv3 implementation.

Accessing the PMCEID2

This register can be read using MRC with the following syntax:

MRC <syntax>

This syntax is encoded with the following settings in the instruction encoding:

<syntax>	opc1	opc2	CRn	coproc	CRm
p15, 0, <Rt>, c9, c14, 4	000	100	1001	1111	1110

Accessibility

The register is accessible in software as follows:

Control			Accessibility			
E2H	TGE	NS	EL0	EL1	EL2	EL3
x	x	0	RO	RO	n/a	RO
x	0	1	RO	RO	RO	RO
x	1	1	RO	n/a	RO	RO

Traps and Enables

For a description of the prioritization of any generated exceptions, see [Synchronous exception prioritization for exceptions taken to AArch32 state on page G1-4344](#) for exceptions taken to AArch32 state and [Synchronous exception prioritization for exceptions taken to AArch64 on page D1-1827](#) for exceptions taken to AArch64 state. Subject to the prioritization rules:

- In both security states, and not dependent on other bits:
 - If `PMUSERENR.EN==0`, read accesses to this register from EL0 are trapped to Undefined mode.
 - If `PMUSERENR_EL0.EN==0`, read accesses to this register from EL0 are trapped to EL1.

G6.4.6 PMCEID3, Performance Monitors Common Event Identification register 3

The PMCEID3 characteristics are:

Purpose

Defines which common architectural and common microarchitectural feature events in the range 0x4020 to 0x403F are implemented. If a particular bit is set to 1, then the event for that bit is implemented.

Configurations

There is one instance of this register that is used in both Secure and Non-secure states.

AArch32 System register PMCEID3 is architecturally mapped to AArch64 System register [PMCEID1_EL0](#)[63:32].

AArch32 System register PMCEID3 is architecturally mapped to External register [PMCEID3](#)[63:32].

This register is introduced in ARMv8.1.

Attributes

PMCEID3 is a 32-bit register.

Field descriptions

The PMCEID3 bit assignments are:

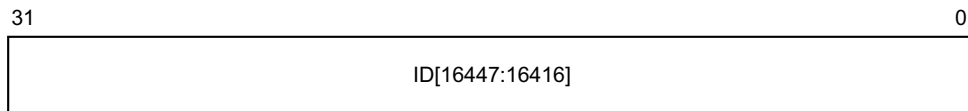

ID[16447:16416], bits [31:0]

PMCEID3[31:0] maps to common events 0x4020 to 0x403F. For a list of event numbers and descriptions, see [Events, event numbers, and mnemonics on page D5-2152](#).

For each bit:

0 The common event is not implemented.

1 The common event is implemented.

Bits that map to reserved event numbers are reserved to identify events that might be defined in future revisions to the architecture.

Events that do not require additional features in the PMU can be defined retrospectively, meaning that they can be implemented as part of a PMUv3 implementation.

Accessing the PMCEID3

This register can be read using MRC with the following syntax:

MRC <syntax>

This syntax is encoded with the following settings in the instruction encoding:

<syntax>	opc1	opc2	CRn	coproc	CRm
p15, 0, <Rt>, c9, c14, 5	000	101	1001	1111	1110

Accessibility

The register is accessible in software as follows:

Control			Accessibility			
E2H	TGE	NS	EL0	EL1	EL2	EL3
x	x	0	RO	RO	n/a	RO
x	0	1	RO	RO	RO	RO
x	1	1	RO	n/a	RO	RO

Traps and Enables

For a description of the prioritization of any generated exceptions, see [Synchronous exception prioritization for exceptions taken to AArch32 state on page G1-4344](#) for exceptions taken to AArch32 state and [Synchronous exception prioritization for exceptions taken to AArch64 on page D1-1827](#) for exceptions taken to AArch64 state. Subject to the prioritization rules:

- In both security states, and not dependent on other bits:
 - If `PMUSERENR.EN==0`, read accesses to this register from EL0 are trapped to Undefined mode.
 - If `PMUSERENR_EL0.EN==0`, read accesses to this register from EL0 are trapped to EL1.

G6.4.7 PMCNTENCLR, Performance Monitors Count Enable Clear register

The PMCNTENCLR characteristics are:

Purpose

Disables the Cycle Count Register, [PMCCNTR](#), and any implemented event counters [PMEVCNTR<n>](#). Reading this register shows which counters are enabled.

PMCNTENCLR is used in conjunction with the [PMCNTENSET](#) register.

Configurations

There is one instance of this register that is used in both Secure and Non-secure states.

AArch32 System register PMCNTENCLR is architecturally mapped to AArch64 System register [PMCNTENCLR_ELO](#).

AArch32 System register PMCNTENCLR is architecturally mapped to External register [PMCNTENCLR_ELO](#).

This register is in the Warm reset domain. On a Warm or Cold reset RW fields in this register reset to architecturally UNKNOWN values.

Attributes

PMCNTENCLR is a 32-bit register.

Field descriptions

The PMCNTENCLR bit assignments are:

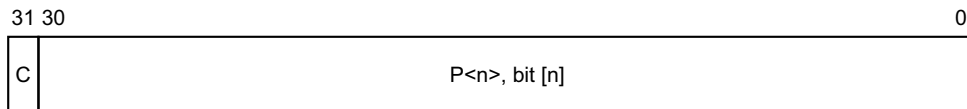

C, bit [31]

[PMCCNTR](#) disable bit. Disables the cycle counter register. Possible values are:

- 0 When read, means the cycle counter is disabled. When written, has no effect.
- 1 When read, means the cycle counter is enabled. When written, disables the cycle counter.

P<n>, bit [n], for n = 0 to 30

Event counter disable bit for [PMEVCNTR<n>](#).

Bits [30:N] are RAZ/WI. When EL2 is implemented, in Non-secure EL1 and EL0, N is the value in [MDCR_EL2.HPMN](#) if EL2 is using AArch64 or in [HDCR.HPMN](#) if EL2 is using AArch32.

Otherwise, N is the value in [PMCR.N](#).

Possible values of each bit are:

- 0 When read, means that [PMEVCNTR<n>](#) is disabled. When written, has no effect.
- 1 When read, means that [PMEVCNTR<n>](#) is enabled. When written, disables [PMEVCNTR<n>](#).

Accessing the PMCNTENCLR

This register can be read using MRC with the following syntax:

MRC <syntax>

This register can be written using MCR with the following syntax:

MCR <syntax>

This syntax is encoded with the following settings in the instruction encoding:

<syntax>	opc1	opc2	CRn	coproc	CRm
p15, 0, <Rt>, c9, c12, 2	000	010	1001	1111	1100

Accessibility

The register is accessible in software as follows:

Control			Accessibility			
E2H	TGE	NS	EL0	EL1	EL2	EL3
x	x	0	RW	RW	n/a	RW
x	0	1	RW	RW	RW	RW
x	1	1	RW	n/a	RW	RW

If EL2 is implemented, in Non-secure EL1 and EL0 modes, the value of [HDCR.HPMN](#) or [MDCR_EL2.HPMN](#) can change the behavior of accesses to PMCNTENCLR. See the description of the P<n> bit.

Traps and Enables

For a description of the prioritization of any generated exceptions, see [Synchronous exception prioritization for exceptions taken to AArch32 state on page G1-4344](#) for exceptions taken to AArch32 state and [Synchronous exception prioritization for exceptions taken to AArch64 on page D1-1827](#) for exceptions taken to AArch64 state. Subject to the prioritization rules:

- In both security states, and not dependent on other bits:
 - If [PMUSERENR.EN](#)==0, accesses to this register from EL0 are trapped to Undefined mode.
 - If [PMUSERENR_EL0.EN](#)==0, accesses to this register from EL0 are trapped to EL1.
- When EL2 is implemented and is using AArch64 and ([SCR_EL3.NS](#) == 1) && ([HCR_EL2.E2H](#) == 0):
 - If [HSTR_EL2.T9](#)==1, Non-secure accesses to this register from EL0 and EL1 are trapped to EL2.
- When EL2 is implemented and is using AArch64 and [SCR_EL3.NS](#) == 1:
 - If [MDCR_EL2.TPM](#)==1, Non-secure accesses to this register from EL0 and EL1 are trapped to EL2.
- When EL2 is implemented and is using AArch64 and ([SCR_EL3.NS](#) == 1) && ([HCR_EL2.E2H](#) == 1) && ([HCR_EL2.TGE](#) == 0):
 - If [HSTR_EL2.T9](#)==1, Non-secure write accesses to this register from EL0 and EL1 are trapped to EL2.
- When EL2 is implemented and is using AArch32 and [SCR_EL3.NS](#) == 1:
 - If [HSTR.T9](#)==1, Non-secure accesses to this register from EL0 and EL1 are trapped to Hyp mode.
- When EL3 is implemented and is using AArch64:
 - If [MDCR_EL3.TPM](#)==1, accesses to this register from EL0, EL1, and EL2 are trapped to EL3.

G6.4.8 PMCNTENSET, Performance Monitors Count Enable Set register

The PMCNTENSET characteristics are:

Purpose

Enables the Cycle Count Register, [PMCCNTR](#), and any implemented event counters [PMEVCNTR<n>](#). Reading this register shows which counters are enabled.

PMCNTENSET is used in conjunction with the [PMCNTENCLR](#) register.

Configurations

There is one instance of this register that is used in both Secure and Non-secure states.

AArch32 System register PMCNTENSET is architecturally mapped to AArch64 System register [PMCNTENSET_EL0](#).

AArch32 System register PMCNTENSET is architecturally mapped to External register [PMCNTENSET_EL0](#).

This register is in the Warm reset domain. On a Warm or Cold reset RW fields in this register reset to architecturally UNKNOWN values.

Attributes

PMCNTENSET is a 32-bit register.

Field descriptions

The PMCNTENSET bit assignments are:

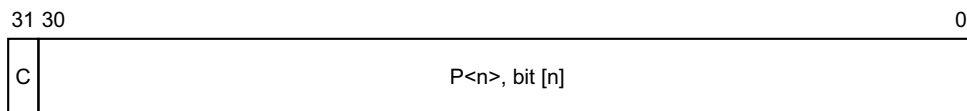

C, bit [31]

[PMCCNTR](#) enable bit. Enables the cycle counter register. Possible values are:

- 0 When read, means the cycle counter is disabled. When written, has no effect.
- 1 When read, means the cycle counter is enabled. When written, enables the cycle counter.

P<n>, bit [n], for n = 0 to 30

Event counter enable bit for [PMEVCNTR<n>](#).

Bits [30:N] are RAZ/WI. When EL2 is implemented, in Non-secure EL1 and EL0, N is the value in [MDCR_EL2.HPMN](#), if EL2 is using AArch64 or in [HDCR.HPMN](#) if EL2 is using AArch32. Otherwise, N is the value in [PMCR.N](#).

Possible values of each bit are:

- 0 When read, means that [PMEVCNTR<n>](#) is disabled. When written, has no effect.
- 1 When read, means that [PMEVCNTR<n>](#) event counter is enabled. When written, enables [PMEVCNTR<n>](#).

Accessing the PMCNTENSET

This register can be read using MRC with the following syntax:

MRC <syntax>

This register can be written using MCR with the following syntax:

MCR <syntax>

This syntax is encoded with the following settings in the instruction encoding:

<syntax>	opc1	opc2	CRn	coproc	CRm
p15, 0, <Rt>, c9, c12, 1	000	001	1001	1111	1100

Accessibility

The register is accessible in software as follows:

Control			Accessibility			
E2H	TGE	NS	EL0	EL1	EL2	EL3
x	x	0	RW	RW	n/a	RW
x	0	1	RW	RW	RW	RW
x	1	1	RW	n/a	RW	RW

If EL2 is implemented, in Non-secure EL1 and EL0 modes, the value of [HDCR.HPMN](#) can change the behavior of accesses to [PMCNTENSET](#). See the description of the P<n> bit.

Traps and Enables

For a description of the prioritization of any generated exceptions, see [Synchronous exception prioritization for exceptions taken to AArch32 state on page G1-4344](#) for exceptions taken to AArch32 state and [Synchronous exception prioritization for exceptions taken to AArch64 on page D1-1827](#) for exceptions taken to AArch64 state. Subject to the prioritization rules:

- In both security states, and not dependent on other bits:
 - If [PMUSERENR.EN](#)==0, accesses to this register from EL0 are trapped to Undefined mode.
 - If [PMUSERENR_EL0.EN](#)==0, accesses to this register from EL0 are trapped to EL1.
- When EL2 is implemented and is using AArch64 and ([SCR_EL3.NS](#) == 1) && ([HCR_EL2.E2H](#) == 0):
 - If [HSTR_EL2.T9](#)==1, Non-secure accesses to this register from EL0 and EL1 are trapped to EL2.
- When EL2 is implemented and is using AArch64 and [SCR_EL3.NS](#) == 1:
 - If [MDCR_EL2.TPM](#)==1, Non-secure accesses to this register from EL0 and EL1 are trapped to EL2.
- When EL2 is implemented and is using AArch64 and ([SCR_EL3.NS](#) == 1) && ([HCR_EL2.E2H](#) == 1) && ([HCR_EL2.TGE](#) == 0):
 - If [HSTR_EL2.T9](#)==1, Non-secure write accesses to this register from EL0 and EL1 are trapped to EL2.
- When EL2 is implemented and is using AArch32 and [SCR_EL3.NS](#) == 1:
 - If [HDCR.TPM](#)==1, Non-secure accesses to this register from EL0 and EL1 are trapped to Hyp mode.
 - If [HSTR.T9](#)==1, Non-secure accesses to this register from EL0 and EL1 are trapped to Hyp mode.
- When EL3 is implemented and is using AArch64:
 - If [MDCR_EL3.TPM](#)==1, accesses to this register from EL0, EL1, and EL2 are trapped to EL3.

G6.4.9 PMCR, Performance Monitors Control Register

The PMCR characteristics are:

Purpose

Provides details of the Performance Monitors implementation, including the number of counters implemented, and configures and controls the counters.

Configurations

There is one instance of this register that is used in both Secure and Non-secure states.

AArch32 System register PMCR is architecturally mapped to AArch64 System register [PMCR_ELO](#).

AArch32 System register PMCR[6:0] is architecturally mapped to External register [PMCR_ELO](#)[6:0].

This register is in the Warm reset domain. Some or all RW fields of this register have defined reset values. On a Warm or Cold reset these apply only if the PE resets into an Exception level that is using AArch32. Otherwise, on a Warm or Cold reset RW fields in this register reset to architecturally UNKNOWN values.

Attributes

PMCR is a 32-bit register.

Field descriptions

The PMCR bit assignments are:

31	24 23	16 15	11 10	7 6	5	4	3	2	1	0
IMP	IDCODE	N	RES0	LCDP	X	D	C	P	E	

IMP, bits [31:24]

Implementer code. This field is RO with an IMPLEMENTATION DEFINED value.

The implementer codes are allocated by ARM. Values have the same interpretation as bits [31:24] of the [MIDR](#).

IDCODE, bits [23:16]

Identification code. This field is RO with an IMPLEMENTATION DEFINED value.

Each implementer must maintain a list of identification codes that is specific to the implementer. A specific implementation is identified by the combination of the implementer code and the identification code.

N, bits [15:11]

Number of event counters. A RO field that indicates the number counters implemented. A value of `0b00000` in this field indicates that only the Cycle Count Register [PMCCNTR](#) is implemented.

The value of this field is the number of event counters implemented. This value is in the range of `0b00000`, in which case only the [PMCCNTR](#) is implemented, to `0b11111`, which indicates that the [PMCCNTR](#) and 31 event counters are implemented.

In an implementation that includes EL2, reads of this field from Non-secure EL1 and Non-secure EL0 return the value of [HDCR.HPMN](#) if EL2 is using AArch32, or the value of [MDCR_EL2.HPMN](#) if EL2 is using AArch64.

Bits [10:7]

Reserved, RES0.

LC, bit [6]

Long cycle counter enable. Determines which [PMCCNTR](#) bit generates an overflow recorded by [PMOVSRR\[31\]](#).

- 0 Cycle counter overflow on increment that changes [PMCCNTR\[31\]](#) from 1 to 0.
- 1 Cycle counter overflow on increment that changes [PMCCNTR\[63\]](#) from 1 to 0.

ARM deprecates use of $PMCR.LC = 0$.

This field resets to a value that is architecturally UNKNOWN.

DP, bit [5]

Disable cycle counter when event counting is prohibited. The possible values of this bit are:

- 0 [PMCCNTR](#), if enabled, counts when event counting is prohibited.
- 1 [PMCCNTR](#) does not count when event counting is prohibited.

Counting events is never prohibited in Non-secure state. However, there are some restrictions on counting events in Secure state. For more information about the interaction between the Performance Monitors and EL3, see [Interaction with EL3 on page D5-2145](#)

When EL3 is not implemented, this field is RES0:

- When [ARMv8.1-PMU](#) is not implemented.
- When [ARMv8.1-PMU](#) is implemented, only if EL2 is not implemented.

Otherwise this field is RW.

When this register has an architecturally-defined reset value, if this field is implemented as an RW field, it resets to 0.

X, bit [4]

Enable export of events in an IMPLEMENTATION DEFINED event stream. The possible values of this bit are:

- 0 Do not export events.
- 1 Export events where not prohibited.

This field enables the exporting of events over an event bus to another device, for example to an OPTIONAL trace macrocell. If the implementation does not include such an event bus then this field is RAZ/WI, otherwise it is an RW field.

In an implementation that includes an event bus, no events are exported when counting is prohibited.

This field does not affect the generation of Performance Monitors overflow interrupt requests or signaling to a cross-trigger interface (CTI) that can be implemented as signals exported from the PE.

When this register has an architecturally-defined reset value, if this field is implemented as an RW field, it resets to 0.

D, bit [3]

Clock divider. The possible values of this bit are:

- 0 When enabled, [PMCCNTR](#) counts every clock cycle.
- 1 When enabled, [PMCCNTR](#) counts once every 64 clock cycles.

This bit is RW.

If $PMCR.LC = 1$, this bit is ignored and the cycle counter counts every clock cycle.

ARM deprecates use of $PMCR.D = 1$.

When this register has an architecturally-defined reset value, this field resets to 0.

C, bit [2]

Cycle counter reset. This bit is WO. The effects of writing to this bit are:

- 0 No action.
- 1 Reset [PMCCNTR](#) to zero.

This bit is always RAZ.

Resetting **PMCCNTR** does not clear the **PMCCNTR** overflow bit to 0.

P, bit [1]

Event counter reset. This bit is WO. The effects of writing to this bit are:

0 No action.

1 Reset all event counters accessible in the current EL, not including **PMCCNTR**, to zero.

This bit is always RAZ.

In Non-secure EL0 and EL1, if EL2 is implemented, a write of 1 to this bit does not reset event counters that **HDCR.HPMN** or **MDCR_EL2.HPMN** reserves for EL2 use.

In EL2 and EL3, a write of 1 to this bit resets all the event counters.

Resetting the event counters does not clear any overflow bits to 0.

E, bit [0]

Enable. The possible values of this bit are:

0 All counters that are accessible at Non-secure EL1, including **PMCCNTR**, are disabled.

1 All counters that are accessible at Non-secure EL1 are enabled by **PMCNTENSET**.

This bit is RW.

If EL2 is implemented, this bit does not affect the operation of event counters that **HDCR.HPMN** or **MDCR_EL2.HPMN** reserves for EL2 use.

When this register has an architecturally-defined reset value, this field resets to 0.

Accessing the PMCR

This register can be read using MRC with the following syntax:

MRC <syntax>

This register can be written using MCR with the following syntax:

MCR <syntax>

This syntax is encoded with the following settings in the instruction encoding:

<syntax>	opc1	opc2	CRn	coproc	CRm
p15, 0, <Rt>, c9, c12, 0	000	000	1001	1111	1100

Accessibility

The register is accessible in software as follows:

Control			Accessibility			
E2H	TGE	NS	EL0	EL1	EL2	EL3
x	x	0	RW	RW	n/a	RW
x	0	1	RW	RW	RW	RW
x	1	1	RW	n/a	RW	RW

Traps and Enables

For a description of the prioritization of any generated exceptions, see *Synchronous exception prioritization for exceptions taken to AArch32 state* on page G1-4344 for exceptions taken to AArch32 state and *Synchronous exception prioritization for exceptions taken to AArch64* on page D1-1827 for exceptions taken to AArch64 state. Subject to the prioritization rules:

- In both security states, and not dependent on other bits:
 - If `PMUSERENR.EN==0`, accesses to this register from EL0 are trapped to Undefined mode.
 - If `PMUSERENR_EL0.EN==0`, accesses to this register from EL0 are trapped to EL1.
- When EL2 is implemented and is using AArch64 and `(SCR_EL3.NS == 1) && (HCR_EL2.E2H == 0)`:
 - If `HSTR_EL2.T9==1`, Non-secure accesses to this register from EL0 and EL1 are trapped to EL2.
- When EL2 is implemented and is using AArch64 and `SCR_EL3.NS == 1`:
 - If `MDCR_EL2.TPM==1`, Non-secure accesses to this register from EL0 and EL1 are trapped to EL2.
 - If `MDCR_EL2.TPMCR==1`, Non-secure accesses to this register from EL0 and EL1 are trapped to EL2.
- When EL2 is implemented and is using AArch64 and `(SCR_EL3.NS == 1) && (HCR_EL2.E2H == 1) && (HCR_EL2.TGE == 0)`:
 - If `HSTR_EL2.T9==1`, Non-secure write accesses to this register from EL0 and EL1 are trapped to EL2.
- When EL2 is implemented and is using AArch32 and `SCR_EL3.NS == 1`:
 - If `HDCR.TPM==1`, Non-secure accesses to this register from EL0 and EL1 are trapped to Hyp mode.
 - If `HDCR.TPMCR==1`, Non-secure accesses to this register from EL0 and EL1 are trapped to Hyp mode.
 - If `HSTR.T9==1`, Non-secure accesses to this register from EL0 and EL1 are trapped to Hyp mode.
- When EL3 is implemented and is using AArch64:
 - If `MDCR_EL3.TPM==1`, accesses to this register from EL0, EL1, and EL2 are trapped to EL3.

G6.4.10 PMEVCNTR<n>, Performance Monitors Event Count Registers, n = 0 - 30

The PMEVCNTR<n> characteristics are:

Purpose

Holds event counter n, which counts events, where n is 0 to 30.

Configurations

There is one instance of this register that is used in both Secure and Non-secure states.

AArch32 System register PMEVCNTR<n> is architecturally mapped to AArch64 System register [PMEVCNTR<n>_EL0](#).

AArch32 System register PMEVCNTR<n> is architecturally mapped to External register [PMEVCNTR<n>_EL0](#).

This register is in the Warm reset domain. On a Warm or Cold reset RW fields in this register reset to architecturally UNKNOWN values.

Attributes

PMEVCNTR<n> is a 32-bit register.

Field descriptions

The PMEVCNTR<n> bit assignments are:

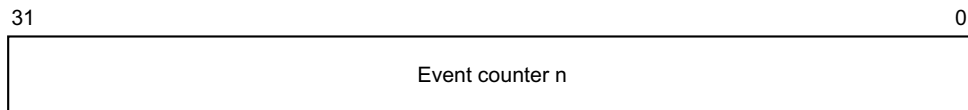

Bits [31:0]

Event counter n. Value of event counter n, where n is the number of this register and is a number from 0 to 30.

Accessing the PMEVCNTR<n>

This register can be read using MRC with the following syntax:

MRC <syntax>

This register can be written using MCR with the following syntax:

MCR <syntax>

This syntax is encoded with the following settings in the instruction encoding:

<syntax>	opc1	opc2	CRn	coproc	CRm
p15, 0, <Rt>, c14, <CRm>, <opc2>	000	n<2:0>	1110	1111	10:n<4:3>

- <opc2> is in the range 0 - 7.
- <CRm> is in the range c8 - c11.

PMEVCNTR<n> can also be accessed by using [PMXEVCNTR](#) with [PMSELR](#).SEL set to the value of <n>.

Accessibility

The register is accessible in software as follows:

Control			Accessibility			
E2H	TGE	NS	EL0	EL1	EL2	EL3
x	x	0	RW	RW	n/a	RW
x	0	1	RW	RW	RW	RW
x	1	1	RW	n/a	RW	RW

If <n> is greater than or equal to the number of accessible counters, reads and writes of PMEVCNTR<n> are CONSTRAINED UNPREDICTABLE, and the following behaviors are permitted:

- Accesses to the register are UNDEFINED.
- Accesses to the register behave as RAZ/WI.
- Accesses to the register execute as a NOP.
- In Non-secure state, for an access from PL1 or a permitted access from PL0, if [PMSELR.SEL](#), or [PMSELR_EL0.SEL](#) if EL1 is using AArch64, is greater than or equal to the number of accessible counters but is less than the number of implemented counters, the register access is trapped to EL2. Accesses from PL0 are permitted when:
 - EL1 is using AArch32 and the value of [PMUSERENR.EN](#) is 1.
 - EL1 is using AArch64 and the value of [PMUSERENR_EL0.EN](#) is 1.

———— Note —————

In an implementation that includes EL2, in Non-secure state at EL0 and EL1:

- If EL2 is using AArch32, [HDCR.HPMN](#) identifies the number of accessible counters.
- If EL2 is using AArch64, [MDCR_EL2.HPMN](#) identifies the number of accessible counters.

Otherwise, the number of accessible counters is the number of implemented counters.

Traps and Enables

For a description of the prioritization of any generated exceptions, see [Synchronous exception prioritization for exceptions taken to AArch32 state on page G1-4344](#) for exceptions taken to AArch32 state and [Synchronous exception prioritization for exceptions taken to AArch64 on page D1-1827](#) for exceptions taken to AArch64 state. Subject to the prioritization rules:

- In both security states, and not dependent on other bits:
 - If [PMUSERENR.EN](#)==0, and [PMUSERENR.ER](#)==0, read accesses to this register from EL0 are trapped to Undefined mode.
 - If [PMUSERENR.EN](#)==0, write accesses to this register from EL0 are trapped to Undefined mode.
 - If [PMUSERENR_EL0.EN](#)==0, and [PMUSERENR_EL0.ER](#)==0, read accesses to this register from EL0 are trapped to EL1.
 - If [PMUSERENR_EL0.EN](#)==0, write accesses to this register from EL0 are trapped to EL1.
- When EL2 is implemented and is using AArch64 and [SCR_EL3.NS](#) == 1:
 - If [MDCR_EL2.TPM](#)==1, Non-secure accesses to this register from EL0 and EL1 are trapped to EL2.

- When EL2 is implemented and is using AArch32 and SCR_EL3.NS == 1:
 - If [HDCR.TPM==1](#), Non-secure accesses to this register from EL0 and EL1 are trapped to Hyp mode.
- When EL3 is implemented and is using AArch64:
 - If [MDCR_EL3.TPM==1](#), accesses to this register from EL0, EL1, and EL2 are trapped to EL3.

G6.4.11 PMEVTYPER<n>, Performance Monitors Event Type Registers, n = 0 - 30

The PMEVTYPER<n> characteristics are:

Purpose

Configures event counter n, where n is 0 to 30.

Configurations

There is one instance of this register that is used in both Secure and Non-secure states.

AArch32 System register PMEVTYPER<n> is architecturally mapped to AArch64 System register [PMEVTYPER<n>_EL0](#).

AArch32 System register PMEVTYPER<n> is architecturally mapped to External register [PMEVTYPER<n>_EL0](#).

This register is in the Warm reset domain. On a Warm or Cold reset RW fields in this register reset to architecturally UNKNOWN values.

Attributes

PMEVTYPER<n> is a 32-bit register.

Field descriptions

The PMEVTYPER<n> bit assignments are:

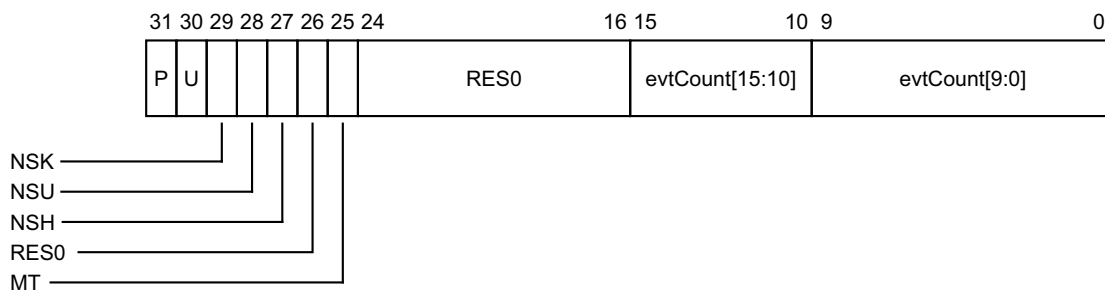

P, bit [31]

Privileged filtering bit. Controls counting in EL1. If EL3 is implemented, then counting in Non-secure EL1 is further controlled by the NSK bit. The possible values of this bit are:

- 0 Count events in EL1.
- 1 Do not count events in EL1.

U, bit [30]

User filtering bit. Controls counting in EL0. If EL3 is implemented, then counting in Non-secure EL0 is further controlled by the NSU bit. The possible values of this bit are:

- 0 Count events in EL0.
- 1 Do not count events in EL0.

NSK, bit [29]

Non-secure EL1 (kernel) modes filtering bit. Controls counting in Non-secure EL1. If EL3 is not implemented, this bit is RES0.

If the value of this bit is equal to the value of P, events in Non-secure EL1 are counted.

Otherwise, events in Non-secure EL1 are not counted.

NSU, bit [28]

Non-secure EL0 (Unprivileged) filtering. Controls counting in Non-secure EL0. If EL3 is not implemented, this bit is RES0.

If the value of this bit is equal to the value of U, events in Non-secure EL0 are counted.

Otherwise, events in Non-secure EL0 are not counted.

NSH, bit [27]

Non-secure EL2 (Hyp mode) filtering bit. Controls counting in Non-secure EL2. If EL2 is not implemented, this bit is RES0.

0 Do not count events in EL2.

1 Count events in EL2.

Bit [26]

Reserved, RES0.

MT, bit [25]

Multithreading. When the implementation is multi-threaded, the valid values for this bit are:

0 Count events only on controlling PE.

1 Count events from any PE with the same affinity at level 1 and above as this PE.

When the implementation is not multi-threaded, this bit is RES0.

Note

- An implementation is described as multi-threaded when the lowest level of affinity consists of logical PEs that are implemented using a multi-threading type approach. That is, the performance of PEs at the lowest affinity level is highly interdependent. On such an implementation, the value of MPIDR_EL1.MT, when read at the highest implemented Exception level, is 1.
- Events from a different thread of a multithreaded implementation are not Attributable to the thread counting the event.

Bits [24:16]

Reserved, RES0.

evtCount[15:10], bits [15:10]

In ARMv8.2 and ARMv8.1

Extension to evtCount[9:0]. See evtCount[9:0] for more details.

In ARMv8.0.

Reserved, RES0.

evtCount[9:0], bits [9:0]

Event to count. The event number of the event that is counted by event counter **PMEVCNTR<n>**.

Software must program this field with an event that is supported by the PE being programmed.

There are three ranges of event numbers:

- Event numbers in the range 0x000 to 0x03F are common architectural and microarchitectural events.
- Event numbers in the range 0x040 to 0x0BF are ARM recommended common architectural and microarchitectural events.
- Event numbers in the range 0x0C0 to 0x3FF are IMPLEMENTATION DEFINED events.

If evtCount is programmed to an event that is reserved or not supported by the PE, the behavior depends on the event type:

- For the range 0x000 to 0x03F, no events are counted, and the value returned by a direct or external read of the evtCount field is the value written to the field.
- For IMPLEMENTATION DEFINED events, it is UNPREDICTABLE what event, if any, is counted, and the value returned by a direct or external read of the evtCount field is UNKNOWN.

———— **Note** —————

UNPREDICTABLE means the event must not expose privileged information.

ARM recommends that the behavior across a family of implementations is defined such that if a given implementation does not include an event from a set of common IMPLEMENTATION DEFINED events, then no event is counted and the value read back on evtCount is the value written.

Accessing the PMEVTYPER<n>

This register can be read using MRC with the following syntax:

MRC <syntax>

This register can be written using MCR with the following syntax:

MCR <syntax>

This syntax is encoded with the following settings in the instruction encoding:

<syntax>	opc1	opc2	CRn	coproc	CRm
p15, 0, <Rt>, c14, <CRm>, <opc2>	000	n<2:0>	1110	1111	11:n<4:3>

- <opc2> is in the range 0 - 7.
- <CRm> is in the range c12 - c15.

Accessibility

The register is accessible in software as follows:

Control			Accessibility			
E2H	TGE	NS	EL0	EL1	EL2	EL3
x	x	0	RW	RW	n/a	n/a
x	0	1	RW	RW	RW	n/a
x	1	1	RW	n/a	RW	n/a

This register is accessible at EL0 when [PMUSERENR.EN](#) is set to 1.

PMEVTYPER<n> can also be accessed by using [PMXEVTYPER](#) with [PMSCLR.SEL](#) set to n.

If <n> is greater or equal to the number of accessible counters, reads and writes of PMEVTYPER<n> are CONSTRAINED UNPREDICTABLE, and the following behaviors are permitted:

- Accesses to the register are UNDEFINED.
- Accesses to the register behave as RAZ/WI.
- Accesses to the register execute as a NOP.

- In Non-secure state, for an access from PL1 or a permitted access from PL0, if [PMSELR.SEL](#), or [PMSELR_EL0.SEL](#) if EL1 is using AArch64, is greater than or equal to the number of accessible counters but is less than the number of implemented counters, the register access is trapped to EL2. Accesses from PL0 are permitted when:
 - EL1 is using AArch32 and the value of [PMUSERENR.EN](#) is 1.
 - EL1 is using AArch64 and the value of [PMUSERENR_EL0.EN](#) is 1.

———— **Note** —————

In an implementation that includes EL2, in Non-secure state at EL0 and EL1:

- If EL2 is using AArch32, [HDCR.HPMN](#) identifies the number of accessible counters.
- If EL2 is using AArch64, [MDCR_EL2.HPMN](#) identifies the number of accessible counters.

Otherwise, the number of accessible counters is the number of implemented counters.

Traps and Enables

For a description of the prioritization of any generated exceptions, see *Synchronous exception prioritization for exceptions taken to AArch32 state* on page G1-4344 for exceptions taken to AArch32 state and *Synchronous exception prioritization for exceptions taken to AArch64* on page D1-1827 for exceptions taken to AArch64 state. Subject to the prioritization rules:

- In both security states, and not dependent on other bits:
 - If [PMUSERENR.EN](#)==0, accesses to this register from EL0 are trapped to Undefined mode.
 - If [PMUSERENR_EL0.EN](#)==0, accesses to this register from EL0 are trapped to EL1.
- When EL2 is implemented and is using AArch64 and [SCR_EL3.NS](#) == 1:
 - If [MDCR_EL2.TPM](#)==1, Non-secure accesses to this register from EL0 and EL1 are trapped to EL2.
- When EL2 is implemented and is using AArch32 and [SCR_EL3.NS](#) == 1:
 - If [HDCR.TPM](#)==1, Non-secure accesses to this register from EL0 and EL1 are trapped to Hyp mode.
- When EL3 is implemented and is using AArch64:
 - If [MDCR_EL3.TPM](#)==1, accesses to this register from EL0, EL1, and EL2 are trapped to EL3.

G6.4.12 PMINTENCLR, Performance Monitors Interrupt Enable Clear register

The PMINTENCLR characteristics are:

Purpose

Disables the generation of interrupt requests on overflows from the Cycle Count Register, [PMCCNTR](#), and the event counters [PMEVCNTR<n>](#). Reading the register shows which overflow interrupt requests are enabled.

PMINTENCLR is used in conjunction with the [PMINTENSET](#) register.

Configurations

There is one instance of this register that is used in both Secure and Non-secure states.

AArch32 System register PMINTENCLR is architecturally mapped to AArch64 System register [PMINTENCLR_EL1](#).

AArch32 System register PMINTENCLR is architecturally mapped to External register [PMINTENCLR_EL1](#).

This register is in the Warm reset domain. On a Warm or Cold reset RW fields in this register reset to architecturally UNKNOWN values.

Attributes

PMINTENCLR is a 32-bit register.

Field descriptions

The PMINTENCLR bit assignments are:

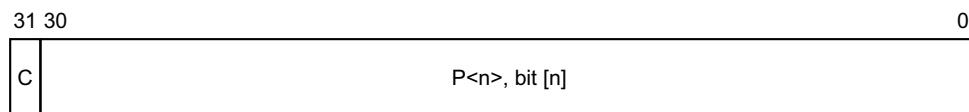

C, bit [31]

[PMCCNTR](#) overflow interrupt request disable bit. Possible values are:

- 0 When read, means the cycle counter overflow interrupt request is disabled. When written, has no effect.
- 1 When read, means the cycle counter overflow interrupt request is enabled. When written, disables the cycle count overflow interrupt request.

P<n>, bit [n], for n = 0 to 30

Event counter overflow interrupt request disable bit for [PMEVCNTR<n>](#).

When EL2 is implemented, in Non-secure EL1 and EL0, N is the value in [HDCR.HPMN](#). Otherwise, N is the value in [PMCR.N](#).

Bits [30:N] are RAZ/WI.

Possible values are:

- 0 When read, means that the [PMEVCNTR<n>](#) event counter interrupt request is disabled. When written, has no effect.
- 1 When read, means that the [PMEVCNTR<n>](#) event counter interrupt request is enabled. When written, disables the [PMEVCNTR<n>](#) interrupt request.

Accessing the PMINTENCLR

This register can be read using MRC with the following syntax:

MRC <syntax>

This register can be written using MCR with the following syntax:

MCR <syntax>

This syntax is encoded with the following settings in the instruction encoding:

<syntax>	opc1	opc2	CRn	coproc	CRm
p15, 0, <Rt>, c9, c14, 2	000	010	1001	1111	1110

Accessibility

The register is accessible in software as follows:

Control			Accessibility			
E2H	TGE	NS	EL0	EL1	EL2	EL3
x	x	0	RW	RW	n/a	RW
x	0	1	RW	RW	RW	RW
x	1	1	RW	n/a	RW	RW

If EL2 is implemented, in Non-secure EL1 and EL0 modes, the value of [HDCR.HPMN](#) can change the behavior of accesses to [PMINTENCLR](#). See the description of the P<n> bit.

Traps and Enables

For a description of the prioritization of any generated exceptions, see [Synchronous exception prioritization for exceptions taken to AArch32 state on page G1-4344](#) for exceptions taken to AArch32 state and [Synchronous exception prioritization for exceptions taken to AArch64 on page D1-1827](#) for exceptions taken to AArch64 state. Subject to the prioritization rules:

- When EL2 is implemented and is using AArch64 and (SCR_EL3.NS == 1) && (HCR_EL2.E2H == 0):
 - If [HSTR_EL2.T9](#)==1, Non-secure accesses to this register from EL1 are trapped to EL2.
- When EL2 is implemented and is using AArch64 and SCR_EL3.NS == 1:
 - If [MDCR_EL2.TPM](#)==1, Non-secure accesses to this register from EL1 are trapped to EL2.
- When EL2 is implemented and is using AArch64 and (SCR_EL3.NS == 1) && (HCR_EL2.E2H == 1) && (HCR_EL2.TGE == 0):
 - If [HSTR_EL2.T9](#)==1, Non-secure write accesses to this register from EL1 are trapped to EL2.
- When EL2 is implemented and is using AArch32 and SCR_EL3.NS == 1:
 - If [HDCR.TPM](#)==1, Non-secure accesses to this register from EL1 are trapped to Hyp mode.
 - If [HSTR.T9](#)==1, Non-secure accesses to this register from EL1 are trapped to Hyp mode.
- When EL3 is implemented and is using AArch64:
 - If [MDCR_EL3.TPM](#)==1, accesses to this register from EL1 and EL2 are trapped to EL3.

G6.4.13 PMINTENSET, Performance Monitors Interrupt Enable Set register

The PMINTENSET characteristics are:

Purpose

Enables the generation of interrupt requests on overflows from the Cycle Count Register, [PMCCNTR](#), and the event counters [PMEVCNTR<n>](#). Reading the register shows which overflow interrupt requests are enabled.

PMINTENSET is used in conjunction with the [PMINTENCLR](#) register.

Configurations

There is one instance of this register that is used in both Secure and Non-secure states.

AArch32 System register PMINTENSET is architecturally mapped to AArch64 System register [PMINTENSET_EL1](#).

AArch32 System register PMINTENSET is architecturally mapped to External register [PMINTENSET_EL1](#).

This register is in the Warm reset domain. On a Warm or Cold reset RW fields in this register reset to architecturally UNKNOWN values.

Attributes

PMINTENSET is a 32-bit register.

Field descriptions

The PMINTENSET bit assignments are:

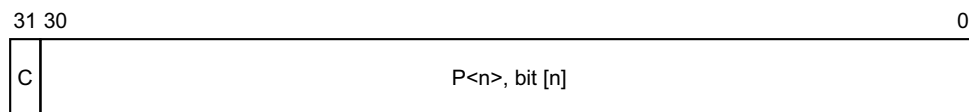

C, bit [31]

[PMCCNTR](#) overflow interrupt request enable bit. Possible values are:

- 0 When read, means the cycle counter overflow interrupt request is disabled. When written, has no effect.
- 1 When read, means the cycle counter overflow interrupt request is enabled. When written, enables the cycle count overflow interrupt request.

P<n>, bit [n], for n = 0 to 30

Event counter overflow interrupt request enable bit for [PMEVCNTR<n>](#).

When EL2 is implemented, in Non-secure EL1 and EL0, N is the value in [HDCR.HPMN](#). Otherwise, N is the value in [PMCR.N](#).

Bits [30:N] are RAZ/WI.

Possible values are:

- 0 When read, means that the [PMEVCNTR<n>](#) event counter interrupt request is disabled. When written, has no effect.
- 1 When read, means that the [PMEVCNTR<n>](#) event counter interrupt request is enabled. When written, enables the [PMEVCNTR<n>](#) interrupt request.

Accessing the PMINTENSET

This register can be read using MRC with the following syntax:

MRC <syntax>

This register can be written using MCR with the following syntax:

MCR <syntax>

This syntax is encoded with the following settings in the instruction encoding:

<syntax>	opc1	opc2	CRn	coproc	CRm
p15, 0, <Rt>, c9, c14, 1	000	001	1001	1111	1110

Accessibility

The register is accessible in software as follows:

Control			Accessibility			
E2H	TGE	NS	EL0	EL1	EL2	EL3
x	x	0	RW	RW	n/a	RW
x	0	1	RW	RW	RW	RW
x	1	1	RW	n/a	RW	RW

If EL2 is implemented, in Non-secure EL1 and EL0 modes, the value of [HDCR.HPMN](#) can change the behavior of accesses to [PMINTENSET](#). See the description of the P<n> bit.

Traps and Enables

For a description of the prioritization of any generated exceptions, see [Synchronous exception prioritization for exceptions taken to AArch32 state on page G1-4344](#) for exceptions taken to AArch32 state and [Synchronous exception prioritization for exceptions taken to AArch64 on page D1-1827](#) for exceptions taken to AArch64 state. Subject to the prioritization rules:

- When EL2 is implemented and is using AArch64 and (SCR_EL3.NS == 1) && (HCR_EL2.E2H == 0):
 - If [HSTR_EL2.T9](#)==1, Non-secure accesses to this register from EL1 are trapped to EL2.
- When EL2 is implemented and is using AArch64 and SCR_EL3.NS == 1:
 - If [MDCR_EL2.TPM](#)==1, Non-secure accesses to this register from EL1 are trapped to EL2.
- When EL2 is implemented and is using AArch64 and (SCR_EL3.NS == 1) && (HCR_EL2.E2H == 1) && (HCR_EL2.TGE == 0):
 - If [HSTR_EL2.T9](#)==1, Non-secure write accesses to this register from EL1 are trapped to EL2.
- When EL2 is implemented and is using AArch32 and SCR_EL3.NS == 1:
 - If [HDCR.TPM](#)==1, Non-secure accesses to this register from EL1 are trapped to Hyp mode.
 - If [HSTR.T9](#)==1, Non-secure accesses to this register from EL1 are trapped to Hyp mode.
- When EL3 is implemented and is using AArch64:
 - If [MDCR_EL3.TPM](#)==1, accesses to this register from EL1 and EL2 are trapped to EL3.

G6.4.14 PMOVSR, Performance Monitors Overflow Flag Status Register

The PMOVSR characteristics are:

Purpose

Contains the state of the overflow bit for the Cycle Count Register, [PMCCNTR](#), and each of the implemented event counters [PMEVCNTR<n>](#). Writing to this register clears these bits.

Configurations

There is one instance of this register that is used in both Secure and Non-secure states.

AArch32 System register PMOVSR is architecturally mapped to AArch64 System register [PMOVSLR_ELO](#).

AArch32 System register PMOVSR is architecturally mapped to External register [PMOVSLR_ELO](#).

This register is in the Warm reset domain. On a Warm or Cold reset RW fields in this register reset to architecturally UNKNOWN values.

Attributes

PMOVSR is a 32-bit register.

Field descriptions

The PMOVSR bit assignments are:

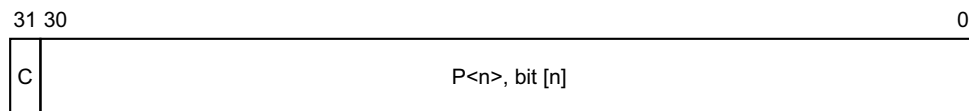

C, bit [31]

[PMCCNTR](#) overflow bit. Possible values are:

- 0 When read, means the cycle counter has not overflowed. When written, has no effect.
- 1 When read, means the cycle counter has overflowed. When written, clears the overflow bit to 0.

[PMCR.LC](#) controls whether an overflow is detected from [PMCCNTR\[31\]](#) or from [PMCCNTR\[63\]](#).

P<n>, bit [n], for n = 0 to 30

Event counter overflow clear bit for [PMEVCNTR<n>](#).

Bits [30:N] are RAZ/WI. When EL2 is implemented, in Non-secure EL1 and EL0, N is the value in [MDCR_EL2.HPMN](#) if EL2 is using AArch64 or in [HDCR.HPMN](#) if EL2 is using AArch32. Otherwise, N is the value in [PMCR.N](#).

Possible values of each bit are:

- 0 When read, means that [PMEVCNTR<n>](#) has not overflowed. When written, has no effect.
- 1 When read, means that [PMEVCNTR<n>](#) has overflowed. When written, clears the [PMEVCNTR<n>](#) overflow bit to 0.

Accessing the PMOVSR

This register can be read using MRC with the following syntax:

MRC <syntax>

This register can be written using MCR with the following syntax:

MCR <syntax>

This syntax is encoded with the following settings in the instruction encoding:

<syntax>	opc1	opc2	CRn	coproc	CRm
p15, 0, <Rt>, c9, c12, 3	000	011	1001	1111	1100

Accessibility

The register is accessible in software as follows:

Control			Accessibility			
E2H	TGE	NS	EL0	EL1	EL2	EL3
x	x	0	RW	RW	n/a	RW
x	0	1	RW	RW	RW	RW
x	1	1	RW	n/a	RW	RW

Traps and Enables

For a description of the prioritization of any generated exceptions, see [Synchronous exception prioritization for exceptions taken to AArch32 state on page G1-4344](#) for exceptions taken to AArch32 state and [Synchronous exception prioritization for exceptions taken to AArch64 on page D1-1827](#) for exceptions taken to AArch64 state. Subject to the prioritization rules:

- In both security states, and not dependent on other bits:
 - If `PMUSERENR.EN==0`, accesses to this register from EL0 are trapped to Undefined mode.
 - If `PMUSERENR_EL0.EN==0`, accesses to this register from EL0 are trapped to EL1.
- When EL2 is implemented and is using AArch64 and `(SCR_EL3.NS == 1) && (HCR_EL2.E2H == 0)`:
 - If `HSTR_EL2.T9==1`, Non-secure accesses to this register from EL0 and EL1 are trapped to EL2.
- When EL2 is implemented and is using AArch64 and `SCR_EL3.NS == 1`:
 - If `MDCR_EL2.TPM==1`, Non-secure accesses to this register from EL0 and EL1 are trapped to EL2.
- When EL2 is implemented and is using AArch64 and `(SCR_EL3.NS == 1) && (HCR_EL2.E2H == 1) && (HCR_EL2.TGE == 0)`:
 - If `HSTR_EL2.T9==1`, Non-secure write accesses to this register from EL0 and EL1 are trapped to EL2.
- When EL2 is implemented and is using AArch32 and `SCR_EL3.NS == 1`:
 - If `HDCR.TPM==1`, Non-secure accesses to this register from EL0 and EL1 are trapped to Hyp mode.
 - If `HSTR.T9==1`, Non-secure accesses to this register from EL0 and EL1 are trapped to Hyp mode.
- When EL3 is implemented and is using AArch64:
 - If `MDCR_EL3.TPM==1`, accesses to this register from EL0, EL1, and EL2 are trapped to EL3.

G6.4.15 PMOVSSET, Performance Monitors Overflow Flag Status Set register

The PMOVSSET characteristics are:

Purpose

Sets the state of the overflow bit for the Cycle Count Register, [PMCCNTR](#), and each of the implemented event counters [PMEVCNTR<n>](#).

Configurations

There is one instance of this register that is used in both Secure and Non-secure states.

AArch32 System register PMOVSSET is architecturally mapped to AArch64 System register [PMOVSSET_EL0](#).

AArch32 System register PMOVSSET is architecturally mapped to External register [PMOVSSET_EL0](#).

This register is in the Warm reset domain. On a Warm or Cold reset RW fields in this register reset to architecturally UNKNOWN values.

Attributes

PMOVSSET is a 32-bit register.

Field descriptions

The PMOVSSET bit assignments are:

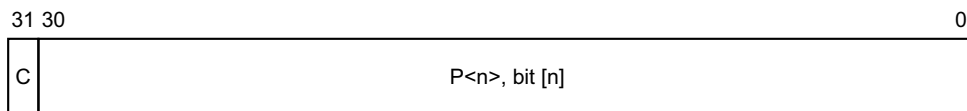

C, bit [31]

[PMCCNTR](#) overflow bit. Possible values are:

- 0 When read, means the cycle counter has not overflowed. When written, has no effect.
- 1 When read, means the cycle counter has overflowed. When written, sets the overflow bit to 1.

P<n>, bit [n], for n = 0 to 30

Event counter overflow set bit for [PMEVCNTR<n>](#).

Bits [30:N] are RAZ/WI. When EL2 is implemented, in Non-secure EL1 and EL0, N is the value in [MDCR_EL2.HPMN](#) if EL2 is using AArch64 or in [HDCR.HPMN](#) if EL2 is using AArch32. Otherwise, N is the value in [PMCR.N](#).

Possible values are:

- 0 When read, means that [PMEVCNTR<n>](#) has not overflowed. When written, has no effect.
- 1 When read, means that [PMEVCNTR<n>](#) has overflowed. When written, sets the [PMEVCNTR<n>](#) overflow bit to 1.

Accessing the PMOVSSET

This register can be read using MRC with the following syntax:

```
MRC <syntax>
```

This register can be written using MCR with the following syntax:

```
MCR <syntax>
```

This syntax is encoded with the following settings in the instruction encoding:

<syntax>	opc1	opc2	CRn	coproc	CRm
p15, 0, <Rt>, c9, c14, 3	000	011	1001	1111	1110

Accessibility

The register is accessible in software as follows:

Control			Accessibility			
E2H	TGE	NS	EL0	EL1	EL2	EL3
x	x	0	RW	RW	n/a	RW
x	0	1	RW	RW	RW	RW
x	1	1	RW	n/a	RW	RW

Traps and Enables

For a description of the prioritization of any generated exceptions, see [Synchronous exception prioritization for exceptions taken to AArch32 state on page G1-4344](#) for exceptions taken to AArch32 state and [Synchronous exception prioritization for exceptions taken to AArch64 on page D1-1827](#) for exceptions taken to AArch64 state. Subject to the prioritization rules:

- In both security states, and not dependent on other bits:
 - If `PMUSERENR.EN==0`, accesses to this register from EL0 are trapped to Undefined mode.
 - If `PMUSERENR_EL0.EN==0`, accesses to this register from EL0 are trapped to EL1.
- When EL2 is implemented and is using AArch64 and `(SCR_EL3.NS == 1) && (HCR_EL2.E2H == 0)`:
 - If `HSTR_EL2.T9==1`, Non-secure accesses to this register from EL0 and EL1 are trapped to EL2.
- When EL2 is implemented and is using AArch64 and `SCR_EL3.NS == 1`:
 - If `MDCR_EL2.TPM==1`, Non-secure accesses to this register from EL0 and EL1 are trapped to EL2.
- When EL2 is implemented and is using AArch64 and `(SCR_EL3.NS == 1) && (HCR_EL2.E2H == 1) && (HCR_EL2.TGE == 0)`:
 - If `HSTR_EL2.T9==1`, Non-secure write accesses to this register from EL0 and EL1 are trapped to EL2.
- When EL2 is implemented and is using AArch32 and `SCR_EL3.NS == 1`:
 - If `HDCR.TPM==1`, Non-secure accesses to this register from EL0 and EL1 are trapped to Hyp mode.
 - If `HSTR.T9==1`, Non-secure accesses to this register from EL0 and EL1 are trapped to Hyp mode.
- When EL3 is implemented and is using AArch64:
 - If `MDCR_EL3.TPM==1`, accesses to this register from EL0, EL1, and EL2 are trapped to EL3.

G6.4.16 PMSELR, Performance Monitors Event Counter Selection Register

The PMSELR characteristics are:

Purpose

Selects the current event counter [PMEVCNTR<n>](#) or the cycle counter, CCNT.

PMSELR is used in conjunction with [PMXEVTYPER](#) to determine the event that increments a selected event counter, and the modes and states in which the selected counter increments.

It is also used in conjunction with [PMXVCNTR](#), to determine the value of a selected event counter.

Configurations

There is one instance of this register that is used in both Secure and Non-secure states.

AArch32 System register PMSELR is architecturally mapped to AArch64 System register [PMSELR_ELO](#).

This register is in the Warm reset domain. On a Warm or Cold reset RW fields in this register reset to architecturally UNKNOWN values.

Attributes

PMSELR is a 32-bit register.

Field descriptions

The PMSELR bit assignments are:

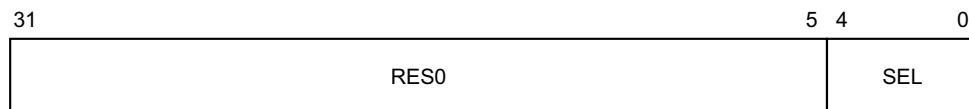

Bits [31:5]

Reserved, RES0.

SEL, bits [4:0]

Selects event counter, [PMEVCNTR<n>](#), where n is the value held in this field. This value identifies which event counter is accessed when a subsequent access to [PMXEVTYPER](#) or [PMXVCNTR](#) occurs.

This field can take any value from 0 ([0b00000](#)) to (PMCR.N)-1, or 31 ([0b11111](#)).

When PMSELR.SEL is [0b11111](#) it selects the cycle counter and:

- A read of the [PMXEVTYPER](#) returns the value of [PMCCFILTR](#).
- A write of the [PMXEVTYPER](#) writes to [PMCCFILTR](#).
- A read or write of [PMXVCNTR](#) has CONSTRAINED UNPREDICTABLE effects, that can be one of the following:
 - Access to [PMXVCNTR](#) is UNDEFINED.
 - Access to [PMXVCNTR](#) behaves as a NOP.
 - Access to [PMXVCNTR](#) behaves as if the register is RAZ/WI.
 - Access to [PMXVCNTR](#) behaves as if the PMSELR.SEL field contains an UNKNOWN value.

If this field is set to a value greater than or equal to the number of implemented counters, but not equal to 31, the results of access to [PMXEVTYPER](#) or [PMXVCNTR](#) are CONSTRAINED UNPREDICTABLE, and can be one of the following:

- Access to [PMXEVTYPER](#) or [PMXVCNTR](#) is UNDEFINED.

- Access to [PMXEVTYPER](#) or [PMXEVCNTR](#) behaves as a NOP.
- Access to [PMXEVTYPER](#) or [PMXEVCNTR](#) behaves as if the register is RAZ/WI.
- Access to [PMXEVTYPER](#) or [PMXEVCNTR](#) behaves as if the PMSELR.SEL field contains an UNKNOWN value.
- Access to [PMXEVTYPER](#) or [PMXEVCNTR](#) behaves as if the PMSELR.SEL field contains 0b11111.

Direct reads of this field return an UNKNOWN value.

Accessing the PMSELR

This register can be read using MRC with the following syntax:

MRC <syntax>

This register can be written using MCR with the following syntax:

MCR <syntax>

This syntax is encoded with the following settings in the instruction encoding:

<syntax>	opc1	opc2	CRn	coproc	CRm
p15, 0, <Rt>, c9, c12, 5	000	101	1001	1111	1100

Accessibility

The register is accessible in software as follows:

Control			Accessibility			
E2H	TGE	NS	EL0	EL1	EL2	EL3
x	x	0	RW	RW	n/a	RW
x	0	1	RW	RW	RW	RW
x	1	1	RW	n/a	RW	RW

Traps and Enables

For a description of the prioritization of any generated exceptions, see [Synchronous exception prioritization for exceptions taken to AArch32 state on page G1-4344](#) for exceptions taken to AArch32 state and [Synchronous exception prioritization for exceptions taken to AArch64 on page D1-1827](#) for exceptions taken to AArch64 state. Subject to the prioritization rules:

- In both security states, and not dependent on other bits:
 - If [PMUSERENR.EN](#)==0, and [PMUSERENR.ER](#)==0, accesses to this register from EL0 are trapped to Undefined mode.
 - If [PMUSERENR_EL0.EN](#)==0, and [PMUSERENR_EL0.ER](#)==0, accesses to this register from EL0 are trapped to EL1.
- When EL2 is implemented and is using AArch64 and ([SCR_EL3.NS](#) == 1) && ([HCR_EL2.E2H](#) == 0):
 - If [HSTR_EL2.T9](#)==1, Non-secure accesses to this register from EL0 and EL1 are trapped to EL2.
- When EL2 is implemented and is using AArch64 and [SCR_EL3.NS](#) == 1:
 - If [MDCR_EL2.TPM](#)==1, Non-secure accesses to this register from EL0 and EL1 are trapped to EL2.

- When EL2 is implemented and is using AArch64 and (SCR_EL3.NS == 1) && (HCR_EL2.E2H == 1) && (HCR_EL2.TGE == 0):
 - If [HSTR_EL2.T9](#)==1, Non-secure write accesses to this register from EL0 and EL1 are trapped to EL2.
- When EL2 is implemented and is using AArch32 and SCR_EL3.NS == 1:
 - If [HDCR.TPM](#)==1, Non-secure accesses to this register from EL0 and EL1 are trapped to Hyp mode.
 - If [HSTR.T9](#)==1, Non-secure accesses to this register from EL0 and EL1 are trapped to Hyp mode.
- When EL3 is implemented and is using AArch64:
 - If [MDCR_EL3.TPM](#)==1, accesses to this register from EL0, EL1, and EL2 are trapped to EL3.

G6.4.17 PMSWINC, Performance Monitors Software Increment register

The PMSWINC characteristics are:

Purpose

Increments a counter that is configured to count the Software increment event, event 0x00. For more information, see [SW_INCR](#).

Configurations

There is one instance of this register that is used in both Secure and Non-secure states.

AArch32 System register PMSWINC is architecturally mapped to AArch64 System register [PMSWINC_ELO](#).

AArch32 System register PMSWINC is architecturally mapped to External register [PMSWINC_ELO](#).

Attributes

PMSWINC is a 32-bit register.

Field descriptions

The PMSWINC bit assignments are:

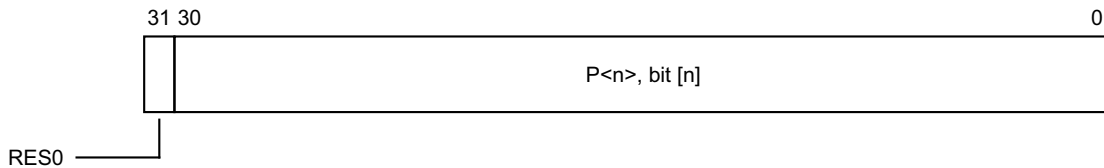

Bit [31]

Reserved, RES0.

P<n>, bit [n], for n = 0 to 30

Event counter software increment bit for [PMEVCNTR<n>](#).

Bits [30:N] are RAZ/WI. When EL2 is implemented, in Non-secure EL1 and EL0, N is the value in [MDCR_EL2.HPMN](#) if EL2 is using AArch64 or in [HDCR.HPMN](#) if EL2 is using AArch32. Otherwise, N is the value in [PMCR.N](#).

The effects of writing to this bit are:

- 0 No action. The write to this bit is ignored.
- 1 If [PMEVCNTR<n>](#) is enabled and configured to count the software increment event, increments [PMEVCNTR<n>](#) by 1. If [PMEVCNTR<n>](#) is disabled, or not configured to count the software increment event, the write to this bit is ignored.

Accessing the PMSWINC

This register can be read using MRC with the following syntax:

MRC <syntax>

This register can be written using MCR with the following syntax:

MCR <syntax>

This syntax is encoded with the following settings in the instruction encoding:

<syntax>	opc1	opc2	CRn	coproc	CRm
p15, 0, <Rt>, c9, c12, 4	000	100	1001	1111	1100

Accessibility

The register is accessible in software as follows:

Control			Accessibility			
E2H	TGE	NS	EL0	EL1	EL2	EL3
x	x	0	RW	RW	n/a	RW
x	0	1	RW	RW	RW	RW
x	1	1	RW	n/a	RW	RW

Traps and Enables

For a description of the prioritization of any generated exceptions, see [Synchronous exception prioritization for exceptions taken to AArch32 state on page G1-4344](#) for exceptions taken to AArch32 state and [Synchronous exception prioritization for exceptions taken to AArch64 on page D1-1827](#) for exceptions taken to AArch64 state. Subject to the prioritization rules:

- In both security states, and not dependent on other bits:
 - If `PMUSERENR.EN==0`, and `PMUSERENR.SW==0`, write accesses to this register from EL0 are trapped to Undefined mode.
 - If `PMUSERENR_EL0.EN==0`, and `PMUSERENR_EL0.SW==0`, write accesses to this register from EL0 are trapped to EL1.
- When EL2 is implemented and is using AArch64 and `(SCR_EL3.NS == 1) && (HCR_EL2.E2H == 0)`:
 - If `HSTR_EL2.T9==1`, Non-secure write accesses to this register from EL0 and EL1 are trapped to EL2.
- When EL2 is implemented and is using AArch64 and `SCR_EL3.NS == 1`:
 - If `MDCR_EL2.TPM==1`, Non-secure write accesses to this register from EL0 and EL1 are trapped to EL2.
- When EL2 is implemented and is using AArch64 and `(SCR_EL3.NS == 1) && (HCR_EL2.E2H == 1) && (HCR_EL2.TGE == 0)`:
 - If `HSTR_EL2.T9==1`, Non-secure write accesses to this register from EL0 and EL1 are trapped to EL2.
- When EL2 is implemented and is using AArch32 and `SCR_EL3.NS == 1`:
 - If `HDCR.TPM==1`, Non-secure write accesses to this register from EL0 and EL1 are trapped to Hyp mode.
 - If `HSTR.T9==1`, Non-secure write accesses to this register from EL0 and EL1 are trapped to Hyp mode.
- When EL3 is implemented and is using AArch64:
 - If `MDCR_EL3.TPM==1`, write accesses to this register from EL0, EL1, and EL2 are trapped to EL3.

G6.4.18 PMUSERENR, Performance Monitors User Enable Register

The PMUSERENR characteristics are:

Purpose

Enables or disables User mode access to the Performance Monitors.

Configurations

There is one instance of this register that is used in both Secure and Non-secure states.

AArch32 System register PMUSERENR is architecturally mapped to AArch64 System register [PMUSERENR_ELO](#).

This register is in the Warm reset domain. Some or all RW fields of this register have defined reset values. On a Warm or Cold reset these apply only if the PE resets into an Exception level that is using AArch32. Otherwise, on a Warm or Cold reset RW fields in this register reset to architecturally UNKNOWN values.

Attributes

PMUSERENR is a 32-bit register.

Field descriptions

The PMUSERENR bit assignments are:

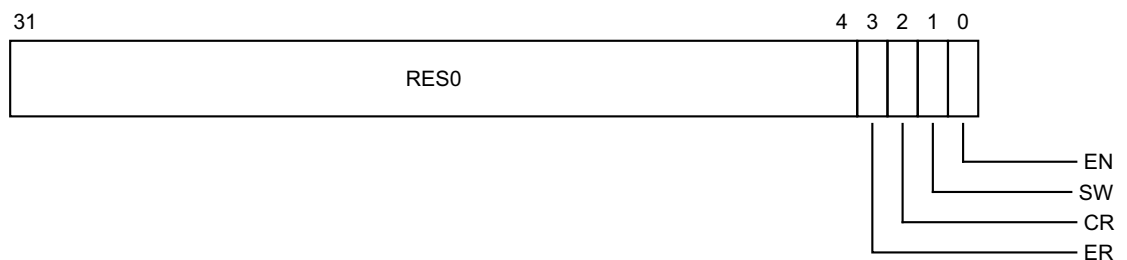

Bits [31:4]

Reserved, RES0.

ER, bit [3]

Event counter read trap control:

0 EL0 reads of the [PMXVCNTR](#) and [PMEVCNTR<n>](#), and EL0 read/write access to the [PMSELR](#), are trapped to Undefined mode if PMUSERENR.EN is also 0.

1 This control does not cause any instructions to be trapped.

When this register has an architecturally-defined reset value, this field resets to 0.

CR, bit [2]

Cycle counter read trap control:

0 EL0 reads of the [PMCCNTR](#) are trapped to Undefined mode if PMUSERENR.EN is also 0.

1 This control does not cause any instructions to be trapped.

When this register has an architecturally-defined reset value, this field resets to 0.

SW, bit [1]

Software increment write trap control:

0 EL0 writes to the [PMSWINC](#) are trapped to Undefined mode if PMUSERENR.EN is also 0.

1 This control does not cause any instructions to be trapped.
When this register has an architecturally-defined reset value, this field resets to 0.

EN, bit [0]

Traps EL0 accesses to the Performance Monitors registers to Undefined mode:

- 0 EL0 accesses to the Performance Monitors registers are trapped to Undefined mode, unless enabled by one of PMUSERENR.{ER, CR, SW}.
- 1 This control does not cause any instructions to be trapped. Software can access all PMU registers at EL0.

Note

- The PMUSERENR register is always RO at EL0 and not trapped by this bit.
- EL0 cannot read or write [PMINTENSET](#) and [PMINTENCLR](#).

When this register has an architecturally-defined reset value, this field resets to 0.

Accessing the PMUSERENR

This register can be read using MRC with the following syntax:

MRC <syntax>

This register can be written using MCR with the following syntax:

MCR <syntax>

This syntax is encoded with the following settings in the instruction encoding:

<syntax>	opc1	opc2	CRn	coproc	CRm
p15, 0, <Rt>, c9, c14, 0	000	000	1001	1111	1110

Accessibility

The register is accessible in software as follows:

Control			Accessibility			
E2H	TGE	NS	EL0	EL1	EL2	EL3
x	x	0	RO	RW	n/a	RW
x	0	1	RO	RW	RW	RW
x	1	1	RO	n/a	RW	RW

Traps and Enables

For a description of the prioritization of any generated exceptions, see [Synchronous exception prioritization for exceptions taken to AArch32 state on page G1-4344](#) for exceptions taken to AArch32 state and [Synchronous exception prioritization for exceptions taken to AArch64 on page D1-1827](#) for exceptions taken to AArch64 state. Subject to the prioritization rules:

- When EL2 is implemented and is using AArch64 and (SCR_EL3.NS == 1) && (HCR_EL2.E2H == 0):
 - If [HSTR_EL2.T9](#)==1, Non-secure accesses to this register from EL0 and EL1 are trapped to EL2.

- When EL2 is implemented and is using AArch64 and $SCR_EL3.NS == 1$:
 - If $MDCR_EL2.TPM == 1$, Non-secure accesses to this register from EL0 and EL1 are trapped to EL2.
- When EL2 is implemented and is using AArch64 and $(SCR_EL3.NS == 1) \&\& (HCR_EL2.E2H == 1) \&\& (HCR_EL2.TGE == 0)$:
 - If $HSTR_EL2.T9 == 1$, Non-secure write accesses to this register from EL1 are trapped to EL2.
- When EL2 is implemented and is using AArch32 and $SCR_EL3.NS == 1$:
 - If $HDCR.TPM == 1$, Non-secure accesses to this register from EL0 and EL1 are trapped to Hyp mode.
 - If $HSTR.T9 == 1$, Non-secure accesses to this register from EL0 and EL1 are trapped to Hyp mode.
- When EL3 is implemented and is using AArch64:
 - If $MDCR_EL3.TPM == 1$, accesses to this register from EL0, EL1, and EL2 are trapped to EL3.

G6.4.19 PMXEVNTR, Performance Monitors Selected Event Count Register

The PMXEVNTR characteristics are:

Purpose

Reads or writes the value of the selected event counter, [PMEVCNTR<n>](#). [PMSELR.SEL](#) determines which event counter is selected.

Configurations

There is one instance of this register that is used in both Secure and Non-secure states.

AArch32 System register PMXEVNTR is architecturally mapped to AArch64 System register [PMEVCNTR_ELO](#).

This register is in the Warm reset domain. On a Warm or Cold reset RW fields in this register reset to architecturally UNKNOWN values.

Attributes

PMXEVNTR is a 32-bit register.

Field descriptions

The PMXEVNTR bit assignments are:



PMEVCNTR<n>, bits [31:0]

Value of the selected event counter, [PMEVCNTR<n>](#), where n is the value stored in [PMSELR.SEL](#).

Accessing the PMXEVNTR

This register can be read using MRC with the following syntax:

MRC <syntax>

This register can be written using MCR with the following syntax:

MCR <syntax>

This syntax is encoded with the following settings in the instruction encoding:

<syntax>	opc1	opc2	CRn	coproc	CRm
p15, 0, <Rt>, c9, c13, 2	000	010	1001	1111	1101

Accessibility

The register is accessible in software as follows:

Control			Accessibility			
E2H	TGE	NS	EL0	EL1	EL2	EL3
x	x	0	RW	RW	n/a	RW
x	0	1	RW	RW	RW	RW
x	1	1	RW	n/a	RW	RW

If `PMSELR.SEL` is greater than or equal to the number of accessible counters then reads and writes of `PMXVCNTR` are CONstrained UNPREDICTABLE, and the following behaviors are permitted:

- Accesses to the register are UNDEFINED.
- Accesses to the register behave as RAZ/WI.
- Accesses to the register execute as a NOP.
- Accesses to the register behave as if `PMSELR.SEL` has an UNKNOWN value less than the number of counters accessible at the current Exception level and Security state.
- Accesses to the register behave as if `PMSELR.SEL` is 31.
- In Non-secure state, for an access from PL1 or a permitted access from PL0, if `PMSELR.SEL`, or `PMSELR_EL0.SEL` if EL1 is using AArch64, is greater than or equal to the number of accessible counters but is less than the number of implemented counters, the register access is trapped to EL2. Accesses from PL0 are permitted when:
 - EL1 is using AArch32 and the value of `PMUSERENR.EN` is 1.
 - EL1 is using AArch64 and the value of `PMUSERENR_EL0.EN` is 1.

Note

In an implementation that includes EL2, in Non-secure state at EL0 and EL1:

- If EL2 is using AArch32, `HDCR.HPMN` identifies the number of accessible counters.
- If EL2 is using AArch64, `MDCR_EL2.HPMN` identifies the number of accessible counters.

Otherwise, the number of accessible counters is the number of implemented counters.

Traps and Enables

For a description of the prioritization of any generated exceptions, see *Synchronous exception prioritization for exceptions taken to AArch32 state* on page G1-4344 for exceptions taken to AArch32 state and *Synchronous exception prioritization for exceptions taken to AArch64* on page D1-1827 for exceptions taken to AArch64 state. Subject to the prioritization rules:

- In both security states, and not dependent on other bits:
 - If `PMUSERENR.EN`==0, and `PMUSERENR.ER`==0, read accesses to this register from EL0 are trapped to Undefined mode.
 - If `PMUSERENR.EN`==0, write accesses to this register from EL0 are trapped to Undefined mode.
 - If `PMUSERENR_EL0.EN`==0, and `PMUSERENR_EL0.ER`==0, read accesses to this register from EL0 are trapped to EL1.
 - If `PMUSERENR_EL0.EN`==0, write accesses to this register from EL0 are trapped to EL1.

- When EL2 is implemented and is using AArch64 and $(SCR_EL3.NS == 1) \ \&\& \ (HCR_EL2.E2H == 0)$:
 - If $HSTR_EL2.T9 == 1$, Non-secure accesses to this register from EL0 and EL1 are trapped to EL2.
- When EL2 is implemented and is using AArch64 and $SCR_EL3.NS == 1$:
 - If $MDCR_EL2.TPM == 1$, Non-secure accesses to this register from EL0 and EL1 are trapped to EL2.
- When EL2 is implemented and is using AArch64 and $(SCR_EL3.NS == 1) \ \&\& \ (HCR_EL2.E2H == 1) \ \&\& \ (HCR_EL2.TGE == 0)$:
 - If $HSTR_EL2.T9 == 1$, Non-secure write accesses to this register from EL0 and EL1 are trapped to EL2.
- When EL2 is implemented and is using AArch32 and $SCR_EL3.NS == 1$:
 - If $HDCR.TPM == 1$, Non-secure accesses to this register from EL0 and EL1 are trapped to Hyp mode.
 - If $HSTR.T9 == 1$, Non-secure accesses to this register from EL0 and EL1 are trapped to Hyp mode.
- When EL3 is implemented and is using AArch64:
 - If $MDCR_EL3.TPM == 1$, accesses to this register from EL0, EL1, and EL2 are trapped to EL3.

G6.4.20 PMXEVTYPER, Performance Monitors Selected Event Type Register

The PMXEVTYPER characteristics are:

Purpose

When `PMSELR.SEL` selects an event counter, this accesses a `PMEVTYPER<n>` register. When `PMSELR.SEL` selects the cycle counter, this accesses `PMCCFILTR`.

Configurations

There is one instance of this register that is used in both Secure and Non-secure states.

AArch32 System register `PMXEVTYPER` is architecturally mapped to AArch64 System register `PMXEVTYPER_ELO`.

When the value of `PMSELR.SEL` is 31, to select the cycle counter, RW fields in this register have defined reset values that apply only when the PE resets into an Exception level that is using AArch32. See `PMCCFILTR` for the reset values.

Otherwise, RW fields in this register reset to IMPLEMENTATION DEFINED values that might be UNKNOWN. This applies whenever `PMSELR.SEL` selects an event counter.

Attributes

`PMXEVTYPER` is a 32-bit register.

Field descriptions

The `PMXEVTYPER` bit assignments are:

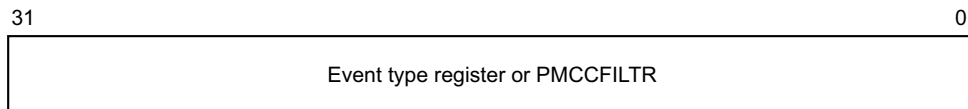

Bits [31:0]

Event type register or `PMCCFILTR`.

When `PMSELR.SEL` = 31, this register accesses `PMCCFILTR`.

Otherwise, this register accesses `PMEVTYPER<n>` where `n` is the value in `PMSELR.SEL`.

Accessing the PMXEVTYPER

This register can be read using MRC with the following syntax:

MRC <syntax>

This register can be written using MCR with the following syntax:

MCR <syntax>

This syntax is encoded with the following settings in the instruction encoding:

<syntax>	opc1	opc2	CRn	coproc	CRm
p15, 0, <Rt>, c9, c13, 1	000	001	1001	1111	1101

Accessibility

The register is accessible in software as follows:

Control			Accessibility			
E2H	TGE	NS	EL0	EL1	EL2	EL3
x	x	0	RW	RW	n/a	RW
x	0	1	RW	RW	RW	RW
x	1	1	RW	n/a	RW	RW

If `PMSELR.SEL` is greater than or equal to the number of accessible counters then reads and writes of `PMXEVTYPER` are **CONSTRAINED UNPREDICTABLE**, and the following behaviors are permitted:

- Accesses to the register are **UNDEFINED**.
- Accesses to the register behave as **RAZ/WI**.
- Accesses to the register execute as a **NOP**.
- Accesses to the register behave as if `PMSELR.SEL` has an **UNKNOWN** value less than the number of counters accessible at the current Exception level and Security state.
- Accesses to the register behave as if `PMSELR.SEL` is 31.
- In Non-secure state, for an access from PL1 or a permitted access from PL0, if `PMSELR.SEL`, or `PMSELR_EL0.SEL` if EL1 is using AArch64, is greater than or equal to the number of accessible counters but is less than the number of implemented counters, the register access is trapped to EL2. Accesses from PL0 are permitted when:
 - EL1 is using AArch32 and the value of `PMUSERENR.EN` is 1.
 - EL1 is using AArch64 and the value of `PMUSERENR_EL0.EN` is 1.

Note

In an implementation that includes EL2, in Non-secure state at EL0 and EL1:

- If EL2 is using AArch32, `HDCR.HPMN` identifies the number of accessible counters.
- If EL2 is using AArch64, `MDCR_EL2.HPMN` identifies the number of accessible counters.

Otherwise, the number of accessible counters is the number of implemented counters.

Traps and Enables

For a description of the prioritization of any generated exceptions, see *Synchronous exception prioritization for exceptions taken to AArch32 state* on page G1-4344 for exceptions taken to AArch32 state and *Synchronous exception prioritization for exceptions taken to AArch64* on page D1-1827 for exceptions taken to AArch64 state. Subject to the prioritization rules:

- In both security states, and not dependent on other bits:
 - If `PMUSERENR.EN`==0, accesses to this register from EL0 are trapped to Undefined mode.
 - If `PMUSERENR_EL0.EN`==0, accesses to this register from EL0 are trapped to EL1.
- When EL2 is implemented and is using AArch64 and `(SCR_EL3.NS == 1) && (HCR_EL2.E2H == 0)`:
 - If `HSTR_EL2.T9`==1, Non-secure accesses to this register from EL0 and EL1 are trapped to EL2.

- When EL2 is implemented and is using AArch64 and $SCR_EL3.NS == 1$:
 - If $MDCR_EL2.TPM == 1$, Non-secure accesses to this register from EL0 and EL1 are trapped to EL2.
- When EL2 is implemented and is using AArch64 and $(SCR_EL3.NS == 1) \&\& (HCR_EL2.E2H == 1) \&\& (HCR_EL2.TGE == 0)$:
 - If $HSTR_EL2.T9 == 1$, Non-secure write accesses to this register from EL0 and EL1 are trapped to EL2.
- When EL2 is implemented and is using AArch32 and $SCR_EL3.NS == 1$:
 - If $HDCR.TPM == 1$, Non-secure accesses to this register from EL0 and EL1 are trapped to Hyp mode.
 - If $HSTR.T9 == 1$, Non-secure accesses to this register from EL0 and EL1 are trapped to Hyp mode.
- When EL3 is implemented and is using AArch64:
 - If $MDCR_EL3.TPM == 1$, accesses to this register from EL0, EL1, and EL2 are trapped to EL3.

G6.5 Generic Timer registers

This section lists the Generic Timer registers in AArch32.

G6.5.1 CNTFRQ, Counter-timer Frequency register

The CNTFRQ characteristics are:

Purpose

This register is provided so that software can discover the frequency of the system counter. It must be programmed with this value as part of system initialization. The value of the register is not interpreted by hardware.

Configurations

There is one instance of this register that is used in both Secure and Non-secure states.

AArch32 System register CNTFRQ is architecturally mapped to AArch64 System register [CNTFRQ_EL0](#).

RW fields in this register reset to architecturally UNKNOWN values.

Attributes

CNTFRQ is a 32-bit register.

Field descriptions

The CNTFRQ bit assignments are:

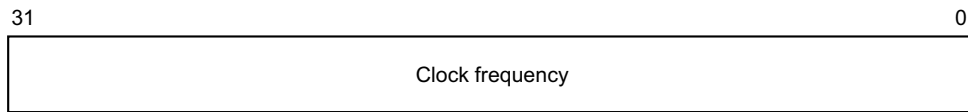

Bits [31:0]

Clock frequency. Indicates the system counter clock frequency, in Hz.

Accessing the CNTFRQ

This register can be read using MRC with the following syntax:

MRC <syntax>

This register can be written using MCR with the following syntax:

MCR <syntax>

This syntax is encoded with the following settings in the instruction encoding:

<syntax>	opc1	opc2	CRn	coproc	CRm
p15, 0, <Rt>, c14, c0, 0	000	000	1110	1111	0000

Accessibility

The register is accessible in software as follows:

Configuration	Control			Accessibility			
	E2H	TGE	NS	EL0	EL1	EL2	EL3
EL1 is the highest implemented Exception level.	x	x	x	RO	RW	n/a	n/a
EL2 is the highest implemented Exception level.	x	0	1	RO	RO	RW	n/a
EL2 is the highest implemented Exception level.	x	1	1	RO	n/a	RW	n/a
EL3 is the highest implemented Exception level.	x	x	0	RO	RO	RO	RW
EL3 is the highest implemented Exception level.	x	0	1	RO	RO	RO	RW
EL3 is the highest implemented Exception level.	x	1	1	RO	n/a	RO	RW

Traps and Enables

For a description of the prioritization of any generated exceptions, see [Synchronous exception prioritization for exceptions taken to AArch32 state on page G1-4344](#) for exceptions taken to AArch32 state and [Synchronous exception prioritization for exceptions taken to AArch64 on page D1-1827](#) for exceptions taken to AArch64 state. Subject to the prioritization rules:

- When $HCR_EL2.E2H == 0$:
 - If $CNTKCTL_EL1.EL0PCTEN == 0$, and $CNTKCTL_EL1.EL0VCTEN == 0$, read accesses to this register from EL0 are trapped to EL1.
 - If $CNTKCTL.PL0PCTEN == 0$, and $CNTKCTL.PL0VCTEN == 0$, read accesses to this register from EL0 are trapped to Undefined mode.
- When EL2 is implemented and is using AArch64 and $(SCR_EL3.NS == 1) \&\& (HCR_EL2.E2H == 1) \&\& (HCR_EL2.TGE == 0)$:
 - If $CNTKCTL_EL1.EL0PCTEN == 0$, and $CNTKCTL_EL1.EL0VCTEN == 0$, Non-secure read accesses to this register from EL0 are trapped to EL1.
 - If $CNTKCTL.PL0PCTEN == 0$, and $CNTKCTL.PL0VCTEN == 0$, Non-secure read accesses to this register from EL0 are trapped to Undefined mode.
- When EL2 is implemented and is using AArch64 and $(SCR_EL3.NS == 1) \&\& (HCR_EL2.E2H == 1) \&\& (HCR_EL2.TGE == 1)$:
 - If $CNTHCTL_EL2.EL0PCTEN == 0$, and $CNTHCTL_EL2.EL0VCTEN == 0$, Non-secure read accesses to this register from EL0 are trapped to EL2.

G6.5.2 CNTHCTL, Counter-timer Hyp Control register

The CNTHCTL characteristics are:

Purpose

Controls the generation of an event stream from the physical counter, and access from Non-secure EL1 modes to the physical counter and the Non-secure EL1 physical timer.

Configurations

AArch32 System register CNTHCTL is architecturally mapped to AArch64 System register [CNTHCTL_EL2](#).

If EL2 is not implemented, this register is RES0 from EL3.

RW fields in this register reset to architecturally UNKNOWN values.

Attributes

CNTHCTL is a 32-bit register.

Field descriptions

The CNTHCTL bit assignments are:

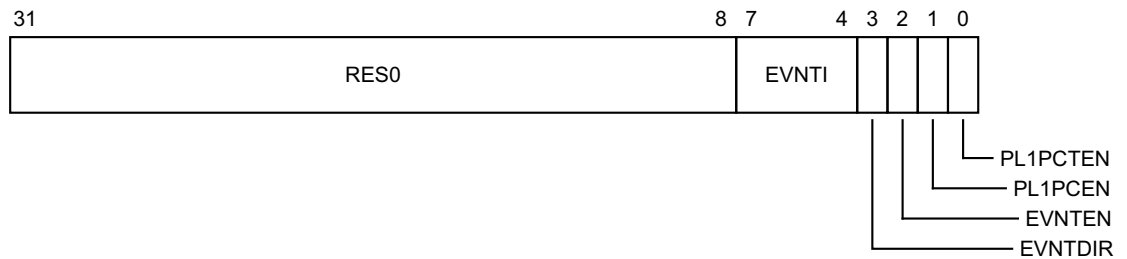

Bits [31:8]

Reserved, RES0.

EVNTI, bits [7:4]

Selects which bit (0 to 15) of the counter register [CNTPCT](#) is the trigger for the event stream generated from that counter, when that stream is enabled.

EVNTDIR, bit [3]

Controls which transition of the counter register [CNTPCT](#) trigger bit, defined by EVNTI, generates an event when the event stream is enabled:

- 0 A 0 to 1 transition of the trigger bit triggers an event.
- 1 A 1 to 0 transition of the trigger bit triggers an event.

EVNTEN, bit [2]

Enables the generation of an event stream from the counter register [CNTPCT](#):

- 0 Disables the event stream.
- 1 Enables the event stream.

PL1PCEN, bit [1]

Traps Non-secure EL0 and EL1 accesses to the physical timer registers to Hyp mode.

- 0 Non-secure EL0 and EL1 accesses to the [CNTP_CTL](#), [CNTP_CVAL](#), and [CNTP_TVAL](#) are trapped to Hyp mode, unless the it is trapped by [CNTKCTL.PL0PTEN](#).

1 This control does not cause any instructions to be trapped.

If EL3 is implemented and EL2 is not implemented, behavior is as if this bit is 1 other than for the purpose of a direct read.

PL1PCTEN, bit [0]

Traps Non-secure EL0 and EL1 accesses to the physical counter register to Hyp mode.

0 Non-secure EL0 and EL1 accesses to the **CNTPCT** are trapped to Hyp mode, unless it is trapped by **CNTKCTL.PL0PCTEN**.

1 This control does not cause any instructions to be trapped.

If EL3 is implemented and EL2 is not implemented, behavior is as if this bit is 1 other than for the purpose of a direct read.

Accessing the CNTHCTL

This register can be read using MRC with the following syntax:

MRC <syntax>

This register can be written using MCR with the following syntax:

MCR <syntax>

This syntax is encoded with the following settings in the instruction encoding:

<syntax>	opc1	opc2	CRn	coproc	CRm
p15, 4, <Rt>, c14, c1, 0	100	000	1110	1111	0001

Accessibility

The register is accessible in software as follows:

Control			Accessibility			
E2H	TGE	NS	EL0	EL1	EL2	EL3
x	x	0	-	-	n/a	-
x	0	1	-	-	RW	RW
x	1	1	-	n/a	RW	RW

G6.5.3 CNTHP_CTL, Counter-timer Hyp Physical Timer Control register

The CNTHP_CTL characteristics are:

Purpose

Control register for the Hyp mode physical timer.

Configurations

AArch32 System register CNTHP_CTL is architecturally mapped to AArch64 System register [CNTHP_CTL_EL2](#).

If EL2 is not implemented, this register is RES0 from EL3.

Some or all RW fields of this register have defined reset values. These apply only if the PE resets into EL2 with EL2 using AArch32, or into EL3 with EL3 using AArch32. Otherwise, RW fields in this register reset to architecturally UNKNOWN values.

Attributes

CNTHP_CTL is a 32-bit register.

Field descriptions

The CNTHP_CTL bit assignments are:

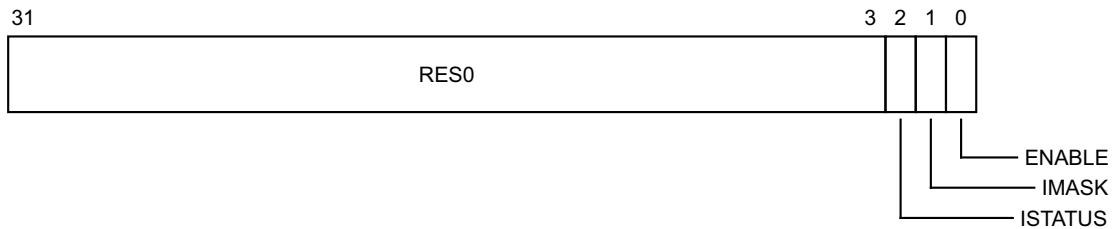

Bits [31:3]

Reserved, RES0.

ISTATUS, bit [2]

The status of the timer. This bit indicates whether the timer condition is met:

- 0 Timer condition is not met.
- 1 Timer condition is met.

When the value of the ENABLE bit is 1, ISTATUS indicates whether the timer condition is met. ISTATUS takes no account of the value of the IMASK bit. If the value of ISTATUS is 1 and the value of IMASK is 0 then the timer interrupt is asserted.

When the value of the ENABLE bit is 0, the ISTATUS field is UNKNOWN.

For more information see [Operation of the CompareValue views of the timers on page D6-2187](#) and [Operation of the TimerValue views of the timers on page D6-2188](#).

This bit is read-only.

This field resets to a value that is architecturally UNKNOWN.

IMASK, bit [1]

Timer interrupt mask bit. Permitted values are:

- 0 Timer interrupt is not masked by the IMASK bit.
- 1 Timer interrupt is masked by the IMASK bit.

For more information, see the description of the ISTATUS bit.

This field resets to a value that is architecturally UNKNOWN.

ENABLE, bit [0]

Enables the timer. Permitted values are:

- 0 Timer disabled.
- 1 Timer enabled.

Setting this bit to 0 disables the timer output signal, but the timer value accessible from [CNTHP_TVAL](#) continues to count down.

———— Note ————

Disabling the output signal might be a power-saving option.

When this register has an architecturally-defined reset value, this field resets to 0.

Accessing the CNTHP_CTL

This register can be read using MRC with the following syntax:

MRC <syntax>

This register can be written using MCR with the following syntax:

MCR <syntax>

This syntax is encoded with the following settings in the instruction encoding:

<syntax>	opc1	opc2	CRn	coproc	CRm
p15, 4, <Rt>, c14, c2, 1	100	001	1110	1111	0010
p15, 0, <Rt>, c14, c2, 1	000	001	1110	1111	0010

Accessibility

The register is accessible in software as follows:

<syntax>	Control			Accessibility			
	E2H	TGE	NS	EL0	EL1	EL2	EL3
p15, 4, <Rt>, c14, c2, 1	x	x	0	-	-	n/a	-
p15, 4, <Rt>, c14, c2, 1	x	0	1	-	-	RW	RW
p15, 4, <Rt>, c14, c2, 1	x	1	1	-	n/a	RW	RW
p15, 0, <Rt>, c14, c2, 1	x	x	0	CNTP_CTL	CNTP_CTL	n/a	CNTP_CTL
p15, 0, <Rt>, c14, c2, 1	0	0	1	CNTP_CTL	CNTP_CTL	CNTP_CTL	CNTP_CTL
p15, 0, <Rt>, c14, c2, 1	0	1	1	CNTP_CTL	n/a	CNTP_CTL	CNTP_CTL
p15, 0, <Rt>, c14, c2, 1	1	0	1	CNTP_CTL	CNTP_CTL	n/a	n/a
p15, 0, <Rt>, c14, c2, 1	1	1	1	RW	n/a	n/a	n/a

This table applies to all instructions that can access this register.

Traps and Enables

For a description of the prioritization of any generated exceptions, see *Synchronous exception prioritization for exceptions taken to AArch32 state* on page G1-4344 for exceptions taken to AArch32 state and *Synchronous exception prioritization for exceptions taken to AArch64* on page D1-1827 for exceptions taken to AArch64 state. Subject to the prioritization rules:

- When EL2 is implemented and is using AArch64 and $(SCR_EL3.NS == 1) \ \&\& \ (HCR_EL2.E2H == 1) \ \&\& \ (HCR_EL2.TGE == 1)$:
 - If $CNTHCTL_EL2.EL0PTEN == 0$, Non-secure accesses to this register from EL0 are trapped to EL2.

G6.5.4 CNTHP_CVAL, Counter-timer Hyp Physical CompareValue register

The CNTHP_CVAL characteristics are:

Purpose

Holds the compare value for the Hyp mode physical timer.

Configurations

AArch32 System register CNTHP_CVAL is architecturally mapped to AArch64 System register [CNTHP_CVAL_EL2](#).

If EL2 is not implemented, this register is RES0 from EL3.

RW fields in this register reset to architecturally UNKNOWN values.

Attributes

CNTHP_CVAL is a 64-bit register.

Field descriptions

The CNTHP_CVAL bit assignments are:

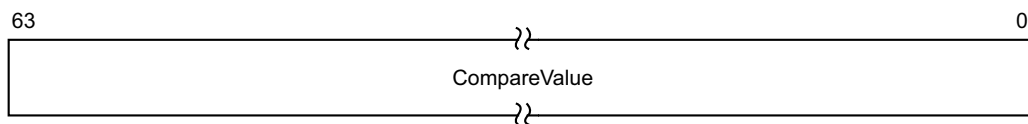

CompareValue, bits [63:0]

Holds the EL2 physical timer CompareValue.

When [CNTHP_CTL.ENABLE](#) is 1, the timer condition is met when ([CNTPCT](#) - CompareValue) is greater than zero. This means that CompareValue acts like a 64-bit upcounter timer. When the timer condition is met:

- [CNTHP_CTL.ISTATUS](#) is set to 1.
- If [CNTHP_CTL.IMASK](#) is 0, an interrupt is generated.

When [CNTHP_CTL.ENABLE](#) is 0, the timer condition is not met, but [CNTPCT](#) continues to count.

Accessing the CNTHP_CVAL

This register can be read using MRRC with the following syntax:

MRRC <syntax>

This register can be written using MCRR with the following syntax:

MCRR <syntax>

This syntax is encoded with the following settings in the instruction encoding:

<syntax>	opc1	coproc	CRm
p15, 6, <Rt>, <Rt2>, c14	0110	1111	1110
p15, 2, <Rt>, <Rt2>, c14	0010	1111	1110

Accessibility

The register is accessible in software as follows:

<syntax>	Control			Accessibility			
	E2H	TGE	NS	EL0	EL1	EL2	EL3
p15, 6, <Rt>, <Rt2>, c14	x	x	0	-	-	n/a	-
p15, 6, <Rt>, <Rt2>, c14	x	0	1	-	-	RW	RW
p15, 6, <Rt>, <Rt2>, c14	x	1	1	-	n/a	RW	RW
p15, 2, <Rt>, <Rt2>, c14	x	x	0	CNTP_CVAL	CNTP_CVAL	n/a	CNTP_CVAL
p15, 2, <Rt>, <Rt2>, c14	0	0	1	CNTP_CVAL	CNTP_CVAL	CNTP_CVAL	CNTP_CVAL
p15, 2, <Rt>, <Rt2>, c14	0	1	1	CNTP_CVAL	n/a	CNTP_CVAL	CNTP_CVAL
p15, 2, <Rt>, <Rt2>, c14	1	0	1	CNTP_CVAL	CNTP_CVAL	n/a	n/a
p15, 2, <Rt>, <Rt2>, c14	1	1	1	RW	n/a	n/a	n/a

This table applies to all instructions that can access this register.

Traps and Enables

For a description of the prioritization of any generated exceptions, see *Synchronous exception prioritization for exceptions taken to AArch32 state* on page G1-4344 for exceptions taken to AArch32 state and *Synchronous exception prioritization for exceptions taken to AArch64* on page D1-1827 for exceptions taken to AArch64 state. Subject to the prioritization rules:

- When EL2 is implemented and is using AArch64 and (SCR_EL3.NS == 1) && (HCR_EL2.E2H == 1) && (HCR_EL2.TGE == 1):
 - If CNTHCTL_EL2.ELOPTEN==0, Non-secure accesses to this register from EL0 are trapped to EL2.

G6.5.5 CNTHP_TVAL, Counter-timer Hyp Physical Timer TimerValue register

The CNTHP_TVAL characteristics are:

Purpose

Holds the timer value for the Hyp mode physical timer.

Configurations

AArch32 System register CNTHP_TVAL is architecturally mapped to AArch64 System register [CNTHP_TVAL_EL2](#).

If EL2 is not implemented, this register is RES0 from EL3.

RW fields in this register reset to architecturally UNKNOWN values.

Attributes

CNTHP_TVAL is a 32-bit register.

Field descriptions

The CNTHP_TVAL bit assignments are:

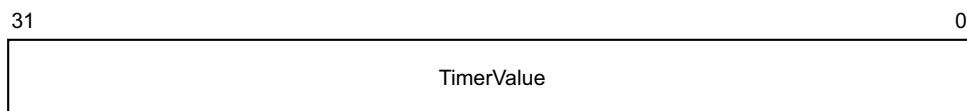

TimerValue, bits [31:0]

The TimerValue view of the EL2 physical timer.

On a read of this register:

- If [CNTHP_CTL.ENABLE](#) is 0, the value returned is UNKNOWN.
- If [CNTHP_CTL.ENABLE](#) is 1, the value returned is ([CNTHP_CVAL](#) - [CNTPCT](#)).

On a write of this register, [CNTHP_CVAL](#) is set to ([CNTPCT](#) + TimerValue), where TimerValue is treated as a signed 32-bit integer.

When [CNTHP_CTL.ENABLE](#) is 1, the timer condition is met when ([CNTPCT](#) - [CNTHP_CVAL](#)) is greater than zero. This means that TimerValue acts like a 32-bit downcounter timer. When the timer condition is met:

- [CNTHP_CTL.ISTATUS](#) is set to 1.
- If [CNTHP_CTL.IMASK](#) is 0, an interrupt is generated.

When [CNTHP_CTL.ENABLE](#) is 0, the timer condition is not met, but [CNTPCT](#) continues to count, so the TimerValue view appears to continue to count down.

Accessing the CNTHP_TVAL

This register can be read using MRC with the following syntax:

```
MRC <syntax>
```

This register can be written using MCR with the following syntax:

```
MCR <syntax>
```

This syntax is encoded with the following settings in the instruction encoding:

<syntax>	opc1	opc2	CRn	coproc	CRm
p15, 4, <Rt>, c14, c2, 0	100	000	1110	1111	0010
p15, 0, <Rt>, c14, c2, 0	000	000	1110	1111	0010

Accessibility

The register is accessible in software as follows:

<syntax>	Control			Accessibility			
	E2H	TGE	NS	EL0	EL1	EL2	EL3
p15, 4, <Rt>, c14, c2, 0	x	x	0	-	-	n/a	-
p15, 4, <Rt>, c14, c2, 0	x	0	1	-	-	RW	RW
p15, 4, <Rt>, c14, c2, 0	x	1	1	-	n/a	RW	RW
p15, 0, <Rt>, c14, c2, 0	x	x	0	CNTP_TVAL	CNTP_TVAL	n/a	CNTP_TVAL
p15, 0, <Rt>, c14, c2, 0	0	0	1	CNTP_TVAL	CNTP_TVAL	CNTP_TVAL	CNTP_TVAL
p15, 0, <Rt>, c14, c2, 0	0	1	1	CNTP_TVAL	n/a	CNTP_TVAL	CNTP_TVAL
p15, 0, <Rt>, c14, c2, 0	1	0	1	CNTP_TVAL	CNTP_TVAL	n/a	n/a
p15, 0, <Rt>, c14, c2, 0	1	1	1	RW	n/a	n/a	n/a

This table applies to all instructions that can access this register.

Traps and Enables

For a description of the prioritization of any generated exceptions, see [Synchronous exception prioritization for exceptions taken to AArch32 state on page G1-4344](#) for exceptions taken to AArch32 state and [Synchronous exception prioritization for exceptions taken to AArch64 on page D1-1827](#) for exceptions taken to AArch64 state. Subject to the prioritization rules:

- When EL2 is implemented and is using AArch64 and (SCR_EL3.NS == 1) && (HCR_EL2.E2H == 1) && (HCR_EL2.TGE == 1):
 - If CNTHCTL_EL2.EL0PTEN==0, Non-secure accesses to this register from EL0 are trapped to EL2.

G6.5.6 CNTHV_CTL, Counter-timer Virtual Timer Control register (EL2)

The CNTHV_CTL characteristics are:

Purpose

Provides AArch32 access to the control register for the EL2 virtual timer.

Note

The EL2 virtual timer is implemented by [ARMv8.1-VHE](#). It is only accessible from AArch32 state when EL0 is using AArch32, EL2 is using AArch64, and the value of [HCR_EL2](#).{E2H, TGE} is {1, 1}.

Configurations

There is one instance of this register that is used in both Secure and Non-secure states.

AArch32 System register CNTHV_CTL is architecturally mapped to AArch64 System register [CNTHV_CTL_EL2](#).

This register is introduced in ARMv8.1.

Attributes

CNTHV_CTL is a 32-bit register.

Field descriptions

The CNTHV_CTL bit assignments are:

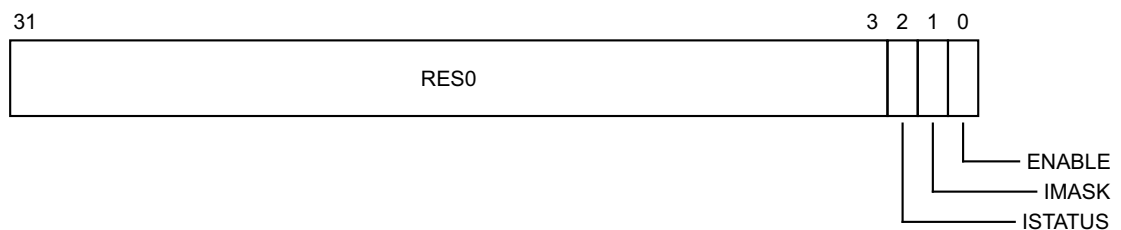

Bits [31:3]

Reserved, RES0.

ISTATUS, bit [2]

The status of the timer. This bit indicates whether the timer condition is met:

- 0 Timer condition is not met.
- 1 Timer condition is met.

When the value of the ENABLE bit is 1, ISTATUS indicates whether the timer condition is met. ISTATUS takes no account of the value of the IMASK bit. If the value of ISTATUS is 1 and the value of IMASK is 0 then the timer interrupt is asserted.

When the value of the ENABLE bit is 0, the ISTATUS field is UNKNOWN.

For more information see [Operation of the CompareValue views of the timers on page D6-2187](#) and [Operation of the TimerValue views of the timers on page D6-2188](#).

This bit is read-only.

IMASK, bit [1]

Timer interrupt mask bit. Permitted values are:

- 0 Timer interrupt is not masked by the IMASK bit.
- 1 Timer interrupt is masked by the IMASK bit.

For more information, see the description of the ISTATUS bit.

ENABLE, bit [0]

Enables the timer. Permitted values are:

- 0 Timer disabled.
- 1 Timer enabled.

Setting this bit to 0 disables the timer output signal, but the timer value accessible from [CNTHV_TVAL](#) continues to count down.

Note

Disabling the output signal might be a power-saving option.

Accessing the CNTHV_CTL

This register can be read using MRC with the following syntax:

MRC <syntax>

This register can be written using MCR with the following syntax:

MCR <syntax>

This syntax is encoded with the following settings in the instruction encoding:

<syntax>	opc1	opc2	CRn	coproc	CRm
p15, 0, <Rt>, c14, c3, 1	000	001	1110	1111	0011

This register is accessed using the encoding for [CNTV_CTL](#).

Accessibility

The register is accessible in software as follows:

Control			Accessibility			
E2H	TGE	NS	EL0	EL1	EL2	EL3
x	x	0	CNTV_CTL	CNTV_CTL	n/a	CNTV_CTL
0	0	1	CNTV_CTL	CNTV_CTL	CNTV_CTL	CNTV_CTL
0	1	1	CNTV_CTL	n/a	CNTV_CTL	CNTV_CTL
1	0	1	CNTV_CTL	CNTV_CTL	n/a	n/a
1	1	1	RW	n/a	n/a	n/a

Traps and Enables

For a description of the prioritization of any generated exceptions, see *Synchronous exception prioritization for exceptions taken to AArch32 state* on page G1-4344 for exceptions taken to AArch32 state and *Synchronous exception prioritization for exceptions taken to AArch64* on page D1-1827 for exceptions taken to AArch64 state. Subject to the prioritization rules:

- When EL2 is implemented and is using AArch64 and $(SCR_EL3.NS == 1) \ \&\& \ (HCR_EL2.E2H == 1) \ \&\& \ (HCR_EL2.TGE == 1)$:
 - If $CNTHCTL_EL2.EL0VTEN == 0$, Non-secure accesses to this register from EL0 are trapped to EL2.

G6.5.7 CNTHV_CVAL, Counter-timer Virtual Timer CompareValue register (EL2)

The CNTHV_CVAL characteristics are:

Purpose

Provides AArch32 access to the compare value for the EL2 virtual timer.

Note

The EL2 virtual timer is implemented by [ARMv8.1-VHE](#). It is only accessible from AArch32 state when EL0 is using AArch32, EL2 is using AArch64, and the value of [HCR_EL2](#).{E2H, TGE} is {1, 1}.

Configurations

There is one instance of this register that is used in both Secure and Non-secure states.

AArch32 System register CNTHV_CVAL is architecturally mapped to AArch64 System register [CNTHV_CVAL_EL2](#).

This register is introduced in ARMv8.1.

Attributes

CNTHV_CVAL is a 64-bit register.

Field descriptions

The CNTHV_CVAL bit assignments are:

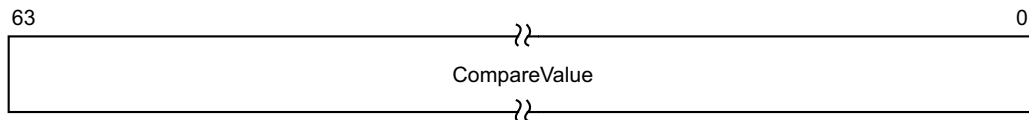

CompareValue, bits [63:0]

Holds the EL2 virtual timer CompareValue.

When [CNTHV_CTL](#).ENABLE is 1, the timer condition is met when ([CNTVCT](#) - CompareValue) is greater than zero. This means that CompareValue acts like a 64-bit upcounter timer. When the timer condition is met:

- [CNTHV_CTL](#).ISTATUS is set to 1.
- If [CNTHV_CTL](#).IMASK is 0, an interrupt is generated.

When [CNTHV_CTL](#).ENABLE is 0, the timer condition is not met, but [CNTVCT](#) continues to count.

Accessing the CNTHV_CVAL

This register can be read using MRRC with the following syntax:

MRRC <syntax>

This register can be written using MCRR with the following syntax:

MCRR <syntax>

This syntax is encoded with the following settings in the instruction encoding:

<syntax>	opc1	coproc	CRm
p15, 3, <Rt>, <Rt2>, c14	0011	1111	1110

Accessibility

The register is accessible in software as follows:

Control			Accessibility			
E2H	TGE	NS	EL0	EL1	EL2	EL3
x	x	0	CNTV_CVAL	CNTV_CVAL	n/a	CNTV_CVAL
0	0	1	CNTV_CVAL	CNTV_CVAL	CNTV_CVAL	CNTV_CVAL
0	1	1	CNTV_CVAL	n/a	CNTV_CVAL	CNTV_CVAL
1	0	1	CNTV_CVAL	CNTV_CVAL	n/a	n/a
1	1	1	RW	n/a	n/a	n/a

Traps and Enables

For a description of the prioritization of any generated exceptions, see [Synchronous exception prioritization for exceptions taken to AArch32 state on page G1-4344](#) for exceptions taken to AArch32 state and [Synchronous exception prioritization for exceptions taken to AArch64 on page D1-1827](#) for exceptions taken to AArch64 state. Subject to the prioritization rules:

- When EL2 is implemented and is using AArch64 and (SCR_EL3.NS == 1) && (HCR_EL2.E2H == 1) && (HCR_EL2.TGE == 1):
 - If CNTHCTL_EL2.EL0VTEN==0, Non-secure accesses to this register from EL0 are trapped to EL2.

G6.5.8 CNTHV_TVAL, Counter-timer Virtual Timer TimerValue register (EL2)

The CNTHV_TVAL characteristics are:

Purpose

Provides AArch32 access to the timer value for the EL2 virtual timer.

Note

The EL2 virtual timer is implemented by [ARMv8.1-VHE](#). It is only accessible from AArch32 state when EL0 is using AArch32, EL2 is using AArch64, and the value of [HCR_EL2](#).{E2H, TGE} is {1, 1}.

Configurations

There is one instance of this register that is used in both Secure and Non-secure states.

AArch32 System register CNTHV_TVAL is architecturally mapped to AArch64 System register [CNTHV_TVAL_EL2](#).

This register is introduced in ARMv8.1.

Attributes

CNTHV_TVAL is a 32-bit register.

Field descriptions

The CNTHV_TVAL bit assignments are:

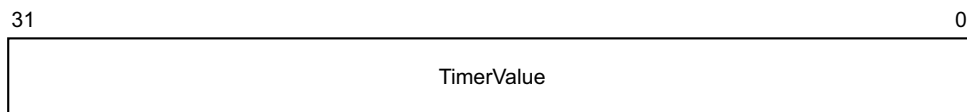

TimerValue, bits [31:0]

The TimerValue view of the EL2 virtual timer.

On a read of this register:

- If [CNTHV_CTL.ENABLE](#) is 0, the value returned is UNKNOWN.
- If [CNTHV_CTL.ENABLE](#) is 1, the value returned is $(\text{CNTHV_CVAL} - \text{CNTVCT})$.

On a write of this register, [CNTHV_CVAL](#) is set to $(\text{CNTVCT} + \text{TimerValue})$, where TimerValue is treated as a signed 32-bit integer.

When [CNTHV_CTL.ENABLE](#) is 1, the timer condition is met when $(\text{CNTVCT} - \text{CNTHV_CVAL})$ is greater than zero. This means that TimerValue acts like a 32-bit downcounter timer. When the timer condition is met:

- [CNTV_CTL.ISTATUS](#) is set to 1.
- If [CNTV_CTL.IMASK](#) is 0, an interrupt is generated.

When [CNTV_CTL.ENABLE](#) is 0, the timer condition is not met, but [CNTVCT](#) continues to count, so the TimerValue view appears to continue to count down.

Accessing the CNTHV_TVAL

This register can be read using MRC with the following syntax:

MRC <syntax>

This register can be written using MCR with the following syntax:

MCR <syntax>

This syntax is encoded with the following settings in the instruction encoding:

<syntax>	opc1	opc2	CRn	coproc	CRm
p15, 0, <Rt>, c14, c3, 0	000	000	1110	1111	0011

This register is accessed using the encoding for [CNTV_TVAL](#).

Accessibility

The register is accessible in software as follows:

Control			Accessibility			
E2H	TGE	NS	EL0	EL1	EL2	EL3
x	x	0	CNTV_TVAL	CNTV_TVAL	n/a	CNTV_TVAL
0	0	1	CNTV_TVAL	CNTV_TVAL	CNTV_TVAL	CNTV_TVAL
0	1	1	CNTV_TVAL	n/a	CNTV_TVAL	CNTV_TVAL
1	0	1	CNTV_TVAL	CNTV_TVAL	n/a	n/a
1	1	1	RW	n/a	n/a	n/a

Traps and Enables

For a description of the prioritization of any generated exceptions, see [Synchronous exception prioritization for exceptions taken to AArch32 state on page G1-4344](#) for exceptions taken to AArch32 state and [Synchronous exception prioritization for exceptions taken to AArch64 on page D1-1827](#) for exceptions taken to AArch64 state. Subject to the prioritization rules:

- When EL2 is implemented and is using AArch64 and (SCR_EL3.NS == 1) && (HCR_EL2.E2H == 1) && (HCR_EL2.TGE == 1):
 - If [CNTHCTL_EL2.EL0VTEN](#)==0, Non-secure accesses to this register from EL0 are trapped to EL2.

G6.5.9 CNTKCTL, Counter-timer Kernel Control register

The CNTKCTL characteristics are:

Purpose

Controls the generation of an event stream from the virtual counter, and access from EL0 modes to the physical counter, virtual counter, EL1 physical timers, and the virtual timer.

Configurations

There is one instance of this register that is used in both Secure and Non-secure states.

AArch32 System register CNTKCTL is architecturally mapped to AArch64 System register [CNTKCTL_EL1](#).

RW fields in this register reset to architecturally UNKNOWN values.

Attributes

CNTKCTL is a 32-bit register.

Field descriptions

The CNTKCTL bit assignments are:

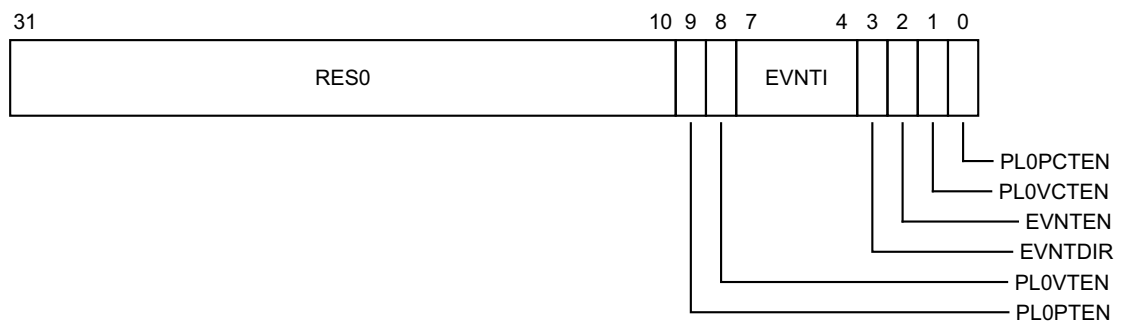

Bits [31:10]

Reserved, RES0.

PL0PTEN, bit [9]

Traps PL0 accesses to the physical timer registers to Undefined mode.

0 PL0 accesses to the [CNTP_CTL](#), [CNTP_CVAL](#), and [CNTP_TVAL](#) registers are trapped to Undefined mode.

1 This control does not cause any instructions to be trapped.

PL0VTEN, bit [8]

Traps PL0 accesses to the virtual timer registers to Undefined mode.

0 PL0 accesses to the [CNTV_CTL](#), [CNTV_CVAL](#), and [CNTV_TVAL](#) registers are trapped to Undefined mode.

1 This control does not cause any instructions to be trapped.

EVNTI, bits [7:4]

Selects which bit (0 to 15) of the counter register [CNTVCT](#) is the trigger for the event stream generated from that counter, when that stream is enabled.

EVNTDIR, bit [3]

Controls which transition of the counter register **CNTVCT** trigger bit, defined by EVNTI, generates an event when the event stream is enabled:

- 0 A 0 to 1 transition of the trigger bit triggers an event.
- 1 A 1 to 0 transition of the trigger bit triggers an event.

EVNTEN, bit [2]

Enables the generation of an event stream from the counter register **CNTVCT**:

- 0 Disables the event stream.
- 1 Enables the event stream.

PL0VCTEN, bit [1]

Traps PL0 accesses to the frequency register and virtual counter register to Undefined mode.

- 0 PL0 accesses to the **CNTVCT** are trapped to Undefined mode.
PL0 accesses to the **CNTFRQ** register are trapped to Undefined mode, if **CNTKCTL.PL0PCTEN** is also 0.
- 1 This control does not cause any instructions to be trapped.

PL0PCTEN, bit [0]

Traps PL0 accesses to the frequency register and physical counter register to Undefined mode.

- 0 PL0 accesses to the **CNTPCT** are trapped to Undefined mode.
PL0 accesses to the **CNTFRQ** register are trapped to Undefined mode, if **CNTKCTL.PL0VCTEN** is also 0.
- 1 This control does not cause any instructions to be trapped.

Accessing the CNTKCTL

This register can be read using MRC with the following syntax:

MRC <syntax>

This register can be written using MCR with the following syntax:

MCR <syntax>

This syntax is encoded with the following settings in the instruction encoding:

<syntax>	opc1	opc2	CRn	coproc	CRm
p15, 0, <Rt>, c14, c1, 0	000	000	1110	1111	0001

Accessibility

The register is accessible in software as follows:

Control			Accessibility			
E2H	TGE	NS	EL0	EL1	EL2	EL3
x	x	0	-	RW	n/a	RW
x	0	1	-	RW	RW	RW
x	1	1	-	n/a	RW	RW

G6.5.10 CNTP_CTL, Counter-timer Physical Timer Control register

The CNTP_CTL characteristics are:

Purpose

Control register for the EL1 physical timer.

Configurations

AArch32 System register CNTP_CTL is architecturally mapped to AArch64 System register [CNTP_CTL_ELO](#).

Some or all RW fields of this register have defined reset values. These apply only if the PE resets into an Exception level that is using AArch32. If the PE resets into EL3 using AArch32 they apply only to the Secure instance of the register. Otherwise, RW fields in this register reset to architecturally UNKNOWN values.

Attributes

CNTP_CTL is a 32-bit register.

Field descriptions

The CNTP_CTL bit assignments are:

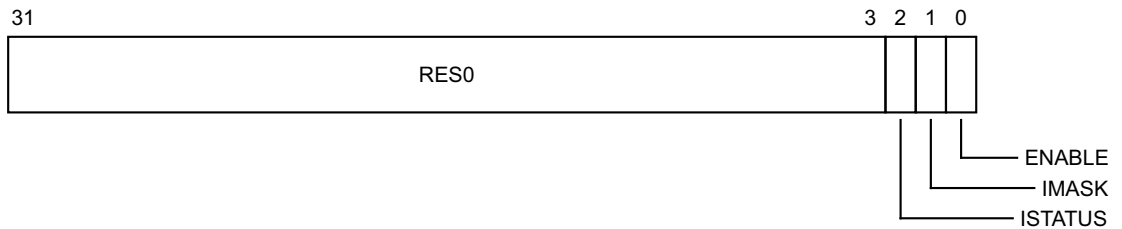

Bits [31:3]

Reserved, RES0.

ISTATUS, bit [2]

The status of the timer. This bit indicates whether the timer condition is met:

- 0 Timer condition is not met.
- 1 Timer condition is met.

When the value of the ENABLE bit is 1, ISTATUS indicates whether the timer condition is met. ISTATUS takes no account of the value of the IMASK bit. If the value of ISTATUS is 1 and the value of IMASK is 0 then the timer interrupt is asserted.

When the value of the ENABLE bit is 0, the ISTATUS field is UNKNOWN.

For more information see [Operation of the CompareValue views of the timers on page D6-2187](#) and [Operation of the TimerValue views of the timers on page D6-2188](#).

This bit is read-only.

This field resets to a value that is architecturally UNKNOWN.

IMASK, bit [1]

Timer interrupt mask bit. Permitted values are:

- 0 Timer interrupt is not masked by the IMASK bit.
- 1 Timer interrupt is masked by the IMASK bit.

For more information, see the description of the ISTATUS bit.

This field resets to a value that is architecturally UNKNOWN.

ENABLE, bit [0]

Enables the timer. Permitted values are:

- 0 Timer disabled.
- 1 Timer enabled.

Setting this bit to 0 disables the timer output signal, but the timer value accessible from [CNTP_TVAL](#) continues to count down.

———— Note ————

Disabling the output signal might be a power-saving option.

When this register has an architecturally-defined reset value, this field resets to 0.

Accessing the CNTP_CTL

This register can be read using MRC with the following syntax:

MRC <syntax>

This register can be written using MCR with the following syntax:

MCR <syntax>

This syntax is encoded with the following settings in the instruction encoding:

<syntax>	opc1	opc2	CRn	coproc	CRm
p15, 0, <Rt>, c14, c2, 1	000	001	1110	1111	0010

Accessibility

The register is accessible in software as follows:

Configuration	Control			Accessibility				Instance
	E2H	TGE	NS	EL0	EL1	EL2	EL3	
EL3 is not implemented.	x	x	0	RW	RW	n/a	n/a	CNTP_CTL
EL3 is not implemented.	0	0	1	RW	RW	RW	n/a	CNTP_CTL
EL3 is not implemented.	0	1	1	RW	n/a	RW	n/a	CNTP_CTL
EL3 is not implemented.	1	0	1	RW	RW	n/a	n/a	CNTP_CTL
EL3 is not implemented.	1	1	1	CNTHP_CTL	n/a	n/a	n/a	-
EL3 is using AArch64.	x	x	0	RW	RW	n/a	n/a	CNTP_CTL
EL3 is using AArch64.	0	0	1	RW	RW	RW	n/a	CNTP_CTL
EL3 is using AArch64.	0	1	1	RW	n/a	RW	n/a	CNTP_CTL
EL3 is using AArch64.	1	0	1	RW	RW	n/a	n/a	CNTP_CTL
EL3 is using AArch64.	1	1	1	CNTHP_CTL	n/a	n/a	n/a	-

Configuration	Control			Accessibility				Instance
	E2H	TGE	NS	EL0	EL1	EL2	EL3	
EL3 is using AArch32.	x	x	0	RW	n/a	n/a	RW	CNTP_CTL_s
EL3 is using AArch32.	x	0	1	RW	RW	RW	RW	CNTP_CTL_ns
EL3 is using AArch32.	x	1	1	RW	n/a	RW	RW	CNTP_CTL_ns

Traps and Enables

For a description of the prioritization of any generated exceptions, see *Synchronous exception prioritization for exceptions taken to AArch32 state* on page G1-4344 for exceptions taken to AArch32 state and *Synchronous exception prioritization for exceptions taken to AArch64* on page D1-1827 for exceptions taken to AArch64 state. Subject to the prioritization rules:

- When $HCR_EL2.E2H == 0$:
 - If $CNTKCTL_EL1.EL0PTEN == 0$, accesses to this register from EL0 are trapped to EL1.
 - If $CNTKCTL.PL0PTEN == 0$, accesses to this register from EL0 are trapped to Undefined mode.
- When EL2 is implemented and is using AArch64 and $(SCR_EL3.NS == 1) \&\& (HCR_EL2.E2H == 0)$:
 - If $CNTHCTL_EL2.EL1PCEN == 0$, Non-secure accesses to this register from EL1 are trapped to EL2.
 - If $CNTHCTL_EL2.EL1PCEN == 0$, and $CNTKCTL_EL1.EL0PTEN == 1$, Non-secure accesses to this register from EL0 are trapped to EL2.
- When EL2 is implemented and is using AArch64 and $(SCR_EL3.NS == 1) \&\& (HCR_EL2.E2H == 1) \&\& (HCR_EL2.TGE == 0)$:
 - If $CNTHCTL_EL2.EL1PTEN == 0$, Non-secure accesses to this register from EL1 are trapped to EL2.
 - If $CNTHCTL_EL2.EL1PTEN == 0$, and $CNTKCTL_EL1.EL0PTEN == 1$, Non-secure accesses to this register from EL0 are trapped to EL2.
 - If $CNTKCTL_EL1.EL0PTEN == 0$, Non-secure accesses to this register from EL0 are trapped to EL1.
 - If $CNTKCTL.PL0PTEN == 0$, Non-secure accesses to this register from EL0 are trapped to Undefined mode.
- When EL2 is implemented and is using AArch64 and $(SCR_EL3.NS == 1) \&\& (HCR_EL2.E2H == 1) \&\& (HCR_EL2.TGE == 1)$:
 - If $CNTHCTL_EL2.EL0PTEN == 0$, Non-secure accesses to this register from EL0 are trapped to EL2.
- When EL2 is implemented and is using AArch32 and $SCR_EL3.NS == 1$:
 - If $CNTHCTL.PL1PCEN == 0$, Non-secure accesses to this register from EL0 and EL1 are trapped to Hyp mode.

G6.5.11 CNTP_CVAL, Counter-timer Physical Timer CompareValue register

The CNTP_CVAL characteristics are:

Purpose

Holds the compare value for the EL1 physical timer.

Configurations

AArch32 System register CNTP_CVAL is architecturally mapped to AArch64 System register [CNTP_CVAL_EL0](#).

RW fields in this register reset to architecturally UNKNOWN values.

Attributes

CNTP_CVAL is a 64-bit register.

Field descriptions

The CNTP_CVAL bit assignments are:

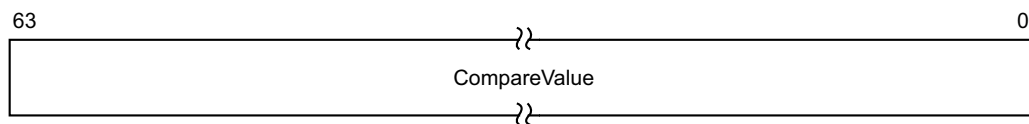

CompareValue, bits [63:0]

Holds the EL1 physical timer CompareValue.

When [CNTP_CTL.ENABLE](#) is 1, the timer condition is met when ([CNTPCT](#) - CompareValue) is greater than zero. This means that CompareValue acts like a 64-bit upcounter timer. When the timer condition is met:

- [CNTP_CTL.ISTATUS](#) is set to 1.
- If [CNTP_CTL.IMASK](#) is 0, an interrupt is generated.

When [CNTP_CTL.ENABLE](#) is 0, the timer condition is not met, but [CNTPCT](#) continues to count.

Accessing the CNTP_CVAL

This register can be read using MRRC with the following syntax:

MRRC <syntax>

This register can be written using MCRR with the following syntax:

MCRR <syntax>

This syntax is encoded with the following settings in the instruction encoding:

<syntax>	opc1	coproc	CRm
p15, 2, <Rt>, <Rt2>, c14	0010	1111	1110

Accessibility

The register is accessible in software as follows:

Configuration	Control			Accessibility				Instance
	E2H	TGE	NS	EL0	EL1	EL2	EL3	
EL3 is using AArch32.	x	x	0	RW	n/a	n/a	RW	CNTP_CVAL_s
EL3 is using AArch32.	x	0	1	RW	RW	RW	RW	CNTP_CVAL_ns
EL3 is using AArch32.	x	1	1	RW	n/a	RW	RW	CNTP_CVAL_ns
EL3 is not implemented.	x	x	0	RW	RW	n/a	n/a	CNTP_CVAL
EL3 is not implemented.	0	0	1	RW	RW	RW	n/a	CNTP_CVAL
EL3 is not implemented.	0	1	1	RW	n/a	RW	n/a	CNTP_CVAL
EL3 is not implemented.	1	0	1	RW	RW	n/a	n/a	CNTP_CVAL
EL3 is not implemented.	1	1	1	CNTHP_CVAL	n/a	n/a	n/a	-
EL3 is using AArch64.	x	x	0	RW	RW	n/a	n/a	CNTP_CVAL
EL3 is using AArch64.	0	0	1	RW	RW	RW	n/a	CNTP_CVAL
EL3 is using AArch64.	0	1	1	RW	n/a	RW	n/a	CNTP_CVAL
EL3 is using AArch64.	1	0	1	RW	RW	n/a	n/a	CNTP_CVAL
EL3 is using AArch64.	1	1	1	CNTHP_CVAL	n/a	n/a	n/a	-

Traps and Enables

For a description of the prioritization of any generated exceptions, see [Synchronous exception prioritization for exceptions taken to AArch32 state on page G1-4344](#) for exceptions taken to AArch32 state and [Synchronous exception prioritization for exceptions taken to AArch64 on page D1-1827](#) for exceptions taken to AArch64 state. Subject to the prioritization rules:

- When $HCR_EL2.E2H == 0$:
 - If $CNTKCTL_EL1.EL0PTEN == 0$, accesses to this register from EL0 are trapped to EL1.
 - If $CNTKCTL.PL0PTEN == 0$, accesses to this register from EL0 are trapped to Undefined mode.
- When EL2 is implemented and is using AArch64 and $(SCR_EL3.NS == 1) \&\& (HCR_EL2.E2H == 0)$:
 - If $CNTHCTL_EL2.EL1PCEN == 0$, Non-secure accesses to this register from EL1 are trapped to EL2.
 - If $CNTHCTL_EL2.EL1PCEN == 0$, and $CNTKCTL_EL1.EL0PTEN == 1$, Non-secure accesses to this register from EL0 are trapped to EL2.
- When EL2 is implemented and is using AArch64 and $(SCR_EL3.NS == 1) \&\& (HCR_EL2.E2H == 1) \&\& (HCR_EL2.TGE == 0)$:
 - If $CNTHCTL_EL2.EL1PTEN == 0$, Non-secure accesses to this register from EL1 are trapped to EL2.
 - If $CNTHCTL_EL2.EL1PTEN == 0$, and $CNTKCTL_EL1.EL0PTEN == 1$, Non-secure accesses to this register from EL0 are trapped to EL2.
 - If $CNTKCTL_EL1.EL0PTEN == 0$, Non-secure accesses to this register from EL0 are trapped to EL1.
 - If $CNTKCTL.PL0PTEN == 0$, Non-secure accesses to this register from EL0 are trapped to Undefined mode.

- When EL2 is implemented and is using AArch64 and (SCR_EL3.NS == 1) && (HCR_EL2.E2H == 1) && (HCR_EL2.TGE == 1):
 - If CNTHCTL_EL2.EL0PTEN==0, Non-secure accesses to this register from EL0 are trapped to EL2.
- When EL2 is implemented and is using AArch32 and SCR_EL3.NS == 1:
 - If CNTHCTL.PL1PCEN==0, Non-secure accesses to this register from EL0 and EL1 are trapped to Hyp mode.

G6.5.12 CNTP_TVAL, Counter-timer Physical Timer TimerValue register

The CNTP_TVAL characteristics are:

Purpose

Holds the timer value for the EL1 physical timer.

Configurations

AArch32 System register CNTP_TVAL is architecturally mapped to AArch64 System register [CNTP_TVAL_ELO](#).

RW fields in this register reset to architecturally UNKNOWN values.

Attributes

CNTP_TVAL is a 32-bit register.

Field descriptions

The CNTP_TVAL bit assignments are:

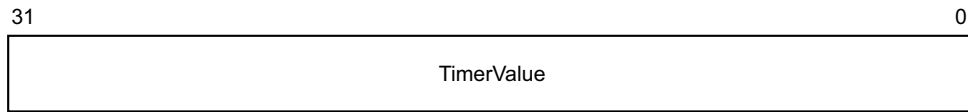

TimerValue, bits [31:0]

The TimerValue view of the EL1 physical timer.

On a read of this register:

- If [CNTP_CTL.ENABLE](#) is 0, the value returned is UNKNOWN.
- If [CNTP_CTL.ENABLE](#) is 1, the value returned is ([CNTP_CVAL](#) - [CNTPCT](#)).

On a write of this register, [CNTP_CVAL](#) is set to ([CNTPCT](#) + TimerValue), where TimerValue is treated as a signed 32-bit integer.

When [CNTP_CTL.ENABLE](#) is 1, the timer condition is met when ([CNTPCT](#) - [CNTP_CVAL](#)) is greater than zero. This means that TimerValue acts like a 32-bit downcounter timer. When the timer condition is met:

- [CNTP_CTL.ISTATUS](#) is set to 1.
- If [CNTP_CTL.IMASK](#) is 0, an interrupt is generated.

When [CNTP_CTL.ENABLE](#) is 0, the timer condition is not met, but [CNTPCT](#) continues to count, so the TimerValue view appears to continue to count down.

Accessing the CNTP_TVAL

This register can be read using MRC with the following syntax:

MRC <syntax>

This register can be written using MCR with the following syntax:

MCR <syntax>

This syntax is encoded with the following settings in the instruction encoding:

<syntax>	opc1	opc2	CRn	coproc	CRm
p15, 0, <Rt>, c14, c2, 0	000	000	1110	1111	0010

Accessibility

The register is accessible in software as follows:

Configuration	Control			Accessibility				Instance
	E2H	TGE	NS	EL0	EL1	EL2	EL3	
EL3 is not implemented.	x	x	0	RW	RW	n/a	n/a	CNTP_TVAL
EL3 is not implemented.	0	0	1	RW	RW	RW	n/a	CNTP_TVAL
EL3 is not implemented.	0	1	1	RW	n/a	RW	n/a	CNTP_TVAL
EL3 is not implemented.	1	0	1	RW	RW	n/a	n/a	CNTP_TVAL
EL3 is not implemented.	1	1	1	CNTHP_TVAL	n/a	n/a	n/a	-
EL3 is using AArch64.	x	x	0	RW	RW	n/a	n/a	CNTP_TVAL
EL3 is using AArch64.	0	0	1	RW	RW	RW	n/a	CNTP_TVAL
EL3 is using AArch64.	0	1	1	RW	n/a	RW	n/a	CNTP_TVAL
EL3 is using AArch64.	1	0	1	RW	RW	n/a	n/a	CNTP_TVAL
EL3 is using AArch64.	1	1	1	CNTHP_TVAL	n/a	n/a	n/a	-
EL3 is using AArch32.	x	0	1	RW	RW	RW	RW	CNTP_TVAL_ns
EL3 is using AArch32.	x	1	1	RW	n/a	RW	RW	CNTP_TVAL_ns
EL3 is using AArch32.	x	x	0	RW	n/a	n/a	RW	CNTP_TVAL_s

Traps and Enables

For a description of the prioritization of any generated exceptions, see [Synchronous exception prioritization for exceptions taken to AArch32 state on page G1-4344](#) for exceptions taken to AArch32 state and [Synchronous exception prioritization for exceptions taken to AArch64 on page D1-1827](#) for exceptions taken to AArch64 state. Subject to the prioritization rules:

- When $HCR_EL2.E2H == 0$:
 - If $CNTKCTL_EL1.EL0PTEN == 0$, accesses to this register from EL0 are trapped to EL1.
 - If $CNTKCTL.PL0PTEN == 0$, accesses to this register from EL0 are trapped to Undefined mode.
- When EL2 is implemented and is using AArch64 and $(SCR_EL3.NS == 1) \&\& (HCR_EL2.E2H == 0)$:
 - If $CNTHCTL_EL2.EL1PCEN == 0$, Non-secure accesses to this register from EL1 are trapped to EL2.
 - If $CNTHCTL_EL2.EL1PCEN == 0$, and $CNTKCTL_EL1.EL0PTEN == 1$, Non-secure accesses to this register from EL0 are trapped to EL2.
- When EL2 is implemented and is using AArch64 and $(SCR_EL3.NS == 1) \&\& (HCR_EL2.E2H == 1) \&\& (HCR_EL2.TGE == 0)$:
 - If $CNTHCTL_EL2.EL1PTEN == 0$, Non-secure accesses to this register from EL1 are trapped to EL2.
 - If $CNTHCTL_EL2.EL1PTEN == 0$, and $CNTKCTL_EL1.EL0PTEN == 1$, Non-secure accesses to this register from EL0 are trapped to EL2.
 - If $CNTKCTL_EL1.EL0PTEN == 0$, Non-secure accesses to this register from EL0 are trapped to EL1.
 - If $CNTKCTL.PL0PTEN == 0$, Non-secure accesses to this register from EL0 are trapped to Undefined mode.

- When EL2 is implemented and is using AArch64 and (SCR_EL3.NS == 1) && (HCR_EL2.E2H == 1) && (HCR_EL2.TGE == 1):
 - If CNTHCTL_EL2.EL0PTEN==0, Non-secure accesses to this register from EL0 are trapped to EL2.
- When EL2 is implemented and is using AArch32 and SCR_EL3.NS == 1:
 - If CNTHCTL.PL1PCEN==0, Non-secure accesses to this register from EL0 and EL1 are trapped to Hyp mode.

G6.5.13 CNTPCT, Counter-timer Physical Count register

The CNTPCT characteristics are:

Purpose

Holds the 64-bit physical count value.

Configurations

There is one instance of this register that is used in both Secure and Non-secure states.

AArch32 System register CNTPCT is architecturally mapped to AArch64 System register [CNTPCT_EL0](#).

Attributes

CNPCT is a 64-bit register.

Field descriptions

The CNTPCT bit assignments are:

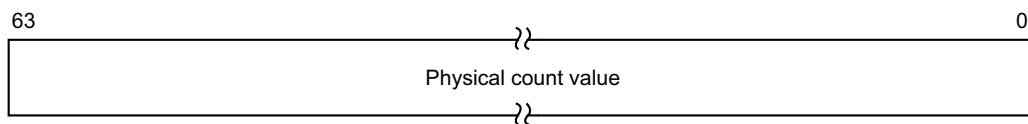

Bits [63:0]

Physical count value.

Accessing the CNTPCT

This register can be read using MRRC with the following syntax:

MRRC <syntax>

This syntax is encoded with the following settings in the instruction encoding:

<syntax>	opc1	coproc	CRm
p15, 0, <Rt>, <Rt2>, c14	0000	1111	1110

Accessibility

The register is accessible in software as follows:

Control			Accessibility			
E2H	TGE	NS	EL0	EL1	EL2	EL3
x	x	0	RO	RO	n/a	RO
x	0	1	RO	RO	RO	RO
x	1	1	RO	n/a	RO	RO

Traps and Enables

For a description of the prioritization of any generated exceptions, see *Synchronous exception prioritization for exceptions taken to AArch32 state* on page G1-4344 for exceptions taken to AArch32 state and *Synchronous exception prioritization for exceptions taken to AArch64* on page D1-1827 for exceptions taken to AArch64 state. Subject to the prioritization rules:

- When $\text{HCR_EL2.E2H} == 0$:
 - If $\text{CNTKCTL_EL1.EL0PCTEN} == 0$, read accesses to this register from EL0 are trapped to EL1.
 - If $\text{CNTKCTL.PL0PCTEN} == 0$, read accesses to this register from EL0 are trapped to Undefined mode.
- When EL2 is implemented and is using AArch64 and $(\text{SCR_EL3.NS} == 1) \ \&\& \ (\text{HCR_EL2.E2H} == 0)$:
 - If $\text{CNTHCTL_EL2.EL1PCTEN} == 0$, Non-secure read accesses to this register from EL1 are trapped to EL2.
 - If $\text{CNTHCTL_EL2.EL1PCTEN} == 0$, and $\text{CNTKCTL_EL1.EL0PCTEN} == 1$, Non-secure read accesses to this register from EL0 are trapped to EL2.
- When EL2 is implemented and is using AArch64 and $(\text{SCR_EL3.NS} == 1) \ \&\& \ (\text{HCR_EL2.E2H} == 1) \ \&\& \ (\text{HCR_EL2.TGE} == 0)$:
 - If $\text{CNTHCTL_EL2.EL1PCTEN} == 0$, Non-secure read accesses to this register from EL1 are trapped to EL2.
 - If $\text{CNTHCTL_EL2.EL1PCTEN} == 0$, and $\text{CNTKCTL_EL1.EL0PCTEN} == 1$, Non-secure read accesses to this register from EL0 are trapped to EL2.
 - If $\text{CNTKCTL_EL1.EL0PCTEN} == 0$, Non-secure read accesses to this register from EL0 are trapped to EL1.
 - If $\text{CNTKCTL.PL0PCTEN} == 0$, Non-secure read accesses to this register from EL0 are trapped to Undefined mode.
- When EL2 is implemented and is using AArch64 and $(\text{SCR_EL3.NS} == 1) \ \&\& \ (\text{HCR_EL2.E2H} == 1) \ \&\& \ (\text{HCR_EL2.TGE} == 1)$:
 - If $\text{CNTHCTL_EL2.EL0PCTEN} == 0$, Non-secure read accesses to this register from EL0 are trapped to EL2.
- When EL2 is implemented and is using AArch32 and $\text{SCR_EL3.NS} == 1$:
 - If $\text{CNTHCTL.PL1PCTEN} == 0$, Non-secure read accesses to this register from EL0 and EL1 are trapped to Hyp mode.

G6.5.14 CNTV_CTL, Counter-timer Virtual Timer Control register

The CNTV_CTL characteristics are:

Purpose

Control register for the virtual timer.

Configurations

There is one instance of this register that is used in both Secure and Non-secure states.

AArch32 System register CNTV_CTL is architecturally mapped to AArch64 System register [CNTV_CTL_EL0](#).

Some or all RW fields of this register have defined reset values. These apply only if the PE resets into an Exception level that is using AArch32. Otherwise, RW fields in this register reset to architecturally UNKNOWN values.

Attributes

CNTV_CTL is a 32-bit register.

Field descriptions

The CNTV_CTL bit assignments are:

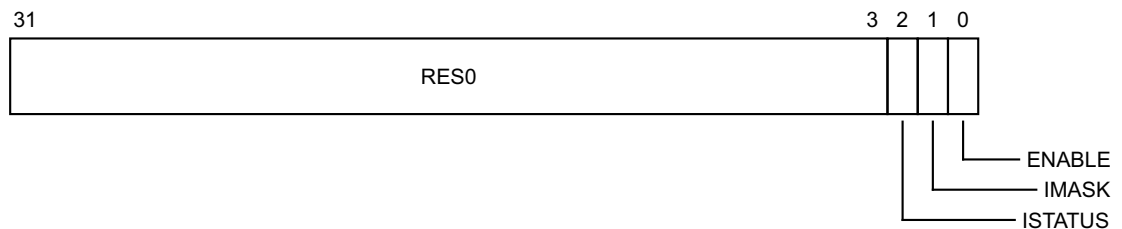

Bits [31:3]

Reserved, RES0.

ISTATUS, bit [2]

The status of the timer. This bit indicates whether the timer condition is met:

- 0 Timer condition is not met.
- 1 Timer condition is met.

When the value of the ENABLE bit is 1, ISTATUS indicates whether the timer condition is met. ISTATUS takes no account of the value of the IMASK bit. If the value of ISTATUS is 1 and the value of IMASK is 0 then the timer interrupt is asserted.

When the value of the ENABLE bit is 0, the ISTATUS field is UNKNOWN.

For more information see [Operation of the CompareValue views of the timers on page D6-2187](#) and [Operation of the TimerValue views of the timers on page D6-2188](#).

This bit is read-only.

This field resets to a value that is architecturally UNKNOWN.

IMASK, bit [1]

Timer interrupt mask bit. Permitted values are:

- 0 Timer interrupt is not masked by the IMASK bit.
- 1 Timer interrupt is masked by the IMASK bit.

For more information, see the description of the ISTATUS bit.

This field resets to a value that is architecturally UNKNOWN.

ENABLE, bit [0]

Enables the timer. Permitted values are:

- 0 Timer disabled.
- 1 Timer enabled.

Setting this bit to 0 disables the timer output signal, but the timer value accessible from [CNTV_TVAL](#) continues to count down.

Note

Disabling the output signal might be a power-saving option.

When this register has an architecturally-defined reset value, this field resets to 0.

Accessing the CNTV_CTL

This register can be read using MRC with the following syntax:

MRC <syntax>

This register can be written using MCR with the following syntax:

MCR <syntax>

This syntax is encoded with the following settings in the instruction encoding:

<syntax>	opc1	opc2	CRn	coproc	CRm
p15, 0, <Rt>, c14, c3, 1	000	001	1110	1111	0011

Accessibility

The register is accessible in software as follows:

Control			Accessibility			
E2H	TGE	NS	EL0	EL1	EL2	EL3
x	x	0	RW	RW	n/a	RW
0	0	1	RW	RW	RW	RW
0	1	1	RW	n/a	RW	RW
1	0	1	RW	RW	n/a	n/a
1	1	1	CNTHV_CTL	n/a	n/a	n/a

Traps and Enables

For a description of the prioritization of any generated exceptions, see [Synchronous exception prioritization for exceptions taken to AArch32 state on page G1-4344](#) for exceptions taken to AArch32 state and [Synchronous exception prioritization for exceptions taken to AArch64 on page D1-1827](#) for exceptions taken to AArch64 state. Subject to the prioritization rules:

- When HCR_EL2.E2H == 0:
 - If CNTKCTL_EL1.EL0VTEN==0, accesses to this register from EL0 are trapped to EL1.
 - If CNTKCTL.PL0VTEN==0, accesses to this register from EL0 are trapped to Undefined mode.

- When EL2 is implemented and is using AArch64 and (SCR_EL3.NS == 1) && (HCR_EL2.E2H == 1) && (HCR_EL2.TGE == 0):
 - If `CNTKCTL_EL1.EL0VTEN==0`, Non-secure accesses to this register from EL0 are trapped to EL1.
 - If `CNTKCTL.PL0VTEN==0`, Non-secure accesses to this register from EL0 are trapped to Undefined mode.
- When EL2 is implemented and is using AArch64 and (SCR_EL3.NS == 1) && (HCR_EL2.E2H == 1) && (HCR_EL2.TGE == 1):
 - If `CNTHCTL_EL2.EL0VTEN==0`, Non-secure accesses to this register from EL0 are trapped to EL2.

G6.5.15 CNTV_CVAL, Counter-timer Virtual Timer CompareValue register

The CNTV_CVAL characteristics are:

Purpose

Holds the compare value for the virtual timer.

Configurations

There is one instance of this register that is used in both Secure and Non-secure states.

AArch32 System register CNTV_CVAL is architecturally mapped to AArch64 System register [CNTV_CVAL_EL0](#).

RW fields in this register reset to architecturally UNKNOWN values.

Attributes

CNTV_CVAL is a 64-bit register.

Field descriptions

The CNTV_CVAL bit assignments are:

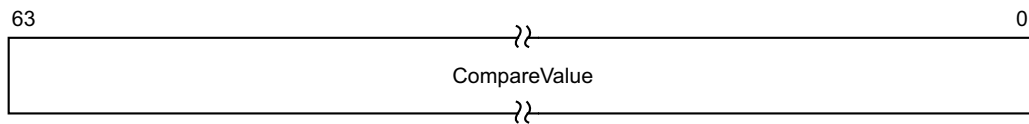

CompareValue, bits [63:0]

Holds the EL1 virtual timer CompareValue.

When [CNTV_CTL.ENABLE](#) is 1, the timer condition is met when ([CNTVCT](#) - CompareValue) is greater than zero. This means that CompareValue acts like a 64-bit upcounter timer. When the timer condition is met:

- [CNTV_CTL.ISTATUS](#) is set to 1.
- If [CNTV_CTL.IMASK](#) is 0, an interrupt is generated.

When [CNTV_CTL.ENABLE](#) is 0, the timer condition is not met, but [CNTVCT](#) continues to count.

Accessing the CNTV_CVAL

This register can be read using MRRC with the following syntax:

MRRC <syntax>

This register can be written using MCRR with the following syntax:

MCRR <syntax>

This syntax is encoded with the following settings in the instruction encoding:

<syntax>	opc1	coproc	CRm
p15, 3, <Rt>, <Rt2>, c14	0011	1111	1110

Accessibility

The register is accessible in software as follows:

Control			Accessibility			
E2H	TGE	NS	EL0	EL1	EL2	EL3
x	x	0	RW	RW	n/a	RW
0	0	1	RW	RW	RW	RW
0	1	1	RW	n/a	RW	RW
1	0	1	RW	RW	n/a	n/a
1	1	1	CNTHV_CVAL	n/a	n/a	n/a

Traps and Enables

For a description of the prioritization of any generated exceptions, see *Synchronous exception prioritization for exceptions taken to AArch32 state* on page G1-4344 for exceptions taken to AArch32 state and *Synchronous exception prioritization for exceptions taken to AArch64* on page D1-1827 for exceptions taken to AArch64 state. Subject to the prioritization rules:

- When $\text{HCR_EL2.E2H} == 0$:
 - If $\text{CNTKCTL_EL1.EL0VTEN} == 0$, accesses to this register from EL0 are trapped to EL1.
 - If $\text{CNTKCTL.PL0VTEN} == 0$, accesses to this register from EL0 are trapped to Undefined mode.
- When EL2 is implemented and is using AArch64 and $(\text{SCR_EL3.NS} == 1) \ \&\& \ (\text{HCR_EL2.E2H} == 1) \ \&\& \ (\text{HCR_EL2.TGE} == 0)$:
 - If $\text{CNTKCTL_EL1.EL0VTEN} == 0$, Non-secure accesses to this register from EL0 are trapped to EL1.
 - If $\text{CNTKCTL.PL0VTEN} == 0$, Non-secure accesses to this register from EL0 are trapped to Undefined mode.
- When EL2 is implemented and is using AArch64 and $(\text{SCR_EL3.NS} == 1) \ \&\& \ (\text{HCR_EL2.E2H} == 1) \ \&\& \ (\text{HCR_EL2.TGE} == 1)$:
 - If $\text{CNTHCTL_EL2.EL0VTEN} == 0$, Non-secure accesses to this register from EL0 are trapped to EL2.

G6.5.16 CNTV_TVAL, Counter-timer Virtual Timer TimerValue register

The CNTV_TVAL characteristics are:

Purpose

Holds the timer value for the virtual timer.

Configurations

There is one instance of this register that is used in both Secure and Non-secure states.

AArch32 System register CNTV_TVAL is architecturally mapped to AArch64 System register [CNTV_TVAL_ELO](#).

RW fields in this register reset to architecturally UNKNOWN values.

Attributes

CNTV_TVAL is a 32-bit register.

Field descriptions

The CNTV_TVAL bit assignments are:

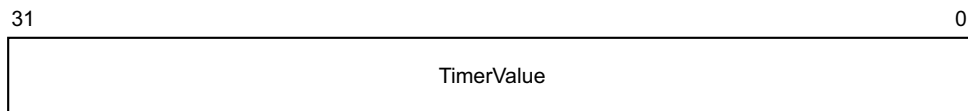

TimerValue, bits [31:0]

The TimerValue view of the virtual timer.

On a read of this register:

- If [CNTV_CTL.ENABLE](#) is 0, the value returned is UNKNOWN.
- If [CNTV_CTL.ENABLE](#) is 1, the value returned is $(\text{CNTV_CVAL} - (\text{CNTPCT} - \text{CNTVOFF}))$.

On a write of this register, [CNTV_CVAL](#) is set to $(\text{CNTPCT} + \text{TimerValue})$, where TimerValue is treated as a signed 32-bit integer.

When [CNTP_CTL.ENABLE](#) is 1, the timer condition is met when $(\text{CNTPCT} - \text{CNTP_CVAL})$ is greater than zero. This means that TimerValue acts like a 32-bit downcounter timer. When the timer condition is met:

- [CNTV_CTL.ISTATUS](#) is set to 1.
- If [CNTV_CTL.IMASK](#) is 0, an interrupt is generated.

When [CNTV_CTL.ENABLE](#) is 0, the timer condition is not met, but [CNTVCT](#) continues to count, so the TimerValue view appears to continue to count down.

Accessing the CNTV_TVAL

This register can be read using MRC with the following syntax:

MRC <syntax>

This register can be written using MCR with the following syntax:

MCR <syntax>

This syntax is encoded with the following settings in the instruction encoding:

<syntax>	opc1	opc2	CRn	coproc	CRm
p15, 0, <Rt>, c14, c3, 0	000	000	1110	1111	0011

Accessibility

The register is accessible in software as follows:

Control			Accessibility			
E2H	TGE	NS	EL0	EL1	EL2	EL3
x	x	0	RW	RW	n/a	RW
0	0	1	RW	RW	RW	RW
0	1	1	RW	n/a	RW	RW
1	0	1	RW	RW	n/a	n/a
1	1	1	CNTHV_TVAL	n/a	n/a	n/a

Traps and Enables

For a description of the prioritization of any generated exceptions, see [Synchronous exception prioritization for exceptions taken to AArch32 state on page G1-4344](#) for exceptions taken to AArch32 state and [Synchronous exception prioritization for exceptions taken to AArch64 on page D1-1827](#) for exceptions taken to AArch64 state. Subject to the prioritization rules:

- When $HCR_EL2.E2H == 0$:
 - If $CNTKCTL_EL1.EL0VTEN == 0$, accesses to this register from EL0 are trapped to EL1.
 - If $CNTKCTL.PL0VTEN == 0$, accesses to this register from EL0 are trapped to Undefined mode.
- When EL2 is implemented and is using AArch64 and $(SCR_EL3.NS == 1) \&\& (HCR_EL2.E2H == 1) \&\& (HCR_EL2.TGE == 0)$:
 - If $CNTKCTL_EL1.EL0VTEN == 0$, Non-secure accesses to this register from EL0 are trapped to EL1.
 - If $CNTKCTL.PL0VTEN == 0$, Non-secure accesses to this register from EL0 are trapped to Undefined mode.
- When EL2 is implemented and is using AArch64 and $(SCR_EL3.NS == 1) \&\& (HCR_EL2.E2H == 1) \&\& (HCR_EL2.TGE == 1)$:
 - If $CNTHCTL_EL2.EL0VTEN == 0$, Non-secure accesses to this register from EL0 are trapped to EL2.

G6.5.17 CNTVCT, Counter-timer Virtual Count register

The CNTVCT characteristics are:

Purpose

Holds the 64-bit virtual count value. The virtual count value is equal to the physical count value visible in [CNTPCT](#) minus the virtual offset visible in [CNTVOFF](#).

Configurations

There is one instance of this register that is used in both Secure and Non-secure states.

AArch32 System register CNTVCT is architecturally mapped to AArch64 System register [CNTVCT_EL0](#).

The value of this register is the same as the value of [CNTPCT](#) in the following conditions:

- When EL2 is not implemented.
- When EL2 is implemented and is using AArch64, [HCR_EL2](#).{E2H, TGE} is {1, 1}, and this register is read from Non-secure EL0.

Attributes

CNTVCT is a 64-bit register.

Field descriptions

The CNTVCT bit assignments are:

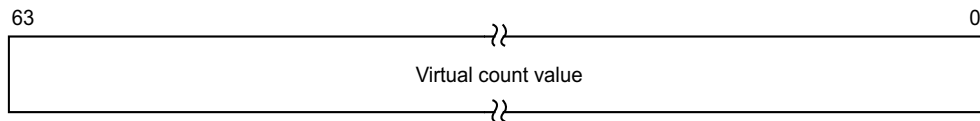

Bits [63:0]

Virtual count value.

Accessing the CNTVCT

This register can be read using MRRC with the following syntax:

MRRC <syntax>

This syntax is encoded with the following settings in the instruction encoding:

<syntax>	opc1	coproc	CRm
p15, 1, <Rt>, <Rt2>, c14	0001	1111	1110

Accessibility

The register is accessible in software as follows:

Control			Accessibility			
E2H	TGE	NS	EL0	EL1	EL2	EL3
x	x	0	RO	RO	n/a	RO
x	0	1	RO	RO	RO	RO
x	1	1	RO	n/a	RO	RO

Traps and Enables

For a description of the prioritization of any generated exceptions, see [Synchronous exception prioritization for exceptions taken to AArch32 state](#) on page G1-4344 for exceptions taken to AArch32 state and [Synchronous exception prioritization for exceptions taken to AArch64](#) on page D1-1827 for exceptions taken to AArch64 state. Subject to the prioritization rules:

- When $\text{HCR_EL2.E2H} == 0$:
 - If $\text{CNTKCTL.PL0VCTEN} == 0$, read accesses to this register from EL0 are trapped to Undefined mode.
 - If $\text{CNTKCTL_EL1.EL0VCTEN} == 0$, read accesses to this register from EL0 are trapped to EL1.
- When EL2 is implemented and is using AArch64 and $(\text{SCR_EL3.NS} == 1) \ \&\& \ (\text{HCR_EL2.E2H} == 1) \ \&\& \ (\text{HCR_EL2.TGE} == 0)$:
 - If $\text{CNTKCTL.PL0VCTEN} == 0$, Non-secure read accesses to this register from EL0 are trapped to Undefined mode.
 - If $\text{CNTKCTL_EL1.EL0VCTEN} == 0$, Non-secure read accesses to this register from EL0 are trapped to EL1.
- When EL2 is implemented and is using AArch64 and $(\text{SCR_EL3.NS} == 1) \ \&\& \ (\text{HCR_EL2.E2H} == 1) \ \&\& \ (\text{HCR_EL2.TGE} == 1)$:
 - If $\text{CNTHCTL_EL2.EL0PCTEN} == 0$, Non-secure read accesses to this register from EL0 are trapped to EL2.

G6.5.18 CNTVOFF, Counter-timer Virtual Offset register

The CNTVOFF characteristics are:

Purpose

Holds the 64-bit virtual offset. This is the offset between the physical count value visible in CNTPCT and the virtual count value visible in CNTVCT.

Configurations

AArch32 System register CNTVOFF is architecturally mapped to AArch64 System register CNTVOFF_EL2.

If EL2 is not implemented, this register is RES0 from EL3 and the virtual counter uses a fixed virtual offset of zero.

———— **Note** —————

When EL2 is implemented and is using AArch64, if HCR_EL2.{E2H, TGE} is {1, 1}, the virtual counter uses a fixed virtual offset of zero when CNTVCT is read from Non-secure EL0.

When EL2 is implemented and can use AArch32, on a reset into an Exception level that is using AArch32 this register resets to an IMPLEMENTATION DEFINED value that might be UNKNOWN.

Attributes

CNTVOFF is a 64-bit register.

Field descriptions

The CNTVOFF bit assignments are:

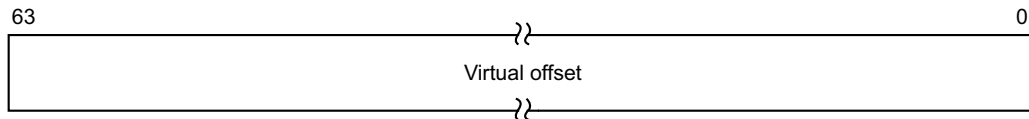

Bits [63:0]

Virtual offset.

Accessing the CNTVOFF

This register can be read using MRRC with the following syntax:

MRRC <syntax>

This register can be written using MCRR with the following syntax:

MCRR <syntax>

This syntax is encoded with the following settings in the instruction encoding:

<syntax>	opc1	coproc	CRm
p15, 4, <Rt>, <Rt2>, c14	0100	1111	1110

Accessibility

The register is accessible in software as follows:

Control			Accessibility			
E2H	TGE	NS	EL0	EL1	EL2	EL3
x	x	0	-	-	n/a	-
x	0	1	-	-	RW	RW
x	1	1	-	n/a	RW	RW

Part H

External Debug

Chapter H1

About External Debug

This chapter gives an overview of ARMv8 external debug, and specifies the required debug authentication. It contains the following sections:

- [Introduction to external debug](#) on page H1-5430.
- [External debug](#) on page H1-5431.
- [Required debug authentication](#) on page H1-5432.

———— **Note** —————

For information about self-hosted debug, see [Chapter D2 AArch64 Self-hosted Debug](#) and [Chapter G2 AArch32 Self-hosted Debug](#).

H1.1 Introduction to external debug

ARMv8 supports both:

Self-hosted debug

The PE itself hosts a debugger. That is, developers developing software to run on the PE use debugger software running on the same PE.

External debug

The debugger is external to the PE. The debugging might be either on-chip, for example in a second PE, or off-chip, for example a JTAG debugger. External debug is particularly useful for:

- Hardware bring-up. That is, debugging during development when a system is first powered up and not all of the software functionality is available.
- PEs that are deeply embedded inside systems.

To support external debug, the ARM architecture defines required features that are called *external debug features*.

H1.1.1 Definition of a debugger in the context of external debug

When the description of external debug in this Part of the manual describes a *debugger* as controlling external debug this debugger might be a second on-chip PE or an off-chip device such as a JTAG debugger.

H1.2 External debug

Debug events allow an external debugger to halt the PE. ARMv8 provides the following debug events:

- [Halting Step debug events on page H3-5476:](#)
 - The debugger can use this resource to make the PE step through code one line at a time.
- [Halt Instruction debug event on page H3-5486:](#)
 - This might occur when software executes the Halting breakpoint instruction, HLT.
- [Exception Catch debug event on page H3-5487:](#)
 - This can be programmed to occur on all entries to a given Exception level.
- [External Debug Request debug event on page H3-5490:](#)
 - An embedded cross-trigger can signal this debug event.
- [OS Unlock Catch debug event on page H3-5491:](#)
 - This might occur when the state of the OS Lock changes from locked to unlocked.
- [Reset Catch debug events on page H3-5492:](#)
 - This might occur when the PE exits reset state.
- [Software Access debug event on page H3-5493:](#)
 - This can be programmed to occur when software tries to access the Breakpoint Value registers, the Breakpoint Control registers, the Watchpoint value registers, or the Watchpoint Control registers. It caused a trap to Debug state.

Breakpoints and watchpoints can also halt the PE.

When the PE is in Debug state:

- It stops executing instructions from the location indicated by the program counter, and is instead controlled through the external debug interface.
- The *Instruction Transfer Register*, ITR, passes instructions to the PE to execute in Debug state:
 - The ITR contains a single register, EDITR, and associated flow-control flags.
- The *Debug Communications Channel*, DCC, passes data between the PE and the debugger:
 - The DCC includes the data transfer registers, DTRRX and DTRTX, and associated flow-control flags.
 - Although the DCC is an essential part of Debug state operation, it can also be used in Non-debug state.
- The PE cannot service any interrupts in Debug state.

[Chapter H2 Debug State](#) describes Debug state in more detail.

H1.3 Required debug authentication

Any implementation must provide the debug authentication defined in this section, that controls:

- Whether the PE can halt.
- Whether non-invasive debug is permitted.
- Some legacy aspects of the AArch32 self-hosted debug model.

The pseudocode functions shown in [Table H1-1](#), and the conditions that follow that table, define the architectural requirements for debug authentication.

Table H1-1 Debug authentication functions

Pseudocode function	Description
ExternalSecureNoninvasiveDebugEnabled()	Returns TRUE if Secure non-invasive debug is enabled.
AArch32.SelfHostedSecurePrivilegedInvasiveDebugEnabled()	Returns TRUE if Secure invasive self-hosted debug is enabled in AArch32 state.
ExternalSecureInvasiveDebugEnabled()	Returns TRUE if Secure invasive debug is enabled.
ExternalNoninvasiveDebugEnabled()	Returns TRUE if Non-secure non-invasive debug is enabled.
ExternalInvasiveDebugEnabled()	Returns TRUE if Non-secure invasive debug is enabled.

The following conditions always apply:

- if [ExternalInvasiveDebugEnabled\(\)](#) is FALSE then [ExternalSecureInvasiveDebugEnabled\(\)](#) is FALSE.
- if [ExternalNoninvasiveDebugEnabled\(\)](#) is FALSE then [ExternalSecureNoninvasiveDebugEnabled\(\)](#) is FALSE.
- if [ExternalInvasiveDebugEnabled\(\)](#) is TRUE then [ExternalNoninvasiveDebugEnabled\(\)](#) is TRUE.
- if [ExternalSecureInvasiveDebugEnabled\(\)](#) is TRUE then [ExternalSecureNoninvasiveDebugEnabled\(\)](#) is TRUE.

ARM recommends the use of the interface described in [Recommended authentication interface on page K2-6140](#) to provide this debug authentication. The pseudocode functions in [Chapter J1 ARMv8 Pseudocode](#), that are linked to by the entries in the [Pseudocode function](#) column of [Table H1-1](#), assume that this interface is implemented.

Chapter H2

Debug State

This chapter describes Debug state. It contains the following sections:

- [About Debug state on page H2-5434.](#)
- [Halting the PE on debug events on page H2-5435.](#)
- [Entering Debug state on page H2-5442.](#)
- [Behavior in Debug state on page H2-5445.](#)
- [Exiting Debug state on page H2-5471.](#)

———— **Note** —————

[Table K11-1 on page K11-6282](#) disambiguates the general register references used in this chapter.

H2.1 About Debug state

In external debug, debug events allow an external debugger to halt the PE. The PE then enters Debug state. When the PE is in Debug state:

- It stops executing instructions from the location indicated by the program counter, and is instead controlled through the external debug interface.
- The *Instruction Transfer Register*, ITR, passes instructions to the PE to execute in Debug state.
- The *Debug Communications Channel*, DCC, passes data between the PE and the debugger.

The PE cannot service any interrupts in Debug state.

H2.2 Halting the PE on debug events

For details of debug events, see [Introduction to Halting debug events on page H3-5474](#) and [Breakpoint and Watchpoint debug events on page H2-5436](#).

On a debug event, the PE must do one of the following:

- Enter Debug state.
- Pend the debug event.
- Generate a debug exception.
- Ignore the debug event.

This behavior depends on both:

- Whether halting is allowed by the current state of the debug authentication interface. See [Halting allowed and halting prohibited](#).
- The type of debug event and the programming of the debug control registers.
 - See [Halting debug events](#) for all Halting debug events.
 - See [Breakpoint and Watchpoint debug events on page H2-5436](#) for Breakpoint and Watchpoint debug events.

See also [Other debug exceptions on page H2-5437](#).

This means that behavior can be CONSTRAINED UNPREDICTABLE if the conditions change. See [Synchronization and Halting debug events on page H3-5494](#).

[Summary of debug events and possible outcomes on page H3-5474](#) summarizes the possible outcomes of each type of debug event.

H2.2.1 Halting allowed and halting prohibited

Halting can be either allowed or prohibited:

- Halting is always prohibited in Debug state.
- Halting is always prohibited when `DoubleLockStatus() == TRUE`.
 - This means that OS Double Lock is locked.
- Halting is also controlled by the IMPLEMENTATION DEFINED authentication interface, and is prohibited when either:
 - The PE is in Non-secure state and `ExternalInvasiveDebugEnabled() == FALSE`.
 - The PE is in Secure state and `ExternalSecureInvasiveDebugEnabled() == FALSE`.

———— **Note** ————

See [Appendix K2 Recommended External Debug Interface](#) for more information on these functions.

- Otherwise, halting is allowed.

See

- [Pseudocode description of Halting on debug events on page H2-5441](#)
- [Required debug authentication on page H1-5432](#).

H2.2.2 Halting debug events

The Halting debug events are described in [Chapter H3 Halting Debug Events](#).

When a Halting debug event is generated, it causes entry to Debug state if all of:

- Halting is allowed. See [Halting allowed and halting prohibited on page H2-5435](#).
- The Halting debug event is one of:
 - A Halt Instruction debug event and `EDSCR.HDE == 1`.
 - A Software Access debug event and `OSLSR_EL1.OSLK == 0`, meaning that the OS Lock is unlocked.
 - Neither a Halt Instruction debug event nor a Software Access debug event.

———— **Note** —————

- A Halt Instruction debug event is the only Halting debug event that relies on `EDSCR.HDE == 1`.
- Halting on Breakpoint and Watchpoint debug events is also controlled by `EDSCR.HDE`. See [Breakpoint and Watchpoint debug events](#).
- `EDSCR.HDE` can be written by software when the OS Lock is locked. Privileged code can use `SDCR.TDOSA` and `HDCR.TDOSA` to trap writes to these registers.

If a Halting debug event does not generate entry to Debug state because the conditions listed in this section do not hold, then:

- If the Halting debug event is a Halt Instruction debug event, the instruction that generated the Halting debug event is treated as UNDEFINED.
- If the Halting debug event is an Exception Catch debug event or a Software Access debug event, it is ignored.

In all other cases the Halting debug event is pended, see [Pending Halting debug events on page H3-5494](#).

[Summary of actions from debug events on page H2-5439](#) summarizes the possible outcome for each type of Debug event.

———— **Note** —————

Halting debug events never generate debug exceptions.

H2.2.3 Breakpoint and Watchpoint debug events

A breakpoint or watchpoint generates an entry to Debug state if all of the following conditions hold:

- Halting debug is enabled, that is `EDSCR.HDE == 1`.
- Halting is allowed. See [Halting allowed and halting prohibited on page H2-5435](#).
- The OS Lock is unlocked, that is `OSLSR.OSLK == 0`.

The Address Mismatch breakpoint type is reserved when all of these conditions are met.

`MDSCR_EL1.MDE` or `DBGDSCRext.MDBGen` is ignored when determining whether to enter Debug state. A breakpoint or watchpoint that generates entry to Debug state is a Breakpoint or Watchpoint debug event and does not generate a debug exception.

A breakpoint or watchpoint that does not generate an entry to Debug state either:

- Generates a Breakpoint or Watchpoint exception.
- Is ignored.

———— **Note** —————

`EDSCR.HDE` is ignored when determining whether to generate a debug exception. The debug exception is suppressed only if the PE enters Debug state. This means that the use of Halting debug mode in Non-secure state does not affect the Exception model in Secure state.

See [Chapter D2 AArch64 Self-hosted Debug](#), [Chapter G2 AArch32 Self-hosted Debug](#), and the Note in [Other debug exceptions on page H2-5437](#).

H2.2.4 Other debug exceptions

The following events never generate entry to Debug state:

- Breakpoint Instruction exceptions.
- Software Step exceptions.
- Vector Catch exceptions.

The behavior of these events is unchanged when Halting debug mode is enabled, that is when `EDSCR.HDE == 1`. This means that these events can do one of the following:

- They can generate a debug exception.
- They can be ignored.

For additional information, see [Chapter D2 AArch64 Self-hosted Debug](#) and [Chapter G2 AArch32 Self-hosted Debug](#).

H2.2.5 Debug state entry and debug event prioritization

The following are synchronous debug events:

- Breakpoint debug event.
- Watchpoint debug event.
- Halting Step debug event.
- Halt Instruction debug event.
- Exception Catch debug event.
- Software Access debug event.
- Reset Catch debug event.

Each of these synchronous debug events are treated as a synchronous exception generated by an instruction, or by the taking of an exception or reset. That is, if halting is allowed, the synchronous debug event must be taken before any subsequent instructions are executed. Reset Catch debug events must be taken before the PE executes the instruction at the reset vector.

Note

- Reset Catch and Exception Catch debug events might be generated asynchronously, because they can result from an asynchronous exception. However, if halting is allowed after the reset or asynchronous exception has been processed, the Reset Catch or Exception Catch debug event is taken synchronously.
- The Halting Step debug event is generated by the instruction after the stepped instruction. Therefore, if the stepped instruction generates any other synchronous exceptions or debug events these are taken first.

If halting is prohibited then Halting Step debug events and Reset Catch debug events might be pended and taken asynchronously. OS Unlock Catch debug events are always pended and taken asynchronously. See [Pending Halting debug events on page H3-5494](#).

The architecture does not define when asynchronous debug events are taken, and therefore the prioritization of asynchronous debug events is IMPLEMENTATION DEFINED. See [Synchronization and Halting debug events on page H3-5494](#).

The following list shows how the synchronous debug events are prioritized, with -2 being the highest priority.

Note

The priority numbering is the same as the numbering for AArch64 synchronous exception priorities listed in [Synchronous exception types, routing and priorities on page D1-1826](#), and in particular [Prioritization and recognition of interrupts on page D1-1841](#). The Debug events in this section with a negative priority are a higher priority than any synchronous exception. The debug events with fractional priorities have a priority between two or more exceptions. This numbering has no global significance and, for example, does not correlate with the equivalent AArch32 list in [Exception prioritization for exceptions taken to AArch32 state on page G1-4344](#).

The priority for synchronous debug events is as follows:

- 2 Reset Catch debug event. See [Reset Catch debug events on page H3-5492](#).
This debug event has a higher priority than the synchronous exceptions listed in [Synchronous exception types, routing and priorities on page D1-1826](#).
- 1 Exception Catch debug event. See [Exception Catch debug event on page H3-5487](#).
This debug event can be assigned one of two priorities. When it has a priority of -1, it has a higher priority than the synchronous exceptions listed in the Exception model. See [Exception Catch debug event on page H3-5487](#).
- 0 Halting Step debug event. See [Halting Step debug events on page H3-5476](#).
This debug event has a higher priority than the synchronous exceptions listed in the Exception model.
- 1 Software Step debug event. See [Software Step exceptions on page D2-1956](#).
- 1.5 Exception Catch debug event. See [Exception Catch debug event on page H3-5487](#).
This debug event can be assigned one of two priorities, -1 or 1.5. See [Exception Catch debug event on page H3-5487](#).
- 2 - 3 These events are not debug events.
- 4 Breakpoint exception or debug event or Address Matching Vector Catch exception. See [Breakpoint exceptions on page D2-1921](#), and [Vector Catch exceptions on page G2-4510](#).
These two debug events have the same priority.
- 5 - 13 These events are not debug events.
- 14 Halt Instruction debug event. See [Halt Instruction debug event on page H3-5486](#).
- 15 - 19 These events are not debug events.
- 19.5 Software Access debug event. See [Software Access debug event on page H3-5493](#).
- 20 - 21 These events are not debug events.
- 22 Watchpoint exception or debug event. See [Watchpoint exceptions on page D2-1940](#) for exceptions taken from AArch64 state, or [Watchpoint exceptions on page G2-4496](#) for exceptions taken from AArch32 state.
- 23 This event is not a debug event.

For Reset Catch debug events and Halting Step debug events the priorities listed in this section only apply when halting is allowed at the time the event is generated. This means that the event is taken synchronously and not pending.

For more information on the prioritization of exceptions see:

- [Synchronous exception types, routing and priorities on page D1-1826](#).
- [Prioritization and recognition of interrupts on page D1-1841](#).
- [Exception prioritization for exceptions taken to AArch32 state on page G1-4344](#).
- This section covers synchronous and asynchronous exceptions.

Breakpoint debug events and Vector Catch exception

An Address Matching Vector Catch exception has the same priority as a Breakpoint debug event. See [Synchronous exception prioritization for exceptions taken to AArch64 on page D1-1827](#).

The prioritization of these events is unchanged even if the breakpoint generates entry to Debug state instead of a Breakpoint exception. This means that if a single instruction generates both an Address Matching Vector Catch exception and a Breakpoint debug event, there is a CONSTRAINED UNPREDICTABLE choice of:

- The PE entering Debug state due to the Breakpoint debug event.
- A Vector Catch exception.

This only applies if all of the following are true:

- Halting debug is enabled.
- Halting is allowed.
- The OS Lock is unlocked.

An Exception Trapping Vector Catch exception must be generated immediately following the exception that generated it. This means that it does not appear in the priority table.

H2.2.6 Imprecise entry to Debug state

Entry to Debug state is normally precise, meaning that the PE cannot enter Debug state if it can neither complete nor abandon all currently executing instructions and leave the PE in a precise state.

A debugger can write a value of 1 to [EDRCCR.CBRRQ](#) to allow imprecise entry to Debug state. An External Debug Request debug event must be pending before writing 1 to this bit. Support for this feature is OPTIONAL and it is IMPLEMENTATION DEFINED when it is effective at forcing entry to Debug state.

The PE ignores writes to this bit if either:

- External debugging is not enabled, meaning `ExternalInvasiveDebugEnabled() == FALSE`.
- Secure external debugging is not enabled, meaning `ExternalSecureInvasiveDebugEnabled() == FALSE`, and either:
 - EL3 is not implemented and the implemented Security state is Secure state.
 - EL3 is implemented.

[Example H2-1](#) shows how entry to Debug state can be forced.

Example H2-1 Forcing entry to Debug state

The debugger pends an External Debug Request debug event through the CTI to halt a program that has stopped responding. However, the memory system is not responding and a memory access instruction cannot complete. This means that Debug state cannot be entered precisely. The debugger writes a value of 1 to [EDRCCR.CBRRQ](#). The PE cancels all outstanding memory accesses and enters Debug state. As some instructions might not have completed correctly, entry to Debug state is imprecise.

When Debug state is entered imprecisely, all memory access instructions executed through the ITR have UNPREDICTABLE behavior. The value of all registers is UNKNOWN, but might be useful for diagnostic purposes.

H2.2.7 Summary of actions from debug events

[Table H2-1](#) shows the Software and Halting debug events. In [Table H2-1](#) the columns have the following meaning:

Debug event type

This means the type of debug event where:

Other software

Means one of:

- [Software Step exceptions on page D2-1956](#).

- [Breakpoint Instruction exceptions](#) on page D2-1919.
- [Vector Catch exceptions](#) on page D2-1955 for AArch64 state or [Vector Catch exceptions](#) on page G2-4510 for AArch32 state.

Other Halting

Means one of the following:

- [Halting Step debug events](#) on page H3-5476.
- [External Debug Request debug event](#) on page H3-5490.
- [Reset Catch debug events](#) on page H3-5492.
- [OS Unlock Catch debug event](#) on page H3-5491.

Other debug events are referred to explicitly.

Authentication

This means halting is allowed by the IMPLEMENTATION DEFINED external authentication interface. It is the result of one of the following pseudocode functions:

In Secure state ExternalSecureInvasiveDebugEnabled().

In Non-secure state ExternalInvasiveDebugEnabled().

DLK This indicates whether the OS Double Lock is locked, DoubleLockStatus() == TRUE.

OSLK This is the value of OSLSR.OSLK. It indicates whether the OS Lock is locked.

HDE This is the value of EDSCR.HDE. It indicates whether Halting debug is enabled.

The letter X in [Table H2-1](#) indicates that the value can be either 0 or 1.

Table H2-1 Debug authentication for external debug

Debug event type	Authentication	DLK	OSLK	HDE	Behavior
Other software	X	X	X	X	Handled by the Exception model
Breakpoint or Watchpoint debug event	X	TRUE	X	X	Handled by the Exception model (ignored)
	X	FALSE	1	X	Handled by the Exception model (ignored)
	FALSE	FALSE	0	X	Handled by the Exception model
	TRUE	FALSE	0	0	Handled by the Exception model
	TRUE	FALSE	0	1	Entry to Debug state
Halt Instruction debug event	FALSE	X	X	X	UNDEFINED
	TRUE	TRUE	X	X	UNDEFINED
	TRUE	FALSE	X	0	UNDEFINED
	TRUE	FALSE	X	1	Entry to Debug state
Exception Catch debug event	FALSE	X	X	X	Ignored
	TRUE	TRUE	X	X	Ignored
	TRUE	FALSE	X	X	Entry to Debug state
Software Access debug event	FALSE	X	X	X	Ignored
	TRUE	TRUE	X	X	Ignored
	TRUE	FALSE	1	X	Ignored
	TRUE	FALSE	0	X	Entry to Debug state

Table H2-1 Debug authentication for external debug (continued)

Debug event type	Authentication	DLK	OSLK	HDE	Behavior
Other Halting	FALSE	X	X	X	Debug event is pended
	TRUE	TRUE	X	X	Debug event is pended
	TRUE	FALSE	X	X	Entry to Debug state

H2.2.8 Pseudocode description of Halting on debug events

The `Halted()`, `Restarting()`, `HaltingAllowed()`, and `HaltOnBreakpointOrWatchpoint()` functions are described in the ARMv8 pseudocode.

H2.3 Entering Debug state

On entry to Debug state, the preferred restart address and **PSTATE** are saved in **DLR** and **DSPSR**. The PE remains in the mode and security state from which it entered Debug state.

If **EDRCR.CBRRQ** has a value of 0, entry to Debug state is precise. If **EDRCR.CBRRQ** has a value of 1, then imprecise entry to Debug state is permitted.

If a Watchpoint debug event causes an entry to Debug state, the address of the access that generated the Watchpoint debug event is recorded in **EDWAR**.

See:

- [Determining the memory location that caused a Watchpoint exception on page D2-1948](#) for a debug event taken from AArch64 state.
- [Determining the memory location that caused a Watchpoint exception on page G2-4504](#) for a debug event taken from AArch32 state.

Other than the effect on **PSTATE** and **EDSCR**, entry to Debug state is not a *Context synchronization event*. The effects of entry to Debug state on **PSTATE** and **EDSCR** are synchronized.

H2.3.1 Entering Debug state from AArch32 state

When entering Debug state from AArch32 state, the PE remains in AArch32 state. In AArch32 Debug state the PE executes T32 instructions, regardless of the value of **PSTATE.T** before entering Debug state.

To allow the debugger to determine the state of the PE, the current Execution state for all four Exception levels can be read from **EDSCR.RW**, and the current Exception level can be read from **EDSCR.EL**.

The current endianness state, **PSTATE.E**, is unchanged on entry to Debug state.

———— **Note** —————

- If EL1 is using AArch32 state, the current endianness state can differ from that indicated by **SCTLR.EE**.
- If EL2 is using AArch32 state, the current endianness state can differ from that indicated by **HSCTLR.EE**.
- On entry to Debug state from AArch32 state, **PSTATE.SS** is copied to **DSPSR.SS**, even though the PE remains in AArch32 state.

See also [Effect of entering Debug state on PSTATE on page H2-5443](#).

H2.3.2 Effect of Debug state entry on DLR and DSPSR

DLR is set to the preferred restart address for the debug event, that depends on the event type. The value of **PSTATE** is saved in **DSPSR**. For entry to Debug state from AArch32 state, the values saved in **DSPSR.IT** are always correct for the preferred restart address.

For synchronous Halting debug events, the preferred restart address is the address of the instruction that generated the debug event.

For asynchronous Halting debug events, including pending Halting debug events taken asynchronously, the preferred restart address is the address of the first instruction that must be executed on exit from Debug state.

This means that:

- For Breakpoint and Watchpoint debug events, the preferred restart address is the same as the preferred return address for a debug exception, as described in [Chapter D2 AArch64 Self-hosted Debug](#) and [Chapter G2 AArch32 Self-hosted Debug](#).
- For Halt Instruction debug events **DLR** is set to the address of the HLT instruction and **DSPSR.IT** is correct for the HLT instruction.

- For Software Access debug events, **DLR** is set to the address of the accessing instruction and **DSPSR.IT** is correct for this instruction.
 - For Halting Step debug events taken synchronously, **DLR** and **DSPSR** are set as the ELR and SPSR would be set for a Software Step exception. This is usually the address of, and **PSTATE** for, the instruction after the one that was stepped.
 - For Exception Catch debug events:
 - If the debug event is generated on taking an exception to a trapped Exception level, the **DLR** is set to the address of the exception vector the PE would have started fetching from. This is UNKNOWN if the **VBAR** for the Exception level has never been initialized. The **DSPSR** records the value of **PSTATE** after taking the exception. The Exception Catch occurs after the **SPSR** and the Link register are set, and the debugger can use these registers to determine where in the application program the exception occurred.
- **Note** —————
- Depending on the target Exception level and Execution state for the exception, the Link register is one of **ELR_EL1**, **ELR_EL2**, **ELR_EL3**, **ELR_hyp**, or LR (R14).
- If the debug event is generated on an exception return to a trapped Exception level, the **DLR** is set to the target address of the exception return and the **DSPSR** records the value of **PSTATE** after the exception return.
- Reset Catch debug events taken synchronously behave like Exception Catch debug events.
 - For Reset Catch debug events and Exception Catch debug events generated on reset to a trapped Exception level, the **DLR** is set to is set to the reset address and the **DSPSR** records the reset value of **PSTATE**.
 - For pending Halting debug events and External Debug Request debug events, **DLR** is set to the address of the first instruction that must be executed on exit from Debug state and **DSPSR.IT** is correct for this instruction. See *Pending Halting debug events on page H3-5494*.

Normally **DLR** is aligned according to the instruction set state indicated in **DSPSR**. However, a debug event might be taken at a point where the PC is not aligned.

H2.3.3 Effect of Debug state entry on System registers, the Event register, and Exclusives monitors

Entering Debug state has no effect on System registers other than **DLR** and **DSPSR**. In particular, ESRs, FARs, and FSRs are not updated on entering Debug state. **SCR** is unchanged, even when entering Debug state from EL3.

Entering Debug state has no architecturally-defined effect on the Event Register and Exclusives monitors.

———— **Note** —————

Entry to Debug state might set the Event Register or clear the Exclusives monitors, or both. However, this is not a requirement, and debuggers must not rely on any implementation specific behavior.

Unless otherwise described in this reference manual, instructions executed in Debug state have their architecturally-defined effects on the System registers, the Event register, and Exclusives monitors.

H2.3.4 Effect of entering Debug state on PSTATE

The effect of an entry to Debug state on **PSTATE** is described in *Entering Debug state on page H2-5442* and *Entering Debug state from AArch32 state on page H2-5442*.

PSTATE.{E, M, nRW, EL, SP} are unchanged on entry to Debug state.

PSTATE.IL is cleared to 0 on entry to Debug state, after being saved in **DSPSR_EL0**.

PSTATE.PAN is saved in **DSPSR_EL0.PAN**.

PSTATE.UAO is saved in **DSPSR_EL0.UAO**.

The other `PSTATE` fields are ignored and not observable in Debug state:

- `PSTATE`.{N, Z, C, V, Q, GE} are unchanged.
- `PSTATE`.{IT, T, SS, D, A, I, F} are set to UNKNOWN values, after being saved in `DSPSR_EL0`.

For more information see *Process state (PSTATE) in Debug state* on page H2-5445.

H2.3.5 Entering Debug state during loads and stores

The PE can enter Debug state during instructions that perform a sequence of memory accesses, as opposed to a single single-copy atomic access, because of a Watchpoint debug event. The effect of entering Debug state on such an instruction is the same as taking a Data Abort exception during such an instruction.

In addition, when executing in AArch64 state, the PE can enter Debug state during instructions that perform a sequence of memory accesses because of an External Debug Request debug event. The effect of entering Debug state on such an instruction is the same as taking an interrupt exception during such an instruction.

This applies to all memory types.

H2.3.6 Entering Debug state and Software Step

When Software Step is active, a debug event that causes entry to Debug state behaves like an exception taken to an Exception level above the debug target Exception level. That is:

- If the instruction that is stepped generates a synchronous debug event that causes entry to Debug state, or an asynchronous debug event is taken before the step completes, the PE enters Debug state with `DSPSR.SS` set to 1.
- A pending Halting debug event or an asynchronous debug event can be taken after the step has completed. In this case the PE enters Debug state with `DSPSR.SS` set to 0.

In addition:

- If the instruction that is stepped generates an exception trapped by an Exception Catch debug event, the PE enters Debug state at the exception vector with `DSPSR.SS` set to 0. This is because `PSTATE.SS` is set to 0 by taking the exception.
- If the PE is reset, `PSTATE.SS` is reset to 0. If the following debug events are enabled, the PE enters Debug state with `DSPSR.SS` set to 0:
 - Reset Catch debug event at the reset Exception level.
 - Exception Catch debug event at the reset Exception level.
 - Halting Step debug event.
- If Halting Step is also active, then Halting Step and Software Step operate in parallel and can both become active-pending. In this case Halting step has a higher priority than Software step. This means that the PE enters Debug state and `DSPSR.SS` is set to 0.

H2.3.7 Pseudocode description of entering Debug state

The `DebugHalt` constants are described in *shared/debug/halting/DebugHalt* on page J1-6015 in the ARMv8 pseudocode. The `UpdateEDSFields()` and `Halt()` functions are described in *Chapter J1 ARMv8 Pseudocode*.

H2.4 Behavior in Debug state

Instructions are executed in Debug state from the Instruction Transfer Register, ITR. The debugger controls which instructions are executed in Debug state by writing the instructions to the External Debug Instruction Transfer register, [EDITR](#). The Execution state of the PE determines which instruction set is executed:

- If the PE is in AArch64 state it executes A64 instructions.
- If the PE is in AArch32 state it executes T32 instructions:
 - For a 32-bit T32 instruction, [EDITR\[15:0\]](#) specifies the first halfword and [EDITR\[31:16\]](#) specifies the second halfword.
 - For a 16-bit T32 instruction, [EDITR\[15:0\]](#) contains the instruction and [EDITR\[31:16\]](#) is ignored. All 16-bit T32 instructions are UNPREDICTABLE in debug state.

The PE does not execute A32 instructions in Debug state.

Some instructions are available only in Debug state. See *Debug state operations, DCPS, DRPS, MRS, MSR* on page H2-5461. In Non-debug state these instructions are UNDEFINED.

The following sections describe behavior in Debug state:

- *Process state (PSTATE) in Debug state.*
- *Executing instructions in Debug state* on page H2-5446.
- *Decode tables* on page H2-5457.
- *Security in Debug state* on page H2-5460.
- *Privilege in Debug state* on page H2-5461.
- *Debug state operations, DCPS, DRPS, MRS, MSR* on page H2-5461.
- *Exceptions in Debug state* on page H2-5465.
- *Accessing registers in Debug state* on page H2-5467.
- *Accessing memory in Debug state* on page H2-5470.

This section specifies the CONSTRAINED UNPREDICTABLE behaviors that apply in Debug state, but see *Changing the value of EDECR.SS when not in Debug state* on page H3-5483 for a change in Non-debug state that causes CONSTRAINED UNPREDICTABLE behavior.

H2.4.1 Process state (PSTATE) in Debug state

[PSTATE](#).{N, Z, C, V, Q, GE, IT, T, SS, D, A, I, F} are all ignored in Debug state:

- There are no conditional instructions in Debug state.
- In AArch32 state, the PE only executes T32 instructions and [PSTATE.IT](#) is ignored.
- Asynchronous exceptions and debug events are ignored.
- Software step is inactive.

Instructions executed in Debug state indirectly read [PSTATE](#).{IL, E, M, nRW, EL, SP} as they would in Non-debug state.

On entry to Debug state from AArch64:

- [PSTATE.PAN](#) is copied to [DSPSR_EL0.PAN](#).
- [PSTATE.UAO](#) is copied to [DSPSR_EL0.UAO](#).

On exit from Debug state to AArch64:

- [DSPSR_EL0.PAN](#) is copied to [PSTATE.PAN](#).
- [DSPSR_EL0.UAO](#) is copied to [PSTATE.UAO](#).

On entry to Debug state from AArch32, [CPSR.PAN](#) is copied to [DSPSR.PAN](#).

On exit from Debug state to AArch32, [DSPSR.PAN](#) is copied to [CPSR.PAN](#).

In Debug state:

- **PSTATE.PAN** is set to 1 by:
 - A DCPS instruction to EL1 using AArch64 if **SCTLR_EL1.SPAN** == 0.
 - A DCPS instruction to EL2 using AArch64 if **SCTLR_EL2.SPAN** == 0.
- **SPSR_ELx.PAN** is copied to:
 - **PSTATE.PAN** by the DRPS instruction to AArch64 from AArch64.
 - **CPSR.PAN** by the DRPS instruction to AArch32 from AArch64.

———— **Note** —————

A debugger can use a DRPS instruction to modify the PAN state bit.

- **PSTATE.UAO** is set to 0 by a DCPS instruction to AArch64.
- **SPSR_ELx.UAO** is copied to **PSTATE.UAO** by the DRPS instruction to AArch64 from AArch64.
- **PSTATE.UAO** operates as in Non-debug state.

H2.4.2 Executing instructions in Debug state

The instructions executed in Debug state must be either A64 instructions or T32 instructions, depending on the current Execution state.

Each instruction falls into one of the following groups:

- Debug state instructions. These are instructions that are changed in Debug state. See *A64 instructions that are changed in Debug state* and *T32 instructions that are changed in Debug state* on page H2-5452.
- Instructions that are unchanged in Debug state. See *A64 instructions that are unchanged in Debug state* on page H2-5447 and *T32 instructions that are unchanged in Debug state* on page H2-5452.
- Instructions that are UNPREDICTABLE or CONSTRAINED UNPREDICTABLE in Debug state. See *A64 instructions that are CONSTRAINED UNPREDICTABLE in Debug state* on page H2-5449 and *T32 instructions that are CONSTRAINED UNPREDICTABLE in Debug state* on page H2-5454.

All T32 instructions are treated as unconditional, regardless of **PSTATE.IT**. See *Process state (PSTATE) in Debug state* on page H2-5445.

If **EDSCR.SDD** == 1 then an instruction executed in Non-secure state cannot cause entry into Secure state. See *Security in Debug state* on page H2-5460

Executing A64 instructions in Debug state

The following sections describe the behavior of the A64 instructions in Debug state:

- *A64 instructions that are changed in Debug state.*
- *A64 instructions that are unchanged in Debug state* on page H2-5447.
- *A64 instructions that are CONSTRAINED UNPREDICTABLE in Debug state* on page H2-5449.

A64 instructions that are changed in Debug state

The following A64 instructions are defined in Debug state, but are UNDEFINED in Non-debug state:

- DCPS.

———— **Note** —————

DCPS can be UNDEFINED in certain conditions in Debug state. See *DCPS<n>* on page H2-5461.

- DRPS.
- MRS (**DLR_EL0**), MRS (**DSPSR_EL0**), MSR (**DLR_EL0**), MSR (**DSPSR_EL0**)

For more information see [Debug state operations, DCPS, DRPS, MRS, MSR](#) on page H2-5461.

A64 instructions that are unchanged in Debug state

The following list shows the instructions that are unchanged in Debug state:

Any instruction that is UNDEFINED in Non-debug state

This list of instructions excludes:

- Any instruction listed in [A64 instructions that are changed in Debug state](#) on page H2-5446.
- Any instruction listed in [A64 instructions that are CONSTRAINED UNPREDICTABLE in Debug state](#) on page H2-5449 that is UNDEFINED because an enable or disable bit is not RES0 or RES1

Instructions that move System or Special-purpose registers to or from a general-purpose register

This list of instructions:

- Includes the instructions to transfer a general-purpose register to or from the DTR, which can be executed at any Exception level.
- Excludes PSTATE access instructions.

These instructions are:

- MRS <special_reg>, MSR <special_reg>.

———— **Note** ————

This does not include NZCV, DAIF, DAIFSet, DAIFClr, SPSel, and CurrentEL.

- MRS <system_reg>, MSR <system_reg>.

Floating-point moves between a SIMD&FP register and a general-purpose register

These instructions are:

- **FMOV (between a general-purpose register and a half-precision register).**
- FMOV (between a general-purpose register and a single-precision register).
- FMOV (between a general-purpose register and a double-precision register).
- FMOV (between a general-purpose register and a SIMD element).

SIMD moves between a SIMD&FP register and a general-purpose register

These instructions are:

- INS (from a general-purpose register to a SIMD element).
- UMOV (from a SIMD element to a general-purpose register).

Barriers

These instructions are:

- ISB.
- DSB.
- DMB.

Memory access instructions at various access sizes

The following constraints apply:

- General purpose-registers only.
- One of the following addressing modes:
 - Unscaled (9-bit signed) immediate offset.
 - Immediate (9-bit signed) post-indexed.
 - Immediate (9-bit signed) pre-indexed.
 - Unprivileged (9-bit signed).
- Not literal.

- One of the following types:
 - (Single) register.
 - Exclusive.
 - Exclusive pair.
 - Acquire/Release.
 - Acquire/Release Exclusive.
 - Acquire/Release Exclusive pair.
- 32-bit and 64-bit target register variants.

These instructions are:

- LDR, LDRB, LDRH, LDRSB, LDRSH, LDRSW (immediate, not literal).
- LDUR, LDURB, LDURH, LDURSB, LDURSH, LDURSW (immediate).
- LDTR, LDTRB, LDTRH, LDTRSB, LDTRSH, LDTRSW (immediate).
- LDAR, LDARB, LDARH, LDXR, LDXRB, LDXRH, LDAXR, LDAXRB, LDAXRH.
- LDXP, LDAXP.
- STR, STRB, STRH (immediate).
- STUR, STURB, STURH (immediate).
- STTR, STTRB, STTRH (immediate).
- STLR, STLRB, STLRH, STXR, STXRB, STXRH, STLXR, STLXRB, STLXRH.
- STXP, STLXP.
- LDLAR, LDLARB, LDLARH - ARMv8.1 instructions.
- STLLR, STLLRB, STLLRH - ARMv8.1 instructions.
- CAS, CASB, CASH, CASP - ARMv8.1 instructions.
- SWP, SWPB, SWPH - ARMv8.1 instructions.
- LDADD, LDADDB, LDADDH - ARMv8.1 instructions.
- LDCLR, LDCLB, LDCLR - ARMv8.1 instructions.
- LDEOR, LDEORB, LDEORH - ARMv8.1 instructions.
- LDSET, LDSETB, LDSETH - ARMv8.1 instructions.
- LDSMAX, LDSMAXB, LDSMAXH - ARMv8.1 instructions.
- LDSMIN, LDSMINB, LDSMINH - ARMv8.1 instructions.
- LDUMAX, LDUMAXB, LDUMAXH - ARMv8.1 instructions.
- LDUMIN, LDUMINB, LDUMINH - ARMv8.1 instructions.
- STADD, STADDB, STADDH - ARMv8.1 instructions.
- STCLR, STCLB, STCLR - ARMv8.1 instructions.
- STEOR, STEORB, STEORH - ARMv8.1 instructions.
- STSET, STSETB, STSETH - ARMv8.1 instructions.
- STSMAX, STSMAXB, STSMAXH - ARMv8.1 instructions.
- STSMIN, STSMINB, STSMINH - ARMv8.1 instructions.
- STUMAX, STUMAXB, STUMAXH - ARMv8.1 instructions.
- STUMIN, STUMINB, STUMINH - ARMv8.1 instructions.

Move immediate to general-purpose register

These instructions are:

- MOVZ, MOVN, MOVK (immediate).
- MOV (between a general-purpose register and the stack pointer).

System instructions, Send Event, NOP, and Clear Exclusive

In this context, the System instructions are the Cache maintenance instructions, TLB maintenance instructions, and the Address translation instructions.

These instructions are:

- IC.
- DC.
- TLBI.
- AT.
- SEV, SEVL.
- NOP.
- CLREX.

A64 instructions that are **CONSTRAINED UNPREDICTABLE** in Debug state

This subsection describes all instruction not listed in either:

- [A64 instructions that are changed in Debug state on page H2-5446](#).
- [A64 instructions that are unchanged in Debug state on page H2-5447](#).

These instructions are **CONSTRAINED UNPREDICTABLE** in Debug state. In general, the permissible behaviors are:

- The instruction is **UNDEFINED**.
- The instruction executes as a **NOP**.
- If the instruction reads the PC or PSTATE, it uses an **UNKNOWN** value.
- If the instruction modifies the PC or PSTATE, other than by advancing the PC to the sequentially next instruction, it sets **DLR_EL0** and **DSPSR_EL0** to **UNKNOWN** values.
- If the instruction is similar to a Debug state instruction, it executes as that Debug state instruction.
- The instruction has the same behavior as in Non-debug state.

The following list shows the permissible behaviors for A64 instruction in Debug state. An instruction might appear multiple times in the list, in which case the choice of permissible behaviors is any of those listed. An example of this is **CCMP**.

Exception-generating instructions

These instructions are:

- SVC.
- HVC.
- SMC.
- BRK.
- HLT.

These instructions behave in one of the following ways:

- They are **UNDEFINED**.
- They execute as a **NOP**.
- SVC behaves as **DCPS1**.
- HVC behaves as **DCPS2**.
- SMC behaves as **DCPS3**.
- They generate the exception that the instruction would generate in Non-debug state. The exception is taken as described in [Exceptions in Debug state on page H2-5465](#)

————— **Note** —————

SMC must not generate a Secure Monitor Call exception from Non-secure state if **EDSCR.SDD** is set to 1.

Instructions that explicitly write to the PC (branches)

These instructions are:

- B, B.cond, BL, BLR, BR, CBZ, CBNZ, RET, TBZ, TBNZ.

These instructions behave in one of the following ways:

- They are UNDEFINED.
- They execute as a NOP.
- They execute as in Non-debug state without branching and set [DSPSR_ELO](#) and [DLR_ELO](#) to UNKNOWN values.

Exception return and related instructions

These instructions are:

- ERET.

These instructions behave in one of the following ways:

- They are UNDEFINED.
- They execute as a NOP.
- They execute as in Non-debug state without branching. They set [DSPSR_ELO](#) and [DLR_ELO](#) to UNKNOWN values, and either:
 - Execute the DRPS operation instead of performing an exception return, using UNKNOWN SPSR values.
 - Not change the Exception level.

Instructions that explicitly modify PSTATE, other than DCPS and DRPS

These instructions are:

- MSR DAIFSet (immediate), MSR DAIFClr (immediate), MSR SPSe1 (immediate).
- MSR NZCV (register), MSR DAIF (register), MSR SPSe1 (register).
- MSR PAN (immediate) - ARMv8.1 instruction.
- **MSR UAO (immediate) - ARMv8.2 instruction.**

These instructions behave in one of the following ways:

- They are UNDEFINED.
- They execute as a NOP.
- They execute as in Non-debug state, setting [DSPSR_ELO](#) and [DLR_ELO](#) to UNKNOWN values.

Instructions that request entry to a low-power state

These instructions are:

- WFE, WFI.

These instructions behave in one of the following ways:

- They are UNDEFINED.
- They execute as a NOP.
- They generate a synchronous exception if the corresponding instruction would be trapped in Non-debug state. See [Configurable instruction enables and disables, and trap controls on page D1-1842](#).
- A WFE instruction clears the Event register if it is set.

————— **Note** —————

This means that these instructions must not suspend execution.

Instructions that read the PC

These instructions are:

- LDR (literal), LDRSW (literal).
- ADR, ADRP.
- PRFM (literal).

These instructions behave in one of the following ways:

- They are UNDEFINED.
- They execute as a NOP.
- They execute as in Non-debug state, using an UNKNOWN value for the PC operand.

Instructions that read the PSTATE.{N, Z, C, V} or other PSTATE fields

These instructions are:

- CSEL, CSINC, CSINV, CSNEG, CCMN, CCMP, FCSEL, FCCMP, FCCMPE.
- ADC, ADCS, SBC, SBCS.
- MRS NZCV, MRS DAIF, MRS SPSEL, MRS CurrentEL.

These instructions behave in one of the following ways:

- They are UNDEFINED.
- They execute as a NOP.
- They execute as in Non-debug state:
 - For the conditional operations and those using the PSTATE.C flag as an input, these instructions use an UNKNOWN value for the Condition flag.
 - For the MRS instruction, they return an UNKNOWN value.

Instructions that explicitly modify the PSTATE. {N, Z, C, V, Q, GE}

These instructions are:

- ADDS, SUBS, ADCS, SBCS, ANDS, BICS, CCMN, CCMP.
- FCMP, FCMPE, FCCMP, FCCMPE.
- MSR NZCV (register).

These instructions behave in one of the following ways:

- They are UNDEFINED.
- They execute as a NOP.
- They execute as in Non-debug state, setting [DPSR_ELO](#) and [DLR_ELO](#) to UNKNOWN values.

All other instructions

These instructions behave in one of the following ways:

- They are UNDEFINED.
- They execute as a NOP.
- They have the same behavior as in Non-debug state.

————— Note —————

This includes instructions defined as UNPREDICTABLE or CONSTRAINED UNPREDICTABLE in Non-debug state. These instructions are UNPREDICTABLE or CONSTRAINED UNPREDICTABLE in Debug state.

Executing T32 instructions in Debug state

The following sections describe the behavior of the T32 instructions in Debug state:

- [T32 instructions that are changed in Debug state.](#)
- [T32 instructions that are unchanged in Debug state.](#)
- [T32 instructions that are CONstrained UNPREDICTABLE in Debug state on page H2-5454.](#)

T32 instructions that are changed in Debug state

The following T32 instructions are defined in Debug state, but are UNDEFINED in Non-debug state:

- DCPS

———— **Note** —————

DCPS can be UNDEFINED in certain conditions in Debug state. See [DCPS<n> on page H2-5461.](#)

- MRC p15, 3, <Rt>, c4, c5, 0 (DSPSR).
- MCR p15, 3, <Rt>, c4, c5, 0 (DSPSR).
- MRC p15, 3, <Rt>, c4, c5, 1 (DLR).
- MCR p15, 3, <Rt>, c4, c5, 1 (DLR).

In addition, ERET executes the DRPS operation in Debug state.

For more information see [Debug state operations, DCPS, DRPS, MRS, MSR on page H2-5461.](#)

T32 instructions that are unchanged in Debug state

The following list shows the instructions that are unchanged in Debug state. Any T32 instruction that uses the PC or APSR. {N, Z, C, V} as the source or destination register is not included in the list. Moreover, the list only includes the 32-bit T32 encodings.

Any instruction that is UNDEFINED in Non-debug state

The list of instructions:

- Excludes any instruction listed in [T32 instructions that are changed in Debug state.](#)
- Excludes any instruction listed in [T32 instructions that are CONstrained UNPREDICTABLE in Debug state on page H2-5454](#) that is UNDEFINED because an enable or disable bit is not RES0 or RES1

Instructions that move System or Special-purpose registers to or from a general-purpose register

The list of instructions:

- Includes the instructions to transfer a general-purpose register to or from the DTR, which can be executed at any Exception level.
- Excludes APSR and CPSR access instructions.
- Excludes instructions for accessing banked registers for the current mode.

These instructions are:

- MRS <banked_reg>, MSR <banked_reg>.

———— **Note** —————

This does not apply to cases which are UNPREDICTABLE or CONstrained UNPREDICTABLE in Non-debug state in the current mode.

- MRC, MCR.

———— **Note** —————

This includes all allocated System registers in the (coproc==0b111x) encoding space other than an MRC move to APSR_nzcv.

- MRS SPSR, MSR SPSR.

- VMRS <vfp_system_reg>, VMSR <vfp_system_reg>.

———— **Note** ————

This includes all allocated Advanced SIMD and floating-point System registers, other than an a VMRS move to APSR_nzcv.

Floating-point moves between a SIMD&FP register and a general-purpose register

These instructions are:

- VMOV (between a general-purpose register and a single-precision register).
- VMOV (between a general-purpose register and a doubleword floating-point register).

SIMD moves between a SIMD&FP register and a general-purpose register

These instructions are:

- VMOV (between a general-purpose register and a scalar).

Barriers

These instructions are:

- ISB.
- DSB.
- DMB.

Memory access instructions at various access sizes

The following constraints apply:

- General purpose-registers only.
- One of the following addressing modes:
 - Immediate (8-bit or 12-bit) offset.
 - Immediate (8-bit) post-indexed.
 - Immediate (8-bit) pre-indexed.
 - Unprivileged (8-bit).
- Not literal.
- One of the following types:
 - (Single) register.
 - Dual.
 - Exclusive.
 - Exclusive doubleword.
 - Acquire/Release.
 - Acquire/Release Exclusive.
 - Acquire/Release Exclusive doubleword.

These instructions are:

- LDR.W, LDRB.W, LDRH.W, LDRD, LDRSB.W, LDRSH.W (immediate, not literal).
- LDRT, LDRBT, LDRHT, LDRSBT, LDRSHT (immediate).
- LDREX, LDREXB, LDREXH, LDA, LDAB, LDAH, LDAEX, LDAEXB, LDAEXH.
- LDREXD, LDAEXD.
- STR.W, STRB.W, STRH.W, STRD (immediate).
- STRT, STRBT, STRHT (immediate).
- STREX, STREXB, STREXH, STL, STLB, STLH, STLEX, STLEXB, STLEXH.
- STREXD, STLEXD.

Move to general-purpose register

These instructions are:

- MOVW, MOVT (immediate).

System instructions, Send Event, NOP, and Clear Exclusive

The System instructions are Cache maintenance instructions, TLB maintenance instructions, and Address translation instructions. These are encoded in the (coproc==0b1111) System register encoding space.

These instructions are:

- [ICIALLU, ICIALLUIS, ICIMVAU.](#)
- [DCCIMVAC, DCCISW, DCCMVAC, DCCMVAU, DCCSW, DCIMVAC, DCISW.](#)
- [TLBIALL, TLBIALLH, TLBIALLHIS, TLBIALLIS, TLBIALLNSNH, TLBIALLNSNHIS, TLBIASID, TLBIASIDIS, TLBIIPAS2, TLBIIPAS2IS, TLBIIPAS2L, TLBIIPAS2LIS, TLBIMVA, TLBIMVAA, TLBIMVAAIS, TLBIMVAAL, TLBIMVAALIS, TLBIMVAH, TLBIMVAHIS, TLBIMVAIS, TLBIMVAL, TLBIMVALH, TLBIMVALHIS, TLBIMVALIS.](#)
- [ATS12NSOPR, ATS12NSOPW, ATS12NSOUR, ATS12NSOUW, ATS1CPR, ATS1CPW, ATS1CUR, ATS1CUW, ATS1HR, ATS1HW.](#)
- [BPIALL, BPIALLIS, BPIMVA.](#)
- [SEV.W, SEVL.W.](#)
- [NOP.W.](#)
- [CLREX.](#)

T32 instructions that are **CONSTRAINED UNPREDICTABLE** in Debug state

This subsection describes all instruction not listed in either:

- [T32 instructions that are changed in Debug state on page H2-5452.](#)
- [T32 instructions that are unchanged in Debug state on page H2-5452.](#)

These instructions are **CONSTRAINED UNPREDICTABLE** in Debug state. In general, the permissible behaviors are:

- The instruction generates an Undefined Instruction exception.
- The instruction executes as a NOP.
- If the instruction reads the PC or PSTATE, it uses an UNKNOWN value.
- If the instruction modifies the PC or PSTATE, other than by advancing the PC to the sequentially next instruction, it sets [DLR](#) and [DSPSR](#) to UNKNOWN values.
- If the instruction is similar to a Debug state instruction, it executes as that Debug state instruction.
- The instruction has the same behavior as in Non-debug state.

The following list shows the permissible behaviors for T32 instruction in Debug state. An instruction might appear multiple times in the list, in which case the choice of permissible behaviors is any of those listed.

Exception-generating instructions

These instructions are:

- [SVC.](#)
- [HVC.](#)
- [SMC.](#)
- [UDF.](#)
- [BKPT.](#)
- [HLT.](#)

These instructions behave in one of the following ways:

- They are UNDEFINED.
- They execute as a NOP.
- SVC behaves as DCPS1.

- HVC behaves as DCPS2.
- SMC behaves as DCPS3.
- They generate the exception the instruction would generate in Non-debug state. The exception is taken as described in *Exceptions in Debug state* on page H2-5465

———— **Note** ————

SMC must not generate a Secure Monitor Call exception from Non-secure state if EDSCR.SDD is set to 1.

Instructions that explicitly write to the PC (branches)

These instructions are:

- B, B (conditional), CBZ, CBNZ BL.
- BX, BLX (register or immediate).
- BXJ, TBB, TBH.
- MOV pc and related instructions.
- LDR pc, LDM (with a register list includes the PC), POP (with a register list that includes the PC).

These instructions behave in one of the following ways:

- They are UNDEFINED.
- They execute as a NOP.
- They execute as in Non-debug state without branching and set **DSPSR** and **DLR** to UNKNOWN values.

Exception return and related instructions, other than ERET

These instructions are:

- SRS, RFE, SUBS pc, 1r, and related instructions.

These instructions behave in one of the following ways:

- They are UNDEFINED.
- They execute as a NOP.
- They execute as in Non-debug state without branching, setting **DSPSR_EL0** and **DLR_EL0** to UNKNOWN values, and either:
 - Execute the DPRS operation instead of performing an exception return, using UNKNOWN SPSR values.
 - Not changing Exception level or PE mode.

Instructions that explicitly modify PSTATE, other than DCPS and ERET

These instructions are:

- CPS, SETEND, IT.
- MSR APSR, CPSR (register or immediate).
- SETPAN.

These instructions behave in one of the following ways:

- They are UNDEFINED.
- They execute as a NOP.
- They execute as in Non-debug state, setting **DSPSR_EL0** and **DLR_EL0** to UNKNOWN values.

Instructions that request entry to a low-power state

These instructions are:

- WFE, WFI.

These instructions behave in one of the following ways:

- They are UNDEFINED.

- They execute as a NOP.
- They generate a synchronous exception if the corresponding instruction would be trapped in Non-debug state. See [Configurable instruction enables and disables, and trap controls on page G1-4418](#).
- A WFE instruction is permitted to clear the Event register if it is set.

———— **Note** ————

This means that these instructions must not suspend execution.

Instructions that read the PC

These instructions are:

- LDR (literal), LDRB (literal), LDRH (literal), LDRSB (literal), LDRSH (literal).
- ADR, ADRL, ADRH.
- PLD (literal), PLI (literal).

These instructions behave in one of the following ways:

- They are UNDEFINED.
- They execute as a NOP.
- They execute as in Non-debug state using an UNKNOWN value for the PC operand.

Instructions that read PSTATE.{N, Z, C, V} or other PSTATE fields

These instructions are:

- SEL, VSEL.
- ADC, SBC, all instructions with an RRX shift.
- MRS CPSR.

These instructions behave in one of the following ways:

- They are UNDEFINED.
- They execute as a NOP.
- They execute as in Non-debug state:
 - For the conditional operations and those using the PSTATE.C flag as an input, these instructions use an UNKNOWN value for the Condition flag.
 - For the MRS instruction, they return an UNKNOWN value

Instructions that explicitly modify PSTATE.{N, Z, C, V, Q, GE}

These instructions are:

- CMP, TST, TEQ, CMN.
- <opc>S.
- MRC p14, 0, APSR_nzcv, c0, c1, 0 (DBGDSCRint).
- MSR CPSR, MSR APSR, (register or immediate).
- VMRS APSR_nzcv, FPSCR.
- QADD, QDADD, QSUB, QDSUB.
- SMLABB, SMLABT, SMLATB, SMLATT, SMLAD, SMLAWB, SMLAWT, SMLSD, SMUAD.
- SSAT, SSAT16, USAT, USAT16.
- SADD, SADD8, SADD16, SASX, SSAX, SSUB, SSUB8, SSUB16.
- UADD, UADD8, UADD16, UASX, USAX, USAUB, USUN8, USUB16.

These instructions behave in one of the following ways:

- They are UNDEFINED.
- They execute as a NOP.
- They execute as in Non-debug state, setting [DSPSR_ELO](#) and [DLR_ELO](#) to UNKNOWN values.

All other instructions

These instructions behave in one of the following ways:

- They are UNDEFINED.
- They execute as a NOP.
- They have the same behavior as in Non-debug state.

Note

This includes instructions defined as UNPREDICTABLE or CONSTRAINED UNPREDICTABLE in Non-debug state. These instructions are CONSTRAINED UNPREDICTABLE in Debug state. This includes some T32 instructions that specify R15 as a destination or source register.

[Appendix K1 Architectural Constraints on UNPREDICTABLE behaviors](#) describes the CONSTRAINED UNPREDICTABLE behavior for these instructions. In Debug state these CONSTRAINED UNPREDICTABLE choices are further restricted:

- Instructions that specify R15 as a destination register:
 - Are not permitted to branch, because the architecture does not define a branch operation in Debug state.
 - Might set [DLR](#) and [DSPSR](#) to UNKNOWN values.
 - Might have any of the other permitted behaviors.
 - Instructions that specify R15 as a source operand:
 - Cannot use PC + offset, because there is no architecturally-defined PC in Debug state.
 - Might have any of the other permitted behaviors, including using an UNKNOWN value.
-

H2.4.3 Decode tables

The syntax in the tables is defined as follows:

1	The bit has a fixed value of 1.
0	The bit has a fixed value of 0.
!=	The field has any value other than the value or values specified. The field might be an encoding field in the instruction whose value is supplied by the debugger.

Note

The instruction encodings in [Chapter C6 A64 Base Instruction Descriptions](#) and [Chapter F5 T32 and A32 Base Instruction Set Instruction Descriptions](#) might show these bits as (0) or (1). A debugger must set these bits to 0 or 1, as appropriate.

Any other value indicates an encoding field in the instruction whose value is supplied by the debugger. Some values might be reserved or UNDEFINED, in which case the instruction is UNDEFINED or CONSTRAINED UNPREDICTABLE in Debug state, as it is in Non-debug state.

For more information about the instruction encodings, see:

- [Chapter C6 A64 Base Instruction Descriptions](#).
- [Chapter F5 T32 and A32 Base Instruction Set Instruction Descriptions](#).

For information about the syntax used in [Table H2-2 on page H2-5458](#), [Table H2-3 on page H2-5458](#), [Table H2-4 on page H2-5459](#), and [Table H2-5 on page H2-5460](#), see:

- [Common syntax terms on page C1-137](#).
- [Assembler symbols on page F2-2846](#).

Table H2-2 shows the A64 instructions that are modified in Debug state. For details of how these are packed in EDITR, see *EDITR, External Debug Instruction Transfer Register* on page H9-5632.

Table H2-2 Modified A64 instructions in Debug state

31 30 29 28	27 26 25 24	23 22 21 20	19 18 17 16	15 14 13 12	11 10 9 8	7 6 5 4	3 2 1 0	Description
1 1 0 1	0 1 0 0	1 0 1 0	0 0 0 0	0 0 0 0	0 0 0 0	0 0 0 0	0 0 !=00	DCPS<opt>
1 1 0 1	0 1 0 1	0 0 L 1	1 1 0 1 1	0 1 0 0	0 1 0 1	0 0 0 0	Rt	MRS MSR accessing DSPSR_ELO
1 1 0 1	0 1 0 1	0 0 L 1	1 1 0 1 1	0 1 0 0	0 1 0 1	0 0 0 1	Rt	MRS MSR accessing DLR_ELO
1 1 0 1	0 1 1 0	1 0 1 1	1 1 1 1	0 0 0 0	0 0 1 1	1 1 1 0	0 0 0 0	DRPS

Table H2-3 show the T32 instructions that are modified in Debug state, with the first halfword on the left side and the second halfword on the right side. For details of how these are packed in EDITR, See *EDITR, External Debug Instruction Transfer Register* on page H9-5632.

Table H2-3 Modified T32 instructions in Debug state

15 14 13 12	11 10 9 8	7 6 5 4	3 2 1 0	15 14 13 12	11 10 9 8	7 6 5 4	3 2 1 0	Description
1 1 1 0	1 1 1 0	0 1 1 L	0 1 0 0	!=1111	1 1 1 1	0 0 0 1	0 1 0 1	MRC MCR accessing DSPSR
1 1 1 0	1 1 1 0	0 1 1 L	0 1 0 0	!=1111	1 1 1 1	0 0 1 1	0 1 0 1	MRC MCR accessing DLR
1 1 1 1	0 0 1 1	1 1 0 1	1 1 1 0	1 0 0 0	1 1 1 1	0 0 0 0	0 0 0 0	ERET
1 1 1 1	0 1 1 1	1 0 0 0	1 1 1 1	1 0 0 0	0 0 0 0	0 0 0 0	0 0 !=00	DCPS<opt>

Table H2-4 lists the A64 instructions that are unchanged in Debug state.

Table H2-4 A64 instructions that are unchanged in Debug state

31	30	29	28	27	26	25	24	23	22	21	20	19	18	17	16	15	14	13	12	11	10	9	8	7	6	5	4	3	2	1	0	Description								
sf	0	0	1	0	0	0	1	0	0	0	0	0	0	0	0	0	0	0	0	0	0	1	1	1	1					Rd	MOV <Rn>,SP									
sf	0	0	1	0	0	0	1	0	0	0	0	0	0	0	0	0	0	0	0	0	0	0					1	1	1	1		MOV SP,<Rn>								
sf	!=01	1	0	0	1	0	1	hw	imm16																														Rd	MOVN, MOVK, MOVZ
1	1	0	1	0	1	0	1	0	0	0	0	0	0	0	1	1	0	0	1	0	0	0	0	0	0	0	0	0	1	1	1	1		NOP						
1	1	0	1	0	1	0	1	0	0	0	0	0	0	0	1	1	0	0	1	0	0	0	0	0	1	0	L	1	1	1	1	1		SEV, SEVL						
1	1	0	1	0	1	0	1	0	0	0	0	0	0	0	1	1	0	0	1	1	0	0	0	0	0	1	0	1	1	1	1	1		CLREX						
1	1	0	1	0	1	0	1	0	0	0	0	0	0	0	1	1	0	0	1	1	option	1	!=11	1	1	1	1	1	1	1	1	1		DSB, DMB, ISB						
1	1	0	1	0	1	0	1	0	0	0	0	1	op1	CRn	CRm	op2																Rt	IC, DC, TLBI, AT							
1	1	0	1	0	1	0	1	0	0	L	1	0	op1	CRn	CRm	op2																Rt	MRS MSR accessing System register							
1	1	0	1	0	1	0	1	0	0	L	1	1	op1	!=0100	CRm	op2																Rt	MRS MSR accessing System register							
1	1	0	1	0	1	0	1	0	0	L	1	1	op1	0 1 0 0	!=0010	op2																Rt	MRS MSR accessing Special-purpose register							
size	0	0	1	0	0	0	0	o2	L	0		Rs	o0	Rt2		Rn																Rt	LD{A X AX}R{B H}, ST{L X LX}R{B H}							
size	0	0	1	0	0	0	0	o2	L	1		Rs	o0	Rt2		Rn																Rt	LD{A}XP, ST{L}XP							
!=11	1	1	1	0	0	0	0	opc	0			imm9		0	0	Rn																Rt	LDUR{B H SB SH SW}, STUR{B H}							
1	1	1	1	1	0	0	0	!=10	0			imm9		0	0	Rn																Rt	LDUR, STUR							
size	1	1	1	0	0	0	0	opc	0			imm9		1	0	Rn																Rt	LDTR{B H SB SH SW}, STTR{B H}							
size	1	1	1	0	0	0	0	opc	0			imm9		P	1	Rn																Rt	LDR{B H SB SH SW}, STR{B H}							
0	1	0	0	1	1	1	0	0	0	0		imm5		0	0	0	1	1	1													Rd	INS <Vd>.<Ts>[<index>], <R><n>							
0	Q	0	0	1	1	1	0	0	0	0		imm5		0	0	1	1	1	1													Rd	UMOV <R><d>, <Vn>.<Ts>[<index>]							
0	0	0	1	1	1	0	0	0	1	0	0	0	1	1	op	0	0	0	0	0	0											Rd	FMOV <Sd>, <Wn>, FMOV <Wd>, <Sn>							
1	0	0	1	1	1	0	0	1	1	0	0	1	1	op	0	0	0	0	0	0												Rd	FMOV <Dd>, <Xn>, FMOV <Xd>, <Dn>							
1	0	0	1	1	1	0	1	0	1	0	1	1	1	op	0	0	0	0	0	0												Rd	FMOV <Vd>.D[1], <Xn> FMOV <Xd>, <Vn>.D[1]							

Table H2-5 lists the T32 instructions that are unchanged in Debug state. It shows the T32 instructions with the first halfword on the left side and the second halfword on the right side.

Table H2-5 T32 instructions that are unchanged in Debug state

15 14 13 12	11 10 9 8	7 6 5 4	3 2 1 0	15 14 13 12	11 10 9 8	7 6 5 4	3 2 1 0	Description
1 1 1 0	1 1 0 0	0 1 0	op	!=1111	!=1111	1 0 1 1	0 0 M 1	Vm VMOV <Dm>, <Rt>, <Rt2> VMOV <Rt>, <Rt2>, <Dm>
1 1 1 0	1 1 1 0	0 0 0	op	Vn	!=1111	1 0 1 0	N 0 0 1	0 0 0 0 VMOV <Sn>, <Rt>, VMOV <Rt>, <Sn>
1 1 1 0	1 1 1 0	0	opc	0	Vd	!=1111	1 0 1 1	D op2 1 VMOV.<size> <Dd>[<x>], <Rt>
1 1 1 0	1 1 1 0	U	opc	1	Vn	!=1111	1 0 1 1	D op2 1 VMOV.<dt> <Rt>, <Dd>[<x>]
1 1 1 0	1 1 1 0	1 1 1	op	reg	!=1111	1 0 1 0	0 0 0 1	0 0 0 0 VMRS, VMSR
1 1 1 0	1 1 0 0	0 1 0	op	!=1111	!=1111	1 1 1	cp op1	CRm MCRR MRRC accessing System registers
1 1 1 0	1 1 1 0	opc1	op	CRn	!=1111	1 1 1	cp op2 1	CRm MCR MRC accessing System registers
1 1 1 0	1 0 0 0	0 1 0	L	!=1111	!=1111	Rd	imm8	LDREX, STREX
1 1 1 0	1 0 0 0	1 1 0	L	!=1111	!=1111	Rt2	0 1 !=10	Rd LDREX(B H D), STREX(B H D)
1 1 1 0	1 0 0 0	1 1 0	L	!=1111	!=1111	Rt2	1 op3	Rd LDA{EX}{B H D}, STL{EX}{B H D}
1 1 1 0	1 0 0	!=0x10 !=xx0x	L	!=1111	!=1111	!=1111	imm8	LDRD, STRD
1 1 1 1	0 i 1 0	T 1 0 0		imm4	0 imm3	!=1111	imm8	MOVW, MOVW
1 1 1 1	0 0 1 1	1 0 0	R	!=1111	1 0 0 0	M1	0 0 1 M	0 0 0 0 MSR <spec_reg><mode>, <Rn>
1 1 1 1	0 0 1 1	1 0 0 1		!=1111	1 0 0 0	1 1 1 1	0 0 0 0	0 0 0 0 MSR SPSR, <Rn>
1 1 1 1	0 0 1 1	1 0 1 0	1 1 1 1	1 0 0 0	0 0 0 0	0 0 0 0	0 0 0 0	0 0 0 0 NOP.W
1 1 1 1	0 0 1 1	1 0 1 0	1 1 1 1	1 0 0 0	0 0 0 0	0 0 0 0	0 1 0	L SEV.W, SEVL.W
1 1 1 1	0 0 1 1	1 0 1 1	1 1 1 1	1 0 0 0	1 1 1 1	0 0 1 0	1 1 1 1	CLREX
1 1 1 1	0 0 1 1	1 0 1 1	1 1 1 1	1 0 0 0	1 1 1 1	0 1 !=11	option	DSB, DMB, ISB
1 1 1 1	0 0 1 1	1 1 1	R	M1	1 0 0 0	!=1111	0 0 1 M	0 0 0 0 MRS <Rd>, <spec_reg><mode>
1 1 1 1	0 0 1 1	1 1 1 1	1 1 1 1	1 0 0 0	!=1111	0 0 0 0	0 0 0 0	MRS <Rd>, SPSR
1 1 1 1	1 0 0 0	1 !=11	0	!=1111	!=1111	imm12		STR{B H}.W (12-bit immediate)
1 1 1 1	1 0 0 0	!=11	0	!=1111	!=1111	1 !=000	imm8	STR{B H}{T} (8-bit immediate)
1 1 1 1	1 0 0	S 1 !=11	1	!=1111	!=1111	imm12		LDR{SB SH B H}.W (12-bit immediate)
1 1 1 1	1 0 0	S 0 !=11	1	!=1111	!=1111	1 !=000	imm8	LDR{SB SH B H}{T} (8-bit immediate)

H2.4.4 Security in Debug state

If EL3 is implemented or the implemented Security state is Secure state, security in Debug state is governed by the Secure debug disabled flag, [EDSCR.SDD](#).

On entry to Debug state

If entering in Secure state, [EDSCR.SDD](#) is set to 0. Otherwise [EDSCR.SDD](#) is set to the inverse of `ExternalSecureInvasiveDebugEnabled()`. That is:

- If `ExternalSecureInvasiveDebugEnabled() == TRUE`, [EDSCR.SDD](#) is set to 0.
- If `ExternalSecureInvasiveDebugEnabled() == FALSE`, [EDSCR.SDD](#) is set to 1.

Note

Normally, if `ExternalSecureInvasiveDebugEnabled() == FALSE` then halting is prohibited and it is not possible to enter Debug state from Secure state. However, because changes to the authentication signals require a *Context synchronization event* to guarantee their effect, there is a period during which the PE might halt even though the authentication signals prohibit halting.

In Debug state

The value of `EDSCR.SDD` does not change, even if `ExternalSecureInvasiveDebugEnabled()` changes.

———— **Note** —————

- `DBGAUTHSTATUS_EL1`. {SNID, SID, NSNID, NSID} are not frozen in Debug state.
- If `EDSCR.SDD` set to 1 in Debug state, then there is no means to enter Secure state from Non-secure state. In this case it is impossible for the PE to be in Secure state. This is a general principle of behavior in Debug state.

In Non-debug state

`EDSCR.SDD` returns the inverse of `ExternalSecureInvasiveDebugEnabled()`. If the authentication signals that control `ExternalSecureInvasiveDebugEnabled()` change, a *Context synchronization event* is required to guarantee their effect.

———— **Note** —————

- In Non-debug state, `EDSCR.SDD` is unaffected by the Security state of the PE.
- A *Context synchronization event* is also required to guarantee that changes in the authentication signals are visible in `DBGAUTHSTATUS_EL1`. {SNID, SID, NSNID, NSID}.

If EL3 is not implemented and the implemented Security state is Non-Secure state, `EDSCR.SDD` is RES1.

H2.4.5 Privilege in Debug state

The only additional privileges offered to Debug state are:

- The privilege to execute *Debug state operations*, `DCPS`, `DRPS`, `MRS`, `MSR`.
- The privilege to execute DTR access instructions regardless of the Exception level and traps.

The DTR access instructions can be executed at any Exception level, including EL0, regardless of any control register settings that might force these instructions to be UNDEFINED or trapped in Non-debug state. These instruction are:

- The MRS and MSR instructions that access `DBGDTR_EL0`, `DBGDTRTX_EL0`, and `DBGDTRRX_EL0` in AArch64 state.
- The MRC and MCR instructions that access `DBGDTRTXint` and `DBGDTRRXint` in AArch32 state.

All other instructions operate with the privilege determined by the current Exception level and security state. This applies to all Special-purpose and System registers accesses, memory accesses, and UNDEFINED instructions, and includes generating exceptions when the System registers trap or disable an instruction.

H2.4.6 Debug state operations, DCPS, DRPS, MRS, MSR

ARMv8 defines operations to change between Exception levels in Debug state. These operations can also change the mode at the current Exception level.

DCPS<n>

Executing a `DCPS<n>` instruction in Debug state moves the PE to a higher Exception level or to a specific mode at the current Exception level.

If the `DCPS<n>` instruction is executed in AArch32 state and the target Exception level is using AArch64:

- The current instruction set switches from T32 to A64.
- The effect on registers that are not visible or only partially visible in AArch32 state is the same as for system calls in Non-debug state. See *Execution state* on page D1-1779.

Otherwise, the instruction set state does not change.

If the target Exception level is the same as the current Exception level, then the PE does not change Exception level. However, the PE might change mode.

The effect on endianness is the same as for exceptions and exception returns in Non-debug state:

- In AArch64 state the current endianness is determined by the value of `SCTLR_ELx.EE` for the target Exception level.
- In AArch32 state the current endianness is determined by the value of `SCTLR.EE` or `HSCTLR.EE` for the target Exception level.

The DCPS<n> instructions are:

In AArch64 state

- `DCPS1`
- `DCPS2`
- `DCPS3`

In AArch32 state, in the T32 instruction set only

- `DCPS1 variant`
- `DCPS2 variant`
- `DCPS3 variant`

The DCPS instructions are UNDEFINED in Non-debug state.

Table H2-6 shows the target of the instruction. In Table H2-6 the entries have the following meaning:

EL1h/Svc	This means that the target is: <ul style="list-style-type: none"> • EL1h if EL1 is using AArch64. • EL1 and Supervisor mode if EL1 is using AArch32.
EL2h/Hyp	This means that the target is: <ul style="list-style-type: none"> • EL2h if EL2 is using AArch64. • EL2 and Hyp mode if EL2 is using AArch32.
EL3h/Monitor	This means that the target is: <ul style="list-style-type: none"> • EL3h if EL3 is using AArch64. • EL3 and Monitor mode if EL3 is using AArch32.
Svc	Secure Supervisor mode, in EL3 using AArch32.
Monitor	Secure Monitor mode, in EL3 using AArch32.

Table H2-6 Target for DCPS instructions in Debug state

Instruction	Target when DCPS instruction executed at stated Exception level:				
	EL0	EL1	EL2	EL3 (AArch64)	EL3 (AArch32)
<code>DCPS1</code>	EL1h/Svc	EL1h/Svc	EL2h/Hyp	EL3h	Svc, clears <code>SCR.NS</code> to 0
<code>DCPS2</code>	EL2h/Hyp	EL2h/Hyp	EL2h/Hyp	EL3h	UNDEFINED
<code>DCPS3</code>	EL3h/Monitor	EL3h/Monitor	EL3h/Monitor	EL3h	Monitor, clears <code>SCR.NS</code> to 0

In AArch32 Monitor mode, `DCPS1` and `DCPS3` clear `SCR.NS` to 0.

Note

In AArch64 state, at EL3, DCPS<n> does not change [SCR_EL3.NS](#).

However:

- [DCPS1](#) is UNDEFINED at EL0 in Non-secure state if either:
 - EL2 is implemented and using AArch64 and [HCR_EL2.TGE](#) == 1.
 - EL2 is implemented and using AArch32 and [HCR.TGE](#) == 1.
- [DCPS2](#) is UNDEFINED at all Exception levels if EL2 is not implemented.
- [DCPS2](#) is UNDEFINED at the following Exception levels if EL2 is implemented:
 - At EL0 and EL1 in Secure state.
 - At EL3 if EL3 is using AArch32.
- [DCPS3](#) is UNDEFINED at all Exception levels if either:
 - [EDSCR.SDD](#) == 1.
 - EL3 is not implemented.

Note

The references to [DCPS1](#), [DCPS2](#), and [DCPS3](#) in this section link to the descriptions of the instructions in the A64 instruction set. The DCPS<n> instructions are also defined in the T32 instruction set, see [DCPS1](#), [DCPS2](#), [DCPS3](#) on [page F5-3101](#). These instructions are not defined in the A32 instruction set, because A32 instructions cannot be executed in Debug state.

On executing a DCPS instruction:

- If the target Exception level is using AArch64:
 - [ELR_ELx](#) of the target Exception level becomes UNKNOWN.
 - [SPSR_ELx](#) of the target Exception level becomes UNKNOWN.
 - [ESR_ELx](#) of the target Exception level becomes UNKNOWN.
 - [DLR_EL0](#) and [DSPSR_EL0](#) become UNKNOWN.
- If the target Exception level is using AArch32 [DLR](#) and [DSPSR](#) become UNKNOWN and:
 - If the target Exception level is EL1 or EL3, the LR and SPSR of the target mode become UNKNOWN.
 - If the target Exception level is EL2, then [ELR_hyp](#), [SPSR_hyp](#), and [HSR](#) become UNKNOWN.

If the target Exception level is using AArch32, and the target Exception level is EL1 or EL3, the LR and SPSR of the target mode become UNKNOWN.

The [DCPSInstruction\(\)](#) function is described in [Chapter J1 ARMv8 Pseudocode](#).

DRPS

Executing the DRPS operation in Debug state moves the PE to a lower Exception level, or to another PE mode at the current Exception level, by copying the current SPSR to [PSTATE](#).

If [DRPS](#) is executed in AArch64 state and the target Exception level is using AArch32:

- The current instruction set switches from A64 to T32.
- The effect on registers that are not visible or only partially visible in AArch32 state is the same as for exception returns in Non-debug state. See [Execution state on page D1-1779](#).

Otherwise the instruction set state does not change.

If the target Exception level is the same as the current Exception level, then the PE does not change Exception level. However, the PE might change mode.

The effect on endianness is the same as for exceptions and exception returns in Non-debug state:

- If targeting an Exception level using AArch64, current endianness is set according to [SCTLR_ELx.EE](#), or [SCTLR_EL1.EOE](#) for the target Exception level.
- If targeting an Exception level using AArch32, current endianness is set by [SPSR.E](#) as appropriate.

The DRPS instructions are:

In AArch64 state

- [DRPS](#)

In AArch32 state, in the T32 instruction set only

- [ERET](#)

If the SPSR specifies an illegal exception return, then [PSTATE](#).{M, nRW, EL, SP} are unchanged and [PSTATE.IL](#) is set to 1. For further information on illegal exception returns, see [Illegal return events from AArch64 state on page D1-1816](#).

[PSTATE](#).{N, Z, C, V, Q, GE, IT, T, SS, D, A, I, F} are ignored in Debug state. This means that the effect of the DRPS operation on these fields is to set them to an UNKNOWN value that might be the value from the SPSR. For more information see [Process state \(PSTATE\) in Debug state on page H2-5445](#).

All other [PSTATE](#) fields are copied from SPSR.

[DRPS](#) is UNDEFINED at EL0 and in Non-debug state.

———— Note —————

Unlike an exception return, the DRPS operation has no architecturally-defined effect on the Event Register and Exclusives monitors. DRPS might set the Event Register or clear the Exclusives monitors, or both, but this is not a requirement and debuggers must not rely on any implementation specific behavior.

On executing a DRPS instruction:

- If the target Exception level is using AArch64:
 - [DLR_EL0](#) and [DSPSR_EL0](#) become UNKNOWN.
- If the target Exception level is using AArch32:
 - [DLR](#) and [DSPSR](#) become UNKNOWN.

The [DRPSInstruction\(\)](#) function is described in [Chapter J1 ARMv8 Pseudocode](#).

MRS and MSR

The other Debug state instructions are used to read or write [DLR_EL0](#) and [DSPSR_EL0](#).

These instructions are:

In AArch64 state

- [MRS](#)
- [MSR \(register\)](#)

In AArch32 state

- [MRC](#)
- [MCR](#)

```
MRS <Xt>, DLR_EL0      ; Copy DLR_EL0 to <Xt>
MRS <Xt>, DSPSR_EL0    ; Copy DSPSR_EL0 to <Xt>
MSR DLR_EL0, <Xt>      ; Copy <Xt> to DLR_EL0
MSR DSPSR_EL0, <Xt>    ; Copy <Xt> to DSPSR_EL0
```

These instructions can be executed at any Exception level when in Debug state, including EL0. They are UNDEFINED in Non-debug state.

H2.4.7 Exceptions in Debug state

The following sections describe how exceptions are handled in Debug state:

- [Generating exceptions when in Debug state.](#)
- [Taking exceptions when in Debug state.](#)
- [Reset in Debug state on page H2-5467.](#)

Generating exceptions when in Debug state

In Debug state:

- Instruction Abort exceptions cannot happen because instructions are not fetched from memory.
- Interrupts, including SError and virtual interrupts are ignored and remain pending:
 - The pending interrupt remains visible in [ISR](#).
- Debug exceptions and debug events are ignored.
- [SCR.EA](#) is treated as if it were set to 0, regardless of its actual state, other than for the purpose of reading the bit.
- Any attempt to execute an instruction bit pattern that is an allocated instruction at the current Exception level, but is listed in [Executing instructions in Debug state on page H2-5446](#) as UNDEFINED in Debug state, generates an exception, that is taken to the current Exception level, or to EL1 if executing at EL0.

———— **Note** —————

If the exception is taken to an Exception level that is using AArch32 then it is taken as an Undefined Instruction exception.

The priority and syndrome for these exceptions is the same as for executing an encoding that does not have an allocated instruction.

- Instructions executed at EL2, EL1 and EL0 that are configured by EL3 control registers to trap to EL3:
 - When the value of [EDSCR.SDD](#) is 0, generate the appropriate trap exception that is taken to EL3.
 - When the value of [EDSCR.SDD](#) is 1, are treated as UNDEFINED and generate an exception that is taken to the current Exception level, or to EL1 if the instruction is executed at EL0. If the exception is taken to an Exception level that is using AArch32 it is taken as an Undefined Instruction exception.
If the exception is taken to an Exception level using AArch64 or to AArch32 Hyp mode, then it is reported with an EC value of 0x00.

Otherwise configurable traps, enables, and disables for instructions are unaffected by Debug state, and executing an affected instruction generates the appropriate exception.

Otherwise, synchronous exceptions, including Data Aborts, are generated as they would be in Non-debug state and taken to the appropriate Exception level in Debug state.

———— **Note** —————

If [EDSCR.SDD](#) == 1 then an exception from Non-secure state is never taken to Secure state. See [Security in Debug state on page H2-5460](#).

Taking exceptions when in Debug state

When the PE is in Debug state, all exceptions are synchronous. When an exception is generated, it is taken to Debug state. This means that:

- The target Exception level is as defined for the exception in Non-debug state.

- If the target Exception level is using AArch32 then the target PE mode is as defined for the exception in Non-debug state.
- The exception syndrome is reported as defined for the exception in Non-debug state, except for the case described in [Data Aborts in Memory access mode on page H4-5504](#) for which the reporting requirements are relaxed.

The exception syndrome is reported using the syndrome register or registers for the target Exception level. In AArch64 state, these are [ESR_ELx](#), and [FAR_ELx](#). In AArch32 state, these are [DFSR](#), [DFAR](#), [HSR](#), [HDFAR](#), and [HPFAR](#). For example:

- If a Data Abort exception is taken to Abort mode at EL1 or EL3 and the exception is taken from AArch32 state and using the Short-descriptor translation table format, the [DFSR](#) reports the exception using the Short-descriptor format fault encoding. For exceptions other than Data Abort exceptions taken to Abort mode, [DFSR](#) is not updated.
- If an instruction is trapped to an Exception level using AArch64 due to a configurable trap, disable, or enable, the exception code reported is the same as it would be in Non-debug state.

The effect on auxiliary syndrome registers, such as AFSR, is IMPLEMENTATION DEFINED.

———— **Note** —————

Generally, the AArch32 Fault Address Registers (FARs) and Fault Status Registers (FSRs) are not described as *syndrome registers*, although the term is appropriate to their function.

- The PE remains in Debug state and changes to the target mode.
- If EL3 is using AArch32 and the exception is taken from Monitor mode, [SCR.NS](#) is cleared to 0.
- If the exception is taken to an Exception level using AArch32, the PE continues to execute T32 instructions, regardless of the TE bit in the System register for the target Exception level.
- The endianness switches to that indicated by the EE bit of the System register for the target Exception level.
- The SPSR for the target Exception level or mode is corrupted and becomes UNKNOWN.
- If the target Exception level is using AArch64, [ELR_ELx](#) for the target Exception level becomes UNKNOWN.
- If the target Exception level is EL2 using AArch32, [ELR_hyp](#) becomes UNKNOWN.
- If the target Exception level is EL1 or EL3 using AArch32, [LR_<mode>](#) for the target mode becomes UNKNOWN.
- [DLR](#) and [DSPSR](#) become UNKNOWN.
- The cumulative error flag, [EDSCR.ERR](#), is set to 1. See [Cumulative error flag on page H4-5508](#).
- [PSTATE.IL](#) is cleared to 0.
- [PSTATE](#).{IT, T, SS, D, A, I, F} are set to UNKNOWN values, and [PSTATE](#).{N, Z, C, V, Q, GE} are unchanged. However, these fields are ignored and are not observable in Debug state. For more information see [Process state \(PSTATE\) in Debug state on page H2-5445](#).

The debugger must save any state that can be corrupted by an exception before executing an instruction that might generate another exception.

Pseudocode description of taking exceptions in Debug state

The pseudocode function [AArch64.TakeException\(\)](#) shows the behavior when the PE takes an exception to an Exception level using AArch64 in Non-debug state. In Debug state, this is replaced with the function [AArch64.TakeExceptionInDebugState\(\)](#).

The pseudocode functions `AArch32.EnterMode()`, `AArch32.EnterHypMode()`, and `AArch32.EnterMonitorMode()` show the behavior when the PE takes an exception to an Exception level using AArch32 in Non-debug state. In Debug state:

- `AArch32.EnterMode()` is replaced with the function `AArch32.EnterModeInDebugState()`.
- `AArch32.EnterHypMode()` is replaced with the function `AArch32.EnterHypModeInDebugState()`.
- `AArch32.EnterMonitorMode()` is replaced with `AArch32.EnterMonitorModeInDebugState()`.

Reset in Debug state

If the PE is reset when in Debug state, it exits Debug state and enters Non-debug reset state. When the PE is in reset state, `EDSCR.STATUS == 0b000010` and writes to `EDITR` are ignored.

———— **Note** —————

If `EDECR.RCE == 1`, meaning that a Reset Catch debug event is programmed, and if halting is allowed on exiting reset state, then on exiting reset state the PE halts and re-enters Debug state. See [Reset Catch debug events on page H3-5492](#). All PE registers have taken their reset values, which might be UNKNOWN.

H2.4.8 Accessing registers in Debug state

Register accesses are unchanged in Debug state. The view of each register is determined by either the current Exception level or the mode, or both, and accesses might be disabled or trapped by controls at a higher Exception level.

General-purpose register access, other than AArch64 state SP access

A single general-purpose register can be read by issuing an MSR instruction through the ITR to write `DBGDTR_EL0` in AArch64 state, or an MCR instruction through the ITR to write `DBGDTRXint` in AArch32 state. The debugger can then read the DTR register or registers through the external debug interface. The reverse sequence writes to a general-purpose register.

[Figure H2-1 on page H2-5468](#) shows the reading and writing of general-purpose registers, other than SP, in Debug state in AArch64 state.

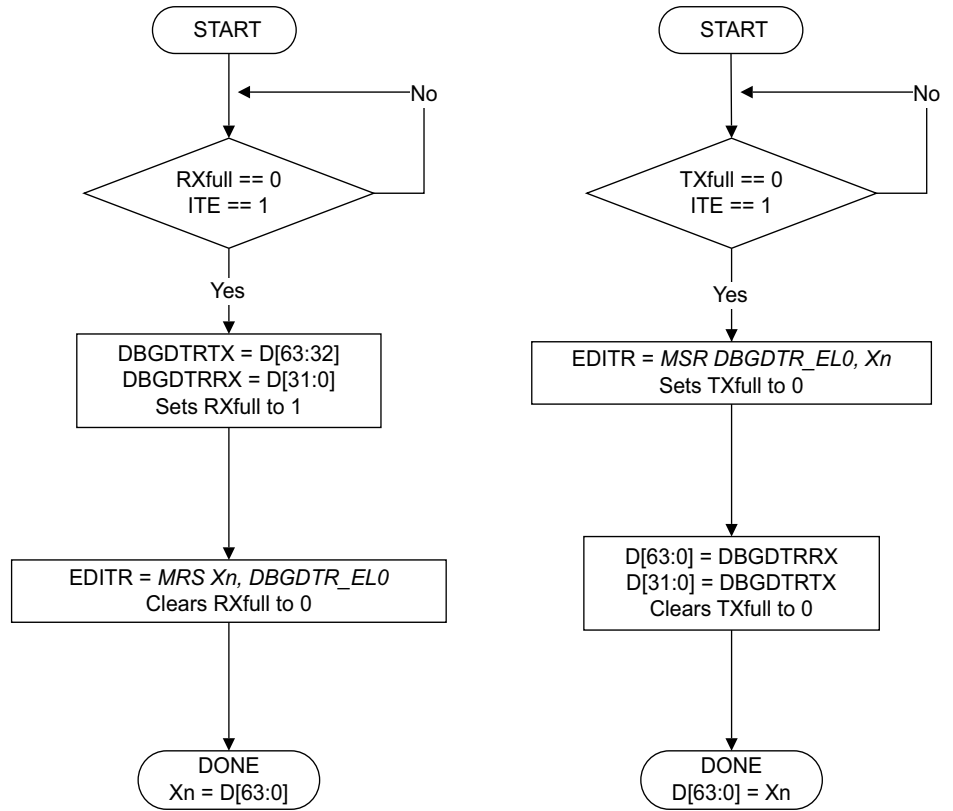

Figure H2-1 Reading and writing general-purpose registers, other than SP, in Debug state in AArch64 state

Figure H2-2 shows the reading and writing of general-purpose registers in Debug state in AArch32 state.

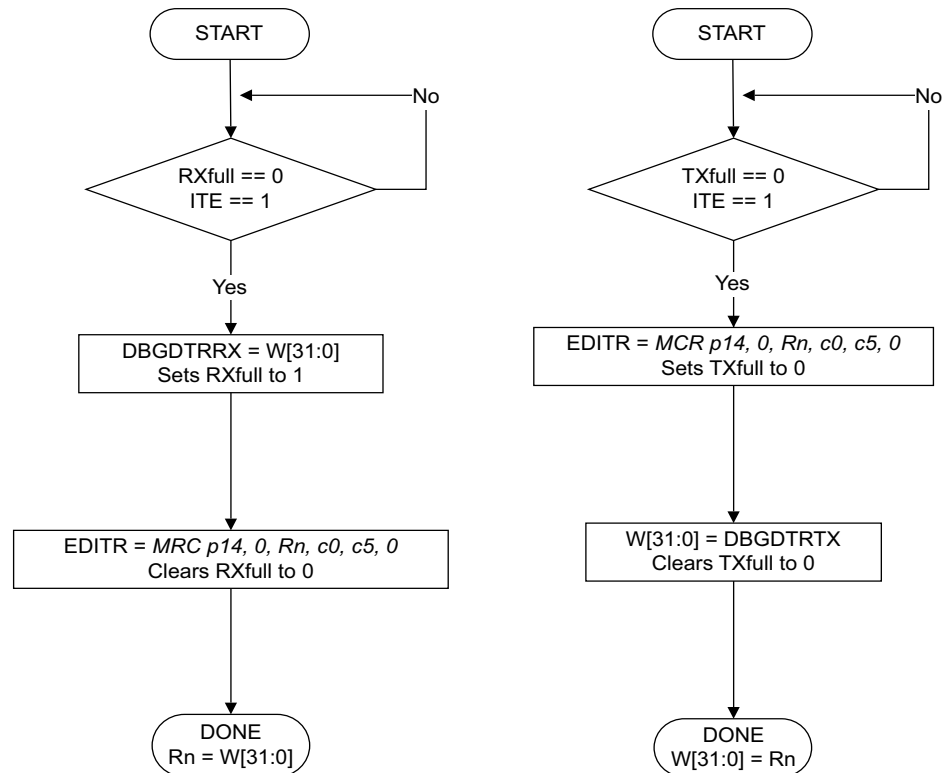

Figure H2-2 Reading and writing general-purpose registers in Debug state in AArch32 state

SIMD and floating-point register, System register, and AArch64 state SP accesses

To read a SIMD and floating-point register or a System register, the debugger must first copy the value into a general-purpose register using:

- An FMOV instruction in AArch64 state or a VMOV instruction in AArch32 state for floating-point transfers to SIMD and FP registers.
- A UMOV instruction in AArch64 state or a VMOV instruction in AArch32 state for SIMD transfers to SIMD and FP registers.
- An MRS instruction in AArch64 state or an MRC instruction in AArch32 state for System registers.
- A MOV Xd,SP instruction for the SP register in AArch64 state.

The debugger can then read out the particular general-purpose register. The reverse sequence writes a register.

PC and PSTATE access

The debugger reads the program counter and PSTATE of the process being debugged through the DLR_ELO and DSPSR_ELO System registers. The actual values of PC and PSTATE cannot be directly observed in Debug state:

- Instructions that are used for direct reads and writes of PC and PSTATE in Non-debug state are UNDEFINED in Debug state.
- On taking an exception, ELR_ELx and SPSR_ELx at the target Exception level are UNKNOWN. They do not record the PC and PSTATE.

PSTATE. {IL, E, M, nRW, EL, SP} are indirectly read by instructions executed in Debug state, but all other PSTATE fields are ignored and cannot be observed. See also:

- [Process state \(PSTATE\) in Debug state on page H2-5445.](#)
- [Executing instructions in Debug state on page H2-5446.](#)

- [Exceptions in Debug state on page H2-5465.](#)

H2.4.9 Accessing memory in Debug state

How the PE accesses memory is unchanged in Debug state. This includes:

- The operation of the MMU, including address translation, tagged address handling, access permissions, memory attribute determination, and the operation of any TLBs.
- The operation of any caches and coherency mechanisms.
- Alignment support.
- Endianness support.
- The Memory order model.

Simple memory transfers

Simple memory accesses can be performed in Debug state by issuing memory access instructions through the ITR and passing data through the DTR registers. [Executing instructions in Debug state on page H2-5446](#) lists the memory access instructions that are supported in Debug state.

Bulk memory transfers

Memory access mode can accelerate bulk memory transfers in Debug state. See [DCC and ITR access modes on page H4-5502](#).

H2.5 Exiting Debug state

The PE exits Debug state when it receives a Restart request trigger event. If `EDSCR.ITE == 0` the behavior of any instruction issued through the ITR in Normal access mode or an operation issued by a DTR access in memory access mode that has not completed execution is `CONSTRAINED UNPREDICTABLE`, and must do one of the following:

- It must complete execution in Debug state before the PE executes the restart sequence.
- It must complete execution in Non-debug state after the PE executes the restart sequence.
- It must be abandoned. This means that the instruction does not execute. Any registers or memory accessed by the instruction are left in an `UNKNOWN` state.

Note

- Implementations can set `EDSCR.ITE` to 1 to indicate that further instructions can be accepted by ITR before the previous instructions have completed. If any previous instruction has not completed and `EDSCR.ITE == 1`, then the PE must complete these instructions in Debug state before executing the restart sequence. `EDSCR.ITE == 0` indicates that the PE is not ready to restart.
- A debugger must observe that any instructions issued through `EDITR` that might generate a synchronous exception, as complete, before issuing a restart request. It can do this by observing the completion of a later instruction, as synchronous exceptions must occur in program order. For example, a debugger can observe that an instruction that reads or writes a DTR register is complete because of its effect on the `EDSCR.{TXfull, RXfull}` flags.

On exiting Debug state, the PE sets the program counter to the address in `DLR`, where:

- If exiting to AArch32 state:
 - Bits[31:1] of the PC are set to the value of bits[31:1] of `DLR`.
 - Bit[0] of the PC is set to a `CONSTRAINED UNPREDICTABLE` choice of 0 or the value of bit[0] in `DLR`.
- If exiting to AArch64 state:
 - Bits[63:56] of `DLR_ELO` might be ignored as part of tagged address handling. See *Address tagging in AArch64 state* on page D4-2006.
 - Otherwise the PC is set from `DLR_ELO`.

Note

Bits[63:32] of `DLR_ELO` are ignored when exiting to AArch32 state.

Exit from Debug state can give rise to a PC alignment fault exception when the program counter is used. Unlike an exception return, this might also happen when returning to AArch32 state. For more information, see *PC alignment checking* on page D1-1793.

On exiting Debug state, `PSTATE` is set from `DSPSR` in the same way that an exception return sets `PSTATE` from `SPSR_ELx`:

- The same illegal exception return checks that apply to an exception return also apply to exiting Debug state. If the return from Debug state is an illegal exception return then the effect on `PSTATE` and the PC is the same as for any other illegal exception return. See *Exception return on page D1-1815* and *Exception return to an Exception level using AArch32 on page G1-4360*.
- The checks on the `PSTATE.IT` bits that apply to exiting Debug state into AArch32 state are the same as those that apply to an exception return. See *Appendix K1 Architectural Constraints on UNPREDICTABLE behaviors*.

- **PSTATE.SS** is copied from **DSPSR.SS** if all of the following hold:
 - **MDSCR_ELI.SS** == 1.
 - The debug target Exception level is using AArch64.
 - Software step exceptions from the restart Exception level are enabled.

Otherwise **PSTATE.SS** is set to 0.

———— **Note** —————

Unlike a return using ERET, **PSTATE.SS** must be restored from **DSPSR.SS** because otherwise it is UNKNOWN.

However, if **OSDLR.DLK** == 1 and **DBGPRCR.CORENPDRQ** == 0, meaning the OS Double Lock is locked in Non-debug state and therefore Software Step exceptions are disabled, but otherwise Software Step exceptions would be enabled from the restart Exception level, it is CONstrained UNPREDICTABLE whether **PSTATE.SS** is copied from **DSPSR.SS**.

- **PSTATE.PAN** is copied from **DSPSR_EL0.PAN**.
- **PSTATE.UAO** is copied from **DSPSR_EL0.UAO**.

———— **Note** —————

- One important difference between Debug state exit and an exception return is that the PE can exit Debug state at EL0. Despite this, the behavior of an exit from Debug state is similar to an exception return. For example, **PSTATE.{D, A, I, F}** is updated regardless of the value of **SCTLR_ELI.UMA**.
- Exit from Debug state has no architecturally-defined effect on the Event Register and Exclusives monitors. An exit from Debug state might set the Event Register or clear the Exclusives monitors, or both, but this is not a requirement and debuggers must not rely on any implementation specific behavior.

The `ExitDebugState()` function is described in [Chapter J1 ARMv8 Pseudocode](#).

Chapter H3

Halting Debug Events

This chapter describes a particular class of debug events. It contains the following sections:

- *Introduction to Halting debug events* on page H3-5474.
- *Halting Step debug events* on page H3-5476.
- *Halt Instruction debug event* on page H3-5486.
- *Exception Catch debug event* on page H3-5487.
- *External Debug Request debug event* on page H3-5490.
- *OS Unlock Catch debug event* on page H3-5491.
- *Reset Catch debug events* on page H3-5492.
- *Software Access debug event* on page H3-5493.
- *Synchronization and Halting debug events* on page H3-5494.

Note

Table K11-1 on page K11-6282 disambiguates the general register references used in this chapter.

H3.1 Introduction to Halting debug events

External debug defines Halting debug events. The following Halting debug events are available in ARMv8:

- [Halting Step debug events on page H3-5476](#).
- [Halt Instruction debug event on page H3-5486](#).
- [Exception Catch debug event on page H3-5487](#).
- [External Debug Request debug event on page H3-5490](#).
- [OS Unlock Catch debug event on page H3-5491](#).
- [Reset Catch debug events on page H3-5492](#).
- [Software Access debug event on page H3-5493](#).

If halting is allowed, a Halting debug event halts the PE. The PE enters Debug state.

In addition, breakpoints and watchpoints might halt the PE if halting is allowed. See [Breakpoint and Watchpoint debug events on page H2-5436](#). Because breakpoints and watchpoints can generate an exception or halt the PE, Breakpoint and Watchpoint debug events are not classified as Halting debug events.

For a definition of Debug state, see [Chapter H2 Debug State](#). For a definition of halting allowed, see [Halting allowed and halting prohibited on page H2-5435](#).

[Debug state entry and debug event prioritization on page H2-5437](#) describes the behavior when multiple debug events are generated by an instruction.

See also [Synchronization and Halting debug events on page H3-5494](#).

[Table H3-1](#) shows the behavior of Breakpoint, Watchpoint, and Halting debug events.

Table H3-1 Summary of debug events and possible outcomes

Debug event type	PE behavior when halting is:	
	Allowed	Prohibited
Breakpoint and Watchpoint debug events on page H2-5436	Halt	See Table D2-1 on page D2-1908 and Table G2-1 on page G2-4457
Halt Instruction debug event on page H3-5486	Halt	UNDEFINED
Software Access debug event on page H3-5493	Halt	Ignored
Exception Catch debug event on page H3-5487	Halt	Ignored
Halting Step debug events on page H3-5476	Halt	Pended
External Debug Request debug event on page H3-5490	Halt	Pended
Reset Catch debug events on page H3-5492	Halt	Pended
OS Unlock Catch debug event on page H3-5491	Pended	Pended

[Table H3-2](#) shows where the pseudocode for each Halting debug event type is located.

Table H3-2 Pseudocode description of Halting debug events

Halting debug event type	Pseudocode
Halt Instruction debug event on page H3-5486	HLT on page C6-628 for AArch64 and HLT on page F5-3121 for AArch32
Software Access debug event on page H3-5493	Pseudocode description of Software Access debug event on page H3-5493
Exception Catch debug event on page H3-5487	Pseudocode description of Exception Catch debug events on page H3-5489
Halting Step debug events on page H3-5476	Pseudocode description of Halting Step debug events on page H3-5485

Table H3-2 Pseudocode description of Halting debug events (continued)

Halting debug event type	Pseudocode
<i>External Debug Request debug event on page H3-5490</i>	<i>Pseudocode description of External Debug Request debug events on page H3-5490</i>
<i>Reset Catch debug events on page H3-5492</i>	<i>Pseudocode description of Reset Catch debug event on page H3-5492</i>
<i>OS Unlock Catch debug event on page H3-5491</i>	<i>Pseudocode description of OS Unlock Catch debug event on page H3-5491</i>

H3.2 Halting Step debug events

Halting Step is a debug resource that a debugger can use to make the PE step through code one instruction at a time. This section describes the Halting Step debug events. It is divided into the following sections:

- [Overview of a Halting Step debug event.](#)
- [The Halting Step state machine.](#)
- [Using Halting Step on page H3-5479.](#)
- [Detailed Halting Step state machine behavior on page H3-5479.](#)
- [Synchronization and the Halting Step state machine on page H3-5482.](#)
- [Stepping T32 IT instructions on page H3-5483.](#)
- [Disabling interrupts while stepping on page H3-5484.](#)
- [Syndrome information on Halting Step on page H3-5484.](#)
- [Pseudocode description of Halting Step debug events on page H3-5485.](#)

The architecture describes the behavior as a simple Halting Step state machine. See [The Halting Step state machine.](#)

H3.2.1 Overview of a Halting Step debug event

The behavior of Halting Step is defined by a state machine, shown in [Figure H3-1 on page H3-5478](#). A Halting Step debug event executes a single instruction and then returns control to the debugger. When the debugger software wants to execute a Halting Step:

1. With the PE in Debug state, the debugger activates Halting Step.
2. The debugger signals the PE to exit Debug state and return to the instruction that is to be stepped.
3. The PE executes that single instruction.
4. The PE enters Debug state before executing the next instruction.

However, an exception might be generated while the instruction is being stepped. That is either:

- A synchronous exception generated by the instruction being stepped.
- An asynchronous exception taken before or after the instruction being stepped.

Halting Step has its own enable control bit, [EDECR.SS](#) and [EDES.R.SS](#).

———— Note ————

Because the Halting Step state machine states occur as a result of normal PE operation, the states can be described as both:

- PE states.
- Halting Step states.

H3.2.2 The Halting Step state machine

The state machine states are:

- Inactive** Halting Step is inactive. No Halting Step debug events can be generated, therefore execution is not affected by Halting Step. The PE is in this state whenever either of the following is true:
- Halting Step is disabled. That is, [EDECR.SS](#) is set to 0 and [EDES.R.SS](#) is set to 0.
 - Halting is prohibited. See [Halting the PE on debug events on page H2-5435](#). In this state, if [EDECR.SS](#) is set to 1 then a Halting Step debug event is pending.

In [Figure H3-1 on page H3-5478](#) this state is shown in red.

Active-not-pending

Halting Step is enabled and active. This is the state in which the PE steps an instruction. [EDECR.SS](#) == 1 and [EDES.R.SS](#) == 0. Software must not set [EDECR.SS](#) to 1 unless the PE is in Debug state, otherwise behavior is CONSTRAINED UNPREDICTABLE, as described in [Changing the value of EDECR.SS when not in Debug state on page H3-5483](#).

In [Figure H3-1 on page H3-5478](#) this state is shown in green.

Active-pending

Halting Step is enabled and active. The step has completed, and the PE enters Debug state.
`EDESR.SS == 1`.

In [Figure H3-1 on page H3-5478](#) this state is shown in green.

Whenever Halting Step is enabled and active, whether the state machine is in the active-not-pending state or in the active-pending state depends on `EDESR.SS`. [Halting Step state machine states on page H3-5479](#) shows this.

In the simple sequential execution of the program the PE executes the Halting Step state machine, as follows:

1. Initially, Halting Step is inactive.
2. After exiting Debug state, Halting Step is active-not-pending.
3. The PE executes an instruction and Halting Step is active-pending.
4. The pending Debug state entry is taken on the next instruction and the step is complete.

Exceptions and other changes to the PE context can interrupt this sequence.

Figure H3-1 shows a Halting Step state machine.

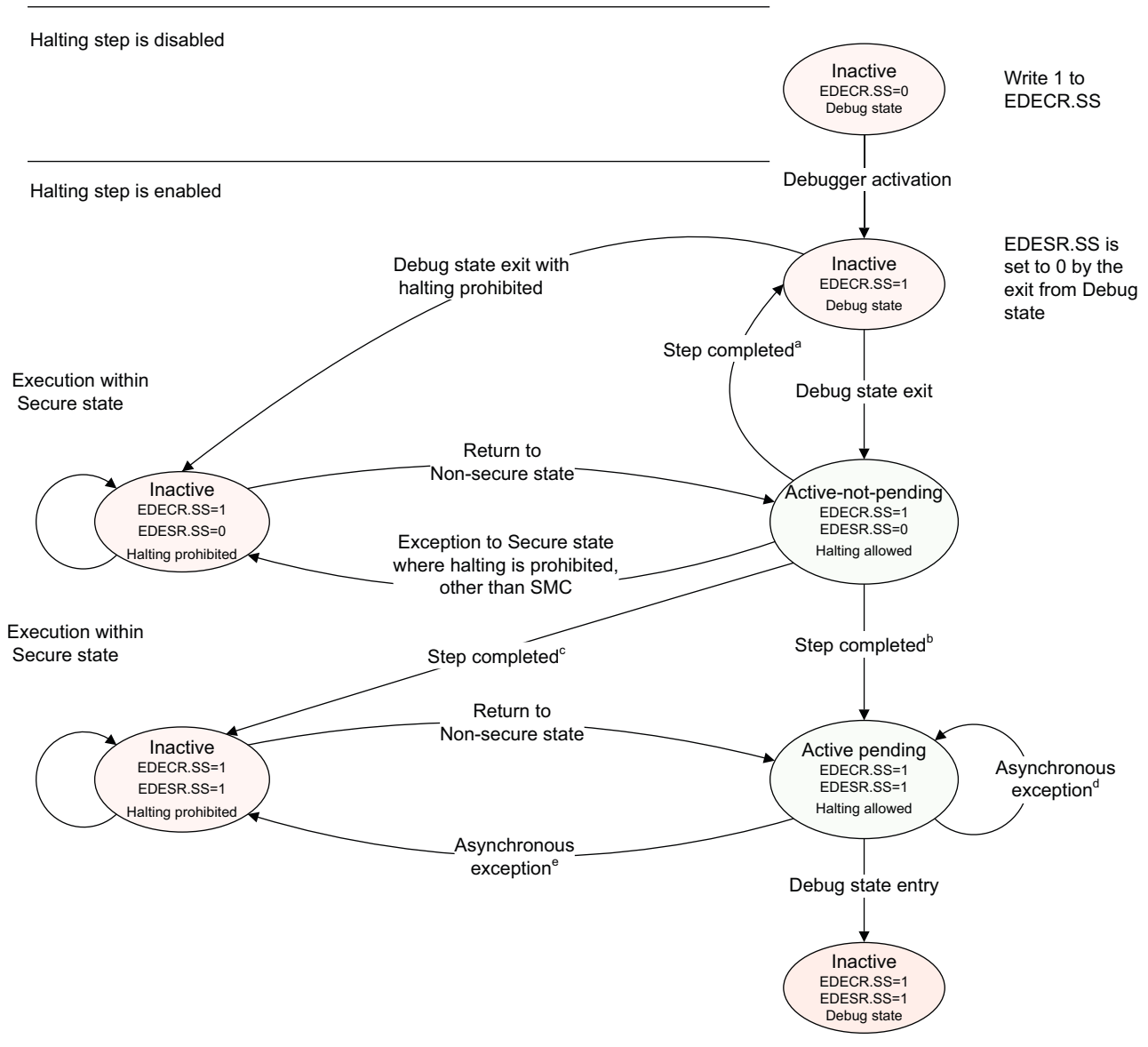

- Step completed occurs when:
 - A debug event, other than a Halting Step debug event, causes entry into Debug state.
- Step completed occurs when:
 - An instruction is executed without taking an exception.
 - An exception is taken to a state where halting is allowed.
 - A reset.
- Step completed occurs when:
 - An SMC exception is taken to Secure state where halting is prohibited.
- An asynchronous exception taken to a state where halting is allowed.
- An asynchronous exception taken to Secure state where halting is prohibited.

Figure H3-1 Halting Step state machine

———— **Note** ————

Figure H3-1 on page H3-5478 only describes state transitions to and from the inactive state by exit from Debug state, executing an exception return, or taking an exception. Other changes to the PE context, including writes to registers such as [EDECRCR](#) and [OSDLR](#) and changes to the authentication interface can also cause changes to the Halting Step state machine. These can lead to UNPREDICTABLE or CONSTRAINED UNPREDICTABLE behavior. See [Synchronization and the Halting Step state machine on page H3-5482](#).

The following bits control the state machine, as shown in [Table H3-3](#):

- [EDECRCR.SS](#). This is the Halting Step enable bit.

———— **Note** ————

- The [EDECRCR](#) value is preserved over powerdown, meaning that the step active state is maintained over a powerdown event.
- A debugger must only change the value of [EDECRCR.SS](#) when the PE is in Debug state, otherwise behavior is CONSTRAINED UNPREDICTABLE as described in [Changing the value of EDECRCR.SS when not in Debug state on page H3-5483](#).

- [EDESRCR.SS](#). This is the Halting Step debug event pending bit.

[Table H3-3](#) shows the Halting Step state machine states. The letter X in a register column means that the relevant bit can be set to either zero or one.

Table H3-3 Halting Step state machine states

Halting	EDECRCR.SS	EDESRCR.SS	Halting Step state
Prohibited	X	X	Inactive (Halting Step debug even not pending)
Prohibited	X	1	Inactive (Halting Step debug event pending).
Allowed	0	0	Inactive
Allowed	1	0	Active-not-pending
Allowed	X	1	Active-pending

H3.2.3 Using Halting Step

To step a single instruction the PE must be in Debug state:

1. The debugger sets [EDECRCR.SS](#) to 1 to enable Halting step.
2. The debugger signals the PE to exit Debug state with [DLR](#) set to the address of the instruction being stepped. The PE clears [EDESRCR.SS](#) to 0 and the Halting Step state machine enter the active-not-pending state.
3. The PE executes the instruction being stepped.
If an exception is taken to a state where halting is prohibited, then [EDESRCR.SS](#) is always correct for the preferred return address of the exception.
4. The PE enters Debug state before executing the next instruction and the step is complete.

H3.2.4 Detailed Halting Step state machine behavior

The behavior of the Halting Step state machine is described in the following sections:

- [Entering the active-not-pending state on page H3-5480](#).
- [PE behavior in the active-not-pending state on page H3-5480](#).
- [Entering the active-pending state on page H3-5481](#).
- [PE behavior in the active-pending state on page H3-5482](#).
- [PE behavior in the inactive state when in Non-debug state on page H3-5482](#).
- [PE behavior in Debug state on page H3-5482](#).

Entering the active-not-pending state

The PE enters the active-not-pending state:

- By exiting Debug state with `EDECR.SS == 1`.
- By an exception return from a state where halting is prohibited to a state where halting is allowed with `EDECR.SS == 1` and `EDESR.SS == 0`.
- As described in *Synchronization and the Halting Step state machine* on page H3-5482.

PE behavior in the active-not-pending state

When the PE is in the active-not-pending state it does one of the following:

- It executes one instruction and does one of the following:
 - Completes it without generating a synchronous exception.
 - Generates a synchronous exception.
 - Generates a debug event that causes entry to Debug state.
- It takes an asynchronous exception without executing any instruction.
- It takes an asynchronous debug event into Debug state.

If no exception or debug event is generated

If no exception or debug event is generated the PE sets `EDESR.SS` to 1. This means that the Halting Step state machine advances to the active-pending state.

If an exception or debug event is generated

The PE sets `EDESR.SS` according to all of the following:

- The type of exception.
- The target Exception level of the exception.
- If the exception is taken to Secure state, whether halting is prohibited in Secure state.
 - This is determined by the result of `ExternalSecureInvasiveDebugEnabled()`.

If an exception or debug event is generated, the PE sets `EDESR.SS` to 1 if one of the following applies:

- A synchronous exception is generated by the instruction and one of the following applies:
 - The exception is taken to EL1 or EL2.
 - The exception is taken to EL3, it is not an SMC exception, and `ExternalSecureInvasiveDebugEnabled() == TRUE`.
 - The exception is an SMC exception.
- An asynchronous exception is generated before executing an instruction and this is either:
 - Taken to EL1 or EL2.
 - Taken to EL3 and `ExternalSecureInvasiveDebugEnabled() == TRUE`.
- A PE reset occurs.

Otherwise `EDESR.SS` is unchanged. This happens when:

- No instruction is executed because either:
 - An asynchronous exception is taken to EL3 and `ExternalSecureInvasiveDebugEnabled() == FALSE`.
 - An asynchronous debug event causes entry to Debug state.
- An instruction is executed and either:
 - Generates a synchronous exception other than an SMC exception which is taken to EL3, and `ExternalSecureInvasiveDebugEnabled() == FALSE`.

- Generates a synchronous debug event and causes entry to Debug state.

If halting is prohibited after taking the exception or debug event, then the Halting Step state machine advances to the inactive state. Otherwise the Halting Step state machine advances to the active-pending state.

———— **Note** —————

The underlying criteria for the value of `EDESR.SS` on an exception are:

- Whether halting is allowed at the target of the exception. If halting is allowed, the PE must step into the exception. If halting is prohibited, the PE must step over the exception.
- Whether the preferred return address of the exception is the instruction itself or the next instruction, if the PE steps over the exception.

Table H3-4 shows the behavior of the active-not-pending state. The letter X indicates that `ExternalSecureInvasiveDebugEnabled()` can be either TRUE or FALSE.

Table H3-4 Summary of active-not-pending state behavior

Event	Target Exception level	<code>ExternalSecureInvasiveDebugEnabled()</code>	Value written to <code>EDESR.SS</code>
No exception or debug event	Not applicable	X	1
SMC exception	EL3	X	1
Reset	Highest	X	1
Exception, other than SMC exception	EL1	X	1
	EL2	X	1
	EL3	TRUE	1
		FALSE	Unchanged
Debug event	Debug state	X	Unchanged

Entering the active-pending state

The PE enters the active-pending state by one of the following:

- From the active-not-pending state by:
 - Executing an instruction without taking an exception.
 - Taking an exception so that the PE remains in a state where halting is allowed.
- An exception return from a state where halting is prohibited when `EDESR.SS == 1`.

———— **Note** —————

That is, an exception return from Secure state with `ExternalSecureInvasiveDebugEnabled() == FALSE` to Non-secure state with `ExternalInvasiveDebugEnabled() == TRUE`.

- A reset when the value of `EDEC.R.SS == 1`, regardless of the state the PE was in before the reset occurred.
- From the active-pending state by taking an asynchronous exception to a state where halting is allowed.
- Following the description in *Synchronization and the Halting Step state machine* on page H3-5482.

PE behavior in the active-pending state

When the PE is in the active-pending state, it enters Debug state before executing an instruction.

The entry into Debug state has higher priority than all other types of synchronous debug event and synchronous exception. However, the architecture does not define the prioritization of this Debug state entry with respect to any unmasked pending asynchronous exception. If an asynchronous exception is prioritized over the entry to Debug state, then EDESR.SS is unchanged.

For more information on the prioritization of debug events, see [Debug state entry and debug event prioritization on page H2-5437](#).

PE behavior in the inactive state when in Non-debug state

EDESR.SS is not updated by the execution of an instruction or the taking of an exception when Halting Step is inactive. This means that EDESR.SS is not changed by an exception handled in a state where halting is prohibited.

On return to a state where halting is allowed, the Halting Step state machine is restored either to the active-pending state or the active-not-pending state, depending on the value of EDESR.SS. The return to a state where halting is allowed is normally by an exception return, which is a *Context synchronization event*.

See also [Synchronization and the Halting Step state machine](#).

PE behavior in Debug state

Halting Step is inactive in Debug state because halting is prohibited, see [Halting allowed and halting prohibited on page H2-5435](#).

Entry to Debug state does not change EDESR.SS.

EDESR.SS is cleared to 0 on exiting Debug state as the result of a restart request. If EDECR.SS == 1, Halting Step enters the active-not-pending state.

———— Note —————

This means that EDESR.SS is never cleared to 0 by the execution of an instruction in Debug state, or by taking an exception when in Debug state as described in [PE behavior in the active-not-pending state on page H3-5480](#), because the Halting Step state machine is not in the active-not-pending state. EDESR.SS can be cleared by a write to EDESR, see the register description.

However, if the PE exits Debug state as the result of a PE reset and EDECR.SS == 1, then Halting Step immediately enters the active-pending state, as EDESR.SS is set to the value of EDECR.SS.

H3.2.5 Synchronization and the Halting Step state machine

The Halting Step state machine also changes state if:

- Halting becomes allowed or prohibited other than by exit from Debug state, an exception return, or taking an exception. This means that halting becomes allowed or prohibited because:
 - The security state changes without an exception return. See [State and mode changes without explicit context synchronization events on page G2-4519](#).
 - The external authentication interface changes.
 - The OS Double Lock status, DoubleLockStatus(), changes.
- A write to EDECR when the PE is in Non-debug state changes the value of EDECR.SS.

———— Note —————

Behavior is CONSTRAINED UNPREDICTABLE if the value of EDECR.SS is changed when the PE is in Non-debug state, see [Changing the value of EDECR.SS when not in Debug state on page H3-5483](#).

- A write to `EDESR` when the PE is in Non-debug state clears `EDESR.SS` to 0.

These operations are guaranteed to take effect only after a *Context synchronization event*. If the instruction being stepped generates a *Context synchronization event*, then the PE might use the old or new state.

The PE must perform the required behavior of the new state before or immediately following the next *Context synchronization event*, but it is not required to do so immediately. This means that the PE can perform the required behavior of the old state before the next *Context synchronization event*. This is illustrated in [Example H3-1](#) and [Example H3-2](#).

Example H3-1 Synchronization requirements 1

`EDECR.SS` is set to 1 in Debug state, requesting the active-not-pending state on exit from Debug state. On exit from Debug state the PE immediately takes an exception to Secure state. `ExternalSecureInvasiveDebugEnabled() == FALSE`, meaning that halting is prohibited in Secure state. The PE does not step any instructions but executes the software in Secure state as normal. `EDESR.SS` remains set to 0. If `ExternalSecureInvasiveDebugEnabled()` subsequently becomes TRUE, meaning that halting is now allowed, the PE must perform the required behavior of the active-not-pending state before or immediately following the next *Context synchronization event*, but it is not required to do so immediately.

Example H3-2 Synchronization requirements 2

`EDECR.SS` is set to 1 in Debug state. On exit from Debug the PE executes an MSR instruction that sets `OSDLR_EL1.DLK` to 1 and `DoubleLockStatus()` becomes TRUE. This change requires a *Context synchronization event* to guarantee its effect, meaning it is CONstrained UNPREDICTABLE whether:

- Halting is allowed:
 - The PE enters Debug state on the next instruction.
- Halting is prohibited:
 - The PE does not enter Debug state.

The value in `EDESR.SS` depends on whether halting was allowed or prohibited when the write to `OSDLR_EL1.DLK` completed, and so it might be 0 or 1. If a second MSR instruction clears `OSDLR_EL1.DLK` to 0, the PE must perform the required behavior of the state indicated by `EDESR.SS` before or immediately following the next *Context synchronization event*, but it is not required to do so immediately.

See also [Synchronization and Halting debug events on page H3-5494](#).

Changing the value of `EDECR.SS` when not in Debug state

If software changes the value of `EDECR.SS` when the PE is not in Debug state then behavior is CONstrained UNPREDICTABLE, and one or more of the following behaviors occurs:

- The value of `EDECR.SS` becomes UNKNOWN.
- The state of the Halting Step state machine becomes UNKNOWN.
- On a reset of the PE, the value of `EDECR.SS` and the state of the Halting Step state machine are UNKNOWN.

H3.2.6 Stepping T32 IT instructions

In an implementation that supports the ITD control, the architecture permits a combination of one T32 IT instruction and another 16-bit T32 instruction to be treated as a single 32-bit instruction when the value of the ITD field that applies to the current Exception level is 1.

For the purpose of stepping an item, it is IMPLEMENTATION DEFINED whether:

- The PE considers such a pair of instructions to be one instruction.

- The PE considers such a pair of instructions be two instructions.

It is IMPLEMENTATION DEFINED whether this behavior depends on the value of the applicable ITD bit. For example:

- The debug logic might consider such a pair of instructions as one instruction, regardless of the state of the applicable ITD field.
- The debug logic might consider such a pair of instructions as two instructions, regardless of the state of the applicable ITD field.
- The debug logic might consider such a pair of instructions as one instruction when the value of the applicable ITD field is 1, and as two instructions when the value of the ITD field is 0.

An implementation that does not support the ITD control behaves as if the value of the ITD field is 0.

The ITD control fields are:

HSTCLR.ITD Applies to execution at EL2 when EL2 is using AArch32.

SCTLR.ITD Applies to execution at EL0 or EL1 when EL1 is using AArch32.

SCTLR_EL1.ITD

Applies to execution at EL0 using AArch32 when EL1 is using AArch64.

H3.2.7 Disabling interrupts while stepping

When using Halting Step, the sequence of entering Debug state, interacting with the debugger, and then exiting Debug state for each instruction reduces the rate at which the PE executes instructions. However, the rate at which certain interrupts, such as timer interrupts, are generated might be fixed by the system. This means it might be necessary to disable interrupts while using Halting Step by setting **EDSCR.INTdis**, to allow the code being debugged to make forward progress.

H3.2.8 Syndrome information on Halting Step

Three **EDSCR.STATUS** encodings record different scenarios for entering Debug state on a Halting Step debug event:

Halting Step, normal

An instruction other than a Load-Exclusive instruction was stepped.

Halting Step, exclusive

A Load-Exclusive instruction was stepped.

Halting Step, no syndrome

The syndrome data is not available.

If the PE enters Debug state due to a Halting Step debug event immediately after stepping an instruction in the active-not-pending state, **EDSCR.STATUS** is set to either:

- Halting Step, normal, if the stepped instruction was not a Load-Exclusive instruction.
- Halting Step, exclusive, if the stepped instruction was a Load-Exclusive instruction.

If the stepped instruction was a conditional Load-Exclusive instruction that failed its Condition code check, **EDSCR.STATUS** is set to a CONSTRAINED UNPREDICTABLE choice of Halting Step, normal, or Halting Step, exclusive.

Otherwise the PE enters Debug state without stepping an instruction. This means that the Halting Step state machine enters the active-pending state directly from the inactive state, without going through active-not-pending state. In this case, **EDSCR.STATUS** is set to Halting Step, no syndrome. This happens when:

- The PE enters directly into the active-pending state on an exception return to Non-secure state from EL3 when Halting is prohibited in Secure state.
- The active-pending state is entered for other reasons. See [Synchronization and the Halting Step state machine on page H3-5482](#)

In addition, `EDSCR.STATUS` is set to one of a CONSTRAINED UNPREDICTABLE choice if:

- The instruction being stepped generated a synchronous exception, or a pending asynchronous exception was taken before the instruction was executed.

In this case `EDSCR.STATUS` is set to a CONSTRAINED UNPREDICTABLE choice of:

- Halting Step, no syndrome, or Halting Step, normal, if the stepped instruction was not a Load-Exclusive instruction.
 - Halting Step, no syndrome, or Halting Step, exclusive, if the stepped instruction was a Load-Exclusive instruction.
- The instruction that was stepped was an exception return instruction or an ISB. As these instructions are not in the Load-Exclusive instructions, `EDSCR.STATUS` is set to a CONSTRAINED UNPREDICTABLE choice of Halting Step, no syndrome or Halting Step, normal.
 - The PE enters directly into the active-pending state on reset because `EDECR.SS` is set to 1. `EDSCR.STATUS` is set to a CONSTRAINED UNPREDICTABLE choice of Halting Step, no syndrome or Halting Step, normal.

In all cases, if `EDSCR.STATUS` is not set to Halting Step, no syndrome, then it must indicate whether the stepped instruction was a Load-Exclusive instruction by setting `EDSCR.STATUS` to Halting Step, normal or Halting Step, exclusive.

———— **Note** —————

In an implementation that always sets `EDSCR.STATUS` to Halting Step, no syndrome is not compliant.

H3.2.9 Pseudocode description of Halting Step debug events

There are two pseudocode functions for Halting Step debug events:

- `RunHaltingStep()`. This is called after an instruction has executed and any exception generated by the instruction is taken. It is also called after taking a reset before executing any instructions. That is, reset is treated like an asynchronous exception, even if `EDECR.RCE == 1`. `RunHaltingStep()` affects the next instruction.
- `CheckHaltingStep()`. This is called before the next instruction is executed. If a step is pending, it generates the debug event.

H3.3 Halt Instruction debug event

A Halt Instruction debug event is generated when `EDSCR.HDE == 1`, halting is allowed, and the PE executes the Halt instruction, HLT.

The pseudocode for Halt Instruction debug events is described in [HLT on page C6-628](#) for A64 and [HLT on page F5-3121](#) for A32 and T32.

HLT never generates a debug exception. It is treated as UNDEFINED if `EDSCR.HDE == 0`, or if halting is prohibited.

———— **Note** —————

A debugger can replace a program instruction with a Halt instruction to generate a Halt Instruction debug event. Debuggers that use the HLT instruction must be aware of the ARMv8-A rules for concurrent modification of executable code, CMODX. The rules for concurrent modification and execution of instructions do not allow one thread of execution or an external debugger to replace an instruction with an HLT instruction when these same instructions are being executed by a different thread of execution. See [Concurrent modification and execution of instructions on page B2-84](#).

The T32 HLT instruction is unconditionally executed inside an IT block, even when it is treated as UNDEFINED. The A32 HLT instruction is CONSTRAINED UNPREDICTABLE if the Condition code field is not `0b1110`, with the set of behaviors the same as for BKPT. See [Appendix K1 Architectural Constraints on UNPREDICTABLE behaviors](#).

———— **Note** —————

The HLT instruction is part of the external debug solution for ARMv8-A. As such, the presence of the HLT instruction is not indicated in the ID registers. In particular, the AArch32 System register `ID_ISAR0`. Debug does not indicate the presence of the HLT instruction.

H3.3.1 HLT instructions as the first instruction in a T32 IT block

In an implementation that supports the ITD control, the architecture permits a combination of one T32 IT instruction and certain other 16-bit T32 instruction to be treated as a single 32-bit instruction when the value of the ITD field that applies to the current Exception level is 1.

The T32 HLT instruction cannot be combined with an IT instruction in this way. In an implementation that supports the ITD control, if the first instruction in an IT block is an HLT instruction, then the behavior of the instruction depends on the value of the applicable ITD field:

- If the value of the ITD field is 1, then the combination is treated as UNDEFINED and an Undefined Instruction exception is generated either by the IT instruction or by the HLT instruction.
- If the value of the ITD field is 0, then the HLT instruction unconditionally executed.

An implementation that does not support the ITD control behaves as if the value of the ITD field is 0.

To set an Halt Instruction debug event on the first instruction of an IT block, debuggers must replace the IT instruction with an HLT instruction to ensure consistent behavior.

The ITD control fields are:

HSCTLR.ITD Applies to execution at EL2 when EL2 is using AArch32.

SCTLR.ITD Applies to execution at EL0 or EL1 when EL1 is using AArch32.

SCTLR_EL1.ITD

Applies to execution at EL0 using AArch32 when EL1 is using AArch64.

———— **Note** —————

An HLT instruction is always unconditional, even within an IT block.

H3.4 Exception Catch debug event

Exception Catch debug events:

- Are generated when the corresponding bit in the Exception Catch Control Register, [EDEC](#)CR, is set to 1 on all entries to a given Exception level. This means:
 - Exceptions taken to the Exception level.
 - Exception returns to the Exception level.
- Are taken synchronously, after entry to the Exception level.
- Ignore the Execution state of the target Exception level.
- Are ignored if halting is prohibited.

From ARMv8.2 the definition is extended to include generation of Exception Catch debug events on reset entry, see [Exception Catch debug events from ARMv8.2 on page H3-5489](#).

The [EDEC](#)CR contains two sets of fields:

- One set for Non-secure state.
- One set for Secure state.

Each set of fields control generation of Exception Catch debug events:

- On exception entry [and, from ARMv8.2, on reset entry](#).
- On exception return.

Each field within each set contains one bit for each Exception level in that state. Bits corresponding to Exception levels that are not implemented are RES0. See [EDEC](#)CR, [External Debug Exception Catch Control Register on page H9-5622](#).

———— Note —————

- [EDEC](#)CR does not replace [DBG](#)VCR:
 - [DBG](#)VCR is retained in AArch32 state for backwards compatibility.
 - [DBG](#)VCR is ignored in AArch64 state and never generates entries to Debug state.
 - [DBG](#)VCR cannot be accessed by the external debug interface.
- [EDEC](#)CR is only visible as [OSEC](#)CR_EL1 by System register instructions in AArch64 state, and as [DBG](#)OSECCR by System register access instructions in AArch32 state, when the OS Lock is locked to allow software to save and restore it over a powerdown.
- Exception Catch debug events are not disabled when the OS Lock is locked.

For an Exception Catch debug event generated after taking an exception to a trapped Exception level:

- The PE must not fetch instructions from the vector address before entering Debug state, if address translation is disabled in the translation regime at the target Exception level.
- On entering Debug state:
 - The current Exception level is the target Exception level of the exception.
 - The ELR, SPSR, ESR, and other syndrome registers contain information about the exception.
 - [DLR](#) contains the exception vector address [or, from ARMv8.2, the reset address](#).

H3.4.1 Prioritization of Exception Catch debug events

The following rules define the prioritization of Exception Catch debug events:

- It is IMPLEMENTATION DEFINED whether Exception Catch debug events are higher or lower priority than each of [Software Step exceptions](#) and [Halting Step debug events](#).

- Exception Catch debug events are higher priority than all synchronous exceptions other than [Software Step exceptions](#).
- Exception Catch debug events are lower priority than [Reset Catch debug events](#).

———— **Note** —————

As described in [Synchronous exception prioritization for exceptions taken to AArch64](#) on page D1-1827, an exception trapping form of a Vector Catch debug event might generate a second debug exception as part of the exception entry, before the Exception Catch debug event is taken. See [Vector Catch exceptions](#) on page D2-1955 or [Vector Catch exceptions](#) on page G2-4510.

A second unmasked asynchronous exception can be taken before the PE enters Debug state. If this second exception does not generate an Exception Catch debug event, the exception handler executed at the higher Exception level later returns to the trapped Exception level, causing the Exception Catch debug event to be generated again.

See also [Debug state entry and debug event prioritization](#) on page H2-5437.

From ARMv8.2, when an Exception Catch debug event is generated on exception entry, the PE must enter Debug state as part of the exception entry:

- After the exception entry has updated the program counter, PSTATE and syndrome registers for the exception.
- Before the first instruction at the handler is executed.
- Before any asynchronous or lower priority synchronous exception or debug event is taken at the first instruction in the exception handler.

From ARMv8.2, when an Exception Catch debug event is generated on exception return, the PE must enter Debug state:

- After the exception return has updated the program counter and PSTATE.
- Before the execution of the first instruction at the return address is completed.

———— **Note** —————

From ARMv8.2, there is no prioritization between asynchronous exceptions, asynchronous debug events, and an Exception Catch debug event generated on an exception return.

H3.4.2 CONSTRAINED UNPREDICTABLE generation of Exception Catch debug events

When [ARMv8.2-Debug is not implemented](#), the PE is executing code at a given Exception level, and the corresponding [EDECCR](#) bit is 1, it is CONSTRAINED UNPREDICTABLE whether an Exception Catch debug event is generated.

———— **Note** —————

It is possible to generate Exception Catch debug events:

- As a trap on all instruction fetches from the trapped Exception level as part of an instruction fetch.
- On entry to the Exception level, as described in [Detailed Halting Step state machine behavior](#) on page H3-5479.

This is similar to the implementation options allowed for Vector Catch debug events. The architecture does not require that the event is generated following an ISB operation executed at the Exception level.

Examples of this are:

- If the debugger writes to [EDECCR](#) so that the current Exception level is trapped.
- If the OS restore code writes to [OSECCR](#) so that the current Exception level is trapped.

- If the code executing in AArch32 state changes the Exception level or security state other than by an exception return, and the target Exception level is trapped. See [State and mode changes without explicit context synchronization events](#) on page G2-4519.

When ARMv8.2-Debug is implemented, there are no CONSTRAINED UNPREDICTABLE cases that are permitted to generate Exception Catch debug events.

H3.4.3 Exception Catch debug events from ARMv8.2

From ARMv8.2, the definition of Exception Catch debug events is extended so that Exception Catch debug events can be generated from:

- Exception entry.
- Reset entry.
- Exception return.

It is IMPLEMENTATION DEFINED whether a reset into an Exception level generates an Exception Catch debug event.

Exception catch debug events are taken synchronously, after the exception or reset entry or the exception return has been processed by the PE.

For exception returns, the final Exception level of the exception return determines whether an Exception Catch debug event is generated. On an illegal exception return an Exception Catch debug event is generated only if EDECCR is programmed to generate an Exception Catch debug event for an exception return to the current Exception level.

H3.4.4 Examples of Exception Catch debug events

If EDECCR == 0x20, meaning that the Exception Catch debug event is enabled for Non-secure EL1, then the following exceptions generate Exception Catch debug events:

- An exception taken from Non-secure EL0 to Non-secure EL1.
- An exception return from EL2 to Non-secure EL1.
- An exception return from EL3 to Non-secure EL1.

For example, on taking a Data Abort exception from Non-secure EL0 to Non-secure EL1, using AArch64:

- ELR_EL1 and SPSR_EL1 are written with the preferred return address and PE state for a return to EL0.
- ESR_EL1 and FAR_EL1 are written with the syndrome information for the exception.
- DLR_EL0 is set to VBAR_EL1 + 0x400, the synchronous exception vector.
- DSPSR_EL0 is written with the PE state for an exit to EL1.

The following do not generate Exception Catch debug events:

- An exception taken from Non-secure EL0 to EL2 or EL3.
- An exception return from EL2 to Non-secure EL0.
- An exception taken from Secure EL0 to Secure EL1.
- An exception return from EL3 to Secure EL1.

H3.4.5 Pseudocode description of Exception Catch debug events

The pseudocode function `CheckExceptionCatch()` is described in [Chapter J1 ARMv8 Pseudocode](#).

H3.5 External Debug Request debug event

External Debug Request debug events are asynchronous debug events.

An External Debug Request debug event is generated when signaled by the embedded cross-trigger. See [Chapter H5 The Embedded Cross-Trigger Interface](#).

———— **Note** —————

ARMv8-A requires the implementation of an embedded cross-trigger.

An implementation might also support IMPLEMENTATION DEFINED ways of generating an External Debug Request debug event.

H3.5.1 Synchronization and External Debug Request debug events

An External Debug Request debug event that is asserted before a [Context synchronization event](#) is taken and the PE enters Debug state before the first instruction following the [Context synchronization event](#) completes its execution, provided that halting is allowed after completion of the [Context synchronization event](#).

An External Debug Request debug event that is being asserted when the PE comes out of reset is taken, and the PE enters Debug state before the first instruction after the reset completes its execution, provided that halting is allowed when the PE exits reset state.

If the first instruction after the [Context synchronization event](#) or after coming out of reset generates a synchronous exception then the architecture does not define the order in which the debug event and the exception or exceptions are taken.

Otherwise, when halting is allowed, External Debug Request debug events must be taken in finite time, without requiring the synchronization of any necessary change to the external authentication interface.

———— **Note** —————

These rules are based on the rules that apply when taking asynchronous exceptions. See [Asynchronous exception types, routing, masking and priorities](#) on page D1-1834.

If an unmasked External Debug Request debug event was pending but is changed to not pending before it is taken, then the architecture permits the External Debug Request debug event to be taken, but does not require this to happen. If the External Debug Request debug event is taken then it must be taken before the first [Context synchronization event](#) after the External Debug Request debug event was changed to not pending.

[Example H3-3](#) shows an example of the synchronization requirements.

Example H3-3 Synchronization requirements

Secure software locks up in a tight loop, so it executes indefinitely without any synchronization operations. An External debug request must be able to break the PE out of that loop. This is a requirement even if **DBGEN** or **SPIDEN** or both are LOW on entry to the loop, meaning that halting is prohibited, and are only asserted HIGH later.

H3.5.2 Pseudocode description of External Debug Request debug events

The `ExternalDebugRequest()` function is described in [Chapter J1 ARMv8 Pseudocode](#).

H3.6 OS Unlock Catch debug event

An OS Unlock Catch debug event is generated when `EDECR.OSUCE == 1` and the state of the OS Lock changes from locked to unlocked.

When the OS Lock is unlocked, the PE sets `EDESR.OSUC` to 1 if `EDECR.OSUCE` is set to 1 and the PE is in Non-debug state, meaning the OS Unlock Catch debug event becomes pending. However, this is an indirect write to `EDESR.OSUC`, meaning the OS Unlock Catch debug event is not guaranteed to be taken before a subsequent context synchronization event. If the PE enters Debug state or `EDECR.OSUCE` is cleared to 0 before `EDESR.OSUC` becomes set to 1, then `EDESR.OSUC` might not be set.

OS Unlock Catch debug events are not generated if the OS Lock is unlocked when the PE is in Debug state. See also:

- [Synchronization and Halting debug events on page H3-5494.](#)
- [EDECR, External Debug Execution Control Register on page H9-5626.](#)
- [EDESR, External Debug Event Status Register on page H9-5628.](#)

`EDESR.OSUC` is cleared to 0 on a Warm reset and on exiting Debug state.

H3.6.1 Using the OS Unlock Catch debug event

If the debugger attempts to access a debug register when the Core power down domain is completely off or in a low-power state in which the core power domain registers cannot be accessed, and that access returns an error, then the debugger must retry the access. However, if the Core power domain is regularly powered down, this can lead to unreliable debugger behavior.

The debugger can program a Reset Catch debug event to halt the PE when it has powered up, and can program the debug registers from Debug state. However, if the PE boot software restores the debug registers, as described in [Debug OS Save and Restore sequences on page H6-5541](#), then newly written values are overwritten by the restore sequence.

The debugger can program an OS Unlock Catch debug event to halt the PE after the restore sequence has completed, and program the debug registers from Debug state.

H3.6.2 Pseudocode description of OS Unlock Catch debug event

The `CheckOSUnlockCatch()` function is called when the OS Lock is unlocked.

The `CheckPendingOSUnlockCatch()` function is called before an instruction is executed. If an OS Unlock Catch is pending, it generates the debug event.

H3.7 Reset Catch debug events

A Reset Catch debug event is generated when `EDECR.RCE == 1` and the PE exits reset state. When the Reset Catch debug event is generated, it is recorded by setting `EDESR.RC` to 1.

If halting is allowed when the event is generated, the Reset Catch debug event is taken immediately and synchronously. On entering Debug state, `DLR` has the address of the reset vector. The PE must not fetch any instructions from memory.

Otherwise, the Reset Catch debug event is pended and taken when halting is allowed. See also:

- [Synchronization and Halting debug events](#) on page H3-5494.
- [EDECR, External Debug Execution Control Register](#) on page H9-5626.
- [EDESR, External Debug Event Status Register](#) on page H9-5628.

This means that `EDESR.RC` is set to the value of `EDECR.RCE` on a Warm reset. `EDESR.RC` is cleared to 0 on exiting Debug state.

H3.7.1 Pseudocode description of Reset Catch debug event

The `CheckResetCatch()` function is called after reset before executing any instruction.

The `CheckPendingResetCatch()` function is called before an instruction is executed. If a Reset Catch is pending, it generates the Reset Catch debug event.

H3.8 Software Access debug event

When the value of `EDSCR.TDA == 1`, software access to the following debug AArch64 and AArch32 System registers cause a trap to Debug state:

- The Breakpoint Value Registers, [DBGBVR](#).
- The Breakpoint Control Registers, [DBGBCR](#).
- The Watchpoint Value Registers, [DBGWVR](#).
- The Watchpoint Control Registers, [DBGWCR](#).

However, `EDSCR.TDA` is ignored if one of:

- The value of `OSLSR.OSLK == 1`, meaning that the OS Lock is locked.
- Halting is prohibited. See *Halting allowed and halting prohibited* on page H2-5435.
- The register access generates an exception.

Note

- `DBGPRCR.CORENPDRQ` (Core No-powerdown Request), DCC registers, and CLAIM tag bits are also shared, but are deliberately excluded from this list.
 - The only accesses that generate a trap are:
 - Accesses to System registers in AArch64 state.
 - Accesses to System registers in the (coproc==0b1110) encoding space in AArch32 state.Accesses to the external debug interface by a PE are not trapped.
-

H3.8.1 Pseudocode description of Software Access debug event

The `CheckSoftwareAccessToDebugRegisters()` function is described in [Chapter J1 ARMv8 Pseudocode](#).

H3.9 Synchronization and Halting debug events

The behavior of external debug depends on:

- Indirect reads of:
 - External debug registers.
 - System registers, including system debug registers.
 - Special-purpose registers.
- The state of the external authentication interface.

For some registers, all read and write accesses that update the register occur in program order, without any additional synchronization, but others require an explicit *Context synchronization event*. For more information on the synchronization of register updates see:

- [Synchronization requirements for AArch64 System registers on page D7-2191](#).
- [Synchronization of changes to the external debug registers on page H8-5554](#).
- [State and mode changes without explicit context synchronization events on page G2-4519](#).

Changes to the external authentication interface do not require explicit synchronization to affect External Debug Request debug events. See [Synchronization and External Debug Request debug events on page H3-5490](#).

For changes that require explicit synchronization, it is CONSTRAINED UNPREDICTABLE whether instructions between the change and the *Context synchronization event* observe the old state or the new state.

This means that any change to these registers or the external authentication interface requires explicit synchronization by a *Context synchronization event* before the change takes effect. This ensures that for instructions appearing in program order after the change, the change affects the following:

- The generation and behavior of Breakpoint and Watchpoint debug events. See [Synchronization and debug exceptions on page D2-1970](#) for exceptions taken from AArch64 state, or [Synchronization and debug exceptions on page G2-4518](#) for exceptions taken from AArch32 state.
- The generation of all Halting debug events by instructions.
- Taking a pending Halting debug event or other asynchronous Debug event. See:
 - [Pending Halting debug events](#).
 - [Synchronization and External Debug Request debug events on page H3-5490](#).
- The behavior of the Halting Step state machine. See [Synchronization and the Halting Step state machine on page H3-5482](#).

H3.9.1 Pending Halting debug events

A Halting debug event might be pending:

1. If Halting Step of an instruction sets [EDES.RC](#) to 1, and halting is prohibited following the step, then the Halting Step state machine is inactive but a Halting Step debug event is pending.
2. If a Reset Catch debug event sets [EDES.RC](#) to 1, and halting is prohibited following reset, then a Reset Catch debug event is pending.
3. If an OS Unlock Catch debug event sets [EDES.OSUC](#) to 1, then an OS Unlock Catch debug event is pending.

Pending Halting debug events are taken asynchronously when halting is allowed.

Pending Halting debug events are discarded by a Cold reset. The debugger can also force a pending event to be dropped by writing to [EDES](#).

Any Halting debug event that is observed as pending in the [EDES](#) before a *Context synchronization event* is taken and the PE enters Debug state before the first instruction following the *Context synchronization event* completes its execution. This is only possible if halting is allowed after completion of the *Context synchronization event*.

If the first instruction after the *Context synchronization event* generates a synchronous exception then the architecture does not define the order in which the debug event and the exception or exceptions are taken, unless both:

- A Halting Step debug event is pending. `EDESR.SS == 1`.
- The *Context synchronization event* is an exception return from a state where halting is prohibited to a state where halting is allowed.

———— **Note** —————

This applies to an exception return from Secure state with `ExternalSecureInvasiveDebugEnabled() == FALSE` to Non-secure state with `ExternalInvasiveDebugEnabled() == TRUE`.

In this case the order in which the debug events are handled is specified to avoid a double-step. See *Entering the active-pending state* on page H3-5481.

If an asynchronous exception is also pending after the *Context synchronization event* then the architecture does not define the order in which the debug event and the exception or exceptions are taken.

———— **Note** —————

These rules are based on the rules that apply to taking asynchronous exceptions. See *Asynchronous exception types, routing, masking and priorities* on page D1-1834.

Chapter H4

The Debug Communication Channel and Instruction Transfer Register

This chapter describes communication between a debugger and the implemented debug logic, using the *Debug Communications Channel* (DCC) and the *Instruction Transfer Register* (ITR), and associated control flags. It contains the following sections:

- [Introduction on page H4-5498.](#)
- [DCC and ITR registers on page H4-5499.](#)
- [DCC and ITR access modes on page H4-5502.](#)
- [Flow control of the DCC and ITR registers on page H4-5506.](#)
- [Synchronization of DCC and ITR accesses on page H4-5509.](#)
- [Interrupt-driven use of the DCC on page H4-5514.](#)
- [Pseudocode description of the operation of the DCC and ITR registers on page H4-5515.](#)

———— **Note** —————

Where necessary [Table K11-1 on page K11-6282](#) disambiguates the general register references used in this chapter.

H4.1 Introduction

The *Debug Communications Channel*, DCC, is a channel for passing data between the PE and an external agent, such as a debugger. The DCC provides a communications channel between:

- An external debugger, described as the *debug host*.
- The debug implementation on the PE, described as the *debug target*.

The DCC can be used:

- As a 32-bit full-duplex channel.
- As a 64-bit half-duplex channel.

The DCC is an essential part of Debug state operation and can also be used in Non-debug state.

The *Instruction Transfer Register*, ITR, passes instructions to the PE to execute in Debug state.

The PE includes flow-control mechanisms for both the DCC and ITR.

H4.2 DCC and ITR registers

The DCC comprises *data transfer registers*, the DTRs, and associated flow-control flags. The data transfer registers are DTRRX and DTRTX.

The ITR comprises a single register, [EDITR](#), and associated flow-control flags.

In AArch64 state, software can access the data transfer registers as:

- A receive and transmit pair for 32-bit full duplex operation:
 - The write-only [DBGDTRTX_EL0](#) register to transmit data.
 - The read-only [DBGDTRRX_EL0](#) register to receive data.
- A single 64-bit read/write register, [DBGDTR_EL0](#), for 64-bit half-duplex operation.
- The read/write [OSDTRTX_EL1](#) and [OSDTRRX_EL1](#) registers for save and restore.

In AArch32 state, software can only access the data transfer registers as:

- A receive and transmit pair, for 32-bit full duplex operation:
 - The write-only [DBGDTRTXint](#) register to transmit data.
 - The read-only [DBGDTRRXint](#) register to receive data.
- The read/write [DBGDTRTXext](#) and [DBGDTRRXext](#) registers for save and restore.

The data transfer registers are also accessible by the external debug interface as a pair of 32-bit registers, [DBGDTRRX_EL0](#) and [DBGDTRTX_EL0](#). Both registers are read/write, allowing both 32-bit full-duplex and 64-bit half-duplex operation.

The DCC flow-control flags are [EDSCR](#). {RXfull, TXfull, RXO, TXU}:

- The RXfull and TXfull ready flags are used for flow-control and are visible to software in the debug System registers in [DCCSR](#).
- The RX overrun flag, RXO, and the TX underrun flag, TXU, report flow-control errors.
- The flow-control flags are also accessible by software as simple read/write bits for saving and restoring over a powerdown when the OS Lock is locked in [DSCR](#).
- The flow-control flags are accessible from the external debug interface in [EDSCR](#).

[Figure H4-1 on page H4-5500](#) shows the System register and external debug interface views of the [EDSCR](#) and DTR registers in both AArch64 state and AArch32 state. These figures do not include the save and restore views.

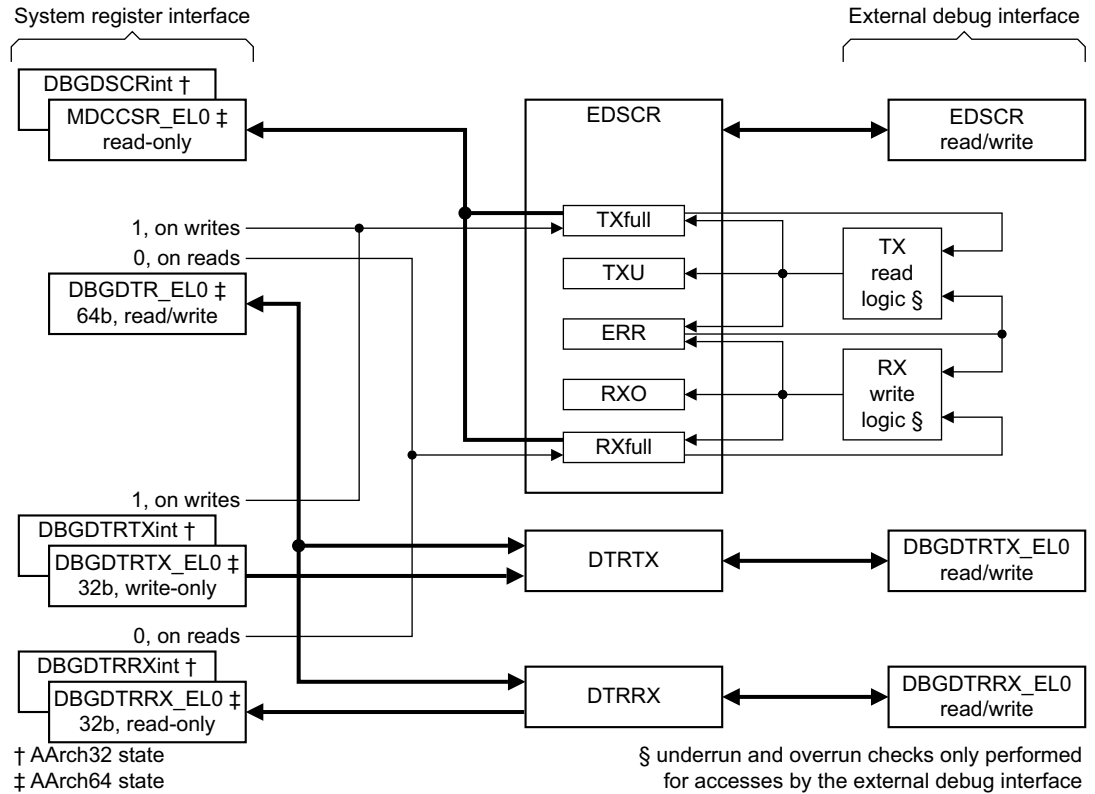

Figure H4-1 System register and external debug interface views of EDSCR and DTR registers, Normal access mode

EDITR and the ITR flow-control flags, EDSCR.{ITE, ITO} are accessible only by the external debug interface:

- The EDITR specifies an instruction to execute in Debug state.
- The ITR empty flag, ITE, is used for flow-control.
- The ITR overrun flag, ITO, reports flow-control errors.

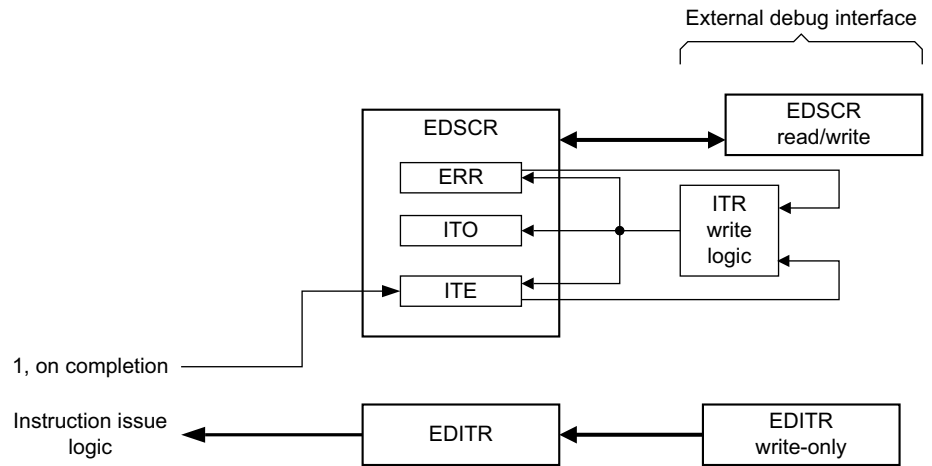

Figure H4-2 External debug interface views of EDSCR and EDITR registers, Normal access mode

The sticky overflow flag, EDSCR.ERR, is used by both the DCC and ITR to report flow-control errors.

To save and restore the DCC registers for an external debugger over powerdown, software uses:

- The MDSCR_EL1, OSDTRTX_EL1, and OSDTRRX_EL1 registers in AArch32 state.

- The `DBGDSCRext`, `DBGDTRTXext`, and `DBGDTRRXext` registers in AArch64 state.

Note

There is no save and restore mechanism for the ITR registers as the ITR is only used in Debug state.

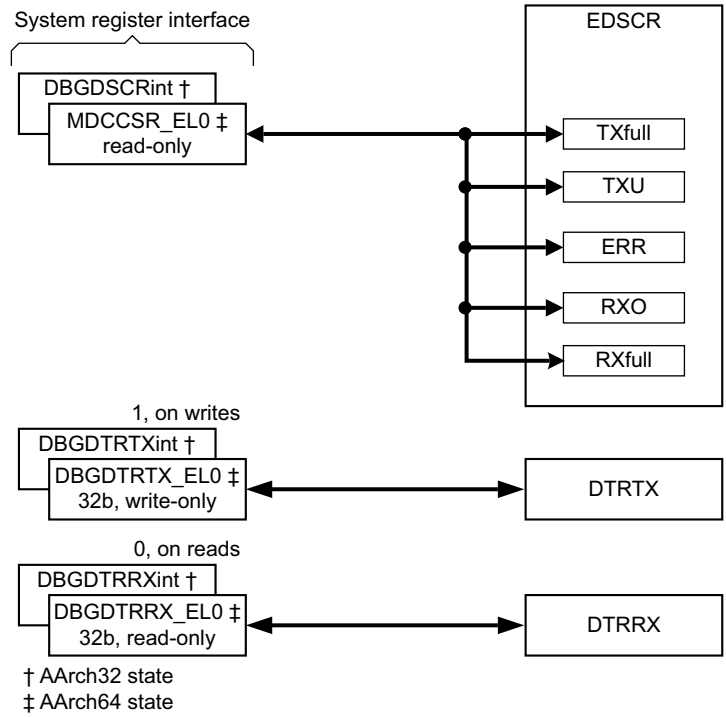

Figure H4-3 System register views of EDSCR and DTR registers for save and restore

H4.3 DCC and ITR access modes

The DCC and ITR support two access modes:

DCC and ITR access mode, links to description	Applies when:
Normal access mode	EDSCR.MA == 0 or the PE is in Non-debug state
Memory access mode on page H4-5503	EDSCR.MA == 1 and the PE is in Debug state

H4.3.1 Normal access mode

The Normal access mode allows use of the DCC as a communications channel between target and host. It also allows the use of the ITR for issuing instructions to the PE in Debug state.

In Normal access mode, if there is no overrun or underrun, the following occurs:

For accesses by software:

- Direct writes to [DBGDTRTX](#) update the value in DTRTX and indirectly write 1 to TXfull.
- Direct reads from [DBGDTRRX](#) return the value in DTRRX and indirectly write 0 to RXfull.
- In AArch64 state, direct writes to [DBGDTR_EL0](#) update both DTRTX and DTRRX, indirectly write 1 to TXfull, and do not change RXfull:
 - DTRTX is set from bits[31:0] of the transfer register.
 - DTRRX is set from bits[63:32] of the transfer register.
- In AArch64 state, direct reads from [DBGDTR_EL0](#) return the concatenation of DTRRX and DTRTX, indirectly write 0 to RXfull, and do not change TXfull:
 - Bits[31:0] of the transfer register are set from DTRRX.
 - Bits[63:32] of the transfer register are set from DTRTX.

Note

For [DBGDTR_EL0](#), the word order is reversed for reads with respect to writes.

Software reads TXfull and RXfull using [DCCSR](#).

For accesses by the external debug interface:

- Writes to [EDITR](#) trigger the instruction to be executed if the PE is in Debug state:
 - If the PE is in AArch64 state, this is an A64 instruction.
 - If the PE is in AArch32 state, this is a T32 instruction. The T32 instruction is a pair of halfwords where the first halfword is taken from the lower 16-bits, and the second halfword is taken from the upper 16-bits.
- Reads of [DBGDTRTX_EL0](#) return the value in DTRTX and indirectly write 0 to TXfull.
- Writes to [DBGDTRTX_EL0](#) update the value in DTRTX and do not change TXfull.
- Reads of [DBGDTRRX_EL0](#) return the value in DTRRX and do not change RXfull.
- Writes to [DBGDTRRX_EL0](#) update the value in DTRRX and indirectly write 1 to RXfull.

TXfull and RXfull are visible to the external debug interface in [EDSCR](#).

The PE detects overrun and underrun by the external debug interface, and records errors in [EDSCR](#). {TXU, RXO, ITO, ERR}. See [Flow control of the DCC and ITR registers on page H4-5506](#).

See also [Synchronization of DCC and ITR accesses on page H4-5509](#).

H4.3.2 Memory access mode

When the PE is in Debug state, *Memory access mode* can be selected to accelerate word-aligned block reads or writes of memory by an external debugger. Memory access mode can only be enabled in Debug state, and no instructions can be issued directly by the debugger when in Memory access mode.

If there is no overrun or underrun when in Memory access mode, an access by the external debug interface results in the following:

- External reads from [DBGDTRTX_EL0](#) cause:
 1. The existing value in DTRTX to be returned. This clears [EDSCR.TXfull](#) to 0.
 2. The equivalent of `LDR W1, [X0], #4`, if in AArch64 state, or `LDR R1, [R0], #4`, if in AArch32 state, to be executed.
 3. The equivalent of the MSR `DBGDTRTX_EL0, X1` instruction, if in AArch64 state, or the MCR `p14, 0, R1, c0, c5, 0` instruction, if in AArch32 state, to be executed.
 4. [EDSCR.{TXfull, ITE}](#) to be set to {1,1}, and X1 or R1 to be set to an UNKNOWN value.
- External writes to [DBGDTRRX_EL0](#) cause:
 1. The value in DTRRX to be updated. This sets [EDSCR.RXfull](#) to 1.
 2. The equivalent of the instruction `MRS X1, DBGDTRRX_EL0`, if in AArch64 state, or `MRC p14, 0, R1, c0, c5, 0` if in AArch32 state, to be executed.
 3. The equivalent of the instruction `STR W1, [X0], #4`, if in AArch64 state, or `STR R1, [R0], #4`, if in AArch32 state, to be executed.
 4. [EDSCR.{RXfull, ITE}](#) to be set to {0,1}, and X1 or R1 to be set to an UNKNOWN value.
- External reads from [DBGDTRRX_EL0](#) return the last value written to DTRRX.
- External writes to [EDITR](#) generate an overrun error.

During these accesses, [EDSCR.{TXfull, RXfull, ITE}](#) are used for flow control.

The architecture does not require precisely when these flags are set or cleared by the sequence of operations outlined in this section. For example, in the case of an external write to [DBGDTRRX_EL0](#), in AArch64 state, `RXfull` might be cleared after step 2, or it might not be cleared until after step 3, as an implementation is free to fuse these steps into a single operation. The architecture does require that the flags are set as at step 4 when the PE is ready to accept a further read or write without causing an overrun error or an underrun error.

The process outlined in this section represents a simple sequential execution model of Memory access mode. An implementation is free to pipeline, buffer, and re-order instructions and transactions, as long as the following remain true:

- Data items are transferred into and out of the DTR in order and without loss of data, other than as a result of an overrun or an underrun.
- Data Aborts occur in order.
- The constraints of the memory type are met.
- In the list describing *External reads from [DBGDTRTX_EL0](#)*:
 - The MSR equivalent operation at step 3 of the sequence reads the value loaded by step 2.
 - If the list is performed in a loop, for all but the first iteration of this list, the value read by step 1 returns the values written by the MSR equivalent operation at the previous iteration of step 3.
- In the list describing *External writes to [DBGDTRRX_EL0](#)*:
 - The MRS equivalent operation at step 2 of the sequence returns the value written at step 1.
 - The STR equivalent at step 3 of the sequence writes the value read at step 2.
- If the PE cannot accept a read or write, as applicable, during the sequence, then the flags are updated to indicate an overrun or underrun

See *Flow control of the DCC and ITR registers* on page H4-5506 for more information on overrun and underrun.

Ordering, access sizes and effect on Exclusives monitors

For the purposes of memory ordering, access sizes, and effect on the Exclusives monitor, accesses in Memory access mode are consistent with Load/Store word instructions executed by the PE.

The simple sequential access model of Memory-access mode, as stated in *Memory access mode* on page H4-5503, must also be ordered with respect to instructions executed as a result of explicit writes to **EDITR** in Normal mode both before and after accesses to the DTR registers in Memory-access mode.

Data Aborts in Memory access mode

If a memory access generates a Data Abort, then:

- The Data Abort exception is taken. See *Exceptions in Debug state* on page H2-5465:
 - This means **EDSCR.ERR** is set to 1, see *Cumulative error flag* on page H4-5508.
 - If the Data Abort occurs on stage 2 of an address translation, then the values returned in the ISV field and in bits[23:14] of the ISS are UNKNOWN.
If this Data Abort is taken to EL2 using AArch64, the ISS is returned by **ESR_EL2**. *ISS encoding for an exception from a Data Abort* on page D7-2277 describes the usual encoding of this ISS.
If EL2 is using AArch32 and this Data Abort is taken to Hyp mode, the ISS is returned by **HSR**. *ISS encoding for an exception from a Data Abort* on page G6-4960 describes the usual encoding of this ISS.
- Register R0 retains the address that generated the abort.
- Register R1 is set to an UNKNOWN value.
- **EDSCR.TXfull**, for a load, or **EDSCR.RXfull**, for a store, is set to an UNKNOWN value.
- **DTRTX**, for a load, or **DTRRX**, for a store, is set to an UNKNOWN value.
- **EDSCR.ITE** is set to 1.

Illegal Execution state exception

If **PSTATE.IL** is set to 1 when **EDSCR.MA** == 1, then on an external write access to **DBGDTRRX_ELO** or an external read from **DBGDTRTX_ELO**, it is CONSTRAINED UNPREDICTABLE whether the PE:

- Takes an Illegal Execution state exception without performing any operations. In this case:
 - **EDSCR.ERR** is set to 1, see *Cumulative error flag* on page H4-5508.
 - Register R0 is unchanged.
 - Register R1 is set to an UNKNOWN value.
 - **EDSCR.TXfull** or **EDSCR.RXfull**, as applicable, is set to an UNKNOWN value.
 - **DTRTX** or **DTRRX**, as applicable, is set to an UNKNOWN value.
 - **EDSCR.ITE** is set to 1.See also *Exceptions in Debug state* on page H2-5465.
- Ignores **PSTATE.IL**.

———— Note —————

The typical usage model for Memory access mode involves executing instructions in Normal access mode to set up X0 before setting **EDSCR.MA** to 1. These instructions generate an Illegal state exception if **PSTATE.IL** is set to 1.

Alignment constraints

If the address in R0 is not aligned to a multiple of four, the behavior is as follows:

- For each external DTR access a CONSTRAINED UNPREDICTABLE choice of:
 1. The PE makes an unaligned memory access to R0. If alignment checking is enabled for the memory access, this generates an Alignment fault.
 2. The PE makes a memory access to $\text{Align}(X[0], 4)$ in AArch64 state, or $\text{Align}(R[0], 4)$ in AArch32 state.
 3. The PE generates an Alignment fault, regardless of whether alignment checking is enabled.
 4. The PE does nothing.
- Following each memory access, if there is no Data Abort, R0 is updated with an UNKNOWN value.
- For external writes to `DBGDTRRX_ELO`, if the PE writes to memory, an UNKNOWN value is written.
- For external reads of `DBGDTRTX_ELO` an UNKNOWN value is returned.
- The RXfull and TXfull flags are left in an UNKNOWN state, meaning that a `DBGDTRTX_ELO` read can trigger a TX underrun, and a `DBGDTRTX_ELO` write can trigger an RX overrun.

H4.3.3 Memory-mapped accesses to the DCC and ITR

Writes to the flags in `EDSCR` by external debug interface accesses to the DCC and the ITR registers are indirect writes, because they are a side-effect of the access. The indirect write might not occur for a memory-mapped access to the external debug interface. For more information, see *Register access permissions for memory-mapped accesses* on page H8-5558.

H4.4 Flow control of the DCC and ITR registers

This sub-section describes the flow-control of the DCC and ITR registers:

- [Ready flags](#).
- [Buffering writes to EDITR](#).
- [Overrun and underrun flags on page H4-5507](#).
- [Cumulative error flag on page H4-5508](#).

H4.4.1 Ready flags

In Normal access mode:

- For the DTR registers there are two ready flags:
 - `EDSCR.RXfull == 1` indicates that `DBGDTRRX_EL0` contains a valid value that has been written by the external debugger and not yet read by software running on the target.
 - `EDSCR.TXfull == 1` indicates that `DBGDTRTX_EL0` contains a valid value that has been written by software running on the target and not yet read by an external debugger.
- For the ITR register there is a single ready flag:
 - `EDSCR.ITE == 1` indicates that the PE is ready to accept an instruction to the ITR.

———— **Note** —————

The architecture permits a PE to continue to accept and buffer instructions when previous instructions have not completed their architecturally defined behavior, as long as those instructions are discarded if `EDSCR.ERR` is set, either by an underrun or overrun or by any of the other error conditions described in this architecture, such as an instruction generating an abort.

In Memory access mode:

- `EDSCR.{RXfull, ITE} == {0,1}` indicates that `DBGDTRRX_EL0` is empty and the PE is ready to accept a word external write to `DBGDTRRX_EL0`.
- `EDSCR.{TXfull, ITE} == {1,1}` indicates that `DBGDTRTX_EL0` is full and the PE is ready to accept a word external read from `DBGDTRTX_EL0`.

All other values indicate that the PE is not ready, and result in a DTR overrun or underrun error, an ITR overrun error, or both, as defined in [Overrun and underrun flags on page H4-5507](#).

`EDSCR.{ITE, RXfull, TXfull}` shows the status of the ITR and DCC registers. It ignores the question of whether a read or write cannot be accepted because, for example, `EDSCR.ERR` is set or the OPTIONAL Software Lock is locked for memory-mapped accesses (`EDLSR.SLK == 1`).

H4.4.2 Buffering writes to EDITR

The architecture permits a processor to continue to accept and buffer instructions when previous instructions have not completed their architecturally defined behavior, provided that:

- Those instructions are discarded if `EDSCR.ERR` is set to 1, either by an underrun or an overrun, or by any other error conditions described in this architecture, such as an instruction generating an abort.
- The PE maintains the simple sequential execution model with the order of instructions determined by the order in which the PE accepts the EDITR writes. In particular, the buffered instructions must be executed in the Execution state consistent with a simple sequential execution of the instructions, even if one of the previous instructions is a state changing operation, such as DCPS or DRPS.

H4.4.3 Overrun and underrun flags

Each of the ready flags has a corresponding overrun or a corresponding underrun flag. These are sticky status flags that are set if the register is accessed using the external debug interface when the corresponding ready flag is not in the ready state.

If the PE is in Debug state and Memory access mode, the corresponding error flag is also set if the PE is not ready to accept an operation because a previous load or store is still in progress. The sticky status flag remains set until cleared by writing 1 to [EDSCR.CSE](#).

———— **Note** ————

The architecture permits a PE to continue to accept and buffer data to write to memory in Memory access mode.

[Table H4-1](#) shows DCC and ITR ready flags and the overrun and underrun flags associated with them.

Table H4-1 DCC and ITR ready flags and the associated overrun/underrun flags

External debug interface access	Overrun/Underrun condition	EDSCR flag
Write DBGDTRRX_EL0	$\text{EDSCR.RXfull} == '1' \ \ (\text{Halted}() \ \&\& \ \text{EDSCR.MA} == '1' \ \&\& \ \text{EDSCR.ITE} == '0')$	RXO
Read DBGDTRTX_EL0	$\text{EDSCR.TXfull} == '0' \ \ (\text{Halted}() \ \&\& \ \text{EDSCR.MA} == '1' \ \&\& \ \text{EDSCR.ITE} == '0')$	TXU
Write EDITR	$\text{Halted}() \ \&\& \ (\text{EDSCR.ITE} == '0' \ \ \text{EDSCR.MA} == '1')$	ITO

When an overrun or underrun flag is set to 1, the cumulative error flag, [EDSCR.ERR](#), described in [Cumulative error flag on page H4-5508](#), is also set to 1.

In the event of an external write to [DBGDTRRX_EL0](#) or [EDITR](#) generating an overrun, or an external read from [DBGDTRTX_EL0](#) generating an underrun:

- For a write, the written value is ignored.
- For a read, an UNKNOWN value is returned.
- [EDSCR.TXfull](#), [EDSCR.RXfull](#) or [EDSCR.ITE](#), as applicable, are not updated.

There is no overrun or underrun detection on external reads of [DBGDTRRX_EL0](#) or external writes of [DBGDTRTX_EL0](#).

There is no overrun or underrun detection of direct reads and direct writes of the DTR System registers by software:

- If $\text{RXfull} == 0$, a direct read of [DBGDTRRX](#) or [DBGDTR_EL0](#) returns UNKNOWN.
- If $\text{TXfull} == 1$, a direct write of:
 - [DBGDTRTX](#) sets DTRTX to UNKNOWN.
 - [DBGDTR_EL0](#) sets DTRRX and DTRTX to UNKNOWN.

See [DCC accesses in Non-debug state on page H4-5510](#) for more information.

Accessing 64-bit data

In AArch64 state, a software access to the [DBGDTR_EL0](#) register and an external debugger access to both [DBGDTRRX_EL0](#) and [DBGDTRTX_EL0](#) can perform a 64-bit half-duplex operation.

However, there is only overrun and underrun detection on one of the external debug registers. That is:

- If software directly writes a 64-bit value to [DBGDTR_EL0](#), only TXfull is set to 1, meaning:
 - A subsequent external write to [DBGDTRRX_EL0](#) would not be detected as an overrun.
 - If the external debugger reads [DBGDTRTX_EL0](#) first, software might observe [MDCCSR_EL0.TXfull](#) == 0 and send a second value before the external debugger reads [DBGDTRRX_EL0](#), leading to an undetected overrun.

- On external writes to both [DBGDTRRX_EL0](#) and [DBGDTRTX_EL0](#) only RXfull is set to 1, meaning:
 - A subsequent direct write of [DBGDTRTX_EL0](#) would not be detected as an overrun.
 - If the external debugger writes to [DBGDTRRX_EL0](#) first, software might observe [MDCCSR_EL0.RXfull](#) == 1 and read a full 64-bit value, before the external debugger writes to [DBGDTRTX_EL0](#), leading to an undetected underrun.

To avoid this, debuggers need to be aware of the data size used by software for transfers and ensure that 64-bit data is read or written in the correct order. If the PE is in Non-debug state, this order is as follows:

- The external debugger must check [EDSCR](#).{RXfull, TXfull} before each transfer.
- To receive a 64-bit value from the target, the external debugger must read [DBGDTRRX_EL0](#) before reading [DBGDTRTX_EL0](#).
- To send a 64-bit value to the target, the external debugger must write to [DBGDTRTX_EL0](#) before writing [DBGDTRRX_EL0](#).

Because three accesses are required to transfer 64 bits of data, 64-bit transfers are not recommended for regular communication between host and target. The use of overrun and underrun detection means that only one access is required for 32 bits of data when using 32-bit transfers.

In Debug state, the debugger controls the instructions executed by the PE, so these limitations do not apply. 64-bit transfers provide a means to transfer a 64-bit general register between the host and the target in Debug state.

H4.4.4 Cumulative error flag

The cumulative error flag, [EDSCR](#).ERR, is set to 1:

- On taking an exception from Debug state.
- On any signaled overrun or underrun in the DCC or ITR.

When [EDSCR](#).ERR == 1:

- External reads of [DBGDTRTX_EL0](#) do not have any side-effects.
- External writes to [DBGDTRRX_EL0](#) are ignored.
- External writes to [EDITR](#) are ignored.
- No further instructions can be issued in Debug state. This includes any instructions previously accepted as external writes to [EDITR](#) that occur in program order after the instruction or access that caused the error.

This allows a debugger to stream data, or, in Debug state, instructions, to the target without having to:

- Check [EDSCR](#).{RXfull, TXfull, ITE} before each access.
- Check [EDSCR](#).{ITO, RXO, TXU} following each access, for overrun or underrun.
- Check [PSTATE](#) or other syndrome registers, or both, for an exception following each instruction executed in Debug state that might generate a synchronous exception.

The cumulative error flag remains set until cleared by writing 1 to [EDRCR](#).CSE. See [EDRCR](#), *External Debug Reserve Control Register* on page H9-5660.

For overruns and underruns, [EDSCR](#).{ITO, RXO, TXU} record the error type.

Pseudocode description of clearing the error flag

The [ClearStickyErrors\(\)](#) pseudocode function is described in [Chapter J1 ARMv8 Pseudocode](#).

H4.5 Synchronization of DCC and ITR accesses

In addition to the standard synchronization requirements for register accesses, the following subsections describe additional requirements that apply for the DCC and ITR registers:

- [Summary of System register accesses to the DCC.](#)
- [DCC accesses in Non-debug state on page H4-5510.](#)

In these sections, accesses by the external debug interface are referred to as external reads and external writes. Accesses to System registers are referred to as direct reads, direct writes, indirect reads, and indirect writes.

———— **Note** —————

In [Synchronization requirements for AArch64 System registers on page D7-2191](#) external reads and external writes are described as forms of indirect access. This whole section uses more explicit terminology.

The DTR registers and the DCC flags, TXfull and RXfull, form a communication channel, with one end operating asynchronously to the other. Implementations must respect the ordering of accesses to these registers in order to maintain the correct behavior of the channel.

External reads of, and external writes to [DBGDTRRX_EL0](#) and [DBGDTRTX_EL0](#) are asynchronous to direct reads of, and direct writes to, [DBGDTRRX](#), [DBGDTRTX](#), and in AArch64 state [DBGDTR_EL0](#), made by software using System register access instructions. The direct reads and direct writes indirectly write to the DCC flags. The external reads and external writes indirectly read the DCC flags to check for underrun and overrun.

Throughout this section:

- DCC flags** Means any or all of the following:
- The [EDSCR](#).{RXfull.TXfull} ready flags.
 - The [EDSCR](#).RXO overrun flag.
 - The [EDSCR](#).TXU underrun flag.
 - The [EDSCR](#).ERR cumulative error flag.
- ITR flags** Means any or all of the following:
- The [EDSCR](#).ITE ready flag.
 - The [EDSCR](#).ITO overrun flag.
 - The [EDSCR](#).ERR cumulative error flag.

H4.5.1 Summary of System register accesses to the DCC

System register accesses to the DTR registers are direct reads and writes of those registers, as shown in [Table H4-2 on page H4-5510](#). Several of these instructions access the same registers using different encodings.

With the exception of the read and write bits, [DBGDTRRX](#) and [DBGDTRTX](#) are the same encoding, with exception of the read/write bits, but use different registers. The ARMv8 architecture governs the order of these instructions, as described in [Synchronization requirements for AArch64 System registers on page D7-2191](#). For more details, see the description of the individual register in the relevant chapter, [Chapter D7 AArch64 System Register Descriptions](#) or [Chapter G6 AArch32 System Register Descriptions](#).

Table H4-2 shows a summary of System register accesses to the DCC.

Table H4-2 Summary of System register accesses to the DCC

Operation	OS Lock	AArch64 (MRS/MSR)	AArch32 (MRC/MCR)	Description
Read	-	DBGDTRRX_EL0	DBGDTRRXint	Direct read of DTRRX Indirect write to the DCC flags
Write	-	DBGDTRTX_EL0	DBGDTRTXint	Direct read of DTRTX Indirect write to the DCC flags
Read/write	-	DBGDTR_EL0	-	Direct read/write of both DTRRX and DTRTX Indirect write to the DCC flags
Read	-	MDCCSR_EL0	DBGDSCRint	Direct read of the DCC flags
Read/write	-	OSDTRRX_EL1	DBGDTRRXext	Direct read/write of DTRRX
Read/write	-	OSDTRTX_EL1	DBGDTRTXext	Direct read/write of DTRTX
Read	Unlocked	MDSCR_EL1	DBGDSCRext	Direct read of DCC flags
Read/write	Locked	MDSCR_EL1	DBGDSCRext	Direct read/write of DCC flags

H4.5.2 DCC accesses in Non-debug state

In Non-debug state DCC accesses are as described in *Normal access mode* on page H4-5502:

- If a direct read of [DCCSR](#) returns `RXfull == 1`, then a following direct read of [DBGDTRRX](#), or in AArch64 state of [DBGDTR_EL0](#), returns valid data and indirectly writes 0 to [DCCSR.RXfull](#) as a side-effect.
- If a direct read of [DCCSR](#) returns `TXfull == 0`, then a following direct write to [DBGDTRTX](#), or in AArch64 state to [DBGDTR_EL0](#), writes the intended value, and indirectly writes 1 to [DCCSR.TXfull](#) as a side-effect.

No *Context synchronization event* is required between these two instructions. Overrun and underrun detection prevents intervening external reads and external writes affecting the outcome of the second instruction.

The indirect write to the [DCC flags](#) as part of the DTR access instruction is made atomically with the DTR access.

Because a direct read of [DBGDTRRX](#) is an indirect write to [DCCSR.RXfull](#), it must occur in program order with respect to the direct read of [DCCSR](#), meaning it must not return a speculative value for DTRTX that predates the `RXfull` flag returned by the read of [DCCSR](#). The direct write to [DBGDTRTX](#) must not be executed speculatively.

Direct reads of [DBGDTRRX](#), or in AArch64 state [DBGDTR_EL0](#), and [DCCSR](#), must occur in program order with respect to other direct reads of the same register using the same encoding.

The following accesses have an implied order within the atomic access:

- In the simple sequential execution of the program the indirect write of the [DCC flags](#) occurs immediately after the direct DTR access.

———— **Note** —————

For an access to [DBGDTR_EL0](#), this means the indirect write happens after both [DBGDTRRX_EL0](#) and [DBGDTRTX_EL0](#) have been accessed.

- In the simple sequential execution model, for an external read of `DBGDTRTX_EL0` or an external write of `DBGDTRRX_EL0`:
 - The check of the **DCC flags** for overrun or underrun occurs immediately before the access.
 - If there is no underrun or overrun, the update of the **DCC flags** occurs immediately after the access.
 - If there is underrun or overrun, the update of the DCC underrun or overrun flags occurs immediately after the access.

All observers must observe the same order for accesses.

———— **Note** —————

These requirements do not create order where order does not otherwise exist. It applies only for ordered accesses.

Without explicit synchronization following external writes and external reads:

- The value written by the external write to `DBGDTRRX_EL0` that does not overrun, must be observable to direct reads of `DBGDTRRX` and `DBGDTR_EL0` in finite time.
- The **DCC flags** that are updated as a side-effect of the external write or external read must be observable:
 - To subsequent external reads of `EDSCR`.
 - To subsequent external reads of `DBGDTRRX_EL0` when checking for underrun.
 - To subsequent external writes to `DBGDTRTX_EL0` when checking for overrun.
 - To direct reads of `DCCSR` in finite time.

However, explicit synchronization is required to guarantee that a direct read of `DCCSR` returns up-to-date **DCC flags**. This means that if a signal is received from another agent that indicates that `DCCSR` must be read, an ISB is required to ensure that the direct read of `DCCSR` occurs after the signal has been received. This also synchronizes the value in `DBGDTRRX`, if applicable. However, if that signal is an interrupt exception triggered by `COMMIRQ`, `COMMTX`, or `COMMRX`, the exception entry is sufficient synchronization. See *Synchronization of DCC interrupt request signals* on page H4-5513.

Explicit synchronization is required following a direct read or direct write:

- To ensure that a value directly written to `DBGDTRTX` is observable to external reads of `DBGDTRTX_EL0`.
- To ensure that a value directly written to `DBGDTR_EL0` is observable to external reads of `DBGDTRTX_EL0` and `DBGDTRRX_EL0`.
- To guarantee that the indirect writes to the **DCC flags** that were a side-effect of the direct read or direct write have occurred, and therefore that the updated values are:
 - Observable to external reads of `EDSCR`.
 - Observable to external reads of `DBGDTRRX_EL0` when checking for underrun.
 - Observable to external writes of `DBGDTRTX_EL0` when checking for overrun.
 - Returned by a following direct read of `DCCSR`.

See also *Memory-mapped accesses to the DCC and ITR* on page H4-5505 and *Synchronization of changes to the external debug registers* on page H8-5554.

———— **Note** —————

These ordering rules mean that software:

- Must not read `DBGDTRRX` without first checking `DCCSR.RXfull` or if the previously-read value of `DCCSR.RXfull` is 0.
It is not sufficient to read both registers and then later decide whether to discard the read value, as there might be an intervening write from the external debug interface.

- Must not write **DBGDTRTX** without first checking **DCCSR.TXfull** or if the previously-read value of **DCCSR.TXfull** is 1.
The write to **DBGDTRTX** overwrites the value in **DTRTX**, and the external debugger might or might not have read this value.
 - Must ensure there is an explicit *Context synchronization event* following a DTR access, even if not immediately returning to read **DCCSR** again. This synchronization operation can be an exception return.
-

Derived requirements

The rules for DCC accesses in Non-debug state are as follows:

- Following a direct read of **DBGDTRRX** when **RXfull** is 1:
 - If an external write to **DBGDTRRX** checks the **RXfull** flag for overrun and observes that the value of **RXfull** is 0, the value returned by the previous direct read must not be affected by the external write.
 - If an external read of **EDSCR** returns a **RXfull** value of 0, then the value returned by the previous direct read must not be affected by a following external write to **DBGDTRRX**, and the following external write does not overrun.
- Following a direct read of **DBGDTR_EL0**, when **RXfull** is 1:
 - If an external write to **DBGDTRRX** checks the **RXfull** flag for overrun and observes that the value of **RXfull** is 0, the value returned by the previous direct read must not be affected by the external write nor by a following direct write to **DBGDTRTX**.
 - If an external read of **EDSCR** returns a **RXfull** value of 0, then the value returned by the previous direct read must not be affected by subsequent external writes to **DBGDTRRX** and **DBGDTRTX** in any order, and the following external write of **DBGDTRRX** will not overrun.
- Following a direct write to **DBGDTRTX**, when **TXfull** is 0:
 - If an external read of **DBGDTRTX** checks the **TXfull** flag for underrun and observes that the value of **TXfull** is 1, the value returned by the external read must be the value written by the previous direct write.
 - If an external read of **EDSCR** returns a **TXfull** value of 1, then the value returned by a following external read of **DBGDTRRX** must be the value written by the previous direct read, and the subsequent external read will not underrun.
- Following a direct write to **DBGDTR_EL0**, when **TXfull** is 0:
 - If an external read of **DBGDTRTX** checks the **TXfull** flag for underrun and observes that the value of **TXfull** is 1, the values returned by the external read and by a subsequent external read of **DBGDTRRX** must be the value written by the previous direct write.
 - If an external read of **EDSCR** returns a **TXfull** value of 1, then the value returned by subsequent external reads of **DBGDTRRX** and **DBGDTRTX**, in any order, must be the value written by the previous direct read, and the subsequent external read of **DBGDTRTX** does not underrun.
- Following an external read of **DBGDTRTX** that does not underrun, if a direct read of **DCCSR** returns a **TXfull** value of 0, then the value returned by the external read must not be affected by a following direct write to **DBGDTRTX**.
- Following a first external read **DBGDTRRX** and a following second external read of **DBGDTRTX** that does not underrun, if a direct read of **DCCSR** returns a **TXfull** value of 0, then the values returned by the external reads must not be affected by a following direct write to **DBGDTR_EL0**.
- Following an external write to **DBGDTRRX** that does not overrun, if a direct read of **DCCSR** returns an **RXfull** value of 1, then the value returned by a following direct read of **DBGDTRRX** or **DBGDTR_EL0** must be the value written by the previous external write.

- Following a first external write to **DBGDTRTX** and a following second external write to **DBGDTRRX** that does not overrun, if a direct read of **DCCSR** returns an **RXfull** value of 1, then the value returned by a subsequent direct read of **DBGDTR_EL0** must return the values written by the previous external writes.

H4.5.3 Synchronization of DCC interrupt request signals

Following an external read or external write access to the DTR registers, the interrupt request signals, **COMMIRQ**, **COMMTX**, and **COMMRX**, must be updated in finite time without explicit synchronization.

The updated values must be observable to a direct read of **DCCSR** or **DBGDTRRX**, or a direct write of **DBGDTRTX** executed after taking an interrupt exception generated by the interrupt request. The updated values must also be observable to a direct write of **DBGDTRTX** executed after taking an interrupt exception generated by the interrupt request.

Following a direct read of **DBGDTRRX** or a direct write to **DBGDTRRX**, software must execute a *Context synchronization event* to guarantee the interrupt request signals have been updated in finite time. This synchronization operation can be an exception return.

H4.5.4 DCC and ITR access in Debug state

In Debug state, stricter observability rules apply for instructions issued through the ITR, to maintain communication between a debugger and the PE, without requiring excessive explicit synchronization.

In Normal access mode, without explicit synchronization:

- A direct read or direct write of the DTR registers by an instruction written to **EDITR** must be observable to an external write or an external read in finite time:
 - A direct read of **DBGDTRRX** must be observable to an external write of **DBGDTRRX_EL0**.
 - A direct read of **DBGDTR_EL0** must be observable to an external write of **DBGDTRRX_EL0** and **DBGDTRTX_EL0**.
 - A direct write of **DBGDTRTX** must be observable to an external read of **DBGDTRTX_EL0**.
 - A direct write of **DBGDTR_EL0** must be observable to an external read of **DBGDTRRX_EL0** and **DBGDTRTX_EL0**.

This includes the indirect write to the **DCC flags** that occurs atomically with the access as described in *DCC accesses in Non-debug state* on page H4-5510.

The subsequent external write or external read must observe either the old or the new values of both the DTR contents and **DCC flags**. If the old values are observed, this typically results in overrun or underrun, assuming the old values of the **DCC flags** indicate an overrun or underrun condition, as would normally be the case.

This means the debugger can observe the direct read or direct write without explicit synchronization and without explicitly testing the **DCC flags** in **EDSCR**, because it can rely on overrun and underrun tests.

- External reads of **DBGDTRTX_EL0** that do not underrun and external writes to **DBGDTRRX_EL0** that do not overrun must be observable to an instruction subsequently written to **EDITR** on completion of the first external access. This includes the indirect write to the **DCC flags**.

This means that without explicit synchronization and without the need to first check the **DCC flags** in **DCCSR**:

- If the instruction is a direct read of **DBGDTRRX**, it observes the external write.
- If the instruction is a direct write of **DBGDTRTX**, it observes the external read.
- Writes to **EDITR** that do not overrun commit an instruction for execution immediately. The instruction must complete execution in finite time without requiring any further operation by the debugger.
- After an external write to the **EDITR**, the **ITR flags** that are updated as a side effect of that write must be observable by:
 - An external read of the **EDSCR** that follows the external write to the **EDITR**.
 - When checking for overrun, another external write to the **EDITR** that follows the original external write to the **EDITR**.

In Memory access mode, these requirements shift to the instructions implicitly executed by external reads and external writes of the DTR registers, as described in *Memory access mode* on page H4-5503.

H4.6 Interrupt-driven use of the DCC

ARM recommends implementations provide a level-sensitive DCC interrupt request through the IMPLEMENTATION DEFINED interrupt controller as a private peripheral interrupt for the originating PE.

———— **Note** —————

- In addition to connection to the interrupt controller ARM also recommends **COMMIRQ**, **COMMTX**, and **COMMRX** signals that might be implemented for use by any legacy system peripherals.
- GICv3 reserves a private peripheral interrupt number for the **COMMIRQ** interrupt.

The **DCCINT** register provides a first level of interrupt masking within the PE, meaning only a single interrupt source, **COMMIRQ**, is needed at the interrupt controller.

See also [Synchronization of DCC interrupt request signals on page H4-5513](#).

H4.7 Pseudocode description of the operation of the DCC and ITR registers

The basic operation of the DCC and ITR registers is shown by the following pseudocode functions. These functions do not cover the behavior when `OSLSR.OSLK == 1`, meaning that the OS lock is locked:

- `DBGDTR_EL0[]`.
- `DBGDTRRX_EL0[]`.
- `DBGDTRTX_EL0[]`.
- `EDITR[]`.
- `CheckForDCCInterrupts()`.

For the definition of the DTR Registers, see [shared/debug/dccanditr/DTR](#) on page J1-6013.

Chapter H5

The Embedded Cross-Trigger Interface

This chapter describes the embedded cross-trigger interface. It contains the following sections:

- *About the Embedded Cross-Trigger (ECT) on page H5-5518.*
- *Basic operation on the ECT on page H5-5520.*
- *Cross-triggers on a PE in an ARMv8 implementation on page H5-5524.*
- *Description and allocation of CTI triggers on page H5-5525.*
- *CTI registers programmers' model on page H5-5529.*
- *Examples on page H5-5530.*

H5.1 About the Embedded Cross-Trigger (ECT)

The *Embedded Cross-Trigger*, ECT, allows a debugger to:

- Send trigger events to a PE. For example, this might be done to halt the PE.
- Send a trigger event to one or more PEs when a trigger event occurs on another PE. For example, this might be done to halt all PEs when one individual PE halts.

Figure H5-1 shows the logical structure of an ECT.

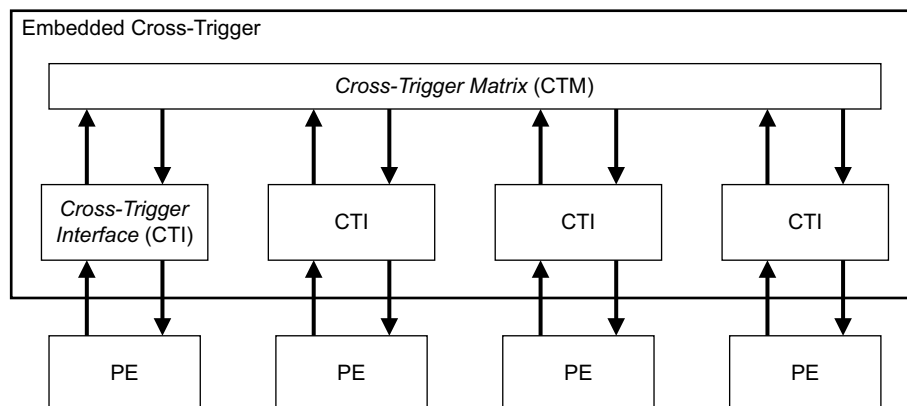

Figure H5-1 Structure of an embedded cross-trigger

The ECT can deliver many types of trigger events, which are described in the following sections:

- [Debug request trigger event on page H5-5526.](#)
- [Restart request trigger event on page H5-5526.](#)
- [Cross-halt trigger event on page H5-5526.](#)
- [Performance Monitors overflow trigger event on page H5-5527.](#)
- [Generic trace external input trigger events on page H5-5527.](#)
- [Generic trace external output trigger events on page H5-5527.](#)
- [Generic CTI interrupt trigger event on page H5-5527.](#)

An ARMv8-A implementation must:

- Include a cross-trigger interface, CTI.
- Implement at least the input and output triggers defined in this architecture.

See [Cross-triggers on a PE in an ARMv8 implementation on page H5-5524.](#)

In addition, ARM recommends that the cross-trigger includes:

- The ability to route trigger events between Trace macrocells:
These typically have advanced event triggering logic.
- An output trigger to the interrupt controller.

———— Note ————

The ECT and CTI must only signal trigger events for external debugging. They must not route software events, such as interrupts. For example, the Performance Monitors overflow input trigger is provided to allow entry to Debug state on a counter overflow, and the output trigger to the interrupt controller is provided to generally allow events from the external debug sub-system to be routed to a software agent. However, the combination of the two must not be used as a mechanism to route Performance Monitors overflows to an interrupt controller.

H5.1.1 Implementation with a CoreSight CTI

For details of the recommended connections in an ARMv8-A implementation, see [Appendix K2 Recommended External Debug Interface](#). See also *CoreSight™ SoC Technical Reference Manual*.

H5.2 Basic operation on the ECT

The ECT comprises a Cross-Trigger Matrix, CTM, and one Cross-Trigger Interface, CTI, for each PE. The CTM passes events between the CTI blocks over channels. The CTM can have a maximum of 32 channels.

The main interfaces of the cross-trigger interface, CTI, are:

- The input triggers:
 - These are trigger event inputs from the PE to the CTI.
- The output triggers:
 - These are trigger event outputs from the CTI to the PE.
- The input channels:
 - These are channel event inputs from the cross-trigger matrix, CTM, to the CTI.
- The output channels:
 - These are channel event outputs from the CTI to the CTM.

Each CTI block has:

- Up to 32 input triggers that come from the PE:
 - The input triggers are numbered 0-31.
- Up to 32 output triggers that go to the PE:
 - The output triggers are numbered 0-31.

[Figure H5-2 on page H5-5521](#) shows the logical internal structure of a CTI.

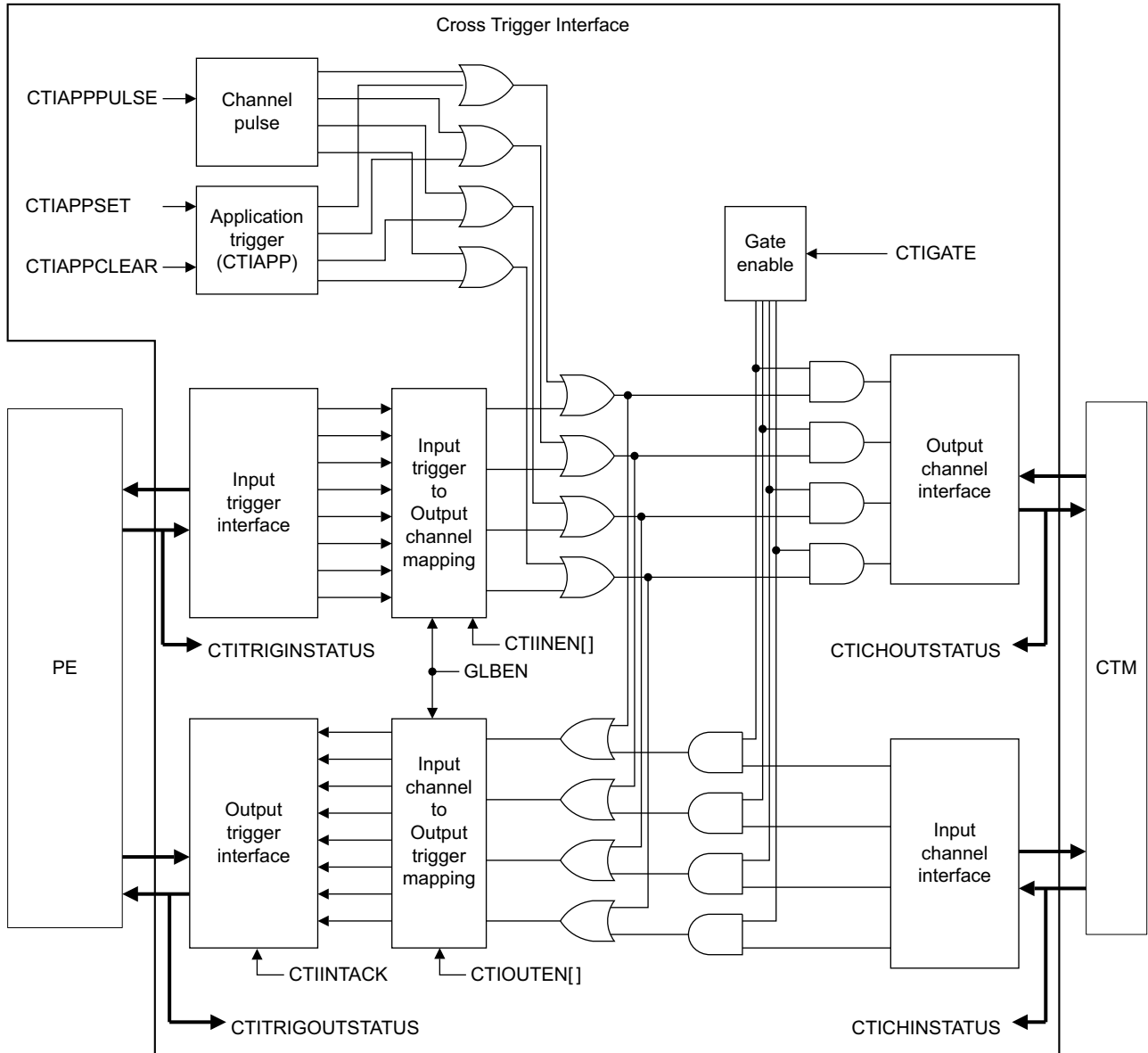

Figure H5-2 Structure of a cross-trigger interface

Note

- The number of triggers is IMPLEMENTATION DEFINED. Figure H5-2 shows eight input and eight output triggers.
- The number of channels is IMPLEMENTATION DEFINED. Figure H5-2 shows four channels.
- In Figure H5-2 the input channel gate function is a CTIv2 feature.

When the CTI receives an input trigger event, this generates channel events on one or more internal channels, according to the *mapping function* defined by the *Input trigger→output channel mapping registers*, CTIINEN<n>.

The CTI also contains an *application trigger* and *channel pulse* to allow a debugger to create channel events directly on internal channels by writing to the CTI control registers.

Channel events on each internal channel are passed to a corresponding output channel that is controlled by a *channel gate*. The channel gate can block propagation of channel events from an internal channel to an output channel.

The output channels from a CTI are combined, using a logical OR function, with the output channels from all other CTIs to form the input channels on other CTIs. The input channels of this CTI are the logical OR of the output channels on all other CTIs. This is the *cross-trigger matrix*, CTM. Therefore, the number of input channels must equal the number of output channels.

———— **Note** ————

The number of input triggers and output triggers is not required to be the same.

The internal channels form an internal cross-trigger matrix within the CTI. This delivers events directly from the input triggers to the output triggers. Therefore the number of internal channels is the same as the number of input and output channels on the external CTM, and there is a direct mapping between the two.

Channel events received on each input channel are passed to the corresponding internal channel. It is IMPLEMENTATION DEFINED whether the cross-trigger gate also blocks propagation of channel events from input channels to internal channels.

When the CTI receives a channel event on an internal channel this generates trigger events on one or more output triggers, according to the mapping function defined by the *Input channel* → *output trigger mapping registers*, `CTIOUTEN<n>`.

The CTI contains the input and output trigger interfaces to the PE and the interface of the cross-trigger matrix. The architecture does not define the signal protocol used on the trigger interfaces, and:

- It is IMPLEMENTATION DEFINED whether the CTI supports multicycle input trigger events.
- It is IMPLEMENTATION DEFINED whether the CTM supports multicycle channel events.

See *Multicycle events*.

However, an output trigger is asserted until acknowledged. The output trigger can be:

- Self-acknowledging. This means that no further action is required from the debugger.
- Acknowledged by the debugger writing 1 to the corresponding bit of `CTIINTACK`.

The time taken to propagate a trigger event from the first PE, through its CTI, across the CTM to another CTI, and thereby to a second PE is IMPLEMENTATION DEFINED.

———— **Note** ————

ARM recommends that this path is not longer than the shortest software communication path between those PEs. This is because if the first PE halts, the Cross-halt trigger event can propagate through the ECT and halt the second PE without causing software on the second PE to malfunction because the first PE is in Debug state and is not responding.

H5.2.1 Multicycle events

A multicycle event is one with a continuous state that might persist over many cycles, as opposed to a discrete event. A typical implementation of a multicycle event is a level-based signal interface, whereas a discrete event might be implemented as a pulse signal or message.

CTI support for multicycle trigger events is IMPLEMENTATION DEFINED. Use of multicycle trigger events is deprecated. Of the architecturally defined input trigger events, the Performance Monitors overflow trigger event and Generic trace external output trigger events can be multicycle input triggers.

CTM support for multicycle channel events is IMPLEMENTATION DEFINED. A CTM that does not support multicycle channel events cannot propagate a multicycle trigger event between CTIs.

———— **Note** ————

A full ECT might comprise a mix of CTIs, some of which can support multicycle trigger events. In bridging these components, multicycle channel events become single channel events at the boundary between the CTIs.

An ECT that supports multicycle trigger events

When an ECT supports multicycle trigger events, an input trigger event to the CTI continuously asserts channel events on all output channels mapped to it until either:

- The input trigger event is removed.
- The channel mapping function is disabled.

This means that an input trigger that is asserted for multiple cycles causes any channels that are mapped to it to become active for multiple cycles. Consequently, any output triggers mapped from that channel are asserted for multiple cycles.

Note

The output trigger remains asserted for at least as long as the channel remains active. This means that even if the output trigger is acknowledged, it remains asserted until the channel deactivates.

The CTI does not guarantee that these events have precisely the same duration, as the triggers and channels can cross between clock domains.

[CTIAPPSET](#) and [CTIAPPCLEAR](#) can set a channel active for multiple cycles. [CTIAPPULSE](#) generates a single channel event. [CTICHINSTATUS](#) and [CTICHOUTSTATUS](#) can report whether a channel is active.

An ECT that does not support multicycle trigger events

When an ECT does not support multicycle trigger events, an input trigger event to the CTI generates a single channel event on all output channels mapped to it, regardless of how long the input trigger event is asserted.

This means that an input trigger event that is asserted for multiple cycles generates a single channel event on any channels mapped to it. Consequently any self-acknowledging output triggers mapped from those channels are single trigger events.

Note

A single event is typically a single cycle, but there is no guarantee that this is always the case.

[CTIAPPSET](#) and [CTIAPPCLEAR](#) can only generate a single channel event. [CTIAPPULSE](#) generates a single channel event. If the ECT does not support multicycle channel events, use of [CTIAPPSET](#) and [CTIAPPCLEAR](#) is deprecated, and the debugger must only use [CTIAPPULSE](#). [CTICHINSTATUS](#) and [CTICHOUTSTATUS](#) must be treated as UNKNOWN.

H5.3 Cross-triggers on a PE in an ARMv8 implementation

An ARMv8 PE must include a cross-trigger interface, and the implementation must include at least the input and output triggers defined in this architecture. The number of channels in the cross-trigger matrix is IMPLEMENTATION DEFINED, but there must be a minimum of three. Software can read CTIDEVID.NUMCHAN to discover the number of implemented channels.

The CTM must connect to all PEs in the same Inner Shareability domain as the ARMv8-A PE, but can also connect to additional PEs. ARM strongly recommends that the CTM connects all PEs implementing a CTI in the system. This includes ARMv7-A PEs and other PEs that can be connected using a CoreSight CTI module.

———— **Note** —————

In a uniprocessor system the CTM is OPTIONAL. The CTM might be connected other CTI modules for non-PEs, such as triggers for system visibility components. ARM recommends that the CTM is implemented.

Any CTI connected to a PE that is not an ARMv8-A PE must implement at least:

- The Debug request trigger event.
- The Restart trigger event.
- The Cross-halt trigger event.

For more information about the CTI, see the *CoreSight™ SoC Technical Reference Manual*. ARMv8-A refines the generic CTI by defining roles for each of the implemented input and output triggers.

H5.4 Description and allocation of CTI triggers

Table H5-1 shows the output trigger events defined by the architecture and the related trigger numbers.

Table H5-1 Allocation of CTI output trigger events

Number	Source	Destination	Event description
0	CTI	PE	<i>Debug request trigger event on page H5-5526</i>
1	CTI	PE	<i>Restart request trigger event on page H5-5526</i>
2	CTI	IRQ controller	<i>Generic CTI interrupt trigger event on page H5-5527</i>
3	-	-	Reserved
4 - 7	CTI	Trace macrocell	OPTIONAL <i>Generic trace external input trigger events on page H5-5527</i>

———— **Note** —————

Output triggers from the CTI are inputs to other blocks.

Table H5-2 shows the input trigger events defined by the architecture and the related trigger numbers.

Table H5-2 Allocation of CTI input trigger events

Number	Source	Destination	Event description
0	PE	CTI	<i>Cross-halt trigger event on page H5-5526</i>
1	PE	CTI	<i>Performance Monitors overflow trigger event on page H5-5527</i>
2 - 3	-	-	Reserved
4 - 7	Trace macrocell	CTI	OPTIONAL <i>Generic trace external output trigger events on page H5-5527</i>

———— **Note** —————

Input triggers to the CTI are outputs from other blocks.

Table H5-1 and Table H5-2 show the minimum set of trigger events defined by the architecture. However:

- The Generic trace external input and output trigger events are only required if the OPTIONAL Trace macrocell is implemented. If the OPTIONAL Trace macrocell is not implemented, these trigger events are reserved.
- Support for the generic CTI interrupt trigger event is IMPLEMENTATION DEFINED because details of interrupt handling in the system, including any interrupt controllers, are IMPLEMENTATION DEFINED. Details regarding how the CTI interrupt is connected to an interrupt controller and its allocated interrupt number lie outside the scope of the architecture. ARM strongly recommends that implementations provide a means to generate interrupts based on external debug events.
- The other trigger events are required by the architecture.

An ARMv8-A implementation can extend the CTI with additional triggers. These start with the number eight.

H5.4.1 Debug request trigger event

This is an output trigger event from the CTI, and an input trigger event to the PE, asserted by the CTI to force the PE into Debug state. The trigger event is asserted until acknowledged by the debugger. The debugger acknowledges the trigger event by writing 1 to [CTIINTACK](#)[0].

———— **Note** —————

A debugger must poll [CTITRIGOUTSTATUS](#)[0] until it reads as 0, to confirm that the output trigger has been deasserted before generating any event that must be ordered after the write to [CTIINTACK](#), such as a write to [CTIAPPULSE](#) to activate another trigger.

If the PE is already in Debug state, the PE ignores the trigger event, but the CTI continues to assert it until it is removed by the debugger. See also [External Debug Request debug event on page H3-5490](#).

H5.4.2 Restart request trigger event

This is an output trigger event from the CTI, and an input trigger event to the PE, asserted by the CTI to request the PE to exit Debug state. If the PE is in Non-debug state, the request is ignored by the PE.

If a Restart request trigger event is received at or about the same time as the PE enters Debug state, it is CONstrained UNPREDICTABLE whether:

- The request is ignored by the PE. In this case the PE enters Debug state and remains in Debug state.
- The PE enters Debug state and then immediately restarts.

Debuggers must program the CTI to send Restart request trigger events only to PEs that are halted. To enable the PE to disambiguate discrete Restart request trigger events, after sending a Restart request trigger event, the debugger must confirm that the PE has restarted and halted before sending another Restart request trigger event. Debuggers can use [EDPRSR](#).{SDR, HALTED} to determine the Execution state of the PE.

———— **Note** —————

Before generating a Restart request trigger event for a PE, a debugger must ensure any Debug request trigger event targeting that PE is cleared. [Debug request trigger event](#) describes how to do this.

The trigger event is self-acknowledging, meaning that the debugger requires no further action to remove the trigger event. The trigger event is acknowledged even if the request is ignored by the PE. See also [Exiting Debug state on page H2-5471](#).

H5.4.3 Cross-halt trigger event

This is an input trigger event to the CTI, and an output trigger event from the PE, asserted by a PE when it is entering Debug state.

———— **Note** —————

To reduce the latency of halting, ARM recommends that an implementation issues the Cross-halt trigger event early in the committed process of entering Debug state. This means that there is no requirement to wait until all aspects of entry to Debug state have completed before issuing the trigger event. Speculative emission of Cross-halt trigger events is not allowed. The Cross-halt trigger event must not be issued early enough for a subsequent Debug request trigger event, that might be derived from the Cross-halt trigger event, to be recorded in the [EDSCR](#).STATUS field. This applies to Debug request trigger events that are acting as inputs to the PE.

H5.4.4 Performance Monitors overflow trigger event

This is an input trigger event to the CTI, and an output trigger event from the PE, asserted each time the PE asserts a new Performance Monitors counter overflow interrupt request. See [Chapter D5 The Performance Monitors Extension](#).

If the CTI supports multicycle trigger events, then the trigger event remains asserted until the overflow is cleared by a write to `PMOVSCLR_ELO`. Otherwise, the trigger event is asserted when the value of `PMOVSCLR_ELO` changes from zero to a non-zero value.

———— **Note** —————

- This does not replace the recommended connection of Performance Monitors overflow trigger event to an interrupt controller. Software must be able to program an interrupt on Performance Monitors overflow without programming the CTI.
- Events can be counted when `ExternalNoninvasiveDebugEnabled()==FALSE`, and, in Secure state, when `ExternalSecureNoninvasiveDebugEnabled()==FALSE`. Secure software must be aware that overflow trigger events are nevertheless visible to the CTI.

H5.4.5 Generic trace external input trigger events

These are output trigger events from the CTI, and input trigger events to the OPTIONAL Trace macrocell, that are used in conjunction with the Generic trace external output trigger events to pass trigger events between:

- The PE and the OPTIONAL Trace macrocell.
- The OPTIONAL Trace macrocell and any other component attached to the CTM, including other Trace macrocells.

There are four Generic trace external input trigger events.

The trigger events are self-acknowledging. This means that the debugger does not have to take any further action to remove the events.

H5.4.6 Generic trace external output trigger events

These are input trigger events to the CTI, and output trigger events from the OPTIONAL Trace macrocell, used in conjunction with the Generic trace external input trigger events to pass trigger events between:

- The PE and the OPTIONAL Trace macrocell.
- The OPTIONAL Trace macrocell and any other component attached to the CTM, including other Trace macrocells.

There are four Generic trace external output trigger events.

H5.4.7 Generic CTI interrupt trigger event

This is an output trigger event from the CTI, and an input to an IMPLEMENTATION DEFINED interrupt controller, and can transfer trigger events from the PE, Trace macrocell, or any other component attached to the CTI and CTM to software as an interrupt. The Generic CTI interrupt trigger event must be connected to the interrupt controller as an interrupt that can target the originating PE.

———— **Note** —————

- ARM recommends that the Generic CTI interrupt trigger event is a private peripheral interrupt, but implementations might instead make this trigger event available as a shared peripheral interrupt or a local peripheral interrupt.
- GICv3 reserves a private peripheral interrupt number for this interrupt.

It is IMPLEMENTATION DEFINED whether this trigger event is:

- Self-acknowledging. This means that the debugger is not required to take any further action, and that the interrupt controller must treat the trigger event as a pulse or edge-sensitive interrupt.
- Acknowledged by the debugger. The debugger acknowledges the trigger event by writing 1 to [CTIINTACK\[2\]](#). This means that the interrupt controller must treat the trigger event as a level-sensitive interrupt.

ARM recommends that the Generic CTI interrupt trigger event is a self-acknowledging trigger event.

H5.5 CTI registers programmers' model

The CTI registers programmers' model is described in [Chapter H8 About the External Debug Registers](#). The following sections contain information specific to the CTI:

- [External debug register resets](#) on page H8-5572.
- [External debug interface register access permissions](#) on page H8-5561.
- [Cross-trigger interface registers](#) on page H8-5570.
- The individual register descriptions in [Cross-Trigger Interface registers](#) on page H9-5677.

See also [Memory-mapped accesses to the external debug interface](#) on page H8-5558.

H5.5.1 CTI reset

An External Debug reset resets the CTI. See [External debug register resets](#) on page H8-5572 for details of CTI register resets. All CTI output triggers and output channels are deasserted on an External Debug reset.

———— **Note** —————

An indirect read of an output trigger might not observe the deasserted state until the processor is Cold reset. For more information, see [Synchronization of changes to the external debug registers](#) on page H8-5554.

H5.5.2 CTI authentication

The CTI ignores the state of the IMPLEMENTATION DEFINED authentication interface. This means that:

- [CTITRIGINSTATUS](#) shows the status of the input triggers and [CTICHINSTATUS](#) shows the status of the input channels, regardless of the value of `ExternalNoninvasiveDebugEnabled()`.

———— **Note** —————

The PE does not generate the Cross-halt trigger event and the Trace macrocell does not generate Generic trace external output trigger events when `ExternalNoninvasiveDebugEnabled()==FALSE`. However, the PE can generate Performance Monitors overflow trigger events.

- The CTI can generate external triggers regardless of the value of `ExternalInvasiveDebugEnabled()`.

———— **Note** —————

The PE ignores Debug request and Restart request trigger events when `ExternalInvasiveDebugEnabled()==FALSE`. The Trace macrocell ignores Generic trace external input trigger events when `ExternalNoninvasiveDebugEnabled()==FALSE`. The behavior of Generic CTI interrupt requests is part of the IMPLEMENTATION DEFINED handling of these interrupts, but it is permissible for an interrupt controller to receive these requests even when `ExternalInvasiveDebugEnabled()==FALSE`.

H5.6 Examples

The CTI is fully programmable and allows for flexible cross-triggering of events within a PE and between PEs in a multiprocessor system. For example:

- The Cross-halt trigger event and the Debug request trigger event can be used for cross-triggering in a multiprocessor system.
- The Cross-halt trigger event and the Generic interrupt trigger event can be used for event-driven debugging in a multiprocessor system.
- The Performance Monitors overflow trigger event and the Debug request trigger event can force entry to Debug state on overflow of a Performance Monitors event counter, for event-driven profiling.

———— **Note** —————

This does not replace the recommended connection of Performance Monitors overflow trigger events to an interrupt controller. Software must be able to program an interrupt on Performance Monitors overflow without programming the CTI. ARM recommends that the Performance Monitors overflow signal is directly available as a local interrupt source.

- The Generic trace external input and Generic trace external output trigger events can pass trace events into and out of the event logic of the Trace macrocell. They can do this:
 - To pass trace events between Trace macrocells.
 - In conjunction with the Performance Monitors overflow trigger event, to couple the Performance Monitors to the Trace macrocell.
 - In conjunction with the Debug request trigger event, to trigger entry to Debug state on a trace event.
 - In conjunction with other CTIs, to signal a trace trigger event onto a CoreSight trace interconnect.

The following sections describe some examples in more detail:

- [Halting a single PE.](#)
- [Halting all PEs in a group when any one PE halts on page H5-5531.](#)
- [Synchronously restarting a group of PEs on page H5-5531.](#)
- [Halting a single PE on Performance Monitors overflow on page H5-5532.](#)

Example H5-1 Halting a single PE

To halt a single PE, set:

1. `CTIGATE[0]` to 0, so that the CTI does not pass channel events on internal channel 0 to the CTM.
2. `CTIOUTEN0[0]` to 1, so that the CTI generates a Debug request trigger event in response to a channel event on channel 0.

———— **Note** —————

The Cross-halt trigger event is input trigger 0, meaning it is controlled by the instance of `CTIOUTEN<n>` for which `<n>` is 0.

3. `CTIAPPULSE[0]` to 1, to generate a channel event on channel 0.

When the PE has entered Debug state, clear the Debug request trigger event by writing 1 to `CTIINTACK[0]`, before restarting the PE.

Example H5-2 Halting all PEs in a group when any one PE halts

To program a group of PEs so that when one PE in the group halts, all of the PEs in that group halt, set the following registers for each PE in the group:

1. `CTIGATE[2]` to 1, so that each CTI passes channel events on internal channel 2 to the CTM.
2. `CTIINEN0[2]` to 1, so that each CTI generates a channel event on channel 2 in response to a Cross-halt trigger event.
3. `CTIOUTEN0[2]` to 1, so that each CTI generates a Debug request trigger event in response to a channel event on channel 2.

———— **Note** —————

The Cross-halt trigger event is input trigger 0, meaning it is controlled by the instances of `CTIINEN<n>` and `CTIOUTEN<n>` for which `<n>` is 0.

When a PE has halted, clear the Debug request trigger event by writing a value of 1 to `CTIINTACK[0]`, before restarting the PE.

Example H5-3 Synchronously restarting a group of PEs

To restart a group of PEs, for each PE in the group:

1. If the PE was halted because of a Debug request trigger event, the debugger must ensure the trigger event is deasserted. It can do this by:
 - a. Writing 1 to `CTIINTACK[0]` to clear the Debug request trigger event.
 - b. Polling `CTITRIGOUTSTATUS[0]`, until it reads as 0, to confirm that the trigger event has been deasserted.
2. Set `CTIGATE[1]` to 1, so that each CTI passes channel events on internal channel 1 to the CTM.
3. Set `CTIOUTEN1[1]` to 1, so that each CTI generates a Restart request trigger event in response to a channel event on channel 1.

———— **Note** —————

This example must use the instance of `CTIOUTEN<n>` for which `<n>` is 1.

4. Set `CTIAPPULSE[1]` to 1 on any one PE in the group, to generate a channel event on channel 1.
-

Example H5-4 Halting a single PE on Performance Monitors overflow

To halt a single PE on a Performance Monitors overflow set:

1. `CTIGATE[3]` to 0, so that the CTI does not pass channel events on internal channel 3 to the CTM.
2. `CTIINEN1[3]` to 1, so that the CTI generates a channel event on channel 3 in response to a Performance Monitors overflow trigger event.

———— **Note** —————

This step of this example must use the instance of `CTIINEN<n>` for which `<n>` is 1.

3. `CTIOUTEN0[3]` to 1, so that the CTI generates a Debug request trigger event in response to a channel event on channel 3.

———— **Note** —————

This step of this example must use the instance of `CTIOUTEN<n>` for which `<n>` is 0.

When the PE has entered Debug state, clear the Debug request trigger event by writing 1 to `CTIINTACK[0]`, before restarting the PE. Clear the overflow status by writing to `PMOVSLR_ELO`.

Chapter H6

Debug Reset and Powerdown Support

This chapter describes the reset and powerdown support in the Debug architecture. It contains the following sections:

- *About Debug over powerdown* on page H6-5534.
- *Power domains and debug* on page H6-5535.
- *Core power domain power states* on page H6-5536.
- *Emulating low-power states* on page H6-5539.
- *Debug OS Save and Restore sequences* on page H6-5541.
- *Reset and debug* on page H6-5545.

———— **Note** —————

Where necessary, [Table K11-1 on page K11-6282](#) disambiguates the general register references used in this chapter.

H6.1 About Debug over powerdown

Debug over powerdown is a facility for an operating system to save and restore the PE state on behalf of a self-hosted or external debugger or both.

For external debug over powerdown, the architecture defines the OS Lock, OS Double Lock, and the logical split of the hardware on which a PE executes into the *Core power domain* and the *Debug power domain*. See:

- [Power domains and debug on page H6-5535](#).
- [Core power domain power states on page H6-5536](#).

H6.2 Power domains and debug

The external debug component of ARMv8-A has two logical power domains, each with its own reset:

- The debug power domain contains the interface between the PE and the external debugger, and is powered up whenever an external debugger is connected to the SoC. It remains powered up while the external debugger is connected. Registers in this domain are reset by an external debug reset.
- The core power domain contains the rest of the PE, and is allowed to power up and power down independently of the Debug power domain.

The core power domain contains several types of registers:

- Non-debug logic refers to all registers and logic that are not associated with debug.
- Self-hosted debug logic refers to registers and logic associated solely with the self-hosted debug aspects of the architecture.
- Shared debug logic refers to registers and logic associated with both the self-hosted and external debug aspects of the architecture.
- External debug logic refers to registers and logic associated solely with the external debug aspects of the architecture.

———— **Note** ————

- The model of two logical power domains has an impact on the reset and access permission requirements of the debug programmers' model.
- The power domains are described as logical because the architecture defines the requirements but does not require two physical power domains. Any power domain split that meets the requirements of the programmers' model is a valid implementation.

Figure H6-1 shows the recommended power domain split. The signals **DBGPWRUPREQ**, **DBGNOPWRDWN**, and **DBGPWRDUP** shown in Figure H6-1 provide an interface between the power controller and the PE debug logic that is in the debug power domain. They are part of the recommended interface. See [Appendix K2 Recommended External Debug Interface](#).

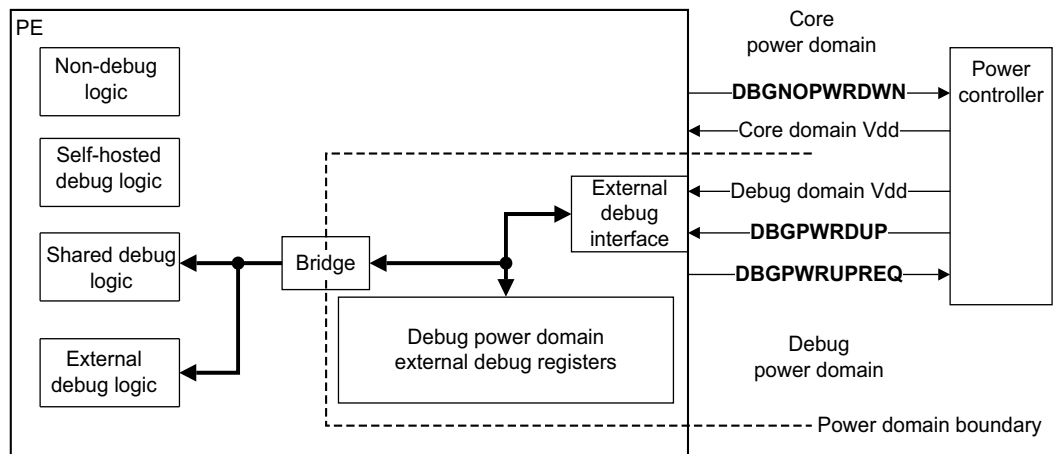

Figure H6-1 Recommended power domain split between core and debug power domains

H6.3 Core power domain power states

The ARM architecture does not define the power states of the PE as these are not normally visible to software. However, they are visible to the external debugger. The Debug architecture uses a four logical power states model for the core power domain. The four logical power states are as follows:

Normal The core power domain is fully powered up and the debug registers are accessible.

Standby The core power domain is on, but there are measures to reduce energy consumption. In a typical implementation, the PE enters standby by executing a WFI or WFE instruction, and exits on a wake-up event. There can be other IMPLEMENTATION DEFINED measures the OS can take to enter standby. The PE preserves the PE state, including the debug logic state. Changing from standby to normal operation does not involve a reset of the PE.

Standby is the least invasive OS energy saving state. Standby implies only that the PE is unavailable and does not clear any debug settings. For standby, the Debug architecture requires only the following:

- An External Debug Request debug event is a wake-up event when halting is allowed. This means that the PE must exit standby to handle the debug event. If the PE executed a WFE or a WFI instruction to enter standby, then it retires that instruction,
- If the external debug interface is accessed, the PE must respond to that access. ARM recommends that, if the PE executed a WFI or WFE instruction to enter standby, then it does not retire that instruction.

Standby is transparent, meaning that to software and to an external debugger it is indistinguishable from normal operation.

Retention The OS takes some measures, including IMPLEMENTATION DEFINED code sequences and registers, to reduce energy consumption. The PE state, including debug settings, is preserved in low-power structures, allowing the core power domain to be at least partially turned off.

Changing from low-power retention to normal operation does not involve a reset of the PE. The saved PE state is restored on changing from low-power retention state to normal operation. If software has to use an IMPLEMENTATION DEFINED code sequence before entering, or after leaving, a retention state, this is referred to as a *software-visible retention state*. It is IMPLEMENTATION DEFINED whether the value of `DBGPRCR.CORENPDRQ` is set to the value of `EDPRCR.COREPURQ` on leaving the software-visible retention state.

External Debug Request debug events stay pending and debug registers in the core power domain cannot be accessed.

Note

- This model of retention does not include implementations where the PE exits the state in response to a debug register access. From the Debug architecture perspective, implementations like this are forms of standby.

Powerdown The OS takes some measures to reduce energy consumption by turning the core power domain off. These measures must include the OS saving any PE state, including the debug settings, that must be preserved over powerdown. Changing from powerdown to normal operation must include:

- A Cold reset of the PE after the power level has been restored.
- The OS restoring the saved PE state.

External Debug Request debug events stay pending and debug registers in the core power domain cannot be accessed.

An implementation might support enabling and disabling threads, either dynamically or once at reset time. Threads that are disabled in this way must appear to the external debugger as either:

- Powered off, meaning they are either:
 - In a powerdown state.
 - In a retention state.
- Held in reset state.

The Debug architecture uses a simpler two states model for the Debug power domain. The two states are:

- Off** The debug power domain is turned off.
- On** The debug power domain is turned on.

The available power states, including the cross-product of core power domain and debug power domain power states is IMPLEMENTATION DEFINED. Implementations are not required to implement all of these states and might include additional states. These additional states must appear to the debugger as one of the logical power states defined by this model. The control of power states is IMPLEMENTATION DEFINED.

———— **Note** —————

As a result, it is IMPLEMENTATION DEFINED whether it is possible for the debug power domain to be on when the core power domain is off.

H6.3.1 EDPRSR.{DLK, SPD, PU} and the Core power domain

Software interprets EDPRSR.{DLK, SPD, PU} to determine whether registers in the Core power domain can be accessed, and whether their state has been lost since the last time the register was read.

Table H6-1 Interpretation of the EDPRSR.{DLK, SPD, PU} bits

EDPRSR			Core power domain			Notes
DLK	SPD	PU	Power	Accesses	State lost	
0	0	1	On	OK	No	-
0	1	1	On	OK	Yes	SPD is cleared to 0 following the read.
1	X	1	On	Error	Not known	OS double-lock is locked. Software locks the OS double-lock before removing power.
X	1	0	Off	Error	Yes	A Cold reset will be asserted on exiting powerdown state, but not on exiting low-power retention state.
X	0	0	Not known	Error	Not known	

If the Core power domain is powered up and DoubleLockStatus() == TRUE, then:

- When ARMv8.2-Debug is not implemented, EDPRSR.{DLK, SPD, PU} can read either {1, UNKNOWN, 1} or {UNKNOWN, 0, 0}.
- **When ARMv8.2-Debug is implemented, EDPRSR.{DLK, SPD, PU} can only read {UNKNOWN, 0, 0}.**

H6.3.2 EDPRSR.SPD when the Core domain is in either retention or powerdown state

When the Core power domain is in either the retention or powerdown state, EDPRSR.SPD is not cleared following a read of EDPRSR and it is IMPLEMENTATION DEFINED whether:

- EDPRSR.SPD shows whether the state of the debug registers in the Core power domain has been lost since the last time that EDPRSR was read. This means that:
 - When the Core power domain is in the powerdown state, EDPRSR.SPD is RAO, this indicates that the state of the debug registers has been lost.
 - When the Core power domain is in the retention state, EDPRSR.SPD indicates whether the state of the debug registers was lost before the Core power domain entered retention state.
- EDPRSR.SPD is RAZ, and:
 - On leaving the powerdown state, EDPRSR.SPD is set to 1 which indicates that the state of the debug registers has been lost.

- On leaving the retention state, `EDPRSR.SPD` reverts the value it had on entering the retention state.

———— **Note** —————

ARM recommends that an implementation makes `EDPRSR.SPD` fixed as RAO when in the power-down state, particularly if it does not support a low-power retention state.

—————

H6.3.3 EDPRSR.{DLK, R} and reset state

`EDPRSR.R` is UNKNOWN when `DoubleLockStatus() == TRUE`. `OSDLR_EL1.DLK` is cleared to 0 by a reset. If the Core power domain is powered up and entered reset state with the OS double-lock locked, it is CONSTRAINED UNPREDICTABLE whether a read of `EDPRSR` while the PE is in reset state returns:

- `EDPRSR.{DLK, R, PU} == {1, UNKNOWN, 1}` indicating that the OS double-lock is locked. **This is not permitted from ARMv8.2.**
- `EDPRSR.{DLK, R, PU} == {0, 1, 1}` indicating that the PE is in reset state.
- `EDPRSR.{DLK, R, PU} == {UNKNOWN, UNKNOWN, 0}` indicating that the registers in the Core power domain cannot be accessed because the OS double-lock is locked.

If the PE was powered up and the OS double-lock was unlocked when the PE was reset, then `EDPRSR.{DLK, R, PU}` reads as `{0, 1, 1}` while the PE is in reset state.

On leaving reset state, `EDPRSR.{DLK, R}` reads as `{0, 0}`.

H6.4 Emulating low-power states

The control registers [DBGPRCR.CORENPDRQ](#) and [EDPRCR.COREPURQ](#) provide an interface between the power controller and the PE. They typically map directly to signals in the recommended external debug interface. With this interface the external debugger can request the power controller to:

- Emulate states where the core power domain is completely off or in a low-power state where the core power domain registers cannot be accessed. This simplifies the requirements on software by sacrificing entirely realistic behavior.
- Restore full power to the core power domain.

[EDPRSR](#).{SPD, PU} indicates the core power domain power state. For more information see:

- [DBGPRCR_EL1, Debug Power Control Register on page D7-2576](#) and [DBGPRCR, Debug Power Control Register on page G6-5298](#).
- [EDPRCR, External Debug Power/Reset Control Register on page H9-5649](#).
- [EDPRSR, External Debug Processor Status Register on page H9-5652](#).
- [Appendix K2 Recommended External Debug Interface](#).

The measures to emulate powerdown are IMPLEMENTATION DEFINED. The ability of the debugger to access the state of the PE and the system might be limited as a result of the measures adopted.

In an emulated powerdown state, the debugger must be able to access all debug, PMU, CTI, and trace unit registers that are accessible on the external debug interface and are in one of:

- The debug power domain.
- The core power domain.
- When a trace unit with a separate trace unit core power domain is implemented, and the trace unit core power domain is powered on, the trace unit core power domain.

That is, the debugger must be able to read and write to such registers without receiving errors. This allows an external debugger to debug the powerup sequence.

ARM recommends that any IMPLEMENTATION DEFINED registers that are on the external debug interface and in either the core power domain or the debug power domain are also accessible in an emulated powerdown state.

To stop the OS Double Lock preventing access to debug registers when powerdown is being emulated, `DoubleLockStatus() == FALSE` when [DBGPRCR.CORENPDRQ](#) == 1.

Otherwise, the behavior of the PE in emulated powerdown must be similar to that in a real powerdown state. In particular, the PE must not respond to other system stimuli, such as interrupts.

[Example H6-1](#) and [Example H6-2](#) are examples of two approaches to emulating powerdown.

Example H6-1 An example of emulating powerdown

The PE is held in Standby state, isolated from any system stimuli. It is IMPLEMENTATION DEFINED whether the PE can respond to debug stimuli such as an External Debug Request debug event.

If the PE can enter Debug state, then the external debugger is able to use the ITR to execute instructions, such as loads and stores. This causes the external debugger to interact with the system. If the external debugger restarts the PE, the PE leaves Standby state and restarts fetching instructions from memory.

Example H6-2 Another example of emulating powerdown

The PE is held in Warm reset. This limits the ability of an external debugger to access the resources of the PE. For example, the PE cannot be put into Debug state.

On exit from emulated powerdown the PE is reset. However, the debug registers that are only reset by a Cold reset must not be reset. Typically this means that a Warm reset is substituted for the Cold reset. As such, the effect of accessing any register that is reset by a Warm reset while the PE is in the emulated powerdown state will have an IMPLEMENTATION DEFINED effect on that register.

Note

- Warm reset and Cold reset have different effects apart from resetting the debug registers. In particular, [RMR_ELx](#) is reset by a Cold reset and controls the reset state on a Warm reset. This means that if a Cold reset is substituted by a Warm reset, the behavior of the reset code might be different.
 - The timing effects of powering down are typically not factored in the powerdown emulation. Examples of these timing effects are clock and voltage stabilization.
 - Emulation does not model the state lost during powerdown, meaning that it might mask errors in the state storage and recovery routines.
-

H6.5 Debug OS Save and Restore sequences

In ARMv8-A, the following registers provide the OS Save and restore mechanism:

- The *OS Lock Access Register*, [OSLAR](#), locks the OS Lock to restrict access to debug registers before starting an OS Save sequence, and unlocks the OS Lock after an OS Restore sequence.
- The *OS Lock Status Register*, [OSLSR](#), shows the status of the OS Lock.
- The *External Debug Execution Control Register*, [EDECR](#), can be configured to generate a debug event when the OS Lock is unlocked.
- The *OS Double Lock Register*, [OSDLR](#), locks out an external debug interface entirely. This is only used immediately before a powerdown sequence.

See also:

- [Reset and debug on page H6-5545](#)
- [Appendix K7 Example OS Save and Restore Sequences](#)

H6.5.1 Debug registers to save over powerdown

[Table H6-2](#) shows the different requirements for self-hosted debug over powerdown and external debug over powerdown:

- The column labeled Self-hosted lists registers that software must preserve over powerdown so that it can support self-hosted debug over powerdown. This does not require use of the OS Save and Restore mechanism.
- The column labeled External lists registers that software must preserve over powerdown so that it can support external debug over powerdown. This requires use of the OS Save and Restore mechanism:
 - Some external debug registers are not normally accessible to software executing on the PE. Additional debug registers are provided that give software the required access to save and restore these external debug registers when [OSLSR.OSLK](#) is locked. These registers include [OSECCR](#), [OSDTRRX](#), and [OSDTRTX](#).
- Some registers might only present in some implementations, or might not be accessible at all Exception levels or in Non-secure state. [DBGVCR32_EL2](#) and [SDER32_EL3](#) are only required to support AArch32.

[Table H6-2](#) does not include registers for the OPTIONAL Trace and Performance Monitor extensions.

Table H6-2 Debug registers to save over powerdown

Register in AArch64 state	Register in AArch32 state	Self-hosted	External
MDCR_EL1	DBGDSCRext	Yes	Yes ^a
DBGBVR<n>_EL1	DBGBVR<n>	Yes	Yes
DBGBCR<n>_EL1	DBGBCR<n>	Yes	Yes
DBGWVR<n>_EL1	DBGWVR<n>	Yes	Yes
DBGWCR<n>_EL1	DBGWCR<n>	Yes	Yes
DBGVCR32_EL2	DBGVCR	Yes	-
MDCR_EL2	HDCR	Yes	-
SDER32_EL3	SDER	Yes	-
MDCR_EL3	SDCR	Yes ^b	-
MDCCINT_EL1	DBGDCCINT	-	Yes ^b

Table H6-2 Debug registers to save over powerdown (continued)

Register in AArch64 state	Register in AArch32 state	Self-hosted	External
DBGCLAIMSET_EL1 DBGCLAIMCLR_EL1	DBGCLAIMSET, DBGCLAIMCLR	-	Yes ^c
OSECCR_EL1	DBGOSECCR	-	Yes ^{ab}
OSDTRRX_EL1 OSDTRTX_EL1	DBGDTRRXext DBGDTRTXext	-	Yes

- The OS Lock must be locked to save and restore for external debug. When the OS Lock is locked, **DSCR** is part of the software save and restore mechanism for external debug. It provides a mechanism for an operating system to access some fields of **EDSCR** that are otherwise read-only or not visible to software. This allows the operating system to save and restore these settings over a powerdown for the external debugger.
- This register is new in ARMv8-A. Sequences written for ARMv7 do not preserve the register over powerdown.
- Read **DBGCLAIMCLR** to save, write **DBGCLAIMSET** to restore.

H6.5.2 OS Save sequence

To preserve the debug logic state over a powerdown, the state must be saved to nonvolatile storage. This means the OS Save sequence must:

- Lock the OS Lock by:
 - Writing the key value 0xC5ACCE55 to the **DBGOSLAR** in AArch32 state.
 - Writing 1 to **OSLAR_EL1.OSLK** in AArch64 state.
- Execute an ISB instruction.
- Walk through the debug registers listed in *Debug registers to save over powerdown on page H6-5541* and save the values to the nonvolatile storage.

Before removing power from the core power domain, software must:

- Lock the OS Double Lock by writing 1 to **OSDLR_EL1.DLK**.
- Execute a *Context synchronization event*.

H6.5.3 OS Restore sequence

After a powerdown, the OS Restore sequence must perform the following steps to restore the debug logic state from the non-volatile storage:

- Lock the OS Lock, as described in *OS Save sequence*. The OS Lock is generally locked by the Cold reset, but this step ensures that it is locked.
- Execute an ISB instruction.
- To ensure that, if an external debugger clears the OS Lock before the end of this sequence, no debug exceptions are generated:
 - Write 0 to **MDSCR_EL1** if executing in AArch64 state.
 - Write 0 to **DBGDSCRExt** if executing in AArch32 state.
- Walk through the debug registers listed in *Debug registers to save over powerdown on page H6-5541*, and restore the values from the nonvolatile storage. The last register to be restored must be:
 - MDSCR_EL1** if executing in AArch64 state.
 - DBGDSCRExt** if executing in AArch32 state.
- Execute an ISB instruction.

6. Unlock the OS Lock by:
 - Writing any non-key value to [DBGOSLAR](#) if executing in AArch32 state.
 - Writing 0 to [OSLAR_EL1.OSLK](#) if executing in AArch64 state.
7. Execute a [Context synchronization event](#).

———— **Note** ————

The OS Restore sequence overwrites the debug registers with the values that were saved. If there are valid values in these registers immediately before the restore sequence, then those values are lost.

H6.5.4 Debug behavior when the OS Lock is locked

The main purpose of the OS Lock is to prevent updates to debug registers during an OS Save or OS Restore operation. The OS Lock is locked on a Cold reset.

When the OS Lock is locked:

- Access to debug registers through the System register interface is mainly unchanged except that:
 - Certain registers are read and written without side-effects.
 - Fields in [DSCR](#) and [OSECCR](#) that are normally read-only become read/write.This allows the state to be saved or restored. For more information, see the relevant register description in [Chapter H9 External Debug Register Descriptions](#).
- Access to debug registers by the external debug interface is restricted to prevent an external debugger modifying the registers that are being saved or restored. For more information see [External debug interface register access permissions summary](#) on page H8-5563.
- Debug exceptions, other than Breakpoint Instruction exceptions are not generated.
- Breakpoint and Watchpoint debug events are not generated. The OS Lock has no effect on Breakpoint Instruction exceptions and other debug events.

H6.5.5 Debug behavior when the OS Lock is unlocked

When the OS Lock is unlocked, the PE sets [EDES.R.OSUC](#) to 1 if [EDES.R.OUCE](#) is set to 1 and the PE is in Non-debug state, meaning the OS Unlock Catch debug event becomes pending. See [OS Unlock Catch debug event](#) on page H3-5491.

H6.5.6 Debug behavior when the OS Double Lock is locked

The OS Double Lock is locked immediately before a powerdown sequence. The OS Double Lock ensures that it is safe to remove core power by forcing the debug interfaces to be quiescent.

When `DoubleLockStatus() == TRUE`:

- The external debug interface only has restricted access to the debug registers, so that it is quiescent before removing power. See [External debug interface register access permissions summary](#) on page H8-5563.
- Debug exceptions, other than Breakpoint Instruction exceptions, are not generated.
- Halting is prohibited. See [Halting allowed and halting prohibited](#) on page H2-5435.

———— **Note** ————

Pending Halting debug events might be lost when core power is removed.

- No asynchronous debug events are WFI or WFE wake-up events.

Software must synchronize the update to [OSDLR](#) before it indicates to the system that core power can be removed. The interface between the PE and its power controller is IMPLEMENTATION DEFINED.

Typically software indicates that core power can be removed by entering the Wait For Interrupt state. This means that software must explicitly synchronize the `OSDLR.DLK` update before issuing the WFI instruction.

`OSDLR.DLK` is ignored and `DoubleLockStatus() == FALSE` if either:

- The PE is in Debug state.
- `DBGPRCR.CORENPDRQ` is set to 1.

———— **Note** —————

It is possible to enter Debug state with `OSDLR.DLK` set to 1. This is because a *Context synchronization event* is required to ensure the OS Double Lock is locked, meaning that Debug state might be entered before the `OSDLR` update is synchronized.

Because `OSDLR.DLK` is ignored when `DBGPRCR.CORENPDRQ` is set to 1, and an external debugger can write to `DBGPRCR.CORENPDRQ`, software must not rely on using the OS Double Lock to disable debug exceptions or to prohibit halting, or both. ARM deprecates use of the OS Double Lock for these purposes, and instead recommends that software:

- Uses the OS Lock to disable debug exceptions during save or restore sequences.
- Uses the debug authentication interface to prohibit halting and external debug access to debug registers at times other than immediately prior to removing power.

As the purpose of the OS Double Lock is to ensure that it is safe to remove core power, it is important to avoid race conditions that defeat this purpose. ARM recommends that:

- Once the write to `OSDLR.DLK` has been synchronized by a *Context synchronization event* and `DoubleLockStatus() == TRUE`, a PE must:
 - Not allow a debug event generated before the *Context synchronization event* to cause an entry to Debug state or act as a wake-up event for a WFI or WFE instruction after the *Context synchronization event* has completed.
 - Complete any external debug access started before the *Context synchronization event* by the time the *Context synchronization event* completes.

———— **Note** —————

A debug register access might be in progress when software sets `OSDLR.DLK` to 1. An implementation must not permit the synchronization of locking the OS Double Lock to stall indefinitely while waiting for that access to complete. This means that any debug register access that is in progress when software sets `OSDLR.DLK` to 1 must complete or return an error in finite time.

- If a write to `DBGPRCR` or `EDPRCR` made when `OSDLR.DLK == 1` changes `DBGPRCR.CORENPDRQ` or `EDPRCR.CORENPDRQ` from 1 to 0, meaning `DoubleLockStatus()` changes from `FALSE` to `TRUE`, then before signaling to the system that the `CORENPDRQ` field has been cleared and emulation of powerdown is no longer requested, meaning the system can remove core power, the PE must ensure that all the requirements for `DoubleLockStatus() == TRUE` listed in this section are met.

In the standard OS Save sequence, the OS Lock is locked before the OS Double Lock is locked. This means that writes to `CORENPDRQ` are ignored by the time the OS Double Lock is locked. However, if `DoubleLockStatus() == FALSE`, an external debugger can clear the OS Lock at any time, and then write to `EDPRCR`.

H6.6 Reset and debug

All registers in the Core power domain are reset either by a Warm reset or a Cold reset, as described in [Reset on page D1-1795](#), including external debug logic registers.

All registers in the Debug power domain are reset by an External Debug reset.

[Figure H6-2](#) shows this reset scheme. The following three reset signals are an example implementation of the reset scheme:

- **CORERESET**, which must be asserted for a Warm reset.
- **CPUPORESET**, which must be asserted for a Cold reset.
- **PRESETDBG**, which must be asserted for an External Debug reset.

As shown in the figure, the external debug logic is split between the Debug power domain and the Core power domain.

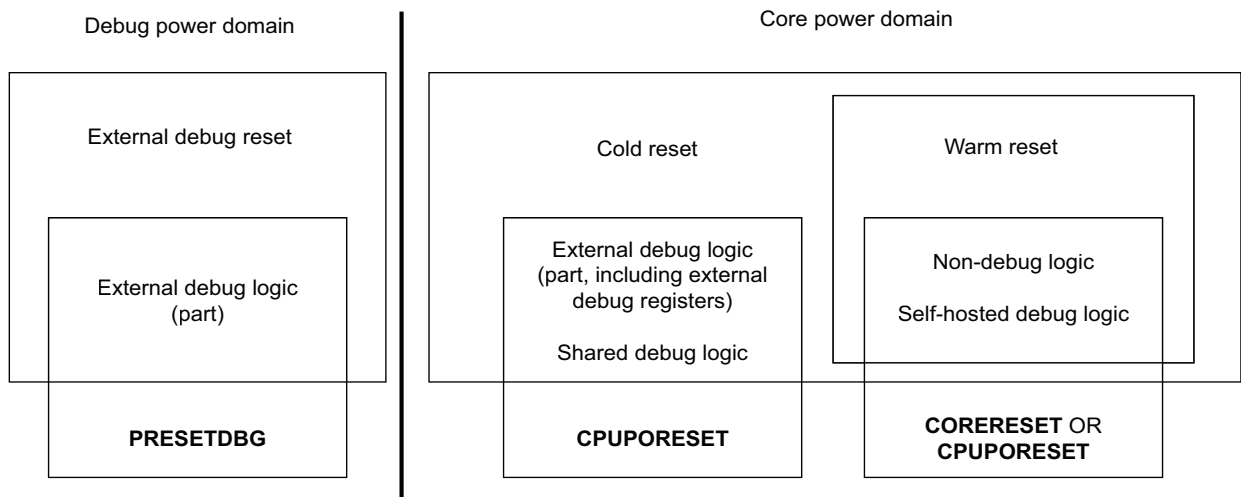

Figure H6-2 Power and reset domains

For more information about power domains and power states, see [Power domains and debug on page H6-5535](#).

When power is first applied to the Debug power domain, **PRESETDBG** must be asserted.

When power is first applied to the Core power domain, **CPUPORESET** must be asserted.

———— **Note** ————

In this scheme, logic in the Warm reset domain is reset by asserting either **CORERESET** or **CPUPORESET**. This implies a particular implementation style that permits these approaches.

CPUPORESET is not normally asserted on moving from a low-power state, where power has not been removed, to a full-power state. This can occur, for example, on exiting a low-power retention state. See also [Emulating low-power states on page H6-5539](#) and [EDPRSR, External Debug Processor Status Register on page H9-5652](#).

H6.6.1 External debug interface accesses to registers in reset

If a reset signal is asserted and the external debug interface:

- Writes a register, or indirectly writes a register or register field as a side-effect of an access:
 - Then, if the register or register field is reset by that reset signal, it is **CONSTRAINED UNPREDICTABLE** whether the register or register field takes the reset value or the value written. The reset value might be **UNKNOWN**.
 - Otherwise the register or register field takes the value that is written.

- Reads a register, or indirectly reads a register or register field, as part of an access:
 - Then, if the register or register field is reset by that reset signal, the value returned is UNKNOWN.
 - Otherwise, the value of the register or register field is returned.

It is IMPLEMENTATION DEFINED whether any register can be accessed when External Debug reset is being asserted. The result of these accesses is IMPLEMENTATION DEFINED.

Chapter H7

The PC Sample-based Profiling Extension

This chapter describes the OPTIONAL PC Sample-based Profiling Extension that provides a non-invasive external debug component.

It contains the following section:

- [About the PC Sample-based Profiling Extension on page H7-5548.](#)

H7.1 About the PC Sample-based Profiling Extension

The PC Sample-based Profiling Extension provides coarse-grained, non-invasive profiling by an external debugger. See also [Non-invasive behavior on page D5-2140](#).

PC Sample-based Profiling creates samples so that tools can populate a statistical model of the performance of software executing on the PE.

Under normal operating conditions, the sample must reference an instruction that was committed for execution, including its context, and must not reference instructions that are fetched but not committed for execution.

It must be possible to sample references to branch targets. It is IMPLEMENTATION DEFINED whether references to other instructions can be sampled. The branch target for a conditional branch instruction that fails its condition check is the instruction that follows the conditional branch instruction. The branch target for an exception is the exception vector address.

To keep the implementation and validation cost low, a reasonable degree of inaccuracy in the sampled data is acceptable. ARM does not define *a reasonable degree of inaccuracy* but recommends the following guidelines:

- In exceptional circumstances, such as a change in Security state or other boundary condition, it is acceptable for the sample to represent an instruction that was not committed for execution.
- Under unusual non-repeating pathological cases, the sample can represent an instruction that was not committed for execution. These cases are likely to occur as a result of asynchronous exceptions, such as interrupts, where the chance of a systematic error in sampling is very unlikely.

———— Note —————

In the ARMv7 PC Sample-based Profiling Extension, an offset was applied to the sampled program counter value and this offset and the instruction set state indicated in bits [1:0] of the sampled value. In the ARMv8 PC Sample-based Profiling Extension, the sampled value is the address of an instruction that has executed, with no offset and no indication of the instruction set state.

H7.1.1 Controlling the PC Sample-based Profiling Extension

PC Sample-based Profiling is controlled by the IMPLEMENTATION DEFINED authentication interface [ExternalNoninvasiveDebugEnabled\(\)](#).

PC Sample-based Profiling is prohibited unless both:

- Allowed by the IMPLEMENTATION DEFINED authentication interface [ExternalNoninvasiveDebugEnabled](#).
- Any one of
 - The PE is executing in Non-secure state.
 - EL3 is not implemented.
 - EL3 is implemented, the PE is executing in Secure state, and allowed by the IMPLEMENTATION DEFINED authentication interface [ExternalSecureNoninvasiveDebugEnabled\(\)](#).
 - EL3 is implemented, EL3 or EL1 is using AArch32, the PE is executing at EL0 in Secure state, and the value of [SDER.SUNIDEN](#) is 1.

The state of the IMPLEMENTATION DEFINED authentication interface is visible through [DBGAUTHSTATUS_EL1](#). See [Recommended authentication interface on page K2-6140](#).

H7.1.2 Registers implemented by the PC Sample-based Profiling Extension

If PC Sample-based Profiling is implemented but not with [ARMv8.2-PCSample](#), [EDDEVID.PCSample](#) and [EDDEVID1.PCSROffset](#) define the level of profiling and the offset.

If PC Sample-based Profiling is implemented but not with [ARMv8.2-PCSample](#) and [ARMv8.1-VHE](#) is implemented, [EDSCR.SC2](#) controls what PC Sample-based Profiling samples.

If PC Sample-based Profiling is implemented but not with [ARMv8.2-PCSample](#), the following external debug registers can be implemented:

- [EDCIDSR](#).
- [EDPCSR](#).
- [EDVIDSR](#).

See *External debug interface register map* on page H8-5565.

If PC Sample-based Profiling is implemented and [ARMv8.2-PCSample](#) is implemented, [PMDEVID.PCSample](#) identifies the level of profiling. The following registers can be implemented in the Performance Monitors external debug page:

- [PMCID1SR](#) and [PMCID2SR](#).
- [PMPCSR](#).
- [PMVIDSR](#).

See *Performance Monitors external register views* on page I3-5746.

In a full [ARMv8.2](#) implementation if the Performance Monitors Extension is not implemented but the PC Sample-based Profiling is implemented with [ARMv8.2-PCSample](#), then the PC Sample-based Profiling Extension is implemented in a separate external debug page. In the memory maps of the [ARMv8-A](#) architecture profile, this page is located at the location that is reserved for the Performance Monitors, see [Table H7-1](#). For [CoreSight](#) compliance, the management registers are defined as in [Table K2-3](#) on page K2-6141 and the support for PC Sample-based profiling is defined in the following registers:

- [PMDEVTYPE.MAJOR](#) has the value 0x0.
- [PMDEVARCH.ARCHID](#) has the value 0x0A10.

Table H7-1 PC Sample-based Profiling register offsets without the Performance Monitors Extension

Offset	Description
0x200	PMPCSR [31:0]
0x204	PMPCSR [63:32]
0x208	PMCID1SR
0x20C	PMVIDSR
0x220	PMPCSR [31:0] (alias)
0x224	PMPCSR [63:32] (alias)
0x228	PMCID1SR (alias)
0x22C	PMCID2SR
0x600-0x6FC	IMPLEMENTATION DEFINED
0xE80-0xEFC	IMPLEMENTATION DEFINED for CoreSight compliance
0xFF0-0xFFC	Management and CoreSight compliance registers

H7.1.3 Pseudocode description of PC Sample-based Profiling

When PC Sample-based Profiling is implemented but not with [ARMv8.2-PCSample](#), the functionality is described by the pseudocode functions:

- [CreatePCSample\(\)](#), which populates a variable of type [PCSample](#).
- [EDPCSRto\[\]](#), which writes a PC sample to the [EDPCSR](#) and associated registers.

Chapter H8

About the External Debug Registers

This chapter provides some additional information about the external debug registers. It contains the following sections:

- *Relationship between external debug and System registers* on page H8-5552.
- *Endianness and supported access sizes* on page H8-5553.
- *Synchronization of changes to the external debug registers* on page H8-5554.
- *Memory-mapped accesses to the external debug interface* on page H8-5558.
- *External debug interface register access permissions* on page H8-5561.
- *External debug interface registers* on page H8-5565.
- *Cross-trigger interface registers* on page H8-5570.
- *External debug register resets* on page H8-5572.

———— **Note** —————

Where necessary [Table K11-1 on page K11-6282](#) disambiguates the general register references used in this chapter.

H8.1 Relationship between external debug and System registers

Table H8-1 shows the relationship between external debug registers and System registers. Where no relationship exists, the registers are not listed.

Table H8-1 Equivalence between external debug and System registers

External debug register	System register		Notes
	AArch64	AArch32	
DBGDTRRX_EL0	DBGDTRRX_EL0	DBGDTRRXint	See also <i>Summary of System register accesses to the DCC</i> on page H4-5509
DBGDTRTX_EL0	DBGDTRTX_EL0	DBGDTRTXint	
OSLAR_EL1	OSLAR_EL1	DBGOSLAR	-
DBGBVR<n>_EL1[31:0]	DBGBVR<n>_EL1[31:0]	DBGBVR<n>	-
DBGBVR<n>_EL1[63:32]	DBGBVR<n>_EL1[63:32]	DBGBXR<n>	
DBGBCR<n>_EL1	DBGBCR<n>_EL1	DBGBCR<n>	-
DBGWVR<n>_EL1[31:0]	DBGWVR<n>_EL1[31:0]	DBGWVR<n>	-
DBGWVR<n>_EL1[63:32]	DBGWVR<n>_EL1[63:32]		
DBGWCR<n>_EL1	DBGWCR<n>_EL1	DBGWCR<n>	-
DBGCLAIMSET_EL1	DBGCLAIMSET_EL1	DBGCLAIMSET	-
DBGCLAIMCLR_EL1	DBGCLAIMCLR_EL1	DBGCLAIMCLR	-
DBGAUTHSTATUS_EL1	DBGAUTHSTATUS_EL1	DBGAUTHSTATUS	Read-only
EDSCR	MDSCR_EL1	DBGDSCRext	Only some fields map
EDECCR	OSECRR_EL1	DBGOSECRR	Applies when the OS Lock is locked.
MIDR_EL1	MIDR_EL1	MIDR	Read-only copies of Processor ID Registers
EDDEVAFF0	MPIDR_EL1[31:0] ^a	MPIDR	Read-only copies of system ID registers
EDDEVAFF1	MPIDR_EL1[63:32] ^a		

a. This is a word of a 64-bit register.

In addition:

- **EDSCR**.{TXfull, RXfull} are read-only aliases for **DCCSR**.{TXfull, RXfull}.
- **EDPRCR**.CORENPDRQ is a read/write alias for **DBGPRCR**.CORENPDRQ.
- **EDPRSR**.OSLK is a read-only alias for **OSLSR**.OSLK.
- **EDPRSR**.DLK is a read-only function of **OSDLR**.DLK.

H8.2 Endianness and supported access sizes

The debug registers, Performance Monitor registers, and CTI registers are implemented as memory-mapped peripherals. The ARM architecture requires memory-mapped peripherals to be little-endian.

The memory access sizes supported by any peripheral is IMPLEMENTATION DEFINED by the peripheral. For accesses to the debug registers, Performance Monitor registers, and CTI registers, implementations must support:

- Word-aligned 32-bit accesses to access 32-bit registers or either half of a 64-bit register mapped to a doubleword-aligned pair of adjacent 32-bit locations.
- Doubleword-aligned 64-bit accesses to access 64-bit registers mapped to a doubleword-aligned pair of adjacent 32-bit locations.

———— **Note** —————

This means that a system implementing the debug registers using a 32-bit bus, such as a AMBA APB3, with a wider system interconnect must implement a bridge between the system and the debug bus that can split 64-bit accesses.

All registers are only single-copy atomic at word granularity. This means that for 64-bit accesses to a 64-bit register, the system might generate a pair of 32-bit accesses. The order in which the two halves are accessed is not specified.

The following accesses are not supported:

- Byte.
- Halfword.
- Unaligned word. These accesses are not word single-copy atomic.
- Unaligned doubleword. These accesses are not doubleword single-copy atomic.
- Doubleword accesses to a pair of 32-bit locations that are not a doubleword-aligned pair forming a 64-bit register.
- Quadword or higher.
- Exclusive accesses.

For each of these access types, it is CONSTRAINED UNPREDICTABLE whether:

- The access generates an external abort or not.
- The defined side-effects of a read occur or not. A read returns UNKNOWN data.
- A write is ignored or sets the accessed register or registers to UNKNOWN.

For accesses from the external debug interface, the size of an access is determined by the interface. For an access from an ADIV5-compliant Memory Access Port, MEM-AP, this is specified by the MEM-AP CSW register.

See [Access sizes for memory-mapped accesses](#) on page H8-5559.

H8.3 Synchronization of changes to the external debug registers

This section describes the synchronization requirements for the external debug interface.

For more information on how these requirements affect debug, see:

- [Synchronization and debug exceptions on page D2-1970](#) for exceptions taken from AArch64 state, or [Synchronization and debug exceptions on page G2-4518](#) for exceptions taken from AArch32 state.
- [Synchronization and Halting debug events on page H3-5494](#).
- [Synchronization of DCC and ITR accesses on page H4-5509](#).

This section refers to accesses from the external debug interface as external reads and external writes. It refers to accesses to System registers as direct reads, direct writes, indirect reads, and indirect writes.

———— Note —————

[Synchronization requirements for AArch64 System registers on page D7-2191](#) defines direct read, direct write, indirect read, and indirect write, and classifies external reads as indirect reads, and external writes as indirect writes.

Writes to the same register are serialized, meaning they are observed in the same order by all observers, although some observers might not observe all of the writes. With the exception of [DBGBCR<n>_EL1](#), [DBGBVR<n>_EL1](#), [DBGWCR<n>_EL1](#), and [DBGWVR<n>_EL1](#), external writes to different registers are not necessarily observed in the same order by all observers as the order in which they complete.

[Synchronization of DCC and ITR accesses on page H4-5509](#) describes the synchronization requirements for the DCC and ITR.

Changes to the IMPLEMENTATION DEFINED authentication interface are external writes to the authentication status registers by the master of the authentication interface. See [Synchronization and the authentication interface on page H8-5555](#).

Explicit synchronization is not required for an external read or an external write by an external agent to be observable to a following external read or external write by that agent to the same register using the same address, and so is never required for registers that are accessible only in the external debug interface.

Some registers are guaranteed to be observable to all observers in finite time, without explicit synchronization. For more information, see [Synchronization requirements for AArch64 System registers on page D7-2191](#) or [Synchronization of changes to AArch32 System registers on page G6-4768](#). Otherwise, explicit synchronization is normally required following an external write to any register for that write to be observable by:

- A direct access.
- An indirect read by an instruction.
- An external read of the register using a different address.

This means that an external write by an external agent is guaranteed to have an effect on subsequent instructions executed by the PE only if all of the following are true:

- The write has completed.
- The PE has executed a [Context synchronization event](#).
- The [Context synchronization event](#) was executed after the write completed.

The order and synchronization of direct reads and direct writes of System registers is defined by [Synchronization requirements for AArch64 System registers on page D7-2191](#).

The external agent must be able to guarantee completion of a write. For example by:

- Marking the memory as Device-nGnRnE and executing a DSB barrier, if the system supports this property.
- Reading back the value written.
- Some guaranteed property of the connection between the PE and the external agent.

———— **Note** ————

For an external Debug Access Port, this is an IMPLEMENTATION DEFINED property. For a CoreSight system using APB-AP to access a debug APB, a write is guaranteed to complete before the APB-AP allows a second APB transaction to complete.

The external agent and PE can guarantee ordering by, for example, passing messages in an ordered way with respect to the external write and the [Context synchronization event](#), and relying on the memory ordering rules provided by the memory model.

External reads and external writes complete in the order in which they arrive at the PE. For accesses to different register locations the external agent must create this order by:

- Marking the memory as Device-nGnRnE or Device-nGnRE.
- Using the appropriate memory barriers.
- Some guaranteed property of the connection between the PE and the external agent.

———— **Note** ————

For an external Debug Access Port, this is an IMPLEMENTATION DEFINED property. For a CoreSight system using APB-AP to access a debug APB, accesses complete in order.

However, the external agent cannot force synchronization of completed writes without halting the PE. Executing an ISB instruction, either in Debug state or in Non-debug state, and exiting from Debug state forces synchronization. If the PE is in Debug state, executing an ISB instruction is guaranteed to explicitly synchronize any external reads, external writes, and changes to the authentication interface that are ordered before the external write to [EDITR](#).

For any given observer, external writes to the following register groups are guaranteed to be observable in the same order in which they complete:

- The breakpoint registers, [DBGBCR<n>_EL1](#) and [DBGBVR<n>_EL1](#).
- The watchpoint registers, [DBGWCR<n>_EL1](#) and [DBGWVR<n>_EL1](#).

This guarantee only applies to external writes to registers within one of these groups. There is no guarantee regarding the ordering of the observability of external writes within these groups with respect to external writes to registers, for example [EDSCR](#), or between breakpoints and watchpoints, including watchpoints linked to context matching breakpoints.

———— **Note** ————

This means that a debugger can rely on the external writes to be observed in the same order in which they complete. It does not mean that a debugger can rely on the external writes being observed in finite time.

In a simple sequential execution an indirect write that occurs as a side-effect of an access happens atomically with the access, meaning no other accesses are allowed between the register access and its side-effect.

If two or more interfaces simultaneously access a register, the behavior must be as if the accesses occurred atomically and in any order. This is described in [Examples of the synchronization of changes to the external debug registers on page H8-5556](#).

Some registers have the property that for certain bits a write of 0 is ignored and a write of 1 has an effect. This means that simultaneous writes must be merged. Registers that have this property and support both external debug and System register access include [DBGCLAIMSET_EL1](#), [DBGCLAIMCLR_EL1](#), [PMCR_EL0](#).{C,P}, [PMOVSSET_EL0](#), [PMOVSLR_EL0](#), [PMCNTENSET_EL0](#), [PMCNTENCLR_EL0](#), [PMINTENSET_EL1](#), [PMINTENCLR_EL1](#), and [PMSWINC_EL0](#). This last register is OPTIONAL and deprecated in the external debug interface.

H8.3.1 Synchronization and the authentication interface

Changes to the authentication interface are indirect writes to the Authentication Status registers by the master of the authentication interface. For each of these Authentication Status registers, it is IMPLEMENTATION DEFINED whether a change on the authentication interface is guaranteed to be observable to an external debug interface read of the register only after a [Context synchronization event](#) or in finite time.

For `DBGAUTHSTATUS_EL1`, a change on the authentication interface is guaranteed to be observable to a System register read of `DBGAUTHSTATUS_EL1` only after a *Context synchronization event*.

H8.3.2 Examples of the synchronization of changes to the external debug registers

[Example H8-1](#), [Example H8-2](#), and [Example H8-3](#) show the synchronization of changes to the external debug registers.

Example H8-1 Order of synchronization of Breakpoint and Watchpoint register writes

Initially `DBGBVR<n>_EL1` is `0x8000` and `DBGBCR<n>_EL1` is `0x0181`. This means that a breakpoint is enabled on the halfword T32 instruction at address `0x8000`.

A sequence of external writes occurs in the following order:

1. `0x0000` is written to `DBGBCR<n>_EL1`, disabling the breakpoint.
2. `0x9000` is written to `DBGBVR<n>_EL1[31:0]`.
3. `0x0061` is written to `DBGBCR<n>_EL1`, enabling a breakpoint on the halfword at address `0x9002`.

The external writes must be observable to indirect reads in the same order as the external writes complete. This means that at no point is there a breakpoint enabled on either of the halfwords at address `0x8002` and `0x9000`.

Similarly a breakpoint or watchpoint must be disabled:

- If both halves of a 64-bit address have to be updated.
- If any of the `DBGBCR<n>_EL1` or `DBGWCR<n>_EL1` fields are modified at the same time as updating the address.

Example H8-2 Simultaneous accesses to DTR registers

Initially `EDSCR.{TXfull, TXU, ERR}` are 0. Then:

- `0x0DCCDA7A` is directly written to `DBGDTRTX_EL0` by an MSR instruction.
- `DBGDTRTX_EL0` is indirectly read by the external debug interface.

These accesses might happen at the same time and in any order.

If the direct write of `0x0DCCDA7A` to `DBGDTRTX_EL0` is handled first, then:

- The external debug interface read of `DBGDTRTX_EL0` clears `EDSCR.TXfull` to 0.
- `EDSCR.{TXU, ERR}` are unchanged.
- The external debug interface read returns `0x0DCCDA7A`.

If the indirect read of `DBGDTRTX_EL0` by the external debug interface is handled first, then:

- The external debug interface read of `DBGDTRTX_EL0` causes an underrun and as a result `EDSCR.{TXU, ERR}` are both set to 1.
- The external debug interface returns an UNKNOWN value.
- Writing `0x0DCCDA7A` to `DBGDTRTX_EL0` sets `DTRTX` to `0x0DCCDA7A` and `EDSCR.TXfull` to 1.

Example H8-3 Simultaneous writes to CLAIM registers

Initially all CLAIM tag bits are 0. Then:

- `0x01` is written to `DBGCLAIMSET_EL1` by a direct write, followed by an explicit *Context synchronization event*.
- `0x02` is written to `DBGCLAIMSET_EL1` by an external write.

These events might happen at the same time and in either order.

After this:

- [DBGCLAIMCLR_EL1](#) is read by a direct read.
- [DBGCLAIMCLR_EL1](#) is read by an external read.

In this case, a direct read can return either 0x01 or 0x03, and the external read can return either 0x02 or 0x03.

The only permitted final result for the CLAIM tags is the value 0x03, because this would be the result regardless of whether 0x01 or 0x02 is written first. This is because the external write is guaranteed to be observable to a direct read in finite time. See *Synchronization requirements for AArch64 System registers* on page D7-2191.

It is not possible for a direct read to return 0x01 and the external read to return 0x02, because the writes to [DBGCLAIMCLR_EL1](#) are serialized.

In the following scenario, there is only one permitted result. Both observers observe the value 0x03, and then, at the same time, two writes occur:

- 0x04 is written to [DBGCLAIMSET_EL1](#) by a direct write, followed by an explicit *Context synchronization event*.
- 0x01 is written to [DBGCLAIMCLR_EL1](#) by an external write.

In this case only permitted final result for the CLAIM tags is the value 0x06.

H8.4 Memory-mapped accesses to the external debug interface

Support for memory-mapped access to the external debug interface is **OPTIONAL**. When memory-mapped access to the external debug interface is supported, the external debug interface is accessed as a little-endian memory-mapped peripheral.

If the external debug interface is CoreSight compliant, then an **OPTIONAL** Software Lock can be implemented for memory-mapped accesses to each component.

The Software Lock is **OPTIONAL** and deprecated. If it is not implemented, the behavior is as if it is unlocked. The Software Locks are controlled by **EDLSR** and **EDLAR**, **PMLSR** and **PMLAR**, and **CTILSR** and **CTILAR**. See *Management registers and CoreSight compliance* on page K2-6141.

With the exception of these registers and the effect of the Software Lock, the behavior of the memory-mapped accesses is the same as for other accesses to the external debug interface.

———— Note ————

The recommended memory-mapped accesses to the external debug interface are not compatible with the memory-mapped interface defined in ARMv7. In particular:

- The memory map is different.
- Memory-mapped accesses do not behave differently to Debug Access Port accesses when **OSLSR.OSLK == 1**, meaning that the OS Lock is locked.

H8.4.1 Register access permissions for memory-mapped accesses

It is **IMPLEMENTATION DEFINED** whether unprivileged memory-mapped accesses are allowed. Privileged software is responsible for controlling memory-mapped accesses using the MMU.

If memory-mapped accesses are made through an ADiv5 interface, the Debug Access Port can block the access using **DBGSWENABLE**. This is outside the scope of the ARMv8-A architecture. See *ARM® Debug Interface Architecture Specification ADiv5.0 to ADiv5.2*.

Effect of the **OPTIONAL** Software Lock on memory-mapped access

For memory-mapped accesses, if other controls permit access to a register, the **OPTIONAL** Software Lock is implemented, and **EDLSR.SLK**, **PMLSR.SLK**, or **CTILSR.SLK** is set to 1, meaning the Software Lock is locked, then with the exception of the LAR itself:

- If other controls permit access to a register, then writes are ignored. That is:
 - Read/write (RW) registers become read-only, writes ignored (RO/WI).
 - Write-only (WO) registers become writes ignored (WI).
- Reads and writes have no side-effects. A side-effect is where a direct read or a direct write of a register creates an indirect write of the same or another register. When the Software Lock is locked, the indirect write does not occur.
- Writes to **EDLAR**, **PMLAR**, and **CTILAR** are unaffected.

This behavior must also apply to all **IMPLEMENTATION DEFINED** registers.

For example, if **EDLSR.SLK** is set to 1:

- **EDSCR**. {TXfull, TXU, ERR} are unchanged by a memory-mapped read from **DBGDTRTX_EL0**.
- **EDSCR**. {RXfull, RXO, ERR} are unchanged by a memory-mapped write to **DBGDTRRX_EL0** that is ignored.
- **EDSCR**. {ITE, ITO, ERR} are unchanged by a memory-mapped write to **EDITR** that is ignored.
- **OSLSR.OSLK** is unchanged by a memory-mapped write to **OSLAR_EL1** that is ignored.

- [EDPCSR\[63:32\]](#), [EDCIDSR](#), and [EDVIDSR](#) are unchanged by a memory-mapped read from [EDPCSR\[31:0\]](#).

———— **Note** ————

Updating [EDVIDSR](#), [EDCIDSR](#), and [EDPCSR](#)hi are side-effects of reading [EDPCSR](#)lo, such that these registers contain the matching context for [EDPCSR](#)lo. The process that updates [EDPCSR](#)lo with PC samples is not a side-effect of the access. Reads of [EDPCSR](#)lo made when the Software Lock is locked can be used to profile software.

- [PMPCSR\[63:32\]](#), [PMCID1SR/PMCID2SR](#), and [PMVIDSR](#) are unchanged by a memory-mapped read from [PMPCSR\[31:0\]](#).

———— **Note** ————

Updating [PMVIDSR](#), [PMCID1SR/PMCID2SR](#), and [PMPCSR\[31:0\]](#) are side-effects of reading [PMPCSR\[63:32\]](#), such that these registers contain the matching context for [PMPCSR\[63:32\]](#). The process that updates [PMPCSR\[63:32\]](#) with PC samples is not a side-effect of the access. Reads of [PMPCSR\[63:32\]](#) made when the Software Lock is locked can be used to profile software.

- [EDPRSR](#) {SDR, SPMAD, SDAD, SR, SPD} are unchanged by a memory-mapped read from [EDPRSR](#).
- [EDPRSR](#).SDAD is not set if an error response is returned due to a memory-mapped read or write of any debug register as the result of the value of the EDAD field.
- The CLAIM tags are unchanged by memory-mapped writes to [DBGCLAIMSET_EL1](#) and [DBGCLAIMCLR_EL1](#) which are ignored.

Similarly, if [PMLSR](#).SLK is set to 1, then [EDPRSR](#).SPMAD is not set if an error response is returned to a memory-mapped read or write of any Performance Monitors register due to the value of the EPMAD field.

Behavior of a not permitted memory-mapped access

Where the architecture requires that an external debug interface access generates an error response, a memory-mapped access must also generate an error response. However, it is IMPLEMENTATION DEFINED how the error response is handled, as this depends on the system.

ARM recommends that the error is returned as either:

- A synchronous external Data Abort.
- An SError interrupt.

H8.4.2 Synchronization of memory-mapped accesses to external debug registers

The synchronization requirements for memory-mapped accesses to the external debug interface is described in [Synchronization of changes to the external debug registers on page H8-5554](#).

The synchronization requirements between different routes to the external debug interface, that is, between Debug Access Port accesses and memory-mapped accesses are IMPLEMENTATION DEFINED.

H8.4.3 Access sizes for memory-mapped accesses

For memory-mapped accesses from a PE that complies with an ARM architecture, the single-copy atomicity rules for the instruction, the type of instruction, and the type of memory accessed, determine the size of the access made by an instruction. [Example H8-4 on page H8-5560](#) shows this.

Example H8-4 Access sizes for memory-mapped accesses

Two Load Doubleword instructions made to consecutive doubleword-aligned locations generate a pair of single-copy atomic doubleword reads. However, if the accesses are made to Normal memory or Device-GRE memory they might appear as a single quadword access that is not supported by the peripheral.

ARMv8 does not require the size of each element accessed by a multi-register load or store instruction to be identifiable by the memory system beyond the PE. Any memory-mapped access to a debug register is defined to be beyond the PE.

Software must use a Device-nGRE or stronger memory-type and use only single register load and store instructions to create memory accesses that are supported by the peripheral. For more information, see [Memory types and attributes on page B2-107](#).

H8.5 External debug interface register access permissions

Some external accesses to debug registers and Performance Monitor registers are not permitted and return an error response if:

- The Core power domain is powered down or is in low-power state where the registers cannot be accessed.
- [OSLSR.OSLK](#) == 1. The OS Lock is locked.
- [DoubleLockStatus\(\)](#) == TRUE. The OS Double Lock is locked.
- Access by the external debug interface is disabled by the authentication interface or secure monitor.

Not all registers are affected in all of these cases. For details, see [External debug interface register access permissions summary](#) on page H8-5563.

———— **Note** —————

[OSLSR.OSLK](#) is visible through [EDPRSR](#).

H8.5.1 External debug over powerdown and locks

Accessing registers using the external debug interface is not possible when the Debug power domain is off. In this case all accesses return an error.

External accesses to debug and Performance Monitors registers in the Core power domain are not permitted and return an error response if:

- The Core power domain is off or in low-power state where the registers cannot be accessed.
- [OSLSR.OSLK](#) == 1, meaning that the OS Lock is locked. This allows software to prevent external debugger modification of the registers while it saves and restores them over powerdown.
- [DoubleLockStatus\(\)](#) == TRUE. This means that the OS Double Lock is locked. The OS Double Lock ensures that it is safe to remove Core power by forcing the debug interface to be quiescent.

It is IMPLEMENTATION DEFINED whether the ID registers that describe the PE to the debugger are in the Debug power domain or the Core power domain.

———— **Note** —————

This applies only to the [MIDR_EL1](#), [EDPFR](#), [EDDFR](#), and [EDAA32PFR](#) registers. It does not include the CoreSight ID registers in the management register address range.

The OS lock condition does not apply to the following debug registers:

- [OSLAR_EL1](#). This means that an external debugger can override this lock.
- [EDESRR](#). This means that an external debugger can program a debug event for when software unlocks the OS lock. See [OS Unlock Catch debug event](#) on page H3-5491.
- The ID registers that describe the PE to the debugger.

See also [Debug registers to save over powerdown](#) on page H6-5541.

H8.5.2 External access disabled

Accesses are further controlled by the external authentication interface. An untrusted external debugger cannot program the breakpoint and watchpoint registers to generate spurious debug exceptions. If external invasive debugging is not enabled, these external accesses to the registers are disabled. If EL3 is implemented, then [SDCR](#) provides additional external access disable controls for those registers if Secure external invasive debugging is disabled.

The disable applies to:

- [DBGBVR<n>_EL1](#), *Debug Breakpoint Value Registers, n = 0 - 15* on page H9-5584.
- [DBGBCR<n>_EL1](#), *Debug Breakpoint Control Registers, n = 0 - 15* on page H9-5580.

- [DBGWVR<n>_EL1, Debug Watchpoint Value Registers, n = 0 - 15](#) on page H9-5600.
- [DBGWCR<n>_EL1, Debug Watchpoint Control Registers, n = 0 - 15](#) on page H9-5597.
- [From ARMv8.2, OSLAR_EL1, OS Lock Access Register](#) on page H9-5675.

In ARMv8.0 and ARMv8.1 implementations, it is IMPLEMENTATION DEFINED whether the disable applies to [OSLAR_EL1](#).

The external debug interface cannot access these registers if either:

- External debugging is not enabled, meaning `ExternalInvasiveDebugEnabled() == FALSE`.
- Secure external debugging is not enabled, meaning `ExternalSecureInvasiveDebugEnabled() == FALSE`, and any of the following:
 - EL3 is not implemented and the implemented Security state is Secure state.
 - EL3 is implemented and `SDCR.EDAD == 1`.

The `AllowExternalDebugAccess()` pseudocode function describes these accessibility rules.

PEs might also provide an OPTIONAL external debug interface to the Performance Monitor registers. The authentication interface and [SDCR](#) provide similar external access disable controls for those registers.

The external debug interface cannot access the Performance Monitor registers if either:

- External non-invasive debug is not enabled. `ExternalNoninvasiveDebugEnabled() == FALSE`.
- Secure external non-invasive debugging is not enabled, `ExternalSecureNoninvasiveDebugEnabled() == FALSE`, and any of:
 - EL3 is not implemented and the implemented Security state is Secure state.
 - EL3 is implemented and `SDCR.EPMAD == 1`.

The `AllowExternalPMUAccess()` pseudocode function describes these accessibility rules.

———— **Note** —————

- ARM recommends that secure software that is not making use of debug hardware does not lock out the external debug interface.
- ARMv8-A does not provide the equivalent control over access to Trace extension registers.

H8.5.3 Behavior of a not permitted access

For an external debug interface access by a Debug Access Port, the Debug Access Port receives the error response and must signal this to the external debugger. For an ADIV5 implementation of a Debug Access Port, the error sets a sticky error flag in the Debug Access Port that the debugger can poll, and that suppresses further accesses until it is explicitly cleared.

When an error is returned because external access is disabled, and this is the highest priority error condition, a sticky error flag in [EDPRSR](#) is indirectly written to 1 as a side-effect of the access:

- For a debug register access when `AllowExternalDebugAccess() == FALSE`, [EDPRSR.SDAD](#) is indirectly written to 1.
- For Performance Monitor register access when `AllowExternalPMUAccess() == FALSE`, [EDPRSR.SPMAD](#) is indirectly written to 1.

The indirect write might not occur for a memory-mapped access to the external debug interface. For more information, see [Register access permissions for memory-mapped accesses](#) on page H8-5558.

If no error is returned, or the error is returned because of a higher priority error condition, the flag in [EDPRSR](#) is unchanged.

See also [Behavior of a not permitted memory-mapped access](#) on page H8-5559.

For more information, see *ARM® Debug Interface Architecture Specification*.

H8.5.4 Trapping software access to debug registers

When `EDSCR.TDA == 1`, software access to the breakpoint and watchpoint registers generate a Halting debug event and entry to Debug state. For more information see [Software Access debug event on page H3-5493](#).

H8.5.5 External debug interface register access permissions summary

For accesses to:

- IMPLEMENTATION DEFINED registers, see [IMPLEMENTATION DEFINED registers](#).
- OPTIONAL registers for CoreSight compliance, see [OPTIONAL CoreSight management registers](#).
- Reserved, unallocated, or unimplemented registers, writes to read-only registers, and reads of write-only registers, see [Reserved and unallocated registers](#).

For all other external debug interface, CTI, and Performance Monitor registers, [Table H8-3 on page H8-5568](#), [Table H8-4 on page H8-5570](#) and [Table I2-1 on page I2-5740](#), show the response of the PE to accesses by the external debug interface.

H8.5.6 IMPLEMENTATION DEFINED registers

For debug registers, Performance Monitors registers, CTI registers, IMPLEMENTATION DEFINED register access permissions are IMPLEMENTATION DEFINED. The power domain in which these registers are implemented is also IMPLEMENTATION DEFINED.

If OPTIONAL memory-mapped access to the external debug interface is supported, there are additional constraints on memory-mapped accesses to registers. These constraints must also apply to IMPLEMENTATION DEFINED registers. In particular, if the OPTIONAL Software Lock is locked, writes are ignored and accesses have no side-effects. For more information see [Register access permissions for memory-mapped accesses on page H8-5558](#).

H8.5.7 OPTIONAL CoreSight management registers

Compliance with CoreSight architecture requires additional registers in the range `0xF00 - 0xFFC` that are always accessible. See [Management registers and CoreSight compliance on page K2-6141](#).

H8.5.8 Reserved and unallocated registers

The following information relates to certain types of reserved accesses:

- Reads and writes of unallocated locations. These accesses are reserved for the architecture.
- Reads and writes of locations for features that are not implemented, including:
 - OPTIONAL features that are not implemented.
 - Breakpoints and watchpoints that are not implemented.
 - Performance Monitors counters that are not implemented.
 - CTI triggers that are not implemented.

These accesses are reserved.

- Reads of WO locations. These accesses are reserved for the architecture.
- Writes to RO locations. These accesses are reserved for the architecture.

Reserved accesses normally RAZ/WI. However, software must not rely on this property as the behavior of reserved values might change in a future revision of the architecture.

———— **Note** —————

Reads of WO and writes to RO refers to the default access permissions for a register. For example, when the SLK field is set, meaning that the relevant registers become RO, a memory-mapped write to a RW register is ignored, and not treated as a reserved access.

The following reserved registers are RES0 in all conditions, other than when debug power is off:

- If the implementation is CoreSight architecture compliant, all reserved registers in the range 0xF00 - 0xFFC. See [Management register access permissions on page K2-6142](#).
- All reserved CTI registers.

Otherwise, the architecture defines that:

1. If debug power is off, all register accesses, including reserved accesses, return an error.
2. For reserved debug registers and Performance Monitors registers, the response is a CONSTRAINED UNPREDICTABLE choice of error or RES0, when any of the following hold:
 - Off** The Core power domain is either completely off or in a low-power state in which the Core power domain registers cannot be accessed.
 - DLK** DoubleLockStatus() == TRUE. The OS Double Lock is locked.
 - OSLK** OSLSR.OSLK == 1. The OS Lock is locked.
3. In addition, for reserved debug registers in the address ranges 0x400 - 0x4FC and 0x800 - 0x8FC, the response is a CONSTRAINED UNPREDICTABLE choice of error or RES0 when conditions 1 or 2 do not apply and:
 - EDAD** AllowExternalDebugAccess() == FALSE. External debug is disabled.

———— **Note** —————

See also [Behavior of a not permitted access on page H8-5562](#).

4. In addition, for reserved Performance Monitors registers in the address ranges 0x000 - 0x0FC and 0x400 - 0x47C, the response is a CONSTRAINED UNPREDICTABLE choice of error or RES0 when conditions 1 or 2 do not apply and:
 - EPMAD** AllowExternalPMUAccess() == FALSE. External Performance Monitor access is disabled.

———— **Note** —————

See also [Behavior of a not permitted access on page H8-5562](#).

H8.6 External debug interface registers

The external debug interface register map is described by:

- *Performance Monitors external register views* on page I3-5746.
- *Cross-trigger interface registers* on page H8-5570.
- *External debug interface register map*.

Table H8-2 External debug interface register map

Offset	Mnemonic	Register, or additional information
0x020	EDES _R	<i>EDES_R, External Debug Event Status Register</i> on page H9-5628
0x024	EDECR	<i>EDECR, External Debug Execution Control Register</i> on page H9-5626
0x030 0x034	EDWAR[31:0] EDWAR[63:32]	<i>EDWAR, External Debug Watchpoint Address Register</i> on page H9-5671
0x080	DBGDTRRX_EL0	Chapter H4 <i>The Debug Communication Channel and Instruction Transfer Register</i>
0x084	EDITR	<i>EDITR, External Debug Instruction Transfer Register</i> on page H9-5632
0x088	EDSCR	<i>EDSCR, External Debug Status and Control Register</i> on page H9-5662
0x08C	DBGDTRTX_EL0	Chapter H4 <i>The Debug Communication Channel and Instruction Transfer Register</i>
0x090	EDRCR	<i>EDRCR, External Debug Reserve Control Register</i> on page H9-5660
0x094	EDACR	<i>EDACR, External Debug Auxiliary Control Register</i> on page H9-5604
0x098	EDECCR	<i>EDECCR, External Debug Exception Catch Control Register</i> on page H9-5622
0x0A0	EDPCSR _{lo} ^a	<i>EDPCSR, External Debug Program Counter Sample Register</i> on page H9-5637
0x0A4	EDCIDS _R ^a	<i>EDCIDS_R, External Debug Context ID Sample Register</i> on page H9-5609
0x0A8	EDVIDS _R ^a	<i>EDVIDS_R, External Debug Virtual Context Sample Register</i> on page H9-5667
0x0AC	EDPCSR _{hi} ^a	<i>EDPCSR, External Debug Program Counter Sample Register</i> on page H9-5637
0x0300	OSLAR_EL1	<i>OSLAR_EL1, OS Lock Access Register</i> on page H9-5675
0x0310	EDPRCR	<i>EDPRCR, External Debug Power/Reset Control Register</i> on page H9-5649
0x0314	EDPRSR	<i>EDPRSR, External Debug Processor Status Register</i> on page H9-5652
0x0400+16×n 0x0404+16×n	DBGBVR<n>_EL1[31:0] ^{bc} DBGBVR<n>_EL1[63:32] ^{bc}	<i>DBGBVR<n>_EL1, Debug Breakpoint Value Registers, n = 0 - 15</i> on page H9-5584
0x0408+16×n	DBGBCR<n>_EL1	<i>DBGBCR<n>_EL1, Debug Breakpoint Control Registers, n = 0 - 15</i> on page H9-5580
0x800+16 0x804+16×n	DBGWVR<n>_EL1[31:0] ^{bc} DBGWVR<n>_EL1[63:32] ^{bc}	<i>DBGWVR<n>_EL1, Debug Watchpoint Value Registers, n = 0 - 15</i> on page H9-5600
0x808+16×n	DBGWCR<n>_EL1 ^c	<i>DBGWCR<n>_EL1, Debug Watchpoint Control Registers, n = 0 - 15</i> on page H9-5597
0xC00-0xCFC	IMPLEMENTATION DEFINED	-
0xD00	MIDR_EL1	Main ID register
0xD04-0xD1C	-	Reserved, RES0

Table H8-2 External debug interface register map (continued)

Offset	Mnemonic	Register, or additional information
0xD20	EDPFR[31:0]	External Debug Processor Feature Register 0
0xD24	EDPFR[63:32]	
0xD28	EDDFR[31:0]	External Debug Feature Register 0
0xD2C	EDDFR[63:32]	
0xD30	Reserved, see next column	Previously defined as Instruction Set Attribute Register 0 bits[31:0]. Behavior is: Bits[31:20] RES0. Bits[19:4] UNKNOWN. Bits[3:0] RES0.
0xD34	RES0	Previously defined as Instruction Set Attribute Register 0 bits[63:32]
0xD38	UNKNOWN	Previously defined as Memory Model Feature Register 0
0xD3C	RES0	
0xD40–0xDFC	RES0	Reserved, RES0
0xD60	EDAA32PFR[31:0]	External Debug AArch32 Processor Feature Register
0xD64	EDAA32PFR[63:32]	External Debug AArch32 Processor Feature Register
0xE80–EFC	IMPLEMENTATION DEFINED	-
0xF00–E8C	Management registers	<i>Management registers and CoreSight compliance on page K2-6141</i>
0xFA0	DBGCLAIMSET_EL1	<i>DBGCLAIMSET_EL1, Debug Claim Tag Set register on page H9-5591</i>
0xFA4	DBGCLAIMCLR_EL1	<i>DBGCLAIMCLR_EL1, Debug Claim Tag Clear register on page H9-5589</i>
0xFA8	EDDEVAFF0	<i>EDDEVAFF0, External Debug Device Affinity register 0 on page H9-5611</i>
0xFAC	EDDEVAFF1	<i>EDDEVAFF1, External Debug Device Affinity register 1 on page H9-5612</i>
0xFB0–FB4	Management registers	<i>Management registers and CoreSight compliance on page K2-6141</i>
0xFB8	DBGAUTHSTATUS_EL1	<i>DBGAUTHSTATUS_EL1, Debug Authentication Status register on page H9-5578</i>
0xFC0	EDDEVID2	<i>EDDEVID, External Debug Device ID register 0 on page H9-5615</i>
0xFC4	EDDEVID1	<i>EDDEVID1, External Debug Device ID register 1 on page H9-5617</i>
0xFC8	EDDEVID	<i>EDDEVID2, External Debug Device ID register 2 on page H9-5618</i>
0xFD0–FFC	Management registers	<i>Management registers and CoreSight compliance on page K2-6141</i>

- a. **Supported only if the OPTIONAL PC Sample-Based Profiling is implemented but ARMv8.2-PCSample is not implemented. See Chapter H7 The PC Sample-based Profiling Extension.**
Implemented only if the OPTIONAL PC Sample-based Profiling Extension is implemented.
- b. A 64-bit register mapped to a pair of 32-bit locations. Doubleword accesses to this register are not guaranteed to be 64-bit single copy atomic. See *Endianness and supported access sizes on page H8-5553*. Software must ensure a breakpoint or watchpoint is disabled before altering the value register.
- c. Implemented breakpoints and watchpoints only. *n* is the breakpoint or the watchpoint number.

————— Note —————
All other locations are reserved.

H8.6.1 Access permissions for the External debug interface registers

Table H8-3 on page H8-5568 shows the access permissions for the external debug interface registers in an ARMv8-A Debug implementation. The terms are defined as follows:

Domain	This describes the power domain in which the register is logically implemented. Registers described as implemented in the Core power domain might be implemented in the Debug power domain, as long as they exhibit the required behavior.
Conditions	This lists the conditions under which the access is attempted. To determine the access permissions for a register, read these columns from left to right, and stop at first column which lists the condition as being true. The conditions are:
Off	<code>EDPRSR.PU == 0</code> . The Core power domain is completely off, or in low-power state. In these cases the Core power domain registers cannot be accessed.
Note	
If debug power is off, then all external debug interface accesses return an error.	
DLK	<code>DoubleLockStatus() == TRUE</code> . The OS Double Lock is locked.
OSLK	<code>OSLSR.OSLK == 1</code> . The OS Lock is locked.
EDAD	<code>AllowExternalDebugAccess() == FALSE</code> . External debug access is disabled. See also <i>Behavior of a not permitted access on page H8-5562</i> .
EPMAD	<code>AllowExternalPMUAccess() == FALSE</code> . Access to the external Performance Monitors is disabled. See also <i>Behavior of a not permitted access on page H8-5562</i> .
SLK	This provides the modified default access permissions for OPTIONAL memory-mapped accesses to the external debug interface if the OPTIONAL Software Lock is locked. See <i>Register access permissions for memory-mapped accesses on page H8-5558</i> . For all other accesses, this column is ignored.
Default	This provides the default access permissions, if there are no conditions that prevent access to the register.

The access permissions are:

-	This means that the default access permission applies. See the Default column, or the SLK column, if applicable.
RO	This means that the register or field is read-only, and: <ul style="list-style-type: none"> Unless the register description states otherwise, a RO field in an RW register ignores writes. Where the SLK control makes a RW register RO, the register ignores writes.
RW	This means that the register or field is read/write. Individual fields within the register might be RO or WO. See the relevant register description for details.
RC	This means that a read of the register bit clears the field to 0.
WO	This means that the register or field is write-only. Unless the register description states otherwise, a WO field in a RW register returns an UNKNOWN value on a read of the register.
WI	This means that the register or field ignores writes.
IMP DEF	This means that the access permissions are IMPLEMENTATION DEFINED.

If OPTIONAL memory-mapped access to the external debug interface is supported, there might be additional constraints on memory-mapped accesses. See [Register access permissions for memory-mapped accesses on page H8-5558](#).

Table H8-3 Access permissions for the external debug interface registers

Offset	Register	Domain	Conditions (priority from left to right)				Default	SLK
			Off	DLK	OSLK	EDAD		
0x020	EDESR	Core	Error	Error	-	-	RW	RO
0x024	EDECR	Debug	-	-	-	-	RW	RO
0x030	EDWAR[31:0]	Core	Error	Error	Error	-	RO	-
0x034	EDWAR[63:32]							
0x080	DBGDTRRX_EL0	Core	Error	Error	Error	-	RW	RO
0x084	EDITR	Core	Error	Error	Error	-	WO	WI
0x088	EDSCR	Core	Error	Error	Error	-	RW	RO
0x08C	DBGDTRTX_EL0	Core	Error	Error	Error	-	RW	RO
0x090	EDRCR	Core	Error	Error	Error	-	WO	WI
0x094	EDACR	IMP DEF	IMP DEF	IMP DEF	IMP DEF	-	RW	RO
0x098	EDECCR	Core	Error	Error	Error	-	RW	RO
0x0A0	EDPCSR[31:0] ^a	Core	Error	Error	Error	-	RO	RO
0x0A4	EDCIDS ^a	Core	Error	Error	Error	-	RO	RO
0x0A8	EDVIDS ^a	Core	Error	Error	Error	-	RO	RO
0x0AC	EDPCSR[63:32] ^a	Core	Error	Error	Error	-	RO	RO
0x0300	OSLAR_EL1	Core	Error	Error	-	IMP DEF ^b	WO	WI
0x0310 ^c	EDPRCR	See register field descriptions for information						
0x0314 ^d	EDPRSR	See register field descriptions for information						
0x0400+16×n	DBGBVR<n>_EL1[31:0] ^e	Core	Error	Error	Error	Error	RW	RO
0x0404+16×n	DBGBVR<n>_EL1[63:32] ^e	Core	Error	Error	Error	Error	RW	RO
0x0408+16×n	DBGBCR<n>_EL1 ^e	Core	Error	Error	Error	Error	RW	RO
0x800+16×n	DBGWVR<n>_EL1[31:0] ^e	Core	Error	Error	Error	Error	RW	RO
0x804+16×n	DBGWVR<n>_EL1[63:32] ^e	Core	Error	Error	Error	Error	RW	RO
0x808+16×n	DBGWCR<n>_EL1 ^e	Core	Error	Error	Error	Error	RW	RO
0xD00	MIDR_EL1	IMP DEF	IMP DEF ^f	IMP DEF ^f	-	-	RO	RO
0xD20	EDPFR[31:0]	IMP DEF	IMP DEF ^f	IMP DEF ^f	-	-	RO	RO
0xD24	EDPFR[63:32]	IMP DEF	IMP DEF ^f	IMP DEF ^f	-	-	RO	RO
0xD28	EDDFR[31:0]	IMP DEF	IMP DEF ^f	IMP DEF ^f	-	-	RO	RO
0xD2C	EDDFR[63:32]	IMP DEF	IMP DEF ^f	IMP DEF ^f	-	-	RO	RO

Table H8-3 Access permissions for the external debug interface registers (continued)

Offset	Register	Domain	Conditions (priority from left to right)					Default	SLK
			Off	DLK	OSLK	EDAD			
0xD60	EDAA32PFR[31:0]	IMP DEF	IMP DEF ^f	IMP DEF ^f	-	-	RO	RO	
0xD64	EDAA32PFR[63:32]	IMP DEF	IMP DEF ^f	IMP DEF ^f	-	-	RO	RO	
0xFA0	DBGCLAIMSET_EL1	Core	Error	Error	Error	-	RW	RO	
0xFA4	DBGCLAIMCLR_EL1	Core	Error	Error	Error	-	RW	RO	
0xFA8	EDDEVAFF0	Debug	-	-	-	-	RO	RO	
0xFAC	EDDEVAFF1	Debug	-	-	-	-	RO	RO	
0xFB8	DBGAUTHSTATUS_EL1	Debug	-	-	-	-	RO	RO	
0xFC0	EDDEVID2	Debug	-	-	-	-	RO	RO	
0xFC4	EDDEVID1	Debug	-	-	-	-	RO	RO	
0xFC8	EDDEVID	Debug	-	-	-	-	RO	RO	

- a. Implemented only if the PC Sample-based profiling Extension is implemented.
- b. It is IMPLEMENTATION DEFINED whether an error is returned. See [External access disabled on page H8-5561](#). If no error is returned, the access is permitted.
- c. Some control bits are in the Core power domain. These bits ignore writes when Core power domain registers cannot be accessed as shown.
- d. Some status bits are fetched from the Core power domain. These bits read UNKNOWN when Core power domain registers cannot be accessed as shown.
- e. Implemented breakpoints and watchpoints only. *n* is the breakpoint or watchpoint number.
- f. It is IMPLEMENTATION DEFINED whether an error is returned. See [External debug over powerdown and locks on page H8-5561](#). If no error is returned, the access is permitted.

For the reset values for the external debug interface registers, see [Table H8-6 on page H8-5572](#).

H8.7 Cross-trigger interface registers

The embedded Cross-trigger Interface, CTI, is located within its own block of the external debug memory map. There must be one such block for each PE.

If the CTI of a PE does not implement the [CTIDEVAFF0](#) or [CTIDEVAFF1](#) registers it must be located 64KB above the debug registers in the external debug interface.

[Table H8-4](#) shows the CTI register map.

Table H8-4 Cross-trigger interface map

Offset	Mnemonic	Location of further details
0x000	CTICONTROL	CTICONTROL , CTI Control register on page H9-5692
0x010	CTIINTACK	CTIINTACK , CTI Output Trigger Acknowledge register on page H9-5705
0x014	CTIAPPSET	CTIAPPSET , CTI Application Trigger Set register on page H9-5681
0x018	CTIAPPCLEAR	CTIAPPCLEAR , CTI Application Trigger Clear register on page H9-5679
0x01C	CTIAPPPULSE	CTIAPPPULSE , CTI Application Pulse register on page H9-5680
0x020+4×n	CTIINEN<n> ^a	CTIINEN<n> , CTI Input Trigger to Output Channel Enable registers , $n = 0 - 31$ on page H9-5704
0x0A0+4×n	CTIOUTEN<n> ^a	CTIOUTEN<n> , CTI Input Channel to Output Trigger Enable registers , $n = 0 - 31$ on page H9-5712
0x130	CTITRIGINSTATUS	CTITRIGINSTATUS , CTI Trigger In Status register on page H9-5718
0x134	CTITRIGOUTSTATUS	CTITRIGOUTSTATUS , CTI Trigger Out Status register on page H9-5719
0x138	CTICHINSTATUS	CTICHINSTATUS , CTI Channel In Status register on page H9-5684
0x13C	CTICHOUTSTATUS	CTICHOUTSTATUS , CTI Channel Out Status register on page H9-5685
0x140	CTIGATE	CTIGATE , CTI Channel Gate Enable register on page H9-5703
0x144	ASICCTL	ASICCTL , CTI External Multiplexer Control register on page H9-5678
0xE80 – 0xEFC	IMPLEMENTATION DEFINED	IMPLEMENTATION DEFINED. See Management registers and CoreSight compliance on page K2-6141
0xF00 – 0xFBC	Management registers	Management registers and CoreSight compliance on page K2-6141
0xFC0	CTIDEVID2	CTIDEVID2 , CTI Device ID register 2 on page H9-5701
0xFC4	CTIDEVID1	CTIDEVID1 , CTI Device ID register 1 on page H9-5700
0xFC8	CTIDEVID	CTIDEVID , CTI Device ID register 0 on page H9-5698
0xFD0 – 0xFFC	Management registers	Management registers and CoreSight compliance on page K2-6141

a. Implemented triggers, including triggers that are not connected, only. n is the trigger number.

Table H8-5 shows the access permissions for the CTI registers in an ARMv8-A Debug implementation. For a definition of the terms used, see [External debug interface registers on page H8-5565](#).

Table H8-5 Access permissions for the CTI registers

Offset	Register	Domain	Conditions (priority from left to right)				Default	SLK
			Off	DLK	OSLK	EDAD		
0x000	CTICONTROL	Debug	-	-	-	-	RW	RO
0x010	CTIINTACK	Debug	-	-	-	-	WO	WI
0x014	CTIAPPSET	Debug	-	-	-	-	RW	RO
0x018	CTIAPPCLEAR	Debug	-	-	-	-	WO	WI
0x01C	CTIAPPULSE	Debug	-	-	-	-	WO	WI
0x020+4×n	CTIINEN<n>^a	Debug	-	-	-	-	RW	RO
0x0A0+4×n	CTIOUTEN<n>	Debug	-	-	-	-	RW	RO
0x130	CTITRIGINSTATUS	Debug	-	-	-	-	RO	RO
0x134	CTITRIGOUTSTATUS	Debug	-	-	-	-	RO	RO
0x138	CTICHINSTATUS	Debug	-	-	-	-	RO	RO
0x13C	CTICHOUTSTATUS	Debug	-	-	-	-	RO	RO
0x140	CTIGATE	Debug	-	-	-	-	RW	RO
0xFC0	CTIDEVID2	Debug	-	-	-	-	RO	RO
0xFC4	CTIDEVID1	Debug	-	-	-	-	RO	RO
0xFC8	CTIDEVID	Debug	-	-	-	-	RO	RO

a. Implemented triggers only (including triggers that are not connected). *n* is the trigger number.

For the reset values of the CTI registers, see [Table H8-7 on page H8-5574](#).

H8.8 External debug register resets

Each register or field has a defined reset domain:

- Registers and fields in the Warm reset domain are also reset by a Cold reset and unchanged by an External Debug reset that is not coincident with a Cold reset or a Warm reset.
- Registers and fields in the Cold reset domain are unchanged by a Warm reset or an External Debug reset that is not coincident with a Cold reset.
- Registers and fields in the External Debug reset domain are unchanged by a Cold reset or a Warm reset that is not coincident with an External Debug reset.

A reset might change the value of a register. Specific rules apply to the observability of registers in the External Debug reset domain by indirect reads from the Core power domain when an External Debug reset is asserted without a coincident Cold reset. For more information, see [Synchronization of changes to the external debug registers on page H8-5554](#).

[Table H8-6](#) and [Table H8-7 on page H8-5574](#) show the external debug register and CTI register resets. For other debug registers and Performance Monitors registers, see [Management register resets on page K2-6146](#) and [Power domains and Performance Monitors registers reset on page I2-5741](#).

———— **Note** —————

By reference to [Figure H6-2 on page H6-5545](#) the power domain can be deduced from the reset domain. [Table K2-7 on page K2-6146](#) also shows reset power domains.

[Table H8-6](#) and [Table H8-7 on page H8-5574](#) do not include:

- Read-only identification registers, such as Processor ID Registers and [PMCFGR](#), that have a fixed value from reset.
- Read-only status registers, such as [EDSCR.RW](#), that are evaluated each time the register is read and that have no meaningful reset value.
- Write-only registers, such as [EDRCR](#), that only have an effect on writes, and have no meaningful reset value.
- Read/write registers, such as breakpoint and watchpoint registers, and [EDPRCR.CORENPDRQ](#), that alias other registers. The reset values are described by the descriptions of those other registers.
- IMPLEMENTATION DEFINED registers. The reset values and reset domains of these registers are also IMPLEMENTATION DEFINED and might be UNKNOWN.

All other fields in the registers are set to an IMPLEMENTATION DEFINED value, that can be UNKNOWN. The register is in the specified reset domain.

———— **Note** —————

An IMPLEMENTATION DEFINED reset value, which can be UNKNOWN, means that hardware is not required to reset the register on the specified reset, but software must not rely on the register being preserved over reset.

Table H8-6 Summary of external debug register resets, debug registers

Register	Reset domain	Field	Value	Description
EDES _R	Warm	SS	EDECR.SS	Halting Step debug event pending
		RC	EDECR.RCE	Reset Catch debug event pending
		OSUC	0	OS Unlock Catch debug event pending

Table H8-6 Summary of external debug register resets, debug registers (continued)

Register	Reset domain	Field	Value	Description
EDECR	External debug	SS	0	Halting Step debug event enable
		RCE	0	Reset Catch debug event enable
		OSUCE	0	OS Unlock Catch debug event enable
EDWAR	Cold	-	-	All fields
EDSCR	Cold	RXfull	0	DTRRX register full
		TXfull	0	DTRTX register full
		RXO	0	DTRRX overrun
		TXU	0	DTRTX underrun
		INTdis	0	Interrupt disable
		TDA	0	Trap debug register accesses to Debug state
		MA	0	Memory access mode in Debug state
		HDE	0	Halting debug mode enable
		ERR	0	Cumulative error flag
EDECCR	Cold	NSE[2:1]	0b00	Coarse-grained Non-secure Exception Catch
		SE[3,1]	0b00	Coarse-grained Secure Exception Catch
EDPCSR	Cold	-	-	All fields
EDCIDSR	Cold	-	-	All fields
EDVIDSR	Cold	-	-	All fields
EDPRCR	External debug	COREPURQ ^a	0	Core powerup request
EDPRSR	Warm	SDR	-	Sticky debug restart
	Cold	SPMAD	0	Sticky EPMAD error
		SDAD	0	Sticky EDAD error
	Warm	SR	1	Sticky reset status
	Cold	SPD	1	Sticky powerdown status

- a. On a cold reset into AArch64 state, [DBGPRCR_EL1.CORENPRDRQ](#) resets to the value of [EDPRCR.COREPURQ](#). On a cold reset into AArch32 state, [DBGPRCR.CORENPRDRQ](#) resets to the value of [EDPRCR.COREPURQ](#). If an External Debug reset and a Cold reset coincide, both [EDPRCR.COREPURQ](#) and the [CORENPRDRQ](#) field of the appropriate System register are reset to 0.

Table H8-7 shows the reset values for the CTI registers

Table H8-7 Summary of external debug register resets, CTI registers

Register	Reset domain	Field	Value	Description
CTICONTROL	External debug	GLBEN	0	CTI global enable
CTIAPPSET	External debug	-	-	All fields
CTIINEN<n>	External debug	-	-	All fields
CTIOUTEN<n>	External debug	-	-	All fields
CTIGATE	External debug	-	-	All fields
ASICCTL	IMPLEMENTATION DEFINED	-	IMPLEMENTATION DEFINED	All of register

Chapter H9

External Debug Register Descriptions

This chapter provides a description of the external debug registers.

It contains the following sections:

- [About the debug registers on page H9-5576.](#)
- [External debug registers on page H9-5577.](#)
- [Cross-Trigger Interface registers on page H9-5677.](#)

H9.1 About the debug registers

The following sections describe the registers that are accessible through the external debug interface:

- [External debug registers on page H9-5577.](#)
- [Cross-Trigger Interface registers on page H9-5677.](#)

H9.2 External debug registers

This section describes the debug registers that are accessible through the external debug interface and are used for external debug.

This section lists the registers that are accessible through the external debug interface.

H9.2.1 DBGAUTHSTATUS_EL1, Debug Authentication Status register

The DBGAUTHSTATUS_EL1 characteristics are:

Purpose

Provides information about the state of the IMPLEMENTATION DEFINED authentication interface for debug.

Usage constraints

This register is accessible as follows:

Default

RO

Configurations

External register DBGAUTHSTATUS_EL1 is architecturally mapped to AArch64 System register [DBGAUTHSTATUS_EL1](#).

External register DBGAUTHSTATUS_EL1 is architecturally mapped to AArch32 System register [DBGAUTHSTATUS](#).

DBGAUTHSTATUS_EL1 is in the Debug power domain.

Attributes

DBGAUTHSTATUS_EL1 is a 32-bit register.

Field descriptions

The DBGAUTHSTATUS_EL1 bit assignments are:

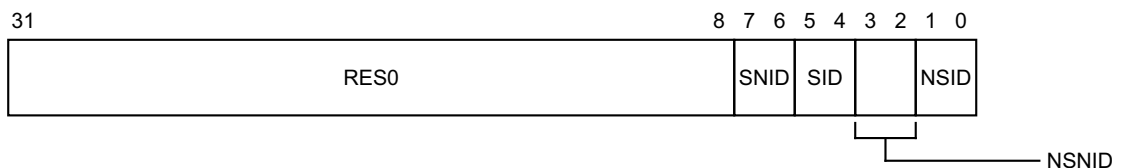

Bits [31:8]

Reserved, RES0.

SNID, bits [7:6]

Secure non-invasive debug. Possible values of this field are:

- 00 Not implemented. EL3 is not implemented and the implemented Security state is Non-secure state.
- 10 Implemented and disabled. ExternalSecureNoninvasiveDebugEnabled() == FALSE.
- 11 Implemented and enabled. ExternalSecureNoninvasiveDebugEnabled() == TRUE.

Other values are reserved.

SID, bits [5:4]

Secure invasive debug. Possible values of this field are:

- 00 Not implemented. EL3 is not implemented and the implemented Security state is Non-secure state.
- 10 Implemented and disabled. ExternalSecureInvasiveDebugEnabled() == FALSE.
- 11 Implemented and enabled. ExternalSecureInvasiveDebugEnabled() == TRUE.

Other values are reserved.

NSNID, bits [3:2]

Non-secure non-invasive debug. Possible values of this field are:

- 00 Not implemented. EL3 is not implemented and the implemented Security state is Secure state.
- 10 Implemented and disabled. ExternalNoninvasiveDebugEnabled() == FALSE.
- 11 Implemented and enabled. ExternalNoninvasiveDebugEnabled() == TRUE.

Other values are reserved.

NSID, bits [1:0]

Non-secure invasive debug. Possible values of this field are:

- 00 Not implemented. EL3 is not implemented and the implemented Security state is Secure state.
- 10 Implemented and disabled. ExternalInvasiveDebugEnabled() == FALSE.
- 11 Implemented and enabled. ExternalInvasiveDebugEnabled() == TRUE.

Other values are reserved.

Accessing the DBGAUTHSTATUS_EL1:

DBGAUTHSTATUS_EL1 can be accessed through the external debug interface:

Component	Offset
Debug	0xFB8

H9.2.2 DBGBCR<n>_EL1, Debug Breakpoint Control Registers, n = 0 - 15

The DBGBCR<n>_EL1 characteristics are:

Purpose

Holds control information for a breakpoint. Forms breakpoint n together with value register [DBGBVR<n>_EL1](#).

Usage constraints

This register is accessible as follows:

Off	DLK	OSLK	EDAD	SLK	Default
Error	Error	Error	Error	RO	RW

Configurations

External register DBGBCR<n>_EL1 is architecturally mapped to AArch64 System register [DBGBCR<n>_EL1](#).

External register DBGBCR<n>_EL1 is architecturally mapped to AArch32 System register [DBGBCR<n>](#).

DBGBCR<n>_EL1 is in the Core power domain. RW fields in this register reset to architecturally UNKNOWN values. These apply only on a Cold reset. The register is not affected by a Warm reset and is not affected by an External debug reset.

If breakpoint n is not implemented then this register is unallocated.

Attributes

DBGBCR<n>_EL1 is a 32-bit register.

Field descriptions

The DBGBCR<n>_EL1 bit assignments are:

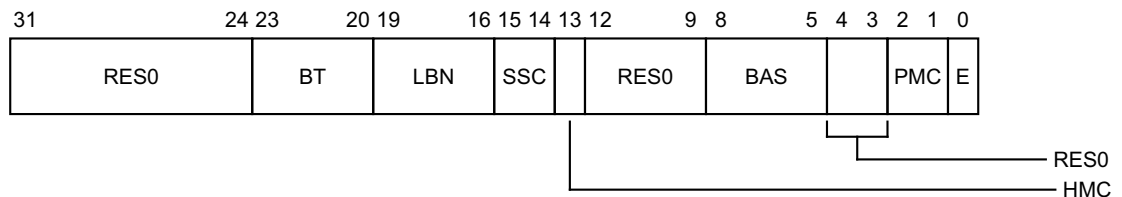

When the E field is zero, all the other fields in the register are ignored.

Bits [31:24]

Reserved, RES0.

BT, bits [23:20]

Breakpoint Type. Possible values are:

- 0000 Unlinked instruction address match.
- 0001 Linked instruction address match.
- 0010 Unlinked Context ID match.
- 0011 Linked Context ID match.
- 0100 Unlinked instruction address mismatch.
- 0101 Linked instruction address mismatch.

0110	Unlinked <code>CONTEXTIDR_EL1</code> match (introduced in ARMv8.1).
0111	Linked <code>CONTEXTIDR_EL1</code> match (introduced in ARMv8.1).
1000	Unlinked VMID match.
1001	Linked VMID match.
1010	Unlinked VMID and Context ID match.
1011	Linked VMID and Context ID match.
1100	Unlinked <code>CONTEXTIDR_EL2</code> match (introduced in ARMv8.1).
1101	Linked <code>CONTEXTIDR_EL2</code> match (introduced in ARMv8.1).
1110	Unlinked Full Context ID match (introduced in ARMv8.1).
1111	Linked Full Context ID match (introduced in ARMv8.1).

The field breaks down as follows:

- BT[3:1]: Base type.
 - 000 Match address. `DBGBVR<n>_EL1` is the address of an instruction.
 - 001 Match Context ID. `DBGBVR<n>_EL1.ContextID` is a Context ID compared against `CONTEXTIDR_EL1` when `ARMv8.1-VHE` is not implemented, or not in a Host OS or a Host Application. When `ARMv8.1-VHE` is implemented, and in a Host OS or Host Application, the Context ID is compared against `CONTEXTIDR_EL2`.
 - 010 Mismatch address. `DBGBVR<n>_EL1` is the address of an instruction to be stepped.
 - 011 Match `CONTEXTIDR_EL1`. `DBGBVR<n>_EL1.ContextID` is a Context ID compared against `CONTEXTIDR_EL1`.
 - 100 Match VMID. `DBGBVR<n>_EL1.VMID` is a VMID compared against `VTTBR_EL2.VMID`.
 - 101 Match VMID and Context ID. `DBGBVR<n>_EL1.ContextID` is a Context ID compared against `CONTEXTIDR_EL1`, and `DBGBVR<n>_EL1.VMID` is a VMID compared against `VTTBR_EL2.VMID`.
 - 110 Match `CONTEXTIDR_EL2`. `DBGBVR<n>_EL1.ContextID2` is a Context ID compared against `CONTEXTIDR_EL2`.
 - 111 Match Full Context ID. `DBGBVR<n>_EL1.ContextID` is compared against `CONTEXTIDR_EL1`, and `DBGBVR<n>_EL1.ContextID2` is compared against `CONTEXTIDR_EL2`.
- BT[0]: Enable linking.

Constraints on breakpoint programming mean some values are reserved under certain conditions. For more information, see [Reserved `DBGBCR<n>_EL1.BT` values on page D2-1935](#).

This field resets to a value that is architecturally UNKNOWN.

LBN, bits [19:16]

Linked breakpoint number. For Linked address matching breakpoints, this specifies the index of the Context-matching breakpoint linked to.

For all other breakpoint types this field is ignored and reads of the register return an UNKNOWN value.

This field is ignored when the value of `DBGBCR<n>_EL1.E` is 0.

This field resets to a value that is architecturally UNKNOWN.

SSC, bits [15:14]

Security state control. Determines the Security states under which a Breakpoint debug event for breakpoint n is generated. This field must be interpreted along with the HMC and PMC fields, and there are constraints on the permitted values of the {HMC, SSC, PMC} fields. For more information, including the effect of programming the fields to a reserved set of values, see [Reserved DBGBCR<n>_EL1.{SSC, HMC, PMC} values on page D2-1936](#).

This field resets to a value that is architecturally UNKNOWN.

HMC, bit [13]

Higher mode control. Determines the debug perspective for deciding when a Breakpoint debug event for breakpoint n is generated. This field must be interpreted along with the SSC and PMC fields, and there are constraints on the permitted values of the {HMC, SSC, PMC} fields. For more information see [DBGBCR<n>_EL1.SSC](#) description.

This field resets to a value that is architecturally UNKNOWN.

Bits [12:9]

Reserved, RES0.

BAS, bits [8:5]

Byte address select. Defines which half-words an address-matching breakpoint matches, regardless of the instruction set and Execution state. In an AArch64-only implementation, this field is reserved, RES1.

The permitted values depend on the breakpoint type.

For Address match breakpoints in either AArch32 or AArch64 state, the permitted values are:

BAS	Match instruction at	Constraint for debuggers
0011	DBGBVR<n>_EL1	Use for T32 instructions.
1100	DBGBVR<n>_EL1+2	Use for T32 instructions.
1111	DBGBVR<n>_EL1	Use for A64 and A32 instructions.

All other values are reserved.

For more information, see [Using the BAS field in Address Match breakpoints on page G2-4483](#).

For Address mismatch breakpoints in an AArch32 stage 1 translation regime, the permitted values are:

BAS	Step instruction at	Constraint for debuggers
0000	-	Use for a match anywhere breakpoint.
0011	DBGBVR<n>_EL1	Use for stepping T32 instructions.
1100	DBGBVR<n>_EL1+2	Use for stepping T32 instructions.
1111	DBGBVR<n>_EL1	Use for stepping A64 and A32 instructions.

For more information, see [Using the BAS field in Address Match breakpoints on page G2-4483](#).

For Context matching breakpoints, this field is RES1 and ignored.

If this field is implemented as an RW field, it resets to a value that is architecturally UNKNOWN.

Bits [4:3]

Reserved, RES0.

PMC, bits [2:1]

Privilege mode control. Determines the Exception level or levels at which a Breakpoint debug event for breakpoint n is generated. This field must be interpreted along with the SSC and HMC fields, and there are constraints on the permitted values of the {HMC, SSC, PMC} fields. For more information see the [DBGBCR<n>_EL1.SSC](#) description.

This field resets to a value that is architecturally UNKNOWN.

E, bit [0]

Enable breakpoint [DBGBVR<n>_EL1](#). Possible values are:

0 Breakpoint disabled.

1 Breakpoint enabled.

This field resets to a value that is architecturally UNKNOWN.

Accessing the DBGBCR<n>_EL1:

DBGBCR<n>_EL1 can be accessed through the external debug interface:

Component	Offset
Debug	0x408 + 16n

H9.2.3 DBGBVR<n>_EL1, Debug Breakpoint Value Registers, n = 0 - 15

The DBGBVR<n>_EL1 characteristics are:

Purpose

Holds a virtual address, or a VMID and/or a context ID, for use in breakpoint matching. Forms breakpoint n together with control register [DBGBCR<n>_EL1](#).

Usage constraints

This register is accessible as follows:

Off	DLK	OSLK	EDAD	SLK	Default
Error	Error	Error	Error	RO	RW

Configurations

External register DBGBVR<n>_EL1 is architecturally mapped to AArch64 System register [DBGBVR<n>_EL1](#).

External register DBGBVR<n>_EL1[31:0] is architecturally mapped to AArch32 System register [DBGBVR<n>](#).

If the breakpoint is context-aware and EL2 is implemented then External register [DBGBVR<n>_EL1](#) [63:32] is architecturally mapped to AArch32 System register [DBGBXVR<n>](#). Otherwise there is no External register access to [DBGBVR<n>_EL1](#)[63:32] from AArch32 state.

DBGBVR<n>_EL1 is in the Core power domain. RW fields in this register reset to architecturally UNKNOWN values. These apply only on a Cold reset. The register is not affected by a Warm reset and is not affected by an External debug reset.

If breakpoint n is not implemented then this register is unallocated.

Attributes

How this register is interpreted depends on the value of [DBGBCR<n>_EL1.BT](#).

- When [DBGBCR<n>_EL1.BT](#) is 0b0x0x, this register holds a virtual address.
- When [DBGBCR<n>_EL1.BT](#) is 0b001x, 0b011x, or 0b110x, this register holds a Context ID.
- When [DBGBCR<n>_EL1.BT](#) is 0b100x, this register holds a VMID.
- When [DBGBCR<n>_EL1.BT](#) is 0b101x, this register holds a VMID and a Context ID.
- When [DBGBCR<n>_EL1.BT](#) is 0b111x, this register holds two Context ID values.

For other values of [DBGBCR<n>_EL1.BT](#), this register is RES0.

Field descriptions

The DBGBVR<n>_EL1 bit assignments are:

When [DBGBCR<n>_EL1.BT](#)==0b0x0x:

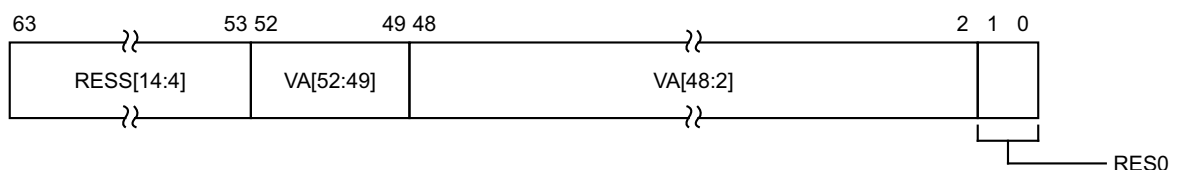

RESS[14:4], bits [63:53]

Reserved, Sign extended. Software must treat this field as RES0 if the most significant bit of VA is 0 or RES0, and as RES1 if the most significant bit of VA is 1.

Hardware always ignores the value of these bits and it is IMPLEMENTATION DEFINED whether:

- The bits are hardwired to a copy of the most significant bit of VA, meaning writes to these bits are ignored, and reads to the bits always return the hardwired value.
- The value in those bits can be written, and reads will return the last value written. The value held in those bits is ignored by hardware.

VA[52:49], bits [52:49]

In ARMv8.2

Extension to VA[48:2]. See VA[48:2] for more details.

This field resets to a value that is architecturally UNKNOWN.

In ARMv8.1 and ARMv8.0.

Extension to RESS[14:4]. See RESS[14:4] for more details.

VA[48:2], bits [48:2]

If the address is being matched in an AArch64 stage 1 translation regime:

- This field contains bits[48:2] of the address for comparison.
- When [ARMv8.2-LVA](#) is implemented, and 52-bit addresses and a 64KB translation granule are in use, VA[52:49] form the upper part of the address value. Otherwise, VA[52:49] are RESS.

If the address is being matched in an AArch32 stage 1 translation regime, the first 20 bits of this field are RES0, and the rest of the field contains bits[31:2] of the address for comparison.

This field resets to a value that is architecturally UNKNOWN.

Bits [1:0]

Reserved, RES0.

When $DBGBCR\langle n \rangle_EL1.BT == 0b001x$:

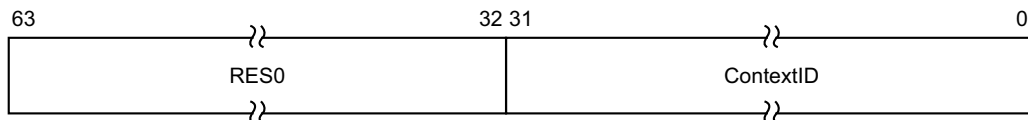

Bits [63:32]

Reserved, RES0.

ContextID, bits [31:0]

Context ID value for comparison.

The value is compared against [CONTEXTIDR](#) and [CONTEXTIDR_EL1](#) in the following cases:

- The PE is in Secure state.
- EL2 is using AArch32.
- When [ARMv8.1-VHE](#) is not implemented.
- When [ARMv8.1-VHE](#) is implemented, [HCR_EL2.E2H](#) is 0 and the PE is in Non-secure EL0, EL1 or EL2.
- When [ARMv8.1-VHE](#) is implemented, [HCR_EL2](#).{E2H, TGE} is {1, 0} and the PE is in Non-secure EL0 or EL1.

When [ARMv8.1-VHE](#) is implemented, [HCR_EL2.E2H](#) is 1, the value is compared against [CONTEXTIDR_EL2](#) in the following cases:

- The PE is executing at EL2.
- [HCR_EL2.TGE](#) is 1 and the PE is in Non-secure EL0.

This field resets to a value that is architecturally UNKNOWN.

When [DBGBCR<n>_EL1.BT==0b011x](#):

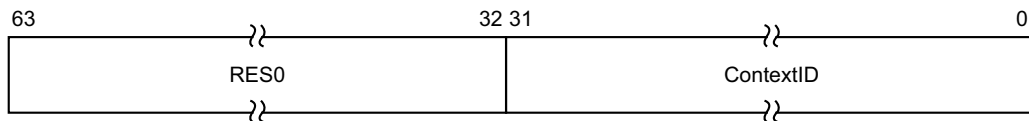

Bits [63:32]

Reserved, RES0.

ContextID, bits [31:0]

Context ID value for comparison against [CONTEXTIDR_EL1](#).

This field resets to a value that is architecturally UNKNOWN.

When [DBGBCR<n>_EL1.BT==0b100x](#) and [EL2](#) implemented:

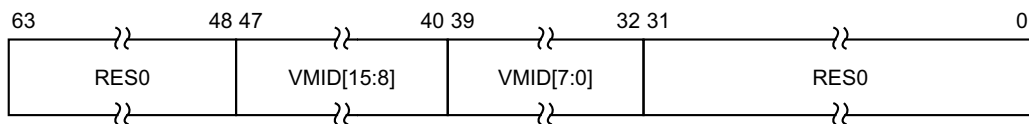

Bits [63:48]

Reserved, RES0.

VMID[15:8], bits [47:40]

In [ARMv8.2](#) and [ARMv8.1](#)

Extension to [VMID\[7:0\]](#). See [VMID\[7:0\]](#) for more details.

This field resets to a value that is architecturally UNKNOWN.

In [ARMv8.0](#).

Reserved, RES0.

VMID[7:0], bits [39:32]

VMID value for comparison.

The VMID is 8 bits in the following cases.

- [EL2](#) is using [AArch32](#).
- [ARMv8.1-VMID16](#) is not implemented.

When [ARMv8.1-VMID16](#) is implemented and [EL2](#) is using [AArch64](#), it is IMPLEMENTATION DEFINED whether the VMID is 8 bits or 16 bits.

[VMID\[15:8\]](#) is RES0 if any of the following applies:

- The implementation has an 8-bit VMID.
- [VTCR_EL2.VS](#) has a value of 0.
- [EL2](#) is using [AArch32](#).

This field resets to a value that is architecturally UNKNOWN.

Bits [31:0]

Reserved, RES0.

When $DBGBCR<n>_EL1.BT==0b101x$ and EL2 implemented:

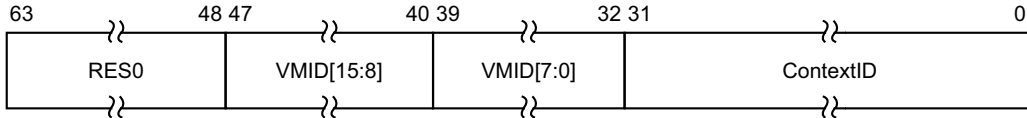

Bits [63:48]

Reserved, RES0.

VMID[15:8], bits [47:40]

In ARMv8.2 and ARMv8.1

Extension to VMID[7:0]. See VMID[7:0] for more details.

This field resets to a value that is architecturally UNKNOWN.

In ARMv8.0.

Reserved, RES0.

VMID[7:0], bits [39:32]

VMID value for comparison.

The VMID is 8 bits in the following cases.

- EL2 is using AArch32.
- [ARMv8.1-VMID16](#) is not implemented.

When [ARMv8.1-VMID16](#) is implemented and EL2 is using AArch64, it is IMPLEMENTATION DEFINED whether the VMID is 8 bits or 16 bits.

VMID[15:8] is RES0 if any of the following applies:

- The implementation has an 8-bit VMID.
- [VTCR_EL2.VS](#) has a value of 0.
- EL2 is using AArch32.

This field resets to a value that is architecturally UNKNOWN.

ContextID, bits [31:0]

Context ID value for comparison against [CONTEXTIDR_EL1](#).

This field resets to a value that is architecturally UNKNOWN.

When $DBGBCR<n>_EL1.BT==0b110x$ and EL2 implemented:

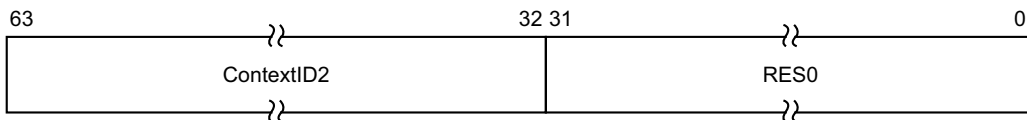

ContextID2, bits [63:32]

Context ID value for comparison against [CONTEXTIDR_EL2](#).

This field resets to a value that is architecturally UNKNOWN.

Bits [31:0]

Reserved, RES0.

When $DBGBCR\langle n \rangle_EL1.BT=0b111x$ and EL2 implemented:

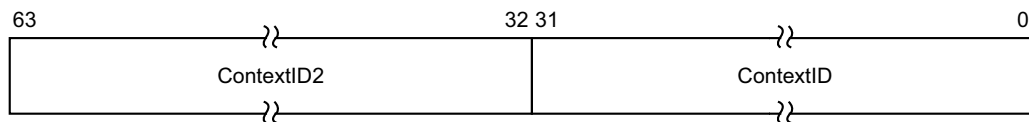

ContextID2, bits [63:32]

Context ID value for comparison against `CONTEXTIDR_EL2`.
This field resets to a value that is architecturally UNKNOWN.

ContextID, bits [31:0]

Context ID value for comparison against `CONTEXTIDR_EL1`.
This field resets to a value that is architecturally UNKNOWN.

Accessing the $DBGBVR\langle n \rangle_EL1$:

`DBGBVR<n>_EL1[31:0]` can be accessed through the external debug interface:

Component	Offset
Debug	$0x400 + 16n$

`DBGBVR<n>_EL1[63:32]` can be accessed through the external debug interface:

Component	Offset
Debug	$0x404 + 16n$

H9.2.4 DBGCLAIMCLR_EL1, Debug Claim Tag Clear register

The DBGCLAIMCLR_EL1 characteristics are:

Purpose

Used by software to read the values of the CLAIM tag bits, and to clear these bits to 0.
The architecture does not define any functionality for the CLAIM tag bits.

———— Note —————

CLAIM tags are typically used for communication between the debugger and target software.

Used in conjunction with the [DBGCLAIMSET_EL1](#) register.

Usage constraints

This register is accessible as follows:

Off	DLK	OSLK	SLK	Default
Error	Error	Error	RO	RW

Configurations

External register DBGCLAIMCLR_EL1 is architecturally mapped to AArch64 System register [DBGCLAIMCLR_EL1](#).

External register DBGCLAIMCLR_EL1 is architecturally mapped to AArch32 System register [DBGCLAIMCLR](#).

DBGCLAIMCLR_EL1 is in the Core power domain.

See the CLAIM field description for the effect of a Cold reset on the value returned by this register. This register is not affected by a Warm reset, and is not affected by an External debug reset.

An implementation must include 8 CLAIM tag bits.

Attributes

DBGCLAIMCLR_EL1 is a 32-bit register.

Field descriptions

The DBGCLAIMCLR_EL1 bit assignments are:

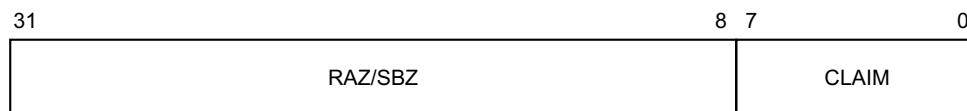

Bits [31:8]

Reserved, RAZ/SBZ. Software can rely on these bits reading as zero, and must use a should-be-zero policy on writes. Implementations must ignore writes.

CLAIM, bits [7:0]

Read or clear CLAIM tag bits. Reading this field returns the current value of the CLAIM tag bits.

Writing a 1 to one of these bits clears the corresponding CLAIM tag bit to 0. This is an indirect write to the CLAIM tag bits. A single write operation can clear multiple CLAIM tag bits to 0.

Writing 0 to one of these bits has no effect.

A cold reset clears the CLAIM tag bits to 0.

Accessing the DBGCLAIMCLR_EL1:

DBGCLAIMCLR_EL1 can be accessed through the external debug interface:

Component	Offset
Debug	0xFA4

H9.2.5 DBGCLAIMSET_EL1, Debug Claim Tag Set register

The DBGCLAIMSET_EL1 characteristics are:

Purpose

Used by software to set the CLAIM tag bits to 1.

The architecture does not define any functionality for the CLAIM tag bits.

———— Note —————

CLAIM tags are typically used for communication between the debugger and target software.

Used in conjunction with the [DBGCLAIMCLR_EL1](#) register.

Usage constraints

This register is accessible as follows:

Off	DLK	OSLK	SLK	Default
Error	Error	Error	RO	RW

Configurations

External register DBGCLAIMSET_EL1 is architecturally mapped to AArch64 System register [DBGCLAIMSET_EL1](#).

External register DBGCLAIMSET_EL1 is architecturally mapped to AArch32 System register [DBGCLAIMSET](#).

DBGCLAIMSET_EL1 is in the Core power domain.

An implementation must include 8 CLAIM tag bits.

Attributes

DBGCLAIMSET_EL1 is a 32-bit register.

Field descriptions

The DBGCLAIMSET_EL1 bit assignments are:

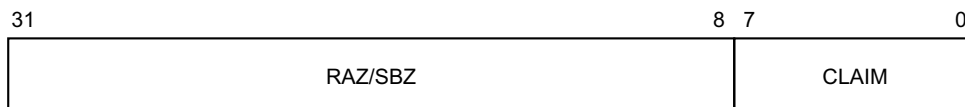

Bits [31:8]

Reserved, RAZ/SBZ. Software can rely on these bits reading as zero, and must use a should-be-zero policy on writes. Implementations must ignore writes.

CLAIM, bits [7:0]

Set CLAIM tag bits. RAO.

Writing a 1 to one of these bits sets the corresponding CLAIM tag bit to 1. This is an indirect write to the CLAIM tag bits. A single write operation can set multiple CLAIM tag bits to 1.

Writing 0 to one of these bits has no effect.

A cold reset clears the CLAIM tag bits to 0.

Accessing the DBGCLAIMSET_EL1:

DBGCLAIMSET_EL1 can be accessed through the external debug interface:

Component	Offset
Debug	0xFA0

H9.2.6 DBGDTRRX_EL0, Debug Data Transfer Register, Receive

The DBGDTRRX_EL0 characteristics are:

Purpose

Transfers data from an external debugger to the PE. For example, it is used by a debugger transferring commands and data to a debug target. It is a component of the Debug Communications Channel.

Usage constraints

This register is accessible as follows:

Off	DLK	OSLK	SLK	Default
Error	Error	Error	RO	RW

If `EDSCR.ITE == 0` when the PE exits Debug state on receiving a Restart request trigger event, the behavior of any operation issued by a DTR access in memory access mode that has not completed execution is `CONSTRAINED UNPREDICTABLE`, and must do one of the following:

- It must complete execution in Debug state before the PE executes the restart sequence.
- It must complete execution in Non-debug state before the PE executes the restart sequence.
- It must be abandoned. This means that the instruction does not execute. Any registers or memory accessed by the instruction are left in an `UNKNOWN` state.

Configurations

External register DBGDTRRX_EL0 is architecturally mapped to AArch64 System register [DBGDTRRX_EL0](#).

External register DBGDTRRX_EL0 is architecturally mapped to AArch32 System register [DBGDTRRXint](#).

DBGDTRRX_EL0 is in the Core power domain. RW fields in this register reset to architecturally `UNKNOWN` values. These apply only on a Cold reset. The register is not affected by a Warm reset and is not affected by an External debug reset.

Attributes

DBGDTRRX_EL0 is a 32-bit register.

Field descriptions

The DBGDTRRX_EL0 bit assignments are:

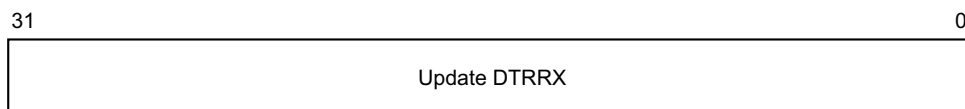

Bits [31:0]

Update DTRRX.

If `RXfull` is set to 0, then writes to this register update the value in `DTRRX` and set `RXfull` to 1.

Reads of this register return the last value written to `DTRRX` and do not change `RXfull`.

For the full behavior of the Debug Communications Channel, see [Chapter H4 The Debug Communication Channel and Instruction Transfer Register](#).

This field resets to a value that is architecturally `UNKNOWN`.

Accessing the DBGDTRRX_EL0:

DBGDTRRX_EL0 can be accessed through the external debug interface:

Component	Offset
Debug	0x080

H9.2.7 DBGDTRTX_EL0, Debug Data Transfer Register, Transmit

The DBGDTRTX_EL0 characteristics are:

Purpose

Transfers data from the PE to an external debugger. For example, it is used by a debug target to transfer data to the debugger. It is a component of the Debug Communication Channel.

Usage constraints

This register is accessible as follows:

Off	DLK	OSLK	SLK	Default
Error	Error	Error	RO	RW

If `EDSCR.ITE == 0` when the PE exits Debug state on receiving a Restart request trigger event, the behavior of any operation issued by a DTR access in memory access mode that has not completed execution is `CONSTRAINED UNPREDICTABLE`, and must do one of the following:

- It must complete execution in Debug state before the PE executes the restart sequence.
- It must complete execution in Non-debug state before the PE executes the restart sequence.
- It must be abandoned. This means that the instruction does not execute. Any registers or memory accessed by the instruction are left in an `UNKNOWN` state.

Configurations

External register DBGDTRTX_EL0 is architecturally mapped to AArch64 System register [DBGDTRTX_EL0](#).

External register DBGDTRTX_EL0 is architecturally mapped to AArch32 System register [DBGDTRTXint](#).

DBGDTRTX_EL0 is in the Core power domain. RW fields in this register reset to architecturally `UNKNOWN` values. These apply only on a Cold reset. The register is not affected by a Warm reset and is not affected by an External debug reset.

Attributes

DBGDTRTX_EL0 is a 32-bit register.

Field descriptions

The DBGDTRTX_EL0 bit assignments are:

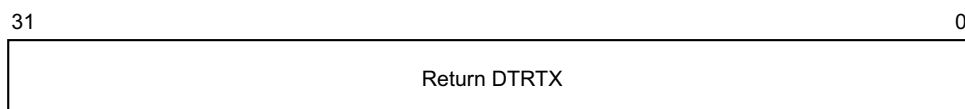

Bits [31:0]

Return DTRTX.

If `TXfull` is set to 1, then reads of this register return the value in `DTRTX` and clear `TXfull` to 0.

Writes of this register update the value in `DTRTX` and do not change `TXfull`.

For the full behavior of the Debug Communications Channel, see [Chapter H4 The Debug Communication Channel and Instruction Transfer Register](#).

This field resets to a value that is architecturally `UNKNOWN`.

Accessing the DBGDTRTX_EL0:

DBGDTRTX_EL0 can be accessed through the external debug interface:

Component	Offset
Debug	0x08C

H9.2.8 DBGWCR<n>_EL1, Debug Watchpoint Control Registers, n = 0 - 15

The DBGWCR<n>_EL1 characteristics are:

Purpose

Holds control information for a watchpoint. Forms watchpoint n together with value register [DBGWVR<n>_EL1](#).

Usage constraints

This register is accessible as follows:

Off	DLK	OSLK	EDAD	SLK	Default
Error	Error	Error	Error	RO	RW

Configurations

External register DBGWCR<n>_EL1 is architecturally mapped to AArch64 System register [DBGWCR<n>_EL1](#).

External register DBGWCR<n>_EL1 is architecturally mapped to AArch32 System register [DBGWCR<n>](#).

DBGWCR<n>_EL1 is in the Core power domain. RW fields in this register reset to architecturally UNKNOWN values. These apply only on a Cold reset. The register is not affected by a Warm reset and is not affected by an External debug reset.

If breakpoint n is not implemented then this register is unallocated.

Attributes

DBGWCR<n>_EL1 is a 32-bit register.

Field descriptions

The DBGWCR<n>_EL1 bit assignments are:

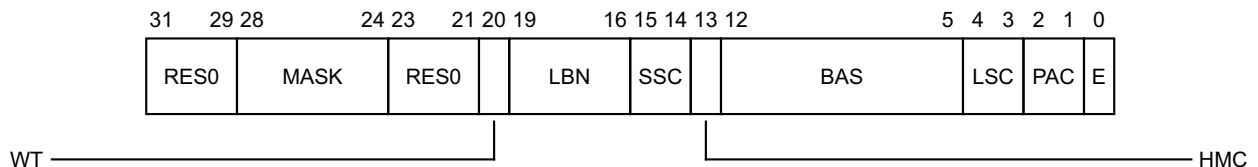

When the E field is zero, all the other fields in the register are ignored.

Bits [31:29]

Reserved, RES0.

MASK, bits [28:24]

Address mask. Only objects up to 2GB can be watched using a single mask.

- 00000 No mask.
- 00001 Reserved.
- 00010 Reserved.

If programmed with a reserved value, a watchpoint must behave as if either:

- MASK has been programmed with a defined value, which might be 0 (no mask), other than for a direct read of DBGWCRn_EL1.
- The watchpoint is disabled.

Software must not rely on this property because the behavior of reserved values might change in a future revision of the architecture.

Other values mask the corresponding number of address bits, from 0b00011 masking 3 address bits (0x0000007 mask for address) to 0b11111 masking 31 address bits (0x7FFFFFFF mask for address).

This field resets to a value that is architecturally UNKNOWN.

Bits [23:21]

Reserved, RES0.

WT, bit [20]

Watchpoint type. Possible values are:

- 0 Unlinked data address match.
- 1 Linked data address match.

This field resets to a value that is architecturally UNKNOWN.

LBN, bits [19:16]

Linked breakpoint number. For Linked data address watchpoints, this specifies the index of the Context-matching breakpoint linked to.

This field resets to a value that is architecturally UNKNOWN.

SSC, bits [15:14]

Security state control. Determines the Security states under which a Watchpoint debug event for watchpoint n is generated. This field must be interpreted along with the HMC and PAC fields.

This field resets to a value that is architecturally UNKNOWN.

HMC, bit [13]

Higher mode control. Determines the debug perspective for deciding when a Watchpoint debug event for watchpoint n is generated. This field must be interpreted along with the SSC and PAC fields.

This field resets to a value that is architecturally UNKNOWN.

BAS, bits [12:5]

Byte address select. Each bit of this field selects whether a byte from within the word or double-word addressed by `DBGWVR<n>_EL1` is being watched.

BAS	Description
xxxxxx1	Match byte at <code>DBGWVR<n>_EL1</code>
xxxxxx1x	Match byte at <code>DBGWVR<n>_EL1+1</code>
xxxxxx1xx	Match byte at <code>DBGWVR<n>_EL1+2</code>
xxxxxx1xxx	Match byte at <code>DBGWVR<n>_EL1+3</code>

In cases where `DBGWVR<n>_EL1` addresses a double-word:

BAS	Description, if <code>DBGWVR<n>_EL1[2] == 0</code>
xxx1xxxx	Match byte at <code>DBGWVR<n>_EL1+4</code>
xx1xxxxx	Match byte at <code>DBGWVR<n>_EL1+5</code>
x1xxxxxx	Match byte at <code>DBGWVR<n>_EL1+6</code>
1xxxxxxx	Match byte at <code>DBGWVR<n>_EL1+7</code>

If `DBGWVR<n>_EL1[2] == 1`, only `BAS[3:0]` is used. ARM deprecates setting `DBGWVR<n>_EL1[2] == 1`.

The valid values for `BAS` are non-zero binary number all of whose set bits are contiguous. All other values are reserved and must not be used by software. See *Reserved `DBGWCR<n>.BAS` values on page G2-4507*.

This field resets to a value that is architecturally UNKNOWN.

LSC, bits [4:3]

Load/store control. This field enables watchpoint matching on the type of access being made. Possible values of this field are:

- 01 Match instructions that load from a watchpointed address.
- 10 Match instructions that store to a watchpointed address.
- 11 Match instructions that load from or store to a watchpointed address.

All other values are reserved, but must behave as if the watchpoint is disabled. Software must not rely on this property as the behavior of reserved values might change in a future revision of the architecture.

This field resets to a value that is architecturally UNKNOWN.

PAC, bits [2:1]

Privilege of access control. Determines the Exception level or levels at which a Watchpoint debug event for watchpoint `n` is generated. This field must be interpreted along with the `SSC` and `HMC` fields.

This field resets to a value that is architecturally UNKNOWN.

E, bit [0]

Enable watchpoint `n`. Possible values are:

- 0 Watchpoint disabled.
- 1 Watchpoint enabled.

This field resets to a value that is architecturally UNKNOWN.

Accessing the `DBGWCR<n>_EL1`:

`DBGWCR<n>_EL1` can be accessed through the external debug interface:

Component	Offset
Debug	$0x808 + 16n$

H9.2.9 DBGWVR<n>_EL1, Debug Watchpoint Value Registers, n = 0 - 15

The DBGWVR<n>_EL1 characteristics are:

Purpose

Holds a data address value for use in watchpoint matching. Forms watchpoint n together with control register [DBGWCR<n>_EL1](#).

Usage constraints

This register is accessible as follows:

Off	DLK	OSLK	EDAD	SLK	Default
Error	Error	Error	Error	RO	RW

Configurations

External register DBGWVR<n>_EL1 is architecturally mapped to AArch64 System register [DBGWVR<n>_EL1](#).

External register DBGWVR<n>_EL1[31:0] is architecturally mapped to AArch32 System register [DBGWVR<n>](#).

DBGWVR<n>_EL1 is in the Core power domain. RW fields in this register reset to architecturally UNKNOWN values. These apply only on a Cold reset. The register is not affected by a Warm reset and is not affected by an External debug reset.

If breakpoint n is not implemented then this register is unallocated.

Attributes

DBGWVR<n>_EL1 is a 64-bit register.

Field descriptions

The DBGWVR<n>_EL1 bit assignments are:

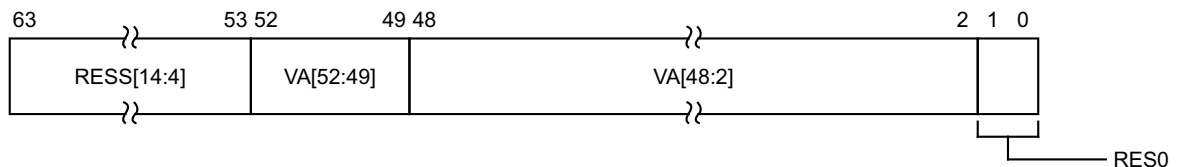

RESS[14:4], bits [63:53]

Reserved, Sign extended. Hardware and software must treat this field as RES0 if the most significant bit of VA is 0 or RES0, and as RES1 if the most significant bit of VA is 1.

Hardware always ignores the value of these bits and it is IMPLEMENTATION DEFINED whether:

- The bits are hardwired to a copy of the most significant bit of VA, meaning writes to these bits are ignored, and reads to the bits always return the hardwired value.
- The value in those bits can be written, and reads will return the last value written. The value held in those bits is ignored by hardware.

VA[52:49], bits [52:49]

In ARMv8.2

Extension to VA[48:2]. See VA[48:2] for more details.

This field resets to a value that is architecturally UNKNOWN.

In ARMv8.1 and ARMv8.0.

Extension to RESS[14:4]. See RESS[14:4] for more details.

VA[48:2], bits [48:2]

Bits[48:2] of the address value for comparison.

When [ARMv8.2-LVA](#) is implemented, and 52-bit addresses and a 64KB translation granule are in use, VA[52:49] forms the upper part of the address value. Otherwise, VA[52:49] are RESS.

ARM deprecates setting `DBGWVR<n>_EL1[2] == 1`.

This field resets to a value that is architecturally UNKNOWN.

Bits [1:0]

Reserved, RES0.

Accessing the `DBGWVR<n>_EL1`:

`DBGWVR<n>_EL1[31:0]` can be accessed through the external debug interface:

Component	Offset
Debug	$0x800 + 16n$

`DBGWVR<n>_EL1[63:32]` can be accessed through the external debug interface:

Component	Offset
Debug	$0x804 + 16n$

H9.2.10 EDAA32PFR, External Debug AArch32 Processor Feature Register

The EDAA32PFR characteristics are:

Purpose

Provides information about implemented PE features.

For general information about the interpretation of the ID registers see [Principles of the ID scheme for fields in ID registers on page D7-2195](#).

Usage constraints

This register is accessible as follows:

Off	DLK	Default
IMP DEF	IMP DEF	RO

Configurations

It is IMPLEMENTATION DEFINED whether EDAA32PFR is implemented in the Core power domain or in the Debug power domain.

EDAA32PFR is only accessible in an implementation that only supports execution in AA32 state. If AArch64 state is supported at any Exception level, EDAA32PFR is RES0.

Attributes

EDAA32PFR is a 64-bit register.

Field descriptions

The EDAA32PFR bit assignments are:

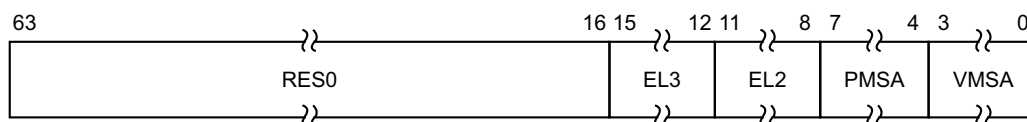

Bits [63:16]

Reserved, RES0.

EL3, bits [15:12]

AArch32 EL3 Exception level handling. Defined values are:

0000 EL3 is not implemented.

0001 EL3 can be executed in AArch32 state only.

When the value of [EDPFR.EL3](#) is non-zero, this field must be 0000.

All other values are reserved.

————— **Note** —————

[EDPFR](#).{EL1, EL0} indicate whether EL1 and EL0 can only be executed in AArch32 state.

EL2, bits [11:8]

AArch32 EL2 Exception level handling. Defined values are:

0000 EL2 is not implemented.

0001 EL2 can be executed in AArch32 state only.

When the value of [EDPFR.EL2](#) is non-zero, this field must be 0000.

All other values are reserved.

Note

EDPFR.{EL1, EL0} indicate whether EL1 and EL0 can only be executed in AArch32 state.

PMSA, bits [7:4]

Indicates support for a PMSA. Defined values are:

0000 PMSA not supported.

0100 Support for an ARMv8-R PMSAv8-32.

All other values are reserved. In ARMv8-A, the only permitted value is 0000.

VMSA, bits [3:0]

Indicates support for a VMSA. When the PMSA field is nonzero, determines support for a VMSA. When the PMSA field is 0000, VMSA is supported. Defined values are:

0000 VMSA not supported.

All other values are reserved. In ARMv8-A, the only permitted value is 0000.

Accessing the EDAA32PFR:

EDAA32PFR can be accessed through the external debug interface:

Component	Offset
Debug	0xD60

H9.2.11 EDACR, External Debug Auxiliary Control Register

The EDACR characteristics are:

Purpose

Allows implementations to support IMPLEMENTATION DEFINED controls.

Usage constraints

This register is accessible as follows:

Off	DLK	OSLK	SLK	Default
IMP DEF	IMP DEF	IMP DEF	RO	RW

Configurations

It is IMPLEMENTATION DEFINED whether EDACR is implemented in the Core power domain or in the Debug power domain. RW fields in this register reset to architecturally UNKNOWN values, and:

- The register is not affected by a Warm reset.
- If the register is implemented in the Core power domain the reset values apply on a Cold reset, and the register is not affected by an External debug reset.
- If the register is implemented in the Debug power domain the reset values apply on an External debug reset, and the register is not affected by a Cold reset.

Changing this register from its reset value causes IMPLEMENTATION DEFINED behavior, including possible deviation from the architecturally-defined behavior.

If the EDACR contains any control bits that must be preserved over power down, then these bits must be accessible by the external debug interface when `OSLSR_EL1.OSLK == 1` (OS lock is locked) and when the Core is powered off.

Attributes

EDACR is a 32-bit register.

Field descriptions

The EDACR bit assignments are:



IMPLEMENTATION DEFINED, bits [31:0]

IMPLEMENTATION DEFINED.

This field resets to a value that is architecturally UNKNOWN.

Accessing the EDACR:

EDACR can be accessed through the external debug interface:

Component	Offset
Debug	0x094

H9.2.12 EDCIDR0, External Debug Component Identification Register 0

The EDCIDR0 characteristics are:

Purpose

Provides information to identify an external debug component.

For more information see [About the Component Identification scheme on page K2-6149](#).

Usage constraints

This register is accessible as follows:

Default

RO

Configurations

EDCIDR0 is in the Debug power domain.

Implementation of this register is OPTIONAL.

This register is required for CoreSight compliance.

Attributes

EDCIDR0 is a 32-bit register.

Field descriptions

The EDCIDR0 bit assignments are:

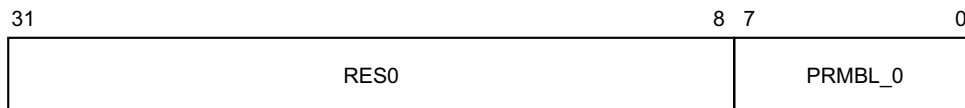

Bits [31:8]

Reserved, RES0.

PRMBL_0, bits [7:0]

Preamble. Must read as 0x0D.

Accessing the EDCIDR0:

EDCIDR0 can be accessed through the external debug interface:

Component	Offset
-----------	--------

Debug	0xFF0
-------	-------

H9.2.13 EDCIDR1, External Debug Component Identification Register 1

The EDCIDR1 characteristics are:

Purpose

Provides information to identify an external debug component.

For more information see [About the Component Identification scheme on page K2-6149](#).

Usage constraints

This register is accessible as follows:

Default

RO

Configurations

EDCIDR1 is in the Debug power domain.

Implementation of this register is OPTIONAL.

This register is required for CoreSight compliance.

Attributes

EDCIDR1 is a 32-bit register.

Field descriptions

The EDCIDR1 bit assignments are:

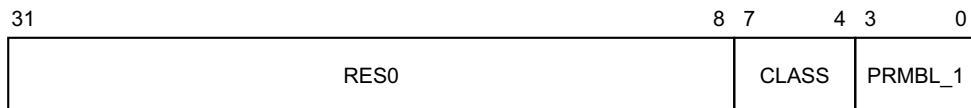

Bits [31:8]

Reserved, RES0.

CLASS, bits [7:4]

Component class. Reads as 0x9, debug component.

PRMBL_1, bits [3:0]

Preamble. RAZ.

Accessing the EDCIDR1:

EDCIDR1 can be accessed through the external debug interface:

Component	Offset
------------------	---------------

Debug	0xFF4
-------	-------

H9.2.14 EDCIDR2, External Debug Component Identification Register 2

The EDCIDR2 characteristics are:

Purpose

Provides information to identify an external debug component.

For more information see [About the Component Identification scheme on page K2-6149](#).

Usage constraints

This register is accessible as follows:

Default

RO

Configurations

EDCIDR2 is in the Debug power domain.

Implementation of this register is OPTIONAL.

This register is required for CoreSight compliance.

Attributes

EDCIDR2 is a 32-bit register.

Field descriptions

The EDCIDR2 bit assignments are:

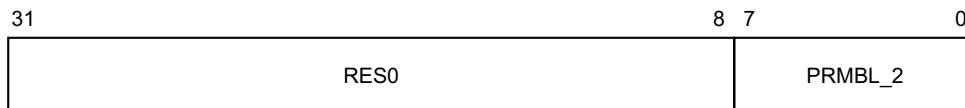

Bits [31:8]

Reserved, RES0.

PRMBL_2, bits [7:0]

Preamble. Must read as 0x05.

Accessing the EDCIDR2:

EDCIDR2 can be accessed through the external debug interface:

Component	Offset
-----------	--------

Debug	0xFF8
-------	-------

H9.2.15 EDCIDR3, External Debug Component Identification Register 3

The EDCIDR3 characteristics are:

Purpose

Provides information to identify an external debug component.

For more information see [About the Component Identification scheme on page K2-6149](#).

Usage constraints

This register is accessible as follows:

Default

RO

Configurations

EDCIDR3 is in the Debug power domain.

Implementation of this register is OPTIONAL.

This register is required for CoreSight compliance.

Attributes

EDCIDR3 is a 32-bit register.

Field descriptions

The EDCIDR3 bit assignments are:

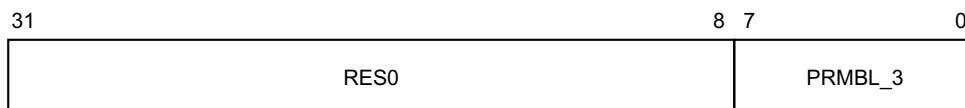

Bits [31:8]

Reserved, RES0.

PRMBL_3, bits [7:0]

Preamble. Must read as 0xB1.

Accessing the EDCIDR3:

EDCIDR3 can be accessed through the external debug interface:

Component	Offset
------------------	---------------

Debug	0xFFC
-------	-------

H9.2.16 EDCIDSR, External Debug Context ID Sample Register

The EDCIDSR characteristics are:

Purpose

Contains the sampled value of the Context ID, captured on reading [EDPCSR](#)[31:0].

Usage constraints

This register is accessible as follows:

Off	DLK	OSLK	Default
Error	Error	Error	RO

Configurations

EDCIDSR is in the Core power domain.

Fields in this register reset to architecturally UNKNOWN values. These apply only on a Cold reset. The register is not affected by a Warm reset and is not affected by an External debug reset.

Implemented only if the OPTIONAL PC Sample-based Profiling Extension is implemented but not with [ARMv8.2-PCSample](#). If [ARMv8.2-PCSample](#) is implemented, this register is RES0 and the architecture defines the functionality in [PMCID1SR](#) and [PMCID2SR](#).

Attributes

EDCIDSR is a 32-bit register.

Field descriptions

The EDCIDSR bit assignments are:

When ARMv8.2-PCSample is not implemented:

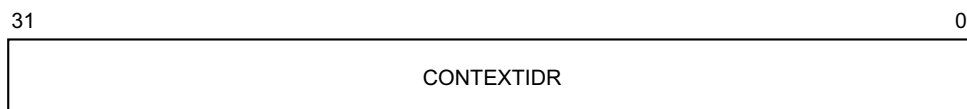

CONTEXTIDR, bits [31:0]

Context ID. The value of [CONTEXTIDR](#) that is associated with the most recent [EDPCSR](#) sample.

- If EL1 is using AArch64, then the Context ID is held in [CONTEXTIDR_EL1](#).
- If EL1 is using AArch32, then the Context ID is held in [CONTEXTIDR](#).
- If EL3 is implemented and is using AArch32, then [CONTEXTIDR](#) is a banked register, and EDCIDSR samples the current banked copy of [CONTEXTIDR](#) for the Security state that is associated with the most recent [EDPCSR](#) sample.

Because the value written to EDCIDSR is an indirect read of [CONTEXTIDR](#), therefore it is CONSTRAINED UNPREDICTABLE whether EDCIDSR is set to the original or new value if a read of [EDPCSR](#)_{lo} samples:

- An instruction that writes to [CONTEXTIDR_EL1](#).
- The next Context synchronization event.
- Any instruction executed between these two instructions.

When this register has an architecturally-defined reset value, this field resets to a value that is architecturally UNKNOWN.

When ARMv8.2-PCSample is implemented:

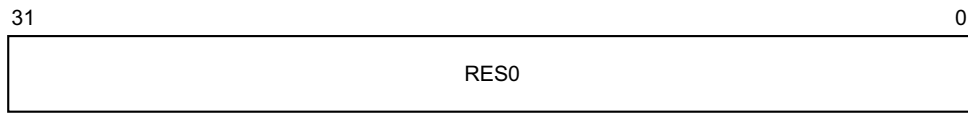

Bits [31:0]

Reserved, RES0.

Accessing the EDCIDSR:

EDCIDSR can be accessed through the external debug interface:

Component	Offset
Debug	0x0A4

H9.2.17 EDDEVAFF0, External Debug Device Affinity register 0

The EDDEVAFF0 characteristics are:

Purpose

Copy of the low half of the PE [MPIDR_EL1](#) register that allows a debugger to determine which PE in a multiprocessor system the external debug component relates to.

Usage constraints

This register is accessible as follows:

Default
RO

Configurations

EDDEVAFF0 is in the Debug power domain.

Implementation of this register is OPTIONAL.

Attributes

EDDEVAFF0 is a 32-bit register.

Field descriptions

The EDDEVAFF0 bit assignments are:

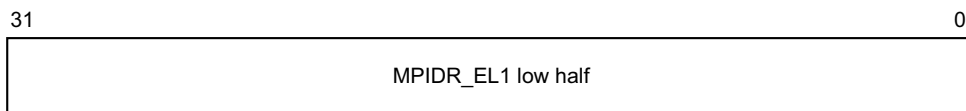

Bits [31:0]

[MPIDR_EL1](#) low half. Read-only copy of the low half of [MPIDR_EL1](#), as seen from the highest implemented Exception level.

Accessing the EDDEVAFF0:

EDDEVAFF0 can be accessed through the external debug interface:

Component	Offset
Debug	0xFA8

H9.2.18 EDDEVAFF1, External Debug Device Affinity register 1

The EDDEVAFF1 characteristics are:

Purpose

Copy of the high half of the PE [MPIDR_EL1](#) register that allows a debugger to determine which PE in a multiprocessor system the external debug component relates to.

Usage constraints

This register is accessible as follows:

Default

RO

Configurations

EDDEVAFF1 is in the Debug power domain.

Implementation of this register is OPTIONAL.

Attributes

EDDEVAFF1 is a 32-bit register.

Field descriptions

The EDDEVAFF1 bit assignments are:

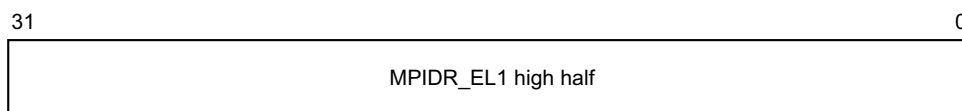

Bits [31:0]

[MPIDR_EL1](#) high half. Read-only copy of the high half of [MPIDR_EL1](#), as seen from the highest implemented Exception level.

Accessing the EDDEVAFF1:

EDDEVAFF1 can be accessed through the external debug interface:

Component	Offset
-----------	--------

Debug	0xFAC
-------	-------

H9.2.19 EDDEVARCH, External Debug Device Architecture register

The EDDEVARCH characteristics are:

Purpose

Identifies the programmers' model architecture of the external debug component.

Usage constraints

This register is accessible as follows:

Default

RO

Configurations

EDDEVARCH is in the Debug power domain.

Implementation of this register is OPTIONAL.

Attributes

EDDEVARCH is a 32-bit register.

Field descriptions

The EDDEVARCH bit assignments are:

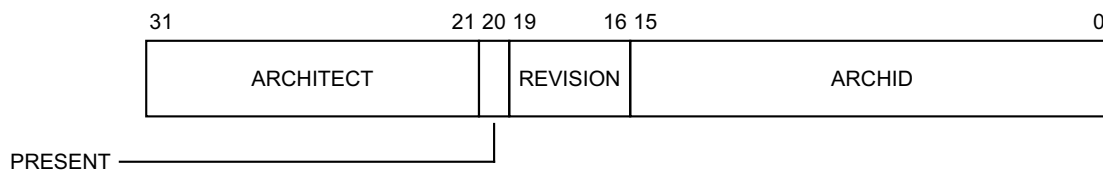

ARCHITECT, bits [31:21]

Defines the architecture of the component. For debug, this is ARM Limited.

Bits [31:28] are the JEP106 continuation code, 0x4.

Bits [27:21] are the JEP106 ID code, 0x3B.

PRESENT, bit [20]

When set to 1, indicates that the DEVARCH is present.

This field is 1 in ARMv8.

REVISION, bits [19:16]

Defines the architecture revision. For architectures defined by ARM this is the minor revision.

For debug, the revision defined by ARMv8 is 0x0.

All other values are reserved.

ARCHID, bits [15:0]

Defines this part to be an ARMv8 debug component. For architectures defined by ARM this is further subdivided.

For debug:

- Bits [15:12] are the architecture version.
 - In an ARMv8.0 implementation, the only permitted value is 0x6.

- In an ARMv8.1 implementation that includes [ARMv8.1-VHE](#), the only permitted value is 0x7.
- In an ARMv8.1 implementation that does not include [ARMv8.1-VHE](#), the permitted values are 0x6 and 0x7.
- In an ARMv8.2 implementation, the only permitted value is 0x8.
- Bits [11:0] are the architecture part number, 0xA15.

This corresponds to the ARMv8 debug architecture version.

Accessing the EDDEVARCH:

EDDEVARCH can be accessed through the external debug interface:

Component	Offset
Debug	0xFBC

H9.2.20 EDDEVID, External Debug Device ID register 0

The EDDEVID characteristics are:

Purpose

Provides extra information for external debuggers about features of the debug implementation.

Usage constraints

This register is accessible as follows:

Default

RO

Configurations

EDDEVID is in the Debug power domain.

Attributes

EDDEVID is a 32-bit register.

Field descriptions

The EDDEVID bit assignments are:

31	28 27	24 23	4 3	0
RES0	AuxRegs	RES0	PCSample	

Bits [31:28]

Reserved, RES0.

AuxRegs, bits [27:24]

Indicates support for Auxiliary registers. Permitted values for this field are:

0000 None supported.

0001 Support for External Debug Auxiliary Control Register, [EDACR](#).

All other values are reserved.

Bits [23:4]

Reserved, RES0.

PCSample, bits [3:0]

Indicates the level of PC Sample-based Profiling support using external debug registers. Permitted values of this field are:

0000 Architecture-defined form of PC Sample-based Profiling not implemented using external debug registers.

0010 Only [EDPCSR](#) and [EDCIDSR](#) are implemented. This option is only permitted if EL3 and EL2 are not implemented.

0011 [EDPCSR](#), [EDCIDSR](#), and [EDVIDSR](#) are implemented.

All other values are reserved.

From ARMv8.2 onwards, the only permitted value is 0b0000. The architecture defines the functionality in a different set of registers, see [PMDEVID](#).

Accessing the EDDEVID:

EDDEVID can be accessed through the external debug interface:

Component	Offset
Debug	0xFC8

H9.2.21 EDDEVID1, External Debug Device ID register 1

The EDDEVID1 characteristics are:

Purpose

Provides extra information for external debuggers about features of the debug implementation.

Usage constraints

This register is accessible as follows:

Default

RO

Configurations

EDDEVID1 is in the Debug power domain.

Attributes

EDDEVID1 is a 32-bit register.

Field descriptions

The EDDEVID1 bit assignments are:

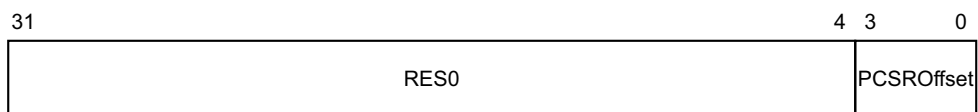

Bits [31:4]

Reserved, RES0.

PCSROffset, bits [3:0]

This field indicates the offset applied to PC samples returned by reads of [EDPCSR](#). Permitted values of this field in ARMv8 are:

0000 [EDPCSR](#) not implemented.

0010 [EDPCSR](#) implemented, and samples have no offset applied and do not sample the instruction set state in AArch32 state.

From ARMv8.2 onwards, the only permitted value is 0b0000. The architecture defines the functionality in a different set of registers, see [PMDEVID](#).

Accessing the EDDEVID1:

EDDEVID1 can be accessed through the external debug interface:

Component	Offset
Debug	0xFC4

H9.2.22 EDDEVID2, External Debug Device ID register 2

The EDDEVID2 characteristics are:

Purpose

Reserved for future descriptions of features of the debug implementation.

Usage constraints

This register is accessible as follows:

Default

RO

Configurations

EDDEVID2 is in the Debug power domain.

Attributes

EDDEVID2 is a 32-bit register.

Field descriptions

The EDDEVID2 bit assignments are:

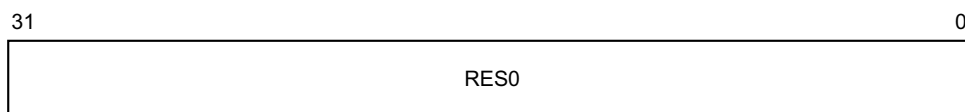

Bits [31:0]

Reserved, RES0.

Accessing the EDDEVID2:

EDDEVID2 can be accessed through the external debug interface:

Component	Offset
Debug	0xFC0

H9.2.23 EDDEVTYPE, External Debug Device Type register

The EDDEVTYPE characteristics are:

Purpose

Indicates to a debugger that this component is part of a PE's debug logic.

Usage constraints

This register is accessible as follows:

Default

RO

Configurations

EDDEVTYPE is in the Debug power domain.

Implementation of this register is OPTIONAL.

Attributes

EDDEVTYPE is a 32-bit register.

Field descriptions

The EDDEVTYPE bit assignments are:

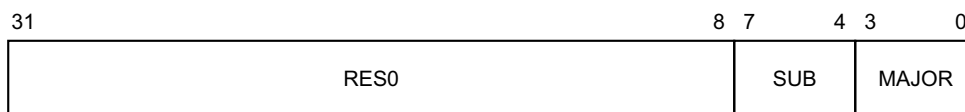

Bits [31:8]

Reserved, RES0.

SUB, bits [7:4]

Subtype. Must read as 0x1 to indicate this is a component within a PE.

MAJOR, bits [3:0]

Major type. Must read as 0x5 to indicate this is a debug logic component.

Accessing the EDDEVTYPE:

EDDEVTYPE can be accessed through the external debug interface:

Component	Offset
Debug	0xFCC

H9.2.24 EDDFR, External Debug Feature Register

The EDDFR characteristics are:

Purpose

Provides top level information about the debug system.

Note

Debuggers must use [EDDEVARCH](#) to determine the Debug architecture version.

For general information about the interpretation of the ID registers see [Principles of the ID scheme for fields in ID registers on page D7-2195](#).

Usage constraints

This register is accessible as follows:

Off	DLK	Default
IMP DEF	IMP DEF	RO

Configurations

It is IMPLEMENTATION DEFINED whether EDDFR is implemented in the Core power domain or in the Debug power domain.

Attributes

EDDFR is a 64-bit register.

Field descriptions

The EDDFR bit assignments are:

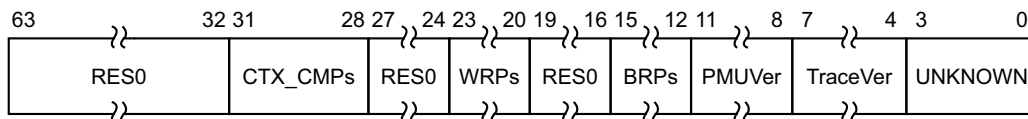

Bits [63:32]

Reserved, RES0.

CTX_CMPs, bits [31:28]

Number of breakpoints that are context-aware, minus 1. These are the highest numbered breakpoints.

In an ARMv8-A implementation that supports AArch64 state in at least one Exception level, this field returns the value of [ID_AA64DFR0_EL1.CTX_CMPs](#).

Bits [27:24]

Reserved, RES0.

WRPs, bits [23:20]

Number of watchpoints, minus 1. The value of 0b0000 is reserved.

In an ARMv8-A implementation that supports AArch64 state in at least one Exception level, this field returns the value of [ID_AA64DFR0_EL1.WRPs](#).

Bits [19:16]

Reserved, RES0.

BRPs, bits [15:12]

Number of breakpoints, minus 1. The value of 0b0000 is reserved.

In an ARMv8-A implementation that supports AArch64 state in at least one Exception level, this field returns the value of [ID_AA64DFR0_EL1](#).BRPs.

PMUVer, bits [11:8]

Performance Monitors Extension version. Indicates whether System register interface to Performance Monitors extension is implemented. Defined values are:

- 0000 Performance Monitors Extension System registers not implemented.
- 0001 Performance Monitors Extension System registers implemented, PMUv3.
- 0100 Performance Monitors Extension System registers implemented, PMUv3, with a 16-bit evtCount field, and if EL2 is implemented, the addition of the MDCR_EL2.HPMD bit.
- 1111 IMPLEMENTATION DEFINED form of performance monitors supported, PMUv3 not supported.

All other values are reserved.

In ARMv8.0 the permitted values are 0b0000, 0b0001 and 0b1111.

From ARMv8.1 the permitted values are 0b0000, 0b0100 and 0b1111.

In an ARMv8-A implementation that supports AArch64 state in at least one Exception level, this field returns the value of [ID_AA64DFR0_EL1](#).PMUVer.

TraceVer, bits [7:4]

Trace support. Indicates whether System register interface to a trace macrocell is implemented. Defined values are:

- 0000 Trace macrocell System registers not implemented.
- 0001 Trace macrocell System registers implemented.

All other values are reserved.

A value of 0b0000 only indicates that no System register interface to a trace macrocell is implemented. A trace macrocell might nevertheless be implemented without a System register interface.

In an ARMv8-A implementation that supports AArch64 state in at least one Exception level, this field returns the value of [ID_AA64DFR0_EL1](#).TraceVer.

UNKNOWN, bits [3:0]

Reserved, UNKNOWN.

Accessing the EDDFR:

EDDFR[31:0] can be accessed through the external debug interface:

Component	Offset
Debug	0xD28

EDDFR[63:32] can be accessed through the external debug interface:

Component	Offset
Debug	0xD2C

H9.2.25 EDECCR, External Debug Exception Catch Control Register

The EDECCR characteristics are:

Purpose

Controls Exception Catch debug events.

Usage constraints

This register is accessible as follows:

Off	DLK	OSLK	SLK	Default
Error	Error	Error	RO	RW

Configurations

External register EDECCR is architecturally mapped to AArch64 System register [OSECCR_EL1](#).

External register EDECCR is architecturally mapped to AArch32 System register [DBGOSECCR](#).

EDECCR is in the Core power domain. Some or all RW fields of this register have defined reset values. These apply only on a Cold reset. The register is not affected by a Warm reset and is not affected by an External debug reset.

Attributes

EDECCR is a 32-bit register.

Field descriptions

The EDECCR bit assignments are:

31	16 15	12 11	8 7	4 3	0
RES0		NSR<n>	SR<n>	NSE<n>	SE<n>

Bits [31:16]

Reserved, RES0.

NSR<n>, bits [15:12]

In ARMv8.2

Controls Non-secure exception catch on exception return to EL<n> in conjunction with NSE<n>. If EL3 and EL2 are not implemented and the PE behaves as if [SCR_EL3.NS](#) is set to 0, this field is reserved, RES0. Otherwise, possible values for this field are:

- 0 If the corresponding NSE<n> bit is 0, then Exception Catch debug events are disabled for Non-secure Exception level <n>.
 - If the corresponding NSE<n> bit is 1, then Exception Catch debug events are enabled for exception entry, reset entry and exception return to Non-secure Exception level <n>.
- 1 If the corresponding NSE<n> bit is 0, then Exception Catch debug events are enabled for exception returns to Non-secure Exception level <n>.
 - If the corresponding NSE<n> bit is 1, then Exception Catch debug events are enabled for exception entry and reset entry to Non-secure Exception level <n>.

Note

It is IMPLEMENTATION DEFINED whether a reset entry to an Exception level is permitted to generate an Exception Catch debug event.

NSR[3] is RES0.

If EL2 is not implemented, NSR[2] is RES0.

A value that enables an Exception Catch debug event for an Exception level that is not implemented is reserved. If this field is programmed with a reserved value then:

- The PE behaves as if it is programmed with a defined value, other than for a read of EDECCR.
- The value returned for NSR<n> by a read of EDECCR is UNKNOWN.

When this register has an architecturally-defined reset value, this field resets to 0.

In ARMv8.1 and ARMv8.0.

Reserved, RES0.

SR<n>, bits [11:8]

In ARMv8.2

Controls Secure exception catch on exception return to EL<n> in conjunction with SE<n>. If EL3 is not implemented and the PE behaves as if SCR_EL3.NS is set to 1, this field is reserved, RES0. Otherwise, possible values for this field are:

- 0
- If the corresponding SE<n> bit is 0, then Exception Catch debug events are disabled for Secure Exception level <n>.
- If the corresponding SE<n> bit is 1, then Exception Catch debug events are enabled for exception entry, reset entry and exception return to Secure Exception level <n>.
- 1
- If the corresponding SE<n> bit is 0, then Exception Catch debug events are enabled for exception returns to Secure Exception level <n>.
- If the corresponding SE<n> bit is 1, then Exception Catch debug events are enabled for exception entry and reset entry to Secure Exception level <n>.

Note

It is IMPLEMENTATION DEFINED whether a reset entry to an Exception level is permitted to generate an Exception Catch debug event.

SR[2] is RES0.

If EL3 is not implemented, SR[3] is RES0.

A value that enables an Exception Catch debug event for an Exception level that is not implemented is reserved. If this field is programmed with a reserved value then:

- The PE behaves as if it is programmed with a defined value, other than for a read of EDECCR.
- The value returned for SR<n> by a read of EDECCR is UNKNOWN.

If ExternalSecureInvasiveDebugEnabled() == FALSE, then this field is ignored.

When this register has an architecturally-defined reset value, this field resets to 0.

In ARMv8.1 and ARMv8.0.

Reserved, RES0.

NSE<n>, bits [7:4]

In ARMv8.2

Coarse-grained Non-secure exception catch for EL<n>. This controls whether Exception Catch debug events are enabled for Non-secure EL<n>. This also controls:

- The behavior of exception catch on exception entry to EL<n>.
- The behavior of exception catch on exception return to EL<n> in conjunction with NSR<n>.

If EL3 and EL2 are not implemented and the PE behaves as if SCR_EL3.NS is set to 0, this field is reserved, RES0. Otherwise, possible values for this field are:

- 0
- Exception Catch debug events are disabled for Non-secure Exception level <n>.

1 Exception Catch debug events are enabled for Non-secure Exception level <n>. NSE[3,0] are RES0.

A value that enables an Exception Catch debug event for an Exception level that is not implemented is reserved. If this field is programmed with a reserved value then:

- The PE behaves as if it is programmed with a defined value, other than for a read of EDECCR.
- The value returned for NSE<n> by a read of EDECCR is UNKNOWN.

When this register has an architecturally-defined reset value, this field resets to 0.

In ARMv8.1 and ARMv8.0.

Coarse-grained Non-secure exception catch. If EL3 and EL2 are not implemented and the PE behaves as if SCR_EL3.NS is set to 0, this field is reserved, RES0. Otherwise, possible values for this field are:

0000 Exception Catch debug event disabled for Non-secure Exception levels.
0010 Exception Catch debug event enabled for Non-secure EL1.
0100 Exception Catch debug event enabled for Non-secure EL2.
0110 Exception Catch debug event enabled for Non-secure EL1 and EL2.

All other values are reserved. A value that enables an Exception Catch debug event for an Exception level that is not implemented is reserved. If this field is programmed with a reserved value then:

- The PE behaves as if it is programmed with a defined value, other than for a read of EDECCR.
- The value returned for NSE by a read of EDECCR is UNKNOWN.

SE<n>, bits [3:0]

In ARMv8.2

Coarse-grained Secure exception catch for EL<n>. This field controls whether Exception Catch debug events are enabled for Secure EL<n>.

- The behavior of exception catch on exception entry to EL<n>.
- The behavior of exception catch on exception return to EL<n> in conjunction with SR<n>.

If EL3 is not implemented and the PE behaves as if SCR_EL3.NS is set to 1, this field is reserved, RES0. Otherwise, possible values for this field are:

0 Exception Catch debug events are disabled for Secure Exception level <n>.
1 Exception Catch debug events are enabled for Secure Exception level <n>.

SE[2,0] are RES0.

If EL3 is not implemented, SE[3] is RES0.

A value that enables an Exception Catch debug event for an Exception level that is not implemented is reserved. If this field is programmed with a reserved value then:

- The PE behaves as if it is programmed with a defined value, other than for a read of EDECCR.
- The value returned for SE<n> by a read of EDECCR is UNKNOWN.

If ExternalSecureInvasiveDebugEnabled() == FALSE, then this field is ignored.

When this register has an architecturally-defined reset value, this field resets to 0.

In ARMv8.1 and ARMv8.0.

Coarse-grained Secure exception catch. If EL3 is not implemented and the PE behaves as if SCR_EL3.NS is set to 1, this field is reserved, RES0. Otherwise, possible values for this field are:

0000 Exception Catch debug event disabled for Secure Exception levels.
0010 Exception Catch debug event enabled for Secure EL1.
1000 Exception Catch debug event enabled for Secure EL3.

1010 Exception Catch debug event enabled for Secure EL1 and EL3.

All other values are reserved. A value that enables an Exception Catch debug event for an Exception level that is not implemented is reserved. If this field is programmed with a reserved value then:

- The PE behaves as if it is programmed with a defined value, other than for a read of EDECCR.
- The value returned for SE by a read of EDECCR is UNKNOWN.

The NSR<n>, SR<n>, NSE<n>, and SE<n> fields combine to control Exception Catch as follows:

(N)SR<n>	(N)SE<n>	Behavior on exception return to ELn	Behavior on exception taken to ELn
0	0	No action	No action
0	1	Halt if allowed	Halt if allowed
1	0	Halt if allowed	No action
1	1	No action	Halt if allowed

Accessing the EDECCR:

EDECCR can be accessed through the external debug interface:

Component	Offset
Debug	0x098

H9.2.26 EDECR, External Debug Execution Control Register

The EDECR characteristics are:

Purpose

Controls Halting debug events.

Usage constraints

This register is accessible as follows:

SLK	Default
RO	RW

Configurations

EDECR is in the Debug power domain. Some or all RW fields of this register have defined reset values. These apply only on an External debug reset. The register is not affected by a Warm reset and is not affected by a Cold reset.

Attributes

EDECR is a 32-bit register.

Field descriptions

The EDECR bit assignments are:

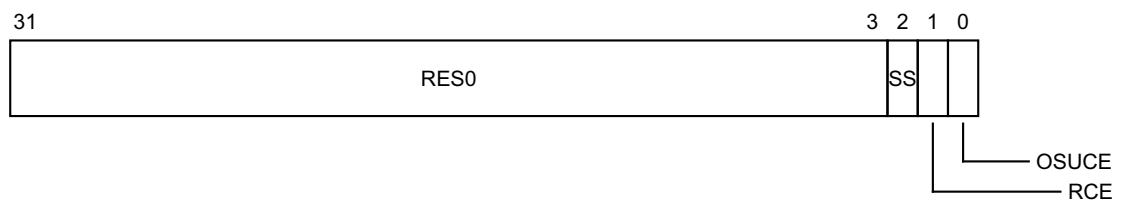

Bits [31:3]

Reserved, RES0.

SS, bit [2]

Halting step enable. Possible values of this field are:

0 Halting step debug event disabled.

1 Halting step debug event enabled.

If the value of EDECR.SS is changed when the PE is in Non-debug state, behavior is CONSTRAINED UNPREDICTABLE as described in [Changing the value of EDECR.SS when not in Debug state on page H3-5483](#).

When this register has an architecturally-defined reset value, this field resets to 0.

RCE, bit [1]

Reset Catch enable. Possible values of this field are:

0 Reset Catch debug event disabled.

1 Reset Catch debug event enabled.

When this register has an architecturally-defined reset value, this field resets to 0.

OSUCE, bit [0]

OS Unlock Catch enabled. Possible values of this field are:

0 OS Unlock Catch debug event disabled.

1 OS Unlock Catch debug event enabled.

When this register has an architecturally-defined reset value, this field resets to 0.

Accessing the EDECR:

EDECR can be accessed through the external debug interface:

Component	Offset
Debug	0x024

H9.2.27 EDESR, External Debug Event Status Register

The EDESR characteristics are:

Purpose

Indicates the status of internally pending Halting debug events.

Usage constraints

This register is accessible as follows:

Off	DLK	SLK	Default
Error	Error	RO	RW

If a request to clear a pending Halting debug event is received at or about the time when halting becomes allowed, it is **CONSTRAINED UNPREDICTABLE** whether the event is taken.

If Core power is removed while a Halting debug event is pending, it is lost. However, it might become pending again when the Core is powered back on and Cold reset.

Configurations

EDESR is in the Core power domain. Some or all RW fields of this register have defined reset values. These apply on a Warm or Cold reset. The register is not affected by an External debug reset.

Attributes

EDESR is a 32-bit register.

Field descriptions

The EDESR bit assignments are:

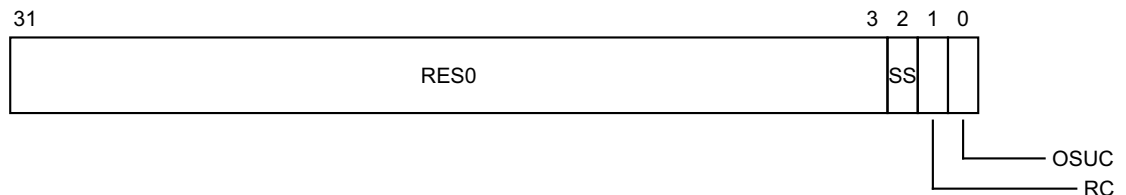

Bits [31:3]

Reserved, RES0.

SS, bit [2]

Halting step debug event pending. Possible values of this field are:

- 0 Reading this means that a Halting step debug event is not pending. Writing this means no action.
- 1 Reading this means that a Halting step debug event is pending. Writing this clears the pending Halting step debug event.

When this register has an architecturally-defined reset value, this field resets to the value of [EDECR.SS](#).

RC, bit [1]

Reset Catch debug event pending. Possible values of this field are:

- 0 Reading this means that a Reset Catch debug event is not pending. Writing this means no action.

- 1 Reading this means that a Reset Catch debug event is pending. Writing this clears the pending Reset Catch debug event.

When this register has an architecturally-defined reset value, this field resets to the value of [EDEC.RCE](#).

OSUC, bit [0]

OS Unlock Catch debug event pending. Possible values of this field are:

- 0 Reading this means that an OS Unlock Catch debug event is not pending. Writing this means no action.
- 1 Reading this means that an OS Unlock Catch debug event is pending. Writing this clears the pending OS Unlock Catch debug event.

When this register has an architecturally-defined reset value, this field resets to 0.

Accessing the EDESR:

EDESR can be accessed through the external debug interface:

Component	Offset
Debug	0x020

H9.2.28 EDITCTRL, External Debug Integration mode Control register

The EDITCTRL characteristics are:

Purpose

Enables the external debug to switch from its default mode into integration mode, where test software can control directly the inputs and outputs of the PE, for integration testing or topology detection.

Usage constraints

This register is accessible as follows:

Off	DLK	OSLK	Default
IMP DEF	IMP DEF	IMP DEF	RW

Configurations

It is IMPLEMENTATION DEFINED whether EDITCTRL is implemented in the Core power domain or in the Debug power domain. Some or all RW fields of this register have defined reset values, and:

- The register is not affected by a Warm reset.
- If the register is implemented in the Core power domain the reset values apply on a Cold reset, and the register is not affected by an External debug reset.
- If the register is implemented in the Debug power domain the reset values apply on an External debug reset, and the register is not affected by a Cold reset.

Implementation of this register is OPTIONAL.

Attributes

EDITCTRL is a 32-bit register.

Field descriptions

The EDITCTRL bit assignments are:

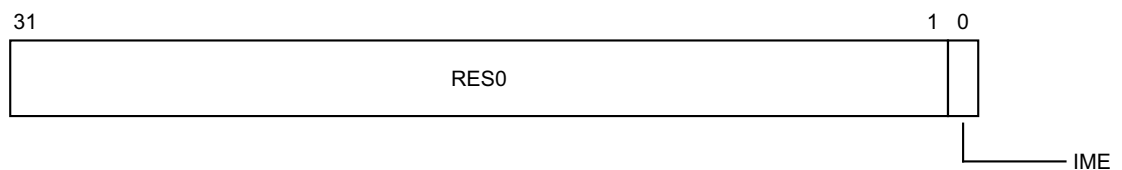

Bits [31:1]

Reserved, RES0.

IME, bit [0]

Integration mode enable. When IME == 1, the device reverts to an integration mode to enable integration testing or topology detection. The integration mode behavior is IMPLEMENTATION DEFINED.

0 Normal operation.

1 Integration mode enabled.

When this register has an architecturally-defined reset value, this field resets to 0.

Accessing the EDITCTRL:

EDITCTRL can be accessed through the external debug interface:

Component	Offset
Debug	0xF00

H9.2.29 EDITR, External Debug Instruction Transfer Register

The EDITR characteristics are:

Purpose

Used in Debug state for passing instructions to the PE for execution.

Usage constraints

This register is accessible as follows:

Off	DLK	OSLK	SLK	Default
Error	Error	Error	WI	WO

If `EDSCR.ITE == 0` when the PE exits Debug state on receiving a Restart request trigger event, the behavior of any instruction issued through the ITR in Normal access mode that has not completed execution is **CONSTRAINED UNPREDICTABLE**, and must do one of the following:

- It must complete execution in Debug state before the PE executes the restart sequence.
- It must complete execution in Non-debug state before the PE executes the restart sequence.
- It must be abandoned. This means that the instruction does not execute. Any registers or memory accessed by the instruction are left in an UNKNOWN state.

EDITR ignores writes if the PE is in Non-debug state.

Configurations

EDITR is in the Core power domain.

Attributes

EDITR is a 32-bit register.

Field descriptions

The EDITR bit assignments are:

When in AArch32 state:

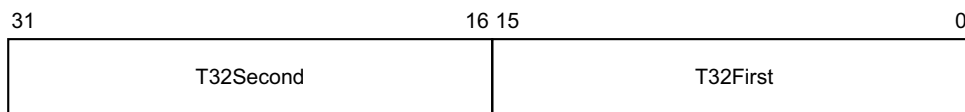

T32Second, bits [31:16]

Second halfword of the T32 instruction to be executed on the PE. When EDITR contains a 16-bit T32 instruction, this field is ignored. For more information see [Behavior in Debug state on page H2-5445](#)

T32First, bits [15:0]

First halfword of the T32 instruction to be executed on the PE.

When in AArch64 state:

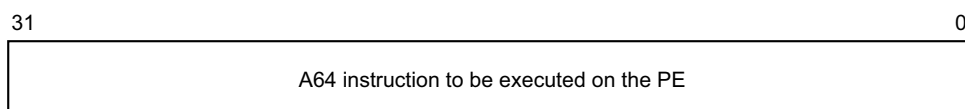

Bits [31:0]

A64 instruction to be executed on the PE.

Accessing the EDITR:

EDITR can be accessed through the external debug interface:

Component	Offset
Debug	0x084

H9.2.30 EDLAR, External Debug Lock Access Register

The EDLAR characteristics are:

Purpose

Allows or disallows access to the external debug registers through a memory-mapped interface.

Usage constraints

This register is accessible as follows:

Default

WO

Configurations

EDLAR is in the Debug power domain.

If OPTIONAL memory-mapped access to the external debug interface is supported then an OPTIONAL Software Lock can be implemented as part of CoreSight compliance.

EDLAR ignores writes if the Software Lock is not implemented and ignores writes for other accesses to the external debug interface.

The Software Lock provides a lock to prevent memory-mapped writes to the debug registers. Use of this lock mechanism reduces the risk of accidental damage to the contents of the debug registers. It does not, and cannot, prevent all accidental or malicious damage.

Software uses EDLAR to set or clear the lock, and [EDLSR](#) to check the current status of the lock.

Attributes

EDLAR is a 32-bit register.

Field descriptions

The EDLAR bit assignments are:

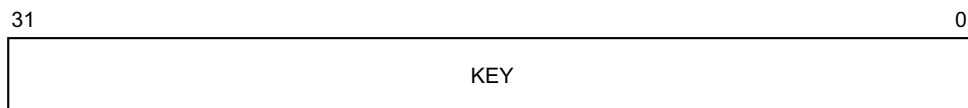

KEY, bits [31:0]

Lock Access control. Writing the key value 0xC5ACCE55 to this field unlocks the lock, enabling write accesses to this component's registers through a memory-mapped interface.

Writing any other value to this register locks the lock, disabling write accesses to this component's registers through a memory mapped interface.

Accessing the EDLAR:

EDLAR can be accessed through a memory-mapped interface access to the external debug interface:

Component	Offset
Debug	0xFB0

H9.2.31 EDLSR, External Debug Lock Status Register

The EDLSR characteristics are:

Purpose

Indicates the current status of the software lock for external debug registers.

Usage constraints

This register is accessible as follows:

Default

RO

Configurations

EDLSR is in the Debug power domain. Some or all RW fields of this register have defined reset values. These apply only on an External debug reset. The register is not affected by a Warm reset and is not affected by a Cold reset.

If OPTIONAL memory-mapped access to the external debug interface is supported then an OPTIONAL Software Lock can be implemented as part of CoreSight compliance.

EDLSR is RAZ if the Software Lock is not implemented and is RAZ for other accesses to the external debug interface.

The Software Lock provides a lock to prevent memory-mapped writes to the debug registers. Use of this lock mechanism reduces the risk of accidental damage to the contents of the debug registers. It does not, and cannot, prevent all accidental or malicious damage.

Software uses [EDLAR](#) to set or clear the lock, and EDLSR to check the current status of the lock.

Attributes

EDLSR is a 32-bit register.

Field descriptions

The EDLSR bit assignments are:

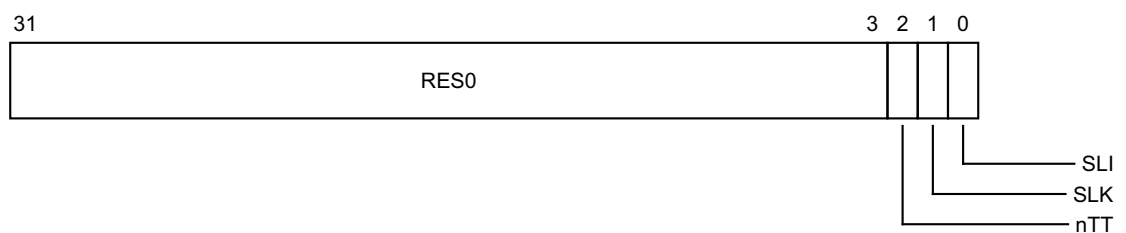

Bits [31:3]

Reserved, RES0.

nTT, bit [2]

Not thirty-two bit access required. RAZ.

SLK, bit [1]

Software Lock status for this component. For an access to LSR that is not a memory-mapped access, or when the Software Lock is not implemented, this field is RES0.

For memory-mapped accesses when the Software Lock is implemented, possible values of this field are:

- 0 Lock clear. Writes are permitted to this component's registers.
- 1 Lock set. Writes to this component's registers are ignored, and reads have no side effects.

When this register has an architecturally-defined reset value, this field resets to 1.

SLI, bit [0]

Software Lock implemented. For an access to LSR that is not a memory-mapped access, this field is RAZ. For memory-mapped accesses, the value of this field is IMPLEMENTATION DEFINED.

Permitted values are:

- 0 Software Lock not implemented or not memory-mapped access.
- 1 Software Lock implemented and memory-mapped access.

Accessing the EDLSR:

EDLSR can be accessed through a memory-mapped interface access to the external debug interface:

Component	Offset
Debug	0xFB4

H9.2.32 EDPCSR, External Debug Program Counter Sample Register

The EDPCSR characteristics are:

Purpose

Holds a sampled instruction address value.

Usage constraints

This register is accessible as follows:

Off	DLK	OSLK	SLK	Default
Error	Error	Error	RO	RO

Configurations

EDPCSR is in the Core power domain.

Fields in this register reset to architecturally UNKNOWN values. These apply only on a Cold reset. The register is not affected by a Warm reset and is not affected by an External debug reset.

Implemented only if the OPTIONAL PC Sample-based Profiling Extension is implemented and [ARMv8.2-PCSample](#) is not implemented. If [ARMv8.2-PCSample](#) is implemented, this register is RES0 and the architecture defines the functionality in [PMPCSR](#).

Attributes

EDPCSR is a pair of 32-bit registers.

If [ARMv8.1-VHE](#) is implemented, the format of this register differs depending on the value of [EDSCR.SC2](#).

Field descriptions

The EDPCSR bit assignments are:

When ARMv8.1-VHE is not implemented:

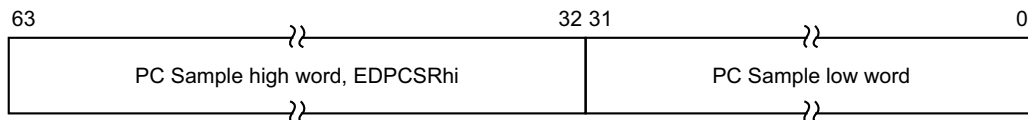

Bits [63:32]

PC Sample high word, EDPCSRhi. If [EDVIDSR.HV](#) == 0 then this field is RAZ, otherwise bits [63:32] of the sampled instruction address value. The translation regime that EDPCSR samples can be determined from [EDVIDSR](#).{NS,E2,E3}.

When this register has an architecturally-defined reset value, this field resets to a value that is architecturally UNKNOWN.

Bits [31:0]

PC Sample low word. EDPCSRlo, bits[31:0] of the sampled instruction address value. The translation regime that EDPCSR samples can be determined from [EDVIDSR](#).{NS,E2,E3}.

- For a read of EDPCSR[31:0] from the memory-mapped interface, if [EDLSR.SLK](#) == 1, meaning the OPTIONAL Software Lock is locked, then the access has no side-effects.
- In any other cases, a read of EDPCSR[31:0] has the side-effect of indirectly writing to EDPCSRhi, [EDCIDSR](#), and [EDVIDSR](#):
 - If the PE is in Debug state, or PC Sample-based profiling is prohibited, EDPCSRlo reads as 0xFFFFFFFF, and EDPCSRhi, [EDCIDSR](#), and [EDVIDSR](#) become UNKNOWN.

- If the PE is in Reset state, the sampled value is UNKNOWN and EDPCSRhi, EDCIDSR, and EDVIDSR become UNKNOWN.
- If no instruction has been retired since the PE left Reset state, Debug state, or a state where PC Sample-based Profiling is prohibited, the sampled value is UNKNOWN, and EDPCSRhi, EDCIDSR, and EDVIDSR become UNKNOWN.

When this register has an architecturally-defined reset value, this field resets to a value that is architecturally UNKNOWN.

When ARMv8.1-VHE is implemented and EDSCR.SC2 == 0:

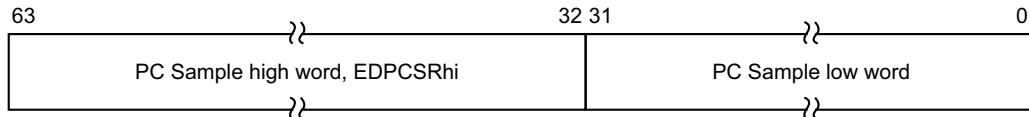

Bits [63:32]

PC Sample high word, EDPCSRhi. If EDVIDSR.HV == 0 then this field is RAZ, otherwise bits [63:32] of the sampled instruction address value. The translation regime that EDPCSR samples can be determined from EDVIDSR.{NS,E2,E3}.

When this register has an architecturally-defined reset value, this field resets to a value that is architecturally UNKNOWN.

Bits [31:0]

PC Sample low word. EDPCSRlo, bits[31:0] of the sampled instruction address value. The translation regime that EDPCSR samples can be determined from EDVIDSR.{NS,E2,E3}.

- For a read of EDPCSR[31:0] from the memory-mapped interface, if EDLSR.SLK == 1, meaning the OPTIONAL Software Lock is locked, then the access has no side-effects.
- In any other cases, a read of EDPCSR[31:0] has the side-effect of indirectly writing to EDPCSRhi, EDCIDSR, and EDVIDSR:
 - If the PE is in Debug state, or PC Sample-based profiling is prohibited, EDPCSRlo reads as 0xFFFFFFFF, and EDPCSRhi, EDCIDSR, and EDVIDSR become UNKNOWN.
 - If the PE is in Reset state, the sampled value is UNKNOWN and EDPCSRhi, EDCIDSR, and EDVIDSR become UNKNOWN.
 - If no instruction has been retired since the PE left Reset state, Debug state, or a state where PC Sample-based Profiling is prohibited, the sampled value is UNKNOWN, and EDPCSRhi, EDCIDSR, and EDVIDSR become UNKNOWN.

When this register has an architecturally-defined reset value, this field resets to a value that is architecturally UNKNOWN.

When ARMv8.1-VHE is implemented and EDSCR.SC2 == 1:

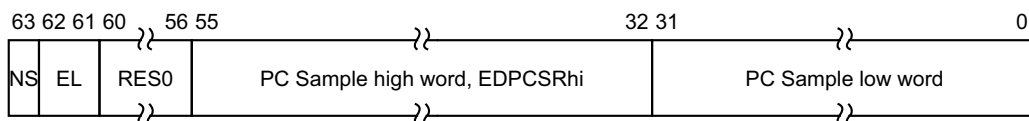

NS, bit [63]

Non-secure state sample. Indicates the Security state that is associated with the most recent EDPCSR sample.

When this register has an architecturally-defined reset value, this field resets to a value that is architecturally UNKNOWN.

EL, bits [62:61]

Exception level status sample. Indicates the Exception level that is associated with the most recent EDPCSR sample.

- 00 Sample is from EL0.
- 01 Sample is from EL1.
- 10 Sample is from EL2.
- 11 Sample is from EL3.

When this register has an architecturally-defined reset value, this field resets to a value that is architecturally UNKNOWN.

Bits [60:56]

Reserved, RES0.

Bits [55:32]

PC Sample high word, EDPCSRhi. Bits [55:32] of the sampled instruction address value. The translation regime that EDPCSR samples can be determined from EDPCSR.{NS,EL}.

When this register has an architecturally-defined reset value, this field resets to a value that is architecturally UNKNOWN.

Bits [31:0]

PC Sample low word, EDPCSRlo. Bits[31:0] of the sampled instruction address value. The translation regime that EDPCSR samples can be determined from EDVIDSR.{NS,E2,E3}.

- For a read of EDPCSR[31:0] from the memory-mapped interface, if EDLSR.SLK == 1, meaning the OPTIONAL Software Lock is locked, then the access has no side-effects.
- In any other cases, a read of EDPCSR[31:0] has the side-effect of indirectly writing to EDPCSR[63:32], EDCIDSR, and EDVIDSR:
 - If the PE is in Debug state, or PC Sample-based profiling is prohibited, EDPCSR[31:0] reads as 0xFFFFFFFF, and EDPCSR[63:32], EDCIDSR, and EDVIDSR become UNKNOWN.
 - If the PE is in Reset state, the sampled value is UNKNOWN and EDPCSR[63:32], EDCIDSR, and EDVIDSR become UNKNOWN.
 - If no instruction has been retired since the PE left Reset state, Debug state, or a state where PC Sample-based Profiling is prohibited, the sampled value is UNKNOWN, and EDPCSR[63:32], EDCIDSR, and EDVIDSR become UNKNOWN.

When this register has an architecturally-defined reset value, this field resets to a value that is architecturally UNKNOWN.

When ARMv8.2-PCSample is implemented:

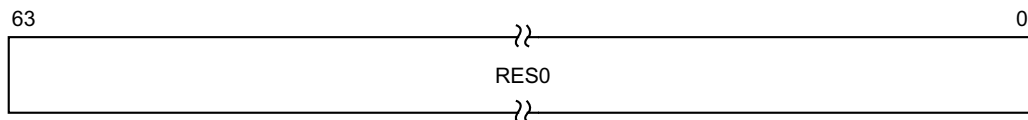

Bits [63:0]

Reserved, RES0.

Accessing the EDPCSR:

EDPCSR[31:0] can be accessed through the external debug interface:

Component	Offset
Debug	0x0A0

EDPCSR[63:32] can be accessed through the external debug interface:

Component	Offset
Debug	0x0AC

H9.2.33 EDPFR, External Debug Processor Feature Register

The EDPFR characteristics are:

Purpose

Provides information about implemented PE features.

For general information about the interpretation of the ID registers see [Principles of the ID scheme for fields in ID registers on page D7-2195](#).

Usage constraints

This register is accessible as follows:

Off	DLK	Default
IMP DEF	IMP DEF	RO

Configurations

It is IMPLEMENTATION DEFINED whether EDPFR is implemented in the Core power domain or in the Debug power domain.

Attributes

EDPFR is a 64-bit register.

Field descriptions

The EDPFR bit assignments are:

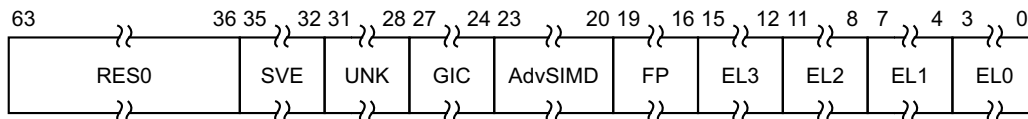

Bits [63:36]

Reserved, RES0.

SVE, bits [35:32]

In ARMv8.2 and ARMv8.1

Present only if [SVE](#) is implemented.

Scalable Vector Extension. Defined values are:

0000 Scalable Vector Extension is not implemented.

0001 Scalable Vector Extension is implemented.

All other values are reserved.

If [SVE](#) is not implemented, this field is RES0.

In ARMv8.0.

Reserved, RES0.

UNK, bits [31:28]

This field is UNKNOWN.

GIC, bits [27:24]

System register GIC interface support. Defined values are:

0000 No System register interface to the GIC is supported.

0001 System register interface to versions 3.0 and 4.0 of the GIC CPU interface is supported.

All other values are reserved.

In an ARMv8-A implementation that supports AArch64 state in at least one Exception level, this field returns the value of [ID_AA64PFR0_EL1.GIC](#).

AdvSIMD, bits [23:20]

Advanced SIMD. Defined values are:

0000 Advanced SIMD is implemented, including support for the following SISO and SIMD operations:

- Integer byte, halfword, word and doubleword element operations.
- Single-precision and double-precision floating-point arithmetic.
- Conversions between single-precision and half-precision data types, and double-precision and half-precision data types.

0001 As for 0000, and also includes support for half-precision floating-point arithmetic.

1111 Advanced SIMD is not implemented.

All other values are reserved.

This field must have the same value as the FP field.

The permitted values are:

- 0000 in an implementation with Advanced SIMD support, that does not include the [ARMv8.2-FP16](#) extension.
- 0001 in an implementation with Advanced SIMD support, that includes the [ARMv8.2-FP16](#) extension.
- 1111 in an implementation without Advanced SIMD support.

In an ARMv8-A implementation that supports AArch64 state in at least one Exception level, this field returns the value of [ID_AA64PFR0_EL1.AdvSIMD](#).

FP, bits [19:16]

Floating-point. Defined values are:

0000 Floating-point is implemented, and includes support for:

- Single-precision and double-precision floating-point types.
- Conversions between single-precision and half-precision data types, and double-precision and half-precision data types.

0001 As for 0000, and also includes support for half-precision floating-point arithmetic.

1111 Floating-point is not implemented.

All other values are reserved.

This field must have the same value as the AdvSIMD field.

The permitted values are:

- 0000 in an implementation with floating-point support, that does not include the [ARMv8.2-FP16](#) extension.
- 0001 in an implementation with floating-point support, that includes the [ARMv8.2-FP16](#) extension.
- 1111 in an implementation without floating-point support.

In an ARMv8-A implementation that supports AArch64 state in at least one Exception level, this field returns the value of [ID_AA64PFR0_EL1.FP](#).

EL3, bits [15:12]

AArch64 EL3 Exception level handling. Defined values are:

0000 EL3 is not implemented or cannot be executed in AArch64 state.

0001 EL3 can be executed in AArch64 state only.

0010 EL3 can be executed in either AArch64 or AArch32 state.
When the value of `EDAA32PFR.EL3` is non-zero, this field must be 0000.
All other values are reserved.

In an ARMv8-A implementation that supports AArch64 state in at least one Exception level, this field returns the value of `ID_AA64PFR0_EL1.EL3`.

EL2, bits [11:8]

AArch64 EL2 Exception level handling. Defined values are:

0000 EL2 is not implemented or cannot be executed in AArch64 state.
0001 EL2 can be executed in AArch64 state only.
0010 EL2 can be executed in either AArch64 or AArch32 state.

When the value of `EDAA32PFR.EL2` is non-zero, this field must be 0000.
All other values are reserved.

In an ARMv8-A implementation that supports AArch64 state in at least one Exception level, this field returns the value of `ID_AA64PFR0_EL1.EL2`.

EL1, bits [7:4]

AArch64 EL1 Exception level handling. Defined values are:

0000 EL1 can be executed in AArch32 state only.
0001 EL1 can be executed in AArch64 state only.
0010 EL1 can be executed in either AArch64 or AArch32 state.

All other values are reserved.

In an ARMv8-A implementation that supports AArch64 state in at least one Exception level, this field returns the value of `ID_AA64PFR0_EL1.EL1`.

EL0, bits [3:0]

AArch64 EL0 Exception level handling. Defined values are:

0000 EL0 can be executed in AArch32 state only.
0001 EL0 can be executed in AArch64 state only.
0010 EL0 can be executed in either AArch64 or AArch32 state.

All other values are reserved.

In an ARMv8-A implementation that supports AArch64 state in at least one Exception level, this field returns the value of `ID_AA64PFR0_EL1.EL0`.

Accessing the EDPFR:

EDPFR[31:0] can be accessed through the external debug interface:

Component	Offset
Debug	0xD20

EDPFR[63:32] can be accessed through the external debug interface:

Component	Offset
Debug	0xD24

H9.2.34 EDPIDR0, External Debug Peripheral Identification Register 0

The EDPIDR0 characteristics are:

Purpose

Provides information to identify an external debug component.

For more information see [About the Peripheral identification scheme on page K2-6146](#).

Usage constraints

This register is accessible as follows:

Default

RO

Configurations

EDPIDR0 is in the Debug power domain.

Implementation of this register is OPTIONAL.

This register is required for CoreSight compliance.

Attributes

EDPIDR0 is a 32-bit register.

Field descriptions

The EDPIDR0 bit assignments are:

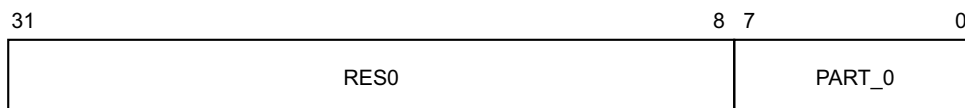

Bits [31:8]

Reserved, RES0.

PART_0, bits [7:0]

Part number, least significant byte.

Accessing the EDPIDR0:

EDPIDR0 can be accessed through the external debug interface:

Component	Offset
-----------	--------

Debug	0xFE0
-------	-------

H9.2.35 EDPIDR1, External Debug Peripheral Identification Register 1

The EDPIDR1 characteristics are:

Purpose

Provides information to identify an external debug component.

For more information see [About the Peripheral identification scheme on page K2-6146](#).

Usage constraints

This register is accessible as follows:

Default

RO

Configurations

EDPIDR1 is in the Debug power domain.

Implementation of this register is OPTIONAL.

This register is required for CoreSight compliance.

Attributes

EDPIDR1 is a 32-bit register.

Field descriptions

The EDPIDR1 bit assignments are:

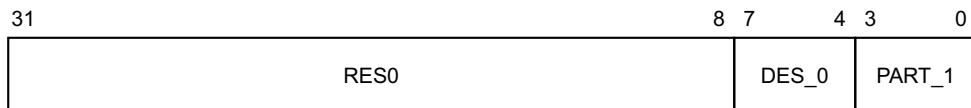

Bits [31:8]

Reserved, RES0.

DES_0, bits [7:4]

Designer, least significant nibble of JEP106 ID code. For ARM Limited, this field is 0b1011.

PART_1, bits [3:0]

Part number, most significant nibble.

Accessing the EDPIDR1:

EDPIDR1 can be accessed through the external debug interface:

Component	Offset
-----------	--------

Debug	0xFE4
-------	-------

H9.2.36 EDPIDR2, External Debug Peripheral Identification Register 2

The EDPIDR2 characteristics are:

Purpose

Provides information to identify an external debug component.

For more information see [About the Peripheral identification scheme on page K2-6146](#).

Usage constraints

This register is accessible as follows:

Default
RO

Configurations

EDPIDR2 is in the Debug power domain.

Implementation of this register is OPTIONAL.

This register is required for CoreSight compliance.

Attributes

EDPIDR2 is a 32-bit register.

Field descriptions

The EDPIDR2 bit assignments are:

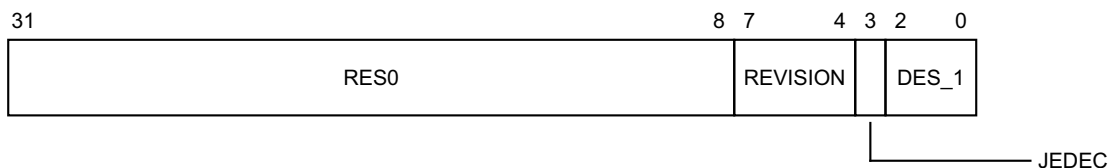

Bits [31:8]

Reserved, RES0.

REVISION, bits [7:4]

Part major revision. Parts can also use this field to extend Part number to 16-bits.

JEDEC, bit [3]

RAO. Indicates a JEP106 identity code is used.

DES_1, bits [2:0]

Designer, most significant bits of JEP106 ID code. For ARM Limited, this field is 0b011.

Accessing the EDPIDR2:

EDPIDR2 can be accessed through the external debug interface:

Component	Offset
Debug	0xFE8

H9.2.37 EDPIDR3, External Debug Peripheral Identification Register 3

The EDPIDR3 characteristics are:

Purpose

Provides information to identify an external debug component.

For more information see [About the Peripheral identification scheme on page K2-6146](#).

Usage constraints

This register is accessible as follows:

Default

RO

Configurations

EDPIDR3 is in the Debug power domain.

Implementation of this register is OPTIONAL.

This register is required for CoreSight compliance.

Attributes

EDPIDR3 is a 32-bit register.

Field descriptions

The EDPIDR3 bit assignments are:

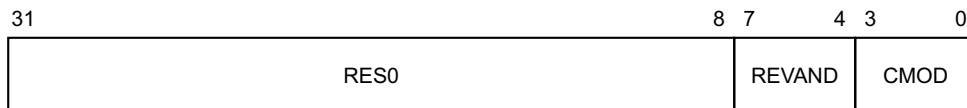

Bits [31:8]

Reserved, RES0.

REVAND, bits [7:4]

Part minor revision. Parts using [EDPIDR2.REVISION](#) as an extension to the Part number must use this field as a major revision number.

CMOD, bits [3:0]

Customer modified. Indicates someone other than the Designer has modified the component.

Accessing the EDPIDR3:

EDPIDR3 can be accessed through the external debug interface:

Component	Offset
-----------	--------

Debug	0xFEC
-------	-------

H9.2.38 EDPIDR4, External Debug Peripheral Identification Register 4

The EDPIDR4 characteristics are:

Purpose

Provides information to identify an external debug component.

For more information see [About the Peripheral identification scheme on page K2-6146](#).

Usage constraints

This register is accessible as follows:

Default

RO

Configurations

EDPIDR4 is in the Debug power domain.

Implementation of this register is OPTIONAL.

This register is required for CoreSight compliance.

Attributes

EDPIDR4 is a 32-bit register.

Field descriptions

The EDPIDR4 bit assignments are:

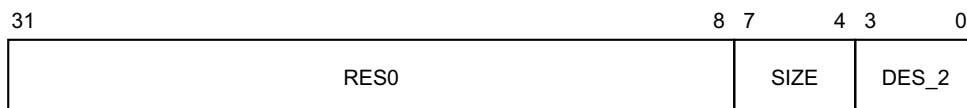

Bits [31:8]

Reserved, RES0.

SIZE, bits [7:4]

Size of the component. RAZ. \log_2 of the number of 4KB pages from the start of the component to the end of the component ID registers.

DES_2, bits [3:0]

Designer, JEP106 continuation code, least significant nibble. For ARM Limited, this field is 0b0100.

Accessing the EDPIDR4:

EDPIDR4 can be accessed through the external debug interface:

Component **Offset**

Debug 0xFD0

H9.2.39 EDPRCR, External Debug Power/Reset Control Register

The EDPRCR characteristics are:

Purpose

Controls the PE functionality related to powerup, reset, and powerdown.

Usage constraints

This register is accessible as follows:

SLK	Default
RO	RW

On permitted accesses to the register, other access controls affect the behavior of some fields. See the field descriptions for more information.

Configurations

EDPRCR contains fields that are in the Core power domain and fields that are in the Debug power domain.

For RW fields see the field description for a description of the behavior of the field on a reset that applies to its power domain. However:

- Fields that are in the Core power domain are not affected by a warm reset and are not affected by an External debug reset.
- Fields that are in the Debug power domain reset to their defined reset values on an External debug reset, and are not affected by a Warm reset and are not affected by a Cold reset.

CORENPDRQ is the only field that is mapped between the EDPRCR and DBGPRCR and DBGPRCR_EL1.

Attributes

EDPRCR is a 32-bit register.

Field descriptions

The EDPRCR bit assignments are:

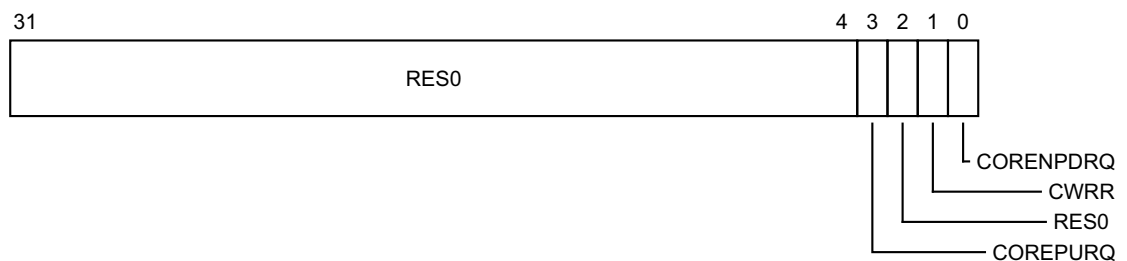

Bits [31:4]

Reserved, RES0.

COREPURQ, bit [3]

Core powerup request. Allows a debugger to request that the power controller power up the core, enabling access to the debug register in the Core power domain. The actions on writing to this bit are:

- 0 Do not request power up of the Core power domain.

1 Request power up of the Core power domain, and emulation of powerdown.

In an implementation that includes the recommended external debug interface, this bit drives the DBGPWRUPREQ signal.

Typically, this request is passed to an external power controller. This means that whether a request causes power up is dependent on the IMPLEMENTATION DEFINED nature of the system.

This field is in the Debug power domain and can be read and written when the Core power domain is powered off. On an External debug reset this field resets to 0.

The power controller must not allow the Core power domain to switch off while this bit is 1.

When this register has an architecturally-defined reset value, this field resets to 0.

This field is accessible as shown below:

SLK	Default
RO	RW

[Access permissions for the External debug interface registers on page H8-5567](#) describes the conditions shown in this table. These conditions are prioritized, with the leftmost condition having the highest priority and priority decreasing from left to right.

Bit [2]

Reserved, RES0.

CWRR, bit [1]

Warm reset request. Write only bit that reads as zero. The actions on writing to this bit are:

- 0 No action.
- 1 Request Warm reset.

The PE ignores writes to this bit if any of the following are true:

- ExternalInvasiveDebugEnabled() == FALSE, EL3 is not implemented, and the implemented Security state is Non-Secure state.
- ExternalSecureInvasiveDebugEnabled() == FALSE and one of the following is true:
 - EL3 is implemented.
 - The implemented Security state is Secure state.
- The Core power domain is either off or in a low-power state where the Core power domain registers cannot be accessed.
- DoubleLockStatus() == TRUE (OS Double Lock is set).
- OSLSR.OSLK == 1 (OS lock is locked).

In an implementation that includes the recommended external debug interface, this bit drives the DBGRSTREQ signal.

The extent of the reset is IMPLEMENTATION DEFINED, but must be one of:

- The request is ignored.
- Only this PE is Warm reset.
- This PE and other components of the system, possibly including other PEs, are Warm reset.

———— Note —————

Although the ARM architecture permits the first option from the above list, ARM recommends that either of the other options is implemented.

When this register has an architecturally-defined reset value, this field resets to 0.

This field is accessible as shown below:

Off	DLK	OSLK	SLK	Default
WI	WI	WI	WI	WO

Access permissions for the External debug interface registers on page H8-5567 describes the conditions shown in this table. These conditions are prioritized, with the leftmost condition having the highest priority and priority decreasing from left to right.

CORENPDRQ, bit [0]

Core no powerdown request. Requests emulation of powerdown. Possible values of this bit are:

- 0 If the system responds to a powerdown request, it powers down Core power domain.
- 1 If the system responds to a powerdown request, it does not powerdown the Core power domain, but instead emulates a powerdown of that domain.

This bit is UNKNOWN, and the PE ignores writes to this bit if any of the following are true:

- The Core power domain is either off or in a low-power state where the Core power domain registers cannot be accessed.
- DoubleLockStatus() == TRUE (OS Double Lock is set).
- OSLSR.OSLK == 1 (OS lock is locked).

Permitted accesses to this field map to the [DBGPRCR.CORENPDRQ](#) and [DBGPRCR_EL1.CORENPDRQ](#) fields.

This field is in the Core reset domain. See the descriptions of the [DBGPRCR.CORENPDRQ](#) and [DBGPRCR_EL1.CORENPDRQ](#) fields for information about the effect of a Cold reset on the value returned by a permitted read of this field.

This field is accessible as shown below:

Off	DLK	OSLK	SLK	Default
WI	WI	WI	RO	RW

Access permissions for the External debug interface registers on page H8-5567 describes the conditions shown in this table. These conditions are prioritized, with the leftmost condition having the highest priority and priority decreasing from left to right.

Accessing the EDPRCR:

EDPRCR can be accessed through the external debug interface:

Component	Offset
Debug	0x310

H9.2.40 EDPRSR, External Debug Processor Status Register

The EDPRSR characteristics are:

Purpose

Holds information about the reset and powerdown state of the PE.

Usage constraints

This register is accessible as follows:

SLK	Default
RO	RO

On permitted accesses to the register, other access controls affect the behavior of some fields. See the field descriptions for more information.

If the Core power domain is powered up ($\text{EDPRSR.PU} == 1$), then following a read of EDPRSR:

- If $\text{DoubleLockStatus()} == \text{FALSE}$, then:
 - $\text{EDPRSR}\{ \text{SDR}, \text{SPMAD}, \text{SDAD}, \text{SPD} \}$ are cleared to 0.
 - EDPRSR.SR is cleared to 0 if the non-debug logic of the PE is not in reset state ($\text{EDPRSR.R} == 0$).
- Otherwise it is **CONSTRAINED UNPREDICTABLE** whether or not this clearing occurs.

If the Core power domain is powered down ($\text{EDPRSR.PU} == 0$), then:

- $\text{EDPRSR}\{ \text{SDR}, \text{SPMAD}, \text{SDAD}, \text{SR} \}$ are all **UNKNOWN**, and are either reset or restored on being powered up.
- EDPRSR.SPD is not cleared following a read of EDPRSR. See the SPD bit description for more information.

The clearing of bits is an indirect write to EDPRSR.

Configurations

EDPRSR contains fields that are in the Core power domain and fields that are in the Debug power domain.

Some of the fields in the Core power domain are in the Cold reset domain and others are in the Warm reset domain. See the field descriptions for more information. However:

- Fields that are in the Cold reset domain are not affected by a warm reset and are not affected by an External debug reset.
- Fields in the Warm reset domain are also reset by a Cold reset but are not affected by an External debug reset.
- Fields in the Debug power domain are not affected by a Warm reset and are not affected by a Cold reset.

Attributes

EDPRSR is a 32-bit register.

Field descriptions

The EDPRSR bit assignments are:

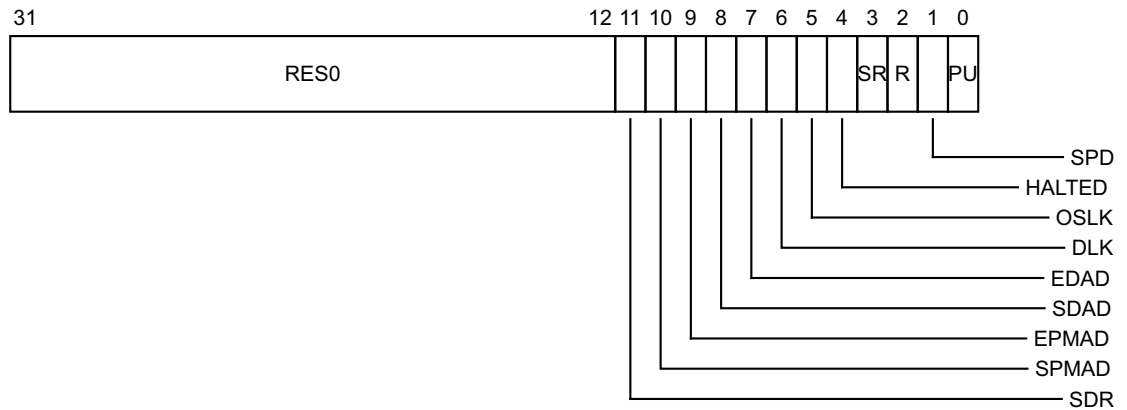

Bits [31:12]

Reserved, RES0.

SDR, bit [11]

Sticky debug restart. Set to 1 when the PE exits Debug state.

This bit is UNKNOWN on reads if any of the following are true:

- DoubleLockStatus() == TRUE. The OS double-lock is locked.
- EDPRSR.R == 1. The PE is in Reset state.
- EDPRSR.PU == 0. The Core power domain is powered down.

Otherwise permitted values are:

- 0 The PE has not restarted since EDPRSR was last read.
- 1 The PE has restarted since EDPRSR was last read.

Note

If a reset occurs when the PE is in Debug state, the PE exits Debug state. SDR is UNKNOWN on Warm reset, meaning a debugger must also use the SR bit to determine whether the PE has left Debug state.

If EDPRSR.PU reads as 1, which means that the Core power domain is in a powerup state, then following a read of EDPRSR:

- If DoubleLockStatus() == FALSE this bit clears to 0.
- If DoubleLockStatus() == TRUE, it is CONSTRAINED UNPREDICTABLE whether this bit clears to 0 or is unchanged.

This field is in the Core power domain and the Warm reset domain. On a Warm or Cold reset it resets to an UNKNOWN value.

This field resets to a value that is architecturally UNKNOWN.

This field is accessible as shown below:

Off	DLK	SLK	Default
UNK	UNK	RO	RC

Access permissions for the External debug interface registers on page H8-5567 describes the conditions shown in this table. These conditions are prioritized, with the leftmost condition having the highest priority and priority decreasing from left to right.

SPMAD, bit [10]

Sticky EPMAD error. Set to 1 if an external debug interface access to a Performance Monitors register returns an error because AllowExternalPMUAccess() == FALSE.

This bit is UNKNOWN on reads if any of the following are true:

- DoubleLockStatus() == TRUE
- EDPRSR.{OSLK, R} is 1.
- EDPRSR.PU is 0.

Otherwise permitted values are:

- | | |
|---|---|
| 0 | No accesses to the external Performance Monitors registers have failed since EDPRSR was last read. |
| 1 | At least one access to the external Performance Monitors registers has failed since EDPRSR was last read. |

If the Core power domain is powered up, then, following a read of EDPRSR:

- If DoubleLockStatus() == FALSE this bit clears to 0.
- If DoubleLockStatus() == TRUE, it is CONSTRAINED UNPREDICTABLE whether this bit clears to 0 or is unchanged.

The write to SPMAD is an indirect write to EDPRSR that is a side effect of the access. The indirect write might not occur for a memory-mapped access to the external debug interface.

This field is in the Core power domain and the Cold reset domain. On a Cold reset it resets to 0.

When this register has an architecturally-defined reset value, this field resets to 0.

This field is accessible as shown below:

Off	DLK	OSLK	SLK	Default
UNK	UNK	UNK	RO	RC

[Access permissions for the External debug interface registers on page H8-5567](#) describes the conditions shown in this table. These conditions are prioritized, with the leftmost condition having the highest priority and priority decreasing from left to right.

EPMAD, bit [9]

External Performance Monitors access disable status.

This bit is UNKNOWN on reads if any of the following is true:

- DoubleLockStatus() == TRUE
- EDPRSR.{OSLK, R} is 1.
- EDPRSR.PU is 0.

Otherwise permitted values are:

- | | |
|---|---|
| 0 | External Performance Monitors access enabled. AllowExternalPMUAccess() == TRUE. |
| 1 | External Performance Monitors access disabled. AllowExternalPMUAccess() == FALSE. |

If external performance monitors access is not implemented, EPMAD is RAO.

This field is in the Core power domain.

This field is accessible as shown below:

Off	DLK	OSLK	EPMAD	Default
UNK	UNK	UNK	RAO	RO

[Access permissions for the External debug interface registers on page H8-5567](#) describes the conditions shown in this table. These conditions are prioritized, with the leftmost condition having the highest priority and priority decreasing from left to right.

SDAD, bit [8]

Sticky EDAD error. Set to 1 if an external debug interface access to a debug register returns an error because `AllowExternalDebugAccess() == FALSE`.

This bit is UNKNOWN on reads if any of the following are true:

- `DoubleLockStatus() == TRUE`
- `EDPRSR.R` is 1.
- `EDPRSR.PU` is 0.
- `EDPRSR.OSLK` is 1 and external debug writes to [OSLAR_EL1](#) do not return an error when `AllowExternalDebugAccess() == FALSE`.

Otherwise permitted values are:

- | | |
|---|---|
| 0 | No accesses to the external debug registers have failed since <code>EDPRSR</code> was last read. |
| 1 | At least one access to the external debug registers has failed since <code>EDPRSR</code> was last read. |

If the Core power domain is powered up, then, following a read of `EDPRSR`:

- If `DoubleLockStatus() == FALSE` this bit clears to 0.
- If `DoubleLockStatus() == TRUE`, it is CONSTRAINED UNPREDICTABLE whether this bit clears to 0 or is unchanged.

The write to `SDAD` is an indirect write to `EDPRSR` that is a side effect of the access. The indirect write might not occur for a memory-mapped access to the external debug interface.

This field is in the Core power domain and the Cold reset domain. On a Cold reset it resets to 0.

When this register has an architecturally-defined reset value, this field resets to 0.

This field is accessible as shown below:

Off	DLK	OSLK	SLK	Default
UNK	UNK	See text	RO	RC

[Access permissions for the External debug interface registers on page H8-5567](#) describes the conditions shown in this table. These conditions are prioritized, with the leftmost condition having the highest priority and priority decreasing from left to right.

EDAD, bit [7]

External debug access disable status.

This bit is UNKNOWN on reads if any of the following are true:

- `DoubleLockStatus() == TRUE`
- `EDPRSR.R` is 1.
- `EDPRSR.PU` is 0.
- `EDPRSR.OSLK` is 1 and external debug writes to [OSLAR_EL1](#) do not return an error when `AllowExternalDebugAccess() == FALSE`.

Otherwise permitted values are:

- | | |
|---|--|
| 0 | External debug access enabled. <code>AllowExternalDebugAccess() == TRUE</code> . |
| 1 | External debug access disabled. <code>AllowExternalDebugAccess() == FALSE</code> . |

This field is in the Core power domain.

This field is accessible as shown below:

Off	DLK	OSLK	EDAD	Default
UNK	UNK	See text	RAO	RAZ

[Access permissions for the External debug interface registers on page H8-5567](#) describes the conditions shown in this table. These conditions are prioritized, with the leftmost condition having the highest priority and priority decreasing from left to right.

DLK, bit [6]

OS Double Lock status bit. Returns the result of the pseudocode function DoubleLockStatus().

This bit is UNKNOWN on reads if EDPRSR.PU is 0.

Otherwise reads as zero if any of the following are true, that is when DoubleLockStatus() == FALSE:

- [OSDLR_EL1](#).DLK == 0.
- [DBGPRCR_EL1](#).CORENPDRQ == 1.
- The PE is in Debug state.

In ARMv8.0 and ARMv8.1, if the Core power domain is powered up and DoubleLockStatus() == TRUE, it is IMPLEMENTATION DEFINED whether:

- EDPRSR.PU reads as 1, EDPRSR.DLK reads as 1, and EDPRSR.SPD is UNKNOWN.
- EDPRSR.PU reads as 0, EDPRSR.DLK is UNKNOWN, and EDPRSR.SPD reads as 0.

From ARMv8.2, if the Core power domain is powered up and DoubleLockStatus() == TRUE, then EDPRSR.PU reads as 0, EDPRSR.DLK is UNKNOWN, and EDPRSR.SPD reads as 0.

If the Core power domain is powered up and entered reset state with the OS double-lock locked this bit has a CONSTRAINED UNPREDICTABLE value, for more information see [EDPRSR.{DLK, R} and reset state on page H6-5538](#)

EDPRSR.{DLK, SPD, PU} describe whether registers in the Core power domain can be accessed, and whether their state has been lost since the last time the register was read. For more information, see [EDPRSR.{DLK, SPD, PU} and the Core power domain on page H6-5537](#)

———— Note —————

Use of this bit by debuggers is deprecated from ARMv8.2.

This field is in the Core power domain.

This field is accessible as shown below:

Off	DLK	Default
UNK	See text	RAZ

[Access permissions for the External debug interface registers on page H8-5567](#) describes the conditions shown in this table. These conditions are prioritized, with the leftmost condition having the highest priority and priority decreasing from left to right.

OSLK, bit [5]

OS lock status bit.

This bit is UNKNOWN on reads if either:

- DoubleLockStatus() == TRUE
- EDPRSR.R is 1.
- EDPRSR.PU is 0.

A read of this bit returns the value of `OSLSR_EL1.OSLK`.

This field is in the Core power domain.

This field is accessible as shown below:

Off	DLK	OSLK	Default
UNK	UNK	RAO	RAZ

[Access permissions for the External debug interface registers on page H8-5567](#) describes the conditions shown in this table. These conditions are prioritized, with the leftmost condition having the highest priority and priority decreasing from left to right.

HALTED, bit [4]

Halted status bit.

This bit is UNKNOWN on reads if `EDPRSR.PU` is 0.

Otherwise permitted values are:

0 PE is in Non-debug state.

1 PE is in Debug state.

Because the OS Double Lock is never set when the PE is in Debug state, this bit is always RAZ when `DoubleLockStatus() == TRUE`.

This field is in the Core power domain.

This field is accessible as shown below:

Off	DLK	Default
UNK	See text	RO

[Access permissions for the External debug interface registers on page H8-5567](#) describes the conditions shown in this table. These conditions are prioritized, with the leftmost condition having the highest priority and priority decreasing from left to right.

SR, bit [3]

Sticky core reset status bit.

This bit is UNKNOWN on reads if either:

- `DoubleLockStatus() == TRUE`
- `EDPRSR.PU` is 0.

Otherwise permitted values are:

0 The non-debug logic of the PE is not in reset state and has not been reset since the last time `EDPRSR` was read.

1 The non-debug logic of the PE is in reset state or has been reset since the last time `EDPRSR` was read.

If `EDPRSR.PU` reads as 1 and `EDPRSR.R` reads as 0, which means that the Core power domain is in a powerup state and that the non-debug logic of the PE is not in reset state, then following a read of `EDPRSR`:

- If `DoubleLockStatus() == FALSE` this bit clears to 0.
- If `DoubleLockStatus() == TRUE`, it is UNPREDICTABLE whether this bit clears to 0 or is unchanged.

This field is in the Core power domain and the Warm reset domain. On a Warm or Cold reset it resets to 1.

When this register has an architecturally-defined reset value, this field resets to 1.

This field is accessible as shown below:

Off	DLK	SLK	Default
UNK	UNK	RO	RC

[Access permissions for the External debug interface registers on page H8-5567](#) describes the conditions shown in this table. These conditions are prioritized, with the leftmost condition having the highest priority and priority decreasing from left to right.

R, bit [2]

PE reset status bit.

This bit is UNKNOWN on reads if either:

- DoubleLockStatus() == TRUE
- EDPRSR.PU is 0.

Otherwise permitted values are:

- 0 The non-debug logic of the PE is not in reset state.
- 1 The non-debug logic of the PE is in reset state.

If the Core power domain is powered up and entered reset state with the OS double-lock locked this bit has a CONSTRAINED UNPREDICTABLE value, for more information see [EDPRSR.{DLK, R} and reset state on page H6-5538](#)

This field is in the Core power domain.

This field is accessible as shown below:

Off	DLK	Default
UNK	UNK	RO

[Access permissions for the External debug interface registers on page H8-5567](#) describes the conditions shown in this table. These conditions are prioritized, with the leftmost condition having the highest priority and priority decreasing from left to right.

SPD, bit [1]

Sticky core powerdown status bit.

This bit is UNKNOWN on reads if EDPRSR.PU is 1 and DoubleLockStatus() == TRUE .

Otherwise, permitted values are:

- 0 If EDPRSR.PU is 0, it is not known whether the state of the debug registers in the Core power domain is lost.
If EDPRSR.PU is 1, the state of the debug registers in the Core power domain has not been lost.
- 1 The state of the debug registers in the Core power domain has been lost.

If the Core power domain is powered up, then, following a read of EDPRSR:

- If DoubleLockStatus() == FALSE this bit clears to 0.
- If DoubleLockStatus() == TRUE, it is CONSTRAINED UNPREDICTABLE whether this bit clears to 0 or is unchanged.

When the value of EDPRSR.PU is 0 indicating that the Core power domain is in either retention or powerdown state, EDPRSR.SPD reads as 0. For more information, see [EDPRSR.SPD when the Core domain is in either retention or powerdown state on page H6-5537](#).

EDPRSR.{DLK, SPD, PU} describe whether registers in the Core power domain can be accessed, and whether their state has been lost since the last time the register was read. For more information, see [EDPRSR.{DLK, SPD, PU} and the Core power domain on page H6-5537](#).

This field is in the Core power domain and the Cold reset domain. On a Cold reset it resets to 1.
When this register has an architecturally-defined reset value, this field resets to 1.
This field is accessible as shown below:

Off	DLK	SLK	Default
RO	UNK	RO	RC

[Access permissions for the External debug interface registers on page H8-5567](#) describes the conditions shown in this table. These conditions are prioritized, with the leftmost condition having the highest priority and priority decreasing from left to right.

PU, bit [0]

Core powerup status bit. Indicates whether the Core power domain debug registers can be accessed.
When the Core power domain is powered-up and OS double-lock is locked, then:

- When [ARMv8.2-Debug](#) is implemented, the value of EDPRSR.PU reads as 0.
- When [ARMv8.2-Debug](#) is not implemented, the value of EDPRSR.PU is IMPLEMENTATION DEFINED.

See the description of DLK for more information.

Otherwise, permitted values are:

- 0 Core is in a low-power or powerdown state where the debug registers cannot be accessed.
- 1 Core is in a powerup state where the debug registers can be accessed.

If the Core power domain is powered up and entered reset state with the OS double-lock locked this bit has a CONSTRAINED UNPREDICTABLE value, for more information see [EDPRSR.{DLK, R} and reset state on page H6-5538](#)

EDPRSR.{DLK, SPD, PU} describe whether registers in the Core power domain can be accessed, and whether their state has been lost since the last time the register was read. For more information, see [EDPRSR.{DLK, SPD, PU} and the Core power domain on page H6-5537](#)

This field is accessible as shown below:

Off	DLK	Default
RAZ	See text	RAO

[Access permissions for the External debug interface registers on page H8-5567](#) describes the conditions shown in this table. These conditions are prioritized, with the leftmost condition having the highest priority and priority decreasing from left to right.

Accessing the EDPRSR:

EDPRSR can be accessed through the external debug interface:

Component	Offset
Debug	0x314

H9.2.41 EDRCR, External Debug Reserve Control Register

The EDRCR characteristics are:

Purpose

This register is used to allow imprecise entry to Debug state and clear sticky bits in [EDSCR](#).

Usage constraints

This register is accessible as follows:

Off	DLK	OSLK	SLK	Default
Error	Error	Error	WI	WO

Configurations

EDRCR is in the Core power domain.

Attributes

EDRCR is a 32-bit register.

Field descriptions

The EDRCR bit assignments are:

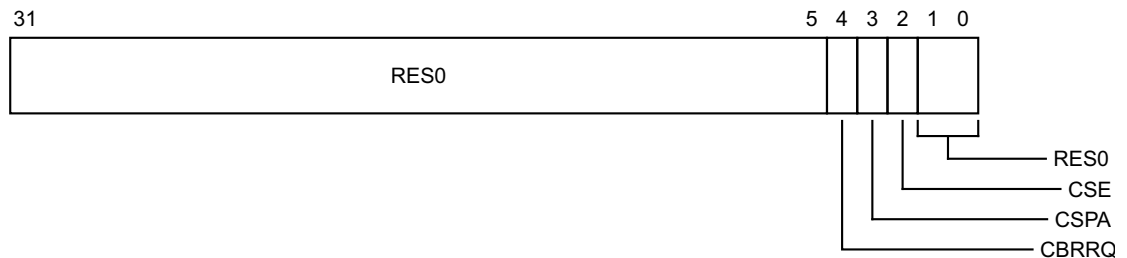

Bits [31:5]

Reserved, RES0.

CBRRQ, bit [4]

Allow imprecise entry to Debug state. The actions on writing to this bit are:

0 No action.

1 Allow imprecise entry to Debug state, for example by canceling pending bus accesses.

Setting this bit to 1 allows a debugger to request imprecise entry to Debug state. An External Debug Request debug event must be pending before the debugger sets this bit to 1.

This feature is optional. If this feature is not implemented, writes to this bit are ignored.

CSPA, bit [3]

Clear Sticky Pipeline Advance. This bit is used to clear the [EDSCR](#).PipeAdv bit to 0. The actions on writing to this bit are:

0 No action.

1 Clear the [EDSCR](#).PipeAdv bit to 0.

CSE, bit [2]

Clear Sticky Error. Used to clear the **EDSCR** cumulative error bits to 0. The actions on writing to this bit are:

- 0 No action.
- 1 Clear the **EDSCR**.{TXU, RXO, ERR} bits, and, if the PE is in Debug state, the **EDSCR.ITO** bit, to 0.

Bits [1:0]

Reserved, RES0.

Accessing the EDRCR:

EDRCR can be accessed through the external debug interface:

Component	Offset
Debug	0x090

H9.2.42 EDSCR, External Debug Status and Control Register

The EDSCR characteristics are:

Purpose

Main control register for the debug implementation.

Usage constraints

This register is accessible as follows:

Off	DLK	OSLK	SLK	Default
Error	Error	Error	RO	RW

Configurations

EDSCR is in the Core power domain. Some or all RW fields of this register have defined reset values. These apply only on a Cold reset. The register is not affected by a Warm reset and is not affected by an External debug reset.

Attributes

EDSCR is a 32-bit register.

Field descriptions

The EDSCR bit assignments are:

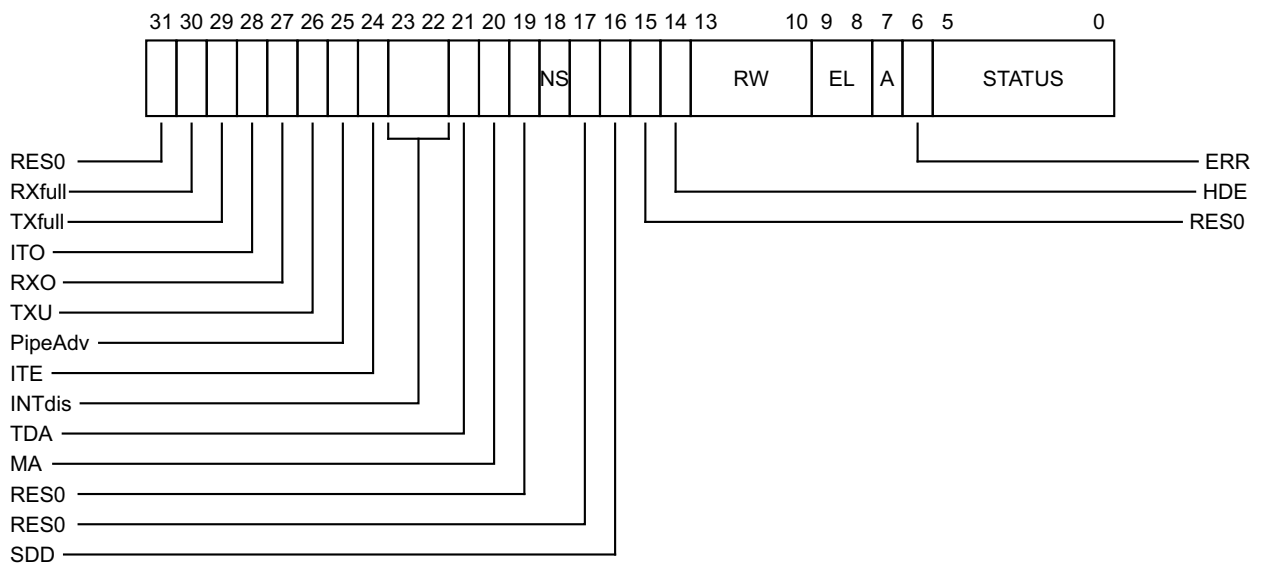

Bit [31]

Reserved, RES0.

RXfull, bit [30]

DTRRX full. This bit is RO.

When this register has an architecturally-defined reset value, this field resets to 0.

TXfull, bit [29]

DTRTX full. This bit is RO.

When this register has an architecturally-defined reset value, this field resets to 0.

ITO, bit [28]

ITR overrun. This bit is RO.

If the PE is in Non-debug state, this bit is UNKNOWN. ITO is set to 0 on entry to Debug state.

RXO, bit [27]

DTRRX overrun. This bit is RO.

When this register has an architecturally-defined reset value, this field resets to 0.

TXU, bit [26]

DTRTX underrun. This bit is RO.

When this register has an architecturally-defined reset value, this field resets to 0.

PipeAdv, bit [25]

Pipeline advance. This bit is RO. Set to 1 every time the PE pipeline retires one or more instructions. Cleared to 0 by a write to [EDRCR.CSPA](#).

The architecture does not define precisely when this bit is set to 1. It requires only that this happen periodically in Non-debug state to indicate that software execution is progressing.

ITE, bit [24]

ITR empty. This bit is RO.

If the PE is in Non-debug state, this bit is UNKNOWN. It is always valid in Debug state.

INTdis, bits [23:22]

Interrupt disable. Disables taking interrupts (including virtual interrupts and System Error interrupts) in Non-Debug state.

If `ExternalInvasiveDebugEnabled() = FALSE`, the value of this field is ignored.

If `ExternalInvasiveDebugEnabled() = TRUE`, the possible values of this field are:

- | | |
|----|--|
| 00 | Do not disable interrupts. |
| 01 | Disable interrupts taken to Non-secure EL1. |
| 10 | Disable interrupts taken only to Non-secure EL1 and Non-secure EL2. If external secure invasive debug is enabled, also disable interrupts taken to Secure EL1. |
| 11 | Disable interrupts taken only to Non-secure EL1 and Non-secure EL2. If external secure invasive debug is enabled, also disable all other interrupts. |

The value of INTdis does not affect whether an interrupt is a WFI wake-up event, but can mask an interrupt as a WFE wake-up event.

If EL3 and EL2 are not implemented, the values 0b01 and 0b10 are reserved. If programmed with a reserved value the PE behaves as if INTdis has been programmed with a defined value, other than for a direct read of EDSCR, and the value returned by a read of EDSCR.INTdis is UNKNOWN.

When this register has an architecturally-defined reset value, this field resets to 0.

TDA, bit [21]

Traps accesses to the following Debug System registers:

- AArch64: [DBGBCR<n>_EL1](#), [DBGBVR<n>_EL1](#), [DBGWCR<n>_EL1](#), [DBGWVR<n>_EL1](#).
- AArch32: [DBGBCR<n>](#), [DBGBVR<n>](#), [DBGXVR<n>](#), [DBGWCR<n>](#), [DBGWVR<n>](#).

The possible values of this field are:

- | | |
|---|--|
| 0 | Accesses to Debug System registers do not generate a Software Access debug event. |
| 1 | Accesses to Debug System registers generate a Software Access debug event, if OSLSR.OSLK is 0 and if halting is allowed. |

When this register has an architecturally-defined reset value, this field resets to 0.

MA, bit [20]

Memory access mode. Controls use of memory-access mode for accessing ITR and the DCC. This bit is ignored if in Non-debug state and set to zero on entry to Debug state.

Possible values of this field are:

- 0 Normal access mode.
- 1 Memory access mode.

SC2, bit [19]

In ARMv8.1

Sample CONTEXTIDR_EL2. Controls whether the Sample-based Profiling Extension samples CONTEXTIDR_EL2 or VTTBR_EL2.VMID.

- 0 Sample VTTBR_EL2.VMID.
- 1 Sample CONTEXTIDR_EL2.

If the PC Sample-based Profiling Extension is not implemented, then this field is RES0.

In ARMv8.2 and ARMv8.0.

Reserved, RES0.

NS, bit [18]

Non-secure status. Read-only. When in Debug state, gives the current Security state:

- 0 Secure state, IsSecure() == TRUE.
- 1 Non-secure state, IsSecure() == FALSE.

In Non-debug state, this bit is UNKNOWN.

Bit [17]

Reserved, RES0.

SDD, bit [16]

Secure debug disabled. This bit is RO.

On entry to Debug state:

- If entering in Secure state, SDD is set to 0.
- If entering in Non-secure state, SDD is set to the inverse of ExternalSecureInvasiveDebugEnabled().

In Debug state, the value of the SDD bit does not change, even if ExternalSecureInvasiveDebugEnabled() changes.

In Non-debug state:

- SDD returns the inverse of ExternalSecureInvasiveDebugEnabled(). If the authentication signals that control ExternalSecureInvasiveDebugEnabled() change, a context synchronization event is required to guarantee their effect.
- This bit is unaffected by the Security state of the PE.

If EL3 is not implemented and the implementation is Non-secure, this bit is RES1.

Bit [15]

Reserved, RES0.

HDE, bit [14]

Halting debug enable. The possible values of this field are:

- 0 Halting disabled for Breakpoint, Watchpoint and Halt Instruction debug events.
- 1 Halting enabled for Breakpoint, Watchpoint and Halt Instruction debug events.

When this register has an architecturally-defined reset value, this field resets to 0.

RW, bits [13:10]

Exception level Execution state status. Read-only. In Debug state, each bit gives the current Execution state of each EL:

RW	Meaning
1111	All Exception levels are using AArch64.
1110	EL0 is using AArch32. All other Exception levels are using AArch64.
110x	EL0 and EL1 are using AArch32. All other Exception levels are using AArch64. Never seen if EL2 is not implemented in the current Security state.
10xx	EL0, EL1, and, if implemented in the current Security state, EL2 are using AArch32. All other Exception levels are using AArch64.
0xxx	All Exception levels are using AArch32.

However:

- The value of 1110 is only permitted at EL0.
- The values 110x are not permitted if either:
 - EL2 is not implemented.
 - EL3 is implemented and SCR_EL3.NS/SCR.NS == 0.
- The values 10xx are not permitted if EL3 is not implemented.

In Non-debug state, this field is RAO.

EL, bits [9:8]

Exception level. Read-only. In Debug state, this gives the current EL of the PE.

In Non-debug state, this field is RAZ.

A, bit [7]

System Error interrupt pending. Read-only. In Debug state, indicates whether a SError interrupt is pending:

- If [HCR_EL2](#).{AMO, TGE} = {1, 0} and in Non-secure EL0 or EL1, a virtual SError interrupt.
 - Otherwise, a physical SError interrupt.
- 0 No SError interrupt pending.
1 SError interrupt pending.

A debugger can read EDSCR to check whether an SError interrupt is pending without having to execute further instructions. A pending SError might indicate data from target memory is corrupted. UNKNOWN in Non-debug state.

ERR, bit [6]

Cumulative error flag. This field is RO. It is set to 1 following exceptions in Debug state and on any signaled overrun or underrun on the DTR or EDITR.

When this register has an architecturally-defined reset value, this field resets to 0.

STATUS, bits [5:0]

Debug status flags. This field is RO.

The possible values of this field are:

- 000010 PE is in Non-debug state.
- 000001 PE is restarting, exiting Debug state.

000111	Breakpoint.
010011	External debug request.
011011	Halting step, normal.
011111	Halting step, exclusive.
100011	OS Unlock Catch.
100111	Reset Catch.
101011	Watchpoint.
101111	HLT instruction.
110011	Software access to debug register.
110111	Exception Catch.
111011	Halting step, no syndrome.
All other values of STATUS are reserved.	

Accessing the EDSCR:

EDSCR can be accessed through the external debug interface:

Component	Offset
Debug	0x088

H9.2.43 EDVIDSR, External Debug Virtual Context Sample Register

The EDVIDSR characteristics are:

Purpose

Contains sampled values captured on reading [EDPCSR](#)[31:0].

Usage constraints

This register is accessible as follows:

Off	DLK	OSLK	Default
Error	Error	Error	RO

Configurations

EDVIDSR is in the Core power domain.

Fields in this register reset to architecturally UNKNOWN values. These apply only on a Cold reset. The register is not affected by a Warm reset and is not affected by an External debug reset.

Implemented only if the OPTIONAL PC Sample-based Profiling Extension is implemented and [ARMv8.2-PCSample](#) is not implemented. If [ARMv8.2-PCSample](#) is implemented, this register is RES0 and the architecture defines the functionality in [PMPCSR](#), [PMCID2SR](#), and [PMVIDSR](#).

If EL2 is not implemented and EL3 is not implemented, it is IMPLEMENTATION DEFINED whether EDVIDSR is implemented.

Attributes

If [ARMv8.1-VHE](#) is implemented, the format of this register differs depending on the value of [EDSCR.SC2](#).

Field descriptions

The EDVIDSR bit assignments are:

When ARMv8.1-VHE is not implemented:

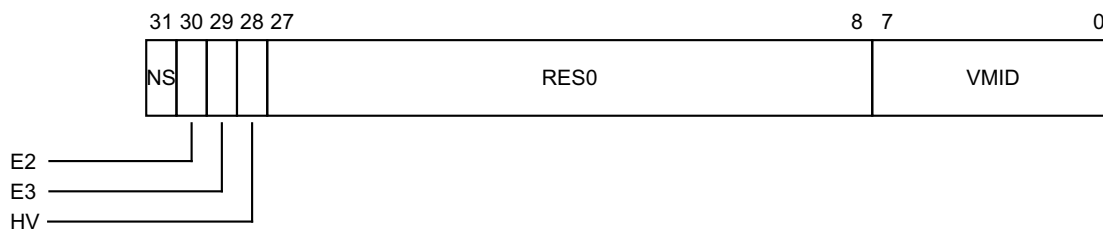

NS, bit [31]

Non-secure state sample. Indicates the Security state associated with the most recent [EDPCSR](#) sample.

If EL3 is not implemented, this bit indicates the Effective value of [SCR.NS](#).

When this register has an architecturally-defined reset value, this field resets to a value that is architecturally UNKNOWN.

E2, bit [30]

Exception level 2 status sample. Indicates whether the most recent [EDPCSR](#) sample was associated with EL2.

If EL2 is not implemented, this bit is RES0.

When this register has an architecturally-defined reset value, this field resets to a value that is architecturally UNKNOWN.

E3, bit [29]

Exception level 3 status sample. Indicates whether the most recent **EDPCSR** sample was associated with EL3 using AArch64.

If EDVIDSR.NS == 1 or the PE was in AArch32 state when EDPCSRlo (**EDPCSR**[31:0]) was read, this bit is 0.

If EL3 is not implemented, this bit is RES0.

When this register has an architecturally-defined reset value, this field resets to a value that is architecturally UNKNOWN.

HV, bit [28]

EDPCSRhi (**EDPCSR**[63:32]) valid. Indicates whether bits [63:32] of the most recent **EDPCSR** sample might be nonzero:

0 Bits[63:32] of the most recent EDPCSR sample are zero.

1 Bits[63:32] of the most recent EDPCSR sample might be nonzero.

An EDVIDSR.HV value of 1 does not mean that the value of EDPCSRhi is nonzero.

When this register has an architecturally-defined reset value, this field resets to a value that is architecturally UNKNOWN.

Bits [27:8]

Reserved, RES0.

VMID, bits [7:0]

VMID sample. The VMID associated with the most recent EDPCSRlo (**EDPCSR**[31:0]) sample.

If the value of EDVIDSR.NS is 0 or the value of EDVIDSR.E2 is 1 this field is RES0.

If EL2 is not implemented, this field is RES0.

When this register has an architecturally-defined reset value, this field resets to a value that is architecturally UNKNOWN.

When ARMv8.1-VHE is implemented and EDSCR.SC2 == 0:

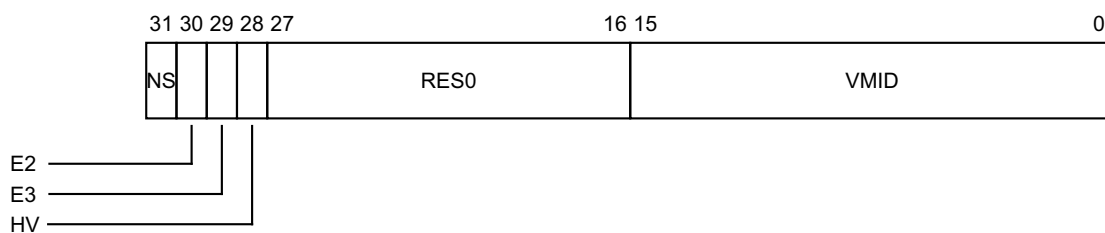

NS, bit [31]

Non-secure state sample. Indicates the Security state associated with the most recent **EDPCSR** sample or, when it is read as a single atomic 64-bit read, the current EDPCSR sample.

If EL3 is not implemented, this bit has a fixed read-only value that indicates the Effective value of **SCR.NS**.

When this register has an architecturally-defined reset value, this field resets to a value that is architecturally UNKNOWN.

E2, bit [30]

Exception level 2 status sample. Indicates whether the most recent **EDPCSR** sample or, when it is read as a single atomic 64-bit read, the current EDPCSR sample, was associated with EL2.

If EDVIDSR.NS == 0, this bit is 0.

If EL2 is not implemented, this bit is RES0.

When this register has an architecturally-defined reset value, this field resets to a value that is architecturally UNKNOWN.

E3, bit [29]

Exception level 3 status sample. Indicates whether the most recent EDPCSR sample or, when it is read as a single atomic 64-bit read, was associated with EL3 using AArch64.

If EDVIDSR.NS == 1 or the PE was in AArch32 state when EDPCSRlo (EDPCSR[31:0]) was read, this bit is 0.

If EL3 is not implemented, this bit is RES0.

When this register has an architecturally-defined reset value, this field resets to a value that is architecturally UNKNOWN.

HV, bit [28]

EDPCSRhi (EDPCSR[63:32]) valid. Indicates whether bits [63:32] of the most recent EDPCSR sample might be nonzero:

0 Bits[63:32] of the most recent EDPCSR sample are zero.

1 Bits[63:32] of the most recent EDPCSR sample might be nonzero.

An EDVIDSR.HV value of 1 does not mean that the value of EDPCSRhi is nonzero. An EDVIDSR.HV value of 0 is a hint that EDPCSRhi (EDPCSR[63:32]) does not need to be read.

When this register has an architecturally-defined reset value, this field resets to a value that is architecturally UNKNOWN.

Bits [27:16]

Reserved, RES0.

VMID, bits [15:0]

VMID sample. The VMID associated with the most recent EDPCSRlo (EDPCSR[31:0]) sample.

If the value of EDVIDSR.NS is 0 or the value of EDVIDSR.E2 is 1 this field is RES0.

If EL2 is not implemented, then this field is RES0.

If EL2 is implemented and is using AArch64, the VMID is held in VTTBR_EL2.VMID.

If EL2 is implemented and is using AArch32, the VMID is held in VTTBR.VMID.

If 16-bit VMIDs are not supported, EDVIDSR.VMID[15:8] is RES0.

If 16-bit VMIDs are supported, but VTTBRx.VMID[15:8] are not used, EDVIDSR.VMID[15:8] is set to 0.

When this register has an architecturally-defined reset value, this field resets to a value that is architecturally UNKNOWN.

When ARMv8.1-VHE is implemented and EDSCR.SC2 == 1:

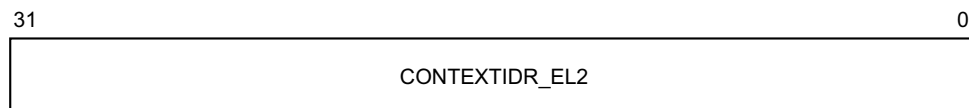

CONTEXTIDR_EL2, bits [31:0]

Context ID.

- If EL2 is using AArch64, the value of CONTEXTIDR_EL2 as associated with the most recent EDPCSR sample.
- If EDPCSR.NS == 0, then this field is set to an UNKNOWN value.

- Otherwise this field is set to an UNKNOWN value.

When this register has an architecturally-defined reset value, this field resets to a value that is architecturally UNKNOWN.

When ARMv8.2-PCSample is implemented:

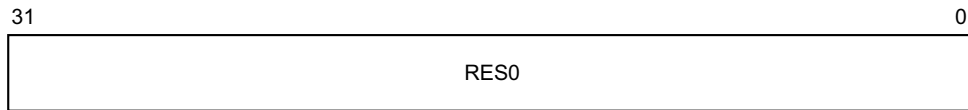

Bits [31:0]

Reserved, RES0.

Accessing the EDVIDSR:

EDVIDSR can be accessed through the external debug interface:

Component	Offset
Debug	0x0A8

H9.2.44 EDWAR, External Debug Watchpoint Address Register

The EDWAR characteristics are:

Purpose

Returns the virtual data address being accessed when a Watchpoint Debug Event was triggered.

Usage constraints

This register is accessible as follows:

Off	DLK	OSLK	Default
Error	Error	Error	RO

Configurations

EDWAR is in the Core power domain. RW fields in this register reset to architecturally UNKNOWN values. These apply only on a Cold reset. The register is not affected by a Warm reset and is not affected by an External debug reset.

Attributes

EDWAR is a 64-bit register.

Field descriptions

The EDWAR bit assignments are:

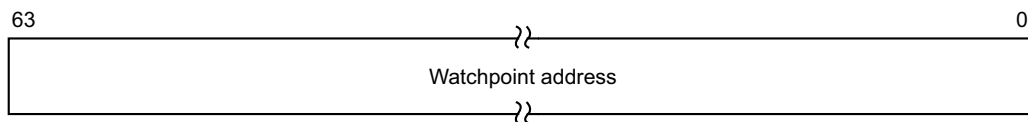

Bits [63:0]

Watchpoint address. The data virtual address being accessed when a Watchpoint Debug Event was triggered and caused entry to Debug state. This address must be within a naturally-aligned block of memory of power-of-two size no larger than the [DC ZVA](#) block size.

The value of this register is UNKNOWN if the PE is in Non-debug state, or if Debug state was entered other than for a Watchpoint debug event.

The value of EDWAR[63:32] is UNKNOWN if Debug state was entered for a Watchpoint debug event taken from AArch32 state.

The EDWAR is subject to the same alignment rules as the reporting of a watchpointed address in the FAR. See [Determining the memory location that caused a Watchpoint exception on page D2-1948](#)

This field resets to a value that is architecturally UNKNOWN.

Accessing the EDWAR:

EDWAR[31:0] can be accessed through the external debug interface:

Component	Offset
Debug	0x030

EDWAR[63:32] can be accessed through the external debug interface:

Component	Offset
Debug	0x034

H9.2.45 MIDR_EL1, Main ID Register

The MIDR_EL1 characteristics are:

Purpose

Provides identification information for the PE, including an implementer code for the device and a device ID number.

Usage constraints

This register is accessible as follows:

Off	DLK	Default
IMP DEF	IMP DEF	RO

Configurations

External register MIDR_EL1 is architecturally mapped to AArch64 System register [MIDR_EL1](#).

External register MIDR_EL1 is architecturally mapped to AArch32 System register [MIDR](#).

It is IMPLEMENTATION DEFINED whether MIDR_EL1 is implemented in the Core power domain or in the Debug power domain.

Attributes

MIDR_EL1 is a 32-bit register.

Field descriptions

The MIDR_EL1 bit assignments are:

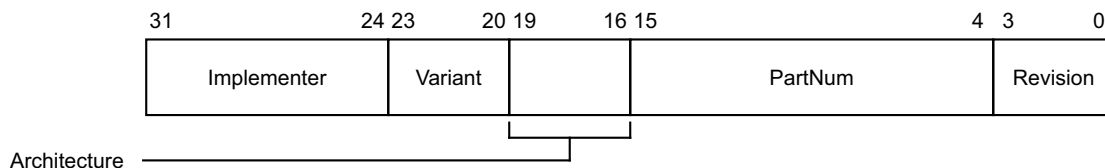

Implementer, bits [31:24]

The Implementer code. This field must hold an implementer code that has been assigned by ARM. Assigned codes include the following:

Hex representation	ASCII representation	Implementer
0x41	A	ARM Limited
0x42	B	Broadcom Corporation
0x43	C	Cavium Inc.
0x44	D	Digital Equipment Corporation
0x49	I	Infineon Technologies AG
0x4D	M	Motorola or Freescale Semiconductor Inc.
0x4E	N	NVIDIA Corporation
0x50	P	Applied Micro Circuits Corporation

Hex representation	ASCII representation	Implementer
0x51	Q	Qualcomm Inc.
0x56	V	Marvell International Ltd.
0x69	i	Intel Corporation

ARM can assign codes that are not published in this manual. All values not assigned by ARM are reserved and must not be used.

Variant, bits [23:20]

An IMPLEMENTATION DEFINED variant number. Typically, this field is used to distinguish between different product variants, or major revisions of a product.

Architecture, bits [19:16]

The permitted values of this field are:

0001	ARMv4
0010	ARMv4T
0011	ARMv5 (obsolete)
0100	ARMv5T
0101	ARMv5TE
0110	ARMv5TEJ
0111	ARMv6
1111	Architectural features are individually identified in the ID_* registers, see Identification registers, functional group on page G4-4727 .

All other values are reserved.

PartNum, bits [15:4]

An IMPLEMENTATION DEFINED primary part number for the device.

On processors implemented by ARM, if the top four bits of the primary part number are 0x0 or 0x7, the variant and architecture are encoded differently.

Revision, bits [3:0]

An IMPLEMENTATION DEFINED revision number for the device.

Accessing the MIDR_EL1:

MIDR_EL1 can be accessed through the external debug interface:

Component	Offset
Debug	0xD00

H9.2.46 OSLAR_EL1, OS Lock Access Register

The OSLAR_EL1 characteristics are:

Purpose

Used to lock or unlock the OS lock.

Usage constraints

This register is accessible as follows:

Off	DLK	EDAD	SLK	Default
Error	Error	IMP DEF	WI	WO

Configurations

External register OSLAR_EL1 is architecturally mapped to AArch64 System register [OSLAR_EL1](#).

External register OSLAR_EL1 is architecturally mapped to AArch32 System register [DBGOSLAR](#).

OSLAR_EL1 is in the Core power domain.

From ARMv8.2, external debug accesses to OSLAR_EL1 are ignored and return an error when any of:

- ExternalInvasiveDebugEnabled() == FALSE.
- ExternalSecureInvasiveDebugEnabled() == FALSE and any of:
 - EL3 is not implemented and the PE is in Secure state.
 - EL3 is implemented and is using AArch64 and [MDCR_EL3.EDAD](#) == 1
 - EL3 is implemented and is using AArch32 and [SDCR.EDAD](#) == 1.

Attributes

OSLAR_EL1 is a 32-bit register.

Field descriptions

The OSLAR_EL1 bit assignments are:

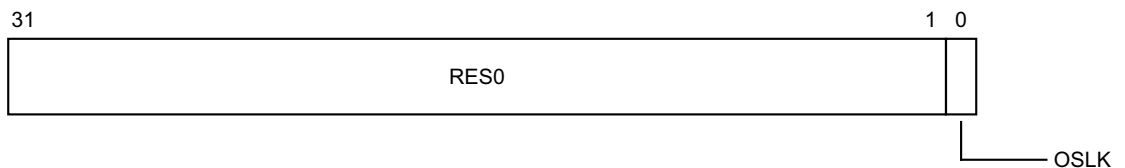

Bits [31:1]

Reserved, RES0.

OSLK, bit [0]

On writes to OSLAR_EL1, bit[0] is copied to the OS lock.

Use [EDPRSR.OSLK](#) to check the current status of the lock.

Accessing the OSLAR_EL1:

OSLAR_EL1 can be accessed through the external debug interface:

Component	Offset
Debug	0x300

H9.3 Cross-Trigger Interface registers

This section lists the Cross-Trigger Interface registers.

H9.3.1 ASICCTL, CTI External Multiplexer Control register

The ASICCTL characteristics are:

Purpose

Can be used to provide IMPLEMENTATION DEFINED controls for the CTI. For example, the register might be used to control multiplexors for additional IMPLEMENTATION DEFINED triggers. The IMPLEMENTATION DEFINED controls provided by this register might modify the architecturally defined behavior of the CTI.

———— **Note** —————

The architecturally-defined triggers must not be multiplexed.

Usage constraints

This register is accessible as follows:

Off	DLK	OSLK	EDAD	SLK	Default
IMP DEF	IMP DEF	IMP DEF	IMP DEF	RO	IMP DEF

Configurations

It is IMPLEMENTATION DEFINED whether ASICCTL is implemented in the Core power domain or in the Debug power domain.

If it is implemented in the Core power domain then it is IMPLEMENTATION DEFINED whether it is in the Cold reset domain or the Warm reset domain.

This register must reset to a value that supports the architecturally-defined behavior of the CTI. Changing the value of the register from its reset value causes IMPLEMENTATION DEFINED behavior that might differ from the architecturally-defined behavior of the CTI.

Other than the requirements listed in this register description, all aspects of the reset behavior of the ASICCTL are IMPLEMENTATION DEFINED.

Attributes

ASICCTL is a 32-bit register.

Field descriptions

The ASICCTL bit assignments are:



IMPLEMENTATION DEFINED, bits [31:0]

IMPLEMENTATION DEFINED.

Accessing the ASICCTL:

ASICCTL can be accessed through the external debug interface:

Component	Offset
CTI	0x144

H9.3.2 CTIAPPCLEAR, CTI Application Trigger Clear register

The CTIAPPCLEAR characteristics are:

Purpose

Clears bits of the Application Trigger register.

Usage constraints

This register is accessible as follows:

SLK	Default
RO	WO

Configurations

CTIAPPCLEAR is in the Debug power domain.

Attributes

CTIAPPCLEAR is a 32-bit register.

Field descriptions

The CTIAPPCLEAR bit assignments are:

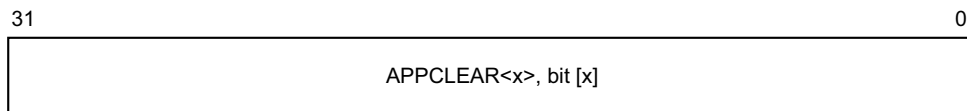

APPCLEAR<x>, bit [x], for x = 0 to 31

Application trigger <x> disable.

Bits [31:N] are RAZ/WI. N is the number of ECT channels implemented as defined by the [CTIDEVID.NUMCHAN](#) field.

Writing to this bit has the following effect:

- 0 No effect.
- 1 Clear corresponding bit in CTIAPPTRIG to 0 and clear the corresponding channel event.

If the ECT does not support multicycle channel events, use of CTIAPPCLEAR is deprecated and the debugger must only use [CTIAPPULSE](#).

Accessing the CTIAPPCLEAR:

CTIAPPCLEAR can be accessed through the external debug interface:

Component	Offset
CTI	0x018

H9.3.3 CTIAPPULSE, CTI Application Pulse register

The CTIAPPULSE characteristics are:

Purpose

Causes event pulses to be generated on ECT channels.

Usage constraints

This register is accessible as follows:

SLK	Default
RO	WO

It is CONSTRAINED UNPREDICTABLE whether a write to CTIAPPULSE generates an event on a channel if CTICONTROL.GLBEN is 0.

Configurations

CTIAPPULSE is in the Debug power domain.

Attributes

CTIAPPULSE is a 32-bit register.

Field descriptions

The CTIAPPULSE bit assignments are:

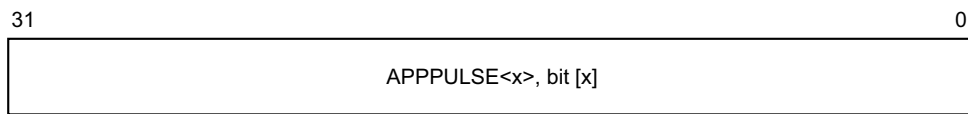

APPULSE<x>, bit [x], for x = 0 to 31

Generate event pulse on ECT channel <x>.

Bits [31:N] are RAZ/WI. N is the number of ECT channels implemented as defined by the CTIDEVID.NUMCHAN field.

Writing to this bit has the following effect:

- 0 No effect.
- 1 Channel <x> event pulse generated.

Note

- The CTIAPPULSE operation does not affect the state of the Application Trigger register, CTIAPPTRIG. If the channel is active, either because of an earlier event or from the application trigger, then the value written to CTIAPPULSE might have no effect.
- Multiple pulse events that occur close together might be merged into a single pulse event.

Accessing the CTIAPPULSE:

CTIAPPULSE can be accessed through the external debug interface:

Component	Offset
CTI	0x01C

H9.3.4 CTIAPPSET, CTI Application Trigger Set register

The CTIAPPSET characteristics are:

Purpose

Sets bits of the Application Trigger register.

Usage constraints

This register is accessible as follows:

SLK	Default
RO	RW

Configurations

CTIAPPSET is in the Debug power domain. RW fields in this register reset to architecturally UNKNOWN values. These apply only on an External debug reset. The register is not affected by a Warm reset and is not affected by a Cold reset.

Attributes

CTIAPPSET is a 32-bit register.

Field descriptions

The CTIAPPSET bit assignments are:

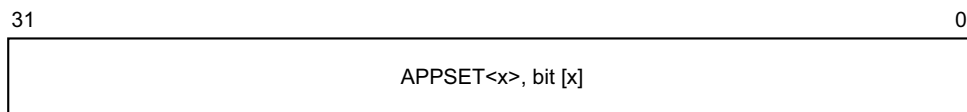

APPSET<x>, bit [x], for x = 0 to 31

Application trigger <x> enable.

Bits [31:N] are RAZ/WI. N is the number of ECT channels implemented as defined by the [CTIDEVID.NUMCHAN](#) field.

Possible values of this bit are:

- 0 Reading this means the application trigger is inactive. Writing this has no effect.
- 1 Reading this means the application trigger is active. Writing this sets the corresponding bit in CTIAPPTRIG to 1 and generates a channel event.

If the ECT does not support multicycle channel events, use of CTIAPPSET is deprecated and the debugger must only use [CTIAPPULSE](#).

This field resets to a value that is architecturally UNKNOWN.

Accessing the CTIAPPSET:

CTIAPPSET can be accessed through the external debug interface:

Component	Offset
CTI	0x014

H9.3.5 CTIAUTHSTATUS, CTI Authentication Status register

The CTIAUTHSTATUS characteristics are:

Purpose

Provides information about the state of the IMPLEMENTATION DEFINED authentication interface for CTI.

Usage constraints

This register is accessible as follows:

SLK	Default
RO	RO

Configurations

CTIAUTHSTATUS is in the Debug power domain.

This register is OPTIONAL, and is required for CoreSight compliance.

Attributes

CTIAUTHSTATUS is a 32-bit register.

Field descriptions

The CTIAUTHSTATUS bit assignments are:

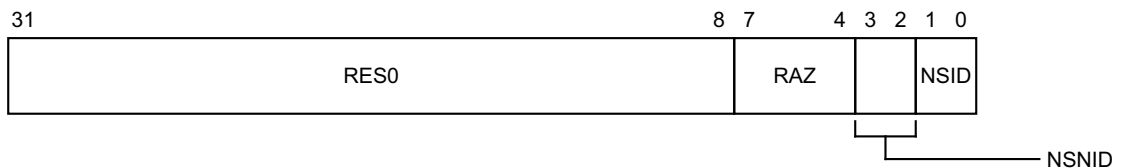

Bits [31:8]

Reserved, RES0.

Bits [7:4]

Reserved, RAZ.

NSNID, bits [3:2]

If EL3 is not implemented and the implemented Security state is Secure state, holds the same value as [DBGAUTHSTATUS_EL1.SNID](#).

Otherwise, holds the same value as [DBGAUTHSTATUS_EL1.NSNID](#).

NSID, bits [1:0]

If EL3 is not implemented and the implemented Security state is Secure state, holds the same value as [DBGAUTHSTATUS_EL1.SID](#).

Otherwise, holds the same value as [DBGAUTHSTATUS_EL1.NSID](#).

Accessing the CTIAUTHSTATUS:

CTIAUTHSTATUS can be accessed through the external debug interface:

Component	Offset
CTI	0xFB8

H9.3.6 CTICHINSTATUS, CTI Channel In Status register

The CTICHINSTATUS characteristics are:

Purpose

Provides the raw status of the ECT channel inputs to the CTI.

Usage constraints

This register is accessible as follows:

SLK	Default
RO	RO

Configurations

CTICHINSTATUS is in the Debug power domain.

Attributes

CTICHINSTATUS is a 32-bit register.

Field descriptions

The CTICHINSTATUS bit assignments are:

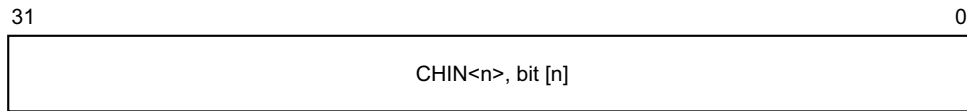

CHIN<n>, bit [n], for n = 0 to 31

Input channel <n> status.

Bits [31:N] are RAZ. N is the number of ECT channels implemented as defined by the [CTIDEVID.NUMCHAN](#) field.

Possible values of this bit are:

0 Input channel <n> is inactive.

1 Input channel <n> is active.

If the ECT channels do not support multicycle events then it is IMPLEMENTATION DEFINED whether an input channel can be observed as active.

Accessing the CTICHINSTATUS:

CTICHINSTATUS can be accessed through the external debug interface:

Component	Offset
CTI	0x138

H9.3.7 CTICHOUTSTATUS, CTI Channel Out Status register

The CTICHOUTSTATUS characteristics are:

Purpose

Provides the status of the ECT channel outputs from the CTI.

Usage constraints

This register is accessible as follows:

SLK	Default
RO	RO

Configurations

CTICHOUTSTATUS is in the Debug power domain.

Attributes

CTICHOUTSTATUS is a 32-bit register.

Field descriptions

The CTICHOUTSTATUS bit assignments are:

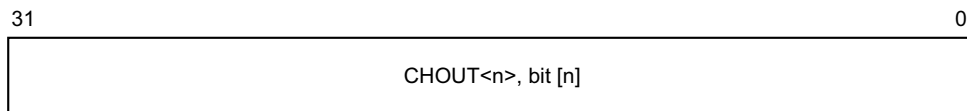

CHOUT<n>, bit [n], for n = 0 to 31

Output channel <n> status.

Bits [31:N] are RAZ. N is the number of ECT channels implemented as defined by the [CTIDEVID.NUMCHAN](#) field.

Possible values of this bit are:

- 0 Output channel <n> is inactive.
- 1 Output channel <n> is active.

If the ECT channels do not support multicycle events then it is IMPLEMENTATION DEFINED whether an input channel can be observed as active.

————— Note —————

The value in CTICHOUTSTATUS is after gating by the channel gate. For more information, see [CTIGATE](#).

Accessing the CTICHOUTSTATUS:

CTICHOUTSTATUS can be accessed through the external debug interface:

Component	Offset
CTI	0x13C

H9.3.8 CTICIDR0, CTI Component Identification Register 0

The CTICIDR0 characteristics are:

Purpose

Provides information to identify a CTI component.

For more information see [About the Component Identification scheme on page K2-6149](#).

Usage constraints

This register is accessible as follows:

SLK	Default
RO	RO

Configurations

CTICIDR0 is in the Debug power domain.

Implementation of this register is OPTIONAL.

This register is required for CoreSight compliance.

Attributes

CTICIDR0 is a 32-bit register.

Field descriptions

The CTICIDR0 bit assignments are:

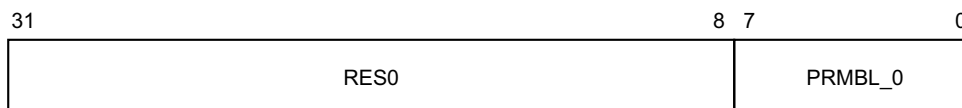

Bits [31:8]

Reserved, RES0.

PRMBL_0, bits [7:0]

Preamble. Must read as 0x0D.

Accessing the CTICIDR0:

CTICIDR0 can be accessed through the external debug interface:

Component	Offset
CTI	0xFF0

H9.3.9 CTICIDR1, CTI Component Identification Register 1

The CTICIDR1 characteristics are:

Purpose

Provides information to identify a CTI component.

For more information see [About the Component Identification scheme on page K2-6149](#).

Usage constraints

This register is accessible as follows:

SLK	Default
RO	RO

Configurations

CTICIDR1 is in the Debug power domain.

Implementation of this register is OPTIONAL.

This register is required for CoreSight compliance.

Attributes

CTICIDR1 is a 32-bit register.

Field descriptions

The CTICIDR1 bit assignments are:

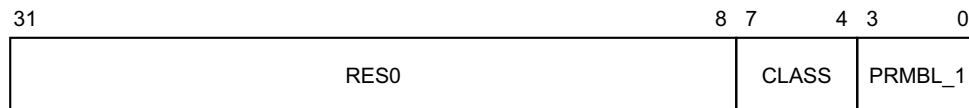

Bits [31:8]

Reserved, RES0.

CLASS, bits [7:4]

Component class. Reads as 0x9, debug component.

PRMBL_1, bits [3:0]

Preamble. RAZ.

Accessing the CTICIDR1:

CTICIDR1 can be accessed through the external debug interface:

Component	Offset
CTI	0xFF4

H9.3.10 CTICIDR2, CTI Component Identification Register 2

The CTICIDR2 characteristics are:

Purpose

Provides information to identify a CTI component.

For more information see [About the Component Identification scheme on page K2-6149](#).

Usage constraints

This register is accessible as follows:

SLK	Default
RO	RO

Configurations

CTICIDR2 is in the Debug power domain.

Implementation of this register is OPTIONAL.

This register is required for CoreSight compliance.

Attributes

CTICIDR2 is a 32-bit register.

Field descriptions

The CTICIDR2 bit assignments are:

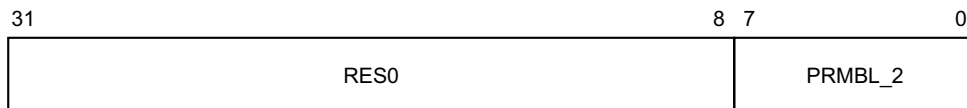

Bits [31:8]

Reserved, RES0.

PRMBL_2, bits [7:0]

Preamble. Must read as 0x05.

Accessing the CTICIDR2:

CTICIDR2 can be accessed through the external debug interface:

Component	Offset
CTI	0xFF8

H9.3.11 CTICIDR3, CTI Component Identification Register 3

The CTICIDR3 characteristics are:

Purpose

Provides information to identify a CTI component.

For more information see [About the Component Identification scheme on page K2-6149](#).

Usage constraints

This register is accessible as follows:

SLK	Default
RO	RO

Configurations

CTICIDR3 is in the Debug power domain.

Implementation of this register is OPTIONAL.

This register is required for CoreSight compliance.

Attributes

CTICIDR3 is a 32-bit register.

Field descriptions

The CTICIDR3 bit assignments are:

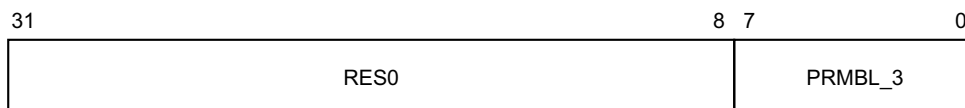

Bits [31:8]

Reserved, RES0.

PRMBL_3, bits [7:0]

Preamble. Must read as 0xB1.

Accessing the CTICIDR3:

CTICIDR3 can be accessed through the external debug interface:

Component	Offset
CTI	0xFFC

H9.3.12 CTICLAIMCLR, CTI Claim Tag Clear register

The CTICLAIMCLR characteristics are:

Purpose

Used by software to read the values of the CLAIM bits, and to clear these bits to 0.

Usage constraints

This register is accessible as follows:

SLK	Default
RO	RW

Configurations

CTICLAIMCLR is in the Debug power domain.

See the CLAIM field description for the effect of an External debug reset on the value returned by this register. This register is not affected by a Warm reset, and is not affected by a Cold reset.

Implementation of this register is OPTIONAL.

Attributes

CTICLAIMCLR is a 32-bit register.

Field descriptions

The CTICLAIMCLR bit assignments are:

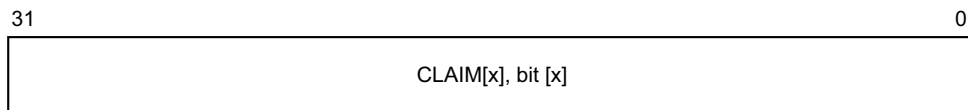

CLAIM[x], bit [x], for x = 0 to 31

CLAIM tag clear bit.

For values of x greater than or equal to the IMPLEMENTATION DEFINED number of CLAIM tags, this bit is RAZ/SBZ. Software can rely on these bits reading as zero, and must use a Should-Be-Zero policy on writes. Implementations must ignore writes.

For other values of x, reads return the value of CLAIM[x] and the behavior on writes is:

0 No action.

1 Indirectly clear CLAIM[x] to 0.

A single write to CTICLAIMCLR can clear multiple tags to 0.

An External Debug reset clears the CLAIM tag bits to 0.

Accessing the CTICLAIMCLR:

CTICLAIMCLR can be accessed through the external debug interface:

Component	Offset
CTI	0xFA4

H9.3.13 CTICLAIMSET, CTI Claim Tag Set register

The CTICLAIMSET characteristics are:

Purpose

Used by software to set CLAIM bits to 1.

Usage constraints

This register is accessible as follows:

SLK	Default
RO	RW

Configurations

CTICLAIMSET is in the Debug power domain.

Implementation of this register is OPTIONAL.

Attributes

CTICLAIMSET is a 32-bit register.

Field descriptions

The CTICLAIMSET bit assignments are:

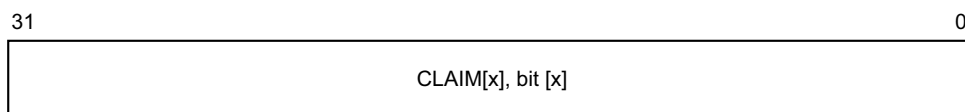

CLAIM[x], bit [x], for x = 0 to 31

CLAIM tag set bit.

For values of x greater than or equal to the IMPLEMENTATION DEFINED number of CLAIM tags, this bit is RAZ/SBZ. Software can rely on these bits reading as zero, and must use a Should-Be-Zero policy on writes. Implementations must ignore writes.

For other values of x, the bit is RAO and the behavior on writes is:

0 No action.

1 Indirectly set CLAIM[x] tag to 1.

A single write to CTICLAIMSET can set multiple tags to 1.

An External Debug reset clears the CLAIM tag bits to 0.

Accessing the CTICLAIMSET:

CTICLAIMSET can be accessed through the external debug interface:

Component	Offset
CTI	0xFA0

H9.3.14 CTICONTROL, CTI Control register

The CTICONTROL characteristics are:

Purpose

Controls whether the CTI is enabled.

Usage constraints

This register is accessible as follows:

SLK	Default
RO	RW

Configurations

CTICONTROL is in the Debug power domain. Some or all RW fields of this register have defined reset values. These apply only on an External debug reset. The register is not affected by a Warm reset and is not affected by a Cold reset.

Attributes

CTICONTROL is a 32-bit register.

Field descriptions

The CTICONTROL bit assignments are:

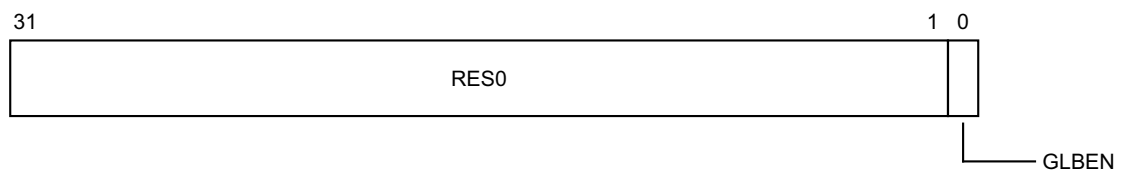

Bits [31:1]

Reserved, RES0.

GLBEN, bit [0]

Enables or disables the CTI mapping functions. Possible values of this field are:

0 CTI mapping functions disabled.

1 CTI mapping functions enabled.

When the mapping functions are disabled, no new events are signaled on either output triggers or output channels. If a previously asserted output trigger has not been acknowledged, it remains asserted after the mapping functions are disabled. All output triggers are disabled by CTI reset.

If the ECT supports multicycle channel events any existing output channel events will be terminated.

When this register has an architecturally-defined reset value, this field resets to 0.

Accessing the CTICONTROL:

CTICONTROL can be accessed through the external debug interface:

Component	Offset
CTI	0x000

H9.3.15 CTIDEVAFF0, CTI Device Affinity register 0

The CTIDEVAFF0 characteristics are:

Purpose

Copy of the low half of the PE [MPIDR_EL1](#) register that allows a debugger to determine which PE in a multiprocessor system the CTI component relates to.

Usage constraints

This register is accessible as follows:

SLK	Default
RO	RO

Configurations

CTIDEVAFF0 is in the Debug power domain.

Implementation of this register is OPTIONAL.

Attributes

CTIDEVAFF0 is a 32-bit register.

Field descriptions

The CTIDEVAFF0 bit assignments are:

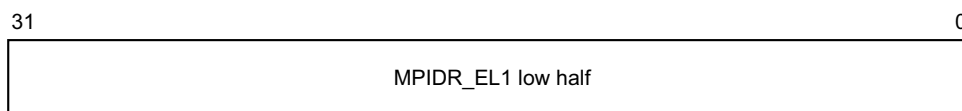

Bits [31:0]

[MPIDR_EL1](#) low half. Read-only copy of the low half of [MPIDR_EL1](#), as seen from the highest implemented Exception level.

Accessing the CTIDEVAFF0:

CTIDEVAFF0 can be accessed through the external debug interface:

Component	Offset
CTI	0xFA8

H9.3.16 CTIDEVAFF1, CTI Device Affinity register 1

The CTIDEVAFF1 characteristics are:

Purpose

Copy of the high half of the PE [MPIDR_EL1](#) register that allows a debugger to determine which PE in a multiprocessor system the CTI component relates to.

Usage constraints

This register is accessible as follows:

SLK	Default
RO	RO

Configurations

CTIDEVAFF1 is in the Debug power domain.
Implementation of this register is OPTIONAL.

Attributes

CTIDEVAFF1 is a 32-bit register.

Field descriptions

The CTIDEVAFF1 bit assignments are:

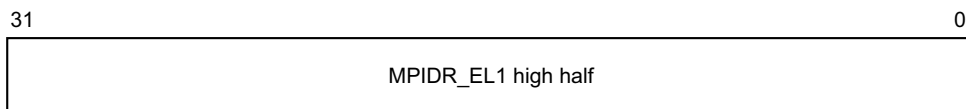

Bits [31:0]

[MPIDR_EL1](#) high half. Read-only copy of the high half of [MPIDR_EL1](#), as seen from the highest implemented Exception level.

Accessing the CTIDEVAFF1:

CTIDEVAFF1 can be accessed through the external debug interface:

Component	Offset
CTI	0xFAC

H9.3.17 CTIDEVARCH, CTI Device Architecture register

The CTIDEVARCH characteristics are:

Purpose

Identifies the programmers' model architecture of the CTI component.

Usage constraints

This register is accessible as follows:

SLK	Default
RO	RO

Configurations

CTIDEVARCH is in the Debug power domain.

Implementation of this register is OPTIONAL.

Attributes

CTIDEVARCH is a 32-bit register.

Field descriptions

The CTIDEVARCH bit assignments are:

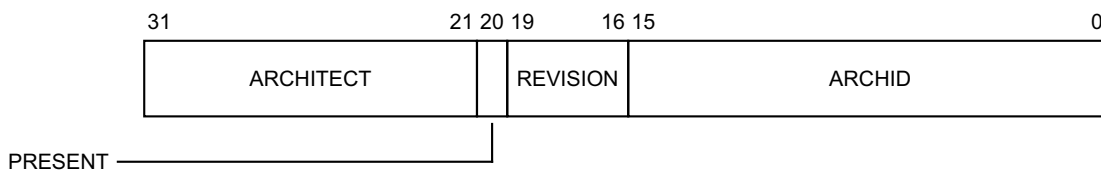

ARCHITECT, bits [31:21]

Defines the architecture of the component. For CTI, this is ARM Limited.

Bits [31:28] are the JEP106 continuation code, 0x4.

Bits [27:21] are the JEP106 ID code, 0x3B.

PRESENT, bit [20]

When set to 1, indicates that the DEVARCH is present.

This field is 1 in ARMv8.

REVISION, bits [19:16]

Defines the architecture revision. For architectures defined by ARM this is the minor revision.

For CTI, the revision defined by ARMv8 is 0x0.

All other values are reserved.

ARCHID, bits [15:0]

Defines this part to be an ARMv8 debug component. For architectures defined by ARM this is further subdivided.

For CTI:

- Bits [15:12] are the architecture version, 0x1.
- Bits [11:0] are the architecture part number, 0xA14.

This corresponds to CTI architecture version CTIv2.

Accessing the CTIDEVARCH:

CTIDEVARCH can be accessed through the external debug interface:

Component	Offset
CTI	0xFBC

H9.3.18 CTIDEVID, CTI Device ID register 0

The CTIDEVID characteristics are:

Purpose

Describes the CTI component to the debugger.

Usage constraints

This register is accessible as follows:

SLK	Default
RO	RO

Configurations

CTIDEVID is in the Debug power domain.

Attributes

CTIDEVID is a 32-bit register.

Field descriptions

The CTIDEVID bit assignments are:

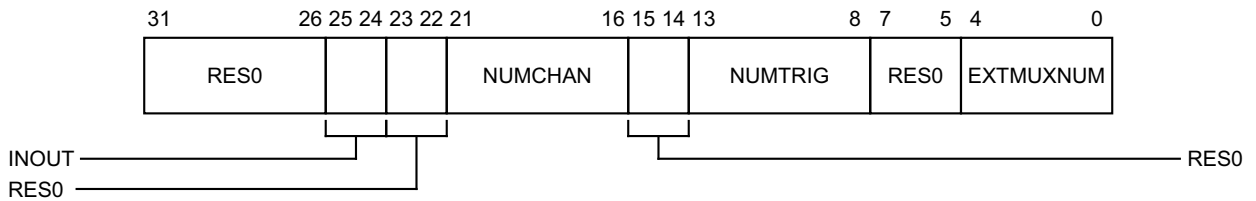

Bits [31:26]

Reserved, RES0.

INOUT, bits [25:24]

Input/output options. Indicates presence of the input gate. If the CTM is not implemented, this field is RAZ.

00 **CTIGATE** does not mask propagation of input events from external channels.

01 **CTIGATE** masks propagation of input events from external channels.

All other values are reserved.

Bits [23:22]

Reserved, RES0.

NUMCHAN, bits [21:16]

Number of ECT channels implemented. IMPLEMENTATION DEFINED. For ARMv8, valid values are:

000011 3 channels (0..2) implemented.

000100 4 channels (0..3) implemented.

000101 5 channels (0..4) implemented.

000110 6 channels (0..5) implemented.

and so on up to 100000, 32 channels (0..31) implemented.

All other values are reserved.

Bits [15:14]

Reserved, RES0.

NUMTRIG, bits [13:8]

Number of triggers implemented. IMPLEMENTATION DEFINED. This is one more than the index of the largest trigger, rather than the actual number of triggers.

For ARMv8, valid values are:

000011 Up to 3 triggers (0..2) implemented.

001000 Up to 8 triggers (0..7) implemented.

001001 Up to 9 triggers (0..8) implemented.

001010 Up to 10 triggers (0..9) implemented.

and so on up to 100000, 32 triggers (0..31) implemented.

All other values are reserved. If the contains a Trace extension, this field must be at least 0b001000. There is no guarantee that any of the implemented triggers, including the highest numbered, are connected to any components.

Bits [7:5]

Reserved, RES0.

EXTMUXNUM, bits [4:0]

Number of multiplexors available on triggers. This value is used in conjunction with External Control register, [ASICCTL](#).

Accessing the CTIDEVID:

CTIDEVID can be accessed through the external debug interface:

Component	Offset
CTI	0xFC8

H9.3.19 CTIDEVID1, CTI Device ID register 1

The CTIDEVID1 characteristics are:

Purpose

Reserved for future information about the CTI component to the debugger.

Usage constraints

This register is accessible as follows:

SLK	Default
RO	RO

Configurations

CTIDEVID1 is in the Debug power domain.

Attributes

CTIDEVID1 is a 32-bit register.

Field descriptions

The CTIDEVID1 bit assignments are:

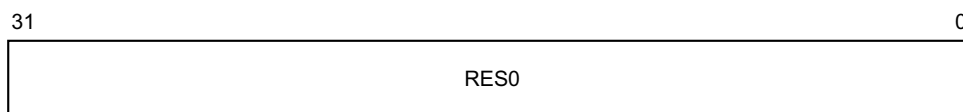

Bits [31:0]

Reserved, RES0.

Accessing the CTIDEVID1:

CTIDEVID1 can be accessed through the external debug interface:

Component	Offset
CTI	0xFC4

H9.3.20 CTIDEVID2, CTI Device ID register 2

The CTIDEVID2 characteristics are:

Purpose

Reserved for future information about the CTI component to the debugger.

Usage constraints

This register is accessible as follows:

SLK	Default
RO	RO

Configurations

CTIDEVID2 is in the Debug power domain.

Attributes

CTIDEVID2 is a 32-bit register.

Field descriptions

The CTIDEVID2 bit assignments are:

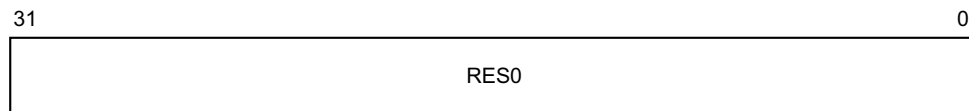

Bits [31:0]

Reserved, RES0.

Accessing the CTIDEVID2:

CTIDEVID2 can be accessed through the external debug interface:

Component	Offset
CTI	0xFC0

H9.3.21 CTIDEVTYPE, CTI Device Type register

The CTIDEVTYPE characteristics are:

Purpose

Indicates to a debugger that this component is part of a PE's cross-trigger interface.

Usage constraints

This register is accessible as follows:

SLK	Default
RO	RO

Configurations

CTIDEVTYPE is in the Debug power domain.

Implementation of this register is OPTIONAL.

Attributes

CTIDEVTYPE is a 32-bit register.

Field descriptions

The CTIDEVTYPE bit assignments are:

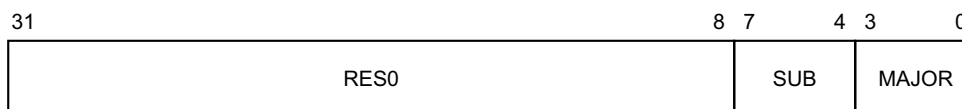

Bits [31:8]

Reserved, RES0.

SUB, bits [7:4]

Subtype. Must read as 0x1 to indicate this is a component within a PE.

MAJOR, bits [3:0]

Major type. Must read as 0x4 to indicate this is a cross-trigger component.

Accessing the CTIDEVTYPE:

CTIDEVTYPE can be accessed through the external debug interface:

Component	Offset
CTI	0xFCC

H9.3.22 CTIGATE, CTI Channel Gate Enable register

The CTIGATE characteristics are:

Purpose

Determines whether events on channels propagate through the CTM to other ECT components, or from the CTM into the CTI.

Usage constraints

This register is accessible as follows:

SLK	Default
RO	RW

Configurations

CTIGATE is in the Debug power domain. RW fields in this register reset to architecturally UNKNOWN values. These apply only on an External debug reset. The register is not affected by a Warm reset and is not affected by a Cold reset.

Attributes

CTIGATE is a 32-bit register.

Field descriptions

The CTIGATE bit assignments are:

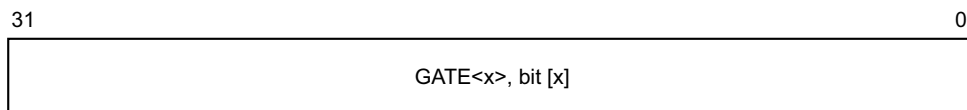

GATE<x>, bit [x], for x = 0 to 31

Channel <x> gate enable.

Bits [31:N] are RAZ/WI. N is the number of ECT channels implemented as defined by the [CTIDEVID.NUMCHAN](#) field.

Possible values of this bit are:

- 0 Disable output and, if [CTIDEVID.INOUT](#) == 0b01, input channel <x> propagation.
- 1 Enable output and, if [CTIDEVID.INOUT](#) == 0b01, input channel <x> propagation.

If GATE[x] is set to 0, no new events will be propagated to the ECT, and if the ECT supports multicycle channel events any existing output channel events will be terminated.

This field resets to a value that is architecturally UNKNOWN.

Accessing the CTIGATE:

CTIGATE can be accessed through the external debug interface:

Component	Offset
CTI	0x140

H9.3.23 CTIINEN<n>, CTI Input Trigger to Output Channel Enable registers, n = 0 - 31

The CTIINEN<n> characteristics are:

Purpose

Enables the signaling of an event on output channels when input trigger event n is received by the CTI.

Usage constraints

This register is accessible as follows:

SLK	Default
RO	RW

Configurations

CTIINEN<n> is in the Debug power domain. RW fields in this register reset to architecturally UNKNOWN values. These apply only on an External debug reset. The register is not affected by a Warm reset and is not affected by a Cold reset.

If input trigger n is not connected, the behavior of CTIINEN<n> is IMPLEMENTATION DEFINED.

Attributes

CTIINEN<n> is a 32-bit register.

Field descriptions

The CTIINEN<n> bit assignments are:

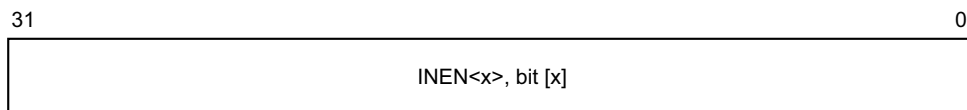

INEN<x>, bit [x], for x = 0 to 31

Input trigger <n> to output channel <x> enable.

Bits [31:N] are RAZ/WI. N is the number of ECT channels implemented as defined by the CTIDEVID.NUMCHAN field.

Possible values of this bit are:

0 Input trigger <n> will not generate an event on output channel <x>.

1 Input trigger <n> will generate an event on output channel <x>.

This field resets to a value that is architecturally UNKNOWN.

Accessing the CTIINEN<n>:

CTIINEN<n> can be accessed through the external debug interface:

Component	Offset
CTI	0x020 + 4n

H9.3.24 CTIINTACK, CTI Output Trigger Acknowledge register

The CTIINTACK characteristics are:

Purpose

Can be used to deactivate the output triggers.

Usage constraints

This register is accessible as follows:

SLK	Default
RO	WO

A debugger must read [CTITRIGOUTSTATUS](#) to confirm that the output trigger has been acknowledged before generating any event that must be ordered after the write to CTIINTACK, such as a write to CTIAPPULSE to activate another trigger.

Configurations

CTIINTACK is in the Debug power domain.

Attributes

CTIINTACK is a 32-bit register.

Field descriptions

The CTIINTACK bit assignments are:

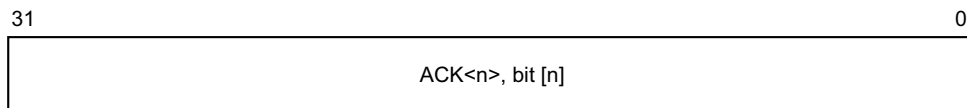

ACK<n>, bit [n], for n = 0 to 31

Acknowledge for output trigger <n>.

Bits [31:N] are RAZ/WI. N is the number of CTI triggers implemented as defined by the [CTIDEVID.NUMTRIG](#) field.

If any of the following is true, writes to ACK<n> are ignored:

- $n \geq \text{CTIDEVID.NUMTRIG}$, the number of implemented triggers.
- Output trigger n is not active.
- The channel mapping function output, as controlled by [CTIOUTEN<n>](#), is still active.

Otherwise, if any of the following are true, it is IMPLEMENTATION DEFINED whether writes to ACK<n> are ignored:

- Output trigger n is not implemented.
- Output trigger n is not connected.
- Output trigger n is self-acknowledging and does not require software acknowledge.

Otherwise, the behavior on writes to ACK<n> is as follows:

- | | |
|---|-------------------------|
| 0 | No effect |
| 1 | Deactivate the trigger. |

Accessing the CTIINTACK:

CTIINTACK can be accessed through the external debug interface:

Component	Offset
CTI	0x010

H9.3.25 CTIITCTRL, CTI Integration mode Control register

The CTIITCTRL characteristics are:

Purpose

Enables the CTI to switch from its default mode into integration mode, where test software can control directly the inputs and outputs of the PE, for integration testing or topology detection.

Usage constraints

This register is accessible as follows:

Default

RW

Configurations

It is IMPLEMENTATION DEFINED whether CTIITCTRL is implemented in the Core power domain or in the Debug power domain. Some or all RW fields of this register have defined reset values, and:

- The register is not affected by a Warm reset.
- If the register is implemented in the Core power domain the reset values apply on a Cold reset, and the register is not affected by an External debug reset.
- If the register is implemented in the Debug power domain the reset values apply on an External debug reset, and the register is not affected by a Cold reset.

Implementation of this register is OPTIONAL.

Attributes

CTIITCTRL is a 32-bit register.

Field descriptions

The CTIITCTRL bit assignments are:

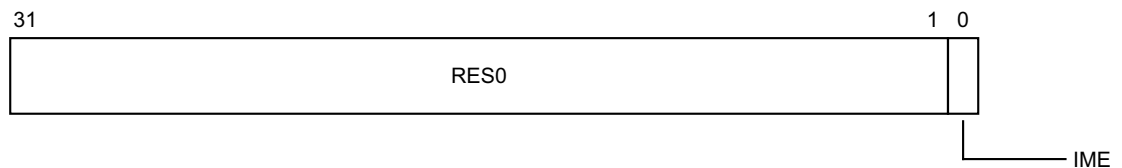

Bits [31:1]

Reserved, RES0.

IME, bit [0]

Integration mode enable. When IME == 1, the device reverts to an integration mode to enable integration testing or topology detection. The integration mode behavior is IMPLEMENTATION DEFINED.

0 Normal operation.

1 Integration mode enabled.

When this register has an architecturally-defined reset value, this field resets to 0.

Accessing the CTIITCTRL:

CTIITCTRL can be accessed through the external debug interface:

Component	Offset
CTI	0xF00

H9.3.26 CTILAR, CTI Lock Access Register

The CTILAR characteristics are:

Purpose

Allows or disallows access to the CTI registers through a memory-mapped interface.

Usage constraints

This register is accessible as follows:

Default

WO

Configurations

CTILAR is in the Debug power domain.

If OPTIONAL memory-mapped access to the external debug interface is supported then an OPTIONAL Software Lock can be implemented as part of CoreSight compliance.

CTILAR ignores writes if the Software lock is not implemented and ignores writes for other accesses to the external debug interface.

The Software Lock provides a lock to prevent memory-mapped writes to the Cross-Trigger Interface registers. Use of this lock mechanism reduces the risk of accidental damage to the contents of the Cross-Trigger Interface registers. It does not, and cannot, prevent all accidental or malicious damage.

Software uses CTILAR to set or clear the lock, and CTILSR to check the current status of the lock.

Attributes

CTILAR is a 32-bit register.

Field descriptions

The CTILAR bit assignments are:



KEY, bits [31:0]

Lock Access control. Writing the key value 0xC5ACCE55 to this field unlocks the lock, enabling write accesses to this component's registers through a memory-mapped interface.

Writing any other value to this register locks the lock, disabling write accesses to this component's registers through a memory mapped interface.

Accessing the CTILAR:

CTILAR can be accessed through a memory-mapped interface access to the external debug interface:

Component	Offset
CTI	0xFB0

H9.3.27 CTILSR, CTI Lock Status Register

The CTILSR characteristics are:

Purpose

Indicates the current status of the Software Lock for CTI registers.

Usage constraints

This register is accessible as follows:

Default
RO

Configurations

CTILSR is in the Debug power domain. Some or all RW fields of this register have defined reset values. These apply only on an External debug reset. The register is not affected by a Warm reset and is not affected by a Cold reset.

If OPTIONAL memory-mapped access to the external debug interface is supported then an OPTIONAL Software Lock can be implemented as part of CoreSight compliance.

CTILSR is RAZ if the Software Lock is not implemented and is RAZ for other accesses to the external debug interface.

The Software Lock provides a lock to prevent memory-mapped writes to the Cross-Trigger Interface registers. Use of this lock mechanism reduces the risk of accidental damage to the contents of the Cross-Trigger Interface registers. It does not, and cannot, prevent all accidental or malicious damage.

Software uses [CTILAR](#) to set or clear the lock, and CTILSR to check the current status of the lock.

Attributes

CTILSR is a 32-bit register.

Field descriptions

The CTILSR bit assignments are:

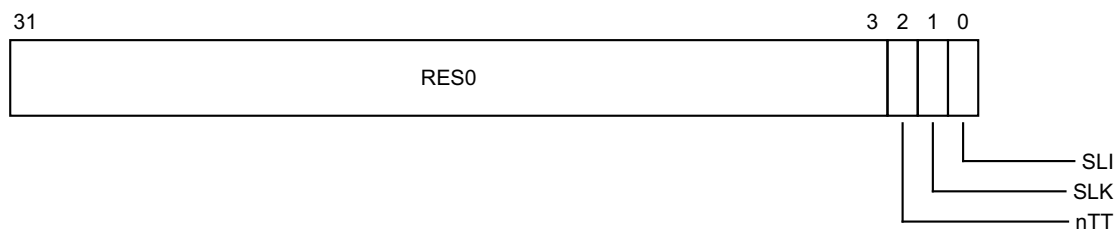

Bits [31:3]

Reserved, RES0.

nTT, bit [2]

Not thirty-two bit access required. RAZ.

SLK, bit [1]

Software Lock status for this component. For an access to LSR that is not a memory-mapped access, or when the Software Lock is not implemented, this field is RES0.

For memory-mapped accesses when the Software Lock is implemented, possible values of this field are:

- 0 Lock clear. Writes are permitted to this component's registers.
- 1 Lock set. Writes to this component's registers are ignored, and reads have no side effects.

When this register has an architecturally-defined reset value, this field resets to 1.

SLI, bit [0]

Software Lock implemented. For an access to LSR that is not a memory-mapped access, this field is RAZ. For memory-mapped accesses, the value of this field is IMPLEMENTATION DEFINED.

Permitted values are:

- 0 Software Lock not implemented or not memory-mapped access.
- 1 Software Lock implemented and memory-mapped access.

Accessing the CTILSR:

CTILSR can be accessed through a memory-mapped interface access to the external debug interface:

Component	Offset
CTI	0xFB4

H9.3.28 CTIOUTEN<n>, CTI Input Channel to Output Trigger Enable registers, n = 0 - 31

The CTIOUTEN<n> characteristics are:

Purpose

Defines which input channels generate output trigger n.

Usage constraints

This register is accessible as follows:

SLK	Default
RO	RW

Configurations

CTIOUTEN<n> is in the Debug power domain. RW fields in this register reset to architecturally UNKNOWN values. These apply only on an External debug reset. The register is not affected by a Warm reset and is not affected by a Cold reset.

If output trigger n is not connected, the behavior of CTIOUTEN<n> is IMPLEMENTATION DEFINED.

Attributes

CTIOUTEN<n> is a 32-bit register.

Field descriptions

The CTIOUTEN<n> bit assignments are:

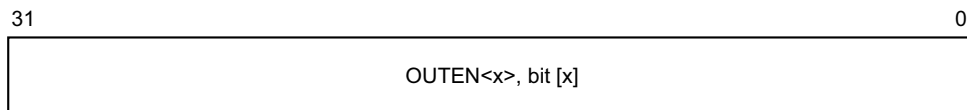

OUTEN<x>, bit [x], for x = 0 to 31

Input channel <x> to output trigger <n> enable.

Bits [31:N] are RAZ/WI. N is the number of ECT channels implemented as defined by the CTIDEVID.NUMCHAN field.

Possible values of this bit are:

- 0 An event on input channel <x> will not cause output trigger <n> to be asserted.
- 1 An event on input channel <x> will cause output trigger <n> to be asserted.

This field resets to a value that is architecturally UNKNOWN.

Accessing the CTIOUTEN<n>:

CTIOUTEN<n> can be accessed through the external debug interface:

Component	Offset
CTI	0x0A0 + 4n

H9.3.29 CTIPIDR0, CTI Peripheral Identification Register 0

The CTIPIDR0 characteristics are:

Purpose

Provides information to identify a CTI component.

For more information see [About the Peripheral identification scheme on page K2-6146](#).

Usage constraints

This register is accessible as follows:

SLK	Default
RO	RO

Configurations

CTIPIDR0 is in the Debug power domain.

Implementation of this register is OPTIONAL.

This register is required for CoreSight compliance.

Attributes

CTIPIDR0 is a 32-bit register.

Field descriptions

The CTIPIDR0 bit assignments are:

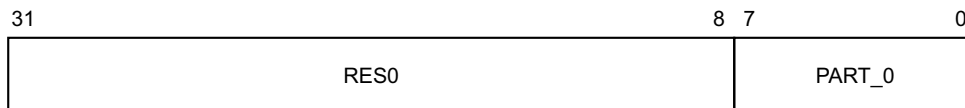

Bits [31:8]

Reserved, RES0.

PART_0, bits [7:0]

Part number, least significant byte.

Accessing the CTIPIDR0:

CTIPIDR0 can be accessed through the external debug interface:

Component	Offset
CTI	0xFE0

H9.3.30 CTIPIDR1, CTI Peripheral Identification Register 1

The CTIPIDR1 characteristics are:

Purpose

Provides information to identify a CTI component.

For more information see [About the Peripheral identification scheme on page K2-6146](#).

Usage constraints

This register is accessible as follows:

SLK	Default
RO	RO

Configurations

CTIPIDR1 is in the Debug power domain.

Implementation of this register is OPTIONAL.

This register is required for CoreSight compliance.

Attributes

CTIPIDR1 is a 32-bit register.

Field descriptions

The CTIPIDR1 bit assignments are:

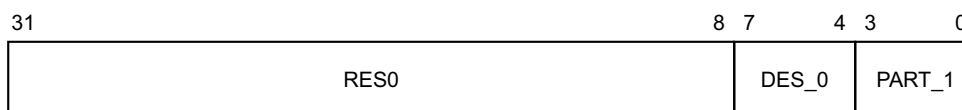

Bits [31:8]

Reserved, RES0.

DES_0, bits [7:4]

Designer, least significant nibble of JEP106 ID code. For ARM Limited, this field is 0b1011.

PART_1, bits [3:0]

Part number, most significant nibble.

Accessing the CTIPIDR1:

CTIPIDR1 can be accessed through the external debug interface:

Component	Offset
CTI	0xFE4

H9.3.31 CTIPIDR2, CTI Peripheral Identification Register 2

The CTIPIDR2 characteristics are:

Purpose

Provides information to identify a CTI component.

For more information see [About the Peripheral identification scheme on page K2-6146](#).

Usage constraints

This register is accessible as follows:

SLK	Default
RO	RO

Configurations

CTIPIDR2 is in the Debug power domain.

Implementation of this register is OPTIONAL.

This register is required for CoreSight compliance.

Attributes

CTIPIDR2 is a 32-bit register.

Field descriptions

The CTIPIDR2 bit assignments are:

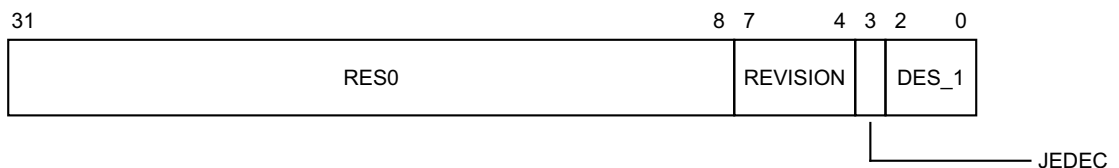

Bits [31:8]

Reserved, RES0.

REVISION, bits [7:4]

Part major revision. Parts can also use this field to extend Part number to 16-bits.

JEDEC, bit [3]

RAO. Indicates a JEP106 identity code is used.

DES_1, bits [2:0]

Designer, most significant bits of JEP106 ID code. For ARM Limited, this field is 0b011.

Accessing the CTIPIDR2:

CTIPIDR2 can be accessed through the external debug interface:

Component	Offset
CTI	0xFE8

H9.3.32 CTIPIDR3, CTI Peripheral Identification Register 3

The CTIPIDR3 characteristics are:

Purpose

Provides information to identify a CTI component.

For more information see [About the Peripheral identification scheme on page K2-6146](#).

Usage constraints

This register is accessible as follows:

SLK	Default
RO	RO

Configurations

CTIPIDR3 is in the Debug power domain.

Implementation of this register is OPTIONAL.

This register is required for CoreSight compliance.

Attributes

CTIPIDR3 is a 32-bit register.

Field descriptions

The CTIPIDR3 bit assignments are:

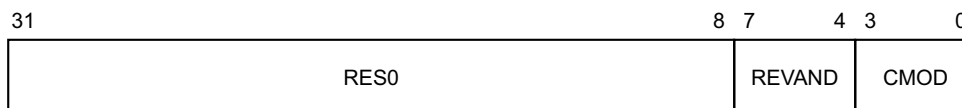

Bits [31:8]

Reserved, RES0.

REVAND, bits [7:4]

Part minor revision. Parts using [CTIPIDR2.REVISION](#) as an extension to the Part number must use this field as a major revision number.

CMOD, bits [3:0]

Customer modified. Indicates someone other than the Designer has modified the component.

Accessing the CTIPIDR3:

CTIPIDR3 can be accessed through the external debug interface:

Component	Offset
CTI	0xFEC

H9.3.33 CTIPIDR4, CTI Peripheral Identification Register 4

The CTIPIDR4 characteristics are:

Purpose

Provides information to identify a CTI component.

For more information see [About the Peripheral identification scheme on page K2-6146](#).

Usage constraints

This register is accessible as follows:

SLK	Default
RO	RO

Configurations

CTIPIDR4 is in the Debug power domain.

Implementation of this register is OPTIONAL.

This register is required for CoreSight compliance.

Attributes

CTIPIDR4 is a 32-bit register.

Field descriptions

The CTIPIDR4 bit assignments are:

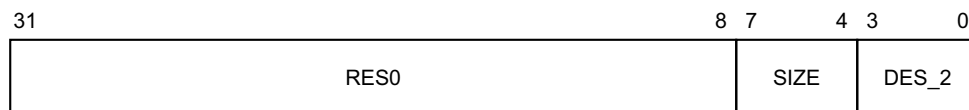

Bits [31:8]

Reserved, RES0.

SIZE, bits [7:4]

Size of the component. RAZ. \log_2 of the number of 4KB pages from the start of the component to the end of the component ID registers.

DES_2, bits [3:0]

Designer, JEP106 continuation code, least significant nibble. For ARM Limited, this field is 0b0100.

Accessing the CTIPIDR4:

CTIPIDR4 can be accessed through the external debug interface:

Component	Offset
CTI	0xFD0

H9.3.34 CTITRIGINSTATUS, CTI Trigger In Status register

The CTITRIGINSTATUS characteristics are:

Purpose

Provides the status of the trigger inputs.

Usage constraints

This register is accessible as follows:

SLK	Default
RO	RO

Configurations

CTITRIGINSTATUS is in the Debug power domain.

Attributes

CTITRIGINSTATUS is a 32-bit register.

Field descriptions

The CTITRIGINSTATUS bit assignments are:

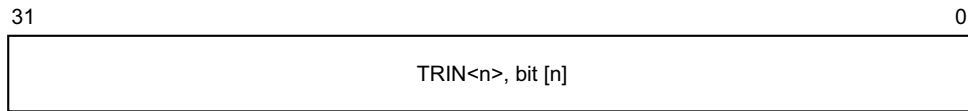

TRIN<n>, bit [n], for n = 0 to 31

Trigger input <n> status.

Bits [31:N] are RAZ. N is the number of CTI triggers implemented as defined by the [CTIDEVID.NUMTRIG](#) field.

Possible values of this bit are:

- 0 Input trigger n is inactive.
- 1 Input trigger n is active.

Not implemented and not-connected input triggers are always inactive.

It is IMPLEMENTATION DEFINED whether an input trigger that does not support multicyle events can be observed as active.

Accessing the CTITRIGINSTATUS:

CTITRIGINSTATUS can be accessed through the external debug interface:

Component	Offset
CTI	0x130

H9.3.35 CTITRIGOUTSTATUS, CTI Trigger Out Status register

The CTITRIGOUTSTATUS characteristics are:

Purpose

Provides the raw status of the trigger outputs, after processing by any IMPLEMENTATION DEFINED trigger interface logic. For output triggers that are self-acknowledging, this is only meaningful if the CTI implements multicycle channel events.

Usage constraints

This register is accessible as follows:

SLK	Default
RO	RO

Configurations

CTITRIGOUTSTATUS is in the Debug power domain.

Attributes

CTITRIGOUTSTATUS is a 32-bit register.

Field descriptions

The CTITRIGOUTSTATUS bit assignments are:

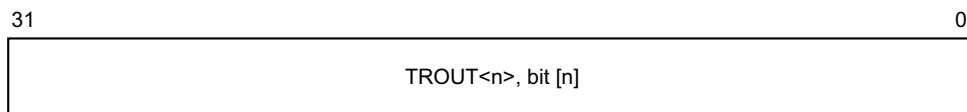

TROUT<n>, bit [n], for n = 0 to 31

Trigger output <n> status.

Bits [31:N] are RAZ, where N is the value of the CTIDEVID.NUMTRIG field.

If $n < N$, and output trigger <n> is implemented and connected, and either the trigger is not self-acknowledging or the CTI implements multicycle channel events, then permitted values for TROUT<n> are:

- 0 Output trigger n is inactive.
- 1 Output trigger n is active.

Otherwise when $n < N$ it is IMPLEMENTATION DEFINED whether TROUT<n> behaves as described here or is RAZ.

Accessing the CTITRIGOUTSTATUS:

CTITRIGOUTSTATUS can be accessed through the external debug interface:

Component	Offset
CTI	0x134

Part I

Memory-mapped Components of the ARMv8 Architecture

Chapter I1

System Level Implementation of the Generic Timer

This chapter defines the system level implementation of the Generic Timer. It contains the following sections:

- [About the Generic Timer specification on page I1-5724.](#)
- [Memory-mapped counter module on page I1-5726.](#)
- [Memory-mapped timer components on page I1-5730.](#)
- [Providing a complete set of counter and timer features on page I1-5734.](#)
- [Gray-count scheme for timer distribution scheme on page I1-5736.](#)

Note

- [Generic Timer memory-mapped register descriptions on page I3-5816](#) describes the System level Generic Timer registers. These registers are memory-mapped.
 - [Chapter D6 The Generic Timer in AArch64 state](#) gives a general description of the AArch64 state view of the Generic Timer, and describes the AArch64 System register interface to the Generic Timer.
 - [Chapter G5 The Generic Timer in AArch32 state](#) gives a general description of the AArch32 state view of the Generic Timer, and describes the AArch32 System register interface to the Generic Timer.
-

I1.1 About the Generic Timer specification

[Chapter D6 The Generic Timer in AArch64 state](#) describes the ARM Generic Timer and its implementation as seen from AArch64 state. [Chapter G5 The Generic Timer in AArch32 state](#) describes the ARM Generic Timer and its implementation as seen from AArch32 state. These chapters include the definition of the low-latency System register interface to the Generic Timer. However, the ARM Generic Timer architecture also defines a memory-mapped component, that comprises:

- A memory-mapped counter module, that controls the generation of the Count value used by the Generic Timer.
This memory-mapped counter module is required in any ARM Generic Timer implementation that requires software control of the Count value of the Generic Timer.
- Optional memory-mapped timer modules. These give a standardized way of providing timers for programmable system components other than PEs that implement the ARM architecture.

[The full set of Generic Timer components on page D6-2181](#) summarizes these components as seen from AArch64 state, and [The full set of Generic Timer components on page G5-4753](#) summarizes them as seen from AArch32 state. [The system level components of the Generic Timer on page I1-5725](#) summarizes the system level components.

I1.1.1 Registers in the system level implementation of the Generic Timer

Registers that control components of the system level implementation of the Generic Timer are grouped into *frames*. This specification defines the registers in each frame, and their offsets within the frame. The system defines the position of each frame in the memory map. This means the base addresses for each frame is IMPLEMENTATION DEFINED.

———— **Note** —————

The final twelve words of the first or only 4KB block of a register memory frame is an ID block.

All memory-mapped peripherals defined in the ARM architecture must be little-endian. This means the system-level Generic Timer registers, and the register frames, are little-endian.

Power and reset domains for the system level implementation of the Generic Timer

The power and reset domains of the system level implementation of the Generic Timer are IMPLEMENTATION DEFINED as part of the system implementation. These domains can be outside the PE power and reset domains defined by the remainder of this manual.

The ARM architecture requires that the `CNTCR`.{FCREQ, EN} and `CNTSR`.FCACK fields reset to 0. These reset values apply only on powerup of the power domain in which the registers are implemented or a reset of the reset domain in which they are implemented.

Every other register, or register field, of a system level implementation of the Generic Timer resets to a value that is architecturally UNKNOWN if it has a meaningful reset value. This applies on powerup of the power domain in which the register is implemented, and on a reset of the reset domain in which it is implemented.

I1.1.2 The system level components of the Generic Timer

Each system level component has one or two register frames. The possible system level components are:

The memory-mapped counter module, required

This module controls the system counter. It has two frames:

- A control frame, [CNTControlBase](#).
- A status frame, [CNTReadBase](#).

[Memory-mapped counter module on page I1-5726](#) describes this component.

The memory-mapped timer control module, required

The system level implementation of the Generic Timer can provide up to eight timers, and the memory-mapped timer control module identifies:

- Which timers are implemented.
- The features of each implemented timer.

This module has a single frame, [CNTCTLBase](#).

[The CNTCTLBase frame on page I1-5731](#) describes this frame.

Memory-mapped timers, optional

An implemented memory-mapped timer:

- Must provide a privileged view of the timer, in the [CNTBaseN](#) frame.
- Optionally provides an unprivileged view of the timer in the [CNTELOBaseN](#) frame.

N is the timer number, and the corresponding frame number, in the range 0-7.

[The CNTBaseN and CNTELOBaseN frames on page I1-5732](#) describes these frames.

I1.2 Memory-mapped counter module

The memory-mapped counter module provides top-level control of the system counter. The [CNTControlBase](#) frame holds the registers for the memory-mapped counter, and provides:

- A RW control register [CNTCR](#), that provides:
 - An enable bit for the system counter.
 - An enable bit for Halt-on-Debug. When this is enabled, if the debug halt signal into the system counter is asserted, it halts the system counter. Otherwise, the system counter ignores the state of this halt signal. For more information about Halt-on-Debug, contact ARM.
 - A field that can be written to request a change to the update frequency of the system counter, with a corresponding change to the increment made at each update. This mechanism means that, for example, if the update frequency is halved, the increment at each update is doubled.
For more information see [Control of counter operating frequency and increment on page I1-5727](#).

Writes to this register are rare. In a system that supports two Security states, this register is writable only by Secure writes.

- A RO status register, [CNTSR](#), that provides:
 - A bit that indicates whether the system counter is halted because of an asserted Halt-on-Debug signal.
 - A field that indicates the current update frequency of the system counter. This field can be polled to determine when a requested change to the update frequency has been made.

- Two contiguous 32-bit RW registers that hold the current system counter value, [CNTCV](#). If the system supports 64-bit atomic accesses, these two registers must be accessible by such accesses.

The system counter must be disabled before writing to these registers, otherwise the effect of the write is UNPREDICTABLE.

Writes to these registers are rare. In a system that supports two Security states, these registers are writable only by Secure writes.

- A *Frequency modes table* of one or more 32-bit entries, where:
 - The first entry in the table defines the *base frequency* of the system counter. This is the maximum frequency at which the counter updates.
 - Each subsequent entry in the table defines an alternative frequency of the system counter, that must be an exact divisor of the base frequency.

A 32-bit zero entry immediately follows the last table entry.

This table can be RO or RW. For more information, see [The Frequency modes table on page I1-5727](#).

In addition, the [CNTReadBase](#) frame includes a read-only copy of the system counter value, [CNTCV](#), as two contiguous 32-bit RO registers. If the system supports 64-bit atomic accesses, these two registers must be accessible by such accesses.

[Counter module control and status register summary on page I1-5728](#) describes [CNTReadBase](#) and [CNTControlBase](#) memory maps, and the registers in each frame.

I1.2.1 Control of counter operating frequency and increment

The system counter has a fixed *base frequency*, and must maintain the required counter accuracy, meaning ARM recommends that it does not gain or lose more than ten seconds in a 24-hour period, see [The system counter on page D6-2182](#). However, the counter can increment at a lower frequency than the base frequency, using a correspondingly larger increment. For example, it can increment by four at a quarter of the base frequency. Any lower-frequency operation, and any switching between operating frequencies, must not reduce the accuracy of the counter.

Control of the system counter frequency and increment is provided only through the memory-mapped counter module. The following sections describe this control:

- [The Frequency modes table](#).
- [Changing the system counter and increment](#).

The Frequency modes table

The Frequency modes table starts at offset 0x20 in the [CNTControlBase](#) frame.

Table entries are 32-bits, and each entry specifies a system counter update frequency, in Hz.

The first entry in the table specifies the base frequency of the system counter.

When the system timer is operating at a lower frequency than the base frequency, the increment applied at each counter update is given by:

$$\text{increment} = (\text{base_frequency}) / (\text{selected_frequency})$$

A 32-bit word of zero value marks the end of the table. That is, the word of memory immediately after the last entry in the table must be zero.

The only required entry in the table is the entry for the base frequency.

Typically, the Frequency modes table is in RO memory. However, a system implementation might use RW memory for the table, and initialize the table entries as part of its startup sequence. Therefore, the [CNTControlBase](#) memory map shows the table region as RO or RW.

ARM strongly recommends that the Frequency modes table is not updated once the system is running.

The architecture can support up to 1004 entries in the Frequency modes table, including the zero-word end marker, and the maximum number of entries is IMPLEMENTATION DEFINED, up to this limit.

————— **Note** —————

- ARM considers it likely that implementations will require significantly fewer entries than the architectural limit.
- In the [CNTControlBase](#) frame, the offset range 0x0C0-0x0FC can be used for IMPLEMENTATION DEFINED registers. If any registers are defined in this space then the Frequency modes table cannot extend beyond offset 0x0B8, with a zero word at offset 0x0BC. This means the maximum number of entries in the table is 40, including the zero-word end marker.

Changing the system counter and increment

The value of the [CNTCR.FCREQ](#) field specifies which entry in the Frequency modes table specifies the system counter update frequency.

Changing the value of [CNTCR.FCREQ](#) requests a change to the system counter update frequency. To ensure the frequency change does not affect the overall accuracy of the counter, a change is made as follows:

- When changing from a higher frequency to a lower frequency, the counter:
 1. Continues running at the higher frequency until the count reaches an integer multiple of the required lower frequency.
 2. Switches to operating at the lower frequency.

- When changing from a lower frequency to a higher frequency, the counter:
 1. Waits until the end of the current lower-frequency cycle.
 2. Makes the counter increment required for operation at that lower frequency.
 3. Switches to operating at the higher frequency.

When the frequency has changed, [CNTSR](#) is updated to indicate the new frequency. Therefore, a system component that is waiting for a frequency change can poll [CNTSR](#) to detect the change.

11.2.2 Counter module control and status register summary

The Counter module control and status registers are memory-mapped registers in the following register memory frames:

- A control frame, with base address [CNTControlBase](#).
- A status frame, with base address [CNTReadBase](#).

Each of these register memory frames is at least 4KB in size, or is at least the size of the memory protection granule if this granule size is larger than 4KB. Similarly, each base address must be aligned to 4KB, or to the memory protection granule if that is larger than 4KB.

———— **Note** —————

- The memory protection granule is either 4KB, 16KB or 64KB.
- Each frame of a memory-mapped Generic Timer takes the name of its base address.

In each register memory frame, the memory at offset 0xFD0-0xFFF is reserved for twelve 32-bit IMPLEMENTATION DEFINED ID registers, see the [CounterID<n>](#) register descriptions for more information.

———— **Note** —————

The ARM architecture requires memory-mapped peripherals to be little-endian, and therefore the counter is little-endian.

In an implementation that supports Secure and Non-secure memory maps, [CNTControlBase](#) is implemented only in the Secure memory map.

[Table I1-1](#) shows the [CNTControlBase](#) control registers, in order of their offsets from the [CNTControlBase](#) base address, for an implementation that includes registers in the implementation defined register space 0x0C0-0x0FC, and also has fewer than 39 [CNTFID<n>](#) registers. [The Frequency modes table on page I1-5727](#) describes how this memory map differs if more [CNTFID<n>](#) registers are implemented.

[Generic Timer memory-mapped register descriptions on page I3-5816](#) describes each of these registers.

Table I1-1 CNTControlBase memory map

Offset	Name	Type	Description
0x000	CNTCR	RW	Counter Control Register.
0x004	CNTSR	RO	Counter Status Register.
0x008	CNTCV[31:0]	RW	Counter Count Value register.
0x00C	CNTCV[63:32]	RW	
0x010-0x01C	-	RES0	Reserved.
0x020	CNTFID0	RO or RW	Frequency modes table, and end marker.
0x020+4n	CNTFID<n>	RO or RW	For more information see The Frequency modes table on page I1-5727 .
0x024+4n	-	RO or RW, RAZ	

Table 11-1 CNTControlBase memory map (continued)

Offset	Name	Type	Description
(0x028+4n)-0x0BC	-	RO, RES0	Reserved.
0x0C0-0x0FC	-	IMPLEMENTATION DEFINED	Reserved for IMPLEMENTATION DEFINED registers.
0x100-0xFCC	-	RO, RES0	Reserved.
0xFD0-0xFFC	CounterID<n>	RO	Counter ID registers 0-11.

Table 11-2 shows the CNTReadBase control registers, in order of their offsets from the CNTReadBase base address. *Generic Timer memory-mapped register descriptions on page 13-5816* describes each of these registers.

Table 11-2 CNTReadBase memory map

Offset	Name	Type	Description
0x000	CNTCV[31:0]	RO	Counter Count Value register
0x004	CNTCV[63:32]	RO	
0x008-0xFCC	-	RES0	Reserved
0xFD0-0xFFC	CounterID<n>	RO	Counter ID registers 0-11

I1.3 Memory-mapped timer components

This part of the ARM Generic Timer specification defines an optional memory-mapped timer component. This can be implemented as part of any programmable system component that does not incorporate a System register mapped ARM Generic Timer, to provide that system component with the timer functionality of an ARM Generic Timer.

The memory map consists of up to 8 timer *frames*. Each timer frame:

- Provides its own set of timers and associated interrupts.
- Is in its own memory protection region that is:
 - In its own memory protection region, with a system-defined size of 4KB, 16KB or 64KB.
 - At a start address that is aligned to 4KB.

———— **Note** —————

The start address 4KB alignment requirement applies regardless of the memory protection region size.

The base address of a frame is `CNTBaseN`, where *N* numbers from 0 up to a maximum permitted value of 7.

For each implemented `CNTBaseN` frame the system can optionally provide an unprivileged view of the frame, described as the EL0 view of the frame. The base address of this second view of the `CNTBaseN` frame is `CNTELOBaseN`.

———— **Note** —————

In the naming of the registers associated with a `CNTBaseN` or `CNTELOBaseN` frame, the value of *N* is represented as `<n>`, for example `CNTACR<n>`.

If a `CNTELOBaseN` frame is implemented:

- All registers visible in `CNTBaseN` can be visible, except for `CNTVOFF` and `CNTELOACR`.
 - Control fields in `CNTELOACR` determine whether the registers are visible.
- The offsets of all visible registers are the same as their offsets in the `CNTBaseN` frame.

In addition to the implemented `CNTBaseN` and `CNTELOBaseN` frames, the system must provide a single control frame at base address `CNTCTLBase`.

The memory protection region and alignment requirements for the `CNTELOBaseN` and `CNTCTLBase` frames are the same as the requirements for the `CNTBaseN` frames.

The system defines the position of each frame in the memory map. This means the values of each of the `CNTBaseN`, `CNTELOBaseN`, and `CNTCTLBase` base addresses is IMPLEMENTATION DEFINED.

———— **Note** —————

The ARM architecture requires memory-mapped peripherals to be little-endian, and therefore the memory-mapped timers are little-endian.

The following sections describe the implementation of a memory-mapped view of the counter and timer:

- [The `CNTCTLBase` frame on page I1-5731.](#)
- [The `CNTBaseN` and `CNTELOBaseN` frames on page I1-5732.](#)
- [Providing a complete set of counter and timer features on page I1-5734.](#)

I1.3.1 The CNTCTLBase frame

The CNTCTLBase frame contains:

- An identification register for the features of the memory-mapped counter and timer implementation.
- Access controls for each CNTBaseN frame.
- A virtual offset register for frames that implement a virtual timer.

Table I1-3 shows the CNTCTLBase registers, in order of their offsets from the CNTCTLBase base address.

———— **Note** ————

CNTFRQ and CNTVOFF registers are also implemented in a System register interface to the Generic Timer.

Generic Timer memory-mapped register descriptions on page I3-5816 describes each of these registers.

Table I1-3 CNTCTLBase memory map

Offset	Register	Type	Security ^a	Description
0x000	CNTFRQ ^b	RW	Secure	Counter Frequency register.
0x004	CNTNSAR	RW	Secure	Counter Non-Secure Access register.
0x008	CNTTIDR	RO	Both	Counter Timer ID register.
0x00C- 0x03F	-	RES0	-	Reserved.
0x040+4N ^c	CNTACR<n>	RW	Configurable ^d	Counter Access Control register N.
0x060- 0x07F	-	RES0	-	Reserved.
0x080+8N ^c	CNTVOFF<n>[31:0] ^b	RW ^e	Configurable ^d	Virtual Offset register N. If the CNTBaseN frame has virtual timer capability then CNTVOFF is implemented as a RW register, otherwise its location is RAZ/WI.
0x084+8N ^c	CNTVOFF<n>[63:32] ^b	RW ^e		
0x0C0-0x0FC	-	RES0	-	Reserved.
0x100-0x7FC	-	-	-	IMPLEMENTATION DEFINED.
0x800-0xFBC	-	RES0	-	Reserved.
0xFC0-0xFCF	-	-	-	IMPLEMENTATION DEFINED.
0xFD0- 0xFFC	CounterID<n>	RO	Both	Counter ID registers 0-11.

- Access security requirement in an implementation that supports two Security states. In an implementation that does not support multiple Security states all registers are accessible as shown in the *Type* column.
- These registers are also defined in the System register interface to the Generic Timer, and therefore are also described in *Generic Timer registers on page D7-2672* and *Generic Timer registers on page G6-5383*. The bit assignments of the registers are identical in the System register interface and in the memory-mapped system level interface.
- Implemented for each value of N from 0 to 7 for which a CNTBaseN frame is implemented.
- The CNTNSAR determines the Non-secure accessibility of the CNTACR<n>s and the CNTVOFF<n>s in the CNTCTLBase frame. For more information, see the register descriptions.
- Address is reserved, RAZ/WI if register not implemented.

All implementations of the Generic Timer include the virtual counter. Therefore, conceptually, all implementations include the CNTVOFF register that defines the virtual offset between the physical count and the virtual count. If a memory-mapped Generic Timer component does not distinguish between real time and virtual time then it can implement CNTVOFF as RAZ/WI. Otherwise CNTVOFF is a RW register, and ARM strongly recommends that the system only permits access to CNTVOFF from EL2 or higher.

11.3.2 The CNTBaseN and CNTEL0BaseN frames

Each CNTBaseN frame, or {CNTBaseN, CNTEL0BaseN} pair of frames, provides a memory-mapped counter and timer, see:

- [The CNTBaseN frame.](#)
- [The CNTEL0BaseN frame on page I1-5733.](#)
- [CNTCTLBase status and control fields for the CNTBaseN and CNTEL0BaseN frames on page I1-5733.](#)

The CNTBaseN frame

Table I1-4 shows the CNTBaseN registers, in order of their offsets from the CNTBaseN base address. Whether a frame includes a virtual timer is IMPLEMENTATION DEFINED. If it does not then memory at offsets 0x030-0x03C is RAZ/WI. Except for CNTEL0ACR and the CounterID<n> registers, equivalent registers are also implemented in a System register interface to the timer component of a Generic Timer.

[Generic Timer memory-mapped register descriptions on page I3-5816](#) describes each of these registers.

Table I1-4 CNTBaseN memory map

Offset	Register	Type	Description
0x000	CNTPCT[31:0] ^a	RO	Physical Count register.
0x004	CNTPCT[63:32] ^a	RO	
0x008	CNTVCT[31:0] ^a	RO	Virtual Count register.
0x00C	CNTVCT[63:32] ^a	RO	
0x010	CNTFRQ ^a	RO ^c	Counter Frequency register.
0x014	CNTEL0ACR	RW ^b	Counter EL0 Access Control Register, optional in the CNTBaseN memory map.
0x018	CNTVOFF[31:0] ^a	RO ^c	Virtual Offset register. If CNTVOFF<n> in the CNTCTLBase frame is a RW register, a read of this register returns the value of that register.
0x01C	CNTVOFF[63:32] ^a	RO ^c	Otherwise is RAZ.
0x020	CNTP_CVAL[31:0] ^a	RW	Physical Timer CompareValue register.
0x024	CNTP_CVAL[63:32] ^a	RW	
0x028	CNTP_TVAL ^a	RW	Physical TimerValue register.
0x02C	CNTP_CTL ^a	RW	Physical Timer Control register.
0x030	CNTV_CVAL[31:0] ^a	RW ^b	Virtual Timer CompareValue register, optional in the CNTBaseN memory map.
0x034	CNTV_CVAL[63:32] ^a	RW ^b	
0x038	CNTV_TVAL ^a	RW ^b	Virtual TimerValue register, optional in the CNTBaseN memory map.
0x03C	CNTV_CTL ^a	RW ^b	Virtual Timer Control register, optional in the CNTBaseN memory map.
0x040-0xFCF	-	RES0	Reserved.
0xFD0-0xFFC	CounterID<n>	RO	Counter ID registers 0-11.

a. These registers are also defined in the System register interface to the Generic Timer, and therefore are also described in [Generic Timer registers on page D7-2672](#) and [Generic Timer registers on page G6-5383](#). The bit assignments of the registers are identical in the System register interface and in the memory-mapped system level interface.

b. Address is reserved, RAZ/WI if register not implemented

c. The CNTCTLBase frame includes a RW view of this register.

The CNTEL0BaseN frame

For any value of N , the layout of the registers in the CNTEL0BaseN frame is identical to the CNTBaseN frame, except that, in the CNTEL0BaseN frame:

- CNTVOFF is never visible, and the memory at 0x018-0x01C is RAZ/WI.
- CNTEL0ACR is never visible, and the memory at 0x014 is RAZ/WI.
- If implemented in the CNTBaseN frame, CNTEL0ACR controls whether CNTPCT, CNTVCT, CNTFRQ, the Physical Timer, and the Virtual Timer registers are visible in the CNTEL0BaseN frame.
If CNTEL0ACR is not implemented then these registers are not visible in the CNTEL0BaseN frame, and their addresses in that frame are RAZ/WI.

If an implementation supports 64-bit atomic accesses, then CNTPCT, CNTVCT, CNTVOFF, CNTP_CVAL, and CNTV_CVAL must be accessible as atomic 64-bit values.

CNTCTLBase status and control fields for the CNTBaseN and CNTEL0BaseN frames

In the CNTCTLBase frame:

CNTTIDR controls:

- Whether each CNTBaseN frame is implemented.
- If a CNTBaseN frame is implemented, whether:
 - That CNTBaseN frame has virtual timer capability.
 - A corresponding CNTEL0BaseN frame is implemented.

CNTNSAR controls:

In an implementation that recognizes two Security states, determines whether each implemented CNTBaseN frame, and any corresponding CNTEL0BaseN frame, is accessible by Non-secure accesses.

This control also determines whether, in the CNTCTLBase frame, the CNTACR<n> and CNTVOFF<n> registers are accessible by Non-secure accesses.

The CNTACR<n> registers control:

For each implemented CNTBaseN frame, the accessibility of the following registers in that frame:

- CNTP_CTL, CNTP_CVAL, and CNTP_TVAL.
- CNTV_CTL, CNTV_CVAL, and CNTV_TVAL.
- CNTVOFF.
- CNTFRQ.
- CNTPCT.
- CNTVCT.

For CNTACR<n>, the value of <n> corresponds to the value of N for the controlled CNTBaseN frame.

The CNTVOFF<n> registers provide:

For each implemented CNTBaseN frame that has virtual capability, the RW copy of the CNTVOFF register for that frame.

————— Note —————

In a CNTBaseN frame that has virtual timer capability the CNTVOFF register is RO.

For CNTVOFF<n>, the value of <n> corresponds to the value of N for the controlled CNTBaseN frame.

11.4 Providing a complete set of counter and timer features

Using the general model for implementing a memory-mapped interface to the Generic Timer described in this section, the feature set of a System registers counter and timer, in an implementation that includes EL2 and EL3, can be implemented using the following set of timer frames:

- A **CNTCTLBase** control frame.
- The following **CNTBaseN** timer frames:
 - Frame 0** Accessible from Non-secure state, with second view and virtual capability. This provides the Non-secure EL1&0 timers.
 - Frame 1** Accessible from Non-secure state, with no second view and no virtual capability. This provides the Non-secure EL2 timers.
 - Frame 2** Accessible only from Secure state, with a second view but no virtual capability. This provides the Secure PL1&0 timers, meaning:
 - Compared to a PE where EL3 is using AArch32, it provides the only Secure state timer.
 - Compared to a PE where EL3 is using AArch64, it provides the Secure EL1&0 timer.
 - Frame 3** Accessible only Secure state, with no second view and no virtual capability. This provides the Secure EL3 timers.

———— **Note** —————

This frame is not required for a memory-mapped timer that provides only the feature set of a PE for which EL3 is using AArch32.

In this implementation, the full set of implemented frames, and their configuration in the memory map, is as follows:

CNTCTLBase

The control frame. This frame is located in both Secure and Non-secure physical memory, and:

- In the Secure EL1&0 translation regime, this frame is accessible only at EL1.
- In the Non-secure EL2 translation regime, this frame is accessible.
- In the Non-secure EL1&0 translation regime, this frame is not accessible.

CNTBase0 The first view of the Non-secure EL1&0 timers. This frame is located only in Non-secure physical memory, and:

- In the Secure EL1&0 translation regime, this frame is accessible only at EL1.
- In the Non-secure EL2 translation regime, this frame is accessible.
- In the Non-secure EL1&0 translation regime, this frame is accessible only at EL1.

CNTEL0Base0

The second view of **CNTBase0**, meaning it is the EL0 view of the Non-secure EL1&0 timers. This frame is located only in Non-secure physical memory, and:

- In the Secure EL1&0 translation regime, the architecture permits this frame to be accessible at EL1, or at EL1 and EL0, but does not require either of these options.
- In the Non-secure EL2 translation regime, this frame is accessible.
- In the Non-secure EL1&0 translation regime, this frame is accessible at EL1 and EL0.

CNTBase1 The first and only view of the Non-secure EL2 timers. This frame is located only in Non-secure physical memory, and:

- When EL3 is using AArch64:
 - In the Secure EL1&0 translation regime, this frame is accessible only at EL1.
 - In the Secure EL3 translation regime, this frame is accessible.
- When EL3 is using AArch32, in the Secure PL1&0 translation regime, this frame is accessible only at PL1 (EL3).
- In the Non-secure EL2 translation regime, this frame is accessible.
- In the Non-secure EL1&0 translation regime, this frame is not accessible.

CNTBase2 The first view of the Secure EL1&0, or PL1&0 timers.

———— **Note** —————

In AArch64 state, these timers are always called the Secure EL1&0 timers. In AArch32 state they are usually called the Secure PL1&0 timers because, in AArch32 Secure state, whether some of the PE modes map to EL1 or to EL3 depends on whether EL3 is using AArch64 or is using AArch32, see [Security state, Exception levels, and AArch32 execution privilege](#) on page G1-4318.

—————

This frame is located only in Secure physical memory, and:

- When EL3 is using AArch64:
 - In the Secure EL1&0 translation regime, this frame is accessible only at EL1.
 - In the Secure EL3 translation regime, this frame is accessible.
- When EL3 is using AArch32, in the Secure PL1&0 translation regime, this frame is accessible only at PL1 (EL3).
- Because the frame is in Secure memory, it is not accessible in any Non-secure translation regime.

CNTEL0Base2

The second view of **CNTBase2**, meaning it is the EL0 view of the Secure EL1&0, or PL1&0, timers.

———— **Note** —————

See the Note in the description of the CNTBase2 frame for more information about the naming of these timers.

—————

This frame is located only in Secure physical memory, and:

- When EL3 is using AArch64:
 - In the Secure EL1&0 translation regime, this frame is accessible at EL1 and EL0.
 - In the Secure EL3 translation regime, this frame is accessible.
- When EL3 is using AArch32, in the Secure PL1&0 translation regime, this frame is accessible at PL1 (EL3) and EL0.
- Because the frame is in Secure memory, it is not accessible in any Non-secure translation regime.

CNTBase3 The first and only view of the EL3 timers. This frame is located only in Secure physical memory, and:

- When EL3 is using AArch64:
 - In the Secure EL1&0 translation regime, this frame is not accessible.
 - In the Secure EL3 translation regime, this frame is accessible.
- When EL3 is using AArch32, this frame is not accessible.
- Because the frame is in Secure memory, it is not accessible in any Non-secure translation regime.

———— **Note** —————

[About the Virtual Memory System Architecture \(VMSA\)](#) on page D4-2004 describes the VMSAv8-64 translation regimes, and [About VMSAv8-32](#) on page G4-4558 describes the VMSAv8-32 translation regimes.

I1.5 Gray-count scheme for timer distribution scheme

The distribution of the Counter value using a Gray-code provides a relatively simple mechanism to avoid any danger of the count being sampled with an intermediate value even if the clocking is asynchronous. It has a further advantage that the distribution is relatively low power, since only one bit changes on the main distribution wires for each clock tick.

A suitable Gray-coding scheme can be achieved with the following logic:

$$\text{Gray}[N] = \text{Count}[N]$$

$$\text{Gray}[i] = (\text{XOR}(\text{Gray}[N:i+1])) \text{ XOR } \text{Count}[i] \text{ for } N-1 \geq i \geq 0$$

$$\text{Count}[i] = \text{XOR}(\text{Gray}[N:i]) \text{ for } N \geq i \geq 0$$

This is for an $N+1$ bit counter, where Count is a conventional binary count value, and Gray is the corresponding Gray count value.

———— **Note** —————

This scheme has the advantage of being relatively simple to switch, in either direction, between operating with low-frequency and low-precision, and operating with high-frequency and high-precision. To achieve this, the ratio of the frequencies must be 2^n , where n is an integer. A switch-over can occur only on the $2n+1$ boundary to avoid losing the Gray-coding property on a switch-over.

Chapter I2

Recommended External Interface to the Performance Monitors

This chapter describes the recommended external interface to the Performance Monitors. It contains the following section:

- [About the external interface to the Performance Monitors registers on page I2-5738.](#)

———— **Note** —————

[Performance Monitors external register descriptions on page I3-5749](#) describes the external view of the Performance Monitors registers.

I2.1 About the external interface to the Performance Monitors registers

ARM recommends that:

- An implementation provides the OPTIONAL external debug interface to the Performance Monitors registers.

———— **Note** —————

A debugger can use this interface to access counters in the Performance Monitors.

- The implementation includes the OPTIONAL support for memory-mapped access to the External debug interface.

———— **Note** —————

— Software running on any PE in a system can use this interface to access counters in the Performance Monitors.

— Privileged software should use the MMU to control access to this interface.

- The external debug interface is implemented as defined in [Appendix K2 Recommended External Debug Interface](#).

When an implementation supports memory-mapped access to the external debug interface the interface is accessed as a little-endian memory-mapped peripheral. [External Performance Monitors registers summary on page I3-5746](#) gives the memory map of these registers.

The following sections describe the memory-mapped views of the Performance Monitors registers:

- [Differences in the external views of the Performance Monitors registers](#).
- [Synchronization of changes to the memory-mapped views on page I2-5739](#).
- [Access permissions for external views of the Performance Monitors on page I2-5739](#).

In this section, unless the context explicitly indicates otherwise, any reference to *a memory-mapped view* applies equally to a register view using:

- A access through an external debug interface.
- A memory-mapped access.

I2.1.1 Differences in the external views of the Performance Monitors registers

An external view of the Performance Monitors registers accesses the same registers as the System registers interface described in [Performance Monitors Extension registers on page D5-2176](#), except that:

1. The [PMSELR](#) is accessible only in the System registers interface.
2. The following registers are accessible only in external views:
 - [PMCFGR](#)
 - [PMDEVAFF0](#)
 - [PMDEVAFF1](#)
 - [PMLAR](#)
 - [PMLSR](#)
 - [PMAUTHSTATUS](#)
 - [PMDEVARCH](#)
 - [PMDEVTYPE](#)
 - [PMPIDR0](#)
 - [PMPIDR1](#)
 - [PMPIDR2](#)
 - [PMPIDR3](#)

- [PMPIDR4](#)
- [PMCIDR0](#)
- [PMCIDR1](#)
- [PMCIDR2](#)
- [PMCIDR3](#)

[Performance Monitors external register descriptions on page I3-5749](#) describes these registers.

3. The following controls do not affect the external views:
 - [PMSELR](#).
 - [PMUSERENR](#).
 - [HDCR](#). {TPM, TPMCR, HPMN}.

Instead, see the register descriptions in [Chapter I3 External System Control Register Descriptions](#).

I2.1.2 Synchronization of changes to the memory-mapped views

If a Performance Monitor is visible in both System register and an external view, and is accessed simultaneously through these two mechanisms, the behavior must be as if the access occurred atomically in any order. For more information, see [Synchronization of changes to the external debug registers on page H8-5554](#).

I2.1.3 Access permissions for external views of the Performance Monitors

For more information, see [External debug interface register access permissions on page H8-5561](#).

[Table I2-1 on page I2-5740](#) shows the access permissions for the Performance Monitors registers in a v8 Debug implementation. This table uses the following terms:

DLK	When the OS Double Lock is locked, DoubleLockStatus() == TRUE, accesses to some registers produce an error. Applies to both interfaces.
EPMAD	When AllowExternalPMUAccess() == FALSE, external debug access is disabled. See also Behavior of a not permitted memory-mapped access on page H8-5559 .
Error	Indicates that the access gives an error response.
Default	This shows the default access permissions, if none of the conditions in this list prevent access to the register.
Off	When EDPRSR.PU == 0, the Core power domain is completely off, or in a low-power state where the Core power domain registers cannot be accessed.

———— **Note** —————

If debug power is off, then all external debug interface accesses return an error.

OSLK	When the OS Lock is locked, OSLAR_EL1.OSLK == 1, accesses to some registers produces an error. This column shows the effect of this control on accesses using the external debug interface.
SLK	This indicates the modified default access permissions for OPTIONAL memory-mapped accesses to the external debug interface if the OPTIONAL Software Lock is locked. See Register access permissions for memory-mapped accesses on page H8-5558 . For all other accesses, this column is ignored.
-	Indicates that the control has no effect on the behavior of the access: <ul style="list-style-type: none">• If no other control affects the behavior, the Default access behavior applies.

- However, another control might determine the behavior.

Table I2-1 Access permissions for the Performance Monitors registers

Offset	Register	Domain	Off	DLK	OSLK	EPMA	Default	SLK
0x000+8xn	PMEVCNTR<n>_EL0 ^a	Core	Error	Error	Error	Error	RW	RO
0x0F8	PMCCNTR_EL0[31:0]	Core	Error	Error	Error	Error	RW	RO
0x0FC	PMCCNTR_EL0[63:32]	Core	Error	Error	Error	Error	RW	RO
0x200	PMPCSR[31:0] ^b	Core	Error	Error	Error	-	RO	RO
0x204	PMPCSR[63:32] ^b	Core	Error	Error	Error	-	RO	RO
0x208	PMCID1SR ^b	Core	Error	Error	Error	-	RO	RO
0x20C	PMVIDSR ^b	Core	Error	Error	Error	-	RO	RO
0x220	PMPCSR[31:0] ^b	Core	Error	Error	Error	-	RO	RO
0x224	PMPCSR[63:32] ^b	Core	Error	Error	Error	-	RO	RO
0x228	PMCID1SR ^b	Core	Error	Error	Error	-	RO	RO
0x22C	PMCID2SR ^b	Core	Error	Error	Error	-	RO	RO
0x400+4xn	PMEVTPYPER<n>_EL0 ^a	Core	Error	Error	Error	Error	RW	RO
0x47C	PMCCFILTR_EL0	Core	Error	Error	Error	Error	RW	RO
0x600-0x6FC	-	-	Access is IMPLEMENTATION DEFINED					
0xA00-0xBFC	-	-	Access is IMPLEMENTATION DEFINED					
0xC00	PMCNTENSET_EL0	Core	Error	Error	Error	Error	RW	RO
0xC20	PMCNTENCLR_EL0	Core	Error	Error	Error	Error	RW	RO
0xC40	PMINTENSET_EL1	Core	Error	Error	Error	Error	RW	RO
0xC60	PMINTENCLR_EL1	Core	Error	Error	Error	Error	RW	RO
0xC80	PMOVSLR_EL0	Core	Error	Error	Error	Error	RW	RO
0xCA0	PMSWINC_EL0 ^c	Core	Error	Error	Error	Error	WO	WI
0xCC0	PMOVSSET_EL0	Core	Error	Error	Error	Error	RW	RO
0xD80-0xDFC	-	-	Access is IMPLEMENTATION DEFINED					
0xE00	PMCFGR	Core	Error	Error	Error	Error	RO	RO
0xE04	PMCR_EL0	Core	Error	Error	Error	Error	RW	RO
0xE20	PMCEID0	Core	Error	Error	Error	Error	RO	RO
0xE24	PMCEID1	Core	Error	Error	Error	Error	RO	RO
0xE80-0xEFC	Integration registers	-	Access is IMPLEMENTATION DEFINED					
0xF00-0xFFC	<i>Management registers and CoreSight compliance on page K2-6141</i>							

a. Implemented counters only. *n* is the counter number.

- b. Implemented only if the [OPTIONAL PC Sample-based Profiling Extension](#) is implemented and [ARMv8.2-PCSample](#) is implemented. See [Chapter H7 The PC Sample-based Profiling Extension](#).
- c. Only if the [OPTIONAL PMSWINC_EL0](#) register is implemented in the external debug interface.

I2.1.4 Power domains and Performance Monitors registers reset

For ARMv8-A implementations, ARM recommends that Performance Monitors are implemented as part of the core power domain, not as part of a separate debug power domain. There is no interface to access the Performance Monitors registers when the core power domain is powered down.

A Warm or Cold reset sets the Performance Monitors registers to their reset values. An External Debug reset does not change the values of the Performance Monitors registers.

For more information about the reset scheme recommended for a v8 Debug implementation see [Chapter H6 Debug Reset and Powerdown Support](#).

[Table I2-2](#) shows the Performance Monitors register resets for writable register fields. The column headings use the following terms:

- 64** This is the architectural reset value when resetting into AArch64 state.
- 32** This is the architectural reset value when resetting into AArch32 state.
- This indicates an IMPLEMENTATION DEFINED reset value on the specified reset. This might be UNKNOWN.

———— **Note** —————

This table does not include:

- Read-only identification registers and fields that have a fixed value. In this case, the reset value is that fixed value. An example of this is [PMCR_EL0.N](#).
- Write-only registers and fields that only have an effect on writes. These do not have a reset value. An example of this is [PMSWINC_EL0](#).
- IMPLEMENTATION DEFINED registers. In this case, the reset domains are IMPLEMENTATION DEFINED. The reset values are IMPLEMENTATION DEFINED and might be UNKNOWN.

Table I2-2 Performance Monitors System register resets

Register	Domain	Field	64	32	Description
PMCR_EL0	Warm	DP	-	0	Disable PMCCNTR_EL0 when prohibited
		X	-	0	Export enable
		D	-	0	Clock divider
		E	0	0	Performance Monitors enable
PMCNTENSET_EL0 PMCNTENCLR_EL0	Warm	-	-	-	All fields in register
PMOVSSET_EL0 PMOVSCLR_EL0	Warm	-	-	-	All fields in register
PMSELR_EL0	Warm	SEL	-	-	Selected event counter
PMCCNTR_EL0	Warm	-	-	-	All fields in register
PMEVTYPER<n>_EL0	Warm	-	-	-	All fields in register

Table I2-2 Performance Monitors System register resets (continued)

Register	Domain	Field	64	32	Description
PMCCFILTR_EL0	Warm	[31:26]	-	0x00	PMCCNTR_EL0 filtering controls
PMEVCNTR<n>_EL0	Warm	-	-	-	All fields in register
PMUSERENR_EL0	Warm	ER	-	0	Enable counter read access in EL0
		CR	-	0	Enable PMCCNTR_EL0 read access in EL0
		SW	-	0	Enable PMSWINC_EL0 write access in EL0
		EN	-	0	Enable Performance Monitors access in EL0
PMINTENSET_EL1 PMINTENCLR_EL1	Warm	-	-	-	All fields in register

Chapter I3

External System Control Register Descriptions

This chapter describes the external system control registers and supported access sizes. It excludes the External debug registers that are described in [Chapter H9 External Debug Register Descriptions](#). It contains the following sections:

- [About the external system control register descriptions on page I3-5744.](#)
- [Supported access sizes on page I3-5745.](#)
- [External Performance Monitors registers summary on page I3-5746.](#)
- [Performance Monitors external register descriptions on page I3-5749.](#)
- [Generic Timer memory-mapped registers overview on page I3-5815.](#)
- [Generic Timer memory-mapped register descriptions on page I3-5816.](#)

13.1 About the external system control register descriptions

This chapter describes the external system control registers other than the external debug registers. That is, it describes:

An external view of the Performance Monitors registers

ARM recommends that implementations provide access to the Performance Monitors registers through the OPTIONAL External debug interface, and provide the OPTIONAL memory-mapped interface to this interface:

- [External Performance Monitors registers summary on page I3-5746](#) lists the registers that are accessible in this view of the Performance Monitors, and describes their memory map.
- [Performance Monitors external register descriptions on page I3-5749](#) describes each of the memory-mapped registers.

[Chapter I2 Recommended External Interface to the Performance Monitors](#) describes the recommended interface to these registers.

Note

[Chapter D5 The Performance Monitors Extension](#) describes the Performance Monitors. The following sections describe the System register interfaces to the Performance Monitors:

- [Performance Monitors registers on page D7-2629](#), for accesses from an Exception level that is using AArch64.
 - [Performance Monitors registers on page G6-5331](#), for accesses from an Exception level that is using AArch32.
-

The registers for the system level Generic Timer component

Any implementation that includes the Generic Timer must include the memory-mapped system level component described in [Chapter I1 System Level Implementation of the Generic Timer](#). In this chapter:

- [Generic Timer memory-mapped registers overview on page I3-5815](#) gives an overview of the registers, referring to [Chapter I1](#) for more information.
- [Generic Timer memory-mapped register descriptions on page I3-5816](#) describes each of the memory-mapped registers.

Note

[Chapter D6 The Generic Timer in AArch64 state](#) describes the Generic Timer component that is accessible using the System registers. The following sections describe the System register interfaces to that component:

- [Generic Timer registers on page D7-2672](#), for accesses from an Exception level that is using AArch64.
 - [Generic Timer registers on page G6-5383](#), for accesses from an Exception level that is using AArch32.
-

Note

[Chapter H9 External Debug Register Descriptions](#) describes the external debug registers.

I3.2 Supported access sizes

All of the information that is provided in this section applies to all accesses to memory-mapped components of the ARMv8 architecture, unless a register or component description explicitly states otherwise.

The memory access sizes that are supported by any peripheral are IMPLEMENTATION DEFINED by the peripheral.

For accesses to memory-mapped components of the ARMv8 architecture, implementations must support the following options:

- Word-aligned 32-bit accesses to access 32-bit registers.
- Word-aligned 32-bit accesses to either half of a 64-bit register that is mapped to a doubleword-aligned pair of adjacent 32-bit locations,
- Doubleword-aligned 64-bit accesses to access 64-bit registers that are mapped to a doubleword-aligned pair of adjacent 32-bit locations.

All registers are only single-copy atomic at word granularity. This means that for 64-bit accesses to a 64-bit register, the system might generate a pair of 32-bit accesses. The order in which the two halves are accessed is not specified.

The following accesses are not supported:

- Byte accesses.
- Halfword accesses.
- Unaligned word accesses. These accesses are not word single-copy atomic.
- Unaligned doubleword accesses. These accesses are not doubleword single-copy atomic.
- Doubleword accesses to a pair of 32-bit locations that are not a doubleword-aligned pair that forms a 64-bit register.
- Quadword accesses or higher accesses.
- Exclusive accesses.

For unsupported accesses, it is CONSTRAINED UNPREDICTABLE whether:

- The access generates an external abort or not.
- The defined side-effects of a read occur or not. A read returns UNKNOWN values.
- A write is ignored or sets the accessed register or registers to UNKNOWN.

For memory-mapped accesses from a PE that complies with an ARM architecture, the single-copy atomicity rules for the instruction, the type of instruction, and the type of memory that is accessed, determine the size of the access that is made by an instruction. [Example I3-1](#) shows this.

Example I3-1 Access sizes for memory-mapped accesses

Two Load Doubleword instructions that are made to consecutive doubleword-aligned locations generate a pair of single-copy atomic doubleword reads. However, if the accesses are made to Normal memory or Device-GRE memory they might appear as a single quadword access that is not supported by the peripheral.

The ARMv8 architecture does not require the size of each element that is accessed by a multi-register load or store instruction to be identifiable by the memory system beyond the PE. Unless otherwise specified by the component, any access to a memory-mapped component of the ARMv8 architecture is defined to be beyond the PE.

Software must use a Device-nGRE or stronger memory type, and only single register load and store instructions, to create memory accesses that are supported by the peripheral. For more information, see [Memory types and attributes on page B2-107](#).

I3.3 External Performance Monitors registers summary

When an implementation provides access to the Performance Monitors registers through the External debug interface, that interface provides access to:

- Performance Monitors System registers.
- A read-only configuration register, [PMCFGR](#).
- The OPTIONAL CoreSight registers for the Performance Monitors, if they are implemented.

The locations of the registers are defined as offsets from a system-defined base address. [Performance Monitors external register views](#) defines this memory map.

I3.3.1 Performance Monitors external register views

[Table I3-1](#) shows the external view of the Performance Monitors registers. All other entries are reserved.

———— **Note** —————

- Counters that are reserved because [HDCR.HPMN](#) has been changed from its reset value remain visible in any external view.
- The registers that relate to an implemented event counter, PMN_x, are [PMEVCNTR<n>](#) and [PMEVTYPER<n>](#).
- The mapping of the *Performance Monitors Event Counter Registers*, at offsets 0x000-0x0F4, has changed compared to the mappings of the equivalent registers in ARMv7.

Each entry in the Name column links to the register description in [Performance Monitors external register descriptions](#) on page I3-5749, and:

- If the *System register?* column of the table shows that the register is a System register, the memory-mapped interface provides a view of the System register described in:
 - [Performance Monitors registers](#) on page D7-2629, for the AArch64 System register
 - [Performance Monitors registers](#) on page G6-5331, for the AArch32 System register
- Otherwise, the register is accessible only using the external interface.

Table I3-1 Performance Monitors external register views

Name	Type	Description	System register?	Offset
PMEVCNTR<n>_EL0	RW	Performance Monitors Event Counter Register.	Yes	0x000+8n
PMCCNTR_EL0[31:0] PMCCNTR_EL0[63:32]	RW	Performance Monitors Cycle Counter Register ^a	Yes	0x0F8 0x0FC
PMPCSR[31:0]^b	RW	Program Counter Sample Register, bits[31:0]	No	0x200
PMPCSR[63:32]	RW	Program Counter Sample Register, bits[63:32]	No	0x204
PMCID1SR	RW	CONTEXTIDR_EL1 Sample Register	No	0x208
PMVIDSR	RW	VMID Sample Register	No	0x20C
PMPCSR[31:0]	RW	Program Counter Sample Register, bits[31:0] (alias)	No	0x220
PMPCSR[63:32]	RW	Program Counter Sample Register, bits[63:32] (alias)	No	0x224
PMCID1SR	RW	CONTEXTIDR_EL1 Sample Register (alias)	No	0x248
PMCID2SR	RW	CONTEXTIDR_EL2 Sample Register	No	0x22C

Table I3-1 Performance Monitors external register views (continued)

Name	Type	Description	System register?	Offset
PMEVTYPER<n>_EL0	RW	Performance Monitors Event Type and Filter Register.	Yes	0x400+4n
PMCCFILTR_EL0	RW	Performance Monitors Cycle Counter Filter Register	Yes	0x47C
-	-	IMPLEMENTATION DEFINED	-	0x600-0x6FC
-	-	IMPLEMENTATION DEFINED	-	0xA00-0xBFC
PMCNTENSET_EL0	RW	Performance Monitors Count Enable Set register	Yes	0xC00
PMCNTENCLR_EL0	RW	Performance Monitors Count Enable Clear register	Yes	0xC20
PMINTENSET_EL1	RW	Performance Monitors Interrupt Enable Set register	Yes	0xC40
PMINTENCLR_EL1	RW	Performance Monitors Interrupt Enable Clear register	Yes	0xC60
PMOVSLR_EL0	RW	Performance Monitors Overflow Flag Status Clear register	Yes	0xC80
PMSWINC_EL0	WO	Performance Monitors Software Increment register	Yes	0xCA0
PMOVSSSET_EL0	RW	Performance Monitors Overflow Flag Status Set register	Yes	0xCC0
-	-	IMPLEMENTATION DEFINED	-	0xD80-0xDFC
PMCFGR	RO	Performance Monitors Configuration Register	No	0xE00
PMCR_EL0	RW	Performance Monitors Control Register	Yes	0xE04
PMCEID0	RO	Performance Monitors Common Event Identification register 0	Yes	0xE20
PMCEID1	RO	Performance Monitors Common Event Identification register 1	Yes	0xE24
-	-	IMPLEMENTATION DEFINED	-	0xE80-0xEFC
PMITCTRL ^c	RW	Integration Model Control registers	No	0xF00
PMDEVAFF0 ^c	RO	Device Affinity registers	No	0xFA8
PMDEVAFF1 ^c	RO			0xFAC
PMLAR ^{c, d}	WO	Lock Access register	No	0xFB0
PMLSR ^{c, d}	RO	Lock Status register	No	0xFB4
PMAUTHSTATUS ^c	RO	Authentication Status register	No	0xFB8
PMDEVARCH ^c	RO	Device Architecture register	No	0xFBC
PMDEVID	RO	Performance Monitors Device ID register	No	0xFC8
PMDEVTYPE ^c	RO	Device Type register	No	0xFCC
PMPIDR4 ^c	RO	Peripheral ID registers	No	0xFD0
PMPIDR0 ^c	RO			0xFE0
PMPIDR1 ^c	RO			0xFE4
PMPIDR2 ^c	RO			0xFE8
PMPIDR3 ^c	RO			0xFEC

Table I3-1 Performance Monitors external register views (continued)

Name	Type	Description	System register?	Offset
PMCIDR0^c	RO	Component ID registers	No	0xFF0
PMCIDR1^c	RO			0xFF4
PMCIDR2^c	RO			0xFF8
PMCIDR3^c	RO			0xFFC

- a. The interface must support at least single-copy atomic 32-bit accesses. If single-copy atomic 64-bit access to the registers is not possible, software must use a high-low-high read access to read the counter value if the counter is enabled.
- b. Supported from ARMv8.2. Until ARMv8.1, the functionality of PC Sample-Based Profiling is implemented with registers in the EDxxx space. See Chapter H7 *The PC Sample-based Profiling Extension*.
 Implemented only if the OPTIONAL PC Sample-based Profiling Extension is implemented.
- c. CoreSight interface registers, see [Management registers and CoreSight compliance on page K2-6141](#).
- d. The Software lock registers are defined as part of CoreSight compliance, but their contents depend on the type of access that is made and whether the OPTIONAL Software lock is implemented. See the register description for details.

I3.4 Performance Monitors external register descriptions

This section describes the external view of the Performance Monitors registers. [External Performance Monitors registers summary on page I3-5746](#) lists these registers in offset order.

13.4.1 PMAUTHSTATUS, Performance Monitors Authentication Status register

The PMAUTHSTATUS characteristics are:

Purpose

Provides information about the state of the IMPLEMENTATION DEFINED authentication interface for Performance Monitors.

Usage constraints

This register is accessible as follows:

SLK	Default
RO	RO

Configurations

PMAUTHSTATUS is in the Debug power domain.

This register is OPTIONAL, and is required for CoreSight compliance. ARM recommends that this register is implemented.

Attributes

PMAUTHSTATUS is a 32-bit register.

Field descriptions

The PMAUTHSTATUS bit assignments are:

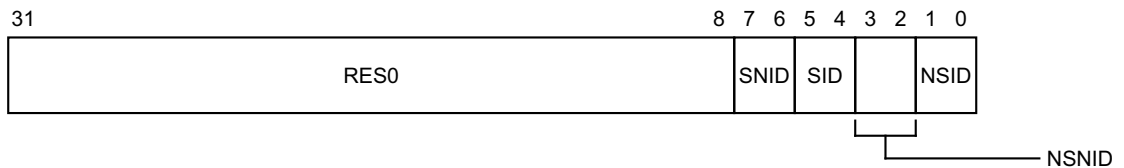

Bits [31:8]

Reserved, RES0.

SNID, bits [7:6]

Holds the same value as [DBGAUTHSTATUS_EL1.SNID](#).

SID, bits [5:4]

Secure invasive debug. Possible values of this field are:

00 Not implemented.

All other values are reserved.

NSNID, bits [3:2]

Holds the same value as [DBGAUTHSTATUS_EL1.NSNID](#).

NSID, bits [1:0]

Non-secure invasive debug. Possible values of this field are:

00 Not implemented.

All other values are reserved.

Accessing the PMAUTHSTATUS:

PMAUTHSTATUS can be accessed through the external debug interface:

Component	Offset
PMU	0xFB8

13.4.2 PMCCFILTR_EL0, Performance Monitors Cycle Counter Filter Register

The PMCCFILTR_EL0 characteristics are:

Purpose

Determines the modes in which the Cycle Counter, [PMCCNTR_EL0](#), increments.

Usage constraints

This register is accessible as follows:

Off	DLK	OSLK	EPMAD	SLK	Default
Error	Error	Error	Error	RO	RW

Configurations

External register PMCCFILTR_EL0 is architecturally mapped to AArch64 System register [PMCCFILTR_EL0](#).

External register PMCCFILTR_EL0 is architecturally mapped to AArch32 System register [PMCCFILTR](#).

PMCCFILTR_EL0 is in the Core power domain.

On a Warm or Cold reset RW fields in this register reset:

- To architecturally UNKNOWN values if the reset is to an Exception level that is using AArch64.
- To 0 if the reset is to an Exception level that is using AArch32.

The register is not affected by an External debug reset.

Attributes

PMCCFILTR_EL0 is a 32-bit register.

Field descriptions

The PMCCFILTR_EL0 bit assignments are:

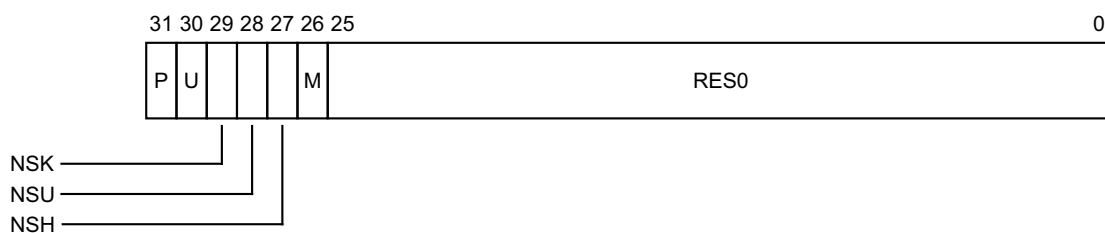

P, bit [31]

Privileged filtering bit. Controls counting in EL1. If EL3 is implemented, then counting in Non-secure EL1 is further controlled by the NSK bit. The possible values of this bit are:

- 0 Count cycles in EL1.
- 1 Do not count cycles in EL1.

U, bit [30]

User filtering bit. Controls counting in EL0. If EL3 is implemented, then counting in Non-secure EL0 is further controlled by the NSU bit. The possible values of this bit are:

- 0 Count cycles in EL0.

1 Do not count cycles in EL0.

NSK, bit [29]

Non-secure EL1 (kernel) modes filtering bit. Controls counting in Non-secure EL1. If EL3 is not implemented, this bit is RES0.

If the value of this bit is equal to the value of P, cycles in Non-secure EL1 are counted.

Otherwise, cycles in Non-secure EL1 are not counted.

NSU, bit [28]

Non-secure EL0 (Unprivileged) filtering. Controls counting in Non-secure EL0. If EL3 is not implemented, this bit is RES0.

If the value of this bit is equal to the value of U, cycles in Non-secure EL0 are counted.

Otherwise, cycles in Non-secure EL0 are not counted.

NSH, bit [27]

Non-secure EL2 (Hypervisor) filtering bit. Controls counting in Non-secure EL2. If EL2 is not implemented, this bit is RES0.

0 Do not count cycles in EL2.

1 Count cycles in EL2.

M, bit [26]

Secure EL3 filtering bit. If EL3 is not implemented, this bit is RES0.

If the value of this bit is equal to the value of P, cycles in Secure EL3 are counted.

Otherwise, cycles in Secure EL3 are not counted.

Most applications can ignore this field and set its value to 0.

———— **Note** —————

This field is not visible in the AArch32 PMCCFILTR System register.

Bits [25:0]

Reserved, RES0.

Accessing the PMCCFILTR_EL0:

PMCCFILTR_EL0 can be accessed through the external debug interface:

Component	Offset
PMU	0x47C

13.4.3 PMCCNTR_EL0, Performance Monitors Cycle Counter

The PMCCNTR_EL0 characteristics are:

Purpose

Holds the value of the processor Cycle Counter, CCNT, that counts processor clock cycles. See [Time as measured by the Performance Monitors cycle counter on page D5-2139](#) for more information.

[PMCCFILTR_EL0](#) determines the modes and states in which the PMCCNTR_EL0 can increment.

Usage constraints

This register is accessible as follows:

Off	DLK	OSLK	EPMAD	SLK	Default
Error	Error	Error	Error	RO	RW

Configurations

External register PMCCNTR_EL0 is architecturally mapped to AArch64 System register [PMCCNTR_EL0](#).

External register PMCCNTR_EL0 is architecturally mapped to AArch32 System register [PMCCNTR](#).

PMCCNTR_EL0 is in the Core power domain. RW fields in this register reset to architecturally UNKNOWN values. These apply on a Warm or Cold reset. The register is not affected by an External debug reset.

Attributes

PMCCNTR_EL0 is a 64-bit register.

Field descriptions

The PMCCNTR_EL0 bit assignments are:

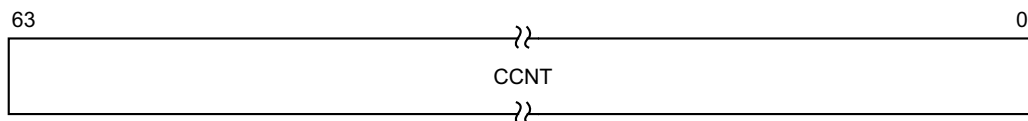

CCNT, bits [63:0]

Cycle count. Depending on the values of [PMCR_EL0](#).{LC, D}, the cycle count increments in one of the following ways:

- Every processor clock cycle.
- Every 64th processor clock cycle.

Writing 1 to [PMCR_EL0](#).C sets this field to 0.

This field resets to a value that is architecturally UNKNOWN.

Accessing the PMCCNTR_EL0:

PMCCNTR_EL0[31:0] can be accessed through the external debug interface:

Component	Offset
PMU	0x0F8

PMCCNTR_EL0[63:32] can be accessed through the external debug interface:

Component	Offset
PMU	0x0FC

I3.4.4 PMCEID0, Performance Monitors Common Event Identification register 0

The PMCEID0 characteristics are:

Purpose

Defines which common architectural and common microarchitectural feature events in the range 0x000 to 0x01F are implemented. If a particular bit is set to 1, then the event for that bit is implemented.

———— **Note** —————

This view of the register has previously been called PMCEID0_EL0.

Usage constraints

This register is accessible as follows:

Off	DLK	OSLK	EPMAD	SLK	Default
Error	Error	Error	Error	RO	RO

Configurations

External register PMCEID0 is architecturally mapped to AArch64 System register [PMCEID0_EL0](#)[31:0].

External register PMCEID0[31:0] is architecturally mapped to AArch32 System register [PMCEID0](#).

PMCEID0 is in the Core power domain.

Attributes

PMCEID0 is a 32-bit register.

Field descriptions

The PMCEID0 bit assignments are:

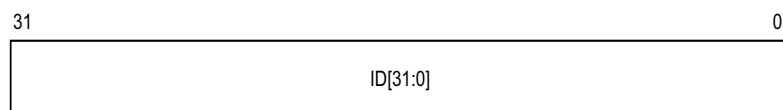

ID[31:0], bits [31:0]

PMCEID0[n] maps to event n. For a list of event numbers and descriptions, see [Events, event numbers, and mnemonics on page D5-2152](#).

For each bit:

- 0 The common event is not implemented.
- 1 The common event is implemented.

Bits that map to reserved event numbers are reserved to identify events that might be defined in future revisions to the architecture.

Events that do not require additional features in the PMU can be defined retrospectively, meaning that they can be implemented as part of a PMUv3 implementation.

Accessing the PMCEID0:

PMCEID0 can be accessed through the external debug interface:

Component	Offset
PMU	0xE20

I3.4.5 PMCEID1, Performance Monitors Common Event Identification register 1

The PMCEID1 characteristics are:

Purpose

Defines which common architectural and common microarchitectural feature events in the range 0x020 to 0x03F are implemented. If a particular bit is set to 1, then the event for that bit is implemented.

———— **Note** —————

This view of the register has previously been called PMCEID1_EL0.

Usage constraints

This register is accessible as follows:

Off	DLK	OSLK	EPMAD	SLK	Default
Error	Error	Error	Error	RO	RO

Configurations

External register PMCEID1 is architecturally mapped to AArch64 System register [PMCEID1_EL0](#)[31:0].

External register PMCEID1[31:0] is architecturally mapped to AArch32 System register [PMCEID1](#).

PMCEID1 is in the Core power domain.

Attributes

PMCEID1 is a 32-bit register.

Field descriptions

The PMCEID1 bit assignments are:

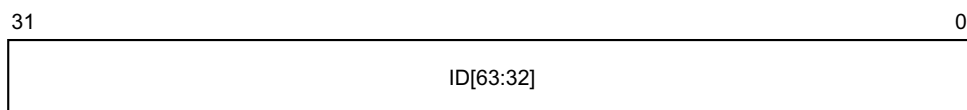

ID[63:32], bits [31:0]

PMCEID1[n] maps to event (n + 32). For a list of event numbers and descriptions, see [Events, event numbers, and mnemonics on page D5-2152](#).

For each bit:

0 The common event is not implemented.

1 The common event is implemented.

Bits that map to reserved event numbers are reserved to identify events that might be defined in future revisions to the architecture.

Events that do not require additional features in the PMU can be defined retrospectively, meaning that they can be implemented as part of a PMUv3 implementation.

Accessing the PMCEID1:

PMCEID1 can be accessed through the external debug interface:

Component	Offset
PMU	0xE24

13.4.6 PMCEID2, Performance Monitors Common Event Identification register 2

The PMCEID2 characteristics are:

Purpose

Defines which common architectural and common microarchitectural feature events in the range 0x4000 to 0x401F are implemented. If a particular bit is set to 1, then the event for that bit is implemented.

Usage constraints

This register is accessible as follows:

Off	DLK	OSLK	EPMA	SLK	Default
Error	Error	Error	Error	RO	RO

Configurations

External register PMCEID2 is architecturally mapped to AArch64 System register [PMCEID0_EL0](#)[63:32].

External register PMCEID2[63:32] is architecturally mapped to AArch32 System register [PMCEID2](#).

PMCEID2 is in the Core power domain.

This register is introduced in ARMv8.1.

Attributes

PMCEID2 is a 32-bit register.

Field descriptions

The PMCEID2 bit assignments are:

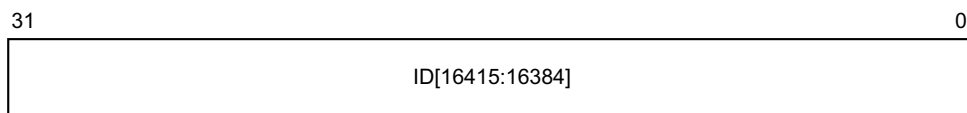

ID[16415:16384], bits [31:0]

PMCEID2[31:0] maps to common events 0x4000 to 0x401F. For a list of event numbers and descriptions, see [Events, event numbers, and mnemonics on page D5-2152](#).

For each bit:

0 The common event is not implemented.

1 The common event is implemented.

Bits that map to reserved event numbers are reserved to identify events that might be defined in future revisions to the architecture.

Events that do not require additional features in the PMU can be defined retrospectively, meaning that they can be implemented as part of a PMUv3 implementation.

Accessing the PMCEID2:

PMCEID2 can be accessed through the external debug interface:

Component	Offset
PMU	0xE28

13.4.7 PMCEID3, Performance Monitors Common Event Identification register 3

The PMCEID3 characteristics are:

Purpose

Defines which common architectural and common microarchitectural feature events in the range 0x4020 to 0x403F are implemented. If a particular bit is set to 1, then the event for that bit is implemented.

Usage constraints

This register is accessible as follows:

Off	DLK	OSLK	EPMA	SLK	Default
Error	Error	Error	Error	RO	RO

Configurations

External register PMCEID3 is architecturally mapped to AArch64 System register [PMCEID1_ELO](#)[63:32].

External register PMCEID3[63:32] is architecturally mapped to AArch32 System register [PMCEID3](#).

PMCEID3 is in the Core power domain.

This register is introduced in ARMv8.1.

Attributes

PMCEID3 is a 32-bit register.

Field descriptions

The PMCEID3 bit assignments are:

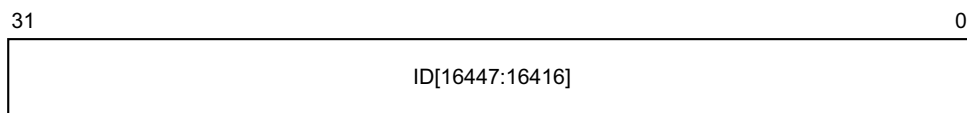

ID[16447:16416], bits [31:0]

PMCEID3[31:0] maps to common events 0x4020 to 0x403F. For a list of event numbers and descriptions, see [Events, event numbers, and mnemonics on page D5-2152](#).

For each bit:

0 The common event is not implemented.

1 The common event is implemented.

Bits that map to reserved event numbers are reserved to identify events that might be defined in future revisions to the architecture.

Events that do not require additional features in the PMU can be defined retrospectively, meaning that they can be implemented as part of a PMUv3 implementation.

Accessing the PMCEID3:

PMCEID3 can be accessed through the external debug interface:

Component	Offset
PMU	0xE2C

13.4.8 PMCFGR, Performance Monitors Configuration Register

The PMCFGR characteristics are:

Purpose

Contains PMU-specific configuration data.

Usage constraints

This register is accessible as follows:

Off	DLK	OSLK	EPMAD	SLK	Default
Error	Error	Error	Error	RO	RO

Configurations

PMCFGR is in the Core power domain.

Attributes

PMCFGR is a 32-bit register.

Field descriptions

The PMCFGR bit assignments are:

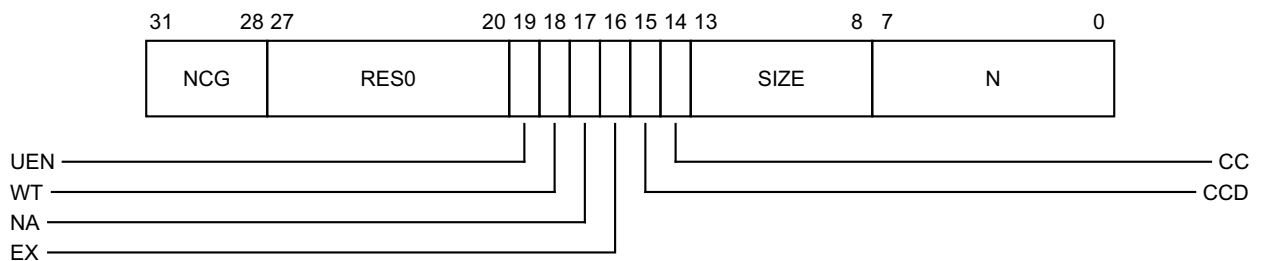

NCG, bits [31:28]

This feature is not supported, so this field is RAZ.

Bits [27:20]

Reserved, RES0.

UEN, bit [19]

User-mode Enable Register supported. [PMUSERENR_ELO](#) is not visible in the external debug interface, so this bit is RAZ.

WT, bit [18]

This feature is not supported, so this bit is RAZ.

NA, bit [17]

This feature is not supported, so this bit is RAZ.

EX, bit [16]

Export supported. Value is IMPLEMENTATION DEFINED.

0 [PMCR_ELO.X](#) is RES0.

1 [PMCR_ELO.X](#) is read/write.

CCD, bit [15]

Cycle counter has prescale. This is RES1 if AArch32 is supported at any EL, and RAZ otherwise.

0 [PMCR_ELO.D](#) is RES0.

1 [PMCR_ELO.D](#) is read/write.

CC, bit [14]

Dedicated cycle counter (counter 31) supported. This bit is RAO.

SIZE, bits [13:8]

Size of counters. This field determines the spacing of counters in the memory-map.

In ARMv8 the counters are at doubleword-aligned addresses, and the largest counter is 64-bits, so this field is 0b111111.

N, bits [7:0]

Number of counters implemented in addition to the cycle counter, [PMCCNTR_ELO](#). The maximum number of event counters is 31.

00000000 Only [PMCCNTR_ELO](#) implemented.

00000001 [PMCCNTR_ELO](#) plus one event counter implemented.

and so on up to 0b00011111, which indicates [PMCCNTR_ELO](#) and 31 event counters implemented.

Accessing the PMCFGR:

PMCFGR can be accessed through the external debug interface:

Component	Offset
PMU	0xE00

13.4.9 PMCIDR0, Performance Monitors Component Identification Register 0

The PMCIDR0 characteristics are:

Purpose

Provides information to identify a Performance Monitor component.

For more information see [About the Component Identification scheme on page K2-6149](#).

Usage constraints

This register is accessible as follows:

SLK	Default
RO	RO

Configurations

PMCIDR0 is in the Debug power domain.

Implementation of this register is OPTIONAL.

This register is required for CoreSight compliance.

Attributes

PMCIDR0 is a 32-bit register.

Field descriptions

The PMCIDR0 bit assignments are:

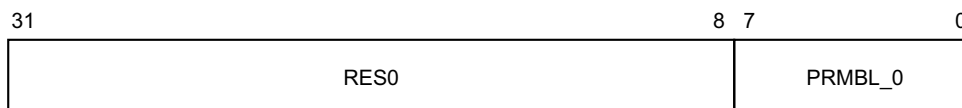

Bits [31:8]

Reserved, RES0.

PRMBL_0, bits [7:0]

Preamble. Must read as 0x00.

Accessing the PMCIDR0:

PMCIDR0 can be accessed through the external debug interface:

Component	Offset
PMU	0xFF0

13.4.10 PMCIDR1, Performance Monitors Component Identification Register 1

The PMCIDR1 characteristics are:

Purpose

Provides information to identify a Performance Monitor component.

For more information see [About the Component Identification scheme on page K2-6149](#).

Usage constraints

This register is accessible as follows:

SLK	Default
RO	RO

Configurations

PMCIDR1 is in the Debug power domain.

Implementation of this register is OPTIONAL.

This register is required for CoreSight compliance.

Attributes

PMCIDR1 is a 32-bit register.

Field descriptions

The PMCIDR1 bit assignments are:

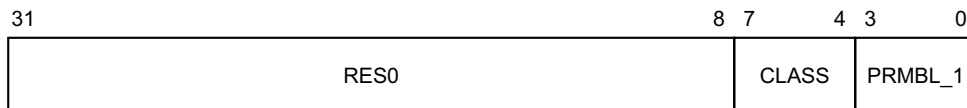

Bits [31:8]

Reserved, RES0.

CLASS, bits [7:4]

Component class. Reads as 0x9, debug component.

PRMBL_1, bits [3:0]

Preamble. RAZ.

Accessing the PMCIDR1:

PMCIDR1 can be accessed through the external debug interface:

Component	Offset
PMU	0xFF4

13.4.11 PMCIDR2, Performance Monitors Component Identification Register 2

The PMCIDR2 characteristics are:

Purpose

Provides information to identify a Performance Monitor component.

For more information see [About the Component Identification scheme on page K2-6149](#).

Usage constraints

This register is accessible as follows:

SLK	Default
RO	RO

Configurations

PMCIDR2 is in the Debug power domain.

Implementation of this register is OPTIONAL.

This register is required for CoreSight compliance.

Attributes

PMCIDR2 is a 32-bit register.

Field descriptions

The PMCIDR2 bit assignments are:

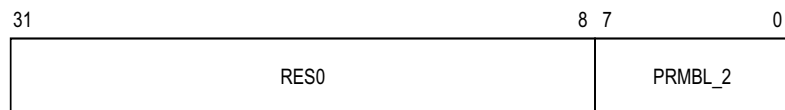

Bits [31:8]

Reserved, RES0.

PRMBL_2, bits [7:0]

Preamble. Must read as 0x05.

Accessing the PMCIDR2:

PMCIDR2 can be accessed through the external debug interface:

Component	Offset
PMU	0xFF8

13.4.12 PMCIDR3, Performance Monitors Component Identification Register 3

The PMCIDR3 characteristics are:

Purpose

Provides information to identify a Performance Monitor component.

For more information see [About the Component Identification scheme on page K2-6149](#).

Usage constraints

This register is accessible as follows:

SLK	Default
RO	RO

Configurations

PMCIDR3 is in the Debug power domain.

Implementation of this register is OPTIONAL.

This register is required for CoreSight compliance.

Attributes

PMCIDR3 is a 32-bit register.

Field descriptions

The PMCIDR3 bit assignments are:

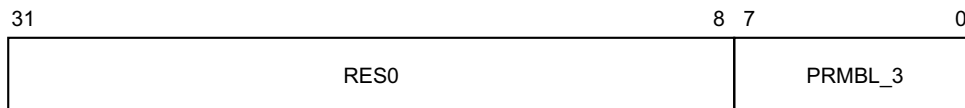

Bits [31:8]

Reserved, RES0.

PRMBL_3, bits [7:0]

Preamble. Must read as 0xB1.

Accessing the PMCIDR3:

PMCIDR3 can be accessed through the external debug interface:

Component	Offset
PMU	0xFFC

I3.4.13 PMCID1SR, CONTEXTIDR_EL1 Sample Register

The PMCID1SR characteristics are:

Purpose

Contains the sampled value of [CONTEXTIDR_EL1](#), captured on reading [PMPCSR](#)[31:0].

Usage constraints

This register is accessible as follows:

Off	DLK	OSLK	SLK	Default
Error	Error	Error	RO	RO

Configurations

PMCID1SR is in the Core power domain.

Fields in this register reset to architecturally UNKNOWN values. These apply only on a Cold reset. The register is not affected by a Warm reset and is not affected by an External debug reset.

Implemented only if the OPTIONAL PC Sample-based Profiling Extension is implemented and [ARMv8.2-PCSample](#) is implemented. If the OPTIONAL PC Sample-based Profiling Extension is implemented and [ARMv8.2-PCSample](#) is not implemented, this register is not implemented and the architecture defines the functionality in [EDCIDS](#).

This register is introduced in ARMv8.2.

Attributes

PMCID1SR is a 32-bit register.

Field descriptions

The PMCID1SR bit assignments are:



CONTEXTIDR_EL1, bits [31:0]

Context ID. The value of [CONTEXTIDR](#) that is associated with the most recent [PMPCSR](#) sample.

- If EL1 is using AArch64, then the Context ID is held in [CONTEXTIDR_EL1](#).
- If EL1 is using AArch32, then the Context ID is held in [CONTEXTIDR](#).
- If EL3 is implemented and is using AArch32, then [CONTEXTIDR](#) is a banked register and PMCID1SR samples the current banked copy of [CONTEXTIDR](#) for the Security state that is associated with the most recent [PMPCSR](#) sample.

Because the value written to PMCID1SR is an indirect read of [CONTEXTIDR](#), therefore it is CONSTRAINED UNPREDICTABLE whether PMCID1SR is set to the original or new value if a read of [PMPCSR](#) samples:

- An instruction that writes to [CONTEXTIDR_EL1](#).
- The next Context synchronization event.
- Any instruction executed between these two instructions.

When this register has an architecturally-defined reset value, this field resets to a value that is architecturally UNKNOWN.

Accessing the PMCID1SR:

PMCID1SR can be accessed through the external debug interface:

Component	Offset
PMU	0x208
PMU	0x228

I3.4.14 PMCID2SR, CONTEXTIDR_EL2 Sample Register

The PMCID2SR characteristics are:

Purpose

Contains the sampled value of [CONTEXTIDR_EL2](#), captured on reading [PMPCSR](#)[31:0].

Usage constraints

This register is accessible as follows:

Off	DLK	OSLK	SLK	Default
Error	Error	Error	RO	RO

Configurations

PMCID2SR is in the Core power domain.

Fields in this register reset to architecturally UNKNOWN values. These apply only on a Cold reset. The register is not affected by a Warm reset and is not affected by an External debug reset.

Implemented only if the OPTIONAL PC Sample-based Profiling Extension is implemented and [ARMv8.2-PCSample](#) is implemented. If the OPTIONAL PC Sample-based Profiling Extension is implemented and [ARMv8.2-PCSample](#) is not implemented, this register is not implemented and the architecture defines the functionality in [EDCDSR](#).

If EL2 is not implemented, this register is RES0.

This register is introduced in ARMv8.2.

Attributes

PMCID2SR is a 32-bit register.

Field descriptions

The PMCID2SR bit assignments are:

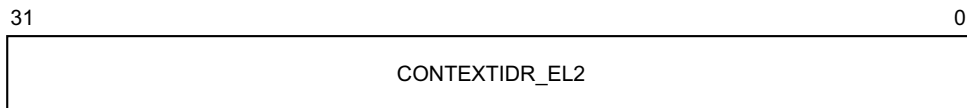

CONTEXTIDR_EL2, bits [31:0]

Context ID. The value of [CONTEXTIDR](#) that is associated with the most recent [PMPCSR](#) sample.

- If EL2 is using AArch64, then the Context ID is in [CONTEXTIDR_EL2](#).
- If EL2 is using AArch32, then this field is set to an UNKNOWN value.
- If [PMPCSR.NS](#)==0, this field is set to an UNKNOWN value.

Because the value written to PMCID2SR is an indirect read of [CONTEXTIDR](#), therefore it is CONSTRAINED UNPREDICTABLE whether PMCID2SR is set to the original or new value if a read of [PMPCSR](#) samples:

- An instruction that writes to [CONTEXTIDR_EL2](#).
- The next Context synchronization event.
- Any instruction executed between these two instructions.

When this register has an architecturally-defined reset value, this field resets to a value that is architecturally UNKNOWN.

Accessing the PMCID2SR:

PMCID2SR can be accessed through the external debug interface:

Component	Offset
PMU	0x22C

13.4.15 PMCNTENCLR_EL0, Performance Monitors Count Enable Clear register

The PMCNTENCLR_EL0 characteristics are:

Purpose

Disables the Cycle Count Register, [PMCCNTR_EL0](#), and any implemented event counters [PMEVCNTR<n>](#). Reading this register shows which counters are enabled.

Usage constraints

This register is accessible as follows:

Off	DLK	OSLK	EPMA	SLK	Default
Error	Error	Error	Error	RO	RW

Configurations

External register PMCNTENCLR_EL0 is architecturally mapped to AArch64 System register [PMCNTENCLR_EL0](#).

External register PMCNTENCLR_EL0 is architecturally mapped to AArch32 System register [PMCNTENCLR](#).

PMCNTENCLR_EL0 is in the Core power domain. RW fields in this register reset to architecturally UNKNOWN values. These apply on a Warm or Cold reset. The register is not affected by an External debug reset.

Attributes

PMCNTENCLR_EL0 is a 32-bit register.

Field descriptions

The PMCNTENCLR_EL0 bit assignments are:

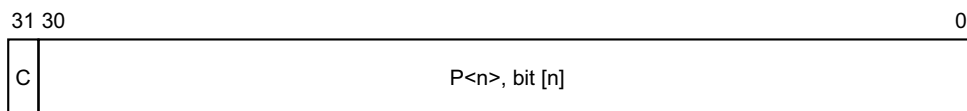

C, bit [31]

[PMCCNTR_EL0](#) disable bit. Disables the cycle counter register. Possible values are:

- 0 When read, means the cycle counter is disabled. When written, has no effect.
- 1 When read, means the cycle counter is enabled. When written, disables the cycle counter.

This field resets to a value that is architecturally UNKNOWN.

P<n>, bit [n], for n = 0 to 30

Event counter disable bit for [PMEVCNTR<n>_EL0](#).

Bits [30:N] are RAZ/WI. N is the value in [PMCFGR.N](#).

Possible values of each bit are:

- 0 When read, means that [PMEVCNTR<n>_EL0](#) is disabled. When written, has no effect.
- 1 When read, means that [PMEVCNTR<n>_EL0](#) is enabled. When written, disables [PMEVCNTR<n>_EL0](#).

This field resets to a value that is architecturally UNKNOWN.

Accessing the PMCNTENCLR_ELO:

PMCNTENCLR_ELO can be accessed through the external debug interface:

Component	Offset
PMU	0xC20

13.4.16 PMCNTENSET_EL0, Performance Monitors Count Enable Set register

The PMCNTENSET_EL0 characteristics are:

Purpose

Enables the Cycle Count Register, [PMCCNTR_EL0](#), and any implemented event counters [PMEVCNTR<n>](#). Reading this register shows which counters are enabled.

Usage constraints

This register is accessible as follows:

Off	DLK	OSLK	EPMA	SLK	Default
Error	Error	Error	Error	RO	RW

Configurations

External register PMCNTENSET_EL0 is architecturally mapped to AArch64 System register [PMCNTENSET_EL0](#).

External register PMCNTENSET_EL0 is architecturally mapped to AArch32 System register [PMCNTENSET](#).

PMCNTENSET_EL0 is in the Core power domain. RW fields in this register reset to architecturally UNKNOWN values. These apply on a Warm or Cold reset. The register is not affected by an External debug reset.

Attributes

PMCNTENSET_EL0 is a 32-bit register.

Field descriptions

The PMCNTENSET_EL0 bit assignments are:

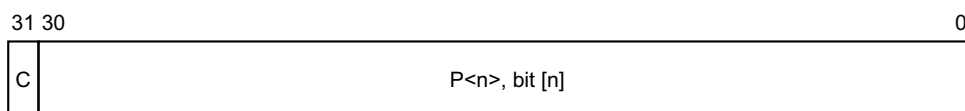

C, bit [31]

[PMCCNTR_EL0](#) enable bit. Enables the cycle counter register. Possible values are:

- 0 When read, means the cycle counter is disabled. When written, has no effect.
- 1 When read, means the cycle counter is enabled. When written, enables the cycle counter.

This field resets to a value that is architecturally UNKNOWN.

P<n>, bit [n], for n = 0 to 30

Event counter enable bit for [PMEVCNTR<n>_EL0](#).

Bits [30:N] are RAZ/WI. N is the value in [PMCFGR.N](#).

Possible values of each bit are:

- 0 When read, means that [PMEVCNTR<n>_EL0](#) is disabled. When written, has no effect.
- 1 When read, means that [PMEVCNTR<n>_EL0](#) event counter is enabled. When written, enables [PMEVCNTR<n>_EL0](#).

This field resets to a value that is architecturally UNKNOWN.

Accessing the PMCNTENSET_ELO:

PMCNTENSET_ELO can be accessed through the external debug interface:

Component	Offset
PMU	0xC00

13.4.17 PMCR_EL0, Performance Monitors Control Register

The PMCR_EL0 characteristics are:

Purpose

Provides details of the Performance Monitors implementation, including the number of counters implemented, and configures and controls the counters.

Usage constraints

This register is accessible as follows:

Off	DLK	OSLK	EPMAD	SLK	Default
Error	Error	Error	Error	RO	RW

Configurations

External register PMCR_EL0[6:0] is architecturally mapped to AArch32 System register [PMCR](#)[6:0].

External register PMCR_EL0[6:0] is architecturally mapped to AArch64 System register [PMCR_EL0](#)[6:0].

PMCR_EL0 is in the Core power domain. Some or all RW fields of this register have defined reset values. These apply on a Warm or Cold reset. The register is not affected by an External debug reset.

This register is only partially mapped to the internal [PMCR](#) System register. An external agent must use other means to discover the information held in [PMCR](#)[31:11], such as accessing [PMCFGR](#) and the ID registers.

Attributes

PMCR_EL0 is a 32-bit register.

Field descriptions

The PMCR_EL0 bit assignments are:

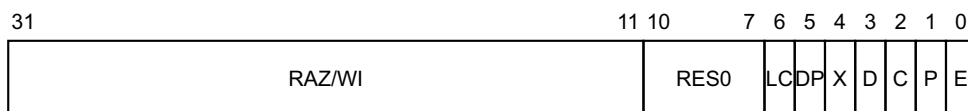

Bits [31:11]

RAZ/WI. Hardware must implement this field as RAZ/WI. Software must not rely on the register reading as zero, and must use a read-modify-write sequence to write to the register.

Bits [10:7]

Reserved, RES0.

LC, bit [6]

Long cycle counter enable. Determines which [PMCCNTR_EL0](#) bit generates an overflow recorded by [PMOVSRR](#)[31].

0 Cycle counter overflow on increment that changes [PMCCNTR_EL0](#)[31] from 1 to 0.

1 Cycle counter overflow on increment that changes [PMCCNTR_EL0](#)[63] from 1 to 0.

ARM deprecates use of [PMCR_EL0](#).LC = 0.

In an AArch64-only implementation, this field is RES1.

If this field is implemented as an RW field, it resets to a value that is architecturally UNKNOWN.

DP, bit [5]

Disable cycle counter when event counting is prohibited. The possible values of this bit are:

- 0 `PMCCNTR_ELO`, if enabled, counts when event counting is prohibited.
- 1 `PMCCNTR_ELO` does not count when event counting is prohibited.

Counting events is never prohibited in Non-secure state. However, there are some restrictions on counting events in Secure state. For more information about the interaction between the Performance Monitors and EL3, see [Interaction with EL3 on page D5-2145](#).

When EL3 is not implemented, this field is RES0:

- When [ARMv8.1-PMU](#) is not implemented.
- When [ARMv8.1-PMU](#) is implemented, only if EL2 is not implemented.

Otherwise this field is RW.

When this register has an architecturally-defined reset value, if this field is implemented as an RW field it resets to:

- A value that is architecturally UNKNOWN if the reset is into an Exception level that is using AArch64.
- 0 if the reset is into an Exception level that is using AArch32.

X, bit [4]

Enable export of events in an IMPLEMENTATION DEFINED event stream. The possible values of this bit are:

- 0 Do not export events.
- 1 Export events where not prohibited.

This field enables the exporting of events over an event bus to another device, for example to an OPTIONAL trace macrocell. If the implementation does not include such an event bus then this field is RAZ/WI, otherwise it is an RW field.

In an implementation that includes an event bus, no events are exported when counting is prohibited.

This field does not affect the generation of Performance Monitors overflow interrupt requests or signaling to a cross-trigger interface (CTI) that can be implemented as signals exported from the PE.

When this register has an architecturally-defined reset value, if this field is implemented as an RW field it resets to:

- A value that is architecturally UNKNOWN if the reset is into an Exception level that is using AArch64.
- 0 if the reset is into an Exception level that is using AArch32.

D, bit [3]

Clock divider. The possible values of this bit are:

- 0 When enabled, `PMCCNTR_ELO` counts every clock cycle.
- 1 When enabled, `PMCCNTR_ELO` counts once every 64 clock cycles.

In an AArch64-only implementation this field is RES0, otherwise it is an RW field. If `PMCR_ELO.LC == 1`, this bit is ignored and the cycle counter counts every clock cycle.

ARM deprecates use of `PMCR_ELO.D = 1`.

When this register has an architecturally-defined reset value, if this field is implemented as an RW field it resets to:

- A value that is architecturally UNKNOWN if the reset is into an Exception level that is using AArch64.
- 0 if the reset is into an Exception level that is using AArch32.

C, bit [2]

Cycle counter reset. This bit is WO. The effects of writing to this bit are:

- 0 No action.
- 1 Reset [PMCCNTR_EL0](#) to zero.

This bit is always RAZ.

Resetting [PMCCNTR_EL0](#) does not clear the [PMCCNTR_EL0](#) overflow bit to 0.

P, bit [1]

Event counter reset. This bit is WO. The effects of writing to this bit are:

- 0 No action.
- 1 Reset all event counters, not including [PMCCNTR_EL0](#), to zero.

This bit is always RAZ.

Resetting the event counters does not clear any overflow bits to 0.

E, bit [0]

Enable. The possible values of this bit are:

- 0 All counters, including [PMCCNTR_EL0](#), are disabled.
- 1 All counters are enabled by [PMCNTENSET_EL0](#).

This bit is RW.

When this register has an architecturally-defined reset value, this field resets to 0.

Accessing the PMCR_EL0:

PMCR_EL0 can be accessed through the external debug interface:

Component	Offset
PMU	0xE04

I3.4.18 PMDEVAFF0, Performance Monitors Device Affinity register 0

The PMDEVAFF0 characteristics are:

Purpose

Copy of the low half of the PE [MPIDR_EL1](#) register that allows a debugger to determine which PE in a multiprocessor system the Performance Monitor component relates to.

Usage constraints

This register is accessible as follows:

SLK	Default
RO	RO

Configurations

PMDEVAFF0 is in the Debug power domain.

Implementation of this register is OPTIONAL.

Attributes

PMDEVAFF0 is a 32-bit register.

Field descriptions

The PMDEVAFF0 bit assignments are:

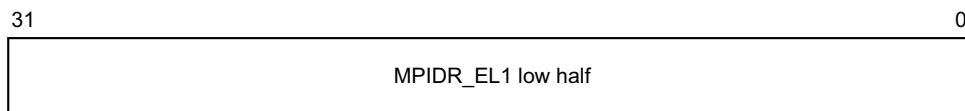

Bits [31:0]

[MPIDR_EL1](#) low half. Read-only copy of the low half of [MPIDR_EL1](#), as seen from the highest implemented Exception level.

Accessing the PMDEVAFF0:

PMDEVAFF0 can be accessed through the external debug interface:

Component	Offset
PMU	0xFA8

I3.4.19 PMDEVAFF1, Performance Monitors Device Affinity register 1

The PMDEVAFF1 characteristics are:

Purpose

Copy of the high half of the PE [MPIDR_EL1](#) register that allows a debugger to determine which PE in a multiprocessor system the Performance Monitor component relates to.

Usage constraints

This register is accessible as follows:

SLK	Default
RO	RO

Configurations

PMDEVAFF1 is in the Debug power domain.

Implementation of this register is OPTIONAL.

Attributes

PMDEVAFF1 is a 32-bit register.

Field descriptions

The PMDEVAFF1 bit assignments are:

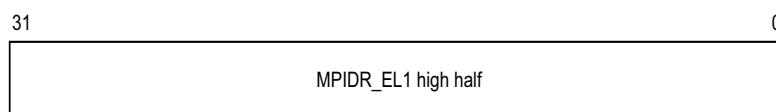

Bits [31:0]

[MPIDR_EL1](#) high half. Read-only copy of the high half of [MPIDR_EL1](#), as seen from the highest implemented Exception level.

Accessing the PMDEVAFF1:

PMDEVAFF1 can be accessed through the external debug interface:

Component	Offset
PMU	0xFAC

13.4.20 PMDEVARCH, Performance Monitors Device Architecture register

The PMDEVARCH characteristics are:

Purpose

Identifies the programmers' model architecture of the Performance Monitor component.

Usage constraints

This register is accessible as follows:

SLK	Default
RO	RO

Configurations

PMDEVARCH is in the Debug power domain.

Attributes

PMDEVARCH is a 32-bit register.

Field descriptions

The PMDEVARCH bit assignments are:

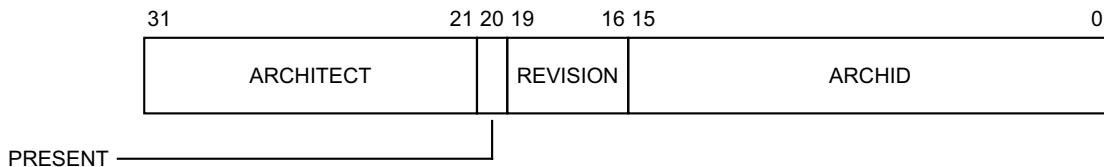

ARCHITECT, bits [31:21]

Defines the architecture of the component. For Performance Monitors, this is ARM Limited.

Bits [31:28] are the JEP106 continuation code, 0x4.

Bits [27:21] are the JEP106 ID code, 0x3B.

PRESENT, bit [20]

When set to 1, indicates that the DEVARCH is present.

This field is 1 in ARMv8.

REVISION, bits [19:16]

Defines the architecture revision. For architectures defined by ARM this is the minor revision.

For Performance Monitors, the revision defined by ARMv8 is 0x0.

All other values are reserved.

ARCHID, bits [15:0]

Defines this part to be an ARMv8 debug component. For architectures defined by ARM this is further subdivided.

For Performance Monitors:

- Bits [15:12] are the architecture version, 0x2.
- Bits [11:0] are the architecture part number, 0xA16.

This corresponds to Performance Monitors architecture version PMUv3.

———— **Note** ————

The PMUv3 memory-mapped programmers' model can be used by devices other than ARMv8 processors. Software must determine whether the PMU is attached to an ARMv8 processor by using the [PMDEVAFF0](#) and [PMDEVAFF1](#) registers to discover the affinity of the PMU to any ARMv8 processors.

Accessing the PMDEVARCH:

PMDEVARCH can be accessed through the external debug interface:

Component	Offset
PMU	0xFBC

13.4.21 PMDEVID, Performance Monitors Device ID register

The PMDEVID characteristics are:

Purpose

Provides information about features of the debug implementation.

Usage constraints

Accessing this register depends on which field is being accessed; see the register field descriptions for the states that they are accessible in.

Configurations

PMDEVID is in the Debug power domain.

This register is required in all implementations.

Up until and including ARMv8.1, the architecture defines the functionality in a different set of registers, see [DBGDEVID](#).

Attributes

PMDEVID is a 32-bit register.

Field descriptions

The PMDEVID bit assignments are:

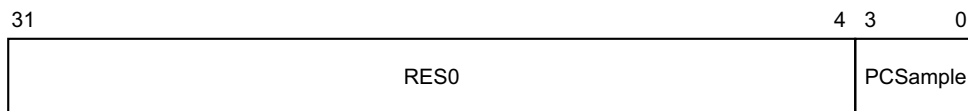

Bits [31:4]

Reserved, RES0.

PCSample, bits [3:0]

Indicates the level of PC Sample-based Profiling support using performance monitor registers. Permitted values of this field are:

- 0000 Architecture-defined form of PC Sample-based Profiling not implemented with performance monitor registers.
- 0001 Architecture-defined form of PC Sample-based Profiling is implemented with performance monitor registers.

All other values are reserved.

Accessing the PMDEVID:

PMDEVID can be accessed through the external debug interface:

Component	Offset
PMU	0xFC8

13.4.22 PMDEVTYPE, Performance Monitors Device Type register

The PMDEVTYPE characteristics are:

Purpose

Indicates to a debugger that this component is part of a PE's performance monitor interface.

Usage constraints

This register is accessible as follows:

SLK	Default
RO	RO

Configurations

PMDEVTYPE is in the Debug power domain.

Implementation of this register is OPTIONAL.

Attributes

PMDEVTYPE is a 32-bit register.

Field descriptions

The PMDEVTYPE bit assignments are:

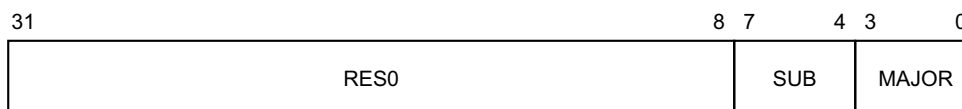

Bits [31:8]

Reserved, RES0.

SUB, bits [7:4]

Subtype. Must read as 0x1 to indicate this is a component within a PE.

MAJOR, bits [3:0]

Major type. Must read as 0x6 to indicate this is a performance monitor component.

Accessing the PMDEVTYPE:

PMDEVTYPE can be accessed through the external debug interface:

Component	Offset
PMU	0xFCC

13.4.23 PMEVCNTR<n>_EL0, Performance Monitors Event Count Registers, n = 0 - 30

The PMEVCNTR<n>_EL0 characteristics are:

Purpose

Holds event counter n, which counts events, where n is 0 to 30.

Usage constraints

This register is accessible as follows:

Off	DLK	OSLK	EPMA	SLK	Default
Error	Error	Error	Error	RO	RW

External accesses to the performance monitors ignore [PMUSERENR_EL0](#) and, if implemented, [MDCR_EL2](#).{TPM, TPMCR, HPMN} and [MDCR_EL3](#).TPM. This means that all counters are accessible regardless of the current EL or privilege of the access.

Configurations

External register PMEVCNTR<n>_EL0 is architecturally mapped to AArch64 System register [PMEVCNTR<n>_EL0](#).

External register PMEVCNTR<n>_EL0 is architecturally mapped to AArch32 System register [PMEVCNTR<n>](#).

PMEVCNTR<n>_EL0 is in the Core power domain. RW fields in this register reset to architecturally UNKNOWN values. These apply on a Warm or Cold reset. The register is not affected by an External debug reset.

Attributes

PMEVCNTR<n>_EL0 is a 32-bit register.

Field descriptions

The PMEVCNTR<n>_EL0 bit assignments are:

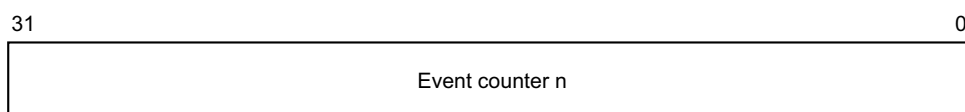

Bits [31:0]

Event counter n. Value of event counter n, where n is the number of this register and is a number from 0 to 30.

This field resets to a value that is architecturally UNKNOWN.

Accessing the PMEVCNTR<n>_EL0:

PMEVCNTR<n>_EL0 can be accessed through the external debug interface:

Component	Offset
PMU	0x000 + 8n

13.4.24 PMEVTYPER<n>_EL0, Performance Monitors Event Type Registers, n = 0 - 30

The PMEVTYPER<n>_EL0 characteristics are:

Purpose

Configures event counter n, where n is 0 to 30.

Usage constraints

This register is accessible as follows:

Off	DLK	OSLK	EPMA	SLK	Default
Error	Error	Error	Error	RO	RW

Configurations

External register PMEVTYPER<n>_EL0 is architecturally mapped to AArch64 System register [PMEVTYPER<n>_EL0](#).

External register PMEVTYPER<n>_EL0 is architecturally mapped to AArch32 System register [PMEVTYPER<n>](#).

PMEVTYPER<n>_EL0 is in the Core power domain. RW fields in this register reset to architecturally UNKNOWN values. These apply on a Warm or Cold reset. The register is not affected by an External debug reset.

Attributes

PMEVTYPER<n>_EL0 is a 32-bit register.

Field descriptions

The PMEVTYPER<n>_EL0 bit assignments are:

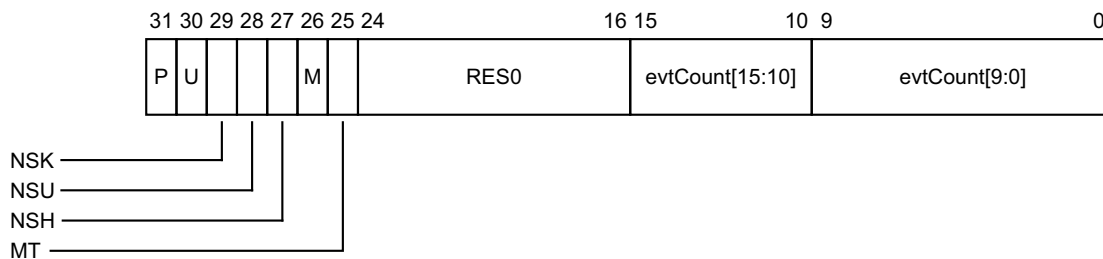

P, bit [31]

Privileged filtering bit. Controls counting in EL1. If EL3 is implemented, then counting in Non-secure EL1 is further controlled by the NSK bit. The possible values of this bit are:

- 0 Count events in EL1.
- 1 Do not count events in EL1.

This field resets to a value that is architecturally UNKNOWN.

U, bit [30]

User filtering bit. Controls counting in EL0. If EL3 is implemented, then counting in Non-secure EL0 is further controlled by the NSU bit. The possible values of this bit are:

- 0 Count events in EL0.
- 1 Do not count events in EL0.

This field resets to a value that is architecturally UNKNOWN.

NSK, bit [29]

Non-secure EL1 (kernel) modes filtering bit. Controls counting in Non-secure EL1. If EL3 is not implemented, this bit is RES0.

If the value of this bit is equal to the value of P, events in Non-secure EL1 are counted.

Otherwise, events in Non-secure EL1 are not counted.

This field resets to a value that is architecturally UNKNOWN.

NSU, bit [28]

Non-secure EL0 (Unprivileged) filtering. Controls counting in Non-secure EL0. If EL3 is not implemented, this bit is RES0.

If the value of this bit is equal to the value of U, events in Non-secure EL0 are counted.

Otherwise, events in Non-secure EL0 are not counted.

This field resets to a value that is architecturally UNKNOWN.

NSH, bit [27]

Non-secure EL2 (Hypervisor) filtering. Controls counting in Non-secure EL2. If EL2 is not implemented, this bit is RES0.

0 Do not count events in EL2.

1 Count events in EL2.

This field resets to a value that is architecturally UNKNOWN.

M, bit [26]

Secure EL3 filtering bit. If EL3 is not implemented, this bit is RES0.

If the value of this bit is equal to the value of P, cycles in Secure EL3 are counted.

Otherwise, cycles in Secure EL3 are not counted.

Most applications can ignore this field and set its value to 0.

———— **Note** —————

This field is not visible in the AArch32 PMEVTYPER System register.

This field resets to a value that is architecturally UNKNOWN.

MT, bit [25]

Multithreading. When the implementation is multi-threaded, the valid values for this bit are:

0 Count events only on controlling PE.

1 Count events from any PE with the same affinity at level 1 and above as this PE.

When the implementation is not multi-threaded, this bit is RES0.

———— **Note** —————

- An implementation is described as multi-threaded when the lowest level of affinity consists of logical PEs that are implemented using a multi-threading type approach. That is, the performance of PEs at the lowest affinity level is highly interdependent. On such an implementation, the value of MPIDR_EL1.MT, when read at the highest implemented Exception level, is 1.
- Events from a different thread of a multithreaded implementation are not Attributable to the thread counting the event.

This field resets to a value that is architecturally UNKNOWN.

Bits [24:16]

Reserved, RES0.

evtCount[15:10], bits [15:10]

In ARMv8.2 and ARMv8.1

Extension to evtCount[9:0]. See evtCount[9:0] for more details.

This field resets to a value that is architecturally UNKNOWN.

In ARMv8.0.

Reserved, RES0.

evtCount[9:0], bits [9:0]

Event to count. The event number of the event that is counted by event counter [PMEVCNTR<n>_EL0](#).

Software must program this field with an event that is supported by the PE being programmed.

There are three ranges of event numbers:

- Event numbers in the range 0x000 to 0x03F are common architectural and microarchitectural events.
- Event numbers in the range 0x040 to 0x0BF are ARM recommended common architectural and microarchitectural events.
- Event numbers in the range 0x0C0 to 0x3FF are IMPLEMENTATION DEFINED events.

If evtCount is programmed to an event that is reserved or not supported by the PE, the behavior depends on the event type:

- For the range 0x000 to 0x03F, no events are counted, and the value returned by a direct or external read of the evtCount field is the value written to the field.
- For IMPLEMENTATION DEFINED events, it is UNPREDICTABLE what event, if any, is counted, and the value returned by a direct or external read of the evtCount field is UNKNOWN.

Note

UNPREDICTABLE means the event must not expose privileged information.

ARM recommends that the behavior across a family of implementations is defined such that if a given implementation does not include an event from a set of common IMPLEMENTATION DEFINED events, then no event is counted and the value read back on evtCount is the value written.

This field resets to a value that is architecturally UNKNOWN.

Accessing the PMEVTYPER<n>_EL0:

PMEVTYPER<n>_EL0 can be accessed through the external debug interface:

Component	Offset
PMU	0x400 + 4n

13.4.25 PMINTENCLR_EL1, Performance Monitors Interrupt Enable Clear register

The PMINTENCLR_EL1 characteristics are:

Purpose

Disables the generation of interrupt requests on overflows from the Cycle Count Register, [PMCCNTR_ELO](#), and the event counters [PMEVCNTR<n>_ELO](#). Reading the register shows which overflow interrupt requests are enabled.

Usage constraints

This register is accessible as follows:

Off	DLK	OSLK	EPMA	SLK	Default
Error	Error	Error	Error	RO	RW

Configurations

External register PMINTENCLR_EL1 is architecturally mapped to AArch64 System register [PMINTENCLR_EL1](#).

External register PMINTENCLR_EL1 is architecturally mapped to AArch32 System register [PMINTENCLR](#).

PMINTENCLR_EL1 is in the Core power domain. RW fields in this register reset to architecturally UNKNOWN values. These apply on a Warm or Cold reset. The register is not affected by an External debug reset.

Attributes

PMINTENCLR_EL1 is a 32-bit register.

Field descriptions

The PMINTENCLR_EL1 bit assignments are:

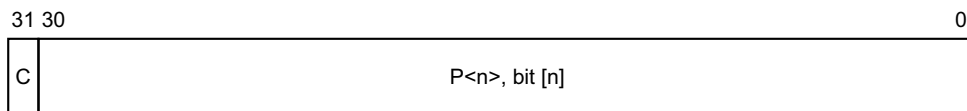

C, bit [31]

[PMCCNTR_ELO](#) overflow interrupt request disable bit. Possible values are:

- 0 When read, means the cycle counter overflow interrupt request is disabled. When written, has no effect.
- 1 When read, means the cycle counter overflow interrupt request is enabled. When written, disables the cycle count overflow interrupt request.

This field resets to a value that is architecturally UNKNOWN.

P<n>, bit [n], for n = 0 to 30

Event counter overflow interrupt request disable bit for [PMEVCNTR<n>_ELO](#).

Bits [30:N] are RAZ/WI. N is the value in [PMCFGR.N](#).

Possible values are:

- 0 When read, means that the [PMEVCNTR<n>_ELO](#) event counter interrupt request is disabled. When written, has no effect.
- 1 When read, means that the [PMEVCNTR<n>_ELO](#) event counter interrupt request is enabled. When written, disables the [PMEVCNTR<n>_ELO](#) interrupt request.

This field resets to a value that is architecturally UNKNOWN.

Accessing the PMINTENCLR_EL1:

PMINTENCLR_EL1 can be accessed through the external debug interface:

Component	Offset
PMU	0xC60

13.4.26 PMINTENSET_EL1, Performance Monitors Interrupt Enable Set register

The PMINTENSET_EL1 characteristics are:

Purpose

Enables the generation of interrupt requests on overflows from the Cycle Count Register, [PMCCNTR_ELO](#), and the event counters [PMEVCNTR<n>_ELO](#). Reading the register shows which overflow interrupt requests are enabled.

Usage constraints

This register is accessible as follows:

Off	DLK	OSLK	EPMA	SLK	Default
Error	Error	Error	Error	RO	RW

Configurations

External register PMINTENSET_EL1 is architecturally mapped to AArch64 System register [PMINTENSET_EL1](#).

External register PMINTENSET_EL1 is architecturally mapped to AArch32 System register [PMINTENSET](#).

PMINTENSET_EL1 is in the Core power domain. RW fields in this register reset to architecturally UNKNOWN values. These apply on a Warm or Cold reset. The register is not affected by an External debug reset.

Attributes

PMINTENSET_EL1 is a 32-bit register.

Field descriptions

The PMINTENSET_EL1 bit assignments are:

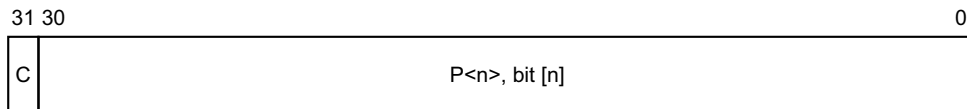

C, bit [31]

[PMCCNTR_ELO](#) overflow interrupt request enable bit. Possible values are:

- 0 When read, means the cycle counter overflow interrupt request is disabled. When written, has no effect.
- 1 When read, means the cycle counter overflow interrupt request is enabled. When written, enables the cycle count overflow interrupt request.

This field resets to a value that is architecturally UNKNOWN.

P<n>, bit [n], for n = 0 to 30

Event counter overflow interrupt request enable bit for [PMEVCNTR<n>_ELO](#).

Bits [30:N] are RAZ/WI. N is the value in [PMCFGR.N](#).

Possible values are:

- 0 When read, means that the [PMEVCNTR<n>_ELO](#) event counter interrupt request is disabled. When written, has no effect.
- 1 When read, means that the [PMEVCNTR<n>_ELO](#) event counter interrupt request is enabled. When written, enables the [PMEVCNTR<n>_ELO](#) interrupt request.

This field resets to a value that is architecturally UNKNOWN.

Accessing the PMINTENSET_EL1:

PMINTENSET_EL1 can be accessed through the external debug interface:

Component	Offset
PMU	0xC40

13.4.27 PMITCTRL, Performance Monitors Integration mode Control register

The PMITCTRL characteristics are:

Purpose

Enables the Performance Monitors to switch from default mode into integration mode, where test software can control directly the inputs and outputs of the PE, for integration testing or topology detection.

Usage constraints

This register is accessible as follows:

Off	DLK	OSLK	Default
IMP DEF	IMP DEF	IMP DEF	RW

Configurations

It is IMPLEMENTATION DEFINED whether PMITCTRL is implemented in the Core power domain or in the Debug power domain. Some or all RW fields of this register have defined reset values, and:

- The register is not affected by a Warm reset.
- If the register is implemented in the Core power domain the reset values apply on a Cold reset, and the register is not affected by an External debug reset.
- If the register is implemented in the Debug power domain the reset values apply on an External debug reset, and the register is not affected by a Cold reset.

Implementation of this register is OPTIONAL.

Attributes

PMITCTRL is a 32-bit register.

Field descriptions

The PMITCTRL bit assignments are:

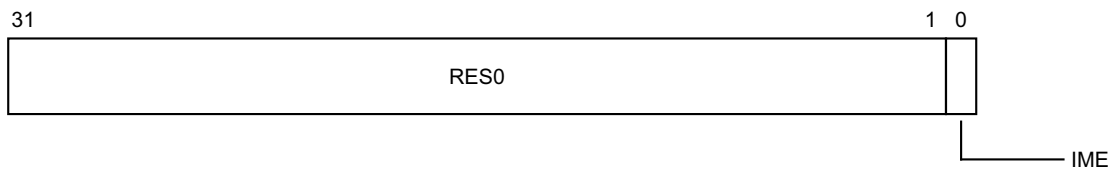

Bits [31:1]

Reserved, RES0.

IME, bit [0]

Integration mode enable. When IME == 1, the device reverts to an integration mode to enable integration testing or topology detection. The integration mode behavior is IMPLEMENTATION DEFINED.

- 0 Normal operation.
- 1 Integration mode enabled.

When this register has an architecturally-defined reset value, this field resets to 0.

Accessing the PMITCTRL:

PMITCTRL can be accessed through the external debug interface:

Component	Offset
PMU	0xF00

13.4.28 PMLAR, Performance Monitors Lock Access Register

The PMLAR characteristics are:

Purpose

Allows or disallows access to the Performance Monitors registers through a memory-mapped interface.

Usage constraints

This register is accessible as follows:

Default
WO

Configurations

PMLAR is in the Debug power domain.

If OPTIONAL memory-mapped access to the external debug interface is supported then an OPTIONAL Software Lock can be implemented as part of CoreSight compliance.

PMLAR ignores writes if the Software Lock is not implemented and ignores writes for other accesses to the external debug interface.

The Software Lock provides a lock to prevent memory-mapped writes to the Performance Monitors registers. Use of this lock mechanism reduces the risk of accidental damage to the contents of the Performance Monitors registers. It does not, and cannot, prevent all accidental or malicious damage.

Software uses PMLAR to set or clear the lock, and [PMLSR](#) to check the current status of the lock.

Attributes

PMLAR is a 32-bit register.

Field descriptions

The PMLAR bit assignments are:



KEY, bits [31:0]

Lock Access control. Writing the key value 0xC5ACCE55 to this field unlocks the lock, enabling write accesses to this component's registers through a memory-mapped interface.

Writing any other value to this register locks the lock, disabling write accesses to this component's registers through a memory mapped interface.

Accessing the PMLAR:

PMLAR can be accessed through a memory-mapped interface access to the external debug interface:

Component	Offset
PMU	0xFB0

13.4.29 PMLSR, Performance Monitors Lock Status Register

The PMLSR characteristics are:

Purpose

Indicates the current status of the software lock for Performance Monitors registers.

Usage constraints

This register is accessible as follows:

Default
RO

Configurations

PMLSR is in the Debug power domain. Some or all RW fields of this register have defined reset values. These apply only on an External debug reset. The register is not affected by a Warm reset and is not affected by a Cold reset.

If OPTIONAL memory-mapped access to the external debug interface is supported then an OPTIONAL Software Lock can be implemented as part of CoreSight compliance.

PMLSR is RAZ if the Software Lock is not implemented and is RAZ for other accesses to the external debug interface.

The Software Lock provides a lock to prevent memory-mapped writes to the Performance Monitors registers. Use of this lock mechanism reduces the risk of accidental damage to the contents of the Performance Monitors registers. It does not, and cannot, prevent all accidental or malicious damage.

Software uses PMLAR to set or clear the lock, and PMLSR to check the current status of the lock.

Attributes

PMLSR is a 32-bit register.

Field descriptions

The PMLSR bit assignments are:

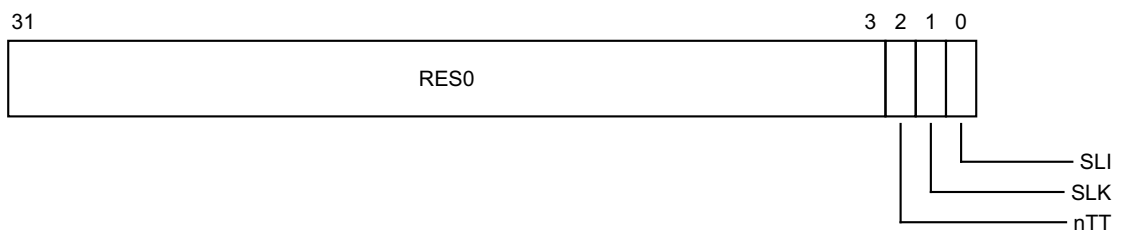

Bits [31:3]

Reserved, RES0.

nTT, bit [2]

Not thirty-two bit access required. RAZ.

SLK, bit [1]

Software Lock status for this component. For an access to LSR that is not a memory-mapped access, or when the Software Lock is not implemented, this field is RES0.

For memory-mapped accesses when the software lock is implemented, possible values of this field are:

- 0 Lock clear. Writes are permitted to this component's registers.
- 1 Lock set. Writes to this component's registers are ignored, and reads have no side effects.

When this register has an architecturally-defined reset value, this field resets to 1.

SLI, bit [0]

Software Lock implemented. For an access to LSR that is not a memory-mapped access, this field is RAZ. For memory-mapped accesses, the value of this field is IMPLEMENTATION DEFINED.

Permitted values are:

- 0 Software Lock not implemented or not memory-mapped access.
- 1 Software Lock implemented and memory-mapped access.

Accessing the PMLSR:

PMLSR can be accessed through a memory-mapped interface access to the external debug interface:

Component	Offset
PMU	0xFB4

13.4.30 PMOVSCLR_EL0, Performance Monitors Overflow Flag Status Clear register

The PMOVSCLR_EL0 characteristics are:

Purpose

Contains the state of the overflow bit for the Cycle Count Register, [PMCCNTR_EL0](#), and each of the implemented event counters [PMEVCNTR<n>](#). Writing to this register clears these bits.

Usage constraints

This register is accessible as follows:

Off	DLK	OSLK	EPMA	SLK	Default
Error	Error	Error	Error	RO	RW

Configurations

External register PMOVSCLR_EL0 is architecturally mapped to AArch64 System register [PMOVSCLR_EL0](#).

External register PMOVSCLR_EL0 is architecturally mapped to AArch32 System register [PMOVSR](#).

PMOVSCLR_EL0 is in the Core power domain. RW fields in this register reset to architecturally UNKNOWN values. These apply on a Warm or Cold reset. The register is not affected by an External debug reset.

Attributes

PMOVSCLR_EL0 is a 32-bit register.

Field descriptions

The PMOVSCLR_EL0 bit assignments are:

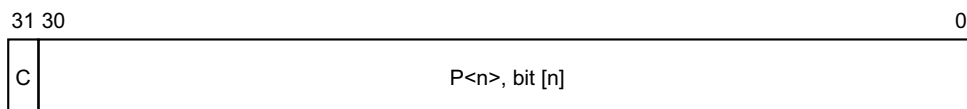

C, bit [31]

[PMCCNTR_EL0](#) overflow bit. Possible values are:

- 0 When read, means the cycle counter has not overflowed. When written, has no effect.
- 1 When read, means the cycle counter has overflowed. When written, clears the overflow bit to 0.

[PMCR_EL0](#).LC controls whether an overflow is detected from [PMCCNTR_EL0](#)[31] or from [PMCCNTR_EL0](#)[63].

This field resets to a value that is architecturally UNKNOWN.

P<n>, bit [n], for n = 0 to 30

Event counter overflow clear bit for [PMEVCNTR<n>_EL0](#).

Bits [30:N] are RAZ/WI. N is the value in [PMCFGR.N](#).

Possible values of each bit are:

- 0 When read, means that [PMEVCNTR<n>_EL0](#) has not overflowed. When written, has no effect.
- 1 When read, means that [PMEVCNTR<n>_EL0](#) has overflowed. When written, clears the [PMEVCNTR<n>_EL0](#) overflow bit to 0.

This field resets to a value that is architecturally UNKNOWN.

Accessing the PMOVSLR_EL0:

PMOVSLR_EL0 can be accessed through the external debug interface:

Component	Offset
PMU	0xC80

13.4.31 PMOVSET_EL0, Performance Monitors Overflow Flag Status Set register

The PMOVSET_EL0 characteristics are:

Purpose

Sets the state of the overflow bit for the Cycle Count Register, [PMCCNTR_EL0](#), and each of the implemented event counters [PMEVCNTR<n>](#).

Usage constraints

This register is accessible as follows:

Off	DLK	OSLK	EPMA	SLK	Default
Error	Error	Error	Error	RO	RW

Configurations

External register PMOVSET_EL0 is architecturally mapped to AArch64 System register [PMOVSET_EL0](#).

External register PMOVSET_EL0 is architecturally mapped to AArch32 System register [PMOVSET](#).

PMOVSET_EL0 is in the Core power domain. RW fields in this register reset to architecturally UNKNOWN values. These apply on a Warm or Cold reset. The register is not affected by an External debug reset.

Attributes

PMOVSET_EL0 is a 32-bit register.

Field descriptions

The PMOVSET_EL0 bit assignments are:

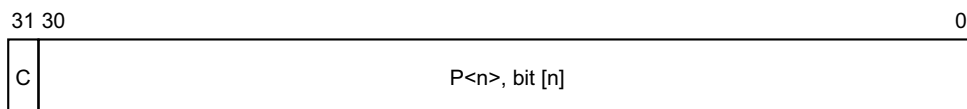

C, bit [31]

[PMCCNTR_EL0](#) overflow bit. Possible values are:

- 0 When read, means the cycle counter has not overflowed. When written, has no effect.
- 1 When read, means the cycle counter has overflowed. When written, sets the overflow bit to 1.

This field resets to a value that is architecturally UNKNOWN.

P<n>, bit [n], for n = 0 to 30

Event counter overflow set bit for [PMEVCNTR<n>_EL0](#).

Bits [30:N] are RAZ/WI. N is the value in [PMCFGR.N](#).

Possible values are:

- 0 When read, means that [PMEVCNTR<n>_EL0](#) has not overflowed. When written, has no effect.
- 1 When read, means that [PMEVCNTR<n>_EL0](#) has overflowed. When written, sets the [PMEVCNTR<n>_EL0](#) overflow bit to 1.

This field resets to a value that is architecturally UNKNOWN.

Accessing the PMOVSSET_EL0:

PMOVSSET_EL0 can be accessed through the external debug interface:

Component	Offset
PMU	0xCC0

13.4.32 PMPCSR, Program Counter Sample Register

The PMPCSR characteristics are:

Purpose

Holds a sampled instruction address value.

Usage constraints

This register is accessible as follows:

Off	DLK	OSLK	SLK	Default
Error	Error	Error	RO	RO

Configurations

PMPCSR is in the Core power domain.

Fields in this register reset to architecturally UNKNOWN values. These apply only on a Cold reset. The register is not affected by a Warm reset and is not affected by an External debug reset.

Implemented only if the OPTIONAL PC Sample-based Profiling Extension is implemented and [ARMv8.2-PCSample](#) is implemented.

Support for 64-bit atomic reads is IMPLEMENTATION DEFINED. If 64-bit atomic reads are implemented, a 64-bit read of PMPCSR has the same side-effect as a 32-bit read of PMCSR[31:0] followed by a 32-bit read of PMPCSR[63:32], returning the combined value. For example, if the PE is in Debug state then a 64-bit atomic read returns bits[31:0] == 0xFFFFFFFF and bits[63:32] UNKNOWN.

If the OPTIONAL PC Sample-based Profiling Extension is implemented and [ARMv8.2-PCSample](#) is not implemented, this register is not implemented and the architecture defines the functionality in [EDPCSR](#).

This register is introduced in ARMv8.2.

Attributes

PMPCSR is a 64-bit register.

Field descriptions

The PMPCSR bit assignments are:

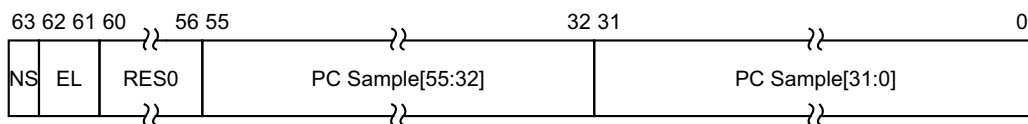

NS, bit [63]

Non-secure state sample. Indicates the Security state that is associated with the most recent PMPCSR sample or, when it is read as a single atomic 64-bit read, the current PMPCSR sample.

When this register has an architecturally-defined reset value, this field resets to a value that is architecturally UNKNOWN.

EL, bits [62:61]

Exception level status sample. Indicates the Exception level that is associated with the most recent PMPCSR sample or, when it is read as a single atomic 64-bit read, the current PMPCSR sample.

00 Sample is from EL0.

01 Sample is from EL1.

10 Sample is from EL2.

11 Sample is from EL3.

When this register has an architecturally-defined reset value, this field resets to a value that is architecturally UNKNOWN.

Bits [60:56]

Reserved, RES0.

PC Sample[55:32], bits [55:32]

Bits[55:32] of the sampled instruction address value. The translation regime that PMPCSR samples can be determined from PMPCSR.{NS,EL}.

When this register has an architecturally-defined reset value, this field resets to a value that is architecturally UNKNOWN.

PC Sample[31:0], bits [31:0]

Bits[31:0] of the sampled instruction address value. The translation regime that PMPCSR samples can be determined from PMPCSR.{NS,EL}.

- For a read of PMPCSR[31:0] from the memory-mapped interface, if `PMLSR.SLK == 1`, meaning the OPTIONAL Software Lock is locked, then the access has no side-effects.
- In any other cases, a read of PMPCSR[31:0] has the side-effect of indirectly writing to PMPCSR[63:32], `PMCID1SR`, `PMCID2SR`, and `PMVIDSR`:
 - If the PE is in Debug state, or PC Sample-based profiling is prohibited, PMPCSR[31:0] reads as 0xFFFFFFFF, and PMPCSR[63:32], `PMCID1SR`, `PMCID2SR`, and `PMVIDSR` become UNKNOWN.
 - If the PE is in Reset state, the sampled value is UNKNOWN and PMPCSR[63:32], `PMCID1SR`, `PMCID2SR`, and `PMVIDSR` become UNKNOWN.
 - If no instruction has been retired since the PE left Reset state, Debug state, or a state where PC Sample-based Profiling is prohibited, the sampled value is UNKNOWN, and PMPCSR[63:32], `PMCID1SR`, `PMCID2SR`, and `PMVIDSR` become UNKNOWN.

When this register has an architecturally-defined reset value, this field resets to a value that is architecturally UNKNOWN.

Accessing the PMPCSR:

PMPCSR[31:0] can be accessed through the external debug interface:

Component	Offset
PMU	0x200
PMU	0x220

PMPCSR[63:32] can be accessed through the external debug interface:

Component	Offset
PMU	0x204
PMU	0x224

13.4.33 PMPIDR0, Performance Monitors Peripheral Identification Register 0

The PMPIDR0 characteristics are:

Purpose

Provides information to identify a Performance Monitor component.

For more information see [About the Peripheral identification scheme on page K2-6146](#).

Usage constraints

This register is accessible as follows:

SLK	Default
RO	RO

Configurations

PMPIDR0 is in the Debug power domain.

Implementation of this register is OPTIONAL.

This register is required for CoreSight compliance.

Attributes

PMPIDR0 is a 32-bit register.

Field descriptions

The PMPIDR0 bit assignments are:

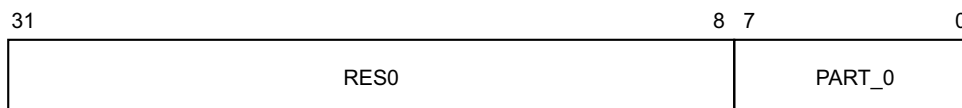

Bits [31:8]

Reserved, RES0.

PART_0, bits [7:0]

Part number, least significant byte.

Accessing the PMPIDR0:

PMPIDR0 can be accessed through the external debug interface:

Component	Offset
PMU	0xFE0

13.4.34 PMPIDR1, Performance Monitors Peripheral Identification Register 1

The PMPIDR1 characteristics are:

Purpose

Provides information to identify a Performance Monitor component.

For more information see [About the Peripheral identification scheme on page K2-6146](#).

Usage constraints

This register is accessible as follows:

SLK	Default
RO	RO

Configurations

PMPIDR1 is in the Debug power domain.

Implementation of this register is OPTIONAL.

This register is required for CoreSight compliance.

Attributes

PMPIDR1 is a 32-bit register.

Field descriptions

The PMPIDR1 bit assignments are:

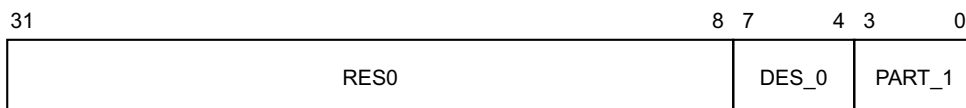

Bits [31:8]

Reserved, RES0.

DES_0, bits [7:4]

Designer, least significant nibble of JEP106 ID code. For ARM Limited, this field is 0b1011.

PART_1, bits [3:0]

Part number, most significant nibble.

Accessing the PMPIDR1:

PMPIDR1 can be accessed through the external debug interface:

Component	Offset
PMU	0xFE4

13.4.35 PMPIDR2, Performance Monitors Peripheral Identification Register 2

The PMPIDR2 characteristics are:

Purpose

Provides information to identify a Performance Monitor component.

For more information see [About the Peripheral identification scheme on page K2-6146](#).

Usage constraints

This register is accessible as follows:

SLK	Default
RO	RO

Configurations

PMPIDR2 is in the Debug power domain.

Implementation of this register is OPTIONAL.

This register is required for CoreSight compliance.

Attributes

PMPIDR2 is a 32-bit register.

Field descriptions

The PMPIDR2 bit assignments are:

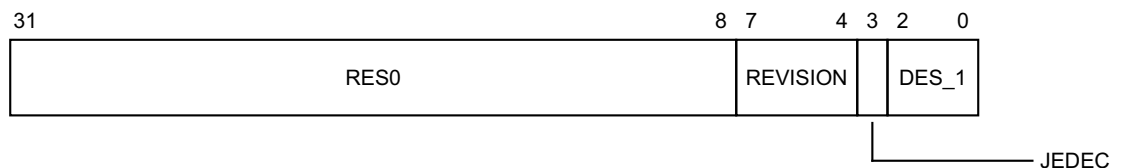

Bits [31:8]

Reserved, RES0.

REVISION, bits [7:4]

Part major revision. Parts can also use this field to extend Part number to 16-bits.

JEDEC, bit [3]

RAO. Indicates a JEP106 identity code is used.

DES_1, bits [2:0]

Designer, most significant bits of JEP106 ID code. For ARM Limited, this field is 0b011.

Accessing the PMPIDR2:

PMPIDR2 can be accessed through the external debug interface:

Component	Offset
PMU	0xFE8

13.4.36 PMPIDR3, Performance Monitors Peripheral Identification Register 3

The PMPIDR3 characteristics are:

Purpose

Provides information to identify a Performance Monitor component.

For more information see [About the Peripheral identification scheme on page K2-6146](#).

Usage constraints

This register is accessible as follows:

SLK	Default
RO	RO

Configurations

PMPIDR3 is in the Debug power domain.

Implementation of this register is OPTIONAL.

This register is required for CoreSight compliance.

Attributes

PMPIDR3 is a 32-bit register.

Field descriptions

The PMPIDR3 bit assignments are:

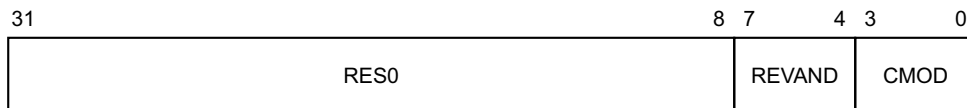

Bits [31:8]

Reserved, RES0.

REVAND, bits [7:4]

Part minor revision. Parts using [PMPIDR2.REVISION](#) as an extension to the Part number must use this field as a major revision number.

CMOD, bits [3:0]

Customer modified. Indicates someone other than the Designer has modified the component.

Accessing the PMPIDR3:

PMPIDR3 can be accessed through the external debug interface:

Component	Offset
PMU	0xFEC

13.4.37 PMPIDR4, Performance Monitors Peripheral Identification Register 4

The PMPIDR4 characteristics are:

Purpose

Provides information to identify a Performance Monitor component.

For more information see [About the Peripheral identification scheme on page K2-6146](#).

Usage constraints

This register is accessible as follows:

SLK	Default
RO	RO

Configurations

PMPIDR4 is in the Debug power domain.

Implementation of this register is OPTIONAL.

This register is required for CoreSight compliance.

Attributes

PMPIDR4 is a 32-bit register.

Field descriptions

The PMPIDR4 bit assignments are:

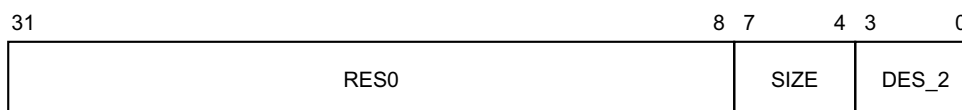

Bits [31:8]

Reserved, RES0.

SIZE, bits [7:4]

Size of the component. RAZ. \log_2 of the number of 4KB pages from the start of the component to the end of the component ID registers.

DES_2, bits [3:0]

Designer, JEP106 continuation code, least significant nibble. For ARM Limited, this field is 0b0100.

Accessing the PMPIDR4:

PMPIDR4 can be accessed through the external debug interface:

Component	Offset
PMU	0xFD0

13.4.38 PMSWINC_EL0, Performance Monitors Software Increment register

The PMSWINC_EL0 characteristics are:

Purpose

Increments a counter that is configured to count the Software increment event, event 0x00. For more information, see [SW_INCR](#).

Usage constraints

This register is accessible as follows:

Off	DLK	OSLK	EPMAD	SLK	Default
Error	Error	Error	Error	WI	WO

Configurations

External register PMSWINC_EL0 is architecturally mapped to AArch64 System register [PMSWINC_EL0](#).

External register PMSWINC_EL0 is architecturally mapped to AArch32 System register [PMSWINC](#).

PMSWINC_EL0 is in the Core power domain.

Implementation of this register is OPTIONAL.

If this register is implemented, use of it is deprecated.

If 1 is written to bit [n] from the external debug interface, it is CONstrained UNPREDICTABLE whether or not a SW_INCR event is created for counter n. This is consistent with not implementing the register in the external debug interface.

Attributes

PMSWINC_EL0 is a 32-bit register.

Field descriptions

The PMSWINC_EL0 bit assignments are:

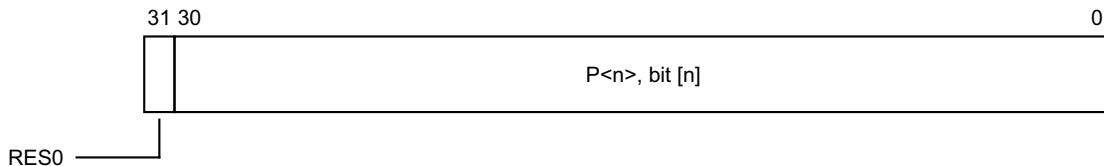

Bit [31]

Reserved, RES0.

P<n>, bit [n], for n = 0 to 30

Event counter software increment bit for [PMEVCNTR<n>_EL0](#).

P<n> is WI if n >= [PMCR_EL0.N](#), the number of implemented counters.

Otherwise, the effects of writing to this bit are:

- 0 No action. The write to this bit is ignored.
- 1 It is CONstrained UNPREDICTABLE whether a SW_INCR event is generated for event counter n.

Accessing the PMSWINC_EL0:

PMSWINC_EL0 can be accessed through the external debug interface:

Component	Offset
PMU	0xCA0

13.4.39 PMVIDSR, VMID Sample Register

The PMVIDSR characteristics are:

Purpose

Contains the sampled VMID value that is captured on reading [PMPCSR](#)[31:0].

Usage constraints

This register is accessible as follows:

Off	DLK	OSLK	SLK	Default
Error	Error	Error	RO	RO

Configurations

PMVIDSR is in the Core power domain.

Fields in this register reset to architecturally UNKNOWN values. These apply only on a Cold reset. The register is not affected by a Warm reset and is not affected by an External debug reset.

Implemented only if the OPTIONAL PC Sample-based Profiling Extension is implemented and [ARMv8.2-PCSample](#) is implemented. If the OPTIONAL PC Sample-based Profiling Extension is implemented and [ARMv8.2-PCSample](#) is not implemented, this register is not implemented and the architecture defines the functionality in [EDVIDSR](#).

If EL2 is not implemented, this register is RES0.

This register is introduced in ARMv8.2.

Attributes

PMVIDSR is a 32-bit register.

Field descriptions

The PMVIDSR bit assignments are:

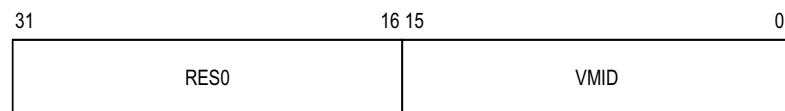

Bits [31:16]

Reserved, RES0.

VMID, bits [15:0]

VMID sample. The VMID associated with the most recent [PMPCSR](#) sample.

- If EL2 is implemented and is using AArch64, then the VMID is held in [VTTBR_EL2](#).VMID.
- If EL2 is implemented and is using AArch32, then the VMID is held in [VTTBR](#).VMID.
- This field is set to an UNKNOWN value if:
 - [PMPCSR](#).NS == 0.
 - [PMPCSR](#).EL == 0b10.
 - [PMPCSR](#).NS == 1, [PMPCSR](#).EL == 0b00, EL2 is using AArch64, [HCR_EL2](#).E2H == 1, and [HCR_EL2](#).TGE == 1.
- If EL2 is not implemented, then this field is RES0.
- If 16-bit VMIDs are not supported, [PMVIDSR](#).VMID[15:8] is RES0.

- If 16-bit VMIDs are supported, but VTTBRx.VMID[15:8] are not used, PMVIDSR.VMID[15:8] is set to 0.

When this register has an architecturally-defined reset value, this field resets to a value that is architecturally UNKNOWN.

Accessing the PMVIDSR:

PMVIDSR can be accessed through the external debug interface:

Component	Offset
PMU	0x20C

I3.5 Generic Timer memory-mapped registers overview

The Generic Timer memory-mapped registers are implemented as multiple register frames, with each register frame having its own base address, as follows:

- A single CNTCTLBase register frame, at base address CNTCTLBase.
- Between one and seven CNTBaseN register frames, each with its own base address CNTBaseN.
- For each CNTBaseN register frame, if required, a CNTEL0BaseN register frame, at base address CNTEL0BaseN, that provides an EL0 view of the CNTBaseN register frame.

For more information, see:

- [Memory-mapped timer components on page I1-5730.](#)
- [The CNTBaseN and CNTEL0BaseN frames on page I1-5732.](#) This section includes the memory map of the CNTBaseN and CNTEL0BaseN register frames.
- [The CNTCTLBase frame on page I1-5731.](#) This section includes the memory map of the CNTCTLBase register frame.
- [Providing a complete set of counter and timer features on page I1-5734.](#)

I3.6 Generic Timer memory-mapped register descriptions

This section describes the Generic Timer registers. [Generic Timer memory-mapped registers overview on page I3-5815](#) gives an overview of these registers, and includes links to their memory maps.

13.6.1 CNTACR<n>, Counter-timer Access Control Registers, n = 0 - 7

The CNTACR<n> characteristics are:

Purpose

Provides top-level access controls for the elements of a timer frame. CNTACR<n> provides the controls for frame CNTBaseN.

In addition to the CNTACR<n> control:

- CNTNSAR controls whether CNTACR<n> is accessible by Non-secure accesses.
- If frame CNTELOBaseN is implemented, the CNTELOACR in frame CNTBaseN provides additional control of accesses to frame CNTELOBaseN.

Usage constraints

This register is accessible as follows:

Default

RW

In a system that recognizes two Security states:

- CNTACR<n> is always accessible by Secure accesses.
- CNTNSAR.NS<n> determines whether CNTACR<n> is accessible by Non-secure accesses.

Configurations

The power domain of CNTACR<n> is IMPLEMENTATION DEFINED.

On a reset of the reset domain in which it is implemented, RW fields in this register reset to UNKNOWN values. The register is not affected by a reset of any other reset domain. For more information see [Power and reset domains for the system level implementation of the Generic Timer on page I1-5724](#).

Implemented only if the value of CNTTIDR.Frame<n> is 1.

An implementation of the counters might not provide configurable access to some or all of the features. In this case, the associated field in the CNTACR<n> register is:

- RAZ/WI if access is always denied.
- RAO/WI if access is always permitted.

Attributes

CNTACR<n> is a 32-bit register.

Field descriptions

The CNTACR<n> bit assignments are:

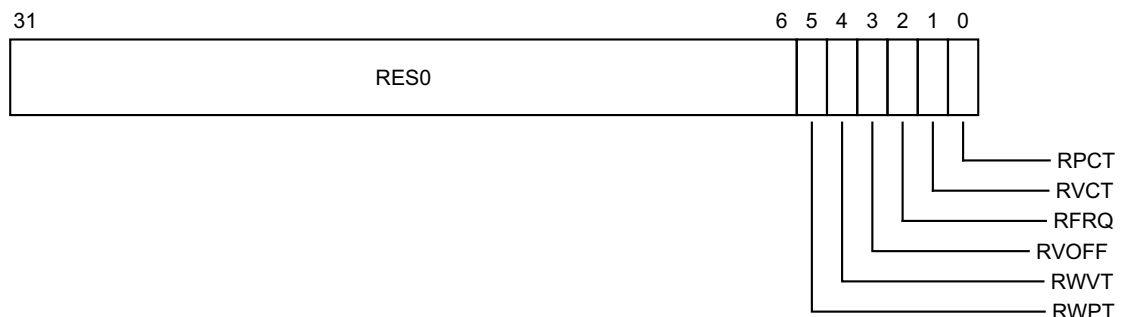

Bits [31:6]

Reserved, RES0.

RWPT, bit [5]

Read/write access to the EL1 Physical Timer registers [CNTP_CVAL](#), [CNTP_TVAL](#), and [CNTP_CTL](#), in frame <n>. The possible values of this bit are:

- 0 No access to the EL1 Physical Timer registers in frame <n>. The registers are RES0.
- 1 Read/write access to the EL1 Physical Timer registers in frame <n>.

RWVT, bit [4]

Read/write access to the Virtual Timer register [CNTV_CVAL](#), [CNTV_TVAL](#), and [CNTV_CTL](#), in frame <n>. The possible values of this bit are:

- 0 No access to the Virtual Timer registers in frame <n>. The registers are RES0.
- 1 Read/write access to the Virtual Timer registers in frame <n>.

RVOFF, bit [3]

Read-only access to [CNTVOFF](#), in frame <n>. The possible values of this bit are:

- 0 No access to [CNTVOFF](#) in frame <n>. The register is RES0.
- 1 Read-only access to [CNTVOFF](#) in frame <n>.

RFrq, bit [2]

Read-only access to [CNTFRQ](#), in frame <n>. The possible values of this bit are:

- 0 No access to [CNTFRQ](#) in frame <n>. The register is RES0.
- 1 Read-only access to [CNTFRQ](#) in frame <n>.

RVCT, bit [1]

Read-only access to [CNTVCT](#), in frame <n>. The possible values of this bit are:

- 0 No access to [CNTVCT](#) in frame <n>. The register is RES0.
- 1 Read-only access to [CNTVCT](#) in frame <n>.

RPCT, bit [0]

Read-only access to [CNTPCT](#), in frame <n>. The possible values of this bit are:

- 0 No access to [CNTPCT](#) in frame <n>. The register is RES0.
- 1 Read-only access to [CNTPCT](#) in frame <n>.

Accessing the CNTACR<n>:

CNTACR<n> can be accessed through its memory-mapped interface:

Component	Frame	Offset
Timer	CNTCTLBase	0x040 + 4n

13.6.2 CNTCR, Counter Control Register

The CNTCR characteristics are:

Purpose

Enables the counter, controls the counter frequency setting, and controls counter behavior during debug.

Usage constraints

This register is accessible as follows:

Default

RW

In a system that supports Secure and Non-secure memory maps the CNTControlBase frame, that includes this register, is implemented only in the Secure memory map.

Configurations

The power domain of CNTCR is IMPLEMENTATION DEFINED.

Some or all fields in this register have defined reset values. These apply only on a reset of the reset domain in which the register is implemented. The register is not affected by a reset of any other reset domain. For more information see [Power and reset domains for the system level implementation of the Generic Timer](#) on page I1-5724.

Attributes

CNTCR is a 32-bit register.

Field descriptions

The CNTCR bit assignments are:

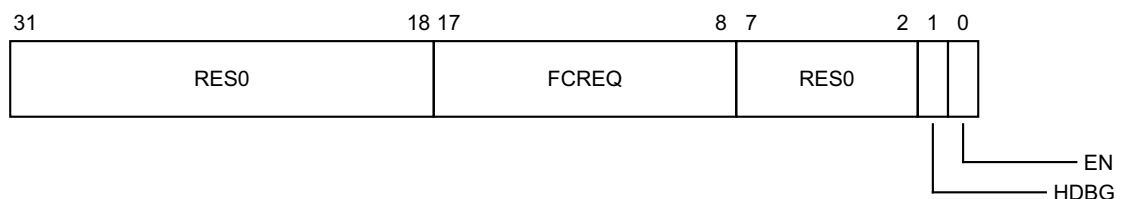

Bits [31:18]

Reserved, RES0.

FCREQ, bits [17:8]

Frequency change request. Indicates the number of the entry in the Frequency modes table to select. Selecting an unimplemented entry, or an entry that contains 0, has no effect on the counter.

The maximum number of entries in the Frequency modes table is IMPLEMENTATION DEFINED up to a maximum of 1004 entries, see [The Frequency modes table](#) on page I1-5727. An implementation is only required to implement an FCREQ field that can hold values from 0 to the highest supported Frequency modes table entry. Any unrequired most-significant bits of FCREQ can be implemented as RES0.

When this register has an architecturally-defined reset value, this field resets to 0.

Bits [7:2]

Reserved, RES0.

HDBG, bit [1]

Halt-on-debug. Controls whether a Halt-on-debug signal halts the system counter:

- 0 System counter ignores Halt-on-debug.
- 1 Asserted Halt-on-debug signal halts system counter update.

This field resets to a value that is architecturally UNKNOWN.

EN, bit [0]

Enables the counter:

- 0 System counter disabled.
- 1 System counter enabled.

When this register has an architecturally-defined reset value, this field resets to 0.

Accessing the CNTCR:

CNTCR can be accessed through its memory-mapped interface:

Component	Frame	Offset
Timer	CNTControlBase	0x000

I3.6.3 CNTCV, Counter Count Value register

The CNTCV characteristics are:

Purpose

Indicates the current count value.

Usage constraints

This register is accessible as follows:

Frame	Accessibility
CNTControlBase	RW
CNTReadBase	RO

A write to CNTCV must be visible in the [CNTPCT](#) register of each running processor in a finite time.

For the instance of the register in the CNTControlBase frame:

- In a system that supports Secure and Non-secure memory maps the CNTControlBase frame, and therefore this register instance, is implemented only in the Secure memory map.
- If the counter is enabled, the effect of writing to the register is UNKNOWN.

In an implementation that supports 64-bit atomic memory accesses, this register must be accessible using a 64-bit atomic access.

Configurations

The power domain of CNTCV is IMPLEMENTATION DEFINED.

On a reset of the reset domain in which an RW instance of this register is implemented, RW fields in the register reset to UNKNOWN values. The register is not affected by a reset of any other reset domain. For more information see [Power and reset domains for the system level implementation of the Generic Timer](#) on page I1-5724.

Attributes

CNTCV is a 64-bit register.

Field descriptions

The CNTCV bit assignments are:

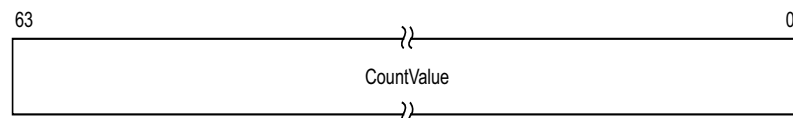

CountValue, bits [63:0]

Indicates the counter value.

Accessing the CNTCV:

CNTCV[31:0] can be accessed through its memory-mapped interface:

Component	Frame	Offset
Timer	CNTControlBase	0x008
Timer	CNTReadBase	0x000

CNTCV[63:32] can be accessed through its memory-mapped interface:

Component	Frame	Offset
Timer	CNTControlBase	0x00C
Timer	CNTReadBase	0x004

13.6.4 CNTEL0ACR, Counter-timer EL0 Access Control Register

The CNTEL0ACR characteristics are:

Purpose

An implementation of CNTEL0ACR in the frame at CNTBaseN controls whether the [CNTPCT](#), [CNTVCT](#), [CNTFRQ](#), EL1 Physical Timer, and Virtual Timer registers are visible in the frame at CNTEL0BaseN.

Usage constraints

CNTEL0ACR can be implemented in any implemented CNTBaseN frame.

[CNTCTLBase status and control fields for the CNTBaseN and CNTEL0BaseN frames on page I1-5733](#) describes the status fields that identify whether a CNTBaseN frame is implemented, and for an implemented frame:

- Whether the CNTBaseN frame has virtual timer capability.
- Whether the corresponding CNTEL0BaseN frame is implemented.
- For an implementation that recognizes two Security states, whether the CNTBaseN frame, and any corresponding CNTEL0BaseN frame, is accessible by Non-secure accesses.

If CNTEL0ACR is not implemented in an implemented CNTBaseN frame:

- The register location in that frame is RAZ/WI.
- If the corresponding CNTEL0BaseN frame is implemented, the registers [CNTFRQ](#), [CNTP_CTL](#), [CNTP_CVAL](#), [CNTP_TVAL](#), [CNTPCT](#), [CNTV_CTL](#), [CNTV_CVAL](#), [CNTV_TVAL](#), and [CNTVCT](#) are not visible in that frame.

Configurations

The power domain of CNTEL0ACR is IMPLEMENTATION DEFINED.

On a reset of the reset domain in which it is implemented, RW fields in this register reset to UNKNOWN values. The register is not affected by a reset of any other reset domain. For more information see [Power and reset domains for the system level implementation of the Generic Timer on page I1-5724](#).

Implementation of this register is OPTIONAL.

Attributes

CNTEL0ACR is a 32-bit register.

Field descriptions

The CNTEL0ACR bit assignments are:

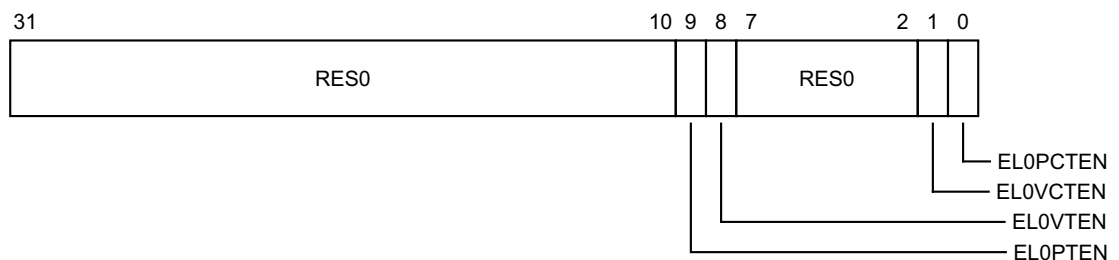

Bits [31:10]

Reserved, RES0.

EL0PTEN, bit [9]

Second view read/write access control for the EL1 Physical Timer registers. This bit controls whether the [CNTP_CVAL](#), [CNTP_TVAL](#), and [CNTP_CTL](#) registers in the current CNTBaseN frame are also accessible in the corresponding CNTELOBaseN frame. The possible values of this bit are:

- 0 No access. Registers are RES0 in the second view.
- 1 Access permitted. If the registers are accessible in the current frame then they are accessible in the second view.

EL0VTEN, bit [8]

Second view read/write access control for the Virtual Timer registers. This bit controls whether the [CNTV_CVAL](#), [CNTV_TVAL](#), and [CNTV_CTL](#) registers in the current CNTBaseN frame are also accessible in the corresponding CNTELOBaseN frame. The possible values of this bit are:

- 0 No access. Registers are RES0 in the second view.
- 1 Access permitted. If the registers are accessible in the current frame then they are accessible in the second view.

The definition of this bit means that, if the Virtual Timer registers are not implemented in the current CNTBaseN frame, then the Virtual Timer register addresses are RES0 in the corresponding CNTELOBaseN frame, regardless of the value of this bit.

Bits [7:2]

Reserved, RES0.

EL0VCTEN, bit [1]

Second view read access control for [CNTVCT](#) and [CNTFRQ](#). The possible values of this bit are:

- 0 [CNTVCT](#) is not visible in the second view.
If EL0PCTEN is set to 0, [CNTFRQ](#) is not visible in the second view.
- 1 Access permitted. If [CNTVCT](#) and [CNTFRQ](#) are visible in the current frame then they are visible in the second view.

EL0PCTEN, bit [0]

Second view read access control for [CNTPCT](#) and [CNTFRQ](#). The possible values of this bit are:

- 0 [CNTPCT](#) is not visible in the second view.
If EL0VCTEN is set to 0, [CNTFRQ](#) is not visible in the second view.
- 1 Access permitted. If [CNTPCT](#) and [CNTFRQ](#) are visible in the current frame then they are visible in the second view.

Accessing the CNTELOACR:

CNTELOACR can be accessed through its memory-mapped interface:

Component	Frame	Accessibility	Offset
Timer	CNTBaseN	RW	0x014

13.6.5 CNTFID0, Counter Frequency ID

The CNTFID0 characteristics are:

Purpose

Indicates the base frequency of the system counter.

Usage constraints

This register is accessible as follows:

Default

RO or RW

In a system that supports Secure and Non-secure memory maps the CNTControlBase frame, that includes this register, is implemented only in the Secure memory map.

Configurations

The power domain of CNTFID0 is IMPLEMENTATION DEFINED.

If this register is implemented as an RW register, on a reset of the reset domain in which it is implemented, RW fields in this register reset to UNKNOWN values. The register is not affected by a reset of any other reset domain. For more information see [Power and reset domains for the system level implementation of the Generic Timer on page 11-5724](#).

The possible frequencies for the system counter are stored in the Frequency modes table as 32-bit words starting with the base frequency, CNTFID0. For more information see [The Frequency modes table on page 11-5727](#).

The final entry in the Frequency modes table must be followed by a 32-bit word of zero value, to mark the end of the table.

Typically, the Frequency modes table will be in read-only memory. However, a system implementation might use read/write memory for the table, and initialize the table entries as part of its start-up sequence.

If the Frequency modes table is in read/write memory, ARM strongly recommends that the table is not updated once the system is running.

Attributes

CNTFID0 is a 32-bit register.

Field descriptions

The CNTFID0 bit assignments are:

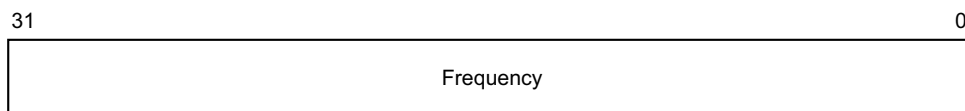

Frequency, bits [31:0]

The base frequency of the system counter, in Hz.

Accessing the CNTFID0:

CNTFID0 can be accessed through its memory-mapped interface:

Component	Frame	Offset
Timer	CNTControlBase	0x020

13.6.6 CNTFID<n>, Counter Frequency IDs, n > 0

The CNTFID<n> characteristics are:

Purpose

Indicates alternative system counter update frequencies.

Usage constraints

This register is accessible as follows:

Default

RO or RW

In a system that supports Secure and Non-secure memory maps the CNTControlBase frame, that includes these registers, is implemented only in the Secure memory map.

Configurations

The power domain of CNTFID<n> is IMPLEMENTATION DEFINED.

If this register is implemented as an RW register, on a reset of the reset domain in which it is implemented, RW fields in this register reset to UNKNOWN values. The register is not affected by a reset of any other reset domain. For more information see *Power and reset domains for the system level implementation of the Generic Timer* on page 11-5724.

The possible frequencies for the system counter are stored in the Frequency modes table as 32-bit words starting with the base frequency, CNTFID0, see *The Frequency modes table* on page 11-5727.

The number of CNTFID<n> registers is IMPLEMENTATION DEFINED, and the only required CNTFID<n> register is CNTFID0.

The final entry in the Frequency modes table must be followed by a 32-bit word of zero value, to mark the end of the table.

Typically, the Frequency modes table will be in read-only memory. However, a system implementation might use read/write memory for the table, and initialize the table entries as part of its start-up sequence.

If the Frequency modes table is in read/write memory, ARM strongly recommends that the table is not updated once the system is running.

Attributes

CNTFID<n> is a 32-bit register.

Field descriptions

The CNTFID<n> bit assignments are:

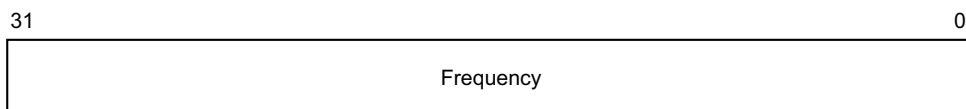

Frequency, bits [31:0]

A system counter update frequency, in Hz. Must be an exact divisor of the base frequency. ARM strongly recommends that all frequency values in the Frequency modes table are integer power-of-two divisors of the base frequency.

When the system timer is operating at a lower frequency than the base frequency, the increment applied at each counter update is given by:

$$\text{increment} = (\text{base frequency}) / (\text{selected frequency})$$

Accessing the CNTFID<n>:

CNTFID<n> can be accessed through its memory-mapped interface:

Component	Frame	Offset
Timer	CNTControlBase	0x020 + 4n

13.6.7 CNTFRQ, Counter-timer Frequency

The CNTFRQ characteristics are:

Purpose

This register is provided so that software can discover the frequency of the system counter. The instance of this register in the CNTCTLBase frame must be programmed with this value as part of system initialization. The value of the register is not interpreted by hardware.

Usage constraints

CNTFRQ must be implemented as an RW register in the CNTCTLBase frame.

In a system that recognizes two Security states, the instance of this register in the CNTCTLBase frame is only accessible by Secure accesses.

CNTFRQ can be implemented as a RO register in any implemented CNTBaseN frame, and in the corresponding CNTEL0BaseN frame.

CNTCTLBase status and control fields for the CNTBaseN and CNTEL0BaseN frames on page I1-5733 describes the status fields that identify whether a CNTBaseN frame is implemented, and for an implemented frame:

- Whether the CNTBaseN frame has virtual timer capability.
- Whether the corresponding CNTEL0BaseN frame is implemented.
- For an implementation that recognizes two Security states, whether the CNTBaseN frame, and any corresponding CNTEL0BaseN frame, is accessible by Non-secure accesses.

For an implemented CNTBaseN frame:

- CNTFRQ is accessible in that frame, as a RO register, if the value of CNTACR<n>.RFRQ is 1.
- Otherwise, the CNTFRQ address in that frame is RAZ/WI.

For an implemented CNTEL0BaseN frame:

- CNTFRQ is accessible in that frame if both:
 - CNTFRQ is accessible in the corresponding CNTBaseN frame.
 - The value of at least one of CNTEL0ACR.ELOVCTEN and CNTEL0ACR.ELOPCTEN is 1.
- Otherwise, the CNTFRQ address in that frame is RAZ/WI.

Configurations

The power domain of CNTFRQ is IMPLEMENTATION DEFINED.

On a reset of the reset domain in which an RW instance of this register is implemented, RW fields in the register reset to UNKNOWN values. The register is not affected by a reset of any other reset domain. For more information see *Power and reset domains for the system level implementation of the Generic Timer on page I1-5724*.

Attributes

CNTFRQ is a 32-bit register.

Field descriptions

The CNTFRQ bit assignments are:

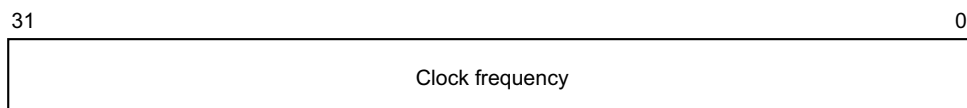

Bits [31:0]

Clock frequency. Indicates the system counter clock frequency, in Hz.

Accessing the CNTFRQ:

CNTFRQ can be accessed through its memory-mapped interface:

Component	Frame	Accessibility	Offset
Timer	CNTBaseN	RW	0x010
Timer	CNTEL0BaseN	RO	0x010
Timer	CNTCTLBase	RO	0x000

13.6.8 CNTNSAR, Counter-timer Non-secure Access Register

The CNTNSAR characteristics are:

Purpose

Provides the highest-level control of whether frames CNTBaseN and CNTEL0BaseN are accessible by Non-secure accesses.

Usage constraints

This register is accessible as follows:

Default
RW

In a system that recognizes two Security states, this register is only accessible by Secure accesses.

Configurations

The power domain of CNTNSAR is IMPLEMENTATION DEFINED.

On a reset of the reset domain in which it is implemented, RW fields in this register reset to UNKNOWN values. The register is not affected by a reset of any other reset domain. For more information see *Power and reset domains for the system level implementation of the Generic Timer* on page I1-5724.

Attributes

CNTNSAR is a 32-bit register.

Field descriptions

The CNTNSAR bit assignments are:

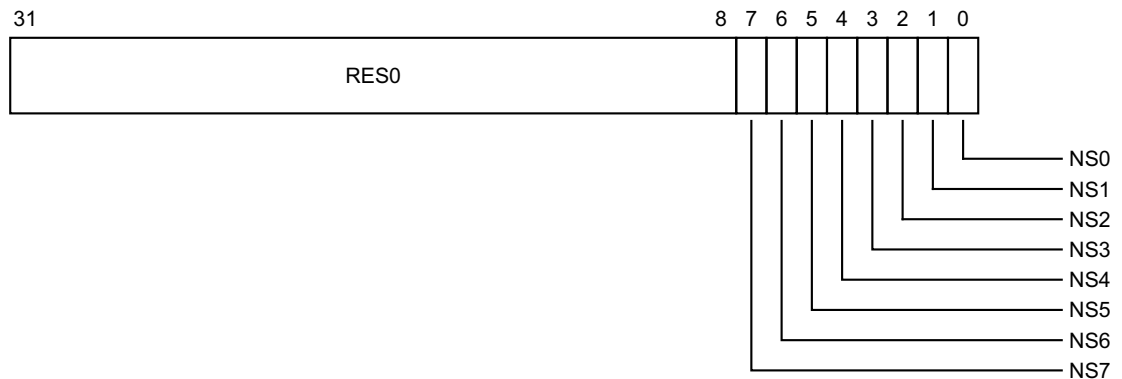

Bits [31:8]

Reserved, RES0.

NS<n>, bit [n], for n = 0 to 7

Non-secure access to frame n. The possible values of this bit are:

- 0 Secure access only. Behaves as RES0 to Non-secure accesses.
- 1 Secure and Non-secure accesses permitted.

This bit also determines whether, in the CNTCTLBase frame, CNTACR<n> and CNTVOFF<n> are accessible to Non-secure accesses.

If frame CNTBase<n>:

- Is not implemented, then NS<n> is RES0.
- Is not Configurable access, and is accessible only by Secure accesses, then NS<n> is RES0.
- Is not Configurable access, and is accessible by both Secure and Non-secure accesses, then NS<n> is RES1.

Accessing the CNTNSAR:

CNTNSAR can be accessed through its memory-mapped interface:

Component	Frame	Offset
Timer	CNTCTLBase	0x004

13.6.9 CNTP_CTL, Counter-timer Physical Timer Control

The CNTP_CTL characteristics are:

Purpose

Control register for the physical timer.

Usage constraints

CNTP_CTL can be implemented in any implemented CNTBaseN frame, and in the corresponding CNTELOBaseN frame.

CNTCTLBase status and control fields for the CNTBaseN and CNTELOBaseN frames on page I1-5733 describes the status fields that identify whether a CNTBaseN frame is implemented, and for an implemented frame:

- Whether the CNTBaseN frame has virtual timer capability.
- Whether the corresponding CNTELOBaseN frame is implemented.
- For an implementation that recognizes two Security states, whether the CNTBaseN frame, and any corresponding CNTELOBaseN frame, is accessible by Non-secure accesses.

For an implemented CNTBaseN frame:

- CNTP_CTL is accessible in that frame if the value of CNTACR<n>.RWPT is 1.
- Otherwise, the CNTP_CTL address in that frame is RAZ/WI.

For an implemented CNTELOBaseN frame:

- CNTP_CTL is accessible in that frame if both:
 - CNTP_CTL is accessible in the corresponding CNTBaseN frame.
 - The value of CNTELOACR.ELOPTEN is 1.
- Otherwise, the CNTP_CTL address in that frame is RAZ/WI.

Configurations

The power domain of CNTP_CTL is IMPLEMENTATION DEFINED.

On a reset of the reset domain in which an RW instance of this register is implemented, RW fields in the register reset to UNKNOWN values. The register is not affected by a reset of any other reset domain. For more information see *Power and reset domains for the system level implementation of the Generic Timer on page I1-5724*.

Attributes

CNTP_CTL is a 32-bit register.

Field descriptions

The CNTP_CTL bit assignments are:

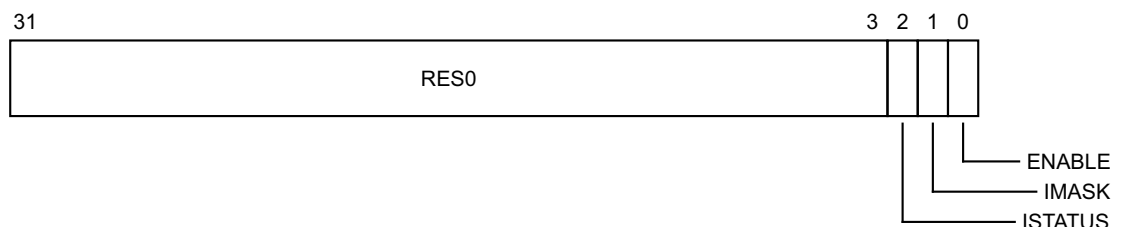

Bits [31:3]

Reserved, RES0.

ISTATUS, bit [2]

The status of the timer. This bit indicates whether the timer condition is met:

- 0 Timer condition is not met.
- 1 Timer condition is met.

When the value of the ENABLE bit is 1, ISTATUS indicates whether the timer condition is met. ISTATUS takes no account of the value of the IMASK bit. If the value of ISTATUS is 1 and the value of IMASK is 0 then the timer interrupt is asserted.

When the value of the ENABLE bit is 0, the ISTATUS field is UNKNOWN.

For more information see [Operation of the CompareValue views of the timers on page D6-2187](#) and [Operation of the TimerValue views of the timers on page D6-2188](#).

This bit is read-only.

IMASK, bit [1]

Timer interrupt mask bit. Permitted values are:

- 0 Timer interrupt is not masked by the IMASK bit.
- 1 Timer interrupt is masked by the IMASK bit.

For more information, see the description of the ISTATUS bit.

ENABLE, bit [0]

Enables the timer. Permitted values are:

- 0 Timer disabled.
- 1 Timer enabled.

Setting this bit to 0 disables the timer output signal, but the timer value accessible from [CNTP_TVAL](#) continues to count down.

———— **Note** —————

Disabling the output signal might be a power-saving option.

Accessing the CNTP_CTL:

CNTP_CTL can be accessed through its memory-mapped interface:

Component	Frame	Accessibility	Offset
Timer	CNTBaseN	RW	0x02C
Timer	CNTELOBaseN	RW	0x02C

13.6.10 CNTP_CVAL, Counter-timer Physical Timer CompareValue

The CNTP_CVAL characteristics are:

Purpose

Holds the 64-bit compare value for the EL1 physical timer.

Usage constraints

CNTP_CVAL can be implemented in any implemented CNTBaseN frame, and in the corresponding CNTELOBaseN frame.

CNTCTLBase status and control fields for the CNTBaseN and CNTELOBaseN frames on page I1-5733 describes the status fields that identify whether a CNTBaseN frame is implemented, and for an implemented frame:

- Whether the CNTBaseN frame has virtual timer capability.
- Whether the corresponding CNTELOBaseN frame is implemented.
- For an implementation that recognizes two Security states, whether the CNTBaseN frame, and any corresponding CNTELOBaseN frame, is accessible by Non-secure accesses.

For an implemented CNTBaseN frame:

- CNTP_CVAL is accessible in that frame if the value of CNTACR<n>.RWPT is 1.
- Otherwise, the CNTP_CVAL address in that frame is RAZ/WI.

For an implemented CNTELOBaseN frame:

- CNTP_CVAL is accessible in that frame if both:
 - CNTP_CVAL is accessible in the corresponding CNTBaseN frame.
 - The value of CNTELOACR.ELOPTEN is 1.
- Otherwise, the CNTP_CVAL address in that frame is RAZ/WI.

If the implementation supports 64-bit atomic accesses, then the CNTP_CVAL register must be accessible as an atomic 64-bit value.

Configurations

The power domain of CNTP_CVAL is IMPLEMENTATION DEFINED.

On a reset of the reset domain in which an RW instance of this register is implemented, RW fields in the register reset to UNKNOWN values. The register is not affected by a reset of any other reset domain. For more information see *Power and reset domains for the system level implementation of the Generic Timer on page I1-5724*.

Attributes

CNTP_CVAL is a 64-bit register.

Field descriptions

The CNTP_CVAL bit assignments are:

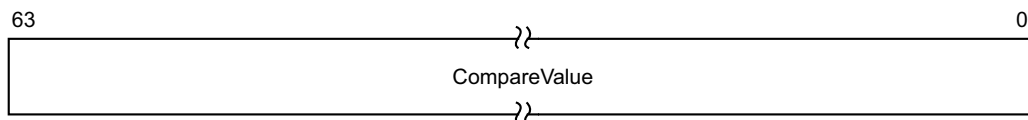

CompareValue, bits [63:0]

Holds the EL1 physical timer CompareValue.

When CNTP_CTL.ENABLE is 1, the timer condition is met when (CNTPCT - CompareValue) is greater than zero. This means that CompareValue acts like a 64-bit upcounter timer. When the timer condition is met:

- CNTP_CTL.ISTATUS is set to 1.

- An interrupt is generated if `CNTP_CTL.IMASK` is 0.
When `CNTP_CTL.ENABLE` is 0, the timer condition is not met, but `CNTPCT` continues to count.

Accessing the `CNTP_CVAL`:

`CNTP_CVAL[31:0]` can be accessed through its memory-mapped interface:

Component	Frame	Accessibility	Offset
Timer	<code>CNTBaseN</code>	RW	<code>0x020</code>
Timer	<code>CNTELOBaseN</code>	RW	<code>0x020</code>

`CNTP_CVAL[63:32]` can be accessed through its memory-mapped interface:

Component	Frame	Accessibility	Offset
Timer	<code>CNTBaseN</code>	RW	<code>0x024</code>
Timer	<code>CNTELOBaseN</code>	RW	<code>0x024</code>

I3.6.11 CNTP_TVAL, Counter-timer Physical Timer TimerValue

The CNTP_TVAL characteristics are:

Purpose

Holds the timer value for the EL1 physical timer.

Usage constraints

CNTP_TVAL can be implemented in any implemented CNTBaseN frame, and in the corresponding CNTELOBaseN frame.

CNTCTLBase status and control fields for the CNTBaseN and CNTELOBaseN frames on page I1-5733 describes the status fields that identify whether a CNTBaseN frame is implemented, and for an implemented frame:

- Whether the CNTBaseN frame has virtual timer capability.
- Whether the corresponding CNTELOBaseN frame is implemented.
- For an implementation that recognizes two Security states, whether the CNTBaseN frame, and any corresponding CNTELOBaseN frame, is accessible by Non-secure accesses.

For an implemented CNTBaseN frame:

- CNTP_TVAL is accessible in that frame if the value of CNTACR<n>.RWPT is 1.
- Otherwise, the CNTP_TVAL address in that frame is RAZ/WI.

For an implemented CNTELOBaseN frame:

- CNTP_TVAL is accessible in that frame if both:
 - CNTP_TVAL is accessible in the corresponding CNTBaseN frame.
 - The value of CNTELOACR.ELOPTEN is 1.
- Otherwise, the CNTP_TVAL address in that frame is RAZ/WI.

Configurations

The power domain of CNTP_TVAL is IMPLEMENTATION DEFINED.

On a reset of the reset domain in which an RW instance of this register is implemented, RW fields in the register reset to UNKNOWN values. The register is not affected by a reset of any other reset domain. For more information see *Power and reset domains for the system level implementation of the Generic Timer on page I1-5724*.

Attributes

CNTP_TVAL is a 32-bit register.

Field descriptions

The CNTP_TVAL bit assignments are:

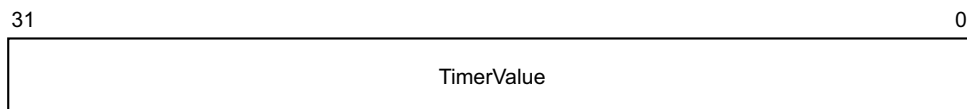

TimerValue, bits [31:0]

The TimerValue view of the EL1 physical timer.

On a read of this register:

- If CNTP_CTL.ENABLE is 0, the value returned is UNKNOWN.
- If CNTP_CTL.ENABLE is 1, the value returned is (CompareValue - CNTPCT).

On a write of this register, CompareValue is set to (CNTPCT + TimerValue), where TimerValue is treated as a signed 32-bit integer.

When `CNTP_CTL.ENABLE` is 1, the timer condition is met when $(\text{CNTPCT} - \text{CompareValue})$ is greater than zero. This means that `TimerValue` acts like a 32-bit downcounter timer. When the timer condition is met:

- `CNTP_CTL.ISTATUS` is set to 1.
- If `CNTP_CTL.IMASK` is 0, an interrupt is generated.

When `CNTP_CTL.ENABLE` is 0, the timer condition is not met, but `CNTPCT` continues to count, so the `TimerValue` view appears to continue to count down.

Accessing the `CNTP_TVAL`:

`CNTP_TVAL` can be accessed through its memory-mapped interface:

Component	Frame	Accessibility	Offset
Timer	CNTBaseN	RW	0x028
Timer	CNTELOBaseN	RW	0x028

13.6.12 CNTPCT, Counter-timer Physical Count

The CNTPCT characteristics are:

Purpose

Holds the 64-bit physical count value.

Usage constraints

CNPCT can be implemented in any implemented CNTBaseN frame, and in the corresponding CNTELOBaseN frame, as a RO register.

CNCTLBase status and control fields for the CNTBaseN and CNTELOBaseN frames on page I1-5733 describes the status fields that identify whether a CNTBaseN frame is implemented, and for an implemented frame:

- Whether the CNTBaseN frame has virtual timer capability.
- Whether the corresponding CNTELOBaseN frame is implemented.
- For an implementation that recognizes two Security states, whether the CNTBaseN frame, and any corresponding CNTELOBaseN frame, is accessible by Non-secure accesses.

For an implemented CNTBaseN frame:

- CNPCT is accessible in that frame, as a RO register, if the value of CNTACR<n>.RPCT is 1.
- Otherwise, the CNPCT address in that frame is RAZ/WI.

For an implemented CNTELOBaseN frame:

- CNPCT is accessible in that frame if both:
 - CNPCT is accessible in the corresponding CNTBaseN frame.
 - The value of CNTELOACR.EL0PCTEN is 1.
- Otherwise, the CNPCT address in that frame is RAZ/WI.

If the implementation supports 64-bit atomic accesses, then the CNPCT register must be accessible as an atomic 64-bit value.

Configurations

The power domain of CNPCT is IMPLEMENTATION DEFINED.

For more information see *Power and reset domains for the system level implementation of the Generic Timer on page I1-5724*.

Attributes

CNPCT is a 64-bit register.

Field descriptions

The CNPCT bit assignments are:

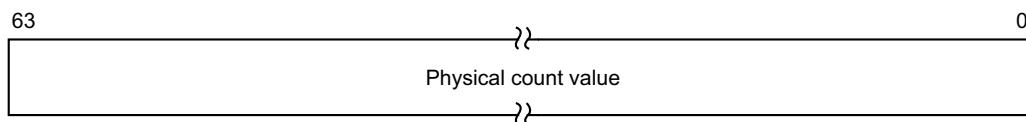

Bits [63:0]

Physical count value.

Accessing the CNTPCT:

CNTPCT[31:0] can be accessed through its memory-mapped interface:

Component	Frame	Accessibility	Offset
Timer	CNTBaseN	RO	0x000
Timer	CNTELOBaseN	RO	0x000

CNTPCT[63:32] can be accessed through its memory-mapped interface:

Component	Frame	Accessibility	Offset
Timer	CNTBaseN	RO	0x004
Timer	CNTELOBaseN	RO	0x004

13.6.13 CNTSR, Counter Status Register

The CNTSR characteristics are:

Purpose

Provides counter frequency status information.

Usage constraints

This register is accessible as follows:

Default
RO

In a system that supports Secure and Non-secure memory maps the CNTControlBase frame, that includes this register, is implemented only in the Secure memory map.

Configurations

The power domain of CNTSR is IMPLEMENTATION DEFINED.

Some or all fields in this register have defined reset values. These apply only on a reset of the reset domain in which the register is implemented. The register is not affected by a reset of any other reset domain. For more information see *Power and reset domains for the system level implementation of the Generic Timer* on page I1-5724.

Attributes

CNTSR is a 32-bit register.

Field descriptions

The CNTSR bit assignments are:

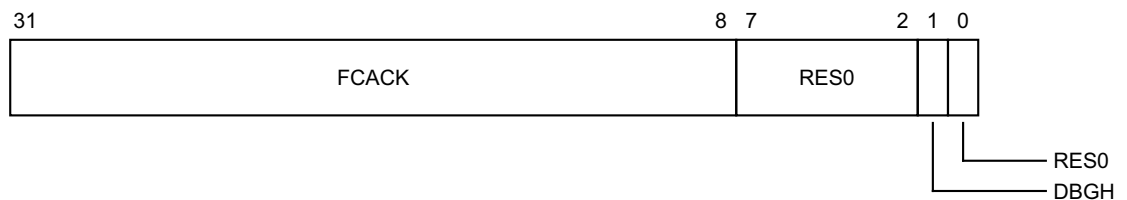

FCKACK, bits [31:8]

Frequency change acknowledge. Indicates the currently selected entry in the Frequency modes table, see *The Frequency modes table* on page I1-5727.

When this register has an architecturally-defined reset value, this field resets to 0.

Bits [7:2]

Reserved, RES0.

DBGH, bit [1]

Indicates whether the counter is halted because the Halt-on-Debug signal is asserted:

- 0 Counter is not halted.
- 1 Counter is halted.

This field resets to a value that is architecturally UNKNOWN.

Bit [0]

Reserved, RES0.

Accessing the CNTSR:

CNTSR can be accessed through its memory-mapped interface:

Component	Frame	Offset
Timer	CNTControlBase	0x004

13.6.14 CNTTIDR, Counter-timer Timer ID Register

The CNTTIDR characteristics are:

Purpose

Indicates the implemented timers in the memory map, and their features. For each value of N from 0 to 7 it indicates whether:

- Frame CNTBaseN is a view of an implemented timer.
- Frame CNTBaseN has a second view, CNTEL0BaseN.
- Frame CNTBaseN has a virtual timer capability.

Usage constraints

This register is accessible as follows:

Default

RO

In a system that recognizes two Security states this register is accessible by both Secure and Non-secure accesses.

Configurations

The power domain of CNTTIDR is IMPLEMENTATION DEFINED.

For more information see [Power and reset domains for the system level implementation of the Generic Timer on page I1-5724](#).

Attributes

CNTTIDR is a 32-bit register.

Field descriptions

The CNTTIDR bit assignments are:

31	28 27	24 23	20 19	16 15	12 11	8 7	4 3	0
Frame7	Frame6	Frame5	Frame4	Frame3	Frame2	Frame1	Frame0	

Frame<n>, bits [4n+3:4n], for n = 0 to 7

A 4-bit field indicating the features of frame CNTBase<n>.

Bit[3] of the field is RES0.

Bit[2] indicates whether frame CNTBase<n> has a second view, CNTEL0Base<n>. The possible values of this bit are:

Bit[2]	Meaning
--------	---------

0	Frame <n> does not have a second view. CNTEL0Base<n> is RES0.
---	---

1	Frame <n> has a second view, CNTEL0Base<n>.
---	---

If bit[0] is 0, bit[2] is RES0.

Bit[1] indicates whether both:

- Frame CNTBase<n> implements the virtual timer registers CNTV_CVAL, CNTV_TVAL, and CNTV_CTL.
- This CNTCTLBase frame implements the virtual timer offset register CNTVOFF<n>.

The possible values of bit[1] are:

Bit[1]	Meaning
0	Frame <n> does not have virtual capability. The virtual time and offset registers are RES0.
1	Frame <n> has virtual capability. The virtual time and offset registers are implemented.

If bit[0] is 0, bit[1] is RES0.

Bit[0] indicates whether frame CNTBase<n> is implemented. The possible values of this bit are:

Bit[0]	Meaning
0	Frame <n> not implemented. All registers associated with the frame are RES0.
1	Frame <n> is implemented.

Accessing the CNTTIDR:

CNTTIDR can be accessed through its memory-mapped interface:

Component	Frame	Offset
Timer	CNTCTLBase	0x008

13.6.15 CNTV_CTL, Counter-timer Virtual Timer Control

The CNTV_CTL characteristics are:

Purpose

Control register for the virtual timer.

Usage constraints

CNTV_CTL can be implemented in any implemented CNTBaseN frame that has virtual timer capability, and in the corresponding CNTEL0BaseN frame.

[CNTCTLBase status and control fields for the CNTBaseN and CNTEL0BaseN frames on page I1-5733](#) describes the status fields that identify whether a CNTBaseN frame is implemented, and for an implemented frame:

- Whether the CNTBaseN frame has virtual timer capability.
- Whether the corresponding CNTEL0BaseN frame is implemented.
- For an implementation that recognizes two Security states, whether the CNTBaseN frame, and any corresponding CNTEL0BaseN frame, is accessible by Non-secure accesses.

For an implemented CNTBaseN frame that has virtual timer capability:

- CNTV_CTL is accessible in that frame if the value of CNTACR<n>.RWVT is 1.
- Otherwise, the CNTV_CTL address in that frame is RAZ/WI.

For an implemented CNTEL0BaseN frame:

- CNTV_CTL is accessible in that frame if both:
 - CNTV_CTL is accessible in the corresponding CNTBaseN frame.
 - The value of CNTEL0ACR.EL0VTEN is 1.
- Otherwise, the CNTV_CTL address in that frame is RAZ/WI.

Configurations

The power domain of CNTV_CTL is IMPLEMENTATION DEFINED.

On a reset of the reset domain in which an RW instance of this register is implemented, RW fields in the register reset to UNKNOWN values. The register is not affected by a reset of any other reset domain. For more information see [Power and reset domains for the system level implementation of the Generic Timer on page I1-5724](#).

Implementation of this register is OPTIONAL.

Attributes

CNTV_CTL is a 32-bit register.

Field descriptions

The CNTV_CTL bit assignments are:

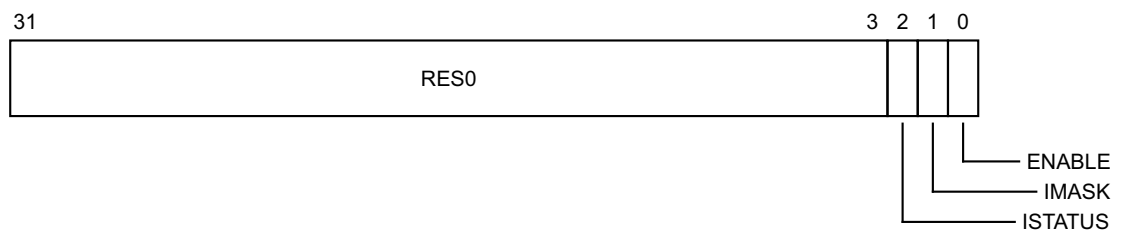

Bits [31:3]

Reserved, RES0.

ISTATUS, bit [2]

The status of the timer. This bit indicates whether the timer condition is met:

- 0 Timer condition is not met.
- 1 Timer condition is met.

When the value of the ENABLE bit is 1, ISTATUS indicates whether the timer condition is met. ISTATUS takes no account of the value of the IMASK bit. If the value of ISTATUS is 1 and the value of IMASK is 0 then the timer interrupt is asserted.

When the value of the ENABLE bit is 0, the ISTATUS field is UNKNOWN.

For more information see [Operation of the CompareValue views of the timers on page D6-2187](#) and [Operation of the TimerValue views of the timers on page D6-2188](#).

This bit is read-only.

IMASK, bit [1]

Timer interrupt mask bit. Permitted values are:

- 0 Timer interrupt is not masked by the IMASK bit.
- 1 Timer interrupt is masked by the IMASK bit.

For more information, see the description of the ISTATUS bit.

ENABLE, bit [0]

Enables the timer. Permitted values are:

- 0 Timer disabled.
- 1 Timer enabled.

Setting this bit to 0 disables the timer output signal, but the timer value accessible from [CNTV_TVAL](#) continues to count down.

———— **Note** —————

Disabling the output signal might be a power-saving option.

Accessing the CNTV_CTL:

CNTV_CTL can be accessed through its memory-mapped interface:

Component	Frame	Accessibility	Offset
Timer	CNTBaseN	RW	0x03C
Timer	CNTELOBaseN	RW	0x03C

13.6.16 CNTV_CVAL, Counter-timer Virtual Timer CompareValue

The CNTV_CVAL characteristics are:

Purpose

Holds the 64-bit compare value for the virtual timer.

Usage constraints

CNTV_CVAL can be implemented in any implemented CNTBaseN frame that has virtual timer capability, and in the corresponding CNTEL0BaseN frame.

[CNTCTLBase status and control fields for the CNTBaseN and CNTEL0BaseN frames on page I1-5733](#) describes the status fields that identify whether a CNTBaseN frame is implemented, and for an implemented frame:

- Whether the CNTBaseN frame has virtual timer capability.
- Whether the corresponding CNTEL0BaseN frame is implemented.
- For an implementation that recognizes two Security states, whether the CNTBaseN frame, and any corresponding CNTEL0BaseN frame, is accessible by Non-secure accesses.

For an implemented CNTBaseN frame that has virtual timer capability:

- CNTV_CVAL is accessible in that frame if the value of CNTACR<n>.RWVT is 1.
- Otherwise, the CNTV_CVAL address in that frame is RAZ/WI.

For an implemented CNTEL0BaseN frame:

- CNTV_CVAL is accessible in that frame if both:
 - CNTV_CVAL is accessible in the corresponding CNTBaseN frame.
 - The value of CNTEL0ACR.EL0VTEN is 1.
- Otherwise, the CNTV_CVAL address in that frame is RAZ/WI.

If the implementation supports 64-bit atomic accesses, then the CNTV_CVAL register must be accessible as an atomic 64-bit value.

Configurations

The power domain of CNTV_CVAL is IMPLEMENTATION DEFINED.

On a reset of the reset domain in which an RW instance of this register is implemented, RW fields in the register reset to UNKNOWN values. The register is not affected by a reset of any other reset domain. For more information see [Power and reset domains for the system level implementation of the Generic Timer on page I1-5724](#).

Implementation of this register is OPTIONAL.

Attributes

CNTV_CVAL is a 64-bit register.

Field descriptions

The CNTV_CVAL bit assignments are:

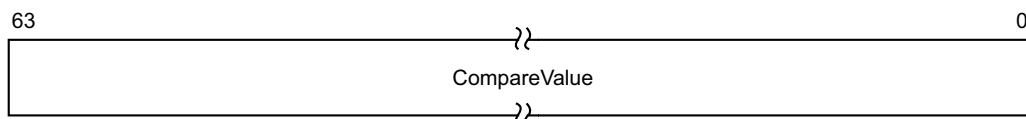

CompareValue, bits [63:0]

Holds the virtual timer CompareValue.

When `CNTV_CTL.ENABLE` is 1, the timer condition is met when $(CNTVCT - CompareValue)$ is greater than zero. This means that `CompareValue` acts like a 64-bit upcounter timer. When the timer condition is met:

- `CNTV_CTL.ISTATUS` is set to 1.
- An interrupt is generated if `CNTV_CTL.IMASK` is 0.

When `CNTV_CTL.ENABLE` is 0, the timer condition is not met, but `CNTVCT` continues to count.

Accessing the `CNTV_CVAL`:

`CNTV_CVAL[31:0]` can be accessed through its memory-mapped interface:

Component	Frame	Accessibility	Offset
Timer	CNTBaseN	RW	0x030
Timer	CNTELOBaseN	RW	0x030

`CNTV_CVAL[63:32]` can be accessed through its memory-mapped interface:

Component	Frame	Accessibility	Offset
Timer	CNTBaseN	RW	0x034
Timer	CNTELOBaseN	RW	0x034

13.6.17 CNTV_TVAL, Counter-timer Virtual Timer TimerValue

The CNTV_TVAL characteristics are:

Purpose

Holds the timer value for the virtual timer.

Usage constraints

CNTV_TVAL can be implemented in any implemented CNTBaseN frame that has virtual timer capability, and in the corresponding CNTELOBaseN frame.

[CNTCTLBase status and control fields for the CNTBaseN and CNTELOBaseN frames on page I1-5733](#) describes the status fields that identify whether a CNTBaseN frame is implemented, and for an implemented frame:

- Whether the CNTBaseN frame has virtual timer capability.
- Whether the corresponding CNTELOBaseN frame is implemented.
- For an implementation that recognizes two Security states, whether the CNTBaseN frame, and any corresponding CNTELOBaseN frame, is accessible by Non-secure accesses.

For an implemented CNTBaseN frame that has virtual timer capability:

- CNTV_TVAL is accessible in that frame if the value of CNTACR<n>.RWVT is 1.
- Otherwise, the CNTV_TVAL address in that frame is RAZ/WI.

For an implemented CNTELOBaseN frame:

- CNTV_TVAL is accessible in that frame if both:
 - CNTV_TVAL is accessible in the corresponding CNTBaseN frame.
 - The value of CNTELOACR.EL0VTEN is 1.
- Otherwise, the CNTV_TVAL address in that frame is RAZ/WI.

Configurations

The power domain of CNTV_TVAL is IMPLEMENTATION DEFINED.

On a reset of the reset domain in which an RW instance of this register is implemented, RW fields in the register reset to UNKNOWN values. The register is not affected by a reset of any other reset domain. For more information see [Power and reset domains for the system level implementation of the Generic Timer on page I1-5724](#).

Implementation of this register is OPTIONAL.

Attributes

CNTV_TVAL is a 32-bit register.

Field descriptions

The CNTV_TVAL bit assignments are:

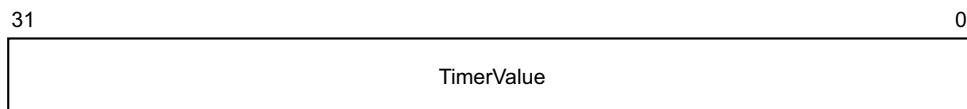

TimerValue, bits [31:0]

The TimerValue view of the virtual timer.

On a read of this register:

- If CNTV_CTL.ENABLE is 0, the value returned is UNKNOWN.
- If CNTV_CTL.ENABLE is 1, the value returned is (CompareValue - CNTVCT).

On a write of this register, CompareValue is set to $(CNTVCT + \text{TimerValue})$, where TimerValue is treated as a signed 32-bit integer.

When `CNTV_CTL.ENABLE` is 1, the timer condition is met when $(CNTVCT - \text{CompareValue})$ is greater than zero. This means that TimerValue acts like a 32-bit downcounter timer. When the timer condition is met:

- `CNTV_CTL.ISTATUS` is set to 1.
- If `CNTV_CTL.IMASK` is 0, an interrupt is generated.

When `CNTV_CTL.ENABLE` is 0, the timer condition is not met, but `CNTVCT` continues to count, so the TimerValue view appears to continue to count down.

Accessing the CNTV_TVAL:

`CNTV_TVAL` can be accessed through its memory-mapped interface:

Component	Frame	Accessibility	Offset
Timer	CNTBaseN	RW	0x038
Timer	CNTEL0BaseN	RW	0x038

13.6.18 CNTVCT, Counter-timer Virtual Count

The CNTVCT characteristics are:

Purpose

Holds the 64-bit virtual count value.

Usage constraints

CNTVCT can be implemented in any implemented CNTBaseN frame, and in the corresponding CNTELOBaseN frame, as a RO register.

CNTCTLBase status and control fields for the CNTBaseN and CNTELOBaseN frames on page I1-5733 describes the status fields that identify whether a CNTBaseN frame is implemented, and for an implemented frame:

- Whether the CNTBaseN frame has virtual timer capability.
- Whether the corresponding CNTELOBaseN frame is implemented.
- For an implementation that recognizes two Security states, whether the CNTBaseN frame, and any corresponding CNTELOBaseN frame, is accessible by Non-secure accesses.

For an implemented CNTBaseN frame:

- CNTVCT is accessible in that frame, as a RO register, if the value of CNTACR<n>.RVCT is 1.
- Otherwise, the CNTVCT address in that frame is RAZ/WI.

For an implemented CNTELOBaseN frame:

- CNTVCT is accessible in that frame if both:
 - CNTVCT is accessible in the corresponding CNTBaseN frame.
 - The value of CNTELOACR.EL0VCTEN is 1.
- Otherwise, the CNTVCT address in that frame is RAZ/WI.

If the implementation supports 64-bit atomic accesses, then the CNTVCT register must be accessible as an atomic 64-bit value.

Configurations

The power domain of CNTVCT is IMPLEMENTATION DEFINED.

For more information see *Power and reset domains for the system level implementation of the Generic Timer on page I1-5724*.

Attributes

CNTVCT is a 64-bit register.

Field descriptions

The CNTVCT bit assignments are:

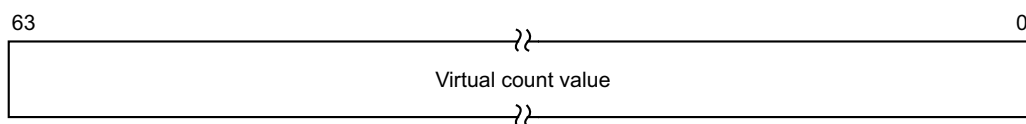

Bits [63:0]

Virtual count value.

Accessing the CNTVCT:

CNTVCT[31:0] can be accessed through its memory-mapped interface:

Component	Frame	Accessibility	Offset
Timer	CNTBaseN	RO	0x008
Timer	CNTELOBaseN	RO	0x008

CNTVCT[63:32] can be accessed through its memory-mapped interface:

Component	Frame	Accessibility	Offset
Timer	CNTBaseN	RO	0x00C
Timer	CNTELOBaseN	RO	0x00C

13.6.19 CNTVOFF{<n>}, Counter-timer Virtual Offset

The CNTVOFF{<n>} characteristics are:

Purpose

Holds the 64-bit virtual offset.

Usage constraints

In the CNTCTLBase frame a CNTVOFF<n> register must be implemented, as a RW register, for each CNTBaseN frame that has virtual timer capability.

———— Note —————

The value of <n> in an instance of CNTVOFF<n> specifies the value of N for the associated CNTBaseN frame.

In a system that recognizes two Security states, for any CNTVOFF<n> register in the CNTCTLBase frame:

- CNTVOFF<n> is always accessible by Secure accesses.
- CNTNSAR.NS<n> determines whether CNTVOFF<n> is accessible by Non-secure accesses.

The register location of any unimplemented CNTVOFF<n> register in the CNTCTLBase frame is RAZ/WI.

CNTVOFF is implemented, as a RO register, in any implemented CNTBaseN frame that has virtual timer capability.

CNTCTLBase status and control fields for the CNTBaseN and CNTEL0BaseN frames on page I1-5733 describes the status fields that identify whether a CNTBaseN frame is implemented, and for an implemented frame:

- Whether the CNTBaseN frame has virtual timer capability.
- Whether the corresponding CNTEL0BaseN frame is implemented.
- For an implementation that recognizes two Security states, whether the CNTBaseN frame, and any corresponding CNTEL0BaseN frame, is accessible by Non-secure accesses.

For an implemented CNTBaseN frame that has virtual timer capability:

- CNTVOFF is accessible in that frame, as a RO register, if the value of CNTACR<n>.RVOFF is 1.
- Otherwise, the CNTVOFF address in that frame is RAZ/WI.

———— Note —————

CNTVOFF is never visible in any CNTEL0BaseN frame. This means that the CNTVOFF address in any implemented CNTEL0BaseN frame is RAZ/WI.

In an implementation that supports 64-bit atomic accesses, then the CNTVOFF{<n>} register must be accessible as an atomic 64-bit value.

Configurations

The power domain of CNTVOFF is IMPLEMENTATION DEFINED.

On a reset of the reset domain in which an RW instance of this register is implemented, RW fields in the register reset to UNKNOWN values. The register is not affected by a reset of any other reset domain. For more information see *Power and reset domains for the system level implementation of the Generic Timer on page I1-5724*.

Implementation of CNTVOFF<n> is OPTIONAL.

CNTACR<n>.RVOFF enables access to this register for frame CNTBase<n>.

Attributes

CNTVOFF{<n>} is a 64-bit register.

Field descriptions

The CNTVOFF{<n>} bit assignments are:

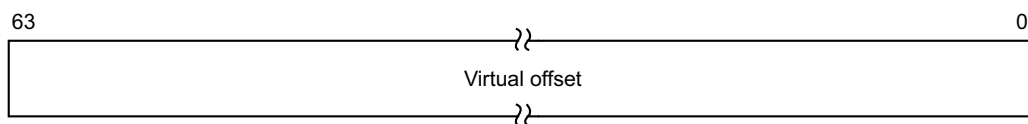

Bits [63:0]

Virtual offset.

Accessing the CNTVOFF{<n>}:

CNTVOFF{<n>} can be accessed through its memory-mapped interface:

Component	Mnemonic	Frame	Accessibility	Offset
Timer	CNTVOFF<n>[31:0]	CNTCTLBase	RW	0x080 + 8n
Timer	CNTVOFF<n>[64:32]	CNTCTLBase	RW	0x084 + 8n
Timer	CNTVOFF[31:0]	CNTBaseN	RO	0x018
Timer	CNTVOFF[64:32]	CNTBaseN	RO	0x01C

13.6.20 CounterID<n>, Counter ID registers, n = 0 - 11

The CounterID<n> characteristics are:

Purpose

IMPLEMENTATION DEFINED identification registers 0 to 11 for the memory-mapped Generic Timer.

Usage constraints

These registers must be implemented, as RO registers, in every implemented frame of a Generic Timer memory-mapped component.

For the CNTCTLBase frame, in a system that recognizes two Security states these registers are accessible by both Secure and Non-secure accesses.

For the CNTControlBase frame, in a system that supports Secure and Non-secure memory maps the frame is implemented only in the Secure memory map, meaning these registers are implemented only in the Secure memory map.

For the CNTBaseN frames, [CNTCTLBase status and control fields for the CNTBaseN and CNTELOBaseN frames on page I1-5733](#) describes the status fields that identify whether a frame is implemented, and for an implemented frame:

- Whether the CNTBaseN frame has virtual timer capability.
- Whether the corresponding CNTELOBaseN frame is implemented.
- For an implementation that recognizes two Security states, whether the CNTBaseN frame, and any corresponding CNTELOBaseN frame, is accessible by Non-secure accesses.

Configurations

The power domain of CounterID<n> is IMPLEMENTATION DEFINED.

For more information see [Power and reset domains for the system level implementation of the Generic Timer on page I1-5724](#).

These registers are implemented independently in each implemented frame of a Generic Timer memory-mapped component.

If the implementation of the Counter ID registers requires an architecture version, the value for this version of the ARM Generic Timer is version 0.

The Counter ID registers can be implemented as a set of CoreSight ID registers, comprising Peripheral ID Registers and Component ID Registers. An implementation of these registers for the Generic Timer must use a Component class value of 0xF.

Attributes

CounterID<n> is a 32-bit register.

Field descriptions

The CounterID<n> bit assignments are:



IMPLEMENTATION DEFINED, bits [31:0]

IMPLEMENTATION DEFINED.

Accessing the CounterID<n>:

CounterID<n> can be accessed through its memory-mapped interface:

Component	Frame	Accessibility	Offset
Timer	CNTControlBase	RO	0xFD0 + 4n
Timer	CNTReadBase	RO	0xFD0 + 4n
Timer	CNTBaseN	RO	0xFD0 + 4n
Timer	CNTELOBaseN	RO	0xFD0 + 4n
Timer	CNTCTLBase	RO	0xFD0 + 4n

Part J

Architectural Pseudocode

Chapter J1

ARMv8 Pseudocode

This chapter contains pseudocode that describes many features of the ARMv8 architecture. It contains the following sections:

- *Pseudocode for AArch64 operations on page J1-5860.*
- *Pseudocode for AArch32 operation on page J1-5930.*
- *Shared pseudocode on page J1-6006.*

J1.1 Pseudocode for AArch64 operations

This section holds the pseudocode for execution in AArch64 state. Functions that are listed in this section are identified as `AArch64.FunctionName`. Some of these functions have an equivalent AArch32 function, `AArch32.FunctionName`. This section is organized by functional groups, with the functional groups being indicated by hierarchical path names, for example `aarch64/debug/breakpoint`.

The top-level sections of the AArch64 pseudocode hierarchy are:

- [aarch64/debug](#).
- [aarch64/exceptions](#) on page J1-5869.
- [aarch64/functions](#) on page J1-5887.
- [aarch64/instrs](#) on page J1-5903.
- [aarch64/translation](#) on page J1-5911.

J1.1.1 aarch64/debug

This section includes the following pseudocode functions:

- [aarch64/debug/breakpoint/AArch64.BreakpointMatch](#).
- [aarch64/debug/breakpoint/AArch64.BreakpointValueMatch](#) on page J1-5861.
- [aarch64/debug/breakpoint/AArch64.StateMatch](#) on page J1-5862.
- [aarch64/debug/enables/AArch64.GenerateDebugExceptions](#) on page J1-5863.
- [aarch64/debug/enables/AArch64.GenerateDebugExceptionsFrom](#) on page J1-5863.
- [aarch64/debug/pmu/AArch64.CheckForPMUOverflow](#) on page J1-5864.
- [aarch64/debug/pmu/AArch64.CountEvents](#) on page J1-5864.
- [aarch64/debug/statisticalprofiling/CheckProfilingBufferAccess](#) on page J1-5865.
- [aarch64/debug/statisticalprofiling/CheckStatisticalProfilingAccess](#) on page J1-5865.
- [aarch64/debug/statisticalprofiling/CollectContextIDR1](#) on page J1-5866.
- [aarch64/debug/statisticalprofiling/CollectContextIDR2](#) on page J1-5866.
- [aarch64/debug/statisticalprofiling/CollectPhysicalAddress](#) on page J1-5866.
- [aarch64/debug/statisticalprofiling/CollectRecord](#) on page J1-5866.
- [aarch64/debug/statisticalprofiling/CollectTimeStamp](#) on page J1-5867.
- [aarch64/debug/statisticalprofiling/OpType](#) on page J1-5867.
- [aarch64/debug/statisticalprofiling/ProfilingBufferEnabled](#) on page J1-5867.
- [aarch64/debug/statisticalprofiling/ProfilingBufferOwner](#) on page J1-5867.
- [aarch64/debug/statisticalprofiling/ProfilingSynchronizationBarrier](#) on page J1-5867.
- [aarch64/debug/statisticalprofiling/StatisticalProfilingEnabled](#) on page J1-5867.
- [aarch64/debug/statisticalprofiling/SysRegAccess](#) on page J1-5868.
- [aarch64/debug/takeexceptiondbg/AArch64.TakeExceptionInDebugState](#) on page J1-5868.
- [aarch64/debug/watchpoint/AArch64.WatchpointByteMatch](#) on page J1-5868.
- [aarch64/debug/watchpoint/AArch64.WatchpointMatch](#) on page J1-5869.

aarch64/debug/breakpoint/AArch64.BreakpointMatch

```
// AArch64.BreakpointMatch()
// =====
// Breakpoint matching in an AArch64 translation regime.

boolean AArch64.BreakpointMatch(integer n, bits(64) vaddress, integer size)
    assert !ELUsingAArch32(S1TranslationRegime());
    assert n <= UInt(ID_AA64DFR0_EL1.BRPs);

    enabled = DBGBCR_EL1[n].E == '1';
    ispriv = PSTATE.EL != EL0;
    linked = DBGBCR_EL1[n].BT == '0x01';
    isbreakpt = TRUE;
    linked_to = FALSE;
```

```

state_match = AArch64.StateMatch(DBGBCR_EL1[n].SSC, DBGBCR_EL1[n].HMC, DBGBCR_EL1[n].PMC,
                                linked, DBGBCR_EL1[n].LBN, isbreakpt, ispriv);
value_match = AArch64.BreakpointValueMatch(n, vaddress, linked_to);

if HaveAnyAArch32() && size == 4 then // Check second halfword
  // If the breakpoint address and BAS of an Address breakpoint match the address of the
  // second halfword of an instruction, but not the address of the first halfword, it is
  // CONSTRAINED UNPREDICTABLE whether or not this breakpoint generates a Breakpoint debug
  // event.
  match_i = AArch64.BreakpointValueMatch(n, vaddress + 2, linked_to);
  if !value_match && match_i then
    value_match = ConstrainUnpredictableBool();

if vaddress<1> == '1' && DBGBCR_EL1[n].BAS == '1111' then
  // The above notwithstanding, if DBGBCR_EL1[n].BAS == '1111', then it is CONSTRAINED
  // UNPREDICTABLE whether or not a Breakpoint debug event is generated for an instruction
  // at the address DBGBCR_EL1[n]+2.
  if value_match then value_match = ConstrainUnpredictableBool();

match = value_match && state_match && enabled;

return match;

```

aarch64/debug/breakpoint/AArch64.BreakpointValueMatch

```

// AArch64.BreakpointValueMatch()
// =====

boolean AArch64.BreakpointValueMatch(integer n, bits(64) vaddress, boolean linked_to)

  // "n" is the identity of the breakpoint unit to match against
  // "vaddress" is the current instruction address, ignored if linked_to is TRUE and for Context
  // matching breakpoints.
  // "linked_to" is TRUE if this is a call from StateMatch for linking.

  // If a non-existent breakpoint then it is CONSTRAINED UNPREDICTABLE whether this gives
  // no match or the breakpoint is mapped to another UNKNOWN implemented breakpoint.
  if n > UInt(ID_AA64DFR0_EL1.BRPs) then
    (c, n) = ConstrainUnpredictableInteger(0, UInt(ID_AA64DFR0_EL1.BRPs));
    assert c IN {Constraint_DISABLED, Constraint_UNKNOWN};
    if c == Constraint_DISABLED then return FALSE;

  // If this breakpoint is not enabled, it cannot generate a match. (This could also happen on a
  // call from StateMatch for linking.)
  if DBGBCR_EL1[n].E == '0' then return FALSE;

  context_aware = (n >= UInt(ID_AA64DFR0_EL1.BRPs) - UInt(ID_AA64DFR0_EL1.CTX_CMPs));

  // If BT is set to a reserved type, behaves either as disabled or as a not-reserved type.
  type = DBGBCR_EL1[n].BT;

  if ((type IN {'011x', '11xx'}) && !HaveVirtHostExt()) || // Context matching
      type == '010x' || // Reserved
      (type != '0x0x' && !context_aware) || // Context matching
      (type == '1xxx' && !HaveEL(EL2))) then // EL2 extension
    (c, type) = ConstrainUnpredictableBits();
    assert c IN {Constraint_DISABLED, Constraint_UNKNOWN};
    if c == Constraint_DISABLED then return FALSE;
    // Otherwise the value returned by ConstrainUnpredictableBits must be a not-reserved value

  // Determine what to compare against.
  match_addr = (type == '0x0x');
  match_vmid = (type == '10xx');
  match_cid = (type == '001x');
  match_cid1 = (type IN {'101x', 'x11x'});
  match_cid2 = (type == '11xx');

```

```

linked    = (type == 'xxx1');

// If this is a call from StateMatch, return FALSE if the breakpoint is not programmed for a
// VMID and/or context ID match, of if not context-aware. The above assertions mean that the
// code can just test for match_addr == TRUE to confirm all these things.
if linked_to && (!linked || match_addr) then return FALSE;

// If called from BreakpointMatch return FALSE for Linked context ID and/or VMID matches.
if !linked_to && linked && !match_addr then return FALSE;

// Do the comparison.
if match_addr then
  byte = UInt(vaddress<1:0>);
  if HaveAnyAArch32() then
    // T32 instructions can be executed at EL0 in an AArch64 translation regime.
    assert byte IN {0,2}; // "vaddress" is halfword aligned.
    byte_select_match = (DBGBCR_EL1[n].BAS<byte> == '1');
  else
    assert byte == 0; // "vaddress" is word aligned
    byte_select_match = TRUE; // DBGBCR_EL1[n].BAS<byte> is RES1
  top = AddrTop(vaddress, PSTATE.EL);
  BVR_match = vaddress<top:2> == DBGGBR_EL1[n]<top:2> && byte_select_match;
elseif match_cid then
  if IsInHost() then
    BVR_match = (CONTEXTIDR_EL2 == DBGGBR_EL1[n]<31:0>);
  else
    BVR_match = (PSTATE.EL IN {EL0,EL1} && CONTEXTIDR_EL1 == DBGGBR_EL1[n]<31:0>);
elseif match_cid1 then
  BVR_match = (PSTATE.EL IN {EL0,EL1} && !IsInHost() && CONTEXTIDR_EL1 == DBGGBR_EL1[n]<31:0>);
if match_vmid then
  if !Have16bitVMID() || VTCR_EL2.VS == '0' then
    vmid = ZeroExtend(VTTBR_EL2.VMID<7:0>, 16);
    bvr_vmid = ZeroExtend(DBGGBR_EL1[n]<39:32>, 16);
  else
    vmid = VTTBR_EL2.VMID;
    bvr_vmid = DBGGBR_EL1[n]<47:32>;
  BXVR_match = (HaveEL(EL2) && !IsSecure() && PSTATE.EL IN {EL0,EL1} &&
    !IsInHost() &&
    vmid == bvr_vmid);
elseif match_cid2 then
  BXVR_match = (!IsSecure() && HaveVirtHostExt() &&
    DBGGBR_EL1[n]<63:32> == CONTEXTIDR_EL2);

bvr_match_valid = (match_addr || match_cid || match_cid1);
bxvr_match_valid = (match_vmid || match_cid2);

match = (!bxvr_match_valid || BXVR_match) && (!bvr_match_valid || BVR_match);

return match;

```

aarch64/debug/breakpoint/AArch64.StateMatch

```

// AArch64.StateMatch()
// =====
// Determine whether a breakpoint or watchpoint is enabled in the current mode and state.

boolean AArch64.StateMatch(bits(2) SSC, bit HMC, bits(2) PxC, boolean linked, bits(4) LBN,
  boolean isbreakpt, boolean ispriv)
// "SSC", "HMC", "PxC" are the control fields from the DBGBCR[n] or DBGWCR[n] register.
// "linked" is TRUE if this is a linked breakpoint/watchpoint type.
// "LBN" is the linked breakpoint number from the DBGBCR[n] or DBGWCR[n] register.
// "isbreakpt" is TRUE for breakpoints, FALSE for watchpoints.
// "ispriv" is valid for watchpoints, and selects between privileged and unprivileged accesses.

// If parameters are set to a reserved type, behaves as either disabled or a defined type
if ((HMC:SSC:PxC) IN {'011xx', '100x0', '101x0', '11010', '11101', '1111x'}) || // Reserved
  (HMC == '0' && PxC == '00' && (!isbreakpt || !HaveAArch32EL(EL1))) || // Usr/Svc/Sys

```

```

(SSC IN {'01','10'} && !HaveEL(EL3)) || // No EL3
(HMC:SSC != '000' && HMC:SSC != '111' && !HaveEL(EL3) && !HaveEL(EL2)) || // No EL3/EL2
(HMC:SSC:PxC == '11100' && !HaveEL(EL2))) then // No EL2
(c, <HMC,SSC,PxC>) = ConstrainUnpredictableBits();
assert c IN {Constraint_DISABLED, Constraint_UNKNOWN};
if c == Constraint_DISABLED then return FALSE;
// Otherwise the value returned by ConstrainUnpredictableBits must be a not-reserved value

EL3_match = HaveEL(EL3) && HMC == '1' && SSC<0> == '0';
EL2_match = HaveEL(EL2) && HMC == '1';
EL1_match = PxC<0> == '1';
EL0_match = PxC<1> == '1';

case PSTATE.EL of
when EL3 priv_match = EL3_match;
when EL2 priv_match = EL2_match;
when EL1 priv_match = if ispriv || isbreakpnt then EL1_match else EL0_match;
when EL0 priv_match = EL0_match;

case SSC of
when '00' security_state_match = TRUE; // Both
when '01' security_state_match = !IsSecure(); // Non-secure only
when '10' security_state_match = IsSecure(); // Secure only
when '11' security_state_match = TRUE; // Both

if linked then
// "LBN" must be an enabled context-aware breakpoint unit. If it is not context-aware then
// it is CONSTRAINED UNPREDICTABLE whether this gives no match, or LBN is mapped to some
// UNKNOWN breakpoint that is context-aware.
lbn = UInt(LBN);
first_ctx_cmp = (UInt(ID_AA64DFR0_EL1.BRPs) - UInt(ID_AA64DFR0_EL1.CTX_CMPs));
last_ctx_cmp = UInt(ID_AA64DFR0_EL1.BRPs);
if (lbn < first_ctx_cmp || lbn > last_ctx_cmp) then
(c, lbn) = ConstrainUnpredictableInteger(first_ctx_cmp, last_ctx_cmp);
assert c IN {Constraint_DISABLED, Constraint_NONE, Constraint_UNKNOWN};
case c of
when Constraint_DISABLED return FALSE; // Disabled
when Constraint_NONE linked = FALSE; // No linking
// Otherwise ConstrainUnpredictableInteger returned a context-aware breakpoint

if linked then
vaddress = bits(64) UNKNOWN;
linked_to = TRUE;
linked_match = AArch64.BreakpointValueMatch(lbn, vaddress, linked_to);

return priv_match && security_state_match && (!linked || linked_match);

```

aarch64/debug/enables/AArch64.GenerateDebugExceptions

```

// AArch64.GenerateDebugExceptions()
// =====

boolean AArch64.GenerateDebugExceptions()
return AArch64.GenerateDebugExceptionsFrom(PSTATE.EL, IsSecure(), PSTATE.D);

```

aarch64/debug/enables/AArch64.GenerateDebugExceptionsFrom

```

// AArch64.GenerateDebugExceptionsFrom()
// =====

boolean AArch64.GenerateDebugExceptionsFrom(bits(2) from, boolean secure, bit mask)

if OSLSR_EL1.OSLK == '1' || DoubleLockStatus() || Halted() then
return FALSE;

route_to_el2 = HaveEL(EL2) && !secure && (HCR_EL2.TGE == '1' || MDCR_EL2.TDE == '1');

```

```
target = (if route_to_el2 then EL2 else EL1);

enabled = !HaveEL(EL3) || !secure || MDCR_EL3.SDD == '0';

if from == target then
    enabled = enabled && MDSCR_EL1.KDE == '1' && mask == '0';
else
    enabled = enabled && UInt(target) > UInt(from);

return enabled;
```

aarch64/debug/pmu/AArch64.CheckForPMUOverflow

```
// AArch64.CheckForPMUoverflow()
// =====
// Signal Performance Monitors overflow IRQ and CTI overflow events

boolean AArch64.CheckForPMUoverflow()

    pmuirq = (PMCR_EL0.E == '1' && PMINTENSET_EL1<31> == '1' && PMOVSSET_EL0<31> == '1');
    for n = 0 to UInt(PMCR_EL0.N) - 1
        if HaveEL(EL2) then
            E = (if n < UInt(MDCR_EL2.HPMN) then PMCR_EL0.E else MDCR_EL2.HPME);
        else
            E = PMCR_EL0.E;
        if E == '1' && PMINTENSET_EL1<n> == '1' && PMOVSSET_EL0<n> == '1' then pmuirq = TRUE;

    SetInterruptRequestLevel(InterruptID_PMUIRQ, if pmuirq then HIGH else LOW);

    CTI_SetEventLevel(CrossTriggerIn_PMUoverflow, if pmuirq then HIGH else LOW);

    // The request remains set until the condition is cleared. (For example, an interrupt handler
    // or cross-triggered event handler clears the overflow status flag by writing to PMOVSLR_EL0.)

    return pmuirq;
```

aarch64/debug/pmu/AArch64.CountEvents

```
// AArch64.CountEvents()
// =====
// Return TRUE if counter "n" should count its event. For the cycle counter, n == 31.

boolean AArch64.CountEvents(integer n)
    assert (n == 31 || n < UInt(PMCR_EL0.N));

    // Event counting is disabled in Debug state
    debug = Halted();

    // In Non-secure state, some counters are reserved for EL2
    if HaveEL(EL2) then
        E = (if n < UInt(MDCR_EL2.HPMN) || n == 31 then PMCR_EL0.E else MDCR_EL2.HPME);
    else
        E = PMCR_EL0.E;
    enabled = (E == '1' && PMCNTENSET_EL0<n> == '1');

    if !IsSecure() then
        // Event counting in Non-secure state is allowed unless all of:
        // * EL2 and the HPMD Extension are implemented
        // * Executing at EL2
        // * PMNx is not reserved for EL2
        // * MDCR_EL2.HPMD == 1
        if HaveHPMDExt() && PSTATE.EL == EL2 && (n < UInt(MDCR_EL2.HPMN) || n == 31) then
            prohibited = (MDCR_EL2.HPMD == '1');
        else
            prohibited = FALSE;
    else
```

```

    // Event counting in Secure state is prohibited unless any one of:
    // * EL3 is not implemented
    // * EL3 is using AArch64 and MDCR_EL3.SPME == 1
    prohibited = (HaveEL(EL3) && MDCR_EL3.SPME == '0');

    // The IMPLEMENTATION DEFINED authentication interface might override software controls
    if ExternalSecureNoninvasiveDebugEnabled() then prohibited = FALSE;

    // For the cycle counter, PMCR_EL0.DP enables counting when otherwise prohibited
    if prohibited && n == 31 then prohibited = (PMCR_EL0.DP == '1');

    // Event counting can be filtered by the {P, U, NSK, NSU, NSH, M} bits
    filter = (if n == 31 then PMCCFILTR else PMEVTYPER[n]);

    P = filter<31>;
    U = filter<30>;
    NSK = (if HaveEL(EL3) then filter<29> else '0');
    NSU = (if HaveEL(EL3) then filter<28> else '0');
    NSH = (if HaveEL(EL2) then filter<27> else '0');
    M = (if HaveEL(EL3) then filter<26> else '0');

    case PSTATE.EL of
      when EL0 filtered = (if IsSecure() then U == '1' else U != NSU);
      when EL1 filtered = (if IsSecure() then P == '1' else P != NSK);
      when EL2 filtered = (NSH == '0');
      when EL3 filtered = (M != P);

    return !debug && enabled && !prohibited && !filtered;
  
```

aarch64/debug/statisticalprofiling/CheckProfilingBufferAccess

```

  // CheckProfilingBufferAccess()
  // =====

  SysRegAccess CheckProfilingBufferAccess()
    if !HaveStatisticalProfiling() || PSTATE.EL == EL0 || UsingAArch32() then
      return SysRegAccess_UNDEFINED;

    if HaveEL(EL2) && !IsSecure() && PSTATE.EL == EL1 && MDCR_EL2.E2PB<0> != '1' then
      return SysRegAccess_TrapToEL2;

    if HaveEL(EL3) && PSTATE.EL != EL3 && MDCR_EL3.NSPB != SCR_EL3.NS:'1' then
      return SysRegAccess_TrapToEL3;

    return SysRegAccess_OK;
  
```

aarch64/debug/statisticalprofiling/CheckStatisticalProfilingAccess

```

  // CheckStatisticalProfilingAccess()
  // =====

  SysRegAccess CheckStatisticalProfilingAccess()
    if !HaveStatisticalProfiling() || PSTATE.EL == EL0 || UsingAArch32() then
      return SysRegAccess_UNDEFINED;

    if HaveEL(EL2) && !IsSecure() && PSTATE.EL == EL1 && MDCR_EL2.TPMS == '1' then
      return SysRegAccess_TrapToEL2;

    if HaveEL(EL3) && PSTATE.EL != EL3 && MDCR_EL3.NSPB != SCR_EL3.NS:'1' then
      return SysRegAccess_TrapToEL3;

    return SysRegAccess_OK;
  
```

aarch64/debug/statisticalprofiling/CollectContextIDR1

```
// CollectContextIDR1()
// =====

boolean CollectContextIDR1()
    if !StatisticalProfilingEnabled() then return FALSE;
    if PSTATE.EL == EL2 then return FALSE;
    if HaveEL(EL2) && !IsSecure() && HCR_EL2.TGE == '1' then return FALSE;
    return PMSCR_EL1.CX == '1';
```

aarch64/debug/statisticalprofiling/CollectContextIDR2

```
enumeration TimeStamp { TimeStamp_None,
                        TimeStamp_Virtual,
                        TimeStamp_Physical };

// CollectContextIDR2()
// =====

boolean CollectContextIDR2()
    if !StatisticalProfilingEnabled() then return FALSE;
    if !HaveEL(EL2) || IsSecure() then return FALSE;
    return PMSCR_EL2.CX == '1';
```

aarch64/debug/statisticalprofiling/CollectPhysicalAddress

```
// CollectPhysicalAddress()
// =====

boolean CollectPhysicalAddress()
    if !StatisticalProfilingEnabled() then return FALSE;
    (secure, e1) = ProfilingBufferOwner();
    if !secure && HaveEL(EL2) then
        return PMSCR_EL2.PA == '1' && (e1 == EL2 || PMSCR_EL1.PA == '1');
    else
        return PMSCR_EL1.PA == '1';
```

aarch64/debug/statisticalprofiling/CollectRecord

```
// CollectRecord()
// =====

boolean CollectRecord(bits(64) events, integer total_latency, OpType optype)
    assert StatisticalProfilingEnabled();
    if PMSFPCR_EL1.FE == '1' then
        e = events<63:48,31:24,15:12,7,5,3,1>;
        m = PMSEVFR_EL1<63:48,31:24,15:12,7,5,3,1>;
        // Check for UNPREDICTABLE case
        if IsZero(PMSEVFR_EL1) && ConstrainUnpredictableBool() then return FALSE;
        if !IsZero(NOT(e) AND m) then return FALSE;
    if PMSFPCR_EL1.FT == '1' then
        // Check for UNPREDICTABLE case
        if IsZero(PMSFPCR_EL1.<B,LD,ST>) && ConstrainUnpredictableBool() then
            return FALSE;
        case optype of
            when OpType_Branch if PMSFPCR_EL1.B == '0' then return FALSE;
            when OpType_Load   if PMSFPCR_EL1.LD == '0' then return FALSE;
            when OpType_Store   if PMSFPCR_EL1.ST == '0' then return FALSE;
            otherwise          return FALSE;
    if PMSFPCR_EL1.FL == '1' then
        if IsZero(PMSLATFR_EL1.MINLAT) && ConstrainUnpredictableBool() then // UNPREDICTABLE case
            return FALSE;
        if total_latency < UInt(PMSLATFR_EL1.MINLAT) then return FALSE;
    return TRUE;
```

aarch64/debug/statisticalprofiling/CollectTimeStamp

```
// CollectTimeStamp()
// =====

TimeStamp CollectTimeStamp()
  if !StatisticalProfilingEnabled() then return TimeStamp_None;
  (secure, e1) = ProfilingBufferOwner();
  if e1 == EL2 then
    if PMSCR_EL2.TS == '0' then return TimeStamp_None;
  else
    if PMSCR_EL1.TS == '0' then return TimeStamp_None;
  if !secure && HaveEL(EL2) then
    pct = PMSCR_EL2.PCT == '1' && (e1 == EL2 || PMSCR_EL1.PCT == '1');
  else
    pct = PMSCR_EL1.PCT == '1';
  return (if pct then TimeStamp_Physical else TimeStamp_Virtual);
```

aarch64/debug/statisticalprofiling/OpType

```
enumeration OpType { OpType_Other, OpType_Load, OpType_Store, OpType_Branch };
```

aarch64/debug/statisticalprofiling/ProfilingBufferEnabled

```
// ProfilingBufferEnabled()
// =====

boolean ProfilingBufferEnabled()
  if !HaveStatisticalProfiling() then return FALSE;
  (secure, e1) = ProfilingBufferOwner();
  non_secure_bit = if secure then '0' else '1';
  return (!ELUsingAArch32(e1) && non_secure_bit == SCR_EL3.NS &&
    PMBLIMITR_EL1.E == '1' && PMBSR_EL1.S == '0');
```

aarch64/debug/statisticalprofiling/ProfilingBufferOwner

```
// ProfilingBufferOwner()
// =====

(boolean, bits(2)) ProfilingBufferOwner()
  secure = if HaveEL(EL3) then (MDCR_EL3.NSPB<1> == '0') else IsSecure();
  e1 = if !secure && HaveEL(EL2) && MDCR_EL2.E2PB == '00' then EL2 else EL1;
  return (secure, e1);
```

aarch64/debug/statisticalprofiling/ProfilingSynchronizationBarrier

```
// Barrier to ensure that all existing profiling data has been formatted, and profiling buffer
// addresses have been translated such that writes to the profiling buffer have been initiated.
// A following DSB completes when writes to the profiling buffer have completed.
ProfilingSynchronizationBarrier();
```

aarch64/debug/statisticalprofiling/StatisticalProfilingEnabled

```
// StatisticalProfilingEnabled()
// =====

boolean StatisticalProfilingEnabled()
  if !HaveStatisticalProfiling() || UsingAArch32() || !ProfilingBufferEnabled() then
    return FALSE;

  in_host = !IsSecure() && HaveEL(EL2) && HCR_EL2.TGE == '1';
  (secure, e1) = ProfilingBufferOwner();
  if UInt(e1) < UInt(PSTATE.EL) || secure != IsSecure() || (in_host && e1 == EL1) then
    return FALSE;
```

```

case PSTATE.EL of
  when EL3 Unreachable();
  when EL2 spe_bit = PMSCR_EL2.E2SPE;
  when EL1 spe_bit = PMSCR_EL1.E1SPE;
  when EL0 spe_bit = (if in_host then PMSCR_EL2.E0HSPE else PMSCR_EL1.E0SPE);

return spe_bit == '1';

```

aarch64/debug/statisticalprofiling/SysRegAccess

```

enumeration SysRegAccess { SysRegAccess_OK,
                           SysRegAccess_UNDEFINED,
                           SysRegAccess_TrapToEL1,
                           SysRegAccess_TrapToEL2,
                           SysRegAccess_TrapToEL3 };

```

aarch64/debug/takeexceptiondbg/AArch64.TakeExceptionInDebugState

```

// AArch64.TakeExceptionInDebugState()
// =====
// Take an exception in Debug state to an Exception Level using AArch64.

AArch64.TakeExceptionInDebugState(bits(2) target_el, ExceptionRecord exception)
  assert HaveEL(target_el) && !ELUsingAArch32(target_el) && UInt(target_el) >= UInt(PSTATE.EL);

  // If coming from AArch32 state, the top parts of the X[] registers might be set to zero
  from_32 = UsingAArch32();
  if from_32 then AArch64.MaybeZeroRegisterUppers();

  AArch64.ReportException(exception, target_el);

  PSTATE.EL = target_el; PSTATE.nRW = '0'; PSTATE.SP = '1';

  SPSR[] = bits(32) UNKNOWN;
  ELR[] = bits(64) UNKNOWN;

  // PSTATE.{SS,D,A,I,F} are not observable and ignored in Debug state, so behave as if UNKNOWN.
  PSTATE.<SS,D,A,I,F> = bits(5) UNKNOWN;
  DLR_EL0 = bits(64) UNKNOWN;
  DSPSR_EL0 = bits(32) UNKNOWN;
  PSTATE.IL = '0';
  if from_32 then // Coming from AArch32
    PSTATE.IT = '00000000'; PSTATE.T = '0'; // PSTATE.J is RES0
  if HavePANExt() && (PSTATE.EL == EL1 || (PSTATE.EL == EL2 && ELIsInHost(EL0))) && SCTLR[].SPAN ==
'0' then
    PSTATE.PAN = '1';

  EDSCR.ERR = '1';
  UpdateEDSCRFields(); // Update EDSCR processor state flags.

  // SCTLR[].IESB might be ignored in Debug state.
  if HaveRASExt() && SCTLR[].IESB == '1' && ConstrainUnpredictableBool() then
    ErrorSynchronizationBarrier(MBReqDomain_FullSystem, MBReqTypes_All);

  EndOfInstruction();

```

aarch64/debug/watchpoint/AArch64.WatchpointByteMatch

```

// AArch64.WatchpointByteMatch()
// =====

boolean AArch64.WatchpointByteMatch(integer n, bits(64) vaddress)

  top = AddrTop(vaddress, PSTATE.EL);
  bottom = if DBGWVR_EL1[n]<2> == '1' then 2 else 3; // Word or doubleword

```

```

byte_select_match = (DBGWCR_EL1[n].BAS<UInt(vaddress<bottom-1:0>)> != '0');
mask = UInt(DBGWCR_EL1[n].MASK);

// If DBGWCR_EL1[n].MASK is non-zero value and DBGWCR_EL1[n].BAS is not set to '11111111', or
// DBGWCR_EL1[n].BAS specifies a non-contiguous set of bytes behavior is CONSTRAINED
// UNPREDICTABLE.
if mask > 0 && !IsOnes(DBGWCR_EL1[n].BAS) then
  byte_select_match = ConstrainUnpredictableBool();
else
  LSB = (DBGWCR_EL1[n].BAS AND NOT(DBGWCR_EL1[n].BAS - 1)); MSB = (DBGWCR_EL1[n].BAS + LSB);
  if !IsZero(MSB AND (MSB - 1)) then // Not contiguous
    byte_select_match = ConstrainUnpredictableBool();
    bottom = 3; // For the whole doubleword

// If the address mask is set to a reserved value, the behavior is CONSTRAINED UNPREDICTABLE.
if mask > 0 && mask <= 2 then
  (c, mask) = ConstrainUnpredictableInteger(3, 31);
  assert c IN {Constraint_DISABLED, Constraint_NONE, Constraint_UNKNOWN};
  case c of
    when Constraint_DISABLED return FALSE; // Disabled
    when Constraint_NONE mask = 0; // No masking
    // Otherwise the value returned by ConstrainUnpredictableInteger is a not-reserved value

if mask > bottom then
  WVR_match = (vaddress<top:mask> == DBGWVR_EL1[n]<top:mask>);
  // If masked bits of DBGWVR_EL1[n] are not zero, the behavior is CONSTRAINED UNPREDICTABLE.
  if WVR_match && !IsZero(DBGWVR_EL1[n]<mask-1:bottom>) then
    WVR_match = ConstrainUnpredictableBool();
else
  WVR_match = vaddress<top:bottom> == DBGWVR_EL1[n]<top:bottom>;

return WVR_match && byte_select_match;

```

aarch64/debug/watchpoint/AArch64.WatchpointMatch

```

// AArch64.WatchpointMatch()
// =====
// Watchpoint matching in an AArch64 translation regime.

boolean AArch64.WatchpointMatch(integer n, bits(64) vaddress, integer size, boolean ispriv,
                                boolean iswrite)
assert !ELUsingAArch32(S1TranslationRegime());
assert n <= UInt(ID_AA64DFR0_EL1.WRPs);

// "ispriv" is FALSE for LDTR/STTR instructions executed at EL1 and all
// load/stores at EL0, TRUE for all other load/stores. "iswrite" is TRUE for stores, FALSE for
// loads.
enabled = DBGWCR_EL1[n].E == '1';
linked = DBGWCR_EL1[n].WT == '1';
isbreakpnt = FALSE;

state_match = AArch64.StateMatch(DBGWCR_EL1[n].SSC, DBGWCR_EL1[n].HMC, DBGWCR_EL1[n].PAC,
                                linked, DBGWCR_EL1[n].LBN, isbreakpnt, ispriv);

ls_match = (DBGWCR_EL1[n].LSC<(if iswrite then 1 else 0)> == '1');

value_match = FALSE;
for byte = 0 to size - 1
  value_match = value_match || AArch64.WatchpointByteMatch(n, vaddress + byte);

return value_match && state_match && ls_match && enabled;

```

J1.1.2 aarch64/exceptions

This section includes the following pseudocode functions:

- [aarch64/exceptions/aborts/AArch64.Abort](#) on page J1-5870.

- [aarch64/exceptions/aborts/AArch64.AbortSyndrome](#) on page J1-5871.
- [aarch64/exceptions/aborts/AArch64.CheckPCAlignment](#) on page J1-5871.
- [aarch64/exceptions/aborts/AArch64.DataAbort](#) on page J1-5871.
- [aarch64/exceptions/aborts/AArch64.InstructionAbort](#) on page J1-5872.
- [aarch64/exceptions/aborts/AArch64.PCAlignmentFault](#) on page J1-5872.
- [aarch64/exceptions/aborts/AArch64.SPAlignmentFault](#) on page J1-5872.
- [aarch64/exceptions/asynch/AArch64.TakePhysicalFIQException](#) on page J1-5873.
- [aarch64/exceptions/asynch/AArch64.TakePhysicalIRQException](#) on page J1-5873.
- [aarch64/exceptions/asynch/AArch64.TakePhysicalSErrorException](#) on page J1-5873.
- [aarch64/exceptions/asynch/AArch64.TakeVirtualFIQException](#) on page J1-5874.
- [aarch64/exceptions/asynch/AArch64.TakeVirtualIRQException](#) on page J1-5874.
- [aarch64/exceptions/asynch/AArch64.TakeVirtualSErrorException](#) on page J1-5874.
- [aarch64/exceptions/debug/AArch64.BreakpointException](#) on page J1-5875.
- [aarch64/exceptions/debug/AArch64.SoftwareBreakpoint](#) on page J1-5875.
- [aarch64/exceptions/debug/AArch64.SoftwareStepException](#) on page J1-5875.
- [aarch64/exceptions/debug/AArch64.VectorCatchException](#) on page J1-5876.
- [aarch64/exceptions/debug/AArch64.WatchpointException](#) on page J1-5876.
- [aarch64/exceptions/exceptions/AArch64.ExceptionClass](#) on page J1-5876.
- [aarch64/exceptions/exceptions/AArch64.ReportException](#) on page J1-5877.
- [aarch64/exceptions/exceptions/AArch64.ResetControlRegisters](#) on page J1-5877.
- [aarch64/exceptions/exceptions/AArch64.TakeReset](#) on page J1-5878.
- [aarch64/exceptions/ieeefp/AArch64.FPTrappedException](#) on page J1-5878.
- [aarch64/exceptions/syscalls/AArch64.CallHypervisor](#) on page J1-5879.
- [aarch64/exceptions/syscalls/AArch64.CallSecureMonitor](#) on page J1-5879.
- [aarch64/exceptions/syscalls/AArch64.CallSupervisor](#) on page J1-5879.
- [aarch64/exceptions/takeexception/AArch64.TakeException](#) on page J1-5880.
- [aarch64/exceptions/traps/AArch64.AArch32SystemAccessTrap](#) on page J1-5881.
- [aarch64/exceptions/traps/AArch64.AArch32SystemAccessTrapSyndrome](#) on page J1-5881.
- [aarch64/exceptions/traps/AArch64.AdvSIMDFPAccessTrap](#) on page J1-5882.
- [aarch64/exceptions/traps/AArch64.CheckAArch32SystemAccess](#) on page J1-5882.
- [aarch64/exceptions/traps/AArch64.CheckAArch32SystemAccessTraps](#) on page J1-5883.
- [aarch64/exceptions/traps/AArch64.CheckCPI5InstrCoarseTraps](#) on page J1-5883.
- [aarch64/exceptions/traps/AArch64.CheckFPAdvSIMDEnabled](#) on page J1-5884.
- [aarch64/exceptions/traps/AArch64.CheckFPAdvSIMDTrap](#) on page J1-5884.
- [aarch64/exceptions/traps/AArch64.CheckForSMCTrap](#) on page J1-5884.
- [aarch64/exceptions/traps/AArch64.CheckForWFXTrap](#) on page J1-5885.
- [aarch64/exceptions/traps/AArch64.CheckIllegalState](#) on page J1-5885.
- [aarch64/exceptions/traps/AArch64.MonitorModeTrap](#) on page J1-5885.
- [aarch64/exceptions/traps/AArch64.SystemRegisterTrap](#) on page J1-5885.
- [aarch64/exceptions/traps/AArch64.UndefinedFault](#) on page J1-5886.
- [aarch64/exceptions/traps/AArch64.WFXTrap](#) on page J1-5886.
- [aarch64/exceptions/traps/CheckFPAdvSIMDEnabled64](#) on page J1-5886.

aarch64/exceptions/aborts/AArch64.Abort

```
// AArch64.Abort()  
// =====  
// Abort and Debug exception handling in an AArch64 translation regime.  
  
AArch64.Abort(bits(64) vaddress, FaultRecord fault)  
  
if IsDebugException(fault) then  
    if fault.acctype == AccType_IFETCH then
```

```

    if UsingAArch32() && fault.debugmoe == DebugException_VectorCatch then
        AArch64.VectorCatchException(fault);
    else
        AArch64.BreakpointException(fault);
    else
        AArch64.WatchpointException(vaddress, fault);
  elseif fault.acctype == AccType_IFETCH then
    AArch64.InstructionAbort(vaddress, fault);
  else
    AArch64.DataAbort(vaddress, fault);

```

aarch64/exceptions/aborts/AArch64.AbortSyndrome

```

// AArch64.AbortSyndrome()
// =====
// Creates an exception syndrome record for Abort and Watchpoint exceptions
// from an AArch64 translation regime.

ExceptionRecord AArch64.AbortSyndrome(Exception type, FaultRecord fault, bits(64) vaddress)

    exception = ExceptionSyndrome(type);

    d_side = type IN {Exception_DataAbort, Exception_Watchpoint};

    exception.syndrome = AArch64.FaultSyndrome(d_side, fault);
    exception.vaddress = ZeroExtend(vaddress);
    if IPValid(fault) then
        exception.ipvalid = TRUE;
        exception.ipaddress = fault.ipaddress;
    else
        exception.ipvalid = FALSE;

    return exception;

```

aarch64/exceptions/aborts/AArch64.CheckPCAlignment

```

// AArch64.CheckPCAlignment()
// =====

AArch64.CheckPCAlignment()

    bits(64) pc = ThisInstrAddr();
    if pc<1:0> != '00' then
        AArch64.PCAlignmentFault();

```

aarch64/exceptions/aborts/AArch64.DataAbort

```

// AArch64.DataAbort()
// =====

AArch64.DataAbort(bits(64) vaddress, FaultRecord fault)
    route_to_e13 = HaveEL(EL3) && SCR_EL3.EA == '1' && IsExternalAbort(fault);
    route_to_e12 = (HaveEL(EL2) && !IsSecure()) && PSTATE.EL IN {EL0,EL1} &&
        (HCR_EL2.TGE == '1' || IsSecondStage(fault) ||
        (HaveRASExt() && HCR_EL2.TEA == '1' && IsExternalAbort(fault)));

    bits(64) preferred_exception_return = ThisInstrAddr();
    vect_offset = 0x0;

    exception = AArch64.AbortSyndrome(Exception_DataAbort, fault, vaddress);

    if PSTATE.EL == EL3 || route_to_e13 then
        AArch64.TakeException(EL3, exception, preferred_exception_return, vect_offset);
    elseif PSTATE.EL == EL2 || route_to_e12 then

```

```
    AArch64.TakeException(EL2, exception, preferred_exception_return, vect_offset);  
else  
    AArch64.TakeException(EL1, exception, preferred_exception_return, vect_offset);
```

aarch64/exceptions/aborts/AArch64.InstructionAbort

```
// AArch64.InstructionAbort()  
// =====  
  
AArch64.InstructionAbort(bits(64) vaddress, FaultRecord fault)  
    route_to_el3 = HaveEL(EL3) && SCR_EL3.EA == '1' && IsExternalAbort(fault);  
    route_to_el2 = (HaveEL(EL2) && !IsSecure() && PSTATE.EL IN {EL0,EL1} &&  
        (HCR_EL2.TGE == '1' || IsSecondStage(fault) ||  
        (HaveRASExt() && HCR_EL2.TEA == '1' && IsExternalAbort(fault))));  
  
bits(64) preferred_exception_return = ThisInstrAddr();  
vect_offset = 0x0;  
  
exception = AArch64.AbortSyndrome(Exception_InstructionAbort, fault, vaddress);  
  
if PSTATE.EL == EL3 || route_to_el3 then  
    AArch64.TakeException(EL3, exception, preferred_exception_return, vect_offset);  
elseif PSTATE.EL == EL2 || route_to_el2 then  
    AArch64.TakeException(EL2, exception, preferred_exception_return, vect_offset);  
else  
    AArch64.TakeException(EL1, exception, preferred_exception_return, vect_offset);
```

aarch64/exceptions/aborts/AArch64.PCAlignmentFault

```
// AArch64.PCAlignmentFault()  
// =====  
// Called on unaligned program counter in AArch64 state.  
  
AArch64.PCAlignmentFault()  
  
bits(64) preferred_exception_return = ThisInstrAddr();  
vect_offset = 0x0;  
  
exception = ExceptionSyndrome(Exception_PCAlignment);  
exception.vaddress = ThisInstrAddr();  
  
if UInt(PSTATE.EL) > UInt(EL1) then  
    AArch64.TakeException(PSTATE.EL, exception, preferred_exception_return, vect_offset);  
elseif HaveEL(EL2) && !IsSecure() && HCR_EL2.TGE == '1' then  
    AArch64.TakeException(EL2, exception, preferred_exception_return, vect_offset);  
else  
    AArch64.TakeException(EL1, exception, preferred_exception_return, vect_offset);
```

aarch64/exceptions/aborts/AArch64.SPAlignmentFault

```
// AArch64.SPAlignmentFault()  
// =====  
// Called on an unaligned stack pointer in AArch64 state.  
  
AArch64.SPAlignmentFault()  
  
bits(64) preferred_exception_return = ThisInstrAddr();  
vect_offset = 0x0;  
  
exception = ExceptionSyndrome(Exception_SPAlignment);  
  
if UInt(PSTATE.EL) > UInt(EL1) then  
    AArch64.TakeException(PSTATE.EL, exception, preferred_exception_return, vect_offset);  
elseif HaveEL(EL2) && !IsSecure() && HCR_EL2.TGE == '1' then
```

```

    AArch64.TakeException(EL2, exception, preferred_exception_return, vect_offset);
  else
    AArch64.TakeException(EL1, exception, preferred_exception_return, vect_offset);

```

aarch64/exceptions/asynch/AArch64.TakePhysicalFIQException

```

// AArch64.TakePhysicalFIQException()
// =====

AArch64.TakePhysicalFIQException()

    route_to_e13 = HaveEL(EL3) && SCR_EL3.FIQ == '1';
    route_to_e12 = (HaveEL(EL2) && !IsSecure() && PSTATE.EL IN {EL0,EL1} &&
        (HCR_EL2.TGE == '1' || HCR_EL2.FMO == '1'));
    bits(64) preferred_exception_return = ThisInstrAddr();
    vect_offset = 0x100;
    exception = ExceptionSyndrome(Exception_FIQ);

    if route_to_e13 then
        AArch64.TakeException(EL3, exception, preferred_exception_return, vect_offset);
    elseif PSTATE.EL == EL2 || route_to_e12 then
        assert PSTATE.EL != EL3;
        AArch64.TakeException(EL2, exception, preferred_exception_return, vect_offset);
    else
        assert PSTATE.EL IN {EL0,EL1};
        AArch64.TakeException(EL1, exception, preferred_exception_return, vect_offset);

```

aarch64/exceptions/asynch/AArch64.TakePhysicalIRQException

```

// AArch64.TakePhysicalIRQException()
// =====
// Take an enabled physical IRQ exception.

AArch64.TakePhysicalIRQException()

    route_to_e13 = HaveEL(EL3) && SCR_EL3.IRQ == '1';
    route_to_e12 = (HaveEL(EL2) && !IsSecure() && PSTATE.EL IN {EL0,EL1} &&
        (HCR_EL2.TGE == '1' || HCR_EL2.IMO == '1'));
    bits(64) preferred_exception_return = ThisInstrAddr();
    vect_offset = 0x80;

    exception = ExceptionSyndrome(Exception_IRQ);

    if route_to_e13 then
        AArch64.TakeException(EL3, exception, preferred_exception_return, vect_offset);
    elseif PSTATE.EL == EL2 || route_to_e12 then
        assert PSTATE.EL != EL3;
        AArch64.TakeException(EL2, exception, preferred_exception_return, vect_offset);
    else
        assert PSTATE.EL IN {EL0,EL1};
        AArch64.TakeException(EL1, exception, preferred_exception_return, vect_offset);

```

aarch64/exceptions/asynch/AArch64.TakePhysicalSErrorException

```

// AArch64.TakePhysicalSErrorException()
// =====

AArch64.TakePhysicalSErrorException(boolean impdef_syndrome, bits(24) syndrome)

    route_to_e13 = HaveEL(EL3) && SCR_EL3.EA == '1';
    route_to_e12 = (HaveEL(EL2) && !IsSecure() && PSTATE.EL IN {EL0,EL1} &&
        (HCR_EL2.TGE == '1' || (!IsInHost() && HCR_EL2.AMO == '1')));
    bits(64) preferred_exception_return = ThisInstrAddr();
    vect_offset = 0x180;

    exception = ExceptionSyndrome(Exception_SError);

```

```
exception.syndrome<24> = if impdef_syndrome then '1' else '0';  
exception.syndrome<23:0> = syndrome;  
  
ClearPendingPhysicalSError();  
  
if PSTATE.EL == EL3 || route_to_el3 then  
    AArch64.TakeException(EL3, exception, preferred_exception_return, vect_offset);  
elseif PSTATE.EL == EL2 || route_to_el2 then  
    AArch64.TakeException(EL2, exception, preferred_exception_return, vect_offset);  
else  
    AArch64.TakeException(EL1, exception, preferred_exception_return, vect_offset);
```

aarch64/exceptions/asynch/AArch64.TakeVirtualFIQException

```
// AArch64.TakeVirtualFIQException()  
// =====  
  
AArch64.TakeVirtualFIQException()  
    assert HaveEL(EL2) && !IsSecure() && PSTATE.EL IN {EL0,EL1};  
    assert HCR_EL2.TGE == '0' && HCR_EL2.FMO == '1'; // Virtual IRQ enabled if TGE==0 and FMO==1  
  
    bits(64) preferred_exception_return = ThisInstrAddr();  
    vect_offset = 0x100;  
  
    exception = ExceptionSyndrome(Exception_FIQ);  
  
    AArch64.TakeException(EL1, exception, preferred_exception_return, vect_offset);
```

aarch64/exceptions/asynch/AArch64.TakeVirtualIRQException

```
// AArch64.TakeVirtualIRQException()  
// =====  
  
AArch64.TakeVirtualIRQException()  
    assert HaveEL(EL2) && !IsSecure() && PSTATE.EL IN {EL0,EL1};  
    assert HCR_EL2.TGE == '0' && HCR_EL2.IMO == '1'; // Virtual IRQ enabled if TGE==0 and IMO==1  
  
    bits(64) preferred_exception_return = ThisInstrAddr();  
    vect_offset = 0x80;  
  
    exception = ExceptionSyndrome(Exception_IRQ);  
  
    AArch64.TakeException(EL1, exception, preferred_exception_return, vect_offset);
```

aarch64/exceptions/asynch/AArch64.TakeVirtualSErrorException

```
// AArch64.TakeVirtualSErrorException()  
// =====  
  
AArch64.TakeVirtualSErrorException(boolean impdef_syndrome, bits(24) syndrome)  
  
    assert HaveEL(EL2) && !IsSecure() && PSTATE.EL IN {EL0,EL1};  
    assert HCR_EL2.TGE == '0' && HCR_EL2.AMO == '1'; // Virtual SError enabled if TGE==0 and AMO==1  
  
    bits(64) preferred_exception_return = ThisInstrAddr();  
    vect_offset = 0x180;  
  
    exception = ExceptionSyndrome(Exception_SError);  
    exception.syndrome<24> = if impdef_syndrome then '1' else '0';  
    exception.syndrome<23:0> = syndrome;  
  
    HCR_EL2.VSE = '0';  
    AArch64.TakeException(EL1, exception, preferred_exception_return, vect_offset);
```

aarch64/exceptions/debug/AArch64.BreakpointException

```
// AArch64.BreakpointException()
// =====

AArch64.BreakpointException(FaultRecord fault)
  assert PSTATE.EL != EL3;

  route_to_el2 = (HaveEL(EL2) && !IsSecure() && PSTATE.EL IN {EL0,EL1} &&
    (HCR_EL2.TGE == '1' || MDCR_EL2.TDE == '1'));

  bits(64) preferred_exception_return = ThisInstrAddr();
  vect_offset = 0x0;

  vaddress = bits(64) UNKNOWN;
  exception = AArch64.AbortSyndrome(Exception_Breakpoint, fault, vaddress);

  if PSTATE.EL == EL2 || route_to_el2 then
    AArch64.TakeException(EL2, exception, preferred_exception_return, vect_offset);
  else
    AArch64.TakeException(EL1, exception, preferred_exception_return, vect_offset);
```

aarch64/exceptions/debug/AArch64.SoftwareBreakpoint

```
// AArch64.SoftwareBreakpoint()
// =====

AArch64.SoftwareBreakpoint(bits(16) immediate)

  route_to_el2 = (HaveEL(EL2) && !IsSecure() && PSTATE.EL IN {EL0,EL1} &&
    (HCR_EL2.TGE == '1' || MDCR_EL2.TDE == '1'));

  bits(64) preferred_exception_return = ThisInstrAddr();
  vect_offset = 0x0;

  exception = ExceptionSyndrome(Exception_SoftwareBreakpoint);
  exception.syndrome<15:0> = immediate;

  if UInt(PSTATE.EL) > UInt(EL1) then
    AArch64.TakeException(PSTATE.EL, exception, preferred_exception_return, vect_offset);
  elseif route_to_el2 then
    AArch64.TakeException(EL2, exception, preferred_exception_return, vect_offset);
  else
    AArch64.TakeException(EL1, exception, preferred_exception_return, vect_offset);
```

aarch64/exceptions/debug/AArch64.SoftwareStepException

```
// AArch64.SoftwareStepException()
// =====

AArch64.SoftwareStepException()
  assert PSTATE.EL != EL3;

  route_to_el2 = (HaveEL(EL2) && !IsSecure() && PSTATE.EL IN {EL0,EL1} &&
    (HCR_EL2.TGE == '1' || MDCR_EL2.TDE == '1'));

  bits(64) preferred_exception_return = ThisInstrAddr();
  vect_offset = 0x0;

  exception = ExceptionSyndrome(Exception_SoftwareStep);
  if SoftwareStep_DidNotStep() then
    exception.syndrome<24> = '0';
  else
    exception.syndrome<24> = '1';
    exception.syndrome<6> = if SoftwareStep_SteppedEX() then '1' else '0';
```

```
if PSTATE.EL == EL2 || route_to_el2 then
    AArch64.TakeException(EL2, exception, preferred_exception_return, vect_offset);
else
    AArch64.TakeException(EL1, exception, preferred_exception_return, vect_offset);
```

aarch64/exceptions/debug/AArch64.VectorCatchException

```
// AArch64.VectorCatchException()
// =====
// Vector Catch taken from EL0 or EL1 to EL2. This can only be called when debug exceptions are
// being routed to EL2, as Vector Catch is a legacy debug event.

AArch64.VectorCatchException(FaultRecord fault)
    assert PSTATE.EL != EL2;
    assert HaveEL(EL2) && !IsSecure() && (HCR_EL2.TGE == '1' || MDCR_EL2.TDE == '1');

    bits(64) preferred_exception_return = ThisInstrAddr();
    vect_offset = 0x0;

    vaddress = bits(64) UNKNOWN;
    exception = AArch64.AbortSyndrome(Exception_VectorCatch, fault, vaddress);

    AArch64.TakeException(EL2, exception, preferred_exception_return, vect_offset);
```

aarch64/exceptions/debug/AArch64.WatchpointException

```
// AArch64.WatchpointException()
// =====

AArch64.WatchpointException(bits(64) vaddress, FaultRecord fault)
    assert PSTATE.EL != EL3;

    route_to_el2 = (HaveEL(EL2) && !IsSecure() && PSTATE.EL IN {EL0,EL1} &&
        (HCR_EL2.TGE == '1' || MDCR_EL2.TDE == '1'));

    bits(64) preferred_exception_return = ThisInstrAddr();
    vect_offset = 0x0;

    exception = AArch64.AbortSyndrome(Exception_Watchpoint, fault, vaddress);

    if PSTATE.EL == EL2 || route_to_el2 then
        AArch64.TakeException(EL2, exception, preferred_exception_return, vect_offset);
    else
        AArch64.TakeException(EL1, exception, preferred_exception_return, vect_offset);
```

aarch64/exceptions/exceptions/AArch64.ExceptionClass

```
// AArch64.ExceptionClass()
// =====
// Return the Exception Class and Instruction Length fields for reported in ESR

(integer,bit) AArch64.ExceptionClass(Exception type, bits(2) target_el)

    il = if ThisInstrLength() == 32 then '1' else '0';
    from_32 = UsingAArch32();
    assert from_32 || il == '1'; // AArch64 instructions always 32-bit

    case type of
        when Exception_Uncategorized    ec = 0x00; il = '1';
        when Exception_WFxTrap          ec = 0x01;
        when Exception_CP15RRTTrap      ec = 0x03;          assert from_32;
        when Exception_CP15RRTTrap      ec = 0x04;          assert from_32;
        when Exception_CP14RTTrap       ec = 0x05;          assert from_32;
        when Exception_CP14DTTrap       ec = 0x06;          assert from_32;
        when Exception_AdvSIMDFPAccessTrap ec = 0x07;
        when Exception_FPIDTrap         ec = 0x08;
```

```

when Exception_CP14RRTTrap      ec = 0x0C;          assert from_32;
when Exception_IllegalState     ec = 0x0E; i1 = '1';
when Exception_SupervisorCall   ec = 0x11;
when Exception_HypervisorCall  ec = 0x12;
when Exception_MonitorCall     ec = 0x13;
when Exception_SystemRegisterTrap ec = 0x18;          assert !from_32;
when Exception_InstructionAbort ec = 0x20; i1 = '1';
when Exception_PCAlignment     ec = 0x22; i1 = '1';
when Exception_DataAbort       ec = 0x24;
when Exception_SPAlignment     ec = 0x26; i1 = '1'; assert !from_32;
when Exception_FPTrappedException ec = 0x28;
when Exception_SError          ec = 0x2F; i1 = '1';
when Exception_Breakpoint      ec = 0x30; i1 = '1';
when Exception_SoftwareStep    ec = 0x32; i1 = '1';
when Exception_Watchpoint      ec = 0x34; i1 = '1';
when Exception_SoftwareBreakpoint ec = 0x38;
when Exception_VectorCatch     ec = 0x3A; i1 = '1'; assert from_32;
otherwise                       Unreachable();

if ec IN {0x20,0x24,0x30,0x32,0x34} && target_el == PSTATE.EL then
  ec = ec + 1;

if ec IN {0x11,0x12,0x13,0x28,0x38} && !from_32 then
  ec = ec + 4;

return (ec,i1);

```

aarch64/exceptions/exceptions/AArch64.ReportException

```

// AArch64.ReportException()
// =====
// Report syndrome information for exception taken to AArch64 state.

AArch64.ReportException(ExceptionRecord exception, bits(2) target_el)

  Exception type = exception.type;

  (ec,i1) = AArch64.ExceptionClass(type, target_el);
  iss = exception.syndrome;

  // IL is not valid for Data Abort exceptions without valid instruction syndrome information
  if ec IN {0x24,0x25} && iss<24> == '0' then
    i1 = '1';

  ESR[target_el] = ec<5:0>;i1:iss;

  if type IN {Exception_InstructionAbort, Exception_PCAlignment, Exception_DataAbort,
             Exception_Watchpoint} then
    FAR[target_el] = exception.vaddress;
  else
    FAR[target_el] = bits(64) UNKNOWN;

  if target_el == EL2 then
    if exception.ipavalid then
      HPFAR_EL2<43:4> = exception.ipaddress<51:12>;
    else
      HPFAR_EL2<43:4> = bits(40) UNKNOWN;

  return;

```

aarch64/exceptions/exceptions/AArch64.ResetControlRegisters

```

// Resets System registers and memory-mapped control registers that have architecturally-defined
// reset values to those values.
AArch64.ResetControlRegisters(boolean cold_reset);

```

aarch64/exceptions/exceptions/AArch64.TakeReset

```
// AArch64.TakeReset()
// =====
// Reset into AArch64 state

AArch64.TakeReset(boolean cold_reset)
    assert !HighestELUsingAArch32();

    // Enter the highest implemented Exception level in AArch64 state
    PSTATE.nRW = '0';
    if HaveEL(EL3) then
        PSTATE.EL = EL3;
    elsif HaveEL(EL2) then
        PSTATE.EL = EL2;
    else
        PSTATE.EL = EL1;

    // Reset the system registers and other system components
    AArch64.ResetControlRegisters(cold_reset);

    // Reset all other PSTATE fields
    PSTATE.SP = '1'; // Select stack pointer
    PSTATE.<D,A,I,F> = '1111'; // All asynchronous exceptions masked
    PSTATE.SS = '0'; // Clear software step bit
    PSTATE.IL = '0'; // Clear Illegal Execution state bit

    // All registers, bits and fields not reset by the above pseudocode or by the BranchTo() call
    // below are UNKNOWN bitstrings after reset. In particular, the return information registers
    // ELR_ELx and SPSR_ELx have UNKNOWN values, so that it
    // is impossible to return from a reset in an architecturally defined way.
    AArch64.ResetGeneralRegisters();
    AArch64.ResetSIMDFPRegisters();
    AArch64.ResetSpecialRegisters();
    ResetExternalDebugRegisters(cold_reset);

    bits(64) rv; // IMPLEMENTATION DEFINED reset vector

    if HaveEL(EL3) then
        rv = RVBAR_EL3;
    elsif HaveEL(EL2) then
        rv = RVBAR_EL2;
    else
        rv = RVBAR_EL1;
    // The reset vector must be correctly aligned
    assert IsZero(rv<63:PAMax(>)) && IsZero(rv<1:0>);

    BranchTo(rv, BranchType_UNKNOWN);
```

aarch64/exceptions/ieefp/AArch64.FPTrappedException

```
// AArch64.FPTrappedException()
// =====

AArch64.FPTrappedException(boolean is_ase, integer element, bits(8) accumulated_exceptions)
    exception = ExceptionSyndrome(Exception_FPTrappedException);
    exception.syndrome<23> = '1'; // TFV
    if is_ase then exception.syndrome<10:8> = element<2:0>; // VECITR
    exception.syndrome<7,4:0> = accumulated_exceptions<7,4:0>; // IDF,IXF,UFF,OFF,DZF,IOF

    route_to_el2 = HaveEL(EL2) && !IsSecure() && HCR_EL2.TGE == '1';

    bits(64) preferred_exception_return = ThisInstrAddr();
    vect_offset = 0x0;

    if UInt(PSTATE.EL) > UInt(EL1) then
        AArch64.TakeException(PSTATE.EL, exception, preferred_exception_return, vect_offset);
```

```

elseif route_to_el2 then
  AArch64.TakeException(EL2, exception, preferred_exception_return, vect_offset);
else
  AArch64.TakeException(EL1, exception, preferred_exception_return, vect_offset);

```

aarch64/exceptions/syscalls/AArch64.CallHypervisor

```

// AArch64.CallHypervisor()
// =====
// Performs a HVC call

AArch64.CallHypervisor(bits(16) immediate)
  assert HaveEL(EL2);

  if UsingAArch32() then AArch32.ITAdvance();
  SSAdvance();
  bits(64) preferred_exception_return = NextInstrAddr();
  vect_offset = 0x0;

  exception = ExceptionSyndrome(Exception_HypervisorCall);
  exception.syndrome<15:0> = immediate;

  if PSTATE.EL == EL3 then
    AArch64.TakeException(EL3, exception, preferred_exception_return, vect_offset);
  else
    AArch64.TakeException(EL2, exception, preferred_exception_return, vect_offset);

```

aarch64/exceptions/syscalls/AArch64.CallSecureMonitor

```

// AArch64.CallSecureMonitor()
// =====

AArch64.CallSecureMonitor(bits(16) immediate)
  assert HaveEL(EL3) && !ELUsingAArch32(EL3);

  if UsingAArch32() then AArch32.ITAdvance();
  SSAdvance();

  bits(64) preferred_exception_return = NextInstrAddr();
  vect_offset = 0x0;

  exception = ExceptionSyndrome(Exception_MonitorCall);
  exception.syndrome<15:0> = immediate;

  AArch64.TakeException(EL3, exception, preferred_exception_return, vect_offset);

```

aarch64/exceptions/syscalls/AArch64.CallSupervisor

```

// AArch64.CallSupervisor()
// =====
// Calls the Supervisor

AArch64.CallSupervisor(bits(16) immediate)

  if UsingAArch32() then AArch32.ITAdvance();
  SSAdvance();
  route_to_el2 = HaveEL(EL2) && !IsSecure() && PSTATE.EL == EL0 && HCR_EL2.TGE == '1';

  bits(64) preferred_exception_return = NextInstrAddr();
  vect_offset = 0x0;

  exception = ExceptionSyndrome(Exception_SupervisorCall);
  exception.syndrome<15:0> = immediate;

  if UInt(PSTATE.EL) > UInt(EL1) then
    AArch64.TakeException(PSTATE.EL, exception, preferred_exception_return, vect_offset);

```

```

elseif route_to_el2 then
  AArch64.TakeException(EL2, exception, preferred_exception_return, vect_offset);
else
  AArch64.TakeException(EL1, exception, preferred_exception_return, vect_offset);

```

aarch64/exceptions/takeexception/AArch64.TakeException

```

// AArch64.TakeException()
// =====
// Take an exception to an Exception Level using AArch64.

AArch64.TakeException(bits(2) target_el, ExceptionRecord exception,
                      bits(64) preferred_exception_return, integer vect_offset)
assert HaveEL(target_el) && !ELUsingAArch32(target_el) && UInt(target_el) >= UInt(PSTATE.EL);

// If coming from AArch32 state, the top parts of the X[] registers might be set to zero
from_32 = UsingAArch32();
if from_32 then AArch64.MaybeZeroRegisterUppers();

if UInt(target_el) > UInt(PSTATE.EL) then
  boolean lower_32;
  if target_el == EL3 then
    if !IsSecure() && HaveEL(EL2) then
      lower_32 = ELUsingAArch32(EL2);
    else
      lower_32 = ELUsingAArch32(EL1);
  elseif IsInHost() && PSTATE.EL == EL0 && target_el == EL2 then
    lower_32 = ELUsingAArch32(EL0);
  else
    lower_32 = ELUsingAArch32(target_el - 1);
  vect_offset = vect_offset + (if lower_32 then 0x600 else 0x400);

elseif PSTATE.SP == '1' then
  vect_offset = vect_offset + 0x200;

spsr = GetPSRFromPSTATE();

if HaveUA0Ext() then PSTATE.UA0 = '0';
if !(exception.type IN {Exception_IRQ, Exception_FIQ}) then
  AArch64.ReportException(exception, target_el);

PSTATE.EL = target_el; PSTATE.nRW = '0'; PSTATE.SP = '1';

SPSR[] = spsr;
ELR[] = preferred_exception_return;

PSTATE.SS = '0';
PSTATE.<D,A,I,F> = '1111';
PSTATE.IL = '0';
if from_32 then // Coming from AArch32
  PSTATE.IT = '00000000'; PSTATE.T = '0'; // PSTATE.J is RES0
if HavePANExt() && (PSTATE.EL == EL1 || (PSTATE.EL == EL2 && ELIsInHost(EL0))) && SCTLRL.SPAN ==
'0' then
  PSTATE.PAN = '1';

BranchTo(VBAR[]<63:11>:vect_offset<10:0>, BranchType_EXCEPTION);

if HaveRASExt() && SCTLRL.IESB == '1' then
  ErrorSynchronizationBarrier(MBReqDomain_FullSystem, MBReqTypes_All);
  iesb_req = TRUE;
  TakeUnmaskedPhysicalErrorInterrupts(iesb_req);

EndOfInstruction();

```

aarch64/exceptions/traps/AArch64.AArch32SystemAccessTrap

```
// AArch64.AArch32SystemAccessTrap()
// =====
// Trapped AArch32 System register access other than due to CPTR_EL2 or CPACR_EL1.

AArch64.AArch32SystemAccessTrap(bits(2) target_el, bits(32) aarch32_instr)
  assert HaveEL(target_el) && target_el != EL0 && UInt(target_el) >= UInt(PSTATE.EL);

  bits(64) preferred_exception_return = ThisInstrAddr();
  vect_offset = 0x0;

  exception = AArch64.AArch32SystemAccessTrapSyndrome(aarch32_instr);

  if target_el == EL1 && HaveEL(EL2) && !IsSecure() && HCR_EL2.TGE == '1' then
    AArch64.TakeException(EL2, exception, preferred_exception_return, vect_offset);
  else
    AArch64.TakeException(target_el, exception, preferred_exception_return, vect_offset);
```

aarch64/exceptions/traps/AArch64.AArch32SystemAccessTrapSyndrome

```
// AArch64.AArch32SystemAccessTrapSyndrome()
// =====
// Return the syndrome information for traps on AArch32 MCR, MCRR, MRC, MRRC, and VMRS instructions,
// other than traps that are due to HCPTR or CPACR.

ExceptionRecord AArch64.AArch32SystemAccessTrapSyndrome(bits(32) instr)

  ExceptionRecord exception;
  cpnum = UInt(instr<11:8>);

  bits(20) iss = Zeros();
  if instr<27:24> == '1110' && instr<4> == '1' && instr<31:28> != '1111' then
    // MRC/MCR
    case cpnum of
      when 10 exception = ExceptionSyndrome(Exception_FPIDTrap);
      when 14 exception = ExceptionSyndrome(Exception_CP14RTTTrap);
      when 15 exception = ExceptionSyndrome(Exception_CP15RTTTrap);
      otherwise Unreachable();
    iss<19:17> = instr<7:5>; // opc2
    iss<16:14> = instr<23:21>; // opc1
    iss<13:10> = instr<19:16>; // CRn
    iss<9:5> = LookupRIndex(UInt(instr<15:12>), PSTATE.M)<4:0>; // Rt
    iss<4:1> = instr<3:0>; // CRm
  elseif instr<27:21> == '1100010' && instr<31:28> != '1111' then
    // MRRC/MCRR
    case cpnum of
      when 14 exception = ExceptionSyndrome(Exception_CP14RRTTTrap);
      when 15 exception = ExceptionSyndrome(Exception_CP15RRTTTrap);
      otherwise Unreachable();
    iss<19:16> = instr<7:4>; // opc1
    iss<14:10> = LookupRIndex(UInt(instr<19:16>), PSTATE.M)<4:0>; // Rt2
    iss<9:5> = LookupRIndex(UInt(instr<15:12>), PSTATE.M)<4:0>; // Rt
    iss<4:1> = instr<3:0>; // CRm
  elseif instr<27:25> == '110' && instr<31:28> != '1111' then
    // LDC/STC
    assert cpnum == 14;
    exception = ExceptionSyndrome(Exception_CP14DTTTrap);
    iss<19:12> = instr<7:0>; // imm8
    iss<4> = instr<23>; // U
    iss<2:1> = instr<24,21>; // P,W
    if instr<19:16> == '1111' then // Literal addressing
      iss<9:5> = bits(5) UNKNOWN;
      iss<3> = '1';
    else
      iss<9:5> = LookupRIndex(UInt(instr<19:16>), PSTATE.M)<4:0>; // Rn
      iss<3> = '0';
```

```

else
    Unreachable();
    iss<0> = instr<20>; // Direction

    exception.syndrome<24:20> = ConditionSyndrome();
    exception.syndrome<19:0> = iss;

    return exception;
  
```

aarch64/exceptions/traps/AArch64.AdvSIMDFPAccessTrap

```

// AArch64.AdvSIMDFPAccessTrap()
// =====
// Trapped access to Advanced SIMD or FP registers due to CPACR[].

AArch64.AdvSIMDFPAccessTrap(bits(2) target_e1)

    bits(64) preferred_exception_return = ThisInstrAddr();
    vect_offset = 0x0;

    route_to_el2 = (target_e1 == EL1 && HaveEL(EL2) && !IsSecure() && HCR_EL2.TGE == '1');

    if route_to_el2 then
        exception = ExceptionSyndrome(Exception_Uncategorized);
        AArch64.TakeException(EL2, exception, preferred_exception_return, vect_offset);
    else
        exception = ExceptionSyndrome(Exception_AdvSIMDFPAccessTrap);
        exception.syndrome<24:20> = ConditionSyndrome();
        AArch64.TakeException(target_e1, exception, preferred_exception_return, vect_offset);

    return;
  
```

aarch64/exceptions/traps/AArch64.CheckAArch32SystemAccess

```

// AArch64.CheckAArch32SystemAccess()
// =====
// Check AArch32 System register access instruction for enables and disables

AArch64.CheckAArch32SystemAccess(bits(32) instr)
    cp_num = UInt(instr<11:8>);
    assert cp_num IN {14,15};

    // Decode the AArch32 System register access instruction
    if instr<31:28> != '1111' && instr<27:24> == '1110' && instr<4> == '1' then // MRC/MCR
        cpnt = TRUE; cpdt = FALSE; nreg = 1;
        opc1 = UInt(instr<23:21>);
        opc2 = UInt(instr<7:5>);
        CRn = UInt(instr<19:16>);
        CRm = UInt(instr<3:0>);
    elseif instr<31:28> != '1111' && instr<27:21> == '1100010' then // MRRC/MCRR
        cpnt = TRUE; cpdt = FALSE; nreg = 2;
        opc1 = UInt(instr<7:4>);
        CRm = UInt(instr<3:0>);
    elseif instr<31:28> != '1111' && instr<27:25> == '110' && instr<22> == '0' then // LDC/STC
        cpnt = FALSE; cpdt = TRUE; nreg = 0;
        opc1 = 0;
        CRn = UInt(instr<15:12>);
    else
        allocated = FALSE;

    //
    // Coarse-grain decode into CP14 or CP15 encoding space. Each of the CPxxxInstrDecode functions
    // returns TRUE if the instruction is allocated at the current Exception level, FALSE otherwise.
    if cp_num == 14 then
        // LDC and STC only supported for c5 in CP14 encoding space
        if cpdt && CRn != 5 then
  
```



```

    allocated = FALSE;
  else
    // Coarse-grained decode of CP14 based on opc1 field
    case opc1 of
      when 0    allocated = CP14DebugInstrDecode(instr);
      when 1    allocated = CP14TraceInstrDecode(instr);
      when 7    allocated = CP14JazelleInstrDecode(instr); // JIDR only
      otherwise allocated = FALSE; // All other values are unallocated

  elseif cp_num == 15 then
    // LDC and STC not supported in CP15 encoding space
    if !cprt then
      allocated = FALSE;
    else
      allocated = CP15InstrDecode(instr);

      // Coarse-grain traps to EL2 have a higher priority than exceptions generated because
      // the access instruction is UNDEFINED
      if AArch64.CheckCP15InstrCoarseTraps(CRn, nreg, CRm) then
        // For a coarse-grain trap, if it is IMPLEMENTATION DEFINED whether an access from
        // Non-secure User mode is UNDEFINED when the trap is disabled, then it is
        // IMPLEMENTATION DEFINED whether the same access is UNDEFINED or generates a trap
        // when the trap is enabled.
        if PSTATE.EL == EL0 && !IsSecure() && !allocated then
          if boolean IMPLEMENTATION_DEFINED "UNDEF unallocated CP15 access at NS EL0" then
            UNDEFINED;
            AArch64.AArch32SystemAccessTrap(EL2, instr);

      else
        allocated = FALSE;

    if !allocated then
      UNDEFINED;

    // If the instruction is not UNDEFINED, it might be disabled or trapped to a higher EL.
    AArch64.CheckAArch32SystemAccessTraps(instr);

  return;

```

aarch64/exceptions/traps/AArch64.CheckAArch32SystemAccessTraps

```

// Check for configurable disables or traps to a higher EL of an AArch32 System register access.
AArch64.CheckAArch32SystemAccessTraps(bits(32) instr);

```

aarch64/exceptions/traps/AArch64.CheckCP15InstrCoarseTraps

```

// AArch64.CheckCP15InstrCoarseTraps()
// =====
// Check for coarse-grained AArch32 CP15 traps in HSTR_EL2 and HCR_EL2.

boolean AArch64.CheckCP15InstrCoarseTraps(integer CRn, integer nreg, integer CRm)

// Check for coarse-grained Hyp traps
if HaveEL(EL2) && !IsSecure() && PSTATE.EL IN {EL0,EL1} then
  // Check for MCR, MRC, MCRR and MRRC disabled by HSTR_EL2<CRn/CRm>
  major = if nreg == 1 then CRn else CRm;
  if !IsInHost() && !(major IN {4,14}) && HSTR_EL2<major> == '1' then
    return TRUE;

// Check for MRC and MCR disabled by HCR_EL2.TIDCP
if (HCR_EL2.TIDCP == '1' && nreg == 1 &&
    ((CRn == 9 && CRm IN {0,1,2, 5,6,7,8 }) ||
     (CRn == 10 && CRm IN {0,1, 4, 8 }) ||
     (CRn == 11 && CRm IN {0,1,2,3,4,5,6,7,8,15}))) then

```

```
        return TRUE;

return FALSE;
```

aarch64/exceptions/traps/AArch64.CheckFPAdvSIMDEnabled

```
// AArch64.CheckFPAdvSIMDEnabled()
// =====
// Check against CPACR[]

AArch64.CheckFPAdvSIMDEnabled()
  if PSTATE.EL IN {EL0, EL1} then
    // Check if access disabled in CPACR_EL1
    case CPACR[].FPEN of
      when 'x0' disabled = TRUE;
      when '01' disabled = PSTATE.EL == EL0;
      when '11' disabled = FALSE;
    if disabled then AArch64.AdvSIMDFPAccessTrap(EL1);

    AArch64.CheckFPAdvSIMDTrap();           // Also check against CPTR_EL2 and CPTR_EL3
```

aarch64/exceptions/traps/AArch64.CheckFPAdvSIMDTrap

```
// AArch64.CheckFPAdvSIMDTrap()
// =====
// Check against CPTR_EL2 and CPTR_EL3.

AArch64.CheckFPAdvSIMDTrap()

  if HaveEL(EL2) && !IsSecure() then
    // Check if access disabled in CPTR_EL2
    if HaveVirtHostExt() && HCR_EL2.E2H == '1' then
      case CPTR_EL2.FPEN of
        when 'x0' disabled = !(PSTATE.EL == EL1 && HCR_EL2.TGE == '1');
        when '01' disabled = (PSTATE.EL == EL0 && HCR_EL2.TGE == '1');
        when '11' disabled = FALSE;
      if disabled then AArch64.AdvSIMDFPAccessTrap(EL2);
    else
      if CPTR_EL2.TFP == '1' then AArch64.AdvSIMDFPAccessTrap(EL2);

  if HaveEL(EL3) then
    // Check if access disabled in CPTR_EL3
    if CPTR_EL3.TFP == '1' then AArch64.AdvSIMDFPAccessTrap(EL3);

return;
```

aarch64/exceptions/traps/AArch64.CheckForSMCTrap

```
// AArch64.CheckForSMCTrap()
// =====
// Check for trap on SMC instruction

AArch64.CheckForSMCTrap(bits(16) imm)

route_to_el2 = HaveEL(EL2) && !IsSecure() && PSTATE.EL IN {EL0, EL1} && HCR_EL2.TSC == '1';
if route_to_el2 then
  bits(64) preferred_exception_return = ThisInstrAddr();
  vect_offset = 0x0;
  exception = ExceptionSyndrome(Exception_MonitorCall);
  exception.syndrome<15:0> = imm;
  AArch64.TakeException(EL2, exception, preferred_exception_return, vect_offset);
```

aarch64/exceptions/traps/AArch64.CheckForWfxTrap

```
// AArch64.CheckForWfxTrap()
// =====
// Check for trap on WFE or WFI instruction

AArch64.CheckForWfxTrap(bits(2) target_el, boolean is_wfe)
  assert HaveEL(target_el);

  case target_el of
    when EL1 trap = (if is_wfe then SCTLR[.nTWE else SCTLR[.nTWI]) == '0';
    when EL2 trap = (if is_wfe then HCR_EL2.TWE else HCR_EL2.TWI) == '1';
    when EL3 trap = (if is_wfe then SCR_EL3.TWE else SCR_EL3.TWI) == '1';
  if trap then
    AArch64.WfxTrap(target_el, is_wfe);
```

aarch64/exceptions/traps/AArch64.CheckIllegalState

```
// AArch64.CheckIllegalState()
// =====
// Check PSTATE.IL bit and generate Illegal Execution state exception if set.

AArch64.CheckIllegalState()

  if PSTATE.IL == '1' then
    route_to_el2 = HaveEL(EL2) && !IsSecure() && PSTATE.EL == EL0 && HCR_EL2.TGE == '1';

    bits(64) preferred_exception_return = ThisInstrAddr();
    vect_offset = 0x0;

    exception = ExceptionSyndrome(Exception_IllegalState);

    if UInt(PSTATE.EL) > UInt(EL1) then
      AArch64.TakeException(PSTATE.EL, exception, preferred_exception_return, vect_offset);
    elseif route_to_el2 then
      AArch64.TakeException(EL2, exception, preferred_exception_return, vect_offset);
    else
      AArch64.TakeException(EL1, exception, preferred_exception_return, vect_offset);
```

aarch64/exceptions/traps/AArch64.MonitorModeTrap

```
// AArch64.MonitorModeTrap()
// =====
// Trapped use of Monitor mode features in a Secure EL1 AArch32 mode

AArch64.MonitorModeTrap()

  bits(64) preferred_exception_return = ThisInstrAddr();
  vect_offset = 0x0;

  exception = ExceptionSyndrome(Exception_Uncategorized);

  AArch64.TakeException(EL3, exception, preferred_exception_return, vect_offset);
```

aarch64/exceptions/traps/AArch64.SystemRegisterTrap

```
// AArch64.SystemRegisterTrap()
// =====
// Trapped system register access other than due to CPTR_EL2 and CPACR_EL1

AArch64.SystemRegisterTrap(bits(2) target_el, bits(2) op0, bits(3) op2, bits(3) op1, bits(4) crn,
  bits(5) rt, bits(4) crm, bit dir)
  assert UInt(target_el) >= UInt(PSTATE.EL);

  bits(64) preferred_exception_return = ThisInstrAddr();
  vect_offset = 0x0;
```

```
exception = ExceptionSyndrome(Exception_SystemRegisterTrap);
exception.syndrome<21:20> = op0;
exception.syndrome<19:17> = op2;
exception.syndrome<16:14> = op1;
exception.syndrome<13:10> = crn;
exception.syndrome<9:5> = rt;
exception.syndrome<4:1> = crm;
exception.syndrome<0> = dir;

if target_el == EL1 && HaveEL(EL2) && !IsSecure() && HCR_EL2.TGE == '1' then
    AArch64.TakeException(EL2, exception, preferred_exception_return, vect_offset);
else
    AArch64.TakeException(target_el, exception, preferred_exception_return, vect_offset);
```

aarch64/exceptions/traps/AArch64.UndefinedFault

```
// AArch64.UndefinedFault()
// =====

AArch64.UndefinedFault()

    route_to_el2 = HaveEL(EL2) && !IsSecure() && PSTATE.EL == EL0 && HCR_EL2.TGE == '1';

    bits(64) preferred_exception_return = ThisInstrAddr();
    vect_offset = 0x0;

    exception = ExceptionSyndrome(Exception_Uncategorized);

    if UInt(PSTATE.EL) > UInt(EL1) then
        AArch64.TakeException(PSTATE.EL, exception, preferred_exception_return, vect_offset);
    elsif route_to_el2 then
        AArch64.TakeException(EL2, exception, preferred_exception_return, vect_offset);
    else
        AArch64.TakeException(EL1, exception, preferred_exception_return, vect_offset);
```

aarch64/exceptions/traps/AArch64.WFxTrap

```
// AArch64.WFxTrap()
// =====

AArch64.WFxTrap(bits(2) target_el, boolean is_wfe)
    assert UInt(target_el) > UInt(PSTATE.EL);

    bits(64) preferred_exception_return = ThisInstrAddr();
    vect_offset = 0x0;

    exception = ExceptionSyndrome(Exception_WFxTrap);
    exception.syndrome<24:20> = ConditionSyndrome();
    exception.syndrome<0> = if is_wfe then '1' else '0';

    if target_el == EL1 && HaveEL(EL2) && !IsSecure() && HCR_EL2.TGE == '1' then
        AArch64.TakeException(EL2, exception, preferred_exception_return, vect_offset);
    else
        AArch64.TakeException(target_el, exception, preferred_exception_return, vect_offset);
```

aarch64/exceptions/traps/CheckFPAdvSIMDEnabled64

```
// CheckFPAdvSIMDEnabled64()
// =====
// AArch64 instruction wrapper

CheckFPAdvSIMDEnabled64()
    AArch64.CheckFPAdvSIMDEnabled();
```

J1.1.3 aarch64/functions

This section includes the following pseudocode functions:

- [aarch64/functions/aborts/AArch64.CreateFaultRecord](#) on page J1-5888.
- [aarch64/functions/aborts/AArch64.FaultSyndrome](#) on page J1-5888.
- [aarch64/functions/exclusive/AArch64.ExclusiveMonitorsPass](#) on page J1-5888.
- [aarch64/functions/exclusive/AArch64.IsExclusiveVA](#) on page J1-5889.
- [aarch64/functions/exclusive/AArch64.MarkExclusiveVA](#) on page J1-5889.
- [aarch64/functions/exclusive/AArch64.SetExclusiveMonitors](#) on page J1-5889.
- [aarch64/functions/fusedrstep/FPResqrtStepFused](#) on page J1-5890.
- [aarch64/functions/fusedrstep/FPRecipStepFused](#) on page J1-5890.
- [aarch64/functions/memory/AArch64.CheckAlignment](#) on page J1-5891.
- [aarch64/functions/memory/AArch64.MemSingle](#) on page J1-5891.
- [aarch64/functions/memory/CheckSPAlignment](#) on page J1-5892.
- [aarch64/functions/memory/Mem](#) on page J1-5892.
- [aarch64/functions/ras/AArch64.ESBOperation](#) on page J1-5893.
- [aarch64/functions/ras/AArch64.PhysicalSErrorSyndrome](#) on page J1-5894.
- [aarch64/functions/ras/AArch64.ReportDeferredSError](#) on page J1-5894.
- [aarch64/functions/ras/AArch64.vESBOperation](#) on page J1-5894.
- [aarch64/functions/registers/AArch64.MaybeZeroRegisterUppers](#) on page J1-5895.
- [aarch64/functions/registers/AArch64.ResetGeneralRegisters](#) on page J1-5895.
- [aarch64/functions/registers/AArch64.ResetSIMDFPRegisters](#) on page J1-5895.
- [aarch64/functions/registers/AArch64.ResetSpecialRegisters](#) on page J1-5895.
- [aarch64/functions/registers/AArch64.ResetSystemRegisters](#) on page J1-5896.
- [aarch64/functions/registers/PC](#) on page J1-5896.
- [aarch64/functions/registers/SP](#) on page J1-5896.
- [aarch64/functions/registers/V](#) on page J1-5897.
- [aarch64/functions/registers/Vpart](#) on page J1-5897.
- [aarch64/functions/registers/X](#) on page J1-5897.
- [aarch64/functions/sysregisters/CNTKCTL](#) on page J1-5898.
- [aarch64/functions/sysregisters/CNTKCTLType](#) on page J1-5898.
- [aarch64/functions/sysregisters/CPACR](#) on page J1-5898.
- [aarch64/functions/sysregisters/CPACRType](#) on page J1-5898.
- [aarch64/functions/sysregisters/ELR](#) on page J1-5898.
- [aarch64/functions/sysregisters/ESR](#) on page J1-5899.
- [aarch64/functions/sysregisters/ESRType](#) on page J1-5899.
- [aarch64/functions/sysregisters/FAR](#) on page J1-5900.
- [aarch64/functions/sysregisters/MAIR](#) on page J1-5900.
- [aarch64/functions/sysregisters/MAIRType](#) on page J1-5900.
- [aarch64/functions/sysregisters/SCTLR](#) on page J1-5901.
- [aarch64/functions/sysregisters/SCTLRType](#) on page J1-5901.
- [aarch64/functions/sysregisters/VBAR](#) on page J1-5901.
- [aarch64/functions/system/AArch64.CheckAdvSIMDFPSystemRegisterTraps](#) on page J1-5901.
- [aarch64/functions/system/AArch64.CheckSystemAccess](#) on page J1-5901.
- [aarch64/functions/system/AArch64.CheckSystemRegisterTraps](#) on page J1-5902.
- [aarch64/functions/system/AArch64.CheckUnallocatedSystemAccess](#) on page J1-5902.
- [aarch64/functions/system/AArch64.ExecutingATSIxPInstr](#) on page J1-5902.
- [aarch64/functions/system/AArch64.SysInstr](#) on page J1-5903.
- [aarch64/functions/system/AArch64.SysInstrWithResult](#) on page J1-5903.
- [aarch64/functions/system/AArch64.SysRegRead](#) on page J1-5903.
- [aarch64/functions/system/AArch64.SysRegWrite](#) on page J1-5903.

aarch64/functions/aborts/AArch64.CreateFaultRecord

```
// AArch64.CreateFaultRecord()
// =====

FaultRecord AArch64.CreateFaultRecord(Fault type, bits(52) ipaddress,
                                       integer level, AccType acctype, boolean write, bit extflag,
                                       bits(2) errortype, boolean secondstage, boolean s2fs1walk)

    FaultRecord fault;
    fault.type = type;
    fault.domain = bits(4) UNKNOWN;           // Not used from AArch64
    fault.debugmoe = bits(4) UNKNOWN;        // Not used from AArch64
    fault.errortype = errortype;
    fault.ipaddress = ipaddress;
    fault.level = level;
    fault.acctype = acctype;
    fault.write = write;
    fault.extflag = extflag;
    fault.secondstage = secondstage;
    fault.s2fs1walk = s2fs1walk;

    return fault;
```

aarch64/functions/aborts/AArch64.FaultSyndrome

```
// AArch64.FaultSyndrome()
// =====
// Creates an exception syndrome value for Abort and Watchpoint exceptions taken to
// an Exception Level using AArch64.

bits(25) AArch64.FaultSyndrome(boolean d_side, FaultRecord fault)
    assert fault.type != Fault_None;

    bits(25) iss = Zeros();
    if HaveRASExt() && IsExternalSyncAbort(fault) then iss<12:11> = fault.errortype; // SET
    if d_side then
        if IsSecondStage(fault) && !fault.s2fs1walk then iss<24:14> = LSInstructionSyndrome();
        if fault.acctype IN {AccType_DC, AccType_IC, AccType_AT} then
            iss<8> = '1'; iss<6> = '1';
        else
            iss<6> = if fault.write then '1' else '0';
    if IsExternalAbort(fault) then iss<9> = fault.extflag;
    iss<7> = if fault.s2fs1walk then '1' else '0';
    iss<5:0> = EncodeLDFSC(fault.type, fault.level);

    return iss;
```

aarch64/functions/exclusive/AArch64.ExclusiveMonitorsPass

```
// AArch64.ExclusiveMonitorsPass()
// =====

// Return TRUE if the Exclusive Monitors for the current PE include all of the addresses
// associated with the virtual address region of size bytes starting at address.
// The immediately following memory write must be to the same addresses.

boolean AArch64.ExclusiveMonitorsPass(bits(64) address, integer size)

    // It is IMPLEMENTATION DEFINED whether the detection of memory aborts happens
    // before or after the check on the local Exclusive Monitor. As a result a failure
    // of the local monitor can occur on some implementations even if the memory
    // access would give an memory abort.

    acctype = AccType_ATOMIC;
    iswrite = TRUE;
```

```

aligned = (address == Align(address, size));

if !aligned then
  secondstage = FALSE;
  AArch64.Abort(address, AArch64.AlignmentFault(acctype, iswrite, secondstage));

passed = AArch64.IsExclusiveVA(address, ProcessorID(), size);
if !passed then
  return FALSE;
memaddrdesc = AArch64.TranslateAddress(address, acctype, iswrite, aligned, size);

// Check for aborts or debug exceptions
if IsFault(memaddrdesc) then
  AArch64.Abort(address, memaddrdesc.fault);

passed = IsExclusiveLocal(memaddrdesc.paddress, ProcessorID(), size);

if passed then
  ClearExclusiveLocal(ProcessorID());
  if memaddrdesc.memattrs.shareable then
    passed = IsExclusiveGlobal(memaddrdesc.paddress, ProcessorID(), size);

return passed;

```

aarch64/functions/exclusive/AArch64.IsExclusiveVA

```

// An optional IMPLEMENTATION DEFINED test for an exclusive access to a virtual
// address region of size bytes starting at address.
//
// It is permitted (but not required) for this function to return FALSE and
// cause a store exclusive to fail if the virtual address region is not
// totally included within the region recorded by MarkExclusiveVA().
//
// It is always safe to return TRUE which will check the physical address only.
boolean AArch64.IsExclusiveVA(bits(64) address, integer processorid, integer size);

```

aarch64/functions/exclusive/AArch64.MarkExclusiveVA

```

// Optionally record an exclusive access to the virtual address region of size bytes
// starting at address for processorid.
AArch64.MarkExclusiveVA(bits(64) address, integer processorid, integer size);

```

aarch64/functions/exclusive/AArch64.SetExclusiveMonitors

```

// AArch64.SetExclusiveMonitors()
// =====

// Sets the Exclusive Monitors for the current PE to record the addresses associated
// with the virtual address region of size bytes starting at address.

AArch64.SetExclusiveMonitors(bits(64) address, integer size)

acctype = AccType_ATOMIC;
iswrite = FALSE;
aligned = (address != Align(address, size));
memaddrdesc = AArch64.TranslateAddress(address, acctype, iswrite, aligned, size);

// Check for aborts or debug exceptions
if IsFault(memaddrdesc) then
  return;

if memaddrdesc.memattrs.shareable then
  MarkExclusiveGlobal(memaddrdesc.paddress, ProcessorID(), size);

```

```
MarkExclusiveLocal(memaddrdesc.paddress, ProcessorID(), size);
```

```
AArch64.MarkExclusiveVA(address, ProcessorID(), size);
```

aarch64/functions/fusedrstep/FPRSqrtStepFused

```
// FPRSqrtStepFused()
// =====

bits(N) FPRSqrtStepFused(bits(N) op1, bits(N) op2)
    assert N IN {16, 32, 64};
    bits(N) result;
    op1 = FPNeg(op1);
    (type1,sign1,value1) = FPUnpack(op1, FPCR);
    (type2,sign2,value2) = FPUnpack(op2, FPCR);
    (done,result) = FPProcessNaNs(type1, type2, op1, op2, FPCR);
    if !done then
        inf1 = (type1 == FPType_Infinity);
        inf2 = (type2 == FPType_Infinity);
        zero1 = (type1 == FPType_Zero);
        zero2 = (type2 == FPType_Zero);
        if (inf1 && zero2) || (zero1 && inf2) then
            result = FPOnePointFive('0');
        elsif inf1 || inf2 then
            result = FPinfinity(sign1 EOR sign2);
        else
            // Fully fused multiply-add and halve
            result_value = (3.0 + (value1 * value2)) / 2.0;
            if result_value == 0.0 then
                // Sign of exact zero result depends on rounding mode
                sign = if FPRoundingMode(FPCR) == FPRounding_NEGINF then '1' else '0';
                result = FPZero(sign);
            else
                result = FPRound(result_value, FPCR);
    return result;
```

aarch64/functions/fusedrstep/FPRecipStepFused

```
// FPRecipStepFused()
// =====

bits(N) FPRecipStepFused(bits(N) op1, bits(N) op2)
    assert N IN {16, 32, 64};
    bits(N) result;
    op1 = FPNeg(op1);
    (type1,sign1,value1) = FPUnpack(op1, FPCR);
    (type2,sign2,value2) = FPUnpack(op2, FPCR);
    (done,result) = FPProcessNaNs(type1, type2, op1, op2, FPCR);
    if !done then
        inf1 = (type1 == FPType_Infinity);
        inf2 = (type2 == FPType_Infinity);
        zero1 = (type1 == FPType_Zero);
        zero2 = (type2 == FPType_Zero);
        if (inf1 && zero2) || (zero1 && inf2) then
            result = FPTwo('0');
        elsif inf1 || inf2 then
            result = FPinfinity(sign1 EOR sign2);
        else
            // Fully fused multiply-add
            result_value = 2.0 + (value1 * value2);
            if result_value == 0.0 then
                // Sign of exact zero result depends on rounding mode
                sign = if FPRoundingMode(FPCR) == FPRounding_NEGINF then '1' else '0';
                result = FPZero(sign);
```



```

    else
        result = FPRound(result_value, FPCR);
    return result;

```

aarch64/functions/memory/AArch64.CheckAlignment

```

// AArch64.CheckAlignment()
// =====

boolean AArch64.CheckAlignment(bits(64) address, integer alignment, AccType acctype,
                               boolean iswrite)

    aligned = (address == Align(address, alignment));
    atomic = acctype IN { AccType_ATOMIC, AccType_ATOMICRW };
    ordered = acctype IN { AccType_ORDERED, AccType_ORDEREDRW, AccType_LIMITEDORDERED };
    vector = acctype == AccType_VEC;
    check = (atomic || ordered || SCTLR[.A == '1']);

    if check && !aligned then
        secondstage = FALSE;
        AArch64.Abort(address, AArch64.AlignmentFault(acctype, iswrite, secondstage));

    return aligned;

```

aarch64/functions/memory/AArch64.MemSingle

```

// AArch64.MemSingle[] - non-assignment (read) form
// =====
// Perform an atomic, little-endian read of 'size' bytes.

bits(size*8) AArch64.MemSingle(bits(64) address, integer size, AccType acctype, boolean wasaligned)
    assert size IN {1, 2, 4, 8, 16};
    assert address == Align(address, size);

    AddressDescriptor memaddrdesc;
    bits(size*8) value;
    iswrite = FALSE;

    // MMU or MPU
    memaddrdesc = AArch64.TranslateAddress(address, acctype, iswrite, wasaligned, size);
    // Check for aborts or debug exceptions
    if IsFault(memaddrdesc) then
        AArch64.Abort(address, memaddrdesc.fault);

    // Memory array access
    accdesc = CreateAccessDescriptor(acctype);
    value = _Mem[memaddrdesc, size, accdesc];
    return value;

// AArch64.MemSingle[] - assignment (write) form
// =====
// Perform an atomic, little-endian write of 'size' bytes.

AArch64.MemSingle(bits(64) address, integer size, AccType acctype, boolean wasaligned) = bits(size*8)
value
    assert size IN {1, 2, 4, 8, 16};
    assert address == Align(address, size);

    AddressDescriptor memaddrdesc;
    iswrite = TRUE;

    // MMU or MPU
    memaddrdesc = AArch64.TranslateAddress(address, acctype, iswrite, wasaligned, size);

    // Check for aborts or debug exceptions
    if IsFault(memaddrdesc) then

```

```
    AArch64.Abort(address, memaddrdesc.fault);

// Effect on exclusives
if memaddrdesc.memattrs.shareable then
    ClearExclusiveByAddress(memaddrdesc.paddress, ProcessorID(), size);

// Memory array access
accdesc = CreateAccessDescriptor(acctype);
_Mem[memaddrdesc, size, accdesc] = value;
return;
```

aarch64/functions/memory/CheckSPAlignment

```
// CheckSPAlignment()
// =====
// Check correct stack pointer alignment for AArch64 state.

CheckSPAlignment()
    bits(64) sp = SP[];

    if PSTATE.EL == EL0 then
        stack_align_check = (SCTLR[].SA0 != '0');
    else
        stack_align_check = (SCTLR[].SA != '0');

    if stack_align_check && sp != Align(sp, 16) then
        AArch64.SPAlignmentFault();

return;
```

aarch64/functions/memory/Mem

```
// Mem[] - non-assignment (read) form
// =====
// Perform a read of 'size' bytes. The access byte order is reversed for a big-endian access.
// Instruction fetches would call AArch64.MemSingle directly.

bits(size*8) Mem[bits(64) address, integer size, AccType acctype]
    assert size IN {1, 2, 4, 8, 16};
    bits(size*8) value;
    integer i;
    boolean iswrite = FALSE;

    aligned = AArch64.CheckAlignment(address, size, acctype, iswrite);
    if size != 16 || !(acctype IN {AccType_VEC, AccType_VECSTREAM}) then
        atomic = aligned;
    else
        // 128-bit SIMD&FP loads are treated as a pair of 64-bit single-copy atomic accesses
        // 64-bit aligned.
        atomic = address == Align(address, 8);

    if !atomic then
        assert size > 1;
        value<7:0> = AArch64.MemSingle[address, 1, acctype, aligned];

        // For subsequent bytes it is CONSTRAINED UNPREDICTABLE whether an unaligned Device memory
        // access will generate an Alignment Fault, as to get this far means the first byte did
        // not, so we must be changing to a new translation page.
        if !aligned then
            c = ConstrainUnpredictable();
            assert c IN {Constraint_FAULT, Constraint_NONE};
            if c == Constraint_NONE then aligned = TRUE;

        for i = 1 to size-1
            value<8*i+7:8*i> = AArch64.MemSingle[address+i, 1, acctype, aligned];
    elsif size == 16 && acctype IN {AccType_VEC, AccType_VECSTREAM} then
```

```

    value<63:0> = AArch64.MemSingle[address, 8, acctype, aligned];
    value<127:64> = AArch64.MemSingle[address+8, 8, acctype, aligned];
  else
    value = AArch64.MemSingle[address, size, acctype, aligned];

  if BigEndian() then
    value = BigEndianReverse(value);
  return value;

// Mem[] - assignment (write) form
// =====
// Perform a write of 'size' bytes. The byte order is reversed for a big-endian access.

Mem[bits(64) address, integer size, AccType acctype] = bits(size*8) value
  integer i;
  boolean iswrite = TRUE;

  if BigEndian() then
    value = BigEndianReverse(value);

  aligned = AArch64.CheckAlignment(address, size, acctype, iswrite);
  if size != 16 || !(acctype IN {AccType_VEC, AccType_VECSTREAM}) then
    atomic = aligned;
  else
    // 128-bit SIMD&FP stores are treated as a pair of 64-bit single-copy atomic accesses
    // 64-bit aligned.
    atomic = address == Align(address, 8);

  if !atomic then
    assert size > 1;
    AArch64.MemSingle[address, 1, acctype, aligned] = value<7:0>;

    // For subsequent bytes it is CONSTRAINED UNPREDICTABLE whether an unaligned Device memory
    // access will generate an Alignment Fault, as to get this far means the first byte did
    // not, so we must be changing to a new translation page.
    if !aligned then
      c = ConstrainUnpredictable();
      assert c IN {Constraint_FAULT, Constraint_NONE};
      if c == Constraint_NONE then aligned = TRUE;

    for i = 1 to size-1
      AArch64.MemSingle[address+i, 1, acctype, aligned] = value<8*i+7:8*i>;
    elsif size == 16 && acctype IN {AccType_VEC, AccType_VECSTREAM} then
      AArch64.MemSingle[address, 8, acctype, aligned] = value<63:0>;
      AArch64.MemSingle[address+8, 8, acctype, aligned] = value<127:64>;
    else
      AArch64.MemSingle[address, size, acctype, aligned] = value;
  return;

```

aarch64/functions/ras/AArch64.ESBOperation

```

// AArch64.ESBOperation()
// =====
// Perform the AArch64 ESB operation, either for ESB executed in AArch64 state, or for
// ESB in AArch32 state when SError interrupts are routed to an Exception level using
// AArch64

AArch64.ESBOperation()

route_to_el3 = (HaveEL(EL3) && SCR_EL3.EA == '1');
route_to_el2 = (HaveEL(EL2) && !IsSecure() &&
  (HCR_EL2.TGE == '1' || HCR_EL2.AMO == '1'));

target = (if route_to_el3 then EL3 elsif route_to_el2 then EL2 else EL1);

if target == EL1 then
  mask_active = (PSTATE.EL IN {EL0, EL1});

```

```
elseif HaveVirtHostExt() && target == EL2 && HCR_EL2.<E2H,TGE> == '11' then
    mask_active = (PSTATE.EL IN {EL0,EL2});
else
    mask_active = (PSTATE.EL == target);

mask_set = (PSTATE.A == '1');
intdis = (Halted() || ExternalDebugInterruptsDisabled(target));
masked = (UInt(target) < UInt(PSTATE.EL)) || intdis || (mask_active && mask_set);

// Check for a masked Physical SError pending
if SErrorPending() && masked then // ISR_EL1.A is set to 1
    // This function might be called for an interworking case, and INTdis is masking
    // the SError interrupt.
    if ELUsingAArch32(SITranslationRegime()) then
        syndrome32 = AArch32.PhysicalErrorSyndrome();
        DISR = AArch32.ReportDeferredSError(syndrome32.AET, syndrome32.EXT);
    else
        implicit_esb = FALSE;
        syndrome64 = AArch64.PhysicalErrorSyndrome(implicit_esb);
        DISR_EL1 = AArch64.ReportDeferredSError(syndrome64);
        ClearPendingPhysicalSError(); // Set ISR_EL1.A to 0

return;
```

aarch64/functions/ras/AArch64.PhysicalErrorSyndrome

```
// Return the SError syndrome
bits(25) AArch64.PhysicalErrorSyndrome(boolean implicit_esb);
```

aarch64/functions/ras/AArch64.ReportDeferredSError

```
// AArch64.ReportDeferredSError()
// =====
// Generate deferred SError syndrome

bits(64) AArch64.ReportDeferredSError(bits(25) syndrome)
    bits(64) target;
    target<31> = '1'; // A
    target<24> = syndrome<24>; // IDS
    target<23:0> = syndrome<23:0>; // ISS
    return target;
```

aarch64/functions/ras/AArch64.vESBOperation

```
// AArch64.vESBOperation()
// =====
// Perform the AArch64 ESB operation for virtual SError interrupts, either for ESB
// executed in AArch64 state, or for ESB in AArch32 state with EL2 using AArch64 state

AArch64.vESBOperation()
    assert HaveEL(EL2) && !IsSecure() && PSTATE.EL IN {EL0,EL1};

    // If physical SError interrupts are routed to EL2, and TGE is not set, then a virtual
    // SError interrupt might be pending
    vSEI_enabled = (HCR_EL2.TGE == '0' && HCR_EL2.AMO == '1');
    vSEI_pending = (vSEI_enabled && HCR_EL2.VSE == '1');
    vintdis = (Halted() || ExternalDebugInterruptsDisabled(EL1));
    vmasked = (vintdis || PSTATE.A == '1');

    // Check for a masked virtual SError pending
    if vSEI_pending && vmasked then
        // This function might be called for the interworking case, and INTdis is masking
        // the virtual SError interrupt.
        if ELUsingAArch32(EL1) then
            VDISR = AArch32.ReportDeferredSError(VDFSR<15:14>, VDFSR<12>);
        else
```

```

    VDISR_EL2 = AArch64.ReportDeferredSError(VSESR_EL2<24:0>);
    HCR_EL2.VSE = '0'; // Clear pending virtual SError

    return;
  
```

aarch64/functions/registers/AArch64.MaybeZeroRegisterUppers

```

// AArch64.MaybeZeroRegisterUppers()
// =====
// On taking an exception to AArch64 from AArch32, it is CONSTRAINED UNPREDICTABLE whether the top
// 32 bits of registers visible at any lower Exception level using AArch32 are set to zero.

AArch64.MaybeZeroRegisterUppers()
    assert UsingAArch32(); // Always called from AArch32 state before entering AArch64 state

    if PSTATE.EL == EL0 && !ELUsingAArch32(EL1) then
        first = 0; last = 14; include_R15 = FALSE;
    elseif PSTATE.EL IN {EL0,EL1} && HaveEL(EL2) && !IsSecure() && !ELUsingAArch32(EL2) then
        first = 0; last = 30; include_R15 = FALSE;
    else
        first = 0; last = 30; include_R15 = TRUE;

    for n = first to last
        if (n != 15 || include_R15) && ConstrainUnpredictableBool() then
            _R[n]<63:32> = Zeros();

    return;
  
```

aarch64/functions/registers/AArch64.ResetGeneralRegisters

```

// AArch64.ResetGeneralRegisters()
// =====

AArch64.ResetGeneralRegisters()

    for i = 0 to 30
        X[i] = bits(64) UNKNOWN;

    return;
  
```

aarch64/functions/registers/AArch64.ResetSIMDFPRegisters

```

// AArch64.ResetSIMDFPRegisters()
// =====

AArch64.ResetSIMDFPRegisters()

    for i = 0 to 31
        V[i] = bits(128) UNKNOWN;

    return;
  
```

aarch64/functions/registers/AArch64.ResetSpecialRegisters

```

// AArch64.ResetSpecialRegisters()
// =====

AArch64.ResetSpecialRegisters()

    // AArch64 special registers
    SP_EL0 = bits(64) UNKNOWN;
    SP_EL1 = bits(64) UNKNOWN;
    SPSR_EL1 = bits(32) UNKNOWN;
    ELR_EL1 = bits(64) UNKNOWN;
    if HaveEL(EL2) then
  
```

```
    SP_EL2 = bits(64) UNKNOWN;
    SPSR_EL2 = bits(32) UNKNOWN;
    ELR_EL2 = bits(64) UNKNOWN;
    if HaveEL(EL3) then
        SP_EL3 = bits(64) UNKNOWN;
        SPSR_EL3 = bits(32) UNKNOWN;
        ELR_EL3 = bits(64) UNKNOWN;

    // AArch32 special registers that are not architecturally mapped to AArch64 registers
    if HaveAArch32EL(EL1) then
        SPSR_fiq = bits(32) UNKNOWN;
        SPSR_irq = bits(32) UNKNOWN;
        SPSR_abt = bits(32) UNKNOWN;
        SPSR_und = bits(32) UNKNOWN;

    // External debug special registers
    DLR_EL0 = bits(64) UNKNOWN;
    DSPSR_EL0 = bits(32) UNKNOWN;

    return;
```

aarch64/functions/registers/AArch64.ResetSystemRegisters

```
AArch64.ResetSystemRegisters(boolean cold_reset);
```

aarch64/functions/registers/PC

```
// PC - non-assignment form
// =====
// Read program counter.
```

```
bits(64) PC[]
    return _PC;
```

aarch64/functions/registers/SP

```
// SP[] - assignment form
// =====
// Write to stack pointer from either a 32-bit or a 64-bit value.
```

```
SP[] = bits(width) value
    assert width IN {32,64};
    if PSTATE.SP == '0' then
        SP_EL0 = ZeroExtend(value);
    else
        case PSTATE.EL of
            when EL0 SP_EL0 = ZeroExtend(value);
            when EL1 SP_EL1 = ZeroExtend(value);
            when EL2 SP_EL2 = ZeroExtend(value);
            when EL3 SP_EL3 = ZeroExtend(value);
    return;
```

```
// SP[] - non-assignment form
// =====
// Read stack pointer with implicit slice of 8, 16, 32 or 64 bits.
```

```
bits(width) SP[]
    assert width IN {8,16,32,64};
    if PSTATE.SP == '0' then
        return SP_EL0<width-1:0>;
    else
        case PSTATE.EL of
            when EL0 return SP_EL0<width-1:0>;
            when EL1 return SP_EL1<width-1:0>;
            when EL2 return SP_EL2<width-1:0>;
            when EL3 return SP_EL3<width-1:0>;
```

aarch64/functions/registers/V

```
// V[] - assignment form
// =====
// Write to SIMD&FP register with implicit extension from
// 8, 16, 32, 64 or 128 bits.
```

```
V[integer n] = bits(width) value
  assert n >= 0 && n <= 31;
  assert width IN {8,16,32,64,128};
  _V[n] = ZeroExtend(value);
  return;
```

```
// V[] - non-assignment form
// =====
// Read from SIMD&FP register with implicit slice of 8, 16
// 32, 64 or 128 bits.
```

```
bits(width) V[integer n]
  assert n >= 0 && n <= 31;
  assert width IN {8,16,32,64,128};
  return _V[n]<width-1:0>;
```

aarch64/functions/registers/Vpart

```
// Vpart[] - non-assignment form
// =====
// Reads a 128-bit SIMD&FP register in up to two parts:
// part 0 returns the bottom 8, 16, 32 or 64 bits of the register;
// part 1 returns only the top 64 bits of the register.
```

```
bits(width) Vpart[integer n, integer part]
  assert n >= 0 && n <= 31;
  assert part IN {0, 1};
  if part == 0 then
    assert width IN {8,16,32,64};
    return _V[n]<width-1:0>;
  else
    assert width == 64;
    return _V[n]<127:64>;
```

```
// Vpart[] - assignment form
// =====
// Write a 128-bit SIMD&FP register in up to two parts:
// part 0 zero extends a 8, 16, 32, or 64-bit value to fill the whole register;
// part 1 inserts a 64-bit value into the top 64 bits of the register.
```

```
Vpart[integer n, integer part] = bits(width) value
  assert n >= 0 && n <= 31;
  assert part IN {0, 1};
  if part == 0 then
    assert width IN {8,16,32,64};
    _V[n] = ZeroExtend(value);
  else
    assert width == 64;
    _V[n]<127:64> = value<63:0>;
```

aarch64/functions/registers/X

```
// X[] - assignment form
// =====
// Write to general-purpose register from either a 32-bit or a 64-bit value.
```

```
X[integer n] = bits(width) value
  assert n >= 0 && n <= 31;
  assert width IN {32,64};
```

```
    if n != 31 then
        _R[n] = ZeroExtend(value);
    return;

// X[] - non-assignment form
// =====
// Read from general-purpose register with implicit slice of 8, 16, 32 or 64 bits.

bits(width) X[integer n]
    assert n >= 0 && n <= 31;
    assert width IN {8,16,32,64};
    if n != 31 then
        return _R[n]<width-1:0>;
    else
        return Zeros(width);
```

aarch64/functions/sysregisters/CNTKCTL

```
// CNTKCTL[] - non-assignment form
// =====

CNTKCTLType CNTKCTL[]
    if IsInHost() then
        return CNTKCTL_EL2;
    return CNTKCTL_EL1;
```

aarch64/functions/sysregisters/CNTKCTLType

```
type CNTKCTLType;
```

aarch64/functions/sysregisters/CPACR

```
// CPACR[] - non-assignment form
// =====

CPACRType CPACR[]
    if IsInHost() then
        return CPTR_EL2;
    return CPACR_EL1;
```

aarch64/functions/sysregisters/CPACRType

```
type CPACRType;
```

aarch64/functions/sysregisters/ELR

```
// ELR[] - non-assignment form
// =====

bits(64) ELR[bits(2) e1]
    bits(64) r;
    case e1 of
        when EL1 r = ELR_EL1;
        when EL2 r = ELR_EL2;
        when EL3 r = ELR_EL3;
        otherwise Unreachable();
    return r;

// ELR[] - non-assignment form
// =====

bits(64) ELR[]
    assert PSTATE.EL != EL0;
    return ELR[PSTATE.EL];
```



```
// ELR[] - assignment form
// =====

ELR[bits(2) e1] = bits(64) value
  bits(64) r = value;
  case e1 of
    when EL1 ELR_EL1 = r;
    when EL2 ELR_EL2 = r;
    when EL3 ELR_EL3 = r;
    otherwise Unreachable();
  return;

// ELR[] - assignment form
// =====

ELR[] = bits(64) value
  assert PSTATE.EL != EL0;
  ELR[PSTATE.EL] = value;
  return;
```

aarch64/functions/sysregisters/ESR

```
// ESR[] - non-assignment form
// =====

ESRType ESR[bits(2) regime]
  bits(32) r;
  case regime of
    when EL1 r = ESR_EL1;
    when EL2 r = ESR_EL2;
    when EL3 r = ESR_EL3;
    otherwise Unreachable();
  return r;

// ESR[] - non-assignment form
// =====

ESRType ESR[]
  return ESR[S1TranslationRegime()];

// ESR[] - assignment form
// =====

ESR[bits(2) regime] = ESRType value
  bits(32) r = value;
  case regime of
    when EL1 ESR_EL1 = r;
    when EL2 ESR_EL2 = r;
    when EL3 ESR_EL3 = r;
    otherwise Unreachable();
  return;

// ESR[] - assignment form
// =====

ESR[] = ESRType value
  ESR[S1TranslationRegime()] = value;
```

aarch64/functions/sysregisters/ESRType

```
type ESRType;
```

aarch64/functions/sysregisters/FAR

```
// FAR[] - non-assignment form
// =====

bits(64) FAR[bits(2) regime]
bits(64) r;
case regime of
    when EL1 r = FAR_EL1;
    when EL2 r = FAR_EL2;
    when EL3 r = FAR_EL3;
    otherwise Unreachable();
return r;

// FAR[] - non-assignment form
// =====

bits(64) FAR[]
return FAR[S1TranslationRegime()];

// FAR[] - assignment form
// =====

FAR[bits(2) regime] = bits(64) value
bits(64) r = value;
case regime of
    when EL1 FAR_EL1 = r;
    when EL2 FAR_EL2 = r;
    when EL3 FAR_EL3 = r;
    otherwise Unreachable();
return;

// FAR[] - assignment form
// =====

FAR[] = bits(64) value
FAR[S1TranslationRegime()] = value;
return;
```

aarch64/functions/sysregisters/MAIR

```
// MAIR[] - non-assignment form
// =====

MAIRType MAIR[bits(2) regime]
bits(64) r;
case regime of
    when EL1 r = MAIR_EL1;
    when EL2 r = MAIR_EL2;
    when EL3 r = MAIR_EL3;
    otherwise Unreachable();
return r;

// MAIR[] - non-assignment form
// =====

MAIRType MAIR[]
return MAIR[S1TranslationRegime()];
```

aarch64/functions/sysregisters/MAIRType

```
type MAIRType;
```

aarch64/functions/sysregisters/SCTLR

```
// SCTLR[] - non-assignment form
// =====

SCTLRType SCTLR[bits(2) regime]
  bits(32) r;
  case regime of
    when EL1 r = SCTLR_EL1;
    when EL2 r = SCTLR_EL2;
    when EL3 r = SCTLR_EL3;
    otherwise Unreachable();
  return r;

// SCTLR[] - non-assignment form
// =====

SCTLRType SCTLR[]
  return SCTLR[S1TranslationRegime()];
```

aarch64/functions/sysregisters/SCTLRType

```
type SCTLRType;
```

aarch64/functions/sysregisters/VBAR

```
// VBAR[] - non-assignment form
// =====

bits(64) VBAR[bits(2) regime]
  bits(64) r;
  case regime of
    when EL1 r = VBAR_EL1;
    when EL2 r = VBAR_EL2;
    when EL3 r = VBAR_EL3;
    otherwise Unreachable();
  return r;

// VBAR[] - non-assignment form
// =====

bits(64) VBAR[]
  return VBAR[S1TranslationRegime()];
```

aarch64/functions/system/AArch64.CheckAdvSIMDFPSystemRegisterTraps

```
// Checks if an AArch64 MSR, MRS or SYS instruction on a SIMD or floating-point
// register is trapped under the current configuration. Returns a boolean which
// is TRUE if trapping occurs, plus a binary value that specifies the Exception
// level trapped to.
(boolean, bits(2)) AArch64.CheckAdvSIMDFPSystemRegisterTraps(bits(2) op0, bits(3) op1, bits(4) crn,
bits(4) crm, bits(3) op2, bit read);
```

aarch64/functions/system/AArch64.CheckSystemAccess

```
// AArch64.CheckSystemAccess()
// =====

AArch64.CheckSystemAccess(bits(2) op0, bits(3) op1, bits(4) crn, bits(4) crm, bits(3) op2, bits(5) rt,
bit read)
  // Checks if an AArch64 MSR, MRS or SYS instruction is UNALLOCATED or trapped at the current
  // exception level, security state and configuration, based on the opcode's encoding.
  boolean unallocated = FALSE;
  boolean need_secure = FALSE;
  bits(2) min_EL;
```

```
// Check for traps by HCR_EL2.TIDCP
if HaveEL(EL2) && !IsSecure() && HCR_EL2.TIDCP == 1 && op0 == 'x1' && crn == '1x11' then
    // At Non-secure EL0, it is IMPLEMENTATION_DEFINED whether attempts to execute system
    // register access instructions with reserved encodings are trapped to EL2 or UNDEFINED
    rcs_el0_trap = boolean IMPLEMENTATION_DEFINED "Reserved Control Space EL0 Trapped";
    if PSTATE.EL == EL0 && rcs_el0_trap then
        AArch64.SystemRegisterTrap(EL2, op0, op2, op1, crn, rt, crm, read);
    elseif PSTATE.EL == EL1 then
        AArch64.SystemRegisterTrap(EL2, op0, op2, op1, crn, rt, crm, read);

// Check for unallocated encodings
case op1 of
    when '00x', '010'
        min_EL = EL1;
    when '011'
        min_EL = EL0;
    when '100'
        min_EL = EL2;
    when '101'
        if !HaveVirtHostExt() then UnallocatedEncoding();
        min_EL = EL2;
    when '110'
        min_EL = EL3;
    when '111'
        min_EL = EL1;
        need_secure = TRUE;
if UInt(PSTATE.EL) < UInt(min_EL) then
    UnallocatedEncoding();
elseif need_secure && !IsSecure() then
    UnallocatedEncoding();
elseif AArch64.CheckUnallocatedSystemAccess(op0, op1, crn, crm, op2, read) then
    UnallocatedEncoding();

// Check for traps on accesses to SIMD or floating-point registers
(take_trap, target_el) = AArch64.CheckAdvSIMDFPSystemRegisterTraps(op0, op1, crn, crm, op2);
if take_trap then
    AArch64.AdvSIMDFPAccessTrap(target_el);

// Check for traps on access to all other system registers
(take_trap, target_el) = AArch64.CheckSystemRegisterTraps(op0, op1, crn, crm, op2, read);
if take_trap then
    AArch64.SystemRegisterTrap(target_el, op0, op2, op1, crn, rt, crm, read);
```

aarch64/functions/system/AArch64.CheckSystemRegisterTraps

```
// Checks if an AArch64 MSR, MRS or SYS instruction on a system register is trapped
// under the current configuration. Returns a boolean which is TRUE if trapping
// occurs, plus a binary value that specifies the Exception level trapped to.
(boolean, bits(2)) AArch64.CheckSystemRegisterTraps(bits(2) op0, bits(3) op1, bits(4) crn, bits(4) crm,
bits(3) op2, bit read);
```

aarch64/functions/system/AArch64.CheckUnallocatedSystemAccess

```
// Checks if an AArch64 MSR, MRS or SYS instruction is unallocated under the current
// configuration.
boolean AArch64.CheckUnallocatedSystemAccess(bits(2) op0, bits(3) op1, bits(4) crn, bits(4) crm, bits(3)
op2, bit read);
```

aarch64/functions/system/AArch64.ExecutingATS1xPInstr

```
// AArch64.ExecutingATS1xPInstr()
// =====
// Return TRUE if current instruction is AT S1E1R/WP

boolean AArch64.ExecutingATS1xPInstr()
```

```

if !HavePrivATExt() then return FALSE;

instr = ThisInstr();
if instr<22+:10> == '1101010100' then
  op1 = instr<16+:3>;
  CRn = instr<12+:4>;
  CRm = instr<8+:4>;
  op2 = instr<5+:3>;
  return (op1 == '000' && CRn == '0111' && CRm == '1001' && op2 IN {'000','001'});
else
  return FALSE;

```

aarch64/functions/system/AArch64.SysInstr

// Execute a system instruction with write (source operand).
 AArch64.SysInstr(integer op0, integer op1, integer crn, integer crm, integer op2, bits(64) val);

aarch64/functions/system/AArch64.SysInstrWithResult

// Execute a system instruction with read (result operand).
 // Returns the result of the instruction.
 bits(64) AArch64.SysInstrWithResult(integer op0, integer op1, integer crn, integer crm, integer op2);

aarch64/functions/system/AArch64.SysRegRead

// Read from a system register and return the contents of the register.
 bits(64) System_Get(integer op0, integer op1, integer crn, integer crm, integer op2);

aarch64/functions/system/AArch64.SysRegWrite

// Write to a system register.
 AArch64.SysRegWrite(integer op0, integer op1, integer crn, integer crm, integer op2, bits(64) val);

J1.1.4 aarch64/instrs

This section includes the following pseudocode functions:

- [aarch64/instrs/branch/eret/AArch64.ExceptionReturn](#) on page J1-5904.
- [aarch64/instrs/countop/CountOp](#) on page J1-5904.
- [aarch64/instrs/extendreg/DecodeRegExtend](#) on page J1-5905.
- [aarch64/instrs/extendreg/ExtendReg](#) on page J1-5905.
- [aarch64/instrs/extendreg/ExtendType](#) on page J1-5905.
- [aarch64/instrs/float/arithmic/max-min/fpmaxminop/FPMaxMinOp](#) on page J1-5905.
- [aarch64/instrs/float/arithmic/unary/fpunaryop/FPUUnaryOp](#) on page J1-5905.
- [aarch64/instrs/float/convert/fpconvop/FPCConvOp](#) on page J1-5906.
- [aarch64/instrs/integer/bitfield/bfxpreferred/BFXPreferred](#) on page J1-5906.
- [aarch64/instrs/integer/bitmasks/DecodeBitMasks](#) on page J1-5906.
- [aarch64/instrs/integer/ins-ext/insert/movewide/movewideop/MoveWideOp](#) on page J1-5907.
- [aarch64/instrs/integer/logical/movwpreferred/MoveWidePreferred](#) on page J1-5907.
- [aarch64/instrs/integer/shiftrg/DecodeShift](#) on page J1-5907.
- [aarch64/instrs/integer/shiftrg/ShiftReg](#) on page J1-5907.
- [aarch64/instrs/integer/shiftrg/ShiftType](#) on page J1-5908.
- [aarch64/instrs/logicalop/LogicalOp](#) on page J1-5908.
- [aarch64/instrs/memory/memop/MemAtomicOp](#) on page J1-5908.
- [aarch64/instrs/memory/memop/MemOp](#) on page J1-5908.
- [aarch64/instrs/memory/prefetch/Prefetch](#) on page J1-5908.
- [aarch64/instrs/system/barriers/barrierop/MemBarrierOp](#) on page J1-5908.
- [aarch64/instrs/system/hints/syshintop/SystemHintOp](#) on page J1-5908.

- [aarch64/instrs/system/register/cpsr/pstatefield/PSTATEField](#) on page J1-5909.
- [aarch64/instrs/system/sysops/sysop/SysOp](#) on page J1-5909.
- [aarch64/instrs/system/sysops/sysop/SystemOp](#) on page J1-5910.
- [aarch64/instrs/vector/arithmetic/binary/uniform/logical/bsl-eor/vbitop/VBitOp](#) on page J1-5910.
- [aarch64/instrs/vector/arithmetic/unary/cmp/compareop/CompareOp](#) on page J1-5910.
- [aarch64/instrs/vector/crypto/enabled/CheckCryptoEnabled64](#) on page J1-5910.
- [aarch64/instrs/vector/logical/immediateop/ImmediateOp](#) on page J1-5910.
- [aarch64/instrs/vector/reduce/reduceop/Reduce](#) on page J1-5910.
- [aarch64/instrs/vector/reduce/reduceop/ReduceOp](#) on page J1-5911.

aarch64/instrs/branch/eret/AArch64.ExceptionReturn

```
// AArch64.ExceptionReturn()
// =====

AArch64.ExceptionReturn(bits(64) new_pc, bits(32) spsr)

if HaveRASExt() && SCTLR[.IESB] == '1' then
    ErrorSynchronizationBarrier(MBReqDomain_FullSystem, MBReqTypes_All);
    iesb_req = TRUE;
    TakeUnmaskedPhysicalSErrorInterrupts(iesb_req);
// Attempts to change to an illegal state will invoke the Illegal Execution state mechanism
SetPSTATEFromSPSR(spsr);
ClearExclusiveLocal(ProcessorID());
SendEventLocal();

if PSTATE.IL == '1' then
    // If the exception return is illegal, PC[63:32,1:0] are UNKNOWN
    new_pc<63:32> = bits(32) UNKNOWN;
    new_pc<1:0> = bits(2) UNKNOWN;
elseif UsingAArch32() then // Return to AArch32
    // ELR_ELx[1:0] or ELR_ELx[0] are treated as being 0, depending on the target
    // instruction set state
    if PSTATE.T == '0' then
        new_pc<0> = '0'; // T32
    else
        new_pc<1:0> = '00'; // A32
else // Return to AArch64
    // ELR_ELx[63:56] might include a tag
    new_pc = AArch64.BranchAddr(new_pc, PSTATE.EL);

if UsingAArch32() then
    // 32 most significant bits are ignored
    BranchTo(new_pc<31:0>, BranchType_UNKNOWN);
else
    target_el = PSTATE.EL; valid = TRUE;
    if PSTATE.IL == '1' then
        // For an illegal exception return it is IMPLEMENTATION DEFINED whether the Exception
        // level indicated by the SPSR or the Exception level in which the exception return was
        // executed is used when determining tagged address handling on the branch target
        // address.
        if boolean IMPLEMENTATION_DEFINED "EL from SPSR on illegal exception return" then
            (valid, target_el) = ELFromSPSR(spsr);
        // If the target is not valid, or is using AArch32, the target TBI bits are RES0.
        if valid && !ELUsingAArch32(target_el) then
            new_pc = AArch64.BranchAddr(new_pc, target_el);
            BranchToAddr(new_pc, BranchType_ERET);
```

aarch64/instrs/countop/CountOp

```
enumeration CountOp {CountOp_CLZ, CountOp_CLS, CountOp_CNT};
```

aarch64/instrs/extendreg/DecodeRegExtend

```
// DecodeRegExtend()
// =====
// Decode a register extension option

ExtendType DecodeRegExtend(bits(3) op)
  case op of
    when '000' return ExtendType_UXTB;
    when '001' return ExtendType_UXTH;
    when '010' return ExtendType_UXTW;
    when '011' return ExtendType_UXTX;
    when '100' return ExtendType_SXTB;
    when '101' return ExtendType_SXTH;
    when '110' return ExtendType_SXTW;
    when '111' return ExtendType_SXTX;
```

aarch64/instrs/extendreg/ExtendReg

```
// ExtendReg()
// =====
// Perform a register extension and shift

bits(N) ExtendReg(integer reg, ExtendType type, integer shift)
  assert shift >= 0 && shift <= 4;
  bits(N) val = X[reg];
  boolean unsigned;
  integer len;

  case type of
    when ExtendType_SXTB unsigned = FALSE; len = 8;
    when ExtendType_SXTH unsigned = FALSE; len = 16;
    when ExtendType_SXTW unsigned = FALSE; len = 32;
    when ExtendType_SXTX unsigned = FALSE; len = 64;
    when ExtendType_UXTB unsigned = TRUE; len = 8;
    when ExtendType_UXTH unsigned = TRUE; len = 16;
    when ExtendType_UXTW unsigned = TRUE; len = 32;
    when ExtendType_UXTX unsigned = TRUE; len = 64;

  // Note the extended width of the intermediate value and
  // that sign extension occurs from bit <len+shift-1>, not
  // from bit <len-1>. This is equivalent to the instruction
  // [SU]BFIZ Rtmp, Rreg, #shift, #len
  // It may also be seen as a sign/zero extend followed by a shift:
  // LSL(Extend(val<len-1:0>, N, unsigned), shift);

  len = Min(len, N - shift);
  return Extend(val<len-1:0> : Zeros(shift), N, unsigned);
```

aarch64/instrs/extendreg/ExtendType

```
enumeration ExtendType {ExtendType_SXTB, ExtendType_SXTH, ExtendType_SXTW, ExtendType_SXTX,
  ExtendType_UXTB, ExtendType_UXTH, ExtendType_UXTW, ExtendType_UXTX};
```

aarch64/instrs/float/arithmetic/max-min/fpmaxminop/FPMaxMinOp

```
enumeration FPMaxMinOp {FPMaxMinOp_MAX, FPMaxMinOp_MIN,
  FPMaxMinOp_MAXNUM, FPMaxMinOp_MINNUM};
```

aarch64/instrs/float/arithmetic/unary/fpunaryop/FPUUnaryOp

```
enumeration FPUUnaryOp {FPUUnaryOp_ABS, FPUUnaryOp_MOV,
  FPUUnaryOp_NEG, FPUUnaryOp_SQRT};
```

aarch64/instrs/float/convert/fpconvop/FPConvOp

```
enumeration FPConvOp {FPConvOp_CVT_FtoI, FPConvOp_CVT_ItoF,  
FPConvOp_MOV_FtoI, FPConvOp_MOV_ItoF};
```

aarch64/instrs/integer/bitfield/bfxpreferred/BFXPreferred

```
// BFXPreferred()  
// =====  
//  
// Return TRUE if UBFX or SBFX is the preferred disassembly of a  
// UBFM or SBFM bitfield instruction. Must exclude more specific  
// aliases UBFIZ, SBFIZ, UXT[BH], SXT[BHW], LSL, LSR and ASR.  
  
boolean BFXPreferred(bit sf, bit uns, bits(6) imms, bits(6) immr)  
    integer S = UInt(imms);  
    integer R = UInt(immr);  
  
    // must not match UBFIZ/SBFIX alias  
    if UInt(imms) < UInt(immr) then  
        return FALSE;  
  
    // must not match LSR/ASR/LSL alias (imms == 31 or 63)  
    if imms == sf:'11111' then  
        return FALSE;  
  
    // must not match UXTx/SXTx alias  
    if immr == '000000' then  
        // must not match 32-bit UXT[BH] or SXT[BH]  
        if sf == '0' && imms IN {'000111', '001111'} then  
            return FALSE;  
        // must not match 64-bit SXT[BHW]  
        if sf:uns == '10' && imms IN {'000111', '001111', '011111'} then  
            return FALSE;  
  
    // must be UBFX/SBFX alias  
    return TRUE;
```

aarch64/instrs/integer/bitmasks/DecodeBitMasks

```
// DecodeBitMasks()  
// =====  
  
// Decode AArch64 bitfield and logical immediate masks which use a similar encoding structure  
  
(bits(M), bits(M)) DecodeBitMasks(bit immN, bits(6) imms, bits(6) immr, boolean immediate)  
    bits(M) tmask, wmask;  
    bits(6) levels;  
  
    // Compute log2 of element size  
    // 2^len must be in range [2, M]  
    len = HighestSetBit(immN:NOT(imms));  
    if len < 1 then ReservedValue();  
    assert M >= (1 << len);  
  
    // Determine S, R and S - R parameters  
    levels = ZeroExtend(Ones(len), 6);  
  
    // For logical immediates an all-ones value of S is reserved  
    // since it would generate a useless all-ones result (many times)  
    if immediate && (imms AND levels) == levels then  
        ReservedValue();  
  
    S = UInt(imms AND levels);  
    R = UInt(immr AND levels);  
    diff = S - R; // 6-bit subtract with borrow
```



```

esize = 1 << len;
d = UInt(diff<len-1:0>);
welem = ZeroExtend(Ones(S + 1), esize);
telem = ZeroExtend(Ones(d + 1), esize);
wmask = Replicate(ROR(welem, R));
tmask = Replicate(telem);
return (wmask, tmask);

```

aarch64/instrs/integer/ins-ext/insert/movewide/movewideop/MoveWideOp

```

enumeration MoveWideOp {MoveWideOp_N, MoveWideOp_Z, MoveWideOp_K};

```

aarch64/instrs/integer/logical/movwpreferred/MoveWidePreferred

```

// MoveWidePreferred()
// =====
//
// Return TRUE if a bitmask immediate encoding would generate an immediate
// value that could also be represented by a single MOVZ or MOVN instruction.
// Used as a condition for the preferred MOV<-ORR alias.

boolean MoveWidePreferred(bit sf, bit immN, bits(6) imms, bits(6) immr)
  integer S = UInt(imms);
  integer R = UInt(immr);
  integer width = if sf == '1' then 64 else 32;

  // element size must equal total immediate size
  if sf == '1' && immN:imms != '1xxxxx' then
    return FALSE;
  if sf == '0' && immN:imms != '00xxxxx' then
    return FALSE;

  // for MOVZ must contain no more than 16 ones
  if S < 16 then
    // ones must not span halfword boundary when rotated
    return (-R MOD 16) <= (15 - S);

  // for MOVN must contain no more than 16 zeros
  if S >= width - 15 then
    // zeros must not span halfword boundary when rotated
    return (R MOD 16) <= (S - (width - 15));

  return FALSE;

```

aarch64/instrs/integer/shiftreg/DecodeShift

```

// DecodeShift()
// =====
// Decode shift encodings

ShiftType DecodeShift(bits(2) op)
  case op of
    when '00' return ShiftType_LSL;
    when '01' return ShiftType_LSR;
    when '10' return ShiftType_ASR;
    when '11' return ShiftType_ROR;

```

aarch64/instrs/integer/shiftreg/ShiftReg

```

// ShiftReg()
// =====
// Perform shift of a register operand

bits(N) ShiftReg(integer reg, ShiftType type, integer amount)

```

```
bits(N) result = X[reg];
case type of
    when ShiftType_LSL result = LSL(result, amount);
    when ShiftType_LSR result = LSR(result, amount);
    when ShiftType_ASR result = ASR(result, amount);
    when ShiftType_ROR result = ROR(result, amount);
return result;
```

aarch64/instrs/integer/shiftreg/ShiftType

```
enumeration ShiftType {ShiftType_LSL, ShiftType_LSR, ShiftType_ASR, ShiftType_ROR};
```

aarch64/instrs/logicalop/LogicalOp

```
enumeration LogicalOp {LogicalOp_AND, LogicalOp_EOR, LogicalOp_ORR};
```

aarch64/instrs/memory/memop/MemAtomicOp

```
enumeration MemAtomicOp {MemAtomicOp_ADD,
    MemAtomicOp_BIC,
    MemAtomicOp_EOR,
    MemAtomicOp_ORR,
    MemAtomicOp_SMAX,
    MemAtomicOp_SMIN,
    MemAtomicOp_UMAX,
    MemAtomicOp_UMIN,
    MemAtomicOp_SWP};
```

aarch64/instrs/memory/memop/MemOp

```
enumeration MemOp {MemOp_LOAD, MemOp_STORE, MemOp_PREFETCH};
```

aarch64/instrs/memory/prefetch/Prefetch

```
// Prefetch()
// =====

// Decode and execute the prefetch hint on ADDRESS specified by PRFOP

Prefetch(bits(64) address, bits(5) prfop)
    PrefetchHint hint;
    integer target;
    boolean stream;

    case prfop<4:3> of
        when '00' hint = Prefetch_READ;           // PLD: prefetch for load
        when '01' hint = Prefetch_EXEC;          // PLI: preload instructions
        when '10' hint = Prefetch_WRITE;        // PST: prepare for store
        when '11' return;                        // unallocated hint
    target = UInt(prfop<2:1>);                   // target cache level
    stream = (prfop<0> != '0');                 // streaming (non-temporal)
    Hint_Prefetch(address, hint, target, stream);
return;
```

aarch64/instrs/system/barriers/barrierop/MemBarrierOp

```
enumeration MemBarrierOp {MemBarrierOp_DSB, MemBarrierOp_DMB, MemBarrierOp_ISB};
```

aarch64/instrs/system/hints/syshintop/SystemHintOp

```
enumeration SystemHintOp {
    SystemHintOp_NOP,
    SystemHintOp_YIELD,
```

```

SystemHintOp_WFE,
SystemHintOp_WFI,
SystemHintOp_SEV,
SystemHintOp_SEVL,
SystemHintOp_ESB,
SystemHintOp_PSB,
};

```

aarch64/instrs/system/register/cpsr/pstatefield/PSTATEField

```

enumeration PSTATEField {PSTATEField_DAIFFSet, PSTATEField_DAIFFClr,
                          PSTATEField_PAN, // ARMv8.1
                          PSTATEField_UAO, // ARMv8.2
                          PSTATEField_SP
};

```

aarch64/instrs/system/sysops/sysop/SysOp

```

// SysOp()
// =====

SystemOp SysOp(bits(3) op1, bits(4) CRn, bits(4) CRm, bits(3) op2)
case op1:CRn:CRm:op2 of
  when '000 0111 1000 000' return Sys_AT; // S1E1R
  when '100 0111 1000 000' return Sys_AT; // S1E2R
  when '110 0111 1000 000' return Sys_AT; // S1E3R
  when '000 0111 1000 001' return Sys_AT; // S1E1W
  when '100 0111 1000 001' return Sys_AT; // S1E2W
  when '110 0111 1000 001' return Sys_AT; // S1E3W
  when '000 0111 1000 010' return Sys_AT; // S1E0R
  when '000 0111 1000 011' return Sys_AT; // S1E0W
  when '100 0111 1000 100' return Sys_AT; // S1E1R
  when '100 0111 1000 101' return Sys_AT; // S1E1W
  when '100 0111 1000 110' return Sys_AT; // S1E0R
  when '100 0111 1000 111' return Sys_AT; // S1E0W
  when '011 0111 0100 001' return Sys_DC; // ZVA
  when '000 0111 0110 001' return Sys_DC; // IVAC
  when '000 0111 0110 010' return Sys_DC; // ISW
  when '011 0111 1010 001' return Sys_DC; // CVAC
  when '000 0111 1010 010' return Sys_DC; // CSW
  when '011 0111 1011 001' return Sys_DC; // CVAU
  when '011 0111 1110 001' return Sys_DC; // CIVAC
  when '000 0111 1110 010' return Sys_DC; // CISW
  when '000 0111 0001 000' return Sys_IC; // IALLUIS
  when '000 0111 0101 000' return Sys_IC; // IALLU
  when '011 0111 0101 001' return Sys_IC; // IVAU
  when '100 1000 0000 001' return Sys_TLBI; // IPAS2E1IS
  when '100 1000 0000 101' return Sys_TLBI; // IPAS2LE1IS
  when '000 1000 0011 000' return Sys_TLBI; // VMALLE1IS
  when '100 1000 0011 000' return Sys_TLBI; // ALLE2IS
  when '110 1000 0011 000' return Sys_TLBI; // ALLE3IS
  when '000 1000 0011 001' return Sys_TLBI; // VAE1IS
  when '100 1000 0011 001' return Sys_TLBI; // VAE2IS
  when '110 1000 0011 001' return Sys_TLBI; // VAE3IS
  when '000 1000 0011 010' return Sys_TLBI; // ASIDE1IS
  when '000 1000 0011 011' return Sys_TLBI; // VAAE1IS
  when '100 1000 0011 100' return Sys_TLBI; // ALLE1IS
  when '000 1000 0011 101' return Sys_TLBI; // VALE1IS
  when '100 1000 0011 101' return Sys_TLBI; // VALE2IS
  when '110 1000 0011 101' return Sys_TLBI; // VALE3IS
  when '100 1000 0011 110' return Sys_TLBI; // VMALLS12E1IS
  when '000 1000 0011 111' return Sys_TLBI; // VAALE1IS
  when '100 1000 0100 001' return Sys_TLBI; // IPAS2E1
  when '100 1000 0100 101' return Sys_TLBI; // IPAS2LE1
  when '000 1000 0111 000' return Sys_TLBI; // VMALLE1
  when '100 1000 0111 000' return Sys_TLBI; // ALLE2

```

```
when '110 1000 0111 000' return Sys_TLBI; // ALLE3
when '000 1000 0111 001' return Sys_TLBI; // VAE1
when '100 1000 0111 001' return Sys_TLBI; // VAE2
when '110 1000 0111 001' return Sys_TLBI; // VAE3
when '000 1000 0111 010' return Sys_TLBI; // ASIDE1
when '000 1000 0111 011' return Sys_TLBI; // VAAE1
when '100 1000 0111 100' return Sys_TLBI; // ALLE1
when '000 1000 0111 101' return Sys_TLBI; // VALE1
when '100 1000 0111 101' return Sys_TLBI; // VALE2
when '110 1000 0111 101' return Sys_TLBI; // VALE3
when '100 1000 0111 110' return Sys_TLBI; // VMALLS12E1
when '000 1000 0111 111' return Sys_TLBI; // VAALE1
return Sys_SYS;
```

aarch64/instrs/system/sysops/sysop/SystemOp

```
enumeration SystemOp {Sys_AT, Sys_DC, Sys_IC, Sys_TLBI, Sys_SYS};
```

aarch64/instrs/vector/arithmetic/binary/uniform/logical/bsl-eor/vbitop/VBitOp

```
enumeration VBitOp {VBitOp_VBIF, VBitOp_VBIT, VBitOp_VBSL, VBitOp_VEOR};
```

aarch64/instrs/vector/arithmetic/unary/cmp/compareop/CompareOp

```
enumeration CompareOp {CompareOp_GT, CompareOp_GE, CompareOp_EQ,
                       CompareOp_LE, CompareOp_LT};
```

aarch64/instrs/vector/crypto/enabled/CheckCryptoEnabled64

```
// CheckCryptoEnabled64()
// =====

CheckCryptoEnabled64()
  AArch64.CheckFPAdvSIMDEnabled();
  return;
```

aarch64/instrs/vector/logical/immediateop/ImmediateOp

```
enumeration ImmediateOp {ImmediateOp_MOVI, ImmediateOp_MVNI,
                        ImmediateOp_ORR, ImmediateOp_BIC};
```

aarch64/instrs/vector/reduce/reduceop/Reduce

```
// Reduce()
// =====

bits(esize) Reduce(ReduceOp op, bits(N) input, integer esize)
  integer half;
  bits(esize) hi;
  bits(esize) lo;
  bits(esize) result;

  if N == esize then
    return input;

  half = N DIV 2;
  hi = Reduce(op, input<N-1:half>, esize);
  lo = Reduce(op, input<half-1:0>, esize);

  case op of
  when ReduceOp_FMINNUM
    result = FPMinNum(lo, hi, FPCR);
  when ReduceOp_FMAXNUM
```

```

    result = FPMaxNum(lo, hi, FPCR);
  when ReduceOp_FMIN
    result = FPMIn(lo, hi, FPCR);
  when ReduceOp_FMAX
    result = FPMax(lo, hi, FPCR);
  when ReduceOp_FADD
    result = FPAdd(lo, hi, FPCR);
  when ReduceOp_ADD
    result = lo + hi;

  return result;

```

aarch64/instrs/vector/reduce/reduceop/ReduceOp

```

enumeration ReduceOp {ReduceOp_FMInNUM, ReduceOp_FMAXNUM,
  ReduceOp_FMIN, ReduceOp_FMAX,
  ReduceOp_FADD, ReduceOp_ADD};

```

J1.1.5 aarch64/translation

This section includes the following pseudocode functions:

- [aarch64/translation/attrs/AArch64.InstructionDevice](#).
- [aarch64/translation/attrs/AArch64.S1AttrDecode](#) on page J1-5912.
- [aarch64/translation/attrs/AArch64.TranslateAddressS1Off](#) on page J1-5912.
- [aarch64/translation/checks/AArch64.CheckPermission](#) on page J1-5913.
- [aarch64/translation/checks/AArch64.CheckS2Permission](#) on page J1-5914.
- [aarch64/translation/debug/AArch64.CheckBreakpoint](#) on page J1-5915.
- [aarch64/translation/debug/AArch64.CheckDebug](#) on page J1-5916.
- [aarch64/translation/debug/AArch64.CheckWatchpoint](#) on page J1-5916.
- [aarch64/translation/faults/AArch64.AccessFlagFault](#) on page J1-5916.
- [aarch64/translation/faults/AArch64.AddressSizeFault](#) on page J1-5916.
- [aarch64/translation/faults/AArch64.AlignmentFault](#) on page J1-5917.
- [aarch64/translation/faults/AArch64.AsynchExternalAbort](#) on page J1-5917.
- [aarch64/translation/faults/AArch64.DebugFault](#) on page J1-5917.
- [aarch64/translation/faults/AArch64.NoFault](#) on page J1-5918.
- [aarch64/translation/faults/AArch64.PermissionFault](#) on page J1-5918.
- [aarch64/translation/faults/AArch64.TranslationFault](#) on page J1-5918.
- [aarch64/translation/translation/AArch64.CheckAndUpdateDescriptor](#) on page J1-5918.
- [aarch64/translation/translation/AArch64.FirstStageTranslate](#) on page J1-5919.
- [aarch64/translation/translation/AArch64.FullTranslate](#) on page J1-5920.
- [aarch64/translation/translation/AArch64.SecondStageTranslate](#) on page J1-5920.
- [aarch64/translation/translation/AArch64.SecondStageWalk](#) on page J1-5921.
- [aarch64/translation/translation/AArch64.TranslateAddress](#) on page J1-5921.
- [aarch64/translation/walk/AArch64.TranslationTableWalk](#) on page J1-5922.

aarch64/translation/attrs/AArch64.InstructionDevice

```

// AArch64.InstructionDevice()
// =====
// Instruction fetches from memory marked as Device but not execute-never might generate a
// Permission Fault but are otherwise treated as if from Normal Non-cacheable memory.

AddressDescriptor AArch64.InstructionDevice(AddressDescriptor addrdesc, bits(64) vaddress,
  bits(52) ipaddress, integer level,
  AccType acctype, boolean iswrite, boolean secondstage,
  boolean s2fs1walk)

  c = ConstrainUnpredictable();

```

```

assert c IN {Constraint_NONE, Constraint_FAULT};

if c == Constraint_FAULT then
  addrdesc.fault = AArch64.PermissionFault(ipaddress, level, acctype, iswrite,
                                           secondstage, s2fs1walk);
else
  addrdesc.memattrs.type = MemType_Normal;
  addrdesc.memattrs.inner.attrs = MemAttr_NC;
  addrdesc.memattrs.inner.hints = MemHint_No;
  addrdesc.memattrs.outer = addrdesc.memattrs.inner;
  addrdesc.memattrs = MemAttrDefaults(addrdesc.memattrs);

return addrdesc;

```

aarch64/translation/attrs/AArch64.S1AttrDecode

```

// AArch64.S1AttrDecode()
// =====
// Converts the Stage 1 attribute fields, using the MAIR, to orthogonal
// attributes and hints.

MemoryAttributes AArch64.S1AttrDecode(bits(2) SH, bits(3) attr, AccType acctype)

MemoryAttributes memattrs;

mair = MAIR[];
index = 8 * UInt(attr);
attrfield = mair<index+7:index>;

if ((attrfield<7:4> != '0000' && attrfield<3:0> == '0000') ||
    (attrfield<7:4> == '0000' && attrfield<3:0> != 'xx00')) then
  // Reserved, maps to an allocated value
  (-, attrfield) = ConstrainUnpredictableBits();

if attrfield<7:4> == '0000' then // Device
  memattrs.type = MemType_Device;
  case attrfield<3:0> of
    when '0000' memattrs.device = DeviceType_nGnRnE;
    when '0100' memattrs.device = DeviceType_nGnRE;
    when '1000' memattrs.device = DeviceType_nGRE;
    when '1100' memattrs.device = DeviceType_GRE;
    otherwise Unreachable(); // Reserved, handled above

elseif attrfield<3:0> != '0000' then // Normal
  memattrs.type = MemType_Normal;
  memattrs.outer = LongConvertAttrHints(attrfield<7:4>, acctype);
  memattrs.inner = LongConvertAttrHints(attrfield<3:0>, acctype);
  memattrs.shareable = SH<1> == '1';
  memattrs.outershareable = SH == '10';

else
  Unreachable(); // Reserved, handled above

return MemAttrDefaults(memattrs);

```

aarch64/translation/attrs/AArch64.TranslateAddressS1Off

```

// AArch64.TranslateAddressS1Off()
// =====
// Called for stage 1 translations when translation is disabled to supply a default translation.
// Note that there are additional constraints on instruction prefetching that are not described in
// this pseudocode.

TLBRecord AArch64.TranslateAddressS1Off(bits(64) vaddress, AccType acctype, boolean iswrite)
assert !ELUsingAArch32(S1TranslationRegime());

```

```

TLBRecord result;

Top = AddrTop(vaddress, PSTATE.EL);
if !IsZero(vaddress<Top:PAMax(>)) then
    level = 0;
    ipaddress = bits(52) UNKNOWN;
    secondstage = FALSE;
    s2fs1walk = FALSE;
    result.addrdesc.fault = AArch64.AddressSizeFault(ipaddress, level, acctype,
                                                    iswrite, secondstage, s2fs1walk);

    return result;

default_cacheable = (HasS2Translation() && HCR_EL2.DC == '1');

if default_cacheable then
    // Use default cacheable settings
    result.addrdesc.memattrs.type = MemType_Normal;
    result.addrdesc.memattrs.inner.attrs = MemAttr_WB;           // Write-back
    result.addrdesc.memattrs.inner.hints = MemHint_RWA;
    result.addrdesc.memattrs.shareable = FALSE;
    result.addrdesc.memattrs.outershareable = FALSE;
elseif acctype != AccType_IFETCH then
    // Treat data as Device
    result.addrdesc.memattrs.type = MemType_Device;
    result.addrdesc.memattrs.device = DeviceType_nGnRnE;
    result.addrdesc.memattrs.inner = MemAttrHints UNKNOWN;
else
    // Instruction cacheability controlled by SCTLR_ELx.I
    cacheable = SCTLR[].I == '1';
    result.addrdesc.memattrs.type = MemType_Normal;
    if cacheable then
        result.addrdesc.memattrs.inner.attrs = MemAttr_WT;
        result.addrdesc.memattrs.inner.hints = MemHint_RA;
    else
        result.addrdesc.memattrs.inner.attrs = MemAttr_NC;
        result.addrdesc.memattrs.inner.hints = MemHint_No;
        result.addrdesc.memattrs.shareable = TRUE;
        result.addrdesc.memattrs.outershareable = TRUE;

result.addrdesc.memattrs.outer = result.addrdesc.memattrs.inner;

result.addrdesc.memattrs = MemAttrDefaults(result.addrdesc.memattrs);

result.perms.ap = bits(3) UNKNOWN;
result.perms.xn = '0';
result.perms.pxn = '0';

result.nG = bit UNKNOWN;
result.contiguous = boolean UNKNOWN;
result.domain = bits(4) UNKNOWN;
result.level = integer UNKNOWN;
result.blocksize = integer UNKNOWN;
result.addrdesc.paddress.physicaladdress = vaddress<51:0>;
result.addrdesc.paddress.NS = if IsSecure() then '0' else '1';
result.addrdesc.fault = AArch64.NoFault();
return result;

```

aarch64/translation/checks/AArch64.CheckPermission

```

// AArch64.CheckPermission()
// =====
// Function used for permission checking from AArch64 stage 1 translations

FaultRecord AArch64.CheckPermission(Permissions perms, bits(64) vaddress, integer level,
                                     bit NS, AccType acctype, boolean iswrite)
assert !ELUsingAArch32(S1TranslationRegime());

```

```
wxn = SCTRL[].WXN == '1';

if PSTATE.EL IN {EL0,EL1} || IsInHost() then
    priv_r = TRUE;
    priv_w = perms.ap<2> == '0';
    user_r = perms.ap<1> == '1';
    user_w = perms.ap<2:1> == '01';

    if PSTATE.EL == EL0 then
        ispriv = FALSE;
    elseif PSTATE.EL == EL2 && HCR_EL2.E2H == '1' && HCR_EL2.TGE == '0' then
        ispriv = TRUE;
    elseif HaveUAOExt() && PSTATE.UAO == '1' then
        ispriv = TRUE;
    else
        ispriv = (acctype != AccType_UNPRIV);

    if (HavePANExt() && PSTATE.PAN == '1' && user_r && ispriv &&
        !(acctype IN {AccType_DC,AccType_AT,AccType_IFETCH}) ||
        (acctype == AccType_AT && AArch64.ExecutingATS1xpInstr())) then
        priv_r = FALSE; priv_w = FALSE;
        user_xn = perms.xn == '1' || (user_w && wxn);
        priv_xn = perms.pxn == '1' || (priv_w && wxn) || user_w;
        if ispriv then
            (r, w, xn) = (priv_r, priv_w, priv_xn);
        else
            (r, w, xn) = (user_r, user_w, user_xn);
    else
        // Access from EL2 or EL3
        r = TRUE;
        w = perms.ap<2> == '0';
        xn = perms.xn == '1' || (w && wxn);

    // Restriction on Secure instruction fetch
    if HaveEL(EL3) && IsSecure() && NS == '1' && SCR_EL3.SIF == '1' then
        xn = TRUE;

    if acctype == AccType_IFETCH then
        fail = xn;
        failedread = TRUE;
    elseif acctype IN { AccType_ATOMICRW, AccType_ORDEREDRW } then
        fail = !r || !w;
        failedread = !r;
    elseif iswrite then
        fail = !w;
        failedread = FALSE;
    else
        fail = !r;
        failedread = TRUE;

    if fail then
        secondstage = FALSE;
        s2fs1walk = FALSE;
        ipaddress = bits(52) UNKNOWN;
        return AArch64.PermissionFault(ipaddress, level, acctype,
            !failedread, secondstage, s2fs1walk);
    else
        return AArch64.NoFault();
```

aarch64/translation/checks/AArch64.CheckS2Permission

```
// AArch64.CheckS2Permission()
// =====
// Function used for permission checking from AArch64 stage 2 translations

FaultRecord AArch64.CheckS2Permission(Permissions perms, bits(64) address, bits(52) ipaddress,
    integer level, AccType acctype, boolean iswrite,
```



```

    boolean s2fs1walk, boolean hwupdatewalk)

assert HaveEL(EL2) && !IsSecure() && !ELUsingAArch32(EL2) && HasS2Translation();

r = perms.ap<1> == '1';
w = perms.ap<2> == '1';
if HaveExtendedExecuteNeverExt() then
    case perms.xn:perms.xxn of
        when '00' xn = FALSE;
        when '01' xn = PSTATE.EL == EL1;
        when '10' xn = TRUE;
        when '11' xn = PSTATE.EL == EL0;
    else
        xn = perms.xn == '1';
// Stage 1 walk is checked as a read, regardless of the original type
if acctype == AccType_IFETCH && !s2fs1walk then
    fail = xn;
    failedread = TRUE;
elseif (acctype IN { AccType_ATOMICRW, AccType_ORDEREDRW }) && !s2fs1walk then
    fail = !r || !w;
    failedread = !r;
elseif iswrite && !s2fs1walk then
    fail = !w;
    failedread = FALSE;
elseif hwupdatewalk then
    fail = !w;
    failedread = !iswrite;
else
    fail = !r;
    failedread = !iswrite;

if fail then
    domain = bits(4) UNKNOWN;
    secondstage = TRUE;
    return AArch64.PermissionFault(ipaddress, level, acctype,
        !failedread, secondstage, s2fs1walk);
else
    return AArch64.NoFault();

```

aarch64/translation/debug/AArch64.CheckBreakpoint

```

// AArch64.CheckBreakpoint()
// =====
// Called before executing the instruction of length "size" bytes at "vaddress" in an AArch64
// translation regime.
// The breakpoint can in fact be evaluated well ahead of execution, for example, at instruction
// fetch. This is the simple sequential execution of the program.

FaultRecord AArch64.CheckBreakpoint(bits(64) vaddress, integer size)
assert !ELUsingAArch32(S1TranslationRegime());
assert (UsingAArch32() && size IN {2,4}) || size == 4;

match = FALSE;

for i = 0 to UInt(ID_AA64DFR0_EL1.BRPs)
    match_i = AArch64.BreakpointMatch(i, vaddress, size);
    match = match || match_i;

if match && HaltOnBreakpointOrWatchpoint() then
    reason = DebugHalt_Breakpoint;
    Halt(reason);
elseif match && MDCR_EL1.MDE == '1' && AArch64.GenerateDebugExceptions() then
    acctype = AccType_IFETCH;
    iswrite = FALSE;
    return AArch64.DebugFault(acctype, iswrite);
else
    return AArch64.NoFault();

```

aarch64/translation/debug/AArch64.CheckDebug

```
// AArch64.CheckDebug()
// =====
// Called on each access to check for a debug exception or entry to Debug state.

FaultRecord AArch64.CheckDebug(bits(64) vaddress, AccType acctype, boolean iswrite, integer size)

    FaultRecord fault = AArch64.NoFault();

    d_side = (acctype != AccType_IFETCH);
    generate_exception = AArch64.GenerateDebugExceptions() && MDSCR_EL1.MDE == '1';
    halt = HaltOnBreakpointOrWatchpoint();

    if generate_exception || halt then
        if d_side then
            fault = AArch64.CheckWatchpoint(vaddress, acctype, iswrite, size);
        else
            fault = AArch64.CheckBreakpoint(vaddress, size);

    return fault;
```

aarch64/translation/debug/AArch64.CheckWatchpoint

```
// AArch64.CheckWatchpoint()
// =====
// Called before accessing the memory location of "size" bytes at "address".

FaultRecord AArch64.CheckWatchpoint(bits(64) vaddress, AccType acctype,
                                     boolean iswrite, integer size)
    assert !ELUsingAArch32(S1TranslationRegime());

    match = FALSE;
    ispriv = PSTATE.EL != EL0 && !(PSTATE.EL == EL1 && acctype == AccType_UNPRIV);

    for i = 0 to UInt(ID_AA64DFR0_EL1.WRPs)
        match = match || AArch64.WatchpointMatch(i, vaddress, size, ispriv, iswrite);

    if match && HaltOnBreakpointOrWatchpoint() then
        reason = DebugHalt_Watchpoint;
        Halt(reason);
    elseif match && MDSCR_EL1.MDE == '1' && AArch64.GenerateDebugExceptions() then
        return AArch64.DebugFault(acctype, iswrite);
    else
        return AArch64.NoFault();
```

aarch64/translation/faults/AArch64.AccessFlagFault

```
// AArch64.AccessFlagFault()
// =====

FaultRecord AArch64.AccessFlagFault(bits(52) ipaddress, integer level,
                                     AccType acctype, boolean iswrite, boolean secondstage,
                                     boolean s2fs1walk)

    extflag = bit UNKNOWN;
    errortype = bits(2) UNKNOWN;
    return AArch64.CreateFaultRecord(Fault_AccessFlag, ipaddress, level, acctype, iswrite,
                                     extflag, errortype, secondstage, s2fs1walk);
```

aarch64/translation/faults/AArch64.AddressSizeFault

```
// AArch64.AddressSizeFault()
// =====

FaultRecord AArch64.AddressSizeFault(bits(52) ipaddress, integer level,
```

```
        AccType acctype, boolean iswrite, boolean secondstage,  
        boolean s2fs1walk)  
  
    extflag = bit UNKNOWN;  
    errortype = bits(2) UNKNOWN;  
    return AArch64.CreateFaultRecord(Fault_AddressSize, ipaddress, level, acctype, iswrite,  
        extflag, errortype, secondstage, s2fs1walk);
```

aarch64/translation/faults/AArch64.AlignmentFault

```
// AArch64.AlignmentFault()  
// =====  
  
FaultRecord AArch64.AlignmentFault(ArchType acctype, boolean iswrite, boolean secondstage)  
  
    ipaddress = bits(52) UNKNOWN;  
    level = integer UNKNOWN;  
    extflag = bit UNKNOWN;  
    errortype = bits(2) UNKNOWN;  
    s2fs1walk = boolean UNKNOWN;  
  
    return AArch64.CreateFaultRecord(Fault_Alignment, ipaddress, level, acctype, iswrite,  
        extflag, errortype, secondstage, s2fs1walk);
```

aarch64/translation/faults/AArch64.AsynchExternalAbort

```
// AArch64.AsynchExternalAbort()  
// =====  
// Wrapper function for asynchronous external aborts  
  
FaultRecord AArch64.AsynchExternalAbort(boolean parity, bits(2) errortype, bit extflag)  
  
    type = if parity then Fault_AsyncParity else Fault_AsyncExternal;  
    ipaddress = bits(52) UNKNOWN;  
    level = integer UNKNOWN;  
    acctype = ArchType_NORMAL;  
    iswrite = boolean UNKNOWN;  
    errortype = bits(2) UNKNOWN;  
    secondstage = FALSE;  
    s2fs1walk = FALSE;  
  
    return AArch64.CreateFaultRecord(type, ipaddress, level, acctype, iswrite, extflag,  
        errortype, secondstage, s2fs1walk);
```

aarch64/translation/faults/AArch64.DebugFault

```
// AArch64.DebugFault()  
// =====  
  
FaultRecord AArch64.DebugFault(ArchType acctype, boolean iswrite)  
  
    ipaddress = bits(52) UNKNOWN;  
    errortype = bits(2) UNKNOWN;  
    level = integer UNKNOWN;  
    extflag = bit UNKNOWN;  
    secondstage = FALSE;  
    s2fs1walk = FALSE;  
  
    return AArch64.CreateFaultRecord(Fault_Debug, ipaddress, level, acctype, iswrite,  
        extflag, errortype, secondstage, s2fs1walk);
```

aarch64/translation/faults/AArch64.NoFault

```
// AArch64.NoFault()
// =====

FaultRecord AArch64.NoFault()

    ipaddress = bits(52) UNKNOWN;
    level = integer UNKNOWN;
    acctype = AccType_NORMAL;
    iswrite = boolean UNKNOWN;
    extflag = bit UNKNOWN;
    errortype = bits(2) UNKNOWN;
    secondstage = FALSE;
    s2fs1walk = FALSE;

    return AArch64.CreateFaultRecord(Fault_None, ipaddress, level, acctype, iswrite,
                                     extflag, errortype, secondstage, s2fs1walk);
```

aarch64/translation/faults/AArch64.PermissionFault

```
// AArch64.PermissionFault()
// =====

FaultRecord AArch64.PermissionFault(bits(52) ipaddress, integer level,
                                     AccType acctype, boolean iswrite, boolean secondstage,
                                     boolean s2fs1walk)

    extflag = bit UNKNOWN;
    errortype = bits(2) UNKNOWN;
    return AArch64.CreateFaultRecord(Fault_Permission, ipaddress, level, acctype, iswrite,
                                     extflag, errortype, secondstage, s2fs1walk);
```

aarch64/translation/faults/AArch64.TranslationFault

```
// AArch64.TranslationFault()
// =====

FaultRecord AArch64.TranslationFault(bits(52) ipaddress, integer level,
                                       AccType acctype, boolean iswrite, boolean secondstage,
                                       boolean s2fs1walk)

    extflag = bit UNKNOWN;
    errortype = bits(2) UNKNOWN;
    return AArch64.CreateFaultRecord(Fault_Translation, ipaddress, level, acctype, iswrite,
                                     extflag, errortype, secondstage, s2fs1walk);
```

aarch64/translation/translation/AArch64.CheckAndUpdateDescriptor

```
// AArch64.CheckAndUpdateDescriptor()
// =====
// Check and update translation table descriptor if hardware update is configured

FaultRecord AArch64.CheckAndUpdateDescriptor(DescriptorUpdate result, FaultRecord fault,
                                             boolean secondstage, bits(64) vaddress, AccType acctype,
                                             boolean iswrite, boolean s2fs1walk, boolean hwupdatewalk)

    // Check if access flag can be updated
    // Address translation instructions are permitted to update AF but not required
    if result.AF then
        if fault.type == Fault_None then
            hw_update_AF = TRUE;
        elseif ConstrainUnpredictable() == Constraint_TRUE then
            hw_update_AF = TRUE;
        else
            hw_update_AF = FALSE;
```

```

if result.AP && fault.type == Fault_None then
  write_perm_req = (iswrite || acctype IN {AccType_ATOMICRW, AccType_ORDEREDRW}) && !s2fs1walk;
  hw_update_AP = (write_perm_req && !(acctype IN {AccType_AT, AccType_DC})) || hwupdatewalk;
else
  hw_update_AP = FALSE;

if hw_update_AF || hw_update_AP then
  if secondstage || !HasS2Translation() then
    descaddr2 = result.descaddr;
  else
    hwupdatewalk = TRUE;
    descaddr2 = AArch64.SecondStageWalk(result.descaddr, vaddress, acctype, iswrite, 8,
hwupdatewalk);
    if IsFault(descaddr2) then
      return descaddr2.fault;

  accdesc = CreateAccessDescriptor(ArchType_ATOMICRW);
  desc = _Mem[descaddr2, 8, accdesc];

  if hw_update_AF then
    desc<10> = '1';
  if hw_update_AP then
    desc<7> = (if secondstage then '1' else '0');

  _Mem[descaddr2, 8, accdesc] = desc;

return fault;

```

aarch64/translation/translation/AArch64.FirstStageTranslate

```

// AArch64.FirstStageTranslate()
// =====
// Perform a stage 1 translation walk. The function used by Address Translation operations is
// similar except it uses the translation regime specified for the instruction.

AddressDescriptor AArch64.FirstStageTranslate(bits(64) vaddress, AccType acctype, boolean iswrite,
boolean wasaligned, integer size)

if HasS2Translation() then
  s1_enabled = HCR_EL2.TGE == '0' && HCR_EL2.DC == '0' && SCTLR_EL1.M == '1';
else
  s1_enabled = SCTLR[.].M == '1';

ipaddress = bits(52) UNKNOWN;
secondstage = FALSE;
s2fs1walk = FALSE;

if s1_enabled then // First stage enabled
  S1 = AArch64.TranslationTableWalk(ipaddress, vaddress, acctype, iswrite, secondstage,
s2fs1walk, size);
  permissioncheck = TRUE;
else
  S1 = AArch64.TranslateAddressS1off(vaddress, acctype, iswrite);
  permissioncheck = FALSE;

if UsingAArch32() && HaveTrapLoadStoreMultipleDeviceExt() && AArch32.ExecutingLSMInstr() then
  if S1.addrdesc.memattrs.type == MemType_Device && S1.addrdesc.memattrs.device !=
DeviceType_GRE then
    nTLSMD = if S1TranslationRegime() == EL2 then SCTLR_EL2.nTLSMD else SCTLR_EL1.nTLSMD;
    if nTLSMD == '0' then
      S1.addrdesc.fault = AArch64.AlignmentFault(acctype, iswrite, secondstage);
  // Check for unaligned data accesses to Device memory
  if ((!wasaligned && acctype != AccType_IFETCH) || (acctype == AccType_DCZVA)
&& S1.addrdesc.memattrs.type == MemType_Device && !IsFault(S1.addrdesc) then
    S1.addrdesc.fault = AArch64.AlignmentFault(acctype, iswrite, secondstage);
  if !IsFault(S1.addrdesc) && permissioncheck then

```

```
S1.addrdesc.fault = AArch64.CheckPermission(S1.perms, vaddress, S1.level,
                                             S1.addrdesc.paddress.NS,
                                             acctype, iswrite);

// Check for instruction fetches from Device memory not marked as execute-never. If there has
// not been a Permission Fault then the memory is not marked execute-never.
if (!IsFault(S1.addrdesc) && S1.addrdesc.memattrs.type == MemType_Device &&
    acctype == AccType_IFETCH) then
    S1.addrdesc = AArch64.InstructionDevice(S1.addrdesc, vaddress, ipaddress, S1.level,
                                             acctype, iswrite,
                                             secondstage, s2fs1walk);

// Check and update translation table descriptor if required
hwupdatewalk = FALSE;
s2fs1walk = FALSE;
S1.addrdesc.fault = AArch64.CheckAndUpdateDescriptor(S1.descupdate, S1.addrdesc.fault,
                                                     secondstage, vaddress, acctype,
                                                     iswrite, s2fs1walk, hwupdatewalk);

return S1.addrdesc;
```

aarch64/translation/translation/AArch64.FullTranslate

```
// AArch64.FullTranslate()
// =====
// Perform both stage 1 and stage 2 translation walks for the current translation regime. The
// function used by Address Translation operations is similar except it uses the translation
// regime specified for the instruction.

AddressDescriptor AArch64.FullTranslate(bits(64) vaddress, AccType acctype, boolean iswrite,
                                       boolean wasaligned, integer size)

// First Stage Translation
S1 = AArch64.FirstStageTranslate(vaddress, acctype, iswrite, wasaligned, size);
if !IsFault(S1) && HasS2Translation() then
    s2fs1walk = FALSE;
    hwupdatewalk = FALSE;
    result = AArch64.SecondStageTranslate(S1, vaddress, acctype, iswrite, wasaligned, s2fs1walk,
                                          size, hwupdatewalk);
else
    result = S1;

return result;
```

aarch64/translation/translation/AArch64.SecondStageTranslate

```
// AArch64.SecondStageTranslate()
// =====
// Perform a stage 2 translation walk. The function used by Address Translation operations is
// similar except it uses the translation regime specified for the instruction.

AddressDescriptor AArch64.SecondStageTranslate(AddressDescriptor S1, bits(64) vaddress,
                                              AccType acctype, boolean iswrite, boolean wasaligned,
                                              boolean s2fs1walk, integer size, boolean hwupdatewalk)

assert HasS2Translation();

s2_enabled = HCR_EL2.VM == '1' || HCR_EL2.DC == '1';
secondstage = TRUE;

if s2_enabled then // Second stage enabled
    ipaddress = S1.paddress.physicaladdress<51:0>;

    S2 = AArch64.TranslationTableWalk(ipaddress, vaddress, acctype, iswrite, secondstage,
                                       s2fs1walk, size);

// Check for unaligned data accesses to Device memory
```

```

if ((!wasaligned && acctype != AccType_IFETCH) || (acctype == AccType_DCZVA)
    && S2.addrdesc.memattrs.type == MemType_Device && !IsFault(S2.addrdesc) then
    S2.addrdesc.fault = AArch64.AlignmentFault(acctype, iswrite, secondstage);

if !IsFault(S2.addrdesc) then
    S2.addrdesc.fault = AArch64.CheckS2Permission(S2.perms, vaddress, ipaddress, S2.level,
        acctype, iswrite, s2fs1walk, hwupdatewalk);
// Check for instruction fetches from Device memory not marked as execute-never. As there
// has not been a Permission Fault then the memory is not marked execute-never.
if (!s2fs1walk && !IsFault(S2.addrdesc) && S2.addrdesc.memattrs.type == MemType_Device &&
    acctype == AccType_IFETCH) then
    S2.addrdesc = AArch64.InstructionDevice(S2.addrdesc, vaddress, ipaddress, S2.level,
        acctype, iswrite,
        secondstage, s2fs1walk);

// Check for protected table walk
if (s2fs1walk && !IsFault(S2.addrdesc) && HCR_EL2.PTW == '1' &&
    S2.addrdesc.memattrs.type == MemType_Device) then
    S2.addrdesc.fault = AArch64.PermissionFault(ipaddress, S2.level, acctype,
        iswrite, secondstage, s2fs1walk);

// Check and update translation table descriptor if required
S2.addrdesc.fault = AArch64.CheckAndUpdateDescriptor(S2.descupdate, S2.addrdesc.fault,
    secondstage, vaddress, acctype,
    iswrite, s2fs1walk, hwupdatewalk);

result = CombineS1S2Desc(S1, S2.addrdesc);
else
    result = S1;

return result;
  
```

aarch64/translation/translation/AArch64.SecondStageWalk

```

// AArch64.SecondStageWalk()
// =====
// Perform a stage 2 translation on a stage 1 translation page table walk access.

AddressDescriptor AArch64.SecondStageWalk(AddressDescriptor S1, bits(64) vaddress, AccType acctype,
    boolean iswrite, integer size, boolean hwupdatewalk)

assert HasS2Translation();

s2fs1walk = TRUE;
wasaligned = TRUE;
return AArch64.SecondStageTranslate(S1, vaddress, acctype, iswrite, wasaligned, s2fs1walk,
    size, hwupdatewalk);
  
```

aarch64/translation/translation/AArch64.TranslateAddress

```

// AArch64.TranslateAddress()
// =====
// Main entry point for translating an address

AddressDescriptor AArch64.TranslateAddress(bits(64) vaddress, AccType acctype, boolean iswrite,
    boolean wasaligned, integer size)

result = AArch64.FullTranslate(vaddress, acctype, iswrite, wasaligned, size);

if !(acctype IN {AccType_PTW, AccType_IC, AccType_AT}) && !IsFault(result) then
    result.fault = AArch64.CheckDebug(vaddress, acctype, iswrite, size);

// Update virtual address for abort functions
result.vaddress = ZeroExtend(vaddress);

return result;
  
```

aarch64/translation/walk/AArch64.TranslationTableWalk

```

// AArch64.TranslationTableWalk()
// =====
// Returns a result of a translation table walk
//
// Implementations might cache information from memory in any number of non-coherent TLB
// caching structures, and so avoid memory accesses that have been expressed in this
// pseudocode. The use of such TLBs is not expressed in this pseudocode.

TLBRecord AArch64.TranslationTableWalk(bits(52) ipaddress, bits(64) vaddress,
                                         AccType acctype, boolean iswrite, boolean secondstage,
                                         boolean s2fs1walk, integer size)

  if !secondstage then
    assert !ELUsingAArch32(S1TranslationRegime());
  else
    assert HaveEL(EL2) && !IsSecure() && !ELUsingAArch32(EL2) && HasS2Translation();

  TLBRecord result;
  AddressDescriptor descaddr;
  bits(64) baseregister;
  bits(64) inputaddr;      // Input Address is 'vaddress' for stage 1, 'ipaddress' for stage 2

  descaddr.memattrs.type = MemType_Normal;

  // Derived parameters for the page table walk:
  // grainsize = Log2(Size of Table)      - Size of Table is 4KB, 16KB or 64KB in AArch64
  // stride = Log2(Address per Level)     - Bits of address consumed at each level
  // firstblocklevel = First level where a block entry is allowed
  // ps = Physical Address size as encoded in TCR_EL1.IPS or TCR_ELx/VTOR_EL2.PS
  // inputsize = Log2(Size of Input Address) - Input Address size in bits
  // level = Level to start walk from
  // This means that the number of levels after start level = 3-level

  if !secondstage then
    // First stage translation
    inputaddr = ZeroExtend(vaddress);
    top = AddrTop(inputaddr, PSTATE.EL);
    if PSTATE.EL == EL3 then
      largegrain = TCR_EL3.TG0 == '01';
      midgrain = TCR_EL3.TG0 == '10';
      inputsize = 64 - UInt(TCR_EL3.T0SZ);
      inputsize_max = (if Have52BitVAExt() && largegrain then 52 else 48);
      if inputsize > inputsize_max then
        c = ConstrainUnpredictable();
        assert c IN {Constraint_FORCE, Constraint_FAULT};
        if c == Constraint_FORCE then inputsize = inputsize_max;
      if inputsize < 25 then
        c = ConstrainUnpredictable();
        assert c IN {Constraint_FORCE, Constraint_FAULT};
        if c == Constraint_FORCE then inputsize = 25;
      ps = TCR_EL3.PS;
      basefound = inputsize >= 25 && inputsize <= inputsize_max &&
        IsZero(inputaddr<top:inputsize>);
      disabled = FALSE;
      baseregister = TTBR0_EL3;
      descaddr.memattrs = WalkAttrDecode(TCR_EL3.SH0, TCR_EL3.ORGNO, TCR_EL3.IRGN0, secondstage);
      reversedescriptors = SCTLRL_EL3.EE == '1';
      lookupsecure = TRUE;
      singlepriv = TRUE;
      update_AF = HaveAccessFlagUpdateExt() && TCR_EL3.HA == '1';
      update_AP = HaveDirtyBitModifierExt() && update_AF && TCR_EL3.HD == '1';
      hierattrdisabled = AArch64.HaveHPDEExt() && TCR_EL3.HPD == '1';
    elseif IsInHost() then
      if inputaddr<top> == '0' then
        largegrain = TCR_EL2.TG0 == '01';
        midgrain = TCR_EL2.TG0 == '10';
        inputsize = 64 - UInt(TCR_EL2.T0SZ);

```



```

inputsize_max = (if Have52BitVAExt() && largegrain then 52 else 48);
if inputsize > inputsize_max then
  c = ConstrainUnpredictable();
  assert c IN {Constraint_FORCE, Constraint_FAULT};
  if c == Constraint_FORCE then inputsize = inputsize_max;
if inputsize < 25 then
  c = ConstrainUnpredictable();
  assert c IN {Constraint_FORCE, Constraint_FAULT};
  if c == Constraint_FORCE then inputsize = 25;
basefound = inputsize >= 25 && inputsize <= inputsize_max &&
IsZero(inputaddr<top:inputsize>);
disabled = TCR_EL2.EPD0 == '1';
baseregister = TTBR0_EL2;
descaddr.memattrs = WalkAttrDecode(TCR_EL2.SH0, TCR_EL2.ORGNO, TCR_EL2.IRGN0,
secondstage);
  hierattrsdissabled = AArch64.HaveHPDExt() && TCR_EL2.HPD0 == '1';
else
  inputsize = 64 - UInt(TCR_EL2.T1SZ);
  largegrain = TCR_EL2.TG1 == '11'; // TG1 and TG0 encodings differ
  midgrain = TCR_EL2.TG1 == '01';
  inputsize_max = (if Have52BitVAExt() && largegrain then 52 else 48);
  if inputsize > inputsize_max then
    c = ConstrainUnpredictable();
    assert c IN {Constraint_FORCE, Constraint_FAULT};
    if c == Constraint_FORCE then inputsize = inputsize_max;
  if inputsize < 25 then
    c = ConstrainUnpredictable();
    assert c IN {Constraint_FORCE, Constraint_FAULT};
    if c == Constraint_FORCE then inputsize = 25;
  basefound = inputsize >= 25 && inputsize <= inputsize_max &&
IsOnes(inputaddr<top:inputsize>);
disabled = TCR_EL2.EPD1 == '1';
baseregister = TTBR1_EL2;
descaddr.memattrs = WalkAttrDecode(TCR_EL2.SH1, TCR_EL2.ORGNO, TCR_EL2.IRGN1,
secondstage);
  hierattrsdissabled = AArch64.HaveHPDExt() && TCR_EL2.HPD1 == '1';
  ps = TCR_EL2.IPS;
  reversedescriptors = SCTLRL_EL2.EE == '1';
  lookupsecure = FALSE;
  singlepriv = FALSE;
  update_AF = HaveAccessFlagUpdateExt() && TCR_EL2.HA == '1';
  update_AP = HaveDirtyBitModifierExt() && update_AF && TCR_EL2.HD == '1';
elseif PSTATE.EL == EL2 then
  inputsize = 64 - UInt(TCR_EL2.T0SZ);
  largegrain = TCR_EL2.TG0 == '01';
  midgrain = TCR_EL2.TG0 == '10';
  inputsize_max = (if Have52BitVAExt() && largegrain then 52 else 48);
  if inputsize > inputsize_max then
    c = ConstrainUnpredictable();
    assert c IN {Constraint_FORCE, Constraint_FAULT};
    if c == Constraint_FORCE then inputsize = inputsize_max;
  if inputsize < 25 then
    c = ConstrainUnpredictable();
    assert c IN {Constraint_FORCE, Constraint_FAULT};
    if c == Constraint_FORCE then inputsize = 25;
  ps = TCR_EL2.PS;
  basefound = inputsize >= 25 && inputsize <= inputsize_max &&
IsZero(inputaddr<top:inputsize>);
disabled = FALSE;
baseregister = TTBR0_EL2;
descaddr.memattrs = WalkAttrDecode(TCR_EL2.SH0, TCR_EL2.ORGNO, TCR_EL2.IRGN0, secondstage);
reversedescriptors = SCTLRL_EL2.EE == '1';
lookupsecure = FALSE;
singlepriv = TRUE;
update_AF = HaveAccessFlagUpdateExt() && TCR_EL2.HA == '1';
update_AP = HaveDirtyBitModifierExt() && update_AF && TCR_EL2.HD == '1';
hierattrsdissabled = AArch64.HaveHPDExt() && TCR_EL2.HPD == '1';
else

```

```

    if inputaddr<top> == '0' then
        inputsize = 64 - UInt(TCR_EL1.T0SZ);
        largegrain = TCR_EL1.TG0 == '01';
        midgrain = TCR_EL1.TG0 == '10';
        inputsize_max = (if Have52BitVAExt() && largegrain then 52 else 48);
        if inputsize > inputsize_max then
            c = ConstrainUnpredictable();
            assert c IN {Constraint_FORCE, Constraint_FAULT};
            if c == Constraint_FORCE then inputsize = inputsize_max;
        if inputsize < 25 then
            c = ConstrainUnpredictable();
            assert c IN {Constraint_FORCE, Constraint_FAULT};
            if c == Constraint_FORCE then inputsize = 25;
        basefound = inputsize >= 25 && inputsize <= inputsize_max &&
IsZero(inputaddr<top:inputsize>);
        disabled = TCR_EL1.EPD0 == '1';
        baseregister = TTBR0_EL1;
        descaddr.memattrs = WalkAttrDecode(TCR_EL1.SH0, TCR_EL1.ORGNO, TCR_EL1.IRGN0,
secondstage);
        hierattrsdissabled = AArch64.HaveHPDExt() && TCR_EL1.HPD0 == '1';
    else
        inputsize = 64 - UInt(TCR_EL1.T1SZ);
        largegrain = TCR_EL1.TG1 == '11'; // TG1 and TG0 encodings differ
        midgrain = TCR_EL1.TG1 == '01';
        inputsize_max = (if Have52BitVAExt() && largegrain then 52 else 48);
        if inputsize > inputsize_max then
            c = ConstrainUnpredictable();
            assert c IN {Constraint_FORCE, Constraint_FAULT};
            if c == Constraint_FORCE then inputsize = inputsize_max;
        if inputsize < 25 then
            c = ConstrainUnpredictable();
            assert c IN {Constraint_FORCE, Constraint_FAULT};
            if c == Constraint_FORCE then inputsize = 25;
        basefound = inputsize >= 25 && inputsize <= inputsize_max &&
IsOnes(inputaddr<top:inputsize>);
        disabled = TCR_EL1.EPD1 == '1';
        baseregister = TTBR1_EL1;
        descaddr.memattrs = WalkAttrDecode(TCR_EL1.SH1, TCR_EL1.ORGNI, TCR_EL1.IRGN1,
secondstage);
        hierattrsdissabled = AArch64.HaveHPDExt() && TCR_EL1.HPD1 == '1';
        ps = TCR_EL1.IPS;
        reversedescriptors = SCTRLR_EL1.EE == '1';
        lookupsecure = IsSecure();
        singlepriv = FALSE;
        update_AF = HaveAccessFlagUpdateExt() && TCR_EL1.HA == '1';
        update_AP = HaveDirtyBitModifierExt() && update_AF && TCR_EL1.HD == '1';
        if largegrain then
            grainsize = 16; // Log2(64KB page size)
            firstblocklevel = (if Have52BitPAExt() then 1 else 2); // Largest block is 4TB (2^42
bytes) for 52 bit PA // and 512MB (2^29 bytes)
        otherwise
            elseif midgrain then
                grainsize = 14; // Log2(16KB page size)
                firstblocklevel = 2; // Largest block is 32MB (2^25
bytes)
            else // Small grain
                grainsize = 12; // Log2(4KB page size)
                firstblocklevel = 1; // Largest block is 1GB (2^30
bytes)
            stride = grainsize - 3; // Log2(page size / 8 bytes)
            // The starting level is the number of strides needed to consume the input address
            level = 4 - RoundUp(Real(inputsize - grainsize) / Real(stride));
        else
            // Second stage translation
            inputaddr = ZeroExtend(ipaddress);
            inputsize = 64 - UInt(VTCR_EL2.T0SZ);

```

```

Largegrain = VTCR_EL2.TG0 == '01';
midgrain = VTCR_EL2.TG0 == '10';
inputsize_max = (if Have52BitVAExt() && largegrain then 52 else 48);
if inputsize > inputsize_max then
  c = ConstrainUnpredictable();
  assert c IN {Constraint_FORCE, Constraint_FAULT};
  if c == Constraint_FORCE then inputsize = inputsize_max;
if inputsize < 25 then
  c = ConstrainUnpredictable();
  assert c IN {Constraint_FORCE, Constraint_FAULT};
  if c == Constraint_FORCE then inputsize = 25;
ps = VTCR_EL2.PS;
basefound = inputsize >= 25 && inputsize <= inputsize_max && IsZero(inputaddr<63:inputsize>);
disabled = FALSE;
baseregister = VTTBR_EL2;
descaddr.memattrs = WalkAttrDecode(VTCR_EL2.IRGN0, VTCR_EL2.ORGNO, VTCR_EL2.SH0, secondstage);
reversedescriptors = SCTLR_EL2.EE == '1';
lookupsecure = FALSE;
singlepriv = TRUE;
update_AF = HaveAccessFlagUpdateExt() && VTCR_EL2.HA == '1';
update_AP = HaveDirtyBitModifierExt() && update_AF && VTCR_EL2.HD == '1';

startlevel = UInt(VTCR_EL2.SL0);
if largegrain then
  grainsize = 16; // Log2(64KB page size)
  level = 3 - startlevel;
  firstblocklevel = (if Have52BitPAExt() then 1 else 2); // Largest block is 4TB (2^42 bytes)
for 52 bit PA // and 512MB (2^29 bytes) otherwise
  elseif midgrain then
    grainsize = 14; // Log2(16KB page size)
    level = 3 - startlevel;
    firstblocklevel = 2; // Largest block is 32MB (2^25
bytes)
  else // Small grain
    grainsize = 12; // Log2(4KB page size)
    level = 2 - startlevel;
    firstblocklevel = 1; // Largest block is 1GB (2^30 bytes)
    stride = grainsize - 3; // Log2(page size / 8 bytes)

// Limits on IPA controls based on implemented PA size. Level 0 is only
// supported by small grain translations
if largegrain then // 64KB pages
  // Level 1 only supported if implemented PA size is greater than 2^42 bytes
  if level == 0 || (level == 1 && PAMax() <= 42) then basefound = FALSE;
elseif midgrain then // 16KB pages
  // Level 1 only supported if implemented PA size is greater than 2^40 bytes
  if level == 0 || (level == 1 && PAMax() <= 40) then basefound = FALSE;
else // Small grain, 4KB pages
  // Level 0 only supported if implemented PA size is greater than 2^42 bytes
  if level < 0 || (level == 0 && PAMax() <= 42) then basefound = FALSE;

// If the inputsize exceeds the PAMax value, the behavior is CONSTRAINED UNPREDICTABLE
inputsizecheck = inputsize;
if inputsize > PAMax() && (!ELUsingAArch32(EL1) || inputsize > 40) then
  case ConstrainUnpredictable() of
  when Constraint_FORCE
    // Restrict the inputsize to the PAMax value
    inputsize = PAMax();
    inputsizecheck = PAMax();
  when Constraint_FORCENOSLCHECK
    // As FORCE, except use the configured inputsize in the size checks below
    inputsize = PAMax();
  when Constraint_FAULT
    // Generate a translation fault
    basefound = FALSE;
  otherwise
    Unreachable();

```

```

// Number of entries in the starting level table =
// (Size of Input Address)/((Address per level)^(Num levels remaining)*(Size of Table))
startsizecheck = inputsizecheck - ((3 - level)*stride + grainsize); // Log2(Num of entries)

// Check for starting level table with fewer than 2 entries or longer than 16 pages.
// Lower bound check is: startsizecheck < Log2(2 entries)
// Upper bound check is: startsizecheck > Log2(pagesize/8*16)
if startsizecheck < 1 || startsizecheck > stride + 4 then basefound = FALSE;

if !basefound || disabled then
  level = 0; // AArch32 reports this as a level 1 fault
  result.addrdesc.fault = AArch64.TranslationFault(ipaddress, level, acctype, iswrite,
                                                    secondstage, s2fs1walk);
  return result;

case ps of
  when '000' outputsize = 32;
  when '001' outputsize = 36;
  when '010' outputsize = 40;
  when '011' outputsize = 42;
  when '100' outputsize = 44;
  when '101' outputsize = 48;
  when '110' outputsize = (if Have52BitPAExt() && largegrain then 52 else 48);
  otherwise outputsize = 48;

if outputsize > PAMax() then outputsize = PAMax();

if outputsize < 48 && !IsZero(baseregister<47:outputsize>) then
  level = 0;
  result.addrdesc.fault = AArch64.AddressSizeFault(ipaddress, level, acctype, iswrite,
                                                    secondstage, s2fs1walk);
  return result;

// Bottom bound of the Base address is:
// Log2(8 bytes per entry)+Log2(Number of entries in starting level table)
// Number of entries in starting level table =
// (Size of Input Address)/((Address per level)^(Num levels remaining)*(Size of Table))
baselowerbound = 3 + inputsize - ((3-level)*stride + grainsize); // Log2(Num of entries*8)
if outputsize == 52 then
  z = (if baselowerbound < 6 then 6 else baselowerbound);
  baseaddress = baseregister<5:2>:baseregister<47:z>:Zeros(z);
else
  baseaddress = ZeroExtend(baseregister<47:baselowerbound>:Zeros(baselowerbound));

ns_table = if lookupsecure then '0' else '1';
ap_table = '00';
xn_table = '0';
pxn_table = '0';

addrselecttop = inputsize - 1;

repeat
  addrselectbottom = (3-level)*stride + grainsize;

  bits(52) index = ZeroExtend(inputaddr<addrselecttop:addrselectbottom>:'000');
  descaddr.paddress.physicaladdress = baseaddress OR index;
  descaddr.paddress.NS = ns_table;

  // If there are two stages of translation, then the first stage table walk addresses
  // are themselves subject to translation
  if secondstage || !HasS2Translation() then
    descaddr2 = descaddr;
  else
    hwupdatewalk = FALSE;
    descaddr2 = AArch64.SecondStageWalk(descaddr, vaddress, acctype, iswrite, 8, hwupdatewalk);
    // Check for a fault on the stage 2 walk
    if IsFault(descaddr2) then

```

```

    result.addrdesc.fault = descaddr2.fault;
    return result;

// Update virtual address for abort functions
descaddr2.vaddress = ZeroExtend(vaddress);

accdesc = CreateAccessDescriptorPTW(acctype, secondstage, s2fs1walk, level);
desc = _Mem[descaddr2, 8, accdesc];

if reversedescriptors then desc = BigEndianReverse(desc);

if desc<0> == '0' || (desc<1:0> == '01' && level == 3) then
    // Fault (00), Reserved (10), or Block (01) at level 3
    result.addrdesc.fault = AArch64.TranslationFault(ipaddress, level, acctype,
                                                    iswrite, secondstage, s2fs1walk);
    return result;

// Valid Block, Page, or Table entry
if desc<1:0> == '01' || level == 3 then // Block (01) or Page (11)
    blocktranslate = TRUE;
else // Table (11)
    if (outputsize < 52 && largegrain && !IsZero(desc<15:12>)) || (outputsize < 48 &&
!IsZero(desc<47:outputsize>)) then
        result.addrdesc.fault = AArch64.AddressSizeFault(ipaddress, level, acctype,
                                                         iswrite, secondstage, s2fs1walk);
        return result;

    if outputsize == 52 then
        baseaddress = desc<15:12>:desc<47:grainsize>:Zeros(grainsize);
    else
        baseaddress = ZeroExtend(desc<47:grainsize>:Zeros(grainsize));
    if !secondstage then
        // Unpack the upper and lower table attributes
        ns_table = ns_table OR desc<63>;
    if !secondstage && !hierattrrdisabled then
        ap_table<1> = ap_table<1> OR desc<62>; // read-only
        xn_table = xn_table OR desc<60>;
        // pxn_table and ap_table[0] apply in EL1&& or EL2&& translation regimes
        if !singlepriv then
            ap_table<0> = ap_table<0> OR desc<61>; // privileged
            pxn_table = pxn_table OR desc<59>;

    level = level + 1;
    addrselecttop = addrselectbottom - 1;
    blocktranslate = FALSE;
until blocktranslate;

// Check block size is supported at this level
if level < firstblocklevel then
    result.addrdesc.fault = AArch64.TranslationFault(ipaddress, level, acctype,
                                                    iswrite, secondstage, s2fs1walk);
    return result;

// Check for misprogramming of the contiguous bit
if largegrain then
    contiguousbitcheck = level == 2 && inputsize < 34;
elseif midgrain then
    contiguousbitcheck = level == 2 && inputsize < 30;
else
    contiguousbitcheck = level == 1 && inputsize < 34;

if contiguousbitcheck && desc<52> == '1' then
    if boolean IMPLEMENTATION_DEFINED "Translation fault on misprogrammed contiguous bit" then
        result.addrdesc.fault = AArch64.TranslationFault(ipaddress, level, acctype,
                                                         iswrite, secondstage, s2fs1walk);
        return result;

// Check the output address is inside the supported range

```

```

    if (outputsize < 52 && largegrain && !IsZero(desc<15:12>)) || (outputsize < 48 &&
    !IsZero(desc<47:outputsize>)) then
        result.addrdesc.fault = AArch64.AddressSizeFault(ipaddress, level, acctype,
        iswrite, secondstage, s2fs1walk);
        return result;

    // Unpack the descriptor into address and upper and lower block attributes
    if outputsize == 52 then
        outputaddress = desc<15:12>:desc<47:addrselectbottom>:inputaddr<addrselectbottom-1:0>;
    else
        outputaddress = ZeroExtend(desc<47:addrselectbottom>:inputaddr<addrselectbottom-1:0>);
    // Check Access Flag
    if desc<10> == '0' then
        if !update_AF then
            result.addrdesc.fault = AArch64.AccessFlagFault(ipaddress, level, acctype,
            iswrite, secondstage, s2fs1walk);
            return result;
        else
            result.descupdate.AF = TRUE;

    if update_AP && desc<51> == '1' then
        // If hw update of access permission field is configured consider AP[2] as '0' / S2AP[2] as '1'
        if !secondstage && desc<7> == '1' then
            desc<7> = '0';
            result.descupdate.AP = TRUE;
        elseif secondstage && desc<7> == '0' then
            desc<7> = '1';
            result.descupdate.AP = TRUE;

    // Required descriptor if AF or AP[2]/S2AP[2] needs update
    result.descupdate.descaddr = descaddr;

    xn = desc<54>;
    pxn = desc<53>;
    contiguousbit = desc<52>;
    nG = desc<11>;
    sh = desc<9:8>;
    ap = desc<7:6>:'1';
    memattr = desc<5:2>; // AttrIndx and NS bit in stage 1

    result.domain = bits(4) UNKNOWN; // Domains not used
    result.level = level;
    result.blocksize = 2^(3-level)*stride + grainsize;

    // Stage 1 translation regimes also inherit attributes from the tables
    if !secondstage then
        result.perms.xn = xn OR xn_table;
        result.perms.ap<2> = ap<2> OR ap_table<1>; // Force read-only
        // PXN, nG and AP[1] apply in EL1&0 or EL2&0 stage 1 translation regimes
        if !singlepriv then
            result.perms.ap<1> = ap<1> AND NOT(ap_table<0>); // Force privileged only
            result.perms.pxn = pxn OR pxn_table;
            // Pages from Non-secure tables are marked non-global in Secure EL1&0
            if IsSecure() then
                result.nG = nG OR ns_table;
            else
                result.nG = nG;
        else
            result.perms.ap<1> = '1';
            result.perms.pxn = '0';
            result.nG = '0';
            result.perms.ap<0> = '1';
            result.addrdesc.memattrs = AArch64.S1AttrDecode(sh, memattr<2:0>, acctype);
            result.addrdesc.paddress.NS = memattr<3> OR ns_table;
    else
        result.perms.ap<2:1> = ap<2:1>;
        result.perms.ap<0> = '1';
        result.perms.xn = xn;
  
```

```
if HaveExtendedExecuteNeverExt() then result.perms.xxn = desc<53>;
result.perms.pxn      = '0';
result.nG             = '0';
result.addrdesc.memattrs = S2AttrDecode(sh, memattr, acctype);
result.addrdesc.paddress.NS = '1';

result.addrdesc.paddress.physicaladdress = outputaddress;
result.addrdesc.fault = AArch64.NoFault();
result.contiguous = contiguousbit == '1';
if HaveCommonNotPrivateTransExt() then result.CnP = baseregister<0>;
return result;
```

J1.2 Pseudocode for AArch32 operation

This section holds the pseudocode for execution in AArch32 state. Functions that are listed in this section are identified as `AArch32.FunctionName`. Some of these functions have an equivalent AArch64 function, `AArch64.FunctionName`. This section is organized by functional groups, with the functional groups being indicated by hierarchical path names, for example `aarch32/debug/breakpoint`.

———— Note ————

Many AArch32 pseudocode functions have not been updated to show the constraints on the ARMv7 UNPREDICTABLE behaviors that are described in [Appendix K1 Architectural Constraints on UNPREDICTABLE behaviors](#). Where AArch32 pseudocode shows something to be UNPREDICTABLE, check [Appendix K1](#) for possible constraints on the permitted behavior.

The top-level sections of the AArch32 pseudocode hierarchy are:

- [aarch32/debug](#).
- [aarch32/exceptions](#) on page J1-5938.
- [aarch32/functions](#) on page J1-5956.
- [aarch32/translation](#) on page J1-5985.

J1.2.1 aarch32/debug

This section includes the following pseudocode functions:

- [aarch32/debug/VCRMatch/AArch32.VCRMatch](#).
- [aarch32/debug/authentication/AArch32.SelfHostedSecurePrivilegedInvasiveDebugEnabled](#) on page J1-5931.
- [aarch32/debug/breakpoint/AArch32.BreakpointMatch](#) on page J1-5931.
- [aarch32/debug/breakpoint/AArch32.BreakpointValueMatch](#) on page J1-5932.
- [aarch32/debug/breakpoint/AArch32.StateMatch](#) on page J1-5933.
- [aarch32/debug/enables/AArch32.GenerateDebugExceptions](#) on page J1-5934.
- [aarch32/debug/enables/AArch32.GenerateDebugExceptionsFrom](#) on page J1-5934.
- [aarch32/debug/pmu/AArch32.CheckForPMUOverflow](#) on page J1-5935.
- [aarch32/debug/pmu/AArch32.CountEvents](#) on page J1-5935.
- [aarch32/debug/takeexceptiondbg/AArch32.EnterHypModeInDebugState](#) on page J1-5936.
- [aarch32/debug/takeexceptiondbg/AArch32.EnterModeInDebugState](#) on page J1-5936.
- [aarch32/debug/takeexceptiondbg/AArch32.EnterMonitorModeInDebugState](#) on page J1-5937.
- [aarch32/debug/watchpoint/AArch32.WatchpointByteMatch](#) on page J1-5937.
- [aarch32/debug/watchpoint/AArch32.WatchpointMatch](#) on page J1-5938.

aarch32/debug/VCRMatch/AArch32.VCRMatch

```
// AArch32.VCRMatch()
// =====

boolean AArch32.VCRMatch(bits(32) vaddress)

if UsingAArch32() && ELUsingAArch32(EL1) && IsZero(vaddress<1:0>) && PSTATE.EL != EL2 then
    // Each bit position in this string corresponds to a bit in DBGVCR and an exception vector.
    match_word = Zeros(32);

    if vaddress<31:5> == ExcVectorBase()<31:5> then
        if HaveEL(EL3) && !IsSecure() then
            match_word<UInt(vaddress<4:2>) + 24> = '1';    // Non-secure vectors
        else
            match_word<UInt(vaddress<4:2>) + 0> = '1';    // Secure vectors (or no EL3)

    if HaveEL(EL3) && ELUsingAArch32(EL3) && IsSecure() && vaddress<31:5> == MVBAR<31:5> then
        match_word<UInt(vaddress<4:2>) + 8> = '1';    // Monitor vectors
```



```

// Mask out bits not corresponding to vectors.
if !HaveEL(EL3) then
    mask = '00000000':'00000000':'00000000':'11011110'; // DBGVCR[31:8] are RES0
elseif !ELUsingAArch32(EL3) then
    mask = '11011110':'00000000':'00000000':'11011110'; // DBGVCR[15:8] are RES0
else
    mask = '11011110':'00000000':'11011100':'11011110';

match_word = match_word AND DBGVCR AND mask;
match = !IsZero(match_word);

// Check for UNPREDICTABLE case - match on Prefetch Abort and Data Abort vectors
if !IsZero(match_word<28:27,12:11,4:3>) && DebugTarget() == PSTATE.EL then
    match = ConstrainUnpredictableBool();
else
    match = FALSE;

return match;

```

aarch32/debug/authentication/AArch32.SelfHostedSecurePrivilegedInvasiveDebugEnabled

```

// AArch32.SelfHostedSecurePrivilegedInvasiveDebugEnabled()
// =====

boolean AArch32.SelfHostedSecurePrivilegedInvasiveDebugEnabled()
// The definition of this function is IMPLEMENTATION DEFINED.
// In the recommended interface, AArch32.SelfHostedSecurePrivilegedInvasiveDebugEnabled returns
// the state of the (DBGEN AND SPIDEN) signal.
if !HaveEL(EL3) && !IsSecure() then return FALSE;
return DBGEN == HIGH && SPIDEN == HIGH;

```

aarch32/debug/breakpoint/AArch32.BreakpointMatch

```

// AArch32.BreakpointMatch()
// =====
// Breakpoint matching in an AArch32 translation regime.

(boolean,boolean) AArch32.BreakpointMatch(integer n, bits(32) vaddress, integer size)
    assert ELUsingAArch32(S1TranslationRegime());
    assert n <= UInt(DBGDIDR.BRPs);

    enabled = DBGBCR[n].E == '1';
    ispriv = PSTATE.EL != EL0;
    linked = DBGBCR[n].BT == '0x01';
    isbreakpt = TRUE;
    linked_to = FALSE;

    state_match = AArch32.StateMatch(DBGBCR[n].SSC, DBGBCR[n].HMC, DBGBCR[n].PMC,
        linked, DBGBCR[n].LBN, isbreakpt, ispriv);
    (value_match, value_mismatch) = AArch32.BreakpointValueMatch(n, vaddress, linked_to);

    if size == 4 then // Check second halfword
        // If the breakpoint address and BAS of an Address breakpoint match the address of the
        // second halfword of an instruction, but not the address of the first halfword, it is
        // CONSTRAINED UNPREDICTABLE whether or not this breakpoint generates a Breakpoint debug
        // event.
        (match_i, mismatch_i) = AArch32.BreakpointValueMatch(n, vaddress + 2, linked_to);
        if !value_match && match_i then
            value_match = ConstrainUnpredictableBool();
        if value_mismatch && !mismatch_i then
            value_mismatch = ConstrainUnpredictableBool();

    if vaddress<1> == '1' && DBGBCR[n].BAS == '1111' then
        // The above notwithstanding, if DBGBCR[n].BAS == '1111', then it is CONSTRAINED

```

```

    // UNPREDICTABLE whether or not a Breakpoint debug event is generated for an instruction
    // at the address DBGVBR[n]+2.
    if value_match then value_match = ConstrainUnpredictableBool();
    if !value_mismatch then value_mismatch = ConstrainUnpredictableBool();

    match = value_match && state_match && enabled;
    mismatch = value_mismatch && state_match && enabled;

    return (match, mismatch);
  
```

aarch32/debug/breakpoint/AArch32.BreakpointValueMatch

```

// AArch32.BreakpointValueMatch()
// =====
// The first result is whether an Address Match or Context breakpoint is programmed on the
// instruction at "address". The second result is whether an Address Mismatch breakpoint is
// programmed on the instruction, that is, whether the instruction should be stepped.

(booleant,booleant) AArch32.BreakpointValueMatch(integer n, bits(32) vaddress, booleant linked_to)

// "n" is the identity of the breakpoint unit to match against
// "vaddress" is the current instruction address, ignored if linked_to is TRUE and for Context
// matching breakpoints.
// "linked_to" is TRUE if this is a call from StateMatch for linking.

// If a non-existent breakpoint then it is CONSTRAINED UNPREDICTABLE whether this gives
// no match or the breakpoint is mapped to another UNKNOWN implemented breakpoint.
if n > UInt(DBGDIDR.BRPs) then
  (c, n) = ConstrainUnpredictableInteger(0, UInt(DBGDIDR.BRPs));
  assert c IN {Constraint_DISABLED, Constraint_UNKNOWN};
  if c == Constraint_DISABLED then return (FALSE,FALSE);

// If this breakpoint is not enabled, it cannot generate a match. (This could also happen on a
// call from StateMatch for linking.)
if DBGBCR[n].E == '0' then return (FALSE,FALSE);

context_aware = (n >= UInt(DBGDIDR.BRPs) - UInt(DBGDIDR.CTX_CMPs));

// If BT is set to a reserved type, behaves either as disabled or as a not-reserved type.
type = DBGBCR[n].BT;

if ((type IN {'011x','11xx'} && !HaveVirtHostExt()) || // Context matching
     (type == '010x' && HaltOnBreakpointOrWatchpoint()) || // Address mismatch
     (type != '0x0x' && !context_aware) || // Context matching
     (type == '1xxx' && !HaveEL(EL2))) then // EL2 extension
  (c, type) = ConstrainUnpredictableBits();
  assert c IN {Constraint_DISABLED, Constraint_UNKNOWN};
  if c == Constraint_DISABLED then return (FALSE,FALSE);
  // Otherwise the value returned by ConstrainUnpredictableBits must be a not-reserved value

// Determine what to compare against.
match_addr = (type == '0x0x');
mismatch   = (type == '010x');
match_vmid = (type == '10xx');
match_cid1 = (type == 'xx1x');
match_cid2 = (type == '11xx');
linked     = (type == 'xxx1');

// If this is a call from StateMatch, return FALSE if the breakpoint is not programmed for a
// VMID and/or context ID match, or if not context-aware. The above assertions mean that the
// code can just test for match_addr == TRUE to confirm all these things.
if linked_to && (!linked || match_addr) then return (FALSE,FALSE);

// If called from BreakpointMatch return FALSE for Linked context ID and/or VMID matches.
if !linked_to && linked && !match_addr then return (FALSE,FALSE);

// Do the comparison.
  
```

```

if match_addr then
    byte = UInt(vaddress<1:0>);
    assert byte IN {0,2}; // "vaddress" is halfword aligned.
    byte_select_match = (DBGBCR[n].BAS<byte> == '1');
    BVR_match = vaddress<31:2> == DBGBVR[n]<31:2> && byte_select_match;
elseif match_cid1 then
    BVR_match = (PSTATE.EL != EL2 && CONTEXTIDR == DBGBVR[n]<31:0>);
if match_vmid then
    if ELUsingAArch32(EL2) then
        vmid = ZeroExtend(VTTBR.VMID, 16);
        bvr_vmid = ZeroExtend(DBGXVR[n]<7:0>, 16);
    elseif !Have16bitVMID() || VTCR_EL2.VS == '0' then
        vmid = ZeroExtend(VTTBR_EL2.VMID<7:0>, 16);
        bvr_vmid = ZeroExtend(DBGXVR[n]<7:0>, 16);
    else
        vmid = VTTBR_EL2.VMID;
        bvr_vmid = DBGXVR[n]<15:0>;
    BXVR_match = (HaveEL(EL2) && !IsSecure() && PSTATE.EL IN {EL0,EL1} &&
        vmid == bvr_vmid);
elseif match_cid2 then
    BXVR_match = (!IsSecure() && HaveVirtHostExt() &&
    !ELUsingAArch32(EL2) &&
    DBGXVR[n]<31:0> == CONTEXTIDR_EL2);

bvr_match_valid = (match_addr || match_cid1);
bxvr_match_valid = (match_vmid || match_cid2);

match = (!bxvr_match_valid || BXVR_match) && (!bvr_match_valid || BVR_match);

return (match && !mismatch, !match && mismatch);

```

aarch32/debug/breakpoint/AArch32.StateMatch

```

// AArch32.StateMatch()
// =====
// Determine whether a breakpoint or watchpoint is enabled in the current mode and state.

boolean AArch32.StateMatch(bits(2) SSC, bit HMC, bits(2) PxC, boolean linked, bits(4) LBN,
    boolean isbreakpnt, boolean ispriv)
// "SSC", "HMC", "PxC" are the control fields from the DBGBCR[n] or DBGWCR[n] register.
// "linked" is TRUE if this is a linked breakpoint/watchpoint type.
// "LBN" is the linked breakpoint number from the DBGBCR[n] or DBGWCR[n] register.
// "isbreakpnt" is TRUE for breakpoints, FALSE for watchpoints.
// "ispriv" is valid for watchpoints, and selects between privileged and unprivileged accesses.

// If parameters are set to a reserved type, behaves as either disabled or a defined type
if ((HMC:SSC:PxC) IN {'011xx', '100x0', '101x0', '11010', '11101', '1111x'}) || // Reserved
    (HMC == '0' && PxC == '00' && !isbreakpnt) || // Usr/Svc/Sys
    (SSC IN {'01', '10'} && !HaveEL(EL3)) || // No EL3
    (HMC:SSC:PxC == '11000' && ELUsingAArch32(EL3)) || // AArch64 only
    (HMC:SSC != '000' && HMC:SSC != '111' && !HaveEL(EL3) && !HaveEL(EL2)) || // No EL3/EL2
    (HMC:SSC:PxC == '11100' && !HaveEL(EL2)) then // No EL2
    (c, <HMC,SSC,PxC>) = ConstrainUnpredictableBits();
    assert c IN {Constraint_DISABLED, Constraint_UNKNOWN};
    if c == Constraint_DISABLED then return FALSE;
    // Otherwise the value returned by ConstrainUnpredictableBits must be a not-reserved value

PL2_match = HaveEL(EL2) && HMC == '1';
PL1_match = PxC<0> == '1';
PL0_match = PxC<1> == '1';
SSU_match = isbreakpnt && HMC == '0' && PxC == '00' && SSC != '11';

if SSU_match then
    priv_match = PSTATE.M IN {M32_User,M32_Svc,M32_System};
else
    case PSTATE.EL of
        when EL3, EL1 priv_match = if ispriv then PL1_match else PL0_match;

```

```

    when EL2      priv_match = PL2_match;
    when EL0      priv_match = PL0_match;

case SSC of
  when '00' security_state_match = TRUE;      // Both
  when '01' security_state_match = !IsSecure(); // Non-secure only
  when '10' security_state_match = IsSecure(); // Secure only
  when '11' security_state_match = TRUE;      // Both

if linked then
  // "LBN" must be an enabled context-aware breakpoint unit. If it is not context-aware then
  // it is CONSTRAINED UNPREDICTABLE whether this gives no match, or LBN is mapped to some
  // UNKNOWN breakpoint that is context-aware.
  lbn = UInt(LBN);
  first_ctx_cmp = (UInt(DBGDIDR.BRPs) - UInt(DBGDIDR.CTX_CMPs));
  last_ctx_cmp = UInt(DBGDIDR.BRPs);
  if (lbn < first_ctx_cmp || lbn > last_ctx_cmp) then
    (c, lbn) = ConstrainUnpredictableInteger(first_ctx_cmp, last_ctx_cmp);
    assert c IN {Constraint_DISABLED, Constraint_NONE, Constraint_UNKNOWN};
    case c of
      when Constraint_DISABLED return FALSE; // Disabled
      when Constraint_NONE     linked = FALSE; // No linking
      // Otherwise ConstrainUnpredictableInteger returned a context-aware breakpoint

if linked then
  vaddress = bits(32) UNKNOWN;
  linked_to = TRUE;
  (linked_match,-) = AArch32.BreakpointValueMatch(lbn, vaddress, linked_to);

return priv_match && security_state_match && (!linked || linked_match);

```

aarch32/debug/enables/AArch32.GenerateDebugExceptions

```

// AArch32.GenerateDebugExceptions()
// =====

boolean AArch32.GenerateDebugExceptions()
  return AArch32.GenerateDebugExceptionsFrom(PSTATE.EL, IsSecure());

```

aarch32/debug/enables/AArch32.GenerateDebugExceptionsFrom

```

// AArch32.GenerateDebugExceptionsFrom()
// =====

boolean AArch32.GenerateDebugExceptionsFrom(bits(2) from, boolean secure)

if from == EL0 && !ELStateUsingAArch32(EL1, secure) then
  mask = bit UNKNOWN; // PSTATE.D mask, unused for EL0 case
  return AArch64.GenerateDebugExceptionsFrom(from, secure, mask);

if DBGOSLSR.OSLK == '1' || DoubleLockStatus() || Halted() then
  return FALSE;

if HaveEL(EL3) && secure then
  spd = (if ELUsingAArch32(EL3) then SDCR.SPD else MDCR_EL3.SPD32);
  if spd<1> == '1' then
    enabled = spd<0> == '1';
  else
    // SPD == 0b01 is reserved, but behaves the same as 0b00.
    enabled = AArch32.SelfHostedSecurePrivilegedInvasiveDebugEnabled();
  if from == EL0 then enabled = enabled || SDER.SUIDEN == '1';
else
  enabled = from != EL2;

return enabled;

```

aarch32/debug/pmu/AArch32.CheckForPMUOverflow

```
// AArch32.CheckForPMUOverflow()
// =====
// Signal Performance Monitors overflow IRQ and CTI overflow events

boolean AArch32.CheckForPMUOverflow()

    if !ELUsingAArch32(EL1) then return AArch64.CheckForPMUOverflow();
    pmuirq = (PMCR.E == '1' && PMINTENSET<31> == '1' && PMOVSSET<31> == '1');
    for n = 0 to UInt(PMCR.N) - 1
        if HaveEL(EL2) then
            hpmn = (if !ELUsingAArch32(EL2) then MDCR_EL2.HPMN else HDCR.HPMN);
            hpme = (if !ELUsingAArch32(EL2) then MDCR_EL2.HPME else HDCR.HPME);
            E = (if n < UInt(hpmn) then PMCR.E else hpme);
        else
            E = PMCR.E;
        if E == '1' && PMINTENSET<n> == '1' && PMOVSSET<n> == '1' then pmuirq = TRUE;

    SetInterruptRequestLevel(InterruptID_PMUIRQ, if pmuirq then HIGH else LOW);

    CTI_SetEventLevel(CrossTriggerIn_PMUOverflow, if pmuirq then HIGH else LOW);

    // The request remains set until the condition is cleared. (For example, an interrupt handler
    // or cross-triggered event handler clears the overflow status flag by writing to PMOVSLR_EL0.)

    return pmuirq;
```

aarch32/debug/pmu/AArch32.CountEvents

```
// AArch32.CountEvents()
// =====
// Return TRUE if counter "n" should count its event. For the cycle counter, n == 31.

boolean AArch32.CountEvents(integer n)
    assert (n == 31 || n < UInt(PMCR.N));

    if !ELUsingAArch32(EL1) then return AArch64.CountEvents(n);
    // Event counting is disabled in Debug state
    debug = Halted();

    // In Non-secure state, some counters are reserved for EL2
    if HaveEL(EL2) then
        hpmn = (if !ELUsingAArch32(EL2) then MDCR_EL2.HPMN else HDCR.HPMN);
        hpme = (if !ELUsingAArch32(EL2) then MDCR_EL2.HPME else HDCR.HPME);
        E = (if n < UInt(hpmn) || n == 31 then PMCR.E else hpme);
    else
        E = PMCR.E;
    enabled = (E == '1' && PMCNTENSET<n> == '1');

    if !IsSecure() then
        // Event counting in Non-secure state is allowed unless all of:
        // * EL2 and the HPMD Extension are implemented
        // * Executing at EL2
        // * PMNx is not reserved for EL2
        // * HDCR.HPMD == 1
        if HaveHPMDExt() && PSTATE.EL == EL2 && (n < UInt(hpmn) || n == 31) then
            hpmn = (if !ELUsingAArch32(EL2) then MDCR_EL2.HPMD else HDCR.HPMD);
            prohibited = (hpmn == '1');
        else
            prohibited = FALSE;
    else
        // Event counting in Secure state is prohibited unless any one of:
        // * EL3 is not implemented
        // * EL3 is using AArch64 and MDCR_EL3.SPME == 1
        // * EL3 is using AArch32 and SDCR.SPME == 1
        // * Executing at EL0, and SDER.SUNIDEN == 1.
```

```

    spme = (if ELUsingAArch32(EL3) then SDCR.SPME else MDCR_EL3.SPME);
    prohibited = (HaveEL(EL3) && spme == '0' && (PSTATE.EL != EL0 || SDER.SUNIDEN == '0'));

// The IMPLEMENTATION DEFINED authentication interface might override software controls
if ExternalSecureNoninvasiveDebugEnabled() then prohibited = FALSE;

// For the cycle counter, PMCR.DP enables counting when otherwise prohibited
if prohibited && n == 31 then prohibited = (PMCR.DP == '1');

// Event counting can be filtered by the {P, U, NSK, NSU, NSH} bits
filter = (if n == 31 then PMCCFILTR else PMEVTYPER[n]);

P = filter<31>;
U = filter<30>;
NSK = (if HaveEL(EL3) then filter<29> else '0');
NSU = (if HaveEL(EL3) then filter<28> else '0');
NSH = (if HaveEL(EL2) then filter<27> else '0');

case PSTATE.EL of
  when EL0 filtered = (if IsSecure() then U == '1' else U != NSU);
  when EL1 filtered = (if IsSecure() then P == '1' else P != NSK);
  when EL2 filtered = (NSH == '0');
  when EL3 filtered = (P == '1');

return !debug && enabled && !prohibited && !filtered;

```

aarch32/debug/takeexceptiondbg/AArch32.EnterHypModeInDebugState

```

// AArch32.EnterHypModeInDebugState()
// =====
// Take an exception in Debug state to Hyp mode.

AArch32.EnterHypModeInDebugState(ExceptionRecord exception)
  assert HaveEL(EL2) && !IsSecure() && ELUsingAArch32(EL2);

  AArch32.ReportHypEntry(exception);
  AArch32.WriteMode(M32_Hyp);
  SPSR[] = bits(32) UNKNOWN;
  ELR_hyp = bits(32) UNKNOWN;
  // In Debug state, the PE always execute T32 instructions when in AArch32 state, and
  // PSTATE.{SS,A,I,F} are not observable so behave as UNKNOWN.
  PSTATE.T = '1'; // PSTATE.J is RES0
  PSTATE.<SS,A,I,F> = bits(4) UNKNOWN;
  DLR = bits(32) UNKNOWN;
  DSPSR = bits(32) UNKNOWN;
  PSTATE.E = HSCTLR.EE;
  PSTATE.IL = '0';
  PSTATE.IT = '00000000';
  EDSCR.ERR = '1';
  UpdateEDSCRFields();
  EndOfInstruction();

```

aarch32/debug/takeexceptiondbg/AArch32.EnterModeInDebugState

```

// AArch32.EnterModeInDebugState()
// =====
// Take an exception in Debug state to a mode other than Monitor and Hyp mode.

AArch32.EnterModeInDebugState(bits(5) target_mode)
  assert ELUsingAArch32(EL1) && PSTATE.EL != EL2;

  if PSTATE.M == M32_Monitor then SCR.NS = '0';
  AArch32.WriteMode(target_mode);
  SPSR[] = bits(32) UNKNOWN;
  R[14] = bits(32) UNKNOWN;
  // In Debug state, the PE always execute T32 instructions when in AArch32 state, and

```

```
// PSTATE.{SS,A,I,F} are not observable so behave as UNKNOWN.
PSTATE.T = '1'; // PSTATE.J is RES0
PSTATE.<SS,A,I,F> = bits(4) UNKNOWN;
DLR = bits(32) UNKNOWN;
DSPSR = bits(32) UNKNOWN;
PSTATE.E = SCTLR.EE;
PSTATE.IL = '0';
PSTATE.IT = '00000000';
if HavePANExt() && SCTLR.SPAN == '0' then PSTATE.PAN = '1';
EDSCR.ERR = '1';
UpdateEDSCRFields(); // Update EDSCR processor state flags.
EndOfInstruction();
```

aarch32/debug/takeexceptiondbg/AArch32.EnterMonitorModeInDebugState

```
// AArch32.EnterMonitorModeInDebugState()
// =====
// Take an exception in Debug state to Monitor mode.

AArch32.EnterMonitorModeInDebugState()
assert HaveEL(EL3) && ELUsingAArch32(EL3);
from_secure = IsSecure();
if PSTATE.M == M32_Monitor then SCR.NS = '0';
AArch32.WriteMode(M32_Monitor);
SPSR[] = bits(32) UNKNOWN;
R[14] = bits(32) UNKNOWN;
// In Debug state, the PE always execute T32 instructions when in AArch32 state, and
// PSTATE.{SS,A,I,F} are not observable so behave as UNKNOWN.
PSTATE.T = '1'; // PSTATE.J is RES0
PSTATE.<SS,A,I,F> = bits(4) UNKNOWN;
DLR = bits(32) UNKNOWN;
DSPSR = bits(32) UNKNOWN;
PSTATE.E = SCTLR.EE;
PSTATE.IL = '0';
PSTATE.IT = '00000000';
if HavePANExt() then
  if !from_secure then
    PSTATE.PAN = '0';
  elseif SCTLR.SPAN == '0' then
    PSTATE.PAN = '1';
EDSCR.ERR = '1';
UpdateEDSCRFields(); // Update EDSCR processor state flags.
EndOfInstruction();
```

aarch32/debug/watchpoint/AArch32.WatchpointByteMatch

```
// AArch32.WatchpointByteMatch()
// =====

boolean AArch32.WatchpointByteMatch(integer n, bits(32) vaddress)

bottom = if DBGWVR[n]<2> == '1' then 2 else 3; // Word or doubleword
byte_select_match = (DBGWCR[n].BAS<UInt'(vaddress<bottom-1:0>)> != '0');
mask = UInt(DBGWCR[n].MASK);

// If DBGWCR[n].MASK is non-zero value and DBGWCR[n].BAS is not set to '11111111', or
// DBGWCR[n].BAS specifies a non-contiguous set of bytes behavior is CONSTRAINED
// UNPREDICTABLE.
if mask > 0 && !IsOnes(DBGWCR[n].BAS) then
  byte_select_match = ConstrainUnpredictableBool();
else
  LSB = (DBGWCR[n].BAS AND NOT(DBGWCR[n].BAS - 1)); MSB = (DBGWCR[n].BAS + LSB);
  if !IsZero(MSB AND (MSB - 1)) then // Not contiguous
    byte_select_match = ConstrainUnpredictableBool();
    bottom = 3; // For the whole doubleword
```

```

// If the address mask is set to a reserved value, the behavior is CONSTRAINED UNPREDICTABLE.
if mask > 0 && mask <= 2 then
  (c, mask) = ConstrainUnpredictableInteger(3, 31);
  assert c IN {Constraint_DISABLED, Constraint_NONE, Constraint_UNKNOWN};
  case c of
    when Constraint_DISABLED return FALSE;           // Disabled
    when Constraint_NONE     mask = 0;              // No masking
    // Otherwise the value returned by ConstrainUnpredictableInteger is a not-reserved value

if mask > bottom then
  WVR_match = (vaddress<31:mask> == DBGWVR[n]<31:mask>);
  // If masked bits of DBGWVR_EL1[n] are not zero, the behavior is CONSTRAINED UNPREDICTABLE.
  if WVR_match && !IsZero(DBGWVR[n]<mask-1:bottom>) then
    WVR_match = ConstrainUnpredictableBool();
  else
    WVR_match = vaddress<31:bottom> == DBGWVR[n]<31:bottom>;

return WVR_match && byte_select_match;

```

aarch32/debug/watchpoint/AArch32.WatchpointMatch

```

// AArch32.WatchpointMatch()
// =====
// Watchpoint matching in an AArch32 translation regime.

boolean AArch32.WatchpointMatch(integer n, bits(32) vaddress, integer size, boolean ispriv,
                                boolean iswrite)
  assert ELUsingAArch32(S1TranslationRegime());
  assert n <= UInt(DBGDIDR.WRPs);

  // "ispriv" is FALSE for LDRT/STRT instructions executed at EL1 and all
  // load/stores at EL0, TRUE for all other load/stores. "iswrite" is TRUE for stores, FALSE for
  // loads.
  enabled = DBGWCR[n].E == '1';
  linked = DBGWCR[n].WT == '1';
  isbreakpt = FALSE;

  state_match = AArch32.StateMatch(DBGWCR[n].SSC, DBGWCR[n].HMC, DBGWCR[n].PAC,
                                   linked, DBGWCR[n].LBN, isbreakpt, ispriv);

  ls_match = (DBGWCR[n].LSC<(if iswrite then 1 else 0)> == '1');

  value_match = FALSE;
  for byte = 0 to size - 1
    value_match = value_match || AArch32.WatchpointByteMatch(n, vaddress + byte);

  return value_match && state_match && ls_match && enabled;

```

J1.2.2 aarch32/exceptions

This section includes the following pseudocode functions:

- [aarch32/exceptions/aborts/AArch32.Abort](#) on page J1-5939.
- [aarch32/exceptions/aborts/AArch32.AbortSyndrome](#) on page J1-5940.
- [aarch32/exceptions/aborts/AArch32.CheckPCAlignment](#) on page J1-5940.
- [aarch32/exceptions/aborts/AArch32.ReportDataAbort](#) on page J1-5940.
- [aarch32/exceptions/aborts/AArch32.ReportPrefetchAbort](#) on page J1-5941.
- [aarch32/exceptions/aborts/AArch32.TakeDataAbortException](#) on page J1-5942.
- [aarch32/exceptions/aborts/AArch32.TakePrefetchAbortException](#) on page J1-5942.
- [aarch32/exceptions/asynch/AArch32.TakePhysicalFIQException](#) on page J1-5943.
- [aarch32/exceptions/asynch/AArch32.TakePhysicalIRQException](#) on page J1-5943.
- [aarch32/exceptions/asynch/AArch32.TakePhysicalSErrorException](#) on page J1-5943.
- [aarch32/exceptions/asynch/AArch32.TakeVirtualFIQException](#) on page J1-5944.

- [aarch32/exceptions/asynch/AArch32.TakeVirtualIRQException](#) on page J1-5944.
- [aarch32/exceptions/asynch/AArch32.TakeVirtualSErrorException](#) on page J1-5945.
- [aarch32/exceptions/debug/AArch32.SoftwareBreakpoint](#) on page J1-5945.
- [aarch32/exceptions/debug/DebugException](#) on page J1-5945.
- [aarch32/exceptions/exceptions/AArch32.ExceptionClass](#) on page J1-5946.
- [aarch32/exceptions/exceptions/AArch32.GeneralExceptionsToAArch64](#) on page J1-5946.
- [aarch32/exceptions/exceptions/AArch32.ReportHypEntry](#) on page J1-5946.
- [aarch32/exceptions/exceptions/AArch32.ResetControlRegisters](#) on page J1-5947.
- [aarch32/exceptions/exceptions/AArch32.TakeReset](#) on page J1-5947.
- [aarch32/exceptions/exceptions/ExcVectorBase](#) on page J1-5948.
- [aarch32/exceptions/ieeefp/AArch32.FPTrappedException](#) on page J1-5948.
- [aarch32/exceptions/syscalls/AArch32.CallHypervisor](#) on page J1-5948.
- [aarch32/exceptions/syscalls/AArch32.CallSupervisor](#) on page J1-5948.
- [aarch32/exceptions/syscalls/AArch32.TakeHVCException](#) on page J1-5949.
- [aarch32/exceptions/syscalls/AArch32.TakeSMCException](#) on page J1-5949.
- [aarch32/exceptions/syscalls/AArch32.TakeSVCEException](#) on page J1-5949.
- [aarch32/exceptions/takeexception/AArch32.EnterHypMode](#) on page J1-5950.
- [aarch32/exceptions/takeexception/AArch32.EnterMode](#) on page J1-5950.
- [aarch32/exceptions/takeexception/AArch32.EnterMonitorMode](#) on page J1-5950.
- [aarch32/exceptions/traps/AArch32.AArch32SystemAccessTrap](#) on page J1-5951.
- [aarch32/exceptions/traps/AArch32.AArch32SystemAccessTrapSyndrome](#) on page J1-5951.
- [aarch32/exceptions/traps/AArch32.CheckAdvSIMDOrFPEEnabled](#) on page J1-5952.
- [aarch32/exceptions/traps/AArch32.CheckFPAdvSIMDTrap](#) on page J1-5953.
- [aarch32/exceptions/traps/AArch32.CheckForSMCTrap](#) on page J1-5953.
- [aarch32/exceptions/traps/AArch32.CheckForWFxTrap](#) on page J1-5953.
- [aarch32/exceptions/traps/AArch32.CheckITEnabled](#) on page J1-5954.
- [aarch32/exceptions/traps/AArch32.CheckIllegalState](#) on page J1-5954.
- [aarch32/exceptions/traps/AArch32.CheckSETENDEnabled](#) on page J1-5955.
- [aarch32/exceptions/traps/AArch32.TakeHypTrapException](#) on page J1-5955.
- [aarch32/exceptions/traps/AArch32.TakeMonitorTrapException](#) on page J1-5955.
- [aarch32/exceptions/traps/AArch32.TakeUndefInstrException](#) on page J1-5955.
- [aarch32/exceptions/traps/AArch32.UndefinedFault](#) on page J1-5956.

aarch32/exceptions/aborts/AArch32.Abort

```
// AArch32.Abort()
// =====
// Abort and Debug exception handling in an AArch32 translation regime.

AArch32.Abort(bits(32) vaddress, FaultRecord fault)

// Check if routed to AArch64 state
route_to_aarch64 = PSTATE.EL == EL0 && !ELUsingAArch32(EL1);

if !route_to_aarch64 && HaveEL(EL2) && !IsSecure() && !ELUsingAArch32(EL2) then
    route_to_aarch64 = (HCR_EL2.TGE == '1' || IsSecondStage(fault) ||
        (HaveRASExt() && HCR2.TEA == '1' && IsExternalAbort(fault)) ||
        (IsDebugException(fault) && MDCR_EL2.TDE == '1'));

if !route_to_aarch64 && HaveEL(EL3) && !ELUsingAArch32(EL3) then
    route_to_aarch64 = SCR_EL3.EA == '1' && IsExternalAbort(fault);

if route_to_aarch64 then
    AArch64.Abort(ZeroExtend(vaddress), fault);
elseif fault.acctype == AccType_IFETCH then
```

```
        AArch32.TakePrefetchAbortException(vaddress, fault);  
    else  
        AArch32.TakeDataAbortException(vaddress, fault);
```

aarch32/exceptions/aborts/AArch32.AbortSyndrome

```
// AArch32.AbortSyndrome()  
// =====  
// Creates an exception syndrome record for Abort exceptions taken to Hyp mode  
// from an AArch32 translation regime.  
  
ExceptionRecord AArch32.AbortSyndrome(Exception type, FaultRecord fault, bits(32) vaddress)  
  
    exception = ExceptionSyndrome(type);  
  
    d_side = type == Exception_DataAbort;  
  
    exception.syndrome = AArch32.FaultSyndrome(d_side, fault);  
    exception.vaddress = ZeroExtend(vaddress);  
    if IPAValid(fault) then  
        exception.ipavalid = TRUE;  
        exception.ipaddress = ZeroExtend(fault.ipaddress);  
    else  
        exception.ipavalid = FALSE;  
  
    return exception;
```

aarch32/exceptions/aborts/AArch32.CheckPCAlignment

```
// AArch32.CheckPCAlignment()  
// =====  
  
AArch32.CheckPCAlignment()  
  
    bits(32) pc = ThisInstrAddr();  
    if (CurrentInstrSet() == InstrSet_A32 && pc<1> == '1' || pc<0> == '1' then  
        if AArch32.GeneralExceptionsToAArch64() then AArch64.PCAlignmentFault();  
  
        // Generate an Alignment fault Prefetch Abort exception  
        vaddress = pc;  
        acctype = AccType_IFETCH;  
        iswrite = FALSE;  
        secondstage = FALSE;  
        AArch32.Abort(vaddress, AArch32.AlignmentFault(acctype, iswrite, secondstage));
```

aarch32/exceptions/aborts/AArch32.ReportDataAbort

```
// AArch32.ReportDataAbort()  
// =====  
// Report syndrome information for aborts taken to modes other than Hyp mode.  
  
AArch32.ReportDataAbort(boolean route_to_monitor, FaultRecord fault, bits(32) vaddress)  
  
    // The encoding used in the IFSR or DFSR can be Long-descriptor format or Short-descriptor  
    // format. Normally, the current translation table format determines the format. For an abort  
    // from Non-secure state to Monitor mode, the IFSR or DFSR uses the Long-descriptor format if  
    // any of the following applies:  
    // * The Secure TTBCR.EAE is set to 1.  
    // * The abort is synchronous and either:  
    //   - It is taken from Hyp mode.  
    //   - It is taken from EL1 or EL0, and the Non-secure TTBCR.EAE is set to 1.  
    long_format = FALSE;  
    if route_to_monitor && !IsSecure() then  
        long_format = TTBCR_S.EAE == '1';  
    if !IsSErrorInterrupt(fault) && !long_format then  
        long_format = PSTATE.EL == EL2 || TTBCR.EAE == '1';
```

```

else
    long_format = TTBCR.EAE == '1';
d_side = TRUE;
if long_format then
    syndrome = AArch32.FaultStatusLD(d_side, fault);
else
    syndrome = AArch32.FaultStatusSD(d_side, fault);

if fault.acctype == AccType_IC then
    if (!long_format &&
        boolean IMPLEMENTATION_DEFINED "Report I-cache maintenance fault in IFSR") then
        i_syndrome = syndrome;
        syndrome<10,3:0> = EncodeSDFSC(Fault_ICacheMaint, 1);
    else
        i_syndrome = bits(32) UNKNOWN;
    if route_to_monitor then
        IFSR_S = i_syndrome;
    else
        IFSR = i_syndrome;

if route_to_monitor then
    DFSR_S = syndrome;
    DFAR_S = vaddress;
else
    DFSR = syndrome;
    DFAR = vaddress;

return;
  
```

aarch32/exceptions/aborts/AArch32.ReportPrefetchAbort

```

// AArch32.ReportPrefetchAbort()
// =====
// Report syndrome information for aborts taken to modes other than Hyp mode.

AArch32.ReportPrefetchAbort(boolean route_to_monitor, FaultRecord fault, bits(32) vaddress)
    // The encoding used in the IFSR can be Long-descriptor format or Short-descriptor format.
    // Normally, the current translation table format determines the format. For an abort from
    // Non-secure state to Monitor mode, the IFSR uses the Long-descriptor format if any of the
    // following applies:
    // * The Secure TTBCR.EAE is set to 1.
    // * It is taken from Hyp mode.
    // * It is taken from EL1 or EL0, and the Non-secure TTBCR.EAE is set to 1.
    long_format = FALSE;
    if route_to_monitor && !IsSecure() then
        long_format = TTBCR_S.EAE == '1' || PSTATE.EL == EL2 || TTBCR.EAE == '1';
    else
        long_format = TTBCR.EAE == '1';

    d_side = FALSE;
    if long_format then
        fsr = AArch32.FaultStatusLD(d_side, fault);
    else
        fsr = AArch32.FaultStatusSD(d_side, fault);

    if route_to_monitor then
        IFSR_S = fsr;
        IFAR_S = vaddress;
    else
        IFSR = fsr;
        IFAR = vaddress;

return;
  
```

aarch32/exceptions/aborts/AArch32.TakeDataAbortException

```
// AArch32.TakeDataAbortException()
// =====

AArch32.TakeDataAbortException(bits(32) vaddress, FaultRecord fault)
    route_to_monitor = HaveEL(EL3) && SCR.EA == '1' && IsExternalAbort(fault);
    route_to_hyp = (HaveEL(EL2) && !IsSecure() && PSTATE.EL IN {EL0,EL1} &&
        (HCR.TGE == '1' || IsSecondStage(fault) ||
        (HaveRAExt() && HCR2.TEA == '1' && IsExternalAbort(fault)) ||
        (IsDebugException(fault) && HDCR.TDE == '1')));
    bits(32) preferred_exception_return = ThisInstrAddr();
    vect_offset = 0x10;
    lr_offset = 8;

    if IsDebugException(fault) then DBGDSCRExt.MOE = fault.debugmoe;
    if route_to_monitor then
        AArch32.ReportDataAbort(route_to_monitor, fault, vaddress);
        AArch32.EnterMonitorMode(preferred_exception_return, lr_offset, vect_offset);
    elseif PSTATE.EL == EL2 || route_to_hyp then
        exception = AArch32.AbortSyndrome(Exception_DataAbort, fault, vaddress);
        if PSTATE.EL == EL2 then
            AArch32.EnterHypMode(exception, preferred_exception_return, vect_offset);
        else
            AArch32.EnterHypMode(exception, preferred_exception_return, 0x14);
    else
        AArch32.ReportDataAbort(route_to_monitor, fault, vaddress);
        AArch32.EnterMode(M32_Abort, preferred_exception_return, lr_offset, vect_offset);
```

aarch32/exceptions/aborts/AArch32.TakePrefetchAbortException

```
// AArch32.TakePrefetchAbortException()
// =====

AArch32.TakePrefetchAbortException(bits(32) vaddress, FaultRecord fault)
    route_to_monitor = HaveEL(EL3) && SCR.EA == '1' && IsExternalAbort(fault);
    route_to_hyp = (HaveEL(EL2) && !IsSecure() && PSTATE.EL IN {EL0,EL1} &&
        (HCR.TGE == '1' || IsSecondStage(fault) ||
        (HaveRAExt() && HCR2.TEA == '1' && IsExternalAbort(fault)) ||
        (IsDebugException(fault) && HDCR.TDE == '1')));

    bits(32) preferred_exception_return = ThisInstrAddr();
    vect_offset = 0x0C;
    lr_offset = 4;

    if IsDebugException(fault) then DBGDSCRExt.MOE = fault.debugmoe;
    if route_to_monitor then
        AArch32.ReportPrefetchAbort(route_to_monitor, fault, vaddress);
        AArch32.EnterMonitorMode(preferred_exception_return, lr_offset, vect_offset);
    elseif PSTATE.EL == EL2 || route_to_hyp then
        if fault.type == Fault_Alignment then // PC Alignment fault
            exception = ExceptionSyndrome(Exception_PCAlignment);
            exception.vaddress = ThisInstrAddr();
        else
            exception = AArch32.AbortSyndrome(Exception_InstructionAbort, fault, vaddress);
        if PSTATE.EL == EL2 then
            AArch32.EnterHypMode(exception, preferred_exception_return, vect_offset);
        else
            AArch32.EnterHypMode(exception, preferred_exception_return, 0x14);
    else
        AArch32.ReportPrefetchAbort(route_to_monitor, fault, vaddress);
        AArch32.EnterMode(M32_Abort, preferred_exception_return, lr_offset, vect_offset);
```

aarch32/exceptions/asynch/AArch32.TakePhysicalFIQException

```
// AArch32.TakePhysicalFIQException()
// =====

AArch32.TakePhysicalFIQException()

    // Check if routed to AArch64 state
    route_to_aarch64 = PSTATE.EL == EL0 && !ELUsingAArch32(EL1);
    if !route_to_aarch64 && HaveEL(EL2) && !IsSecure() && !ELUsingAArch32(EL2) then
        route_to_aarch64 = HCR_EL2.TGE == '1' || (HCR_EL2.FMO == '1' && !IsInHost());

    if !route_to_aarch64 && HaveEL(EL3) && !ELUsingAArch32(EL3) then
        route_to_aarch64 = SCR_EL3.FIQ == '1';

    if route_to_aarch64 then AArch64.TakePhysicalFIQException();
    route_to_monitor = HaveEL(EL3) && SCR.FIQ == '1';
    route_to_hyp = (HaveEL(EL2) && !IsSecure() && PSTATE.EL IN {EL0,EL1} &&
        (HCR.TGE == '1' || HCR.FMO == '1'));
    bits(32) preferred_exception_return = ThisInstrAddr();
    vect_offset = 0x1C;
    lr_offset = 4;
    if route_to_monitor then
        AArch32.EnterMonitorMode(preferred_exception_return, lr_offset, vect_offset);
    elseif PSTATE.EL == EL2 || route_to_hyp then
        exception = ExceptionSyndrome(Exception_FIQ);
        AArch32.EnterHypMode(exception, preferred_exception_return, vect_offset);
    else
        AArch32.EnterMode(M32_FIQ, preferred_exception_return, lr_offset, vect_offset);
```

aarch32/exceptions/asynch/AArch32.TakePhysicalIRQException

```
// AArch32.TakePhysicalIRQException()
// =====
// Take an enabled physical IRQ exception.

AArch32.TakePhysicalIRQException()

    // Check if routed to AArch64 state
    route_to_aarch64 = PSTATE.EL == EL0 && !ELUsingAArch32(EL1);
    if !route_to_aarch64 && HaveEL(EL2) && !IsSecure() && !ELUsingAArch32(EL2) then
        route_to_aarch64 = HCR_EL2.TGE == '1' || (HCR_EL2.IMO == '1' && !IsInHost());
    if !route_to_aarch64 && HaveEL(EL3) && !ELUsingAArch32(EL3) then
        route_to_aarch64 = SCR_EL3.IRQ == '1';

    if route_to_aarch64 then AArch64.TakePhysicalIRQException();

    route_to_monitor = HaveEL(EL3) && SCR.IRQ == '1';
    route_to_hyp = (HaveEL(EL2) && !IsSecure() && PSTATE.EL IN {EL0,EL1} &&
        (HCR.TGE == '1' || HCR.IMO == '1'));
    bits(32) preferred_exception_return = ThisInstrAddr();
    vect_offset = 0x18;
    lr_offset = 4;
    if route_to_monitor then
        AArch32.EnterMonitorMode(preferred_exception_return, lr_offset, vect_offset);
    elseif PSTATE.EL == EL2 || route_to_hyp then
        exception = ExceptionSyndrome(Exception_IRQ);
        AArch32.EnterHypMode(exception, preferred_exception_return, vect_offset);
    else
        AArch32.EnterMode(M32_IRQ, preferred_exception_return, lr_offset, vect_offset);
```

aarch32/exceptions/asynch/AArch32.TakePhysicalSErrorException

```
// AArch32.TakePhysicalSErrorException()
// =====
```

```

AArch32.TakePhysicalSErrorException(boolean parity, bit extflag, bits(2) errortype,
                                     boolean impdef_syndrome, bits(24) full_syndrome)

// Check if routed to AArch64 state
route_to_aarch64 = PSTATE.EL == EL0 && !ELUsingAArch32(EL1);

if !route_to_aarch64 && HaveEL(EL2) && !IsSecure() && !ELUsingAArch32(EL2) then
  route_to_aarch64 = (HCR_EL2.TGE == '1' || (!IsInHost() && HCR_EL2.AMO == '1'));
if !route_to_aarch64 && HaveEL(EL3) && !ELUsingAArch32(EL3) then
  route_to_aarch64 = SCR_EL3.EA == '1';

if route_to_aarch64 then
  AArch64.TakePhysicalSErrorException(impdef_syndrome, full_syndrome);

route_to_monitor = HaveEL(EL3) && SCR.EA == '1';
route_to_hyp = (HaveEL(EL2) && !IsSecure() && PSTATE.EL IN {EL0,EL1} &&
               (HCR.TGE == '1' || HCR.AMO == '1'));
bits(32) preferred_exception_return = ThisInstrAddr();
vect_offset = 0x10;
lr_offset = 8;

fault = AArch32.AsynchExternalAbort(parity, errortype, extflag);
vaddress = bits(32) UNKNOWN;
if route_to_monitor then
  AArch32.ReportDataAbort(route_to_monitor, fault, vaddress);
  AArch32.EnterMonitorMode(preferred_exception_return, lr_offset, vect_offset);
elseif PSTATE.EL == EL2 || route_to_hyp then
  exception = AArch32.AbortSyndrome(Exception_DataAbort, fault, vaddress);
  if PSTATE.EL == EL2 then
    AArch32.EnterHypMode(exception, preferred_exception_return, vect_offset);
  else
    AArch32.EnterHypMode(exception, preferred_exception_return, 0x14);
else
  AArch32.ReportDataAbort(route_to_monitor, fault, vaddress);
  AArch32.EnterMode(M32_Abort, preferred_exception_return, lr_offset, vect_offset);

```

aarch32/exceptions/asynch/AArch32.TakeVirtualFIQException

```

// AArch32.TakeVirtualFIQException()
// =====

AArch32.TakeVirtualFIQException()
  assert HaveEL(EL2) && !IsSecure() && PSTATE.EL IN {EL0,EL1};
  if ELUsingAArch32(EL2) then // Virtual IRQ enabled if TGE==0 and FMO==1
    assert HCR.TGE == '0' && HCR.FMO == '1';
  else
    assert HCR_EL2.TGE == '0' && HCR_EL2.FMO == '1';
  // Check if routed to AArch64 state
  if PSTATE.EL == EL0 && !ELUsingAArch32(EL1) then AArch64.TakeVirtualFIQException();

  bits(32) preferred_exception_return = ThisInstrAddr();
  vect_offset = 0x1C;
  lr_offset = 4;

  AArch32.EnterMode(M32_FIQ, preferred_exception_return, lr_offset, vect_offset);

```

aarch32/exceptions/asynch/AArch32.TakeVirtualIRQException

```

// AArch32.TakeVirtualIRQException()
// =====

AArch32.TakeVirtualIRQException()
  assert HaveEL(EL2) && !IsSecure() && PSTATE.EL IN {EL0,EL1};

  if ELUsingAArch32(EL2) then // Virtual IRQs enabled if TGE==0 and IMO==1
    assert HCR.TGE == '0' && HCR.IMO == '1';

```

```

else
  assert HCR_EL2.TGE == '0' && HCR_EL2.IMO == '1';

  // Check if routed to AArch64 state
  if PSTATE.EL == EL0 && !ELUsingAArch32(EL1) then AArch64.TakeVirtualIRQException();

  bits(32) preferred_exception_return = ThisInstrAddr();
  vect_offset = 0x18;
  lr_offset = 4;

  AArch32.EnterMode(M32_IRQ, preferred_exception_return, lr_offset, vect_offset);
  
```

aarch32/exceptions/asynch/AArch32.TakeVirtualSErrorException

```

// AArch32.TakeVirtualSErrorException()
// =====

AArch32.TakeVirtualSErrorException(bit extflag, bits(2) errortype, boolean impdef_syndrome, bits(24)
full_syndrome)

  assert HaveEL(EL2) && !IsSecure() && PSTATE.EL IN {EL0,EL1};
  if ELUsingAArch32(EL2) then // Virtual SError enabled if TGE==0 and AMO==1
    assert HCR.TGE == '0' && HCR.AMO == '1';
  else
    assert HCR_EL2.TGE == '0' && HCR_EL2.AMO == '1';
  // Check if routed to AArch64 state
  if PSTATE.EL == EL0 && !ELUsingAArch32(EL1) then AArch64.TakeVirtualSErrorException(impdef_syndrome,
full_syndrome);

  route_to_monitor = FALSE;

  bits(32) preferred_exception_return = ThisInstrAddr();
  vect_offset = 0x10;
  lr_offset = 8;

  vaddress = bits(32) UNKNOWN;
  parity = FALSE;
  fault = AArch32.AsynchExternalAbort(parity, errortype, extflag);
  if ELUsingAArch32(EL2) then HCR.VA = '0'; else HCR_EL2.VSE = '0';
  AArch32.ReportDataAbort(route_to_monitor, fault, vaddress);
  AArch32.EnterMode(M32_Abort, preferred_exception_return, lr_offset, vect_offset);
  
```

aarch32/exceptions/debug/AArch32.SoftwareBreakpoint

```

// AArch32.SoftwareBreakpoint()
// =====

AArch32.SoftwareBreakpoint(bits(16) immediate)

  if (HaveEL(EL2) && !IsSecure() && !ELUsingAArch32(EL2) &&
    (HCR_EL2.TGE == '1' || MDCR_EL2.TDE == '1')) || !ELUsingAArch32(EL1) then
    AArch64.SoftwareBreakpoint(immediate);
  vaddress = bits(32) UNKNOWN;
  acctype = AccType_IFETCH; // Take as a Prefetch Abort
  iswrite = FALSE;
  entry = DebugException_BKPT;

  fault = AArch32.DebugFault(acctype, iswrite, entry);
  AArch32.Abort(vaddress, fault);
  
```

aarch32/exceptions/debug/DebugException

```

constant bits(4) DebugException_Breakpoint = '0001';
constant bits(4) DebugException_BKPT      = '0011';
constant bits(4) DebugException_VectorCatch = '0101';
constant bits(4) DebugException_Watchpoint = '1010';
  
```

aarch32/exceptions/exceptions/AArch32.ExceptionClass

```
// AArch32.ExceptionClass()
// =====
// Return the Exception Class and Instruction Length fields for reported in HSR

(integer,bit) AArch32.ExceptionClass(Exception type)

    il = if ThisInstrLength() == 32 then '1' else '0';

    case type of
        when Exception_Uncategorized          ec = 0x00; il = '1';
        when Exception_WFxTrap                ec = 0x01;
        when Exception_CP15RRTTrap            ec = 0x03;
        when Exception_CP15RRTTrap            ec = 0x04;
        when Exception_CP14RRTTrap            ec = 0x05;
        when Exception_CP14DTTrap             ec = 0x06;
        when Exception_AdvSIMDFPAccessTrap    ec = 0x07;
        when Exception_FPIDTrap               ec = 0x08;
        when Exception_CP14RRTTrap            ec = 0x0C;
        when Exception_IllegalState           ec = 0x0E; il = '1';
        when Exception_SupervisorCall         ec = 0x11;
        when Exception_HypervisorCall         ec = 0x12;
        when Exception_MonitorCall           ec = 0x13;
        when Exception_InstructionAbort        ec = 0x20; il = '1';
        when Exception_PCAlignment            ec = 0x22; il = '1';
        when Exception_DataAbort              ec = 0x24;
        when Exception_FPtrappedException     ec = 0x28;
        otherwise                             Unreachable();

    if ec IN {0x20,0x24} && PSTATE.EL == EL2 then
        ec = ec + 1;

    return (ec,il);
```

aarch32/exceptions/exceptions/AArch32.GeneralExceptionsToAArch64

```
// AArch32.GeneralExceptionsToAArch64()
// =====
// Returns TRUE if exceptions normally routed to EL1 are being handled at an Exception
// level using AArch64, because either EL1 is using AArch64 or TGE is in force and EL2
// is using AArch64.

boolean AArch32.GeneralExceptionsToAArch64()
    return ((PSTATE.EL == EL0 && !ELUsingAArch32(EL1)) ||
            (HaveEL(EL2) && !IsSecure() && !ELUsingAArch32(EL2) && HCR_EL2.TGE == '1'));
```

aarch32/exceptions/exceptions/AArch32.ReportHypEntry

```
// AArch32.ReportHypEntry()
// =====
// Report syndrome information to Hyp mode registers.

AArch32.ReportHypEntry(ExceptionRecord exception)

    Exception type = exception.type;

    (ec,il) = AArch32.ExceptionClass(type);
    iss = exception.syndrome;

    // IL is not valid for Data Abort exceptions without valid instruction syndrome information
    if ec IN {0x24,0x25} && iss<24> == '0' then
        il = '1';

    HSR = ec<5:0>:il:iss;
```



```

if type IN {Exception_InstructionAbort, Exception_PCAlignment} then
    HIFAR = exception.vaddress<31:0>;
    HDFAR = bits(32) UNKNOWN;
elseif type == Exception_DataAbort then
    HIFAR = bits(32) UNKNOWN;
    HDFAR = exception.vaddress<31:0>;

if exception.ipavalid then
    HPFAR<31:4> = exception.ipaddress<39:12>;
else
    HPFAR<31:4> = bits(28) UNKNOWN;

return;

```

aarch32/exceptions/exceptions/AArch32.ResetControlRegisters

```

// Resets System registers and memory-mapped control registers that have architecturally-defined
// reset values to those values.
AArch32.ResetControlRegisters(boolean cold_reset);

```

aarch32/exceptions/exceptions/AArch32.TakeReset

```

// AArch32.TakeReset()
// =====
// Reset into AArch32 state

AArch32.TakeReset(boolean cold_reset)
    assert HighestELUsingAArch32();

    // Enter the highest implemented Exception level in AArch32 state
    if HaveEL(EL3) then
        AArch32.WriteMode(M32_Svc);
        SCR.NS = '0'; // Secure state
    elseif HaveEL(EL2) then
        AArch32.WriteMode(M32_Hyp);
    else
        AArch32.WriteMode(M32_Svc);

    // Reset the CP14 and CP15 registers and other system components
    AArch32.ResetControlRegisters(cold_reset);
    FPEXC.EN = '0';

    // Reset all other PSTATE fields, including instruction set and endianness according to the
    // SCTLR values produced by the above call to ResetControlRegisters()
    PSTATE.<A,I,F> = '111'; // All asynchronous exceptions masked
    PSTATE.IT = '00000000'; // IT block state reset
    PSTATE.T = SCTLR.TE; // Instruction set: TE=0: A32, TE=1: T32. PSTATE.J is RES0.
    PSTATE.E = SCTLR.EE; // Endianness: EE=0: little-endian, EE=1: big-endian
    PSTATE.IL = '0'; // Clear Illegal Execution state bit

    // All registers, bits and fields not reset by the above pseudocode or by the BranchTo() call
    // below are UNKNOWN bitstrings after reset. In particular, the return information registers
    // R14 or ELR_hyp and SPSR have UNKNOWN values, so that it
    // is impossible to return from a reset in an architecturally defined way.
    AArch32.ResetGeneralRegisters();
    AArch32.ResetSIMDFPRegisters();
    AArch32.ResetSpecialRegisters();
    ResetExternalDebugRegisters(cold_reset);

    bits(32) rv; // IMPLEMENTATION DEFINED reset vector

    if HaveEL(EL3) then
        if MVBAR<0> == '1' then // Reset vector in MVBAR
            rv = MVBAR<31:1>:'0';
        else
            rv = bits(32) IMPLEMENTATION_DEFINED "reset vector address";

```

```
else
    rv = RVBAR<31:1>:'0';
    // The reset vector must be correctly aligned
    assert rv<0> == '0' && (PSTATE.T == '1' || rv<1> == '0');

    BranchTo(rv, BranchType_UNKNOWN);
```

aarch32/exceptions/exceptions/ExcVectorBase

```
// ExcVectorBase()
// =====

bits(32) ExcVectorBase()
    if SCTL.R.V == '1' then // Hivecs selected, base = 0xFFFF0000
        return Ones(16):Zeros(16);
    else
        return VBAR<31:5>:Zeros(5);
```

aarch32/exceptions/ieeefp/AArch32.FPTrappedException

```
// AArch32.FPTrappedException()
// =====

AArch32.FPTrappedException(bits(8) accumulated_exceptions)
    if AArch32.GeneralExceptionsToAArch64() then
        is_ase = FALSE;
        element = 0;
        AArch64.FPTrappedException(is_ase, element, accumulated_exceptions);
    FPEXC.DEX = '1';
    FPEXC.TFV = '1';
    FPEXC<7,4:0> = accumulated_exceptions<7,4:0>; // IDF,IXF,UFF,OFF,DZF,I0F

    AArch32.TakeUndefInstrException();
```

aarch32/exceptions/syscalls/AArch32.CallHypervisor

```
// AArch32.CallHypervisor()
// =====
// Performs a HVC call

AArch32.CallHypervisor(bits(16) immediate)
    assert HaveEL(EL2);

    if !ELUsingAArch32(EL2) then
        AArch64.CallHypervisor(immediate);
    else
        AArch32.TakeHVCEXception(immediate);
```

aarch32/exceptions/syscalls/AArch32.CallSupervisor

```
// AArch32.CallSupervisor()
// =====
// Calls the Supervisor

AArch32.CallSupervisor(bits(16) immediate)

    if AArch32.CurrentCond() != '1110' then
        immediate = bits(16) UNKNOWN;
    if AArch32.GeneralExceptionsToAArch64() then
        AArch64.CallSupervisor(immediate);
    else
        AArch32.TakeSVCEXception(immediate);
```

aarch32/exceptions/syscalls/AArch32.TakeHVCException

```
// AArch32.TakeHVCException()
// =====

AArch32.TakeHVCException(bits(16) immediate)
  assert HaveEL(EL2) && ELUsingAArch32(EL2);

  AArch32.ITAdvance();
  SSAdvance();
  bits(32) preferred_exception_return = NextInstrAddr();
  vect_offset = 0x08;

  exception = ExceptionSyndrome(Exception_HypervisorCall);
  exception.syndrome<15:0> = immediate;

  if PSTATE.EL == EL2 then
    AArch32.EnterHypMode(exception, preferred_exception_return, vect_offset);
  else
    AArch32.EnterHypMode(exception, preferred_exception_return, 0x14);
```

aarch32/exceptions/syscalls/AArch32.TakeSMCException

```
// AArch32.TakeSMCException()
// =====

AArch32.TakeSMCException()
  assert HaveEL(EL3) && ELUsingAArch32(EL3);

  AArch32.ITAdvance();
  SSAdvance();

  bits(32) preferred_exception_return = NextInstrAddr();
  vect_offset = 0x08;
  lr_offset = 0;

  AArch32.EnterMonitorMode(preferred_exception_return, lr_offset, vect_offset);
```

aarch32/exceptions/syscalls/AArch32.TakeSVCEException

```
// AArch32.TakeSVCEException()
// =====

AArch32.TakeSVCEException(bits(16) immediate)

  AArch32.ITAdvance();
  SSAdvance();
  route_to_hyp = HaveEL(EL2) && !IsSecure() && PSTATE.EL == EL0 && HCR.TGE == '1';

  bits(32) preferred_exception_return = NextInstrAddr();
  vect_offset = 0x08;
  lr_offset = 0;

  if PSTATE.EL == EL2 || route_to_hyp then
    exception = ExceptionSyndrome(Exception_SupervisorCall);
    exception.syndrome<15:0> = immediate;
    if PSTATE.EL == EL2 then
      AArch32.EnterHypMode(exception, preferred_exception_return, vect_offset);
    else
      AArch32.EnterHypMode(exception, preferred_exception_return, 0x14);
  else
    AArch32.EnterMode(M32_Svc, preferred_exception_return, lr_offset, vect_offset);
```

aarch32/exceptions/takeexception/AArch32.EnterHypMode

```
// AArch32.EnterHypMode()
// =====
// Take an exception to Hyp mode.

AArch32.EnterHypMode(ExceptionRecord exception, bits(32) preferred_exception_return,
                    integer vect_offset)
    assert HaveEL(EL2) && !IsSecure() && ELUsingAArch32(EL2);

    spsr = GetPSRFromPSTATE();
    if !(exception.type IN {Exception_IRQ, Exception_FIQ}) then
        AArch32.ReportHypEntry(exception);
    AArch32.WriteMode(M32_Hyp);
    SPSR[] = spsr;
    ELR_hyp = preferred_exception_return;
    PSTATE.T = HSCTLR.TE; // PSTATE.J is RES0
    PSTATE.SS = '0';
    if !HaveEL(EL3) || SCR_GEN[].EA == '0' then PSTATE.A = '1';
    if !HaveEL(EL3) || SCR_GEN[].IRQ == '0' then PSTATE.I = '1';
    if !HaveEL(EL3) || SCR_GEN[].FIQ == '0' then PSTATE.F = '1';
    PSTATE.E = HSCTLR.EE;
    PSTATE.IL = '0';
    PSTATE.IT = '00000000';
    BranchTo(HVBAR<31:5>:vect_offset<4:0>, BranchType_UNKNOWN);
    EndOfInstruction();
```

aarch32/exceptions/takeexception/AArch32.EnterMode

```
// AArch32.EnterMode()
// =====
// Take an exception to a mode other than Monitor and Hyp mode.

AArch32.EnterMode(bits(5) target_mode, bits(32) preferred_exception_return, integer lr_offset,
                 integer vect_offset)
    assert ELUsingAArch32(EL1) && PSTATE.EL != EL2;

    spsr = GetPSRFromPSTATE();
    if PSTATE.M == M32_Monitor then SCR.NS = '0';
    AArch32.WriteMode(target_mode);
    SPSR[] = spsr;
    R[14] = preferred_exception_return + lr_offset;
    PSTATE.T = SCTLR.TE; // PSTATE.J is RES0
    PSTATE.SS = '0';
    if target_mode == M32_FIQ then
        PSTATE.<A,I,F> = '111';
    elseif target_mode IN {M32_Abort, M32_IRQ} then
        PSTATE.<A,I> = '11';
    else
        PSTATE.I = '1';
    PSTATE.E = SCTLR.EE;
    PSTATE.IL = '0';
    PSTATE.IT = '00000000';
    if HavePANExt() && SCTLR.SPAN == '0' then PSTATE.PAN = '1';
    BranchTo(ExcVectorBase()<31:5>:vect_offset<4:0>, BranchType_UNKNOWN);
    EndOfInstruction();
```

aarch32/exceptions/takeexception/AArch32.EnterMonitorMode

```
// AArch32.EnterMonitorMode()
// =====
// Take an exception to Monitor mode.

AArch32.EnterMonitorMode(bits(32) preferred_exception_return, integer lr_offset,
                        integer vect_offset)
    assert HaveEL(EL3) && ELUsingAArch32(EL3);
```

```

from_secure = IsSecure();
spsr = GetPSRFromPSTATE();
if PSTATE.M == M32_Monitor then SCR.NS = '0';
AArch32.WriteMode(M32_Monitor);
SPSR[] = spsr;
R[14] = preferred_exception_return + 1r_offset;
PSTATE.T = SCTLR.TE; // PSTATE.J is RES0
PSTATE.SS = '0';
PSTATE.<A,I,F> = '111';
PSTATE.E = SCTLR.EE;
PSTATE.IL = '0';
PSTATE.IT = '00000000';
if HavePANExt() then
  if !from_secure then
    PSTATE.PAN = '0';
  elseif SCTLR.SPAN == '0' then
    PSTATE.PAN = '1';
BranchTo(MVBAR<31:5>.vect_offset<4:0>, BranchType_UNKNOWN);
EndOfInstruction();

```

aarch32/exceptions/traps/AArch32.AArch32SystemAccessTrap

```

// AArch32.AArch32SystemAccessTrap()
// =====
// Trapped AArch32 System register access other than due to CPTR_EL2 or CPACR_EL1.

AArch32.AArch32SystemAccessTrap(bits(2) target_el, bits(32) instr)
  assert HaveEL(target_el) && target_el != EL0 && UInt(target_el) >= UInt(PSTATE.EL);

  if !ELUsingAArch32(target_el) || AArch32.GeneralExceptionsToAArch64() then
    AArch64.AArch32SystemAccessTrap(target_el, instr);

  assert target_el IN {EL1,EL2};

  if target_el == EL2 then
    exception = AArch32.AArch32SystemAccessTrapSyndrome(instr);
    AArch32.TakeHypTrapException(exception);
  else
    AArch32.TakeUndefInstrException();

```

aarch32/exceptions/traps/AArch32.AArch32SystemAccessTrapSyndrome

```

// AArch32.AArch32SystemAccessTrapSyndrome()
// =====
// Return the syndrome information for traps on AArch32 MCR, MCRR, MRC, MRRC, and VMRS instructions,
// other than traps that are due to HCPTR or CPACR.

ExceptionRecord AArch32.AArch32SystemAccessTrapSyndrome(bits(32) instr)

  ExceptionRecord exception;
  cpnum = UInt(instr<11:8>);

  bits(20) iss = Zeros();
  if instr<27:24> == '1110' && instr<4> == '1' && instr<31:28> != '1111' then
    // MRC/MCR
    case cpnum of
      when 10 exception = ExceptionSyndrome(Exception_FPIDTrap);
      when 14 exception = ExceptionSyndrome(Exception_CP14RTTTrap);
      when 15 exception = ExceptionSyndrome(Exception_CP15RTTTrap);
      otherwise Unreachable();
    iss<19:17> = instr<7:5>; // opc2
    iss<16:14> = instr<23:21>; // opc1
    iss<13:10> = instr<19:16>; // CRn
    iss<8:5> = instr<15:12>; // Rt
    iss<4:1> = instr<3:0>; // CRm
  elseif instr<27:21> == '110010' && instr<31:28> != '1111' then

```

```

// MRRC/MCRR
case cpnum of
  when 14   exception = ExceptionSyndrome(Exception_CP14RRTrap);
  when 15   exception = ExceptionSyndrome(Exception_CP15RRTrap);
  otherwise Unreachable();
  iss<19:16> = instr<7:4>; // opc1
  iss<13:10> = instr<19:16>; // Rt2
  iss<8:5>   = instr<15:12>; // Rt
  iss<4:1>   = instr<3:0>; // CRm
elseif instr<27:25> == '110' && instr<31:28> != '1111' then
// LDC/STC
assert cpnum == 14;
exception = ExceptionSyndrome(Exception_CP14DTTrap);
  iss<19:12> = instr<7:0>; // imm8
  iss<4>     = instr<23>; // U
  iss<2:1>   = instr<24,21>; // P,W
  if instr<19:16> == '1111' then // Literal addressing
    iss<8:5> = bits(4) UNKNOWN;
    iss<3>   = '1';
  else
    iss<8:5> = instr<19:16>; // Rn
    iss<3>   = '0';
else
  Unreachable();
  iss<0> = instr<20>; // Direction

exception.syndrome<24:20> = ConditionSyndrome();
exception.syndrome<19:0> = iss;

return exception;

```

aarch32/exceptions/traps/AArch32.CheckAdvSIMDOrFPEEnabled

```

// AArch32.CheckAdvSIMDOrFPEEnabled()
// =====
// Check against CPACR, FPEXC, HCPTR, NSACR, and CPTR_EL3.

AArch32.CheckAdvSIMDOrFPEEnabled(boolean fpexc_check, boolean advsimd)
  if PSTATE.EL == EL0 && !ELUsingAArch32(EL1) then
    AArch64.CheckFPAdvSIMDEnabled();
  else
    cpacr_asedis = CPACR.ASEDIS;
    cpacr_cp10 = CPACR.cp10;

    if HaveEL(EL3) && ELUsingAArch32(EL3) && !IsSecure() then
      // Check if access disabled in NSACR
      if NSACR.NSASEDIS == '1' then cpacr_asedis = '1';
      if NSACR.cp10 == '0' then cpacr_cp10 = '00';

    if PSTATE.EL != EL2 then
      // Check if Advanced SIMD disabled in CPACR
      if advsimd && cpacr_asedis == '1' then UNDEFINED;

      // Check if access disabled in CPACR
      case cpacr_cp10 of
        when 'x0' disabled = TRUE;
        when '01' disabled = PSTATE.EL == EL0;
        when '11' disabled = FALSE;
      if disabled then UNDEFINED;

    // If required, check FPEXC enabled bit.
    if fpexc_check && FPEXC.EN == '0' then UNDEFINED;

    AArch32.CheckFPAdvSIMDTrap(advsimd); // Also check against HCPTR and CPTR_EL3

```

aarch32/exceptions/traps/AArch32.CheckFPAdvSIMDTrap

```
// AArch32.CheckFPAdvSIMDTrap()
// =====
// Check against CPTR_EL2 and CPTR_EL3.

AArch32.CheckFPAdvSIMDTrap(boolean advsimd)
  if HaveEL(EL2) && !IsSecure() && !ELUsingAArch32(EL2) then
    AArch64.CheckFPAdvSIMDTrap();
  else
    if HaveEL(EL2) && !IsSecure() then
      hcptr_tase = HCPTR.TASE;
      hcptr_cp10 = HCPTR.TCP10;

      if HaveEL(EL3) && ELUsingAArch32(EL3) && !IsSecure() then
        // Check if access disabled in NSACR
        if NSACR.NSASEDIS == '1' then hcptr_tase = '1';
        if NSACR.cp10 == '0' then hcptr_cp10 = '1';

        // Check if access disabled in HCPTR
        if (advsimd && hcptr_tase == '1') || hcptr_cp10 == '1' then
          exception = ExceptionSyndrome(Exception_AdvSIMDFPAccessTrap);
          exception.syndrome<24:20> = ConditionSyndrome();

          if advsimd then
            exception.syndrome<5> = '1';
          else
            exception.syndrome<5> = '0';
            exception.syndrome<3:0> = '1010';          // coproc field, always 0xA

          if PSTATE.EL == EL2 then
            AArch32.TakeUndefInstrException(exception);
          else
            AArch32.TakeHypTrapException(exception);

      if HaveEL(EL3) && !ELUsingAArch32(EL3) then
        // Check if access disabled in CPTR_EL3
        if CPTR_EL3.TFP == '1' then AArch64.AdvSIMDFPAccessTrap(EL3);
    return;
```

aarch32/exceptions/traps/AArch32.CheckForSMCTrap

```
// AArch32.CheckForSMCTrap()
// =====
// Check for trap on SMC instruction

AArch32.CheckForSMCTrap()

  if HaveEL(EL2) && !IsSecure() && !ELUsingAArch32(EL2) then
    AArch64.CheckForSMCTrap(Zeros(16));
  else
    route_to_hyp = HaveEL(EL2) && !IsSecure() && PSTATE.EL IN {EL0,EL1} && HCR.TSC == '1';
    if route_to_hyp then
      exception = ExceptionSyndrome(Exception_MonitorCall);
      AArch32.TakeHypTrapException(exception);
```

aarch32/exceptions/traps/AArch32.CheckForWFXTrap

```
// AArch32.CheckForWFXTrap()
// =====
// Check for trap on WFE or WFI instruction

AArch32.CheckForWFXTrap(bits(2) target_el, boolean is_wfe)
  assert HaveEL(target_el);

  // Check for routing to AArch64
```

```
if !ELUsingAArch32(target_el) then
    AArch64.CheckForWfxTrap(target_el, is_wfe);
return;
case target_el of
    when EL1 trap = (if is_wfe then SCTL.R.nTWE else SCTL.R.nTWI) == '0';
    when EL2 trap = (if is_wfe then HCR.TWE else HCR.TWI) == '1';
    when EL3 trap = (if is_wfe then SCR.TWE else SCR.TWI) == '1';
if trap then
    if (target_el == EL1 && HaveEL(EL2) && !IsSecure() && !ELUsingAArch32(EL2) &&
        HCR_EL2.TGE == '1') then
        AArch64.WfxTrap(target_el, is_wfe);
    if target_el == EL3 then
        AArch32.TakeMonitorTrapException();
    elseif target_el == EL2 then
        exception = ExceptionSyndrome(Exception_WfxTrap);
        exception.syndrome<24:20> = ConditionSyndrome();
        exception.syndrome<0> = if is_wfe then '1' else '0';
        AArch32.TakeHypTrapException(exception);
    else
        AArch32.TakeUndefInstrException();
```

aarch32/exceptions/traps/AArch32.CheckITEnabled

```
// AArch32.CheckITEnabled()
// =====
// Check whether the T32 IT instruction is disabled.

AArch32.CheckITEnabled(bits(4) mask)

if PSTATE.EL == EL2 then
    it_disabled = HSCTLR.ITD;
else
    it_disabled = (if ELUsingAArch32(EL1) then SCTL.R.ITD else SCTL[.].ITD);
if it_disabled == '1' then
    if mask != '1000' then UNDEFINED;

// Otherwise whether the IT block is allowed depends on hw1 of the next instruction.
next_instr = AArch32.MemSingle[NextInstrAddr(), 2, AccType_IFETCH, TRUE];

if next_instr IN {'11xxxxxxxxxxxx', '1011xxxxxxxxxxxx', '10100xxxxxxxxxxxx',
    '01001xxxxxxxxxxxx', '010001xxx1111xxx', '010001xx1xxx111'} then
    // It is IMPLEMENTATION DEFINED whether the Undefined Instruction exception is
    // taken on the IT instruction or the next instruction. This is not reflected in
    // the pseudocode, which always takes the exception on the IT instruction. This
    // also does not take into account cases where the next instruction is UNPREDICTABLE.
    UNDEFINED;

return;
```

aarch32/exceptions/traps/AArch32.CheckIllegalState

```
// AArch32.CheckIllegalState()
// =====
// Check PSTATE.IL bit and generate Illegal Execution state exception if set.

AArch32.CheckIllegalState()

if AArch32.GeneralExceptionsToAArch64() then
    AArch64.CheckIllegalState();
elseif PSTATE.IL == '1' then
    route_to_hyp = HaveEL(EL2) && !IsSecure() && PSTATE.EL == EL0 && HCR.TGE == '1';

    bits(32) preferred_exception_return = ThisInstrAddr();
    vect_offset = 0x04;

    if PSTATE.EL == EL2 || route_to_hyp then
```



```

exception = ExceptionSyndrome(Exception_IllegalState);
if PSTATE.EL == EL2 then
    AArch32.EnterHypMode(exception, preferred_exception_return, vect_offset);
else
    AArch32.EnterHypMode(exception, preferred_exception_return, 0x14);
else
    AArch32.TakeUndefInstrException();
  
```

aarch32/exceptions/traps/AArch32.CheckSETENDEnabled

```

// AArch32.CheckSETENDEnabled()
// =====
// Check whether the AArch32 SETEND instruction is disabled.
  
```

```

AArch32.CheckSETENDEnabled()

    if PSTATE.EL == EL2 then
        setend_disabled = HSCTLR.SED;
    else
        setend_disabled = (if ELUsingAArch32(EL1) then SCTLR.SED else SCTLR[.].SED);
    if setend_disabled == '1' then
        UNDEFINED;

    return;
  
```

aarch32/exceptions/traps/AArch32.TakeHypTrapException

```

// AArch32.TakeHypTrapException()
// =====
// Exceptions routed to Hyp mode as a Hyp Trap exception.
  
```

```

AArch32.TakeHypTrapException(ExceptionRecord exception)
    assert HaveEL(EL2) && !IsSecure() && ELUsingAArch32(EL2);

    bits(32) preferred_exception_return = ThisInstrAddr();
    vect_offset = 0x14;

    AArch32.EnterHypMode(exception, preferred_exception_return, vect_offset);
  
```

aarch32/exceptions/traps/AArch32.TakeMonitorTrapException

```

// AArch32.TakeMonitorTrapException()
// =====
// Exceptions routed to Monitor mode as a Monitor Trap exception.
  
```

```

AArch32.TakeMonitorTrapException()
    assert HaveEL(EL3) && ELUsingAArch32(EL3);

    bits(32) preferred_exception_return = ThisInstrAddr();
    vect_offset = 0x04;
    lr_offset = if CurrentInstrSet() == InstrSet_A32 then 4 else 2;

    AArch32.EnterMonitorMode(preferred_exception_return, lr_offset, vect_offset);
  
```

aarch32/exceptions/traps/AArch32.TakeUndefInstrException

```

// AArch32.TakeUndefInstrException()
// =====

AArch32.TakeUndefInstrException()
    exception = ExceptionSyndrome(Exception_Uncategorized);
    AArch32.TakeUndefInstrException(exception);

// AArch32.TakeUndefInstrException()
// =====
  
```

```

AArch32.TakeUndefInstrException(ExceptionRecord exception)

    route_to_hyp = HaveEL(EL2) && !IsSecure() && PSTATE.EL == EL0 && HCR.TGE == '1';

    bits(32) preferred_exception_return = ThisInstrAddr();
    vect_offset = 0x04;
    lr_offset = if CurrentInstrSet() == InstrSet_A32 then 4 else 2;

    if PSTATE.EL == EL2 then
        AArch32.EnterHypMode(exception, preferred_exception_return, vect_offset);
    elsif route_to_hyp then
        AArch32.EnterHypMode(exception, preferred_exception_return, 0x14);
    else
        AArch32.EnterMode(M32_Undef, preferred_exception_return, lr_offset, vect_offset);
  
```

aarch32/exceptions/traps/AArch32.UndefinedFault

```

// AArch32.UndefinedFault()
// =====

AArch32.UndefinedFault()

    if AArch32.GeneralExceptionsToAArch64() then AArch64.UndefinedFault();
    AArch32.TakeUndefInstrException();
  
```

J1.2.3 aarch32/functions

This section includes the following pseudocode functions:

- [aarch32/functions/aborts/AArch32.CreateFaultRecord](#) on page J1-5958.
- [aarch32/functions/aborts/AArch32.DomainValid](#) on page J1-5958.
- [aarch32/functions/aborts/AArch32.FaultStatusLD](#) on page J1-5959.
- [aarch32/functions/aborts/AArch32.FaultStatusSD](#) on page J1-5959.
- [aarch32/functions/aborts/AArch32.FaultSyndrome](#) on page J1-5959.
- [aarch32/functions/aborts/EncodeSDFSC](#) on page J1-5960.
- [aarch32/functions/common/A32ExpandImm](#) on page J1-5961.
- [aarch32/functions/common/A32ExpandImm_C](#) on page J1-5961.
- [aarch32/functions/common/DecodeImmShift](#) on page J1-5961.
- [aarch32/functions/common/DecodeRegShift](#) on page J1-5961.
- [aarch32/functions/common/RRX](#) on page J1-5962.
- [aarch32/functions/common/RRX_C](#) on page J1-5962.
- [aarch32/functions/common/SRType](#) on page J1-5962.
- [aarch32/functions/common/Shift](#) on page J1-5962.
- [aarch32/functions/common/Shift_C](#) on page J1-5962.
- [aarch32/functions/common/T32ExpandImm](#) on page J1-5962.
- [aarch32/functions/common/T32ExpandImm_C](#) on page J1-5963.
- [aarch32/functions/coproc/AArch32.CheckCP15InstrCoarseTraps](#) on page J1-5963.
- [aarch32/functions/coproc/AArch32.CheckSystemAccess](#) on page J1-5963.
- [aarch32/functions/coproc/AArch32.CheckSystemAccessTraps](#) on page J1-5965.
- [aarch32/functions/coproc/CP14DebugInstrDecode](#) on page J1-5965.
- [aarch32/functions/coproc/CP14JazelleInstrDecode](#) on page J1-5965.
- [aarch32/functions/coproc/CP14TraceInstrDecode](#) on page J1-5965.
- [aarch32/functions/coproc/CP15InstrDecode](#) on page J1-5965.
- [aarch32/functions/exclusive/AArch32.ExclusiveMonitorsPass](#) on page J1-5965.
- [aarch32/functions/exclusive/AArch32.IsExclusiveVA](#) on page J1-5966.
- [aarch32/functions/exclusive/AArch32.MarkExclusiveVA](#) on page J1-5966.
- [aarch32/functions/exclusive/AArch32.SetExclusiveMonitors](#) on page J1-5966.

- [aarch32/functions/float/CheckAdvSIMDEnabled](#) on page J1-5966.
- [aarch32/functions/float/CheckAdvSIMDOrVFPEEnabled](#) on page J1-5967.
- [aarch32/functions/float/CheckCryptoEnabled32](#) on page J1-5967.
- [aarch32/functions/float/CheckVFPEEnabled](#) on page J1-5967.
- [aarch32/functions/float/FPHalvedSub](#) on page J1-5967.
- [aarch32/functions/float/FPResqrtStep](#) on page J1-5968.
- [aarch32/functions/float/FPRecipStep](#) on page J1-5968.
- [aarch32/functions/float/StandardFPSCRValue](#) on page J1-5968.
- [aarch32/functions/memory/AArch32.CheckAlignment](#) on page J1-5968.
- [aarch32/functions/memory/AArch32.MemSingle](#) on page J1-5969.
- [aarch32/functions/memory/Hint_PreloadData](#) on page J1-5970.
- [aarch32/functions/memory/Hint_PreloadDataForWrite](#) on page J1-5970.
- [aarch32/functions/memory/Hint_PreloadInstr](#) on page J1-5970.
- [aarch32/functions/memory/MemA](#) on page J1-5970.
- [aarch32/functions/memory/MemO](#) on page J1-5970.
- [aarch32/functions/memory/MemU](#) on page J1-5970.
- [aarch32/functions/memory/MemU_unpriv](#) on page J1-5971.
- [aarch32/functions/memory/Mem_with_type](#) on page J1-5971.
- [aarch32/functions/ras/AArch32.ESBOperation](#) on page J1-5972.
- [aarch32/functions/ras/AArch32.PhysicalErrorSyndrome](#) on page J1-5973.
- [aarch32/functions/ras/AArch32.ReportDeferredSErrors](#) on page J1-5973.
- [aarch32/functions/ras/AArch32.SErrorSyndrome](#) on page J1-5973.
- [aarch32/functions/ras/AArch32.vESBOperation](#) on page J1-5973.
- [aarch32/functions/registers/AArch32.ResetGeneralRegisters](#) on page J1-5974.
- [aarch32/functions/registers/AArch32.ResetSIMDFPRegisters](#) on page J1-5974.
- [aarch32/functions/registers/AArch32.ResetSpecialRegisters](#) on page J1-5974.
- [aarch32/functions/registers/AArch32.ResetSystemRegisters](#) on page J1-5975.
- [aarch32/functions/registers/ALUExceptionReturn](#) on page J1-5975.
- [aarch32/functions/registers/ALUWritePC](#) on page J1-5975.
- [aarch32/functions/registers/BXWritePC](#) on page J1-5975.
- [aarch32/functions/registers/BranchWritePC](#) on page J1-5975.
- [aarch32/functions/registers/D](#) on page J1-5976.
- [aarch32/functions/registers/Din](#) on page J1-5976.
- [aarch32/functions/registers/LR](#) on page J1-5976.
- [aarch32/functions/registers/LoadWritePC](#) on page J1-5976.
- [aarch32/functions/registers/LookUpRIndex](#) on page J1-5976.
- [aarch32/functions/registers/Monitor_mode_registers](#) on page J1-5977.
- [aarch32/functions/registers/PC](#) on page J1-5977.
- [aarch32/functions/registers/PCStoreValue](#) on page J1-5977.
- [aarch32/functions/registers/Q](#) on page J1-5977.
- [aarch32/functions/registers/Qin](#) on page J1-5977.
- [aarch32/functions/registers/R](#) on page J1-5977.
- [aarch32/functions/registers/RBankSelect](#) on page J1-5978.
- [aarch32/functions/registers/Rmode](#) on page J1-5978.
- [aarch32/functions/registers/S](#) on page J1-5979.
- [aarch32/functions/registers/SP](#) on page J1-5979.
- [aarch32/functions/registers/_Dclone](#) on page J1-5979.
- [aarch32/functions/system/AArch32.ExceptionReturn](#) on page J1-5979.
- [aarch32/functions/system/AArch32.ExecutingATSIxPInstr](#) on page J1-5980.
- [aarch32/functions/system/AArch32.ExecutingCP10or11Instr](#) on page J1-5980.

- [aarch32/functions/system/AArch32.ExecutingLSMInstr](#) on page J1-5980.
- [aarch32/functions/system/AArch32.ITAdvance](#) on page J1-5981.
- [aarch32/functions/system/AArch32.SysRegRead](#) on page J1-5981.
- [aarch32/functions/system/AArch32.SysRegRead64](#) on page J1-5981.
- [aarch32/functions/system/AArch32.SysRegReadCanWriteAPSR](#) on page J1-5981.
- [aarch32/functions/system/AArch32.SysRegWrite](#) on page J1-5981.
- [aarch32/functions/system/AArch32.SysRegWrite64](#) on page J1-5981.
- [aarch32/functions/system/AArch32.WriteMode](#) on page J1-5981.
- [aarch32/functions/system/AArch32.WriteModeByInstr](#) on page J1-5982.
- [aarch32/functions/system/BadMode](#) on page J1-5982.
- [aarch32/functions/system/BankedRegisterAccessValid](#) on page J1-5982.
- [aarch32/functions/system/CPSRWriteByInstr](#) on page J1-5983.
- [aarch32/functions/system/ConditionPassed](#) on page J1-5984.
- [aarch32/functions/system/CurrentCond](#) on page J1-5984.
- [aarch32/functions/system/InITBlock](#) on page J1-5984.
- [aarch32/functions/system/LastInITBlock](#) on page J1-5984.
- [aarch32/functions/system/SPSRWriteByInstr](#) on page J1-5984.
- [aarch32/functions/system/SPSRaccessValid](#) on page J1-5984.
- [aarch32/functions/system/SelectInstrSet](#) on page J1-5985.
- [aarch32/functions/v6simd/Sat](#) on page J1-5985.
- [aarch32/functions/v6simd/SignedSat](#) on page J1-5985.
- [aarch32/functions/v6simd/UnsignedSat](#) on page J1-5985.

aarch32/functions/aborts/AArch32.CreateFaultRecord

```
// AArch32.CreateFaultRecord()
// =====

FaultRecord AArch32.CreateFaultRecord(Fault type, bits(40) ipaddress, bits(4) domain,
                                       integer level, AccType acctype, boolean write, bit extflag,
                                       bits(4) debugmoe, bits(2) errortype, boolean secondstage, boolean
s2fs1walk)

    FaultRecord fault;
    fault.type = type;
    if (type != Fault_None && PSTATE.EL != EL2 && TTBCR.EAE == '0' && !secondstage && !s2fs1walk &&
        AArch32.DomainValid(type, level)) then
        fault.domain = domain;
    else
        fault.domain = bits(4) UNKNOWN;
    fault.debugmoe = debugmoe;
    fault.errortype = errortype;
    fault.ipaddress = ZeroExtend(ipaddress);
    fault.level = level;
    fault.acctype = acctype;
    fault.write = write;
    fault.extflag = extflag;
    fault.secondstage = secondstage;
    fault.s2fs1walk = s2fs1walk;

    return fault;
```

aarch32/functions/aborts/AArch32.DomainValid

```
// AArch32.DomainValid()
// =====
// Returns TRUE if the Domain is valid for a Short-descriptor translation scheme.

boolean AArch32.DomainValid(Fault type, integer level)
```

```

assert type != Fault_None;

case type of
  when Fault_Domain
    return TRUE;
  when Fault_Translation, Fault_AccessFlag, Fault_SyncExternalOnWalk, Fault_SyncParityOnWalk
    return level == 2;
  otherwise
    return FALSE;

```

aarch32/functions/aborts/AArch32.FaultStatusLD

```

// AArch32.FaultStatusLD()
// =====
// Creates an exception fault status value for Abort and Watchpoint exceptions taken
// to Abort mode using AArch32 and Long-descriptor format.

bits(32) AArch32.FaultStatusLD(boolean d_side, FaultRecord fault)
  assert fault.type != Fault_None;

  bits(32) fsr = Zeros();
  if HaveRASExt() && IsAsyncAbort(fault) then fsr<15:14> = fault.errortype;
  if d_side then
    if fault.acctype IN {AccType_DC, AccType_IC, AccType_AT} then
      fsr<13> = '1'; fsr<11> = '1';
    else
      fsr<11> = if fault.write then '1' else '0';
  if IsExternalAbort(fault) then fsr<12> = fault.extflag;
  fsr<9> = '1';
  fsr<5:0> = EncodeLDFSC(fault.type, fault.level);

  return fsr;

```

aarch32/functions/aborts/AArch32.FaultStatusSD

```

// AArch32.FaultStatusSD()
// =====
// Creates an exception fault status value for Abort and Watchpoint exceptions taken
// to Abort mode using AArch32 and Short-descriptor format.

bits(32) AArch32.FaultStatusSD(boolean d_side, FaultRecord fault)
  assert fault.type != Fault_None;

  bits(32) fsr = Zeros();
  if HaveRASExt() && IsAsyncAbort(fault) then fsr<15:14> = fault.errortype;
  if d_side then
    if fault.acctype IN {AccType_DC, AccType_IC, AccType_AT} then
      fsr<13> = '1'; fsr<11> = '1';
    else
      fsr<11> = if fault.write then '1' else '0';
  if IsExternalAbort(fault) then fsr<12> = fault.extflag;
  fsr<9> = '0';
  fsr<10,3:0> = EncodeSDFSC(fault.type, fault.level);
  if d_side then
    fsr<7:4> = fault.domain; // Domain field (data fault only)

  return fsr;

```

aarch32/functions/aborts/AArch32.FaultSyndrome

```

// AArch32.FaultSyndrome()
// =====
// Creates an exception syndrome value for Abort and Watchpoint exceptions taken to
// AArch32 Hyp mode.

bits(25) AArch32.FaultSyndrome(boolean d_side, FaultRecord fault)

```

```

assert fault.type != Fault_None;

bits(25) iss = Zeros();
if HaveRASExt() && IsAsyncAbort(fault) then iss<11:10> = fault.errorrtype; // AET
if d_side then
  if IsSecondStage(fault) && !fault.s2fs1walk then iss<24:14> = LSInstructionSyndrome();
  if fault.acctype IN {AccType_DC, AccType_IC, AccType_AT} then
    iss<8> = '1'; iss<6> = '1';
  else
    iss<6> = if fault.write then '1' else '0';
if IsExternalAbort(fault) then iss<9> = fault.extflag;
iss<7> = if fault.s2fs1walk then '1' else '0';
iss<5:0> = EncodeLDFSC(fault.type, fault.level);

return iss;

```

aarch32/functions/aborts/EncodeSDFSC

```

// EncodeSDFSC()
// =====
// Function that gives the Short-descriptor FSR code for different types of Fault

```

```

bits(5) EncodeSDFSC(Fault type, integer level)

bits(5) result;
case type of
  when Fault_AccessFlag
    assert level IN {1,2};
    result = if level == 1 then '00011' else '00110';
  when Fault_Alignment
    result = '00001';
  when Fault_Permission
    assert level IN {1,2};
    result = if level == 1 then '01101' else '01111';
  when Fault_Domain
    assert level IN {1,2};
    result = if level == 1 then '01001' else '01011';
  when Fault_Translation
    assert level IN {1,2};
    result = if level == 1 then '00101' else '00111';
  when Fault_SyncExternal
    result = '01000';
  when Fault_SyncExternalOnWalk
    assert level IN {1,2};
    result = if level == 1 then '01100' else '01110';
  when Fault_SyncParity
    result = '11001';
  when Fault_SyncParityOnWalk
    assert level IN {1,2};
    result = if level == 1 then '11100' else '11110';
  when Fault_AsyncParity
    result = '11000';
  when Fault_AsyncExternal
    result = '10110';
  when Fault_Debug
    result = '00010';
  when Fault_TLBConflict
    result = '10000';
  when Fault_Lockdown
    result = '10100'; // IMPLEMENTATION DEFINED
  when Fault_Exclusive
    result = '10101'; // IMPLEMENTATION DEFINED
  when Fault_ICacheMaint
    result = '00100';
  otherwise

```

```

    Unreachable();

    return result;
  
```

aarch32/functions/common/A32ExpandImm

```

// A32ExpandImm()
// =====

bits(32) A32ExpandImm(bits(12) imm12)

    // PSTATE.C argument to following function call does not affect the imm32 result.
    (imm32, -) = A32ExpandImm_C(imm12, PSTATE.C);

    return imm32;
  
```

aarch32/functions/common/A32ExpandImm_C

```

// A32ExpandImm_C()
// =====

(bits(32), bit) A32ExpandImm_C(bits(12) imm12, bit carry_in)

    unrotated_value = ZeroExtend(imm12<7:0>, 32);
    (imm32, carry_out) = Shift_C(unrotated_value, SRTYPE_ROR, 2*UInt(imm12<11:8>), carry_in);

    return (imm32, carry_out);
  
```

aarch32/functions/common/DecodeImmShift

```

// DecodeImmShift()
// =====

(SRType, integer) DecodeImmShift(bits(2) type, bits(5) imm5)

    case type of
    when '00'
        shift_t = SRTYPE_LSL; shift_n = UInt(imm5);
    when '01'
        shift_t = SRTYPE_LSR; shift_n = if imm5 == '00000' then 32 else UInt(imm5);
    when '10'
        shift_t = SRTYPE_ASR; shift_n = if imm5 == '00000' then 32 else UInt(imm5);
    when '11'
        if imm5 == '00000' then
            shift_t = SRTYPE_RRX; shift_n = 1;
        else
            shift_t = SRTYPE_ROR; shift_n = UInt(imm5);

    return (shift_t, shift_n);
  
```

aarch32/functions/common/DecodeRegShift

```

// DecodeRegShift()
// =====

SRType DecodeRegShift(bits(2) type)

    case type of
    when '00' shift_t = SRTYPE_LSL;
    when '01' shift_t = SRTYPE_LSR;
    when '10' shift_t = SRTYPE_ASR;
    when '11' shift_t = SRTYPE_ROR;
    return shift_t;
  
```

aarch32/functions/common/RRX

```
// RRX()
// =====

bits(N) RRX(bits(N) x, bit carry_in)
    (result, -) = RRX_C(x, carry_in);
    return result;
```

aarch32/functions/common/RRX_C

```
// RRX_C()
// =====

(bits(N), bit) RRX_C(bits(N) x, bit carry_in)
    result = carry_in : x<N-1:1>;
    carry_out = x<0>;
    return (result, carry_out);
```

aarch32/functions/common/SRType

```
enumeration SRType {SRType_LSL, SRType_LSR, SRType_ASR, SRType_ROR, SRType_RRX};
```

aarch32/functions/common/Shift

```
// Shift()
// =====

bits(N) Shift(bits(N) value, SRType type, integer amount, bit carry_in)
    (result, -) = Shift_C(value, type, amount, carry_in);
    return result;
```

aarch32/functions/common/Shift_C

```
// Shift_C()
// =====

(bits(N), bit) Shift_C(bits(N) value, SRType type, integer amount, bit carry_in)
    assert !(type == SRType_RRX && amount != 1);

    if amount == 0 then
        (result, carry_out) = (value, carry_in);
    else
        case type of
            when SRType_LSL
                (result, carry_out) = LSL_C(value, amount);
            when SRType_LSR
                (result, carry_out) = LSR_C(value, amount);
            when SRType_ASR
                (result, carry_out) = ASR_C(value, amount);
            when SRType_ROR
                (result, carry_out) = ROR_C(value, amount);
            when SRType_RRX
                (result, carry_out) = RRX_C(value, carry_in);

        return (result, carry_out);
```

aarch32/functions/common/T32ExpandImm

```
// T32ExpandImm()
// =====

bits(32) T32ExpandImm(bits(12) imm12)
```



```
// PSTATE.C argument to following function call does not affect the imm32 result.
(imm32, -) = T32ExpandImm_C(imm12, PSTATE.C);

return imm32;
```

aarch32/functions/common/T32ExpandImm_C

```
// T32ExpandImm_C()
// =====

(bits(32), bit) T32ExpandImm_C(bits(12) imm12, bit carry_in)

if imm12<11:10> == '00' then
  case imm12<9:8> of
    when '00'
      imm32 = ZeroExtend(imm12<7:0>, 32);
    when '01'
      imm32 = '00000000' : imm12<7:0> : '00000000' : imm12<7:0>;
    when '10'
      imm32 = imm12<7:0> : '00000000' : imm12<7:0> : '00000000';
    when '11'
      imm32 = imm12<7:0> : imm12<7:0> : imm12<7:0> : imm12<7:0>;
  carry_out = carry_in;
else
  unrotated_value = ZeroExtend('1':imm12<6:0>, 32);
  (imm32, carry_out) = ROR_C(unrotated_value, UInt(imm12<11:7>));

return (imm32, carry_out);
```

aarch32/functions/coproc/AArch32.CheckCP15InstrCoarseTraps

```
// AArch32.CheckCP15InstrCoarseTraps()
// =====
// Check for coarse-grained CP15 traps in HSTR and HCR.

boolean AArch32.CheckCP15InstrCoarseTraps(integer CRn, integer nreg, integer CRm)

// Check for coarse-grained Hyp traps
if HaveEL(EL2) && !IsSecure() && PSTATE.EL IN {EL0,EL1} then
  if PSTATE.EL == EL0 && !ELUsingAArch32(EL2) then
    return AArch64.CheckCP15InstrCoarseTraps(CRn, nreg, CRm);

// Check for MCR, MRC, MCRR and MRRC disabled by HSTR<CRn/CRm>
major = if nreg == 1 then CRn else CRm;
if !(major IN {4,14}) && HSTR<major> == '1' then
  return TRUE;

// Check for MRC and MCR disabled by HCR.TIDCP
if (HCR.TIDCP == '1' && nreg == 1 &&
    ((CRn == 9 && CRm IN {0,1,2, 5,6,7,8 }) ||
     (CRn == 10 && CRm IN {0,1, 4, 8 }) ||
     (CRn == 11 && CRm IN {0,1,2,3,4,5,6,7,8,15}))) then
  return TRUE;

return FALSE;
```

aarch32/functions/coproc/AArch32.CheckSystemAccess

```
// AArch32.CheckSystemAccess()
// =====
// Check System register access instruction for enables and disables

AArch32.CheckSystemAccess(integer cp_num, bits(32) instr)
assert cp_num == UInt(instr<11:8>) && (cp_num IN {14,15});

if PSTATE.EL == EL0 && !ELUsingAArch32(EL1) then
```

```

    AArch64.CheckAArch32SystemAccess(instr);
    return;

// Decode the AArch32 System register access instruction
if instr<31:28> != '1111' && instr<27:24> == '1110' && instr<4> == '1' then // MRC/MCR
    cpvt = TRUE; cpdt = FALSE; nreg = 1;
    opc1 = UInt(instr<23:21>);
    opc2 = UInt(instr<7:5>);
    CRn = UInt(instr<19:16>);
    CRm = UInt(instr<3:0>);
elseif instr<31:28> != '1111' && instr<27:21> == '110010' then // MRRC/MCRR
    cpvt = TRUE; cpdt = FALSE; nreg = 2;
    opc1 = UInt(instr<7:4>);
    CRm = UInt(instr<3:0>);
elseif instr<31:28> != '1111' && instr<27:25> == '110' && instr<22> == '0' then // LDC/STC
    cpvt = FALSE; cpdt = TRUE; nreg = 0;
    opc1 = 0;
    CRn = UInt(instr<15:12>);
else
    allocated = FALSE;

//
// Coarse-grain decode into CP14 or CP15 encoding space. Each of the CPxxxInstrDecode functions
// returns TRUE if the instruction is allocated at the current Exception level, FALSE otherwise.
if cp_num == 14 then
    // LDC and STC only supported for c5 in CP14 encoding space
    if cpdt && CRn != 5 then
        allocated = FALSE;
    else
        // Coarse-grained decode of CP14 based on opc1 field
        case opc1 of
            when 0    allocated = CP14DebugInstrDecode(instr);
            when 1    allocated = CP14TraceInstrDecode(instr);
            when 7    allocated = CP14JazelleInstrDecode(instr); // JIDR only
            otherwise allocated = FALSE; // All other values are unallocated

elseif cp_num == 15 then
    // LDC and STC not supported in CP15 encoding space
    if !cpvt then
        allocated = FALSE;
    else
        allocated = CP15InstrDecode(instr);

        // Coarse-grain traps to EL2 have a higher priority than exceptions generated because
        // the access instruction is UNDEFINED
        if AArch32.CheckCP15InstrCoarseTraps(CRn, nreg, CRm) then
            // For a coarse-grain trap, if it is IMPLEMENTATION DEFINED whether an access from
            // Non-secure User mode is UNDEFINED when the trap is disabled, then it is
            // IMPLEMENTATION DEFINED whether the same access is UNDEFINED or generates a trap
            // when the trap is enabled.
            if PSTATE.EL == EL0 && !IsSecure() && !allocated then
                if boolean IMPLEMENTATION_DEFINED "UNDEF unallocated CP15 access at NS EL0" then
                    UNDEFINED;
                    AArch32.AArch32SystemAccessTrap(EL2, instr);

else
    allocated = FALSE;

if !allocated then
    UNDEFINED;

// If the instruction is not UNDEFINED, it might be disabled or trapped to a higher EL.
AArch32.CheckSystemAccessTraps(instr);

return;

```

aarch32/functions/coproc/AArch32.CheckSystemAccessTraps

```
// Check for configurable disables or traps to a higher EL of an System register access.
AArch32.CheckSystemAccessTraps(bits(32) instr);
```

aarch32/functions/coproc/CP14DebugInstrDecode

```
// Decodes an accepted access to a debug System register in the CP14 encoding space.
// Returns TRUE if the instruction is allocated at the current Exception level, FALSE otherwise.
boolean CP14DebugInstrDecode(bits(32) instr);
```

aarch32/functions/coproc/CP14JazelleInstrDecode

```
// Decodes an accepted access to a Jazelle System register in the CP14 encoding space.
// Returns TRUE if the instruction is allocated at the current Exception level, FALSE otherwise.
boolean CP14JazelleInstrDecode(bits(32) instr);
```

aarch32/functions/coproc/CP14TraceInstrDecode

```
// Decodes an accepted access to a trace System register in the CP14 encoding space.
// Returns TRUE if the instruction is allocated at the current Exception level, FALSE otherwise.
boolean CP14TraceInstrDecode(bits(32) instr);
```

aarch32/functions/coproc/CP15InstrDecode

```
// Decodes an accepted access to a System register in the CP15 encoding space.
// Returns TRUE if the instruction is allocated at the current Exception level, FALSE otherwise.
boolean CP15InstrDecode(bits(32) instr);
```

aarch32/functions/exclusive/AArch32.ExclusiveMonitorsPass

```
// AArch32.ExclusiveMonitorsPass()
// =====

// Return TRUE if the Exclusive Monitors for the current PE include all of the addresses
// associated with the virtual address region of size bytes starting at address.
// The immediately following memory write must be to the same addresses.

boolean AArch32.ExclusiveMonitorsPass(bits(32) address, integer size)

    // It is IMPLEMENTATION DEFINED whether the detection of memory aborts happens
    // before or after the check on the local Exclusive Monitor. As a result a failure
    // of the local monitor can occur on some implementations even if the memory
    // access would give an memory abort.

    acctype = AccType_ATOMIC;
    iswrite = TRUE;
    aligned = (address == Align(address, size));

    if !aligned then
        secondstage = FALSE;
        AArch32.Abort(address, AArch32.AlignmentFault(acctype, iswrite, secondstage));

    passed = AArch32.IsExclusiveVA(address, ProcessorID(), size);
    if !passed then
        return FALSE;
    memaddrdesc = AArch32.TranslateAddress(address, acctype, iswrite, aligned, size);

    // Check for aborts or debug exceptions
    if IsFault(memaddrdesc) then
        AArch32.Abort(address, memaddrdesc.fault);

    passed = IsExclusiveLocal(memaddrdesc.paddress, ProcessorID(), size);
```

```
if passed then
    ClearExclusiveLocal(ProcessorID());
    if memaddrdesc.memattrs.shareable then
        passed = IsExclusiveGlobal(memaddrdesc.paddress, ProcessorID(), size);

return passed;
```

aarch32/functions/exclusive/AArch32.IsExclusiveVA

```
// An optional IMPLEMENTATION DEFINED test for an exclusive access to a virtual
// address region of size bytes starting at address.
//
// It is permitted (but not required) for this function to return FALSE and
// cause a store exclusive to fail if the virtual address region is not
// totally included within the region recorded by MarkExclusiveVA().
//
// It is always safe to return TRUE which will check the physical address only.
boolean AArch32.IsExclusiveVA(bits(32) address, integer processorid, integer size);
```

aarch32/functions/exclusive/AArch32.MarkExclusiveVA

```
// Optionally record an exclusive access to the virtual address region of size bytes
// starting at address for processorid.
AArch32.MarkExclusiveVA(bits(32) address, integer processorid, integer size);
```

aarch32/functions/exclusive/AArch32.SetExclusiveMonitors

```
// AArch32.SetExclusiveMonitors()
// =====

// Sets the Exclusive Monitors for the current PE to record the addresses associated
// with the virtual address region of size bytes starting at address.

AArch32.SetExclusiveMonitors(bits(32) address, integer size)

    acctype = AccType_ATOMIC;
    iswrite = FALSE;
    aligned = (address != Align(address, size));
    memaddrdesc = AArch32.TranslateAddress(address, acctype, iswrite, aligned, size);

    // Check for aborts or debug exceptions
    if IsFault(memaddrdesc) then
        return;

    if memaddrdesc.memattrs.shareable then
        MarkExclusiveGlobal(memaddrdesc.paddress, ProcessorID(), size);

        MarkExclusiveLocal(memaddrdesc.paddress, ProcessorID(), size);

        AArch32.MarkExclusiveVA(address, ProcessorID(), size);
```

aarch32/functions/float/CheckAdvSIMDEnabled

```
// CheckAdvSIMDEnabled()
// =====

CheckAdvSIMDEnabled()

    fpexc_check = TRUE;
    advsimd = TRUE;

    AArch32.CheckAdvSIMDorFPEEnabled(fpexc_check, advsimd);
    // Return from CheckAdvSIMDorFPEEnabled() occurs only if Advanced SIMD access is permitted

    // Make temporary copy of D registers
```

```
// _Dclone[] is used as input data for instruction pseudocode
for i = 0 to 31
    _Dclone[i] = D[i];

return;
```

aarch32/functions/float/CheckAdvSIMDOrVFPEEnabled

```
// CheckAdvSIMDOrVFPEEnabled()
// =====

CheckAdvSIMDOrVFPEEnabled(boolean include_fpxc_check, boolean advsimd)
    AArch32.CheckAdvSIMDOrVFPEEnabled(include_fpxc_check, advsimd);
    // Return from CheckAdvSIMDOrVFPEEnabled() occurs only if VFP access is permitted
return;
```

aarch32/functions/float/CheckCryptoEnabled32

```
// CheckCryptoEnabled32()
// =====

CheckCryptoEnabled32()
    CheckAdvSIMDEnabled();
    // Return from CheckAdvSIMDEnabled() occurs only if access is permitted
return;
```

aarch32/functions/float/CheckVFPEEnabled

```
// CheckVFPEEnabled()
// =====

CheckVFPEEnabled(boolean include_fpxc_check)
    advsimd = FALSE;
    AArch32.CheckAdvSIMDOrVFPEEnabled(include_fpxc_check, advsimd);
    // Return from CheckAdvSIMDOrVFPEEnabled() occurs only if VFP access is permitted
return;
```

aarch32/functions/float/FPHalvedSub

```
// FPHalvedSub()
// =====

bits(N) FPHalvedSub(bits(N) op1, bits(N) op2, FPCRType fpcr)
    assert N IN {16,32,64};
    rounding = FPRoundingMode(fpcr);
    (type1,sign1,value1) = FPUnpack(op1, fpcr);
    (type2,sign2,value2) = FPUnpack(op2, fpcr);
    (done,result) = FPProcessNaNs(type1, type2, op1, op2, fpcr);
    if !done then
        inf1 = (type1 == FPType_Infinity); inf2 = (type2 == FPType_Infinity);
        zero1 = (type1 == FPType_Zero); zero2 = (type2 == FPType_Zero);
        if inf1 && inf2 && sign1 == sign2 then
            result = FPDefaultNaN();
            FPProcessException(FPExc_InvalidOp, fpcr);
        elseif (inf1 && sign1 == '0') || (inf2 && sign2 == '1') then
            result = FPInfinity('0');
        elseif (inf1 && sign1 == '1') || (inf2 && sign2 == '0') then
            result = FPInfinity('1');
        elseif zero1 && zero2 && sign1 != sign2 then
            result = FPZero(sign1);
        else
            result_value = (value1 - value2) / 2.0;
            if result_value == 0.0 then // Sign of exact zero result depends on rounding mode
                result_sign = if rounding == FPRounding_NEGINF then '1' else '0';
                result = FPZero(result_sign);
```

```
        else  
            result = FPRound(result_value, fpcr);  
    return result;
```

aarch32/functions/float/FPRSqrtStep

```
// FPRSqrtStep()  
// =====  
  
bits(N) FPRSqrtStep(bits(N) op1, bits(N) op2)  
    assert N IN {16,32};  
    FPCRTYPE fpcr = StandardFPSCRValue();  
    (type1,sign1,value1) = FPUnpack(op1, fpcr);  
    (type2,sign2,value2) = FPUnpack(op2, fpcr);  
    (done,result) = FPProcessNaNs(type1, type2, op1, op2, fpcr);  
    if !done then  
        inf1 = (type1 == FPTYPE_Infinity);  inf2 = (type2 == FPTYPE_Infinity);  
        zero1 = (type1 == FPTYPE_Zero);      zero2 = (type2 == FPTYPE_Zero);  
        bits(N) product;  
        if (inf1 && zero2) || (zero1 && inf2) then  
            product = FPZero('0');  
        else  
            product = FPMul(op1, op2, fpcr);  
            bits(N) three = FPTThree('0');  
            result = FPHalvedSub(three, product, fpcr);  
    return result;
```

aarch32/functions/float/FPRecipStep

```
// FPRecipStep()  
// =====  
  
bits(N) FPRecipStep(bits(N) op1, bits(N) op2)  
    assert N IN {16,32};  
    FPCRTYPE fpcr = StandardFPSCRValue();  
    (type1,sign1,value1) = FPUnpack(op1, fpcr);  
    (type2,sign2,value2) = FPUnpack(op2, fpcr);  
    (done,result) = FPProcessNaNs(type1, type2, op1, op2, fpcr);  
    if !done then  
        inf1 = (type1 == FPTYPE_Infinity);  inf2 = (type2 == FPTYPE_Infinity);  
        zero1 = (type1 == FPTYPE_Zero);      zero2 = (type2 == FPTYPE_Zero);  
        bits(N) product;  
        if (inf1 && zero2) || (zero1 && inf2) then  
            product = FPZero('0');  
        else  
            product = FPMul(op1, op2, fpcr);  
            bits(N) two = FPTTwo('0');  
            result = FPSub(two, product, fpcr);  
    return result;
```

aarch32/functions/float/StandardFPSCRValue

```
// StandardFPSCRValue()  
// =====  
  
FPCRTYPE StandardFPSCRValue()  
    return '00000' : FPSCR.AHP : '110000' : FPSCR.FZ16 : '00000000000000000000';
```

aarch32/functions/memory/AArch32.CheckAlignment

```
// AArch32.CheckAlignment()  
// =====  
  
boolean AArch32.CheckAlignment(bits(32) address, integer alignment, AccType acctype,  
                                boolean iswrite)
```

```

if PSTATE.EL == EL0 && !ELUsingAArch32(S1TranslationRegime()) then
    A = SCTLR].A; //use AArch64 register, when higher Exception level is using AArch64
elseif PSTATE.EL == EL2 then
    A = HSCTLR.A;
else
    A = SCTLR.A;
aligned = (address == Align(address, alignment));
atomic = acctype IN { AccType_ATOMIC, AccType_ATOMICRW };
ordered = acctype IN { AccType_ORDERED, AccType_ORDEREDRW, AccType_LIMITEDORDERED };
vector = acctype == AccType_VEC;

// AccType_VEC is used for SIMD element alignment checks only
check = (atomic || ordered || vector || A == '1');

if check && !aligned then
    secondstage = FALSE;
    AArch32.Abort(address, AArch32.AlignmentFault(acctype, iswrite, secondstage));

return aligned;

```

aarch32/functions/memory/AArch32.MemSingle

```

// AArch32.MemSingle[] - non-assignment (read) form
// =====
// Perform an atomic, little-endian read of 'size' bytes.

bits(size*8) AArch32.MemSingle[bits(32) address, integer size, AccType acctype, boolean wasaligned]
assert size IN {1, 2, 4, 8, 16};
assert address == Align(address, size);

AddressDescriptor memaddrdesc;
bits(size*8) value;
iswrite = FALSE;

// MMU or MPU
memaddrdesc = AArch32.TranslateAddress(address, acctype, iswrite, wasaligned, size);
// Check for aborts or debug exceptions
if IsFault(memaddrdesc) then
    AArch32.Abort(address, memaddrdesc.fault);

// Memory array access
accdesc = CreateAccessDescriptor(acctype);
value = _Mem[memaddrdesc, size, accdesc];
return value;

// AArch32.MemSingle[] - assignment (write) form
// =====
// Perform an atomic, little-endian write of 'size' bytes.

AArch32.MemSingle[bits(32) address, integer size, AccType acctype, boolean wasaligned] = bits(size*8)
value
assert size IN {1, 2, 4, 8, 16};
assert address == Align(address, size);

AddressDescriptor memaddrdesc;
iswrite = TRUE;

// MMU or MPU
memaddrdesc = AArch32.TranslateAddress(address, acctype, iswrite, wasaligned, size);

// Check for aborts or debug exceptions
if IsFault(memaddrdesc) then
    AArch32.Abort(address, memaddrdesc.fault);

// Effect on exclusives
if memaddrdesc.memattrs.shareable then

```

```
        ClearExclusiveByAddress(memaddrdesc.paddress, ProcessorID(), size);

// Memory array access
accdesc = CreateAccessDescriptor(acctype);
_Mem[memaddrdesc, size, accdesc] = value;
return;
```

aarch32/functions/memory/Hint_PreloadData

```
Hint_PreloadData(bits(32) address);
```

aarch32/functions/memory/Hint_PreloadDataForWrite

```
Hint_PreloadDataForWrite(bits(32) address);
```

aarch32/functions/memory/Hint_PreloadInstr

```
Hint_PreloadInstr(bits(32) address);
```

aarch32/functions/memory/MemA

```
// MemA[] - non-assignment form
// =====

bits(8*size) MemA(bits(32) address, integer size)
    acctype = AccType_ATOMIC;
    return Mem_with_type[address, size, acctype];

// MemA[] - assignment form
// =====

MemA(bits(32) address, integer size) = bits(8*size) value
    acctype = AccType_ATOMIC;
    Mem_with_type[address, size, acctype] = value;
    return;
```

aarch32/functions/memory/MemO

```
// MemO[] - non-assignment form
// =====

bits(8*size) MemO(bits(32) address, integer size)
    acctype = AccType_ORDERED;
    return Mem_with_type[address, size, acctype];

// MemO[] - assignment form
// =====

MemO(bits(32) address, integer size) = bits(8*size) value
    acctype = AccType_ORDERED;
    Mem_with_type[address, size, acctype] = value;
    return;
```

aarch32/functions/memory/MemU

```
// MemU[] - non-assignment form
// =====

bits(8*size) MemU(bits(32) address, integer size)
    acctype = AccType_NORMAL;
    return Mem_with_type[address, size, acctype];

// MemU[] - assignment form
```



```
// =====
MemU[bits(32) address, integer size] = bits(8*size) value
  acctype = AccType_NORMAL;
  Mem_with_type[address, size, acctype] = value;
  return;
```

aarch32/functions/memory/MemU_unpriv

```
// MemU_unpriv[] - non-assignment form
// =====

bits(8*size) MemU_unpriv[bits(32) address, integer size]
  acctype = AccType_UNPRIV;
  return Mem_with_type[address, size, acctype];

// MemU_unpriv[] - assignment form
// =====

MemU_unpriv[bits(32) address, integer size] = bits(8*size) value
  acctype = AccType_UNPRIV;
  Mem_with_type[address, size, acctype] = value;
  return;
```

aarch32/functions/memory/Mem_with_type

```
// Mem_with_type[] - non-assignment (read) form
// =====
// Perform a read of 'size' bytes. The access byte order is reversed for a big-endian access.
// Instruction fetches would call AArch32.MemSingle directly.

bits(size*8) Mem_with_type[bits(32) address, integer size, AccType acctype]
  assert size IN {1, 2, 4, 8, 16};
  bits(size*8) value;
  integer i;
  boolean iswrite = FALSE;

  aligned = AArch32.CheckAlignment(address, size, acctype, iswrite);
  if !aligned then
    assert size > 1;
    value<7:0> = AArch32.MemSingle[address, 1, acctype, aligned];

    // For subsequent bytes it is CONSTRAINED UNPREDICTABLE whether an unaligned Device memory
    // access will generate an Alignment Fault, as to get this far means the first byte did
    // not, so we must be changing to a new translation page.
    c = ConstrainUnpredictable();
    assert c IN {Constraint_FAULT, Constraint_NONE};
    if c == Constraint_NONE then aligned = TRUE;

    for i = 1 to size-1
      value<8*i+7:8*i> = AArch32.MemSingle[address+i, 1, acctype, aligned];
    else
      value = AArch32.MemSingle[address, size, acctype, aligned];

  if BigEndian() then
    value = BigEndianReverse(value);
  return value;

// Mem_with_type[] - assignment (write) form
// =====
// Perform a write of 'size' bytes. The byte order is reversed for a big-endian access.

Mem_with_type[bits(32) address, integer size, AccType acctype] = bits(size*8) value
  integer i;
  boolean iswrite = TRUE;
```

```

if BigEndian() then
    value = BigEndianReverse(value);

aligned = AArch32.CheckAlignment(address, size, acctype, iswrite);

if !aligned then
    assert size > 1;
    AArch32.MemSingle[address, 1, acctype, aligned] = value<7:0>;

    // For subsequent bytes it is CONSTRAINED UNPREDICTABLE whether an unaligned Device memory
    // access will generate an Alignment Fault, as to get this far means the first byte did
    // not, so we must be changing to a new translation page.
    c = ConstrainUnpredictable();
    assert c IN {Constraint_FAULT, Constraint_NONE};
    if c == Constraint_NONE then aligned = TRUE;

    for i = 1 to size-1
        AArch32.MemSingle[address+i, 1, acctype, aligned] = value<8*i+7:8*i>;
    else
        AArch32.MemSingle[address, size, acctype, aligned] = value;
return;

```

aarch32/functions/ras/AArch32.ESBOperation

```

// AArch32.ESBOperation()
// =====
// Perform the AArch32 ESB operation for ESB executed in AArch32 state

AArch32.ESBOperation()

// Check if routed to AArch64 state
route_to_aarch64 = (PSTATE.EL == EL0 && !ELUsingAArch32(EL1));
if !route_to_aarch64 && HaveEL(EL2) && !IsSecure() && !ELUsingAArch32(EL2) then
    route_to_aarch64 = (HCR_EL2.TGE == '1' || HCR_EL2.AMO == '1');
if !route_to_aarch64 && HaveEL(EL3) && !ELUsingAArch32(EL3) then
    route_to_aarch64 = (SCR_EL3.EA == '1');

if route_to_aarch64 then
    AArch64.ESBOperation();
return;

route_to_monitor = (HaveEL(EL3) && ELUsingAArch32(EL3) && SCR.EA == '1');
route_to_hyp = (HaveEL(EL2) && !IsSecure() && PSTATE.EL IN {EL0,EL1} &&
    (HCR.TGE == '1' || HCR.AMO == '1'));

if route_to_monitor then
    target = M32_Monitor;
elseif route_to_hyp || PSTATE.M == M32_Hyp then
    target = M32_Hyp;
else
    target = M32_Abort;

if IsSecure() then
    mask_active = TRUE;
elseif target == M32_Monitor then
    mask_active = (SCR.AW == '1' &&
        (!HaveEL(EL2) || (HCR.TGE == '0' && HCR.AMO == '0')));
else
    mask_active = (target == M32_Abort || PSTATE.M == M32_Hyp);

mask_set = (PSTATE.A == '1');
(-, e1) = ELFromM32(target);
intdis = (Halted() || ExternalDebugInterruptsDisabled(e1));
masked = intdis || (mask_active && mask_set);

// Check for a masked Physical SError pending
if SErrorPending() && masked then // i.e. ISR.A is set to 1

```

```

    syndrome32 = AArch32.PhysicalErrorSyndrome();
    DISR = AArch32.ReportDeferredError(syndrome32.AET, syndrome32.ExT);
    ClearPendingPhysicalError(); // Clear ISR.A to 0

return;

```

aarch32/functions/ras/AArch32.PhysicalErrorSyndrome

```

// Return the SError syndrome
AArch32.SErrorSyndrome AArch32.PhysicalErrorSyndrome();

```

aarch32/functions/ras/AArch32.ReportDeferredError

```

// AArch32.ReportDeferredError()
// =====
// Return deferred SError syndrome

bits(32) AArch32.ReportDeferredError(bits(2) AET, bit ExT)
    bits(32) target;
    target<31> = '1'; // A
    syndrome = Zeros(16);
    if PSTATE.EL == EL2 then
        syndrome<11:10> = AET; // AET
        syndrome<9> = ExT; // EA
        syndrome<5:0> = '010001'; // DFSC
    else
        syndrome<15:14> = AET; // AET
        syndrome<12> = ExT; // ExT
        syndrome<9> = TTBCR.EAE; // LPAE
        if TTBCR.EAE == '1' then // Long-descriptor format
            syndrome<5:0> = '010001'; // STATUS
        else // Short-descriptor format
            syndrome<10,3:0> = '10110'; // FS
    if HaveAnyAArch64() then
        target<24:0> = ZeroExtend(syndrome); // Any RES0 fields must be set to zero
    else
        target<15:0> = syndrome;
    return target;

```

aarch32/functions/ras/AArch32.SErrorSyndrome

```

type AArch32.SErrorSyndrome is (
    bits(2) AET,
    bit ExT
)

```

aarch32/functions/ras/AArch32.vESBOperation

```

// AArch32.vESBOperation()
// =====
// Perform the ESB operation for virtual SError interrupts executed in AArch32 state

AArch32.vESBOperation()
    assert HaveEL(EL2) && !IsSecure() && PSTATE.EL IN {EL0,EL1};

    // Check for EL2 using AArch64 state
    if !ELUsingAArch32(EL2) then
        AArch64.vESBOperation();
        return;

    // If physical SError interrupts are routed to Hyp mode, and TGE is not set, then a
    // virtual SError interrupt might be pending
    vSEI_enabled = (HCR.TGE == '0' && HCR.AMO == '1');
    vSEI_pending = (vSEI_enabled && HCR.VA == '1');
    vintdis = (Halted() || ExternalDebugInterruptsDisabled(EL1));

```

```
vmasked      = (vintdis || PSTATE.A == '1');

// Check for a masked virtual SError pending
if vSEI_pending && vmasked then
    VDISR = AArch32.ReportDeferredSError(VDFSR<15:14>, VDFSR<12>);
    HCR.VA = '0';           // Clear pending virtual SError

return;
```

aarch32/functions/registers/AArch32.ResetGeneralRegisters

```
// AArch32.ResetGeneralRegisters()
// =====

AArch32.ResetGeneralRegisters()

for i = 0 to 7
    R[i] = bits(32) UNKNOWN;
for i = 8 to 12
    Rmode[i, M32_User] = bits(32) UNKNOWN;
    Rmode[i, M32_FIQ] = bits(32) UNKNOWN;
if HaveEL(EL2) then Rmode[13, M32_Hyp] = bits(32) UNKNOWN; // No R14_hyp
for i = 13 to 14
    Rmode[i, M32_User] = bits(32) UNKNOWN;
    Rmode[i, M32_FIQ] = bits(32) UNKNOWN;
    Rmode[i, M32_IRQ] = bits(32) UNKNOWN;
    Rmode[i, M32_Svc] = bits(32) UNKNOWN;
    Rmode[i, M32_Abort] = bits(32) UNKNOWN;
    Rmode[i, M32_Undef] = bits(32) UNKNOWN;
    if HaveEL(EL3) then Rmode[i, M32_Monitor] = bits(32) UNKNOWN;

return;
```

aarch32/functions/registers/AArch32.ResetSIMDFPRegisters

```
// AArch32.ResetSIMDFPRegisters()
// =====

AArch32.ResetSIMDFPRegisters()

for i = 0 to 15
    Q[i] = bits(128) UNKNOWN;

return;
```

aarch32/functions/registers/AArch32.ResetSpecialRegisters

```
// AArch32.ResetSpecialRegisters()
// =====

AArch32.ResetSpecialRegisters()

// AArch32 special registers
SPSR_fiq = bits(32) UNKNOWN;
SPSR_irq = bits(32) UNKNOWN;
SPSR_svc = bits(32) UNKNOWN;
SPSR_abt = bits(32) UNKNOWN;
SPSR_und = bits(32) UNKNOWN;
if HaveEL(EL2) then
    SPSR_hyp = bits(32) UNKNOWN;
    ELR_hyp = bits(32) UNKNOWN;
if HaveEL(EL3) then
    SPSR_mon = bits(32) UNKNOWN;

// External debug special registers
DLR = bits(32) UNKNOWN;
```

```
DSPSR = bits(32) UNKNOWN;

return;
```

aarch32/functions/registers/AArch32.ResetSystemRegisters

```
AArch32.ResetSystemRegisters(boolean cold_reset);
```

aarch32/functions/registers/ALUExceptionReturn

```
// ALUExceptionReturn()
// =====

ALUExceptionReturn(bits(32) address)
  if PSTATE.EL == EL2 then
    UNDEFINED;
  elseif PSTATE.M IN {M32_User, M32_System} then
    UNPREDICTABLE; // UNDEFINED or NOP
  else
    AArch32.ExceptionReturn(address, SPSR[]);
```

aarch32/functions/registers/ALUWritePC

```
// ALUWritePC()
// =====

ALUWritePC(bits(32) address)
  if CurrentInstrSet() == InstrSet_A32 then
    BXWritePC(address);
  else
    BranchWritePC(address);
```

aarch32/functions/registers/BXWritePC

```
// BXWritePC()
// =====

BXWritePC(bits(32) address)
  if address<0> == '1' then
    SelectInstrSet(InstrSet_T32);
    address<0> = '0';
  else
    SelectInstrSet(InstrSet_A32);
    // For branches to an unaligned PC counter in A32 state, the processor takes the branch
    // and does one of:
    // * Forces the address to be aligned
    // * Leaves the PC unaligned, meaning the target generates a PC Alignment fault.
    if address<1> == '1' && ConstrainUnpredictableBool() then
      address<1> = '0';
    BranchTo(address, BranchType_UNKNOWN);
```

aarch32/functions/registers/BranchWritePC

```
// BranchWritePC()
// =====

BranchWritePC(bits(32) address)
  if CurrentInstrSet() == InstrSet_A32 then
    address<1:0> = '00';
  else
    address<0> = '0';
    BranchTo(address, BranchType_UNKNOWN);
```

aarch32/functions/registers/D

```
// D[] - non-assignment form
// =====

bits(64) D[integer n]
    assert n >= 0 && n <= 31;
    base = (n MOD 2) * 64;
    return _V[n DIV 2]<base+63:base>;

// D[] - assignment form
// =====

D[integer n] = bits(64) value
    assert n >= 0 && n <= 31;
    base = (n MOD 2) * 64;
    _V[n DIV 2]<base+63:base> = value;
    return;
```

aarch32/functions/registers/Din

```
// Din[] - non-assignment form
// =====

bits(64) Din[integer n]
    assert n >= 0 && n <= 31;
    return _Dclone[n];
```

aarch32/functions/registers/LR

```
// LR - assignment form
// =====

LR = bits(32) value
    R[14] = value;
    return;

// LR - non-assignment form
// =====

bits(32) LR
    return R[14];
```

aarch32/functions/registers/LoadWritePC

```
// LoadWritePC()
// =====

LoadWritePC(bits(32) address)
    BXWritePC(address);
```

aarch32/functions/registers/LookUpRIndex

```
// LookUpRIndex()
// =====

integer LookUpRIndex(integer n, bits(5) mode)
    assert n >= 0 && n <= 14;

    case n of // Select index by mode:    usr fiq irq svc abt und hyp
        when 8    result = RBankSelect(mode, 8, 24, 8, 8, 8, 8, 8);
        when 9    result = RBankSelect(mode, 9, 25, 9, 9, 9, 9, 9);
        when 10   result = RBankSelect(mode, 10, 26, 10, 10, 10, 10, 10);
        when 11   result = RBankSelect(mode, 11, 27, 11, 11, 11, 11, 11);
        when 12   result = RBankSelect(mode, 12, 28, 12, 12, 12, 12, 12);
```

```

    when 13    result = RBankSelect(mode, 13, 29, 17, 19, 21, 23, 15);
    when 14    result = RBankSelect(mode, 14, 30, 16, 18, 20, 22, 14);
    otherwise  result = n;

    return result;
  
```

aarch32/functions/registers/Monitor_mode_registers

```

bits(32) SP_mon;
bits(32) LR_mon;
  
```

aarch32/functions/registers/PC

```

// PC - non-assignment form
// =====

bits(32) PC
    return R[15];           // This includes the offset from AArch32 state
  
```

aarch32/functions/registers/PCStoreValue

```

// PCStoreValue()
// =====

bits(32) PCStoreValue()
    // This function returns the PC value. On architecture versions before ARMv7, it
    // is permitted to instead return PC+4, provided it does so consistently. It is
    // used only to describe A32 instructions, so it returns the address of the current
    // instruction plus 8 (normally) or 12 (when the alternative is permitted).
    return PC;
  
```

aarch32/functions/registers/Q

```

// Q[] - non-assignment form
// =====

bits(128) Q[integer n]
    assert n >= 0 && n <= 15;
    return _V[n];

// Q[] - assignment form
// =====

Q[integer n] = bits(128) value
    assert n >= 0 && n <= 15;
    _V[n] = value;
    return;
  
```

aarch32/functions/registers/Qin

```

// Qin[] - non-assignment form
// =====

bits(128) Qin[integer n]
    assert n >= 0 && n <= 15;
    return Din[2*n+1]:Din[2*n];
  
```

aarch32/functions/registers/R

```

// R[] - assignment form
// =====

R[integer n] = bits(32) value
  
```

```
Rmode[n, PSTATE.M] = value;
return;

// R[] - non-assignment form
// =====

bits(32) R[integer n]
  if n == 15 then
    offset = (if CurrentInstrSet() == InstrSet_A32 then 8 else 4);
    return _PC<31:0> + offset;
  else
    return Rmode[n, PSTATE.M];
```

aarch32/functions/registers/RBankSelect

```
// RBankSelect()
// =====

integer RBankSelect(bits(5) mode, integer usr, integer fiq, integer irq,
                    integer svc, integer abt, integer und, integer hyp)

  case mode of
    when M32_User    result = usr; // User mode
    when M32_FIQ    result = fiq; // FIQ mode
    when M32_IRQ    result = irq; // IRQ mode
    when M32_Svc    result = svc; // Supervisor mode
    when M32_Abort  result = abt; // Abort mode
    when M32_Hyp    result = hyp; // Hyp mode
    when M32_Undef  result = und; // Undefined mode
    when M32_System result = usr; // System mode uses User mode registers
    otherwise       Unreachable(); // Monitor mode

  return result;
```

aarch32/functions/registers/Rmode

```
// Rmode[] - non-assignment form
// =====

bits(32) Rmode[integer n, bits(5) mode]
  assert n >= 0 && n <= 14;

  // Check for attempted use of Monitor mode in Non-secure state.
  if !IsSecure() then assert mode != M32_Monitor;
  assert !BadMode(mode);

  if mode == M32_Monitor then
    if n == 13 then return SP_mon;
    elsif n == 14 then return LR_mon;
    else return _R[n]<31:0>;
  else
    return _R[LookUpRIndex(n, mode)]<31:0>;

// Rmode[] - assignment form
// =====

Rmode[integer n, bits(5) mode] = bits(32) value
  assert n >= 0 && n <= 14;

  // Check for attempted use of Monitor mode in Non-secure state.
  if !IsSecure() then assert mode != M32_Monitor;
  assert !BadMode(mode);

  if mode == M32_Monitor then
    if n == 13 then SP_mon = value;
    elsif n == 14 then LR_mon = value;
```



```

    else _R[n]<31:0> = value;
  else
    // It is CONSTRAINED UNPREDICTABLE whether the upper 32 bits of the X
    // register are unchanged or set to zero. This is also tested for on
    // exception entry, as this applies to all AArch32 registers.
    if !HighestELUsingAArch32() && ConstrainUnpredictableBool() then
      _R[LookupRIndex(n, mode)] = ZeroExtend(value);
    else
      _R[LookupRIndex(n, mode)]<31:0> = value;

  return;

```

aarch32/functions/registers/S

```

// S[] - non-assignment form
// =====

bits(32) S[integer n]
  assert n >= 0 && n <= 31;
  base = (n MOD 4) * 32;
  return _V[n DIV 4]<base+31:base>;

// S[] - assignment form
// =====

S[integer n] = bits(32) value
  assert n >= 0 && n <= 31;
  base = (n MOD 4) * 32;
  _V[n DIV 4]<base+31:base> = value;
  return;

```

aarch32/functions/registers/SP

```

// SP - assignment form
// =====

SP = bits(32) value
  R[13] = value;
  return;

// SP - non-assignment form
// =====

bits(32) SP
  return R[13];

```

aarch32/functions/registers/_Dclone

```

array bits(64) _Dclone[0..31];

```

aarch32/functions/system/AArch32.ExceptionReturn

```

// AArch32.ExceptionReturn()
// =====

AArch32.ExceptionReturn(bits(32) new_pc, bits(32) spsr)

  // Attempts to change to an illegal mode or state will invoke the Illegal Execution state
  // mechanism
  SetPSTATEFromPSR(spsr);
  ClearExclusiveLocal(ProcessorID());
  SendEventLocal();

  if PSTATE.IL == '1' then
    // If the exception return is illegal, PC[1:0] are UNKNOWN

```

```
        new_pc<1:0> = bits(2) UNKNOWN;
    else
        // LR[1:0] or LR[0] are treated as being 0, depending on the target instruction set state
        if PSTATE.T == '0' then
            new_pc<0> = '0';           // T32
        else
            new_pc<1:0> = '00';       // A32

    BranchTo(new_pc, BranchType_UNKNOWN);
```

aarch32/functions/system/AArch32.ExecutingATS1xPInstr

```
// AArch32.ExecutingATS1xPInstr()
// =====
// Return TRUE if current instruction is AT S1CPR/WP

boolean AArch32.ExecutingATS1xPInstr()
    if !HavePrivATExt() then return FALSE;

    instr = ThisInstr();
    if instr<24+:4> == '1110' && instr<8+:4> == '1110' then
        op1 = instr<21+:3>;
        CRn = instr<16+:4>;
        CRm = instr<0+:4>;
        op2 = instr<5+:3>;
        return (op1 == '000' && CRn == '0111' && CRm == '1001' && op2 IN {'000','001'});
    else
        return FALSE;
```

aarch32/functions/system/AArch32.ExecutingCP10or11Instr

```
// AArch32.ExecutingCP10or11Instr()
// =====

boolean AArch32.ExecutingCP10or11Instr()
    instr = ThisInstr();
    instr_set = CurrentInstrSet();
    assert instr_set IN {InstrSet_A32, InstrSet_T32};

    if instr_set == InstrSet_A32 then
        return ((instr<27:24> == '1110' || instr<27:25> == '110') && instr<11:8> == '101x');
    else // InstrSet_T32
        return (instr<31:28> == '111x' && (instr<27:24> == '1110' || instr<27:25> == '110') &&
            instr<11:8> == '101x');
```

aarch32/functions/system/AArch32.ExecutingLSMInstr

```
// AArch32.ExecutingLSMInstr()
// =====
// Returns TRUE if processor is executing a Load/Store Multiple instruction

boolean AArch32.ExecutingLSMInstr()
    instr = ThisInstr();
    instr_set = CurrentInstrSet();
    assert instr_set IN {InstrSet_A32, InstrSet_T32};

    if instr_set == InstrSet_A32 then
        return (instr<28+:4> != '1111' && instr<25+:3> == '100');
    else // InstrSet_T32
        if ThisInstrLength() == 16 then
            return (instr<12+:4> == '1100');
        else
            return (instr<25+:7> == '1110100' && instr<22> == '0');
```

aarch32/functions/system/AArch32.ITAdvance

```
// AArch32.ITAdvance()
// =====

AArch32.ITAdvance()
  if PSTATE.IT<2:0> == '000' then
    PSTATE.IT = '0000000';
  else
    PSTATE.IT<4:0> = LSL(PSTATE.IT<4:0>, 1);
  return;
```

aarch32/functions/system/AArch32.SysRegRead

```
// Read from a 32-bit AArch32 System register and return the register's contents.
bits(32) AArch32.SysRegRead(integer cp_num, bits(32) instr);
```

aarch32/functions/system/AArch32.SysRegRead64

```
// Read from a 64-bit AArch32 System register and return the register's contents.
bits(64) AArch32.SysRegRead64(integer cp_num, bits(32) instr);
```

aarch32/functions/system/AArch32.SysRegReadCanWriteAPSR

```
// AArch32.SysRegReadCanWriteAPSR()
// =====
// Determines whether the AArch32 System register read instruction can write to APSR flags.

boolean AArch32.SysRegReadCanWriteAPSR(integer cp_num, bits(32) instr)
  assert UsingAArch32();
  assert (cp_num IN {14,15});
  assert cp_num == UInt(instr<11:8>);

  opc1 = UInt(instr<23:21>);
  opc2 = UInt(instr<7:5>);
  CRn = UInt(instr<19:16>);
  CRm = UInt(instr<3:0>);

  if cp_num == 14 && opc1 == 0 && CRn == 0 && CRm == 1 && opc2 == 0 then // DBGDSCRint
    return TRUE;

  return FALSE;
```

aarch32/functions/system/AArch32.SysRegWrite

```
// Write to a 32-bit AArch32 System register.
AArch32.SysRegWrite(integer cp_num, bits(32) instr, bits(32) val);
```

aarch32/functions/system/AArch32.SysRegWrite64

```
// Write to a 64-bit AArch32 System register.
AArch32.SysRegWrite64(integer cp_num, bits(32) instr, bits(64) val);
```

aarch32/functions/system/AArch32.WriteMode

```
// AArch32.WriteMode()
// =====
// Function for dealing with writes to PSTATE.M from AArch32 state only.
// This ensures that PSTATE.EL and PSTATE.SP are always valid.

AArch32.WriteMode(bits(5) mode)
  (valid,e1) = ELFFromM32(mode);
  assert valid;
```

```
PSTATE.M = mode;
PSTATE.EL = e1;
PSTATE.nRW = '1';
PSTATE.SP = (if mode IN {M32_User,M32_System} then '0' else '1');
return;
```

aarch32/functions/system/AArch32.WriteModeByInstr

```
// AArch32.WriteModeByInstr()
// =====
// Function for dealing with writes to PSTATE.M from an AArch32 instruction, and ensuring that
// illegal state changes are correctly flagged in PSTATE.IL.

AArch32.WriteModeByInstr(bits(5) mode)
    (valid,e1) = ELFromM32(mode);

    // 'valid' is set to FALSE if 'mode' is invalid for this implementation or the current value
    // of SCR.NS/SCR_EL3.NS. Additionally, it is illegal for an instruction to write 'mode' to
    // PSTATE.EL if it would result in any of:
    // * A change to a mode that would cause entry to a higher Exception level.
    if UInt(e1) > UInt(PSTATE.EL) then
        valid = FALSE;

    // * A change to or from Hyp mode.
    if (PSTATE.M == M32_Hyp || mode == M32_Hyp) && PSTATE.M != mode then
        valid = FALSE;

    // * When EL2 is implemented, the value of HCR.TGE is '1', a change to a Non-secure EL1 mode.
    if PSTATE.M == M32_Monitor && HaveEL(EL2) && e1 == EL1 && SCR.NS == '1' && HCR.TGE == '1' then
        valid = FALSE;

    if !valid then
        PSTATE.IL = '1';
    else
        AArch32.WriteMode(mode);
```

aarch32/functions/system/BadMode

```
// BadMode()
// =====

boolean BadMode(bits(5) mode)
    // Return TRUE if 'mode' encodes a mode that is not valid for this implementation
    case mode of
        when M32_Monitor
            valid = HaveAArch32EL(EL3);
        when M32_Hyp
            valid = HaveAArch32EL(EL2);
        when M32_FIQ, M32_IRQ, M32_Svc, M32_Abort, M32_Undef, M32_System
            // If EL3 is implemented and using AArch32, then these modes are EL3 modes in Secure
            // state, and EL1 modes in Non-secure state. If EL3 is not implemented or is using
            // AArch64, then these modes are EL1 modes.
            // Therefore it is sufficient to test this implementation supports EL1 using AArch32.
            valid = HaveAArch32EL(EL1);
        when M32_User
            valid = HaveAArch32EL(EL0);
        otherwise
            valid = FALSE; // Passed an illegal mode value
    return !valid;
```

aarch32/functions/system/BankedRegisterAccessValid

```
// BankedRegisterAccessValid()
// =====
// Checks for MRS (Banked register) or MSR (Banked register) accesses to registers
// other than the SPSRs that are invalid. This includes ELR_hyp accesses.
```

BankedRegisterAccessValid(bits(5) SYSm, bits(5) mode)

```

case SYSm of
  when '000xx', '00100' // R8_usr to R12_usr
    if mode != M32_FIQ then UNPREDICTABLE;
  when '00101' // SP_usr
    if mode == M32_System then UNPREDICTABLE;
  when '00110' // LR_usr
    if mode IN {M32_Hyp,M32_System} then UNPREDICTABLE;
  when '010xx', '0110x', '01110' // R8_fiq to R12_fiq, SP_fiq, LR_fiq
    if mode == M32_FIQ then UNPREDICTABLE;
  when '1000x' // LR_irq, SP_irq
    if mode == M32_IRQ then UNPREDICTABLE;
  when '1001x' // LR_svc, SP_svc
    if mode == M32_Svc then UNPREDICTABLE;
  when '1010x' // LR_abt, SP_abt
    if mode == M32_Abort then UNPREDICTABLE;
  when '1011x' // LR_und, SP_und
    if mode == M32_Undef then UNPREDICTABLE;
  when '1110x' // LR_mon, SP_mon
    if !HaveEL(EL3) || !IsSecure() || mode == M32_Monitor then UNPREDICTABLE;
  when '11110' // ELR_hyp, only from Monitor or Hyp mode
    if !HaveEL(EL2) || !(mode IN {M32_Monitor,M32_Hyp}) then UNPREDICTABLE;
  when '11111' // SP_hyp, only from Monitor mode
    if !HaveEL(EL2) || mode != M32_Monitor then UNPREDICTABLE;
  otherwise
    UNPREDICTABLE;

return;

```

aarch32/functions/system/CPSRWriteByInstr

```

// CPSRWriteByInstr()
// =====
// Update PSTATE.<N,Z,C,V,Q,GE,E,A,I,F,M> from a CPSR value written by an MSR instruction.

CPSRWriteByInstr(bits(32) value, bits(4) bytemask)
  privileged = PSTATE.EL != EL0; // PSTATE.<A,I,F,M> are not writable at EL0

  // Write PSTATE from 'value', ignoring bytes masked by 'bytemask'
  if bytemask<3> == '1' then
    PSTATE.<N,Z,C,V,Q> = value<31:27>;
    // Bits <26:24> are ignored

  if bytemask<2> == '1' then
    // Bit <23> is RES0
    if privileged then
      PSTATE.PAN = value<22>;
    // Bits <21:20> are RES0
    PSTATE.GE = value<19:16>;
  if bytemask<1> == '1' then
    // Bits <15:10> are RES0
    PSTATE.E = value<9>; // PSTATE.E is writable at EL0
    if privileged then
      PSTATE.A = value<8>;

  if bytemask<0> == '1' then
    if privileged then
      PSTATE.<I,F> = value<7:6>;
      // Bit <5> is RES0
      // AArch32.WriteModeByInstr() sets PSTATE.IL to 1 if this is an illegal mode change.
      AArch32.WriteModeByInstr(value<4:0>);

return;

```

aarch32/functions/system/ConditionPassed

```
// ConditionPassed()
// =====

boolean ConditionPassed()
    return ConditionHolds(AArch32.CurrentCond());
```

aarch32/functions/system/CurrentCond

```
bits(4) AArch32.CurrentCond();
```

aarch32/functions/system/InITBlock

```
// InITBlock()
// =====

boolean InITBlock()
    if CurrentInstrSet() == InstrSet_T32 then
        return PSTATE.IT<3:0> != '0000';
    else
        return FALSE;
```

aarch32/functions/system/LastInITBlock

```
// LastInITBlock()
// =====

boolean LastInITBlock()
    return (PSTATE.IT<3:0> == '1000');
```

aarch32/functions/system/SPSRWriteByInstr

```
// SPSRWriteByInstr()
// =====

SPSRWriteByInstr(bits(32) value, bits(4) bytemask)

    new_spsr = SPSR[];

    if bytemask<3> == '1' then
        new_spsr<31:24> = value<31:24>; // N,Z,C,V,Q flags, IT[1:0],J bits

    if bytemask<2> == '1' then
        new_spsr<23:16> = value<23:16>; // IL bit, GE[3:0] flags

    if bytemask<1> == '1' then
        new_spsr<15:8> = value<15:8>; // IT[7:2] bits, E bit, A interrupt mask

    if bytemask<0> == '1' then
        new_spsr<7:0> = value<7:0>; // I,F interrupt masks, T bit, Mode bits

    SPSR[] = new_spsr; // UNPREDICTABLE if User or System mode

    return;
```

aarch32/functions/system/SPSRAccessValid

```
// SPSRAccessValid()
// =====
// Checks for MRS (Banked register) or MSR (Banked register) accesses to the SPSRs
// that are UNPREDICTABLE

SPSRAccessValid(bits(5) SYSm, bits(5) mode)
```

```

case SYSm of
  when '01110' // SPSR_fiq
    if mode == M32_FIQ then UNPREDICTABLE;
  when '10000' // SPSR_irq
    if mode == M32_IRQ then UNPREDICTABLE;
  when '10010' // SPSR_svc
    if mode == M32_Svc then UNPREDICTABLE;
  when '10100' // SPSR_abt
    if mode == M32_Abort then UNPREDICTABLE;
  when '10110' // SPSR_und
    if mode == M32_Undef then UNPREDICTABLE;
  when '11100' // SPSR_mon
    if !HaveEL(EL3) || mode == M32_Monitor || !IsSecure() then UNPREDICTABLE;
  when '11110' // SPSR_hyp
    if !HaveEL(EL2) || mode != M32_Monitor then UNPREDICTABLE;
  otherwise
    UNPREDICTABLE;

return;

```

aarch32/functions/system/SelectInstrSet

```

// SelectInstrSet()
// =====

SelectInstrSet(InstrSet iset)
  assert CurrentInstrSet() IN {InstrSet_A32, InstrSet_T32};
  assert iset IN {InstrSet_A32, InstrSet_T32};

  PSTATE.T = if iset == InstrSet_A32 then '0' else '1';

return;

```

aarch32/functions/v6simd/Sat

```

// Sat()
// =====

bits(N) Sat(integer i, integer N, boolean unsigned)
  result = if unsigned then UnsignedSat(i, N) else SignedSat(i, N);
  return result;

```

aarch32/functions/v6simd/SignedSat

```

// SignedSat()
// =====

bits(N) SignedSat(integer i, integer N)
  (result, -) = SignedSatQ(i, N);
  return result;

```

aarch32/functions/v6simd/UnsignedSat

```

// UnsignedSat()
// =====

bits(N) UnsignedSat(integer i, integer N)
  (result, -) = UnsignedSatQ(i, N);
  return result;

```

J1.2.4 aarch32/translation

This section includes the following pseudocode functions:

- [aarch32/translation/attrs/AArch32.DefaultTEXDecode](#) on page J1-5986.

- [aarch32/translation/attrs/AArch32.InstructionDevice](#) on page J1-5987.
- [aarch32/translation/attrs/AArch32.RemappedTEXDecode](#) on page J1-5987.
- [aarch32/translation/attrs/AArch32.S1AttrDecode](#) on page J1-5988.
- [aarch32/translation/attrs/AArch32.TranslateAddressSIOff](#) on page J1-5989.
- [aarch32/translation/checks/AArch32.CheckDomain](#) on page J1-5990.
- [aarch32/translation/checks/AArch32.CheckPermission](#) on page J1-5990.
- [aarch32/translation/checks/AArch32.CheckS2Permission](#) on page J1-5991.
- [aarch32/translation/debug/AArch32.CheckBreakpoint](#) on page J1-5992.
- [aarch32/translation/debug/AArch32.CheckDebug](#) on page J1-5992.
- [aarch32/translation/debug/AArch32.CheckVectorCatch](#) on page J1-5993.
- [aarch32/translation/debug/AArch32.CheckWatchpoint](#) on page J1-5993.
- [aarch32/translation/faults/AArch32.AccessFlagFault](#) on page J1-5993.
- [aarch32/translation/faults/AArch32.AddressSizeFault](#) on page J1-5994.
- [aarch32/translation/faults/AArch32.AlignmentFault](#) on page J1-5994.
- [aarch32/translation/faults/AArch32.AsynchExternalAbort](#) on page J1-5994.
- [aarch32/translation/faults/AArch32.DebugFault](#) on page J1-5995.
- [aarch32/translation/faults/AArch32.DomainFault](#) on page J1-5995.
- [aarch32/translation/faults/AArch32.NoFault](#) on page J1-5995.
- [aarch32/translation/faults/AArch32.PermissionFault](#) on page J1-5995.
- [aarch32/translation/faults/AArch32.TranslationFault](#) on page J1-5996.
- [aarch32/translation/translation/AArch32.FirstStageTranslate](#) on page J1-5996.
- [aarch32/translation/translation/AArch32.FullTranslate](#) on page J1-5997.
- [aarch32/translation/translation/AArch32.SecondStageTranslate](#) on page J1-5997.
- [aarch32/translation/translation/AArch32.SecondStageWalk](#) on page J1-5998.
- [aarch32/translation/translation/AArch32.TranslateAddress](#) on page J1-5998.
- [aarch32/translation/walk/AArch32.TranslationTableWalkLD](#) on page J1-5999.
- [aarch32/translation/walk/AArch32.TranslationTableWalkSD](#) on page J1-6002.
- [aarch32/translation/walk/RemapRegsHaveResetValues](#) on page J1-6005.

aarch32/translation/attrs/AArch32.DefaultTEXDecode

```
// AArch32.DefaultTEXDecode()
// =====

MemoryAttributes AArch32.DefaultTEXDecode(bits(3) TEX, bit C, bit B, bit S, AccType acctype)

MemoryAttributes memattrs;

// Reserved values map to allocated values
if (TEX == '001' && C:B == '01') || (TEX == '010' && C:B != '00') || TEX == '011' then
  bits(5) texcb;
  (-, texcb) = ConstrainUnpredictableBits();
  TEX = texcb<4:2>; C = texcb<1>; B = texcb<0>;

case TEX:C:B of
  when '00000'
    // Device-nGnRnE
    memattrs.type = MemType_Device;
    memattrs.device = DeviceType_nGnRnE;
  when '00001', '01000'
    // Device-nGnRE
    memattrs.type = MemType_Device;
    memattrs.device = DeviceType_nGnRE;
  when '00010', '00011', '00100'
    // Write-back or Write-through Read allocate, or Non-cacheable
    memattrs.type = MemType_Normal;
    memattrs.inner = ShortConvertAttrsHints(C:B, acctype, FALSE);
    memattrs.outer = ShortConvertAttrsHints(C:B, acctype, FALSE);
```



```

    memattrs.shareable = (S == '1');
  when '00110'
    memattrs = MemoryAttributes IMPLEMENTATION_DEFINED;
  when '00111'
    // Write-back Read and Write allocate
    memattrs.type = MemType_Normal;
    memattrs.inner = ShortConvertAttrHints('01', acctype, FALSE);
    memattrs.outer = ShortConvertAttrHints('01', acctype, FALSE);
    memattrs.shareable = (S == '1');
  when '1xxxx'
    // Cacheable, TEX<1:0> = Outer attrs, {C,B} = Inner attrs
    memattrs.type = MemType_Normal;
    memattrs.inner = ShortConvertAttrHints(C:B, acctype, FALSE);
    memattrs.outer = ShortConvertAttrHints(TEX<1:0>, acctype, FALSE);
    memattrs.shareable = (S == '1');
  otherwise
    // Reserved, handled above
    Unreachable();

  // transient bits are not supported in this format
  memattrs.inner.transient = FALSE;
  memattrs.outer.transient = FALSE;

  // distinction between inner and outer shareable is not supported in this format
  memattrs.outershareable = memattrs.shareable;

  return MemAttrDefaults(memattrs);

```

aarch32/translation/attrs/AArch32.InstructionDevice

```

// AArch32.InstructionDevice()
// =====
// Instruction fetches from memory marked as Device but not execute-never might generate a
// Permission Fault but are otherwise treated as if from Normal Non-cacheable memory.

AddressDescriptor AArch32.InstructionDevice(AddressDescriptor addrdesc, bits(32) vaddress,
                                           bits(40) ipaddress, integer level, bits(4) domain,
                                           AccType acctype, boolean iswrite, boolean secondstage,
                                           boolean s2fs1walk)

  c = ConstrainUnpredictable();
  assert c IN {Constraint_NONE, Constraint_FAULT};

  if c == Constraint_FAULT then
    addrdesc.fault = AArch32.PermissionFault(ipaddress, domain, level, acctype, iswrite,
                                              secondstage, s2fs1walk);
  else
    addrdesc.memattrs.type = MemType_Normal;
    addrdesc.memattrs.inner.attrs = MemAttr_NC;
    addrdesc.memattrs.inner.hints = MemHint_No;
    addrdesc.memattrs.outer = addrdesc.memattrs.inner;
    addrdesc.memattrs = MemAttrDefaults(addrdesc.memattrs);

  return addrdesc;

```

aarch32/translation/attrs/AArch32.RemappedTEXDecode

```

// AArch32.RemappedTEXDecode()
// =====

MemoryAttributes AArch32.RemappedTEXDecode(bits(3) TEX, bit C, bit B, bit S, AccType acctype)

  MemoryAttributes memattrs;

  region = UInt(TEX<0>:C:B); // TEX<2:1> are ignored in this mapping scheme
  if region == 6 then

```

```

    memattrs = MemoryAttributes IMPLEMENTATION_DEFINED;
  else
    base = 2 * region;
    attrfield = PRRR<base+1:base>;

    if attrfield == '11' then      // Reserved, maps to allocated value
      (-, attrfield) = ConstrainUnpredictableBits();

    case attrfield of
      when '00'                    // Device-nGnRnE
        memattrs.type = MemType_Device;
        memattrs.device = DeviceType_nGnRnE;
      when '01'                    // Device-nGnRE
        memattrs.type = MemType_Device;
        memattrs.device = DeviceType_nGnRE;
      when '10'
        memattrs.type = MemType_Normal;
        memattrs.inner = ShortConvertAttrHints(NMRR<base+1:base>, acctype, FALSE);
        memattrs.outer = ShortConvertAttrHints(NMRR<base+17:base+16>, acctype, FALSE);
        s_bit = if S == '0' then PRRR.NS0 else PRRR.NS1;
        memattrs.shareable = (s_bit == '1');
        memattrs.outershareable = (s_bit == '1' && PRRR<region+24> == '0');
      when '11'
        Unreachable();

    // transient bits are not supported in this format
    memattrs.inner.transient = FALSE;
    memattrs.outer.transient = FALSE;

  return MemAttrDefaults(memattrs);

```

aarch32/translation/attrs/AArch32.S1AttrDecode

```

// AArch32.S1AttrDecode()
// =====
// Converts the Stage 1 attribute fields, using the MAIR, to orthogonal
// attributes and hints.

MemoryAttributes AArch32.S1AttrDecode(bits(2) SH, bits(3) attr, AccType acctype)

MemoryAttributes memattrs;

if PSTATE.EL == EL2 then
  mair = HMAIR1:HMAIR0;
else
  mair = MAIR1:MAIR0;
index = 8 * UInt(attr);
attrfield = mair<index+7:index>;

if ((attrfield<7:4> != '0000' && attrfield<3:0> == '0000') ||
    (attrfield<7:4> == '0000' && attrfield<3:0> != 'xx00')) then
  // Reserved, maps to an allocated value
  (-, attrfield) = ConstrainUnpredictableBits();

if attrfield<7:4> == '0000' then      // Device
  memattrs.type = MemType_Device;
  case attrfield<3:0> of
    when '0000' memattrs.device = DeviceType_nGnRnE;
    when '0100' memattrs.device = DeviceType_nGnRE;
    when '1000' memattrs.device = DeviceType_nGRE;
    when '1100' memattrs.device = DeviceType_GRE;
    otherwise   Unreachable();      // Reserved, handled above

elseif attrfield<3:0> != '0000' then // Normal
  memattrs.type = MemType_Normal;
  memattrs.outer = LongConvertAttrHints(attrfield<7:4>, acctype);
  memattrs.inner = LongConvertAttrHints(attrfield<3:0>, acctype);

```

```

    memattrs.shareable = SH<1> == '1';
    memattrs.outershareable = SH == '10';

else
    Unreachable(); // Reserved, handled above

return MemAttrDefaults(memattrs);

```

aarch32/translation/attrs/AArch32.TranslateAddressS1Off

```

// AArch32.TranslateAddressS1Off()
// =====
// Called for stage 1 translations when translation is disabled to supply a default translation.
// Note that there are additional constraints on instruction prefetching that are not described in
// this pseudocode.

TLBRecord AArch32.TranslateAddressS1Off(bits(32) vaddress, AccType acctype, boolean iswrite)
    assert ELUsingAArch32(S1TranslationRegime());

    TLBRecord result;

    default_cacheable = (HasS2Translation() && ((if ELUsingAArch32(EL2) then HCR.DC else HCR_EL2.DC) ==
'1'));

    if default_cacheable then
        // Use default cacheable settings
        result.addrdesc.memattrs.type = MemType_Normal;
        result.addrdesc.memattrs.inner.attrs = MemAttr_WB; // Write-back
        result.addrdesc.memattrs.inner.hints = MemHint_RWA;
        result.addrdesc.memattrs.shareable = FALSE;
        result.addrdesc.memattrs.outershareable = FALSE;
    elsif acctype != Acctype_IFETCH then
        // Treat data as Device
        result.addrdesc.memattrs.type = MemType_Device;
        result.addrdesc.memattrs.device = DeviceType_nGnRnE;
        result.addrdesc.memattrs.inner = MemAttrHints_UNKNOWN;
    else
        // Instruction cacheability controlled by SCTL/HSCTLR.I
        if PSTATE.EL == EL2 then
            cacheable = HSCTLR.I == '1';
        else
            cacheable = SCTL.I == '1';
        result.addrdesc.memattrs.type = MemType_Normal;
        if cacheable then
            result.addrdesc.memattrs.inner.attrs = MemAttr_WT;
            result.addrdesc.memattrs.inner.hints = MemHint_RA;
        else
            result.addrdesc.memattrs.inner.attrs = MemAttr_NC;
            result.addrdesc.memattrs.inner.hints = MemHint_No;
            result.addrdesc.memattrs.shareable = TRUE;
            result.addrdesc.memattrs.outershareable = TRUE;

        result.addrdesc.memattrs.outer = result.addrdesc.memattrs.inner;

        result.addrdesc.memattrs = MemAttrDefaults(result.addrdesc.memattrs);

        result.perms.ap = bits(3) UNKNOWN;
        result.perms.xn = '0';
        result.perms.pxn = '0';

        result.nG = bit UNKNOWN;
        result.contiguous = boolean UNKNOWN;
        result.domain = bits(4) UNKNOWN;
        result.level = integer UNKNOWN;
        result.blocksize = integer UNKNOWN;
        result.addrdesc.paddress.physicaladdress = ZeroExtend(vaddress);

```

```
result.addrdesc.address.NS = if IsSecure() then '0' else '1';  
result.addrdesc.fault = AArch32.NoFault();  
return result;
```

aarch32/translation/checks/AArch32.CheckDomain

```
// AArch32.CheckDomain()  
// =====  
  
(boolean, FaultRecord) AArch32.CheckDomain(bits(4) domain, bits(32) vaddress, integer level,  
                                           AccType acctype, boolean iswrite)  
  
    index = 2 * UInt(domain);  
    attrfield = DACR<index+1:index>;  
  
    if attrfield == '10' then // Reserved, maps to an allocated value  
        // Reserved value maps to an allocated value  
        (-, attrfield) = ConstrainUnpredictableBits();  
  
    if attrfield == '00' then  
        fault = AArch32.DomainFault(domain, level, acctype, iswrite);  
    else  
        fault = AArch32.NoFault();  
  
    permissioncheck = (attrfield == '01');  
  
    return (permissioncheck, fault);
```

aarch32/translation/checks/AArch32.CheckPermission

```
// AArch32.CheckPermission()  
// =====  
// Function used for permission checking from AArch32 stage 1 translations  
  
FaultRecord AArch32.CheckPermission(Permissions perms, bits(32) vaddress, integer level,  
                                     bits(4) domain, bit NS, AccType acctype, boolean iswrite)  
    assert ELUsingAArch32(S1TranslationRegime());  
  
    if PSTATE.EL != EL2 then  
        wxn = SCTL.R.WXN == '1';  
        if TTBCR.EAE == '1' || SCTL.R.AFE == '1' || perms.ap<0> == '1' then  
            priv_r = TRUE;  
            priv_w = perms.ap<2> == '0';  
            user_r = perms.ap<1> == '1';  
            user_w = perms.ap<2:1> == '01';  
        else  
            priv_r = perms.ap<2:1> != '00';  
            priv_w = perms.ap<2:1> == '01';  
            user_r = perms.ap<1> == '1';  
            user_w = FALSE;  
        uwxn = SCTL.R.UWXN == '1';  
  
        if PSTATE.EL == EL0 then  
            ispriv = FALSE;  
        else  
            ispriv = (acctype != AccType_UNPRIV);  
  
        if (HavePANExt() && PSTATE.PAN == '1' && user_r && ispriv &&  
            !(acctype IN {AccType_DC, AccType_AT, AccType_IFETCH}) ||  
            (acctype == AccType_AT && AArch32.ExecutingATS1xPInstr())) then  
            priv_r = FALSE; priv_w = FALSE;  
            user_xn = !user_r || perms.xn == '1' || (user_w && wxn);  
            priv_xn = (!priv_r || perms.xn == '1' || perms.pxn == '1' ||  
                (priv_w && wxn) || (user_w && uwxn));  
            if ispriv then  
                (r, w, xn) = (priv_r, priv_w, priv_xn);
```

```

    else
      (r, w, xn) = (user_r, user_w, user_xn);
    else
      // Access from EL2
      wxn = HSCTLR.WXN == '1';
      r = TRUE;
      w = perms.ap<2> == '0';
      xn = perms.xn == '1' || (w && wxn);

      // Restriction on Secure instruction fetch
      if HaveEL(EL3) && IsSecure() && NS == '1' then
        secure_instr_fetch = if ELUsingAArch32(EL3) then SCR.SIF else SCR_EL3.SIF;
        if secure_instr_fetch == '1' then xn = TRUE;

      if acctype == AccType_IFETCH then
        fail = xn;
        failedread = TRUE;
      elseif acctype IN { AccType_ATOMICRW, AccType_ORDEREDRW } then
        fail = !r || !w;
        failedread = !r;
      elseif iswrite && !IsSecure() && PSTATE.EL == EL1 && (acctype != AccType_DC) then
        fail = !w;
        failedread = FALSE;
      else
        fail = !r;
        failedread = TRUE;

      if fail then
        secondstage = FALSE;
        s2fs1walk = FALSE;
        ipaddress = bits(40) UNKNOWN;
        return AArch32.PermissionFault(ipaddress, domain, level, acctype,
                                       !failedread, secondstage, s2fs1walk);
      else
        return AArch32.NoFault();
  
```

aarch32/translation/checks/AArch32.CheckS2Permission

```

// AArch32.CheckS2Permission()
// =====
// Function used for permission checking from AArch32 stage 2 translations

FaultRecord AArch32.CheckS2Permission(Permissions perms, bits(32) vaddress, bits(40) ipaddress,
                                       integer level, AccType acctype, boolean iswrite,
                                       boolean s2fs1walk)

  assert HaveEL(EL2) && !IsSecure() && ELUsingAArch32(EL2) && HasS2Translation();

  r = perms.ap<1> == '1';
  w = perms.ap<2> == '1';
  if HaveExtendedExecuteNeverExt() then
    case perms.xn:perms.xxn of
      when '00' xn = !r;
      when '01' xn = !r || PSTATE.EL == EL1;
      when '10' xn = TRUE;
      when '11' xn = !r || PSTATE.EL == EL0;
    else
      xn = !r || perms.xn == '1';
  // Stage 1 walk is checked as a read, regardless of the original type
  if acctype == AccType_IFETCH && !s2fs1walk then
    fail = xn;
    failedread = TRUE;
  elseif (acctype IN { AccType_ATOMICRW, AccType_ORDEREDRW }) && !s2fs1walk then
    fail = !r || !w;
    failedread = !r;
  elseif iswrite && !s2fs1walk then
    fail = !w;
  
```

```
        failedread = FALSE;
    else
        fail = !r;
        failedread = !iswrite;

    if fail then
        domain = bits(4) UNKNOWN;
        secondstage = TRUE;
        return AArch32.PermissionFault(ipaddress, domain, level, acctype,
                                       !failedread, secondstage, s2fs1walk);
    else
        return AArch32.NoFault();
```

aarch32/translation/debug/AArch32.CheckBreakpoint

```
// AArch32.CheckBreakpoint()
// =====
// Called before executing the instruction of length "size" bytes at "vaddress" in an AArch32
// translation regime.
// The breakpoint can in fact be evaluated well ahead of execution, for example, at instruction
// fetch. This is the simple sequential execution of the program.

FaultRecord AArch32.CheckBreakpoint(bits(32) vaddress, integer size)
    assert ELUsingAArch32(S1TranslationRegime());
    assert size IN {2,4};

    match = FALSE;
    mismatch = FALSE;

    for i = 0 to UInt(DBGDIDR.BRPs)
        (match_i, mismatch_i) = AArch32.BreakpointMatch(i, vaddress, size);
        match = match || match_i;
        mismatch = mismatch || mismatch_i;

    if match && HaltOnBreakpointOrWatchpoint() then
        reason = DebugHalt_Breakpoint;
        Halt(reason);
    elseif (match || mismatch) && DBGDSCRExt.MDBGGen == '1' && AArch32.GenerateDebugExceptions() then
        acctype = AccType_IFETCH;
        iswrite = FALSE;
        debugmoe = DebugException_Breakpoint;
        return AArch32.DebugFault(acctype, iswrite, debugmoe);
    else
        return AArch32.NoFault();
```

aarch32/translation/debug/AArch32.CheckDebug

```
// AArch32.CheckDebug()
// =====
// Called on each access to check for a debug exception or entry to Debug state.

FaultRecord AArch32.CheckDebug(bits(32) vaddress, AccType acctype, boolean iswrite, integer size)

    FaultRecord fault = AArch32.NoFault();

    d_side = (acctype != AccType_IFETCH);
    generate_exception = AArch32.GenerateDebugExceptions() && DBGDSCRExt.MDBGGen == '1';
    halt = HaltOnBreakpointOrWatchpoint();
    // Relative priority of Vector Catch and Breakpoint exceptions not defined in the architecture
    vector_catch_first = ConstrainUnpredictableBool();

    if !d_side && vector_catch_first && generate_exception then
        fault = AArch32.CheckVectorCatch(vaddress, size);

    if fault.type == Fault_None && (generate_exception || halt) then
        if d_side then
```

```

    fault = AArch32.CheckWatchpoint(vaddress, acctype, iswrite, size);
  else
    fault = AArch32.CheckBreakpoint(vaddress, size);

  if fault.type == Fault_None && !d_side && !vector_catch_first && generate_exception then
    return AArch32.CheckVectorCatch(vaddress, size);

  return fault;

```

aarch32/translation/debug/AArch32.CheckVectorCatch

```

// AArch32.CheckVectorCatch()
// =====
// Called before executing the instruction of length "size" bytes at "vaddress" in an AArch32
// translation regime.
// Vector Catch can in fact be evaluated well ahead of execution, for example, at instruction
// fetch. This is the simple sequential execution of the program.

FaultRecord AArch32.CheckVectorCatch(bits(32) vaddress, integer size)
  assert ELUsingAArch32(S1TranslationRegime());

  match = AArch32.VCRMatch(vaddress);
  if size == 4 && !match && AArch32.VCRMatch(vaddress + 2) then
    match = ConstrainUnpredictableBool();

  if match && DBGDSCRExt.MDBGGen == '1' && AArch32.GenerateDebugExceptions() then
    acctype = AccType_IFETCH;
    iswrite = FALSE;
    debugmoe = DebugException_VectorCatch;
    return AArch32.DebugFault(acctype, iswrite, debugmoe);
  else
    return AArch32.NoFault();

```

aarch32/translation/debug/AArch32.CheckWatchpoint

```

// AArch32.CheckWatchpoint()
// =====
// Called before accessing the memory location of "size" bytes at "address".

FaultRecord AArch32.CheckWatchpoint(bits(32) vaddress, AccType acctype,
                                     boolean iswrite, integer size)
  assert ELUsingAArch32(S1TranslationRegime());

  match = FALSE;
  ispriv = PSTATE.EL != EL0 && !(PSTATE.EL == EL1 && acctype == AccType_UNPRIV);

  for i = 0 to UInt(DBGDIDR.WRPs)
    match = match || AArch32.WatchpointMatch(i, vaddress, size, ispriv, iswrite);

  if match && HaltOnBreakpointOrWatchpoint() then
    reason = DebugHalt_Watchpoint;
    Halt(reason);
  elseif match && DBGDSCRExt.MDBGGen == '1' && AArch32.GenerateDebugExceptions() then
    debugmoe = DebugException_Watchpoint;
    return AArch32.DebugFault(acctype, iswrite, debugmoe);
  else
    return AArch32.NoFault();

```

aarch32/translation/faults/AArch32.AccessFlagFault

```

// AArch32.AccessFlagFault()
// =====

FaultRecord AArch32.AccessFlagFault(bits(40) ipaddress, bits(4) domain, integer level,
                                     AccType acctype, boolean iswrite, boolean secondstage,
                                     boolean s2fs1walk)

```

```
extflag = bit UNKNOWN;
debugmoe = bits(4) UNKNOWN;
errortype = bits(2) UNKNOWN;
return AArch32.CreateFaultRecord(Fault_AccessFlag, ipaddress, domain, level, acctype, iswrite,
                                extflag, debugmoe, errortype, secondstage, s2fs1walk);
```

aarch32/translation/faults/AArch32.AddressSizeFault

```
// AArch32.AddressSizeFault()
// =====

FaultRecord AArch32.AddressSizeFault(bits(40) ipaddress, bits(4) domain, integer level,
                                     AccType acctype, boolean iswrite, boolean secondstage,
                                     boolean s2fs1walk)

    extflag = bit UNKNOWN;
    debugmoe = bits(4) UNKNOWN;
    errortype = bits(2) UNKNOWN;
    return AArch32.CreateFaultRecord(Fault_AddressSize, ipaddress, domain, level, acctype, iswrite,
                                    extflag, debugmoe, errortype, secondstage, s2fs1walk);
```

aarch32/translation/faults/AArch32.AlignmentFault

```
// AArch32.AlignmentFault()
// =====

FaultRecord AArch32.AlignmentFault(AccType acctype, boolean iswrite, boolean secondstage)

    ipaddress = bits(40) UNKNOWN;
    domain = bits(4) UNKNOWN;
    level = integer UNKNOWN;
    extflag = bit UNKNOWN;
    debugmoe = bits(4) UNKNOWN;
    errortype = bits(2) UNKNOWN;
    s2fs1walk = boolean UNKNOWN;

    return AArch32.CreateFaultRecord(Fault_Alignment, ipaddress, domain, level, acctype, iswrite,
                                    extflag, debugmoe, errortype, secondstage, s2fs1walk);
```

aarch32/translation/faults/AArch32.AsynchExternalAbort

```
// AArch32.AsynchExternalAbort()
// =====
// Wrapper function for asynchronous external aborts

FaultRecord AArch32.AsynchExternalAbort(boolean parity, bits(2) errortype, bit extflag)

    type = if parity then Fault_AsyncParity else Fault_AsyncExternal;
    ipaddress = bits(40) UNKNOWN;
    domain = bits(4) UNKNOWN;
    level = integer UNKNOWN;
    acctype = AccType_NORMAL;
    iswrite = boolean UNKNOWN;
    debugmoe = bits(4) UNKNOWN;
    secondstage = FALSE;
    s2fs1walk = FALSE;

    return AArch32.CreateFaultRecord(type, ipaddress, domain, level, acctype, iswrite, extflag,
                                    debugmoe, errortype, secondstage, s2fs1walk);
```

aarch32/translation/faults/AArch32.DebugFault

```
// AArch32.DebugFault()
// =====

FaultRecord AArch32.DebugFault(ArchType acctype, boolean iswrite, bits(4) debugmoe)

    ipaddress = bits(40) UNKNOWN;
    domain = bits(4) UNKNOWN;
    errortype = bits(2) UNKNOWN;
    level = integer UNKNOWN;
    extflag = bit UNKNOWN;
    secondstage = FALSE;
    s2fs1walk = FALSE;

    return AArch32.CreateFaultRecord(Fault_Debug, ipaddress, domain, level, acctype, iswrite,
                                     extflag, debugmoe, errortype, secondstage, s2fs1walk);
```

aarch32/translation/faults/AArch32.DomainFault

```
// AArch32.DomainFault()
// =====

FaultRecord AArch32.DomainFault(bits(4) domain, integer level, ArchType acctype, boolean iswrite)

    ipaddress = bits(40) UNKNOWN;
    extflag = bit UNKNOWN;
    debugmoe = bits(4) UNKNOWN;
    errortype = bits(2) UNKNOWN;
    secondstage = FALSE;
    s2fs1walk = FALSE;

    return AArch32.CreateFaultRecord(Fault_Domain, ipaddress, domain, level, acctype, iswrite,
                                     extflag, debugmoe, errortype, secondstage, s2fs1walk);
```

aarch32/translation/faults/AArch32.NoFault

```
// AArch32.NoFault()
// =====

FaultRecord AArch32.NoFault()

    ipaddress = bits(40) UNKNOWN;
    domain = bits(4) UNKNOWN;
    level = integer UNKNOWN;
    acctype = ArchType_NORMAL;
    iswrite = boolean UNKNOWN;
    extflag = bit UNKNOWN;
    debugmoe = bits(4) UNKNOWN;
    errortype = bits(2) UNKNOWN;
    secondstage = FALSE;
    s2fs1walk = FALSE;

    return AArch32.CreateFaultRecord(Fault_None, ipaddress, domain, level, acctype, iswrite,
                                     extflag, debugmoe, errortype, secondstage, s2fs1walk);
```

aarch32/translation/faults/AArch32.PermissionFault

```
// AArch32.PermissionFault()
// =====

FaultRecord AArch32.PermissionFault(bits(40) ipaddress, bits(4) domain, integer level,
                                     ArchType acctype, boolean iswrite, boolean secondstage,
                                     boolean s2fs1walk)

    extflag = bit UNKNOWN;
```

```

debugmoe = bits(4) UNKNOWN;
errortype = bits(2) UNKNOWN;
return AArch32.CreateFaultRecord(Fault_Permission, ipaddress, domain, level, acctype, iswrite,
                                extflag, debugmoe, errortype, secondstage, s2fs1walk);

```

aarch32/translation/faults/AArch32.TranslationFault

```

// AArch32.TranslationFault()
// =====

FaultRecord AArch32.TranslationFault(bits(40) ipaddress, bits(4) domain, integer level,
                                     AccType acctype, boolean iswrite, boolean secondstage,
                                     boolean s2fs1walk)

    extflag = bit UNKNOWN;
    debugmoe = bits(4) UNKNOWN;
    errortype = bits(2) UNKNOWN;
    return AArch32.CreateFaultRecord(Fault_Translation, ipaddress, domain, level, acctype, iswrite,
                                    extflag, debugmoe, errortype, secondstage, s2fs1walk);

```

aarch32/translation/translation/AArch32.FirstStageTranslate

```

// AArch32.FirstStageTranslate()
// =====
// Perform a stage 1 translation walk. The function used by Address Translation operations is
// similar except it uses the translation regime specified for the instruction.

AddressDescriptor AArch32.FirstStageTranslate(bits(32) vaddress, AccType acctype, boolean iswrite,
                                             boolean wasaligned, integer size)

    if PSTATE.EL == EL2 then
        s1_enabled = HSCTLR.M == '1';
    elseif HaveEL(EL2) && !IsSecure() then
        tge = (if ELUsingAArch32(EL2) then HCR.TGE else HCR_EL2.TGE);
        dc = (if ELUsingAArch32(EL2) then HCR.DC else HCR_EL2.DC);
        s1_enabled = tge == '0' && dc == '0' && SCTLR.M == '1';
    else
        dc = (if ELUsingAArch32(EL2) then HCR.DC else HCR_EL2.DC);
        s1_enabled = dc == '0' && SCTLR.M == '1';

    ipaddress = bits(40) UNKNOWN;
    secondstage = FALSE;
    s2fs1walk = FALSE;

    if s1_enabled then // First stage enabled
        use_long_descriptor_format = PSTATE.EL == EL2 || TTBCR.EAE == '1';
        if use_long_descriptor_format then
            S1 = AArch32.TranslationTableWalkLD(ipaddress, vaddress, acctype, iswrite, secondstage,
                                                s2fs1walk, size);
            permissioncheck = TRUE; domaincheck = FALSE;
        else
            S1 = AArch32.TranslationTableWalkSD(vaddress, acctype, iswrite, size);
            permissioncheck = TRUE; domaincheck = TRUE;
    else
        S1 = AArch32.TranslateAddressS1Off(vaddress, acctype, iswrite);
        permissioncheck = FALSE; domaincheck = FALSE;

    if UsingAArch32() && HaveTrapLoadStoreMultipleDeviceExt() && AArch32.ExecutingLSMInstr() then
        if S1.addrdesc.memattrs.type == MemType_Device && S1.addrdesc.memattrs.device !=
DeviceType_GRE then
            nTLSMD = if S1TranslationRegime() == EL2 then HSCTLR.nTLSMD else SCTLR.nTLSMD;
            if nTLSMD == '0' then
                S1.addrdesc.fault = AArch32.AlignmentFault(acctype, iswrite, secondstage);
            // Check for unaligned data accesses to Device memory
            if ((!wasaligned && acctype != AccType_IFETCH) || (acctype == AccType_DCZVA))
                && S1.addrdesc.memattrs.type == MemType_Device && !IsFault(S1.addrdesc) then

```

```

    S1.addrdesc.fault = AArch32.AlignmentFault(acctype, iswrite, secondstage);
    if !IsFault(S1.addrdesc) && domaincheck then
        (permissioncheck, abort) = AArch32.CheckDomain(S1.domain, vaddress, S1.level, acctype,
                                                    iswrite);
        S1.addrdesc.fault = abort;

    if !IsFault(S1.addrdesc) && permissioncheck then
        S1.addrdesc.fault = AArch32.CheckPermission(S1.perms, vaddress, S1.level,
                                                    S1.domain, S1.addrdesc.paddress.NS,
                                                    acctype, iswrite);

    // Check for instruction fetches from Device memory not marked as execute-never. If there has
    // not been a Permission Fault then the memory is not marked execute-never.
    if (!IsFault(S1.addrdesc) && S1.addrdesc.memattrs.type == MemType_Device &&
        acctype == AccType_IFETCH) then
        S1.addrdesc = AArch32.InstructionDevice(S1.addrdesc, vaddress, ipaddress, S1.level,
                                                S1.domain, acctype, iswrite,
                                                secondstage, s2fs1walk);

    return S1.addrdesc;
  
```

aarch32/translation/translation/AArch32.FullTranslate

```

  // AArch32.FullTranslate()
  // =====
  // Perform both stage 1 and stage 2 translation walks for the current translation regime. The
  // function used by Address Translation operations is similar except it uses the translation
  // regime specified for the instruction.

  AddressDescriptor AArch32.FullTranslate(bits(32) vaddress, AccType acctype, boolean iswrite,
                                          boolean wasaligned, integer size)

    // First Stage Translation
    S1 = AArch32.FirstStageTranslate(vaddress, acctype, iswrite, wasaligned, size);
    if !IsFault(S1) && HasS2Translation() then
        s2fs1walk = FALSE;
        result = AArch32.SecondStageTranslate(S1, vaddress, acctype, iswrite, wasaligned, s2fs1walk,
                                              size);
    else
        result = S1;

    return result;
  
```

aarch32/translation/translation/AArch32.SecondStageTranslate

```

  // AArch32.SecondStageTranslate()
  // =====
  // Perform a stage 2 translation walk. The function used by Address Translation operations is
  // similar except it uses the translation regime specified for the instruction.

  AddressDescriptor AArch32.SecondStageTranslate(AddressDescriptor S1, bits(32) vaddress,
                                                  AccType acctype, boolean iswrite, boolean wasaligned,
                                                  boolean s2fs1walk, integer size)

    assert HasS2Translation();
    assert IsZero(S1.paddress.physicaladdress<47:40>);
    hwupdatewalk = FALSE;
    if !ELUsingAArch32(EL2) then
        return AArch64.SecondStageTranslate(S1, ZeroExtend(vaddress, 64), acctype, iswrite,
                                              wasaligned, s2fs1walk, size, hwupdatewalk);

    s2_enabled = HCR.VM == '1' || HCR.DC == '1';
    secondstage = TRUE;

    if s2_enabled then // Second stage enabled
        ipaddress = S1.paddress.physicaladdress<39:0>;
  
```

```

S2 = AArch32.TranslationTableWalkLD(ipaddress, vaddress, acctype, iswrite, secondstage,
                                     s2fs1walk, size);

// Check for unaligned data accesses to Device memory
if (!(wasaligned && acctype != AccType_IFETCH) || (acctype == AccType_DCZVA))
    && S2.addrdesc.memattrs.type == MemType_Device && !IsFault(S2.addrdesc) then
    S2.addrdesc.fault = AArch32.AlignmentFault(acctype, iswrite, secondstage);

if !IsFault(S2.addrdesc) then
    S2.addrdesc.fault = AArch32.CheckS2Permission(S2.perms, vaddress, ipaddress, S2.level,
                                                  acctype, iswrite, s2fs1walk);
// Check for instruction fetches from Device memory not marked as execute-never. As there
// has not been a Permission Fault then the memory is not marked execute-never.
if (!s2fs1walk && !IsFault(S2.addrdesc) && S2.addrdesc.memattrs.type == MemType_Device &&
    acctype == AccType_IFETCH) then
    domain = bits(4) UNKNOWN;
    S2.addrdesc = AArch32.InstructionDevice(S2.addrdesc, vaddress, ipaddress, S2.level,
                                             domain, acctype, iswrite,
                                             secondstage, s2fs1walk);

// Check for protected table walk
if (s2fs1walk && !IsFault(S2.addrdesc) && HCR.PTW == '1' &&
    S2.addrdesc.memattrs.type == MemType_Device) then
    domain = bits(4) UNKNOWN;
    S2.addrdesc.fault = AArch32.PermissionFault(ipaddress, domain, S2.level, acctype,
                                                iswrite, secondstage, s2fs1walk);

result = CombineS1S2Desc(S1, S2.addrdesc);
else
    result = S1;

return result;

```

aarch32/translation/translation/AArch32.SecondStageWalk

```

// AArch32.SecondStageWalk()
// =====
// Perform a stage 2 translation on a stage 1 translation page table walk access.

AddressDescriptor AArch32.SecondStageWalk(AddressDescriptor S1, bits(32) vaddress, AccType acctype,
                                          boolean iswrite, integer size)

assert HasS2Translation();

s2fs1walk = TRUE;
wasaligned = TRUE;
return AArch32.SecondStageTranslate(S1, vaddress, acctype, iswrite, wasaligned, s2fs1walk,
                                     size);

```

aarch32/translation/translation/AArch32.TranslateAddress

```

// AArch32.TranslateAddress()
// =====
// Main entry point for translating an address

AddressDescriptor AArch32.TranslateAddress(bits(32) vaddress, AccType acctype, boolean iswrite,
                                          boolean wasaligned, integer size)

if !ELUsingAArch32(S1TranslationRegime()) then
    return AArch64.TranslateAddress(ZeroExtend(vaddress, 64), acctype, iswrite, wasaligned,
                                     size);
result = AArch32.FullTranslate(vaddress, acctype, iswrite, wasaligned, size);

if !(acctype IN {AccType_PTW, AccType_IC, AccType_AT}) && !IsFault(result) then
    result.fault = AArch32.CheckDebug(vaddress, acctype, iswrite, size);

```

```
// Update virtual address for abort functions
result.vaddress = ZeroExtend(vaddress);

return result;
```

aarch32/translation/walk/AArch32.TranslationTableWalkLD

```
// AArch32.TranslationTableWalkLD()
// =====
// Returns a result of a translation table walk using the Long-descriptor format
//
// Implementations might cache information from memory in any number of non-coherent TLB
// caching structures, and so avoid memory accesses that have been expressed in this
// pseudocode. The use of such TLBs is not expressed in this pseudocode.

TLBRecord AArch32.TranslationTableWalkLD(bits(40) ipaddress, bits(32) vaddress,
                                         AccType acctype, boolean iswrite, boolean secondstage,
                                         boolean s2fs1walk, integer size)

if !secondstage then
  assert ELUsingAArch32(S1TranslationRegime());
else
  assert HaveEL(EL2) && !IsSecure() && ELUsingAArch32(EL2) && HasS2Translation();

  TLBRecord result;
  AddressDescriptor descaddr;
  bits(64) baseregister;
  bits(40) inputaddr; // Input Address is 'vaddress' for stage 1, 'ipaddress' for stage 2
  domain = bits(4) UNKNOWN;

  descaddr.memattrs.type = MemType_Normal;

  // Fixed parameters for the page table walk:
  // grainsize = Log2(Size of Table) - Size of Table is 4KB in AArch32
  // stride = Log2(Address per Level) - Bits of address consumed at each level
  constant integer grainsize = 12; // Log2(4KB page size)
  constant integer stride = grainsize - 3; // Log2(page size / 8 bytes)

  // Derived parameters for the page table walk:
  // inputsize = Log2(Size of Input Address) - Input Address size in bits
  // level = Level to start walk from
  // This means that the number of levels after start level = 3-level

  if !secondstage then
    // First stage translation
    inputaddr = ZeroExtend(vaddress);
    if PSTATE.EL == EL2 then
      inputsize = 32 - UInt(HTCR.T0SZ);
      basefound = inputsize == 32 || IsZero(inputaddr<31:inputsize>);
      disabled = FALSE;
      baseregister = HTTBR;
      descaddr.memattrs = WalkAttrDecode(HTCR.SH0, HTCR.ORGNO, HTCR.IRGNO, secondstage);
      reversedescriptors = HSCTLR.EE == '1';
      lookupsecure = FALSE;
      singlepriv = TRUE;
      hierattrsdissabled = AArch32.HaveHPDExt() && HTCR.HPD == '1';
    else
      basefound = FALSE;
      disabled = FALSE;
      t0size = UInt(TTBCR.T0SZ);
      if t0size == 0 || IsZero(inputaddr<31:(32-t0size)>) then
        inputsize = 32 - t0size;
        basefound = TRUE;
        disabled = TTBCR.EPD0 == '1';
        baseregister = TTBR0;
        descaddr.memattrs = WalkAttrDecode(TTBCR.SH0, TTBCR.ORGNO, TTBCR.IRGNO, secondstage);
        hierattrsdissabled = AArch32.HaveHPDExt() && TTBCR.T2E == '1' && TTBCR2.HPD0 == '1';
      t1size = UInt(TTBCR.T1SZ);
```

```

    if (t1size == 0 && !basefound) || (t1size > 0 && IsOnes(inputaddr<31:(32-t1size)>)) then
        inputsize = 32 - t1size;
        basefound = TRUE;
        disabled = TTBCR.EPD1 == '1';
        baseregister = TTBR1;
        descaddr.memattr = WalkAttrDecode(TTBCR.SH1, TTBCR.ORG1, TTBCR.IRG1, secondstage);
        hierattrdisabled = AArch32.HaveHPDExt() && TTBCR.T2E == '1' && TTBCR2.HPD1 == '1';
        reversedescriptors = SCTL.R.EE == '1';
        lookupsecure = IsSecure();
        singlepriv = FALSE;
    // The starting level is the number of strides needed to consume the input address
    level = 4 - RoundUp(Real(inputsize - grainsize) / Real(stride));
else
    // Second stage translation
    inputaddr = ipaddress;
    inputsize = 32 - SInt(VTCR.T0SZ);
    // VTCR.S must match VTCR.T0SZ[3]
    if VTCR.S != VTCR.T0SZ<3> then
        (-, inputsize) = ConstrainUnpredictableInteger(32-7, 32+8);
    basefound = inputsize == 40 || IsZero(inputaddr<39:inputsize>);
    disabled = FALSE;
    baseregister = VTTBR;
    descaddr.memattr = WalkAttrDecode(VTCR.IRG0, VTCR.ORG0, VTCR.SH0, secondstage);
    reversedescriptors = HSCTLR.EE == '1';
    lookupsecure = FALSE;
    singlepriv = TRUE;

    startlevel = UInt(VTCR.SL0);
    level = 2 - startlevel;
    if level <= 0 then basefound = FALSE;

    // Number of entries in the starting level table =
    // (Size of Input Address)/((Address per level)^(Num levels remaining)*(Size of Table))
    startsizecheck = inputsize - ((3 - level)*stride + grainsize); // Log2(Num of entries)

    // Check for starting level table with fewer than 2 entries or longer than 16 pages.
    // Lower bound check is: startsizecheck < Log2(2 entries)
    // That is, VTCR.SL0 == '00' and SInt(VTCR.T0SZ) > 1, Size of Input Address < 2^31 bytes
    // Upper bound check is: startsizecheck > Log2(pagesize/8*16)
    // That is, VTCR.SL0 == '01' and SInt(VTCR.T0SZ) < -2, Size of Input Address > 2^34 bytes
    if startsizecheck < 1 || startsizecheck > stride + 4 then basefound = FALSE;

    if !basefound || disabled then
        level = 1; // AArch64 reports this as a level 0 fault
        result.addrdesc.fault = AArch32.TranslationFault(ipaddress, domain, level, acctype, iswrite,
            secondstage, s2fs1walk);
        return result;

    if !IsZero(baseregister<47:40>) then
        level = 0;
        result.addrdesc.fault = AArch32.AddressSizeFault(ipaddress, domain, level, acctype, iswrite,
            secondstage, s2fs1walk);
        return result;

    // Bottom bound of the Base address is:
    // Log2(8 bytes per entry)+Log2(Number of entries in starting level table)
    // Number of entries in starting level table =
    // (Size of Input Address)/((Address per level)^(Num levels remaining)*(Size of Table))
    baselowerbound = 3 + inputsize - ((3-level)*stride + grainsize); // Log2(Num of entries*8)
    baseaddress = baseregister<39:baselowerbound>:Zeros(baselowerbound);

    ns_table = if lookupsecure then '0' else '1';
    ap_table = '00';
    xn_table = '0';
    pxn_table = '0';

    addrselecttop = inputsize - 1;

```

```

repeat
  addrselectbottom = (3-level)*stride + grainsize;

  bits(40) index = ZeroExtend(inputaddr<addrselecttop:addrselectbottom>:'000');
  descaddr.paddress.physicaladdress = ZeroExtend(baseaddress OR index);
  descaddr.paddress.NS = ns_table;

  // If there are two stages of translation, then the first stage table walk addresses
  // are themselves subject to translation
  if secondstage || !HasS2Translation() then
    descaddr2 = descaddr;
  else
    descaddr2 = AArch32.SecondStageWalk(descaddr, vaddress, acctype, iswrite, 8);
    // Check for a fault on the stage 2 walk
    if IsFault(descaddr2) then
      result.addrdesc.fault = descaddr2.fault;
      return result;

  // Update virtual address for abort functions
  descaddr2.vaddress = ZeroExtend(vaddress);

  accdesc = CreateAccessDescriptorPTW(acctype, secondstage, s2fs1walk, level);
  desc = _Mem[descaddr2, 8, accdesc];

  if reversedescriptors then desc = BigEndianReverse(desc);

  if desc<0> == '0' || (desc<1:0> == '01' && level == 3) then
    // Fault (00), Reserved (10), or Block (01) at level 3
    result.addrdesc.fault = AArch32.TranslationFault(ipaddress, domain, level, acctype,
      iswrite, secondstage, s2fs1walk);

    return result;

  // Valid Block, Page, or Table entry
  if desc<1:0> == '01' || level == 3 then // Block (01) or Page (11)
    blocktranslate = TRUE;
  else // Table (11)
    if !IsZero(desc<47:40>) then
      result.addrdesc.fault = AArch32.AddressSizeFault(ipaddress, domain, level, acctype,
        iswrite, secondstage, s2fs1walk);

      return result;

  baseaddress = desc<39:grainsize>:Zeros(grainsize);
  if !secondstage then
    // Unpack the upper and lower table attributes
    ns_table = ns_table OR desc<63>;
  if !secondstage && !hierattrdisabled then
    ap_table<1> = ap_table<1> OR desc<62>; // read-only
    xn_table = xn_table OR desc<60>;
    // pxn_table and ap_table[0] apply only in EL1&0 translation regimes
    if !singlepriv then
      ap_table<0> = ap_table<0> OR desc<61>; // privileged
      pxn_table = pxn_table OR desc<59>;

  level = level + 1;
  addrselecttop = addrselectbottom - 1;
  blocktranslate = FALSE;
until blocktranslate;

// Check the output address is inside the supported range
if !IsZero(desc<47:40>) then
  result.addrdesc.fault = AArch32.AddressSizeFault(ipaddress, domain, level, acctype,
    iswrite, secondstage, s2fs1walk);

  return result;

// Unpack the descriptor into address and upper and lower block attributes
outputaddress = desc<39:addrselectbottom>:inputaddr<addrselectbottom-1:0>;
// Check the access flag

```

```

if desc<10> == '0' then
    result.addrdesc.fault = AArch32.AccessFlagFault(ipaddress, domain, level, acctype,
                                                    iswrite, secondstage, s2fslwalk);
    return result;
xn = desc<54>;
pxn = desc<53>;
contiguousbit = desc<52>;
nG = desc<11>;
sh = desc<9:8>;
ap = desc<7:6>:'1';
memattr = desc<5:2>; // AttrIndx and NS bit in stage 1

result.domain = bits(4) UNKNOWN; // Domains not used
result.level = level;
result.blocksize = 2^((3-level)*stride + grainsize);

// Stage 1 translation regimes also inherit attributes from the tables
if !secondstage then
    result.perms.xn = xn OR xn_table;
    result.perms.ap<2> = ap<2> OR ap_table<1>; // Force read-only
    // PXN, nG and AP[1] apply only in EL1&0 stage 1 translation regimes
    if !singlepriv then
        result.perms.ap<1> = ap<1> AND NOT(ap_table<0>); // Force privileged only
        result.perms.pxn = pxn OR pxn_table;
        // Pages from Non-secure tables are marked non-global in Secure EL1&0
        if IsSecure() then
            result.nG = nG OR ns_table;
        else
            result.nG = nG;
    else
        result.perms.ap<1> = '1';
        result.perms.pxn = '0';
        result.nG = '0';
        result.perms.ap<0> = '1';
        result.addrdesc.memattrs = AArch32.S1AttrDecode(sh, memattr<2:0>, acctype);
        result.addrdesc.paddress.NS = memattr<3> OR ns_table;
else
    result.perms.ap<2:1> = ap<2:1>;
    result.perms.ap<0> = '1';
    result.perms.xn = xn;
    if HaveExtendedExecuteNeverExt() then result.perms.xxn = desc<53>;
    result.perms.pxn = '0';
    result.nG = '0';
    result.addrdesc.memattrs = S2AttrDecode(sh, memattr, acctype);
    result.addrdesc.paddress.NS = '1';

result.addrdesc.paddress.physicaladdress = ZeroExtend(outputaddress);
result.addrdesc.fault = AArch32.NoFault();
result.contiguous = contiguousbit == '1';
if HaveCommonNotPrivateTransExt() then result.CnP = baseregister<0>;
return result;

```

aarch32/translation/walk/AArch32.TranslationTableWalkSD

```

// AArch32.TranslationTableWalkSD()
// =====
// Returns a result of a translation table walk using the Short-descriptor format
//
// Implementations might cache information from memory in any number of non-coherent TLB
// caching structures, and so avoid memory accesses that have been expressed in this
// pseudocode. The use of such TLBs is not expressed in this pseudocode.

TLBRecord AArch32.TranslationTableWalkSD(bits(32) vaddress, AccType acctype, boolean iswrite,
                                         integer size)
    assert ELUsingAArch32(S1TranslationRegime());

// This is only called when address translation is enabled

```



```

TLBRecord      result;
AddressDescriptor l1descaddr;
AddressDescriptor l2descaddr;
bits(40)       outputaddress;

// Variables for Abort functions
ipaddress = bits(40) UNKNOWN;
secondstage = FALSE;
s2fs1walk = FALSE;

// Default setting of the domain
domain = bits(4) UNKNOWN;

// Determine correct Translation Table Base Register to use.
bits(64) ttbr;
n = UInt(TTBCR.N);
if n == 0 || IsZero(vaddress<31:(32-n)>) then
  ttbr = TTBR0;
  disabled = (TTBCR.PD0 == '1');
else
  ttbr = TTBR1;
  disabled = (TTBCR.PD1 == '1');
  n = 0; // TTBR1 translation always works like N=0 TTBR0 translation

// Check this Translation Table Base Register is not disabled.
if disabled then
  level = 1;
  result.addrdesc.fault = AArch32.TranslationFault(ipaddress, domain, level, acctype, iswrite,
                                                    secondstage, s2fs1walk);
  return result;

// Obtain descriptor from initial lookup.
l1descaddr.paddress.physicaladdress = ZeroExtend(ttbr<31:14-n>;vaddress<31-n:20>;'00');
l1descaddr.paddress.NS = if IsSecure() then '0' else '1';
IRGN = ttbr<0>;ttbr<6>; // TTBR.IRGN
RGN = ttbr<4:3>; // TTBR.RGN
SH = ttbr<1>;ttbr<5>; // TTBR.S:TTBR.NOS
l1descaddr.memattrs = WalkAttrDecode(SH, RGN, IRGN, secondstage);

if !HaveEL(EL2) || IsSecure() then
  // if only 1 stage of translation
  l1descaddr2 = l1descaddr;
else
  l1descaddr2 = AArch32.SecondStageWalk(l1descaddr, vaddress, acctype, iswrite, 4);
  // Check for a fault on the stage 2 walk
  if IsFault(l1descaddr2) then
    result.addrdesc.fault = l1descaddr2.fault;
    return result;

// Update virtual address for abort functions
l1descaddr2.vaddress = ZeroExtend(vaddress);

accdesc = CreateAccessDescriptorPTW(acctype, secondstage, s2fs1walk, level);
l1desc = _Mem[l1descaddr2, 4,accdesc];

if SCTLR.EE == '1' then l1desc = BigEndianReverse(l1desc);

// Process descriptor from initial lookup.
case l1desc<1:0> of
  when '00' // Fault, Reserved
    level = 1;
    result.addrdesc.fault = AArch32.TranslationFault(ipaddress, domain, level, acctype,
                                                    iswrite, secondstage, s2fs1walk);
    return result;

  when '01' // Large page or Small page
    domain = l1desc<8:5>;
    level = 2;

```

```

pxn = l1desc<2>;
NS = l1desc<3>;

// Obtain descriptor from level 2 lookup.
l2descaddr.paddress.physicaladdress = ZeroExtend(l1desc<31:10>:vaddress<19:12>:'00');
l2descaddr.paddress.NS = if IsSecure() then '0' else '1';
l2descaddr.memattrs = l1descaddr.memattrs;

if !HaveEL(EL2) || IsSecure() then
  // if only 1 stage of translation
  l2descaddr2 = l2descaddr;
else
  l2descaddr2 = AArch32.SecondStageWalk(l2descaddr, vaddress, acctype, iswrite, 4);
  // Check for a fault on the stage 2 walk
  if IsFault(l2descaddr2) then
    result.addrdesc.fault = l2descaddr2.fault;
    return result;

// Update virtual address for abort functions
l2descaddr2.vaddress = ZeroExtend(vaddress);

accdesc = CreateAccessDescriptorPTW(acctype, secondstage, s2fs1walk, level);
l2desc = _Mem[l2descaddr2, 4, accdesc];

if SCTL.R.EE == '1' then l2desc = BigEndianReverse(l2desc);

// Process descriptor from level 2 lookup.
if l2desc<1:0> == '00' then
  result.addrdesc.fault = AArch32.TranslationFault(ipaddress, domain, level, acctype,
                                                    iswrite, secondstage, s2fs1walk);
  return result;

nG = l2desc<11>;
S = l2desc<10>;
ap = l2desc<9,5:4>;

if SCTL.R.AFE == '1' && l2desc<4> == '0' then
  // Hardware access to the Access Flag is not supported in ARMv8
  result.addrdesc.fault = AArch32.AccessFlagFault(ipaddress, domain, level, acctype,
                                                    iswrite, secondstage, s2fs1walk);
  return result;

if l2desc<1> == '0' then // Large page
  xn = l2desc<15>;
  tex = l2desc<14:12>;
  c = l2desc<3>;
  b = l2desc<2>;
  blocksize = 64;
  outputaddress = ZeroExtend(l2desc<31:16>:vaddress<15:0>);
else // Small page
  tex = l2desc<8:6>;
  c = l2desc<3>;
  b = l2desc<2>;
  xn = l2desc<0>;
  blocksize = 4;
  outputaddress = ZeroExtend(l2desc<31:12>:vaddress<11:0>);

when '1x' // Section or Supersection
  NS = l1desc<19>;
  nG = l1desc<17>;
  S = l1desc<16>;
  ap = l1desc<15,11:10>;
  tex = l1desc<14:12>;
  xn = l1desc<4>;
  c = l1desc<3>;
  b = l1desc<2>;
  pxn = l1desc<0>;
  level = 1;

```

```

if SCTL.AFE == '1' && l1desc<10> == '0' then
  // Hardware management of the Access Flag is not supported in ARMv8
  result.addrdesc.fault = AArch32.AccessFlagFault(ipaddress, domain, level, acctype,
                                                    iswrite, secondstage, s2fslwalk);

  return result;

if l1desc<18> == '0' then // Section
  domain = l1desc<8:5>;
  blocksize = 1024;
  outputaddress = ZeroExtend(l1desc<31:20>:vaddress<19:0>);
else // Supersection
  domain = '0000';
  blocksize = 16384;
  outputaddress = l1desc<8:5>:l1desc<23:20>:l1desc<31:24>:vaddress<23:0>;

// Decode the TEX, C, B and S bits to produce the TLBRecord's memory attributes
if SCTL.TRE == '0' then
  if RemapRegsHaveResetValues() then
    result.addrdesc.memattrs = AArch32.DefaultTEXDecode(tex, c, b, S, acctype);
  else
    result.addrdesc.memattrs = MemoryAttributes IMPLEMENTATION_DEFINED;
else
  result.addrdesc.memattrs = AArch32.RemappedTEXDecode(tex, c, b, S, acctype);

// Set the rest of the TLBRecord, try to add it to the TLB, and return it.
result.perms.ap = ap;
result.perms.xn = xn;
result.perms.pxn = pxn;
result.nG = nG;
result.domain = domain;
result.level = level;
result.blocksize = blocksize;
result.addrdesc.paddress.physicaladdress = ZeroExtend(outputaddress);
result.addrdesc.paddress.NS = if IsSecure() then NS else '1';
result.addrdesc.fault = AArch32.NoFault();

return result;

```

aarch32/translation/walk/RemapRegsHaveResetValues

```

boolean RemapRegsHaveResetValues();

```

J1.3 Shared pseudocode

This section holds the pseudocode that is common to execution in AArch64 state and in AArch32 state. Functions listed in this section are identified only by a `FunctionName`, without an `AArch64.` or `AArch32.` prefix. This section is organized by functional groups, with the functional groups being indicated by hierarchical path names, for example `shared/debug/DebugTarget`.

———— Note ————

Currently, the following pseudocode functions in this group reference C program functions, that are not linked from the pseudocode, to describe their operation:

`UnsignedRecipEstimate()`

Calls the C function `recip_estimate()`. This function is defined in *Floating-point reciprocal estimate and step* on page E1-2749.

`UnsignedRSqrtEstimate()`

Calls the C function `recip_sqrt_estimate()`. This function is defined in *Floating-point reciprocal square root estimate and step* on page E1-2750.

The top-level sections of the shared pseudocode hierarchy are:

- [shared/debug](#).
- [shared/exceptions](#) on page J1-6024.
- [shared/functions](#) on page J1-6026.
- [shared/translation](#) on page J1-6086.

J1.3.1 shared/debug

This section includes the following pseudocode functions:

- [shared/debug/ClearStickyErrors/ClearStickyErrors](#) on page J1-6007.
- [shared/debug/DebugTarget/DebugTarget](#) on page J1-6007.
- [shared/debug/DebugTarget/DebugTargetFrom](#) on page J1-6008.
- [shared/debug/DoubleLockStatus/DoubleLockStatus](#) on page J1-6008.
- [shared/debug/FindWatchpoint/FindWatchpoint](#) on page J1-6008.
- [shared/debug/authentication/AllowExternalDebugAccess](#) on page J1-6008.
- [shared/debug/authentication/AllowExternalPMUAccess](#) on page J1-6009.
- [shared/debug/authentication/Debug_authentication](#) on page J1-6009.
- [shared/debug/authentication/ExternalInvasiveDebugEnabled](#) on page J1-6009.
- [shared/debug/authentication/ExternalNoninvasiveDebugAllowed](#) on page J1-6009.
- [shared/debug/authentication/ExternalNoninvasiveDebugEnabled](#) on page J1-6009.
- [shared/debug/authentication/ExternalSecureInvasiveDebugEnabled](#) on page J1-6010.
- [shared/debug/authentication/ExternalSecureNoninvasiveDebugEnabled](#) on page J1-6010.
- [shared/debug/cti/CTI_SetEventLevel](#) on page J1-6010.
- [shared/debug/cti/CTI_SignalEvent](#) on page J1-6010.
- [shared/debug/cti/CrossTrigger](#) on page J1-6010.
- [shared/debug/dccanditr/CheckForDCCInterrupts](#) on page J1-6010.
- [shared/debug/dccanditr/DBGDTRRX_EL0](#) on page J1-6011.
- [shared/debug/dccanditr/DBGDTRTX_EL0](#) on page J1-6012.
- [shared/debug/dccanditr/DBGDTR_EL0](#) on page J1-6013.
- [shared/debug/dccanditr/DTR](#) on page J1-6013.
- [shared/debug/dccanditr/EDITR](#) on page J1-6013.
- [shared/debug/halting/DCPSInstruction](#) on page J1-6014.
- [shared/debug/halting/DRPSInstruction](#) on page J1-6015.
- [shared/debug/halting/DebugHalt](#) on page J1-6015.

- [shared/debug/halting/DisableITRAndResumeInstructionPrefetch](#) on page J1-6016.
- [shared/debug/halting/ExecuteA64](#) on page J1-6016.
- [shared/debug/halting/ExecuteT32](#) on page J1-6016.
- [shared/debug/halting/ExitDebugState](#) on page J1-6016.
- [shared/debug/halting/Halt](#) on page J1-6016.
- [shared/debug/halting/HaltOnBreakpointOrWatchpoint](#) on page J1-6017.
- [shared/debug/halting/Halted](#) on page J1-6017.
- [shared/debug/halting/HaltingAllowed](#) on page J1-6017.
- [shared/debug/halting/Restarting](#) on page J1-6018.
- [shared/debug/halting/StopInstructionPrefetchAndEnableITR](#) on page J1-6018.
- [shared/debug/halting/UpdateEDSCRFIELDS](#) on page J1-6018.
- [shared/debug/haltingevents/CheckExceptionCatch](#) on page J1-6018.
- [shared/debug/haltingevents/CheckHaltingStep](#) on page J1-6019.
- [shared/debug/haltingevents/CheckOSUnlockCatch](#) on page J1-6019.
- [shared/debug/haltingevents/CheckPendingOSUnlockCatch](#) on page J1-6019.
- [shared/debug/haltingevents/CheckPendingResetCatch](#) on page J1-6019.
- [shared/debug/haltingevents/CheckResetCatch](#) on page J1-6019.
- [shared/debug/haltingevents/CheckSoftwareAccessToDebugRegisters](#) on page J1-6020.
- [shared/debug/haltingevents/ExternalDebugRequest](#) on page J1-6020.
- [shared/debug/haltingevents/HaltingStep_DidNotStep](#) on page J1-6020.
- [shared/debug/haltingevents/HaltingStep_SteppedEX](#) on page J1-6020.
- [shared/debug/haltingevents/RunHaltingStep](#) on page J1-6020.
- [shared/debug/interrupts/ExternalDebugInterruptsDisabled](#) on page J1-6021.
- [shared/debug/interrupts/InterruptID](#) on page J1-6021.
- [shared/debug/interrupts/SetInterruptRequestLevel](#) on page J1-6021.
- [shared/debug/samplebasedprofiling/CreatePCSample](#) on page J1-6021.
- [shared/debug/samplebasedprofiling/EDPCSRL0](#) on page J1-6021.
- [shared/debug/samplebasedprofiling/PCSample](#) on page J1-6022.
- [shared/debug/softwarestep/CheckSoftwareStep](#) on page J1-6022.
- [shared/debug/softwarestep/DebugExceptionReturnSS](#) on page J1-6023.
- [shared/debug/softwarestep/SSAdvance](#) on page J1-6023.
- [shared/debug/softwarestep/SoftwareStep_DidNotStep](#) on page J1-6023.
- [shared/debug/softwarestep/SoftwareStep_SteppedEX](#) on page J1-6024.

shared/debug/ClearStickyErrors/ClearStickyErrors

```
// ClearStickyErrors()
// =====

ClearStickyErrors()
    EDSCR.TXU = '0';           // Clear TX underrun flag
    EDSCR.RXO = '0';           // Clear RX overrun flag
    if Halted() then          // in Debug state
        EDSCR.ITO = '0';       // Clear ITR overrun flag
    EDSCR.ERR = '0';           // Clear cumulative error flag
    return;
```

shared/debug/DebugTarget/DebugTarget

```
// DebugTarget()
// =====
// Returns the debug exception target Exception level
```

```
bits(2) DebugTarget()  
    secure = IsSecure();  
    return DebugTargetFrom(secure);
```

shared/debug/DebugTarget/DebugTargetFrom

```
// DebugTargetFrom()  
// =====  
  
bits(2) DebugTargetFrom(boolean secure)  
    if HaveEL(EL2) && !secure then  
        if ELUsingAArch32(EL2) then  
            route_to_e12 = (HDCR.TDE == '1' || HCR.TGE == '1');  
        else  
            route_to_e12 = (MDCR_EL2.TDE == '1' || HCR_EL2.TGE == '1');  
    else  
        route_to_e12 = FALSE;  
  
    if route_to_e12 then  
        target = EL2;  
    elseif HaveEL(EL3) && HighestELUsingAArch32() && secure then  
        target = EL3;  
    else  
        target = EL1;  
  
    return target;
```

shared/debug/DoubleLockStatus/DoubleLockStatus

```
// DoubleLockStatus()  
// =====  
// Returns the state of the OS Double Lock.  
// FALSE if OSDLR_EL1.DLK == 0 or DBGPRCR_EL1.CORENPDRQ == 1 or the PE is in Debug state.  
// TRUE if OSDLR_EL1.DLK == 1 and DBGPRCR_EL1.CORENPDRQ == 0 and the PE is in Non-debug state.  
  
boolean DoubleLockStatus()  
    if ELUsingAArch32(EL1) then  
        return DBGOSDLR.DLK == '1' && DBGPRCR.CORENPDRQ == '0' && !Halted();  
    else  
        return OSDLR_EL1.DLK == '1' && DBGPRCR_EL1.CORENPDRQ == '0' && !Halted();
```

shared/debug/FindWatchpoint/FindWatchpoint

```
// FindWatchpoint()  
// =====  
  
integer FindWatchpoint()  
    address = FAR[];  
    base = Align(address, ZVAGranuleSize());  
    limit = base + ZVAGranuleSize();  
    repeat  
        for i = 0 to UInt(ID_AA64DFR0_EL1.WRPs)  
            if WatchpointByteMatch(i, address) then // Candidate found  
                return i;  
            address = address + 1;  
            if address == limit then address = base; // Wrap round, as this must be a DC ZVA  
    while address != FAR[];  
    return -1; // No candidate found (should not happen)
```

shared/debug/authentication/AllowExternalDebugAccess

```
// AllowExternalDebugAccess()  
// =====  
// Returns the status of EDPRSR.EDAD.
```

```

boolean AllowExternalDebugAccess()
// The access may also be subject to OS lock, power-down, etc.
if ExternalInvasiveDebugEnabled() then
  if ExternalSecureInvasiveDebugEnabled() then
    return TRUE;
  elseif HaveEL(EL3) then
    return (if ELUsingAArch32(EL3) then SDCR.EDAD else MDCR_EL3.EDAD) == '0';
  else
    return !IsSecure();
else
  return FALSE;
  
```

shared/debug/authentication/AllowExternalPMUAccess

```

// AllowExternalPMUAccess()
// =====
// Returns the status of EDPRSR.EPMAD.

boolean AllowExternalPMUAccess()
// The access may also be subject to OS lock, power-down, etc.
if ExternalNoninvasiveDebugEnabled() then
  if ExternalSecureNoninvasiveDebugEnabled() then
    return TRUE;
  elseif HaveEL(EL3) then
    return (if ELUsingAArch32(EL3) then SDCR.EPMAD else MDCR_EL3.EPMAD) == '0';
  else
    return !IsSecure();
else
  return FALSE;
  
```

shared/debug/authentication/Debug_authentication

```

signal DBGGEN;
signal NIDEN;
signal SPIDEN;
signal SPNIDEN;
  
```

shared/debug/authentication/ExternalInvasiveDebugEnabled

```

// ExternalInvasiveDebugEnabled()
// =====

boolean ExternalInvasiveDebugEnabled()
// The definition of this function is IMPLEMENTATION DEFINED.
// In the recommended interface, ExternalInvasiveDebugEnabled returns the state of the DBGGEN
// signal.
return DBGGEN == HIGH;
  
```

shared/debug/authentication/ExternalNoninvasiveDebugAllowed

```

// ExternalNoninvasiveDebugAllowed()
// =====

boolean ExternalNoninvasiveDebugAllowed()
// Return TRUE if Trace and PC Sample-based Profiling are allowed
return (ExternalNoninvasiveDebugEnabled() &&
  (!IsSecure() || ExternalSecureNoninvasiveDebugEnabled() ||
  (ELUsingAArch32(EL1) && PSTATE.EL == EL0 && SDER.SUNIDEN == '1')));
  
```

shared/debug/authentication/ExternalNoninvasiveDebugEnabled

```

// ExternalNoninvasiveDebugEnabled()
// =====
  
```

```
boolean ExternalNoninvasiveDebugEnabled()  
    // The definition of this function is IMPLEMENTATION DEFINED.  
    // In the recommended interface, ExternalNoninvasiveDebugEnabled returns the state of the (DBGEN  
    // OR NIDEN) signal.  
    return ExternalInvasiveDebugEnabled() || NIDEN == HIGH;
```

shared/debug/authentication/ExternalSecureInvasiveDebugEnabled

```
// ExternalSecureInvasiveDebugEnabled()  
// =====  
  
boolean ExternalSecureInvasiveDebugEnabled()  
    // The definition of this function is IMPLEMENTATION DEFINED.  
    // In the recommended interface, ExternalSecureInvasiveDebugEnabled returns the state of the  
    // (DBGEN AND SPIDEN) signal.  
    // CoreSight allows asserting SPIDEN without also asserting DBGEN, but this is not recommended.  
    if !HaveEL(EL3) && !IsSecure() then return FALSE;  
    return ExternalInvasiveDebugEnabled() && SPIDEN == HIGH;
```

shared/debug/authentication/ExternalSecureNoninvasiveDebugEnabled

```
// ExternalSecureNoninvasiveDebugEnabled()  
// =====  
  
boolean ExternalSecureNoninvasiveDebugEnabled()  
    // The definition of this function is IMPLEMENTATION DEFINED.  
    // In the recommended interface, ExternalSecureNoninvasiveDebugEnabled returns the state of the  
    // (DBGEN OR NIDEN) AND (SPIDEN OR SPNIDEN) signal.  
    if !HaveEL(EL3) && !IsSecure() then return FALSE;  
    return ExternalNoninvasiveDebugEnabled() && (SPIDEN == HIGH || SPNIDEN == HIGH);
```

shared/debug/cti/CTI_SetEventLevel

```
// Set a Cross Trigger multi-cycle input event trigger to the specified level.  
CTI_SetEventLevel(CrossTriggerIn id, signal level);
```

shared/debug/cti/CTI_SignalEvent

```
// Signal a discrete event on a Cross Trigger input event trigger.  
CTI_SignalEvent(CrossTriggerIn id);
```

shared/debug/cti/CrossTrigger

```
enumeration CrossTriggerOut {CrossTriggerOut_DebugRequest, CrossTriggerOut_RestartRequest,  
                             CrossTriggerOut_IRQ,           CrossTriggerOut_RSVD3,  
                             CrossTriggerOut_TraceExtIn0,    CrossTriggerOut_TraceExtIn1,  
                             CrossTriggerOut_TraceExtIn2,    CrossTriggerOut_TraceExtIn3};  
  
enumeration CrossTriggerIn {CrossTriggerIn_CrossHalt,       CrossTriggerIn_PMUOverflow,  
                             CrossTriggerIn_RSVD2,          CrossTriggerIn_RSVD3,  
                             CrossTriggerIn_TraceExtOut0,   CrossTriggerIn_TraceExtOut1,  
                             CrossTriggerIn_TraceExtOut2,   CrossTriggerIn_TraceExtOut3};
```

shared/debug/dccanditr/CheckForDCCInterrupts

```
// CheckForDCCInterrupts()  
// =====  
  
CheckForDCCInterrupts()  
    commrx = (EDSCR.RXfull == '1');  
    commtx = (EDSCR.TXfull == '0');  
  
    // COMMRX and COMMTX support is optional and not recommended for new designs.
```



```
// SetInterruptRequestLevel(InterruptID_COMMRX, if commrX then HIGH else LOW);
// SetInterruptRequestLevel(InterruptID_COMMTX, if commtX then HIGH else LOW);

// The value to be driven onto the common COMMIRQ signal.
if ELUsingAArch32(EL1) then
  commirq = ((commrX && DBGDCCINT.RX == '1') ||
             (commtX && DBGDCCINT.TX == '1'));
else
  commirq = ((commrX && MDCCINT_EL1.RX == '1') ||
             (commtX && MDCCINT_EL1.TX == '1'));
SetInterruptRequestLevel(InterruptID_COMMIRQ, if commirq then HIGH else LOW);

return;
```

shared/debug/dccanditr/DBGDTRRX_EL0

```
// DBGDTRRX_EL0[] (external write)
// =====
// Called on writes to debug register 0x08C.

DBGDTRRX_EL0[boolean memory_mapped] = bits(32) value

if EDPRSR<6:5,0> != '001' then // Check DLK, OSLK and PU bits
  IMPLEMENTATION_DEFINED "signal slave-generated error";
  return;

if EDSCR.ERR == '1' then return; // Error flag set: ignore write

// The Software lock is OPTIONAL.
if memory_mapped && EDLSR.SLK == '1' then return; // Software lock locked: ignore write

if EDSCR.RXfull == '1' || (Halted() && EDSCR.MA == '1' && EDSCR.ITE == '0') then
  EDSCR.RX0 = '1'; EDSCR.ERR = '1'; // Overrun condition: ignore write
  return;

EDSCR.RXfull = '1';
DTRRX = value;

if Halted() && EDSCR.MA == '1' then
  EDSCR.ITE = '0'; // See comments in EDITR[] (external write)

if !UsingAArch32() then
  ExecuteA64(0xD5330501<31:0>); // A64 "MRS X1,DBGDTRRX_EL0"
  ExecuteA64(0xB8004401<31:0>); // A64 "STR W1,[X0],#4"
  X[1] = bits(64) UNKNOWN;
else
  ExecuteT32(0xEE10<15:0> /*hw1*/, 0x1E15<15:0> /*hw2*/); // T32 "MRS R1,DBGDTRRXint"
  ExecuteT32(0xF840<15:0> /*hw1*/, 0x1B04<15:0> /*hw2*/); // T32 "STR R1,[R0],#4"
  R[1] = bits(32) UNKNOWN;
// If the store aborts, the Data Abort exception is taken and EDSCR.ERR is set to 1
if EDSCR.ERR == '1' then
  EDSCR.RXfull = bit UNKNOWN;
  DBGDTRRX_EL0 = bits(32) UNKNOWN;
else
  // "MRS X1,DBGDTRRX_EL0" calls DBGDTR_EL0[] (read) which clears RXfull.
  assert EDSCR.RXfull == '0';

  EDSCR.ITE = '1'; // See comments in EDITR[] (external write)
return;

// DBGDTRRX_EL0[] (external read)
// =====

bits(32) DBGDTRRX_EL0[boolean memory_mapped]
return DTRRX;
```

shared/debug/dccanditr/DBGDTRTX_EL0

```

// DBGDTRTX_EL0[] (external read)
// =====
// Called on reads of debug register 0x080.

bits(32) DBGDTRTX_EL0[boolean memory_mapped]

    if EDPRSR<6:5,0> != '001' then // Check DLK, OSLK and PU bits
        IMPLEMENTATION_DEFINED "signal slave-generated error";
        return bits(32) UNKNOWN;

    underrun = EDSCR.TXfull == '0' || (Halted() && EDSCR.MA == '1' && EDSCR.ITE == '0');
    value = if underrun then bits(32) UNKNOWN else DTRTX;

    if EDSCR.ERR == '1' then return value; // Error flag set: no side-effects

    // The Software lock is OPTIONAL.
    if memory_mapped && EDLSR.SLK == '1' then // Software lock locked: no side-effects
        return value;

    if underrun then
        EDSCR.TXU = '1'; EDSCR.ERR = '1'; // Underrun condition: block side-effects
        return value; // Return UNKNOWN

    EDSCR.TXfull = '0';
    if Halted() && EDSCR.MA == '1' then
        EDSCR.ITE = '0'; // See comments in EDITR[] (external write)

        if !UsingAArch32() then
            ExecuteA64(0xB8404401<31:0>); // A64 "LDR W1,[X0],#4"
        else
            ExecuteT32(0xF850<15:0> /*hw1*/, 0x1B04<15:0> /*hw2*/); // T32 "LDR R1,[R0],#4"
            // If the load aborts, the Data Abort exception is taken and EDSCR.ERR is set to 1
            if EDSCR.ERR == '1' then
                EDSCR.TXfull = bit UNKNOWN;
                DBGDTRTX_EL0 = bits(32) UNKNOWN;
            else
                if !UsingAArch32() then
                    ExecuteA64(0xD5130501<31:0>); // A64 "MSR DBGDTRTX_EL0,X1"
                else
                    ExecuteT32(0xEE00<15:0> /*hw1*/, 0x1E15<15:0> /*hw2*/); // T32 "MSR DBGDTRTXint,R1"
                    // "MSR DBGDTRTX_EL0,X1" calls DBGDTR_EL0[] (write) which sets TXfull.
                    assert EDSCR.TXfull == '1';

                if !UsingAArch32() then
                    X[1] = bits(64) UNKNOWN;
                else
                    R[1] = bits(32) UNKNOWN;

                EDSCR.ITE = '1'; // See comments in EDITR[] (external write)

    return value;

// DBGDTRTX_EL0[] (external write)
// =====

DBGDTRTX_EL0[boolean memory_mapped] = bits(32) value
// The Software lock is OPTIONAL.
if memory_mapped && EDLSR.SLK == '1' then return; // Software lock locked: ignore write
DTRTX = value;
return;

```

shared/debug/dccanditr/DBGDTR_EL0

```
// DBGDTR_EL0[] (write)
// =====
// System register writes to DBGDTR_EL0, DBGDTRTX_EL0 (AArch64) and DBGDTRTXint (AArch32)

DBGDTR_EL0[] = bits(N) value
  // For MSR DBGDTRTX_EL0,<Rt> N=32, value=X[t]<31:0>, X[t]<63:32> is ignored
  // For MSR DBGDTR_EL0,<Xt> N=64, value=X[t]<63:0>
  assert N IN {32,64};
  if EDSCR.TXfull == '1' then
    value = bits(N) UNKNOWN;
  // On a 64-bit write, implement a half-duplex channel
  if N == 64 then DTRRX = value<63:32>;
  DTRTX = value<31:0>; // 32-bit or 64-bit write
  EDSCR.TXfull = '1';
  return;

// DBGDTR_EL0[] (read)
// =====
// System register reads of DBGDTR_EL0, DBGDTRRX_EL0 (AArch64) and DBGDTRRXint (AArch32)

bits(N) DBGDTR_EL0[]
  // For MRS <Rt>,DBGDTRTX_EL0 N=32, X[t]=Zeros(32):result
  // For MRS <Xt>,DBGDTR_EL0 N=64, X[t]=result
  assert N IN {32,64};
  bits(N) result;
  if EDSCR.RXfull == '0' then
    result = bits(N) UNKNOWN;
  else
    // On a 64-bit read, implement a half-duplex channel
    // NOTE: the word order is reversed on reads with regards to writes
    if N == 64 then result<63:32> = DTRTX;
    result<31:0> = DTRRX;
  EDSCR.RXfull = '0';
  return result;
```

shared/debug/dccanditr/DTR

```
bits(32) DTRRX;
bits(32) DTRTX;
```

shared/debug/dccanditr/EDITR

```
// EDITR[] (external write)
// =====
// Called on writes to debug register 0x084.

EDITR[boolean memory_mapped] = bits(32) value
  if EDPRSR<6:5,0> != '001' then // Check DLK, OSLK and PU bits
    IMPLEMENTATION_DEFINED "signal slave-generated error";
    return;

  if EDSCR.ERR == '1' then return; // Error flag set: ignore write

  // The Software lock is OPTIONAL.
  if memory_mapped && EDLSR.SLK == '1' then return; // Software lock locked: ignore write

  if !Halted() then return; // Non-debug state: ignore write

  if EDSCR.ITE == '0' || EDSCR.MA == '1' then
    EDSCR.ITO = '1'; EDSCR.ERR = '1'; // Overrun condition: block write
    return;

  // ITE indicates whether the processor is ready to accept another instruction; the processor
  // may support multiple outstanding instructions. Unlike the "InstrComp1" flag in [v7A] there
```

```
// is no indication that the pipeline is empty (all instructions have completed). In this
// pseudocode, the assumption is that only one instruction can be executed at a time,
// meaning ITE acts like "InstrComp1".
EDSCR.ITE = '0';

if !UsingAArch32() then
  ExecuteA64(value);
else
  ExecuteT32(value<15:0> /*hw1*/, value<31:16> /*hw2*/);

EDSCR.ITE = '1';

return;
```

shared/debug/halting/DCPSInstruction

```
// DCPSInstruction()
// =====
// Operation of the DCPS instruction in Debug state

DCPSInstruction(bits(2) target_e1)

  SynchronizeContext();

  case target_e1 of
    when EL1
      if PSTATE.EL == EL2 || (PSTATE.EL == EL3 && !UsingAArch32()) then handle_e1 = PSTATE.EL;
      elsif HaveEL(EL2) && !IsSecure() && HCR_EL2.TGE == '1' then UndefinedFault();
      else handle_e1 = EL1;

    when EL2
      if !HaveEL(EL2) then UndefinedFault();
      elsif PSTATE.EL == EL3 && !UsingAArch32() then handle_e1 = EL3;
      elsif IsSecure() then UndefinedFault();
      else handle_e1 = EL2;

    when EL3
      if EDSCR.SDD == '1' || !HaveEL(EL3) then UndefinedFault();
      handle_e1 = EL3;

    otherwise
      Unreachable();

  from_secure = IsSecure();
  if ELUsingAArch32(handle_e1) then
    if PSTATE.M == M32_Monitor then SCR.NS = '0';
    assert UsingAArch32(); // Cannot move from AArch64 to AArch32
    case handle_e1 of
      when EL1
        AArch32.WriteMode(M32_Svc);
        if HavePANExt() && SCTL.R.SPAN == '0' then
          PSTATE.PAN = '1';
      when EL2 AArch32.WriteMode(M32_Hyp);
      when EL3
        AArch32.WriteMode(M32_Monitor);
        if HavePANExt() then
          if !from_secure then
            PSTATE.PAN = '0';
          elsif SCTL.R.SPAN == '0' then
            PSTATE.PAN = '1';
    if handle_e1 == EL2 then
      ELR_hyp = bits(32) UNKNOWN; HSR = bits(32) UNKNOWN;
    else
      LR = bits(32) UNKNOWN;
      SPSR[] = bits(32) UNKNOWN;
      PSTATE.E = SCTL.R.EE;
      DLR = bits(32) UNKNOWN; DSPSR = bits(32) UNKNOWN;

  else // Targeting AArch64
```

```

if UsingAArch32() then
  AArch64.MaybeZeroRegisterUppers();
PSTATE.nRW = '0'; PSTATE.SP = '1'; PSTATE.EL = handle_e1;
if (HavePANExt() && ((handle_e1 == EL1 && SCTL_EL1.SPAN == '0') ||
  (handle_e1 == EL2 && SCTL_EL2.SPAN == '0' &&
  HCR_EL2.E2H == '1' && HCR_EL2.TGE == '1'))) then
  PSTATE.PAN = '1';
ELR[] = bits(64) UNKNOWN; SPSR[] = bits(32) UNKNOWN; ESR[] = bits(32) UNKNOWN;
DLR_EL0 = bits(64) UNKNOWN; DSPSR_EL0 = bits(32) UNKNOWN;

if HaveUAOExt() then PSTATE.UAO = '0';

UpdateEDSCRFIELDS(); // Update EDSCR PE state flags.

// SCTLR[].IESB might be ignored in Debug state.
if HaveRASExt() && SCTLR[].IESB == '1' && ConstrainUnpredictableBool() then
  ErrorSynchronizationBarrier(MBReqDomain_FullSystem, MBReqTypes_All);
return;

```

shared/debug/halting/DRPSInstruction

```

// DRPSInstruction()
// =====
// Operation of the A64 DRPS and T32 ERET instructions in Debug state

DRPSInstruction()

  SynchronizeContext();

  // SCTLR[].IESB might be ignored in Debug state.
  if HaveRASExt() && SCTLR[].IESB == '1' && ConstrainUnpredictableBool() then
    ErrorSynchronizationBarrier(MBReqDomain_FullSystem, MBReqTypes_All);

  SetPSTATEFromPSR(SPSR[]);

  // PSTATE.<N,Z,C,V,Q,GE,SS,D,A,I,F> are not observable and ignored in Debug state, so
  // behave as if UNKNOWN.
  if UsingAArch32() then
    PSTATE.<N,Z,C,V,Q,GE,SS,A,I,F> = bits(13) UNKNOWN;
    // In AArch32, all instructions are T32 and unconditional.
    PSTATE.IT = '00000000'; PSTATE.T = '1'; // PSTATE.J is RES0
    DLR = bits(32) UNKNOWN; DSPSR = bits(32) UNKNOWN;
  else
    PSTATE.<N,Z,C,V,SS,D,A,I,F> = bits(9) UNKNOWN;
    DLR_EL0 = bits(64) UNKNOWN; DSPSR_EL0 = bits(32) UNKNOWN;

  UpdateEDSCRFIELDS(); // Update EDSCR PE state flags.

  return;

```

shared/debug/halting/DebugHalt

```

constant bits(6) DebugHalt_Breakpoint = '000111';
constant bits(6) DebugHalt_EDBGRQ = '010011';
constant bits(6) DebugHalt_Step_Normal = '011011';
constant bits(6) DebugHalt_Step_Exclusive = '011111';
constant bits(6) DebugHalt_OSUnlockCatch = '100011';
constant bits(6) DebugHalt_ResetCatch = '100111';
constant bits(6) DebugHalt_Watchpoint = '101011';
constant bits(6) DebugHalt_HaltInstruction = '101111';
constant bits(6) DebugHalt_SoftwareAccess = '110011';
constant bits(6) DebugHalt_ExceptionCatch = '110111';
constant bits(6) DebugHalt_Step_NoSyndrome = '111011';

```

shared/debug/halting/DisableITRAndResumeInstructionPrefetch

```
DisableITRAndResumeInstructionPrefetch();
```

shared/debug/halting/ExecuteA64

```
// Execute an A64 instruction in Debug state.  
ExecuteA64(bits(32) instr);
```

shared/debug/halting/ExecuteT32

```
// Execute a T32 instruction in Debug state.  
ExecuteT32(bits(16) hw1, bits(16) hw2);
```

shared/debug/halting/ExitDebugState

```
// ExitDebugState()  
// =====  
  
ExitDebugState()  
    assert Halted();  
    SynchronizeContext();  
  
    // Although EDSCR.STATUS signals that the PE is restarting, debuggers must use EDPRSR.SDR to  
    // detect that the PE has restarted.  
    EDSCR.STATUS = '00001'; // Signal restarting  
    EDESR<2:0> = '000'; // Clear any pending Halting debug events  
  
    bits(64) new_pc;  
    bits(32) spsr;  
  
    if UsingAArch32() then  
        new_pc = ZeroExtend(DLR);  
        spsr = DSPSR;  
    else  
        new_pc = DLR_EL0;  
        spsr = DSPSR_EL0;  
    // If this is an illegal return, SetPSTATEFromPSR() will set PSTATE.IL.  
    SetPSTATEFromPSR(spsr); // Can update privileged bits, even at EL0.  
  
    if UsingAArch32() then  
        if ConstrainUnpredictableBool() then new_pc<0> = '0';  
        BranchTo(new_pc<31:0>, BranchType_UNKNOWN); // AArch32 branch  
    else  
        // If targeting AArch32 then possibly zero the 32 most significant bits of the target PC  
        if spsr<4> == '1' && ConstrainUnpredictableBool() then  
            new_pc<63:32> = Zeros();  
            BranchTo(new_pc, BranchType_DBGEXIT); // A type of branch that is never predicted  
  
    (EDSCR.STATUS, EDPRSR.SDR) = ('00010', '1'); // Atomically signal restarted  
    UpdateEDSCRFields(); // Stop signalling PE state.  
    DisableITRAndResumeInstructionPrefetch();  
  
    return;
```

shared/debug/halting/Halt

```
// Halt()  
// =====  
  
Halt(bits(6) reason)  
  
    CTI_SignalEvent(CrossTriggerIn_CrossHalt); // Trigger other cores to halt  
    if UsingAArch32() then  
        DLR = ThisInstrAddr();
```

```

    DSPSR = GetPSRFromPSTATE();
    DSPSR.SS = PSTATE.SS; // Always save PSTATE.SS
else
    DLR_EL0 = ThisInstrAddr();
    DSPSR_EL0 = GetPSRFromPSTATE();
    DSPSR_EL0.SS = PSTATE.SS; // Always save PSTATE.SS

EDSCR.ITE = '1'; EDSCR.ITO = '0';
if IsSecure() then
    EDSCR.SDD = '0'; // If entered in Secure state, allow debug
elseif HaveEL(EL3) then
    EDSCR.SDD = (if ExternalSecureInvasiveDebugEnabled() then '0' else '1');
else
    assert EDSCR.SDD == '1'; // Otherwise EDSCR.SDD is RES1
EDSCR.MA = '0';
// PSTATE.{SS,D,A,I,F} are not observable and ignored in Debug state, so behave as if
// UNKNOWN. PSTATE.{N,Z,C,V,Q,GE} are also not observable, but since these are not changed on
// exception entry, this function also leaves them unchanged. PSTATE.{E,M,nRW,EL,SP} are
// unchanged. PSTATE.IL is set to 0.
if UsingAArch32() then
    PSTATE.<SS,A,I,F> = bits(4) UNKNOWN;
    // In AArch32, all instructions are T32 and unconditional.
    PSTATE.IT = '00000000'; PSTATE.T = '1'; // PSTATE.J is RES0
else
    PSTATE.<SS,D,A,I,F> = bits(5) UNKNOWN;
PSTATE.IL = '0';

StopInstructionPrefetchAndEnableITR();
EDSCR.STATUS = reason; // Signal entered Debug state
UpdateEDSCRFields(); // Update EDSCR PE state flags.

return;

```

shared/debug/halting/HaltOnBreakpointOrWatchpoint

```

// HaltOnBreakpointOrWatchpoint()
// =====
// Returns TRUE if the Breakpoint and Watchpoint debug events should be considered for Debug
// state entry, FALSE if they should be considered for a debug exception.

boolean HaltOnBreakpointOrWatchpoint()
    return HaltingAllowed() && EDSCR.HDE == '1' && OSLSR_EL1.OSLK == '0';

```

shared/debug/halting/Halted

```

// Halted()
// =====

boolean Halted()
    return !(EDSCR.STATUS IN {'000001', '000010'}); // Halted

```

shared/debug/halting/HaltingAllowed

```

// HaltingAllowed()
// =====
// Returns TRUE if halting is currently allowed, FALSE if halting is prohibited.

boolean HaltingAllowed()
    if Halted() || DoubleLockStatus() then
        return FALSE;
    elseif IsSecure() then
        return ExternalSecureInvasiveDebugEnabled();
    else
        return ExternalInvasiveDebugEnabled();

```

shared/debug/halting/Restarting

```
// Restarting()
// =====

boolean Restarting()
    return EDSCR.STATUS == '000001'; // Restarting
```

shared/debug/halting/StopInstructionPrefetchAndEnableITR

```
StopInstructionPrefetchAndEnableITR();
```

shared/debug/halting/UpdateEDSCRFields

```
// UpdateEDSCRFields()
// =====
// Update EDSCR PE state fields

UpdateEDSCRFields()

    if !Halted() then
        EDSCR.EL = '00';
        EDSCR.NS = bit UNKNOWN;
        EDSCR.RW = '1111';
    else
        EDSCR.EL = PSTATE.EL;
        EDSCR.NS = if IsSecure() then '0' else '1';

        bits(4) RW;
        RW<1> = (if ELUsingAArch32(EL1) then '0' else '1');
        if PSTATE.EL != EL0 then
            RW<0> = RW<1>;
        else
            RW<0> = (if UsingAArch32() then '0' else '1');
        if !HaveEL(EL2) || (HaveEL(EL3) && SCR_GEN[].NS == '0') then
            RW<2> = RW<1>;
        else
            RW<2> = (if ELUsingAArch32(EL2) then '0' else '1');
        if !HaveEL(EL3) then
            RW<3> = RW<2>;
        else
            RW<3> = (if ELUsingAArch32(EL3) then '0' else '1');

        // The least-significant bits of EDSCR.RW are UNKNOWN if any higher EL is using AArch32.
        if RW<3> == '0' then RW<2:0> = bits(3) UNKNOWN;
        elsif RW<2> == '0' then RW<1:0> = bits(2) UNKNOWN;
        elsif RW<1> == '0' then RW<0> = bit UNKNOWN;
        EDSCR.RW = RW;

    return;
```

shared/debug/haltingevents/CheckExceptionCatch

```
// CheckExceptionCatch()
// =====
// Check whether an Exception Catch debug event is set on the current Exception level

CheckExceptionCatch(boolean exception_entry)
    // Called after an exception entry or exit, that is, such that IsSecure() and PSTATE.EL are correct
    // for the exception target.
    base = if IsSecure() then 0 else 4;
    if HaltingAllowed() then
        if HaveExtendedECCDebugEvents() then
            exception_exit = !exception_entry;
            ctrl = EDECCR<UInt>(PSTATE.EL) + base + 8>; EDECCR<UInt>(PSTATE.EL) + base>;
            case ctrl of
                when '00' halt = FALSE;
```



```

    when '01' halt = TRUE;
    when '10' halt = (exception_exit == TRUE);
    when '11' halt = (exception_entry == TRUE);
  else
    halt = (EDECRC<U>Int(PSTATE.EL) + base> == '1');
  if halt then Halt(DebugHalt_ExceptionCatch);

```

shared/debug/haltingevents/CheckHaltingStep

```

// CheckHaltingStep()
// =====
// Check whether EDESR.SS has been set by Halting Step

CheckHaltingStep()
  if HaltingAllowed() && EDESR.SS == '1' then
    // The STATUS code depends on how we arrived at the state where EDESR.SS == 1.
    if HaltingStep_DidNotStep() then
      Halt(DebugHalt_Step_NoSyndrome);
    elseif HaltingStep_SteppedEX() then
      Halt(DebugHalt_Step_Exclusive);
    else
      Halt(DebugHalt_Step_Normal);

```

shared/debug/haltingevents/CheckOSUnlockCatch

```

// CheckOSUnlockCatch()
// =====
// Called on unlocking the OS Lock to pend an OS Unlock Catch debug event

CheckOSUnlockCatch()
  if EDECRC.OSUCE == '1' && !Halted() then EDESR.OSUC = '1';

```

shared/debug/haltingevents/CheckPendingOSUnlockCatch

```

// CheckPendingOSUnlockCatch()
// =====
// Check whether EDESR.OSUC has been set by an OS Unlock Catch debug event

CheckPendingOSUnlockCatch()
  if HaltingAllowed() && EDESR.OSUC == '1' then
    Halt(DebugHalt_OSUnlockCatch);

```

shared/debug/haltingevents/CheckPendingResetCatch

```

// CheckPendingResetCatch()
// =====
// Check whether EDESR.RC has been set by a Reset Catch debug event

CheckPendingResetCatch()
  if HaltingAllowed() && EDESR.RC == '1' then
    Halt(DebugHalt_ResetCatch);

```

shared/debug/haltingevents/CheckResetCatch

```

// CheckResetCatch()
// =====
// Called after reset

CheckResetCatch()
  if EDECRC.RCE == '1' then
    EDESR.RC = '1';
    // If halting is allowed then halt immediately
    if HaltingAllowed() then Halt(DebugHalt_ResetCatch);

```

shared/debug/haltingevents/CheckSoftwareAccessToDebugRegisters

```
// CheckSoftwareAccessToDebugRegisters()
// =====
// Check for access to Breakpoint and Watchpoint registers.

CheckSoftwareAccessToDebugRegisters()
    os_lock = (if ELUsingAArch32(EL1) then DBGOSLSR.OSLK e1se OSLSR_EL1.OSLK);
    if HaltingAllowed() && EDCR.TDA == '1' && os_lock == '0' then
        Halt(DebugHalt_SoftwareAccess);
```

shared/debug/haltingevents/ExternalDebugRequest

```
// ExternalDebugRequest()
// =====

ExternalDebugRequest()
    if HaltingAllowed() then
        Halt(DebugHalt_EDBGRQ);
    // Otherwise the CTI continues to assert the debug request until it is taken.
```

shared/debug/haltingevents/HaltingStep_DidNotStep

```
// Returns TRUE if the previously executed instruction was executed in the inactive state, that is,
// if it was not itself stepped.
boolean HaltingStep_DidNotStep();
```

shared/debug/haltingevents/HaltingStep_SteppedEX

```
// Returns TRUE if the previously executed instruction was a Load-Exclusive class instruction
// executed in the active-not-pending state.
boolean HaltingStep_SteppedEX();
```

shared/debug/haltingevents/RunHaltingStep

```
// RunHaltingStep()
// =====

RunHaltingStep(boolean exception_generated, bits(2) exception_target, boolean syscall,
               boolean reset)
    // "exception_generated" is TRUE if the previous instruction generated a synchronous exception
    // or was cancelled by an asynchronous exception.
    // if "exception_generated" is TRUE then "exception_target" is the target of the exception, and
    // "syscall" is TRUE if the exception is a synchronous exception where the preferred return
    // address is the instruction following that which generated the exception.
    // "reset" is TRUE if exiting reset state into the highest EL.

    if reset then assert !Halted(); // Cannot come out of reset halted
    active = EDCR.SS == '1' && !Halted();

    if active && reset then // Coming out of reset with EDCR.SS set.
        EDCR.SS = '1';
    elseif active && HaltingAllowed() then
        if exception_generated && exception_target == EL3 then
            advance = syscall || ExternalSecureInvasiveDebugEnabled();
        else
            advance = TRUE;
        if advance then EDCR.SS = '1';

    return;
```

shared/debug/interrupts/ExternalDebugInterruptsDisabled

```
// ExternalDebugInterruptsDisabled()
// =====
// Determine whether EDSCR disables interrupts routed to 'target'

boolean ExternalDebugInterruptsDisabled(bits(2) target)
  case target of
    when EL3
      int_dis = (EDSCR.INTdis == '11' && ExternalSecureInvasiveDebugEnabled());
    when EL2
      int_dis = (EDSCR.INTdis == '1x' && ExternalInvasiveDebugEnabled());
    when EL1
      if IsSecure() then
        int_dis = (EDSCR.INTdis == '1x' && ExternalSecureInvasiveDebugEnabled());
      else
        int_dis = (EDSCR.INTdis != '00' && ExternalInvasiveDebugEnabled());
  return int_dis;
```

shared/debug/interrupts/InterruptID

```
enumeration InterruptID {InterruptID_PMUIRQ, InterruptID_COMMIRQ, InterruptID_CTIIRQ,
  InterruptID_COMMRX, InterruptID_COMMTX};
```

shared/debug/interrupts/SetInterruptRequestLevel

```
// Set a level-sensitive interrupt to the specified level.
SetInterruptRequestLevel(InterruptID id, signal level);
```

shared/debug/samplebasedprofiling/CreatePCSample

```
// CreatePCSample()
// =====

CreatePCSample()
  // In a simple sequential execution of the program, CreatePCSample is executed each time the PE
  // executes an instruction that can be sampled. An implementation is not constrained such that
  // reads of EDPCSRlo return the current values of PC, etc.

  pc_sample.valid = ExternalNoninvasiveDebugEnabled() && !Halted();
  pc_sample.pc = ThisInstrAddr();
  pc_sample.el = PSTATE.EL;
  pc_sample.rw = if UsingAArch32() then '0' else '1';
  pc_sample.ns = if IsSecure() then '0' else '1';
  pc_sample.contextidr = if ELUsingAArch32(EL1) then CONTEXTIDR else CONTEXTIDR_EL1;
  if HaveEL(EL2) && !IsSecure() then
    if ELUsingAArch32(EL2) then
      pc_sample.vmid = ZeroExtend(VTTBR.VMID, 16);
    elseif !Have16bitVMID() || VTCR_EL2.VS == '0' then
      pc_sample.vmid = ZeroExtend(VTTBR_EL2.VMID<7:0>, 16);
    else
      pc_sample.vmid = VTTBR_EL2.VMID;
  if HaveVirtHostExt() && !IsSecure() && !ELUsingAArch32(EL2) then
    pc_sample.contextidr_el2 = CONTEXTIDR_EL2;
  else
    pc_sample.contextidr_el2 = bits(32) UNKNOWN;
  return;
```

shared/debug/samplebasedprofiling/EDPCSRlo

```
// EDPCSRlo[] (read)
// =====

bits(32) EDPCSRlo[boolean memory_mapped]
```

```

if EDPRSR<6:5,0> != '001' then // Check DLK, OSLK and PU bits
    IMPLEMENTATION_DEFINED "signal slave-generated error";
    return bits(32) UNKNOWN;

// The Software lock is OPTIONAL.
update = !memory_mapped || EDLSR.SLK == '0'; // Software locked: no side-effects

if pc_sample.valid then
    sample = pc_sample.pc<31:0>;
    if update then
        if HaveVirtHostExt() && EDSCR.SC2 == '1' then
            EDPCRhi.PC = (if pc_sample.rw == '0' then Zeros(24) else pc_sample.pc<55:32>);
            EDPCRhi.EL = pc_sample.e1;
            EDPCRhi.NS = pc_sample.ns;
        else
            EDPCRhi = (if pc_sample.rw == '0' then Zeros(32) else pc_sample.pc<63:32>);
            EDCIDSR = pc_sample.contextidr;
            if HaveVirtHostExt() && EDSCR.SC2 == '1' then
                EDVIDSR = pc_sample.contextidr_e12;
            else
                EDVIDSR.VMID = (if HaveEL(EL2) && pc_sample.ns == '1' && pc_sample.e1 IN {EL1,EL0}
                    then pc_sample.vmid else Zeros(16));
                EDVIDSR.NS = pc_sample.ns;
                EDVIDSR.E2 = (if pc_sample.e1 == EL2 then '1' else '0');
                EDVIDSR.E3 = (if pc_sample.e1 == EL3 then '1' else '0') AND pc_sample.rw;
                // The conditions for setting HV are not specified if PCRhi is zero.
                // An example implementation may be "pc_sample.rw".
                EDVIDSR.HV = (if !IsZero(EDPCRhi) then '1' else bit IMPLEMENTATION_DEFINED "0 or 1");
        else
            sample = Ones(32);
            if update then
                EDPCRhi = bits(32) UNKNOWN;
                EDCIDSR = bits(32) UNKNOWN;
                EDVIDSR = bits(32) UNKNOWN;

    return sample;
  
```

shared/debug/samplebasedprofiling/PCSample

```

type PCSample is (
    boolean valid,
    bits(64) pc,
    bits(2) e1,
    bit rw,
    bit ns,
    bits(32) contextidr,
    bits(32) contextidr_e12,
    bits(16) vmid
)
  
```

```
PCSample pc_sample;
```

shared/debug/softwarestep/CheckSoftwareStep

```

// CheckSoftwareStep()
// =====
// Take a Software Step exception if in the active-pending state

CheckSoftwareStep()

// Other self-hosted debug functions will call AArch32.GenerateDebugExceptions() if called from
// AArch32 state. However, because Software Step is only active when the debug target Exception
// level is using AArch64, CheckSoftwareStep only calls AArch64.GenerateDebugExceptions().
if !ELUsingAArch32(DebugTarget()) && AArch64.GenerateDebugExceptions() then
    if MDSCR_EL1.SS == '1' && PSTATE.SS == '0' then
        AArch64.SoftwareStepException();
  
```

shared/debug/softwarestep/DebugExceptionReturnSS

```
// DebugExceptionReturnSS()
// =====
// Returns value to write to PSTATE.SS on an exception return or Debug state exit.

bit DebugExceptionReturnSS(bits(32) spsr)
  assert Halted() || Restarting() || PSTATE.EL != EL0;

  SS_bit = '0';

  if MDSCR_EL1.SS == '1' then
    if Restarting() then
      enabled_at_source = FALSE;
    elseif UsingAArch32() then
      enabled_at_source = AArch32.GenerateDebugExceptions();
    else
      enabled_at_source = AArch64.GenerateDebugExceptions();

    if IllegalExceptionReturn(spsr) then
      dest = PSTATE.EL;
    else
      (valid, dest) = ELFromSPSR(spsr); assert valid;

    secure = IsSecureBelowEL3() || dest == EL3;

    if ELUsingAArch32(dest) then
      enabled_at_dest = AArch32.GenerateDebugExceptionsFrom(dest, secure);
    else
      mask = spsr<9>;
      enabled_at_dest = AArch64.GenerateDebugExceptionsFrom(dest, secure, mask);

    ELd = DebugTargetFrom(secure);
    if !ELUsingAArch32(ELd) && !enabled_at_source && enabled_at_dest then
      SS_bit = spsr<21>;
  return SS_bit;
```

shared/debug/softwarestep/SSAdvance

```
// SSAdvance()
// =====
// Advance the Software Step state machine.

SSAdvance()

// A simpler implementation of this function just clears PSTATE.SS to zero regardless of the
// current Software Step state machine. However, this check is made to illustrate that the
// processor only needs to consider advancing the state machine from the active-not-pending
// state.
target = DebugTarget();
step_enabled = !ELUsingAArch32(target) && MDSCR_EL1.SS == '1';
active_not_pending = step_enabled && PSTATE.SS == '1';

if active_not_pending then PSTATE.SS = '0';

return;
```

shared/debug/softwarestep/SoftwareStep_DidNotStep

```
// Returns TRUE if the previously executed instruction was executed in the inactive state, that is,
// if it was not itself stepped.
boolean SoftwareStep_DidNotStep();
```

shared/debug/softwarestep/SoftwareStep_SteppedEX

```
// Returns TRUE if the previously executed instruction was a Load-Exclusive class instruction
// executed in the active-not-pending state.
boolean SoftwareStep_SteppedEX();
```

J1.3.2 shared/exceptions

This section includes the following pseudocode functions:

- [shared/exceptions/exceptions/ConditionSyndrome](#).
- [shared/exceptions/exceptions/Exception](#).
- [shared/exceptions/exceptions/ExceptionRecord](#) on page J1-6025.
- [shared/exceptions/exceptions/ExceptionSyndrome](#) on page J1-6025.
- [shared/exceptions/traps/ReservedValue](#) on page J1-6025.
- [shared/exceptions/traps/UnallocatedEncoding](#) on page J1-6026.

shared/exceptions/exceptions/ConditionSyndrome

```
// ConditionSyndrome()
// =====
// Return CV and COND fields of instruction syndrome

bits(5) ConditionSyndrome()

    bits(5) syndrome;

    if UsingAArch32() then
        cond = AArch32.CurrentCond();
        if PSTATE.T == '0' then // A32
            syndrome<4> = '1';
            // A conditional A32 instruction that is known to pass its condition code check
            // can be presented either with COND set to 0xE, the value for unconditional, or
            // the COND value held in the instruction.
            if ConditionHolds(cond) && ConstrainUnpredictableBool() then
                syndrome<3:0> = '1110';
            else
                syndrome<3:0> = cond;
        else // T32
            // When a T32 instruction is trapped, it is IMPLEMENTATION DEFINED whether:
            // * CV set to 0 and COND is set to an UNKNOWN value
            // * CV set to 1 and COND is set to the condition code for the condition that
            // applied to the instruction.
            if boolean IMPLEMENTATION_DEFINED "Condition valid for trapped T32" then
                syndrome<4> = '1';
                syndrome<3:0> = cond;
            else
                syndrome<4> = '0';
                syndrome<3:0> = bits(4) UNKNOWN;
    else
        syndrome<4> = '1';
        syndrome<3:0> = '1110';

    return syndrome;
```

shared/exceptions/exceptions/Exception

```
enumeration Exception {Exception_Uncategorized, // Uncategorized or unknown reason
                        Exception_WFxTrap, // Trapped WFI or WFE instruction
                        Exception_CP15SRTTrap, // Trapped AArch32 MCR or MRC access to CP15
                        Exception_CP15RRTTrap, // Trapped AArch32 MCRR or MRRC access to CP15
                        Exception_CP14RTTrap, // Trapped AArch32 MCR or MRC access to CP14
                        Exception_CP14DTTrap, // Trapped AArch32 LDC or STC access to CP14
                        Exception_AdvSIMDFPAccessTrap, // HCPTR-trapped access to SIMD or FP
```

```

Exception_FPIDTrap,           // Trapped access to SIMD or FP ID register
// Trapped BXJ instruction not supported in ARMv8
Exception_CP14RRTTrap,       // Trapped MRRC access to CP14 from AArch32
Exception_IllegalState,      // Illegal Execution state
Exception_SupervisorCall,    // Supervisor Call
Exception_HypervisorCall,    // Hypervisor Call
Exception_MonitorCall,      // Monitor Call or Trapped SMC instruction
Exception_SystemRegisterTrap, // Trapped MRS or MSR system register access
Exception_InstructionAbort,  // Instruction Abort or Prefetch Abort
Exception_PCAlignment,      // PC alignment fault
Exception_DataAbort,        // Data Abort
Exception_SPAAlignment,     // SP alignment fault
Exception_FPTrappedException, // IEEE trapped FP exception
Exception_SError,           // SError interrupt
Exception_Breakpoint,       // (Hardware) Breakpoint
Exception_SoftwareStep,     // Software Step
Exception_Watchpoint,       // Watchpoint
Exception_SoftwareBreakpoint, // Software Breakpoint Instruction
Exception_VectorCatch,      // AArch32 Vector Catch
Exception_IRQ,              // IRQ interrupt
Exception_FIQ;              // FIQ interrupt
  
```

shared/exceptions/exceptions/ExceptionRecord

```

type ExceptionRecord is (Exception type,           // Exception class
  bits(25) syndrome,                               // Syndrome record
  bits(64) vaddress,                               // Virtual fault address
  boolean ipavalid,                               // Physical fault address is valid
  bits(52) ipaddress)                             // Physical fault address for second stage faults
  
```

shared/exceptions/exceptions/ExceptionSyndrome

```

// ExceptionSyndrome()
// =====
// Return a blank exception syndrome record for an exception of the given type.
  
```

```

ExceptionRecord ExceptionSyndrome(Exception type)
  
```

```

  ExceptionRecord r;

  r.type = type;

  // Initialize all other fields
  r.syndrome = Zeros();
  r.vaddress = Zeros();
  r.ipavalid = FALSE;
  r.ipaddress = Zeros();

  return r;
  
```

shared/exceptions/traps/ReservedValue

```

// ReservedValue()
// =====
ReservedValue()

if UsingAArch32() && !AArch32.GeneralExceptionsToAArch64() then
  AArch32.TakeUndefInstrException();
else
  AArch64.UndefinedFault();
  
```

shared/exceptions/traps/UnallocatedEncoding

```
// UnallocatedEncoding()
// =====

UnallocatedEncoding()
  if UsingAArch32() && AArch32.ExecutingCP10or11Instr() then
    FPEXC.DEX = '0';
  if UsingAArch32() && !AArch32.GeneralExceptionsToAArch64() then
    AArch32.TakeUndefInstrException();
  else
    AArch64.UndefinedFault();
```

J1.3.3 shared/functions

This section includes the following pseudocode functions:

- [shared/functions/aborts/EncodeLDFSC](#) on page J1-6031.
- [shared/functions/aborts/IPAValid](#) on page J1-6031.
- [shared/functions/aborts/IsAsyncAbort](#) on page J1-6031.
- [shared/functions/aborts/IsDebugException](#) on page J1-6032.
- [shared/functions/aborts/IsExternalAbort](#) on page J1-6032.
- [shared/functions/aborts/IsExternalSyncAbort](#) on page J1-6032.
- [shared/functions/aborts/IsFault](#) on page J1-6032.
- [shared/functions/aborts/IsSErrorInterrupt](#) on page J1-6033.
- [shared/functions/aborts/IsSecondStage](#) on page J1-6033.
- [shared/functions/aborts/LSInstructionSyndrome](#) on page J1-6033.
- [shared/functions/common/ASR](#) on page J1-6033.
- [shared/functions/common/ASR_C](#) on page J1-6033.
- [shared/functions/common/Abs](#) on page J1-6033.
- [shared/functions/common/Align](#) on page J1-6034.
- [shared/functions/common/BitCount](#) on page J1-6034.
- [shared/functions/common/CountLeadingSignBits](#) on page J1-6034.
- [shared/functions/common/CountLeadingZeroBits](#) on page J1-6034.
- [shared/functions/common/Elem](#) on page J1-6034.
- [shared/functions/common/Extend](#) on page J1-6035.
- [shared/functions/common/HighestSetBit](#) on page J1-6035.
- [shared/functions/common/Int](#) on page J1-6035.
- [shared/functions/common/IsOnes](#) on page J1-6035.
- [shared/functions/common/IsZero](#) on page J1-6035.
- [shared/functions/common/IsZeroBit](#) on page J1-6036.
- [shared/functions/common/LSL](#) on page J1-6036.
- [shared/functions/common/LSL_C](#) on page J1-6036.
- [shared/functions/common/LSR](#) on page J1-6036.
- [shared/functions/common/LSR_C](#) on page J1-6036.
- [shared/functions/common/LowestSetBit](#) on page J1-6036.
- [shared/functions/common/Max](#) on page J1-6037.
- [shared/functions/common/Min](#) on page J1-6037.
- [shared/functions/common/NOT](#) on page J1-6037.
- [shared/functions/common/Ones](#) on page J1-6037.
- [shared/functions/common/ROR](#) on page J1-6037.
- [shared/functions/common/ROR_C](#) on page J1-6038.
- [shared/functions/common/Replicate](#) on page J1-6038.
- [shared/functions/common/RoundDown](#) on page J1-6038.
- [shared/functions/common/RoundTowardsZero](#) on page J1-6038.

- *shared/functions/common/RoundUp* on page J1-6038.
- *shared/functions/common/SInt* on page J1-6038.
- *shared/functions/common/SignExtend* on page J1-6038.
- *shared/functions/common/UInt* on page J1-6039.
- *shared/functions/common/ZeroExtend* on page J1-6039.
- *shared/functions/common/Zeros* on page J1-6039.
- *shared/functions/crc/BitReverse* on page J1-6039.
- *shared/functions/crc/HaveCRCExt* on page J1-6039.
- *shared/functions/crc/Poly32Mod2* on page J1-6040.
- *shared/functions/crypto/AESInvMixColumns* on page J1-6040.
- *shared/functions/crypto/AESInvShiftRows* on page J1-6040.
- *shared/functions/crypto/AESInvSubBytes* on page J1-6040.
- *shared/functions/crypto/AESMixColumns* on page J1-6040.
- *shared/functions/crypto/AESShiftRows* on page J1-6040.
- *shared/functions/crypto/AESSubBytes* on page J1-6040.
- *shared/functions/crypto/HaveCryptoExt* on page J1-6040.
- *shared/functions/crypto/ROL* on page J1-6040.
- *shared/functions/crypto/SHA256hash* on page J1-6040.
- *shared/functions/crypto/SHAchoose* on page J1-6041.
- *shared/functions/crypto/SHAhashSIGMA0* on page J1-6041.
- *shared/functions/crypto/SHAhashSIGMA1* on page J1-6041.
- *shared/functions/crypto/SHAmajority* on page J1-6041.
- *shared/functions/crypto/SHAparity* on page J1-6041.
- *shared/functions/exclusive/ClearExclusiveByAddress* on page J1-6041.
- *shared/functions/exclusive/ClearExclusiveLocal* on page J1-6041.
- *shared/functions/exclusive/ClearExclusiveMonitors* on page J1-6042.
- *shared/functions/exclusive/ExclusiveMonitorsStatus* on page J1-6042.
- *shared/functions/exclusive/IsExclusiveGlobal* on page J1-6042.
- *shared/functions/exclusive/IsExclusiveLocal* on page J1-6042.
- *shared/functions/exclusive/MarkExclusiveGlobal* on page J1-6042.
- *shared/functions/exclusive/MarkExclusiveLocal* on page J1-6042.
- *shared/functions/exclusive/ProcessorID* on page J1-6042.
- *shared/functions/extension/AArch32.HaveHPDExt* on page J1-6042.
- *shared/functions/extension/AArch64.HaveHPDExt* on page J1-6042.
- *shared/functions/extension/Have52BitPAExt* on page J1-6043.
- *shared/functions/extension/Have52BitVAExt* on page J1-6043.
- *shared/functions/extension/HaveAtomicExt* on page J1-6043.
- *shared/functions/extension/HaveCommonNotPrivateTransExt* on page J1-6043.
- *shared/functions/extension/HaveExtendedECDebugEvents* on page J1-6043.
- *shared/functions/extension/HaveExtendedExecuteNeverExt* on page J1-6043.
- *shared/functions/extension/HaveHPMDExt* on page J1-6043.
- *shared/functions/extension/HavePANExt* on page J1-6043.
- *shared/functions/extension/HavePageBasedHardwareAttributes* on page J1-6044.
- *shared/functions/extension/HavePrivAExt* on page J1-6044.
- *shared/functions/extension/HaveQRDMLAExt* on page J1-6044.
- *shared/functions/extension/HaveRASExt* on page J1-6044.
- *shared/functions/extension/HaveStatisticalProfiling* on page J1-6044.
- *shared/functions/extension/HaveTrapLoadStoreMultipleDeviceExt* on page J1-6044.
- *shared/functions/extension/HaveUAOExt* on page J1-6044.
- *shared/functions/extension/HaveVirtHostExt* on page J1-6045.

- [shared/functions/float/fixedtofp/FixedToFP](#) on page J1-6045.
- [shared/functions/float/fpabs/FPAbs](#) on page J1-6045.
- [shared/functions/float/fpadd/FPAdd](#) on page J1-6045.
- [shared/functions/float/fpcompare/FPCompare](#) on page J1-6046.
- [shared/functions/float/fpcompareeq/FPCompareEQ](#) on page J1-6046.
- [shared/functions/float/fpcomparege/FPCompareGE](#) on page J1-6046.
- [shared/functions/float/fpcomparegt/FPCompareGT](#) on page J1-6047.
- [shared/functions/float/fpconvert/FPConvert](#) on page J1-6047.
- [shared/functions/float/fpconvertnan/FPConvertNaN](#) on page J1-6048.
- [shared/functions/float/fpcrtype/FP CRTType](#) on page J1-6048.
- [shared/functions/float/fpdecoderm/FPDecodeRM](#) on page J1-6048.
- [shared/functions/float/fpdecoderounding/FPDecodeRounding](#) on page J1-6048.
- [shared/functions/float/fpdefaultnan/FPDefaultNaN](#) on page J1-6049.
- [shared/functions/float/fpdiv/FPDiv](#) on page J1-6049.
- [shared/functions/float/fpexc/FPExc](#) on page J1-6049.
- [shared/functions/float/fpinfinity/FPInfinity](#) on page J1-6049.
- [shared/functions/float/fpmax/FPMax](#) on page J1-6049.
- [shared/functions/float/fpmaxnormal/FPMaxNormal](#) on page J1-6050.
- [shared/functions/float/fpmaxnum/FPMaxNum](#) on page J1-6050.
- [shared/functions/float/fpmin/FPMin](#) on page J1-6050.
- [shared/functions/float/fpminnum/FPMinNum](#) on page J1-6051.
- [shared/functions/float/fpmul/FPMul](#) on page J1-6051.
- [shared/functions/float/fpmuladd/FPMulAdd](#) on page J1-6051.
- [shared/functions/float/fpmulx/FPMulX](#) on page J1-6052.
- [shared/functions/float/fpneg/FPNeg](#) on page J1-6053.
- [shared/functions/float/fponepointfive/FPOnePointFive](#) on page J1-6053.
- [shared/functions/float/fpprocessexception/FPProcessException](#) on page J1-6053.
- [shared/functions/float/fpprocessnan/FPProcessNaN](#) on page J1-6053.
- [shared/functions/float/fpprocessnans/FPProcessNaNs](#) on page J1-6054.
- [shared/functions/float/fpprocessnans3/FPProcessNaNs3](#) on page J1-6054.
- [shared/functions/float/fpprecipestimate/FPRecipEstimate](#) on page J1-6055.
- [shared/functions/float/fpprecpx/FPRecpX](#) on page J1-6056.
- [shared/functions/float/fpround/FPRound](#) on page J1-6057.
- [shared/functions/float/fpround/FPRoundCV](#) on page J1-6058.
- [shared/functions/float/fprounding/FP Rounding](#) on page J1-6059.
- [shared/functions/float/fproundingmode/FP RoundingMode](#) on page J1-6059.
- [shared/functions/float/fproundint/FPRoundInt](#) on page J1-6059.
- [shared/functions/float/fprsqrtestimate/FP RSqrtEstimate](#) on page J1-6060.
- [shared/functions/float/fpsqrt/FP Sqrt](#) on page J1-6061.
- [shared/functions/float/fpsub/FPSub](#) on page J1-6061.
- [shared/functions/float/fpthree/FPThree](#) on page J1-6061.
- [shared/functions/float/fptofixed/FPToFixed](#) on page J1-6062.
- [shared/functions/float/fptwo/FPTwo](#) on page J1-6062.
- [shared/functions/float/fptype/FPType](#) on page J1-6063.
- [shared/functions/float/fpunpack/FPUnpack](#) on page J1-6063.
- [shared/functions/float/fpunpack/FPUnpackBase](#) on page J1-6063.
- [shared/functions/float/fpunpack/FPUnpackCV](#) on page J1-6064.
- [shared/functions/float/fpzzero/FPZero](#) on page J1-6064.
- [shared/functions/float/vfpexpandimm/VFPExpandImm](#) on page J1-6065.
- [shared/functions/integer/AddWithCarry](#) on page J1-6065.

- *shared/functions/memory/AArch64.BranchAddr* on page J1-6065.
- *shared/functions/memory/AccType* on page J1-6065.
- *shared/functions/memory/AccessDescriptor* on page J1-6066.
- *shared/functions/memory/AddrTop* on page J1-6066.
- *shared/functions/memory/AddressDescriptor* on page J1-6066.
- *shared/functions/memory/Allocation* on page J1-6066.
- *shared/functions/memory/BigEndian* on page J1-6066.
- *shared/functions/memory/BigEndianReverse* on page J1-6067.
- *shared/functions/memory/Cacheability* on page J1-6067.
- *shared/functions/memory/DataMemoryBarrier* on page J1-6067.
- *shared/functions/memory/DataSynchronizationBarrier* on page J1-6067.
- *shared/functions/memory/DescriptorUpdate* on page J1-6068.
- *shared/functions/memory/DeviceType* on page J1-6068.
- *shared/functions/memory/Fault* on page J1-6068.
- *shared/functions/memory/FaultRecord* on page J1-6068.
- *shared/functions/memory/FullAddress* on page J1-6068.
- *shared/functions/memory/Hint_Prefetch* on page J1-6068.
- *shared/functions/memory/MBReqDomain* on page J1-6069.
- *shared/functions/memory/MBReqTypes* on page J1-6069.
- *shared/functions/memory/MemAttrHints* on page J1-6069.
- *shared/functions/memory/MemType* on page J1-6069.
- *shared/functions/memory/MemoryAttributes* on page J1-6069.
- *shared/functions/memory/CreateAccessDescriptor* on page J1-6067.
- *shared/functions/memory/CreateAccessDescriptorPTW* on page J1-6067.
- *shared/functions/memory/Permissions* on page J1-6069.
- *shared/functions/memory/PrefetchHint* on page J1-6069.
- *shared/functions/memory/TLBRecord* on page J1-6069.
- *shared/functions/memory/_Mem* on page J1-6070.
- *shared/functions/registers/BranchTo* on page J1-6070.
- *shared/functions/registers/BranchToAddr* on page J1-6070.
- *shared/functions/registers/BranchType* on page J1-6071.
- *shared/functions/registers/Hint_Branch* on page J1-6071.
- *shared/functions/registers/NextInstrAddr* on page J1-6071.
- *shared/functions/registers/ResetExternalDebugRegisters* on page J1-6071.
- *shared/functions/registers/ThisInstrAddr* on page J1-6071.
- *shared/functions/registers/_PC* on page J1-6071.
- *shared/functions/registers/_R* on page J1-6071.
- *shared/functions/registers/_V* on page J1-6071.
- *shared/functions/sysregisters/SPSR* on page J1-6071.
- *shared/functions/system/ArchVersion* on page J1-6072.
- *shared/functions/system/ClearEventRegister* on page J1-6072.
- *shared/functions/system/ClearPendingPhysicalSError* on page J1-6072.
- *shared/functions/system/ConditionHolds* on page J1-6072.
- *shared/functions/system/CurrentInstrSet* on page J1-6073.
- *shared/functions/system/CurrentPL* on page J1-6073.
- *shared/functions/system/EL0* on page J1-6073.
- *shared/functions/system/ELFromM32* on page J1-6073.
- *shared/functions/system/ELFromSPSR* on page J1-6074.
- *shared/functions/system/ELIsInHost* on page J1-6074.
- *shared/functions/system/ELStateUsingAArch32* on page J1-6074.

- *shared/functions/system/ELStateUsingAArch32K* on page J1-6075.
- *shared/functions/system/ELUsingAArch32* on page J1-6075.
- *shared/functions/system/ELUsingAArch32K* on page J1-6075.
- *shared/functions/system/EndOfInstruction* on page J1-6075.
- *shared/functions/system/EnterLowPowerState* on page J1-6075.
- *shared/functions/system/ErrorSynchronizationBarrier* on page J1-6075.
- *shared/functions/system/EventRegister* on page J1-6076.
- *shared/functions/system/GetPSRFromPSTATE* on page J1-6076.
- *shared/functions/system/HasArchVersion* on page J1-6076.
- *shared/functions/system/HaveAArch32EL* on page J1-6076.
- *shared/functions/system/HaveAnyAArch32* on page J1-6077.
- *shared/functions/system/HaveAnyAArch64* on page J1-6077.
- *shared/functions/system/HaveEL* on page J1-6077.
- *shared/functions/system/HighestEL* on page J1-6077.
- *shared/functions/system/HighestELUsingAArch32* on page J1-6077.
- *shared/functions/system/Hint_Yield* on page J1-6077.
- *shared/functions/system/IllegalExceptionReturn* on page J1-6077.
- *shared/functions/system/InstrSet* on page J1-6078.
- *shared/functions/system/InstructionSynchronizationBarrier* on page J1-6078.
- *shared/functions/system/InterruptPending* on page J1-6078.
- *shared/functions/system/IsEventRegisterSet* on page J1-6078.
- *shared/functions/system/IsInHost* on page J1-6078.
- *shared/functions/system/IsSecure* on page J1-6079.
- *shared/functions/system/IsSecureBelowEL3* on page J1-6079.
- *shared/functions/system/Mode_Bits* on page J1-6079.
- *shared/functions/system/PLOfEL* on page J1-6079.
- *shared/functions/system/PSTATE* on page J1-6079.
- *shared/functions/system/PrivilegeLevel* on page J1-6080.
- *shared/functions/system/ProcState* on page J1-6080.
- *shared/functions/system/RestoredITBits* on page J1-6080.
- *shared/functions/system/SCRType* on page J1-6080.
- *shared/functions/system/SCR_GEN* on page J1-6081.
- *shared/functions/system/SErrorPending* on page J1-6081.
- *shared/functions/system/SendEvent* on page J1-6081.
- *shared/functions/system/SendEventLocal* on page J1-6081.
- *shared/functions/system/SetPSTATEFromPSR* on page J1-6081.
- *shared/functions/system/SynchronizeContext* on page J1-6082.
- *shared/functions/system/TakeUnmaskedPhysicalSErrorInterrupts* on page J1-6082.
- *shared/functions/system/TakeUnmaskedSErrorInterrupts* on page J1-6082.
- *shared/functions/system/ThisInstr* on page J1-6082.
- *shared/functions/system/ThisInstrLength* on page J1-6082.
- *shared/functions/system/Unreachable* on page J1-6082.
- *shared/functions/system/UsingAArch32* on page J1-6082.
- *shared/functions/system/WaitForEvent* on page J1-6082.
- *shared/functions/system/WaitForInterrupt* on page J1-6083.
- *shared/functions/unpredictable/ConstrainUnpredictable* on page J1-6083.
- *shared/functions/unpredictable/ConstrainUnpredictableBits* on page J1-6083.
- *shared/functions/unpredictable/ConstrainUnpredictableBool* on page J1-6083.
- *shared/functions/unpredictable/ConstrainUnpredictableInteger* on page J1-6083.
- *shared/functions/unpredictable/Constraint* on page J1-6083.

- [shared/functions/vector/AdvSIMDExpandImm](#) on page J1-6084.
- [shared/functions/vector/PolynomialMult](#) on page J1-6084.
- [shared/functions/vector/SatQ](#) on page J1-6084.
- [shared/functions/vector/SignedSatQ](#) on page J1-6085.
- [shared/functions/vector/UnsignedRSqrtEstimate](#) on page J1-6085.
- [shared/functions/vector/UnsignedRecipEstimate](#) on page J1-6085.
- [shared/functions/vector/UnsignedSatQ](#) on page J1-6086.

shared/functions/aborts/EncodeLDFSC

```
// EncodeLDFSC()
// =====
// Function that gives the Long-descriptor FSC code for types of Fault

bits(6) EncodeLDFSC(Fault type, integer level)

    bits(6) result;
    case type of
        when Fault_AddressSize      result = '0000':level<1:0>; assert level IN {0,1,2,3};
        when Fault_AccessFlag       result = '0010':level<1:0>; assert level IN {1,2,3};
        when Fault_Permission       result = '0011':level<1:0>; assert level IN {1,2,3};
        when Fault_Translation      result = '0001':level<1:0>; assert level IN {0,1,2,3};
        when Fault_SyncExternal     result = '010000';
        when Fault_SyncExternalOnWalk result = '0101':level<1:0>; assert level IN {0,1,2,3};
        when Fault_SyncParity       result = '011000';
        when Fault_SyncParityOnWalk result = '0111':level<1:0>; assert level IN {0,1,2,3};
        when Fault_AsyncParity      result = '011001';
        when Fault_AsyncExternal    result = '010001';
        when Fault_Alignment        result = '100001';
        when Fault_Debug            result = '100010';
        when Fault_TLBConflict      result = '110000';
        when Fault_Lockdown         result = '110100'; // IMPLEMENTATION DEFINED
        when Fault_Exclusive        result = '110101'; // IMPLEMENTATION DEFINED
        otherwise                   Unreachable();

    return result;
```

shared/functions/aborts/IPAValid

```
// IPAValid()
// =====
// Return TRUE if the IPA is reported for the abort

boolean IPAValid(FaultRecord fault)
    assert fault.type != Fault_None;

    if fault.s2fs1walk then
        return fault.type IN {Fault_AccessFlag, Fault_Permission, Fault_Translation,
                               Fault_AddressSize};
    elseif fault.secondstage then
        return fault.type IN {Fault_AccessFlag, Fault_Translation, Fault_AddressSize};
    else
        return FALSE;
```

shared/functions/aborts/IsAsyncAbort

```
// IsAsyncAbort()
// =====
// Returns TRUE if the abort currently being processed is an asynchronous abort, and FALSE
// otherwise.

boolean IsAsyncAbort(Fault type)
    assert type != Fault_None;
```

```
        return (type IN {Fault_AsyncExternal, Fault_AsyncParity});

// IsAsyncAbort()
// =====

boolean IsAsyncAbort(FaultRecord fault)
    return IsAsyncAbort(fault.type);
```

shared/functions/aborts/IsDebugException

```
// IsDebugException()
// =====

boolean IsDebugException(FaultRecord fault)
    assert fault.type != Fault_None;
    return fault.type == Fault_Debug;
```

shared/functions/aborts/IsExternalAbort

```
// IsExternalAbort()
// =====
// Returns TRUE if the abort currently being processed is an external abort and FALSE otherwise.

boolean IsExternalAbort(Fault type)
    assert type != Fault_None;

    return (type IN {Fault_SyncExternal, Fault_SyncParity, Fault_SyncExternalOnWalk,
                    Fault_SyncParityOnWalk,
                    Fault_AsyncExternal, Fault_AsyncParity });

// IsExternalAbort()
// =====

boolean IsExternalAbort(FaultRecord fault)
    return IsExternalAbort(fault.type);
```

shared/functions/aborts/IsExternalSyncAbort

```
// IsExternalSyncAbort()
// =====
// Returns TRUE if the abort currently being processed is an external synchronous abort and FALSE
otherwise.

boolean IsExternalSyncAbort(Fault type)
    assert type != Fault_None;

    return (type IN {Fault_SyncExternal, Fault_SyncParity, Fault_SyncExternalOnWalk,
                    Fault_SyncParityOnWalk});

// IsExternalSyncAbort()
// =====

boolean IsExternalSyncAbort(FaultRecord fault)
    return IsExternalSyncAbort(fault.type);
```

shared/functions/aborts/IsFault

```
// IsFault()
// =====
// Return TRUE if a fault is associated with an address descriptor

boolean IsFault(AddressDescriptor addrdesc)
    return addrdesc.fault.type != Fault_None;
```

shared/functions/aborts/IsSErrorInterrupt

```
// IsSErrorInterrupt()
// =====
// Returns TRUE if the abort currently being processed is an SError interrupt, and FALSE
// otherwise.

boolean IsSErrorInterrupt(Fault type)
  assert type != Fault_None;

  return (type IN {Fault_AsyncExternal, Fault_AsyncParity});

// IsSErrorInterrupt()
// =====

boolean IsSErrorInterrupt(FaultRecord fault)
  return IsSErrorInterrupt(fault.type);
```

shared/functions/aborts/IsSecondStage

```
// IsSecondStage()
// =====

boolean IsSecondStage(FaultRecord fault)
  assert fault.type != Fault_None;

  return fault.secondstage;
```

shared/functions/aborts/LSInstructionSyndrome

```
bits(11) LSInstructionSyndrome();
```

shared/functions/common/ASR

```
// ASR()
// =====

bits(N) ASR(bits(N) x, integer shift)
  assert shift >= 0;
  if shift == 0 then
    result = x;
  else
    (result, -) = ASR_C(x, shift);
  return result;
```

shared/functions/common/ASR_C

```
// ASR_C()
// =====

(bits(N), bit) ASR_C(bits(N) x, integer shift)
  assert shift > 0;
  extended_x = SignExtend(x, shift+N);
  result = extended_x<shift+N-1:shift>;
  carry_out = extended_x<shift-1>;
  return (result, carry_out);
```

shared/functions/common/Abs

```
// Abs()
// =====

integer Abs(integer x)
  return if x >= 0 then x else -x;
```



```
// Abs()
// =====

real Abs(real x)
    return if x >= 0.0 then x else -x;
```

shared/functions/common/Align

```
// Align()
// =====

integer Align(integer x, integer y)
    return y * (x DIV y);

// Align()
// =====

bits(N) Align(bits(N) x, integer y)
    return Align(UInt(x), y)<N-1:0>;
```

shared/functions/common/BitCount

```
// BitCount()
// =====

integer BitCount(bits(N) x)
    integer result = 0;
    for i = 0 to N-1
        if x<i> == '1' then
            result = result + 1;
    return result;
```

shared/functions/common/CountLeadingSignBits

```
// CountLeadingSignBits()
// =====

integer CountLeadingSignBits(bits(N) x)
    return CountLeadingZeroBits(x<N-1:1> EOR x<N-2:0>);
```

shared/functions/common/CountLeadingZeroBits

```
// CountLeadingZeroBits()
// =====

integer CountLeadingZeroBits(bits(N) x)
    return N - 1 - HighestSetBit(x);
```

shared/functions/common/Elem

```
// Elem[] - non-assignment form
// =====

bits(size) Elem[bits(N) vector, integer e, integer size]
    assert e >= 0 && (e+1)*size <= N;
    return vector<e*size+size-1 : e*size>;

// Elem[] - non-assignment form
// =====

bits(size) Elem[bits(N) vector, integer e]
    return Elem[vector, e, size];
```



```
// Elem[] - assignment form
// =====

Elem[bits(N) &vector, integer e, integer size] = bits(size) value
  assert e >= 0 && (e+1)*size <= N;
  vector<(e+1)*size-1:e*size> = value;
  return;

// Elem[] - assignment form
// =====

Elem[bits(N) &vector, integer e] = bits(size) value
  Elem[vector, e, size] = value;
  return;
```

shared/functions/common/Extend

```
// Extend()
// =====

bits(N) Extend(bits(M) x, integer N, boolean unsigned)
  return if unsigned then ZeroExtend(x, N) else SignExtend(x, N);

// Extend()
// =====

bits(N) Extend(bits(M) x, boolean unsigned)
  return Extend(x, N, unsigned);
```

shared/functions/common/HighestSetBit

```
// HighestSetBit()
// =====

integer HighestSetBit(bits(N) x)
  for i = N-1 downto 0
    if x<i> == '1' then return i;
  return -1;
```

shared/functions/common/Int

```
// Int()
// =====

integer Int(bits(N) x, boolean unsigned)
  result = if unsigned then UInt(x) else SInt(x);
  return result;
```

shared/functions/common/IsOnes

```
// IsOnes()
// =====

boolean IsOnes(bits(N) x)
  return x == Ones(N);
```

shared/functions/common/IsZero

```
// IsZero()
// =====

boolean IsZero(bits(N) x)
  return x == Zeros(N);
```

shared/functions/common/IsZeroBit

```
// IsZeroBit()
// =====

bit IsZeroBit(bits(N) x)
    return if IsZero(x) then '1' else '0';
```

shared/functions/common/LSL

```
// LSL()
// =====

bits(N) LSL(bits(N) x, integer shift)
    assert shift >= 0;
    if shift == 0 then
        result = x;
    else
        (result, -) = LSL_C(x, shift);
    return result;
```

shared/functions/common/LSL_C

```
// LSL_C()
// =====

(bits(N), bit) LSL_C(bits(N) x, integer shift)
    assert shift > 0;
    extended_x = x : Zeros(shift);
    result = extended_x<N-1:0>;
    carry_out = extended_x<N>;
    return (result, carry_out);
```

shared/functions/common/LSR

```
// LSR()
// =====

bits(N) LSR(bits(N) x, integer shift)
    assert shift >= 0;
    if shift == 0 then
        result = x;
    else
        (result, -) = LSR_C(x, shift);
    return result;
```

shared/functions/common/LSR_C

```
// LSR_C()
// =====

(bits(N), bit) LSR_C(bits(N) x, integer shift)
    assert shift > 0;
    extended_x = ZeroExtend(x, shift+N);
    result = extended_x<shift+N-1:shift>;
    carry_out = extended_x<shift-1>;
    return (result, carry_out);
```

shared/functions/common/LowestSetBit

```
// LowestSetBit()
// =====

integer LowestSetBit(bits(N) x)
```

```

for i = 0 to N-1
  if x<i> == '1' then return i;
return N;

```

shared/functions/common/Max

```

// Max()
// =====

integer Max(integer a, integer b)
  return if a >= b then a else b;

// Max()
// =====

real Max(real a, real b)
  return if a >= b then a else b;

```

shared/functions/common/Min

```

// Min()
// =====

integer Min(integer a, integer b)
  return if a <= b then a else b;

// Min()
// =====

real Min(real a, real b)
  return if a <= b then a else b;

```

shared/functions/common/NOT

```

bits(N) NOT(bits(N) x);

```

shared/functions/common/Ones

```

// Ones()
// =====

bits(N) Ones(integer N)
  return Replicate('1',N);

// Ones()
// =====

bits(N) Ones()
  return Ones(N);

```

shared/functions/common/ROR

```

// ROR()
// =====

bits(N) ROR(bits(N) x, integer shift)
  assert shift >= 0;
  if shift == 0 then
    result = x;
  else
    (result, -) = ROR_C(x, shift);
  return result;

```

shared/functions/common/ROR_C

```
// ROR_C()
// =====

(bits(N), bit) ROR_C(bits(N) x, integer shift)
    assert shift != 0;
    m = shift MOD N;
    result = LSR(x,m) OR LSL(x,N-m);
    carry_out = result<N-1>;
    return (result, carry_out);
```

shared/functions/common/Replicate

```
// Replicate()
// =====

bits(N) Replicate(bits(M) x)
    assert N MOD M == 0;
    return Replicate(x, N DIV M);

bits(M*N) Replicate(bits(M) x, integer N);
```

shared/functions/common/RoundDown

```
integer RoundDown(real x);
```

shared/functions/common/RoundTowardsZero

```
// RoundTowardsZero()
// =====

integer RoundTowardsZero(real x)
    return if x == 0.0 then 0 else if x >= 0.0 then RoundDown(x) else RoundUp(x);
```

shared/functions/common/RoundUp

```
integer RoundUp(real x);
```

shared/functions/common/SInt

```
// SInt()
// =====

integer SInt(bits(N) x)
    result = 0;
    for i = 0 to N-1
        if x<i> == '1' then result = result + 2i;
    if x<N-1> == '1' then result = result - 2N;
    return result;
```

shared/functions/common/SignExtend

```
// SignExtend()
// =====

bits(N) SignExtend(bits(M) x, integer N)
    assert N >= M;
    return Replicate(x<M-1>, N-M) : x;

// SignExtend()
// =====
```

```
bits(N) SignExtend(bits(M) x)
    return SignExtend(x, N);
```

shared/functions/common/UInt

```
// UInt()
// =====

integer UInt(bits(N) x)
    result = 0;
    for i = 0 to N-1
        if x<i> == '1' then result = result + 2i;
    return result;
```

shared/functions/common/ZeroExtend

```
// ZeroExtend()
// =====

bits(N) ZeroExtend(bits(M) x, integer N)
    assert N >= M;
    return Zeros(N-M) : x;

// ZeroExtend()
// =====

bits(N) ZeroExtend(bits(M) x)
    return ZeroExtend(x, N);
```

shared/functions/common/Zeros

```
// Zeros()
// =====

bits(N) Zeros(integer N)
    return Replicate('0', N);

// Zeros()
// =====

bits(N) Zeros()
    return Zeros(N);
```

shared/functions/crc/BitReverse

```
// BitReverse()
// =====

bits(N) BitReverse(bits(N) data)
    bits(N) result;
    for i = 0 to N-1
        result<N-i-1> = data<i>;
    return result;
```

shared/functions/crc/HaveCRCExt

```
// HaveCRCExt()
// =====

boolean HaveCRCExt()
    return HasArchVersion(ARMv8p1) || boolean IMPLEMENTATION_DEFINED "Have CRC extension";
```

shared/functions/crc/Poly32Mod2

```
// Poly32Mod2()  
// =====  
  
// Poly32Mod2 on a bitstring does a polynomial Modulus over {0,1} operation  
  
bits(32) Poly32Mod2(bits(N) data, bits(32) poly)  
    assert N > 32;  
    for i = N-1 downto 32  
        if data<i> == '1' then  
            data<i-1:0> = data<i-1:0> EOR poly:Zeros(i-32);  
    return data<31:0>;
```

shared/functions/crypto/AESInvMixColumns

```
bits(128) AESInvMixColumns(bits (128) op);
```

shared/functions/crypto/AESInvShiftRows

```
bits(128) AESInvShiftRows(bits(128) op);
```

shared/functions/crypto/AESInvSubBytes

```
bits(128) AESInvSubBytes(bits(128) op);
```

shared/functions/crypto/AESMixColumns

```
bits(128) AESMixColumns(bits (128) op);
```

shared/functions/crypto/AESShiftRows

```
bits(128) AESShiftRows(bits(128) op);
```

shared/functions/crypto/AESSubBytes

```
bits(128) AESSubBytes(bits(128) op);
```

shared/functions/crypto/HaveCryptoExt

```
boolean HaveCryptoExt();
```

shared/functions/crypto/ROL

```
// ROL()  
// =====  
  
bits(N) ROL(bits(N) x, integer shift)  
    assert shift >= 0 && shift <= N;  
    if (shift == 0) then  
        return x;  
    return ROR(x, N-shift);
```

shared/functions/crypto/SHA256hash

```
// SHA256hash()  
// =====  
  
bits(128) SHA256hash (bits (128) X, bits(128) Y, bits(128) W, boolean part1)  
    bits(32) chs, maj, t;
```

```

for e = 0 to 3
  chs = SHAchoose(Y<31:0>, Y<63:32>, Y<95:64>);
  maj = SHAmajority(X<31:0>, X<63:32>, X<95:64>);
  t = Y<127:96> + SHAhashSIGMA1(Y<31:0>) + chs + Elem[W, e, 32];
  X<127:96> = t + X<127:96>;
  Y<127:96> = t + SHAhashSIGMA0(X<31:0>) + maj;
  <Y, X> = ROL(Y : X, 32);
return (if part1 then X else Y);

```

shared/functions/crypto/SHAchoose

```

// SHAchoose()
// =====

bits(32) SHAchoose(bits(32) x, bits(32) y, bits(32) z)
  return ((y EOR z) AND x) EOR z;

```

shared/functions/crypto/SHAhashSIGMA0

```

// SHAhashSIGMA0()
// =====

bits(32) SHAhashSIGMA0(bits(32) x)
  return ROR(x, 2) EOR ROR(x, 13) EOR ROR(x, 22);

```

shared/functions/crypto/SHAhashSIGMA1

```

// SHAhashSIGMA1()
// =====

bits(32) SHAhashSIGMA1(bits(32) x)
  return ROR(x, 6) EOR ROR(x, 11) EOR ROR(x, 25);

```

shared/functions/crypto/SHAmajority

```

// SHAmajority()
// =====

bits(32) SHAmajority(bits(32) x, bits(32) y, bits(32) z)
  return ((x AND y) OR ((x OR y) AND z));

```

shared/functions/crypto/SHAparity

```

// SHAparity()
// =====

bits(32) SHAparity(bits(32) x, bits(32) y, bits(32) z)
  return (x EOR y EOR z);

```

shared/functions/exclusive/ClearExclusiveByAddress

```

// Clear the global Exclusive Monitors for all PEs EXCEPT processorid if they
// record any part of the physical address region of size bytes starting at paddress.
// It is IMPLEMENTATION DEFINED whether the global Exclusive Monitor for processorid
// is also cleared if it records any part of the address region.
ClearExclusiveByAddress(FullAddress paddress, integer processorid, integer size);

```

shared/functions/exclusive/ClearExclusiveLocal

```

// Clear the local Exclusive Monitor for the specified processorid.
ClearExclusiveLocal(integer processorid);

```

shared/functions/exclusive/ClearExclusiveMonitors

```
// ClearExclusiveMonitors()
// =====

// Clear the local Exclusive Monitor for the executing PE.

ClearExclusiveMonitors()
    ClearExclusiveLocal(ProcessorID());
```

shared/functions/exclusive/ExclusiveMonitorsStatus

```
// Returns '0' to indicate success if the last memory write by this PE was to
// the same physical address region endorsed by ExclusiveMonitorsPass().
// Returns '1' to indicate failure if address translation resulted in a different
// physical address.
bit ExclusiveMonitorsStatus();
```

shared/functions/exclusive/IsExclusiveGlobal

```
// Return TRUE if the global Exclusive Monitor for processorid includes all of
// the physical address region of size bytes starting at paddress.
boolean IsExclusiveGlobal(FullAddress paddress, integer processorid, integer size);
```

shared/functions/exclusive/IsExclusiveLocal

```
// Return TRUE if the local Exclusive Monitor for processorid includes all of
// the physical address region of size bytes starting at paddress.
boolean IsExclusiveLocal(FullAddress paddress, integer processorid, integer size);
```

shared/functions/exclusive/MarkExclusiveGlobal

```
// Record the physical address region of size bytes starting at paddress in
// the global Exclusive Monitor for processorid.
MarkExclusiveGlobal(FullAddress paddress, integer processorid, integer size);
```

shared/functions/exclusive/MarkExclusiveLocal

```
// Record the physical address region of size bytes starting at paddress in
// the local Exclusive Monitor for processorid.
MarkExclusiveLocal(FullAddress paddress, integer processorid, integer size);
```

shared/functions/exclusive/ProcessorID

```
// Return the ID of the currently executing PE.
integer ProcessorID();
```

shared/functions/extension/AArch32.HaveHPDExt

```
// AArch32.HaveHPDExt()
// =====

boolean AArch32.HaveHPDExt()
    return HasArchVersion(ARMv8p2);
```

shared/functions/extension/AArch64.HaveHPDExt

```
// AArch64.HaveHPDExt()
// =====

boolean AArch64.HaveHPDExt()
    return HasArchVersion(ARMv8p1);
```

shared/functions/extension/Have52BitPAExt

```
// Have52BitPAExt()  
// =====  
  
boolean Have52BitPAExt()  
    return HasArchVersion(ARMv8p2);
```

shared/functions/extension/Have52BitVAExt

```
// Have52BitVAExt()  
// =====  
  
boolean Have52BitVAExt()  
    return HasArchVersion(ARMv8p2);
```

shared/functions/extension/HaveAtomicExt

```
// HaveAtomicExt()  
// =====  
  
boolean HaveAtomicExt()  
    return HasArchVersion(ARMv8p1);
```

shared/functions/extension/HaveCommonNotPrivateTransExt

```
// HaveCommonNotPrivateTransExt()  
// =====  
  
boolean HaveCommonNotPrivateTransExt()  
    return HasArchVersion(ARMv8p2);
```

shared/functions/extension/HaveExtendedECDebugEvents

```
// HaveExtendedECDebugEvents()  
// =====  
  
boolean HaveExtendedECDebugEvents()  
    return HasArchVersion(ARMv8p2);
```

shared/functions/extension/HaveExtendedExecuteNeverExt

```
// HaveExtendedExecuteNeverExt()  
// =====  
  
boolean HaveExtendedExecuteNeverExt()  
    return HasArchVersion(ARMv8p2);
```

shared/functions/extension/HaveHPMDEExt

```
// HaveHPMDEExt()  
// =====  
  
boolean HaveHPMDEExt()  
    return HasArchVersion(ARMv8p1);
```

shared/functions/extension/HavePANExt

```
// HavePANExt()  
// =====  
  
boolean HavePANExt()  
    return HasArchVersion(ARMv8p1);
```

shared/functions/extension/HavePageBasedHardwareAttributes

```
// HavePageBasedHardwareAttributes()
// =====

boolean HavePageBasedHardwareAttributes()
    return HasArchVersion(ARMv8p2);
```

shared/functions/extension/HavePrivAExt

```
// HavePrivAExt()
// =====

boolean HavePrivAExt()
    return HasArchVersion(ARMv8p2);
```

shared/functions/extension/HaveQRDMLAExt

```
// HaveQRDMLAExt()
// =====

boolean HaveQRDMLAExt()
    return HasArchVersion(ARMv8p1);

boolean HaveAccessFlagUpdateExt()
    return HasArchVersion(ARMv8p1);

boolean HaveDirtyBitModifierExt()
    return HasArchVersion(ARMv8p1);
```

shared/functions/extension/HaveRASExt

```
// HaveRASExt()
// =====

boolean HaveRASExt()
    return (HasArchVersion(ARMv8p2) ||
           boolean IMPLEMENTATION_DEFINED "Has RAS extension");
```

shared/functions/extension/HaveStatisticalProfiling

```
// HaveStatisticalProfiling()
// =====

boolean HaveStatisticalProfiling()
    return HasArchVersion(ARMv8p2);
```

shared/functions/extension/HaveTrapLoadStoreMultipleDeviceExt

```
// HaveTrapLoadStoreMultipleDeviceExt()
// =====

boolean HaveTrapLoadStoreMultipleDeviceExt()
    return HasArchVersion(ARMv8p2);
```

shared/functions/extension/HaveUAOExt

```
// HaveUAOExt()
// =====

boolean HaveUAOExt()
    return HasArchVersion(ARMv8p2);
```

shared/functions/extension/HaveVirtHostExt

```
// HaveVirtHostExt()
// =====

boolean HaveVirtHostExt()
    return HasArchVersion(ARMv8p1);
```

shared/functions/float/fixedtofp/FixedToFP

```
// FixedToFP()
// =====

// Convert M-bit fixed point OP with FBITS fractional bits to
// N-bit precision floating point, controlled by UNSIGNED and ROUNDING.

bits(N) FixedToFP(bits(M) op, integer fbits, boolean unsigned, FPCRTYPE fpcr, FPRounding rounding)
    assert N IN {16,32,64};
    assert M IN {16,32,64};
    bits(N) result;
    assert fbits >= 0;
    assert rounding != FPRounding_ODD;

    // Correct signed-ness
    int_operand = Int(op, unsigned);

    // Scale by fractional bits and generate a real value
    real_operand = Real(int_operand) / 2.0^fbits;

    if real_operand == 0.0 then
        result = FPZero('0');
    else
        result = FPRound(real_operand, fpcr, rounding);

    return result;
```

shared/functions/float/fpabs/FPAbs

```
// FPAbs()
// =====

bits(N) FPAbs(bits(N) op)
    assert N IN {16,32,64};
    return '0' : op<N-2:0>;
```

shared/functions/float/fpadd/FPAdd

```
// FPAdd()
// =====

bits(N) FPAdd(bits(N) op1, bits(N) op2, FPCRTYPE fpcr)
    assert N IN {16,32,64};
    rounding = FPRoundingMode(fpcr);
    (type1,sign1,value1) = FPUnpack(op1, fpcr);
    (type2,sign2,value2) = FPUnpack(op2, fpcr);
    (done,result) = FPProcessNaNs(type1, type2, op1, op2, fpcr);
    if !done then
        inf1 = (type1 == FPTYPE_Infinity); inf2 = (type2 == FPTYPE_Infinity);
        zero1 = (type1 == FPTYPE_Zero); zero2 = (type2 == FPTYPE_Zero);
        if inf1 && inf2 && sign1 == NOT(sign2) then
            result = FPDefaultNaN();
            FPProcessException(FPExc_InvalidOp, fpcr);
        elsif (inf1 && sign1 == '0') || (inf2 && sign2 == '0') then
            result = FPInfinity('0');
        elsif (inf1 && sign1 == '1') || (inf2 && sign2 == '1') then
            result = FPInfinity('1');
```

```

    elsif zero1 && zero2 && sign1 == sign2 then
        result = FPZero(sign1);
    else
        result_value = value1 + value2;
        if result_value == 0.0 then // Sign of exact zero result depends on rounding mode
            result_sign = if rounding == FPRounding_NEGINF then '1' else '0';
            result = FPZero(result_sign);
        else
            result = FPRound(result_value, fpcr, rounding);
    return result;
  
```

shared/functions/float/fcompare/FPCompare

```

// FPCompare()
// =====

bits(4) FPCompare(bits(N) op1, bits(N) op2, boolean signal_nans, FPCRTYPE fpcr)
  assert N IN {16,32,64};
  (type1,sign1,value1) = FPUntpack(op1, fpcr);
  (type2,sign2,value2) = FPUntpack(op2, fpcr);
  if type1==FPTYPE_SNaN || type1==FPTYPE_QNaN || type2==FPTYPE_SNaN || type2==FPTYPE_QNaN then
    result = '0011';
    if type1==FPTYPE_SNaN || type2==FPTYPE_SNaN || signal_nans then
      FPProcessException(FPExc_InvalidOp, fpcr);
  else
    // All non-NaN cases can be evaluated on the values produced by FPUntpack()
    if value1 == value2 then
      result = '0110';
    elsif value1 < value2 then
      result = '1000';
    else // value1 > value2
      result = '0010';
  return result;
  
```

shared/functions/float/fcompareeq/FPCompareEQ

```

// FPCompareEQ()
// =====

boolean FPCompareEQ(bits(N) op1, bits(N) op2, FPCRTYPE fpcr)
  assert N IN {16,32,64};
  (type1,sign1,value1) = FPUntpack(op1, fpcr);
  (type2,sign2,value2) = FPUntpack(op2, fpcr);
  if type1==FPTYPE_SNaN || type1==FPTYPE_QNaN || type2==FPTYPE_SNaN || type2==FPTYPE_QNaN then
    result = FALSE;
    if type1==FPTYPE_SNaN || type2==FPTYPE_SNaN then
      FPProcessException(FPExc_InvalidOp, fpcr);
  else
    // All non-NaN cases can be evaluated on the values produced by FPUntpack()
    result = (value1 == value2);
  return result;
  
```

shared/functions/float/fcomparege/FPCompareGE

```

// FPCompareGE()
// =====

boolean FPCompareGE(bits(N) op1, bits(N) op2, FPCRTYPE fpcr)
  assert N IN {16,32,64};
  (type1,sign1,value1) = FPUntpack(op1, fpcr);
  (type2,sign2,value2) = FPUntpack(op2, fpcr);
  if type1==FPTYPE_SNaN || type1==FPTYPE_QNaN || type2==FPTYPE_SNaN || type2==FPTYPE_QNaN then
    result = FALSE;
    FPProcessException(FPExc_InvalidOp, fpcr);
  else
  
```

```

    // All non-NaN cases can be evaluated on the values produced by FPUunpack()
    result = (value1 >= value2);
  return result;

```

shared/functions/float/fcomparegt/FPCompareGT

```

// FPCompareGT()
// =====

boolean FPCompareGT(bits(N) op1, bits(N) op2, FPCRTYPE fpcr)
  assert N IN {16,32,64};
  (type1,sign1,value1) = FPUunpack(op1, fpcr);
  (type2,sign2,value2) = FPUunpack(op2, fpcr);
  if type1==FPTYPE_SNaN || type1==FPTYPE_QNaN || type2==FPTYPE_SNaN || type2==FPTYPE_QNaN then
    result = FALSE;
    FPPROCESSException(FPEXC_InvalidOp, fpcr);
  else
    // All non-NaN cases can be evaluated on the values produced by FPUunpack()
    result = (value1 > value2);
  return result;

```

shared/functions/float/fpconvert/FPConvert

```

// FPConvert()
// =====

// Convert floating point OP with N-bit precision to M-bit precision,
// with rounding controlled by ROUNDING.
// This is used by the FP-to-FP conversion instructions and so for
// half-precision data ignores FZ16, but observes AHP.

bits(M) FPConvert(bits(N) op, FPCRTYPE fpcr, FPROUNDING rounding)
  assert M IN {16,32,64};
  assert N IN {16,32,64};
  bits(M) result;

  // Unpack floating-point operand optionally with flush-to-zero.
  (type,sign,value) = FPUunpackCV(op, fpcr);

  alt_hp = (M == 16) && (fpcr.AHP == '1');

  if type == FPTYPE_SNaN || type == FPTYPE_QNaN then
    if alt_hp then
      result = FPZero(sign);
    elseif fpcr.DN == '1' then
      result = FPDefaultNaN();
    else
      result = FPConvertNaN(op);
    if type == FPTYPE_SNaN || alt_hp then
      FPPROCESSException(FPEXC_InvalidOp, fpcr);
  elseif type == FPTYPE_Infinity then
    if alt_hp then
      result = sign:Ones(M-1);
      FPPROCESSException(FPEXC_InvalidOp, fpcr);
    else
      result = FPinfinity(sign);
  elseif type == FPTYPE_Zero then
    result = FPZero(sign);
  else
    result = FPRoundCV(value, fpcr, rounding);
  return result;

// FPConvert()
// =====

```

```
bits(M) FPConvert(bits(N) op, FPCRType fpcr)
    return FPConvert(op, fpcr, FPRoundingMode(fpcr));
```

shared/functions/float/fpconvertnan/FPConvertNaN

```
// FPConvertNaN()
// =====

// Converts a NaN of one floating-point type to another

bits(M) FPConvertNaN(bits(N) op)
    assert N IN {16,32,64};
    assert M IN {16,32,64};
    bits(M) result;
    bits(51) frac;

    sign = op<N-1>;

    // Unpack payload from input NaN
    case N of
        when 64 frac = op<50:0>;
        when 32 frac = op<21:0>:Zeros(29);
        when 16 frac = op<8:0>:Zeros(42);

    // Repack payload into output NaN, while
    // converting an SNaN to a QNaN.
    case M of
        when 64 result = sign:Ones(M-52):frac;
        when 32 result = sign:Ones(M-23):frac<50:29>;
        when 16 result = sign:Ones(M-10):frac<50:42>;

    return result;
```

shared/functions/float/fpcrtype/FPCRType

```
type FPCRType;
```

shared/functions/float/fpdecoderm/FPDecodeRM

```
// FPDecodeRM()
// =====

// Decode most common AArch32 floating-point rounding encoding.

FPRounding FPDecodeRM(bits(2) rm)
    case rm of
        when '00' return FPRounding_TIEAWAY; // A
        when '01' return FPRounding_TIEEVEN; // N
        when '10' return FPRounding_POSINF; // P
        when '11' return FPRounding_NEGINF; // M
```

shared/functions/float/fpdecoderounding/FPDecodeRounding

```
// FPDecodeRounding()
// =====

// Decode floating-point rounding mode and common AArch64 encoding.

FPRounding FPDecodeRounding(bits(2) rmode)
    case rmode of
        when '00' return FPRounding_TIEEVEN; // N
        when '01' return FPRounding_POSINF; // P
        when '10' return FPRounding_NEGINF; // M
        when '11' return FPRounding_ZERO; // Z
```

shared/functions/float/fpdefaultnan/FPDefaultNaN

```
// FPDefaultNaN()
// =====

bits(N) FPDefaultNaN()
  assert N IN {16,32,64};
  constant integer E = (if N == 16 then 5 elsif N == 32 then 8 else 11);
  constant integer F = N - E - 1;
  sign = '0';
  exp = Ones(E);
  frac = '1':Zeros(F-1);
  return sign : exp : frac;
```

shared/functions/float/fpdiv/FPDiv

```
// FPDiv()
// =====

bits(N) FPDiv(bits(N) op1, bits(N) op2, FPCRTYPE fpcr)
  assert N IN {16,32,64};
  (type1,sign1,value1) = FPUnpack(op1, fpcr);
  (type2,sign2,value2) = FPUnpack(op2, fpcr);
  (done,result) = FPProcessNaNs(type1, type2, op1, op2, fpcr);
  if !done then
    inf1 = (type1 == FPTYPE_Infinity);
    inf2 = (type2 == FPTYPE_Infinity);
    zero1 = (type1 == FPTYPE_Zero);
    zero2 = (type2 == FPTYPE_Zero);
    if (inf1 && inf2) || (zero1 && zero2) then
      result = FPDefaultNaN();
      FPProcessException(FPEXC_InvalidOp, fpcr);
    elsif inf1 || zero2 then
      result = FPInfinity(sign1 EOR sign2);
      if !inf1 then FPProcessException(FPEXC_DivideByZero, fpcr);
    elsif zero1 || inf2 then
      result = FPZero(sign1 EOR sign2);
    else
      result = FPRound(value1/value2, fpcr);
  return result;
```

shared/functions/float/fpexc/FPEXC

```
enumeration FPEXC      {FPEXC_InvalidOp, FPEXC_DivideByZero, FPEXC_Overflow,
                       FPEXC_Underflow, FPEXC_Inexact, FPEXC_InputDenorm};
```

shared/functions/float/fpinfinity/FPInfinity

```
// FPInfinity()
// =====

bits(N) FPInfinity(bit sign)
  assert N IN {16,32,64};
  constant integer E = (if N == 16 then 5 elsif N == 32 then 8 else 11);
  constant integer F = N - E - 1;
  exp = Ones(E);
  frac = Zeros(F);
  return sign : exp : frac;
```

shared/functions/float/fpmax/FPMax

```
// FPMax()
// =====

bits(N) FPMax(bits(N) op1, bits(N) op2, FPCRTYPE fpcr)
```

```
assert N IN {16,32,64};
(type1,sign1,value1) = FPUnpack(op1, fpcr);
(type2,sign2,value2) = FPUnpack(op2, fpcr);
(done,result) = FPProcessNaNs(type1, type2, op1, op2, fpcr);
if !done then
  if value1 > value2 then
    (type,sign,value) = (type1,sign1,value1);
  else
    (type,sign,value) = (type2,sign2,value2);
  if type == FPType_Infinity then
    result = FPInfinity(sign);
  elseif type == FPType_Zero then
    sign = sign1 AND sign2; // Use most positive sign
    result = FPZero(sign);
  else
    result = FPRound(value, fpcr);
return result;
```

shared/functions/float/fpmaxnormal/FMaxNormal

```
// FMaxNormal()
// =====

bits(N) FMaxNormal(bit sign)
assert N IN {16,32,64};
constant integer E = (if N == 16 then 5 elsif N == 32 then 8 else 11);
constant integer F = N - E - 1;
exp = Ones(E-1):'0';
frac = Ones(F);
return sign : exp : frac;
```

shared/functions/float/fpmaxnum/FMaxNum

```
// FMaxNum()
// =====

bits(N) FMaxNum(bits(N) op1, bits(N) op2, FPCRTYPE fpcr)
assert N IN {16,32,64};
(type1,-,-) = FPUnpack(op1, fpcr);
(type2,-,-) = FPUnpack(op2, fpcr);

// treat a single quiet-NaN as -Infinity
if type1 == FPType_QNaN && type2 != FPType_QNaN then
  op1 = FPInfinity('1');
elseif type1 != FPType_QNaN && type2 == FPType_QNaN then
  op2 = FPInfinity('1');

return FMax(op1, op2, fpcr);
```

shared/functions/float/fpmin/FMin

```
// FMin()
// =====

bits(N) FMin(bits(N) op1, bits(N) op2, FPCRTYPE fpcr)
assert N IN {16,32,64};
(type1,sign1,value1) = FPUnpack(op1, fpcr);
(type2,sign2,value2) = FPUnpack(op2, fpcr);
(done,result) = FPProcessNaNs(type1, type2, op1, op2, fpcr);
if !done then
  if value1 < value2 then
    (type,sign,value) = (type1,sign1,value1);
  else
    (type,sign,value) = (type2,sign2,value2);
  if type == FPType_Infinity then
    result = FPInfinity(sign);
```



```

    elsif type == FPType_Zero then
        sign = sign1 OR sign2; // Use most negative sign
        result = FPZero(sign);
    else
        result = FPRound(value, fpcr);
    return result;
  
```

shared/functions/float/fpminnum/FPMinNum

```

// FPMinNum()
// =====

bits(N) FPMinNum(bits(N) op1, bits(N) op2, FPCRTYPE fpcr)
  assert N IN {16,32,64};
  (type1,-,-) = FPUunpack(op1, fpcr);
  (type2,-,-) = FPUunpack(op2, fpcr);

  // Treat a single quiet-NaN as +Infinity
  if type1 == FPType_QNaN && type2 != FPType_QNaN then
    op1 = FPinfinity('0');
  elsif type1 != FPType_QNaN && type2 == FPType_QNaN then
    op2 = FPinfinity('0');

  return FPMIn(op1, op2, fpcr);
  
```

shared/functions/float/fpmul/FPMul

```

// FPMul()
// =====

bits(N) FPMul(bits(N) op1, bits(N) op2, FPCRTYPE fpcr)
  assert N IN {16,32,64};
  (type1,sign1,value1) = FPUunpack(op1, fpcr);
  (type2,sign2,value2) = FPUunpack(op2, fpcr);
  (done,result) = FPProcessNaNs(type1, type2, op1, op2, fpcr);
  if !done then
    inf1 = (type1 == FPType_Infinity);
    inf2 = (type2 == FPType_Infinity);
    zero1 = (type1 == FPType_Zero);
    zero2 = (type2 == FPType_Zero);
    if (inf1 && zero2) || (zero1 && inf2) then
      result = FPDefaultNaN();
      FPProcessException(FPExc_InvalidOp, fpcr);
    elsif inf1 || inf2 then
      result = FPinfinity(sign1 EOR sign2);
    elsif zero1 || zero2 then
      result = FPZero(sign1 EOR sign2);
    else
      result = FPRound(value1*value2, fpcr);
  return result;
  
```

shared/functions/float/fpmuladd/FPMulAdd

```

// FPMulAdd()
// =====
//
// Calculates addend + op1*op2 with a single rounding.

bits(N) FPMulAdd(bits(N) addend, bits(N) op1, bits(N) op2, FPCRTYPE fpcr)
  assert N IN {16,32,64};
  rounding = FPRoundingMode(fpcr);
  (typeA,signA,valueA) = FPUunpack(addend, fpcr);
  (type1,sign1,value1) = FPUunpack(op1, fpcr);
  (type2,sign2,value2) = FPUunpack(op2, fpcr);
  inf1 = (type1 == FPType_Infinity); zero1 = (type1 == FPType_Zero);
  inf2 = (type2 == FPType_Infinity); zero2 = (type2 == FPType_Zero);
  
```

```

(done,result) = FPProcessNaNs3(typeA, type1, type2, addend, op1, op2, fpcr);

if typeA == FPType_QNaN && ((inf1 && zero2) || (zero1 && inf2)) then
  result = FPDefaultNaN();
  FPProcessException(FPExc_InvalidOp, fpcr);

if !done then
  infA = (typeA == FPType_Infinity); zeroA = (typeA == FPType_Zero);

  // Determine sign and type product will have if it does not cause an Invalid
  // Operation.
  signP = sign1 EOR sign2;
  infP = inf1 || inf2;
  zeroP = zero1 || zero2;

  // Non SNaN-generated Invalid Operation cases are multiplies of zero by infinity and
  // additions of opposite-signed infinities.
  if (inf1 && zero2) || (zero1 && inf2) || (infA && infP && signA != signP) then
    result = FPDefaultNaN();
    FPProcessException(FPExc_InvalidOp, fpcr);

  // Other cases involving infinities produce an infinity of the same sign.
  elsif (infA && signA == '0') || (infP && signP == '0') then
    result = FPInfinity('0');
  elsif (infA && signA == '1') || (infP && signP == '1') then
    result = FPInfinity('1');

  // Cases where the result is exactly zero and its sign is not determined by the
  // rounding mode are additions of same-signed zeros.
  elsif zeroA && zeroP && signA == signP then
    result = FPZero(signA);

  // Otherwise calculate numerical result and round it.
  else
    result_value = valueA + (value1 * value2);
    if result_value == 0.0 then // Sign of exact zero result depends on rounding mode
      result_sign = if rounding == FPRounding_NEGINF then '1' else '0';
      result = FPZero(result_sign);
    else
      result = FPRound(result_value, fpcr);

return result;

```

shared/functions/float/fpmulx/FPMuIX

```

// FPMuIX()
// =====

bits(N) FPMuIX(bits(N) op1, bits(N) op2, FPCRTYPE fpcr)
  assert N IN {16,32,64};
  bits(N) result;
  (type1,sign1,value1) = FPUntpack(op1, fpcr);
  (type2,sign2,value2) = FPUntpack(op2, fpcr);
  (done,result) = FPProcessNaNs(type1, type2, op1, op2, fpcr);
  if !done then
    inf1 = (type1 == FPType_Infinity);
    inf2 = (type2 == FPType_Infinity);
    zero1 = (type1 == FPType_Zero);
    zero2 = (type2 == FPType_Zero);
    if (inf1 && zero2) || (zero1 && inf2) then
      result = FPTwo(sign1 EOR sign2);
    elsif inf1 || inf2 then
      result = FPInfinity(sign1 EOR sign2);
    elsif zero1 || zero2 then
      result = FPZero(sign1 EOR sign2);

```

```

    else
      result = FPRound(value1*value2, fpcr);
    return result;
  
```

shared/functions/float/fpneg/FPNeg

```

// FPNeg()
// =====

bits(N) FPNeg(bits(N) op)
  assert N IN {16,32,64};
  return NOT(op<N-1>) : op<N-2:0>;
  
```

shared/functions/float/fponepointfive/FPOnePointFive

```

// FPOnePointFive()
// =====

bits(N) FPOnePointFive(bit sign)
  assert N IN {16,32,64};
  constant integer E = (if N == 16 then 5 elsif N == 32 then 8 else 11);
  constant integer F = N - E - 1;
  exp = '0':Ones(E-1);
  frac = '1':Zeros(F-1);
  return sign : exp : frac;
  
```

shared/functions/float/fpprocessexception/FPPProcessException

```

// FPPProcessException()
// =====
//
// The 'fpcr' argument supplies FPCR control bits. Status information is
// updated directly in the FPSR where appropriate.

FPPProcessException(FPExc exception, FPCRTYPE fpcr)
  // Determine the cumulative exception bit number
  case exception of
    when FPExc_InvalidOp      cumul = 0;
    when FPExc_DivideByZero   cumul = 1;
    when FPExc_Overflow       cumul = 2;
    when FPExc_Underflow     cumul = 3;
    when FPExc_Inexact       cumul = 4;
    when FPExc_InputDenorm   cumul = 7;
  enable = cumul + 8;
  if fpcr<enable> == '1' then
    // Trapping of the exception enabled.
    // It is IMPLEMENTATION DEFINED whether the enable bit may be set at all, and
    // if so then how exceptions may be accumulated before calling FPTrapException()
    IMPLEMENTATION_DEFINED "floating-point trap handling";
  elsif UsingAArch32() then
    // Set the cumulative exception bit
    FPSCR<cumul> = '1';
  else
    // Set the cumulative exception bit
    FPSR<cumul> = '1';
  return;
  
```

shared/functions/float/fpprocessnan/FPProcessNaN

```

// FPProcessNaN()
// =====

bits(N) FPProcessNaN(FPTYPE type, bits(N) op, FPCRTYPE fpcr)
  assert N IN {16,32,64};
  assert type IN {FPTYPE_QNaN, FPTYPE_SNaN};
  
```

```
case N of
    when 16 topfrac = 9;
    when 32 topfrac = 22;
    when 64 topfrac = 51;

result = op;
if type == FPType_SNaN then
    result<topfrac> = '1';
    FPPProcessException(FPExc_InvalidOp, fpcr);
if fpcr.DN == '1' then // DefaultNaN requested
    result = FPDefaultNaN();
return result;
```

shared/functions/float/fpprocessnans/FPPProcessNaNs

```
// FPPProcessNaNs()
// =====
//
// The boolean part of the return value says whether a NaN has been found and
// processed. The bits(N) part is only relevant if it has and supplies the
// result of the operation.
//
// The 'fpcr' argument supplies FPCR control bits. Status information is
// updated directly in the FPSR where appropriate.

(boolean, bits(N)) FPPProcessNaNs(FPType type1, FPType type2,
                                   bits(N) op1, bits(N) op2,
                                   FPCRTYPE fpcr)

assert N IN {16,32,64};
if type1 == FPType_SNaN then
    done = TRUE; result = FPPProcessNaN(type1, op1, fpcr);
elseif type2 == FPType_SNaN then
    done = TRUE; result = FPPProcessNaN(type2, op2, fpcr);
elseif type1 == FPType_QNaN then
    done = TRUE; result = FPPProcessNaN(type1, op1, fpcr);
elseif type2 == FPType_QNaN then
    done = TRUE; result = FPPProcessNaN(type2, op2, fpcr);
else
    done = FALSE; result = Zeros(); // 'Don't care' result
return (done, result);
```

shared/functions/float/fpprocessnans3/FPPProcessNaNs3

```
// FPPProcessNaNs3()
// =====
//
// The boolean part of the return value says whether a NaN has been found and
// processed. The bits(N) part is only relevant if it has and supplies the
// result of the operation.
//
// The 'fpcr' argument supplies FPCR control bits. Status information is
// updated directly in the FPSR where appropriate.

(boolean, bits(N)) FPPProcessNaNs3(FPType type1, FPType type2, FPType type3,
                                   bits(N) op1, bits(N) op2, bits(N) op3,
                                   FPCRTYPE fpcr)

assert N IN {16,32,64};
if type1 == FPType_SNaN then
    done = TRUE; result = FPPProcessNaN(type1, op1, fpcr);
elseif type2 == FPType_SNaN then
    done = TRUE; result = FPPProcessNaN(type2, op2, fpcr);
elseif type3 == FPType_SNaN then
    done = TRUE; result = FPPProcessNaN(type3, op3, fpcr);
elseif type1 == FPType_QNaN then
    done = TRUE; result = FPPProcessNaN(type1, op1, fpcr);
```

```

elseif type2 == FPType_QNaN then
  done = TRUE; result = FPProcessNaN(type2, op2, fpcr);
elseif type3 == FPType_QNaN then
  done = TRUE; result = FPProcessNaN(type3, op3, fpcr);
else
  done = FALSE; result = Zeros(); // 'Don't care' result
return (done, result);

```

shared/functions/float/fpreciestimate/FPRecipEstimate

```

// FPRecipEstimate()
// =====

bits(N) FPRecipEstimate(bits(N) operand, FPCRType fpcr)
  assert N IN {16,32,64};
  (type,sign,value) = FPUntpack(operand, fpcr);
  if type == FPType_SNaN || type == FPType_QNaN then
    result = FPProcessNaN(type, operand, fpcr);
  elseif type == FPType_Infinity then
    result = FPZero(sign);
  elseif type == FPType_Zero then
    result = FPIInfinity(sign);
    FPProcessException(FPExc_DivideByZero, fpcr);
  elseif (
    (N == 16 && Abs(value) < 2.0^-16) ||
    (N == 32 && Abs(value) < 2.0^-128) ||
    (N == 64 && Abs(value) < 2.0^-1024)
  ) then
    case FPRoundingMode(fpcr) of
      when FPRounding_TIEEVEN
        overflow_to_inf = TRUE;
      when FPRounding_POSINF
        overflow_to_inf = (sign == '0');
      when FPRounding_NEGINF
        overflow_to_inf = (sign == '1');
      when FPRounding_ZERO
        overflow_to_inf = FALSE;
    result = if overflow_to_inf then FPIInfinity(sign) else FPMMaxNormal(sign);
    FPProcessException(FPExc_Overflow, fpcr);
    FPProcessException(FPExc_Inexact, fpcr);
  elseif ((fpcr.FZ == '1' && N != 16) || (fpcr.FZ16 == '1' && N == 16))
    && (
      (N == 16 && Abs(value) >= 2.0^14) ||
      (N == 32 && Abs(value) >= 2.0^126) ||
      (N == 64 && Abs(value) >= 2.0^1022)
    ) then
    // Result flushed to zero of correct sign
    result = FPZero(sign);
    if UsingAArch32() then
      FPSR.UFC = '1';
    else
      FPSR.UFC = '1';
  else
    // Scale to a double-precision value in the range 0.5 <= x < 1.0, and
    // calculate result exponent. Scaled value has copied sign bit,
    // exponent = 1022 = double-precision biased version of -1,
    // fraction = original fraction extended with zeros.
    case N of
      when 16
        fraction = operand<9:0> : Zeros(42);
        exp = UInt(operand<14:10>);
      when 32
        fraction = operand<22:0> : Zeros(29);
        exp = UInt(operand<30:23>);
      when 64
        fraction = operand<51:0>;
        exp = UInt(operand<62:52>);

```

```

if exp == 0 then
  if fraction<51> == 0 then
    exp = -1;
    fraction = fraction<49:0>:'00';
  else
    fraction = fraction<50:0>:'0';

scaled = '0' : '0111111110' : fraction<51:44> : Zeros(44);

case N of
  when 16 result_exp = 29 - exp; // In range 29-30 = -1 to 29+1 = 30
  when 32 result_exp = 253 - exp; // In range 253-254 = -1 to 253+1 = 254
  when 64 result_exp = 2045 - exp; // In range 2045-2046 = -1 to 2045+1 = 2046

// Call C function to get reciprocal estimate of scaled value.
// Input is rounded down to a multiple of 1/512.
estimate = recip_estimate(scaled);

// Result is double-precision and a multiple of 1/256 in the range 1 to 511/256.
// Convert to scaled single-precision result with copied sign bit and high-order
// fraction bits, and exponent calculated above.

fraction = estimate<51:0>;
if result_exp == 0 then
  fraction = '1' : fraction<51:1>;
elseif result_exp == -1 then
  fraction = '01' : fraction<51:2>;
  result_exp = 0;

case N of
  when 16 result = sign : result_exp<N-12:0> : fraction<51:42>;
  when 32 result = sign : result_exp<N-25:0> : fraction<51:29>;
  when 64 result = sign : result_exp<N-54:0> : fraction<51:0>;

return result;

```

shared/functions/float/fprecpX/FPRecpX

```

// FPRecpX()
// =====

bits(N) FPRecpX(bits(N) op, FPCRTType fpcr)
  assert N IN {16,32,64};

case N of
  when 16 esize = 5;
  when 32 esize = 8;
  when 64 esize = 11;

bits(N)      result;
bits(esize)  exp;
bits(esize)  max_exp;
bits(N-esize-1) frac = Zeros();

case N of
  when 16 exp = op<10+esize-1:10>;
  when 32 exp = op<23+esize-1:23>;
  when 64 exp = op<52+esize-1:52>;

max_exp = Ones(esize) - 1;

(type,sign,value) = FPUnpack(op, fpcr);
if type == FPTType_SNaN || type == FPTType_QNaN then
  result = FPPProcessNaN(type, op, fpcr);
else
  if IsZero(exp) then // Zero and denormals

```

```

    result = sign:max_exp:frac;
  else // Infinities and normals
    result = sign:NOT(exp):frac;

  return result;

```

shared/functions/float/fpround/FPRound

```

// FPRound()
// =====
// Used by data processing and int/fixed <-> FP conversion instructions.
// For half-precision data it ignores AHP, and observes FZ16.

bits(N) FPRound(real op, FPCRTType fpcr, FPRounding rounding)
  fpcr.AHP = '0';
  return FPRoundBase(op, fpcr, rounding);

// Convert a real number OP into an N-bit floating-point value using the
// supplied rounding mode RMODE.

bits(N) FPRoundBase(real op, FPCRTType fpcr, FPRounding rounding)
  assert N IN {16,32,64};
  assert op != 0.0;
  assert rounding != FPRounding_TIEAWAY;
  bits(N) result;

  // Obtain format parameters - minimum exponent, numbers of exponent and fraction bits.
  if N == 16 then
    minimum_exp = -14; E = 5; F = 10;
  elseif N == 32 then
    minimum_exp = -126; E = 8; F = 23;
  else // N == 64
    minimum_exp = -1022; E = 11; F = 52;

  // Split value into sign, unrounded mantissa and exponent.
  if op < 0.0 then
    sign = '1'; mantissa = -op;
  else
    sign = '0'; mantissa = op;
  exponent = 0;
  while mantissa < 1.0 do
    mantissa = mantissa * 2.0; exponent = exponent - 1;
  while mantissa >= 2.0 do
    mantissa = mantissa / 2.0; exponent = exponent + 1;

  // Deal with flush-to-zero.
  if ((fpcr.FZ == '1' && N != 16) || (fpcr.FZ16 == '1' && N == 16)) && exponent < minimum_exp then
    // Flush-to-zero never generates a trapped exception
    if UsingAArch32() then
      FPSCR.UFC = '1';
    else
      FPSR.UFC = '1';
    return FPZero(sign);

  // Start creating the exponent value for the result. Start by biasing the actual exponent
  // so that the minimum exponent becomes 1, lower values 0 (indicating possible underflow).
  biased_exp = Max(exponent - minimum_exp + 1, 0);
  if biased_exp == 0 then mantissa = mantissa / 2.0^(minimum_exp - exponent);

  // Get the unrounded mantissa as an integer, and the "units in last place" rounding error.
  int_mant = RoundDown(mantissa * 2.0^F); // < 2.0^F if biased_exp == 0, >= 2.0^F if not
  error = mantissa * 2.0^F - Real(int_mant);

  // Underflow occurs if exponent is too small before rounding, and result is inexact or
  // the Underflow exception is trapped.
  if biased_exp == 0 && (error != 0.0 || fpcr.UFE == '1') then
    FPProcessException(FPExc_Underflow, fpcr);

```

```

// Round result according to rounding mode.
case rounding of
  when FPRounding_TIEEVEN
    round_up = (error > 0.5 || (error == 0.5 && int_mant<0> == '1'));
    overflow_to_inf = TRUE;
  when FPRounding_POSINF
    round_up = (error != 0.0 && sign == '0');
    overflow_to_inf = (sign == '0');
  when FPRounding_NEGINF
    round_up = (error != 0.0 && sign == '1');
    overflow_to_inf = (sign == '1');
  when FPRounding_ZERO, FPRounding_ODD
    round_up = FALSE;
    overflow_to_inf = FALSE;

if round_up then
  int_mant = int_mant + 1;
  if int_mant == 2^F then // Rounded up from denormalized to normalized
    biased_exp = 1;
  if int_mant == 2^(F+1) then // Rounded up to next exponent
    biased_exp = biased_exp + 1; int_mant = int_mant DIV 2;

// Handle rounding to odd aka Von Neumann rounding
if error != 0.0 && rounding == FPRounding_ODD then
  int_mant<0> = '1';

// Deal with overflow and generate result.
if N != 16 || fpcr.AHP == '0' then // Single, double or IEEE half precision
  if biased_exp >= 2^E - 1 then
    result = if overflow_to_inf then FPInfinity(sign) else FPMMaxNormal(sign);
    FPPProcessException(FPExc_Overflow, fpcr);
    error = 1.0; // Ensure that an Inexact exception occurs
  else
    result = sign : biased_exp<N-F-2:0> : int_mant<F-1:0>;
else // Alternative half precision
  if biased_exp >= 2^E then
    result = sign : Ones(N-1);
    FPPProcessException(FPExc_InvalidOp, fpcr);
    error = 0.0; // Ensure that an Inexact exception does not occur
  else
    result = sign : biased_exp<N-F-2:0> : int_mant<F-1:0>;

// Deal with Inexact exception.
if error != 0.0 then
  FPPProcessException(FPExc_Inexact, fpcr);

return result;

// FPRound()
// =====

bits(N) FPRound(real op, FPCRTYPE fpcr)
  return FPRound(op, fpcr, FPRoundingMode(fpcr));

```

shared/functions/float/fpround/FPRoundCV

```

// FPRoundCV()
// =====
// Used for FP <-> FP conversion instructions.
// For half-precision data ignores FZ16 and observes AHP.

bits(N) FPRoundCV(real op, FPCRTYPE fpcr, FPRounding rounding)
  fpcr.FZ16 = '0';
  return FPRoundBase(op, fpcr, rounding);

```

shared/functions/float/fprounding/FP Rounding

```
enumeration FP Rounding {FP Rounding_TIEEVEN, FP Rounding_POSINF,
                        FP Rounding_NEGINF, FP Rounding_ZERO,
                        FP Rounding_TIEAWAY, FP Rounding_ODD};
```

shared/functions/float/fproundingmode/FP Rounding Mode

```
// FP Rounding Mode()
// =====

// Return the current floating-point rounding mode.

FP Rounding FP Rounding Mode(FPCRType fpcr)
    return FP Decode Rounding(fpcr.RMode);
```

shared/functions/float/fproundint/FP Round Int

```
// FP Round Int()
// =====

// Round OP to nearest integral floating point value using rounding mode ROUNDING.
// If EXACT is TRUE, set FPSR.IXC if result is not numerically equal to OP.

bits(N) FP Round Int(bits(N) op, FPCRType fpcr, FP Rounding rounding, boolean exact)
    assert rounding != FP Rounding_ODD;
    assert N IN {16,32,64};

    // Unpack using FPCR to determine if subnormals are flushed-to-zero
    (type,sign,value) = FP Unpack(op, fpcr);

    if type == FPType_SNaN || type == FPType_QNaN then
        result = FP Process NaN(type, op, fpcr);
    elseif type == FPType_Infinity then
        result = FP Infinity(sign);
    elseif type == FPType_Zero then
        result = FP Zero(sign);
    else
        // extract integer component
        int_result = Round Down(value);
        error = value - Real(int_result);

        // Determine whether supplied rounding mode requires an increment
        case rounding of
            when FP Rounding_TIEEVEN
                round_up = (error > 0.5 || (error == 0.5 && int_result<0> == '1'));
            when FP Rounding_POSINF
                round_up = (error != 0.0);
            when FP Rounding_NEGINF
                round_up = FALSE;
            when FP Rounding_ZERO
                round_up = (error != 0.0 && int_result < 0);
            when FP Rounding_TIEAWAY
                round_up = (error > 0.5 || (error == 0.5 && int_result >= 0));

        if round_up then int_result = int_result + 1;

        // Convert integer value into an equivalent real value
        real_result = Real(int_result);

        // Re-encode as a floating-point value, result is always exact
        if real_result == 0.0 then
            result = FP Zero(sign);
        else
            result = FP Round(real_result, fpcr, FP Rounding_ZERO);
```

```

    // Generate inexact exceptions
    if error != 0.0 && exact then
        FPProcessException(FPExc_Inexact, fpcr);

return result;

```

shared/functions/float/fprsqrtestimate/FPRSqrtEstimate

```

// FPRSqrtEstimate()
// =====

bits(N) FPRSqrtEstimate(bits(N) operand, FPCRTYPE fpcr)
    assert N IN {16,32,64};
    (type,sign,value) = FPUnpack(operand, fpcr);
    if type == FPTYPE_SNaN || type == FPTYPE_QNaN then
        result = FPProcessNaN(type, operand, fpcr);
    elseif type == FPTYPE_Zero then
        result = FPInfinity(sign);
        FPProcessException(FPExc_DivideByZero, fpcr);
    elseif sign == '1' then
        result = FPDefaultNaN();
        FPProcessException(FPExc_InvalidOp, fpcr);
    elseif type == FPTYPE_Infinity then
        result = FPZero('0');
    else
        // Scale to a double-precision value in the range 0.25 <= x < 1.0, with the
        // evenness or oddness of the exponent unchanged, and calculate result exponent.
        // Scaled value has copied sign bit, exponent = 1022 or 1021 = double-precision
        // biased version of -1 or -2, fraction = original fraction extended with zeros.

        case N of
            when 16
                fraction = operand<9:0> : Zeros(42);
                exp = UInt(operand<14:10>);
            when 32
                fraction = operand<22:0> : Zeros(29);
                exp = UInt(operand<30:23>);
            when 64
                fraction = operand<51:0>;
                exp = UInt(operand<62:52>);

        if exp == 0 then
            while fraction<51> == 0 do
                fraction = fraction<50:0> : '0';
                exp = exp - 1;
            fraction = fraction<50:0> : '0';

        if exp<0> == '0' then
            scaled = '0' : '0111111110' : fraction<51:44> : Zeros(44);
        else
            scaled = '0' : '01111111101' : fraction<51:44> : Zeros(44);

        case N of
            when 16 result_exp = ( 44 - exp) DIV 2;
            when 32 result_exp = ( 380 - exp) DIV 2;
            when 64 result_exp = (3068 - exp) DIV 2;

        // Call C function to get reciprocal estimate of scaled value.
        estimate = recip_sqrt_estimate(scaled);

        // Result is double-precision and a multiple of 1/256 in the range 1 to 511/256.
        // Convert to scaled single-precision result with copied sign bit and high-order
        // fraction bits, and exponent calculated above.
        case N of
            when 16 result = '0' : result_exp<N-12:0> : estimate<51:42>;

```

```

    when 32 result = '0' : result_exp<N-25:0> : estimate<51:29>;
    when 64 result = '0' : result_exp<N-54:0> : estimate<51:0>;
  return result;

```

shared/functions/float/fpsqrt/FPSqrt

```

// FPSqrt()
// =====

bits(N) FPSqrt(bits(N) op, FPCRType fpcr)
  assert N IN {16,32,64};
  (type,sign,value) = FPUnpack(op, fpcr);
  if type == FPType_SNaN || type == FPType_QNaN then
    result = FPProcessNaN(type, op, fpcr);
  elseif type == FPType_Zero then
    result = FPZero(sign);
  elseif type == FPType_Infinity && sign == '0' then
    result = FPInfinity(sign);
  elseif sign == '1' then
    result = FPDefaultNaN();
    FPProcessException(FPExc_InvalidOp, fpcr);
  else
    result = FPRound(Sqrt(value), fpcr);
  return result;

```

shared/functions/float/fpsub/FPSub

```

// FPSub()
// =====

bits(N) FPSub(bits(N) op1, bits(N) op2, FPCRType fpcr)
  assert N IN {16,32,64};
  rounding = FPRoundingMode(fpcr);
  (type1,sign1,value1) = FPUnpack(op1, fpcr);
  (type2,sign2,value2) = FPUnpack(op2, fpcr);
  (done,result) = FPProcessNaNs(type1, type2, op1, op2, fpcr);
  if !done then
    inf1 = (type1 == FPType_Infinity);
    inf2 = (type2 == FPType_Infinity);
    zero1 = (type1 == FPType_Zero);
    zero2 = (type2 == FPType_Zero);
    if inf1 && inf2 && sign1 == sign2 then
      result = FPDefaultNaN();
      FPProcessException(FPExc_InvalidOp, fpcr);
    elseif (inf1 && sign1 == '0') || (inf2 && sign2 == '1') then
      result = FPInfinity('0');
    elseif (inf1 && sign1 == '1') || (inf2 && sign2 == '0') then
      result = FPInfinity('1');
    elseif zero1 && zero2 && sign1 == NOT(sign2) then
      result = FPZero(sign1);
    else
      result_value = value1 - value2;
      if result_value == 0.0 then // Sign of exact zero result depends on rounding mode
        result_sign = if rounding == FPRounding_NEGINF then '1' else '0';
        result = FPZero(result_sign);
      else
        result = FPRound(result_value, fpcr, rounding);
  return result;

```

shared/functions/float/fpthree/FPThree

```

// FPThree()
// =====

bits(N) FPThree(bit sign)
  assert N IN {16,32,64};

```

```
constant integer E = (if N == 16 then 5 elsif N == 32 then 8 else 11);
constant integer F = N - E - 1;
exp = '1':Zeros(E-1);
frac = '1':Zeros(F-1);
return sign : exp : frac;
```

shared/functions/float/fptofixed/FPToFixed

```
// FPToFixed()
// =====

// Convert N-bit precision floating point OP to M-bit fixed point with
// FBITS fractional bits, controlled by UNSIGNED and ROUNDING.

bits(M) FPToFixed(bits(N) op, integer fbits, boolean unsigned, FPCRType fpcr, FPRounding rounding)
  assert N IN {16,32,64};
  assert M IN {16,32,64};
  assert fbits >= 0;
  assert rounding != FPRounding_ODD;

  // Unpack using fpcr to determine if subnormals are flushed-to-zero
  (type,sign,value) = FPUntpack(op, fpcr);

  // If NaN, set cumulative flag or take exception
  if type == FPType_SNaN || type == FPType_QNaN then
    FPProcessException(FPExc_InvalidOp, fpcr);

  // Scale by fractional bits and produce integer rounded towards minus-infinity
  value = value * 2.0^fbits;
  int_result = RoundDown(value);
  error = value - Real(int_result);

  // Determine whether supplied rounding mode requires an increment
  case rounding of
    when FPRounding_TIEEVEN
      round_up = (error > 0.5 || (error == 0.5 && int_result<0> == '1'));
    when FPRounding_POSINF
      round_up = (error != 0.0);
    when FPRounding_NEGINF
      round_up = FALSE;
    when FPRounding_ZERO
      round_up = (error != 0.0 && int_result < 0);
    when FPRounding_TIEAWAY
      round_up = (error > 0.5 || (error == 0.5 && int_result >= 0));

  if round_up then int_result = int_result + 1;

  // Generate saturated result and exceptions
  (result, overflow) = SatQ(int_result, M, unsigned);
  if overflow then
    FPProcessException(FPExc_InvalidOp, fpcr);
  elsif error != 0.0 then
    FPProcessException(FPExc_Inexact, fpcr);

  return result;
```

shared/functions/float/fptwo/FPTwo

```
// FPTwo()
// =====

bits(N) FPTwo(bit sign)
  assert N IN {16,32,64};
  constant integer E = (if N == 16 then 5 elsif N == 32 then 8 else 11);
  constant integer F = N - E - 1;
```

```
exp = '1':Zeros(E-1);
frac = Zeros(F);
return sign : exp : frac;
```

shared/functions/float/fptype/FType

```
enumeration FType      {FType_Nonzero, FType_Zero, FType_Infinity,
                        FType_QNaN, FType_SNaN};
```

shared/functions/float/fpunpack/FPUnpack

```
// FPUnpack()
// =====
//
// Used by data processing and int/fixed <-> FP conversion instructions.
// For half-precision data it ignores AHP, and observes FZ16.

(FType, bit, real) FPUnpack(bits(N) fpval, FPCRType fpcr)
    fpcr.AHP = '0';
    (fp_type, sign, value) = FPUnpackBase(fpval, fpcr);
    return (fp_type, sign, value);
```

shared/functions/float/fpunpack/FPUnpackBase

```
// FPUnpackBase()
// =====
//
// Unpack a floating-point number into its type, sign bit and the real number
// that it represents. The real number result has the correct sign for numbers
// and infinities, is very large in magnitude for infinities, and is 0.0 for
// NaNs. (These values are chosen to simplify the description of comparisons
// and conversions.)
//
// The 'fpcr' argument supplies FPCR control bits. Status information is
// updated directly in the FPSR where appropriate.

(FType, bit, real) FPUnpackBase(bits(N) fpval, FPCRType fpcr)
    assert N IN {16,32,64};

    if N == 16 then
        sign = fpval<15>;
        exp16 = fpval<14:10>;
        frac16 = fpval<9:0>;
        if IsZero(exp16) then
            // Produce zero if value is zero or flush-to-zero is selected
            if IsZero(frac16) || fpcr.FZ16 == '1' then
                type = FType_Zero; value = 0.0;
            else
                type = FType_Nonzero; value = 2.0^-14 * (Real(UInt(frac16)) * 2.0^-10);
        elsif IsOnes(exp16) && fpcr.AHP == '0' then // Infinity or NaN in IEEE format
            if IsZero(frac16) then
                type = FType_Infinity; value = 2.0^1000000;
            else
                type = if frac16<9> == '1' then FType_QNaN else FType_SNaN;
                value = 0.0;
        else
            type = FType_Nonzero;
            value = 2.0^(UInt(exp16)-15) * (1.0 + Real(UInt(frac16)) * 2.0^-10);

    elsif N == 32 then

        sign = fpval<31>;
        exp32 = fpval<30:23>;
        frac32 = fpval<22:0>;
        if IsZero(exp32) then
            // Produce zero if value is zero or flush-to-zero is selected.
```

```

    if IsZero(frac32) || fpcr.FZ == '1' then
      type = FPType_Zero; value = 0.0;
      if !IsZero(frac32) then // Denormalized input flushed to zero
        FPProcessException(FPExc_InputDenorm, fpcr);
    else
      type = FPType_Nonzero; value = 2.0-126 * (Real(UInt(frac32)) * 2.0-23);
  elseif IsOnes(exp32) then
    if IsZero(frac32) then
      type = FPType_Infinity; value = 2.01000000;
    else
      type = if frac32<22> == '1' then FPType_QNaN else FPType_SNaN;
      value = 0.0;
  else
    type = FPType_Nonzero;
    value = 2.0(UInt(exp32)-127) * (1.0 + Real(UInt(frac32)) * 2.0-23);

else // N == 64

  sign = fpval<63>;
  exp64 = fpval<62:52>;
  frac64 = fpval<51:0>;
  if IsZero(exp64) then
    // Produce zero if value is zero or flush-to-zero is selected.
    if IsZero(frac64) || fpcr.FZ == '1' then
      type = FPType_Zero; value = 0.0;
      if !IsZero(frac64) then // Denormalized input flushed to zero
        FPProcessException(FPExc_InputDenorm, fpcr);
    else
      type = FPType_Nonzero; value = 2.0-1022 * (Real(UInt(frac64)) * 2.0-52);
  elseif IsOnes(exp64) then
    if IsZero(frac64) then
      type = FPType_Infinity; value = 2.01000000;
    else
      type = if frac64<51> == '1' then FPType_QNaN else FPType_SNaN;
      value = 0.0;
  else
    type = FPType_Nonzero;
    value = 2.0(UInt(exp64)-1023) * (1.0 + Real(UInt(frac64)) * 2.0-52);

  if sign == '1' then value = -value;
  return (type, sign, value);

```

shared/functions/float/fpunpack/FPUnpackCV

```

// FPUnpackCV()
// =====
//
// Used for FP <-> FP conversion instructions.
// For half-precision data ignores FZ16 and observes AHP.

(FPType, bit, real) FPUnpackCV(bits(N) fpval, FPCRTYPE fpcr)
  fpcr.FZ16 = '0';
  (fp_type, sign, value) = FPUnpackBase(fpval, fpcr);
  return (fp_type, sign, value);

```

shared/functions/float/fpzero/FPZero

```

// FPZero()
// =====

bits(N) FPZero(bit sign)
  assert N IN {16,32,64};
  constant integer E = (if N == 16 then 5 elseif N == 32 then 8 else 11);
  constant integer F = N - E - 1;

```

```
exp = Zeros(E);
frac = Zeros(F);
return sign : exp : frac;
```

shared/functions/float/vfpexpandimm/VFPEExpandImm

```
// VFPEExpandImm()
// =====

bits(N) VFPEExpandImm(bits(8) imm8)
  assert N IN {16,32,64};
  constant integer E = (if N == 16 then 5 elsif N == 32 then 8 else 11);
  constant integer F = N - E - 1;
  sign = imm8<7>;
  exp = NOT(imm8<6>):Replicate(imm8<6>,E-3):imm8<5:4>;
  frac = imm8<3:0>:Zeros(F-4);
  return sign : exp : frac;
```

shared/functions/integer/AddWithCarry

```
// AddWithCarry()
// =====
// Integer addition with carry input, returning result and NZCV flags

(bits(N), bits(4)) AddWithCarry(bits(N) x, bits(N) y, bit carry_in)
  integer unsigned_sum = UInt(x) + UInt(y) + UInt(carry_in);
  integer signed_sum = SInt(x) + SInt(y) + UInt(carry_in);
  bits(N) result = unsigned_sum<N-1:0>; // same value as signed_sum<N-1:0>
  bit n = result<N-1>;
  bit z = if IsZero(result) then '1' else '0';
  bit c = if UInt(result) == unsigned_sum then '0' else '1';
  bit v = if SInt(result) == signed_sum then '0' else '1';
  return (result, n:z:c:v);
```

shared/functions/memory/AArch64.BranchAddr

```
// AArch64.BranchAddr()
// =====
// Return the virtual address with tag bits removed for storing to the program counter.
// On an exception return, "e1" specifies the target Exception level. Otherwise, "e1" is the
// current Exception level.

bits(64) AArch64.BranchAddr(bits(64) vaddress)
  assert !UsingAArch32();
  msbit = AddrTop(vaddress, PSTATE.EL);
  if msbit == 63 then
    return vaddress;
  elsif (PSTATE.EL IN {EL0, EL1} || ELIsInHost(e1)) && vaddress<msbit> == '1' then
    return SignExtend(vaddress<msbit:0>);
  else
    return ZeroExtend(vaddress<msbit:0>);
```

shared/functions/memory/AccType

```
enumeration AccType {AccType_NORMAL, AccType_VEC, // Normal loads and stores
  AccType_STREAM, AccType_VECSTREAM, // Streaming loads and stores
  AccType_ATOMIC, AccType_ATOMICRW, // Atomic loads and stores
  AccType_ORDERED, AccType_ORDEREDRW, // Load-Acquire and Store-Release
  AccType_LIMITEDORDERED, // Load-LOAcquire and Store-LORelease
  AccType_UNPRIV, // Load and store unprivileged
  AccType_IFETCH, // Instruction fetch
  AccType_PTW, // Page table walk
  // Other operations
  AccType_DC, // Data cache maintenance
```

```
AccType_IC,           // Instruction cache maintenance
AccType_DCZVA,       // DC ZVA instructions
AccType_AT};        // Address translation
```

shared/functions/memory/AccessDescriptor

```
type AccessDescriptor is (
    AccType acctype,
    boolean page_table_walk,
    boolean secondstage,
    boolean s2fs1walk,
    integer level
)
```

shared/functions/memory/AddrTop

```
// AddrTop()
// =====
// Return the MSB number of a virtual address in the stage 1 translation regime for "el".
// If EL1 is using AArch64 then addresses from EL0 using AArch32 are zero-extended to 64 bits.

integer AddrTop(bits(64) address, bits(2) el)
    assert HaveEL(e1);
    regime = S1TranslationRegime(e1);
    if ELUsingAArch32(regime) then
        // AArch32 translation regime.
        return 31;
    else
        // AArch64 translation regime.
        case regime of
            when EL1
                tbi = (if address<55> == '1' then TCR_EL1.TBI1 else TCR_EL1.TBI0);
            when EL2
                if HaveVirtHostExt() && ELIsInHost(e1) then
                    tbi = (if address<55> == '1' then TCR_EL2.TBI1 else TCR_EL2.TBI0);
                else
                    tbi = TCR_EL2.TBI;
            when EL3
                tbi = TCR_EL3.TBI;
        return (if tbi == '1' then 55 else 63);
```

shared/functions/memory/AddressDescriptor

```
type AddressDescriptor is (
    FaultRecord fault, // fault.type indicates whether the address is valid
    MemoryAttributes memattrs,
    FullAddress address,
    bits(64) vaddress
)
```

shared/functions/memory/Allocation

```
constant bits(2) MemHint_No = '00'; // No Read-Allocate, No Write-Allocate
constant bits(2) MemHint_WA = '01'; // No Read-Allocate, Write-Allocate
constant bits(2) MemHint_RA = '10'; // Read-Allocate, No Write-Allocate
constant bits(2) MemHint_RWA = '11'; // Read-Allocate, Write-Allocate
```

shared/functions/memory/BigEndian

```
// BigEndian()
// =====

boolean BigEndian()
    boolean bigend;
```



```

if UsingAArch32() then
    bigend = (PSTATE.E != '0');
elseif PSTATE.EL == EL0 then
    bigend = (SCTLR[].E0E != '0');
else
    bigend = (SCTLR[].EE != '0');
return bigend;

```

shared/functions/memory/BigEndianReverse

```

// BigEndianReverse()
// =====

bits(width) BigEndianReverse (bits(width) value)
    assert width IN {8, 16, 32, 64, 128};
    integer half = width DIV 2;
    if width == 8 then return value;
    return BigEndianReverse(value<half-1:0>) : BigEndianReverse(value<width-1:half>);

```

shared/functions/memory/Cacheability

```

constant bits(2) MemAttr_NC = '00'; // Non-cacheable
constant bits(2) MemAttr_WT = '10'; // Write-through
constant bits(2) MemAttr_WB = '11'; // Write-back

```

shared/functions/memory/CreateAccessDescriptor

```

// CreateAccessDescriptor()
// =====

AccessDescriptor CreateAccessDescriptor(AccType acctype)
    AccessDescriptor accdesc;
    accdesc.acctype = acctype;
    accdesc.page_table_walk = FALSE;
    return accdesc;

```

shared/functions/memory/CreateAccessDescriptorPTW

```

// CreateAccessDescriptorPTW()
// =====

AccessDescriptor CreateAccessDescriptorPTW(AccType acctype, boolean secondstage,
                                           boolean s2fs1walk, integer level)
    AccessDescriptor accdesc;
    accdesc.acctype = acctype;
    accdesc.page_table_walk = TRUE;
    accdesc.secondstage = s2fs1walk;
    accdesc.secondstage = secondstage;
    accdesc.level = level;
    return accdesc;

```

shared/functions/memory/DataMemoryBarrier

```
DataMemoryBarrier(MBReqDomain domain, MBReqTypes types);
```

shared/functions/memory/DataSynchronizationBarrier

```
DataSynchronizationBarrier(MBReqDomain domain, MBReqTypes types);
```

shared/functions/memory/DescriptorUpdate

```
type DescriptorUpdate is (  
    boolean AF,           // AF needs to be set  
    boolean AP,           // AP[2] / S2AP[2] will be modified  
    AddressDescriptor descaddr // Descriptor to be updated  
)
```

shared/functions/memory/DeviceType

```
enumeration DeviceType {DeviceType_GRE, DeviceType_nGRE, DeviceType_nGnRE, DeviceType_nGnRnE};
```

shared/functions/memory/Fault

```
enumeration Fault {Fault_None,  
    Fault_AccessFlag,  
    Fault_Alignment,  
    Fault_Background,  
    Fault_Domain,  
    Fault_Permission,  
    Fault_Translation,  
    Fault_AddressSize,  
    Fault_SyncExternal,  
    Fault_SyncExternalOnWalk,  
    Fault_SyncParity,  
    Fault_SyncParityOnWalk,  
    Fault_AsyncParity,  
    Fault_AsyncExternal,  
    Fault_Debug,  
    Fault_TLBConflict,  
    Fault_Lockdown,  
    Fault_Exclusive,  
    Fault_ICacheMaint};
```

shared/functions/memory/FaultRecord

```
type FaultRecord is (Fault type, // Fault Status  
    Acctype acctype, // Type of access that faulted  
    bits(52) ipaddress, // Intermediate physical address  
    boolean s2fs1walk, // Is on a Stage 1 page table walk  
    boolean write, // TRUE for a write, FALSE for a read  
    integer level, // For translation, access flag and permission faults  
    bit extflag, // IMPLEMENTATION DEFINED syndrome for external aborts  
    boolean secondstage, // Is a Stage 2 abort  
    bits(4) domain, // Domain number, AArch32 only  
    bits(2) errortype, // [ARMv8.2 RAS] AArch32 AET or AArch64 SET  
    bits(4) debugmoe) // Debug method of entry, from AArch32 only
```

shared/functions/memory/FullAddress

```
type FullAddress is (  
    bits(52) physicaladdress,  
    bit NS // '0' = Secure, '1' = Non-secure  
)
```

shared/functions/memory/Hint_Prefetch

```
// Signals the memory system that memory accesses of type HINT to or from the specified address are  
// likely in the near future. The memory system may take some action to speed up the memory  
// accesses when they do occur, such as pre-loading the the specified address into one or more  
// caches as indicated by the innermost cache level target (0=L1, 1=L2, etc) and non-temporal hint  
// stream. Any or all prefetch hints may be treated as a NOP. A prefetch hint must not cause a  
// synchronous abort due to Alignment or Translation faults and the like. Its only effect on  
// software-visiblestate should be on caches and TLBs associated with address, which must be
```

```
// accessible by reads, writes or execution, as defined in the translation regime of the current
// Exception level. It is guaranteed not to access Device memory.
// A Prefetch_EXEC hint must not result in an access that could not be performed by a speculative
// instruction fetch, therefore if all associated MMUs are disabled, then it cannot access any
// memory location that cannot be accessed by instruction fetches.
Hint_Prefetch(bits(64) address, PrefetchHint hint, integer target, boolean stream);
```

shared/functions/memory/MBReqDomain

```
enumeration MBReqDomain {MBReqDomain_Nonshareable, MBReqDomain_InnerShareable,
                          MBReqDomain_OuterShareable, MBReqDomain_FullSystem};
```

shared/functions/memory/MBReqTypes

```
enumeration MBReqTypes {MBReqTypes_Reads, MBReqTypes_Writes, MBReqTypes_All};
```

shared/functions/memory/MemAttrHints

```
type MemAttrHints is (
  bits(2) attrs, // The possible encodings for each attributes field are as below
  bits(2) hints, // The possible encodings for the hints are below
  boolean transient
)
```

shared/functions/memory/MemType

```
enumeration MemType {MemType_Normal, MemType_Device};
```

shared/functions/memory/MemoryAttributes

```
type MemoryAttributes is (
  MemType type,

  DeviceType device, // For Device memory types
  MemAttrHints inner, // Inner hints and attributes
  MemAttrHints outer, // Outer hints and attributes

  boolean shareable,
  boolean outershareable
)
```

shared/functions/memory/Permissions

```
type Permissions is (
  bits(3) ap, // Access permission bits
  bit xn, // Execute-never bit
  bit xxn, // [ARMv8.2] Extended execute-never bit for stage 2
  bit pxn // Privileged execute-never bit
)
```

shared/functions/memory/PrefetchHint

```
enumeration PrefetchHint {Prefetch_READ, Prefetch_WRITE, Prefetch_EXEC};
```

shared/functions/memory/TLBRecord

```
type TLBRecord is (
  Permissions perms,
  bit nG, // '0' = Global, '1' = not Global
  bits(4) domain, // AArch32 only
  boolean contiguous, // Contiguous bit from page table
  integer level, // AArch32 Short-descriptor format: Indicates Section/Page
```

```
integer      blocksize,    // Describes size of memory translated in KBytes
DescriptorUpdate descupdate, // [ARMv8.1] Context for h/w update of table descriptor
bit         CnP,          // [ARMv8.2] TLB entry can be shared between different PEs
AddressDescriptor addrdesc
)
```

shared/functions/memory/_Mem

```
// These two _Mem[] accessors are the hardware operations which perform
// single-copy atomic, aligned, little-endian memory accesses of size
// bytes from/to the underlying physical memory array of bytes.
//
// The functions address the array using desc.address which supplies:
//
// * A MAX_PASIZE-bit physical address
// * A single NS bit to select between Secure and Non-secure parts of
//   the array.
//
// The accdesc descriptor describes the access type: normal, exclusive,
// ordered, streaming, etc and other parameters required to access the
// physical memory or for setting syndrome register in the event of an
// external abort.
bits(8*size) _Mem[AddressDescriptor desc, integer size, AccessDescriptor accdesc];

_Mem[AddressDescriptor desc, integer size, AccessDescriptor accdesc] = bits(8*size) value;
```

shared/functions/registers/BranchTo

```
// BranchTo()
// =====

// Set program counter to a new address, which may include a tag in the top eight bits,
// with a branch reason hint for possible use by hardware fetching the next instruction.

BranchTo(bits(N) target, BranchType branch_type)
    Hint_Branch(branch_type);
    if N == 32 then
        assert UsingAArch32();
        _PC = ZeroExtend(target);
    else
        assert N == 64 && !UsingAArch32();
        _PC = AArch64.BranchAddr(target<63:0>);
    return;
```

shared/functions/registers/BranchToAddr

```
// BranchToAddr()
// =====

// Set program counter to a new address, which does not include a tag in the top eight bits,
// with a branch reason hint for possible use by hardware fetching the next instruction.

BranchToAddr(bits(N) target, BranchType branch_type)
    Hint_Branch(branch_type);
    if N == 32 then
        assert UsingAArch32();
        _PC = ZeroExtend(target);
    else
        assert N == 64 && !UsingAArch32();
        _PC = target<63:0>;
    return;
```

shared/functions/registers/BranchType

```
enumeration BranchType {BranchType_CALL, BranchType_ERET, BranchType_DBGEXIT,
                        BranchType_RET, BranchType_JMP, BranchType_EXCEPTION,
                        BranchType_UNKNOWN};
```

shared/functions/registers/Hint_Branch

```
// Report the hint passed to BranchTo() and BranchToAddr(), for consideration when processing
// the next instruction.
Hint_Branch(BranchType hint);
```

shared/functions/registers/NextInstrAddr

```
// Return address of the next instruction.
bits(N) NextInstrAddr();
```

shared/functions/registers/ResetExternalDebugRegisters

```
// Reset the External Debug registers in the Core power domain.
ResetExternalDebugRegisters(boolean cold_reset);
```

shared/functions/registers/ThisInstrAddr

```
// ThisInstrAddr()
// =====
// Return address of the current instruction.

bits(N) ThisInstrAddr()
    assert N == 64 || (N == 32 && UsingAArch32());
    return _PC<N-1:0>;
```

shared/functions/registers/_PC

```
bits(64) _PC;
```

shared/functions/registers/_R

```
array bits(64) _R[0..30];
```

shared/functions/registers/_V

```
array bits(128) _V[0..31];
```

shared/functions/sysregisters/SPSR

```
// SPSR[] - non-assignment form
// =====

bits(32) SPSR[]
    bits(32) result;
    if UsingAArch32() then
        case PSTATE.M of
            when M32_FIQ      result = SPSR_fiq;
            when M32_IRQ      result = SPSR_irq;
            when M32_Svc      result = SPSR_svc;
            when M32_Monitor  result = SPSR_mon;
            when M32_Abort    result = SPSR_abt;
            when M32_Hyp      result = SPSR_hyp;
            when M32_Undef    result = SPSR_und;
            otherwise        Unreachable();
    else
```

```

    case PSTATE.EL of
    when EL1      result = SPSR_EL1;
    when EL2      result = SPSR_EL2;
    when EL3      result = SPSR_EL3;
    otherwise     Unreachable();

    return result;

// SPSR[] - assignment form
// =====

SPSR[] = bits(32) value
  if UsingAArch32() then
    case PSTATE.M of
    when M32_FIQ   SPSR_fiq = value;
    when M32_IRQ   SPSR_irq = value;
    when M32_Svc   SPSR_svc = value;
    when M32_Monitor SPSR_mon = value;
    when M32_Abort SPSR_abt = value;
    when M32_Hyp   SPSR_hyp = value;
    when M32_Undef SPSR_und = value;
    otherwise     Unreachable();
  else
    case PSTATE.EL of
    when EL1      SPSR_EL1 = value;
    when EL2      SPSR_EL2 = value;
    when EL3      SPSR_EL3 = value;
    otherwise     Unreachable();

    return;

```

shared/functions/system/ArchVersion

```

enumeration ArchVersion {
    ARMv8p0,
    ARMv8p1,
    ARMv8p2
};

```

shared/functions/system/ClearEventRegister

```

// ClearEventRegister()
// =====
// Clear the Event Register of this PE

ClearEventRegister()
  EventRegister = '0';
  return;

```

shared/functions/system/ClearPendingPhysicalSError

```

// Clear a pending physical SError interrupt
ClearPendingPhysicalSError();

```

shared/functions/system/ConditionHolds

```

// ConditionHolds()
// =====

// Return TRUE iff COND currently holds

boolean ConditionHolds(bits(4) cond)
  // Evaluate base condition.
  case cond<3:1> of
  when '000' result = (PSTATE.Z == '1'); // EQ or NE

```

```

when '001' result = (PSTATE.C == '1');           // CS or CC
when '010' result = (PSTATE.N == '1');         // MI or PL
when '011' result = (PSTATE.V == '1');         // VS or VC
when '100' result = (PSTATE.C == '1' && PSTATE.Z == '0'); // HI or LS
when '101' result = (PSTATE.N == PSTATE.V);    // GE or LT
when '110' result = (PSTATE.N == PSTATE.V && PSTATE.Z == '0'); // GT or LE
when '111' result = TRUE;                       // AL

// Condition flag values in the set '111x' indicate always true
// Otherwise, invert condition if necessary.
if cond<0> == '1' && cond != '1111' then
    result = !result;

return result;

```

shared/functions/system/CurrentInstrSet

```

// CurrentInstrSet()
// =====

InstrSet CurrentInstrSet()

    if UsingAArch32() then
        result = if PSTATE.T == '0' then InstrSet_A32 else InstrSet_T32;
        // PSTATE.J is RES0. Implementation of T32EE or Jazelle state not permitted.
    else
        result = InstrSet_A64;
    return result;

```

shared/functions/system/CurrentPL

```

// CurrentPL()
// =====

PrivilegeLevel CurrentPL()
    return PLOFEL(PSTATE.EL);

```

shared/functions/system/EL0

```

constant bits(2) EL3 = '11';
constant bits(2) EL2 = '10';
constant bits(2) EL1 = '01';
constant bits(2) EL0 = '00';

```

shared/functions/system/ELFromM32

```

// ELFromM32()
// =====

(boolean, bits(2)) ELFromM32(bits(5) mode)
    // Convert an AArch32 mode encoding to an Exception level.
    // Returns (valid, EL):
    // 'valid' is TRUE if 'mode<4:0>' encodes a mode that is both valid for this implementation
    // and the current value of SCR.NS/SCR_EL3.NS.
    // 'EL' is the Exception level decoded from 'mode'.
    bits(2) e1;
    boolean valid = !BadMode(mode); // Check for modes that are not valid for this implementation
    case mode of
        when M32_Monitor
            e1 = EL3;
        when M32_Hyp
            e1 = EL2;
            valid = valid && (!HaveEL(EL3) || SCR_GEN[].NS == '1');
        when M32_FIQ, M32_IRQ, M32_Svc, M32_Abort, M32_Undef, M32_System
            // If EL3 is implemented and using AArch32, then these modes are EL3 modes in Secure

```

```

    // state, and EL1 modes in Non-secure state. If EL3 is not implemented or is using
    // AArch64, then these modes are EL1 modes.
    e1 = (if HaveEL(EL3) && HighestELUsingAArch32() && SCR.NS == '0' then EL3 else EL1);
  when M32_User
    e1 = EL0;
  otherwise
    valid = FALSE; // Passed an illegal mode value
  if !valid then e1 = bits(2) UNKNOWN;
  return (valid, e1);

```

shared/functions/system/ELFromSPSR

```

// ELFromSPSR()
// =====

// Convert an SPSR value encoding to an Exception level.
// Returns (valid,EL):
// 'valid' is TRUE if 'spsr<4:0>' encodes a valid mode for the current state.
// 'EL' is the Exception level decoded from 'spsr'.

(boolean, bits(2)) ELFromSPSR(bits(32) spsr)
  if spsr<4> == '0' then // AArch64 state
    e1 = spsr<3:2>;
    if HighestELUsingAArch32() then // No AArch64 support
      valid = FALSE;
    elseif !HaveEL(e1) then // Exception level not implemented
      valid = FALSE;
    elseif spsr<1> == '1' then // M[1] must be 0
      valid = FALSE;
    elseif e1 == EL0 && spsr<0> == '1' then // for EL0, M[0] must be 0
      valid = FALSE;
    elseif e1 == EL2 && HaveEL(EL3) && SCR_EL3.NS == '0' then // EL2 only valid in Non-secure state
      valid = FALSE;
    else
      valid = TRUE;
  elseif !HaveAnyAArch32() then // AArch32 not supported
    valid = FALSE;
  else // AArch32 state
    (valid, e1) = ELFromM32(spsr<4:0>);
  if !valid then e1 = bits(2) UNKNOWN;
  return (valid, e1);

```

shared/functions/system/ELIsInHost

```

// ELIsInHost()
// =====
// Returns TRUE if HaveVirtHostExt() is TRUE and executing at 'e1' would mean be executing within
// an EL2 Host OS or an EL0 application of a Host OS in Non-secure state using AArch64 with
// HCR_EL2.E2H set to 1, and FALSE otherwise.

boolean ELIsInHost(bits(2) e1)
  return (!IsSecureBelowEL3() && HaveVirtHostExt() && !ELUsingAArch32(EL2) &&
    HCR_EL2.E2H == '1' && (e1 == EL2 || (e1 == EL0 && HCR_EL2.TGE == '1')));

```

shared/functions/system/ELStateUsingAArch32

```

// ELStateUsingAArch32()
// =====

boolean ELStateUsingAArch32(bits(2) e1, boolean secure)
  // See ELStateUsingAArch32K() for description. Must only be called in circumstances where
  // result is valid (typically, that means 'e1 IN {EL1,EL2,EL3}').
  (known, aarch32) = ELStateUsingAArch32K(e1, secure);
  assert known;
  return aarch32;

```

shared/functions/system/ELStateUsingAArch32K

```
// ELStateUsingAArch32K()
// =====

(boolean,boolean) ELStateUsingAArch32K(bits(2) e1, boolean secure)
// Returns (known, aarch32):
// 'known' is FALSE for EL0 if the current Exception level is not EL0 and EL1 is
// using AArch64, since it cannot determine the state of EL0; TRUE otherwise.
// 'aarch32' is TRUE if the specified Exception level is using AArch32; FALSE otherwise.
boolean aarch32;
known = TRUE;
if !HaveAArch32EL(e1) then
  aarch32 = FALSE; // Exception level is using AArch64
elseif HighestELUsingAArch32() then
  aarch32 = TRUE; // All levels are using AArch32
else
  aarch32_below_e13 = HaveEL(EL3) && SCR_EL3.RW == '0';

  aarch32_at_e11 = (aarch32_below_e13 || (HaveEL(EL2) && !secure && HCR_EL2.RW == '0' &&
    !(HCR_EL2.E2H == '1' && HCR_EL2.TGE == '1' && HaveVirtHostExt())));
  if e1 == EL0 && !aarch32_at_e11 then // Only know if EL0 using AArch32 from PSTATE
    if PSTATE.EL == EL0 then
      aarch32 = PSTATE.nRW == '1'; // EL0 controlled by PSTATE
    else
      known = FALSE; // EL0 state is UNKNOWN
  else
    aarch32 = (aarch32_below_e13 && e1 != EL3) || (aarch32_at_e11 && e1 IN {EL1,EL0});
  if !known then aarch32 = boolean UNKNOWN;
  return (known, aarch32);
```

shared/functions/system/ELUsingAArch32

```
// ELUsingAArch32()
// =====

boolean ELUsingAArch32(bits(2) e1)
  return ELStateUsingAArch32(e1, IsSecureBelowEL3());
```

shared/functions/system/ELUsingAArch32K

```
// ELUsingAArch32K()
// =====

(boolean,boolean) ELUsingAArch32K(bits(2) e1)
  return ELStateUsingAArch32K(e1, IsSecureBelowEL3());
```

shared/functions/system/EndOfInstruction

```
// Terminate processing of the current instruction.
EndOfInstruction();
```

shared/functions/system/EnterLowPowerState

```
// PE enters a low-power state
EnterLowPowerState();
```

shared/functions/system/ErrorSynchronizationBarrier

```
// Perform an Error Synchronization Barrier operation
ErrorSynchronizationBarrier(MBReqDomain domain, MBReqTypes types);
```

shared/functions/system/EventRegister

```
bits(1) EventRegister;
```

shared/functions/system/GetPSRFromPSTATE

```
// GetPSRFromPSTATE()
// =====
// Return a PSR value which represents the current PSTATE

bits(32) GetPSRFromPSTATE()
  bits(32) spsr = Zeros();
  spsr<31:28> = PSTATE.<N,Z,C,V>;
  if HavePANExt() then spsr<22> = PSTATE.PAN;
  spsr<21>    = PSTATE.SS;
  spsr<20>    = PSTATE.IL;
  if PSTATE.nRW == '1' then // AArch32 state
    spsr<27>    = PSTATE.Q;
    spsr<26:25> = PSTATE.IT<1:0>;
    if HaveUAOExt() then spsr<23> = '0';
    spsr<19:16> = PSTATE.GE;
    spsr<15:10> = PSTATE.IT<7:2>;
    spsr<9>     = PSTATE.E;
    spsr<8:6>   = PSTATE.<A,I,F>;           // No PSTATE.D in AArch32 state
    spsr<5>     = PSTATE.T;
    assert PSTATE.M<4> == PSTATE.nRW;     // bit [4] is the discriminator
    spsr<4:0>   = PSTATE.M;
  else // AArch64 state
    if HaveUAOExt() then spsr<23> = PSTATE.UAO;
    spsr<9:6>   = PSTATE.<D,A,I,F>;
    spsr<4>     = PSTATE.nRW;
    spsr<3:2>   = PSTATE.EL;
    spsr<0>     = PSTATE.SP;
  return spsr;
```

shared/functions/system/HasArchVersion

```
// HasArchVersion()
// =====

// Return TRUE if the implemented architecture includes the extensions defined in the specified
// architecture version.

boolean HasArchVersion(ArchVersion version)
  return version == ARMv8p0 || boolean IMPLEMENTATION_DEFINED;
```

shared/functions/system/HaveAArch32EL

```
// HaveAArch32EL()
// =====

boolean HaveAArch32EL(bits(2) e1)
  // Return TRUE if Exception level 'e1' supports AArch32 in this implementation
  if !HaveEL(e1) then
    return FALSE; // The Exception level is not implemented
  elseif !HaveAnyAArch32() then
    return FALSE; // No Exception level can use AArch32
  elseif HighestELUsingAArch32() then
    return TRUE; // All Exception levels are using AArch32
  elseif e1 == HighestEL() then
    return FALSE; // The highest Exception level is using AArch64
  elseif e1 == EL0 then
    return TRUE; // EL0 must support using AArch32 if any AArch32
  return boolean IMPLEMENTATION_DEFINED;
```

shared/functions/system/HaveAnyAArch32

```
// HaveAnyAArch32()
// =====
// Return TRUE if AArch32 state is supported at any Exception level

boolean HaveAnyAArch32()
    return boolean IMPLEMENTATION_DEFINED;
```

shared/functions/system/HaveAnyAArch64

```
// HaveAnyAArch64()
// =====
// Return TRUE if AArch64 state is supported at any Exception level

boolean HaveAnyAArch64()
    return !HighestELUsingAArch32();
```

shared/functions/system/HaveEL

```
// HaveEL()
// =====
// Return TRUE if Exception level 'e1' is supported

boolean HaveEL(bits(2) e1)
    if e1 IN {EL1,EL0} then
        return TRUE; // EL1 and EL0 must exist
    return boolean IMPLEMENTATION_DEFINED;
```

shared/functions/system/HighestEL

```
// HighestEL()
// =====
// Returns the highest implemented Exception level.

bits(2) HighestEL()
    if HaveEL(EL3) then
        return EL3;
    elseif HaveEL(EL2) then
        return EL2;
    else
        return EL1;
```

shared/functions/system/HighestELUsingAArch32

```
// HighestELUsingAArch32()
// =====
// Return TRUE if configured to boot into AArch32 operation

boolean HighestELUsingAArch32()
    if !HaveAnyAArch32() then return FALSE;
    return boolean IMPLEMENTATION_DEFINED; // e.g. CFG32SIGNAL == HIGH
```

shared/functions/system/Hint_Yield

```
Hint_Yield();
```

shared/functions/system/IllegalExceptionReturn

```
// IllegalExceptionReturn()
// =====

boolean IllegalExceptionReturn(bits(32) spsr)
```

```
// Check for return:
// * To an unimplemented Exception level.
// * To EL2 in Secure state.
// * To EL0 using AArch64 state, with SPSR.M[0]==1.
// * To AArch64 state with SPSR.M[1]==1.
// * To AArch32 state with an illegal value of SPSR.M.
(valid, target) = ELFromSPSR(spsr);
if !valid then return TRUE;

// Check for return to higher Exception level
if UInt(target) > UInt(PSTATE.EL) then return TRUE;

spsr_mode_is_aarch32 = (spsr<4> == '1');

// Check for return:
// * To EL1, EL2 or EL3 with register width specified in the SPSR different from the
//   Execution state used in the Exception level being returned to, as determined by
//   the SCR_EL3.RW or HCR_EL2.RW bits, or as configured from reset.
// * To EL0 using AArch64 state when EL1 is using AArch32 state as determined by the
//   SCR_EL3.RW or HCR_EL2.RW bits or as configured from reset.
// * To AArch64 state from AArch32 state (should be caught by above)
(known, target_el_is_aarch32) = ELUsingAArch32K(target);
assert known || (target == EL0 && !ELUsingAArch32(EL1));
if known && spsr_mode_is_aarch32 != target_el_is_aarch32 then return TRUE;

// Check for illegal return from AArch32 to AArch64
if UsingAArch32() && !spsr_mode_is_aarch32 then return TRUE;

// Check for return to EL1 in Non-secure state when HCR.TGE is set
if HaveEL(EL2) && target == EL1 && !IsSecureBelowEL3() && HCR_EL2.TGE == '1' then return TRUE;
return FALSE;
```

shared/functions/system/InstrSet

```
enumeration InstrSet {InstrSet_A64, InstrSet_A32, InstrSet_T32};
```

shared/functions/system/InstructionSynchronizationBarrier

```
InstructionSynchronizationBarrier();
```

shared/functions/system/InterruptPending

```
// Return TRUE if there are any pending physical or virtual interrupts, and FALSE otherwise
boolean InterruptPending();
```

shared/functions/system/IsEventRegisterSet

```
// IsEventRegisterSet()
// =====
// Return TRUE if the Event Register of this PE is set, and FALSE otherwise
```

```
boolean IsEventRegisterSet()
    return EventRegister == '1';
```

shared/functions/system/IsInHost

```
// IsInHost()
// =====
// Returns TRUE if HaveVirtHostExt() is TRUE and executing within a Host OS or an EL0 application
// of a Host OS using AArch64 with HCR_EL2.E2H set to 1, and FALSE otherwise.
```

```
boolean IsInHost()
    return ELIsInHost(PSTATE.EL);
```

shared/functions/system/IsSecure

```
// IsSecure()
// =====

boolean IsSecure()
  // Return TRUE if current Exception level is in Secure state.
  if HaveEL(EL3) && !UsingAArch32() && PSTATE.EL == EL3 then
    return TRUE;
  elseif HaveEL(EL3) && UsingAArch32() && PSTATE.M == M32_Monitor then
    return TRUE;
  return IsSecureBelowEL3();
```

shared/functions/system/IsSecureBelowEL3

```
// IsSecureBelowEL3()
// =====

// Return TRUE if an Exception level below EL3 is in Secure state
// or would be following an exception return to that level.
//
// Differs from IsSecure in that it ignores the current EL or Mode
// in considering security state.
// That is, if at AArch64 EL3 or in AArch32 Monitor mode, whether an
// exception return would pass to Secure or Non-secure state.

boolean IsSecureBelowEL3()
  if HaveEL(EL3) then
    return SCR_GEN[].NS == '0';
  elseif HaveEL(EL2) then
    return FALSE;
  else
    // TRUE if processor is Secure or FALSE if Non-secure;
    return boolean IMPLEMENTATION_DEFINED;
```

shared/functions/system/Mode_Bits

```
constant bits(5) M32_User    = '10000';
constant bits(5) M32_FIQ    = '10001';
constant bits(5) M32_IRQ    = '10010';
constant bits(5) M32_Svc    = '10011';
constant bits(5) M32_Monitor = '10110';
constant bits(5) M32_Abort  = '10111';
constant bits(5) M32_Hyp    = '11010';
constant bits(5) M32_Undef  = '11011';
constant bits(5) M32_System = '11111';
```

shared/functions/system/PLOfEL

```
// PLOfEL()
// =====

PrivilegeLevel PLOfEL(bits(2) e1)
  case e1 of
    when EL3 return if HighestELUsingAArch32() then PL1 else PL3;
    when EL2 return PL2;
    when EL1 return PL1;
    when EL0 return PL0;
```

shared/functions/system/PSTATE

```
ProcState PSTATE;
```

shared/functions/system/PrivilegeLevel

```
enumeration PrivilegeLevel {PL3, PL2, PL1, PL0};
```

shared/functions/system/ProcState

```
type ProcState is (  
    bits (1) N,          // Negative condition flag  
    bits (1) Z,          // Zero condition flag  
    bits (1) C,          // Carry condition flag  
    bits (1) V,          // oVerflow condition flag  
    bits (1) D,          // Debug mask bit [AArch64 only]  
    bits (1) A,          // SError interrupt mask bit  
    bits (1) I,          // IRQ mask bit  
    bits (1) F,          // FIQ mask bit  
    bits (1) PAN,        // Privileged Access Never Bit [v8.1]  
    bits (1) UAO,        // User Access Override [v8.2]  
    bits (1) SS,         // Software step bit  
    bits (1) IL,         // Illegal Execution state bit  
    bits (2) EL,         // Exception Level  
    bits (1) nRW,        // not Register Width: 0=64, 1=32  
    bits (1) SP,         // Stack pointer select: 0=SP0, 1=SPx [AArch64 only]  
    bits (1) Q,          // Cumulative saturation flag [AArch32 only]  
    bits (4) GE,         // Greater than or Equal flags [AArch32 only]  
    bits (8) IT,         // If-then bits, RES0 in CPSR [AArch32 only]  
    bits (1) J,          // J bit, RES0 [AArch32 only, RES0 in SPSR and CPSR]  
    bits (1) T,          // T32 bit, RES0 in CPSR [AArch32 only]  
    bits (1) E,          // Endianness bit [AArch32 only]  
    bits (5) M           // Mode field [AArch32 only]  
)
```

shared/functions/system/RestoredITBits

```
// RestoredITBits()  
// =====  
// Get the value of PSTATE.IT to be restored on this exception return.  
  
bits(8) RestoredITBits(bits(32) spsr)  
    it = spsr<15:10,26:25>;  
  
// When PSTATE.IL is set, it is CONSTRAINED UNPREDICTABLE whether the IT bits are each set  
// to zero or copied from the SPSR.  
if PSTATE.IL == '1' then  
    if ConstrainUnpredictableBool() then return '00000000';  
    else return it;  
  
// The IT bits are forced to zero when they are set to a reserved value.  
if !IsZero(it<7:4>) && IsZero(it<3:0>) then  
    return '00000000';  
  
// The IT bits are forced to zero when returning to A32 state, or when returning to an EL  
// with the ITD bit set to 1, and the IT bits are describing a multi-instruction block.  
itd = if PSTATE.EL == EL2 then HSCTLR.ITD else SCTLR.ITD;  
if (spsr<5> == '0' && !IsZero(it)) || (itd == '1' && !IsZero(it<2:0>)) then  
    return '00000000';  
else  
    return it;
```

shared/functions/system/SCRType

```
type SCRType;
```

shared/functions/system/SCR_GEN

```
// SCR_GEN[]
// =====

SCRType SCR_GEN[]
// AArch32 secure & AArch64 EL3 registers are not architecturally mapped
assert HaveEL(EL3);
bits(32) r;
if HighestELUsingAArch32() then
    r = SCR;
else
    r = SCR_EL3;
return r;
```

shared/functions/system/SErrorPending

```
// Return TRUE if a physical SError interrupt is pending; that is, if ISR_EL1.A == 1
boolean SErrorPending();
```

shared/functions/system/SendEvent

```
// Signal an event to all PEs in a multiprocessor system to set their Event Registers.
// When a PE executes the SEV instruction, it causes this function to be executed
SendEvent();
```

shared/functions/system/SendEventLocal

```
// SendEventLocal()
// =====
// Set the local Event Register of this PE.
// When a PE executes the SEVL instruction, it causes this function to be executed

SendEventLocal()
    EventRegister = '1';
    return;
```

shared/functions/system/SetPSTATEFromPSR

```
// SetPSTATEFromPSR()
// =====
// Set PSTATE based on a PSR value

SetPSTATEFromPSR(bits(32) spsr)

    SynchronizeContext();
    PSTATE.SS = DebugExceptionReturnSS(spsr);
    if IllegalExceptionReturn(spsr) then
        PSTATE.IL = '1';
    else
        // State that is reinstated only on a legal exception return
        PSTATE.IL = spsr<20>;
        if spsr<4> == '1' then // AArch32 state
            AArch32.WriteMode(spsr<4:0>); // Sets PSTATE.EL correctly
        else // AArch64 state
            PSTATE.nRW = '0';
            PSTATE.EL = spsr<3:2>;
            PSTATE.SP = spsr<0>;

        // If PSTATE.IL is set and returning to AArch32 state, it is CONSTRAINED UNPREDICTABLE whether
        // the T bit is set to zero or copied from SPSR.
        if PSTATE.IL == '1' && PSTATE.nRW == '1' then
            if ConstrainUnpredictableBool() then spsr<5> = '0';

        // State that is reinstated regardless of illegal exception return
        PSTATE.<N,Z,C,V> = spsr<31:28>;
```

```
if PSTATE.nRW == '1' then // AArch32 state
    PSTATE.Q = spsr<27>;
    PSTATE.IT = RestoredITBits(spsr);
    PSTATE.GE = spsr<19:16>;
    PSTATE.E = spsr<9>;
    PSTATE.<A,I,F> = spsr<8:6>; // No PSTATE.D in AArch32 state
    PSTATE.T = spsr<5>; // PSTATE.J is RES0
else // AArch64 state
    PSTATE.<D,A,I,F> = spsr<9:6>; // No PSTATE.<Q,IT,GE,E,T> in AArch64 state

if HavePANExt() then PSTATE.<PAN> = spsr<22>;
if HaveUAOExt() then PSTATE.UAO = spsr<23>;
return;
```

shared/functions/system/SynchronizeContext

```
SynchronizeContext();
```

shared/functions/system/TakeUnmaskedPhysicalSErrorInterrupts

```
// Take any pending unmasked physical SError interrupt
TakeUnmaskedPhysicalSErrorInterrupts(boolean iesb_req);
```

shared/functions/system/TakeUnmaskedSErrorInterrupts

```
// Take any pending unmasked physical SError interrupt or unmasked virtual SError
// interrupt.
TakeUnmaskedSErrorInterrupts();
```

shared/functions/system/ThisInstr

```
bits(32) ThisInstr();
```

shared/functions/system/ThisInstrLength

```
integer ThisInstrLength();
```

shared/functions/system/Unreachable

```
Unreachable()
    assert FALSE;
```

shared/functions/system/UsingAArch32

```
// UsingAArch32()
// =====
// Return TRUE if the current Exception level is using AArch32, FALSE if using AArch64.

boolean UsingAArch32()
    boolean aarch32 = (PSTATE.nRW == '1');
    if !HaveAnyAArch32() then assert !aarch32;
    if HighestELUsingAArch32() then assert aarch32;
    return aarch32;
```

shared/functions/system/WaitForEvent

```
// WaitForEvent()
// =====
// PE suspends its operation and enters a low-power state
// if the Event Register is clear when the WFE is executed

WaitForEvent()
```



```

if EventRegister == '0' then
    EnterLowPowerState();
return;

```

shared/functions/system/WaitForInterrupt

```

// WaitForInterrupt()
// =====
// PE suspends its operation to enter a low-power state
// until a WFI wake-up event occurs or the PE is reset

WaitForInterrupt()
    EnterLowPowerState();
return;

```

shared/functions/unpredictable/ConstrainUnpredictable

```

// Return the appropriate Constraint result to control the caller's behavior. The return value
// is IMPLEMENTATION DEFINED within a permitted list for each UNPREDICTABLE case.
// (The permitted list is determined by an assert or case statement at the call site.)
Constraint ConstrainUnpredictable();

```

shared/functions/unpredictable/ConstrainUnpredictableBits

```

// This is a variant of ConstrainUnpredictable for when the result can be Constraint_UNKNOWN.
// If the result is Constraint_UNKNOWN then the function also returns UNKNOWN value, but that
// value is always an allocated value; that is, one for which the behavior is not itself
// CONSTRAINED.
(Constraint,bits(width)) ConstrainUnpredictableBits();

```

shared/functions/unpredictable/ConstrainUnpredictableBool

```

// ConstrainUnpredictableBool()
// =====

// This is a simple wrapper function for cases where the constrained result is either TRUE or FALSE.

boolean ConstrainUnpredictableBool()

    c = ConstrainUnpredictable();
    assert c IN {Constraint_TRUE, Constraint_FALSE};
    return (c == Constraint_TRUE);

```

shared/functions/unpredictable/ConstrainUnpredictableInteger

```

// This is a variant of ConstrainUnpredictable for when the result can be Constraint_UNKNOWN. If
// the result is Constraint_UNKNOWN then the function also returns an UNKNOWN value in the range
// low to high, inclusive.
(Constraint,integer) ConstrainUnpredictableInteger(integer low, integer high);

```

shared/functions/unpredictable/Constraint

```

enumeration Constraint    { // General:
    Constraint_NONE, Constraint_UNKNOWN,
    Constraint_UNDEF, Constraint_NOP,
    Constraint_TRUE, Constraint_FALSE,
    Constraint_DISABLED,
    Constraint_UNCOND, Constraint_COND, Constraint_ADDITIONAL_DECODE,
    // Load-store:
    Constraint_WBSUPPRESS, Constraint_FAULT,
    // IPA too large
    Constraint_FORCE, Constraint_FORCENOSLCHECK};

```

shared/functions/vector/AdvSIMDExpandImm

```
// AdvSIMDExpandImm()
// =====

bits(64) AdvSIMDExpandImm(bit op, bits(4) cmode, bits(8) imm8)
  case cmode<3:1> of
    when '000'
      imm64 = Replicate(Zeros(24):imm8, 2);
    when '001'
      imm64 = Replicate(Zeros(16):imm8:Zeros(8), 2);
    when '010'
      imm64 = Replicate(Zeros(8):imm8:Zeros(16), 2);
    when '011'
      imm64 = Replicate(imm8:Zeros(24), 2);
    when '100'
      imm64 = Replicate(Zeros(8):imm8, 4);
    when '101'
      imm64 = Replicate(imm8:Zeros(8), 4);
    when '110'
      if cmode<0> == '0' then
        imm64 = Replicate(Zeros(16):imm8:Ones(8), 2);
      else
        imm64 = Replicate(Zeros(8):imm8:Ones(16), 2);
    when '111'
      if cmode<0> == '0' && op == '0' then
        imm64 = Replicate(imm8, 8);
      if cmode<0> == '0' && op == '1' then
        imm8a = Replicate(imm8<7>, 8); imm8b = Replicate(imm8<6>, 8);
        imm8c = Replicate(imm8<5>, 8); imm8d = Replicate(imm8<4>, 8);
        imm8e = Replicate(imm8<3>, 8); imm8f = Replicate(imm8<2>, 8);
        imm8g = Replicate(imm8<1>, 8); imm8h = Replicate(imm8<0>, 8);
        imm64 = imm8a:imm8b:imm8c:imm8d:imm8e:imm8f:imm8g:imm8h;
      if cmode<0> == '1' && op == '0' then
        imm32 = imm8<7>:NOT(imm8<6>):Replicate(imm8<6>,5):imm8<5>:0:Zeros(19);
        imm64 = Replicate(imm32, 2);
      if cmode<0> == '1' && op == '1' then
        if UsingAArch32() then ReservedEncoding();
        imm64 = imm8<7>:NOT(imm8<6>):Replicate(imm8<6>,8):imm8<5>:0:Zeros(48);

  return imm64;
```

shared/functions/vector/PolynomialMult

```
// PolynomialMult()
// =====

bits(M+N) PolynomialMult(bits(M) op1, bits(N) op2)
  result = Zeros(M+N);
  extended_op2 = ZeroExtend(op2, M+N);
  for i=0 to M-1
    if op1<i> == '1' then
      result = result EOR LSL(extended_op2, i);
  return result;
```

shared/functions/vector/SatQ

```
// SatQ()
// =====

(bits(N), boolean) SatQ(integer i, integer N, boolean unsigned)
  (result, sat) = if unsigned then UnsignedSatQ(i, N) else SignedSatQ(i, N);
  return (result, sat);
```

shared/functions/vector/SignedSatQ

```
// SignedSatQ()
// =====

(bits(N), boolean) SignedSatQ(integer i, integer N)
  if i > 2^(N-1) - 1 then
    result = 2^(N-1) - 1; saturated = TRUE;
  elsif i < -(2^(N-1)) then
    result = -(2^(N-1)); saturated = TRUE;
  else
    result = i; saturated = FALSE;
  return (result<N-1:0>, saturated);
```

shared/functions/vector/UnsignedRSqrtEstimate

```
// UnsignedRSqrtEstimate()
// =====

bits(N) UnsignedRSqrtEstimate(bits(N) operand)
  assert N IN {16,32};
  if operand<N-1:N-2> == '00' then // Operands <= 0x3FFFFFF produce 0xFFFFFFFF
    result = Ones(N);
  else
    // Generate double-precision value = operand * 2^(-32). This has zero sign bit, with:
    //   exponent = 1022 or 1021 = double-precision representation of 2^(-1) or 2^(-2)
    //   fraction taken from operand, excluding its most significant one or two bits.
    if operand<N-1> == '1' then
      dp_operand = '0 0111111110' : operand<N-2:0> : Zeros(64-(N-1)-12);
    else // operand<N-1:N-2> == '01'
      dp_operand = '0 0111111101' : operand<N-3:0> : Zeros(64-(N-2)-12);

    // Call C function to get reciprocal estimate of scaled value.
    estimate = recip_sqrt_estimate(dp_operand);

    // Result is double-precision and a multiple of 1/256 in the range 1 to 511/256.
    // Multiply by 2^31 and convert to an unsigned integer - this just involves
    // concatenating the implicit units bit with the top N-1 fraction bits.
    bits(N-1) frac = estimate<51:51-(N-1)+1>;
    result = '1' : frac;

  return result;
```

shared/functions/vector/UnsignedRecipEstimate

```
// UnsignedRecipEstimate()
// =====

bits(N) UnsignedRecipEstimate(bits(N) operand)
  assert N IN {16,32};
  if operand<N-1> == '0' then // Operands <= 0x7FFFFFFF produce 0xFFFFFFFF
    result = Ones(N);
  else
    // Generate double-precision value = operand * 2^(-32). This has zero sign bit, with:
    //   exponent = 1022 = double-precision representation of 2^(-1)
    //   fraction taken from operand, excluding its most significant bit.
    dp_operand = '0 0111111110' : operand<N-2:0> : Zeros(64-(N-1)-12);

    // Call C function to get reciprocal estimate of scaled value.
    estimate = recip_estimate(dp_operand);

    // Result is double-precision and a multiple of 1/256 in the range 1 to 511/256.
    // Multiply by 2^31 and convert to an unsigned integer - this just involves
    // concatenating the implicit units bit with the top N-1 fraction bits.
    bits(N-1) frac = estimate<51:51-(N-1)+1>;
```

```
        result = '1' : frac;

    return result;
```

shared/functions/vector/UnsignedSatQ

```
// UnsignedSatQ()
// =====

(bits(N), boolean) UnsignedSatQ(integer i, integer N)
    if i > 2N - 1 then
        result = 2N - 1; saturated = TRUE;
    elsif i < 0 then
        result = 0; saturated = TRUE;
    else
        result = i; saturated = FALSE;
    return (result<N-1:0>, saturated);
```

J1.3.4 shared/translation

This section includes the following pseudocode functions:

- [shared/translation/attrs/CombineS1S2AttrHints](#).
- [shared/translation/attrs/CombineS1S2Desc](#) on page J1-6087.
- [shared/translation/attrs/CombineS1S2Device](#) on page J1-6087.
- [shared/translation/attrs/LongConvertAttrsHints](#) on page J1-6087.
- [shared/translation/attrs/MemAttrDefaults](#) on page J1-6088.
- [shared/translation/attrs/S1CacheDisabled](#) on page J1-6088.
- [shared/translation/attrs/S2AttrDecode](#) on page J1-6088.
- [shared/translation/attrs/S2CacheDisabled](#) on page J1-6089.
- [shared/translation/attrs/S2ConvertAttrsHints](#) on page J1-6089.
- [shared/translation/attrs/ShortConvertAttrsHints](#) on page J1-6090.
- [shared/translation/attrs/WalkAttrDecode](#) on page J1-6090.
- [shared/translation/translation/HasS2Translation](#) on page J1-6090.
- [shared/translation/translation/Have16bitVMID](#) on page J1-6090.
- [shared/translation/translation/PAMax](#) on page J1-6091.
- [shared/translation/translation/S1TranslationRegime](#) on page J1-6091.

shared/translation/attrs/CombineS1S2AttrHints

```
// CombineS1S2AttrHints()
// =====

MemAttrHints CombineS1S2AttrHints(MemAttrHints s1desc, MemAttrHints s2desc)

    MemAttrHints result;

    if s2desc.attrs == '01' || s1desc.attrs == '01' then
        result.attrs = bits(2) UNKNOWN; // Reserved
    elsif s2desc.attrs == MemAttr_NC || s1desc.attrs == MemAttr_NC then
        result.attrs = MemAttr_NC; // Non-cacheable
    elsif s2desc.attrs == MemAttr_WT || s1desc.attrs == MemAttr_WT then
        result.attrs = MemAttr_WT; // Write-through
    else
        result.attrs = MemAttr_WB; // Write-back

    result.hints = s1desc.hints;
    result.transient = s1desc.transient;

    return result;
```

shared/translation/attrs/CombineS1S2Desc

```
// CombineS1S2Desc()
// =====
// Combines the address descriptors from stage 1 and stage 2

AddressDescriptor CombineS1S2Desc(AddressDescriptor s1desc, AddressDescriptor s2desc)

    AddressDescriptor result;

    result.paddress = s2desc.paddress;

    if IsFault(s1desc) || IsFault(s2desc) then
        result = if IsFault(s1desc) then s1desc else s2desc;
    elseif s2desc.memattrs.type == MemType_Device || s1desc.memattrs.type == MemType_Device then
        result.memattrs.type = MemType_Device;
        if s1desc.memattrs.type == MemType_Normal then
            result.memattrs.device = s2desc.memattrs.device;
        elseif s2desc.memattrs.type == MemType_Normal then
            result.memattrs.device = s1desc.memattrs.device;
        else
            // Both Device
            result.memattrs.device = CombineS1S2Device(s1desc.memattrs.device,
                s2desc.memattrs.device);
    else
        // Both Normal
        result.memattrs.type = MemType_Normal;
        result.memattrs.device = DeviceType_UNKNOWN;
        result.memattrs.inner = CombineS1S2AttrHints(s1desc.memattrs.inner, s2desc.memattrs.inner);
        result.memattrs.outer = CombineS1S2AttrHints(s1desc.memattrs.outer, s2desc.memattrs.outer);
        result.memattrs.shareable = (s1desc.memattrs.shareable || s2desc.memattrs.shareable);
        result.memattrs.outershareable = (s1desc.memattrs.outershareable ||
            s2desc.memattrs.outershareable);

    result.memattrs = MemAttrDefaults(result.memattrs);

    return result;
```

shared/translation/attrs/CombineS1S2Device

```
// CombineS1S2Device()
// =====
// Combines device types from stage 1 and stage 2

DeviceType CombineS1S2Device(DeviceType s1device, DeviceType s2device)

    if s2device == DeviceType_nGnRnE || s1device == DeviceType_nGnRnE then
        result = DeviceType_nGnRnE;
    elseif s2device == DeviceType_nGnRE || s1device == DeviceType_nGnRE then
        result = DeviceType_nGnRE;
    elseif s2device == DeviceType_nGRE || s1device == DeviceType_nGRE then
        result = DeviceType_nGRE;
    else
        result = DeviceType_GRE;

    return result;
```

shared/translation/attrs/LongConvertAttrsHints

```
// LongConvertAttrsHints()
// =====
// Convert the long attribute fields for Normal memory as used in the MAIR fields
// to orthogonal attributes and hints

MemAttrHints LongConvertAttrsHints(bits(4) attrfield, AccType acctype)
    assert !IsZero(attrfield);
    MemAttrHints result;
    if S1CacheDisabled(acctype) then // Force Non-cacheable
```

```

    result.attrs = MemAttr_NC;
    result.hints = MemHint_No;
  else
    if attrfield<3:2> == '00' then // Write-through transient
      result.attrs = MemAttr_WT;
      result.hints = attrfield<1:0>;
      result.transient = TRUE;
    elseif attrfield<3:0> == '0100' then // Non-cacheable (no allocate)
      result.attrs = MemAttr_NC;
      result.hints = MemHint_No;
      result.transient = FALSE;
    elseif attrfield<3:2> == '01' then // Write-back transient
      result.attrs = attrfield<1:0>;
      result.hints = MemAttr_WB;
      result.transient = TRUE;
    else // Write-through/Write-back non-transient
      result.attrs = attrfield<3:2>;
      result.hints = attrfield<1:0>;
      result.transient = FALSE;

  return result;

```

shared/translation/atrrs/MemAttrDefaults

```

// MemAttrDefaults()
// =====
// Supply default values for memory attributes, including overriding the shareability attributes
// for Device and Non-cacheable memory types.

```

MemoryAttributes MemAttrDefaults(MemoryAttributes memattrs)

```

  if memattrs.type == MemType_Device then
    memattrs.inner = MemAttrHints UNKNOWN;
    memattrs.outer = MemAttrHints UNKNOWN;
    memattrs.shareable = TRUE;
    memattrs.outershareable = TRUE;
  else
    memattrs.device = DeviceType UNKNOWN;
    if memattrs.inner.attrs == MemAttr_NC && memattrs.outer.attrs == MemAttr_NC then
      memattrs.shareable = TRUE;
      memattrs.outershareable = TRUE;

  return memattrs;

```

shared/translation/atrrs/S1CacheDisabled

```

// S1CacheDisabled()
// =====
boolean S1CacheDisabled(AccType acctype)
  if ELUsingAArch32(S1TranslationRegime()) then
    if PSTATE.EL == EL2 then
      enable = if acctype == AccType_IFETCH then HSCTLR.I else HSCTLR.C;
    else
      enable = if acctype == AccType_IFETCH then SCTLR.I else SCTLR.C;
  else
    enable = if acctype == AccType_IFETCH then SCTLR[.I else SCTLR[.C;
  return enable == '0';

```

shared/translation/atrrs/S2AttrDecode

```

// S2AttrDecode()
// =====
// Converts the Stage 2 attribute fields into orthogonal attributes and hints

```

MemoryAttributes S2AttrDecode(bits(2) SH, bits(4) attr, AccType acctype)

```

MemoryAttributes memattrs;

if attr<3:2> == '00' then // Device
  memattrs.type = MemType_Device;
  case attr<1:0> of
    when '00' memattrs.device = DeviceType_nGnRnE;
    when '01' memattrs.device = DeviceType_nGnRE;
    when '10' memattrs.device = DeviceType_nGRE;
    when '11' memattrs.device = DeviceType_GRE;

elseif attr<1:0> != '00' then // Normal
  memattrs.type = MemType_Normal;
  memattrs.outer = S2ConvertAttrsHints(attr<3:2>, acctype);
  memattrs.inner = S2ConvertAttrsHints(attr<1:0>, acctype);
  memattrs.shareable = SH<1> == '1';
  memattrs.outershareable = SH == '10';

else
  memattrs = MemoryAttributes UNKNOWN; // Reserved

return MemAttrDefaults(memattrs);

```

shared/translation/attrs/S2CacheDisabled

```

// S2CacheDisabled()
// =====

boolean S2CacheDisabled(AccType acctype)
if ELUsingAArch32(EL2) then
  disable = if acctype == AccType_IFETCH then HCR2.ID else HCR2.CD;
else
  disable = if acctype == AccType_IFETCH then HCR_EL2.ID else HCR_EL2.CD;

return disable == '1';

```

shared/translation/attrs/S2ConvertAttrsHints

```

// S2ConvertAttrsHints()
// =====
// Converts the attribute fields for Normal memory as used in stage 2
// descriptors to orthogonal attributes and hints

MemAttrHints S2ConvertAttrsHints(bits(2) attr, AccType acctype)
assert !IsZero(attr);

MemAttrHints result;

if S2CacheDisabled(acctype) then // Force Non-cacheable
  result.attrs = MemAttr_NC;
  result.hints = MemHint_No;
else
  case attr of
    when '01' // Non-cacheable (no allocate)
      result.attrs = MemAttr_NC;
      result.hints = MemHint_No;
    when '10' // Write-through
      result.attrs = MemAttr_WT;
      result.hints = MemHint_RWA;
    when '11' // Write-back
      result.attrs = MemAttr_WB;
      result.hints = MemHint_RWA;

  result.transient = FALSE;

return result;

```

shared/translation/attrs/ShortConvertAttrsHints

```
// ShortConvertAttrsHints()
// =====
// Converts the short attribute fields for Normal memory as used in the TTBR and
// TEX fields to orthogonal attributes and hints

MemAttrHints ShortConvertAttrsHints(bits(2) RGN, AccType acctype, boolean secondstage)

    MemAttrHints result;

    if (!secondstage && S1CacheDisabled(acctype)) || (secondstage && S2CacheDisabled(acctype)) then
        // Force Non-cacheable
        result.attrs = MemAttr_NC;
        result.hints = MemHint_No;
    else
        case RGN of
            when '00' // Non-cacheable (no allocate)
                result.attrs = MemAttr_NC;
                result.hints = MemHint_No;
            when '01' // Write-back, Read and Write allocate
                result.attrs = MemAttr_WB;
                result.hints = MemHint_RWA;
            when '10' // Write-through, Read allocate
                result.attrs = MemAttr_WT;
                result.hints = MemHint_RA;
            when '11' // Write-back, Read allocate
                result.attrs = MemAttr_WB;
                result.hints = MemHint_RA;

        result.transient = FALSE;

    return result;
```

shared/translation/attrs/WalkAttrDecode

```
// WalkAttrDecode()
// =====

MemoryAttributes WalkAttrDecode(bits(2) SH, bits(2) ORGN, bits(2) IRGN, boolean secondstage)

    MemoryAttributes memattrs;

    AccType acctype = AccType_NORMAL;

    memattrs.type = MemType_Normal;
    memattrs.inner = ShortConvertAttrsHints(IRGN, acctype, secondstage);
    memattrs.outer = ShortConvertAttrsHints(ORGN, acctype, secondstage);
    memattrs.shareable = SH<1> == '1';
    memattrs.outershareable = SH == '10';

    return MemAttrDefaults(memattrs);
```

shared/translation/translation/HasS2Translation

```
// HasS2Translation()
// =====
// Returns TRUE if stage 2 translation is present for the current translation regime

boolean HasS2Translation()
    return (HaveEL(EL2) && !IsSecure()) && !IsInHost() && PSTATE.EL IN {EL0, EL1};
```

shared/translation/translation/Have16bitVMID

```
// Returns TRUE if EL2 and support for a 16-bit VMID are implemented.
boolean Have16bitVMID();
```

shared/translation/translation/PAMax

```
// PAMax()
// =====
// Returns the IMPLEMENTATION_DEFINED upper limit on the physical address
// size for this processor, as log2().

integer PAMax()
    return integer IMPLEMENTATION_DEFINED "Maximum Physical Address Size";
```

shared/translation/translation/S1TranslationRegime

```
// S1TranslationRegime()
// =====
// Stage 1 translation regime for the given Exception level

bits(2) S1TranslationRegime(bits(2) e1)
    if e1 != EL0 then
        return e1;
    elseif HaveEL(EL3) && ELUsingAArch32(EL3) && SCR.NS == '0' then
        return EL3;
    elseif HaveVirtHostExt() && ELIsInHost(e1) then
        return EL2;
    else
        return EL1;

// S1TranslationRegime()
// =====
// Returns the Exception level controlling the current Stage 1 translation regime. For the most
// part this is unused in code because the system register accessors (SCTLR[], etc.) implicitly
// return the correct value.

bits(2) S1TranslationRegime()
    return S1TranslationRegime(PSTATE.EL);
```

Part K

Appendixes

Appendix K1

Architectural Constraints on UNPREDICTABLE behaviors

This chapter describes the architectural constraints on UNPREDICTABLE behaviors in the ARMv8 architecture. It contains the following sections:

- [AArch32 CONSTRAINED UNPREDICTABLE behaviors on page K1-6096.](#)
- [AArch64 CONSTRAINED UNPREDICTABLE behaviors on page K1-6119.](#)

K1.1 AArch32 CONSTRAINED UNPREDICTABLE behaviors

ARMv8 defines architecturally-required constraints on many behaviors that are UNPREDICTABLE in ARMv7. The following sections define those constraints:

- *Overview of the constraints on ARMv7 UNPREDICTABLE behaviors on page K1-6097.*
- *Using R13 on page K1-6097.*
- *Using R15 on page K1-6097.*
- *Branching into an IT block on page K1-6098.*
- *Branching to an unaligned PC on page K1-6098.*
- *Loads and Stores to unaligned locations on page K1-6098.*
- *CONSTRAINED UNPREDICTABLE behavior associated with IT instructions and PSTATE.IT on page K1-6098.*
- *Unallocated System register access instructions on page K1-6100.*
- *SBZ or SBO fields T32 and A32 in instructions on page K1-6100.*
- *UNPREDICTABLE cases in immediate constants in T32 data-processing instructions on page K1-6100.*
- *UNPREDICTABLE cases in immediate constants in Advanced SIMD instructions on page K1-6101.*
- *CONSTRAINED UNPREDICTABLE behaviors due to caching of control or data values on page K1-6101.*
- *CONSTRAINED UNPREDICTABLE behavior due to inadequate context synchronization on page K1-6102.*
- *Translation Table Base Address alignment on page K1-6102.*
- *Handling of System register control fields for Advanced SIMD and floating-point operation on page K1-6102.*
- *The Performance Monitors Extension on page K1-6103.*
- *Syndrome register handling for CONSTRAINED UNPREDICTABLE instructions treated as UNDEFINED on page K1-6104.*
- *Out of range virtual address on page K1-6105.*
- *Instruction fetches from Device memory on page K1-6105.*
- *Multi-access instructions that load the PC from Device memory on page K1-6105.*
- *Programming CSSELR.Level for a cache level that is not implemented on page K1-6105.*
- *Crossing a page boundary with different memory types or Shareability attributes on page K1-6105.*
- *Crossing a 4KB boundary with a Device access on page K1-6106.*
- *UNPREDICTABLE behaviors with Load-Exclusive/Store-Exclusive pairs on page K1-6106.*
- *CONSTRAINED UNPREDICTABLE behavior for A32 and T32 instruction encodings on page K1-6107.*
- *Out of range values of the Set/Way/Index fields in cache maintenance instructions on page K1-6107.*
- *CONSTRAINED UNPREDICTABLE behavior for A32 and T32 system instructions in the base instruction set on page K1-6108.*
- *CONSTRAINED UNPREDICTABLE behavior, A32 and T32 Advanced SIMD and floating-point instructions on page K1-6110.*
- *CONSTRAINED UNPREDICTABLE behaviors associated with the VTCR on page K1-6114.*

- [CONSTRAINED UNPREDICTABLE behavior of EL2 features on page K1-6114.](#)
- [Reserved values in System and memory-mapped registers and translation table entries on page K1-6117.](#)
- [CONSTRAINED UNPREDICTABLE behavior in Debug state on page K1-6118.](#)

K1.1.1 Overview of the constraints on ARMv7 UNPREDICTABLE behaviors

The term UNPREDICTABLE describes a number of cases where the architecture has a feature that software must not use. For execution in AArch32 state, where previous versions of the architecture define behavior as UNPREDICTABLE, the ARMv8-A architecture specifies a narrow range of permitted behaviors. This range is the range of CONSTRAINED UNPREDICTABLE behavior. All implementations that are compliant with the architecture must follow the CONSTRAINED UNPREDICTABLE behavior.

———— **Note** —————

Software designed to be compatible with the ARMv8-A architecture must not rely on these CONSTRAINED UNPREDICTABLE cases.

K1.1.2 Using R13

In prior versions of the architecture, the use of R13 as a named register specifier was described as UNPREDICTABLE in the pseudocode. In the ARMv8-A architecture, the use of R13 as a named register specifier is not UNPREDICTABLE, unless this is specifically stated, and R13 can be used in the regular form. Bits[1:0] of R13 are not treated as RES0, but can hold any values programmed into them.

K1.1.3 Using R15

All uses of R15 as a named register specifier for a source register that are described as CONSTRAINED UNPREDICTABLE in the pseudocode or in other places in this Manual must do one of the following:

- Cause the instruction to be treated as UNDEFINED.
- Cause the instruction to execute as a NOP.
- Read or return an UNKNOWN value for the source register specified as R15.

All uses of R15 as a named register specifier for a destination register that are described as CONSTRAINED UNPREDICTABLE in the pseudocode or in other places in this reference manual must do one of the following:

- Cause the instruction to be treated as UNDEFINED.
- Cause the instruction to execute as a NOP.
- Ignore the write.
- Branch to an UNKNOWN location in either A32 or T32 state.

The choice between these behaviors might in some implementations vary from instruction to instruction, or between different instances of the same instruction.

Instructions that are CONSTRAINED UNPREDICTABLE when the base register is R15 and the instruction specifies a writeback of the base register, are treated as having R15 as both a source register and a destination register.

For instructions that have two destination registers, for example LDRD, MRRC, and many of the multiply instructions, if Rt, Rt2, RdLo, or RdHi is R15, then the other destination register of the pair is UNKNOWN, if the CONSTRAINED UNPREDICTABLE behavior for the write to R15 is either to ignore the write or to branch to an UNKNOWN location.

For instructions that affect any or all of **PSTATE**.{N, Z, C, V}, **PSTATE**.Q, and **PSTATE**.GE when the register specifier is not R15, any flags affected by an instruction that is CONSTRAINED UNPREDICTABLE when the register specifier is R15 become UNKNOWN,

In addition, for MRC instructions that use R15 as the destination register descriptor, and therefore target APSR_nzcv where these are described as being CONSTRAINED UNPREDICTABLE, **PSTATE**.{N, Z, C, V} becomes UNKNOWN.

K1.1.4 Branching into an IT block

Branching into an IT block leads to CONSTRAINED UNPREDICTABLE behavior. Execution starts from the address determined by the branch, but each instruction in the IT block is:

- Executed as if it were not in an IT block. This means that it is executed unconditionally.
- Executed as if it had passed its [Condition code check](#) within an IT block.
- Executed as a NOP. That is, it behaves as if it had failed the [Condition code check](#).

K1.1.5 Branching to an unaligned PC

In A32 state, when branching to an address that is not word aligned and is defined to be CONSTRAINED UNPREDICTABLE, one of the following behaviors must occur:

- The unaligned location is forced to be aligned.
 - The unaligned address generates an exception on the first instruction using the unaligned PC value. If that instruction is executed at EL0 and either of the following applies, the exception is taken to EL2:
 - EL2 is using AArch32 and the value of [HCR.TGE](#) is 1
 - EL2 is using AArch64 and the value of [HCR_EL2.TGE](#) is 1.If the instruction is executed at EL0 when the applicable TGE bit is 0 the exception is taken to EL1. If the instruction is executed at an Exception level that is higher than EL0 the exception is taken to the Exception level at which the instruction was executed.
- In all cases, the exception is generated only if the first instruction using the unaligned PC value is architecturally executed.

If the exception that results from a branch to an unaligned PC value:

- Is taken to an Exception level that is using AArch64, it is reported as a PC alignment fault exception, see [Exception from an Illegal Execution state, PC alignment fault, or SP alignment fault on page D1-1808](#).
- Is taken to an Exception level that is using AArch32, it is reported as a Prefetch Abort exception, see [Prefetch Abort exception reporting a PC alignment fault exception on page G1-4385](#).

———— **Note** —————

Because bit[0] is used for interworking, it is impossible to specify a branch to A32 state when the bottom bit of the target address is 1. Therefore the bottom bit of [IFAR](#), [HIFAR](#), or [FAR_ELx](#) is 0 for all these cases.

K1.1.6 Loads and Stores to unaligned locations

Some unaligned loads and stores in the ARMv7 architecture are described as UNPREDICTABLE. These are defined in the ARMv8-A architecture to do one of the following:

- Take an alignment fault.
- Perform the specified load or store to the unaligned memory location.

K1.1.7 CONSTRAINED UNPREDICTABLE behavior associated with IT instructions and PSTATE.IT

A number of instructions in the architecture are described as being CONSTRAINED UNPREDICTABLE either:

- Anywhere within an IT block.
- As an instruction within an IT block, other than the last instruction within an IT block.

Unless otherwise stated in this manual, when these instructions are committed for execution, one of the following occurs:

- An UNDEFINED exception results.
- The instructions are executed as if they had passed the [Condition code check](#).
- The instructions execute as NOPs. This means that they behave as if they had failed the [Condition code check](#).

The behavior might in some implementations vary from instruction to instruction, or between different instances of the same instruction.

Many instructions that are CONSTRAINED UNPREDICTABLE in an IT block are branch instructions or other non-sequential instructions that change the PC. Where these instructions are not treated as UNDEFINED within an IT block, the remaining iterations of the PSTATE.IT state machine must be treated in one of the following ways:

- PSTATE.IT is cleared to 0.
- PSTATE.IT advances for either a sequential or a nonsequential change of the PC in the same way as it does for instructions that are not CONSTRAINED UNPREDICTABLE that cause a sequential change of the PC.

———— **Note** —————

This does not apply to an instruction that is the last instruction in an IT block.

The instructions addressed by the updated PC must do one of the following:

- Execute as if they had passed the [Condition code check](#) for the remaining iterations of the PSTATE.IT state machine.
- Execute as NOPs. That is, they behave as if they had failed the [Condition code check](#) for the remaining iterations of the PSTATE.IT state machine.
- Execute as if they were unconditional, or, if the instructions are part of another IT block, in accordance with the behavior described in [Branching into an IT block on page K1-6098](#).

The behavior might in some implementations vary from instruction to instruction, or between different instances of the same instruction.

For exception returns or Debug state exits that cause PSTATE.IT to be set to a reserved value in T32 state or that return to A32 state with a nonzero value in PSTATE.IT, the PSTATE.IT bits are forced to '00000000'. The reserved values are:

```
PSTATE.IT[7:4] != '0000' && PSTATE.IT[3:0] = '0000'  
PSTATE.IT[2:0] != '000' when SCTLR/SCTLR_EL1.ITD == '1'
```

Exception returns or Debug state exits that set PSTATE.IT to a non-reserved value in T32 state can occur when the flow of execution returns to a point:

- Outside an IT block, but with the PSTATE.IT bits set to a value other than '00000000'.
- Inside an IT block, but with a different value of the PSTATE.IT bits than if the IT block had been executed without an exception return or Debug state exit.

In this case the instructions at the target of the exception return or Debug state exit must do one of the following:

- Execute as if they passed the [Condition code check](#) for the remaining iterations of the PSTATE.IT state machine.
- Execute as NOPs. That is, they behave as if they failed the [Condition code check](#) for the remaining iterations of the PSTATE.IT state machine.
- Execute as if they were unconditional, or as if the instruction were part of another IT block, in accordance with the behavior in [Branching into an IT block on page K1-6098](#).

The remaining iterations of the PSTATE.IT state machine must behave in one of the following ways:

- The PSTATE.IT state machine advances as if it were in an IT block.
- The PSTATE.IT bits are ignored.
- The PSTATE.IT bits are forced to '00000000'.

K1.1.8 Unallocated System register access instructions

In ARMv8-A, accesses to unallocated System register encodings are UNDEFINED.

This includes:

- Reads using encodings that are defined as WO.
- Writes using encodings that are defined as RO.
- MCR or MRC accesses to using a set of {coproc, CRn, opc1, CRm, opc2} values that the ARMv7 architecture defined as UNPREDICTABLE.
- Accesses to System registers in the (coproc==0b111x) encoding space that the ARMv7 architecture defined as UNPREDICTABLE when particular functionality was not implemented, when an ARMv8 implementation does not include the Exception level that provides that functionality.

K1.1.9 SBZ or SBO fields T32 and A32 in instructions

Many of the A32 and T32 instructions have (0) or (1) in the instruction decode to indicate *should-be-zero*, SBZ, or *should-be-one*, SBO. If the instruction bit pattern of an instruction is executed with these fields not having the *should be* values, one of the following must occur:

- The instruction is UNDEFINED.
- The instruction executes as a NOP.
- The instruction operates as if the bit had the *should-be* value.
- Any destination registers of the instruction become UNKNOWN.

The exceptions to this rule are:

- [LDM, LDMIA, LDMFD](#) on page F5-3144.
- [LDMDB, LDMEA](#) on page F5-3154.
- [LDR \(literal\)](#) on page F5-3163.
- [LDRB \(literal\)](#) on page F5-3172.
- [LDRD \(immediate\)](#) on page F5-3180.
- [LDRD \(register\)](#) on page F5-3186.
- [LDRD \(literal\)](#) on page F5-3183.
- [LDRH \(literal\)](#) on page F5-3200.
- [LDRSB \(literal\)](#) on page F5-3211.
- [LDRSH \(literal\)](#) on page F5-3222.
- [POP](#) on page F5-3325.
- [PUSH](#) on page F5-3331.
- [SDIV](#) on page F5-3407.
- [STM, STMIA, STMEA](#) on page F5-3495.
- [STMDB, STMFD](#) on page F5-3503.
- [UDIV](#) on page F5-3610.

K1.1.10 UNPREDICTABLE cases in immediate constants in T32 data-processing instructions

The description of immediate constants in T32 data processing [Modified immediate constants in T32 instructions](#) on page F2-2863 include constant values that were UNPREDICTABLE in ARMv7. [Instruction encodings](#) on page F2-2844 describes 32-bit T32 instructions as {hw1, hw2}, where hw1 is the left-hand halfword in the 32-bit encoding diagram for the instruction. The UNPREDICTABLE cases are those where both:

- hw2[7:0] == 0b0000000.
- hw1[10] == 0 and either:
 - hw2[14:12] == 0b001.
 - hw2[14:12] == 0b010.
 - hw2[14:12] == 0b011.

In ARMv8 the CONSTRAINED UNPREDICTABLE behavior is that these encodings produce the value `0b0000000`.

K1.1.11 UNPREDICTABLE cases in immediate constants in Advanced SIMD instructions

The description of immediate constants in *Modified immediate constants in T32 and A32 Advanced SIMD instructions* on page F2-2865 include constant values that were UNPREDICTABLE in ARMv7. The UNPREDICTABLE cases are those where:

- The bits that the encoding diagram shows as `abcd` are all 0.
In the A32 encoding these are bits[24, 18:6, 3:0]. In the T32 encoding they are bits {hw1[12, 2:0], hw2[3:0]}.
- The bits that the encoding diagram shows as `cmode[3:1]` are one of {0b001, 0b010, 0b011, 0b101, 0b110}.
In the A32 encoding these are bits[11:9]. In the T32 encoding they are bits hw2[11:9].

In ARMv8 the CONSTRAINED UNPREDICTABLE behavior is that these encodings produce an immediate constant value of zero.

K1.1.12 CONSTRAINED UNPREDICTABLE behaviors due to caching of control or data values

The ARM architecture allows copies of control values or data values to be cached in a cache or TLB. This can lead to CONSTRAINED UNPREDICTABLE behavior if the cache or TLB has not been correctly invalidated following a change of the control or data values.

Unless explicitly stated otherwise, the behavior of the PE is consistent with one of:

- The old data or control value.
- The new data or control value.
- An amalgamation of the old and new data or control values.

In an implementation that includes ARMv8.2-TTCNP, this CONSTRAINED UNPREDICTABLE case can arise from misprogramming when setting `TTBR.CnP` to 1, as identified in the descriptions of the `TTBR.CnP` field. In this case, for a particular `TTBR`, the behavior of the PE is consistent with one of:

- The value of the translation table entry pointed to by that `TTBR` on one of the PEs within the Inner Shareable domain for which both the value of `TTBR.CnP` is 1 and the other conditions for sharing translation table entries pointed to by that `TTBR` are met.
- An amalgamation of the values of the translation table entries pointed to by that `TTBR` on two or more of the PEs within the Inner Shareable domain for which both the value of `TTBR.CnP` is 1 and the other conditions for sharing translation table entries pointed to by that `TTBR` are met.

————— Note —————

If the effective control or data value that determines the behavior of the PE results from the amalgamation of two or more values then that effective value must not generate a privilege violation. So, for example:

- Where the CONSTRAINED UNPREDICTABLE behavior occurs because inadequate invalidation of the TLB causes multiple hits in the TLB, the failure to invalidate the TLB by software executing at a given Exception level and Security state must not make it possible to access regions of memory with permissions or attributes that could not be accessed at that Exception level and Security state.
- Where the CONSTRAINED UNPREDICTABLE behavior occurs because of a programming error, on one or more PEs in the Inner Shareable domain, when using a `TTBR.CnP` value of 1 to share translation table entries, the misprogramming must not make it possible to access regions of memory with permissions or attributes that could not be accessed at the Exception level of that `TTBR` and the Security state corresponding to the translation table entries being shared.

Alternatively to this CONSTRAINED UNPREDICTABLE behavior, an implementation detecting multiple hits within a TLB might generate an exception, reporting the exception using the TLB Conflict fault code, see *TLB conflict aborts* on page G4-4630.

The choice between the behaviors might, in some implementations, vary for each use of a control or data value.

K1.1.13 CONSTRAINED UNPREDICTABLE behavior due to inadequate context synchronization

The ARM architecture requires that changes to System registers must be synchronized before they take effect. This can lead to CONSTRAINED UNPREDICTABLE behavior if the synchronization has not been performed.

In these cases, the behavior of the PE is consistent with the unsynchronized control value being either the old value or the new value.

Where multiple control values are updated but not yet synchronized, each control value might independently be the old value or the new value.

In addition, where the unsynchronized control value applies to different areas of functionality, or what an implementation has constructed as different areas of functionality, those areas might independently treat the control value as being either the old value or the new value.

The choice between these behaviors might, in some implementations, vary for each use of a control value.

K1.1.14 Translation Table Base Address alignment

A misaligned Translation Table Base Address can occur if:

- The VMSAv8-32 Short-descriptor translation table format is enabled and `TTBR0[13-N:7]`, which is defined to be `RES0`, contains one or more nonzero values.
- The VMSAv8-32 Long-descriptor translation table format is enabled, and `TTBR0[x-1:3]`, `TTBR1[x-1:3]`, `HTTBR[x-1:3]`, or `VTTBR[x-1:3]`, which are defined to be `RES0`, contain one or more nonzero values.

In the event of a misaligned Translation Table Base Address, one of the following behaviors must occur:

- The field that is defined to be `RES0` is treated as if all bits were zero:
 - The value that is read back might be the value written or it might be zero.
- The calculation of an address for a translation table walk using that register might be corrupted in those bits that are nonzero.

K1.1.15 Handling of System register control fields for Advanced SIMD and floating-point operation

For historical reasons described in *Background to the System register interface on page G1-4410*, each of the `CPACR`, `HCPTR`, and `NSACR` has a pair of control fields that were defined to have identical functionality for controlling Advanced SIMD and floating-point operation. These fields are:

- `CPACR`.{cp10, cp11}.
- `HCPTR`.{TCP10, TCP11}.
- `NSACR`.{cp10, cp11}.

The architecture requires that both fields in one of these pairs are programmed to the same value. If this is not done, then the CONSTRAINED UNPREDICTABLE behavior is that behavior is the same as if the cp11, or TCP11, control field was equal to the cp10, or TCP10, field in all respects other than the value read back by a direct read of the register. After a register write that writes different values to the two fields of a pair, a direct read of the register might return an UNKNOWN value for the cp11 or TCP11 field.

———— **Note** —————

This means that, when different values are written to the {cp10, cp11} fields in a single register, the architecture permits but does not require that a read of that register returns the value written to the cp11 field.

CONSTRAINED UNPREDICTABLE CPACR and NSACR settings

If **CPACR**.cp<n> contains the encoding '10', then one of the following behaviors must occur:

- The encoding maps onto any of the allocated values, but otherwise does not cause UNPREDICTABLE behavior.
- The encoding causes effects that could be achieved by a combination of more than one of the allocated encodings.

———— Note —————

In ARMv7, **CPACR** had a D32DIS bit, and **NSACR** had an NSD32DIS bit. There is no **CPACR**.D32DIS or **NSACR**.NSD32DIS in ARMv8-A, and the corresponding bits in the two registers are RES0.

K1.1.16 The Performance Monitors Extension

The following subsections describe CONSTRAINED UNPREDICTABLE behaviors when accessing the Performance Monitors Extension in AArch32 state:

- *CONSTRAINED UNPREDICTABLE accesses to **PMXEVTYPER** or **PMXVCNTR**.*
- *CONSTRAINED UNPREDICTABLE accesses to **PMEVCNTR**<n> and **PMEVTYPER**<n> on page K1-6104.*
- *CONSTRAINED UNPREDICTABLE behavior caused by **HDCR**.HPMN on page K1-6104.*

CONSTRAINED UNPREDICTABLE accesses to **PMXEVTYPER** or **PMXVCNTR**

The following cases can cause CONSTRAINED UNPREDICTABLE behavior:

- If **PMSELR**.SEL is not equal to 31, and **PMSELR**.SEL is greater than or equal to **PMCR**.N, and the PE is executing in Secure state or in Non-secure Hyp mode.
- If **PMSELR**.SEL is not 31, and **PMSELR**.SEL is greater than or equal to **HDCR**.HPMN, and the PE is executing in a Non-secure mode other than Hyp mode.

In these UNPREDICTABLE cases, one of the following behaviors must occur:

- Accesses to **PMXEVTYPER** or **PMXVCNTR** from that mode are UNDEFINED.
- Accesses to **PMXEVTYPER** or **PMXVCNTR** from that mode behave as RAZ/WI.
- Accesses to **PMXEVTYPER** or **PMXVCNTR** from that mode execute as NOPs.
- Accesses to **PMXEVTYPER** or **PMXVCNTR** from that mode behave as if **PMSELR**.SEL contains an UNKNOWN value that is less than the number of counters accessible at the current Exception level and Security state.
- Accesses to **PMXEVTYPER** or **PMXVCNTR** behave as if **PMSELR**.SEL is 31.
- In Non-secure state, for an access to **PMXEVTYPER** or **PMXVCNTR** from PL1 or a permitted access from PL0, if the counter is implemented but not accessible at the current Exception level, the register access is trapped to EL2. Accesses from PL0 are permitted when:
 - EL1 is using AArch32 and the value of **PMUSERENR**.EN is 1.
 - EL1 is using AArch64 and the value of **PMUSERENR**._EL0.EN is 1.

If **PMSELR**.SEL is equal to 31, then one of the following behaviors must occur:

- Accesses to **PMXVCNTR** are UNDEFINED.
- Accesses to **PMXVCNTR** behave as RAZ/WI.
- Accesses to **PMXVCNTR** execute as NOPs.
- Accesses to **PMXVCNTR** behave as if **PMSELR**.SEL contains an UNKNOWN value that is less than the number of counters accessible at the current Exception level and Security state.

- In Non-secure state, for an access to [PMXEVNTR](#) from PL1 or a permitted access from PL0, if the counter is implemented but not accessible at the current Exception level, the register access is trapped to EL2. Accesses from PL0 are permitted when:
 - EL1 is using AArch32 and the value of [PMUSERENR.EN](#) is 1.
 - EL1 is using AArch64 and the value of [PMUSERENR_EL0.EN](#) is 1.

———— **Note** —————

In an implementation that includes EL2, in Non-secure state at PL0 and PL1, [HDCR.HPMN](#), or [MDCR_EL2.HPMN](#), identifies the number of accessible counters. Otherwise, the number of accessible counters is the number of implemented counters.

CONSTRAINED UNPREDICTABLE accesses to [PMEVCNTR<n>](#) and [PMEVTYPER<n>](#)

If [<n>](#) is greater than the number of counters available in the current Exception level and state, reads and writes of [PMEVCNTR<n>](#) and [PMEVTYPER<n>](#) are CONSTRAINED UNPREDICTABLE, and the following behaviors are permitted:

- Accesses to the register are UNDEFINED.
- Accesses to the register behave as RAZ/WI.
- Accesses to the register execute as a NOP.
- In Non-secure state, for an access to [PMEVCNTR<n>](#) or [PMEVTYPER<n>](#) from PL1 or a permitted access from PL0, if the counter is implemented but not accessible at the current Exception level, the register access is trapped to EL2. Accesses from PL0 are permitted when:
 - EL1 is using AArch32 and the value of [PMUSERENR.EN](#) is 1.
 - EL1 is using AArch64 and the value of [PMUSERENR_EL0.EN](#) is 1.

———— **Note** —————

In an implementation that includes EL2, in Non-secure state at PL0 and PL1, [HDCR.HPMN](#), or [MDCR_EL2.HPMN](#), identifies the number of accessible counters. Otherwise, the number of accessible counters is the number of implemented counters.

CONSTRAINED UNPREDICTABLE behavior caused by [HDCR.HPMN](#)

If [HDCR.HPMN](#) is set to 0 or to a value greater than [PMCR.N](#), then the CONSTRAINED UNPREDICTABLE behavior is:

- The value returned by a direct read of [HDCR.HPMN](#) is UNKNOWN.
- Either:
 - An UNKNOWN number of counters are reserved for EL2 use. That is, the PE behaves as if [HDCR.HPMN](#) is set to an UNKNOWN non-zero value less than [PMCR.N](#).
 - All counters are reserved for EL2 use, meaning no counters are accessible from Non-secure EL1 and Non-secure EL0.

K1.1.17 Syndrome register handling for CONSTRAINED UNPREDICTABLE instructions treated as UNDEFINED

When a CONSTRAINED UNPREDICTABLE instruction is treated as UNDEFINED, this generates an exception:

- If this exception is taken to an Exception level that is using AArch64 then [ESR_ELx](#) is UNKNOWN.
- If this exception is taken to EL2 and EL2 is using AArch32, then the [HSR](#) is UNKNOWN.

———— **Note** —————

The value written to ESR or HSR must be consistent with a value that could be created as the result of an exception from the same Exception level that generated the exception, but resulted from a situation that is not CONSTRAINED UNPREDICTABLE at that Exception level. This is to avoid a possible privilege violation.

K1.1.18 Out of range virtual address

If the PE executes an instruction for which the instruction address, size, and alignment mean it contains the bytes 0xFFFF FFFF and 0x0000 0000, then the bytes that wrap around and appear to be from 0x0000 0000 onwards come from an UNKNOWN address.

If the PE executes a load or store instruction for which the computed address, total access size, and alignment mean it accesses bytes 0xFFFF FFFF and 0x0000 0000, then the bytes that wrap around and appear to be from 0x0000 0000 onwards come from an UNKNOWN address.

K1.1.19 Instruction fetches from Device memory

Instruction fetches from Device memory are CONSTRAINED UNPREDICTABLE.

If a location in memory has the Device attribute and is not marked as execute-never, then an implementation might perform speculative instruction accesses to this memory location when address translation is enabled.

If a branch causes the program counter to point to a location in memory with the Device attribute that is not marked as execute-never for the current Exception level for instruction fetches, then an implementation must perform one of the following behaviors:

- It treats the instruction fetch as if it were to a memory location with the Normal, Non-cacheable attribute.
- It generates a Permission fault.

K1.1.20 Multi-access instructions that load the PC from Device memory

Multi-access instructions that load the PC from Device memory when address translation is enabled are UNPREDICTABLE in AArch32 state. In the ARMv8-A architecture in AArch32 state an implementation must perform one of the following behaviors:

- It loads the PC from the memory location as if the memory location had the Normal Non-cacheable attribute.
- It generates a permission fault.

K1.1.21 Programming CSSELR.Level for a cache level that is not implemented

If CSSELR.Level is programmed to a cache level that is not implemented, then a read of CSSELR returns an UNKNOWN value in CSSELR.Level.

If the CSSELR.Level is programmed to a cache level that is not implemented, then on a read of CCSIDR an implementation must perform one of the following behaviors:

- The CCSIDR read executes as a NOP.
- The CCSIDR read is UNDEFINED.
- The CCSIDR read returns an UNKNOWN value.

K1.1.22 Crossing a page boundary with different memory types or Shareability attributes

A memory access from a load or store instruction that crosses a page boundary to a memory location that has a different memory type or Shareability attribute results in CONSTRAINED UNPREDICTABLE behavior. In this case, the implementation must perform one of the following behaviors:

- All memory accesses generated by the instruction use the memory type and Shareability attributes associated with the first address accessed by the instruction.
- All memory accesses generated by the instruction use the memory type and Shareability attributes associated with the last address accessed by the instruction.
- Each memory access generated by the instruction uses the memory type and Shareability attribute associated with its own address.

- The instruction generates an alignment fault caused by the memory type.
For the Non-secure PL1&0 translation regime:
 - If the stage 1 translation causes the mismatch then the resulting exception is taken to PL1.
 - If the stage 2 translation causes the mismatch then the resulting exception is taken to PL2.
 - If both stages of translation cause the mismatch then the resulting exception can be taken to either PL1 or PL2.
- The instruction executes as a NOP.

K1.1.23 Crossing a 4KB boundary with a Device access

A memory access from a load or store instruction to Device memory that crosses a 4KB boundary results in CONSTRAINED UNPREDICTABLE behavior. In this case, the implementation must perform one of the following behaviors:

- All memory accesses generated by the instruction are performed as if the presence of the boundary had no effect on the memory accesses.
- All memory accesses generated by the instruction are performed as if the presence of the boundary had no effect on the memory accesses, except that there is no guarantee of ordering between memory accesses.
- The instruction generates an Alignment fault caused by the memory type.
For the Non-secure PL1&0 translation regime:
 - If the stage 1 translation causes the boundary to be crossed then the resulting exception is taken to PL1.
 - If the stage 2 translation causes the boundary to be crossed then the resulting exception is taken to PL2.
 - If both stages of translation cause the boundary to be crossed then the resulting exception can be taken to either PL1 or PL2.
- The instruction executes as a NOP.

———— **Note** —————

The boundary referred to is between two Device memory regions that are both of 4KB and aligned to 4KB.

K1.1.24 UNPREDICTABLE behaviors with Load-Exclusive/Store-Exclusive pairs

[Load-Exclusive and Store-Exclusive instruction usage restrictions on page E2-2802](#) defines a Load-Exclusive/Store-Exclusive pair, and identifies various CONSTRAINED UNPREDICTABLE behaviors associated with using Load-Exclusive/Store-Exclusive pairs. These cases were UNPREDICTABLE in ARMv7. In summary, these cases are:

- The target virtual address of a StoreExc1 instruction is different from the virtual address of the preceding LoadExc1 instruction in the same thread of execution.
- The transaction size of a StoreExc1 instruction is different from the transaction size of the preceding LoadExc1 instruction in the same thread of execution.
- The memory attributes for a StoreExc1 instruction are different from the memory attributes for the preceding LoadExc1 instruction in the same thread of execution, either:
 - Because the translation of the accessed address changes between the LoadExc1 instruction and the StoreExc1 instruction.
 - Because the LoadExc1 instruction and the StoreExc1 instruction use different virtual addresses, with different attributes, that point to the same physical address.

In addition, the effect of a data or unified cache invalidate, clean, or clean and invalidate instruction on a local or global Exclusives monitor that is in the Exclusive Access state is CONSTRAINED UNPREDICTABLE.

See the descriptions in [Load-Exclusive and Store-Exclusive instruction usage restrictions on page E2-2802](#) for the permitted behavior in each of these cases, and any constraints that might apply to whether the case is CONSTRAINED UNPREDICTABLE.

———— **Note** ————

Additional CONSTRAINED UNPREDICTABLE cases can apply to Load-Exclusive and Store-Exclusive instructions, see [CONSTRAINED UNPREDICTABLE behavior for A32 and T32 system instructions in the base instruction set on page K1-6108](#).

K1.1.25 CONSTRAINED UNPREDICTABLE behavior for A32 and T32 instruction encodings

The A32 and T32 instruction sets include encodings that result in CONSTRAINED UNPREDICTABLE behavior when they are decoded.

CONSTRAINED UNPREDICTABLE behavior of CRC32 instruction encodings

In the A32 and T32 instruction sets, there are encodings of the [CRC32](#) and [CRC32C](#) instructions that result in CONSTRAINED UNPREDICTABLE behavior. These encodings are listed in the following places in the A32 and T32 instruction sets:

- [Cyclic Redundancy Check on page F4-2952](#) for the A32 instruction set, with $sz = 11$.
- [Data-processing \(two source registers\) on page F3-2937](#) for the T32 instruction set, with $op1 = 10x$ and $op2 = 11$.

The CONSTRAINED UNPREDICTABLE behavior for these encodings is described in [CRC32 on page F5-3094](#) and [CRC32C on page F5-3097](#).

CONSTRAINED UNPREDICTABLE behavior of other A32 instruction encodings

In the A32 instruction set, there are encodings that result in CONSTRAINED UNPREDICTABLE behavior. These encodings are listed in:

- [Miscellaneous on page F4-2984](#).
- [Memory hints and barriers on page F4-2995](#).
- [Barriers on page F4-2996](#).

The CONSTRAINED UNPREDICTABLE behavior is that an implementation must treat the encodings in one of the following ways:

- The instruction encoding is UNDEFINED.
- The instruction encoding executes as NOP.

K1.1.26 Out of range values of the Set/Way/Index fields in cache maintenance instructions

In the cache maintenance by set/way instructions [DCCISW](#), [DCCSW](#), and [DCISW](#), if any set/way/index argument is larger than the value supported by the implementation, then the behavior is CONSTRAINED UNPREDICTABLE and one of the following occurs:

- The instruction is UNDEFINED.
- The instruction performs cache maintenance on one of:
 - No cache lines.
 - A single arbitrary cache line.
 - Multiple arbitrary cache lines.

———— **Note** —————

This CONSTRAINED UNPREDICTABLE behavior applies, also, to the A64 cache maintenance by set/way instructions [DC CISW](#), [DC CSW](#), and [DC ISW](#).

K1.1.27 CONSTRAINED UNPREDICTABLE behavior for A32 and T32 system instructions in the base instruction set

This section lists the CONSTRAINED UNPREDICTABLE behavior for the different A32 and T32 system instructions.

———— **Note** —————

If an instruction can result in CONSTRAINED UNPREDICTABLE behavior that is not specific to that particular instruction, see the relevant section in this appendix for a description of the CONSTRAINED UNPREDICTABLE behavior.

SRS (T32)

For a description of this instruction and the encoding, see [SRS](#), [SRSDA](#), [SRSDB](#), [SRSIA](#), [SRSIB](#) on page F5-3464.

CONSTRAINED UNPREDICTABLE behavior

For all encodings:

- If the instruction specifies an illegal mode field, then one of the following behaviors must occur:
 - The instruction is UNDEFINED.
 - The instruction executes as a NOP.
 - R13 of the current mode is used.
 - The store occurs to an UNKNOWN address, and if the instruction specifies writeback, any general-purpose register that can be accessed without privilege violation from the current Exception level become UNKNOWN.

SRS (A32)

For a description of this instruction and the encoding, see [SRS](#), [SRSDA](#), [SRSDB](#), [SRSIA](#), [SRSIB](#) on page F5-3464.

CONSTRAINED UNPREDICTABLE behavior

For all encodings:

- If the instruction specifies an illegal mode field, then one of the following behaviors must occur:
 - The instruction is UNDEFINED.
 - The instruction executes as a NOP.
 - R13 of the current mode is used.
 - The store occurs to an UNKNOWN address, and if the instruction specifies writeback, any general-purpose register that can be accessed without privilege violation from the current Exception level become UNKNOWN.

SUBS PC, LR and related instructions (T32)

For a description of this instruction and the encoding, see the exception return form of *SUB, SUBS (immediate)* on page F5-3560.

CONSTRAINED UNPREDICTABLE behavior

For all encodings:

- If this instruction is executed in User mode or in System mode, then one of the following behaviors must occur:
 - The instruction is UNDEFINED.
 - The instruction executes as a NOP.
- If the instruction transfers an illegal mode encoding to *PSTATE.M*, then this invokes the illegal exception return.

———— **Note** —————

An illegal mode encoding is either an unallocated mode encoding or one that is not accessible at the current Exception level.

For this encoding:

- If *hw2[3:0]* are *0b1110*, and the instruction is executed when not in Hyp mode, System mode, or User mode, then one of the following behaviors must occur:
 - The instruction is UNDEFINED.
 - The instruction is treated as a NOP.
 - The instruction is treated as if *hw2[3:0]* are *0b1110*.
 - The program counter is set using the value in the register specified by *hw2[3:0]*.

SUBS PC, LR and related instructions (A32)

For a description of this instruction and the encoding, see the exception return forms of *MOV, MOVS (register)* on page F5-3260 and *SUB, SUBS (immediate)* on page F5-3560.

CONSTRAINED UNPREDICTABLE behavior

For all encodings:

- If this instruction is executed in User mode or in System mode, then one of the following behaviors must occur:
 - The instruction is UNDEFINED.
 - The instruction executes as a NOP.
- If the instruction transfers an illegal mode encoding to *PSTATE.M*, then this invokes the illegal exception return.

———— **Note** —————

An illegal mode encoding is either an unallocated mode encoding or one that is not accessible at the current Exception level.

K1.1.28 CONSTRAINED UNPREDICTABLE behavior, A32 and T32 Advanced SIMD and floating-point instructions

This section lists the CONSTRAINED UNPREDICTABLE behavior for the different A32 and T32 Advanced SIMD and floating-point instructions listed in [Alphabetical list of floating-point and Advanced SIMD instructions on page F6-3680](#).

Note

- The pseudocode used in this section to describe cases that can result in CONSTRAINED UNPREDICTABLE behavior does not necessarily match the encoding specific pseudocode for a specific instruction.
- If an instruction can result in CONSTRAINED UNPREDICTABLE behavior that is not specific to that particular instruction, see the relevant section in this appendix for a description of the CONSTRAINED UNPREDICTABLE behavior.

VCVT (between floating-point and fixed-point)

For a description of this instruction and the encoding, see [VCVT \(between floating-point and fixed-point, floating-point\) on page F6-3819](#).

If this instruction is not UNDEFINED, then whether it is affected by traps or enables relating to the use of the SIMD&FP registers when it is CONSTRAINED UNPREDICTABLE, is IMPLEMENTATION DEFINED. The implementation must ensure that the CONSTRAINED UNPREDICTABLE behavior does not corrupt registers that are not accessible at the current Exception level by instructions that are not CONSTRAINED UNPREDICTABLE.

VLD1 (multiple single elements)

For a description of this instruction and the encoding, see [VLD1 \(multiple single elements\) on page F6-3889](#).

If this instruction is not UNDEFINED, then whether it is affected by traps or enables relating to the use of the SIMD&FP registers when it is CONSTRAINED UNPREDICTABLE, is IMPLEMENTATION DEFINED. The implementation must ensure that the CONSTRAINED UNPREDICTABLE behavior does not corrupt registers that are not accessible at the current Exception level by instructions that are not CONSTRAINED UNPREDICTABLE.

VLD1 (single element to all lanes)

For a description of this instruction and the encoding, see [VLD1 \(single element to all lanes\) on page F6-3886](#).

If this instruction is not UNDEFINED, then whether it is affected by traps or enables relating to the use of the SIMD&FP registers when it is CONSTRAINED UNPREDICTABLE, is IMPLEMENTATION DEFINED. The implementation must ensure that the CONSTRAINED UNPREDICTABLE behavior does not corrupt registers that are not accessible at the current Exception level by instructions that are not CONSTRAINED UNPREDICTABLE.

VLD2 (multiple 2-element structures)

For a description of this instruction and the encoding, see [VLD2 \(multiple 2-element structures\) on page F6-3906](#).

If this instruction is not UNDEFINED, then whether it is affected by traps or enables relating to the use of the SIMD&FP registers when it is CONSTRAINED UNPREDICTABLE, is IMPLEMENTATION DEFINED. The implementation must ensure that the CONSTRAINED UNPREDICTABLE behavior does not corrupt registers that are not accessible at the current Exception level by instructions that are not CONSTRAINED UNPREDICTABLE.

VLD2 (single 2-element structure to one lane)

For a description of this instruction and the encoding, see [VLD2 \(single 2-element structure to one lane\) on page F6-3897](#).

If this instruction is not UNDEFINED, then whether it is affected by traps or enables relating to the use of the SIMD&FP registers when it is CONSTRAINED UNPREDICTABLE, is IMPLEMENTATION DEFINED. The implementation must ensure that the CONSTRAINED UNPREDICTABLE behavior does not corrupt registers that are not accessible at the current Exception level by instructions that are not CONSTRAINED UNPREDICTABLE.

VLD2 (single 2-element structure to all lanes)

For a description of this instruction and the encoding, see [VLD2 \(single 2-element structure to all lanes\)](#) on page F6-3903.

If this instruction is not UNDEFINED, then whether it is affected by traps or enables relating to the use of the SIMD&FP registers when it is CONSTRAINED UNPREDICTABLE, is IMPLEMENTATION DEFINED. The implementation must ensure that the CONSTRAINED UNPREDICTABLE behavior does not corrupt registers that are not accessible at the current Exception level by instructions that are not CONSTRAINED UNPREDICTABLE.

VLD3 (multiple 3-element structures)

For a description of this instruction and the encoding, see [VLD3 \(multiple 3-element structures\)](#) on page F6-3920.

If this instruction is not UNDEFINED, then whether it is affected by traps or enables relating to the use of the SIMD&FP registers when it is CONSTRAINED UNPREDICTABLE, is IMPLEMENTATION DEFINED. The implementation must ensure that the CONSTRAINED UNPREDICTABLE behavior does not corrupt registers that are not accessible at the current Exception level by instructions that are not CONSTRAINED UNPREDICTABLE.

VLD3 (single 3-element structure to one lane)

For a description of this instruction and the encoding, see [VLD3 \(single 3-element structure to one lane\)](#) on page F6-3911.

If this instruction is not UNDEFINED, then whether it is affected by traps or enables relating to the use of the SIMD&FP registers when it is CONSTRAINED UNPREDICTABLE, is IMPLEMENTATION DEFINED. The implementation must ensure that the CONSTRAINED UNPREDICTABLE behavior does not corrupt registers that are not accessible at the current Exception level by instructions that are not CONSTRAINED UNPREDICTABLE.

VLD3 (single 3-element structure to all lanes)

For a description of this instruction and the encoding, see [VLD3 \(single 3-element structure to all lanes\)](#) on page F6-3917.

If this instruction is not UNDEFINED, then whether it is affected by traps or enables relating to the use of the SIMD&FP registers when it is CONSTRAINED UNPREDICTABLE, is IMPLEMENTATION DEFINED. The implementation must ensure that the CONSTRAINED UNPREDICTABLE behavior does not corrupt registers that are not accessible at the current Exception level by instructions that are not CONSTRAINED UNPREDICTABLE.

VLD4 (multiple 4-element structures)

For a description of this instruction and the encoding, see [VLD4 \(multiple 4-element structures\)](#) on page F6-3932.

If this instruction is not UNDEFINED, then whether it is affected by traps or enables relating to the use of the SIMD&FP registers when it is CONSTRAINED UNPREDICTABLE, is IMPLEMENTATION DEFINED. The implementation must ensure that the CONSTRAINED UNPREDICTABLE behavior does not corrupt registers that are not accessible at the current Exception level by instructions that are not CONSTRAINED UNPREDICTABLE.

VLD4 (single 4-element structure to one lane)

For a description of this instruction and the encoding, see [VLD4 \(single 4-element structure to one lane\)](#) on page F6-3923.

If this instruction is not UNDEFINED, then whether it is affected by traps or enables relating to the use of the SIMD&FP registers when it is CONSTRAINED UNPREDICTABLE, is IMPLEMENTATION DEFINED. The implementation must ensure that the CONSTRAINED UNPREDICTABLE behavior does not corrupt registers that are not accessible at the current Exception level by instructions that are not CONSTRAINED UNPREDICTABLE.

VLD4 (single 4-element structure to all lanes)

For a description of this instruction and the encoding, see [VLD4 \(single 4-element structure to all lanes\)](#) on page F6-3929.

If this instruction is not UNDEFINED, then whether it is affected by traps or enables relating to the use of the SIMD&FP registers when it is CONSTRAINED UNPREDICTABLE is IMPLEMENTATION DEFINED. The implementation must ensure that the CONSTRAINED UNPREDICTABLE behavior does not corrupt registers that are not accessible at the current Exception level by instructions that are not CONSTRAINED UNPREDICTABLE.

VLDM

For a description of this instruction and the encoding, see [VLDM, VLDMDB, VLDMIA](#) on page F6-3935.

If this instruction is not UNDEFINED, then whether it is affected by traps or enables relating to the use of the SIMD&FP registers when it is CONSTRAINED UNPREDICTABLE, is IMPLEMENTATION DEFINED. The implementation must ensure that the CONSTRAINED UNPREDICTABLE behavior does not corrupt registers that are not accessible at the current Exception level by instructions that are not CONSTRAINED UNPREDICTABLE.

VMOV (between two general-purpose registers and two single-precision registers)

For a description of this instruction and the encoding, see [VMOV \(between two general-purpose registers and two single-precision registers\)](#) on page F6-4008.

If this instruction is not UNDEFINED, then whether it is affected by traps or enables relating to the use of the SIMD&FP registers when it is CONSTRAINED UNPREDICTABLE, is IMPLEMENTATION DEFINED. The implementation must ensure that the CONSTRAINED UNPREDICTABLE behavior does not corrupt registers that are not accessible at the current Exception level by instructions that are not CONSTRAINED UNPREDICTABLE.

VMOV (between two general-purpose registers and a doubleword floating-point register)

For a description of this instruction and the encoding, see [VMOV \(between two general-purpose registers and a doubleword floating-point register\)](#) on page F6-3988.

If this instruction is not UNDEFINED, then whether it is affected by traps or enables relating to the use of the SIMD&FP registers when it is CONSTRAINED UNPREDICTABLE, is IMPLEMENTATION DEFINED. The implementation must ensure that the CONSTRAINED UNPREDICTABLE behavior does not corrupt registers that are not accessible at the current Exception level by instructions that are not CONSTRAINED UNPREDICTABLE.

VST1 (multiple single elements)

For a description of this instruction and the encoding, see [VST1 \(multiple single elements\)](#) on page F6-4231.

If this instruction is not UNDEFINED, then whether it is affected by traps or enables relating to the use of the SIMD&FP registers when it is CONSTRAINED UNPREDICTABLE, is IMPLEMENTATION DEFINED. The implementation must ensure that the CONSTRAINED UNPREDICTABLE behavior does not corrupt registers that are not accessible at the current Exception level by instructions that are not CONSTRAINED UNPREDICTABLE.

VST2 (multiple 2-element structures)

For a description of this instruction and the encoding, see [VST2 \(multiple 2-element structures\)](#) on page F6-4245.

If this instruction is not UNDEFINED, then whether it is affected by traps or enables relating to the use of the SIMD&FP registers when it is CONSTRAINED UNPREDICTABLE, is IMPLEMENTATION DEFINED. The implementation must ensure that the CONSTRAINED UNPREDICTABLE behavior does not corrupt registers that are not accessible at the current Exception level by instructions that are not CONSTRAINED UNPREDICTABLE.

VST2 (single 2-element structure from one lane)

For a description of this instruction and the encoding, see [VST2 \(single 2-element structure from one lane\)](#) on page F6-4239.

If this instruction is not UNDEFINED, then whether it is affected by traps or enables relating to the use of the SIMD&FP registers when it is CONSTRAINED UNPREDICTABLE, is IMPLEMENTATION DEFINED. The implementation must ensure that the CONSTRAINED UNPREDICTABLE behavior does not corrupt registers that are not accessible at the current Exception level by instructions that are not CONSTRAINED UNPREDICTABLE.

VST3 (multiple 3-element structures)

For a description of this instruction and the encoding, see [VST3 \(multiple 3-element structures\)](#) on page F6-4256.

If this instruction is not UNDEFINED, then whether it is affected by traps or enables relating to the use of the SIMD&FP registers when it is CONSTRAINED UNPREDICTABLE, is IMPLEMENTATION DEFINED. The implementation must ensure that the CONSTRAINED UNPREDICTABLE behavior does not corrupt registers that are not accessible at the current Exception level by instructions that are not CONSTRAINED UNPREDICTABLE.

VST3 (single 3-element structure from one lane)

For a description of this instruction and the encoding, see [VST3 \(single 3-element structure from one lane\)](#) on page F6-4250.

If this instruction is not UNDEFINED, then whether it is affected by traps or enables relating to the use of the SIMD&FP registers when it is CONSTRAINED UNPREDICTABLE, is IMPLEMENTATION DEFINED. The implementation must ensure that the CONSTRAINED UNPREDICTABLE behavior does not corrupt registers that are not accessible at the current Exception level by instructions that are not CONSTRAINED UNPREDICTABLE.

VST4 (multiple 4-element structures)

For a description of this instruction and the encoding, see [VST4 \(multiple 4-element structures\)](#) on page F6-4265.

If this instruction is not UNDEFINED, then whether it is affected by traps or enables relating to the use of the SIMD&FP registers when it is CONSTRAINED UNPREDICTABLE, is IMPLEMENTATION DEFINED. The implementation must ensure that the CONSTRAINED UNPREDICTABLE behavior does not corrupt registers that are not accessible at the current Exception level by instructions that are not CONSTRAINED UNPREDICTABLE.

VST4 (single 4-element structure from one lane)

For a description of this instruction and the encoding, see [VST4 \(single 4-element structure from one lane\)](#) on page F6-4259.

If this instruction is not UNDEFINED, then whether it is affected by traps or enables relating to the use of the SIMD&FP registers when it is CONSTRAINED UNPREDICTABLE, is IMPLEMENTATION DEFINED. The implementation must ensure that the CONSTRAINED UNPREDICTABLE behavior does not corrupt registers that are not accessible at the current Exception level by instructions that are not CONSTRAINED UNPREDICTABLE.

VSTM

For a description of this instruction and the encoding, see [VSTM, VSTMDB, VSTMIA](#) on page F6-4268.

If this instruction is not UNDEFINED, then whether it is affected by traps or enables relating to the use of the SIMD&FP registers when it is CONSTRAINED UNPREDICTABLE, is IMPLEMENTATION DEFINED. The implementation must ensure that the CONSTRAINED UNPREDICTABLE behavior does not corrupt registers that are not accessible at the current Exception level by instructions that are not CONSTRAINED UNPREDICTABLE.

K1.1.29 CONSTRAINED UNPREDICTABLE behaviors associated with the VTCR

The following subsections describe the CONSTRAINED UNPREDICTABLE behavior associated with programming the VTCR:

- *Misprogramming VTCR.S.*
- *Misprogramming VTCR.{SL0, T0SZ}.*

Misprogramming VTCR.S

VTCR.S must be programmed to the value of T0SZ[3], or the effect is CONSTRAINED UNPREDICTABLE. For the ARMv8-A architecture, if VTCR.S is not programmed correctly, then the VTCR.T0SZ value is treated as an UNKNOWN value.

———— Note —————

The CONSTRAINED UNPREDICTABLE behavior described in *Misprogramming VTCR.{SL0, T0SZ}* means the UNKNOWN VTCR.T0SZ value might generate a Translation fault.

Misprogramming VTCR.{SL0, T0SZ}

If the stage 2 input address size, as programmed in VTCR.T0SZ, is out of range with respect to the starting level, as programmed in the VTCR.SL0 field, or the VTCR.SL0 field is programmed to a reserved value, then at the time of a translation walk that uses the stage 2 translation, a stage 2 level 1 Translation Fault is generated.

K1.1.30 CONSTRAINED UNPREDICTABLE behavior of EL2 features

The following sections describe CONSTRAINED UNPREDICTABLE behavior that can occur in an implementation that includes EL2 where EL2 can use AArch32:

- *ERET in User mode or System mode.*
- *Accessing Hyp mode from outside Hyp mode.*
- *Modifying PSTATE.M when in Hyp mode on page K1-6115*
- *Use of Hyp mode in Secure state on page K1-6115.*
- *Execution of Load/Store unprivileged instructions in Hyp mode on page K1-6115.*
- *Exception return to Hyp mode on page K1-6115.*
- *Accessing registers that cannot be accessed using MSR/MRS instructions on page K1-6115.*
- *Memory type handling on page K1-6116.*
- *Hyp mode TLB maintenance instructions on page K1-6116.*
- *Hyp mode VA to PA address translation instructions on page K1-6116.*
- *Stage 1 default memory type on page K1-6116.*
- *Trapping of general exceptions to Hyp mode on page K1-6116.*
- *Prevention of rootkits using Hyp mode or Secure state on page K1-6117.*
- *HVC on page K1-6117.*
- *MSR/MRS Banked registers on page K1-6117.*

ERET in User mode or System mode

If ERET is executed in User mode or System mode, it behaves as described in *SUBS PC, LR and related instructions (T32) on page K1-6109.*

Accessing Hyp mode from outside Hyp mode

Attempting to change into Hyp mode or out of Hyp mode using the MSR or CPS instruction invokes the ARMv8 illegal exception return by not changing the mode, and setting PSTATE.IL to 1.

SRS using the Hyp mode SP from Non-secure modes other than Hyp mode, or from Secure state, is handled as described in *SRS (T32) on page K1-6108* and *SRS (A32) on page K1-6108.*

Modifying PSTATE.M when in Hyp mode

Attempting to change into Hyp mode or out of Hyp mode using the MSR or CPS instruction invokes the ARMv8 illegal exception return by not changing the mode, and setting PSTATE.IL to 1.

SRS using the Hyp mode SP from Non-secure modes other than Hyp mode, or from Secure state, is handled as described in [SRS \(T32\) on page K1-6108](#) and [SRS \(A32\) on page K1-6108](#).

Use of Hyp mode in Secure state

Attempting to change into Hyp mode or out of Hyp mode using the MSR or CPS instruction invokes the ARMv8 illegal exception return by not changing the mode, and setting PSTATE.IL to 1.

SRS using the Hyp mode SP from Non-secure modes other than Hyp mode, or from Secure state, is handled as described in [SRS \(T32\) on page K1-6108](#) and [SRS \(A32\) on page K1-6108](#).

Execution of Load/Store unprivileged instructions in Hyp mode

If LDRT, LDRSHT, LDRHT, LDRSBT, LDRBT, STRT, STRHT or STRBT are executed in Hyp mode, then one of the following behaviors must occur:

- The instruction is UNDEFINED.
- The instruction executes as a NOP.
- The instruction performs the equivalent, corresponding LDR, LDRSH, LDRH, LDRSB, LDRB, STR, STRH or STRB instruction in Hyp mode.

Exception return to Hyp mode

Exception returns to Hyp mode when SCR.NS == 0 or from a Non-secure PL1 mode invokes the ARMv8 illegal exception return.

Accessing registers that cannot be accessed using MSR/MRS instructions

The following MSR and MRS instructions can lead to CONSTRAINED UNPREDICTABLE behavior:

```
MSR <Rm>_<mode>, <Rn>
MSR SPSR_<mode>, <Rn>
MSR ELR_hyp, <Rn>
MRS <Rn>, <Rm>_<mode>
MRS <Rn>, SPSR_<mode>
MRS <Rn>, ELR_hyp
```

If these instructions are executed in either Secure or Non-secure User mode, then one of the following behaviors must occur:

- The instruction is UNDEFINED.
- The instruction executes as a NOP.

If the MSR and MRS instructions attempt to access a register that cannot be legally accessed, then one of the following behaviors must occur:

- The instruction is UNDEFINED.
- The instruction executes as a NOP.
- For MRS instructions, the destination general-purpose register becomes UNKNOWN.
- For MSR instructions, if the register specified could be accessed from the current mode by other mechanisms, then this register is UNKNOWN. Otherwise the instruction executes as a NOP.

Memory type handling

If the attributes for a memory location after combining stage 1 and stage 2 of a translation regime is Normal Inner Non-cacheable, Outer Non-cacheable, then the shareability attributes after combining the two stages of translation is Outer Shareable.

Hyp mode TLB maintenance instructions

If a [TLBIMVAH](#), [TLBIMVALH](#), [TLBIMVAHIS](#), [TLBIMVALHIS](#), [TLBIALLH](#), [TLBIALLHIS](#), [TLBIALLNSNH](#), [TLBIALLNSNHIS](#), [TLBIIPAS2](#), [TLBIIPAS2L](#), [TLBIIPAS2IS](#), or [TLBIIPAS2LIS](#) instruction is executed in a Secure Privileged mode other than Monitor mode, then one of the following behaviors must occur:

- The instruction is UNDEFINED.
- The instruction is treated as a NOP.
- The instruction is executed as if it had been executed in Monitor mode.

For more information about these instructions see [The scope of TLB maintenance instructions on page G4-4641](#).

Hyp mode VA to PA address translation instructions

If an [ATS1HR](#) or [ATS1HW](#) instruction is executed in a Secure Privileged mode other than Monitor mode, then one of the following behaviors must occur:

- The instruction is UNDEFINED.
- The instruction is treated as a NOP.
- The instruction is executed as if it had been executed in Monitor mode.

For more information about these instructions see [Address translation instruction naming and operation summary on page G4-4682](#).

Stage 1 default memory type

If [HCR.DC](#) == 1, then the behavior of the PE when executing in a Non-secure mode other than Hyp mode is consistent with:

- [SCTLR.M](#) == 0, regardless of the actual value of [SCTLR.M](#), other than for the value returned by an explicit read of [SCTLR.M](#).
- [HCR.VM](#) == 1, regardless of the actual value of [HCR.VM](#), other than for an explicit read of this bit.

Trapping of general exceptions to Hyp mode

Attempting to perform an exception return to a Non-secure PL1 mode when [HCR.TGE](#) == 1 invokes an illegal exception return.

Attempting to change from Monitor mode to a Non-secure PL1 mode when [HCR.TGE](#) == 1 by executing a CPS or MSR instruction generates an Illegal Execution state exception, by not changing the mode, and setting [PSTATE.IL](#) to 1.

When EL3 is using AArch32, attempting to change from a Secure PL1 mode to a Non-secure PL1 mode when [HCR.TGE](#) is set, by changing [SCR.NS](#) from 0 to 1, results in no change of [SCR.NS](#).

Because taking an exception into Non-secure PL1 modes leads to a CONSTRAINED UNPREDICTABLE situation, the following additional properties apply when [HCR.TGE](#) == 1:

- All exceptions that would be routed to EL1 are routed to EL2.
- Non-secure [SCTLR.M](#) is treated as being 0, regardless of its actual value, other than for an explicit read of of this bit.
- [HCR.FMO](#), [HCR.IMO](#), and [HCR.AMO](#) are treated as being 1, regardless of their actual value, other than for an explicit read of these bits.

- All virtual interrupts are disabled.
- Any IMPLEMENTATION DEFINED mechanisms for signalling virtual interrupts are disabled.

Prevention of rootkits using Hyp mode or Secure state

If an **HVC** instruction is executed in Hyp mode when **SCR.HCE** == 0, then one of the following behaviors must occur:

- The instruction is UNDEFINED.
- The instruction executes as a NOP.

If an **SMC** instruction is executed in a Secure privileged mode when **SCR.SCD** == 1, then one of the following behaviors must occur:

- The instruction is UNDEFINED.
- The instruction executes as a NOP.

HVC

For a description of this instruction and the encoding, see [HVC on page F5-3123](#).

For the A1 encoding, if cond field != 1110, then one of the following behaviors must occur:

- The instruction is UNDEFINED.
- The instruction executes as a NOP.
- The instruction executes unconditionally.
- The instruction executes conditionally.

MSR/MRS Banked registers

[Encoding and use of Banked register transfer instructions on page F5-3674](#) identifies cases where attempted execution of an MRS (Banked register) or MSR (Banked register) was UNPREDICTABLE in ARMv7 and becomes CONSTRAINED UNPREDICTABLE in ARMv8. This includes cases where:

- The target register specified by the {R, SYSm} fields of the instruction encoding is not accessible from the PE mode in which the instruction was executed, see [Usage restrictions on the Banked register transfer instructions on page F5-3675](#).
- The instruction was executed specifying unallocated {R, SYSm} field values, see [Encoding the register argument in the Banked register transfer instructions on page F5-3676](#).

If one of these encodings for the MSR/MRS (Banked register) instructions is executed, then one of the following behaviors must occur:

- The instruction is UNDEFINED.
- The instruction executes as a NOP.
- An allocated MSR/MRS (Banked register) instruction is executed.

K1.1.31 Reserved values in System and memory-mapped registers and translation table entries

Unless otherwise stated, all unallocated or reserved values of fields with allocated values within the AArch32 System registers, memory-mapped registers, and translation table entries behave in one of the following ways:

- The encoding maps onto any of the allocated values, but otherwise does not cause CONSTRAINED UNPREDICTABLE behavior.
- The encoding causes effects that could be achieved by a combination of more than one of the allocated encodings.
- The encoding causes the field to have no functional effect.

———— **Note** —————

These constraints are identical to those for the equivalent AArch64 definitions, as given in [Reserved values in System and memory-mapped registers and translation table entries](#) on page K1-6133.

K1.1.32 CONSTRAINED UNPREDICTABLE behavior in Debug state

[Behavior in Debug state on page H2-5445](#) of this manual describes the CONSTRAINED UNPREDICTABLE behaviors that are specifically associated with Debug state.

K1.2 AArch64 CONSTRAINED UNPREDICTABLE behaviors

It contains the following sections:

- [Overview of the constraints on AArch64 UNPREDICTABLE behaviors.](#)
- [SBZ or SBO fields in A64 instructions.](#)
- [CONSTRAINED UNPREDICTABLE behaviors due to caching of control or data values on page K1-6120.](#)
- [CONSTRAINED UNPREDICTABLE behavior due to inadequate context synchronization on page K1-6120.](#)
- [Translation table base address alignment on page K1-6121.](#)
- [The Performance Monitors Extension on page K1-6121.](#)
- [Syndrome register handling for CONSTRAINED UNPREDICTABLE instructions treated as UNDEFINED on page K1-6122.](#)
- [Out of range virtual address on page K1-6122.](#)
- [Instruction fetches from Device memory on page K1-6122.](#)
- [Programming the CSSELR_EL1.Level for a cache level that is not implemented on page K1-6123.](#)
- [Crossing a page boundary with different memory types or Shareability attributes on page K1-6123.](#)
- [Crossing a peripheral boundary with a Device access on page K1-6123.](#)
- [CONSTRAINED UNPREDICTABLE behaviors with Load-Exclusive/Store-Exclusive pairs on page K1-6124.](#)
- [CONSTRAINED UNPREDICTABLE behavior for A64 instructions on page K1-6124.](#)
- [Out of range values of the Set/Way/Index fields in cache maintenance instructions on page K1-6133.](#)
- [Reserved values in System and memory-mapped registers and translation table entries on page K1-6133.](#)
- [CONSTRAINED UNPREDICTABLE behavior in Debug state on page K1-6133.](#)

K1.2.1 Overview of the constraints on AArch64 UNPREDICTABLE behaviors

The term UNPREDICTABLE describes a number of cases where the architecture has a feature that software must not use. For execution in AArch64 state, the ARMv8-A architecture specifies a narrow range of permitted behaviors. This range is the range of CONSTRAINED UNPREDICTABLE behavior. All implementations that are compliant with the architecture must follow the CONSTRAINED UNPREDICTABLE behavior.

———— **Note** —————

Software designed to be compatible with the ARMv8-A architecture must not rely on these CONSTRAINED UNPREDICTABLE cases being handled in any way other than those listed under the heading CONSTRAINED UNPREDICTABLE.

K1.2.2 SBZ or SBO fields in A64 instructions

Some A64 instructions have (0) or (1) in the instruction decode to indicate *should-be-zero*, SBZ, or *should-be-one*, SBO, as described in [Fixed values in AArch64 instruction and System register descriptions on page C2-151](#). Except for specific cases identified in [CONSTRAINED UNPREDICTABLE behaviors with Load-Exclusive/Store-Exclusive pairs on page K1-6124](#), if the instruction bit pattern of an instruction is executed with these fields not having the *should be* values, one of the following must occur:

- The instruction is UNDEFINED.
- The instruction executes as a NOP.
- The instruction operates as if the bit had the *should-be* value.
- Any destination registers of the instruction become UNKNOWN.

K1.2.3 CONSTRAINED UNPREDICTABLE behaviors due to caching of control or data values

The ARM architecture allows copies of control values or data values to be cached in a cache or TLB. This can lead to UNPREDICTABLE behavior if the cache or TLB has not been correctly invalidated following a change of the control or data values.

Unless explicitly stated otherwise, the behavior of the PE is consistent with one of:

- The old data or control value.
- The new data or control value.
- An amalgamation of the old and new data or control values.

In an implementation that includes ARMv8.2-TTCNP, this CONSTRAINED UNPREDICTABLE case can arise from misprogramming when setting TTBR.CnP to 1, as identified in the descriptions of the TTBR.CnP field. In this case, for a particular TTBR, the behavior of the PE is consistent with one of:

- The value of the translation table entry pointed to by that TTBR on one of the PEs within the Inner Shareable domain for which both the value of TTBR.CnP is 1 and the other conditions for sharing translation table entries pointed to by that TTBR are met.
- An amalgamation of the values of the translation table entries pointed to by that TTBR on two or more of the PEs within the Inner Shareable domain for which both the value of TTBR.CnP is 1 and the other conditions for sharing translation table entries pointed to by that TTBR are met.

———— Note ————

If the effective control or data value that determines the behavior of the PE results from the amalgamation of two or more values then that effective value must not generate a privilege violation. So, for example:

- Where the CONSTRAINED UNPREDICTABLE behavior occurs because inadequate invalidation of the TLB causes multiple hits in the TLB, the failure to invalidate the TLB by software executing at a given Exception level and Security state must not make it possible to access regions of memory with permissions or attributes that could not be accessed at that Exception level and Security state.
- Where the CONSTRAINED UNPREDICTABLE behavior occurs because of a programming error, on one or more PEs in the Inner Shareable domain, when using a TTBR.CnP value of 1 to share translation table entries, the misprogramming must not make it possible to access regions of memory with permissions or attributes that could not be accessed at the Exception level of that TTBR and the Security state corresponding to the translation table entries being shared.

Alternatively to this CONSTRAINED UNPREDICTABLE behavior, an implementation detecting multiple hits in a TLB might generate an exception, reporting the exception using the TLB conflict fault code, see [TLB conflict aborts on page D4-2118](#).

The choice between the behaviors might, in some implementations, vary for each use of a control or data value.

K1.2.4 CONSTRAINED UNPREDICTABLE behavior due to inadequate context synchronization

The ARM architecture requires that changes to System registers must be synchronized before they take effect. This can lead to UNPREDICTABLE behavior if the synchronization has not been performed.

In these cases, the behavior of the PE is consistent with the unsynchronized control value being either the old value or the new value.

Where multiple control values are updated but not yet synchronized, each control value might independently be the old value or the new value.

In addition, where the unsynchronized control value applies to different areas of functionality, or what an implementation has constructed as different areas of functionality, those areas might independently treat the control value as being either the old value or the new value.

The choice between these behaviors might, in some implementations, vary for each use of a control value.

K1.2.5 Translation table base address alignment

In the translation table base registers `TTBR0_EL1`, `TTBR1_EL1`, `TTBR0_EL2`, `VTTBR_EL2`, and `TTBR0_EL3`, register bits[48:*x*] hold the translation table base address, where *x* depends on the translation table granule size and the size of the addressed translation table, as described in *Memory translation granule size on page D4-2021*. Register bits[(*x*-1):0], **unless redefined for another purpose**, correspond to bits[(*x*-1):0] of the translation table base address and therefore are RES0.

———— **Note** ————

- When ARMv8.2-LPA is implemented and the 64KB granule size is used, register bits[5:2] are redefined to hold bits[51:48] of the translation table base address.
- When ARMv8.2-TTCNP is implemented register bit[0] is redefined as the CnP bit.

For these registers, if one or more RES0 bits in register bits [(*x*-1):0] does not have a value of 0, this can result in a misaligned translation table base address. In this case, one of the following behaviors must occur:

- The field that is defined to be RES0 is treated as if all the bits had a value of 0:
 - The value read back might be the value written or it might be zero.
- The calculation of an address for a translation table walk using those registers might be corrupted in those bits that are nonzero.

For more information, see the appropriate `TTBR.BADDR` field description.

K1.2.6 The Performance Monitors Extension

The following cases can cause CONSTRAINED UNPREDICTABLE behavior:

- If `PMSELR_EL0.SEL` is not equal to 31, and `PMSELR_EL0.SEL` is greater than or equal to `PMCR_EL0.N`, and the PE is executing in an Exception level in Secure state or in EL2.
- If `PMSELR_EL0.SEL` is not 31, and `PMSELR_EL0.SEL` is greater than or equal to `MDCR_EL2.HPMN`, and the PE is executing in an Exception level in Non-secure state other than in EL2.

In these cases, one of the following behaviors must occur:

- Accesses to `PMXEVTYPER_EL0` or `PMXVCNTR_EL0` from that state are UNDEFINED.
- Accesses to `PMXEVTYPER_EL0` or `PMXVCNTR_EL0` from that state behave as RAZ/WI.
- Accesses to `PMXEVTYPER_EL0` or `PMXVCNTR_EL0` from that state execute as NOPs.
- Accesses to `PMXEVTYPER_EL0` or `PMXVCNTR_EL0` from that state behave as if `PMSELR_EL0.SEL` contains an UNKNOWN value that is less than the number of counters accessible at the current Exception level and Security state.
- Accesses to `PMXEVTYPER_EL0` or `PMXVCNTR_EL0` from that state behave as if `PMSELR_EL0.SEL` is 31.
- In Non-secure state, for an access to `PMXEVTYPER_EL0` or `PMXVCNTR_EL0` from EL1 or a permitted access from EL0, if the counter is implemented but not accessible at the current Exception level, the register access is trapped to EL2. Accesses from EL0 are permitted when:
 - EL1 is using AArch32 and the value of `PMUSERENR.EN` is 1.
 - EL1 is using AArch64 and the value of `PMUSERENR_EL0.EN` is 1.

If `PMSELR_EL0.SEL` is equal to 31, then one of the following behaviors must occur:

- Accesses to `PMXVCNTR_EL0` are UNDEFINED.
- Accesses to `PMXVCNTR_EL0` behave as RAZ/WI.
- Accesses to `PMXVCNTR_EL0` execute as NOPs.

- Accesses to `PMXEVCNTR_EL0` behave as if `PMSELR_EL0.SEL` contains an UNKNOWN value that is less than the number of counters accessible at the current Exception level and Security state.

If `MDCR_EL2.HPMN` is set to 0, or to a value larger than `PMCR_EL0.N`, then the following CONSTRAINED UNPREDICTABLE behavior applies:

- The value returned by a direct read of `MDCR_EL2.HPMN` is UNKNOWN.
- Either:
 - An UNKNOWN number of counters are reserved for EL2 use. That is, the PE behaves as if `MDCR_EL2.HPMN` is set to an UNKNOWN non-zero value less than `PMCR_EL0.N`.
 - All counters are reserved for EL2 use, meaning no counters are accessible from Non-secure EL1 and Non-secure EL0.

K1.2.7 Syndrome register handling for CONSTRAINED UNPREDICTABLE instructions treated as UNDEFINED

When a CONSTRAINED UNPREDICTABLE instruction is treated as UNDEFINED, `ESR_ELx` is UNKNOWN.

———— **Note** ————

The value written to `ESR_ELx` must be consistent with a value that could be created as the result of an exception from the same Exception level that generated the exception, but was the result of a situation that is not CONSTRAINED UNPREDICTABLE at that Exception level. This is to avoid a possible privilege violation.

K1.2.8 Out of range virtual address

If the PE executes a load or store instruction with tagged addressing disabled in the current translation regime, and where the computed virtual address, total access size, and alignment mean that it accesses the bytes at `0xFFFF FFFF FFFF FFFF` and `0x0000 0000 0000 0000`, then the bytes that appear to be from `0x0000 0000 0000 0000` onwards are accessed at an UNKNOWN address.

If the PE executes a load or store instruction with tagged addressing enabled in the current translation regime, and where the computed address, total access size, and alignment mean that it accesses the bytes at `0xFFFF FFFF FFFF FFFF` and `0x0000 0000 0000 0000`, then the bytes that appear to be from `0x0000 0000 0000 0000` onwards are accessed at an UNKNOWN address and the tags associated with address also become UNKNOWN.

———— **Note** ————

Because of program counter alignment constraints, it is impossible for a PE to fetch an A64 instruction that includes both the byte at virtual address `0xFFFF FFFF FFFF FFFF` and the byte at virtual address `0x0000 0000 0000 0000`.

K1.2.9 Instruction fetches from Device memory

Instruction fetches from Device memory are CONSTRAINED UNPREDICTABLE.

If a location in memory has the Device attribute and is not marked as execute-never, then an implementation might perform speculative instruction accesses to this memory location at times when address translation is enabled.

If a branch causes the program counter to point to an area of memory with the Device attribute that is not marked as execute-never for the current Exception level for instruction fetches, then an implementation must perform one of the following behaviors:

- It treats the instruction fetch as if it were to a memory location with the Normal, Non-cacheable attribute.
- It generates a Permission fault.

K1.2.10 Programming the CSSELR_EL1.Level for a cache level that is not implemented

If the CSSELR_EL1.Level is programmed to a cache level that is not implemented, then a read of CSSELR_EL1 returns an UNKNOWN value in CSSELR_EL1.Level.

If the CSSELR_EL1.Level is programmed to a cache level that is not implemented, then on a read of CCSIDR_EL1 an implementation must perform one of the following behaviors:

- The CCSIDR_EL1 read executes as a NOP.
- The CCSIDR_EL1 read is UNDEFINED.
- The CCSIDR_EL1 read returns an UNKNOWN value.

K1.2.11 Crossing a page boundary with different memory types or Shareability attributes

A memory access from a load or store instruction that crosses a page boundary to a memory location that has a different memory type or Shareability attribute results in CONSTRAINED UNPREDICTABLE behavior. In this case, the implementation must perform one of the following behaviors:

- All memory accesses generated by the instruction use the memory type and Shareability attributes associated with the first address accessed by the instruction.
- All memory accesses generated by the instruction use the memory type and Shareability attributes associated with the last address accessed by the instruction.
- Each memory access generated by the instruction uses the memory type and Shareability attribute associated with its own address.
- The instruction generates an Alignment fault caused by the memory type.

For the Non-secure EL1&0 translation regime:

- If the stage 1 translation generated the mismatch then the resulting exception is taken to EL1.
 - If the stage 2 translation generated the mismatch then the resulting exception is taken to EL2.
 - If both stages of translation generate the mismatch then the exception can be taken to either EL1 or EL2.
- The instruction executes as a NOP.

K1.2.12 Crossing a peripheral boundary with a Device access

Performing memory accesses from one load or store instruction to Device memory that crosses a boundary corresponding to the smallest translation granule size of the implementation causes CONSTRAINED UNPREDICTABLE behavior. In this case, the implementation performs one of the following behaviors:

- All memory accesses generated by the instruction are performed as if the boundary has no effect on the memory accesses.
- All memory accesses generated by the instruction are performed as if the boundary has no effect on the memory accesses except that there is no guarantee of ordering between memory accesses.
- The instruction generates an alignment fault caused by the memory type.

For the Non-secure EL1&0 translation regime:

- If the stage 1 translation causes the boundary to be crossed then the resulting exception is taken to EL1.
 - If the stage 2 translation causes the boundary to be crossed then the resulting exception is taken to EL2.
 - If both stages of translation cause the boundary to be crossed then the resulting exception can be taken to either EL1 or EL2.
- The instruction executes as a NOP.

———— **Note** —————

The boundary referred to is between two Device memory regions that are both:

- Of the size of the smallest implemented translation granule.
- Aligned to the size of the smallest implemented translation granule.

K1.2.13 CONSTRAINED UNPREDICTABLE behaviors with Load-Exclusive/Store-Exclusive pairs

[Load-Exclusive and Store-Exclusive instruction usage restrictions on page B2-128](#) defines a Load-Exclusive/Store-Exclusive pair, and identifies various CONSTRAINED UNPREDICTABLE behaviors associated with using Load-Exclusive/Store-Exclusive pairs. In summary, these cases are:

- The target virtual address of a StoreExc1 instruction is different from the virtual address of the preceding LoadExc1 instruction in the same thread of execution.
- The transaction size of a StoreExc1 instruction is different from the transaction size of the preceding LoadExc1 instruction in the same thread of execution.
- The StoreExc1 instruction accesses a different number of registers than the preceding LoadExc1 instruction in the same thread of execution.
- The memory attributes for a StoreExc1 instruction are different from the memory attributes for the preceding LoadExc1 instruction in the same thread of execution, either:
 - Because the translation of the accessed address changes between the LoadExc1 instruction and the StoreExc1 instruction.
 - Because the LoadExc1 instruction and the StoreExc1 instruction use different virtual addresses, with different attributes, that point to the same physical address.

In addition, the effect of a data or unified cache invalidate, clean, or clean and invalidate instruction on a local or global Exclusives monitor that is in the Exclusive Access state is CONSTRAINED UNPREDICTABLE.

See the descriptions in [Load-Exclusive and Store-Exclusive instruction usage restrictions on page B2-128](#) for the permitted behavior in each of these cases, and any constraints that might apply to whether the case is CONSTRAINED UNPREDICTABLE.

K1.2.14 CONSTRAINED UNPREDICTABLE behavior for A64 instructions

This section lists the CONSTRAINED UNPREDICTABLE behavior for the different A64 instructions listed in [Chapter C6 A64 Base Instruction Descriptions](#) and [Chapter C7 A64 Advanced SIMD and Floating-point Instruction Descriptions](#).

LDAXP

For a description of this instruction and the encoding, see [LDAXP on page C6-641](#).

CONSTRAINED UNPREDICTABLE behavior

If $t == t2$, then one of the following behaviors must occur:

- The instruction is UNDEFINED.
- The instruction executes as a NOP.
- The instruction performs a load using the specified addressing mode, and the base register is set to an UNKNOWN value.

LDNP

For a description of this instruction and the encoding, see [LDNP on page C6-662](#).

CONSTRAINED UNPREDICTABLE behavior

If $t == t2$, then one of the following behaviors must occur:

- The instruction is UNDEFINED.
- The instruction executes as a NOP.
- The instruction performs a load using the specified addressing mode, and the base register is set to an UNKNOWN value.

LDNP (SIMD&FP)

For a description of this instruction and the encoding, see [LDNP \(SIMD&FP\) on page C7-1353](#).

CONSTRAINED UNPREDICTABLE behavior

If $t == t2$, then one of the following behaviors must occur:

- The instruction is UNDEFINED.
- The instruction executes as a NOP.
- The instruction performs a load using the specified addressing mode, and the base register is set to an UNKNOWN value.

LDP

For a description of this instruction and the encoding, see [LDP on page C6-664](#).

CONSTRAINED UNPREDICTABLE behavior

If the instruction encoding specifies pre-indexed addressing or post-indexed addressing, and $(t == n \mid t2 == n) \ \&\& \ n \neq 31$, then one of the following behaviors must occur:

- The instruction is UNDEFINED.
- The instruction executes as a NOP.
- The instruction performs a load using the specified addressing mode, and the base register is set to an UNKNOWN value. In addition, if an exception occurs during such an instruction, the base register might be corrupted so that the instruction cannot be repeated.

If $t == t2$, then one of the following behaviors must occur:

- The instruction is UNDEFINED.
- The instruction executes as a NOP.
- The instruction performs all of the loads using the specified addressing mode, and the register loaded is set to an UNKNOWN value.

Note

Pre-indexed addressing and post-indexed addressing imply writeback.

LDP (SIMD&FP)

For a description of this instruction and the encoding, see [LDP \(SIMD&FP\) on page C7-1355](#).

CONSTRAINED UNPREDICTABLE behavior

If $t == t2$, then one of the following behaviors must occur:

- The instruction is UNDEFINED.
- The instruction executes as a NOP.

- The instruction performs a load using the specified addressing mode, and the base register is set to an UNKNOWN value.

LDPSW

For a description of this instruction and the encoding, see [LDPSW](#) on page C6-667.

CONSTRAINED UNPREDICTABLE behavior

If the instruction encoding specifies pre-indexed addressing or post-indexed addressing, and $(t == n \ || \ t2 == n) \ \&\& \ n \ != \ 31$, then one of the following behaviors must occur:

- The instruction is UNDEFINED.
- The instruction executes as a NOP.
- The instruction performs a load using the specified addressing mode, and the base register is set to an UNKNOWN value. In addition, if an exception occurs during such an instruction, the base register might be corrupted so that the instruction cannot be repeated.

If $t == t2$, then one of the following behaviors must occur:

- The instruction is UNDEFINED.
- The instruction executes as a NOP.
- The instruction performs all of the loads using the specified addressing mode, and the register loaded is set to an UNKNOWN value.

Note

Pre-indexed addressing and post-indexed addressing imply writeback.

LDR (immediate)

For a description of this instruction and the encoding, see [LDR \(immediate\)](#) on page C6-670.

CONSTRAINED UNPREDICTABLE behavior

If the instruction encoding specifies pre-indexed addressing or post-indexed addressing, and $n == t \ \&\& \ n \ != \ 31$, then one of the following behaviors must occur:

- The instruction is UNDEFINED.
- The instruction executes as a NOP.
- The instruction performs the load using the specified addressing mode, and the base register is set to an UNKNOWN value. In addition, if an exception occurs during such an instruction, the base register might be corrupted so that the instruction cannot be repeated.

Note

Pre-indexed addressing and post-indexed addressing imply writeback.

LDRB (immediate)

For a description of this instruction and the encoding, see [LDRB \(immediate\)](#) on page C6-677.

CONSTRAINED UNPREDICTABLE behavior

If the instruction encoding specifies pre-indexed addressing or post-indexed addressing, and $n == t \ \&\& \ n \neq 31$, then one of the following behaviors must occur:

- The instruction is UNDEFINED.
- The instruction executes as a NOP.
- The instruction performs the load using the specified addressing mode, and the base register is set to an UNKNOWN value. In addition, if an exception occurs during such an instruction, the base register might be corrupted so that the instruction cannot be repeated.

———— **Note** —————

Pre-indexed addressing and post-indexed addressing imply writeback.

LDRH (immediate)

For a description of this instruction and the encoding, see [LDRH \(immediate\)](#) on page C6-681.

CONSTRAINED UNPREDICTABLE behavior

If the instruction encoding specifies pre-indexed addressing or post-indexed addressing, and $n == t \ \&\& \ n \neq 31$, then one of the following behaviors must occur:

- The instruction is UNDEFINED.
- The instruction executes as a NOP.
- The instruction performs the load using the specified addressing mode, and the base register is set to an UNKNOWN value. In addition, if an exception occurs during such an instruction, the base register might be corrupted so that the instruction cannot be repeated.

———— **Note** —————

Pre-indexed addressing and post-indexed addressing imply writeback.

LDRSB (immediate)

For a description of this instruction and the encoding, see [LDRSB \(immediate\)](#) on page C6-685.

CONSTRAINED UNPREDICTABLE behavior

If the instruction encoding specifies pre-indexed addressing or post-indexed addressing, and $n == t \ \&\& \ n \neq 31$, then one of the following behaviors must occur:

- The instruction is UNDEFINED.
- The instruction executes as a NOP.
- The instruction performs the load using the specified addressing mode, and the base register is set to an UNKNOWN value. In addition, if an exception occurs during such an instruction, the base register might be corrupted so that the instruction cannot be repeated.

———— **Note** —————

Pre-indexed addressing and post-indexed addressing imply writeback.

LDRSH (immediate)

For a description of this instruction and the encoding, see [LDRSH \(immediate\)](#) on page C6-690.

CONSTRAINED UNPREDICTABLE behavior

If the instruction encoding specifies pre-indexed addressing or post-indexed addressing, and $n \neq t$ & $n \neq 31$, then one of the following behaviors must occur:

- The instruction is UNDEFINED.
- The instruction executes as a NOP.
- The instruction performs the load using the specified addressing mode, and the base register is set to an UNKNOWN value. In addition, if an exception occurs during such an instruction, the base register might be corrupted so that the instruction cannot be repeated.

———— **Note** —————

Pre-indexed addressing and post-indexed addressing imply writeback.

LDRSW (immediate)

For a description of this instruction and the encoding, see [LDRSW \(immediate\)](#) on page C6-695.

CONSTRAINED UNPREDICTABLE behavior

If the instruction encoding specifies pre-indexed addressing or post-indexed addressing, and $n \neq t$ & $n \neq 31$, then one of the following behaviors must occur:

- The instruction is UNDEFINED.
- The instruction executes as a NOP.
- The instruction performs the load using the specified addressing mode, and the base register is set to an UNKNOWN value. In addition, if an exception occurs during such an instruction, the base register might be corrupted so that the instruction cannot be repeated.

———— **Note** —————

Pre-indexed addressing and post-indexed addressing imply writeback.

LDXP

For a description of this instruction and the encoding, see [LDXP](#) on page C6-748.

CONSTRAINED UNPREDICTABLE behavior

If $t \neq t2$, then one of the following behaviors must occur:

- The instruction is UNDEFINED.
- The instruction executes as a NOP.
- The instruction performs a load using the specified addressing mode, and the base register is set to an UNKNOWN value.

STP

For a description of this instruction and the encoding, see [STP on page C6-867](#).

CONSTRAINED UNPREDICTABLE behavior

If the instruction encoding specifies pre-indexed addressing or post-indexed addressing, and $(t == n \ || \ t2 == n) \ \&\& \ n \ != \ 31$, then one of the following behaviors must occur:

- The instruction is UNDEFINED.
- The instruction executes as a NOP.
- The instruction performs a store using the specified addressing mode but the value stored is UNKNOWN.

———— **Note** —————

Pre-indexed addressing and post-indexed addressing imply writeback.

STLXP

For a description of this instruction and the encoding, see [STLXP on page C6-856](#).

CONSTRAINED UNPREDICTABLE behavior

If $s == t \ || \ (s == t2)$, then one of the following behaviors must occur:

- The instruction is UNDEFINED.
- The instruction executes as a NOP.
- The instruction performs the store to the specified address, but the value stored is UNKNOWN.

If $s == n \ \&\& \ n \ != \ 31$ then one of the following behaviors must occur:

- The instruction is UNDEFINED.
- The instruction executes as a NOP.
- The instruction performs the store to an UNKNOWN address.

STLXR

For a description of this instruction and the encoding, see [STLXR on page C6-859](#).

CONSTRAINED UNPREDICTABLE behavior

If $s == t$, then one of the following behaviors must occur:

- The instruction is UNDEFINED.
- The instruction executes as a NOP.
- The instruction performs the store to the specified address, but the value stored is UNKNOWN.

If $s == n \ \&\& \ n \ != \ 31$ then one of the following behaviors must occur:

- The instruction is UNDEFINED.
- The instruction executes as a NOP.
- The instruction performs the store to an UNKNOWN address.

STLXRB

For a description of this instruction and the encoding, see [STLXRB](#) on page C6-861.

CONSTRAINED UNPREDICTABLE behavior

If $s == t$, then one of the following behaviors must occur:

- The instruction is UNDEFINED.
- The instruction executes as a NOP.
- The instruction performs the store to the specified address, but the value stored is UNKNOWN.

If $s == n$ && $n != 31$ then one of the following behaviors must occur:

- The instruction is UNDEFINED.
- The instruction executes as a NOP.
- The instruction performs the store to an UNKNOWN address.

STLXRH

For a description of this instruction and the encoding, see [STLXRH](#) on page C6-863.

CONSTRAINED UNPREDICTABLE behavior

If $s == t$, then one of the following behaviors must occur:

- The instruction is UNDEFINED.
- The instruction executes as a NOP.
- The instruction performs the store to the specified address, but the value stored is UNKNOWN.

If $s == n$ && $n != 31$ then one of the following behaviors must occur:

- The instruction is UNDEFINED.
- The instruction executes as a NOP.
- The instruction performs the store to an UNKNOWN address.

STR (immediate)

For a description of this instruction and the encoding, see [STR \(immediate\)](#) on page C6-870.

CONSTRAINED UNPREDICTABLE behavior

If the instruction encoding specifies pre-indexed addressing or post-indexed addressing, and $n == t$ && $n != 31$, then one of the following behaviors must occur:

- The instruction is UNDEFINED.
- The instruction executes as a NOP.
- The instruction performs a store using the specified addressing mode but the value stored is UNKNOWN.

———— **Note** —————

Pre-indexed addressing and post-indexed addressing imply writeback.

STRB (immediate)

For a description of this instruction and the encoding, see [STRB \(immediate\)](#) on page C6-875.

CONSTRAINED UNPREDICTABLE behavior

If the instruction encoding specifies pre-indexed addressing or post-indexed addressing, and $n == t$ && $n != 31$, then one of the following behaviors must occur:

- The instruction is UNDEFINED.
- The instruction executes as a NOP.
- The instruction performs a store using the specified addressing mode but the value stored is UNKNOWN.

———— Note —————

Pre-indexed addressing and post-indexed addressing imply writeback.

STRH (immediate)

For a description of this instruction and the encoding, see [STRH \(immediate\)](#) on page C6-879.

CONSTRAINED UNPREDICTABLE behavior

If the instruction encoding specifies pre-indexed addressing or post-indexed addressing, and $n == t$ && $n != 31$, then one of the following behaviors must occur:

- The instruction is UNDEFINED.
- The instruction executes as a NOP.
- The instruction performs a store using the specified addressing mode but the value stored is UNKNOWN.

———— Note —————

Pre-indexed addressing and post-indexed addressing imply writeback.

STXP

For a description of this instruction and the encoding, see [STXP](#) on page C6-920.

CONSTRAINED UNPREDICTABLE behavior

If $s == t$ || ($s == t2$), then one of the following behaviors must occur:

- The instruction is UNDEFINED.
- The instruction executes as a NOP.
- The instruction performs the store to the specified address, but the value stored is UNKNOWN.

If $s == n$ && $n != 31$ then one of the following behaviors must occur:

- The instruction is UNDEFINED.
- The instruction executes as a NOP.
- The instruction performs the store to an UNKNOWN address.

STXR

For a description of this instruction and the encoding, see [STXR on page C6-922](#).

CONSTRAINED UNPREDICTABLE behavior

If $s == t$, then one of the following behaviors must occur:

- The instruction is UNDEFINED.
- The instruction executes as a NOP.
- The instruction performs the store to the specified address, but the value stored is UNKNOWN.

If $s == n$ && $n != 31$ then one of the following behaviors must occur:

- The instruction is UNDEFINED.
- The instruction executes as a NOP.
- The instruction performs the store to an UNKNOWN address.

STXRB

For a description of this instruction and the encoding, see [STXRB on page C6-924](#).

CONSTRAINED UNPREDICTABLE behavior

If $s == t$, then one of the following behaviors must occur:

- The instruction is UNDEFINED.
- The instruction executes as a NOP.
- The instruction performs the store to the specified address, but the value stored is UNKNOWN.

If $s == n$ && $n != 31$ then one of the following behaviors must occur:

- The instruction is UNDEFINED.
- The instruction executes as a NOP.
- The instruction performs the store to an UNKNOWN address.

STXRH

For a description of this instruction and the encoding, see [STXRH on page C6-926](#).

CONSTRAINED UNPREDICTABLE behavior

If $s == t$, then one of the following behaviors must occur:

- The instruction is UNDEFINED.
- The instruction executes as a NOP.
- The instruction performs the store to the specified address, but the value stored is UNKNOWN.

If $s == n$ && $n != 31$ then one of the following behaviors must occur:

- The instruction is UNDEFINED.
- The instruction executes as a NOP.
- The instruction performs the store to an UNKNOWN address.

K1.2.15 Out of range values of the Set/Way/Index fields in cache maintenance instructions

In the cache maintenance by set/way instructions [DC CISW](#), [DC CSW](#), and [DC ISW](#), if any set/way/index argument is larger than the value supported by the implementation, then the behavior is CONSTRAINED UNPREDICTABLE and one of the following occurs:

- The instruction is UNDEFINED.
- The instruction performs cache maintenance on one of:
 - No cache lines.
 - A single arbitrary cache line.
 - Multiple arbitrary cache lines.

———— **Note** —————

This CONSTRAINED UNPREDICTABLE behavior applies, also, to the AArch32 cache maintenance by set/way instructions [DCCISW](#), [DCCSW](#), and [DCISW](#).

K1.2.16 Reserved values in System and memory-mapped registers and translation table entries

Unless otherwise stated in this manual, all unallocated or reserved values of fields with allocated values within AArch64 System registers, memory-mapped registers, and translation table entries behave in one of the following ways:

- The unallocated value maps onto any of the allocated values, but otherwise does not cause CONSTRAINED UNPREDICTABLE behavior.
- The unallocated value causes effects that could be achieved by a combination of more than one of the allocated values.
- The unallocated value causes the field to have no functional effect.

———— **Note** —————

These constraints are identical to those for the equivalent AArch32 definitions, as given in [Reserved values in System and memory-mapped registers and translation table entries on page K1-6117](#).

K1.2.17 CONSTRAINED UNPREDICTABLE behavior in Debug state

[Behavior in Debug state on page H2-5445](#) of this manual describes the CONSTRAINED UNPREDICTABLE behaviors that are specifically associated with Debug state.

Appendix K2

Recommended External Debug Interface

This appendix describes the recommended external debug interface. It contains the following sections:

- [About the recommended external debug interface on page K2-6136.](#)
- [PMUEVENT bus on page K2-6139.](#)
- [Recommended authentication interface on page K2-6140.](#)
- [Management registers and CoreSight compliance on page K2-6141.](#)

———— **Note** —————

This recommended external debug interface specification is not part of the ARM architecture specification. Implementers and users of the ARMv8 architecture must not consider this appendix as a requirement of the architecture. It is included as an appendix to this manual only:

- As reference material for users of ARM products that implement this interface.
- As an example of how an external debug interface might be implemented.

The inclusion of this appendix is no indication of whether any ARM products might, or might not, implement this external debug interface. For details of the implemented external debug interface you must always see the appropriate product documentation.

K2.1 About the recommended external debug interface

See the *Note* on the first page of this appendix for information about the architectural status of this recommended debug interface.

This specification provides a recommended external debug interface for ARMv8 to define a standard set of connections for validation environments. In general, the connection between components, such as between the PE and Trace extension, is not described here, although the table does include the signals for the CTI connection.

[Table K2-1](#) shows the signals in the recommended interface.

Table K2-1 Recommended debug interface signals

Name	Direction	Description	Notes
DBGEN	In	External debug enable	-
SPIDEN	In	Secure privileged external debug enable Secure privileged self-hosted debug enable	- Only in Secure AArch32 modes when enabled by MDCR_EL3.SPD32
NIDEN	In	External profiling and trace enable	-
SPNIDEN	In	Secure external profiling and trace enable	-
EDBGRQ	In	External halt request	Provided for legacy connections only.
DBGACK	Out	External halt request acknowledge	
COMMIRQ	Out	DCC interrupt	Interface to an interrupt controller. See Interrupt-driven use of the DCC on page H4-5514 and the pseudocode for function CheckForDCCInterrupts() .
PMUIRQ	Out	Performance Monitor overflow	Interface to an interrupt controller. See Behavior on overflow on page D5-2142 .
COMMRX	Out	DTRRX is full	Provided for legacy connection to an interrupt controller only. See Interrupt-driven use of the DCC on page H4-5514 and the pseudocode for function CheckForDCCInterrupts() .
COMMTX	Out	DTRTX is empty	
PMUEVENT[n:0]	Out	Performance Monitors event bus	See PMUEVENT bus on page K2-6139 .
DBGNOPWRDWN	Out	Core no powerdown request	Interface to a power controller. See DBGPRCR_EL1.CORENPDRQ .
DBGPWRUPREQ	Out	Core powerup request	Interface to a power controller. See EDPRCR.COREPURQ .
DBGRSTREQ	Out	Warm reset request	Interface to a power controller. See EDPRCR.CWRR .
DBGBUSCANCELREQ	Out	All asynchronous entry to Debug state	Extension to the bus interface. See EDRCR.CBRRQ .
DBGPWRDUP	In	Core powerup status	Interface to a power controller. See EDPRSR.PU .
DBGROMADDR[n:12]	In	MDRAR_EL1.ROMADDR	<i>n</i> depends on the size of the physical address space.

Table K2-1 Recommended debug interface signals (continued)

Name	Direction	Description	Notes	
DBGROMADDRV	In	MDRAR_EL1 . Valid	-	
PRESETDBG	In	External debug reset	-	
CPUPORESET	In	Cold reset	-	
CORERESET	In	Warm reset	-	
PSELDBG	In	Debug APB slave port	For details see <i>AMBA APB3</i> . ARM recommends a single slave port for all integrated debug components. PADDRDBG31 distinguishes memory-mapped and DAP accesses: 0 Memory-mapped access 1 DAP access	
PENABLEDBG	In			
PWRITDBG	In			
PRDATADBG[31:0]	Out			
PWDATADBG[31:0]	In			
PADDRDBG[n:2] ^a	In			
PREADYDBG	Out			
PSLVERRDBG	Out			
PCLKDBG	In			
PCLKENDBG	In			
CTICHIN	In	CoreSight channel interface		For details, see the <i>ARM® CoreSight™ Architecture Specification</i> . The ACK signals are not required if the channel interface is synchronous.
CTICHOUTACK	In			
CTICHOUT	Out			
CTICHINACK	Out			
CTHIRQ	Out	CTI interrupt, see Description and allocation of CTI triggers on page H5-5525	Implements a handshake for an edge-sensitive interrupt.	
CTHIRQACK	In			
ATDATA[nx8-1:0]	Out	AMBA 4 ATB interface	For details, see the <i>AMBA 4 ATB Protocol Specification, ATBv1.0 and ATBv1.1</i> . Only available if the OPTIONAL Trace extension is implemented.	
ATBYTES[n-1:0]	Out			
ATID[6:0]	Out			
ATREADY	In			
ATVALID	Out			
AFREADY	Out			
AFVALID	Out			
SYNCREQ	In			
ATCLK	In			
ATCLKEN	In			
ATRESET	In			

a. The value of *n* depends on the size of the address space occupied by the Debug port.

Figure K2-1 shows the recommended debug interface.

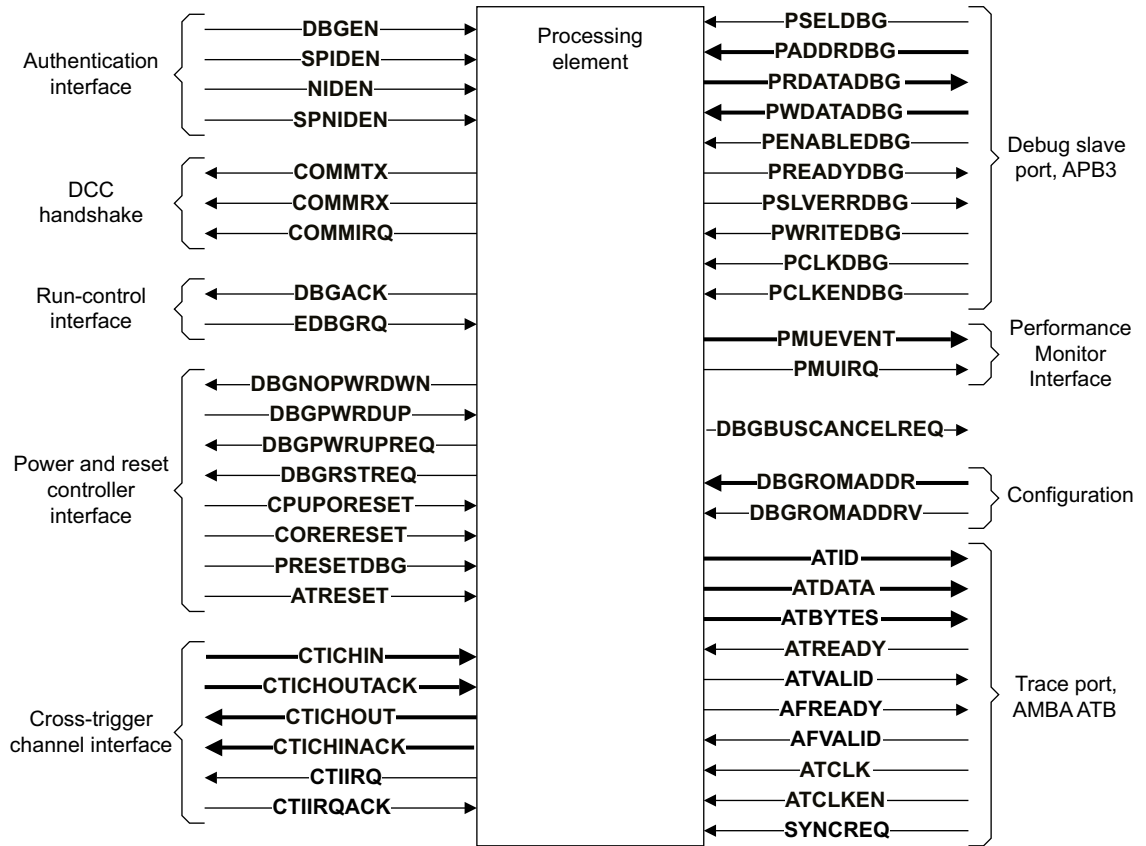

Figure K2-1 Recommended external debug interface, including the APB3 slave port

K2.2 PMUEVENT bus

The **PMUEVENT** bus exports Performance Monitor events from the PE to an on-chip agent. ARM recommends that it has the following characteristics:

- The bus is synchronous.
- The width of the bus is IMPLEMENTATION DEFINED.
- It is IMPLEMENTATION DEFINED which events are exported on the bus.
- Each exported event occupies a contiguous sub-field of the bus. ARM recommends that the sub-fields of the bus are occupied in the same order as the event numbers.
- If the event can only occur once per cycle, it occupies a single bit. If the event can occur more than once per cycle, it is IMPLEMENTATION DEFINED how the event is encoded. The encoding depends on constraints such as the designated use of the event bus and the number of pins available. For example, the event can be encoded:
 - As a count, using a plain binary number. This is the most useful encoding when exporting to an external counter. It is not a useful encoding for exporting to a Trace extension external input.
 - As a count, using thermometer encoding. This is the most useful encoding when exporting to a Trace extension.
 - Using a single bit encoding to indicate whether the event count is zero or nonzero. This is useful for exporting to an activity monitor where the number of pins is constrained.

If a Trace extension is implemented, the **PMUEVENT** bus is normally connected to the Trace extension using the external inputs. TRCEXTINSEL multiplexes a wide **PMUEVENT** bus to a narrow set of inputs. An external **PMUEVENT** bus might also be provided. For more information, contact ARM.

K2.3 Recommended authentication interface

An implementation of the ARMv8 architecture must support debug authentication described in [Required debug authentication on page H1-5432](#).

The details of the debug authentication interface are IMPLEMENTATION DEFINED, but ARM recommends the use of the CoreSight interface, which includes the following signals for external debug authentication:

- **DBGEN**.
- **SPIDEN**.
- **NIDEN**.
- **SPNIDEN**.

ARM recommends an interface in which **DBGEN** and **SPIDEN** are also used for self-hosted Secure debug authentication if either:

- EL3 is using AArch32 and `SDCR.SPD == 0b00`.
- Secure EL1 is using AArch32 and `MDCR_EL3.SPD32 == 0b00`.

If EL3 is not implemented and the PE is in Non-secure state, **SPIDEN** and **SPNIDEN** are not implemented, and the PE behaves as if these signals were tied LOW.

If EL3 is not implemented and the PE is in Secure state, **SPIDEN** is usually connected to **DBGEN** and **SPNIDEN** is connected to **NIDEN**, but this is not required. The recommended interface is defined as if all four signals are implemented.

How the authentication signals are driven is IMPLEMENTATION DEFINED. For example, the signals might be hard-wired, connected to fuses, or to an authentication module. The architecture permits PEs within a cluster to have independent authentication interfaces, but this is not required. ARM recommends that any Trace extension has the same authentication interface as the PE it is connected to.

[Table K2-2](#) shows the debug authentication pseudocode functions and the recommended implementations.

Table K2-2 Recommended implementation of debug enable pseudocode functions

Pseudocode function	Description	Implementation
<code>AArch32.SelfHostedSecurePrivilegedInvasiveDebugEnabled()</code>	Secure invasive self-hosted debug enabled in AArch32 state (legacy)	(DBGEN AND SPIDEN)
<code>ExternalSecureNoninvasiveDebugEnabled()</code>	Secure non-invasive debug enabled	(DBGEN OR NIDEN) AND (SPIDEN OR SPNIDEN)
<code>ExternalSecureInvasiveDebugEnabled()</code>	Secure invasive debug enabled	(DBGEN AND SPIDEN)
<code>ExternalNoninvasiveDebugEnabled()</code>	Non-secure non-invasive debug enabled	(DBGEN OR NIDEN)
<code>ExternalInvasiveDebugEnabled()</code>	Non-secure invasive debug enabled	DBGEN

The `Debug_authentication()` pseudocode function on [shared/debug on page J1-6006](#) defines the authentication signals **DBGEN**, **SPIDEN**, **NIDEN** and **SPNIDEN**.

K2.4 Management registers and CoreSight compliance

The CoreSight architecture requires the implementation of a set of management registers that occupy the memory map from 0xF00 upwards in each of the debug components.

CoreSight compliance and complete implementation of the management registers is OPTIONAL, but ARM recommends that the registers are implemented.

The CoreSight architecture specification recommends that any integration test registers are implemented starting from 0xEFC downwards. Each of the debug components has an IMPLEMENTATION DEFINED region from 0xE80 to 0xEFC for this purpose.

K2.4.1 Coresight interface register map

Table K2-3 shows the external management register maps for the following registers:

- ED** These are the external debug register.
- CTI** These are the Cross-trigger interface registers.
- PMU** These are the Performance Monitors registers.

Table K2-3 Coresight interface register map

Offset	Mnemonic			Name
	ED	CTI	PMU	
0xF00	EDITCTRL	CTIITCTRL	PMITCTRL	Integration Model Control registers
0xF04-0xF9C	-	-	-	Reserved, RES0
0xFA0	DBGCLAIMSET_EL1 ^a	CTICLAIMSET ^b	-	CLAIM Tag Set registers
0xFA4	DBGCLAIMCLR_EL1 ^a	CTICLAIMCLR ^b	-	CLAIM Tag Clear registers
0xFA8	EDDEVAFF0 ^a	CTIDEVAFF0 ^c	PMDEVAFF0	Device Affinity registers
0xFAC	EDDEVAFF1 ^a	CTIDEVAFF1 ^c	PMDEVAFF1	
0xFB0	EDLAR ^d	CTILAR ^d	PMLAR ^d	Lock Access register
0xFB4	EDLSR ^d	CTILSR ^d	PMLSR ^d	Lock Status register
0xFB8	DBGAUTHSTATUS_EL1 ^a	CTIAUTHSTATUS	PMAUTHSTATUS	Authentication Status register
0xFBC	EDDEVARCH	CTIDEVARCH	PMDEVARCH	Device Architecture register
0xFC0	EDDEVID2 ^a	CTIDEVID2 ^a	-	Device ID register
0xFC4	EDDEVID1 ^a	CTIDEVID1 ^a	-	
0xFC8	EDDEVID ^a	CTIDEVID ^a	PMDEVID ^a	
0xFCC	EDDEVTYPE	CTIDEVTYPE	PMDEVTYPE	Device Type register
0xFD0	EDPIDR4	CTIPIDR4	PMPIDR4	Peripheral ID registers
0xFD4-0xFDC	-	-	-	Reserved, RES0
0xFE0	EDPIDR0	CTIPIDR0	PMPIDR0	Peripheral ID registers
0xFE4	EDPIDR1	CTIPIDR1	PMPIDR1	
0xFE8	EDPIDR2	CTIPIDR2	PMPIDR2	
0xFEC	EDPIDR3	CTIPIDR3	PMPIDR3	

Table K2-3 Coresight interface register map (continued)

Offset	Mnemonic			Name
	ED	CTI	PMU	
0xFF0	EDCIDR0	CTICIDR0	PMCIDR0	Component ID registers
0xFF4	EDCIDR1	CTICIDR1	PMCIDR1	
0xFF8	EDCIDR2	CTICIDR2	PMCIDR2	
0xFFC	EDCIDR3	CTICIDR3	PMCIDR3	

- This register must always be implemented, regardless of whether the component is CoreSight compliant.
- If implemented, the number of CLAIM bits is IMPLEMENTATION DEFINED and can be discovered by reading CLAIMSET.
- If the CTI implements CTIV1, this register is not implemented. See the register description for details.
- The Software lock registers are defined as part of CoreSight compliance, but their contents depend on the type of access that is made and whether the OPTIONAL Software lock is implemented. See the register description for details.

K2.4.2 Management register access permissions

Access to the OPTIONAL Integration Control register (ITCTRL) is IMPLEMENTATION DEFINED.

If the Debug power domain is off, all register accesses return an error.

Otherwise, [Table K2-4 on page K2-6143](#), [Table K2-5 on page K2-6144](#), and [Table K2-6 on page K2-6145](#) show the response to accesses by the external debug interface to the CoreSight management registers. For definitions of the terms used in the tables, see [External debug interface register access permissions summary on page H8-5563](#).

———— Note —————

Access to the CoreSight management registers is not affected by the values of EDAD and EPMAD.

[Table K2-4 on page K2-6143](#), [Table K2-5 on page K2-6144](#), and [Table K2-6 on page K2-6145](#) include reserved management registers, because the CoreSight architecture requires that these registers are always RES0. The descriptions in [Reserved and unallocated registers on page H8-5563](#) does not apply to reserved management registers if the implementation is CoreSight compliant.

If OPTIONAL memory-mapped access to the external debug interface is supported, there are additional constraints on memory-mapped accesses. See [Register access permissions for memory-mapped accesses on page H8-5558](#).

The terms in [Table K2-4 on page K2-6143](#), [Table K2-5 on page K2-6144](#), and [Table K2-6 on page K2-6145](#) are defined as follows:

Domain This describes the power domain in which the register is logically implemented. Registers described as implemented in the Core power domain might be implemented in the Debug power domain, as long as they exhibit the required behavior.

Conditions This lists the conditions under which the access is attempted.
To determine the access permissions for a register, read these columns from left to right, and stop at first column which lists the condition as being true.

The conditions are:

Off [EDPRSR.PU](#) == 0. The Core power domain is completely off, or in low-power state. In these cases the Core power domain registers cannot be accessed.

———— Note —————

If debug power is off, then all external debug interface accesses return an error.

DLK [DoubleLockStatus\(\)](#) == TRUE. The OS Double Lock is locked.

OSLK [OSLSR.OSLK](#) == 1. The OS Lock is locked.

- Default** This provides the default access permissions, if there are no conditions that prevent access to the register.
- SLK** This provides the modified default access permissions for OPTIONAL memory-mapped accesses to the external debug interface if the OPTIONAL Software Lock is locked. See [Register access permissions for memory-mapped accesses on page H8-5558](#). For all other accesses, this column is ignored.

The access permissions are:

- This means that the default access permission applies. See the Default column, or the SLK column, if applicable.
- RO** This means that the register or field is read-only.
- RW** This means that the register or field is read/write. Individual fields within the register might be RO. See the relevant register description for details.
- RC** This means that the bit clears to 0 after a read.
- (SE)** This means that accesses to this register have indirect write side effects. A side effect occurs when a direct read or a direct write of a register creates an indirect write to the same register or to another register.
- WO** This means that the register or field is write-only.
- WI** This means that the register or field ignores writes.
- IMP DEF** This means that the access permissions are IMPLEMENTATION DEFINED.

Table K2-4 External debug interface access permissions, CoreSight registers (debug)

Offset	Register	Domain	Conditions (priority left to right)			Default	SLK
			Off	DLK	OSLK		
0xF00	EDITCTRL	IMP DEF	IMPLEMENTATION DEFINED			IMP DEF	RO/WI
0xF04-0xF8C	Reserved	Debug	-	-	-	RES0	-
0xFA0	DBGCLAIMSET_EL1	Core	Error	Error	Error	RW (SE)	RO
0xFA4	DBGCLAIMCLR_EL1	Core	Error	Error	Error	RW (SE)	RO
0xFA8	EDDEVAFF0	Debug	-	-	-	RO	-
0xFAC	EDDEVAFF1	Debug	-	-	-	RO	-
0xFB0	EDLAR	Debug	-	-	-	WO (SE)	-
0xFB4	EDLSR	Debug	-	-	-	RO	-
0xFB8	DBGAUTHSTATUS_EL1	Debug	-	-	-	RO	-
0xFBC	EDDEVARCH	Debug	-	-	-	RO	-
0xFC0	EDDEVID2	Debug	-	-	-	RO	-
0xFC4	EDDEVID1	Debug	-	-	-	RO	-
0xFC8	EDDEVID	Debug	-	-	-	RO	-
0xFCC	EDDEVTYPE	Debug	-	-	-	RO	-
0xFD0	EDPIDR4	Debug	-	-	-	RO	-

Table K2-4 External debug interface access permissions, CoreSight registers (debug) (continued)

Offset	Register	Domain	Conditions (priority left to right)			Default	SLK
			Off	DLK	OSLK		
0xFD4-0xFDC	Reserved	Debug	-	-	-	RES0	-
0xFE0-0xFEC	EDPIDR0	Debug	-	-	-	RO	-
0xFE4	EDPIDR1	Debug	-	-	-	RO	-
0xFE8	EDPIDR2	Debug	-	-	-	RO	-
0xFEC	EDPIDR3	Debug	-	-	-	RO	-
0xFF0	EDCIDR0	Debug	-	-	-	RO	-
0xFF4	EDCIDR1	Debug	-	-	-	RO	-
0xFF8	EDCIDR2	Debug	-	-	-	RO	-
0xFFC	EDCIDR3	Debug	-	-	-	RO	-

Table K2-5 External debug interface access permissions, CoreSight registers (CTI)

Offset	Register	Domain	Conditions (priority left to right)			Default	SLK
			Off	DLK	OSLK		
0xF00	CTIITCTRL	IMP DEF	IMPLEMENTATION DEFINED			IMP DEF	RO/WI
0xF04-0xF8C	Reserved	Debug	-	-	-	RES0	-
0xFA0	CTICLAIMSET	Debug	-	-	-	RW (SE)	RO
0xFA4	CTICLAIMCLR	Debug	-	-	-	RW (SE)	RO
0xFA8	CTIDEVAFF0	Debug	-	-	-	RO	-
0xFAC	CTIDEVAFF1	Debug	-	-	-	RO	-
0xFB0	CTILAR	Debug	-	-	-	WO (SE)	-
0xFB4	CTILSR	Debug	-	-	-	RO	-
0xFB8	CTIAUTHSTATUS	Debug	-	-	-	RO	-
0xFBC	CTIDEVARCH	Debug	-	-	-	RO	-
0xFC0	CTIDEVID2	Debug	-	-	-	RO	-
0xFC4	CTIDEVID1	Debug	-	-	-	RO	-
0xFC8	CTIDEVID	Debug	-	-	-	RO	-
0xFCC	CTIDEVTYPE	Debug	-	-	-	RO	-
0xFD0	CTIPIDR4	Debug	-	-	-	RO	-
0xFD4-0xFDC	Reserved	Debug	-	-	-	RES0	-

Table K2-5 External debug interface access permissions, CoreSight registers (CTI) (continued)

Offset	Register	Domain	Conditions (priority left to right)			Default	SLK
			Off	DLK	OSLK		
0xFE0	CTIPIDR0	Debug	-	-	-	RO	-
0xFE4	CTIPIDR1	Debug	-	-	-	RO	-
0xFE8	CTIPIDR2	Debug	-	-	-	RO	-
0xFEC	CTIPIDR3	Debug	-	-	-	RO	-
0xFF0	CTICIDR0	Debug	-	-	-	RO	-
0xFF4	CTICIDR1	Debug	-	-	-	RO	-
0xFF8	CTICIDR2	Debug	-	-	-	RO	-
0xFFC	CTICIDR3	Debug	-	-	-	RO	-

Table K2-6 External debug interface access permissions, CoreSight registers (PMU)

Offset	Register	Domain	Conditions (priority left to right)			Default	SLK
			Off	DLK	OSLK		
0xF00	PMITCTRL	IMP DEF	IMPLEMENTATION DEFINED			IMP DEF	RO/WI
0xF04-0xFA4	Reserved	Debug	-	-	-	RES0	-
0xFA8	PMDEVAFF0	Debug	-	-	-	RO	-
0xFAC	PMDEVAFF1	Debug	-	-	-	RO	-
0xFB0	PMLAR	Debug	-	-	-	WO (SE)	-
0xFB4	PMLSR	Debug	-	-	-	RO	-
0xFB8	PMAUTHSTATUS	Debug	-	-	-	RO	-
0xFBC	PMDEVARCH	Debug	-	-	-	RO	-
0xFC0-0xFC8	Reserved	Debug	-	-	-	RES0	-
0xFCC	PMDEVTYPE	Debug	-	-	-	RO	-
0xFD0	PMPIDR4	Debug	-	-	-	RO	-
0xFD4-0xFDC	Reserved	Debug	-	-	-	RES0	-
0xFE0	PMPIDR0	Debug	-	-	-	RO	-
0xFE4	PMPIDR1	Debug	-	-	-	RO	-
0xFE8	PMPIDR2	Debug	-	-	-	RO	-
0xFEC	PMPIDR3	Debug	-	-	-	RO	-
0xFF0	PMCIDR0	Debug	-	-	-	RO	-

Table K2-6 External debug interface access permissions, CoreSight registers (PMU) (continued)

Offset	Register	Domain	Conditions (priority left to right)			Default	SLK
			Off	DLK	OSLK		
0xFF4	PMCIDR1	Debug	-	-	-	RO	-
0xFF8	PMCIDR2	Debug	-	-	-	RO	-
0xFFC	PMCIDR3	Debug	-	-	-	RO	-

K2.4.3 Management register resets

Table K2-7 shows the management register resets. This table does not include:

- Read-only identification registers that have a fixed value from reset. These registers include those with the DEVAFFn, DEVARCH, DEVID{n}, DEVTYPE, PIDRn, and CIDRn mnemonics.
- Registers that have the AUTHSTATUS mnemonic. This is a read-only status register that reflects the status outside of the reset domain of the register.
- Registers that have the LAR mnemonic. These are write-only registers that only have an effect on writes.

All other fields in the management registers are reset to an IMPLEMENTATION DEFINED value which can be UNKNOWN. The registers are in the reset domain specified in the table.

Table K2-7 shows a summary of the management register resets.

Table K2-7 Management register resets

Register	Reset domain	Field	Value	Description
CTIITCTRL EDITCTRL PMITCTRL	IMPLEMENTATION DEFINED	IME	0	Integration mode enable
DBGCLAIMCLR_EL1	Cold reset	CLAIM	0x00	CLAIM tags
CTICLAIMCLR	External debug	CLAIM	0x00000000	
CTILSR ^a EDLSR ^a PMLSR ^a	External debug	SLK	1	Software Lock

a. Only if the OPTIONAL Software Lock is implemented

K2.4.4 About the Peripheral identification scheme

The Peripheral Identification scheme provides the standard information required by all components that conform to the *ARM® Debug Interface Architecture Specification, ADIv5.0 to ADIv5.2*, that implements the CoreSight identification scheme. They identify a peripheral in a particular namespace. For more information, see the *ARM® CoreSight™ Architecture Specification*.

Table K2-8 on page K2-6147 lists the Peripheral ID Registers that make up the Peripheral Identification scheme for each component.

Table K2-8 Peripheral Identification Registers

Register offset	Description	Reference		
		External Debug	CTI	Performance Monitors
0xFD0	Peripheral ID4	EDPIDR4	CTIPIDR4	PMPIDR4
0xFD4	Reserved for Peripheral ID5	-	-	-
0xFD8	Reserved for Peripheral ID6	-	-	-
0xFDC	Reserved for Peripheral ID7	-	-	-
0xFE0	Peripheral ID0	EDPIDR0	CTIPIDR0	PMPIDR0
0xFE4	Peripheral ID1	EDPIDR1	CTIPIDR1	PMPIDR1
0xFE8	Peripheral ID2	EDPIDR2	CTIPIDR2	PMPIDR2
0xFEC	Peripheral ID3	EDPIDR3	CTIPIDR3	PMPIDR3

Figure K2-2 shows the register field allocation scheme for the Peripheral ID Registers.

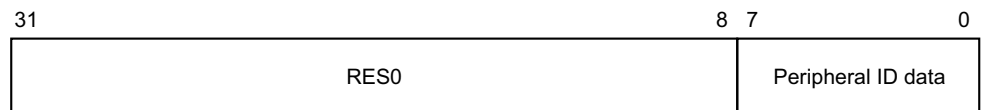

Figure K2-2 Peripheral ID register format

Software can consider the eight Peripheral ID Registers as defining a single 64-bit Peripheral ID, as shown in Figure K2-3.

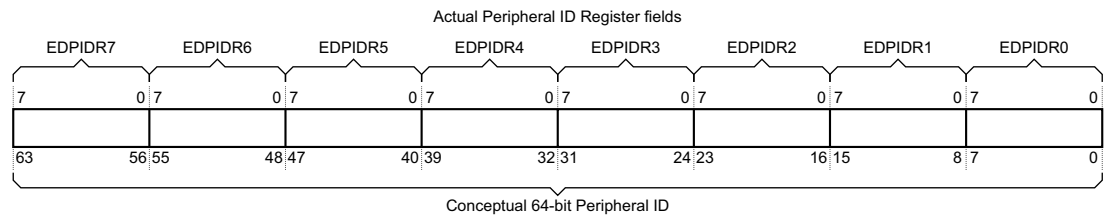

Figure K2-3 Mapping between Peripheral ID Registers and a 64-bit Peripheral ID Value

Figure K2-3 shows the fields in the 64-bit Peripheral ID value, and includes the field values for fields that:

- Have fixed values, including the bits that are reserved.
- Have fixed values in an implementation that is designed by ARM.

For more information about the fields and their values see Table K2-9 on page K2-6148.

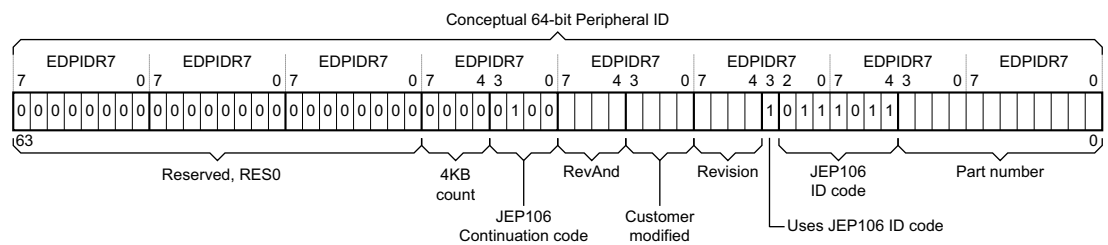

Figure K2-4 Peripheral ID fields, with values for a implementation designed by ARM

Table K2-9 shows the fields in the Peripheral ID.

Table K2-9 Fields in the Peripheral Identification Registers

Name	Size	Description	Registers
4KB count	4 bits	Log2 of the number of 4KB blocks occupied by the implementation.	EDPIDR4 CTIPIDR4 PMPIDR4
JEP106 code	4-7 bits	Identifies the designer of the implementation. This value consists of: <ul style="list-style-type: none"> A 4-bit continuation code, also described as the bank number. A 7-bit identification code. For implementations designed by ARM, the continuation code is 0x4, indicating bank 5, and the identity code is 0x3B.	EDPIDR1, EDPIDR2, EDPIDR4 CTIPIDR1, CTIPIDR2, CTIPIDR4 PMPIDR1, PMPIDR2, PMPIDR4
RevAnd	4 bits	Manufacturing revision number. Indicates a late modification to the implementation, usually as a result of an <i>Engineering Change Order</i> (ECO). This field starts at 0x0 and is incremented by the integrated circuit manufacturer on metal fixes.	EDPIDR3 CTIPIDR3 PMPIDR3
Customer modified	4 bits	Indicates an endorsed modification to the implementation. If the system designer cannot modify the implementation supplied by the implementation designer then this field is RES0.	EDPIDR3 CTIPIDR3 PMPIDR3
Revision	4 bits	Revision number for the implementation. Starts at 0x0 and increments by 1 at both major and minor revisions.	EDPIDR2 CTIPIDR2 PMPIDR2
Uses JEP106 ID code	1 bit	This bit is set to 1 when a JEP106 identification code is used. This bit must be 1 on all ARMv8 implementations.	EDPIDR2 CTIPIDR2 PMPIDR2
Part number	12 bits	Part number for the implementation. Each organization designing to the ARM Debug architecture specification keeps its own part number list.	EDPIDR0, EDPIDR1 CTIPIDR0, CTIPIDR1 PMPIDR0, PMPIDR1

A component is identified uniquely by the combination of the following fields:

- JEP106 continuation code.
- JEP106 identity code.
- Part number.
- Revision.
- Customer Modified.
- RevAnd.

For components with a *Component class* of 0x9, Debug component, indicated by the Component Identification Registers, multiple components can have the same Part number, provided each component has a different CoreSight *Device type*. However, ARM strongly recommends that each device has a unique Part number. For more information:

- About the Component Identification Registers, see [About the Component Identification scheme on page K2-6149](#).
- About the CoreSight Device type, see [EDDEVTYPE](#), [CTIDEVTYPE](#), or [PMDEVTYPE](#).
- About CoreSight components and their identification, see the *ARM® Debug Interface Architecture Specification*.

Allocating revisions and part numbers

Within the Peripheral Identification registers, the allocation of major and minor revisions, part numbers, and customer-modified fields is IMPLEMENTATION DEFINED, with the following set of restrictions so that:

- The REVISION field must increase monotonically with revisions.

———— **Note** —————

ARM recommends that the REVISION field is updated for each update to the RTL, regardless of whether this is a major or minor update.

- The REVAND field should increase monotonically with revisions.

———— **Note** —————

ARM recommends that the REVAND field is used only for post-release changes. For example, those due to engineering change order (ECO) fixes related to the debug component of the processor.

- The PART field must have a degree of uniqueness:

- Two component designs can have the same part number so long as they are sub-components of the same part and the programmers' model for the part has the means to disambiguate sub-components.
- Otherwise, two component designs must have unique part numbers.

The DEVARCH (if implemented) or DEVTYPE (otherwise) register provides the means to disambiguate sub-components of the Debug Architecture.

A ROM table has no DEVTYPE or DEVARCH register. However, if it is the only CLASS 0x1 component in a processor cluster, it can still be disambiguated.

Multiple instances of the same component design have the same part number.

K2.4.5 About the Component Identification scheme

The Component Identification Registers identify the processor as an ARM Debug Interface v5 component. For more information, see the *ARM® Debug Interface Architecture Specification* and the *ARM® CoreSight™ Architecture Specification*.

The Component Identification Registers occupy the last four words of the 4KB block of debug registers.

Table K2-10 Component Identification Registers

Register offset	Description	External debug	CTI	Performance Monitors
0xFF0	Component ID0	EDCIDR0	CTICIDR0	PMCIDR0
0xFF0	Component ID1	EDCIDR1	CTICIDR1	PMCIDR1
0xFF0	Component ID2	EDCIDR2	CTICIDR2	PMCIDR2
0xFF0	Component ID3	EDCIDR3	CTICIDR3	PMCIDR3

Figure K2-5 shows the register field allocation scheme for the Component ID Registers.

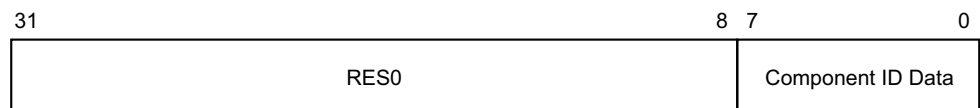

Figure K2-5 Component ID Register format

Software can consider the eight Component ID Registers as defining a single 32-bit Component ID, as shown in Figure K2-6 on page K2-6150.

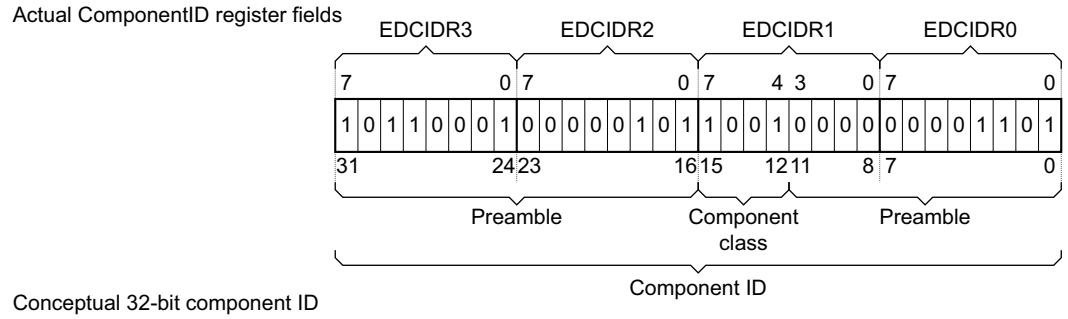

Figure K2-6 Mapping between Component ID Registers and a 32-bit Component ID Value

Appendix K3

Recommendations for Performance Monitors Event Numbers for IMPLEMENTATION DEFINED Events

This appendix describes the ARM recommendations for the use of the IMPLEMENTATION DEFINED event numbers. It contains the following sections:

- *ARM recommendations for IMPLEMENTATION DEFINED event numbers on page K3-6152.*
- *Summary of events for exceptions taken to an Exception level using AArch64 on page K3-6166.*

K3.1 ARM recommendations for IMPLEMENTATION DEFINED event numbers

These are the ARM recommendations for the use of the IMPLEMENTATION DEFINED event numbers. ARM does not define these events as rigorously as those in the architectural and microarchitectural event lists, and an implementation might:

- Modify the definition of an event to better correspond to the implementation.
- Not use some, or many, of these event numbers.

Table K3-1 lists the PMU IMPLEMENTATION DEFINED event numbers in event number order.

Table K3-1 PMU IMPLEMENTATION DEFINED event numbers

Event number	Event mnemonic	Description
0x0040	L1D_CACHE_RD	Attributable Level 1 data cache access, read
0x0041	L1D_CACHE_WR	Attributable Level 1 data cache access, write
0x0042	L1D_CACHE_REFILL_RD ^a	Attributable Level 1 data cache refill, read
0x0043	L1D_CACHE_REFILL_WR ^a	Attributable Level 1 data cache refill, write
0x0044	L1D_CACHE_REFILL_INNER	Attributable Level 1 data cache refill, inner
0x0045	L1D_CACHE_REFILL_OUTER	Attributable Level 1 data cache refill, outer
0x0046	L1D_CACHE_WB_VICTIM	Attributable Level 1 data cache Write-Back, victim
0x0047	L1D_CACHE_WB_CLEAN	Level 1 data cache Write-Back, cleaning and coherency
0x0048	L1D_CACHE_INVAL	Attributable Level 1 data cache invalidate
0x0049-0x004B	-	Reserved
0x004C	L1D_TLB_REFILL_RD ^a	Attributable Level 1 data TLB refill, read
0x004D	L1D_TLB_REFILL_WR ^a	Attributable Level 1 data TLB refill, write
0x004E	L1D_TLB_RD	Attributable Level 1 data or unified TLB access, read
0x004F	L1D_TLB_WR	Attributable Level 1 data or unified TLB access, write
0x0050	L2D_CACHE_RD	Attributable Level 2 data cache access, read
0x0051	L2D_CACHE_WR	Attributable Level 2 data cache access, write
0x0052	L2D_CACHE_REFILL_RD ^a	Attributable Level 2 data cache refill, read
0x0053	L2D_CACHE_REFILL_WR ^a	Attributable Level 2 data cache refill, write
0x0054-0x0055	-	Reserved
0x0056	L2D_CACHE_WB_VICTIM	Attributable Level 2 data cache Write-Back, victim
0x0057	L2D_CACHE_WB_CLEAN	Level 2 data cache Write-Back, cleaning and coherency
0x0058	L2D_CACHE_INVAL	Attributable Level 2 data cache invalidate
0x0059-0x005B	-	Reserved
0x005C	L2D_TLB_REFILL_RD ^a	Attributable Level 2 data or unified TLB refill, read
0x005D	L2D_TLB_REFILL_WR ^a	Attributable Level 2 data or unified TLB refill, write

Table K3-1 PMU IMPLEMENTATION DEFINED event numbers (continued)

Event number	Event mnemonic	Description
0x005E	L2D_TLB_RD	Attributable Level 2 data or unified TLB access, read
0x005F	L2D_TLB_WR	Attributable Level 2 data or unified TLB access, write
0x0060	BUS_ACCESS_RD	Bus access, read
0x0061	BUS_ACCESS_WR	Bus access, write
0x0062	BUS_ACCESS_SHARED	Bus access, Normal, Cacheable, Shareable
0x0063	BUS_ACCESS_NOT_SHARED	Bus access, not Normal, Cacheable, Shareable
0x0064	BUS_ACCESS_NORMAL	Bus access, normal
0x0065	BUS_ACCESS_PERIPH	Bus access, peripheral
0x0066	MEM_ACCESS_RD	Data memory access, read
0x0067	MEM_ACCESS_WR	Data memory access, write
0x0068	UNALIGNED_LD_SPEC	Unaligned access, read
0x0069	UNALIGNED_ST_SPEC	Unaligned access, write
0x006A	UNALIGNED_LDST_SPEC	Unaligned access
0x006B	-	Reserved
0x006C	LDREX_SPEC	Exclusive operation speculatively executed, LDREX or LDX
0x006D	STREX_PASS_SPEC	Exclusive operation speculatively executed, STREX or STX pass
0x006E	STREX_FAIL_SPEC	Exclusive operation speculatively executed, STREX or STX pass
0x006F	STREX_SPEC	Exclusive operation speculatively executed, STREX or STX
0x0070	LD_SPEC	Operation speculatively executed, load
0x0071	ST_SPEC	Operation speculatively executed, store
0x0072	LDST_SPEC	Operation speculatively executed, load or store
0x0073	DP_SPEC	Operation speculatively executed, integer data processing
0x0074	ASE_SPEC	Operation speculatively executed, Advanced SIMD instruction
0x0075	VFP_SPEC	Operation speculatively executed, floating-point instruction
0x0076	PC_WRITE_SPEC	Operation speculatively executed, software change of the PC
0x0077	CRYPTO_SPEC	Operation speculatively executed, Cryptographic instruction
0x0078	BR_IMMED_SPEC	Branch speculatively executed, immediate branch
0x0079	BR_RETURN_SPEC	Branch speculatively executed, procedure return
0x007A	BR_INDIRECT_SPEC	Branch speculatively executed, indirect branch
0x007B	-	Reserved
0x007C	ISB_SPEC	Barrier speculatively executed, ISB
0x007D	DSB_SPEC	Barrier speculatively executed, DSB

Table K3-1 PMU IMPLEMENTATION DEFINED event numbers (continued)

Event number	Event mnemonic	Description
0x007E	DMB_SPEC	Barrier speculatively executed, DMB
0x007F-0x0080	-	Reserved
0x0081	EXC_UNDEF	Exception taken, Other synchronous
0x0082	EXC_SVC	Exception taken, Supervisor Call
0x0083	EXC_PABORT	Exception taken, Instruction Abort
0x0084	EXC_DABORT	Exception taken, Data Abort and SError
0x0085	-	Reserved
0x0086	EXC_IRQ	Exception taken, IRQ
0x0087	EXC_FIQ	Exception taken, FIQ
0x0088	EXC_SMC	Exception taken, Secure Monitor Call
0x0089	-	Reserved
0x008A	EXC_HVC	Exception taken, Hypervisor Call
0x008B	EXC_TRAP_PABORT	Exception taken, Instruction Abort not taken locally ^b
0x008C	EXC_TRAP_DABORT	Exception taken, Data Abort or SError not taken locally ^b
0x008D	EXC_TRAP_OTHER	Exception taken, Other traps not taken locally ^b
0x008E	EXC_TRAP_IRQ	Exception taken, IRQ not taken locally ^b
0x008F	EXC_TRAP_FIQ	Exception taken, FIQ not taken locally ^b
0x0090	RC_LD_SPEC	Release consistency operation speculatively executed, Load-Acquire
0x0091	RC_ST_SPEC	Release consistency operation speculatively executed, Store-Release
0x0092-0x009F	-	Reserved
0x00A0	L3D_CACHE_RD	Attributable Level 3 data or unified cache access, read
0x00A1	L3D_CACHE_WR	Attributable Level 3 data or unified cache access, write
0x00A2	L3D_CACHE_REFILL_RD ^a	Attributable Level 3 data or unified cache refill, read
0x00A3	L3D_CACHE_REFILL_WR ^a	Attributable Level 3 data or unified cache refill, write
0x00A4-0x00A5	-	Reserved
0x00A6	L3D_CACHE_WB_VICTIM	Attributable Level 3 data or unified cache Write-Back, victim
0x00A7	L3D_CACHE_WB_CLEAN	Attributable Level 3 data or unified cache Write-Back, cache clean
0x00A8	L3D_CACHE_INVAL	Attributable Level 3 data or unified cache access, invalidate

a. For more information, see *Relationship between REFILL events and associated access events* on page K3-6165.

b. In these definitions, an exception that is *taken locally* means an exception that is taken to the default Exception level, and is not routed to another Exception level. See *Exception levels* on page D1-1776 for more information.

0x0040, L1D_CACHE_RD, Attributable Level 1 data cache access, read

This event is similar to Level 1 data cache access, [L1D_CACHE](#), but the counter counts only memory-read operations that access at least the Level 1 data or unified cache.

0x0041, L1D_CACHE_WR, Attributable Level 1 data cache access, write

This event is similar to Level 1 data cache access, [L1D_CACHE](#), but the counter counts only memory-write operations that access at least the Level 1 data or unified cache.

The counter counts [DC ZVA](#) as a store instruction.

0x0042, L1D_CACHE_REFILL_RD, Attributable Level 1 data cache refill, read

This event is similar to Level 1 data cache refill, [L1D_CACHE_REFILL](#), but the counter counts only memory-read operations that cause a refill of at least the Level 1 data or unified cache.

See also [Relationship between REFILL events and associated access events](#). on page K3-6165.

0x0043, L1D_CACHE_REFILL_WR, Attributable Level 1 data cache refill, write

This event is similar to Level 1 data cache refill, [L1D_CACHE_REFILL](#), but the counter counts only memory-write operations that cause a refill of at least the Level 1 data or unified cache.

The counter counts [DC ZVA](#) as a store instruction.

See also [Relationship between REFILL events and associated access events](#). on page K3-6165.

0x0044, L1D_CACHE_REFILL_INNER, Attributable Level 1 data cache refill, inner

This event is similar to Level 1 data cache refill, [L1D_CACHE_REFILL](#), but the counter counts only memory-read and memory-write operations that generate refills satisfied by transfer from another cache inside of the immediate cluster.

———— **Note** —————

The boundary between *inner* and *outer* is IMPLEMENTATION DEFINED, and it is not necessarily linked to other similar boundaries, such as the boundary between Inner Cacheable and Outer Cacheable or the boundary between Inner Shareable and Outer Shareable.

0x0045, L1D_CACHE_REFILL_OUTER, Attributable Level 1 data cache refill, outer

This event is similar to Level 1 data cache refill, [L1D_CACHE_REFILL](#), but the counter counts only memory-read and memory-write operations that generate refills satisfied from outside of the immediate cluster.

0x0046, L1D_CACHE_WB_VICTIM, Attributable Level 1 data cache Write-Back, victim

This event is similar to Level 1 data cache Write-Back, [L1D_CACHE_WB](#), but the counter counts only Write-Backs that are a result of the line being allocated for an access made by the PE.

Write-Backs caused by the execution of a cache maintenance instruction are not counted.

It is IMPLEMENTATION DEFINED whether a write of a whole cache line that is not the result of the eviction of a line from the cache is counted. For example, this might occur if the PE detects streaming writes to memory and does not allocate lines to the cache, or as the result of a [DC ZVA](#).

0x0047, L1D_CACHE_WB_CLEAN, Level 1 data cache Write-Back, cleaning and coherency

This event is similar to Attributable Level 1 data cache Write-Back, [L1D_CACHE_WB](#), but the counter counts only Write-Backs that are a result of a coherency operation made by another PE or are caused by the execution of a cache maintenance instruction. Whether Write-Backs caused by the execution of a cache maintenance instruction are counted is IMPLEMENTATION DEFINED.

If a coherency request from a requestor outside the PE results in a Write-Back, it is an Unattributable event.

———— **Note** —————

The transfer of a dirty cache line from the Level 1 data cache of this PE to the Level 1 data cache of another PE due to a hardware coherency operation is not counted unless the dirty cache line is also written back to a Level 2 cache or memory.

0x0048, L1D_CACHE_INVALID, Attributable Level 1 data cache invalidate

The counter counts each invalidation of a cache line in the Level 1 data or unified cache.

The counter does not count events:

- If a cache refill invalidates a line.
- For locally-executed cache maintenance instructions that operate by set/way.

If a coherency request from a requestor outside the PE results in a Write-Back, it is an Unattributable event.

0x004C, L1D_TLB_REFILL_RD, Attributable Level 1 data TLB refill, read

This event is similar to Level 1 data TLB refill, [L1D_TLB_REFILL](#), but the counter counts only memory-read operations that cause a data TLB refill of at least the Level 1 data or unified TLB.

See also [Relationship between REFILL events and associated access events](#). on page K3-6165.

0x004D, L1D_TLB_REFILL_WR, Attributable Level 1 data TLB refill, write

This event is similar to Level 1 data TLB refill, [L1D_TLB_REFILL](#), but the counter counts only memory-write operations that cause a data TLB refill of at least the Level 1 data or unified TLB.

The counter counts [DC ZVA](#) as a store instruction.

See also [Relationship between REFILL events and associated access events](#). on page K3-6165.

0x004E, L1D_TLB_RD, Attributable Level 1 data or unified TLB access, read

This event is similar to Level 1 data or unified TLB access, [L1D_TLB](#), but the counter counts only memory-read operations that cause a TLB access to at least the Level 1 data or unified TLB.

0x004F, L1D_TLB_WR, Attributable Level 1 data or unified TLB access, write

This event is similar to Level 1 data or unified TLB access, [L1D_TLB](#), but the counter counts only memory-write operations that cause a TLB access to at least the Level 1 data or unified TLB.

0x0050, L2D_CACHE_RD, Attributable Level 2 data cache access, read

This event is similar to Attributable Level 2 data cache access, [L2D_CACHE](#), but the counter counts only memory-read operations that access at least the Level 2 data or unified cache.

0x0051, L2D_CACHE_WR, Attributable Level 2 data cache access, write

This event is similar to Attributable Level 2 data cache access, [L2D_CACHE](#), but the counter counts only memory-write operations that access at least the Level 2 data or unified cache.

The counter counts [DC ZVA](#) as a store instruction.

0x0052, L2D_CACHE_REFILL_RD, Attributable Level 2 data cache refill, read

This event is similar to Attributable Level 2 data cache refill, [L2D_CACHE_REFILL](#), but the counter counts only memory-read operations that cause a refill of at least the Level 2 data or unified cache.

See also [Relationship between REFILL events and associated access events](#). on page K3-6165.

0x0053, L2D_CACHE_REFILL_WR, Attributable Level 2 data cache refill, write

This event is similar to Attributable Level 2 data cache refill, [L2D_CACHE_REFILL](#), but the counter counts only memory-write operations that cause a refill of at least the Level 2 data or unified cache.

The counter counts [DC ZVA](#) as a store instruction.

See also [Relationship between REFILL events and associated access events](#). on page K3-6165.

0x0056, L2D_CACHE_WB_VICTIM, Attributable Level 2 data cache Write-Back, victim

This event is similar to Attributable Level 2 data cache Write-Back, [L2D_CACHE_WB](#), but the counter counts only Write-Backs that are a result of the line being allocated for an access made by the PE.

Write-Backs caused by the execution of a cache maintenance instruction are not counted.

It is IMPLEMENTATION DEFINED whether a write of a whole cache line that is not the result of the eviction of a line from the cache is counted. For example, this might occur if the PE detects streaming writes to memory and does not allocate lines to the cache, or as the result of a [DC ZVA](#).

0x0057, L2D_CACHE_WB_CLEAN, Level 2 data cache Write-Back, cleaning and coherency

This event is similar to Attributable Level 2 data cache Write-Back, [L2D_CACHE_WB](#), but the counter counts only Write-Backs that are a result of a coherency operation made by another PE or are caused by the execution of a cache maintenance instruction. Whether Write-Backs caused by the execution of a cache maintenance instruction are counted as IMPLEMENTATION DEFINED.

———— **Note** —————

The transfer of a dirty cache line from the Level 2 data cache of this PE to the Level 2 data cache of another PE due to a hardware coherency operation is not counted unless the dirty cache line is also written back to a Level 3 cache or memory.

—————

If a coherency request from a requestor outside the PE results in a Write-Back, it is an Unattributable event.

0x0058, L2D_CACHE_INVAL, Attributable Level 2 data cache invalidate

The counter counts each invalidation of a cache line in the Level 2 data or unified cache.

The counter does not count events:

- If a cache refill invalidates a line.
- For locally executed cache maintenance instructions that operate by set/way.

———— **Note** —————

Software that uses this event must know whether the Level 2 data cache is shared with other PEs. This event does not follow the general rule of Level 2 data cache events of only counting events that directly affect this PE.

—————

If a coherency request from a requestor outside the PE results in a Write-Back, it is an Unattributable event.

0x005C, L2D_TLB_REFILL_RD, Attributable Level 2 data or unified TLB refill, read

This event is similar to Attributable Level 2 data or unified TLB refill, [L2D_TLB_REFILL](#), but the counter counts only Attributable memory read operations that cause a TLB refill of at least the Level 2 data or unified TLB. See also [Relationship between REFILL events and associated access events](#) on page K3-6165.

0x005D, L2D_TLB_REFILL_WR, Attributable Level 2 data or unified TLB refill, write

This event is similar to Attributable Level 2 data or unified TLB refill, [L2D_TLB_REFILL](#), but the counter counts only Attributable memory write operations that cause a TLB refill of at least the Level 2 data or unified TLB. See also [Relationship between REFILL events and associated access events](#) on page K3-6165.

0x005E, L2D_TLB_RD, Attributable Level 2 data or unified TLB access, read

This event is similar to Attributable Level 2 data or unified TLB access, [L2D_TLB](#), but the counter counts only Attributable memory read operations that cause a TLB access to at least the Level 2 data or unified TLB.

0x005F, L2D_TLB_WR, Attributable Level 2 data or unified TLB access, write

This event is similar to Attributable Level 2 data or unified TLB access, [L2D_TLB](#), but the counter counts only Attributable memory write operations that cause a TLB access to at least the Level 2 data or unified TLB.

0x0060, BUS_ACCESS_RD, Bus access, read

This event is similar to Bus access, [BUS_ACCESS](#), but the counter counts only memory-read operations that access outside the boundary of the PE and its closely-coupled caches.

0x0061, BUS_ACCESS_WR, Bus access, write

This event is similar to Bus access, [BUS_ACCESS](#), but the counter counts only memory-write operations that access outside the boundary of the PE and its closely-coupled caches.

0x0062, BUS_ACCESS_SHARED, Bus access, Normal, Cacheable, Shareable

This event is similar to Bus access, [BUS_ACCESS](#), but the counter counts only memory-read and memory-write operations that make Normal, Cacheable, Shareable accesses outside the boundary of the PE and its closely-coupled caches.

———— **Note** —————

It is IMPLEMENTATION DEFINED how the PE translates the attributes from the translation table entry for a region to the attributes on the bus.

In particular, a region of memory designated as Normal, Cacheable, Inner Shareable, Not Outer Shareable by a translation table entry, might be marked as either shareable or Non-shareable at the boundary of the PE and its closely-coupled caches. This depends on where the IMPLEMENTATION DEFINED boundary lies, between Inner and Outer Shareable.

If the Inner Shareable extends beyond the PE boundary, and the bus indicates the distinction between Inner and Outer Shareable, then either is counted as shareable for the purposes of defining this event.

0x0063, BUS_ACCESS_NOT_SHARED, Bus access, not Normal, Cacheable, Shareable

This event is similar to Bus access, [BUS_ACCESS](#), but the counter counts only memory-read and memory-write operations that make accesses outside the boundary of the PE and its closely-coupled caches that are not Normal, Cacheable, Shareable. For example, the counter counts accesses marked as:

- Normal, Cacheable, Non-shareable.
- Normal, Non-cacheable.
- Device.

———— **Note** —————

It is IMPLEMENTATION DEFINED, how the PE translates the attributes from the translation table entries for a region to the attributes on the bus.

In particular, a region of memory designated as Normal, Cacheable, Inner Shareable, Not Outer Shareable by a translation table entry, might be marked as either shareable or Non-shareable at the boundary of the PE and its closely-coupled caches. This depends on where the IMPLEMENTATION DEFINED boundary lies, between Inner and Outer Shareable.

If the Inner Shareable extends beyond the PE boundary, and the bus indicates the distinction between Inner and Outer Shareable, then either is counted as shareable for the purposes of defining this event.

0x0064, BUS_ACCESS_NORMAL, Bus access, normal

This event is similar to Bus access, [BUS_ACCESS](#), but the counter counts only memory-read and memory-write operations that make Normal accesses outside the boundary of the PE and its closely-coupled caches. For example, the counter counts Normal, Cacheable and Normal, Non-cacheable accesses but does not count Device accesses.

0x0065, BUS_ACCESS_PERIPH, Bus access, peripheral

This event is similar to Bus access, [BUS_ACCESS](#), but the counter counts only memory-read and memory-write operations that make Device accesses outside the boundary of the PE and its closely-coupled caches.

0x0066, MEM_ACCESS_RD, Data memory access, read

This event is similar to Data memory access, [MEM_ACCESS](#), but the counter counts only memory-read operations that the PE made.

0x0067, MEM_ACCESS_WR, Data memory access, write

This event is similar to Data memory access, [MEM_ACCESS](#), but the counter counts only memory-write operations made by the PE.

0x0068, UNALIGNED_LD_SPEC, Unaligned access, read

This event is similar to Data memory access, [MEM_ACCESS](#), but the counter counts only unaligned memory-read operations that the PE made. It also counts unaligned accesses if they are subsequently transposed into multiple aligned accesses.

0x0069, UNALIGNED_ST_SPEC, Unaligned access, write

This event is similar to Data memory access, [MEM_ACCESS](#), but the counter counts only unaligned memory-read operations that the PE made. It also counts unaligned accesses if they are subsequently transposed into multiple aligned accesses.

0x006A, UNALIGNED_LDST_SPEC, Unaligned access

This event is similar to Data memory access, [MEM_ACCESS](#), but the counter counts only unaligned memory-read operations and unaligned memory-write operations that the PE made. It also counts unaligned accesses if they are subsequently transposed into multiple aligned accesses.

0x006C, LDREX_SPEC, Exclusive operation speculatively executed, Load-Exclusive

The counter counts Load-Exclusive instructions speculatively executed.

The definition of speculatively executed is IMPLEMENTATION DEFINED.

0x006D, STREX_PASS_SPEC, Exclusive operation speculatively executed, Store-Exclusive pass

The counter counts Store-Exclusive instructions speculatively executed that completed a write.

The definition of speculatively executed is IMPLEMENTATION DEFINED but must be the same as for the [LDREX_SPEC](#) event.

0x006E, STREX_FAIL_SPEC, Exclusive operation speculatively executed, Store-Exclusive fail

The counter counts Store-Exclusive instructions speculatively executed that fail to complete a write. It is within the IMPLEMENTATION DEFINED definition of speculatively executed whether this includes conditional instructions that fail the condition code check.

The definition of speculatively executed is IMPLEMENTATION DEFINED but must be the same as for the [LDREX_SPEC](#) event.

0x006F, STREX_SPEC, Exclusive operation speculatively executed, Store-Exclusive

The counter counts Store-Exclusive instructions speculatively executed.

The definition of speculatively executed is IMPLEMENTATION DEFINED but it must be the same as for the [LDREX_SPEC](#) event.

ARM recommends that this event is implemented if it is not possible to implement the exclusive operation speculatively executed, Store-Exclusive pass, and exclusive operation speculatively executed, Store-Exclusive fail, events with the same degree of speculation as the [LDREX_SPEC](#) event.

0x0070, LD_SPEC, Operation speculatively executed, load

This event is similar to Operation speculatively executed, [INST_SPEC](#), but the counter counts only memory-reading instructions, as defined by the [LD_RETIRED](#) event.

The definition of speculatively executed is IMPLEMENTATION DEFINED but must be the same as for the [INST_SPEC](#) event.

0x0071, ST_SPEC, Operation speculatively executed, store

This event is similar to Operation speculatively executed, INST_SPEC, but the counter counts only memory-writing instructions, as defined by the ST_RETIRED event.

The counter counts DC ZVA as a store operation.

The definition of speculatively executed is IMPLEMENTATION DEFINED but must be the same as for the INST_SPEC event.

0x0072, LDST_SPEC, Operation speculatively executed, load or store

This event is similar to Operation speculatively executed, INST_SPEC, but the counter counts only memory-reading instructions and memory-writing instructions, as defined by the LD_RETIRED and ST_RETIRED events.

The definition of speculatively executed is IMPLEMENTATION DEFINED but must be the same as for the INST_SPEC event.

0x0073, DP_SPEC, Operation speculatively executed, integer data processing

This event is similar to Operation speculatively executed, INST_SPEC, but counts only integer data-processing instructions. It counts the following operations that operate on the general-purpose registers:

- In AArch64 state, *Data processing - immediate* on page C3-176 and *Data processing - register* on page C3-181.
- In AArch32 state, *Data-processing instructions* on page F1-2812.

This includes MOV and MVN operations.

This event also counts the following miscellaneous instructions:

- In AArch64 state, *System register instructions* on page C3-158, *System instructions* on page C3-158, and *Hint instructions* on page C3-159.
- In AArch32 state, *PSTATE and banked register access instructions* on page F1-2820, *Banked register access instructions* on page F1-2820, *Miscellaneous instructions* on page F1-2825, other than ISB and preloads, and *System register access instructions* on page F1-2828, other than LDC and STC instructions.

If the preload instructions PRFM, PLD, PLDW, and PLI, do not count as memory-reading instructions then they must count as integer data-processing instructions.

If ISBs do not count as software change of the PC then they must count as integer data-processing instructions.

The definition of speculatively executed is IMPLEMENTATION DEFINED, but must be the same as for the INST_SPEC event.

It is IMPLEMENTATION DEFINED whether the following instructions are counted as integer data-processing operations, SIMD operations, or floating-point operations, but ARM recommends that the instructions are all counted as integer data-processing operations:

- For AArch64 state, from the A64 floating-point convert to integer class, operations that move a value between a general-purpose register and a SIMD and floating-point register without type conversion:
 - FMOV (general).
- For AArch64 state, from the SIMD Move group, operations that move a values between a general-purpose register and an element or elements in a SIMD and floating-point register:
 - DUP (general).
 - SMOV.
 - UMOV.
 - INS (general).

- For AArch32 state:
 - VDUP (general-purpose register) and all VMOV instructions that transfer data between a general-purpose register and a SIMD and floating-point register.
 - VMRS.
 - VMSR.

0x0074, ASE_SPEC, Operation speculatively executed, Advanced SIMD

This event is similar to Operation speculatively executed, [INST_SPEC](#), but the counter counts only Advanced SIMD data-processing instructions, see:

- For AArch64 state, the SIMD operations listed in [Data processing - SIMD and floating-point on page C3-189](#).
- For AArch32 state, [Advanced SIMD data-processing instructions on page F1-2832](#).

This includes all operations that operate on the SIMD and floating-point registers, except those that are counted as:

- Integer data-processing operations.
- Floating-point data-processing operations.
- Memory-reading operations.
- Memory-writing operations.
- Cryptographic operations other than PMULL, in AArch64 state.
- VMULL, in AArch32 state.

Advanced SIMD scalar operations are counted as Advanced SIMD operations, including those which operate on floating-point values. In AArch64 state, PMULL, and in AArch32 state, VMULL are counted as Advanced SIMD operations.

The definition of speculatively executed is IMPLEMENTATION DEFINED, but must be the same as for the [INST_SPEC](#) event.

0x0075, VFP_SPEC, Operation speculatively executed, floating-point

This event is similar to Operation speculatively executed, [INST_SPEC](#), but the counter counts only floating-point data-processing instructions, see:

- In AArch64 state, only the scalar floating-point operations listed in [Data processing - SIMD and floating-point on page C3-189](#).

———— **Note** ————

This event does not count the SIMD floating-point operations listed in [Data processing - SIMD and floating-point on page C3-189](#).

- In AArch32 state, [Floating-point data-processing instructions on page F1-2840](#).

This includes all operations that operate on the SIMD and floating-point registers as floating-point values, except for SIMD scalar operations and those that are counted as one of:

- Integer data processing.
- Memory-reading operations.
- Memory-writing operations.

The following instructions that take both an integer register and a floating-point register argument and perform a type conversion (to/from integer or to/from fixed-point), are counted as floating-point data-processing operations:

- In AArch64 state, FCVT{<mode>}, UCVTF, and SCVTF.
- In AArch32 state, VCVT<mode>(floating-point), VCVT, VCVTT, and VCVTB.

The definition of speculatively executed is IMPLEMENTATION DEFINED, but must be the same as for the [INST_SPEC](#) event.

0x0076, PC_WRITE_SPEC, Operation speculatively executed, software change of the PC

This event is similar to Operation speculatively executed, [INST_SPEC](#), but the counter counts only software changes of the PC. Defined by the instruction architecturally executed, condition code check pass, software change of the PC event, see [Common event numbers on page D5-2156](#).

The definition of speculatively executed is IMPLEMENTATION DEFINED but must be the same as for the [INST_SPEC](#) event.

See also [PC_WRITE_RETIRED](#).

0x0077, CRYPTO_SPEC, Operation speculatively executed, Cryptographic instruction

This event is similar to Operation speculatively executed, [INST_SPEC](#), but the counter counts only Cryptographic instructions, except PMULL and VMULL, see [The Cryptographic Extension on page C3-207](#).

The definition of speculatively executed is IMPLEMENTATION DEFINED but must be the same as for the [INST_SPEC](#) event.

0x0078, BR_IMMED_SPEC, Branch speculatively executed, immediate branch

The counter counts immediate branch instructions speculatively executed. Defined by the instruction architecturally executed, immediate branch event, see [Common event numbers on page D5-2156](#).

The definition of speculatively executed is IMPLEMENTATION DEFINED.

See also [BR_IMMED_RETIRED](#).

0x0079, BR_RETURN_SPEC, Branch speculatively executed, procedure return

The counter counts procedure return instructions speculatively executed. Defined by the [BR_RETURN_RETIRED](#) event.

The definition of speculatively executed is IMPLEMENTATION DEFINED.

See also [BR_RETURN_RETIRED](#).

0x007A, BR_INDIRECT_SPEC, Branch speculatively executed, indirect branch

The counter counts indirect branch instructions speculatively executed. This includes software change of the PC other than exception-generating instructions and immediate branch instructions.

The definition of speculatively executed is IMPLEMENTATION DEFINED.

0x007C, ISB_SPEC, Barrier speculatively executed, ISB

The counter counts Instruction Synchronization Barrier instructions speculatively executed, including [CP15ISB](#).

The definition of speculatively executed is IMPLEMENTATION DEFINED.

0x007D, DSB_SPEC, Barrier speculatively executed, DSB

The counter counts data synchronization barrier instructions speculatively executed, including [CP15DSB](#).

The definition of speculatively executed is IMPLEMENTATION DEFINED.

0x007E, DMB_SPEC, Barrier speculatively executed, DMB

The counter counts data memory barrier instructions speculatively executed, including [CP15DSB](#). It does not include the implied barrier operations of load/store operations with release consistency semantics.

The definition of speculatively executed is IMPLEMENTATION DEFINED.

0x0081, EXC_UNDEF, Exception taken, other synchronous

This event is similar to Exception taken, [EXC_TAKEN](#), but the counter counts only synchronous exceptions that are not counted by the other Exception taken events. This event counts only exceptions taken locally.

0x0082, EXC_SVC, Exception taken, Supervisor Call

This event is similar to Exception taken, [EXC_TAKEN](#), but the counter counts only Supervisor Call exceptions. This event counts only exceptions taken locally.

0x0083, EXC_PABORT, Exception taken, Instruction Abort

This event is similar to Exception taken, [EXC_TAKEN](#), but the counter counts only Instruction Abort exceptions. This event counts only exceptions taken locally.

0x0084, EXC_DABORT, Exception taken, Data Abort or SError

This event is similar to Exception taken, [EXC_TAKEN](#), but the counter counts only Data Abort or SError interrupt exceptions. The counter counts only exceptions taken locally.

0x0086, EXC_IRQ, Exception taken, IRQ

This event is similar to Exception taken, [EXC_TAKEN](#), but the counter counts only IRQ exceptions. The counter counts only exceptions taken locally, including Virtual IRQ exceptions.

0x0087, EXC_FIQ, Exception taken, FIQ

This event is similar to Exception taken, [EXC_TAKEN](#), but the counter counts only FIQ exceptions. The counter counts only exceptions taken locally, including Virtual FIQ exceptions.

0x0088, EXC_SMC, Exception taken, Secure Monitor Call

This event is similar to Exception taken, [EXC_TAKEN](#), but the counter counts only Secure Monitor Call exceptions. The counter does not increment on SMC instructions trapped as a Hyp Trap exception.

0x008A, EXC_HVC, Exception taken, Hypervisor Call

This event is similar to Exception taken, [EXC_TAKEN](#), but the counter counts only Hypervisor Call exceptions. The counter counts for both Hypervisor Call exceptions taken locally in the hypervisor and those taken as an exception from Non-secure EL1.

0x008B, EXC_TRAP_PABORT, Exception taken, Instruction Abort not taken locally

This event is similar to Exception taken, [EXC_TAKEN](#), but the counter counts only Instruction Abort exceptions not taken locally.

0x008C, EXC_TRAP_DABORT, Exception taken, Data Abort or SError not taken locally

This event is similar to Exception taken, [EXC_TAKEN](#), but the counter counts only Data Abort or SError interrupt exceptions not taken locally.

0x008D, EXC_TRAP_OTHER, Exception taken, other traps not taken locally

This event is similar to Exception taken, [EXC_TAKEN](#), but the counter counts only those traps that are not counted as:

- Exception taken, Hypervisor Call.
- Exception taken, Instruction Abort not taken locally.
- Exception taken, Data Abort or SError not taken locally.
- Exception taken, IRQ not taken locally.
- Exception taken, FIQ not taken locally.

0x008E, EXC_TRAP_IRQ, Exception taken, IRQ not taken locally

This event is similar to Exception taken, [EXC_TAKEN](#), but the counter counts only IRQ exceptions not taken locally.

0x008F, EXC_TRAP_FIQ, Exception taken, FIQ not taken locally

This event is similar to Exception taken, [EXC_TAKEN](#), but the counter counts only FIQ exceptions not taken locally.

0x0090, RC_LD_SPEC, Release consistency operation speculatively executed, Load-Acquire

The counter counts Load-Acquire operations that are speculatively executed. The definition of speculatively executed is IMPLEMENTATION DEFINED.

0x0091, RC_ST_SPEC, Release consistency operation speculatively executed, Store-Release

The counter counts Store-Release operations that are speculatively executed. The definition of speculatively executed is IMPLEMENTATION DEFINED.

0x00A0, L3D_CACHE_RD, Attributable Level 3 data or unified cache access, read

This event is similar to Attributable Level 3 data or unified cache access, [L3D_CACHE](#), but the counter counts only attributable memory read operations that cause a cache access to at least the Level 3 data or unified cache.

0x00A1, L3D_CACHE_WR, Attributable Level 3 data or unified cache access, write

This event is similar to Attributable Level 3 data or unified cache access, [L3D_CACHE](#), but the counter counts only attributable memory write operations that cause a cache access to at least the Level 3 data or unified cache.

0x00A2, L3D_CACHE_REFILL_RD, Attributable Level 3 data or unified cache refill, read

This event is similar to Attributable Level 3 data or unified cache refill, [L3D_CACHE_REFILL](#), but the counter counts only attributable memory read operations that cause a refill of at least the Level 3 data or unified cache from outside the Level 3 cache. See also [Relationship between REFILL events and associated access events](#). on page K3-6165

0x00A3, L3D_CACHE_REFILL_WR, Attributable Level 3 data or unified cache refill, write

This event is similar to Attributable Level 3 data or unified cache refill, [L3D_CACHE_REFILL](#), but the counter counts only attributable memory write operations that cause a refill of at least the Level 3 data or unified cache from outside the Level 3 cache. See also [Relationship between REFILL events and associated access events](#). on page K3-6165

0x00A6, L3D_CACHE_WB_VICTIM, Attributable Level 3 data or unified cache Write-Back, victim

This event is similar to Attributable Level 3 data cache Write-Back, [L3D_CACHE_WB](#), but the counter counts only Write-Backs that are a result of the line being allocated for an access made by the PE.

Write-Backs caused by the execution of a cache maintenance instruction are not counted.

It is IMPLEMENTATION DEFINED whether a write of a whole cache line that is not the result of the eviction of a line from the cache is counted. For example, this might occur if the PE detects streaming writes to memory and does not allocate lines to the cache, or as the result of a [DC ZVA](#).

0x00A7, L3D_CACHE_WB_CLEAN, Level 3 data or unified cache Write-Back, cache clean

This event is similar to Attributable Level 3 data cache Write-Back, [L3D_CACHE_WB](#), but the counter counts only Write-Backs that are a result of a coherency operation made by another PE or are caused by the execution of a cache maintenance instruction. Whether Write-Backs that are caused by the execution of a cache maintenance instruction are counted is IMPLEMENTATION DEFINED.

———— **Note** —————

The transfer of a dirty cache line from the Level 3 data cache of this PE to the Level 3 data cache of another PE due to a hardware coherency operation is not counted unless the dirty cache line is also written back to a Level 3 cache or memory.

If a coherency request from a requestor outside the PE results in a Write-Back, it is an Unattributable event.

0x00A8, L3D_CACHE_INVALID, Attributable Level 3 data or unified cache access, invalidate

The counter counts each invalidation of a cache line in the Level 3 data or unified cache.

The counter does not count events:

- If a cache refill invalidates a line.
- For locally-executed cache maintenance instructions that operate by set/way.

———— **Note** —————

Software that uses this event must know whether the Level 3 data cache is shared with other PEs. This event does not follow the general rule of Level 3 data cache events of only counting Attributable events.

K3.1.1 Relationship between REFILL events and associated access events.

CACHE_REFILL and TLB_REFILL events count the refills for accesses that are counted by the corresponding CACHE or TLB event. Table K3-2 shows this correspondence.

Table K3-2 Relationship between REFILL events and associated access events

REFILL event	Access event	Ratio REFILL/Access
0x0042 L1D_CACHE_REFILL_RD	0x0040 L1D_CACHE_RD	Attributable Level 1 cache refill rate, read
0x0043 L1D_CACHE_REFILL_WR	0x0041 L1D_CACHE_WR	Attributable Level 1 cache refill rate, write
0x004C L1D_TLB_REFILL_RD	0x004E L1D_TLB_RD	Attributable Level 1 TLB refill rate, read
0x004D L1D_TLB_REFILL_WR	0x004F L1D_TLB_WR	Attributable Level 1 TLB refill rate, write
0x0052 L2D_CACHE_REFILL_RD	0x0050 L2D_CACHE_RD	Attributable Level 2 data cache refill rate, read
0x0053 L2D_CACHE_REFILL_WR	0x0051 L2D_CACHE_WR	Attributable Level 2 data cache refill rate, write
0x005C L2D_TLB_REFILL_RD	0x005E L2D_TLB_RD	Attributable Level 2 data TLB refill rate, read
0x005D L2D_TLB_REFILL_WR	0x005F L2D_TLB_WR	Attributable Level 2 data TLB refill rate, write
0x00A2 L3D_CACHE_REFILL_RD	0x00A0 L3D_CACHE_RD	Attributable Level 3 data cache refill rate, read
0x00A3 L3D_CACHE_REFILL_WR	0x00A1 L3D_CACHE_WR	Attributable Level 3 data cache refill rate, write

K3.2 Summary of events for exceptions taken to an Exception level using AArch64

Table K3-3 shows the events for exceptions taken to an Exception level using AArch64.

Table K3-3 Events for exceptions taken to an Exception level using AArch64

ESR.EC	Description	Event number and classification for exception taken to	
		EL1, or the current Exception level	EL2 or EL3, from below
0x00	Unknown or uncategorized	0x0081, Other synchronous	0x008D, Other traps not taken locally
0x01	WFE/WFI traps	0x0081, Other synchronous	0x008D, Other traps not taken locally
0x03	AArch32 MCR/MRC traps on (coproc==0b1111) accesses	0x0081, Other synchronous	0x008D, Other traps not taken locally
0x04	AArch32 MCRR/MRRC traps on (coproc==0b1111) accesses	0x0081, Other synchronous	0x008D, Other traps not taken locally
0x05	AArch32 MCR/MRC traps on (coproc==0b1110) accesses	0x0081, Other synchronous	0x008D, Other traps not taken locally
0x06	AArch32 LDC/STC traps on (coproc==0b1110) accesses	0x0081, Other synchronous	0x008D, Other traps not taken locally
0x07	Advanced SIMD or FP traps	0x0081, Other synchronous	0x008D, Other traps not taken locally
0x08	AArch32 MVFR* and FPSID traps	-	0x008D, Other traps not taken locally
0x0C	AArch32 MCRR/MRRC traps on (coproc==0b1110) accesses	0x0081, Other synchronous	0x008D, Other traps not taken locally
0x0E	Illegal instruction set state	0x0081, Other synchronous	0x008D, Other traps not taken locally
0x11	AArch32 SVC	0x0082, Supervisor Call	0x008D, Other traps not taken locally
0x12	AArch32 HVC that is not disabled	-	0x008A, Hypervisor Call
0x13	AArch32 SMC that is not disabled	to EL2 -	0x008D, Other traps not taken locally
		to EL3 -	0x0088, Secure Monitor Call
0x15	AArch64 SVC	0x0082, Supervisor Call	0x008D, Other traps not taken locally
0x16	AArch64 HVC that is not disabled	0x008A, Hypervisor Call	0x008A, Hypervisor Call
0x17	AArch64 SMC that is not disabled	to EL2 -	0x008D, Other traps not taken locally
		to EL3 0x0088, Secure Monitor Call	0x0088, Secure Monitor Call
0x18	AArch64 MSR, MRS and system instruction traps	0x0081, Other synchronous	0x008D, Other traps not taken locally
0x20	Instruction Abort from below	0x0083, Instruction Abort	0x008B, Instruction Abort not taken locally
0x21	Instruction Abort from current Exception level	0x0083, Instruction Abort	-
0x22	PC alignment	0x0083, Instruction Abort	0x008B, Instruction Abort not taken locally

Table K3-3 Events for exceptions taken to an Exception level using AArch64 (continued)

ESR.EC	Description	Event number and classification for exception taken to	
		EL1, or the current Exception level	EL2 or EL3, from below
0x24	Data Abort from below	0x0084, Data Abort or SError	0x008C, Data Abort or SError not taken locally
0x25	Data Abort from current Exception level	0x0084, Data Abort or SError	-
0x26	SP alignment fault exception	0x0084, Data Abort or SError	0x008C, Data Abort or SError not taken locally
0x28	AArch32 FP exception	0x0081, Other synchronous	0x008D, Other traps not taken locally
0x2C	AArch64 FP exception	0x0081, Other synchronous	0x008D, Other traps not taken locally
0x2F	SError interrupt	0x0084, Data Abort or SError	0x008C, Data Abort or SError not taken locally
0x30	Breakpoint from below	0x0083, Instruction Abort	0x008B, Instruction Abort not taken locally
0x31	Breakpoint from current Exception level	0x0083, Instruction Abort	-
0x32	Software step from below	0x0083, Instruction Abort	0x008B, Instruction Abort not taken locally
0x33	Software step from current Exception level	0x0083, Instruction Abort	-
0x34	Watchpoint from below	0x0084, Data Abort or SError	0x008C, Data Abort or SError not taken locally
0x35	Watchpoint from current Exception level	0x0084, Data Abort or SError	-
0x38	AArch32 BKPT instruction	0x0083, Instruction Abort	0x008B, Instruction Abort not taken locally
0x3A	AArch32 Vector Catch debug event	0x0083, Instruction Abort	0x008B, Instruction Abort not taken locally
0x3C	AArch64 BRK instruction	0x0083, Instruction Abort	0x008B, Instruction Abort not taken locally
-	IRQ interrupt	0x0086, IRQ	0x008E, IRQ not taken locally
-	FIQ interrupt	0x0087, FIQ	0x008F, FIQ not taken locally

———— **Note** ————

In these definitions, an exception that is *taken locally* means an exception that is taken to the default Exception level, and is not routed to another Exception level. See [Exception levels on page D1-1776](#) for more information.

Appendix K4

Recommendations for reporting memory attributes on an interconnect

This appendix describes the ARM recommendations for reporting the memory attributes that are assigned by the PE. It contains the following section:

- [ARM recommendations for reporting memory attributes on an interconnect on page K4-6170.](#)

K4.1 ARM recommendations for reporting memory attributes on an interconnect

The ARM architecture defines the architectural interface between software and the PE hardware. This means the mechanisms by which different memory type and Cacheability attributes are presented on an interface to an interconnect fabric such as AMBA® AXI are, strictly, outside the scope of the architecture. This appendix describes an approach for the interface between a PE implementation and an interconnect fabric that ARM strongly recommends, but these recommendations do not form part of the ARMv8 architecture.

K4.1.1 Effect of microarchitectural choices on memory attributes

Implementations of the ARM architecture permit considerable variability in the presentation of memory attributes on the interconnect fabric, particularly in cases where the PE implementation does not provide optimized support for a memory type. For example, an implementation might treat Write-Through locations as Non-cacheable at some level of cache, because functionally this is consistent with the definition of Write-Through, but for the particular implementation the performance trade-off does not merit the hardware directly providing Write-Through capability. However, in such implementations, the assigned memory attributes are not changed by the microarchitectural choices. The microarchitecture simply implements different ways of handling some memory attributes.

Therefore, ARM strongly recommended that where any or all of the following memory attributes are presented on the interface between a PE and an interconnect fabric, the attributes that are presented are completely consistent with the attributes defined by the translation system:

- The memory type, Normal or Device.
- The Early write acknowledgement attribute.
- The ordering requirements.
- The Shareability.
- The Cacheability, including where practicable, the allocation hints.

Effect when memory accesses are forced to be Non-cacheable

ARM also strongly recommends that the effects of forcing accesses to Normal memory to be Non-cacheable, as described in [Enabling and disabling the caching of memory accesses on page D3-1978](#) for AArch64 and in [Enabling and disabling the caching of memory accesses in AArch32 state on page G3-4529](#) for AArch32, are reflected on the interconnect by the memory type and attributes used for memory transactions generated while the cache is disabled.

Appendix K5

Legacy Instruction Syntax for AArch32 Instruction Sets

This appendix describes the legacy instruction syntax in the ARM instruction sets, and their *Unified Assembler Language* (UAL) equivalents. It contains the following section:

- [Legacy Instruction Syntax on page K5-6172.](#)

K5.1 Legacy Instruction Syntax

Early versions of the ARM Architecture defined an assembly language for A32 (ARM) instructions, and a separate assembly language for T32 (Thumb) instructions. UAL is based on the A32 assembly language, with some changes to the instruction syntax. The appendix describes those changes. The pre-UAL mnemonics are compatible with UAL, and might be supported by an assembler.

The original T32 assembly language is not compatible with UAL, and is not described in the manual.

K5.1.1 Pre-UAL instruction syntax for the A32 base instructions

Table K5-1 lists the syntax for the A32 base instructions that have changed after UAL was introduced.

Table K5-1 Pre-UAL instruction syntax for the A32 base instructions

Pre-UAL syntax	UAL equivalent	See
ADC<c>S	ADCS<c>	<i>ADC, ADCS (immediate)</i> on page F5-3005, <i>ADC, ADCS (register)</i> on page F5-3007, <i>ADC, ADCS (register-shifted register)</i> on page F5-3011
ADD<c>S	ADDS<c>	<i>ADD, ADDS (immediate)</i> on page F5-3013, <i>ADD, ADDS (register)</i> on page F5-3017, <i>ADD, ADDS (register-shifted register)</i> on page F5-3021, <i>ADD, ADDS (SP plus immediate)</i> on page F5-3023, <i>ADD, ADDS (SP plus register)</i> on page F5-3026
AND<c>S	ANDS<c>	<i>AND, ANDS (immediate)</i> on page F5-3035, <i>AND, ANDS (register)</i> on page F5-3037, <i>AND, ANDS (register-shifted register)</i> on page F5-3041
BIC<c>S	BICS<c>	<i>BIC, BICS (immediate)</i> on page F5-3058, <i>BIC, BICS (register)</i> on page F5-3060, <i>BIC, BICS (register-shifted register)</i> on page F5-3063
EOR<c>S	EORS<c>	<i>EOR, EORS (immediate)</i> on page F5-3109, <i>EOR, EORS (register)</i> on page F5-3111, <i>EOR, EORS (register-shifted register)</i> on page F5-3115
LDC<c>L	LDCL<c>	<i>LDC (immediate)</i> on page F5-3140, <i>LDC (literal)</i> on page F5-3142
LDM<c>IA, LDM<c>FD	LDM<c>	<i>LDM, LDMIA, LDMFD</i> on page F5-3144
LDM<c>DA, LDM<c>FA	LDMDA<c>	<i>LDMDA, LDMFA</i> on page F5-3152
LDM<c>DB, LDM<c>EA	LDMDB<c>	<i>LDMDB, LDMEA</i> on page F5-3154
LDM<c>IB, LDM<c>ED	LDMIB<c>	<i>LDMIB, LDMEB</i> on page F5-3157
LDR<c>B	LDRB<c>	<i>LDRB (immediate)</i> on page F5-3169, <i>LDRB (literal)</i> on page F5-3172, <i>LDRB (register)</i> on page F5-3174
LDR<c>BT	LDRBT<c>	<i>LDRBT</i> on page F5-3177
LDR<c>D	LDRD<c>	<i>LDRD (immediate)</i> on page F5-3180, <i>LDRD (literal)</i> on page F5-3183, <i>LDRD (register)</i> on page F5-3186

Table K5-1 Pre-UAL instruction syntax for the A32 base instructions (continued)

Pre-UAL syntax	UAL equivalent	See
LDR<c>H	LDRH<c>	<i>LDRH (immediate)</i> on page F5-3196, <i>LDRH (literal)</i> on page F5-3200, <i>LDRH (register)</i> on page F5-3202
LDR<c>SB	LDRSB<c>	<i>LDRSB (immediate)</i> on page F5-3208. <i>LDRSB (literal)</i> on page F5-3211, <i>LDRSB (register)</i> on page F5-3213
LDR<c>SH	LDRSH<c>	<i>LDRSH (immediate)</i> on page F5-3219, <i>LDRSH (literal)</i> on page F5-3222, <i>LDRSH (register)</i> on page F5-3224
LDR<c>T	LDRT<c>	<i>LDRT</i> on page F5-3230
MLA<c>S	MLAS<c>	<i>MLA, MLAS</i> on page F5-3253
LSLS <Rd>, <Rn>, #0	MOVS <Rd>, <Rm>	<i>MOV, MOVS (immediate)</i> on page F5-3257, <i>MOV, MOVS (register)</i> on page F5-3260
MOV<c>S	MOVS<c>	
MUL<c>S	MULS<c>	<i>MUL, MULS</i> on page F5-3290
MVN<c>S	MVNS<c>	<i>MVN, MVNS (immediate)</i> on page F5-3292, <i>MVN, MVNS (register)</i> on page F5-3294, <i>MVN, MVNS (register-shifted register)</i> on page F5-3297
ORR<c>S	ORRS<c>	<i>ORR, ORRS (immediate)</i> on page F5-3304, <i>ORR, ORRS (register)</i> on page F5-3306, <i>ORR, ORRS (register-shifted register)</i> on page F5-3310
QADDSUBX	QASX	<i>QASX</i> on page F5-3341
QSUBADDX	QSAX	<i>QSAX</i> on page F5-3347
RSB<c>S	RSBS<c>	<i>RSB, RSBS (immediate)</i> on page F5-3378, <i>RSB, RSBS (register)</i> on page F5-3381, <i>RSB, RSBS (register-shifted register)</i> on page F5-3384
RSC<c>S	RSCS<c>	<i>RSC, RSCS (immediate)</i> on page F5-3386, <i>RSC, RSCS (register)</i> on page F5-3388, <i>RSC, RSCS (register-shifted register)</i> on page F5-3390
SADDSUBX	SASX	<i>SASX</i> on page F5-3396
SBC<c>S	SBCS<c>	<i>SBC, SBCS (immediate)</i> on page F5-3398, <i>SBC, SBCS (register)</i> , <i>SBC, SBCS (register-shifted register)</i> on page F5-3403
SHADDSUBX	SHASX	<i>SHASX</i> on page F5-3421
SHSUBADDX	SHSAX	<i>SHSAX</i> on page F5-3423
SMI<c>	SMC<c>	<i>SMC</i> on page F5-3429
SMLAL<c>S	SMLALS<c>	<i>SMLAL, SMLALS</i> on page F5-3435
SMULL<c>S	SMULLS<c>	<i>SMULL, SMULLS</i> on page F5-3458

Table K5-1 Pre-UAL instruction syntax for the A32 base instructions (continued)

Pre-UAL syntax	UAL equivalent	See
SSUBADDX<c>	SSAX<c>	<i>SSAX</i> on page F5-3472
STC<c>L	STCL<c>	<i>STC</i> on page F5-3478
STM<c>EA, STM<c>IA	STM<c>	<i>STM, STMIA, STMEA</i> on page F5-3495
STM<c>DA, STM<c>ED	STMDA<c>	<i>STMDA, STMED</i> on page F5-3501
STM<c>DB, STM<c>FD	STMDB<c>	<i>STMDB, STMFD</i> on page F5-3503
STM<c>IB, STM<c>FA	STMIB<c>	<i>STMIB, STMFA</i> on page F5-3506
STR<c>B	STRB<c>	<i>STRB (immediate)</i> on page F5-3515, <i>STRB (register)</i> on page F5-3519
STR<c>BT	STRBT<c>	<i>STRBT</i> on page F5-3522
STR<c>D	STRD<c>	<i>STRD (immediate)</i> on page F5-3526, <i>STRD (register)</i> on page F5-3530
STR<c>H	STRH<c>	<i>STRH (immediate)</i> on page F5-3544, <i>STRH (register)</i> on page F5-3548
STR<c>T	STRT<c>	<i>STRT</i> on page F5-3555
SUB<c>S	SUBS<c>	<i>SUB, SUBS (immediate)</i> on page F5-3560, <i>SUB, SUBS (register)</i> on page F5-3564, <i>SUB, SUBS (register-shifted register)</i> on page F5-3567, <i>SUB, SUBS (SP minus immediate)</i> on page F5-3569, <i>SUB, SUBS (SP minus register)</i> on page F5-3572
SWI	SVC	<i>SVC</i> on page F5-3575
UADDSUBX	UASX	<i>UASX</i> on page F5-3604
UHADDSUBX	UHASX	<i>UHASX</i> on page F5-3616
UHSUBADDX	UHSAX	<i>UHSAX</i> on page F5-3618
UMLAL<c>S	UMLALS<c>	<i>UMLAL, UMLALS</i> on page F5-3626
UMULL<c>S	UMULLS<c>	<i>UMULL, UMULLS</i> on page F5-3628
UQADDSUBX	UQASX	<i>UQASX</i> on page F5-3634
UQSUBADDX	UQSAX	<i>UQSAX</i> on page F5-3636
USUBADDX	USAX	<i>USAX</i> on page F5-3650
UEXT8	UXTB	<i>UXTB</i> on page F5-3662
UEXT16	UXTH	<i>UXTH</i> on page F5-3666

K5.1.2 Pre-UAL instruction syntax for the A32 floating-point instructions

Table K5-2 lists the syntax for A32 floating-point instructions that have changed after UAL was introduced.

Table K5-2 Pre-UAL instruction syntax for A32 floating-point instructions

Pre-UAL syntax	UAL equivalent	See
FABSD	VABS.F64	<i>VABS</i> on page F6-3721
FABSS	VABS.F32	
FADDD	VADD.F64	<i>VADD (floating-point)</i> on page F6-3733
FADDS	VADD.F32	
FCMPEZD	VCMP.E.F64	<i>VCMP.E</i> on page F6-3796
FCMPEZS	VCMP.E.F32	
FCMPZD	VCMP.F64	<i>VCMP</i> on page F6-3792,
FCMPZS	VCMP.F32	
FCONSTD <Dd>, #<imm8>	VMOV.F64 <Dd>, #<fpimm>	<i>VMOV (immediate)</i> on page F6-3992
FCONSTS <Sd>, #<imm8>	VMOV.F32 <Sd>, #<fpimm>	For more information, see <i>FCONST</i> on page K5-6178.
FCPYD	VMOV.F64	<i>VMOV (register)</i> on page F6-3998
FCPYS	VMOV.F32	
FCVTDS	VCVT.F64.F32	<i>VCVT (between double-precision and single-precision)</i> on page F6-3802
FCVTSD	VCVT.F32.F64	
FDIVD	VDIV.F64	<i>VDIV</i> on page F6-3849
FDIVS	VDIV.F32	
FLDD	VLDR.F64	<i>VLDR (immediate)</i> on page F6-3940 <i>VLDR (literal)</i> on page F6-3943
FLDMD, FLDMIAD	VLDM.F64	<i>VLDM, VLDMDB, VLDMIA</i> on page F6-3935
FLDMS	VLDM.F32	
FLDS	VLDR.F32	<i>VLDR (immediate)</i> on page F6-3940 <i>VLDR (literal)</i> on page F6-3943
FMACD	VMLA.F64	<i>VMLA (floating-point)</i> on page F6-3962
FMACS	VMLA.F32	
FMDHR <Dd>, <Rt>	VMOV <Dd[1]>, <Rt>	<i>VMOV (general-purpose register to scalar)</i> on page F6-4002
FMDLR <Dd>, <Rt>	VMOV <Dd[0]>, <Rt>	
FMDRR	VMOV	<i>VMOV (between two general-purpose registers and a doubleword floating-point register)</i> on page F6-3988
FMRDH <Rt>, <Dd>	VMOV <Rt>, <Dd[1]>	<i>VMOV (scalar to general-purpose register)</i> on page F6-4006
FMRDL <Rt>, <Dd>	VMOV <Rt>, <Dd[0]>	

Table K5-2 Pre-UAL instruction syntax for A32 floating-point instructions (continued)

Pre-UAL syntax	UAL equivalent	See
FMRRD	VMOV	<i>VMOV</i> (between two general-purpose registers and a doubleword floating-point register) on page F6-3988
FMRRS	VMOV	<i>VMOV</i> (between two general-purpose registers and two single-precision registers) on page F6-4008
FMRS	VMOV	<i>VMOV</i> (between general-purpose register and single-precision) on page F6-4004
FMRX	VMRS	<i>VMRS</i> on page F6-4017
FMSCD	VNMLS.F64	<i>VNMLS</i> on page F6-4048
FMSCS	VNMLS.F32	
FMSR	VMOV	<i>VMOV</i> (between general-purpose register and single-precision) on page F6-4004
FMSRR	VMOV	<i>VMOV</i> (between two general-purpose registers and two single-precision registers) on page F6-4008
FMSTAT	VMRS APSR_nzcv, FPSCR	<i>VMRS</i> on page F6-4017
FMULD	VMUL.F64	<i>VMUL</i> (floating-point) on page F6-4022
FMULS	VMUL.F32	
FMXR	VMSR	<i>VMSR</i> on page F6-4020
FNEGD	VNEG.F64	<i>VNEG</i> on page F6-4041
FNEGS	VNEG.F32	
FNMACD	VMLS.F64	<i>VNMLS</i> on page F6-4048
FNMACS	VMLS.F32	
FNMSCD	VNMLA.F64	<i>VNMLA</i> on page F6-4045
FNMSCS	VNMLA.F32	
FNMULD	VNMUL.F64	<i>VNMUL</i> on page F6-4051
FNMULS	VNMUL.F32	
FSHTOD	VCVT.F64.S16	<i>VCVT</i> (between floating-point and fixed-point, floating-point) on page F6-3819
FSHTOS	VCVT.F32.S16	
FSITOD	VCVT.F64.S32	<i>VCVT</i> (between floating-point and integer, Advanced SIMD) on page F6-3806, <i>VCVTR</i> on page F6-3842
FSITOS	VCVT.F32.S32	
FSLTOD	VCVT.F64.S32	<i>VCVT</i> (between floating-point and fixed-point, floating-point) on page F6-3819
FSLTOS	VCVT.F32.S32	
FSQRTD	VSQRT.F64	<i>VSQRT</i> on page F6-4220
FSQRTS	VSQRT.F32	
FSTD	VSTR	<i>VSTR</i> on page F6-4273

Table K5-2 Pre-UAL instruction syntax for A32 floating-point instructions (continued)

Pre-UAL syntax	UAL equivalent	See
FSTMD, FSTMIA	VSTM.F64	<i>VSTM, VSTMDB, VSTMIA</i> on page F6-4268
FSTMS	VSTM.F32	
FSTS	VSTR	<i>VSTR</i> on page F6-4273
FSUBD	VSUB.F64	<i>VSUB (floating-point)</i> on page F6-4276
FSUBS	VSUB.F32	
FTOSHD	VCVT.S16.F64	<i>VCVT (between floating-point and fixed-point, floating-point)</i> on page F6-3819
FTOSHS	VCVT.S16.F32	
FTOSID	VCVT.S32.F64	<i>VCVT (between floating-point and integer, Advanced SIMD)</i> on page F6-3806
FTOSIS	VCVT.S32.F32	
FTOSIZD	VCVTR.S32.F64	<i>VCVTR</i> on page F6-3842
FTOSIZS	VCVTR.S32.F32	
FTOSLD	VCVT.S32.F64	<i>VCVT (between floating-point and fixed-point, floating-point)</i> on page F6-3819
FTOSLS	VCVT.S32.F32	
FTOUHD	VCVT.U16.F64	
FTOUHS	VCVT.U16.F32	
FTOUID	VCVT.U32.F64	<i>VCVT (between floating-point and integer, Advanced SIMD)</i> on page F6-3806
FTOUIS	VCVT.U32.F32	
FTOUIZD	VCVTR.U32.F64	<i>VCVTR</i> on page F6-3842
FTOUIZS	VCVTR.U32.F32	
FTOULD	VCVT.U32.F64	<i>VCVT (between floating-point and fixed-point, floating-point)</i> on page F6-3819
FTOULS	VCVT.U32.F32	
FUHTOD,	VCVT.F64.U16	
FUHTOS	VCVT.F64.U16	
FUITOD	VCVT.F64.U32	<i>VCVT (between floating-point and integer, Advanced SIMD)</i> on page F6-3806
FUITOS	VCVT.F32.U32	
FULTOD	VCVT.F64.U32	<i>VCVT (between floating-point and fixed-point, floating-point)</i> on page F6-3819
FULTOS	VCVT.F32.U32	

K5.1.3 FCONST

The syntax of FCONST is

FCONST<dest>{<c>} <Fd>, #<imm8>

where:

<dest> Specifies the destination data type. It must be one of:

S . Single-precision floating-point.

D . Double-precision floating-point.

<c> This is an optional field. It specifies the condition under which the instruction is executed. See [Conditional execution on page F2-2849](#) for the range of available conditions and their encoding. If <c> is omitted, it defaults to *always* (AL).

<Fd> Specifies the destination register. It must be one of:

<Dd> 64-bit name of the SIMD&FP destination register.

<Sd> 32-bit name of the SMID&FP destination register.

<imm8> Specifies the immediate value used to generate the floating-point constant.

FCONSTD{<c>} <Dd>, #<imm8> maps to VMOV.F64 <Dd>, #<fpimm>

FCONSTS{<c>} <Sd>, #<imm8> maps to VMOV.F32 <Sd>, #<fpimm>

Appendix K6

Address translation examples

This appendix gives examples of address translations using the translation regimes described in [Chapter D4 The AArch64 Virtual Memory System Architecture](#) and [Chapter G4 The AArch32 Virtual Memory System Architecture](#). It contains the following sections:

- [AArch64 Address translation examples](#) on page K6-6180.
- [AArch32 Address translation examples](#) on page K6-6193.

———— **Note** —————

This chapter gives examples of translation table lookups for the ARMv8 address translation stages. It does not define any part of the address translation mechanism. If any information in this appendix appears to contradict the information in [Chapter D4 The AArch64 Virtual Memory System Architecture](#) or [Chapter G4 The AArch32 Virtual Memory System Architecture](#) then the information in [Chapter D4](#) or [Chapter G4](#) must be taken as the definition of the required behavior.

K6.1 AArch64 Address translation examples

Figure D4-1 on page D4-2009 shows the VMSAv8 address translation stages that are controlled by an Exception level that is using AArch64. *The VMSAv8-64 address translation system on page D4-2008* describes the VMSAv8-64 address translation scheme. This section gives examples of the use of that scheme, for common translation requirements.

System registers relevant to MMU operation on page D4-2014 specifies the relevant registers, including the TCR_ELx and TTBR_ELx, or TTBR_ELxs, for each stage of address translation.

For any stage of translation, a TCR_ELx.TnSZ field indicates the supported input address size. For a stage of address translation controlled from an Exception level using AArch64, the supported input address size is $2^{(64-TnSZ)}$.

This section describes:

- Performing the initial lookup, for an address for which the initial lookup is either:
 - At the highest lookup level used for the appropriate translation granule size.
 - Because of the concatenation of translation tables at the initial lookup level, one level down from the highest level used for the translation granule size.

These descriptions take account of the following cases:

- The IA size is smaller than the largest size for the translation level, see *Reduced IA width on page D4-2025*.
- For a stage 2 translation, translation tables are concatenated, to move the initial lookup level down by one level, see *Concatenated translation tables on page D4-2025*.

For examples of performing the initial lookup, see *Examples of performing the initial lookup*.

- The full translation flow for resolving a page of memory. These examples describe resolving the largest IA size supported by the initial lookup level. For these examples, see *Full translation flows for VMSAv8-64 address translation on page K6-6187*.

K6.1.1 Examples of performing the initial lookup

The address ranges used for the initial translation table lookup depend on the translation granule, as described in:

- *Performing the initial lookup using the 4KB translation granule*.
- *Performing the initial lookup using the 16KB granule on page K6-6183*.
- *Performing the initial lookup using the 64KB translation granule on page K6-6185*.

Performing the initial lookup using the 4KB translation granule

This subsection describes examples of the initial lookup when using the 4KB translation granule that [Table D4-13 on page D4-2031](#) shows as starting at level 0 or at level 1. It includes those stage 2 translations where concatenation of translation tables is required for the lookup to start at level 1. This means that it gives specific examples of the mechanisms described in *The VMSAv8-64 address translation system on page D4-2008*.

————— Note —————

For stage 2 translations, the same principles apply to an initial lookup that [Table D4-13 on page D4-2031](#) shows as starting at level 1. In this case, for some IA sizes concatenation of translation tables means the lookup can, instead, start at level 2.

The following subsections describe these examples of the initial lookup:

- *Initial lookup at level 0, 4KB translation granule on page K6-6181*.
- *Initial lookup at level 1, 4KB translation granule on page K6-6181*.

In all cases, for a stage 2 translation, the VTCR_EL2.SL0 field must indicate the required initial lookup level, and this level must be consistent with the value of the VTCR_EL2.T0SZ field, see *Overview of stage 2 translations, 4KB granule on page D4-2031*.

Initial lookup at level 0, 4KB translation granule

This subsection describes initial lookups with an input address width of $(n+1)$ bits, meaning the input address is $IA[n:0]$. As Table D4-13 on page D4-2031 shows, a stage 1 or stage 2 initial lookup at level 0 is required when $39 \leq n \leq 47$. For these lookups:

- $TTBR_ELx[47:(n-35)]$ specify the translation table base address.
- Bits $[n:39]$ of the input address are bits $[(n-36):3]$ of the descriptor offset in the translation table.

———— **Note** ————

This means that, when the input address width is less than 48 bits

- The size of the translation table is reduced.
- More low-order bits of the $TTBR_ELx$ are required to specify the translation table base address.
- Fewer input address bit are used to specify the descriptor offset in the translation table.

For example, if the input address width is 46 bits:

- The translation table size is 1KB,
- $TTBR_ELx$ bits $[47:10]$ specify the translation table base address.
- Input address bits $[45:39]$ specify bits $[9:3]$ of the descriptor offset.

Figure K6-1 shows this lookup.

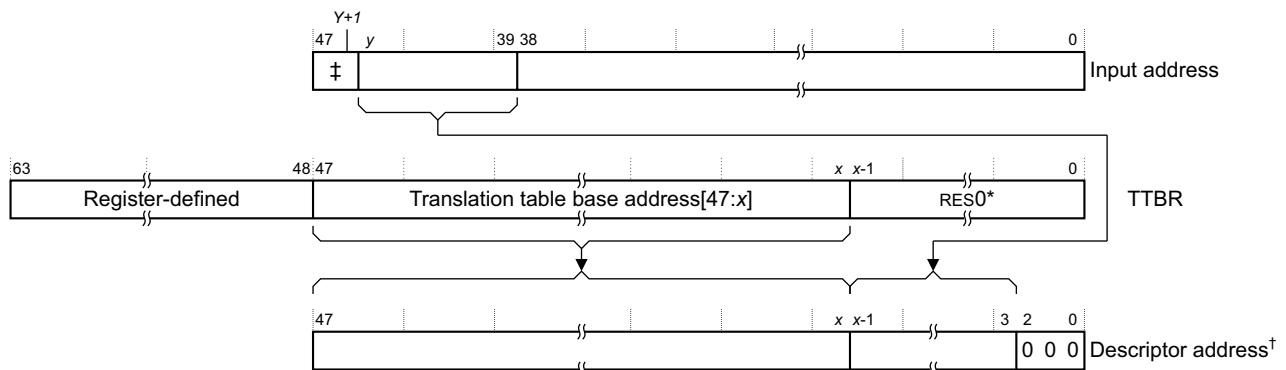

Supported input address range is $IA[y:0]$, $4 \leq x \leq 12$, $y = x + 35$. When y is 47 the field marked † is absent.

† For a Non-secure EL1&0 stage 1 translation, the IPA of the descriptor. Otherwise, the PA of the descriptor.

* Field has additional properties to the default RES0 definition, see the register description for more information.

Figure K6-1 Initial lookup for VMSAv8-64 using the 4KB granule, starting at level 0

Initial lookup at level 1, 4KB translation granule

This subsection describes initial lookups with an input address width of $(n+1)$ bits, meaning the input address is $IA[n:0]$.

For a stage 1 or stage 2 initial lookup at level 1, without use of concatenated translation tables

As Table D4-13 on page D4-2031 shows, this applies to $IA[n:0]$, where $30 \leq n \leq 38$. For these lookups:

- There is a single translation table at this level.
- $TTBR_ELx[47:(n-26)]$ specify the translation table base address.
- Bits $[n:30]$ of the input address are bits $[(n-27):3]$ of the descriptor offset in the translation table.

Figure K6-2 on page K6-6182 shows this lookup.

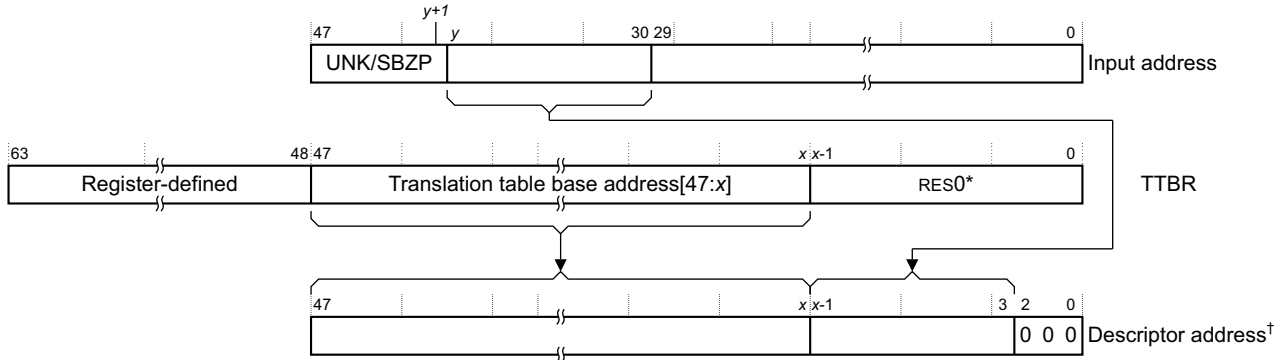

Supported input address range is $IA[y:0]$, $4 \leq x \leq 12$, $y = x + 26$.

[†] For a Non-secure EL1&0 stage 1 translation, the IPA of the descriptor. Otherwise, the PA of the descriptor.

* Field has additional properties to the default RES0 definition, see the register description for more information.

Figure K6-2 Initial lookup for VMSAv8-64 using the 4KB granule, starting at level 1, without concatenation

For a stage 2 initial lookup at level 1, with concatenated translation tables

As Table D4-13 on page D4-2031 shows, this applies to $IA[n:0]$, where $39 \leq n \leq 42$. For these lookups:

- There are $2^{(n-38)}$ concatenated translation tables at this level.
- These concatenated translation tables must be aligned to $2^{(n-38)} \times 4\text{KB}$. This means $TTBR_ELx[(n-27):12]$ must be zero.
- $TTBR_ELx[47:(n-26)]$ specify the base address of the block of concatenated translation tables.
- Bits $[n:30]$ of the input address are bits $[(n-27):3]$ of the descriptor offset from the base address of the block of concatenated translation tables.

Figure K6-3 shows this lookup.

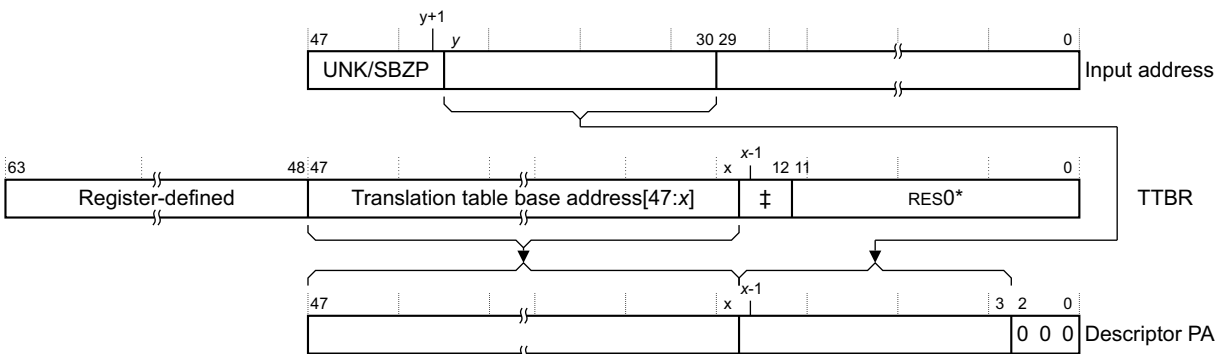

Supported input address range is $IPA[y:0]$, $4 \leq x \leq 16$, $y = x + 26$. The field marked ‡ must be zero.

* Field has additional properties to the default RES0 definition, see the register description for more information.

Figure K6-3 Initial lookup for VMSAv8-64 using the 4KB granule, starting at level 1, with concatenation

Performing the initial lookup using the 16KB granule

This subsection describes examples of the initial lookup when using the 16KB translation granule that Table D4-16 on page D4-2035 shows as starting at level 0 or at level 1. It includes those stage 2 translations where concatenation of translation tables is required for the lookup to start at level 1. This means that it gives specific examples of the mechanisms described in *The VMSAv8-64 address translation system* on page D4-2008.

———— Note ————

For stage 2 translations, the same principles apply to an initial lookup that Table D4-16 on page D4-2035 shows as starting at level 1. In this case, for some IA sizes concatenation of translation tables means the lookup can, instead, start at level 2.

The following subsections describe these examples of the initial lookup:

- [Initial lookup at level 0, 16KB translation granule.](#)
- [Initial lookup at level 1, 16KB translation granule on page K6-6184.](#)

In all cases, for a stage 2 translation, the `VTCCR_EL2.SL0` field must indicate the required initial lookup level, and this level must be consistent with the value of the `VTCCR_EL2.T0SZ` field, see [Overview of stage 2 translations, 16KB granule on page D4-2035.](#)

Initial lookup at level 0, 16KB translation granule

This subsection describes initial lookups with an input address width of $(n+1)$ bits, meaning the input address is `IA[n:0]`. As Table D4-15 on page D4-2034 shows, the only case where an address translation using the 16KB granule starts at level 0 is a stage 1 translation of a 48-bit input address, `IA[47:0]`. For this lookup:

- The required translation table has only two entries, meaning its size is 16 bytes, and it must be aligned to 16 bytes.
- `TTBR_ELx[47:4]` specify the translation table base address.
- Bit[47] of the input address is bits[3] of the descriptor offset in the translation table.

Figure K6-4 shows this lookup.

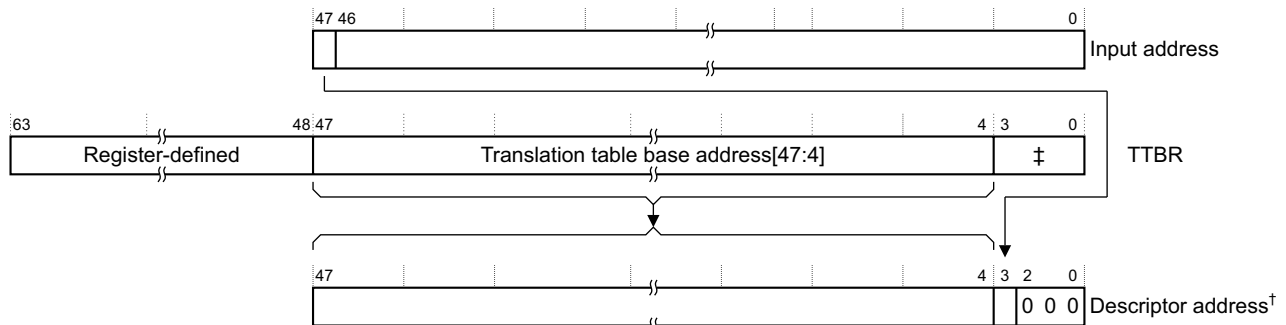

Supported input address range is `IA[47:0]`. The field marked † is `RES0*`.

† For a Non-secure EL1&0 stage 1 translation, the IPA of the descriptor. Otherwise, the PA of the descriptor.

* Field has additional properties to the default `RES0` definition, see the register description for more information.

Figure K6-4 Initial lookup for VMSAv8-64 using the 16KB granule, starting at level 0

Initial lookup at level 1, 16KB translation granule

This subsection describes initial lookups with an input address width of $(n+1)$ bits, meaning the input address is $IA[n:0]$.

For a stage 1 or stage 2 initial lookup at level 1, without use of concatenated translation tables

As Table D4-16 on page D4-2035 shows, this applies to $IA[n:0]$, where $36 \leq n \leq 46$. For these lookups:

- There is a single translation table at this level.
- $TTBR_ELx[47:(n-32)]$ specify the translation table base address.
- Bits $[n:36]$ of the input address are bits $[(n-33):3]$ of the descriptor offset in the translation table.

Figure K6-5 shows this lookup.

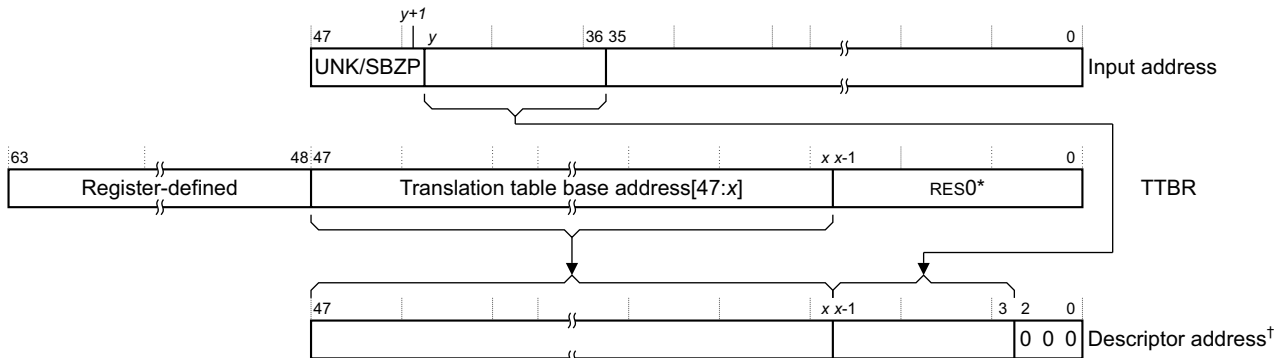

Supported input address range is $IA[y:0]$, $4 \leq x \leq 14$, $y = x + 32$.

† For a Non-secure EL1&0 stage 1 translation, the IPA of the descriptor. Otherwise, the PA of the descriptor.

* Field has additional properties to the default RES0 definition, see the register description for more information.

Figure K6-5 Initial lookup for VMSAv8-64 using the 16KB granule, starting at level 1, without concatenation

For a stage 2 initial lookup at level 1, with concatenated translation tables

As Table D4-16 on page D4-2035 shows, the only case where an address translation using the 16KB granule starts at level 1 because of concatenation of translation tables is a stage 2 translation of a 48-bit input address, $IA[47:0]$. For this lookup:

- There are two concatenated translation tables at this level.
- These concatenated translation tables must be aligned to $2 \times 16KB$. This means $TTBR_ELx[14]$ must be zero.
- $TTBR_ELx[47:15]$ specify the base address of the block of two concatenated translation tables.
- Bits $[47:36]$ of the input address are bits $[14:3]$ of the descriptor offset from the base address of the block of concatenated translation tables.

Figure K6-6 on page K6-6185 shows this lookup.

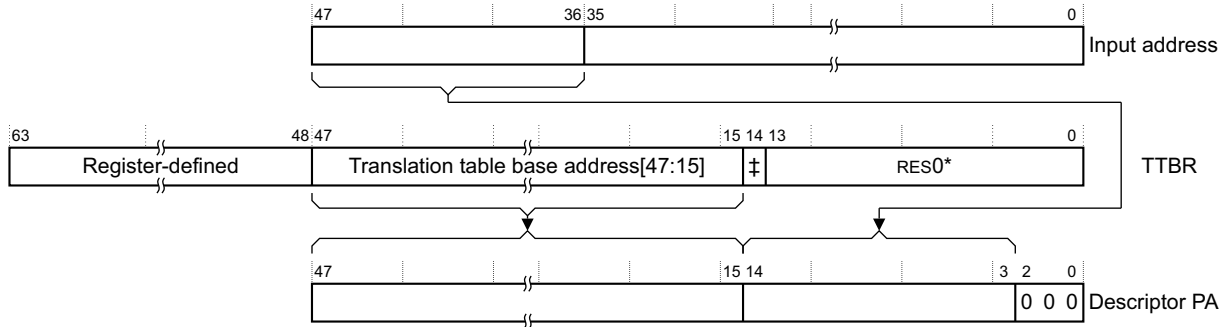

Supported input address range is IPA[47:0]. The bit marked ‡ must be zero.

* Field has additional properties to the default RES0 definition, see the register description for more information.

Figure K6-6 Initial lookup for VMSAv8-64 using the 16KB granule, starting at level 1, with concatenation

Performing the initial lookup using the 64KB translation granule

This subsection describes examples of the initial lookup when using the 64KB translation granule that [Table D4-19 on page D4-2039](#) shows as starting at level 1 or at level 2. It includes those stage 2 translations where concatenation of translation tables is required for the lookup to start at level 2. This means that it gives specific examples of the mechanisms described in *The VMSAv8-64 address translation system on page D4-2008*.

Note

For stage 2 translations, the same principles apply to an initial lookup that [Table D4-19 on page D4-2039](#) shows as starting at level 2. In this case, for some IA sizes concatenation of translation tables means the lookup can, instead, start at level 3.

The following subsections describe these examples of the initial lookup:

- [Initial lookup at level 1, 64KB translation granule.](#)
- [Initial lookup at level 2, 64KB translation granule on page K6-6186.](#)

In all cases, for a stage 2 translation, the `VTCR_EL2.SL0` field must indicate the required initial lookup level, and this level must be consistent with the value of the `VTCR_EL2.T0SZ` field, see *Overview of stage 2 translations, 64KB granule on page D4-2039*.

Initial lookup at level 1, 64KB translation granule

This subsection describes initial lookups with an input address width of $(n+1)$ bits, meaning the input address is `IA[n:0]`. As [Table D4-19 on page D4-2039](#) shows, a stage 1 or stage 2 initial lookup at level 1 is required when $42 \leq n \leq 47$. For these lookups:

- The size of the translation table is $2^{(n-39)}$ bytes. This means the size of the translation table, at this level, is always less than the granule size. The address of this translation table must align to the size of the table.
- Bits `[n:42]` of the input address are bits `[(n-39):3]` of the descriptor offset in the translation table.
- Bits `[47:(n-38)]` of the `TTBR_ELx` specify the translation table base address.

[Figure K6-7 on page K6-6186](#) shows this lookup.



Supported input address range is $IA[y:0]$, $4 \leq x \leq 9$, $y = x + 38$. When y is 47 the field marked ‡ is absent.
 † For a Non-secure EL1&0 stage 1 translation, the IPA of the descriptor. Otherwise, the PA of the descriptor.
 * Field has additional properties to the default RES0 definition, see the register description for more information.

Figure K6-7 Initial lookup for VMSAv8-64 using the 64KB granule, starting at level 1

Initial lookup at level 2, 64KB translation granule

This subsection describes initial lookups with an input address width of $(n+1)$ bits, meaning the input address is $IA[n:0]$.

For a stage 1 or stage 2 initial lookup at level 2, without the use of concatenated translation tables

As Table D4-19 on page D4-2039 shows, this applies to $IA[n:0]$, where $29 \leq n \leq 41$. For these lookups:

- There is a single translation table at this level.
- $TTBR_ELx[47:(n-25)]$ of the specify the translation table base address.
- Bits $[n:29]$ of the input address are bits $[(n-26):3]$ of the descriptor offset in the translation table.

Figure K6-8 shows this lookup.

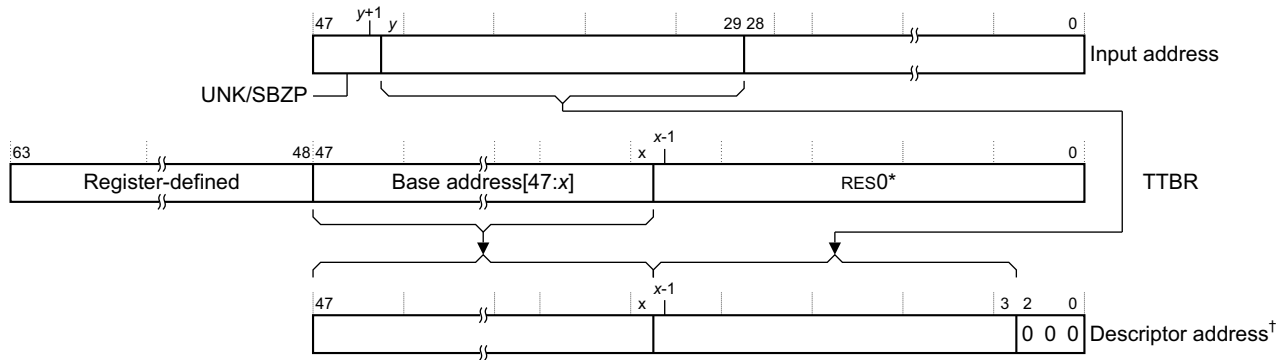

Supported input address range is $IA[y:0]$. $4 \leq x \leq 16$, $y = x + 25$.
 † For a Non-secure EL1&0 stage 1 translation, the IPA of the descriptor. Otherwise, the PA of the descriptor.
 * Field has additional properties to the default RES0 definition, see the register description for more information.

Figure K6-8 Initial lookup for VMSAv8-64 using the 64KB granule, starting at level 2, without concatenation

For a stage 2 initial lookup at level 2, with concatenated translation tables

As Table D4-19 on page D4-2039 shows, this applies to IA[n:0], where $42 \leq n \leq 45$. For these lookups:

- There are $2^{(m-41)}$ concatenated translation tables at this level.
- These concatenated translation tables must be aligned to $2^{(m-41)} \times 64\text{KB}$. This means $\text{TTBR_ELx}[(n-26):16]$ must be zero.
- $\text{TTBR_ELx}[47:(n-25)]$ specify the base address of the block of translation tables.
- Bits[n:42] of the input address are bits[(n-26):16] of the descriptor offset from the base address of the block of translation tables.

Figure K6-9 shows this lookup.

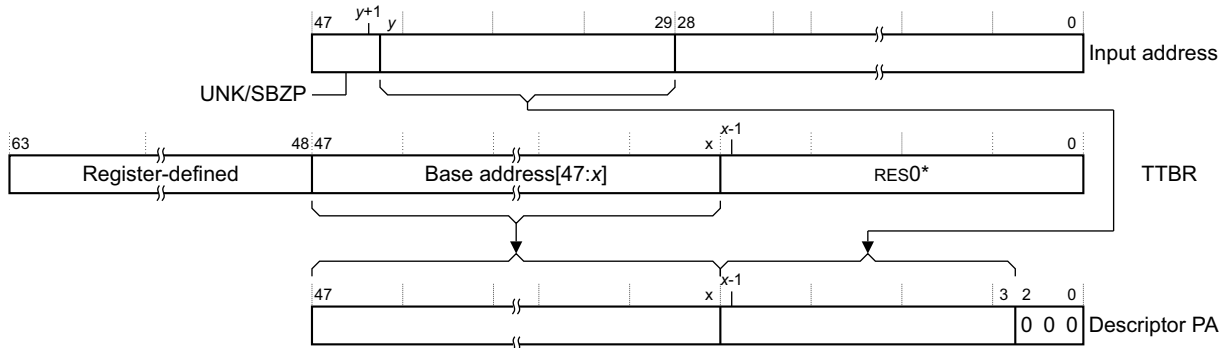

Supported input address range is $\text{IPA}[y:0]$, $4 \leq x \leq 20$, $y = x + 25$.

* Field has additional properties to the default RES0 definition, see the register description for more information.

Figure K6-9 Initial lookup for VMSAv8-64 using the 64KB granule, starting at level 2, with concatenation

K6.1.2 Full translation flows for VMSAv8-64 address translation

In a translation table walk, only the first lookup uses the translation table base address from the appropriate TTBR_ELx . Subsequent lookups use a combination of address information from:

- The table descriptor read in the previous lookup.
- The input address.

This section describes example full translation flows, from the initial lookup to the address of a memory page. The example flows:

- Resolve the maximum-sized IA range supported by the initial lookup level.
- Do not have any concatenation of translation tables.
- Cover only the 4KB and the 64KB translation granules.

Examples of performing the initial lookup on page K6-6180 described how either reducing the IA range or concatenating translation tables affects the initial lookup.

Note

Reducing the IA range or concatenating translation tables affects only the initial lookup.

The following sections describe full VMSAv8-64 translation flows, down to an entry for a memory page:

- *The address and properties fields shown in the translation flows on page K6-6188.*
- *Full translation flow using the 4KB granule and starting at level 0 on page K6-6189.*
- *Full translation flow using the 4KB granule and starting at level 1 on page K6-6190.*
- *Full translation flow using the 64KB granule and starting at level 1 on page K6-6191.*
- *Full translation flow using the 64KB granule and starting at level 2 on page K6-6192.*

The address and properties fields shown in the translation flows

For the Non-secure EL1&0 stage 1 translation:

- Any descriptor address is the IPA of the required descriptor.
- The final output address is the IPA of the block or page.

In these cases, an EL1&0 stage 2 translation is performed to translate the IPA to the required PA.

For all other translations, the final output address is the PA of the block or page, and any descriptor address is the PA of the descriptor.

Properties indicates register or translation table fields that return information, other than address information, about the translation or the targeted memory region. For more information see [Memory attribute fields in the VMSAv8-64 translation table format descriptors](#) on page D4-2064.

Full translation flow using the 4KB granule and starting at level 0

Figure K6-10 shows the complete translation flow for a stage 1 translation table walk for a 48-bit input address. This lookup must start with a level 0 lookup. For more information about the fields shown in the figure see *The address and properties fields shown in the translation flows* on page K6-6188.

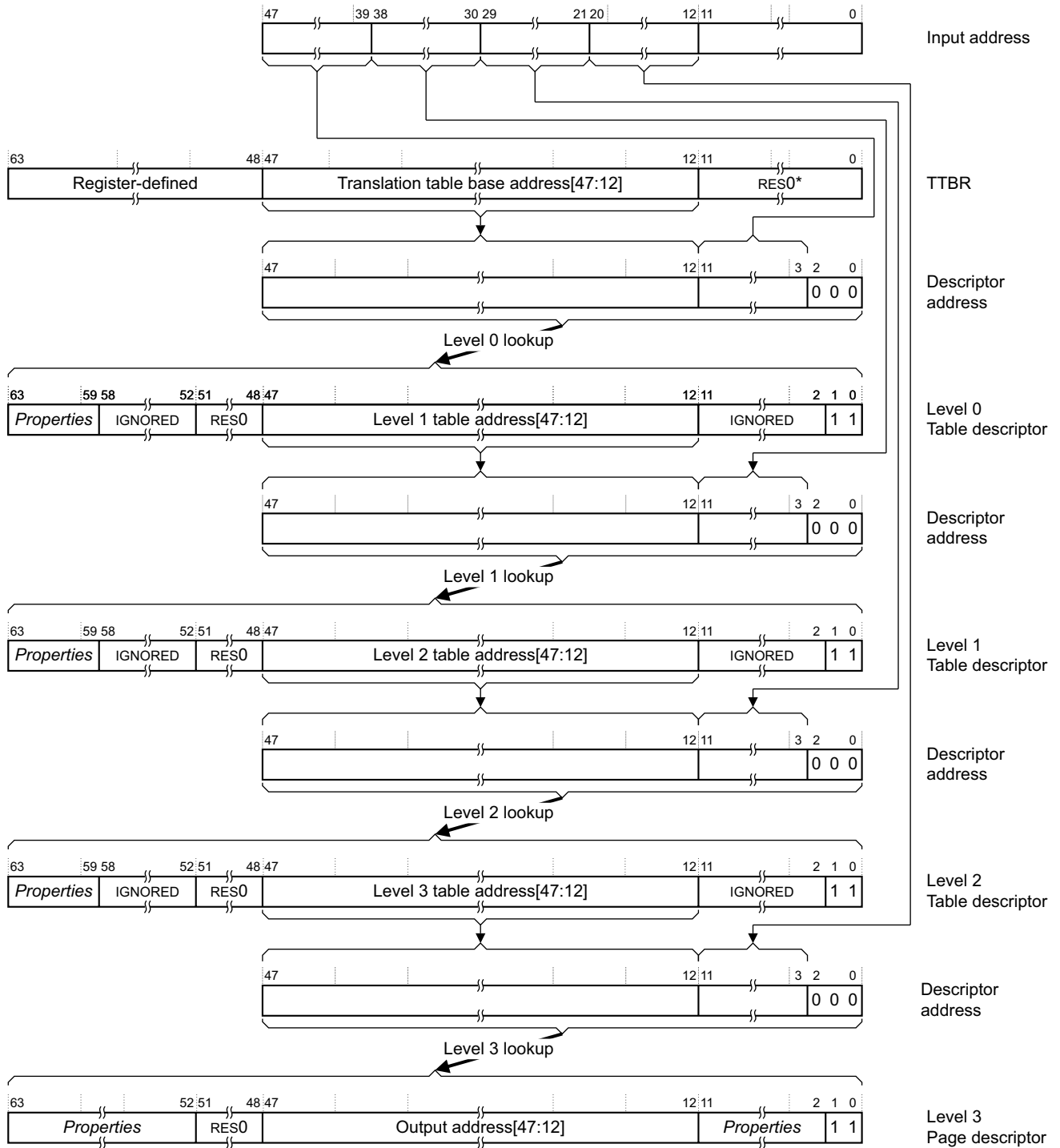

For details of *Properties* fields, see the register or descriptor description.

* Field has additional properties to the default RES0 definition, see the register description for more information.

Figure K6-10 Complete stage 1 translation of a 48-bit address using the 4KB translation granule

If the level 1 lookup or level 2 lookup returns a block descriptor then the translation table walk completes at that level.

Figure K6-10 on page K6-6189 shows a stage 1 translation. The only difference for a stage 2 translation is that bits[63:58] of the Table descriptors are SBZ.

Full translation flow using the 4KB granule and starting at level 1

Figure K6-11 shows the complete translation flow for a stage 1 translation table walk for a 39-bit input address. This lookup must start with a level 1 lookup. For more information about the fields shown in the figure see *The address and properties fields shown in the translation flows on page K6-6188*.

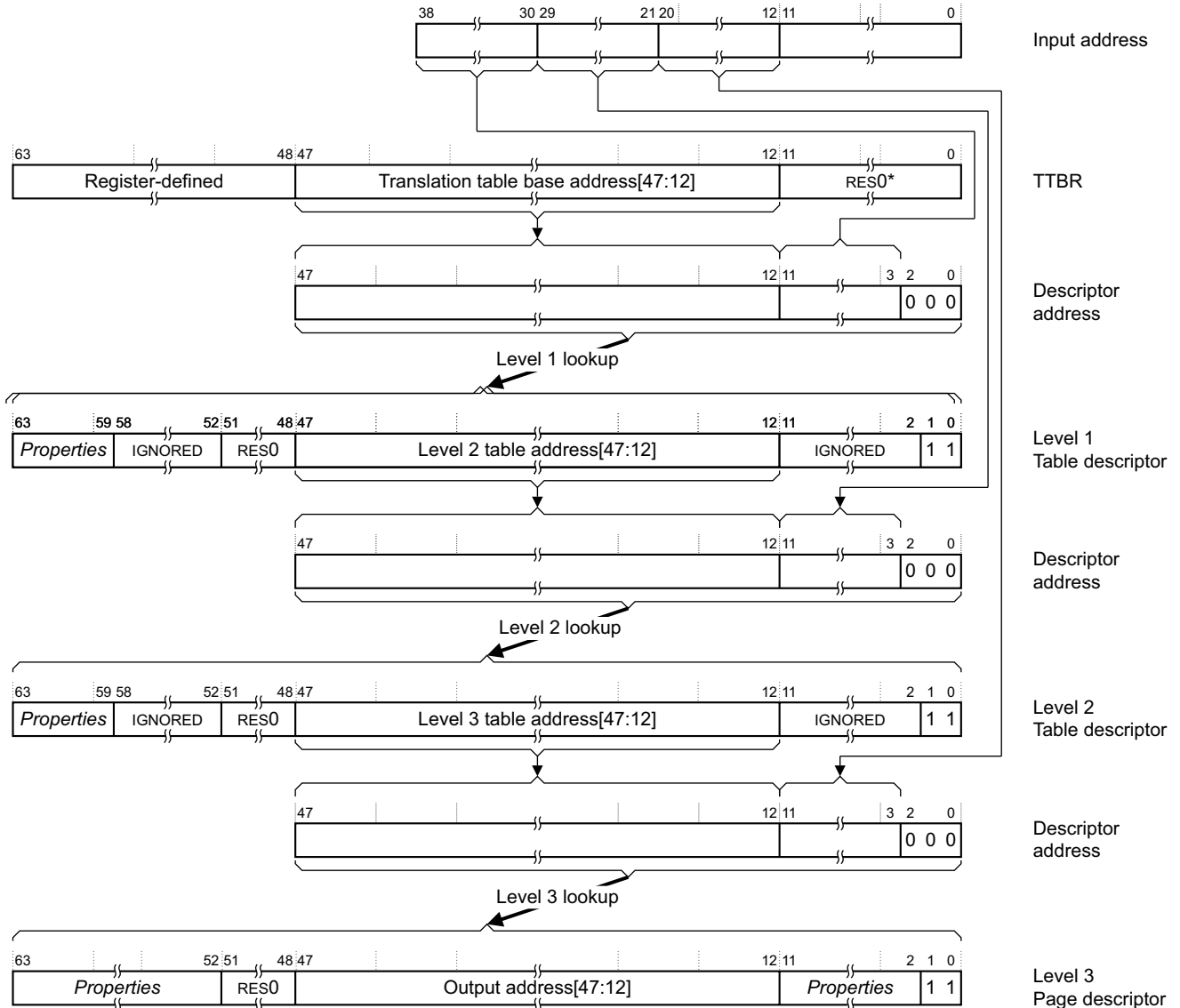

For details of *Properties* fields, see the register or descriptor description.

* Field has additional properties to the default RES0 definition, see the register description for more information.

Figure K6-11 Complete stage 1 translation of a 39-bit address using the 4KB translation granule

If the level 1 lookup or the level 2 lookup returns a block descriptor then the translation table walk completes at that level.

Figure K6-11 on page K6-6190 shows a stage 1 translation. The only difference for a stage 2 translation is that bits[63:58] of the Table descriptors are SBZ.

Comparing this translation with the translation for a 48-bit address, shown in Figure K6-10 on page K6-6189, shows how the translation for the 42-bit address start the same lookup process one stage later.

Full translation flow using the 64KB granule and starting at level 1

Figure K6-10 on page K6-6189 shows the complete translation flow for a stage 1 translation table walk for a 48-bit input address. This lookup must start with a level 0 lookup. For more information about the fields shown in the figure see *The address and properties fields shown in the translation flows on page K6-6188*.

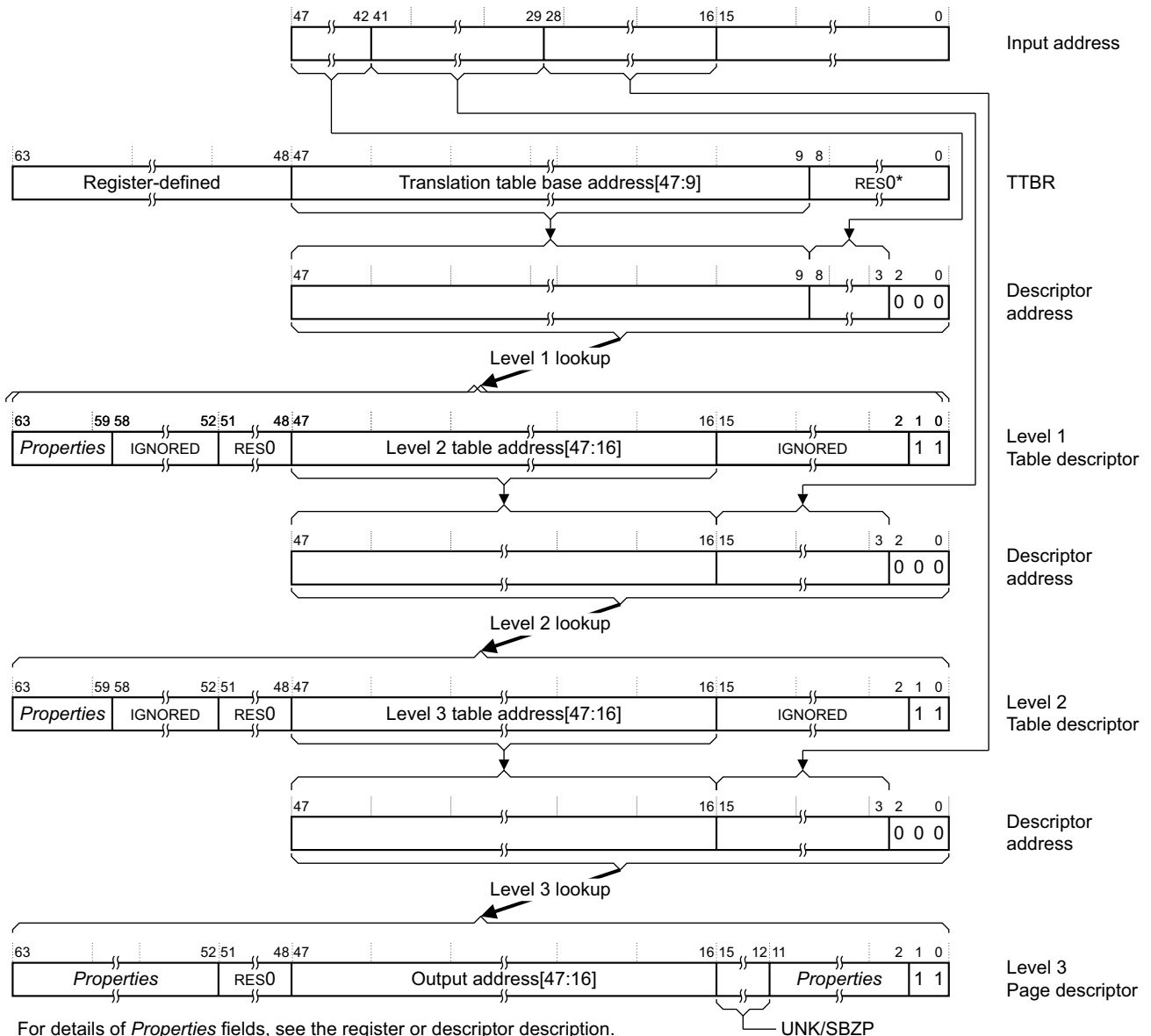

For details of *Properties* fields, see the register or descriptor description.
* Field has additional properties to the default RES0 definition, see the register description for more information.

Figure K6-12 Complete stage 1 translation of a 48-bit address using the 64KB translation granule

If the level 2 lookup returns a block descriptor then the translation table walk completes at that level.

Figure K6-12 shows a stage 1 translation. The only difference for a stage 2 translation is that bits[63:58] of the Table descriptors are SBZ.

The level 1 lookup resolves only 6 bits of the input address. As described in *Performing the initial lookup using the 64KB translation granule* on page K6-6185, this means:

- The translation table size for this level is only 512 bytes.
- The required translation table alignment for this level is 512 bytes.
- The Base address field in the `TTBR_ELx` is extended, at the low-order end, to be bits[47:9].

Full translation flow using the 64KB granule and starting at level 2

Figure K6-11 on page K6-6190 shows the complete translation flow for a stage 1 translation table walk for a 42-bit input address. This lookup must start with a level 2 lookup. For more information about the fields shown in the figure see *The address and properties fields shown in the translation flows* on page K6-6188.

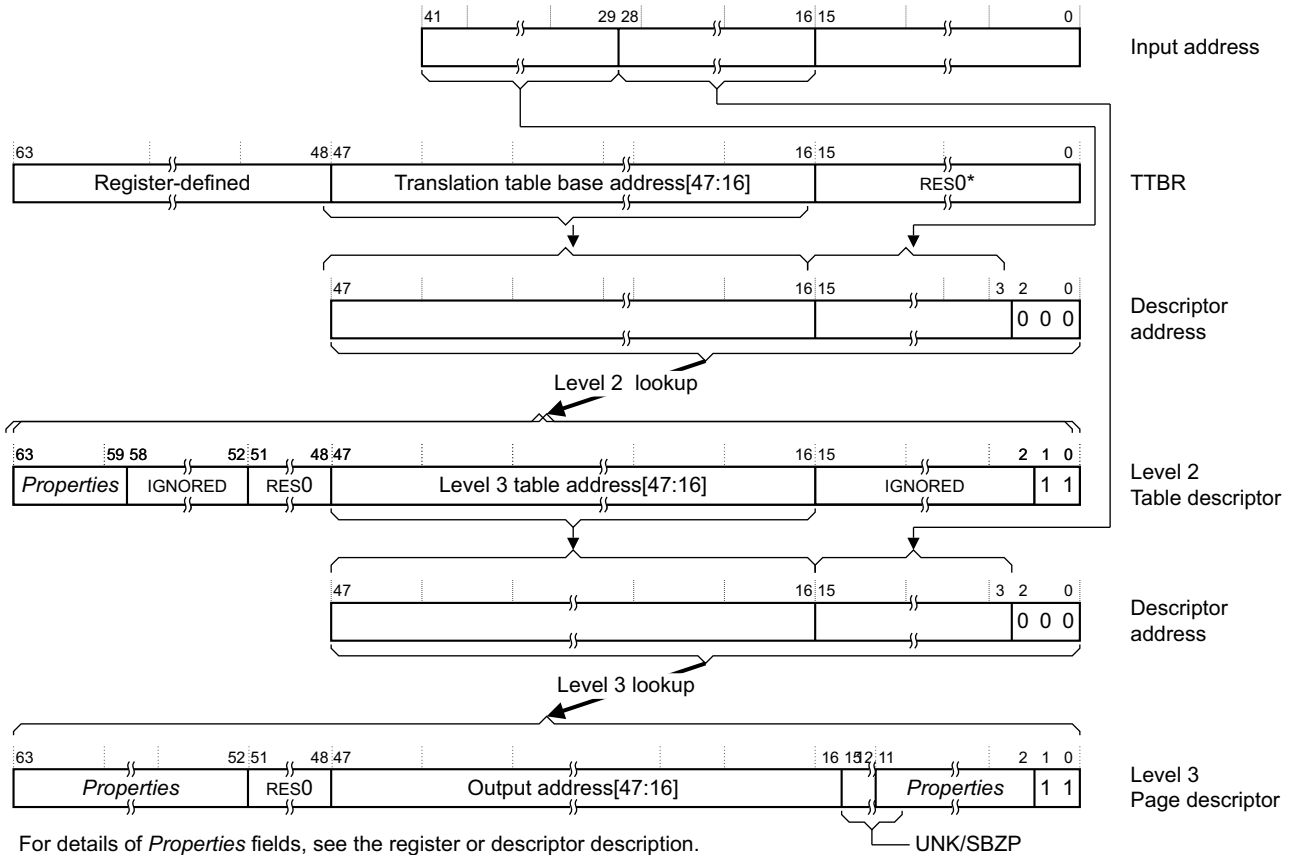

Figure K6-13 Complete stage 1 translation of a 42-bit address using the 64KB translation granule

If the level 2 lookup returns a block descriptor then the translation table walk completes at that level.

Figure K6-13 shows a stage 1 translation. The only difference for a stage 2 translation is that bits[63:58] of the Table descriptors are SBZ.

Comparing this translation with the translation for a 48-bit address, shown in Figure K6-12 on page K6-6191, shows:

- The translation for the 42-bit address starts the same lookup process one stage later.
- Because the initial lookup resolves 13 bits of address:
 - The translation table size for this level is 64KB.
 - The required translation table alignment for this level is 64KB.
 - The Base address field in the `TTBR_ELx` is bits[47:16].

K6.2 AArch32 Address translation examples

The following sections give address translation examples for the VMSSAv8-32 address translation formats:

- [Address translation examples using the VMSSAv8-32 Short descriptor translation table format.](#)
- [Address translation examples using the VMSSAv8-32 Long descriptor translation table format on page K6-6198.](#)

K6.2.1 Address translation examples using the VMSSAv8-32 Short descriptor translation table format

[VMSSAv8-32 Short-descriptor translation table format descriptors on page G4-4577](#) describes the memory section and page option for a single VMSSAv8-32 address translation. The following sections show the full translation flow for each of these options:

- [Translation flow for a Supersection on page K6-6194.](#)
- [Translation flow for a Section on page K6-6195.](#)
- [Translation flow for a Large page on page K6-6196.](#)
- [Translation flow for a Small page on page K6-6197.](#)

[The address and Properties fields shown in the translation flows on page K6-6198](#) summarizes the information returned by the lookup.

Translation flow for a Supersection

Figure K6-14 shows the complete translation flow for a Supersection. For more information about the fields shown in this figure see *The address and Properties fields shown in the translation flows* on page K6-6198.

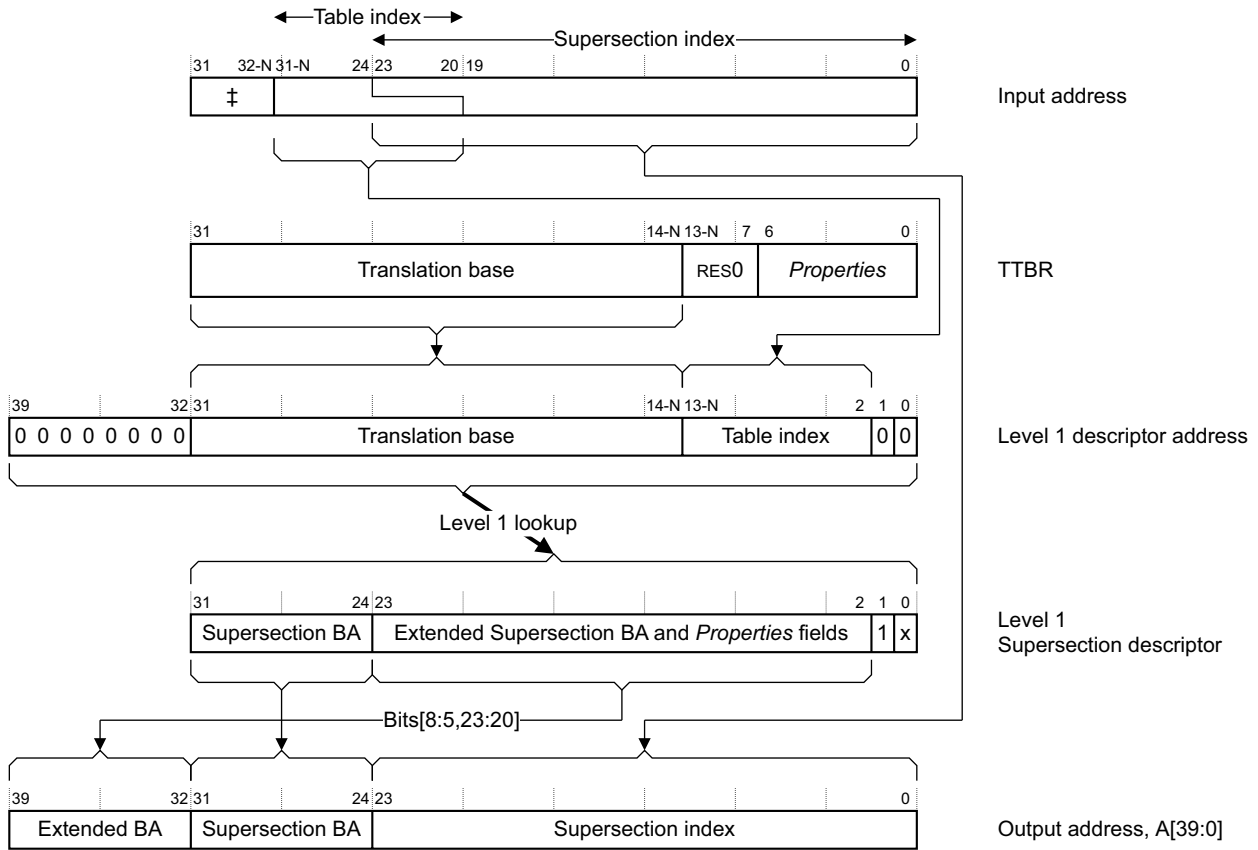

‡ This field is absent if N is 0
 BA = Base address
 For a translation based on TTBR0, N is the value of TTBCR.N
 For a translation based on TTBR1, N is 0
 For details of *Properties* fields, see the register or descriptor description

Figure K6-14 VMSAv8-32 Short-descriptor Supersection address translation

Note

Figure K6-14 shows how, when the input address, the VA, addresses a Supersection, the top four bits of the *Supersection index* bits of the address overlap the bottom four bits of the *Table index* bits. For more information, see *Additional requirements for Short-descriptor format translation tables* on page G4-4580.

Translation flow for a Section

Figure K6-15 shows the complete translation flow for a Section. For more information about the fields shown in this figure see *The address and Properties fields shown in the translation flows on page K6-6198*.

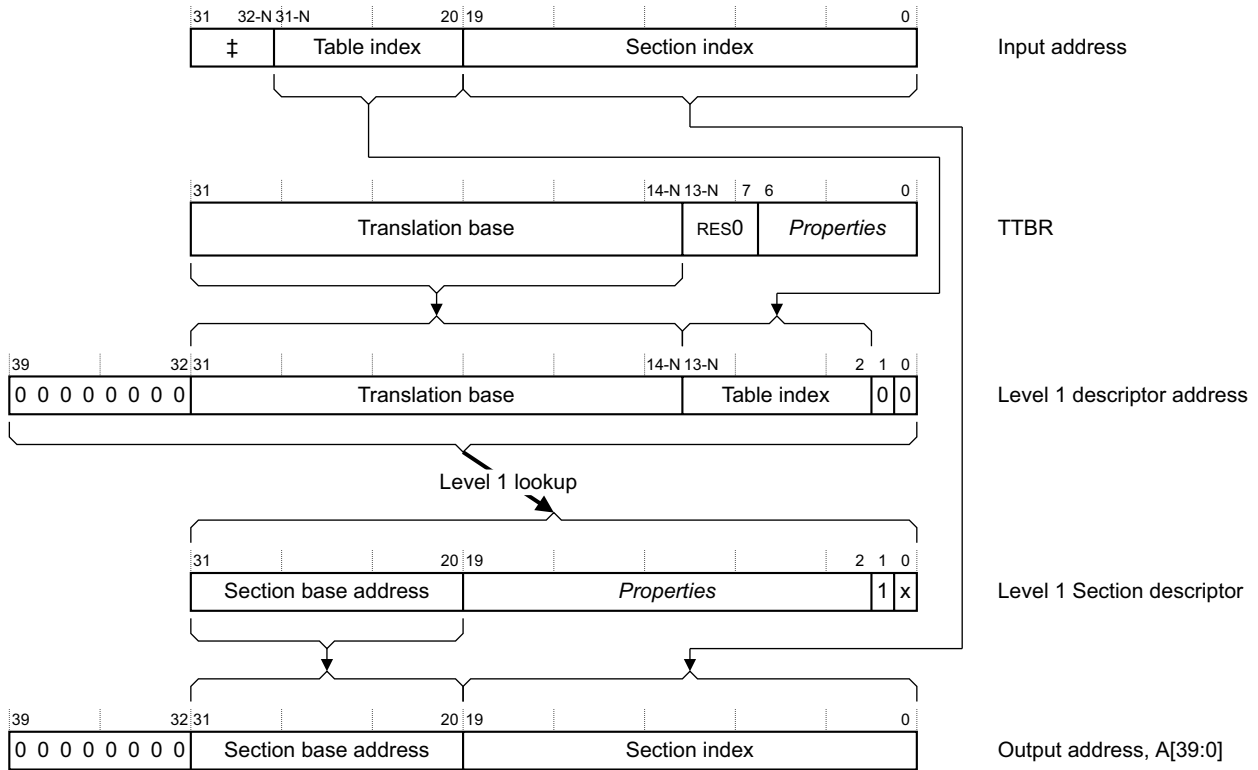

‡ This field is absent if N is 0
 For a translation based on TTBR0, N is the value of TTBCR.N
 For a translation based on TTBR1, N is 0
 For details of *Properties* fields, see the register or descriptor description.

Figure K6-15 VMSAv8-32 Short-descriptor Section address translation

Translation flow for a Large page

Figure K6-16 shows the complete translation flow for a Large page. For more information about the fields shown in this figure see *The address and Properties fields shown in the translation flows on page K6-6198*.

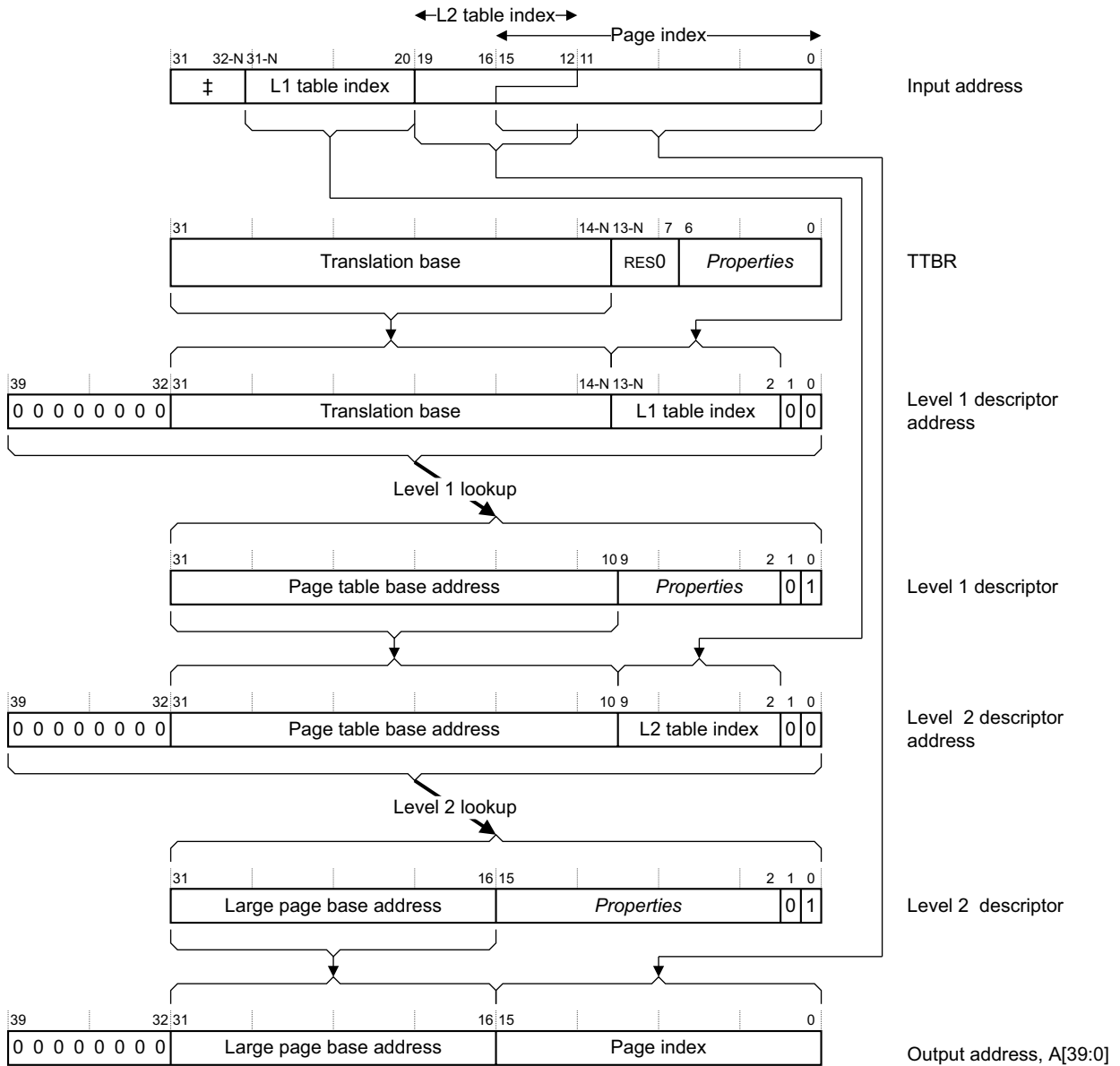

‡ This field is absent if N is 0
 L1 = Level 1, L2 = Level 2
 For a translation based on TTBR0, N is the value of TTBCR.N
 For a translation based on TTBR1, N is 0
 For details of *Properties* fields, see the register or descriptor description

Figure K6-16 VMSAv8-32 Short-descriptor Large page address translation

Note

Figure K6-16 shows how, when the input address, the VA, addresses a Large page, the top four bits of the *page index* bits of the address overlap the bottom four bits of the *level 1 table index* bits of the address. For more information, see *Additional requirements for Short-descriptor format translation tables on page G4-4580*.

Translation flow for a Small page

Figure K6-17 shows the complete translation flow for a Small page. For more information about the fields shown in this figure see *The address and Properties fields shown in the translation flows on page K6-6198*.

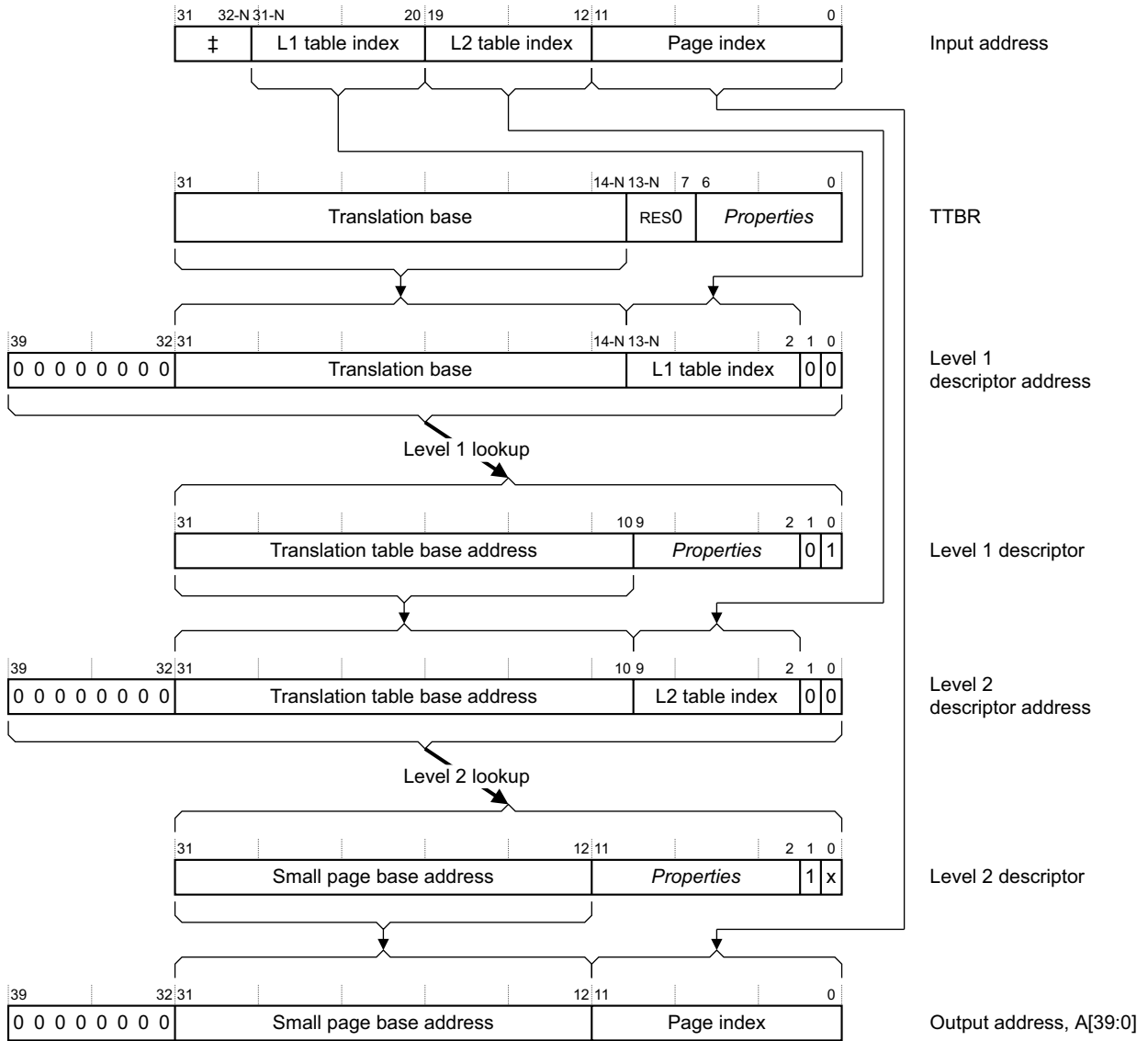

‡ This field is absent if N is 0
L1 = Level 1, L2 = Level 2
For a translation based on TTBR0, N is the value of TTBCR.N
For a translation based on TTBR1, N is 0
For details of *Properties* fields, see the register or descriptor description.

Figure K6-17 VMSAv8-32 Short-descriptor Small page address translation

The address and Properties fields shown in the translation flows

For the Non-secure PL1&0 stage 1 translation tables:

- Any descriptor address is the IPA of the required descriptor.
- The final output address is the IPA of the Section, Supersection, Large page, or Small page.

In these cases, a PL1&0 stage 2 translation is performed to translate the IPA to the required PA.

Otherwise, the address is the PA of the descriptor, Section, Supersection, Large page, or Small page.

Properties indicates register or translation table fields that return information, other than address information, about the translation or the targeted memory region. For more information see [Information returned by a translation table lookup on page G4-4572](#), and the description of the register or translation table descriptor.

For translations using the Short-descriptor translation table format, [VMSAv8-32 Short-descriptor translation table format descriptors on page G4-4577](#) describes the descriptors formats.

K6.2.2 Address translation examples using the VMSAv8-32 Long descriptor translation table format

As described in [Translation table walks, when using the VMSAv8-32 Long-descriptor translation table format on page G4-4600](#), in a translation table walk, only the first lookup uses the translation table base address from the appropriate [TTBR](#). Subsequent lookups use a combination of address information from:

- The table descriptor read in the previous lookup.
- The input address.

The following sections give examples of full VMSAv8-32 Long-descriptor format address translation flows, down to an entry for a 4KB page:

- [Full translation flow, starting at level 1 lookup on page K6-6199](#).
- [Full translation flow, starting at level 2 lookup on page K6-6200](#).

[The address and Properties fields shown in the translation flows](#) summarizes the information returned by the lookup.

Full translation flow, starting at level 1 lookup

Figure K6-18 shows the complete translation flow for a VMSAv8-32 Long-descriptor stage 1 translation table walk that starts with a level 1 lookup. For more information about the fields shown in the figure see *The address and Properties fields shown in the translation flows* on page K6-6198.

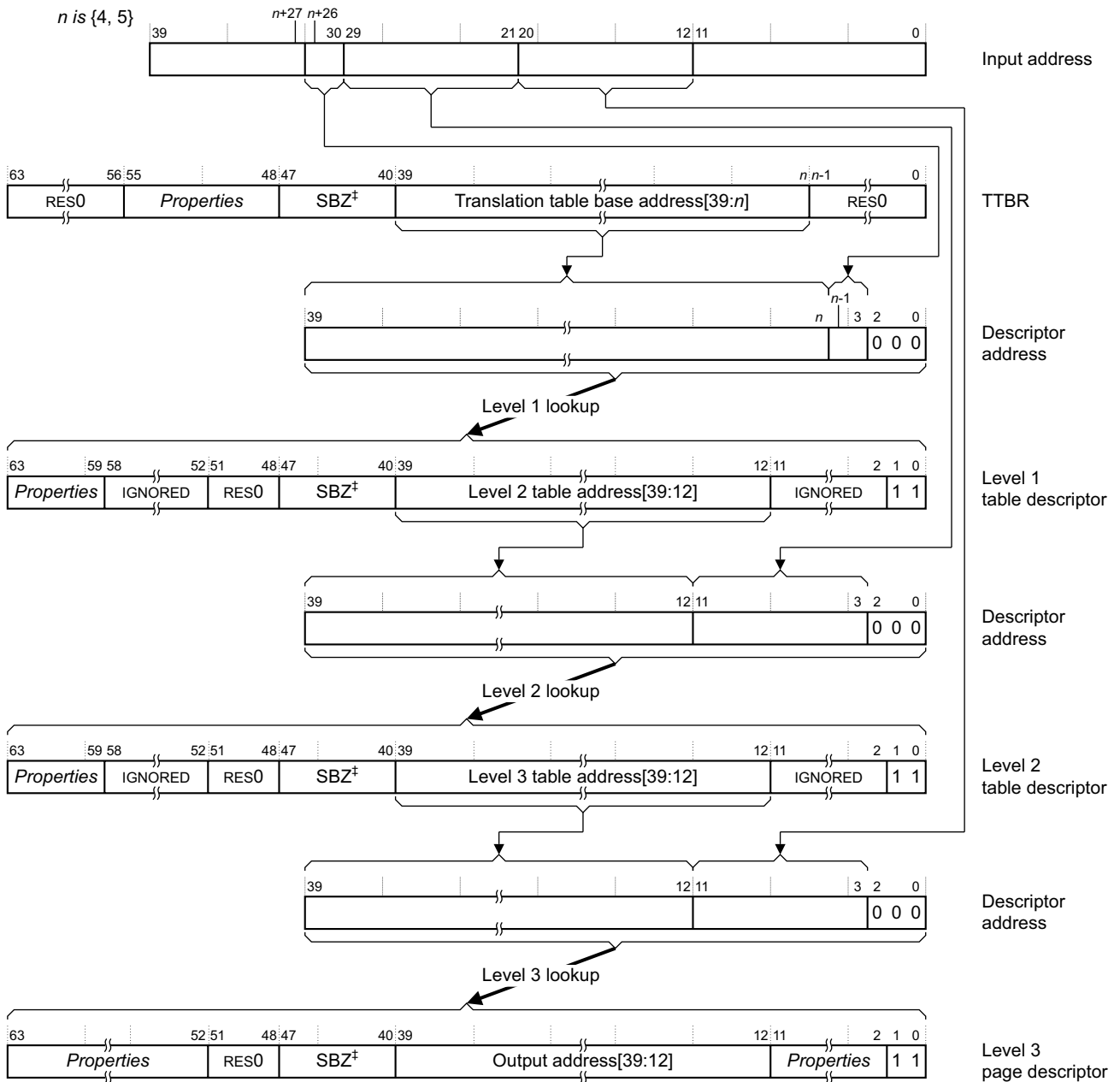

For details of *Properties* fields, see the register or descriptor description.

‡ See the lookup description for more information about bits[40:47] of the TTBR and descriptors

Figure K6-18 Complete VMSAv8-32 Long-descriptor format stage 1 translation, starting at level 1

If the level 1 lookup or the level 2 lookup returns a block descriptor then the translation table walk completes at that level.

If bits[47:40] of the TTBR or the descriptor are not zero then the lookup will generate an Address size fault, see *Address size fault* on page G4-4658.

A stage 2 translation that starts at a level 1 lookup differs from the translation shown in [Figure K6-18 on page K6-6199](#) only as follows:

- The possible values of n are 4-13, to support an input address of between 31 and 40 bits.
- A descriptor and output addresses are always PAs.

Full translation flow, starting at level 2 lookup

[Figure K6-19](#) shows the complete translation flow for a stage 1 VMSAv8-32 Long-descriptor translation table walk that starts at a level 2 lookup. For more information about the fields shown in the figure see [The address and Properties fields shown in the translation flows on page K6-6198](#).

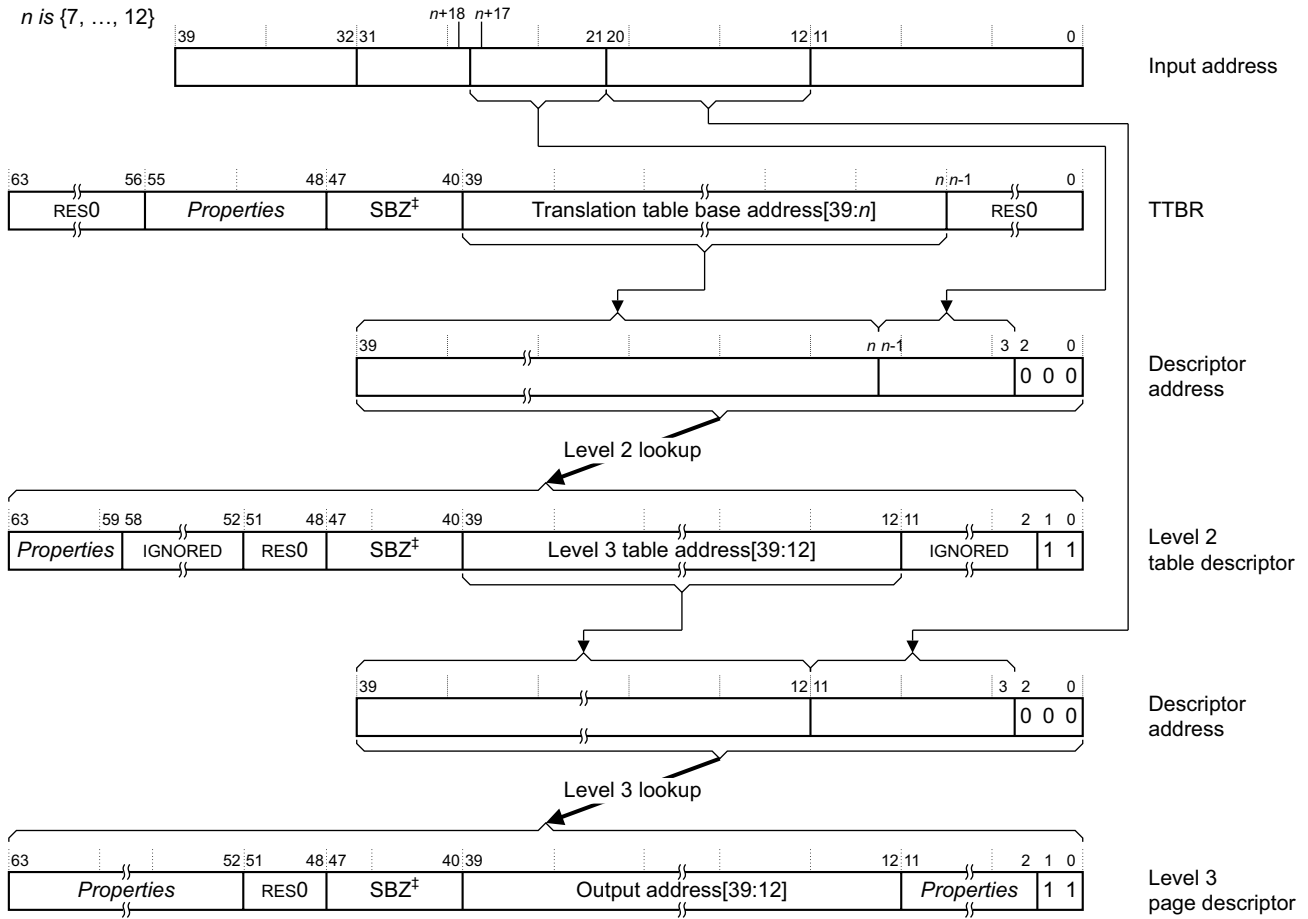

For details of *Properties* fields, see the register or descriptor description.
[‡] See the lookup description for more information about bits[40:47] of the TTBR and descriptors

Figure K6-19 Complete VMSAv8-32 Long-descriptor format stage 1 translation, starting at level 2

If the level 2 lookup returns a block descriptor then the translation table walk completes at that level.

If bits[47:40] of the **TTBR** or the descriptor are not zero then the lookup will generate an Address size fault, see [Address size fault on page G4-4658](#).

A stage 2 translation that starts at a level 2 lookup differs from the translation shown in [Figure K6-19](#) only as follows:

- The possible values of n are 7-16, to support an input address of up to 34 bits.
- The descriptor and output addresses are always PAs.

The address and Properties fields shown in the translation flows

For the Non-secure PL1&0 stage 1 translation:

- Any descriptor address is the IPA of the required descriptor.
- The final output address is the IPA of the block or page.

In these cases, a PL1&0 stage 2 translation is performed to translate the IPA to the required PA.

For all other translations, the final output address is the PA of the block or page, and any descriptor address is the PA of the descriptor.

Properties indicates register or translation table fields that return information, other than address information, about the translation or the targeted memory region. For more information see [Information returned by a translation table lookup on page G4-4572](#), and the description of the register or translation table descriptor.

For translations using the Long-descriptor translation table format, [VMSAv8-32 Long-descriptor translation table format descriptors on page G4-4586](#) describes the descriptors formats.

Appendix K7

Example OS Save and Restore Sequences

This appendix provides possible OS Save and Restore sequences for a v8 Debug implementation. It contains the following sections:

- [Save Debug registers on page K7-6204.](#)
- [Restore Debug registers on page K7-6206.](#)

K7.1 Save Debug registers

This section shows how to save the registers that are used by an external debugger.

; On entry, X0 points to a block to save the debug registers in.
 ; Returns the pointer beyond the block and corrupts X1-X3

SaveDebugRegisters

```
; (1) Set OS lock.
MOV    X2,#1                ; Set the OS lock. In AArch64 state, the OS lock
MSR    OSLAR_EL1,X2        ; is writable via OSLAR.
ISB                                ; Context synchronization event
```

```
; (2) Walk through the registers, saving them
MRS    X1,OSDTRRX_EL1      ; Read DTRRX
MRS    X2,OSDTRTX_EL1      ; Read DTRTX
STP    W1,W2,[X0],#8       ; Save { DTRRX, DTRTX }
MRS    X1,OSECCR_EL1       ; Read ECCR
MRS    X2,MDSCR_EL1        ; Read DSCR
STP    W1,W2,[X0],#8       ; Save { ECCR, DSCR }
[ AARCH32_SUPPORTED
MRS    X1,DBGVCR32_EL2     ; Read DBGVCR
MRS    X2,DBGCLAIMCLR_EL1  ; Read CLAIM - note, have to read via CLAIMCLR
STP    W1,W2,[X0],#8       ; Save { VCR, CLAIM }
]
```

```
; Macros for saving off a "register pair"
;; $WB      is W for watchpoint, B for breakpoint
;; $num     is the pair's number
;; X0 contains a pointer for the value words
;; X1 contains a pointer for the control words
;; W2 contains the max index
MACRO
SaveRP $WB,$num, $exit
MRS    X3,DBG$WB.VR$num._EL1 ; Read DBGxVRn
STR    X3,[X0],#8            ; Save { xVRn }
MRS    X3,DBG$WB.CR$num._EL1 ; Read DBGxCRn
STR    W3,[X0],#4            ; Save { xCRn }.
[ $num > 1 :LAND: $num < 15
CMP    W1,#$num
BEQ    $exit
]
MEND
```

```
; (3) Breakpoints
MRS    X1,ID_AA64DFR0_EL1
UBFX   W1,W1,#12,#4         ; Extract BRPs field
MACRO
SaveBRP $num                ; Save a Breakpoint Register Pair
SaveRP B,$num,SaveDebugRegisters_Watchpoints
MEND
SaveBRP 0
SaveBRP 1
SaveBRP 2
;; and so on to ...
SaveBRP 15
```

SaveDebugRegisters_Watchpoints

```
; (4) Watchpoints
MRS    X1,ID_AA64DFR0_EL1  ; Read DBGDIDR
UBFX   W1,W1,#20,#4        ; Extract WRPs field
MACRO
SaveWRP $num                ; Save a Watchpoint Register Pair
SaveRP W,$num,SaveDebugRegisters_Exit
MEND
SaveWRP 0
SaveWRP 1
SaveWRP 2
```

```
;; and so on to ...  
SaveWRP 15
```

```
SaveDebugRegisters_Exit
```

```
; (5) Return the pointer to first word not read. This pointer is already in X0, so  
; all that is needed is to return from this function. The OS double-lock (OSDLR_EL1.DLK) is  
; locked later, just before the final entry to WFI state.  
RET
```

K7.2 Restore Debug registers

This section shows how to restore the registers that are used by an external debugger.

; On entry, X0 points to a block of saved debug registers.
 ; Returns the pointer beyond the block and corrupts R1-R3,R12.

```
RestoreDebugRegisters
; (1) Lock OS lock. The lock will already be set, but this write is included to ensure it
; is locked.
MOV    X2,#1                ; Lock the OS lock. In AArch64 state, the OS lock
MSR    OSLAR_EL1,X2        ; is writable via OSLAR.
ISB                               ; Context synchronization event

MSR    MDSCR_EL1, XZR       ; Initialize MDSCR_EL1

; (2) Walk through the registers, restoring them
LDP    W1,W2,[X0],#8        ; Read { DTRRX,DTRTX }
MSR    OSDTRRX_EL1,X1      ; Restore DTRRX
MSR    OSDTRTX_EL1,X2      ; Restore DTRTX
LDP    W1,W3,[X0],#8        ; Read { DSCR, ECCR }
MSR    OSECCR_EL1,X2       ; Restore ECCR
[ AARCH32_SUPPORTED
LDP    W1,W2,[X0],#8        ; Read { VCR,CLAIM }
MSR    DBGVCR32_EL2,X1     ; Restore DBGVCR
MSR    DBGCLAIMSET_EL1,X2  ; Restore CLAIM - note, writes CLAIMSET
]

;; Macro for restoring a "register pair"
MACRO
RestoreRP $WB,$num,$exit
LDR    X3,[X0],#8          ; Read { xVRn }
MSR    DBG$WB.VR$num._EL1,X3 ; Restore DBGxVRn
LDR    W3,[X0],#4          ; Read { xCRn }
MSR    DBG$WB.CR$num._EL1,X3 ; Restore DBGxCRn
[ $num >= 1 :LAND: $num < 15
CMP    W1,#$num
BEQ    $exit
]
MEND

; (3) Breakpoints
MRS    X1,ID_AA64DFR0_EL1
UBFX   W1,W1,#12,#4        ; Extract BRPs field
MACRO
RestoreBRP $num            ; Restore a Breakpoint Register Pair
RestoreRP B,$num,RestoreDebugRegisters_Watchpoints
MEND
RestoreBRP 0
RestoreBRP 1
RestoreBRP 2
;; and so on until ...
RestoreBRP 15

RestoreDebugRegisters_Watchpoints
; (4) Watchpoints
MRS    X1,ID_AA64DFR0_EL1  ; Read DBGDIDR
UBFX   W1,W1,#20,#4        ; Extract WRPs field
MACRO
RestoreWRP $num            ; Restore a Watchpoint Register Pair
RestoreRP W,$num,RestoreDebugRegisters_Exit
MEND
RestoreWRP 0
RestoreWRP 1
RestoreWRP 2
;; and so on until ...
RestoreWRP 15
```

```
RestoreDebugRegisters_Exit
    MSR MDSCR_EL1, X3                ; Restore DSCR

    ; (5) Clear the OS lock.
    ISB
    MOV    X2,#0                    ; Clear the OS lock. In AArch64 state, the OS lock
    MSR    OSLAR_EL1,X2            ; is writable via OSLAR.

    ; (6) A final ISB guarantees the restored register values are visible to subsequent
    ; instructions.
    ISB

    ; (7) Return the pointer to first word not read. This pointer is already in X0, so
    ; all that is needed is to return from this function.
    RET
```

Appendix K8

Recommended Upload and Download Processes for External Debug

This appendix contains the following section:

- [Using memory access mode in AArch64 state on page K8-6210.](#)

———— **Note** —————

This description is not part of the ARM architecture specification. It is included here as supplementary information, for the convenience of developers and users who might find this information useful.

—————

K8.1 Using memory access mode in AArch64 state

Figure K8-1 and Figure K8-2 on page K8-6211 show the processes for using memory access mode to implement a download (external host to target) and an upload (target to external host).

To transfer n words of data:

- The download sequence needs $n+6$ accesses by the external debug interface.
- The upload sequence needs $n+8$ accesses by the external debug interface.

In both cases, in the innermost loop the debugger can make an external access to a DTR without polling `EDSCR` after each write as underrun and overrun detection prevent failure. Normally external accesses from the debugger are outpaced by the memory accesses of the PE, making underruns and overruns unlikely. If this is not the case, the `EDSCR.ERR` flag is set to 1. This is checked once at the end of the sequence, although a debugger can check it more often, for example once for each page. If the `EDSCR.ERR` flag is set to 1 because of overrun or underrun, the debugger can restart. The address to restart from is frozen in `X0`. `EDSCR.ERR` might also be set because of a Data abort.

If underruns and overruns are common, the debugger can pace itself accordingly.

———— **Note** ————

- The base address must be a multiple of 4.
- The order of the writes that set up the address does not matter in Debug state.

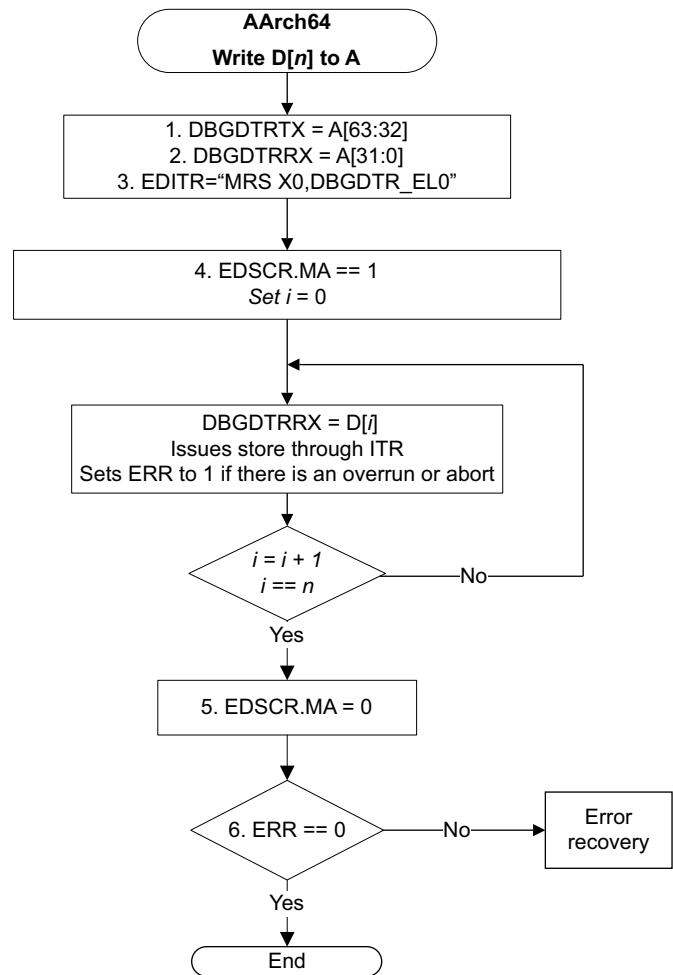

Figure K8-1 Fast code download in AArch64 state (external host to target)

In Figure K8-1 on page K8-6210, the sequence for the fast code download is as follows:

1. Setup. From the external debug interface:
 - a. Write address [31:0] to `DBGDTRRX_EL0`.
 - b. Write address [63:32] to `DBGDTRTX_EL0`.
 - c. Write `MRS X0, DBGDTR_EL0` to `EDITR`. The PE executes this instruction.
 - d. Set `EDSCR.MA` to 1.
2. Loop n times. From the external debug interface:
 - a. Write to `DBGDTRRX_EL0`. The PE reads the word from `DTRRX` and stores it to memory. It increments `X0` by 4.
3. Epilogue. From the external debug interface:
 - a. Clear `EDSCR.MA` to 0.
 - b. Read `EDSCR` to check for overruns or Data Aborts during download.

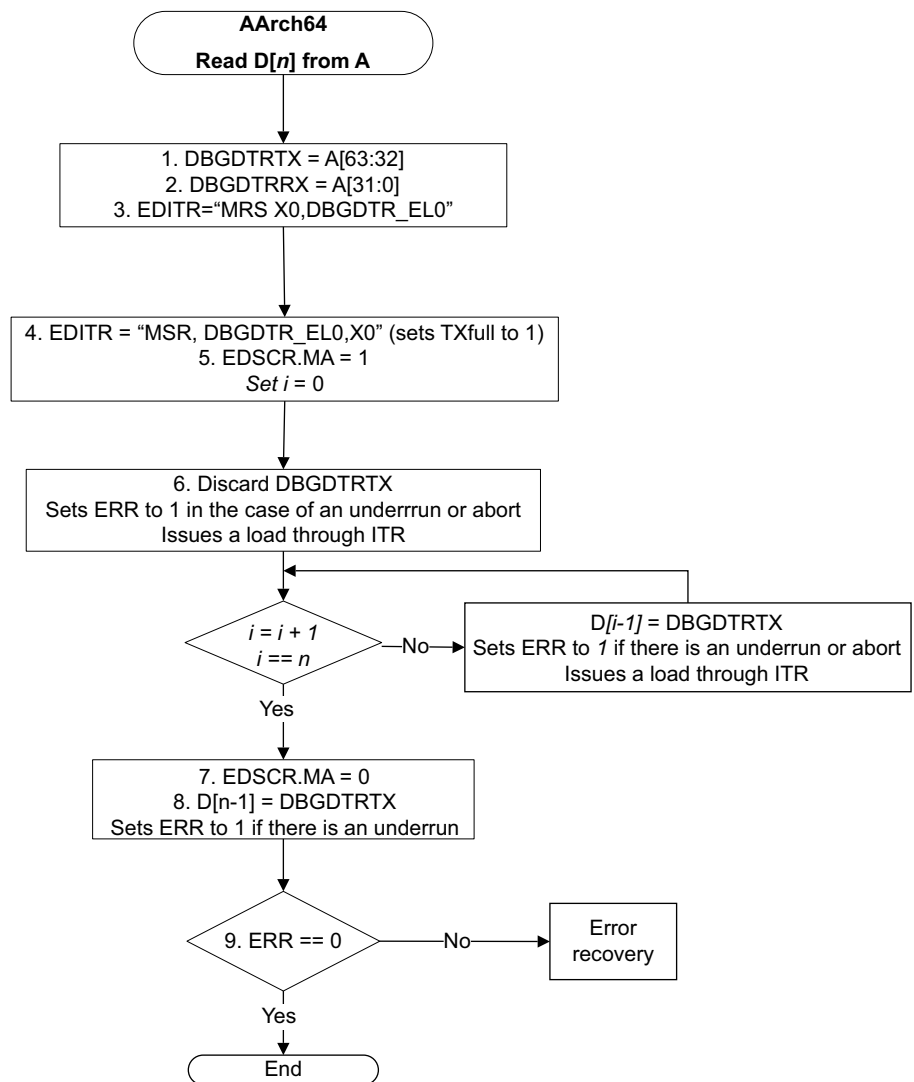

Figure K8-2 Fast data upload in AArch64 state (target to external host)

In Figure K8-2 on page K8-6211, the sequence for the fast code download is as follows:

1. Setup. From the external debug interface:
 - a. Write address [31:0] to `DBGDTRRX_EL0`.
 - b. Write address [63:32] to `DBGDTRTX_EL0`.
 - c. Write MRS `X0`, `DBGDTR_EL0` to `EDITR`.
 - d. Write MSR `DBGDTR_EL0`, `X0` to `EDITR`. This dummy operation ensures `EDSCR.TXfull == 1`.
 - e. Set `EDSCR.MA` to 1.
 - f. Read `DBGDTRTX_EL0` and discard the value. The PE returns the previous DTR value, loads the first word, and writes it to DTR. It increments `X0` by 4.
2. Loop $n-1$ times. From the external debug interface:
 - a. Read `DBGDTRTX_EL0`. The PE returns the previous DTRTX value, loads a new word, and writes it to DTRTX. It increments `X0` by 4.
3. Epilogue. From the external debug interface:
 - a. Clear `EDSCR.MA` to 0.
 - b. Read `DBGDTRTX_EL0` for the n^{th} value.
 - c. Read `EDSCR` to check for underruns, overruns or Data Aborts during upload.

Appendix K9

Barrier Litmus Tests

This appendix gives examples of the use of the barrier instructions provided by the ARMv8 architecture. It contains the following sections:

- [Introduction on page K9-6214.](#)
- [Load-Acquire, Store-Release and barriers on page K9-6217.](#)
- [Load-Acquire Exclusive, Store-Release Exclusive and barriers on page K9-6221.](#)
- [Using a mailbox to send an interrupt on page K9-6226.](#)
- [Cache and TLB maintenance instructions and barriers on page K9-6227.](#)
- [ARMv7 compatible approaches for ordering, using DMB and DSB barriers on page K9-6239.](#)

———— **Note** —————

This information is not part of the ARM architecture specification. It is included here as supplementary information, for the convenience of developers and users who might require this information.

K9.1 Introduction

The exact rules for the insertion of barriers into code sequences is a very complicated subject, and this appendix describes many of the corner cases and behaviors that are possible in an implementation of the ARMv8 architecture.

This appendix is to help programmers, hardware design engineers, and validation engineers understand the need for the different kinds of barriers.

K9.1.1 Overview of memory consistency

Early generations of microprocessors were relatively simple processing engines that executed each instruction in program order. In such processors, the effective behavior was that each instruction was executed in its entirety before a subsequent instruction started to be executed. This behavior is sometimes referred to as the *Sequential Execution Model* (SEM), and in this Manual it is described as *Simple sequential execution* of the program.

In later processor generations, the needs to increase processor performance, both in terms of the frequency of operation and the number of instructions executed each cycle, mean that such a simple form of execution is abandoned. Many techniques, such as pipelining, write buffering, caching, speculation, and out-of-order execution, are introduced to provide improved performance.

For general purpose PEs, such as ARM, these microarchitectural innovations are largely hidden from the programmer by a number of microarchitectural techniques. These techniques ensure that, within an individual PE, the behavior of the PE largely remains the same as the SEM. There are some exceptions to this where explicit synchronization is required. In the ARM architecture, these are limited to cases such as:

- Synchronization of changes to the instruction stream.
- Synchronization of changes to System registers.

In both these cases, the ISB instruction provides the necessary synchronization.

While the effect of ordering is largely hidden from the programmer within a single PE, the microarchitectural innovations have a profound impact on the ordering of memory accesses. Write buffering, speculation, and cache coherency protocols, in particular, can all mean that the order in which memory accesses occur, as seen by an external observer, differs significantly from the order of accesses that would appear in the SEM. This is usually invisible in a uniprocessor environment, but the effect becomes much more significant when multiple PEs are trying to communicate with memory. In reality, these effects are often only significant at particular synchronization boundaries between the different threads of execution.

The problems that arise from memory ordering considerations are sometimes described as the problem of *memory consistency*. Processor architectures have adopted one or more *memory consistency models*, or *memory models*, that describe the permitted limits of the memory re-ordering that can be performed by an implementation of the architecture. The comparison and categorization of these has generated significant research and comment in academic circles, and ARM recommends the *Memory Consistency Models for Shared Memory-Multiprocessors* paper as an excellent detailed treatment of this subject.

This appendix does not reproduce such a work, but instead concentrates on some cases that demonstrate the features of the weakly-ordered memory model of the ARM architecture from ARMv6. In particular, the examples show how the use of the DMB and DSB memory barrier instructions can provide the necessary safeguards to limit memory ordering effects at the required synchronization points.

K9.1.2 Barrier operation definitions

The following reference, or provide, definitions of terms used in this appendix:

DMB See *Data Memory Barrier (DMB)* on page B2-92.

DSB See *Data Synchronization Barrier (DSB)* on page B2-93.

ISB See *Instruction Synchronization Barrier (ISB)* on page B2-92.

Observer, Completion

See *Definition of the ARMv8 memory model* on page B2-86.

See *Completion and endpoint ordering* on page B2-91.

Program order

The order of instructions as they appear in an assembly language program. This appendix does not attempt to describe or define the legal transformations from a program written in a higher level programming language, such as C or C++, into the machine language that can then be disassembled to give an equivalent assembly language program. Such transformations are a function of the semantics of the higher level language and the capabilities and options on the compiler.

K9.1.3 Conventions

Many of the examples are written in a stylized extension to ARM assembler, to avoid confusing the examples with unnecessary code sequences.

AArch32

The construct `WAIT([Rx]==1)` describes the following sequence:

```
loop
  LDR R12, [Rx]
  CMP R12, #1
  BNE loop
```

Also, the construct `WAIT_ACQ([Rx]==1)` describes the following sequence:

```
loop
  LDA R12, [Rx]      ; load acquire ensures it is ordered before subsequent loads/stores
  CMP R12, #1
  BNE loop
```

R12 is chosen as an arbitrary temporary register that is not in use. It is named to permit the generation of a false dependency to ensure ordering.

AArch64

The construct `WAIT([Xx]==1)` describes the following sequence:

```
loop
  LDR W12, [Xx]
  CMP W12, #1
  B.NE loop
```

Also, the construct `WAIT_ACQ([Xx]==1)` and describes the following sequence:

```
loop
  LDAR W12, [Xx]    ; load acquire ensures it is ordered before subsequent loads/stores
  CMP W12, #1
  B.NE loop
```

For each example, a code sequence is preceded by an identifier of the observer running it:

- P0, P1...Px refer to caching coherent PEs that implement the ARMv8 architecture, and are in the same shareability domain.
- E0, E1...Ex refer to non-caching observers, that do not participate in the coherency protocol, but execute ARM instructions and have a weakly-ordered memory model. This does not preclude these observers being different objects, such as DMA engines or other system masters.

These observers are unsynchronized other than as required by the documented code sequence.

———— Note —————

Throughout this appendix, *ARM instruction* and *instruction* refer to instructions from the A64, A32, or T32 instruction set, provided by ARMv8 implementations.

Results are expressed in terms of <agent>:<register>, such as P0:R5. The results can be described as:

Permissible This does not imply that the results expressed are required or are the only possible results. In most cases they are results that would not be possible under a sequentially consistent running of the code sequences on the agents involved. In general terms, this means that these results might be unexpected to anyone unfamiliar with memory consistency issues.

Not permissible Results that the architecture expressly forbids.

Required Results that the architecture expressly requires.

The examples omit the required shareability domain arguments of DMB and DSB instructions. The arguments are assumed to be selected appropriately for the shareability domains of the observers.

In AArch32 state, where the barrier function in the litmus test can be achieved by a DMB ST, that is a barrier to stores only, this is shown by the use of DMB [ST]. This indicates that the ST qualifier can be omitted without affecting the result of the test. In some implementations DMB ST is faster than DMB.

For AArch64 code, the shareability domain of the DMB or DSB must be included. This is shown in this manual using the notation DMB <domain> and DSB <domain> respectively.

Except where otherwise stated, other conventions are:

- All memory initializes to 0.
- R0 and W0 contain the value 1.
- R1 - R4 and W1 - W4 contain arbitrary independent addresses that initialize to the same value on all PEs. The addresses held in these registers are shareable and:
 - The addresses held in R1 and R2 are in Write-Back Cacheable Normal memory.
 - The address held in R3 is in Write-Through Cacheable Normal memory.
 - The address held in R4 is in Non-cacheable Normal memory.
- R5 - R8 and W5 - W8 contain:
 - When used with an STR instruction, 0x55, 0x66, 0x77, and 0x88 respectively.
 - When used with an LDR instruction, the value 0.
- R11 and W11 contain a new instruction or new translation table entry, as appropriate, and R10 contains the virtual address and the ASID, for use in this change of translation table entry.
- Memory locations are Normal memory locations unless otherwise stated.

The examples use mnemonics for the cache maintenance and TLB maintenance instructions. The following tables describe the mnemonics:

- [Cache maintenance instructions, functional group on page G4-4734.](#)
- [TLB maintenance instructions, functional group on page G4-4735.](#)

K9.2 Load-Acquire, Store-Release and barriers

The Load-Acquire and Store-Release instructions are described in [Load-Acquire, Store-Release](#) on page B2-94.

The following sections show that most of the examples in sections [Simple ordering and barrier cases](#) on page K9-6239 and [Load-Exclusive, Store-Exclusive and barriers](#) on page K9-6243 can be achieved using the Load-Acquire and Store-Release instructions without the need for additional barriers.

K9.2.1 Message passing

The following sections describe:

- [Resolving weakly-ordered message passing by using Acquire and Release.](#)
- [Resolving message passing by the use of Store-Release and address dependency](#) on page K9-6218.

Resolving weakly-ordered message passing by using Acquire and Release

The message passing problem described in [Weakly-ordered message passing problem](#) on page K9-6239 can be solved by the use of Load-Acquire and Store-Release instructions when accessing the communications flag:

AArch32

P1

```
STR R5, [R1]           ; sets new data
STL R0, [R2]           ; sends flag indicating data ready, which is ordered after the STR
```

P2

```
WAIT_ACQ([R2]==1)     ; waits on flag
LDR R5, [R1]
```

AArch64

P1

```
STR W5, [X1]           ; sets new data
STLR W0, [X2]          ; sends flag indicating data ready, which is ordered after the STR
```

P2

```
WAIT_ACQ([X2]==1)     ; waits on flag
LDR W5, [X1]
```

This ensures the observed order of both the reads and the writes allows transfer of data such that the result P2:R5==0x55 is guaranteed.

This approach also works with multiple observers, in a way that further observers use the same sequence as P2 uses:

AArch32

P3

```
WAIT_ACQ([R2]==1)     ; waits on flag
LDR R5, [R1]
```

AArch64

P3

```
WAIT_ACQ([X2]==1)     ; waits on flag
LDR W5, [X1]
```

Resolving message passing by the use of Store-Release and address dependency

The lack of ordering of stores discussed in *Message passing with multiple observers* on page K9-6241 can be resolved by the use of Store-Release for the store of the valid flag by P1, even when the observers are using an address dependency:

AArch32

P1

```
STR R5, [R1]          ; sets new data
STL R0, [R2]          ; sends flag indicating data ready using a Store-Release
```

P2

```
WAIT([R2]==1)
AND R12, R12, #0      ; R12 is the destination of LDR in the WAIT macro
LDR R5, [R1, R12]    ; the load has an address dependency on R12
                     ; and so is ordered after the flag has been seen
```

AArch64

P1

```
STR W5, [X1]          ; sets new data
STLR W0, [X2]         ; sends flag indicating data ready using a Store-Release
```

P2

```
WAIT([X2]==1)
AND W12, W12, WZR     ; W12 is the destination of LDR in the WAIT macro
LDR W5, [X1, X12]    ; the load has an address dependency on W12
                     ; and so is ordered after the flag has been seen
```

This ensures the observed order of the writes allows transfer of data such that P2:R5 and P3:R5 contain the same value of 0x55.

This approach also works with multiple observers, in a way that further observers use the same sequence as P2 uses:

AArch32

P3

```
WAIT([R2]==1)
AND R12, R12, #0      ; R12 is the destination of LDR in the WAIT macro
LDR R5, [R1, R12]    ; the load has an address dependency on R12
                     ; and so is ordered after the flag has been seen
```

AArch64

P3

```
WAIT([X2]==1)
AND W12, W12, WZR     ; R12 is the destination of LDR in the WAIT macro
LDR W5, [X1, X12]    ; the load has an address dependency on W12
                     ; and so is ordered after the flag has been seen
```

K9.2.2 Address dependency with object construction

When accessing an object-oriented data structure, the address dependency rule means that barriers are not required, even when initializing the object. A Store-Release can be used to ensure the order of the update of the base address:

AArch32

P1

```
STR R5, [R1, #offset] ; sets new data in a field
STL R1, [R2]           ; updates base address
```

P2

```
LDR R1, [R2]           ; reads base address
CMP R1, #0             ; checks if it is valid
BEQ null_trap
LDR R5, [R1, #offset] ; uses base address to read field
```

AArch64

P1

```
STR W5, [X1, #offset] ; sets new data in a field
STLR X1, [X2]          ; updates base address
```

P2

```
LDR X1, [X2]           ; reads base address
CMP X1, #0             ; check if it is valid
B.EQ null_trap
LDR W5, [X1, #offset] ; uses base address to read field
```

It is required that P2:R5==0x55 if the null_trap is not taken. This avoids P2 observing a partially constructed object from P1. Significantly, P2 does not need a barrier to ensure this behavior.

The read of the base address in P2 could be a Load-Acquire, but it is not necessary in this case.

K9.2.3 WFE and WFI and barriers

The Wait For Event and Wait For Interrupt instructions permit the PE to suspend execution and enter a low-power state. An explicit DSB barrier instruction is required if it is necessary to ensure memory accesses made before the WFI or WFE are visible to other observers, unless some other mechanism has ensured this visibility. Examples of other mechanism that would guarantee the required visibility are the DMB described in [Posting a store before polling for acknowledgement on page K9-6242](#), or a dependency on a load.

The following example requires the DSB to ensure that the store is visible:

AArch32

```
P1
    STR R0, [R2]
    DSB
Loop
    WFI
    B Loop
```

AArch64

```
P1
    STR W0, [X2]
    DSB <domain>
Loop
    WFI
    B Loop
```

This requirement is unchanged in ARMv8 by the presence of Load-Acquire or Store-Release.

K9.3 Load-Acquire Exclusive, Store-Release Exclusive and barriers

The ARMv8 architecture adds the acquire and release semantics to Load-Exclusive and Store-Exclusive instructions, which allows them to gain ordering acquire and/or release semantics.

The Load-Exclusive instruction can be specified to have acquire semantics, and the Store-Exclusive instruction can be specified to have release semantics. These can be arbitrarily combined to allow the atomic update created by a successful Load-Exclusive and Store-Exclusive pair to have any of:

- No Ordering semantics (using LDREX and STREX).
- Acquire only semantics (using LDAEX and STREX).
- Release only semantics (using LDREX and STLEX).
- Sequentially consistent semantics (using LDAEX and STLEX).

In addition, the ARMv8 specification requires that the clearing of a global monitor will generate an event for the PE associated with the global monitor, which can simplify the use of WFE, by removing the need for a DSB barrier and SEV instruction.

K9.3.1 Acquiring a lock

A common use of Load-Exclusive and Store-Exclusive instructions is to claim a lock to permit entry into a critical region. This is typically performed by testing a lock variable that indicates 0 for a free lock and some other value, commonly 1 or an identifier of the process holding the lock, for a taken lock.

For a critical region, the requirement on taking a lock is usually for acquire semantics, while the clearing of a lock requires release semantics:

AArch32

```
Px
    PLDW[R1]          ; preload into cache in unique state
Loop
    LDAEX R5, [R1]    ; read lock with acquire
    CMP R5, #0        ; check if 0
    STREXEQ R5, R0, [R1] ; attempt to store new value
    CMPEQ R5, #0      ; test if store succeeded
    BNE Loop          ; retry if not

    ; loads and stores in the critical region can now be performed
```

AArch64

```
Px
    PRFM PSTL1KEEP, [X1] ; preload into cache in unique state
Loop
    LDAXR W5, [X1]       ; read lock with acquire
    CBNZ W5, Loop        ; check if 0
    STXR W5, W0, [X1]    ; attempt to store new value
    CBNZ W5, Loop        ; test if store succeeded and retry if not

    ; loads and stores in the critical region can now be performed
```

The acquire associated with the load is sufficient to ensure the required ordering in a lock situation. The Store-Exclusive will fail (and so be retried) if there is a store to the location being monitored between the Load-Exclusive and the Store-Exclusive.

K9.3.2 Releasing a lock

The converse operation of releasing a lock does not require the use of Load-Exclusive and Store-Exclusive instructions, because only a single observer is able to write to the lock. However, often it is necessary for any observer to observe any memory updates, or any values that are loaded into memory, before they observe the release of the lock. Therefore, the lock release needs release semantics:

AArch32

```
Px
; loads and stores in the critical region
MOV R0, #0
STL R0, [R1] ; clear the lock with release semantics
```

AArch64

```
Px
; loads and stores in the critical region
STLR WZR, [X1] ; clear the lock with release semantics
```

K9.3.3 Ticket locks

When a lock is free, in order to avoid a rush to get the lock by many PEs, the use of ticket locks is common in more advanced systems. When the use is requested, the ticket locks determine the order of the users of the critical sections, in order to avoid starvation that can occur with a simple contention based spin lock.

A ticket lock allocates each thread a ticket number when it first requests the lock, and then compares that number with the current number for the lock. If they are the same, then the critical section can be entered. Otherwise the thread waits until the current number is equal to the ticket number for that thread.

The reading of the current number of the lock needs acquire semantics for the lock to be acquired.

———— Note ————

The code in this section is little-endian code, as it views the combined current and next values as a single combined quantity. The addresses of the current and next ticket values need to be adjusted for a big-endian system.

This is shown in the implementation below:

AArch32

```
Px
; R1 holds two 16 bit quantities
; the lower halfword holds the current ticket number
; the higher halfword holds the next ticket number

PLDW[R1] ; preload into cache in unique state
Loop1
LDAEX R5, [R1] ; read current and next
ADD R5, R5, #0x10000 ; increment the next number
STREX R6, R5, [R1] ; and update the value
CMP R6, #0 ; did the exclusive pass
BNE Loop1 ; retry if not
CMP R5, R5, ROR #16 ; is the current ticket ours
BEQ block_start
Loop2
LDAH R6, [R1] ; read current value
CMP R6, R5, LSR #16 ; compare it with our allocated ticket
BNE Loop2 ; retry (spin) if it is not the same
block_start
```

AArch64

```
Px
    ; X1 holds 2 16 bit quantities
    ; the lower halfword holds the current ticket number
    ; the higher halfword holds the next ticket number

    PRFM PSTL1KEEP, [X1] ; preload into cache in unique state
Loop1
    LDAXR W5, [X1] ; read current and next
    ADD W5, W5, #0x10000 ; increment the next number
    STXR W6, W5, [X1] ; and update the value
    CBNZ W6, Loop1 ; did the exclusive pass - retry if not

    AND W6, W5, #0xFFFF
    CMP W6, W5, LSR #16 ; is the current ticket ours
    B.EQ block_start
Loop2
    LDARH W6, [X1] ; read current value
    CMP W6, W5, LSR #16 ; compare it with the our allocated ticket
    B.NE Loop2 ; retry (spin) if it isn't the same
block_start
```

Releasing the ticket lock simply involves incrementing the current ticket number, that is still assumed to be in R3, and doing a Store-Release:

AArch32

```
ADD R6, R6, #1
STLH R6, [R1]
```

AArch64

```
ADD W6, W6, #1
STLRH W6, [X1]
```

K9.3.4 Use of Wait For Event (WFE) and Send Event (SEV) with locks

The ARMv8 architecture can use the Wait For Event mechanism to minimise the energy cost of polling variables by putting the PE into a low power state, suspending execution, until an asynchronous exception or an explicit event is seen by that PE. In ARMv8, the event can be generated as a result of clearing the global monitor, so removing the need for a DSB barrier or an explicit send event message.

This can be used with simple locks or with ticket locks.

Simple lock

The following is an example of lock acquire code using WFE:

AArch32

```
Px
    PLDW[R1] ; preload into cache in unique state
Loop
    LDAEX R5, [R1] ; read lock with acquire
    CMP R5, #0 ; check if 0
    WFENE ; sleep if the lock is held
    STREXEQ R5, R0, [R1] ; attempt to store new value
    CMPEQ R5, #0 ; test if store succeeded
    BNE Loop ; retry if not
```

AArch64

Px

```
    SEVL                ; invalidates the WFE on the first loop iteration
    PRFM PSTL1KEEP, [X1] ; allocate into cache in unique state
Loop
    WFE
    LDAXR W5, [X1]      ; read lock with acquire
    CBNZ W5, Loop       ; check if 0
    STXR W5, W0, [X1]   ; attempt to store new value
    CBNZ W5, Loop       ; test if store succeeded and retry if not

    ; loads and stores in the critical region can now be performed
```

And the following is an example of lock release code:

AArch32

Px

```
    ; loads and stores in the critical region
    MOV R0, #0
    STL R0, [R1]        ; clear the lock
```

AArch64

Px

```
    ; loads and stores in the critical region
    STLR WZR, [X1]     ; clear the lock
```

Ticket lock

In the Ticket lock case, the Load-Exclusive instruction can be used to move the monitor into the exclusive state for the express purpose of creating an event when the monitor changes state:

AArch32

Px

```
    ; R1 holds 2 16 bit quantities
    ; the lower halfword holds the current ticket number
    ; the higher halfword holds the next ticket number

    PLDW[R1]           ; preload into cache in unique state
Loop1
    LDAEX R5, [R1]     ; read current and next
    ADD R5, R5, #0x10000 ; increment the next number
    STREX R6, R5, [R1] ; and update the value
    CMP R6, #0         ; did the exclusive pass
    BNE Loop           ; retry if not
    CMP R5, R5, ROR #16 ; is the current ticket ours
    BEQ block_start
    SEVL
Loop2
    WFE                ; wait if there has not been a change to the count since last
                       ; read
    LDAEXH R6, [R1]    ; check the current count
    CMP R6, R5, LSR #16 ; check if it is equal
    BNE Loop2
block_start
```

AArch64

Px

```
; X1 holds 2 16 bit quantities
; the lower halfword holds the current ticket number
; the higher halfword holds the next ticket number

PRFM PSTL1KEEP, [X1] ; preload into cache in unique state
Loop1
LDAXR W5, [X1] ; read current and next
ADD W5, W5, #0x10000 ; increment the next number
STXR W6, W5, [X1] ; and update the value
CBNZ W6, Loop1 ; did the exclusive pass - retry if not

AND W6, W5, 0xFFFF
CMP W6, W5, LSR #16 ; is the current ticket ours
B.EQ block_start
SEVL
Loop2
WFE
LDAXRH W6, [X1] ; read current value
CMP W6, W5, LSR #16 ; compare it with our allocated ticket
B.NE Loop2 ; retry (spin) if it is not the same
block_start
```

K9.4 Using a mailbox to send an interrupt

In some message passing systems, it is common for one observer to update memory and then notify a second observer of the update by sending an interrupt, using a mailbox.

Although a memory access might be made to initiate the sending of the mailbox interrupt, a DSB instruction is required to ensure the completion of previous memory accesses.

Therefore, the following sequence is required to ensure that P2 observes the updated value:

AArch32

P1

```
STR R5, [R1]          ; message stored to shared memory location
DSB ST
STR R0, [R4]          ; R4 contains the address of a mailbox
```

P2

```
; interrupt service routine
LDR R5, [R1]
```

AArch64

P1

```
STR W5, [X1]          ; message stored to shared memory location
DSB ST
STR W0, [X4]          ; R4 contains the address of a mailbox
```

P2

```
; interrupt service routine
LDR W5, [X1]
```

K9.5 Cache and TLB maintenance instructions and barriers

The following sections describe the use of barriers with cache and TLB maintenance instructions:

- [Data cache maintenance instructions](#).
- [Instruction cache maintenance instructions on page K9-6231](#).
- [TLB maintenance instructions and barriers on page K9-6234](#).

K9.5.1 Data cache maintenance instructions

The following sections describe the use of barriers with data cache maintenance instructions:

- [Message passing to non-caching observers](#).
- [Multiprocessing message passing to non-caching observers on page K9-6228](#).
- [Invalidating DMA buffers, non-functional example on page K9-6229](#).
- [Invalidating DMA buffers, functional example with single PE on page K9-6229](#).
- [Invalidating DMA buffers, functional example with multiple coherent PEs on page K9-6230](#).

Message passing to non-caching observers

The ARMv8 architecture requires the use of DMB instructions to ensure the ordering of data cache maintenance instructions and their effects. The Load-Acquire and Store-Release instructions have no effect on cache maintenance instruction. This means the following message passing approaches can be used when communicating between caching observers and non-caching observers:

AArch32

P1

```
STR R5, [R1]           ; updates data (assumed to be in P1 cache)
DCCMVAC R1             ; cleans cache to point of coherency
DMB                   ; ensures effects of the clean will be observed before the
                       ; flag is set
STR R0, [R4]          ; sends flag to external agent (Non-cacheable location)
```

E1

```
WAIT_ACQ ([R4] == 1) ; waits for the flag (with order)
LDR R5, [R1]         ; reads the data
```

AArch64

P1

```
STR W5, [X1]          ; updates data (assumed to be in P1 cache)
DC CVAC, X1           ; cleans cache to point of coherency
DMB ISH               ; ensures effects of the clean will be observed before the
                       ; flag is set
STR W0, [X4]          ; sends flag to external agent (Non-cacheable location)
```

E1

```
WAIT_ACQ ([X4] == 1) ; waits for the flag (with order)
LDR W5, [X1]         ; reads the data
```

In this example, it is required that E1:R5==0x55.

Multiprocessing message passing to non-caching observers

The broadcast nature of the cache maintenance instructions combined with properties of barriers, means that the message passing principle for non-caching observers is:

AArch32

P1

```
STR R5, [R1]      ; updates data (assumed to be in P1 cache)
STL R0, [R2]      ; sends a flag for P2 (ordered by the store release)
```

P2

```
WAIT ([R2] == 1) ; waits for P1 flag
DMB              ; ensures cache clean is observed after P1 flag is observed
DCCMVAC R1       ; cleans cache to point of coherency - will clean P1 cache
DMB              ; ensures effects of the clean will be observed before the
                 ; flag to E1 is set
STR R0, [R4]     ; sends flag to E1
```

E1

```
WAIT_ACQ ([R4] == 1) ; waits for P2 flag (ordered)
LDR R5, [R1]         ; reads data
```

AArch64

P1

```
STR W5, [X1]      ; updates data (assumed to be in P1 cache)
STLR W0, [X2]     ; sends a flag for P2 (ordered)
```

P2

```
WAIT ([X2] == 1) ; waits sfor P1 flag
DMB SY           ; ensure cache clean is observed after P1 flag is observed
DC CVAC, X1      ; cleans cache to point of coherency, will clean P1 cache
DMB SY           ; ensures effects of the clean will be observed before the
                 ; flag to E1 is set
STR W0, [X4]     ; sends flag to E1
```

E1

```
WAIT_ACQ ([X4] == 1) ; waits for P2 flag
LDR W5, [X1]         ; reads data
```

In this example, it is required that E1:R5==0x55. The clean operation executed by P2 affects the data location in the P1 cache. The cast-out from the P1 cache is guaranteed to be observed before P2 updates [R4].

————— Note —————

The cache maintenance instructions are not ordered by the Load-Acquire and Store-Release instructions.

Invalidate DMA buffers, non-functional example

The basic scheme for communicating with an external observer that is a process that passes data in to a Cacheable memory region must take account of the architectural requirement that regions with a Normal Cacheable attribute can be allocated into a cache at any time, for example as a result of speculation. The following example shows this possibility:

AArch32

P1

```
DCIMVAC R1      ; ensures cache is not dirty. A clean operation could be used
                ; but as the DMA will subsequently overwrite this region an
                ; invalidate operation is sufficient and usually more efficient
DMB             ; ensures cache invalidation is observed before the next store
                ; is observed
STR R0, [R3]    ; sends flag to external agent
WAIT_ACQ ([R4]==1) ; waits for a different flag from an external agent
LDR R5, [R1]
```

E1

```
WAIT ([R3] == 1) ; waits for flag
STR R5, [R1]     ; stores new data
STL R0, [R4]     ; sends a flag
```

AArch64

P1

```
DC IVAC, X1     ; ensure cache is not dirty. A clean operation could be used
                ; but as the DMA will subsequently overwrite this region an
                ; invalidate operation is sufficient and usually more efficient
DMB SY         ; ensures cache invalidation is observed before the next store
                ; is observed
STR W0, [X3]    ; sends flag to external agent
WAIT_ACQ ([X4]==1) ; waits for a different flag from an external agent
LDR W5, [X1]
```

E1

```
WAIT ([X3] == 1) ; waits for flag
STR W5, [X1]     ; stores new data
STLR W0, [X4]    ; sends a flag
```

If a speculative access occurs, there is no guarantee that the cache line containing [R1] is not brought back into the cache after the cache invalidation, but before [R1] is written by E1. Therefore, the result P1:R5=0 is permissible.

Invalidate DMA buffers, functional example with single PE

AArch32

P1

```
DCIMVAC R1      ; ensures cache is not dirty. A clean operation could be used
                ; but as the DMA will subsequently overwrite this region an
                ; invalidate operation is sufficient and usually more efficient
DMB             ; ensures cache invalidation is observed before the next store
                ; is observed
STR R0, [R3]    ; sends flag to external agent
WAIT ([R4]==1) ; waits for a different flag from an external agent
DMB            ; ensures that cache invalidate is observed after the flag
                ; from external agent is observed
DCIMVAC R1      ; ensures cache discards stale copies before use
LDR R5, [R1]
```

E1

```
WAIT ([R3] == 1) ; waits for flag
```

```
STR R5, [R1]      ; stores new data
STL R0, [R4]      ; sends a flag
```

AArch64

P1

```
DC IVAC, X1      ; ensures cache is not dirty. A clean operation could be used
                  ; but as the DMA will subsequently overwrite this region an
                  ; invalidate operation is sufficient and usually more efficient
DMB SY           ; ensures cache invalidation is observed before the next store
                  ; is observed
STR W0, [X3]     ; sends flag to external agent
WAIT ([X4]==1)   ; waits for a different flag from an external agent
DMB SY           ; ensures that cache invalidate is observed after the flag
                  ; from external agent is observed
DC IVAC, X1     ; ensures cache discards stale copies before use
LDR W5, [X1]
```

E1

```
WAIT ([X3] == 1) ; waits for flag
STR W5, [X1]     ; stores new data
STLR W0, [X4]    ; sends a flag
```

In this example, the result P1:R5 == 0x55 is required. Including a cache invalidation after the store by E1 to [R1] is observed ensures that the line is fetched from external memory after it has been updated.

Invalidating DMA buffers, functional example with multiple coherent PEs

The broadcasting of cache maintenance instructions, and the use of DMB instructions to ensure their observability, means that the previous example extends naturally to a multiprocessor system. Typically this requires a transfer of ownership of the region that the external observer is updating.

AArch32

P0

```
(Use data from [R1], potentially using [R1] as scratch space)
STL R0, [R2]      ; signals release of [R1]
WAIT_ACQ ([R2] == 0) ; waits for new value from DMA
LDR R5, [R1]
```

P1

```
WAIT ([R2] == 1) ; waits for release of [R1] by P0
DCIMVAC R1      ; ensures caches are not dirty, an invalidate is sufficient
DMB
STR R0, [R3]    ; requests new data for [R1]
WAIT ([R4] == 1) ; waits for new data
DMB
DCIMVAC R1      ; ensures caches discard stale copies before use
DMB
MOV R0, #0
STR R0, [R2]    ; signals availability of new [R1]
```

E1

```
WAIT ([R3] == 1) ; waits for new data request
STR R5, [R1]     ; sends new [R1]
DMB [ST]
STR R0, [R4]     ; indicates that new data is available to P1
```

AArch64

P0

```
(Use data from [X1], potentially using [X1] as scratch space)
STLR W0, [X2]    ; signals release of [X1]
```

```
WAIT_ACQ ([X2] == 0) ; waits for new value from DMA
LDR W5, [X1]
```

P1

```
WAIT ([X2] == 1) ; waits for release of [R1] by P0
DC IVAC, X1 ; ensures caches are not dirty, an invalidate is sufficient
DMB SY
STR W0, [X3] ; requests new data for [R1]
WAIT ([X4] == 1) ; waits for new data
DMB SY
DCIMVAC X1 ; ensures caches discard stale copies before use
DMB SY
STR WZR, [X2] ; signals availability of new [R1]
```

E1

```
WAIT ([X3] == 1) ; waits for new data request
STR W5, [X1] ; sends new [R1]
STR W0, [X4] ; indicates new data is available to P1
```

In this example, the result P0:R5 == 0x55 is required. The DMB issued by P1 after the first data cache invalidation ensures that effect of the cache invalidation on P0 is seen by E1 before the store by E1 to [R1]. The DMB issued by P1 after the second data cache invalidation ensures that its effects are seen before the store of 0 to the semaphore location in [R2].

K9.5.2 Instruction cache maintenance instructions

The following sections describe the use of barriers with instruction cache maintenance instructions:

- [Ensuring the visibility of updates to instructions for a uniprocessor.](#)
- [Ensuring the visibility of updates to instructions for a multiprocessor on page K9-6232.](#)

Ensuring the visibility of updates to instructions for a uniprocessor

On a single PE, the agent that causes instruction fetches, or instruction cache linefills, is a separate memory system observer from the agent that causes data accesses. Therefore, any operations to invalidate the instruction cache can rely only on seeing updates to memory that are complete. This must be ensured by the use of a DSB instruction.

Also, instruction cache maintenance instructions are only guaranteed to complete after the execution of a DSB, and an ISB is required to discard any instructions that might have been prefetched before the instruction cache invalidation completed. Therefore, on a uniprocessor, to ensure the visibility of an update to code and to branch to it, the following sequence is required:

AArch32

P1

```
STR R11, [R1] ; R11 contains a new instruction to be stored in program memory
DCCMVAU R1 ; clean to PoU makes the new instruction visible to the instruction cache
DSB
ICIMVAU R1 ; ensures instruction cache/branch predictor discards stale data
BPIMVA R1
DSB ; ensures completion of the invalidation
ISB ; ensures instruction fetch path sees new instruction cache state
BX R1
```

In AArch64 state, the branch predictor maintenance is not required.

AArch64

P1

```
STR W11, [X1] ; W11 contains a new instruction to be stored in program memory
DC CVAU, X1 ; clean to PoU makes the new instruction visible to instruction cache
DSB ISH
IC IVAU, X1 ; ensures instruction cache/branch predictor discards stale data
```

```
DSB ISH          ; ensures completion of the invalidation
ISB              ; ensures instruction fetch path sees new instruction cache state
BR X1
```

———— **Note** ————

Where the changes to the instructions span multiple cache lines, then the data cache and instruction cache maintenance instructions can be duplicated to cover each of the lines to be cleaned and to be invalidated.

Ensuring the visibility of updates to instructions for a multiprocessor

The ARMv8 architecture requires a PE that executes an instruction cache maintenance instruction to execute a DSB instruction to ensure completion of the maintenance operation. This ensures that the cache maintenance instruction is complete on all PEs in the Inner Shareable shareability domain.

An ISB is not broadcast, and so does not affect other PEs. This means that any other PE must perform its own ISB synchronization after it knows that the update is visible, if it is necessary to ensure its synchronization with the update. The following example shows how this might be done:

AArch32

P1

```
STR R11, [R1]    ; R11 contains a new instruction to be stored in program memory
DCCMVAU R1      ; clean to PoU makes the new instruction visible to the instruction cache
DSB             ; ensures completion of the clean on all PEs
ICIMVAU R1      ; ensures instruction cache discards stale data
BPIMVA R        ; ensures branch predictor discards stale data
DSB             ; ensures completion of the instruction cache and branch predictor
                ; invalidation on all PEs
STR R0, [R2]    ; sets flag to signal completion
ISB             ; synchronizes context on this PE
BX R1           ; branches to new code
```

P2-Px

```
WAIT ([R2] == 1) ; waits for flag signalling completion
ISB              ; synchronizes context on this PE
BX R1           ; branches to new code
```

AArch64

P1

```
STR X11, [X1]   ; X11 contains a new instruction to be stored in program memory
DC CVAU, X1     ; clean to PoU makes the new instruction visible to the instruction cache
DSB ISH        ; ensures completion of the clean on all PEs
IC IVAU, X1     ; ensures instruction cache/branch predictor discards stale data
DSB ISH        ; ensures completion of the instruction cache/branch predictor
                ; invalidation on all PEs
STR W0, [X2]   ; sets flag to signal completion
ISB            ; synchronizes context on this PE
BR R1          ; branches to new code
```

P2-Px

```
WAIT ([X2] == 1) ; waits for flag signalling completion
ISB              ; synchronizes context on this PE
BR X1           ; branches to new code
```

Nonfunctional approach

The following sequence does not have the same effect, because a DSB is not required to complete the instruction cache maintenance instructions that other PEs issue:

AArch32

P1

```

STR R11, [R1]      ; R11 contains a new instruction to be stored in program memory
DCCMVAU R1        ; clean to PoU makes the new instruction visible to the instruction cache
DSB               ; ensures completion of the clean on all PEs
ICIMVAU R1        ; ensures instruction cache discards stale data
BPIMVA R1         ; ensures branch predictor discards stale data
DMB               ; ensures ordering of the store after the invalidation
                  ; DOES NOT guarantee completion of instruction cache/branch
                  ; predictor on other PEs
STR R0, [R2]      ; sets flag to signal completion
DSB               ; ensures completion of the invalidation on all PEs
ISB               ; synchronizes context on this PE
BX R1             ; branches to new code

```

P2-Px

```

WAIT ([R2] == 1)  ; waits for flag signalling completion
DSB               ; this DSB does not guarantee completion of P1
                  ; ICIMVAU/BPIMVA
ISB
BX R1

```

AArch64

P1

```

STR W11, [X1]     ; W11 contains a new instruction to be stored in program memory
DC CVAU, X1       ; clean to PoU makes the new instruction visible to instruction cache
DSB ISH           ; ensures completion of the clean on all PEs
IC IVAU, X1       ; ensures instruction cache/branch predictor discards stale data
DMB ISH           ; ensures ordering of the store after the invalidation
                  ; DOES NOT guarantee completion of instruction cache/branch
                  ; predictor on other PEs
STR W0, [X2]      ; sets flag to signal completion
DSB ISH           ; ensures completion of the invalidation on all PEs
ISB               ; synchronizes context on this PE
BR X1             ; branches to new code

```

P2-Px

```

WAIT ([X2] == 1)  ; waits for flag signalling completion
DSB ISH           ; this DSB does not guarantee completion of P1
                  ; ICIMVAU/BPIMVA
ISB
BR X1

```

In this example, P2...Px might not see the updated region of code at R1.

K9.5.3 TLB maintenance instructions and barriers

The following sections describe the use of barriers with TLB maintenance instructions:

- [Ensuring the visibility of updates to translation tables for a uniprocessor.](#)
- [Ensuring the visibility of updates to translation tables for a multiprocessor on page K9-6235.](#)
- [Paging memory in and out on page K9-6235.](#)
- [Using break-before-make when updating translation table entries on page K9-6236.](#)

Ensuring the visibility of updates to translation tables for a uniprocessor

On a single PE, the agent that causes translation table walks is a separate memory system observer from the agent that causes data accesses. Therefore, any operations to invalidate the TLB can only rely on seeing updates to memory that are complete. This must be ensured by the use of a DSB instruction.

The ARMv8 architecture requires that translation table walks look in the data or unified caches at L1, so such systems do not require data cache cleaning.

After the translation tables update, any old copies of entries that might be held in the TLBs must be invalidated. This operation is only guaranteed to affect all instructions, including instruction fetches and data accesses, after the execution of a DSB and an ISB. Therefore, the code for updating a translation table entry is:

AArch32

P1

```
STR R11, [R1]      ; updates the translation table entry
DSB                ; ensures visibility of the update to translation table walks
TLBIMVA R10
BPIALL
DSB                ; ensures completion of the BP and TLB invalidation
ISB                ; synchronises context on this PE
; new translation table entry can be relied upon at this point and all accesses
; generated by this observer using
; the old mapping have been completed
```

AArch64

P1

```
STR X11, [X1]     ; updates the translation table entry
DSB ISH           ; ensures visibility of the update to translation table walks
TLBI VAE1, X10    ; assumes we are in the EL1
DSB ISH           ; ensures completion of the TLB invalidation
ISB               ; synchronise context on this PE
; new translation table entry can be relied upon at this point and all accesses
; generated by this observer using
; the old mapping have been completed
```

Importantly, by the end of this sequence, all accesses that used the old translation table mappings have been observed by all observers.

An example of this is where a translation table entry is marked as invalid. Such a system must provide a mechanism to ensure that any access to a region of memory being marked as invalid has completed before any action is taken as a result of the region being marked as invalid.

Ensuring the visibility of updates to translation tables for a multiprocessor

The same code sequence can be used in a multiprocessing system. The ARMv8 architecture requires a PE that executes a TLB maintenance instruction to execute a DSB instruction to ensure completion of the maintenance operation. This ensures that the TLB maintenance instruction is complete on all PEs in the Inner Shareable shareability domain.

The completion of a DSB that completes a TLB maintenance instruction ensures that all accesses that used the old mapping have completed.

AArch32

P1

```

STR R11, [R1]      ; updates the translation table entry
DSB                ; ensures visibility of the update to translation table walks
TLBIMVAIS R10
BPIALLIS
DSB                ; ensures completion of the BP and TLB invalidation
ISB                ; Note ISB is not broadcast and must be executed locally
                  ; on other PEs
; new translation table entry can be relied upon at this point and all accesses
; generated by any observers affected by the broadcast TLBIMVAIS operation using
; the old mapping have been completed

```

AArch64

P1

```

STR X11, [X1]      ; updates the translation table entry
DSB ISH            ; ensures visibility of the update to translation table walks
TLBI VAE1IS, X10
DSB ISH            ; ensures completion of the TLB invalidation
ISB                ; Note ISB is not broadcast and must be executed locally
                  ; on other PEs
; new translation table entry can be relied upon at this point and all accesses
; generated by any observers affected by the broadcast TLBIMVAIS operation using
; the old mapping have been completed

```

The completion of the TLB maintenance instruction is guaranteed only by the execution of a DSB by the observer that performed the TLB maintenance instruction. The execution of a DSB by a different observer does not have this effect, even if the DSB is known to be executed after the TLB maintenance instruction is observed by that different observer.

Paging memory in and out

In a multiprocessor system there is a requirement to ensure the visibility of translation table updates when paging regions of memory into RAM from a backing store. This might, or might not, also involve paging existing locations in memory from RAM to a backing store. In such situations, the operating system selects one or more pages of memory that might be in use but are suitable to discard, with or without copying to a backing store, depending on whether or not the region of memory is writable. Disabling the translation table mappings for a page, and ensuring the visibility of that update to the translation tables, prevents agents accessing the page.

For this reason, it is important that the DSB that is performed after the TLB invalidation ensures that no other updates to memory using those mappings are possible.

An example sequence for the paging out of an updated region of memory, and the subsequent paging in of memory, is as follows:

AArch32

P1

```

STR R11, [R1]      ; updates the translation table for the region being paged out
DSB                ; ensures visibility of the update to translation table walks
TLBIMVAIS R10      ; invalidates the old entry
DSB                ; ensures completion of the invalidation on all PEs

```

```
ISB          ; ensures visibility of the invalidation
BL SaveMemoryPageToBackingStore
BL LoadMemoryFromBackingStore
DSB          ; ensures completion of the memory transfer (this could be part of
              ; LoadMemoryFromBackingStore)
ICIAILLUIS   ; also invalidates the branch predictor
STR R9, [R1] ; creates a new translation table entry with a new mapping
DSB          ; ensures completion of the instruction cache
              ; and branch predictor invalidation
              ; AND ensures visibility of the new translation table mapping
ISB          ; ensures synchronisation of this instruction stream
```

AArch64

P1

```
STR X11, [X1] ; updates the translation table for the region being paged out
DSB ISH       ; ensures visibility of the update to translation table walks
TLBI VAE1IS, X10 ; invalidates the old entry
DSB ISH       ; ensures completion of the invalidation on all PEs
ISB          ; ensures visibility of the invalidation
BL SaveMemoryPageToBackingStore
BL LoadMemoryFromBackingStore
DSB ISH       ; ensures completion of the memory transfer (this could be part of
              ; LoadMemoryFromBackingStore)
IC IALLUIS   ; also invalidates the branch predictor
STR X9, [X1] ; creates a new translation table entry with a new mapping
DSB ISH       ; ensures completion of the instruction cache
              ; and branch predictor invalidation
              ; AND ensures visibility of the new translation table mapping
ISB          ; ensures synchronisation of this instruction stream
```

This example assumes the memory copies are performed by an observer that is coherent with the caches of PE P1. This observer might be P1 itself, using a specific paging mapping. For clarity, the example omits the functional descriptions of `SaveMemoryPageToBackingStore` and `LoadMemoryFromBackingStore`. `LoadMemoryFromBackingStore` is required to ensure that the memory updates that it makes are visible to instruction fetches.

In this example, the use of `ICIAILLUIS` in AArch32 state and `IC IALLUIS` in AArch64 state to invalidate the entire instruction cache is a simplification, that might not be optimal for performance. An alternative approach involves invalidating all of the lines in the caches using `ICIMVAU` in AArch32 state and `IC IVAU` operations in AArch64 state. This invalidation must be done when the mapping used for the `ICIMVAU` and `IC IVAU` operations is valid but not executable.

Using break-before-make when updating translation table entries

The ARM Architecture requires that reads to the same location are observed in order, and since application level software relies on this behavior, the operating system needs to maintain this illusion when it is changing a virtual to physical address mapping for a location, as is the case with copy on write or other memory management techniques. This illusion can be maintained provided that the software uses a break-before-make sequence when updating translation table entries whenever multiple threads of execution can use the same translation tables and the change to the translation entries involves any of:

- Changing the memory type.
- Changing the cacheability attributes
- Changing the output address (OA), if the OA of at least one of the old translation table entry and the new translation table entry is writable.

The architecture requires use of a break-before make sequence in these situations, see [Using break-before-make when updating translation table entries on page D4-2120](#) for more information. However, if software did not use a break-before-make approach, an implementation might give a result that would occur if the two reads to the same virtual address did not occur in program order. An example of such an occurrence would be an implementation of copy-on-write, where one PE is performing two reads to the same virtual address at the same time as a second PE,

running code associated with the operating system, is copying the data from one physical location that is mapped to by that virtual address, where the page was mapped as read-only, to a different physical location which will be mapped as read-write.

If the operating system changed the address mapping without going through an invalid entry, then it would be possible for a third PE to perform a write to the location that would be seen by the first load by the first PE, and not seen by the second load by the same PE.

The required break-before-make code sequence in this case is:

AArch32

P1

```

; R1, R2 contain an invalid translation table entry (that is, one with bit[0] == 0)
; R3 contains the address of the translation table entry
; R4 contains the Virtual Address and ASID of the VA being remapped
; R5, R6 contain the new valid translation table entry
STRD R1, R2, [R3]      ; stores invalid entry
DSB ISH                ; ensures visibility of the update to translation table walks
TLBIMVAIS R4          ; invalidates the old entry
DSB ISH                ; ensures completion of the invalidation on all PEs
ICIALLUIS             ; also invalidates the branch predictor
STRD R5, R6, [R3]     ; store new mapping
DSB ISH                ; ensures visibility of the update to translation table walks
ISB                    ; ensures synchronisation of this instruction stream

```

———— Note ————

This example shows an update to an entry in a translation table that is using the long-descriptor format.

AArch64

P1

```

; X1 contains an invalid translation table entry (that is, one with bit[0] == 0)
; X2 contains the address of the translation table entry
; X3 contains the Virtual Address and ASID of the VA being remapped
; X4 contains the new valid translation table entry
STR X1, [X2]          ; stores invalid entry
DSB ISH                ; ensures visibility of the update to translation table walks
TLBI VAE1IS, X3      ; invalidates the old entry
DSB ISH                ; ensures completion of the invalidation on all PEs
IC IALLUIS            ; also invalidates the branch predictor
STR X4, [X2]         ; store new mapping
DSB ISH                ; ensures visibility of the update to translation table walks
ISB                    ; ensures synchronisation of this instruction stream

```

If this sequence is correctly followed, then the architecture guarantees that the loads to a virtual address being remapped will be seen in the correct order.

The instruction cache maintenance is only required if the mapping from input address to output address has been changed as part of the change of the translation table entries, and the memory being moved is executable. In this example, the use of ICIALLUIS in AArch32 state and IC IALLUIS in AArch64 state to invalidate the entire instruction cache is a simplification, that might not be optimal for performance. An alternative approach involves invalidating all of the lines in the caches using ICIMVAU in AArch32 state, and IC IVAU in AArch64 state. This invalidation must be done when the mapping used for the ICIMVAU and IC IVAU operations is valid but not executable.

K9.5.4 Ordering of Memory-mapped device control with payloads

With a Memory-mapped peripheral, such as a DMA, which can also access memory for its own use, it is common to have control or status registers which are Memory-mapped. These registers need to be accessed in an ordered manner with respect to the data that the Memory-mapped peripheral is handling.

Two simple examples of this are:

- When a processing element is writing a buffer of data, and then writing to a control register in the DMA peripheral to start that peripheral to access the buffer of data.
- When a DMA peripheral has written to a buffer of data in memory, and the processing element is reading a status register to determine that the DMA transfer has completed, and then is reading the data.

For the case of the processing element writing a buffer of data, before starting the DMA peripheral, the ordering requirements between the stores to the data buffer and the stores to the Memory-mapped peripheral can be met by the insertion of a DSB <domain> instruction between these sets of accesses as this ensures the global observation of the stores before the DMA is started. This is shown by the following code:

AArch32

P1

```
STR R5, [R2]          ; data written to the data buffer
DSB
STR R0, [R4]          ; R4 contains the address of the DMA control register
```

AArch64

P1

```
STR W5, [X2]          ; data written to the data buffer
DSB <domain>
STR W0, [X4]          ; X4 contains the address of the DMA control register
```

For the case of DMA peripheral writing the data buffer and then setting a status register when those stores are complete (and so globally observed) and then having this status register polled by the processing element before the processing element reads the data buffer, the processing element must insert a DSB <domain> between the load that reads the status register, and the read of the buffer. A DMB, or load-acquire, is not sufficient as this problem is not solely concerned with observation order, since the polling read is actually a read of a status register at a slave, not the polling a data value that has been written by an observer.

For this case, the code is therefore:

AArch32

P1

```
WAIT ([R4] == 1)      ; R4 contains the address of the status register,
                      ; and the value '1' indicates completion of the DMA transfer
DSB
LDR R5, [R2]          ; reads data from the data buffer
```

AArch64

P1

```
WAIT ([X4] == 1)      ; X4 contains the address of the status register,
                      ; and the value '1' indicates completion of the DMA transfer
DSB <domain>
LDR W5, [X2]          ; reads data from the data buffer
```

K9.6 ARMv7 compatible approaches for ordering, using DMB and DSB barriers

The following sections describe the ARMv7 compatible approaches for ordering, using DMB and DSB barriers:

- [Simple ordering and barrier cases.](#)
- [Load-Exclusive, Store-Exclusive and barriers on page K9-6243.](#)
- [Using a mailbox to send an interrupt on page K9-6245.](#)
- [Cache and TLB maintenance instructions and barriers on page K9-6245.](#)

K9.6.1 Simple ordering and barrier cases

ARM implements a weakly consistent memory model for Normal memory. In general terms, this means that the order of memory accesses observed by other observers might not be the order that appears in the program, for either loads or stores.

This section includes examples of this.

Simple weakly consistent ordering example

P1

```
STR R5, [R1]
LDR R6, [R2]
```

P2

```
STR R6, [R2]
LDR R5, [R1]
```

In the absence of barriers, the result of P1: R6=0, P2: R5=0 is permissible.

Message passing

The following sections describe:

- [Weakly-ordered message passing problem.](#)
- [Message passing with multiple observers on page K9-6241.](#)

Weakly-ordered message passing problem

P1

```
STR R5, [R1]           ; sets new data
STR R0, [R2]           ; sends flag indicating data ready
```

P2

```
WAIT([R2]==1)         ; waits on flag
LDR R5, [R1]           ; reads new data
```

In the absence of barriers, an end result of P2: R5=0 is permissible.

Resolving by the addition of barriers

The addition of barriers, to ensure the observed order of the reads and the writes, ensures that data is transferred so that the result P2:R5==0x55 is guaranteed, as follows:

P1

```
STR R5, [R1]           ; sets new data
DMB [ST]               ; ensures all observers observe data before the flag
STR R0, [R2]           ; sends flag indicating data ready
```

```
P2
    WAIT([R2]==1)          ; waits on flag
    DMB                    ; ensures that the load of data is after the flag has been observed
    LDR R5, [R1]
```

Resolving by the use of barriers and address dependency

There is a rule within the ARM architecture that:

- Where the value returned by a read is used for computation of the virtual address of a subsequent read or write, then these two memory accesses are observed in program order.
 Where the value returned by a read is used for computation of the virtual address of a subsequent read or write, this is called an *address dependency*. An address dependency exists even if the value returned by the first read has no effect on the virtual address. This might occur if the value returned is masked off before it is used, or if it confirms a predicted address value that it might have changed.
 This restriction applies only when the data value returned by a read is used as a data value to calculate the address of a subsequent read or write. It does not apply if the data value returned by a read determines the condition flags values, and the values of the flags are used for condition code evaluation to determine the address of a subsequent read, either through conditional execution or the evaluation of a branch. This is called a *control dependency*.
 Where both a control and address dependency exist, the ordering behavior is consistent with the address dependency.

Table K9-1 shows examples of address dependencies, control dependencies, and an address and control dependency.

Table K9-1 Dependency examples

Address dependency		Control dependency		Address and control dependency ^a
(a)	(b)	(c)	(d)	(e)
LDR r1, [r0]	LDR r1, [r0]	LDR r1, [r0]	LDR r1, [r0]	LDR r1, [r0]
LDR r2, [r1]	AND r1, r1, #0	CMP r1, #55	CMP r1, #55	CMP r1, #0
	LDR r2, [r3, r1]	LDRNE r2, [r3]	MOVNE r4, #22	LDRNE r2, [r1]
			LDR r2, [r3, r4]	

a. The address dependency takes priority.

This means that the data transfer example of *Weakly-ordered message passing problem* on page K9-6239 can also be satisfied as shown in the following example:

```
P1
    STR R5, [R1]          ; sets new data
    DMB [ST]              ; ensures all observers observe data before the flag
    STR R0, [R2]          ; sends flag indicating data ready

P2
    WAIT([R2]==1)
    AND R12, R12, #0      ; R12 is destination of LDR in WAIT macro
    LDR R5, [R1, R12]     ; the load has an address dependency on R12
                          ; and so is ordered after the flag has been seen
```

The load of R5 by P2 is ordered with respect to the load from [R2] because there is an address dependency using R12. P1 uses a DMB to ensure that P2 does not observe the write of [R2] before the write of [R1].

Message passing with multiple observers

Where the ordering of Normal memory accesses is not resolved by the use of barriers or dependencies, then different observers might observe the accesses in a different order, as shown in the following example:

```
P1
    STR R5, [R1]           ; sets new data
    STR R0, [R2]           ; sends flag indicating data ready

P2
    WAIT([R2]==1)
    AND R12, R12, #0       ; R12 is destination of LDR in WAIT macro
    LDR R5, [R1, R12]     ; the load has an address dependency on R12
                           ; and so is ordered after the flag has been seen

P3
    WAIT([R2]==1)
    AND R12, R12, #0       ; R12 is destination of LDR in WAIT macro
    LDR R5, [R1, R12]     ; the load is address dependent on R12
                           ; and so is ordered after the flag has been seen
```

In this case, it is permissible for P2:R5 and P3:R5 to contain different values, because there is no order guaranteed between the two stores performed by P1.

Resolving by the addition of barriers

The addition of a barrier by P1, as shown in the following example, ensures the observed order of the writes, transferring data so that P2:R5 and P3:R5 both contain the value 0x55:

```
P1
    STR R5, [R1]           ; sets new data
    DMB [ST]              ; ensures all observers observe data before the flag
    STR R0, [R2]           ; sends flag indicating data ready

P2
    WAIT([R2]==1)
    AND R12, R12, #0       ; R12 is the destination of LDR in WAIT macro
    LDR R5, [R1, R12]     ; the load has an address dependency on R12
                           ; and so is ordered after the flag has been seen

P3
    WAIT([R2]==1)
    AND R12, R12, #0       ; R12 is the destination of LDR in WAIT macro
    LDR R5, [R1, R12]     ; the load has an address dependency on R12
                           ; and so is ordered after the flag has been seen
```

Address dependency with object construction

When accessing an object-oriented data structure, the address dependency rule means that barriers are not required, even when initializing the object:

```
P1
    STR R5, [R1, #offset]  ; sets new data in a field
    DMB [ST]              ; ensures all observers observe data before base address is updated
    STR R1, [R2]           ; updates base address

P2
    LDR R1, [R2]           ; reads for base address
    CMP R1, #0             ; checks if it is valid
    BEQ null_trap
```

```
LDR R5, [R1, #offset] ; uses base address to read field
```

If the null trap is not taken, it is required that P2:R5==0x55. This avoids P2 observing a partially constructed object from P1. Significantly, P2 does not require a barrier to ensure this behavior.

P1 requires a barrier to ensure the observed order of the writes by P1. In general, the impact of requiring a barrier during the construction phase is much less than the impact of requiring a barrier for every read access.

Posting a store before polling for acknowledgement

In the case where an observer stores to a location, and then polls for an acknowledge from a different observer, the weak ordering of the memory model can lead to a deadlock, as the following example shows:

```
P1
STR R0, [R2]
WAIT ([R3]==1)
```

```
P2
WAIT ([R2]==1)
STR R0, [R3]
```

In ARMv7 implementations that do not include the Multiprocessing Extensions, then this can deadlock because P2 might not observe the store by P1 in finite time. For ARMv7 implementations with the Multiprocessing Extensions and for ARMv8, this is not an issue as all stores must be observed by all observers within their shareability domain in finite time.

The addition of a DMB instruction prevents this deadlock in ARMv7 implementations that do not include the Multiprocessing Extensions:

```
P1
STR R0, [R2]
DMB
WAIT ([R3]==1)
```

```
P2
WAIT ([R2]==1)
STR R0, [R3]
```

The DMB executed by P1 ensures that P2 observes the store by P1 before it observes the load by P1. This ensures a timely completion.

The following example is a variant of the previous example, where the two observers poll the same memory location:

```
P1
STR R0, [R2]
WAIT ([R2]==2)
```

```
P2
WAIT ([R2]==1)
LDR R0, [R2]
ADD R0, R0, #1
STR R0, [R2]
```

In this example, the same deadlock can occur in ARMv7 implementations that do not include the Multiprocessing Extensions, because the architecture permits P1 to read the result of its own store to [R2] early, and continue doing so for an indefinite amount of time. The addition of a DMB instruction prevents this deadlock:

```
P1
STR R0, [R2]
DMB
WAIT ([R2]==2)
```

P2

```
WAIT ([R2]==1)
LDR R0, [R2]
ADD R0, R0, #1
STR R0, [R2]
```

WFE and WFI and barriers

The Wait For Event and Wait For Interrupt instructions permit the PE to suspend execution and enter a low-power state. A DSB barrier instruction is required if it is necessary to ensure that memory accesses made before the WFI or WFE are visible to other observers, unless some other mechanism has ensured this visibility. Examples of other mechanism that would guarantee the required visibility are the DMB described in [Posting a store before polling for acknowledgement on page K9-6242](#), or a dependency on a load.

The following example requires the DSB to ensure that the store is visible:

P1

```
STR R0, [R2]
DSB
Loop
WFI
B Loop
```

However, if the example in [Posting a store before polling for acknowledgement on page K9-6242](#) is extended to include a WFE, there is no risk of a deadlock. The extended example is:

P1

```
STR R0, [R2]
DMB
Loop
LDR R12, [R3]
CMP R12, #1
WFENE
BNE Loop
```

P2

```
WAIT ([R2]==1)
STR R0, [R3]
DSB
SEV
```

In this example:

- The DMB by P1 ensures that P2 observes the store by P1 before it observes the load by P1.
- The dependency of the WFE on the result of the load by P1 means that this load must complete before P1 executes the WFE.

For more information about SEV, see [Use of Wait For Event \(WFE\) and Send Event \(SEV\) with locks on page K9-6244](#).

K9.6.2 Load-Exclusive, Store-Exclusive and barriers

The Load-Exclusive and Store-Exclusive instructions, described in [Synchronization and semaphores on page B2-121](#), are predictable only with Normal memory. These instructions do not have any implicit barrier functionality. Therefore, any use of these instructions to implement locks of any type requires the addition of explicit barriers.

Acquiring a lock

A common use of Load-Exclusive and Store-Exclusive instructions is to claim a lock to permit entry into a critical region. This is typically performed by testing a lock variable that indicates 0 for a free lock and some other value, commonly 1 or an identifier of the process holding the lock, for a taken lock.

The lack of implicit barriers in the Load-Exclusive and Store-Exclusive instructions means that the mechanism requires a DMB instruction between acquiring a lock and making the first access to the critical region, to ensure that all observers observe the successful claim of the lock before they observe any subsequent loads or stores to the region. This example shows Px acquiring a lock:

```
Px
Loop
LDREX R5, [R1]      ; reads lock
CMP R5, #0          ; checks if 0
STREXEQ R5, R0, [R1] ; attempts to store new value
CMPEQ R5, #0        ; tests if store succeeded
BNE Loop            ; retries if not
DMB                 ; ensures that all subsequent accesses are observed after the
                    ; gaining of the lock is observed
                    ; loads and stores in the critical region can now be performed
```

Releasing a lock

The converse operation of releasing a lock does not require the use of Load-Exclusive and Store-Exclusive instructions, because only a single observer is able to write to the lock. However, often it is necessary for any observer to observe any memory updates, or any values that are loaded into memory, before they observe the release of the lock. Therefore, a DMB usually precedes the lock release, as the following example shows.

```
Px
                    ; loads and stores in the critical region
MOV R0, #0
DMB                 ; ensures all previous accesses are observed before the lock is cleared
STR R0, [R1]        ; clears the lock
```

Use of Wait For Event (WFE) and Send Event (SEV) with locks

The ARMv8 architecture includes Wait For Event and Send Event instructions, that can be executed to reduce the required number of iterations of a lock-acquire loop, or *spinlock*, to reduce power. The basic mechanism involves an observer that is in a spinlock executing a WFE instruction that suspends execution on that observer until an asynchronous exception or an explicit event, sent by some other observer using the SEV instruction, is seen by the suspended observer. An observer that holds the lock executes an SEV instruction to send an event after it has released the lock.

The Event signal is a non-memory communication, and therefore the memory update that releases the lock must be observable by all observers before the SEV instruction is executed and the event is sent. This requires the use of DSB instruction, rather than DMB.

Therefore, the following is an example of lock acquire code using WFE:

```
Px
Loop
LDREX R5, [R1]      ; reads lock
CMP R5, #0          ; checks if 0
WFE                 ; sleeps if the lock is held
STREXEQ R5, R0, [R1] ; attempts to store new value
CMPEQ R5, #0        ; tests if store succeeded
BNE Loop            ; retries if not
DMB                 ; ensures that all subsequent accesses are observed after the
                    ; gaining of the lock is observed
                    ; loads and stores in the critical region can now be performed
```

And the following is an example of lock release code using SEV:

```

Px
    ; loads and stores in the critical region
    MOV R0, #0
    DMB                ; ensures all previous accesses are observed before the lock is cleared
    STR R0, [R1]       ; clears the lock
    DSB                ; ensures completion of the store that cleared the lock before
                        ; sending the event
    SEV

```

K9.6.3 Using a mailbox to send an interrupt

In some message passing systems, it is common for one observer to update memory and then notify a second observer of the update by sending an interrupt, using a mailbox.

Although a memory access might be made to initiate the sending of the mailbox interrupt, a DSB instruction is required to ensure the completion of previous memory accesses.

Therefore, the following sequence is required to ensure that P2 observes the updated value:

```

P1
    STR R5, [R1]       ; message stored to shared memory location
    DSB [ST]
    STR R1, [R4]       ; R4 contains the address of a mailbox

P2
    ; interrupt service routine
    LDR R5, [R1]

```

———— **Note** ————

The DSB executed by P1 ensures global observation of the store to [R1]. The interrupt timing ensures that the code executed by P2 is executed after the global observation of the update to [R1], and therefore must see this update. In some implementations, this might be implemented by requiring that interrupts flush non-coherent buffers that hold speculatively loaded data.

K9.6.4 Cache and TLB maintenance instructions and barriers

The following sections describe the use of barriers with cache and TLB maintenance instructions:

- [Data cache maintenance instructions](#).
- [Instruction cache maintenance instructions](#) on page K9-6248.
- [TLB maintenance instructions and barriers](#) on page K9-6249.

Data cache maintenance instructions

The following sections describe the use of barriers with data cache maintenance instructions:

- [Message passing to non-caching observers](#).
- [Multiprocessing message passing to non-caching observers](#) on page K9-6246.
- [Invalidating DMA buffers, non-functional example](#) on page K9-6246.
- [Invalidating DMA buffers, functional example with single PE](#) on page K9-6247.
- [Invalidating DMA buffers, functional example with multiple coherent PEs](#) on page K9-6247.

Message passing to non-caching observers

The ARMv8 architecture requires the use of DMB instructions to ensure the ordering of data cache maintenance instructions and their effects. This means the following message passing approaches can be used when communicating between caching observers and non-caching observers:

```

P1

```

```
STR R5, [R1]           ; updates data (assumed to be in P1's cache)
DCCMVAC R1             ; cleans cache to point of coherency
DMB                    ; ensures effects of the clean will be observed before the flag is set
STR R0, [R4]           ; sends flag to external agent (Non-cacheable location)
```

E1

```
WAIT ([R4] == 1)       ; waits for the flag
DMB                    ; ensures that flag has been seen before reading data
LDR R5, [R1]           ; reads the data
```

In this example, it is required that E1:R5==0x55.

Multiprocessing message passing to non-caching observers

The broadcast nature of the cache maintenance instructions in ARMv8, and in ARMv7 implementations that include the Multiprocessing Extensions, combined with properties of barriers, means that the message passing principle for non-caching observers is:

P1

```
STR R5, [R1]           ; updates data (assumed to be in P1's cache)
DMB [ST]               ; ensures new data is observed before the flag to P2 is set
STR R0, [R2]           ; sends flag to P2
```

P2

```
WAIT ([R2] == 1)       ; waits for flag from P1
DMB                    ; ensures cache clean is observed after P1 flag is observed
DCCMVAC R1             ; cleans cache to point of coherency - this cleans the cache of P1
DMB                    ; ensures effects of the clean are observed before the flag to E1 is set
STR R0, [R4]           ; sends flag to E1
```

E1

```
WAIT ([R4] == 1)       ; waits for flag from P2
DMB                    ; ensures that flag has been observed before reading the data
LDR R5, [R1]           ; reads the data
```

In this example, it is required that E1:R5==0x55. The clean operation executed by P2 affects the data location in the P1 cache. The cast-out from the P1 cache is guaranteed to be observed before P2 updates [R4].

Invalidating DMA buffers, non-functional example

The basic scheme for communicating with an external observer that is a process that passes data in to a Cacheable memory region must take account of the architectural requirement that regions with a Normal Cacheable attribute can be allocated into a cache at any time, for example as a result of speculation. The following example shows this possibility:

P1

```
DCIMVAC R1             ; ensures caches are not dirty. A clean operation could be
                        ; used but the DMA overwrites this region so an invalidate operation
                        ; is sufficient and usually more efficient
DMB                    ; ensures cache invalidation is observed before the next store is observed
STR R0, [R3]           ; sends flag to external agent
WAIT ([R4]==1)         ; waits for a different flag from an external agent
DMB                    ; observes flag from external agent before reading new data. However [R1]
                        ; could have been brought into cache earlier
LDR R5, [R1]
```

E1

```
WAIT ([R3] == 1)       ; waits for flag
STR R5, [R1]           ; stores new data
DMB                    ;
STR R0, [R4]           ; sends a flag
```

If a speculative access occurs, there is no guarantee that the cache line containing [R1] is not brought back into the cache after the cache invalidation, but before [R1] is written by E1. Therefore, the result P1:R5=0 is permissible.

Invalidating DMA buffers, functional example with single PE

P1

```

DCIMVAC R1          ; ensures cache is not dirty. A clean operation could be
                    ; used but the DMA overwrites this region so an invalidate operation
                    ; is sufficient and usually more efficient
DMB                 ; ensures cache invalidation is observed before the next store is observed
STR R0, [R3]        ; sends flag to external agent
WAIT ([R4]==1)      ; waits for a different flag from an external agent
DMB                 ; ensures that cache invalidate is observed after the flag
                    ; from external agent is observed
DCIMVAC R1          ; ensures cache discards stale copies before use
LDR R5, [R1]

```

E1

```

WAIT ([R3] == 1)    ; waits for flag
STR R5, [R1]        ; stores new data
DMB [ST]
STR R0, [R4]        ; sends a flag

```

In this example, the result P1:R5 == 0x55 is required. Including a cache invalidation after the store by E1 to [R1] is observed ensures that the line is fetched from external memory after it has been updated.

Invalidating DMA buffers, functional example with multiple coherent PEs

The broadcasting of cache maintenance instructions, and the use of DMB instructions to ensure their observability, means that the previous example extends naturally to a multiprocessor system. Typically this requires a transfer of ownership of the region that the external observer is updating.

P0

```

(Use data from [R1], potentially using [R1] as scratch space)
DMB
STR R0, [R2]        ; signals release of [R1]
WAIT ([R2] == 0)    ; waits for new value from DMA
DMB
LDR R5, [R1]

```

P1

```

WAIT ([R2] == 1)    ; waits for release of [R1] by P0
DCIMVAC R1          ; ensures caches are not dirty, invalidate is sufficient
DMB
STR R0, [R3]        ; requests new data for [R1]
WAIT ([R4] == 1)    ; waits for new data
DMB
DCIMVAC R1          ; ensures caches discard stale copies before use
DMB
MOV R0, #0
STR R0, [R2]        ; signals availability of new [R1]

```

E1

```

WAIT ([R3] == 1)    ; waits for new data request
STR R5, [R1]        ; sends new [R1]
DMB [ST]
STR R0, [R4]        ; indicates new data available to P1

```

In this example, the result P0:R5 == 0x55 is required. The DMB issued by P1 after the first data cache invalidation ensures that effect of the cache invalidation on P0 is seen by E1 before the store by E1 to [R1]. The DMB issued by P1 after the second data cache invalidation ensures that its effects are seen before the store of 0 to the semaphore location in [R2].

Instruction cache maintenance instructions

The following sections describe the use of barriers with instruction cache maintenance instructions:

- [Ensuring the visibility of updates to instructions for a uniprocessor.](#)
- [Ensuring the visibility of updates to instructions for a multiprocessor.](#)

Ensuring the visibility of updates to instructions for a uniprocessor

On a single PE, the agent that causes instruction fetches, or instruction cache linefills, is a separate memory system observer from the agent that causes data accesses. Therefore, any operations to invalidate the instruction cache can rely only on seeing updates to memory that are complete. This must be ensured by the use of a DSB instruction.

Also, instruction cache maintenance instructions are only guaranteed to complete after the execution of a DSB, and an ISB is required to discard any instructions that might have been prefetched before the instruction cache invalidation completed. Therefore, on a uniprocessor, to ensure the visibility of an update to code and to branch to it, the following sequence is required:

P1

```
STR R11, [R1]           ; R11 contains a new instruction to store in program memory
DCCMVAU R1              ; clean to PoU makes new instructions visible to instruction cache
DSB                     ; ensures instruction cache and branch predictor discard stale data
ICIMVAU R1              ; ensures instruction cache and branch predictor discard stale data
BPIMVA R1               ; ensures instruction cache and branch predictor discard stale data
DSB                     ; ensures completion of the invalidation
ISB                     ; ensures instruction fetch path observes new instruction cache state
BX R1
```

Ensuring the visibility of updates to instructions for a multiprocessor

ARMv8, and an ARMv7 implementation that includes the Multiprocessing Extensions, requires a PE that executes an instruction cache maintenance instruction to execute a DSB instruction to ensure completion of the maintenance operation. This ensures that the cache maintenance instruction is complete on all PEs in the Inner Shareable shareability domain.

An ISB is not broadcast, and so does not affect other PEs. This means that any other PE must perform its own ISB synchronization after it knows that the update is visible, if it is necessary to ensure its synchronization with the update. The following example shows how this might be done:

P1

```
STR R11, [R1]           ; R11 contains a new instruction to store in program memory
DCCMVAU R1              ; clean to PoU makes new instructions visible to instruction cache
DSB                     ; ensures completion of the clean on all processors
ICIMVAU R1              ; ensures instruction cache/branch predictor discards stale data
BPIMVA R1               ; ensures instruction cache/branch predictor discards stale data
DSB                     ; ensures completion of the instruction cache and branch predictor
                       ; invalidation on all PEs
STR R0, [R2]            ; sets flag to signal completion
ISB                     ; synchronizes context on this PE
BX R1                   ; branches to new code
```

P2-Px

```
WAIT ([R2] == 1)        ; waits for flag signaling completion
ISB                     ; synchronizes context on this processor
BX R1                   ; branches to new code
```

Nonfunctional approach

The following sequence does not have the same effect, because a DSB is not required to complete the instruction cache maintenance instructions that other PEs issue:

P1

```
STR R11, [R1]           ; R11 contains a new instruction to store in program memory
DCCMVAU R1              ; clean to PoU makes new instructions visible to instruction cache
```

```

DSB                ; ensure completion of the clean on all PEs
ICIMVAU R1        ; ensure instruction cache/branch predictor discards stale data
BPIMVA R1
DMB                ; ensure ordering of the store after the invalidation
                  ; DOES NOT guarantee completion of instruction cache/branch
                  ; predictor on other PEs
STR R0, [R2]      ; sets flag to signal completion
DSB                ; ensures completion of the invalidation on all PEs
ISB                ; synchronizes context on this PE
BX R1              ; branches to new code
    
```

P2-Px

```

WAIT ([R2] == 1)   ; waits for flag signaling completion
DSB                ; this DSB does not guarantee completion of P1's ICIMVAU/BPIMVA
ISB
BX R1
    
```

In this example, P2...Px might not see the updated region of code at R1.

TLB maintenance instructions and barriers

The following sections describe the use of barriers with TLB maintenance instructions:

- [Ensuring the visibility of updates to translation tables for a uniprocessor.](#)
- [Ensuring the visibility of updates to translation tables for a multiprocessor on page K9-6250.](#)
- [Paging memory in and out on page K9-6250.](#)

Ensuring the visibility of updates to translation tables for a uniprocessor

On a single PE, the agent that causes translation table walks is a separate memory system observer from the agent that causes data accesses. Therefore, any operations to invalidate the TLB can only rely on seeing updates to memory that are complete. This must be ensured by the use of a DSB instruction.

In the ARMv8 architecture, and in an ARMv7 implementation that includes the Multiprocessing Extensions, translation table walks must look in the data or unified caches at L1, so such systems do not require data cache cleaning.

After the translation tables update, any old copies of entries that might be held in the TLBs must be invalidated. This operation is only guaranteed to affect all instructions, including instruction fetches and data accesses, after the execution of a DSB and an ISB. Therefore, the code for updating a translation table entry is:

P1

```

STR R11, [R1]      ; updates the translation table entry
DSB                ; ensures visibility of the update to translation table walks
TLBIMVA R10
BPIALL
DSB                ; ensures completion of the BP and TLB invalidation
ISB                ; synchronizes context on this PE
;
; new translation table entry can be relied upon at this point and all accesses
; generated by this observer using the old mapping have been completed
    
```

Importantly, by the end of this sequence, all accesses that used the old translation table mappings have been observed by all observers.

An example of this is where a translation table entry is marked as invalid. Such a system must provide a mechanism to ensure that any access to a region of memory being marked as invalid has completed before any action is taken as a result of the region being marked as invalid.

Ensuring the visibility of updates to translation tables for a multiprocessor

The same code sequence can be used in a multiprocessing system. In the ARMv8 architecture, and in an ARMv7 implementation that includes the Multiprocessing Extensions, a PE that executes a TLB maintenance instruction must execute a DSB instruction to ensure completion of the maintenance operation. This ensures that the TLB maintenance instruction is complete on all PEs in the Inner Shareable shareability domain.

The completion of a DSB that completes a TLB maintenance instruction ensures that all accesses that used the old mapping have completed.

P1

```
STR R11, [R1]          ; updates the translation table entry
DSB                    ; ensures visibility of the update to translation table walks
TLBIMVAIS R10
BPIALLIS
DSB                    ; ensures completion of the BP and TLB invalidation
ISB                    ; Note ISB is not broadcast and must be executed locally on other PEs
;
; new translation table entry can be relied upon at this point and all accesses generated by any
; observers affected by the broadcast TLBIMVAIS operation using the old mapping have completed
```

The completion of the TLB maintenance instruction is guaranteed only by the execution of a DSB by the observer that performed the TLB maintenance instruction. The execution of a DSB by a different observer does not have this effect, even if the DSB is known to be executed after the TLB maintenance instruction is observed by that different observer.

Paging memory in and out

In a multiprocessor system there is a requirement to ensure the visibility of translation table updates when paging regions of memory into RAM from a backing store. This might, or might not, also involve paging existing locations in memory from RAM to a backing store. In such situations, the operating system selects one or more pages of memory that might be in use but are suitable to discard, with or without copying to a backing store, depending on whether or not the region of memory is writable. Disabling the translation table mappings for a page, and ensuring the visibility of that update to the translation tables, prevents agents accessing the page.

For this reason, it is important that the DSB that is performed after the TLB invalidation ensures that no other updates to memory using those mappings are possible.

An example sequence for the paging out of an updated region of memory, and the subsequent paging in of memory, is as follows:

P1

```
STR R11, [R1]          ; updates the translation table for the region being paged out
DSB                    ; ensures visibility of the update to translation table walks
TLBIMVAIS R10          ; invalidates the old entry
DSB                    ; ensures completion of the invalidation on all processors
ISB                    ; ensures visibility of the invalidation
BL SaveMemoryPageToBackingStore
BL LoadMemoryFromBackingStore
DSB                    ; ensures completion of the memory transfer (this could be part of
; LoadMemoryFromBackingStore
ICIAILLUIS             ; also invalidates the branch predictor
STR R9, [R1]           ; creates a new translation table entry with a new mapping
DSB                    ; ensures completion of instruction cache and branch predictor invalidation
; and ensures visibility of the new translation table mapping
ISB                    ; ensures synchronization of this instruction stream
```

This example assumes the memory copies are performed by an observer that is coherent with the caches of PE P1. This observer might be P1 itself, using a specific paging mapping. For clarity, the example omits the functional descriptions of `SaveMemoryPageToBackingStore` and `LoadMemoryFromBackingStore`. `LoadMemoryFromBackingStore` is required to ensure that the memory updates that it makes are visible to instruction fetches.

In this example, the use of `ICIALUIS` to invalidate the entire instruction cache is a simplification, that might not be optimal for performance. An alternative approach involves invalidating all of the lines in the caches using `ICIMVAU` operations. This invalidation must be done when the mapping used for the `ICIMVAU` operations is valid but not executable.

Appendix K10

ARM Pseudocode Definition

This appendix provides a definition of the pseudocode that is used in this manual, and defines some *helper* procedures and functions that are used by pseudocode. It contains the following sections:

- [About the ARM pseudocode on page K10-6254.](#)
- [Pseudocode for instruction descriptions on page K10-6255.](#)
- [Data types on page K10-6257.](#)
- [Operators on page K10-6262.](#)
- [Statements and control structures on page K10-6268.](#)
- [Built-in functions on page K10-6273.](#)
- [Miscellaneous helper procedures and functions on page K10-6276.](#)
- [ARM pseudocode definition index on page K10-6278.](#)

Note

This appendix is not a formal language definition for the pseudocode. It is a guide to help understand the use of ARM pseudocode. This appendix is not complete. Changes are planned for future releases.

K10.1 About the ARM pseudocode

The ARM pseudocode provides precise descriptions of some areas of the ARM architecture. This includes description of the decoding and operation of all valid instructions. [Pseudocode for instruction descriptions on page K11-6021](#) gives general information about this instruction pseudocode, including its limitations.

The following sections describe the ARM pseudocode in detail:

- [Data types on page K10-6257](#).
- [Operators on page K10-6262](#).
- [Statements and control structures on page K10-6268](#).

[Built-in functions on page K10-6273](#) and [Miscellaneous helper procedures and functions on page K10-6276](#) describe some built-in functions and pseudocode helper functions that are used by the pseudocode functions that are described elsewhere in this manual. [ARM pseudocode definition index on page K10-6278](#) contains the indexes to the pseudocode.

K10.1.1 General limitations of ARM pseudocode

The pseudocode statements IMPLEMENTATION_DEFINED, SEE, UNDEFINED, and UNPREDICTABLE indicate behavior that differs from that indicated by the pseudocode being executed. If one of them is encountered:

- Earlier behavior indicated by the pseudocode is only specified as occurring to the extent required to determine that the statement is executed.
- No subsequent behavior indicated by the pseudocode occurs.

For more information, see [Special statements on page K10-6272](#).

K10.2 Pseudocode for instruction descriptions

Each instruction description includes pseudocode that provides a precise description of what the instruction does, subject to the limitations described in [General limitations of ARM pseudocode on page K10-6254](#) and [Limitations of the instruction pseudocode on page K10-6256](#).

In the instruction pseudocode, instruction fields are referred to by the names shown in the encoding diagram for the instruction. [Instruction encoding diagrams and instruction pseudocode](#) gives more information about the pseudocode provided for each instruction.

K10.2.1 Instruction encoding diagrams and instruction pseudocode

Instruction descriptions in this manual contain:

- An Encoding section, containing one or more encoding diagrams, each followed by some encoding-specific pseudocode that translates the fields of the encoding into inputs for the common pseudocode of the instruction, and picks out any encoding-specific special cases.
- An Operation section, containing common pseudocode that applies to all of the encodings being described. The Operation section pseudocode contains a call to the `EncodingSpecificOperations()` function, either at its start or only after a condition code check performed by `if ConditionPassed()` then.

An encoding diagram specifies each bit of the instruction as one of the following:

- An obligatory 0 or 1, represented in the diagram as 0 or 1. If this bit does not have this value, the encoding corresponds to a different instruction.
- A *should be* 0 or 1, represented in the diagram as (0) or (1). If this bit does not have this value, the instruction is `CONSTRAINED UNPREDICTABLE`. For more information, see [SBZ or SBO fields T32 and A32 in instructions on page K1-6100](#).
- A named single bit or a bit in a named multi-bit field. The `cond` field in bits[31:28] of many A32/T32 instructions has some special rules associated with it.

An encoding diagram matches an instruction if all obligatory bits are identical in the encoding diagram and the instruction, and one of the following is true:

- The encoding diagram is not for an A32/T32 instruction.
- The encoding diagram is for an A32/T32 instruction that does not have a `cond` field in bits[31:28].
- The encoding diagram is for an A32/T32 instruction that has a `cond` field in bits[31:28], and bits[31:28] of the instruction are not `0b1111`.

In the context of the instruction pseudocode, the execution model for an instruction is:

1. Find all encoding diagrams that match the instruction. It is possible that no encoding diagram matches. In that case, abandon this execution model and consult the relevant instruction set chapter instead to find out how the instruction is to be treated. The bit pattern of such an instruction is usually reserved and `UNDEFINED`, though there are some other possibilities. For example, unallocated hint instructions are documented as being reserved and executed as NOPs.
2. If the operation pseudocode for the matching encoding diagrams starts with a condition code check, perform that check. If the condition code check fails, abandon this execution model and treat the instruction as a NOP. If there are multiple matching encoding diagrams, either all or none of their corresponding pieces of common pseudocode start with a condition code check.
3. Perform the encoding-specific pseudocode for each of the matching encoding diagrams independently and in parallel. Each such piece of encoding-specific pseudocode starts with a bitstring variable for each named bit or multi-bit field in its corresponding encoding diagram, named the same as the bit or multi-bit field and initialized with the values of the corresponding bit or bits from the bit pattern of the instruction.

In a few cases, the encoding diagram contains more than one bit or field with same name. In these cases, the values of the different instances of those bits or fields must be identical. The encoding-specific pseudocode contains a special case using the `Consistent()` function to specify what happens if they are not identical. `Consistent()` returns TRUE if all instruction bits or fields with the same name as its argument have the same value, and FALSE otherwise.

If there are multiple matching encoding diagrams, all but one of the corresponding pieces of pseudocode must contain a special case that indicates that it does not apply. Discard the results of all such pieces of pseudocode and their corresponding encoding diagrams.

There is now one remaining piece of pseudocode and its corresponding encoding diagram left to consider. This pseudocode might also contain a special case, most commonly one indicating that it is `CONSTRAINED UNPREDICTABLE`. If so, abandon this execution model and treat the instruction according to the special case.

4. Check the *should be* bits of the encoding diagram against the corresponding bits of the bit pattern of the instruction. If any of them do not match, abandon this execution model and treat the instruction as `CONSTRAINED UNPREDICTABLE`, see [SBZ or SBO fields T32 and A32 in instructions on page K1-6100](#).
5. Perform the rest of the operation pseudocode for the instruction description that contains the encoding diagram. That pseudocode starts with all variables set to the values they were left with by the encoding-specific pseudocode.

The `ConditionPassed()` call in the common pseudocode, if present, performs step 2, and the `EncodingSpecificOperations()` call performs steps 3 and 4.

K10.2.2 Limitations of the instruction pseudocode

The pseudocode descriptions of instruction functionality have a number of limitations. These are mainly due to the fact that, for clarity and brevity, the pseudocode is a sequential and mostly deterministic language.

These limitations include:

- Pseudocode does not describe the ordering requirements when an instruction generates multiple memory accesses. For a description of the ordering requirements on memory accesses see [Ordering constraints on page E2-2766](#).
- Pseudocode does not describe the exact rules when an `UNDEFINED` instruction fails its condition code check. In such cases, the `UNDEFINED` pseudocode statement lies inside the `if ConditionPassed() then ...` structure, either directly or in the `EncodingSpecificOperations()` function call, and so the pseudocode indicates that the instruction executes as a NOP. [Conditional execution of undefined instructions on page G1-4378](#) describes the exact rules.
- Pseudocode does not describe the exact ordering requirements when a single floating-point instruction generates more than one floating-point exception and one or more of those floating-point exceptions is trapped. [Combinations of floating-point exceptions on page E1-2745](#) describes the exact rules.

————— Note —————

There is no limitation in the case where all the floating-point exceptions are untrapped, because the pseudocode specifies the same behavior as the cross-referenced section.

- An exception can be taken during execution of the pseudocode for an instruction, either explicitly as a result of the execution of a pseudocode function such as `Abort()`, or implicitly, for example if an interrupt is taken during execution of an LDM instruction. If this happens, the pseudocode does not describe the extent to which the normal behavior of the instruction occurs. To determine that, see the descriptions of the exceptions in [Handling exceptions that are taken to an Exception level using AArch32 on page G1-4340](#).

K10.3 Data types

This section describes:

- [General data type rules](#).
- [Bitstrings](#).
- [Integers](#) on page K10-6258.
- [Reals](#) on page K10-6258.
- [Booleans](#) on page K10-6258.
- [Enumerations](#) on page K10-6259.
- [Structures](#) on page K10-6259.
- [Tuples](#) on page K10-6260.
- [Arrays](#) on page K10-6261.

K10.3.1 General data type rules

ARM architecture pseudocode is a strongly typed language. Every literal and variable is of one of the following types:

- Bitstring.
- Integer.
- Boolean.
- Real.
- Enumeration.
- Tuple.
- Struct.
- Array.

The type of a literal is determined by its syntax. A variable can be assigned to without an explicit declaration. The variable implicitly has the type of the assigned value. For example, the following assignments implicitly declare the variables `x`, `y` and `z` to have types integer, bitstring of length 1, and Boolean, respectively.

```
x = 1;
y = '1';
z = TRUE;
```

Variables can also have their types declared explicitly by preceding the variable name with the name of the type. The following example declares explicitly that a variable named `count` is an integer.

```
integer count;
```

This is most often done in function definitions for the arguments and the result of the function.

The remaining subsections describe each data type in more detail.

K10.3.2 Bitstrings

This section describes the bitstring data type.

Syntax

`bits(N)` The type name of a bitstring of length `N`.
`bit` A synonym of `bits(1)`.

Description

A bitstring is a finite-length string of 0s and 1s. Each length of bitstring is a different type. The minimum permitted length of a bitstring is 0.

Bitstring constants literals are written as a single quotation mark, followed by the string of 0s and 1s, followed by another single quotation mark. For example, the two constants literals of type bit are '0' and '1'. Spaces can be included in bitstrings for clarity.

The bits in a bitstring are numbered from left to right $N-1$ to 0. This numbering is used when accessing the bitstring using bitslices. In conversions to and from integers, bit $N-1$ is the MSByte and bit 0 is the LSByte. This order matches the order in which bitstrings derived from encoding diagrams are printed.

Every bitstring value has a left-to-right order, with the bits being numbered in standard *little-endian* order. That is, the leftmost bit of a bitstring of length N is bit $(N-1)$ and its right-most bit is bit 0. This order is used as the most-significant-to-least-significant bit order in conversions to and from integers. For bitstring constants and bitstrings that are derived from encoding diagrams, this order matches the way that they are printed.

Bitstrings are the only concrete data type in pseudocode, corresponding directly to the contents values that are manipulated in registers, memory locations, and instructions. All other data types are abstract.

K10.3.3 Integers

This section describes the data type for integer numbers.

Syntax

integer The type name for the integer data type.

Description

Pseudocode integers are unbounded in size and can be either positive or negative. That is, they are mathematical integers rather than what computer languages and architectures commonly call integers. Computer integers are represented in pseudocode as bitstrings of the appropriate length, and the pseudocode provides functions to interpret those bitstrings as integers.

Integer literals are normally written in decimal form, such as 0, 15, -1234. They can also be written in C-style hexadecimal form, such as 0x55 or 0x80000000. Hexadecimal integer literals are treated as positive unless they have a preceding minus sign. For example, 0x80000000 is the integer +2³¹. If -2³¹ needs to be written in hexadecimal, it must be written as -0x80000000.

K10.3.4 Reals

This section describes the data type for real numbers.

Syntax

real The type name for the real data type.

Description

Pseudocode reals are unbounded in size and precision. That is, they are mathematical real numbers, not computer floating-point numbers. Computer floating-point numbers are represented in pseudocode as bitstrings of the appropriate length, and the pseudocode provides functions to interpret those bitstrings as reals.

Real constant literals are written in decimal form with a decimal point. This means 0 is an integer constant literal, but 0.0 is a real constant literal.

K10.3.5 Booleans

This section describes the Boolean data type.

Syntax

`boolean` The type name for the Boolean data type.
`TRUE` The two values a Boolean variable can take.

Description

A Boolean is a logical TRUE or FALSE value.

———— Note —————

This is not the same type as `bit`, which is a bitstring of length 1. A Boolean can only take on one of two values: TRUE or FALSE.

K10.3.6 Enumerations

This section describes the enumeration data type.

Syntax and examples

`enumeration` Keyword to defined a new enumeration type.
`enumeration Example {Example_One, Example_Two, Example_Three};`
 A definition of a new enumeration called `Example`, which can take on the values `Example_One`, `Example_Two`, `Example_Three`.

Description

An enumeration is a defined set of named values.

An enumeration must contain at least one named value. A named value must not be shared between enumerations.

Enumerations must be defined explicitly, although a variable of an enumeration type can be declared implicitly by assigning one of the named values to it. By convention, each named value starts with the name of the enumeration followed by an underscore. The name of the enumeration is its *type name*, or *type*, and the named values are its possible *values*.

K10.3.7 Structures

This section describes the structure data type.

Syntax and examples

`type` The keyword used to declare the structure data type.
`type ShiftSpec is (bits(2) shift, integer amount)`
 An example definition for a new structure called `ShiftSpec` that contains an bitstring member called `shift` and a integer member named `amount`. Structure definitions must not be terminated with a semicolon.
`ShiftSpec abc;`
 A declaration of a variable named `abc` of type `ShiftSpec`.
`abc.shift`
 Syntax to refer to the individual members within the structure variable.

Description

A structure is a compound data type composed of one or more data items. The data items can be of different data types. This can include compound data types. The data items of a structure are called its members and are named.

In the syntax section, the example defines a structure called `ShiftSpec` with two members. The first is a bitstring of length 2 named `shift` and the second is an integer named `amount`. After declaring a variable of that type named `abc`, the members of this structure are referred to as `abc.shift` and `abc.amount`.

Every definition of a structure creates a different type, even if the number and type of their members are identical. For example:

```
type ShiftSpec1 is (bits(2) shift, integer amount)
type ShiftSpec2 is (bits(2) shift, integer amount)
```

`ShiftSpec1` and `ShiftSpec2` are two different types despite having identical definitions. This means that the value in a variable of type `ShiftSpec1` cannot be assigned to variable of type `ShiftSpec2`.

K10.3.8 Tuples

This section describes the tuple data type.

Examples

```
(bits(32) shifter_result, bit shifter_carry_out)
```

An example of the tuple syntax.

```
(shift_t, shift_n) = ('00', 0);
```

An example of assigning values to a tuple.

Description

A tuple is an ordered set of data items, separated by commas and enclosed in parentheses. The items can be of different types and a tuple must contain at least one data item.

Tuples are often used as the return type for functions that return multiple results. For example, in the syntax section, the example tuple is the return type of the function `Shift_C()`, which performs a standard A32/T32 shift or rotation. Its return type is a tuple containing two data items, with the first of type `bits(32)` and the second of type `bit`.

Each tuple is a separate compound data type. The compound data type is represented as a comma-separated list of ordered data types between parentheses. This means that the example tuple at the start of this section is of type `(bits(32), bit)`. The general principle that types can be implied by an assignment extends to implying the type of the elements in the tuple. For example, in the syntax section, the example assignment implicitly declares:

- `shift_t` to be of type `bits(2)`.
- `shift_n` to be of type `integer`.
- `(shift_t, shift_n)` to be a tuple of type `(bits(2), integer)`.

K10.3.9 Arrays

This section describes the array data type.

Syntax

array The type name for the array data type.

```
array data_type array_name[A..B];
```

Declaration of an array of type `data_type`, which might be compound data type. It is named `array_name` and is indexed with an integer range from A to B.

Description

An array is an ordered set of fixed size containing items of a single data type. This can include compound data types. Pseudocode arrays are indexed by either enumerations or integer ranges. An integer range is represented by the lower inclusive end of the range, then `..`, then the upper inclusive end of the range.

For example:

The following example declares an array of 31 bitstrings of length 64, indexed from 0 to 30.

```
array bits(64) _R[0..30];
```

Arrays are always explicitly declared, and there is no notation for a constant literal array. Arrays always contain at least one element data item, because:

- Enumerations always contain at least one symbolic constant named value.
- Integer ranges always contain at least one integer.

An array declared with an enumeration type as the index must be accessed using enumeration values of that enumeration type. An array declared with an integer range type as the index must be accessed using integer values from that inclusive range. Accessing such an array with an integer value outside of the range is a coding error.

Arrays do not usually appear directly in pseudocode. The items that syntactically look like arrays in pseudocode are usually array-like functions such as `R[i]`, `MemU[address, size]` or `Elem[vector, i, size]`. These functions package up and abstract additional operations normally performed on accesses to the underlying arrays, such as register banking, memory protection, endian-dependent byte ordering, exclusive-access housekeeping and Advanced SIMD element processing. See [Function and procedure calls on page K10-6268](#).

K10.4 Operators

This section describes:

- *Relational operators.*
- *Boolean operators.*
- *Bitstring operators on page K10-6263.*
- *Arithmetic operators on page K10-6263.*
- *The assignment operator on page K10-6264.*
- *Precedence rules on page K10-6266.*
- *Conditional expressions on page K10-6266.*
- *Operator polymorphism on page K10-6266.*

K10.4.1 Relational operators

The following operations yield results of type `boolean`.

Equality and non-equality

If two variables `x` and `y` are of the same type, their values can be tested for equality by using the expression `x == y` and for non-equality by using the expression `x != y`. In both cases, the result is of type `boolean`.

Both `x` and `y` must be of type `bits(N)`, `real`, `enumeration`, `boolean`, or `integer`. Named values from an enumeration can only be compared if they are both from the same enumeration. An exception is that a bitstring can be tested for equality with an integer to allow a `d==15` test.

A special form of comparison is defined with a bitstring literal that can contain bit values `'0'`, `'1'`, and `'x'`. Any bit with value `'x'` is ignored in determining the result of the comparison. For example, if `opcode` is a 4-bit bitstring, the expression `opcode == '1x0x'` matches the values `'1000'`, `'1100'`, `'1001'`, and `'1101'`. This is known as a bitmask.

———— Note ————

This special form is permitted in the implied equality comparisons in the `when` parts of `case ... of ...` structures.

Comparisons

If `x` and `y` are integers or reals, then `x < y`, `x <= y`, `x > y`, and `x >= y` are less than, less than or equal, greater than, and greater than or equal comparisons between them, producing Boolean results.

Set membership with `IN`

`<expression> IN {<set>}` produces `TRUE` if `<expression>` is a member of `<set>`. Otherwise, it is `FALSE`. `<set>` must be a list of expressions separated by commas.

K10.4.2 Boolean operators

If `x` is a Boolean expression, then `!x` is its logical inverse.

If `x` and `y` are Boolean expressions, then `x && y` is the result of ANDing them together. As in the C language, if `x` is `FALSE`, the result is determined to be `FALSE` without evaluating `y`.

———— Note ————

This is known as short circuit evaluation.

If `x` and `y` are booleans, then `x || y` is the result of ORing them together. As in the C language, if `x` is `TRUE`, the result is determined to be `TRUE` without evaluating `y`.

Note

If x and y are booleans or Boolean expressions, then the result of $x != y$ is the same as the result of exclusive-ORing x and y together. The operator EOR only accepts bitstring arguments.

K10.4.3 Bitstring operators

The following operations can be applied only to bitstrings.

Logical operations on bitstrings

If x is a bitstring, NOT(x) is the bitstring of the same length obtained by logically inverting every bit of x .

If x and y are bitstrings of the same length, x AND y , x OR y , and x EOR y are the bitstrings of that same length obtained by logically ANDing, logically ORing, and exclusive-ORing corresponding bits of x and y together.

Bitstring concatenation and slicing

If x and y are bitstrings of lengths N and M respectively, then $x:y$ is the bitstring of length $N+M$ constructed by concatenating x and y in left-to-right order.

The bitstring slicing operator addresses specific bits in a bitstring. This can be used to create a new bitstring from extracted bits or to set the value of specific bits. Its syntax is $x<integer_list>$, where x is the integer or bitstring being sliced, and $<integer_list>$ is a comma-separated list of integers enclosed in angle brackets. The length of the resulting bitstring is equal to the number of integers in $<integer_list>$. In $x<integer_list>$, each of the integers in $<integer_list>$ must be:

- ≥ 0 .
- $< \text{Len}(x)$ if x is a bitstring.

The definition of $x<integer_list>$ depends on whether $integer_list$ contains more than one integer:

- If $integer_list$ contains more than one integer, $x<i, j, k, \dots, n>$ is defined to be the concatenation:
 $x<i> : x<j> : x<k> : \dots : x<n>$.
- If $integer_list$ consists of just one integer i , $x<i>$ is defined to be:
 - If x is a bitstring, '0' if bit i of x is a zero and '1' if bit i of x is a one.
 - If x is an integer, and y is the unique integer in the range 0 to $2^{i+1}-1$ that is congruent to x modulo 2^{i+1} . Then $x<i>$ is '0' if $y < 2^i$ and '1' if $y \geq 2^i$.

Loosely, this definition treats an integer as equivalent to a sufficiently long two's complement representation of it as a bitstring.

The notation for a range expression is $i:j$ with $i \geq j$ is shorthand for the integers in order from i down to j , with both end values included. For example, $instr<31:28>$ represents $instr<31, 30, 29, 28>$.

$x<integer_list>$ is assignable provided x is an assignable bitstring and no integer appears more than once in $<integer_list>$. In particular, $x<i>$ is assignable if x is an assignable bitstring and $0 \leq i < \text{Len}(x)$.

Encoding diagrams for registers frequently show named bits or multi-bit fields. For example, the encoding diagram for the APSR shows its bit<31> as N. In such cases, the syntax APSR.N is used as a more readable synonym for APSR<31> as named bits can be referred to with the same syntax as referring to members of a struct. A comma-separated list of named bits enclosed in angle brackets following the register name allows multiple bits to be addressed simultaneously. For example, APSR.<N, C, Q> is synonymous with APSR <31, 29, 27>.

K10.4.4 Arithmetic operators

Most pseudocode arithmetic is performed on integer or real values, with operands obtained by conversions from bitstrings and results converted back to bitstrings. As these data types are the unbounded mathematical types, no issues arise about overflow or similar errors.

Unary plus and minus

If x is an integer or real, then $+x$ is x unchanged, $-x$ is x with its sign reversed. Both are of the same type as x .

Addition and subtraction

If x and y are integers or reals, $x+y$ and $x-y$ are their sum and difference. Both are of type integer if x and y are both of type integer, and real otherwise.

There are two cases where the types of x and y can be different. A bitstring and an integer can be added together to allow the operation $PC + 4$. An integer can be subtracted from a bitstring to allow the operation $PC - 2$.

If x and y are bitstrings of the same length N , so that $N = \text{Len}(x) = \text{Len}(y)$, then $x+y$ and $x-y$ are the least significant N bits of the results of converting x and y to integers and adding or subtracting them. Signed and unsigned conversions produce the same result:

$$\begin{aligned}x+y &= (\text{SInt}(x) + \text{SInt}(y))\langle N-1:0 \rangle \\ &= (\text{UInt}(x) + \text{UInt}(y))\langle N-1:0 \rangle \\ x-y &= (\text{SInt}(x) - \text{SInt}(y))\langle N-1:0 \rangle \\ &= (\text{UInt}(x) - \text{UInt}(y))\langle N-1:0 \rangle\end{aligned}$$

If x is a bitstring of length N and y is an integer, $x+y$ and $x-y$ are the bitstrings of length N defined by $x+y = x + y\langle N-1:0 \rangle$ and $x-y = x - y\langle N-1:0 \rangle$. Similarly, if x is an integer and y is a bitstring of length M , $x+y$ and $x-y$ are the bitstrings of length M defined by $x+y = x\langle M-1:0 \rangle + y$ and $x-y = x\langle M-1:0 \rangle - y$.

Multiplication

If x and y are integers or reals, then $x * y$ is the product of x and y . It is of type integer if x and y are both of type integer, and real otherwise.

Division and modulo

If x and y are reals, then x/y is the result of dividing x by y , and is always of type real.

If x and y are integers, then $x \text{ DIV } y$ and $x \text{ MOD } y$ are defined by:

$$\begin{aligned}x \text{ DIV } y &= \text{RoundDown}(x/y) \\ x \text{ MOD } y &= x - y * (x \text{ DIV } y)\end{aligned}$$

It is a pseudocode error to use any of x/y , $x \text{ MOD } y$, or $x \text{ DIV } y$ in any context where y can be zero.

Scaling

If x and n are of type integer, then:

- $x \ll n = \text{RoundDown}(x * 2^n)$.
- $x \gg n = \text{RoundDown}(x * 2^{(-n)})$.

Raising to a power

If x is an integer or a real and n is an integer then x^n is the result of raising x to the power of n , and:

- If x is of type integer then x^n is of type integer.
- If x is of type real then x^n is of type real.

K10.4.5 The assignment operator

The assignment operator is the $=$ character, which assigns the value of the right-hand side to the left-hand side. An assignment statement takes the form:

```
<assignable_expression> = <expression>;
```

This following subsection defines valid expression syntax.

General expression syntax

An expression is one of the following:

- A literal.
- A variable, optionally preceded by a data type name to declare its type.
- The word UNKNOWN preceded by a data type name to declare its type.
- The result of applying a language-defined operator to other expressions.
- The result of applying a function to other expressions.

Variable names normally consist of alphanumeric and underscore characters, starting with an alphabetic or underscore character.

Each register defined in an ARM architecture specification defines a correspondingly named pseudocode bitstring variable, and that variable has the stated behavior of the register. For example, if a bit of a register is defined as RAZ/WI, then the corresponding bit of its variable reads as '0' and ignore writes.

An expression like `bits(32) UNKNOWN` indicates that the result of the expression is a value of the given type, but the architecture does not specify what value it is and software must not rely on such values. The value produced must not:

- Return information that cannot be accessed at the current or a lower level of privilege using instructions that are not UNPREDICTABLE or CONSTRAINED UNPREDICTABLE and do not return UNKNOWN values,
- Be promoted as providing any useful information to software.

———— Note ————

UNKNOWN values are similar to the definition of UNPREDICTABLE, but do not indicate that the entire architectural state becomes unspecified.

Only the following expressions are assignable. This means that these are the only expressions that can be placed on the left-hand side of an assignment.

- Variables.
- The results of applying some operators to other expressions.
The description of each language-defined operator that can generate an assignable expression specifies the circumstances under which it does so. For example, those circumstances might require that one or more of the expressions the operator operates on is an assignable expression.
- The results of applying array-like functions to other expressions. The description of an array-like function specifies the circumstances under which it can generate an assignable expression.

———— Note ————

If the right-hand side in an assignment is a function returning a tuple, an item in the assignment destination can be written as `-` to indicate that the corresponding item of the assigned tuple value is discarded. For example:

```
(shifted, -) = LSL_C(operand, amount);
```

The expression on the right-hand side itself can be a tuple. For example:

```
(x, y) = (function_1(), function_2());
```

Every expression has a data type.

- For a literal, this data type is determined by the syntax of the literal.
- For a variable, there are the following possible sources for the data type
 - An optional preceding data type name.
 - A data type the variable was given earlier in the pseudocode by recursive application of this rule.

- A data type the variable is being given by assignment, either by direct assignment to the variable, or by assignment to a list of which the variable is a member.

It is a pseudocode error if none of these data type sources exists for a variable, or if more than one of them exists and they do not agree about the type.

- For a language-defined operator, the definition of the operator determines the data type.
- For a function, the definition of the function determines the data type.

K10.4.6 Precedence rules

The precedence rules for expressions are:

1. Literals, variables and function invocations are evaluated with higher priority than any operators using their results, but see [Boolean operators on page K10-6262](#).
2. Operators on integers follow the normal operator precedence rules of *exponentiation before multiply/divide before add/subtract*, with sequences of multiply/divides or add/subtracts evaluated left-to-right.
3. Other expressions must be parenthesized to indicate operator precedence if ambiguity is possible, but need not be if all permitted precedence orders under the type rules necessarily lead to the same result. For example, if *i*, *j* and *k* are integer variables, *i* > 0 && *j* > 0 && *k* > 0 is acceptable, but *i* > 0 && *j* > 0 || *k* > 0 is not.

K10.4.7 Conditional expressions

If *x* and *y* are two values of the same type and *t* is a value of type `boolean`, then `if t then x else y` is an expression of the same type as *x* and *y* that produces *x* if *t* is `TRUE` and *y* if *t* is `FALSE`.

K10.4.8 Operator polymorphism

Operators in pseudocode can be polymorphic, with different functionality when applied to different data types. Each resulting form of an operator has a different prototype definition. For example, the operator `+` has forms that act on various combinations of integers, reals and bitstrings.

[Table K10-1](#) summarizes the operand types valid for each unary operator and the result type. [Table K10-2](#) summarizes the operand types valid for each binary operator and the result type.

Table K10-1 Result and operand types permitted for unary operators

Operator	Operand Type	Result Type
-	integer	integer
	real	real
NOT	bits(N)	bits(N)
!	boolean	boolean

Table K10-2 Result and operand types permitted for binary operators

Operator	First operand type	Second operand type	Result type
==	bits(N)	integer	boolean
		bits(N)	
==	integer	integer	boolean
	real	real	
==	enumeration	enumeration	boolean
	boolean	boolean	

Table K10-2 Result and operand types permitted for binary operators (continued)

Operator	First operand type	Second operand type	Result type
!=	bits(N)	bits(N)	
	integer	integer	boolean
	real	real	
<, >	integer	integer	boolean
	<=, >=	real	
+, -	integer	integer	integer
	real	real	real
	bits(N)	bits(N) integer	bits(N)
<<, >>	integer	integer	integer
	integer	integer	integer
*	real	real	real
	bits(N)	bits(N)	bits(N)
/	real	real	real
DIV	integer	integer	integer
MOD	integer	integer	integer
	bits(N)	integer	
&&,	boolean	boolean	boolean
AND, OR, EOR	bits(N)	bits(N)	bits(N)
^	integer	integer	integer
	real	integer	real

K10.5 Statements and control structures

This section describes the statements and program structures available in the pseudocode:

- [Statements and Indentation](#).
- [Function and procedure calls](#).
- [Conditional control structures](#) on page K10-6270.
- [Loop control structures](#) on page K10-6271.
- [Special statements](#) on page K10-6272.
- [Comments](#) on page K10-6272.

K10.5.1 Statements and Indentation

A simple statement is either an assignment, a function call, or a procedure call. Each statement must be terminated with a semicolon.

Indentation normally indicates the structure in compound statements. The statements contained in structures such as `if ... then ... else ...` or procedure and function definitions are indented more deeply than the statement structure itself. The end of a compound statement structure and their end is indicated by returning to the original indentation level or less.

Indentation is normally done by four spaces for each level. Standard indentation uses four spaces for each level of indent.

K10.5.2 Function and procedure calls

This section describes how functions and procedures are defined and called in the pseudocode.

Procedure and function definitions

A procedure definition has the form:

```
<procedure name>(<argument prototypes>)
  <statement 1>;
  <statement 2>;
  ...
  <statement n>;
```

where <argument prototypes> consists of zero or more argument definitions, separated by commas. Each argument definition consists of a type name followed by the name of the argument.

Note

This first definition line is not terminated by a semicolon. This distinguishes it from a procedure call.

A function definition is similar, but also declares the return type of the function:

```
<return type> <function name>(<argument prototypes>)
  <statement 1>;
  <statement 2>;
  ...
  <statement n>;
```

Note

A function or procedure name can include a ".". This is a convention used for functions that have similar but different behaviors in AArch32 and AArch64 states.

Array-like functions are similar, but are written with square brackets and have two forms. These two forms exist because reading from and writing to an array element require different functions. They are frequently used in memory operations. An array-like function definition with a return type is equivalent to reading from an array. For example:

```
<return type> <function name>[<argument prototypes>]
  <statement 1>;
  <statement 2>;
  ...
  <statement n>;
```

Its related function definition with no return type is equivalent to writing to an array. For example:

```
<function name>[<argument prototypes>] = <value prototype>
  <statement 1>;
  <statement 2>;
  ...
  <statement n>;
```

The value prototype determines what data type can be written to the array. The two related functions must share the same name, but the value prototype and return type can be different.

Procedure calls

A procedure call has the form:

```
<procedure_name>(<arguments>);
```

Return statements

A procedure return has the form:

```
return;
```

A function return has the form:

```
return <expression>;
```

where <expression> is of the type declared in the function prototype line.

K10.5.3 Conditional control structures

This section describes how conditional control structures are used in the pseudocode.

if ... then ... else ...

In addition to being a ternary operator, a multi-line if ... then ... else ... structure can act as a control structure and has the form:

```
if <boolean_expression> then
    <statement 1>;
    <statement 2>;
    ...
    <statement n>;

elsif <boolean_expression> then
    <statement a>;
    <statement b>;
    ...
    <statement z>;
else
    <statement A>;
    <statement B>;
    ...
    <statement Z>;
```

The block of lines consisting of `elsif` and its indented statements is optional, and multiple `elsif` blocks can be used.

The block of lines consisting of `else` and its indented statements is optional.

Abbreviated one-line forms can be used when the `then` part, and in the `else` part if it is present, contain only simple statements such as:

```
if <boolean_expression> then <statement 1>;
if <boolean_expression> then <statement 1>; else <statement A>;
if <boolean_expression> then <statement 1>; <statement 2>; else <statement A>;
```

————— **Note** —————

In these forms, <statement 1>, <statement 2> and <statement A> must be terminated by semicolons. This and the fact that the `else` part is optional distinguish its use as a control structure from its use as a ternary operator.

case ... of ...

A case ... of ... structure has the form:

```
case <expression> of
    when <literal values1>
        <statement 1>;
        <statement 2>;
        ...
        <statement n>;

    when <literal values2>
        <statement 1>;
        <statement 2>;
        ...
        <statement n>;

    ... more "when" groups if required ...
```

```

otherwise
  <statement A>;
  <statement B>;
  ...
  <statement Z>;

```

In this structure, <literal values1> and <literal values2> consist of literal values of the same type as <expression>, separated by commas. There can be additional when groups in the structure. Abbreviated one line forms of when and otherwise parts can be used when they contain only simple statements.

If <expression> has a bitstring type, the literal values can also include bitstring literals containing 'x' bits, known as bitmasks. For details see [Equality and non-equality on page K10-6262](#).

K10.5.4 Loop control structures

This section describes the three loop control structures used in the pseudocode.

repeat ... until ...

A repeat ... until ... structure has the form:

```

repeat
  <statement 1>;
  <statement 2>;
  ...
  <statement n>;
until <boolean_expression>;

```

It executes the statement block at least once, and the loop repeats until <boolean expression> evaluates to TRUE. Variables explicitly declared inside the loop body have scope local to that loop and might not be accessed outside the loop body.

while ... do

A while ... do structure has the form:

```

while <boolean_expression> do
  <statement 1>;
  <statement 2>;
  ...
  <statement n>;

```

It begins executing the statement block only if the Boolean expression is true. The loop then runs until the expression is false.

for ...

A for ... structure has the form:

```

for <assignable_expression> = <integer_expr1> to <integer_expr2>
  <statement 1>;
  <statement 2>;
  ...
  <statement n>;

```

The <assignable_expression> is initialized to <integer_expr1> and compared to <integer_expr2>. If <integer_expr1> is less than <integer_expr2>, the loop body is executed and the <assignable_expression> incremented by one. This repeats until <assignable expression> is more than or equal to <integer_expr2>.

There is an alternate form:

```

for <assignable_expression> = <integer_expr1> downto <integer_expr2>

```

where <integer_expr1> is decremented after the loop body executes and continues until <assignable expression> is less than or equal than <integer_expr2>.

K10.5.5 Special statements

This section describes statements with particular architecturally-defined behaviors.

UNDEFINED

This subsection describes the statement:

```
UNDEFINED;
```

This statement indicates a special case that replaces the behavior defined by the current pseudocode, apart from behavior required to determine that the special case applies. The replacement behavior is that the Undefined Instruction exception is taken.

UNPREDICTABLE

This subsection describes the statement:

```
UNPREDICTABLE;
```

This statement indicates a special case that replaces the behavior defined by the current pseudocode, apart from behavior required to determine that the special case applies. The replacement behavior is UNPREDICTABLE.

SEE...

This subsection describes the statement:

```
SEE <reference>;
```

This statement indicates a special case that replaces the behavior defined by the current pseudocode, apart from behavior required to determine that the special case applies. The replacement behavior is that nothing occurs as a result of the current pseudocode because some other piece of pseudocode defines the required behavior. The <reference> indicates where that other pseudocode can be found.

It usually refers to another instruction, but can also refer to another encoding or note of the same instruction.

IMPLEMENTATION_DEFINED

This subsection describes the statement:

```
IMPLEMENTATION_DEFINED {"<text>"};
```

This statement indicates a special case that replaces the behavior defined by the current pseudocode, apart from behavior required to determine that the special case applies. The replacement behavior is IMPLEMENTATION_DEFINED. An optional <text> field can give more information.

K10.5.6 Comments

The pseudocode supports two styles of comments:

- `//` starts a comment that is terminated by the end of the line.
- `/*` starts a comment that is terminated by `*/`.

`/**/` statements might not be nested, and the first `*/` ends the comment.

———— **Note** —————

Comment lines do not require a terminating semicolon.

K10.6 Built-in functions

This section describes:

- [Bitstring manipulation functions](#).
- [Arithmetic functions](#) on page K10-6274.

K10.6.1 Bitstring manipulation functions

The following bitstring manipulation functions are defined:

Bitstring length and most significant bit

If x is a bitstring:

- The bitstring length function $\text{Len}(x)$ returns the length of x as an integer.

Bitstring concatenation and replication

If x is a bitstring and n is an integer with $n \geq 0$:

- $\text{Replicate}(x, n)$ is the bitstring of length $n \cdot \text{Len}(x)$ consisting of n copies of x concatenated together.
- $\text{Zeros}(n) = \text{Replicate}('0', n)$.
- $\text{Ones}(n) = \text{Replicate}('1', n)$.

Bitstring count

If x is a bitstring, $\text{BitCount}(x)$ is an integer result equal to the number of bits of x that are ones.

Testing a bitstring for being all zero or all ones

If x is a bitstring:

- $\text{IsZero}(x)$ produces TRUE if all of the bits of x are zeros and FALSE if any of them are ones
- $\text{IsZeroBit}(x)$ produces '1' if all of the bits of x are zeros and '0' if any of them are ones.

$\text{IsOnes}(x)$ and $\text{IsOnesBit}(x)$ work in the corresponding ways. This means:

```
IsZero(x)    = (BitCount(x) == 0)
IsOnes(x)    = (BitCount(x) == Len(x))
IsZeroBit(x) = if IsZero(x) then '1' else '0'
IsOnesBit(x) = if IsOnes(x) then '1' else '0'
```

Lowest and highest set bits of a bitstring

If x is a bitstring, and $N = \text{Len}(x)$:

- $\text{LowestSetBit}(x)$ is the minimum bit number of any of the bits of x that are ones. If all of its bits are zeros, $\text{LowestSetBit}(x) = N$.
- $\text{HighestSetBit}(x)$ is the maximum bit number of any of the bits of x that are ones. If all of its bits are zeros, $\text{HighestSetBit}(x) = -1$.
- $\text{CountLeadingZeroBits}(x)$ is the number of zero bits at the left end of x , in the range 0 to N . This means:
 $\text{CountLeadingZeroBits}(x) = N - 1 - \text{HighestSetBit}(x)$.
- $\text{CountLeadingSignBits}(x)$ is the number of copies of the sign bit of x at the left end of x , excluding the sign bit itself, and is in the range 0 to $N-1$. This means:
 $\text{CountLeadingSignBits}(x) = \text{CountLeadingZeroBits}(x \ll N-1 : 1 \gg \text{EOR } x \ll N-2 : 0 \gg)$.

Zero-extension and sign-extension of bitstrings

If x is a bitstring and i is an integer, then $\text{ZeroExtend}(x, i)$ is x extended to a length of i bits, by adding sufficient zero bits to its left. That is, if $i = \text{Len}(x)$, then $\text{ZeroExtend}(x, i) = x$, and if $i > \text{Len}(x)$, then:

```
ZeroExtend(x, i) = Replicate('0', i-Len(x)) : x
```

If x is a bitstring and i is an integer, then $\text{SignExtend}(x, i)$ is x extended to a length of i bits, by adding sufficient copies of its leftmost bit to its left. That is, if $i = \text{Len}(x)$, then $\text{SignExtend}(x, i) = x$, and if $i > \text{Len}(x)$, then:

```
SignExtend(x, i) = Replicate(TopBit(x), i-Len(x)) : x
```

It is a pseudocode error to use either $\text{ZeroExtend}(x, i)$ or $\text{SignExtend}(x, i)$ in a context where it is possible that $i < \text{Len}(x)$.

Converting bitstrings to integers

If x is a bitstring, $\text{SInt}()$ is the integer whose two's complement representation is x .

$\text{UInt}()$ is the integer whose unsigned representation is x .

$\text{Int}(x, \text{unsigned})$ returns either $\text{SInt}(x)$ or $\text{UInt}(x)$ depending on the value of its second argument.

K10.6.2 Arithmetic functions

This section defines built-in arithmetic functions.

Absolute value

If x is either of type real or integer, $\text{Abs}(x)$ returns the absolute value of x . The result is the same type as x .

Rounding and aligning

If x is a real:

- $\text{RoundDown}(x)$ produces the largest integer n such that $n \leq x$.
- $\text{RoundUp}(x)$ produces the smallest integer n such that $n \geq x$.
- $\text{RoundTowardsZero}(x)$ produces:
 - $\text{RoundDown}(x)$ if $x > 0.0$.
 - 0 if $x == 0.0$.
 - $\text{RoundUp}(x)$ if $x < 0.0$.

If x and y are both of type integer, $\text{Align}(x, y) = y * (x \text{ DIV } y)$, and is of type integer.

If x is of type bitstring and y is of type integer, $\text{Align}(x, y) = (\text{Align}(\text{UInt}(x), y)) \langle \text{Len}(x) - 1 : 0 \rangle$, and is a bitstring of the same length as x .

It is a pseudocode error to use either form of $\text{Align}(x, y)$ in any context where y can be 0. In practice, $\text{Align}(x, y)$ is only used with y a constant power of two, and the bitstring form used with $y = 2^n$ has the effect of producing its argument with its n low-order bits forced to zero.

Maximum and minimum

If x and y are integers or reals, then $\text{Max}(x, y)$ and $\text{Min}(x, y)$ are their maximum and minimum respectively. x and y must both be of type integer or of type real. The function returns a value of the same type as its operands.

K10.7 Miscellaneous helper procedures and functions

This section lists the prototypes of miscellaneous *helper* procedures and functions used by the pseudocode, together with a brief description of the effect of the procedure or function. The pseudocode does not define the operation of these helper procedures and functions.

———— **Note** —————

[Chapter J1 ARMv8 Pseudocode](#) also has an entry for each of these functions, but currently these entries do not say anything about the effect of the function. When this information is added in [Chapter J1](#) this section will be removed from the manual.

K10.7.1 EndOfInstruction()

This procedure terminates processing of the current instruction.

```
EndOfInstruction();
```

K10.7.2 Hint_Debug()

This procedure supplies a hint to the debug system.

```
Hint_Debug(bits(4) option);
```

K10.7.3 Hint_PreloadData()

This procedure performs a *preload data* hint.

```
Hint_PreloadData(bits(32) address);
```

K10.7.4 Hint_PreloadDataForWrite()

This procedure performs a *preload data* hint with a probability that the use will be for a write.

```
Hint_PreloadDataForWrite(bits(32) address);
```

K10.7.5 Hint_PreloadInstr()

This procedure performs a *preload instructions* hint.

```
Hint_PreloadInstr(bits(32) address);
```

K10.7.6 Hint_Yield()

This procedure performs a *yield* hint.

```
Hint_Yield();
```

K10.7.7 IsExternalAbort()

This function returns TRUE if the abort currently being processed is an external abort and FALSE otherwise. It is used only in exception entry pseudocode.

```
boolean IsExternalAbort(Fault type)  
    assert type != Fault_None;
```

```
boolean IsExternalAbort(FaultRecord fault);
```

K10.7.8 IsAsyncAbort()

This function returns TRUE if the abort currently being processed is an asynchronous abort, and FALSE otherwise. It is used only in exception entry pseudocode.

```
boolean IsAsyncAbort(Fault type)
    assert type != Fault_None;

boolean IsAsyncAbort(FaultRecord fault);
```

K10.7.9 LSInstructionSyndrome()

This function returns the extended syndrome information for a fault reported in the [HSR](#).

```
bits(11) LSInstructionSyndrome();
```

K10.7.10 ProcessorID()

This function returns an integer that uniquely identifies the executing PE in the system.

```
integer ProcessorID();
```

K10.7.11 RemapRegsHaveResetValues()

This function returns TRUE if the remap registers PRRR and NMRR have their IMPLEMENTATION DEFINED reset values, and FALSE otherwise.

```
boolean RemapRegsHaveResetValues();
```

K10.7.12 ResetControlRegisters()

This function resets the System registers and memory-mapped control registers that have architecturally-defined reset values to those values. For more information about the affected registers see:

- [PE state on reset to AArch64 state on page D1-1796.](#)
- [PE state on reset into AArch32 state on page G1-4400.](#)

```
AArch64.ResetControlRegisters(boolean ResetIsCold)
AArch32.ResetControlRegisters(boolean ResetIsCold)
```

K10.7.13 ThisInstr()

This function returns the bitstring encoding of the currently-executing instruction.

```
bits(32) ThisInstr();
```

———— **Note** —————

Currently, this function is used only on 32-bit instruction encodings.

K10.7.14 ThisInstrLength()

This function returns the length, in bits, of the current instruction. This means it returns 32 or 16:

```
integer ThisInstrLength();
```

K10.8 ARM pseudocode definition index

This section contains the following tables:

- [Table K10-3](#) which contains the pseudocode data types.
- [Table K10-4](#) which contains the pseudocode operators.
- [Table K10-5 on page K10-6279](#) which contains the pseudocode keywords and control structures.
- [Table K10-6 on page K10-6280](#) which contains the statements with special behaviors.

Table K10-3 Index of pseudocode data types

Keyword	Meaning
array	Type name for the array type
bit	Keyword equivalent to bits(1)
bits(N)	Type name for the bitstring of length N data type
boolean	Type name for the Boolean data type
enumeration	Keyword to define a new enumeration type
integer	Type name for the integer data type
real	Type name for the real data type
type	Keyword to define a new structure

Table K10-4 Index of pseudocode operators

Operator	Meaning
-	Unary minus on integers or reals
	Subtraction of integers, reals and bitstrings
	Used in the left-hand side of an assignment or a tuple to discard the result
+	Unary plus on integers or reals
	Addition of integers, reals and bitstrings
.	Extract named member from a list
	Extract named bit or field from a register
:	Bitstring concatenation
	Integer range in bitstring extraction operator
!	Boolean NOT
!=	Comparison for inequality
(...)	Around arguments of procedure or function
[...]	Around array index
	Around arguments of array-like function
*	Multiplication of integers, reals, and bitstrings
/	Division of reals

Table K10-4 Index of pseudocode operators (continued)

Operator	Meaning
&&	Boolean AND
<	<i>Less than</i> comparison of integers and reals
<...>	Slicing of specified bits of bitstring or integer
<<	Multiply integer by power of 2
<=	<i>Less than or equal</i> comparison of integers and reals
=	Assignment operator
==	Comparison for equality
>	<i>Greater than</i> comparison of integers and reals
>=	<i>Greater than or equal</i> comparison of integers and reals
>>	Divide integer by power of 2
	Boolean OR
^	Exponential operator
AND	Bitwise AND of bitstrings
DIV	Quotient from integer division
EOR	Bitwise EOR of bitstrings
IN	Tests membership of a certain expression in a set of values
MOD	Remainder from integer division
NOT	Bitwise inversion of bitstrings
OR	Bitwise OR of bitstrings

Table K10-5 Index of pseudocode keywords and control structures

Operator	Meaning
/*...*/	Comment delimiters
//	Introduces comment terminated by end of line
case ... of ...	Control structure for the
FALSE	One of two values a Boolean can take (other than TRUE)
for ... = ...to ...	Loop control structure, counting up from the initial value to the upper limit
for ... = ... downto ...	Loop control structure, counting down from the initial value to the lower limit
if ... then ... else ...	Condition expression selecting between two values
if ... then ... else ...	Conditional control structure
otherwise	Introduces default case in case ... of ... control structure

Table K10-5 Index of pseudocode keywords and control structures (continued)

Operator	Meaning
repeat ... until ...	Loop control structure that runs at least once until the termination condition is satisfied
return	Procedure or function return
TRUE	One of two values a Boolean can take (other than FALSE)
when	Introduces specific case in case ... of ... control structure
while ... do ...	Loop control structure that runs until the termination condition is satisfied

Table K10-6 Index of special statements

Keyword	Meaning
IMPLEMENTATION_DEFINED	Describes IMPLEMENTATION_DEFINED behavior
SEE	Points to other pseudocode to use instead
UNDEFINED	Cause Undefined Instruction exception
UNKNOWN	Unspecified value
UNPREDICTABLE	Unspecified behavior

Appendix K11

Registers Index

This appendix provides indexes to the register descriptions in this manual. It contains the following sections:

- *Introduction and register disambiguation* on page K11-6282.
- *Alphabetical index of AArch64 registers and system instructions* on page K11-6287.
- *Functional index of AArch64 registers and system instructions* on page K11-6296.
- *Alphabetical index of AArch32 registers and system instructions* on page K11-6306.
- *Functional index of AArch32 registers and system instructions* on page K11-6314.
- *Alphabetical index of memory-mapped registers* on page K11-6324.
- *Functional index of memory-mapped registers* on page K11-6329.

K11.1 Introduction and register disambiguation

In some sections of this manual, registers are referred to by a *general name*, where the description applies to more than one context. Generally, this is one of the following:

- The description applies to both AArch32 state and AArch64 state, and therefore the register names could apply to either AArch32 System registers or AArch64 System registers.
- The description applies to multiple Exception levels, and therefore at a particular Exception level the register names need to take the appropriate Exception. level suffix, `_EL0`, `_EL1`, `_EL2`, or `_EL3`.

The following sections disambiguate the general register names:

- [Register name disambiguation by Execution state.](#)
- [Register name disambiguation by Exception level on page K11-6285.](#)

K11.1.1 Register name disambiguation by Execution state

[Table K11-1](#) disambiguates the general names of the registers by Execution state.

Table K11-1 Disambiguation of general names of registers by Execution state

General name	Short description	AArch64 register	AArch32 register
CONTEXTIDR	Context ID	CONTEXTIDR_EL1	CONTEXTIDR
DBGBCR	Debug Breakpoint Control Registers	DBGBCR<n>_EL1	DBGBCR<n>
DBGBVR	Debug Breakpoint Value Registers	DBGBVR<n>_EL1	DBGBVR<n> DBGXVR<n>
DBGCLAIMCLR	Debug CLAIM Tag Clear register	DBGCLAIMCLR_EL1	DBGCLAIMCLR
DBGCLAIMSET	Debug CLAIM Tag Set register	DBGCLAIMSET_EL1	DBGCLAIMSET
DBGDTRRX	Debug Data Transfer Register, Receive	DBGDTRRX_EL0	DBGDTRRXint
DBGDTRTX	Debug Data Transfer Register, Transmit	DBGDTRTX_EL0	DBGDTRTXint
DBGPRCR	Debug Power Control Register	DBGPRCR_EL1	DBGPRCR
DBGVCR	Debug Vector Catch Register	DBGVCR32_EL2	DBGVCR
DBGWCR	Debug Watchpoint Control Registers	DBGWCR<n>_EL1	DBGWCR<n>
DBGWVR	Debug Watchpoint Value Registers	DBGWVR<n>_EL1	DBGWVR<n>
DCCINT	Debug Comms Channel Interrupt Enable Register	MDCCINT_EL1	DBGDCCINT
DCCSR	Debug Comms Channel Status Register	MDCCSR_EL0	DBGDSCRint
DBGAUTHSTATUS	Debug Authentication Status	DBGAUTHSTATUS_EL1	DBGAUTHSTATUS
DLR	Debug Link Register	DLR_EL0[31:0]	DLR
DSCR	Debug System Control Register	MDSCR_EL1	DBGDSCRExt
DSPSR	Debug Saved PE State Register	DSPSR_EL0	DSPSR
FAR	Fault Address Register	FAR_EL1 FAR_EL2 FAR_EL3 HPFAR_EL2	DFAR, IFAR HDFAR, HIFAR FAR_EL3 HPFAR

Table K11-1 Disambiguation of general names of registers by Execution state (continued)

General name	Short description	AArch64 register	AArch32 register
HCR	Hypervisor Configuration Register	HCR_EL2	HCR HCR2
HDCCR	Hyp or EL2 Debug Control Register	MDCR_EL2	HDCCR
HSCTLR	Hypervisor System Control Register	SCTLR_EL2	HSCTLR
HTTBR	EL2 Translation Table Base Register	TTBR0_EL2	HTTBR
ISR	Interrupt Status Register	ISR_EL1	ISR
MPIDR	Multiprocessor Affinity Register	MPIDR_EL1	MPIDR
OSDLR	OS Double-Lock Register	OSDLR_EL1	DBGOSDLR
OSDTRRX	OS Lock Data Transfer Register, Receive	OSDTRRX_EL1	DBGDTRRXext
OSDTRTX	OS Lock Data Transfer Register, Transmit	OSDTRTX_EL1	DBGDTRTXext
OSECRCR	OS Lock Exception Catch Control Register	OSECRCR_EL1	DBGOSECRCR
OSLAR	OS Lock Access Register	OSLAR_EL1	DBGOSLAR
OSLSR	OS Lock Status Register	OSLSR_EL1	DBGOSLSR
SCR	Secure Configuration Register	SCR_EL3	SCR
SCTLR	System Control Register	SCTLR_EL1 SCTLR_EL2 SCTLR_EL3	SCTLR (NS) HSCTLR SCTLR (S)
SDCR	Secure or EL3 Debug Configuration Register	MDCR_EL3	SDCR
SDER	Secure Debug Enable Register	SDER32_EL3	SDER
SPSR	Saved Program Status Register	SPSR_EL1 SPSR_EL2 SPSR_EL3	SPSR (general description) SPSR_abt SPSR_fiq SPSR_hyp SPSR_irq SPSR_mon SPSR_svc SPSR_und
TCR	Translation Control Register	TCR_EL1 TCR_EL2 TCR_EL3 VTCR_EL2	TTBCR(NS) HTCR TTBCR(S) VTCR
TTBR	Translation Table Base Register	TTBR0_EL1 TTBR0_EL2 TTBR0_EL3 TTBR1_EL1 VTTBR_EL2	TTBR0 TTBR1 HTTBR VTTBR

Table K11-1 Disambiguation of general names of registers by Execution state (continued)

General name	Short description	AArch64 register	AArch32 register
VCR	PL1&0 stage 2 Translation Control Register	VTCR_EL2	VTCR
VBAR	Vector Base Address Register	VBAR_EL1 VBAR_EL2 VBAR_EL3	VBAR HVBAR MVBAR
VTTBR	PL1&0 stage 2 Translation Table Base Register	VTTBR_EL2	VTTBR

Table K11-2 disambiguates the general names of the System registers that provide access to the Performance Monitors by Execution state.

Table K11-2 Disambiguation of general names of the Performance Monitors System registers by Execution state

General name	Short description	AArch64 register	AArch32 register
PMCCFILTR	Cycle Count Filter Register	PMCCFILTR_EL0	PMCCFILTR
PMCCNTR	Cycle Count Register	PMCCNTR_EL0	PMCCNTR
PMCEID0	Performance Monitors Cycle Count Filter Register 0	PMCEID0_EL0	PMCEID0
PMCEID1	Performance Monitors Cycle Count Filter Register 1	PMCEID1_EL0	PMCEID1
PMCNTENCLR	Performance Monitors Count Enable Clear register	PMCNTENCLR_EL0	PMINTENCLR
PMCNTENSET	Performance Monitors Count Enable Set register	PMCNTENSET_EL0	PMCNTENSET
PMCR	Performance Monitors Control Register	PMCR_EL0	PMCR
PMEVCNTR<n>	Performance Monitors Event Count Registers, n = 0-30	PMEVCNTR<n>_EL0	PMEVCNTR<n>
PMEVTYPER<n>	Performance Monitors Event Type Registers, n = 0-30	PMEVTYPER<n>_EL0	PMEVTYPER<n>
PMINTENCLR	Performance Monitors Interrupt Enable Clear register	PMINTENCLR_EL1	PMINTENCLR
PMINTENSET	Performance Monitors Interrupt Enable Set register	PMINTENSET_EL1	PMINTENSET
PMOVSCLR	Performance Monitors Overflow Flag Status Register	PMOVSCLR_EL0	PMOVSR
PMOVSSET	Performance Monitors Overflow Flag Status Set register	PMOVSSET_EL0	PMOVSSET
PMSELR	Performance Monitors Event Counter Selection Register	PMSELR_EL0	PMSELR
PMSWINC	Performance Monitors Software Increment register	PMSWINC_EL0	PMSWINC
PMUSERENR	Performance Monitors User Enable Register	PMUSERENR_EL0	PMUSERENR
PMXEVCNTR	Performance Monitors Selected Event Count Register	PMXEVCNTR_EL0	PMXEVCNTR
PMXEVTYPER	Performance Monitors Selected Event Type Register	PMXEVTYPER_EL0	PMXEVTYPER

Table K11-3 disambiguates the general names of the System registers that provide access to the Performance Monitors by Execution state.

Table K11-3 Disambiguation of general names of the Generic Timer System registers by Execution state

General name	Short description	AArch64 register	AArch32 register
CNTFRQ	Counter-timer Frequency register	CNTFRQ_EL0	CNTFRQ
CNTHCTL	Counter-timer Hypervisor Control register	CNTHCTL_EL2	CNTHCTL
CNTHP_CTL	Counter-timer Hypervisor Physical Timer Control register	CNTHP_CTL_EL2	CNTHP_CTL
CNTHP_CVAL	Counter-timer Hypervisor Physical Timer CompareValue register	CNTHP_CVAL_EL2	CNTHP_CVAL
CNTHP_TVAL	Counter-timer Hypervisor Physical Timer TimerValue register	CNTHP_TVAL_EL2	CNTHP_TVAL
CNTKCTL	Counter-timer Kernel Control register	CNTKCTL_EL1	CNTKCTL
CNTP_CTL	Counter-timer Physical Timer Control register	CNTP_CTL_EL0	CNTP_CTL
CNTP_CVAL	Counter-timer Physical Timer CompareValue register	CNTP_CVAL_EL0	CNTP_CVAL
CNTP_TVAL	Counter-timer Physical Timer TimerValue register	CNTP_TVAL_EL0	CNTP_TVAL
CNTPCT	Counter-timer Physical Count register	CNTPCT_EL0	CNTPCT
CNTPS_CTL	Counter-timer Physical Secure Timer Control register	CNTPS_CTL_EL1	-
CNTPS_CVAL	Counter-timer Physical Secure Timer CompareValue register	CNTPS_CVAL_EL1	-
CNTPS_TVAL	Counter-timer Physical Secure Timer TimerValue register	CNTPS_TVAL_EL1	-
CNTV_CTL	Counter-timer Virtual Timer Control register	CNTV_CTL_EL0	CNTV_CTL
CNTV_CVAL	Counter-timer Virtual Timer CompareValue register	CNTV_CVAL_EL0	CNTV_CVAL
CNTV_TVAL	Counter-timer Virtual Timer TimerValue register	CNTV_TVAL_EL0	CNTV_TVAL
CNTVCT	Counter-timer Virtual Count register	CNTVCT_EL0	CNTVCT
CNTVOFF	Counter-timer Virtual Offset register	CNTVOFF_EL2	CNTVOFF

K11.1.2 Register name disambiguation by Exception level

Table K11-4 disambiguates the general names of the AArch64 System registers by Exception level.

Table K11-4 Disambiguation of AArch64 System registers by Exception level

General form	EL0	EL1	EL2	EL3
AFSR0_ELx	-	AFSR0_EL1	AFSR0_EL2	AFSR0_EL3
AFSR1_ELx	-	AFSR1_EL1	AFSR1_EL2	AFSR1_EL3
CONTEXTIDR_ELx	-	CONTEXTIDR_EL1	-	-
CPTR_ELx	-	-	CPTR_EL2	CPTR_EL3
ELR_ELx	-	ELR_EL1	ELR_EL2	ELR_EL3
ESR_ELx	-	ESR_EL1	ESR_EL2	ESR_EL3
FAR_ELx	-	FAR_EL1	FAR_EL2	FAR_EL3

Table K11-4 Disambiguation of AArch64 System registers by Exception level (continued)

General form	EL0	EL1	EL2	EL3
MAIR_ELx	-	MAIR_EL1	MAIR_EL2	MAIR_EL3
RMR_ELx	-	RMR_EL1	RMR_EL2	RMR_EL3
RVBAR_ELx	-	RVBAR_EL1	RVBAR_EL2	RVBAR_EL3
SCTLR_ELx	-	SCTLR_EL1	SCTLR_EL2	SCTLR_EL3
SP_ELx	SP_EL0	SP_EL1	SP_EL2	SP_EL3
SPSR_ELx	-	SPSR_EL1	SPSR_EL2	SPSR_EL3
TCR_ELx	-	TCR_EL1	TCR_EL2	TCR_EL3
TTBR0_ELx	-	TTBR0_EL1	TTBR0_EL2	TTBR0_EL3
TTBR1_ELx	-	TTBR1_EL1	-	-
VBAR_ELx	-	VBAR_EL1	VBAR_EL2	VBAR_EL3

K11.2 Alphabetical index of AArch64 registers and system instructions

This section is an index of AArch64 registers and system instructions in alphabetical order.

Table K11-5 Alphabetical index of AArch64 Registers

Register	Description, see
ACTLR_EL1	<i>ACTLR_EL1, Auxiliary Control Register (EL1) on page D7-2199</i>
ACTLR_EL2	<i>ACTLR_EL2, Auxiliary Control Register (EL2) on page D7-2201</i>
ACTLR_EL3	<i>ACTLR_EL3, Auxiliary Control Register (EL3) on page D7-2203</i>
AFSR0_EL1	<i>AFSR0_EL1, Auxiliary Fault Status Register 0 (EL1) on page D7-2204</i>
AFSR0_EL2	<i>AFSR0_EL2, Auxiliary Fault Status Register 0 (EL2) on page D7-2206</i>
AFSR0_EL3	<i>AFSR0_EL3, Auxiliary Fault Status Register 0 (EL3) on page D7-2208</i>
AFSR1_EL1	<i>AFSR1_EL1, Auxiliary Fault Status Register 1 (EL1) on page D7-2209</i>
AFSR1_EL2	<i>AFSR1_EL2, Auxiliary Fault Status Register 1 (EL2) on page D7-2211</i>
AFSR1_EL3	<i>AFSR1_EL3, Auxiliary Fault Status Register 1 (EL3) on page D7-2213</i>
AIDR_EL1	<i>AIDR_EL1, Auxiliary ID Register on page D7-2214</i>
AMAIR_EL1	<i>AMAIR_EL1, Auxiliary Memory Attribute Indirection Register (EL1) on page D7-2216</i>
AMAIR_EL2	<i>AMAIR_EL2, Auxiliary Memory Attribute Indirection Register (EL2) on page D7-2218</i>
AMAIR_EL3	<i>AMAIR_EL3, Auxiliary Memory Attribute Indirection Register (EL3) on page D7-2220</i>
AT S12E0R	<i>AT S12E0R, Address Translate Stages 1 and 2 EL0 Read on page C5-428</i>
AT S12E0W	<i>AT S12E0W, Address Translate Stages 1 and 2 EL0 Write on page C5-430</i>
AT S12E1R	<i>AT S12E1R, Address Translate Stages 1 and 2 EL1 Read on page C5-432</i>
AT S12E1W	<i>AT S12E1W, Address Translate Stages 1 and 2 EL1 Write on page C5-434</i>
AT S1E0R	<i>AT S1E0R, Address Translate Stage 1 EL0 Read on page C5-436</i>
AT S1E0W	<i>AT S1E0W, Address Translate Stage 1 EL0 Write on page C5-438</i>
AT S1E1R	<i>AT S1E1R, Address Translate Stage 1 EL1 Read on page C5-440</i>
AT S1E1RP	<i>AT S1E1RP, Address Translate Stage 1 EL1 Read PAN on page C5-442</i>
AT S1E1W	<i>AT S1E1W, Address Translate Stage 1 EL1 Write on page C5-444</i>
AT S1E1WP	<i>AT S1E1WP, Address Translate Stage 1 EL1 Write PAN on page C5-446</i>
AT S1E2R	<i>AT S1E2R, Address Translate Stage 1 EL2 Read on page C5-448</i>
AT S1E2W	<i>AT S1E2W, Address Translate Stage 1 EL2 Write on page C5-450</i>
AT S1E3R	<i>AT S1E3R, Address Translate Stage 1 EL3 Read on page C5-452</i>
AT S1E3W	<i>AT S1E3W, Address Translate Stage 1 EL3 Write on page C5-453</i>
CCSIDR_EL1	<i>CCSIDR_EL1, Current Cache Size ID Register on page D7-2221</i>
CLIDR_EL1	<i>CLIDR_EL1, Cache Level ID Register on page D7-2223</i>
CNTFRQ_EL0	<i>CNTFRQ_EL0, Counter-timer Frequency register on page D7-2673</i>

Table K11-5 Alphabetical index of AArch64 Registers (continued)

Register	Description, see
CNTHCTL_EL2	<i>CNTHCTL_EL2</i> , Counter-timer Hypervisor Control register on page D7-2675
CNTHP_CTL_EL2	<i>CNTHP_CTL_EL2</i> , Counter-timer Hypervisor Physical Timer Control register on page D7-2680
CNTHP_CVAL_EL2	<i>CNTHP_CVAL_EL2</i> , Counter-timer Hypervisor Physical Timer CompareValue register on page D7-2683
CNTHP_TVAL_EL2	<i>CNTHP_TVAL_EL2</i> , Counter-timer Hypervisor Physical Timer TimerValue register on page D7-2685
CNTHV_CTL_EL2	<i>CNTHV_CTL_EL2</i> , Counter-timer Virtual Timer Control register (EL2) on page D7-2687
CNTHV_CVAL_EL2	<i>CNTHV_CVAL_EL2</i> , Counter-timer Virtual Timer CompareValue register (EL2) on page D7-2690
CNTHV_TVAL_EL2	<i>CNTHV_TVAL_EL2</i> , Counter-timer Virtual Timer TimerValue register (EL2) on page D7-2692
CNTKCTL_EL1	<i>CNTKCTL_EL1</i> , Counter-timer Kernel Control register on page D7-2694
CNTP_CTL_EL0	<i>CNTP_CTL_EL0</i> , Counter-timer Physical Timer Control register on page D7-2697
CNTP_CVAL_EL0	<i>CNTP_CVAL_EL0</i> , Counter-timer Physical Timer CompareValue register on page D7-2700
CNTP_TVAL_EL0	<i>CNTP_TVAL_EL0</i> , Counter-timer Physical Timer TimerValue register on page D7-2702
CNTPCT_EL0	<i>CNTPCT_EL0</i> , Counter-timer Physical Count register on page D7-2705
CNTPS_CTL_EL1	<i>CNTPS_CTL_EL1</i> , Counter-timer Physical Secure Timer Control register on page D7-2707
CNTPS_CVAL_EL1	<i>CNTPS_CVAL_EL1</i> , Counter-timer Physical Secure Timer CompareValue register on page D7-2709
CNTPS_TVAL_EL1	<i>CNTPS_TVAL_EL1</i> , Counter-timer Physical Secure Timer TimerValue register on page D7-2711
CNTV_CTL_EL0	<i>CNTV_CTL_EL0</i> , Counter-timer Virtual Timer Control register on page D7-2713
CNTV_CVAL_EL0	<i>CNTV_CVAL_EL0</i> , Counter-timer Virtual Timer CompareValue register on page D7-2716
CNTV_TVAL_EL0	<i>CNTV_TVAL_EL0</i> , Counter-timer Virtual Timer TimerValue register on page D7-2718
CNTVCT_EL0	<i>CNTVCT_EL0</i> , Counter-timer Virtual Count register on page D7-2720
CNTVOFF_EL2	<i>CNTVOFF_EL2</i> , Counter-timer Virtual Offset register on page D7-2722
CONTEXTIDR_EL1	<i>CONTEXTIDR_EL1</i> , Context ID Register (EL1) on page D7-2225
CONTEXTIDR_EL2	<i>CONTEXTIDR_EL2</i> , Context ID Register (EL2) on page D7-2227
CPACR_EL1	<i>CPACR_EL1</i> , Architectural Feature Access Control Register on page D7-2229
CPTR_EL2	<i>CPTR_EL2</i> , Architectural Feature Trap Register (EL2) on page D7-2232
CPTR_EL3	<i>CPTR_EL3</i> , Architectural Feature Trap Register (EL3) on page D7-2237
CSSELR_EL1	<i>CSSELR_EL1</i> , Cache Size Selection Register on page D7-2240
CTR_EL0	<i>CTR_EL0</i> , Cache Type Register on page D7-2242
CurrentEL	<i>CurrentEL</i> , Current Exception Level on page C5-337
DACR32_EL2	<i>DACR32_EL2</i> , Domain Access Control Register on page D7-2245
DAIF	<i>DAIF</i> , Interrupt Mask Bits on page C5-339

Table K11-5 Alphabetical index of AArch64 Registers (continued)

Register	Description, see
DBGAUTHSTATUS_EL1	<i>DBGAUTHSTATUS_EL1, Debug Authentication Status register on page D7-2555</i>
DBGBCR<n>_EL1	<i>DBGBCR<n>_EL1, Debug Breakpoint Control Registers, n = 0 - 15 on page D7-2557</i>
DBGBVR<n>_EL1	<i>DBGBVR<n>_EL1, Debug Breakpoint Value Registers, n = 0 - 15 on page D7-2561</i>
DBGCLAIMCLR_EL1	<i>DBGCLAIMCLR_EL1, Debug Claim Tag Clear register on page D7-2566</i>
DBGCLAIMSET_EL1	<i>DBGCLAIMSET_EL1, Debug Claim Tag Set register on page D7-2568</i>
DBGDTR_EL0	<i>DBGDTR_EL0, Debug Data Transfer Register; half-duplex on page D7-2570</i>
DBGDTRRX_EL0	<i>DBGDTRRX_EL0, Debug Data Transfer Register; Receive on page D7-2572</i>
DBGDTRTX_EL0	<i>DBGDTRTX_EL0, Debug Data Transfer Register; Transmit on page D7-2574</i>
DBGPRCR_EL1	<i>DBGPRCR_EL1, Debug Power Control Register on page D7-2576</i>
DBGVCR32_EL2	<i>DBGVCR32_EL2, Debug Vector Catch Register on page D7-2578</i>
DBGWCR<n>_EL1	<i>DBGWCR<n>_EL1, Debug Watchpoint Control Registers, n = 0 - 15 on page D7-2582</i>
DBGWVR<n>_EL1	<i>DBGWVR<n>_EL1, Debug Watchpoint Value Registers, n = 0 - 15 on page D7-2586</i>
DC CISW	<i>DC CISW, Data or unified Cache line Clean and Invalidate by Set/Way on page C5-406</i>
DC CIVAC	<i>DC CIVAC, Data or unified Cache line Clean and Invalidate by VA to PoC on page C5-408</i>
DC CSW	<i>DC CSW, Data or unified Cache line Clean by Set/Way on page C5-410</i>
DC CVAC	<i>DC CVAC, Data or unified Cache line Clean by VA to PoC on page C5-412</i>
DC CVAP	<i>DC CVAP, Data or unified Cache line Clean by VA to PoP on page C5-414</i>
DC CVAU	<i>DC CVAU, Data or unified Cache line Clean by VA to PoU on page C5-415</i>
DC ISW	<i>DC ISW, Data or unified Cache line Invalidate by Set/Way on page C5-417</i>
DC IVAC	<i>DC IVAC, Data or unified Cache line Invalidate by VA to PoC on page C5-419</i>
DC ZVA	<i>DC ZVA, Data Cache Zero by VA on page C5-421</i>
DCZID_EL0	<i>DCZID_EL0, Data Cache Zero ID register on page D7-2247</i>
DLR_EL0	<i>DLR_EL0, Debug Link Register on page D7-2588</i>
DSPSR_EL0	<i>DSPSR_EL0, Debug Saved Program Status Register on page D7-2589</i>
ELR_EL1	<i>ELR_EL1, Exception Link Register (EL1) on page C5-343</i>
ELR_EL2	<i>ELR_EL2, Exception Link Register (EL2) on page C5-345</i>
ELR_EL3	<i>ELR_EL3, Exception Link Register (EL3) on page C5-347</i>
ESR_EL1	<i>ESR_EL1, Exception Syndrome Register (EL1) on page D7-2249</i>
ESR_EL2	<i>ESR_EL2, Exception Syndrome Register (EL2) on page D7-2251</i>
ESR_EL3	<i>ESR_EL3, Exception Syndrome Register (EL3) on page D7-2253</i>
ESR_ELx	<i>ESR_ELx, Exception Syndrome Register (ELx) on page D7-2254</i>
FAR_EL1	<i>FAR_EL1, Fault Address Register (EL1) on page D7-2288</i>

Table K11-5 Alphabetical index of AArch64 Registers (continued)

Register	Description, see
FAR_EL2	<i>FAR_EL2, Fault Address Register (EL2) on page D7-2291</i>
FAR_EL3	<i>FAR_EL3, Fault Address Register (EL3) on page D7-2293</i>
FPCR	<i>FPCR, Floating-point Control Register on page C5-348</i>
FPEXC32_EL2	<i>FPEXC32_EL2, Floating-Point Exception Control register on page D7-2295</i>
FPSR	<i>FPSR, Floating-point Status Register on page C5-353</i>
HACR_EL2	<i>HACR_EL2, Hypervisor Auxiliary Control Register on page D7-2300</i>
HCR_EL2	<i>HCR_EL2, Hypervisor Configuration Register on page D7-2302</i>
HPFAR_EL2	<i>HPFAR_EL2, Hypervisor IPA Fault Address Register on page D7-2317</i>
HSTR_EL2	<i>HSTR_EL2, Hypervisor System Trap Register on page D7-2319</i>
IC IALLU	<i>IC IALLU, Instruction Cache Invalidate All to PoU on page C5-423</i>
IC IALLUIS	<i>IC IALLUIS, Instruction Cache Invalidate All to PoU, Inner Shareable on page C5-424</i>
IC IVAU	<i>IC IVAU, Instruction Cache line Invalidate by VA to PoU on page C5-425</i>
ID_AA64AFR0_EL1	<i>ID_AA64AFR0_EL1, AArch64 Auxiliary Feature Register 0 on page D7-2321</i>
ID_AA64AFR1_EL1	<i>ID_AA64AFR1_EL1, AArch64 Auxiliary Feature Register 1 on page D7-2323</i>
ID_AA64DFR0_EL1	<i>ID_AA64DFR0_EL1, AArch64 Debug Feature Register 0 on page D7-2325</i>
ID_AA64DFR1_EL1	<i>ID_AA64DFR1_EL1, AArch64 Debug Feature Register 1 on page D7-2328</i>
ID_AA64ISAR0_EL1	<i>ID_AA64ISAR0_EL1, AArch64 Instruction Set Attribute Register 0 on page D7-2330</i>
ID_AA64ISAR1_EL1	<i>ID_AA64ISAR1_EL1, AArch64 Instruction Set Attribute Register 1 on page D7-2333</i>
ID_AA64MMFR0_EL1	<i>ID_AA64MMFR0_EL1, AArch64 Memory Model Feature Register 0 on page D7-2335</i>
ID_AA64MMFR1_EL1	<i>ID_AA64MMFR1_EL1, AArch64 Memory Model Feature Register 1 on page D7-2338</i>
ID_AA64MMFR2_EL1	<i>ID_AA64MMFR2_EL1, AArch64 Memory Model Feature Register 2 on page D7-2342</i>
ID_AA64PFR0_EL1	<i>ID_AA64PFR0_EL1, AArch64 Processor Feature Register 0 on page D7-2344</i>
ID_AA64PFR1_EL1	<i>ID_AA64PFR1_EL1, AArch64 Processor Feature Register 1 on page D7-2347</i>
ID_AFR0_EL1	<i>ID_AFR0_EL1, AArch32 Auxiliary Feature Register 0 on page D7-2349</i>
ID_DFR0_EL1	<i>ID_DFR0_EL1, AArch32 Debug Feature Register 0 on page D7-2351</i>
ID_ISAR0_EL1	<i>ID_ISAR0_EL1, AArch32 Instruction Set Attribute Register 0 on page D7-2354</i>
ID_ISAR1_EL1	<i>ID_ISAR1_EL1, AArch32 Instruction Set Attribute Register 1 on page D7-2357</i>
ID_ISAR2_EL1	<i>ID_ISAR2_EL1, AArch32 Instruction Set Attribute Register 2 on page D7-2360</i>
ID_ISAR3_EL1	<i>ID_ISAR3_EL1, AArch32 Instruction Set Attribute Register 3 on page D7-2363</i>
ID_ISAR4_EL1	<i>ID_ISAR4_EL1, AArch32 Instruction Set Attribute Register 4 on page D7-2366</i>
ID_ISAR5_EL1	<i>ID_ISAR5_EL1, AArch32 Instruction Set Attribute Register 5 on page D7-2369</i>
ID_MMFR0_EL1	<i>ID_MMFR0_EL1, AArch32 Memory Model Feature Register 0 on page D7-2372</i>

Table K11-5 Alphabetical index of AArch64 Registers (continued)

Register	Description, see
ID_MMFR1_EL1	<i>ID_MMFR1_EL1, AArch32 Memory Model Feature Register 1 on page D7-2375</i>
ID_MMFR2_EL1	<i>ID_MMFR2_EL1, AArch32 Memory Model Feature Register 2 on page D7-2379</i>
ID_MMFR3_EL1	<i>ID_MMFR3_EL1, AArch32 Memory Model Feature Register 3 on page D7-2383</i>
ID_MMFR4_EL1	<i>ID_MMFR4_EL1, AArch32 Memory Model Feature Register 4 on page D7-2387</i>
ID_PFR0_EL1	<i>ID_PFR0_EL1, AArch32 Processor Feature Register 0 on page D7-2390</i>
ID_PFR1_EL1	<i>ID_PFR1_EL1, AArch32 Processor Feature Register 1 on page D7-2393</i>
IFSR32_EL2	<i>IFSR32_EL2, Instruction Fault Status Register (EL2) on page D7-2397</i>
ISR_EL1	<i>ISR_EL1, Interrupt Status Register on page D7-2401</i>
LORC_EL1	<i>LORC_EL1, LORegion Control (EL1) on page D7-2403</i>
LOREA_EL1	<i>LOREA_EL1, LORegion End Address (EL1) on page D7-2405</i>
LORID_EL1	<i>LORID_EL1, LORegionID (EL1) on page D7-2407</i>
LORN_EL1	<i>LORN_EL1, LORegion Number (EL1) on page D7-2409</i>
LORSA_EL1	<i>LORSA_EL1, LORegion Start Address (EL1) on page D7-2411</i>
MAIR_EL1	<i>MAIR_EL1, Memory Attribute Indirection Register (EL1) on page D7-2413</i>
MAIR_EL2	<i>MAIR_EL2, Memory Attribute Indirection Register (EL2) on page D7-2416</i>
MAIR_EL3	<i>MAIR_EL3, Memory Attribute Indirection Register (EL3) on page D7-2419</i>
MDCCINT_EL1	<i>MDCCINT_EL1, Monitor DCC Interrupt Enable Register on page D7-2595</i>
MDCCSR_EL0	<i>MDCCSR_EL0, Monitor DCC Status Register on page D7-2597</i>
MDCR_EL2	<i>MDCR_EL2, Monitor Debug Configuration Register (EL2) on page D7-2599</i>
MDCR_EL3	<i>MDCR_EL3, Monitor Debug Configuration Register (EL3) on page D7-2604</i>
MDRAR_EL1	<i>MDRAR_EL1, Monitor Debug ROM Address Register on page D7-2608</i>
MDSCR_EL1	<i>MDSCR_EL1, Monitor Debug System Control Register on page D7-2610</i>
MIDR_EL1	<i>MIDR_EL1, Main ID Register on page D7-2421</i>
MPIDR_EL1	<i>MPIDR_EL1, Multiprocessor Affinity Register on page D7-2423</i>
MVFR0_EL1	<i>MVFR0_EL1, AArch32 Media and VFP Feature Register 0 on page D7-2425</i>
MVFR1_EL1	<i>MVFR1_EL1, AArch32 Media and VFP Feature Register 1 on page D7-2429</i>
MVFR2_EL1	<i>MVFR2_EL1, AArch32 Media and VFP Feature Register 2 on page D7-2432</i>
NZCV	<i>NZCV, Condition Flags on page C5-356</i>
OSDLR_EL1	<i>OSDLR_EL1, OS Double Lock Register on page D7-2615</i>
OSDTRRX_EL1	<i>OSDTRRX_EL1, OS Lock Data Transfer Register, Receive on page D7-2617</i>
OSDTRTX_EL1	<i>OSDTRTX_EL1, OS Lock Data Transfer Register, Transmit on page D7-2619</i>
OSECCR_EL1	<i>OSECCR_EL1, OS Lock Exception Catch Control Register on page D7-2621</i>

Table K11-5 Alphabetical index of AArch64 Registers (continued)

Register	Description, see
OSLAR_EL1	<i>OSLAR_EL1, OS Lock Access Register on page D7-2623</i>
OSLSR_EL1	<i>OSLSR_EL1, OS Lock Status Register on page D7-2625</i>
PAN	<i>PAN, Privileged Access Never on page C5-358</i>
PAR_EL1	<i>PAR_EL1, Physical Address Register on page D7-2434</i>
PMCCFILTR_EL0	<i>PMCCFILTR_EL0, Performance Monitors Cycle Count Filter Register on page D7-2630</i>
PMCCNTR_EL0	<i>PMCCNTR_EL0, Performance Monitors Cycle Count Register on page D7-2633</i>
PMCEID0_EL0	<i>PMCEID0_EL0, Performance Monitors Common Event Identification register 0 on page D7-2635</i>
PMCEID1_EL0	<i>PMCEID1_EL0, Performance Monitors Common Event Identification register 1 on page D7-2637</i>
PMCNTENCLR_EL0	<i>PMCNTENCLR_EL0, Performance Monitors Count Enable Clear register on page D7-2639</i>
PMCNTENSET_EL0	<i>PMCNTENSET_EL0, Performance Monitors Count Enable Set register on page D7-2641</i>
PMCR_EL0	<i>PMCR_EL0, Performance Monitors Control Register on page D7-2643</i>
PMEVCNTR<n>_EL0	<i>PMEVCNTR<n>_EL0, Performance Monitors Event Count Registers, n = 0 - 30 on page D7-2647</i>
PMEVTYPER<n>_EL0	<i>PMEVTYPER<n>_EL0, Performance Monitors Event Type Registers, n = 0 - 30 on page D7-2649</i>
PMINTENCLR_EL1	<i>PMINTENCLR_EL1, Performance Monitors Interrupt Enable Clear register on page D7-2653</i>
PMINTENSET_EL1	<i>PMINTENSET_EL1, Performance Monitors Interrupt Enable Set register on page D7-2655</i>
PMOVSCLR_EL0	<i>PMOVSCLR_EL0, Performance Monitors Overflow Flag Status Clear Register on page D7-2657</i>
PMOVSSET_EL0	<i>PMOVSSET_EL0, Performance Monitors Overflow Flag Status Set register on page D7-2659</i>
PMSELR_EL0	<i>PMSELR_EL0, Performance Monitors Event Counter Selection Register on page D7-2661</i>
PMSWINC_EL0	<i>PMSWINC_EL0, Performance Monitors Software Increment register on page D7-2663</i>
PMUSERENR_EL0	<i>PMUSERENR_EL0, Performance Monitors User Enable Register on page D7-2665</i>
PMXEVCNTR_EL0	<i>PMXEVCNTR_EL0, Performance Monitors Selected Event Count Register on page D7-2668</i>
PMXEVTYPER_EL0	<i>PMXEVTYPER_EL0, Performance Monitors Selected Event Type Register on page D7-2670</i>
REVIDR_EL1	<i>REVIDR_EL1, Revision ID Register on page D7-2438</i>
RMR_EL1	<i>RMR_EL1, Reset Management Register (EL1) on page D7-2440</i>
RMR_EL2	<i>RMR_EL2, Reset Management Register (EL2) on page D7-2442</i>
RMR_EL3	<i>RMR_EL3, Reset Management Register (EL3) on page D7-2444</i>
RVBAR_EL1	<i>RVBAR_EL1, Reset Vector Base Address Register (if EL2 and EL3 not implemented) on page D7-2446</i>
RVBAR_EL2	<i>RVBAR_EL2, Reset Vector Base Address Register (if EL3 not implemented) on page D7-2447</i>
RVBAR_EL3	<i>RVBAR_EL3, Reset Vector Base Address Register (if EL3 implemented) on page D7-2448</i>

Table K11-5 Alphabetical index of AArch64 Registers (continued)

Register	Description, see
S3_<op1>_<Cn>_<Cm>_<op2>	<i>S3_<op1>_<Cn>_<Cm>_<op2></i> , IMPLEMENTATION DEFINED registers on page D7-2449
SCR_EL3	<i>SCR_EL3</i> , Secure Configuration Register on page D7-2451
SCTLR_EL1	<i>SCTLR_EL1</i> , System Control Register (EL1) on page D7-2456
SCTLR_EL2	<i>SCTLR_EL2</i> , System Control Register (EL2) on page D7-2465
SCTLR_EL3	<i>SCTLR_EL3</i> , System Control Register (EL3) on page D7-2476
SDER32_EL3	<i>SDER32_EL3</i> , AArch32 Secure Debug Enable Register on page D7-2627
SP_EL0	<i>SP_EL0</i> , Stack Pointer (EL0) on page C5-360
SP_EL1	<i>SP_EL1</i> , Stack Pointer (EL1) on page C5-362
SP_EL2	<i>SP_EL2</i> , Stack Pointer (EL2) on page C5-364
SP_EL3	<i>SP_EL3</i> , Stack Pointer (EL3) on page C5-366
SPSel	<i>SPSel</i> , Stack Pointer Select on page C5-367
SPSR_abt	<i>SPSR_abt</i> , Saved Program Status Register (Abort mode) on page C5-369
SPSR_EL1	<i>SPSR_EL1</i> , Saved Program Status Register (EL1) on page C5-373
SPSR_EL2	<i>SPSR_EL2</i> , Saved Program Status Register (EL2) on page C5-379
SPSR_EL3	<i>SPSR_EL3</i> , Saved Program Status Register (EL3) on page C5-385
SPSR_fiq	<i>SPSR_fiq</i> , Saved Program Status Register (FIQ mode) on page C5-391
SPSR_irq	<i>SPSR_irq</i> , Saved Program Status Register (IRQ mode) on page C5-395
SPSR_und	<i>SPSR_und</i> , Saved Program Status Register (Undefined mode) on page C5-399
TCR_EL1	<i>TCR_EL1</i> , Translation Control Register (EL1) on page D7-2480
TCR_EL2	<i>TCR_EL2</i> , Translation Control Register (EL2) on page D7-2490
TCR_EL3	<i>TCR_EL3</i> , Translation Control Register (EL3) on page D7-2503
TLBI ALLE1	<i>TLBI ALLE1</i> , TLB Invalidate All, EL1 on page C5-455
TLBI ALLE1IS	<i>TLBI ALLE1IS</i> , TLB Invalidate All, EL1, Inner Shareable on page C5-457
TLBI ALLE2	<i>TLBI ALLE2</i> , TLB Invalidate All, EL2 on page C5-459
TLBI ALLE2IS	<i>TLBI ALLE2IS</i> , TLB Invalidate All, EL2, Inner Shareable on page C5-460
TLBI ALLE3	<i>TLBI ALLE3</i> , TLB Invalidate All, EL3 on page C5-461
TLBI ALLE3IS	<i>TLBI ALLE3IS</i> , TLB Invalidate All, EL3, Inner Shareable on page C5-462
TLBI ASIDE1	<i>TLBI ASIDE1</i> , TLB Invalidate by ASID, EL1 on page C5-463
TLBI ASIDE1IS	<i>TLBI ASIDE1IS</i> , TLB Invalidate by ASID, EL1, Inner Shareable on page C5-465
TLBI IPAS2E1	<i>TLBI IPAS2E1</i> , TLB Invalidate by Intermediate Physical Address, Stage 2, EL1 on page C5-467
TLBI IPAS2E1IS	<i>TLBI IPAS2E1IS</i> , TLB Invalidate by Intermediate Physical Address, Stage 2, EL1, Inner Shareable on page C5-469

Table K11-5 Alphabetical index of AArch64 Registers (continued)

Register	Description, see
TLBI IPAS2LE1	<i>TLBI IPAS2LE1, TLB Invalidate by Intermediate Physical Address, Stage 2, Last level, EL1 on page C5-471</i>
TLBI IPAS2LE1IS	<i>TLBI IPAS2LE1IS, TLB Invalidate by Intermediate Physical Address, Stage 2, Last level, EL1, Inner Shareable on page C5-473</i>
TLBI VAAE1	<i>TLBI VAAE1, TLB Invalidate by VA, All ASID, EL1 on page C5-475</i>
TLBI VAAE1IS	<i>TLBI VAAE1IS, TLB Invalidate by VA, All ASID, EL1, Inner Shareable on page C5-477</i>
TLBI VAALE1	<i>TLBI VAALE1, TLB Invalidate by VA, All ASID, Last level, EL1 on page C5-479</i>
TLBI VAALE1IS	<i>TLBI VAALE1IS, TLB Invalidate by VA, All ASID, EL1, Last Level, Inner Shareable on page C5-481</i>
TLBI VAE1	<i>TLBI VAE1, TLB Invalidate by VA, EL1 on page C5-483</i>
TLBI VAE1IS	<i>TLBI VAE1IS, TLB Invalidate by VA, EL1, Inner Shareable on page C5-486</i>
TLBI VAE2	<i>TLBI VAE2, TLB Invalidate by VA, EL2 on page C5-488</i>
TLBI VAE2IS	<i>TLBI VAE2IS, TLB Invalidate by VA, EL2, Inner Shareable on page C5-490</i>
TLBI VAE3	<i>TLBI VAE3, TLB Invalidate by VA, EL3 on page C5-492</i>
TLBI VAE3IS	<i>TLBI VAE3IS, TLB Invalidate by VA, EL3, Inner Shareable on page C5-494</i>
TLBI VALE1	<i>TLBI VALE1, TLB Invalidate by VA, Last level, EL1 on page C5-496</i>
TLBI VALE1IS	<i>TLBI VALE1IS, TLB Invalidate by VA, Last level, EL1, Inner Shareable on page C5-499</i>
TLBI VALE2	<i>TLBI VALE2, TLB Invalidate by VA, Last level, EL2 on page C5-501</i>
TLBI VALE2IS	<i>TLBI VALE2IS, TLB Invalidate by VA, Last level, EL2, Inner Shareable on page C5-503</i>
TLBI VALE3	<i>TLBI VALE3, TLB Invalidate by VA, Last level, EL3 on page C5-505</i>
TLBI VALE3IS	<i>TLBI VALE3IS, TLB Invalidate by VA, Last level, EL3, Inner Shareable on page C5-507</i>
TLBI VMALLE1	<i>TLBI VMALLE1, TLB Invalidate by VMID, All at stage 1, EL1 on page C5-509</i>
TLBI VMALLE1IS	<i>TLBI VMALLE1IS, TLB Invalidate by VMID, All at stage 1, EL1, Inner Shareable on page C5-511</i>
TLBI VMALLS12E1	<i>TLBI VMALLS12E1, TLB Invalidate by VMID, All at Stage 1 and 2, EL1 on page C5-513</i>
TLBI VMALLS12E1IS	<i>TLBI VMALLS12E1IS, TLB Invalidate by VMID, All at Stage 1 and 2, EL1, Inner Shareable on page C5-515</i>
TPIDR_EL0	<i>TPIDR_EL0, EL0 Read/Write Software Thread ID Register on page D7-2508</i>
TPIDR_EL1	<i>TPIDR_EL1, EL1 Software Thread ID Register on page D7-2510</i>
TPIDR_EL2	<i>TPIDR_EL2, EL2 Software Thread ID Register on page D7-2512</i>
TPIDR_EL3	<i>TPIDR_EL3, EL3 Software Thread ID Register on page D7-2514</i>
TPIDRRO_EL0	<i>TPIDRRO_EL0, EL0 Read-Only Software Thread ID Register on page D7-2515</i>
TTBR0_EL1	<i>TTBR0_EL1, Translation Table Base Register 0 (EL1) on page D7-2517</i>
TTBR0_EL2	<i>TTBR0_EL2, Translation Table Base Register 0 (EL2) on page D7-2521</i>
TTBR0_EL3	<i>TTBR0_EL3, Translation Table Base Register 0 (EL3) on page D7-2525</i>

Table K11-5 Alphabetical index of AArch64 Registers (continued)

Register	Description, see
TTBR1_EL1	<i>TTBR1_EL1, Translation Table Base Register 1 (EL1) on page D7-2528</i>
TTBR1_EL2	<i>TTBR1_EL2, Translation Table Base Register 1 (EL2) on page D7-2532</i>
UAO	<i>UAO, User Access Override on page C5-403</i>
VBAR_EL1	<i>VBAR_EL1, Vector Base Address Register (EL1) on page D7-2536</i>
VBAR_EL2	<i>VBAR_EL2, Vector Base Address Register (EL2) on page D7-2538</i>
VBAR_EL3	<i>VBAR_EL3, Vector Base Address Register (EL3) on page D7-2540</i>
VMPIDR_EL2	<i>VMPIDR_EL2, Virtualization Multiprocessor ID Register on page D7-2542</i>
VPIDR_EL2	<i>VPIDR_EL2, Virtualization Processor ID Register on page D7-2544</i>
VTCR_EL2	<i>VTCR_EL2, Virtualization Translation Control Register on page D7-2546</i>
VTTBR_EL2	<i>VTTBR_EL2, Virtualization Translation Table Base Register on page D7-2551</i>

K11.3 Functional index of AArch64 registers and system instructions

This section is an index of the AArch64 registers and system instructions, divided by functional group.

K11.3.1 Special-purpose registers

This section is an index to the registers in the Special-purpose registers functional group.

Table K11-6 Special-purpose registers

Register	Description, see
DLR_EL0	DLR_EL0
DSPSR_EL0	DSPSR_EL0
ELR_EL1	ELR_EL1
ELR_EL2	ELR_EL2
ELR_EL3	ELR_EL3
FPCR	FPCR
FPSR	FPSR
SP_EL0	SP_EL0
SP_EL1	SP_EL1
SP_EL2	SP_EL2
SP_EL3	SP_EL3
SPSR_abt	SPSR_abt
SPSR_EL1	SPSR_EL1
SPSR_EL2	SPSR_EL2
SPSR_EL3	SPSR_EL3
SPSR_fiq	SPSR_fiq
SPSR_irq	SPSR_irq
SPSR_und	SPSR_und

K11.3.2 VMSA-specific registers

This section is an index to the registers in the Virtual memory control registers functional group.

Table K11-7 VMSA-specific registers

Register	Description, see
AMAIR_EL1	AMAIR_EL1
AMAIR_EL2	AMAIR_EL2
AMAIR_EL3	AMAIR_EL3
CONTEXTIDR_EL1	CONTEXTIDR_EL1

Table K11-7 VMSA-specific registers (continued)

Register	Description, see
CONTEXTIDR_EL2	CONTEXTIDR_EL2
DACR32_EL2	DACR32_EL2
LORC_EL1	LORC_EL1
LOREA_EL1	LOREA_EL1
LORID_EL1	LORID_EL1
LORN_EL1	LORN_EL1
LORSA_EL1	LORSA_EL1
MAIR_EL1	MAIR_EL1
MAIR_EL2	MAIR_EL2
MAIR_EL3	MAIR_EL3
TCR_EL1	TCR_EL1
TCR_EL2	TCR_EL2
TCR_EL3	TCR_EL3
TTBR0_EL1	TTBR0_EL1
TTBR0_EL2	TTBR0_EL2
TTBR0_EL3	TTBR0_EL3
TTBR1_EL1	TTBR1_EL1
TTBR1_EL2	TTBR1_EL2
VTCR_EL2	VTCR_EL2
VTTBR_EL2	VTTBR_EL2

K11.3.3 ID registers

This section is an index to the registers in the Identification registers functional group.

Table K11-8 ID registers

Register	Description, see
AIDR_EL1	AIDR_EL1
CCSIDR_EL1	CCSIDR_EL1
CLIDR_EL1	CLIDR_EL1
CSSELR_EL1	CSSELR_EL1
CTR_EL0	CTR_EL0
DCZID_EL0	DCZID_EL0
ID_AA64AFR0_EL1	ID_AA64AFR0_EL1

Table K11-8 ID registers (continued)

Register	Description, see
ID_AA64AFR1_EL1	ID_AA64AFR1_EL1
ID_AA64DFR0_EL1	ID_AA64DFR0_EL1
ID_AA64DFR1_EL1	ID_AA64DFR1_EL1
ID_AA64ISAR0_EL1	ID_AA64ISAR0_EL1
ID_AA64ISAR1_EL1	ID_AA64ISAR1_EL1
ID_AA64MMFR0_EL1	ID_AA64MMFR0_EL1
ID_AA64MMFR1_EL1	ID_AA64MMFR1_EL1
ID_AA64MMFR2_EL1	ID_AA64MMFR2_EL1
ID_AA64PFR0_EL1	ID_AA64PFR0_EL1
ID_AA64PFR1_EL1	ID_AA64PFR1_EL1
ID_AFR0_EL1	ID_AFR0_EL1
ID_DFR0_EL1	ID_DFR0_EL1
ID_ISAR0_EL1	ID_ISAR0_EL1
ID_ISAR1_EL1	ID_ISAR1_EL1
ID_ISAR2_EL1	ID_ISAR2_EL1
ID_ISAR3_EL1	ID_ISAR3_EL1
ID_ISAR4_EL1	ID_ISAR4_EL1
ID_ISAR5_EL1	ID_ISAR5_EL1
ID_MMFR0_EL1	ID_MMFR0_EL1
ID_MMFR1_EL1	ID_MMFR1_EL1
ID_MMFR2_EL1	ID_MMFR2_EL1
ID_MMFR3_EL1	ID_MMFR3_EL1
ID_MMFR4_EL1	ID_MMFR4_EL1
ID_PFR0_EL1	ID_PFR0_EL1
ID_PFR1_EL1	ID_PFR1_EL1
MIDR_EL1	MIDR_EL1
MPIDR_EL1	MPIDR_EL1
MVFR0_EL1	MVFR0_EL1
MVFR1_EL1	MVFR1_EL1
MVFR2_EL1	MVFR2_EL1

Table K11-8 ID registers (continued)

Register	Description, see
REVIDR_EL1	REVIDR_EL1
VMPIDR_EL2	VMPIDR_EL2
VPIDR_EL2	VPIDR_EL2

K11.3.4 Performance monitors registers

This section is an index to the registers in the Performance Monitors registers functional group.

Table K11-9 Performance monitors registers

Register	Description, see
PMCCFILTR_EL0	PMCCFILTR_EL0
PMCCNTR_EL0	PMCCNTR_EL0
PMCEID0_EL0	PMCEID0_EL0
PMCEID1_EL0	PMCEID1_EL0
PMCNTENCLR_EL0	PMCNTENCLR_EL0
PMCNTENSET_EL0	PMCNTENSET_EL0
PMCR_EL0	PMCR_EL0
PMEVCNTR<n>_EL0	PMEVCNTR<n>_EL0
PMEVTYPER<n>_EL0	PMEVTYPER<n>_EL0
PMINTENCLR_EL1	PMINTENCLR_EL1
PMINTENSET_EL1	PMINTENSET_EL1
PMOVSCLR_EL0	PMOVSCLR_EL0
PMOVSSET_EL0	PMOVSSET_EL0
PMSELR_EL0	PMSELR_EL0
PMSWINC_EL0	PMSWINC_EL0
PMUSERENR_EL0	PMUSERENR_EL0
PMXEVCNTR_EL0	PMXEVCNTR_EL0
PMXEVTYPER_EL0	PMXEVTYPER_EL0

K11.3.5 Debug registers

This section is an index to the registers in the Debug registers functional group.

Table K11-10 Debug registers

Register	Description, see
DBGAUTHSTATUS_EL1	DBGAUTHSTATUS_EL1
DBGBCR<n>_EL1	DBGBCR<n>_EL1
DBGBVR<n>_EL1	DBGBVR<n>_EL1
DBGCLAIMCLR_EL1	DBGCLAIMCLR_EL1
DBGCLAIMSET_EL1	DBGCLAIMSET_EL1
DBGDTR_EL0	DBGDTR_EL0
DBGDTRRX_EL0	DBGDTRRX_EL0
DBGDTRTX_EL0	DBGDTRTX_EL0
DBGPRCR_EL1	DBGPRCR_EL1
DBGVCR32_EL2	DBGVCR32_EL2
DBGWCR<n>_EL1	DBGWCR<n>_EL1
DBGWVR<n>_EL1	DBGWVR<n>_EL1
DLR_EL0	DLR_EL0
DSPSR_EL0	DSPSR_EL0
MDCCINT_EL1	MDCCINT_EL1
MDCCSR_EL0	MDCCSR_EL0
MDCR_EL2	MDCR_EL2
MDCR_EL3	MDCR_EL3
MDRAR_EL1	MDRAR_EL1
MDSCR_EL1	MDSCR_EL1
OSDLR_EL1	OSDLR_EL1
OSDTRRX_EL1	OSDTRRX_EL1
OSDTRTX_EL1	OSDTRTX_EL1
OSECCR_EL1	OSECCR_EL1
OSLAR_EL1	OSLAR_EL1
OSLSR_EL1	OSLSR_EL1
SDER32_EL3	SDER32_EL3

K11.3.6 Generic timer registers

This section is an index to the registers in the Generic Timer registers functional group.

Table K11-11 Generic timer registers

Register	Description, see
CNTRQ_EL0	CNTRQ_EL0
CNTHCTL_EL2	CNTHCTL_EL2
CNTHP_CTL_EL2	CNTHP_CTL_EL2
CNTHP_CVAL_EL2	CNTHP_CVAL_EL2
CNTHP_TVAL_EL2	CNTHP_TVAL_EL2
CNTHV_CTL_EL2	CNTHV_CTL_EL2
CNTHV_CVAL_EL2	CNTHV_CVAL_EL2
CNTHV_TVAL_EL2	CNTHV_TVAL_EL2
CNTKCTL_EL1	CNTKCTL_EL1
CNTP_CTL_EL0	CNTP_CTL_EL0
CNTP_CVAL_EL0	CNTP_CVAL_EL0
CNTP_TVAL_EL0	CNTP_TVAL_EL0
CNTPCT_EL0	CNTPCT_EL0
CNTPS_CTL_EL1	CNTPS_CTL_EL1
CNTPS_CVAL_EL1	CNTPS_CVAL_EL1
CNTPS_TVAL_EL1	CNTPS_TVAL_EL1
CNTV_CTL_EL0	CNTV_CTL_EL0
CNTV_CVAL_EL0	CNTV_CVAL_EL0
CNTV_TVAL_EL0	CNTV_TVAL_EL0
CNTVCT_EL0	CNTVCT_EL0
CNTVOFF_EL2	CNTVOFF_EL2

K11.3.7 Cache maintenance system instructions

This section is an index to the registers in the Cache maintenance instructions functional group.

Table K11-12 Cache maintenance system instructions

Register	Description, see
DC CISW	DC CISW
DC CIVAC	DC CIVAC
DC CSW	DC CSW
DC CVAC	DC CVAC

Table K11-12 Cache maintenance system instructions (continued)

Register	Description, see
DC CVAP	DC CVAP
DC CVAU	DC CVAU
DC ISW	DC ISW
DC IVAC	DC IVAC
DC ZVA	DC ZVA
IC IALLU	IC IALLU
IC IALLUIS	IC IALLUIS
IC IVAU	IC IVAU

K11.3.8 Address translation system instructions

This section is an index to the registers in the Address translation instructions functional group.

Table K11-13 Address translation system instructions

Register	Description, see
AT S12E0R	AT S12E0R
AT S12E0W	AT S12E0W
AT S12E1R	AT S12E1R
AT S12E1W	AT S12E1W
AT S1E0R	AT S1E0R
AT S1E0W	AT S1E0W
AT S1E1R	AT S1E1R
AT S1E1RP	AT S1E1RP
AT S1E1W	AT S1E1W
AT S1E1WP	AT S1E1WP
AT S1E2R	AT S1E2R
AT S1E2W	AT S1E2W
AT S1E3R	AT S1E3R
AT S1E3W	AT S1E3W

K11.3.9 TLB maintenance system instructions

This section is an index to the registers in the TLB maintenance instructions functional group.

Table K11-14 TLB maintenance system instructions

Register	Description, see
TLBI ALLE1	TLBI ALLE1
TLBI ALLE1IS	TLBI ALLE1IS
TLBI ALLE2	TLBI ALLE2
TLBI ALLE2IS	TLBI ALLE2IS
TLBI ALLE3	TLBI ALLE3
TLBI ALLE3IS	TLBI ALLE3IS
TLBI ASIDE1	TLBI ASIDE1
TLBI ASIDE1IS	TLBI ASIDE1IS
TLBI IPAS2E1	TLBI IPAS2E1
TLBI IPAS2E1IS	TLBI IPAS2E1IS
TLBI IPAS2LE1	TLBI IPAS2LE1
TLBI IPAS2LE1IS	TLBI IPAS2LE1IS
TLBI VAAE1	TLBI VAAE1
TLBI VAAE1IS	TLBI VAAE1IS
TLBI VAALE1	TLBI VAALE1
TLBI VAALE1IS	TLBI VAALE1IS
TLBI VAE1	TLBI VAE1
TLBI VAE1IS	TLBI VAE1IS
TLBI VAE2	TLBI VAE2
TLBI VAE2IS	TLBI VAE2IS
TLBI VAE3	TLBI VAE3
TLBI VAE3IS	TLBI VAE3IS
TLBI VALE1	TLBI VALE1
TLBI VALE1IS	TLBI VALE1IS
TLBI VALE2	TLBI VALE2
TLBI VALE2IS	TLBI VALE2IS
TLBI VALE3	TLBI VALE3
TLBI VALE3IS	TLBI VALE3IS
TLBI VMALLE1	TLBI VMALLE1

Table K11-14 TLB maintenance system instructions (continued)

Register	Description, see
TLBI VMALLE1IS	TLBI VMALLE1IS
TLBI VMALLS12E1	TLBI VMALLS12E1
TLBI VMALLS12E1IS	TLBI VMALLS12E1IS

K11.3.10 Base system registers

This section is an index to the registers in the functional group.

Table K11-15 Base system registers

Register	Description, see
ACTLR_EL1	ACTLR_EL1
ACTLR_EL2	ACTLR_EL2
ACTLR_EL3	ACTLR_EL3
AFSR0_EL1	AFSR0_EL1
AFSR0_EL2	AFSR0_EL2
AFSR0_EL3	AFSR0_EL3
AFSR1_EL1	AFSR1_EL1
AFSR1_EL2	AFSR1_EL2
AFSR1_EL3	AFSR1_EL3
CPACR_EL1	CPACR_EL1
CPTR_EL2	CPTR_EL2
CPTR_EL3	CPTR_EL3
CurrentEL	CurrentEL
DAIF	DAIF
ESR_EL1	ESR_EL1
ESR_EL2	ESR_EL2
ESR_EL3	ESR_EL3
ESR_ELx	ESR_ELx
FAR_EL1	FAR_EL1
FAR_EL2	FAR_EL2
FAR_EL3	FAR_EL3
FPEXC32_EL2	FPEXC32_EL2
HACR_EL2	HACR_EL2
HCR_EL2	HCR_EL2

Table K11-15 Base system registers (continued)

Register	Description, see
HPFAR_EL2	HPFAR_EL2
HSTR_EL2	HSTR_EL2
IFSR32_EL2	IFSR32_EL2
ISR_EL1	ISR_EL1
NZCV	NZCV
PAN	PAN
PAR_EL1	PAR_EL1
RMR_EL1	RMR_EL1
RMR_EL2	RMR_EL2
RMR_EL3	RMR_EL3
RVBAR_EL1	RVBAR_EL1
RVBAR_EL2	RVBAR_EL2
RVBAR_EL3	RVBAR_EL3
S3_<op1>_<Cn>_<Cm>_<op2>	S3_<op1>_<Cn>_<Cm>_<op2>
SCR_EL3	SCR_EL3
SCTLR_EL1	SCTLR_EL1
SCTLR_EL2	SCTLR_EL2
SCTLR_EL3	SCTLR_EL3
SPSel	SPSel
TPIDR_EL0	TPIDR_EL0
TPIDR_EL1	TPIDR_EL1
TPIDR_EL2	TPIDR_EL2
TPIDR_EL3	TPIDR_EL3
TPIDRRO_EL0	TPIDRRO_EL0
UAO	UAO
VBAR_EL1	VBAR_EL1
VBAR_EL2	VBAR_EL2
VBAR_EL3	VBAR_EL3

K11.4 Alphabetical index of AArch32 registers and system instructions

This section is an index of AArch32 registers and system instructions in alphabetical order.

Table K11-16 Alphabetical index of AArch32 Registers

Register	Description, see
ACTLR	<i>ACTLR, Auxiliary Control Register on page G6-4775</i>
ACTLR2	<i>ACTLR2, Auxiliary Control Register 2 on page G6-4777</i>
ADFSR	<i>ADFSR, Auxiliary Data Fault Status Register on page G6-4779</i>
AIDR	<i>AIDR, Auxiliary ID Register on page G6-4781</i>
AIFSR	<i>AIFSR, Auxiliary Instruction Fault Status Register on page G6-4783</i>
AMAIRO	<i>AMAIRO, Auxiliary Memory Attribute Indirection Register 0 on page G6-4785</i>
AMAIR1	<i>AMAIR1, Auxiliary Memory Attribute Indirection Register 1 on page G6-4787</i>
APSR	<i>APSR, Application Program Status Register on page G6-4789</i>
ATS12NSOPR	<i>ATS12NSOPR, Address Translate Stages 1 and 2 Non-secure Only PL1 Read on page G6-4791</i>
ATS12NSOPW	<i>ATS12NSOPW, Address Translate Stages 1 and 2 Non-secure Only PL1 Write on page G6-4793</i>
ATS12NSOUR	<i>ATS12NSOUR, Address Translate Stages 1 and 2 Non-secure Only Unprivileged Read on page G6-4795</i>
ATS12NSOUW	<i>ATS12NSOUW, Address Translate Stages 1 and 2 Non-secure Only Unprivileged Write on page G6-4797</i>
ATS1CPR	<i>ATS1CPR, Address Translate Stage 1 Current state PL1 Read on page G6-4799</i>
ATS1CPRP	<i>ATS1CPRP, Address Translate Stage 1 Current state PL1 Read PAN on page G6-4801</i>
ATS1CPW	<i>ATS1CPW, Address Translate Stage 1 Current state PL1 Write on page G6-4803</i>
ATS1CPWP	<i>ATS1CPWP, Address Translate Stage 1 Current state PL1 Write PAN on page G6-4805</i>
ATS1CUR	<i>ATS1CUR, Address Translate Stage 1 Current state Unprivileged Read on page G6-4807</i>
ATS1CUW	<i>ATS1CUW, Address Translate Stage 1 Current state Unprivileged Write on page G6-4809</i>
ATS1HR	<i>ATS1HR, Address Translate Stage 1 Hyp mode Read on page G6-4811</i>
ATS1HW	<i>ATS1HW, Address Translate Stage 1 Hyp mode Write on page G6-4813</i>
BPIALL	<i>BPIALL, Branch Predictor Invalidate All on page G6-4815</i>
BPIALLIS	<i>BPIALLIS, Branch Predictor Invalidate All, Inner Shareable on page G6-4817</i>
BPIMVA	<i>BPIMVA, Branch Predictor Invalidate by VA on page G6-4819</i>
CCSIDR	<i>CCSIDR, Current Cache Size ID Register on page G6-4821</i>
CLIDR	<i>CLIDR, Cache Level ID Register on page G6-4823</i>
CNTFRQ	<i>CNTFRQ, Counter-timer Frequency register on page G6-5384</i>
CNTHCTL	<i>CNTHCTL, Counter-timer Hyp Control register on page G6-5386</i>
CNTHP_CTL	<i>CNTHP_CTL, Counter-timer Hyp Physical Timer Control register on page G6-5388</i>
CNTHP_CVAL	<i>CNTHP_CVAL, Counter-timer Hyp Physical CompareValue register on page G6-5391</i>

Table K11-16 Alphabetical index of AArch32 Registers (continued)

Register	Description, see
CNTHP_TVAL	<i>CNTHP_TVAL</i> , Counter-timer Hyp Physical Timer TimerValue register on page G6-5393
CNTHV_CTL	<i>CNTHV_CTL</i> , Counter-timer Virtual Timer Control register (EL2) on page G6-5395
CNTHV_CVAL	<i>CNTHV_CVAL</i> , Counter-timer Virtual Timer CompareValue register (EL2) on page G6-5398
CNTHV_TVAL	<i>CNTHV_TVAL</i> , Counter-timer Virtual Timer TimerValue register (EL2) on page G6-5400
CNTKCTL	<i>CNTKCTL</i> , Counter-timer Kernel Control register on page G6-5402
CNTP_CTL	<i>CNTP_CTL</i> , Counter-timer Physical Timer Control register on page G6-5404
CNTP_CVAL	<i>CNTP_CVAL</i> , Counter-timer Physical Timer CompareValue register on page G6-5407
CNTP_TVAL	<i>CNTP_TVAL</i> , Counter-timer Physical Timer TimerValue register on page G6-5410
CNTPCT	<i>CNTPCT</i> , Counter-timer Physical Count register on page G6-5413
CNTV_CTL	<i>CNTV_CTL</i> , Counter-timer Virtual Timer Control register on page G6-5415
CNTV_CVAL	<i>CNTV_CVAL</i> , Counter-timer Virtual Timer CompareValue register on page G6-5418
CNTV_TVAL	<i>CNTV_TVAL</i> , Counter-timer Virtual Timer TimerValue register on page G6-5420
CNTVCT	<i>CNTVCT</i> , Counter-timer Virtual Count register on page G6-5422
CNTVOFF	<i>CNTVOFF</i> , Counter-timer Virtual Offset register on page G6-5424
CONTEXTIDR	<i>CONTEXTIDR</i> , Context ID Register on page G6-4825
CP15DMB	<i>CP15DMB</i> , Data Memory Barrier System instruction on page G6-4828
CP15DSB	<i>CP15DSB</i> , Data Synchronization Barrier System instruction on page G6-4830
CP15ISB	<i>CP15ISB</i> , Instruction Synchronization Barrier System instruction on page G6-4832
CPACR	<i>CPACR</i> , Architectural Feature Access Control Register on page G6-4834
CPSR	<i>CPSR</i> , Current Program Status Register on page G6-4838
CSSELR	<i>CSSELR</i> , Cache Size Selection Register on page G6-4841
CTR	<i>CTR</i> , Cache Type Register on page G6-4843
DACR	<i>DACR</i> , Domain Access Control Register on page G6-4846
DBGAUTHSTATUS	<i>DBGAUTHSTATUS</i> , Debug Authentication Status register on page G6-5240
DBGBCR<n>	<i>DBGBCR<n></i> , Debug Breakpoint Control Registers, $n = 0 - 15$ on page G6-5242
DBGBVR<n>	<i>DBGBVR<n></i> , Debug Breakpoint Value Registers, $n = 0 - 15$ on page G6-5247
DBGBXVR<n>	<i>DBGBXVR<n></i> , Debug Breakpoint Extended Value Registers, $n = 0 - 15$ on page G6-5250
DBGCLAIMCLR	<i>DBGCLAIMCLR</i> , Debug Claim Tag Clear register on page G6-5253
DBGCLAIMSET	<i>DBGCLAIMSET</i> , Debug Claim Tag Set register on page G6-5255
DBGDCCINT	<i>DBGDCCINT</i> , DCC Interrupt Enable Register on page G6-5257
DBGDEVID	<i>DBGDEVID</i> , Debug Device ID register 0 on page G6-5259
DBGDEVID1	<i>DBGDEVID1</i> , Debug Device ID register 1 on page G6-5262

Table K11-16 Alphabetical index of AArch32 Registers (continued)

Register	Description, see
DBGDEVID2	<i>DBGDEVID2, Debug Device ID register 2 on page G6-5264</i>
DBGDIDR	<i>DBGDIDR, Debug ID Register on page G6-5266</i>
DBGDRAR	<i>DBGDRAR, Debug ROM Address Register on page G6-5269</i>
DBGDSAR	<i>DBGDSAR, Debug Self Address Register on page G6-5272</i>
DBGDSCRext	<i>DBGDSCRext, Debug Status and Control Register, External View on page G6-5274</i>
DBGDSCRint	<i>DBGDSCRint, Debug Status and Control Register, Internal View on page G6-5279</i>
DBGDTRRText	<i>DBGDTRRText, Debug OS Lock Data Transfer Register, Receive, External View on page G6-5282</i>
DBGDTRRXint	<i>DBGDTRRXint, Debug Data Transfer Register, Receive on page G6-5284</i>
DBGDTRTText	<i>DBGDTRTText, Debug OS Lock Data Transfer Register, Transmit on page G6-5286</i>
DBGDTRTXint	<i>DBGDTRTXint, Debug Data Transfer Register, Transmit on page G6-5288</i>
DBGOSDLR	<i>DBGOSDLR, Debug OS Double Lock Register on page G6-5290</i>
DBGOSECCR	<i>DBGOSECCR, Debug OS Lock Exception Catch Control Register on page G6-5292</i>
DBGOSLAR	<i>DBGOSLAR, Debug OS Lock Access Register on page G6-5294</i>
DBGOSLSR	<i>DBGOSLSR, Debug OS Lock Status Register on page G6-5296</i>
DBGPRCR	<i>DBGPRCR, Debug Power Control Register on page G6-5298</i>
DBGVCR	<i>DBGVCR, Debug Vector Catch Register on page G6-5300</i>
DBGWCR<n>	<i>DBGWCR<n>, Debug Watchpoint Control Registers, n = 0 - 15 on page G6-5307</i>
DBGWFAR	<i>DBGWFAR, Debug Watchpoint Fault Address Register on page G6-5311</i>
DBGWVR<n>	<i>DBGWVR<n>, Debug Watchpoint Value Registers, n = 0 - 15 on page G6-5313</i>
DCCIMVAC	<i>DCCIMVAC, Data Cache line Clean and Invalidate by VA to PoC on page G6-4848</i>
DCCISW	<i>DCCISW, Data Cache line Clean and Invalidate by Set/Way on page G6-4850</i>
DCCMVAC	<i>DCCMVAC, Data Cache line Clean by VA to PoC on page G6-4852</i>
DCCMVAU	<i>DCCMVAU, Data Cache line Clean by VA to PoU on page G6-4854</i>
DCCSW	<i>DCCSW, Data Cache line Clean by Set/Way on page G6-4856</i>
DCIMVAC	<i>DCIMVAC, Data Cache line Invalidate by VA to PoC on page G6-4858</i>
DCISW	<i>DCISW, Data Cache line Invalidate by Set/Way on page G6-4860</i>
DFAR	<i>DFAR, Data Fault Address Register on page G6-4862</i>
DFSR	<i>DFSR, Data Fault Status Register on page G6-4864</i>
DLR	<i>DLR, Debug Link Register on page G6-5315</i>
DSPSR	<i>DSPSR, Debug Saved Program Status Register on page G6-5317</i>
DTLBIALL	<i>DTLBIALL, Data TLB Invalidate All on page G6-4871</i>
DTLBIASID	<i>DTLBIASID, Data TLB Invalidate by ASID match on page G6-4873</i>

Table K11-16 Alphabetical index of AArch32 Registers (continued)

Register	Description, see
DTLBIMVA	<i>DTLBIMVA, Data TLB Invalidate by VA</i> on page G6-4875
ELR_hyp	<i>ELR_hyp, Exception Link Register (Hyp mode)</i> on page G6-4877
FCSEIDR	<i>FCSEIDR, FCSE Process ID register</i> on page G6-4878
FPEXC	<i>FPEXC, Floating-Point Exception Control register</i> on page G6-4880
FPSCR	<i>FPSCR, Floating-Point Status and Control Register</i> on page G6-4885
FPSID	<i>FPSID, Floating-Point System ID register</i> on page G6-4892
HACR	<i>HACR, Hyp Auxiliary Configuration Register</i> on page G6-4895
HACTLR	<i>HACTLR, Hyp Auxiliary Control Register</i> on page G6-4897
HACTLR2	<i>HACTLR2, Hyp Auxiliary Control Register 2</i> on page G6-4899
HADFSR	<i>HADFSR, Hyp Auxiliary Data Fault Status Register</i> on page G6-4901
HAIFSR	<i>HAIFSR, Hyp Auxiliary Instruction Fault Status Register</i> on page G6-4903
HAMAIRO	<i>HAMAIRO, Hyp Auxiliary Memory Attribute Indirection Register 0</i> on page G6-4905
HAMAIR1	<i>HAMAIR1, Hyp Auxiliary Memory Attribute Indirection Register 1</i> on page G6-4907
HCPTR	<i>HCPTR, Hyp Architectural Feature Trap Register</i> on page G6-4909
HCR	<i>HCR, Hyp Configuration Register</i> on page G6-4913
HCR2	<i>HCR2, Hyp Configuration Register 2</i> on page G6-4922
HDCR	<i>HDCR, Hyp Debug Control Register</i> on page G6-5321
HDFAR	<i>HDFAR, Hyp Data Fault Address Register</i> on page G6-4925
HIFAR	<i>HIFAR, Hyp Instruction Fault Address Register</i> on page G6-4927
HMAIRO	<i>HMAIRO, Hyp Memory Attribute Indirection Register 0</i> on page G6-4929
HMAIR1	<i>HMAIR1, Hyp Memory Attribute Indirection Register 1</i> on page G6-4932
HPFAR	<i>HPFAR, Hyp IPA Fault Address Register</i> on page G6-4935
HRMR	<i>HRMR, Hyp Reset Management Register</i> on page G6-4937
HSCTLR	<i>HSCTLR, Hyp System Control Register</i> on page G6-4939
HSR	<i>HSR, Hyp Syndrome Register</i> on page G6-4945
HSTR	<i>HSTR, Hyp System Trap Register</i> on page G6-4966
HTCR	<i>HTCR, Hyp Translation Control Register</i> on page G6-4968
HTPIDR	<i>HTPIDR, Hyp Software Thread ID Register</i> on page G6-4972
HTTBR	<i>HTTBR, Hyp Translation Table Base Register</i> on page G6-4974
HVBAR	<i>HVBAR, Hyp Vector Base Address Register</i> on page G6-4977
ICIALLU	<i>ICIALLU, Instruction Cache Invalidate All to PoU</i> on page G6-4979
ICIALLUIS	<i>ICIALLUIS, Instruction Cache Invalidate All to PoU, Inner Shareable</i> on page G6-4981

Table K11-16 Alphabetical index of AArch32 Registers (continued)

Register	Description, see
ICIMVAU	<i>ICIMVAU, Instruction Cache line Invalidate by VA to PoU</i> on page G6-4983
ID_AFR0	<i>ID_AFR0, Auxiliary Feature Register 0</i> on page G6-4985
ID_DFR0	<i>ID_DFR0, Debug Feature Register 0</i> on page G6-4987
ID_ISAR0	<i>ID_ISAR0, Instruction Set Attribute Register 0</i> on page G6-4990
ID_ISAR1	<i>ID_ISAR1, Instruction Set Attribute Register 1</i> on page G6-4993
ID_ISAR2	<i>ID_ISAR2, Instruction Set Attribute Register 2</i> on page G6-4996
ID_ISAR3	<i>ID_ISAR3, Instruction Set Attribute Register 3</i> on page G6-4999
ID_ISAR4	<i>ID_ISAR4, Instruction Set Attribute Register 4</i> on page G6-5002
ID_ISAR5	<i>ID_ISAR5, Instruction Set Attribute Register 5</i> on page G6-5005
ID_MMFR0	<i>ID_MMFR0, Memory Model Feature Register 0</i> on page G6-5008
ID_MMFR1	<i>ID_MMFR1, Memory Model Feature Register 1</i> on page G6-5011
ID_MMFR2	<i>ID_MMFR2, Memory Model Feature Register 2</i> on page G6-5015
ID_MMFR3	<i>ID_MMFR3, Memory Model Feature Register 3</i> on page G6-5019
ID_MMFR4	<i>ID_MMFR4, Memory Model Feature Register 4</i> on page G6-5023
ID_PFR0	<i>ID_PFR0, Processor Feature Register 0</i> on page G6-5026
ID_PFR1	<i>ID_PFR1, Processor Feature Register 1</i> on page G6-5029
IFAR	<i>IFAR, Instruction Fault Address Register</i> on page G6-5033
IFSR	<i>IFSR, Instruction Fault Status Register</i> on page G6-5035
ISR	<i>ISR, Interrupt Status Register</i> on page G6-5040
ITLBIALL	<i>ITLBIALL, Instruction TLB Invalidate All</i> on page G6-5042
ITLBIASID	<i>ITLBIASID, Instruction TLB Invalidate by ASID match</i> on page G6-5044
ITLBIMVA	<i>ITLBIMVA, Instruction TLB Invalidate by VA</i> on page G6-5046
JIDR	<i>JIDR, Jazelle ID Register</i> on page G6-5048
JMCR	<i>JMCR, Jazelle Main Configuration Register</i> on page G6-5050
JOSCR	<i>JOSCR, Jazelle OS Control Register</i> on page G6-5051
MAIRO	<i>MAIRO, Memory Attribute Indirection Register 0</i> on page G6-5052
MAIR1	<i>MAIR1, Memory Attribute Indirection Register 1</i> on page G6-5055
MIDR	<i>MIDR, Main ID Register</i> on page G6-5058
MPIDR	<i>MPIDR, Multiprocessor Affinity Register</i> on page G6-5061
MVBAR	<i>MVBAR, Monitor Vector Base Address Register</i> on page G6-5063
MVFR0	<i>MVFR0, Media and VFP Feature Register 0</i> on page G6-5065
MVFR1	<i>MVFR1, Media and VFP Feature Register 1</i> on page G6-5069

Table K11-16 Alphabetical index of AArch32 Registers (continued)

Register	Description, see
MVFR2	<i>MVFR2, Media and VFP Feature Register 2</i> on page G6-5073
NMRR	<i>NMRR, Normal Memory Remap Register</i> on page G6-5076
NSACR	<i>NSACR, Non-Secure Access Control Register</i> on page G6-5079
PAR	<i>PAR, Physical Address Register</i> on page G6-5083
PMCCFILTR	<i>PMCCFILTR, Performance Monitors Cycle Count Filter Register</i> on page G6-5332
PMCCNTR	<i>PMCCNTR, Performance Monitors Cycle Count Register</i> on page G6-5335
PMCEID0	<i>PMCEID0, Performance Monitors Common Event Identification register 0</i> on page G6-5338
PMCEID1	<i>PMCEID1, Performance Monitors Common Event Identification register 1</i> on page G6-5340
PMCEID2	<i>PMCEID2, Performance Monitors Common Event Identification register 2</i> on page G6-5342
PMCEID3	<i>PMCEID3, Performance Monitors Common Event Identification register 3</i> on page G6-5344
PMCNTENCLR	<i>PMCNTENCLR, Performance Monitors Count Enable Clear register</i> on page G6-5346
PMCNTENSET	<i>PMCNTENSET, Performance Monitors Count Enable Set register</i> on page G6-5348
PMCR	<i>PMCR, Performance Monitors Control Register</i> on page G6-5350
PMEVCNTR<n>	<i>PMEVCNTR<n>, Performance Monitors Event Count Registers, n = 0 - 30</i> on page G6-5354
PMEVTYPER<n>	<i>PMEVTYPER<n>, Performance Monitors Event Type Registers, n = 0 - 30</i> on page G6-5357
PMINTENCLR	<i>PMINTENCLR, Performance Monitors Interrupt Enable Clear register</i> on page G6-5361
PMINTENSET	<i>PMINTENSET, Performance Monitors Interrupt Enable Set register</i> on page G6-5363
PMOVSr	<i>PMOVSr, Performance Monitors Overflow Flag Status Register</i> on page G6-5365
PMOVSSET	<i>PMOVSSET, Performance Monitors Overflow Flag Status Set register</i> on page G6-5367
PMSELR	<i>PMSELR, Performance Monitors Event Counter Selection Register</i> on page G6-5369
PMSWINC	<i>PMSWINC, Performance Monitors Software Increment register</i> on page G6-5372
PMUSERENR	<i>PMUSERENR, Performance Monitors User Enable Register</i> on page G6-5374
PMXEVCNTR	<i>PMXEVCNTR, Performance Monitors Selected Event Count Register</i> on page G6-5377
PMXEVTYPER	<i>PMXEVTYPER, Performance Monitors Selected Event Type Register</i> on page G6-5380
PRRR	<i>PRRR, Primary Region Remap Register</i> on page G6-5091
REVIDR	<i>REVIDR, Revision ID Register</i> on page G6-5095
RMR	<i>RMR, Reset Management Register</i> on page G6-5097
RVBAR	<i>RVBAR, Reset Vector Base Address Register</i> on page G6-5099
SCR	<i>SCR, Secure Configuration Register</i> on page G6-5101
SCTLR	<i>SCTLR, System Control Register</i> on page G6-5106
SDCR	<i>SDCR, Secure Debug Control Register</i> on page G6-5326
SDER	<i>SDER, Secure Debug Enable Register</i> on page G6-5329

Table K11-16 Alphabetical index of AArch32 Registers (continued)

Register	Description, see
SPSR	<i>SPSR, Saved Program Status Register on page G6-5114</i>
SPSR_abt	<i>SPSR_abt, Saved Program Status Register (Abort mode) on page G6-5117</i>
SPSR_fiq	<i>SPSR_fiq, Saved Program Status Register (FIQ mode) on page G6-5121</i>
SPSR_hyp	<i>SPSR_hyp, Saved Program Status Register (Hyp mode) on page G6-5125</i>
SPSR_irq	<i>SPSR_irq, Saved Program Status Register (IRQ mode) on page G6-5129</i>
SPSR_mon	<i>SPSR_mon, Saved Program Status Register (Monitor mode) on page G6-5133</i>
SPSR_svc	<i>SPSR_svc, Saved Program Status Register (Supervisor mode) on page G6-5137</i>
SPSR_und	<i>SPSR_und, Saved Program Status Register (Undefined mode) on page G6-5141</i>
TCMTR	<i>TCMTR, TCM Type Register on page G6-5145</i>
TLBIALL	<i>TLBIALL, TLB Invalidate All on page G6-5147</i>
TLBIALLH	<i>TLBIALLH, TLB Invalidate All, Hyp mode on page G6-5149</i>
TLBIALLHIS	<i>TLBIALLHIS, TLB Invalidate All, Hyp mode, Inner Shareable on page G6-5151</i>
TLBIALLIS	<i>TLBIALLIS, TLB Invalidate All, Inner Shareable on page G6-5153</i>
TLBIALLNSNH	<i>TLBIALLNSNH, TLB Invalidate All, Non-Secure Non-Hyp on page G6-5155</i>
TLBIALLNSNHIS	<i>TLBIALLNSNHIS, TLB Invalidate All, Non-Secure Non-Hyp, Inner Shareable on page G6-5157</i>
TLBIASID	<i>TLBIASID, TLB Invalidate by ASID match on page G6-5159</i>
TLBIASIDIS	<i>TLBIASIDIS, TLB Invalidate by ASID match, Inner Shareable on page G6-5161</i>
TLBIIPAS2	<i>TLBIIPAS2, TLB Invalidate by Intermediate Physical Address, Stage 2 on page G6-5163</i>
TLBIIPAS2IS	<i>TLBIIPAS2IS, TLB Invalidate by Intermediate Physical Address, Stage 2, Inner Shareable on page G6-5165</i>
TLBIIPAS2L	<i>TLBIIPAS2L, TLB Invalidate by Intermediate Physical Address, Stage 2, Last level on page G6-5167</i>
TLBIIPAS2LIS	<i>TLBIIPAS2LIS, TLB Invalidate by Intermediate Physical Address, Stage 2, Last level, Inner Shareable on page G6-5169</i>
TLBIMVA	<i>TLBIMVA, TLB Invalidate by VA on page G6-5171</i>
TLBIMVAA	<i>TLBIMVAA, TLB Invalidate by VA, All ASID on page G6-5173</i>
TLBIMVAAIS	<i>TLBIMVAAIS, TLB Invalidate by VA, All ASID, Inner Shareable on page G6-5175</i>
TLBIMVAAL	<i>TLBIMVAAL, TLB Invalidate by VA, All ASID, Last level on page G6-5177</i>
TLBIMVAALIS	<i>TLBIMVAALIS, TLB Invalidate by VA, All ASID, Last level, Inner Shareable on page G6-5179</i>
TLBIMVAH	<i>TLBIMVAH, TLB Invalidate by VA, Hyp mode on page G6-5181</i>
TLBIMVAHIS	<i>TLBIMVAHIS, TLB Invalidate by VA, Hyp mode, Inner Shareable on page G6-5183</i>
TLBIMVAIS	<i>TLBIMVAIS, TLB Invalidate by VA, Inner Shareable on page G6-5185</i>
TLBIMVAL	<i>TLBIMVAL, TLB Invalidate by VA, Last level on page G6-5187</i>

Table K11-16 Alphabetical index of AArch32 Registers (continued)

Register	Description, see
TLBIMVALH	<i>TLBIMVALH, TLB Invalidate by VA, Last level, Hyp mode on page G6-5189</i>
TLBIMVALHIS	<i>TLBIMVALHIS, TLB Invalidate by VA, Last level, Hyp mode, Inner Shareable on page G6-5191</i>
TLBIMVALIS	<i>TLBIMVALIS, TLB Invalidate by VA, Last level, Inner Shareable on page G6-5193</i>
TLBTR	<i>TLBTR, TLB Type Register on page G6-5195</i>
TPIDRPRW	<i>TPIDRPRW, PL1 Software Thread ID Register on page G6-5197</i>
TPIDRURO	<i>TPIDRURO, PL0 Read-Only Software Thread ID Register on page G6-5199</i>
TPIDRURW	<i>TPIDRURW, PL0 Read/Write Software Thread ID Register on page G6-5201</i>
TTBCR	<i>TTBCR, Translation Table Base Control Register on page G6-5203</i>
TTBCR2	<i>TTBCR2, Translation Table Base Control Register 2 on page G6-5209</i>
TTBR0	<i>TTBR0, Translation Table Base Register 0 on page G6-5214</i>
TTBR1	<i>TTBR1, Translation Table Base Register 1 on page G6-5219</i>
VBAR	<i>VBAR, Vector Base Address Register on page G6-5224</i>
VMPIDR	<i>VMPIDR, Virtualization Multiprocessor ID Register on page G6-5226</i>
VPIDR	<i>VPIDR, Virtualization Processor ID Register on page G6-5229</i>
VTCR	<i>VTCR, Virtualization Translation Control Register on page G6-5232</i>
VTTBR	<i>VTTBR, Virtualization Translation Table Base Register on page G6-5236</i>

K11.5 Functional index of AArch32 registers and system instructions

This section is an index of the AArch32 registers and system instructions, divided by functional group. Each of the following sections lists the registers for a functional group:

- [Special-purpose registers](#).
- [VMSA-specific registers](#) on page K11-6315.
- [ID registers](#) on page K11-6315.
- [Performance monitors registers](#) on page K11-6317.
- [Debug registers](#) on page K11-6317.
- [Generic timer registers](#) on page K11-6319.
- [Cache maintenance system instructions](#) on page K11-6319.
- [Address translation system instructions](#) on page K11-6320.
- [TLB maintenance system instructions](#) on page K11-6320.
- [Legacy feature registers and system instructions](#) on page K11-6322.
- [Base system registers](#) on page K11-6322.

K11.5.1 Special-purpose registers

This section is an index to the registers in the Processor state registers functional group.

Table K11-17 Special-purpose registers

Register	Description, see
DLR	DLR
DSPSR	DSPSR
ELR_hyp	ELR_hyp
FPSCR	FPSCR
SPSR	SPSR
SPSR_abt	SPSR_abt
SPSR_fiq	SPSR_fiq
SPSR_hyp	SPSR_hyp
SPSR_irq	SPSR_irq
SPSR_mon	SPSR_mon
SPSR_svc	SPSR_svc
SPSR_und	SPSR_und

K11.5.2 VMSA-specific registers

This section is an index to the registers in the Virtual memory control registers functional group.

Table K11-18 VMSA-specific registers

Register	Description, see
AMAIRO	AMAIRO
AMAIR1	AMAIR1
CONTEXTIDR	CONTEXTIDR
DACR	DACR
HAMAIRO	HAMAIRO
HMAIR1	HMAIR1
HMAIRO	HMAIRO
HMAIR1	HMAIR1
HTCR	HTCR
HTTBR	HTTBR
MAIRO	MAIRO
MAIR1	MAIR1
NMRR	NMRR
PRRR	PRRR
TTBCR	TTBCR
TTBCR2	TTBCR2
TTBR0	TTBR0
TTBR1	TTBR1
VTCR	VTCR
VTBR	VTBR

K11.5.3 ID registers

This section is an index to the registers in the Identification registers functional group.

Table K11-19 ID registers

Register	Description, see
AIDR	AIDR
CCSIDR	CCSIDR
CLIDR	CLIDR
CSSELR	CSSELR
CTR	CTR

Table K11-19 ID registers (continued)

Register	Description, see
FPSID	FPSID
ID_AFR0	ID_AFR0
ID_DFR0	ID_DFR0
ID_ISAR0	ID_ISAR0
ID_ISAR1	ID_ISAR1
ID_ISAR2	ID_ISAR2
ID_ISAR3	ID_ISAR3
ID_ISAR4	ID_ISAR4
ID_ISAR5	ID_ISAR5
ID_MMFR0	ID_MMFR0
ID_MMFR1	ID_MMFR1
ID_MMFR2	ID_MMFR2
ID_MMFR3	ID_MMFR3
ID_MMFR4	ID_MMFR4
ID_PFR0	ID_PFR0
ID_PFR1	ID_PFR1
MIDR	MIDR
MPIDR	MPIDR
MVFR0	MVFR0
MVFR1	MVFR1
MVFR2	MVFR2
REVIDR	REVIDR
TCMTR	TCMTR
TLBTR	TLBTR
VMPIDR	VMPIDR
VPIDR	VPIDR

K11.5.4 Performance monitors registers

This section is an index to the registers in the Performance Monitors registers functional group.

Table K11-20 Performance monitors registers

Register	Description, see
PMCCFILTR	PMCCFILTR
PMCCNTR	PMCCNTR
PMCEID0	PMCEID0
PMCEID1	PMCEID1
PMCEID2	PMCEID2
PMCEID3	PMCEID3
PMCNTENCLR	PMCNTENCLR
PMCNTENSET	PMCNTENSET
PMCR	PMCR
PMEVCNTR<n>	PMEVCNTR<n>
PMEVTYPER<n>	PMEVTYPER<n>
PMINTENCLR	PMINTENCLR
PMINTENSET	PMINTENSET
PMOVSRR	PMOVSRR
PMOVSSET	PMOVSSET
PMSELR	PMSELR
PMSWINC	PMSWINC
PMUSERENR	PMUSERENR
PMXVCNTR	PMXVCNTR
PMXEVTYPER	PMXEVTYPER

K11.5.5 Debug registers

This section is an index to the registers in the Debug registers functional group.

Table K11-21 Debug registers

Register	Description, see
DBGAUTHSTATUS	DBGAUTHSTATUS
DBGBCR<n>	DBGBCR<n>
DBGBVR<n>	DBGBVR<n>
DBGBXVR<n>	DBGBXVR<n>
DBGCLAIMCLR	DBGCLAIMCLR

Table K11-21 Debug registers (continued)

Register	Description, see
DBGCLAIMSET	DBGCLAIMSET
DBGDCCINT	DBGDCCINT
DBGDEVID	DBGDEVID
DBGDEVID1	DBGDEVID1
DBGDEVID2	DBGDEVID2
DBGDIDR	DBGDIDR
DBGDRAR	DBGDRAR
DBGDSAR	DBGDSAR
DBGDSCRext	DBGDSCRext
DBGDSCRint	DBGDSCRint
DBGDTRRXext	DBGDTRRXext
DBGDTRRXint	DBGDTRRXint
DBGDTRTXext	DBGDTRTXext
DBGDTRTXint	DBGDTRTXint
DBGOSDLR	DBGOSDLR
DBGOSECCR	DBGOSECCR
DBGOSLAR	DBGOSLAR
DBGOSLSR	DBGOSLSR
DBGPRCR	DBGPRCR
DBGVCR	DBGVCR
DBGWCR<n>	DBGWCR<n>
DBGWFAR	DBGWFAR
DBGWVR<n>	DBGWVR<n>
DLR	DLR
DSPSR	DSPSR
HDCR	HDCR
SDCR	SDCR
SDER	SDER

K11.5.6 Generic timer registers

This section is an index to the registers in the Generic Timer registers functional group.

Table K11-22 Generic timer registers

Register	Description, see
CNTFRQ	CNTFRQ
CNTHCTL	CNTHCTL
CNTHP_CTL	CNTHP_CTL
CNTHP_CVAL	CNTHP_CVAL
CNTHP_TVAL	CNTHP_TVAL
CNTHV_CTL	CNTHV_CTL
CNTHV_CVAL	CNTHV_CVAL
CNTHV_TVAL	CNTHV_TVAL
CNTKCTL	CNTKCTL
CNTP_CTL	CNTP_CTL
CNTP_CVAL	CNTP_CVAL
CNTP_TVAL	CNTP_TVAL
CNTPCT	CNTPCT
CNTV_CTL	CNTV_CTL
CNTV_CVAL	CNTV_CVAL
CNTV_TVAL	CNTV_TVAL
CNTVCT	CNTVCT
CNTVOFF	CNTVOFF

K11.5.7 Cache maintenance system instructions

This section is an index to the registers in the Cache maintenance instructions functional group.

Table K11-23 Cache maintenance system instructions

Register	Description, see
BPIALL	BPIALL
BPIALLIS	BPIALLIS
BPIMVA	BPIMVA
DCCIMVA C	DCCIMVAC
DCCISW	DCCISW
DCCMVAC	DCCMVAC

Table K11-23 Cache maintenance system instructions (continued)

Register	Description, see
DCCMVAU	DCCMVAU
DCCSW	DCCSW
DCIMVAC	DCIMVAC
DCISW	DCISW
ICIALLU	ICIALLU
ICIALLUIS	ICIALLUIS
ICIMVAU	ICIMVAU

K11.5.8 Address translation system instructions

This section is an index to the registers in the Address translation instructions functional group.

Table K11-24 Address translation system instructions

Register	Description, see
ATS12NSOPR	ATS12NSOPR
ATS12NSOPW	ATS12NSOPW
ATS12NSOUR	ATS12NSOUR
ATS12NSOUW	ATS12NSOUW
ATS1CPR	ATS1CPR
ATS1CPRP	ATS1CPRP
ATS1CPW	ATS1CPW
ATS1CPWP	ATS1CPWP
ATS1CUR	ATS1CUR
ATS1CUW	ATS1CUW
ATS1HR	ATS1HR
ATS1HW	ATS1HW

K11.5.9 TLB maintenance system instructions

This section is an index to the registers in the TLB maintenance instructions functional group.

Table K11-25 TLB maintenance system instructions

Register	Description, see
DTLBIALL	DTLBIALL
DTLBIASID	DTLBIASID
DTLBIMVA	DTLBIMVA

Table K11-25 TLB maintenance system instructions (continued)

Register	Description, see
ITLBIALL	ITLBIALL
ITLBIASID	ITLBIASID
ITLBIMVA	ITLBIMVA
TLBIALL	TLBIALL
TLBIALLH	TLBIALLH
TLBIALLHIS	TLBIALLHIS
TLBIALLIS	TLBIALLIS
TLBIALLNSNH	TLBIALLNSNH
TLBIALLNSNHIS	TLBIALLNSNHIS
TLBIASID	TLBIASID
TLBIASIDIS	TLBIASIDIS
TLBIIPAS2	TLBIIPAS2
TLBIIPAS2IS	TLBIIPAS2IS
TLBIIPAS2L	TLBIIPAS2L
TLBIIPAS2LIS	TLBIIPAS2LIS
TLBIMVA	TLBIMVA
TLBIMVAA	TLBIMVAA
TLBIMVAAIS	TLBIMVAAIS
TLBIMVAAL	TLBIMVAAL
TLBIMVAALIS	TLBIMVAALIS
TLBIMVAH	TLBIMVAH
TLBIMVAHIS	TLBIMVAHIS
TLBIMVAIS	TLBIMVAIS
TLBIMVAL	TLBIMVAL
TLBIMVALH	TLBIMVALH
TLBIMVALHIS	TLBIMVALHIS
TLBIMVALIS	TLBIMVALIS

K11.5.10 Legacy feature registers and system instructions

This section is an index to the registers in the Legacy feature registers functional group.

Table K11-26 Legacy feature registers and system instructions

Register	Description, see
CP15DMB	CP15DMB
CP15DSB	CP15DSB
CP15ISB	CP15ISB
FCSEIDR	FCSEIDR
JIDR	JIDR
JMCR	JMCR
JOSCR	JOSCR

K11.5.11 Base system registers

This section is an index to the registers in the functional group.

Table K11-27 Base system registers

Register	Description, see
ACTLR	ACTLR
ACTLR2	ACTLR2
ADFSR	ADFSR
AIFSR	AIFSR
APSR	APSR
CPACR	CPACR
CPSR	CPSR
DFAR	DFAR
DFSR	DFSR
FPEXC	FPEXC
HACR	HACR
HACTLR	HACTLR
HACTLR2	HACTLR2
HADFSR	HADFSR
HAIFSR	HAIFSR
HCPTR	HCPTR
HCR	HCR
HCR2	HCR2

Table K11-27 Base system registers (continued)

Register	Description, see
HDFAR	HDFAR
HIFAR	HIFAR
HPFAR	HPFAR
HRMR	HRMR
HSCTLR	HSCTLR
HSR	HSR
HSTR	HSTR
HTPIDR	HTPIDR
HVBAR	HVBAR
IFAR	IFAR
IFSR	IFSR
ISR	ISR
MVBAR	MVBAR
NSACR	NSACR
PAR	PAR
RMR	RMR
RVBAR	RVBAR
SCR	SCR
SCTLR	SCTLR
TPIDRPRW	TPIDRPRW
TPIDRURO	TPIDRURO
TPIDRURW	TPIDRURW
VBAR	VBAR

K11.6 Alphabetical index of memory-mapped registers

This section is an index of memory-mapped registers in alphabetical order.

Table K11-28 Alphabetical index of Memory-Mapped Registers

Register	Description, see
ASICCTL	<i>ASICCTL, CTI External Multiplexer Control register on page H9-5678</i>
CNTACR<n>	<i>CNTACR<n>, Counter-timer Access Control Registers, n = 0 - 7 on page I3-5817</i>
CNTCR	<i>CNTCR, Counter Control Register on page I3-5819</i>
CNTCV	<i>CNTCV, Counter Count Value register on page I3-5821</i>
CNTEL0ACR	<i>CNTEL0ACR, Counter-timer EL0 Access Control Register on page I3-5823</i>
CNTFID0	<i>CNTFID0, Counter Frequency ID on page I3-5825</i>
CNTFID<n>	<i>CNTFID<n>, Counter Frequency IDs, n > 0 on page I3-5827</i>
CNTFRQ	<i>CNTFRQ, Counter-timer Frequency on page I3-5829</i>
CNTNSAR	<i>CNTNSAR, Counter-timer Non-secure Access Register on page I3-5831</i>
CNTP_CTL	<i>CNTP_CTL, Counter-timer Physical Timer Control on page I3-5833</i>
CNTP_CVAL	<i>CNTP_CVAL, Counter-timer Physical Timer CompareValue on page I3-5835</i>
CNTP_TVAL	<i>CNTP_TVAL, Counter-timer Physical Timer TimerValue on page I3-5837</i>
CNTPCT	<i>CNTPCT, Counter-timer Physical Count on page I3-5839</i>
CNTSR	<i>CNTSR, Counter Status Register on page I3-5841</i>
CNTTIDR	<i>CNTTIDR, Counter-timer Timer ID Register on page I3-5843</i>
CNTV_CTL	<i>CNTV_CTL, Counter-timer Virtual Timer Control on page I3-5845</i>
CNTV_CVAL	<i>CNTV_CVAL, Counter-timer Virtual Timer CompareValue on page I3-5847</i>
CNTV_TVAL	<i>CNTV_TVAL, Counter-timer Virtual Timer TimerValue on page I3-5849</i>
CNTVCT	<i>CNTVCT, Counter-timer Virtual Count on page I3-5851</i>
CNTVOFF	<i>CNTVOFF{<n>}, Counter-timer Virtual Offset on page I3-5853</i>
CNTVOFF<n>	<i>CNTVOFF{<n>}, Counter-timer Virtual Offset on page I3-5853</i>
CounterID<n>	<i>CounterID<n>, Counter ID registers, n = 0 - 11 on page I3-5855</i>
CTIAPPCLEAR	<i>CTIAPPCLEAR, CTI Application Trigger Clear register on page H9-5679</i>
CTIAPPULSE	<i>CTIAPPULSE, CTI Application Pulse register on page H9-5680</i>
CTIAPPSET	<i>CTIAPPSET, CTI Application Trigger Set register on page H9-5681</i>
CTIAUTHSTATUS	<i>CTIAUTHSTATUS, CTI Authentication Status register on page H9-5682</i>
CTICHINSTATUS	<i>CTICHINSTATUS, CTI Channel In Status register on page H9-5684</i>
CTICHOUTSTATUS	<i>CTICHOUTSTATUS, CTI Channel Out Status register on page H9-5685</i>
CTICIDR0	<i>CTICIDR0, CTI Component Identification Register 0 on page H9-5686</i>
CTICIDR1	<i>CTICIDR1, CTI Component Identification Register 1 on page H9-5687</i>

Table K11-28 Alphabetical index of Memory-Mapped Registers (continued)

Register	Description, see
CTICIDR2	<i>CTICIDR2, CTI Component Identification Register 2</i> on page H9-5688
CTICIDR3	<i>CTICIDR3, CTI Component Identification Register 3</i> on page H9-5689
CTICLAIMCLR	<i>CTICLAIMCLR, CTI Claim Tag Clear register</i> on page H9-5690
CTICLAIMSET	<i>CTICLAIMSET, CTI Claim Tag Set register</i> on page H9-5691
CTICONTROL	<i>CTICONTROL, CTI Control register</i> on page H9-5692
CTIDEVAFF0	<i>CTIDEVAFF0, CTI Device Affinity register 0</i> on page H9-5694
CTIDEVAFF1	<i>CTIDEVAFF1, CTI Device Affinity register 1</i> on page H9-5695
CTIDEVARCH	<i>CTIDEVARCH, CTI Device Architecture register</i> on page H9-5696
CTIDEVID	<i>CTIDEVID, CTI Device ID register 0</i> on page H9-5698
CTIDEVID1	<i>CTIDEVID1, CTI Device ID register 1</i> on page H9-5700
CTIDEVID2	<i>CTIDEVID2, CTI Device ID register 2</i> on page H9-5701
CTIDEVTYPE	<i>CTIDEVTYPE, CTI Device Type register</i> on page H9-5702
CTIGATE	<i>CTIGATE, CTI Channel Gate Enable register</i> on page H9-5703
CTIINEN<n>	<i>CTIINEN<n>, CTI Input Trigger to Output Channel Enable registers, n = 0 - 31</i> on page H9-5704
CTIINTACK	<i>CTIINTACK, CTI Output Trigger Acknowledge register</i> on page H9-5705
CTIITCTRL	<i>CTIITCTRL, CTI Integration mode Control register</i> on page H9-5707
CTILAR	<i>CTILAR, CTI Lock Access Register</i> on page H9-5709
CTILSR	<i>CTILSR, CTI Lock Status Register</i> on page H9-5710
CTIOUTEN<n>	<i>CTIOUTEN<n>, CTI Input Channel to Output Trigger Enable registers, n = 0 - 31</i> on page H9-5712
CTIPIDR0	<i>CTIPIDR0, CTI Peripheral Identification Register 0</i> on page H9-5713
CTIPIDR1	<i>CTIPIDR1, CTI Peripheral Identification Register 1</i> on page H9-5714
CTIPIDR2	<i>CTIPIDR2, CTI Peripheral Identification Register 2</i> on page H9-5715
CTIPIDR3	<i>CTIPIDR3, CTI Peripheral Identification Register 3</i> on page H9-5716
CTIPIDR4	<i>CTIPIDR4, CTI Peripheral Identification Register 4</i> on page H9-5717
CTITRIGINSTATUS	<i>CTITRIGINSTATUS, CTI Trigger In Status register</i> on page H9-5718
CTITRIGOUTSTATUS	<i>CTITRIGOUTSTATUS, CTI Trigger Out Status register</i> on page H9-5719
DBGAUTHSTATUS_EL1	<i>DBGAUTHSTATUS_EL1, Debug Authentication Status register</i> on page H9-5578
DBGBCR<n>_EL1	<i>DBGBCR<n>_EL1, Debug Breakpoint Control Registers, n = 0 - 15</i> on page H9-5580
DBGBVR<n>_EL1	<i>DBGBVR<n>_EL1, Debug Breakpoint Value Registers, n = 0 - 15</i> on page H9-5584
DBGCLAIMCLR_EL1	<i>DBGCLAIMCLR_EL1, Debug Claim Tag Clear register</i> on page H9-5589
DBGCLAIMSET_EL1	<i>DBGCLAIMSET_EL1, Debug Claim Tag Set register</i> on page H9-5591
DBGDTRRX_EL0	<i>DBGDTRRX_EL0, Debug Data Transfer Register; Receive</i> on page H9-5593

Table K11-28 Alphabetical index of Memory-Mapped Registers (continued)

Register	Description, see
DBGDTRTX_EL0	<i>DBGDTRTX_EL0, Debug Data Transfer Register, Transmit</i> on page H9-5595
DBGWCR<n>_EL1	<i>DBGWCR<n>_EL1, Debug Watchpoint Control Registers, n = 0 - 15</i> on page H9-5597
DBGWVR<n>_EL1	<i>DBGWVR<n>_EL1, Debug Watchpoint Value Registers, n = 0 - 15</i> on page H9-5600
EDAA32PFR	<i>EDAA32PFR, External Debug AArch32 Processor Feature Register</i> on page H9-5602
EDACR	<i>EDACR, External Debug Auxiliary Control Register</i> on page H9-5604
EDCIDR0	<i>EDCIDR0, External Debug Component Identification Register 0</i> on page H9-5605
EDCIDR1	<i>EDCIDR1, External Debug Component Identification Register 1</i> on page H9-5606
EDCIDR2	<i>EDCIDR2, External Debug Component Identification Register 2</i> on page H9-5607
EDCIDR3	<i>EDCIDR3, External Debug Component Identification Register 3</i> on page H9-5608
EDCIDSR	<i>EDCIDSR, External Debug Context ID Sample Register</i> on page H9-5609
EDDEVAFF0	<i>EDDEVAFF0, External Debug Device Affinity register 0</i> on page H9-5611
EDDEVAFF1	<i>EDDEVAFF1, External Debug Device Affinity register 1</i> on page H9-5612
EDDEVARCH	<i>EDDEVARCH, External Debug Device Architecture register</i> on page H9-5613
EDDEVID	<i>EDDEVID, External Debug Device ID register 0</i> on page H9-5615
EDDEVID1	<i>EDDEVID1, External Debug Device ID register 1</i> on page H9-5617
EDDEVID2	<i>EDDEVID2, External Debug Device ID register 2</i> on page H9-5618
EDDEVTYPE	<i>EDDEVTYPE, External Debug Device Type register</i> on page H9-5619
EDDFR	<i>EDDFR, External Debug Feature Register</i> on page H9-5620
EDECCR	<i>EDECCR, External Debug Exception Catch Control Register</i> on page H9-5622
EDECR	<i>EDECR, External Debug Execution Control Register</i> on page H9-5626
EDES	<i>EDES, External Debug Event Status Register</i> on page H9-5628
EDITCTRL	<i>EDITCTRL, External Debug Integration mode Control register</i> on page H9-5630
EDITR	<i>EDITR, External Debug Instruction Transfer Register</i> on page H9-5632
EDLAR	<i>EDLAR, External Debug Lock Access Register</i> on page H9-5634
EDLSR	<i>EDLSR, External Debug Lock Status Register</i> on page H9-5635
EDPCSR	<i>EDPCSR, External Debug Program Counter Sample Register</i> on page H9-5637
EDPFR	<i>EDPFR, External Debug Processor Feature Register</i> on page H9-5641
EDPIDR0	<i>EDPIDR0, External Debug Peripheral Identification Register 0</i> on page H9-5644
EDPIDR1	<i>EDPIDR1, External Debug Peripheral Identification Register 1</i> on page H9-5645
EDPIDR2	<i>EDPIDR2, External Debug Peripheral Identification Register 2</i> on page H9-5646
EDPIDR3	<i>EDPIDR3, External Debug Peripheral Identification Register 3</i> on page H9-5647
EDPIDR4	<i>EDPIDR4, External Debug Peripheral Identification Register 4</i> on page H9-5648

Table K11-28 Alphabetical index of Memory-Mapped Registers (continued)

Register	Description, see
EDPRCR	<i>EDPRCR, External Debug Power/Reset Control Register on page H9-5649</i>
EDPRSR	<i>EDPRSR, External Debug Processor Status Register on page H9-5652</i>
EDRCR	<i>EDRCR, External Debug Reserve Control Register on page H9-5660</i>
EDSCR	<i>EDSCR, External Debug Status and Control Register on page H9-5662</i>
EDVIDSR	<i>EDVIDSR, External Debug Virtual Context Sample Register on page H9-5667</i>
EDWAR	<i>EDWAR, External Debug Watchpoint Address Register on page H9-5671</i>
MIDR_EL1	<i>MIDR_EL1, Main ID Register on page H9-5673</i>
OSLAR_EL1	<i>OSLAR_EL1, OS Lock Access Register on page H9-5675</i>
PMAUTHSTATUS	<i>PMAUTHSTATUS, Performance Monitors Authentication Status register on page I3-5750</i>
PMCCFILTR_EL0	<i>PMCCFILTR_EL0, Performance Monitors Cycle Counter Filter Register on page I3-5752</i>
PMCCNTR_EL0	<i>PMCCNTR_EL0, Performance Monitors Cycle Counter on page I3-5754</i>
PMCEID0	<i>PMCEID0, Performance Monitors Common Event Identification register 0 on page I3-5756</i>
PMCEID1	<i>PMCEID1, Performance Monitors Common Event Identification register 1 on page I3-5758</i>
PMCEID2	<i>PMCEID2, Performance Monitors Common Event Identification register 2 on page I3-5760</i>
PMCEID3	<i>PMCEID3, Performance Monitors Common Event Identification register 3 on page I3-5762</i>
PMCFGR	<i>PMCFGR, Performance Monitors Configuration Register on page I3-5764</i>
PMCID1SR	<i>PMCID1SR, CONTEXTIDR_EL1 Sample Register on page I3-5770</i>
PMCID2SR	<i>PMCID2SR, CONTEXTIDR_EL2 Sample Register on page I3-5772</i>
PMCIDR0	<i>PMCIDR0, Performance Monitors Component Identification Register 0 on page I3-5766</i>
PMCIDR1	<i>PMCIDR1, Performance Monitors Component Identification Register 1 on page I3-5767</i>
PMCIDR2	<i>PMCIDR2, Performance Monitors Component Identification Register 2 on page I3-5768</i>
PMCIDR3	<i>PMCIDR3, Performance Monitors Component Identification Register 3 on page I3-5769</i>
PMCNTENCLR_EL0	<i>PMCNTENCLR_EL0, Performance Monitors Count Enable Clear register on page I3-5774</i>
PMCNTENSET_EL0	<i>PMCNTENSET_EL0, Performance Monitors Count Enable Set register on page I3-5776</i>
PMCR_EL0	<i>PMCR_EL0, Performance Monitors Control Register on page I3-5778</i>
PMDEVAFF0	<i>PMDEVAFF0, Performance Monitors Device Affinity register 0 on page I3-5781</i>
PMDEVAFF1	<i>PMDEVAFF1, Performance Monitors Device Affinity register 1 on page I3-5782</i>
PMDEVARCH	<i>PMDEVARCH, Performance Monitors Device Architecture register on page I3-5783</i>
PMDEVID	<i>PMDEVID, Performance Monitors Device ID register on page I3-5785</i>
PMDEVTYPE	<i>PMDEVTYPE, Performance Monitors Device Type register on page I3-5786</i>
PMEVCNTR<n>_EL0	<i>PMEVCNTR<n>_EL0, Performance Monitors Event Count Registers, n = 0 - 30 on page I3-5787</i>
PMEVTYPER<n>_EL0	<i>PMEVTYPER<n>_EL0, Performance Monitors Event Type Registers, n = 0 - 30 on page I3-5788</i>

Table K11-28 Alphabetical index of Memory-Mapped Registers (continued)

Register	Description, see
PMINTENCLR_EL1	<i>PMINTENCLR_EL1, Performance Monitors Interrupt Enable Clear register on page I3-5791</i>
PMINTENSET_EL1	<i>PMINTENSET_EL1, Performance Monitors Interrupt Enable Set register on page I3-5793</i>
PMITCTRL	<i>PMITCTRL, Performance Monitors Integration mode Control register on page I3-5795</i>
PMLAR	<i>PMLAR, Performance Monitors Lock Access Register on page I3-5797</i>
PMLSR	<i>PMLSR, Performance Monitors Lock Status Register on page I3-5798</i>
PMOVSCLR_EL0	<i>PMOVSCLR_EL0, Performance Monitors Overflow Flag Status Clear register on page I3-5800</i>
PMOVSSET_EL0	<i>PMOVSSET_EL0, Performance Monitors Overflow Flag Status Set register on page I3-5802</i>
PMPCSR	<i>PMPCSR, Program Counter Sample Register on page I3-5804</i>
PMPIDR0	<i>PMPIDR0, Performance Monitors Peripheral Identification Register 0 on page I3-5806</i>
PMPIDR1	<i>PMPIDR1, Performance Monitors Peripheral Identification Register 1 on page I3-5807</i>
PMPIDR2	<i>PMPIDR2, Performance Monitors Peripheral Identification Register 2 on page I3-5808</i>
PMPIDR3	<i>PMPIDR3, Performance Monitors Peripheral Identification Register 3 on page I3-5809</i>
PMPIDR4	<i>PMPIDR4, Performance Monitors Peripheral Identification Register 4 on page I3-5810</i>
PMSWINC_EL0	<i>PMSWINC_EL0, Performance Monitors Software Increment register on page I3-5811</i>
PMVIDSR	<i>PMVIDSR, VMID Sample Register on page I3-5813</i>

K11.7 Functional index of memory-mapped registers

This section is an index of the memory-mapped registers, divided by functional group.

K11.7.1 ID registers

This section is an index to the registers in the Identification registers functional group.

Table K11-29 ID registers

Register	Description, see
EDAA32PFR	EDAA32PFR
EDDFR	EDDFR
EDPFR	EDPFR
MIDR_EL1	MIDR_EL1

K11.7.2 Performance monitors registers

This section is an index to the registers in the Performance Monitors registers functional group.

Table K11-30 Performance monitors registers

Register	Description, see
PMAUTHSTATUS	PMAUTHSTATUS
PMCCFILTR_EL0	PMCCFILTR_EL0
PMCCNTR_EL0	PMCCNTR_EL0
PMCEID0	PMCEID0
PMCEID1	PMCEID1
PMCEID2	PMCEID2
PMCEID3	PMCEID3
PMCFGR	PMCFGR
PMCID1SR	PMCID1SR
PMCID2SR	PMCID2SR
PMCIDR0	PMCIDR0
PMCIDR1	PMCIDR1
PMCIDR2	PMCIDR2
PMCIDR3	PMCIDR3
PMCNTENCLR_EL0	PMCNTENCLR_EL0
PMCNTENSET_EL0	PMCNTENSET_EL0
PMCR_EL0	PMCR_EL0
PMDEVAFF0	PMDEVAFF0

Table K11-30 Performance monitors registers (continued)

Register	Description, see
PMDEVAFF1	PMDEVAFF1
PMDEVARCH	PMDEVARCH
PMDEVID	PMDEVID
PMDEVTYPE	PMDEVTYPE
PMEVCNTR<n>_EL0	PMEVCNTR<n>_EL0
PMEVTYPEPER<n>_EL0	PMEVTYPEPER<n>_EL0
PMINTENCLR_EL1	PMINTENCLR_EL1
PMINTENSET_EL1	PMINTENSET_EL1
PMITCTRL	PMITCTRL
PMLAR	PMLAR
PMLSR	PMLSR
PMOVSCLR_EL0	PMOVSCLR_EL0
PMOVSSET_EL0	PMOVSSET_EL0
PMPCSR	PMPCSR
PMPIDR0	PMPIDR0
PMPIDR1	PMPIDR1
PMPIDR2	PMPIDR2
PMPIDR3	PMPIDR3
PMPIDR4	PMPIDR4
PMSWINC_EL0	PMSWINC_EL0
PMVIDSR	PMVIDSR

K11.7.3 Debug registers

This section is an index to the registers in the Debug registers functional group.

Table K11-31 Debug registers

Register	Description, see
DBGAUTHSTATUS_EL1	DBGAUTHSTATUS_EL1
DBGBCR<n>_EL1	DBGBCR<n>_EL1
DBGBVR<n>_EL1	DBGBVR<n>_EL1
DBGCLAIMCLR_EL1	DBGCLAIMCLR_EL1
DBGCLAIMSET_EL1	DBGCLAIMSET_EL1
DBGDTRRX_EL0	DBGDTRRX_EL0

Table K11-31 Debug registers (continued)

Register	Description, see
DBGDTRTX_EL0	DBGDTRTX_EL0
DBGWCR<n>_EL1	DBGWCR<n>_EL1
DBGWVR<n>_EL1	DBGWVR<n>_EL1
EDACR	EDACR
EDCIDR0	EDCIDR0
EDCIDR1	EDCIDR1
EDCIDR2	EDCIDR2
EDCIDR3	EDCIDR3
EDCIDSR	EDCIDSR
EDDEVAFF0	EDDEVAFF0
EDDEVAFF1	EDDEVAFF1
EDDEVARCH	EDDEVARCH
EDDEVID	EDDEVID
EDDEVID1	EDDEVID1
EDDEVID2	EDDEVID2
EDDEVTYPE	EDDEVTYPE
EDECCR	EDECCR
EDECR	EDECR
EDES	EDES
EDITCTRL	EDITCTRL
EDITR	EDITR
EDLAR	EDLAR
EDLSR	EDLSR
EDPCSR	EDPCSR
EDPIDR0	EDPIDR0
EDPIDR1	EDPIDR1
EDPIDR2	EDPIDR2
EDPIDR3	EDPIDR3
EDPIDR4	EDPIDR4
EDPRCR	EDPRCR
EDPRSR	EDPRSR
EDRCR	EDRCR

Table K11-31 Debug registers (continued)

Register	Description, see
EDSCR	EDSCR
EDVIDSR	EDVIDSR
EDWAR	EDWAR
OSLAR_EL1	OSLAR_EL1

K11.7.4 Cross-trigger interface registers

This section is an index to the registers in the Cross-Trigger Interface registers functional group.

Table K11-32 Cross-trigger interface registers

Register	Description, see
ASICCTL	ASICCTL
CTIAPPCLEAR	CTIAPPCLEAR
CTIAPPULSE	CTIAPPULSE
CTIAPPSET	CTIAPPSET
CTIAUTHSTATUS	CTIAUTHSTATUS
CTICHINSTATUS	CTICHINSTATUS
CTICHOUTSTATUS	CTICHOUTSTATUS
CTICIDR0	CTICIDR0
CTICIDR1	CTICIDR1
CTICIDR2	CTICIDR2
CTICIDR3	CTICIDR3
CTICLAIMCLR	CTICLAIMCLR
CTICLAIMSET	CTICLAIMSET
CTICONTROL	CTICONTROL
CTIDEVAFF0	CTIDEVAFF0
CTIDEVAFF1	CTIDEVAFF1
CTIDEVARCH	CTIDEVARCH
CTIDEVID	CTIDEVID
CTIDEVID1	CTIDEVID1
CTIDEVID2	CTIDEVID2
CTIDEVTYPE	CTIDEVTYPE
CTIGATE	CTIGATE
CTIINEN<n>	CTIINEN<n>

Table K11-32 Cross-trigger interface registers (continued)

Register	Description, see
CTIINTACK	CTIINTACK
CTIITCTRL	CTIITCTRL
CTILAR	CTILAR
CTILSR	CTILSR
CTIOUTEN<n>	CTIOUTEN<n>
CTIPIDR0	CTIPIDR0
CTIPIDR1	CTIPIDR1
CTIPIDR2	CTIPIDR2
CTIPIDR3	CTIPIDR3
CTIPIDR4	CTIPIDR4
CTITRIGINSTATUS	CTITRIGINSTATUS
CTITRIGOUTSTATUS	CTITRIGOUTSTATUS

Glossary

- A32 instruction** A word that specifies an operation to be performed by a PE that is executing in an Exception level that is using AArch32 and is in A32 state. A32 instructions must be word-aligned.
- A32 instructions were previously called ARM instructions.
- See also* [A32 state](#), [A64 instruction](#), [T32 instruction](#).
- A32 state** The AArch32 Instruction set state in which the PE executes A32 instructions.
- A32 state was previously called ARM state.
- See also* [T32 instruction](#), [T32 state](#).
- A64 instruction** A word that specifies an operation to be performed by a PE that is executing in an Exception level that is using AArch64. A64 instructions must be word-aligned.
- See also* [A32 instruction](#), [T32 instruction](#).
- AArch32** The 32-bit Execution state. In AArch32 state, addresses are held in 32-bit registers, and instructions in the base instruction sets use 32-bit registers for their processing. AArch32 state supports the T32 and A32 instruction sets
- See also* [AArch64](#), [A32 instruction](#), [T32 instruction](#).
- AArch64** The 64-bit Execution state. In AArch64 state, addresses are held in 64-bit registers, and instructions in the base instruction set can use 64-bit registers for their processing. AArch64 state supports the A64 instruction set.
- See also* [AArch32](#), [A64 instruction](#).
- Abort** An exception caused by an illegal memory access. Aborts can be caused by the external memory system or the MMU.
- Addressing mode** Means a method for generating the memory address used by a load/store instruction.
- Advanced SIMD** A feature of the ARM architecture that provides SIMD operations on a register file of SIMD and floating-point registers. Where an implementation supports both Advanced SIMD and floating-point instructions, these instructions operate on the same register file.

- Aligned** A data item stored at an address that is exactly divisible by the highest power of 2 that divides exactly into its size in bytes. Aligned halfwords, words and doublewords therefore have addresses that are divisible by 2, 4 and 8 respectively.
- An aligned access is one where the address of the access is aligned to the size of each element of the access.
- Architecturally executed** An instruction is architecturally executed only if it would be executed in a simple sequential execution of the program. When such an instruction has been executed and retired it has been *architecturally executed*. Any instruction that, in a simple sequential execution of a program, is treated as a NOP because it fails its condition code check, is an architecturally executed instruction.
- In a PE that performs speculative execution, an instruction is not architecturally executed if the PE discards the results of a speculative execution.
- See also [Condition code check](#), [Simple sequential execution](#).
- Architecturally mapped** Where this manual describes a register as being *architecturally mapped* to another register, this indicates that, in an implementation that supports both of the registers, the two registers access the same state.
- Architecturally UNKNOWN** An architecturally UNKNOWN value is a value that is not defined by the architecture but must meet the requirements of the definition of [UNKNOWN](#). Implementations can define the value of the field, but are not required to do so.
- See also [IMPLEMENTATION DEFINED](#).
- ARM core registers** Some older documentation uses *ARM core registers* to refer to the following set of registers for execution in AArch32 state:
- The 13 general-purpose registers, R0-R12, that software can use for processing.
 - SP, the *stack pointer*, that can also be referred to as R13.
 - LR, the *link register*, that can also be referred to as R14.
 - PC, the *program counter*, that can also be referred to as R15.
- See also [General-purpose registers](#).
- ARM instruction** See [A32 instruction](#).
- Associativity** See [Cache associativity](#).
- Atomicity** Describes either single-copy atomicity or multi-copy atomicity. [Atomicity in the ARM architecture on page B2-82](#) defines these forms of atomicity for the ARM architecture.
- See also [Multi-copy atomicity](#), [Single-copy atomicity](#).
- Banked register** A register that has multiple instances, with the instance that is in use depending on the PE mode, Security state, or other PE state.
- Base register** A register specified by a load/store instruction that is used as the base value for the address calculation for the instruction. Depending on the instruction and its addressing mode, an offset can be added to or subtracted from the base register value to form the virtual address that is sent to memory.
- Base register writeback** Describes writing back a modified value to the base register used in an address calculation.
- Behaves as if** Where this manual indicates that a PE *behaves as if* a certain condition applies, all descriptions of the operation of the PE must be re-evaluated taking account of that condition, together with any other conditions that affect operation.

Big-endian memory

Means that, for example:

- A byte or halfword at a word-aligned address is the most significant byte or halfword in the word at that address.
- A byte at a halfword-aligned address is the most significant byte in the halfword at that address.

See also [Endianness](#), [Little-endian memory](#).

Blocking

Describes an operation that does not permit following instructions to be executed before the operation completes.

A non-blocking operation can permit following instructions to be executed before the operation completes, and in the event of encountering an exception does not signal an exception to the PE. This enables implementations to retire following instructions while the non-blocking operation is executing, without the need to retain precise PE state.

Branch prediction

Is where a PE selects a future execution path to fetch along. For example, after a branch instruction, the PE can choose to speculatively fetch either the instruction following the branch or the instruction at the branch target.

See also [Prefetching](#).

Breakpoint

A debug event triggered by the execution of a particular instruction, specified by one or both of the address of the instruction and the state of the PE when the instruction is executed.

Byte

An 8-bit data item.

Cache associativity

The number of locations in a cache set to which an address can be assigned. Each location is identified by its *way* value.

Cache level

The position of a cache in the cache hierarchy. In the ARM architecture, the lower numbered levels are those closest to the PE. For more information, see [Terms used in describing the cache maintenance instructions on page D3-1981](#).

Cache line

The basic unit of storage in a cache. Its size in words is always a power of two, usually 4 or 8 words. A cache line must be aligned to a suitable memory boundary. A *memory cache line* is a block of memory locations with the same size and alignment as a cache line. Memory cache lines are sometimes loosely called cache lines.

Cache lockdown

Enables critical software and data to be loaded into the cache so that the cache lines containing them are not subsequently reallocated. It alleviates the delays caused by accessing a cache in a worst-case situation. This ensures that all subsequent accesses to the software and data concerned are cache hits and so complete quickly.

Cache miss

A memory access that cannot be processed at high speed because the data it addresses is not in the cache.

Cache sets

Areas of a cache, divided up to simplify and speed up the process of determining whether a cache hit occurs. The number of cache sets is always a power of two.

Cache way

A cache way consists of one cache line from each cache set. The cache ways are indexed from 0 to (Associativity-1). Each cache line in a cache way is chosen to have the same index as the cache way. For example, cache way *n* consists of the cache line with index *n* from each cache set.

Coherence order

See [Coherent](#).

Coherent

Data accesses from a set of observers to a byte in memory are coherent if accesses to that byte in memory by the members of that set of observers are consistent with there being a single total order of all writes to that byte in memory by all members of the set of observers. This single total order of all to writes to that memory location is the *coherence order* for that byte in memory.

Condition code check

The process of determining whether a conditional instruction executes normally or is treated as a NOP. For an instruction that includes a condition code field, that field is compared with the condition flags to determine whether the instruction is executed normally. For a T32 instruction in an IT block, the value of [PSTATE.IT](#) determines whether the instruction is executed normally.

See also [Condition code field](#), [Condition flags](#), [Conditional execution](#).

Condition code field

A 4-bit field in an instruction that specifies the condition under which the instruction executes.

See also [Condition code check](#).

Condition flags

The N, Z, C, and V bits of PSTATE, an SPSR, or FPSCR. See the register descriptions for more information.

See also [Condition code check](#), [PSTATE](#).

Conditional execution

When a conditional instruction starts executing, if the condition code check returns TRUE, the instruction executes normally. Otherwise, it is treated as a NOP.

See also [Condition code check](#).

CONSTRAINED UNPREDICTABLE

Where an instruction can result in UNPREDICTABLE behavior, the ARMv8 architecture specifies a narrow range of permitted behaviors. This range is the range of CONSTRAINED UNPREDICTABLE behavior. All implementations that are compliant with the architecture must follow the CONSTRAINED UNPREDICTABLE behavior.

Execution at Non-secure EL1 or EL0 of an instruction that is CONSTRAINED UNPREDICTABLE can be implemented as generating a trap exception that is taken to EL2, provided that at least one instruction that is not UNPREDICTABLE and is not CONSTRAINED UNPREDICTABLE causes a trap exception that is taken to EL2.

In body text, the term CONSTRAINED UNPREDICTABLE is shown in SMALL CAPITALS.

See also [UNPREDICTABLE](#).

Context switch

The saving and restoring of computational state when switching between different threads or processes. In this manual, the term context switch describes any situation where the context is switched by an operating system and might or might not include changes to the address space.

Context synchronization event

One of:

- Performing an ISB operation. An ISB operation is performed when an ISB instruction is executed and does not fail its condition code check.
- Taking an exception.
- Returning from an exception.
- Exit from Debug state.
- Executing a DCPS instruction.
- Executing a DRPS instruction.

The effects of a Context synchronization event are:

- All unmasked interrupts that are pending at the time of the Context synchronization event are taken before the first instruction after the Context synchronization event.
- If halting is allowed, all Halting debug events that are pending at the time of the Context synchronization event are taken before the first instruction after the Context synchronization event.
- No instructions appearing in program order after an instruction that causes a Context synchronization event will have performed any part of their functionality until the Context synchronization event has occurred.
- All direct and indirect writes to System registers that are made before the Context synchronization event affect any instruction, including a direct read, that appears in program order after the instruction causing the Context synchronization event.
- All invalidations of TLBs, instruction caches, and, in AArch32 state, branch predictors, that are completed before the Context synchronization event affect all instructions that appear in program order after an instruction causing a Context synchronization event.
- In AArch32 state, all Non-cacheable writes that are completed before the Context synchronization event affect all instructions that appear in program order after an instruction causing a Context synchronization event.

- Changes to the Debug external authentication interfaces that are made before the Context synchronization event affect any instruction that appears in program order after the instruction causing the Context synchronization event.

Note

The architecture requires that instructions that generate Context synchronization events do not appear to be executed speculatively, except that it is permissible that the performance counters can reveal such speculation.

Note

Context synchronization events were previously described as *context synchronization operations*.

Debugger	<p>In most of this manual, <i>debugger</i> refers to any agent that is performing debug. However, some chapters or parts of this manual require a more rigorous definition, and define debugger locally. See:</p> <ul style="list-style-type: none"> • Definition of a debugger in the context of self-hosted debug on page D2-1906. • Definition of a debugger in the context of self-hosted debug on page G2-4454. • Definition of a debugger in the context of external debug on page H1-5430.
Deprecated	<p>Something that is present in the ARM architecture for backwards compatibility. Whenever possible software must avoid using deprecated features. Features that are deprecated but are not optional are present in current implementations of the ARM architecture, but might not be present, or might be deprecated and OPTIONAL, in future versions of the ARM architecture.</p> <p>See also OPTIONAL.</p>
Digital signal processing (DSP)	<p>Algorithms for processing signals that have been sampled and converted to digital form. DSP algorithms often use saturated arithmetic.</p>
Direct Memory Access (DMA)	<p>An operation that accesses main memory directly, without the PE performing any accesses to the data concerned.</p>
Direct read	<p>A direct read of a System register is a read performed by a System register access instruction.</p> <p>For more information, see Direct read on page D7-2193.</p> <p>See also Direct write, Indirect read, Indirect write.</p>
Direct write	<p>A direct write of a System register is a write performed by a System register access instruction.</p> <p>For more information, see Direct write on page D7-2193.</p> <p>See also Direct read, Indirect read, Indirect write.</p>
DMA	<p>See Direct Memory Access (DMA).</p>
DNM	<p>See Do-Not-Modify (DNM).</p>
Domain	<p>In the ARM architecture, <i>domain</i> is used in the following contexts.</p> <p>Shareability domain Defines a set of observers for which the shareability attributes make the data or unified caches transparent for data accesses.</p> <p>Power domain Defines a block of logic with a single, common, power supply.</p> <p>Memory regions domain</p> <p>When using the Short-descriptor translation table format, defines a collection of Sections, Large pages and Small pages of memory, that can have their access permissions switched rapidly by writing to the <i>Domain Access Control Register (DACR)</i>. ARM deprecates any use of memory regions domains.</p>

Do-Not-Modify (DNM)

Means the value must not be altered by software. DNM fields read as UNKNOWN values, and must only be written with the value read from the same field on the same PE.

Double-precision value

Consists of two consecutive 32-bit words that are interpreted as a basic double-precision floating-point number according to the *IEEE Standard for Floating-point Arithmetic*.

Doubleword

A 64-bit data item. Doublewords are normally at least word-aligned in ARM systems.

Doubleword-aligned

Means that the address is divisible by 8.

DSP

See [Digital signal processing \(DSP\)](#).

Effective value

A register control field, meaning a field in a register that controls some aspect of the behavior, can be described as having an Effective value:

- In some cases, the description of a control *a* specifies that when control *a* is active it causes a register control field *b* to be treated as having a fixed value for all purposes other than direct reads, or direct reads and direct writes, of the register containing control field *b*. When control *a* is active that fixed value is described as the *Effective value* of register control field *b*. For example, when the value of HCR.DC is 1, the *Effective value* of HCR.VM is 1, regardless of its actual value.

In other cases, in some contexts a register control field *b* is not implemented or is not accessible, but behavior of the PE is as if control field *b* was implemented and accessible, and had a particular value. In this case, that value is the *Effective value* of register control field *b*.

———— **Note** —————

Where a register control field is introduced in a particular version of the architecture, and is not implemented in an earlier version of the architecture, typically it will have an Effective value in that earlier version of the architecture.

- Otherwise, the *Effective value* of a register control field is the value of that field.

Endianness

An aspect of the system memory mapping.

See also [Big-endian memory](#) and [Little-endian memory](#).

Exception

Handles an event. For example, an exception could handle an external interrupt or an undefined instruction.

Exception vector

A fixed address that contains the address of the first instruction of the corresponding exception handler.

Execution stream

The stream of instructions that would have been executed by sequential execution of the program.

Explicit access

A read from memory, or a write to memory, generated by a load or store instruction executed by the PE. Reads and writes generated by hardware translation table accesses are not explicit accesses.

External abort

An abort that is generated by the external memory system.

Fast Context Switch Extension (FCSE)

Modifies the behavior of an ARM memory system to enable multiple programs running on the ARM PE to use identical address ranges, while ensuring that the addresses they present to the rest of the memory system differ. From ARMv6, ARM deprecates any use of the FCSE. The FCSE is:

- Optional in an ARMv7 implementation that does not include the Multiprocessing Extensions.
- Obsolete from the introduction of the Multiprocessing Extensions.

FCSE

See [Fast Context Switch Extension \(FCSE\)](#).

Flat address mapping

Is where the physical address for every access is equal to its virtual address.

Flush-to-zero mode

A processing mode that optimizes the performance of some floating-point algorithms by replacing the denormalized operands and intermediate results with zeros, without significantly affecting the accuracy of their final results.

General-purpose registers

The registers that the base instructions use for processing:

- In AArch32 state the general-purpose registers are R0-R14, that can also be described as R0-R12, SP, LR.

———— **Note** —————

Older documentation defines the AArch32 general-purpose registers as R0-R12, and the ARM core registers as R0-R12, SP, LR, and PC.

- In AArch64 state the general-purpose registers are:
 - W0-W30 when accessed as 32-bit registers.
 - X0-X30 when accessed as 64-bit registers.

See also [High registers](#), [Low registers](#).

Halfword

A 16-bit data item. Halfwords are normally halfword-aligned in ARM systems.

Halfword-aligned

Means that the address is divisible by 2.

High registers

In AArch32 state, the general-purpose registers R8-R14. Most 16-bit T32 instructions cannot access the high registers.

———— **Note** —————

In some contexts, *high registers* refers to R8-R15, meaning R8-R14 and the PC.

See also [General-purpose registers](#), [Low registers](#).

High vectors

An alternative location for the exception vectors. The high vector address range is near the top of the address space, rather than at the bottom.

IGNORED

Indicates that the architecture guarantees that the bit or field is not interpreted or modified by hardware.

In body text, the term IGNORED is shown in SMALL CAPITALS.

Immediate and offset fields

Are unsigned unless otherwise stated.

Immediate value

A value that is encoded directly in the instruction and used as numeric data when the instruction is executed. Many A64, A32, and T32 instructions can be used with an immediate argument.

IMP

An abbreviation used in diagrams to indicate that one or more bits have IMPLEMENTATION DEFINED behavior.

IMPLEMENTATION DEFINED

Means that the behavior is not architecturally defined, but must be defined and documented by individual implementations.

In body text, the term IMPLEMENTATION DEFINED is shown in SMALL CAPITALS.

Index register

A register specified in some load and store instructions. The value of this register is used as an offset to be added to or subtracted from the base register value to form the virtual address that is sent to memory. Some instruction forms permit the index register value to be shifted before the addition or subtraction.

Indirect read

When an instruction uses a System register value to establish operating conditions, that use of the System register is an indirect read of the System register.

For more information, including additional examples of indirect reads, see [Indirect read on page D7-2194](#).

See also [Direct read](#), [Direct write](#), [Indirect write](#).

Indirect write	<p>An indirect write of a System register occurs when the contents of a register are updated by some mechanism other than a <i>Direct write</i> to that register. For example, an indirect write to a register might occur as a side-effect of executing an instruction that does not perform a direct write to the register, or because of some operation performed by an external agent.</p> <p>For more information, see Indirect write on page D7-2194.</p> <p>See also Direct read, Direct write, Indirect read.</p>
Inline literals	<p>These are constant addresses and other data items held in the same area as the software itself. They are automatically generated by compilers, and can also appear in assembler code.</p>
Intermediate physical address (IPA)	<p>An implementation of virtualization, the address to which a Guest OS maps a VA. A hypervisor might then map the IPA to a PA. Typically, the Guest OS is unaware of the translation from IPA to PA.</p> <p>See also Physical address (PA), Virtual address (VA).</p>
Interworking	<p>A method of working that permits branches between software using the A32 and T32 instruction sets.</p>
IPA	<p>See Intermediate physical address (IPA).</p>
Level	<p>See Cache level.</p>
Level of Coherence (LoC)	<p>The last level of cache that must be cleaned or invalidated when cleaning or invalidating to the point of coherency. For more information, see Terms used in describing the cache maintenance instructions on page D3-1981.</p> <p>See also Cache level, Point of coherency (PoC).</p>
Level of Unification, Inner Shareable (LoUIS)	<p>The last level of cache that must be cleaned or invalidated when cleaning or invalidating to the point of unification for the Inner Shareable shareability domain. For more information, see Terms used in describing the cache maintenance instructions on page D3-1981.</p> <p>See also Cache level, Point of unification (PoU).</p>
Level of Unification, uniprocessor (LoUU)	<p>For a PE, the last level of cache that must be cleaned or invalidated when cleaning or invalidating to the point of unification for that PE. For more information, see Terms used in describing the cache maintenance instructions on page D3-1981.</p> <p>See also Cache level, Point of unification (PoU).</p>
Line	<p>See Cache line.</p>
Little-endian memory	<p>Means that, for example:</p> <ul style="list-style-type: none"> • A byte or halfword at a word-aligned address is the least significant byte or halfword in the word at that address. • A byte at a halfword-aligned address is the least significant byte in the halfword at that address. <p>See also Big-endian memory, Endianness.</p>
Load/Store architecture	<p>An architecture where data-processing operations only operate on register contents, not directly on memory contents.</p>
LoC	<p>See Level of Coherence (LoC).</p>
LoUIS	<p>See Level of Unification, Inner Shareable (LoUIS).</p>
LoUU	<p>See Level of Unification, uniprocessor (LoUU).</p>
Lockdown	<p>See Cache lockdown.</p>

- Low registers** In AArch32 state, general-purpose registers R0-R7. Unlike the high registers, all T32 instructions can access the Low registers.
 See also [General-purpose registers](#), [High registers](#).
- Memory barrier** See [Memory barriers on page B2-92](#).
- Memory coherency**
 The problem of ensuring that when a memory location is read, either by a data read or an instruction fetch, the value actually obtained is always the value that was most recently written to the location. This can be difficult when there are multiple possible physical locations, such as main memory and at least one of a write buffer and one or more levels of cache.
- Memory Management Unit (MMU)**
 Provides detailed control of the part of a memory system that provides a single stage of address translation. Most of the control is provided using translation tables that are held in memory, and define the attributes of different regions of the physical memory map.
- Memory Protection Unit (MPU)**
 A hardware unit whose registers provide simple control of a limited number of protection regions in memory.
- Miss** See [Cache miss](#).
- MMU** See [Memory Management Unit \(MMU\)](#).
- MPU** See [Memory Protection Unit \(MPU\)](#).
- Multi-copy atomicity**
 The form of atomicity described in [Requirements for multi-copy atomicity on page B2-83](#).
 See also [Atomicity](#), [Single-copy atomicity](#).
- NaN** Not a Number. A floating-point value that can be used when neither a numeric value nor an infinity is appropriate. A NaN can be a *quiet* NaN, that propagate through most floating-point operations, or a *signaling* NaN, that causes an Invalid Operation floating-point exception when used. For more information, see the *IEEE Standard for Floating-point Arithmetic*.
 See also [Quiet NaN](#), [Signaling NaN](#).
- Natural eviction** A natural eviction is an eviction that occurs in the course of the normal operation of the memory system, rather than because of an operation that explicitly causes an eviction from the cache, such as the execution of a cache maintenance instruction. Typically, a natural eviction occurs when the caching algorithm requires data to be cached but the cache does not have room for that data.
- Observer** A PE or mechanism in the system, such as a peripheral device, that can generate reads from or writes to memory.
- Obsolete** Obsolete indicates something that is no longer supported by ARM. When an architectural feature is described as obsolete, this indicates that the architecture has no support for that feature, although an earlier version of the architecture did support it.
- Offset addressing** Means that the memory address is formed by adding or subtracting an offset to or from the base register value.
- OPTIONAL** When applied to a feature of the architecture, OPTIONAL indicates a feature that is not required in an implementation of the ARM architecture:
- If a feature is OPTIONAL and deprecated, this indicates that the feature is being phased out of the architecture. ARM expects such a features to be included in a new implementation only if there is a known backwards-compatibility reason for the inclusion of the feature.
 A feature that is OPTIONAL and deprecated might not be present in future versions of the architecture.
 - A feature that is OPTIONAL but not deprecated is, typically, a feature added to a version of the ARM architecture after the initial release of that version of the architecture. ARM recommends that such features are included in all new implementations of the architecture.
- In body text, these meanings of the term OPTIONAL are shown in SMALL CAPITALS.

Note

Do not confuse these ARM-specific uses of **OPTIONAL** with other uses of *optional*, where it has its usual meaning. These include:

- Optional arguments in the syntax of many instructions.
- Behavior determined by an implementation choice, for example the optional byte order reversal in an ARMv7-R implementation, where the **SCTLR.IE** bit indicates the implemented option.

See also [Deprecated](#).

PA See [Physical address \(PA\)](#).

PE See [Processing element \(PE\)](#).

Physical address (PA)

An address that identifies a location in the physical memory map.

See also [Intermediate physical address \(IPA\)](#), [Virtual address \(VA\)](#).

PoC See [Point of coherency \(PoC\)](#).

PoU See [Point of unification \(PoU\)](#).

Point of coherency (PoC)

For a particular VA, the point at which all agents that can access memory are guaranteed to see the same copy of a memory location. For more information, see [Terms used in describing the cache maintenance instructions on page D3-1981](#).

Point of unification (PoU)

For a particular PE, the point by which the instruction and data caches and the translation table walks of that PE are guaranteed to see the same copy of a memory location. For more information, see [Terms used in describing the cache maintenance instructions on page D3-1981](#).

Post-indexed addressing

Means that the memory address is the base register value, but an offset is added to or subtracted from the base register value and the result is written back to the base register.

Prefetching

Prefetching refers to speculatively fetching instructions or data from the memory system. In particular, instruction prefetching is the process of fetching instructions from memory before the instructions that precede them, in simple sequential execution of the program, have finished executing. Prefetching an instruction does not mean that the instruction has to be executed.

In this manual, references to instruction or data fetching apply also to prefetching, unless the context explicitly indicates otherwise.

Note

The Prefetch Abort exception can be generated on any instruction fetch, and is not limited to speculative instruction fetches.

See also [Simple sequential execution](#).

Pre-indexed addressing

Means that the memory address is formed in the same way as for offset addressing, but the memory address is also written back to the base register.

Processing element (PE)

The abstract machine defined in the ARM architecture, as documented in an ARM Architecture Reference Manual. A PE implementation compliant with the ARM architecture must conform with the behaviors described in the corresponding ARM Architecture Reference Manual.

Protection region

A memory region whose position, size, and other properties are defined by Memory Protection Unit registers.

Protection Unit See [Memory Protection Unit \(MPU\)](#).

Pseudo-instruction

UAL assembler syntax that assembles to an instruction encoding that is expected to disassemble to a different assembler syntax, and is described in this manual under that other syntax. For example, `MOV <Rd>, <Rm>, LSL #<n>` is a pseudo-instruction that is expected to disassemble as `LSL <Rd>, <Rm>, #<n>`.

PSTATE An abstraction of process state information. All of the instruction sets provide instructions that operate on elements of PSTATE.

See also [Condition flags](#).

Quadword A 128-bit data item. Quadwords are normally at least word-aligned in ARM systems.

Quadword-aligned

Means that the address is divisible by 16.

Quiet NaN A NaN that propagates unchanged through most floating-point operations.

See also [NaN](#), [Signaling NaN](#).

RAO See [Read-As-One \(RAO\)](#).

RAZ See [Read-As-Zero \(RAZ\)](#).

RAO/SBOP In versions of the ARM architecture before ARMv8, Read-As-One, Should-Be-One-or-Preserved on writes. In ARMv8, RES1 replaces this description.

See also [UNK/SBOP](#), [Read-As-One \(RAO\)](#), [RES1](#), [Should-Be-One-or-Preserved \(SBOP\)](#).

RAO/WI Read-As-One, Writes Ignored.

Hardware must implement the field as Read-as-One, and must ignore writes to the field.

Software can rely on the field reading as all 1s, and on writes being ignored.

This description can apply to a single bit that reads as 1, or to a field that reads as all 1s.

See also [Read-As-One \(RAO\)](#).

RAZ/SBZP In versions of the ARM architecture before ARMv8, Read-As-Zero, Should-Be-Zero-or-Preserved on writes. In ARMv8, RES0 replaces this description.

See also [UNK/SBZP](#), [Read-As-Zero \(RAZ\)](#), [RES0](#), [Should-Be-Zero-or-Preserved \(SBZP\)](#).

RAZ/WI Read-As-Zero, Writes Ignored.

Hardware must implement the field as Read-as-Zero, and must ignore writes to the field.

Software can rely on the field reading as all 0s, and on writes being ignored.

This description can apply to a single bit that reads as 0, or to a field that reads as all 0s.

See also [Read-As-Zero \(RAZ\)](#).

Read-allocate cache

A cache in which a cache miss on reading data causes a cache line to be allocated into the cache.

Read-As-One (RAO)

Hardware must implement the field as reading as all 1s.

Software:

- Can rely on the field reading as all 1s.
- Must use a [SBOP](#) policy to write to the field.

This description can apply to a single bit that reads as 1, or to a field that reads as all 1s.

See also [RAO/SBOP](#), [RAO/WI](#), [RES1](#).

Read-As-Zero (RAZ)

Hardware must implement the field as reading as all 0s.

Software:

- Can rely on the field reading as all 0s
- Must use a [SBZP](#) policy to write to the field.

This description can apply to a single bit that reads as 0, or to a field that reads as all 0s.

See also [RAZ/SBZP](#), [RAZ/WI](#), [RES0](#).

Read, modify, write

In a read, modify, write instruction sequence, a value is read to a general-purpose register, the relevant fields updated in that register, and the new value written back.

RES0

A reserved bit. Used for fields in register descriptions, and for fields in architecturally-defined data structures that are held in memory, for example in translation table descriptors.

Within the architecture, there are some cases where a register bit or field:

- Is RES0 in some defined architectural context.
- Has different defined behavior in a different architectural context.

Note

- RES0 is not used in descriptions of instruction encodings.
 - Where an AArch32 System register is *Architecturally mapped* to an AArch64 System register, and a bit or field in that register is RES0 in one Execution state and has defined behavior in the other Execution state, this is an example of a bit or field with behavior that depends on the architectural context.
-

This means the definition of RES0 for fields in read/write registers is:

If a bit is RES0 in all contexts

For a bit in a read/write register, it is IMPLEMENTATION DEFINED whether:

1. The bit is hardwired to 0. In this case:
 - Reads of the bit always return 0.
 - Writes to the bit are ignored.
2. The bit can be written. In this case:
 - An indirect write to the register sets the bit to 0.
 - A read of the bit returns the last value successfully written, by either a direct or an indirect write, to the bit.
If the bit has not been successfully written since reset, then the read of the bit returns the reset value if there is one, or otherwise returns an UNKNOWN value.
 - A direct write to the bit must update a storage location associated with the bit.
 - The value of the bit must have no effect on the operation of the PE, other than determining the value read back from the bit, unless this Manual explicitly defines additional properties for the bit.

Whether RES0 bits or fields follow behavior 1 or behavior 2 is IMPLEMENTATION DEFINED on a field-by-field basis.

If a bit is RES0 only in some contexts

For a bit in a read/write register, when the bit is described as RES0:

- An indirect write to the register sets the bit to 0.
- A read of the bit must return the value last successfully written to the bit, by either a direct or an indirect write, regardless of the use of the register when the bit was written.
If the bit has not been successfully written since reset, then the read of the bit returns the reset value if there is one, or otherwise returns an UNKNOWN value.

- A direct write to the bit must update a storage location associated with the bit.
- While the use of the register is such that the bit is described as RES0, the value of the bit must have no effect on the operation of the PE, other than determining the value read back from that bit, unless this Manual explicitly defines additional properties for the bit.

Considering only contexts that apply to a particular implementation, if there is a context in which a bit is defined as RES0, another context in which the same bit is defined as RES1, and no context in which the bit is defined as a functional bit, then it is IMPLEMENTATION DEFINED whether:

- Writes to the bit are ignored, and reads of the bit return an UNKNOWN value.
- The value of the bit can be written, and a read returns the last value written to the bit.

The RES0 description can apply to bits or fields that are read-only, or are write-only:

- For a read-only bit, RES0 indicates that the bit reads as 0, but software must treat the bit as UNKNOWN.
- For a write-only bit, RES0 indicates that software must treat the bit as SBZ.

A bit that is RES0 in a context is reserved for possible future use in that context. To preserve forward compatibility, software:

- Must not rely on the bit reading as 0.
- Must use an SBZP policy to write to the bit.

This RES0 description can apply to a single bit, or to a field for which each bit of the field must be treated as RES0.

In body text, the term RES0 is shown in SMALL CAPITALS.

See also [Read-As-Zero \(RAZ\)](#), [RES1](#), [Should-Be-Zero-or-Preserved \(SBZP\)](#), [UNKNOWN](#).

RES1

A reserved bit. Used for fields in register descriptions, and for fields in architecturally-defined data structures that are held in memory, for example in translation table descriptors.

Within the architecture, there are some cases where a register bit or field:

- Is RES1 in some defined architectural context.
- Has different defined behavior in a different architectural context.

————— Note —————

- RES1 is not used in descriptions of instruction encodings.
- Where an AArch32 System register is *Architecturally mapped* to an AArch64 System register, and a bit or field in that register is RES1 in one Execution state and has defined behavior in the other Execution state, this is an example of a bit or field with behavior that depends on the architectural context.

This means the definition of RES1 for fields in read/write registers is:

If a bit is RES1 in all contexts

For a bit in a read/write register, it is IMPLEMENTATION DEFINED whether:

1. The bit is hardwired to 1. In this case:
 - Reads of the bit always return 1.
 - Writes to the bit are ignored.
2. The bit can be written. In this case:
 - An indirect write to the register sets the bit to 1.
 - A read of the bit returns the last value successfully written, by either a direct or an indirect write, to the bit.
If the bit has not been successfully written since reset, then the read of the bit returns the reset value if there is one, or otherwise returns an UNKNOWN value.
 - A direct write to the bit must update a storage location associated with the bit.
 - The value of the bit must have no effect on the operation of the PE, other than determining the value read back from the bit, unless this Manual explicitly defines additional properties for the bit.

Whether RES1 bits or fields follow behavior 1 or behavior 2 is IMPLEMENTATION DEFINED on a field-by-field basis.

If a bit is RES1 only in some contexts

For a bit in a read/write register, when the bit is described as RES1:

- An indirect write to the register sets the bit to 1.
- A read of the bit must return the value last successfully written to the bit, regardless of the use of the register when the bit was written.

————— Note —————

As indicated in this list, this value might be written by an indirect write to the register.

If the bit has not been successfully written since reset, then the read of the bit returns the reset value if there is one, or otherwise returns an UNKNOWN value.

- A direct write to the bit must update a storage location associated with the bit.
- While the use of the register is such that the bit is described as RES1, the value of the bit must have no effect on the operation of the PE, other than determining the value read back from that bit, unless this Manual explicitly defines additional properties for the bit.

Considering only contexts that apply to a particular implementation, if there is a context in which a bit is defined as RES0, another context in which the same bit is defined as RES1, and no context in which the bit is defined as a functional bit, then it is IMPLEMENTATION DEFINED whether:

- Writes to the bit are ignored, and reads of the bit return an UNKNOWN value.
- The value of the bit can be written, and a read returns the last value written to the bit.

The RES1 description can apply to bits or fields that are read-only, or are write-only:

- For a read-only bit, RES1 indicates that the bit reads as 1, but software must treat the bit as UNKNOWN.
- For a write-only bit, RES1 indicates that software must treat the bit as SBO.

A bit that is RES1 in a context is reserved for possible future use in that context. To preserve forward compatibility, software:

- Must not rely on the bit reading as 1.
- Must use an SBOP policy to write to the bit.

This RES1 description can apply to a single bit, or to a field for which each bit of the field must be treated as RES1.

In body text, the term RES1 is shown in SMALL CAPITALS.

See also [Read-As-One \(RAO\)](#), [RES0](#), [Should-Be-One-or-Preserved \(SBOP\)](#), [UNKNOWN](#).

Reserved

Unless otherwise stated:

- Instructions that are reserved or that access reserved registers have UNPREDICTABLE or CONSTRAINED UNPREDICTABLE behavior.
- Bit positions described as reserved are:
 - In an RW or WO register, RES0.
 - In an RO register, UNK.

See also [CONSTRAINED UNPREDICTABLE](#), [RES0](#), [RES1](#), [UNDEFINED](#), [UNK](#), [UNPREDICTABLE](#).

RISC

Reduced Instruction Set Computer.

Rounding error

The value of the rounded result of an arithmetic operation minus the exact result of the operation.

Rounding mode

Specifies how the exact result of a floating-point operation is rounded to a value that is representable in the destination format. The rounding modes are defined by the *IEEE Standard for Floating-point Arithmetic*, see [Floating-point standards, and terminology on page A1-49](#).

Saturated arithmetic

Integer arithmetic in which a result that would be greater than the largest representable number is set to the largest representable number, and a result that would be less than the smallest representable number is set to the smallest representable number. Signed saturated arithmetic is often used in DSP algorithms. It contrasts with the normal signed integer arithmetic used in ARM processors, in which overflowing results wrap around from $+2^{31}-1$ to -2^{31} or vice versa.

SBO See [Should-Be-One \(SBO\)](#).

SBOP See [Should-Be-One-or-Preserved \(SBOP\)](#).

SBZ See [Should-Be-Zero \(SBZ\)](#).

SBZP See [Should-Be-Zero-or-Preserved \(SBZP\)](#).

Security hole

A mechanism by which execution at the current level of privilege can achieve an outcome that cannot be achieved at the current or a lower level of privilege using instructions that are not UNPREDICTABLE and are not CONSTRAINED UNPREDICTABLE. The ARM architecture forbids security holes.

See also [CONSTRAINED UNPREDICTABLE](#), [UNPREDICTABLE](#).

Self-modifying code

Code that writes one or more instructions to memory and then executes them. When using self-modifying code, you must use cache maintenance and barrier instructions to ensure synchronization. For more information, see [Caches and memory hierarchy on page B2-97](#).

Set See [Cache sets](#).

Should-Be-One (SBO)

Hardware must ignore writes to the field.

ARM strongly recommends that software writes the field as all 1s. If software writes a value that is not all 1s, it must expect an UNPREDICTABLE or CONSTRAINED UNPREDICTABLE result.

This description can apply to a single bit that should be written as 1, or to a field that should be written as all 1s.

See also [CONSTRAINED UNPREDICTABLE](#), [UNPREDICTABLE](#).

Should-Be-One-or-Preserved (SBOP)

From the introduction of the ARMv8 architecture, the description *Should-Be-One-or-Preserved (SBOP)* is superseded by [RESI](#).

Note

The ARMv7 Large Physical Address Extension modified the definition of SBOP for register bits that are SBOP in some but not all contexts. The behavior of these bits is covered by the [RESI](#) definition, but not by the generic definition of SBOP given here.

Hardware must ignore writes to the field.

When writing this field, software must either write all 1s to this field or, if the register is being restored from a previously read state, write the previously read value to this field. If this is not done, then the result is UNPREDICTABLE.

This description can apply to a single bit that should be written as its preserved value or as 1, or to a field that should be written as its preserved value or as all 1s.

See also [CONSTRAINED UNPREDICTABLE](#), [UNPREDICTABLE](#).

Should-Be-Zero (SBZ)

Hardware must ignore writes to the field.

ARM strongly recommends that software writes the field as all 0s. If software writes a value that is not all 0s, it must expect an UNPREDICTABLE or CONSTRAINED UNPREDICTABLE result.

This description can apply to a single bit that should be written as 0, or to a field that should be written as all 0s.

See also [CONSTRAINED UNPREDICTABLE](#), [UNPREDICTABLE](#).

Should-Be-Zero-or-Preserved (SBZP)

From the introduction of the ARMv8 architecture, the description *Should-Be-Zero-or-Preserved (SBZP)* is superseded by [RES0](#).

Note

The ARMv7 Large Physical Address Extension modified the definition of SBZP for register bits that are SBZP in some but not all contexts. The behavior of these bits is covered by the [RES0](#) definition, but not by the generic definition of SBZP given here.

Hardware must ignore writes to the field.

When writing this field, software must either write all 0s to this field or, if the register is being restored from a previously read state, write the previously read value to this field. If this is not done, then the result is UNPREDICTABLE.

This description can apply to a single bit that should be written as its preserved value or as 0, or to a field that should be written as its preserved value or as all 0s.

See also [CONSTRAINED UNPREDICTABLE](#), [UNPREDICTABLE](#).

Signaling NaN

An Invalid Operation floating-point exception occurs whenever any floating-point operation receives a signaling NaN as an operand. Signaling NaNs can be used in debugging, to track down some uses of uninitialized variables.

See also [NaN](#), [Quiet NaN](#).

Signed immediate and offset fields

Are encoded in two's complement notation unless otherwise stated.

SIMD

Single-Instruction, Multiple-Data.

The SIMD instructions in AArch32 state are:

- The instructions summarized in [Parallel addition and subtraction instructions on page F1-2818](#).
- The Advanced SIMD instructions summarized in [Advanced SIMD and floating-point instructions on page E1-2740](#), when operating on vectors.

Note

In ARMv7, some VFP instructions can operate on vectors. However, ARM deprecates those instruction uses, and strongly recommends that Advanced SIMD instructions are always used for vector operations.

Simple sequential execution

The behavior of an implementation that fetches, decodes and completely executes each instruction before proceeding to the next instruction. Such an implementation performs no speculative accesses to memory, including to instruction memory. The implementation does not pipeline any phase of execution. In practice, this is the theoretical execution model that the architecture is based on, and ARM does not expect this model to correspond to a realistic implementation of the architecture.

Single-copy atomicity

The form of atomicity described in [Properties of single-copy atomic accesses on page B2-83](#).

See also [Atomicity](#), [Multi-copy atomicity](#).

Single-precision value

A 32-bit word that is interpreted as a basic single-precision floating-point number according to the *IEEE Standard for Floating-point Arithmetic*.

Spatial locality

The observed effect that after a program has accessed a memory location, it is likely to also access nearby memory locations in the near future. Caches with multi-word cache lines exploit this effect to improve performance.

Speculative

Speculative operations are:

- Operations that are generated by instructions that appear in the Execution stream after a branch that is not architecturally resolved.
- Operations that are generated by instructions that appear in the Execution stream after an instruction where a synchronous exception condition has not been architecturally resolved.
- Operations that are generated by conditional instructions for which the conditions for the instruction have not been architecturally resolved.
- Operations that are generated by instructions that appear in the Execution stream after the point at which a precise asynchronous exception will be taken.
- Reads or writes generated by load or store instructions for which the data being written or the address being accessed comes from a register that has not been architecturally resolved.
- Operations generated by the hardware that are not directly generated by any instructions appearing in the Execution stream.

See also [Execution stream](#).

Special-purpose register

One of a specified set of registers for which all direct and indirect reads and writes to the register appear to occur in program order relative to other instructions, without the need for any explicit synchronization:

- [Special-purpose registers on page C5-336](#) specifies the AArch64 Special-purpose registers.
- [AArch32 Special-purpose registers on page G1-4328](#) lists the AArch32 Special-purpose registers.

T32 instruction

One or two halfwords that specify an operation to be performed by a PE that is executing in an Exception level that is using AArch32 and is in T32 state. T32 instructions must be halfword-aligned.

T32 instructions were previously called Thumb instructions.

See also [A32 instruction](#), [A64 instruction](#), [T32 state](#).

T32 state

The AArch32 Instruction set state in which the PE executes T32 instructions.

T32 state was previously called Thumb state.

See also [A32 state](#), [T32 instruction](#).

Taken locally

An exception that is taken locally means an exception that is taken to the default Exception level, and is not routed to another Exception level.

Temporal locality

The observed effect that after a program has accesses a memory location, it is likely to access the same memory location again in the near future. Caches exploit this effect to improve performance.

Thumb instruction

See [T32 instruction](#).

TLB

See [Translation Lookaside Buffer \(TLB\)](#).

TLB lockdown

A way to prevent specific translation table walk results being accessed. This ensures that accesses to the associated memory areas never cause a translation table walk.

Translation Lookaside Buffer (TLB)

A memory structure containing the results of translation table walks. They help to reduce the average cost of a memory access. Usually, there is a TLB for each memory interface of the ARM implementation.

Translation table

A table held in memory that defines the properties of memory areas of various sizes from 1KB to 1MB.

Translation table walk

The process of doing a full translation table lookup. It is performed automatically by hardware.

Trap enable bits

In VFPv2, VFPv3U, and VFPv4U, determine whether trapped or untrapped exception handling is selected. If trapped exception handling is selected, the way it is carried out is IMPLEMENTATION DEFINED.

Unaligned

An unaligned access is an access where the address of the access is not aligned to the size of an element of the access.

Unaligned memory accesses

Are memory accesses that are not, or might not be, appropriately halfword-aligned, word-aligned, or doubleword-aligned.

Unallocated

Except where otherwise stated in this manual, an instruction encoding is unallocated if the architecture does not assign a specific function to the entire bit pattern of the instruction, but instead describes it as CONSTRAINED UNPREDICTABLE, UNDEFINED, UNPREDICTABLE, or as an unallocated hint instruction.

A bit in a register is unallocated if the architecture does not assign a function to that bit.

See also [CONSTRAINED UNPREDICTABLE](#), [UNDEFINED](#), [UNPREDICTABLE](#).

UNDEFINED

Indicates cases where an attempt to execute a particular encoding bit pattern generates an exception, that is taken to the current Exception level, or to the default Exception level for taking exceptions if the UNDEFINED encoding was executed at EL0. This applies to:

- Any encoding that is not allocated to any instruction.
- Any encoding that is defined as never accessible at the current Exception level.
- Some cases where an enable, disable, or trap control means an encoding is not accessible at the current Exception level.

If the generated exception is taken to an Exception level that is using AArch32 then it is taken as an Undefined Instruction exception.

———— **Note** —————

On reset, the default Exception level for taking exceptions from EL0 is EL1. However, an implementation might include controls that can change this, effectively making EL1 inactive. See the description of the Exception model for more information

In body text, the term UNDEFINED is shown in SMALL CAPITALS.

See also [Undefined Instruction exception on page G1-4376](#).

Unified cache

Is a cache used for both processing instruction fetches and processing data loads and stores.

Unindexed addressing

Means addressing in which the base register value is used directly as the virtual address to send to memory, without adding or subtracting an offset. In most types of load/store instruction, unindexed addressing is performed by using offset addressing with an immediate offset of 0.

In ARMv7 and earlier versions of the ARM architecture, and in the M-profile, the LDC, LDC2, STC, and STC2 instructions have an explicit unindexed addressing mode that permits the offset field in the instruction to specify additional coprocessor options.

UNK

An abbreviation indicating that software must treat a field as containing an UNKNOWN value.

Hardware must implement the bit as read as 0, or all 0s for a multi-bit field. Software must not rely on the field reading as zero.

See also [UNKNOWN](#).

UNK/SBOP

Hardware must implement the field as Read-As-One, and must ignore writes to the field.

Software must not rely on the field reading as all 1s, and except for writing back to the register it must treat the value as if it is UNKNOWN. Software must use an SBOP policy to write to the field.

This description can apply to a single bit that should be written as its preserved value or as 1, or to a field that should be written as its preserved value or as all 1s.

See also [Read-As-One \(RAO\)](#), [Should-Be-One-or-Preserved \(SBOP\)](#), [UNKNOWN](#).

UNK/SBZP

Hardware must implement the bit as Read-As-Zero, and must ignore writes to the field.

Software must not rely on the field reading as all 0s, and except for writing back to the register must treat the value as if it is UNKNOWN. Software must use an SBZP policy to write to the field.

This description can apply to a single bit that should be written as its preserved value or as 0, or to a field that should be written as its preserved value or as all 0s.

See also [Read-As-Zero \(RAZ\)](#), [Should-Be-Zero-or-Preserved \(SBZP\)](#), [UNKNOWN](#).

UNKNOWN

An UNKNOWN value does not contain valid data, and can vary from moment to moment, instruction to instruction, and implementation to implementation. An UNKNOWN value must not return information that cannot be accessed at the current or a lower level of privilege using instructions that are not UNPREDICTABLE, are not CONSTRAINED UNPREDICTABLE, and do not return UNKNOWN values.

An UNKNOWN value must not be documented or promoted as having a defined value or effect.

In body text, the term UNKNOWN is shown in SMALL CAPITALS.

See also [CONSTRAINED UNPREDICTABLE](#), [UNDEFINED](#), [UNK](#), [UNPREDICTABLE](#).

UNPREDICTABLE

Means the behavior cannot be relied upon. UNPREDICTABLE behavior must not perform any function that cannot be performed at the current or a lower level of privilege using instructions that are not UNPREDICTABLE.

UNPREDICTABLE behavior must not be documented or promoted as having a defined effect.

An instruction that is UNPREDICTABLE can be implemented as UNDEFINED.

Execution at Non-secure EL1 or EL0 of an instruction that is UNPREDICTABLE can be implemented as generating a trap exception that is taken to EL2, provided that at least one instruction that is not UNPREDICTABLE and is not CONSTRAINED UNPREDICTABLE causes a trap exception that is taken to EL2.

In body text, the term UNPREDICTABLE is shown in SMALL CAPITALS.

See also [CONSTRAINED UNPREDICTABLE](#), [UNDEFINED](#).

VA

See [Virtual address \(VA\)](#).

VFP

In ARMv7, an extension to the ARM architecture, that provides single-precision and double-precision floating-point arithmetic.

Virtual address (VA)

An address generated by an ARM PE. This means it is an address that might be held in the program counter of the PE. For a PMSA implementation, the virtual address is identical to the physical address.

See also [Intermediate physical address \(IPA\)](#), [Physical address \(PA\)](#).

Watchpoint

A debug event triggered by an access to memory, specified in terms of the address of the location in memory being accessed.

Way

See [Cache way](#).

WI

Writes Ignored. In a register that software can write to, a WI attribute applied to a bit or field indicates that the bit or field ignores the value written by software and retains the value it had before that write.

See also [RAO/WI](#), [RAZ/WI](#), [RES0](#), [RES1](#).

Word

A 32-bit data item. Words are normally word-aligned in ARM systems.

Word-aligned

Means that the address is divisible by 4.

Write-allocate cache

A cache in which a cache miss on storing data causes a cache line to be allocated into the cache.

Write-back cache

A cache in which when a cache hit occurs on a store access, the data is only written to the cache. Data in the cache can therefore be more up-to-date than data in main memory. Any such data is written back to main memory when the cache line is cleaned or reallocated. Another common term for a write-back cache is a *copy-back cache*.

Write-through cache

A cache in which when a cache hit occurs on a store access, the data is written both to the cache and to main memory. This is normally done via a write buffer, to avoid slowing down the PE.

Write buffer

A block of high-speed memory that optimizes stores to main memory.